

R&S® RT-ZS60

Active Voltage Probe

User Manual



1418.7342.02 – 01

This User Manual describes the following R&S®RT-ZS models and options:

- R&S®RT-ZS60 (1418.7307.02)

The firmware of the instrument makes use of several valuable open source software packages. The most important of them are listed below, together with their corresponding open source license.

Package	Link	License
Atmel	http://www.atmel.com/dyn/products/tools_card.asp?tool_id=4092	
BOOST Library	http://www.boost.org	Boost Software v.1

Rohde & Schwarz would like to thank the open source community for their valuable contribution to embedded computing.

© 2012 Rohde & Schwarz GmbH & Co. KG

Muehldorfstr. 15, 81671 Munich, Germany

Phone: +49 89 41 29 - 0

Fax: +49 89 41 29 12 164

E-mail: info@rohde-schwarz.com

Internet: <http://www.rohde-schwarz.com>

Printed in Germany – Subject to change – Data without tolerance limits is not binding.

R&S® is a registered trademark of Rohde & Schwarz GmbH & Co. KG.

Trade names are trademarks of the owners.

The following abbreviations are used in this manual: R&S®RT-ZS60 is abbreviated as R&S RT-ZS60. R&S®ProbeMeter is abbreviated as R&S ProbeMeter. R&S®RTO is abbreviated as R&S RTO.

Basic Safety Instructions

Always read through and comply with the following safety instructions!

All plants and locations of the Rohde & Schwarz group of companies make every effort to keep the safety standards of our products up to date and to offer our customers the highest possible degree of safety. Our products and the auxiliary equipment they require are designed, built and tested in accordance with the safety standards that apply in each case. Compliance with these standards is continuously monitored by our quality assurance system. The product described here has been designed, built and tested in accordance with the attached EC Certificate of Conformity and has left the manufacturer's plant in a condition fully complying with safety standards. To maintain this condition and to ensure safe operation, you must observe all instructions and warnings provided in this manual. If you have any questions regarding these safety instructions, the Rohde & Schwarz group of companies will be happy to answer them.

Furthermore, it is your responsibility to use the product in an appropriate manner. This product is designed for use solely in industrial and laboratory environments or, if expressly permitted, also in the field and must not be used in any way that may cause personal injury or property damage. You are responsible if the product is used for any purpose other than its designated purpose or in disregard of the manufacturer's instructions. The manufacturer shall assume no responsibility for such use of the product.













The product is used for its designated purpose if it is used in accordance with its product documentation and within its performance limits (see data sheet, documentation, the following safety instructions). Using the product requires technical skills and, in some cases, a basic knowledge of English. It is therefore essential that only skilled and specialized staff or thoroughly trained personnel with the required skills be allowed to use the product. If personal safety gear is required for using Rohde & Schwarz products, this will be indicated at the appropriate place in the product documentation. Keep the basic safety instructions and the product documentation in a safe place and pass them on to the subsequent users.

Observing the safety instructions will help prevent personal injury or damage of any kind caused by dangerous situations. Therefore, carefully read through and adhere to the following safety instructions before and when using the product. It is also absolutely essential to observe the additional safety instructions on personal safety, for example, that appear in relevant parts of the product documentation. In these safety instructions, the word "product" refers to all merchandise sold and distributed by the Rohde & Schwarz group of companies, including instruments,

Basic Safety Instructions

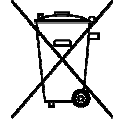
systems and all accessories. For product-specific information, see the data sheet and the product documentation.

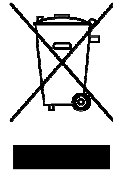



Symbols and safety labels

Symbol	Meaning	Symbol	Meaning
	Notice, general danger location Observe product documentation	○	ON/OFF supply voltage
	Caution when handling heavy equipment	⏻	Standby indication
	Danger of electric shock	— — —	Direct current (DC)
	Warning! Hot surface	~	Alternating current (AC)
	Protective conductor terminal	⎓	Direct/alternating current (DC/AC)
	Ground		Device fully protected by double (reinforced) insulation
	Ground terminal		EU labeling for batteries and accumulators For additional information, see section "Waste disposal/Environmental protection", item 1.
	Be careful when handling electrostatic sensitive devices		EU labeling for separate collection of electrical and electronic devices For additional information, see section "Waste disposal/Environmental protection", item 2.
	Warning! Laser radiation For additional information, see section "Operation", item 7.		

Basic Safety Instructions

Signal words and their meaning

The following signal words are used in the product documentation in order to warn the reader about risks and dangers.

	Indicates an imminently hazardous situation which, if not avoided, will result in death or serious injury.
	Indicates a potentially hazardous situation which, if not avoided, could result in death or serious injury.
	Indicates a potentially hazardous situation which, if not avoided, could result in minor or moderate injury.
	Indicates the possibility of incorrect operation which can result in damage to the product. In the product documentation, the word ATTENTION is used synonymously.

These signal words are in accordance with the standard definition for civil applications in the European Economic Area. Definitions that deviate from the standard definition may also exist in other economic areas or military applications. It is therefore essential to make sure that the signal words described here are always used only in connection with the related product documentation and the related product. The use of signal words in connection with unrelated products or documentation can result in misinterpretation and in personal injury or material damage.

Operating states and operating positions

The product may be operated only under the operating conditions and in the positions specified by the manufacturer, without the product's ventilation being obstructed. If the manufacturer's specifications are not observed, this can result in electric shock, fire and/or serious personal injury or death. Applicable local or national safety regulations and rules for the prevention of accidents must be observed in all work performed.

1. Unless otherwise specified, the following requirements apply to Rohde & Schwarz products:
predefined operating position is always with the housing floor facing down, IP protection 2X, use only indoors, max. operating altitude 2000 m above sea level, max. transport altitude 4500 m above sea level. A tolerance of $\pm 10\%$ shall apply to the nominal voltage and $\pm 5\%$ to the nominal frequency, overvoltage category 2, pollution severity 2.

Basic Safety Instructions

2. Do not place the product on surfaces, vehicles, cabinets or tables that for reasons of weight or stability are unsuitable for this purpose. Always follow the manufacturer's installation instructions when installing the product and fastening it to objects or structures (e.g. walls and shelves). An installation that is not carried out as described in the product documentation could result in personal injury or even death.
3. Do not place the product on heat-generating devices such as radiators or fan heaters. The ambient temperature must not exceed the maximum temperature specified in the product documentation or in the data sheet. Product overheating can cause electric shock, fire and/or serious personal injury or even death.

Electrical safety

If the information on electrical safety is not observed either at all or to the extent necessary, electric shock, fire and/or serious personal injury or death may occur.

1. Prior to switching on the product, always ensure that the nominal voltage setting on the product matches the nominal voltage of the AC supply network. If a different voltage is to be set, the power fuse of the product may have to be changed accordingly.
2. In the case of products of safety class I with movable power cord and connector, operation is permitted only on sockets with a protective conductor contact and protective conductor.
3. Intentionally breaking the protective conductor either in the feed line or in the product itself is not permitted. Doing so can result in the danger of an electric shock from the product. If extension cords or connector strips are implemented, they must be checked on a regular basis to ensure that they are safe to use.
4. If there is no power switch for disconnecting the product from the AC supply network, or if the power switch is not suitable for this purpose, use the plug of the connecting cable to disconnect the product from the AC supply network. In such cases, always ensure that the power plug is easily reachable and accessible at all times. For example, if the power plug is the disconnecting device, the length of the connecting cable must not exceed 3 m. Functional or electronic switches are not suitable for providing disconnection from the AC supply network. If products without power switches are integrated into racks or systems, the disconnecting device must be provided at the system level.

Basic Safety Instructions

5. Never use the product if the power cable is damaged. Check the power cables on a regular basis to ensure that they are in proper operating condition. By taking appropriate safety measures and carefully laying the power cable, ensure that the cable cannot be damaged and that no one can be hurt by, for example, tripping over the cable or suffering an electric shock.
6. The product may be operated only from TN/TT supply networks fuse-protected with max. 16 A (higher fuse only after consulting with the Rohde & Schwarz group of companies).
7. Do not insert the plug into sockets that are dusty or dirty. Insert the plug firmly and all the way into the socket provided for this purpose. Otherwise, sparks that result in fire and/or injuries may occur.
8. Do not overload any sockets, extension cords or connector strips; doing so can cause fire or electric shocks.
9. For measurements in circuits with voltages $V_{\text{rms}} > 30 \text{ V}$, suitable measures (e.g. appropriate measuring equipment, fuse protection, current limiting, electrical separation, insulation) should be taken to avoid any hazards.
10. Ensure that the connections with information technology equipment, e.g. PCs or other industrial computers, comply with the IEC60950-1/EN60950-1 or IEC61010-1/EN 61010-1 standards that apply in each case.
11. Unless expressly permitted, never remove the cover or any part of the housing while the product is in operation. Doing so will expose circuits and components and can lead to injuries, fire or damage to the product.
12. If a product is to be permanently installed, the connection between the protective conductor terminal on site and the product's protective conductor must be made first before any other connection is made. The product may be installed and connected only by a licensed electrician.
13. For permanently installed equipment without built-in fuses, circuit breakers or similar protective devices, the supply circuit must be fuse-protected in such a way that anyone who has access to the product, as well as the product itself, is adequately protected from injury or damage.
14. Use suitable overvoltage protection to ensure that no overvoltage (such as that caused by a bolt of lightning) can reach the product. Otherwise, the person operating the product will be exposed to the danger of an electric shock.
15. Any object that is not designed to be placed in the openings of the housing must not be used for this purpose. Doing so can cause short circuits inside the product and/or electric shocks, fire or injuries.

Basic Safety Instructions

16. Unless specified otherwise, products are not liquid-proof (see also section "Operating states and operating positions", item 1). Therefore, the equipment must be protected against penetration by liquids. If the necessary precautions are not taken, the user may suffer electric shock or the product itself may be damaged, which can also lead to personal injury.
17. Never use the product under conditions in which condensation has formed or can form in or on the product, e.g. if the product has been moved from a cold to a warm environment. Penetration by water increases the risk of electric shock.
18. Prior to cleaning the product, disconnect it completely from the power supply (e.g. AC supply network or battery). Use a soft, non-linting cloth to clean the product. Never use chemical cleaning agents such as alcohol, acetone or diluents for cellulose lacquers.

Operation

1. Operating the products requires special training and intense concentration. Make sure that persons who use the products are physically, mentally and emotionally fit enough to do so; otherwise, injuries or material damage may occur. It is the responsibility of the employer/operator to select suitable personnel for operating the products.
2. Before you move or transport the product, read and observe the section titled "Transport".
3. As with all industrially manufactured goods, the use of substances that induce an allergic reaction (allergens) such as nickel cannot be generally excluded. If you develop an allergic reaction (such as a skin rash, frequent sneezing, red eyes or respiratory difficulties) when using a Rohde & Schwarz product, consult a physician immediately to determine the cause and to prevent health problems or stress.
4. Before you start processing the product mechanically and/or thermally, or before you take it apart, be sure to read and pay special attention to the section titled "Waste disposal/Environmental protection", item 1.
5. Depending on the function, certain products such as RF radio equipment can produce an elevated level of electromagnetic radiation. Considering that unborn babies require increased protection, pregnant women must be protected by appropriate measures. Persons with pacemakers may also be exposed to risks from electromagnetic radiation. The employer/operator must evaluate workplaces where there is a special risk of exposure to radiation and, if necessary, take measures to avert the potential danger.

Basic Safety Instructions

6. Should a fire occur, the product may release hazardous substances (gases, fluids, etc.) that can cause health problems. Therefore, suitable measures must be taken, e.g. protective masks and protective clothing must be worn.
7. Laser products are given warning labels that are standardized according to their laser class. Lasers can cause biological harm due to the properties of their radiation and due to their extremely concentrated electromagnetic power. If a laser product (e.g. a CD/DVD drive) is integrated into a Rohde & Schwarz product, absolutely no other settings or functions may be used as described in the product documentation. The objective is to prevent personal injury (e.g. due to laser beams).
8. EMC classes (in line with CISPR 11)
Class A: Equipment suitable for use in all environments except residential environments and environments that are directly connected to a low-voltage supply network that supplies residential buildings.
Class B: Equipment suitable for use in residential environments and environments that are directly connected to a low-voltage supply network that supplies residential buildings.

Repair and service

1. The product may be opened only by authorized, specially trained personnel. Before any work is performed on the product or before the product is opened, it must be disconnected from the AC supply network. Otherwise, personnel will be exposed to the risk of an electric shock.
2. Adjustments, replacement of parts, maintenance and repair may be performed only by electrical experts authorized by Rohde & Schwarz. Only original parts may be used for replacing parts relevant to safety (e.g. power switches, power transformers, fuses). A safety test must always be performed after parts relevant to safety have been replaced (visual inspection, protective conductor test, insulation resistance measurement, leakage current measurement, functional test). This helps ensure the continued safety of the product.

Batteries and rechargeable batteries/cells

If the information regarding batteries and rechargeable batteries/cells is not observed either at all or to the extent necessary, product users may be exposed to the risk of explosions, fire and/or serious personal injury, and, in some cases, death. Batteries and rechargeable batteries with alkaline electrolytes (e.g. lithium cells) must be handled in accordance with the EN 62133 standard.

Basic Safety Instructions

1. Cells must not be taken apart or crushed.
2. Cells or batteries must not be exposed to heat or fire. Storage in direct sunlight must be avoided. Keep cells and batteries clean and dry. Clean soiled connectors using a dry, clean cloth.
3. Cells or batteries must not be short-circuited. Cells or batteries must not be stored in a box or in a drawer where they can short-circuit each other, or where they can be short-circuited by other conductive materials. Cells and batteries must not be removed from their original packaging until they are ready to be used.
4. Cells and batteries must not be exposed to any mechanical shocks that are stronger than permitted.
5. If a cell develops a leak, the fluid must not be allowed to come into contact with the skin or eyes. If contact occurs, wash the affected area with plenty of water and seek medical aid.
6. Improperly replacing or charging cells or batteries that contain alkaline electrolytes (e.g. lithium cells) can cause explosions. Replace cells or batteries only with the matching Rohde & Schwarz type (see parts list) in order to ensure the safety of the product.
7. Cells and batteries must be recycled and kept separate from residual waste. Rechargeable batteries and normal batteries that contain lead, mercury or cadmium are hazardous waste. Observe the national regulations regarding waste disposal and recycling.

Transport

1. The product may be very heavy. Therefore, the product must be handled with care. In some cases, the user may require a suitable means of lifting or moving the product (e.g. with a lift-truck) to avoid back or other physical injuries.
2. Handles on the products are designed exclusively to enable personnel to transport the product. It is therefore not permissible to use handles to fasten the product to or on transport equipment such as cranes, fork lifts, wagons, etc. The user is responsible for securely fastening the products to or on the means of transport or lifting. Observe the safety regulations of the manufacturer of the means of transport or lifting. Noncompliance can result in personal injury or material damage.

Basic Safety Instructions

3. If you use the product in a vehicle, it is the sole responsibility of the driver to drive the vehicle safely and properly. The manufacturer assumes no responsibility for accidents or collisions. Never use the product in a moving vehicle if doing so could distract the driver of the vehicle. Adequately secure the product in the vehicle to prevent injuries or other damage in the event of an accident.

Waste disposal/Environmental protection

1. Specially marked equipment has a battery or accumulator that must not be disposed of with unsorted municipal waste, but must be collected separately. It may only be disposed of at a suitable collection point or via a Rohde & Schwarz customer service center.
2. Waste electrical and electronic equipment must not be disposed of with unsorted municipal waste, but must be collected separately. Rohde & Schwarz GmbH & Co. KG has developed a disposal concept and takes full responsibility for take-back obligations and disposal obligations for manufacturers within the EU. Contact your Rohde & Schwarz customer service center for environmentally responsible disposal of the product.
3. If products or their components are mechanically and/or thermally processed in a manner that goes beyond their intended use, hazardous substances (heavy-metal dust such as lead, beryllium, nickel) may be released. For this reason, the product may only be disassembled by specially trained personnel. Improper disassembly may be hazardous to your health. National waste disposal regulations must be observed.
4. If handling the product releases hazardous substances or fuels that must be disposed of in a special way, e.g. coolants or engine oils that must be replenished regularly, the safety instructions of the manufacturer of the hazardous substances or fuels and the applicable regional waste disposal regulations must be observed. Also observe the relevant safety instructions in the product documentation. The improper disposal of hazardous substances or fuels can cause health problems and lead to environmental damage.

For additional information about environmental protection, visit the Rohde & Schwarz website.

Instrucciones de seguridad elementales

¡Es imprescindible leer y cumplir las siguientes instrucciones e informaciones de seguridad!

El principio del grupo de empresas Rohde & Schwarz consiste en tener nuestros productos siempre al día con los estándares de seguridad y de ofrecer a nuestros clientes el máximo grado de seguridad. Nuestros productos y todos los equipos adicionales son siempre fabricados y examinados según las normas de seguridad vigentes. Nuestro sistema de garantía de calidad controla constantemente que sean cumplidas estas normas. El presente producto ha sido fabricado y examinado según el certificado de conformidad adjunto de la UE y ha salido de nuestra planta en estado impecable según los estándares técnicos de seguridad. Para poder preservar este estado y garantizar un funcionamiento libre de peligros, el usuario deberá atenerse a todas las indicaciones, informaciones de seguridad y notas de alerta. El grupo de empresas Rohde & Schwarz está siempre a su disposición en caso de que tengan preguntas referentes a estas informaciones de seguridad.









Además queda en la responsabilidad del usuario utilizar el producto en la forma debida. Este producto está destinado exclusivamente al uso en la industria y el laboratorio o, si ha sido expresamente autorizado, para aplicaciones de campo y de ninguna manera deberá ser utilizado de modo que alguna persona/cosa pueda sufrir daño. El uso del producto fuera de sus fines definidos o sin tener en cuenta las instrucciones del fabricante queda en la responsabilidad del usuario. El fabricante no se hace en ninguna forma responsable de consecuencias a causa del mal uso del producto.

Se parte del uso correcto del producto para los fines definidos si el producto es utilizado conforme a las indicaciones de la correspondiente documentación del producto y dentro del margen de rendimiento definido (ver hoja de datos, documentación, informaciones de seguridad que siguen). El uso del producto hace necesarios conocimientos técnicos y ciertos conocimientos del idioma inglés. Por eso se debe tener en cuenta que el producto solo pueda ser operado por personal especializado o personas instruidas en profundidad con las capacidades correspondientes. Si fuera necesaria indumentaria de seguridad para el uso de productos de Rohde & Schwarz, encontraría la información debida en la documentación del producto en el capítulo correspondiente. Guarde bien las informaciones de seguridad elementales, así como la documentación del producto, y entréguelas a usuarios posteriores.



Instrucciones de seguridad elementales

Tener en cuenta las informaciones de seguridad sirve para evitar en lo posible lesiones o daños por peligros de toda clase. Por eso es imprescindible leer detalladamente y comprender por completo las siguientes informaciones de seguridad antes de usar el producto, y respetarlas durante el uso del producto. Deberán tenerse en cuenta todas las demás informaciones de seguridad, como p. ej. las referentes a la protección de personas, que encontrarán en el capítulo correspondiente de la documentación del producto y que también son de obligado cumplimiento. En las presentes informaciones de seguridad se recogen todos los objetos que distribuye el grupo de empresas Rohde & Schwarz bajo la denominación de "producto", entre ellos también aparatos, instalaciones así como toda clase de accesorios. Los datos específicos del producto figuran en la hoja de datos y en la documentación del producto.

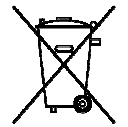
Símbolos y definiciones de seguridad

Símbolo	Significado	Símbolo	Significado
	Aviso: punto de peligro general Observar la documentación del producto	○	Tensión de alimentación de PUESTA EN MARCHA / PARADA
	Atención en el manejo de dispositivos de peso elevado	⏻	Indicación de estado de espera (standby)
	Peligro de choque eléctrico	— — —	Corriente continua (DC)
	Advertencia: superficie caliente	~	Corriente alterna (AC)
	Conexión a conductor de protección	⎓	Corriente continua / Corriente alterna (DC/AC)
	Conexión a tierra		El aparato está protegido en su totalidad por un aislamiento doble (reforzado)
	Conexión a masa		Distintivo de la UE para baterías y acumuladores Más información en la sección "Eliminación/protección del medio ambiente", punto 1.

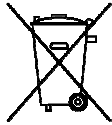
Instrucciones de seguridad elementales

Símbolo	Significado	Símbolo	Significado
	Aviso: Cuidado en el manejo de dispositivos sensibles a la electrostática (ESD)		Distintivo de la UE para la eliminación por separado de dispositivos eléctricos y electrónicos Más información en la sección "Eliminación/protección del medio ambiente", punto 2.
	Advertencia: rayo láser Más información en la sección "Funcionamiento", punto 7.		

Palabras de señal y su significado

En la documentación del producto se utilizan las siguientes palabras de señal con el fin de advertir contra riesgos y peligros.



PELIGRO identifica un peligro inminente con riesgo elevado que provocará muerte o lesiones graves si no se evita.



ADVERTENCIA identifica un posible peligro con riesgo medio de provocar muerte o lesiones (graves) si no se evita.



ATENCIÓN identifica un peligro con riesgo reducido de provocar lesiones leves o moderadas si no se evita.



AVISO indica la posibilidad de utilizar mal el producto y, como consecuencia, dañarlo.
En la documentación del producto se emplea de forma sinónima el término CUIDADO.

Las palabras de señal corresponden a la definición habitual para aplicaciones civiles en el área económica europea. Pueden existir definiciones diferentes a esta definición en otras áreas económicas o en aplicaciones militares. Por eso se deberá tener en cuenta que las palabras de señal aquí descritas sean utilizadas siempre solamente en combinación con la correspondiente documentación del producto y solamente en combinación con el producto correspondiente. La utilización de las palabras de señal en combinación con productos o documentaciones que no les correspondan puede llevar a interpretaciones equivocadas y tener por consecuencia daños en personas u objetos.

Instrucciones de seguridad elementales

Estados operativos y posiciones de funcionamiento

El producto solamente debe ser utilizado según lo indicado por el fabricante respecto a los estados operativos y posiciones de funcionamiento sin que se obstruya la ventilación. Si no se siguen las indicaciones del fabricante, pueden producirse choques eléctricos, incendios y/o lesiones graves con posible consecuencia de muerte. En todos los trabajos deberán ser tenidas en cuenta las normas nacionales y locales de seguridad del trabajo y de prevención de accidentes.

1. Si no se convino de otra manera, es para los productos Rohde & Schwarz válido lo que sigue:
como posición de funcionamiento se define por principio la posición con el suelo de la caja para abajo, modo de protección IP 2X, uso solamente en estancias interiores, utilización hasta 2000 m sobre el nivel del mar, transporte hasta 4500 m sobre el nivel del mar. Se aplicará una tolerancia de $\pm 10\%$ sobre el voltaje nominal y de $\pm 5\%$ sobre la frecuencia nominal. Categoría de sobrecarga eléctrica 2, índice de suciedad 2.
2. No sitúe el producto encima de superficies, vehículos, estantes o mesas, que por sus características de peso o de estabilidad no sean aptos para él. Siga siempre las instrucciones de instalación del fabricante cuando instale y asegure el producto en objetos o estructuras (p. ej. paredes y estantes). Si se realiza la instalación de modo distinto al indicado en la documentación del producto, se pueden causar lesiones o, en determinadas circunstancias, incluso la muerte.
3. No ponga el producto sobre aparatos que generen calor (p. ej. radiadores o calefactores). La temperatura ambiente no debe superar la temperatura máxima especificada en la documentación del producto o en la hoja de datos. En caso de sobrecalentamiento del producto, pueden producirse choques eléctricos, incendios y/o lesiones graves con posible consecuencia de muerte.

Seguridad eléctrica

Si no se siguen (o se siguen de modo insuficiente) las indicaciones del fabricante en cuanto a seguridad eléctrica, pueden producirse choques eléctricos, incendios y/o lesiones graves con posible consecuencia de muerte.

1. Antes de la puesta en marcha del producto se deberá comprobar siempre que la tensión preseleccionada en el producto coincida con la de la red de alimentación eléctrica. Si es necesario modificar el ajuste de tensión, también se deberán cambiar en caso dado los fusibles correspondientes del producto.

Instrucciones de seguridad elementales

2. Los productos de la clase de protección I con alimentación móvil y enchufe individual solamente podrán enchufarse a tomas de corriente con contacto de seguridad y con conductor de protección conectado.
3. Queda prohibida la interrupción intencionada del conductor de protección, tanto en la toma de corriente como en el mismo producto. La interrupción puede tener como consecuencia el riesgo de que el producto sea fuente de choques eléctricos. Si se utilizan cables alargadores o regletas de enchufe, deberá garantizarse la realización de un examen regular de los mismos en cuanto a su estado técnico de seguridad.
4. Si el producto no está equipado con un interruptor para desconectarlo de la red, o bien si el interruptor existente no resulta apropiado para la desconexión de la red, el enchufe del cable de conexión se deberá considerar como un dispositivo de desconexión.
El dispositivo de desconexión se debe poder alcanzar fácilmente y debe estar siempre bien accesible. Si, p. ej., el enchufe de conexión a la red es el dispositivo de desconexión, la longitud del cable de conexión no debe superar 3 m).
Los interruptores selectores o electrónicos no son aptos para el corte de la red eléctrica. Si se integran productos sin interruptor en bastidores o instalaciones, se deberá colocar el interruptor en el nivel de la instalación.
5. No utilice nunca el producto si está dañado el cable de conexión a red. Compruebe regularmente el correcto estado de los cables de conexión a red. Asegúrese, mediante las medidas de protección y de instalación adecuadas, de que el cable de conexión a red no pueda ser dañado o de que nadie pueda ser dañado por él, p. ej. al tropezar o por un choque eléctrico.
6. Solamente está permitido el funcionamiento en redes de alimentación TN/TT aseguradas con fusibles de 16 A como máximo (utilización de fusibles de mayor amperaje solo previa consulta con el grupo de empresas Rohde & Schwarz).
7. Nunca conecte el enchufe en tomas de corriente sucias o llenas de polvo. Introduzca el enchufe por completo y fuertemente en la toma de corriente. La no observación de estas medidas puede provocar chispas, fuego y/o lesiones.
8. No sobrecargue las tomas de corriente, los cables alargadores o las regletas de enchufe ya que esto podría causar fuego o choques eléctricos.
9. En las mediciones en circuitos de corriente con una tensión $U_{\text{eff}} > 30 \text{ V}$ se deberán tomar las medidas apropiadas para impedir cualquier peligro (p. ej. medios de medición adecuados, seguros, limitación de tensión, corte protector, aislamiento etc.).

Instrucciones de seguridad elementales

10. Para la conexión con dispositivos informáticos como un PC o un ordenador industrial, debe comprobarse que éstos cumplan los estándares IEC60950-1/EN60950-1 o IEC61010-1/EN 61010-1 válidos en cada caso.
11. A menos que esté permitido expresamente, no retire nunca la tapa ni componentes de la carcasa mientras el producto esté en servicio. Esto pone a descubierto los cables y componentes eléctricos y puede causar lesiones, fuego o daños en el producto.
12. Si un producto se instala en un lugar fijo, se deberá primero conectar el conductor de protección fijo con el conductor de protección del producto antes de hacer cualquier otra conexión. La instalación y la conexión deberán ser efectuadas por un electricista especializado.
13. En el caso de dispositivos fijos que no estén provistos de fusibles, interruptor automático ni otros mecanismos de seguridad similares, el circuito de alimentación debe estar protegido de modo que todas las personas que puedan acceder al producto, así como el producto mismo, estén a salvo de posibles daños.
14. Todo producto debe estar protegido contra sobretensión (debida p. ej. a una caída del rayo) mediante los correspondientes sistemas de protección. Si no, el personal que lo utilice quedará expuesto al peligro de choque eléctrico.
15. No debe introducirse en los orificios de la caja del aparato ningún objeto que no esté destinado a ello. Esto puede producir cortocircuitos en el producto y/o puede causar choques eléctricos, fuego o lesiones.
16. Salvo indicación contraria, los productos no están impermeabilizados (ver también el capítulo "Estados operativos y posiciones de funcionamiento", punto 1). Por eso es necesario tomar las medidas necesarias para evitar la entrada de líquidos. En caso contrario, existe peligro de choque eléctrico para el usuario o de daños en el producto, que también pueden redundar en peligro para las personas.
17. No utilice el producto en condiciones en las que pueda producirse o ya se hayan producido condensaciones sobre el producto o en el interior de éste, como p. ej. al desplazarlo de un lugar frío a otro caliente. La entrada de agua aumenta el riesgo de choque eléctrico.
18. Antes de la limpieza, desconecte por completo el producto de la alimentación de tensión (p. ej. red de alimentación o batería). Realice la limpieza de los aparatos con un paño suave, que no se deshilache. No utilice bajo ningún concepto productos de limpieza químicos como alcohol, acetona o diluyentes para lacas nitrocelulósicas.

Instrucciones de seguridad elementales

Funcionamiento

1. El uso del producto requiere instrucciones especiales y una alta concentración durante el manejo. Debe asegurarse que las personas que manejen el producto estén a la altura de los requerimientos necesarios en cuanto a aptitudes físicas, psíquicas y emocionales, ya que de otra manera no se pueden excluir lesiones o daños de objetos. El empresario u operador es responsable de seleccionar el personal usuario apto para el manejo del producto.
2. Antes de desplazar o transportar el producto, lea y tenga en cuenta el capítulo "Transporte".
3. Como con todo producto de fabricación industrial no puede quedar excluida en general la posibilidad de que se produzcan alergias provocadas por algunos materiales empleados —los llamados alérgenos (p. ej. el níquel)—. Si durante el manejo de productos Rohde & Schwarz se producen reacciones alérgicas, como p. ej. irritaciones cutáneas, estornudos continuos, enrojecimiento de la conjuntiva o dificultades respiratorias, debe avisarse inmediatamente a un médico para investigar las causas y evitar cualquier molestia o daño a la salud.
4. Antes de la manipulación mecánica y/o térmica o el desmontaje del producto, debe tenerse en cuenta imprescindiblemente el capítulo "Eliminación/protección del medio ambiente", punto 1.
5. Ciertos productos, como p. ej. las instalaciones de radiocomunicación RF, pueden a causa de su función natural, emitir una radiación electromagnética aumentada. Deben tomarse todas las medidas necesarias para la protección de las mujeres embarazadas. También las personas con marcapasos pueden correr peligro a causa de la radiación electromagnética. El empresario/operador tiene la obligación de evaluar y señalar las áreas de trabajo en las que exista un riesgo elevado de exposición a radiaciones.
6. Tenga en cuenta que en caso de incendio pueden desprenderse del producto sustancias tóxicas (gases, líquidos etc.) que pueden generar daños a la salud. Por eso, en caso de incendio deben usarse medidas adecuadas, como p. ej. máscaras antigás e indumentaria de protección.

Instrucciones de seguridad elementales

7. Los productos con láser están provistos de indicaciones de advertencia normalizadas en función de la clase de láser del que se trate. Los rayos láser pueden provocar daños de tipo biológico a causa de las propiedades de su radiación y debido a su concentración extrema de potencia electromagnética. En caso de que un producto Rohde & Schwarz contenga un producto láser (p. ej. un lector de CD/DVD), no debe usarse ninguna otra configuración o función aparte de las descritas en la documentación del producto, a fin de evitar lesiones (p. ej. debidas a irradiación láser).
8. Clases CEM (según CISPR 11)
Clase A: dispositivo apropiado para el uso en cualquier zona excepto en áreas residenciales y en aquellas zonas que se encuentran conectadas a una red de suministro de baja tensión que alimenta un edificio de viviendas.
Clase B: dispositivo apropiado para el uso en áreas residenciales y en aquellas zonas que se encuentran conectadas a una red de suministro de baja tensión que alimenta un edificio de viviendas.

Reparación y mantenimiento

1. El producto solamente debe ser abierto por personal especializado con autorización para ello. Antes de manipular el producto o abrirlo, es obligatorio desconectarlo de la tensión de alimentación, para evitar toda posibilidad de choque eléctrico.
2. El ajuste, el cambio de partes, el mantenimiento y la reparación deberán ser efectuadas solamente por electricistas autorizados por Rohde & Schwarz. Si se reponen partes con importancia para los aspectos de seguridad (p. ej. el enchufe, los transformadores o los fusibles), solamente podrán ser sustituidos por partes originales. Después de cada cambio de partes relevantes para la seguridad deberá realizarse un control de seguridad (control a primera vista, control del conductor de protección, medición de resistencia de aislamiento, medición de la corriente de fuga, control de funcionamiento). Con esto queda garantizada la seguridad del producto.

Baterías y acumuladores o celdas

Si no se siguen (o se siguen de modo insuficiente) las indicaciones en cuanto a las baterías y acumuladores o celdas, pueden producirse explosiones, incendios y/o lesiones graves con posible consecuencia de muerte. El manejo de baterías y acumuladores con electrolitos alcalinos (p. ej. celdas de litio) debe seguir el estándar EN 62133.

Instrucciones de seguridad elementales

1. No deben desmontarse, abrirse ni triturarse las celdas.
2. Las celdas o baterías no deben someterse a calor ni fuego. Debe evitarse el almacenamiento a la luz directa del sol. Las celdas y baterías deben mantenerse limpias y secas. Limpiar las conexiones sucias con un paño seco y limpio.
3. Las celdas o baterías no deben cortocircuitarse. Es peligroso almacenar las celdas o baterías en estuches o cajones en cuyo interior puedan cortocircuitarse por contacto recíproco o por contacto con otros materiales conductores. No deben extraerse las celdas o baterías de sus embalajes originales hasta el momento en que vayan a utilizarse.
4. Las celdas o baterías no deben someterse a impactos mecánicos fuertes indebidos.
5. En caso de falta de estanqueidad de una celda, el líquido vertido no debe entrar en contacto con la piel ni los ojos. Si se produce contacto, lavar con agua abundante la zona afectada y avisar a un médico.
6. En caso de cambio o recarga inadecuados, las celdas o baterías que contienen electrolitos alcalinos (p. ej. las celdas de litio) pueden explotar. Para garantizar la seguridad del producto, las celdas o baterías solo deben ser sustituidas por el tipo Rohde & Schwarz correspondiente (ver lista de recambios).
7. Las baterías y celdas deben reciclarse y no deben tirarse a la basura doméstica. Las baterías o acumuladores que contienen plomo, mercurio o cadmio deben tratarse como residuos especiales. Respete en esta relación las normas nacionales de eliminación y reciclaje.

Transporte

1. El producto puede tener un peso elevado. Por eso es necesario desplazarlo o transportarlo con precaución y, si es necesario, usando un sistema de elevación adecuado (p. ej. una carretilla elevadora), a fin de evitar lesiones en la espalda u otros daños personales.
2. Las asas instaladas en los productos sirven solamente de ayuda para el transporte del producto por personas. Por eso no está permitido utilizar las asas para la sujeción en o sobre medios de transporte como p. ej. grúas, carretillas elevadoras de horquilla, carros etc. Es responsabilidad suya fijar los productos de manera segura a los medios de transporte o elevación. Para evitar daños personales o daños en el producto, siga las instrucciones de seguridad del fabricante del medio de transporte o elevación utilizado.

Instrucciones de seguridad elementales

3. Si se utiliza el producto dentro de un vehículo, recae de manera exclusiva en el conductor la responsabilidad de conducir el vehículo de manera segura y adecuada. El fabricante no asumirá ninguna responsabilidad por accidentes o colisiones. No utilice nunca el producto dentro de un vehículo en movimiento si esto pudiera distraer al conductor. Asegure el producto dentro del vehículo debidamente para evitar, en caso de un accidente, lesiones u otra clase de daños.

Eliminación/protección del medio ambiente

1. Los dispositivos marcados contienen una batería o un acumulador que no se debe desechar con los residuos domésticos sin clasificar, sino que debe ser recogido por separado. La eliminación se debe efectuar exclusivamente a través de un punto de recogida apropiado o del servicio de atención al cliente de Rohde & Schwarz.
2. Los dispositivos eléctricos usados no se deben desechar con los residuos domésticos sin clasificar, sino que deben ser recogidos por separado. Rohde & Schwarz GmbH & Co.KG ha elaborado un concepto de eliminación de residuos y asume plenamente los deberes de recogida y eliminación para los fabricantes dentro de la UE. Para desechar el producto de manera respetuosa con el medio ambiente, diríjase a su servicio de atención al cliente de Rohde & Schwarz.
3. Si se trabaja de manera mecánica y/o térmica cualquier producto o componente más allá del funcionamiento previsto, pueden liberarse sustancias peligrosas (povos con contenido de metales pesados como p. ej. plomo, berilio o níquel). Por eso el producto solo debe ser desmontado por personal especializado con formación adecuada. Un desmontaje inadecuado puede ocasionar daños para la salud. Se deben tener en cuenta las directivas nacionales referentes a la eliminación de residuos.
4. En caso de que durante el trato del producto se formen sustancias peligrosas o combustibles que deban tratarse como residuos especiales (p. ej. refrigerantes o aceites de motor con intervalos de cambio definidos), deben tenerse en cuenta las indicaciones de seguridad del fabricante de dichas sustancias y las normas regionales de eliminación de residuos. Tenga en cuenta también en caso necesario las indicaciones de seguridad especiales contenidas en la documentación del producto. La eliminación incorrecta de sustancias peligrosas o combustibles puede causar daños a la salud o daños al medio ambiente.

Se puede encontrar más información sobre la protección del medio ambiente en la página web de Rohde & Schwarz.

Safety Instructions for Active Voltage Probes

When handling active voltage probes, the following basic rules must be observed. Prior to using an active voltage probe, read the applicable manual including the safety instructions. Keep the safety instructions and the product documentation in a safe place and pass them on to other users. Use active voltage probes exclusively within the measurement ranges specified in the applicable data sheets. Rohde & Schwarz accepts no responsibility for misuse of the product. Use only the accessories supplied with the active voltage probe.

WARNING

Risk of electric shock

Do not connect an active voltage probe to any voltage that exceeds the maximum permissible input voltage specified in the data sheet. Non-compliance with this instruction carries the risk of an electric shock.

Make sure not to cause any short circuits when performing measurements on sources with high output currents. Short circuits may cause injuries or burns.

CAUTION

Risk of injury caused by pointed object

The pins of the active voltage probes are extremely pointed and can easily penetrate clothes and the skin.

Therefore, handle the probe pins with great care. When transporting an active voltage probe, e.g. when carrying it in a pocket or tool bag, always use the box supplied with the probe. To exchange a probe pin, use tweezers or pliers to avoid injuries.

Informaciones de seguridad para el uso de sondas de voltaje activas

A la hora de manejar una sonda de voltaje activa, es necesario seguir las siguientes instrucciones de uso básicas. Lea primero el manual de manejo correspondiente incluyendo las instrucciones de seguridad. Guarde las instrucciones de seguridad y la documentación de producto en un lugar seguro y páselas a otros usuarios. Utilice la sonda de voltaje solamente en el rango de medida indicado en la hoja de datos. Rohde & Schwarz no asume ninguna responsabilidad en el caso del uso inadecuado del producto.

⚠ ADVERTENCIA

Peligro de descarga eléctrica

No conecte la sonda de voltaje a ninguna tensión que supere el valor máximo indicado en la hoja de datos. En caso de incumplimiento se corre el riesgo de una descarga eléctrica.

Tenga cuidado en no ocasionar cortocircuitos a la hora de realizar medidas en fuentes de alta corriente de salida. Los cortocircuitos pueden ocasionar lesiones o quemaduras.

⚠ ATENCIÓN

Riesgo de lesiones por objeto puntiagudo

Los pines de la sonda de voltaje activa son extremadamente puntiagudos y pueden penetrar fácilmente en la ropa y en la piel.

Por eso se recomienda manipularlos cuidadosamente. Por ejemplo, si transportan la sonda en un bolsillo o en la bolsa de herramientas, utilice permanentemente la caja suministrada con la sonda. Para evitar lesiones utilice una pinza o una tenaza a la hora de cambiar un pin de la sonda.

Customer Support

Technical support – where and when you need it

For quick, expert help with any Rohde & Schwarz equipment, contact one of our Customer Support Centers. A team of highly qualified engineers provides telephone support and will work with you to find a solution to your query on any aspect of the operation, programming or applications of Rohde & Schwarz equipment.

Up-to-date information and upgrades

To keep your instrument up-to-date and to be informed about new application notes related to your instrument, please send an e-mail to the Customer Support Center stating your instrument and your wish.

We will take care that you will get the right information.

Europe, Africa, Middle East

Phone +49 89 4129 12345
customersupport@rohde-schwarz.com

North America

Phone 1-888-TEST-RSA (1-888-837-8772)
customer.support@rsa.rohde-schwarz.com

Latin America

Phone +1-410-910-7988
customersupport.la@rohde-schwarz.com

Asia/Pacific

Phone +65 65 13 04 88
customersupport.asia@rohde-schwarz.com

China

Phone +86-800-810-8228 /
+86-400-650-5896
customersupport.china@rohde-schwarz.com



Contents

1 Product Description.....	5
1.1 Key Features and Key Characteristics.....	5
1.1.1 Key Characteristics.....	5
1.1.2 Key Features.....	6
1.2 Unpacking the Instrument.....	7
1.2.1 Inspecting the Contents.....	7
1.3 Description of the Probe.....	8
1.3.1 Probe Head.....	8
1.3.2 Probe Box.....	9
1.4 Accessories and Items.....	10
1.4.1 Accessories Supplied.....	11
1.4.2 Optional Accessories.....	13
1.4.3 Service Accessories.....	14
2 Putting into Operation.....	15
2.1 Installation.....	16
2.1.1 Connecting the Probe to the R&S RTO Oscilloscope.....	17
2.1.2 Identification of the Probe.....	17
2.1.3 Auto Zero.....	18
2.2 Micro Button.....	19
2.3 Offset Compensation.....	19
2.4 R&S ProbeMeter.....	21
3 Connecting the Probe to the DUT.....	23
4 Measurement Principles.....	28
4.1 Signal Integrity of the Transferred Signal.....	30

4.1.1 Bandwidth.....	30
4.1.2 Connection Inductance.....	32
4.2 Performance with Different Connection Types.....	33
4.3 Signal Loading of the Input Signal.....	35
4.3.1 Input Impedance.....	35
4.4 Probing Philosophy.....	38
5 Maintenance and Service.....	40
5.1 Service Strategy.....	40
5.2 Returning the Probe for Servicing.....	40
5.3 Cleaning.....	41
5.4 Calibration Interval.....	41
6 Functional Check.....	42
6.1 Initialization.....	43
6.2 DC Offset.....	44
6.3 DC Accuracy.....	45
6.4 Offset Compensation.....	46
Index.....	47

1 Product Description

1.1 Key Features and Key Characteristics

The R&S RT-ZS60 is a single-ended active voltage probe with high input impedance. It allows the user to make ground-referenced voltage measurements from DC to 6 GHz. The R&S RT-ZS60 is optimized for single-ended measurements in environments characterized by 50 Ω impedance.

The comprehensive accessory set allows this probe to be connected to a wide variety of devices under test (DUT), not impairing the extremely short rise time and the low input capacitance of the R&S RT-ZS60. Provided with special features such as the R&S ProbeMeter and the micro button, the R&S RT-ZS60 is designed to meet tomorrow's challenges in probing.

Since the probe is equipped with Rohde & Schwarz probe interface, it can be connected to any Rohde & Schwarz base unit that is compatible with this interface. When connected to the front panel of an R&S oscilloscope, the probe is controlled via the software menus of the oscilloscope.

Using a specially developed adapter (see [chapter 1.4.2, "Optional Accessories"](#), on page 13), the probe can be connected to any other base unit.

1.1.1 Key Characteristics

The key characteristics of the probe are the following:

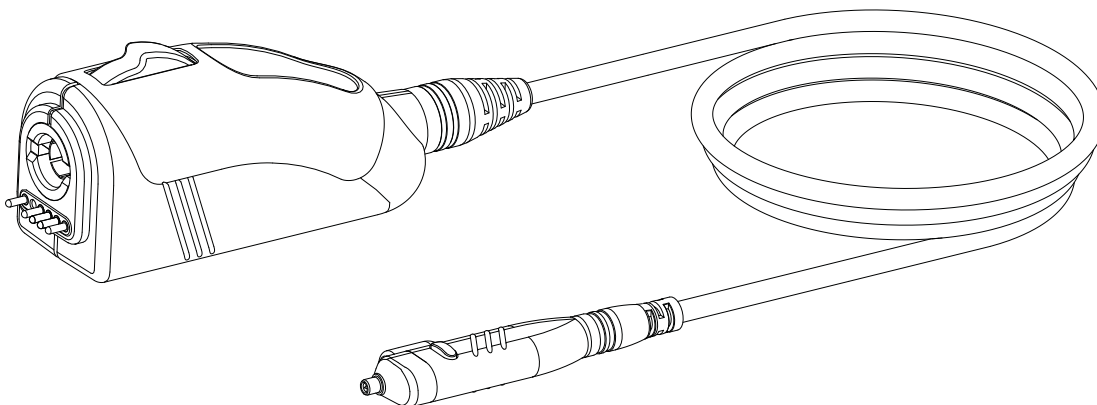

Key Features and Key Characteristics

Bandwidth	DC to 6 GHz
Dynamic range	± 8 V with ± 10 V offset capability 16 V AC (V_{pp})
Input resistance	1 M Ω
Input capacitance	0.3 pF
R&S ProbeMeter, measurement error	<0.1 %
Extremely low zero and gain errors throughout the entire temperature range, no significant temperature drift	
Extremely low noise and virtually no harmonic distortions	
Micro button	
Rohde & Schwarz probe interface	

1.1.2 Key Features

Micro button

The micro button is located at the probe head. The micro button can be configured via the base unit. By pressing it, the user can remotely control different functions on the base unit. For details, see [chapter 2.2, "Micro Button"](#), on page 19.

R&S ProbeMeter

The R&S ProbeMeter measures the DC voltage of the input signal directly at the probe tip. It provides a continuous high-precision DC voltage measurement that is independent of the settings of the oscilloscope and in parallel to the time domain measurement. If activated on the base unit, the measurement value is displayed on the screen of the R&S oscilloscope. For details, see [chapter 2.4, "R&S ProbeMeter"](#), on page 21.

Data memory

The probe includes an integrated data memory with individual probe correction parameters (e.g. gain, delay, offset). These correction parameters are read out and processed by the R&S oscilloscope. As a result, the probe offers a very high degree of accuracy so that additional calibration procedures are not required.

1.2 Unpacking the Instrument

The carrying case contains the following items:



- R&S RT-ZS60 active voltage probe
- Carrying case
- Accessory vials
- User manual
- R&S RT-ZS60 data sheet
- Calibration certificate
- Documentation of calibration values (if ordered)

1.2.1 Inspecting the Contents

- Inspect the package for damage.
Keep a damaged package and the cushioning material until the contents have been checked for completeness and the instrument has been tested.
If the packaging material shows any signs of stress, notify the carrier as well as your Rohde & Schwarz service center. Keep the package and cushioning material for inspection.
- Inspect the probe.
If there is any damage or defect, or if the R&S RT-ZS60 active voltage probe does not operate properly, notify your Rohde & Schwarz service center.
- Inspect the accessories.
If the contents are incomplete or damaged, notify your Rohde & Schwarz service center.
Accessories supplied with the instrument are listed in [chapter 1.4.1, "Accessories Supplied"](#), on page 11.

1.3 Description of the Probe

The probe consists of the probe head for connection to the DUT, the probe box for connection to the oscilloscope, and the probe cable.

1.3.1 Probe Head

The small and lightweight probe head is designed for easy handling and high-performance measurements. The probe head is used for connecting the probe and the DUT. Different accessories for the signal and ground sockets allow the probe head to be connected to a wide range of DUTs.

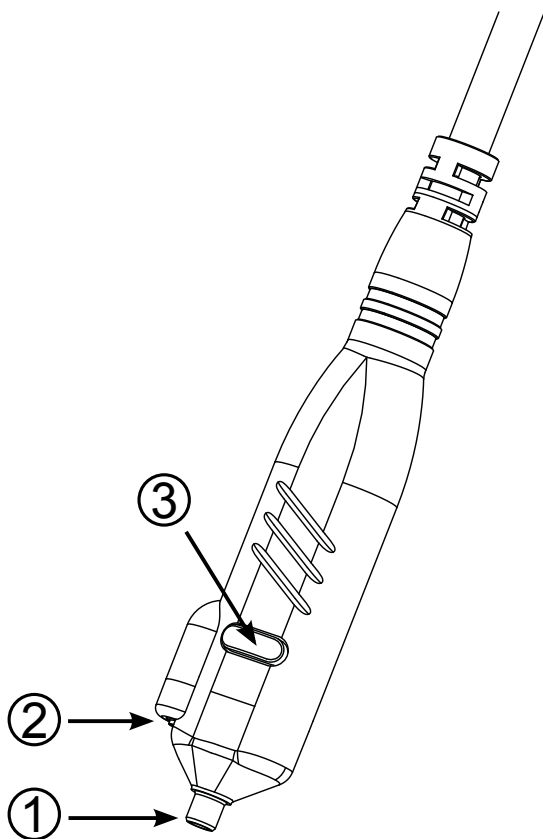

- (1) Signal socket
- (2) Ground socket
- (3) Micro button

The accessories supplied for the probe head sockets are listed in [chapter 1.4.1, "Accessories Supplied"](#), on page 11.

The ground socket is compatible with 0.64 mm (25 mil) square pins and 0.6 mm to 0.8 mm (24 mil to 35 mil) round pins.

NOTICE**Special accessories for signal socket**

The signal socket of the R&S RT-ZS60 has a special design to ensure optimal performance. The signal socket is *not* compatible to standard accessories based on 0.64 mm (25 mil) square pins or 0.8 mm (35 mil) round pins. Use only special accessories for R&S RT-ZS60 provided by Rohde & Schwarz.

1.3.2 Probe Box

The probe box connects the probe and the oscilloscope via the Rohde & Schwarz probe interface. The Rohde & Schwarz probe interface contains a male precision 7 mm (276 mil) BNC connector and six pogo pin connectors. This interface provides the required supply voltage and is also used for simultaneously transmitting analog signals and digital data. All the analog voltages required by the probe are generated in the probe box. This approach ensures that it will be possible to operate future probes on any base unit that features a Rohde & Schwarz probe interface.

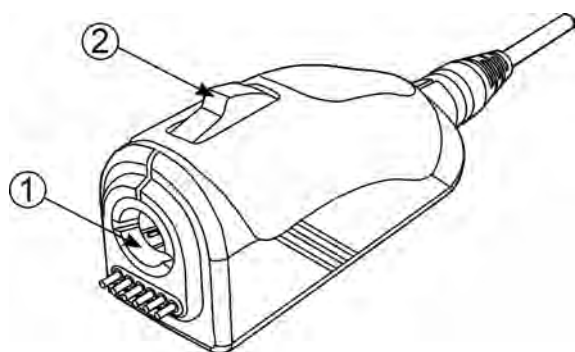

- (1) Rohde & Schwarz probe interface with 7 mm (276 mil) coaxial connector and 6 pogo pins
- (2) Release knob

NOTICE**Risk of interface damage**

Make sure to connect the probe only to a base unit or an adapter having a Rohde & Schwarz interface. Do **not** connect the probe to a commercially available BNC jack, as this can cause irreparable damage to the interface. From the outside, the 7 mm coaxial connector looks like a standard BNC connector. However, it is constructed differently and is capable of a significantly higher frequency limit.

1.4 Accessories and Items

The figure below shows all accessories that are available for the R&S RT-ZS60 active voltage probe.

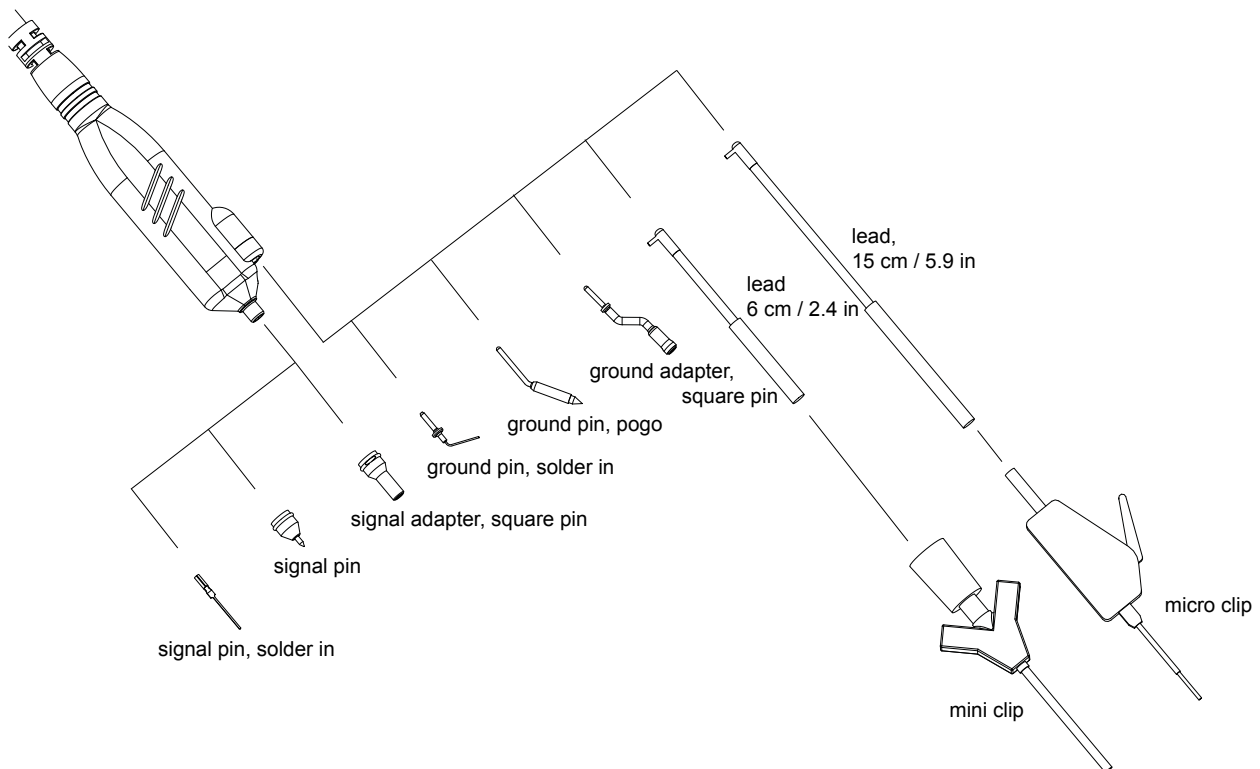
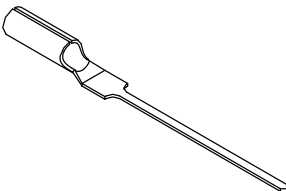
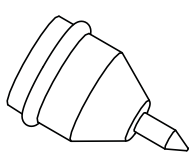
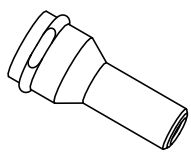
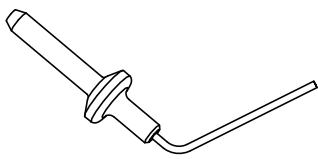
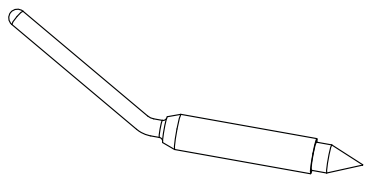
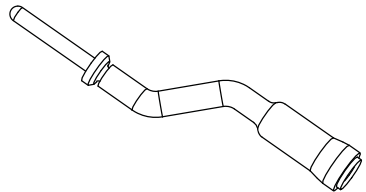

Fig. 1-1: Available accessories

1.4.1 Accessories Supplied

The following table shows the accessories supplied with the R&S RT-ZS60 active voltage probe.

Table 1-1: Accessories supplied

Item	Quantity	Description
	100	Signal pin, solder in
	5	Signal pin
	2	Signal adapter, square pin
	20	Ground pin, solder in
	5	Ground pin, pogo
	2	Ground adapter, square pin

Accessories and Items

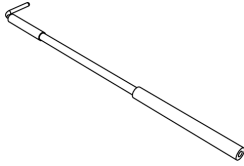
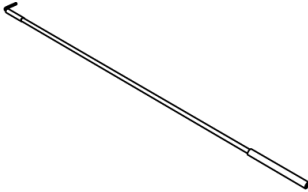
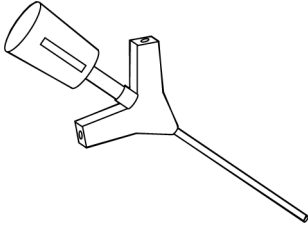
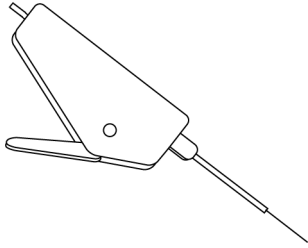
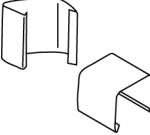
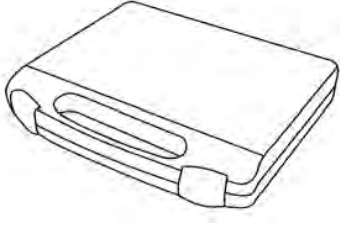
Item	Quantity	Description
	2	Lead, 6 cm / 2.4 in
	2	Lead, 15 cm / 5.9 in
	2	Mini clip
	2	Micro clip
	1	Marker band kit
	1	Carrying case with foam inlay

1.4.2 Optional Accessories

If the included accessories do not meet individual customer requirements, Rohde & Schwarz offers different accessory sets for sale.

Table 1-2: R&S RT-ZA4 Mini Clips

Item	Quantity	Description
Mini clip	10	This set contains mini clips.

Table 1-3: R&S RT-ZA5 Micro Clips

Item	Quantity	Description
Micro clip	4	This set contains micro clips.

Table 1-4: R&S RT-ZA6 Lead Set

Item	Quantity	Description
Lead, 6 cm / 2.4 in	5	This set contains short and long leads.
Lead, 15 cm / 5.9 in	5	

Table 1-5: R&S RT-ZA9 probe box to N / USB adapter

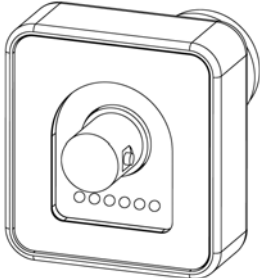
	<p>The adapter can be used to connect the R&S RT-ZS60 active voltage probe to any other oscilloscope or any other measurement instrument (e.g. a network or spectrum analyzer).</p> <p>Using the USB interface of the adapter, the probe can be powered and controlled from any conventional PC.</p>
---	--

1.4.3 Service Accessories

The following accessories are optionally available for servicing the probe.

Table 1-6: R&S RT-ZK2 Service Kit

 A line drawing of a rectangular, light-colored carrying case with a handle on the left side and a latch on the right side.	<p>The R&S RT-ZK2 Service Kit is used for calibrating the R&S RT-ZS60 active voltage probe, for making performance tests and for servicing. The service kit includes all adapters and accessories to match the probe to the required measuring instruments. The R&S RT-ZS60 Service Manual is included in the service kit CD-ROM.</p>
--	---

Table 1-7: R&S RT-ZS60 Service Manual

 A line drawing of a spiral-bound notebook with a dark cover and a lighter page visible.	<p>The Service Manual contains a detailed description of the performance test for verifying the probe specifications.</p>
--	---

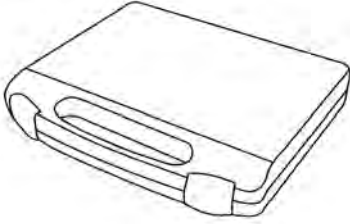
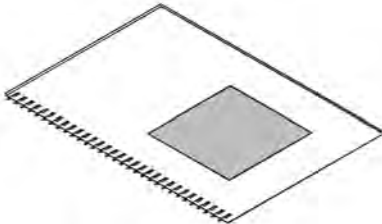

All service accessories and items can be ordered from your Rohde & Schwarz service center.

2 Putting into Operation

The R&S RT-ZS60 active voltage probe has been designed to withstand a moderate amount of physical and electrical stress. You should treat the probe with care. It can be damaged if excessive force is applied to the probe tip.

NOTICE

Exercise care to prevent the probe from receiving mechanical shock.

Always handle the probe by the probe head or probe box.

Avoid putting excessive strain on the probe cable or exposing it to sharp bends.

Store the probe in a shock-resistant case such as the foam-lined shipping case that came with the probe.

NOTICE

Voltages above the specified limits of the R&S RT-ZS60 active voltage probe may damage the probe tip amplifier.

Do not exceed the specified limits.

During operation, the probe slightly heats up. This is normal behavior and not a sign of malfunction.

NOTICE**Risk of damaging electronic components**

To avoid damage of electronic components, the operational site must be protected against electrostatic discharge (ESD).

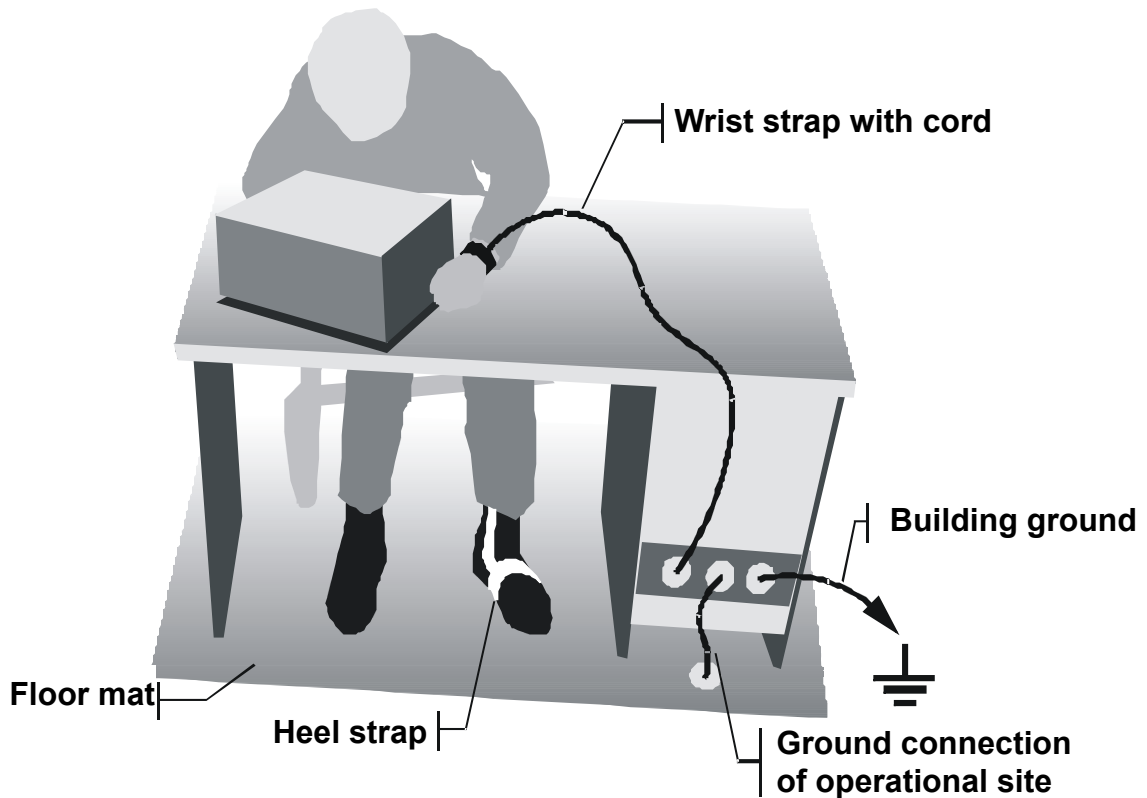

The following two methods of ESD protection may be used together or separately:

- Wrist strap with cord to ground connection
- Conductive floor mat and heel strap combination

2.1 Installation

This section provides a quick introduction to the use of the R&S RT-ZS60 active voltage probe.

 All settings of the base unit described in this section refer to the R&S RTO oscilloscope. If any other oscilloscope is used, differences in settings and menu navigation may be possible.

2.1.1 Connecting the Probe to the R&S RTO Oscilloscope

The R&S RT-ZS60 active voltage probe has been designed for use with R&S RTO oscilloscopes.

- ▶ Connect the probe box (1) to the Rohde & Schwarz probe interface of the base unit (2). The probe will snap in when connected properly to the port.
- ▶ To disconnect, press the release button (3) and pull the probe box away from the front panel of the base unit.

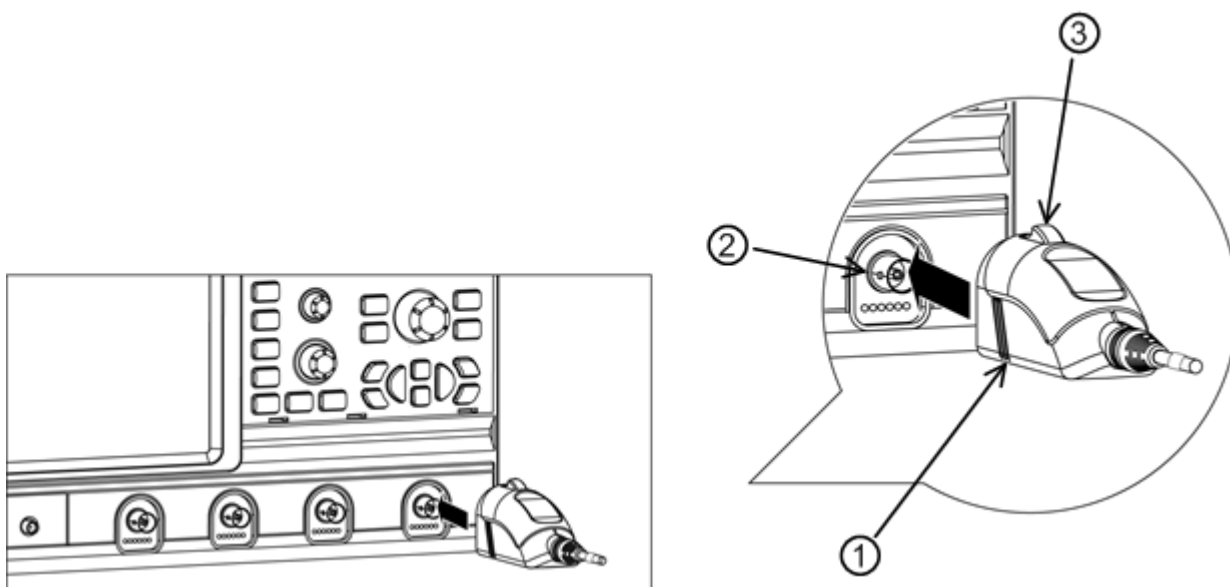

Fig. 2-1: Connecting the probe to the R&S RTO oscilloscope

2.1.2 Identification of the Probe

When the probe is connected to the oscilloscope, the oscilloscope recognizes the probe and reads out the probe-specific parameters. The oscilloscope settings for attenuation and offset are automatically adjusted.

As soon as the probe is connected to the oscilloscope and the settings are adjusted, the waveform is shown for the channel to which the probe is connected.

To display probe-specific settings and information:

- ▶ On the "Vertical" menu, select "Probe Setup" and select the correct channel tab.

2.1.3 Auto Zero

This procedure performs an automatic correction of the zero error displayed on the oscilloscope's screen. The waveform is set to 0 V on the horizontal centerline of the oscilloscope.

The zero error of the R&S RT-ZS60 probe itself is very small, typically in the range of a few hundred micro volts referred to the probe input. However, differences in DUT and oscilloscope ground levels may cause larger zero errors to be displayed on the oscilloscope's screen. If the DUT is not floating but ground-referenced, an auto zero routine may improve the measurement results.

To perform the Auto Zero function using the micro button (see also: [chapter 2.2, "Micro Button"](#), on page 19):

1. Connect the probe to the R&S RTO oscilloscope.
2. Configure the micro button function on the R&S RTO:
"Vertical" menu > "Probe Setup" > "Ch" tab > "Micro button action" = 'Auto zero'.
3. Short the signal pin and the ground pin together and connect them to the ground of the DUT.

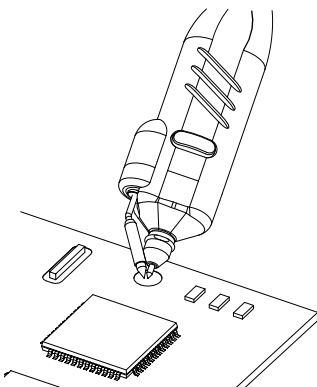

4. Press the micro button.

Alternatively, Auto Zero can be started in the dialog box of the R&S RTO:

- ▶ "Vertical" menu > "Probe Setup" > "Ch" tab > "Auto zero"

2.2 Micro Button

The micro button provides easy and quick access to important functions of the R&S RTO. After a function has been assigned, pressing the micro button remotely controls this specific function on the base unit. For example, Continuous Run and Auto Zero are commonly assigned to the micro button.

To assign a function to the micro button with the R&S RTO oscilloscope:

- ▶ "Vertical" menu > "Probe Setup" > "Ch" tab > "Micro button action"



For more details on the available functions and settings for the micro button, refer to the "User Manual" of the R&S oscilloscope.

2.3 Offset Compensation

The Offset Compensation function can compensate a DC component of the input signal, even in front of the active amplifier in the probe tip. As a result, the entire dynamic range of the probe is maintained. This function is useful when measuring AC signals with high superimposed DC component.

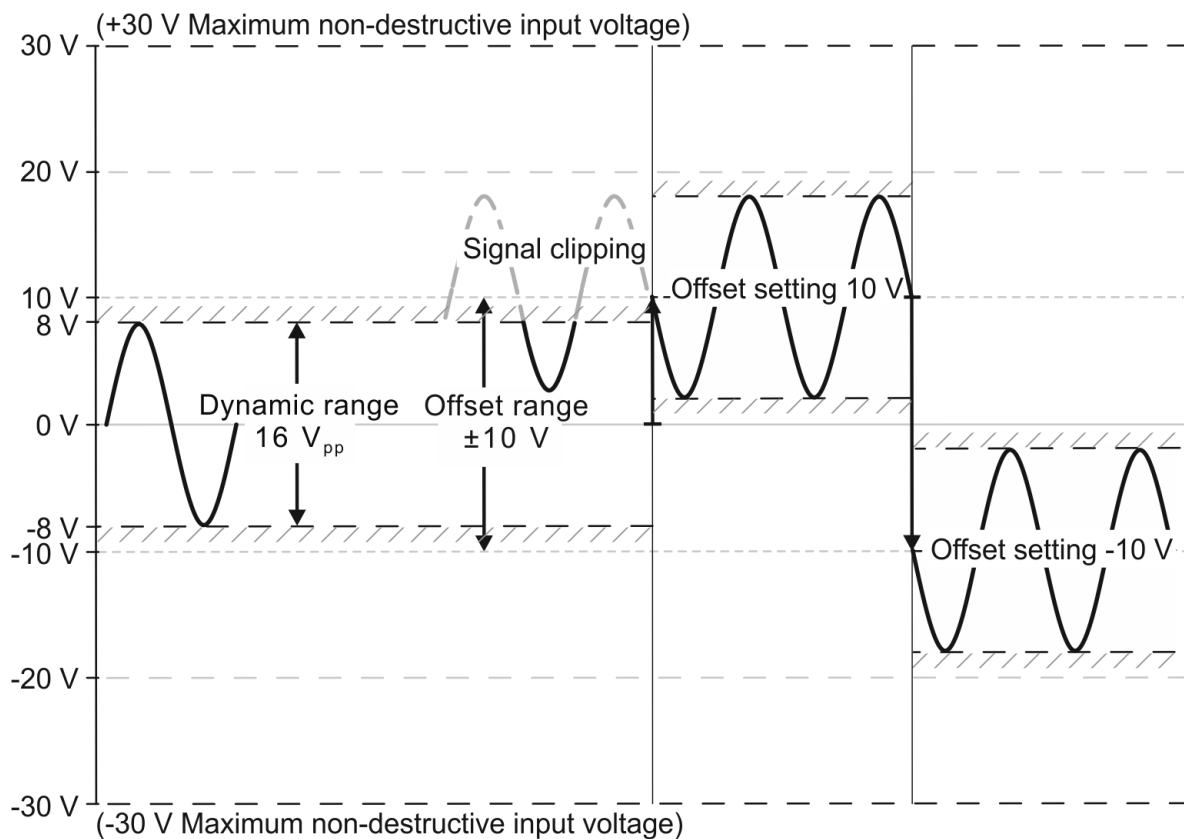

Fig. 2-2: Offset compensation voltage and dynamic range

To set offset compensation on the front panel:

1. Press the Vertical Position knob until the "Offset" setup is shown on the display.
2. Turn the Vertical Position knob.

To automatically set the offset compensation voltage using the menu:

1. On the "Vertical" menu, select "Probe Setup".
2. Select the channel and tap "Set offset to mean".



For more details on setting the offset compensation voltage, refer to the "User Manual" of the R&S oscilloscope.

Additionally, the probe offers automatic offset compensation by means of the micro button. A single push on the button compensates the DC component of the measurement signal which is particularly helpful during measurements of input signals with different DC offsets (see also [chapter 2.2, "Micro Button"](#), on page 19).

To assign "Set offset to mean" to the micro button:

- ▶ "Vertical" menu > "Probe Setup" > "Ch" tab > "Micro button action" = "Set offset to mean"

NOTICE

The maximum input voltage is ± 30 V. A higher input voltage may destroy the probe.

2.4 R&S ProbeMeter

The integrated voltmeter can measure DC voltages with very high precision compared to the oscilloscope's DC accuracy. The DC measurement is performed continuously and in parallel to the time domain measurement of the oscilloscope. High-precision measurements are achieved through immediate digitization of the measured DC voltage inside the probe.

To activate the R&S ProbeMeter:

- ▶ Vertical > Probe Setup > Ch > R&S ProbeMeter 'on'

After the R&S ProbeMeter has been activated, the measured values are displayed on the screen of the oscilloscope.

Advantages of the R&S ProbeMeter:

- Enables the user to check DC voltages with different levels without having to adjust the measurement range of the oscilloscope.
- Provides a simple means of setting the oscilloscope's trigger level and vertical scaling if a waveform is not visible.
- Independent of oscilloscope settings for offset, position, vertical scale, horizontal scale, and trigger.
- True DC measurement (integration time > 100 ms), not mathematical average of displayed waveform.
- Measurement range ± 8 V + offset compensation setting. Maximum measurement accuracy is achieved when offset compensation is switched off.
- High measurement accuracy and low temperature sensitivity, typically 0.1% of reading over the entire temperature range.

The R&S ProbeMeter enables the ground-referenced measurement of voltages. A difference in the ground levels of oscilloscope and DUT can cause an unwanted zero error. Should this happen, use the Auto Zero function (refer to [chapter 2.1.3, "Auto Zero"](#), on page 18).

3 Connecting the Probe to the DUT

This chapter describes the different ways of connecting the probe to the DUT. In addition, the accessories supplied are described and their use is explained.

In order to achieve optimum RF performance, the connections should always be as short as possible. If long connections cannot be avoided, they should preferably be used for the ground socket.

⚠ CAUTION

Risk of injuries

The included probe pins are exceptionally sharp and must be handled with extreme care. To prevent injuries, always use tweezers when inserting or removing pins.



Some solder-in accessories are very fine and sensitive. The probe should be stabilized by using appropriate means (e.g. adhesive tape, probe positioner) in order to protect the solder joint from excessive mechanical stress.

Pins

Signal pin and ground pin, pogo

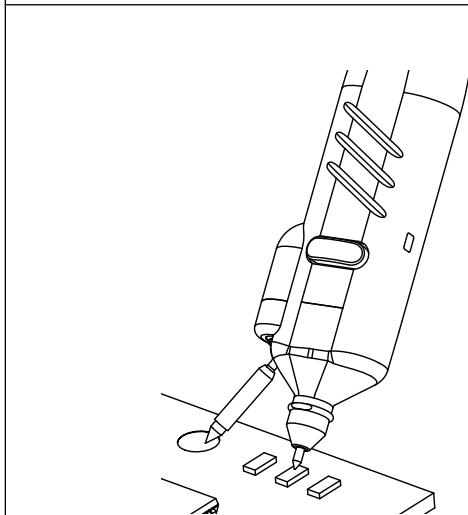

Using the signal pin and ground pin, manual measurements can be performed without or with only minor limitation of the measurement bandwidth. Best results are achieved if the distance between signal and ground is small. Even with maximum distance, rise times shorter 70 ps can be reached.

Because the spring-loaded ground pin compensates for minor unevenness and movements, this pin can establish a firm contact with the test point. It fits into the ground socket of the probe head.

The distance to the signal pin can be varied by turning the ground pin.

Distance range:

0 mm to 10 mm (0 mil to 400 mil)

Signal pin, solder in, and ground pin, solder-in

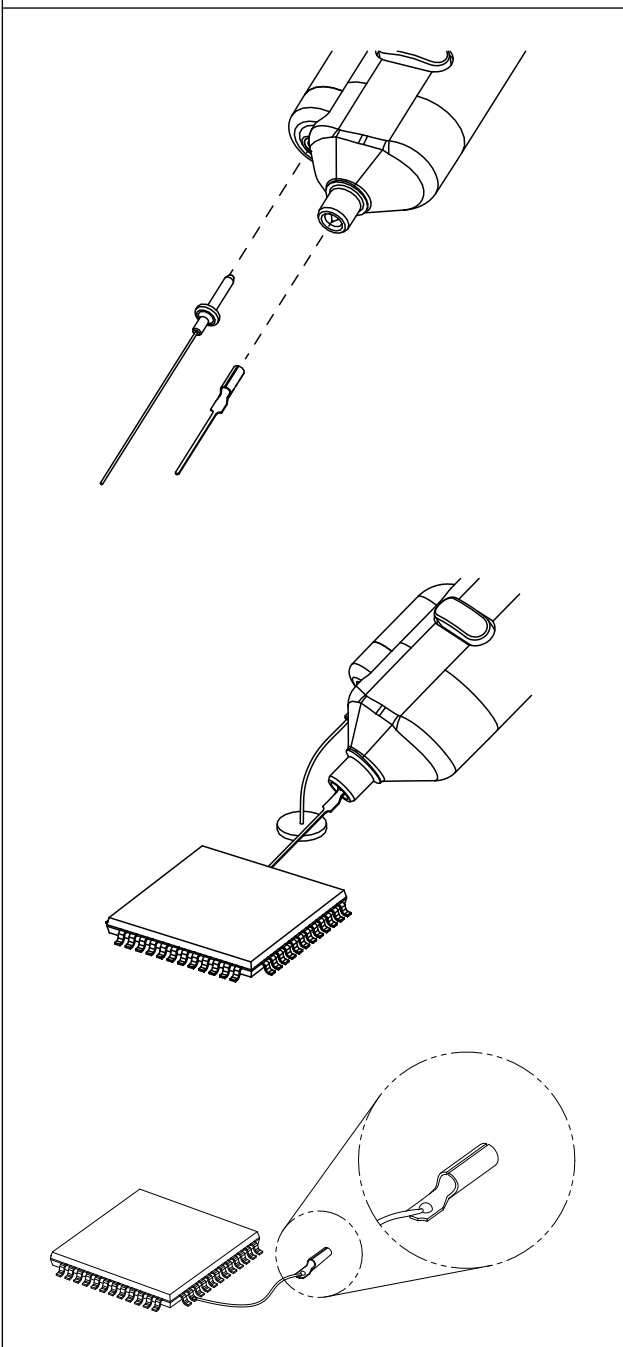

Using two solder-in pins for ground and signal, the R&S RT-ZS60 is soldered directly into the circuit.

The pins can be exchanged on the probe and can remain in the circuit. Thus, you can plug the probe on different test points.

Use tweezers to insert the solder-in pins into the sockets on the probe, and then cut to the appropriate length. Keep the pins as short as possible.

The fine wires on this adapter are best suited to make secure contact with small contact points, such as SMT components or IC pins.

Alternatively, the signal pin has a solder tail for direct soldering of wires.

Distance range:

0 mm to 20 mm (0 mil to 800 mil)

Signal adapter, square pin, and ground adapter, square pin

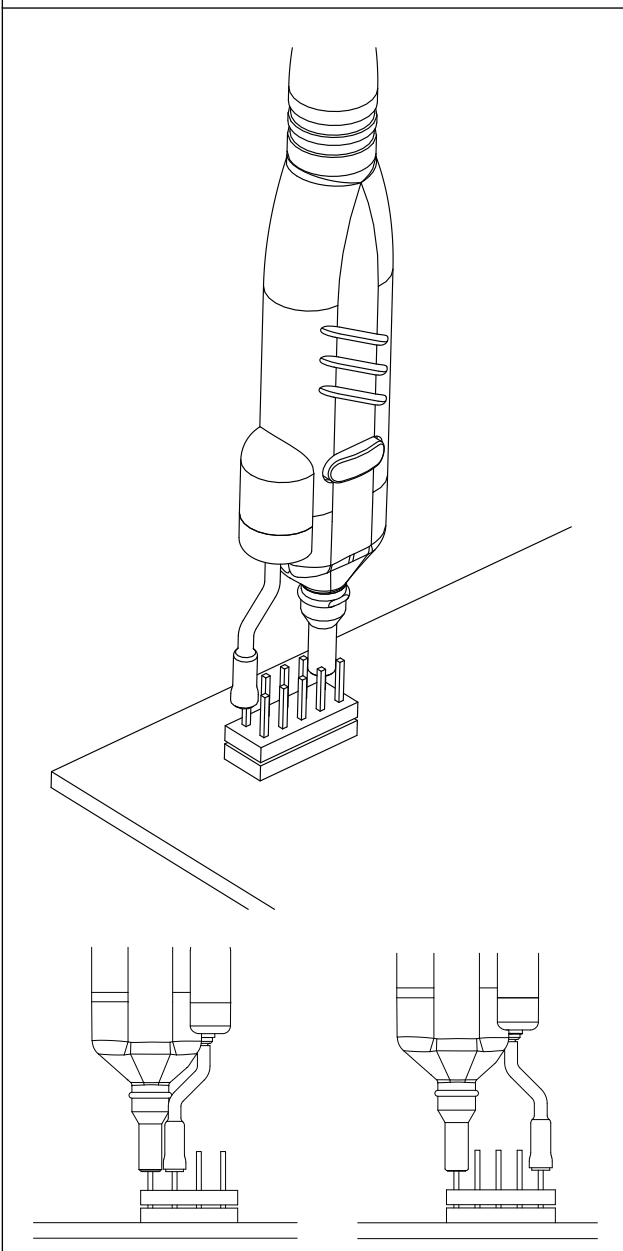

Using signal and ground adapters, the probe can be connected directly to a pin strip.

The sockets are compatible with 0.64 mm (25 mil) square pins and 0.6 mm to 0.8 mm (24 mil to 35 mil) round pins.

The distance between the signal and ground adapter can be adjusted by turning the ground adapter.

Distance range:

2.54 mm to 10.16 mm (1000 mil to 400 mil)

Leads

Short and long lead

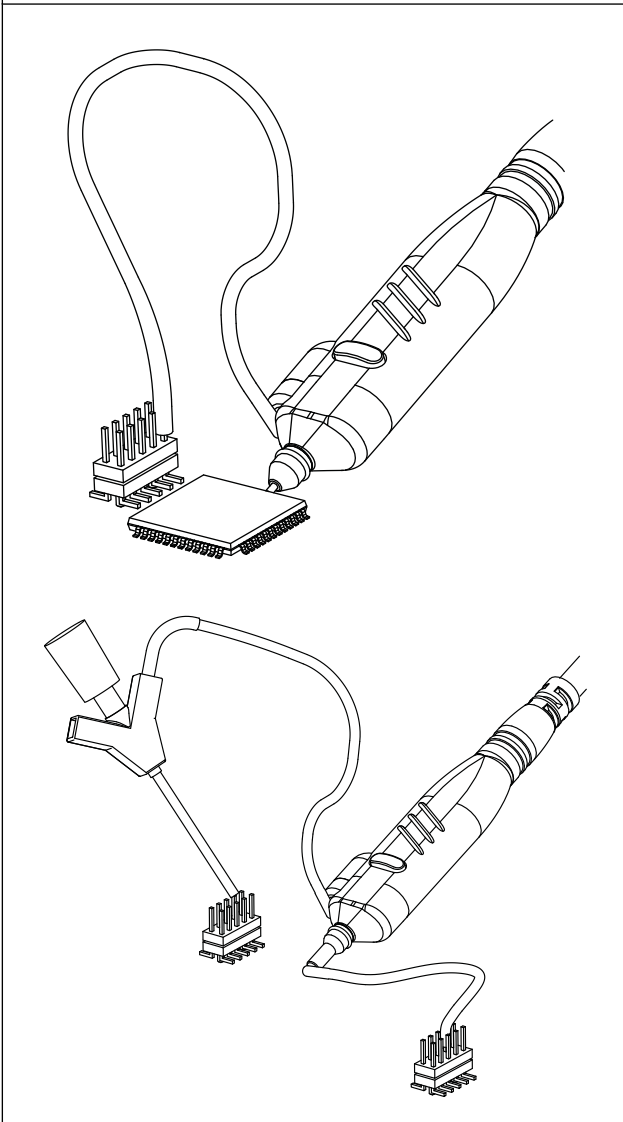

The lead provides a flexible connection to the DUT. It is plugged onto a pin on the DUT and can be used to connect either the signal socket or the ground socket. In addition, it allows micro and mini clips to be connected to the probe.

Connecting a lead to the signal socket of the R&S RT-ZS60 requires a signal adapter, square pin.

Length:

Short lead: 6 mm (236 mil)

Long lead: 15 mm (591 mil)

Clips

Mini and micro clips

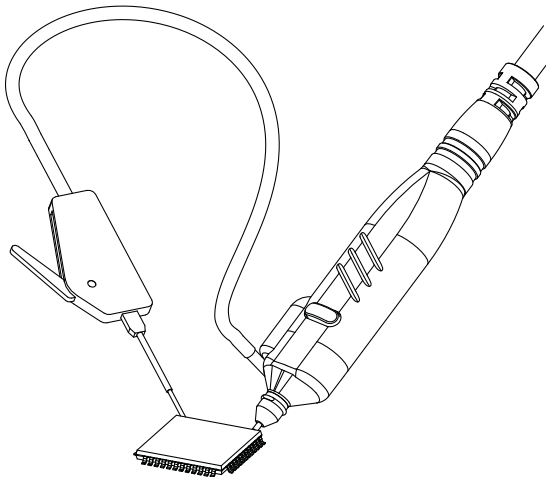
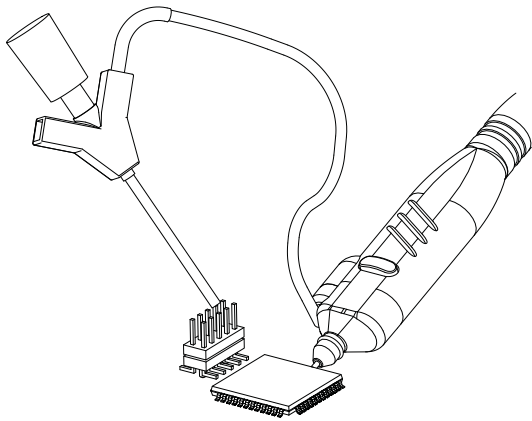

The mini clip is designed for probing large IC pins, wires and through-hole components.

The micro clip is designed for probing IC pins and thin wires in fine-pitch applications.

Clips can be used to contact ground and signal.

To connect a clip to the ground socket, a lead is required.

To connect a clip to the signal socket, the signal adapter, square pin, is required.

4 Measurement Principles

The R&S RT-ZS60 active voltage probe provides an electrical connection between the DUT and the oscilloscope. The probe transfers the voltage of the electrical signal tapped off the DUT to the oscilloscope, where it is displayed graphically. Although a probe has a wide variety of specifications, these specifications can be grouped into two classes of basic requirements:

- High signal integrity of the transferred signal:
With an ideal probe, the output signal that is transferred to the base unit would be identical to the input signal between the probe tips, and signal integrity would be extremely high. Every real probe, however, will transfer the input signal in altered form. A good probe causes only minimum alterations.
How the probe can fulfill this requirement is mainly determined by its bandwidth.
- Low loading of the input signal:
Every probe is a load for the signal to be measured. This means that the signal to be measured changes as soon as the probe is connected. A good probe should cause only a minimum change to the signal, so that the function of the DUT is not adversely affected.
How the probe can fulfill this requirement is mainly determined by its input impedance.

The parameters of a probe are usually specified for a minimally short connection between the probe and the DUT. With longer connections, the connection inductance has a significant effect on the measurement.

The high-frequency behavior of active probes is typically characterized in a 50 Ω measurement environment. The probe is connected to a 50 Ω line that is fed by a source with 50 Ω internal impedance and that is terminated into 50 Ω .

The [figure 4-1](#) shows the equivalent circuit model of a probe that is connected to the DUT.

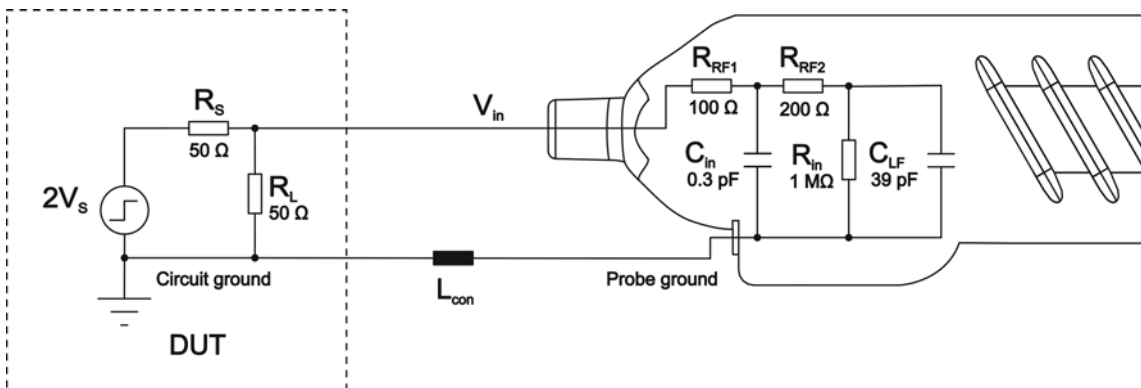

Fig. 4-1: Equivalent circuit model of the R&S RT-ZS60 probe

Table 4-1: Designations

Abbreviation	Description
V_S	Voltage at the test point without probe connected
V_{in}	Voltage at the test point with probe connected, corresponds to the input voltage of the probe
R_S	Source resistance of the DUT
R_L	Load resistance of the DUT
R_{in}	DC input resistance
C_{in}	RF input capacitance of the probe
C_{LF}	LF input capacitance of the probe
R_{RF1}, R_{RF2}	RF input resistance of the probe
L_{con}	Parasitic inductance of the ground connection
V_{out}	Probe output voltage displayed by the oscilloscope

In a 50 Ω system, the output resistance of the source, the load resistance and the characteristic impedance of all lines equal exactly 50 Ω. However, the behavior of the probe in the circuit is determined by the effective source impedance which is the impedance present in the DUT between the probe tip and ground.

Effective source impedance:

$$R'_S = R_S \parallel R_L = 25 \Omega$$

4.1 Signal Integrity of the Transferred Signal

The following sections describe the effect that bandwidth and connection inductance have on signal integrity.

4.1.1 Bandwidth

The bandwidth BW of a probe is one of its specific parameters. The bandwidth of the probe and the bandwidth of the base unit together form the system bandwidth. The following explanations refer to the probe itself, but can also be applied to the entire system.

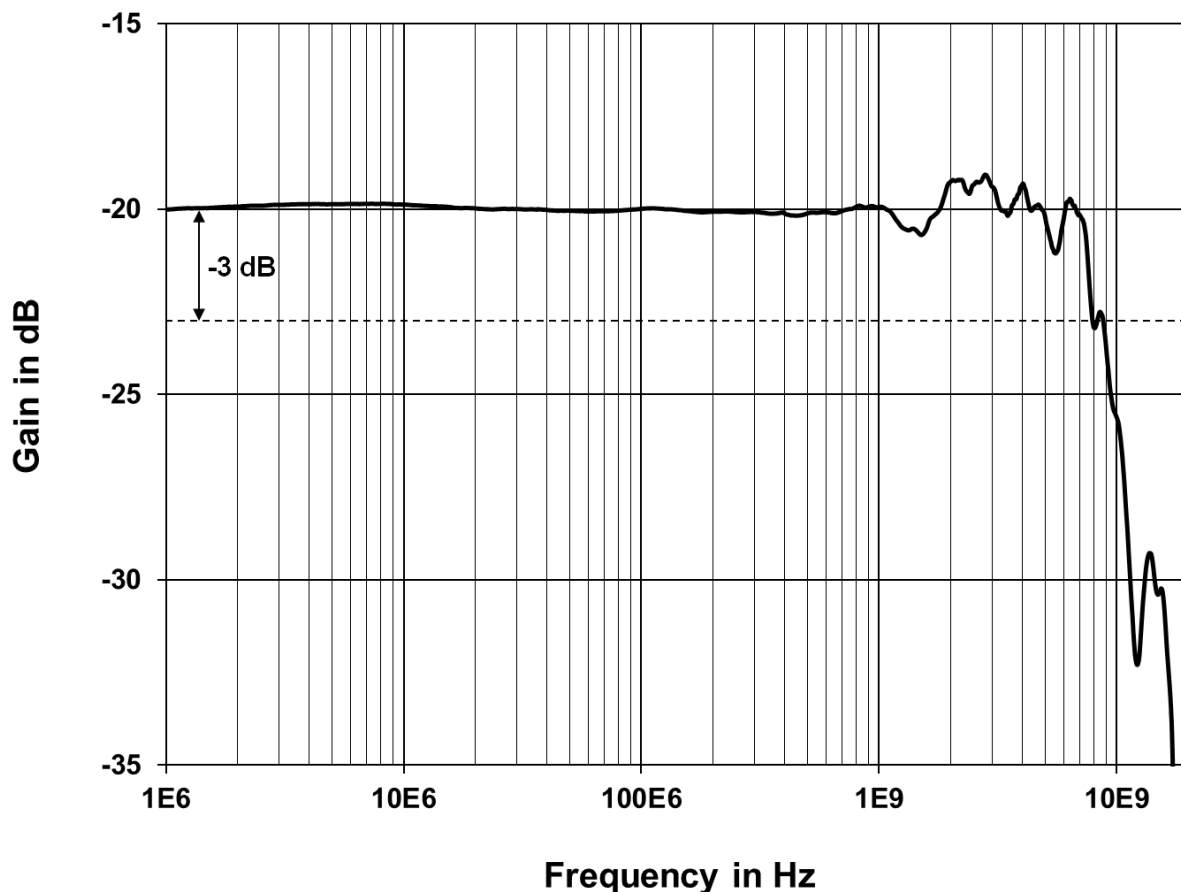

Fig. 4-2: Amplitude frequency response of the R&S RT-ZS60

The bandwidth

- Specifies the maximum frequency at which a purely sinusoidal signal is still transferred at 70 % (–3 dB) of its amplitude.

See [figure 4-2](#).

- Specifies the transferable spectrum for other waveforms. E.g. with square wave signals, the fifth harmonic should still be within the bandwidth for a high signal integrity.
- Determines the minimum measurable signal rise time. The rise time t_{rise} of the probe is inversely proportional to its bandwidth. The following approximation applies:

$$t_{rise} \approx \frac{0.4}{BW}$$

The [figure 4-3](#) shows a typical step response of an R&S RT-ZS60 active voltage probe.

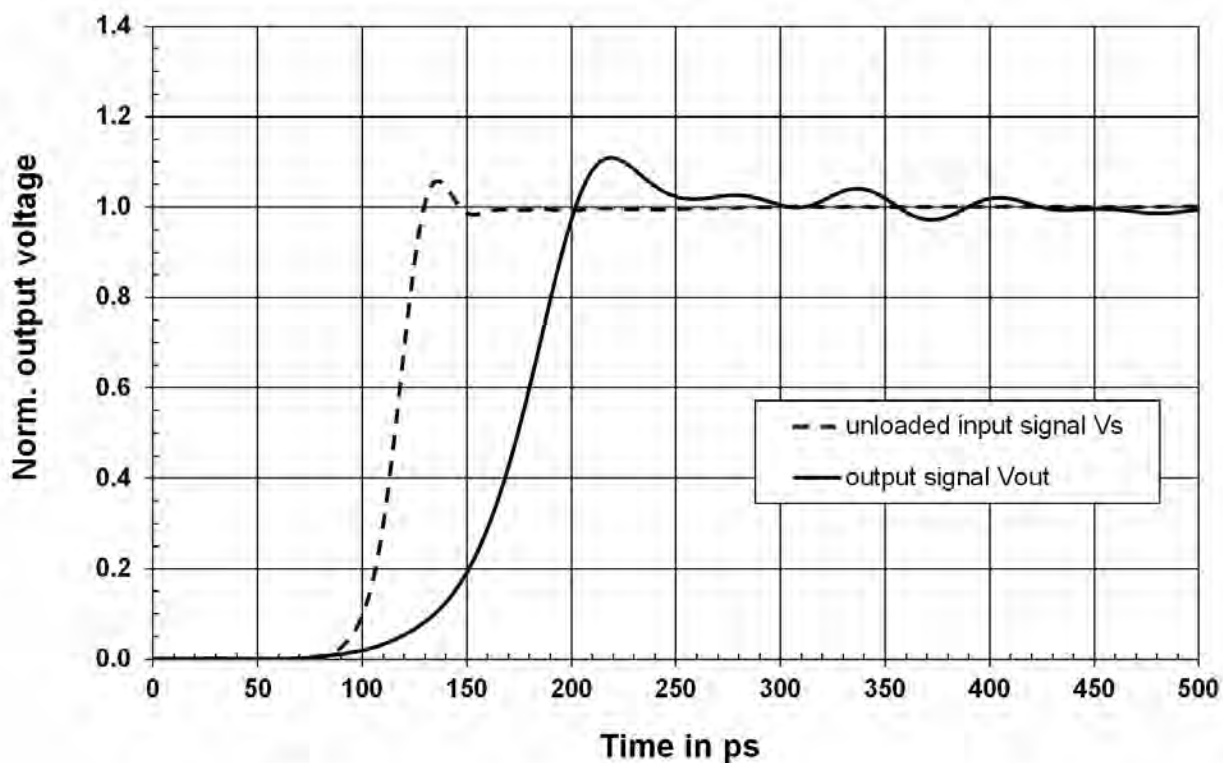

Fig. 4-3: Step response of the R&S RT-ZS60

In addition to bandwidth, a constant amplitude frequency response of the probe is decisive for high signal integrity. The [figure 4-2](#) shows the typical amplitude frequency response of an R&S RT-ZS60 active voltage probe. All frequency components are transferred with the same gain so that the input signal is displayed without distortion.

4.1.2 Connection Inductance

The connection inductance L_{con} is caused by connecting the probe to the DUT. In contrast to the probe-specific bandwidth, the connection inductance mainly depends on the type of connection that the user selects.

The connection inductance

- Increases with the length of the connection and the size of the resulting loop area A .
- Reduces the usable bandwidth and causes ringing with signals having a short rise time (due a series resonance with the input capacitance).
- Should be as small as possible (short lead length) in order to maintain high signal integrity.
- Long leads on the signal input are especially problematic.

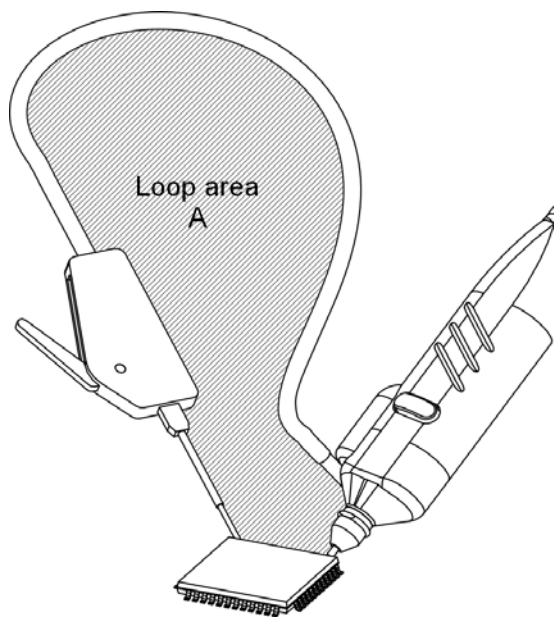

$$L_{con} \text{ proportional to } A$$

$$f_{resonance} \approx \frac{1}{2\pi\sqrt{L_{con} \cdot C_{in}}}$$



$$BW \text{ proportional to } \frac{1}{\sqrt{L_{con}}}$$

Fig. 4-4: Ground connection and connection inductance

4.2 Performance with Different Connection Types

The [table 4-2](#) shows three types of connection between probe and DUT as well as the associated rise times, bandwidths, input impedances and overshoots.

Table 4-2: Typical rise time, bandwidth, input impedance and overshoot with different connection types

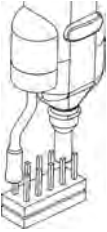
No	Connection Type	Connection			Rise time	Bandwidth	Min. input impedance $ Z_{\min} $	Over-shoot
		Signal socket	Ground socket					
1		signal pin	ground pin, pogo	wide spacing	64 ps	6 GHz	150 Ω	9 %
				narrow spacing	55 ps	8 GHz	110 Ω	25 %
2		signal pin, solder in	ground pin, solder in	short pins	66 ps	6.5 GHz	155 Ω	8 %
				long pins	70 ps	4.5 GHz	235 Ω	11 %
3		signal adapter, square pin	ground adapter, square pin	wide spacing	64 ps	5.5 GHz	120 Ω	11 %
				narrow spacing	52 ps	9 GHz	75 Ω	34 %

Performance with Different Connection Types

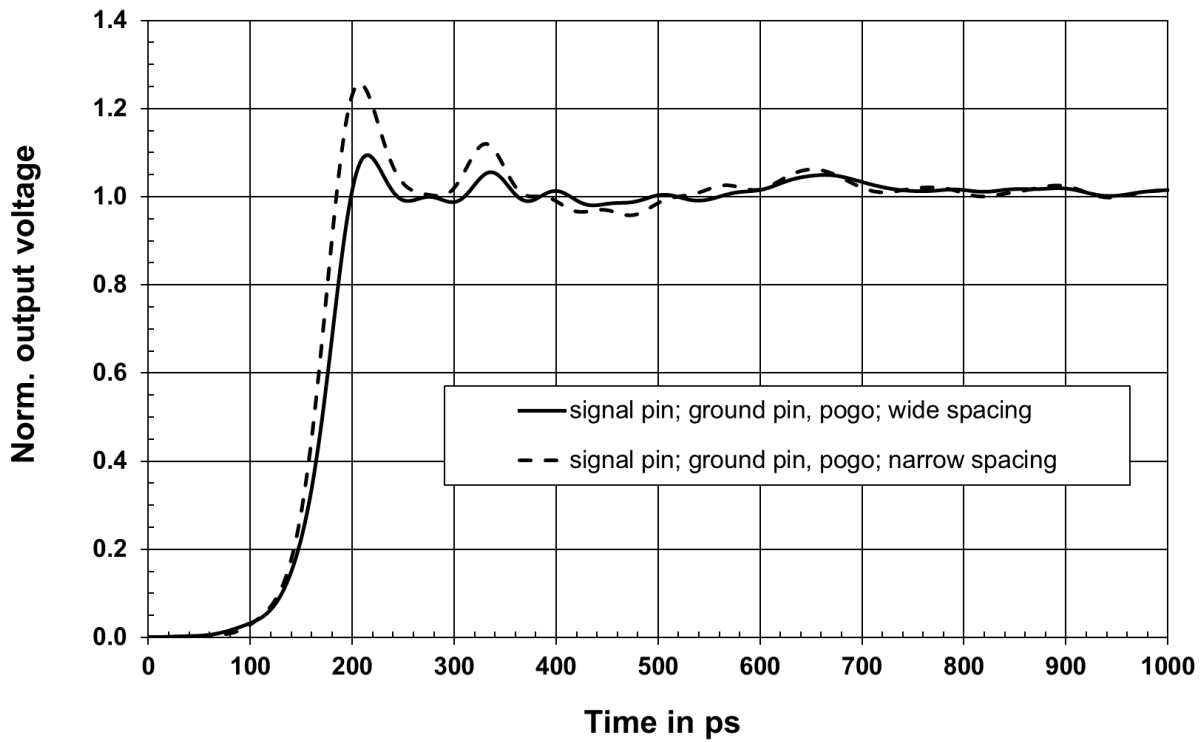

Fig. 4-5: Step response of the R&S RT-ZS60 with a type 1 connection

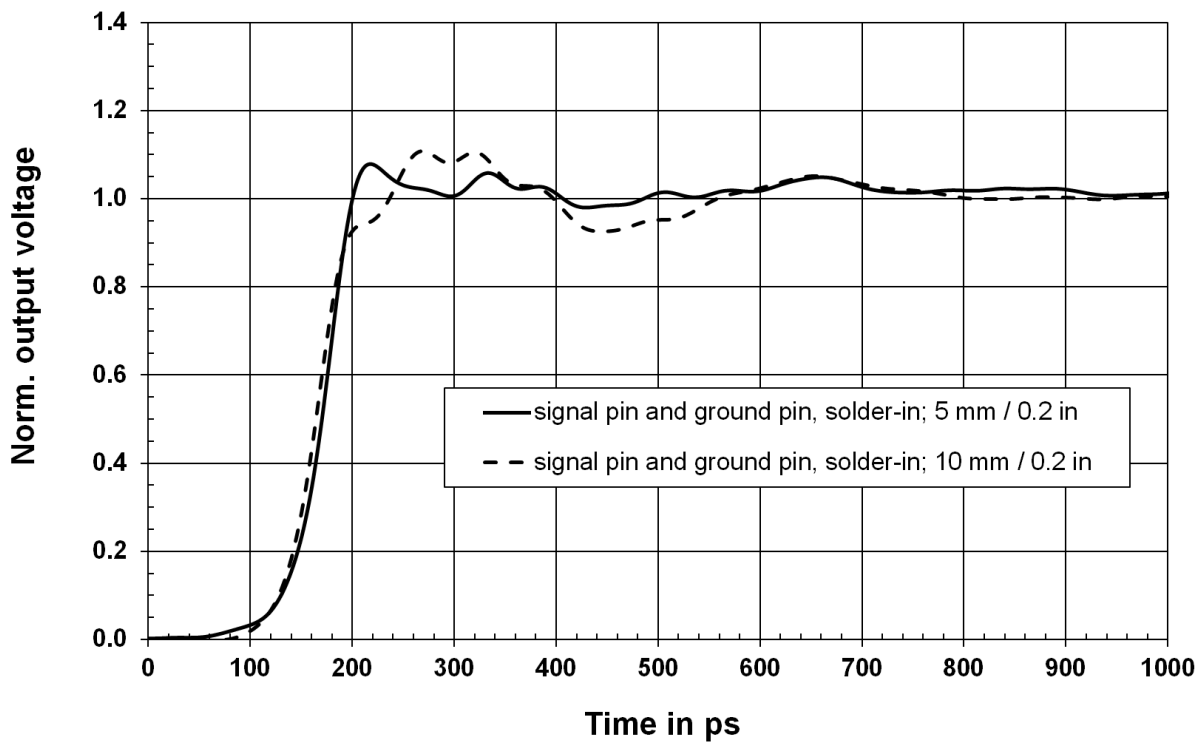

Fig. 4-6: Step response of the R&S RT-ZS60 with a type 2 connection

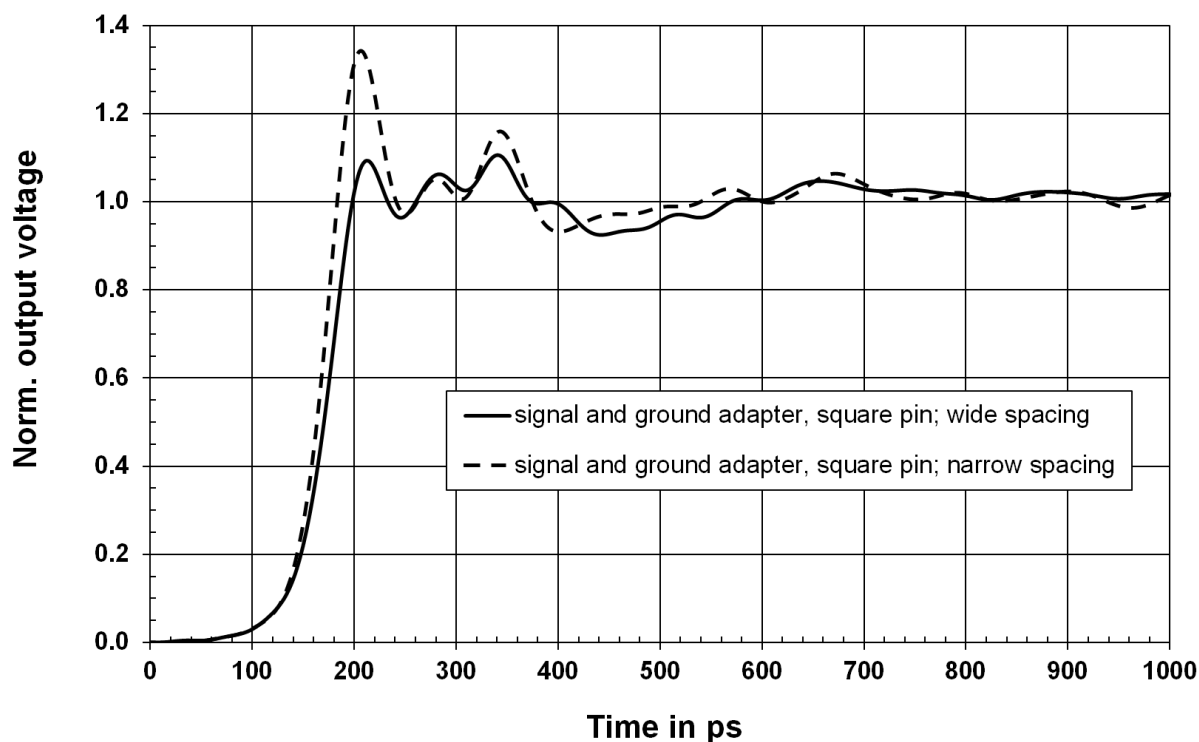

Fig. 4-7: Step response of the R&S RT-ZS60 with a type 3 connection

4.3 Signal Loading of the Input Signal

The previous section dealt with the transfer function and step response of the probe. This section describes how the probe influences the input signal.

4.3.1 Input Impedance

The input signal loading caused by the probe is determined by its input impedance Z_{in} . The [figure 4-1](#) presents an equivalent circuit model.

Z_{in} consists of the following probe-specific parameters.

- Input resistance R_{in}
- LF input capacitance C_{LF}
- RF resistance $R_{RF1} + R_{RF2}$
- RF input capacitance C_{in}

Signal Loading of the Input Signal

- Minimum input impedance $|Z_{min}|$

The resulting input impedance versus frequency is indicated in [figure 4-8](#). The trace shows four characteristic areas that can be assigned to R_{in} , C_{LF} , R_{RF} and C_{in} . The resulting loading of a step signal at the input of the probe is given in [figure 4-9](#).

The connection inductance L_{con} has only a minor effect on the signal loading and is therefore not taken into account in the following.

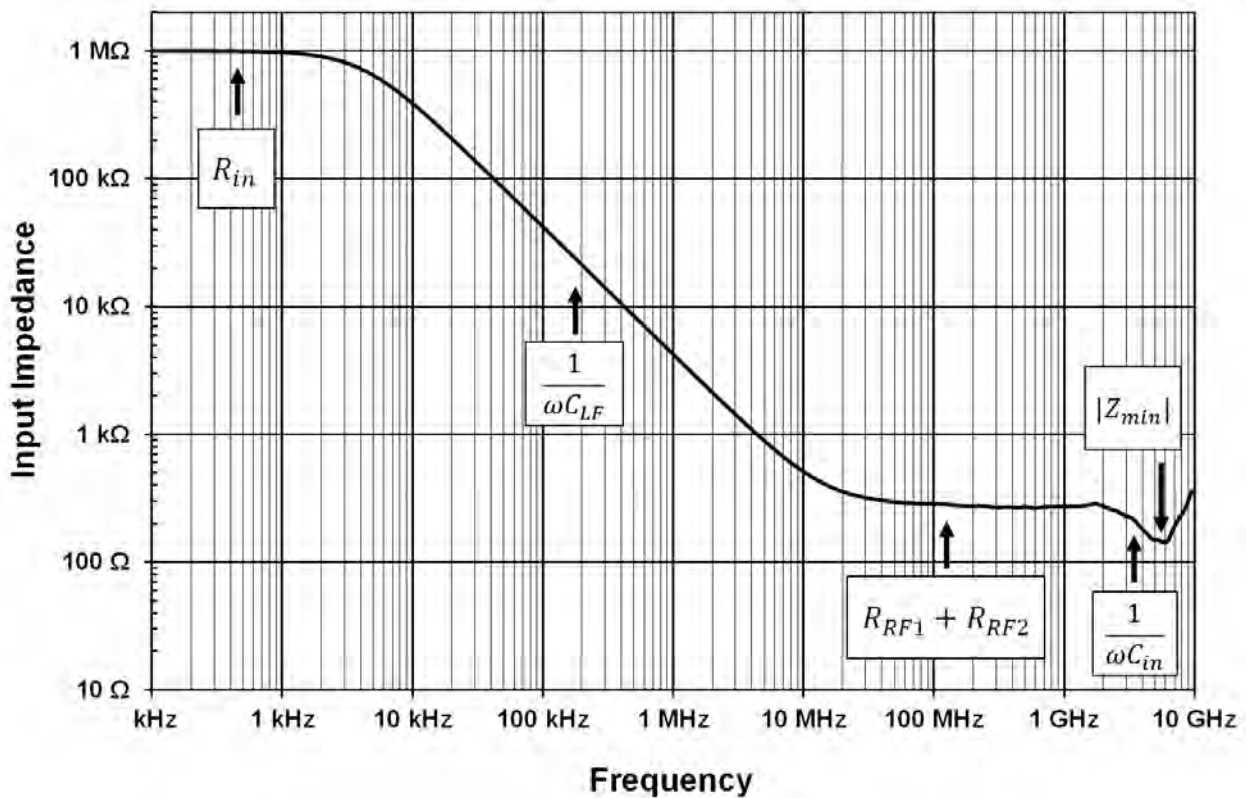

Fig. 4-8: Magnitude of the input impedance of the R&S RT-ZS60 probe as a function of frequency

Signal Loading of the Input Signal

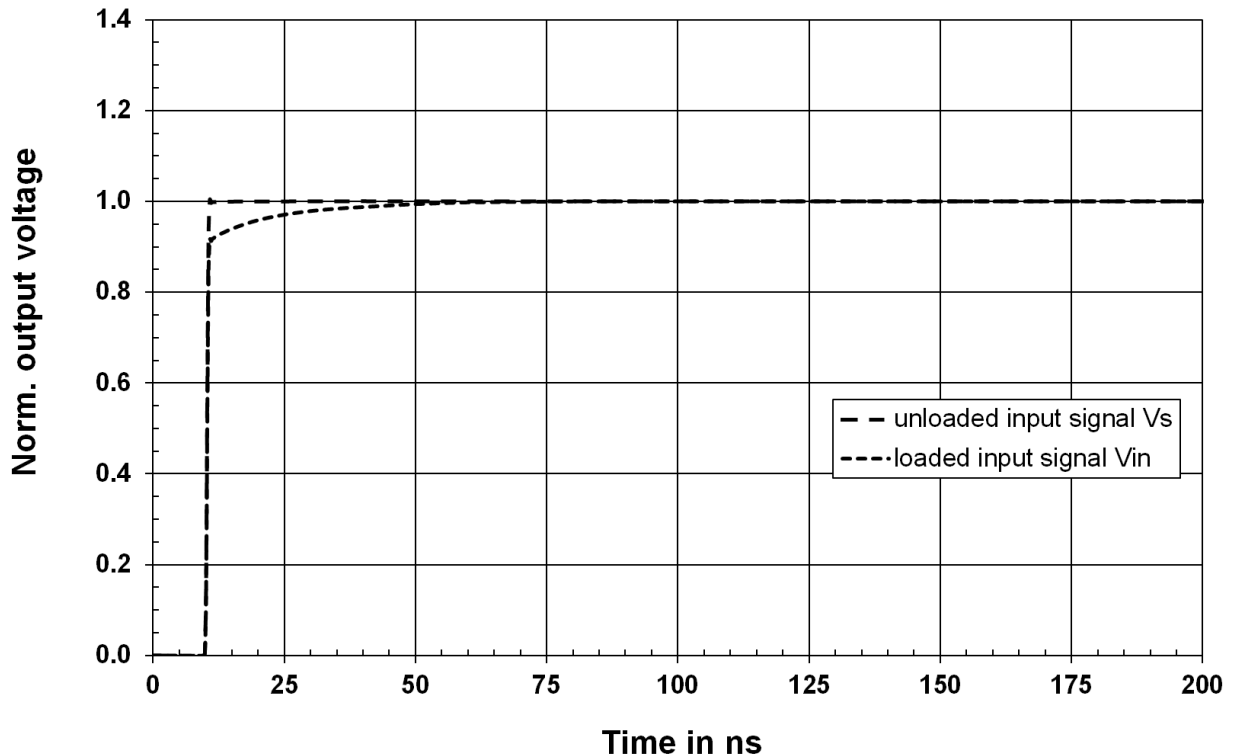

Fig. 4-9: Signal loading caused by the R&S RT-ZS60 probe at an effective source impedance of 25Ω

4.3.1.1 Input Resistance R_{in}

The input resistance determines the loading of the DUT at DC and very low frequencies (< 4 kHz). A low input resistance can potentially disturb measurements of high-frequency signals as it influences the DC operating point of active components. This effect is negligible for the majority of applications involving the R&S RT-ZS60 probe due to the very high input resistance of the probe ($1 \text{ M}\Omega$).

4.3.1.2 LF Capacitance C_{LF}

The LF capacitance causes the input impedance to decrease in the low frequency range (4 kHz to 20 MHz). The LF capacitance affects the settling time of the loaded input voltage in the case of fast transients, see [figure 4-9](#).

4.3.1.3 RF Resistance R_{RF1} and R_{RF2}

R_{RF1} and R_{RF2} (summarized R_{RF}) determine the input impedance in the frequency range from 20 MHz to 2 GHz. Due to the constantly high input impedance of $300\ \Omega$ over the whole range, the loading of high-frequency signals in $50\ \Omega$ environments is very small.

4.3.1.4 Input Capacitance C_{in} and Minimum Input Impedance $|Z_{min}|$

The input capacitance C_{in} causes the input impedance to decrease for high frequencies above 2 GHz. C_{in} is very low - Typically under 300 fF.

The minimum input impedance $|Z_{min}|$ mainly depends on the the connection inductance and the connection type. An overview is given in [table 4-2](#).

4.4 Probing Philosophy

The previous sections made clear that probes exert a load on the signal to be measured and change its characteristic. The signal at the test point where the probe makes contact (V_{in}) is therefore different from the signal that was present before the probe was connected (V_S). This effect cannot be avoided and occurs with all real probes – independent of type and manufacturer.

This has resulted in a difference of opinion as to which of the following two signals should be output by the probe:

1. The initial signal that is not loaded by the probe (V_S) and that corresponds to the signal at the test point without the probe being connected.
2. The input signal that is additionally loaded with the input impedance of the probe (V_{in}) and that is actually present between the probe tips.

Both approaches are physically correct and have their individual advantages and disadvantages. In theory, it is even possible to mathematically convert the two measurement results into each other, but only by performing a complex transformation to and from the frequency domain. Probe manufacturers will use one or the other of these two approaches.

Rohde & Schwarz has decided in favor of the user-friendly approach. In our opinion, most users want to know the signal present in the DUT before it was altered by the influence caused by the probe. After all, users want to characterize their own DUTs, not the Rohde & Schwarz probe.

As long as measurements are carried out in a $50\ \Omega$ (or a comparable) environment, the signal displayed on the oscilloscope's screen is always a direct representation of the unloaded signal V_S , as shown in [figure 4-10](#).

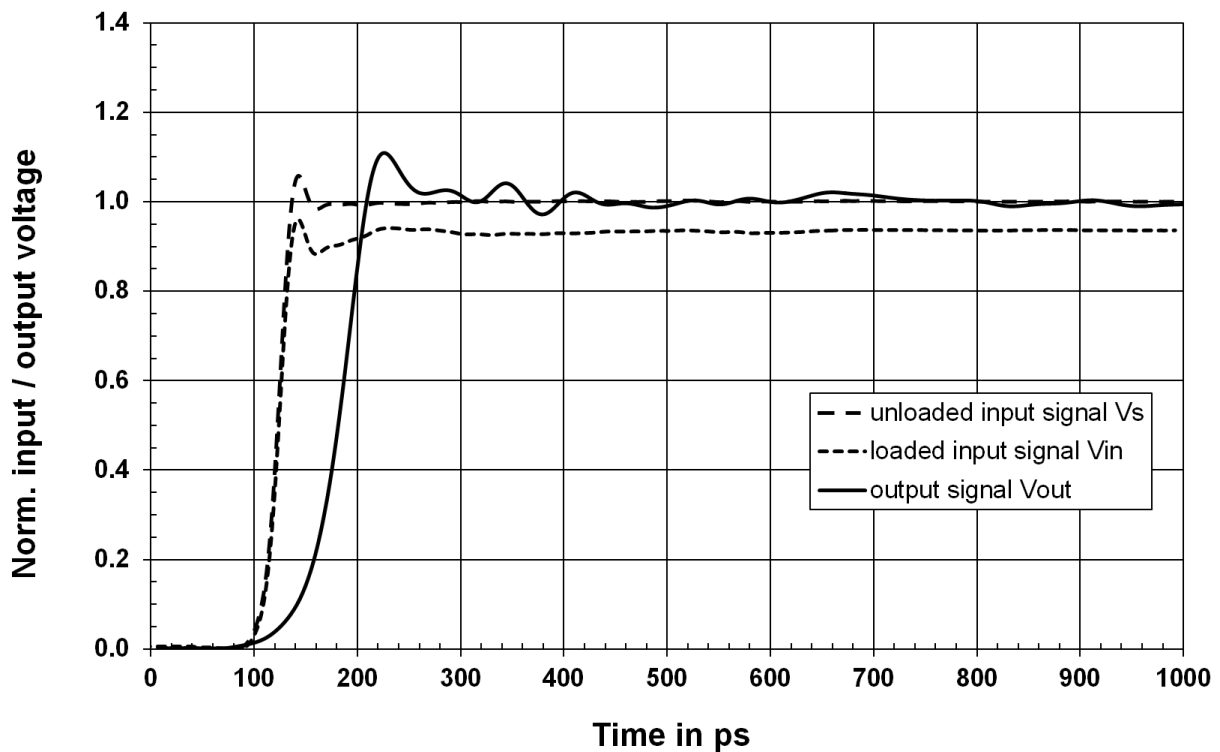

Fig. 4-10: Unloaded and loaded input signal and step response using the example of R&S RT-ZS60

5 Maintenance and Service

5.1 Service Strategy

The R&S RT-ZS60 active voltage probe is a high-precision, high-performance instrument that extends the limits of today's technological possibilities. Like all Rohde & Schwarz instruments, the R&S RT-ZS60 active voltage probe is of high quality and requires only minimum service and repair. However, if the probe needs to be serviced, contact your Rohde & Schwarz service center. Return a defective probe to the Rohde & Schwarz service center for diagnosis and exchange.

You can return the R&S RT-ZS60 active voltage probe for calibration. The service personnel will then perform the required tests.

5.2 Returning the Probe for Servicing

Use the original packaging to return the R&S RT-ZS60 active voltage probe to your Rohde & Schwarz service center.

If you cannot use the original packaging, consider the following:

1. Use a sufficiently sized box.
2. Protect the probe from damage and moisture (e.g. with bubble wrap).
3. Use some kind of protective material (e.g. crumpled newspaper) to stabilize the probe inside the box.
4. Seal the box with tape.
5. Address the package to your nearest Rohde & Schwarz service center.

5.3 Cleaning

To clean the exterior of the probe, use a soft cloth moistened with either distilled water or isopropyl alcohol. Before using the probe again, make sure to dry it completely.

NOTICE**Instrument damage caused by cleaning agents**

Cleaning agents contain substances that may damage the instrument; for example, solvent may damage the labeling or plastic parts.

Never use cleaning agents such as solvents (thinners, acetone, etc.), acids, bases or other substances

5.4 Calibration Interval

The recommended calibration interval is two years. For servicing, send the probe to your nearest Rohde & Schwarz service center (see [chapter 5.2, "Returning the Probe for Servicing"](#), on page 40).

6 Functional Check

The functional check is used to perform a quick check of the most important functions of the R&S RT-ZS60 active voltage probe using simple measurement equipment.

The following functions are checked:

- Initialization
- DC Offset
- DC Accuracy
- Offset

The functional check is not suitable for verifying compliance with the probe specifications, since the test results are influenced by the oscilloscope used.

To verify compliance with the probe specifications, it is necessary to run an independent performance test. This test is described in detail in the R&S RT-ZS60 service manual. The performance test also requires the R&S RT-ZK2 service kit.

NOTICE

All base unit settings described here refer to an R&S RTO oscilloscope. The use of other oscilloscopes may result in different settings and menus.

The following test description always refers to channel 1 (CH1) as the reference channel. The test can also be performed on any other channel of the R&S RTO oscilloscope.

Test equipment

The following list contains the equipment required for the functional check.

Table 6-1: Required test equipment

Description	Minimum requirements	Recommended equipment
R&S RTO oscilloscope		
DC voltage source	±8 V, floating output	Keithley 2420/2601 source meter
Digital multimeter (DMM)	-12 V to +12 V, accuracy ± 0.01 % of measured value	Agilent 34401A

Description	Minimum requirements	Recommended equipment
BNC to 4 mm dual banana adapter		Pomona Model 1269
Two banana leads (red, black)		Multi-Contact ZG410
Probe accessories	1 signal pin 2 mini clips 2 leads, 15 cm	



Let the probe and oscilloscope warm up at least for 15 minutes prior to the test.

Self-alignment

Prior to the functional check, a self-alignment of the R&S RTO oscilloscope must be carried out. Proceed as follows:

Test setup:	R&S RTO oscilloscope
R&S RTO settings:	<ul style="list-style-type: none"> • PRESET • "File" menu > "Selfalignment" > "Control" tab > "Start Alignment"
Measurement:	After a successful self alignment, the label UNCAL is no longer displayed.

6.1 Initialization

The correct initialization of the probe by the oscilloscope has to be checked.

Test setup:	Probe connected to CH1 of the R&S RTO oscilloscope
R&S RTO settings:	"Vertical" menu > "Probe Setup" > "Ch1" tab
Measurement:	<p>If initialization is correct, the following values are displayed on the "Setup" tab of the "Probes" dialog box for the R&S RT-ZS60:</p> <p>Type: active single ended Name: R&S RT-ZS60 Probe attenuation: 10:1 Bandwidth: 6.0 GHz</p>

6.2 DC Offset

The zero error of the probe-oscilloscope system and the zero error of the R&S ProbeMeter are checked.

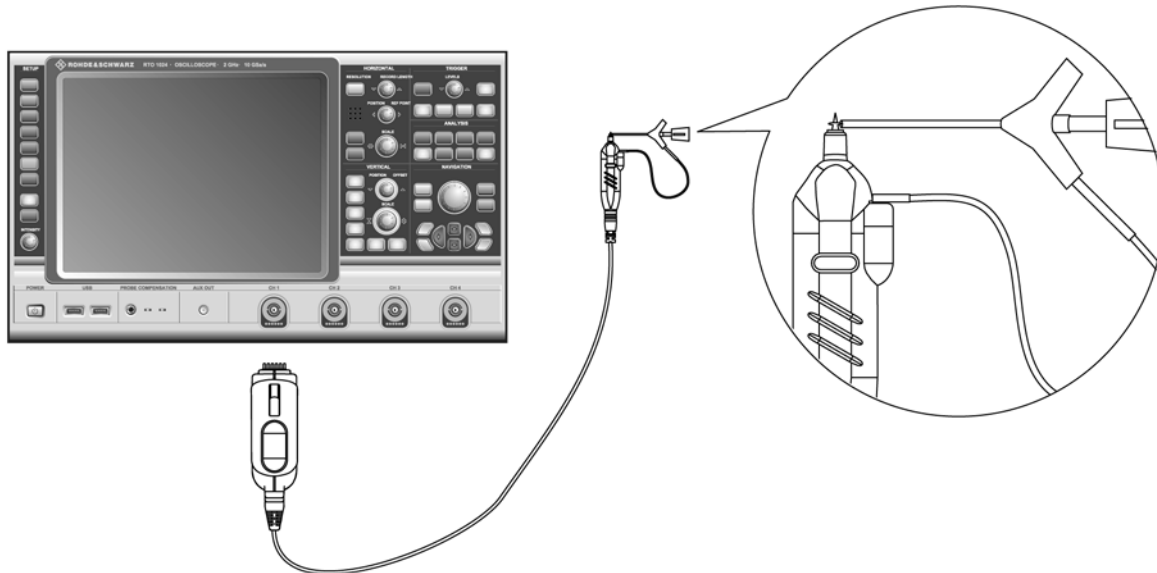

Test setup:	<ul style="list-style-type: none"> • Probe connected to CH1 of the R&S RTO oscilloscope • Inserted signal pin • Signal and ground terminal of the probe shortened by mini clip; make sure that there is no other ground connection.
R&S RTO settings:	<ul style="list-style-type: none"> • Horizontal scale = 10 μs / div • Vertical scale = 10 mV / div • Trigger source = Ch1, Trigger mode = Auto, Run cont • ACQUISITION key > Decimation = 'High res' > Waveform Arithmetics = 'Average' > Average Count = 16 • "Meas" menu > Setup > Source = 'Ch1' > Main Measurement = 'Mean' > State = 'on' • CH1 key > Offset = 0 V, Position = 0 div • "Vertical" menu > Probe Setup > Ch1 > ProbeMeter = 'on' > Micro button action = 'Auto zero'
Measurement:	<ul style="list-style-type: none"> • Check displayed values in the "Measurement Results" box: Mean: 0 V \pm 10 mV ProbeMeter: 0 V \pm 4 mV • Press the micro button: The Auto Zero function automatically compensates the zero error of the probe-oscilloscope combination. • Check again the measurement results: Mean: 0 V \pm 2 mV

6.3 DC Accuracy

The gain of the probe-oscilloscope system and the accuracy of the integrated DC voltmeter are checked.

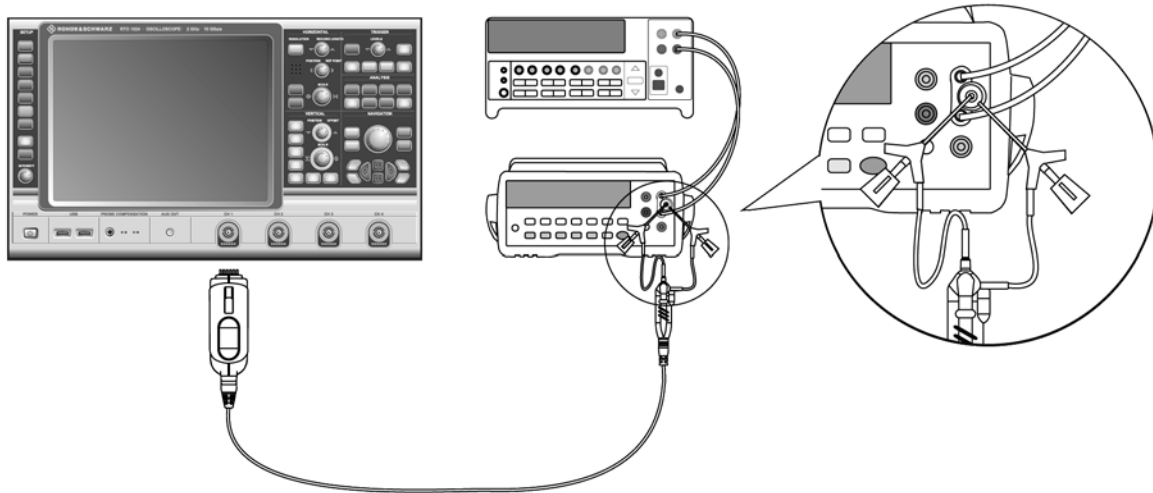

Test setup:	<ul style="list-style-type: none"> • Probe connected to CH1 of the R&S RTO oscilloscope • INPUT HI/LO of the DMM connected to OUTPUT HI/LO of the DC voltage source by banana leads • BNC to 4 mm dual banana adapter plugged onto the banana leads on the DMM – ensure that BNC shield is connected to LO • Signal and ground terminal of the probe connected by mini clips to the BNC to 4 mm dual banana adapter; make sure that probe ground is connected to BNC shield <p>Lead connected to the input socket using a signal adapter, square pin</p>
R&S RTO settings:	<ul style="list-style-type: none"> • Horizontal scale = 10 μs / div • Vertical scale = 1.6 V / div • Trigger source = Ch1, Trigger mode = Auto, Run cont • ACQUISITION key > Decimation = 'High res' > Waveform Arithmetics = 'Average' > Average Count = 16 • "Meas" menu > Setup > Source = 'Ch1' > Main Measurement = 'Mean' > State = 'on' • CH1 key > Offset = 0 V, Position = 0 div • "Vertical" menu > Probe Setup > Ch1 > ProbeMeter = 'on'

Measurement:	<ul style="list-style-type: none"> • Set the voltage on the DC voltage source so that the DMM displays exactly +5.000 V • Check displayed values in the "Measurement Results" box: Mean: +5 V \pm 250 mV ProbeMeter: +5 V \pm 14 mV • Repeat procedure for -5.000 V • Check again the measurement results: Mean -5 V \pm 250 mV ProbeMeter: -5 V \pm 14 mV
--------------	--

6.4 Offset Compensation

The offset compensation is checked.

Test setup:	Same as with DC accuracy
R&S RTO settings:	<ul style="list-style-type: none"> • Horizontal scale = 10 μs / div • Vertical scale = 1.6 V / div • Trigger source = Ch1, Trigger mode = Auto, Run cont • ACQUISITION key > Decimation = 'High res' > Waveform Arithmetics = 'Average' > Average Count = 16 • "Meas" menu > Setup > Source = 'Ch1' > Main Measurement = 'Mean' > State = 'on' • CH1 key > Offset = 0 V, Position = 0 div • "Vertical" menu > Probe Setup > Ch1 > ProbeMeter = 'on' > Micro button action = 'Set offset to mean'
Measurement:	<ul style="list-style-type: none"> • Set the voltage on the DC voltage source so that the DMM displays exactly +5.000 V. • Press the micro button: The "Offset to mean" function of the probe automatically compensates the applied DC voltage. • The oscilloscope waveform should now be on the horizontal center-line. • Switch measurement range: Vertical scale = 10 mV / div • Check displayed values in the "Measurement Results" box: Mean: +5 V \pm 50 mV

Index

- A**
- Accessories 11
 - Auto Zero 18
- B**
- Bandwidth 6, 30
- C**
- Cleaning 41
 - Clips 13, 27
 - Connecting to DUT 23
 - Connection inductance 32
- D**
- DC component of input signal 19
 - DC measurement 21
 - Dynamic range 6, 19
- F**
- Functional check 42
 - DC accuracy 45
 - DC zero 44
 - Initialization 43
 - Offset compensation 46
 - Self-alignment 43
 - Test equipment 42
- I**
- Inductance 32
 - Input capacitance 6
 - Input impedance 35
 - Input resistance 6, 37
- L**
- Leads 13, 26
 - LF capacitance 37
- M**
- Maintenance 40
 - Micro button 6
 - Micro Button 19
- N**
- N/USB adapter 13
- O**
- Offset compensation 19
- P**
- Pins
 - Inserting and removing 23
 - Usage 23
 - Probe
 - Calibration 41
 - Cleaning 41
 - Connection 17
 - Identification 17
 - Returning 40
 - Probe box 9
 - Probe Head 8
 - ProbeMeter 6, 21
 - Probing principles 28
 - Product description 5
- R**
- RF resistance 38
- S**
- Service 40
 - Service Kit 14
 - Signal integrity 30
 - Signal loading 35
 - Step response 31
- U**
- Unpacking 7
 - Using accessories
 - Ground pin, pogo 23
 - Ground pin, solder in 24
 - Leads 26
 - Micro clip 27
 - Mini clip 27
 - Signal pin 23
 - Signal pin, solder in 24