



**HEWLETT
PACKARD**

MICROWAVE MEASUREMENT SYSTEM

Sensor Module
Microwave Converter
Software Pac

models
8902S
11792A
11793A
11794A



TECHNICAL DATA - APRIL 1984

- 150 kHz to 26.5 GHz
- +30 dBm to -105 dBm

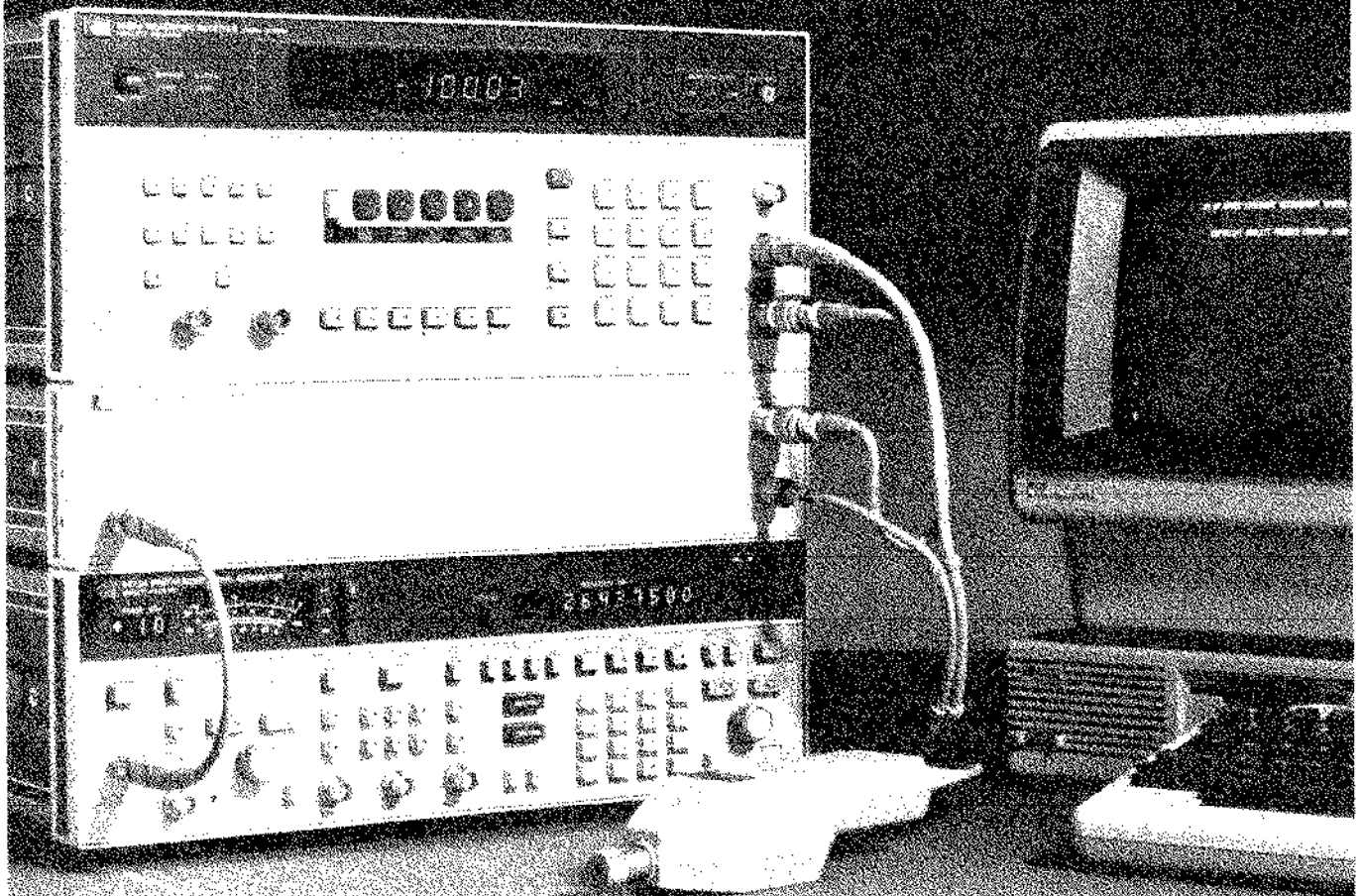

The HP 8902S Microwave Measurement System extends the superb measurement performance of the HP 8902A Measuring Receiver to microwave frequencies. The HP 8902S system delivers the accuracy and resolution of a high performance power meter at frequencies from 50

MHz to 26.5 GHz and levels from +30 dBm to -105 dBm. It accurately measures AM, FM and Φ M, including residuals and incidentals, with a single keystroke. The HP 8902S counts signals to 26.5 GHz with 10 Hz resolution and excellent long-term frequency stability.

The Features You Need For Your Applications

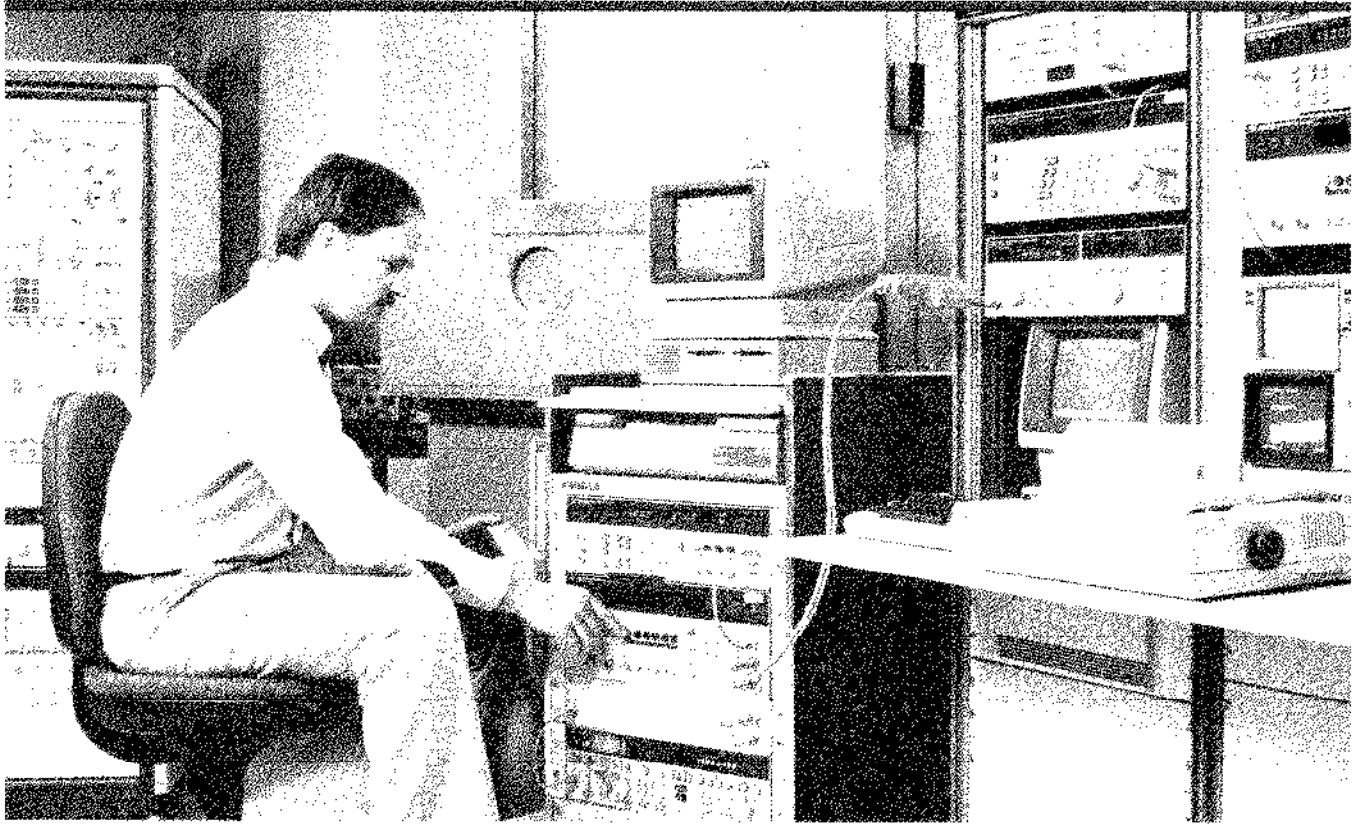

Improves Quality

The HP 8902S minimizes measurement errors. The system's high performance instruments deliver superb accuracy: AM and FM, $\pm 1\%$; level and power, $\pm 0.02 \text{ dB}$ $\pm 0.02 \text{ dB}/10 \text{ dB}$; and carrier frequency, 10 Hz resolution.

Special care is taken to minimize the HP 8902S's input SWR, RFI susceptibility and insertion loss. 26.5 GHz hardware and a specially-designed flexible RF input cable with extremely stable insertion loss and input SWR help make your measurements repeatable.

The HP 8902S down converts with fundamental mixing to 26.5 GHz, eliminating multiple responses.

Saves Time

The HP 8902S is both easy to use and fast. It functions as a single instrument. You control operation from the HP 8902A Measuring Receiver's front panel. With a few keystrokes the system automatically tunes to the signal and makes the measurement. Even difficult tasks such as measuring levels down to -105 dBm , residual FM down to $<17 \text{ Hz}$, and incidental ΦM of <0.03 radians in the presence of 50% AM, are performed in a few seconds.

The HP 8902S can be assembled and running in minutes. For critical down-time applications, move the HP 8902S to the device under test and test it in place.

Increases Confidence

The HP 8902S performs fast, accurate and repeatable microwave measurements traceable to the U.S. National Bureau of Standards. The HP 8902S consists of general purpose HP-IB programmable equipment which can also be used separately for other applications. Add the HP 8903A Audio Analyzer and HP 11795A Software Pac and the system expands to become an HP 8952S Microwave Signal Generator Test System.

Calibrating the HP 8902S system does not require exotic equipment or standards. The system includes an AM/FM calibrator and a 50 MHz power reference. The AM/FM calibrator provides extremely accurate modulated signals with $\pm 0.1\%$ accuracy, for easy self-check of the 8902A's AM and FM calibration factors. The front-panel Power Reference enables precise reference calibration of the system's power sensor. Even the system's low-level power measurement accuracy can be easily verified with a step attenuator and a signal generator.

Signal Generator and Attenuator Calibration

The HP 8902S Microwave Measurement System makes signal generator calibration easier than ever before. It quickly and accurately measures your signal generator's RF frequency, RF level flatness, output level accuracy to -105 dBm, and incidental and residual AM, FM and phase modulation.

For attenuation and other relative measurements, the HP 8902S gives you the accuracy and dynamic range you need. Tuned RF Level makes relative measurements with 100 dB dynamic range at 26.5 GHz. Accuracy is ± 0.02 dB ± 1 digit worst case at 10 dB attenuation, increasing to ± 0.35 dB ± 1 digit at 100 dB attenuation. The combined dynamic range of Tuned RF Level and RF Power is 125 dB.



Research and Development

The HP 8902S Microwave Measurement System is an excellent lab and production tool, accurately characterizing microwave signals to 26.5 GHz.

Level measurements down to -105 dBm with superb accuracy make the HP 8902S ideal for testing devices such as antennas, amplifiers, filters and mixers. Measurements such as directivity, noise figure, harmonic testing and pulse on/off ratio, which require wide dynamic range power measurements, are easy with the HP 8902S.

The HP 8902S makes accurate AM to Φ M and AM to AM conversion measurements of phase- and amplitude-sensitive devices such as bandpass filters and TWT amplifiers. Excellent isolation between AM and FM or AM and Φ M makes it simple to isolate incidental AM on phase-modulated transmitters and the AM, FM and Φ M components of complex signals.

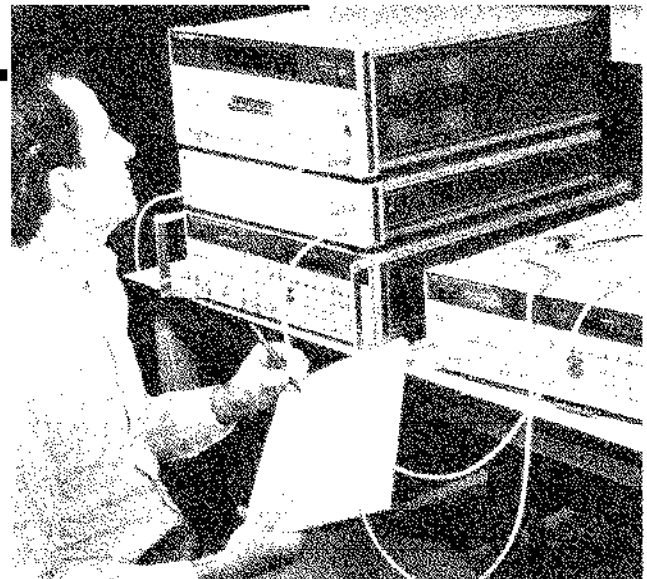

Automatic Test Systems

The HP 8902S is a valuable component in microwave test systems. All functions—power, level, frequency count, and modulation—are fully automatic and easily programmed. With these measurements available at a single connector, interfacing requirements, hardware costs, and software development time are all reduced.

The HP 8902S's excellent measurement accuracy and dynamic range also make it a valuable tool for calibrating automatic test systems.

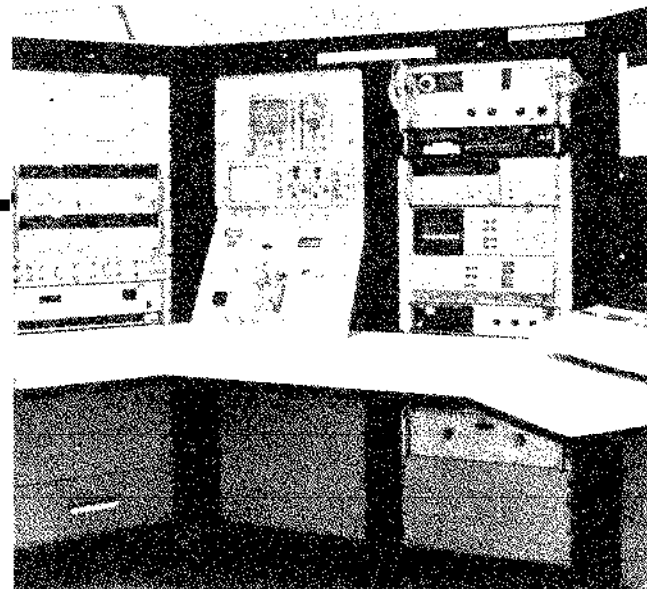

HP 8902S Microwave Measurement System Block Diagram

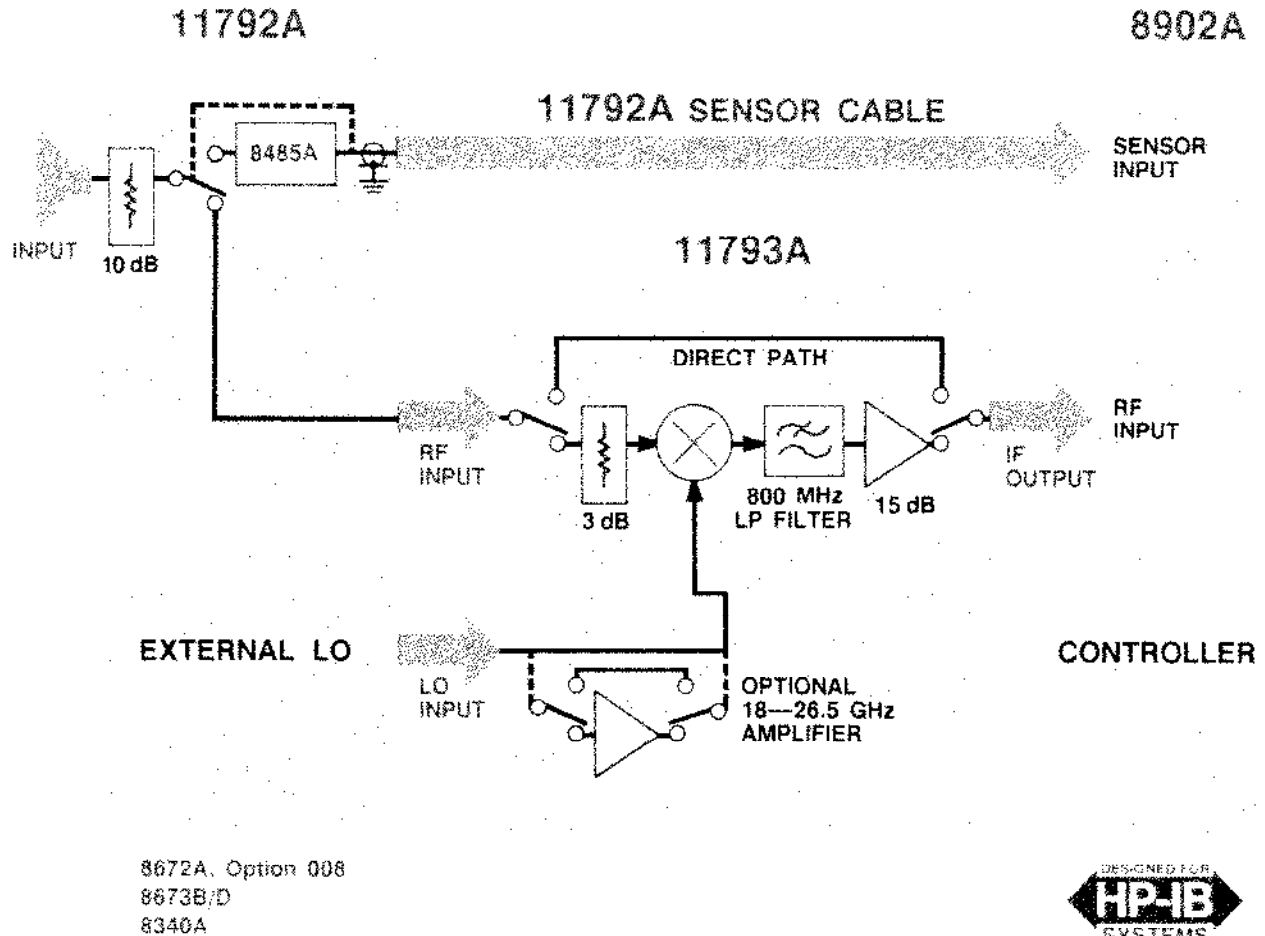

HP 8902S System Configuration

The HP 8902S Microwave Measurement System consists of the HP 8902A Measuring Receiver, HP 11793A Microwave Converter, HP 11792A Sensor Module, an instrument controller, HP 11794A Software Pac and a choice of synthesized microwave local oscillators. For measurements up to 18 GHz, use the HP 8672A option 008 Synthesized Signal Generator. For measurements up to 26.5 GHz you can choose from the HP 8673B/D Synthesized Signal Generators and the HP 8340A Synthesized Sweep Oscillator.

HP 11794A Software Pac

The HP 11794A Software Pac makes testing easy. You select the frequency and measurement from the front panel of the HP 8902A and the system, under the control of the HP 11794A software, does the rest. In only seconds the software asks the HP 8902A for the frequency you entered, calculates and sets the local oscillator (LO) frequency, and releases the HP 8902A to make the measurement and display the results.



HP-IB: Not just IEEE-488, but the hardware, documentation and support that delivers the shortest path to a measurement system.

HP 11793A Microwave Converter

The HP 11793A Microwave Converter down converts microwave signals to the frequency range of the HP 8902A Measuring Receiver. When you want to make a tuned RF level, modulation or frequency measurement above 1.3 GHz, the HP 11793A Microwave Converter routes the signal through its internal mixer. Below 1.3 GHz, signals are routed directly to the input of the HP 8902A.

The HP 11793A requires -8 dBm leveled output from the local oscillator. For LOs with insufficient power above 18 GHz, the HP 11793A offers an optional 18 to 26.5 GHz amplifier.

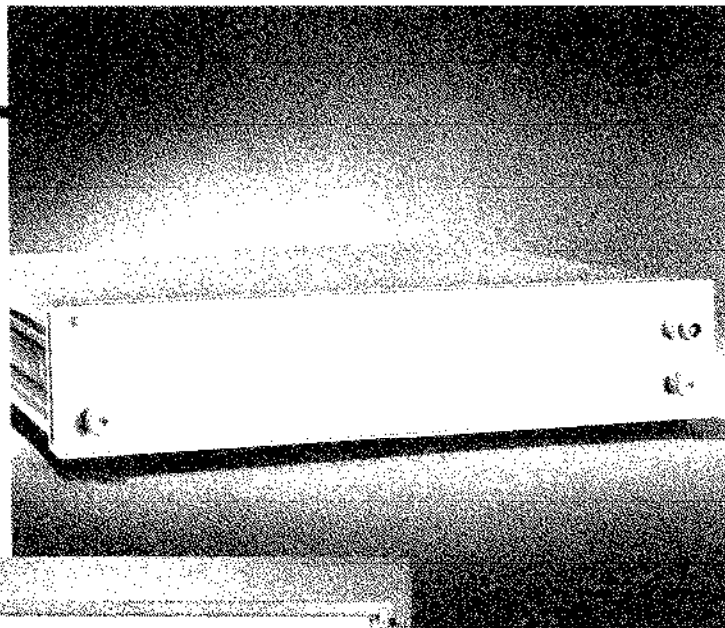

11793A rear panel view.

HP 11792A Sensor Module 50 MHz to 26.5 GHz

When used with the HP 11793A Microwave Converter, the HP 11792A Sensor Module gives you all the performance of the HP 8902S system, plus superb power measurement accuracy, at a single connector. You can characterize a signal without manually switching back and forth between the power sensor and the receiver input.

Each HP 11792A Sensor Module is individually calibrated, traceable to the U.S. National Bureau of Standards. The calibration factors are printed on the sensor module for easy reference. Enter these factors into the HP 8902A's non-volatile memory and the instrument automatically compensates for the power sensor's efficiency and mismatch loss at each frequency. The 11792A is available with either a 3.5 mm precision or Type-N connector.

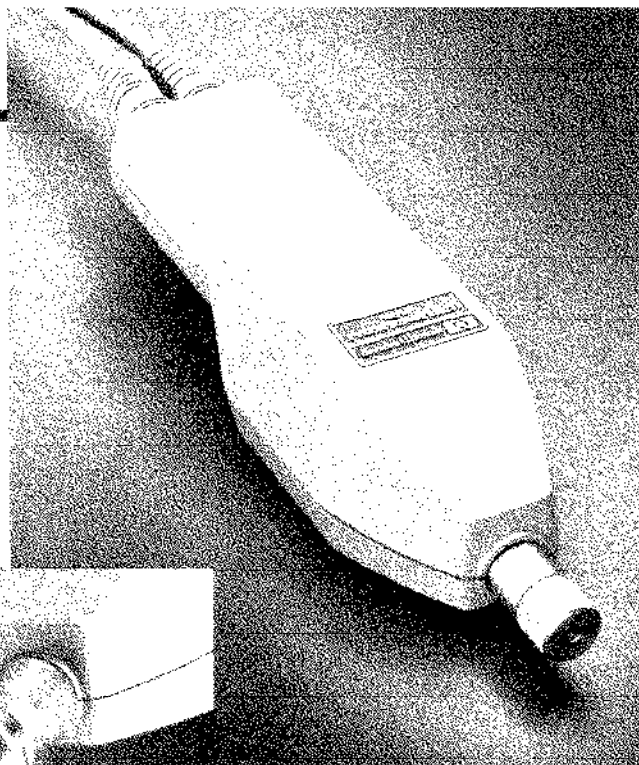

Standard 3.5 mm male input connector

Option 001 type-N male input connector (frequency range to 18 GHz).

HP 8902S SPECIFICATIONS

The HP 8902S system can measure signals to 26.5 GHz. The frequency range of a specific system is determined by the frequency range of the system's local oscillator and the HP 11792A input connector.

Amplitude Modulation

RATES:

20 Hz to 10 kHz, $150 \text{ kHz} \leq f_c < 10 \text{ MHz}$.

20 Hz to 100 kHz, $10 \text{ MHz} \leq f_c \leq 26.5 \text{ GHz}$.

DEPTH: to 99%.

ACCURACY^{1,2,3}:

AM Accuracy	Frequency Range	Rates	Depths
$\pm 2\%$ of reading ± 1 digit	150 kHz—10 MHz	50 Hz—10 kHz	5%—99%
$\pm 3\%$ of reading ± 1 digit	150 kHz—10 MHz	20 Hz—10 kHz	to 99%
$\pm 1\%$ of reading ± 1 digit	10 MHz—1300 MHz	50 Hz—50 kHz	5%—99%
$\pm 1.5\%$ of reading ± 1 digit	1300 MHz—26.5 GHz	50 Hz—50 kHz	5%—99%
$\pm 3\%$ of reading ± 1 digit	10 MHz—26.5 GHz	20 Hz—100 kHz	to 99%

For rms detector add $\pm 3\%$ of reading.

FLATNESS^{4,5}:

Flatness	Frequency Range	Rates	Depths
$\pm 0.3\%$ of reading ± 1 digit	10 MHz—26.5 GHz	90 Hz—10 kHz	20%—80%

DEMODULATED OUTPUT DISTORTION:

<0.3% THD for $\leq 50\%$ depth.

<0.6% THD for $\leq 95\%$ depth.

For $f_c > 1300 \text{ MHz}$ add 0.4% THD.

FM REJECTION (50 Hz to 3 kHz BW)²:

FM Rejection	Frequency Range	Rates	FM Deviations
<0.2% AM	250 kHz—10 MHz	400 Hz or 1 kHz	<5 kHz _{peak}
<0.2% AM	10 MHz—26.5 GHz	400 Hz or 1 kHz	<50 kHz _{peak}

RESIDUAL AM (50 Hz to 3 kHz BW): <0.01%_{rms}.

Supplemental Characteristics:

DETECTORS: +peak, -peak, \pm peak/2, peak hold, average (rms sinewave calibrated), rms.

MAXIMUM DEPTH, RESOLUTION, AND MAXIMUM DEMODULATED OUTPUT SENSITIVITY ACROSS AN OPEN CIRCUIT (600 Ω output impedance)⁷:

Maximum Resolution	Maximum Demodulated Output Sensitivity	Depths
0.1%	0.01 V/percent	$AM_{peak} \geq 40.0\%$
0.01%	0.1 V/percent	$AM_{peak} < 40.0\%$
0.001% (rms detector only)	0.1 V/percent	$AM_{rms} < 3.0\%$

Frequency Modulation

RATES⁶:

20 Hz to 10 kHz, $150 \text{ kHz} \leq f_c < 10 \text{ MHz}$.

20 Hz to 200 kHz, $10 \text{ MHz} \leq f_c \leq 26.5 \text{ GHz}$.

DEVIATIONS⁶:

40 kHz_{peak} maximum, $150 \text{ kHz} \leq f_c < 10 \text{ MHz}$.

400 kHz_{peak} maximum, $10 \text{ MHz} \leq f_c \leq 26.5 \text{ GHz}$.

ACCURACY^{1,2,6}:

FM Accuracy	Frequency Range	Rates	Deviations
$\pm 2\%$ of reading ± 1 digit	250 kHz—10 MHz	20 Hz—10 kHz	$\leq 40 \text{ kHz}_{peak}$
$\pm 1\%$ of reading ± 1 digit	10 MHz—26.5 GHz	50 Hz—100 kHz	$\leq 400 \text{ kHz}_{peak}$
$\pm 5\%$ of reading ± 1 digit	10 MHz—26.5 GHz	20 Hz—200 kHz	$\leq 400 \text{ kHz}_{peak}$

For rms detector add $\pm 3\%$ of reading.

DEMODULATED OUTPUT DISTORTION^{6,7}:

THD	Frequency Range	Rates	Deviations
<0.1%	400 kHz—10 MHz	20 Hz—10 kHz	< 10 kHz
<0.1%	10 MHz—26.5 GHz	20 Hz—100 kHz	<100 kHz

AM REJECTION (50 Hz to 3 kHz BW)²:

AM Rejection	Frequency Range	Rates	AM Depths
<20 Hz peak deviation	150 kHz—26.5 GHz	400 Hz or 1 kHz	$\leq 50\%$

RESIDUAL FM (50 Hz to 3 kHz BW):

<8 Hz_{rms} at 1300 MHz, decreasing linearly with frequency to <1 Hz_{rms} for 100 MHz and below.

<17 Hz_{rms}, $1300 \text{ MHz} < f_c \leq 6.2 \text{ GHz}$.

<33 Hz_{rms}, $6.2 \text{ GHz} < f_c \leq 12.4 \text{ GHz}$.

<49 Hz_{rms}, $12.4 \text{ GHz} < f_c \leq 18.6 \text{ GHz}$.

<65 Hz_{rms}, $18.6 \text{ GHz} < f_c \leq 26.5 \text{ GHz}$.

Supplemental Characteristics:

MAXIMUM FM DEVIATION, RESOLUTION, AND MAXIMUM DEMODULATED OUTPUT SENSITIVITY ACROSS AN OPEN CIRCUIT (600 Ω output impedance)⁷:

Maximum Resolution	Maximum Demodulated Output Sensitivity	Deviations (ΔF)
100 Hz	0.01 mV/Hz	$\Delta F_{peak} \geq 40 \text{ kHz}$
10 Hz	0.1 mV/Hz	$4.0 \text{ kHz} \leq \Delta F_{peak} < 40 \text{ kHz}$
1 Hz	1.0 mV/Hz	$\Delta F_{peak} < 4 \text{ kHz}$
0.1 Hz (rms detector only)	1.0 mV/Hz	$\Delta F_{rms} < 0.3 \text{ kHz}$

Resolution is increased one digit with 750 μ s de-emphasis and pre-display on.

The demodulated output signal present at the Modulation Out/Audio In connector is increased in amplitude by a factor of 10 with 750 μ s de-emphasis.

HP 8902S SPECIFICATIONS

DEMODULATED OUTPUT DISTORTION:

THD	Frequency Range	Rates	Deviations
<0.3%	150 kHz—400 kHz	20 Hz—10 kHz	<10 kHz

DETECTORS: +peak, -peak, \pm peak/2, peak hold, average (rms sinewave calibrated), rms.

Phase Modulation

RATES:

200 Hz to 10 kHz, $150 \text{ kHz} \leq f_c < 10 \text{ MHz}$.

200 Hz to 20 kHz, $10 \text{ MHz} \leq f_c \leq 26.5 \text{ GHz}$.

ACCURACY²:

$\pm 4\%$ of reading ± 1 digit, $150 \text{ kHz} \leq f_c < 10 \text{ MHz}$.

$\pm 3\%$ of reading ± 1 digit, $10 \text{ MHz} \leq f_c \leq 26.5 \text{ GHz}$.

For rms detector add $\pm 3\%$ of reading.

DEMODULATED OUTPUT DISTORTION: <0.1% THD.

AM REJECTION (for 50% AM at 1 kHz rates):²

<0.03 radians peak (50 Hz to 3 kHz BW).

MAXIMUM DEVIATION, RESOLUTION, AND MAXIMUM DEMODULATED OUTPUT SENSITIVITY ACROSS AN OPEN CIRCUIT (600 Ω OUTPUT IMPEDANCE)²:

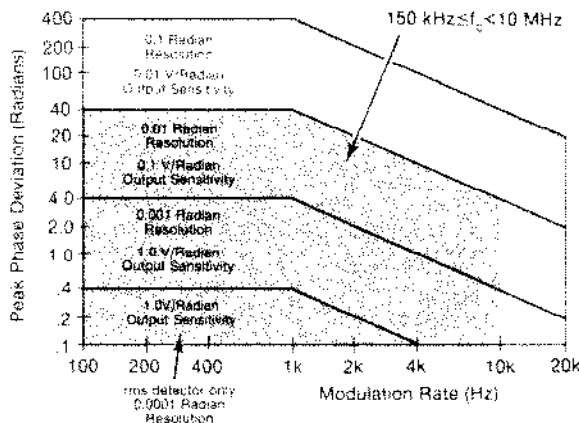

Supplemental Characteristics:

MODULATION RATES: Useable from 20 Hz to 100 kHz with degraded performance.

DETECTORS: +peak, -peak, \pm peak/2, peak hold, average (rms sinewave calibrated), rms.

¹But not to exceed: 50 Hz to 40 kHz rates with rms detector for stated accuracy.

²Peak residuals must be accounted for in peak readings.

³For peak measurements only: AM accuracy may be affected by distortion generated by the Measuring Receiver. In the worst case this distortion can decrease accuracy by 0.1% of reading for each 0.1% of distortion.

⁴Flatness is the variation in indicated AM depth for constant depth on input signal.

⁵For optimum flatness, cables should be terminated with their characteristic impedance.

⁶But not to exceed: 20 kHz rates and 40 kHz peak deviations with 750 μ s de-emphasis filter.

⁷With 750 μ s de-emphasis and pre-display "off," distortion is not specified for modulation outputs >4V peak. This condition can occur near maximum deviation for a measurement range, at rates <2 kHz.

All parameters describe performance in automatic operation or properly set manual conditions. **SPECIFICATIONS** describe the instrument's warranted performance. **Supplemental Characteristics** (shown in *italics*) are intended to provide information useful in applying the instrument by giving typical, but non-warranted, performance parameters.

Modulation Reference

AM CALIBRATOR DEPTH AND ACCURACY:

33.33% depth nominal, internally calibrated to an accuracy of $\pm 0.1\%$.

FM CALIBRATOR DEVIATION AND ACCURACY:

34 kHz_{peak} deviation nominal, internally calibrated to an accuracy of $\pm 0.1\%$.

Supplemental Characteristics:

CARRIER FREQUENCY: 10.1 MHz.

MODULATION RATE: 10 kHz.

OUTPUT LEVEL: -25 dBm.

Frequency Counter

RANGE: 150 kHz to 26.5 GHz.

SENSITIVITY:

40 mV_{rms} (-15 dBm), $150 \text{ kHz} \leq f_c \leq 650 \text{ MHz}$.

71 mV_{rms} (-10 dBm), $650 \text{ MHz} < f_c \leq 1300 \text{ MHz}$.

40 mV_{rms} (-15 dBm), $1300 \text{ MHz} < f_c \leq 26.5 \text{ GHz}$.

MAXIMUM RESOLUTION: 10 Hz.

ACCURACY: ± 3 counts of least-significant digit \pm Reference accuracy.

Supplemental Characteristics:

MODES:

Frequency and Frequency Error (displays the difference between the frequency entered via the keyboard and the actual RF input frequency).

SENSITIVITY IN MANUAL TUNING MODE: (Approximate frequency must be entered from keyboard):

0.71 mV_{rms} (-50 dBm).

Using the RF amplifier and the IF amplifiers, sensitivity can be increased to approximately:

-90 dBm, $f_c \leq 1300 \text{ MHz}$.

-75 dBm, $1300 \text{ MHz} < f_c \leq 26.5 \text{ GHz}$.

Time Base Reference

FREQUENCY: 10 MHz.

AGING RATE⁸:

$< 5 \times 10^{-10}$ /day for 8672A, 8673B/D.

$< 1 \times 10^{-9}$ /day for 8340A.

For detailed specifications see the appropriate local oscillator technical data.

⁸After 10-day warmup (typically 24 hours in normal operating environment).

HP 8902S SPECIFICATIONS

RF Power

The HP 8902A Measuring Receiver, with HP 11792A Sensor Module, performs RF Power Measurements from -20 dBm ($10 \mu\text{W}$) to $+30$ dBm (1W) at frequencies from 50 MHz to 26.5 GHz. The 8902A can be used with the HP 11722A Sensor Module or any of the HP 8480 series power sensors (8481A/1B/1H/2A/2B/2H/3A/4A/5A) to make power measurements from -70 dBm (10 pW) to $+44$ dBm (25W) at frequencies from 100 kHz to 26.5 GHz. The 8480 series sensors also work with the HP 435A, HP 436A, and HP 438A Power Meters.

Unless otherwise specified, the specifications shown below refer to the 8902A only. A detailed explanation of how the uncertainty specifications provided below affect the absolute power measurement accuracy of the 8902A is provided in Application Note 64-1.

RF POWER RESOLUTION⁹:

- 0.1% of full scale in watts or volts mode.
- 0.01 dB in dBm or $\text{dB}_{\text{relative}}$ mode.

LINEARITY (includes sensor non-linearity):

RF range linearity \pm RF range-to-range change error.

RF RANGE LINEARITY (using Recorder Output)¹⁰:

- ± 0.02 dB, RF ranges 2 through 5.
- ± 0.03 dB, RF range 1.
- Using front-panel display add ± 1 count of least-significant digit.

RF RANGE-TO-RANGE CHANGE ERROR (using Recorder Output):

- ± 0.02 dB/RF Range Change from reference range.
- Using front-panel display add ± 1 count of least-significant digit.

INPUT SWR (using HP 11792A Sensor Module):

- < 1.15 , $1300 \text{ MHz} \leq f_c$.
- < 1.25 , $1300 \text{ MHz} < f_c \leq 18.0 \text{ GHz}$.
- < 1.40 , $18.0 \text{ GHz} < f_c \leq 26.5 \text{ GHz}$.

ZERO SET (digital settability of zero):

- $\pm 0.07\%$ of full scale on lowest range.
- Decrease by a factor of 10 for each higher range.

Supplemental Characteristics:

ZERO DRIFT OF METER:

- $\pm 0.03\%$ of full scale/ $^{\circ}\text{C}$ on lowest range.
- Decrease by a factor of 10 for each higher range.

NOISE (at constant temperature, peak change over any 1-minute interval for the 11792A Sensor Module):

- 0.4% of full scale on range 1 (lowest range).
- 0.13% of full scale on range 2.
- 0.013% of full scale on range 3.
- 0.0013% of full scale on range 4.
- 0.00013% of full scale on range 5.

⁹The 8902A fundamental RF Power measurement units are watts. Further internal processing is done on this number to display all other units.

¹⁰When using 8484A sensor the noise specification may mask the linearity specification and become the predominant error. When operating on the top RF power range, add the Power Sensor Linearity percentages found in the power sensor specifications.

ZERO DRIFT OF 11792A (1 hour at constant temperature after 24-hour warm-up):

- $\pm 0.1\%$ of full scale on lowest range.
- Decrease by a factor of 10 for each higher range.

RF POWER RANGES OF 8902A MEASURING RECEIVER WITH 11792A SENSOR MODULE:

- -20 dBm to -10 dBm ($10 \mu\text{W}$ to $100 \mu\text{W}$), range 1.
- -10 dBm to 0 dBm ($100 \mu\text{W}$ to 1 mW), range 2.
- 0 dBm to $+10$ dBm (1 mW to 10 mW), range 3.
- $+10$ dBm to $+20$ dBm (10 mW to 100 mW), range 4.
- $+20$ dBm to $+30$ dBm (100 mW to 1W), range 5.

RESPONSE TIME (0 to 99% of reading):

- < 10 seconds, range 1.
- < 1 second, range 2.
- < 100 milliseconds, range 3 through 5.

DISPLAYED UNITS:

Watts, dBm, $\text{dB}_{\text{relative}}$, $\%_{\text{relative}}$, volts, mV, μV , dBV, dBmV, dB μV .

INTERNAL NON-VOLATILE CAL FACTOR TABLES (user modifiable using special functions):

Maximum Number of CAL Factor/Frequency Entries:

- Table #1 (Primary):
 - 16 pairs plus Reference Cal Factor.
- Table #2 (Frequency Offset):
 - Used with 11792A sensor module; 22 pairs plus Reference Cal Factor.

Maximum Allowed Frequency Entry: 42 GHz.

Frequency Entry Resolution: 50 kHz.

CAL Factor Range: 40 to 120%.

CAL Factor Resolution: 0.1%.

Power Reference

POWER OUTPUT:

1.00 mW. Factory set to $\pm 0.7\%$, traceable to the U.S. National Bureau of Standards.

ACCURACY: $\pm 1.2\%$ worst case ($\pm 0.9\%$ rss) for one year (0°C to 55°C).

Supplemental Characteristics:

FREQUENCY: 50 MHz nominal.

SWR: 1.05 nominal.

FRONT PANEL CONNECTOR: Type-N female.

¹¹The 8902A fundamental Tuned RF Level measurement units are volts. Further internal processing is done on this number to display all other units.

¹²Tuned RF Level accuracy will be affected by residual FM of the source-under-test. If the residual FM_{peak} is > 50 Hz measured over a 30-second period in a 3 kHz BW, Tuned RF Level measurements should be made using the IF Average detector (30 kHz BW) by using special function 4.4.

¹³In automatic operation IF ranges 6 and 7 are only used for Tuned RF Level measurements at the lowest levels.

HP 8902S SPECIFICATIONS

Tuned RF Level

LEVEL RANGE (Using HP 11792A Sensor Module):

For IF Synchronous Detector:

- +10 dBm to -117 dBm, $2.5 \text{ MHz} \leq f_c \leq 1300 \text{ MHz}$.
- +5 dBm to -105 dBm, $1300 \text{ MHz} < f_c \leq 12.4 \text{ GHz}$.
- +5 dBm to -100 dBm, $12.4 \text{ GHz} < f_c \leq 18.0 \text{ GHz}$.
- +5 dBm to -95 dBm, $18.0 \text{ GHz} < f_c \leq 26.5 \text{ GHz}$.

For IF Average Detector:

- +10 dBm to -90 dBm, $2.5 \text{ MHz} \leq f_c \leq 1300 \text{ MHz}$.
- +5 dBm to -80 dBm, $1300 \text{ MHz} < f_c \leq 12.4 \text{ GHz}$.
- +5 dBm to -75 dBm, $12.4 \text{ GHz} < f_c \leq 18.0 \text{ GHz}$.
- +5 dBm to -70 dBm, $18.0 \text{ GHz} < f_c \leq 26.5 \text{ GHz}$.

1.9 Special Function degrades Tuned RF Level minimum sensitivity by 10 dB.

FREQUENCY RANGE: 2.5 MHz to 26.5 GHz.

DISPLAYED RESOLUTION¹¹:

- 4 digits in watts or volts mode.
- 0.01 dB in dBm or $\text{dB}_{\text{relative}}$ mode.

RELATIVE MEASUREMENT ACCURACY (at constant temperature and after RF range calibration is completed)¹²:

Detector Linearity + Mixer Linearity + IF Range-to-range error + RF Range-to-range error + Frequency drift error + Noise error ± 1 digit.

DETECTOR LINEARITY:

For IF Synchronous Detector:

- ± 0.007 dB/dB change, but not more than ± 0.02 dB/10 dB change.
- Typically $< \pm 0.004$ dB/dB change and $< \pm 0.01$ dB/10 dB change.

For IF Average Detector (0°C to +35°C):

- ± 0.013 dB/dB change, but not more than ± 0.06 dB/10 dB change.
- Typically $< \pm 0.008$ dB/dB change and $< \pm 0.05$ dB/10 dB change.

MIXER LINEARITY:

- Negligible, levels ≥ -5 dBm.
- ± 0.04 dB, levels > -5 dBm and frequencies > 1300 MHz.

IF RANGE-TO-RANGE ERROR (see Tuned RF Level Range Plot)¹³:

- ± 0.02 dB/IF Range change, IF ranges 1 through 5.
- ± 0.05 dB/IF Range change, IF ranges 6 and 7.

RF RANGE-TO-RANGE ERROR:

- ± 0.04 dB/RF Range change (tuned RF level only).
- ± 0.06 dB/RF Range change, RF power to tuned RF level.

FREQUENCY DRIFT ERROR:

- ± 0.05 dB/kHz frequency drift from center of IF (using IF synchronous detector).

NOISE ERROR:

- ± 0.18 dB, levels < -110 dBm, $2.5 \text{ MHz} \leq f_c \leq 1300 \text{ MHz}$.
- ± 0.18 dB, levels < -98 dBm, $1300 \text{ MHz} < f_c \leq 12.4 \text{ GHz}$.
- ± 0.18 dB, levels < -93 dBm, $12.4 \text{ GHz} < f_c \leq 18.0 \text{ GHz}$.
- ± 0.18 dB, levels < -88 dBm, $18.0 \text{ GHz} < f_c \leq 26.5 \text{ GHz}$.
- Negligible elsewhere.

INPUT SWR (using HP 11792A Sensor Module):

- < 1.15 , $1300 \text{ MHz} \leq f_c$
- < 1.25 , $1300 \text{ MHz} < f_c \leq 18.0 \text{ GHz}$.
- < 1.40 , $18.0 \text{ GHz} < f_c \leq 26.5 \text{ GHz}$.

Supplemental Characteristics:

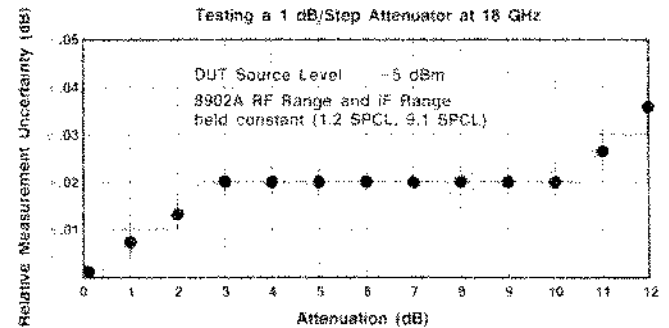
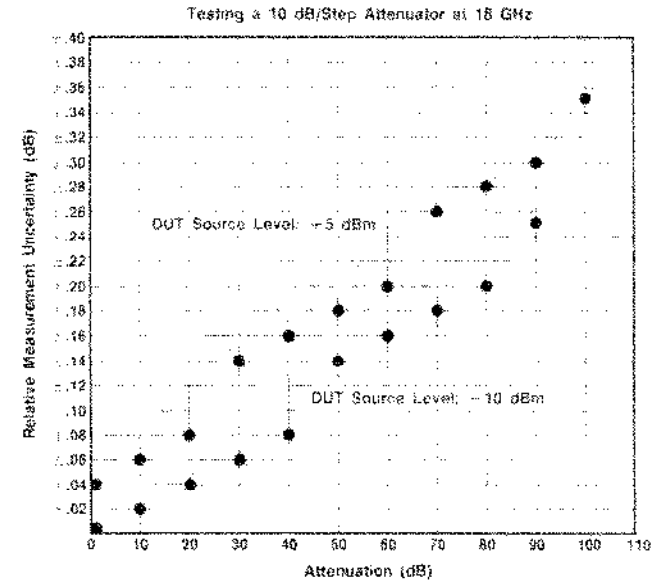

ABSOLUTE LEVEL MEASUREMENT ACCURACY AT LOW LEVELS (at constant temperature and after RF Range Calibration is completed)¹²:

Absolute Level Measurement Accuracy is a function of the RF Power and Tuned RF Level measurement accuracy. Product Note 8902A-1 explains how both of these measurements affect level measurement accuracy.

ACQUISITION TIME:

- < 4 seconds, levels ≥ -85 dBm.
- < 10 seconds, levels < -85 dBm.

RESPONSE TIME (responding to changes in level of an acquired signal):

- < 2 seconds, levels ≥ -85 dBm.
- < 5 seconds, levels < -85 dBm.

DISPLAYED UNITS:

Watts, dBm, $\text{dB}_{\text{relative}}$, % relative, volts, mV, μV , dB V, dB mV, $\text{dB}_{\text{relative}} \mu\text{V}$.

HP 8902S SPECIFICATIONS

Audio Measurements

The HP 8902S system's audio measurement specifications are the same as for the HP 8902A Measuring Receiver. See the 8902A technical data for complete specifications.

RF Input

FREQUENCY RANGE: 150 kHz to 26.5 GHz.

OPERATING LEVEL:

Minimum Operating Level	Maximum Operating Level	Frequency Range
40 mV _{rms} (-15 dBm)	7V _{rms} (1W _{peak})	150 kHz—650 MHz
71 mV _{rms} (-10 dBm)	7V _{rms} (1W _{peak})	650 MHz—1300 MHz
40 mV _{rms} (-15 dBm)	7V _{rms} (1W _{peak})	1300 MHz—26.5 GHz

Supplemental Characteristics:

TUNING: Manual entry of approximate frequency.

INPUT IMPEDANCE: 50Ω nominal.

General Specifications

TEMPERATURE: Operating: 15°C to 35°C.
Storage: -25°C to 60°C.

EMI: Conducted and radiated interference is within the requirements of VDE 0871 (Level B) and CISPR publication 11.

POWER: 100, 120, 220, or 240V (+5%, -10%); 48—66 Hz; 1300 VA maximum (worst case).

WEIGHT: Net 122.3 Kg (270 lb);
Shipping: 153.3 Kg (338.3 lb) worst case.

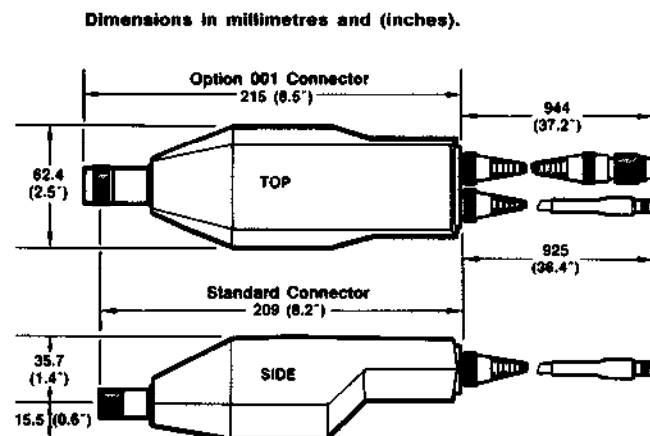

HP 11792A Sensor Module

FREQUENCY RANGE:

RF Power Measurements:
50 MHz to 26.5 GHz.
50 MHz to 18.0 GHz, Option 001.

Other Measurements: to 26.5 GHz.
to 18.0 GHz, Option 001.

POWER RANGE: +30 dBm (1 watt) to -20 dBm (10 μW).

INPUT SWR (connected to an HP 11793A):

<1.15, 1300 MHz ≤ f_c.
<1.25, 1300 MHz < f_c ≤ 18.0 GHz.
<1.40, 18.0 GHz < f_c ≤ 26.5 GHz.

POWER SENSOR LINEARITY:

+2%, -4%; +30 dBm to +20 dBm.
Negligible deviation, levels <+20 dBm.

CALIBRATION FACTORS:

Each 11792A Sensor Module is individually calibrated. The calibration factors are printed on the 11792A Sensor Module for easy reference.

CAL FACTOR UNCERTAINTY:

Frequency	RSS Uncertainty	Worst Case Uncertainty
2.0 GHz	2.3	4.6%
6.0 GHz	2.5	5.0%
10.0 GHz	2.9	5.7%
14.0 GHz	3.4	6.6%
18.0 GHz	3.7	6.9%
22.0 GHz	3.8	7.8%
26.5 GHz	4.1	8.3%

Supplemental Characteristics:

INPUT IMPEDANCE: 50Ω nominal.

INPUT CONNECTOR: 3.5 mm male (Type N male, Option 001).

SWITCH LIFE: >1,000,000 switchings.

WEIGHT: Net 0.8 kg (1.75 lb); Shipping 1.2 kg (2.6 lb);
Gross without manual 1050g.

DIMENSIONS: 51.2 mm H × 62.4 mm W × 1153 mm D
(2" × 2.5" × 45.4").

HP 8902S SPECIFICATIONS

HP 11793A Specifications

LO AMPLITUDE RANGE:

- +8 dBm to +13 dBm, 2 GHz to 18 GHz.
- +7 dBm to +13 dBm, 18 GHz to 26.5 GHz.
- 0 dBm to +5 dBm, 18 GHz to 26.5 GHz with Option 001, 011, or 021.

TEMPERATURE:

- Operation: 0°C to 55°C.
- Storage: -55°C to 75°C.
- 25°C to 75°C (Options 001, 011, and 021).

POWER: 100, 120, 220, or 240 (+5%, -10%); 48—66 Hz; 20 VA maximum.

WEIGHT: Net 7.5 kg (16.5 lb); shipping 10.9 kg (24 lb).

DIMENSIONS: 88 mm H × 425 mm W × 528 D
(3.5" × 16.7" × 20.8").

HP SYSTEM II MODULE SIZE: 3½ H × 1 MW × 20 D.

Dimensions in millimetres and (inches).

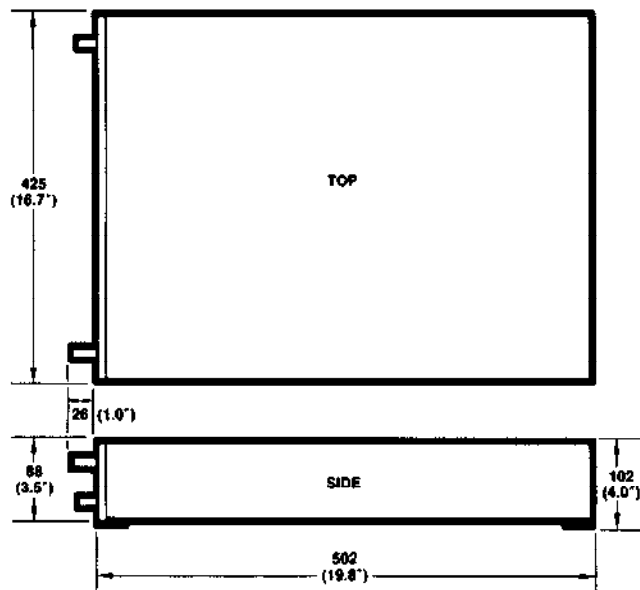

Supplemental Characteristics:

- RF INPUT CONNECTOR:** 3.5 mm male.
- LO INPUT CONNECTOR:** 3.5 mm male.
- IF OUTPUT CONNECTOR:** N type female.
- REAR PANEL CONTROL CONNECTOR:** BNC female.
- INCLUDED ACCESSORIES:**

Control Cable: HP 11170A BNC cable.

LO Output to HP 11793A LO Input Cable: 3.5 mm female to 3.5 mm female flexible cable and 3.5 mm male to N type male adapter; Option 001, 011, and 021 deletes the 3.5 mm to N type adapter.

HP 8902A RF input to HP 11793A IF output cable: N type male to N type male flexible cable.

Warranty

The Hewlett-Packard 8902A Measuring Receiver, 11792A Sensor Module, 11793A Microwave Converter, and Synthesized Source are warranted against defects in materials and workmanship for one year from date of shipment. These instruments must be returned to Hewlett-Packard for repair.

HP controller products are warranted against defects in materials and workmanship for 90 days. Refer to the appropriate controller product data sheet or your HP sales office for details.

Ordering Information

HP 8902S MICROWAVE MEASUREMENT SYSTEM

The HP 8902S system consists of an HP 8902A Measuring Receiver, HP 11792A Sensor Module, HP 11793A Microwave Converter, HP 11794A Software Pac, a controller, two HP 10833A HP-IB cables, three accessory cables (included with HP 11793A) and a choice of synthesized microwave local oscillators. For complete ordering information, see the "HP 8902S Microwave Measurement System Ordering Information" guide, or call your HP sales office.

HP 11792A SENSOR MODULE (3.5 mm male input connector, frequency range to 26.5 GHz).

Option 001 N-type male input connector (frequency range to 18 GHz).

HP 11793A MICROWAVE CONVERTER

Option 001 adds 18 GHz to 26.5 GHz amplifier (required in 26.5 GHz systems which use local oscillators with less than +7 dBm from 18 GHz to 26.5 GHz).

Option 010 Front Right LO Connector (required for systems using a LO with an output connector on the front right side).

Option 011 adds 18 GHz to 26.5 GHz amplifier and front right LO connector (Option 001 and Option 010).

Option 020 Rear Panel Connectors.

Option 021 adds 18 GHz to 26.5 GHz amplifier and rear panel connections (Option 001 and Option 020).

HP 11794A SOFTWARE PAC (Select one controller software and mass storage option):

Controller Software Options:

Option 010 for use with HP 85B, HP 86B and HP 87XM Controllers.

Option 020 for use with HP 9000 Series 216S (HP 9816S), Series 226S (HP 9826S) and Series 236S (HP 9836S) Controller Systems.

Mass Storage Options:

Option 610 for use with HP 85B tape drive.

Option 630 for use with HP 9121D or HP 9133V 3½" external disc drives.

Option 650 for use with HP 82901M 5¼" external disc drives.

Option 655 for use with HP 9826S and HP 9836S Controller Systems internal disc drives.

Automatic Signal Generator Calibration

HP 8952S Microwave Signal Generator Test System

The outstanding performance of the HP 8902S Microwave Measurement System and HP 8903A Audio Analyzer combine with sophisticated but easy-to-use HP 9000 Series 200 software to bring the high productivity of an HP automatic test system to signal generator performance verification. The HP 8952S Microwave Signal Generator Test System improves your efficiency at the same time as it helps you make more thorough measurements in less time than ever before. Three standard report formats simplify record-keeping and eliminate transcription errors. Fully traceable to the U.S. National Bureau of Standards, the 8952S Microwave Signal Generator Test System will be a real time saver in your metrology laboratory.

Save Time

Making a complete performance verification for a signal generator used to take hours. With the 8952S, the measurement procedures, test equipment control, performance limits and data recording are all handled automatically by the HP 11795A Software Pac. All you do is select the tests you want, connect the signal generator to the system, and follow the system prompts. When testing programmable signal generators, you can leave the 8952S to its task while you do other work.

The 11795A software is fully softkey-driven and includes many useful features such as help keys, test menu, interactive system configuration and test sequence selection, plus full softkey control of test execution. With these features, you can select only those tests you want to run, in any order. When you start test execution, you can skip or repeat tests, restart execution, or run any single test out of sequence. A special Continuous Mode even lets you repeat a test sequence indefinitely, helping you to identify intermittent failures.

Reduce Errors

Each software test package follows the test procedures in the Performance Verification section of



the signal generator manual. As the tests are executed, they automatically detect out-of-limit data points and record measurement results. Extensive error-trapping software identifies instrument errors and hardware faults, printing a message which alerts you to the problem.

Simplify Record-keeping

With a choice of three report formats, from a simple Pass-Fail report to a complete listing of every data point, you can match system operation to your needs. Each report includes the serial number of the unit tested, the date, operator's name, temperature and relative humidity, plus the serial numbers and calibration date of each instrument in the 8952S system. This helps to further reduce your workload, saving you time and eliminating transcription errors.

Ordering Information

Complete ordering information is provided in the "8952S Signal Generator Test System Ordering Information" guide.

For more information, call your local HP Sales Office or nearest Regional Office: •Eastern (301) 258-2000; •Midwestern (312) 255-9800; •Southern (404) 955-1500; •Western (213) 506-3700; •Canadian (416) 678-9430. Ask the operator for instrument sales. Or write Hewlett-Packard, 1820 Embarcadero Rd., Palo Alto, CA 94303. **In Europe:** Hewlett-Packard S.A., 7, Rue du Bois-du-Lan, P.O. Box CH 1217 Meyrin 2, Geneva, Switzerland. **In Japan:** Yokogawa-Hewlett-Packard Ltd., 29-21, Takaide-Higashi 3-chome, Suginami-ku, Tokyo 168