

Agilent E364xA Single Output DC Power Supplies

User's and Service Guide



Agilent Technologies

Notices

© Agilent Technologies, Inc. 1999–2013

No part of this manual may be reproduced in any form or by any means (including electronic storage and retrieval or translation into a foreign language) without prior agreement and written consent from Agilent Technologies, Inc. as governed by United States and international copyright laws.

Manual Part Number

E3640-90001

Edition

Tenth Edition, August 6, 2013

Agilent Technologies, Inc.
5301, Stevens Creek Blvd.
Santa Clara, CA 95051 USA

Warranty

The material contained in this document is provided “as is,” and is subject to change, without notice, in future editions. Further, to the maximum extent permitted by the applicable law, Agilent disclaims all warranties, either express or implied, with regard to this manual and any information contained herein, including but not limited to the implied warranties of merchantability and fitness for a particular purpose. Agilent shall not be liable for errors or for incidental or consequential damages in connection with the furnishing, use, or performance of this document or of any information contained herein. Should Agilent and the user have a separate written agreement with warranty terms covering the material in this document that conflict with these terms, the warranty terms in the separate agreement shall control.

Technology Licenses

The hardware and/or software described in this document are furnished under a license and may be used or copied only in accordance with the terms of such license.

Restricted Rights Legend

U.S. Government Restricted Rights. Software and technical data rights granted to the federal government include only those rights customarily provided to end user customers. Agilent provides this customary commercial license in Software and technical data pursuant to FAR 12.211 (Technical Data) and 12.212 (Computer Software) and, for the Department of Defense, DFARS 252.227-7015 (Technical Data - Commercial Items) and DFARS 227.7202-3 (Rights in Commercial Computer Software or Computer Software Documentation).

Safety Notices

CAUTION











A **CAUTION** notice denotes a hazard. It calls attention to an operating procedure, practice, or the likes of that, if not correctly performed or adhered to, could result in damage to the product or loss of important data. Do not proceed beyond a **CAUTION** notice until the indicated conditions are fully understood and met.

WARNING

A **WARNING** notice denotes a hazard. It calls attention to an operating procedure, practice, or the likes of that, if not correctly performed or adhered to, could result in personal injury or death. Do not proceed beyond a **WARNING** notice until the indicated conditions are fully understood and met.

Safety Symbols

The following symbols on the instrument and in the documentation indicate precautions which must be taken to maintain safe operation of the instrument.

	Caution, risk of danger (refer to this manual for specific Warning or Caution information)		In position of a bi-stable push control
	DC (Direct current or voltage)		Terminal is at earth potential. Used for measurement and control circuits designed to be operated with one terminal at earth potential.
	AC (Alternating current or voltage)		Positive binding post
	Protective conductor terminal		Negative binding post
	Out position of a bi-stable push control		Earth (ground) terminal

Safety Considerations

Read the information below before using this instrument.

The following general safety precautions must be observed during all phases of operation, service, and repair of this instrument. Failure to comply with these precautions or with specific warnings elsewhere in this manual violates safety standards for design, manufacture, and intended use of the instrument. Agilent Technologies assumes no liability for the customer's failure to comply with these requirements.

CAUTION

- Use the device with the cables provided with the shipment.
 - If the device is used in a manner not specified by the manufacturer, the device protection may be impaired.
 - Always use a dry cloth to clean the device. Do not use ethyl alcohol or any other volatile liquid to clean the device.
 - Do not permit any blockage of the ventilation holes of the device.
-

WARNING

- **Do not use MAINS supply cords by inadequately RATED cord. Always use the MAINS supply cord provided by the manufacturer.**
 - **Do not use the device if it appears damaged or defective. REMOVE POWER and do not use the device until safe operation is verified by service-trained personnel. If necessary, return the device to Agilent for service and repair to ensure that the safety features are maintained.**
 - **Do not operate the device around flammable gases or fumes, vapor, or wet environments.**
 - **Observe all markings on the device before connecting any wiring to the device.**
 - **Turn off the output of the power supply before connecting to the output terminals.**
 - **When servicing the device, use only the specified replacement parts.**
 - **Do not install substitute parts or perform any unauthorized modification to the device. Return the device to Agilent for service and repair to ensure that the safety features are maintained.**
 - **Do not operate the device with the cover removed or loosened.**
 - **Do not block the ventilation hole or fan when the device is operating.**
-

Safety and EMC Requirements

This power supply is designed to comply with the following safety and Electromagnetic Compatibility (EMC) requirements:

EMC

- IEC61326-1:2005/EN61326-1:2006
- CISPR 11:2003/EN55011:2007
- Canada: ICES/NMB-001: Issue 4, June 2006
- Australia/New Zealand: AS/NZS CISPR11:2004

Safety







- IEC 61010-1:2001/EN 61010-1:2001 (2nd Edition)
- Canada: CAN/GSA-C22.2 No. 61010-1-04
- USA: ANSI/UL 61010-1:2004

Environmental Conditions

This instrument is designed for indoor use. The table below shows the general environmental requirements for this instrument.

Environmental condition	Requirements
Temperature	Operating condition • 0 °C to 40 °C (full rated output) Storage condition • -20 °C to 70 °C
Humidity	Operating condition • 95% RH (maximum)
Altitude	Up to 2000 m
Installation category	II (for indoor use)
Pollution degree	2

Regulatory Markings

	<p>The CE mark is a registered trademark of the European Community. This CE mark shows that the product complies with all the relevant European Legal Directives.</p>		<p>The C-tick mark is a registered trademark of the Spectrum Management Agency of Australia. This signifies compliance with the Australia EMC Framework regulations under the terms of the Radio Communication Act of 1992.</p>
<p>ICES/NMB-001</p>	<p>ICES/NMB-001 indicates that this ISM device complies with the Canadian ICES-001. Cet appareil ISM est conforme a la norme NMB-001 du Canada.</p>		<p>This instrument complies with the WEEE Directive (2002/96/EC) marking requirement. This affixed product label indicates that you must not discard this electrical or electronic product in domestic household waste.</p>
	<p>The CSA mark is a registered trademark of the Canadian Standards Association.</p>		<p>This symbol indicates the time period during which no hazardous or toxic substance elements are expected to leak or deteriorate during normal use. Forty years is the expected useful life of the product.</p>
	<p>This symbol is a South Korean Class A EMC Declaration. This is a Class A instrument suitable for professional use and in electromagnetic environments outside of the home.</p>		

Waste Electrical and Electronic Equipment (WEEE) Directive 2002/96/EC

This instrument complies with the WEEE Directive (2002/96/EC) marking requirement. This affixed product label indicates that you must not discard this electrical or electronic product in domestic household waste.

Product Category:

With reference to the equipment types in the WEEE directive Annex 1, this instrument is classified as a “Monitoring and Control Instrument” product.

The affixed product label is as shown below.



Do not dispose in domestic household waste.

To return this unwanted instrument, contact your nearest Agilent Service Center, or visit

www.agilent.com/environment/product

for more information.

Declaration of Conformity (DoC)

The Declaration of Conformity (DoC) for this instrument is available on the Agilent Web site. You can search the DoC by its product model or description at the Web address below.

<http://regulations.corporate.agilent.com/DoC/search.htm>

NOTE

If you are unable to search for the respective DoC, contact your local Agilent representative.

THIS PAGE HAS BEEN INTENTIONALLY LEFT BLANK.

Table of Contents

1 Getting Started

Introduction	2
Standard Shipped Items	6
Options	6
Accessories	7
Preparing the Power Supply	8
Checking the power supply	8
Connecting power to the power supply	9
Checking the output	10
Converting line voltage	12
Adjusting the carrying handle	15
Rack-mounting the power supply	16
Product at a Glance	18
Front panel	18
Rear panel	21
Display annunciators	22
Output connections	24
Current ratings	24
Voltage drops	25
Load consideration	25
Remote voltage sensing connections	27
Multiple loads	29
Operating the Power Supply	30
Cooling	30
Bench operation	30
Cleaning	30

2 Operation and Features

Overview	32
Constant Voltage Operation	34
Front panel operation	34
Remote interface operation	36
Constant Current Operation	36
Front panel operation	36
Remote interface operation	38
Configuring the Remote Interface	38
GPIB configuration	39
RS-232 configuration	39
Storing and Recalling Operating States	40
Front panel operation	40
Remote interface operation	42
Programming the Overvoltage Protection	42
Front panel operation	42
Remote interface operation	44
Disabling the Output	47
Front panel operation	47
Remote interface operation	47
Disconnecting the output using an external relay	48
System-Related Operations	49
State storage	49
Self-test	50
Error conditions	51
Firmware revision query	51
SCPI language version	52
GPIB Interface Reference	53
RS-232 Interface Reference	54

RS-232 configuration overview	54
RS-232 data frame format	55
Connection to a computer or terminal	55
RS-232 troubleshooting	57
Calibration	58
Calibration security	58
To unsecure for calibration	59
To secure against calibration	60
To change the security code	61
Calibration count	62
Calibration message	63

3 Remote Interface Reference

SCPI Command Summary	66
Introduction to the SCPI Language	71
Command format used in this manual	72
Command separators	73
Using the MIN and MAX parameters	74
Querying parameter settings	74
SCPI command terminators	75
IEEE-488.2 common commands	75
SCPI parameter types	75
Simplified Programming Overview	77
Using the APPLy command	77
Using the low-level commands	77
Reading a query response	78
Selecting a trigger source	78
Power supply programming ranges	79
Using the APPLy Command	81
APPLy {<voltage> DEF MIN MAX}[.{<current> DEF MIN MAX}]	81

APPLY?	81
Output Settings and Operation Commands	82
Triggering	88
Trigger source	88
Triggering commands	90
System-Related Commands	91
State Storage Commands	95
Calibration Commands	97
Calibration example	100
Interface Configuration Commands	102
SCPI Status Registers	103
What is an event register?	103
What is an enable register?	103
Questionable Status register	105
Standard Event register	106
Status Byte register	108
Using service request (SRQ) and serial poll	109
Using *STB? to read the Status Byte	110
Using the Message Available Bit (MAV)	110
Using SRQ to interrupt the bus controller	111
Determining when a command sequence is completed	111
Using *OPC to signal when data is in the output buffer	112
Status Reporting Commands	113
Halting an Output in Progress	116
SCPI Conformance Information	117
SCPI confirmed commands	117
Device-specific commands	119
IEEE-488 Conformance Information	120
Dedicated hardware lines	120

Addressed commands	120
IEEE-488.2 common commands	121

4 Error Messages

Overview	124
Front panel operation	124
Remote interface operation	125
Execution Error Messages	126
Self-Test Error Messages	131
Calibration Error Messages	133

5 Application Programs

Overview	136
Example Program for C and C++	137
Example Program for Excel 97	141

6 Tutorial

Overview of the Power Supply Operation	148
Output Characteristics	150
Unregulated state	152
Unwanted signals	153
Extending the Voltage Range and Current Range	155
Series connections	155
Parallel connections	156
Remote Programming	157

7 Characteristics and Specifications

Physical Characteristics	162
Environmental Characteristics	163

Electrical Specifications	164
Supplemental Characteristics	166

8 Service and Maintenance

Overview	170
Operating Checklist	171
Types of Service Available	172
Standard repair service (worldwide)	172
Repacking for Shipment	173
Electrostatic Discharge (ESD) Precautions	174
Surface Mount Repair	174
Replacing the Power-Line Fuse	174
Troubleshooting Hints	175
Unit reports errors 740 to 755	175
Unit fails self-test	175
Bias supplies problems	176
Self-Test Procedures	177
Power-on self-test	177
Complete self-test	177
General Disassembly	179
Recommended Test Equipment	180
Test Considerations	182
Operation Verification and Performance Tests	183
Operation verification tests	183
Performance tests	183
Measurement Techniques	184
Common test setup	184
Current-monitoring resistor	185

General measurement techniques	185
Electronic load	186
Programming	186
Constant Voltage (CV) Verifications	187
Constant voltage test setup	187
Voltage programming and readback accuracy	187
CV load effect (load regulation)	189
CV source effect (line regulation)	190
CV PARD (ripple and noise)	191
Load transient response time	193
Constant Current (CC) Verifications	195
Constant current test setup	195
Current programming and readback accuracy	195
CC load effect (load regulation)	197
CC source effect (line regulation)	198
CC PARD (ripple and noise)	199
Common Mode Current Noise	201
Performance Test Record	202
Calibration Reference	205
Agilent calibration services	205
Calibration interval	205
To unsecure the power supply without the security code	206
General Calibration or Adjustment Procedure	207
Front panel voltage and current calibration	208
Calibration Record	211
Calibration Error Messages	212
Component Locator Diagram	215
Component locator diagram for the main board assembly — top	215

- Component locator diagram for the main board assembly —
bottom [216](#)
- Component locator diagram for the front panel [217](#)
- Component locator diagram for the main board assembly — top
(serial MY53xx6xxx) [218](#)
- Component locator diagram for the main board assembly —
bottom (serial MY53xx6xxx) [219](#)
- Component locator diagram for the front panel (serial
MY53xx6xxx) [220](#)

List of Figures

- Figure 1-1 Rear output terminals 5
- Figure 1-2 Line voltage selector (set for 115 Vac) 13
- Figure 1-3 Front panel outlook 18
- Figure 1-4 Voltage and current limit settings 20
- Figure 1-5 Rear panel outlook 21
- Figure 1-6 Display annunciators 22
- Figure 1-7 Remote voltage sensing connections 27
- Figure 1-8 Local sensing connections 28
- Figure 2-1 Recommended protection circuit for battery charging 45
- Figure 2-2 Recommended connection to prevent voltage overshoot 46
- Figure 2-3 DB-9 serial connection 56
- Figure 2-4 DB-25 serial connection 57
- Figure 3-1 SCPI status system 104
- Figure 5-1 Example program result 141
- Figure 6-1 Diagram of a simple series power supply 148
- Figure 6-2 Block diagram of the power supply showing the remote interface isolation 149
- Figure 6-3 Ideal constant voltage power supply 150
- Figure 6-4 Ideal constant current power supply 150
- Figure 6-5 Output characteristics 152
- Figure 6-6 Simplified diagram of the common mode and normal mode sources of noise 154
- Figure 6-7 Speed of response — programming up (full load) 157
- Figure 6-8 Speed of response — programming down 158
- Figure 7-1 E364xA dimensions 162
- Figure 7-2 E364xA dimensions for rack mounting 163
- Figure 8-1 Performance verification test setup 184
- Figure 8-2 Front/rear panel terminal connections 185
- Figure 8-3 Front/rear panel terminal connections for the Vrms measurement 191
- Figure 8-4 Transient response time 194
- Figure 8-5 CC PARD (ripple and noise) connections 200

THIS PAGE HAS BEEN INTENTIONALLY LEFT BLANK.

List of Tables

Table 1-1	E364xA options	6
Table 1-2	E364xA accessories	7
Table 1-3	E364xA power-line fuse	9
Table 1-4	Front panel overview	18
Table 1-5	Rear panel overview	21
Table 1-6	Display annunciators overview	22
Table 1-7	Wire rating	24
Table 2-1	Factory-setting security codes	59
Table 3-1	SCPI command summary	67
Table 3-2	Agilent E3640A/E3642A/E3644A programming ranges	79
Table 3-3	Agilent E3641A/E3643A/E3645A programming ranges	80
Table 3-4	Reset state of the power supply	94
Table 3-5	Bit definitions — Questionable Status register	105
Table 3-6	Bit definitions — Standard Event register	106
Table 3-7	Bit definitions — Status Byte summary register	108
Table 3-8	SCPI confirmed commands	117
Table 3-9	Device-specific commands (Non-SCPI)	119
Table 4-1	Execution error messages	126
Table 4-2	Self-test error messages	131
Table 4-3	Calibration error messages	133
Table 7-1	Physical characteristics	162
Table 7-2	Electrical specifications	164
Table 7-3	Supplemental characteristics	166
Table 8-1	Bias supplies voltages	176
Table 8-2	Bias supplies voltages (serial MY53xx6xxx)	176
Table 8-3	Self-test error messages	177
Table 8-4	Recommended test equipment	180
Table 8-5	Verification programming values	187
Table 8-6	CV performance test record	202
Table 8-7	CC performance test record	203
Table 8-8	Parameters for calibration	207
Table 8-9	Calibration record	211
Table 8-10	Calibration error messages	212

THIS PAGE HAS BEEN INTENTIONALLY LEFT BLANK.

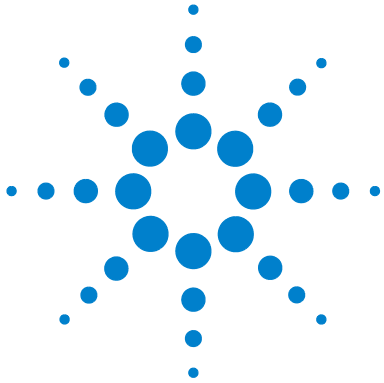

1 Getting Started

Introduction	2
Standard Shipped Items	6
Preparing the Power Supply	8
Product at a Glance	18
Output connections	24
Operating the Power Supply	30

This chapter guides you to set up your power supply for the first time. An introduction to all the features of the power supply is also given.



Introduction

The Agilent E3640A/E3641A (30 W), E3642A/E3643A (50 W), and E3644A/E3645A (80 W) are high performance single output dual range programmable DC power supplies with GPIB and RS-232 interfaces. The combination of bench-top and system features in these power supplies provides versatile solutions for your design and test requirements.

Convenient bench-top features

- Single output dual range
- Output on/off
- High accuracy and high resolution
- Excellent load and line regulation
- Low ripple and noise
- Overvoltage protection
- Five operating states storage
- Easy-to-use controls
- Remote voltage sensing
- Front and rear output terminals
- Portable, ruggedized case with non-skid feet
- Highly visible vacuum-fluorescent display
- Error messages available on the display

Flexible system features

- Standard GPIB (IEEE-488) and RS-232 interfaces
- Standard Commands for Programmable Instruments (SCPI) compatibility
- Easy I/O setup from the front panel
- Software calibration, no internal physical adjustment

The E364xA power supplies feature a combination of programming capabilities and linear power supply performance that makes them ideal for power systems applications. The E364xA power supplies may be programmed locally from the front panel or remotely over the GPIB and RS-232 interfaces.

The E364xA power supplies have two ranges, allowing more voltage at a lower current or more current at a lower voltage. The output range is selected from the front panel or over the remote interfaces.

Operational features

- Single output dual range
- Constant voltage (CV) or constant current (CC) operation
- Overvoltage protection (OVP)
- Five storage locations (1 to 5) for user-defined operating states
- Automatic turn-on self-test
- Remote sense at rear panel terminals
- User calibration from the front panel or over the remote interfaces

Front panel operations

- Easy-to-use control features
- Output range selection
- Enabling or disabling OVP
- Setting the OVP trip levels
- Clearing the OVP conditions
- Setting and displaying the voltage and current limit values
- Storing or recalling the operating state
- Resetting the power supply to the power-on state
- Returning the power supply to the local mode from the remote mode
- Retrieving or scrolling error messages on the display

- Viewing the calibration message or system firmware revision
- Calibrating the power supply, including changing the calibration secure code
- Configuring the remote interfaces
- Enabling or disabling the output

When operated over the remote interface, the E364xA power supplies can be both a listener and a talker. Using an external controller, you can instruct the power supply to set the output and to send the status data back over the GPIB or RS-232 interface. Capabilities include the following features:

- Voltage and current programming
- Voltage and current readback
- Present and stored status readback
- Programming syntax error detection
- Complete self-test

The front panel Vacuum-Fluorescent Display (VFD) includes:

- Displaying the actual values of the output voltage and current (meter mode)
- Displaying the limit values of the voltage and current (limit mode)
- Checking the operating status from the annunciators
- Checking the type of error from the error codes (messages)

Front panel binding posts are available to connect load wires for bench operation. Connections to the power supply's output and to chassis ground are made to the rear output terminals.

WARNING

Floating the power supply output at more than ± 60 Vdc from the chassis presents an electric shock hazard to the user.

Do not float the outputs at more than ± 60 Vdc when uninsulated sense wires are used to connect the (+) output to the (+) sense and the (-) output to the (-) sense terminals on the back of the unit.

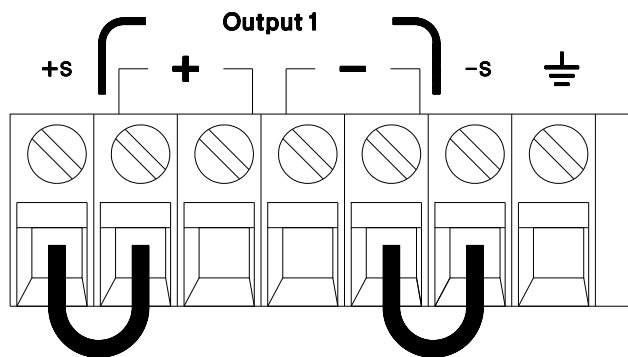

Figure 1-1 Rear output terminals

- 1 Float voltage ± 60 Vdc Max to GND (shorting conductors without insulation).
- 2 Float voltage ± 240 Vdc Max to GND (insulated shorting conductors).

Standard Shipped Items

Verify that you have received the following items in the shipment of your power supply. If anything is missing or damaged, contact your nearest Agilent Sales Office.

- ✓ Power cord
- ✓ Certificate of Calibration
- ✓ E364xA Product Reference CD
- ✓ E364xA User's and Service Guide (this manual)
- ✓ E364xA Quick Reference Card

Options

Options 0EM, 0E3, and 0E9 determine which power-line voltage is selected at the factory. The standard unit is configured for 115 Vac $\pm 10\%$, 47 Hz to 63 Hz input voltage.

For more information about changing the power-line voltage setting, refer to “[Converting line voltage](#)” on page 12.

Table 1-1 E364xA options

Option	Description
0EM	115 Vac $\pm 10\%$, 47 Hz to 63 Hz input voltage
0E3	230 Vac $\pm 10\%$, 47 Hz to 63 Hz input voltage
0E9	100 Vac $\pm 10\%$, 47 Hz to 63 Hz input voltage
1CM	Rack mount kit (Agilent part number 5063-9240)
910	Extra manual (same language as the selected language manual when you order the power supply) ^[1]

[1] To order an extra English user's guide, order Agilent part number E3640-90001.

Accessories

The accessories listed below may be ordered from your local Agilent Sales Office either with the power supply or separately.

Table 1-2 E364xA accessories

Part number	Description
10833A	GPIB cable, 1 m (3.3 ft.)
10833B	GPIB cable, 2 m (6.6 ft.)
34398A	<ul style="list-style-type: none"> • RS-232, 9 pin (f) to 9 pin (f), 2.5 m (8.2 ft.) cable • 9 pin (m) to 25 pin (f) adapter

Preparing the Power Supply

Checking the power supply

1 *Check the shipped items.*

Verify that you have received the items listed in “[Standard Shipped Items](#)” on page 6. If anything is missing or damaged, contact your nearest Agilent Sales Office.

2 *Connect the power cord and turn on the power supply.*

The front panel display will light up briefly while the power supply performs its power-on self-test. The GPIB address is also displayed. To review the power-on display with all annunciators turned on, hold down  as you turn on the power supply. If the power supply does not turn on properly, refer to “[Connecting power to the power supply](#)” on page 9.

3 *Perform a complete self-test.*

The complete self-test performs a more extensive set of tests than those performed at power-on. Hold down  as you turn on the power supply and hold down the key until you hear a long beep. The self-test will begin when you release the key following the beep.

If the self-test fails, refer to [Chapter 8](#), “Service and Maintenance” for instructions on returning the power supply to Agilent for service.

NOTE

The power supply is shipped from the factory with a power-line cord that has a plug appropriate for your location. Your power supply is equipped with a 3-wire grounding type power cord; the third conductor being the ground. The power supply is grounded only when the power-line cord is plugged into an appropriate receptacle. Do not operate your power supply without adequate cabinet ground connection.

Connecting power to the power supply

If the power supply does not turn on

Use the following steps to help solve problems you might encounter when turning on the instrument. If you need more help, refer to [Chapter 8](#), “Service and Maintenance” for instructions on returning the instrument to Agilent for service.

1 *Verify that there is AC power to the power supply.*

First, verify that the power cord is firmly plugged into the power receptacle on the rear panel of the power supply. You should also make sure that the power source you plugged the power supply into is energized. Then, verify that the power supply is turned on.

2 *Verify the power-line voltage setting.*

The line voltage is set to the proper value for your country when the power supply is shipped from the factory. Change the voltage setting if it is not correct. The settings are 100 Vac, 115 Vac, or 230 Vac.

3 *Verify that the correct power-line fuse is installed.*

The correct fuse is installed for your country when the power supply is shipped from the factory. Refer to [Table 1-3](#) to replace the fuse for your power supply.

Table 1-3 E364xA power-line fuse

Model	Agilent part number	Part description
E3640A	2110-0918	Fuse 1.6 A 250 V for 100 Vac and 115 Vac
E3641A	2110-1346	Fuse 1 A T 250 V for 230 Vac
E3642A	2110-1550	Fuse 2.5 A T 125 V for 100 Vac and 115 Vac
E3643A	2110-1346	Fuse 1 A T 250 V for 230 Vac
E3644A	2110-1549	Fuse 3.15 A T 125 V for 100 Vac and 115 Vac
E3645A	2110-1548	Fuse 2 A T 250 V for 230 Vac

Checking the output

The following procedures ensure that the power supply develops its rated outputs and properly responds to operation from the front panel. For complete performance and verification tests, refer to [Chapter 8](#), “Service and Maintenance”.

NOTE

If an error is detected during the output checkout procedures, the **ERROR** annunciator will turn on. Refer to [Chapter 4](#), “Error Messages” for more information.

Voltage output check

The following steps verify the basic voltage functions with no load.



- 1 *Turn on the power supply.*

The power supply will go into the power-on/reset state, the output is disabled (the **OFF** annunciator turns on), and its low voltage range is selected. The **OVP** annunciator and the low voltage range indication annunciator turn on (for example, the 8 V annunciator turns on for the E3640A model), and the knob is selected for voltage control.



- 2 *Enable the outputs.*

The **OFF** annunciator turns off and the **CV** annunciator turns on. Notice that the display is in the meter mode. Meter mode means that the display shows the actual output voltage and current.



- 3 *Check that the front panel voltmeter properly responds to the knob control for both the low and high voltage ranges.*

Turn the knob clockwise or counter-clockwise to check that the voltmeter responds to the knob control and the ammeter indicates nearly zero. The flashing digit can be adjusted by turning the knob.



- 4 *Ensure that the voltage can be adjusted from zero to the full rated value by adjusting the knob.^[1]*

[1] You can use the resolution selection keys to move the flashing digit to the right or left when setting the voltage.

Current output check

The following steps check the basic current functions with a short across the power supply's output.



- 1 *Turn on the power supply.*

Make sure that the output is disabled. The **OFF** annunciator is turned on.

- 2 *Connect a short across the + and – output terminals with an insulated test lead.*

Use a wire size sufficient to handle the maximum current. Refer to [Table 1-7](#) for more information.



- 3 *Enable the output.*

The **CV** or **CC** annunciator turns on depending on the resistance of the test lead. Notice that the display is in the meter mode.



- 4 *Adjust the voltage limit value to 1.0 V.*

Set the display to the limit mode (the **Limit** annunciator will be flashing). Adjust the voltage limit to 1.0 V to assure the CC operation. The **CC** annunciator will turn on. To return to the normal mode, press the  key again or let the display time-out after several seconds.



- 5 *Set the knob to the current control to check that the front panel ammeter properly responds to the knob control.*

Turn the knob clockwise or counter-clockwise when the display is in the meter mode (the **Limit** annunciator is turned off). Check that the ammeter responds to the knob control and the voltmeter indicates nearly zero (the voltmeter will show the voltage drop caused by the test lead). The flashing digit can be adjusted by turning the knob.



- 6 *Ensure that the current can be adjusted from zero to the full rated value.^[1]*
- 7 *Turn off the power supply and remove the short from the output terminals.*

[1] You can use the resolution selection keys to move the flashing digit to the right or left when setting the current.

Converting line voltage

WARNING

Shock Hazard Operating personnel must not remove the power supply covers. Component replacement and internal adjustments must be made only by qualified service personnel.

Line voltage conversion is accomplished by adjusting two components: the line voltage selection switch and the power-line fuse on the rear panel.

- 1 Remove the AC line power.
- 2 Remove the cover. Refer to [“General Disassembly”](#) on page 179.
- 3 Set the two sections of the line voltage selector switch on the PC board for the desired line voltage. Refer to [Figure 1-2](#).
- 4 Refer to [“Replace the power-line fuse”](#) on page 13 to check the rating of the power-line fuse and replace with the correct one if necessary.
- 5 Replace the cover and mark the power supply clearly with a tag or label indicating the correct line voltage and fuse that is in use.

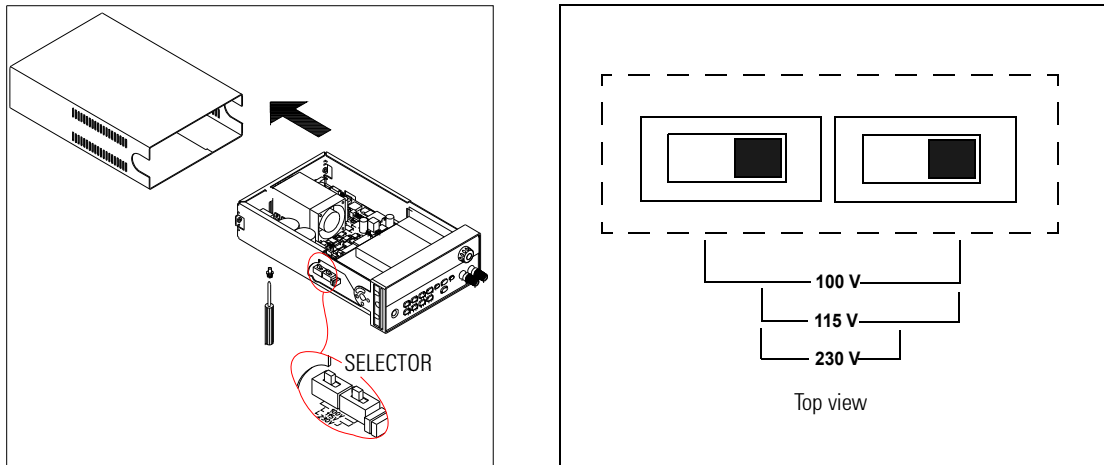
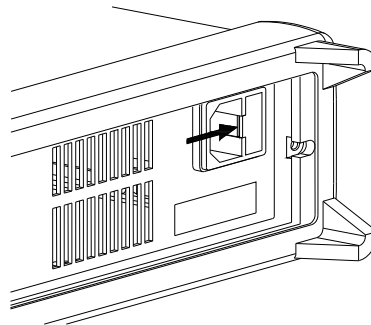

Figure 1-2 Line voltage selector (set for 115 Vac)

Replace the power-line fuse

- 1 Remove the power cord, and remove the fuse-holder assembly from the rear panel with a flat-blade screwdriver.



1 Getting Started

Preparing the Power Supply

2 Remove the fuse-holder from the assembly.

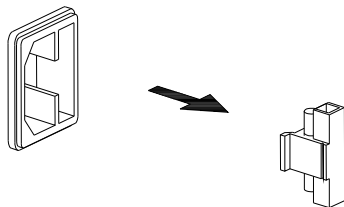

3 Replace with the correct fuse.

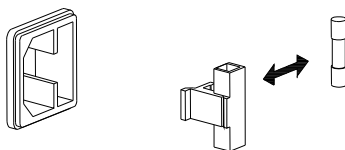

4 Replace the fuse-holder assembly in the rear panel.

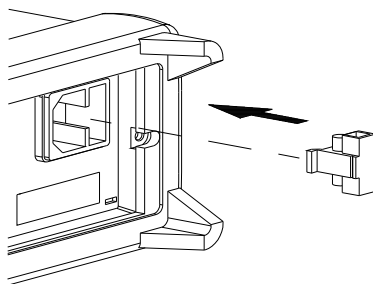

NOTE

Verify that the correct line voltage is selected and the power-line fuse is good.

Adjusting the carrying handle

To adjust the position, grasp the handle by the sides and pull outward. Then, rotate the handle to the desired position.

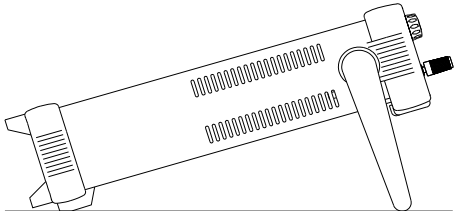
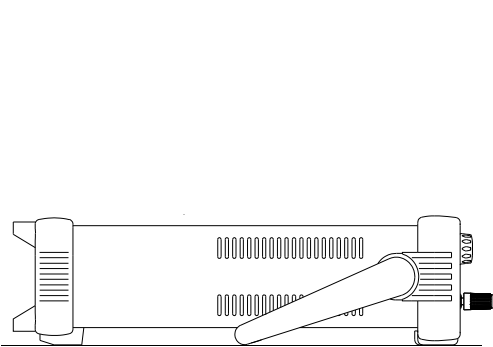

Bench-top viewing positions

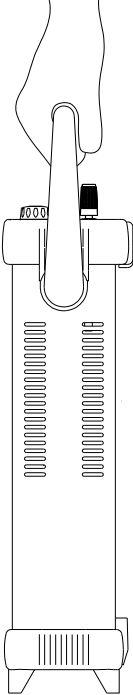

Carrying position

Rack-mounting the power supply

You can mount the power supply in a standard 19-inch rack cabinet using one of three optional kits available.

Instructions and mounting hardware are included with each rack-mounting kit. Any Agilent System II instrument of the same size can be rack-mounted beside the Agilent E3640A, E3641A, E3642A, E3643A, E3644A, or E3645A.

NOTE

Remove the carrying handle and the front and rear rubber bumpers before rack-mounting the power supply.

- 1 To remove the handle, rotate it to the vertical position and pull the ends outward.

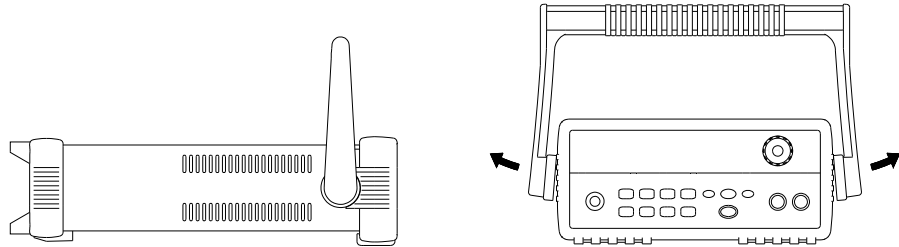

- 2 To remove the rubber bumper, stretch a corner and then slide it off.

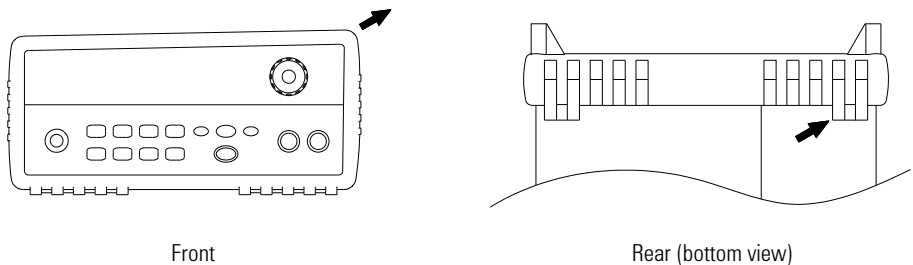

- 3** To rack-mount a single instrument, order the adapter kit (5063-9240).

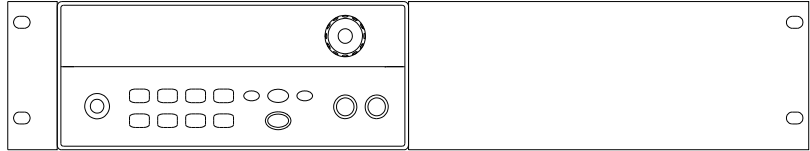

- 4** To rack-mount two instruments side-by-side, order the lock-link kit (5061-9694) and the rack-mount kit (5063-9212). Be sure to use the support rails inside the rack cabinet.

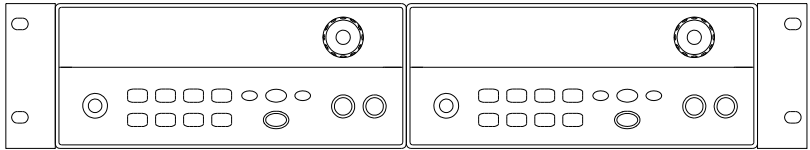

- 5** To install one or two instruments in a sliding support shelf, order the support shelf (5063-9255) and the slide kit (1494-0015). For a single instrument, order the filler panel (5002-3999)

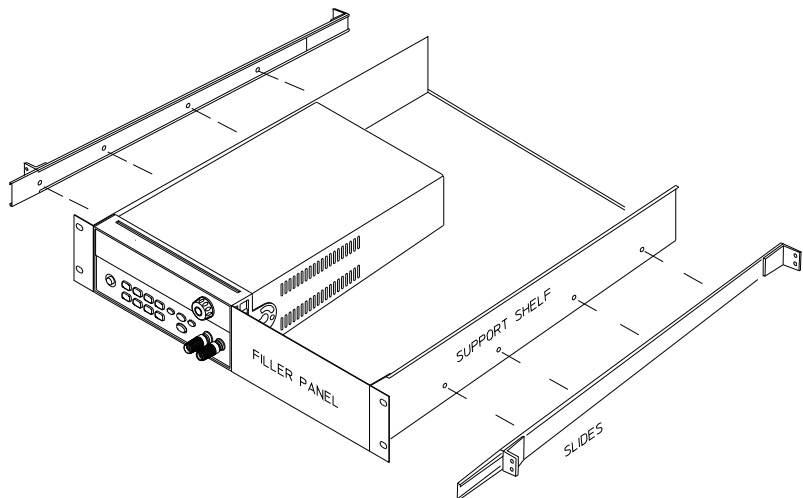

Product at a Glance

Front panel

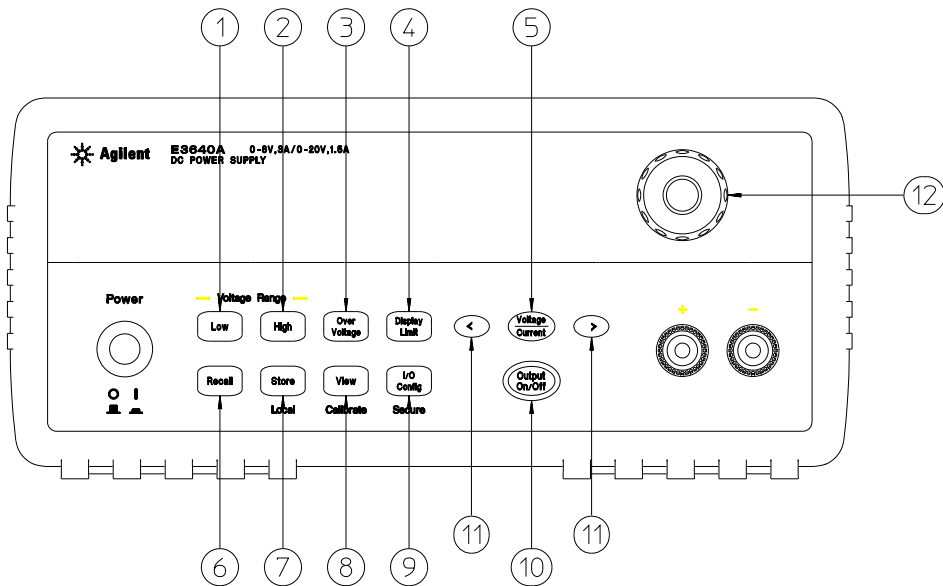

Figure 1-3 Front panel outlook

Table 1-4 Front panel overview

No	Item	Description
1	Low voltage range selection key	Select the low voltage range and allow its full rated output to the output terminals.
2	High voltage range selection key	Select the high voltage range and allow its full rated output to the output terminals.
3	Overvoltage protection key	Enable or disable the overvoltage protection function, set the trip voltage level, and clear the overvoltage condition.

Table 1-4 Front panel overview (continued)

No	Item	Description
4	Display limit key	Show the voltage and current limit values on the display and allow the knob adjustment for setting limit values.
5	Voltage/Current adjust selection key	Select the knob control function for voltage or current adjustment.
6	Stored state recall menu	Recall a stored operating state from location 1 through 5 and reset the power supply to the power-on state (*R.ST command) from the front panel by selecting RESET from this menu.
7	State storage menu/Local key ^[1]	Store up to five power supply states in non-volatile memory and assign a name to each of the storage locations, or return the power supply to the local mode from the remote interface mode.
8	View menu/Calibrate key ^[2]	View the error codes and the text of the error message, calibration string, and system firmware revision, or enable the calibration mode.
9	I/O configuration menu/Secure key ^[3]	Configure the power supply for remote interfaces, or secure or unsecure the power supply for calibration.
10	Output On/Off key	Enable or disable the power supply output. This key toggles between on and off.
11	Resolution selection keys	Move the flashing digit to the right or left, and adjust the scrolling speed of the text being displayed in the View menu.
12	Knob	Increase or decrease the value of the flashing digit by turning clockwise or counter-clockwise.

[1] The key can be used as the **Local** key when the power supply is in the remote interface mode.

[2] You can enable the calibration mode by holding down this key when you turn on the power supply.

[3] You can use it as the **Secure** or **Unsecure** key when the power supply is in the calibration mode.

Voltage and current limit settings

You can set the voltage and current limit values from the front panel using the following method.

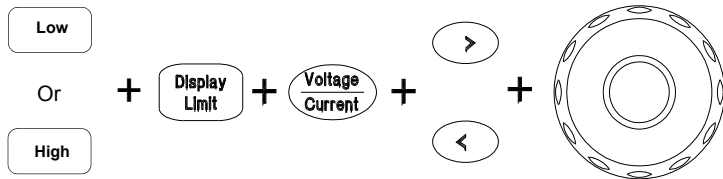





Figure 1-4 Voltage and current limit settings

- 1 Select the desired voltage range using the voltage range selection keys after turning on the power supply.
- 2 Press  to show the limit values on the display.
- 3 Move the blinking digit to the appropriate position using the resolution selection keys and change the blinking digit value to the desired voltage limit by turning the control knob. If the display limit times out, press  again.
- 4 Set the knob to the current control mode by pressing .
- 5 Move the blinking digit to the appropriate position using the resolution selection keys and change the blinking digit value to the desired current limit by turning the control knob.
- 6 Press  to enable the output. After about 5 seconds, the display will go to the output monitoring mode automatically to display the voltage and current at the output.

NOTE

All the front panel keys and controls can be disabled with the remote interface commands. The power supply must be in the Local mode for the front panel keys and controls to function.

Rear panel

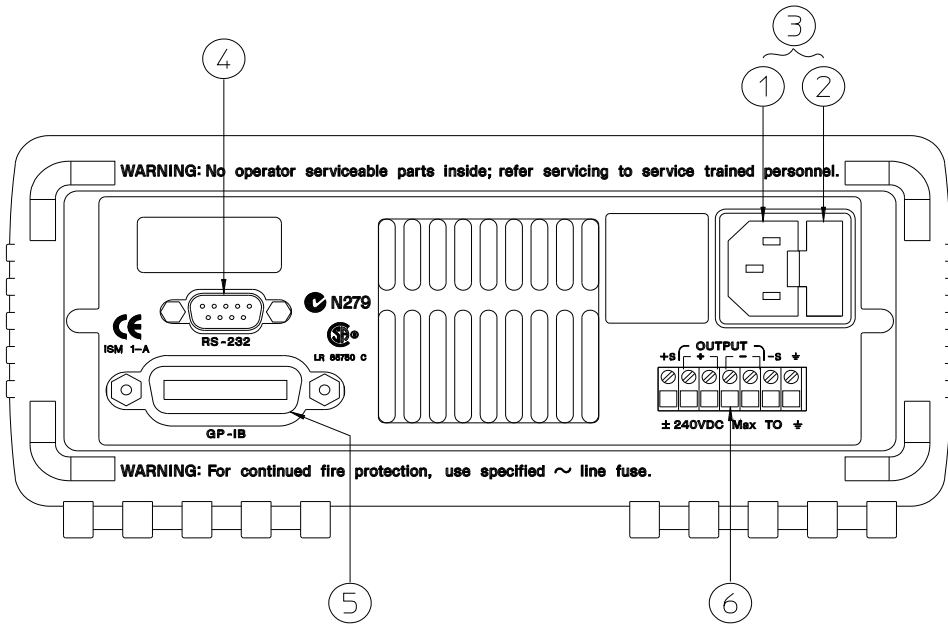

Figure 1-5 Rear panel outlook

NOTE

The supplier code of the C-Tick for the E3643A or E3645A is N10149.

Table 1-5 Rear panel overview

No	Description
1	AC inlet
2	Power-line fuse-holder assembly
3	Power-line module
4	RS-232 interface connector

Table 1-5 Rear panel overview (continued)

No	Description
5	GPIB (IEEE-488) interface connector
6	Rear output terminals

Use the front panel  key to:

- Select the GPIB or RS-232 interface.
- Set the GPIB address.
- Set the RS-232 baud rate and parity.

Display annunciators

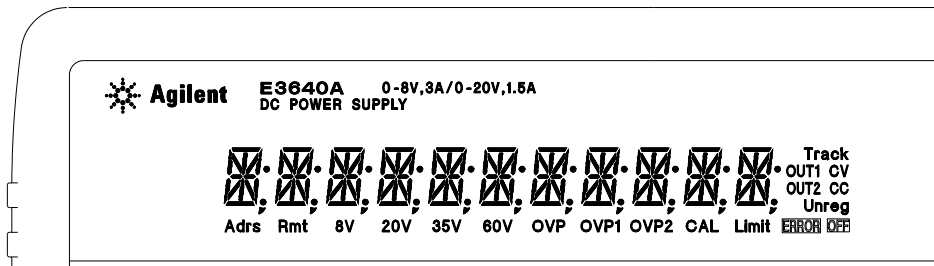

Figure 1-6 Display annunciators

Table 1-6 Display annunciators overview

Item	Description
Adrs	The power supply is addressed to listen or talk over a remote interface.
Rmt	The power supply is in the remote interface mode.
8V ^[1] /35V ^[2]	Indicate that the low voltage range is selected.
20V ^[1] /60V ^[2]	Indicate that the high voltage range is selected.

Table 1-6 Display annunciators overview (continued)

Item	Description
OVP	The overvoltage protection function is enabled when the OVP annunciator turns on or the overvoltage protection circuit has caused the power supply to shut down when the annunciator blinks.
CAL	The power supply is in the calibration mode.
Limit	The display shows the limit values of the voltage and current.
ERROR	Hardware or remote interface command errors are detected and the error bit has not been cleared.
OFF	The output of the power supply is disabled. Refer to “Disabling the Output” on page 47 for more information.
Unreg	The output of the power supply is unregulated (output is neither CV nor CC).
CV	The power supply is in the constant voltage mode.
CC	The power supply is in the constant current mode.

[1] For the E3640A/E3642A/E3644A power supplies.

[2] For the E3641A/E3643A/E3645A power supplies.

NOTE

To review the display annunciators, hold down  as you turn on the power supply.

Output connections

CAUTION

Before attempting to connect wires to the rear output terminals, make sure to turn off the power supply first to avoid damage to the circuits being connected.

Front panel binding posts are available to connect load wires for bench operation and are paralleled with the rear panel (+) and (-) connections. Both the front and rear panel terminals are optimized for noise, regulation, and transient response as documented in [Chapter 7](#).

Available connections on the rear output terminals include the (+) and (-) outputs, the (+) and (-) sense terminals, and an earth ground terminal. The rear output terminals accept wire sizes from American Wire Gage (AWG) 24 to AWG 14.

NOTE

For the E3644A/E3645A power supplies, when making load connections from the rear output terminals, four load wires should be used to keep good CV load regulation if carrying the full-rated current of the power supply.

Current ratings

[Table 1-7](#) lists the characteristics of the AWG copper wire.

Table 1-7 Wire rating

AWG	10	12	14	16	18	20	22	24	26	28
Suggested maximum current (amperes) ^[1]	40	25	20	13	10	7	5	3.5	2.5	1.7
mΩ/ft	1.00	1.59	2.53	4.02	6.39	10.2	16.1	25.7	40.8	64.9
mΩ/m	3.3	5.2	8.3	13.2	21.0	33.5	52.8	84.3	133.9	212.9

[1] Single conductor in free air at 30 °C with insulation.

NOTE

To satisfy safety requirements, load wires must be heavy enough not to overheat when carrying the maximum short-circuit output current of the power supply. If there is more than one load, then any pair of load wires must be capable of safely carrying the full-rated current of the power supply.

Voltage drops

The load wires must also be large enough to avoid excessive voltage drops due to the impedance of the wires. In general, if the wires are heavy enough to carry the maximum short circuit current without overheating, excessive voltage drops will not be a problem. The voltage drops across the load wires should be limited to less than two volts. Refer to [Table 1-7](#) to calculate the voltage drop for some commonly used AWG copper wires.

Load consideration

Capacitive loading

The power supply will be stable for almost any size load capacitance. However, large load capacitors may cause transient response ringing. Certain combinations of load capacitance, equivalent series resistance, and load lead inductance may result in instability (oscillation). If this occurs, the problem may often be solved by either increasing or decreasing the size of the capacitive load.

A large load capacitor may cause the power supply to cross into CC or unregulated mode momentarily when the output voltage is reprogrammed. The slew rate of the output voltage will be limited to the current setting divided by the total load capacitance (internal and external).

Inductive loading

Inductive loads present no loop stability problems in the constant voltage mode. In the constant current mode, inductive loads form a parallel resonance with the power supply's output capacitor. Generally this will not affect the stability of the power supply, but it may cause ringing of the current in the load.

Pulse loading

In some applications, the load current varies periodically from a minimum to a maximum value. The constant current circuit limits the output current. Some peak loading exceeding the current limit can be obtained due to the output capacitor. To stay within the specifications for the output, the current limit should be set greater than the peak current expected or the supply may go into the CC mode or unregulated mode for brief periods.

Reverse current loading

An active load connected to the power supply may actually deliver a reverse current to the supply during a portion of its operating cycle. An external source can not be allowed to pump current into the supply without risking loss of regulation and possible damage.

These effects can be avoided by pre-loading the output with a dummy load resistor. The dummy load resistor should draw at least the same amount of current from the supply as the active load may deliver to the supply. The value of the current for the dummy load plus the value of the current the load draws from the supply must be less than the maximum current of the supply.

Remote voltage sensing connections

Remote voltage sensing is used to maintain regulation at the load and reduce the degradation of regulation that would occur due to the voltage drop in the leads between the power supply and the load.

When the power supply is connected for remote sensing, the OVP circuit senses the voltage at the sensing points (load) and not the output terminals.

Connections between the power supply sensing and output terminals should be removed, and using a shielded two-wire cable, the power supply sensing terminals should be connected to the load as shown in [Figure 1-7](#).

NOTE

Do not use the shield as one of the sensing conductors and the other end should be left unconnected.

Connect one end of the sensing lead shield to the chassis ground (\perp) only. Opening a sensing lead causes the power supply's output voltage to decrease at the load leads. Observe the polarity when connecting the sensing leads to the load.

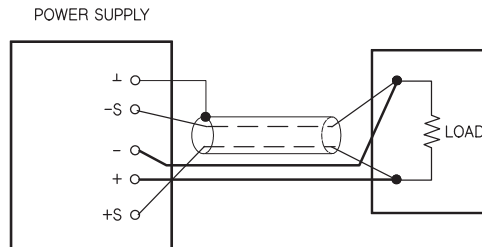

Figure 1-7 Remote voltage sensing connections

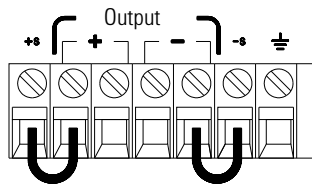

Figure 1-8 Local sensing connections

Stability

Using remote sensing under certain combinations of load lead lengths and large load capacitances may cause your application to form a filter, which becomes part of the voltage feedback loop. The extra phase shift created by this filter can degrade the power supply's stability, resulting in poor transient response or loop instability. In severe cases, it may cause oscillations.

To minimize this possibility, keep the load leads as short as possible and twist them together. As the sense leads are part of the power supply's programming feedback loop, accidental open-connections of sense or load leads during remote sensing operation have various unwanted effects. Provide secure and permanent connections.

NOTE

During remote sensing setup, it is strongly recommended to power off (by pressing the power ON/OFF button) the power supply to avoid undesirable damage to the load or the power supply.

CV regulation

The voltage load regulation specification in [Chapter 7](#) applies at the output terminals of the power supply. When remote sensing, add 5 mV to this specification for each 1 V drop between the positive sensing point and (+) output terminal due to the change in load current. Because the sense leads are part of the power supply's feedback path, keep the resistance of the sense leads at or below 0.5 Ω per lead to maintain the above specified performance.

Output rating

The rated output voltage and current specifications in [Chapter 7](#) apply at the output terminals of the power supply. With remote sensing, any voltage dropped in the load leads must be added to the load voltage to calculate the maximum output voltage. The performance specifications are not guaranteed when the maximum output voltage is exceeded. If the excessive demand on the power supply forces the power supply to lose regulation, the **Unreg** annunciator will turn on to indicate that the output is unregulated.

Output noise

Any noise picked up on the sense leads also appears at the output of the power supply and may adversely affect the voltage load regulation. Twist the sense leads to minimize external noise pickup and run them parallel and close to the load leads. In noisy environments, it may be necessary to shield the sense leads. Ground the shield at the power supply end only. Do not use the shield as one of the sense conductors.

Multiple loads

When connecting multiple loads to the power supply, each load should be connected to the output terminals using separate connecting wires. This minimizes mutual coupling effects between loads and takes full advantage of the low output impedance of the power supply. Each pair of wires should be as short as possible and twisted or bundled to reduce lead inductance and noise pick-up. If a shield is used, connect one end to the power supply ground terminal and leave the other end disconnected.

If cabling considerations require the use of distribution terminals that are located remotely from the power supply, connect output terminals to the distribution terminals by a pair of twisted or shielded wires. Connect each load to the distribution terminals separately.

Operating the Power Supply

Cooling

The power supply can operate at the rated specifications within the temperature range of 0 °C to 40 °C. A fan cools the power supply by drawing air through the sides and exhausting it out the back. Using an Agilent rack-mount will not impede the flow of air.

Bench operation

Your power supply must be installed in a location that allows sufficient space at the sides and rear of the power supply for adequate air circulation. The rubber bumpers must be removed for rack-mounting.

Cleaning

No cleaning is required for this product. If you wish to remove dust from the enclosure, use a dry cloth.



2 Operation and Features





Overview	32
Constant Voltage Operation	34
Constant Current Operation	36
Configuring the Remote Interface	38
Storing and Recalling Operating States	40
Programming the Overvoltage Protection	42
Disabling the Output	47
System-Related Operations	49
GPIB Interface Reference	53
RS-232 Interface Reference	54
Calibration	58

This chapter describes the operations and features for the E364xA single output DC power supplies.



Overview

The following section provides an overview of the front panel keys before operating your power supply.

- The power supply is shipped from the factory configured in the front panel operation mode. At power-on, the power supply is automatically set to operate in the front panel operation mode. When in this mode, the front panel keys can be used.
- When the power supply is in the remote operation mode, you can return to the front panel operation mode at any time by pressing the  (**Local**) key if you did not previously send the front panel lockout command. A change between the front panel and remote operation modes will not result in a change in the output parameters.
- When you press  (the **Limit** annunciator flashes), the display of the power supply goes to the limit mode and the present limit values will be displayed. In this mode, you can also observe the change of the limit values when adjusting the knob. If you press  again or let the display time-out after several seconds, the power supply will return the display to the meter mode (the **Limit** annunciator turns off). In this mode, the actual output voltage and current will be displayed.
- The output of the power supply can be enabled or disabled from the front panel by pressing . When the output is off, the **OFF** annunciator turns on and the output is disabled.
- The display provides the present operating status of the power supply with annunciators and also informs you of error codes. For example, the power supply is operating in the CV mode in the 8 V/3 A range and controlled from the front panel, then the **CV** and **8V** annunciators will turn on. If, however, the power supply is remotely controlled, the **Rmt** annunciator will also turn on, and when the power supply is being addressed over the GPIB interface, the **Adrs** annunciator will turn on. Refer to “[Display annunciators](#)” on page 22 for more information.

- The display provides the present operating status of the power supply with annunciators and also informs you of error codes.

Constant Voltage Operation

To set up the power supply for constant voltage (CV) operation, proceed as follows.

Front panel operation

- 1 *Connect a load to the output terminals.*

With power-off, connect a load to the + and – output terminals.



- 2 *Turn on the power supply.*

The power supply will go into the power-on/reset state and the output is disabled (the **OFF** annunciator turns on). Its low voltage range is selected and the annunciator for the range presently selected turns on, for example, the **8V** annunciator turns on for the E3640A model. The knob is selected for voltage control.

Press  to operate the power supply in the high voltage range before proceeding to the next step. The **20V** or **60V** annunciator turns on depending on which power supply you are using.



- 3 *Set the display to the limit mode.*

Notice that the **Limit** annunciator flashes, indicating that the display is in the limit mode. When the display is in the limit mode, you can see the voltage and current limit values of the power supply.

NOTE

In the constant voltage mode, the voltage values between the meter and limit modes are the same, but the current values are not. Moreover, if the display is in the meter mode, you cannot see the change of current limit value when adjusting the knob. We recommend that you should set the display to the limit mode to see the change of current limit value in the constant voltage mode whenever adjusting the knob.



4 *Adjust the knob for the desired current limit.^[1]*

Check that the **Limit** annunciator still flashes. Set the knob for current control. The flashing digit can be changed using the resolution selection keys and the flashing digit can be adjusted by turning the knob. Adjust the knob to the desired current limit.



5 *Adjust the knob for the desired output voltage.^[2]*

Check that the **Limit** annunciator still flashes. Set the knob for voltage control. Change the flashing digit using the resolution selection keys and adjust the knob for the desired output voltage.



6 *Return to the meter mode.*

Press  or let the display time-out after several seconds to return to the meter mode. Notice that the **Limit** annunciator turns off and the display shows the **OUTPUT OFF** message.



7 *Enable the output.*

The **OFF** annunciator turns off and the **CV** annunciator turns on. Notice that the display is in the meter mode.

8 *Verify that the power supply is in the constant voltage mode.*

If you operate the power supply in the constant voltage (CV) mode, verify that the **CV** annunciator is lit. If the **CC** annunciator is lit, choose a higher current limit.

NOTE

During actual CV operation, if a load change causes the current limit to be exceeded, the power supply will automatically crossover to the constant current mode at the preset current limit and the output voltage will drop proportionately.

[1] You can use the resolution selection keys to move the flashing digit to the right or left when setting current.

[2] You can use the resolution selection keys to move the flashing digit to the right or left when setting voltage.

Remote interface operation

CURRent	{<current> MIN MAX}	<i>Set the current.</i>
VOLTage	{<voltage> MIN MAX}	<i>Set the voltage.</i>
OUTPut	ON	<i>Enable the output.</i>

Constant Current Operation

To set up the power supply for constant current (CC) operation, proceed as follows.

Front panel operation

- 1 *Connect a load to the output terminals.*

With power-off, connect a load to the + and – output terminals.



- 2 *Turn on the power supply.*

The power supply will go into the power-on/reset state and the output is disabled (the **OFF** annunciator turns on). Its low voltage range is selected and the annunciator for the range presently selected turns on, for example, the **8V** annunciator turns on for the E3640A model. The knob is selected for voltage control.

Press  to operate the power supply in the high voltage range before proceeding to the next step. The **20V** or **60V** annunciator turns on depending on which power supply you are using.



- 3 *Set the display to the limit mode.*

Notice that the **Limit** annunciator flashes, indicating that the display is in the limit mode. When the display is in the limit mode, you can see the voltage and current limit values of the selected supply.

NOTE

In constant current mode, the current values between the meter mode and limit mode are the same, but the voltage values are not. Moreover, if the display is in the meter mode, you cannot see the change of voltage limit value when adjusting the knob. We recommend that you should set the display to the limit mode to see the change of voltage limit value in the constant current mode whenever adjusting the knob.



4 *Adjust the knob for the desired voltage limit.^[1]*

Check that the **Limit** annunciator still flashes and the knob is selected for voltage control. The flashing digit can be changed using the resolution keys and the flashing digit can be adjusted by turning the knob. Adjust the knob for the desired voltage limit.



5 *Adjust the knob for the desired output current.^[2]*

Check that the **Limit** annunciator still flashes. Set the knob for current control. Change the flashing digit using the resolution selection keys and adjust the knob to the desired output current.



6 *Return to the meter mode.*

Press  or let the display time-out after several seconds to return to the meter mode. Notice that the **Limit** annunciator turns off and the display shows the **OUTPUT OFF** message.



7 *Enable the output.*

The **OFF** annunciator turns off and the **CC** annunciator turns on. Notice that the display is in the meter mode.

8 *Verify that the power supply is in the constant current mode.*

If you operate the power supply in the constant current (CC) mode, verify that the **CC** annunciator is lit. If the **CV** annunciator is lit, choose a higher voltage limit.

[1] You can use the resolution selection keys to move the flashing digit to the right or left when setting the voltage.

[2] You can use the resolution selection keys to move the flashing digit to the right or left when setting the current.

2 Operation and Features

Configuring the Remote Interface

NOTE

During actual CC operation, if a load change causes the voltage limit to be exceeded, the power supply will automatically crossover to constant voltage mode at the preset voltage limit and the output current will drop proportionately.

Remote interface operation

VOLTage	{<voltage> MIN MAX}	<i>Set the voltage.</i>
CURRent	{<current> MIN MAX}	<i>Set the current.</i>
OUTPut	ON	<i>Enable the output.</i>

Configuring the Remote Interface

This power supply is shipped with both a GPIB (IEEE-488) interface and an RS-232 interface. The GPIB interface is selected when the power supply is shipped from the factory. Only one interface can be enabled at a time. To exit the I/O configuration mode without any changes, press  until the **NO CHANGE** message is displayed.

- You can set the GPIB address, parity, and baud rate from the front panel only.
- The current selection is highlighted for emphasis. All other choices are dimmed.
- The interface selection is stored in the non-volatile memory, and does not change when power has been turned off or after a power-on reset (*RST command).

GPIB configuration



- 1 Turn on the remote configuration mode.

GPIB / 488

If **RS-232** appears, select **GPIB / 488** by turning the knob.



- 2 Select the GPIB address.

ADDR 05

You can set the power supply's address to any value between 0 and 30. The factory setting is address 5.



- 3 Save the change and exit the menu.

SAVED

NOTE

Your computer's GPIB interface card has its own address. Be sure to avoid using the computer's address for any instrument on the interface bus. Agilent GPIB interface cards generally use address 21.

RS-232 configuration



- 1 Turn on the remote configuration mode.

GPIB / 488

Notice that if you changed the remote interface selection to RS-232 before, the **RS-232** message is displayed.



- 2 Choose the RS-232 interface.

RS-232

You can choose the RS-232 interface by turning the knob.



- 3 Select the baud rate.

Select one of the following: 300, 600, 1200, 2400, 4800, or 9600 (factory setting) baud.

9600 BAUD

2 Operation and Features

Storing and Recalling Operating States



4 *Select the parity and number of stop bits.*

Select one of the following: None (8 data bits, factory setting), Odd (7 data bits), or Even (7 data bits). When you set the parity, you are also indirectly setting the number of the data bits.

NONE 8 BITS



5 Save the change and exit the menu.

SAVED

Storing and Recalling Operating States

You can store up to five different operating states in non-volatile storage locations. When shipped from the factory, storage locations 1 through 5 are empty. You can name a location from the front panel or over the remote interface but you can only recall a named state from the front panel.

The following steps show you how to store and recall an operating state.

To cancel the store/recall operation, select the **EXIT** menu by turning the knob and then pressing  or letting the display time-out.

Front panel operation

Storing the operating state



1 *Set up the power supply for the desired operating state.*

The storage feature “remembers” the output voltage range selection, the limit value settings of voltage and current, output on/off state, OVP on/off state, and OVP trip levels.



2 Turn on the storage mode.

STORE STATE

From the front panel, you can assign names (up to nine characters) to each of the five stored states. Turn the knob until **NAME STATE** appears and press  to select the locations. Then press  to name the locations.

NAME STATE

1:P15V_TEST



3 Select the storage location.

Turn the knob to the right to specify the memory location 2.

2: STATE2



4 Save the operating state.

DONE

Recalling a stored state



1 Turn on the recall mode.

Memory location 1 will be displayed in the recall mode.

1: p15v_test



2 Select the stored operating state.

2: STATE2

RESET

You can select the above **RESET** mode to reset the power supply to the power-on state without turning power off/on or without using the *RST command over the remote interface. Refer to “*RST” on page 94 for more details on the *RST command.



3 Recall the stored operating state.

DONE

2 Operation and Features

Programming the Overvoltage Protection

Remote interface operation

Use the following commands to store and recall the power supply state.

*SAV {1|2|3|4|5}

Store an operating state to a specified location.

*RCL {1|2|3|4|5}

Recall a previously stored state from a specified location.

MEM:STAT:NAME 1, 'P15V_TEST'

Name the storage location 1 as "P15V_TEST".

Programming the Overvoltage Protection

Overvoltage protection guards the load against output voltages reaching values greater than the programmed protection level. It is accomplished by shorting the output via an internal SCR when the trip level is set to equal or greater than 3 V, or by programming the output to 1 V when the trip level is set to less than 3 V.

The following steps show how to set the OVP trip level, how to check the OVP operation, and how to clear the overvoltage condition.

Front panel operation

Setting the OVP level and enabling the OVP circuit





1 Turn on the power supply.



2 Enter the OVP menu and set the desired trip level.

LEVEL 22.0V (E3640A)

Use the knob and the resolution selection key  or  to set the desired trip level. Note that you cannot set the trip levels to lower than 1.0 V.



3 Enable the OVP circuit.

OVP ON



4 Exit the OVP menu.

CHANGED

If the OVP settings are not changed, **NO CHANGE** will be displayed. The power supply will exit the OVP menu and the display will return to the meter mode. Check that the **OVP** annunciator turns on if the OVP circuit is enabled.

Checking the OVP operation

To check the OVP operation, raise the output voltage to near the trip point. Then very gradually increase the output by turning the knob until the OVP circuit trips. This will cause the power supply output to drop to near zero, the **OVP** annunciator to flash, and the **CC** annunciator to turn on. The **OVP TRIPPED** message also appears on the display.









Clearing the overvoltage condition

When the OVP condition occurs, the **OVP** annunciator flashes. When it was caused by an external voltage source such as a battery, disconnect it first. Clear the overvoltage condition by adjusting the output voltage level or by adjusting the OVP trip level.

The following steps show you how to clear the overvoltage condition and return to the normal mode operation. In the following steps, the display will return to **OVP TRIPPED** if you allow the display to time-out after about several seconds.

2 Operation and Features

Programming the Overvoltage Protection

- **By adjusting the output voltage level**
 - i *Lower the output voltage level below the OVP trip point.*
The **OVP** and **Limit** annunciators are flashing after  is pressed. 
 - ii *Check that you lowered the voltage level below the OVP trip point.*
The OVP trip point is displayed. Do not adjust the trip point at this step.
 - iii *Select the OVP CLEAR mode by turning the knob.*
OVP ON
OVP CLEAR
 - iv *Clear the overvoltage condition and exit this menu.*
DONE
The **OVP** annunciator will not flash any more. The output will return to the meter mode.
- **By adjusting the OVP trip level**
 - i *Raise the OVP trip level higher than the level tripped.*
 - ii *Select the OVP CLEAR mode by turning the knob.*
OVP ON
OVP CLEAR
 - iii *Clear the overvoltage condition and exit this menu.*
DONE
The **OVP** annunciator will not flash any more. The output will return to the meter mode.

Remote interface operation

VOLT:PROT {<voltage>|MIN|MAX} *Set the OVP level.*

VOLT:PROT:STAT {OFF|ON}

Disable or enable the OVP circuit.

VOLT:PROT:CLE

Clear the tripped OVP circuit.

NOTE

The power supply's OVP circuit contains a crowbar SCR, which effectively shorts the output of the power supply whenever the overvoltage condition occurs. If an external voltage source such as a battery is connected across the output, and the overvoltage condition inadvertently occurs, the SCR will continuously sink a large current from the source and possibly damaging the power supply. To avoid this, a diode must be connected in series with the output as shown in [Figure 2-1](#).

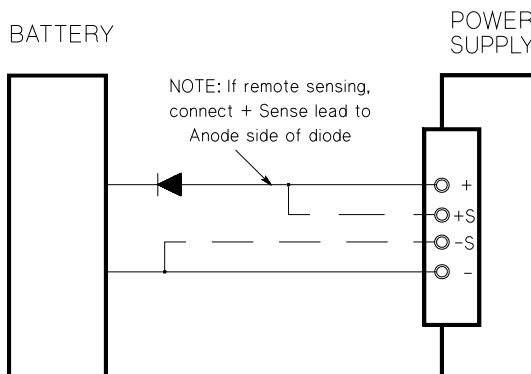

Figure 2-1 Recommended protection circuit for battery charging

When the E364xA is powered up or down, the output voltage will overshoot to not more than ± 1 V (i.e., +1 V max during power up and -1 V max during power down).

To prevent this voltage overshoot, Agilent recommends you to connect the diode(s) in series at the device-under-test's (DUT) input supply as shown in [Figure 2-2](#). This will block

2 Operation and Features

Programming the Overvoltage Protection

any reverse voltage and current flow to the DUT. Note that this recommendation is only suitable for single output applications.

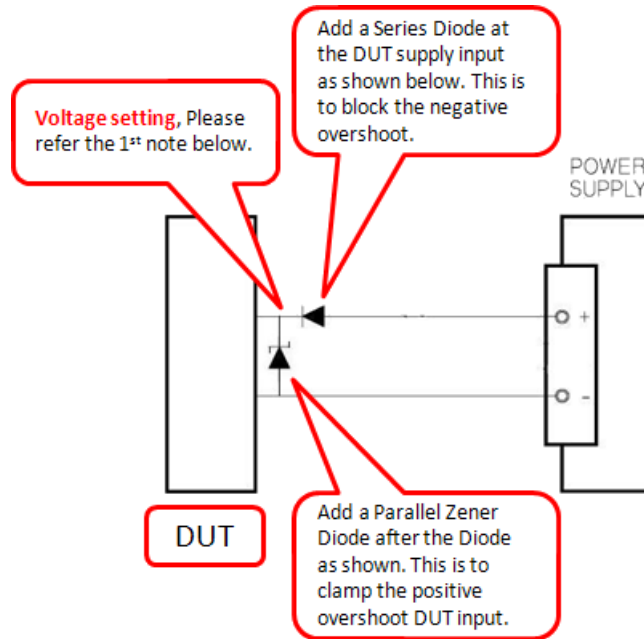





Figure 2-2 Recommended connection to prevent voltage overshoot

Note the following considerations for the diode(s) selection:

- The DUT's input voltage should consider the voltage drop across the diode. The typical threshold voltage of a silicon diode is 0.6 V to 0.7 V.
- The series diode selected must have a current specification of 10% to 20% derating margin.
- Select the zener diode's voltage according to the DUT's input voltage rating and at least 1 watt power rating or higher.

Disabling the Output

The output of the power supply can be disabled or enabled from the front panel.

- When the power supply is in the Off state, the **OFF** annunciator turns on and the output is disabled. The **OFF** annunciator turns off when the power supply returns to the On state. When the output is disabled, the voltage value is 0 V and the current value is 0.02 A. This gives a zero output voltage without actually disconnecting the output.
- The output state is stored in the volatile memory. The output is always disabled when power has been turned off or after a remote interface reset.
- While the output is disabled, the control knob is locked to prevent any unwanted changes from occurring. The other front panel keys are still working.
- To lock the control knob, move the flashing digit to the right or left using the  or  resolution selection keys until the flashing digit disappears.
- To see or check the changes while the output is disabled, press  before returning to the meter mode.

Front panel operation



OUTPUT OFF

Remote interface operation

OUTP {OFF|ON}

Disconnecting the output using an external relay

To disconnect the output, an external relay must be connected between the output and the load. A TTL signal of either low true or high true is provided to control an external relay. This signal can only be controlled with the remote command `OUTPut:RELAy {OFF|ON}`. The TTL output is available on the RS-232 connection pin 1 and pin 9.

When the `OUTPut:RELAy` state is ON, the TTL output of pin 1 is high (4.5 V) and pin 9 is low (0.5 V). The levels are reversed when the `OUTPut:RELAy` state is OFF. The TTL output of pin 1 or pin 9 of the RS-232 connector is available only after installing two jumpers (JP102 and JP103)^[1] inside the power supply. Refer to “[Component Locator Diagram](#)” on page 215 to locate them.

NOTE

Do not use the RS-232 interface if you have configured the power supply to output relay control signals. Internal components on the RS-232 circuitry may be damaged.

[1] For serial MY53xx6xxx, the two jumpers are JP751 and JP752.

System-Related Operations

This section gives information on system-related topics such as storing power supply states, reading errors, running a self-test, displaying messages on the front panel, and reading firmware revisions.

State storage

The power supply has five storage locations in non-volatile memory to store power supply states. The locations are numbered 1 through 5. You can assign a name to each of the locations for use from the front panel.

- You can store the power supply state in any of the five locations. However, you can only recall a state from a location that contains a previously stored state.
- The power supply stores the following: the state of output range selection, flashing digit position on the display, the limit value settings of voltage and current, output on/off state, OVP on/off state, and trip levels.
- When shipped from the factory, storage locations 1 through 5 are empty.
- You can assign a name to the storage locations. You can name a location from the front panel or over the remote interface but you can only recall a named state from the front panel. From the remote interface, you can only recall a stored state using a number (1 through 5).
- The name can contain up to nine characters. A letter (A-Z) or number (0-9) can be used for the first character to name a state. The underscore character (“_”) can be used for the remaining eight characters. Blank spaces are not allowed. An error is generated if you specify a name with more than nine characters.
- A power-on reset (*RST command) does not affect the configurations stored in memory. Once a state is stored, it remains until it is overwritten.

Front panel operation

Store

STORE STATE, NAME STATE, EXIT

To reset the power supply to the power-on reset state without using the *RST command or turning power off/on, select **RESET** from the following.

Recall

5 states, RESET, EXIT

Remote interface operation

Use the following commands to store and recall power supply states.

```
*SAV {1|2|3|4|5}
```

```
*RCL {1|2|3|4|5}
```

To assign a name to a stored state to be recalled from the front panel, send the following command. From the remote interface, you can only recall a stored state using a number (1 through 5).

```
MEM:STAT:NAME 1, 'P15V_TEST'
```

Self-test

A power-on self-test occurs automatically when you turn on the power supply. This test assures you that the power supply is operational. This test does not perform the extensive set of tests that are included as part of the complete self-test described below. If the power-on self-test fails, the **ERROR** annunciator turns on.

A complete self-test performs a series of tests and takes approximately 2 seconds to execute. If all tests pass, you can have a high confidence that the power supply is operational.

If the complete self-test is successful, **PASS** is displayed on the front panel. If the self-test fails, **FAIL** is displayed and the **ERROR** annunciator turns on. Refer to [Chapter 8](#), “Service and Maintenance” for instructions on returning the power supply to Agilent for service.

Front panel operation

To perform the complete front panel self-test, hold down  as you turn on the power supply and hold down the key until you hear a long beep. The self-test will begin when you release the key following the beep.

Remote interface operation

*TST?

Returns 0 if the complete self-test passes or 1 if it fails.

Error conditions

When the front-panel **ERROR** annunciator turns on, one or more command syntax or hardware errors have been detected. A record of up to 20 errors can be stored in the power supply’s error queue. Refer to [Chapter 4](#), “Error Messages” for more information.

Firmware revision query

The power supply has three microprocessors for control of various internal systems. You can query the power supply to determine which revision of firmware is installed for each microprocessor.

The power supply returns three revision numbers. The first number is the firmware revision number for the main processor; the second is for the input/output processor; and the third is for the front panel processor.

Front panel operation

View

REV X.X-YY-Z.Z

Press twice to read the system firmware revision numbers.

Remote interface operation

*IDN?

The above command returns a string in the form of:

“Agilent Technologies,E3640A,0,X.X-Y.Y-Z.Z”
(E3640A)

Make sure to dimension a string variable with at least 40 characters.

SCPI language version

This power supply complies with the rules and regulations of the present version of Standard Commands for Programmable Instruments (SCPI). You can determine the SCPI version with which the power supply is in compliance by sending a command from the remote interface.

You can query the SCPI version from the remote interface only.

Remote interface operation

“SYST:VERS?” *Query the SCPI version*

Returns a string in the form of YYYY.V where the Y represents the year of the version, and the V represents the version number for that year (for example, 1997.0).

GPIB Interface Reference

The GPIB connector on the rear panel connects your power supply to the computer and other GPIB devices. [Chapter 1](#), “Accessories” lists the cables that are available from Agilent. A GPIB system can be connected together in any configuration (star, linear, or both) as long as the following rules are observed:

Each device on the GPIB (IEEE-488) interface must have a unique address. You can set the power supply’s address to any value between 0 and 30. The address is set to 5 when the power supply is shipped from the factory. The GPIB address is displayed at power-on.

You can set the GPIB address from the front panel only.

- The address is stored in the non-volatile memory, and does not change when power has been turned off or after a power-on reset (*RST command).
- Your computer's GPIB interface card has its own address. Avoid using the computer's address for any instrument on the interface bus. Agilent GPIB interface cards generally use address 21.
- The total number of devices including the computer is not more than 15.
- The total length of all the cables used is not more than 2 m times the number of devices connected together, up to a maximum of 20 m.
- Do not stack more than three connector blocks together on any GPIB connector. Make sure that all connectors are fully seated and that the lock screws are firmly finger tightened.

Refer to “[Configuring the Remote Interface](#)” on page 38 for more information on configuring the power supply for remote interface operations from the front panel.

NOTE

IEEE-488 states that you should exercise caution if your individual cable lengths exceed 4 m.

RS-232 Interface Reference

The power supply can be connected to the RS-232 interface using the 9-pin (DB-9) serial connector on the rear panel. The power supply is configured as a Data Terminal Equipment (DTE) device. For all communications over the RS-232 interface, the power supply uses two handshake lines: Data Terminal Ready (DTR, on pin 4) and Data Set Ready (DSR, on pin 6).

The following sections contain information to help you use the power supply over the RS-232 interface. The programming commands for RS-232 are explained on [page 102](#).

RS-232 configuration overview

Configure the RS-232 interface using the parameters as shown below. Use the front panel  key to select the baud rate, parity, and number of data bits (refer to “[Configuring the Remote Interface](#)” on page 38 for more information).

- Baud rate: 300, 600, 1200, 2400, 4800, or 9600 (factory setting)
- Parity and data bits: None/8 data bits (factory setting)
Even/7 data bits, or
Odd/7 data bits
- Number of start bits: 1 bit (fixed)
- Number of stop bits: 2 bits (fixed)

RS-232 data frame format

A character frame consists of all the transmitted bits that make up a single character. The frame is defined as the characters from the start bit to the last stop bit, inclusively. Within the frame, you can select the baud rate, number of data bits, and parity type. The power supply uses the following frame formats for seven and eight data bits.

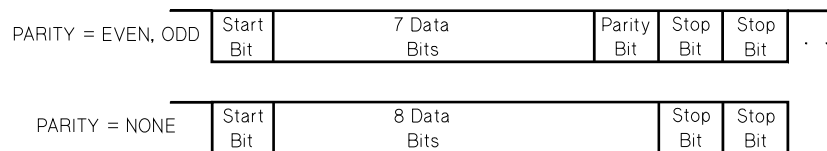

Connection to a computer or terminal

To connect the power supply to a computer or terminal, you must have the proper interface cable. Most computers and terminals are Data Terminal Equipment (DTE) devices. Since the power supply is also a DTE device, you must use a DTE-to-DTE interface cable. These cables are also called null-modem, modem-eliminator, or crossover cables.

The interface cable must also have the proper connector on each end and the internal wiring must be correct. Connectors typically have nine pins (DB-9 connector) or 25 pins (DB-25 connector) with a male or female pin configuration. A male connector has pins inside the connector shell and a female connector has holes inside the connector shell.

If you cannot find the correct cable for your configuration, you may have to use a wiring adapter. If you are using a DTE-to-DTE cable, make sure the adapter is a “straight-through” type. Typical adapters include gender changers, null-modem adapters, and DB-9 to DB-25 adapters.

The cable and adapter diagrams as shown in [Figure 2-3](#) and [Figure 2-4](#) can be used to connect the power supply to most computers or terminals.

DB-9 serial connection

If your computer or terminal has a 9-pin serial port with a male connector, use the null-modem cable included with the Agilent 34398A Cable Kit. This cable has a 9-pin female connector on each end. The cable pin diagram is as shown in [Figure 2-3](#).

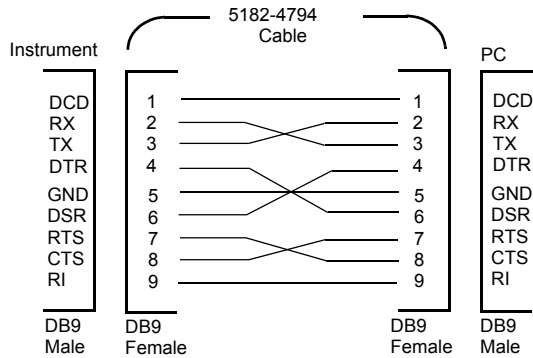

Figure 2-3 DB-9 serial connection

DB-25 serial connection

If your computer or terminal has a 25-pin serial port with a male connector, use the null-modem cable and 25-pin adapter included with the Agilent 34398A Cable Kit. The cable and adapter pin diagrams are as shown in [Figure 2-4](#).

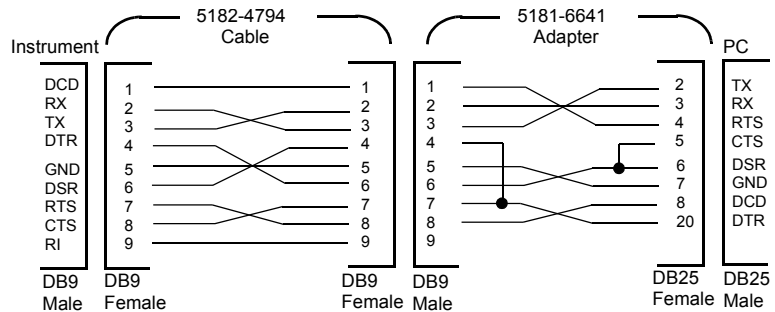

Figure 2-4 DB-25 serial connection

RS-232 troubleshooting

Here are a few things to check if you are having problems communicating over the RS-232 interface. If you need additional help, refer to the documentation that came with your computer.

- Verify that the power supply and your computer are configured for the same baud rate, parity, and number of data bits. Make sure that your computer is set up for one start bit and two stop bits (these values are fixed on the power supply).
- Make sure to execute the `SYSTEM:REMOte` command to place the power supply in the remote mode.
- Verify that you have connected the correct interface cable and adapters. Even if the cable has the proper connectors for your system, the internal wiring may be incorrect. The Agilent 34398A Cable Kit can be used to connect the power supply to most computers or terminals.
- Verify that you have connected the interface cable to the correct serial port on your computer (COM1, COM2, etc.).

Calibration

This section gives an overview of the calibration features of the power supply. For more detailed discussion of the calibration procedures, refer to [Chapter 8](#), “Service and Maintenance”.

Calibration security

This feature allows you to enter a security code to prevent accidental or unauthorized calibrations of the power supply. When you first receive your power supply, it is secured. Before you can calibrate the power supply, you must unsecure it by entering the correct security code.

- [Table 2-1](#) shows the security code for each model when the power supply is shipped from the factory. The security code is stored in non-volatile memory, and does not change when power has been turned off or after a power-on reset (*RST command).
- The security code may contain up to 11 alphanumeric characters or underscore character (“_”). A letter (A-Z) or number (0-9) can be used for the first character. You do not have to use all 11 characters.

_ _ _ _ _ _ _ _ _ _ _ (11 characters)

- When you secure the power supply from the remote interface, use a maximum of eight alphanumeric characters to unsecure the power supply from the front panel also. For example, the security code for E3640A has less than nine characters.

NOTE

If you forget your security code, you can disable the security feature by adding a jumper inside the power supply and then enter a new code. Refer to [Chapter 8](#), “Service and Maintenance” for more information.

Table 2-1 Factory-setting security codes

Model	Security code
E3640A	003640
E3641A	003641
E3642A	003642
E3643A	003643
E3644A	003644
E3645A	003645

To unsecure for calibration

You can unsecure the power supply either from the front panel or over the remote interface. The power supply is secured when shipped from the factory. Refer to [Table 2-1](#) for the factory-setting secure code for your power supply.

Front panel operation

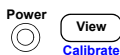

- 1 *Select the calibration mode.*

SECURED

If the power supply is secured, the above message is displayed as you turn on the power supply by holding down the  (**Calibrate**) key. Hold down the key until you hear a long beep and the **CAL MODE** message is displayed.



- 2 *Enter the security code.*

000000

Enter the security code using the control knob and resolution selection keys.



- 3 *Save the change and exit the menu.*

UNSECURED

You will see the above message if the security code is correct, and the **CAL MODE** message is displayed. To exit the calibration mode, turn the power off and on.

Notice that if you enter the wrong secure code, **INVALID** is displayed and the code entering mode is displayed for you to enter the correct code.

Remote interface operation

```
CAL:SEC:STAT {OFF|ON}, <code> Secure or unsecure  
the power supply.
```

To unsecure the power supply, send the above command with the same code used to secure. For example,

```
CAL:SEC:STAT OFF, '003640' (E3640A model)
```

To secure against calibration

You can secure the power supply against calibration either from the front panel or over the remote interface. The power supply is secured when shipped from the factory.

Read the security code rules at “[Calibration security](#)” on page 58 before attempting to secure the power supply.

Front panel operation

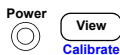

- 1 *Select the calibration mode.*

UNSECURED

If the power supply is unsecured, the above message is displayed as you turn on the power supply by holding down the  (**Calibrate**) key. Hold down the key until you hear a long beep and the **CAL MODE** message is displayed.



- 2 *Enter the security code.*

000000

Enter the desired security code using the control knob and resolution selection keys.



3 Save the change and exit the menu.

secured

The secured setting is stored in non-volatile memory, and does not change when power has been turned off or after a power-on reset (*RST command).

Remote interface operation

CAL:SEC:STAT {OFF|ON}, <code> *Secure or unsecure the power supply.*



To secure the power supply, send the above command with the same code used to unsecure. For example,

“CAL:SEC:STAT ON, ‘003640’” (*E3640A model*)

To change the security code

To change the security code, you must first unsecure the power supply, and then enter a new code. Read the security code rules at “[Calibration security](#)” on page 58 before attempting to secure the power supply.

Front panel operation

To change the security code, first make sure that the power supply is unsecured. Go to the security code entry, press the  (**Secure**) key after the **CAL MODE** message is displayed, enter the new security code using the control knob and resolution selection keys, and then press  (**Secure**) key.

Changing the code from the front panel also changes the code as seen from the remote interface.

Remote interface operation

CAL:SEC:CODE <new code> *Change the security code.*

To change the security code, first unsecure the power supply using the old security code. Then, enter the new code as shown below.

CAL:SEC:STAT OFF, '003640' *Unsecure with the old code.*

CAL:SEC:CODE 'ZZ001443' *Enter the new code.*

CAL:SEC:STAT ON, 'ZZ001443' *Secure with the new code.*

Calibration count

You can determine the number of times that your power supply has been calibrated. Your power supply was calibrated before it left the factory. When you receive your power supply, read the count to determine its initial value.

The calibration count feature can be performed from the remote interface only.

- The calibration count is stored in non-volatile memory, and it does not change when power has been turned off or after a remote interface reset.
- The calibration count increments up to a maximum of 32767 after which it wraps-around to 0. Since the value increments by one for each calibration point, a complete calibration will increase the value by three counts.

Remote interface operation

CAL:COUN? *Query the number of times of calibration.*

Calibration message

The power supply allows you to store one message in calibration memory in the mainframe. For example, you can store such information as the date when the last calibration was performed, the date when the next calibration is due, the power supply's serial number, or even the name and phone number of the person to contact for a new calibration.

- You can record a calibration message only from the remote interface and only when the power supply is unsecured. You can read the message from either the front panel or over the remote interface. You can read the calibration message whether the power supply is secured or unsecured.
- The calibration message may contain up to 40 characters. From the front panel, you can view 11 characters of the message at a time.
- Storing a calibration message will overwrite any message previously stored in memory.
- The calibration message is stored in non-volatile memory, and does not change when power has been turned off or after a remote interface reset.

Front panel operation

To read the calibration message from the front panel, press



and turn the knob until **CAL STRING** is displayed. Press



to scroll through the text of the message. Press



to increase the scrolling speed.



CAL STRING

Remote interface operation

To store the calibration message, send the following command.

```
CAL:STR 'CAL 06-01-99'
```

2 Operation and Features

Calibration

THIS PAGE HAS BEEN INTENTIONALLY LEFT BLANK.

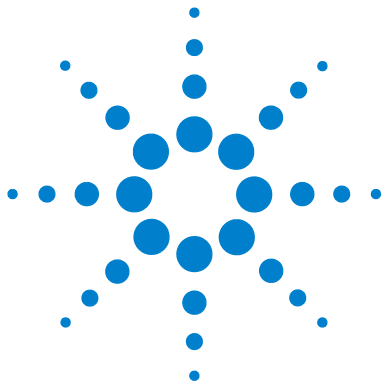

3 Remote Interface Reference

SCPI Command Summary	66
Introduction to the SCPI Language	71
Simplified Programming Overview	77
Using the APPLy Command	81
Output Settings and Operation Commands	82
Triggering	88
System-Related Commands	91
State Storage Commands	95
Calibration Commands	97
Interface Configuration Commands	102
SCPI Status Registers	103
Status Reporting Commands	113
Halting an Output in Progress	116
SCPI Conformance Information	117
IEEE-488.2 common commands	121

This chapter lists the SCPI commands.



SCPI Command Summary

NOTE

If you are a first-time user of the SCPI language, refer to “[Introduction to the SCPI Language](#)” and “[Simplified Programming Overview](#)” to familiarize with the SCPI language before attempting to program the power supply.

This section summarizes the Standard Commands for Programmable Instruments (SCPI) available to program the power supply over the remote interface. Refer to the respective sections in this chapter for more details on each command.

Throughout this manual, the following conventions are used for the SCPI command syntax.

- Square brackets ([]) indicate optional keywords or parameters.
- Braces ({ }) enclose parameters within a command string.
- Triangle brackets (<>) indicate that you must substitute a value or a code for the enclosed parameter.
- A vertical bar (|) separates one of two or more alternative parameters.

Table 3-1 SCPI command summary

Output Settings and Operation Commands

```

APPLy {<voltage>|DEF|MIN|MAX} [, {<current>|DEF|MIN|MAX}]
APPLy?
[SOURce:]
  CURRent[:LEVel][:IMMediate][:AMPLitude] {<current>|MIN|MAX|UP|DOWN}
  CURRent[:LEVel][:IMMediate][:AMPLitude]? [MIN|MAX]
  CURRent[:LEVel][:IMMediate]:STEP[:INCRement] {<numeric value>|DEFAULT}
  CURRent[:LEVel][:IMMediate]:STEP[:INCRement]? [DEFAULT]
  CURRent[:LEVel]:TRIGgered[:AMPLitude] {<current>|MIN|MAX}
  CURRent[:LEVel]:TRIGgered[:AMPLitude]? [MIN|MAX]
  VOLTage[:LEVel][:IMMediate][:AMPLitude] {<voltage>|MIN|MAX|UP|DOWN}
  VOLTage[:LEVel][:IMMediate][:AMPLitude]? [MIN|MAX]
  VOLTage[:LEVel][:IMMediate]:STEP[:INCRement] {<numeric value>|DEFAULT}
  VOLTage[:LEVel][:IMMediate]:STEP[:INCRement]? [DEFAULT]
  VOLTage[:LEVel]:TRIGgered[:AMPLitude] {<voltage>|MIN|MAX}
  VOLTage[:LEVel]:TRIGgered[:AMPLitude]? [MIN|MAX]
  VOLTage:PROTection[:LEVel] {<voltage>|MIN|MAX}
  VOLTage:PROTection[:LEVel]? [MIN|MAX]
  VOLTage:PROTection:STATe {0|1|OFF|ON}
  VOLTage:PROTection:STATe?
  VOLTage:PROTection:TRIPped?
  VOLTage:PROTection:CLEar
  VOLTage:RANGe {P8V[1]|P20V[1]|P35V[2]|P60V[2]|LOW|HIGH}
  VOLTage:RANGe?
MEASure
  [:SCALar]
    :CURRent[:DC]?
    [:VOLTage][:DC]?
  
```

Triggering

```

INITiate[:IMMediate]
TRIGger[:SEQuence]
  :DELay {<seconds>|MIN|MAX}
  :DELay? [MIN|MAX]
  :SOURce {BUS|IMM}
  :SOURce?
*TRG
  
```

3 Remote Interface Reference

SCPI Command Summary

Table 3-1 SCPI command summary (continued)

System-Related Commands

```
DISPlay[:WINDow]
  [:STATe] {OFF|ON}
  [:STATe]?
  :TEXT[:DATA] <quoted string>
  :TEXT[:DATA]?
  :TEXT:CLEar
SYSTem
  :BEEPer[:IMMediate]
  :ERRor?
  :VERSion?
  :COMMunicate:GPIB:RDEvice:ADDRess <numeric value>
  :COMMunicate:GPIB:RDEvice:ADDRess?
OUTPut
  :RELay[:STATe] {OFF|ON}
  :RELay[:STATe]?
  [:STATe] {OFF|ON}
  [:STATe]?
*IDN?
*RST
*TST?
```

State Storage Commands

```
*SAV {1|2|3|4|5}
*RCL {1|2|3|4|5}
MEMory:STATe
  :NAME {1|2|3|4|5}, <quoted name>
  :NAME? {1|2|3|4|5}
```

Calibration Commands

```
CALibration
  :COUNT?
  :CURRENT[:DATA] <numeric value>
  :CURRENT:LEVel {MIN|MID|MAX}
  :SECure:CODE <new code>
  :SECure:STATe {OFF|ON}, <quoted code>
  :SECure:STATe?
  :STRing <quoted string>
  :STRing?
  :VOLTage[:DATA] <numeric value>
  :VOLTage:LEVel {MIN|MID|MAX}
  :VOLTage:PROTection
```

Table 3-1 SCPI command summary (continued)

Interface Configuration Commands

```

SYSTEM
  :INterface {GPIB|RS232}
  :LOCal
  :REMote
  :RWLock
  
```

Status Reporting Commands

```

STATus:QUESTionable
  :CONDition?
  [:EVENT]?
  :ENABle <enable value>
  :ENABle?
SYSTEM:ERRor?
*CLS
*ESE <enable value>
*ESE?
*ESR?
*OPC
*OPC?
*PSC {0|1}
*PSC?
*SRE <enable value>
*SRE?
*STB?
*WAI
  
```

3 Remote Interface Reference

SCPI Command Summary

Table 3-1 SCPI command summary (continued)

IEEE-488.2 common commands

*CLS
*ESR?
*ESE <enable value>
*ESE?
*IDN?
*OPC
*OPC?
*PSC {0|1}
*PSC?
*RST
*SAV {1|2|3|4|5}
*RCL {1|2|3|4|5}
*STB?
*SRE <enable value>
*SRE?
*TRG
*TST?
*WAI

[1] Applicable for E3640A, E3642A, and E3644A only.

[2] Applicable for E3641A, E3643A, and E3645A only.

Introduction to the SCPI Language

Standard Commands for Programmable Instruments (SCPI) is an ASCII-based instrument command language designed for test and measurement instruments. Refer to “[Simplified Programming Overview](#)” for an introduction to the basic techniques used to program the power supply over the remote interface.

SCPI commands are based on a hierarchical structure, also known as a tree system. In this system, associated commands are grouped together under a common node or root, thus forming subsystems. A portion of the SOURCE subsystem is shown below to illustrate the tree system.

```
[SOURce:]
  CURRent {<current>|MIN|MAX|UP|DOWN}
  CURRent? [MIN|MAX]
  CURRent:
    TRIGgered {<current>|MIN|MAX}
    TRIGgered? [MIN|MAX]
  VOLTage {<voltage>|MIN|MAX|UP|DOWN}
  VOLTage? [MIN|MAX]
  VOLTage:
    TRIGgered {<voltage>|MIN|MAX}
    TRIGgered? [MIN|MAX]
```

SOURCE is the root keyword of the command, CURRent and VOLTage are second-level keywords, and TRIGgered is the third-level keyword. A colon (:) separates a command keyword from a lower-level keyword.

Command format used in this manual

The format used to show commands in this manual is shown below:

```
CURRent {<current>|MINimum|MAXimum|UP|DOWN}
```

The command syntax shows most commands (and some parameters) as a mixture of upper-case and lower-case letters. The upper-case letters indicate the abbreviated spelling for the command. For shorter program lines, send the abbreviated form. For better program readability, send the long form.

For example, in the above syntax statement, CURR and CURRENT are both acceptable forms. You can use upper-case or lower-case letters. Therefore, CURRENT, curr, and Curr are all acceptable. Other forms, such as CUR and CUREN, will generate an error.

Braces ({}) enclose the parameter choices for a given command string. The braces are not sent with the command string.

A vertical bar (|) separates multiple parameter choices for a given command string.

Triangle brackets (<>) indicate that you must specify a value for the enclosed parameter. For example, the above syntax statement shows the current parameter enclosed in triangle brackets. The brackets are not sent with the command string. You must specify a value for the parameter (such as CURR 0.1).

Some parameters are enclosed in square brackets ([]). The brackets indicate that the parameter is optional and can be omitted. The brackets are not sent with the command string. If you do not specify a value for an optional parameter, the power supply chooses a default value.

Some portions of commands are enclosed in square brackets ([]). The brackets indicate that this portion of the command is optional. Most optional portions of the command are not shown in the command description. For the full command showing all the options, refer to [Table 3-1](#).

A colon (:) separates a command keyword from a lower-level keyword. You must insert a blank space to separate a parameter from a command keyword. If a command requires more than one parameter, you must separate adjacent parameters using a comma as shown below:

```
SOURce:CURRent:TRIGgered
APPLy 3.5,1.5
```

Command separators

A colon (:) is used to separate a command keyword from a lower-level keyword as shown below:

```
SOURce:CURRent:TRIGgered
```

A semicolon (;) is used to separate two commands within the same subsystem, and can also minimize typing. For example, sending the following command string:

```
SOUR:VOLT MIN;CURR MAX
```

is the same as sending the following two commands:

```
SOUR:VOLT MIN
SOUR:CURR MAX
```

Use a colon and a semicolon to link commands from different subsystems. For example, in the following command string, an error is generated if you do not use the colon and semicolon:

```
DISP:TEXT:CLE;:SOUR:CURR MIN
```

Using the MIN and MAX parameters

You can substitute `MINimum` or `MAXimum` in place of a parameter for many commands. For example, consider the following command:

```
CURRent {<current>|MIN|MAX}
```

Instead of selecting a specific current, you can substitute `MINimum` to set the current to its minimum value or `MAXimum` to set the current to its maximum value.

Querying parameter settings

You can query the value of most parameters by adding a question mark (?) to the command. For example, the following command sets the output current to 5 A:

```
CURR 5
```

You can query the value by executing:

```
CURR?
```

You can also query the maximum or minimum value allowed with the present function as follows:

```
CURR? MAX
```

```
CURR? MIN
```

CAUTION

If you send two query commands without reading the response from the first, and then attempt to read the second response, you may receive some data from the first response followed by the complete second response. To avoid this, do not send a query command without reading the response. When you cannot avoid this situation, send a device clear before sending the second query command.

SCPI command terminators

A command string sent to the power supply must terminate with a <new line> character. The IEEE-488 EOI (end-or-identify) message is interpreted as a <new line> character and can be used to terminate a command string in place of a <new line> character. A <carriage return> followed by a <new line> is also accepted. Command string termination will always reset the current SCPI command path to the root level. The <new line> character has the ASCII decimal code of 10.

IEEE-488.2 common commands

The IEEE-488.2 standard defines a set of common commands that perform functions like reset, self-test, and status operations. Common commands always begin with an asterisk (*), are four to five characters in length, and may include one or more parameters. The command keyword is separated from the first parameter by a blank space. Use a semicolon (;) to separate multiple commands as shown below:

```
*RST; *CLS; *ESE 32; *OPC?
```

SCPI parameter types

The SCPI language defines several different data formats to be used in program messages and response messages.

Numeric parameters

Commands that require numeric parameters will accept all commonly used decimal representations of numbers including optional signs, decimal points, and scientific notation. Special values for numeric parameters such as MINimum, MAXimum, and DEFault are also accepted.

3 Remote Interface Reference

Introduction to the SCPI Language

You can also send engineering unit suffixes (V, A, or SEC) with numeric parameters. If only specific numeric values are accepted, the power supply will automatically round the input numeric parameters. The following command uses a numeric parameter:

```
CURR {<current>|MIN|MAX|UP|DOWN}
```

Discrete parameters

Discrete parameters are used to program settings that have a limited number of values such as BUS and IMM. Query responses will always return the short form in all upper-case letters. The following command uses discrete parameters:

```
TRIG:SOUR {BUS|IMM}
```

Boolean parameters

Boolean parameters represent a single binary condition that is either true or false. For a false condition, the power supply will accept OFF or 0. For a true condition, the power supply will accept ON or 1. When you query a boolean setting, the power supply will always return 0 or 1. The following command uses a boolean parameter:

```
DISP {OFF|ON}
```

String parameters

String parameters can contain virtually any set of ASCII characters. A string must begin and end with matching quotes, either with a single quote or with a double quote. You can include the quote delimiter as part of the string by typing it twice without any characters in between. The following command uses a string parameter:

```
DISP:TEXT <quoted string>
```

Simplified Programming Overview

This section gives an overview of the basic techniques used to program the power supply over the remote interface. This section is only an overview and does not give all of the details you will need to write your own application programs. Refer to the remainder of this chapter and also [Chapter 5](#), “Application Programs” for more details and examples. Also refer to the programming reference manual that came with your computer for details on outputting command strings and entering data.

Using the APPLy command

The APPLy command provides the most straightforward method to program the power supply over the remote interface. For example, the following statement executed from your computer will set the power supply to an output of 3 V rated at 1 A:

```
APPL 3.0, 1.0
```

Using the low-level commands

Although the APPLy command provides the most straightforward method to program the power supply, the low-level commands give you more flexibility to change individual parameters. For example, the following statements executed from your computer will set the power supply to an output of 3 V rated at 1 A:

```
VOLT 3.0           Set the output voltage to 3.0 V.  
CURR 1.0          Set the output current to 1.0 A.
```

Reading a query response

Only the query commands (commands that end with ?) will instruct the power supply to send a response message. Queries return either output values or internal instrument settings. For example, the following statements executed from your computer will read the power supply's error queue and print the most recent error:

dimension statement	<i>Dimension string array (80 elements).</i>
SYST:ERR?	<i>Read the error queue.</i>
bus enter statement	<i>Enter the error string into the computer.</i>
print statement	<i>Print the error string.</i>

Selecting a trigger source

The power supply will accept a bus (software) trigger or an immediate internal trigger as a trigger source. By default, the bus trigger source is selected. If you want the power supply to use an immediate internal trigger, you must select IMMEDIATE. For example, the following statements executed from your computer will set to an output of 3 V/1 A immediately:

VOLT:TRIG 3.0	<i>Set the triggered voltage level to 3.0 V.</i>
CURR:TRIG 1.0	<i>Set the triggered current level to 1.0 A.</i>
TRIG:SOUR IMM	<i>Select the immediate trigger as a source.</i>
INIT	<i>Cause the trigger system to initiate.</i>

Power supply programming ranges

The SOURCE subsystem requires parameters for programming values. The available programming value for a parameter varies according to the desired output range of the power supply. Table 3-2 lists the programming values available and the MINimum, MAXimum, DEFault, and reset values of your power supply.

Refer to Table 3-2 and Table 3-3 to identify the programming values when programming the power supply.

Table 3-2 Agilent E3640A/E3642A/E3644A programming ranges

		E3640A		E3642A		E3644A	
		0 to 8 V/3 A range	0 to 20 V/1.5 A range	0 to 8 V/5 A range	0 to 20 V/2.5 A range	0 to 8 V/8 A range	0 to 20 V/4 A range
Voltage	Programming range	0 V to 8.24 V	0 V to 20.60 V	0 V to 8.24 V	0 V to 20.60 V	0 V to 8.24 V	0 V to 20.60 V
	MAX value	8.24 V	20.60 V	8.24 V	20.60 V	8.24 V	20.60 V
	MIN value		0 V		0 V		0 V
	DEFault value		0 V		0 V		0 V
	*RST value		0 V		0 V		0 V
Current	Programming range	0 A to 3.09 A	0 A to 1.545 A	0 A to 5.15 A	0 A to 2.575 A	0 A to 8.24 A	0 A to 4.12 A
	MAX value	3.09 A	1.545 A	5.15 A	2.575 A	8.24 A	4.12 A
	MIN value		0 A		0 A		0 A
	DEFault value	3 A	1.5 A	5 A	2.5 A	8 A	4 A
	*RST value		3.00 A		5.00 A		8.00 A

3 Remote Interface Reference

Simplified Programming Overview

Table 3-3 Agilent E3641A/E3643A/E3645A programming ranges

		E3641A		E3643A		E3645A	
		0 to 35 V/ 0.8 A range	0 to 60 V/ 0.5 A range	0 to 35 V/ 1.4 A range	0 to 60 V/ 0.8 A range	0 to 35 V/ 2.2 A range	0 to 60 V/ 1.3 A range
Voltage	Programming range	0 V to 36.05 V	0 V to 61.8 V	0 V to 36.05 V	0 V to 61.8 V	0 V to 36.05 V	0 V to 61.8 V
	MAX value	36.05 V	61.8 V	36.05 V	61.8 V	36.05 V	61.8 V
	MIN value	0 V		0 V		0 V	
	DEFault value	0 V		0 V		0 V	
	*RST value	0 V		0 V		0 V	
Current	Programming range	0 A to 0.824 A	0 A to 0.515 A	0 A to 1.442 A	0 A to 0.824 A	0 A to 2.266 A	0 A to 1.339 A
	MAX value	0.824 A	0.515 A	1.442 A	0.824 A	2.266 A	1.339 A
	MIN value	0 A		0 A		0 A	
	DEFault value	0.8 A	0.5 A	1.4 A	0.8 A	2.2 A	1.3 A
	*RST value	0.8 A		1.4 A		2.2 A	

Using the APPLy Command

The APPLy command provides the most straightforward method to program the power supply over the remote interface. You can select the output voltage and current in one command.

APPLy {<voltage> | DEF | MIN | MAX}[,<current> | DEF | MIN | MAX]}

This command is a combination of VOLTage and CURRent commands.

The APPLy command changes the power supply's output to the newly programmed values only if the programmed values are valid within the presently selected range. An execution error will occur if the programmed values are not valid within the selected range.

You can substitute MINimum, MAXimum, or DEFault in place of a specific value for the voltage and current parameters. For more details on the parameters, refer to [Table 3-2](#) for each model.

If you specify only one parameter of the APPLy command, the power supply regards it as the voltage setting value.

APPLy?

This command queries the power supply's present voltage and current setting values and returns a quoted string. The voltage and current are returned in sequence as shown in the sample string below (the quotation marks are returned as part of the string).

"8.00000,3.00000" (*E3640A model*)

Output Settings and Operation Commands

This section describes the low-level commands used to program the power supply. Although the `APPLY` command provides the most straightforward method to program the power supply, the low-level output setting commands give you more flexibility to change the individual parameters.

`CURRENT {<current> | MINimum | MAXimum | UP | DOWN}`

This command programs the immediate current level of the power supply. The immediate level is the current value of the output terminals.

The `CURRENT` command changes the output of the power supply to the newly programmed value regardless of the output range presently selected.

You can substitute `MINimum` or `MAXimum` in place of a specific value for the current parameter. `MIN` selects the lowest current values of 0 A. `MAX` selects the highest current values allowed for the selected range.

This command also increases or decreases the immediate current level using the `UP` or `DOWN` parameter by a predetermined amount. The `CURRENT:STEP` command sets the amount of increment or decrement. Notice that a new increment setting will cause an execution error of -222 (Data out of range) when the maximum or the minimum rated current is exceeded.

`CURRENT? [MINimum | MAXimum]`

Return the presently programmed current level of the power supply. `CURR? MAX` and `CURR? MIN` return the highest and lowest programmable current levels respectively for the selected range.

CURRent:STEP {<numeric value>|DEFault}

Set the step size for current programming with the CURRent UP and CURRent DOWN commands. See the example as shown in “[Example](#)” on page 84.

To set the step size to the minimum resolution, set the step size to DEFault. The minimum resolution of the step size is approximately 0.052 mA (E3640A), 0.015 mA (E3641A), 0.095 mA (E3642A), 0.026 mA (E3643A), 0.152 mA (E3644A), and 0.042 mA (E3645A), respectively.

The CURR:STEP? DEF returns the minimum resolution of your instrument. The immediate current level increases or decreases by the value of the step size. For example, the output current will increase or decrease 10 mA if the step size is 0.01. At *RST, the step size is the value of the minimum resolution.

CURRent:STEP? [DEFault]

Return the value of the step size currently specified. The returned parameter is a numeric value. DEFault gives the minimum resolution of the step size in unit of amperes.

**CURRent:TRIGgered
{<current>|MINimum|MAXimum}**

Program the pending triggered current level. The pending triggered current level is a stored value that is transferred to the output terminals when a trigger occurs. A pending triggered level is not affected by subsequent CURRent commands.

CURRent:TRIGgered? [MINimum|MAXimum]

Query the triggered current level presently programmed. If no triggered level is programmed, the CURRent level is returned.

3 Remote Interface Reference

Output Settings and Operation Commands

Example

The following program segment shows how to use the CURR UP or CURR DOWN command to increase or decrease the output current with the CURR:STEP command.

CURR:STEP 0.01	<i>Set the step size to 0.01 A.</i>
CURR UP	<i>Increase the output current.</i>
CURR:STEP 0.02	<i>Set the step size to 0.02 A.</i>
CURR DOWN	<i>Decrease the output current.</i>

VOLTage {<voltage>|MINimum|MAXimum|UP|DOWN}

Program the immediate voltage level of the power supply. The immediate level is the voltage value of the output terminals.

The VOLTage command changes the output of the power supply to the newly programmed value regardless of the output range presently selected.

This command also increases or decreases the immediate voltage level using the UP or DOWN parameter by a predetermined amount. The VOLTage:STEP command sets the amount of increment or decrement. Notice that a new increment setting will cause an execution error of -222 (Data out of range) when the maximum or the minimum rated voltage is exceeded.

VOLTage? [MINimum|MAXimum]

Query the presently programmed voltage level of the power supply.

VOLTage:STEP {<numeric value>|DEFAULT}

Set the step size for voltage programming with the VOLT UP and VOLT DOWN commands. See the example as shown in “[Example](#)” on page 85.

To set the step size to the minimum resolution, set the step size to `DEFault`. The minimum resolution of the step size is approximately 0.35 mV (E3640A), 1.14 mV (E3641A), 0.38 mV (E3642A), 1.14 mV (E3643A), 0.35 mV (E3644A), and 1.14 mV (E3645A), respectively.

The immediate voltage level increases or decreases by the value of the step size. For example, the output voltage will increase or decrease 10 mV if the step size is 0.01. At `*RST`, the step size is the value of the minimum resolution.

VOLTage:STEP? [DEFault]

Return the value of the step size currently specified. The returned parameter is a numeric value. `DEFault` gives the minimum resolution step size in unit of volts.

Example

The following program segment shows how to use the `VOLT UP` or `VOLT DOWN` command to increase or decrease the output voltage with the `VOLT:STEP` command.

<code>VOLT:STEP 0.01</code>	<i>Set the step size to 0.01 V.</i>
<code>VOLT UP</code>	<i>Increase the output voltage.</i>
<code>VOLT:STEP 0.02</code>	<i>Set the step size to 0.02 V.</i>
<code>VOLT DOWN</code>	<i>Decrease the output voltage.</i>

VOLTage:TRIGgered

{<voltage> | MINimum | MAXimum}

Program the pending triggered voltage level. The pending triggered voltage level is a stored value that is transferred to the output terminals when a trigger occurs. A pending triggered level is not affected by subsequent `VOLTage` commands.

VOLTage:TRIGgered? [MINimum|MAXimum]

Query the triggered voltage level presently programmed. If no triggered level is programmed, the VOLT level is returned.

VOLTage:PROTection

{<voltage>|MINimum|MAXimum}

Set the voltage level at which the overvoltage protection (OVP) circuit will trip. If the peak output voltage exceeds the OVP level, then the power supply output is shorted by an internal SCR. An overvoltage condition can be cleared with the VOLT:PROT:CLE command after the condition that caused the OVP trip is removed.

VOLTage:PROTection? [MINimum|MAXimum]

Query the overvoltage protection trip level presently programmed.

VOLTage:PROTection:STATE {0|1|OFF|ON}

Enable or disable the overvoltage protection function. At *RST, this value is set to ON.

VOLTage:PROTection:STATE?

Query the state of the overvoltage protection function. The returned parameter is 0 (OFF) or 1 (ON).

VOLTage:PROTection:TRIPped?

Return a 1 if the overvoltage protection circuit is tripped and not cleared, or a 0 if not tripped.

VOLTage:PROTection:CLEar

Cause the overvoltage protection circuit to be cleared. After this command is executed, the output voltage is restored to the state it was in before the protection feature occurred and the OVP trip level remains unchanged to the value presently programmed.

Before sending this command, lower the output voltage below the OVP trip point, or raise the OVP trip level above the output setting. Note that the overvoltage condition caused by an external source must be removed first before proceeding with this command.

VOLTage:RANGe

{P8V^[1] | P20V^[1] | P35V^[2] | P60V^[2] | LOW | HIGH}

Select an output range to be programmed by the identifier. For example, P20V or HIGH is the identifier for the 20 V/1.5 A range and P8V or LOW is for the 8 V/3 A range (for the E3640A model). At *RST, the low voltage range is selected.

VOLTage:RANGe?

Query the presently selected range. The returned parameter is P8V or P35V for the low voltage range, or P20V or P60V for the high voltage range.

MEASure:CURRent?

Query the current measured across the current sense resistor inside the power supply.

MEASure[:VOLTage]?

Query the voltage measured at the sense terminals of the power supply.

[1] For the E3640A/E3642A/E3644A models.

[2] For the E3641A/E3643A/E3645A models.

Triggering

The power supply's triggering system allows a change in voltage and current when receiving a trigger, selection of a trigger source, and insertion of a trigger. Triggering the power supply is a multi-step process:

- 1 First, you must specify the source from which the power supply will accept the trigger. The power supply will accept a bus (software) trigger or an immediate trigger from the remote interface.
- 2 Then, you can set the time delay between the detection of the trigger on the specified trigger source and the start of any corresponding output change. Notice that the time delay is valid only for the bus trigger source.
- 3 Finally, you must provide an `INITiate` command. If the `IMMediate` source is selected, the selected output is set to the triggered level immediately. However, if the trigger source is the bus, the power supply is set to the triggered level after receiving the `Group Execute Trigger (GET)` or `*TRG` command.

Trigger source

You must specify the source from which the power supply will accept a trigger. The trigger is stored in volatile memory; the source is set to bus when the power supply has been turned off or after a remote interface reset.

Bus (software) triggering

- To select the bus trigger source, send the following command:

```
TRIG:SOUR BUS
```

- To trigger the power supply from the remote interface (GPIB or RS-232) after selecting the bus source, send the *TRG (trigger) command. When *TRG is sent, the trigger action starts after the specified time delay if any delay is given.
- You can also trigger the power supply from the GPIB interface by sending the IEEE-488 Group Execute Trigger (GET) message. The following statement shows how to send a GET from a Hewlett-Packard controller.

```
TRIGGER 705 (group execute trigger)
```

- To ensure synchronization when the bus source is selected, send the *WAI (wait) command. When *WAI is executed, the power supply waits for all pending operations to complete before executing any additional commands. For example, the following command string guarantees that the first trigger is accepted and is executed before the second trigger is recognized.
- ```
TRIG:SOUR BUS;*TRG;*WAI;*TRG;*WAI
```
- You can use the \*OPC? (operation complete) query or the \*OPC command to indicate when the operation has completed. The \*OPC? query returns 1 to the output buffer when the operation has completed. The \*OPC command sets the OPC bit (bit 0) in the Standard Event register when the operation has completed.

### Immediate triggering

- To select the immediate trigger source, send the following command:

```
TRIG:SOUR IMM
```

- When IMMEDIATE is selected as a trigger source, an INITiate command immediately transfers the VOLT:TRIG or CURR:TRIG value to the VOLT or CURR value. Any delay is ignored.

## Triggering commands

### **INITiate**

Cause the trigger system to initiate. This command completes one full trigger cycle when the trigger source is an immediate and initiates the trigger subsystem when the trigger source is a bus.

### **TRIGger:DELay {<seconds>|MINimum|MAXimum}**

Set the time delay between the detection of an event on the specified trigger source and the start of any corresponding trigger action on the power supply output. Select from 0 to 3600 seconds. MIN = 0 second and MAX = 3600 seconds. At \*RST, this value is set to 0 second.

### **TRIGger:DELay? [MINimum|MAXimum]**

Query the trigger delay.

### **TRIGger:SOURce {BUS|IMMEDIATE}**

Select the source from which the power supply will accept a trigger. The power supply will accept a bus (software) trigger or an internal immediate trigger. At \*RST, the bus trigger source is selected.

### **TRIGger:SOURce?**

Query the present trigger source and return BUS or IMM.

### **\*TRG**

Generate a trigger to the trigger subsystem that has selected a bus (software) trigger as its source (TRIG:SOUR BUS). The command has the same effect as the Group Execute Trigger (GET) command. For the RS-232 operation, make sure the power supply is in the remote interface mode by sending the SYST:REM command first.



## System-Related Commands

### **DISPlay {OFF|ON}**

Turn the front panel display off or on. When the display is turned off, outputs are not sent to the display and all annunciators are disabled except the **ERROR** annunciator.

The display state is automatically turned on when you return to the local mode. Press the  (**Local**) key to return to the local state from the remote interface.

### **DISPlay?**

Query the front panel display setting and return 0 (OFF) or 1 (ON).

### **DISPlay:TEXT <quoted string>**

This command displays a message on the front panel. The power supply will display up to 11 characters in a message; any additional characters are truncated. Commas, periods, and semicolons share a display space with the preceding character and are not considered individual characters.

### **DISPlay:TEXT?**

Query the message sent to the front panel and return a quoted string.

### **DISPlay:TEXT:CLear**

Clear the message displayed on the front panel.

### **OUTPut {OFF|ON}**

Enable or disable the outputs of the power supply. When the output is disabled, the voltage value is 0 V and the current value is 20 mA. At \*RST, the output state is OFF.

#### **OUTPut?**

Query the output state of the power supply. The returned value is 0 (OFF) or 1 (ON).

#### **OUTPut:RELay {OFF|ON}**

Set the state of two TTL signals on the RS-232 connector pin 1 and pin 9. These signals are intended for use with an external relay and relay driver. At \*RST, the OUTPut:RELay state is OFF. Refer to [“Disconnecting the output using an external relay”](#) on page 48 for more information.

#### **NOTE**

Do not use the RS-232 interface if you have configured the power supply to output relay control signals. Internal components on the RS-232 circuitry may be damaged.

---

#### **OUTPut:RELay?**

Query the state of the TTL relay logic signals.

#### **SYSTEM:BEEPer**

Issue a single beep immediately.

#### **SYSTEM:ERRor?**

Query the power supply's error queue. A record of up to 20 errors are stored in the power supply's error queue. Errors are retrieved in the first-in-first-out (FIFO) order. The first error returned is the first error that was stored. When you have read all errors from the queue, the **ERROR** annunciator turns off and the errors are cleared. Refer to [Chapter 4](#), “Error Messages” for more details.

**SYSTem:VERSion?**

Query the power supply to determine the present SCPI version. The returned value is a string in the form of YYYY.V where the Y represents the year of the version and the V represents the version number for that year (for example, 1997.0).

**SYSTem:COMMunicate:GPIB:RDEvice:ADDRESS  
{<numeric value>}****SYSTem:COMMunicate:GPIB:RDEvice:ADDRESS?**

Set or query the bus address of the peripheral device. Changing the address with this command does not affect the address of the peripheral device. It does affect the address to which data is sent by the instrument.

**\*IDN?**

Read the power supply's identification string. The power supply returns four fields separated by commas. The first field is the manufacturer's name, the second field is the model number, the third field is not used (always "0"), and the fourth field is a revision code which contains three numbers. The first number is the firmware revision number for the main power supply processor; the second is for the input/output processor; and the third is for the front panel processor.

The command returns a string with the following format (make sure to dimension a string variable with at least 40 characters):

```
Agilent Technologies,E3640A,0,X.X-Y.Y-Z.Z
(E3640A model)
```

**\*TST?**

Perform a complete self-test of the power supply and return 0 if the self-test passes or 1 or any non-zero value if it fails. If the self-test fails, an error message is also generated with additional information on why the test has failed.

### 3 Remote Interface Reference

#### System-Related Commands

#### **\*RST**

Reset the power supply to its power-on state. [Table 3-4](#) shows the state of the power supply after a **RESET** from the Recall menu or \*RST command from the remote interface.

**Table 3-4** Reset state of the power supply

| Command        | E3640A state | E3641A state | E3642A state | E3643A state | E3644A state | E3645A state |
|----------------|--------------|--------------|--------------|--------------|--------------|--------------|
| CURR           | 3 A          | 0.8 A        | 5 A          | 1.4 A        | 8 A          | 2.2 A        |
| CURR:STEP      | 0.052 mA     | 0.015 mA     | 0.095 mA     | 0.026 mA     | 0.152 mA     | 0.042 mA     |
| CURR:TRIG      | 3 A          | 0.8 A        | 5 A          | 1.4 A        | 8 A          | 2.2 A        |
| DISP           |              | ON           |              |              | ON           |              |
| OUTP           |              | OFF          |              |              | OFF          |              |
| OUTP:REL       |              | OFF          |              |              | OFF          |              |
| TRIG:DEL       |              | 0            |              |              | 0            |              |
| TRIG:SOUR      |              | BUS          |              |              | BUS          |              |
| VOLT           |              | 0 V          |              |              | 0 V          |              |
| VOLT:STEP      | 0.35 mV      | 1.14 mV      | 0.38 mV      | 1.14 mV      | 0.35 mV      | 1.14 mV      |
| VOLT:TRIG      |              | 0 V          |              |              | 0 V          |              |
| VOLT:PROT      | 22.0 V       | 66.0 V       | 22.0 V       | 66.0 V       | 22.0 V       | 66.0 V       |
| VOLT:PROT:STAT |              | ON           |              |              | ON           |              |
| VOLT:RANG      | P8V (Low)    | P35V (Low)   | P8V (Low)    | P35V (Low)   | P8V (Low)    | P35V (Low)   |

#### NOTE

The voltage and current step sizes listed above are typical values.

## State Storage Commands

The power supply has five storage locations in non-volatile memory to store power supply states. The locations are numbered 1 through 5. You can also assign a name to each of the locations (1 through 5) for use from the front panel.

### **\*SAV {1|2|3|4|5}**

Store (Save) the present state of the power supply to the specified location. Any state previously stored in the same location is overwritten (no error is generated).

- A power-on reset (\*RST command) does not affect the configurations stored in memory. Once a state is stored, it remains until it is overwritten or specifically deleted.
- The state storage feature remembers the states or values of the following commands:

CURR, CURR:STEP, CURR:TRIG, OUTP, OUTP:REL,  
TRIG:DEL, TRIG:SOUR, VOLT, VOLT:STEP,  
VOLT:TRIG, VOLT:PROT, VOLT:PROT:STAT, and  
VOLT:RANG

### **\*RCL {1|2|3|4|5}**

Recall the power supply state stored in the specified storage location. When shipped from the factory, storage locations 1 through 5 are empty.

#### NOTE

DISP {OFF|ON} can be stored and recalled in the remote interface mode only. Going to the local mode automatically sets the display state to ON.

**MEMory:STATe:NAME {1|2|3|4|5}, <quoted name>**

**MEMory:STATe:NAME? {1|2|3|4|5}**

Assign a name to the specified storage location. From the remote interface, you can only recall a stored state using a number (1 through 5). The :NAME? query returns a quoted string containing the name currently assigned to the specified storage location. If the specified location has no name assigned, an empty string (" ") is returned. The name can contain up to nine characters. The first character can be an alphanumeric. Blank spaces are not allowed. An error is generated if you specify a name with more than nine characters. Refer to “[State storage](#)” on page 49 for more information. An example is shown below:

```
MEM:STAT:NAME 1, 'P15V_TEST'
```

If you do not specify a name (note that the name parameter is optional), no name is assigned to that state. This provides a way to erase a name (however, the stored state is not deleted).

## Calibration Commands

Refer to “[Calibration](#)” on page 58 for an overview of the calibration features of the power supply. An example program for calibration is listed in “[Calibration example](#)” on page 100. For more detailed information on the calibration procedures, refer to the [Chapter 8](#), “Service and Maintenance”.

**NOTE**

When you calibrate the power supply, you should not set the OVP to the ON state in order to prevent the OVP from tripping.

**CALibration:COUNT?**

Query the power supply to determine the number of times it has been calibrated. Your power supply was calibrated before it left the factory.

When you receive your power supply, read the count to determine its initial value. Since the value increments by one for each calibration point, a complete calibration will increase the value by three counts.

**CALibration:CURRENT[:DATA] <numeric value>**

This command can only be used after calibration is unsecured and the output state is ON. It enters a current value that you obtained by reading an external meter. You must first select the minimum calibration level (CAL:CURR:LEV MIN) for the value being entered, and then select the middle and maximum calibration levels (CAL:CURR:LEV MID and CAL:CURR:LEV MAX) for the value being entered. Three successive values must be selected and entered. The power supply then computes new calibration constants. These constants are then stored in non-volatile memory.

**CALibration:CURRent:LEVel  
{MINimum|MIDDLE|MAXimum}**

This command can only be used after calibration is unsecured and the output state is ON. It sets the power supply to a calibration point that is entered with the CAL:CURR command. During calibration, three points must be entered and the low-end point (MIN) must be selected and entered first.

**CALibration:SECure:CODE <quoted new code>**

Enter a new security code. To change the security code, first unsecure the power supply using the old security code. Then, enter the new code. The calibration code may contain up to 11 characters over the remote interface. Refer to “Calibration” on page 58 for more information.

**CALibration:SECure:STATE {OFF|ON}, <quoted code>**

Unsecure or secure the power supply with a security code for calibration.

**CALibration:SECure:STATE?**

Query the secured state for calibration of the power supply. The returned parameter is 0 (OFF) or 1 (ON).

**CALibration:STRing <quoted string>**

Record calibration information about your power supply. For example, you can store such information as the last calibration date, the next calibration due date, or the power supply's serial number. The calibration message may contain up to 40 characters. The power supply should be unsecured before sending a calibration message.

**CALibration:STRing?**

Query the calibration message and return a quoted string.



**CALibration:VOLTage[:DATA] <numeric value>**

This command can only be used after calibration is unsecured and the output state is ON. It enters a voltage value that you obtained by reading an external meter. You must first select the minimum calibration level (CAL:VOLT:LEV MIN) for the value being entered. You must then select the middle and maximum calibration levels (CAL:VOLT:LEV MID and CAL:VOLT:LEV MAX) for the value being entered. Three successive values must be selected and entered. The power supply then computes new voltage calibration constants. These constants are then stored in non-volatile memory.

**CALibration:VOLTage:LEVel  
{MINimum|MIDDLE|MAXimum}**

This command can only be used after calibration is unsecured and the output state is ON. It sets the power supply to a calibration point that is entered with the CAL:VOLT command. During calibration, three points must be entered and the low-end point (MIN) must be selected and entered first.

**CALibration:VOLTage:PROTection**

Calibrate the overvoltage protection circuit of the power supply. It takes about 10 seconds to execute the command. The calibration must be unsecured and the output be opened before calibrating the overvoltage protection circuit. The power supply automatically performs the calibration and stores the new overvoltage constant in non-volatile memory. Notice that voltage calibration precedes before sending this command.

## Calibration example

- 1** Enable the output of the power supply.

```
OUTP ON
```

- 2** Disable the voltage protection function.

```
VOLT:PROT:STAT OFF
```

- 3** Unsecure the power supply with the security code before calibration.

```
CAL:SEC:STAT OFF, '<code>'
```

- 4** For voltage calibration, connect a digital voltmeter (DVM) across the power supply's output terminals.

- 5** Set the power supply to the low-end (MIN) calibration point.

```
CAL:VOLT:LEV MIN
```

- 6** Enter the reading you obtained from the DVM.

```
CAL:VOLT:DATA 0.549
```

- 7** Set the power supply to the middle (MID) calibration point.

```
CAL:VOLT:LEV MID
```

- 8** Enter the reading you obtained from the DVM.

```
CAL:VOLT:DATA 11.058
```

- 9** Set the power supply to the high (MAX) calibration point.

```
CAL:VOLT:LEV MAX
```

- 10** Enter the reading you obtained from the DVM.

```
CAL:VOLT:DATA 21.566
```

- 11** Set the power supply to the overvoltage protection calibration point.

```
CAL:VOLT:PROT
```

- 12** For current calibration, connect an appropriate current monitoring resistor (shunt) across the output terminals and connect the DVM across the shunt resistor.

- 13** Repeat steps 5 through 9 by substituting CURR for VOLT for current calibration. For example, CAL:CURR:LEV MIN.

- 14 Record calibration information such as the next calibration due date or contact person for future reference. The calibration string may contain up to 40 characters.

```
CALibration:STRing '<string>'
```

**NOTE**

You should wait for the DVM reading to stabilize for accurate calibration.

---

## Interface Configuration Commands

See also [Chapter 2](#), “Configuring the Remote Interface” for more information.

### **SYSTem:INTerface {GPIB|RS232}**

Select the remote interface. Only one interface can be enabled at a time. The GPIB interface is selected when the power supply is shipped from the factory.

### **SYSTem:LOCal**

Place the power supply in the local mode during the RS-232 operation. All keys on the front panel are fully functional.

### **SYSTem:REMote**

Place the power supply in the remote mode for the RS-232 operation. All keys on the front panel, except the **Local** key, are disabled while in the remote mode.

#### NOTE

It is very important that you send the `SYST:REM` command to place the power supply in the remote mode. Sending or receiving data over the RS-232 interface when not configured for remote operation can cause unpredictable results.

### **SYSTem:RWLock**

Place the power supply in the remote mode for the RS-232 operation. This command is the same as the `SYST:REM` command except that all keys on the front panel are disabled, including the **Local** key.

### **<Ctrl-C>**

Clear the operation in progress over the RS-232 interface and discard any pending output data. This is equivalent to the IEEE-488 device clear action over the GPIB interface.

## SCPI Status Registers

All SCPI instruments implement status registers in the same way. The status system records various instrument conditions in three register groups: the Status Byte register, the Standard Event register, and the Questionable Status register groups. The Status Byte register records high-level summary information reported in the other register groups.

Figure 3-1 on page 104 illustrates the SCPI status system used by the power supply.

### What is an event register?

An event register is a read-only register that reports defined conditions within the power supply. Bits in an event register are latched. Once an event bit is set, subsequent state changes are ignored. Bits in an event register are automatically cleared by a query of that register (such as `*ESR?` or `STAT:QUES:EVEN?`) or by sending the `*CLS` (clear status) command. A reset (`*RST`) or device clear will not clear bits in event registers. Querying an event register returns a decimal value which corresponds to the binary-weighted sum of all bits set in the register.

### What is an enable register?

An enable register defines which bits in the corresponding event register are logically ORed together to form a single summary bit. Enable registers are both readable and writable. Querying an enable register will not clear it. The `*CLS` (clear status) command does not clear enable registers but it does clear the bits in the event registers. To enable bits in an enable register, you must write a decimal value which corresponds to the binary-weighted sum of the bits you wish to enable in the register.

### 3 Remote Interface Reference

#### SCPI Status Registers

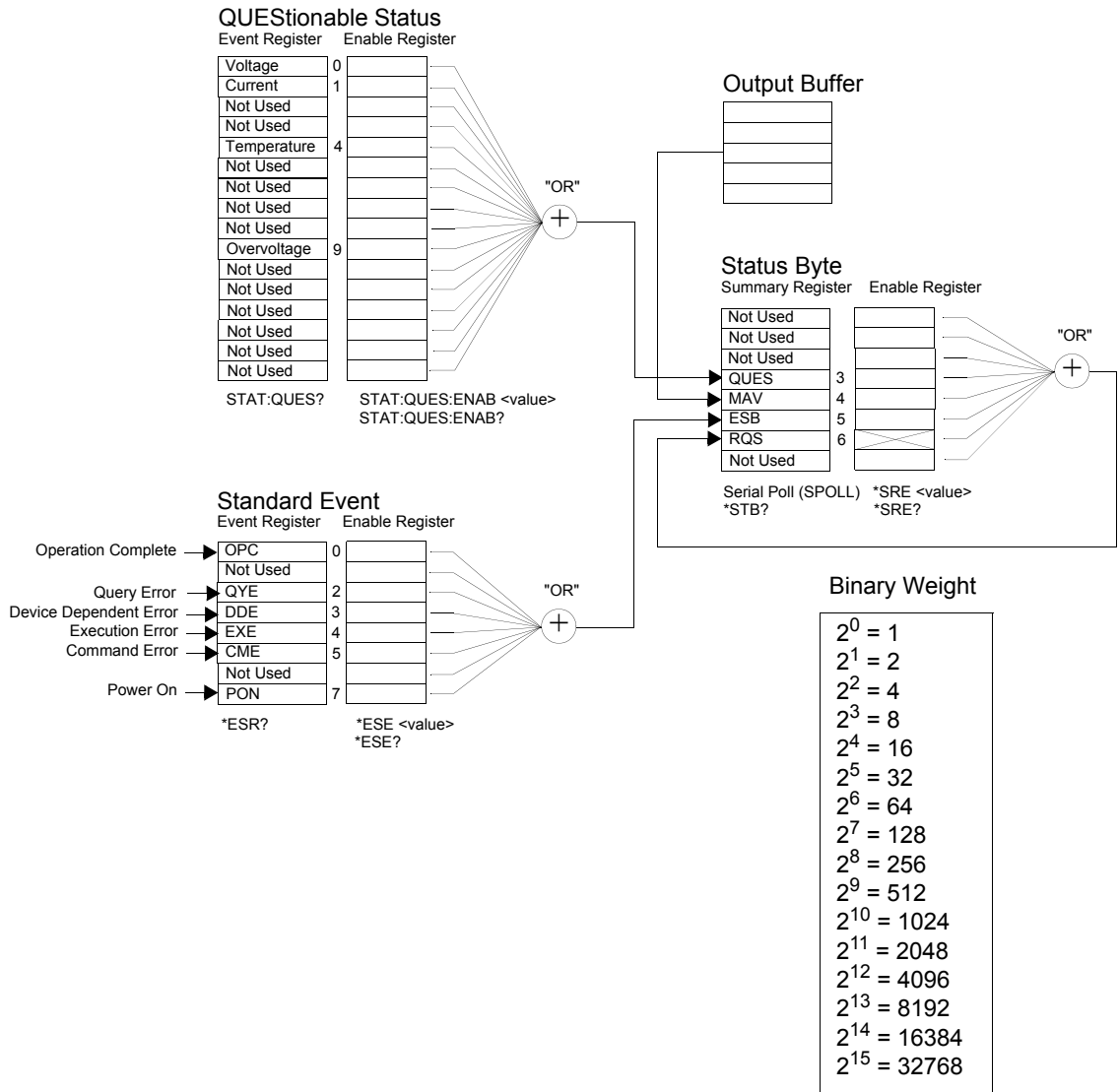

**Figure 3-1** SCPI status system

## Questionable Status register

The Questionable Status register provides information about voltage and current regulation. Bit 0 is set when the voltage becomes unregulated, and bit 1 is set if the current becomes unregulated. For example, if the power supply momentarily goes into the constant current mode when the power supply is operating as a voltage source (constant voltage mode), bit 0 is set to indicate that the voltage output is not regulated.

The Questionable Status register also provides information that the power supply has an overtemperature condition and that the overvoltage protection circuits have tripped. Bit 4 reports an overtemperature condition of the fan and bit 9 reports that the overvoltage protection circuit has tripped. To read the register, send `STATus:QUESTionable?`.

**Table 3-5** Bit definitions — Questionable Status register

| Bit      |                 | Decimal value | Definition                                            |
|----------|-----------------|---------------|-------------------------------------------------------|
| 0        | Voltage         | 1             | The power supply is/was in the constant current mode. |
| 1        | Current         | 2             | The power supply is/was in the constant voltage mode. |
| 2 to 3   | Not Used        | 0             | Always set to 0.                                      |
| 4        | Overtemperature | 16            | The fan has a fault condition.                        |
| 5 to 8   | Not Used        | 0             | Always set to 0.                                      |
| 9        | Overvoltage     | 512           | The overvoltage protection circuit has tripped.       |
| 10 to 15 | Not Used        | 0             | Always set to 0.                                      |

The Questionable Status event register is cleared when:

- you execute the `*CLS` (clear status) command.
- you query the event register using the `STAT:QUES?` (Status Questionable Event register) query.

For example, 16 is returned when you have queried the status of the Questionable Event register, which indicates the temperature condition is questionable.

The Questionable Status Enable register is cleared when you execute the `STAT:QUES:ENAB 0` command.

## Standard Event register

The Standard Event register reports the following types of instrument events: power-on detected, command syntax errors, command execution errors, self-test or calibration errors, query errors, or when an `*OPC` command is executed. Any or all of these conditions can be reported in the Standard Event summary bit (ESB, bit 5) of the Status Byte register through the enable register. To set the enable register mask, you write a decimal value to the register using the `*ESE` (Event Status Enable) command.

### NOTE

An error condition (Standard Event register bit 2, 3, 4, or 5) will always record one or more errors in the power supply's error queue. Read the error queue using the `SYST:ERR?` command.

**Table 3-6** Bit definitions — Standard Event register

| Bit |          | Decimal value | Definition                                                                                                                                                                                                 |
|-----|----------|---------------|------------------------------------------------------------------------------------------------------------------------------------------------------------------------------------------------------------|
| 0   | OPC      | 1             | Operation complete. All commands prior to and including an <code>*OPC</code> command have been executed.                                                                                                   |
| 1   | Not Used | 0             | Always set to 0.                                                                                                                                                                                           |
| 2   | QYE      | 4             | Query error. The power supply tried to read the output buffer but it was empty. Or, a new command line was received before a previous query had been read. Or, both the input and output buffers are full. |
| 3   | DDE      | 8             | Device error. A self-test or calibration error occurred (refer to error numbers 601 through 755 in <a href="#">Chapter 4</a> , "Error Messages").                                                          |
| 4   | EXE      | 16            | Execution error. An execution error occurred (refer to error numbers -211 through -223 in <a href="#">Chapter 4</a> , "Error Messages").                                                                   |
| 5   | CME      | 32            | Command error. A command syntax error occurred (refer to error numbers -104 through -178 in <a href="#">Chapter 4</a> , "Error Messages").                                                                 |



**Table 3-6** Bit definitions — Standard Event register (continued)

| Bit |          | Decimal value | Definition                                                                                             |
|-----|----------|---------------|--------------------------------------------------------------------------------------------------------|
| 6   | Not Used | 0             | Always set to 0.                                                                                       |
| 7   | PON      | 128           | Power on. Power has been turned off and on since the last time the event register was read or cleared. |

The Standard Event register is cleared when:

- you execute the \*CLS (clear status) command.
- you query the event register using the \*ESR? (Event Status Register) command.

For example, 28 (4 + 8 + 16) is returned when you have queried the status of the Standard Event register, which indicates QYE, DDE, and EXE conditions have occurred.

The Standard Event Enable register is cleared when:

- you execute the \*ESE 0 command.
- you turn on the power and have previously configured the power supply using the \*PSC 1 command.

The enable register will not be cleared at power-on if you have previously configured the power supply using the \*PSC 0 command.

## Status Byte register

The Status Byte summary register reports conditions from the other status registers. Query data that is waiting in the power supply's output buffer is immediately reported through the "Message Available" bit (bit 4) of the Status Byte register. Bits in the summary register are not latched.

Clearing an event register will clear the corresponding bits in the Status Byte summary register. Reading all messages in the output buffer, including any pending queries, will clear the message available bit.

To read the register, send `STATus:QUESTionable?`.

**Table 3-7** Bit definitions — Status Byte summary register

| Bit    |          | Decimal value | Definition                                                                                                    |
|--------|----------|---------------|---------------------------------------------------------------------------------------------------------------|
| 0 to 2 | Not Used | 0             | Always set to 0.                                                                                              |
| 3      | QUES     | 8             | One or more bits are set in the Questionable Status register (bits must be "enabled" in the enable register). |
| 4      | MAV      | 16            | Data is available in the power supply's output buffer.                                                        |
| 5      | ESB      | 32            | One or more bits are set in the Standard Event register (bits must be "enabled" in the enable register).      |
| 6      | RQS      | 64            | The power supply is requesting service (serial poll).                                                         |
| 7      | Not Used | 0             | Always set to 0.                                                                                              |

The Status Byte summary register is cleared when you execute the `*CLS` (clear status) command.

Querying the Standard Event register (`*ESR?` command) will clear only bit 5 in the Status Byte summary register.

For example, 24 (8 + 16) is returned when you have queried the status of the Status Byte register, which indicates QUES and MAV conditions have occurred.

The Status Byte enable register (request service) is cleared when:

- you execute the \*SRE 0 command.
- you turn on the power and have previously configured the power supply using the \*PSC 1 command.

The enable register will not be cleared at power-on if you have previously configured the power supply using the \*PSC 0 command.

## Using service request (SRQ) and serial poll

You must configure your bus controller to respond to the IEEE-488 service request (SRQ) interrupt to use this capability. Use the Status Byte enable register (\*SRE command) to select which summary bits will set the low-level IEEE-488 service request signal. When bit 6 (request service) is set in the Status Byte, an IEEE-488 service request interrupt message is automatically sent to the bus controller. The bus controller may then poll the instruments on the bus to identify which one requested service (the instrument with bit 6 set in its Status Byte).

The request service bit is cleared only by reading the Status Byte using an IEEE-488 serial poll or by reading the event register whose summary bit is causing the service request.

To read the Status Byte summary register, send the IEEE-488 serial poll message. Querying the summary register will return a decimal value which corresponds to the binary-weighted sum of the bits set in the register. The serial poll will automatically clear the “request service” bit in the Status Byte summary register. No other bits are affected. Performing a serial poll will not affect the instrument throughput.

#### NOTE

The IEEE-488 standard does not ensure synchronization between your bus controller program and the instrument. Use the \*OPC? command to guarantee that commands previously sent to the instrument have completed. Executing a serial poll before a \*RST, \*CLS, or other commands have completed can cause previous conditions to be reported.

---

### Using \*STB? to read the Status Byte

The \*STB? (Status Byte query) command is similar to a serial poll but it is processed like any other instrument commands. The \*STB? command returns the same result as a serial poll but the “request service” bit (bit 6) is not cleared.

The \*STB? command is not handled automatically by the IEEE-488 bus interface hardware, and will be executed only after previous commands have completed. Polling is not possible using the \*STB? command. Executing the \*STB? command does not clear the Status Byte summary register.

### Using the Message Available Bit (MAV)

You can use the Status Byte “Message Available” bit (bit 4) to determine when data is available to read into your bus controller. The power supply subsequently clears bit 4 only after all messages have been read from the output buffer.

## Using SRQ to interrupt the bus controller

- 1 Send a device clear message to clear the power supply's output buffer (for example, CLEAR 705).
- 2 Clear the event registers with the \*CLS (clear status) command.
- 3 Set up the enable register masks. Execute the \*ESE command to set up the Standard Event register and the \*SRE command for the Status Byte.
- 4 Send the \*OPC? (operation complete query) command and enter the result to ensure synchronization.
- 5 Enable your bus controller's IEEE-488 SRQ interrupt.

## Determining when a command sequence is completed

- 1 Send a device clear message to clear the power supply's output buffer (for example, CLEAR 705).
- 2 Clear the event registers with the \*CLS (clear status) command.
- 3 Enable the "Operation Complete" bit (bit 0) in the Standard Event register by executing the \*ESE 1 command.
- 4 Send the \*OPC? (operation complete query) command and enter the result to ensure synchronization.
- 5 Execute your command string to program the desired configuration, and then execute the \*OPC (operation complete) command as the last command. When the command sequence has completed, the "Operation Complete" bit (bit 0) is set in the Standard Event register.
- 6 Use a serial poll to determine when bit 5 (Standard Event) is set in the Status Byte summary register. You could also configure the power supply for an SRQ interrupt by sending \*SRE 32 (Status Byte enable register, bit 5).

## Using \*OPC to signal when data is in the output buffer

Generally, it is best to use the “Operation Complete” bit (bit 0) in the Standard Event register to signal when a command sequence has completed. This bit is set in the register after an \*OPC command has been executed. If you send \*OPC after a command which loads a message in the power supply’s output buffer (query data), you can use the “Operation Complete” bit to determine when the message is available.

However, if too many messages are generated before the \*OPC command executes (sequentially), the output buffer will overload and the power supply will stop processing commands.

## Status Reporting Commands

Refer to [Figure 3-1](#) on page 104 for detailed information of the status register structure of the power supply.

### **SYSTem:ERROr?**

Query the power supply's error queue. A record of up to 20 errors is stored in the power supply's error queue. Errors are retrieved in the first-in-first-out (FIFO) order. The first error returned is the first error that was stored. When you have read all errors from the queue, the **ERROR** annunciator turns off and the errors are cleared. Refer to [Chapter 4](#), "Error Messages" for more details.

### **STATus:QUESTionable:CONDition?**

Query the Questionable Status condition register to check the CV or CC mode of the power supply. The power supply returns a decimal value which corresponds to the binary-weighted sum of all bits in the register. These bits are not latched. If 0 is returned, the power supply is in the output off or unregulated state. If 1 is returned, the power supply is in the CC operating mode, and if 2 is returned, the power supply is in the CV operating mode. If 3 is returned, the power supply has a failure.

### **STATus:QUESTionable[:EVENT]?**

Query the Questionable Status event register. The power supply returns a decimal value which corresponds to the binary-weighted sum of all bits in the register. These bits are latched. Reading the event register clears it.

### **STATus:QUESTionable:ENABle <enable value>**

Enable bits in the Questionable Status Enable register. The selected bits are then reported to the Status Byte.

**STATUS:QUESTIONABLE:ENABLE?**

Query the Questionable Status Enable register. The power supply returns a binary-weighted decimal value representing the bits set in the enable register.

**\*CLS**

Clear all event registers and the Status Byte register.

**\*ESE <enable value>**

Enable bits in the Standard Event Enable register. The selected bits are then reported to the Status Byte.

**\*ESE?**

Query the Standard Event Enable register. The power supply returns a decimal value which corresponds to the binary-weighted sum of all bits in the register.

**\*ESR?**

Query the Standard Event register. The power supply returns a decimal value which corresponds to the binary-weighted sum of all bits in the register.

**\*OPC**

Set the “Operation Complete” bit (bit 0) of the Standard Event register after the command is executed.

**\*OPC?**

Return 1 to the output buffer after the command is executed.



**\*PSC {0|1}**

This power-on status clear command clears the Status Byte and the Standard Event register enable masks when power is turned on (\*PSC 1). When \*PSC 0 is in effect, the Status Byte and the Standard Event register enable masks are not cleared when power is turned on.

**\*PSC?**

Query the power-on status clear setting. The returned parameter is 0 (\*PSC 0) or 1 (\*PSC 1).

**\*SRE <enable value>**

Enable bits in the Status Byte Enable register.

**\*SRE?**

Query the Status Byte Enable register. The power supply returns a decimal value which corresponds to the binary-weighted sum of all bits set in the enable register.

**\*STB?**

Query the Status Byte summary register. The \*STB? command is similar to a serial poll but it is processed like any other instrument commands.

The \*STB? command returns the same result as a serial poll but the **Request Service** bit (bit 6) is not cleared if a serial poll has occurred.

**\*WAI**

Instruct the power supply to wait for all pending operations to complete before executing any additional commands over the interface.

The \*WAI command is used only in the triggered mode.

## Halting an Output in Progress

You can send a device clear at any time to stop an output in progress over the GPIB interface. The status registers, the error queue, and all configuration states are left unchanged when a device clear message is received.

Device clear performs the following actions.

- The power supply's input and output buffers are cleared.
- The power supply is prepared to accept a new command string.

The following statement shows how to send a device clear over the GPIB interface using Agilent BASIC.

```
CLEAR 705 IEEE-488 Device Clear
```

The following statement shows how to send a device clear over the GPIB interface using the GPIB Command Library for C or QuickBASIC.

```
IOCLEAR (705)
```

### NOTE

- For the RS-232 operation, sending the <Ctrl-C> character will perform the same operation as the IEEE-488 device clear message. The power supply's data terminal ready (DTR) handshake line is set true following a device clear message.
  - All remote interface configurations can be entered only from the front panel. Refer to [“Configuring the Remote Interface”](#) on page 38 to configure the GPIB or RS-232 interface before operating the power supply remotely.
-

## SCPI Conformance Information

The power supply conforms to the ‘1997.0’ version of the SCPI standard. Many of the commands required by the standard are accepted by the power supply but are not described in this manual for simplicity or clarity. Most of these non-documented commands duplicate the functionality of a command already described in this manual.

### SCPI confirmed commands

Table 3-8 lists the SCPI-confirmed commands that are used by the power supply.

**Table 3-8** SCPI confirmed commands

---

```

DISPlay
 [:WINDow][:STATe] {OFF|ON}
 [:WINDow][:STATe]?
 [:WINDow]:TEXT[:DATA] <quoted string>
 [:WINDow]:TEXT[:DATA]?
 [:WINDow]:TEXT:CLear
INITiate[:IMMediate]
MEASure
 :CURRent[:DC]?
 [:VOLTagE][:DC]?
OUTPut
 [:STATe] {OFF|ON}
 [:STATe]?
[SOURce:]
 CURRent[:LEVel][:IMMediate][:AMPLitude] {<current>|MIN|MAX|UP|DOWN}
 CURRent[:LEVel][:IMMediate][:AMPLitude]? [MIN|MAX]
 CURRent[:LEVel][:IMMediate]:STEP[:INCRement] {<numeric value>|DEFAULT}
 CURRent[:LEVel][:IMMediate]:STEP[:INCRement]? [DEFAULT]
 CURRent[:LEVel]:TRIGgered[:AMPLitude] {<current>|MIN|MAX}
 CURRent[:LEVel]:TRIGgered[:AMPLitude]? [MIN|MAX]

```

---

**Table 3-8** SCPI confirmed commands (continued)

---

```

[SOURCE:]
 VOLTage[:LEVel][:IMMediate][:AMPLitude] {<voltage>|MIN|MAX|UP|DOWN}
 VOLTage[:LEVel][:IMMediate][:AMPLitude]? [MIN|MAX]
 VOLTage[:LEVel][:IMMediate]:STEP[:INCRement] {<numeric value>|DEFAULT}
 VOLTage[:LEVel][:IMMediate]:STEP[:INCRement]? [DEFAULT]
 VOLTage[:LEVel]:TRIGgered[:AMPLitude] {<voltage>|MIN|MAX}
 VOLTage[:LEVel]:TRIGgered[:AMPLitude]? [MIN|MAX]
 VOLTage:PROTEction[:LEVel] {<voltage>|MIN|MAX}
 VOLTage:PROTEction[:LEVel]? [MIN|MAX]
 VOLTage:PROTEction:STATe {0|1|OFF|ON}
 VOLTage:PROTEction:STATe?
 VOLTage:PROTEction:TRIPPed?
 VOLTage:PROTEction:CLEar
 VOLTage:RANGE {P8V[1]|P20V[1]|P35V[2]|P60V[2]|LOW|HIGH}
 VOLTage:RANGE?
STATus
 :QUESTionable:CONDition?
 :QUESTionable[:EVENT]?
 :QUESTionable:ENABle <enable value>
 :QUESTionable:ENABle?
SYSTEM
 :BEEPer[:IMMediate]
 :ERRor?
 :VERSion?
TRIGger
 [:SEQuence]:DELay {<seconds>|MIN|MAX}
 [:SEQuence]:DELay? [MIN|MAX]
 [:SEQuence]:SOURce {BUS|IMM}
 [:SEQuence]:SOURce?

```

---

[1] Applicable for E3640A, E3642A, and E3644A only.

[2] Applicable for E3641A, E3643A, and E3645A only.

## Device-specific commands

The following commands are device-specific to your power supply. They are not included in the '1997.0' version of the SCPI standard. However, these commands are designed with the SCPI standard in mind, and they follow all of the command syntax rules defined by the standard.

**Table 3-9** Device-specific commands (Non-SCPI)

---

```

APPLY {<voltage>|DEF|MIN|MAX}[, {<current>|DEF|MIN|MAX}]
APPLY?
CALibration
 :COUNT?
 :CURRENT[:DATA] <numeric value>
 :CURRENT:LEVEL {MIN|MID|MAX}
 :SECure:CODE <new code>
 :SECure:STATE {OFF|ON}, <quoted code>
 :SECure:STATE?
 :STRing <quoted string>
 :STRing?
 :VOLTage[:DATA] <numeric value>
 :VOLTage:LEVEL {MIN|MID|MAX}
 :VOLTage:PROtection
OUTPut
 :RELay[:STATE] {OFF|ON}
 :RELay[:STATE]?
SYSTEM
 :LOCAL
 :REMOte
 :RWLock

```

---

## IEEE-488 Conformance Information

### Dedicated hardware lines

|     |                               |
|-----|-------------------------------|
| ATN | <i>Attention</i>              |
| IFC | <i>Interface Clear</i>        |
| REN | <i>Remote Enable</i>          |
| SRQ | <i>Service Request Enable</i> |

### Addressed commands

|     |                              |
|-----|------------------------------|
| DCL | <i>Device Clear</i>          |
| EOI | <i>End or Identify</i>       |
| GET | <i>Group Execute Trigger</i> |
| GTL | <i>Go to Local</i>           |
| LLO | <i>Local Lockout</i>         |
| SDC | <i>Selected Device Clear</i> |
| SPD | <i>Serial Poll Disable</i>   |
| SPE | <i>Serial Poll Enable</i>    |

## IEEE-488.2 common commands

\*CLS  
\*ESE <enable value>  
\*ESE?  
\*ESR?  
\*IDN?  
\*OPC  
\*OPC?  
\*PSC {0|1}  
\*PSC?  
\*RST  
\*SAV {1|2|3|4|5}  
\*RCL {1|2|3|4|5}  
\*SRE <enable value>  
\*SRE?  
\*STB?  
\*TRG  
\*TST?  
\*WAI

### **3 Remote Interface Reference**

IEEE-488 Conformance Information

**THIS PAGE HAS BEEN INTENTIONALLY LEFT BLANK.**





## 4 Error Messages

|                            |     |
|----------------------------|-----|
| Overview                   | 124 |
| Execution Error Messages   | 126 |
| Self-Test Error Messages   | 131 |
| Calibration Error Messages | 133 |

This chapter lists the error messages that may appear as you are working with the power supply.



# Overview

Errors are retrieved in the first-in-first-out (FIFO) order. The first error returned is the first error that was stored. Errors are cleared as you read them. When you have read all errors from the queue, the **ERROR** annunciator turns off and the errors are cleared. The power supply beeps once each time an error is generated.

If more than 20 errors have occurred, the last error stored in the queue (the most recent error) is replaced with -350, "Queue overflow". No additional errors are stored until you remove errors from the queue. If no errors have occurred when you read the error queue, the power supply responds with +0, "No error" over the remote interface or **NO ERRORS** from the front panel.

The error queue is cleared by the \*CLS (clear status) command or when power is cycled. The errors are also cleared when you read the queue.

### NOTE





The \*RST (reset) command does not clear the error queue.

## Front panel operation

Press the  (**Local**) key to return to the front panel operation mode if you operate the power supply in the remote operation mode.



### ERRORS

If the **ERROR** annunciator is turned on, press  to view the errors. Use the knob to scroll through the error numbers. Press  to view the text of the error message. Press  to increase the scrolling speed of the text on the display. All errors are cleared when you exit the menu by pressing  or let the display time-out for approximately 30 seconds.

## Remote interface operation

SYSTEM:ERROR?

*Read and clear one error from the error queue.*

Errors have the following format (the error string may contain up to 80 characters).

-102, "Syntax error"

# Execution Error Messages

**Table 4-1** Execution error messages

|      |                                                                                                                                                                                                                                                                                                   |
|------|---------------------------------------------------------------------------------------------------------------------------------------------------------------------------------------------------------------------------------------------------------------------------------------------------|
| -101 | <p>Invalid character</p> <p>An invalid character was found in the command string. You may have inserted a character such as #, \$, or % in the command keyword or within a parameter.</p> <p>Example: <code>OUTP : STAT #ON</code></p>                                                            |
| -102 | <p>Syntax error</p> <p>Invalid syntax was found in the command string. You may have inserted a blank space before or after a colon in the command header, or before a comma.</p> <p>Example: <code>VOLT : LEV , 1</code></p>                                                                      |
| -103 | <p>Invalid separator</p> <p>An invalid separator was found in the command string. You may have used a comma instead of a colon, semicolon, or blank space, or you may have used a blank space instead of a comma.</p> <p>Example: <code>TRIG : SOUR , BUS</code> or <code>APPL 1.0 1.0</code></p> |
| -104 | <p>Data type error</p> <p>The wrong parameter type was found in the command string. You may have specified a number where a string was expected, or vice versa.</p>                                                                                                                               |
| -105 | <p>GET not allowed</p> <p>A Group Execute Trigger (GET) is not allowed within a command string.</p>                                                                                                                                                                                               |
| -108 | <p>Parameter not allowed</p> <p>More parameters were received than expected for the command. You may have entered an extra parameter, or added a parameter to a command that does not accept a parameter.</p> <p>Example: <code>APPL? 10</code></p>                                               |
| -109 | <p>Missing parameter</p> <p>Fewer parameters were received than expected for the command. You omitted one or more parameters that are required for this command.</p> <p>Example: <code>APPL</code></p>                                                                                            |
| -112 | <p>Program mnemonic too long</p> <p>A command header was received which contained more than the maximum 12 characters allowed.</p>                                                                                                                                                                |

**Table 4-1** Execution error messages (continued)

|                     |                                                                                                                                                                                                                                                                                                     |
|---------------------|-----------------------------------------------------------------------------------------------------------------------------------------------------------------------------------------------------------------------------------------------------------------------------------------------------|
| -113                | <p>Undefined header</p> <p>A command was received that is not valid for this power supply. You may have misspelled the command or it may not be a valid command. If you are using the short form of the command, remember that it may contain up to four letters.</p> <p>Example: TRIGG : DEL 3</p> |
| -114 <sup>[1]</sup> | <p>Header suffix out of range</p> <p>The numeric suffix attached to a command header is not one of the allowable values.</p> <p>Example: OUTPUT2 ON</p>                                                                                                                                             |
| -120 <sup>[1]</sup> | <p>Numeric data error</p> <p>An invalid number was specified for a numeric parameter.</p> <p>Example: APPL 1.0E+320000</p>                                                                                                                                                                          |
| -121                | <p>Invalid character in number</p> <p>An invalid character was found in the number specified for a parameter value.</p> <p>Example: *ESE #B01010102</p>                                                                                                                                             |
| -123                | <p>Numeric overflow</p> <p>A numeric parameter was found whose exponent was larger than 32000.</p>                                                                                                                                                                                                  |
| -124                | <p>Too many digits</p> <p>A numeric parameter was found whose mantissa contained more than 255 digits, excluding leading zeros.</p>                                                                                                                                                                 |
| -128                | <p>Numeric data not allowed</p> <p>A numeric parameter was received but a character string was expected.</p> <p>Example: DISP : TEXT 123</p>                                                                                                                                                        |
| -130 <sup>[1]</sup> | <p>Suffix error</p> <p>A suffix was incorrectly specified for a numeric parameter. You may have misspelled the suffix or the numeric parameter does not accept a suffix.</p> <p>Example: TRIG : DEL 0.5 SECS</p>                                                                                    |
| -131                | <p>Invalid suffix</p> <p>A suffix was incorrectly specified for a numeric parameter. You may have misspelled the suffix.</p> <p>Example: TRIG : DEL 0.5 SECS</p>                                                                                                                                    |
| -134                | <p>Suffix too long</p> <p>A suffix for a numeric parameter contained too many characters.</p>                                                                                                                                                                                                       |

## 4 Error Messages

### Execution Error Messages

**Table 4-1** Execution error messages (continued)

|              |                                                                                                                                                                                                                                                                    |
|--------------|--------------------------------------------------------------------------------------------------------------------------------------------------------------------------------------------------------------------------------------------------------------------|
| -138         | <p>Suffix not allowed</p> <p>A suffix was received following a numeric parameter which does not accept a suffix.</p> <p>Example: <code>STAT:QUES:ENAB 18 SEC</code> (SEC is not a valid suffix.)</p>                                                               |
| -141         | <p>Invalid character data</p> <p>Either the character data element contained an invalid character or the particular element received was not valid for the header.</p>                                                                                             |
| -144         | <p>Character data too long</p> <p>The character data element contained too many characters.</p>                                                                                                                                                                    |
| -148         | <p>Character data not allowed</p> <p>A discrete parameter was received but a character string or a numeric parameter was expected. Check the list of parameters to verify that you have used a valid parameter type.</p> <p>Example: <code>DISP:TEXT ON</code></p> |
| -151         | <p>Invalid string data</p> <p>An invalid character string was received. Check to see if you have enclosed the character string in single or double quotes.</p> <p>Example: <code>DISP:TEXT 'ON</code></p>                                                          |
| -158         | <p>String data not allowed</p> <p>A character string was received but is not allowed for the command. Check the list of parameters to verify that you have used a valid parameter type.</p> <p>Example: <code>TRIG:DEL `zero`</code></p>                           |
| -160 to -168 | <p>Block data errors</p> <p>The power supply does not accept block data.</p>                                                                                                                                                                                       |
| -170 to -178 | <p>Expression errors</p> <p>The power supply does not accept mathematical expressions.</p>                                                                                                                                                                         |
| -211         | <p>Trigger ignored</p> <p>A Group Execute Trigger (GET) or *TRG was received but the trigger was ignored. The trigger source should be set to bus and the trigger subsystem should be initiated by the <code>INIT[:IMM]</code> command.</p>                        |
| -213         | <p>Init ignored</p> <p>An <code>INITiate</code> command was received but could not be executed because a measurement was already in progress. Send a device clear to halt a measurement in progress, and place the power supply in the "idle" state.</p>           |

**Table 4-1** Execution error messages (continued)

|      |                                                                                                                                                                                                                                                                                                                                                             |
|------|-------------------------------------------------------------------------------------------------------------------------------------------------------------------------------------------------------------------------------------------------------------------------------------------------------------------------------------------------------------|
| -221 | <p>Settings conflict</p> <p>Indicates that a legal program data element was parsed but could not be executed due to the current device state.</p>                                                                                                                                                                                                           |
| -222 | <p>Data out of range</p> <p>A numeric parameter value is outside the valid range for the command.</p> <p>Example: TRIG:DEL -3</p>                                                                                                                                                                                                                           |
| -223 | <p>Too much data</p> <p>A character string was received but could not be executed because the string length was more than 40 characters. This error can be generated by the CALibration:STRing command.</p>                                                                                                                                                 |
| -224 | <p>Illegal parameter value</p> <p>A discrete parameter was received which was not a valid choice for the command. You may have used an invalid parameter choice.</p> <p>Example: DISP:STAT XYZ (XYZ is not a valid choice.)</p>                                                                                                                             |
| -330 | <p>Self-test failed</p> <p>The power supply's complete self-test failed from the remote interface (*TST? command). In addition to this error, more specific self-test errors are also reported. See also "Self-Test Error Messages" on page 131.</p>                                                                                                        |
| -350 | <p>Queue overflow</p> <p>The error queue is full because more than 20 errors have occurred. No additional errors are stored until you remove errors from the queue. The error queue is cleared when power has been turned off, or after a *CLS (clear status) command has been executed.</p>                                                                |
| -410 | <p>Query INTERRUPTED</p> <p>A command was received which sends data to the output buffer, but the output buffer contained data from a previous command (the previous data is not overwritten). The output buffer is cleared when power has been turned off, or after a *RST (reset) command has been executed.</p>                                          |
| -420 | <p>Query UNTERMINATED</p> <p>The power supply was addressed to talk (i.e., to send data over the interface) but a command has not been received which sends data to the output buffer. For example, you may have executed an APPLY command (which does not generate data) and then attempted an ENTER statement to read data from the remote interface.</p> |
| -430 | <p>Query DEADLOCKED</p> <p>A command was received which generates too much data to fit in the output buffer and the input buffer is also full. Command execution continues but all data is lost.</p>                                                                                                                                                        |

## 4 Error Messages

### Execution Error Messages

**Table 4-1** Execution error messages (continued)

|                    |                                                                                                                                                                                                          |
|--------------------|----------------------------------------------------------------------------------------------------------------------------------------------------------------------------------------------------------|
| -440               | Query UNTERMINATED after indefinite response<br>The *IDN? command must be the last query command within a command string.<br>Example: *IDN? ; :SYST:VERS?                                                |
| 501                | Isolator UART framing error                                                                                                                                                                              |
| 502                | Isolator UART overrun error                                                                                                                                                                              |
| 503 <sup>[1]</sup> | SPI data error<br>Data error was detected during the communication between the main controller U10 and the I/O controller U752.                                                                          |
| 511                | RS-232 framing error                                                                                                                                                                                     |
| 512                | RS-232 overrun error                                                                                                                                                                                     |
| 513                | RS-232 parity error                                                                                                                                                                                      |
| 514                | Command allowed only with RS-232<br>There are three commands which are only allowed with the RS-232 interface: <code>SYSTem:LOCa1</code> , <code>SYSTem:REMOte</code> , and <code>SYSTem:RWLOCK</code> . |
| 521                | Input buffer overflow                                                                                                                                                                                    |
| 522                | Output buffer overflow                                                                                                                                                                                   |
| 550                | Command not allowed in local<br>You should always execute the <code>SYSTem:REMOte</code> command before sending other commands over the RS-232 interface.                                                |

[1] This error message is only applicable for serial MY53xx6xxx.



## Self-Test Error Messages

The following errors indicate failures that may occur during a self-test. Refer to [Chapter 8](#), “Service and Maintenance” for more information.

**Table 4-2** Self-test error messages

|     |                                                                                                                                                                                                                                                                                                                                                                                                                                                                                                                                                                                |
|-----|--------------------------------------------------------------------------------------------------------------------------------------------------------------------------------------------------------------------------------------------------------------------------------------------------------------------------------------------------------------------------------------------------------------------------------------------------------------------------------------------------------------------------------------------------------------------------------|
| 601 | <p>Front panel does not respond</p> <p>The main controller U121 (<i>U10 for serial MY53xx6xxx</i>) attempts to establish serial communications with the front panel controller U1 (<i>U602 for serial MY53xx6xxx</i>) on the front panel board. During this test, the U1 (<i>U602 for serial MY53xx6xxx</i>) turns on all display segments. Communication must function in both directions for this test to pass.</p> <p>If this error is detected during the power-on self-test, the power supply will beep twice. This error is only readable from the remote interface.</p> |
| 602 | <p>RAM read/write failed</p> <p>This test writes and reads a 55h and AAh checker board pattern to each address of RAM U125. Any incorrect readback will cause a test failure. This error is only readable from the remote interface.</p>                                                                                                                                                                                                                                                                                                                                       |
| 603 | <p>A/D sync stuck</p> <p>The main controller issues an A/D sync pulse to U121 and U130 to latch the value in the ADC slope counters. A failure is detected when a sync interrupt is not recognized and subsequent timeout occurs.</p>                                                                                                                                                                                                                                                                                                                                          |
| 604 | <p>A/D slope convergence failed</p> <p>The input amplifier is configured to the measure zero (MZ) state in the 10 V range. This test checks whether the ADC integrator produces nominally the same number of positive and negative slope decisions (<math>\pm 10\%</math>) during a 20 ms interval.</p>                                                                                                                                                                                                                                                                        |
| 605 | <p>Cannot calibrate rundown gain</p> <p>This test checks the nominal gain between integrating the ADC and the U121 on-chip ADC. This error is reported if the procedure can not run to completion due to a hardware failure.</p>                                                                                                                                                                                                                                                                                                                                               |
| 606 | <p>Rundown gain out of range</p> <p>This test checks the nominal gain between the integrating ADC and the U121 on-chip ADC. The nominal gain is checked to a <math>\pm 10\%</math> tolerance.</p>                                                                                                                                                                                                                                                                                                                                                                              |
| 607 | <p>Rundown too noisy</p> <p>This test checks the gain repeatability between the integrating ADC and the U121 on-chip ADC. The gain test (606) is performed eight times. Gain noise must be less than <math>\pm 64</math> LSB of the U121 on-chip ADC.</p>                                                                                                                                                                                                                                                                                                                      |

## 4 Error Messages

### Self-Test Error Messages

**Table 4-2** Self-test error messages (continued)

|                    |                                                                                                                                                                                                                                                                                                                                                                                                                                                                                                                      |
|--------------------|----------------------------------------------------------------------------------------------------------------------------------------------------------------------------------------------------------------------------------------------------------------------------------------------------------------------------------------------------------------------------------------------------------------------------------------------------------------------------------------------------------------------|
| 608                | <p>Serial configuration readback failed</p> <p>This test re-sends the last 3 bytes of serial configuration data to all serial paths (SERDAT, SERBCK, and SERCLK). The data is then clocked back into U130 and compared against the original 3 bytes sent. A failure occurs if the data do not match. This test checks the serial data path through U138.</p>                                                                                                                                                         |
| 609 <sup>[1]</sup> | <p>System ADC test failed</p> <p>This test checks if the ADC hardware is functional. The main controller U10 establishes communication with the ADC and checks if there are any error bits set for the ADC's status reporting.</p>                                                                                                                                                                                                                                                                                   |
| 624                | <p>Unable to sense line frequency</p> <p>This test checks that the LSENSE logic input U121 is toggling. If no logic input is detected, the power supply will assume a 50 Hz line operation for all future measurements.</p>                                                                                                                                                                                                                                                                                          |
| 625                | <p>I/O processor did not respond</p> <p>This test checks that communication can be established between U121 (<i>U10 for serial MY53xx6xxx</i>) and U103 (<i>U752 for serial MY53xx6xxx</i>) through the optically-isolated (U108 and U109) (<i>U751 for serial MY53xx6xxx</i>) serial data link. Failure to establish communication in either direction will generate an error. If this condition is detected at the power-on self-test, the power supply will beep and the error annunciator will be turned on.</p> |
| 626                | <p>I/O processor failed self-test</p> <p>This test causes the earth-referenced processor U103 (<i>U752 for serial MY53xx6xxx</i>) to execute an internal RAM test. Failure will generate an error.</p>                                                                                                                                                                                                                                                                                                               |
| 630                | <p>Fan test failed</p> <p>This test checks if the fan current is flowing. If the current is not detected at the power-on self-test, the power supply will beep and the error annunciator will be turned on. Fan test failure could likely induce an overtemperature condition in the power supply.</p>                                                                                                                                                                                                               |
| 631                | <p>System DAC test failed</p> <p>This test checks if the DAC hardware is functional. The main controller U121 (<i>U10 for serial MY53xx6xxx</i>) sends a reference voltage data to the DAC and converts the DAC output to digital data to determine if the digital data is within a valid range.</p>                                                                                                                                                                                                                 |
| 632                | <p>Hardware test failed</p> <p>This test checks the status of voltage and current error amplifiers for the power circuit. If both amplifiers are not operational, the power supply will beep and the error annunciator will turn turned on.</p>                                                                                                                                                                                                                                                                      |

[1] This error message is only applicable for serial MY53xx6xxx.

## Calibration Error Messages

The following errors indicate failures that may occur during a calibration. Refer to [Chapter 8](#), “Service and Maintenance” for more information.

**Table 4-3** Calibration error messages

|     |                                                                                                                                                                                                                                                                                                                        |
|-----|------------------------------------------------------------------------------------------------------------------------------------------------------------------------------------------------------------------------------------------------------------------------------------------------------------------------|
| 701 | <p>Cal security disabled by jumper</p> <p>The calibration security feature has been disabled with a jumper inside the power supply. When applicable, this error will occur at power-on to warn you that the power supply is unsecured.</p>                                                                             |
| 702 | <p>Cal secured</p> <p>The power supply is secured against calibration.</p>                                                                                                                                                                                                                                             |
| 703 | <p>Invalid secure code</p> <p>An invalid calibration security code was received when attempting to unsecure or secure the power supply. You must use the same security code to unsecure the power supply as was used to secure it, and vice versa. The security code may contain up to 11 alphanumeric characters.</p> |
| 704 | <p>Secure code too long</p> <p>A security code was received which contained more than 11 characters.</p>                                                                                                                                                                                                               |
| 705 | <p>Cal aborted</p> <p>A calibration in progress is aborted when you press any front panel key, send a device clear, or change the local/remote state of the instrument.</p>                                                                                                                                            |
| 706 | <p>Cal value out of range</p> <p>The specified calibration value (<code>CALibration:VALue</code>) is not valid for the present measurement function and range.</p>                                                                                                                                                     |
| 708 | <p>Cal output disabled</p> <p>Calibration is aborted by sending the <code>OUTP OFF</code> command during an output calibration.</p>                                                                                                                                                                                    |
| 712 | <p>Bad DAC cal data</p> <p>The specified DAC calibration values (<code>CAL:VOLT</code> or <code>CAL:CURR</code>) are out of range. Note that the new calibration constants are not stored in the non-volatile memory.</p>                                                                                              |
| 713 | <p>Bad readback cal data</p> <p>The specified readback calibration values (<code>CAL:VOLT</code> or <code>CAL:CURR</code>) are out of range. Note that the new calibration constants are not stored in the non-volatile memory.</p>                                                                                    |

## 4 Error Messages

### Calibration Error Messages

**Table 4-3** Calibration error messages (continued)

|     |                                                                                                                                                                                |
|-----|--------------------------------------------------------------------------------------------------------------------------------------------------------------------------------|
| 714 | <b>Bad OVP cal data</b><br>The overvoltage protection calibration constant is out of range. Note that the new calibration constants are not stored in the non-volatile memory. |
| 717 | <b>Cal OVP status enabled</b><br>Overvoltage protection status is enabled. You must set overvoltage to OFF before and during calibration.                                      |
| 718 | <b>Gain out of range for Gain Error Correction</b><br>The slope of the DAC gain is out of range. Hardware fails.                                                               |
| 740 | <b>Cal checksum failed, secure state</b>                                                                                                                                       |
| 741 | <b>Cal checksum failed, string data</b>                                                                                                                                        |
| 743 | <b>Cal checksum failed, store/recall data in location 1</b>                                                                                                                    |
| 744 | <b>Cal checksum failed, store/recall data in location 2</b>                                                                                                                    |
| 745 | <b>Cal checksum failed, store/recall data in location 3</b>                                                                                                                    |
| 746 | <b>Cal checksum failed, DAC cal constants</b>                                                                                                                                  |
| 747 | <b>Cal checksum failed, readback cal constants</b>                                                                                                                             |
| 748 | <b>Cal checksum failed, GPIB address</b>                                                                                                                                       |
| 749 | <b>Cal checksum failed, internal data</b>                                                                                                                                      |
| 754 | <b>Cal checksum failed, store/recall data in location 4</b>                                                                                                                    |
| 755 | <b>Cal checksum failed, store/recall data in location 5</b>                                                                                                                    |



## 5 Application Programs

Overview [136](#)

Example Program for C and C++ [137](#)

Example Program for Excel 97 [141](#)

This chapter contains two application programs that utilize the remote interface.



# Overview

The application program examples in this chapter help you to develop programs for your own application. [Chapter 3](#), “Remote Interface Reference” lists the syntax for the SCPI commands available to program the power supply.

The examples in this chapter have been tested on a PC running Windows 3.1, Windows 95, or Windows NT 4.0. The examples are written for use over the GPIB (IEEE-488) or RS-232 interface. However, the examples for use over the RS-232 interface do not work with Windows 3.1.

These examples require a Virtual Instrument Software Architecture (VISA) driver for use with your GPIB interface card in your PC. You should have the **visa.dll** for Windows 3.1 or **visa32.dll** for Windows 95 or Windows NT 4.0 in your `c:\windows\system` directory for the examples in this chapter to run properly. The examples step through voltages and make corresponding current readings to characterize a power diode.

## Example Program for C and C++

The following C programming example shows you how to send and receive formatted I/O. This programming example shows you how to use SCPI commands for the instrument with VISA functionality and also includes error trapping. For more information on non-formatted I/O and error trapping, refer to the *Agilent VISA User's Guide*.

The following C programming example was written in Microsoft Visual C++ version 1.52 using the **QuickWin application** project type, and using the large memory model and C++ version 4.x or 5.0 using the **Windows 32 application** project type. Make sure to move the **visa.lib** (Windows 3.1) or **visa32.lib** (Windows 95/NT) and **visa.h** file to the lib and include the development directory. These are usually found in the c:\vxiinp\win(win95 or winnt)\lib\msc or c:\vxiinp\win(win95 or winnt)\include directory.

### Diode.c

```

/*Diode.C
This example program steps the power supply through 11 voltages and measures the current
response. It prints the voltage step and the current response as a table. Note that the
GPIB address is the default address from the factory for the power supply.*/

#include <visa.h>
#include <stdio.h>
#include <string.h>
#include <time.h>
#include <conio.h>
#include <stdlib.h>

ViSession defaultRM; /* Resource manager id */
ViSession power_supply; /* Identifies power supply */
int bGPIB = 1; /* Set the number to 0 for use with the RS-232
 interface */
long ErrorStatus; /* VISA Error code */
char commandString[256];
char ReadBuffer[256];

void delay(clock_t wait);
void SendSCPI(char* pString);
void CheckError(char* pMessage);

```

## 5 Application Programs

### Example Program for C and C++

```
void OpenPort();

void main()
{
 double voltage; /* Value of voltage sent to power supply */
 char Buffer[256]; /* String returned from power supply */
 double current; /* Value of current output of power supply */

 OpenPort();

 /* Query the power supply id, read response and print it */
 sprintf(Buffer, "*IDN?");
 SendSCPI(Buffer);
 printf("Instrument identification string:\n %s\n\n", Buffer);

 SendSCPI("*RST"); /* Set power-on condition */
 SendSCPI("Current 2"); /* Set current limit to 2A */
 SendSCPI("Output on"); /* Turn output on */

 printf("Voltage Current\n\n"); /* Print heading */

 /*Step from 0.6 to 0.8 volt in 0.02 steps */
 for(voltage = 0.6; voltage <=0.8001; voltage +=0.02)
 {
 printf("%.3f", voltage); /* Display diode voltage*/
 /* Set output voltage */
 ErrorStatus = viPrintf(power_supply, "Volt %f\n", voltage);
 if(!bGPIB)
 delay(500); /* 500 msec wating for RS-232 interface*/
 CheckError("Unable to set voltage");
 /* Measure output current */
 ErrorStatus = viPrintf(power_supply, "Measure:Current?\n");
 CheckError("Unable to write device");
 delay(500); /* Allow output to wait for 500 msec */
 /* Retrieve reading */
 ErrorStatus = viScanf(power_supply, "%lf", ¤t);
 CheckError("Unable to read voltage");
 printf("%.6.4f\n", current); /* Display diode current */
 }
 SendSCPI("Output off"); /* Turn output off */
 ClosePort();
}

/* Build the address required to open communication with GPIB card or RS-232.*/
/* The address format looks like this: "GPIB0::5::INSTR". */
/* To use the RS-232 interface using COM1 port, change it to "ASRL1::INSTR" */
/* address format */
```



```

void OpenPort()
{
 char GPIB_Address[3];
 char COM_Address[2];
 char VISA_address[40]; /* Complete VISA address sent to card */

 if(bGPIB)
 strcpy(GPIB_Address,"5"); /* Select GPIB address between 0 to 30*/
 else
 strcpy(COM_Address,"1"); /* Set the number to 2 for COM2 port */

 if(bGPIB){ /* For use with GPIB 7 address, use "GPIB::7::INSTR" address format */
 strcpy(VISA_address,"GPIB:");
 strcat(VISA_address,GPIB_Address);
 strcat(VISA_address,"::INSTR");
 }
 else{ /* For use with COM2 port, use "ASRL2::INSTR" address format */
 strcpy(VISA_address,"ASRL");
 strcat(VISA_address,COM_Address);
 strcat(VISA_address,"::INSTR");
 }

 /* Open communication session with the power supply */
 ErrorStatus = viOpenDefaultRM(&defaultRM);
 ErrorStatus = viOpen(defaultRM,VISA_address,0,0,&power_supply);
 CheckError("Unable to open port");

 if(!bGPIB)
 SendSCPI("System:Remote");
}

void SendSCPI(char* pString)
{
 char* pdest;

 strcpy(commandString,pString);
 strcat(commandString,"\n");
 ErrorStatus = viPrintf(power_supply,commandString);
 CheckError("Can't Write to Driver");
 if (bGPIB == 0)
 delay(1000); /* Unit is milliseconds */

 pdest = strchr(commandString, '?'); /* Search for query command */
 if(pdest != NULL){
 ErrorStatus = viScanf(power_supply,"%s",&ReadBuffer);
 CheckError("Can't Read From Driver");
 }
}

```

## 5 Application Programs

### Example Program for C and C++

```
 strcpy(pString,ReadBuffer);
 }
}

void ClosePort()
{
 /* Close the communication port */
 viClose(power_supply);
 viClose(defaultRM);
}

void CheckError(char* pMessage)
{
 if (ErrorStatus < VI_SUCCESS){
 printf("\n %s",pMessage);
 ClosePort();
 exit(0);
 }
}

void delay(clock_t wait)
{
 clock_t goal;
 goal = wait + clock();
 while(goal > clock()) ;
}
```

### End of program

## Example Program for Excel 97

This section contains the example program written using Excel Macros (Visual Basic for Applications) to control your power supply. With Excel, you can take the value of a cell in a spreadsheet, send it to the power supply, and then record the response on the worksheet. The example on the following pages characterizes a component across the terminals of the power supply. This example reads 11 voltages from a worksheet, programs the power supply to that voltage, and then reads the current. The value of current is recorded next to the voltage on the spreadsheet.

### Example program result

The following table shows the result of the example program starting on [page 143](#) for characterizing a diode. (Agilent part number: 1901-1214, manufacturer part number: MUR160, Motorola Co.)

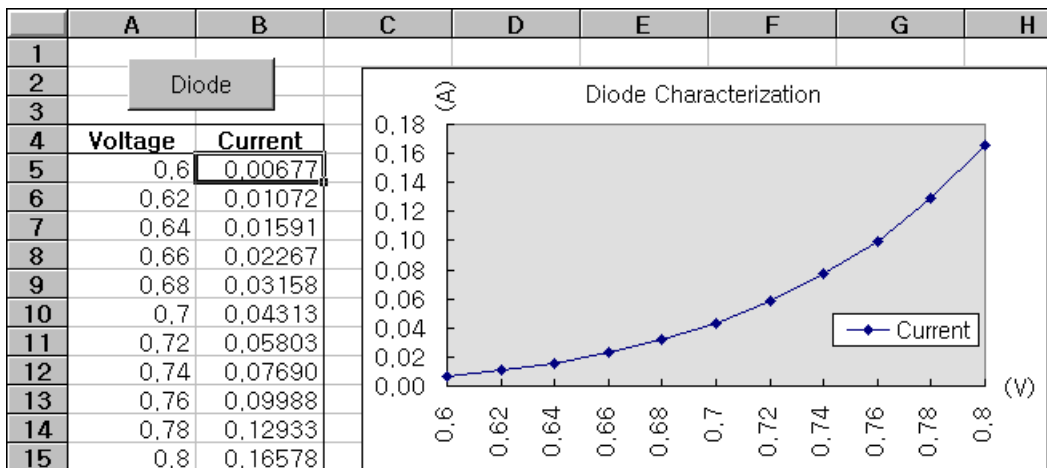

Figure 5-1 Example program result

To write an Excel macro:

- 1 You must first open a module in Excel.
- 2 Go to the **View** menu, choose **Toolbars**, and then select **Control Toolbox**. The Control Toolbox dialog box appears.
- 3 Select the **Command** button in the dialog box.
- 4 Select cell A1 and drag across cell B3. The *CommandButton1* box is created.
- 5 To change the button name, click the right mouse button on that button and then select **Properties**. The Properties dialog box appears.
- 6 In the Properties dialog, change the (**name**) and **caption** to **Diode**.
- 7 To try the example for characterizing a diode, type **Voltages** in cell A4 and **Current** in cell B4. In cell A5, type **0.6**. Fill in cells A5 to A15 in 0.02 increments so that cell A15 contains 0.8.

To enter the **Diode** macro example in this section:

- 1 Go to the **View** menu, choose **Toolbars**, and then select the **Visual Basic Editor** icon. The **Code window** appears.
- 2 Then, type the text as shown on [page 137](#) into the [**Module1 (code)**] window. To enter the declaration for Windows 95/NT, go to the **Insert** menu and choose **Module**. The **Module window** appears.
- 3 Then, type the text as shown starting on [page 139](#). This module will configure all of the overhead required to communicate with the power supply over the interface. Choose the preferred interface by setting **bGPIB=** to **True** or **False** and change the GPIB address or RS-232 port in the routine **OpenPort( )** contained in the module.

To run the macro, return to the Excel window, select the **Run Macro** button in the dialog box, choose the macro name, and then click **Run**. The power supply will reset to the power-on condition and then step through the voltages in the worksheet. After each step, the current is measured and recorded in the worksheet.

Make any changes necessary to suit your application in the **Diode** module. You must enter the information in the modules exactly as shown or an error will be generated. If several system errors occur while attempting to run a macro, you may have to reboot your PC to get the GPIB or RS-232 interface to work properly.

**NOTE**

To use the example with Windows 3.1, you will need to modify the declarations at the top of the module. Change **visa32.dll** to **visa.dll** in all declarations.

**Diode macro**

```

' This is the subroutine first executed. Modify this routine to suit
' your needs. To change the GPIB address, go to the OpenPort module, and
' change the GPIB_Address = "5" variable to the required GPIB address.
' To change the RS-232 interface, go to the OpenPort module, and change the
' COM_Address = "1" variable to the required interface.
Global defaultRM As Long ' Resource manager id for VISA GPIB
Global power_supply As Long ' Identifies power supply
Global bGPIB As Boolean ' A flag using GPIB or RS-232
Global ErrorStatus As Long ' VISA Error code

Sub Diode_Click()
 Range("B5:B15").ClearContents
 Dim I As Integer
 bGPIB = True ' To use RS-232, set the bGPIB to False
 OpenPort
 SendSCPI "*RST" ' Set power-on condition
 SendSCPI "Output on" ' Turn on the output
 For I = 5 To 15
 SendSCPI "Volt " & Str$(Cells(I, 1))
 Cells(I, 2) = Val(SendSCPI("Meas:Current?"))
 Next I
 SendSCPI "Output off" ' Turn off the output
 ClosePort
End Sub

```

## 5 Application Programs

### Example Program for Excel 97

```
Private Function OpenPort()
 Dim GPIB_Address As String
 Dim COM_Address As String

 If bGPIB Then
 GPIB_Address = "5" ' Select GPIB address between 0 to 30
 Else
 COM_Address = "1" ' Set the number to 2 for COM2 port
 End If
 ErrorStatus = viOpenDefaultRM(defaultRM) ' Open the VISA session

 If bGPIB Then
 ErrorStatus = viOpen(defaultRM, "GPIB0:." & GPIB_Address & ":", _
 0, 1000, power_supply)
 Else
 ErrorStatus = viOpen(defaultRM, "ASRL" & COM_Address & ":", _
 0, 1000, power_supply)
 SendSCPI "System:Remote"
 End If
 CheckError "Unable to open interface"
End Function
'*****
' This routine sends a SCPI command string to the GPIB interface or RS-232 interface.
' If the command contains a question mark, the response is read, and returned
'*****
Private Function SendSCPI(command As String) As string
 Dim commandString As String ' Command passed to power supply
 Dim ReturnString As String ' Store the string returned
 Dim crlfpos As Integer ' Location of any nul's in Read Buffer
 Dim ReadBuffer As String * 512 ' Buffer used for returned string
 Dim actual As Long ' Number of characters sent/returned
 commandString = command & Chr$(10) ' The instrumented by linefeed
 ErrorStatus = viWrite(power_supply, ByVal commandString, Len(commandString), _
 actual)
 CheckError "Can't Write to Device"
 If bGPIB = False Then
 delay 0.5
 End If
 If InStr(commandString, "?") Then
 ErrorStatus = viRead(power_supply, ByVal ReadBuffer, 512, actual)
 CheckError "Can't Read From Device"
 ReturnString = ReadBuffer
 crlfpos = InStr(ReturnString, Chr$(0))
 If crlfpos Then
 ReturnString = Left(ReturnString, crlfpos - 1)
 End If
 SendSCPI = ReturnString
 End If
End Function
```

```

Private Function ClosePort()
 ErrorStatus = viClose(power_supply)
 ErrorStatus = viClose(defaultRM)
End Function

Private Function delay(delay_time As Single)
 Dim Finish As Single
 Finish = Timer + delay_time
 Do
 Loop Until Finish <= Timer
End Function

Private Function CheckError(ErrorMessage As String)
 If ErrorStatus < VI_SUCCESS Then
 Cells(5, 2) = ErrorMessage
 ClosePort
 End
End If
End Function

```

**End of program**

**Declaration for Windows 3.1**

```

' *****
' This routine requires the VISA.dll file. It typically resides in the
' c:\windows\system directory. Additional declarations for VISA.DLL are usually in the
' visa.bas file in the c:\vxiinp\win31\include directory on your PC. This routine uses the
' VTL Library to send commands to an instrument. A description of these and additional
' VTL commands are contained in the Agilent Technologies Visa Transition Library book
' Agilent Part Number E2094-90002.
' *****
Declare Function viOpenDefaultRM Lib "VISA.DLL" Alias "#141" (viDefaultRM As Long) As Long

Declare Function viOpen Lib "VISA.DLL" Alias "#131" (ByVal viDefaultRM As Long, ByVal
viDesc
As String, ByVal mode As Long, ByVal timeout As Long, vi As Long) As Long

Declare Function viClose Lib "VISA.DLL" Alias "#132" (ByVal vi As Long) As Long

Declare Function viRead Lib "VISA.DLL" Alias "#256" (ByVal vi As Long, ByVal Buffer As
String, ByVal count As Long, retCount As Long) As Long

Declare Function viWrite Lib "VISA.DLL" Alias "#257" (ByVal vi As Long, ByVal Buffer As
String, ByVal count As Long, retCount As Long) As Long

Declare Function viClear Lib "VISA.DLL" Alias "#260" (ByVal vi As Long) As Long

```

## 5 Application Programs

### Example Program for Excel 97

#### Declaration for Windows 95/NT 4.0

```

' Additional declarations for VISA32.DLL are usually in the visa32.bas file in the
' c:\vxiinp\win95(or winNT)\include directory on your PC. Also see the VISA manual

Declare Function viOpenDefaultRM Lib "visa32.dll" (instrumentHandle As Long) As Long
Declare Function viOpen Lib "visa32.dll" (ByVal instrumentHandle As Long, _
 ByVal viDesc As String, ByVal mode As Long, ByVal timeout As Long, _
 vi As Long) As Long
Declare Function viClose Lib "visa32.dll" (ByVal vi As Long) As Long
Declare Function viWrite Lib "visa32.dll" (ByVal vi As Long, ByVal Buffer As String, _
 ByVal count As Long, retCount As Long) As Long
Declare Function viRead Lib "visa32.dll" (ByVal vi As Long, ByVal Buffer As String, _
 ByVal count As Long, retCount As Long) As Long
```





## 6 Tutorial

|                                               |     |
|-----------------------------------------------|-----|
| Overview of the Power Supply Operation        | 148 |
| Output Characteristics                        | 150 |
| Extending the Voltage Range and Current Range | 155 |
| Remote Programming                            | 157 |

This chapter describes the basic operation of a linear power supply and the operation of this power supply. You will also find information to help you better understand the output characteristics of this power supply as well as an ideal power supply.



## Overview of the Power Supply Operation

The basic design model for power supplies consists of placing a control element in series with the rectifier and load device. **Figure 6-1** shows a simplified schematic of a series regulated supply with the phase-controlled pre-regulator described as a power switch and the series element depicted as a variable resistor. The phase-controlled pre-regulator minimizes the power dissipated at the series element by maintaining the voltage drop across the series element at a low and constant. Feedback control circuits continuously monitor the output and adjust the series resistance to maintain a constant output voltage. Because the variable resistance of **Figure 6-1** is actually one or more power transistor operating in the linear (class A) mode, supplies with this type of regulator are often called linear power supplies. Linear power supplies have many advantages and usually provide the simplest most effective means of satisfying high performance and low power requirements.

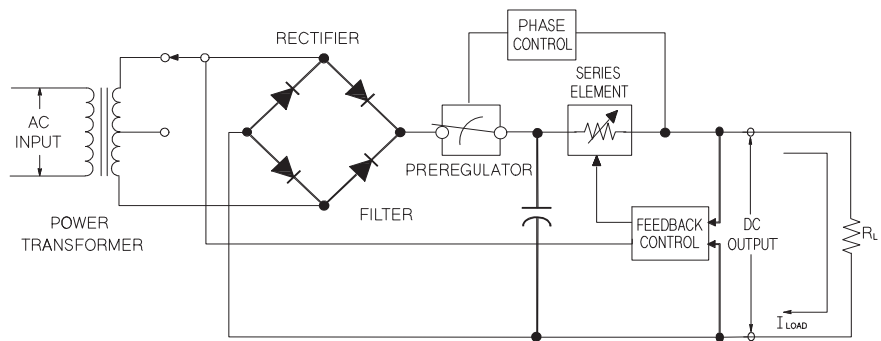
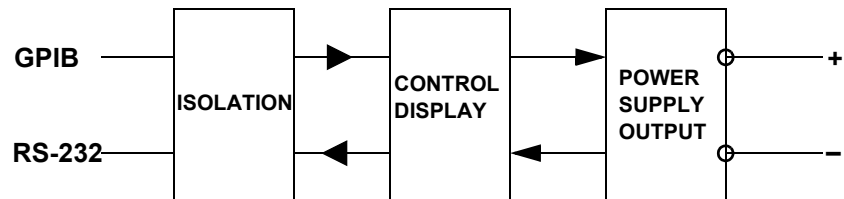

**Figure 6-1** Diagram of a simple series power supply

This power supply has two ranges, allowing more voltage at a lower current or more current at a lower voltage. Single range supplies can only output maximum power at full scale voltages and full scale current. This supply can provide output power that is close to maximum at full scale for both ranges. The pre-regulator in this power supply uses solid state transformer tap switches on the secondary winding of the power transformer. This technique is very effective in reducing the power dissipated in the series element.

In terms of performance, a linear regulated supply has a very precise regulating properties and responds quickly to variations of the line and load. Hence, its line and load regulation and transient recovery time are superior to supplies using other regulation techniques. The power supply also exhibits low ripple and noise, is tolerant of ambient temperature changes, and with its circuit simplicity, has a high reliability.

This power supply contains a linear regulated power supply. It is controlled by a control circuit that provides voltages to program the outputs. The power supply sends back to the control circuits a voltage representing the output at the terminals. The control circuits receive information from the front panel and send information to the display. Similarly the control circuits “talk” to the remote interface for input and output with the GPIB and RS-232 interfaces. The remote interface is at earth ground and isolated from the control circuit and the power supply.



**Figure 6-2** Block diagram of the power supply showing the remote interface isolation

## Output Characteristics

An ideal constant voltage power supply would have a zero output impedance at all frequencies. Thus, as shown in [Figure 6-3](#), the voltage would remain perfectly constant in spite of any changes in output current demanded by the load.

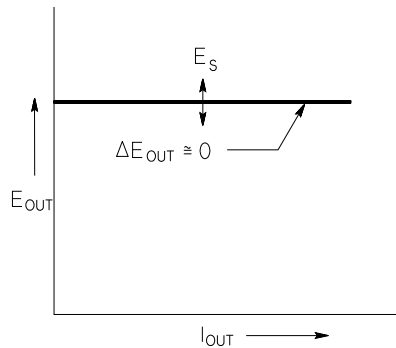

**Figure 6-3** Ideal constant voltage power supply

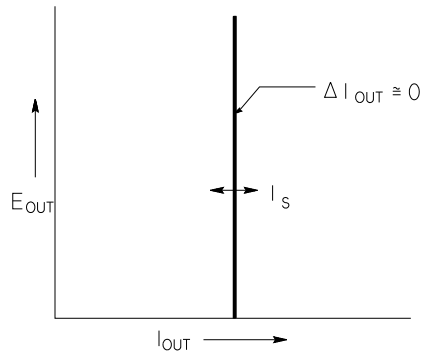
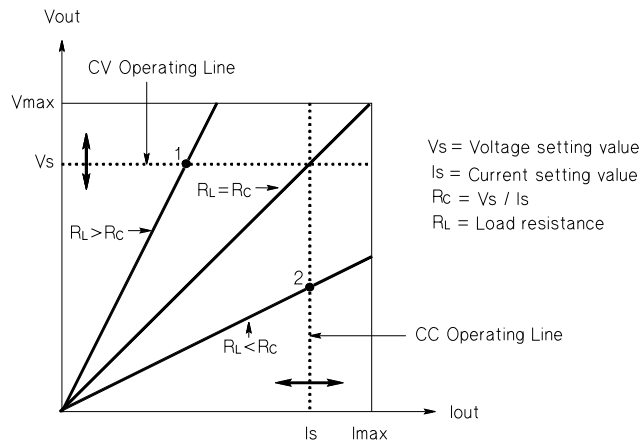

**Figure 6-4** Ideal constant current power supply

The ideal constant current power supply exhibits an infinite output impedance at all frequencies. Thus as [Figure 6-4](#) indicates, the ideal constant current power supply would accommodate a load resistance change by altering its output voltage by just the amount necessary to maintain its output current at a constant value.

The output of this power supply can operate in either the constant voltage (CV) mode or constant current (CC) mode. Under certain fault conditions, the power supply can not operate in either the CV or CC mode and becomes unregulated.

[Figure 6-5](#) shows the operating modes of the output of this power supply. The operating point of one supply will be either above or below the line  $R_L = R_C$ . This line represents a load where the output voltage and the output current are equal to the voltage and current settings. When the load  $R_L$  is greater than  $R_C$ , the output voltage will dominate since the current will be less than the current setting. The power supply is said to be in the constant voltage mode. The load at point 1 has a relatively high resistance value (compared to  $R_C$ ), the output voltage is at the voltage setting, and the output current is less than the current setting. In this case, the power supply is in the constant voltage mode and the current setting acts as a current limit.



**Figure 6-5** Output characteristics

When the load  $R_L$  is less than  $R_C$ , the output current will dominate since the voltage will be less than the set voltage. The power supply is said to be in the constant current mode. The load at point 2 has a relatively low resistance, the output voltage is less than the voltage setting, and the output current is at the current setting. The supply is in the constant current mode and the voltage setting acts as a voltage limit.

## Unregulated state

If the power supply goes into a mode of operation that is neither CV or CC, the power supply is unregulated. In this mode the output is not predictable. The unregulated condition may be the result of the AC line voltage below the specifications. The unregulated condition may occur momentarily. For example, when the output is programmed for a large voltage step, the output capacitor and a large capacitive load will charge up at the current limit setting. During the ramp up of the output voltage, the power supply will be in the unregulated mode. During the transition from CV to CC as when the output is shorted, the unregulated state may occur briefly during the transition.

## Unwanted signals

An ideal power supply has a perfect DC output with no signals across the terminals or from the terminals to earth ground. The actual power supply has finite noise across the output terminals, and a finite current will flow through any impedance connected from either terminal to earth ground. The first is called normal mode voltage noise and the second common mode current noise. [Figure 6-6](#) shows the simplified diagram of common mode and normal mode sources of noise.

Normal mode voltage noise is in the form of ripple related to the line frequency plus some random noise. Both of these are of very low value in the power supply. Careful lead layout and keeping the power supply circuitry away from power devices and other noise sources will keep these values low.

Common mode noise can be a problem for very sensitive circuitry that is referenced to earth ground. When a circuit is referenced to earth ground, a low level line-related AC current will flow from the output terminals to earth ground. Any impedance to earth ground will create a voltage drop equal to the current flow multiplied by the impedance. To minimize this effect, the output terminal can be grounded at the output terminal. Alternatively, any impedances to earth ground should have a complementary impedance to earth ground to cancel any generated voltages. If the circuit is not referenced to earth ground, common mode power line noise is typically not a problem.

The output will also change due to changes in the load. As the load increases, the output current will cause a small drop in the output voltage of the power supply due to the output impedance  $R$ . Any resistance in the connecting wire will add to this resistance and increase the voltage drop. Using the largest possible hook up wire will minimize the voltage drop. Using the remote sense leads at the load will compensate for lead resistance in the load leads.

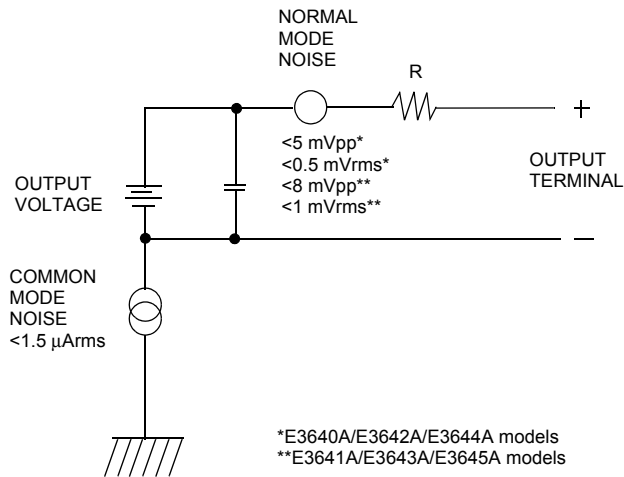

**Figure 6-6** Simplified diagram of the common mode and normal mode sources of noise

When the load changes very rapidly, as when a relay contact is closed, the inductance in the hook up wire and in the power supply output will cause a spike to appear at the load. The spike is a function of the rate of change of the load current. When very rapid changes in load are expected, a capacitor with a low series resistance, in parallel with the power supply, and close to the load is the best way to minimize these voltage spikes.



## Extending the Voltage Range and Current Range

The power supply may be able to provide voltages and currents greater than its rated maximum outputs if the power-line voltage is at or above its nominal value. Operation can be extended up to 3% over the rated output without damage to the power supply, but performance can not be guaranteed to meet specifications in this region. If the power-line voltage is maintained in the upper end of the input voltage range, the power supply will probably operate within its specifications. The power supply is more likely to stay within specifications if only one of the voltage or current outputs is exceeded.

### Series connections

Series operation of two or more power supplies can be accomplished up to the output isolation rating of any one supply to obtain a higher voltage than that available from a single supply. Series-connected power supplies can be operated with one load across both power supplies or with a separate load for each power supply. The power supply has a reverse polarity diode connected across the output terminals so that if operated in series with other power supplies, damage will not occur if the load is short-circuited or if one power supply is turned on separately from its series partners.

When the series connection is used, the output voltage is the sum of the voltages of the individual power supplies. The current is the current of any one power supply. Each of the individual power supplies must be adjusted in order to obtain the total output voltage.

## Parallel connections

Two or more power supplies being capable of the CV/CC automatic crossover operation can be connected in parallel to obtain a total output current greater than that available from one power supply. The total output current is the sum of the output currents of the individual power supplies. The output of each power supply can be set separately. The output voltage controls of one power supply should be set to the desired output voltage; the other power supply should be set for a slightly higher output voltage. The supply with the higher output voltage setting will deliver its constant current output, and drop its output voltage until it equals the output of the other supply, and the other supply will remain in the constant voltage operation and only deliver that fraction of its rated output current which is necessary to fulfill the total load demand.

## Remote Programming

During remote programming, a constant-voltage regulated power supply is called upon to change its output voltage rapidly. The most important factor limiting the speed of output voltage change is the output capacitor and load resistor.

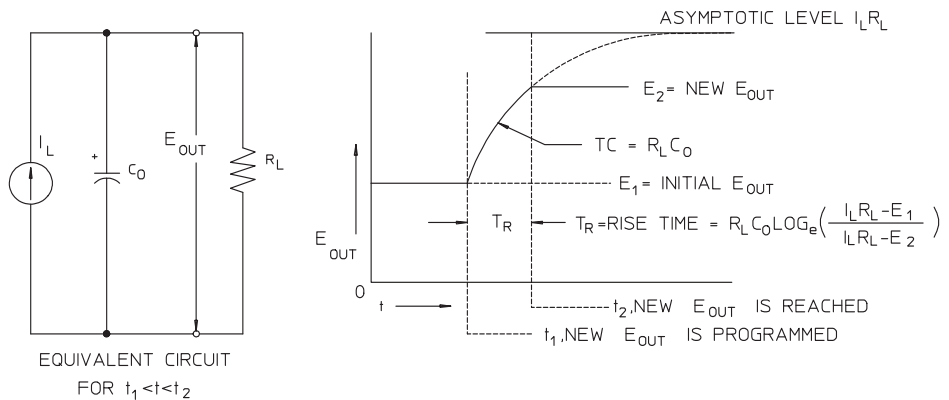

**Figure 6-7** Speed of response — programming up (full load)

The equivalent circuit and the nature of the output voltage waveform when the supply is being programmed upward are shown in [Figure 6-7](#). When the new output is programmed, the power supply regulator circuit senses that the output is less than desired and turns on the series regulator to its maximum value  $I_L$ , the current limit or constant current setting.

This constant current  $I_L$  charges the output capacitor  $C_O$  and load resistor  $R_L$  parallel. The output therefore rises exponentially with a time constant  $R_L C_L$  towards voltage level  $I_L R_L$ , a value higher than the new output voltage being programmed.

When this exponential rise reaches the newly programmed voltage level, the constant voltage amplifier resumes its normal regulating action and holds the output constant. Thus, the rise time can be determined approximately using the formula shown in Figure 6-7.

If no load resistor is attached to the power supply output terminal, then the output voltage will rise linearly at a rate of  $C_0/I_L$  when programmed upward, and  $T_R = C_0(E_2 - E_1)/I_L$ , the shortest possible up-programming time.

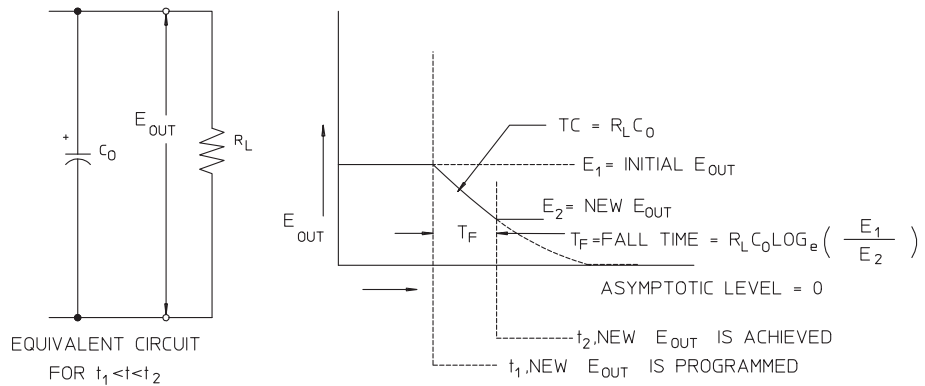

**Figure 6-8** Speed of response — programming down

Figure 6-8 shows that when the power supply is programmed down, the regulator senses that the output voltage is higher than desired and turns off the series transistors entirely. Since the control circuit can in no way cause the series regulator transistors to conduct backwards, the output capacitor can only be discharged through the load resistor and internal current source ( $I_S$ ).

The output voltage decays linearly with a slope of  $I_S/C_0$  with no load and stops falling when it reaches the new output voltage which has been demanded. If a full load is connected, the output voltage will fall exponentially faster.

Since up-programming speed is aided by the conduction of the series regulating transistor, while down-programming normally has no active element aiding in the discharge of the output capacitor, laboratory power supplies normally program upward more rapidly than downward.

**THIS PAGE HAS BEEN INTENTIONALLY LEFT BLANK.**

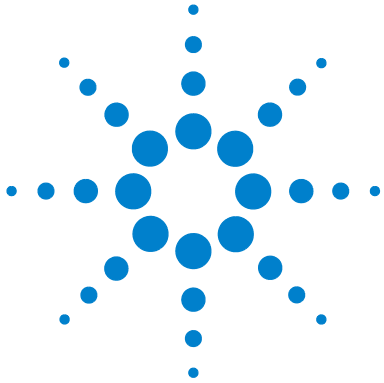

## 7 Characteristics and Specifications

|                               |     |
|-------------------------------|-----|
| Physical Characteristics      | 162 |
| Environmental Characteristics | 163 |
| Electrical Specifications     | 164 |
| Supplemental Characteristics  | 166 |

This chapter lists the characteristics and specifications of the E364xA single output DC power supplies.

### NOTE

Specifications are warranted in the temperature range of 0 °C to 40 °C with a resistive load. Supplemental characteristics are not warranted but are descriptions of performance determined either by design or testing.



## Physical Characteristics

**Table 7-1** Physical characteristics

| Parameter                     |          | E3640A                        | E3641A | E3642A | E3643A | E3644A | E3645A |
|-------------------------------|----------|-------------------------------|--------|--------|--------|--------|--------|
| <b>Dimensions (W × H × D)</b> |          | 212.6 mm × 88.5 mm × 348.3 mm |        |        |        |        |        |
| <b>Weight</b>                 | Net      | 5.3 kg                        | 5.2 kg | 6.3 kg | 6.2 kg | 6.6 kg | 6.7 kg |
|                               | Shipping | 7.2 kg                        | 7.1 kg | 8.2 kg | 8.1 kg | 8.5 kg | 8.6 kg |
| <b>Cooling</b>                |          | Fan cooled                    |        |        |        |        |        |

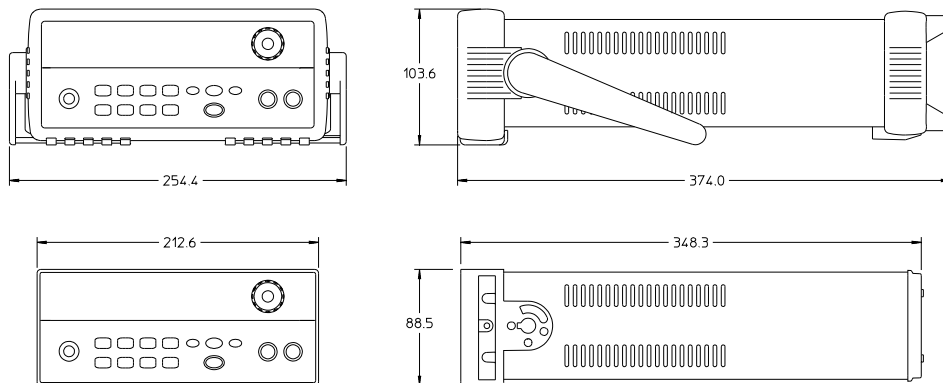

**Figure 7-1** E364xA dimensions



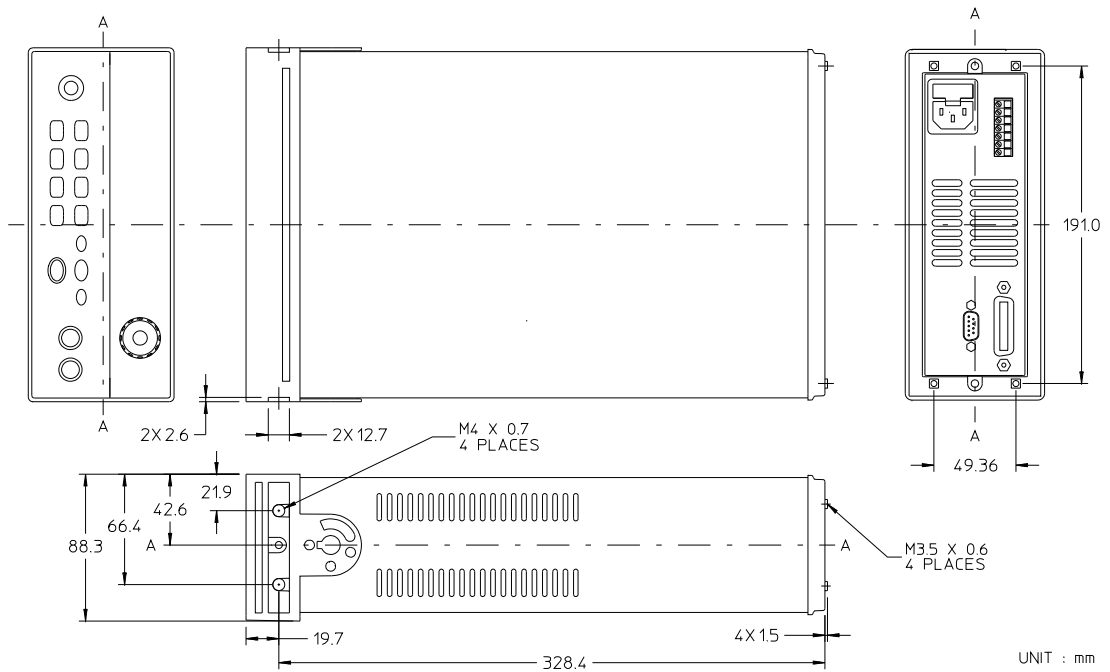

Figure 7-2 E364xA dimensions for rack mounting

## Environmental Characteristics

Refer to “Environmental Conditions” on page VI.

## Electrical Specifications

**Table 7-2** Electrical specifications

| Parameter                                                                                                                                        |                     | E3640A                | E3641A              | E3642A                | E3643A              | E3644A                | E3645A              |
|--------------------------------------------------------------------------------------------------------------------------------------------------|---------------------|-----------------------|---------------------|-----------------------|---------------------|-----------------------|---------------------|
| <b>Voltage output (V)</b><br>(at 0 to 40 °C)                                                                                                     | Low range           | 0 to +8 V             | 0 to +35 V          | 0 to +8 V             | 0 to +35 V          | 0 to +8 V             | 0 to +35 V          |
|                                                                                                                                                  | High range          | 0 to +20 V            | 0 to +60 V          | 0 to +20 V            | 0 to +60 V          | 0 to +20 V            | 0 to +60 V          |
| <b>Current output (A)</b><br>(at 0 to 40 °C)                                                                                                     | Low range           | 0 to 3 A              | 0 to 0.8 A          | 0 to 5 A              | 0 to 1.4 A          | 0 to 8 A              | 0 to 2.2 A          |
|                                                                                                                                                  | High range          | 0 to 1.5 A            | 0 to 0.5 A          | 0 to 2.5 A            | 0 to 0.8 A          | 0 to 4 A              | 0 to 1.3 A          |
| <b>Programming accuracy<sup>[1]</sup></b><br>12 months (at 25 °C ±5 °C), ±(% of output + offset)                                                 | Voltage             | <0.05% + 10 mV        |                     |                       |                     |                       |                     |
|                                                                                                                                                  | Current             | <0.2% + 10 mA         |                     |                       |                     |                       |                     |
| <b>Readback accuracy<sup>[1]</sup></b><br>12 months (over GPIB and RS-232 with respect to actual output at 25 °C ±5 °C), ±(% of output + offset) | Voltage             | <0.05% + 5 mV         |                     |                       |                     |                       |                     |
|                                                                                                                                                  | Current             | <0.15% + 5 mA         |                     |                       |                     |                       |                     |
| <b>Meter accuracy<sup>[1][2]</sup></b><br>12 months (over front panel with respect to actual output at 25 °C ±5 °C), ±(% of output + offset)     | Voltage             | < (0.05% + 2 counts)  |                     |                       |                     |                       |                     |
|                                                                                                                                                  | Current             | <0.15% + 5 mA         |                     |                       |                     |                       |                     |
| <b>Ripple and noise</b><br>(with outputs ungrounded, or with either output terminal grounded, 20 Hz to 20 MHz)                                   | Normal mode voltage | <0.5 mVrms and 5 mVpp | <1 mVrms and 8 mVpp | <0.5 mVrms and 5 mVpp | <1 mVrms and 8 mVpp | <0.5 mVrms and 5 mVpp | <1 mVrms and 8 mVpp |
|                                                                                                                                                  | Normal mode current | <4 mArms              |                     |                       |                     |                       |                     |
|                                                                                                                                                  | Common mode current | <1.5 μArms            |                     |                       |                     |                       |                     |

**Table 7-2** Electrical specifications (continued)

| Parameter                                                                                               | E3640A                                                                                                                                                                                    | E3641A | E3642A | E3643A          | E3644A | E3645A |
|---------------------------------------------------------------------------------------------------------|-------------------------------------------------------------------------------------------------------------------------------------------------------------------------------------------|--------|--------|-----------------|--------|--------|
| <b>Load regulation</b><br>±(% of output + offset)                                                       | Voltage                                                                                                                                                                                   |        |        | <0.01% + 3 mV   |        |        |
|                                                                                                         | Current                                                                                                                                                                                   |        |        | <0.01% + 250 μA |        |        |
| <b>Line regulation</b><br>±(% of output + offset)                                                       | Voltage                                                                                                                                                                                   |        |        | <0.01% + 3 mV   |        |        |
|                                                                                                         | Current                                                                                                                                                                                   |        |        | <0.01% + 250 μA |        |        |
| <b>Programming resolution</b>                                                                           | Voltage                                                                                                                                                                                   |        |        | <5 mV           |        |        |
|                                                                                                         | Current                                                                                                                                                                                   |        |        | <1 mA           |        |        |
| <b>Readback resolution</b>                                                                              | Voltage                                                                                                                                                                                   |        |        | <2 mV           |        |        |
|                                                                                                         | Current                                                                                                                                                                                   |        |        | <1 mA           |        |        |
| <b>Front panel resolution</b>                                                                           | Voltage                                                                                                                                                                                   |        |        | 10 mV           |        |        |
|                                                                                                         | Current                                                                                                                                                                                   |        |        | 1 mA            |        |        |
| <b>Transient response time</b>                                                                          | <50 μs for the output to recover to within 15 mV following a change in the output current from full load to half load or vice versa.                                                      |        |        |                 |        |        |
| <b>Settling time</b>                                                                                    | <90 ms for the output voltage to change from 1% to 99% or vice versa following the receipt of the <code>VOLTage</code> or <code>APPLY</code> command via direct GPIB or RS-232 interface. |        |        |                 |        |        |
| <b>OVP accuracy</b><br>±(% of output + offset)                                                          | <0.5% + 0.5 V                                                                                                                                                                             |        |        |                 |        |        |
| <b>Activation time</b><br>(Average time for the output to start to drop after the OVP condition occurs) | <1.5 msec when the trip voltage is equal or greater than 3 V<br><10 msec when the trip voltage is less than 3 V                                                                           |        |        |                 |        |        |

[1] Accuracy specifications after a 1-hour warm-up period with no load and calibration at 25 °C.

[2] Meter accuracy specification at a minimum of 10 mV decimal limited by the front panel resolution.

## Supplemental Characteristics

**Table 7-3** Supplemental characteristics

| Parameter                                                                |                                                                                                                                                                                                        | E3640A                                                                                          | E3641A        | E3642A       | E3643A        | E3644A       | E3645A        |
|--------------------------------------------------------------------------|--------------------------------------------------------------------------------------------------------------------------------------------------------------------------------------------------------|-------------------------------------------------------------------------------------------------|---------------|--------------|---------------|--------------|---------------|
| <b>Output programming range</b><br>(maximum programmable values)         | Low range                                                                                                                                                                                              | 0 to +8.24 V                                                                                    | 0 to +36.05 V | 0 to +8.24 V | 0 to +36.05 V | 0 to +8.24 V | 0 to +36.05 V |
|                                                                          |                                                                                                                                                                                                        | 0 to 3.09 A                                                                                     | 0 to 0.824 A  | 0 to 5.15 A  | 0 to 1.442 A  | 0 to 8.24 A  | 0 to 2.266 A  |
|                                                                          | High range                                                                                                                                                                                             | 0 to +20.6 V                                                                                    | 0 to +61.8 V  | 0 to +20.6 V | 0 to +61.8 V  | 0 to +20.6 V | 0 to +61.8 V  |
|                                                                          |                                                                                                                                                                                                        | 0 to 1.545 A                                                                                    | 0 to 0.515 A  | 0 to 2.575 A | 0 to 0.824 A  | 0 to 4.12 A  | 0 to 1.339 A  |
| OVP                                                                      | 1 V to 22 V                                                                                                                                                                                            | 1 V to 66 V                                                                                     | 1 V to 22 V   | 1 V to 66 V  | 1 V to 22 V   | 1 V to 66 V  |               |
| <b>Remote sensing capability</b>                                         | Voltage drop                                                                                                                                                                                           | Up to 1 V per each lead                                                                         |               |              |               |              |               |
|                                                                          | Load regulation                                                                                                                                                                                        | Add 5 mV to specification for each 1 V change in the + output lead due to load current changes. |               |              |               |              |               |
|                                                                          | Load voltage                                                                                                                                                                                           | Subtract the voltage drop in load leads from the specified output voltage rating.               |               |              |               |              |               |
| <b>Temperature coefficient</b> <sup>[1]</sup><br>±(% of output + offset) | Voltage                                                                                                                                                                                                | <0.01% + 3 mV                                                                                   |               |              |               |              |               |
|                                                                          | Current                                                                                                                                                                                                | <0.02% + 3 mA                                                                                   |               |              |               |              |               |
| <b>Stability</b> <sup>[2]</sup><br>±(% of output + offset)               | Voltage                                                                                                                                                                                                | <0.02% + 2 mV                                                                                   |               |              |               |              |               |
|                                                                          | Current                                                                                                                                                                                                | <0.1% + 1 mA                                                                                    |               |              |               |              |               |
| <b>Output voltage overshoot</b>                                          | During turn-on or turn-off of AC power, output plus overshoot will not exceed 1 V if the output control is set to less than 1 V. If the output control is set to 1 V or higher, there is no overshoot. |                                                                                                 |               |              |               |              |               |
| <b>Programming language</b>                                              | Standard Commands for Programmable Instruments (SCPI)                                                                                                                                                  |                                                                                                 |               |              |               |              |               |
| <b>State storage memory</b>                                              | Five user-configurable stored states                                                                                                                                                                   |                                                                                                 |               |              |               |              |               |
| <b>Recommended calibration interval</b>                                  | 1 year                                                                                                                                                                                                 |                                                                                                 |               |              |               |              |               |

**Table 7-3** Supplemental characteristics (continued)

| Parameter                                                                | E3640A                                                                                                                                                                                                                                                                                                                                                                                                                                     | E3641A | E3642A | E3643A | E3644A | E3645A |
|--------------------------------------------------------------------------|--------------------------------------------------------------------------------------------------------------------------------------------------------------------------------------------------------------------------------------------------------------------------------------------------------------------------------------------------------------------------------------------------------------------------------------------|--------|--------|--------|--------|--------|
| <b>Output terminal isolation</b><br>(maximum, from chassis ground)       | <ul style="list-style-type: none"> <li>• <math>\pm 60</math> Vdc when connecting shorting conductors without insulation between the (+) output and the (+) sense terminals and between the (-) output and the (-) sense terminals.</li> <li>• <math>\pm 240</math> Vdc when connecting insulated shorting conductors between the (+) output and the (+) sense terminals and between the (-) output and the (-) sense terminals.</li> </ul> |        |        |        |        |        |
| <b>AC input ratings</b><br>(selectable via two switches on the PC board) | <ul style="list-style-type: none"> <li>• 115 Vac <math>\pm 10\%</math>, 47 Hz to 63 Hz (standard)</li> <li>• 230 Vac <math>\pm 10\%</math>, 47 Hz to 63 Hz (option 0E3)</li> <li>• 100 Vac <math>\pm 10\%</math>, 47 Hz to 63 Hz (option 0E9)</li> </ul>                                                                                                                                                                                   |        |        |        |        |        |
| <b>Maximum input power</b>                                               | 105 VA                                                                                                                                                                                                                                                                                                                                                                                                                                     | 105 VA | 205 VA | 175 VA | 300 VA | 270 VA |

[1] Maximum change in the output or readback per  $^{\circ}\text{C}$  after a 30-minute warm-up.

[2] Following a 30-minute warm-up, with the output in the ON state according to the operating mode (CC with load or CV), and with a change in the output over 8 hours under constant load, line, and ambient temperature.

**7 Characteristics and Specifications**  
Supplemental Characteristics

**THIS PAGE HAS BEEN INTENTIONALLY LEFT BLANK.**

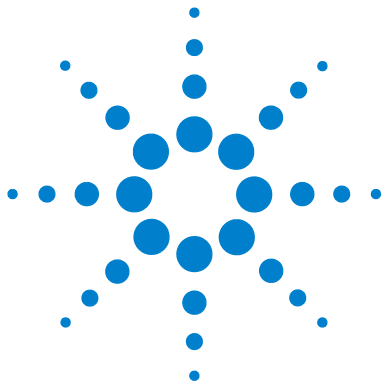

## 8 Service and Maintenance

|                                              |     |
|----------------------------------------------|-----|
| Overview                                     | 170 |
| Operating Checklist                          | 171 |
| Types of Service Available                   | 172 |
| Repacking for Shipment                       | 173 |
| Electrostatic Discharge (ESD) Precautions    | 174 |
| Replacing the Power-Line Fuse                | 174 |
| Troubleshooting Hints                        | 175 |
| Self-Test Procedures                         | 177 |
| General Disassembly                          | 179 |
| Recommended Test Equipment                   | 180 |
| Operation Verification and Performance Tests | 183 |
| Measurement Techniques                       | 184 |
| Constant Voltage (CV) Verifications          | 187 |
| Constant Current (CC) Verifications          | 195 |
| Common Mode Current Noise                    | 201 |
| Calibration Reference                        | 205 |
| General Calibration or Adjustment Procedure  | 207 |
| Calibration Error Messages                   | 212 |
| Component Locator Diagram                    | 215 |

This chapter contains procedures to verify that the power supply is operating normally and is within published specifications.



# Overview

The power supply must pass the complete self-test before calibration or any of the verification or performance tests can be performed. If the power supply fails any of the tests or if abnormal test results are obtained, refer to “[Troubleshooting Hints](#)” on page 175.

This chapter consists of three main sections:

### **Returning a failed power supply to Agilent for service or repair**

- [Operating Checklist](#)
- [Types of Service Available](#)
- [Repacking for Shipment](#)
- [Electrostatic Discharge \(ESD\) Precautions](#)
- [Surface Mount Repair](#)
- [Replacing the Power-Line Fuse](#)
- [Troubleshooting Hints](#)
- [Self-Test Procedures](#)
- [General Disassembly](#)

### **Verification and performance tests, and calibration procedures**

- [Recommended Test Equipment](#)
- [Test Considerations](#)
- [Operation Verification and Performance Tests](#)
- [Measurement Techniques](#)
- [Constant Voltage \(CV\) Verifications](#)
- [Constant Current \(CC\) Verifications](#)
- [Common Mode Current Noise](#)
- [Performance Test Record](#)
- [Calibration Reference](#)
- [General Calibration or Adjustment Procedure](#)
- [Calibration Record](#)
- [Calibration Error Messages](#)

### **Component drawings**

- [Component Locator Diagram](#)



## Operating Checklist

Before returning your power supply to Agilent for service or repair, check the following items:

### Is the power supply inoperative?

- ✓ Verify that the AC power cord is connected to the power supply.
- ✓ Verify that the front panel power switch has been pushed.
- ✓ Verify that the power-line fuse is installed and not open (refer to “[Converting line voltage](#)” on page 12).
- ✓ Verify the power-line voltage setting (refer to “[Connecting power to the power supply](#)” on page 9).

### Does the power supply fail the self-test?

- ✓ Verify that the correct power-line voltage is selected (refer to “[Connecting power to the power supply](#)” on page 9).
- ✓ Remove all load connections to the power supply.  
(*Ensure that all terminal connections are removed while the self-test is performed.*)

## Types of Service Available

If your power supply fails within three years of the original purchased date, Agilent will repair or replace it free of charge. If your unit fails after your three years warranty expires, Agilent will repair or replace it at a very competitive price. Agilent will make the decision locally whether to repair or replace your unit.

### **Standard repair service (worldwide)**

Contact your nearest Agilent Service Center. They will arrange to have your power supply repaired or replaced.

## Repacking for Shipment

If your unit is to be shipped to Agilent for service or repair, you need to:

- attach a tag to the power supply identifying the owner and indicating the required service or repair. Include the instrument model number and full serial number.
- place the power supply in its original container with appropriate packaging material.
- secure the container with a strong tape or metal bands.

If the original shipping container is not available, place your unit in a container which will ensure at least 4 inches of compressible packaging material around all sides of the unit. Use static-free packaging material to avoid additional damage to your unit.

**NOTE**

Agilent recommends that you always insure your shipments.

---

## Electrostatic Discharge (ESD) Precautions

Almost all electrical components can be damaged by electrostatic discharge (ESD) during handling. Component damage can occur at electrostatic discharge voltages as low as 50 V.

The following guidelines will help prevent ESD damage when servicing the power supply or any electronic device.

- Disassemble instruments only in a static-free work area.
- Use a conductive work area to dissipate static charge.
- Use a conductive wrist strap to dissipate static charge accumulation.
- Minimize handling.
- Keep replacement parts in original static-free packaging.
- Remove all plastic, styrofoam, vinyl, paper, and other static-generating material from the immediate work area.
- Use only anti-static solder suckers.

## Surface Mount Repair

Surface mount components should only be removed using soldering irons or desoldering stations expressly designed for surface mount components.

Use of conventional solder removal equipment will almost always result in permanent damage to the printed circuit board and will void your Agilent factory warranty.

## Replacing the Power-Line Fuse

The power-line fuse is located within the fuse-holder assembly on the rear panel of the power supply. Refer to [“Connecting power to the power supply”](#) on page 9 to check the rating of the power-line fuse and replace with the correct one for your power supply.

## Troubleshooting Hints

This section provides a brief checklist of common failures. Before troubleshooting or repairing the power supply, make sure that the failure is in the power supply rather than any external connections. Also make sure that the power supply is accurately calibrated. The circuits of the power supply allow troubleshooting and repair with basic equipment such as a 6½-digit multimeter.

### Unit reports errors 740 to 755

These errors may be produced if you accidentally turn off the power of the unit during a calibration or while changing a non-volatile state of the unit. Recalibration or resetting the state should clear the error. If the error persists, a hardware failure may have occurred.

### Unit fails self-test

Verify that the correct power-line voltage setting is selected. Also, ensure that all terminal connections are removed while the self-test is performed. Failure of the DAC U131<sup>[1]</sup> on the PC board will cause many self-test failures.

[1] For serial MY53xx6xxx, DAC U12 or U15 for E3640A/E3642A/E3644A, or U16 for E3641A/E3643A/E3645A.

## Bias supplies problems

Check that the input to the voltage regulators of the bias supplies is at least 1 V greater than their output. Circuit failures can cause heavy loads of the bias supplies which may pull down the regulator output voltages.

Check the voltages of the bias supplies as tabulated in [Table 8-1](#).

**Table 8-1** Bias supplies voltages

| Bias supply     | Minimum  | Maximum  | Check at         |
|-----------------|----------|----------|------------------|
| +5 V floating   | +4.75 V  | +5.25 V  | U110 pin 2       |
| -5.1 V floating | -4.75 V  | -5.25 V  | Anode of CR114   |
| +15 V floating  | +14.25 V | +15.75 V | Anode of CR104   |
| -15 V floating  | -14.25 V | -15.75 V | Cathode of CR105 |

**Table 8-2** Bias supplies voltages (serial MY53xx6xxx)

| Bias supply     | Minimum  | Maximum  | Check at         |
|-----------------|----------|----------|------------------|
| +3.3 V floating | +3.135 V | +3.465 V | U23 pin 3        |
| +15 V floating  | +14.25 V | +15.75 V | Anode of CR104   |
| -15 V floating  | -14.25 V | -15.75 V | Cathode of CR105 |

Some circuits produce their own local bias supplies from the main bias supplies. Check that these local bias supplies are active. In particular, the analog-to-digital converter (ADC), AC input, and front panel sections have local bias supplies. Always check that the power supplies are free of AC oscillations using an oscilloscope. Failure of bias supplies will cause many self-test failures.

## Self-Test Procedures

### Power-on self-test

Each time the power supply is powered on, a set of self-tests are performed. These tests check that the minimum set of logic and measurement hardware are functioning properly. Failures during the power-on self-test utilize error codes 601 through 604 and 624 through 632. For serial MY53xx6xxx, the power-on self-test utilizes the complete self-test, which covers from error codes 601 through 633.

### Complete self-test

Hold any front panel key except the **View** key for more than 5 seconds while turning on the power to perform a complete self-test. The power supply beeps when the test starts. The tests are performed in the order as shown in [Table 8-3](#). Refer to “[Self-Test Error Messages](#)” on page 131 for more information.

**Table 8-3** Self-test error messages

|     |                                      |
|-----|--------------------------------------|
| 601 | Front panel does not respond         |
| 602 | RAM read/write failed                |
| 603 | A/D sync stuck                       |
| 604 | A/D slope convergence failed         |
| 605 | Cannot calibrate rundown gain        |
| 606 | Rundown gain out of range            |
| 607 | Rundown too noisy                    |
| 608 | Serial configuration readback failed |

## 8 Service and Maintenance

### Self-Test Procedures

**Table 8-3** Self-test error messages (continued)

|                    |                                                                                                                                                                                               |
|--------------------|-----------------------------------------------------------------------------------------------------------------------------------------------------------------------------------------------|
| 609 <sup>[1]</sup> | This test checks if the ADC hardware is functional. The main controller U10 establishes communication with the ADC and checks if there are any error bits set for the ADC's status reporting. |
| 624                | Unable to sense line frequency                                                                                                                                                                |
| 625                | I/O processor did not respond                                                                                                                                                                 |
| 626                | I/O processor failed self-test                                                                                                                                                                |
| 630                | Fan test failed                                                                                                                                                                               |
| 631                | System DAC test failed                                                                                                                                                                        |
| 632                | Hardware test failed                                                                                                                                                                          |

[1] This error message is only applicable for serial MY53xx6xxx.



# General Disassembly

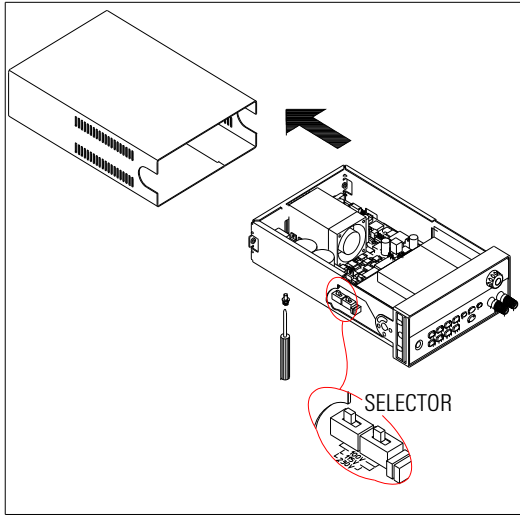
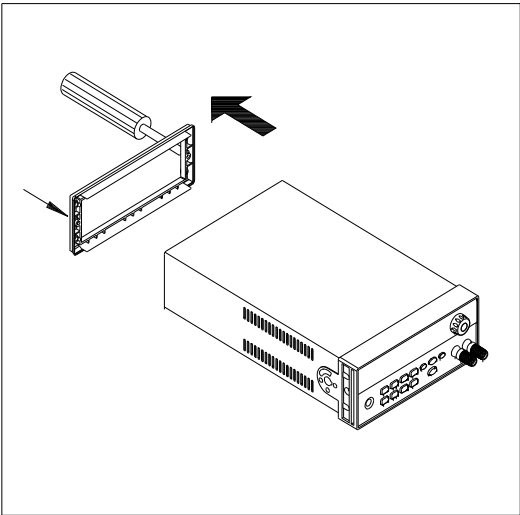
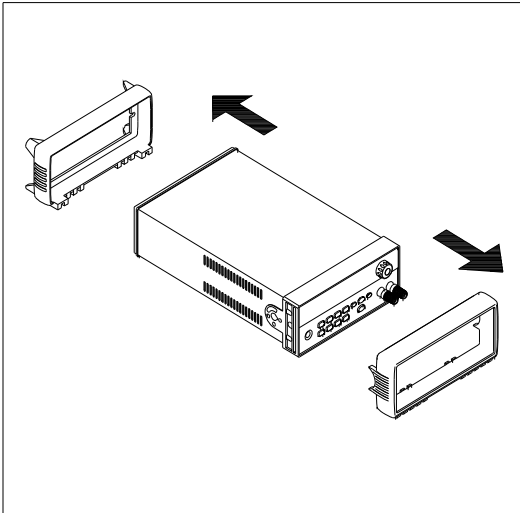
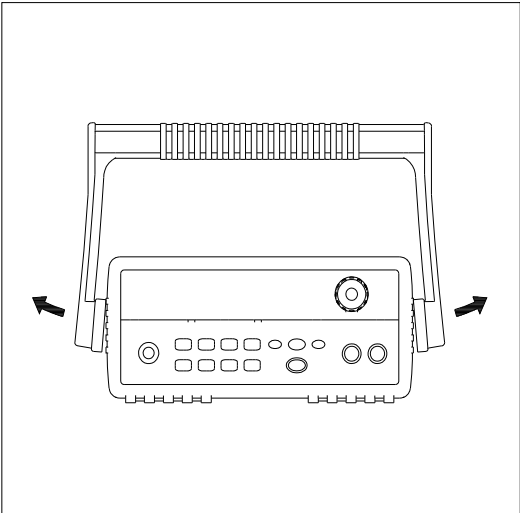

## Recommended Test Equipment

Table 8-4 describes the test equipment recommended for the performance verification and adjustment procedures. If the exact equipment is not available, use the accuracy requirements shown to select substitute calibration standards. If you use equipment other than the recommended equipment shown in Table 8-4, you must recalculate the measurement uncertainties for the actual equipment used.

**Table 8-4** Recommended test equipment

| Equipment                        | Requirement                                                                                                                                                            | Recommended model                                       | Test function                                                 |
|----------------------------------|------------------------------------------------------------------------------------------------------------------------------------------------------------------------|---------------------------------------------------------|---------------------------------------------------------------|
| GPIB controller                  | Full GPIB or RS-232 capabilities                                                                                                                                       | Agilent 82341C interface card or equivalent             | Programming and readback accuracy                             |
| Oscilloscope                     | 100 MHz with 20 MHz bandwidth                                                                                                                                          | Agilent 54602B                                          | Display transient response and ripple and noise waveform      |
| Rms voltmeter                    | 20 Hz to 20 MHz                                                                                                                                                        | —                                                       | Measure rms ripple and noise                                  |
| Cable (BNC-to-BNC)               | 50 $\Omega$ , 9 inch (23 cm)                                                                                                                                           | Agilent 10502A or 10503A if the 10502A is not available | Measure rms ripple and noise (CV PARD, CC PARD)               |
| BNC (female) bulkhead receptacle | <ul style="list-style-type: none"> <li> Isolated ground</li> <li> Nominal impedance: 50 <math>\Omega</math></li> </ul>                                                 | Pomona model 5148                                       | Measure rms ripple and noise (CV PARD, CC PARD)               |
| Split ferrites                   | For use with round cables                                                                                                                                              | Steward Co. 28A2029-0A0                                 | Noise coupling reduction                                      |
| Digital voltmeter                | <ul style="list-style-type: none"> <li> Resolution: 0.1 mV</li> <li> Accuracy: 0.01%</li> </ul>                                                                        | Agilent 34401A                                          | Measure DC voltages                                           |
| Electronic load                  | <ul style="list-style-type: none"> <li> Voltage range: 240 Vdc</li> <li> Current range: 10 Adc</li> <li> Open and short switches</li> <li> Transient on/off</li> </ul> | Agilent 60503B                                          | Measure load and line regulations and transient response time |

**Table 8-4** Recommended test equipment (continued)

| Equipment                                      | Requirement                                                                                                                                                                                                                                                                                                                                                                                                                                                                                                                                                                          | Recommended model                    | Test function                        |
|------------------------------------------------|--------------------------------------------------------------------------------------------------------------------------------------------------------------------------------------------------------------------------------------------------------------------------------------------------------------------------------------------------------------------------------------------------------------------------------------------------------------------------------------------------------------------------------------------------------------------------------------|--------------------------------------|--------------------------------------|
| Resistive loads ( $R_L$ )                      | <ul style="list-style-type: none"> <li>• For E3640A: 2.7 <math>\Omega</math> , 150 W/13.5 <math>\Omega</math> , 150 W</li> <li>• For E3641A: 43.8 <math>\Omega</math> , 300 W/120 <math>\Omega</math> , 300 W</li> <li>• For E3642A: 1.6 <math>\Omega</math> , 300 W/8.0 <math>\Omega</math> , 300 W</li> <li>• For E3643A: 25 <math>\Omega</math> , 300 W/75 <math>\Omega</math> , 300 W</li> <li>• For E3644A: 1.0 <math>\Omega</math> , 300 W/5.0 <math>\Omega</math> , 300 W</li> <li>• For E3645A: 15.9 <math>\Omega</math> , 300 W/46.2 <math>\Omega</math> , 300 W</li> </ul> | —                                    | Measure ripple and noise             |
| Current monitoring resistor (shunt) – $R_{M1}$ | 0.01 $\Omega$ , 0.1% <sup>[1]</sup>                                                                                                                                                                                                                                                                                                                                                                                                                                                                                                                                                  | ISOTEK Co. model A-H or equivalent   | Constant current test setup          |
| Current monitoring resistor (shunt) – $R_{M2}$ | 0.2 $\Omega$ /250 $\Omega$ , 0.1% <sup>[1]</sup>                                                                                                                                                                                                                                                                                                                                                                                                                                                                                                                                     | ISOTEK Co. model RUG-Z or equivalent | Measure current rms ripple and noise |

[1] To find the accurate resistance, it is recommended to use a current monitoring resistor after calibration.

## Test Considerations

To ensure proper operation of the power supply, verify that you have selected the correct power-line voltage prior to attempting any test procedure in this chapter (refer to “[Converting line voltage](#)” on page 12).

Ensure that all terminal connections (both front panel and rear panel) are removed while the internal self-test is being performed.

For optimum performance verification, all test procedures should comply with the following recommendations:

- The calibration ambient temperature is stable and between 20 °C and 30 °C.
- The ambient relative humidity is less than 80%.
- Allow a 1-hour warm-up period before verification or calibration.
- Use short cables to connect test setups.

### CAUTION

The tests should be performed by qualified personnel. Hazardous voltages may be present at the outputs of the power supply during testing.

---

# Operation Verification and Performance Tests

## Operation verification tests

To ensure that the power supply is operating properly, without testing all specified parameters, perform the following verification tests:

- Perform the power-on self-test and follow the procedures for “[Checking the output](#)” on page 10. (Refer to “[Self-test](#)” on page 50 for more information.)
- Perform the “[Voltage programming and readback accuracy](#)” and “[Current programming and readback accuracy](#)” tests.

## Performance tests

The following sections provide the test procedures for verifying the power supply’s compliance with the specifications listed in “[Electrical Specifications](#)” on page 164. All of the performance test specifications and calculated measurement uncertainties are entered in the appropriate performance test record card for your specific model. You can record the actual measured values in the column provided in this card.

If you use equipment other than that recommended in [Table 8-4](#), you must recalculate the measurement uncertainties for the actual equipment used.

## Measurement Techniques

### Common test setup

Most tests are performed at the front terminals as shown in [Figure 8-1](#). Measure the DC voltage directly at the (+) and (-) terminals on the front panel.

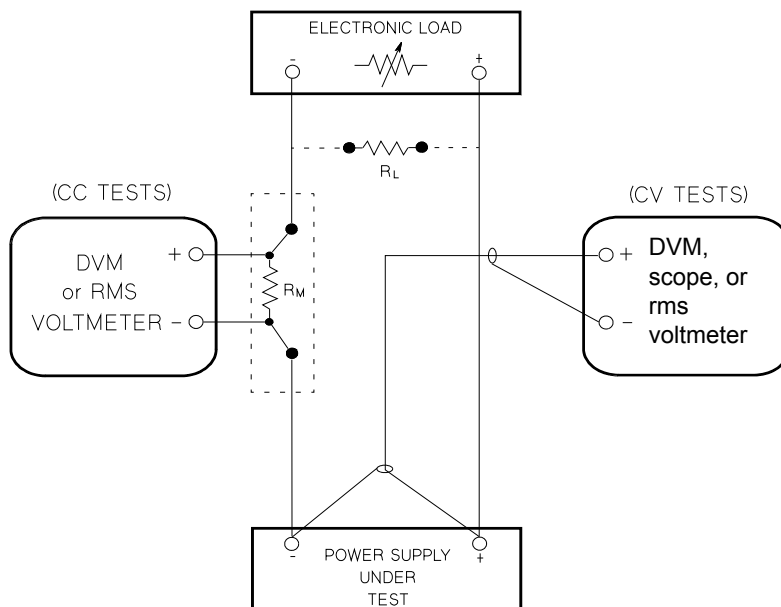

**Figure 8-1** Performance verification test setup

## Current-monitoring resistor

To eliminate the output current measurement error caused by the voltage drops in the leads and connections, connect the current-monitoring resistor between the (-) output terminal and the load as a four-terminal device. Connect the current-monitoring leads inside the load-lead connections directly at the monitoring points on the resistor element (refer to  $R_M$  in Figure 8-1).

## General measurement techniques

To achieve best results when measuring load regulation, peak-to-peak voltage, and transient response time of the power supply, measuring devices must be connected through the hole in the neck of the binding post at (A) while the load resistor is plugged into the front of the output terminals at (B). A measurement made across the load includes the impedance of the leads to the load. The impedance of the load leads can easily be several orders of the magnitude greater than the power supply impedance and thus invalidate the measurement. To avoid mutual coupling effects, each measuring device must be connected directly to the output terminals by separate pairs of leads.

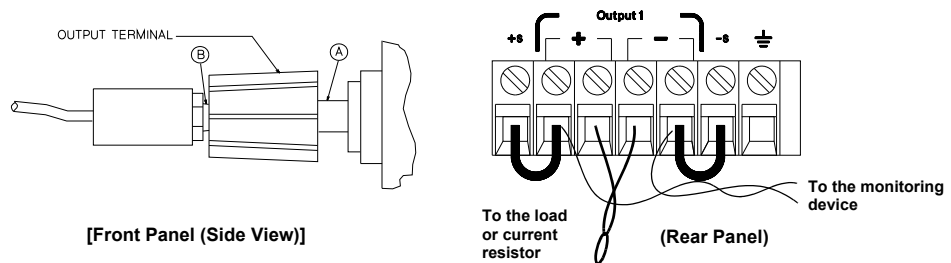

Figure 8-2 Front/rear panel terminal connections

## Electronic load

Many of the test procedures require the use of a variable load resistor capable of dissipating the required power. Using a variable load resistor requires that switches should be used to connect, disconnect, and short the load resistor. An electronic load, if available, can be used in place of a variable load resistor and switches. The electronic load is considerably easier to use than load resistors. It eliminates the need for connecting resistors or rheostats in parallel to handle power. It is much more stable than carbon-pile load, and it makes easy work of switching between load conditions as is required for the load regulation and load response tests. Substitution of the electronic load requires minor changes to the test procedures in this chapter.

## Programming

Most performance tests can be performed from the front panel. However, a GPIB or RS-232 controller is required to perform the voltage and current programming and readback accuracy tests.

The test procedures are written assuming that you know how to program the power supply either from the front panel or from the GPIB or RS-232 controller. Refer to [Chapter 3](#), “Output Settings and Operation Commands” for detailed instructions on remote programming.



## Constant Voltage (CV) Verifications

### Constant voltage test setup

If more than one meter or if a meter and an oscilloscope are used, connect each to the (+) and (–) terminals by a separate pair of leads to avoid mutual coupling effects. Use a coaxial cable or a shielded 2-wire cable to avoid noise pick-up on the test leads.

**Table 8-5** Verification programming values

| Model  | Low voltage range | High voltage range |
|--------|-------------------|--------------------|
| E3640A | 8 V/3 A           | 20 V/1.5 A         |
| E3641A | 35 V/0.8 A        | 60 V/0.5 A         |
| E3642A | 8 V/5 A           | 20 V/2.5 A         |
| E3643A | 35 V/1.4 A        | 60 V/0.8 A         |
| E3644A | 8 V/8 A           | 20 V/4 A           |
| E3645A | 35 V/2.2 A        | 60 V/1.3 A         |

### Voltage programming and readback accuracy

This test verifies that the voltage programming and GPIB or RS-232 readback functions are within specifications.

#### NOTE

- The readback values over the remote interface should be identical to those displayed on the front panel.
- You should program the power supply over the remote interface for this test to avoid round off errors.

**1** Turn off the power supply and connect a digital voltmeter between the (+) and (-) terminals of the output to be tested as shown in [Figure 8-1](#).

**2** Turn on the power supply. Select the high voltage range (20 V/1.5 A)<sup>[1]</sup> and enable the output by sending the following commands:

```
VOLT:RANG P20V (E3640A model)
OUTP ON
```

**3** Program the output voltage to 0 V and current to the full-scale rated value (1.5 A)<sup>[1]</sup> by sending the following commands:

```
VOLT 0
CURR 1.5 (E3640A model)
```

**4** Record the output voltage reading on the digital voltmeter (DVM). The reading should be within the limit of  $0\text{ V} \pm 10\text{ mV}$ . Also, note that the **CV**, **Adrs**, **Limit**, and **Rmt** annunciators are turned on.

**5** Read back the output voltage over the remote interface by sending the MEAS:VOLT? command.

**6** Record the value displayed on the controller. This value should be within the limit of DVM  $\pm 5\text{ mV}$ .

**7** Program the output voltage to the full-scale rated value (20 V)<sup>[1]</sup> by sending the following command:

```
VOLT 20.0 (E3640A model)
```

**8** Record the output voltage reading on the digital voltmeter (DVM). The reading should be within the limit of  $20\text{ V} \pm 20\text{ mV}$ <sup>[2]</sup> or  $60\text{ V} \pm 40\text{ mV}$ <sup>[3]</sup>.

**9** Read back the output voltage over the remote interface by sending the MEAS:VOLT? command.

**10** Record the value displayed on the controller. This value should be within the limit of DVM  $\pm 15\text{ mV}$ <sup>[2]</sup> or DVM  $\pm 35\text{ mV}$ <sup>[3]</sup>.

[1] For the E3640A model. For other models, refer to [Table 8-5](#).

[2] For the E3640A/E3642A/E3644A model.

[3] For the E3641A/E3643A/E3645A model.

## CV load effect (load regulation)

This test measures the immediate change in the output voltage resulting from a change in the output current from full to no load.

- 1 Turn off the power supply and connect a digital voltmeter between the (+) and (-) terminals of the output as shown in [Figure 8-1](#).
- 2 Turn on the power supply. Select the high voltage range (20 V/1.5 A)<sup>[1]</sup>, enable the output, and set the display to the limit mode. When the display is in the limit mode, program the output current to the maximum programmable value and the voltage to the full-scale rated value (20.0 V)<sup>[1]</sup>.
- 3 Operate the electronic load in the constant current mode and set its current to 1.5 A<sup>[1]</sup>. Check that the front panel **CV** annunciator remains lit. If not lit, adjust the load so that the output current drops slightly until the **CV** annunciator lights up. Record the output voltage reading on the digital voltmeter.
- 4 Operate the electronic load in the open mode (input off). Record the output voltage reading on the digital voltmeter immediately. The difference between the digital voltmeter readings in steps 3 and 4 is the CV load regulation. The difference of the readings during the immediate change should be within the limit of 5 mV<sup>[2]</sup> or 9 mV<sup>[3]</sup>.

[1] For the E3640A model. For other models, refer to [Table 8-5](#).

[2] For the E3640A/E3642A/E3644A model.

[3] For the E3641A/E3643A/E3645A model.

## CV source effect (line regulation)

This test measures the immediate change in the output voltage that results from a change in the AC line voltage from the minimum value (10% below the nominal input voltage) to the maximum value (10% above the nominal input voltage).

- 1 Turn off the power supply and connect a digital voltmeter between the (+) and (-) terminals of the output to be tested as shown in [Figure 8-1](#).
- 2 Connect the AC power line through a variable voltage transformer.
- 3 Turn on the power supply. Select the high voltage range (20 V/1.5 A)<sup>[1]</sup>, enable the output, and set the display to the limit mode. When the display is in the limit mode, program the current to the maximum programmable value and the voltage to the full-scale rated value (20.0 V)<sup>[1]</sup>.
- 4 Operate the electronic load in the constant current mode and set its current to 1.5 A<sup>[1]</sup>. Check that the **CV** annunciator remains lit. If not lit, adjust the load so that the output current drops slightly until the **CV** annunciator lights up.
- 5 Adjust the transformer to the low line voltage limit (104 Vac for nominal 115 Vac, 90 Vac for nominal 100 Vac, or 207 Vac for nominal 230 Vac). Record the output reading on the digital voltmeter.
- 6 Adjust the transformer to the high line voltage (127 Vac for nominal 115 Vac, 110 Vac for nominal 100 Vac, or 253 Vac for nominal 230 Vac). Record the voltage reading on the digital voltmeter immediately. The difference between the digital voltmeter readings in steps 5 and 6 is the CV line regulation. The difference of the readings during the immediate change should be within the limit of 5 mV<sup>[2]</sup> or 9 mV<sup>[3]</sup>.

[1] For the E3640A model. For other models, refer to [Table 8-5](#).

[2] For the E3640A/E3642A/E3644A model.

[3] For the E3641A/E3643A/E3645A model.

## CV PARD (ripple and noise)

Periodic and random deviations (PARD) in the output (ripple and noise) combine to produce a residual AC voltage superimposed on the DC output voltage. CV PARD is specified as the rms or peak-to-peak output voltage in the frequency range from 20 Hz to 20 MHz.

### Vrms measurement techniques

When measuring Vrms ripple and noise, the monitoring device should be plugged into the front of the terminals at (A) in Figure 8-2. Use the vertical mini-probe socket and the 1:1 voltage probe to connect the monitor device to the power supply. To reduce the measurement error caused by common mode noise, it is recommended to twist the connection wire between the mini-probe and the output terminals. The load resistor is connected to the terminal at (B) in Figure 8-2. Twisted leads between the load resistor and the power supply help reduce noise pick-up for these measurements.

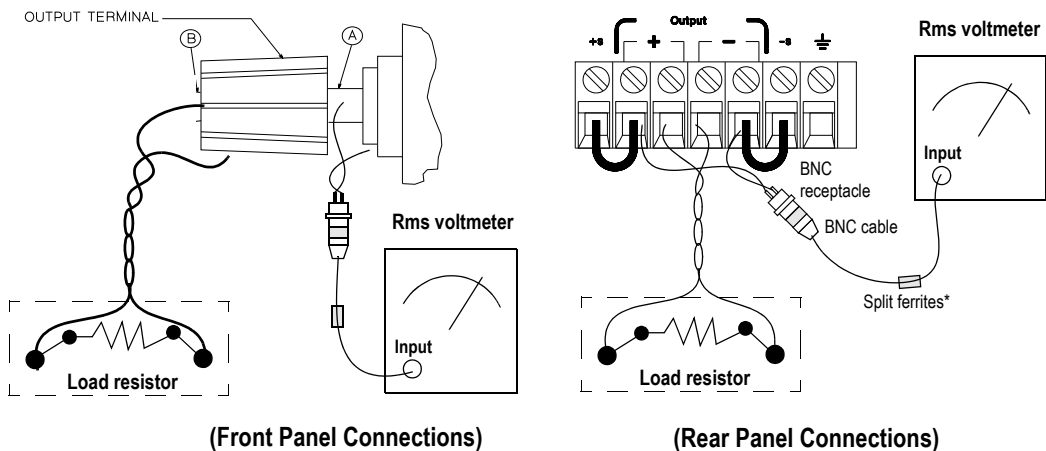

**Figure 8-3** Front/rear panel terminal connections for the Vrms measurement

#### NOTE

For better measurement results, it is recommended to make the connection between the BNC receptacle and the output terminals as short as possible, and to use the recommended split ferrites with the BNC-to-BNC cable as shown in [Figure 8-3](#).

- 1 Turn off the power supply and connect the output to be tested as shown in [Figure 8-1](#) to an oscilloscope (AC-coupled) between the (+) and (-) terminals. Set the oscilloscope to the AC mode and bandwidth limit of 20 MHz. Connect a resistive load ( $13.5\ \Omega$ )<sup>[1]</sup> to the terminal at (B) as shown in [Figure 8-3](#).
- 2 Turn on the power supply. Select the high voltage range (20 V/1.5 A)<sup>[2]</sup>, enable the output, and set the display to the limit mode. When the display is in the limit mode, program the current to the full-scale rated value (1.5 A)<sup>[2]</sup> and the voltage to the full-scale rated value (20.0 V)<sup>[2]</sup>.
- 3 Check that the front panel **CV** annunciator remains lit. If it is not lit, adjust the load down slightly.
- 4 Note that the waveform on the oscilloscope does not exceed the peak-to-peak limit of 5 mV<sup>[3]</sup> or 8 mV<sup>[4]</sup>.
- 5 Disconnect the oscilloscope and connect the AC rms voltmeter in its place according to the Vrms measurement techniques above and as shown in [Figure 8-3](#). The rms voltage reading does not exceed the rms limit of 0.5 mV<sup>[3]</sup> or 1 mV<sup>[4]</sup>.

[1] For the E3640A model. For other models, refer to [Table 8-4](#).

[2] For the E3640A model. For other models, refer to [Table 8-5](#).

[3] For the E3640A/E3642A/E3644A model.

[4] For the E3641A/E3643A/E3645A model.

## Load transient response time

This test measures the time for the output voltage to recover to within 15 mV of the nominal output voltage following a load change from full load to half load, or half load to full load.

- 1 Turn off the power supply and connect the output to be tested as shown in [Table 8-1](#) with an oscilloscope. Operate the electronic load in the constant current mode.
- 2 Turn on the power supply. Select the high voltage range (20 V/1.5 A)<sup>[1]</sup>, enable the output, and set the display to the limit mode. When the display is in the limit mode, program the current to the full-scale rated value (1.5 A)<sup>[1]</sup> and the voltage to the full-scale rated value (20.0 V)<sup>[1]</sup>.
- 3 Set the electronic load to the transient operation mode between one half of the output's full-scale rated value and the output's full-scale rated value at a 1 kHz rate with 50% duty cycle.
- 4 Set the oscilloscope for AC coupling, internal sync, and lock on either the positive or negative load transient.
- 5 Adjust the oscilloscope to display transients as shown in [Figure 8-4](#). Note that the pulse width ( $t_2 - t_1$ ) of the transients at 15 mV from the base line is no more than 50  $\mu$ sec for the output.

[1] For the E3640A model. For other models, refer to [Table 8-5](#).

## 8 Service and Maintenance

### Constant Voltage (CV) Verifications

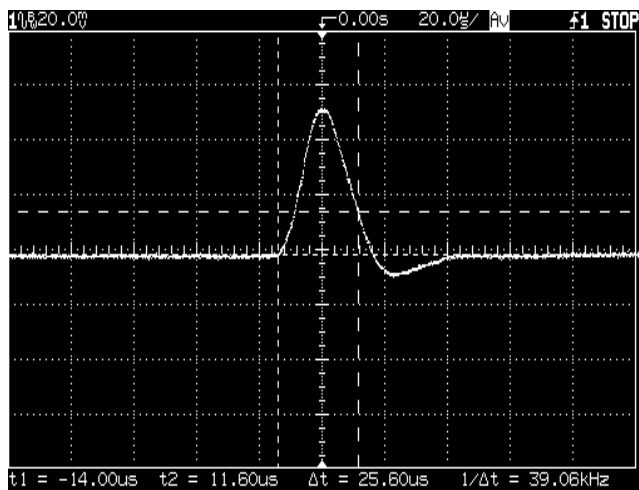

**Figure 8-4** Transient response time



## Constant Current (CC) Verifications

### Constant current test setup

Follow the general setup instructions in the “[General measurement techniques](#)” on page 185. Specific instructions will be given in the following sections.

### Current programming and readback accuracy

This test verifies that the current programming and GPIB or RS-232 readback functions are within specifications.

#### NOTE

- The readback values over the remote interface should be identical to those displayed on the front panel. The accuracy of the current monitoring resistor must be 0.01% or better.
- You should program the power supply over the remote interface for this test to avoid round off errors.

- 1 Turn off the power supply and connect a 0.01  $\Omega$  current monitoring resistor ( $R_{M1}$ ) across the output to be tested and a digital voltmeter (DVM) across the current monitoring resistor ( $R_{M1}$ ) as shown in [Figure 8-1](#).
- 2 Turn on the power supply. Select the low voltage range (8 V/3 A)<sup>[1]</sup> and enable the output by sending the following commands:

```
VOLT:RANG P8V (E3640A model)
OUTP ON
```

[1] For the E3640A model. For other models, refer to [Table 8-5](#).

- 3 Program the output voltage to the full-scale rated voltage (8.0 V)<sup>[1]</sup> and the output current to 0 A by sending the following commands:

```
VOLT 8 (E3640A model)
CURR 0
```

- 4 Divide the voltage drop (DVM reading) across the current monitoring resistor ( $R_M$ ) by its resistance to convert to amperes and record this value ( $I_O$ ). This value should be within the limit of 0 A  $\pm$  10 mA. Also, note that the **CC**, **Adrs**, **Limit**, and **Rmt** annunciators are turned on.
- 5 Read back the output current over the remote interface by sending the MEAS:CURR? command.
- 6 Record the value displayed on the controller. This value should be within the limit of  $I_O \pm 5$  mA.
- 7 Program the output current to the full-scale rated value (3 A)<sup>[1]</sup> by sending the following command:

```
CURR 3.0 (E3640A model)
```

- 8 Divide the voltage drop (DVM reading) across the current monitoring resistor ( $R_M$ ) by its resistance to convert to amperes and record this value ( $I_O$ ). This value should be within the following limits:

| E3640A          | E3641A              | E3642A          | E3643A              | E3644A          | E3645A              |
|-----------------|---------------------|-----------------|---------------------|-----------------|---------------------|
| 3 A $\pm$ 16 mA | 0.8 A $\pm$ 11.6 mA | 5 A $\pm$ 20 mA | 1.4 A $\pm$ 12.8 mA | 8 A $\pm$ 26 mA | 2.2 A $\pm$ 14.4 mA |

- 9 Read back the output current over the remote interface by sending the MEAS:CURR? command.
- 10 Record the value displayed on the controller. This value should be within the following limits:

| E3640A           | E3641A           | E3642A            | E3643A           | E3644A          | E3645A           |
|------------------|------------------|-------------------|------------------|-----------------|------------------|
| $I_O \pm 9.5$ mA | $I_O \pm 6.2$ mA | $I_O \pm 12.5$ mA | $I_O \pm 7.1$ mA | $I_O \pm 17$ mA | $I_O \pm 8.3$ mA |

[1] For the E3640A model. For other models, refer to Table 8-5.

## CC load effect (load regulation)

This test measures the immediate change in output current resulting from a change in the load from the full rated output voltage to short circuit.

- 1** Turn off the power supply and connect the output to be tested as shown in [Figure 8-1](#) with the digital voltmeter connected across the 0.01  $\Omega$  current monitoring resistor ( $R_{M1}$ ).
- 2** Turn on the power supply. Select the low voltage range (8 V/3 A)<sup>[1]</sup>, enable the output, and set the display to the limit mode. When the display is in the limit mode, program the output voltage to the maximum programmable value and the output current to the full-scale rated value (3 A)<sup>[1]</sup>.
- 3** Set the voltage of the electronic load to 8.0 V to operate it in the constant voltage mode since a voltage drop occurs on the load wires. Check that the **CC** annunciator is turned on. If it is not, adjust the load so that the output voltage drops slightly. Record the current reading by dividing the voltage reading on the digital voltmeter by the resistance of the current monitoring resistor.
- 4** Operate the electronic load in the short (input short) mode. Record the current reading immediately by dividing the voltage reading on the digital voltmeter by the resistance of the current monitoring resistor. The difference between the current readings in [step 3](#) and [step 4](#) is the load regulation current. The difference of the readings during the immediate change should be within the following limits:

| E3640A  | E3641A  | E3642A  | E3643A  | E3644A  | E3645A  |
|---------|---------|---------|---------|---------|---------|
| 0.55 mA | 0.33 mA | 0.75 mA | 0.39 mA | 1.05 mA | 0.47 mA |

[1] For the E3640A model. For other models, refer to [Table 8-5](#).

## CC source effect (line regulation)

This test measures the immediate change in output current that results from a change in AC line voltage from the minimum value (10% below the nominal input voltage) to the maximum value (10% above the nominal voltage).

- 1 Turn off the power supply and connect the output to be tested as shown in [Figure 8-1](#) with the digital voltmeter connected across the current monitoring resistor ( $R_{M1}$ ).
- 2 Connect the AC power line through a variable voltage transformer.
- 3 Turn on the power supply. Select the low voltage range (8 V/3 A)<sup>[1]</sup>, enable the output, and set the display to the limit mode. When the display is in the limit mode, program the voltage to the maximum programmable value and the current to the full-scale rated value (3 A)<sup>[1]</sup>.
- 4 Operate the electronic load in the constant voltage mode and set its voltage to 8.0 V<sup>[1]</sup>. Check that the **CC** annunciator remains lit. If not lit, adjust the load so that the output voltage drops slightly until the **CC** annunciator lights up.
- 5 Adjust the transformer to the low line voltage limit (104 Vac for nominal 115 Vac, 90 Vac for nominal 100 Vac, or 207 Vac for nominal 230 Vac). Record the output current reading by dividing the voltage reading on the digital voltmeter by the resistance of the current monitoring resistor.
- 6 Adjust the transformer to 10% above the nominal line voltage (127 Vac for a 115 Vac nominal input, 110 Vac for a 100 Vac nominal input, or 253 Vac for a 230 Vac nominal input). Record the current reading immediately by dividing the voltage reading on the digital voltmeter by the resistance of the current monitoring resistor. The difference between the current readings in [step 5](#) and [step 6](#) is the load regulation current. The difference of the readings during the immediate change should be within the following limits:

[1] For the E3640A model. For other models, refer to [Table 8-5](#).

| E3640A  | E3641A  | E3642A  | E3643A  | E3644A  | E3645A  |
|---------|---------|---------|---------|---------|---------|
| 0.55 mA | 0.33 mA | 0.75 mA | 0.39 mA | 1.05 mA | 0.47 mA |

## CC PARD (ripple and noise)

Periodic and random deviations (PARD) in the output (ripple and noise) combine to produce a residual AC current, as well as an AC voltage superimposed on the DC output. CC PARD is specified as the rms output current in a frequency range of 20 Hz to 20 MHz with the power supply in the constant current operation.

### NOTE

For better measurement results, it is recommended to make the connection between the BNC receptacle and the output terminals as short as possible, and to use the recommended split ferrites with the BNC-to-BNC cable as shown in [Figure 8-5](#).

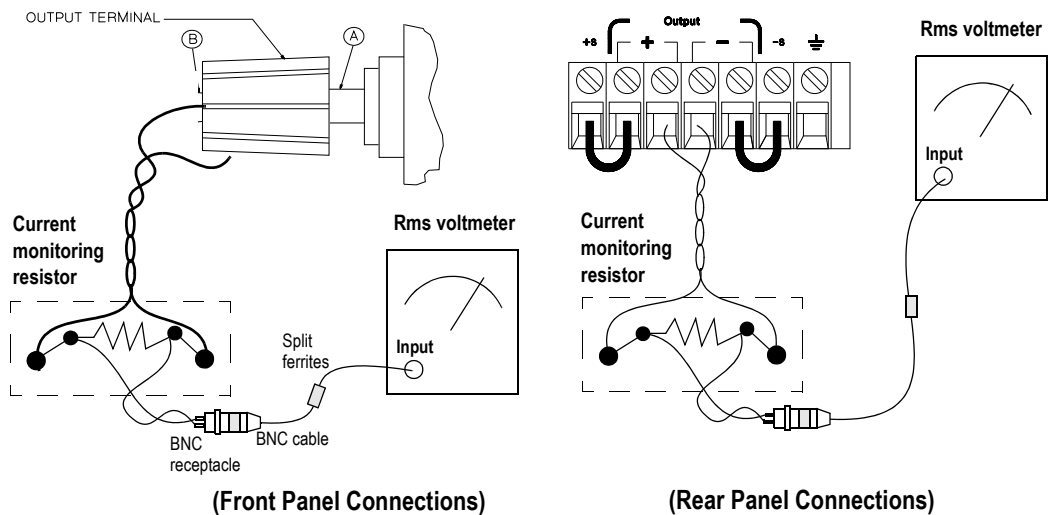

**Figure 8-5** CC PARD (ripple and noise) connections

- 1** Turn off the power supply and connect the output to be tested as shown in [Figure 8-5](#) with the current monitoring resistor  $0.2\ \Omega$  ( $R_{M2}$ ) across output terminals. Connect an rms voltmeter across the current monitoring resistor as shown in [Figure 8-5](#).
- 2** Turn on the power supply. Select the low voltage range (8 V/3 A)<sup>[1]</sup>, enable the output, and set the display to the limit mode. When the display is in the limit mode, program the current to the full-scale rated value (3 A)<sup>[1]</sup> and the voltage to the full-scale rated value (8.0 V)<sup>[1]</sup>.
- 3** Divide the reading on the rms voltmeter by the load resistance to obtain the rms current. The readings should be within the limit of 4 mA.

[1] For the E3640A model. For other models, refer to [Table 8-5](#).

## Common Mode Current Noise

The common mode current is the AC current component which exists between the output or output lines and chassis ground. Common mode noise can be a problem for very sensitive circuitry that is referenced to earth ground. When a circuit is referenced to earth ground, a low level line-related AC current will flow from the output terminals to earth ground. Any impedance to earth ground will create a voltage drop equal to the output current flow multiplied by the impedance.

- 1 Turn off the power supply and connect a 100 k $\Omega$  resistor ( $R_S$ ) and a 2200 pF capacitor in parallel between the (-) terminal and chassis ground at the rear output terminals.
- 2 Connect a digital voltmeter (DVM) across  $R_S$ .
- 3 Turn on the power supply. Select the low voltage range (8 V/3 A)<sup>[1]</sup>, enable the output, and set the display to the limit mode. When the display is in the limit mode, program the output to the full-scale rated value (8.0 V and 3 A)<sup>[1]</sup>.
- 4 Record the voltage across  $R_S$  and convert it to current by dividing by the resistance (DVM reading/100 k $\Omega$ ). Note that the current is less than 1.5  $\mu$ A.

[1] For the E3640A model. For other models, refer to [Table 8-5](#).

## Performance Test Record

**Table 8-6** CV performance test record

| Test description                                    | Model                | Actual result | Specification         |               |
|-----------------------------------------------------|----------------------|---------------|-----------------------|---------------|
|                                                     |                      |               | Upper limit           | Lower limit   |
| CV programming accuracy at 0 V (DVM reading)        | all                  |               | +0.0100 V             | -0.0100 V     |
| CV readback accuracy at 0 V                         | all                  |               | DVM +0.0050 V         | DVM -0.0050 V |
| CV programming accuracy at Full Scale (DVM reading) | E3640A/E3642A/E3644A |               | +20.0200 V            | +19.9800 V    |
|                                                     | E3641A/E3643A/E3645A |               | +60.0400 V            | +59.9600 V    |
| CV readback accuracy at Full Scale                  | E3640A/E3642A/E3644A |               | DVM +0.0150 V         | DVM -0.0150 V |
|                                                     | E3641A/E3643A/E3645A |               | DVM +0.0350 V         | DVM -0.0350 V |
| CV load effect (load regulation)                    | E3640A/E3642A/E3644A |               | Maximum change: <5 mV |               |
|                                                     | E3641A/E3643A/E3645A |               | Maximum change: <9 mV |               |
| CV source effect (line regulation)                  | E3640A/E3642A/E3644A |               | Maximum change: <5 mV |               |
|                                                     | E3641A/E3643A/E3645A |               | Maximum change: <9 mV |               |
| CV PARD (normal mode)                               | E3640A/E3642A/E3644A |               | <5 mVpp / 0.5 mVrms   |               |
|                                                     | E3641A/E3643A/E3645A |               | <8 mVpp / 1 mVrms     |               |
| Load transient response time                        | all                  |               | <50 $\mu$ s           |               |



**Table 8-7** CC performance test record

| Test description                                | Model  | Actual result | Specification            |                  |
|-------------------------------------------------|--------|---------------|--------------------------|------------------|
|                                                 |        |               | Upper limit              | Lower limit      |
| CC programming accuracy at 0 A ( $I_0$ )        | all    |               | +0.0100 A                | -0.0100 A        |
| CC readback accuracy at 0 A                     | all    |               | $I_0 + 0.0050$ A         | $I_0 - 0.0050$ A |
| CC programming accuracy at Full Scale ( $I_0$ ) | E3640A |               | 3.01600 A                | 2.9840 A         |
|                                                 | E3641A |               | 0.8116 A                 | 0.7884 A         |
|                                                 | E3642A |               | 5.02 A                   | 4.98 A           |
|                                                 | E3643A |               | 1.4128 A                 | 1.3872 A         |
|                                                 | E3644A |               | 8.026 A                  | 7.974 A          |
|                                                 | E3645A |               | 2.2144 A                 | 2.1856 A         |
| CC readback accuracy at Full Scale              | E3640A |               | $I_0 + 0.0095$ A         | $I_0 - 0.0095$ A |
|                                                 | E3641A |               | $I_0 + 0.0062$ A         | $I_0 - 0.0062$ A |
|                                                 | E3642A |               | $I_0 + 0.0125$ A         | $I_0 - 0.0125$ A |
|                                                 | E3643A |               | $I_0 + 0.0071$ A         | $I_0 - 0.0071$ A |
|                                                 | E3644A |               | $I_0 + 0.0170$ A         | $I_0 - 0.0170$ A |
|                                                 | E3645A |               | $I_0 + 0.0083$ A         | $I_0 - 0.0083$ A |
| CC load effect (load regulation)                | E3640A |               | Maximum change: <0.55 mA |                  |
|                                                 | E3641A |               | Maximum change: <0.33 mA |                  |
|                                                 | E3642A |               | Maximum change: <0.75 mA |                  |
|                                                 | E3643A |               | Maximum change: <0.39 mA |                  |
|                                                 | E3644A |               | Maximum change: <1.05 mA |                  |
|                                                 | E3645A |               | Maximum change: <0.47 mA |                  |

## 8 Service and Maintenance

### Performance Test Record

**Table 8-7** CC performance test record (continued)

| Test description                   | Model  | Actual result | Specification            |             |
|------------------------------------|--------|---------------|--------------------------|-------------|
|                                    |        |               | Upper limit              | Lower limit |
| CC source effect (line regulation) | E3640A |               | Maximum change: <0.55 mA |             |
|                                    | E3641A |               | Maximum change: <0.33 mA |             |
|                                    | E3642A |               | Maximum change: <0.75 mA |             |
|                                    | E3643A |               | Maximum change: <0.39 mA |             |
|                                    | E3644A |               | Maximum change: <1.05 mA |             |
|                                    | E3645A |               | Maximum change: <0.47 mA |             |
| CC PARD (Normal mode)              | all    |               | <4 mA rms                |             |
| CC PARD (Common mode)              | all    |               | <1.5 $\mu$ A rms         |             |

## Calibration Reference

Before you calibrate the power supply, you must unsecure it by entering the correct security code. Refer to “[Calibration](#)” on page 58 for more detailed procedures to unsecure or secure the power supply.

### Agilent calibration services

When your power supply is due for calibration, contact your local Agilent Service Center for a low-cost calibration. The Agilent E3640A, E3641A, E3642A, E3643A, E3644A, and E3645A power supplies are supported on calibration processes which allow Agilent to provide this service at competitive prices.

### Calibration interval

Recommended calibration interval for this power supply is 1 year. This will ensure that your power supply remains within specification for the next calibration interval. Agilent does not recommend extending calibration intervals beyond 1 year for any application. This criterion for re-adjustment provides the best long-term stability.

## To unsecure the power supply without the security code

To unsecure the power supply without the correct security code (when you forget the security code), follow the steps below. Refer to [“Electrostatic Discharge \(ESD\) Precautions”](#) on page 174 before beginning this procedure.

- 1 Disconnect the power cord and all load connections from the power supply.
- 2 Remove the instrument cover. Refer to the disassembly drawing in [“General Disassembly”](#) on page 179.
- 3 Connect the power cord and turn on the calibration mode by holding down the **Calibrate** key as you turn on the power supply and hold down the key until you hear a long beep. Be careful not to touch the power line connections.
- 4 Apply a short between the two exposed metal pads on JP107<sup>[1]</sup> (located near U121). Refer to [“Component locator diagram for the main board assembly – top”](#) on page 215 and [“Component locator diagram for the main board assembly – bottom”](#) on page 216.
- 5 While maintaining the short, move to the security code and enter any unsecure code in the calibration mode. The power supply is now unsecured.
- 6 Remove the short at JP107<sup>[1]</sup>. (An error occurs if not removed.)
- 7 Turn off and reassemble the power supply.

### NOTE

Now you can enter a new security code. Ensure that you take note of the new security code.

[1] For serial MY53xx6xxx, apply the short at JP12 (located near U10). Refer to [“Component locator diagram for the main board assembly — top \(serial MY53xx6xxx\)”](#) on page 218 and [“Component locator diagram for the main board assembly — bottom \(serial MY53xx6xxx\)”](#) on page 219.

## General Calibration or Adjustment Procedure

### NOTE

The power supply should be calibrated after a 1-hour warm-up with no load connected. Perform the voltage calibration prior to the OVP calibration.

The front panel calibration procedures are described in this section.

- For voltage calibration, disconnect all loads from the power supply and connect a digital voltmeter (DVM) across the output terminals.
- For current calibration, also disconnect all loads from the power supply, connect an appropriate current monitoring resistor  $0.01\ \Omega$  across the output terminals, and connect a DVM across the terminals of the monitoring resistor.
- You can abort a calibration at any time by turning the power supply off from the front panel, by issuing a remote interface device clear message, or by pressing the front panel **Local** key.

Table 8-8 shows the calibration parameters and points which should be used to calibrate the output voltage and current.

**Table 8-8** Parameters for calibration

| Calibration parameter | Voltage/Current | Calibration point mnemonic |
|-----------------------|-----------------|----------------------------|
| VOLT CAL              | Voltage         | V LO                       |
|                       |                 | V MI                       |
|                       |                 | V HI                       |
| OVP CAL               | OVP             | None                       |
| CURR CAL              | Current         | I LO                       |
|                       |                 | I MI                       |
|                       |                 | I HI                       |

## Front panel voltage and current calibration

### NOTE

Before attempting to calibrate the power supply, you must unsecure the power supply, and disconnect all loads from the power supply and connect a DVM across the output terminals. Refer to “Calibration” on page 58 to unsecure.

In the following procedure, the E3640A is referenced to describe the calibration procedure as an example, so a different calibration value for each calibration point may be prompted to be adjusted for your specific model.

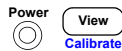

- 1 Turn on the calibration mode.

### CAL MODE

Turn on the calibration mode by holding down the  (**Calibrate**) key as you turn on the power supply and hold down the key until you hear a long beep. Make sure that the power supply is in the **CV** mode. If the power supply is not in the **CV** mode, an error occurs.

### Voltage and OVP calibration



- 2 Move down a level to the voltage calibration mode.

### VOLTAGE CAL



- 3 Select the low-end voltage calibration point.

### V LO 0.5000



- 4 Enter the reading you obtained from the DVM by using the knob and resolution selection keys.

### V LO 0.4500



- 5 Save the changes and select the middle voltage calibration point.

### V MI 10.000

If the entered number is within an acceptable range, an **ENTERED** message appears for a second. If the entered number is not correct, an error message will be displayed for a second and you will hear a beep, and then return to the low, middle, or high voltage calibration point again.



- 6 Enter the reading you obtained from the DVM by using the knob and resolution selection keys.

**V MI 11.058**



- 7 Save the changes and select the high voltage calibration point.

**V HI 19.500**



- 8 Enter the reading you obtained from the DVM by using the knob and resolution selection keys.

**V HI 19.495**



- 9 Save the changes and go to the OVP calibration mode.

**OVP CAL**

If the calibration fails, an error message will be displayed for a second and return to the voltage calibration mode again. A **VOLTAGE CAL** message is displayed. The message above is displayed to indicate that the power supply is ready for the OVP calibration.



- 10 Run the OVP calibration.

**CALibrating**

The above message is displayed to indicate that the calibration is in progress. It takes approximately 10 seconds to complete the calibration. If the calibration fails, an error message will be displayed for a second and you will hear a beep, and then return to the OVP calibration mode again.

## Current calibration

### NOTE

Connect an appropriate shunt 0.01  $\Omega$  across the output terminals, and connect a digital voltmeter across the shunt resistor for the current calibration.



- 11 Select the low-end current calibration point.

**CURRENT CAL**

**I LO 0.2000**



**12** Enter the computed value (DVM reading divided by the shunt resistance) by using the knob and resolution selection keys. *Notice that you should wait for the DVM reading to stabilize for accurate calibration during the current calibration.*

#### **I LO 0.1900**



**13** Save the changes and select the middle current calibration point.

#### **I MI 1.5000**

If the entered number is within an acceptable range, an **ENTERED** message appears for a second. If the entered number is not correct, an error message will be displayed for a second and you will hear a beep, and then return to the low, middle, or high current calibration point again.



**14** Enter the computed value (DVM reading divided by the shunt resistance) by using the knob and resolution selection keys.

#### **I MI 1.5400**



**15** Save the change and select the high current calibration point.

#### **I HI 2.8000**



**16** Enter the computed value (DVM reading divided by the shunt resistance) by using the knob and resolution selection keys.

#### **I HI 2.7890 A**



**17** Save the new current calibration constants and exit the calibration mode.

#### **CAL MODE**

If the calibration fails, an error message will be displayed for one second and you will hear a beep, and then return to the current calibration mode again. A **CURRENT CAL** message is displayed.



## Calibration Record

**Table 8-9** Calibration record

| Step | Calibration description                                                                                                                                                                                                                                  | Measurement mode (DVM) | Supply being adjusted      |
|------|----------------------------------------------------------------------------------------------------------------------------------------------------------------------------------------------------------------------------------------------------------|------------------------|----------------------------|
| 1    | Turn on the calibration mode by holding down the <b>Calibrate</b> key as you turn on the power supply until you hear a long beep.                                                                                                                        |                        |                            |
| 2    | Unsecure the power supply if secured. (Refer to “ <a href="#">Calibration security</a> ” on page 58.)                                                                                                                                                    |                        |                            |
| 3    | Press the <b>Calibrate</b> key to move down the menu to the voltage calibration menu. The <b>VOLTAGE CAL</b> message is displayed. Press the <b>Calibrate</b> key to select the low voltage calibration point.                                           |                        | Voltage calibration        |
| 4    | A low voltage calibration point is displayed. Enter the DVM reading by using the knob and resolution keys. Press the <b>Calibrate</b> key to save the changes and select the middle calibration point.                                                   | V                      | Low voltage calibration    |
| 5    | A middle voltage calibration point is displayed. Enter the DVM reading by using the knob and resolution selection keys. Press the <b>Calibrate</b> key to save the changes and select the high calibration point.                                        | V                      | Middle voltage calibration |
| 6    | A high voltage calibration point is displayed. Enter the DVM reading by using the knob and resolution selection keys. Press the <b>Calibrate</b> key to save the changes and select the OVP calibration.                                                 | V                      | High voltage calibration   |
| 7    | <b>OVP CAL</b> is displayed. Press the <b>Calibrate</b> key to run the overvoltage calibration. The <b>CALIBRATING</b> message is displayed to indicate that the calibration is in progress.                                                             |                        | OVP calibration            |
| 8    | Connect the shunt resistor (0.01 $\Omega$ ) across the output terminals and press the <b>Calibrate</b> key to select the current calibration.                                                                                                            |                        | Current calibration        |
| 9    | A low current calibration point is displayed. Enter the computed value (DVM reading divided by the shunt resistance) by using the knob and resolution keys. Press the <b>Calibrate</b> key to save the changes and select the middle calibration point.  | A                      | Low current calibration    |
| 10   | A middle current calibration point is displayed. Enter the computed value (DVM reading divided by the shunt resistance) by using the knob and resolution keys. Press the <b>Calibrate</b> key to save the changes and select the high calibration point. | A                      | Middle current calibration |

**Table 8-9** Calibration record (continued)

| Step | Calibration description                                                                                                                                                                                          | Measurement mode (DVM) | Supply being adjusted    |
|------|------------------------------------------------------------------------------------------------------------------------------------------------------------------------------------------------------------------|------------------------|--------------------------|
| 11   | A high current calibration point is displayed. Enter the computed value (DVM reading divided by the shunt resistance) by using the knob and resolution keys. Press the <b>Calibrate</b> key to save the changes. | A                      | High current calibration |
| 12   | Turn off the <b>Power</b> switch to exit the calibration menu.                                                                                                                                                   |                        | Exit CAL MODE            |

## Calibration Error Messages

[Table 8-10](#) shows the abbreviated list of error messages for the E364xA. These errors are most likely to occur during calibration and adjustment. Refer to [“Calibration Error Messages”](#) on page 133 for more details.

**Table 8-10** Calibration error messages

|     |                                             |
|-----|---------------------------------------------|
| 701 | Cal security disabled by jumper             |
| 702 | Cal secured                                 |
| 703 | Invalid secure code                         |
| 704 | Secure code too long                        |
| 705 | Cal aborted                                 |
| 706 | Cal value out of range                      |
| 708 | Cal output disabled                         |
| 712 | Bad DAC cal data                            |
| 713 | Bad readback cal data                       |
| 714 | Bad OVP cal data                            |
| 717 | Cal OVP status enabled                      |
| 718 | Gain out of range for gain error correction |

**Table 8-10** Calibration error messages (continued)

|     |                                                      |
|-----|------------------------------------------------------|
| 740 | Cal checksum failed, secure state                    |
| 741 | Cal checksum failed, string data                     |
| 743 | Cal checksum failed, store/recall data in location 1 |
| 744 | Cal checksum failed, store/recall data in location 2 |
| 745 | Cal checksum failed, store/recall data in location 3 |
| 746 | Cal checksum failed, DAC cal constants               |
| 747 | Cal checksum failed, readback cal constants          |
| 748 | Cal checksum failed, GPIB address                    |
| 749 | Cal checksum failed, internal data                   |
| 754 | Cal checksum failed, store/recall data in location 4 |
| 755 | Cal checksum failed, store/recall data in location 5 |

**THIS PAGE HAS BEEN INTENTIONALLY LEFT BLANK.**

### Component Locator Diagram

Component locator diagram for the main board assembly — top

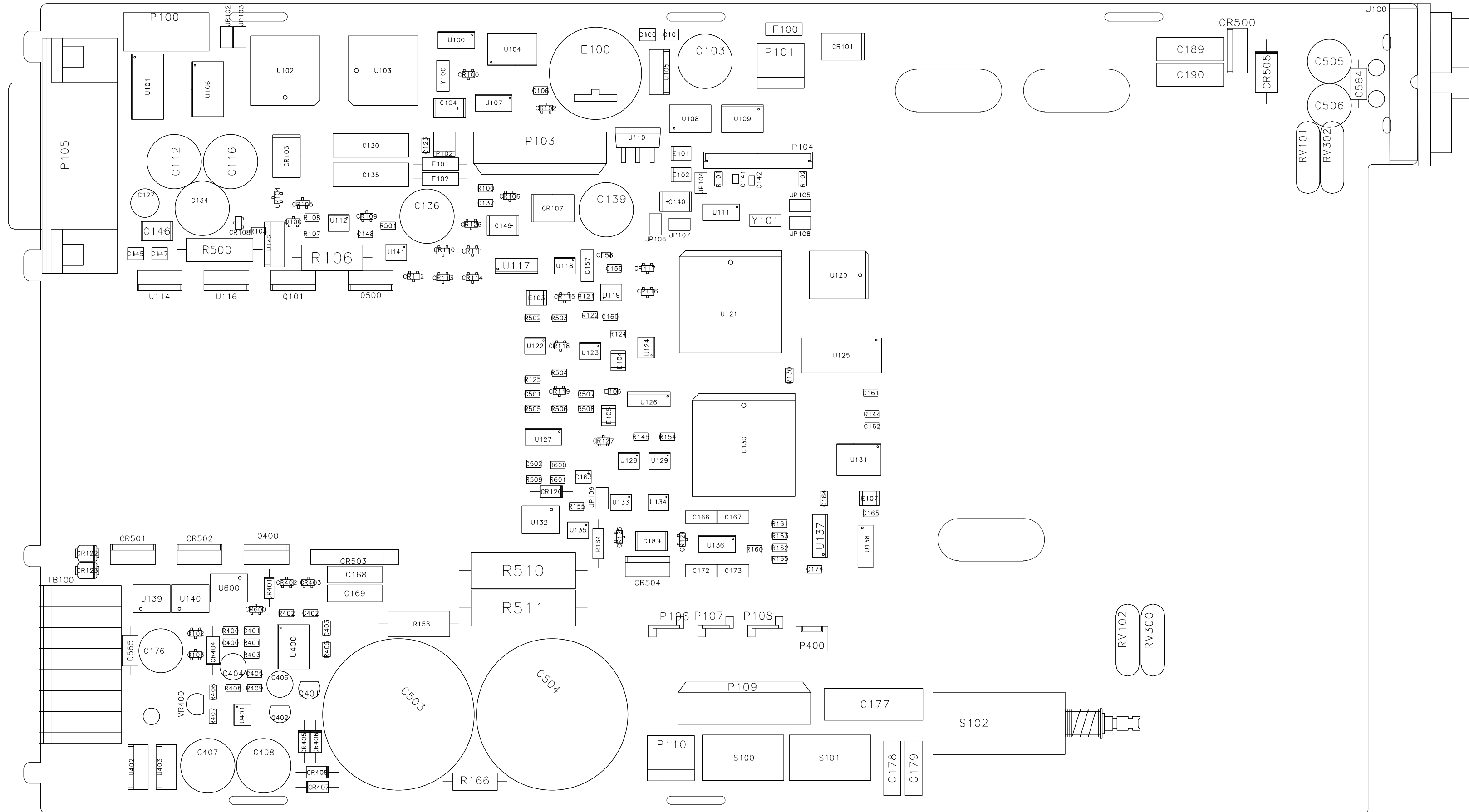

### Component locator diagram for the main board assembly — bottom

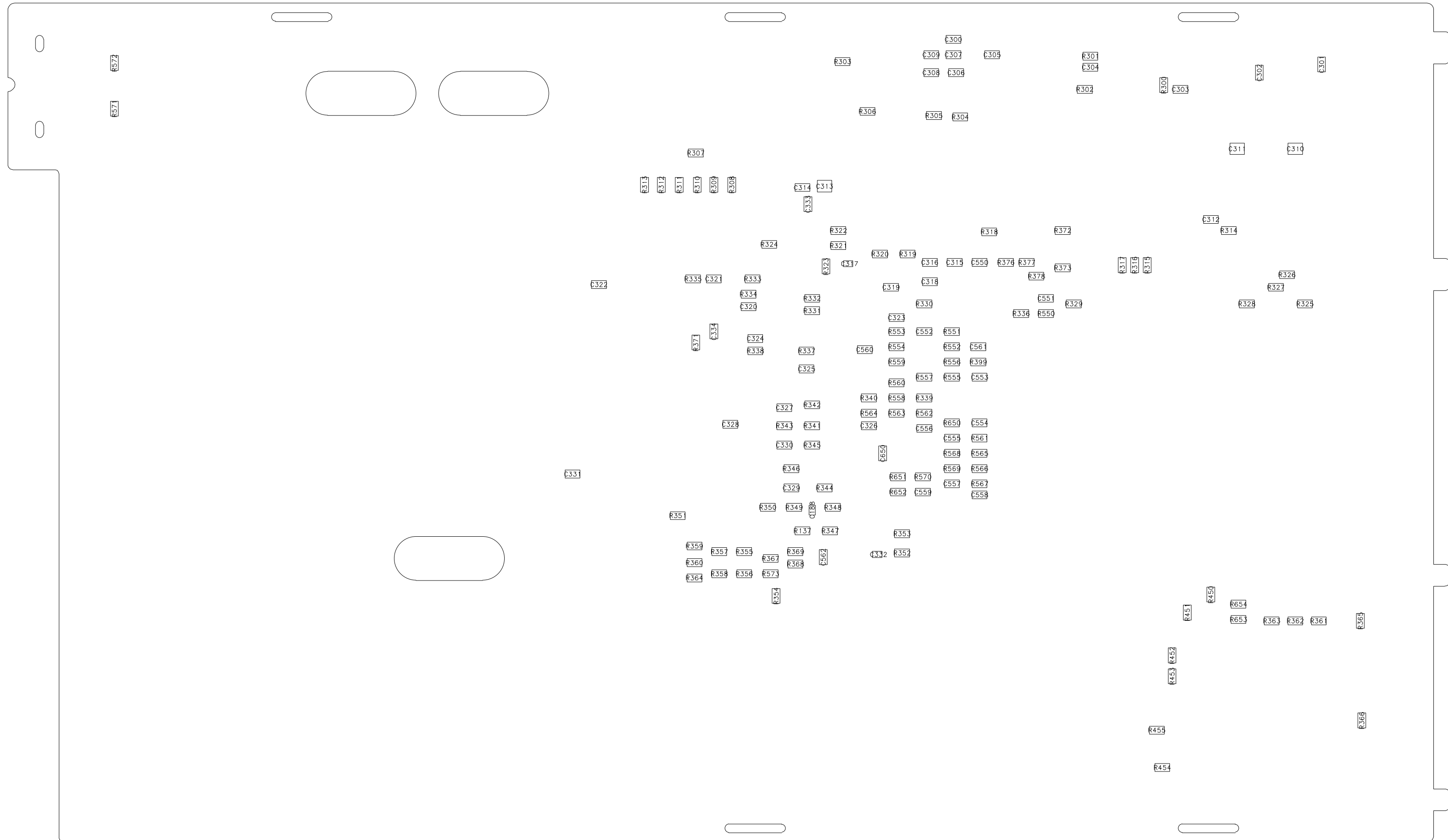

Component locator diagram for the front panel

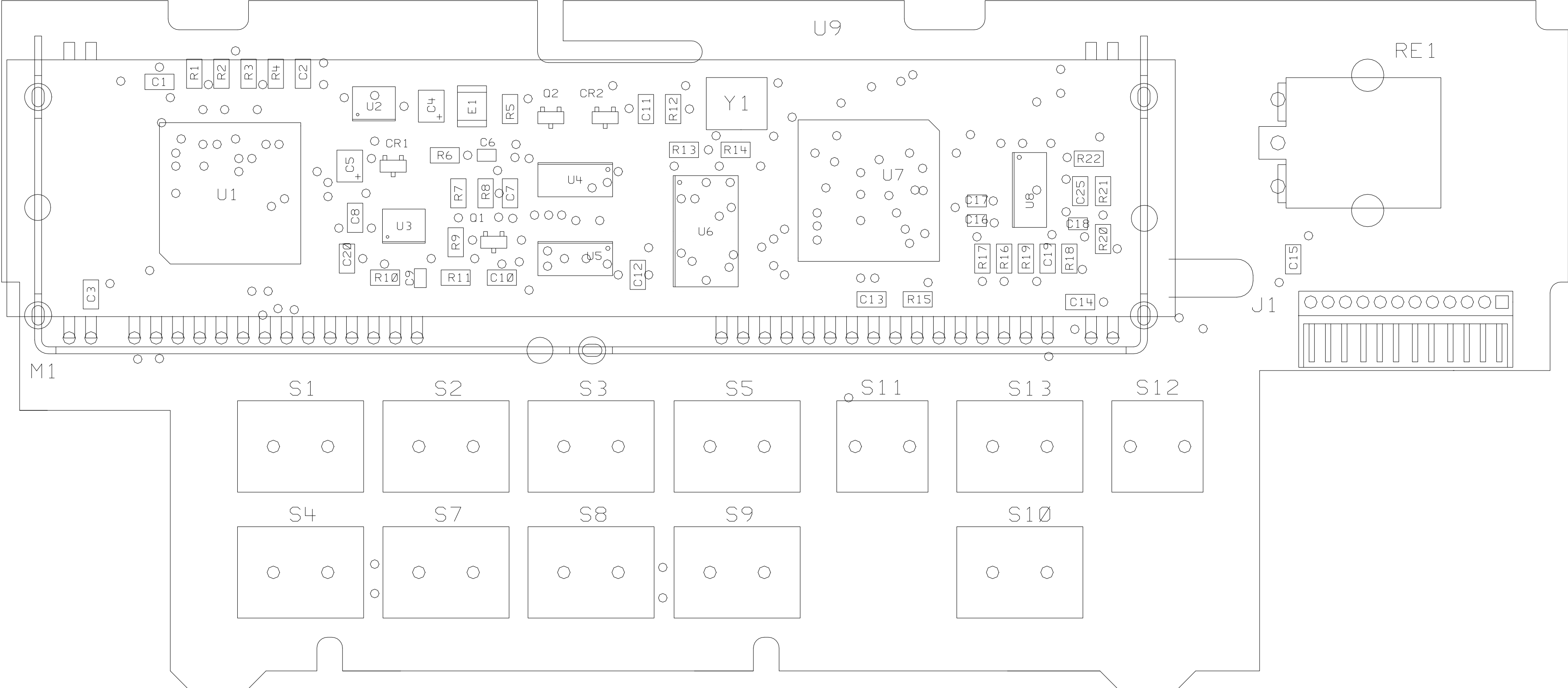

### Component locator diagram for the main board assembly — top (serial MY53xx6xxx)

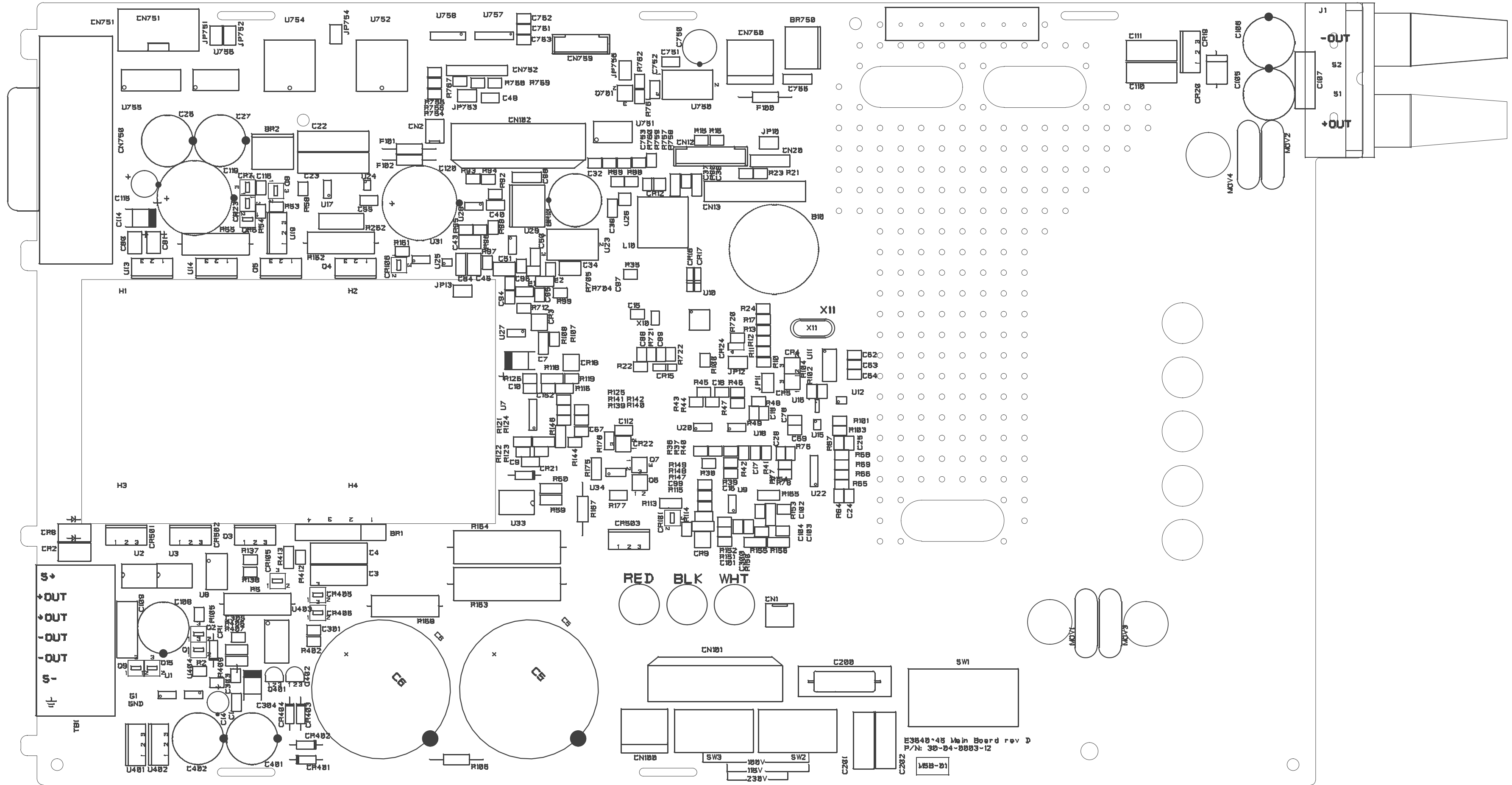



Component locator diagram for the main board assembly — bottom (serial MY53xx6xxx)

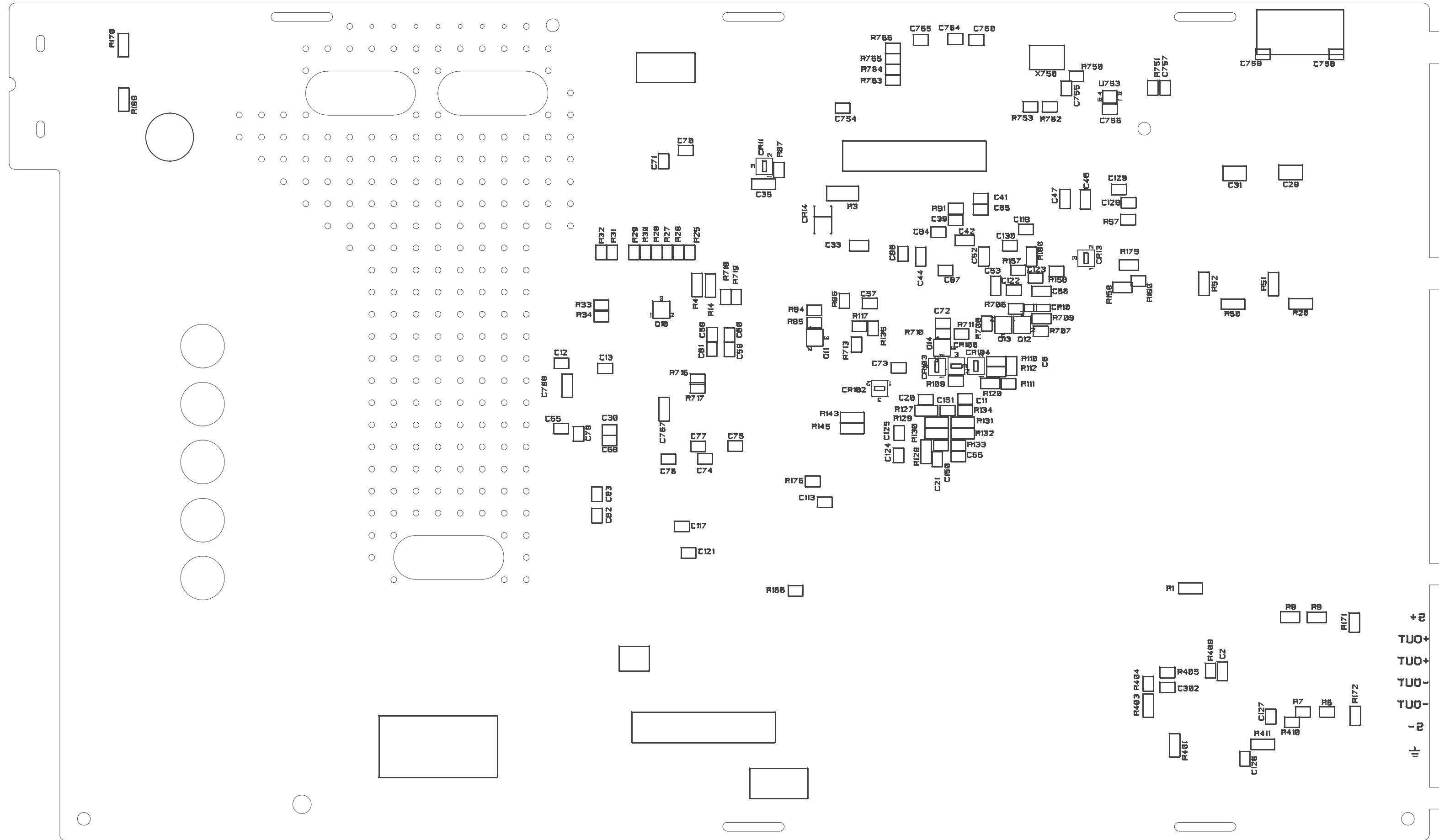

Component locator diagram for the front panel (serial MY53xx6xxx)

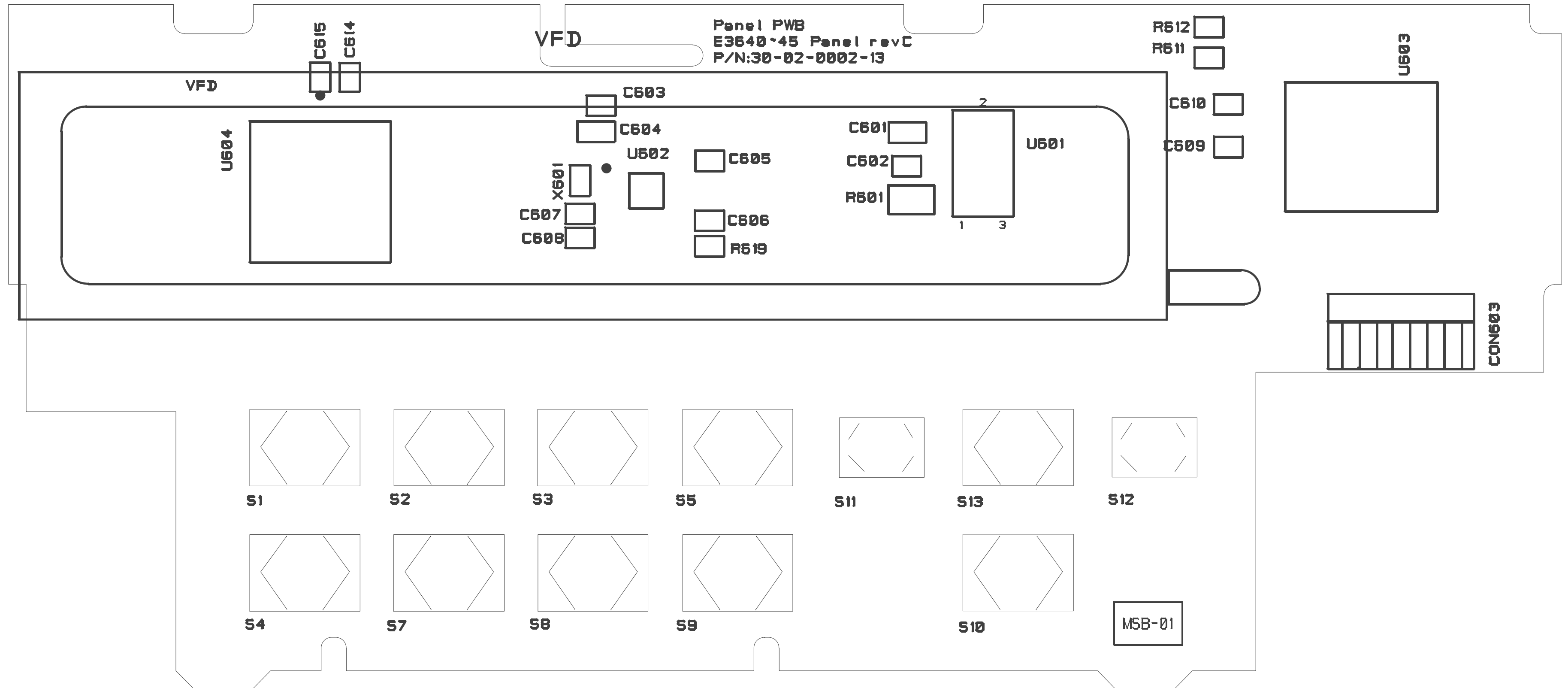

**www.agilent.com**

**Contact us**

To obtain service, warranty, or technical assistance, contact us at the following phone or fax numbers:

United States:

(tel) 800 829 4444 (fax) 800 829 4433

Canada:

(tel) 877 894 4414 (fax) 800 746 4866

China:

(tel) 800 810 0189 (fax) 800 820 2816

Europe:

(tel) 31 20 547 2111

Japan:

(tel) 0120 (421) 345 (fax) 0120 (421) 678

Korea:

(tel) (080) 769 0800 (fax) (080) 769 0900

Latin America:

(tel) (305) 269 7500

Taiwan:

(tel) 0800 047 866 (fax) 0800 286 331

Other Asia Pacific Countries:

(tel) (65) 6375 8100 (fax) (65) 6755 0042

Or visit Agilent World Wide Web at:

[www.agilent.com/find/assist](http://www.agilent.com/find/assist)

Product specifications and descriptions in this document are subject to change without notice. Always refer to the English version at the Agilent Web site for the latest revision.

© Agilent Technologies, Inc. 1999–2013

Tenth Edition, August 6, 2013  
E3640-90001



**Agilent Technologies**