

**OPERATING GUIDE  
GPIB DC POWER SUPPLIES  
Agilent Technologies Models  
664xA, 665xA, 667xA, 668xA, and 669xA**



**Agilent Technologies**

**Agilent Part No. 5964-8267  
Microfiche Part No. 5964-8268**

**Printed in Malaysia  
September, 2009**

## **Certification**

*Agilent Technologies certifies that this product met its published specifications at time of shipment from the factory. Agilent Technologies further certifies that its calibration measurements are traceable to the United States National Institute of Standards and Technology, to the extent allowed by the Institute's calibration facility, and to the calibration facilities of other International Standards Organization members.*

## **Warranty**

This Agilent Technologies hardware product is warranted against defects in material and workmanship for a period of one year from date of delivery. Agilent Technologies software and firmware products, which are designated by Agilent Technologies for use with a hardware product and when properly installed on that hardware product, are warranted not to fail to execute their programming instructions due to defects in material and workmanship for a period of 90 days from date of delivery. During the warranty period Agilent Technologies will, at its option, either repair or replace products which prove to be defective. Agilent Technologies does not warrant that the operation of the software, firmware, or hardware shall be uninterrupted or error free.

For warranty service, with the exception of warranty options, this product must be returned to a service facility designated by Agilent Technologies. Customer shall prepay shipping charges by (and shall pay all duty and taxes) for products returned to Agilent Technologies for warranty service. Except for products returned to Customer from another country, Agilent Technologies shall pay for return of products to Customer.

Warranty services outside the country of initial purchase are included in Agilent Technologies' product price, only if Customer pays Agilent Technologies international prices (defined as destination local currency price, or U.S. or Geneva Export price).

If Agilent Technologies is unable, within a reasonable time to repair or replace any product to condition as warranted, the Customer shall be entitled to a refund of the purchase price upon return of the product to Agilent Technologies.

## **Limitation of Warranty**

The foregoing warranty shall not apply to defects resulting from improper or inadequate maintenance by the Customer, Customer-supplied software or interfacing, unauthorized modification or misuse, operation outside of the environmental specifications for the product, or improper site preparation and maintenance. **NO OTHER WARRANTY IS EXPRESSED OR IMPLIED. Agilent Technologies SPECIFICALLY DISCLAIMS THE IMPLIED WARRANTIES OF MERCHANTABILITY AND FITNESS FOR A PARTICULAR PURPOSE.**

## **Exclusive Remedies**

**THE REMEDIES PROVIDED HEREIN ARE THE CUSTOMER'S SOLE AND EXCLUSIVE REMEDIES. AGILENT TECHNOLOGIES SHALL NOT BE LIABLE FOR ANY DIRECT, INDIRECT, SPECIAL, INCIDENTAL, OR CONSEQUENTIAL DAMAGES, WHETHER BASED ON CONTRACT, TORT, OR ANY OTHER LEGAL THEORY.**

## **Assistance**

*The above statements apply only to the standard product warranty. Warranty options, extended support contracts, product maintenance agreements and customer assistance agreements are also available. Contact your nearest Agilent Technologies Sales and Service offices for further information on Agilent Technologies' full line of Support Programs.*

---

## Safety Summary

*The following general safety precautions must be observed during all phases of operation, service, and repair of this instrument. Failure to comply with these precautions or with specific warnings elsewhere in this manual violates safety standards of design, manufacture, and intended use of the instrument. Agilent Technologies assumes no liability for the customer's failure to comply with these requirements.*

### GENERAL

Any LEDs used in this product are Class 1 LEDs as per IEC 825-1.

This ISM device complies with Canadian ICES-001. Cet appareil ISM est conforme à la norme NMB-001 du Canada.

### ENVIRONMENTAL CONDITIONS

With the exceptions noted, all instruments are intended for indoor use in an installation category II<sup>1</sup>, pollution degree 2 environment. They are designed to operate at a maximum relative humidity of 95% and at altitudes of up to 2000 meters. Refer to the specifications tables for the ac mains voltage requirements and ambient operating temperature range.

**Exceptions:** Agilent Technologies Models 6680A, 6681A, 6682A, 6683A, 6684A, 6690A, 6691A and 6692A are intended for use in an installation category III<sup>2</sup> environment.

<sup>1</sup>Category II - Local level for connection to household outlets for 120 V, 230 V, etc.

<sup>2</sup>Category III - Distribution level or cases where the reliability and availability of the equipment are subject to special requirements.

### BEFORE APPLYING POWER

Verify that the product is set to match the available line voltage and the correct fuse is installed.

### GROUND THE INSTRUMENT.

This product is a Safety Class 1 instrument (provided with a protective earth terminal). To minimize shock hazard, the instrument chassis and cabinet must be connected to an electrical ground. The instrument must be connected to the ac mains through a three-conductor power cable, with the third wire firmly connected to an electrical ground (safety ground) at the power outlet. For instruments designed to be hard-wired to the ac power lines (supply mains), connect the protective earth terminal to a protective conductor before any other connection is made. Any interruption of the protective (grounding) conductor or disconnection of the protective earth terminal will cause a potential shock hazard that could result in personal injury. If the instrument is to be energized via an external autotransformer for voltage reduction, be certain that the autotransformer common terminal is connected to the neutral (earthed pole) of the ac power lines (supply mains).

### FUSES

Only fuses with the required rated current, voltage, and specified type (normal blow, time delay, etc.) should be used. Do not use repaired fuses or short circuited fuseholders. To do so could cause a shock or fire hazard.

### DO NOT OPERATE IN AN EXPLOSIVE ATMOSPHERE

Do not operate the instrument in the presence of flammable gases or fumes.

### KEEP AWAY FROM LIVE CIRCUITS

Operating personnel must not remove instrument covers. Component replacement and internal adjustments must be made by qualified service personnel. Do not replace components with power cable connected. Under certain conditions, dangerous voltages may exist even with the power cable removed. To avoid injuries, always disconnect power, discharge circuits and remove external voltage sources before touching components.

### DO NOT SERVICE OR ADJUST ALONE

Do not attempt internal service or adjustment unless another person, capable of rendering first aid and resuscitation, is present.

### DO NOT EXCEED INPUT RATINGS



















This instrument may be equipped with a line filter to reduce electromagnetic interference and must be connected to a properly grounded receptacle to minimize electric shock hazard. Operation at line voltages or frequencies in excess of those stated on the data plate may cause leakage currents in excess of 5.0 mA peak.

### DO NOT SUBSTITUTE PARTS OR MODIFY INSTRUMENT

Because of the danger of introducing additional hazards, do not install substitute parts or perform any unauthorized modification to the instrument. Return the instrument to an Agilent Technologies Sales and Service Offices for service and repair to ensure that safety features are maintained.

Instruments which appear damaged or defective should be made inoperative and secured against unintended operation until they can be repaired by qualified service personnel.

## Safety Symbol Definitions

Symbol	Description	Symbol	Description
	Direct current		Terminal for Line conductor on permanently installed equipment
	Alternating current		Caution, risk of electric shock
	Both direct and alternating current		Caution, hot surface
	Three-phase alternating current		Caution (refer to accompanying documents)
	Earth (ground) terminal		In position of a bi-stable push control
	Protective earth (ground) terminal		Out position of a bi-stable push control
	Frame or chassis terminal		On (supply)
	Terminal for Neutral conductor on permanently installed equipment		Off (supply)
	Terminal is at earth potential (Used for measurement and control circuits designed to be operated with one terminal at earth potential.)		Standby (supply). Units with this symbol are not completely disconnected from ac mains when this switch is off. To completely disconnect the unit from ac mains, either disconnect the power cord or have a qualified electrician install an external switch.
<div style="border: 1px solid black; padding: 2px; display: inline-block;"><b>WARNING</b></div> <p>The WARNING sign denotes a hazard. It calls attention to a procedure, practice, or the like, which, if not correctly performed or adhered to, could result in personal injury. Do not proceed beyond a WARNING sign until the indicated conditions are fully understood and met.</p>		<div style="border: 1px solid black; padding: 2px; display: inline-block;"><b>CAUTION</b></div> <p>The CAUTION sign denotes a hazard. It calls attention to an operating procedure, or the like, which, if not correctly performed or adhered to, could result in damage to or destruction of part or all of the product. Do not proceed beyond a CAUTION sign until the indicated conditions are fully understood and met.</p>	

## Printing History

The edition and current revision of this manual are indicated below. Reprints of this manual containing minor corrections and updates may have the same printing date. Revised editions are identified by a new printing date. A revised edition incorporates all new or corrected material since the previous printing date. Changes to the manual occurring between revisions are covered by change sheets shipped with the manual. In some cases, the manual change applies only to specific instruments. Instructions provided on the change sheet will indicate if a particular change applies only to certain instruments.

© Copyright 2001, 2002, 2005, 2009 Agilent Technologies Inc.

Edition 1 - July, 2001  
Update1 - March, 2002  
Update2 - January, 2005  
Update3 - September, 2009

This document contains proprietary information protected by copyright. All rights are reserved. No part of this document may be photocopied, reproduced, or translated into another language without the prior consent of Agilent Technologies. Information contained in this document is subject to change without notice.

### Herstellerbescheinigung

Diese Information steht im Zusammenhang mit den Anforderungen der Maschinenläminformationsverordnung vom 18 Januar 1991. \* Schalldruckpegel Lp <70 dB(A) \* Am Arbeitsplatz \* Normaler Betrieb \* Nach EN 27779 (Typproofung).

### Manufacturer's Declaration

This statement is provided to comply with the requirements of the German Sound Emission Directive, from 18 January 1991. \* Sound Pressure Lp <70 dB(A) \* At Operator Position \* Normal Operation \* According to EN 27779 (Type Test).



**DECLARATION OF CONFORMITY**

According to ISO/IEC Guide 22 and CEN/CENELEC EN 45014



**Manufacturer's Name and Address**

Responsible Party

Agilent Technologies, Inc.  
550 Clark Drive, Suite 101  
Budd Lake, New Jersey 07828  
USA

Alternate Manufacturing Site

Agilent Technologies (Malaysia) Sdn. Bhd  
Malaysia Manufacturing  
Bayan Lepas Free Industrial Zone, PH III  
11900 Penang, Malaysia

Declares under sole responsibility that the product as originally delivered

- Product Names**
  - a) Single Output 2,000 Watt System dc Power Supplies
  - b) Single Output 2,000 Watt Manually Controlled dc Power Supplies
  - c) Single Output 5,000 Watt System dc Power Supplies
  - d) Single Output 6,500 Watt System dc Power Supplies
- Model Numbers**
  - a) 6671A, 6672A 6673A, 6674A, 6675A
  - b) 6571A, 6572A 6573A, 6574A, 6575A
  - c) 6680A, 6681A, 6682A, 6683A, 6684A
  - d) 6690A, 6691A, 6692A
  - e) E4356A
- Product Options** This declaration covers all options and customized products based on the above products.

Complies with the essential requirements of the Low Voltage Directive 73/23/EEC and the EMC Directive 89/336/EEC (including 93/68/EEC) and carries the CE Marking accordingly.

**EMC Information** ISM Group 1 Class A Emissions

As detailed in Electromagnetic Compatibility (EMC), Certificate of Conformance Number CC/TCF/02/020 based on Technical Construction File (TCF) HPNJ2, dated June 4, 2002

Assessed by: Celestica Ltd, Appointed Competent Body  
Westfields House, West Avenue  
Kidsgrove, Stoke-on-Trent  
Staffordshire, ST7 1TL  
United Kingdom

**Safety Information** and Conforms to the following safety standards.

- IEC 61010-1:2001 / EN 61010-1:2001
- Canada: CSA C22.2 No. 1010.1:1992
- UL 61010B-1: 2003

This DoC applies to above-listed products placed on the EU market after:

January 1, 2004

Date

Bill Darcy/ Regulations Manager

For further information, please contact your local Agilent Technologies sales office, agent or distributor, or *Agilent Technologies Deutschland GmbH, Herrenberger Straße 130, D71034 Böblingen, Germany*



**Manufacturer's Name and Address**

Responsible Party

Agilent Technologies, Inc.  
550 Clark Drive, Suite 101  
Budd Lake, New Jersey 07828  
USA

Alternate Manufacturing Site

Agilent Technologies (Malaysia) Sdn. Bhd  
Malaysia Manufacturing  
Bayan Lepas Free Industrial Zone, PH III  
11900 Penang, Malaysia

Declares under sole responsibility that the product as originally delivered

**Product Names** a) Single Output 500 Watt System dc Power Supplies  
b) Single Output 500 Watt Manually Controlled dc Power Supplies  
c) Single Output 500 Watt System Solar Array Simulator

**Model Numbers** a) 6651A, 6652A 6653A, 6654A, 6655A  
b) 6551A, 6552A 6553A, 6554A, 6555A  
c) E4350B, E4351B

**Product Options** This declaration covers all options and customized products based on the above products.

Complies with the essential requirements of the Low Voltage Directive 73/23/EEC and the EMC Directive 89/336/EEC (including 93/68/EEC) and carries the CE Marking accordingly.

**EMC Information** ISM Group 1 Class A Emissions

As detailed in Electromagnetic Compatibility (EMC), Certificate of Conformance Number CC/TCF/00/074 based on Technical Construction File (TCF) HPNJ1, dated Oct. 27, 1997

Assessed by: Celestica Ltd, Appointed Competent Body  
Westfields House, West Avenue  
Kidsgrove, Stoke-on-Trent  
Staffordshire, ST7 1TL  
United Kingdom

**Safety Information** and Conforms to the following safety standards.

IEC 61010-1:2001 / EN 61010-1:2001  
Canada: CSA C22.2 No. 1010.1:1992  
UL 61010B-1: 2003

This DoC applies to above-listed products placed on the EU market after:

January 1, 2004

Date

Bill Darcy/ Regulations Manager

For further information, please contact your local Agilent Technologies sales office, agent or distributor, or *Agilent Technologies Deutschland GmbH, Herrenberger Straße 130, D71034 Böblingen, Germany*



**DECLARATION OF CONFORMITY**

According to ISO/IEC Guide 22 and CEN/CENELEC EN 45014



**Manufacturer's Name and Address**

Responsible Party

Agilent Technologies, Inc.  
550 Clark Drive, Suite 101  
Budd Lake, New Jersey 07828  
USA

Alternate Manufacturing Site

Agilent Technologies (Malaysia) Sdn. Bhd  
Malaysia Manufacturing  
Bayan Lepas Free Industrial Zone, PH III  
11900 Penang, Malaysia

Declares under sole responsibility that the product as originally delivered

**Product Names** a) Single Output 200 Watt System dc Power Supplies  
b) Single Output 200 Watt Manually Controlled dc Power Supplies

**Model Numbers** a) 6641A, 6642A 6643A, 6644A, 6645A  
b) 6541A, 6552A 6543A, 6544A, 6545A

**Product Options** This declaration covers all options and customized products based on the above products.

Complies with the essential requirements of the Low Voltage Directive 73/23/EEC and the EMC Directive 89/336/EEC (including 93/68/EEC) and carries the CE Marking accordingly.

**EMC Information** ISM Group 1 Class A Emissions

As detailed in Electromagnetic Compatibility (EMC), Certificate of Conformance Number CC/TCF/00/074 based on Technical Construction File (TCF) HPNJ1, dated Oct. 27, 1997

Assessed by: Celestica Ltd, Appointed Competent Body  
Westfields House, West Avenue  
Kidsgrove, Stoke-on-Trent  
Staffordshire, ST7 1TL  
United Kingdom

**Safety Information** and Conforms to the following safety standards.

IEC 61010-1:2001 / EN 61010-1:2001  
Canada: CSA C22.2 No. 1010.1:1992  
UL 61010B-1: 2003

This DoC applies to above-listed products placed on the EU market after:

January 1, 2004

Date

Bill Darcy/ Regulations Manager

For further information, please contact your local Agilent Technologies sales office, agent or distributor, or *Agilent Technologies Deutschland GmbH, Herrenberger Straße 130, D71034 Böblingen, Germany*

---

## Table of Contents

Certification	2
Safety Summary	3
Printing History	4
Declarations	5
Table of Contents	8
<b>GENERAL INFORMATION</b>	<b>11</b>
Introduction	11
Safety Considerations	12
Instrument Identification	12
Options	12
Accessories	13
Description	13
Front Panel Programming	14
Remote Programming	14
Analog Programming	14
Output Characteristic	15
General	15
Downprogramming	15
Specifications and Supplemental Characteristics	15
<b>INSTALLATION</b>	<b>43</b>
<b>Inspection</b>	<b>43</b>
Damage	43
Packaging Material	43
Items Supplied	43
<b>Location and Temperature</b>	<b>44</b>
Bench Operation	44
Rack Mounting	44
Temperature Performance	44
<b>Input Power Source</b>	<b>45</b>
Installing the Series 664xA and 665xA Power Cord	45
Installing the Series 667xA Power Cord	45
Installing the Series 668xA Power Cord	47
Installing the Series 669xA Power Cord	48
<b>TURN-ON CHECKOUT</b>	<b>51</b>
<b>Introduction</b>	<b>51</b>
<b>Preliminary Checkout (All Models)</b>	<b>51</b>
<b>Power-On Checkout (All Models)</b>	<b>52</b>
<b>Using the Keypad (All Models)</b>	<b>52</b>
Shifted Keys	52
Backspace Key	52
<b>Output Checkout (All Models)</b>	<b>52</b>
Checking the Voltage Function	53
Checking the Current Function	54
<b>Checking the Save and Recall Functions (All Models)</b>	<b>55</b>
<b>Determining the GPIB Address (All Models)</b>	<b>55</b>
<b>In Case of Trouble</b>	<b>55</b>
Line Fuse	55
Series 664xA and 665xA Supplies	56
Series 667xA Supplies	56
Series 668xA Supplies	57
Series 669xA Supplies	57
<b>Error Messages (All Models)</b>	<b>57</b>
Selftest Errors	57
Power-On Error Messages	57



Checksum Errors.	58
Runtime Error Messages	58
<b>USER CONNECTIONS</b>	<b>59</b>
<b>Rear Panel Connections (All Models)</b>	<b>59</b>
<b>Load Wire Selection (All Models)</b>	<b>59</b>
<b>Analog Connector (All Models)</b>	<b>60</b>
<b>Digital Connector (All Models)</b>	<b>60</b>
<b>Connecting Series 664xA and 665xA Power Supplies to the Load</b>	<b>61</b>
Output Isolation	61
Load Considerations	61
Local Voltage Sensing	62
Remote Voltage Sensing	63
Connecting One Supply to the Load	64
Connecting Supplies in Auto-Parallel	65
Connecting Supplies in Series	67
External Voltage Control	67
<b>Connecting Series 667xA Power Supplies to the Load</b>	<b>68</b>
Output Isolation	68
Load Considerations	69
Local Voltage Sensing	70
Remote Voltage Sensing	70
Connecting One Power Supply to a Single Load	72
Connecting One Power Supply To Multiple Loads	72
Connecting Supplies in Auto-Parallel	73
Connecting Supplies in Series	74
External Voltage Control	75
<b>Connecting Series 668xA and 669xA Power Supplies to the Load</b>	<b>76</b>
Output Isolation	76
Load Considerations	76
Local Voltage Sensing	77
Remote Voltage Sensing	77
Connecting One Power Supply to a Single Load	79
Connecting One Power Supply to Multiple Loads	79
Connecting Supplies in Auto-Parallel	80
Connecting Supplies in Series	81
External Voltage Control	82
<b>Controller Connections</b>	<b>83</b>
Stand-Alone Connections	83
Linked Connections	83
<b>FRONT PANEL OPERATION</b>	<b>85</b>
<b>Introduction</b>	<b>85</b>
<b>Getting Acquainted</b>	<b>85</b>
<b>Programming the Output</b>	<b>88</b>
Establishing Initial Conditions	88
Programming Voltage	89
Programming Overvoltage Protection	89
Programming Current	90
Programming Overcurrent Protection	91
<b>CV Mode vs. CC Mode</b>	<b>91</b>
<b>Unregulated Operation</b>	<b>92</b>
<b>Saving and Recalling Operating States</b>	<b>92</b>
<b>Turn-On Conditions</b>	<b>92</b>
<b>Setting the GPIB Address</b>	<b>93</b>
Types of Power Supply GPIB Addresses	93
Changing the Power Supply GPIB Address	93
<b>CALIBRATION</b>	<b>95</b>

<b>Introduction</b>	<b>95</b>
<b>Equipment Required</b>	<b>95</b>
<b>General Procedure</b>	<b>95</b>
Parameters Calibrated	95
Test Setup	96
<b>Front Panel Calibration</b>	<b>96</b>
Entering the Calibration Values	96
Saving the Calibration Constants	96
Disabling the Calibration Mode	96
Changing the Calibration Password	96
Recovering From Calibration Problems	99
Calibration Error Messages	99
<b>Calibration Over the GPIB</b>	<b>100</b>
Calibration Language Dictionary	100
CAL:CURREN	100
CAL:CURREN:LEV	100
CAL:CURREN:MON (Series 668xA/669xA only)	101
CAL:PASS	101
CAL:SAVE	101
CAL:STAT	101
CAL:VOLT	102
CAL:VOLT:LEV	102
CAL:VOLT:PROT	102
Agilent BASIC Calibration Program	102
<b>OPERATION VERIFICATION</b>	<b>105</b>
<b>Introduction</b>	<b>105</b>
<b>Test Equipment Required</b>	<b>105</b>
List of Equipment	105
Current Monitoring Resistor	105
<b>Performing the Tests</b>	<b>107</b>
General Measurement Techniques	107
Programming the Power Supply	107
Order of Tests	107
Turn-on Checkout	107
Voltage Programming and Readback Accuracy	107
Current Programming and Readback Accuracy	108
<b>LINE VOLTAGE CONVERSION</b>	<b>119</b>
Series 664xA and 665xA Power Supplies	119
Series 667xA Power Supplies	120
Series 668xA/669xA Power Supplies	121
<b>DIGITAL PORT FUNCTIONS</b>	<b>123</b>
Digital Connector	123
Fault/Inhibit Operation	123
Changing the Port Configuration	126
Digital I/O Operation	126
Relay Link Operation	127
<b>CURRENT LOOP COMPENSATION (SERIES 668XA ONLY)</b>	<b>129</b>
Introduction	129
Function of Loop Compensation	129
Setting The Loop Compensation Switch	132
<b>USING AGILENT 668XA/669XA SERIES POWER SUPPLIES IN AUTOPARALLEL</b>	<b>133</b>
Introduction	133
<b>OUTPUT BUS BAR OPTIONS</b>	<b>135</b>
Option 602 Installation	135
<b>INDEX</b>	<b>137</b>

# General Information

## Introduction

Two guides are shipped with your power supply - an Operating Guide (this document) and a Programming Guide. You will find information on the following tasks in these guides:

### Quick Document Orientation<sup>1</sup>

Topic	Location
Calibrating the power supply	Appendix A - this guide
Compatibility programming language	Appendix B - Programming Guide
Configuring the digital port	Appendix D - this guide
Line voltage:	
Connecting ac power source	Chapter 2 - this guide
Converting the ac source voltage	Appendix B - this guide
Source current, frequency, and power ratings	Chapter 1- this guide
Operator replaceable parts	Chapter 1- this guide
Operator troubleshooting	Chapter 3 - this guide
Output impedance characteristics	Chapter 1- this guide
Power supply accessories	Chapter 1- this guide
Power supply operating characteristics	Chapter 1- this guide
Power supply options	Chapter 1- this guide
Power supply performance specifications	Chapter 1- this guide
Programming	
discrete fault inhibit (DFI) operation	Chapter 4 - Programming Guide
from the analog port	Chapter 4 - this guide
from the front panel	Chapter 5 - this guide
over the GPIB	Chapter 2 - Programming Guide
remote inhibit (RI) operation	Chapter 4 - Programming Guide
status registers	Chapter 4 - Programming Guide
Quick operating checkout (without load)	Chapter 3 - this guide
Rack mounting	Chapter 2 - this guide
SCPI programming language	Chapter 3 - Programming Guide
Wiring	
analog programming port	Chapter 4 - this guide
discrete fault indicator (DFI) operation	Appendix D - this guide
digital port	Appendix D - this guide
GPIB controller	Chapter 4 - this guide
load or loads	Chapter 4 - this guide
local sensing	Chapter 4 - this guide
remote inhibit (RI) operation	Chapter 4 - this guide
remote sensing	Chapter 4 - this guide

<sup>1</sup> See the Table of Contents for complete list of topics.

## Safety Considerations

This power supply is a Safety Class 1 instrument, which means it has a protective earth terminal. That terminal must be connected to earth ground through a power source equipped with a 3-wire ground receptacle. Refer to the Safety Summary page at the beginning of this guide for general safety information. Before installation or operation, check the power supply and review this guide for safety warnings and instructions. Safety warnings for specific procedures are located at appropriate places in the guide. warning

## Instrument Identification

The power supply is identified by a unique serial number that provides the following information:

**MY** = The letter indicates the country of manufacture, where MY = Malaysia; SG = Singapore; US = USA.

**41000177** = The first two digits indicate the year the product was introduced or the year that the last significant design change was made. Add 1960 to the first two digits to determine the year. The last six digits is the number assigned to each unit.

## Options

Option	Description	Used with Agilent Series				
		664xA	665xA	667xA	668xA	669xA
100	Input power 87-106 Vac, with power cord	x	x			
120	Input power 104-127 Vac, with power cord	x	x			
220	Input power 191-233 Vac, with power cord	x	x			
240	Input power 209-250 Vac, with power cord	x	x			
200	Input power 174-220 Vac, without power cord			x		
230	Input power 191-250 Vac, without power cord			x		
208	Input power 180-235 Vac, 3-phase, without power cord				x	x
400	Input power 360-440 Vac, 3-phase, without power cord				x	x
601	Output connector kit required for bench applications				x	x
602	Bus bar spacers for paralleling power supplies				x	x
831	Power cord, 12 AWG, UL listed, CSA certified, without plug			x		
832	Power cord, 4mm <sup>2</sup> , harmonized, without plug			x		
834	Power cord, 10 AWG, UL listed, CSA certified, without plug			x		
842	Power cord, 4mm <sup>2</sup> , harmonized, with IEC309 32A/220V plug			x		
843	Power cord, 12 AWG, UL listed, CSA certified, with JIS C8303 25A/250V plug			x		
844	Power cord, 10 AWG, UL listed, CSA certified, with NEMA L6-30P-30A/250V locking plug			x		
861	Power cord, 10 AWG, 4-wire, 300V, 25A, 90°C, UL listed, CSA certified, without plug				x	
	Power cord, 8 AWG, 4-wire, 300 V, 35A, 90°C, UL listed, CSA certified, without plug					x
862	Power cord, 2.5mm <sup>2</sup> , 4-wire, 450V, 20A, 70°C, harmonized, without plug				x	x

**List of Options (continued)**

Option	Description	Used with Agilent Series				
		664xA	665xA	667xA	668xA	669xA
<b>908</b>	Rack mount kit (Agilent 5062-3974)	x				
	Rack mount kit (Agilent 5062-3977) <b>Support rails (E3663AC) are required.</b>		x	x		
	Rack mount kit (Agilent 5062-3977 & 5062-3974) <b>Support rails (E3663AC) are required.</b>				x	x
<b>909</b>	Rack mount kit with handles (Agilent 5062-3975)	x				
	Rack mount kit with handles (Agilent 5062-3983) <b>Support rails (E3663AC) are required.</b>		x	x		
	Rack mount kit with handles (Agilent 5062-3983 & 5062-3974) <b>Support rails (E3663AC) are required.</b>				x	x

## Accessories

Description	Agilent No.
Fuse replacement kit for Series 668xA 16 AM for 360-440 Vac, 3-phase line 30 AM for 180-235 Vac, 3-phase line	5060-3512 5060-3513
Fuse replacement kit for Series 669xA 16 AM for 360-440 Vac, 3-phase line 30 AM for 180-235 Vac, 3-phase line	5065-6935 5065-6934
Input line voltage conversion kit for Series 668xA 208 VAC input line conversion kit 400 VAC input line conversion kit	5188-4263 5188-4270
Input line voltage conversion kit for Series 669xA 208 VAC input line conversion kit 400 VAC input line conversion kit	5188-4271 5188-4272
GPIB cable (all models) 0.5 meters (1.6 ft) 1.0 meter (3.3 ft) 2.0 meters (6.6 ft) 4.0 meters ( 13 .2 ft)	10833D 10833A 10833B 10833C
Serial link cable (all models) 2.0 meters (6.6 ft)	5080-2148
Slide mount kit heavy duty, for Series 667xA/668xA/669xA standard, for Series 665xA standard, for Series 664xA	1494-0058 1494-0059 1494-0060

## Description

These units form a family of unipolar, GPIB programmable power supplies organized as follows:

Family	Power	Agilent Models
Series 664xA	200 W	6641A, 6642A, 6643A, 6644A, 6645A
Series 665xA	500 W	6651A, 6652A, 6653A, 6654A, 6655A
Series 667xA	2000 W	6671A, 6672A, 6673A, 6674A, 6675A
Series 668xA	5000 W	6680A, 6681A, 6682A, 6683A, 6684A
Series 669xA	6670 W	6690A, 6691A, 6692A

Each power supply is programmable locally from the front panel or remotely via a rear-panel analog control port. Operational features include:

- Constant voltage (CV) or constant current (CC) output over the rated output range.
- Built-in overvoltage (OV), overcurrent (OC), and overtemperature (OT) protection.
- Automatic turn-on selftest.
- Pushbutton nonvolatile storage and recall of up to 5 operating states (4 in Series 668xA/669xA supplies).
- Local or remote sensing of output voltage.
- Auto-parallel operation for increased total current.
- Series operation for increased total voltage.
- Analog input for remote programming of voltage and current.
- Voltage output for external monitoring of output current.
- User calibration from the front panel.

## Front Panel Programming

The front panel has both rotary (RPG) and keypad controls for setting the output voltage and current. The panel display provides digital readouts of the output voltage and current. Other front panel controls permit:

- Enabling or disabling the output.
- Setting the overvoltage protection (OVP) trip voltage.
- Enabling or disabling the overcurrent protection (OCP) feature.
- Saving and recalling operating states.
- Setting the GPIB address.
- Reading GPIB error message codes.
- Calibrating the power supply, including changing the calibration protection password.

## Remote Programming

The power supply may be remotely programmed via the GPIB bus and/or from an analog input port. GPIB programming is with SCPI (Standard Commands for Programmable Instruments) commands that make the power supply programs compatible with those of other GPIB instruments. (A software-controlled Compatibility Mode also permits programming in the command set of the Agilent 6030xA Autoranging Series.) In addition to control functions, SCPI programming permits writing to the front panel LCD and complete calibration functions. Power supply status registers permit remote monitoring of the following conditions:

- Overvoltage, overcurrent, overtemperature, and unregulated states.
- Operating mode (constant voltage or constant current).
- State of the RI (remote inhibit) input signal.
- Power-on status (PON).
- Status of the output queue (QYE).
- Pending triggers (WTG).
- GPIB interface programming errors (CME, DDE, and EXE).
- Calibration state (enabled or disabled).

The status registers can be programmed to generate an output fault signal (FLT) upon the occurrence of one or more selected status events.

## Analog Programming

The power supply has an analog port for remote programming. The output voltage and/or current of the power supply may be controlled by individual dc programming voltages applied to this port. The port also provides a monitor output that supplies a dc voltage proportional to the output current.

---

## Output Characteristic

### General

The power supply can operate in either CV (constant voltage) or CC (constant current) over its voltage and current ratings (see Table 1-1). The operating locus is shown by the Output Characteristic Curve in Table 1-2. The operating point is determined by the voltage setting ( $V_s$ ), the current setting ( $I_s$ ), and the load impedance. Two operating points are shown. Point 1 is defined by the load line cutting the operating locus in the constant-voltage region. This region defines the CV mode. Point 2 is defined by the load line cutting the operating locus in the constant-current region. This region defines the CC mode.

### Downprogramming

The power supply can sink current for more rapid down programming in the CV mode. For Series 664xA and 665xA supplies, this capability is defined by the second quadrant area ( $-I_s$ ) of the Output Characteristic Curve. These supplies can sink about 20% of their maximum rated positive output current. For Series 667xA, 668xA, and 669xA power supplies, this is an uncharacterized current-sinking area that provides a limited downprogramming capability.

---

## Specifications and Supplemental Characteristics

Tables 1-1 through 1-4 list the specifications and supplemental characteristics for the Series 664xA, 665xA, 667xA, 668xA, and 669xA power supplies. The organization is as follows:

<u>Series</u>	<u>Specifications</u>	<u>Characteristics</u>
6641A-6645A	Table 1-1a	Table 1-1b
6651A-6655A	Table 1-2a	Table 1-2b
6671A-6675A	Table 1-3a	Table 1-3b
6680A-6684A	Table 1-4a	Table 1-4b
6690A-6692A	Table 1-5a	Table 1-5b

**Specifications** are performance parameters warranted over the specified temperature range.

**Supplemental Characteristics** are not warranted but are descriptions of performance determined either by design or type testing.

**Table 1-1a. Performance Specifications for Series 664xA<sup>1</sup>**

Parameter	Agilent Model Number				
	6641A	6642A	6643A	6644A	6645A
<b>Output Ratings</b>					
<b>Voltage:</b>	0 - 8 V	0 - 20 V	0 - 35 V	0 - 60 V	0 - 120 V
<b>Current: @ 40°C</b>	0 - 20 A	0 - 10 A	0 - 6 A	0 - 3.5 A	0 - 1.5 A
<b>Current: @ 50°C</b>	0 - 18 A	0 - 9 A	0 - 5.4 A	0 - 3.2 A	0 - 1.4 A
<b>Current: @ 55°C</b>	0 - 17 A	0 - 8.5 A	0 - 5.1 A	0 - 3.0 A	0 - 1.4 A
<b>Programming Accuracy (@ 25 ± 5 °C)</b>					
<b>Voltage:</b> 0.06% +	5 mV	10 mV	15 mV	26 mV	51 mV
<b>Current:</b> 0.15 % +	26 mA	13 mA	6.7 mA	4.1 mA	1.7 mA
<b>Ripple &amp; Noise</b> (from 20 Hz to 20 MHz with outputs ungrounded, or with either output terminal grounded)					
<b>Constant Voltage:</b> rms	300 µV	300 µV	400 µV	500 µV	700 µV
<b>Constant Voltage:</b> p-p	3 mV	3 mV	4 mV	5 mV	7 mV
<b>Constant Current:</b> rms	10 mA	5 mA	3 mA	1.5 mA	1 mA
<b>Readback Accuracy</b> (from front panel or over GPIB with respect to actual output @ 25 ± 5 °C)					
<b>Voltage:</b> 0.07% +	6 mV	15 mV	25 mV	40 mV	80 mV
<b>+Current</b> 0.15% +	18 mA	9.1 mA	5 mA	3 mA	1.3 mA
<b>-Current</b> 0.35% +	40 mA	20 mA	12 mA	6.8 mA	2.9 mA
<b>Load Regulation</b> (change in output voltage or current for any load change within ratings)					
<b>Voltage</b>	1 mV	2 mV	3 mV	4 mV	5 mV
<b>Current:</b>	1 mA	0.5 mA	0.25 mA	0.25 mA	0.25 mA
<b>Line Regulation</b> (change in output voltage or current for any line change within ratings)					
<b>Voltage:</b>	0.5 mV	0.5 mV	1 mV	1 mV	2 mV
<b>Current:</b>	1 mA	0.5 mA	0.25 mA	0.25 mA	0.25 mA
<b>Transient Response Time</b> (for the output voltage to recover to its previous level (within 0.1% of the rated voltage or 20 mV, whichever is greater) following any step change in load current up to 50% of the rated current.	< 100 µs				
<b>AC Input Ratings</b> (selectable via internal switching - see Appendix C)					
<b>Nominal line voltage:</b>	100, 120, 220, 240 Vac (-13%, +6 %) 230 Vac <sup>2</sup> (-10%, +10%)				
<b>Frequency:</b>	50/60 Hz				
<b>Output Terminal Isolation</b>	±240 Vdc (maximum, from chassis ground)				
Notes: <sup>1</sup> For Supplemental Characteristics, see Table 1-1b. <sup>2</sup> For 230Vac operation, unit is internally set to 240Vac					



**Table 1-1b. Supplemental Characteristics for Series 664xA<sup>1</sup>**

Parameter	Agilent Model Number					
	6641A	6642A	6643A	6644A	6645A	
<b>Output Programming Range</b> (maximum programmable values)						
<b>Voltage:</b>	8.190 V	20.475 V	35.831 V	61.425 V	122.85 V	
<b>Current:</b>	20.475 A	10.237 A	6.142 A	3.583 A	1.535 A	
<b>Overvoltage Protection (OVP):</b>	8.8 V	22.0 V	38.5 V	66.0 V	132.0 V	
<b>Average Resolution</b>						
<b>Voltage:</b>	2 mV	5 mV	10 mV	15 mV	30 mV	
<b>Current:</b>	6 mA	3 mA	2 mA	1.2 mA	0.5 mA	
<b>Overvoltage Protection (OVP):</b>	13 mV	30 mV	54 mV	93 mV	190 mV	
<b>Accuracy</b>						
<b>Overvoltage Protection (OVP):</b>	160 mV	400 mV	700 mV	1.2 V	2.4 V	
<b>Analog Programming (VP):*</b>						
0.36% +	6 mV	15 mV	27 mV	45 mV	90 mV	
<b>Analog Programming (IP):*</b>						
7.6% +	18 mA	9.2 mA				
1.5% +			5.5 mA	3.2 mA	1.4 mA	
<b>Current Monitor (+IM):*</b>						
7.7% +	65 mA	32 mA				
1.6% +			8.1 mA	7.1 mA	1.8 mA	
*Referenced to supply output						
<b>Drift Temperature Stability</b> (following a 30-minute warmup, change in output over 8 hours under constant line, load, and ambient temperature)						
<b>Voltage:</b>	0.02% +	0.4 mV	1 mV	2 mV	3 mV	6 mV
<b>Current:</b>	0.02% +	16 mA	6 mA	3 mA	2 mA	1 mA
<b>Temperature Coefficients</b> (change per °C)						
<b>Voltage:</b>	60 ppm +	0.1 mV	0.2 mV	0.3 mV	0.5 mV	1.1 mV
<b>+Current:</b>	95 ppm +	0.82 mA	0.41 mA	0.18 mA	0.12 mA	0.04 mA
<b>Voltage Readback:</b>	60 ppm +	0.2 mV	0.5 mV	0.75 mV	1.3 mV	2.6 mV
<b>+Current Readback:</b>	95 ppm +	1.2 mA	0.62 mA	0.33 mA	0.20 mA	0.08 mA
<b>--Current Readback:</b>	110 ppm +	1.2 mA	0.62 mA	0.33 mA	0.20 mA	0.08 mA
<b>Overvoltage Protection (OVP):</b>	200 ppm +	1.6 mV	3.3 mV	5 mV	13 mV	24 mV
<b>Analog Programming (VP):</b>	60 ppm +	0.1 mV	0.25 mV	0.4 mV	0.7 mV	1.25 mV
<b>Analog Programming (IP):</b>	90 ppm +	0.56 mA	0.28 mA	0.17 mA	0.1 mA	0.04 mA
<b>Current Monitor (+IM):</b>	75 ppm +	0.61 mA	0.3 mA	0.06 mA	0.06 mA	0.02 mA
<b>Maximum Input Power:</b>	480 VA; 400 W, 60 W with no load					
Notes: <sup>1</sup> For Performance Specifications, see Table 1-1a.						

**Table 1-lb. Supplemental Characteristics for Series 664xA (continued)<sup>1</sup>**

Parameter	Agilent Model Number				
	6641A	6642A	6643A	6644A	6645A
<b>Maximum AC Line Current Ratings</b> <b>100 Vac nominal:</b> <b>120 Vac nominal:</b> <b>220 Vac nominal:</b> <b>230 Vac nominal:</b> <b>240 Vac nominal:</b>	4.4 A rms 3.8 A rms 2.2 A rms 2.1 A rms 2.0 A rms				
<b>Maximum Reverse Bias Current:</b>	With AC input power applied and the dc output reverse biased by an external dc source, the supply will continuously withstand without damage a current equal to its output current rating (see Table 1- 1a).				
<b>Remote Sensing Capability</b> <b>Voltage Drop Per Lead:</b>  <b>Load Regulation:</b>  <b>Load Voltage:</b>	Up to 1/2 of rated output voltage.  Add 3 mV to spec (see Table 1-la) for each 1-volt change in the + output lead due to load current changes.  Subtract voltage drop in load leads from specified output voltage rating.				
<b>Command Processing Time</b> (Average time for output voltage to change after receipt of digital data when the supply is connected directly to the GPIB Bus):	20 ms				
<b>Downprogrammer Current Capability</b> ( $\pm 15\%$ ):	5.8 A	2.5 A	1.5 A	0.9 A	0.75 A
<b>Output Voltage Programming Response Time</b> <b>Rise/Fall Time</b> (time for output to change from 90 % to 10% or from 10% to 90% of its total excursion):  <b>Settling Time</b> (time for output change to settle within 1 LSB (0.025% x rated voltage) of its final value):	<15 ms  <60 ms				
<b>Monotonicity:</b>	Output is monotonic over entire rated voltage, current, and temperature range.				
<b>Auto-Parallel Configuration:</b>	Up to 3 identical models				
<b>Analog Programming (IP &amp; VP)</b> <b>Input Signal:*</b> <b>Input Impedance:</b> *Signal source must be isolated.	0 to -5 V 10 k $\Omega$ , nominal				
<b>Current Monitor Output (+IM):</b>	0 to -5 V represents zero to full-scale current output				
<b>Savable States</b> <b>Nonvolatile Memory Locations:</b> <b>Nonvolatile Memory Write Cycles:</b> <b>Prestored State</b> (factory default):	5 ( 0 through 4) 40,000, typical Location 0				
Notes: <sup>1</sup> For Performance Specifications, see Table 1-la.					

**Table 1-1b. Supplemental Characteristics for Series 664xA (continued)<sup>1</sup>**

Parameter	All Models																								
Digital Port Characteristics	(see Table 1-5)																								
GPIB Interface Capabilities	(see Table 1-5)																								
Serial Link Capabilities	(see Table 1-5)																								
Recommended Calibration Interval:	1 year																								
Safety Compliance Complies with: Designed to comply with:	CSA 22.2 No.231, IEC 348 UL 1244																								
RFI Suppression (complies with):	CISPR-II, Group 1, Class B																								
Dimensions Width: Height (including removable feet): Depth (including safety cover):	425.5 mm (16.75 in) 88.1 mm (3.5 in) 439 mm (17.3 in)																								
<b>Note 1:</b> For Performance Specifications, see Table 1-la.:																									
Weight Net: Shipping:	14.2 kg (31.4 lb) 16.3 kg (36 lb)																								
<p><b>Output Characteristic Curve:</b></p> <table border="1" style="margin-left: auto; margin-right: auto;"> <caption>Maximum Rated Output</caption> <thead> <tr> <th>Agilent Model</th> <th>Vout</th> <th>Iout</th> <th>-Iout</th> </tr> </thead> <tbody> <tr> <td>6641A</td> <td>8 V</td> <td>20 A</td> <td>5.8 A</td> </tr> <tr> <td>6642A</td> <td>20 V</td> <td>10 A</td> <td>2.5 A</td> </tr> <tr> <td>6643A</td> <td>35 V</td> <td>6 A</td> <td>1.5 A</td> </tr> <tr> <td>6644A</td> <td>60 V</td> <td>3.5 A</td> <td>0.9 A</td> </tr> <tr> <td>6645A</td> <td>120 V</td> <td>1.5 A</td> <td>0.75 A</td> </tr> </tbody> </table> <p style="text-align: right; font-size: small;">FIG-11.041</p>		Agilent Model	Vout	Iout	-Iout	6641A	8 V	20 A	5.8 A	6642A	20 V	10 A	2.5 A	6643A	35 V	6 A	1.5 A	6644A	60 V	3.5 A	0.9 A	6645A	120 V	1.5 A	0.75 A
Agilent Model	Vout	Iout	-Iout																						
6641A	8 V	20 A	5.8 A																						
6642A	20 V	10 A	2.5 A																						
6643A	35 V	6 A	1.5 A																						
6644A	60 V	3.5 A	0.9 A																						
6645A	120 V	1.5 A	0.75 A																						
<b>Notes:</b> <sup>1</sup> For Performance Specifications, see Table 1-la.																									

Table 1-1b. Supplemental Characteristics for Series 664xA (continued)<sup>1</sup>

Parameter	All Models
<b>Output Impedance Curves (Typical):</b>	
Agilent 6641A	Agilent 6642A
Agilent 6643A	Agilent 6644A
Agilent 6645A	

Notes: <sup>1</sup>For Performance Specifications, see Table 1-1a.

**Table 1-2a. Performance Specifications for Series 665xA<sup>1</sup>**

Parameter	Agilent Model Number				
	6651A	6652A	6653A	6654A	6655A
<b>Output Ratings</b>					
<b>Voltage:</b>	0 - 8 V	0 - 20 V	0 - 35 V	0 - 60 V	0 - 120 V
<b>Current: @ 40°C</b>	0 - 50 A	0 - 25 A	0 - 15 A	0 - 9 A	0 - 4 A
<b>Current: @ 50°C</b>	0 - 45 A	0 - 22.5 A	0 - 13.5 A	0 - 8.1 A	0 - 3.6 A
<b>Current: @ 55°C</b>	0 - 42.5 A	0 - 21.3 A	0 - 12.8 A	0 - 7.7 A	0 - 3.4 A
<b>Programming Accuracy (@ 25 ± 5 °C)</b>					
<b>Voltage:</b> 0.06% +	5 mV	10 mV	15 mV	26 mV	51 mV
<b>Current:</b> 0.15 % +	60 mA	25 mA	13 mA	8 mA	4 mA
<b>Ripple &amp; Noise</b> (from 20 Hz to 20 MHz with outputs ungrounded, or with either output terminal grounded)					
<b>Constant Voltage:</b> rms	300 μV	300 μV	400 μV	500 μV	700 μV
<b>Constant Voltage:</b> p-p	3 mV	3 mV	4 mV	5 mV	7 mV
<b>Constant Current:</b> rms	25 mA	10 mA	5 mA	3 mA	2 mA
<b>Readback Accuracy</b> (from front panel or over GPIB with respect to actual output @ 25 ± 5 °C)					
<b>Voltage:</b> 0.07% +	6 mV	15 mV	25 mV	40 mV	80 mV
<b>+Current</b> 0.15% +	67 mA	26 mA	15 mA	7 mA	3 mA
<b>-Current</b> 0.35% +	100 mA	44 mA	24 mA	15 mA	7 mA
<b>Load Regulation</b> (change in output voltage or current for any load change within ratings)					
<b>Voltage:</b>	1 mV	2 mV	3 mV	4 mV	5 mV
<b>Current:</b>	2 mA	1 mA	0.5 mA	0.5 mA	0.5 mA
<b>Line Regulation</b> (change in output voltage or current for any line change within ratings)					
<b>Voltage:</b>	0.5 mV	0.5 mV	1 mV	1 mV	2 mV
<b>Current:</b>	2 mA	1 mA	0.75 mA	0.5 mA	0.5 mA
<b>Transient Response Time</b> (for the output voltage to recover to its previous level (within 0.1% of the rated voltage or 20 mV, whichever is greater) following any step change in load current up to 50% of the rated current.	< 100 μs				
<b>AC Input Ratings</b> (selectable via internal switching - see Appendix C)					
<b>Nominal line voltage:</b>	100, 120, 220, 240 Vac (-13%, +6 %) 230 Vac <sup>2</sup> (-10%, +10%)				
<b>Frequency:</b>	50/60 Hz				
<b>Output Terminal Isolation</b>	±240 Vdc (maximum, from chassis ground)				
Notes: <sup>1</sup> For Supplemental Characteristics, see Table 1-2b. <sup>2</sup> For 230Vac operation, unit is internally set to 240Vac					

**Table 1-2b. Supplemental Characteristics for Series 665xA<sup>1</sup>**

Parameter	Agilent Model Number					
	6651A	6652A	6653A	6654A	6655A	
<b>Output Programming Range</b> (maximum programmable values)						
<b>Voltage:</b>	8.190 V	20.475 V	35.831 V	61.425 V	122.85 V	
<b>Current:</b>	51.188 A	25.594 A	15.356 A	9.214 A	4.095 A	
<b>Overvoltage Protection (OVP):</b>	8.8 V	22.0 V	38.5 V	66.0 V	132.0 V	
<b>Average Resolution</b>						
<b>Voltage:</b>	2 mV	5 mV	10 mV	15 mV	30 mV	
<b>Current:</b>	15 mA	7 mA	4 mA	2.5 mA	1 mA	
<b>Overvoltage Protection (OVP):</b>	13 mV	30 mV	54 mV	93 mV	190 mV	
<b>Accuracy</b>						
<b>Overvoltage Protection (OVP):*</b>	160 mV	400 mV	700 mV	1.2 V	2.4 V	
<b>Analog Programming (VP):*</b>						
0.36% +	6 mV	15 mV	27 mV	45 mV	90 mV	
<b>Analog Programming (IP):*</b>						
7% +	75 mA	31 mA	16 mA	8 mA	5 mA	
<b>Current Monitor (+IM):*</b>						
7% +	730 mA	400 mA	120 mA	80 mA	75 mA	
*Referenced to supply output						
<b>Drift Temperature Stability</b> (following a 30-minute warmup, change in output over eight hours under constant line, load, and ambient temperature)						
<b>Voltage:</b>	0.02% +	0.4 mV	1 mV	2 mV	3 mV	6 mV
<b>Current:</b>	0.02% +	40 mA	15 mA	8 mA	5 mA	2.5 mA
<b>Temperature Coefficients</b> (change per °C)						
<b>Voltage:</b>	60 ppm +	0.1 mV	0.2 mV	0.3 mV	0.5 mV	1.1 mV
<b>+Current:</b>	90 ppm +	1.4 mA	0.7 mA	0.3 mA	0.2 mA	0.2 mA
<b>Voltage Readback:</b>	60 ppm +	0.2 mV	0.5 mV	0.75 mV	1.3 mV	2.6 mV
<b>+Current Readback:</b>	90 ppm +	1.7 mA	0.9 mA	0.5 mA	0.3 mA	0.2 mA
<b>-Current Readback:</b>	105 ppm +	1.7 mA	0.9 mA	0.5 mA	0.3 mA	0.2 mA
<b>Overvoltage Protection (OVP):</b>						
200 ppm +	1.6 mV	3.3 mV	5 mV	13 mV	24 mV	
<b>Analog Programming (VP):</b>						
60 ppm +	0.1 mV	0.25 mV	0.4 mV	0.7 mV	1.25 mV	
<b>Analog Programming (IP):</b>						
90 ppm +	1.4 mA	0.7 mA	0.3 mA	0.2 mA	0.15 mA	
<b>Current Monitor (+IM):</b>						
80 ppm +	1.4 mA	0.7 mA	0.3 mA	0.2 mA	0.15 mA	
<b>Maximum Input Power</b>	1380 VA; 1100 W, 120 W with no load					
Notes: <sup>1</sup> For Performance Specifications, see Table 1-2a.						

**Table 1-2b. Supplemental Characteristics for Series 665xA (continued)<sup>1</sup>**

Parameter	Agilent Model Number				
	6651A	6652A	6653A	6654A	6655A
<b>Maximum AC Line Current Ratings</b> <b>100 Vac nominal:</b> <b>120 Vac nominal:</b> <b>220 Vac nominal:</b> <b>230 Vac nominal:</b> <b>240 Vac nominal:</b>	12 A rms (15 AM fuse) 10 A rms (12 AM fuse) 5.7 A rms (7 AM fuse) 5.5 A rms (7 AM fuse) 5.3 A rms (7 AM fuse)				
<b>Maximum Reverse Bias Current:</b>	With AC input power applied and the dc output reverse biased by an external dc source, the supply will continuously withstand without damage a current equal to its output current rating (see Table 1- 2a) .				
<b>Remote Sensing Capability</b> <b>Voltage Drop Per Lead:</b>  <b>Load Regulation:</b>  <b>Load Voltage:</b>	Up to 1/2 of rated output voltage.  Add 3 mV to spec (see Table 1-2a) for each 1-volt change in the + output lead due to load current changes.  Subtract voltage drop in load leads from specified output voltage rating.				
<b>Command Processing Time</b> (Average time for output voltage to change after receipt of digital data when the supply is connected directly to the GPIB Bus):	20 ms				
<b>Downprogrammer Current Capability</b> ( $\pm 15\%$ ):	11.6 A	5 A	3 A	1.8 A	1.5 A
<b>Output Voltage Programming Response Time</b> <b>Rise/Fall Time</b> (time for output to change from 90 % to 10% or from 10% to 90% of its total excursion):  <b>Settling Time</b> (time for output change to settle within 1 LSB (0.025% x rated voltage) of its final value):	<15 ms <60 ms				
<b>Monotonicity:</b>	Output is monotonic over entire rated voltage, current, and temperature range.				
<b>Auto-Parallel Configuration:</b>	Up to 3 identical models				
<b>Analog Programming (IP &amp; VP)</b> <b>Input Signal:*</b> <b>Input Impedance:</b> *Signal source must be isolated.	0 to -5 V 10 k $\Omega$ , nominal				
<b>Current Monitor Output (+IM):</b>	0 to -5 V represents zero to full-scale current output.				
<b>Savable States</b> <b>Nonvolatile Memory Locations:</b> <b>Nonvolatile Memory Write Cycles:</b> <b>Prestored State</b> (factory default):	5 ( 0 through 4) 40,000, typical Location 0				
<b>Notes:</b> <sup>1</sup> For Performance Specifications, see Table 1-2a.					

**Table 1-2b. Supplemental Characteristics for Series 665xA (continued)<sup>1</sup>**

Parameter	All Models																								
Digital Port Characteristics	(see Table 1-5)																								
GPIB Interface Capabilities	(see Table 1-5)																								
Serial Link Capabilities	(see Table 1-5)																								
Recommended Calibration Interval:	1 year																								
Safety Compliance Complies with: Designed to comply with:	CSA 22.2 No.231, IEC 348 UL 1244																								
RFI Suppression (complies with):	CISPR-II, Group 1, Class B																								
Dimensions Width: Height (including removable feet): Depth (including safety cover):	425.5 mm (16.75 in) 132.6 mm (5.22 in) 497.8 mm (19.6 in)																								
Weight Net: Shipping:	25 kg (54 lb) 28 kg (61 lb)																								
Output Characteristic Curve:	<div style="display: flex; justify-content: space-around; align-items: flex-start;"> <div style="text-align: center;"> <p>The graph plots output voltage (Vout) on the vertical axis and output current (Iout) on the horizontal axis. The vertical axis has markers for Vmax and Vs. The horizontal axis has markers for Is and Imax. Two lines originate from the origin: a steeper line labeled '1' and a less steep line labeled '2'. Line 1 is labeled 'CV Operating Line' and line 2 is labeled 'CC Operating Line'. A dashed horizontal line at Vs intersects line 1 at a point that corresponds to Is on the horizontal axis. A dashed vertical line at Imax intersects line 2 at a point that corresponds to Vmax on the vertical axis. The horizontal axis is also labeled with -Iout on the left and Iout on the right.</p> </div> <div style="text-align: center;"> <p><b>Maximum Rated Output</b></p> <table border="1"> <thead> <tr> <th>Agilent Model</th> <th>Vout</th> <th>Iout</th> <th>-Iout</th> </tr> </thead> <tbody> <tr> <td>6651A</td> <td>8 V</td> <td>50 A</td> <td>11.6 A</td> </tr> <tr> <td>6652A</td> <td>20 V</td> <td>25 A</td> <td>5 A</td> </tr> <tr> <td>6653A</td> <td>35 V</td> <td>15 A</td> <td>3 A</td> </tr> <tr> <td>6654A</td> <td>60 V</td> <td>9 A</td> <td>1.8 A</td> </tr> <tr> <td>6655A</td> <td>120 V</td> <td>4 A</td> <td>1.5 A</td> </tr> </tbody> </table> <p><small>FIG 1-28.GAL</small></p> </div> </div>	Agilent Model	Vout	Iout	-Iout	6651A	8 V	50 A	11.6 A	6652A	20 V	25 A	5 A	6653A	35 V	15 A	3 A	6654A	60 V	9 A	1.8 A	6655A	120 V	4 A	1.5 A
Agilent Model	Vout	Iout	-Iout																						
6651A	8 V	50 A	11.6 A																						
6652A	20 V	25 A	5 A																						
6653A	35 V	15 A	3 A																						
6654A	60 V	9 A	1.8 A																						
6655A	120 V	4 A	1.5 A																						
<p>Notes: <sup>1</sup>For Performance Specifications, see Table 1-2a.</p>																									



Table 1-2b. Supplemental Characteristics for Series 665xA (continued)<sup>1</sup>

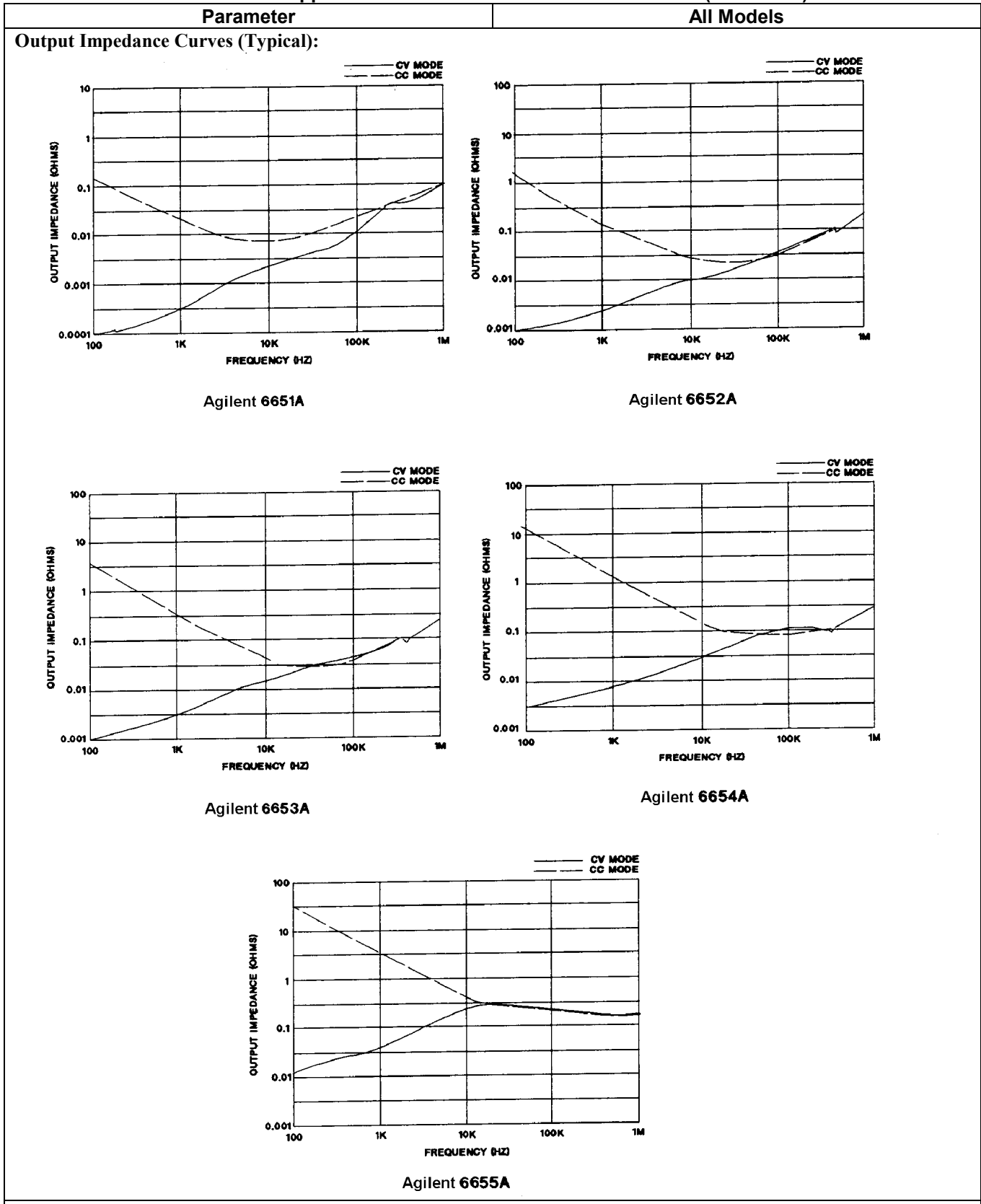

Notes: <sup>1</sup>For Performance Specifications, see Table 1-2a.

**Table 1-3a. Performance Specifications for Series 667xA<sup>1</sup>**

Parameter	Agilent Model Number					
	6671A	6672A	6673A	6674A	6675A	
<b>Output Ratings</b>						
<b>Voltage:</b>	0 - 8 V	0 - 20 V	0- 35 V	0 - 60 V	0 - 120 V	
<b>Current: @ 0 to 55°C</b>	0 - 220 A	0 - 100 A	0 - 60 A	0 - 35 A	0 - 18 A	
<b>Programming Accuracy</b> (@ calibration temperature* ± 5 °C)						
<b>Voltage:</b>	0.04% +	8 mV	20 mV	35 mV	60 mV	120 mV
<b>Current:</b>	0.1% +	125 mA	60 mA	40 mA	25 mA	12 mA
<b>Ripple &amp; Noise</b> (from 20 Hz to 20 MHz with outputs ungrounded, or with either output terminal grounded)						
<b>Constant Voltage:</b>	rms	650 µV	750 µV	800 µV	1.25 mV	1.9 mV
<b>Constant Voltage:</b>	p-p	7 mV	9 mV	9 mV	11 mV	16 mV
<b>Constant Current:</b>	rms	200 mA	100 mA	40 mA	25 mA	12 mA
<b>Readback Accuracy</b> (from front panel or over GPIB with respect to actual output @ calibration temp <sup>1</sup> ± 5 °C)						
<b>Voltage:</b>	0.05% +	12 mV	30 mV	50 mV	90 mV	180 mV
<b>±Current:</b>	0.1% +	150 mA	100 mA	60 mA	35 mA	18 mA
<b>Load Regulation</b> (change in output voltage or current for any load change within ratings)						
<b>Voltage:</b>	0.002% +	300 µV	650 µV	1.2 mV	2 mV	4 mV
<b>Current:</b>	0.005% +	10 mA	7 mA	4 mA	2 mA	1 mA
<b>Line Regulation</b> (change in output voltage or current for any line change within ratings)						
<b>Voltage:</b>	0.002% +	300 µV	650 µV	1.2 mV	2 mV	4 mV
<b>Current:</b>	0.005% +	10 mA	7 mA	4 mA	2 mA	1 mA bisept
<b>Transient Response Time</b> (for the output voltage to recover to its previous level (within 0.1% of the rated voltage or 20 mV, whichever is greater) following any step change in load current up to 50% of the rated current.						
						< 900 µs
<b>AC Input Ratings</b> (selectable via internal switching - see Appendix C)						
<b>Nominal line voltage:</b>						220, 230, 240 Vac (191-253 Vac range) 200 Vac (174-220 Vac range)* *below 185 Vac, derate output voltage linearly to:
<b>Frequency:</b>	7.8 V	18.0 V	31.5 V	56.5 V	108 V	
						50/60 Hz
<b>Output Terminal Isolation</b>	±240 Vdc (maximum, from chassis ground)					
Notes: <sup>1</sup> For Supplemental Characteristics, see Table 1-3b.						

**Table 1-3b. Supplemental Characteristics for Series 667xA<sup>1</sup>**

Parameter	Agilent Model Number					
	6671A	6672A	6673A	6674A	6675A	
<b>Output Programming Range</b> (maximum programmable values)						
<b>Voltage:</b>	8.190 V	20.475 V	35.831 V	61.425 V	122.85 V	
<b>Current:</b>	225.23 A	102.37 A	61.43 A	35.83 A	18.43 A	
<b>Overvoltage Protection (OVP):</b>	10.0 V	24.0 V	42.0 V	72.0 V	144.0 V	
<b>Typical Resolution</b>						
<b>Voltage:</b>	2 mV	5 mV	10 mV	15 mV	30 mV	
<b>Current:</b>	55 mA	25 mA	15 mA	8.75 mA	4.5 mA	
<b>Overvoltage Protection (OVP):</b>	15 mV	35 mV	65 mV	100 mV	215 mV	
<b>Accuracy</b> (@ calibration temp $\pm 5^\circ\text{C}$ )*						
<b>Overvoltage Protection (OVP):*</b>	200 mV	500 mV	900 mV	1.15 V	3.0 V	
<b>Analog Programming (VP):</b>			$\pm 0.3\%$			
<b>Analog Programming (IP):</b>			$\pm 7\%$			
<b>Current Monitor (+IM):</b>			$\pm 7\%$			
*Calibration temp = $25^\circ\text{C}$						
<b>Drift Temperature Stability</b> (following a 30-minute warmup, change in output over eight hours under constant line, load, and ambient temperature)						
<b>Voltage:</b>	0.02% +	0.24 mV	0.6 mV	1 mV	1.8 mV	3.6 mV
<b>Current:</b>	0.02% +	69 mA	35 mA	20 mA	10 mA	6 mA
<b>Temperature Coefficients</b> (change per $^\circ\text{C}$ after 30-minute warmup)						
<b>Voltage:</b>	50 ppm +	0.04 mV	0.2 mV	0.7 mV	1.2 mV	2.4 mV
<b>Current:</b>	75 ppm +	25 mA	12 mA	7 mA	4 mA	2 mA
<b>Voltage Readback:</b>	60 ppm +	0.1 mV	0.3 mV	1 mV	1.2 mV	3 mV
<b><math>\pm</math>Current Readback:</b>	85 ppm +	30 mA	15 mA	9 mA	5 mA	2.5 mA
<b>Overvoltage Protection (OVP):</b>	200 ppm +	1.8 mV	5 mV	8 mV	13 mV	25 mV
<b>Analog Programming (VP):</b>	60 ppm +	0.1 mV	0.3 mV	0.5 mV	0.7 mV	1.5 mV
<b>Analog Programming (<math>\pm</math>IP):</b>	275 ppm +	26 mA	14 mA	9 mA	5 mA	3 mA
<b>Current Monitor (+IM):</b>	50 ppm +	3 mA	2 mA	1 mA	0.6 mA	0.3 mA
<b>Maximum Input VA and Power</b>	3800 VA; 2600 W, 100 W with no load					
<b>Maximum AC Line Current Ratings</b>	19 A rms (25 AM fuse)					
<b>200 Vac nominal:</b>	19 A rms (25 AM fuse)					
<b>230 Vac nominal:</b>	19 A rms (25 AM fuse)					
<b>Maximum Reverse Bias Current:</b>	With AC input power applied and the dc output reverse biased by an external dc source, the supply will continuously withstand without damage a current equal to its output current rating (see Table 1-3a).					
Notes: <sup>1</sup> For Performance Specifications, see Table 1-3a.						

**Table 1-3b. Supplemental Characteristics for Series 667xA (continued)<sup>1</sup>**

Parameter	Agilent Model Number				
	6671A	6672A	6673A	6674A	6675A
<b>Remote Sensing Capability</b> <b>Voltage Drop Per Lead:</b> <b>Load Voltage:</b>  <b>Load Regulation:</b> <b>Degradation due to load lead drop in--output:</b> $\Delta mV \text{ (regulation)} = V_{\text{drop}}(R_{\text{sense-}})/k$ <b>Degradation due to load lead drop in + output:</b> $\Delta mV \text{ (regulation)} = V_{\text{drop}}(R_{\text{sense+}})/k + 2V_{\text{drop}}(V_{\text{rating}})/(V_{\text{rating}} + 10 \text{ V})$ where $R_{\text{sense-}}$ and $R_{\text{sense+}}$ are resistances of respective sense leads and k is the following model-dependent value: 6671A=1; 6672A=1.82; 6673A=4.99; 6674A=10; 6675A=16.2	Up to 1/2 of rated output voltage. Subtract voltage drop in load leads from specified output voltage rating.				
<b>Command Processing Time</b> (Average time for output voltage to change after receipt of digital data when the supply is connected directly to the GPIB Bus):	20 ms				
<b>Output Voltage Programming Response Time**</b> <b>Rise/Fall Time</b> (time for output to change from 90 % to 10% or from 10% to 90% of its total excursion):***  <b>Full-load programming speed up/down time</b> (time for output to settle within 4 LSBs of the final value):***  <b>No-load downprogramming discharge time</b> (time for output to fall to 0.5 V when programmed from full voltage to zero volts):  ** All values exclude command processing time. *** With full resistive load = $V_{\text{RATED}}/I_{\text{RATED}}$ .	30 ms	60 ms	130 ms	130 ms	195 ms
	85 ms	190 ms	380 ms	380 ms	600 ms
	130 ms	250 ms	350 ms	600 ms	600 ms
<b>Monotonicity:</b>	Output is monotonic over entire rated voltage, current, and temperature range.				
<b>Auto-Parallel Configuration:</b>	Up to 5 identical models				
<b>Analog Programming (IP &amp; VP)</b> <b>Input Signal:*</b> <b>VP Input Signal:**</b> (0 to ) <b>VP Input Impedance:</b> <b>IP to -IP Differential Input Signal:</b> (0 to ) *Signal source must be isolated. ** Referenced to output signal common.	-4.72 V	-4.24 V	-4.25 V	-4.24 V	-3.97 V
	+7.79 V	+6.81 V	+6.81 V	+7.01 V	+6.34 V
<b>Current Monitor Output (+IM):</b> <b>Output Signal:*</b> (-0.25 to ) <b>Output Impedance:</b> * Corresponds to 0% to 100% output current.	+9.05 V	+7.70 V	+7.70 V	+7.93 v	+7.15 V
	490 $\Omega$				
<b>Savable States</b> <b>Nonvolatile Memory Locations:</b> <b>Nonvolatile Memory Write Cycles:</b> <b>Prestored State</b> (factory default):	5 ( 0 through 4) 40,000, typical Location 0				
<b>Notes:</b> <sup>1</sup> For Performance Specifications, see Table 1-3a.					

**Table 1-3b. Supplemental Characteristics for Series 667xA (continued)<sup>1</sup>**

Parameter	All Models																		
Digital Port Characteristics	(see Table 1-5)																		
GPIB Interface Capabilities	(see Table 1-5)																		
Serial Link Capabilities	(see Table 1-5)																		
Recommended Calibration Interval:	1 year																		
Safety Compliance Complies with: Designed to comply with:	CSA 22.2 No.231, IEC 348 UL 1244																		
RFI Suppression (complies with):	CISPR-II, Group 1, Class B																		
Dimensions Width: Height (including removable feet): Depth (including safety cover):	425.5 mm (16.75 in) 145.1 mm (5.71 in) 640 mm (25.2 in)																		
Weight Net: Shipping:	27.7 kg (61 lb) 31.4 kg (69 lb)																		
Output Characteristic Curve:	 <p>The graph plots output voltage (Vout) on the y-axis and output current (Iout) on the x-axis. A dashed line represents the CV (Constant Voltage) operating line, extending from the origin to a point (Is, Vmax). A solid line represents the CC (Constant Current) operating line, extending from the origin to a point (Imax, Vmax). The intersection of these two lines is at (Is, Vs). Two regions are labeled: '1' is the area under the CV line and above the CC line, and '2' is the area under the CC line. Arrows point from the labels 'CV Operating Line' and 'CC Operating Line' to their respective lines. The axes are labeled Vmax, Vs, Is, and Imax.</p> <table border="1" data-bbox="885 1081 1307 1407"> <caption>Maximum Rated Output</caption> <thead> <tr> <th>Agilent Model</th> <th>Vout</th> <th>Iout</th> </tr> </thead> <tbody> <tr> <td>6671A</td> <td>8 V</td> <td>220 A</td> </tr> <tr> <td>6672A</td> <td>20 V</td> <td>100 A</td> </tr> <tr> <td>6673A</td> <td>35 V</td> <td>60 A</td> </tr> <tr> <td>6674A</td> <td>60 V</td> <td>35 A</td> </tr> <tr> <td>6675A</td> <td>120 V</td> <td>18 A</td> </tr> </tbody> </table>	Agilent Model	Vout	Iout	6671A	8 V	220 A	6672A	20 V	100 A	6673A	35 V	60 A	6674A	60 V	35 A	6675A	120 V	18 A
Agilent Model	Vout	Iout																	
6671A	8 V	220 A																	
6672A	20 V	100 A																	
6673A	35 V	60 A																	
6674A	60 V	35 A																	
6675A	120 V	18 A																	
Notes: <sup>1</sup> For Performance Specifications, see Table 1-3a.																			

Table 1-3b. Supplemental Characteristics for Series 667xA (continued)<sup>1</sup>



Notes: <sup>1</sup>For Performance Specifications, see Table 1-3a.

**Table 1-4a. Performance Specifications for Series 668xA<sup>1</sup>**

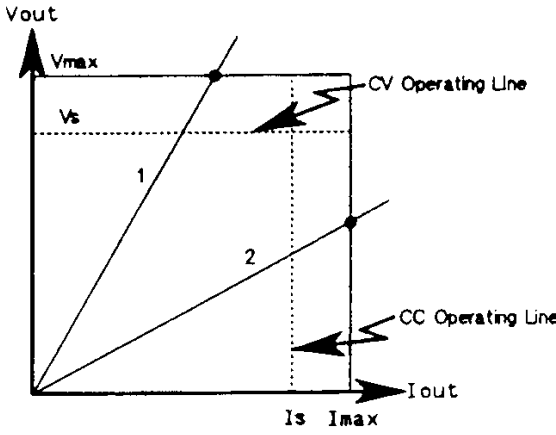
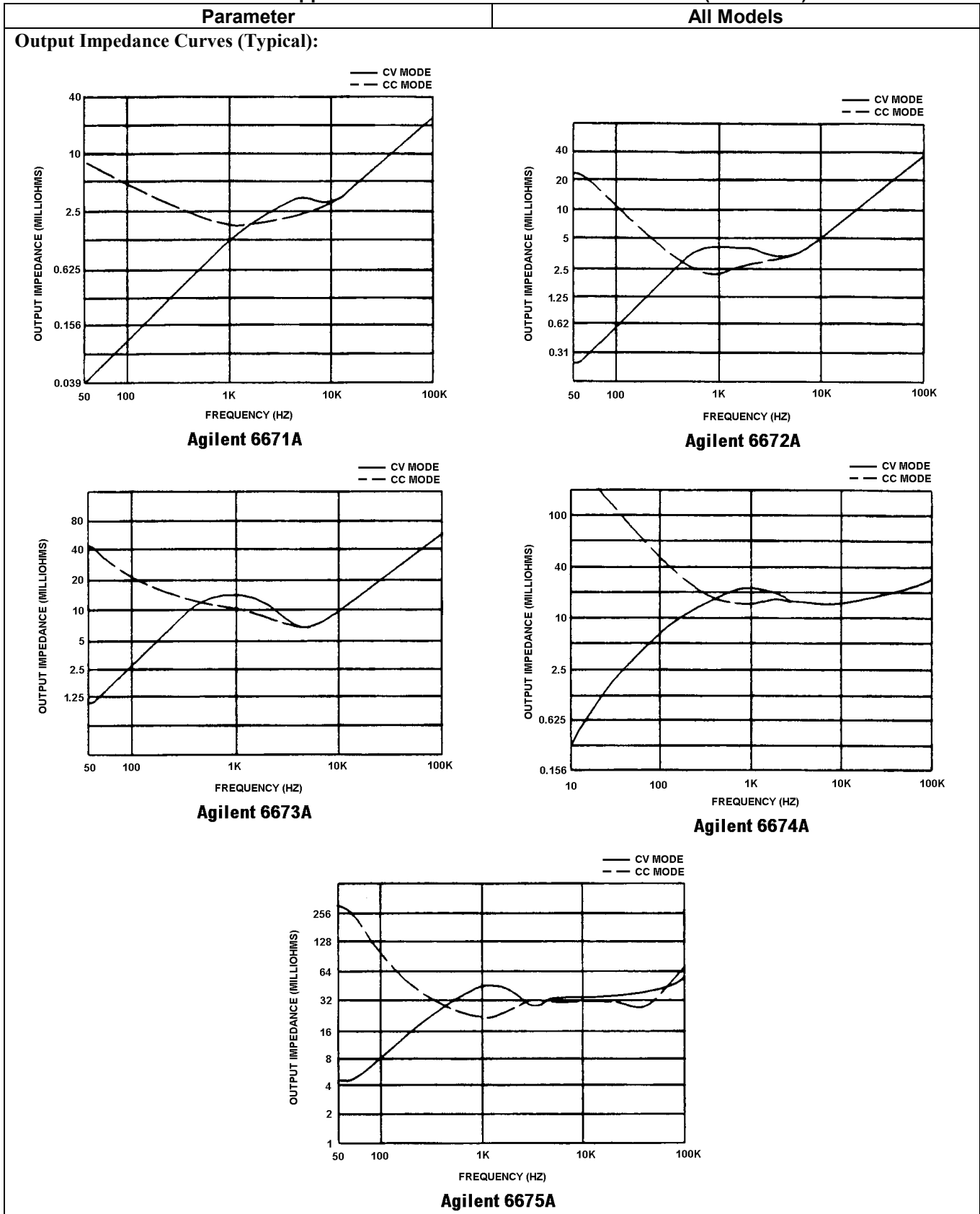
Parameter	Agilent Model Number				
	6680A	6681A	6682A	6683A	6684A
<b>Output Ratings</b>					
<b>Voltage:</b>	0 - 5 V	0 - 8 V	0- 21 V	0 - 32 V	0 - 40 V
<b>Current:*</b>	0 - 875 A	0 - 580 A	0 - 240 A	0 - 160 A	0 - 128 A
*Derated linearly 1%/°C from 40 ° C to 55 °C					
<b>Programming Accuracy (@ 25 ± 5 °C)</b>					
<b>Voltage:</b> 0.04% +	5 mV	8 mV	21 mV	32 mV	40 mV
<b>Current:</b> 0.1% +	450 mA	300 mA	125 mA	85 mA	65 mA
<b>Ripple &amp; Noise</b> (from 20 Hz to 20 MHz with outputs ungrounded, or with either output terminal grounded)					
<b>Constant Voltage:</b> rms	1.5 mV	1.5 mV	1.5 mV	1.0 mV	1.0 mV
<b>Constant Voltage:</b> p-p	10 mV	10 mV	10 mV	10 mV	10 mV
<b>Readback Accuracy</b> (from front panel or over GPIB with respect to actual output @ 25 ± 5 °C)					
<b>Voltage:</b> 0.05% +	7.5 mV	12 mV	32 mV	48 mV	60 mV
<b>±Current</b> 0.1% +	600 mA	400 mA	165 mA	110 mA	90 mA
<b>Load Regulation</b> (change in output voltage or current for any load change within ratings)					
<b>Voltage</b> 0.002% +	190 μV	300 μV	650 μV	1.1 mV	1.5 mV
<b>Current:</b> 0.005% +	65 mA	40 mA	17 mA	12 mA	9 mA
<b>Line Regulation</b> (change in output voltage or current for any line change within ratings)					
<b>Voltage:</b> 0.002% +	190 μV	300 μV	650 μV	1.1 mV	1.5 mV
<b>Current:</b> 0.005% +	65 mA	40 mA	17 mA	12 mA	9 mA
<b>Transient Response Time</b> (for the output voltage to recover to within 150 mV following any step change from 100% to 50% or 50% to 100% of the rated output current): < 900 μs					
<b>AC Line Input</b> * (selectable - see Appendix C)					
<b>Range 1 (180-235 Vac)</b>					
<b>Nominal phase-to-phase voltage:</b>			200, 208 Vac (3-phase)		
<b>Input frequency:</b>			50/60 Hz *		
<b>Range 2 (360-440 Vac)</b>					
<b>Nominal phase-to-phase voltage:</b>			400, 416 Vac (3-phase)		
<b>Input frequency:</b>			50/60 Hz		
* Power source can be DELTA or WYE.					
* For 50 Hz on Range 1 only, derate output voltage linearly from 100% at 200 Vac to 95% at 180 Vac.					
Notes: <sup>1</sup> For Supplemental Characteristics, see Table 1-4b.					

**Table 1-4b. Supplemental Characteristics for Series 668xA<sup>1</sup>**

Parameter	Agilent Model Number					
	6680A	6681A	6682A	6683A	6684A	
<b>Ripple &amp; Noise</b> (from 20 Hz to 20 MHz with outputs ungrounded, or with either output terminal grounded)						
<b>Constant Current:**</b> rms **With load inductance > 5μH.	290 mA	190 mA	40 mA	28 mA	23 mA	
<b>Output Programming Range</b> (maximum programmable values)						
<b>Voltage:</b>	5.125 V	8.190 V	21.50 V	32.8 V	41.0 V	
<b>Current:</b>	895 A	592 A	246 A	164 A	131 A	
<b>Overvoltage Protection (OVP):</b>	6.25 V	10.0 V	26.3 V	40.0 V	50.0 V	
<b>Typical Resolution</b>						
<b>Voltage:</b>	1.35 mV	2.15 mV	5.7 mV	8.6 mV	10.8 mV	
<b>Current:</b>	235 mA	155 mA	64 mA	43 mA	34 mA	
<b>Overvoltage Protection (OVP):</b>	30 mV	45 mV	120 mV	180 mV	225 mV	
<b>Accuracy ( @ 25 ±5 °C)*</b>						
<b>Overvoltage Protection (OVP):</b>	120 mV	180 mV	470 mV	720 V	900 V	
<b>Analog Programming (VP): ±0.3%±</b>	10 mV	20 mV	50 mV	75 mV	100 mV	
<b>Analog Programming (IP): ±2% ±</b>	8 A	4 A	2 A	1.5 A	1 A	
<b>Current Monitor (IM): ±2%±</b>	8 A	4 A	2 A	1.5 A	1 A	
<b>Analog Programming (V<sub>P</sub> &amp; I<sub>P</sub>)</b>						
<b>Input Signal</b> (source must be isolated)						
<b>VP Input Signal:*</b>	0 to -5.0 V					
<b>+ IP Input Signal:**</b>	0 to +5.0 V					
<b>Input Impedance</b>	> 30 kΩ					
<b>V<sub>P</sub> and I<sub>P</sub> Inputs:</b>						
*Referenced to common ↓P.			** Referenced to -IP differential input signal			
<b>Current Monitor (IM) Output Signal:</b>	-0.125 V to +5 V					
<b>Drift Temperature Stability</b> (following a 30-minute warmup, change in output over eight hours under constant line, load, and ambient temperature)						
<b>Voltage:</b>	0.02% +	0.15 mV	0.24 mV	0.63 mV	0.96 mV	1.2 mV
<b>Current:</b>	0.02% +	315 mA	170 mA	71 mA	47 mA	38 mA
<b>Temperature Coefficients</b> (change per °C after 30-minute warmup)						
<b>Voltage:</b>	50 ppm +	0.05 mV	0.08 mV	0.21 mV	0.32 mV	0.40 mV
<b>Current:</b>	75 ppm +	110 mA	62 mA	26 mA	17 mA	14 mA
<b>Voltage Readback:</b>	60 ppm +	0.075 mV	0.1 mV	0.25 mV	0.40 mV	0.50 mV
<b>±Current Readback:</b>	85 ppm +	135 mA	90 mA	37 mA	25 mA	20 mA
<b>Overvoltage Protection (OVP):</b>	200 ppm +	1.25 mV	1.8 mV	4.7 mV	7.2 mV	9.0 mV
<b>Typical Common Mode Noise Current*</b>						
<b>rms:</b>	1.5 mA	1.5 mA	3 mA	3 mA	3 mA	
<b>peak-to-peak:</b>	10 mA	10 mA	20 mA	20 mA	20 mA	
* Referenced to signal ground binding post.						
<b>Output Float Voltage</b> (maximum from output signal ground):	±60 Vdc					
Notes: <sup>1</sup> For Performance Specifications, see Table 1-4a.						



**Table 1-4b. Supplemental Characteristics for Series 668xA (continued)<sup>1</sup>**

Parameter	Agilent Model Number																						
	6680A	6681A	6682A	6683A	6684A																		
<b>Remote Sensing Capability</b> <b>Voltage Drop Per Lead:</b>  <b>Load Voltage:</b>  <b>Load Regulation:</b> <b>Degradation due to load lead drop in--output:</b> $\Delta mV \text{ (regulation)} = V_{\text{drop}}(R_{\text{sense } -})$ <b>Degradation due to load lead drop in + output:</b> $\Delta mV \text{ (regulation)} = V_{\text{drop}}(R_{\text{sense } +}) + 2V_{\text{drop}}(V_{\text{rating}})/(V_{\text{rating}} + 10 \text{ V})$ where $R_{\text{sense } -}$ and $R_{\text{sense } +}$ are resistances of respective sense leads.	Up to 1/2 of rated output voltage.  Subtract voltage drop in load leads from specified output voltage rating.																						
<b>Maximum Reverse Voltage Current Sink Capability:</b> *  * Current must be limited by user's external dc source.	With ac input power applied and the dc output reverse biased by an external dc source, the supply will continuously withstand without damage a current equal to its output current rating.																						
<b>Load Voltage:</b>	Subtract voltage drop in load leads from specified output voltage rating.																						
<b>Maximum Input Power:</b>	7350 VA, 6000 W, 160 W (with no load)																						
<b>Maximum AC Line Current Ratings</b> <b>Range 1</b> Rms line current: Line fuse: <b>Range 2</b> Rms line current: Line fuse: *** Includes 5% unbalanced voltage phase condition.	21.4 A (27.7 A) *** 30 AM  10.7 A (14.4 A) *** 16 AM																						
<b>Output Voltage Programming Response Time**</b> <b>Programming Rise/Fall Time</b> (time for output to change from 90 % to 10% or from 10% to 90% of its total excursion):***  <b>Full-load programming speed up/down time</b> (time for output to settle within 4 LSBs of the final value):***  <b>No-load downprogramming discharge time</b> (time for output to fall to 0.5 V when programmed from full voltage to zero volts):  ** All values exclude command processing time. *** With full resistive load = $V_{\text{RATED}}/I_{\text{RATED}}$	<table style="width:100%; border:none;"> <tr> <td style="width:33%;"></td> <td style="width:10%; text-align:center;">  9 ms  </td> <td style="width:10%; text-align:center;">  12 ms  </td> <td style="width:10%; text-align:center;">  45 ms  </td> <td style="width:10%; text-align:center;">  60 ms  </td> <td style="width:10%; text-align:center;">  60 ms</td> </tr> <tr> <td></td> <td style="text-align:center;">  27 ms  </td> <td style="text-align:center;">  35 ms  </td> <td style="text-align:center;">  140 ms  </td> <td style="text-align:center;">  185 ms  </td> <td style="text-align:center;">  185 ms</td> </tr> <tr> <td></td> <td style="text-align:center;">  90 ms  </td> <td style="text-align:center;">  100 ms  </td> <td style="text-align:center;">  475 ms  </td> <td style="text-align:center;">  650 ms  </td> <td style="text-align:center;">  575 ms</td> </tr> </table>						9 ms	12 ms	45 ms	60 ms	60 ms		27 ms	35 ms	140 ms	185 ms	185 ms		90 ms	100 ms	475 ms	650 ms	575 ms
	9 ms	12 ms	45 ms	60 ms	60 ms																		
	27 ms	35 ms	140 ms	185 ms	185 ms																		
	90 ms	100 ms	475 ms	650 ms	575 ms																		
<b>Notes:</b> <sup>1</sup> For Performance Specifications, see Table 1-4a.																							

**Table 1-4b. Supplemental Characteristics for Series 668xA (continued)<sup>1</sup>**

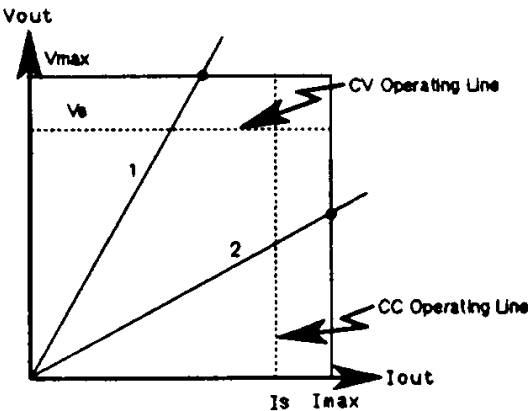
Parameter	All Models																		
<b>Command Processing Time</b> (Average time for output voltage to change after receipt of digital data when the supply is connected directly to the GPIB Bus): 20 ms																			
<b>Monotonicity:</b>	Output is monotonic over entire rated voltage, current, and temperature range.																		
<b>Auto-Parallel Configuration:</b>	Up to 3 identical models																		
<b>Nonvolatile Storage</b> State storage & recall locations: Prestored turn-on state: Maximum memory write cycles:	4 Location 0 40,000, typical																		
<b>Digital Port Characteristics</b>	(see Table 1-5)																		
<b>GPIB Interface Capabilities</b>	(see Table 1-5)																		
<b>Serial Link Capabilities</b>	(see Table 1-5)																		
<b>Recommended Calibration Interval:</b>	1 year																		
<b>Safety Compliance</b> Complies with: Designed to comply with:	CSA 22.2 No.231, IEC 1010 (carries CE mark) UL 1244																		
<b>RFI Suppression</b> (complies with):	CISPR-II, Group 1, Class B																		
<b>Dimensions</b> <b>Width:</b> <b>Height</b> including removable feet excluding removable feet <b>Depth</b> (without output safety cover):	425.5 mm (16.75 in)  234.2 mm (9.25 in) 221.5 mm (8.75 in) 674.7 mm (25.56 in)																		
<b>Weight</b> <b>Net:</b> <b>Shipping:</b>	51.3 kg (113 lb) 63.6 kg (140 lb)																		
<b>Output Characteristic Curve:</b>	 <p>The graph plots output voltage (V<sub>out</sub>) on the y-axis against output current (I<sub>out</sub>) on the x-axis. Two lines originate from the origin: a steeper 'CV Operating Line' and a less steep 'CC Operating Line'. A horizontal dashed line at voltage V<sub>s</sub> intersects the CV line at current I<sub>s</sub> and the CC line at current I<sub>max</sub>. A vertical dashed line at current I<sub>max</sub> intersects the CV line at voltage V<sub>max</sub>. The region between the CV line and the V<sub>s</sub> line is labeled '1', and the region between the CC line and the I<sub>max</sub> line is labeled '2'.</p> <table border="1" data-bbox="889 1386 1302 1696"> <caption>Maximum Rated Output</caption> <thead> <tr> <th>Agilent Model</th> <th>V<sub>out</sub></th> <th>I<sub>out</sub></th> </tr> </thead> <tbody> <tr> <td>6680A</td> <td>5 V</td> <td>875 A</td> </tr> <tr> <td>6681A</td> <td>8 V</td> <td>580 A</td> </tr> <tr> <td>6682A</td> <td>21 V</td> <td>240 A</td> </tr> <tr> <td>6683A</td> <td>32 V</td> <td>160 A</td> </tr> <tr> <td>6684A</td> <td>40 V</td> <td>128 A</td> </tr> </tbody> </table> <p style="text-align: right; font-size: small;">REF-43 CAL</p>	Agilent Model	V <sub>out</sub>	I <sub>out</sub>	6680A	5 V	875 A	6681A	8 V	580 A	6682A	21 V	240 A	6683A	32 V	160 A	6684A	40 V	128 A
Agilent Model	V <sub>out</sub>	I <sub>out</sub>																	
6680A	5 V	875 A																	
6681A	8 V	580 A																	
6682A	21 V	240 A																	
6683A	32 V	160 A																	
6684A	40 V	128 A																	
Notes: <sup>1</sup> For Performance Specifications, see Table 1-4a.																			

**Table 1-4b. Supplemental Characteristics for Series 668xA (continued)<sup>1</sup>**

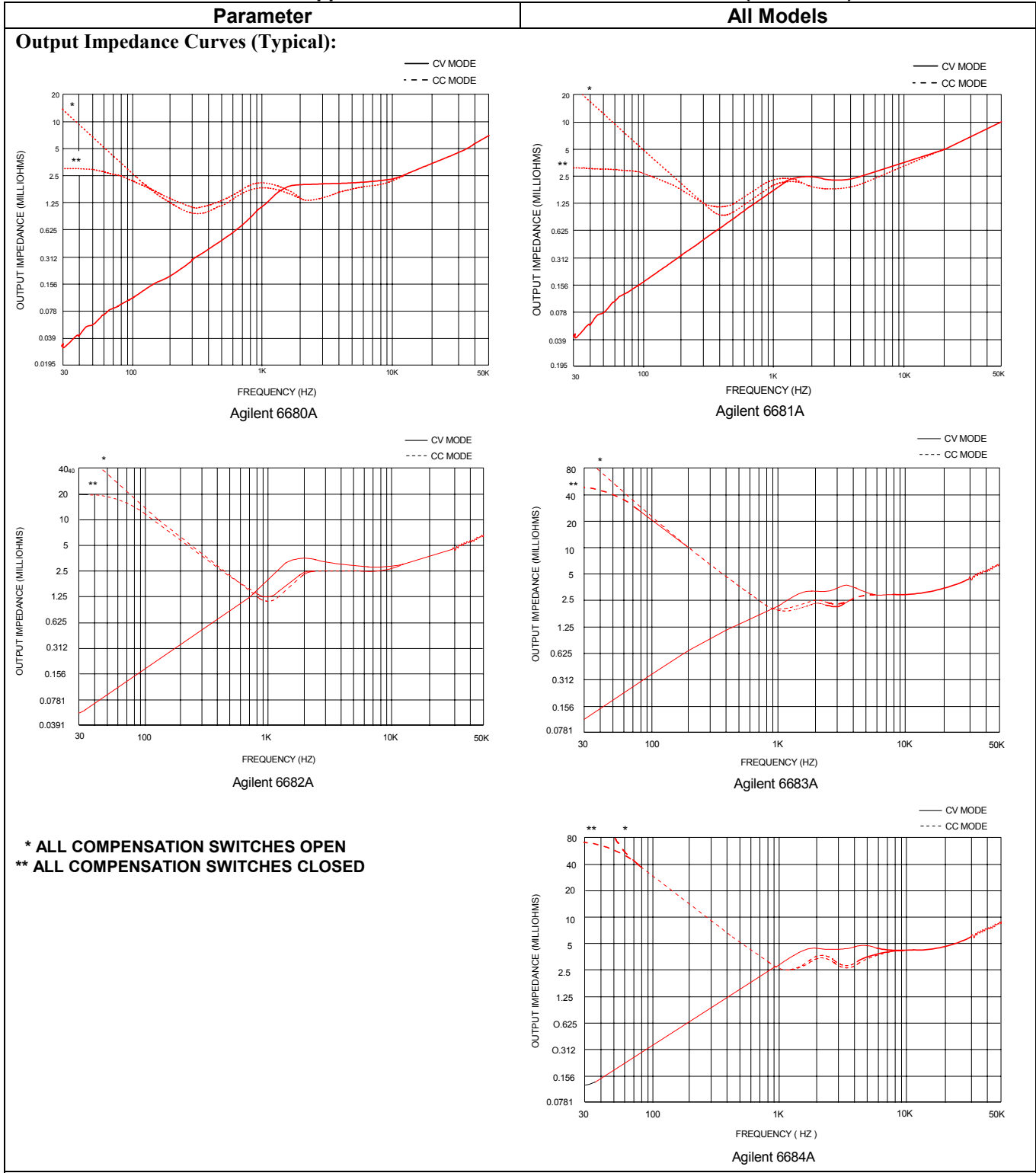

**Notes:** <sup>1</sup>For Performance Specifications, see Table 1-4a.

**Table 1-5a. Performance Specifications for Series 669xA<sup>1</sup>**

Parameter	Agilent Model Number			
	6690A	6691A	6692A	
<b>Output Ratings</b>				
<b>Voltage:</b>	0 - 15 V	0 - 30 V	0- 60 V	
<b>Current:*</b>	0 - 440 A	0 - 220 A	0 – 110 A	
*Derated linearly 1%/°C from 40 ° C to 55 °C				
<b>Programming Accuracy (@ 25 ± 5 °C)</b>				
<b>Voltage:</b>	0.04% +	15 mV	30 mV	60 mV
<b>Current:</b>	0.1 % +	230 mA	125 mA	65 mA
<b>Ripple &amp; Noise</b> (from 20 Hz to 20 MHz with outputs ungrounded, or with either output terminal grounded)				
<b>Constant Voltage:</b>	rms	2.5 mV	2.5 mV	2.5 mV
<b>Constant Voltage:</b>	p-p	15 mV	25 mV	25 mV
<b>Readback Accuracy</b> (from front panel or over GPIB with respect to actual output @ 25 ± 5 °C)				
<b>Voltage:</b>	0.05% +	22.5 mV	45 mV	90 mV
<b>±Current</b>	0.1% +	300 mA	165 mA	80 mA
<b>Load Regulation</b> (change in output voltage or current for any load change within ratings)				
<b>Voltage</b>	0.002% +	650 μV	1.1 mV	2.2 mV
<b>Current:</b>	0.005% +	40 mA	17 mA	9 mA
<b>Line Regulation</b> (change in output voltage or current for any line change within ratings)				
<b>Voltage:</b>	0.002% +	650 μV	650 μV	650 μV
<b>Current:</b>	0.005% +	40.5 mA	17 mA	9 mA
<b>Transient Response Time</b> (for the output voltage to recover to within 150 mV following any step change from 100% to 50% or 50% to 100% of the rated output current): < 900 μs				
<b>AC Line Input</b> * (selectable - see Appendix C)				
<b>Range 1 (180-235 Vac)</b>				
<b>Nominal phase-to-phase voltage:</b>			200, 208 Vac (3-phase)	
<b>Input frequency:</b>			50/60 Hz	
<b>Range 2 (360-440 Vac)</b>				
<b>Nominal phase-to-phase voltage:</b>			400, 416 Vac (3-phase)	
<b>Input frequency:</b>			50/60 Hz	
* Power source can be DELTA or WYE.				
Notes: <sup>1</sup> For Supplemental Characteristics, see Table 1-5b.				



**Table 1-5b. Supplemental Characteristics for Series 669xA (continued)<sup>1</sup>**

Parameter	Agilent Model Number															
	6690A	6691A	6692A													
<b>Remote Sensing Capability</b> <b>Voltage Drop Per Lead:</b>  <b>Load Voltage:</b>  <b>Load Regulation:</b> <b>Degradation due to load lead drop in--output:</b> $\Delta mV \text{ (regulation)} = V_{\text{drop}}(R_{\text{sense } -})$ <b>Degradation due to load lead drop in + output:</b> $\Delta mV \text{ (regulation)} = V_{\text{drop}}(R_{\text{sense } +}) + 2V_{\text{drop}}(V_{\text{rating}})/(V_{\text{rating}} + 10 \text{ V})$ where $R_{\text{sense } -}$ and $R_{\text{sense } +}$ are resistances of respective sense leads.	Up to 1/2 of rated output voltage.  Subtract voltage drop in load leads from specified output voltage rating.															
<b>Maximum Reverse Voltage Current Sink Capability:</b> *  * Current must be limited by user's external dc source.	With ac input power applied and the dc output reverse biased by an external dc source, the supply will continuously withstand without damage a current equal to its output current rating.															
<b>Maximum Input Power:</b>	9000 VA, 7950 W, 175 W (with no load)															
<b>Maximum AC Line Current Ratings</b> <b>Range 1</b> Rms line current: Line fuse: <b>Range 2</b> Rms line current: Line fuse:	26 A *** 40 AM 13 A *** 20 AM															
<b>Output Voltage Programming Response Time**</b> <b>Programming Rise/Fall Time</b> (time for output to change from 90 % to 10% or from 10% to 90% of its total excursion):***  <b>Full-load programming speed up/down time</b> (time for output to settle within 4 LSBs of the final value):***  <b>No-load downprogrammig discharge time</b> (time for output to fall to 0.5 V when programmed from full voltage to zero volts):  ** All values exclude command processing time. *** With full resistive load = $V_{\text{RATED}}/I_{\text{RATED}}$	<table style="width: 100%; border-collapse: collapse;"> <tr> <td style="text-align: center;">  45 ms  </td> <td style="text-align: center;">60 ms  </td> <td style="text-align: center;">100 ms  </td> <td style="text-align: center;"> </td> </tr> <tr> <td style="text-align: center;">  150 ms  </td> <td style="text-align: center;">185 ms  </td> <td style="text-align: center;">280 ms  </td> <td style="text-align: center;"> </td> </tr> <tr> <td style="text-align: center;">  340 ms  </td> <td style="text-align: center;">650 ms  </td> <td style="text-align: center;">870 ms  </td> <td style="text-align: center;"> </td> </tr> </table>				45 ms	60 ms	100 ms		150 ms	185 ms	280 ms		340 ms	650 ms	870 ms	
45 ms	60 ms	100 ms														
150 ms	185 ms	280 ms														
340 ms	650 ms	870 ms														
<b>Notes:</b> <sup>1</sup> For Performance Specifications, see Table 1-5a.																

**Table 1-5b. Supplemental Characteristics for Series 669xA (continued)<sup>1</sup>**

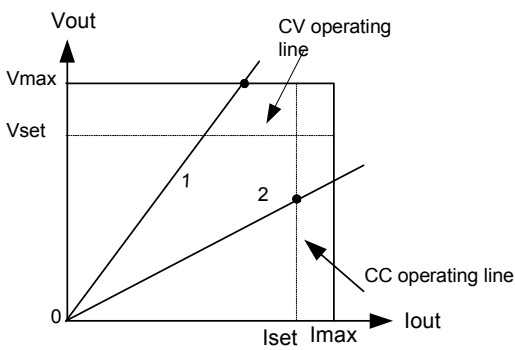
Parameter	All Models												
<b>Command Processing Time</b> (Average time for output voltage to change after receipt of digital data when the supply is connected directly to the GPIB Bus): 20 ms													
<b>Monotonicity:</b>	Output is monotonic over entire rated voltage, current, and temperature range.												
<b>Auto-Parallel Configuration:</b>	Up to 3 identical models												
<b>Nonvolatile Storage</b> State storage & recall locations: Prestored turn-on state: Maximum memory write cycles:	4 Location 0 40,000, typical												
<b>Digital Port Characteristics</b>	(see Table 1-6)												
<b>GPIB Interface Capabilities</b>	(see Table 1-6)												
<b>Serial Link Capabilities</b>	(see Table 1-6)												
<b>Recommended Calibration Interval:</b>	1 year												
<b>Safety Compliance</b> Complies with: Designed to comply with:	CSA 22.2 No.231, IEC 1010 (carries CE mark) UL 1244												
<b>RFI Suppression</b> (complies with):	CISPR-II, Group 1, Class B												
<b>Dimensions</b> <b>Width:</b> <b>Height</b> including removable feet excluding removable feet <b>Depth</b> (without output safety cover):	425.5 mm (16.75 in)  234.2 mm (9.25 in) 221.5 mm (8.75 in) 674.7 mm (25.56 in)												
<b>Weight</b> <b>Net:</b> <b>Shipping:</b>	51.3 kg (113 lb) 63.6 kg (140 lb)												
<p><b>Output Characteristic Curve:</b></p> <p>Output Characteristic Curve:</p>  <table border="1" data-bbox="987 1465 1312 1728"> <caption>Maximum Rated Output</caption> <thead> <tr> <th>Agilent Model</th> <th>Vout</th> <th>Iout</th> </tr> </thead> <tbody> <tr> <td>6690A</td> <td>15V</td> <td>440A</td> </tr> <tr> <td>6691A</td> <td>30V</td> <td>220A</td> </tr> <tr> <td>6692A</td> <td>60V</td> <td>110A</td> </tr> </tbody> </table>		Agilent Model	Vout	Iout	6690A	15V	440A	6691A	30V	220A	6692A	60V	110A
Agilent Model	Vout	Iout											
6690A	15V	440A											
6691A	30V	220A											
6692A	60V	110A											
<p><b>Notes:</b> <sup>1</sup>For Performance Specifications, see Table 1-4a.</p>													

**Table 1-5b. Supplemental Characteristics for Series 669xA (continued)<sup>1</sup>**

Parameter	All Models
<b>Output Impedance Curves (Typical):</b>	
<b>Agilent 6690A</b>	
<b>Agilent 6691A</b>	
<b>Agilent 6692A</b>	
<p>* All compensation switches open                  ** All compensation switches closed</p>	
<p><b>Notes:</b> <sup>1</sup>For Performance Specifications, see Table 1-4a.</p>	





**Table 1-7. Operator Replaceable Parts List (continued)**

Description (Unless otherwise specified, parts apply to all models.)	Agilent Part No.
Fuses, Series 664xA	
M6A 250V (for 100 Vac line voltage, reference designator F450)	2110-0056
M5A 250V (for 120 Vac line voltage, reference designator F450)	2110-0010
M3A 250V (for 220/230/240 Vac line voltage, reference designator F450)	2110-0003
M15A 32V (for secondary rail bias, reference designator F402, F403)	2110-0697
M5A 125V (for ac bias, reference designator F600, F601)	2110-0699
M.125A 125V (for control circuits, reference designator F675, F700, 701)	2110-0671
Fuseholder for Line (Littelfuse 345 101; UL, CSA, SEMKO, VDE approved; 6.3/15A, 250V)	2110-0927
Line Fuses, Series 665xA	
100 Vac line voltage, 15 AM	2110-0054
120 Vac line voltage, 12 AM	2110-0249
220/230/240 Vac line voltage, 7 AM	2110-0614
Line Fuses, Series 667xA *	
*This is an internal fuse not replaceable by the operator.	
Line Fuses, Series 668xA	
16 AM for 360-440 Vac line (set of 3)	5060-3512
30 AM for 180-235 Vac line (set of 3)	5060-3513
Line Fuses, Series 669xA	
20 AM for 360-440 Vac line (set of 3)	5065-6935
40 AM for 180-235 Vac line (set of 3)	5065-6934
Knob, rotary output control	0370-1091
Lockwasher, ac input safety cover (Series 667xA and 668xA)	2190-0484
Lockwasher, output bus bar, 1/4 spring (Series 667xA only)	3050-1690
Manual	
Agilent 59510A/11 Relay Accessories	5957-6382
Series 603xA Operating	5959-3301
Series 664xA and 665xA Service	5959-3376
Series 664xA, 665xA, 667xA, 668xA, and 669xA Programming Guide	5964-8269
Series 667xA Service	5959-3384
Nut, output bus bar, hex 1/4-20x1/2 (Series 667xA)	2950-0084
Nut, power ground, hex w/lw 3/8x32 (Series 667xA)	0590-0305
Nut, power input cable (Series 668xA)	0535-0082
Nut, power input cable (Series 669xA)	0535-0038
Plug, analog connector	1252-3698
Plug, digital connector	1252-1488
Power cord assembly	(See "Options" )
Rack mount kit	(See "Options")
Resistor, calibration	(See Appendix A)
Screw, ac input safety cover, M4.0 x 60 mm long (Series 667xA, 668xA)	0515-0156
Screw, ac input safety cover, M4.0 x 60 mm long (Series 669xA)	0515-0380
Screw, carrying strap, M5x0.8x10 mm	0515-1384
Screw, dc output cover (Series 664xA and 665xA)	0360-2191
Screw, output bus bar	
Series 665xA	0515-1085
Series 667xA, 1/4-20x1/2	2940-0103
Screw, outer cover, M5 x 0.8 mm	0515-0073
Screw, output sense terminal, M3x0.5x8mm (Series 667xA, 668xA, 669xA)	0515-0104
Slide mount kit	( "See Accessories" )
Standoff, GPIB	0380-0643
Terminal, crimp, ac power cord (Series 667xA only)	
L or N terminal	0362-0681
Gnd terminal	0362-0207

# Installation

## Inspection

### Damage

When you receive your power supply, inspect it for any obvious damage that may have occurred during shipment. If there is damage, notify the shipping carrier and the nearest Agilent Sales and Support Office immediately. Warranty information is printed in the front of this guide.

### Packaging Material

Until you have checked out the power supply save the shipping carton and packing materials in case the power supply has to be returned to Agilent Technologies. If you return the power supply for service, attach a tag identifying the model number and the owner. Also include a brief description of the problem.

### Items Supplied

In addition to this manual, check that the following items in Table 2-1 are included with your power supply (see Table 1-6 for part numbers):

**Table 2-1. Items Supplied**

<b>Power cord</b>	<p><b>Series 664xA and 665xA</b></p> <p>Your power supply was shipped with a power cord for the type of outlet specified for your location. If the appropriate cord was not included, contact your nearest Agilent Sales and Support Offices (see end of this guide) to obtain the correct cord. <b>Caution:</b> Your power supply cannot use a standard power cord. The power cords supplied by Agilent Technologies have heavier gauge wire.</p> <p><b>Series 667xA, 668xA, 669xA</b></p> <p>Your power supply was shipped with a power cord appropriate for your location. The cord may or may not be terminated in a power plug (see "Options" in Chapter 1). If the cord is not included, contact your nearest Agilent Sales and Support Office (see end of this guide ) to obtain the correct cord. These models also include a power input safety cover with strain relief connector. It is required to secure the power cord to the power supply.</p>
<b>Analog connector</b>	A 7-terminal analog plug (see Table 1-6) that connects to the back of the supply. Analog connections are described in Chapter 4.
<b>Digital connector</b>	A 4-terminal digital plug (see Table 1-6) that connects to the back of the supply. Digital connections are described in "Appendix D - Digital Port Functions"
<b>Serial cable</b>	A 2-meter cable (see "Accessories" in Chapter 1) that connects to the control bus (next to the GPIB connector). This cable is used to serially connect multiple supplies as described under "Controller Connections" in Chapter 4.

**Table 2-1. Items Supplied (continued)**

<b>Output hardware</b>	<b>Series 667xA only</b> Output hardware (screws with nuts and lockwashers) for securing your load wires to the output bus bars (see Table 1-6).
<b>Guide change page</b>	If applicable, change sheets may be included with this guide. If there are change sheets, make the indicated corrections in this guide.

## Cleaning

**To prevent electric shock, unplug the unit before cleaning.**

Use a dry cloth or one slightly dampened with water to clean the external case parts. Do not attempt to clean internally.

---

## Location and Temperature

### Bench Operation

The “Supplemental Characteristics” in Chapter 1 give the dimensions of your power supply. The cabinet has plastic feet that are shaped to ensure self-alignment when stacked with other Agilent System II cabinets. The feet may be removed for rack mounting. Your power supply must be installed in a location that allows sufficient space at the sides and rear of the cabinet for adequate air circulation. Minimum clearances are 1 inch (25 mm) along the sides. Do not block the fan exhaust at the rear of the supply.

### Rack Mounting

---

**WARNING**

Series 668xA and 669xA supplies weigh 51.3 kg (113 lb). Obtain adequate help when mounting the supply in the rack.

The power supply can be mounted in a standard 19-inch rack panel or cabinet. Rack mounting kits are available as Option 908 or 909 (with handles). Installation instructions are included with each rack mounting kit.

---

**CAUTION**

**Series 667xA, 668xA, & 669xA**

Series 667xA, 668xA, 669xA supplies require instrument support rails for non-stationary installations. These are normally ordered with the cabinet and are not included with the rack mounting kits.

---

## Temperature Performance

A variable-speed fan cools the supply by drawing air through the sides and exhausting it out the back. Using Agilent rack mount or slides will not impede the flow of air. The temperature performance is as follows:

**Series 664xA & 665xA** Operates without loss of performance within the temperature range of 0 °C to 40 °C and with derated output from 40 °C to 55 °C.

**Series 667xA, 668xA, & 669xA** Operates without loss of performance within the temperature range of 0 °C to 55 °C.

---

**WARNING**

If a Series 664xA or 665xA power supply is operated at full output current for several hours, the sheet metal immediately under the transformer (near the right front) can get very hot. Do not touch this area of the cabinet. The line cord also can become quite warm. Both of these conditions are normal.

---

## Input Power Source

Refer to the applicable paragraphs below for information on the input power source. *Do not apply power to the power supply until directed to do so in Chapter 3.*

### CAUTION

Check the line **RATING** label on the rear of your supply and verify that the voltage shown there corresponds to the nominal line voltage of your power source. If it does not, see "Appendix C - Line Voltage Conversion" for instructions on changing the power supply's line voltage configuration.

---

## Installing the Series 664xA and 665xA Power Cord

The supplied cord connects to the power receptacle on the rear panel ( **2**, Figure 2-1).

- You can operate your supply from a nominal 100 V, 120 V, 220 V, 230 V, or 240 V single-phase ac power source as indicated on the rear panel line **RATING** label **1**.
- See "AC Input Ratings" in Table 1-1a or Table 1-2a for the voltage and frequency range for each type of power source. "Maximum AC Line Current Ratings" in Table 1-1b or Table 1-2b show the maximum load current.
- The line fuse is located in a fuseholder on the rear panel **3**. The rear panel label **1** shows the fuse value used in the power supply and Table 1-6 identifies the replacement fuse.

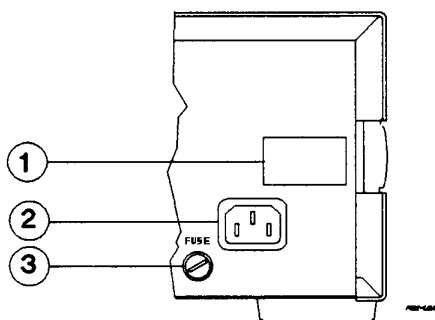

**Figure 2-1. Series 664xA and 665xA Power Connection**

---

**Note** The detachable power cord may be used as an emergency disconnecting device. Removing the power cord from the ac input connector will disconnect ac input power to the unit.

---

## Installing the Series 667xA Power Cord

---

**Note** This product requires single-phase input voltage.

---

You can operate your supply from a nominal 200 V or 230 V, single-phase power source, or from the line-to-line voltage of a 208-volt, 3-phase source. The proper source is indicated on the rear line **RATING** label ( **4**, Figure 2-2). See "AC Input Ratings" in Table 1-3a for the voltage and frequency range for each type of power source.

---

**Note** The power source must be a dedicated line with no other devices drawing current from it.

---

The line fuse is located inside the power supply. Table 1-6 identifies the replacement fuse. See "In Case of Trouble" in Chapter 3 for instructions on fuse replacement.

### WARNING

Installation of the power cord must be done by a qualified electrician and in accordance with local electrical codes.

---

The power cord supplied with power supply may or may not include a power plug (see "Options" in Chapter 1) at one end of the cord. Terminating connections and a ground lug are attached to the other end of the cord.

See Figure 2-2 and proceed as follows:

1. If they are not already in place, position the strain relief connector (11), safety cover (5), rubber boot (9), and connector nut (8) on the power cord (7).
2. Secure the ground wire (2) to the chassis earth ground stud.
3. For single-phase operation, connect the neutral wire (1) to the N input terminal and the line wire (3) to the L input terminal (this line is fused inside the supply).
4. For line-to-line operation from a three-phase source as shown in Figure 2-3, connect one phase to the N input terminal and another phase to the L input terminal (this line is fused inside the supply).

---

**Note** The N terminal is not internally grounded.

---

5. Position the safety cover over the power input terminals and tighten the cover screws (10) and strain relief connector screws (6). Torque the cover screws using 10 to 12 inch-pounds (1.13 to 1.36 Newton meters). Torque the strain relief screws using 2 to 4 inch-pounds (0.23 to 0.45 Newton meters).

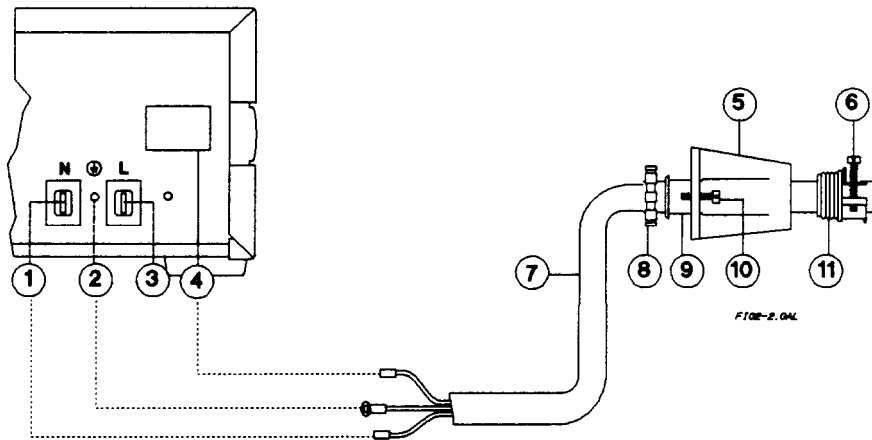

Figure 2-2. Connecting the Series 667xA Power Cord

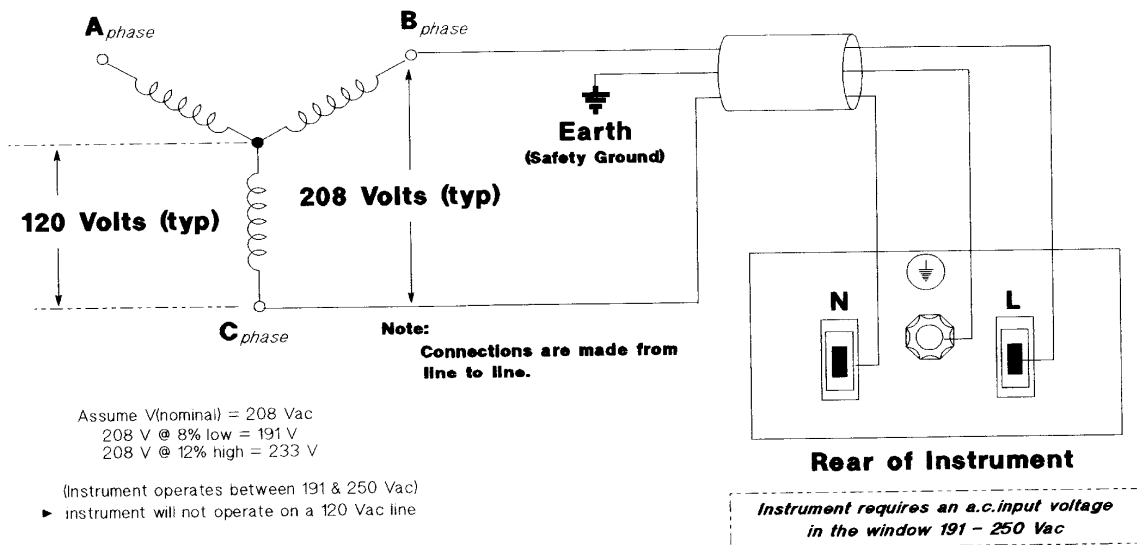

Figure 2-3. 667xA Connection to a 3-Phase Line

## Installing the Series 668xA Power Cord

The Series 668xA power supply requires a 3-phase power source that provides 7350 VA (6000 W) maximum. The supply has a delta input (no neutral connection) and will accept power from either delta (triangle) or wye (star) sources. Two voltage ranges are available (see "AC Input Ratings" in Table 1-4a). *In order to maintain phase current balancing, the power source should be a dedicated line with only Agilent Technologies Series 668xA/669xA supplies drawing current from it.* A disconnect box located near the power supply (see Figure 2-4) is recommended for all installations and is *mandatory for direct-wired installations.*

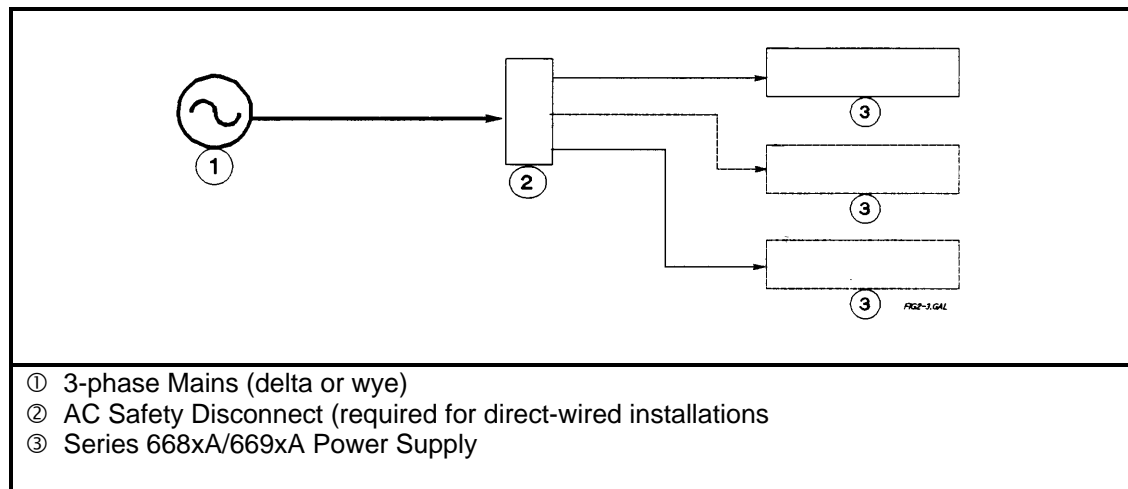

Figure 2-4. Series 668xA/669xA Overall Wiring Diagram.

### WARNING

Installation of the power cord must be done by a qualified electrician and in accordance with local electrical code.

The power cords supplied with the power supply do not include a power plug (see "Options" in Chapter 1) at one end of the cord. Terminating connectors and a ground lug are attached to the other end of the cord.

See Figure 2-5 and proceed as follows:

1. Check the line fuses ( ②, Figure 2-5) as follows:
  - a. Examine the **LINE RATING** label ( ①) on the rear panel.
  - b. Unscrew the line fuse caps ( ②) from the rear panel and verify that all fuses are as specified on the label. Replace the fuses.
2. Open the line clamp ( ⑦) and insert the line cord ( ⑩) through the opening.
3. Position the line cord so that the clamp is near the end of the outside insulating sheath. Tighten the screws ( ⑧) securing the clamp. Torque the screws using 2 to 4 inch-pounds (0.23 to 0.45 Newton meters).
4. Secure the three ac lines to the ac power strip as follows:
  - \* Phase 1 ( ③) to L1. Phase 2 ( ④) to L2. Phase 3 ( ⑥) to L3.
5. Secure the ground wire ( ⑤) to the chassis earth ground stud.

### CAUTION

Do not connect anything to the terminal marked "DO NOT USE".

6. Slip the safety cover ( ⑨) over the fuses and terminal strip and secure the cover with the four cap screws. Torque the screws using 10 to 12 inch-pounds (1.13 to 1.36 Newton meters).
7. If required, wire the appropriate power plug to the other end of the power cord.

### Note

For user-made cable ( ⑩), strip back sheath 100 mm (3.9 in).

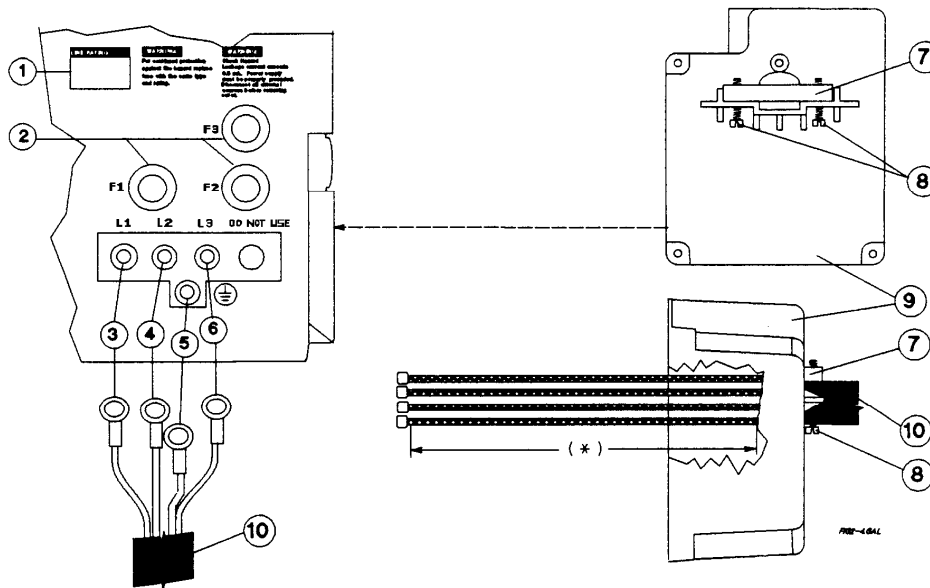

Figure 2-5. Connecting the Series 668xA Power Cord

## Installing the Series 669xA Power Cord

The Series 669xA power supply requires a 3-phase power source that provides 9000 VA (7950 W) maximum. The supply has a delta input (no neutral connection) and will accept power from either delta (triangle) or wye (star) sources. Two voltage ranges are available (see "AC Input Ratings" in Table 1-4a). *In order to maintain phase current balancing, the power source should be a dedicated line with only Agilent Technologies Series 668xA/669xA supplies drawing current from it.* A disconnect box located near the power supply (see Figure 2-4) is recommended for all power cords with plugs and *is mandatory for hard-wired power installations.*

The power cords supplied with the power supply do not include a power plug (see "Options" in Chapter 1) at one end of the cord. Wires are partially stripped back and a ground lug is attached to the other end of the cord.

### WARNING

Installation of the power cord must be done by a qualified electrician and in accordance with the local electrical code.

See Figure 2-6 and proceed as follows:

1. Check the line fuses (3), Figure 2-6) as follows:
  - a. Examine the **LINE RATING** label (1) on the rear panel to make sure the correct voltage and fuses are indicated.
  - b. Pull back on the lever (2) located on each fuseholder and verify that all fuses (3) are as specified on the label.
  - c. Make sure that the fuse indicator pin located in the center of the fuse is facing OUT, not IN
  - d. Close the fuseholder.
  - e. Check to make sure that the red flag does not appear in the fuse holder window (4) after you close the fuseholder.

### CAUTION

When installing the fuses, make sure that the fuse indicator pin located in the center of the fuse is facing OUT, not IN.

2. Open the cable clamp (10). Position the insulating sheath (9) over the end of the power cord where it passes through the cable clamp. Insert the line cord and sheath through the cable clamp making sure that the sheath is between the cord and the clamp.



3. Tighten the screws securing the clamp **10**. Torque the screws using 2 to 4 inch-pounds (0.23 to 0.45 Newton meters).
4. Insert the power cord with the cable clamp into one of the two openings on the safety cover. (The figure shows the power cord installed in the bottom opening.) Tighten the lock nut **11**, and the cable clamp **10** to the safety cover.
 

**Make sure that the cable clamp is securely fastened to the safety cover.**
5. Remove the insulation from the pre-stripped end of the three ac lines. Secure the lines in the top of each fuse holder as follows: Phase 1 **5** to L1. Phase 2 **6** to L2. Phase 3 **7** to L3.
 

Torque the conductive clamp screws to 35 inch-pounds (4 Newton meters).

Pull up on the wire to check that it is securely fastened and cannot pull out.
6. Secure the ground wire **8** to the chassis earth ground stud.
 

Torque the stud nut to 35 inch-pounds (4 Newton meters).
7. Position the safety cover over the fuses and secure the cover with the cover screws. Torque the screws using 10 to 12 inch-pounds (1.13 to 1.36 Newton meters).
8. Place the metal cap **12** into the opening of the safety cover that is not being used by the line cord.
9. **IMPORTANT** To prevent the cable clamp **10** from becoming loose, attach the supplied cable mount **13** to the side of the safety cover as shown. If you are rack mounting the instrument, you could chose to attach the cable mount to the side of the rack. Secure the power cord to the safety cover using the cable tie **14**. Position the cable tie on the power cord so that it is about 12 inches (30 cm) away from the end of the cable clamp **10**.
10. Attach the appropriate power plug to the other end of the power cord.

**WARNING** Do not apply power to the instrument unless the safety cover is in place.

**Note** If you are providing your own power cable, remember to position the insulating sheath **9** over the end of the cable where it passes through the cable clamp **10**.

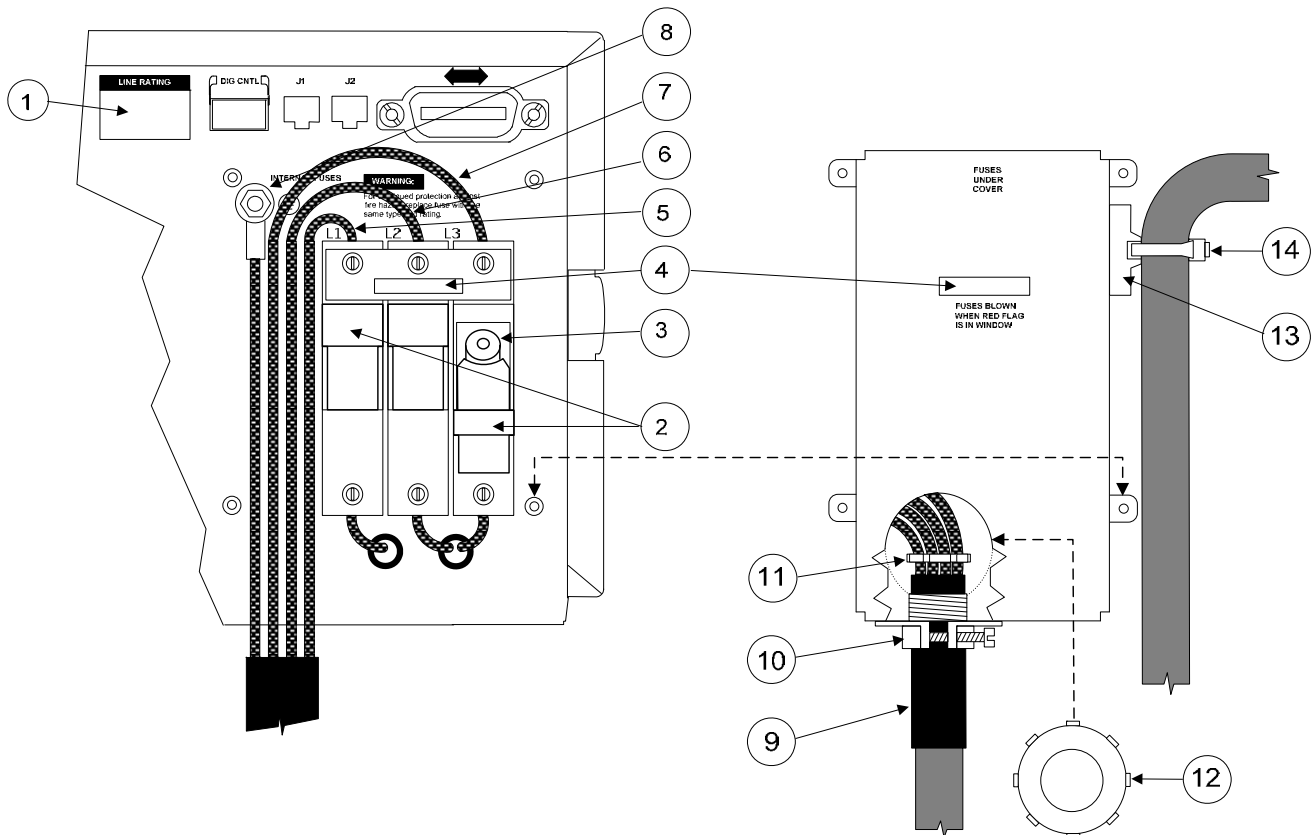

Figure 2-6. Connecting the Series 669xA Power Cord



## Turn-On Checkout

---

**Note** This chapter provides a preliminary introduction to the power supply front panel. See "Chapter 5 - Front Panel" for more details.

---

### Introduction

Successful tests in this chapter provide a high degree of confidence that the power supply is operating properly. For verification tests, see "Appendix B - Operation Verification". Complete performance tests are given in the service manual (see Table 1-5 in Chapter 1). **Do not apply ac power to the power supply until told to do so.**

---

### Preliminary Checkout (All Models)

1. Make certain that the front panel switch is off.
2. Examine the Line Voltage Rating or Line And Fuse Rating label (see "Chapter 2 - Installation" )
  - a. Verify that the line voltage rating agrees with your power source. If it does not, see "Appendix C - Line Voltage Conversion".
  - b. **Series 664xA/665xA** - Use a screwdriver to remove the line fuse from the fuseholder (3, Figure 2-1). Verify that the fuse is as specified on the label. Replace the fuse.
  - c. **Series 668xA** - Unscrew the fuse caps from the rear panel (2, Figure 2-4). Verify that the fuse is as specified on the label. Replace the fuse.
  - d. **Series 669xA** - Flip open the fuseholder located under the ac line safety cover on the rear panel. Verify that the fuse is as specified on the label. Replace the fuse.
3. Check the sense wiring as follows:
  - a. **Series 664xA/665xA** - The **SENSE** switch (4, Figure 4-3a) is set to **Local**.
  - b. **Series 667xA** - Remove the output safety cover (1, Figure 4-4a) and examine the output sense terminals (4 and 5). They should be wired for local sensing as follows:
    1. The **+LS** sense terminal wired to the **+S** terminal of the analog connector (2).
    2. The **-LS** sense terminal wired to the **-S** terminal of the analog connector.
    3. If the power supply is not wired for local sensing, make the above connections, using small-capacity wire (#22 is sufficient).
  - c. **Series 668xA/669xA** - Examine the output bus bars (Figure 4-5a) and make sure they are connected for local sensing as follows:
    1. The **+** bar is wired to the **+S** terminal of the analog connector.
    2. The **-** bar is wired to the **-S** terminal of the analog connector.
    3. If the power supply is not wired for local sensing, make the above connections, using small-capacity wire (#22 is sufficient).
4. Make sure that there is no load connected to the output terminals or bus bars.

---

## Power-On Checkout (All Models)

1. Connect the power cord to the power source (for **Series 668xA & 669xA**, turn on the safety disconnect switch).
2. Turn the front panel power switch to ON (1).
3. The power supply undergoes a self-test when you turn it on. If the test is normal, the following sequence appears on the LCD:
  - a. **Series 664xA/665xA** - The GPIB address (factory default is 5).
  - b. **Series 667xA/668xA/669xA** - The GPIB address (factory default is 5). This is then followed by **PWR ON INIT** for approximately 10 seconds.
4. The display then goes into the meter mode with the **Dis** annunciator on and all others off. “Meter mode” means that the **VOLTS** digits indicate the output voltage and the **AMPS** digits indicate the output current. These values will be at or near zero.
5. Verify that the power supply fan is on by placing your hand near the rear grill to feel the air flow. You may also be able to hear the fan operating.
6. Press **Output on/off** once. The **Dis** annunciator will go off and the CV annunciator will go on .

---

**Note** If the power supply detects an error during self-test, the display will show an error message. Go to “In Case of Trouble” at the end of this chapter.

---

---

## Using the Keypad (All Models)

### Shifted Keys

Some of the front panel keys perform two functions, one labeled in black and the other in blue. You access the blue function by first pressing the blue **Shift** key, which is not labeled. When the **Shift** annunciator is on, you will know you have access to the key's shifted (blue) function.

### Backspace Key

The **←** key is an erase key. If you make a mistake entering a number and have not yet entered it (have not pressed **Enter**), you can delete the number by pressing **←**. You may delete as many numbers as you wish by repeatedly pressing this key.

---

## Output Checkout (All Models)

---

**Important** When the power supply is turned on, it asserts the state stored in EEPROM memory location 0. For a new supply, this is the factory default (\*RST) state. The following procedures assume that the factory default state is still in location 0 (Turn-On Conditions in “Chapter 5 - Front Panel” for details).

---

## Checking the Voltage Function

The tests in Table 3-1 check the basic voltage functions with no load connected to the power supply. The **VOLTS** display will show various readings. Ignore the **AMPS** display.

**Table 3-1. Checking the Voltage Functions (Output Terminals Open)**

Procedure	Display	Explanation
<b>Output Terminals Open or Connected to a Voltmeter</b>		
If <b>Dis</b> is on, turn it off by pressing <b>Output on/off</b>		
Press <b>Voltage</b> key	VOLT 0.000	Default voltage setting. <b>CV</b> annunciator should be on. (If <b>CC</b> annunciator is on, increase the current by pressing <b>Current</b> one or more times until <b>CC</b> turns off and <b>CV</b> turns on.)
Press <b>4</b>	VOLT 4	Program output to 4 volts.
Press <b>Enter</b>	4.000	Enter the voltage. Meter mode displays output voltage. During these tests, there may be a small (relative to full output) <b>AMPS</b> reading that will be ignored.
Press <b>↓Voltage</b> several times		Voltage decreases several millivolts each time you press the key.*
Press <b>↑Voltage</b> the same number of times		Voltage increases several millivolts each time you press the key.*
Rotate <b>Voltage</b> control first counterclockwise and then clockwise		* The number of millivolts change is determined by the voltage programming resolution of your power supply (see "Supplemental Characteristics" in Chapter 1). Control operates similarly to <b>↓Voltage</b> and <b>↑Voltage</b> keys. The control is rate sensitive. Turning it more quickly causes a more rapid change in voltage.
Press <b>Voltage 4 Enter</b>	4.000	Program output to 4 volts.
Press <b>OV</b>		Display shows default OVP (overvoltage protection) trip voltage for your supply (see "Supplemental Characteristics" in Chapter 1).
Press <b>3</b>	OV 3	Program the OVP to 3 volts, which is less than the output voltage.
Press <b>Enter</b>	0.000	OVP voltage entered is less than the output voltage. This causes the OVP circuit to trip. The output drops to zero, <b>CV</b> turns off, and <b>Prot</b> turns on.
Press <b>Protect</b>	OV - - - -	Shows that the power supply shuts down because the OVP circuit has tripped.
Press <b>←</b>		Return display to meter mode (optional step).
Press <b>OV 4.5 Enter</b>	0.000	Program the OVP to 4.5 volts, which is greater than the output voltage. <b>Note:</b> You cannot clear an OVP trip until you have first removed the cause of the condition.
Press <b>Prot Clear</b> <b>(Shift Protect)*</b>	4.000	The OVP circuit is cleared, restoring the output. <b>Prot</b> turns off and <b>CV</b> turns on.

\***Shift** is the unlabeled blue key.

## Checking the Current Function

### WARNING

**ENERGY HAZARD.** Some supplies (Series 668xA/669xA) can provide more than 240 VA at more than 2 V. If the output connections touch, severe arcing may occur resulting in burns, ignition or welding of parts. Do not attempt to make connections while the output is live.

The tests in Table 3-2 check the basic current functions with a short connected across the power supply output. **Do not program maximum output currents unless the shorting wire is capable of handling the current** (see "Supplemental Characteristics" and Table 4-2). The **AMPS** display will show various readings. Ignore the **VOLTS** display.

**Table 3-2. Checking the Current Functions (Output Terminals Shorted)**

Action	Display	Explanation
<p><b>Turn off the power supply</b> and connect a #14 AWG or larger wire across the output (+) and (-) terminals. <b>If you intend to test at full-rated output current, use a wire or wires of sufficient size to carry the maximum current of the supply</b> (see "Supplemental Characteristics" in Chapter 1 and Table 4-2 in Chapter 4).</p>		
<p>Turn on the supply. Set the voltage to its maximum value. This example assumes that you have an 8-volt supply (see "Performance Specifications" in Chapter 1 for the value for your specific supply) .</p> <p>Press <b>Voltage</b> <b>8</b> <b>Enter</b></p> <p>Press <b>Current</b> <b>1</b> <b>Enter</b></p> <p>Press <b>Output on/off</b></p> <p>Press <b>↓Current</b> several times</p> <p>Press <b>↑Current</b> the same number of times</p> <p>Rotate the <b>Current</b> control first counterclockwise and then clockwise</p> <p>Press <b>OCP</b></p>	<p>Meter mode</p> <p>VOLT 8.000</p> <p>AMPS 1.000</p> <p>AMPS 1. 000</p>	<p>Essentially zero outputs with <b>Dis</b> annunciator on.</p> <p>Program output to 8 volts.</p> <p>Program output to 1 ampere.</p> <p><b>CAUTION:</b> Be certain to observe this step with Series 668xA/669xA supplies. Start at 1 ampere before going to greater output currents.</p> <p><b>Dis</b> annunciator turns off, <b>CC</b> annunciator turns on, and <b>AMPS</b> display shows the programmed current. *Current decreases several milliamperes each time you press the key.: *Current increases several milliamperes each time you press the key.</p> <p>*The number of milliamperes is determined by the current programming resolution of the power supply (see "Supplemental Characteristics" in Chapter 1).</p> <p>Control operates similarly to the <b>↓Current</b> and <b>↑Current</b> keys. The control is rate sensitive. Turning it more quickly causes a more rapid change in current.</p> <p>You have enabled the overcurrent protection circuit. The circuit then tripped because of the output short. The <b>CC</b> annunciator turns off and the <b>OCP</b> and <b>Prot</b> annunciators come on. The output current is near zero.</p>

**Table 3-2. Checking the Current Functions (Output Terminals Shorted) (continued)**

Action	Display	Explanation
Press <b>Output on/off</b>	AMPS 0.000	<b>Dis</b> annunciator turns on.
Press <b>OC</b>		You have disabled the overcurrent protection circuit. The <b>OC</b> annunciator turns off.
Press <b>Prot Clear</b> <b>(Shift) Protect)**</b>		You have cleared the overcurrent protection circuit. The <b>Prot</b> annunciator turns off.
Press <b>Output on/off</b>	AMPS 1.000	<b>Dis</b> turns off and <b>CC</b> turns on. The output current is restored.
<p><b>If you have a shorting wire of sufficient capacity</b>, you may continue testing up to the maximum rated current of the power supply (see "Performance Specifications"). When finished, go to the next step.</p>		
Press <b>Output on/off</b>	AMPS 0.000	<b>Dis</b> turns on and output current drops to zero.
<p><b>Turn off the power supply and remove the short from the output terminals.</b></p>		
<p>**<b>Shift</b> is the unlabeled blue key.</p>		

## Checking the Save and Recall Functions (All Models)

The Series 668xA/669xA supplies have four nonvolatile memory storage locations (0 through 3). The supplies of all other series have five (locations 0 through 4). Proceed as follows:

- Make certain that the output is on (**Dis** annunciator is off).
- Set the voltage output to 5 by pressing **Voltage 5 Enter**.
- Save this value to location 1 by pressing **Shift Save 1 Enter**.
- Return the output voltage to 0 by pressing **Recall 0 Enter** (This step is based on the fact that a newly shipped power supply has the \*RST parameters stored in location 0 (see "Chapter 5 - Front Panel" for more information).
- Press **Recall 1 Enter** and notice that the output voltage returns to the value stored in location 1.

## Determining the GPIB Address (All Models)

When the power supply is turned on, the display shows ADDR n, where n is the power supply GPIB address. Any time you want to see the address, press **Address**.

The display will indicate **ADDR 5**, which is the factory default. If the address has been changed, then a different number will appear (see "Setting the GPIB Address" in "Chapter 5 - Front Panel").

## In Case of Trouble

### Line Fuse

If the power supply appears "dead" with a blank display and the fan not running, first check your power source to be certain line voltage is being supplied to the power supply. If the source is normal, the power supply line fuse may be defective. **On**

**Series 669xA supplies**, if the **Red indicator** appears in the fuse window on the rear panel, then one or more of the line fuses are open. If the supply has a defective fuse, replace it only once. If it fails again, investigate the reason for the failure. Proceed as follows:

## Series 664xA and 665xA Supplies

The line fuse is located on the rear panel (3, Figure 2-1). Proceed as follows:

1. Turn off the front panel power switch.
2. Using a screwdriver, remove the fuse from the fuseholder. Replace it with one of the same type (see Table 1-5 in Chapter 1). **Do not use a time-delay** type fuse.
3. Turn on the power supply and check the operation.

## Series 667xA Supplies

### WARNING

Hazardous voltage can remain inside the power supply even after it has been turned off. Fuse replacement should be done only by qualified electronics personnel.



The line fuse is located inside the power supply. To change it, proceed as follows:

1. Turn off the front panel power switch and unplug the line cord from the power source.
2. Remove the power supply dustcover as follows:
  - a. Remove the four screws securing the carrying straps and dustcover.
  - b. Spread the bottom rear of the dustcover and pull it back to disengage it from the front panel.
  - c. Slide the dustcover back far enough to expose the line fuse (1, Figure 3-1).
3. Observe the input rail LED under the RFI shield (4, Figure C-3 in "Appendix C - Line Voltage Conversion"). **If the LED is on, there is still hazardous voltage inside the supply.** Wait until the LED goes out (this may take several minutes) before proceeding.
4. Connect a dc voltmeter across test points TP1 and TP2 (Figure C-3). It may be necessary to remove the RFI shield in order to reach these test points. (The shield is secured by four screws on each side.) When the voltmeter indicates 60 volts or less, it is safe to work inside the power supply.
5. Replace the fuse with one of the same type (see Table 1-5 in Chapter 1). **Do not use a time-delay** type fuse.
6. If you removed it in step b, be sure to replace the RFI shield.
7. Replace the dustcover.
8. Connect the line cord to the power source.
9. Turn on the front panel power switch and check the operation.

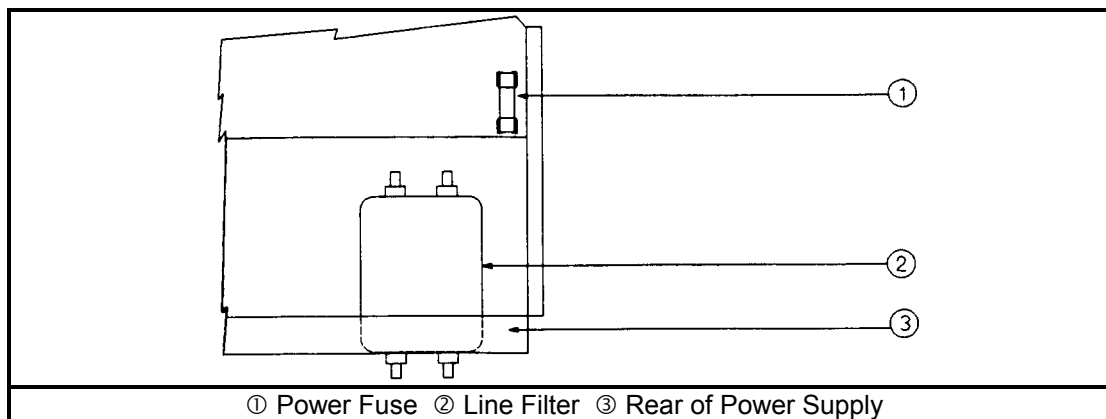

**Figure 3-1. Series 667xA Line Fuse**



## Series 668xA Supplies

The line fuses are located on the rear panel (see Figure 2-5). Proceed as follows:

1. Turn off the front panel power switch and remove the input power (unplug the power cord or open the safety disconnect).
2. Remove the ac input safety cover from the rear panel.
3. Unscrew the fuse caps and remove the fuses.
4. If one or two fuses are defective, replace **all three** with fuses of the same type (see Table 1-5 in Chapter 1).
5. Turn on the power supply and check the operation. If it is normal, replace the ac input safety cover.

## Series 669xA Supplies

The line fuses are located on the rear panel (see Figure 2-6). Check the fuse indicator window on the rear of the ac input safety cover. If the RED indicator is visible in the window, proceed as follows:

1. Turn off the front panel power switch and remove the input power (unplug the power cord or open the safety disconnect).
2. Remove the ac input safety cover from the rear panel.
3. Flip the fuseholder levers down and check the fuses. If a fuse has blown, the indicator pin will extend out of the center of the fuse body (see Figure 2-5)
4. If one or two fuses are defective, replace **all three** with fuses of the same type (see Table 1-5 in Chapter 1). If all three fuses are blown, the power supply probably has a defect that requires service.

---

**Note:** When installing the fuses, make sure that the fuse indicator pin located in the center of the fuse is facing OUT, not IN.

---

5. Replace the ac input safety cover.
6. Turn on the power supply and check the operation.

---

**Maintenance Note** It is recommended that new line fuses be installed every four years.

---

## Error Messages (All Models)

Power supply failure may occur during power-on selftest or during operation. In either case, the display may show an error message that indicates the reason for the failure.

### Selftest Errors

When a selftest error occurs, it prevents all front panel operation. The display may show either a power-on error message or a checksum error message.

### Power-On Error Messages

Power-on messages appear as:

En- - - - -

Where "n" is a number listed in Table 3-3. If this occurs, turn the power off and then back on to see if the error persists. It is possible to recover from the EE CHKSUM error (see "Checksum Errors"). If any other message persists, the power supply requires service.

**Table 3-3. Power-On Selftest Errors**

Error No.	Display	Failed Test	Error No.	Display	Failed Test
E1	<b>FP RAM</b>	Front Panel RAM	E8	<b>SEC RAM</b>	Secondary RAM
E2	<b>FP ROM</b>	Front Panel ROM checksum	E9	<b>SEC ROM</b>	Secondary ROM checksum
E3	<b>EE CHKSUM</b>	EEPROM	E10	<b>SEC 5V</b>	Secondary 5 V ADC reading
E4	<b>PRI XRAM</b>	Primary external RAM	E11	<b>TEMP</b>	Secondary ambient thermistor reading
E5	<b>PRI IRAM</b>	Primary internal RAM	E12	<b>DACS</b>	Secondary VDAC/IDAC readback
E6	<b>PRI ROM</b>	Primary ROM checksum			
E7	<b>GPIB</b>	GPIB R/W to serial poll			

**Checksum Errors.**

If the display shows **EE CHKSUM**, the power supply has detected an EEPROM checksum error. A checksum error can occur due to the following conditions:

- Excessive number of write cycles to an EEPROM (see "Nonvolatile Memory Write Cycles" in "Supplemental Characteristics" tables). This condition, which would appear only after extended use, is not recoverable and requires service.
- Loss of ac input power during a checksum calculation. This condition, which is very unlikely, is recoverable.

You may be able to recover from a checksum error by writing to the EEPROM while the power supply is in the calibration mode. To do this, proceed as follows:

1. Enable the calibration mode by pressing **Shift Cal Enable 1 Enter**.
2. **PASWD** will appear on the display.
3. Press the number keys corresponding to the password, followed by **Enter**. The **Cal** annunciator will go on.

---

**Note** On new equipment, the calibration password corresponds to the four-digit model number (such as **6651**). See "Appendix A - Calibration" for more information about the calibration password.

---

4. Save any operating state (for example, press **Shift Save 0 Enter**).
5. Turn the power off and then back on.

A normal display free of error messages should appear. If not, the power supply requires service.

**Runtime Error Messages**

Under unusual operating conditions, the **VOLT** or **AMPS** display may show **+OL** or **-OL**. This indicates that the output voltage or current is beyond the range of the meter readback circuit. Table 3-4 shows other error messages that may appear at runtime.

**Table 3-4. Runtime Errors**

Display	Meaning	Display	Meaning
<b>EE WRITE ERR</b>	EEPROM status timeout	<b>UART FRAMING</b>	UART byte framing error
<b>SBUB FULL</b>	Message too long for buffer	<b>UART OVERRUN</b>	Overfilled UART receive buffer
<b>SERIAL DOWN</b>	Failed communication with front panel	<b>UART PARITY</b>	UART byte parity error panel
<b>STK OVERFLOW</b>	Front panel stack overflow		

## User Connections

### Rear Panel Connections (All Models)

Make application load connections to the output terminals or bus bars, analog connector, and digital connector as shown on the rear-panel drawing for your model power supply. These connections are organized by series as follows:

- Series 664xA and 665xA
- Series 667xA
- Series 668xA and 669xA

Make controller connections (GPIB and serial link) as shown in Figure 4-6 at the end of this chapter.

### Load Wire Selection (All Models)

#### WARNING

**Fire Hazard** To satisfy safety requirements, load wires must be large enough not to overheat when carrying the maximum short-circuit current of the power supply. If there is more than one load, then any pair of load wires must be capable of safely carrying the full-rated current of the supply. With the larger-capacity supplies (such as Series 668xA), use of two or more load wires in parallel may be required.

Table 4-1 lists the characteristics of AWG (American Wire Gauge) copper wire.

**Table 4-1. Stranded Copper Wire Capacity and Resistance**

AWG No.	Ampacity <sup>1</sup>	Resistance <sup>2</sup> (Ω/m)	AWG No.	Ampacity <sup>1</sup>	Resistance <sup>2</sup> (Ω/m)
14	25	0.0103	2	140	0.00064
12	30	0.0065	1/0	195	0.00040
10	40	0.0041	2/0	225	0.00032
8	60	0.0025	3/0	260	0.00025
6	80	0.0016	4/0	300	0.00020
4	105	0.0010			

**NOTES:**

- Ampacity is based on 30 °C ambient temperature with conductor rated at 60 °C. For ambient temperature other than 30 °C, multiply the above ampacities by the following constants:

Temp (°C)	Constant	Temp (°C)	Constant
21-25	1.08	41-45	0.71
26-30	1.00	46-50	0.58
31-35	0.91	51-55	0.41
36-40	0.82		
- Resistance is nominal at 75 °C wire temperature.

## Analog Connector (All Models)

This connector, which is on the rear panel, is for connecting remote sense leads, external current monitors, and external programming sources. The connector accepts wires sizes from AWG 22 to AWG 12.

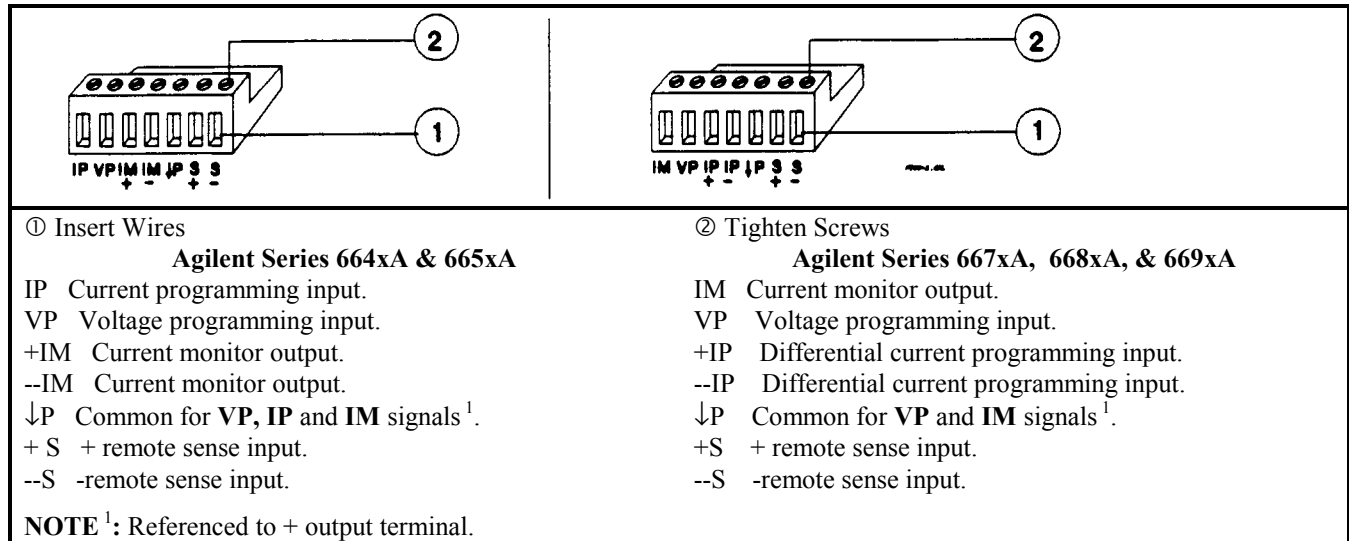

Figure 4-1. Rear Panel Analog Connector

**Note** It is good engineering practice to twist and shield all signal wires to and from the analog and digital connectors.

## Digital Connector (All Models)

This connector, which is on the rear panel, is for connecting fault/inhibit, digital I/O, or relay link signals. The connector accepts wires sizes from AWG 22 to AWG 12. Refer to Appendix D for more information about using this connector.

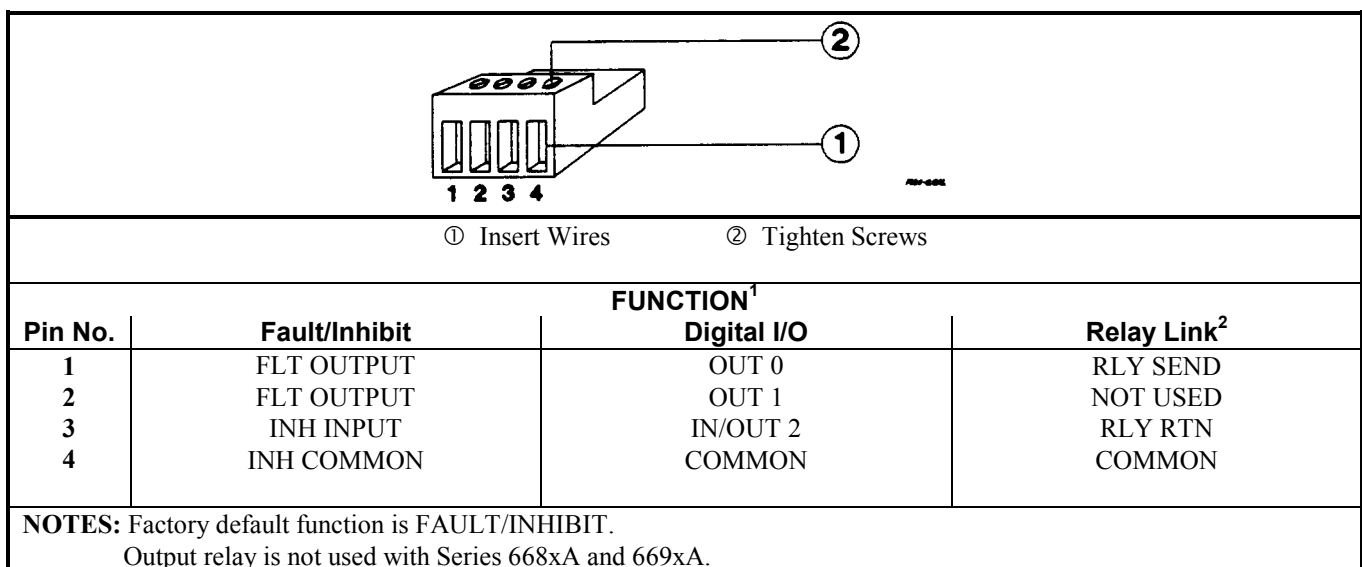

Figure 4-2. Rear Panel Digital Connector

## Connecting Series 664xA and 665xA Power Supplies to the Load

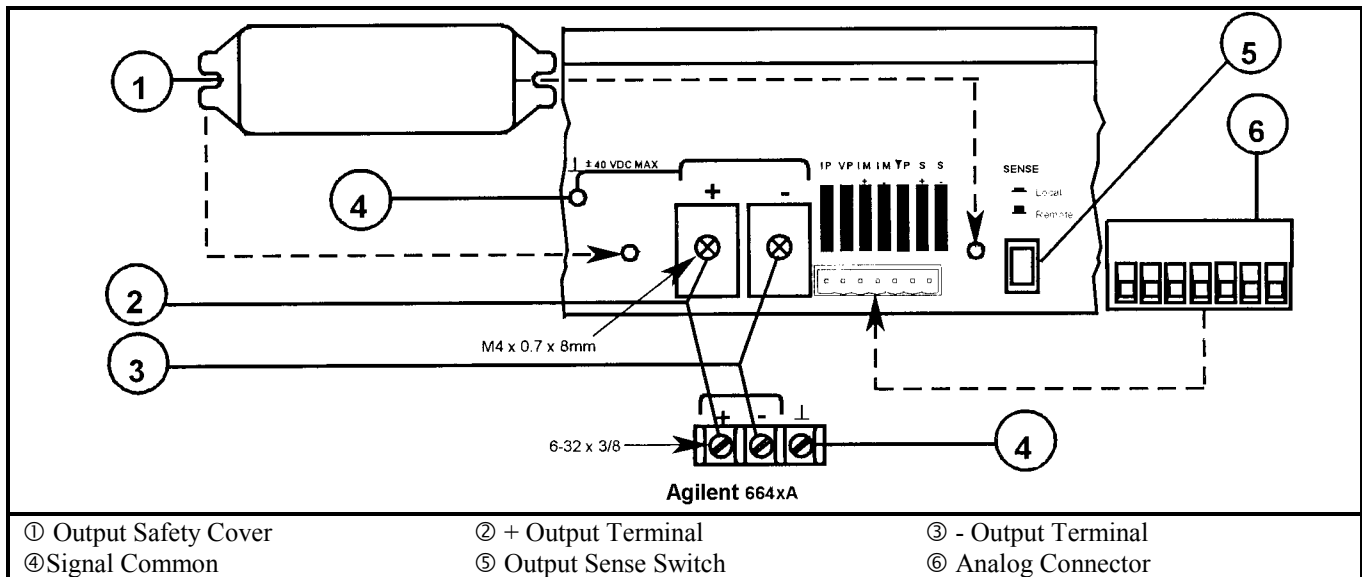

Figure 4-3a. Series 664xA and 665xA Rear Panel Output Connections

### Output Isolation

The output of the power supply is isolated from earth ground. Either output terminal may be grounded, or an external voltage source may be connected between either output and ground. However, both output terminals must be kept within  $\pm 240$  Vdc of ground. An earth ground terminal is provided on the rear panel for convenience, such as grounding wire shields.

### WARNING

The earth ground terminal on the rear panel is a low-noise signal ground for convenience only. It is not designed to function as a safety ground.

## Load Considerations

### Capacitive Loads

**Effect on the Output Circuit.** In most cases, the power supply will continue to be stable with additional external load capacitors (see the following table for recommendations). However, large load capacitors may cause ringing in the supply's transient response. It is possible that certain combinations of load capacitance, equivalent series resistance, and load lead inductance will result in instability. If you need help in solving a stability problem, contact an Agilent service engineer through your local Sales and Support Office (see end of this guide).

#### Series 664xA/665xA Power Supplies, Maximum External Capacitance ( $\mu$ F)

6641A	6642A	6643A	6644A	6645A	6651A	6652A	6653A	6654A	6655A
40,000	20,000	12,000	7,000	3,000	100,000	50,000	30,000	18,000	8,000

If the power supply output is rapidly programmed into capacitive loads, the supply may momentarily cross into CC mode. This extends the CV programming time and limits the maximum slew rate to the programmed current divided by the total internal (see the following section "Inductive Loads") and external capacitance. These momentary crossovers into CC mode will not damage the supply.

**Effect on the OVP Circuit.** The OVP circuit is designed to discharge fully-charged capacitances up to a specified limit for each model. These limits are as follows:

**Series 664xA/665xA Power Supplies, Maximum OVP External Capacitance (μF)**

6641A	6642A	6643A	6644A	6645A	6651A	6652A	6653A	6654A	6655A
700,000	35,000	15,000	7,000	3,000	1.6 (F)	100,000	50,000	18,000	8,000

If a load capacitance approaches the specified limit, it is recommended that you do not make it a normal practice of tripping the OVP circuit and discharging the load capacitance through that circuit. This could cause long-term fatigue in some circuit components.



Because of its high output voltage, the Agilent 6555A generates very high currents when discharging the load capacitor under overvoltage conditions. Excessive currents can damage the supply. The peak discharge current is limited by the sum of the external capacitor's ESR (equivalent series resistance) and the series resistance of the external circuit. For the Agilent 6555A external capacitance limit of 8,000 μF, this total resistance must be not less than 56 milliohms. For smaller values of external capacitance, this resistance may be derated linearly.

### Inductive Loads

Inductive loads provide no loop stability problems in CV mode. However, in CC mode inductive loads will form a parallel resonance network with the power supply's output capacitor. Generally, this will not affect the stability of the supply, but it may cause ringing of the current in the load. Ringing will not occur if the Q (quality factor) of the parallel resonant network is  $\leq 0.5$ . Use the following formula to determine the Q of your output.

$$Q = \frac{1}{R_{int} + R_{ext}} \sqrt{\frac{L}{C}}$$

where: C = model-dependent internal capacitance (see below); L = inductance of the load;  $R_{ext}$  = equivalent series resistance of the load;  $R_{int}$  = model-dependent internal resistance (see below):

	6641A	6642A	6643A	6644A	6645A	6651A	6652A	6653A	6654A	6655A
C =	4,200 μF	550 μF	180 μF	68 μF	33 μF	10,000 μF	1100 μF	440 μF	120 μF	50 μF
$R_{int}$ =	7 mΩ	30 mΩ	50 mΩ	125 mΩ	300 mΩ	4 mΩ	20 mΩ	30 mΩ	80 mΩ	250 mΩ

### Battery Charging

The power supply's OVP circuit contains a crowbar SCR that effectively shorts the output of the supply whenever OVP trips. If a battery (or other external voltage source) is connected across the output and the OVP is inadvertently triggered or the output is programmed below the battery voltage, the power supply will continuously sink a large current from the battery. This could damage the supply. To avoid this, insert a reverse blocking diode in series with the ⊕ output of the supply. Connect the diode **cathode** to the + battery terminal and the diode **anode** to the supply ⊕ output terminal. The diode may require a heat sink.

Note that if the OVP trips, you must remove the external current source in order to reset the internal SCR as part of clearing the OVP circuit (see **Clearing the OV Condition** in “Chapter 5 - Front Panel Operation”).

### Local Voltage Sensing

Your power supply was shipped set up for local sensing. This means that the supply will sense and regulate its output at the output terminals, not at the load. Since local sensing does not compensate for voltage drops across screw terminals, bus bars, or load leads, local sensing should only be used in applications that require low output current or where load regulation is not critical.

Local sensing is obtained by placing the **SENSE switch** (see Figure 4-3a) in the **Local** position. The power supply is shipped with the switch in this position.

---

<b>Note</b>	If the sense terminals are left unconnected, the voltage at the bus bars will increase approximately 3 to 5% over the programmed value. Since it is measured at the sense terminals, the voltage readback will not reflect this increased output.
-------------	---

---

## Remote Voltage Sensing

The dashed lines in the wiring diagrams illustrate remote voltage sensing. The remote sense terminals of the power supply are connected directly to the load rather than to the output terminals. This allows the supply to automatically compensate for the voltage drop in the load leads as well as to accurately read back the voltage directly across the load.

### Setting Up Remote Sense Operation

Remote sensing is obtained by placing the SENSE switch (see Figure 4-3a) in the **Remote** position. The power supply is shipped with the switch in the **Local** position.

### Connecting the Sense Leads

You must connect the positive side of the load to the +S analog connector pin and the negative side of the load to the -S analog connector pin (see Figure 4-1). Connect the sense leads carefully so that they do not become open-circuited. If sense leads are left open during operation, the supply will regulate at the output terminals instead of at the load. Remember to bundle or tie wrap the load leads to minimize inductance and reduce noise pickup.

### CV Regulation

The voltage load regulation specification in Table 1-1a and Table 1-2a applies at the output terminals of the power supply. When remote sensing, this specification must be compensated. Add 3 mV to the voltage load regulation specification for each 1-volt change in the positive load lead due to a change in load current. Because the sense leads are part of the supply's feedback path, keep the resistance of the sense leads at or below 0.5  $\Omega$  to maintain the above specified performance.

### OVP Considerations

The OVP circuit senses the voltage near the output terminals, not at the sense terminals. The voltage sensed by the OVP circuit can be significantly higher than the voltage being maintained at the load. When using remote sensing, you must program the OVP high enough to compensate for the expected voltage drop between the output and the load.

### Output Rating

The rated output voltage and current specification in Table 1-1a and Table 1-2a applies at the output terminals of the power supply. With remote sensing, any voltage dropped in the load leads causes the supply to increase the voltage at the output terminals so it can maintain the proper voltage at the load. When you attempt to operate at the full-rated output at the load, this forces the supply voltage at the output terminals to exceed the supply's rated output.

This will not damage the supply, but may trip the OVP (overvoltage protection) circuit, which senses the voltage at the output. When operated beyond its rated output, the supply's performance specifications are not guaranteed, although typical performance may be good. If the excessive demand on the supply forces it to lose regulation, the **Unr** annunciator will indicate that the output is unregulated.

### Output Noise

Any noise picked up on the sense leads also appears at the output of the power supply and may adversely affect the load voltage regulation. Be sure to twist the sense leads to minimize external noise pickup and route them parallel and close to the load leads. In noisy environments, it may be necessary to shield the sense leads. Ground the shield only at the power supply. *Do not use the shield as one of the sense conductors.*

## Stability

Using remote sensing under unusual combinations of load-lead lengths and large load capacitances may cause your application to form a low-pass filter that becomes part of the voltage feedback loop. The extra phase shift created by this filter can degrade the supply's stability and result in poor transient response. In severe cases, this may cause output oscillations. To minimize this possibility, keep the load leads as short as possible and tie wrap them together.

In most cases, following the above guidelines will prevent problems associated with load lead inductance. This leaves load lead resistance and load capacitance as the major source of reduced stability. Further improvement to the stability of the supply may be obtained by keeping the load capacitance as small as possible and by decreasing the load-lead resistance by using larger diameter wires. However, if heavy gauge wire ( $\geq$  AWG 10) is used, conditions may arise where the load-lead inductance and load capacitance can form an undamped filter. This can actually reduce the damping in the system and create a destabilizing phase response.

---

**Note** If you need help in solving a stability problem with any Series 664xA or 665xA power supply contact an Agilent Service Engineer through your local Agilent Sales and Support Offices.

---

## Connecting One Supply to the Load

Figure 4-3b and Figure 4-3c show how to connect a single power supply to one load and to multiple loads.

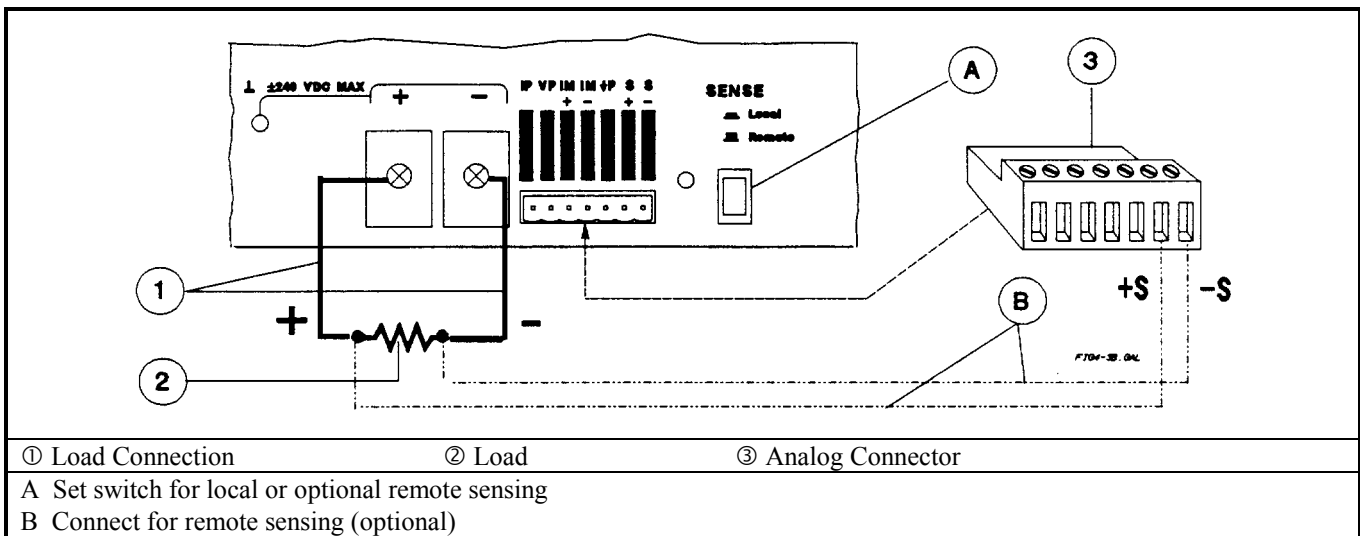

**Figure 4-3b. Series 664xA and 665xA Single Load Connection**



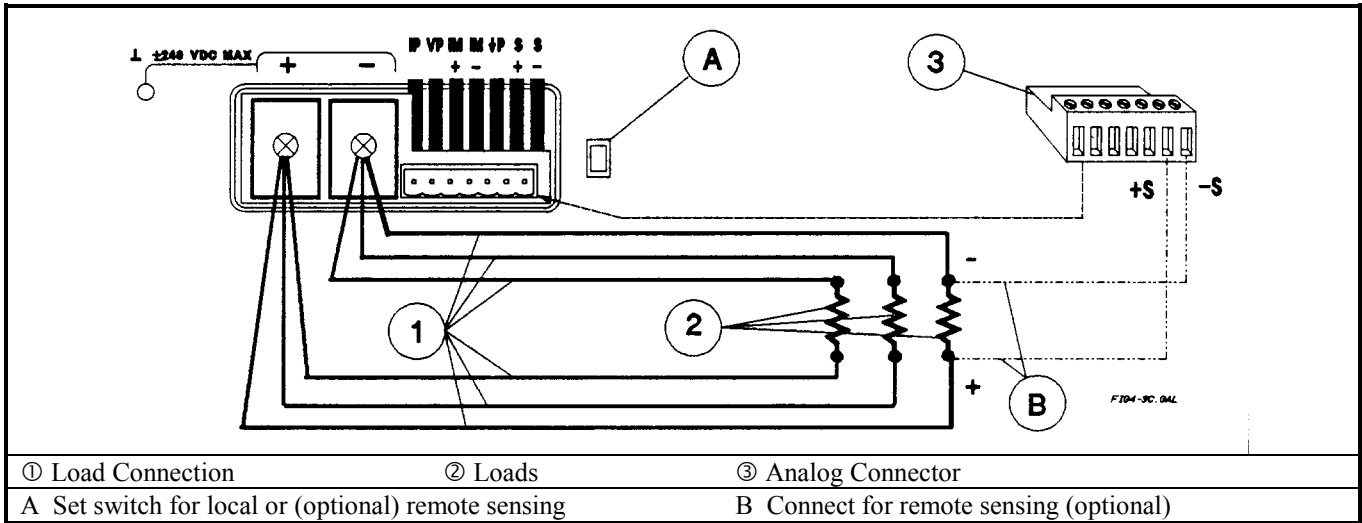
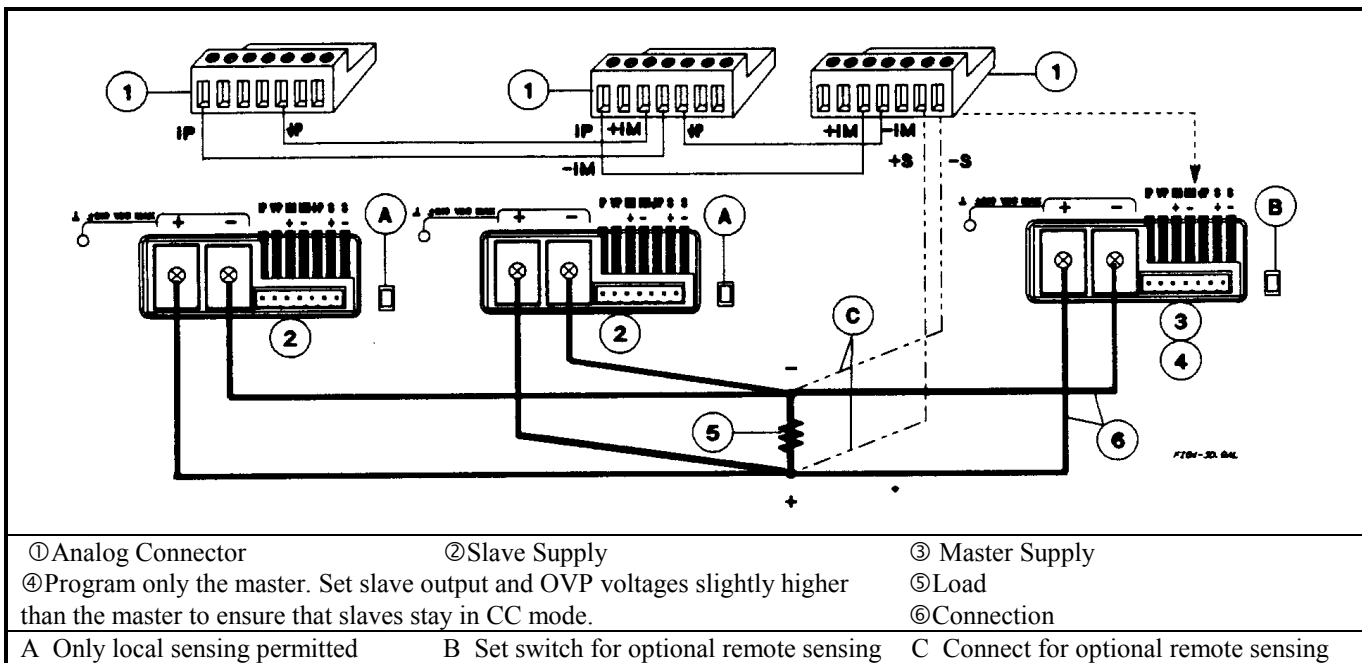

**Figure 4-3c. Series 664xA and 665xA Multiple Load Connection (Remote Sensing Optional)**

## Connecting Supplies in Auto-Parallel

**Auto-Parallel Wiring.** Figure 4-3d illustrates how power supplies can be connected in auto-parallel for increased current output. You can connect up to three supplies of the *same model*.

Use load leads of a sufficient wire size so that the absolute voltage difference between the + output terminal of the "master" supply and the + output terminal of the first "slave" supply is kept under 2 V at rated current. This also applies to the voltage difference between the + output terminals of the first and second slave supplies. If remote sensing is required, connect the load to the remote sense terminals *of the master supply*, as shown by the dashed lines in Figure 4-3d.



**Figure 4-3d. Series 664xA and 665xA Auto-Parallel Connection (Remote Sensing Optional)**

**Note** To avoid output oscillations, observe the wiring suggestions given under "External Voltage Control".

**Auto-Parallel Programming.** Program only the output current of the first ("master") supply in the series; the "slave" supplies automatically track the master's output. Program the output current of the slave supplies to zero. However, the voltage and OVP settings of the slave supplies must be set higher than the operating voltage of the master supply. This ensures that the slave supplies will operate in CC mode. Functions such as status, voltage readback, and current readback can still be read back individually for each supply.

If a "slave" supply experiences a desired shutdown condition (such as overtemperature or overcurrent), it will not automatically shut down all other supplies. You must first enable remote inhibit (RI) and discrete fault indicator (DFI) operation. See "Fault/Inhibit Operation" in Appendix D for wiring information and "Questionable Status Group" in Chapter 4 of the Programming Guide for programming information.



Follow the following operating precautions if you are connecting **three** of these models in auto-parallel.

You must use caution when connecting three Series 664xA or 665xA power supplies for auto-parallel operation. That is because of the OVP crowbar circuits within these supplies. If the OVP circuit of the second "slave" trips, its crowbar circuit will draw current from the other two supplies. Although some models can withstand this current, the higher-current models in each series (particularly the Agilent 6651A) may be damaged in this situation. Use any of the following operating techniques to avoid possible problems.

### 1. Program Slave 2 OVP to the Maximum Level

The following technique minimizes the chance that the slave 2 OVP circuit will trip.

- a. Program the OVP level of the master and of slave 1 to the desired protection level (below the maximum level specified in Table 1-2).
- b. Program the OV protection level of slave 2 to its maximum value.

### 2. Enable OCP on the Master

You can do this if the combination of all three supplies is being used in the CV mode and the CC mode is only being used as a current limit. Enable OCP on the master supply. If the OVP on either slave trips it will drive the master into CC mode, thereby tripping its OCP. This will shut down all three supplies. This technique will work unless the system is programmed for very low (0.5 to 1.5) output voltages.

### 3. Insert Protection Diodes

If you connect the slave 2 supply to the load through a series diode (see Figure 4-3e), its OVP circuit will not draw current from other supplies. Be certain to increase the programmed CV level of slave 2 by at least 0.7 V to compensate for the voltage drop in the diode.

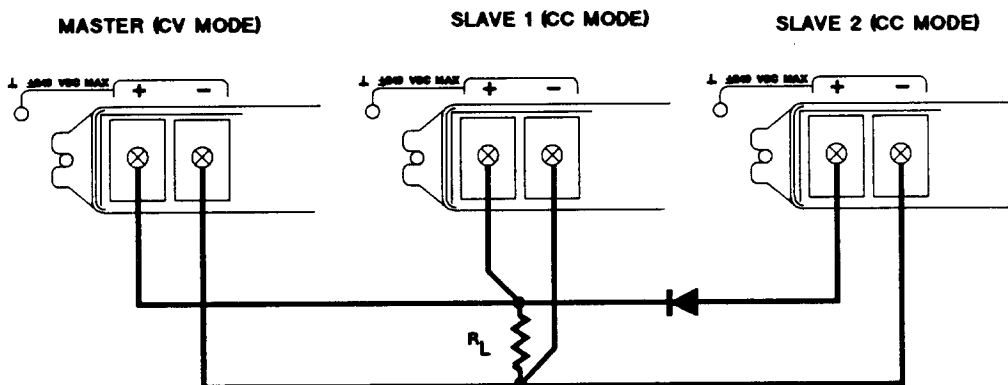

Figure 4-3e. Using Series Diodes with Series 664xA & 665xA Auto-Parallel Operation

### Note

Removing or disabling the power supply OVP crowbar SCR is another possibility. For further information, contact a Agilent Service Engineer through your local Agilent Sales and Support Offices.

## Connecting Supplies in Series

### WARNING

Floating voltages must not exceed  $\pm 240$  Vdc. No output terminal may be more than 240 V from chassis ground.

Figure 4-3f shows how power supplies can be connected in series for higher voltage output.

Series connections are straightforward in this case. Program each power supply independently. If two supplies are used in the series configuration, program each supply for 50% of the total output voltage. Set the current limit of each supply to the maximum that the load can handle without damage.

### CAUTION

Each power supply has a reverse voltage protection diode across its output. If a reverse voltage is applied, the supply cannot control the current conducted through this diode. To avoid damaging the supply, never connect it in such a way that a reverse voltage can force it to conduct current in excess of the supply's maximum reverse diode current (see Table 1-2).

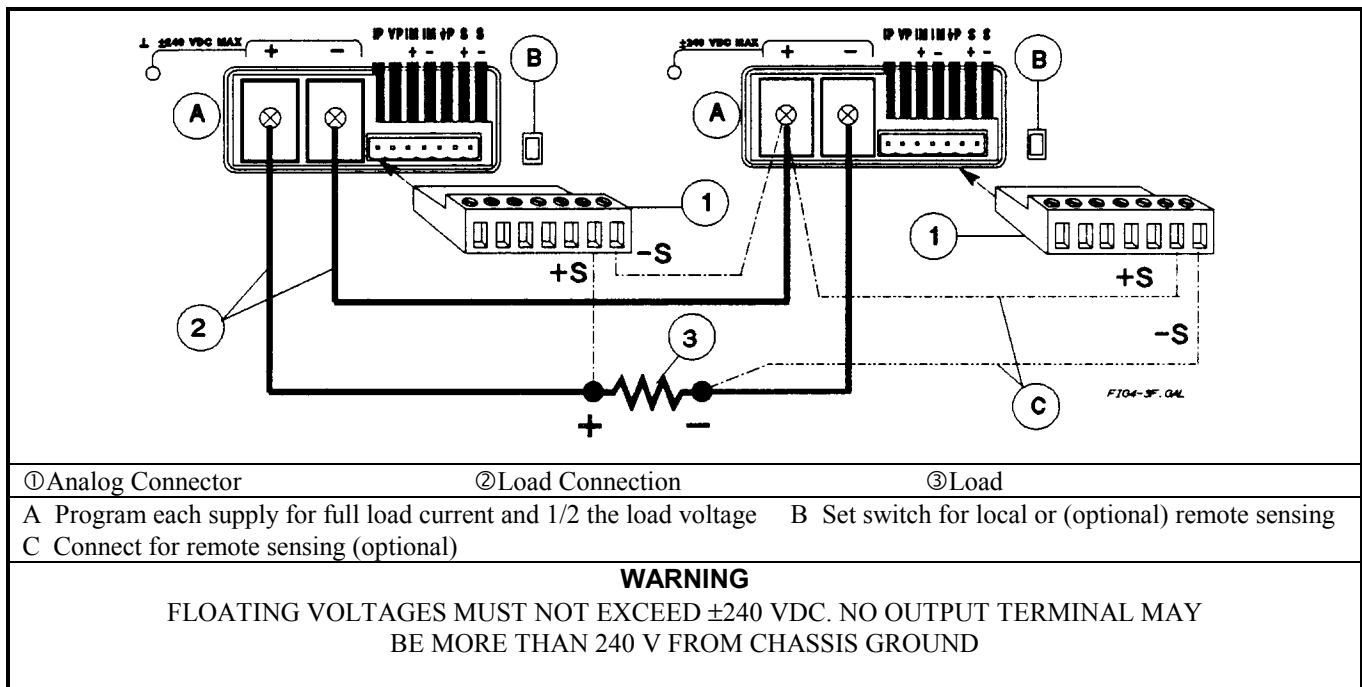

Figure 4-3f. Series 664xA and 665xA Series Connection (Remote Sensing Optional)

## External Voltage Control

The setup shown in Figure 4-3g allows an external dc voltage to program the power supply output. A voltage applied to the voltage programming input programs the output voltage and a voltage applied to the current programming input programs the output current. See Figure 4-1 for an explanation of these programming input connections.

## Wiring Considerations

The input impedance of the analog input is 10 k $\Omega$ . If the output impedance of your programming source is not negligible with this, programming errors will result. Larger output impedances result in proportionally greater errors.

Be careful of capacitive coupling from the programming inputs to other lines wired to the analog connector. Such coupling can cause output oscillations. You can minimize coupling by bundling the **IP**, **VP**, and **Common P** lines and keeping them separated from other wires. Twisting these three lines together is also recommended.

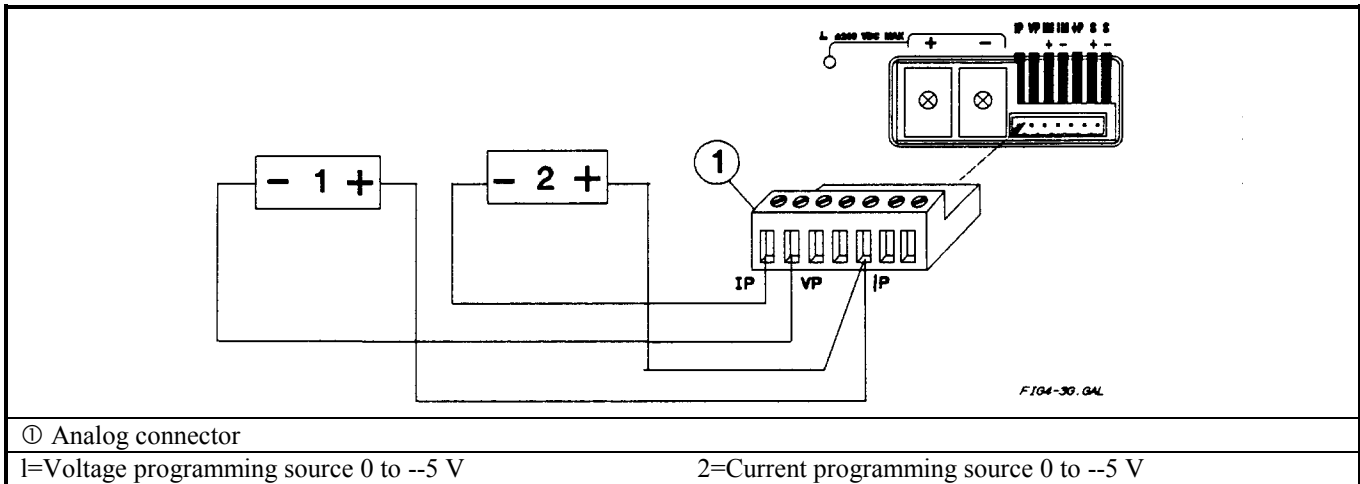

**Figure 4-3g. Series 664xA and 665xA Analog Programming Connections**

If you cannot avoid capacitive coupling, it may help to place capacitors from the unused programming inputs to ground. Especially with auto-parallel operation, connecting a capacitor ( $\geq 4,000$  pF) from **VP** to **P Common** on the master supply will ensure proper operation. Also with auto-parallel operation, do not allow more than about 500 pF capacitive loading between **IM** and **Common P**.

### Programming



Make certain that the common connection for your voltage programming source is isolated from the load. Failure to do this may cause damage to the power supply.

The effect of the analog programming source is always summed with the values programmed over the GPIB or from the front panel. The voltage source can act alone only if you set the other program sources to zero. Keep the total programmed setting of the supply (the analog input summed with the GPIB or front panel settings) at or under the output ratings specified in Table 1-1a. Exceeding the output ratings will not damage the supply, but it may not be able to regulate its output at the higher levels. If this happens, the **Unr** annunciator will light to warn you that the output is unregulated.

When voltage programming the output, the frequency of the programming source is limited by the slew rate of the power supply. To keep the power supply from slewing its output (going into nonlinear operation), the maximum programming rate is 3750 V/s. The maximum downprogramming rate (when the power supply is sinking current) is 750 V/s. These restrictions can be expressed as the maximum programming frequency that can be applied without causing distortion at the output. The following formula can be used to determine this frequency:

$$F_{MAX} = \frac{50(\text{voltage rating of supply})}{\text{p-p amplitude of desired output sine wave}}$$

At frequencies  $>6$  kHz, voltage programming is subject to a 3 dB bandwidth limitation.

## Connecting Series 667xA Power Supplies to the Load

### Output Isolation

The output of the power supply is isolated from earth ground. Either output terminal may be grounded, or an external voltage source may be connected between either output and ground. However, both output terminals must be kept within  $\pm 240$  Vdc of ground. An earth ground terminal is provided on the rear panel for convenience, such as grounding wire shields.

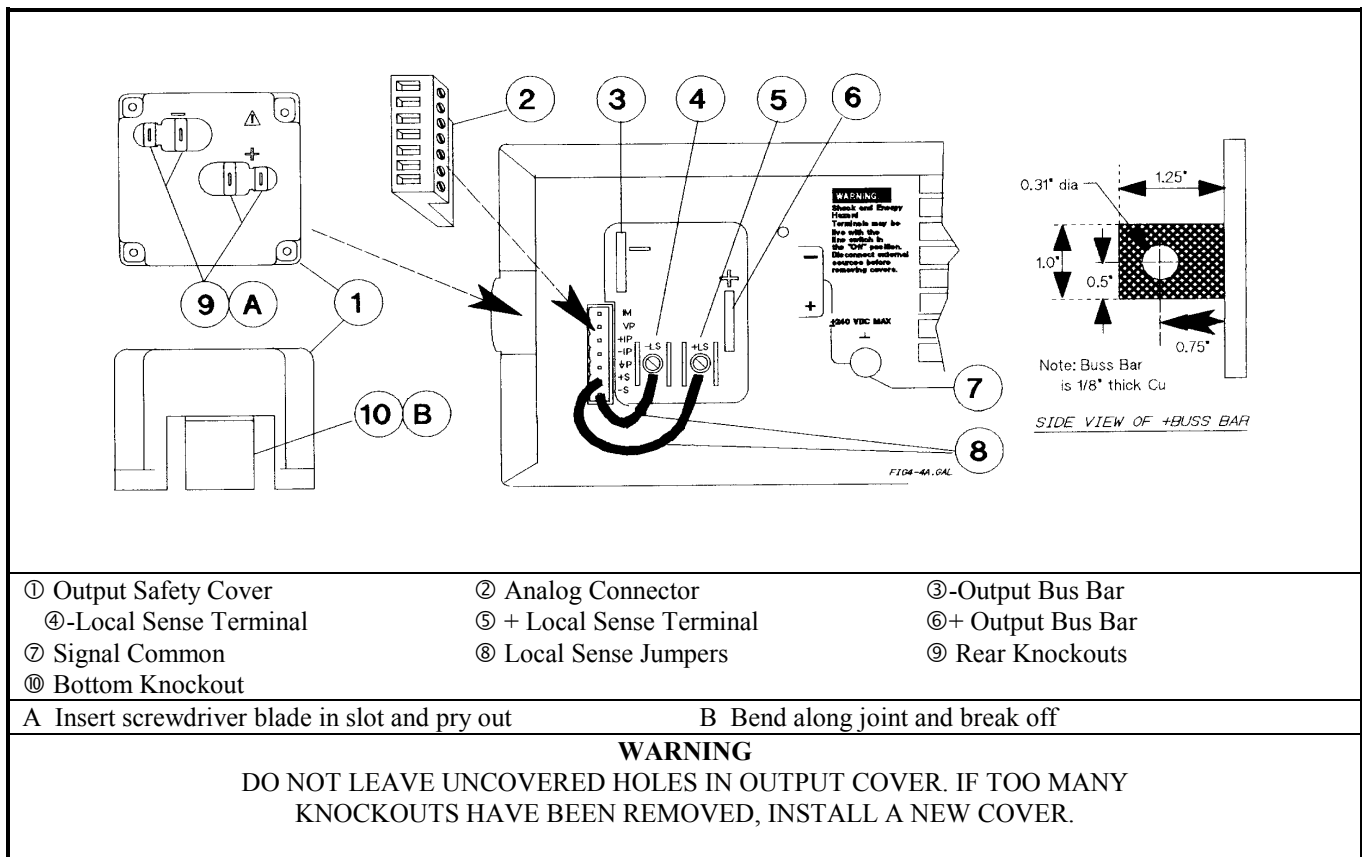

**Figure 4-4a. Series 667xA Rear Panel Output Connections**

**WARNING**

The earth ground terminal on the rear panel is a low-noise signal ground for convenience only. It is not designed to function as a safety ground.

## Load Considerations

### Capacitive Loads

In most cases, the power supply will continue to be stable with additional external load capacitors. However, large load capacitors may cause ringing in the supply's transient response. It is possible that certain combinations of load capacitance, equivalent series resistance, and load lead inductance will result in instability. If you need help in solving a stability problem, contact a service engineer through your local Sales and Support Offices (see end of this guide).

If the power supply output is rapidly programmed into capacitive loads, the supply may momentarily cross into constant current (CC) mode. This extends the CV programming time and limits the maximum slew rate to the programmed current divided by the total internal and external capacitance. These momentary crossovers into CC mode will not damage the supply.

### Inductive Loads

Inductive loads provide no loop stability problems in CV mode. However, in CC mode inductive loads will form a parallel resonance network with the power supply's output capacitor. Generally, this will not affect the stability of the supply, but it may cause ringing of the current in the load. Ringing will not occur if the Q (quality factor) of the parallel resonant network is  $\leq 1.0$ . Use the following formula to determine the Q of your output.

$$Q = \frac{1}{R_{int} + R_{ext}} \sqrt{\frac{L}{C}}$$

where: C = model-dependent internal capacitance (see below); L = inductance of the load; R<sub>ext</sub> = equivalent series resistance of the load; R<sub>int</sub> = model-dependent internal resistance (see below):

	<b>6671A</b>	<b>6672A</b>	<b>6673A</b>	<b>6674A</b>	<b>6675A</b>
C=	44,000 μF	44,000 μF	12,000μF	7,000 μF	2,100 μF
R <sub>int</sub> =	1.8 mΩ	2.2 mΩ	4 mΩ	14 mΩ	30 mΩ

If the Q is greater than 0.5, inductive loads will ring with the output capacitance and will be damped according to the following equation:

$$\delta = \left[ e^{\left( \frac{-t}{\tau} \right)} \sin \omega t \sqrt{1 - \left( \frac{1}{2Q} \right)^2} \right]$$

## Battery Charging

The power supply's OVP circuit has a downprogrammer FET that discharges the power supply output whenever OVP trips. If a battery (or other external voltage source) is connected across the output and the OVP is inadvertently triggered or the output is programmed below the battery voltage, the power supply will sink current from the battery. To avoid this, insert a reverse blocking diode in series with the ⊕ output of the supply. Connect the diode cathode to the + battery terminal and the diode anode to the supply ⊕ output terminal. The diode may require a heat sink.

## Local Voltage Sensing

Your power supply was shipped set up for local sensing. This means that the supply will sense and regulate its output at the output terminals, not at the load. Since local sensing does not compensate for voltage drops across screw terminals, bus bars, or load leads, local sensing should only be used in applications that require low output current or where load regulation is not critical.

Local sensing is obtained by connecting the +LS sense terminal to the +S analog connector pin and the pin and the -LS sense terminal to the -S analog connector pin. The power supply is shipped with these connections made.

---

<b>Note</b>	If the sense terminals are left unconnected, the voltage at the bus bars will increase approximately 3 to 5% over the programmed value. Since it is measured at the sense terminals, the voltage readback will not reflect this increased output.
-------------	---

---

## Remote Voltage Sensing

The dashed lines in the wiring diagrams illustrate remote voltage sensing. The remote sense terminals of the power supply are connected directly to the load rather than to the output terminals. This allows the supply to automatically compensate for the voltage drop in the load leads as well as to accurately read back the voltage directly across the load.

### Setting Up Remote Sense Operation

Remote sensing is obtained by removing the jumpers connecting the +LS sense terminal to the +S analog connector pin and the -LS sense terminal to the -S analog connector pin. The power supply is shipped with these jumpers connected.

## Connecting the Sense Leads

You must connect the positive side of the load to the +S analog connector pin and the negative side of the load to the -S analog connector pin (see Figure 4-1). Connect the sense leads carefully so that they do not become open-circuited. If sense leads are left open during operation, the supply will regulate at the output terminals instead of at the load. Remember to bundle or tie wrap the load leads to minimize inductance and reduce noise pickup.

## CV Regulation

The voltage load regulation specification in Table 1-3a applies at the output terminals of the power supply. When remote sensing, this specification must be compensated. Add an increment to the voltage load regulation specification as specified by “ $\Delta mV$ ” in the equation given under *Load regulation* in Table 1-3b.

## OVP Considerations

The OVP circuit senses the voltage near the output terminals and not at the sense terminals. Depending on the voltage drop between the output terminals and the load, the voltage sensed by the OVP circuit can be significantly higher than actually being regulated at the load. You must program the OVP trip high enough to compensate for the expected higher voltage at the output terminals.

## Output Rating

The rated output voltage and current specification in Table 1-3a applies at the output terminals of the power supply. With remote sensing, any voltage dropped in the load leads causes the supply to increase the voltage at the output terminals so it can maintain the proper voltage at the load. When you attempt to operate at the full-rated output at the load, this forces the supply voltage at the output terminals to exceed the supply's rated output. This will not damage the supply, but may trip the OVP (overvoltage protection) circuit, which senses the voltage at the output bus bars. When operated beyond its rated output, the supply's performance specifications are not guaranteed, although typical performance may be good. If the excessive demand on the supply forces it to lose regulation, the **Unr** annunciator will indicate that the output is unregulated.

## Output Noise

Any noise picked up on the sense leads also appears at the output of the power supply and may adversely affect the load voltage regulation. Be sure to twist the sense leads to minimize external noise pickup and route them parallel and close to the load leads. In noisy environments, it may be necessary to shield the sense leads. Ground the shield only at the power supply. *Do not use the shield as one of the sense conductors.*

---

**Note** The signal ground binding post on the rear panel is a convenient place to ground the sense shield.

---

## Stability

Using remote sensing under unusual combinations of load-lead lengths and large load capacitances may cause your application to form a low-pass filter that becomes part of the voltage feedback loop. The extra phase shift created by this filter can degrade the supply's stability and result in poor transient response. In severe cases, this may cause output oscillations. To minimize this possibility, keep the load leads as short as possible and tie wrap them together.

In most cases, following the above guidelines will prevent problems associated with load lead inductance. However, if a large bypass capacitor is required at the load and load-lead length cannot be reduced, then a sense-lead bypass network may be needed to ensure stability (see Figure 4-4b). The voltage rating of the 33  $\mu F$  capacitors should be about 50% greater than the anticipated load-lead drop. Addition of the 20- $\Omega$  resistors will cause a slight voltage rise at the remote sensing points. For utmost voltage programming accuracy, the supply should be recalibrated with the DVM at the remote sensing points (see “Appendix A - Calibration”).

---

**Note** If you need help in solving a stability problem with any Series 667xA power supply contact an Agilent Service Engineer through your local Agilent Sales and Support Offices.

---

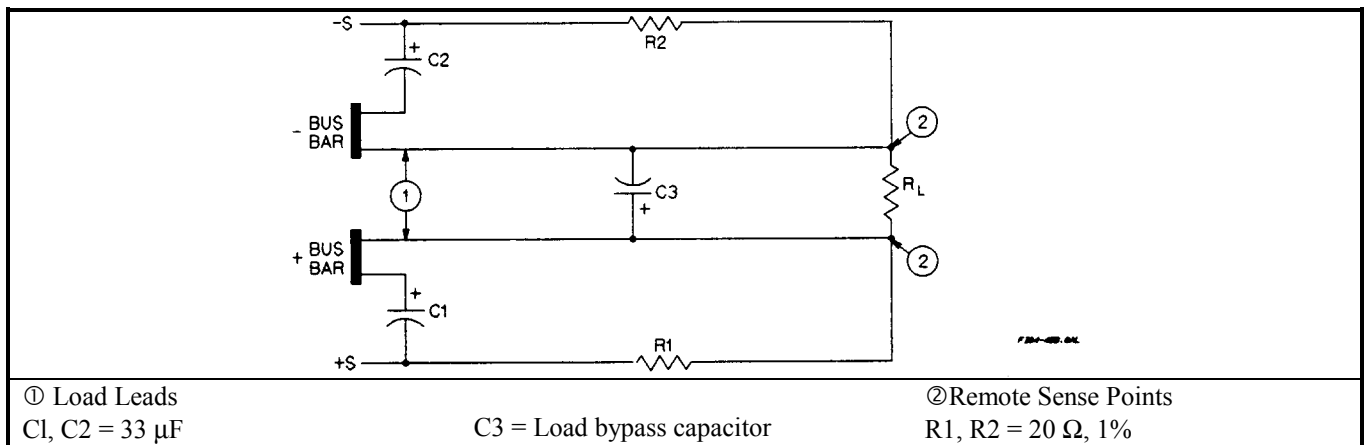

Figure 4-4b. Series 667xA Sense Lead Bypass Network

### Connecting One Power Supply to a Single Load

Figure 4-4c shows how to connect a single power supply to one load. Keep output load leads close together (small loop area) to obtain a low inductance and low impedance connection to the load. If you wish to use remote sensing, connect the sense leads at the load as shown in the figures.

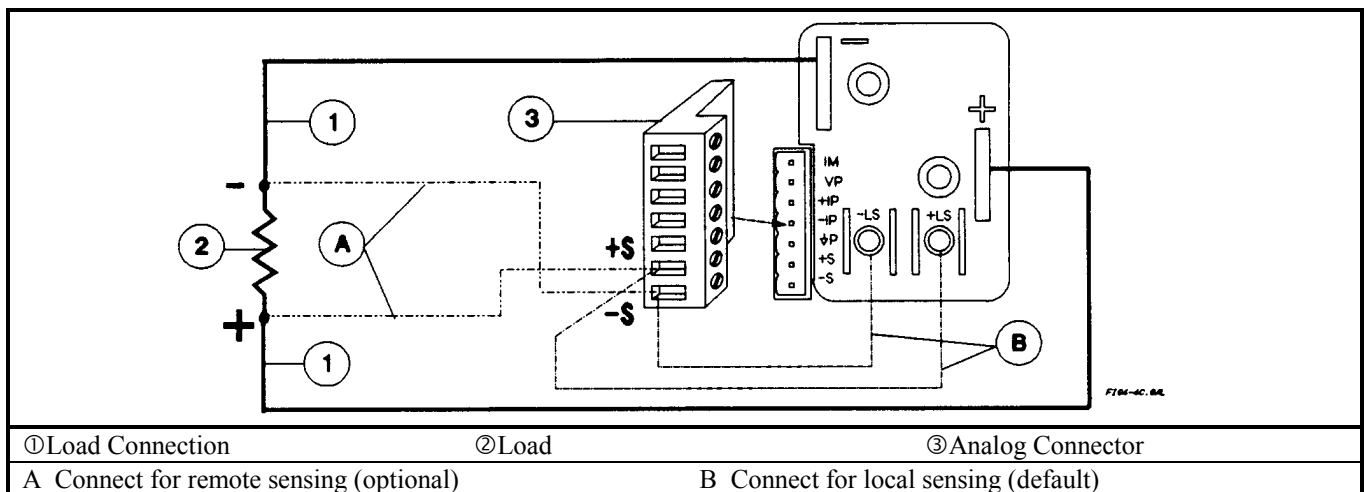

Figure 4-4c. Series 667xA Single Load Connection (Remote Sensing Optional)

### Connecting One Power Supply To Multiple Loads

Figure 4-4d shows how to connect a single power supply to more than one load. When connecting multiple loads to the power supply with local sensing, connect each load to the output bus bars with separate connecting wires. This minimizes mutual coupling effects and takes full advantage of the supply's low output impedance. Keep each pair of load wires as short as possible and twist or bundle them to reduce lead inductance and noise pickup.







## External Voltage Control

The setup shown in Figure 4-4g allows an external dc voltage to program the power supply output. A voltage applied to the voltage programming input programs the output voltage and a voltage applied to the current programming input programs the output current. See Figure 4-1 for an explanation of these programming input connections.

### Wiring Considerations (Figure 4-4g)

The input impedance of the analog input is over 30 k $\Omega$ . If the output impedance of your programming source is not negligible with this, programming errors will result. Larger output impedances result in proportionally greater errors.

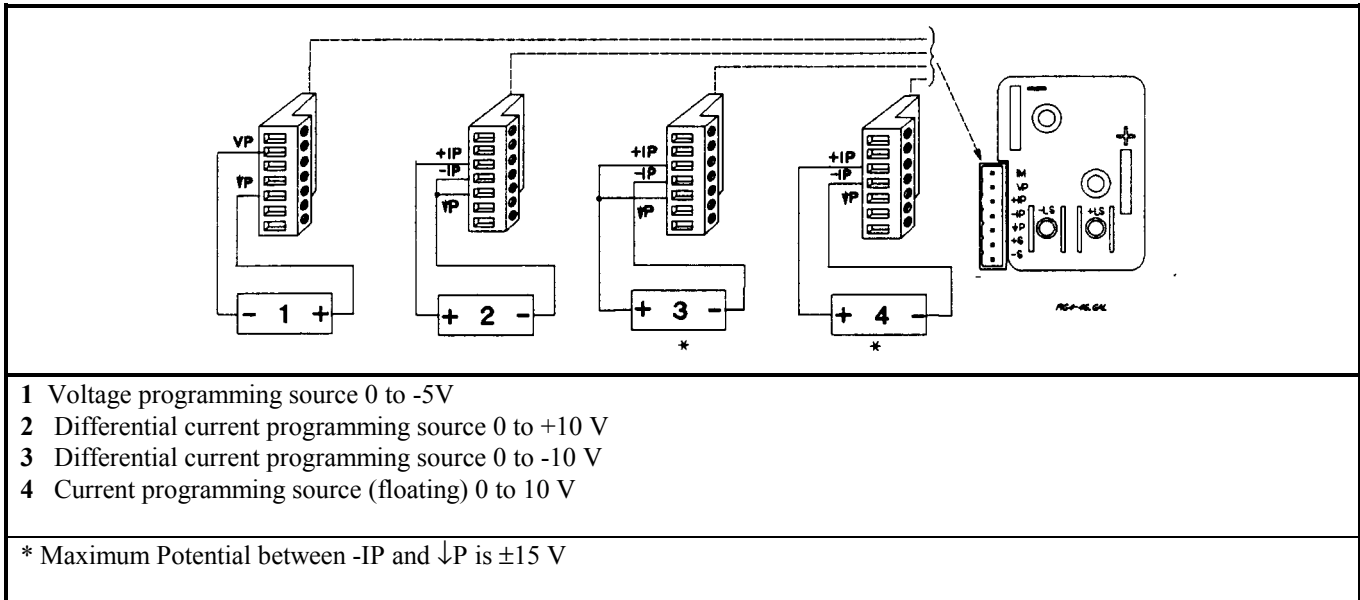

Figure 4-4g. Series 667xA Analog Programming Connections

### Programming

Note from Figure 4-1 that you have three options for programming the current. You can use a voltage source that is positive, negative, or floating with respect to **Common P**. Do not exceed  $\pm 19$  V with respect to **Common P**.

**CAUTION** Make certain that the common connection for your voltage programming source is isolated from the load. Failure to do this may cause damage to the power supply.

The effect of the analog programming source is always summed with the values programmed over the GPIB or from the front panel. The voltage source can act alone only if you set the other program sources to zero. Keep the total programmed setting of the supply (the analog input summed with the GPIB or front panel settings) at or under the output ratings specified in Table 1-2a. Exceeding the output ratings will not damage the supply, but it may not be able to regulate its output at the higher levels. If this happens, the **Unr** annunciator will light to warn you that the output is unregulated.

## Connecting Series 668xA and 669xA Power Supplies to the Load

### WARNING

**ENERGY HAZARD.** These power supplies can provide more than 240 VA at more than 2 V. If the output connections touch, severe arcing may occur resulting in burns, ignition or welding of parts. Do not attempt to make connections to live output circuits.

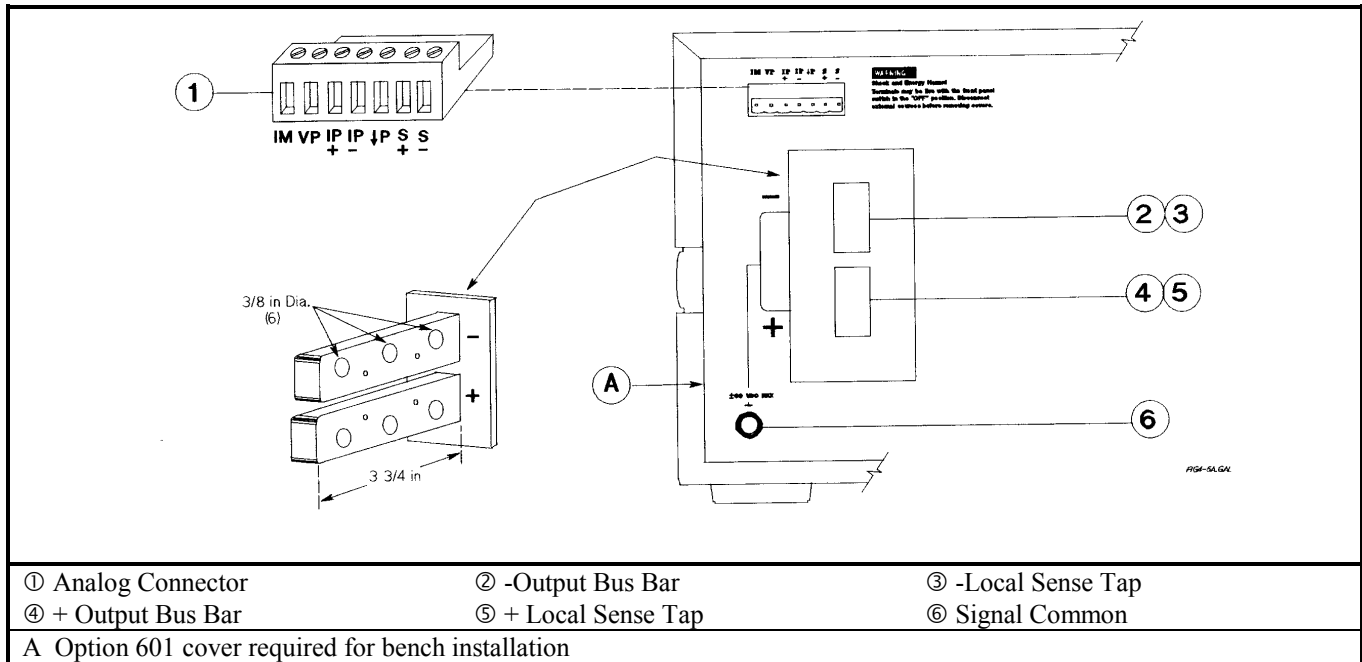

Figure 4-5a. Series 668xA and 669xA Rear Panel Output Connections

### Output Isolation

Except for a high value ( $>1 \text{ M}\Omega$ ) internal bleeder resistor, the output of the power supply is isolated from earth ground. Either output terminal may be grounded or an external dc voltage source may be connected between either output and ground. However, both output terminals must be kept within  $\pm 60 \text{ Vdc}$  of ground.

### WARNING

The earth ground terminal located near the output bus bars is a low-noise signal ground for convenience only. It is not designed to function as a safety ground.

### Load Considerations

#### Capacitive Loads

In most cases, the power supply will maintain stability with external load capacitors. However, large load capacitors may cause ringing in the supply's transient response. It's possible that certain combinations of load capacitance, equivalent series resistance, and load-lead inductance will result in instability (see also "Stability" under "Remote Sensing"). If you need help solving a stability problem, contact an Agilent Service Engineer through your local Agilent Sales and Support Offices.

If the output is rapidly programmed into capacitive loads, the power supply may momentarily cross into CC operation, thereby extending the CV programming time. When it crosses into CC mode, the supply's maximum slew rate is limited by the CC loop and is a function of the loop current compensation. This may be optimized for particular compensation. These momentary crossover situations, which are communicated via the status register, may increase programming times, but will not damage the power supply.

## Inductive Loads

Inductive loads present no loop stability problems in CV mode. In CC mode, inductive loads will form a parallel resonance with the power supply's output capacitor, possibly causing current ringing in the load. For a given inductance, the power supply's CC control loop can be made to stabilize the current. However, stabilizing the current for a very large load inductance creates a much slower mode crossover (CV to CC or vice versa) time. Thus, there is a tradeoff between mode crossover speed and inductive compensation. To allow an optimal solution for each load, a CC loop compensation switch is provided so the CC control loop can be optimized for a specific load inductance. See "Appendix E - Current Loop Compensation" for details.

## Battery Charging

The power supply's OVP circuit has a downprogrammer FET that discharges the power supply output whenever OVP trips. If a battery (or other external voltage source) is connected across the output and the OVP is inadvertently triggered or the output is programmed below the battery voltage, the power supply will sink current from the battery. To avoid this, insert a reverse blocking diode in series with the  $\oplus$  output of the supply. Connect the diode **cathode** to the + battery terminal and the diode **anode** to the supply  $\oplus$  output terminal. The diode will require a heat sink.

## Local Voltage Sensing

For local sensing the +S and -S analog connector pins must be connected to the + and - bus bars (see Figure 4-5b). This is the default configuration as wired at the factory. Each sense lead is connected to the small, tapped hole nearest the corresponding output lead. Since local sensing does not compensate for voltage drops in the screw connections or load leads, local sensing should only be used in applications that require low output currents or where load regulation is not critical.

---

### Note

If the sense terminals are left open, the voltage at the output bus bars will increase approximately 3 to 5% over the programmed value. The readback voltage will not reflect this increase because readback is measured at the sense terminals.

---

## Remote Voltage Sensing

The dashed lines in the wiring diagrams illustrate remote voltage sensing. The remote sense terminals of the power supply are connected directly to the load rather than to the output bus bars. This allows the supply to automatically increase the voltage at the output bus bars to compensate for any voltage drop in the load leads, as well as to accurately read back the voltage directly from the load.

### Setting Up Remote Sense Operation

You must connect the positive side of the load to the +S analog connector pin and the negative side of the load to the -S analog connector pin (see Figure 4-1). Connect the sense leads carefully so that they do not become open-circuited. If sense leads are left open during operation, the supply will regulate at the output bus bars instead of at the load. Remember to bundle or tie wrap the load leads to minimize inductance and reduce noise pickup.

The sense leads are part of the supply's feedback path and must be kept at a low resistance in order to maintain optimal performance. Connect the sense leads carefully so that they do not become open-circuited. If the sense leads are left unconnected or become open during operation, the supply will regulate at the output bus bars, resulting in a 3 to 5% increase in output over the programmed value.

## CV Regulation

The maximum output voltage under remote sensing is reduced by the voltage drop in the load leads. See "Remote Sensing Capability" in Table 1-3b for further characteristics and a general formula for determining the extra degradation in the output due to voltage drop in the output leads.

## OVP Considerations

The power supply OVP circuit senses voltage near the output bus bars, not at the load. Therefore the signal sensed by the OVP circuit can be significantly higher than the actual voltage at the load. When using remote sensing, you must program the OVP trip voltage high enough to compensate for the voltage drop between the output bus bars and the load.

## Output Rating

In remote sense applications, the voltage drop in the load leads subtracts from the available load voltage. As the power supply increases its output to overcome this voltage drop, the sum of the programmed voltage and the load-lead drop may exceed the power supply's maximum voltage rating. This will not damage the supply, but may trip the OV protection circuit, which senses the voltage at the output bus bars. When the supply is operated beyond its rated output the performance specifications are not guaranteed, although typical performance may be good.

## Output Noise

Any noise picked up on the sense leads may appear at the output of the supply and can adversely affect the voltage load regulation. Use shielded twisted pairs for the sense leads and route them parallel and close to the load leads. Ground the shields only at the power-supply end, utilizing the signal ground binding post. *Do not use a shield as one of the sense conductors.* Bundle or tie-wrap the load leads to minimize inductance and reduce noise pickup.

## Stability

Using sensing under unusual combinations of load lead lengths and large load capacitances may cause your application to form a low-pass filter, which becomes part of the voltage feedback loop. The extra phase shift created by this filter can degrade the supply's stability, resulting in poor transient response. In severe cases, it may cause oscillation. To minimize this possibility, keep the load leads as short as possible and tie wrap them together.

In most cases, following these guidelines will eliminate problems associated with load lead inductance. However, if a large bypass capacitor is required at the load and load-lead length cannot be reduced, then a sense-lead bypass network may be needed to ensure stability (see Figure 4-5b).

The voltage rating of the 33  $\mu\text{F}$  capacitors should be about 50% greater than the anticipated load-lead drop. Addition of the 20  $\Omega$  resistors will cause a slight voltage rise at the remote sensing points. For utmost voltage programming accuracy, the supply should be recalibrated with the DVM at the remote sensing points (see "Appendix A - Calibration"). In addition, the sense protect resistors inside the power supply may have to be removed. (If you need help with a stability problem, contact an Support Engineer through your local Agilent Sales and Support offices.)

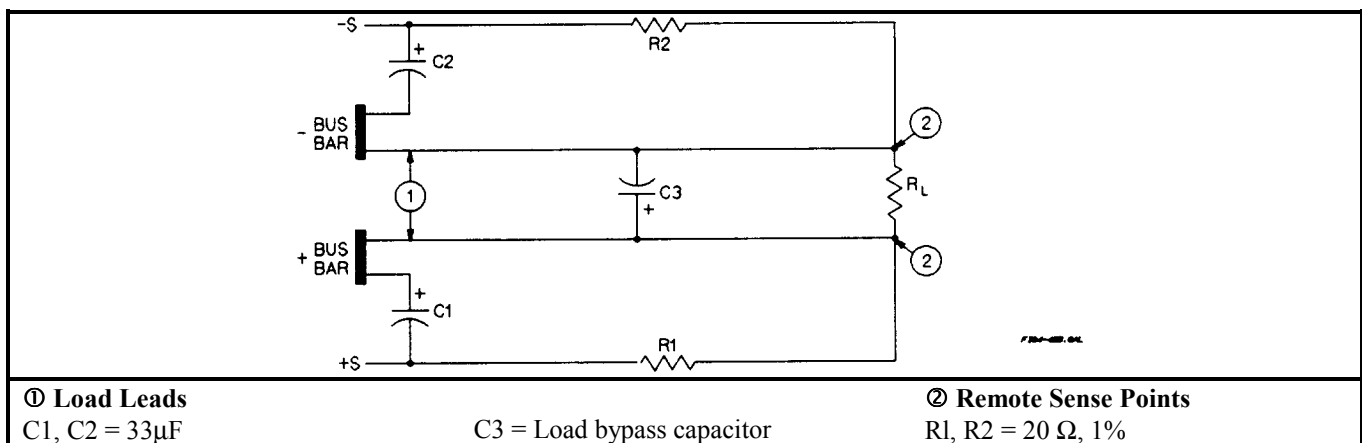
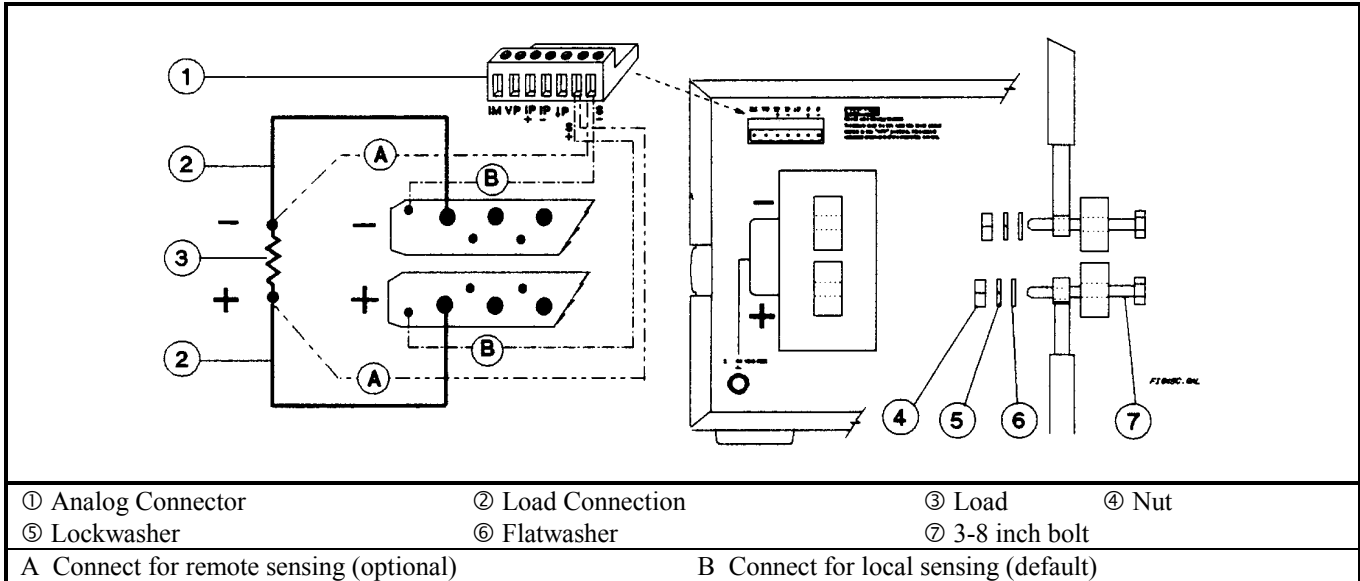

Figure 4-5b. Series 668xA and 669xA Sense Lead Bypass Network

## Connecting One Power Supply to a Single Load

Figure 4-5c shows how to connect a single power supply to one load. Keep output load leads close together (small loop area) to obtain a low inductance and low impedance connection to the load. If you wish to use remote sensing, connect the sense leads at the load as shown in the figures.

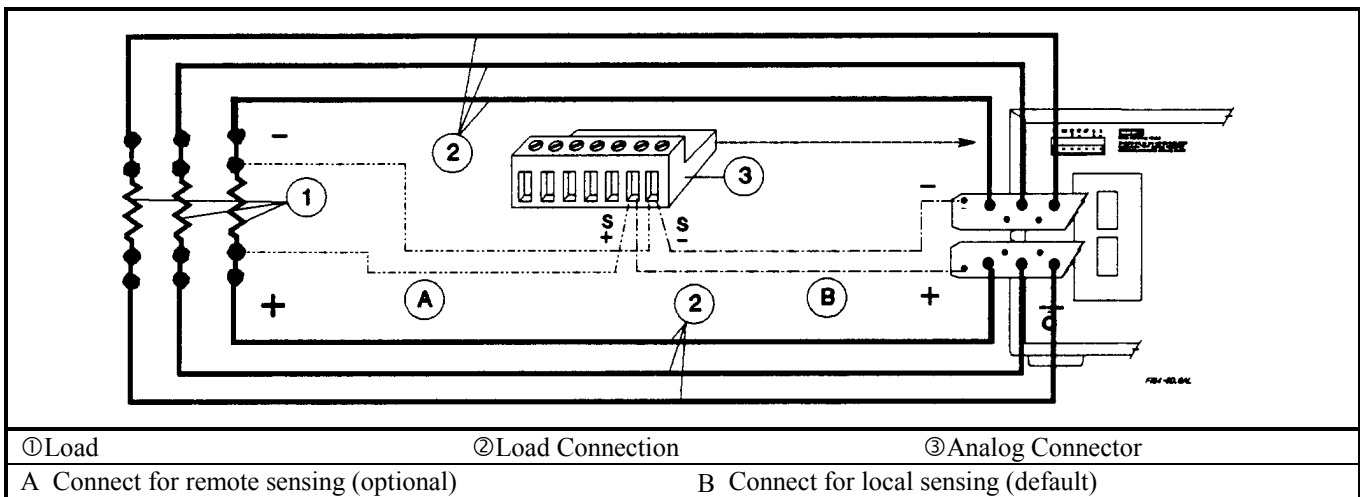

**Figure 4-5c. Series 668xA and 669xA Single Load Connection (Remote Sensing Optional)**

**Note** If you are using a bench application requiring the Option 601 Output Connector Kit, be sure to consult the instructions supplied with the kit.

## Connecting One Power Supply to Multiple Loads

Figure 4-5d shows how to connect a single power supply to more than one load. When connecting multiple loads to the power supply with local sensing, connect each load to the output bus bars with separate connecting wires. This minimizes mutual coupling effects and takes full advantage of the supply's low output impedance. Keep each pair of load wires as short as possible and twist or bundle them to reduce lead inductance and noise pickup.



**Figure 4-5d. Series 668xA and 669xA Multiple Load Connection (Remote Sensing Optional)**

## Connecting Supplies in Auto-Parallel

**Note** Refer to Appendix F for more information about auto-parallel operation.

**Auto-Parallel Wiring (Figure 4-5e).** Figure 4-5e shows how power supplies can be auto-paralleled for increased current output. Up to three supplies can be connected for auto-parallel operation. Use heavy enough load leads so that the absolute voltage difference between the  $\oplus$  output terminals of the "master" supply and the  $\oplus$  output terminal of the first "slave" supply is kept under 2 V at rated current. This also applies to the voltage difference between the  $\oplus$  output terminals of the first and second "slave" supplies. If remote sensing is necessary, connect the remote sense terminals of the "master" supply as shown by the dashed lines in Figure 4-5e. See "Remote Voltage Sensing" for more information.

**Auto-Parallel Programming.** Program only the output current of the first ("master") supply in the series; the "slave" supplies automatically track the master's output. Program the output current of the slave supplies to zero. However, the voltage and OVP settings of the slave supplies must be set higher than the operating voltage of the master supply. This ensures that the slave supplies will operate in CC mode when tracking the output of the master supply. Be sure to set the output current of the slave supplies to zero, because all current programming inputs (GPIB, front panel, and external voltage) are additive. Functions such as status, voltage readback, and current readback can still be read back individually for each supply.

If a "slave" supply experiences a desired shutdown condition (such as caused by overtemperature or overcurrent), it does not automatically shut down all other supplies. You must first enable remote inhibit (RI) and discrete fault indicator (DFI) operation. It is recommended that you use the RI and DFI functions to automatically shut down all supplies whenever one supply experiences a shutdown condition. See "Fault/Inhibit Operation" in "Appendix D - Digital Port Functions" for wiring information and "Questionable Status Group" in the "Programming Guide" for programming information.

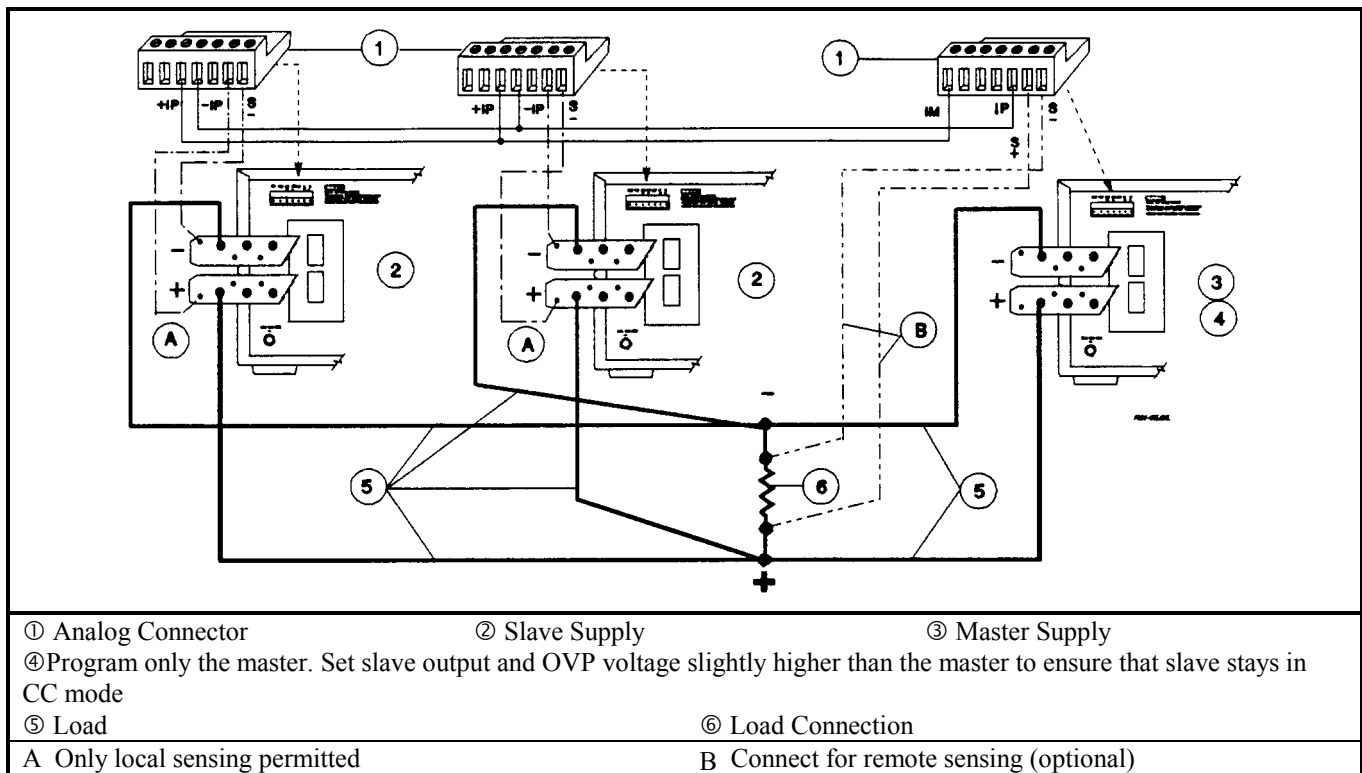

**Figure 4-5e. Series 668xA and 669xA Auto-Parallel Connection (Remote Sensing Optional)**



## Connecting Supplies in Series

**CAUTION** Floating voltages must not exceed  $\pm 60$  Vdc. No output terminal may be more than 60 V from chassis ground.

Figure 4-5f illustrates how power supplies can be connected in series for increased voltage capability. Series connections are straightforward in this case.

Program each power supply as an independent supply. If two supplies are used in series operation, each supply can be programmed to deliver 50% of the total output voltage. Set the current limit of each power supply to the maximum that the load can handle without damage.

If one supply experiences a desired shutdown condition (such as caused by overtemperature or overcurrent), it does not automatically shut down the other supply. You must first enable remote inhibit (RI) and discrete fault indicator (DFI) operation. It is recommended that you use the RI and DFI functions to automatically shut down both supplies whenever one supply experiences a shutdown condition. See "Fault/Inhibit operation" in "Appendix D - Digital Port Functions" for wiring information and "Questionable Status Group" in the "Programming Guide" for programming information.

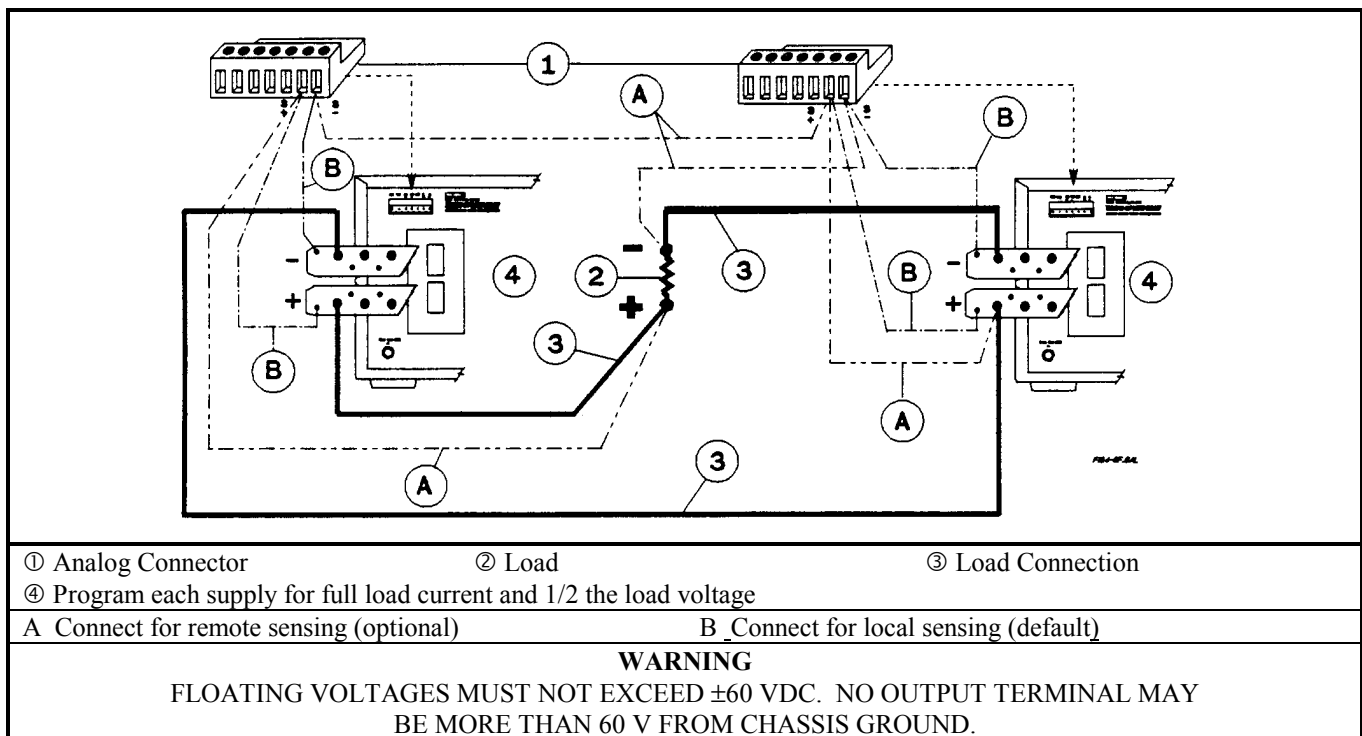

**Figure 4-5f. Series 668xA and 669xA Series Connection (Remote Sensing Optional)**

### WARNING

Each power supply has a reverse voltage protection diode across its output. If the fan in one of the series power supplies shuts down for any reason (such as a fan circuit defect or loss of ac power), the supply may severely overheat due to current forced through its reverse current diode by the functioning supply. This possibility can be eliminated by use of the RI/DFI functions previously noted. Also, if a reverse voltage is applied across a functioning supply, it has no control over the current conducted through this diode. To avoid damaging the supply, never connect it in such a way that a reverse voltage can force it to conduct current in excess of the supply's maximum rated current. (see Table 1-4b)

## External Voltage Control

The setup shown in Figure 4-5g allows an external dc voltage to program the power supply output. A zero-to-full scale voltage applied to the voltage programming input produces a proportional zero-to-full scale output voltage. The voltage programming source is referenced to the programming **Common P** ( $\downarrow P$ ) terminal. A zero-to-full scale voltage applied to one of the current programming inputs produces a proportional zero-to-full scale output current. See Figure 4-1 for an explanation of these programming input connections.

### Wiring Considerations

The input impedance of the analog input is over 30 k $\Omega$ . If the output impedance of your programming source is not negligible with this, programming errors will result. Larger output impedances result in proportionally greater errors.

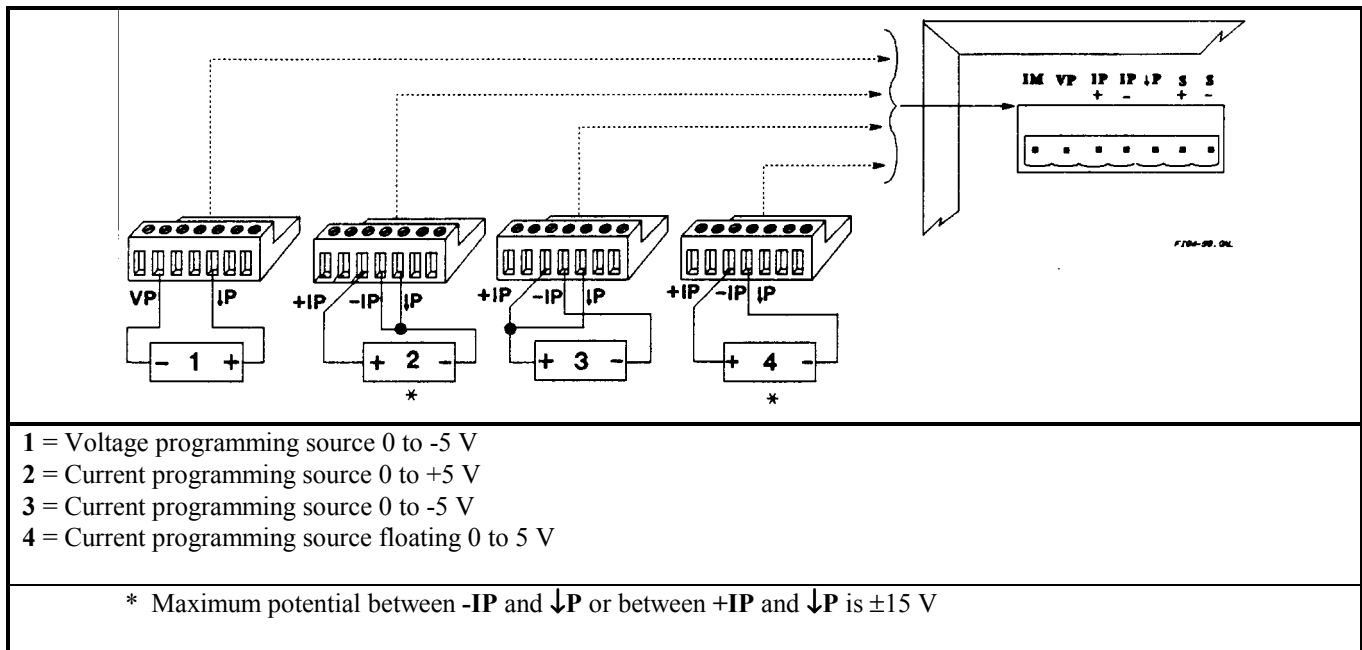

Figure 4-5g. Series 668xA and 669xA Analog Programming Connections

### Programming

Note from Figure 4-1 that you have three options for programming the current. You can use a voltage source that is positive, negative, or floating with respect to **Common P**. Do not exceed +15 V with respect to **Common P**.

**CAUTION** Make certain that the common connection for your voltage programming source is isolated from the load. Failure to do this may cause damage to the power supply.

The effect of the analog programming source is always summed with the values programmed over the GPIB or from the front panel. The voltage source can act alone only if you set the other program sources to zero. Keep the total programmed setting of the supply (the analog input summed with the GPIB or front panel settings) at or under the output ratings specified in Table 1-3a. Exceeding the output ratings will not damage the supply, but it may not be able to regulate its output the higher levels. If this happens, the **Unr** annunciator will light to warn you that the output is unregulated.

---

## Controller Connections

Figure 4-6 shows two basic ways of connecting your power supply to a controller. They are "linked" and "stand-alone" configurations.

### Stand-Alone Connections

See Figure 4-6A. Each stand-alone power supply has its own GPIB bus address. Stand-alone power supplies may be connected to the bus in series configuration, star configuration, or a combination of the two. You may connect from 1 to 15 stand-alone power supplies to a controller GPIB interface.

### Linked Connections

See Figure 4-6B. Up to 16 power supplies may be used at a single GPIB primary bus address by making linked connections. (You cannot use linked connections if you intend to program power supplies with the Compatibility Language - see the power supply "Programming Guide".)

- The first power supply in a linked connection is a "direct supply" connected to the controller via a GPIB cable. The direct supply is the only supply connected directly to the bus and has a unique primary bus address.
- The remaining power supplies are "linked supplies" connected to the direct supply via a serial-link cable. Each linked supply has a unique secondary GPIB address and derives its primary address from the direct supply. You may connect from 1 to 15 linked supplies to each direct supply.

---

#### Note

The power supply is shipped from the factory with its GPIB address set to 5. The power supply primary and secondary addresses can be changed from the front panel as described in "Chapter 2 - Remote Programming" of the "Programming Guide". For power supply GPIB interface capabilities, see Table 1-5 in Chapter 1 of this guide.

---

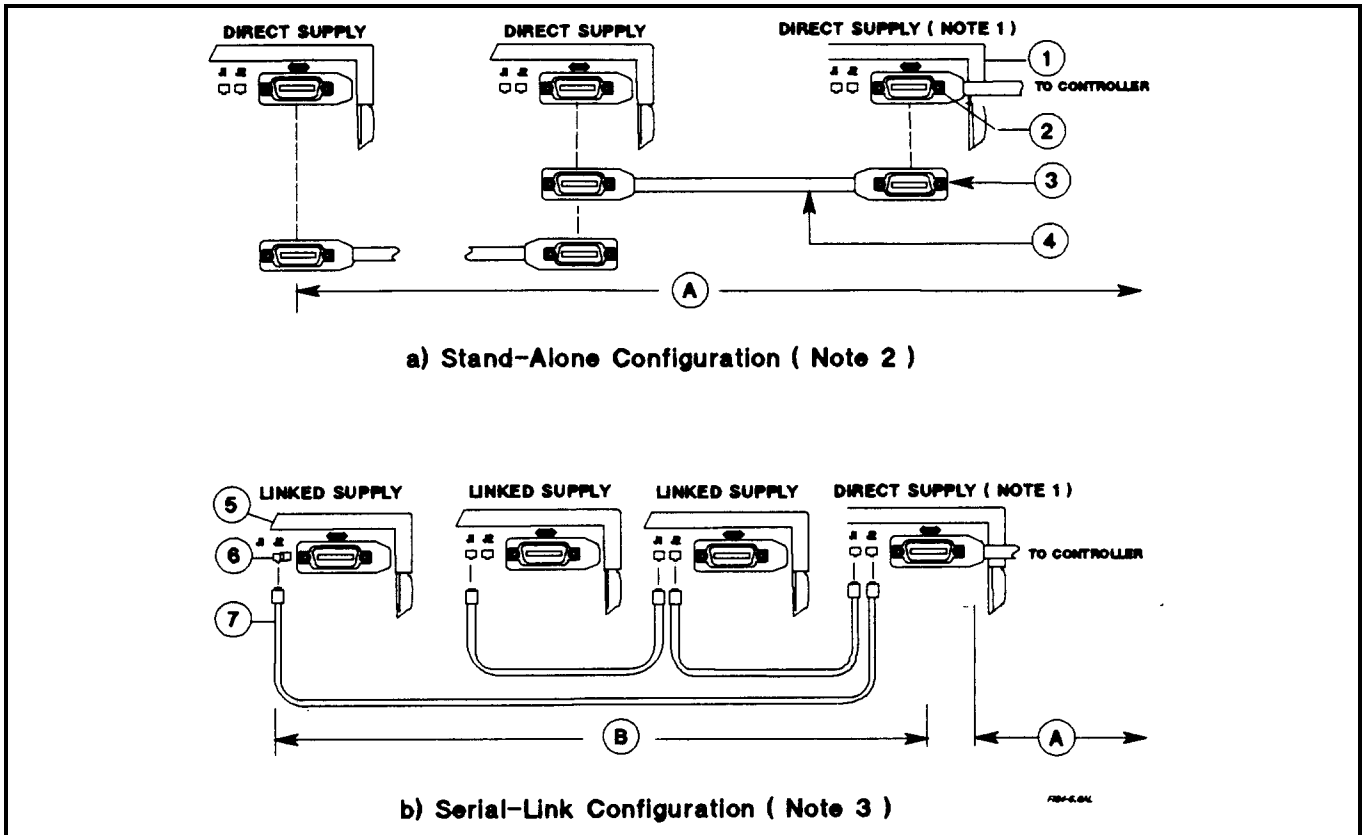

a) Stand-Alone Configuration ( Note 2 )

b) Serial-Link Configuration ( Note 3 )

- ① From 1 to 16 direct supplies may be connected to 1 controller GPIB interface.
- ② Tighten connector thumbscrews by hand. Do not use a screwdriver.
- ③ Do not stack more than 3 connectors on a GPIB receptacle.
- ④ GPIB cable (see **Accessories** in Chapter 1)
- ⑤ From 1 to 15 linked supplies may be connected to 1 direct supply.
- ⑥ Either receptacle (J1 or J2) may be used as an input or an output.
- ⑦ Serial Link Cable (see **Accessories** in Chapter 1), 2 meters. 1 is supplied.
- A Maximum total length of all GPIB cables (including controller) not to exceed 20 meters.
- B Use caution with individual lengths over 4 meters.  
Maximum total length of all serial cables not to exceed 30 meters.

**NOTES:**

- 1. A direct power supply is connected to the controller interface and must have a unique primary GPIB bus address.
- 2. The stand-alone configuration uses only direct supplies connected to the controller interface.
- 3. The linked configuration uses 1 or more linked power supplies connected to each direct supply. Each linked supply has a unique secondary GPIB bus address and derives its primary address from the direct supply.

**Figure 4-6. Controller Connections**

# Front Panel Operation

---

## Introduction

This chapter shows you how to operate the front panel. It is assumed that you are familiar with the turn-on checkout procedure in Chapter 3. That chapter describes how to perform basic power supply functions from the control panel. operations that you can perform are:

- Enabling or disabling the power supply output.
- Setting the output voltage and current.
- Monitoring the output voltage and current.
- Setting the overvoltage protection (OVP) trip point.
- Enabling the overcurrent protection (OCP) circuit.
- Saving operating states in nonvolatile memory.
- Recalling operating states from nonvolatile memory.
- Setting the power supply GPIB bus address.
- Displaying error codes created during remote operation.
- Enabling local (front panel) operation.

---

**Note** You also can calibrate the power supply from the front panel (see Appendix A).

---

## Getting Acquainted

The front panel is summarized in Figure 5-1 and Table 5-1. Note that the panel is organized as follows:

- ① LCD display (including annunciators)
- ② Output VOLTAGE and CURRENT rotary (RPG) knobs
- ③ SYSTEM keypad
- ④ FUNCTION keypad
- ⑤ ENTRY keypad
- ⑥ Power (LINE) switch

Some keys have two functions. For example, the System **Recall** key (3, Figure 5-1) can be used either to recall a stored operating state or to **Save** (store) an operating state. The first operation is shown **on** the key and the second (shifted) operation is shown in blue **above** the key. In order to do a shifted operation, first press the solid blue key, which is unlabeled but shown throughout this manual as **Shift**.

For example, for a recall operation, press the recall key **Recall**. For a save operation, press the save key, which is **Shift Recall**. When you do this, the **Shift** annunciator will light to remind you that the **Recall** key is now functioning as the **Save** key. In this chapter, such a shifted operation may be shown simply as **Save**.

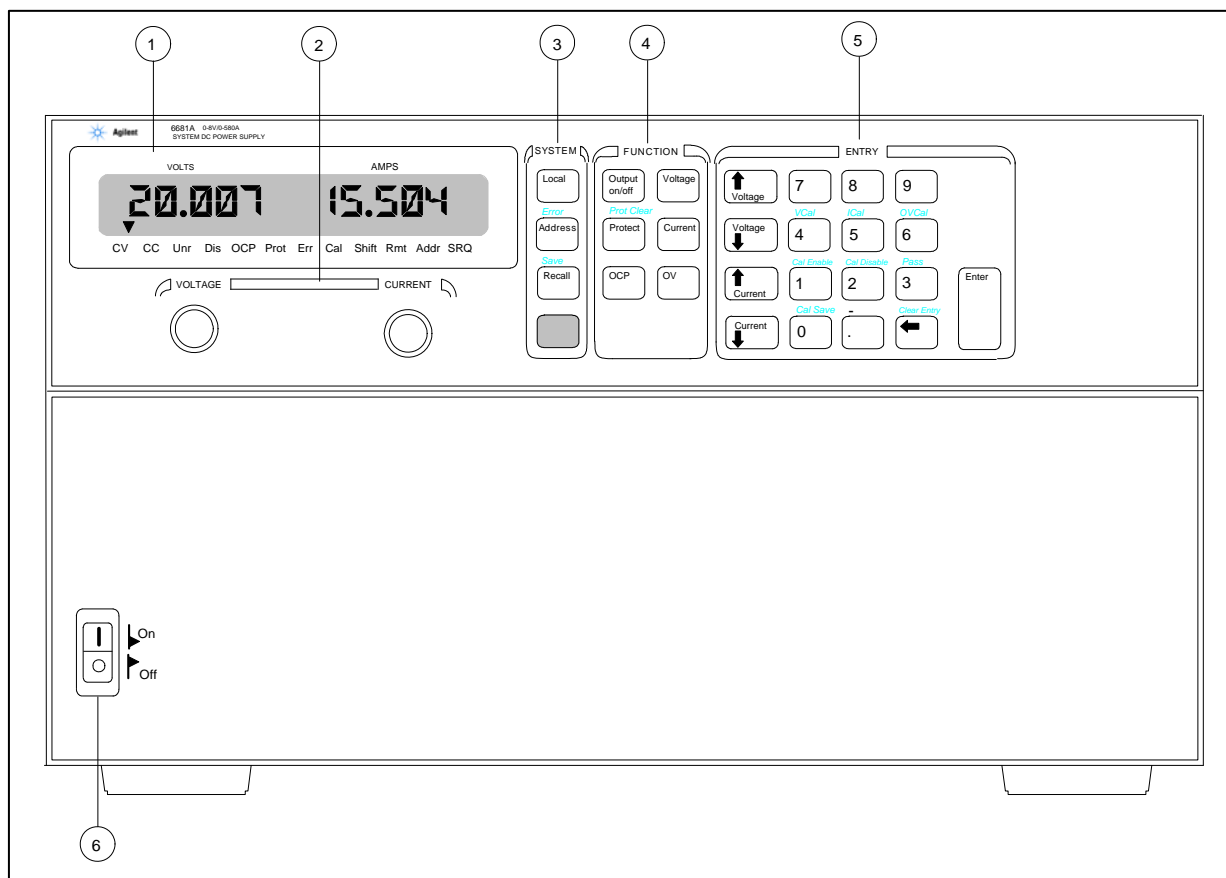



Figure 5-1. Front Panel Controls and Indicators





Table 5-1. Front Panel Controls and Indicators (see Figure 5-1)

Control or Indicator	Function or Indication
① Display	
<b>VOLTS</b>	Shows present output voltage of the power supply.
<b>AMPS</b>	Shows present output current of the power supply.
<b>Status Annunciators</b>	
<b>CV</b>	The power supply is in constant-voltage mode.
<b>CC</b>	The power supply is in constant-current mode.
<b>Unr</b>	The power supply output is unregulated (output is neither CV or CC).
<b>Dis</b>	The power supply output is disabled.
<b>OCP</b>	The overcurrent protection function is enabled.
<b>Prot</b>	A protection circuit has caused the power supply to shut down. (Press <b>Protect</b> to determine the reason.)
<b>Err</b>	An error has been generated as a result of remote operation. (Press <b>Error</b> to display the error code).
<b>Cal</b>	The power supply is in calibration mode.
<b>Shift</b>	The shift key <b>Shift</b> has been pressed.
<b>Rmt</b>	The power supply is in the remote mode (controlled over the GPIB).
<b>Addr</b>	The power supply is addressed to listen or talk.
<b>SRQ</b>	The power supply is requesting service from the controller.

**Table 5-1. Front Panel Controls and Indicators (continued)**

<b>② Output Rotary Controls</b>	
<b>Voltage</b>	Rotate clockwise to increase output voltage or program setting. Use to rapidly set an approximate output value (see <b>↑Voltage</b> and <b>↓Voltage</b> keys).
<b>Current</b>	Rotate clockwise to increase output current or program setting. Use to rapidly set an approximate current value (see <b>↑Current</b> and <b>↓Current</b> keys).
<b>③ SYSTEM Keys</b>	
<b>Local</b>	When the power supply is under remote control, press to enable local operation. <i>This control can be defeated by a lock-out command over the GPIB</i>
<b>Address</b>	Press to display the power supply's GPIB address. You can change the address with the <b>ENTRY</b> keys
<b>Error</b>	Use to display error codes generated during remote operation. (Select by pressing <b>Shift</b> <b>Address</b> .)
<b>Recall</b>	Use to restore a previously saved power supply state. Use <b>ENTRY</b> keys <b>0</b> through <b>4</b> ( <b>0</b> through <b>3</b> on the Series 668xA) to specify which location to recall. (Select by pressing <b>Shift</b> <b>Recall</b> .) <b>Note:</b> Location 0 may contain the power supply turn-on state. See "Turn-on operation" in this chapter.
<b>Save</b>	Use to save the power supply's present state to nonvolatile memory. (Select by pressing <b>Shift</b> <b>Recall</b> .) Use <b>ENTRY</b> keys to specify the location where you want to store the state. You may use locations <b>0</b> through <b>4</b> ( <b>0</b> through <b>3</b> on the Series 668xA).
	This unlabeled blue key is the Shift key. Press to access the shifted (alternate) key functions.
<b>④ Function Keys</b>	
<b>Output on/off</b>	Press to enable or disable the power supply output. This key toggles between the two states. The disabled state programs the output to the *RST voltage and current settings (see the Programming Guide).
<b>Voltage</b>	Press to display the output voltage setting. After pressing <b>Voltage</b> , you may use the <b>ENTRY</b> keys to change the value.
<b>Current</b>	Press to display the output current setting. After pressing <b>Current</b> , you may use the <b>ENTRY</b> keys to change the value.
<b>OV</b>	Press to display the OV trip voltage setting. After pressing <b>OV</b> , you may use the <b>ENTRY</b> keys to change the value.
<b>Protect</b>	When the <b>Prot</b> annunciator is on, press <b>Protect</b> to see which protection circuit caused the power supply to shut down. Response can be OC (overcurrent), OT (overtemperature), or OV (overvoltage). If no protection circuit has tripped, the display will show dashes (- - -).
<b>Prot Clear</b>	Press this key to reset the protection circuit. <i>If the condition that caused the circuit to trip has been removed</i> , the <b>Prot</b> annunciator will go off.
<b>OCP</b>	Press to enable or disable the power supply OCP trip circuit. This key toggles between the two states, which are indicated by the <b>OCP</b> annunciator.
<b>⑤ ENTRY Keys</b>	
<b>↑Voltage</b>	Press to increment the output voltage in the CV mode, or to increase the voltage setting after you have pressed the <b>Voltage</b> key. <sup>3</sup>
<b>↓Voltage</b>	Press to decrement the output voltage in the CV mode, or to decrease the voltage setting after you have pressed the <b>Voltage</b> key. <sup>3</sup>
<b>↑Current</b>	Press to increment the output current in the CC mode, or to increase the current setting after you have pressed the <b>Current</b> key. <sup>3</sup>
<b>↓Current</b>	Press to decrement the output current in the CC mode, or to decrease the current setting after you have pressed the <b>Current</b> key. <sup>3</sup>

**Table 5-1. Front Panel Controls and Indicators (continued)**

⑤ ENTRY Keys (continued)	
<p>0 thru 9 </p> <p></p> <p></p>	<p>Press to select numerical values .</p> <p>Press to enter a minus sign.</p> <p>Press to delete the last keypad entry. Use this key to remove one or more incorrect digits before they are entered.</p>
<p><sup>3</sup> These four entry keys operate in two modes. Press and release for a single minimal change as determined by the programming resolution (see Table 1-2 in Chapter 1). Press and hold for an increasingly rapid output change.</p>	
<p></p> <p></p>	<p>Press to delete an entire keypad entry and return to the meter mode. Use this key to exit from a value before it is entered.</p> <p>Press to enter a value or to accept an existing value and return the display to the meter mode. The remaining shifted keys are for calibration (see "Appendix A - Calibration").</p>
⑥ Line Switch	
<p><b>On / Off</b></p>	<p>Turns the ac line on or off.</p>



## Programming the Output

**Important** These instructions show how to program a single power supply. There are special considerations when you have two or more supplies connected in series or in autoparallel. See "Chapter 4 - User Connections and Considerations".

The power supply accepts values directly in volts and amperes. Values will be rounded off to the nearest multiple of the output resolution (see "Average Resolution" in Table 1-2 of Chapter 1). If you attempt to enter a value not in a valid range, the entry will be ignored and **OUT OF RANGE** appears on the display.

Figure 5-2 shows the general response of a typical power supply. Unless directed otherwise, always keep the output voltage and current within the boundaries of its operating line for the specified mode of operation (CV or CC).

### Establishing Initial Conditions

Set the power supply to its \*RST state by pressing   . This state was stored in location 0 at the factory. If it has since been changed, you can restore it as directed under "Turn-on Conditions", later in this chapter. \*RST results in the following operating conditions:

- Zero voltage output.
- Minimal current output.
- Output disabled (**Dis** annunciator on).
- Overcurrent protection off (**OCP** annunciator off).
- Protection circuits cleared (**Prot** annunciator off).



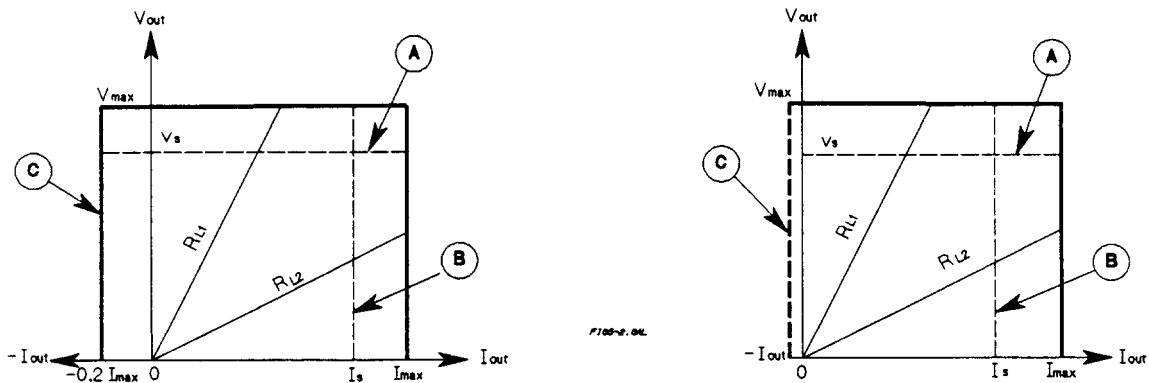

Figure 5-2. Typical Power Supply Operating Curve

## Programming Voltage

To program the output for 4.5 volts, proceed as follows:

- Press **[Voltage]**. The display will change from meter mode to indicate **VOLTS**.
- Press **[4] [.] [5] [Enter]**. If you discover a mistake before pressing **[Enter]**, erase the incorrect value with the backspace key **[←]**.
- The display will return to the meter mode and indicate 0.000 volts.
- Press **[Output on/off]** to enable the output (**Dis** annunciator turns off). The **VOLTS** display will indicate 4.500 volts.

### Note

The power supply must be programmed for a minimal current in order to increase the output voltage beyond zero. Normally, there is sufficient idle current to do this. If the power supply does not respond or the **CC** annunciator turns on, go to "Programming Current" and set the current to a small value.

- Now raise the voltage by pressing **[↑Voltage]**. Note that the voltage increases by a specific increment (depending on the voltage programming resolution) each time you press the key and increases rapidly as you hold down the key. To lower the voltage, press **[↓Voltage]**.
- Try raising and lowering the voltage by rotating the **Voltage** control clockwise and then counterclockwise. Note how the output responds as compared to using the **Entry** keys.

Try to program a voltage greater than the  $V_{MAX}$  for your supply (see "Supplemental Characteristics" for your particular model in Chapter 1). Note that the display shows **OUT OF RANGE**.

## Programming Overvoltage Protection

Overvoltage protection guards the load against voltages that reach a specified value above the programmed output voltage.

### Setting the OVP Level

Assuming that you have programmed the power supply for 4.5 volts, you can set the OVP level to 4.8 volts as follows:

- Press **[OV]**. The display will change from meter mode to indicate 0V, followed by the present OVP value.
- Press **[4] [.] [8] [Enter]**.
- The display will return to the meter mode and indicate the output (4.500 volts).
- Press **[OV]** again. The display will now indicate **0V 4.800**.
- Press **[Enter]** to return to the meter mode.

## Checking OVP Operation

Assuming the above operating conditions (voltage programmed to 4.5 V and OVP programmed to 4.8 V), trip the OVP circuit as follows:

- Gradually increase the output voltage by pressing **↑Voltage** until the OVP circuit trips. This will cause the output voltage to drop to zero and the **Prot** annunciator to go on.
- There now is no power supply output due to an overvoltage condition.
- To verify this, press **Protect** and observe that the display indicates **0V**. This shows that the protection circuit tripped due to an overvoltage condition.

## Clearing The OVP Condition

With the OVP tripped, return to the meter mode and try to clear the condition by pressing **Prot Clear**. Nothing will appear to happen because the OV trip voltage is still below the programmed output voltage. Thus, as soon as the circuit is cleared, it trips again. You can clear the OV condition by:

- Lowering the output voltage below 4.8 (the OV setting), or
- By raising the OV trip voltage above the output voltage setting.

Try either of these methods. Now when you press **Prot Clear**, the **Prot** annunciator will turn off and the output voltage will return to normal.

## Programming Current

---

**WARNING**

**ENERGY HAZARD.** Some power supplies (Series 668xA) can provide more than 240 VA at more than 2 V. If the output connections touch, severe arcing may occur resulting in burns, ignition or welding of parts.

---

You may program the power supply current without a load, but must have a load in order to draw output current. These tests assume you have the load connected in accordance with the information in “Chapter 4 - User Connections and Considerations”. If you do not have a load on the power supply, you may connect a short across the output terminals as described in “Chapter 3 - Turn-on Checkout”.

The example will program a low current. (You may later increase the output current to the levels you will expect to use.) To program the output current to 1.3 amperes, proceed as follows:

- Disable the output by pressing **Output on/off**. The **Dis** annunciator will turn on.
- Program the voltage by pressing **Voltage** **5** **Enter**.
- Press **Current**. The display will change from meter mode to indicate **AMPS**.
- Press **1** **0** **3** **Enter**. If you discover a mistake before pressing **Enter** erase the incorrect value with the backspace key **←**.
- The display will return to the meter mode and indicate up to 0 . 000.
- Press **Output on/off** to enable the output. **Dis** will turn off and the display will indicate **VOLTS 5 . 000 AMPS 1 . 300**.
- Now increase the current by pressing **↑Current**. Note that the current increases by a specific increment (depending on the current programming resolution) each time you press the key and increases rapidly as you hold down the key. To decrease the current, press **↓Current**.
- Try increasing and decreasing the current by rotating the **Current** knob clockwise and counterclockwise. Note how the output responds as compared to using the **Entry** keys.

Disable the output by pressing **Output on/off**. The **Dis** annunciator will turn on. Now try to program a current greater than the  $I_{MAX}$  for your supply. Note that the display shows **OUT OF RANGE**.

## Programming Overcurrent Protection

When enabled, overcurrent protection removes the power supply output whenever it goes into CC operation. This prevents the supply from indefinitely supplying the full programmed current to the load.

### Setting The OCP Protection

To activate overcurrent protection, press **OCP**. The **OCP** annunciator will light and power supply will continue to operate normally until it is forced into CC operation. If that occurs, the OCP circuit will trip and the power supply will remove its output.

### Checking OCP Operation

The easiest way to check this operation at any specified current is to increase the load current beyond the programmed current value and, if necessary, decrease the programmed voltage. This will force the power supply into the CC mode (see Figure 5-2). When OCP trips, the **Prot** annunciator will light and the power supply output will drop to zero.

There is now no power supply output due to an overcurrent condition. To verify this, press **Protect** and observe that the display indicates **OC**.

### Clearing The OCP Condition

With the OCP tripped, return to the meter mode and try to clear the condition by pressing **Prot Clear**. Nothing will appear to happen because the reason for the condition has not been removed. Thus, as soon as the circuit is cleared, it trips again. You can clear the OC condition by:

- Increasing the load resistance to lower the output current below the programmed current value, or
- By raising the programmed current to a value above that required by the load.

Clear the fault by either of the above methods. Then clear the OCP circuit by pressing **Prot Clear**. The **Prot** annunciator will go off and the power supply output will be restored to normal.

If desired, you can also restore the output by disabling the OCP function (press **OCP** to turn off the **OCP** annunciator). This restores the output but does not clear any condition that may have caused OCP to trip.

---

**Note** Under certain conditions, the OCP circuit may fail to clear because load demand occurs before the power supply has time to build up the required output current capacity. In such cases, disable the output (press **Output on/off** before clearing the OCP circuit). After OCP is cleared, enable the power supply output.

---

## CV Mode vs. CC Mode

Once you program a voltage ( $V_S$ ) and a current ( $I_S$ ) in Figure 5-2, the power supply will try to maintain itself in either CV or CC mode, depending on the impedance of the load ( $R_L$ ). If the load demands less current than  $I_S$ , operation will be in CV mode with the voltage maintained at  $V_S$ . The output current will be at some value below  $I_S$  as determined by  $V_S \div R_L$ .

If the current increases beyond  $I_S$  (see  $R_{L2}$ ), the supply will switch to CC mode by varying its output voltage to maintain a constant current value of  $I_S$ . As more current is demanded, the voltage decreases to maintain the increased current level. If the load current increases to the maximum output of the power supply, the output voltage will be maintained at a near-zero level.

---

## Unregulated Operation

If the power supply goes into a mode of operation that is neither CV nor CC, the **Unr** annunciator will light. An unregulated condition limits the output current to a value that is safe for the power supply. Some unregulated states occur so briefly that they do not turn on the **Unr** annunciator, but they may set the **UNR** status bit during remote operation (see the power supply “Programming Guide”). One condition that can cause a noticeable unregulated state is low ac line voltage.

---

## Saving and Recalling Operating States

You can save programming time by storing up to 5 (up to 4 with Series 668xA supplies) operating states in nonvolatile memory. The front panel programming parameters that are saved are:

- Output voltage, Output current, OVP voltage.
- OCP state (on or off), Output state (enabled or disabled).

---

**Note** More power supply parameters are saved in remote operation. See the power supply “Programming Guide”.

---

As an example, set up the following state:

- Voltage = 4 V Current = 5 A OVP voltage = 4.5 V.
- OCP = on (**OCP** annunciator on) Output = off (**Dis** annunciator on).

Save the above state to location 1 by pressing **Save** **1** **Enter**. Now set up the following state:

- Voltage = 4.5 V Current = 2.5 A OVP voltage = 5 V.
- OCP = off (**OCP** annunciator off) Output = on (**Dis** annunciator off).

Save the above state to location 2 by pressing **Save** **2** **Enter**.

Restore the first state by pressing **Recall** **1** **Enter** and verify the parameters. Restore the second state by pressing **Recall** **2** **Enter**. Note how the power supply is automatically programmed each time.

---

## Turn-On Conditions

Whenever you apply power to a new power supply it automatically turns on in a safe reset state with the following parameters:

**Output on/off** off **Voltage** 0 **Current** minimum\* **OV** maximum **OCP** off

\*Minimum is the \*RST value specified in Table 3-1 in the Programming Guide.

It is recommended that you leave the turn-on conditions as programmed. However, you may change them if you wish. To do this, proceed as follows:

1. Set up the power supply to the state you want when it is turned on.
2. Store that state to location 0.
3. Turn off the power supply.
4. Hold in the **0** key and turn the power supply back on. The display indicates **RCL 0 PWR-ON** to verify that the power supply has configured its turn-on state to that stored in location 0.
5. From now on the supply will always turn on to the state defined in location 0.

Whenever you wish, you can return the power supply to the original factory reset state. To do this, simply hold down the **Ⓞ** key when you turn on the supply. The display indicates **RST POWER-ON** to verify that the power supply has configured its turn-on state to the original reset state. From now on it will continue to turn on in that state.

---

## Setting the GPIB Address

### Types of Power Supply GPIB Addresses

Figure 4-6 in Chapter 4 shows the ways the power supply can be connected to the GPIB bus. You can set up the GPIB address in one of three ways:

1. As a stand-alone supply (the only supply at the address). It has a primary address in the range of 0 to 30. For example: **5** or **7**.
2. As the direct supply in a serial link. It is the only supply connected directly to the GPIB bus. The primary address is unique and can be from 0 to 30. It is entered as an integer followed by a decimal separator. The secondary address always is 0, which may be added after the primary address. If the secondary address is omitted, it is assumed to be 0. For example: **5.0** or **7**.
3. As a linked supply in serial link. It gets its primary address from the direct supply. It has a unique secondary address that can be from 1 to 15. It is entered as an integer preceded by a decimal separator. For example: **.1** or **.12**

When you enter a secondary address, leading zeros between the decimal separator and the first digit are ignored. For example, **.1**, **.01**, and **.001** are accepted as secondary address 1 and displayed as **0.01**. Zeros following a digit are not ignored. Thus, **.10** and **.010** are both accepted as secondary address 10 and displayed as **0.10**.

### Changing the Power Supply GPIB Address

Use the **Address** key and numerical keypad for entering addresses. The power supply is shipped with a 5 stand-alone address as the default. The general procedure for setting an address is:

Action	Display Shows
Press <b>Address</b>	Current address
Press new address keys	New address replaces numbers on the display
Press <b>Enter</b>	Display returns to meter mode

If you try to enter a forbidden number, **ADDR ERROR** is displayed.

The following examples show how to set addresses:

- To set stand-alone primary address **6**, press **Address** **6** **Enter**.
- To set direct supply primary address **6**, press **Address** **6** **.** **Enter**.
- To set linked secondary address **1**, press **Address** **.** **1** **Enter**.
- To set linked secondary address **12**, press **Address** **.** **1** **2** **Enter**.

---

**Note** The power supply display will reset (recall the state in location 0) whenever you change between the following types of GPIB addresses:

- a stand-alone primary address and a direct primary address.
- a direct primary address and a secondary address.

---



# Calibration

## Introduction

The power supply may be calibrated either from the front panel or from a controller over the GPIB. The procedures given here apply to all models.

**Important** These instructions do not include verification procedures. If you need to perform verification as a prerequisite to or as part of your calibration procedure, see “Appendix B - Verification”.

## Equipment Required

The equipment listed in Table A-1, or equivalent, is required for calibration.

**Table A-1. Equipment Required for Calibration**

Equipment	Characteristics	Recommended Model
Voltmeter	D-c accuracy 0.005%, 6 digits	Agilent 3456A or 3458A
Shunt resistor		
Agilent 6641A, 51A, 52A	100 A, 0.01 $\Omega$ , 0.04%, 100 W	Guildline 9230/100
Agilent 6642A, 43A, 44A, 45A, 6653A, 54A, 55A	15 A, 0.1 $\Omega$ , 0.04%, 25 W	Guildline 9230/15
Agilent 6671A	300 A, 0.001 $\Omega$ , 0.04%, 100 W	Guildline 9230/300
Agilent 6672A, 73A, 74A, 75A	300 A, 0.001 $\Omega$ , 0.04%, 100 W	Guildline 9230/300
Agilent 6680A, 81A, 6690A	1000 A, 0.1 m $\Omega$ , 0.05%	Burster 1280S
Agilent 6682A, 83A, 84A, 6691A, 92A	300 A, 0.001 $\Omega$ , 0.04%, 100 W	Guildline 9230/300
<b>For Calibration Over the GPIB</b>		
<b>GPIB Controller</b>	IBM compatible PC with GPIB Interface	

## General Procedure

### WARNING

Because the power supply output must be enabled during calibration, voltages or currents hazardous to personnel and/or damaging to equipment can appear at the output terminals.

### WARNING

**ENERGY HAZARD.** Series 668xA/669xA supplies can provide more than 240 VA at more than 2 V. If the output connections touch, severe arcing may occur resulting in burns, ignition or welding of parts. Do not attempt to make connections to live output circuits.

## Parameters Calibrated

The following parameters may be calibrated:

- Output voltage.
- Output voltage readback.

- Overvoltage protection (OVP).
- Output current.
- Output current readback.
- Current monitor input  $I_M$  (Series 668xA/669xA only).

You do not have to do a complete calibration each time. If appropriate, you may calibrate only the voltage or current and proceed to "Saving the Calibration Constants". However, for Series 668xA/669xA supplies, the following sequences must be followed:

- Calibrate voltage before OVP.
- Calibrate the current monitor input before current output.

## Test Setup

Figure A-1 shows the test setups required for voltage and current calibration for each power supply series.

---

## Front Panel Calibration

Eight shifted keys and the Entry keypad are used for calibration functions (see "Chapter 5 - Front Panel Operation" for explanations of shifted keys and the Entry keypad). The following procedures assume you understand how to operate front panel keys.

### Entering the Calibration Values

Follow the steps in Table A-2 for entering calibration values.

### Saving the Calibration Constants



Storing calibration constants overwrites the existing ones in nonvolatile memory. If you are not absolutely sure you want to permanently store the new constants, omit this step. The power supply calibration will then remain unchanged.

To replace any existing calibration constants with ones you have just entered, press **Cal Save**. **CAL SAVED** then appears on the display.

### Disabling the Calibration Mode

To disable the calibration mode, press **Cal Disable**. The display will return to meter mode with the **Cal** annunciator off.

### Changing the Calibration Password

The factory default password is the model number of your supply, such as 6671. You can change the calibration password only when the power supply is in the calibration mode (which requires you to enter the existing password). Proceed as follows:

1. Press **Pass**.
2. Enter the new password from the keypad. (You can use up to six integers and an optional decimal point.) If you want **Cal Enable** to operate without requiring any password, change the password to 0 (zero).
3. **AGAIN** will appear on the display. Enter the password a second time.
4. When **OK** is displayed, the new password has been accepted.



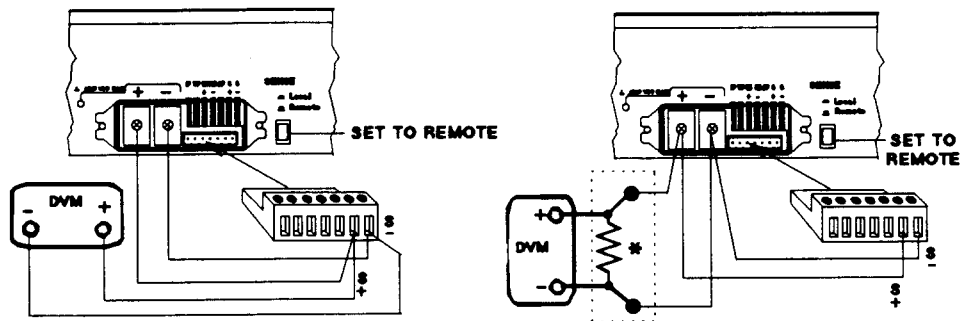

1) CV Test Setup

2) CC Test Setup

a) Series 664xA & 665xA Setup

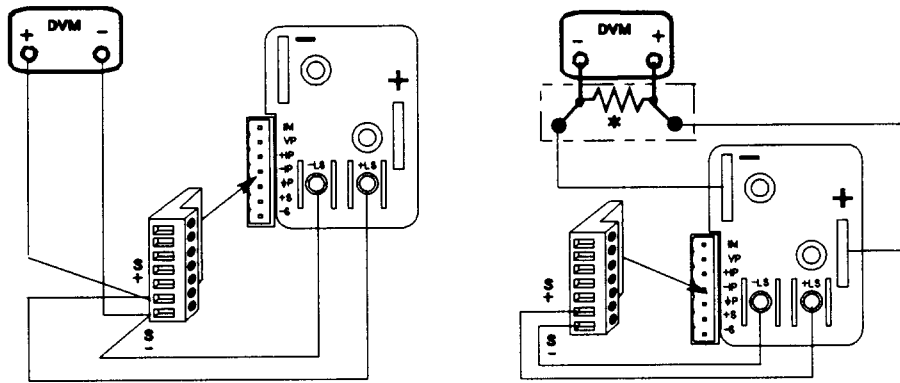

1) CV Test Setup

2) CC Test Setup

b) Series 667xA Setup

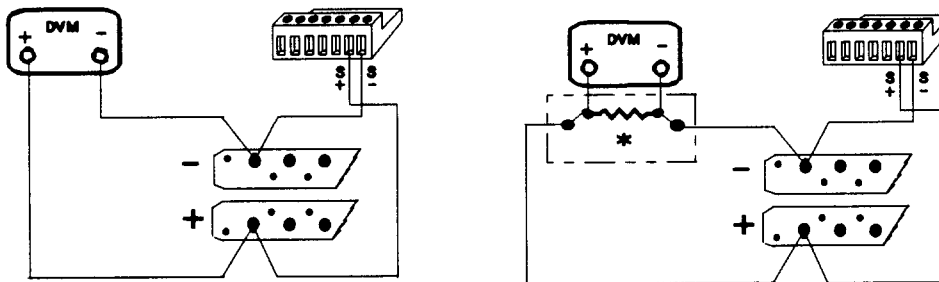

1) CV Test Setup

2) CC Test Setup

c) Series 668xA/669xA Setup

FIG-1.04

\* Current monitor resistor ( see table )

Figure A-1. Calibration Test Setup

**Table A-2. Typical Front Panel Calibration Procedure**

Action	Display Response
<p style="text-align: center;"><b>Enabling the Calibration Mode</b></p> <p>1. Begin calibration by pressing <b>Cal Enable</b>.</p> <p>2. Enter calibration password from Entry keypad. If password is correct the <b>Cal</b> annunciator will come on. If password is incorrect, an error occurs<sup>2</sup>.</p> <p><b>Note:</b> The initial (factory-default) password is the model number of the power supply, but it can be changed (see "Changing the Password" in Appendix A - Calibration).</p>	<p><b>PASWD<sup>1</sup></b></p> <p><b>PASSWD ERROR</b></p>
<p style="text-align: center;"><b>Entering Voltage Calibration Values</b></p> <p>1. Make certain the DVM is the only load on the power supply.</p> <p>2. Select the first calibration point by pressing <b>Vcal</b>. If the power supply is not in CV mode, an error occurs<sup>3</sup></p> <p>3. Read the DVM and use the Entry keypad to enter the first voltage value.</p> <p>4. Select the second calibration point by pressing <b>Vcal</b> again.</p> <p>5. Read the DVM and use the Entry keypad to enter the second voltage value.</p> <p><b>Note:</b> If one of the entered values is not within acceptable range, an error occurs. <i>The power supply is now holding the new voltage calibration constants in RAM.</i></p>	<p>(Meter mode) <b>VRDG1</b> <b>WRONG MODE</b> (Meter mode) <b>VRDG2</b> (Meter mode) <b>CAL ERROR</b></p>
<p style="text-align: center;"><b>Calibrating the OVP Trip Point</b></p> <p>1. Make certain the voltage has been calibrated and there is no load on the power supply.</p> <p>2. Select OVP calibration by pressing <b>OVCAL</b>.</p> <p>3. Wait for the power supply to compute the OVP calibration constant. If the supply goes unregulated or into CC mode during OVP calibration, an error occurs. If the computed constant is out of acceptable range, an error occurs. <i>Wait for the power supply to compute the new OVP calibration constants, which will be stored in RAM.</i></p>	<p>(Meter mode) <b>OVPCAL</b> <b>CAL COMPLETE</b> <b>NOT CV MODE</b> <b>DOES NOT CAL</b></p>
<p style="text-align: center;"><b>Entering Current Calibration Values</b></p> <p>1. Make certain appropriate shunt resistor (see Table A-1) is the only load on the power supply.</p> <p>2. Select the first calibration point by pressing <b>Ical</b>. If the power supply is not in CC mode, an error occurs.<sup>4</sup></p> <p>3. Wait for DVM reading to stabilize. Then read DVM and compute the first current value (DVM reading ÷ shunt resistance).</p> <p>4. Use Entry keypad to enter the first current value.</p> <p>5. Select second calibration point by pressing <b>Ical</b> again.</p> <p>6. Wait for DVM reading to stabilize. Then read DVM and compute the second current value (DVM reading ÷ shunt resistance).</p> <p>7. Use Entry keypad to enter the second current value. <b>Note:</b> If the entered value is not within acceptable range, an error occurs. <i>The power supply is now holding the new current calibration constant in RAM.</i></p>	<p>(Meter mode) <b>IRDG1</b> <b>WRONG MODE</b> (Meter mode) (Meter mode) <b>IRDG2</b> (Meter mode) (Meter mode) <b>CAL ERROR</b> <b>CAL COMPLETE</b></p>
<p><sup>1</sup> If <b>CAL DENIED</b> appears, then an internal jumper has been set to prevent the calibration from being changed. (See the <i>Service Manual</i>.)</p> <p><sup>2</sup> If the active password is lost, the calibration function can be recovered by moving an internal jumper that defeats password protection. However, this also will change all calibration constants to their factory-default values. (For more information, see the <i>Service Manual</i>.)</p> <p><sup>3</sup> Program the output current to 10% of its rated output*</p> <p><sup>4</sup> Program the output voltage to 10% of its rated output*</p> <p style="text-align: center;">* See applicable Output Ratings in "Chapter 1- General Information"</p>	

**Table A-2. Typical Front Panel Calibration Procedure (continued)**

Action	Display Response
<p align="center"><b>Calibrating Current Monitor (<math>I_M</math>) (Series 668xA/669xA Only)</b></p> <p><b>If you perform this calibration, then you must recalibrate the current output.</b></p> <ol style="list-style-type: none"> <li>1. Make certain the appropriate shunt resistor (see Table A-1) is the only load on the power supply.</li> <li>2. Select Imon calibration by pressing <b>IMCal</b> If the power supply is not in CC mode, an error occurs.<sup>4</sup></li> <li>3. Wait for DVM reading to stabilize. Then read DVM and compute the current value (DVM reading ÷ shunt resistance).</li> <li>4. Use Entry keypad to enter the current value.</li> </ol> <p><b>Note:</b> If the entered value is not within acceptable range, an error occurs. <i>Wait for the power supply to compute the new current calibration constants, which will be stored in RAM.</i></p> <p>If the constant is not within acceptable range, an error occurs.</p>	<p>(Meter mode)</p> <p><b>IRDG WRONG MODE</b> (Meter mode)</p> <p>(Meter mode)</p> <p><b>CAL ERROR CAL COMPLETE</b></p> <p><b>CAL ERROR</b></p>
<p><sup>4</sup>. Program the output voltage to 10% of its rated output* *See applicable Output Ratings in “Chapter 1- General Information”</p>	

## Recovering From Calibration Problems

You can encounter serious calibration problems if you cannot determine a calibration password that has been changed or the power supply is severely out of calibration. There are jumpers inside the power supply that permit the calibration password to be defeated and allow the original factory calibration constants to be restored. These jumpers are explained in the *Service Manual*.

## Calibration Error Messages

Error messages that can occur during calibration are shown in Table A-3.

**Table A-3. GPIB Calibration Error Messages**

Error No.	Meaning	Error No.	Meaning
1	CAL jumper prevents calibration <sup>1</sup>	6	Wrong CAL command sequence
2	CAL password is incorrect	7	Incorrect state (CV/CC) for this command
3	CAL mode is not enabled	<sup>1</sup> This is a hardware disable. See the power supply <i>Service Manual</i> .	
4	Incorrect computed readback constants		
5	Incorrect computed programming constants		

## Calibration Over the GPIB

You can calibrate the power supply by using SCPI commands within your controller programming statements. Be sure you are familiar with calibration from the front panel before you calibrate from a controller. The SCPI calibration commands are related to the front panel calibration controls as follows:

Front Panel Command	Corresponding SCPI Command	Front Panel Command	Corresponding SCPI Command
<b>Cal Enable</b>	CAL:STAT {ON 1},<password>	<b>OVCal</b>	CAL:VOLT:PROT
<b>Cal Disable</b>	CAL:STAT {OFF 0}	<b>Ical</b>	CAL:CURR:LEV {MIN MAX}
<b>Pass</b>	CAL:PASS <NRf>	<b>IMCal</b>	CAL:CURR[:DATA] <NRf>
<b>Vcal</b>	CAL:VOLT:LEV {MIN MAX}	<b>Cal Save</b>	CAL:CURR:MON<newline>
	CAL:VOLT[:DATA] <NRf>		CAL:CURR:DATA <NRf>
			CAL:SAVE

A sample calibration program is given at the end of this appendix. If your system is Agilent BASIC, you can use the program with very little modification. Otherwise, use it as a guide for writing your own program.

## Calibration Language Dictionary

The calibration commands are listed in alphabetical order. The format for each command follows that shown in "Chapter 3 - Language Dictionary" of the Programming Guide. Calibration error messages that can occur during GPIB calibration are shown within this guide (Table A-3 in Appendix A - Calibration).

### CAL:CURR

This command is used to calibrate the output current. The command enters current value that you obtain from an external meter. (If you are entering the current value, allow time for the DVM to stabilize.) You must first select a calibration level (CAL:CURR:LEV) for the value being entered. Two successive values (one for each end of the calibration range) must be selected and entered. The power supply then computes new current calibration constants. These constants are **not** stored in nonvolatile memory until saved with the CAL:SAVE command.

<b>Command Syntax</b>	CALibrate:CURRent[:DATA] <NRf>
<b>Parameters</b>	(See applicable Output Ratings specification in "Chapter 1- General Information")
<b>Default Suffix</b>	A
<b>Examples</b>	CAL: CURR 32 . 33 A CAL: CURR: DATA 5 . 00
<b>Query Syntax</b>	(None)
<b>Related Commands</b>	CAL:SAVE CAL:STAT

### CAL:CURR:LEV

This command sets the power supply to a calibration point that is then entered with CAL:CURR[:DATA]. During calibration, two points must be entered and the low-end point (MIN) must be selected and entered first.

<b>Command Syntax</b>	CALibrate:CURRent:LEVel {MIN MAX}
<b>Parameters</b>	{<CRD> MINimum MAXimum}
<b>Examples</b>	CAL: CURR: LEV MIN CAL: CURR: LEV MAX
<b>Query Syntax</b>	(None)
<b>Related Commands</b>	CAL:CURR[:DATA] CAL:STAT

## CAL:CURR:MON (Series 668xA/669xA only)

This command sets the power supply to the current monitor ( $I_{MON}$ ) calibration point that is then entered with **CAL:CURR[:DATA]**. *The output current must be calibrated after CAL:CURR:MON is performed.*

<b>Command Syntax</b>	<b>CALibrate:CURRENT:MONitor</b>
<b>Parameters</b>	<NRf+>
<b>Examples</b>	CAL: CURR: MON    CALibrate: CURRENT: MONitor
<b>Query Syntax</b>	(None)
<b>Related Commands</b>	CAL:CURR[:DATA] CAL:STAT

## CAL:PASS

This command enters a new calibration password. The command is active only when the power supply is already in the calibration mode. Unless it is changed subsequently to shipment, the password is the power supply's four-digit model number. If the password is set to 0, password protection is removed and **CAL:STAT ON** is unrestricted. A new password is automatically stored in nonvolatile memory and does not have to be stored with the **CAL:SAVE** command.

<b>Command Syntax</b>	CALibrate:PASScode <NRf>
<b>Parameters</b>	<NRf>
<b>Examples</b>	CAL:PASS 6671      CAL:PASS 09.1993
<b>Query Syntax</b>	(None)
<b>Related Commands</b>	CAL:STAT

## CAL:SAVE

This command saves any new calibration constants (after a current or voltage calibration procedure has been completed) in nonvolatile memory.

<b>Command Syntax:</b>	CALibrate:SAVE
<b>Parameters</b>	(None)
<b>Examples</b>	CAL: SAVE
<b>Query Syntax</b>	(None)
<b>Related Commands</b>	CAL:CURR    CAL:VOLT    CAL:STAT

## CAL:STAT

This command enables and disables the calibration mode. The calibration mode must be enabled before the power supply will accept any other calibration commands. The first parameter specifies the enabled or disabled state. The second parameter is the password. It is required if the calibration mode is being enabled and the existing password is not 0. If the second parameter is not entered or is incorrect, an error is generated and the calibration mode remains disabled. The query statement returns only the state, not the password.

Whenever the calibration mode is changed from enabled to disabled, any new calibration constants are lost unless they have been stored with **CAL:SAVE**.

<b>Command Syntax:</b>	CALibrate:STATe <bool> [,<NRf>]
<b>Parameters</b>	{0   OFF}   {1   ON} [,<NRf>]
<b>*RST Value</b>	OFF
<b>Examples</b>	CAL:STAT 1,6671    CAL:STAT OFF
<b>Query Syntax</b>	CALibrate:STATe?
<b>Returned Parameters</b>	{0   1 }
<b>Related Commands</b>	CAL:PASS    CAL:SAVE

## CAL:VOLT

This command is used to calibrate the output voltage. The command enters voltage value that you obtain from an external meter. (If you are entering the voltage value, allow time for the DVM to stabilize.) You must first select a calibration level (**CAL:VOLT:LEV**) for the value being entered. Two successive values (one for each end of the calibration range) must be selected and entered. The power supply then computes new voltage calibration constants. These constants are not stored in nonvolatile memory until saved with the **CAL:SAVE** command.

<b>Command Syntax</b>	CALibrate:VOLTage[:DATA] <NRf>
<b>Parameters</b>	(See applicable Output Ratings in "Chapter 1- General Information")
<b>Default Suffix</b>	A
<b>Examples</b>	CAL: VOLT 322 . 5 MV CAL: VOLT: DATA 3 . 225
<b>Query Syntax</b>	(None)
<b>Related Commands</b>	CAL:SAVE CAL:STAT

## CAL:VOLT:LEV

This command sets the power supply to a calibration point that is then entered with **CAL:VOLT[:DATA]**. During calibration, two points must be entered and the low-end point (MIN) must be selected and entered first.

<b>Command Syntax</b>	CALibrate:VOLTage:DATA {MIN MAX}
<b>Parameters</b>	{ < CRD >   MINimum   MAXimum }
<b>Examples</b>	CAL: VOLT: LEV MIN CAL: VOLT: LEV MAX
<b>Query Syntax</b>	(None)
<b>Related Commands</b>	CAL:VOLT[:DATA] CAL:STAT

## CAL:VOLT:PROT

This command calibrates the power supply overvoltage protection (OV) circuit. The *output voltage must be in calibration* before this procedure is performed. Also, the power supply output must be enabled and operating in the constant voltage (CV) mode. If present, the optional relay accessory must either be disconnected or set to the off (open) state. The power supply automatically performs the calibration and stores the new OV constant in nonvolatile memory. **CAL:VOLT:PROT** is a sequential command that takes several seconds to complete.

<b>Command Syntax:</b>	CALibrate:VOLTage:PROTection
<b>Parameters</b>	(None)
<b>Example</b>	CAL: VOLT: PROT
<b>Query Syntax</b>	(None)
<b>Related Commands</b>	CAL:STAT

## Agilent BASIC Calibration Program

The following program can be run on any controller operating under Agilent BASIC. The assumed power supply address is 5 and calibration password is 6680. If required, change these parameters in the appropriate statements.

---

**Note** If you are calibrating models 664x, 665x, or 667x, delete or comment out lines 640 through 670 in the following calibration program. These program lines are only required when calibrating models 668x/669x.

---

```

10      ! Agilent BASIC Calibration Program
20      !
30      DIM Resp$ [255],Err_msg$[255]
40      !
50 Volt_cal: !      Voltage DAC calibration
60      Err_found=0
70      PRINT TABXY(5,10),"CONNECT INSTRUMENTS AS SHOWN IN FIG. A-1(1). Then Press Continue"
80      PAUSE
90      CLEAR SCREEN
100     !
110    ! Assign power supply GPIB address
120    !
130    ASSIGN @Ps TO 705
140    !
150    ! Initialize power supply
160    !
170    OUTPUT @Ps;"*RST;OUTPUT ON"
180    !
190    ! Password is optional - only required if set to non-zero value
200    ! Default password is the four-digit model number
210    !
220    ! LINE 240 PASSWORD MUST BE EDITED FOR MODEL OTHER THAN 6680
230    !
240    OUTPUT @Ps;"CAL:STATE ON, 6680"
250    1
260    OUTPUT @Ps;"CAL:VOLTAGE:LEVEL MIN"
270    INPUT "ENTER VOLTAGE MEASUREMENT FROM EXTERNAL VOLTMETER",Volt_read
280    OUTPUT @Ps;"CAL:VOLTAGE ";Volt_read
290    OUTPUT @Ps;"CAL:VOLTAGE:LEVEL MAX"
300    INPUT "ENTER VOLTAGE MEASUREMENT FROM EXTERNAL VOLTMETER",Volt_read
310    OUTPUT @Ps;"CAL:VOLTAGE ";Volt_read
320    !
330    ! Calibrate overvoltage protection circuit
340    !
350    OUTPUT @Ps;"CAL:VOLTAGE:PROTECTION"
360    !
370    GOSUB Save_cal
380    IF Err_found THEN
390        INPUT "ERRORS have occurred, REPEAT VOLTAGE CALIBRATION ( Y OR N )?",Resp$
400        IF TRIM$(UPC$(Resp$[1,1] ))="Y" THEN GOTO Volt_cal
410    END IF
420    IF Err_found THEN
430        PRINT "VOLTAGE CALIBRATION NOT SAVED"
440    ELSE
450        PRINT "VOLTAGE CALIBRATION COMPLETE"
460    END IF
470    !
480 Current_cal: !      Imon DAC and Current DAC calibration
490    Err_found=0
500    PRINT TABXY(5,10),"CONNECT INSTRUMENTS AS SHOWN IN FIG. A-1(2). Then Press Continue"
510    PAUSE
520    CLEAR SCREEN

```

**Figure A-2. Agilent BASIC Calibration Program**

```

540 Password is optional - only required if set to non-zero value
550 Default password is four-digit model number
560 !
570 ! LINE 590 PASSWORD MUST BE EDITED FOR MODEL OTHER THAN 6680
580 !
590 OUTPUT @Ps;"CAL:STATE ON, 6680"
600 OUTPUT @Ps;"VOLT:LEV 2"
610 ! Refer to Table A-1 for correct shunt value for model being calibrated
620 !
630 INPUT "ENTER VALUE OF CURRENT SHUNT BEING USED",Shunt_val
        STEPS 640 THROUGH 670 NOT USED ON 664x, 665x and 667x
640 OUTPUT @Ps;"CAL:CURRENT:MONITOR"
650 INPUT "ENTER VOLTAGE MEASUREMENT FROM EXTERNAL VOLTMETER",Volt_read
660 Current=Volt_read/Shunt_val
670 OUTPUT @Ps;"CAL:CURRENT ";Current
680 OUTPUT @Ps;"CAL:CURRENT:LEVEL MIN"
690 INPUT "ENTER VOLTAGE MEASUREMENT FROM EXTERNAL VOLTMETER",Volt_read
700 Current=Volt_read/Shunt_val
710 OUTPUT @Ps;"CAL:CURRENT ";Current
720 OUTPUT @Ps;"CAL:CURRENT:LEVEL MAX"
730 INPUT "ENTER VOLTAGE MEASUREMENT FROM EXTERNAL VOLTMETER",Volt_read
740 Current=Volt_read/Shunt_val
750 OUTPUT @Ps;"CAL:CURRENT ";Current
760 GOSUB Save_cal
770 IF Err_found THEN
780     INPUT "ERRORS have occurred, REPEAT CURRENT CALIBRATION ( Y OR N )?",Resp$
790     IF TRIM$(UPC$(Resp$[1,1]))="Y" THEN GOTO Volt_cal
800 END IF
810 IF Err_found THEN
820     PRINT "CURRENT CALIBRATION NOT SAVED"
830 ELSE
840     PRINT "CURRENT CALIBRATION COMPLETE"
850 END IF
860 STOP
870 Save_cal: ! SAVE CALIBRATION
880 REPEAT
890     OUTPUT @Ps;"SYSTEM:ERROR?"
900     ENTER @Ps;Err_num,Err_msg$
910     IF Err_num<>0 THEN
920         PRINT "ERROR: ";Err_msg$
930         Err_found=1
940     END IF
950 UNTIL Err_num=0
960 IF NOT Err_found THEN
970     INPUT "SAVE CALIBRATION CONSTANTS ( Y OR N )?",Resp$
980     IF TRIM$(UPC$(Resp$[1,1]))="Y" THEN
990         OUTPUT @Ps;"CAL:SAVE"
1000    END IF
1010 END IF
1020 OUTPUT @Ps;"CAL:STATE OFF"
1030 RETURN
1040 END

```

Figure A-2. Agilent BASIC Calibration Program (continued)



## Operation Verification

### Introduction

This appendix provides operation verification test procedures. The tests do not check all the operating parameters, but verify that the power supply is performing properly. The required test equipment and acceptable test results are specified in tables at the end of this appendix.

**Note** Performance Tests, which check all the specifications of the power supply, are given in the applicable power supply Service Manual.

### Test Equipment Required

#### List of Equipment

The following equipment is required to perform the tests:

**Table B-1. Equipment Required for Verification Tests**

Equipment	Characteristics	Recommended Model
<b>Digital Voltmeter</b>	Resolution: 10 nV @ 1 V Readout: 8 1/2 digits Accuracy: 20 ppm	Agilent 3458A
<b>Current Monitor Resistor</b>		
Agilent 6641A, 51A, 52A	100 A, 0.01 $\Omega$ , 0.04%, 100 W	Guildline 9230/100
Agilent 6642A, 43A, 44A, 45A, 53A, 54A, 55A	15 A, 0.1 $\Omega$ , 0.04%, 25 W	Guildline 9230/15
Agilent 6671A	300 A, 0.001 $\Omega$ , 0.04%, 100 W	Guildline 9230/300
Agilent 6672A, 73A, 74A, 75A	100 A, 0.001 $\Omega$ , 0.04%, 100 W	Guildline 9230/100
Agilent 6680A, 81A, 6690A	1000 A, 0.1 m $\Omega$ , 0.05%	Burster 1280S
Agilent 6682A, 83A, 84A, 6691A, 92A	300 A, 0.001 $\Omega$ , 0.04%, 100 W	Guildline 9230/300

#### Current Monitoring Resistor

The 4-terminal current-monitoring resistor listed in Table B-1 is required to eliminate output current measurement error caused by voltage drops in leads and connections. The specified resistors have special current-monitoring terminals inside the load connection terminals. Connect the current monitor directly to these current-monitoring terminals.

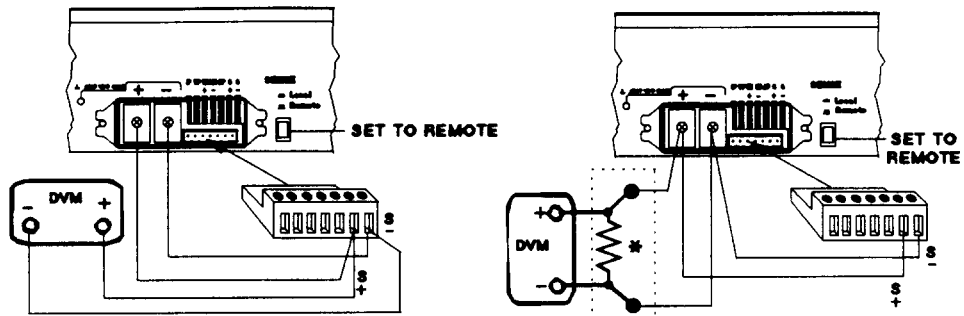

1) CV Test Setup

2) CC Test Setup

a) Series 664xA & 665xA Setup

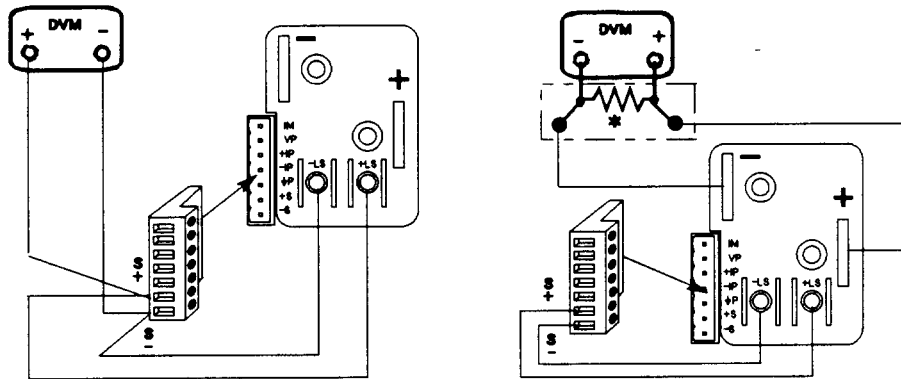

1) CV Test Setup

2) CC Test Setup

b) Series 667xA Setup

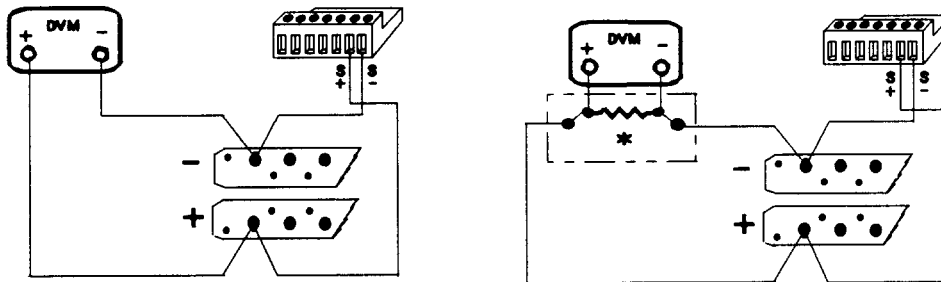

1) CV Test Setup

2) CC Test Setup

c) Series 668xA/669xA Setup

FIG-B-1.GAL

\* Current monitor resistor ( see table )

Figure B-1. Verification Test Setup

---

## Performing the Tests

### General Measurement Techniques

Figure B-1 shows the setup for the tests. Be certain to use load leads of sufficient wire gauge to carry the output current (see Table 4-1). To avoid noise pickup, use coaxial cable or shielded pairs for the test leads.

### Programming the Power Supply

Table 1-1b, Table 1-2b, Table 1-3b and Table 1-4b in Chapter 1 list the programming voltage and current ranges for each model. Enter the appropriate values from the front panel. The programming procedures assume you know how to operate the power supply from the front panel (see "Chapter 5 - Front Panel Operation").

### Order of Tests

Perform the following tests for operation verification. Test 1 must be done first, followed by Tests 2 and 3 in any order.

- 1 Turn-on Checkout
- 2 Voltage Programming and Readback Accuracy
- 3 Current Programming and Readback Accuracy

### Turn-on Checkout

Perform the Turn-on Checkout as directed in "Chapter 3 - Turn-on Checkout".

---

**Note** The power supply must pass turn-on selftest before you can proceed with these tests.

---

### Voltage Programming and Readback Accuracy

This test verifies that the voltage programming, GPIB readback, and front panel display functions are within specifications. Figure B-1 shows the setup for the tests. Measure the dc output voltage directly at the sense connections of the output terminals or bus bars. Connect the output as shown.

**Table B-2. Voltage Programming and Readback Accuracy Tests**

	<b>Action</b>	<b>Normal Result</b>
1	Turn off the power supply and connect a DVM across the sense terminals (see Figure B-1(1)).	
2	Turn on the power supply with no load and program the output for 0 volts and maximum programmable current.	CV annunciator on. Output current near 0.
3	Record voltage readings at DVM and on front panel display. (Subtract or add the specified readback limit to the actual output values).	Readings within Low Voltage limits (see applicable test table).
4	Program voltage to full scale.	
5	Record voltage readings of DVM and on front panel display. (Subtract or add the specified readback limit to the actual output values)	Readings within High Voltage limits (see applicable test table).

## Current Programming and Readback Accuracy

This test verifies that the current programming and readback are within specification. Connect the appropriate current monitoring resistor (see Table B-1) as shown in Figure B-1(2). The accuracy of the resistor must be as specified in the table.

**Table B-3. Current Programming and Readback Accuracy Test**

	Action	Normal Result
1	Turn off the power supply and connect the current monitoring resistor as shown in Figure B-1(2). <b>Be certain to use wire of sufficient size to carry the maximum rated current of the supply</b> (see Table 4-1 in Chapter 4).	
2	Connect a DVM across the resistor.	
3	Turn on the power supply and program the output for 5 volts and 0 amperes.	
4	Disable the output ( <b>Output Off</b> )	
<p><b>WARNING</b>  <b>ENERGY HAZARD for Series 668xA/669xA.</b> The power supply can provide more than 240 VA at more than 2 V. If the output connections touch, severe arcing may occur resulting in burns, ignition or welding of parts. Do not attempt to make connections to live output circuits.</p>		
5	Enable the output ( <b>Output On</b> ) or OUTP ON).	
6	Observe the DVM voltage reading. Divide this by the resistance of the current monitor resistor. Record the result as the Low Current value in applicable test table.	Value within Low Current limits (see applicable test table).
7	Record the front panel display readback	Value within specified readback limits (see applicable test table).
8	Program output current to full scale.	
9	Repeat Steps 6 and 7.	Both current readings within specified High Current and readback limits (see applicable test table).
10	Disable the output ( <b>Output Off</b> ).	
11	<b>Remove the short from across the load.</b>	

**Table B-4. Operation Verification Test Parameters for Series 664xA**

Test Description	Minimum Spec	Results *	Maximum Spec	Measurement Uncertainty
<b>MODEL Agilent 6641A</b>				
<b>Voltage Programming and Readback</b>				
Low Voltage (0 V) $V_{out}$	-5 mV	_____ mV	+ 5 mV	2.0 $\mu$ V
Front Panel Display Readback	Vout -6.0 mV	_____ mV	Vout +6.0 mV	2.0 $\mu$ V
High Voltage (8 V) $V_{out}$	7.990 V	_____ V	8.010 V	88 $\mu$ V
Front Panel Display Readback	Vout -11.6 mV	_____ mV	Vout +11.6 mV	88 $\mu$ V
<b>Current Programming and Readback</b>				
Low Current (0 A) $I_{out}$	-26 mA	_____ mA	+26 mA	153 $\mu$ A
Front Panel Display Readback	Iout -18 mA	_____ mA	Iout +18 mA	153 $\mu$ A
High Current (20 A) $I_{out}$	19.944 A	_____ A	+20.056 A	2.7 mA
Front Panel Display Readback	Iout -48 mA	_____ mA	Iout +48 mA	2.7 mA
<b>MODEL Agilent 6642A</b>				
<b>Voltage Programming and Readback</b>				
Low Voltage (0 V) $V_{out}$	-10 mV	_____ mV	+ 10 mV	2.0 $\mu$ V
Front Panel Display Readback	Vout -15 mV	_____ mV	Vout +15 mV	2.0 $\mu$ V
High Voltage (20 V) $V_{out}$	19.978 V	_____ V	20.022 V	335 $\mu$ V
Front Panel Display Readback	Vout -29 mV	_____ mV	Vout +29 mV	335 $\mu$ V
<b>Current Programming and Readback</b>				
Low Current (0 A) $I_{out}$	-13 mA	_____ mA	+13 mA	20 $\mu$ A
Front Panel Display Readback	Iout -9.1 mA	_____ mA	Iout +9.1 mA	20 $\mu$ A
High Current (10 A) $I_{out}$	9.972 A	_____ A	+10.028 A	3.1 mA
Front Panel Display Readback	Iout -24.1 mA	_____ mA	Iout +24.1 mA	3.1 mA
<b>MODEL Agilent 6643A</b>				
<b>Voltage Programming and Readback</b>				
Low Voltage (0 V) $V_{out}$	-15 mV	_____ mV	+ 15 mV	2.0 $\mu$ V
Front Panel Display Readback	Vout -25 mV	_____ mV	Vout +25 mV	2.0 $\mu$ V
High Voltage ( 35 V) $V_{out}$	34.964 V	_____ V	35.036 V	525 $\mu$ V
Front Panel Display Readback	Vout -50 mV	_____ mV	Vout +50 mV	525 $\mu$ V
<b>Current Programming and Readback</b>				
Low Current (0 A) $I_{out}$	-6.7 mA	_____ mA	+6.7 mA	16 $\mu$ A
Front Panel Display Readback	Iout -5 mA	_____ mA	Iout +5 mA	16 $\mu$ A
High Current ( 6 A) $I_{out}$	5.985 A	_____ A	6.015 A	1.1 mA
Front Panel Display Readback	Iout -14 mA	_____ mA	Iout +14 mA	1.1 mA
<b>MODEL Agilent 6644A</b>				
<b>Voltage Programming and Readback</b>				
Low Voltage (0 V) $V_{out}$	-26 mV	_____ mV	+ 26 mV	2.0 $\mu$ V
Front Panel Display Readback	Vout -40 mV	_____ mV	Vout +40 mV	2.0 $\mu$ V
High Voltage ( 60 V) $V_{out}$	59.938 V	_____ V	60.062 V	845 $\mu$ V
Front Panel Display Readback	Vout -82 mV	_____ mV	Vout +82 mV	845 $\mu$ V
<b>Current Programming and Readback</b>				
Low Current (0 A) $I_{out}$	-4.1 mA	_____ mA	+4.1 mA	16 $\mu$ A
Front Panel Display Readback	Iout -3 mA	_____ mA	Iout +3 mA	16 $\mu$ A
High Current (3.5 A) $I_{out}$	3.491 A	_____ A	+3.509 A	500 $\mu$ A
Front Panel Display Readback	Iout -8.3 mA	_____ mA	Iout +8.3 mA	500 $\mu$ A
* Enter your test results in this column.				

**Table B-4. Operation Verification Test Parameters for Series 664xA (continued)**

<b>Test Description</b>	<b>Minimum Spec</b>	<b>Results *</b>	<b>Maximum Spec</b>	<b>Measurement Uncertainty</b>
<b>MODEL Agilent 6645A</b>				
<b>Voltage Programming and Readback</b>				
Low Voltage (0 V) $V_{out}$	-51 mV	_____ mV	+ 51 mV	2.0 $\mu$ V
Front Panel Display Readback	$V_{out}$ -80 mV	_____ mV	$V_{out}$ +80 mV	2.0 $\mu$ V
High Voltage (120 V) $V_{out}$	119.877 V	_____ V	120.123 V	1.7 mV
Front Panel Display Readback	$V_{out}$ -164 mV	_____ mV	$V_{out}$ +164 mV	1.7 mV
<b>Current Programming and Readback</b>				
Low Current (0 A) $I_{out}$	-1.7 mA	_____ mA	+1.7 mA	16 $\mu$ A
Front Panel Display Readback	$I_{out}$ -1.3 mA	_____ mA	$I_{out}$ +1.3 mA	16 $\mu$ A
High Current (1.5 A) $I_{out}$	1.496 A	_____ A	+1.504 A	188 $\mu$ A
Front Panel Display Readback	$I_{out}$ -3.5 mA	_____ mA	$I_{out}$ +3.5 mA	188 $\mu$ A
* Enter your test results in this column.				

**Table B-5. Operation Verification Test Parameters for Series 665xA**

Test Description	Minimum Spec	Results *	Maximum Spec	Measurement Uncertainty
<b>MODEL Agilent 6651A</b>				
<b>Voltage Programming and Readback</b>				
Low Voltage (0 V) $V_{out}$	-5 mV	_____ mV	+ 5 mV	2.0 $\mu$ V
Front Panel Display Readback	Vout -6.0 mV	_____ mV	Vout +6.0 mV	2.0 $\mu$ V
High Voltage (8 V) $V_{out}$	7.990 V	_____ V	8.010 V	88 $\mu$ V
Front Panel Display Readback	Vout -11.6 mV	_____ mV	Vout +11.6 mV	88 $\mu$ V
<b>Current Programming and Readback</b>				
Low Current (0 A) $I_{out}$	-60 mA	_____ mA	+60 mA	150 $\mu$ A
Front Panel Display Readback	Iout -67 mA	_____ mA	Iout +67 mA	150 $\mu$ A
High Current (50 A) $I_{out}$	49.865 A	_____ A	+50.135 A	10.7 mA
Front Panel Display Readback	Iout -142 mA	_____ mA	Iout +142 mA	10.7 mA
<b>MODEL Agilent 6652A</b>				
<b>Voltage Programming and Readback</b>				
Low Voltage (0 V) $V_{out}$	-10 mV	_____ mV	+ 10 mV	2.0 $\mu$ V
Front Panel Display Readback	Vout -15 mV	_____ mV	Vout +15 mV	2.0 $\mu$ V
High Voltage (20 V) $V_{out}$	19.978 V	_____ V	20.022 V	335 $\mu$ V
Front Panel Display Readback	Vout -29 mV	_____ mV	Vout +29 mV	335 $\mu$ V
<b>Current Programming and Readback</b>				
Low Current (0 A) $I_{out}$	-25 mA	_____ mA	+25 mA	153 $\mu$ A
Front Panel Display Readback	Iout -26 mA	_____ mA	Iout +26 mA	153 $\mu$ A
High Current (25 A) $I_{out}$	24.937 A	_____ A	+25.063 A	3.5 mA
Front Panel Display Readback	Iout -63.5 mA	_____ mA	Iout +63.5 mA	3.5 mA
<b>MODEL Agilent 6653A</b>				
<b>Voltage Programming and Readback</b>				
Low Voltage (0 V) $V_{out}$	-15 mV	_____ mV	+ 15 mV	2.0 $\mu$ V
Front Panel Display Readback	Vout -25 mV	_____ mV	Vout +25 mV	2.0 $\mu$ V
High Voltage ( 35 V) $V_{out}$	34.964 V	_____ V	35.036 V	525 $\mu$ V
Front Panel Display Readback	Vout -50 mV	_____ mV	Vout +50 mV	525 $\mu$ V
<b>Current Programming and Readback</b>				
Low Current (0 A) $I_{out}$	-13 mA	_____ mA	+13 mA	17 $\mu$ A
Front Panel Display Readback	Iout -15 mA	_____ mA	Iout +15 mA	17 $\mu$ A
High Current ( 15 A) $I_{out}$	14.964 A	_____ A	15.036 A	6.2 mA
Front Panel Display Readback	Iout -37.5 mA	_____ mA	Iout +37.5 mA	6.2 mA
<b>MODEL Agilent 6654A</b>				
<b>Voltage Programming and Readback</b>				
Low Voltage (0 V) $V_{out}$	-26 mV	_____ mV	+ 25 mV	2.0 $\mu$ V
Front Panel Display Readback	Vout -40 mV	_____ mV	Vout +40 mV	2.0 $\mu$ V
High Voltage ( 60 V) $V_{out}$	59.938 V	_____ V	60.062 V	845 $\mu$ V
Front Panel Display Readback	Vout -82 mV	_____ mV	Vout +82 mV	845 $\mu$ V
<b>Current Programming and Readback</b>				
Low Current (0 A) $I_{out}$	-8 mA	_____ mA	+8 mA	16 $\mu$ A
Front Panel Display Readback	Iout -7 mA	_____ mA	Iout +7 mA	16 $\mu$ A
High Current (9 A) $I_{out}$	8.978 A	_____ A	+9.022 A	2.5 mA
Front Panel Display Readback	Iout -20.5 mA	_____ mA	Iout +20.5 mA	2.5 mA
* Enter your test results in this column.				

**Table B-5. Operation Verification Test Parameters for Series 665xA (continued)**

<b>Test Description</b>	<b>Minimum Spec</b>	<b>Results *</b>	<b>Maximum Spec</b>	<b>Measurement Uncertainty</b>
<b>MODEL Agilent 6655A</b>				
<b>Voltage Programming and Readback</b>				
Low Voltage (0 V) $V_{out}$	-51 mV	_____ mV	+ 51 mV	2.0 $\mu$ V
Front Panel Display Readback	Vout -80 mV	_____ mV	Vout +80 mV	2.0 $\mu$ V
High Voltage (120 V) $V_{out}$	119.877 V	_____ V	120.123 V	1.7 mV
Front Panel Display Readback	Vout -164 mV	_____ mV	Vout +164 mV	1.7 mV
<b>Current Programming and Readback</b>				
Low Current (0 A) $I_{out}$	-4 mA	_____ mA	+4 mA	15 $\mu$ A
Front Panel Display Readback	Iout -3 mA	_____ mA	Iout +3 mA	15 $\mu$ A
High Current (4 A) $I_{out}$	3.990A	_____ A	+4.010 A	586 $\mu$ A
Front Panel Display Readback	Iout -9 mA	_____ mA	Iout +9 mA	586 $\mu$ A
* Enter your test results in this column.				



**Table B-6. Operation Verification Test Parameters for Series 667xA**

<b>Test Description</b>	<b>Minimum Spec</b>	<b>Results *</b>	<b>Maximum Spec</b>	<b>Measurement Uncertainty</b>
<b>MODEL Agilent 6671A</b>				
<b>Voltage Programming and Readback</b>				
Low Voltage (0 V) $V_{out}$	-8 mV	_____ mV	+ 8 mV	1.6 $\mu$ V
Front Panel Display Readback	$V_{out}$ -12 mV	_____ mV	$V_{out}$ +12 mV	1.6 $\mu$ V
High Voltage (8 V) $V_{out}$	7.9888 V	_____ V	8.0012 V	100 $\mu$ V
Front Panel Display Readback	$V_{out}$ -16 mV	_____ mV	$V_{out}$ +16 mV	100 $\mu$ V
<b>Current Programming and Readback</b>				
Low Current (0 A) $I_{out}$	-125 mA	_____ mA	+125 mA	50 $\mu$ A
Front Panel Display Readback	$I_{out}$ -150 mA	_____ mA	$I_{out}$ +150 mA	50 $\mu$ A
High Current (220 A) $I_{out}$	219.655 A	_____ A	220.345 A	92 mA
Front Panel Display Readback	$I_{out}$ -370 mA	_____ mA	$I_{out}$ +370 mA	92 mA
<b>MODEL Agilent 6672A</b>				
<b>Voltage Programming and Readback</b>				
Low Voltage (0 V) $V_{out}$	-20 mV	_____ mV	+ 20 mV	2.0 $\mu$ V
Front Panel Display Readback	$V_{out}$ -30 mV	_____ mV	$V_{out}$ +30 mV	2.0 $\mu$ V
High Voltage (20 V) $V_{out}$	19.972 V	_____ V	20.028 V	335 $\mu$ V
Front Panel Display Readback	$V_{out}$ -40 mV	_____ mV	$V_{out}$ +40 mV	335 $\mu$ V
<b>Current Programming and Readback</b>				
Low Current (0 A) $I_{out}$	-60 mA	_____ mA	+60 mA	40 $\mu$ A
Front Panel Display Readback	$I_{out}$ -100 mA	_____ mA	$I_{out}$ +100 mA	40 $\mu$ A
High Current (100 A) $I_{out}$	99.84 A	_____ A	+100.16 A	41 mA
Front Panel Display Readback	$I_{out}$ -200 mA	_____ mA	$I_{out}$ +200 mA	41 mA
<b>MODEL Agilent 6673A</b>				
<b>Voltage Programming and Readback</b>				
Low Voltage (0 V) $V_{out}$	-35 mV	_____ mV	+ 35 mV	2.0 $\mu$ V
Front Panel Display Readback	$V_{out}$ -50 mV	_____ mV	$V_{out}$ +50 mV	2.0 $\mu$ V
High Voltage ( 35 V) $V_{out}$	34.951 V	_____ V	35.049 V	526 $\mu$ V
Front Panel Display Readback	$V_{out}$ -68 mV	_____ mV	$V_{out}$ +68 mV	526 $\mu$ V
<b>Current Programming and Readback</b>				
Low Current (0 A) $I_{out}$	-40 mA	_____ mA	+40 mA	31 $\mu$ A
Front Panel Display Readback	$I_{out}$ -60 mA	_____ mA	$I_{out}$ +60 mA	31 $\mu$ A
High Current ( 60 A) $I_{out}$	59.9 A	_____ A	60.1 A	25 mA
Front Panel Display Readback	$I_{out}$ -120 mA	_____ mA	$I_{out}$ +120 mA	25 mA
<b>MODEL Agilent 6674A</b>				
<b>Voltage Programming and Readback</b>				
Low Voltage (0 V) $V_{out}$	-60 mV	_____ mV	+ 60 mV	2.2 $\mu$ V
Front Panel Display Readback	$V_{out}$ -90 mV	_____ mV	$V_{out}$ +90 mV	2.2 $\mu$ V
High Voltage ( 60 V) $V_{out}$	59.916 V	_____ V	60.084 V	1 mV
Front Panel Display Readback	$V_{out}$ -132 mV	_____ mV	$V_{out}$ +132 mV	1 mV
<b>Current Programming and Readback</b>				
Low Current (0 A) $I_{out}$	-25 mA	_____ mA	+25 mA	21 $\mu$ A
Front Panel Display Readback	$I_{out}$ -35 mA	_____ mA	$I_{out}$ +35 mA	21 $\mu$ A
High Current (35 A) $I_{out}$	34.94 A	_____ A	35.06 A	15 mA
Front Panel Display Readback	$I_{out}$ -70 mA	_____ mA	$I_{out}$ +70 mA	15 mA
* Enter your test results in this column.				

**Table B-6. Operation Verification Test Parameters for Series 667xA (continued)**

<b>Test Description</b>	<b>Minimum Spec</b>	<b>Results *</b>	<b>Maximum Spec</b>	<b>Measurement Uncertainty</b>
<b>MODEL Agilent 6675A</b>				
<b>Voltage Programming and Readback</b>				
Low Voltage (0 V) $V_{out}$	-120 mV	_____ mV	+ 120 mV	3.0 $\mu$ V
Front Panel Display Readback	$V_{out}$ -180 mV	_____ mV	$V_{out}$ +180 mV	3.0 $\mu$ V
High Voltage (120 V) $V_{out}$	119.832 V	_____ V	120.168 V	1.7 mV
Front Panel Display Readback	$V_{out}$ -240 mV	_____ mV	$V_{out}$ +240 mV	1.7 mV
<b>Current Programming and Readback</b>				
Low Current (0 A) $I_{out}$	-12 mA	_____ mA	+12 mA	20 $\mu$ A
Front Panel Display Readback	$I_{out}$ -18 mA	_____ mA	$I_{out}$ +18 mA	20 $\mu$ A
High Current (18 A) $I_{out}$	17.97 A	_____ A	+18.03 A	7.5 mA
Front Panel Display Readback	$I_{out}$ -36 mA	_____ mA	$I_{out}$ +36 mA	7.5 mA
* Enter your test results in this column.				

**Table B-7. Operation Verification Test Parameters for Series 668xA**

Test Description	Minimum Spec	Results *	Maximum Spec	Measurement Uncertainty
<b>MODEL Agilent 6680A</b>				
<b>Voltage Programming and Readback</b>				
Low Voltage (0 V) $V_{out}$	-0.005 V	_____ V	+ 0.005 V	1.0 $\mu$ V
Front Panel Display Readback	$V_{out}$ -7.5 mV	_____ mV	$V_{out}$ +7.5 mV	1.0 $\mu$ V
High Voltage (5 V) $V_{out}$	4.9943 V	_____ V	5.0057 V	56 $\mu$ V
Front Panel Display Readback	$V_{out}$ -10 mV	_____ mV	$V_{out}$ +10 V	56 $\mu$ V
<b>Current Programming and Readback</b>				
Low Current (0 A) $I_{out}$	-0.450 A	_____ A	+0.450 A	15 mA
Front Panel Display Readback	$I_{out}$ -600 mA	_____ mA	$I_{out}$ +600 mA	15 mA
High Current (875 A) $I_{out}$	873.675 A	_____ A	+876.325 A	461 mA
Front Panel Display Readback	$I_{out}$ -1.475 A	_____ A	$I_{out}$ +1.475 A	461 mA
<b>MODEL Agilent 6681A</b>				
<b>Voltage Programming and Readback</b>				
Low Voltage (0 V) $V_{out}$	-0.008 V	_____ V	+ 0.008 V	1.0 $\mu$ V
Front Panel Display Readback	$V_{out}$ -12 mV	_____ mV	$V_{out}$ +12 mV	1.0 $\mu$ V
High Voltage (8 V) $V_{out}$	7.9888 V	_____ V	8.0112 V	88 $\mu$ V
Front Panel Display Readback	$V_{out}$ -16 mV	_____ mV	$V_{out}$ +16 mV	88 $\mu$ V
<b>Current Programming and Readback</b>				
Low Current (0 A) $I_{out}$	-0.300 A	_____ A	+0.300 A	15 mA
Front Panel Display Readback	$I_{out}$ -400 mA	_____ mA	$I_{out}$ +400 mA	15 mA
High Current (580 A) $I_{out}$	579.12 A	_____ A	+580.88 A	311 mA
Front Panel Display Readback	$I_{out}$ -980 mA	_____ mA	$I_{out}$ +980 mA	311 mA
<b>MODEL Agilent 6682A</b>				
<b>Voltage Programming and Readback</b>				
Low Voltage (0 V) $V_{out}$	-21 mV	_____ mV	+ 21 mV	1.7 $\mu$ V
Front Panel Display Readback	$V_{out}$ -32 mV	_____ mV	$V_{out}$ +32 mV	1.7 $\mu$ V
High Voltage ( 21 V) $V_{out}$	20.970 V	_____ V	21.030 V	348 $\mu$ V
Front Panel Display Readback	$V_{out}$ -42 mV	_____ mV	$V_{out}$ +42 mV	348 $\mu$ V
<b>Current Programming and Readback</b>				
Low Current (0 A) $I_{out}$	-125 mA	_____ mA	+125 mA	1.5 mA
Front Panel Display Readback	$I_{out}$ -165 mA	_____ mA	$I_{out}$ +165 mA	1.5 mA
High Current ( 240 A) $I_{out}$	239.635 A	_____ A	240.365 A	83 mA
Front Panel Display Readback	$I_{out}$ -405 mA	_____ mA	$I_{out}$ +405 mA	83 mA
<b>MODEL Agilent 6683A</b>				
<b>Voltage Programming and Readback</b>				
Low Voltage (0 V) $V_{out}$	-32 mV	_____ mV	+ 32 mV	1.9 $\mu$ V
Front Panel Display Readback	$V_{out}$ -48 mV	_____ mV	$V_{out}$ +48 mV	1.9 $\mu$ V
High Voltage ( 32 V) $V_{out}$	31.955 V	_____ V	32.045 V	488 $\mu$ V
Front Panel Display Readback	$V_{out}$ -64 mV	_____ mV	$V_{out}$ +64 mV	488 $\mu$ V
<b>Current Programming and Readback</b>				
Low Current (0 A) $I_{out}$	-85 mA	_____ mA	+85 mA	1.5 $\mu$ A
Front Panel Display Readback	$I_{out}$ -60 mA	_____ mA	$I_{out}$ +60 mA	1.5 $\mu$ A
High Current (160 A) $I_{out}$	159.755 A	_____ A	160.245 A	35.6 mA
Front Panel Display Readback	$I_{out}$ -270 mA	_____ mA	$I_{out}$ +270 mA	35.6 mA
* Enter your test results in this column.				

**Table B-7. Operation Verification Test Parameters for Series 668xA (continued)**

<b>Test Description</b>	<b>Minimum Spec</b>	<b>Results *</b>	<b>Maximum Spec</b>	<b>Measurement Uncertainty</b>
<b>MODEL Agilent 6684A</b>				
<b>Voltage Programming and Readback</b>				
Low Voltage (0 V) $V_{out}$	-40 mV	_____ mV	+ 40 mV	2.0 $\mu$ V
Front Panel Display Readback	$V_{out}$ -60 mV	_____ mV	$V_{out}$ +60 mV	2.0 $\mu$ V
High Voltage (40 V) $V_{out}$	39.944 V	_____ V	40.056 V	590 $\mu$ V
Front Panel Display Readback	$V_{out}$ -80 mV	_____ mV	$V_{out}$ +80 mV	590 $\mu$ V
<b>Current Programming and Readback</b>				
Low Current (0 A) $I_{out}$	-65 mA	_____ mA	+65 mA	1.5 mA
Front Panel Display Readback	$I_{out}$ -90 mA	_____ mA	$I_{out}$ +90 mA	1.5 mA
High Current (128 A) $I_{out}$	127.807 A	_____ A	128.193 A	24.1 mA
Front Panel Display Readback	$I_{out}$ -218 mA	_____ mA	$I_{out}$ +218 mA	24.1 mA
* Enter your test results in this column.				

**Table B-8. Operation Verification Test Parameters for Series 669xA**

Test Description	Minimum Spec	Results *	Maximum Spec	Measurement Uncertainty
<b>MODEL Agilent 6690A</b>				
<b>Voltage Programming and Readback</b>				
Low Voltage (0 V) $V_{out}$	-0.015 V	_____ V	+ 0.015 V	1.0 $\mu$ V
Front Panel Display Readback	Vout -22.5 mV	_____ mV	Vout +22.5 mV	1.0 $\mu$ V
High Voltage (15 V) $V_{out}$	14.979 V	_____ V	15.021 V	56 $\mu$ V
Front Panel Display Readback	Vout -30 mV	_____ mV	Vout +30 mV	56 $\mu$ V
<b>Current Programming and Readback</b>				
Low Current (0 A) $I_{out}$	-0.23 A	_____ A	+0.23 A	15 mA
Front Panel Display Readback	Iout -300 mA	_____ mA	Iout +300 mA	15 mA
High Current (440 A) $I_{out}$	439.33 A	_____ A	+440.67 A	461 mA
Front Panel Display Readback	Iout -0.74 A	_____ A	Iout +0.74 A	461 mA
<b>MODEL Agilent 6691A</b>				
<b>Voltage Programming and Readback</b>				
Low Voltage (0 V) $V_{out}$	-0.030 V	_____ V	+ 0.030 V	1.0 $\mu$ V
Front Panel Display Readback	Vout -45 mV	_____ mV	Vout +45 mV	1.0 $\mu$ V
High Voltage (30 V) $V_{out}$	29.958 V	_____ V	30.042 V	88 $\mu$ V
Front Panel Display Readback	Vout -60 mV	_____ mV	Vout +60 mV	88 $\mu$ V
<b>Current Programming and Readback</b>				
Low Current (0 A) $I_{out}$	-0.125 A	_____ A	+0.125 A	15 mA
Front Panel Display Readback	Iout -165 mA	_____ mA	Iout +165 mA	15 mA
High Current (220 A) $I_{out}$	219.655	_____ A	+220.345 A	311 mA
Front Panel Display Readback	Iout -385 mA	_____ mA	Iout +385 mA	311 mA
<b>MODEL Agilent 6692A</b>				
<b>Voltage Programming and Readback</b>				
Low Voltage (0 V) $V_{out}$	-60 mV	_____ mV	+ 60 mV	1.7 $\mu$ V
Front Panel Display Readback	Vout -90 mV	_____ mV	Vout +90 mV	1.7 $\mu$ V
High Voltage ( 60 V) $V_{out}$	59.916 V	_____ V	60.084 V	348 $\mu$ V
Front Panel Display Readback	Vout -120 mV	_____ mV	Vout +120 mV	348 $\mu$ V
<b>Current Programming and Readback</b>				
Low Current (0 A) $I_{out}$	-65 mA	_____ mA	+65 mA	1.5 mA
Front Panel Display Readback	Iout -80 mA	_____ mA	Iout +80 mA	1.5 mA
High Current ( 110 A) $I_{out}$	109.825 A	_____ A	110.175 A	83 mA
Front Panel Display Readback	Iout -190 mA	_____ mA	Iout +190 mA	83 mA
* Enter your test results in this column.				



# Line Voltage Conversion

## Series 664xA and 665xA Power Supplies

### WARNING

**SHOCK HAZARD.** Hazardous voltage can remain inside the power supply even after it has been turned off. This procedure should only be done by qualified electronics service personnel.

Line voltage conversion is accomplished by:

- Series 664xA - setting line voltage select switches.
- Series 665xA - changing wire and jumper positions on the ac input of the main power transformer.

Proceed as follows:

1. Turn off the ac power to the supply and disconnect the power cord from the power source.
2. Remove the four screws that secure the two carrying straps and outer cover.
3. Slightly spread the bottom rear of the cover and pull it back to disengage it from the front panel.
4. Slide the dustcover back far enough to expose the select switches (see Figure C-1) or the line select jumpers (see Figure C-2).
5. **On the Series 664xA supply**, move the line voltage select switches to the positions corresponding to the desired line voltage.
6. **On the Series 665xA supply**, move the line voltage select jumpers to the positions corresponding to the desired line voltage. To disconnect it from the transformer tab, pull the wire straight up. Moving the wire from side-to-side can damage the tab.
7. Replace the top cover and secure the carrying straps.
8. Change the line fuse (on the rear panel) to the proper value for the new line voltage (see Table 1-6 in Chapter 1).

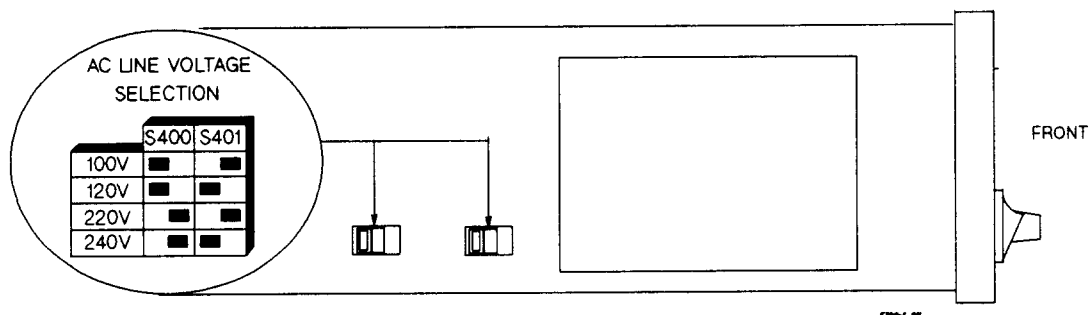

Figure C-1. Series 664xA Line Select Switches

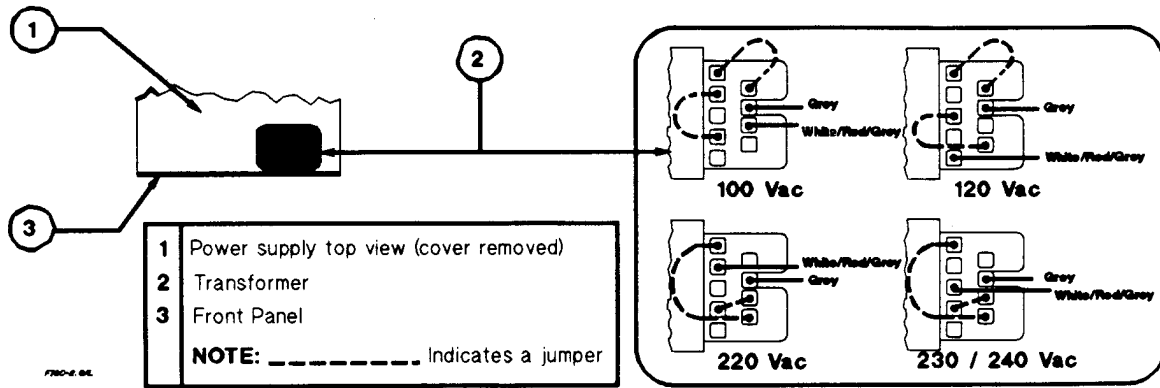

Figure C-2. Series 665xA Line Select Jumpers

## Series 667xA Power Supplies

### WARNING

**SHOCK HAZARD.** Hazardous voltage can remain inside the power supply even after it has been turned off. This procedure should only be done by qualified electronics service personnel.

Line voltage conversion is accomplished by setting a line voltage select switch. Proceed as follows:

1. Turn off the ac power and disconnect the power cord from the power source.
2. Remove the four screws securing the carrying straps and dustcover.
3. Spread the bottom rear of the dustcover and pull it back to disengage it from the front panel.
4. Slide the dustcover back far enough to expose the line select switch (see Figure C-3).
5. Observe the input rail LED under the RFI shield. **If the LED is on, there is still hazardous voltage inside the supply.** Wait until the LED goes out (this may take several minutes) before proceeding.
6. Connect a dc voltmeter across test points TP1 and TP2. (It may be necessary to remove the RFI shield in order to reach these test points. The shield is secured by four screws on each side.) When the voltmeter indicates 60 volts or less, it is safe to work inside the power supply.
7. Locate the line selector switch and slide it to the desired position.
8. If you removed it in step 6, be sure to replace the RFI shield.
9. Replace the dustcover.

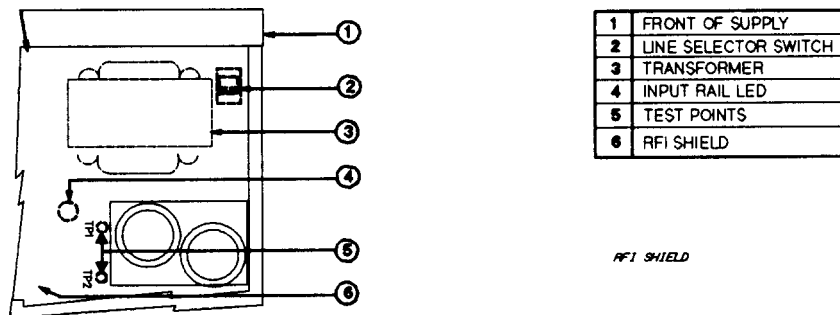

Figure C-3. Series 667xA Line Select Switch



---

## Series 668xA/669xA Power Supplies

Line voltage conversion kits are available for changing the input line voltage on series 668xA/669xA power supplies. Part numbers are listed under “Accessories” in chapter 1. Each line voltage conversion kit contains the following parts which are required to complete the line voltage conversion:

- Input fuses rated for the converted line voltage.
- A rear panel “Line Rating” label to identify the converted line voltage.
- An unterminated line cord rated for the converted line voltage.
- Instruction sheet

---

**WARNING**

**SHOCK HAZARD.** Hazardous voltage can remain inside the power supply even after it has been turned off. This procedure should only be done by qualified electronics service personnel.

---

Line voltage conversion is accomplished by changing jumper cable positions on the ac input of the main power transformer. Proceed as follows:

1. Turn off the power switch and disconnect the power cord from the power source or turn off the power disconnect switch.
2. Remove the four screws that secure the two carrying straps and outer cover.
3. Slightly spread the bottom rear of the cover and pull it back to disengage it from the front panel.
4. Remove the outer cover by sliding it back towards the rear of the supply.
5. Observe the input rail LEDs under the inner cover (see Figure C-4). **If the LEDs are on, there is still hazardous voltage inside the supply.** Wait until they both go out (this may take several minutes) before proceeding. (If one LED remains on while the other goes out, the power supply probably has a defect that requires service.)

---

**WARNING**

If you cannot see the LEDs through the hole in the inner cover, then wait until power has been removed for at least 15 minutes before proceeding to the next step.

---

6. Remove the screws securing the inner cover (see Figure C-4).
7. Remove the inner cover.
8. Locate the three line conversion cables (A,B,C in Figure C-5). All three cables will be connected to the jacks that correspond to one of the voltage ranges (1 or 2, Figure C-5).
9. Unplug the cables from their present jacks and plug them into the jacks for the other range.
10. Replace the inner cover.

---

**Note**

Be sure to replace all of the screws removed in Step 6. All the screws are not needed for mechanical security, but they are required to ensure proper magnetic shielding.

---

11. Replace the outer cover.
12. Remove the three fuses from the rear panel. If required, first remove the ac safety cover (see Figures 2-5 and 2-6).
13. Replace the fuses with the proper ones from the line voltage conversion kit (see “Accessories” in chapter 1).
14. Replace the power cord with the one from the line voltage conversion kit.
15. Place the “Line Rating” label from the conversion kit over the existing label on the rear panel.
16. Replace the ac safety cover.

Reconnect the power and turn on the power supply.

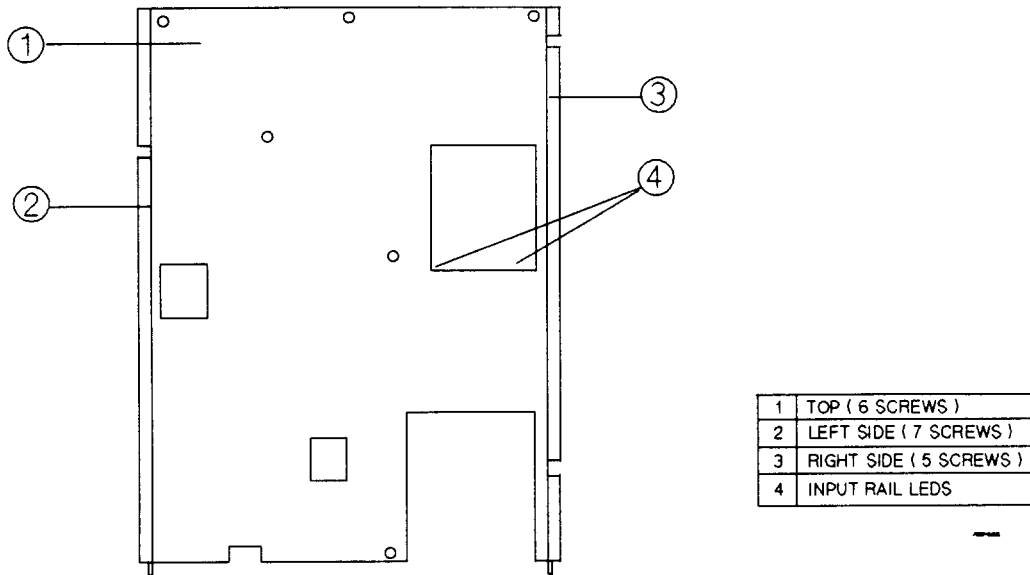
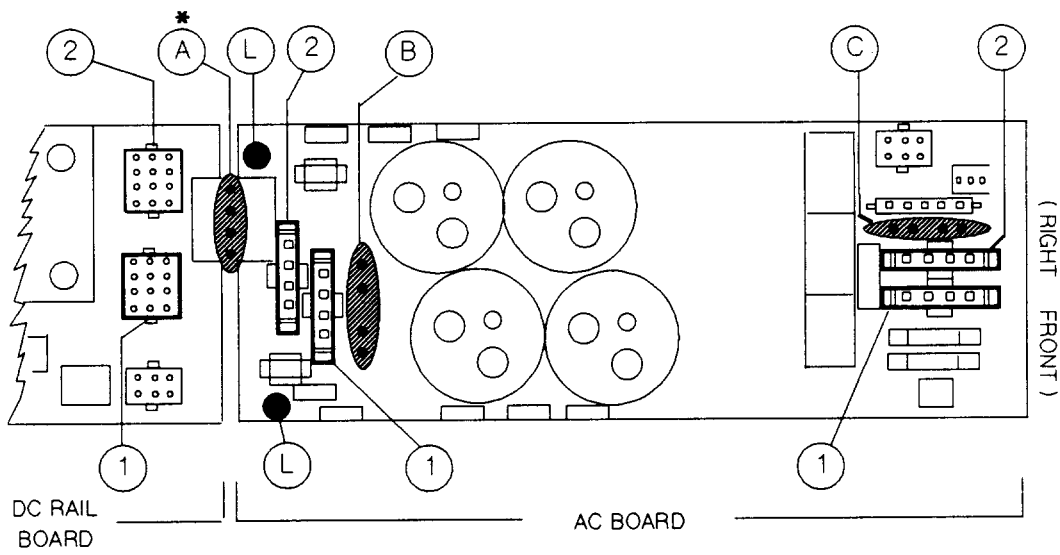

Figure C-4. Removing the Series 668xA/669xA Inner Cover



RANGE ( VAC )	CONNECT CABLES	TO
1 ( 180 - 235 )	A, B, C	1
2 ( 360 - 440 )	A, B, C	2

( L ) = INPUT RAIL LED  
 \* ( A ) = 2 CABLES TERMINATING IN ONE PLUG

Figure C-5. Series 668xA/669xA Line Conversion Jumpers

## Digital Port Functions

### Digital Connector

A 4-pin connector and a quick-disconnect mating plug are provided for digital input and output signals (see Figure D-1 for wiring connections, and Table 1-5 in Chapter 1 for electrical characteristics). This digital port can be configured to provide either Fault/Inhibit or Digital I/O functions.

**Note** Consistent with good engineering practice, twist and shield all signal wires to and from the digital connector.

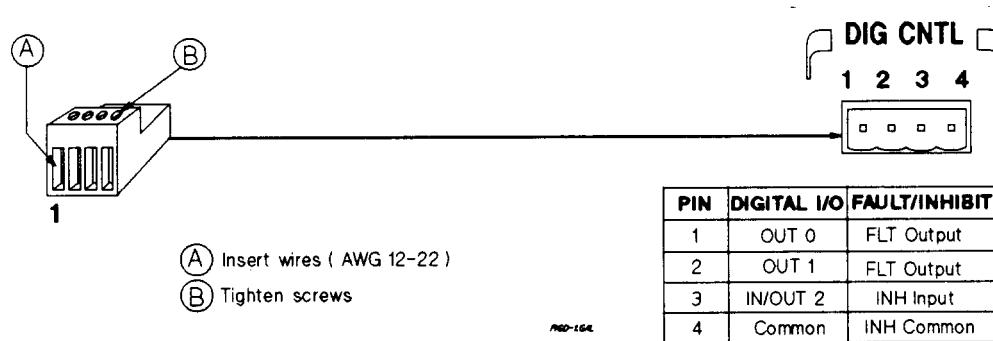

Figure D-1. Digital Port Connector

### Fault/Inhibit Operation

As shipped from the factory, the digital port is configured to provide a fault indicator (FLT) output and a remote (INH) input. Unplug the mating plug to make the connections. After you have finished making all connections, plug the wired plug back into the connector.

- FLT Output** (pins 1 and 2) Used to indicate that a fault has occurred in power supply. Pins 1 and 2 are the open collector output of an optocoupler, with pin 1 the collector and pin 2 the emitter. When a fault has occurred, pin 1 is driven low with respect to pin 2 (negative-true).
- INH Input** (pin 3) Used to shut down the power supply output. Pin 3 is a high impedance input. The supply shuts down when this input is driven low (negative-true). This can be done by shorting pin 3 to pin 4.
- INH Common** (pin 4) Provides the common connection for the INH input.

Three examples are provided to show how to use the FLT/INH circuits of your power supply. Use twisted wire connections to reduce or prevent electromagnetic radiation in all cases. If shielded wire is used, connect only one end of the shield to the chassis signal ground binding post to prevent ground loops.

In Figure D-2, the INH input is connected to a switch that shorts pin 3 to pin 4 whenever it is necessary to externally disable the output of the supply. This will activate the remote inhibit (RI) fault protection circuit, causing the front panel **Prot** annunciator to come on. It also sets the RI event bit in the supply's Questionable Status Event register (see "Chapter 4 - Status Reporting" in the Programming Guide). To re-enable the supply after it has been disabled by the INH input, first open the connection between pins 3 and 4. Then clear the protection circuit either from the front panel (see "Chapter 5 - Front Panel Operation" in this guide) or over the GPIB (see the Programming Guide).

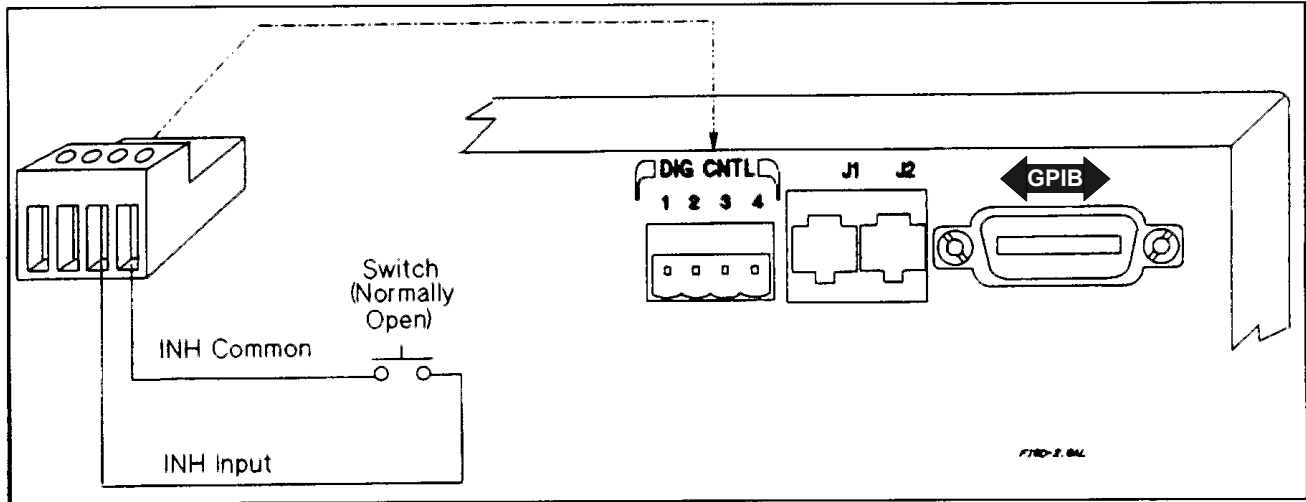

**Figure D-2. Example of Inhibit Input**

In Figure D-3A, the FLT output is connected to a relay driver circuit that energizes a relay whenever a fault condition occurs in the power supply. The relay can be used to physically disconnect the output of the power supply from the load. The FLT output is generated by the logical ORing of the power supply's Operation, Questionable, and Event status summary bits (see "Chapter 4 - Status Reporting" in the Programming Guide). You can cause one or more events to activate the FLT output by enabling the appropriate events in these status registers. The fault condition is cleared by first removing the cause of the fault and then reading the appropriate status event register(s).

In Figure D-3B, the FLT output of one supply is connected to the INH input of another supply. Although only two supplies are shown, it is possible to chain other supplies with this arrangement. A fault condition in any one of the power supplies will disable all of them without intervention either by the controller or external circuitry. The controller can be made aware of the fault via a service request (SRQ) generated by the Questionable Status summary bit (see "Chapter 4 - Status Reporting" in the Programming Guide).

---

**Note** The INH input cannot be used to disable outputs set from the external voltage programming port.

---

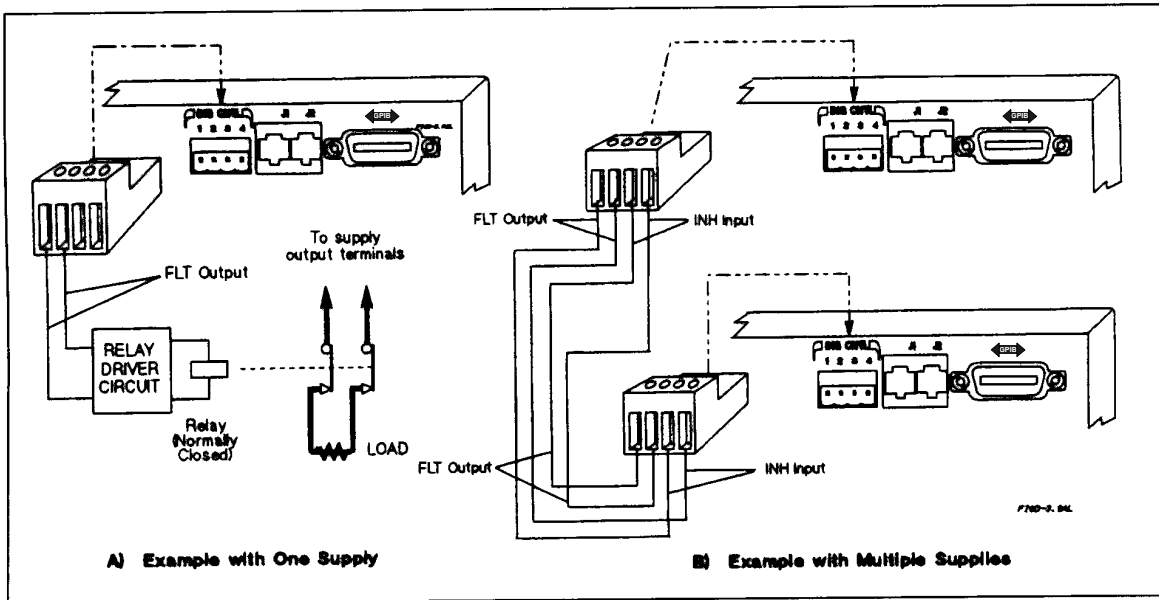

Figure D-3. Examples of FLT Outputs

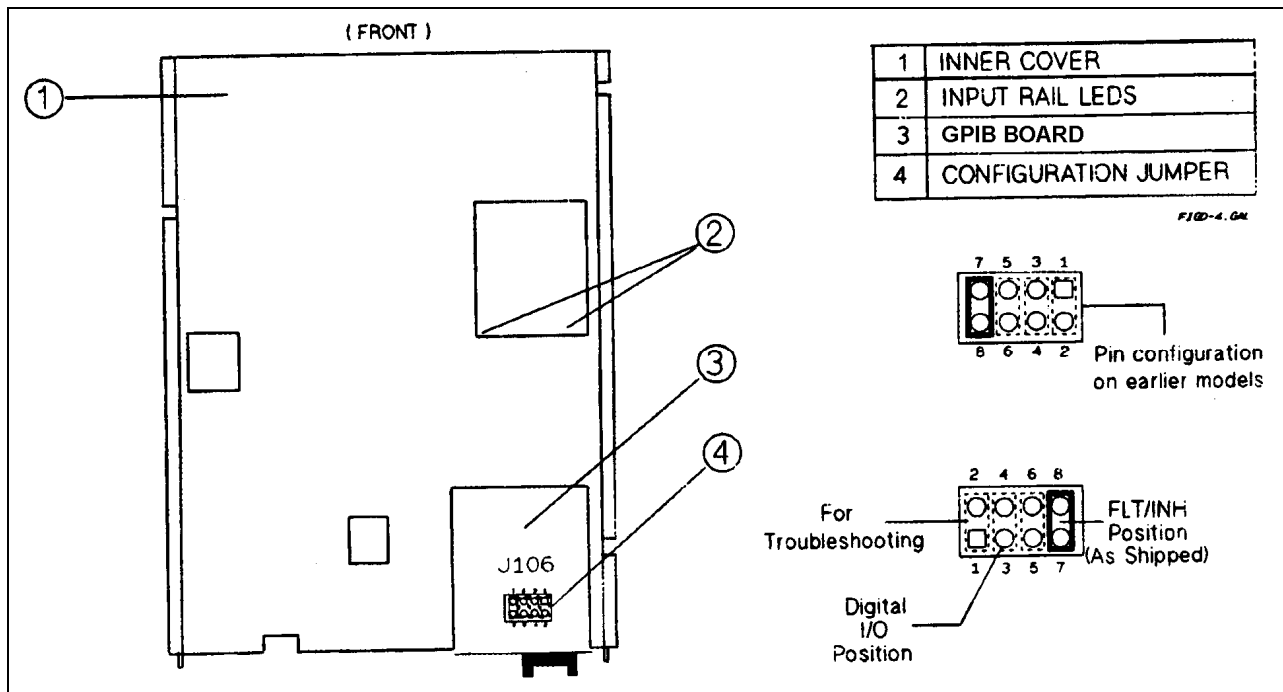

Figure D-4. Digital Port Configuration Jumper

## Changing the Port Configuration

As shipped from the factory, the digital port is configured for FLT/INH operation. You can change the configuration of the port to operate as a general-purpose digital input/output port to control your custom circuitry as shown in Figure D-4. To change the port configuration, you must move a jumper on the GPIB board.

### WARNING

**Shock Hazard.** Hazardous voltage can remain inside the power supply even after it has been turned off. This procedure should only be done by qualified electronics service personnel.

Proceed as follows:

1. Turn off the power supply and disconnect the power cord from the power source or turn off the power disconnect switch (Series 668xA/669xA).
2. Remove the four screws that secure the two carrying straps and outer cover.
3. Spread the bottom rear of the cover and pull it back to disengage it from the front panel.
4. Slide the outer cover back to expose the top of the GPIB board.
5. Refer to Figure D-4 and use needle-nose pliers to move the jumper to the Digital I/O position.
6. Replace the outer cover, and secure the carrying straps.
7. Make the necessary wire connections to the digital connector.

## Digital I/O Operation

The digital port can be configured (see Figure D-4) to provide a digital input/output to be used with custom digital interface circuits or relay circuits. Some examples are shown Figure D-5. See Figure D-1 for the pin assignments of the mating plug and Table 1-5 for the electrical characteristics of the port. See **DIG:DATA[:VAL]** in "Chapter 3 - Language Dictionary" of the Programming Guide for information on programming the port. The digital port pins are as follows:

- OUT 0** (pin 1)      This port can only be used as an open-collector output. It is assigned a bit weight of 1.
- OUT 1** (pin 2)      This port can only be used as an open-collector output. It is assigned a bit weight of 2.
- IN/OUT 2** (pin 3)      This port can be programmed to be either an input, or an open-collector output with an internal 4.6 k pull-up to 5 V.
- Common** (pin 4)      This pin is the common connection for the Digital I/O ports.

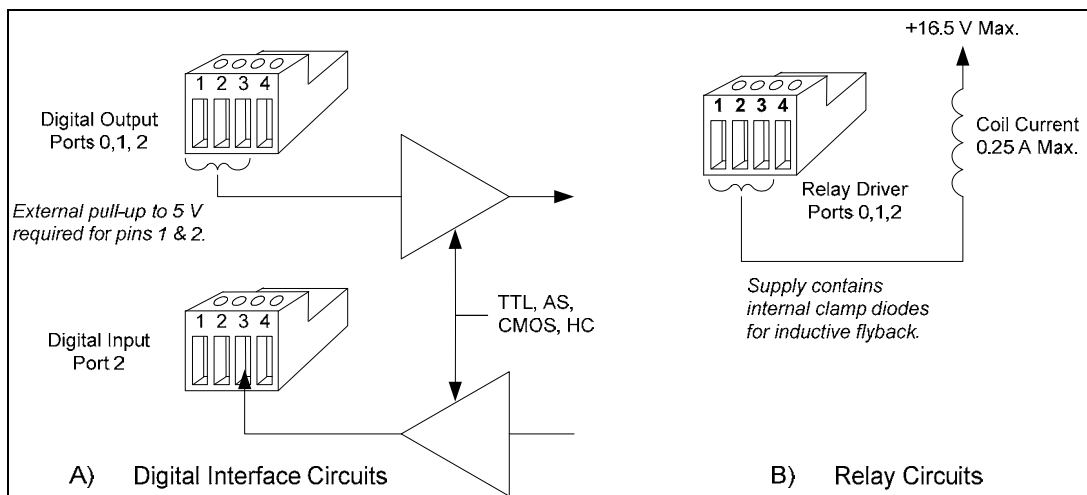

Figure D-5. Digital I/O Port Applications

## Relay Link Operation

### CAUTION

Relay link operation cannot be used with units that output more than 50 amps. (Some 667xA series units; all 668xA and 669xA series units.)

The digital port can be configured to provide relay control outputs for the Agilent 59510A or 59511A Relay Accessory. Refer to Figure D-1 for the pin assignments of the mating plug.

<b>RLY SEND</b> (pin 1)	Provides the serial data to control the relays in the Relay Accessory.
(pin 2)	(Not used)
<b>RLY RTN</b> (pin 3)	Receives the data readback that indicates the status of the relays in the Relay Accessory.
<b>Common</b> (pin 4)	Common connection for the RLY SEND and RLY RTN lines.

Figure D-6 shows how to connect your power supply to an Agilent 59510A or 59511A Relay Accessory when the digital port is configured for relay link operation. *An error will be generated if you attempt to program the relay box without first configuring the digital port for relay link operation.* For more information about programming the relay, refer to **OUTP:REL[:STAT]** in Chapter 3 of the Programming Guide. For more information about the Relay Accessory, refer to its manual (see Table 1-6).

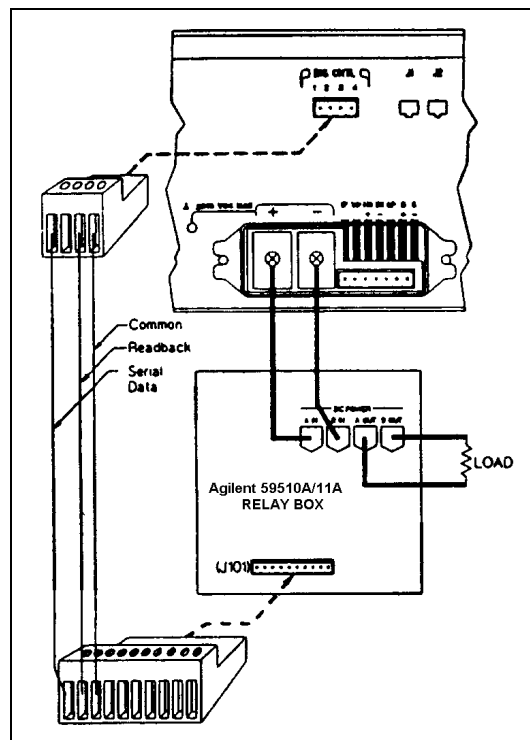

Figure D-6. Relay Link Connections





## Current Loop Compensation (Series 668xA Only)

### Introduction

This section describes how you may use current loop compensation to optimize for inductive loads or for fast CV/CC mode crossover. A 7-position compensation switch for this purpose is located under the cover on the rear of the power supply.

### Function of Loop Compensation

Figure E-1 shows the switch settings for specific combinations of load inductance and resistance. Two sets of curves show the small-signal response for each model. The dashed curves represent programming performance of no more than 10% current overshoot. The solid curves represent operating conditions with 25% overshoot. The curve obtained with all switches open gives the fastest CC mode crossover response time. However, as shown by these curves, the loop will not tolerate larger inductances unless the load resistance is increased. The curve described when all switch positions are closed shows the as-shipped performance curve. This position provides 10% overshoot and fast CV/CC crossover performance for load inductances that are specific for each model. (For Models 6680A and 6681A, this curve ranges from 100  $\mu$ ohms at 15  $\mu$ henries to about 100 milliohms at 40 millihenries.). You can select a different compensation curve by opening a specific switch or combination of switches.

Table E-1 shows some specific L ÷ R ratios and the switch positions required for these ratios. **Table E-1 is valid only for Models 6680A and 6681A - you must use the curves for the remaining models.** The corresponding 10% overshoot curves are shown in Figure E-1. As operation moves along the curves from left to right, the switch positions must be changed as shown along the X-axis.

**Table E-1.**  
**Settings For CC Loop Compensation Switch (Models 6680A and 6681A Only)**

Load Characteristic (L/R)	<sup>1</sup> Switch Setting						
	7	6	5	4	3	2	1
1 $\mu$ H/3 m $\Omega$	0	0	0	0	0	0	0
<sup>2</sup> 15 $\mu$ H/100 $\mu\Omega$	1	1	1	1	1	1	1
30 $\mu$ H/100 $\mu\Omega$	0	0	0	0	0	0	1
100 $\mu$ H/100 $\mu\Omega$	1	1	1	1	1	1	0
150 $\mu$ H/100 $\mu\Omega$	0	0	0	0	0	1	0
600 $\mu$ H/100 $\mu\Omega$	1	1	1	1	1	0	0
1.2 mH/100 $\mu\Omega$	0	0	0	0	1	0	0
4 mH/100 $\mu\Omega$	1	1	1	1	0	0	0
10 mH/100 $\mu\Omega$	0	0	0	1	0	0	0
40 mH/100 $\mu\Omega$	1	1	1	0	0	0	0
100 mH/100 $\mu\Omega$	0	0	1	0	0	0	0
380 mH/100 $\mu\Omega$	1	1	0	0	0	0	0
650 mH/100 $\mu\Omega$	0	1	0	0	0	0	0
7 H/100 $\mu\Omega$	1	0	0	0	0	0	0

<sup>1</sup> "1" = switch closed; "0" = switch open.    <sup>2</sup> Factory setting.

For example, examine Figure E-1 for the Model 6680A/6681A. The chart shows that a load comprised of about 1 millihenry inductance and 100 micro ohms resistance (see point A) requires switch setting 9 (only switch 3 closed) to obtain 10% overshoot. If the load resistance is increased to 1 milliohm, then the operating position will be to the left of the existing compensation curve (see point B). This will result in a stable condition with less overshoot, but greater CV/CC crossover time than if the curve defined by switch setting 8 were used. If the load resistance remains at 1 milliohm but the load inductance increases to 10 millihenries, then the operating position will be far to the right of the compensation curve (see point C). This results in a less stable condition with more overshoot. To obtain better operation at point C, use the compensation curve defined by switch setting 13 (Model 6680A) or 12 (Model 6681A).

Most operating conditions will not fall directly on a curve and you will have to interpolate between curves. Generally, moving to the left of a given curve increases stability. However, at large values of inductance the curves become almost vertical because the load resistance has no effect on dampening the system. For Models 6680A and 6681A, the most stable points are on the solid curves shown in Figure E-1. Points to the right or left of a curve will have more overshoot. Note the two dashed vertical lines at switch setting 25 for Models 6682A, 6683A, and 6684A. Operation between these lines will result in somewhat increased stability.

**Note** The best procedure is to test your settings under real operating conditions. For help in tailoring a specific CC compensation, contact your Agilent Sales and Support Offices.

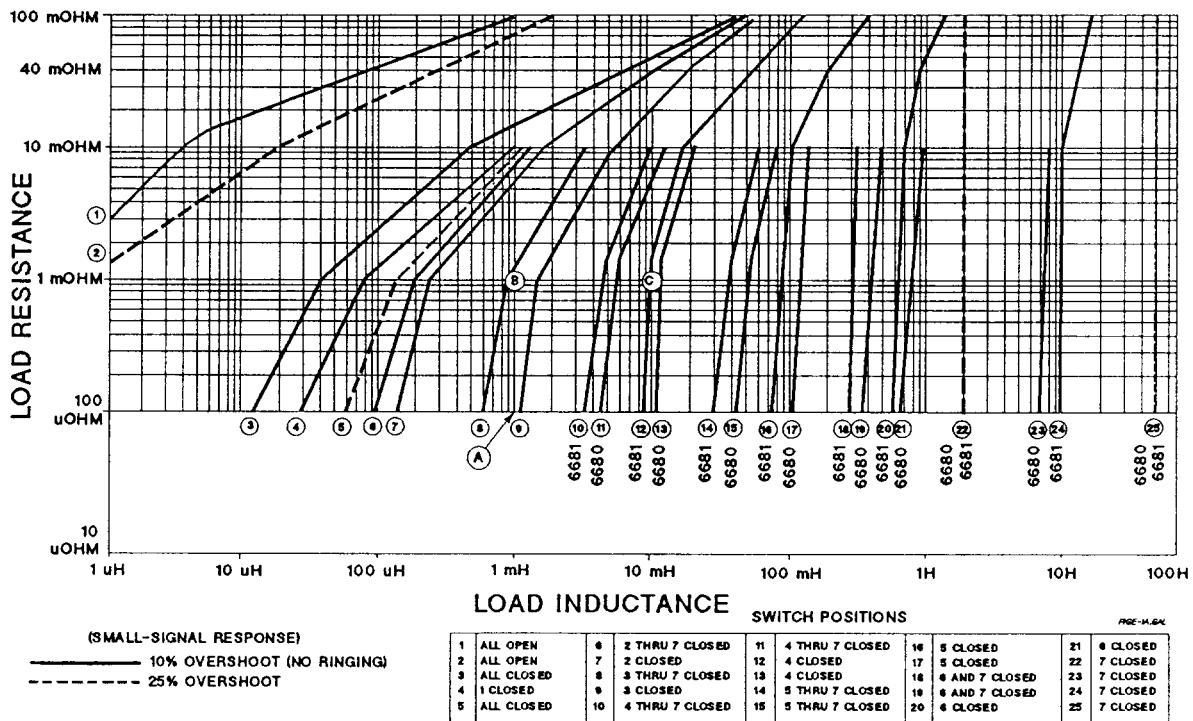
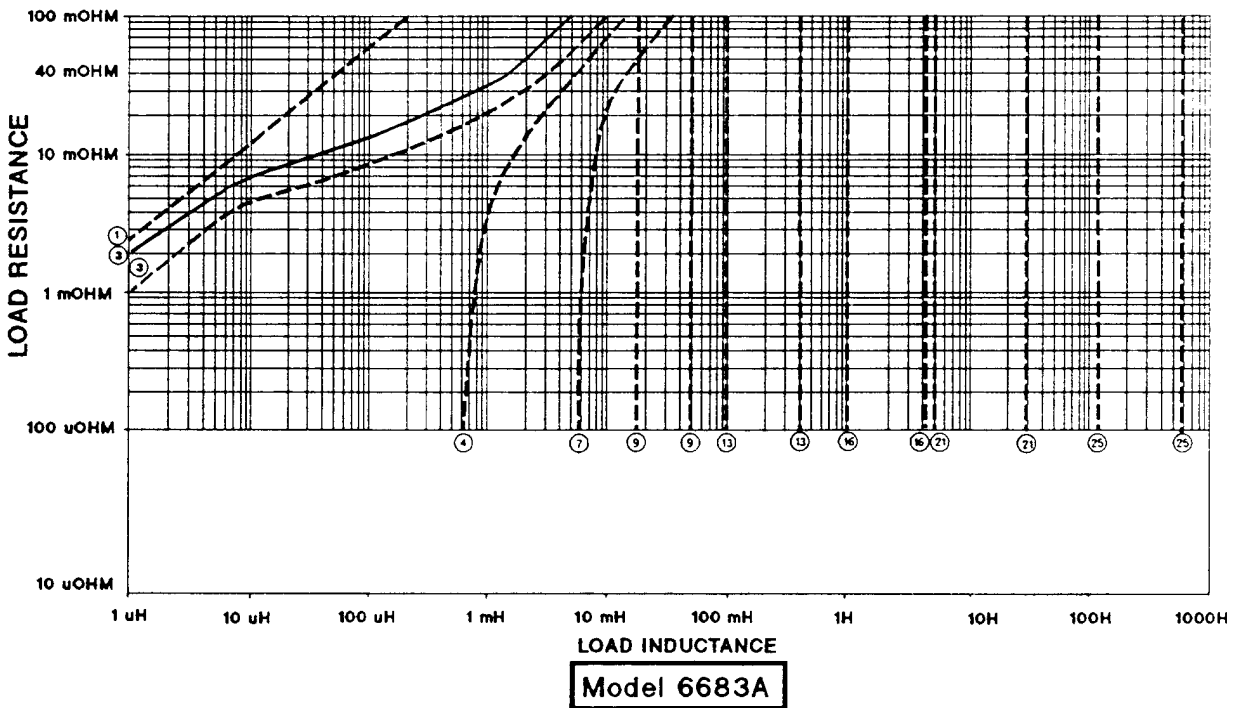
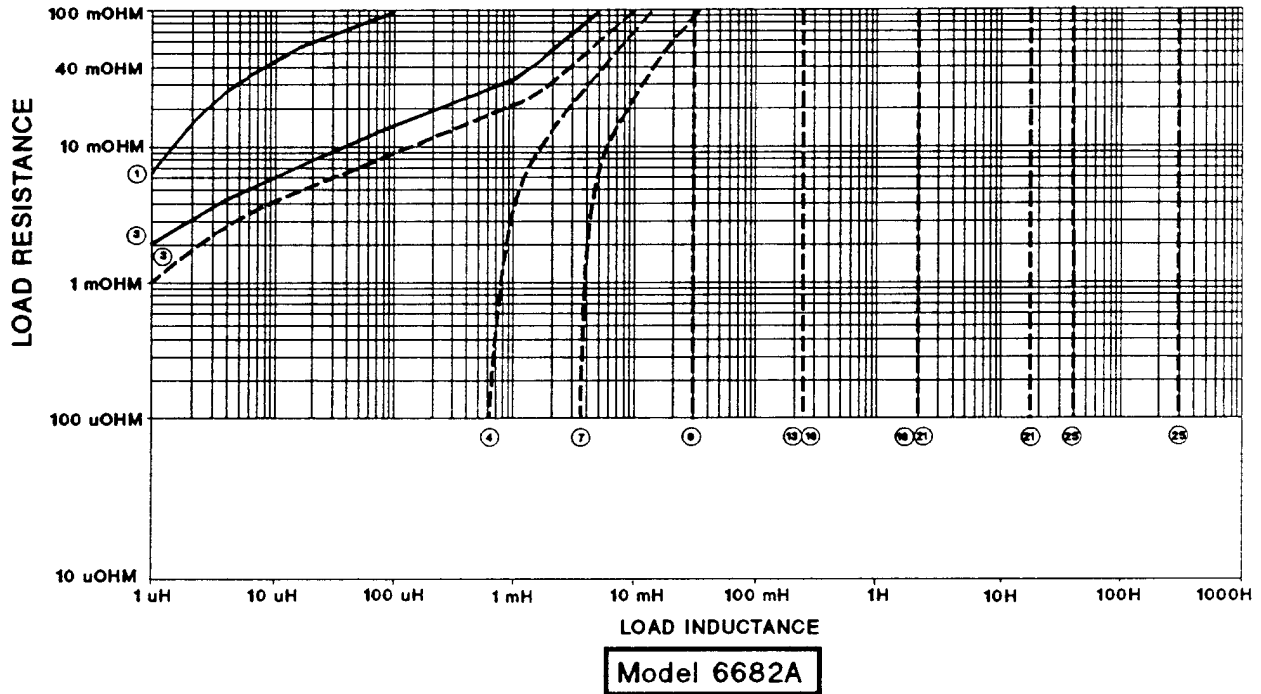

Figure E-1. CC Loop Compensation Curves for Models 6680A and 6681A



SWITCH POSITIONS

1	ALL OPEN	6	2 THRU 7 CLOSED	11	4 THRU 7 CLOSED	16	5 CLOSED	21	6 CLOSED
2	ALL OPEN	7	2 CLOSED	12	4 CLOSED	17	5 CLOSED	22	7 CLOSED
3	ALL CLOSED	8	3 THRU 7 CLOSED	13	4 CLOSED	18	6 AND 7 CLOSED	23	7 CLOSED
4	1 CLOSED	9	3 CLOSED	14	5 THRU 7 CLOSED	19	6 AND 7 CLOSED	24	7 CLOSED
5	ALL CLOSED	10	4 THRU 7 CLOSED	15	5 THRU 7 CLOSED	20	6 CLOSED	25	7 CLOSED

(SMALL-SIGNAL RESPONSE)  
 ——— 10% OVERSHOOT NO RINGING  
 - - - 25% OVERSHOOT

Figure E-1. CC Loop Compensation Curves For Models 6682A and 6683A

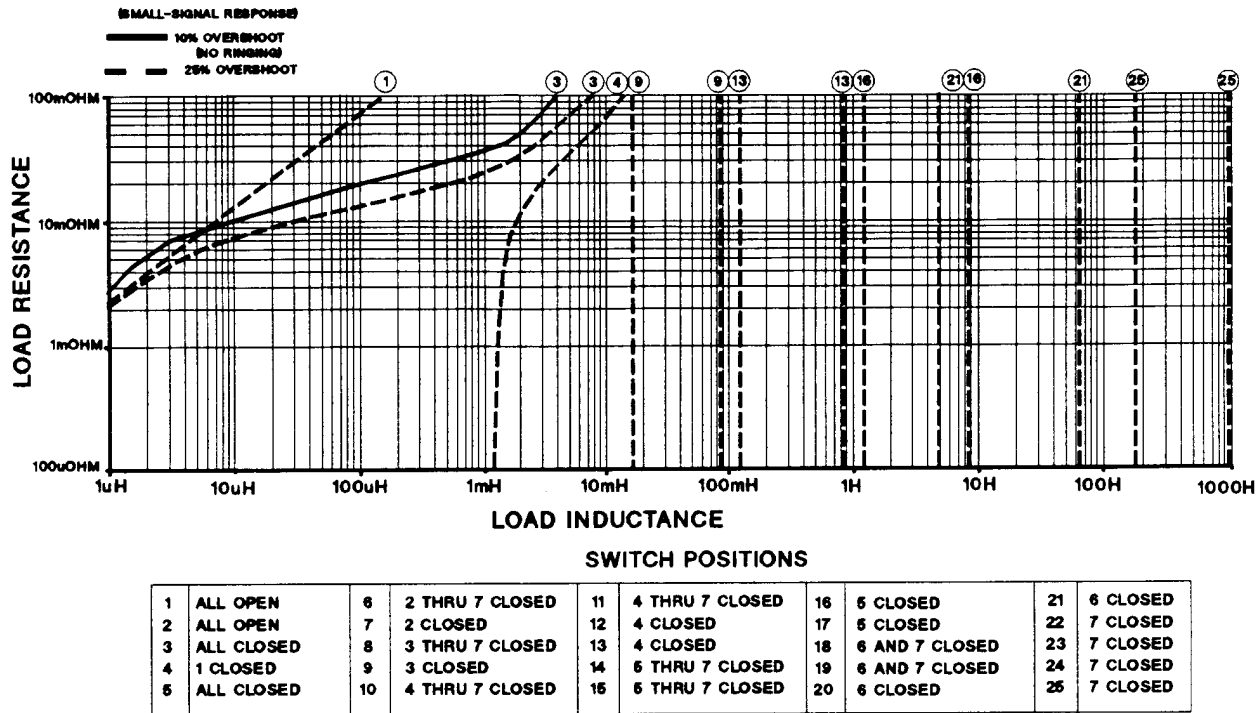

Figure E-1. CC Loop Compensation Curves For Model 6684A

## Setting the Loop Compensation Switch

### WARNING

**SHOCK/ENERGY HAZARD.** This procedure involves removing the outside cover and should only be done by qualified electronics service personnel.

1. Turn off the power switch and disconnect the power cord from the power source. If this is not possible, remove the three line fuses from the rear panel (see Figure 2-4).
2. Remove the four screws that secure the two carrying straps and outside cover.
3. Spread the bottom rear of the cover and pull it back to disengage it from the front panel.
4. Remove the cover by sliding it back towards the rear of the supply.
5. Locate the compensation switch (see Figure E-2).
6. Move the switches to the desired position.
7. Replace the outside cover.

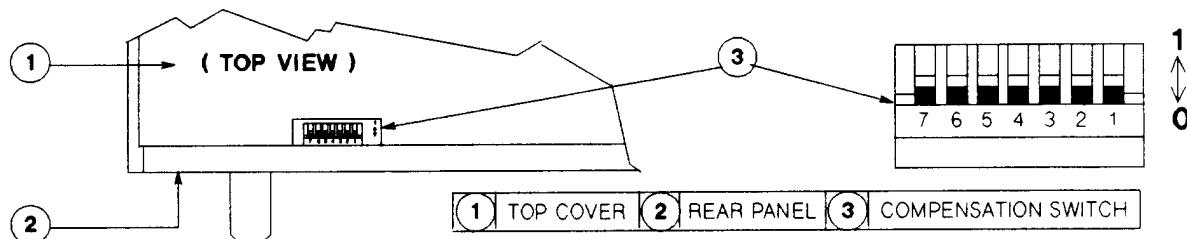

Figure E-2. CC Loop Compensation Switch

# Using Agilent 668xA/669xA Series Power Supplies in Autoparallel

---

## Introduction

This information is supplementary to the information in chapter 4.

A maximum of three Agilent 668xA/669xA series power supplies having the **same** model number, may be configured for autoparallel operation. The Agilent 668xA/669xA power supplies were designed with an external programming offset so that the master unit will output current before the slave units do. Therefore, slave supplies will always sink current when low output current values are desired.

### Autoparallel Procedure

1. Connect the Agilent 668xA/669xA power supplies with the **Im** terminal from the master connected to the **+Ip** terminal of each slave. Connect the **VP** terminal of the master to the **-Ip** terminal of each slave (see Figure 4-5e on page 81).
2. Each load lead should be of the same wire gauge and length.
3. Turn on all power supplies.
4. Program each slave supply for zero (0) output current either by pressing [CURRENT] [0] [ENTER] from the front panel keypad or sending the command "CURR:LEV 0" via the GPIB (see notes 2 and 3 on the following page).
5. Program each slave's output voltage at least 2 volts higher than the output voltage that the master supply will be programmed to.
6. Program the master supply's output current for a value slightly greater than one-half of the total desired output current if there is one slave supply, or one-third of the total desired output current if there are two slave supplies.
7. Enable all power supplies by pressing the [Output On/Off] key.
8. Increase the master supply's output voltage. At low output currents, the master unit will be supplying **all** of the load current and the slave supplies will be sinking current, which is normal. At maximum output current each supply will be delivering an equal amount of output current. When operating at less than maximum current, it is normal to have unequal current sharing between the master and slave supplies. Current sharing among the supplies only becomes equal at maximum output current (see Figure F-1).
9. For remote sensing, connect only the master supply's +S and -S lines. Slave supplies should be connected for local sensing at the rear of their respective output terminals.

---

**Note 1** The current division between the master and slaves can be determined as follows:  

$$I_{out} = I_m [ 1 + N_s ( 1 + 0.127V/5V ) ] - N_s I_{fs} ( 0.127V/5V )$$

---

The amount of current the master unit must output before the slave units will output current can be determined as follows:

$$N_s * I_{fs} ( 0.127V/5V )$$

where  $I_m$  = master current  
 $N_s$  = number of slaves  
 $I_{fs}$  = full scale current

Example: 1 master unit, 2 slave units, Agilent Models 6680A (5V, 875A)

$$I_{out} = I_m ( 3.0508 ) = 44.4A$$

The master current limit must be set above  $44.4A / 3.0508 = 14.55A$  to obtain any output current. For a no-load condition:

$$\text{Master current} = 14.55A$$

$$\text{Each slave current} = -14.55A / 2 = -7.28A$$

$$I_{out} = 0A$$

---

**Note 2** All Agilent 668xA and 669xA power supplies have an output current programmed at power-on. The default current value programmed at power-on can be found in Table 3-1 of the Programming Guide (p/n 5964-8269). See \*RST and \*SAV in the Programming Guide to change the power-on current value.

---

**Note 3** A current programmed via the rear panel +Ip or -Ip inputs will be summed with the current programmed via the front panel keypad or over the GPIB. When programming slave supplies via the rear panel +Ip or -Ip inputs, all slave current programming values must be zero (0).

---

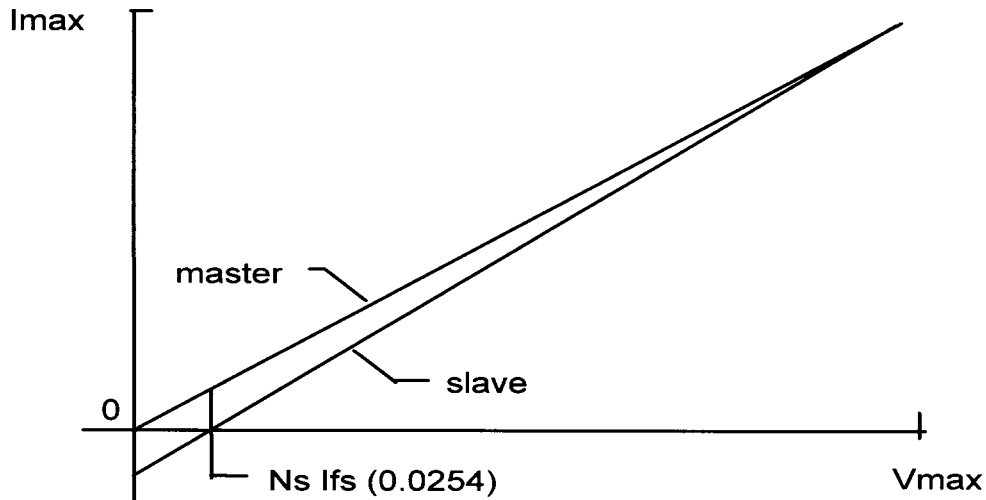

Figure F-1 Master/Slave Current Division

## Output Bus Bar Options

### Option 602 Installation

**WARNING ENERGY HAZARD.** The Series 668xA/669xA power supplies can provide more than 240 VA at more than 2 V. If the output connections touch, severe arcing may occur resulting in burns, ignition or welding of parts. Do not attempt to make connections while the output is live.

The Option 602 kit provides bus bar spacers to permit parallel operation between vertical power supplies, such as those in an equipment rack.

Each kit has two bus bar spacers and the required hardware for attaching the spacers to the – and + bus bars. The spacers have tapped holes for receiving the screws that are inserted through clearance holes in the bus bars. Either spacer may be used with either bus bar. Secure the spacers on opposite sides of the bus bars as shown in the figure. Be sure to insert the flatwashers and lockwashers.

When the spacers have been installed, connect the bus rails between the two power supplies. Use the original bus bar hardware or the hardware provided with the Bus Bar Hardware Kit 5080-2313 (see option 601)

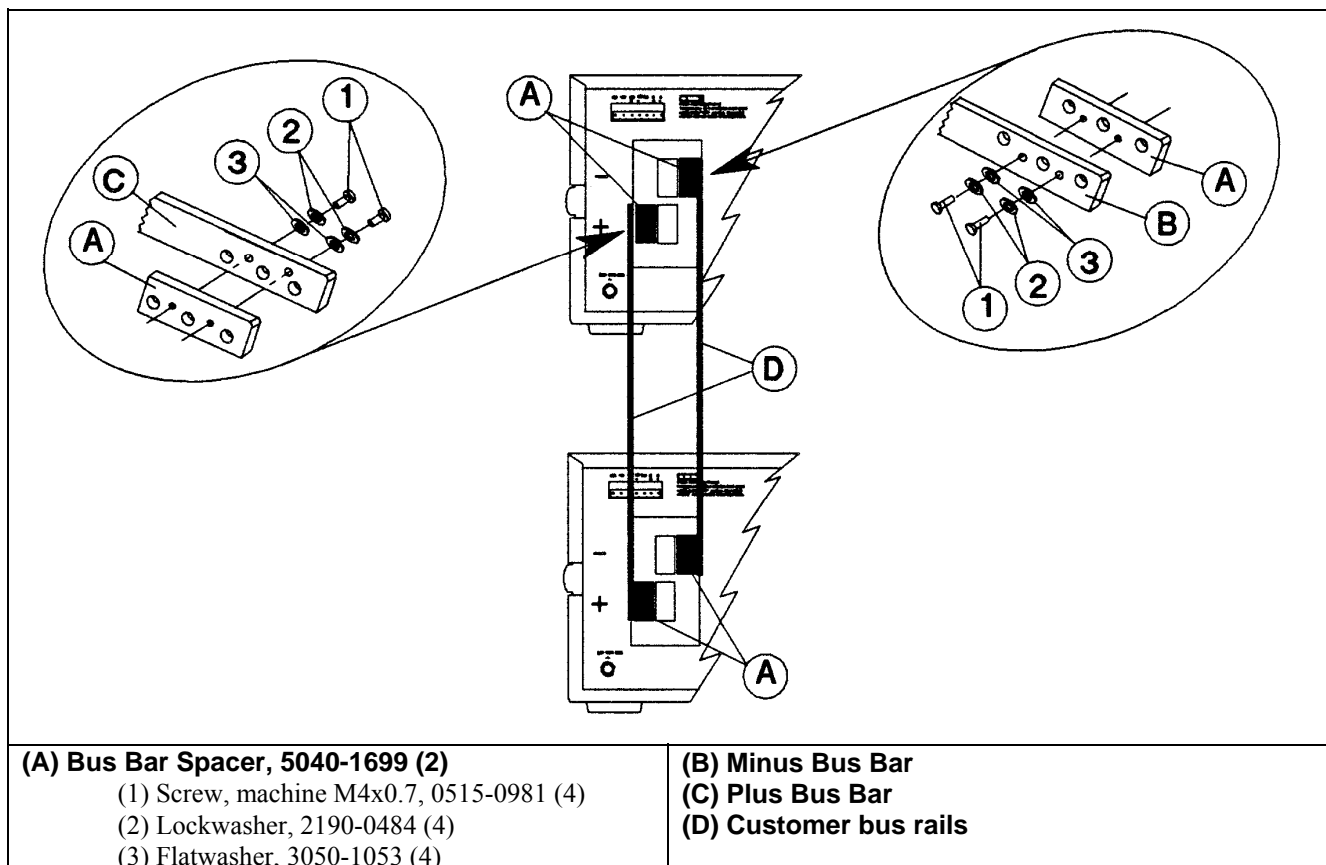





# Index

## —A—

- ac disconnect switch, 47, 48
- accessories, 13
- air clearance, 44
- air flow, 44, 52
- analog
  - connector, 43
- analog port, 60
  - characteristics. *See* Supplemental Characteristics
  - connector configuration, 60
  - signals, 60
- analog programming. *See* external voltage control
- annunciator, 86
  - Addr, 86
  - Cal, 86
  - CC, 53, 86
  - CV, 52, 53, 86
  - Dis, 52, 54, 86
  - Err, 86
  - OCP, 54, 86
  - Prot, 53, 54, 86, 124
  - Rmt, 86
  - Shift, 52, 86
  - SRG, 86
  - Unr, 63, 71, 86, 92
- autoparallel
  - 668xA and 669xA, 133
- AWG ratings, 59

## —B—

- BASIC, 102
- battery charging
  - 664xA and 665xA, 62
  - 667xA, 70
  - 668xA and 669xA, 77

## —C—

- cables, 13
- calibration, 95
  - current, 98
  - current monitor, 99
  - default password, 96
  - disabling, 96
  - enabling, 98
  - equipment required, 95
  - jumper, 98
  - over GPIB, 100
  - OVP, 98
  - program, 102
  - SCPI commands, 100
  - test setup, 97
  - voltage, 98
- capacitive load
  - 664xA and 665xA, 61

- 667xA, 69
- 668xA and 669xA, 76
- CC loop compensation
  - 668xA, 129
  - curves, 130
- CC mode, 91, 129, 130
- characteristics
  - 664xA, 17
  - 665xA, 22
  - 667xA, 27
  - 668xA, 32
  - 669xA, 37
  - output, 15
- checkout, 51
  - output current, 54
  - output voltage, 53
  - power-on, 52
  - preliminary, 51
- common commands. *See* Programming Guide
- common P, 60, 68, 75, 82
- Compatibility language. *See* Programming Guide
- connections
  - 664xA and 665xA in parallel, 65
  - 664xA and 665xA in series, 67, 74
  - 664xA and 665xA with multiple loads, 65
  - 667xA in parallel, 73
  - 667xA with multiple loads, 72
  - 668xA and 669xA in parallel, 80
  - 668xA and 669xA in series, 81
  - 668xA and 669xA with multiple loads, 79
  - controller, 83
- connector
  - analog port, 60
  - digital port, 60, 123
- controller connections, 83
  - linked, 83
  - stand alone, 83
- current control, 14, 54, 87
- current programming, 90
- CV mode, 91

## —D—

- damage, 43
- DFI/RI, 80, 81
- digital connector, 43, 60, 123
- digital port
  - applications, 126
  - characteristics, 41
  - configuration jumper, 125
  - pin configuration, 126
- dimensions, 44
- direct supply, 83, 93
- downprogramming, 15

—E—

energy hazard, 54, 76, 90, 95, 108, 132  
error messages  
  calibration, 99  
  checksum, 58  
  power-on, 57  
  run-time, 58  
  selftest, 57  
  system. *See* Programming Guide  
external voltage control, 14  
  664xA and 665xA, 67  
  667xA, 75  
  668xA and 669xA, 82  
  capacitive coupling, 67

—F—

fan, 44, 52, 55  
features, 14  
fire hazard, 59  
FLT output, 123  
font panel keys  
  Cal Disable, 96  
  Cal Enable, 96  
  Pass, 96  
front panel  
  controls and indicators, 14  
front panel keys  
  ↑Current, 87  
  ↑Voltage, 53, 87  
  Address, 87, 93  
  Back, 52, 88  
  Cal Save, 96  
  Clear Entry, 88  
  Current, 54, 87  
  Current↓, 54  
  Enter, 52, 88  
  Error, 87  
  Local, 87  
  OCP, 54, 87, 91  
  Output On.Off, 87  
  Output On/Off, 52  
  OV, 53, 87  
  Prot Clear, 55, 87, 90  
  Protect, 53, 55, 87, 90  
  Recall, 55, 87  
  Save, 55, 87  
  Shift, 52, 87  
  Voltage, 53, 87  
fuse  
  664xA and 665xA, 45, 56  
  667xA, 45, 56  
  668xA, 47, 57  
  669xA, 48, 57  
  kit, 13  
  power, 41  
fuse indicator window, 669xA, 57

—G—

general information, 11  
GPIB  
  address, 55, 93  
  address, primary, 83, 93  
  address, secondary, 83, 93  
GPIB system supplies, 13  
ground  
  earth, 12, 46, 47, 49  
  signal, 123  
Guide, Operating, 11  
Guide, Programming, 11  
Guide, Service, 13

—H—

hardware, 41  
history, 4

—I—

inductive load  
  664xA and 665xA, 62  
  667xA, 69  
  668xA, 129  
  668xA and 669xA, 77  
INH input, 123  
initial conditions, 88  
input  
  connections, 45  
  power, 12  
input rail LED, 56  
  667xA, 120  
  668xA and 669xA, 121  
inspection, 43  
isolation. *See* output isolation

—J—

jumper  
  calibration, 98  
  line select for 664xA and 665xA, 120  
  line select for 668xA and 669xA, 122  
  local sense, 667xA, 70  
  local sense, 668xA and 669xA, 77

—L—

line fuse, 55  
line voltage conversion  
  664xA and 665xA, 119  
  667xA, 120  
  668xA and 669xA, 121  
linked connections, 83  
linked supply, 83, 93  
load L/R ratio  
  668xA, 129  
local sensing. *See* local voltage sensing  
local voltage sensing, 62, 70, 77

location, 44

## —M—

manuals, 11, 41

message

- CAL DENIED, 98
- error. *See* error messages
- OC, 91
- OUT OF RANGE, 89, 90
- PWR ON INIT, 52
- RCL 0 PWR-ON, 92
- RST POWER-ON, 92

meter mode, 52

multiple load connections

- 664xA and 665xA, 65
- 667xA, 72
- 668xA and 668xA, 79

## —N—

nonvolatile memory, 92

## —O—

OCP key. *See* front panel keys

operating features, 14

Operating Guide, 11

operating modes, 15

options, 12

output characteristic, 15, 89

- 664xA, 19
- 6665xA, 24
- 667xA, 29
- 668xA, 34
- 669xA, 39

output isolation

- 664xA and 665xA, 61
- 667xA, 68
- 668xA and 669xA, 76

overcurrent protection, 91

- clearing, 91
- operation, 91
- setting, 91

overvoltage protection, 89

- clearing, 90
- operation, 90
- setting, 89

## —P—

pack return system, 43

parallel connections

- 664xA and 665xA, 65
- 667xA, 73
- 668xA and 669xA, 80

parallel procedure

- 668xA and 669xA, 133

parts

- operator replaceable, 41

power cord, 12, 43

- 664xA and 665xA, 45
- 667xA, 45
- 668xA, 47
- 669xA, 48
- installation, 45

power receptacle, 12

power-on selftest, 52

preliminary checkout, 51

print date, 4

programming

- accuracy. *See* Performance specifications
- errors. *See* Programming Guide
- parameters. *See* Programming Guide
- resolution. *See* characteristics

Programming Guide, 11

Protect key. *See* front panel keys

## —R—

rack mount kit, 12, 44

rack mounting, 44

recalling states, 55, 92

relay link

- connections, 127
- pin configuration, 127

remote programming, 14

remote voltage sensing

- and 664xA and 665xA load regulation, 63
- and 664xA and 665xA output noise, 63
- and 664xA and 665xA output rating, 63
- and 664xA and 665xA output stability, 64
- and 664xA and 665xA OVP operation, 63
- and 667xA load regulation, 71
- and 667xA output noise, 71
- and 667xA output rating, 71
- and 667xA output stability, 71
- and 667xA OVP operation, 71
- and 668xA and 669xA load regulation, 77
- and 668xA and 669xA output noise, 78
- and 668xA and 669xA output rating, 78
- and 668xA and 669xA output stability, 78
- and 668xA and 669xA OVP operation, 78

repacking, 43

RI, remote inhibit. *See* INH input

## —S—

safety class, 12

safety compliance

- 664xA, 6

safety cover, 41, 47, 49

safety summary, 3

safety warning, 12, 44, 47, 48, 54, 56, 59, 61, 67, 69, 74, 76, 81, 90, 95, 108, 119, 120, 121, 126, 132

saving states, 92

serial cable, 43

serial number, 12

series connections

- 664xA and 665xA, 67, 74
- 668xA and 669xA, 81

Service guide, 13  
shock hazard, 119, 120, 121, 126, 132  
slide mount kit, 13  
specifications, 15  
  664xA, 16  
  665xA, 21  
  667xA, 26  
  668xA, 31  
  669xA, 36  
support rails, 44  
switch  
  CC loop compensation (668xA), 129, 132  
  line select for 664xA and 665xA, 119  
  line select for 667xA, 120  
  local sense (664xA/665xA), 51  
  local sense, 664xA and 665xA, 62

—T—

temperature performance, 44  
turn-on  
  checkout, 51  
  conditions, 92

—U—

unregulated operation, 92  
  664xA and 665xA, 63

667xA, 71

—V—

verification, 105  
  current monitor resistor, 105  
  current programming and readback, 108  
  equipment required, 105  
  test parameters for 664xA, 109  
  test parameters for 665xA, 111  
  test parameters for 667xA, 113  
  test parameters for 668xA, 115  
  test parameters for 669xA, 117  
  test setup, 106  
  voltage programming and readback, 107  
verification tests, 51  
voltage control, 14, 53, 87  
voltage programming, 89  
voltage sensing. *See* local voltage sensing or remote voltage sensing

—W—

warning. *See* safety warning  
warranty, 2  
wire  
  current ratings, 59  
wiring considerations, 59

# Agilent Sales and Support Offices

For more information about Agilent Technologies test and measurement products, applications, services, and for a current sales office listing, visit our web site: <http://www.agilent.com/find/tmdir>

You can also contact one of the following centers and ask for a test and measurement sales representative.

## **United States:**

Agilent Technologies  
Test and Measurement Call Center  
P.O. Box 4026  
Englewood, CO 80155-4026  
(tel) 1 800 452 4844

## **Latin America:**

Agilent Technologies  
Latin American Region Headquarters  
5200 Blue Lagoon Drive, Suite #950  
Miami, Florida 33126  
U.S.A.  
(tel) (305) 267 4245  
(fax) (305) 267 4286

## **Canada:**

Agilent Technologies Canada Inc.  
5150 Spectrum Way  
Mississauga, Ontario  
L4W 5G1  
(tel) 1 877 894 4414

## **Australia/New Zealand:**

Agilent Technologies Australia Pty Ltd  
347 Burwood Highway  
Forest Hill, Victoria 3131  
(tel) 1-800 629 485 (Australia)  
(fax) (61 3) 9272 0749  
(tel) 0 800 738 378 (New Zealand)  
(fax) (64 4) 802 6881

## **Europe:**

Agilent Technologies  
Test & Measurement European Marketing Organisation  
P.O. Box 999  
1180 AZ Amstelveen  
The Netherlands  
(tel) (31 20) 547 9999

## **Asia Pacific:**

Agilent Technologies  
24/F, Cityplaza One, 1111 King's Road,  
Taikoo Shing, Hong Kong  
tel: (852)-3197-7777  
fax: (852)-2506-9284

## **Japan:**

Agilent Technologies Japan Ltd.  
Measurement Assistance Center  
9-1, Takakura-Cho, Hachioji-Shi,  
Tokyo 192-8510, Japan  
(tel) (81) 426 56 7832  
(fax) (81) 426 56 7840

Technical data is subject to change.

## Manual Updates

The following updates have been made to this manual since the original print date.

3/01/02

All references to the front panel Check Fuses LED on series 668xA have been removed.

5/01/02

Additional information has been added about Power Cord options.

The CC rms noise specification for series 668xA and 669xA is categorized as a supplemental characteristics.

Additional information has been added under External Voltage Control for series 664xA and 665xA.

11/06/02

Information has been added to the Safety summary page and Section 2 to comply with EN61010 regulations.

3/11/04

The ac input ratings and fuse information for Series 664xA has been updated as per IEC 61010-1 requirements throughout the manual. The Declarations of Conformity for all models have been updated.

7/16/04

A note has been added to the specifications on pages 16 and 21.

The Declarations of Conformity for all models have been updated.

1/24/05

The ac input ratings information for Series 667xA, 668xA and 669xA has been updated.

1/26/07

The power cord installation procedure for Series 669xA has been updated. Line cord Option 841 is deleted. A typo has been fixed on the transient response spec for Series 667xA.

9/02/09

A URL has been added to the declarations pages to obtain the latest declaration of conformity.

Serial number information has been updated under “Instrument Identification”.

Information about Line Voltage Conversion Kits for models 668xA and 669xA has been added to chapter 1 under “Accessories” and to Appendix C under “Series 668xA/669xA Power Supplies”.

The RF field annotation note has been removed from Table 1-1a. and Table 1-2a.

The power cord installation procedure for Series 668xA and Series 669xA has been updated.

Figure D-5 has been updated.

1/25/12

Option 601 is obsolete and has been removed from the manual.