

***USER'S GUIDE***  
**Agilent Technologies**  
**Model 66319B/D, 66321B/D**  
**Mobile Communications DC Source**

**Featuring programmable output resistance**  
(Refer to page 18 for a brief description of the model differences.)

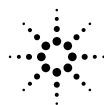

**Agilent Technologies**

---

# Warranty Information

## CERTIFICATION

*Agilent Technologies certifies that this product met its published specifications at time of shipment from the factory. Agilent Technologies further certifies that its calibration measurements are traceable to the United States National Bureau of Standards, to the extent allowed by the Bureau's calibration facility, and to the calibration facilities of other International Standards Organization members.*

## WARRANTY

This Agilent Technologies hardware product is warranted against defects in material and workmanship for a period of one year from date of delivery. Agilent Technologies software and firmware products, which are designated by Agilent Technologies for use with a hardware product and when properly installed on that hardware product, are warranted not to fail to execute their programming instructions due to defects in material and workmanship for a period of 90 days from date of delivery. During the warranty period Agilent Technologies will, at its option, either repair or replace products which prove to be defective. Agilent does not warrant that the operation for the software firmware, or hardware shall be uninterrupted or error free.

For warranty service, with the exception of warranty options, this product must be returned to a service facility designated by Agilent Technologies. Customer shall prepay shipping charges by (and shall pay all duty and taxes) for products returned to Agilent Technologies for warranty service. Except for products returned to Customer from another country, Agilent Technologies shall pay for return of products to Customer.

Warranty services outside the country of initial purchase are included in Agilent Technologies' product price, only if Customer pays Agilent Technologies international prices (defined as destination local currency price, or U.S. or Geneva Export price).

If Agilent is unable, within a reasonable time to repair or replace any product to condition as warranted, the Customer shall be entitled to a refund of the purchase price upon return of the product to Agilent Technologies.

## LIMITATION OF WARRANTY

The foregoing warranty shall not apply to defects resulting from improper or inadequate maintenance by the Customer, Customer-supplied software or interfacing, unauthorized modification or misuse, operation outside of the environmental specifications for the product, or improper site preparation and maintenance. NO OTHER WARRANTY IS EXPRESSED OR IMPLIED. AGILENT TECHNOLOGIES SPECIFICALLY DISCLAIMS THE IMPLIED WARRANTIES OF MERCHANTABILITY AND FITNESS FOR A PARTICULAR PURPOSE.

## EXCLUSIVE REMEDIES

THE REMEDIES PROVIDED HEREIN ARE THE CUSTOMER'S SOLE AND EXCLUSIVE REMEDIES. AGILENT SHALL NOT BE LIABLE FOR ANY DIRECT, INDIRECT, SPECIAL, INCIDENTAL, OR CONSEQUENTIAL DAMAGES, WHETHER BASED ON CONTRACT, TORT, OR ANY OTHER LEGAL THEORY.

## ASSISTANCE

The above statements apply only to the standard product warranty. Warranty options, extended support contacts, product maintenance agreements and customer assistance agreements are also available. Contact your nearest Agilent Technologies Sales and Service office for further information on Agilent Technologies' full line of Support Programs.

---

# Safety Summary

*The following general safety precautions must be observed during all phases of operation of this instrument. Failure to comply with these precautions or with specific warnings elsewhere in this manual violates safety standards of design, manufacture, and intended use of the instrument. Agilent Technologies assumes no liability for the customer's failure to comply with these requirements.*

## GENERAL

This product is a Safety Class 1 instrument (provided with a protective earth terminal). The protective features of this product may be impaired if it is used in a manner not specified in the operation instructions.

Any LEDs used in this product are Class 1 LEDs as per IEC 825-1.

This ISM device complies with Canadian ICES-001. Cet appareil ISM est conforme à la norme NMB-001 du Canada.

## ENVIRONMENTAL CONDITIONS

This instrument is intended for indoor use in an installation category II, pollution degree 2 environment. It is designed to operate at a maximum relative humidity of 95% and at altitudes of up to 2000 meters. Refer to the specifications tables for the ac mains voltage requirements and ambient operating temperature range.

## BEFORE APPLYING POWER

Verify that the product is set to match the available line voltage, the correct fuse is installed, and all safety precautions are taken. Note the instrument's external markings described under "Safety Symbols".

## GROUND THE INSTRUMENT

To minimize shock hazard, the instrument chassis and cover must be connected to an electrical ground. The instrument must be connected to the ac power mains through a grounded power cable, with the ground wire firmly connected to an electrical ground (safety ground) at the power outlet. Any interruption of the protective (grounding) conductor or disconnection of the protective earth terminal will cause a potential shock hazard that could result in personal injury.

**ATTENTION: Un circuit de terre continu est essentiel en vue du fonctionnement sécuritaire de l'appareil. Ne jamais mettre l'appareil en marche lorsque le conducteur de mise ... la terre est d,branch,.**

## FUSES

Only fuses with the required rated current, voltage, and specified type (normal blow, time delay, etc.) should be used. Do not use repaired fuses or short-circuited fuseholders. To do so could cause a shock or fire hazard.

**Vous devrez impérativement utiliser des fusibles calibrés aux spécifications de courant, tension et type (coupure, délai de coupure, etc ...). N'utilisez jamais de fusibles réparés et ne court-circuitiez pas les supports de fusibles. Sinon, vous risquez de provoquer un choc électrique ou un incendie.**

## DO NOT OPERATE IN AN EXPLOSIVE ATMOSPHERE

Do not operate the instrument in the presence of flammable gases or fumes.

## DO NOT REMOVE THE INSTRUMENT COVER

Operating personnel must not remove instrument covers. Component replacement and internal adjustments must be made only by qualified service personnel.

*Instruments that appear damaged or defective should be made inoperative and secured against unintended operation until they can be repaired by qualified service personnel.*

## SAFETY SYMBOLS



Direct current



Alternating current



Both direct and alternating current



Three-phase alternating current



Earth (ground) terminal



Protective earth (ground) terminal



Frame or chassis terminal



Terminal is at earth potential. Used for measurement and control circuits designed to be operated with one terminal at earth potential.



Terminal for Neutral conductor on permanently installed equipment



Terminal for Line conductor on permanently installed equipment



On (supply)



Off (supply)



Standby (supply). Units with this symbol are not completely disconnected from ac mains when this switch is off. To completely disconnect the unit from ac mains, either disconnect the power cord or have a qualified electrician install an external switch.



In position of a bi-stable push control



Out position of a bi-stable push control



Caution, risk of electric shock



Caution, hot surface



Caution (refer to accompanying documents)

### **WARNING**

The **WARNING** sign denotes a hazard. It calls attention to a procedure, practice, or the like, which, if not correctly performed or adhered to, could result in personal injury. Do not proceed beyond a **WARNING** sign until the indicated conditions are fully understood and met.

### **Caution**

The **CAUTION** sign denotes a hazard. It calls attention to an operating procedure, or the like, which, if not correctly performed or adhered to, could result in damage to or destruction of part or all of the product. Do not proceed beyond a **CAUTION** sign until the indicated conditions are fully understood and met.



**Manufacturer's Name and Address**

Responsible Party

Agilent Technologies, Inc.  
550 Clark Drive, Suite 101  
Budd Lake, New Jersey 07828  
USA

Alternate Manufacturing Site

Agilent Technologies (Malaysia) Sdn. Bhd  
Malaysia Manufacturing  
Bayan Lepas Free Industrial Zone, PH III  
11900 Penang,  
Malaysia

Declares under sole responsibility that the product as originally delivered

**Product Names** a) Mobile Communications DC Source  
b) System DC Power Supply

**Model Numbers** a) 66332A, 66312A, 66311B, 66311D  
66309B, 66309D, 66319B, 66319D, 66321B, 66321D  
b) 6631B, 6632B, 6633B, 6634B 6611C  
6612C, 6613C, 6614C

**Product Options** This declaration covers all options and customized products based on the above products.

Complies with the essential requirements of the Low Voltage Directive 73/23/EEC and the EMC Directive 89/336/EEC (including 93/68/EEC) and carries the CE Marking accordingly.

**EMC Information** ISM Group 1 Class A Emissions

As detailed in Electromagnetic Compatibility (EMC), Certificate of Conformance Number CC/TCF/00/030 based on Technical Construction File (TCF) HPNJ8, dated Apr. 25, 2000

Assessed by: Celestica Ltd, Appointed Competent Body  
Westfields House, West Avenue  
Kidsgrove, Stoke-on-Trent  
Staffordshire, ST7 1TL  
United Kingdom

**Safety Information** and Conforms to the following safety standards.

IEC 61010-1:2001 / EN 61010-1:2001  
Canada: CSA C22.2 No. 1010.1:1992  
UL 61010B-1: 2003

This DoC applies to above-listed products placed on the EU market after:

January 1, 2004

Date

Bill Darcy/ Regulations Manager

For further information, please contact your local Agilent Technologies sales office, agent or distributor, or *Agilent Technologies Deutschland GmbH, Herrenberger Straße 130, D71034 Böblingen, Germany*

---

## Acoustic Noise Information

### Herstellerbescheinigung

Diese Information steht im Zusammenhang mit den Anforderungen der Maschinenläminformationsverordnung vom 18 Januar 1991.

- \* Schalldruckpegel  $L_p < 70$  dB(A)
- \* Am Arbeitsplatz
- \* Normaler Betrieb
- \* Nach EN 27779 (Typprüfung).

### Manufacturer's Declaration

This statement is provided to comply with the requirements of the German Sound Emission Directive, from 18 January 1991.

- \* Sound Pressure  $L_p < 70$  dB(A)
- \* At Operator Position
- \* Normal Operation
- \* According to EN 27779 (Type Test).

---

## Printing History

The edition and current revision of this manual are indicated below. Reprints of this manual containing minor corrections and updates may have the same printing date. Revised editions are identified by a new printing date. A revised edition incorporates all new or corrected material since the previous printing date.

Changes to the manual occurring between revisions are covered by change sheets shipped with the manual. In some cases, the manual change applies only to specific instruments. Instructions provided on the change sheet will indicate if a particular change applies only to certain instruments.

This document contains proprietary information protected by copyright. All rights are reserved. No part of this document may be photocopied, reproduced, or translated into another language without the prior consent of Agilent Technologies. The information contained in this document is subject to change without notice.

© Copyright 2000, 2001, 2003, 2005, 2008 Agilent Technologies, Inc. Edition 1 \_\_\_\_ May, 2000  
Update 1 \_\_\_\_ January, 2001  
Update 2 \_\_\_\_ May, 2003  
Update 3 \_\_\_\_ February, 2005  
Update 4 \_\_\_\_ September, 2008

---

# Table of Contents

Warranty Information	2
Safety Summary	3
Declaration Page	5
Acoustic Noise Information	6
Printing History	6
Table of Contents	7
<b>1 - QUICK REFERENCE</b>	<b>9</b>
The Front Panel - At a Glance	9
The Rear Panel - At a Glance	10
Instrument Configuration	10
Front Panel Number Entry	11
Front Panel Annunciators	12
Immediate Action Keys	12
Front Panel Menus - At a Glance	13
SCPI Programming Commands - At a Glance	14
<b>2 - GENERAL INFORMATION</b>	<b>15</b>
Document Orientation	15
Safety Considerations	16
Options and Accessories	16
Description and Model Differences	17
Option 521 Description (Agilent 66319B/D only)	21
<b>3 - INSTALLATION</b>	<b>23</b>
Installation and Operation Checklist	23
Inspection	24
Location	25
Input Connections	26
Output Connections	26
DVM Connections	34
External Protection and Trigger Input Connections	36
Digital I/O Connections	38
Computer Connections	38
<b>4 - TURN-ON CHECKOUT</b>	<b>39</b>
Checkout Procedure	39
In Case of Trouble	41
<b>5 - FRONT PANEL OPERATION</b>	<b>43</b>
Introduction	43
Front Panel Description	43
System Keys	45
Function Keys	46
Entry Keys	49
Examples of Front Panel Programming	50
<b>6 - INTRODUCTION TO PROGRAMMING</b>	<b>59</b>
External References	59
VXIplug&play Power Products Instrument Drivers	60
GPIB Capabilities of the DC Source	61
Introduction to SCPI	61
Types of SCPI Commands	62

Types of SCPI Messages	63
SCPI Data Formats	65
SCPI Command Completion	66
Using Device Clear	66
SCPI Conformance Information	67
<b>7 - PROGRAMMING THE DC SOURCE</b>	<b>69</b>
Introduction	69
Programming the Output	69
Triggering Output Changes	71
Making Basic Measurements	73
Making Enhanced Measurements	74
Making DVM Measurements	77
Triggered Measurements	78
Programming the Status Registers	82
Inhibit/Fault Indicator	87
<b>8 - LANGUAGE DICTIONARY</b>	<b>89</b>
Introduction	89
Calibration Commands	94
Display Commands	97
Measurement Commands	98
Output Commands	108
Status Commands	117
System Commands	121
Trigger Commands	122
Common Commands	130
<b>A - SPECIFICATIONS</b>	<b>137</b>
Specifications	137
Supplemental Characteristics	138
<b>B - PERFORMANCE, CALIBRATION, AND CONFIGURATION</b>	<b>141</b>
Introduction	141
Equipment Required	141
Measurement Techniques	142
Performance Tests	143
Constant Voltage (CV) Tests	144
Constant Current (CC) Tests	146
Resistance Tests	150
DVM Tests	151
Performance Test Equipment Form	151
Performance Test Record Form	152
Performing the Calibration Procedure	154
Performing the Configuration Procedure	159
<b>C - ERROR MESSAGES</b>	<b>161</b>
Error Number List	161
<b>D - EXAMPLE PROGRAMS</b>	<b>165</b>
Pulse Measurements	165
<b>E - LINE VOLTAGE CONVERSION</b>	<b>171</b>





## Quick Reference

### The Front Panel - At a Glance

**1** A 14-character display shows output measurements and programmed values.

**2** Annunciators indicate operating modes and status conditions.

**3** Rotary control sets voltage, current, and menu parameters.

Use  and  to set the resolution; then adjust the value with the knob.

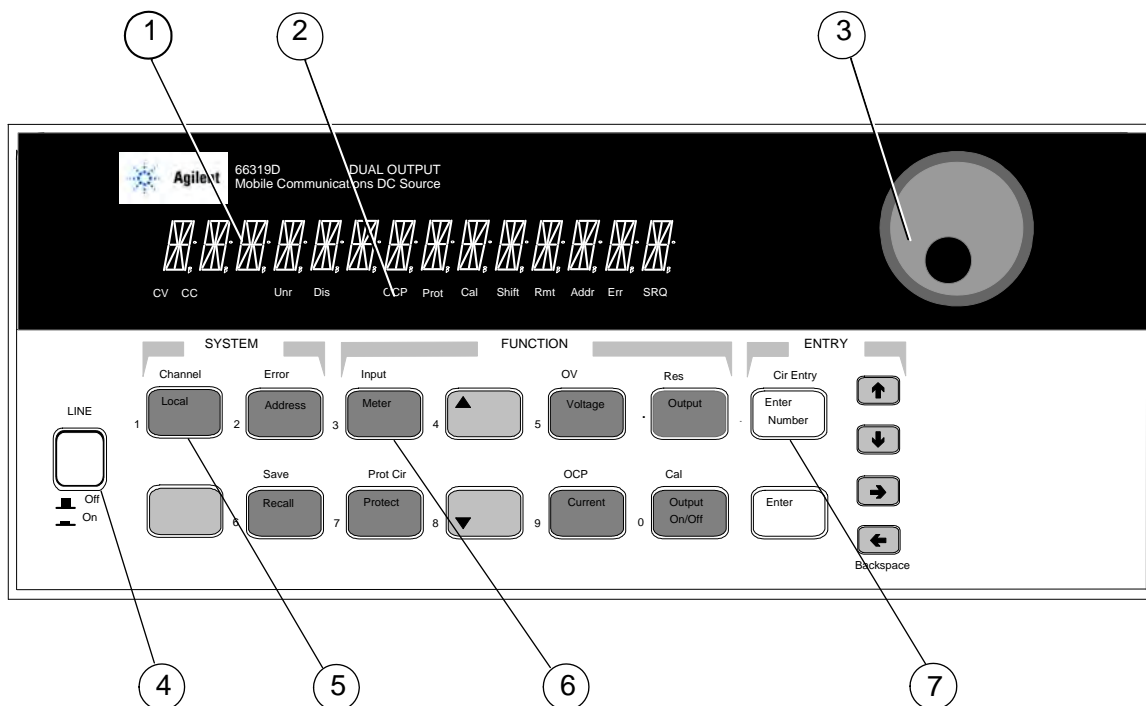



**4** Turns the dc source on and off.





**5** System keys:

- ◆ return to Local mode
- ◆ select output channel
- ◆ set GPIB address
- ◆ display SCPI error codes
- ◆ save and recall instrument states
- ◆ display firmware revision and serial number.

**6** Function keys:

- ◆ enable/disable the output
- ◆ select metering functions
- ◆ program voltage and current
- ◆ set and clear protection functions
- ◆  and  scroll through the front panel menu commands.

**7** Entry keys:

- ◆ enter values
- ◆ increment or decrement values
- ◆  and  select front panel menu parameters.
- ◆  and  select a digit in the numeric entry field.

## The Rear Panel - At a Glance

**1** DVM inputs.  
Connector plug is removable.

**2** GPIB (IEEE-488)  
interface connector.

**3** INH/FLT connector. Can  
be configured for Digital I/O  
and Trigger input. Connector  
plug is removable.

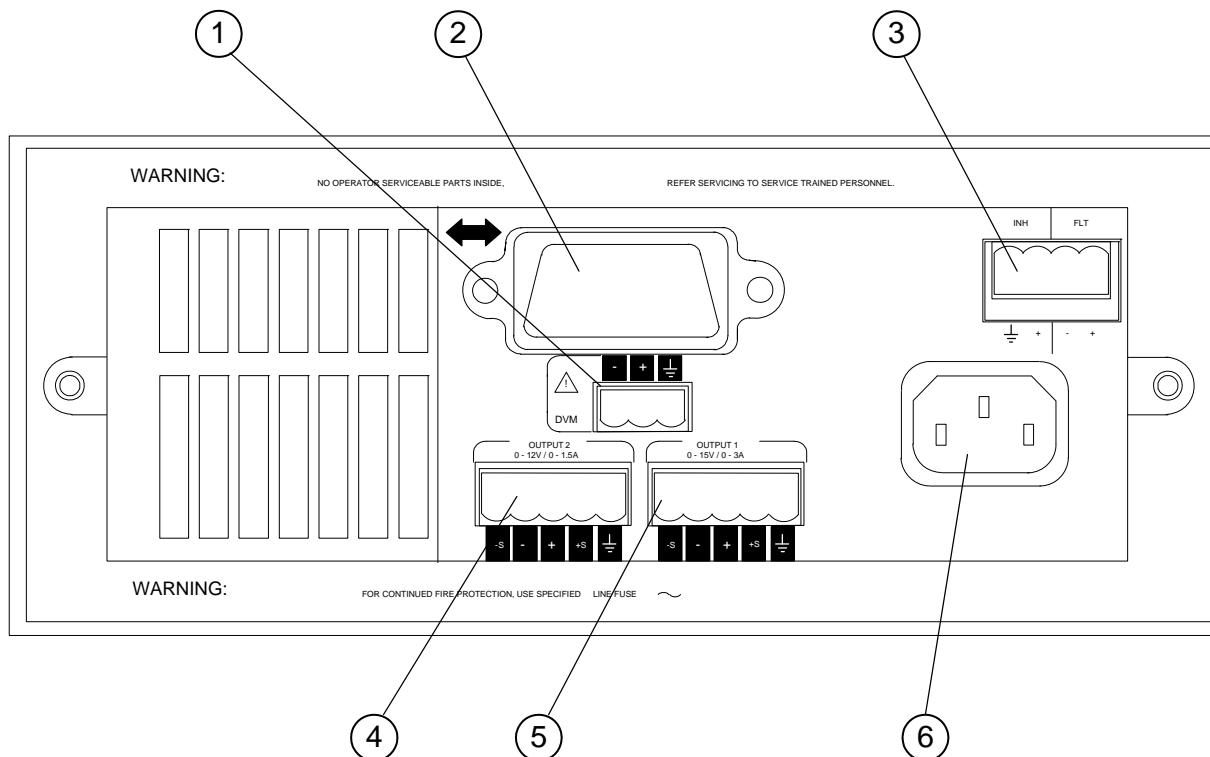

**4** Output 2 connector  
(Agilent 66319B/D only).  
Connector plug is removable.

**5** Output 1 connector.  
Connector plug is removable.  
**IMPORTANT:** Install this connector with  
its supplied sense jumpers before applying  
power to the unit.

**6** Power cord  
connector (IEC 320)

## Instrument Configuration

### Use the front panel Address key to configure the interface

Refer to “Front Panel Menus - At a Glance”

- ◆ Enter the GPIB bus address.
- ◆ Display the firmware revision and serial number.

## Front Panel Number Entry

Enter numbers from the front panel using **one** the following methods:

### Use the arrow keys and knob to change voltage or current settings

**NOTE:** The output must be ON to see the displayed values change in Meter mode. With the output enabled, this method changes the output voltage or current immediately.

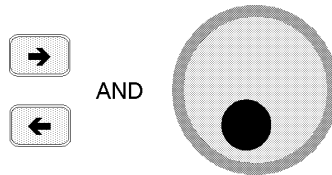

### Use the Function keys and knob to change the displayed settings

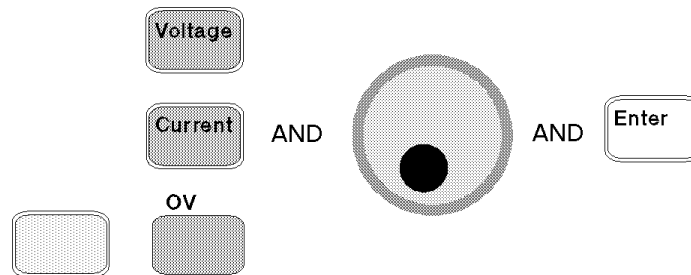

### Use the arrow keys to edit individual digits in the displayed setting

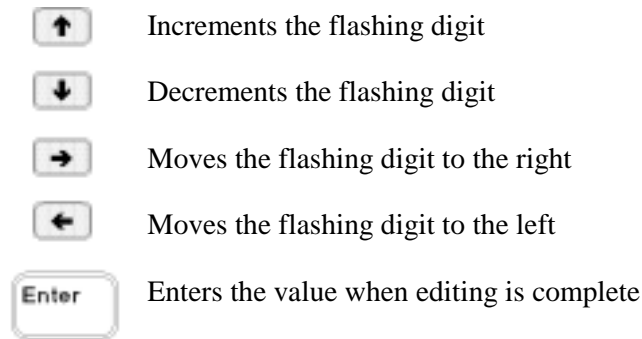

### Use the Function keys and Entry keys to enter a new value

**NOTE:** If you make a mistake, use the Backspace key to delete the number, or press the Meter key to return to meter mode.

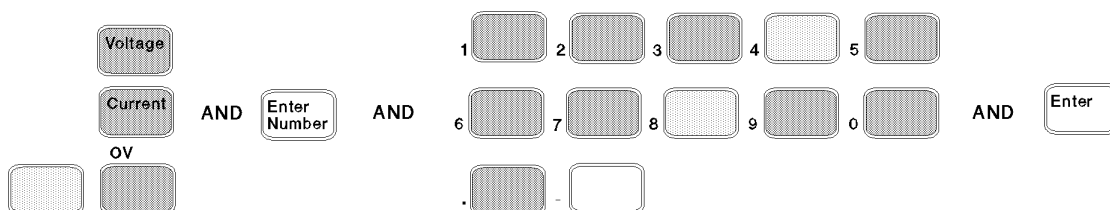





## Front Panel Annunciators



CV CC                      Unr Dis                      OCP Prot Cal Shift Rmt Addr Err SRQ

<b>CV</b>	Output 1 or output 2 is operating in constant voltage mode.
<b>CC</b>	Output 1 or output 2 is operating in constant current mode.
<b>Unr</b>	Output 1 or output 2 is unregulated.
<b>Dis</b>	The output is OFF. Press the Output On/Off key to turn the output on.
<b>OCP</b>	The over-current protection state is ON. Press the OCP key to turn over-current protection off.
<b>Prot</b>	Indicates that the output has been disabled by one of the protection features. Press the Prot Clear key to clear the protection condition.
<b>Cal</b>	Calibration mode is ON. Scroll to the Cal Off command and press the Enter key to exit the calibration mode.
<b>Shift</b>	The Shift key has been pressed.
<b>Rmt</b>	The remote programming interface is active. Press the Local key to return the unit to front panel control.
<b>Addr</b>	The interface is addressed to talk or listen.
<b>Err</b>	There is an error in the SCPI error queue. Press the Error key to view the error code.
<b>SRQ</b>	The interface is requesting service.

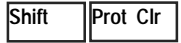
## Immediate Action Keys

	Toggles the output of the selected output between the ON and OFF states. When coupled, turns both output channels ON or OFF.
	Activates front panel control when the unit is in remote mode (unless a Lockout command is in effect).
	Resets the protection circuit and allows the unit to return to its last programmed state.
	A toggle switch that enables or disables overcurrent protection.

## Front Panel Menus - At a Glance

Address		<i>ADDRESS 7</i>	Sets the GPIB Address
	▼	<i>LANG SCPI</i>	Selects language (SCPI)
	▼	<i>ROM: A.00.00</i>	Displays the firmware revision of the instrument
	▼	<i>SN: US12345678</i>	Displays the serial number of the instrument
Recall		<i>*RCL 0</i>	Recalls the instrument state
Shift	Save	<i>*SAV 0</i>	Saves the present instrument state
Shift	Error	<i>ERROR 0</i>	Displays the number of errors in the SCPI error queue
Shift	Channel	<sup>2</sup> <i>5.000V 0.104A</i>	Toggles the display between output 1 and output 2 (output 2 shown)
Meter		<sup>1</sup> <i>12.000V <sup>1</sup> 0.204A</i>	Measures the output voltage and current (output 1 shown)
	▼	<i>12.500V MAX</i>	Measures the peak output voltage
	▼	<i>1.000V MIN</i>	Measures the minimum output voltage
	▼	<i>12.330V HIGH</i>	Measures the high level of a voltage pulse waveform
	▼	<i>0.080V LOW</i>	Measures the low level of a voltage pulse waveform
	▼	<i>12.000V RMS</i>	Measures the rms voltage
	▼	<i>0.350A MAX</i>	Measures the peak output current
	▼	<i>0.050A MIN</i>	Measures the minimum output current
	▼	<i>0.400A HIGH</i>	Measures the high level of a current pulse waveform
	▼	<i>0.012A LOW</i>	Measures the low level of a current pulse waveform
	▼	<i>0.210A RMS</i>	Measures the rms current
	▼	<i>12.000V DC:DVM</i>	Measures the dc voltage on the DVM input <sup>1</sup>
	▼	<i>12.000V RMS:DVM</i>	Measures the rms voltage on the DVM input <sup>1</sup>
Voltage		<sup>1</sup> <i>VOLT 12.000</i>	Sets the voltage of output 1 on all models
		<sup>2</sup> <i>VOLT 2.000</i>	Sets the voltage of output 2 <sup>2</sup>
Current		<sup>1</sup> <i>CURR 2.000</i>	Sets the current limit of output 1 on all models
		<sup>2</sup> <i>CURR 1.000</i>	Sets the current limit of output 2 <sup>2</sup>
Shift	Res	<sup>1</sup> <i>RES 1.000</i>	Sets the resistance of output 1 on all models
Protect		<i>OVERCURRENT</i>	Protection status (example shows overcurrent tripped)
Output		<i>*RST</i>	Places the dc source in the factory-default state
	▼	<i>COUPLING ALL</i>	Couples or decouples output 1 and output 2 (NONE or ALL) <sup>1</sup>
	▼	<i>COMP LLOCAL</i>	Sets the output compensation (HREMOTE, LREMOTE, HLOCAL or LLOCAL)
	▼	<i>PON:STATE RST</i>	Select the power-on state command (RST or RCL0)
	▼	<i>PROT:DLY 0.08</i>	Sets the output protection delay in seconds
	▼	<i>RI LATCHING</i>	Sets the remote inhibit mode (LATCHING, LIVE, or OFF)
	▼	<i>DFI OFF</i>	Sets the discrete fault indicator state (ON or OFF)
	▼	<i>DFI:SOUR OFF</i>	Selects the DFI source (QUES, OPER, ESB, RQS, or OFF)
	▼	<i>PORT RIDFI</i>	Sets the output port functions (RIDFI, DIGIO, or TRIGGER)
	▼	<i>DIGIO 7</i>	Sets and reads the I/O port value (0 through 7)
	▼	<i>SENSE:PROT OFF</i>	Enables or disables the open sense lead detect circuit (ON or OFF)
	▼	<sup>1</sup> <i>REL:MODE DD</i>	Sets the relay mode for Option 521 units (DD, HD, DH, or HH) (output 1 shown)
Shift	OV	<i>VOLT:PROT 10.000</i>	Sets the programmable voltage limit for output 1
	▼	<i>PROT:STAT ON</i>	Enables or disables overvoltage protection for output 1 (ON or OFF)
Shift	Input	<i>CURR:RANG MAX</i>	Sets the current range (3A, 1A, 0.02A, or AUTO)
	▼	<i>CURR:DET ACDC</i>	Sets the current measurement detector (ACDC or DC)
	▼	<i>TINT 46.8</i>	Sets the time interval for a front panel measurement in seconds
	▼	<i>POINT 2048</i>	Sets the buffer size for a front panel measurement
Shift	Cal	<i>CAL ON</i>	Accesses calibration menu (See Appendix B)

Use ▼ and ▲ to select parameters (table shows factory defaults). Use Meter to exit any menu.

<sup>1</sup>Only valid for Agilent Model 66319B/D

<sup>2</sup>Only valid for Agilent Model 66321D/66319D

## SCPI Programming Commands - At a Glance

**NOTE:** Some [optional] commands have been included for clarity. Refer to chapter 8 for a complete description of all programming commands.

### ABORT

#### CALibrate

```
:CURRent [:POSitive]
      :MEASure :LOWRange
      :R3
      :AC

:CURRent2 1
:DATA <n>
:DATE <date>
:DVM 2
:LEVel P1 | P2
:PASSword <n>
:RESistance
:SAVE
:STATe <bool> [, <n>]
:VOLTage [:DC]
:VOLTage2 1
```

#### DISPlay

```
<bool>
:CHANnel <channel> 1
:MODE NORMal | TEXT
:TEXT <display_string>
```

#### FORMat

```
[:DATA] ASCII | REAL [,length]
:BORDer NORM | SWAP
```

#### INITiate

```
:SEQuence[1|2]
:NAME TRANSient | ACQuire
:CONTinuous :SEQuence[1], <bool>
      :NAME TRANSient, <bool>
```

#### INSTRument

```
:COUPling:OUTPut:STATe NONE | ALL 1
```

#### MEASure

```
:CURRent2 [:DC]? 1
:VOLTage2 [:DC]? 1
```

#### MEASure | FETCh

```
:ARRay :CURRent?
      :VOLTage?
[:CURRent] [:DC]?
      :ACDC?
      :HIGH?
      :LOW?
      :MAX?
      :MIN?
:DVM [:DC]? 2
      :ACDC? 2
:VOLTage [:DC]?
      :ACDC?
      :HIGH?
      :LOW?
      :MAX?
      :MIN?
```

#### OUTPut [1|2]

```
<bool>
:COMPensation :MODE LLOCAL | HLOCAL | LREMOTE | HREMOTE
:DFI <bool>
      :SOURce QUES | OPER | ESB | RQS | OFF
:PON :STATe RST | RCL0
:PROTection :CLEar
      :DELay <n>
:RELay :MODE DD | HD | DH | HH 1
:RI :MODE LATCHing | LIVE | OFF
```

### SENSE

```
:CURRent :RANGe <n>
      :DETector ACDC | DC
:FUNCTion "VOLT" | "CURR" | "DVM"
:LEAD :STATus?
:PROTection :STATe <bool>
:SWEEp :OFFSet :POINTS <n>
      :POINTS <n>
      :TINTerval <n>
:WINDow :TYPE "HANN" | "RECT"
```

#### [SOURce:]

```
CURRent <n>
      :TRIGgered <n>
      :PROTection :STATe <bool>
CURRent2 <n> 1
      :TRIGgered <n> 1
DIGital :DATA <n>
      :FUNCTion RIDF | DIG | TRIG
RESistance <n>
      :TRIGgered <n>
VOLTage <n>
      :TRIGgered <n>
      :PROTection <n>
      :STATe <bool>
VOLTage2 <n> 1
      :TRIGgered <n> 1
```

#### STATus

```
:PRESet
:OPERation [:EVENT]?
      :CONDition?
      :ENABle <n>
      :NTRansition <n>
      :PTRansition <n>
:QUEStionable [:EVENT]?
      :CONDition?
      :ENABle <n>
      :NTRansition <n>
      :PTRansition <n>
```

#### SYSTEM

```
:ERRor?
:LANGuage SCPI
:VERSion?
```

#### TRIGger

```
:SEQuence2] :ACQuire [:IMMediate]
      :COUNT :CURRent <n>
      :DVM <n> 2
      :VOLTage <n>
      :HYSTEResis:CURRent <n>
      :DVM <n> 2
      :VOLTage <n>
:LEVel :CURRent <n>
      :DVM <n> 2
      :VOLTage <n>
:SLOPe :CURRent POS | NEG | EITH
      :DVM POS | NEG | EITH 2
      :VOLTage POS | NEG | EITH
:SOURce BUS | INT | EXT
[:SEQuence1] :TRANSient[:IMMediate]
      :SOURce BUS
:SEQuence1 :DEFine TRANSient
:SEQuence2 :DEFine ACQuire
```

<sup>1</sup> Only valid for Agilent 66319B/D    <sup>2</sup> Only valid for 66321D/66319D

## General Information

### Document Orientation

This manual describes the operation of the Agilent Model 66321B/D Mobile Communications and the Agilent Model 66319B/D Dual Output DC Source. Agilent Models 66321D and 66319D have an additional DVM measurement input on the rear panel. Unless otherwise noted, all models will be referred to by the description "dc source" throughout this manual.

The following Getting Started Map will help you find the information you need to complete the specific task that you want to accomplish. Refer to the table of contents or index of each guide for a complete list of the information contained within.

#### Getting Started Map

Task	Where to find information
<b>Quick Reference Section</b>	Chapter 1
<b>General information</b> Model differences Capabilities and characteristics	Chapter 2
<b>Installing the unit</b> Line connections Computer connections Load connections	Chapter 3
<b>Checking out the unit</b> Verifying proper operation Using the front panel Calibrating the unit	Chapter 4
<b>Using the front panel</b> Front panel keys Front panel examples	Chapter 5
<b>Using the programming interface</b> GPIB interface	Chapter 6
<b>Programming the unit using SCPI commands</b> SCPI commands SCPI programming examples SCPI language dictionary	Chapters 7 and 8
<b>Installing the VXIplug&amp;play instrument driver</b>  <b>NOTE:</b> The driver must be installed on your pc to access the on-line information. Drivers are available on the web at <a href="http://www.agilent.com/find/drivers">www.agilent.com/find/drivers</a> .	Chapter 6

## Safety Considerations

This dc source is a Safety Class 1 instrument, which means it has a protective earth terminal. That terminal must be connected to earth ground through a power source equipped with a ground receptacle. Refer to the Safety Summary page at the beginning of this guide for general safety information. Before installation or operation, check the dc source and review this guide for safety warnings and instructions. Safety warnings for specific procedures are located at appropriate places in the guide.

## Options and Accessories

**Table 2-1. Options**

Option	Description
100	87–106 Vac, 47–63 Hz
120	104–127 Vac, 47–63 Hz
220	191–233 Vac, 47–63 Hz
230	207–253 Vac, 47–63 Hz
8ZJ	Delete instrument feet option
004	Output compensation is factory set to HRemote mode for best transient response. (Refer to chapter 3, under "Output Compensation" for more information)
AXS <sup>1</sup>	Rack mount kit for two side-by-side units of equal depth. Consists of: Lock-link kit (p/n 5061-9694) and Flange kit (p/n 5062-3974)
1CM <sup>1</sup>	Rack mount kit for one unit (p/n 5062-3972)
521	Solid-state relays to connect and disconnect the output of the dc source (Agilent 66319B/D only). Provides the ability to either Hot-switch or Dry-switch the solid state relays.
053	Device characterization software for displaying current and voltage measurements.

<sup>1</sup>Support rails are required when rack mounting units. Use E3663A support rails for Agilent rack cabinets. If you are using non-Agilent rack cabinets, contact the rack manufacturer to obtain support rails for your cabinet.

**Table 2-2. Accessories**

Item	Part Number
GPIB cables 1.0 meter (3.3 ft) 2.0 meters (6.6 ft) 4.0 meters (13.2 ft) 0.5 meters (1.6 ft)	Agilent 10833A
	Agilent 10833B
	Agilent 10833C
	Agilent 10833D
Rack mount with slide - for two side-by-side units of different depths	5062-3996; 1494-0015
Rack mount - for two side by side units of different depths	5062-3996
Rack mount with slide - for one unit	5062-3996; 1494-0015; 5062-4022



## Description and Model Differences

### Agilent 66321B

The Agilent 66321B Mobile Communications DC Source is a high performance dc power source that provides peak current sourcing and rapid, basic measurements in a compact, half-rack box. It is designed to simplify the testing of digital wireless communications products. Excellent voltage transient response characteristics prevent test interruptions due to triggering of low voltage phone shutdown. The 15 volt source and 5A peak current capability provides compatibility with a number of communications standards, including: GSM, CDMA, TDMA, PCS, DECT, TERA, PHS, NADC, PHS, and others.

Additional capabilities include fast dynamic measurement and analysis of voltage and current waveforms combined with precision current measurement. This lets you characterize cellular phone current drain under all operating conditions. Programmable output resistance lets you emulate the effects of the internal resistance of a battery. Negative resistance programming lets you compensate for voltage drops that occur between the remote sense points and the phone terminals. Programmable output compensation lets you optimize the transient response for various wire lengths and phone capacitances. Figure 2-1 describes the output characteristic of the dc source.

### Agilent 66319B

The Agilent 66319B Mobile Communications DC Source includes all of the capabilities of the Agilent 66321B with the addition of a second, electrically-isolated output. Figure 2-2 describes output characteristic of this second output, which is primarily used to provide voltage or current for a charger input on the device under test. The second output has all of the basic programmable features as the main output, with the exception of the waveform measurement capability, open sense lead detect capability, resistance programming, overvoltage protection, and low and middle current measurement ranges.

### Agilent 66321D and 66319D

The Agilent 66321D and 66319D Mobile Communications DC Sources also contain an auxiliary DVM, with input terminals located on the rear panel. This provides limited, low voltage dc and ac measurement capability, which can be used to monitor test point voltages on the unit under test as well as on the test fixture. The common mode voltage range is from  $-4.5$  Vdc to  $+25$  Vdc relative to the minus terminal of output 1. The DVM is programmable from the front panel of the instrument as well as remotely using SCPI programming commands.

### Common Features

- ◆ Voltage, current, and resistance control with 12-bit programming resolution on output 1.
  - 3-ampere current source capability (up to 5 amperes for 7 milliseconds).
  - Output resistance programming capability from  $-40$  milliohm to 1 ohm.
  - Four output compensation modes for a variety of wiring configurations.
- ◆ Extensive measurement capability on output 1
  - dc voltage and current.
  - rms and peak voltage and current.
  - Three-range current measurement capability up to approximately 7.0 amperes.
  - 16-bit measurement resolution.

## 2 - General Information

- ❑ Triggered acquisition of digitized current and voltage waveforms
- ❑ External measurement trigger input on units with firmware revision A.03.01 and up
- ◆ Open sense lead protection on output 1.
- ◆ Automatic overvoltage protection tracking.
- ◆ Over-temperature, RI/DFI protection features, programmable voltage limit and current limit.
- ◆ Non-volatile state storage and recall with SCPI command language.
- ◆ User-configurable power-on/reset settings (see Appendix B).

**Table 2-3. Agilent Model Differences**

Item	66321B	66321D	66319B	66319D	66311B/D <sup>1</sup>	66309B/D <sup>1</sup>
0 - 1 A range current measurements (output 1)	YES	YES	YES	YES	NO	NO
0 - 20 mA range current measurements (output 1)	YES	YES	YES	YES	YES	YES
4-mode output compensation (output 1)	YES	YES	YES	YES	2 modes	2 modes
Auxiliary output (output2)	NO	NO	YES	YES	NO	YES
External DVM input	NO	YES	NO	YES	66311D only	66309D only
Output resistance programming (output 1)	YES	YES	YES	YES	NO	NO
Automatic overvoltage tracking (output 1)	YES	YES	YES	YES	NO	NO
Compatibility commands	NO	NO	NO	NO	YES	NO
External measurement trigger input <sup>2</sup>	YES	YES	YES	YES	NO	NO

<sup>1</sup>Earlier models not covered in this manual (order manual p/n 5964-8125)

<sup>2</sup>Available only on units with firmware revision A.03.01 and up

## Front Panel Controls

The front panel has both rotary and keypad controls for setting the output voltage and current. The panel display provides digital readouts of a number of output measurements. Annunciators display the operating status of the dc source. System keys let you perform system functions such as setting the GPIB address and recalling operating states. Front panel Function keys access the dc source function menus. Front panel Entry keys let you select and enter parameter values. Refer to chapter 5 for a complete description of the front panel controls.

## Remote Programming

---

**NOTE:** The dc sources described in this manual can only be programmed using the SCPI programming language.

---

The dc source may be remotely programmed via the GPIB bus. GPIB programming is with SCPI commands (Standard Commands for Programmable Instruments), which make dc source programs compatible with those of other GPIB instruments. Dc source status registers allow remote monitoring of a wide variety of dc source operating conditions. Refer to chapters 6 and 7 for more information. Chapter 8 is a language dictionary of all SCPI commands that can be used to program the dc source.

## Output 1 Characteristic

The dc source's main output (output 1) characteristic is shown in the following figure. The main output of the dc source may be adjusted to any value within the boundaries shown.

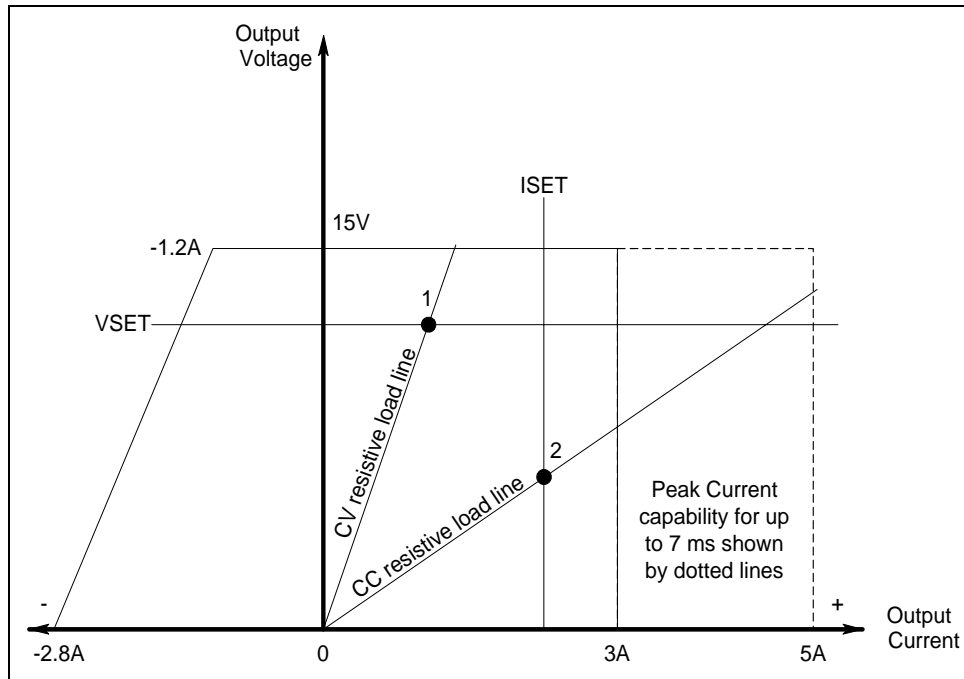

Figure 2-1. Dc Source Output 1 Characteristic

The dc source is capable of providing a constant dc output of 15 volts with up to 3 amperes of current. It is capable of sourcing peak currents of up to 5 amperes -- provided the peak current pulse does not exceed 7 milliseconds, and the *average* current requirement does not exceed 3 amperes. If the unit attempts to draw current for longer than 7 milliseconds, the current limit amplifier will limit the current to a maximum of 3.0712 amps. The peak current capability is illustrated by the dotted line in Figure 2-1.

**NOTE:** To source up to 5 amperes of current for up to 7 milliseconds, **the current limit must be programmed for greater than 3 amperes (up to a maximum of 3.0712 A).**

The dc source can operate in either constant voltage (CV) or constant current (CC) over the rated output voltage and current. Although the dc source can operate in either mode, it is designed as a *constant voltage* source. This means that the unit turns on in constant voltage mode with the output voltage rising to its  $V_{set}$  value. There is no command for constant current operation. The only way to turn the unit on in constant current mode is by placing a short across the output and then enabling or turning the output on.

Note that the dc source cannot be programmed to operate in a specific mode. After initial turn-on, the operating mode of the unit will be determined by the voltage setting, current setting, *and* the load resistance. In figure 2-1, operating point 1 is defined by the load line traversing the positive operating quadrant in the constant voltage region. Operating point 2 is defined by the load line traversing the positive operating quadrant in the constant current region.

Figure 2-1 also shows a single range – two quadrant capability. This means that the dc source is capable of sourcing as well as sinking current over the output voltage range from zero volts to the rated voltage. This negative current sinking capability provides fast downprogramming of the output of the dc source. It can also be used to sink current from a battery charger, thus providing battery charger test capability. The negative current is not programmable, and varies linearly from approximately 1.2 amperes at the full rated voltage, to approximately 2.8 amperes at zero output voltage.

**NOTE:** Operating the dc source beyond its output ratings may cause the output to become unregulated. This is indicated by the UNR annunciator on the front panel. The output may also become unregulated if the ac line voltage drops below the minimum rating specified in Appendix A.

### Programmable Output Resistance

Programmable output resistance lets you emulate the internal resistance of a cell phone battery, which causes the voltage at the phone to drop as the phone draws more current. Different types of phone batteries have different internal resistance values, which typically fall in a range of several hundred milliohms. The internal resistance of a phone battery also changes with age and the number of times the battery is recharged. Therefore, to evaluate the performance of a cell phone using various battery characteristics, use this feature to specify a desired battery resistance.

Alternatively, programmable output resistance can be used to keep the voltage at the phone terminals as constant as possible. In this case, you may program a *negative* output resistance. This compensates for any additional voltage drop in the load leads between the remote sense points and the phone terminals (see Figure 3-4). In phone test fixtures, the cell phone terminals may be located up to 50 centimeters away from the connector where the remote sense terminals of the dc source are connected. This results in a small voltage drop in the wires between the remote sense terminals and the phone terminals. If it is critical that the steady-state voltage at the phone terminals be equal to the programmed voltage of the dc source, a small negative output resistance can be programmed to compensate for this voltage drop.

### Output 2 Characteristic

As shown in the following figure, Agilent 66319B/D units have a second output rated at 12 V and 1.5A. The second output has all of the primary programmable features as the main output, with the exception of the waveform measurement capability, the open sense lead detect capability, overvoltage protection, and low current range.

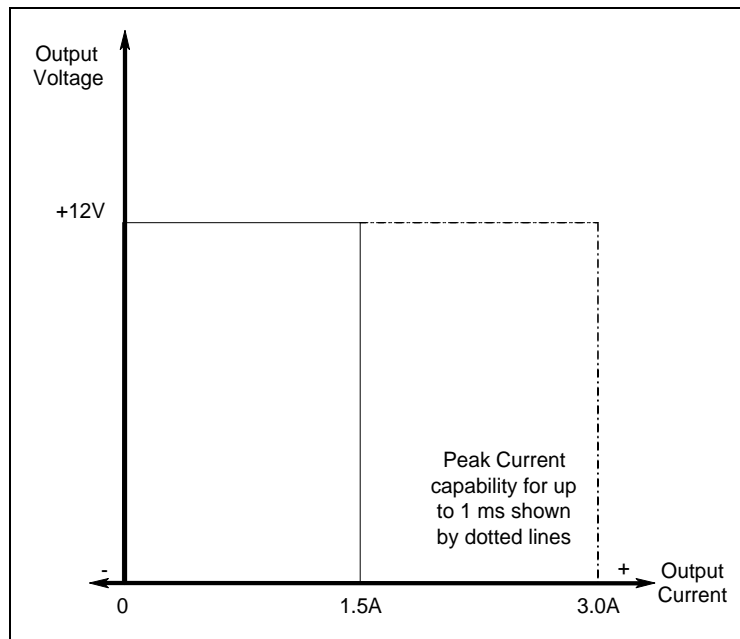

**Figure 2-2. Output 2 Characteristic**

Tables A-1 through A-3 document the specifications and supplemental characteristics of the Agilent dc sources documented in this manual.

## Option 521 Description (Agilent 66319B/D only)

Option 521 consists of the following enhancements to the output capabilities of Agilent models 66319B/66319D:

- ◆ **Solid-state relays to connect and disconnect the output of the dc source.**  
The relays are available on the output and sense terminals of outputs 1 and 2. When the solid state relays are open, the output impedance is effectively raised to about 500k ohms for output 1, and about 200k ohms for output 2. Note that the relays open only in response to an Output OFF command.
- ◆ **The ability to either Hot switch or Dry switch the solid state relays.**  
With Hot switching, the relays control the on/off characteristics of the voltage at the output terminals. With Dry switching, the power mesh controls the on/off characteristics of the voltage at the output terminals. In general, Hot switching activates the relays when current is flowing through them. Dry switching activates the relays when no current is flowing through them. You can specify different relay options for the Output ON and Output OFF commands. The following table describes the actions that occur based on the relay mode selection in response to the ON or OFF commands.

**Table 2-5. Option 521 Relay Modes**

Relay Mode	Output ON	Output OFF
<b>Dry (D)</b>	1. Closes the output relay 2. Closes the sense relay 3. Programs the output	1. Downprograms the output 2. Opens the sense relay 3. Opens the output relay
<b>Hot (H)</b>	1. Programs the power mesh 2. Closes the output relay 3. Closes the sense relay	1. Opens the sense relay 2. Opens the output relay 3. Downprograms the power mesh

The relay modes are stored in non-volatile memory. The last selected mode will be restored when the unit is turned on. When shipped from the factory, the relay mode for both output 1 and output 2 is set to Output ON Hot, Output OFF Hot (HH). The \*RST command has no effect on the relay mode.

- NOTES:**
- Even with open sense lead detection enabled, the dc source does not check for open sense leads when output 1 is enabled if the Output ON relay mode is set to Hot.
  - On output 1 and output 2, with the Output OFF relay mode set to Hot, any external output capacitors will not be downprogrammed or discharged. This is because the output relay opens prior to the downprogramming of the power mesh.
  - With either output 1 or output 2 disabled, the output voltage readback will not be correct. This is because the sense relay is open, effectively breaking the readback path. The voltage readback will be a small negative number.

**Table 2-6. Option 521 Factory Settings**

<b>Output Coupling</b>	None (outputs not coupled)
<b>Output Sense Protection</b>	Off
<b>Output Compensation</b>	HRemote
<b>Output 1 Relay Mode</b>	HH
<b>Output 2 Relay Mode</b>	HH



# Installation

---

## Installation and Operation Checklist

### Check the Output Compensation

**Check that the output compensation of the dc source** is appropriate for your application. Refer to “Output Compensation” in this chapter.

**HRemote** mode provides the best transient response and can be used with phones having input capacitances from 5 $\mu$ F to 12000 $\mu$ F. **Note** that if the last two digits on the front panel display are fluctuating when the phone is in standby, you may want to set the output compensation to a different mode.

**LLocal** mode offer the best stability with the lowest bandwidth.

### Check the Phone Connections

**If you ARE remote sensing, are the + and – sense leads connected ONLY at the test fixture and within 50 cm of the phone contacts?** For best performance, the distance from sense lead termination to the phone contacts should be as short as possible. Refer to “Remote Sense Connections” in this chapter.

**If you are NOT remote sensing, are the sense jumpers installed in the output connector?** Ensure that the output connector plug is installed in the unit with its supplied sense jumpers in place. Without sense jumpers, the unit goes into a protect state with the output disabled.

### Check the Operating Settings and Conditions

**Are you able to communicate remotely with the dc source?** If not, check that the address is set correctly. Refer to “GPIB Interface” in chapter 2.

**Is the Prot or Err annunciator on the front panel on?** If yes, clear the fault condition before continuing. Refer to “Clearing Output Protection” in chapter 5.

**Is the Overvoltage circuit shutting the unit down?** If yes, you can disable the overvoltage circuit. Refer to “Clearing Output Protection” in chapter 5.

**Is the output load regulation of the unit excessive?** If yes, make sure that the output resistance of the unit is set to zero ohms. Refer to “Output Resistance” in chapter 5.

### Check the Measurement Settings

**Are the front panel readings unstable?** If yes, check that the front panel sampling rate is correct. Also check the setting of the output compensation. Refer to “Making Front Panel Measurements” in chapter 5 and “Output Compensation” in this chapter.

**Are you measuring dynamic output currents?** If yes, check that the current detector is set to ACDC. Refer to “Making Front Panel Measurements” in chapter 5.

**Are you measuring output currents < 1 A or < 20 mA?** If yes, check that the current range is set appropriately. Refer to “Making Front Panel Measurements” in chapter 5.

---

## Inspection

### Damage

When you receive your dc source, inspect it for any obvious damage that may have occurred during shipment. If there is damage, notify the shipping carrier and the nearest Agilent Sales and Support Office immediately. The list of Agilent Sales and Support Offices is at the back of this guide. Warranty information is printed in the front of this guide.

### Packaging Material

Until you have checked out the dc source, save the shipping carton and packing materials in case the unit has to be returned. If you return the dc source for service, attach a tag identifying the owner's name and address, the model number, and a brief description of the problem.

### Items Supplied

The following user-replaceable items are included with your dc source. Some of these items are installed in the unit.

**Table 3-1. Items Supplied**

Item	Part Number	Description
Power Cord	contact the nearest Agilent Sales and Support Office	A power cord appropriate for your location.
Digital I/O connector	1252-1488	4-terminal digital plug for connecting digital I/O leads. The connector installs in the back of the unit.
Output connector	0360-2604	5-terminal output plug for connecting load and sense leads. This connector installs in the back of the unit.
DVM connector	1252-8670	3-terminal plug for DVM connections (66319B/D)
Sense jumpers	8120-8821	Jumpers that insert into output connector for local sensing. Connect +s to +, and –s to –.
Line Fuse	2110-0638 2110-0773	3.15 AT (time delay) for 100/120 Vac operation 1.6 AT (time delay) for 220/230 Vac operation
Feet	5041-8801	feet for bench mounting
User's Guide	5964-8125	This manual. Contains installation, checkout, front panel, and programming information.

### Cleaning

Use a dry cloth or one slightly dampened with water to clean the external case parts. Do not attempt to clean internally.

---

**WARNING:** To prevent electric shock, unplug the unit before cleaning.

---



## Location

Figure 3-1 gives the dimensions of your dc source. The dc source must be installed in a location that allows sufficient space at the sides and back of the unit for adequate air circulation (see Bench Operation).

**NOTE:** This dc source generates magnetic fields that may affect the operation of other instruments. If your instrument is susceptible to operating magnetic fields, do not locate it in the immediate vicinity of the dc source. Typically, at three inches from the dc source, the electromagnetic field is less than 5 gauss. Many CRT's, such as those used in computer displays, are susceptible to magnetic fields much lower than 5 gauss. Check susceptibility before mounting any display near the dc source.

## Bench Operation

### Do not block the fan exhaust at the rear of the unit.

A fan cools the dc source by drawing air in through the sides and exhausting it out the back. Minimum clearances for bench operation are 1 inch (25 mm) along the sides.

## Rack Mounting

The dc source can be mounted in a standard 19-inch rack panel or cabinet. Table 2-1 documents the part numbers for the various rack mounting options that are available for the dc source. Installation instructions are included with each rack mount option.

**NOTE:** Support rails or an instrument shelf is required when rack mounting units.

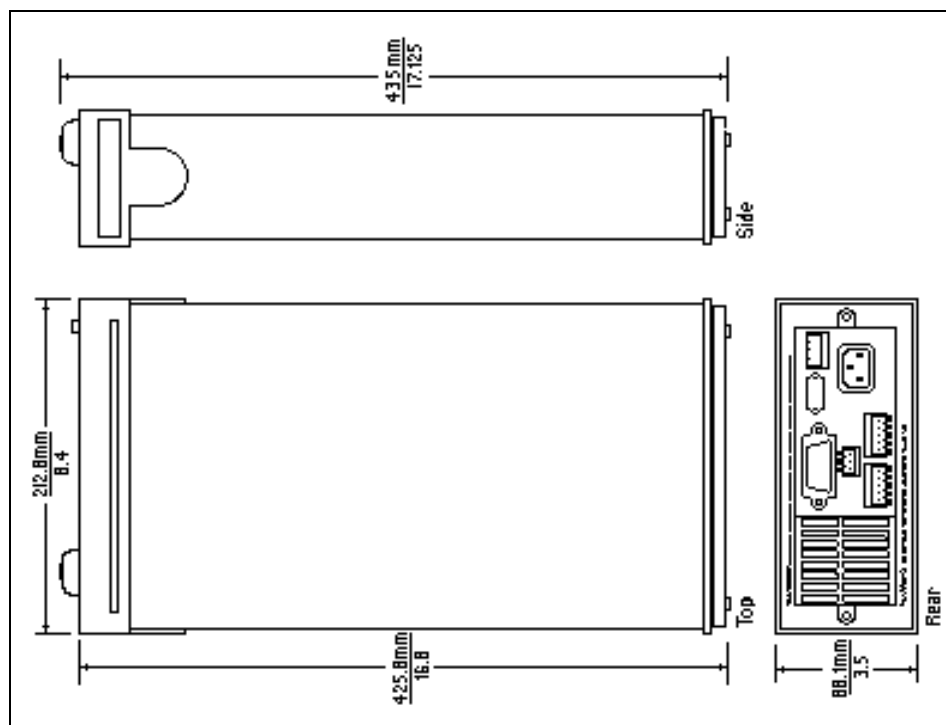

Figure 3-1. Outline Diagram

---

## Input Connections

### Connect the Power Cord

Connect the power cord to the IEC 320 connector on the rear of the unit. If the wrong power cord was shipped with your unit, contact your nearest Agilent Sales and Support Office to obtain the correct cord (refer to the list at the back of this guide).

Check the line voltage rating label on the back of the unit to make sure that it agrees with your ac mains voltage. Refer to appendix E if the voltage at your site is different from the voltage indicated on the unit.

---

## Output Connections

**Turn the unit off before connecting any wires.**

### Output 1

The main output connector (output 1) has a termination for the + and – output, the + and – sense terminals, and an earth ground terminal. The 5-pin connector is removable and accepts wires sizes from AWG 22 to AWG 12. Disconnect the mating plug from the unit by pulling it straight back.

---

**IMPORTANT:** You must connect the sense terminals on Output 1 for the unit to operate properly. Refer to the section on "Open Sense Lead Protection" in this chapter. Install the connector plug with its supplied sense jumpers *before* applying power to the unit. You cannot connect outputs in parallel. Instrument operation can become unstable.

---

### Output 2

Agilent 66319B/D units have a second output connector (output 2). It has the same configuration as the main output connector. It has a termination for the + and – output, the + and – sense terminals, and an earth ground terminal. The 5-pin connector is removable and accepts wires sizes from AWG 22 to AWG 12. Disconnect the mating plug from the unit by pulling it straight back. You must connect the sense terminals on Output 2 for the unit to meet its published specifications.

## Current Ratings

---

**Fire Hazard** To satisfy safety requirements, load wires must be large enough not to overheat when carrying the maximum short-circuit current of the dc source.

---

The following table lists the characteristics of AWG (American Wire Gage) copper wire.

**Table 3-2. Ampacity and Resistance of Stranded Copper Conductors**

AWG No.	Maximum Ampacity (in free air)	Resistance (at 20 deg. C)	
		$\Omega/m$	$\Omega/ft$
24	3.52	0.0843	0.0257
22	5.0	0.0531	0.0162
20	8.33	0.0331	0.0101
18	15.4	0.0210	0.00639
16	19.4	0.0132	0.00402
14	31.2	0.0083	0.00252
12	40	0.0052	0.00159

## Voltage Drops and Lead Resistance

To optimize the performance and transient response in your test system, please observe the following guidelines:

- ◆ Twist the load leads together and keep them short. The shorter the leads, the better the performance.
- ◆ When remote sensing, twist the sense leads together but do not bundle them in with the load leads.
- ◆ For best performance, keep the total cable length to the load to 20 ft or less when remote sensing. (Note that the unit has been tested with cable lengths of up to 40 feet.)

The load wires must also be of a diameter large enough to avoid excessive voltage drops due to the impedance of the wires. In general, if the wires are heavy enough to carry the maximum short circuit current without overheating, excessive voltage drops will not be a problem.

The maximum allowable value of load lead resistance is 4 ohms total (2 ohms per side). This may be further limited to a lower value, based on peak current loading, by the maximum allowable dc voltage drop of 8 volts total (4 volts per side) as specified for remote sense operation. To illustrate, for up to 3 amps peak, the maximum allowable resistance is 2.67 ohms total, resulting in a maximum voltage drop of up to 8 volts. For 5 amps peak the maximum allowable resistance is 1.6 ohms total, again resulting in a maximum allowable voltage drop of up to 8 volts.

In addition to keeping dc resistance low, you also need to minimize the total impedance. For higher slew rate currents (0.2 amps/ $\mu$ s) and long wiring lengths (10 to 20 ft.) the inductance can have as much effect as the resistance. To minimize inductance, twist the load leads. The inductance will be on the order of 0.25  $\mu$ H/ft if twisted, and 0.4  $\mu$ H/ft if untwisted. In addition to lowering the inductance, twisting the leads will reduce noise pick up. If you are using remote sense leads, connect these as a second twisted pair. Do not twist or bundle them with the load leads.

---

**NOTE:** The use of relays between the dc source and the phone also increases impedance. Low resistance relays will improve system performance.

---

## Remote Sense Connections

---

**NOTE:** You must use remote sensing on both Output 1 and Output 2 for the unit to operate properly and meet its published specifications. If you are **not** using output 1 and the open sense protection feature is turned **ON**, you must jumper the + output 1 pin to its + sense pin, and jumper the - output 1 pin to its - sense pin. Otherwise, the unit will go into a protected state and disable the output (unless open sense protection is turned **OFF**).

---

Testing has verified stable performance with up to 20 inches of lead length between the sense lead termination and the phone connection (see figure 3-4). However, for optimum performance, connect the sense leads as close as possible to the phone under test. To minimize inductance, connect the sense leads and load leads as separate twisted pairs (see figure 3-2).

Connect the sense leads carefully so that they do not become open-circuited. If the sense leads are left unconnected or become open during operation, the dc source will not regulate the output voltage. See "Open Sense Lead Protection".

### 3 - Installation

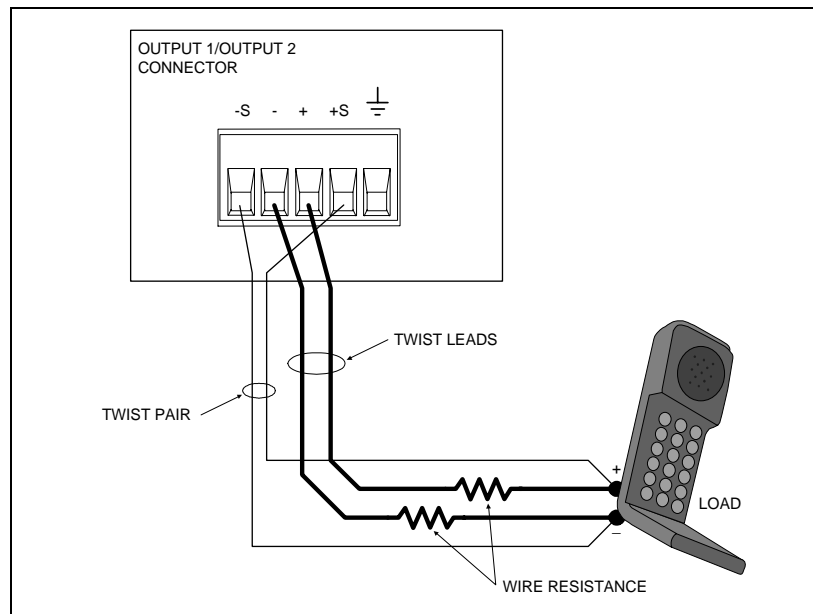

**Figure 3-2. Remote Sense Connections**

Connect the remote sense leads only to the remote sense connections at the output connector and at the location on the test fixture where you want to sense the output voltage. There must not be any continuity from the sense leads to earth ground or from the sense leads to the output leads other than at the test fixture. The open sense detect circuit will check for continuity in the sense leads when the output turned on (from disabled to enabled).

Figure 3-3 shows how to connect remote sense leads and load leads when external disconnect relays are included in the load path.

---

**NOTE:** In this arrangement, the output of the unit should be programmed OFF *before* the relays are switched. This is because if the load leads are opened before the sense leads, the overvoltage protection circuit will trip if it is enabled.

---

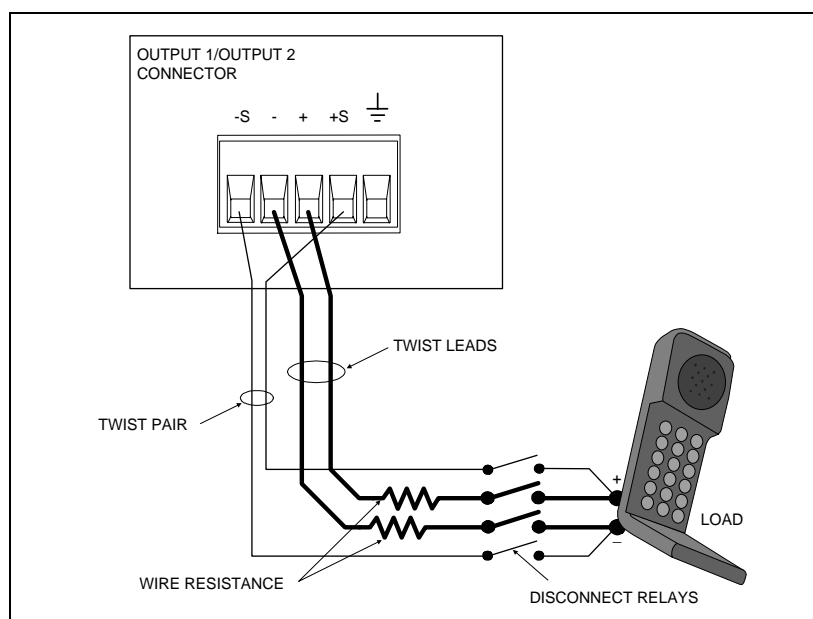

**Figure 3-3. Remote Sense Connections with External Relays**

Figure 3-4 shows how to connect remote sense leads when using a removable test fixture. Note that in this configuration, the wires in the part of the test fixture where the phone is located must be less than 50 cm (20 inches) in length. This is for stability as well as for the fact that the remote sense leads cannot compensate for the voltage drop in this part of the test fixture.

Programming a *negative* output resistance lets you compensate for the unsensed voltage drop in the load leads between the remote sense points and the phone terminals. First, you must measure or calculate the resistance of the wires between the test fixture and the phone terminals (see table 3-2). Then you can program the equivalent negative output resistance. This will compensate for the voltage drop in this short section of wire. Note that the maximum negative resistance that you can program is  $-40$  milliohms.

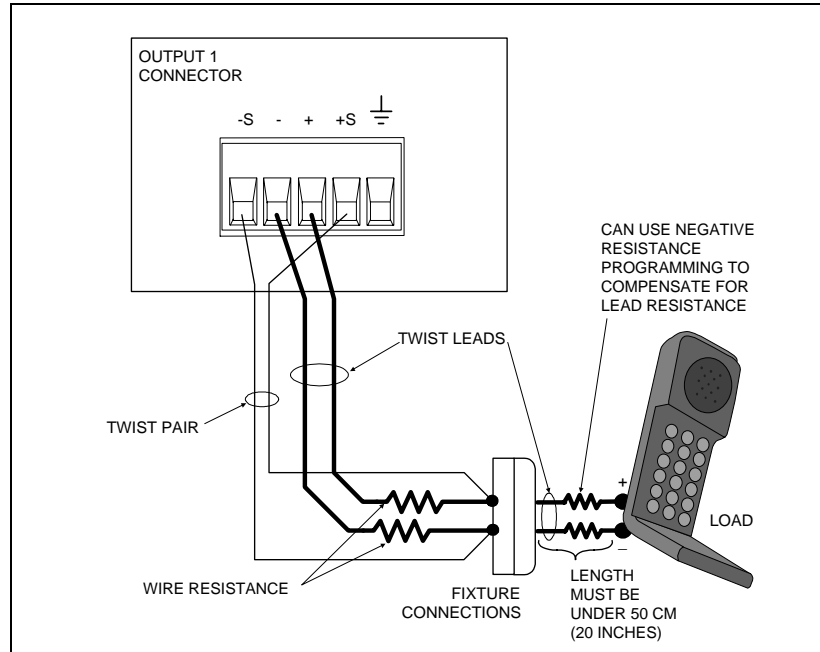

**Figure 3-4. Remote Sense Connections with Test Fixture**

---

**NOTE:** The built-in overvoltage protection circuit automatically compensates for the voltage drop between the output terminals and the remote sense lead connections. Refer to "OVP Considerations" later in this chapter for more information.

---

## Load Regulation and Voltage Drop in the Remote Sense Leads

The sense leads are part of the dc source's feedback path and must be kept at a low resistance to maintain optimal performance. One way to accomplish this is to use larger diameter wires for the sense leads (see Table 3-2).

If this is impractical, you can account for the voltage regulation and readback error that will occur when using higher resistance remote sense leads. The voltage load regulation and readback error can be calculated using the following formula:

$$\Delta V = V_{LD+} \left( \frac{R_{S+}}{R_{S+} + 251} \right) + V_{LD-} \left( \frac{R_{S-}}{R_{S-} + 184} \right)$$

where:  $V_{LD+}$  and  $V_{LD-}$  are the voltage drops in the + and - load leads.  
 $R_{S+}$  and  $R_{S-}$  are the resistances of the + and - sense leads.

### 3 - Installation

Minimizing the load lead resistance reduces voltage drops  $V_{LD+}$  and  $V_{LD-}$ .  $\Delta V$  can be further minimized by decreasing the resistance of the sense leads ( $R_{S+}$  and  $R_{S-}$ ) as much as possible. In situation where  $\Delta V$  cannot be minimized any further, it may be compensated by programming a negative output resistance as previously discussed.

### Maintaining Stability while Remote Sensing

The remote sense bandwidth and slew rate of standard dc power sources are adequate for compensating for load lead voltage drop for slow to moderate rates of load changes. However, the high pulsed current draw of digital cellular phones presents a challenge to standard dc power sources operating in remote sense mode. Their bandwidth and slew rate are not adequate for dealing with the 0.05 to 0.2 amp/ $\mu$ s slew rates imposed by these devices. A large voltage transient occurs at the load, due to the inability of the dc source to keep up with the rate of load change.

The dc source effectively compensates for load lead voltage drops resulting from very high slew rate load current transitions. This keeps the remotely sensed output voltage at a relatively constant level. For 0.05 amp/ $\mu$ s to 0.2 amp/ $\mu$ s slew rate loading in typical test applications, the transient voltage is reduced more than an order of magnitude over that of other standard dc sources.

### Open Sense Lead Protection

The main output (output 1) of the dc source has built-in open sense protection circuitry that detects if there is an open in either the positive or the negative remote sense lead or load lead path. For battery powered devices, undetected open sense connections can cause incorrect battery charger calibration, incorrect test results due to erroneous voltage settings, and low voltage phone shutdown due to a large transient voltage drop.

**To enable open sense lead detection** from the front panel, press the **Output** key, use **▲** to scroll to SENS:PROT, press **▼** to select **ON**, then press **Enter**. To have the unit turn on with open sense detection enabled, save this state in location 0 and set the power-on state to RCL 0.

When this circuit is enabled, **the sense and load leads are checked every time the output transitions from disabled to enabled (off to on)**. If a lead opens while the output is enabled, this will not be detected immediately by the open sense circuit. However, the output voltage will increase or decrease, depending on which one of the leads is open. Turning the output off, then on again, will cause the unit to check the output sense and load leads and determine if a sense lead is open.

If the open sense lead protection circuit detects an open sense lead, the **Prot** annunciator on the front panel turns on and the output turns off. Bit 5 in the Questionable Status Registers is also set (see chapter 7 under "Programming the Status Registers"). On the front panel, press the **Prot** key, and one of the following error messages will be reported on the front panel:

<u>Message</u>	<u>Description</u>
+ sense open	Positive sense or load lead is open
- sense open	Negative sense or load lead is open
+/- sense open	Both positive and negative sense or load leads are open
sense open	Incorrect resistance reading on the sense or load leads. This may be caused by an external power source paralleled with the output, or in rare instances, by the voltage being out of calibration.

The default setting for the open sense lead protection circuit is disabled or **OFF**. This is because applications that apply an external voltage to the output or that use external disconnect relays may interfere with the operation of the open sense detect circuit. If you are using external voltages or relays, you can enable the open sense detect at the beginning of the test procedure. Make sure that the external voltage is disabled and that any relays are in the closed position. Perform the remote sense check by cycling the output off, then on. Then disable the open sense detect circuit and continue using the unit.

## Local Sensing

Local sensing is not recommended for optimal performance. You must use the remote sense connections on both the main output (output 1) and on output 2 for the unit to operate properly and meet its published specifications. If you are **not** using remote sensing and the open sense protection feature is **ON**, you must jumper the + output 1 pin to its + sense pin, and jumper the - output 1 pin to its - sense pin. Otherwise, the unit will go into a protected state with the output disabled.

- ◆ Keep load leads as short as possible. Load leads cannot exceed 18 inches (per side) when local sensing.
- ◆ Bundle or twist the leads tightly together to minimize inductance.
- ◆ Jumper the + output 1 pin to its + sense pin, and the - output 1 pin to its - sense pin.

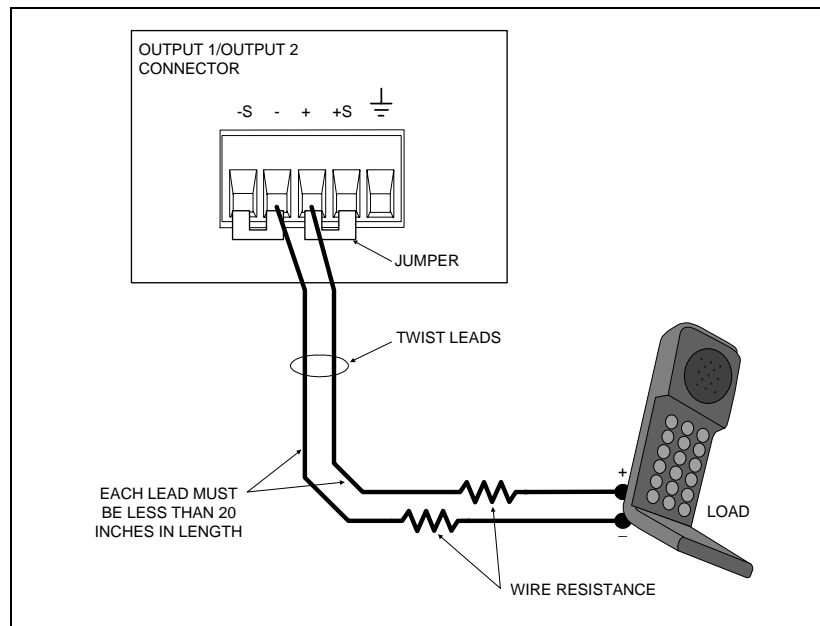

Figure 3-5. Local Sensing

## Output Compensation

High bandwidth performance and stability are achieved by using a software-switchable output compensation circuit. This compensation circuit has four bandwidth positions to optimize the response for different ranges of phone capacitance. The compensation function is set using either the front panel COMP command located in the Output menu (see chapter 5), or the OUTPUT:COMPensation:MODE command as explained in chapter 8. The circuit covers the following approximate capacitance ranges:

- ◆ LLocal mode: 0 to 12,000  $\mu\text{F}$
- ◆ LRemote mode: 2  $\mu\text{F}$  to 12,000  $\mu\text{F}$
- ◆ HLocal mode: 0 to 12,000  $\mu\text{F}$
- ◆ HRemote mode: 5  $\mu\text{F}$  to 12,000  $\mu\text{F}$

### 3 - Installation

Refer to the previous discussion under "Remote Sense Connections" and "Local Sensing" for more information about remote and local sensing. Standard dc source units are shipped from the factory with the output compensation set to HRemote mode. This mode provides the fastest output response but requires an external capacitor for stable operation.

**To program the compensation mode from the front panel**, press the **Output** key, use **▲** to scroll to the COMP command, press **▼** to select one of the four compensation mode settings, and then press **Enter**. To have the unit turn on with a different output compensation setting, save this state in location 0 and set the power-on state to RCL 0. The following table summarizes the four programmable compensation modes.

<b>Mode</b>	<b>Description</b>
<b>LLocal</b> <sup>1</sup>	Used for slower response with short load leads or bench operation. This produces the slowest output response, but provides the best stability (no external capacitor needed).
<b>LRemote</b>	Used for slower response with long load leads using remote sensing.
<b>HLocal</b>	Use for faster response with short load leads or bench operation (no external cap needed).
<b>HRemote</b> <sup>2</sup>	Used for faster response with long load leads using remote sensing. This produces the fastest output response, but requires an external capacitor for stable operation.

<sup>1</sup>Corresponds to Low mode on earlier models (66311B/D, 66309B/D).

<sup>2</sup>Corresponds to High mode on earlier models (66311B/D, 66309B/D).

If you do not know the input capacitance of the phone that you are testing, leave the input capacitance set to LLocal mode initially. This is because in LLocal mode, the output of the dc source will be stable when testing cellular phones that have virtually any input capacitance (from 0  $\mu\text{F}$  to 12,000  $\mu\text{F}$ ). LLocal mode however, has the slowest transient response (see appendix A).

The HRemote mode output compensation setting provides the fastest transient response performance for phones with input capacitances greater than 5 $\mu\text{F}$ . Most phones have input capacitances greater than 5  $\mu\text{F}$ . However, the operation of the dc source may be momentarily unstable with phones that have input capacitances *less* than 5  $\mu\text{F}$ , or if the output sense leads are not connected and you are operating in HRemote mode.

Use the output sense detect circuit to first determine that the sense and load leads are properly connected to the device under test. Then, if you are testing phones in HRemote mode and want to determine if the input capacitance of your phone is less than 5  $\mu\text{F}$ , perform the following test.

---

**NOTE:** It is important that this test is done with the dc source installed in the test system where it will be used, since system stability is also dependent on wiring and the phone impedance.

---

1. Connect the phone to the dc source and place it in standby mode.
2. Check the last *two* digits of the voltage reading on the front panel of the dc source.
3. If the last two digits are fluctuating, it is an indication that the phone capacitance may be less than 5  $\mu\text{F}$  and the dc source is unstable.
4. Place the output compensation of the dc source in LLocal mode.
5. If the last two digits of the voltage reading are now stable, your phone most likely has an input capacitance less than 5  $\mu\text{F}$ .



## OVP Considerations

---

**CAUTION:** Disabling the overvoltage protection circuit may cause excessive output voltages, which can damage the phone under test.

---

The dc source is shipped from the factory with its overvoltage protection (OVP) circuit enabled. This built-in overvoltage protection function is not programmable; it is set to automatically trip when the output voltage measured at the *sense* lead terminals exceeds the programmed voltage by two volts. Having the overvoltage and the output voltage sensing at the same point provides a more effective method of load protection than if the overvoltage is sensed only at the output terminals of the dc source. To disable the OVP circuit, use either the front panel VOLT PROT command located in the OV menu, or the VOLTage:PROTection:STATe SCPI command as explained in chapter 8.

The built-in overvoltage protection circuit reduces the number of nuisance overvoltage shutdown events since it trips only when the *sense* lead voltage exceeds the programmed voltage by two volts. In situations such as where the external remote sense leads are shorted, the OVP circuit will shut down the unit if the voltage measured at the *output* terminals exceeds the programmed voltage by three volts. Lastly, the OVP circuit will shut the unit down if the voltage at the output terminals exceeds 18 volts for any reason, such as when remote sensing around an excessive load lead resistance.

The OVP circuit contains a crowbar SCR, which effectively shorts the output of the dc source whenever the OVP trips. However, if an external current source such as a battery is connected across the output and the OVP is inadvertently triggered, the SCR will continuously sink a large current from the battery, possibly damaging the dc source. To avoid this, you can either disable the OVP circuit or you can connect an external protection diode in series with the output of the dc source. Connect the anode of the diode to the + output terminal.

The OVP circuit's SCR crowbar has also been designed to discharge capacitances up to a specific limit, which is 50,000  $\mu\text{F}$ . If your load capacitance approaches this limit, it is recommended that you do not intentionally trip the OVP and discharge the capacitance through the SCR as part of your normal testing procedure, as this may lead to long-term failure of some components.

## Programmable Voltage Protection

In addition to the automatic overvoltage protection circuit, the dc source includes *programmable* voltage protection for output 1. This feature lets you limit the maximum allowable output voltage that can be programmed either from the front panel or over the GPIB. This feature is useful in situations where accidentally programming higher output voltages within the operating range of the dc source can permanently damage the phone under test.

For example, suppose that a phone under test, which requires the output voltage to be adjusted up to 6 V, can be damaged if the output voltage exceeds 9 volts. You can set the programmable voltage limit to 6 volts using either the front panel VOLT:PROT command in the OV menu, or the VOLTage:PROTection SCPI command as explained in chapter 8. If an attempt is then made to program the output voltage to a value greater than 6 volts, the unit goes into voltage protection mode and turns its output off.

---

**NOTE:** The VOLT:PROT front panel and SCPI commands **do not program the tracking OVP circuit**, which automatically tracks the output voltage and trips when the output voltage exceeds the programmed voltage by two volts.

---

## DVM Connections

**CAUTION:** The DVM may be damaged if voltages at the input terminals exceed  $\pm 50$  Vdc to ground.

The DVM connector has three pins: plus, minus, and earth ground. The 3-pin connector is removable and accepts wires sizes from AWG 22 to AWG 14. Disconnect the mating plug by pulling it straight back.

The DVM is designed as an auxiliary measurement input that can measure voltages on circuits that are powered by the main output (output 1). Voltage measurements can be made on test points inside the phone under test, or on test points located on the test fixture that is connected to the main output. Figure 3-6 illustrates a common measurement application for the DVM. This example is only provided for illustration; your specific application will vary depending on the type of test and type of phone.

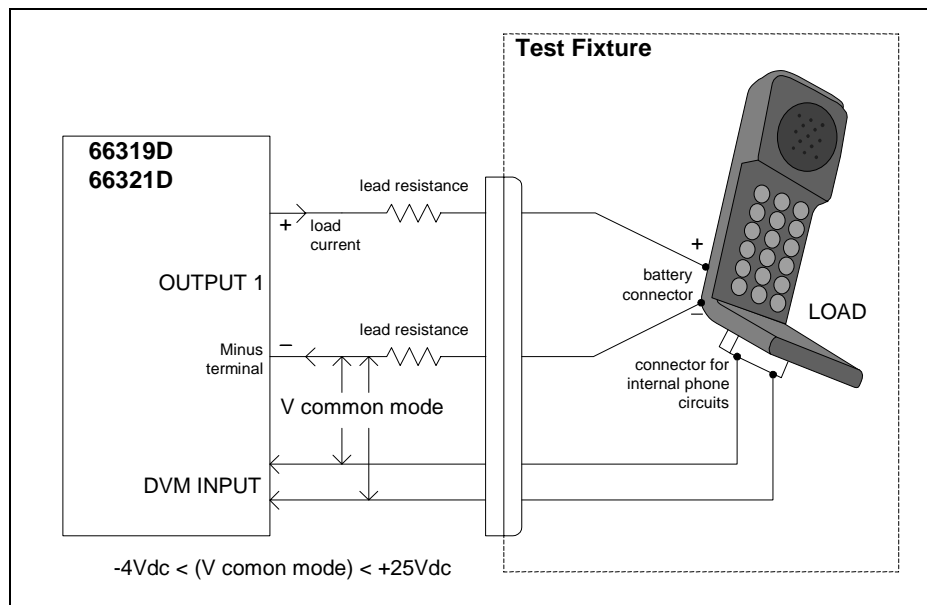

**Figure 3-6. DVM Measurement Example**

**NOTE:** The DVM is not designed to measure voltages that are greater than +25 Vdc or less than -4.5 Vdc with respect to the negative terminal of the main output. The following sections discuss restrictions that apply when using the DVM to measure voltages on circuits that are **not** powered by the main output, or that are floating with respect to the main output.

### Measuring Circuits that are Not Powered by the Main Output

To obtain correct voltage measurements, keep the common mode voltage within the specified limits. Common mode voltage is defined as the voltage between either DVM input terminal and the negative terminal of the main output (output 1). The common mode voltage range is from -4.5 Vdc to +25 Vdc. Attempting to measure voltages outside this range may result in incorrect readings due to clipping by the internal DVM measurement circuits.

**NOTE:** Do not confuse the common mode voltage with the DVM voltage readback. The DVM voltage readback is a differential measurement from one input lead to the other input lead. This quantity may be as high as  $\pm 25$  Vdc, depending on the orientation of the input leads.

Because the measurement circuits of the DVM are internally referenced to the minus terminal of the main output, you must observe the following restrictions in order to guarantee accurate DVM measurements (refer to figure 3-7).

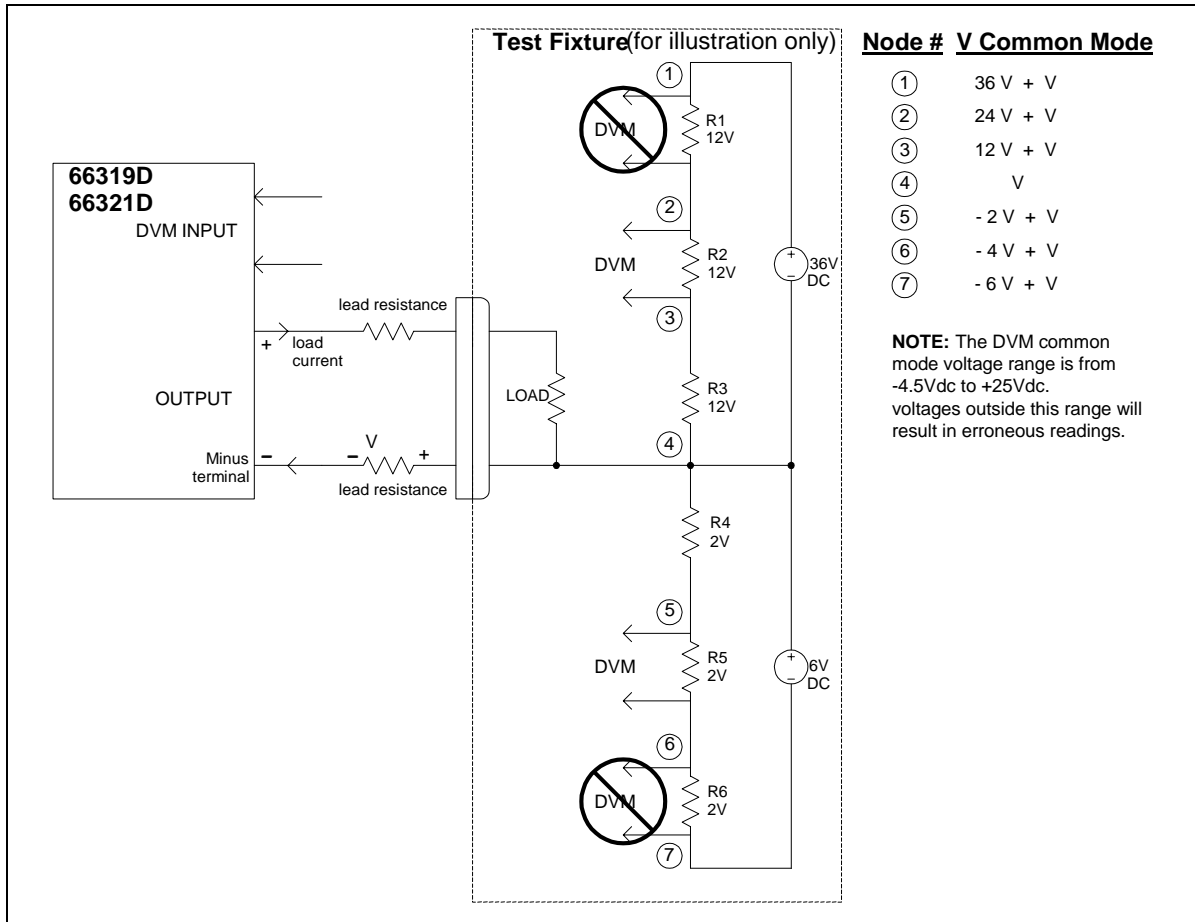

**Figure 3-7. Measuring Circuits Not Powered by the Main Output**

- ◆ You cannot measure voltages greater than +25 Vdc with respect to the negative terminal of the main output. A situation where this could occur is illustrated by R1 in figure 3-7, which has only a 12 Vdc drop across it but is 36 Vdc + V<sub>lead</sub> with respect to the negative terminal of the main output.
- ◆ You cannot measure voltages less than -4.5 Vdc with respect to the negative terminal of the main output. A situation where this could occur is illustrated by R6 in figure 3-7, which has only a -2 Vdc drop across it but is -6 Vdc + V<sub>lead</sub> with respect to the negative terminal of the main output.
- ◆ When calculating the common mode voltage between the point that you wish to measure and the negative terminal of the main output, you must also include any voltage drop in the negative load lead. For example, in figure 3-7, if the voltage drop in the negative load lead is 2 V, you would not be able to correctly measure the 12 Vdc drop across R2. This is because when the voltage drop in the load lead is added to the voltage drops across R2 and R3, the resultant voltage is 26 Vdc, which exceeds the +25 Vdc common mode rating of the DVM.

## Measuring Circuits that are Floating with Respect to the Main Output

In the example shown in figure 3-8, the common mode voltage between the DVM inputs and the minus terminal of the main output (output 1) includes an undefined floating voltage that may result in incorrect readings due to clipping by the internal DVM measurement circuits. This will occur when the  $-4.5\text{ Vdc}$  to  $+25\text{ Vdc}$  common mode voltage range is exceeded.

The solution to this problem would be to provide a known or controlled common mode voltage by connecting a jumper wire from the floating voltage to be measured to the main output. In this example, the main output is set to  $5\text{ V}$ , the ac voltage to be measured is approximately  $6\text{ Vac}$  ( $\pm 8.5\text{ Vpeak}$ ), and a jumper wire connects one side of the bias transformer to the + main output terminal. This stabilizes the common mode voltage and offsets it by the output voltage value ( $5\text{ V}$ ). The peak common mode voltage is now:

$$+8.5\text{ V} + 5\text{ V} = +13.5\text{ V} \text{ on the positive side, and}$$

$$-8.5\text{ V} + 5\text{ V} = -3.5\text{ V} \text{ on the negative side;}$$

with both voltages now being within the common mode range of the DVM.

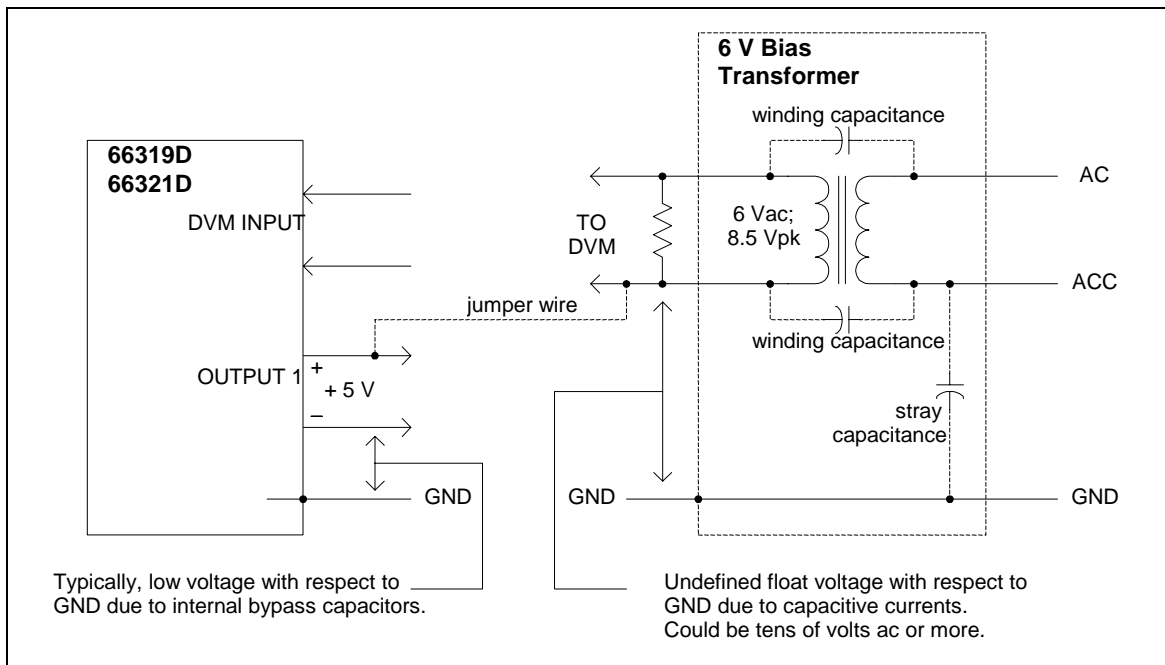

Figure 3-8. Measuring Circuits Floating with Respect to the Main Output

## External Protection and Trigger Input Connections

A 4-pin connector and a quick-disconnect mating plug are provided on each instrument for accessing the Fault/Inhibit functions, the measurement Trigger input, or the Digital I/O functions (see Table 3-3).

The connector accepts wires sizes from AWG 22 to AWG 12. Disconnect the mating plug to make your wire connections.

**NOTE:** It is good engineering practice to twist and shield all signal wires to and from the digital connectors. If shielded wire is used, connect only one end of the shield to chassis ground to prevent ground loops.

**Table 3-3. 4-Pin Connector Configurations**

PIN	TRIGGER	FAULT/INHIBIT	DIGITAL I/O
1	Not used	FLT Output	Output 0
2	Not used	FLT Common	Output 1
3	Trigger Input	INH Input	Input/Output 2
4	Trigger Common	INH Common	Common

When functioning in Fault/Inhibit mode, the fault (FLT) output, also referred to as the DFI (discrete fault indicator) signal, is an open collector circuit that pulls the positive output low with respect to the negative (chassis-referenced) common. The high impedance inhibit (INH) input, also referred to as the RI (remote inhibit) signal, is used to shut down the dc source output whenever the INH + is pulled low with respect to the INH (chassis-referenced) common. Figure 3-9 shows how you can connect the FLT/INH and trigger input circuits of the dc source.

**In example A**, the INH input connects to a switch that shorts the Inhibit pin (+) to common whenever it is necessary to disable output of the unit. This activates the remote inhibit (RI) circuit, which turns off the dc output. The front panel Prot annunciator comes on and the RI bit is set in the Questionable Status Event register. To re-enable the unit, first open the connection between pins INH + and common and then clear the protection circuit. This can be done either from the front panel or over the GPIB.

**In example B**, the FLT output of one unit is connected to the INH input of another unit. A fault condition in one of the units will disable all of them without intervention either by the controller or external circuitry. The computer can be notified of the fault via a service request (SRQ) generated by the Questionable Status summary bit. Note that the FLT output can also be used to drive an external relay circuit or signal other devices whenever a user-definable fault occurs.

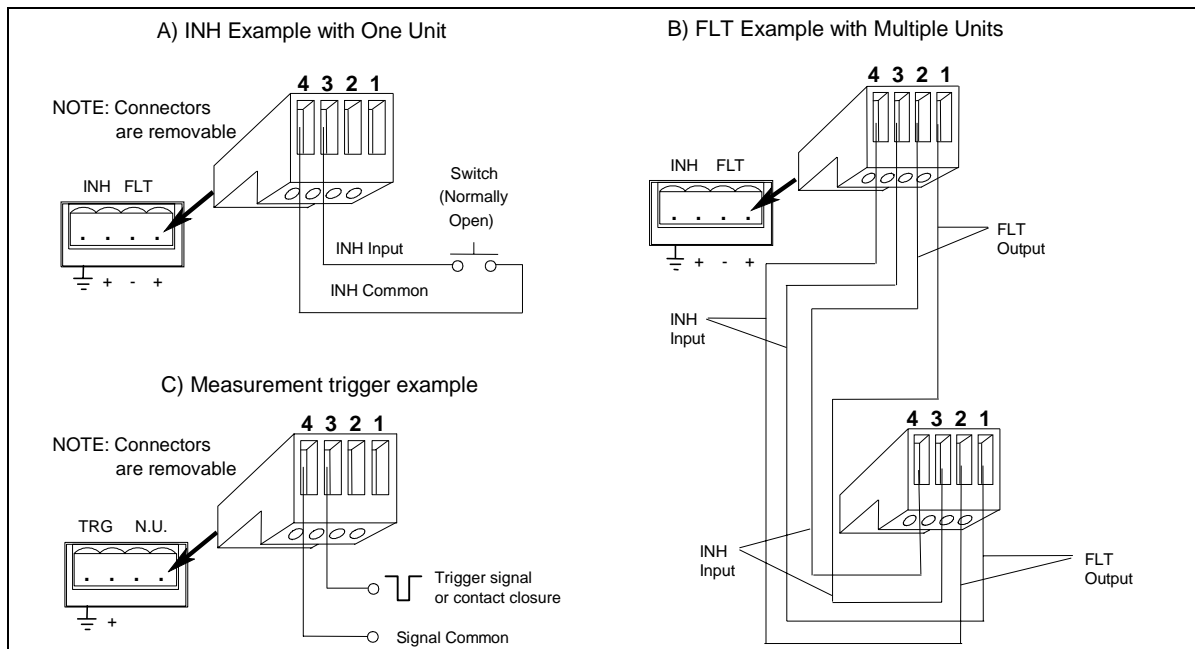

**Figure 3-9. FLT/INH Examples**

**In example C**, when functioning as a measurement trigger input, a negative-going edge signal applied to the TRG input sends an external trigger signal to the trigger system. You can either apply a negative-going edge signal to the TRG input pin (referenced to common), or apply a contact switch to short the TRG input to common. Note that in this configuration, pins 1 and 2 are not used.

## Digital I/O Connections

As shown in Table 3-3 and Figure 3-10, the 4-pin connector can also be configured as a digital I/O port. Information on programming the digital I/O port is found in chapter 5 and under [SOURCE:]DIGital:DATA and [SOURCE:]DIGital:FUNCTION commands in chapter 8. The electrical characteristics of the digital connector are described in appendix A.

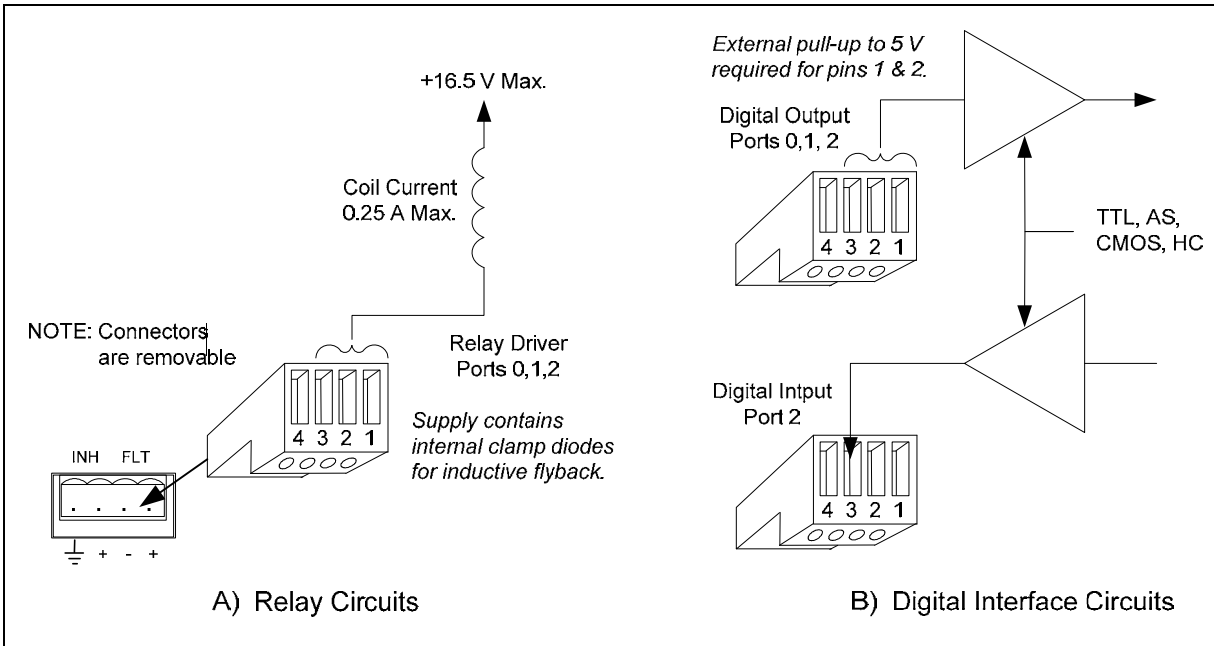

Figure 3-10. Digital I/O Examples

## Computer Connections

The dc source can be controlled through a GPIB interface. Follow the GPIB card manufacturer's directions for card installation and software driver setup.

### GPIB Interface

Each dc source has its own GPIB bus address, which can be set using the front panel **Address** key as described in chapter 5. GPIB address data is stored in non-volatile memory. The dc source is shipped with its GPIB address set to 5.

Dc sources may be connected to the GPIB interface in series configuration, star configuration, or a combination of the two, provided the following rules are observed:

- ◆ The total number of devices including the GPIB interface card is no more than 15.
- ◆ The total length of all cables used is no more than 2 meters times the number of devices connected together, up to a maximum of 20 meters. (Refer to table 2-2 for a list of available GPIB cables.)
- ◆ Do not stack more than three connector blocks together on any GPIB connector.
- ◆ Make sure all connectors are fully seated and the lock screws are firmly finger-tightened.

## Turn-On Checkout

---

### Checkout Procedure

Successful tests in this chapter provide a high degree of confidence that your unit is operating properly. For performance tests, see appendix B.

---

**NOTE:** To perform the checkout procedure, you will need a wire for shorting the output terminals together.

---

The following procedure assumes that the unit turns on in the factory-default state. If you need more information about the factory default state, refer to the \*RST command in chapter 8. Note that the values shown in the Display column may not exactly match the values that appear on the front panel of the unit.

If you have not already done so, connect the power cord to the unit and plug it in. Connect the output connector to the back of the unit with the sense jumpers installed.

Procedure	Display	Explanation
1. Turn the unit on. The dc source undergoes a self-test when you first turn it on.	***** ADDRESS 5 0.000V 0.0001A	During selftest, all display segments are briefly lit, followed by the GPIB Address.  The display then goes into meter mode with the <b>Dis</b> annunciator on, and all others off. In Meter mode the <b>n.nnnV</b> digits indicate the output voltage and the <b>.nnnnA</b> digits indicate the output current. The flashing digit on the display indicates the digit that will be affected if changes are made to the displayed values using the rotary control or the <b>↑</b> and <b>↓</b> keys. <i>You will only see the changes if the output is ON.</i>

---

**NOTE:** Press the Meter key to exit a menu at any time and return to meter mode. If the Err annunciator on the display is on, press the **Shift** key followed by the **Error** key to see the error number. See table 4-1 at the end of this chapter.

---

2. Check that the fan is on.		You should be able to hear the fan and feel the air coming from the back of the unit.
3. Unplug the output connector from the back of the unit.	-0.224V 0.0000A	The output voltage indicates approximately -0.2 volts because the output sense connections have opened.
4. Press <b>Output</b> , scroll to <b>SENSE:PROT</b> and select <b>ON</b> . Press <b>Enter</b>	SENSE:PROT ON	Enables the open sense detect circuit.
5. Press <b>Output On/Off</b>	-0.224V 0.0000A	The open sense detect circuit disables the output. The <b>Dis</b> annunciator is off, but the <b>Prot</b> annunciator is on.
6. Press <b>Protect</b>	+/- SENSE OPEN	Display indicates the protection condition.

## 4 - Turn-On Checkout

	<b>Procedure</b>	<b>Display</b>	<b>Explanation</b>
7.	Plug the output connector back into the unit.		Restores the output sense connections. The <b>Prot</b> annunciator is still on.
8.	Press <b>Shift, Prot Clear</b>	NO FAULT	Clears the protection condition. <b>Prot</b> is off; <b>CV</b> is on.
9.	Press <b>Voltage</b>	VOLT 0.000	Display shows the output voltage setting of the unit.
10.	Press <b>Enter Number, &lt;15&gt;, Enter</b>	VOLT <15> 15.003V 0.0001A	Programs the main output to 15 volts. After the value is entered, the display returns to Meter mode. Because the output is enabled, the meter will indicate the actual output voltage.
11.	Press <b>Output On/Off</b>	0.000V 0.0000A	Turn the output off.
12.	Connect a jumper wire across the + and - output terminals.		Shorts the output of the unit.
13.	Press <b>Output On/Off</b> .	0.004V 3.0712A	The <b>CC</b> annunciator is on, indicating that the unit is in constant current mode. The unit is sourcing output current at the maximum rating, which is the default output current limit setting.
14.	Press <b>Current, Enter Number, &lt;1&gt;, Enter</b> .	CURR <1>	Programs the output current to 1 ampere.
15.	Press <b>Shift, OCP</b>	0.001V 0.0003A	You enabled the overcurrent protection circuit. The circuit then tripped because the unit was operating in constant current mode. The <b>CC</b> annunciator turns off, and the <b>OCP</b> and <b>Prot</b> annunciators turn on.
16.	Press <b>Shift, OCP</b>	0.001V 0.0003A	You have disabled the overcurrent protection circuit. The <b>OCP</b> annunciator turns off.
17.	Press <b>Shift, Prot Clear</b>	0.004V 0.998A	Restores the output. The <b>Prot</b> annunciator turns off. The <b>CC</b> annunciator turns on.
18.	Turn the unit off and remove the shorting wire from the output terminals.		The next time the unit turns on it will be restored to the *RST or factory default state.

**Only perform steps 19 to 29 if you are verifying an Agilent 66319B or 66319D unit.**

	<b>Procedure</b>	<b>Display</b>	<b>Explanation</b>
19.	Turn the unit on. Wait for selftest to complete and press <b>Shift, Channel</b> .	<sup>2</sup> 0.025V 0.0002A	<b>Shift Channel</b> toggles between channel 1 and channel 2. The left-most digit of the display identifies the output channel that is presently being controlled. It will indicate a "1" for channel 1, or "2" for channel 2.
20.	Press <b>Voltage, Enter Number, &lt;12&gt;, Enter</b> .	<sup>2</sup> VOLT <12>	Programs the output 2 voltage to 12 volts.
21.	Press <b>Output On/Off</b>	<sup>2</sup> 12.005V 0.0002A	Turns the main output and output 2 on. The <b>Dis</b> annunciator is off, but the <b>CV</b> annunciator is on.
22.	Press <b>Output On/Off</b>	<sup>2</sup> 0.000V 0.0000A	Turn all outputs off.



<b>Procedure</b>	<b>Display</b>	<b>Explanation</b>
23. Connect a jumper wire across the + and - terminals of output 2.		Shorts output 2 of the unit.
24. Press <b>Output On/Off</b> .	<sup>2</sup> 0.004V 1.520A	The <b>CC</b> annunciator is on, indicating that output 2 is in constant current mode. Output 2 is sourcing current at its maximum rating, which is the default current limit setting.
25. Press <b>Current, Enter Number, &lt;1&gt;, Enter</b> .	<sup>2</sup> CURR <1>	Programs the output 2 current to 1 ampere.
26. Press <b>Shift, OCP</b>	<sup>2</sup> 0.001V 0.0003A	You enabled the overcurrent protection circuit. The circuit then tripped because output 2 was operating in constant current mode. The <b>CC</b> annunciator turns off, and the <b>OCP</b> and <b>Prot</b> annunciators turn on.
27. Press <b>Shift, OCP</b>	<sup>2</sup> 0.001V 0.0003A	You have disabled the overcurrent protection circuit. The <b>OCP</b> annunciator turns off.
28. Press <b>Shift, Prot Clear</b>	<sup>2</sup> 0.004V 0.998A	Restores output 2. The <b>Prot</b> annunciator turns off. The <b>CC</b> annunciator turns on.
29. Turn the unit off and remove the shorting wire from the output terminals.		The next time the unit turns on it will be restored to the *RST or factory default state.

---

## In Case of Trouble

Dc source failure may occur during power-on selftest or during operation. In either case, the display may show an error message that indicates the reason for the failure.

### Selftest Error Messages

Pressing the **Shift, Error** keys will show the error number. Selftest error messages appear as: ERROR <n> where "n" is a number listed in the following table. If this occurs, turn the power off and then back on to see if the error persists. If the error message persists, the dc source requires service.

**Table 4-1. Power-On Selftest Errors**

<b>Error No.</b>	<b>Failed Test</b>
Error 0	No error
Error 1	Non-volatile RAM RD0 section checksum failed
Error 2	Non-volatile RAM CONFIG section checksum failed
Error 3	Non-volatile RAM CAL section checksum failed
Error 4	Non-volatile RAM STATE section checksum failed
Error 5	Non-volatile RST section checksum failed
Error 10	RAM selftest
Error 11 to 14	VDAC/IDAC selftest 1 to 4
Error 15	OVDAC selftest
Error 80	Digital I/O selftest error

## Runtime Error Messages

Appendix C lists other error messages that may appear at runtime. Some of these messages will also appear on the front panel when the Prot key is pressed. To clear the error, you must remove the condition that caused the error and then press the Prot Clear key.

**Table 4-2. Runtime Error Messages**

<b>Error</b>	<b>Description</b>
Overvoltage	an overvoltage condition has occurred
Overcurrent	an overcurrent condition has occurred
Overtemperature	an overtemperature condition has occurred
Remote inhibit	a remote inhibit signal has been applied to the RI input
+ sense open	a positive sense or load lead is open
- sense open	a negative sense or load lead is open
+/- sense open	a positive and negative sense or load lead is open
sense open	incorrect voltage reading on the sense leads, the unit may need to be recalibrated

If the front panel display shows **OVLD** , this indicates that the output voltage or current is beyond the range of the meter readback circuit. If this is the case, check that the setting of the output compensation is correct for the phone you are testing. If the front panel display indicates -- -- -- -- -- , an GPIB measurement is in progress.

## Line Fuse

If the dc source appears "dead" with a blank display and the fan not running, check your ac mains to be certain line voltage is being supplied to the dc source. If the ac mains is normal, the internal line fuse may be defective.

Refer to Appendix E and follow the procedure described in the appendix for accessing and replacing the line fuse located inside the unit. **Do not change any of the line voltage connections.**

---

**NOTE:** If the dc source has a defective fuse, replace it only once. If it fails again, the dc source requires service.

---

# Front Panel Operation

## Introduction

Here is what you will find in this chapter:

- ◆ a complete description of the front panel controls
- ◆ front panel programming examples

**NOTE:** The dc source must be in set to Local mode to use the front panel controls. Press the **Local** key on the front panel to put the unit in local mode.

## Front Panel Description

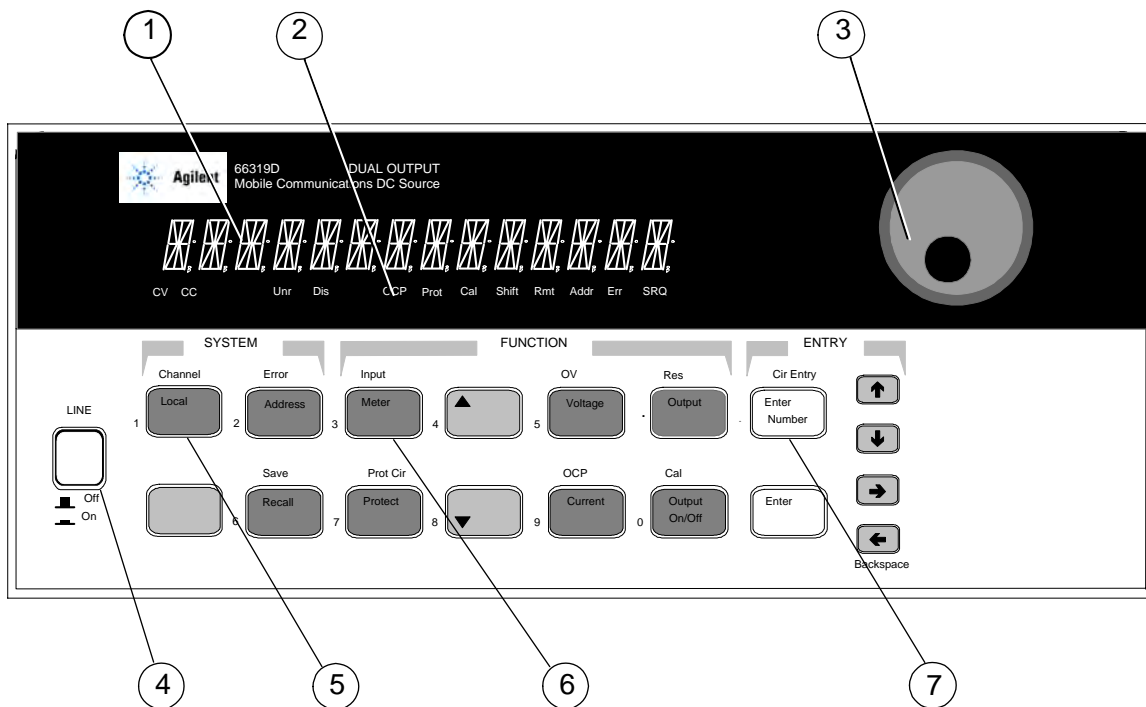

Figure 5-1. Front Panel, Overall View

## 5 – Front Panel Operation

- ① **Display** 14-character vacuum fluorescent display for showing output measurements and programmed values.
- ② **Annunciators** Annunciators light to indicate operating modes and status conditions:  
**CV** The dc source output is in constant-voltage mode.  
**CC** The dc source output is in constant-current mode.  
**Unr** The dc source output is in an unregulated state.  
**Dis** The dc source output is disabled (off).  
**OCP** The overcurrent protection state is enabled.  
**Prot** One of the dc source's output protection features is activated.  
**Cal** The dc source is in calibration mode.  
**Shift** The Shift key is pressed to access an alternate key function.  
**Rmt** The GPIB interface is in a remote state.  
**Addr** The interface is addressed to talk or to listen.  
**Err** There is a message in the SCPI error queue.  
**SRQ** The interface is requesting service from the controller.
- ③ **Rotary Control** The rotary control lets you set the output voltage or current as well as menu parameters. Press ◀ and ▶ to select the resolution, then adjust the value with the knob.
- ④ **Line** This turns the dc source on or off.
- ⑤ **System Keys** The system keys let you:  
Return to Local mode (front panel control)  
Set the dc source GPIB address  
Selects the remote programming interface  
Select the output channel on units with more than one output  
Display SCPI error codes and clear the error queue  
Save and recall up to 4 instrument operating configurations  
Select the programming language
- ⑥ **Function Keys** Function access command menus that let you:  
Enable or disable the output  
Select metering functions  
Program output voltage, current, and resistance  
Display the protection status state  
Set and clear protection functions  
Set the output state at power-on  
Calibrate the dc source  
Select the output compensation  
▲ and ▼ scroll through the front panel menu commands
- ⑦ **Entry Keys** Entry keys let you:  
Enter programming values  
Increment or decrement programming values  
▲ and ▼ select the front panel menu parameters

## System Keys

Refer to the examples later in this chapter for more details on the use of these keys.

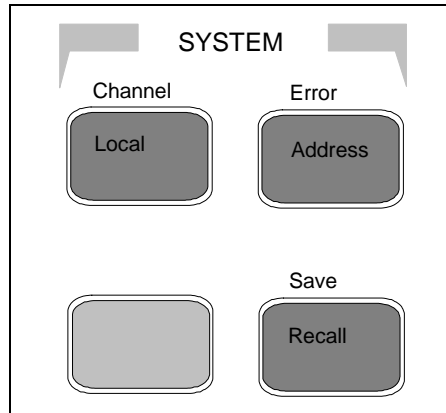



Figure 5-2. System Keys



This is the blue, unlabeled key, which is also shown as  in this guide. Pressing this key accesses the alternate or shifted function of a key (such as **ERROR**). Release the key after you press it. The **Shift** annunciator is lit, indicating that the shifted keys are active.



Press to change the dc source's selected interface from remote operation to local (front panel) operation. Pressing the key will have no effect if the interface state is already Local, Local-with-Lockout, or Remote-with-Lockout.



Press to access the address menu. All entries are stored in non-volatile memory.

Display	Command Function
ADDRESS <value>	Sets the GPIB Address
LANG <char>	Selects language (SCPI)
ROM <char>	Firmware revision number
SN: <char>	Unit serial number



Press to place the dc source into a previously stored state. You can recall up to 4 previously stored states (0 through 3).



Pressing these keys toggles the display between output 1 and output 2.

Display	Measurement
<sup>1</sup> <reading>V <reading>A	Measures output channel 1
<sup>2</sup> <reading>V <reading>A	Measures output channel 2





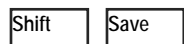

Press to display the system error codes stored in the SCPI error queue. This action also clears the queue. If there is no error in the queue, 0 is displayed.



Press to store an existing dc source state in non-volatile memory. The parameters saved are listed under \*SAV as described in chapter 8. You can save up to 4 states (0 through 3).

**Notes:**

value = a numeric value      char = a character string parameter  
 Use  and  to scroll through the command list.  
 Use  and  to scroll through the parameter list.

## Function Keys

Refer to the examples later in this chapter for more details on the use of these keys.

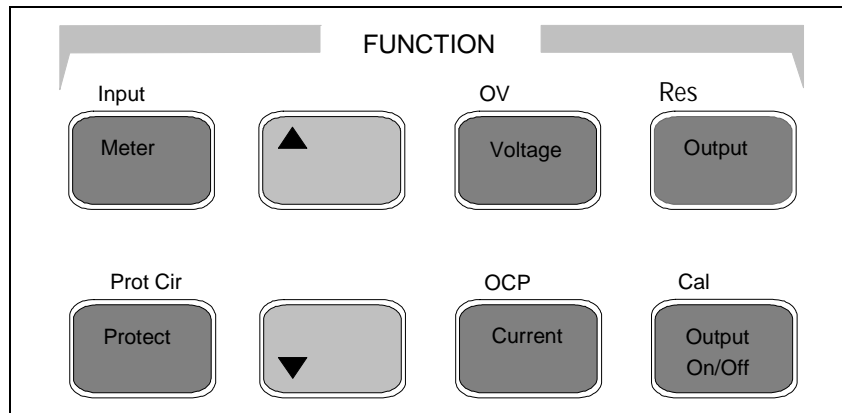

Figure 5-3. Function Keys

### Immediate Action Keys

Immediate action keys immediately execute their corresponding function when pressed. Other function keys have commands underneath them that are accessed when the key is pressed.



This key toggles the output of the dc source between the on and off states. When coupled, the key affects both output channels. It immediately executes its function as soon as you press it. When off, the dc source output is disabled and the **Dis** annunciator is on.



Press this key to reset the protection circuit and allow the unit to return to its last programmed state. The condition that caused the protection circuit to become active must be removed prior to pressing this key, or the unit will shut down again and display the **Prot** annunciator again.

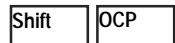





Press this key to toggle between OCP enabled and disabled. If OCP is enabled the output will become disabled if the output mode changes from CV to CC mode. The OCP annunciator indicates the state of OCP.

### Scrolling Keys

Scrolling keys let you move through the commands in the presently selected function menu.



Press  to bring up the next command in the list. Press  to go back to the previous command in the list. Function menus are circular; you can return to the starting position by continuously pressing either key. The following example shows the commands in the Input function menu:

-  CURR:RANGE <char>
-  CURR:DET <char>

## Metering Keys

Metering keys control the metering functions of the dc source. As set from the factory, all front panel measurements from the main output (output 1), are calculated from a total of 2048 readings taken at a 46.8 microsecond sampling rate. Therefore, the factory default acquisition time for a single front panel measurement is about 100 milliseconds. Refer to “Making Front Panel Measurements” for more information about changing the front panel sampling rate and the number of measurement points.

All front panel measurements from the DVM and from output2 are fixed at 2048 measurement readings taken at a 15.6 microsecond sampling rate.

---

**NOTE:** The front panel sample rate and data point settings are separate and independent of the sample rate and data point settings that are programmed over the GPIB interface. When an GPIB measurement is in progress, the front panel display temporarily indicates -- -- -- -- --. Front panel measurements resume when the GPIB measurement completes.

---

Meter

Press this key to access the meter menu list. Also use this key to exit a menu at any time and return to meter mode.

<b>Display</b>	<b>Measurement</b>
<reading>V <reading>A	Measures output dc voltage and current
<reading>V MAX	Measures peak output voltage
<reading>V MIN	Measures minimum output voltage
<reading>V HIGH	Measures the high level of a voltage waveform
<reading>V LOW	Measures the low level of a voltage waveform
<reading>V RMS	Measures rms voltage
<reading>A MAX	Measures peak output current
<reading>A MIN	Measures minimum output current
<reading>A HIGH	Measures the high level of a current waveform
<reading>A LOW	Measures the low level of a current waveform
<reading>A RMS	Measures rms current
<reading>V DC:DVM	Measures dc voltage on DVM input <sup>1</sup>
<reading>V RMS:DVM	Measures rms voltage on DVM input <sup>1</sup>

Shift

Input

Press this key to access the following metering functions.



<b>Display</b>	<b>Command Function</b>
CURR:RANGE <char>	Select current range (3A   1A   0.02A   AUTO)
CURR:DET <char>	Select current measurement bandwidth (ACDC   DC)
TINT <value>	Sets the front panel measurement interval in <i>seconds</i> (15.6 μs to 1 second)
POINTS <char>	Sets the # of points in front panel measurement buffer ( 1, 2, 4, 8, 16, 32, 64, 128, 256, 512, 1024, 2048)



**Notes:** <sup>1</sup>only valid for Agilent 66321D/66319D



reading = the returned measurement

value = a numeric value

char = a character string parameter

Use  and  to scroll through the menu commands.

Use  and  to scroll through the menu parameters.

Use  and  to select a digit in a numeric entry field.

## Output Control Keys

Output control keys control the output functions of the dc source.

**Voltage**

Press this key to access the voltage menu.

**Display**

<sup>1</sup> VOLT <value>

<sup>2</sup> VOLT <value>

<sup>1</sup> LIMIT <char>

**Command Function**

Sets the voltage of output 1 (the main output of all models)

Sets the voltage of output 2

Sets the programmable voltage limit (output 1 shown)

**Current**

Press this key to access the current menu.

**Display**

<sup>1</sup> CURR <value>

<sup>2</sup> CURR <value>

**Command Function**

Sets the current of output 1 (the main output of all models)

Sets the current of output 2

**Shift**

**Res**

Press this key to access the resistance menu.

**Display**

<sup>1</sup> RES <value>

**Command Function**

Sets the resistance of output 1 (the main output of all models)

**Output**

Press this key to access the output menu list.

**Display**

\*RST

COUPLING <char>

COMP <char>

PON:STATE <char>

PROT:DLY <value>

RI <char>

DFI <char>

DFI:SOUR <char>

PORT <char>

DIGIO <char>

SENSE:PROT<char>

<sup>1</sup>REL:MODE <char>

**Command Function**

Places the dc source in the factory-default state

Couples or decouples output 1 and output 2 (NONE | ALL)

Sets output compensation (HREMOTE | LREMOTE | HLOCAL | LLOCAL)<sup>1</sup>

Select the power-on state command (RST | RCL0)

Sets the output protection delay in seconds

Sets the remote inhibit mode (LATCHING | LIVE | OFF)

Sets the discrete fault indicator state (ON | OFF)

Selects the DFI source (QUES | OPER | ESB | RQS | OFF)<sup>2</sup>

Sets the output port functions (RIDFI | DIGIO | TRIGGER)

Sets and reads the I/O port value (0 through 7)

Enables or disables the open sense lead detect circuit (ON | OFF)

Sets the relay mode for option 521units (DD, HD, DH, or HH)<sup>3</sup>  
(applies to both outputs; output 1 shown)

**Protect**

Press this key to display protection status.

**Display**

OVER CURRENT

NO FAULT

**Command Function**

Status of the protection features (example shows overcurrent)

Status of the protection features (example shows none tripped)

**Shift**

**OV**

Press this key to access the overvoltage protection menu.

**Display**

PROT:STAT <char>

**Command Function**

Enables or disables overvoltage protection (ON | OFF)

**Shift**

**Cal**

This key accesses the calibration menu (Refer to Appendix B for details).

**Notes:**



<sup>1</sup>These parameters are explained in chapter 3.



<sup>2</sup>These status summary bits are explained in chapter 7.



<sup>3</sup>These relay modes are explained in chapter 2

value = a numeric value

char = a character string parameter

Use  and  to scroll through the menu commands.

Use  and  to scroll through the menu parameters.

Use  and  to select a digit in a numeric entry field.



## Entry Keys

Refer to the examples later in this chapter for more details on the use of these keys.

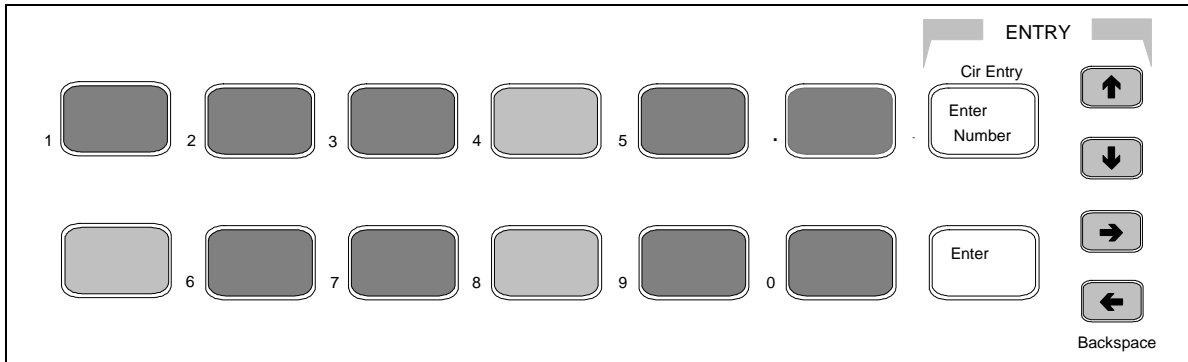

**Figure 5-4. Entry Keys**



These keys let you scroll through choices in a **parameter** list that apply to a specific command. Parameter lists are circular; you can return to the starting position by continuously pressing either key. If the command has a numeric range, these keys increment or decrement the existing value. In meter mode, these keys can be used to adjust the magnitude of the output voltage or current. Only the flashing digit is changed by these keys. Use the ← and → keys to move the flashing digit.



These keys move the flashing digit in a numeric entry field to the right or left. This lets you increment or decrement a specific digit in the entry field using the ↑ and ↓ keys or the RPG knob.

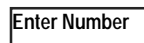

Used only to access a third level key function - the numeric entry keys. These third level function keys are labeled in green.



**0** through **9** are used for entering numeric values. **.** is the decimal point. **-** is the minus sign. For example, to enter 33.6 press: **Enter Number, 3, 3, ., 6, Enter.**

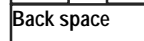
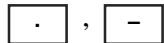

The backspace key deletes the last digit entered from the keypad. This key lets you correct one or more wrong digits before they are entered.

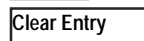

This key aborts a keypad entry by clearing the value. This key is convenient for correcting a wrong value or aborting a value entry. The display then returns to the previously set function.



This key executes the entered value or parameter of the presently accessed command. Until you press this key, the parameters you enter with the other Entry keys are displayed but not entered into the dc source. Before pressing **Enter**, you can change or abort anything previously entered into the display. After **Enter** is pressed, the dc source returns to Meter mode.

## Examples of Front Panel Programming

You will find these examples on the following pages:

- 1 Using the front panel display
- 2 Setting the output voltage, current, and compensation
- 3 Setting the output 2 voltage and current
- 4 Querying and clearing output protection
- 5 Making basic front panel measurements
- 6 Making enhanced front panel measurements
- 7 Making DVM measurements
- 8 Programming the digital port
- 9 Setting the GPIB address
- 10 Storing and recalling instrument states

### 1 - Using the Front Panel Display

#### Select an output on Agilent 66319B/D units

##### Action

Press **Meter** to return the display to Meter mode. Press **Shift Channel** to toggle between channel 1 and channel 2. The left-most digit of the front panel display identifies the output channel that is presently being controlled by the front panel. It will indicate either a "1" for channel 1, or "2" for channel 2.

You can only select an output when the unit is in metering mode. Once an output has been selected, only the menu commands that apply to that output will appear on the display. Output -specific menu commands are identified by a 1 or a 2. Also, the CV, CC, and UNR annunciators apply to the selected channel.

##### Display

<sup>2</sup>7.003V 0.004A

#### Select the DVM on Agilent 66321D/66319D units

##### Action

You must select output 1 to use the DVM. If output 1 is not selected, the DVM's measurement menu is not displayed.

On the Function keypad press **Meter** and press **▼** repeatedly to access the DVM measurement commands. DVM measurement commands are identified by the "DVM" string segment. When accessed, DVM measurement functions are automatically active. Refer to example 3 for more information.

##### Display

<sup>1</sup> 8.013V 0.003A

<sup>1</sup> <reading>V DC:DVM

#### Independently Control Output 1 and Output 2 on Agilent 66319B/D units

##### Action

On the Function keypad, press **Output**. Scroll to the COUPLING command. To uncouple the outputs, use the **↑** numeric key to select NONE, then press **Enter**.

##### Display

COUPLING NONE

### 2 - Setting the Output Voltage, Current, Resistance, Compensation, and Relay Mode

This example shows you how to set the output voltage, current, and resistance. It also shows you how to set the compensation circuit for either high or low capacitance cellular phones. Relay mode only applies to units that have Option 521 installed. Note that no front panel changes affect the output of the unit unless it has been enabled.

**Set the output voltage**

Action	Display
1. To enter an approximate value without using the voltage menu: On the Entry keypad, press <b>←</b> or <b>→</b> to select the 1's digit in the voltage field. Then rotate the front panel RPG knob to obtain 7 V. <i>If the unit is in CC mode, you won't see the output voltage change until the voltage setting is low enough to cause the unit to go into CV mode.</i>	7.003V 0.004A
2. The easiest way to enter an accurate value: On the Function keypad, press <b>Voltage</b> . On the Entry keypad, press <b>Enter Number, 7, Enter</b> .	VOLT 7.000
3. To make minor changes to an existing value: On the Function keypad, press <b>Voltage</b> . On the Entry keypad, press <b>←</b> or <b>→</b> to select the digit in the numeric field that you wish to change. For example, move the flashing digit to the ones column to change a value in this column. Then, press <b>↑</b> to scroll from 7.000 to 8.000. Then press <b>Enter</b> .	VOLT 8.000

**Set the output current limit**

Action	Display
1. To enter an approximate value without using the current menu: On the Entry keypad, press <b>←</b> or <b>→</b> to select the tenths digit in the current field. Rotate the front panel RPG knob to obtain 0.4A. <i>If the unit is in CV mode, you will not see the output current change until the current setting is low enough to cause the unit to go into CC mode.</i>	8.003V 0.400A
2. The easiest way to enter an accurate value: On the Function keypad, press <b>Current</b> . On the Entry keypad, press <b>Enter Number, .4, Enter</b> .	CURR 0.400
3. To make minor changes to an existing value, press <b>Current</b> . The procedure to change an individual digit is explained in step 3 under "Set the output voltage."	

---

**NOTE:** To output currents pulses greater than 3 A and up to 5 A peak, you must set the output current limit to greater than 3 amperes (3.0712 amperes max).

---

**Set the output resistance**

Action	Display
1. On the Function keypad, press <b>Shift Res</b> . On the Entry keypad, press <b>Enter Number, 0.5, Enter</b> .	RES 0.500
2. To make minor changes to an existing value, press <b>Shift Res</b> . The procedure to change an individual digit is explained in step 3 under "Set the output voltage."	

**Set the output compensation**

Action	Display
1. On the Function keypad, press <b>Output</b> . Then press <b>▼</b> until you obtain the COMP command. Use the <b>▼</b> key and select one of the four compensation modes. Then press <b>Enter</b> . Use HREMOTE or HLOCAL compensation for faster transient response when testing phones with input capacitances greater than 5 $\mu$ F, which applies for most phones. Select local or remote depending on your sensing setup. <i>If operation of the dc source becomes momentarily unstable when testing phones that have input capacitances under 5 <math>\mu</math>F, Use either LREMOTE or LLOCAL compensation.</i>	COMP HREMOTE

## 5 – Front Panel Operation

### Setting the relay mode (Agilent 66319B/66319D with Option 521 only)

Action	Display
1. Use <b>Output ON/OFF</b> to make sure that the output of the selected channel is off. The output must be turned off before any relay settings take effect. If the <b>Dis</b> annunciator is lit, the output is off.	
2. Press <b>Meter</b> to return the display to Meter mode.	
3. Press <b>Shift Channel</b> to select either output channel 1 or output channel 2.	<sup>1</sup> 3.6V 2.04A <sup>2</sup> 7.5V 1.04A
4. On the Function keypad, press <b>OUTPUT</b> . Then scroll to the <b>REL:MODE</b> command. Use the <b>↓</b> key to select one of the relay modes (DD, DH, HD, or HH) then press <b>Enter</b> . The Output ON mode is specified first, followed by the Output OFF mode. Relay settings cannot be coupled; they must be set separately for each output.	<sup>2</sup> REL:MODE HH

### Enable the output

Action	Display
1. On the Function keypad, press <b>Output On/Off</b> to enable the output. The <b>Dis</b> annunciator will go off, indicating that the voltage is now applied to the output terminals. The A display indicates the actual output current. Note that when the outputs are coupled, this command also enables or disables output 2.	8.003V 0.500A

## 3 - Setting the Output 2 Voltage and Current (Agilent 66319B/66319D only)

This example shows you how to set the voltage and current for output 2. Selecting an output was discussed in the previous example. Note that no front panel changes affect the output of the unit unless it has been enabled.

### Set the output 2 voltage

Action	Display
1. Press <b>Meter</b> , then <b>Shift, Channel</b> to select output 2. On the Entry keypad, press <b>←</b> or <b>→</b> to select the 1's digit in the voltage field. Then rotate the front panel RPG knob to obtain 7 V. <i>If the unit is in CC mode, you won't see the output voltage change until the voltage setting is low enough to cause the unit to go into CV mode.</i>	<sup>2</sup> 7.003V 0.004A
2. An alternate way to enter a value: On the Function keypad, press <b>Voltage</b> . On the Entry keypad, press <b>Enter Number, 7, Enter</b> .	<sup>2</sup> VOLT 7.000
3. To make minor changes to an existing value: On the Function keypad, press <b>Voltage</b> . On the Entry keypad, press <b>←</b> or <b>→</b> to select the digit in the numeric field that you wish to change. For example, move the flashing digit to the ones column to change a value in this column. Then, press <b>↑</b> on the Entry keypad to scroll from 7.000 to 8.000. Then press <b>Enter</b> .	<sup>2</sup> VOLT 8.000

### Set the output 2 current limit

Action	Display
1. Select output 2 as described in example 1. On the Entry keypad, press <b>←</b> or <b>→</b> to select the tenths digit in the current field. Rotate the front panel RPG knob to obtain 0.4A. <i>If the unit is in CV mode, you will not see the output current change until the current setting is low enough to cause the unit to go into CC mode.</i>	<sup>2</sup> 8.003V 0.400A
2. An alternate way to enter a value: On the Function keypad, press <b>Current</b> . On the Entry keypad, press <b>Enter Number, .4, Enter</b> .	<sup>2</sup> CURR 0.400

- To make minor changes to an existing value, press **Current**. The procedure to change an individual digit is explained in step 3 under "Set the output 2 voltage."

---

**NOTE:** To draw current pulses greater than 1.5 A and up to 2.5 A peak on output 2, set the output current limit higher than 1.5 amperes (1.52 amperes max). Do not enable OCP, or else make sure that the protection delay setting is longer than the expected current pulse.

---

### Enable the output

Action	Display
1. On the Function keypad, press <b>Output On/Off</b> to enable output 2. The <b>Dis</b> annunciator will go off, indicating that the voltage is now applied to the output terminals. The display indicates the actual output values. Note that when the outputs are coupled, this command also enables or disables output 1.	<sup>2</sup> 8.003V 0.500A

## 4 - Querying and Clearing Output Protection and Errors

If an overvoltage, overcurrent, overtemperature or remote inhibit condition occurs, the **Prot** annunciator on the front panel will be on and the dc source will disable its output. If necessary, you can disable the overcurrent or overvoltage protection circuit if its operation interferes with the proper operation of your phone test. Note that if you disable the overvoltage protection, the equipment under test will not be protected from output voltage overshoot conditions. You can also disable the broken sense lead detect circuit if you have an application where an external voltage applied to the output may interfere with the broken sense lead detect circuitry.

Error messages can occur at any time during the operation of the unit. When the **Err** annunciator on the front panel is on it means that either an error has occurred on the GPIB bus, or a selftest error has occurred. Appendix C lists error numbers and descriptions.

### Query and clear the dc source overcurrent protection as follows:

Action	Display
1. On the Function keypad, press <b>Protect</b> . In this example, an over current condition has occurred. Refer to Table 4-2 for other protection indicators.	OVERCURRENT
2. On the Function keypad, press <b>Current</b> . This displays the present current limit.	CURR 3.0712
3. To restore normal operation <i>after the cause of the overcurrent condition has been removed</i> , press <b>Shift, Prot Clr</b> . The <b>Prot</b> annunciator then will go off.	
4. To disable overcurrent protection, press <b>Shift, OCP</b> . This key toggles between OCP enabled and disabled. The OCP annunciator is off when OCP is disabled.	

### Disable Overvoltage Protection as follows:

1. On the Function keypad, press <b>Shift, OV</b> . Use the <b>↓</b> key and select OFF to disable the overvoltage protection function. Then press <b>Enter</b> . To recall this state when the unit turns on, save this state in location 0 and set the power-on state to RCL 0 (see example #10).	PROT:STAT OFF
---	---------------

### Query and Clear Errors as follows:

1. On the Function keypad, press <b>Shift, Error</b> . This displays and clears the error in the error queue. Repeatedly press these keys to clear all errors in the queue. If errors persist, your unit may require service.	ERROR 0
---	---------

## 5 – Making Basic Front Panel Measurements

As shipped from the factory, front panel measurements for the main output (output 1) are calculated from a total of 2048 readings taken at a 46.8 microsecond sampling rate. The unit alternates between voltage and current measurements. Therefore, the data acquisition time for a single front panel voltage or current measurement is about 100 milliseconds. This sampling rate and data acquisition time combined with a built-in windowing function, reduces errors due to sampling a non-integral number of cycles of a waveform for frequencies of 25 Hz or greater. Note that the windowing function is less accurate when measuring output waveforms for frequencies less than 25 Hz, causing the front panel meter to jitter.

There are no trigger controls for front panel measurements. However, you can program both the sampling rate and the number of data points in each front panel measurement using commands in the Input menu. With this flexibility, measurement accuracy can be improved for waveforms with frequencies as low as several Hertz. The sample buffer size may be varied from 1 to 2048 data points in discrete binary values. The sampling rate may be varied from 15.6 microseconds to 1 second. Values are rounded to the nearest 15.6 microsecond interval. Note that the front panel sample interval and buffer size settings are independent of the sample interval and buffer size that you program over the GPIB. This is because you can qualify measurement triggers over the GPIB, which makes the GPIB measurements independent of the front panel measurements. Refer to chapter 8 for more information about GPIB measurements.

To have the unit turn on with the reconfigured buffer size and sampling rate, save this state in location 0 and set the power-on state to RCL 0. Note that front panel measurements parameters for output 2 are not programmable. They are fixed at 2048 data points with a 15.6 microsecond sampling rate.

---

**NOTE:** If the front panel display indicates OVLD, the output has exceeded the measurement capability of the instrument. If the front panel display indicates -- -- -- -- -- , an GPIB measurement is in progress.

---

### Use the Meter menu for making front panel measurements:

<b>Action</b>	<b>Display</b>
1. On the Function keypad press <b>Meter</b> to access the following measurement parameters: dc voltage and current	<reading>V <reading>A
2. To change the front panel time interval and buffer size for output waveform measurements, press <b>Shift, Input</b> . Then press ▼ until you obtain the TINT command. Use the Entry keys to enter a value from 15.6 microseconds to 1 second in <i>seconds</i> . Then press <b>Enter</b> .	TINT 0.002
3. Continue by pressing <b>Shift, Input</b> and ▼ until you obtain the POINT command. Press ▼ to select a different buffer size. The choices are: 1, 2, 4, 8, 16, 32, 64, 128, 256, 512, 1024, and 2048. Then press <b>Enter</b> .	POINT 1024

One reason to change the front panel time interval and data points is if the waveform being measured has a period shorter than 3 times the present front panel acquisition time.

## 6 – Making Enhanced Front Panel Measurements

The following figure illustrates the enhanced measurement capabilities of Agilent Models 66321B/D and 66319B/D for measuring output waveforms. These include peak (max), minimum, high level, and low level measurements as illustrated in the following figure. Rms and dc voltages are calculated from the number of points in the measurement window.

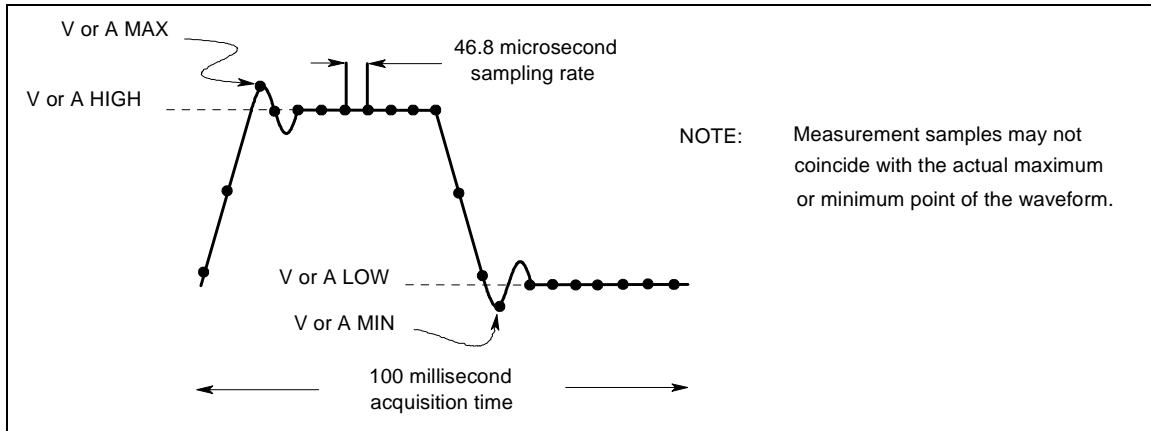

**Figure 5-5. Default Front Panel Measurement Parameters**

All models have three current measurement ranges that can be selected in the Input menu. A maximum current range is available for measuring output currents of up to 7 amperes. A 1 A current range is available for measuring currents up to 1A. A 0.02A current range is available for improved resolution when measuring output currents below 20 milliamperes. The low current measurement range is accurate to 0.1% of the reading  $\pm 2.5$  microamperes. When the current Range is set to AUTO, the unit automatically selects the range with the best measurement resolution.

**NOTE:** In the 0.02A current measurement range, the current detector is fixed at DC. With the current detector in dc, accurate current measurements cannot be made on waveforms with frequency contents over 1 kilohertz.

### Use the Meter menu for making front panel measurements:

Action	Display
1. On the Function keypad press <b>Meter</b> and press ▼ repeatedly to access the following measurement parameters:	
◆ dc voltage and current	<reading>V <reading>A
◆ peak voltage	<reading>V MAX
◆ minimum voltage	<reading>V MIN
◆ high level of a voltage pulse waveform	<reading>V HIGH
◆ low level of a voltage pulse waveform	<reading>V LOW
◆ rms voltage	<reading>V RMS
◆ peak current	<reading>A MAX
◆ minimum current	<reading>A MIN
◆ high level of a current pulse waveform	<reading>A HIGH
◆ low level of a current pulse waveform	<reading>A LOW
◆ rms current	<reading>A RMS
2. To change the front panel time interval and buffer size for output waveform measurements, press <b>Shift, Input</b> . Then press ▼ until you obtain the TINT command. Use the Entry keys to enter a value from 15.6 microseconds to 1 second in <i>seconds</i> . Then press <b>Enter</b> .	TINT 0.002

## 5 – Front Panel Operation

- Continue by pressing **Shift, Input** and ▼ until you obtain the POINT command. POINT 1024  
Press ▼ to select a different buffer size. The choices are: 1, 2, 4, 8, 16, 32, 64, 128, 256, 512, 1024, and 2048. Then press **Enter**.  
  
One reason to change the front panel time interval and data points is if the waveform being measured has a period shorter than 3 times the present front panel acquisition time.
- For current measurements, press **Shift, Input**. Then press ▼ until you obtain the CURR:RANG AUTO command. Press **Enter** to activate autoranging. Three other selections are also available. Select the 3A range when measuring currents up to 7A. Select the 1A range when measuring currents up to 1A. Select the 0.02A range for improved resolution when measuring currents below 20 mA. Note that the 0.02A range is only appropriate for making dc measurements. CURR:RANG AUTO
- For output waveform measurements, press **Shift, Input**. Then press ▼ until you obtain the CURR:DET command. Check to make sure that the ACDC current detector is selected. This provides the best accuracy for waveform measurements. Only select the DC current detector if you are making dc current measurements and you require a dc measurement offset better than 2mA on the High current measurement range. Press **Enter** to activate any changes. CURR:DET ACDC

## 7 – Making DVM Measurements (Agilent 66321D/66319D only)

**The front panel DVM measurement function is only active when Output 1 is selected.**

As shipped from the factory, DVM measurements are calculated from a total of 2048 readings taken at a 15.6 microsecond sampling rate. These parameters are fixed. Therefore, the data acquisition time for a single measurement is about 30 milliseconds. This sampling rate and data acquisition time combined with a built-in windowing function reduces errors due to sampling a non-integral number of cycles of a waveform for frequencies of 47 Hz or greater.

---

**NOTE:** If the front panel display indicates OVLD, the output has exceeded the measurement capability of the instrument. If the front panel display indicates -- -- -- -- -- , a front panel or an GPIB measurement is in progress.

---

**Check that the DVM measurement points are within the DVM measurement capabilities:**

The common mode voltage range of the DVM input is  $-4.5\text{ V}$  to  $+25\text{ V}$  from either DVM input with respect to the negative output terminal of output 1. The maximum isolation voltage to ground is  $\pm 50\text{ Vdc}$ . Refer to chapter 3 under "DVM Connection" for more information on how this affects the DVM's measurement capability.

**Use the Meter menu for making DVM measurements:**

Action	Display
1. On the Function keypad press <b>Meter</b> and press ▼ repeatedly to access the following DVM measurement parameters:	
◆ dc voltage	<sup>1</sup> <reading>V DC:DVM
◆ rms voltage (ac + dc rms)	<sup>1</sup> <reading>V RMS:DVM



## 8 - Programming Output Port Functions

You can configure the output port to perform three different functions. In RIDFI mode, the port functions as a remote inhibit input with a discrete fault indicator output signal. In DIGIO mode, the port acts as a digital Input/Output device. In TRIGGER mode, the port accepts external measurement trigger signals.

**To configure the RIDFI mode of the port, proceed as follows:**

Action	Display
1. On the Function keypad, press <b>Output</b> .	*RST
2. Scroll through the Output menu by pressing ▼. The PORT command lets you select either the RIDFI, DIGIO, or TRIGGER function. Press <b>Enter</b> when done.	PORT RIDFI
3. Scroll to the RI command to configure the Remote INHibit indicator. Use the ▲ and ▼ keys to select either LIVE or LATCHING, either of which enable the RI indicator. Then press <b>Enter</b> . With RI enabled, a low-true on the INH input will disable the output of the unit. LIVE causes the output of the unit to track the state of the INH input. LATCHING latches the output of the unit off in response to the inhibit signal.	RI LIVE RI LATCHING
4. Access the Output menu again and scroll through the menu. The DFI command lets you enable the Discrete Fault Indicator. Use the ▼ key and select ON to enable the FLT output. Then press <b>Enter</b> . With the FLT output enabled, the open-collector logic signal can be used to signal external devices when a fault condition is detected.	DFI ON
5. Scroll to the DFI:SOUR command to select the internal source that drives this signal. Use the ▼ key to select from the RQS or ESB bits, or the Operation or Questionable status registers. Then press <b>Enter</b> . Status summary bits are explained in chapter 7.	DFI:SOUR RQS DFI:SOUR ESB DFI:SOUR OPER DFI:SOUR QUES

**To configure the DIGIO mode of the port, proceed as follows:**

Action	Display
1. On the Function keypad, press <b>Output</b> .	*RST
2. Scroll through the Output menu by pressing ▼. The PORT command lets you select the DIGIO function. Press <b>Enter</b> when done.	PORT DIGIO
3. Scroll to the DIGIO command to set and read the Digital Input/Output Port. Press <b>Enter Number</b> and enter a number from 0 to 7 to program the three bits (0 programs all bits low; 7 programs all bits high). Press <b>Enter</b> when done.	DIGIO 5

**To configure the TRIGGER mode of the port, proceed as follows:**

Action	Display
1. On the Function keypad, press <b>Output</b> .	*RST
2. Scroll through the Output menu by pressing ▼. The PORT command lets you select the TRIGGER function. Press <b>Enter</b> when done.	PORT TRIGGER

## 9 - Setting the GPIB Address

Your dc source is shipped with the GPIB address set to 5. This address can only be changed from the front panel using the Address menu located under the **Address** key.

**Set the GPIB address as follows:**

Action	Display
1. On the System keypad, press <b>Address</b> .	ADDRESS 5
2. Enter the new address. For example, Press <b>Enter Number, 7, Enter</b> .	ADDRESS 7

## 10 - Storing and Recalling Instrument States

You can save up to 4 states (from location 0 to location 3) in non-volatile memory and recall them from the front panel. All programmable settings are saved. This capability is only available when the unit is set to the SCPI programming language.

---

**NOTE:** You can program the unit to automatically power-on according to the instrument state that is saved in state 0 as shown in the third example.

---

### Save an instrument state in location 0 as follows:

<b>Action</b>	<b>Display</b>
1. Set the instrument to the state that you want to save.	
2. Save this state to location 0. Press <b>Save, Enter Number, 0, Enter</b> .	*SAV 0

### Recall a saved state as follows:

<b>Action</b>	<b>Display</b>
1. Recall the state saved in location 0 by pressing <b>Recall, Enter Number, 0, Enter</b>	*RCL 0

### Select the power-on state of the dc source as follows:

<b>Action</b>	<b>Display</b>
1. On the Function keypad, press <b>Output</b> , and scroll through the Output menu until you get to the PON state command.	PON:STATE RST
2. Use the <b>↑</b> and <b>↓</b> keys to select either RST or RCL0. RST sets the power-on state of the unit as defined by the *RST command. RCL0 sets the power-on state of the unit to the state saved in *RCL location 0. Press <b>Enter</b> when done.	

### Clear the non-volatile memory of the dc source as follows:

<b>Action</b>	<b>Display</b>
1. On the Function keypad, press <b>Output, Enter</b> . This returns the unit to the factory-default settings.	*RST
2. Save these settings to location 0. Press <b>Save, Enter Number, 0, Enter</b> .	*SAV 0
3. Repeat step #2 for memory locations 1 through 3.	*SAV 1 *SAV 2 *SAV 3

# Introduction to Programming

---

## External References

### GPIB References

The most important GPIB documents are your controller programming manuals - BASIC, GPIB Command Library for MS DOS, etc. Refer to these for all non-SCPI commands (for example: Local Lockout).

The following are two formal documents concerning the GPIB interface:

- ◆ *ANSI/IEEE Std. 488.1-1987 IEEE Standard Digital Interface for Programmable Instrumentation.*  
Defines the technical details of the GPIB interface. While much of the information is beyond the need of most programmers, it can serve to clarify terms used in this guide and in related documents.
- ◆ *ANSI/IEEE Std. 488.2-1987 IEEE Standard Codes, Formats, Protocols, and Common Commands.*  
Recommended as a reference only if you intend to do fairly sophisticated programming. Helpful for finding precise definitions of certain types of SCPI message formats, data types, or common commands.

The above two documents are available from the IEEE (Institute of Electrical and Electronics Engineers), 345 East 47th Street, New York, NY 10017, USA. The WEB address is [www.ieee.org](http://www.ieee.org).

### SCPI References

The following documents will assist you with programming in SCPI:

- ◆ *Standard Commands for Programmable Instruments Volume 1, Syntax and Style*
- ◆ *Standard Commands for Programmable Instruments Volume 2, Command References*
- ◆ *Standard Commands for Programmable Instruments Volume 3, Data Interchange Format*
- ◆ *Standard Commands for Programmable Instruments Volume 4, Instrument Classes*

To obtain a copy of the above documents, contact: Fred Bode, Executive Director, SCPI Consortium, 8380 Hercules Drive, Suite P3, Ls Mesa, CA 91942, USA

## VXIplug&play Power Products Instrument Drivers

VXIplug&play instrument drivers for Microsoft Windows 95 and Windows NT are now available on the Web at <http://www.agilent.com/find/drivers>. These instrument drivers provide a high-level programming interface to your Agilent Technologies instrument. VXIplug&play instrument drivers are an alternative to programming your instrument with SCPI command strings. Because the instrument driver's function calls work together on top of the VISA I/O library, a single instrument driver can be used with multiple application environments.

### Supported Applications

- Agilent VEE
- Microsoft Visual BASIC
- Microsoft Visual C/C++
- Borland C/C++
- National Instruments LabVIEW
- National Instruments LabWindows/CVI

### System Requirements

The VXIplug&play Power Products instrument driver complies with the following:

- Microsoft Windows 95
- Microsoft Windows NT 4.0
- HP VISA revision F.01.02
- National Instruments VISA 1.1

### Downloading and Installing the Driver

---

**NOTE:** Before installing the VXIplug&play instrument driver, make sure that you have one of the supported applications installed and running on your computer.

---

1. Access Agilent Technologies' Web site at <http://www.agilent.com/find/drivers>.
2. Select the instrument for which you need the driver.
3. Click on the driver, either Windows 95 or Windows NT, and download the executable file to your pc.
4. Locate the file that you downloaded from the Web. From the **Start** menu select **Run** <path>:\agxxxx.exe - where <path> is the directory path where the file is located, and agxxxx is the instrument driver that you downloaded .
5. Follow the directions on the screen to install the software. The default installation selections will work in most cases. The readme.txt file contains product updates or corrections that are not documented in the on-line help. If you decide to install this file, use any text editor to open and read it.
6. To use the VXIplug&play instrument driver, follow the directions in the VXIplug&play online help under "Introduction to Programming".

## Accessing Online Help

A comprehensive online programming reference is provided with the driver. It describes how to get started using the instrument driver with Agilent VEE, LabVIEW, and LabWindows. It includes complete descriptions of all function calls as well as example programs in C/C++ and Visual BASIC.

- To access the online help when you have chosen the default Vxipnp start folder, click on the Start button and select Programs | Vxipnp | Agxxxx Help (32-bit).  
- where agxxxx is the instrument driver.

## GPIB Capabilities of the DC Source

All dc source functions except for setting the GPIB address are programmable over the GPIB. The IEEE 488.2 capabilities of the dc source are listed in the Specifications Table in Appendix A.

### GPIB Address

The dc source operates from an GPIB address that is set from the front panel. To set the GPIB address, press the **Address** key on the front panel and enter the address using the Entry keys. The address can be set from 0 to 30. The GPIB address is stored in non-volatile memory.

ADDRESS <value>            Enter a value to set the GPIB Address

## Introduction to SCPI

SCPI (Standard Commands for Programmable Instruments) is a programming language for controlling instrument functions over the GPIB. SCPI is layered on top of the hardware-portion of IEEE 488.2. The same SCPI commands and parameters control the same functions in different classes of instruments. For example, you would use the same DISPLAY command to control the dc source display and the display of a SCPI-compatible multimeter.

### Conventions Used in This Guide

Angle brackets	< >	Items within angle brackets are parameter abbreviations. For example, <NR1> indicates a specific form of numerical data.
Vertical bar		Vertical bars separate alternative parameters. For example, NORM   TEXT indicates that either "TEXT" or "NORM" can be used as a parameter.
Square Brackets	[ ]	Items within square brackets are optional. The representation [SOURCE:]. VOLTage means that SOURCE: may be omitted.
Braces	{ }	Braces indicate parameters that may be repeated zero or more times. It is used especially for showing arrays. The notation <A>{<,B>} shows that parameter "A" must be entered, while parameter "B" may be omitted or may be entered one or more times.
<b>Boldface font</b>		Boldface font is used to emphasize syntax in command definitions. <b>TRIGger:COUNT:CURRENT</b> <NRf> shows command definition.
Computer font		Computer font is used to show program lines in text. TRIGger:COUNT:CURRENT 10 shows a program line.

## Types of SCPI Commands

SCPI has two types of commands, common and subsystem.

- ◆ Common commands generally are not related to specific operation but to controlling overall dc source functions, such as reset, status, and synchronization. All common commands consist of a three-letter mnemonic preceded by an asterisk: \*RST \*IDN? \*SRE 8
- ◆ Subsystem commands perform specific dc source functions. They are organized into an inverted tree structure with the "root" at the top. The following figure shows a portion of a subsystem command tree, from which you access the commands located along the various paths. You can see the complete tree in Table 8-1.

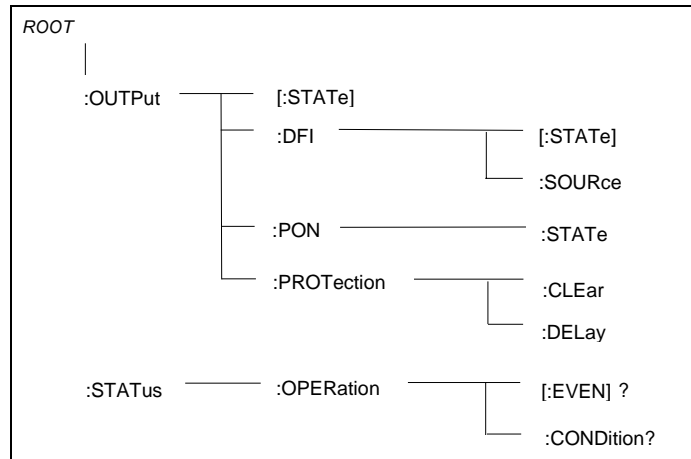

Figure 6-1. Partial Command Tree

## Multiple Commands in a Message

Multiple SCPI commands can be combined and sent as a single message with one message terminator. There are two important considerations when sending several commands within a single message:

- ◆ Use a semicolon to separate commands within a message.
- ◆ There is an implied header path that affects how commands are interpreted by the dc source.

The header path can be thought of as a string that gets inserted **before** each command within a message. For the first command in a message, the header path is a null string. For each subsequent command the header path is defined as the characters that make up the headers of the previous command in the message up to and including the last colon separator. An example of a message with two commands is:

```
OUTP:STAT ON;PROT:DEL 2
```

which shows the use of the semicolon separating the two commands, and also illustrates the header path concept. Note that with the second command, the leading header "OUTP" was omitted because after the "OUTP:STAT ON" command, the header path was became defined as "OUTP" and thus the instrument interpreted the second command as:

```
OUTP:PROT:DEL 2
```

In fact, it would have been syntactically incorrect to include the "OUTP" explicitly in the second command, since the result after combining it with the header path would be:

```
OUTP:OUTP:PROT:DEL 2
```

which is incorrect.

## Moving Among Subsystems

In order to combine commands from different subsystems, you need to be able to reset the header path to a null string within a message. You do this by beginning the command with a colon (:), which discards any previous header path. For example, you could clear the output protection and check the status of the Operation Condition register in one message by using a root specifier as follows:

```
OUTPut:PROTection:CLEAr::STATus:OPERation:CONDition?
```

The following message shows how to combine commands from different subsystems as well as within the same subsystem:

```
VOLTage:LEVel 20;PROTection 28;;CURRent:LEVel 3;PROTection:STATe ON
```

Note the use of the optional header LEVel to maintain the correct path within the voltage and current subsystems, and the use of the root specifier to move between subsystems.

## Including Common Commands

You can combine common commands with system commands in the same message. Treat the common command as a message unit by separating it with a semicolon (the message unit separator). Common commands *do not affect the header path*; you may insert them anywhere in the message.

```
VOLTage:TRIGgered 17.5;;INITialize;*TRG
OUTPut OFF;*RCL 2;OUTPut ON
```

## Using Queries

Observe the following precautions with queries:

- ◆ Set up the proper number of variables for the returned data.
- ◆ Read back all the results of a query before sending another command to the dc source. Otherwise a *Query Interrupted* error will occur and the unreturned data will be lost.

---

## Types of SCPI Messages

There are two types of SCPI messages, program and response.

- ◆ A *program message* consists of one or more properly formatted SCPI commands sent from the controller to the dc source. The message, which may be sent at any time, requests the dc source to perform some action.
- ◆ A *response message* consists of data in a specific SCPI format sent from the dc source to the controller. The dc source sends the message only when commanded by a program message "query."

Figure 6-2 illustrates the SCPI message structure.

## The Message Unit

The simplest SCPI command is a single message unit consisting of a command header (or keyword) followed by a message terminator. The message unit may include a parameter after the header. The parameter can be numeric or a string.

```
ABORt<NL>
VOLTage 20<NL>
```

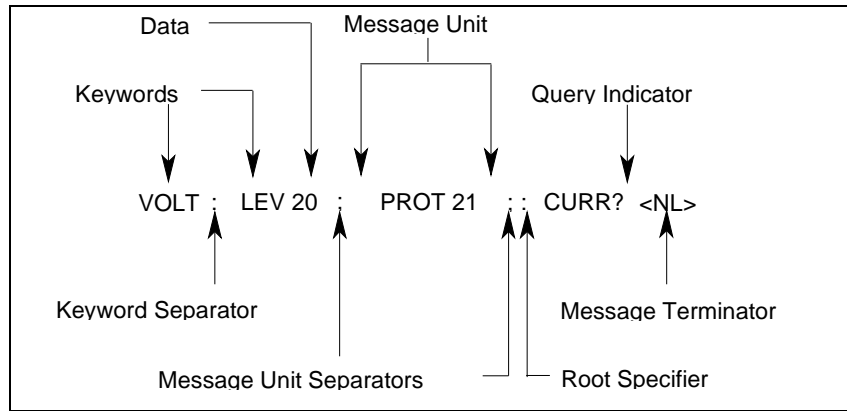

**Figure 6-2. Command Message Structure**

## Headers

Headers, also referred to as keywords, are instructions recognized by the dc source. Headers may be either in the long form or the short form. In the long form, the header is completely spelled out, such as VOLTAGE, STATUS, and DELAY. In the short form, the header has only the first three or four letters, such as VOLT, STAT, and DEL.

## Query Indicator

Following a header with a question mark turns it into a query (VOLTage?, VOLTage:PROTection?). If a query contains a parameter, place the query indicator at the end of the last header.

```
VOLTage:PROTection? MAX
```

## Message Unit Separator

When two or more message units are combined into a compound message, separate the units with a semicolon.

```
STATus:OPERation?;QUESTionable?
```

## Root Specifier

When it precedes the first header of a message unit, the colon becomes the root specifier. It tells the command parser that this is the root or the top node of the command tree.

## Message Terminator

A terminator informs SCPI that it has reached the end of a message. Three permitted message terminators are:

- ◆ newline (<NL>), which is ASCII decimal 10 or hex 0A.
- ◆ end or identify (<END>)
- ◆ both of the above (<NL><END>).

In the examples of this guide, there is an assumed message terminator at the end of each message.



## SCPI Data Formats

All data programmed to or returned from the dc source is ASCII. The data may be numerical or character string.

### Numerical Data Formats

<u>Symbol</u>	<u>Response Formats</u>
<NR1>	Digits with an implied decimal point assumed at the right of the least-significant digit. Examples: <b>273</b>
<NR2>	Digits with an explicit decimal point. Example: <b>.0273</b>
<NR3>	Digits with an explicit decimal point and an exponent. Example: <b>2.73E+2</b>
<u>Parameter Formats</u>	
<Nrf>	Extended format that includes <NR1>, <NR2> and <NR3>. Examples: <b>273 273. 2.73E2</b>
<Nrf+>	Expanded decimal format that includes <Nrf> and MIN MAX. Examples: <b>273 273. 2.73E2 MAX. MIN</b> and MAX are the minimum and maximum limit values that are implicit in the range specification for the parameter.
<Bool>	Boolean Data. Example: <b>0   1 or ON   OFF</b>

### Suffixes and Multipliers

<u>Class</u>	<u>Suffix</u>	<u>Unit</u>	<u>Unit with Multiplier</u>
Current	A	ampere	MA (milliamper)
Amplitude	V	volt	MV (millivolt)
Time	S	second	MS (millisecond)
<u>Common Multipliers</u>			
	1E3	K	kilo
	1E-3	M	milli
	1E-6	U	micro

### Response Data Types

Character strings returned by query statements may take either of the following forms, depending on the length of the returned string:

- <CRD> Character Response Data. Permits the return of character strings.
- <AARD> Arbitrary ASCII Response Data. Permits the return of undelimited 7-bit ASCII. This data type has an implied message terminator.
- <SRD> String Response Data. Returns string parameters enclosed in double quotes.

## SCPI Command Completion

SCPI commands sent to the dc source are processed either sequentially or in parallel. Sequential commands finish execution before a subsequent command begins. Parallel commands allow other commands to begin executing while the parallel command is still executing. Commands that affect trigger actions are among the parallel commands.

The `*WAI`, `*OPC`, and `*OPC?` common commands provide different ways of indicating when all transmitted commands, including any parallel ones, have completed their operations. The syntax and parameters for these commands are described in chapter 8. Some practical considerations for using these commands are as follows:

<code>*WAI</code>	This prevents the dc source from processing subsequent commands until all pending operations are completed.
<code>*OPC?</code>	This places a 1 in the Output Queue when all pending operations have completed. Because it requires your program to read the returned value before executing the next program statement, <code>*OPC?</code> can be used to cause the controller to wait for commands to complete before proceeding with its program.
<code>*OPC</code>	This sets the OPC status bit when all pending operations have completed. Since your program can read this status bit on an interrupt basis, <code>*OPC</code> allows subsequent commands to be executed.

---

**NOTE:** The trigger subsystem must be in the Idle state for the status OPC bit to be true. As far as triggers are concerned, OPC is false whenever the trigger subsystem is in the Initiated state.

---

---

## Using Device Clear

You can send a device clear at any time abort a SCPI command that may be hanging up the GPIB interface. The status registers, the error queue, and all configuration states are left unchanged when a device clear message is received. Device clear performs the following actions:

- ◆ The input and output buffers of the dc source are cleared.
- ◆ The dc source is prepared to accept a new command string.

The following statement shows how to send a device clear over the GPIB interface using *Agilent BASIC*:

```
CLEAR 705      IEEE-488 Device Clear
```

The following statement shows how to send a device clear over the GPIB interface using the GPIB command library for *C* or *QuickBASIC*:

```
IOCLEAR (705)
```

## SCPI Conformance Information

### SCPI Conformed Commands

The Agilent 66321B/D and 66319B/D conform to SCPI Version 1995.0.

ABOR	OUTP:PROT:DEL	STAT:QUES:ENAB
CAL:DATA	OUT:PROT:STAT	STAT:QUES:NTR
CAL:STAT	[SOUR]:CURR[:LEV][:IMM][:AMPL]	STAT:QUES:PTR
DISP[:WIND][:STAT]	[SOUR]:CURR[:LEV]:TRIG[:AMPL]	SYST:ERR?
DISP[:WIND]:TEXT[:DATA]	[SOUR]:CURR:PROT:STAT	SYST:LANG
INIT[:IMM]:SEQ   NAME	[SOUR]:VOLT[:LEV][:IMM][:AMPL]	SYST:VERS?
INIT:CONT:SEQ   NAME	[SOUR]:VOLT[:LEV]:TRIG[:AMPL]	TRIG[:SEQ1   :TRAN][:IMM]
MEAS   FETC:ARR:CURR[:DC]?	[SOUR]:VOLT:PROT	TRIG[:SEQ1   :TRAN]:SOUR
MEAS   FETC:ARR:VOLT[:DC]?	SENS:CURR[:DC]:RANG[:UPP]	TRIG:SEQ2   ACQ[:IMM]
MEAS   FETC[:SCAL]:CURR[:DC]?	SENS:FUNC	TRIG:SEQ2   ACQ:SOUR
MEAS   FETC[:SCAL]:CURR:HIGH?	SENS:SWE:OFFS:POIN	TRIG:SEQ:DEF
MEAS   FETC[:SCAL]:CURR:LOW?	SENS:SWE:POIN	*CLS
MEAS   FETC[:SCAL]:CURR:MAX?	SENS:SWE:TINT	*ESE*ESE?*ESR?
MEAS   FETC[:SCAL]:CURR:MIN?	STAT:OPER[:EVEN]?	*IDN?
MEAS   FETC[:SCAL]:VOLT[:DC]?	STAT:OPER:COND?	*OPC*OPC?*OPT?
MEAS   FETC[:SCAL]:VOLT:HIGH?	STAT:OPER:ENAB	*PSC*PSC?
MEAS   FETC[:SCAL]:VOLT:LOW?	STAT:OPER:NTR	*RCL*RST
MEAS   FETC[:SCAL]:VOLT:MAX?	STAT:OPER:PTR	*SAV*SRE*STB?
MEAS   FETC[:SCAL]:VOLT:MIN?	STAT:PRES	*TRG*TST?
OUTP[:STAT]	STAT:QUES[:EVEN]?	*WAI
OUTP:PROT:CLE	STAT:QUES:COND?	

### Non-SCPI Commands

CAL:CURR[:SOUR][:DC][:POS]	OUTP:DFI:SOUR
CAL:CURR[:SOUR][:DC]:NEG	OUTP:PON:STAT
CAL:MEAS[:DC]:LOWR	OUTP:RI:MODE
CAL:MEAS:AC	OUTP:TYPE
CAL:LEV	SENS:CURR:DET
CAL:PASS	SENS:LEAD:STAT?
CAL:SAVE	[SOUR]:DIG:DATA[:VAL]
CAL:VOLT[:DC]	[SOUR]:DIG:FUNC
CAL:VOLT:PROT	[SOUR]:RES[:LEV][:IMM][:AMPL]
DISP[:WIND]:MODE	TRIG:SEQ2   ACQ:COUN:CURR   :VOLT
MEAS   FETC[:SCAL]:CURR:ACDC?	TRIG:SEQ2   ACQ:HYST:CURR   :VOLT
MEAS   FETC[:SCAL]:VOLT:ACDC?	TRIG:SEQ2   ACQ:LEV:CURR   :VOLT
OUTP:DFI[:STAT]	TRIG:SEQ2   ACQ:SLOP:CURR   :VOLT



# Programming the DC Source

---

## Introduction

This chapter contains examples on how to program your dc source. Simple examples show you how to program:

- ◆ output functions such as voltage, current, and resistance
- ◆ internal and external triggers
- ◆ measurement functions
- ◆ the status and protection functions

---

**NOTE:** The examples in this chapter show which commands are used to perform a particular function, but do not show the commands being used in any particular programming environment. Refer to Appendix D for some examples of SCPI commands in a specific programming environment.

---

## Programming the Output

### Power-on Initialization

When the dc source is first turned on, it wakes up with the output state set OFF. In this state the output voltage is set to 0. The following commands are given implicitly at power-on:

```
*RST
*CLS
STAT:PRES
*SRE 0
*ESE 0
```

\*RST is a convenient way to program all parameters to a known state. Refer to the \*RST command in chapter 8 to see how each programmable parameter is set by \*RST. Refer to the \*PSC command in chapter 8 for more information on the power-on initialization of the \*ESE and the \*SRE registers.

### Enabling the Output

To enable the output, use the command:

```
OUTP ON
```

Note that this command enables *both* outputs on Agilent 66319B/66319D units.

### Output Voltage

The output voltage is controlled with the VOLTage command. To set the output voltage to 5 volts, use:

```
VOLT 5      or
VOLT2 5     for models that have a second output
```

## 7 - Programming the DC Source

### Maximum Voltage

The maximum output voltage that can be programmed can be queried with:

```
VOLT? MAX
```

### Overvoltage Protection

The dc source will turn off its output if the output voltage exceeds its programmed setting by two volts when measured at the + sense and – sense terminals. If the operation of the overvoltage protection circuit interferes with the proper operation of your phone test, you can disable overvoltage protection. As explained in chapter 8, this protection feature is implemented with the following command:

```
VOLT:PROT:STAT <bool> where <bool> is the voltage protection state (0 | OFF; 1 | ON).
```

---

**CAUTION:** If overvoltage protection is disabled, the dc source or the equipment under test will not be protected from excessive external voltages.

---

### Output Current

All models have a programmable current function. The command to program the current is:

```
CURR <n> or  
CURR2 <n> for models that have a second output
```

where <n> is the current limit in amperes.

If the load attempts to draw more current than the programmed limit, the output voltage is reduced to keep the current within the limit.

### Maximum Current

The maximum output current that can be programmed can be queried with:

```
CURR? MAX
```

### Overcurrent Protection

The dc source can also be programmed to turn off its output if the current limit is reached. As explained in chapter 8, this protection feature is implemented the following command:

```
CURR:PROT:STAT ON | OFF
```

---

**NOTE:** Use the OUTPut:PROTection:DELAy command to prevent momentary current limit conditions caused by programmed output changes from tripping the overcurrent protection.

---

### Output Resistance

The output resistance is controlled with the RESistance command. To set the output resistance to 0.5 ohms, use:

```
RES 0.5
```

## Triggering Output Changes

The dc source has two independent trigger systems. One is used for synchronizing output changes, and the other is used for synchronizing measurements. This section describes the output trigger system. The measurement trigger system is described under "Triggering Measurements".

### SCPI Triggering Nomenclature

In SCPI terms, trigger systems are called sequences. When more than one trigger system exists, they are differentiated by naming them SEQUENCE1 and SEQUENCE2. SEQUENCE1 is the transient trigger system and SEQUENCE2 is the measurement trigger system. The dc source uses aliases with more descriptive names for these sequences. These aliases can be used instead of the sequence forms.

Sequence Form	Alias
SEQUENCE1	TRANSIENT
SEQUENCE2	ACQUIRE

### Output Trigger Model

Figure 7-1 is a model of the output trigger system. The rectangular boxes represent states. Arrows show the transitions between states. These are labeled with the input or event that causes the transition to occur.

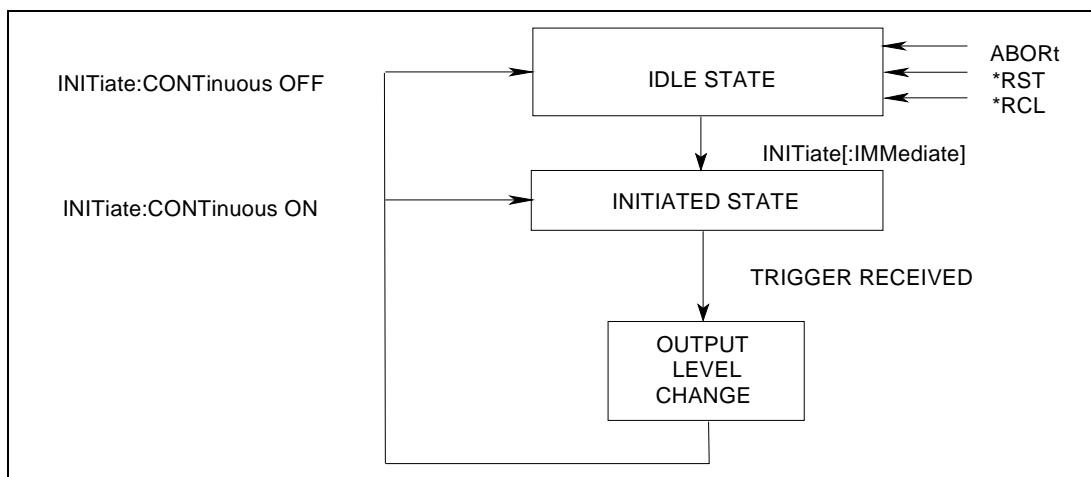

Figure 7-1. Model of Output Trigger System

### Setting the Voltage, Current, or Resistance Transient Levels

To program output trigger levels, you must first specify a voltage or current trigger level that the output will go to once a trigger signal is received. Use the following commands to set the output trigger level:

```

VOLT:TRIG <n>
VOLT2:TRIG <n>   for models that have a second output
CURR:TRIG <n>
CURR2:TRIG <n>   for models that have a second output
RES:TRIG <n>     only applies to output 1 (the main output)
  
```

**NOTE:** Until they are programmed, trigger levels will be the same as the corresponding voltage or current levels. For example, if a dc source is powered up and the voltage is programmed to 6, the trigger level is also set to 6. Once you program a trigger level, it will stay at that value until the output is changed by a transient trigger or reprogrammed.

## 7 - Programming the DC Source

### Enabling the Output Trigger System

When the dc source is turned on, the trigger subsystem is in the idle state. In this state, the trigger subsystem is disabled, ignoring all triggers. Sending the following commands at any time returns the trigger system to the idle state:

```
ABOR
*RST
*RCL
```

The INITiate commands move the trigger system from the idle state to the initiated state. This enables the dc source to receive triggers. To initiate for a single triggered action, use:

```
INIT:SEQ1    or
INIT:NAME  TRAN
```

After a trigger is received and the action completes, the trigger system will return to the idle state. Thus it will be necessary to enable the system each time a triggered action is desired.

To keep the transient trigger system initiated for multiple triggers without having to send an initiate command for each trigger, use:

```
INIT:CONT:SEQ1 ON    or
INIT:CONT:NAME  TRAN, ON
```

### Selecting the Output Trigger Source

The only trigger source for output triggers is a command from the bus. Since BUS is the only trigger source, the following command is provided for completeness only:

```
TRIG:SOUR  BUS
```

### Generating Triggers

#### Single Trigger

After you have specified the appropriate trigger source, you can generate triggers by sending one of the following commands over the GPIB:

```
TRIG:IMM
*TRG
an IEEE-488 Group Execute Trigger bus command
```

When the trigger system enters the Output Change state upon receipt of a trigger (see figure 7-1), the triggered functions are set to their programmed trigger levels. When the triggered actions are completed, the trigger system returns to the idle state.

---

**NOTE:** The external trigger input port does not support output triggers.

---

#### Multiple Triggers

When you have programmed INITiate:CONTinuous:SEQUence1 ON as previously discussed, the trigger system does not need to be initiated for each trigger; it responds to the next trigger as soon as it is received. When each triggered action completes, the trigger system returns to the initiated state to wait for the next trigger. INITiate:CONTinuous:SEQUence1 OFF returns the system to single trigger mode.



## Making Basic Measurements

All dc sources have excellent output voltage and current measurement capability.

**NOTE:** There is only one measurement system in the dc source. Therefore, you can perform only **one** measurement function (voltage, current, or DVM) at a time.

All measurements are performed by digitizing the instantaneous output voltage or current for a defined number of samples and sample interval, storing the results in a buffer, and then calculating the measured result. For the main output (output 1), many parameters of the measurement are programmable. These include the number of samples, the time interval between samples, and the method of triggering. Note that there is a tradeoff between these parameters and the speed, accuracy, and stability of the measurement in the presence of noise.

### Average Measurements

To measure the average output voltage or current for the main output (output 1), use:

```
MEAS : VOLT?
MEAS : CURR?
```

Average voltage and current is measured by acquiring a number of readings at the selected time interval, applying the Hanning window function to the readings, and *averaging* the readings. Windowing is a signal conditioning process that reduces the error in average measurements made in the presence of periodic signals such as pulse current waveforms, which are generated when TDMA cellular phones are transmitting. The power-on and \*RST sample interval and sweep size settings yield a data acquisition time of 32 milliseconds per measurement.

Ripple rejection is a function of the number of cycles of the ripple frequency contained in the acquisition window. More cycles in the acquisition window results in better ripple rejection. If you increase the data acquisition time for each measurement to 45 microseconds for example, this results in 5.53 cycles in the acquisition window at 60 Hz, for a ripple rejection of about 70 dB.

### Controlling Measurement Samples

You can vary both the number of data points in a measurement sample, as well as the time between samples. This is illustrated in Figure 7-2.

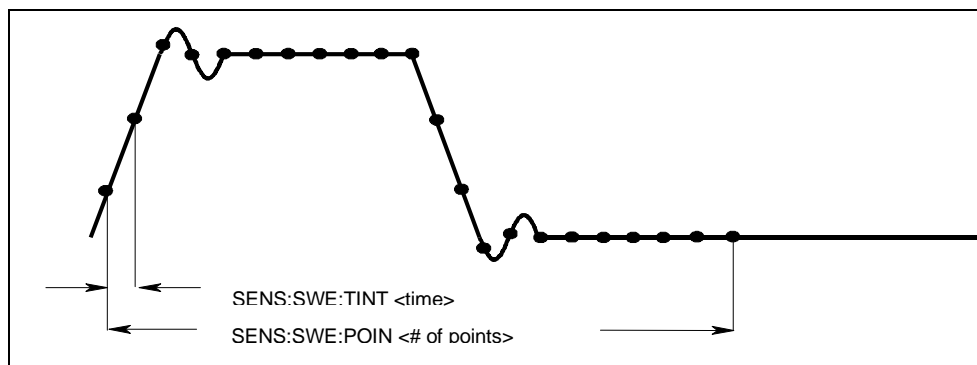

Figure 7-2. Commands that Control Measurement Time

## 7 - Programming the DC Source

When the instrument is turned on and at \*RST, the output voltage or current sampling rate is 15.6 microseconds, and the sweep size is set to 2048 data points. This means that it takes about 32 milliseconds to fill up 2048 data points in the data buffer. Adding a command processing overhead of about 20 milliseconds results in a total measurement time of about 50 milliseconds per measurement. You can vary this data sampling rate with:

```
SENS:SWE:TINT <sample_period>  
SENS:SWE:POIN <points>
```

For example, to set the time interval to 46.8 microseconds per measurement with 1500 samples, use

```
SENS:SWE:TINT 46.8E-6;POIN 1500.
```

Note that reducing the number of sample points increases the speed of the measurement; however, the tradeoff is greater measurement uncertainty in the presence of noise..

### Window Functions

The dc source lets you select from two measurement window functions: Hanning and Rectangular. To select a window function, use:

```
SENS:WIND: HANN | RECT
```

As shipped from the factory, the dc source measurement functions use a Hanning window. The Hanning window applies a  $\cos^4$  weighting function to the data in the measurement buffer when computing average and rms measurements. This returns accurate data even if an integral number of waveform cycles are not captured, provided that at least three or more waveform cycles are in the measurement buffer. If there are only one or two waveform cycles, the Hanning window will not give accurate results.

With a Rectangular window, no weighting function is applied to the data in the measurement buffer. However, to use the Rectangular window function to return accurate data for one or more waveform cycles, an integral number of waveform cycles must be captured in the measurement buffer. This means that you must accurately know the waveform period beforehand. In this way you can chose the sample interval and the number of data points so that an integral number of waveform cycles will end up in the measurement buffer.

### Measuring Output 2 Voltage and Current (Agilent 66319B/66319D only)

The measurement parameters for output 2 are not programmable. They are fixed at 2048 data points with a 15.6 microsecond sampling rate using a Hanning window. To measure the average output voltage or current for output 2, use:

```
MEAS:VOLT2?  
MEAS:CURR2?
```

---

## Making Enhanced Measurements

Agilent Models 66321B/D and 66319B/D have the ability to make several types of voltage or current waveform measurements. These expanded measurement capabilities are particularly useful for loads that draw current in pulses. The SCPI language MEASure and FETCh queries are used to return the various measurement parameters of voltage and current waveforms.

There are two ways to make enhanced measurements:

- ◆ Use the MEASure queries to immediately start acquiring new voltage or current data, and return measurement calculations from this data as soon as the buffer is full. This is the easiest way to make measurements, since it requires no explicit trigger programming. Additional calculations may be obtained from the acquired data using FETCh queries.
- ◆ Use a triggered measurement when the measurement must be synchronized to a signal condition as discussed under “Triggering Measurements”. Then use the FETCh queries to return calculations from the data that was retrieved by the acquisition trigger. This method gives you the flexibility to synchronize the data acquisition with a transition in the output voltage or current. FETCh queries do not trigger the acquisition of new measurement data, but they can be used to return many different calculations from the data that was retrieved by the acquisition trigger. Note that if you acquired voltage data, you can fetch only voltage calculations.

---

**NOTE:** For each MEASure query, there exists a corresponding FETCh query. FETCh queries perform the same calculation as MEASure queries, but do **not** acquire new data.

---

## Current Ranges and Measurement Detector

The dc source has three current measurement ranges. The command that controls the ranges is:

```
SENS:CURR:RANG <value> | MIN | MAX
```

Enter the value of the current that you expect to measure. When the range is set to 3A, the maximum current that can be measured is the maximum rating of the unit. Other current ranges are as follows:

**3A Range:** 0 through MAX (see Table A-2)

**1A Range:** 0 through 1 A

**0.02A Range:** 0 through 0.02 A (MIN)

The dc source also has two measurement detectors. Check that the current detector is set to ACDC when measuring current pulses or other waveforms with a frequency content greater than a few kilohertz.

```
SENS:CURR:DET ACDC
```

Select DC as the measurement detector if you are making only DC current measurements and you require a measurement offset better than 2mA on the High current measurement range. Note that this selection gives inaccurate results on current waveforms that have ac content.

```
SENS:CURR:DET DC
```

## RMS Measurements

To read the rms content of a voltage or current waveform, use:

```
MEAS:VOLT:ACDC? or  
MEAS:CURR:ACDC?
```

This returns the ac+dc rms measurement.

Making rms or average measurements on ac waveforms for which a non-integral number of cycles of data has been acquired may result in measurement errors due to the last partial cycle of acquired data. The instrument reduces this error by using a Hanning window function when making the measurement. If the measurement readings vary from sample to sample, try increasing the data acquisition time to reduce measurement error.

### Pulse Measurements

After pulse data has been acquired, use FETCh queries to return measurement data in the shortest time. FETCh queries do not trigger the acquisition of new measurement data, but return different calculations from the data that was acquired. If you acquired voltage data, you can fetch only voltage measurements; if you acquired current data you can fetch only current measurements, otherwise an error will occur.

The dc source has several measurement queries that return key parameters of pulse waveforms as shown in Figure 7-3.

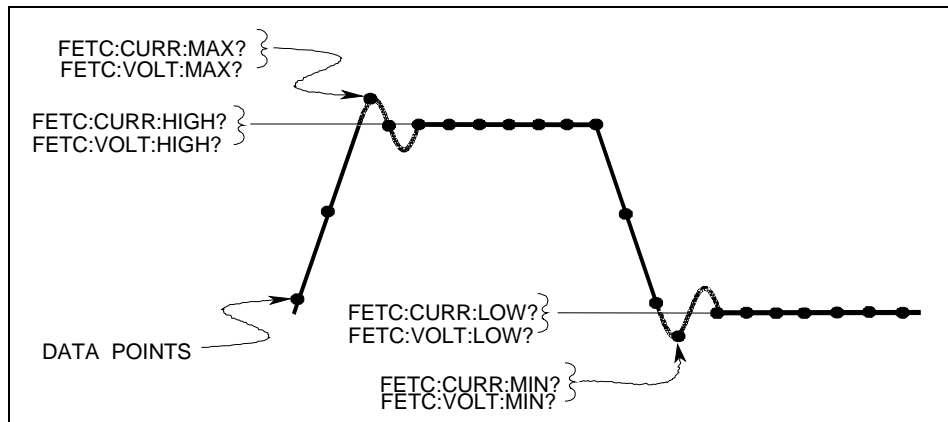

Figure 7-3. Measurement Commands Used to Return Pulse Data

### Minimum and Maximum Measurements

To return the maximum or minimum value of a pulse or ac waveform use:

```
FETC:VOLT:MAX? or  
FETC:VOLT:MIN?  
FETC:CURR:MAX? or  
FETC:CURR:MIN?
```

### High/Low Measurements

The value of the high level or low level of a pulse can also be measured. High and low level measurements are defined as follows: The instrument first measures the minimum and maximum data points of the pulse waveform. It then generates a histogram of the pulse waveform using 16 bins between the maximum and minimum data points. The bin containing the most data points above the 50% point is the high bin. The bin containing the most data points below the 50% point is the low bin. The average of all the data points in the high bin is returned as the High level. The average of all the data points in the low bin is returned as the Low level. If no high or low bin contains more than 1.25% of the total number of acquired points, then the maximum or minimum value is returned by these queries.

To return the average value of the high bin, use:

```
FETC:CURR:HIGH? or  
FETC:VOLT:HIGH?
```

To return the average value of the low bin, use:

```
FETC:CURR:LOW? or  
FETC:VOLT:LOW?
```

## Returning All Measurement Data From the Data Buffer

The MEASure:ARRay and FETCh:ARRay queries return all data values of the instantaneous voltage or current buffer. No weighting function is applied, returning only raw data from the buffer. The commands are:

```
MEAS : ARR : CURR ?
MEAS : ARR : VOLT ?
```

---

## Making DVM Measurements

Agilent Models 66321D and 66319D have a DVM input on the rear panel for making independent voltage measurements. The common mode voltage range of the DVM is  $-4.5\text{ V}$  to  $+25\text{ V}$  from either DVM input with respect to the negative output terminal of output 1. To protect the DVM from damage, keep the maximum isolation voltage to ground at less than  $\pm 50\text{ Vdc}$ . To obtain correct voltage measurements, keep the common mode voltage within the specified limits. Refer to chapter 3 under "DVM Connection" for more information.

The DVM can only measure average and rms voltage. Its measurement parameters are not programmable. They are fixed at 2048 data points with a 15.6 microsecond sampling rate using a Hanning window. Use the SCPI language MEASure and FETCh queries to return measurements. Note that all triggered measurement functions discussed the next section also apply to DVM measurements.

---

**NOTE:** There is only one measurement system in the dc source. Therefore, you can perform only **one** measurement function (voltage, current, or DVM) at a time.

---

## Average Measurements

To measure the average voltage, use:

```
MEAS : DVM : DC ?
```

Average voltage measured by acquiring a number of readings at the selected time interval, applying a Hanning window function to the readings, and *averaging* the readings. Windowing is a signal conditioning process that reduces the error in average measurements made in the presence of periodic signals. The DVM sampling rate and sweep size result in a data acquisition time of 32 milliseconds per measurement. Adding a command processing overhead of about 20 milliseconds results in a total measurement time of about 50 milliseconds per measurement.

## RMS Measurements

To measure rms voltage, use:

```
MEAS : DVM : ACDC ?
```

This returns the total rms measurement. If ac and dc are present, the DVM measures the total rms of ac+dc.

Making rms or average measurements on ac waveforms for which a non-integral number of cycles of data has been acquired may result in measurement errors due to the last partial cycle of acquired data. This error is reduced by using a Hanning window function when making the measurement.

## Triggered Measurements

Use the measurement trigger system to synchronize the acquisition of measurements with either a BUS or internal trigger. You can trigger voltage and current measurements on the main output (output 1) and on the DVM. An internal trigger synchronizes the acquisition to a signal condition. Use `FETCH` commands to return different calculations from the data acquired by the measurement system. Briefly, to make a triggered measurement:

- 1 Select a sweep interval and sample size
- 2 Set up the trigger levels
- 3 Setting the output 2 voltage and current
- 4 Select the trigger source
- 5 Enable the trigger system
- 6 Fetch the triggered measurements

## SCPI Triggering Nomenclature

The dc source uses the following sequence name and alias for the measurement trigger system. The alias can be used instead of the sequence form.

Sequence Form	Alias
SEquence2	ACQuire

## Measurement Trigger Model

Figure 7-4 is a model of the measurement trigger system. The rectangular boxes represent states. The arrows show the transitions between states. These are labeled with the input or event that causes the transition to occur.

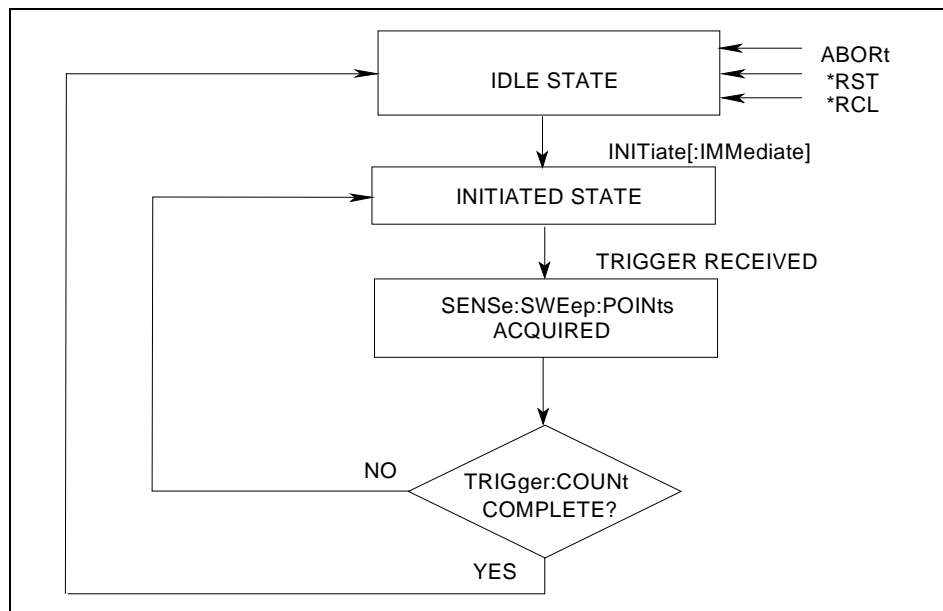

Figure 7-4. Model of Measurement Trigger System

## Enabling the Measurement Trigger System

When the dc source is turned on, the trigger system is in the idle state. In this state, the trigger system is disabled and it ignores all triggers. Sending the following commands at any time returns the trigger system to the idle state:

```
ABORT
*RST
*RCL
```

The INITiate commands move the trigger system from the idle state to the initiated state. This enables the measurement system to receive triggers. To initiate the measurement trigger system, use:

```
INIT:SEQ2 or INIT:NAME ACQ
```

After a trigger is received and the data acquisition completes, the trigger system will return to the idle state (unless multiple triggers are desired). Thus it will be necessary to initiate the system each time a triggered measurement is desired.

---

**NOTE:** The measurement trigger system cannot be initiated continuously. However, it can be repeated for a limited number of times as explained under "Multiple triggers".

---

## Selecting the Measurement Trigger Source

The trigger system is waiting for a trigger signal in the initiated state. Before you generate a trigger, you must select a trigger source. The following measurement trigger sources can be selected:

- BUS -** Selects GPIB bus triggers. This synchronizes the measurement to the bus trigger command
- INTernal -** Selects the signal as the measurement trigger. This synchronizes the measurement to the signal condition present at either the main output (output1) terminals or the DVM inputs.
- EXTernal -** Selects the external trigger input as the measurement trigger source. This capability only applies to units with firmware revision A.03.01 and up.

To select GPIB bus triggers, use:

```
TRIG:SEQ2:SOUR BUS or TRIG:ACQ:SOUR BUS
```

To select internal triggers use:

```
TRIG:SEQ2:SOUR INT or TRIG:ACQ:SOUR INT
```

To select external triggers use:

```
TRIG:SEQ2:SOUR EXT or TRIG:ACQ:SOUR EXT
```

## Selecting the Sensing Function

There is only one measurement system in the dc source. The measurement system supports voltage measurements at the main output, current measurements at the main output, and DVM input measurements. Before you generate a measurement trigger, you must specify one of the following measurement functions:

```
SENS:FUNC "CURR" or
SENS:FUNC "VOLT" or
SENS:FUNC "DVM"
```

## Generating Measurement Triggers

### Single Triggers

After you specify the appropriate trigger source and sensing function, generate triggers as follows:

**GPIB Triggers** Send one of the following commands over the GPIB:  
 TRIG:ACQ  
 \*TRG  
 an IEEE-488 Group Execute Trigger bus command

**Internal Triggers** To trigger off of the output signal, you must specify the output level that generates the trigger, the rising or falling edge of the slope, and a hysteresis to qualify trigger conditions. This is illustrated in figure 7-5 for current triggers.

**External Triggers** To externally trigger the measurement, you must supply either a negative-going edge signal or a contact closure to the external trigger input (see Appendix A). This capability only applies to units with firmware revision A.03.01 and up.

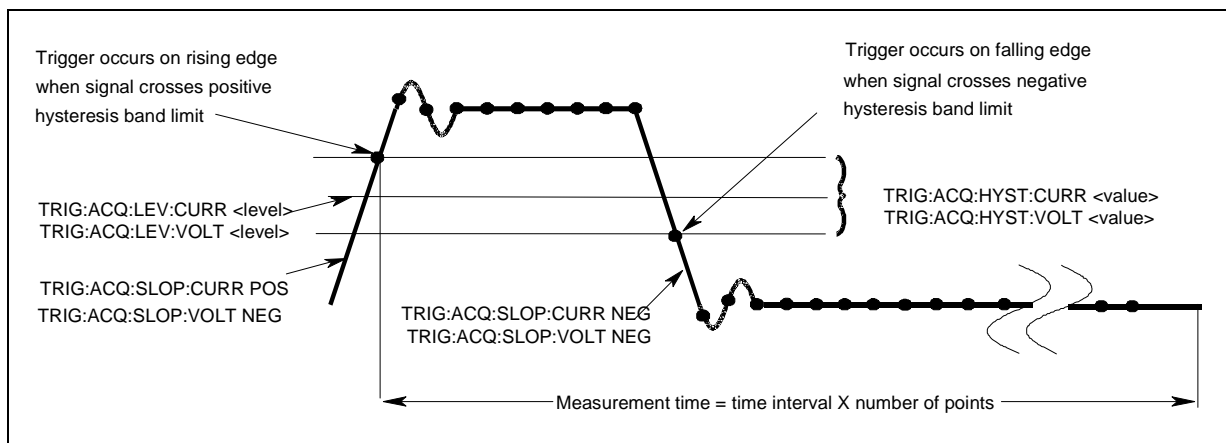

**Figure 7-5. Commands Used to Control Internal Measurement Triggers**

To specify the **current level** that will generate triggers for both positive- and negative-going signals use:

TRIG:SEQ2:LEV:CURR <value> or  
 TRIG:ACQ:LEV:CURR <value>

To specify the **slope** on which triggering occurs use the following commands. You can specify a POSitive, a NEGative, or EITHER type of slope.

TRIG:SEQ2:SLOP:CURR <slope> or  
 TRIG:ACQ:SLOP:CURR <slope>

To specify a **hysteresis band** to qualify the positive- or negative-going signal use:

TRIG:SEQ2:HYST:CURR <value> or  
 TRIG:ACQ:HYST:CURR <value>

---

**NOTE:** When using internal triggers, do not INITiate the measurement until after you have specified the slope, level, and hysteresis.

---

When the acquisition finishes, any of the FETCh queries can be used to return the results. Once the measurement trigger is initiated, if a FETCh query is sent before the data acquisition is triggered or before it is finished, the response data will be delayed until the trigger occurs and the acquisition completes. This may tie up the computer if the trigger condition does not occur immediately.



One way to wait for results without tying up the computer is to use the SCPI command completion commands. For example, you can send the \*OPC command after INITIALize, then occasionally poll the OPC status bit in the standard event status register for status completion while doing other tasks. You can also set up an SRQ condition on the OPC status bit going true and do other tasks until the SRQ interrupts.

## Multiple Triggers

As shown in Figure 7-6, the dc source also has the ability to set up several measurements in succession. This is accomplished by specifying a trigger count.

---

**NOTE:** Multiple triggers can only be programmed for voltage and current measurements on the main output (output 1). Multiple triggers cannot be programmed for DVM measurements.

---

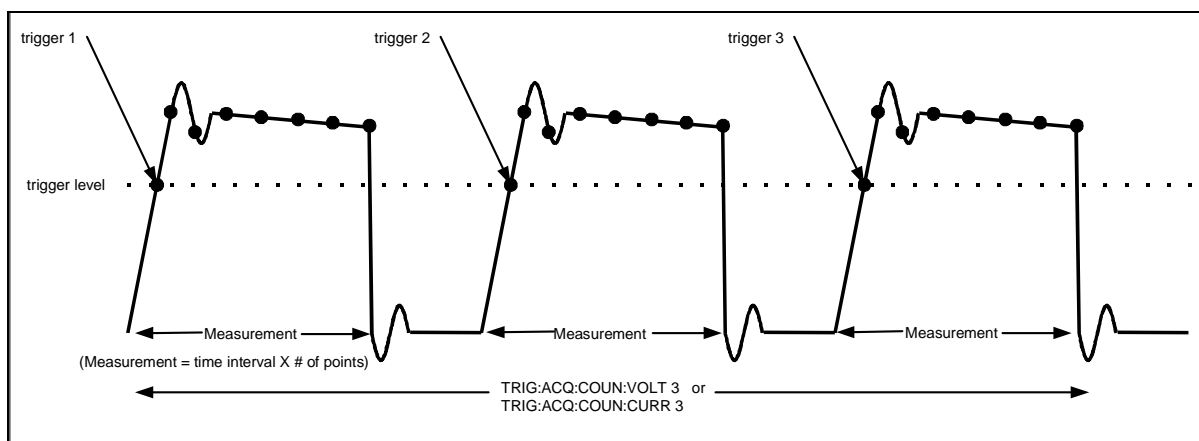

**Figure 7-6. Multiple Measurements**

To set up the trigger system for a number of sequential acquisitions use:

```
TRIG:ACQ:COUN:CURR <number> or
TRIG:ACQ:COUN:VOLT <number>
```

With this setup, the instrument performs each acquisition sequentially, storing the digitized readings in the internal measurement buffer. It is only necessary to initialize the measurement once at the start; after each completed acquisition the instrument will wait for the next valid trigger condition to start another. When all measurements complete, use FETCh commands to return the data.

By varying the measurement parameters, you can accurately measure specific portions of an output pulse. For example, if you set the measurement time to match the pulse width, you can measure just the high level of a specific number of output pulses. If you increase the measurement time to include the entire waveform, you will return measurement data based on the entire waveform. To calculate the correct time interval for your measurement, simply divide the desired measurement time by the number of points or samples in the measurement.

---

**NOTE:** The total number of data points cannot exceed 4096. This means that the count multiplied by the points in each measurement cannot exceed 4096; otherwise an error will occur.

---

## Pre-trigger and Post-trigger Data Acquisition

The measurement system lets you capture data before, after, or at the trigger signal. When a measurement is initiated, the dc source continuously samples the instantaneous signal level of the sensing function. As shown in figure 7-7, you can move the block of data being read into the acquisition buffer with reference to the acquisition trigger. This permits pre-trigger or post-trigger data sampling.

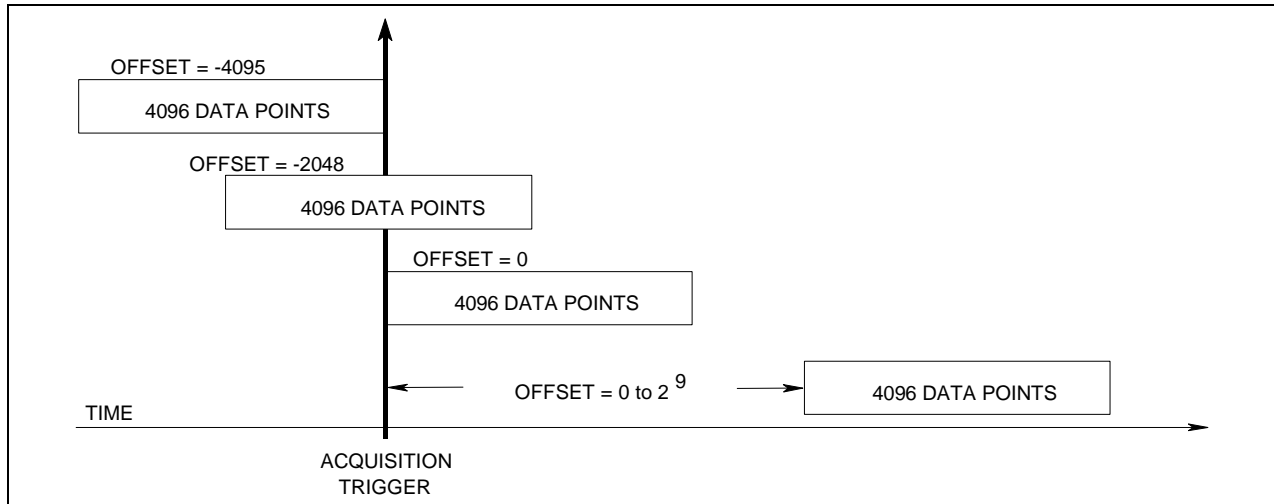

**Figure 7-7. Pre-trigger and Post-trigger Acquisition**

To offset the beginning of the acquisition buffer relative to the acquisition trigger, use:

```
SENS:SWE:OFFS:POIN <offset>
```

The range for the offset is -4095 to 2,000,000,000 points. As shown in the figure, when the offset is negative, the values at the beginning of the data record represent samples taken prior to the trigger. When the value is 0, all of the values are taken after the trigger. Values greater than zero can be used to program a delay time from the receipt of the trigger until the data points that are entered into the buffer are valid. (Delay time = offset x sample period).

---

**NOTE:** If, during a pre-trigger data acquisition, a trigger occurs before the pre-trigger data count is completed, the measurement system ignores this trigger. This will prevent the completion of the measurement if another trigger is not generated.

---

## Programming the Status Registers

Status register programming lets you determine the operating condition of the dc source at any time. For example, you may program the dc source to generate an interrupt (SRQ) when an event such as a current limit occurs. When the interrupt occurs, your program can act on the event in the appropriate fashion.

Figure 7-8 shows the status register structure of the dc source. Table 7-1 defines the status bits. The Standard Event, Status Byte, and Service Request Enable registers and the Output Queue perform standard GPIB functions as defined in the *IEEE 488.2 Standard Digital Interface for Programmable Instrumentation*. The Operation Status and Questionable Status registers implement functions that are specific to the dc source.

## Power-On Conditions

Refer to the \*RST command description in chapter 8 for the power-on conditions of the status registers.

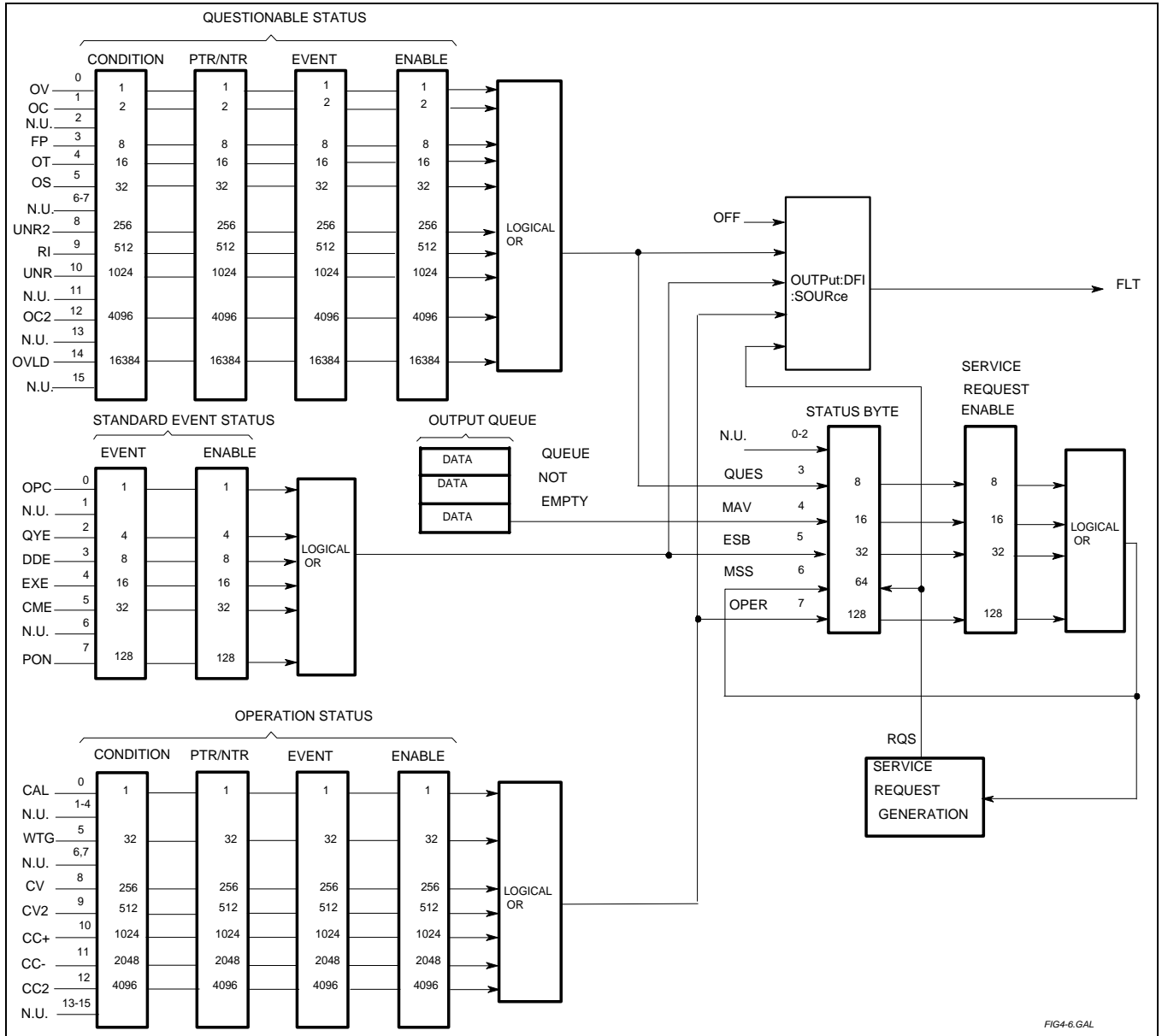

Figure 7-8. DC Source Status Model

FIG4-6.GAL

## 7 - Programming the DC Source

**Table 7-1. Bit Configurations of Status Registers**

Bit	Signal	Meaning
<b>Operation Status Group</b>		
0	CAL	The dc source is computing new calibration constants
5	WTG	The dc source is waiting for a trigger
8	CV	The dc source is in constant voltage mode
9	CV2	Output 2 is operating in constant voltage mode
10	CC+	The dc source is in constant current mode
11	CC-	The dc source is in negative constant current mode
12	CC2	Output 2 is operating in constant current mode
<b>Questionable Status Group</b>		
0	OV	The overvoltage protection has tripped
1	OCP	The overcurrent protection has tripped
3	FP	A front panel key has been depressed while in local mode
4	OT	The overtemperature protection has tripped
5	OS	An open sense lead has been detected
8	UNR2	Output 2 is unregulated
9	RI	The remote inhibit state is active
10	UNR	The output is unregulated
12	OC2	Output 2 overcurrent protection has tripped
14	MeasOvld	Current measurement exceeded capability of low range
<b>Standard Event Status Group</b>		
0	OPC	Operation complete
2	QYE	Query error
3	DDE	Device-dependent error
4	EXE	Execution error
5	CME	Command error
7	PON	Power-on
<b>Status Byte and Service Request Enable Registers</b>		
3	QUES	Questionable status summary bit
4	MAV	Message Available summary bit
5	ESB	Event Status Summary bit
6	MSS	Master Status Summary bit
	RQS	Request Service bit
7	OPER	Operation status summary bit

### Operation Status Group

The Operation Status registers record signals that occur during normal operation. As shown below, the group consists of a Condition, PTR/NTR, Event, and Enable register. The outputs of the Operation Status register group are logically-ORed into the OPERation summary bit (7) of the Status Byte register.

Register	Command	Description
Condition	STAT:OPER:COND?	A register that holds real-time status of the circuits being monitored. It is a read-only register.
PTR Filter	STAT:OPER:PTR <n>	A positive transition filter that functions as described under STAT:OPER:NTR PTR commands in chapter 8. It is a read/write register.
NTR Filter	STAT:OPER:NTR <n>	A negative transition filter that functions as described under STAT:OPER:NTR PTR commands in chapter 8. It is a read/write register.
Event	STAT:OPER:EVEN?	A register that latches any condition that is passed through the PTR or NTR filters. It is a read-only register that is cleared when read.
Enable	STAT:OPER:ENAB <n>	A register that functions as a mask for enabling specific bits from the Event register. It is a read/write register.

## Questionable Status Group

The Questionable Status registers record signals that indicate abnormal operation of the dc source. As shown in figure 7-7, the group consists of the same type of registers as the Status Operation group. The outputs of the Questionable Status group are logically-ORed into the QUEStionable summary bit (3) of the Status Byte register.

Register	Command	Description
Condition	STAT:QUES:COND?	A register that holds real-time status of the circuits being monitored. It is a read-only register.
PTR Filter	STAT:QUES:PTR <n>	A positive transition filter that functions as described under STAT:QUES:NTR   PTR commands in chapter 8. It is a read/write register.
NTR Filter	STAT:QUES:NTR <n>	A negative transition filter that functions as described under STAT:QUES:NTR   PTR commands in chapter 8. It is a read/write register.
Event	STAT:QUES:EVEN?	A register that latches any condition that is passed through the PTR or NTR filters. It is a read-only register that is cleared when read.
Enable	STAT:QUES:ENAB <n>	A register that functions as a mask for enabling specific bits from the Event register. It is a read/write register..

## Standard Event Status Group

This group consists of an Event register and an Enable register that are programmed by Common commands. The Standard Event event register latches events relating to instrument communication status (see figure 7-7). It is a read-only register that is cleared when read. The Standard Event enable register functions similarly to the enable registers of the Operation and Questionable status groups.

Command	Action
*ESE	programs specific bits in the Standard Event enable register.
*PSC ON	clears the Standard Event enable register at power-on.
*ESR?	reads and clears the Standard Event event register.

### The PON (Power On) Bit

The PON bit in the Standard Event event register is set whenever the dc source is turned on. The most common use for PON is to generate an SRQ at power-on following an unexpected loss of power. To do this, bit 7 of the Standard Event enable register must be set so that a power-on event registers in the ESB (Standard Event Summary Bit), bit 5 of the Service Request Enable register must be set to permit an SRQ to be generated, and \*PSC OFF must be sent. The commands to accomplish these conditions are:

```
*PSC OFF
*ESE 128
*SRE 32
```

## Status Byte Register

This register summarizes the information from all other status groups as defined in the *IEEE 488.2 Standard Digital Interface for Programmable Instrumentation*. See Table 7-1 for the bit configuration.

Command	Action
*STB?	reads the data in the register but does not clear it (returns MSS in bit 6)
serial poll	clears RQS inside the register and returns it in bit position 6 of the response.

## 7 - Programming the DC Source

### The MSS Bit

This is a real-time (unlatched) summary of all Status Byte register bits that are enabled by the Service Request Enable register. MSS is set whenever the dc source has one or more reasons for requesting service. \*STB? reads the MSS in bit position 6 of the response but does not clear any of the bits in the Status Byte register.

### The RQS Bit

The RQS bit is a latched version of the MSS bit. Whenever the dc source requests service, it sets the SRQ interrupt line true and latches RQS into bit 6 of the Status Byte register. When the controller does a serial poll, RQS is cleared inside the register and returned in bit position 6 of the response. The remaining bits of the Status Byte register are not disturbed.

### The MAV Bit and Output Queue

The Output Queue is a first-in, first-out (FIFO) data register that stores dc source-to-controller messages until the controller reads them. Whenever the queue holds one or more bytes, it sets the MAV bit (4) of the Status Byte register.

## Determining the Cause of a Service Interrupt

You can determine the reason for an SRQ by the following actions:

- Step 1            Determine which summary bits are active. Use:  
                  \*STB?    or    serial poll
- Step 2            Read the corresponding Event register for each summary bit to determine which events caused the summary bit to be set. Use:  
                  STAT:QUES:EVEN?  
                  STAT:OPER:EVEN?  
                  ESR?  
                  When an Event register is read, it is cleared. This also clears the corresponding summary bit.
- Step 3            Remove the specific condition that caused the event. If this is not possible, the event may be disabled by programming the corresponding bit of the status group Enable register or NTR|PTR filter. A faster way to prevent the interrupt is to disable the service request by programming the appropriate bit of the Service Request Enable register

## Servicing Operation Status and Questionable Status Events

This example assumes you want a service request generated whenever the dc source switches to the CC (constant current) operating mode, or whenever the dc source's overvoltage, overcurrent, or overtemperature circuits have tripped. From figure 7-7, note the required path for a condition at bit 10 (CC) of the Operation Status register to set bit 6 (RQS) of the Status Byte register. Also note the required path for Questionable Status conditions at bits 0, 1, and 4 to generate a service request (RQS) at the Status Byte register. The required register programming is as follows:

- Step 1**                   Program the Operation Status PTR register to allow a positive transition at bit 10 to be latched into the Operation Status Event register, and allow the latched event to be summed into the Operation summary bit. Use:  
`STAT:OPER:PTR 1024;ENAB 1024`
- Step 2**                   Program the Questionable Status PTR register to allow a positive transition at bits 0, 1, or 4 to be latched into the Questionable Status Event register, and allow the latched event to be summed into the Questionable summary bit. Use:  
`STAT:QUES:PTR 19;ENAB 19`                               (1 + 2 + 16 = 19)
- Step 3**                   Program the Service Request Enable register to allow both the Operation and the Questionable summary bits from the Status Byte register to generate RQS. Use:  
`*SRE 136`                               (8 + 128 = 136)
- Step 4**                   When you service the request, read the event registers to determine which Operation Status and Questionable Status Event register bits are set, and clear the registers for the next event. Use:  
`STAT:OPER:EVENT;QUES:EVENT?`

**Monitoring Both Phases of a Status Transition**

You can monitor a status signal for both its positive and negative transitions. For example, to generate RQS when the dc source either enters the CC+ (constant current) condition or leaves that condition, program the Operational Status PTR/NTR filter as follows:

```
STAT:OPER:PTR 1024;NTR 1024
STAT:OPER:ENAB 1024;*SRE 128
```

The PTR filter will cause the OPERational summary bit to set RQS when CC+ occurs. When the controller subsequently reads the event register with STAtus:OPERational:EVENT?, the register is cleared. When CC+ subsequently goes false, the NTR filter causes the OPERational summary bit to again set RQS.

---

**Inhibit/Fault Indicator**

The remote inhibit(INH) and discrete fault(FLT) indicators are implemented through the respective **INH** and **FLT** connections on the rear panel. Refer to Table A-2 for the electrical parameters. Refer to Appendix E for a programming example.

**Remote Inhibit (RI)**

Remote inhibit is an external, chassis-referenced logic signal routed through the rear panel INH connection, which allows an external device to disable the dc source output. To select an operating modes for the remote inhibit signal, use:

```
OUTP:RI:MODE LATC | LIVE | OFF
```

## 7 - Programming the DC Source

### Discrete Fault Indicator (DFI)

The discrete fault indicator is an open-collector logic signal connected to the rear panel FLT connection that can be used to signal external devices when a fault condition is detected. To select the internal fault source that drives this signal, use:

```
OUTPut:DFI:SOURce QUESTIONable | OPERation | ESB | RQS | OFF
```

To enable or disable the DFI output, use:

```
OUTPut:DFI:STATE ON | OFF
```

### Using the Inhibit/Fault Port as a Digital I/O

You can configure the inhibit/fault port to provide a digital input/output to be used with custom digital interface circuits or relay circuits. As shipped from the factory, the port is shipped for inhibit/fault operation. You can change the configuration of the port to operate as a general-purpose digital input output port with the following command:

```
[SOURce:]DIGital:FUNctIon RIDFi | DIGio
```

The following table shows the pin assignments of the mating plug when used in RI/DFI mode as well as Digital I/O mode. Refer to Table A-2 for the electrical characteristics of the port.

Pin	FAULT/INHIBIT	DIGITAL I/O	Bit Weight
1	FLT Output	OUT 0	0
2	FLT Output	OUT 1	1
3	INH Input	IN/OUT 2	2
4	INH Common	Common	not programmable

To program the digital I/O port use:

```
[SOURce:]DIGital:DATA <data>
```

where the data is an integer from 0 to 7 that sets pins 1 to 3 according to their binary weight. Refer to the DIGital:DATA command for more information.



# Language Dictionary

---

## Introduction

This section gives the syntax and parameters for all the IEEE 488.2 SCPI commands and the Common commands used by the dc source. It is assumed that you are familiar with the material in chapter 6, which explains the terms, symbols, and syntactical structures used here and gives an introduction to programming. You should also be familiar with chapter 5, in order to understand how the dc source functions.

The programming examples are simple applications of SCPI commands. Because the SCPI syntax remains the same for all programming languages, the examples given for each command are generic.

<b>Syntax Forms</b>	Syntax definitions use the long form, but only short form headers (or "keywords") appear in the examples. Use the long form to help make your program self-documenting.
<b>Parameters</b>	Most commands require a parameter and all queries will return a parameter. The range for a parameter may vary according to the model of dc source. When this is the case, refer to the Specifications table in the Appendix A.
<b>Related Commands</b>	Where appropriate, related commands or queries are included. These are listed because they are either directly related by function, or because reading about them will clarify or enhance your understanding of the original command or query.
<b>Order of Presentation</b>	The dictionary is organized according to the following functions: calibration, display, measurement, output, status, system, trigger, and common commands. Both the subsystem commands and the common commands that follow are arranged in alphabetical order under each heading.

## Subsystem Commands

Subsystem commands are specific to functions. They can be a single command or a group of commands. The groups are comprised of commands that extend one or more levels below the root.

The subsystem command groups are arranged according to function: Calibration, Display, Measurement, Output, Status, System, and Trigger. Commands under each function are grouped alphabetically. Commands followed by a question mark (?) take only the query form. When commands take both the command and query form, this is noted in the syntax descriptions. Table 8-1 lists all of the subsystem commands in alphabetical order.

Table 8-1. Subsystem Commands Syntax

<b>ABORt</b>	Resets the trigger system to the Idle state
<b>CALibrate</b>	
<b>:CURRent</b>	
<b>[:SOURce] [:DC] [:POSitive]</b>	Calibrate positive output current and high current measurement range
<b>:MEASure [:DC]</b>	
<b>:R3</b>	Calibrate middle current measurement range
<b>:LOWRange</b>	Calibrate low current measurement range
<b>:AC</b>	Calibrate ac current measurement circuits
<b>:CURRent2</b>	Calibrate output2 current
<b>:DATE &lt;date&gt;</b>	Sets and reads the calibration date
<b>:DVM</b>	Calibrate DVM voltage readback
<b>:LEVel &lt;level&gt;</b>	Advance to next calibration step (P1   P2)
<b>:PASSword &lt;n&gt;</b>	Set calibration password
<b>:RESistance</b>	Calibrate output resistance
<b>:SAVE</b>	Save new cal constants in non-volatile memory
<b>:STATE &lt;bool&gt; [,&lt;n&gt;]</b>	Enable or disable calibration mode
<b>:VOLTag e [:DC]</b>	Calibrate output voltage and voltage readback
<b>:VOLTag e2</b>	Calibrate output2 voltage
<b>DISPlay</b>	
<b>[:WINDow]</b>	
<b>[:STATE] &lt;bool&gt;</b>	Enable/disable front panel display
<b>:CHANnel &lt;n&gt;</b>	Select the output that is displayed ( 1   2)
<b>:MODE &lt;mode&gt;</b>	Set display mode (NORM   TEXT)
<b>:TEXT [::DATA] &lt;string&gt;</b>	Sets the text that is displayed
<b>FORMat</b>	
<b>[::DATA] &lt;type&gt;</b>	Specifies data type and length for all array queries
<b>:BORDER &lt;type&gt;</b>	Specifies byte order for all array queries
<b>INITiate</b>	
<b>[:IMMediate]</b>	
<b>:SEquence&lt;n&gt;</b>	Enable the numbered trigger system sequence (1   2)
<b>:NAME &lt;name&gt;</b>	Enable the named trigger system sequence (TRAN   ACQ)
<b>CONTInuous</b>	
<b>:SEquence1, &lt;bool&gt;</b>	Enable continuous output transient triggers
<b>:NAME TRANSient, &lt;bool&gt;</b>	Enable continuous output transient triggers
<b>INSTRument</b>	
<b>:COUple</b>	
<b>:OUTPut</b>	
<b>:STATE &lt;state&gt;</b>	Couples or decouples output 1 and output 2 (NONE or ALL)
<b>MEASure</b>	
<b>:CURRent2?</b>	Returns the output 2 current measurement
<b>:VOLTag e2?</b>	Returns the output 2 voltage measurement
<b>MEASure   FETCh</b>	
<b>:ARRay</b>	
<b>:CURRent [::DC]?</b>	Returns the digitized instantaneous current
<b>:VOLTag e [::DC]?</b>	Returns the digitized instantaneous voltage
<b>[::SCALar]</b>	
<b>:CURRent [::DC]?</b>	Returns dc current
<b>:ACDC?</b>	Returns the total rms current (ac+dc)
<b>:HIGH?</b>	Returns the HIGH level of a current pulse
<b>:LOW?</b>	Returns the LOW level of a current pulse
<b>:MAX?</b>	Returns maximum current
<b>:MIN?</b>	Returns minimum current

Table 8-1. Subsystem Commands Syntax (continued)

<b>:DVM</b> [:DC]?	Returns DVM dc voltage measurement
<b>:ACDC?</b>	Returns DVM rms voltage measurement
<b>:VOLTage</b> [:DC]?	Returns dc voltage
<b>:ACDC?</b>	Returns the total rms voltage (ac+dc)
<b>:HIGH?</b>	Returns the HIGH level of a voltage pulse
<b>:LOW?</b>	Returns the LOW level of a voltage pulse
<b>:MAX?</b>	Returns maximum voltage
<b>:MIN?</b>	Returns minimum voltage
<b>OUTPut</b> [1 2]	
[:STATe] <bool>	Enables/disables the dc source output
<b>:COMPensation</b>	
:MODE <mode>	Sets output compensation (HREMOTE   LREMOTE   HLOCAL   LLOCAL)
<b>:DFI</b>	
[:STATe] <bool>	Enables/disables the DFI output
:SOURce <source>	Selects event source (QUES   OPER   ESB   RQS   OFF)
<b>:PON</b>	
:STATe <state>	Set power-on state (*RST   RCL0)
<b>:PROtection</b>	
:CLEar	Reset latched protection
:DELAy <n>	Delay after programming/before protection
<b>:RELAy:</b>	
:MODE <mode>	Specifies the output relay mode (DD, HD, DH, or HH).
<b>:RI</b>	
:MODE <mode>	Sets remote inhibit operating mode (LATC   LIVE   OFF)
<b>SENSe</b>	
<b>:CURRent</b>	
[:DC] :RANGe [:UPPer] <n>	Selects the high current measurement range
:DETEctor <detector>	Selects the current measurement detector (ACDC   DC)
<b>:FUNCTION</b> <function>	Configures the measurement sensor ("VOLT"   "CURR"   "DVM")
<b>:LEAD</b>	
:STATus?	Returns the setting of the open sense detection circuit
<b>:PROtection</b>	
:STATe <state>	Enables/disables open sense lead detection
<b>:SWEep</b>	
:OFFSet	
:POINts <n>	Defines the pre/post data capture in the measurement
:POINts <n>	Define the number of data points in the measurement
:TINterval <n>	Sets the digitizer sample spacing
:WINDow [:TYPE] <type>	Sets the measurement window function (HANN   RECT)
<b>[SOURce:]</b>	
<b>CURRent</b>	
[:LEVel]	
[:IMMediate][:AMPLitude] <n>	Sets the output current limit
:TRIGgered [:AMPLitude] <n>	Sets the triggered output current limit
<b>:PROtection</b>	
:STATe <bool>	Enables/disables current limit protection
<b>CURRent2</b>	
[:LEVel]	
[:IMMediate][:AMPLitude] <n>	Sets the output2 current level
:TRIGgered [:AMPLitude] <n>	Sets the triggered output2 current level
<b>DIGital</b>	
:DATA [:VALue] <n>	Sets and reads the digital control port
:FUNCtion <function>	Configures digital control port (RIDF   DIG   TRIG)
<b>RESistance</b>	
[:LEVel]	
[:IMMediate][:AMPLitude] <n>	Sets the output resistance
:TRIGgered [:AMPLitude] <n>	Sets the triggered output resistance
<b>VOLTage</b>	
[:LEVel]	
[:IMMediate][:AMPLitude] <n>	Sets the output voltage level
:TRIGgered [:AMPLitude] <n>	Sets the triggered output voltage level

Table 8-1. Subsystem Commands Syntax (continued)

<b>:PROtection</b>	
[:LEVel] <n>	Sets the programmable output voltage limit
:STATe <bool>	Enables/disables automatic overvoltage protection tracking
<b>VOLTage2</b>	
[:LEVel]	
[:IMMediate][:AMPLitude] <n>	Sets the output2 voltage level
:TRIGgered [:AMPLitude] <n>	Sets the triggered output2 voltage level
<b>STATus</b>	
:PRESet	Presets all enable and transition registers to power-on
:OPERation	
[:EVENT]?	Returns the value of the event register
:CONDition?	Returns the value of the condition register
:ENABle <n>	Enables specific bits in the Event register
:NTRansition<n>	Sets the Negative transition filter
:PTRansition<n>	Sets the Positive transition filter
:QUEStionable	
[:EVENT]?	Returns the value of the event register
:CONDition?	Returns the value of the condition register
:ENABle <n>	Enables specific bits in the Event register
:NTRansition<n>	Sets the Negative transition filter
:PTRansition<n>	Sets the Positive transition filter
<b>SYSTem</b>	
:ERRor?	Returns the error number and error string
:LANGUage <language>	Sets the programming language (SCPI)
:VERSion?	Returns the SCPI version number
<b>TRIGger</b>	
:SEQuence2   :ACQuire	
[:IMMediate]	Triggers the measurement immediately
:COUNt	
:CURRent <n>	Sets the number of sweeps per current measurement
:DVM <n>	Sets the number of sweeps per DVM measurement
:VOLTage <n>	Sets the number of sweeps per voltage measurement
:HYSTeresis	
:CURRent <n>	Qualifies the trigger when measuring current
:DVM <n>	Qualifies the trigger when making DVM measurements
:VOLTage <n>	Qualifies the trigger when measuring voltage
:LEVel	
:CURRent <n>	Sets the trigger level for measuring current
:DVM <n>	Sets the trigger level when making DVM measurements
:VOLTage <n>	Sets the trigger level for measuring voltage
:SLOPe	
:CURRent <slope>	Sets the triggered current slope (POS   NEG   EITH)
:DVM <slope>	Sets the triggered DVM measurement slope (POS   NEG   EITH)
:VOLTage <slope>	Sets the triggered voltage slope (POS   NEG   EITH)
:SOURce <source>	Sets the trigger source (BUS   INT   TRIG)
[:SEQuence1   :TRANsient]	
[:IMMediate]	Triggers the output immediately
:SOURce <source>	Sets the trigger source (BUS)
:SEQuence1	
:DEFine TRANsient	Sets or queries the SEQ1 name
:SEQuence2	
:DEFine ACQuire	Sets or queries the SEQ2 name

## Common Commands

Common commands begin with an \* and consist of three letters (command) or three letters and a ? (query). They are defined by the IEEE 488.2 standard to perform common interface functions. Common commands and queries are categorized under System, Status, or Trigger functions and are listed at the end of the chapter. The dc source responds to the following common commands:

**Table 8-2. Common Commands Syntax**

<b>*CLS</b>	Clear status
<b>*ESE &lt;n&gt;</b>	Standard event status enable
<b>*ESE?</b>	Return standard event status enable
<b>*ESR?</b>	Return event status register
<b>*IDN?</b>	Return instrument identification
<b>*OPC</b>	Enable "operation complete" bit in ESR
<b>*OPC?</b>	Return a "1" when operation complete
<b>*OPT?</b>	Return option number
<b>*PSC &lt;bool&gt;</b>	Power-on status clear state set/reset
<b>*PSC?</b>	Return power-on status clear state
<b>*RCL &lt;n&gt;</b>	Recall instrument state
<b>*RST</b>	Reset
<b>*SAV &lt;n&gt;</b>	Save instrument state
<b>*SRE &lt;n&gt;</b>	Set service request enable register
<b>*SRE?</b>	Return service request enable register
<b>*STB?</b>	Return status byte
<b>*TRG</b>	Trigger
<b>*TST?</b>	Perform selftest, then return result
<b>*WAI</b>	Hold off bus until all device commands done

## Programming Parameters

The following table lists the output programming parameters.

**Table 8-3. Output Programming Parameters**

Parameter	Value
[SOUR:]CURR[:LEV][:IMM] and [SOUR:]CURR[:LEV]:TRIG	0 – 3.0712 A
[SOUR:]CURR2[:LEV][:IMM] and [SOUR:]CURR2[:LEV]:TRIG	0 – 1.52 A
*RST Current Value	10% of MAXimum value
[SOUR:]VOLT[:LEV][:IMM] and [SOUR:]VOLT[:LEV]:TRIG [SOUR:]VOLT:PROT[:LEV]	0 – 15.535 V 0 – 22 V
[SOUR:]VOLT2[:LEV][:IMM] and [SOUR:]VOLT2[:LEV]:TRIG	0 – 12.25 V
*RST Voltage Value	0 V
[SOUR:]RES[:LEV][:IMM] and [SOUR:]RES[:LEV]:TRIG	-40 m $\Omega$ – 1 $\Omega$
*RST Resistance Value	0 $\Omega$
OUTP:PROT:DEL	0 – 2,147,483.647
*RST Protection Delay Value	0.08 seconds
SENS:CURR:RANG	0.02A range = 0 – 20 mA 1A range = 20 mA – 1 A 3A range = 1 A – MAX
*RST Current Range	Value MAXimum

---

## Calibration Commands

Calibration commands let you enable and disable the calibration mode, change the calibration password, calibrate current and voltage programming, and store new calibration constants in nonvolatile memory.

---

**NOTE:** If calibration mode has not been enabled with CALibrate:STATe, programming the calibration commands will generate an error. You must also save any changes that you made using CALibrate:SAVE, otherwise all changes will be lost when you exit calibration mode.

---

### CALibrate:CURRENT

This command initiates the calibration of the positive dc output current as well as the high-range current measurement circuit.

<b>Command Syntax</b>	CALibrate:CURRENT[:SOURce][:DC][:POSitive]
<b>Parameters</b>	None
<b>Examples</b>	CAL:STAT 1,           ! enable calibration CAL:CURR,           ! start current calibration
<b>Related Commands</b>	CAL:CURR:NEG,       CAL:LEV,        CAL:DATA

### CALibrate:CURRENT2

Agilent 66319B/D only

This command initiates the current calibration of output 2.

<b>Command Syntax</b>	CALibrate:CURRENT2
<b>Parameters</b>	None
<b>Examples</b>	CAL:CURR2
<b>Related Commands</b>	CAL:CURR:NEG,       CAL:LEV,        CAL:DATA

### CALibrate:CURRENT:MEASure:R3

This command initiates the calibration of the middle-range current measurement circuit.

<b>Command Syntax</b>	CALibrate:CURRENT:MEASure:R3
<b>Parameters</b>	None
<b>Examples</b>	CAL:CURR:MEAS:R3
<b>Related Commands</b>	CAL:CURR

### CALibrate:CURRENT:MEASure:LOWRange

This command initiates the calibration of the low-range current measurement circuit.

<b>Command Syntax</b>	CALibrate:CURRENT:MEASure[:DC]:LOWRange
<b>Parameters</b>	None
<b>Examples</b>	CAL:CURR:MEAS
<b>Related Commands</b>	CAL:CURR

**CALibrate:CURRent:MEASure:AC**

This command initiates the calibration of the high bandwidth (ac) measurement circuit.

**Command Syntax** CALibrate:CURRent:MEASure:AC  
**Parameters** None  
**Examples** CAL:CURR:MEAS:AC

**CALibrate:DATA**

This command enters a calibration value that you obtain by reading an external meter. You must first select a calibration level (with CALibrate:LEVEl) for the value being entered.

**Command Syntax** CALibrate:DATA<NRf>  
**Parameters** <external reading>  
**Unit** A (amperes)  
**Examples** CAL:DATA 3222.3 MA            CAL:DATA 5.000  
**Related Commands** CAL:STAT    CAL:LEV

**CALibrate:DATE**

Use this command to store the date that the unit was last calibrated. You can enter any ASCII string up to 10 characters.

**Command Syntax** CALibrate:DATE <date>  
**Parameters** <date>  
**Examples** CAL:DATE "3/22/99"            CAL:DATE "22.3.99"  
**Query Syntax** CALibrate:DATE?  
**Returned Parameters** <SRD>

**CALibrate:DVM**

**Agilent 66321D/66319D only**

This command initiates the calibration of the DVM.

**Command Syntax** CALibrate:DVM  
**Parameters** None  
**Examples** CAL:DVM

**CALibrate:LEVEl**

This command selects the next point in the calibration sequence. **P1** is the first calibration point, **P2** is the second calibration point.

**Command Syntax** CALibrate:LEVEl <point>  
**Parameters** P1 | P2  
**Examples** CAL:LEV P2

**CALibrate:PASSword**

This command lets you change the calibration password. A new password is automatically stored in nonvolatile memory and does not have to be stored with CALibrate:SAVE. If the password is set to 0, password protection is removed and the ability to enter the calibration mode is unrestricted.

**Command Syntax** CALibrate:PASScode<NRf>  
**Parameters** <model number> (default)  
**Examples** CAL:PASS 6812  
**Related Commands** CAL:SAV

**CALibrate:RESistance**

This command calibrates initiates the calibration of the output resistance circuit.

**Command Syntax** CALibrate:RESistance  
**Parameters** None  
**Examples** CAL:RES

**CALibrate:SAVE**

This command saves any new calibration constants after a calibration procedure has been completed in nonvolatile memory. If CALibrate:STATe OFF is programmed without a CALibrate:SAVE, the previous calibration constants are restored..

**Command Syntax** CALibrate:SAVE  
**Parameters** None  
**Examples** CAL:SAVE  
**Related Commands** CAL:PASS CAL:STAT

**CALibrate:STATE**

This command enables and disables calibration mode. The calibration mode must be enabled before the dc source will accept any other calibration commands.

The first parameter specifies the enabled or disabled state. The second parameter is the password. A password is required if the calibration mode is being enabled and the existing password is not 0. If the password is not entered or is incorrect, an error is generated and the calibration mode remains disabled. The query statement returns only the state, not the password.

---

**NOTE:** Whenever the calibration state is changed from enabled to disabled, any new calibration constants are lost unless they have been stored with CALibrate:SAVE.

---

**Command Syntax** CALibrate:STATe<bool>[,<NRF>]  
**Parameters** 0 | 1 | OFF | ON [,<password>]  
**\*RST Value** OFF  
**Examples** CAL:STAT 1,6812 CAL:STAT OFF  
**Query Syntax** CALibrate:STATe?  
**Returned Parameters** <NR1>  
**Related Commands** CAL:PASS CAL:SAVE \*RST

**CALibrate:VOLTage**

This command initiates the calibration of the output voltage and the voltage readback circuit.

**Command Syntax** CALibrate:VOLTage[:DC]  
**Parameters** None  
**Examples** CAL:VOLT CAL:VOLT:DC

**CALibrate:VOLTage2****Agilent 66319B/D only**

This command initiates the voltage calibration of output 2.

**Command Syntax** CALibrate:VOLTage2  
**Parameters** None  
**Examples** CAL:VOLT2



## Display Commands

Display commands control the front panel display of the dc source. Annunciators are not affected.

### DISPlay

This command turns the front panel display on or off. When off, the front panel display is blank.

**Command Syntax** DISPlay[:WINDow][:STATe] <bool>  
**Parameters** 0 | 1 | OFF | ON  
**\*RST Value** ON  
**Examples** DISP ON          DISPLAY:STATE ON  
**Query Syntax** DISPlay[:WINDow][STATe]?  
**Returned Parameters** <NR1> 0 or 1

### DISPlay:CHANnel

Agilent 66319B/D only

Selects the output channel that will be displayed on the front panel. When output 1 is selected, a small "1" appears in the left-most digit. . When output 2 is selected, a small "2" appears in the left-most digit.

**Command Syntax** DISPlay:CHANnel <channel>  
**Parameters** 1 | 2  
**\*RST Value** 1  
**Examples** DISPLAY:CHANNEL 2  
**Query Syntax** DISPlay:CHANnel?  
**Returned Parameters** <NR1> 0 or 1

### DISPlay:MODE

Switches the display between its normal instrument functions and a mode in which it displays text sent by the user. Text messages are defined with the DISPlay:TEXT command.

**Command Syntax** DISPlay[:WINDow]:MODE <mode>  
**Parameters** NORMal | TEXT  
**\*RST Value** NORM  
**Examples** DISP:MODE NORM    DISPLAY:MODE TEXT  
**Query Syntax** DISPlay[:WINDow]:MODE?  
**Returned Parameters** <CRD>    NORMAL or TEXT

### DISPlay:TEXT

This command sends character strings to the display when the display mode is set to TEXT. The character string is case-sensitive and must be enclosed in either single (') or double (") quotes. The display is capable of showing up to 14 characters. Strings exceeding 14 characters will be truncated.

**Command Syntax** DISPlay[:WINDow]:TEXT [:DATA] <display\_string>  
**Parameters** <display\_string>  
**\*RST Value** " " (null string)  
**Examples** DISP:TEXT "DEFAULT\_MODE"  
**Query Syntax** DISPlay[:WINDow]:TEXT?  
**Returned Parameters** <STR> (Last programmed text string)

## Measurement Commands

Measurement commands consist of format, measure, and sense commands.

**Format commands** specify the data formatting of all array queries. You can specify the data type, type length, and byte order.

**Measure commands** measure the output voltage or current. Measurements are performed by digitizing the instantaneous output voltage or current for a specified number of samples, storing the results in a buffer, and calculating the measured result. Two types of measurement commands are available: MEASure and FETCh. MEASure commands trigger the acquisition of new data before returning the reading. Measurement overflows return a reading of 9.91E+37. FETCh commands return a reading computed from previously acquired data. If you take a voltage measurement, you can fetch only voltage data.

- ◆ Use MEASure when the measurement does not need to be synchronized with any other event.
- ◆ Use FETCh when it is important that the measurement be synchronized with either a trigger or with a particular part of the output waveform.

**Sense commands** control the current measurement range, the bandwidth detector of the dc source, and the data acquisition sequence.

### FORMat

This command selects the data type and the type length for all array queries. Supported types are ASCII and REAL. When ASCII is selected, the response format for these queries is NR3 Numeric Response Data. This format is selected at \*RST. The only valid argument for <length> is 0, which means that the dc source selects the number of significant digits to be returned.

When REAL is selected, the array response format is Definite Length Arbitrary Block Response Data. The data within the Arbitrary Block is coded as IEEE single precision floating point, with 4 bytes per value. The second argument to the FORMat:DATA command specifies the number of bits in the returned data. Only the value 32 is permitted in dc source instruments. The byte order within a single value is determined by the FORMat:BORDER command. Definite Length Arbitrary Block Response Data format begins with a header that describes the number of data bytes in the response. The header begins with a pound sign, followed by a single non-zero digit that defines the number of digits in the block length, followed by the digits contained in the block.

For example: The response to the query "MEAS:ARR:CURR:[DC]? 1" which returns 45 numeric values would be as follows: '# '3' '1' '8' '0' <byte1> <byte2> ... <byte180> <newline>

<b>Command Syntax</b>	FORMat[:DATA] <type> [,length]
<b>Parameters</b>	ASCii   REAL
<b>*RST Value</b>	ASCii
<b>Examples</b>	FORM REAL
<b>Query Syntax</b>	FORMat?
<b>Returned Parameters</b>	<CRD>
<b>Related Commands</b>	FORM:BORD MEAS:ARR:CURR:DC? MEAS:ARR:VOLT:DC?

**FORMat:BORDer**

This command selects whether the binary data is transferred in normal or swapped byte order. When NORMal is selected, the first byte sent is the sign bit and seven most significant bits of the exponent, and the last byte sent is the least significant byte of the mantissa. This ordering is generally used in big-endian controllers such as those that use Motorola processors.

When SWAPped is selected, the least significant byte of the mantissa is sent first and the sign bit and seven most significant bits of the exponent are sent last. This ordering is generally used in little-endian controllers such as those that use Intel processors.

<b>Command Syntax</b>	FORMat:BORDer <type>
<b>Parameters</b>	NORMal   SWAPped
<b>*RST Value</b>	NORMal
<b>Examples</b>	FORM:BORD SWAP
<b>Query Syntax</b>	FORMat:BORDer?
<b>Returned Parameters</b>	<CRD>
<b>Related Commands</b>	FORM[:DATA] MEAS:ARR:CURR:DC? MEAS:ARR:VOLT:DC

**MEASure:ARRay:CURRent?****FETCh:ARRay:CURRent?**

These queries return an array containing the instantaneous output current in amps. The output voltage or current is digitized whenever a measure command is sent or an acquire trigger occurs. The time interval is set by SENSE:SWEEP:TINTERval. The position of the trigger relative to the beginning of the data buffer is determined by SENSE:SWEEP:OFFSet. The number of points returned is set by SENSE:SWEEP:POINTs.

<b>Query Syntax</b>	MEASure:ARRay:CURRent[:DC]? FETCh:ARRay:CURRent[:DC]?
<b>Parameters</b>	None
<b>Examples</b>	MEAS:ARR:CURR? FETC:ARR:CURR?
<b>Returned Parameters</b>	<NR3> [,<NR3>]
<b>Related Commands</b>	SENS:SWEEP:TINT SENS:SWEEP:OFFS SENS:SWEEP:POIN

**MEASure:ARRay:VOLTage?****FETCh:ARRay:VOLTage?**

These queries return an array containing the instantaneous output voltage in volts. The output voltage or current is digitized whenever a measure command is sent or an acquire trigger occurs. The time interval is set by SENSE:SWEEP:TINTERval. The position of the trigger relative to the beginning of the data buffer is determined by SENSE:SWEEP:OFFSet. The number of points returned is set by SENSE:SWEEP:POINTs.

<b>Query Syntax</b>	MEASure:ARRay:VOLTage[:DC]? FETCh:ARRay:VOLTage[:DC]?
<b>Parameters</b>	None
<b>Examples</b>	MEAS:ARR:VOLT? FETC:ARR:VOLT?
<b>Returned Parameters</b>	<NR3> [,<NR3>]
<b>Related Commands</b>	SENS:SWEEP:TINT SENS:SWEEP:OFFS SENS:SWEEP:POIN

## MEASure:CURRent? [MAX | MIN | <NR3>] FETCh:CURRent?

These queries return the dc output current. You can specifying an optional range parameter for the MEASure:CURRent? query. This lets you use a different current range for a single measurement instance without having to change the current range using the SENSE:CURRent:RANGe command. Afer the measurement completes, the range returns to the value specified by SENSE:CURRent:RANGe.

<b>Query Syntax</b>	MEASure[:SCALar]:CURRent[:DC]? [MAX   MIN   <NR3>] FETCh[:SCALar]:CURRent[:DC]?
<b>Parameters</b>	None
<b>Examples</b>	MEAS:CURR? FETC:CURR:DC?
<b>Returned Parameters</b>	<NR3>
<b>Related Commands</b>	MEAS:VOLT?                      SENS:CURR:RANG

## MEASure:CURRent2?

Agilent 66319B/D only

This query measures the output current at the auxiliary output. Output 2 measurements are calculated from a total of 2048 readings taken at a 15.6 microsecond sampling rate. These parameters are fixed.

<b>Query Syntax</b>	MEASure[:SCALar]:CURRent2[:DC]?
<b>Parameters</b>	None
<b>Examples</b>	MEAS:CURR2? FETC:CURR2:DC?
<b>Returned Parameters</b>	<NR3>
<b>Related Commands</b>	MEAS:VOLT2?

## MEASure:CURRent:ACDC? FETCh:CURRent:ACDC?

These queries return the ac+dc rms output current.

<b>Query Syntax</b>	MEASure[:SCALar]:CURRent:ACDC? FETCh[:SCALar]:CURRent:ACDC?
<b>Parameters</b>	None
<b>Examples</b>	MEAS:CURR:ACDC?                      FETC:CURR:ACDC?
<b>Returned Parameters</b>	<NR3>
<b>Related Commands</b>	MEAS:VOLT:ACDC?

## MEASure:CURRent:HIGH? FETCh:CURRent:HIGH?

These queries return the High level current of a current pulse waveform. The instrument first measures the minimum and maximum data points of the pulse waveform. It then generates a histogram of the pulse waveform using 16 bins between the maximum and minimum data points. The bin containing the most data points above the 50% point is the high bin. The average of all the data points in the high bin is returned as the High level. If no high bin contains more than 1.25% of the total number of acquired points, then the maximum value is returned by these queries.

<b>Query Syntax</b>	MEASure[:SCALar]:CURRent:HIGH? FETCh[:SCALar]:CURRent:HIGH?
<b>Parameters</b>	None
<b>Examples</b>	MEAS : CURR : HIGH?      FETC : CURR : HIGH?
<b>Returned Parameters</b>	<NR3>
<b>Related Commands</b>	MEAS:CURR:LOW?    CALC:REF:HIGH

## MEASure:CURRent:LOW? FETCh:CURRent:LOW?

These queries return the Low level current of a current pulse waveform. The instrument first measures the minimum and maximum data points of the pulse waveform. It then generates a histogram of the pulse waveform using 16 bins between the maximum and minimum data points. The bin containing the most data points below the 50% point is the low bin. The average of all the data points in the low bin is returned as the Low level. If no low bin contains more than 1.25% of the total number of acquired points, then the minimum value is returned by these queries.

<b>Query Syntax</b>	MEASure[:SCALar]:CURRent:LOW? FETCh[:SCALar]:CURRent:LOW?
<b>Parameters</b>	None
<b>Examples</b>	MEAS : CURR : LOW?      FETC : CURR : LOW?
<b>Returned Parameters</b>	<NR3>
<b>Related Commands</b>	MEAS:CURR:HIGH?    CALC:REF:LOW

## MEASure:CURRent:MAXimum? FETCh:CURRent: MAXimum?

These queries return the maximum output current.

<b>Query Syntax</b>	MEASure[:SCALar]:CURRent:MAXimum? FETCh[:SCALar]:CURRent:MAXimum?
<b>Parameters</b>	None
<b>Examples</b>	MEAS : CURR : MAX?      FETC : CURR : MAX?
<b>Returned Parameters</b>	<NR3>
<b>Related Commands</b>	MEAS:CURR:MIN?

**MEASure:CURRent:MINimum?**  
**FETCh:CURRent:MINimum?**

These queries return the minimum output current.

<b>Query Syntax</b>	MEASure[:SCALar]:CURRent:MINimum? FETCh[:SCALar]:CURRent:MINimum?
<b>Parameters</b>	None
<b>Examples</b>	MEAS : CURR : MIN?                      FETC : CURR : MIN?
<b>Returned Parameters</b>	<NR3>
<b>Related Commands</b>	MEAS:CURR:MAX?

**MEASure:DVM?**  
**FETCh:DVM?**

Agilent 66321D/66319D only

These queries measure dc voltage.

<b>Query Syntax</b>	MEASure[:SCALar]:DVM[:DC]? FETCh[:SCALar]:DVM[:DC]?
<b>Parameters</b>	None
<b>Examples</b>	MEAS : DVM : DC?                      FETC : DVM : DC?
<b>Returned Parameters</b>	<NR3>

**MEASure:DVM:ACDC?**  
**FETCh:DVM:ACDC?**

Agilent 66321D/66319D only

These queries measure ac+dc (rms) voltage.

<b>Query Syntax</b>	MEASure[:SCALar]:DVM:ACDC? FETCh[:SCALar]:DVM:ACDC?
<b>Parameters</b>	None
<b>Examples</b>	MEAS : DVM : ACDC?                      FETC : DVM : ACDC?
<b>Returned Parameters</b>	<NR3>

**MEASure:VOLTage?**  
**FETCh:VOLTage?**

These queries return the dc output voltage.

<b>Query Syntax</b>	MEASure[:SCALar]:VOLTage[:DC]? MEASure[:SCALar]:VOLTage[:DC]?
<b>Parameters</b>	None
<b>Examples</b>	MEAS : VOLT?                      FETC : VOLT : DC?
<b>Returned Parameters</b>	<NR3>
<b>Related Commands</b>	MEAS:CURR?

**MEASure:VOLTage2****Agilent 66319B/D only**

This query measures the output voltage at the auxiliary output. Output 2 measurements are calculated from a total of 2048 readings taken at a 15.6 microsecond sampling rate. These parameters are fixed.

<b>Query Syntax</b>	MEASure[:SCALar]:VOLTage2[:DC]?
<b>Parameters</b>	None
<b>Examples</b>	MEAS:VOLT2?      FETC:VOLT2:DC?
<b>Returned Parameters</b>	<NR3>
<b>Related Commands</b>	MEAS:CURR2?

**MEASure:VOLTage:ACDC?  
FETCh:VOLTage:ACDC?**

These queries return the ac+dc rms output voltage.

<b>Query Syntax</b>	MEASure[:SCALar]:VOLTage:ACDC? FETCh[:SCALar]:VOLTage:ACDC?
<b>Parameters</b>	None
<b>Examples</b>	MEAS:VOLT:ACDC?      FETC:VOLT:ACDC?
<b>Returned Parameters</b>	<NR3>
<b>Related Commands</b>	MEAS:CURR:ACDC?

**MEASure:VOLTage:HIGH?  
FETCh:VOLTage:HIGH?**

These queries return the High level voltage of a voltage pulse waveform. The instrument first measures the minimum and maximum data points of the pulse waveform. It then generates a histogram of the pulse waveform using 16 bins between the maximum and minimum data points. The bin containing the most data points above the 50% point is the high bin. The average of all the data points in the high bin is returned as the High level. If no high bin contains more than 1.25% of the total number of acquired points, then the maximum value is returned by these queries.

<b>Query Syntax</b>	MEASure[:SCALar]:VOLTage:HIGH? FETCh[:SCALar]:VOLTage:HIGH?
<b>Parameters</b>	None
<b>Examples</b>	MEAS:VOLT:HIGH?      FETC:VOLT:HIGH?
<b>Returned Parameters</b>	<NR3>
<b>Related Commands</b>	MEAS:VOLT:LOW?      CALC:REF:HIGH

## MEASure:VOLTage:LOW? FETCh:VOLTage:LOW?

These queries return the Low level voltage of a voltage pulse waveform. The instrument first measures the minimum and maximum data points of the pulse waveform. It then generates a histogram of the pulse waveform using 16 bins between the maximum and minimum data points. The bin containing the most data points below the 50% point is the low bin. The average of all the data points in the low bin is returned as the Low level. If no low bin contains more than 1.25% of the total number of acquired points, then the minimum value is returned by these queries.

<b>Query Syntax</b>	MEASure[:SCALar]:VOLTage:LOW? FETCh[:SCALar]:VOLTage:LOW?
<b>Parameters</b>	None
<b>Examples</b>	MEAS : VOLT : LOW?          FETC : VOLT : LOW?
<b>Returned Parameters</b>	<NR3>
<b>Related Commands</b>	MEAS:VOLT:HIGH?    CALC:REF:LOW

## MEASure:VOLTage:MAXimum? FETCh:VOLTage:MAXimum?

These queries return the maximum output voltage.

<b>Query Syntax</b>	MEASure[:SCALar]:VOLTage:MAXimum? FETCh[:SCALar]:VOLTage:MAXimum?
<b>Parameters</b>	None
<b>Examples</b>	MEAS : VOLT : MAX?          FETC : VOLT : MAX?
<b>Returned Parameters</b>	<NR3>
<b>Related Commands</b>	MEAS:VOLT:MIN?

## MEASure:VOLTage:MINimum? FETCh:VOLTage:MINimum?

These queries return the minimum output voltage..

<b>Query Syntax</b>	MEASure[:SCALar]:VOLTage:MINimum? FETCh[:SCALar]:VOLTage:MINimum?
<b>Parameters</b>	None
<b>Examples</b>	MEAS : VOLT : MIN?          FETC : VOLT : MIN?
<b>Returned Parameters</b>	<NR3>
<b>Related Commands</b>	MEAS:VOLT:MAX?



## SENSe:CURRent:DETEctor

This command lets you select the type of detector used for output current measurements. Two choices for detecting current measurements are available:

- ACDC** This is the preferred choice for all dynamic current measurements. When ACDC is selected, the measured output current includes the current that flows in the instrument's output capacitor. It is especially important to use ACDC detection when measuring pulse or other waveforms with frequency contents greater than several kilohertz.
- DC** Select *DC* only if you are making dc current measurements and you require a dc measurement offset accuracy better than 2mA on the High current measurement range. When DC is selected, the component of output current that is supplied by the instrument's output filter is not sensed. Note that this selection gives inaccurate results on current waveforms with frequency contents greater than several kilohertz.

---

**NOTE:** This command only applies to the High current measurement range.

---

<b>Command Syntax</b>	SENSe:CURRent:DETEctor <detector>	
<b>Parameters</b>	ACDC or DC	
<b>*RST Value</b>	ACDC	
<b>Examples</b>	SENS:CURR:DET ACDC	SENS:CURR:DET DC
<b>Query Syntax</b>	SENSe:CURRent:DETEctor?	
<b>Returned Parameters</b>	<CRD>	

## SENSe:CURRent:RANGe

This command selects the dc current measurement range:

**3A Range:** 0 through MAX (see table A-2)

**1A Range:** 0 through 1 A

**0.02A Range:** 0 through 0.02 A

The 3A range covers the full current measurement capability of the instrument. The 1A range measures currents up to a maximum of 1 A. This increases the mid-range current measurement sensitivity for greater accuracy and resolution. The 0.02A range measures currents up to a maximum of 20 mA. This increases the current measurement sensitivity for the best accuracy and resolution at the lowest range.

The value that you program with SENSe:CURRent:RANGe must be the maximum current that you expect to measure. The instrument will select the range that gives the best resolution. The range crossover values are 20 mA and 1A respectively. When queried, the returned value is the maximum dc current that can be measured on the range that is presently set.

<b>Command Syntax</b>	SENSe:CURRent[:DC]:RANGe[:UPPer] <NRf+>	
<b>Parameters</b>	0 through MAX (see table A-2)	
<b>Unit</b>	A (amperes)	
<b>*RST Value</b>	3A (high range)	
<b>Examples</b>	SENS:CURR:RANG 4.0	
<b>Query Syntax</b>	SENSe:CURRent:RANGe?	
<b>Returned Parameters</b>	<NR3>	

**SENSe:LEAD:STATus?**

This query returns the status of the open sense detection circuit. The query must be performed with the output disabled. Any external source such as an external capacitor must be discharged. The following status code is returned:

<u>Value</u>	<u>Description</u>	<u>Value</u>	<u>Description</u>
0	Sense lead connections are normal	4	Sense lead status is unknown, possibly caused by an external voltage
1	Positive sense lead is open		
2	Negative sense lead is open	5	The output is not in the disabled state
3	Bothe sense leads are open		

**Query Syntax** SENSe:LEAD:STATus?  
**Returned Parameters** <NR3>  
**Examples** SENS:LEAD:STAT?

**SENSe:FUNction**

This command configures the sensing function for triggered measurements. The dc source has up to three measurement sensors as described below. The query returns the function setting.

**CURRent** Senses the current measurement at the main output (output 1)  
**DVM** Senses the voltage measurement at the DVM inputs (Agilent 66321D/66319D only)  
**VOLTage** Senses the voltage measurement at the main output (output 1)

**Command Syntax** SENSe:FUNction <function>  
**Parameters** "VOLTage" | "CURRent" | "DVM"  
**Examples** SENS:FUNC "VOLT"  
**Query Syntax** SENSe:FUNction?  
**Returned Parameters** <SRD>

**SENSe:PROTection:STATe**

This command enables or disables the open sense lead detection. The default setting for this function is disabled. To permanently enable open sense lead detection, program this command on, save this state in location 0 using \*SAV 0, and set the output power-on state to recall state 0 (OUTP:PON:STAT RCL 0).

**Command Syntax** SENSe:PROTection:STATe <bool>  
**Parameters** 0 | OFF | 1 | ON  
**\*RST Value** 0  
**Examples** SENS:PROT:STAT ON  
**Query Syntax** SENSe:PROTection:STATe?  
**Returned Parameters** <NR3>

**SENSe:SWEep:OFFSet:POINts**

This command defines the offset in a data sweep when an acquire trigger is used. Negative values represent data samples taken prior to the trigger. Positive values represent the delay after the trigger occurs but before the samples are acquired.

**Command Syntax** SENSe:SWEep:OFFSet:POINts <NRf+>  
**Parameters** -4095 through 2,000,000,000  
**\*RST Value** 0  
**Examples** SENS:SWE:OFFS:POIN -2047  
**Query Syntax** SENSe:SWEep:OFFSet:POINts?  
**Returned Parameters** <NR3>  
**Related Commands** SENS:SWE:TINT SENS:SWE:POIN MEAS:ARR

**SENSe:SWEEp:POINTs**

This command defines the number of points in a measurement.

<b>Command Syntax</b>	SENSe:SWEEp:POINTs<NRf+>
<b>Parameters</b>	1 through 4096
<b>*RST Value</b>	2048
<b>Examples</b>	SENS:SWE:POIN 1024
<b>Query Syntax</b>	SENSe:SWEEp:POINTs?
<b>Returned Parameters</b>	<NR3>
<b>Related Commands</b>	SENS:SWE:TINT    SENS:SWE:OFFS    MEAS:ARR

**SENSe:SWEEp:TINTerval**

This command defines the time period between samples. The value that you enter for the time interval will be rounded to the nearest 15.6 microsecond increment.

<b>Command Syntax</b>	SENSe:SWEEp:TINTerval<NRf+>
<b>Parameters</b>	15.6 microseconds through 31200 seconds
<b>*RST Value</b>	15.6 microseconds
<b>Examples</b>	SENS:SWE:TINT 31.2E-6
<b>Query Syntax</b>	SENSe:SWEEp:TINTerval?
<b>Returned Parameters</b>	<NR3>
<b>Related Commands</b>	SENS:SWE:POIN    SENS:SWE:OFFS    MEAS:ARR

**SENSe:WINDow**

This command sets the window function that is used in dc and in ac+dc rms measurement calculations. The following functions can be selected:

<b>HANNing</b>	A signal conditioning window that reduces errors in dc and rms measurement calculations in the presence of periodic signals such as line ripple. It also reduces jitter when measuring successive pulse waveforms. The Hanning window multiplies each point in the measurement sample by the function $\cos^4$ . Do not use the Hanning window when measuring single-shot pulse waveforms.
<b>RECTangular</b>	A window that returns measurement calculations without any signal conditioning. This window may be used for pulse measurements where the exact period of the pulse waveform is known and the measurement interval can be set accordingly using the SENSe:SWEEp:TINTerval command.

---

**NOTE:** Neither window function alters the instantaneous voltage or current data returned in the measurement array.

---

<b>Command Syntax</b>	SENSe:WINDow[:TYPE] <type>
<b>Parameters</b>	HANNing   RECTangular
<b>*RST Value</b>	HANNing
<b>Examples</b>	SENS:WIND RECT
<b>Query Syntax</b>	SENSe:WINDow[:TYPE]?
<b>Returned Parameters</b>	<CRD>

## Output Commands

Output commands consist of instrument, output and source commands.

**Instrument commands** control the output coupling on Agilent 66319B/66319D units.

**Output commands** control the output and digital port functions.

**Source commands** program the actual voltage, current, and digital port output.

### INSTrument:COUPle:OUTPut:STATe

This command controls the ON/OFF function of Output 1 and Output 2. When outputs 1 and 2 are coupled, **ALL** OUTPut commands will turn both outputs ON or OFF together. When not coupled, use OUTPut1 or OUTPut2 to turn the specified output ON or OFF individually.

To have the unit turn on with the outputs uncoupled, set the output coupling to NONE, save this state in location 0, and set the power-on state to RCL 0. Note that when an output state is recalled, the outputs are set to the state in which they were in when the state was saved, regardless of the output coupling setting.

<b>Command Syntax</b>	INSTrument:COUPle:OUTPut:STATe <state>
<b>Parameters</b>	ALL   NONE
<b>*RST Value</b>	ALL (NONE for units with Option 521)
<b>Examples</b>	INST:COUP:OUTP:STAT ALL
<b>Query Syntax</b>	INSTrument:COUPle:OUTPut:STATe?
<b>Returned Parameters</b>	<CRD>

### OUTPut[1 | 2]

This command enables or disables the dc source output. If outputs 1 and 2 are coupled, it affects both the main output and output 2 on Agilent 66319B/D units. If the outputs are not coupled and no output channel is specified, the command applies to the main output. The state of a disabled output is a condition of zero output voltage and a model-dependent minimum source current (see **\*RST**).

<b>Command Syntax</b>	OUTPut[1 2][:STATe] <bool>
<b>Parameters</b>	0   OFF   1   ON
<b>*RST Value</b>	0
<b>Examples</b>	OUTP ON
<b>Query Syntax</b>	OUTPut[1 2][:STATe]?
<b>Returned Parameters</b>	<NR1>0 or 1
<b>Related Commands</b>	*RST *RCL *SAV INST:COUP:OUTP:STAT

**OUTPut[1 | 2]:RELAy:MODE****Agilent 66319B/66319D with Option 521 only**

Specifies one of the relay modes (DD, DH, HD, or HH). The output must be turned off before any programmed mode settings take effect. Relay settings cannot be coupled; they must be set separately for each output. Relay modes are stored in non-volatile memory and will be restored when the unit is turned on. When shipped from the factory, the relay mode for both output 1 and output 2 is set to HH.

	<u>Output ON</u>	<u>Output OFF</u>
<b>DD</b>	Dry	Dry
<b>DH</b>	Dry	Hot
<b>HD</b>	Hot <sup>1</sup>	Dry
<b>HH</b>	Hot <sup>1</sup>	Hot

<sup>1</sup>When the Output ON relay mode is set to Hot, the dc source does not check for open sense leads when the output is turned on or enabled. With Hot output switching, the output is programmed before the sense relays are closed.

<b>Command Syntax</b>	OUTPut[1 2]:RELAy:MODE <mode>
<b>Parameters</b>	DD   DH   HD   HH
<b>Examples</b>	OUTP:REL:MODE DH (sets output 1 relay mode DH) OUTP2:REL:MODE HH (sets output 2 relay mode HH)
<b>Query Syntax</b>	OUTPut[1 2]:REL:MODE?
<b>Returned Parameters</b>	<CRD>

---

**CAUTION:** Non-volatile memory has a finite maximum number of write cycles. Programs that repeatedly cause write cycles to non-volatile memory can eventually exceed the maximum number of write cycles and cause the memory to fail.

---

**OUTPut:COMPensation:MODE**

This command programs the output compensation circuit. This circuit compensates the output of the dc source according to the input capacitance of the phone being tested as well as the type of output connections being used. The following table summarizes the four programmable compensation modes.

<u>Mode</u>	<u>Description</u>
<b>LLocal</b>	Used for slower response with short load leads or bench operation. This produces the slowest output response, but provides the best stability (no external capacitor needed).
<b>LRemote</b>	Used for slower response with long load leads using remote sensing.
<b>HLocal</b>	Use for faster response with short load leads or bench operation (no external cap needed).
<b>HRemote</b>	Used for faster response with long load leads using remote sensing. This produces the fastest output response, but requires an external capacitor for stable operation.

Standard dc source units are shipped from the factory with the output compensation set to HRemote mode. HRemote mode setting provides the fastest transient response performance for phones with input capacitances greater than 5µF. Most phones have input capacitances greater than 5 µF. However, the operation of the dc source may be momentarily unstable with phones that have input capacitances *less* than 5 µF, or if the output sense leads are not connected and you are operating in HRemote mode.

---

**NOTE:** If you want the unit to power up with a different compensation setting, you must first save the desired settings in non-volatile memory location 0 with the \*SAV command. Use OUTP:PON:STAT RCL0 to program the unit to power up with the location 0 settings.

---

<b>Command Syntax</b>	OUTPut:COMPensation:MODE <setting>
<b>Parameters</b>	LLOCAL   LREMOTE   HLOCAL   HREMOTE
<b>*RST Value</b>	HREMOTE
<b>Examples</b>	OUTP : COMP : MODE HREMOTE
<b>Query Syntax</b>	OUTPput:COMPensation:MODE?
<b>Returned Parameters</b>	<CRD>
<b>Backward Compatibility</b>	OUTP:TYPE[:CAPacitance] (LOW mode corresponds to LLocal; HIGH mode corresponds to HRemote)

## OUTPut:DFI

This command enables or disables the discrete fault indicator (DFI) output from the dc source.

<b>Command Syntax</b>	OUTPut:DFI[:STATe] <bool>
<b>Parameters</b>	0   1   OFF   ON
<b>*RST Value</b>	OFF
<b>Examples</b>	OUTP : DFI 1            OUTP : DFI ON
<b>Query Syntax</b>	OUTPut:DFI[:STATe]?
<b>Returned Parameters</b>	0   1
<b>Related Commands</b>	OUTP:DFI:SOUR

## OUTPut:DFI:SOURce

This command selects the source for discrete fault indicator (DFI) events. The choices are:

<b>QUESTIONable</b>	selects the Questionable event summary bit (bit 3 of the Status Byte Register)
<b>OPERation</b>	selects the Operation Event summary bit (bit 7 of the Status Byte Register)
<b>ESB</b>	selects the Standard Event summary bit (bit 5 of the Status Byte Register)
<b>RQS</b>	selects the Request Service bit (bit 6 of the Status Byte Register)
<b>OFF</b>	selects no DFI source

<b>Command Syntax</b>	OUTP:DFI:SOUR <source>
<b>Parameters</b>	QUES   OPER   ESB   RQS   OFF
<b>*RST Value</b>	OFF
<b>Examples</b>	OUTP : DFI : SOUR OPER
<b>Query Syntax</b>	OUTPut:DFI:SOUR?
<b>Returned Parameters</b>	<CRD>
<b>Related Commands</b>	OUTP:DFI

## OUTPut:PON:STATE

This command selects the power-on state of the dc source. This information is saved in non-volatile memory. The following states can be selected:

<b>RST</b>	Sets the power-on state to *RST. Refer to *RST for more information.
<b>RCL0</b>	Sets the power-on state to *RCL 0. Refer to *RCL for more information.

<b>Command Syntax</b>	OUTPut:PON:STATe <state>
<b>Parameters</b>	RST   RCL0
<b>Examples</b>	OUTP : PON : STAT RST
<b>Query Syntax</b>	OUTPut:PON:STATe?
<b>Returned Parameters</b>	<CRD>
<b>Related Commands</b>	*RST    *RCL

## OUTPut:PROTection:CLEAr

This command clears the latch that disables the output when an overvoltage, overcurrent, overtemperature, or remote inhibit status condition is detected. All conditions that generate the fault must be removed before the latch can be cleared. The output is then restored to the state it was in before the fault condition occurred.

<b>Command Syntax</b>	OUTPut:PROTection:CLEAr
<b>Parameters</b>	None
<b>Examples</b>	OUTP:PROT:CLE
<b>Related Commands</b>	OUTP:PROT:DEL *RCL *SAV

## OUTPut:PROTection:DELAy

This command sets the time between the programming of an output change that produces a constant current condition (CC) and the recording of that condition by the Operation Status Condition register. The delay prevents the momentary changes in status that can occur during reprogramming from being registered as events by the status subsystem. Since the constant current condition is used to trigger overcurrent protection (OCP), this command also delays OCP. Overvoltage protection is not affected by this command.

<b>Command Syntax</b>	OUTPut:PROTection:DELAy <NRf+>
<b>Parameters</b>	0 to 2,147,483.647
<b>Unit</b>	seconds
<b>*RST Value</b>	0.08 (Normal)
<b>Examples</b>	OUTP:PROT:DEL 75E-1
<b>Query Syntax</b>	OUTPut:PROTection:DELAy?
<b>Returned Parameters</b>	<NR3>
<b>Related Commands</b>	OUTP:PROT:CLE CURR:PROT:STAT *RCL *SAV

## OUTPut:RI:MODE

This command selects the mode of operation of the Remote Inhibit protection. The RI mode is stored in non-volatile memory. The following modes can be selected:

- LATChing** causes a TTL low signal on the INH input to disable the output. The only way to clear the latch is by sending OUTPut:PROTection:CLEAR while the INH input is false.
- LIVE** allows the INH input to disable the output in a non-latching manner. In other words, the output follows the state of the INH input. When INH is low true, the output is disabled. When INH is high the output is not affected.
- OFF** the INH input is disabled.

<b>Command Syntax</b>	OUTPut:RI:MODE <mode>
<b>Parameters</b>	LATChing   LIVE   OFF
<b>Examples</b>	OUTP:RI:MODE LIVE
<b>Query Syntax</b>	OUTPut:RI:MODE?
<b>Returned Parameters</b>	<CRD>
<b>Related Commands</b>	OUTP:PROT:CLE

**[SOURce:]CURRent**

This command sets the immediate current level of the dc source. The immediate level is the current programmed for the output terminals.

<b>Command Syntax</b>	[SOURce:]CURRent[:LEVel][:IMMediate][:AMPLitude] <NRf+>
<b>Parameters</b>	see Table 8-3
<b>Default Suffix</b>	A (amperes)
<b>*RST Value</b>	10% of MAX
<b>Examples</b>	CURR 200 MA                      CURRENT:LEVEL 200 MA
<b>Query Syntax</b>	[SOURce:]CURRent[:LEVel][:IMMediate][:AMPLitude]?
<b>Returned Parameters</b>	<NR3>
<b>Related Commands</b>	CURR:TRIG

**[SOURce:]CURRent2**

Agilent 66319B/66319D only

This command sets the output current level of the auxiliary output.

<b>Command Syntax</b>	[SOURce:]CURRent2[:LEVel][:IMMediate][:AMPLitude] <NRf+>
<b>Parameters</b>	see Table A-3
<b>Default Suffix</b>	A (amperes)
<b>*RST Value</b>	10% of MAX
<b>Examples</b>	CURR2 200 MA                      CURR2:LEVEL 200 MA
<b>Query Syntax</b>	[SOURce:]CURRent2[:LEVel][:IMMediate][:AMPLitude]?
<b>Returned Parameters</b>	<NR3>

**[SOURce:]CURRent:PROTection:STATe**

This command enables or disables the overcurrent protection (OCP) function on all output channels. If the dc source overcurrent protection function is enabled and the dc source goes into constant current operation, then the output is disabled and the Questionable Condition status register OC bit is set (see chapter 7 about programming the status registers). Note that the [SOURce:]CURRent command sets the current limit, which determines when the dc source goes into constant current operation. An overcurrent condition can be cleared with the OUTPut:PROTection:CLEar command after the cause of the condition is removed.

---

**NOTE:** Use OUTPut:PROTection:DElay to prevent momentary current limit conditions caused by programmed output changes from tripping the overcurrent protection.

---

<b>Command Syntax</b>	[SOURce:]CURRent:PROTection:STATe <bool>
<b>Parameters</b>	0   1   OFF   ON
<b>*RST Value</b>	OFF
<b>Examples</b>	CURR:PROT:STAT 0            !current protection off CURR:PROT:STAT 1            !current protection on
<b>Query Syntax</b>	Syntax [SOURce:]CURRent:PROTection:STATe?
<b>Returned Parameters</b>	<NR1>0 or 1
<b>Related Commands</b>	OUTP:PROT:CLE    *RST



**[SOURce:]CURRent:TRIGger**

This command sets the pending triggered current level of the dc source. The pending triggered level is a stored current value that is transferred to the output terminals when a trigger occurs. In order for a trigger to occur, the trigger subsystem must be initiated (see the INITiate command in the trigger subsystem).

**Command Syntax** [SOURce:]CURRent[:LEVel]:TRIGgered[:AMPLitude] <NRf+>  
**Parameters** see Table 8-3  
**Default Suffix** A ( amperes)  
**\*RST Value** 10% of MAX  
**Examples** CURR:TRIG 1CURRENT:LEVEL:TRIGGERED 1  
**Query Syntax** SOURce:]CURRent[LEVel]:TRIGgered[:AMPLitude]?  
**Returned Parameters** <NR3>

**[SOURce:]CURRent2:TRIGger**

Agilent 66319B/66319D only

This command sets the triggered current level of the auxiliary output. The triggered level is a stored value that is transferred to the output when a trigger occurs. In order for a trigger to occur, the trigger subsystem must be initiated (see the INITiate command).

**Command Syntax** [SOURce:]CURRent2[:LEVel]:TRIGgered[:AMPLitude] <NRf+>  
**Parameters** see Table A-3  
**Default Suffix** A ( amperes)  
**\*RST Value** 10% of MAX  
**Examples** CURR2:TRIG 1 CURR2:LEV:TRIG 1  
**Query Syntax** SOURce:]CURRent2[LEVel]:TRIGgered[:AMPLitude]?  
**Returned Parameters** <NR3>

**[SOURce:]DIGital:DATA**

This command programs the digital control port when the port is configured for Digital I/O operation. The port has three signal pins and a digital ground pin. Pins 1 and 2 are output pins controlled by bits 0 and 1. Pin 3 is controlled by bit 2, and can be programmed to serve either as an input or an output. It normally serves as an output. Bit 2 must be programmed high to use pin 3 as an input. Pin 4 is the digital ground. Refer to the following chart for list of the programmable pin settings. The query returns the last programmed value in bits 0 and 1, and the value read at pin 3 in bit 2.

Program Value	Bit Configuration			Pin Setting			
	2	1	0	4	3	2	1
0	0	0	0	GND	Output	Lo	Lo
1	0	0	1	GND	Output	Lo	Hi
2	0	1	0	GND	Output	Hi	Lo
3	0	1	1	GND	Output	Hi	Hi
4	1	0	0	GND	Input	Lo	Lo
5	1	0	1	GND	Input	Lo	Hi
6	1	1	0	GND	Input	Hi	Lo
7	1	1	1	GND	Input	Hi	Hi

**Command Syntax** [SOURce:]DIGital:DATA[:VALue] <NRf>  
**Parameters** 0 to 7  
**\*RST Value** 0  
**Examples** DIG:DATA 7  
**Query Syntax** [SOURce:]DIGital:DATA?  
**Returned Parameters** <NR1>

## [SOURce:]DIGital:FUNCTION

Configures the 4-pin control port. The configuration setting is saved in non-volatile memory.

**RIDFi** Configures the port for Remote Inhibit/Discrete Fault Interrupt operation  
**DIGio** Configures the port for Digital input/output operation (see DIG:DATA)  
**TRIGger** Configures the port to accept external measurement triggers  
 (only applies to units with firmware revision A.03.01 and up)

**Command Syntax** [SOURce:]DIGital:FUNCTION <CRD>  
**Parameters** RIDFi | DIGio | TRIGger  
**Examples** DIG:FUNC DIG  
**Query Syntax** [SOURce:]DIGital:FUNC?  
**Returned Parameters** <CRD>

---

**CAUTION:** This command causes a write cycle to nonvolatile memory. Nonvolatile memory has a finite maximum number of write cycles. Programs that repeatedly cause write cycles to nonvolatile memory can eventually exceed the maximum number of write cycles and cause the memory to fail.

---

## [SOURce:]RESistance

This command sets the output resistance of the dc source.

**Command Syntax** [SOURce:]RESistance[:LEVel][:IMMediate][:AMPLitude]<NRf+>  
**Parameters** see Table 8-3  
**\*RST Value** 0  
**Examples** RES 0.5 !set output resistance to 0.5Ω  
**Query Syntax** [SOURce:]RESistance[:LEVel][:IMMediate][:AMPLitude]?  
**Returned Parameters** <NR3>  
**Related Commands** RES:TRIG

## [SOURce:]RESistance:TRIGger

This command sets the pending triggered output resistance of the dc source.

**Command Syntax** [SOURce:]RESistance[:LEVel]:TRIGgered[:AMPLitude] <NRf+>  
**Parameters** see Table 8-3  
**\*RST Value** 0  
**Examples** RES:TRIG 1 !set triggerd resistance to 1Ω  
**Query Syntax** [SOURce:]RESistance[:LEVel]:TRIGgered[:AMPLitude]?  
**Returned Parameters** <NR3>  
**Related Commands** RES

**[SOURce:]VOLTage**

This command sets the output voltage level of the dc source.

<b>Command Syntax</b>	[SOURce:]VOLTage[:LEVel][:IMMEDIATE][:AMPLitude]<NRf+>
<b>Parameters</b>	see Table 8-3
<b>Default Suffix</b>	V (volts)
<b>*RST Value</b>	0
<b>Examples</b>	VOLT 2.5 !set output voltage to 2.5V
<b>Query Syntax</b>	[SOURce:]VOLTage[:LEVel][:IMMEDIATE][:AMPLitude]?
<b>Returned Parameters</b>	<NR3>
<b>Related Commands</b>	VOLT:TRIG VOLT:PROT

**[SOURce:]VOLTage2**

Agilent 66319B/66319D only

This command sets the output voltage level of the auxiliary output.

<b>Command Syntax</b>	[SOURce:]VOLTage2[:LEVel][:IMMEDIATE][:AMPLitude]<NRf+>
<b>Parameters</b>	see Table A-3
<b>Default Suffix</b>	V (volts)
<b>*RST Value</b>	0
<b>Examples</b>	VOLT2 500mV !set output2 voltage to 0.5V
<b>Query Syntax</b>	[SOURce:]VOLTage2[:LEVel][:IMMEDIATE][:AMPLitude]?
<b>Returned Parameters</b>	<NR3>
<b>Related Commands</b>	VOLT2:TRIG

**[SOURce:]VOLTage:PROTection**

This command lets you limit the maximum allowable output voltage that can be programmed either from the front panel or over the GPIB. This feature is in addition to the automatic overvoltage protection circuit, and is useful in situations where accidentally programming higher output voltages within the operating range of the dc source can permanently damage the phone under test.

---

**NOTE:** This command **does not program the tracking OVP circuit**, which automatically tracks the output voltage and trips when the output voltage exceeds the programmed voltage by two volts. Also, the programmable voltage protection cannot be disabled by VOLTage:PROTection:STATe.

---

<b>Command Syntax</b>	[SOURce:]VOLTage:PROTection[:LEVel] <NRf+>
<b>Parameters</b>	see Table 8-3
<b>Default Suffix</b>	V (volts)
<b>*RST Value</b>	22 V
<b>Examples</b>	VOLT:PROT 10 !set voltage limit to 10V
<b>Query Syntax</b>	[SOURce:]VOLTage:PROTection[:LEVel]?
<b>Returned Parameters</b>	<NR3>
<b>Related Commands</b>	VOLT VOLT:TRIG

**[SOURCE:]VOLTage:PROTection:STATe**

This command enables or disables the automatic overvoltage protection tracking (OVP) function. It does **not** disable the programmable VOLTage:PROTection level.

---

**CAUTION:** Disabling the overvoltage protection function may cause excessive output voltages, such as can occur if remote sense leads are disconnected, to damage the equipment under test.

---

**Command Syntax** [SOURCE:]VOLTage:PROTection:STATe <bool>  
**Parameters** 0 | 1 | OFF | ON  
**\*RST Value** OFF  
**Examples** VOLT:PROT:STAT 0 !voltage protection is OFF  
 VOLT:PROT:STAT 1 !voltage protection is ON  
**Query Syntax** [SOURCE:]VOLTage:PROTection:STATe?  
**Returned Parameters** <NR1>0 or 1  
**Related Commands** OUTP:PROT:CLE \*RST VOLT:PROT

**[SOURCE:]VOLTage:TRIGger**

This command sets the pending triggered voltage level of the dc source. The pending triggered level is a stored voltage value that is transferred to the output terminals when a trigger occurs. In order for a trigger to occur, the trigger subsystem must be initiated (see the INITiate command in the trigger subsystem).

**Command Syntax** [SOURCE:]VOLTage[:LEVel]:TRIGgered[:AMPLitude] <NRf+>  
**Parameters** see Table 8-3  
**Default Suffix** V (volts)  
**\*RST Value** 0  
**Examples** VOLT:TRIG 20 VOLTAGE:LEVEL:TRIGGERED 20  
**Query Syntax** [SOURCE:]VOLTage[:LEVel]:TRIGgered[:AMPLitude]?  
**Returned Parameters** <NR3>  
**Related Commands** VOLT VOLT:PROT

**[SOURCE:]VOLTage2:TRIGger**

Agilent 66319B/66319D only

This command sets the triggered voltage level of the auxiliary output. The triggered level is a stored value that is transferred to the output when a trigger occurs. In order for a trigger to occur, the trigger subsystem must be initiated (see the INITiate command).

**Command Syntax** [SOURCE:]VOLTage2[:LEVel]:TRIGgered[:AMPLitude] <NRf+>  
**Parameters** see Table A-3  
**Default Suffix** V (volts)  
**\*RST Value** 0  
**Examples** VOLT2:TRIG 20 VOLT2:LEV:TRIG 20  
**Query Syntax** [SOURCE:]VOLTage2[:LEVel]:TRIGgered[:AMPLitude]?  
**Returned Parameters** <NR3>  
**Related Commands** VOLT2 VOLT2:PROT

## Status Commands

Status commands program the dc source status registers. The dc source has three groups of status registers; Operation, Questionable, and Standard Event. The Standard Event group is programmed with Common commands as described later in this section. The Operation and Questionable status groups each consist of the Condition, Enable, and Event registers and the NTR and PTR filters. Chapter 7 explains how to read specific register bits and use the information they return.

### STATus:PRESet

This command sets all defined bits in the Status Subsystem PTR registers and clears all bits in the subsystem NTR and Enable registers.

**Command Syntax** STATus:PRESet  
**Parameters** None  
**Examples** STAT:PRESet STATUS:PRESET

### STATus:OPERation?

This query returns the value of the Operation Event register. The Event register is a read-only register, which holds (latches) all events that are passed by the Operation NTR and/or PTR filter. Reading the Operation Event register clears it.

**Query Syntax** STATus:OPERtion[:EVENT]?  
**Parameters** None  
**Returned Parameters** <NR1>(Register Value)  
**Examples** STAT:OPER?  
**Related Commands** \*CLS STAT:OPER:NTR STAT:OPER:PTR

**Table 8-4. Bit Configuration of Operation Status Registers**

Bit Position	15-13	12	11	10	9	8	7-6	5	4-1	0
Bit Name	not used	CC2	CC-	CC+	CV2	CV	not used	WTG	not used	CAL
Bit Weight		4096	2048	1024	512	256		32		1

CAL = The dc source is computing new calibration constants.  
 WTG = The dc source is waiting for a trigger.  
 CV = The dc source is operating in constant voltage mode.  
 CV2 = Output 2 is operating in constant voltage mode. (Agilent 66319B/D only)  
 CC+ = The dc source is operating in constant current mode.  
 CC- = The dc source is operating in negative constant current mode.  
 CC2 = Output 2 is operating in constant current mode. (Agilent 66319B/D only)

### STATus:OPERation:CONDition?

This query returns the value of the Operation Condition register. That is a read-only register, which holds the real-time (unlatched) operational status of the dc source.

**Query Syntax** STATus:OPERation:CONDition?  
**Parameters** None  
**Examples** STAT:OPER:COND? STATUS:OPERATION:CONDITION?  
**Returned Parameters** <NR1> (register value)

**STATus:OPERation:ENABLE**

This command and its query set and read the value of the Operational Enable register. This register is a mask for enabling specific bits from the Operation Event register to set the operation summary bit (OPER) of the Status Byte register. This bit (bit 7) is the logical OR of all the Operational Event register bits that are enabled by the Status Operation Enable register.

<b>Command Syntax</b>	STATus:OPERation:ENABLE<NRf>
<b>Parameters</b>	0 to 32767
<b>Preset Value</b>	0
<b>Examples</b>	STAT:OPER:ENAB 1312
<b>Query Syntax</b>	STATus:OPERation:ENABLE?
<b>Returned Parameters</b>	<NR1> (register value)
<b>Related Commands</b>	STAT:OPER:EVEN

**STATus:OPERation:NTR****STATus:OPERation:PTR**

These commands set or read the value of the Operation NTR (Negative-Transition) and PTR (Positive-Transition) registers. These registers serve as polarity filters between the Operation Enable and Operation Event registers to cause the following actions:

- ◆ When a bit in the Operation NTR register is set to 1, then a 1-to-0 transition of the corresponding bit in the Operation Condition register causes that bit in the Operation Event register to be set.
- ◆ When a bit of the Operation PTR register is set to 1, then a 0-to-1 transition of the corresponding bit in the Operation Condition register causes that bit in the Operation Event register to be set.
- ◆ If the same bits in both NTR and PTR registers are set to 1, then any transition of that bit at the Operation Condition register sets the corresponding bit in the Operation Event register.
- ◆ If the same bits in both NTR and PTR registers are set to 0, then no transition of that bit at the Operation Condition register can set the corresponding bit in the Operation Event register.

<b>Command Syntax</b>	STATus:OPERtion:NTRansition<NRf>	
	STATus:OPERtion:PTRansition<NRf>	
<b>Parameters</b>	0 to 32767	
<b>Preset Value</b>	NTR register = 0; PTR register = 32767	
<b>Examples</b>	STAT:OPER:NTR 32	STAT:OPER:PTR 1312
<b>Query Syntax</b>	STAT:OPER:NTR?	STAT:OPER:PTR?
<b>Returned Parameters</b>	<NR1> (register value)	
<b>Related Commands</b>	STAT:OPER:ENAB	

**STATus:QUEStionable?**

This query returns the value of the Questionable Event register. The Event register is a read-only register which holds (latches) all events that are passed by the Questionable NTR and/or PTR filter. Reading the Questionable Event register clears it.

**Query Syntax** STATus:QUEStionable[:EVENT]?

**Parameters** None

**Examples** STAT:QUES?

**Returned Parameters** <NR1> (register value)

**Related Commands** \*CLS STAT:QUES:ENAB STAT:QUES:NTR STAT:QUES:PTR

**Table 8-5. Bit Configuration of Questionable Status Registers**

Bit Position	15	14	13	12	11	10	9	8	7-6	5	4	3	2	1	0
Bit Name	not used	Meas Ovld	not used	OC2	not used	UNR	RI	UNR 2	not used	SD	OT	FP	not used	OCP	OV
Bit Weight		16384		4096		1024	512	256		32	16	8		2	1

OV = overvoltage protection has tripped on the main output (output 1)  
 OCP = overcurrent protection has tripped on the main output (output 2)  
 FP = the front panel "Local" key has been depressed  
 OT = overtemperature protection has tripped  
 SD = opened sense lead detected  
 UNR2 = output 2 is unregulated (Agilent 66319B/D only)  
 RI = remote inhibit is active  
 UNR = the output is unregulated  
 OC2 = output 2 overcurrent protection has tripped (Agilent 66319B/D only)  
 Meas Ovld = measurement overload

**STATus:QUEStionable:CONDition?**

This query returns the value of the Questionable Condition register. That is a read-only register, which holds the real-time (unlatched) questionable status of the dc source.

**Query Syntax** STATus:QUEStionable:CONDition?

**Parameters** None

**Examples** STAT:QUES:COND?

**Returned Parameters** <NR1> (register value)

**STATus:QUEStionable:ENABLE**

This command and its query set and read the value of the Questionable Enable register. This register is a mask for enabling specific bits from the Questionable Event register to set the questionable summary bit (QUES) of the Status Byte register. This bit (bit 3) is the logical OR of all the Questionable Event register bits that are enabled by the Questionable Status Enable register..

**Command Syntax** STATus:QUEStionable:ENABLE<NRf>

**Parameters** 0 to 32767

**Preset Value** 0

**Examples** STAT:QUES:ENAB 4098 !enables OC2 and OCP

**Query Syntax** STATus:QUEStionable:ENABLE?

**Returned Parameters** <NR1> (register value)

**Related Commands** STAT:QUES?

## **STATus:QUEStionable:NTR**

### **STATus:QUEStionable:PTR**

These commands allow you to set or read the value of the Questionable NTR (Negative-Transition) and PTR (Positive-Transition) registers. These registers serve as polarity filters between the Questionable Enable and Questionable Event registers to cause the following actions:

- ◆ When a bit of the Questionable NTR register is set to 1, then a 1-to-0 transition of the corresponding bit of the Questionable Condition register causes that bit in the Questionable Event register to be set.
- ◆ When a bit of the Questionable PTR register is set to 1, then a 0-to-1 transition of the corresponding bit in the Questionable Condition register causes that bit in the Questionable Event register to be set.
- ◆ If the same bits in both NTR and PTR registers are set to 1, then any transition of that bit at the Questionable Condition register sets the corresponding bit in the Questionable Event register.
- ◆ If the same bits in both NTR and PTR registers are set to 0, then no transition of that bit at the Questionable Condition register can set the corresponding bit in the Questionable Event register.

<b>Command Syntax</b>	STATus:QUEStionable:NTRansition<NRf> STATus:QUEStionable:PTRansition<NRf>
<b>Parameters</b>	0 to 32767
<b>Preset Value</b>	NTR register = 0; PTR register = 32767
<b>Examples</b>	STAT:QUES:NTR 16 STATUS:QUESTIONABLE:PTR 512
<b>Query Syntax</b>	STAT:QUES:NTR?STAT:QUES:PTR?
<b>Returned Parameters</b>	<NR1>(Register value)
<b>Related Commands</b>	STAT:QUES:ENAB



## System Commands

System commands control system functions that are not directly related to output control or measurement functions.

### SYSTem:ERRor?

This query returns the next error number followed by its corresponding error message string from the remote programming error queue. The queue is a FIFO (first-in, first-out) buffer that stores errors as they occur. As it is read, each error is removed from the queue. When all errors have been read, the query returns 0,NO ERROR. If more errors are accumulated than the queue can hold, the last error in the queue will be -350,TOO MANY ERRORS (see Appendix C for other error codes).

You can use the front panel Error key to read errors from the queue. Errors generated at the front panel are not put into the queue but appear immediately on the display.

<b>Query Syntax</b>	SYSTem:ERRor?
<b>Parameters</b>	None
<b>Returned Parameters</b>	<NR1> , <SRD>
<b>Examples</b>	SYST:ERR?

### SYSTem:LANGuage

This command selects the command language. The SCPI command language is the only language supported.

<b>Command Syntax</b>	SYSTem:LANGuage<string>
<b>Parameters</b>	SCPI
<b>Power-on Value</b>	SCPI
<b>Example</b>	SYST:LANG SCPI
<b>Query Syntax</b>	SYSTem:LANGuage?
<b>Returned Parameters</b>	<CRD>

### SYSTem:VERSion?

This query returns the SCPI version number to which the instrument complies. The returned value is of the form YYYY.V, where YYYY represents the year and V is the revision number for that year.

<b>Query Syntax</b>	SYSTem:VERSion?
<b>Parameters</b>	None
<b>Returned Parameters</b>	<NR2>
<b>Examples</b>	SYST:VERS?

---

## Trigger Commands

Trigger commands consist of trigger and initiate commands. They are used to generate output transients and measurement triggers.

**Initiate commands** initialize the trigger system. **Trigger commands** control the remote triggering of the dc source. Trigger commands (and Initiate commands) are referenced either by name or by number. The correspondence between names and numbers is:

Sequence Number	Sequence Name	Description
1 (the default)	TRANSient	Output transient trigger sequence
2	ACQuire	Measurement acquire trigger sequence

---

**NOTE:** Before you generate a measurement trigger, you must specify either a voltage, current , or DVM measurement acquisition using the SENSE:FUNCTION command.

---

### ABORt

This command cancels any trigger actions presently in process. Pending trigger levels are reset to their corresponding immediate values. ABORt also resets the WTG bit in the Operation Condition Status register (see chapter 7 about programming the status registers). If INITiate:CONTinuous ON has been programmed, the trigger subsystem initiates itself immediately after ABORt, thereby setting WTG. ABORt is executed at power turn on and upon execution of \*RCL or RST.

<b>Command Syntax</b>	ABORt
<b>Parameters</b>	None
<b>Examples</b>	ABOR
<b>Related Commands</b>	INIT *RST *TRG TRIG

### INITiate:SEquence

#### INITiate:NAME

INITiate commands control the enabling of both output and measurement triggers. When a trigger is enabled, an event on a selected trigger source causes the specified triggering action to occur. If the trigger subsystem is not enabled, all triggers are ignored.

<b>Command Syntax</b>	INITiate[:IMMediate]:SEquence[ 1   2 ] INITiate[:IMMediate]:NAME<name>
<b>Parameters</b>	TRANSient   ACQuire (for INIT:NAME )
<b>Examples</b>	INIT:SEQ2 INIT:NAME TRAN
<b>Related Commands</b>	ABOR INIT:CONT TRIG TRIG:SEQ:DEF *TRG

## INITiate:CONTInuous:SEQuence1

### INITiate:CONTInuous:NAME TRANsient

These commands control the output transient trigger system.

**1 or ON** continuously initiates the output trigger system..

**0 or OFF** turns off continuous triggering. In this state, the output trigger system must be initiated for each trigger using INITiate:SEQuence.

**Command Syntax** INITiate:CONTInuous:SEQuence1 <bool>  
INITiate:CONTInuous:NAME TRANsient <bool>

**Parameters** 0 | 1 | OFF | ON

**Examples** INIT:CONT:SEQ1 ON INIT:CONT:NAME TRAN, 1

**Related Commands** ABOR INIT TRIG TRIG:SEQ:DEF \*TRG

## TRIGger

This command generates a BUS trigger for the output transient trigger system. If the transient trigger system is enabled, the trigger will then:

1. Initiate a pending level change as specified by CURRENT:TRIGger or VOLTage:TRIGger.
2. Clear the WTG bit in the Status Operation Condition register after both transient and acquire trigger sequences have completed. (WTG is the logical-or of both transient and acquire sequences.)
3. If INITiate:CONTInuous ON has been programmed, the trigger subsystem is immediately re-enabled for subsequent triggers. As soon as it is cleared, the WTG bit is again set to 1.

**Command Syntax** TRIGger[:SEQuence1][:IMMediate]  
TRIGger[:TRANsient][:IMMediate]

**Parameters** None

**Examples** TRIG TRIG:IMM

**Related Commands** ABOR CURR:TRIG INIT \*TRG VOLT:TRIG

## TRIGger:SOURce

This command selects the trigger source for the output transient trigger system. Since BUS is the only trigger source for transient triggers, this command does not need to be used. It is included for completeness only.

**BUS** GPIB device, \*TRG, or <GET> (Group Execute Trigger)

**Command Syntax** TRIGger[:SEQuence1]:SOURce<source>  
TRIGger[:TRANsient]:SOURce<source>

**Parameters** BUS

**\*RST Value** BUS

**Examples** TRIG:SOUR BUS

**Query Syntax** TRIGger[:SEQuence1]:SOURce?  
TRIGger[:TRANsient]:SOURce?

**Returned Parameters** <CRD>

**TRIGger:SEQuence2****TRIGger:ACQuire**

These commands generate a BUS trigger for the measurement trigger system. When the measurement trigger system is enabled, the measurement trigger causes the dc source to measure either the voltage or current on the main output or the DVM inputs and store the results in a buffer. The SENSE:FUNCTION command selects the signal that will be measured.

<b>Command Syntax</b>	TRIGger:SEQuence2[:IMMediate] TRIGger:ACQuire[:IMMediate]
<b>Parameters</b>	None
<b>Examples</b>	TRIG:SEQ2                      TRIG:ACQ
<b>Related Commands</b>	TRIG:SOUR    TRIG:SEQ2:DEF    TRIG:SEQ2:COUN TRIG:SEQ2:LEV:VOLT    TRIG:SEQ2:SLOP:CURR    SENS:FUNC

**TRIGger:SEQuence2:COUNt:CURRent****TRIGger:ACQuire:COUNt:CURRent**

This command sets up a successive number of triggers for measuring current data. With this command, the trigger system needs to be initialized only once at the start of the acquisition period. After each completed measurement, the instrument waits for the next valid trigger condition to start another measurement. This continues until the count has completed.

<b>Command Syntax</b>	TRIGger:SEQuence2:COUNt:CURRent<NRf+> TRIGger:ACQuire:COUNt:CURRent<NRf+>
<b>Parameters</b>	1 to 100
<b>*RST Value</b>	1
<b>Examples</b>	TRIG:SEQ2:COUN:CURR 5    TRIG:ACQ:COUN:CURR 1
<b>Query Syntax</b>	TRIGger:SEQuence2:COUNt:CURRent? TRIGger:ACQuire:COUNt:CURRent?
<b>Returned Parameters</b>	<NR3>
<b>Related Commands</b>	TRIG:SEQ2    TRIG:ACQ

**TRIGger:SEQuence2:COUNt:DVM****TRIGger:ACQuire:COUNt:DVM**

Agilent 66321D/66319D only

This command specifies a DVM trigger count. Since the trigger count for DVM measurements cannot be set to any value other than 1, this command does not need to be used. It is included for completeness only.

<b>Command Syntax</b>	TRIGger:SEQuence2:COUNt:DVM<NRf+> TRIGger:ACQuire:COUNt:DVM<NRf+>
<b>Parameters</b>	1
<b>*RST Value</b>	1
<b>Examples</b>	TRIG:ACQ:COUN:DVM 1
<b>Query Syntax</b>	TRIGger:SEQuence2:COUNt:DVM? TRIGger:ACQuire:COUNt:DVM?
<b>Returned Parameters</b>	<NR3>

## TRIGger:SEQuence2:COUnT:VOLTAge

### TRIGger:ACQuire:COUnT:VOLTAge

This command sets up a successive number of triggers for measuring voltage data. With this command, the trigger system needs to be initialized only once at the start of the acquisition period. After each completed measurement, the instrument waits for the next valid trigger condition to start another measurement. This continues until the count has completed.

<b>Command Syntax</b>	TRIGger:SEQuence2:COUnT:VOLTAge<NRf+> TRIGger:ACQuire:COUnT:VOLTAge<NRf+>
<b>Parameters</b>	1 to 100
<b>*RST Value</b>	1
<b>Examples</b>	TRIG:SEQ2:COUnT:VOLT 5 TRIG:ACQ:COUnT:VOLT 1
<b>Query Syntax</b>	TRIGger:SEQuence2:COUnT:VOLTAge? TRIGger:ACQuire:COUnT:VOLTAge?
<b>Returned Parameters</b>	<NR3>
<b>Related Commands</b>	TRIG:SEQ2 TRIG:ACQ

## TRIGger:SEQuence2:HYSTeresis:CURRent

### TRIGger:ACQuire:HYSTeresis:CURRent

This command defines a band around the trigger level through which the signal must pass before an internal measurement can occur. The band limit above and below the trigger level is one half of the hysteresis value added to or subtracted from the trigger level.

For a positive trigger to occur, the excursion of an output waveform in the positive direction must start below the lower hysteresis band limit and pass through the upper hysteresis band limit. For a negative trigger to occur, the excursion of an output waveform in the negative direction must start above the upper hysteresis band limit and pass through the lower hysteresis band limit.

<b>Command Syntax</b>	TRIGger:SEQuence2:HYSTeresis:CURRent<NRf+> TRIGger:ACQuire:HYSTeresis:CURRent<NRf+>
<b>Parameters</b>	0 to MAX (see table 8-3)
<b>Unit</b>	A (amperes)
<b>*RST Value</b>	0
<b>Examples</b>	TRIG:SEQ2:HYST:CURR 0.5 TRIG:ACQ:HYST:CURR 0.5
<b>Query Syntax</b>	TRIGger:SEQuence2:HYSTeresis:CURRent? TRIGger:ACQuire:HYSTeresis:CURRent?
<b>Returned Parameters</b>	<NR3>
<b>Related Commands</b>	TRIG:SEQ2:HYST:VOLT TRIG:SEQ2:LEV:CURR

## TRIGger:SEQuence2:HYSTeresis:DVM

### TRIGger:ACQuire:HYSTeresis:DVM

Agilent 66321D/66319D only

This command defines a band around the trigger level through which the input signal must pass before a DVM measurement can occur. The band limit above and below the trigger level is one half of the hysteresis value added to or subtracted from the trigger level. For a positive trigger to occur, the excursion of an input signal in the positive direction must start below the lower hysteresis band limit and pass through the upper hysteresis band limit. For a negative trigger to occur, the excursion of an input signal in the negative direction must start above the upper hysteresis band limit and pass through the lower hysteresis band limit.

<b>Command Syntax</b>	TRIGger:SEQuence2:HYSTeresis:DVM<NRf+> TRIGger:ACQuire:HYSTeresis:DVM<NRf+>
<b>Parameters</b>	0 to MAX (see table A-3)
<b>Unit</b>	V (volts)
<b>*RST Value</b>	0
<b>Examples</b>	TRIG:SEQ2:HYST:DVM 0.5    TRIG:ACQ:HYST:DVM 0.5
<b>Query Syntax</b>	TRIGger:SEQuence2:HYSTeresis:DVM? TRIGger:ACQuire:HYSTeresis:DVM?
<b>Returned Parameters</b>	<NR3>
<b>Related Commands</b>	TRIG:SEQ2:LEV:DVM

## TRIGger:SEQuence2:HYSTeresis:VOLTage

### TRIGger:ACQuire:HYSTeresis:VOLTage

This command defines a band around the trigger level through which the signal must pass before an internal measurement can occur. The band limit above and below the trigger level is one half of the hysteresis value added to or subtracted from the trigger level.

For a positive trigger to occur, the excursion of an output waveform in the positive direction must start below the lower hysteresis band limit and pass through the upper hysteresis band limit. For a negative trigger to occur, the excursion of an output waveform in the negative direction must start above the upper hysteresis band limit and pass through the lower hysteresis band limit.

<b>Command Syntax</b>	TRIGger:SEQuence2:HYSTeresis:VOLTage<NRf+> TRIGger:ACQuire:HYSTeresis:VOLTage<NRf+>
<b>Parameters</b>	0 to MAX (see table 8-3)
<b>Unit</b>	V (volts)
<b>*RST Value</b>	0
<b>Examples</b>	TRIG:SEQ2:HYST:VOLT 2 TRIG:ACQ:HYST:VOLT 2
<b>Query Syntax</b>	TRIGger:SEQuence2:HYSTeresis:VOLTage? TRIGger:ACQuire:HYSTeresis:VOLTage?
<b>Returned Parameters</b>	<NR3>
<b>Related Commands</b>	TRIG:SEQ2:HYST:CURR    TRIG:SEQ2:LEV:VOLT

## TRIGger:SEQuence2:LEVel:CURRent

### TRIGger:ACQuire:LEVel:CURRent

This command sets the trigger level for internally triggered current measurements. A positive current trigger occurs when the current level changes from a value less than the lower hysteresis band limit to a value greater than the upper hysteresis band limit. Similarly, a negative current trigger occurs when the current level changes from a value greater than the upper hysteresis band limit to a value less than the lower hysteresis band limit.

<b>Command Syntax</b>	TRIGger:SEQuence2:LEVel:CURRent<NRf+> TRIGger:ACQuire:LEVel:CURRent<NRf+>
<b>Parameters</b>	0 to MAX (see table 8-3)
<b>Unit</b>	A (amperes)
<b>*RST Value</b>	0
<b>Examples</b>	TRIG:SEQ2:LEV:CURR 5      TRIG:ACQ:LEV:CURR MAX TRIG:ACQ:LEV 2
<b>Query Syntax</b>	TRIGger:SEQuence2:LEVel:CURRent? TRIGger:ACQuire:LEVel:CURRent?
<b>Returned Parameters</b>	<NR3>
<b>Related Commands</b>	TRIG:SEQ2:LEV:VOLT      TRIG:SEQ2:HYST:CURR

## TRIGger:SEQuence2:LEVel:DVM

### TRIGger:ACQuire:LEVel:DVM

Agilent 66321D/66319D only

This command sets the trigger level for DVM measurements. A positive trigger occurs when the input signal changes from a value less than the lower hysteresis band limit to a value greater than the upper hysteresis band limit. Similarly, a negative trigger occurs when the input signal changes from a value greater than the upper hysteresis band limit to a value less than the lower hysteresis band limit.

<b>Command Syntax</b>	TRIGger:SEQuence2:LEVel:DVM<NRf+> TRIGger:ACQuire:LEVel:DVM<NRf+>
<b>Parameters</b>	0 to MAX (see table A-3)
<b>Unit</b>	V (volts)
<b>*RST Value</b>	0
<b>Examples</b>	TRIG:SEQ2:LEV:DVM 5      TRIG:ACQ:LEV:DVM MAX
<b>Query Syntax</b>	TRIGger:SEQuence2:LEVel:DVM? TRIGger:ACQuire:LEVel:DVM?
<b>Returned Parameters</b>	<NR3>
<b>Related Commands</b>	TRIG:SEQ2:HYST:DVM

## TRIGger:SEQuence2:LEVel:VOLTage

### TRIGger:ACQuire:LEVel:VOLTage

This command sets the trigger level for internally triggered voltage measurements. A positive voltage trigger occurs when the voltage level changes from a value less than the lower hysteresis band limit to a value greater than the upper hysteresis band limit. Similarly, a negative voltage trigger occurs when the voltage level changes from a value greater than the upper hysteresis band limit to a value less than the lower hysteresis band limit.

<b>Command Syntax</b>	TRIGger:SEQuence2:LEVel:VOLTage<NRf+> TRIGger:ACQuire:LEVel:VOLTage<NRf+>
<b>Parameters</b>	0 to MAX (see table 8-3)
<b>Unit</b>	V (volts)
<b>*RST Value</b>	0
<b>Examples</b>	TRIG:SEQ2:LEV:VOLT 5 TRIG:ACQ:LEV:VOLT MAX
<b>Query Syntax</b>	TRIGger:SEQuence2:LEVel:VOLTage? TRIGger:ACQuire:LEVel:VOLTage?
<b>Returned Parameters</b>	<NR3>
<b>Related Commands</b>	TRIG:SEQ2:LEV:CURR TRIG:SEQ2:HYST:VOLT

## TRIGger:SEQuence2:SLOPe:CURRent

### TRIGger:ACQuire:SLOPe:CURRent

This command sets the slope of an internally triggered current measurement.

<b>POSitive</b>	triggering occurs on the rising edge.
<b>NEGative</b>	triggering occurs on the falling edge.
<b>EITHer</b>	triggering occurs on either edge.

<b>Command Syntax</b>	TRIGger:SEQuence2:SLOPe:CURRent<slope> TRIGger:ACQuire:SLOPe:CURRent<slope>
<b>Parameters</b>	EITHer   POSitive   NEGative
<b>*RST Value</b>	POSitive
<b>Examples</b>	TRIG:SEQ2:SLOP:CURR POS TRIG:ACQ:SLOP:CURR EITH
<b>Query Syntax</b>	TRIGger:SEQuence2:SLOPe:CURRent? TRIGger:ACQuire:SLOPe:CURRent?
<b>Returned Parameters</b>	<CRD>
<b>Related Commands</b>	TRIG:SEQ2:SLOP:VOLT

## TRIGger:SEQuence2:SLOPe:DVM

### TRIGger:ACQuire:SLOPe:DVM

Agilent 66321D/66319D only

This command sets the slope of the DVM input signal.

<b>POSitive</b>	measurement triggering occurs on the rising edge.
<b>NEGative</b>	measurement triggering occurs on the falling edge.
<b>EITHer</b>	measurement triggering occurs on either edge.



<b>Command Syntax</b>	TRIGger:SEQuence2:SLOPe:DVM<slope> TRIGger:ACQuire:SLOPe:DVM<slope>
<b>Parameters</b>	EITHer   POSitive   NEGative
<b>*RST Value</b>	POSitive
<b>Examples</b>	TRIG:SEQ2:SLOP:DVM POS TRIG:ACQ:SLOP:DVM EITH
<b>Query Syntax</b>	TRIGger:SEQuence2:SLOPe:DVM? TRIGger:ACQuire:SLOPe:DVM?
<b>Returned Parameters</b>	<CRD>
<b>Related Commands</b>	TRIG:SEQ2:LEV:DVM

## TRIGger:SEQuence2:SLOPe:VOLTage

### TRIGger:ACQuire:SLOPe:VOLTage

This command sets the slope of an internally triggered voltage measurement.

<b>POSitive</b>	triggering occurs on the rising edge.
<b>NEGative</b>	triggering occurs on the falling edge.
<b>EITHer</b>	triggering occurs on either edge.

<b>Command Syntax</b>	TRIGger:SEQuence2:SLOPe:VOLTage<slope> TRIGger:ACQuire:SLOPe:VOLTage<slope>
<b>Parameters</b>	EITHer   POSitive   NEGative
<b>*RST Value</b>	POSitive
<b>Examples</b>	TRIG:SEQ2:SLOP:VOLT POS TRIG:ACQ:SLOP:VOLT EITH
<b>Query Syntax</b>	TRIGger:SEQuence2:SLOPe:VOLTage? TRIGger:ACQuire:SLOPe:VOLTage?
<b>Returned Parameters</b>	<CRD>
<b>Related Commands</b>	TRIG:SEQ2:SLOP:CURR

## TRIGger:SEQuence2:SOURce

### TRIGger:ACQuire:SOURce

These commands select the trigger source for measurement triggers as follows:

<b>BUS</b>	GPIB device, *TRG, or <GET> (Group Execute Trigger)
<b>INTernal</b>	trigger is generated internally when the measured waveform crosses the trigger level with the selected slope.
<b>EXTernal</b>	Selects the external trigger input on the 4-pin control connector as the trigger source (only applies to units with firmware revision A.03.01 and up)

<b>Command Syntax</b>	TRIGger:SEQuence2:SOURce<source> TRIGger:ACQuire:SOURce<source>
<b>Parameters</b>	BUS   INTernal
<b>*RST Value</b>	INTernal
<b>Examples</b>	TRIG:ACQ:SOUR BUS
<b>Query Syntax</b>	TRIGger:SEQuence2:SOURce? TRIGger:ACQuire:SOURce?
<b>Returned Parameters</b>	<CRD>

## TRIGger:SEQuence1:DEFine

## TRIGger:SEQuence2:DEFine

These commands define the names that are aliased to trigger sequences 1 and 2. The command accepts only ACQuire for sequence 2 and TRANsient for sequence 1 as predefined names. The query allows the user to query the instrument names aliased to sequences 1 and 2.

<b>Command Syntax</b>	TRIGger:SEQuence1:DEFine TRANsient TRIGger:SEQuence2:DEFine ACQuire
<b>Parameters</b>	TRANsient, ACQuire
<b>Examples</b>	SEQ1:DEF ACQ                      SEQ2:DEF TRAN
<b>Query Syntax</b>	TRIGger:SEQuence1:DEFine? TRIGger:SEQuence2:DEFine?
<b>Returned Parameters</b>	<CRD>
<b>Related Commands</b>	TRIG:SEQ2:ACQ    TRIG:SEQ1:TRAN

---

## Common Commands

### \*CLS

This command causes the following actions (see chapter 7 for the descriptions of all registers):

- ◆ Clears the Standard Event Status, Operation Status Event, and Questionable Status Event registers
- ◆ Clears the Status Byte and the Error Queue
- ◆ If \*CLS immediately follows a program message terminator (<NL>), then the output queue and the MAV bit are also cleared.

<b>Command Syntax</b>	*CLS
<b>Parameters</b>	None

### \*ESE

This command programs the Standard Event Status Enable register bits. The programming determines which events of the Standard Event Status Event register (see \*ESR?) are allowed to set the ESB (Event Summary Bit) of the Status Byte register. A "1" in the bit position enables the corresponding event. All of the enabled events of the Standard Event Status Event Register are logically ORed to cause the Event Summary Bit (ESB) of the Status Byte Register to be set. The query reads the Standard Event The query reads the Standard Event Status Enable register.

**Table 8-6. Bit Configuration of Standard Event Status Enable Register**

Bit Position	7	6	5	4	3	2	1	0
Bit Name	PON	0	CME	EXE	DDE	QUE	0	OPC
Bit Weight	128	64	32	16	8	4	2	1
PON = Power-on has occurred CME = Command error EXE = Execution error				DDE = Device-dependent error QUE = Query error OPC = Operation complete				

<b>Command Syntax</b>	*ESE <NRf>
<b>Parameters</b>	0 to 255
<b>Power-On Value</b>	(See *PSC)
<b>Examples</b>	*ESE 129
<b>Query Syntax</b>	*ESE?
<b>Returned Parameters</b>	<NR1>(Register value)
<b>Related Commands</b>	*ESR? *PSC *STB?

---

**CAUTION:** If \*PSC is programmed to 0, the \*ESE command causes a write cycle to nonvolatile memory. Nonvolatile memory has a finite maximum number of write cycles. Programs that repeatedly cause write cycles to nonvolatile memory can eventually exceed the maximum number of write cycles and cause the memory to fail.

---

### \*ESR?

This query reads the Standard Event Status Event register. Reading the register clears it. The bit configuration is the same as the Standard Event Status Enable register (see \*ESE).

<b>Query Syntax</b>	*ESR?
<b>Parameters</b>	None
<b>Returned Parameters</b>	<NR1>(Register binary value)
<b>Related Commands</b>	*CLS *ESE *ESE? *OPC

### \*IDN?

This query requests the dc source to identify itself. It returns a string composed of four fields separated by commas.

<b>Query Syntax</b>	*IDN?		
<b>Returned Parameters</b>	<AARD>	<b>Field</b>	<b>Information</b>
		Agilent Technologies	Manufacturer
		xxxxxA	model number followed by a letter suffix
		0	zero or the unit's serial number if available
		<A>.xx.xx	Revision levels of firmware.
<b>Example</b>	AGILENT TECHNOLOGIES , 66321B , 0 , A . 00 . 01		

### \*OPC

This command causes the instrument to set the OPC bit (bit 0) of the Standard Event Status register when the dc source has completed all pending operations. (See \*ESE for the bit configuration of the Standard Event Status register.) *Pending operations* are complete when:

- ◆ all commands sent before \*OPC have been executed. This includes overlapped commands. Most commands are sequential and are completed before the next command is executed. Overlapped commands are executed in parallel with other commands. Commands that affect output voltage, current or state, relays, and trigger actions are overlapped with subsequent commands sent to the dc source. The \*OPC command provides notification that all overlapped commands have been completed.
- ◆ all triggered actions are completed

## 8 – Language Dictionary

\*OPC does not prevent processing of subsequent commands, but bit 0 will not be set until all pending operations are completed.

\*OPC? causes the instrument to place an ASCII "1" in the Output Queue when all pending operations are completed. Unlike \*OPC, \*OPC? prevents processing of all subsequent commands. It is intended to be used at the end of a command line so that the application program can then monitor the bus for data until it receives the "1" from the dc source Output Queue.

<b>Command Syntax</b>	*OPC
<b>Parameters</b>	None
<b>Query Syntax</b>	*OPC?
<b>Returned Parameters</b>	<NR1> 1
<b>Related Commands</b>	*OPC *TRIG *WAI

### \*OPT?

This query requests the dc source to identify any options that are installed. Options are identified by number. A 0 indicates no options are installed.

<b>Query Syntax</b>	*OPT?
<b>Returned Parameters</b>	<AARD>

### \*PSC

This command controls the automatic clearing at power-on of the Service Request Enable and the Standard Event Status Enable registers. The query returns the current state of \*PSC.

**\*PSC ON | 1** causes these registers to be cleared at power-on. This prevents a PON event from generating SRQ at power-on.

**\*PSC OFF | 0** causes the contents of the Standard Event Enable and Service Request Enable registers to be saved in nonvolatile memory and recalled at power-on. This allows a PON event to generate SRQ at power-on.

<b>Command Syntax</b>	*PSC <Bool>
<b>Parameters</b>	0   1   OFF   ON
<b>Example</b>	*PSC 0 *PSC 1
<b>Query Syntax</b>	*PSC?
<b>Returned Parameters</b>	<NR1>0 1
<b>Related Commands</b>	*ESE *SRE

---

**CAUTION:** \*PSC causes a write cycle to nonvolatile memory. Nonvolatile memory has a finite maximum number of write cycles. Programs that repeatedly cause write cycles to nonvolatile memory can eventually exceed the maximum number of write cycles and cause the memory to fail.

---

**\*RCL**

This command restores the dc source to a state that was previously stored in memory with the \*SAV command to the specified location. All states are recalled with the following exceptions:

- ◆ the trigger system is set to the Idle state by an implied ABORt command (this cancels any uncompleted trigger actions)
- ◆ the calibration function is disabled by setting CAL:STATe to OFF

---

**NOTE:** The device state stored in location 0 is automatically recalled at power turn-on when the OUTPut:PON:STATe is set to RCL 0.

---

**Command Syntax** \*RCL <NRf>  
**Parameters** 0 | 1 | 2 | 3  
**Example** \*RCL 3  
**Related Commands** \*PSC \*RST \*SAV

**\*RST**

This command resets the dc source to a factory-defined state as defined in the following table. \*RST also forces an ABORt command.

**Table 8-7. \*RST Settings**

CAL:STAT	OFF	[SOUR:]CURR2	10% of MAX
DIG:DATA	0	[SOUR:]CURR2:TRIG	10% of MAX
DISP:STAT	ON	[SOUR:]CURR:PROT:STAT	OFF
DISP:MODE	NORM	[SOUR:]LIST:COUN	0
DISP:TEXT	“ ”	[SOUR:]VOLT	0
INIT:CONT	OFF	[SOUR:]VOLT:LIM	15 V0
INST:COUP:OUTP:STAT	ALL	[SOUR:]VOLT:TRIG	0
	NONE (option 521 units)	[SOUR:]VOLT2	0
OUTP	OFF	[SOUR:]VOLT2:LIM	12 V
OUTP:COMP	HREMOTE	[SOUR:]VOLT2:TRIG	0
OUTP:DFI	OFF	[SOUR:]VOLT:PROT	MAX
OUTP:DFI:SOUR	OFF	[SOUR:]VOLT:PROT:STAT	ON
OUTP:PROT:DEL	.08	TRIG:ACQ:COUN:CURR	1
OUTP:PROT:STAT	OFF	TRIG:ACQ:COUN:VOLT	1
OUTP:RELay	HH	TRIG:ACQ:HYST:CURR	0
SENS:CURR:RANG	3A	TRIG:ACQ:HYST:DVM	0
SENS:CURR:DET	ACDC (all but 66321A) DC (66321A only)	TRIG:ACQ:HYST:VOLT	0
SENS:FUNC	VOLT	TRIG:ACQ:LEV:CURR	0
SENS:SWE:OFFS:POIN	0	TRIG:ACQ:LEV:DVM	0
SENS:SWE:POIN	2048	TRIG:ACQ:LEV:VOLT	0
SENS:SWE:TINT	15.6 $\mu$ s	TRIG:ACQ:SLOP:CURR	POS
[SOUR:]CURR	10% of MAX	TRIG:ACQ:SLOP:DVM	POS
[SOUR:]CURR:TRIG	10% of MAX	TRIG:ACQ:SLOP:VOLT	POS
		TRIG:ACQ:SOUR	INTERNAL
		TRIG:TRAN:SOUR	BUS

---

**NOTE:** You can change the factory default \*RST settings for the OUTput COMPensation, COUPling, RELay, and PROTection parameters. Refer to Appendix B for details.

---

**Command Syntax** \*RST  
**Parameters** None  
**Related Commands** \*PSC \*SAV

**\*SAV**

This command stores the present state of the dc source to the specified location in non-volatile memory. Up to 4 states can be stored. If a particular state is desired at power-on, it should be stored in location 0. It will then be automatically recalled at power turn-on if OUTPUT:PON:STATe is set to RCL0. Use \*RCL to retrieve instrument states.

**Command Syntax** \*SAV <NRf>  
**Parameters** 0 | 1 | 2 | 3  
**Example** \*SAV 3  
**Related Commands** \*RCL \*RST

---

**CAUTION:** \*SAV causes a write cycle to nonvolatile memory. Nonvolatile memory has a finite maximum number of write cycles. Programs that repeatedly cause write cycles to nonvolatile memory can eventually exceed the maximum number of write cycles and cause the memory to fail.

---

**\*SRE**

This command sets the condition of the Service Request Enable Register. This register determines which bits from the Status Byte Register (see \*STB for its bit configuration) are allowed to set the Master Status Summary (MSS) bit and the Request for Service (RQS) summary bit. A 1 in any Service Request Enable Register bit position enables the corresponding Status Byte Register bit and all such enabled bits then are logically ORed to cause Bit 6 of the Status Byte Register to be set.

When the controller conducts a serial poll in response to SRQ, the RQS bit is cleared, but the MSS bit is not. When \*SRE is cleared (by programming it with 0), the dc source cannot generate an SRQ to the controller. The query returns the current state of \*SRE.

**Command Syntax** \*SRE <NRf>  
**Parameters** 0 to 255  
**Power-on Value** see \*PSC  
**Example** \*SRE 20  
**Query Syntax** \*SRE?  
**Returned Parameters** <NR1> (register binary value)  
**Related Commands** \*ESE \*ESR \*PSC

---

**CAUTION:** If \*PSC is programmed to 0, the \*SRE command causes a write cycle to nonvolatile memory. Nonvolatile memory has a finite maximum number of write cycles. Programs that repeatedly cause write cycles to nonvolatile memory can eventually exceed the maximum number of write cycles and cause the memory to fail.

---

**\*STB?**

This query reads the Status Byte register, which contains the status summary bits and the Output Queue MAV bit. Reading the Status Byte register does not clear it. The input summary bits are cleared when the appropriate event registers are read. The MAV bit is cleared at power-on, by \*CLS' or when there is no more response data available.

A serial poll also returns the value of the Status Byte register, except that bit 6 returns Request for Service (RQS) instead of Master Status Summary (MSS). A serial poll clears RQS, but not MSS. When MSS is set, it indicates that the dc source has one or more reasons for requesting service.

**Table 8-8. Bit Configuration of Status Byte Register**

Bit Position	7	6	5	4	3	2	1	0
Bit Name	OPER	MSS (RQS)	ESB	MAV	QUES	0	0	0
Bit Weight	128	64	32	16	8	4	2	1
ESB = Event status byte summary MAV = Message available MSS = Master status summary				OPER = Operation status summary QUES = Questionable status summary RQS = Request for service				

**Query Syntax** \*STB?  
**Returned Parameters** <NR1>(Register binary value)

### \*TRG

This common command generates a trigger when the trigger subsystem has BUS selected as its source. The command has the same affect as the Group Execute Trigger (<GET>) command.

**Command Syntax** \*TRG  
**Parameters** None  
**Related Commands** ABOR INIT TRIG[:IMM] <GET>

### \*TST?

This query causes the dc source to do a self-test and report any errors. 0 indicates that the dc source passed self-test. 1 indicates that one or more tests failed. Selftest errors are written to the error queue (see Appendix C).

**Query Syntax** TST?  
**Returned Parameters** <NR1>

### \*WAI

This command instructs the dc source not to process any further commands until all pending operations are completed. "Pending operations" are as defined under the \*OPC command. \*WAI can be aborted only by sending the dc source an GPIB DCL (Device Clear) command.

**Command Syntax** \*WAI  
**Parameters** None  
**Related Commands** \*OPC\* OPC?





# Specifications

## Specifications

Table A-1 lists the specifications of the dc source. Unless otherwise noted, specifications are warranted over the ambient temperature range of 0 to 55 °C. Specifications apply with typical cellular phone capacitive loads from 0 $\mu$ F to 12,000 $\mu$ F. Sensing is at the rear terminals of the power supply after a 30-minute warm-up period. Sense terminals are externally jumpered to their respective output terminals.

**Table A-1. Performance Specifications**

Parameter		Agilent 66321B/D; Agilent 66319B/D output 1 only	Agilent 66319B/D output 2 only
<b>Output Ratings</b>	Voltage: Current: Peak Current:	0 – 15 V 0 – 3 A 5 A <sup>1</sup>	0 – 12 V 0 – 1.5 A 2.5 A <sup>2</sup>
<b>Programming Accuracy</b> (@ 25°C $\pm$ 5°C)	Voltage: +Current: Resistance:	0.05% + 10 mV 0.05% + 1.33 mA <sup>3</sup> 0.5% + 2 m $\Omega$	0.2% + 40 mV 0.2% + 4.5 mA NA
<b>DC Measurement Accuracy</b> (via GPIB or front panel meters with respect to actual output @ 25°C $\pm$ 5°C)	Voltage: Output 2 Current: <u>3 A Current range</u> –3 A to +5 A: <u>1 A Current range</u> –1 A to +1A: <u>0.02A Current range</u> –20 mA to +20 mA:	0.03% + 5 mV NA 0.2% + 0.5 mA <sup>4</sup> 0.1% + 0.2 mA 0.1% + 2.5 $\mu$ A	0.2% + 15 mV 0.2% + 3 mA NA NA NA
<b>Ripple and Noise</b> (in the range of 20 Hz to 20 MHz with outputs ungrounded or with either terminal grounded)	Voltage (rms/p-p): Current (rms):	1 mV/6 mV <sup>5</sup> 2 mA	1 mV/6 mV <sup>5</sup> 2 mA
<b>Load Regulation</b> (change in output voltage or current for any load change within ratings)	Voltage: Current:	5 mV <sup>6</sup> 0.75 mA	1.6 mV 0.375 mA
<b>Line Regulation</b> (change in output voltage or current for any line change within ratings)	Voltage: Current:	0.5 mV 0.75 mA	0.4 mV 0.25 mA
<b>Transient Response Time</b> (for the output voltage to recover to within 20 mV of its final value)		< 20 $\mu$ s <sup>7</sup>	< 400 $\mu$ s <sup>8</sup>

<sup>1</sup> Peak current for up to a 7 millisecond time period. Average current cannot exceed 3 A.

<sup>2</sup> Peak current for up to a 1 millisecond time period. Average current cannot exceed 1.5 A.

<sup>3</sup> 0.05% + 2.3mA when programming between zero and 0.03% of full scale current

<sup>4</sup> Applies with current detector set to DC. ACDC mode accuracy is 0.2% + 3mA for sourcing and 0.2% + 3.6 mA for sinking.

<sup>5</sup> Specification is for phone capacitance greater than 6 $\mu$ F.

<sup>6</sup> With resistance set to zero ohms.

<sup>7</sup> Following a 0.1 A to 1.5 A load change in the HRemote compensation range.

<sup>8</sup> Following a 0.75 A to 1.5 A load change.

## Supplemental Characteristics

Table A-2 lists the supplemental characteristics, which are not warranted but are descriptions of typical performance determined either by design or type testing.

**Table A-2. Supplemental Characteristics**

Parameter		Agilent 66321B/D; Agilent 66319B/D output 1 only	Agilent 66319B/D output 2 only
<b>Output Programming Range</b>	Voltage: Current: Resistance: Voltage Limit:	0 – 15.535 V 0 – 3.0712 A – 40 mΩ to 1 Ω 0 – 22 V	0 – 12.25 V 0 – 1.52 A NA NA
<b>Average Programming Resolution</b>	Voltage: Current: Resistance:	4.2 mV 0.825 mA 1.2 mΩ	14 mV 1.75 mA NA
<b>Tracking OVP Accuracy</b> (refer to page 35 for details)	Above programmed voltage:	2.0V ± 2%	NA
<b>Average Current Measurement Resolution</b>	3 A Range: 1 A Range: 0.02A Range:	214 μA 32 μA 0.6 μA	55 μA NA NA
<b>Maximum Current Measurement</b>	3 A Range: 1 A Range: 0.02A Range:	7 A 1.05 A 21.5 mA	1.8A NA NA
<b>Sink Current</b>		- 2 A @ 7.5 V <sup>1</sup>	- 0.03 A @ 7.5 V
<b>Programming Accuracy Temperature Coefficient</b> (change/C°)	Voltage: Current: Resistance:	0.01% + 0.5 mV 0.01% + 15 μA 0.1% + 0.2 mΩ	0.03% + 1.5 mV 0.03% + 0.4 mA NA
<b>Readback Accuracy Temperature Coefficient</b> (change/C°)	Voltage: 3 A Current (dc): 3 A Current (acdc): 1 A Current range: 0.02A Current range:	0.01% + 300 μV 0.02% + 15 μA 0.05% + 120 μA 0.01% + 10 μA 0.01% + 0.3 μA	0.02% + 1.5 mV 0.02% + 0.4 mA NA NA NA
<b>Drift<sup>2</sup></b>	Voltage: Current: +	0.01% + 1 mV 0.01% + 30 μA	0.03% + 3 mV 0.03% + 0.8 mA
<b>Remote Sense Capability</b>	In each load lead	up to 4 V <sup>3</sup>	up to 4 V <sup>4</sup>
<b>Output Voltage Rise Time</b> <b>Output Voltage Fall Time</b>	10% to 90%: 90% to 10%:	< 200 μs < 200 μs	< 200 μs < 35 ms
<b>Output Voltage Settling Time<sup>5</sup></b>	0 to rated voltage: rated voltage to 0:	0.5 ms 1 ms	NA NA
<b>Output 2 OFF time</b>	12 V to 2 V:	NA	< 200 μs <sup>6</sup>

<sup>1</sup>The sink current decreases linearly from 2.8A @ 0 V to 1.2 A @ 15 V. Sink current does not track the programmed current.

<sup>2</sup>Following a 30 minute warm-up, the change in output over 8 hours, under constant ambient, load and line conditions.

<sup>3</sup>Add 2 mV to the load regulation for each 1 V change in the positive output lead.

<sup>4</sup>Add 3 mV to the load regulation for each 1 V change in the negative output lead.

<sup>5</sup>To settle within 12 mV of the final value for Output 1.

<sup>6</sup>When output 2 is turned off or disabled, the output voltage reduces from 12 V to less than 2 V in under 200 μs.

Table A-2. Supplemental Characteristics (continued)

Parameter		Agilent 66321B/D; Agilent 66319B/D output 1 only	Agilent 66319B/D output 2 only
<b>Typical Transient Voltage Undershoot Values</b> (actual values are dependent on the test setup)	With short load leads: ( $< 1$ meter) With long load leads: (up to 6 meters)	30mV w/6 $\mu$ F load cap 25mV w/20 $\mu$ F load cap 40mV w/6 $\mu$ F load cap 30mV w/20 $\mu$ F load cap	NA
<b>Dynamic Measurement System</b> <sup>1</sup>	Buffer Length: Sample Rate Range:	1 – 4096 points 15.6 $\mu$ s – 31200s	NA
<b>Measurement Time</b> (includes 30 ms <sup>2</sup> acquisition time and 20 ms processing overhead)	voltage or current	50 ms average	
<b>Command Processing Time</b> (time for output to begin to change following receipt of digital data)		4 ms average	
<b>Savable Instrument States</b>		4 (in locations 0 to 3)	
<b>GPIB Interface Capabilities</b>	Language: Interface:	SCPI AH1, C0, DC1, DT1, E1, L4, PP0, RL1, SH1, SR1, T6	
<b>FLT Output Characteristics INH/Trigger Characteristics</b>	Maximum ratings:  FLT Output Terminals:  INH/Trigger Terminals:	16.5 Vdc between terminals 1 and 2; 3 and 4; and from terminals 1 or 2 to chassis ground  Low-level output current = 1.25 mA max. Low-level output voltage = 0.5 V max.  Low-level input voltage = 0.8 V max. High-level input voltage = 2 V min. Low-level input current = 1 mA Pulse width = 100 $\mu$ s minimum INH time delay = 4 ms typical Trigger latency = – 15.6 $\mu$ s to + 32 $\mu$ s	
<b>Digital I/O Characteristics</b>	Maximum ratings:  Digital OUT Port 0,1,2 (open collector)    Digital IN Port 2: (internal pull-up)	same as FLT/INH/Trigger Characteristics Output leakage @ 16V = 0.1 mA (ports 0,1) = 12.5 mA (port 2) Output leakage @ 5V = 0.1 mA (ports 0,1) = 0.25 mA (port 2) Low-level output sink current @ 0.5 V = 4 mA Low-level output sink current @ 1 V = 50 mA  Low-level input current @ 0.4 V = 1.25 mA High-level input current @ 5 V = 0.25 mA Low-level input voltage = 0.8 V max. High level input voltage = 2.0 V min.	
<b>Isolation to Ground</b>	Maximum from either output terminal to chassis:	50 Vdc	
<b>Mains Input Ratings</b> (at full load from 47–63 Hz)	100 Vac (87-106 Vac): 120 Vac (104-127 Vac): 220 Vac (191-233 Vac): 230 Vac (207-253 Vac):	<b>66321B/D</b> 1.6 A, 125 W 1.4 A, 125 W 0.8 A, 125 W 0.75A, 125 W	<b>66319B/D</b> 2.2 A, 170 W 1.7 A, 170 W 0.96 A, 170 W 0.85A, 170 W

<sup>1</sup>For a pulse waveform, the accuracy of any individual data point in the buffer depends on the rise time of the pulse. For a current pulse of 1.4A with a rise time constant of 50 $\mu$ s, the error in measurement of a single data point during the rise time is  $\approx$  10mA.

<sup>2</sup>May be reduced by changing the default conditions of 2048 data points but measurement uncertainty due to noise will increase.

A - Specifications

**Table A-2. Supplemental Characteristics (continued)**

Parameter		All Models
<b>Calibration Interval</b>	from the date the unit is put into service	1 year (recommended)
<b>Regulatory Compliance</b>	Listing pending: Certified to: Conforms to: Complies with:	UL 3111-1 CSA 22.2 No. 1010.1 IEC 1010-1, EN 61010-1 EMC directive 89/336/EEC (ISM Group1 Class B)
<b>Dimensions</b> (see figure 3-1)	Height: Width: Depth:	88.1 mm (3.5in.) 212.8 mm (8.4in.) 435 mm (17.125 in.)
<b>Net weight</b>		9.07 kg (20 lbs.)
<b>Shipping weight</b>		11.1 kg (24.5 lbs.)

**Table A-3. Agilent 66321D/66319D DVM Specifications and Characteristics**

Performance Specifications (warranted from 0 to 55 °C unless otherwise noted)		
<b>DC Readback Accuracy (@ 25°C ±5°C)</b>		0.04% +5 mV
<b>AC+DC rms Readback Accuracy</b> (@ 25°C ±5°C with dc plus a sinewave input > 25mV rms)	60 Hz to 10 kHz: 45-60 Hz and 10-20 kHz:	1% +5 mV <sup>1</sup> 4 % +5 mV <sup>1</sup>
<b>Common Mode Voltage Range</b> (from either DVM input with respect to the negative output terminal of Output 1)		- 4.5 Vpk to + 25 Vpk
<b>Maximum DC Differential Voltage</b>		± 25 V peak
<b>Maximum AC Differential Voltage</b> (with a sinewave input)		10 V rms <sup>2</sup>
Supplemental Characteristics		
<b>Maximum Continuous Input Capability without damage</b> (between input terminals or from either input to chassis ground)		50 V
<b>Input Resistance</b> (from either DVM input with respect to either output terminal of Output 1)		20 MΩ
<b>Input Capacitance</b> (on either input terminal)		< 60 pF
<b>DC Common Mode Rejection Ratio</b>		> 83 dB
<b>Voltage Readback Resolution</b>	Front panel: GPIB:	1 mV < 0.2 mV
<b>Readback Temperature Coefficient</b> (change per °C)		0.002% + 0.2 mV

<sup>1</sup>+15 mV for dc plus sinewave input < 25 mV rms.

<sup>2</sup>To accept 10 Vrms sinewave input, the common mode voltage with respect to the negative terminal of output 1 must be 10 Vdc. This is required to "center" the DVM in its common mode range.

**Table A-4. Agilent 66319B/D Option 521 Characteristics**

<b>Output Impedance</b> (Output = OFF)	Output 1: Output 2:	500k ohms 200k ohms
<b>Solid State Relay Current rise time</b> (from 10% to 90% of the total output change)	Relay mode =Hot	100 microseconds
<b>Solid State Relay Current fall time</b> (from 10% to 90% of the total output change)	Relay mode =Hot	50 microseconds

## Performance, Calibration, and Configuration

### Introduction

This appendix contains test procedures to verify that the dc source is operating normally and is within published specifications. There are four types of tests as follows:

<b>Built-in Self Tests</b>	These tests run automatically when the dc source is turned on. They check most of the digital circuits and the programming and readback DACs.
<b>Turn on Checkout</b>	These tests, described in chapter four, provide a high degree of confidence that your unit is operating properly.
<b>Calibration</b>	These tests verify that the dc source is properly calibrated.
<b>Performance Tests</b>	These tests check that the dc source meets all of the specifications listed in Appendix A.

**NOTE:** If the dc source fails any of the tests or if abnormal test results are obtained, return the unit to an Agilent Technologies repair facility.

This appendix also includes calibration procedures for the Agilent 66319B/D, 66321B/D Mobile Communications DC Sources. Instructions are given for performing the procedures either from the front panel or from a controller over the GPIB.

**IMPORTANT:** Perform the calibration verification before calibrating your dc source. If the dc source passes the verification procedures, the unit is operating within its calibration limits and does not need to be re-calibrated.

The configuration procedure documented at the end of this appendix lets you customize the power-on (\*RST) default settings of the dc source. This lets you customize the power-on settings of the dc source to a specific application without always having to reconfigure the instrument each time power is applied.

### Equipment Required

The equipment listed in the following table, or the equivalent to this equipment, is required for the calibration and performance tests. A test record sheet with specification limits (when test using the recommended test equipment) may be found at the back of this section.

**Table B-1. Equipment Required**

Type	Specifications	Recommended Model
Digital Voltmeter	Resolution: 10 nV @ 1V; Readout: 8 1/2 digits Accuracy: 20 ppm	Agilent 3458A or equivalent
Current Monitor	15 A (0.1 ohm) 0.04%, TC=5ppm/°C	Guildline 9230/15
Load Resistor (3 W min. TC=20ppm/°C)	400Ω (verification) 800Ω (calibration)	p/n 0811-0942 p/n 0811-0600
Electronic Load	20 V, 5 A minimum, with transient capability and a slew rate of 833kA/s or better.	Agilent N3300A mainframe, with N3303A module

## B - Performance, Calibration, and Configuration

DC Power Supply	8V @ 5A (for current sink verification/calibration) 25 V source (for DVM verification/calibration)	Agilent 6611C, 6631B 6631C, or 6633B
GPIB Controller	Full GPIB capabilities (only required if you are calibrating the unit over the GPIB)	HP Series 200/300 or equivalent
Oscilloscope	Sensitivity: 1 mV Bandwidth Limit: 20 MHz Probe: 1:1 with RF tip	Agilent 54504A or equivalent
RMS Voltmeter	True RMS Bandwidth: 20 MHz Sensitivity: 100 $\mu$ V	Agilent 3400B or equivalent
Variable-Voltage Transformer	Adjustable to highest rated input voltage range. Power: 500 VA	
RC network (required for stable operation in H-remote mode)	Capacitor: fixed film 25 $\mu$ F, 50V Resistor: 0.25 $\Omega$ , 1W	p/n 0160-8387 p/n 0699-4707

## Measurement Techniques

### Test Setup

Figure B-1 shows the setup for the tests. Use load leads of sufficient wire gauge to carry the full output current. An RC network is needed if the unit is operated in LRemote or HRemote mode (see chapter 3).

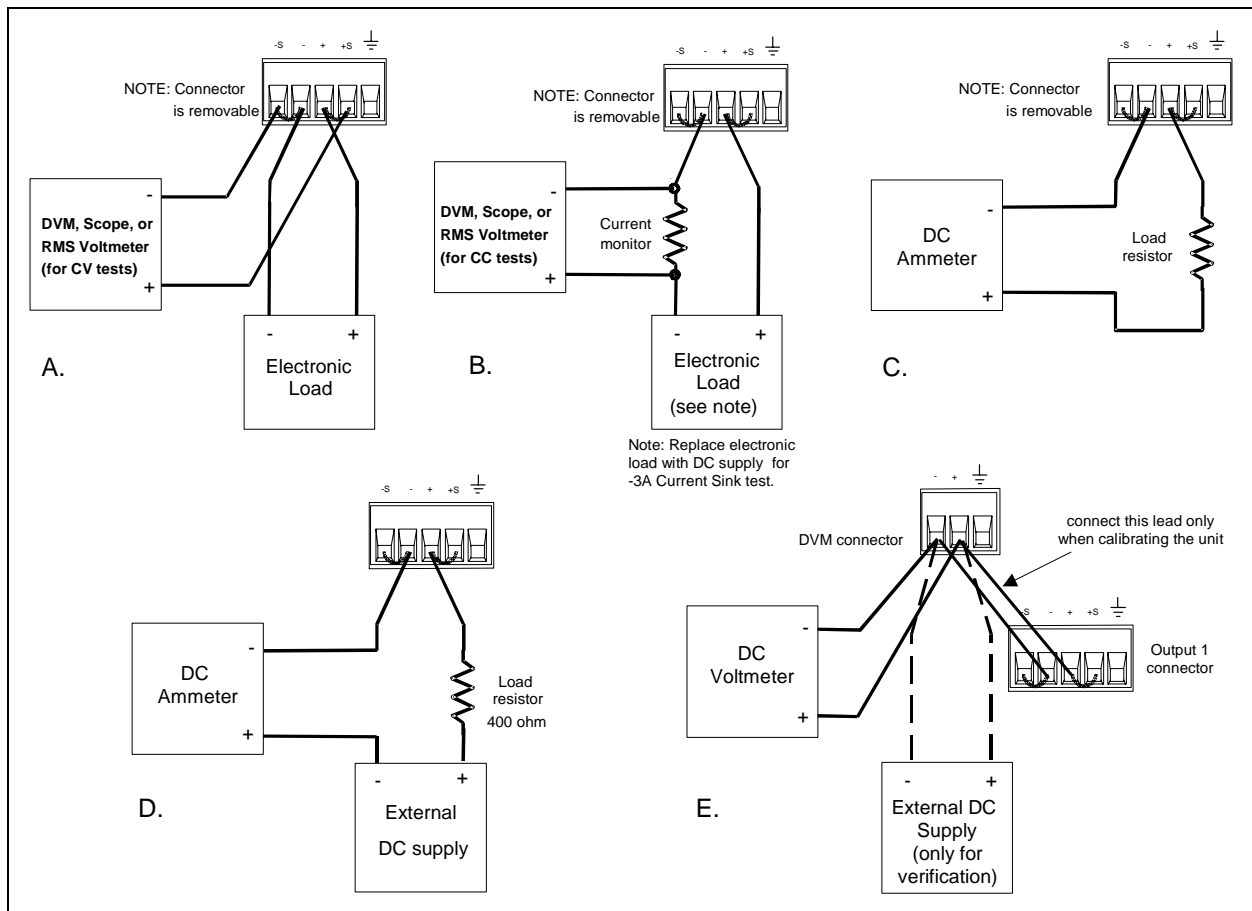

Figure B-1. Verification and Calibration Test Setup

## Electronic Load

Many of the test procedures require the use of a variable load capable of dissipating the required power. If a variable resistor is used, switches should be used to either; connect, disconnect, or short the load resistor. For most tests, an electronic load can be used. The electronic load is considerably easier to use than load resistors, but it may not be fast enough to test transient recovery time and may be too noisy for the noise (PARD) tests.

Fixed load resistors may be used in place of a variable load, with minor changes to the test procedures. Also, if computer controlled test setups are used, the relatively slow (compared to computers and system voltmeters) settling times and slew rates of the dc source may have to be taken into account. "Wait" statements can be used in the test program if the test system is faster than the dc source.

## Current-Monitoring Resistor

The 4-terminal current shunt is used to eliminate output current measurement error caused by voltage drops in the load leads and connections. It has special current-monitoring terminals inside the load connection terminals. Connect the voltmeter directly to these current-monitoring terminals.

---

## Performance Tests

---

**NOTE:** Performance tests verify that the dc source complies with the specifications listed in Table A-1. Performance tests are indicated by the word "performance" after the test. Calibration verification tests are used to verify that the unit is within calibration, and are indicated by the word "calibration" after the test

---

All of the performance test specifications are entered in the appropriate Performance Test Record Card for your specific model. You can record the actual measured values in the column provided in this card.

## Programming

You can program the dc source from the front panel keyboard or from an GPIB controller when performing the tests. The test procedures are written assuming that you know how to program the dc source either remotely from an GPIB controller, or locally using the control keys and indicators on the front panel. Also, when performing the verification tests from an GPIB controller, you may have to consider the relatively slow settling times and slew rates of the dc source as compared to computer and system voltmeters. Suitable WAIT statements can be inserted into the test program to give the dc source time to respond to the test commands.

**Table B-2. Programming and Output Values**

Agilent Model	Full scale Voltage	Vmax	Full Scale Current	I <sub>max</sub>	I <sub>sink</sub>	OV Max
66321B/D	15	15.356	3	3.0712	- 2A	22.0
66319B/D output 1	15	15.356	3	3.0712	- 2A	22.0
66319B/D output 2	12	12.25	1.5	1.52	N.A.	N.A.

## Constant Voltage (CV) Tests

### CV Setup

If more than one meter or if a meter and an oscilloscope are used, connect each to the terminals by a separate pair of leads to avoid mutual coupling effects. For constant voltage dc tests, connect only to +S and -S, since the unit regulates the output voltage that appears between +S and -S, and not between the (+) and (-) output terminals. Use coaxial cable or shielded two-wire cable to avoid noise pickup on the test leads.

### Voltage Programming and Readback Accuracy (performance, calibration)

This test verifies that the voltage programming, GPIB readback and front panel display functions are within specifications. Note that values read back over the GPIB should be identical to those displayed on the front panel.

- a. Turn off the dc source and connect a digital voltmeter (DVM) directly across the +S and -S terminals as shown in Figure B-1a.
- b. Turn on the dc source and program the output to zero volts and the maximum programmable current ( $I_{max}$  in Table B-2) with the load off.
- c. Record the output voltage readings on the DVM and the front panel display. The readings should be within the limits specified in the performance test record card for the appropriate model under Voltage Programming and Readback @ 0 Volts. Also, note that the CV annunciator is on. The output current reading should be approximately zero.
- d. Program the output voltage to full-scale (see Table B-2) .
- e. Record the output voltage readings on the DVM and the front panel display. The readings should be within the limits specified in the performance test record card for the appropriate model under Voltage Programming and Readback @ Full Scale.

### CV Load Effect (performance)

This test measures the change in output voltage resulting from a change in output current from full load to no load.

- a. Turn off the dc source and connect a DVM directly across the +S and -S terminals as shown in Figure B-1a.
- b. Turn on the dc source and program the current to the maximum programmable value ( $I_{max}$ ) and the voltage to the full-scale value in Table B-2.
- c. Adjust the load for the full-scale current in Table B-2 as indicated on the front panel display. The CV annunciator on the front panel must be on. If it is not, adjust the load so that the output current drops slightly.
- d. Record the output voltage reading on the DVM connected to +S and -S.
- e. Open the load and again record the DVM voltage reading. The difference between the DVM readings in steps (d) and (e) is the load effect voltage, and should not exceed the value listed in the performance test record card for the appropriate model under CV Load Effect.



### CV Source Effect (performance)

This test measures the change in output voltage that results from a change in ac line voltage from the minimum to maximum value within the line voltage specifications.

- a. Turn off the dc source and connect the ac power line through a variable voltage transformer.
- b. Connect the output as shown in Figure B-1a with the DVM connected between the +S and the -S terminals. Set the transformer to nominal line voltage.
- c. Turn on the dc source and program the current to the maximum programmable value ( $I_{max}$ ) and the output voltage to the full-scale value in Table B-2.
- d. Adjust the load for the full-scale current value in Table B-2 as indicated on the front panel display. The CV annunciator on the front panel must be on. If it is not, adjust the load so that the output current drops slightly.
- e. Adjust the transformer to the lowest rated line voltage (refer to Table A-2 in Appendix A, under “Mains Input Ratings”).
- f. Record the output voltage reading on the DVM.
- g. Adjust the transformer to the highest rated line voltage (refer to Table A-2 in Appendix A, under “Mains Input Ratings”).
- h. Record the output voltage reading on the DVM. The difference between the DVM reading in steps (f) and (h) is the source effect voltage and should not exceed the value listed in the performance test record card for the appropriate model under CV Source Effect.

### CV Noise (performance)

Periodic and random deviations (PARD) in the output (ripple and noise) combine to produce a residual ac voltage superimposed on the dc output voltage. CV PARD is specified as the rms or peak-to-peak output voltage in the frequency range specified in Appendix A.

- a. Turn off the dc source and connect the output as shown in Figure B-1a to an oscilloscope (ac coupled) between the (+) and the (-) terminals. Set the scope's bandwidth limit to 20 MHz and use an RF tip on the scope probe.
- b. Turn on the dc source and program the current to the maximum programmable value ( $I_{max}$ ) and the output voltage to the full-scale value in Table B-2.
- c. Adjust the load for the full-scale current value in Table B-2 as indicated on the front panel display.
- d. Note that the waveform on the oscilloscope should not exceed the peak-to-peak limits in the performance test record card for the appropriate model under CV Noise (PARD).
- e. Disconnect the oscilloscope and connect an ac rms voltmeter in its place. The rms voltage reading should not exceed the RMS limits in the performance test record card for the appropriate model under CV Noise (PARD).

### Transient Recovery Time (performance)

This test measures the time for the output voltage to recover to within the specified value following the specified load change in HRemote mode (see chapter 3 under “Output Compensation”).

- a. Turn off the dc source and connect the output as in Figure B-1a with the oscilloscope across the +S and -S terminals. Remember to connect the RC network.
- b. Turn on the dc source and program the output current to the maximum programmable value ( $I_{max}$ ) and the voltage to the full-scale value in Table B-2.

## B - Performance, Calibration, and Configuration

- c. Set the load to the Constant Current mode. For output 1, program the load current to 0.1A. For output 2, program the load current to 0.75A.
- d. Set the electronic load's transient generator frequency to 100 Hz and its duty cycle to 50%.
- e. For output 1, program the load's transient current level to 1.5A. For output 2, program the load's transient current level to 1.5A. Turn the transient generator on.
- f. Adjust the oscilloscope for a waveform similar to that in Figure B-2.
- g. The output voltage should return to within the specified voltage in less than 20 microseconds for output 1, and less than 400 microseconds for output 2 following the specified load change in the HRemote compensation range. Check both loading and unloading transients by triggering on the positive and negative slope. Record the voltage at time "t" in the performance test record card under CV Transient Response.

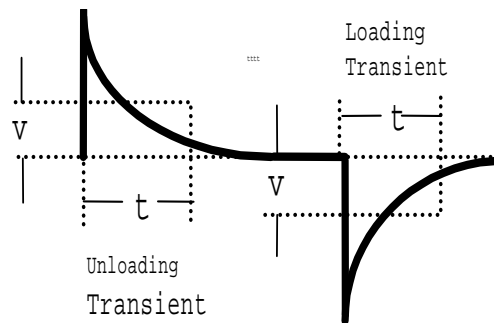

**Figure B-2. Transient Waveform**

---

## Constant Current (CC) Tests

### CC Setup

Follow the general setup instructions in the Measurement Techniques paragraph and the specific instructions given in the following paragraphs.

### Current Programming and Readback Accuracy (performance, calibration)

This test verifies that the current programming and 3A range readback are within specification.

- a. Turn off the dc source and connect the current monitoring resistor across the dc source output and the DVM across the resistor as in Figure B-1b. See "Current Monitoring Resistor" for connection information.
- b. Turn on the dc source and program the output voltage to 5 V and the current to 0 A. The dc source's current detector must be set to DC.
- c. Divide the voltage drop (DVM reading) across the current monitoring resistor by its resistance to convert to amps and record this value ( $I_{out}$ ). Also, record the current reading on the front panel display. The readings should be within the limits specified in the performance test record card for the appropriate model under Current Programming and Readback @ 0 A.
- d. Program the output current to the full-scale value in Table B-2.
- e. Divide the voltage drop (DVM reading) across the current monitoring resistor by its resistance to convert to amps and record this value ( $I_{out}$ ). Also, record the current reading that appears on the front panel display. The readings should be within the limits specified in the performance test record card for the appropriate model under Current Programming and Readback @ Full Scale.

## 1A Range Current Readback Accuracy (performance, calibration)

This test verifies the readback accuracy of the 1 ampere current range.

- a. Turn off the dc source and connect the current monitoring resistor across the dc source output and the DVM across the resistor as in Figure B-1b. See "Current Monitoring Resistor" for connection information.
- b. Turn on the dc source and set the current range readback to 1 A. Program the output voltage to 5 V and the current to 0 A. The dc source's current detector must be set to DC.
- c. Divide the voltage drop (DVM reading) across the current monitoring resistor by its resistance to convert to amps and record this value ( $I_{out}$ ). Also, record the current reading on the front panel display. The difference between the two readings should be within the limits specified in the performance test record card for the appropriate model under 1A Range Current Readback @ 0 A.
- d. Program the output current to 1 A.
- e. Divide the voltage drop (DVM reading) across the current monitoring resistor by its resistance to convert to amps and record this value ( $I_{out}$ ). Also, record the current reading on the front panel display. The difference between the two readings should be within the limits specified in the performance test record card for the appropriate model under 1A Range Current Readback @ 1A.

## 0.02A Range Current Readback Accuracy (performance, calibration)

This test verifies the readback accuracy of the 20 milliamper current range.

- a. Turn off the dc source and connect the output as shown in Figure B-1c using the 400 ohm load resistor. Set the DMM to operate in current mode.
- b. Turn on the dc source and set the current range readback to 0.02A. Program the output voltage to zero and the current to the full scale value in Table B-2. The current on the UUT display should be approximately 0 mA.
- c. Record the current reading on the DMM and the reading on the front panel display. The difference between the two readings should be within the limits specified in the performance test record card under 20mA Range Current Readback @ 0 A.
- d. Program the output voltage to 8V and record the current reading on the DMM and the reading on the front panel display. If the meter indicates overrange, lower the 8 volts slightly. The difference between the readings should be within the limits specified in the performance test record card for the appropriate model under 20mA Range Current Readback @ +20 mA

## - 0.02A Range Current Sink Operation (performance, calibration)

This test verifies current sink operation and readback of the -0.02A range.

- a. Turn off the dc source and connect the output and an external power supply as shown in Figure B-1d using the 400 ohm load resistor. Set the DMM to operate in current mode.
- b. Turn on the dc source and set the current range readback to 0.02A
- c. Turn on the external power supply and program it to 8V and 5A. Then program the dc source to 0V and 1A. If the meter indicates overrange, lower the voltage of the external supply slightly. The UUT display should read approximately -20 mA.
- d. Record the current reading on the DMM and the reading on the front panel display. The difference between the two readings should be within the limits specified in the performance test record card under Current Sink, Front Panel Display Readback @ -20 mA.

## B - Performance, Calibration, and Configuration

### - 3A Range Current Sink Operation (performance, calibration)

This test verifies current sink operation and readback of the –3A range.

- a. Turn off the dc source and connect the current monitoring resistor across the output and the DMM across the resistor as shown in Figure B-1b. Connect an external power supply in place of the electronic load. Set the DMM to operate in voltage mode.
- b. Turn on the dc source and set the current range readback to 3A.
- c. Turn on the external power supply and program it to 7.5V and 3A. Then program the dc source to 0V and the current to the full scale value in Table B-2. The UUT display should read approximately –2A.
- d. Divide the voltage drop (DVM reading) across the current monitoring resistor by its resistance to convert to amperes and record this value. Also, record the current reading that appears on the front panel display. The readings should be within the limits specified in the performance test record card for the appropriate model under Current Sink, Front Panel Display Readback @ –2A.

### CC Load and Line Regulation (performance)

The following CC Load Effect and CC Source Effect tests verify the dc regulation of the output current. To insure that the values read are not the instantaneous measurement of the ac peaks of the output current ripple, several dc measurements should be made and the average of these readings calculated. An example of how to do this is given below using an Agilent 3458A System Voltmeter programmed from the front panel. Set up the voltmeter and execute the "Average Reading" program follows:

- a. Program 10 power line cycles per sample by pressing NPLC 1 0 ENTER .
- b. Program 100 samples per trigger by pressing (N Rdgs/Trig) 1 0 0 ENTER .
- c. Set up voltmeter to take measurements in the statistical mode as follows:  
Press Shift key, f0, Shift key, N  
Press ^ (up arrow) until MATH function is selected, then press >.  
Press ^ (up arrow) until STAT function is selected then press (ENTER).
- d. Set up voltmeter to read the average of the measurements as follows:  
Press Shift key, f1, Shift key, N.  
Press down arrow until RMATH function is selected, then press >.  
Press ^ (up arrow) until MEAN function is selected, then press ENTER.
- e. Execute the program by pressing f0, ENTER, TRIG, ENTER
- f. Wait for 100 readings and then read the average measurement by pressing f1, ENTER.

To repeat the measurement, perform steps (e) and (f).

### CC Load Effect (performance)

This test measures the change in output current for a change in load from full scale output voltage to short circuit.

- a. Turn off the dc source and connect the output as shown in Figure B-1b with the DVM connected across the current monitoring resistor.
- b. Turn on the dc source and if it was set to low range readback in the previous test, set it back to high or auto. Program the current to full scale and the output voltage to the maximum programmable voltage value (Vmax) in Table B-2.

- c. Adjust the load in the CV mode for the UUT full scale voltage in Table B-2 as indicated on the front panel display. Check that the CC annunciator of the UUT is on. If it is not, adjust the load so that the output voltage drops slightly.
- d. Record the output current reading (DVM reading/current monitor resistance value in ohms). You may want to use the average reading program described under “CC Load and Line Regulation”.
- e. Short the load switch and record the output current reading. The difference in the current readings in steps (d) and (e) is the load effect and should not exceed the limit specified in the performance test record card for the appropriate model under CC Load Effect.

### CC Source Effect (performance)

This test measures the change in output current that results when the AC line voltage changes from the minimum to the maximum value within the specifications.

- a. Turn off the dc source and connect the ac power line through a variable voltage transformer.
- b. Connect the output terminals as shown in Figure B-1b with the DVM connected across the current monitoring resistor. Set the transformer to the nominal line voltage.
- c. Turn on the dc source and program the current to the full scale value and the output voltage to the maximum programmable value ( $V_{max}$ ) in Table B-2.
- d. Adjust the load in the CV mode for full scale voltage as indicated on the front panel display. Check that the CC annunciator of the UUT is on. If it is not, adjust the load so that the output voltage drops slightly.
- e. Adjust the transformer to the lowest rated line voltage (refer to Table A-2 in Appendix A, under “Mains Input Ratings”).
- f. Record the output current reading (DVM reading/current monitoring resistor in ohms). You may want to use the average reading program described under “CC Load and Line Regulation”.
- g. Adjust the transformer to the highest rated line voltage (refer to Table A-2 in Appendix A, under “Mains Input Ratings”).
- h. Record the output current reading again. The difference in the current readings in steps (f) and (h) is the CC source effect and should not exceed the values listed in the performance test record card under CC Source Effect.

### CC Noise (performance)

Periodic and random deviations (PARD) in the output combine to produce a residual ac current, as well, as an ac voltage superimposed on the dc output. Constant current (CC) PARD is specified as the rms output current in a frequency range 20 Hz to 20 Mhz with the dc source in CC operation.

- a. Turn off the dc source and connect the load, monitoring resistor, and rms voltmeter as shown in Figure B-1b. The current monitoring resistor may have to be substituted by one with a higher resistance and power rating, such as a 1 ohm 50W, to get the RMS voltage drop high enough to measure with the RMS voltmeter. Leads should be as short as possible to reduce noise pick-up. An electronic load may contribute ripple to the measurement, so if the RMS noise is above the specification a resistive load may have to be substituted for this test.
- b. Check the test setup for noise with the dc source turned off. Other equipment (e.g. computers, DVMs, etc.) may affect the reading.
- c. Turn on the dc source and program the current to full scale and the output voltage to the maximum programmable value ( $V_{max}$ ) in Table B-2.

## B - Performance, Calibration, and Configuration

- d. The output current should be at the full scale rating with the CC annunciator on.
- e. Divide the reading on the rms voltmeter by the current monitor resistance to obtain rms current. It should not exceed the values listed in the performance test record card under CC Noise (RMS).

---

## Resistance Tests

### Resistance Programming (performance, calibration)

This test verifies the resistance programming. Note that the current readback accuracy must be verified before you can perform this test.

- a. Turn off the dc source. Connect an electronic load directly to the output terminals of output 1 as shown in Figure B-1a. Connect an external DMM (3458) directly to the sense terminals of output 1. Turn on the dc source and select output 1.

**Note:** If you do not connect the RC network to the output, you must set the unit to operate in LLOCAL compensation mode (see chapter 3 under “Output Compensation”).

- b. Turn on the electronic load. Program the load to operate in constant current mode. Set the load voltage to 15 V and the current to 0 A.
- c. Program output 1 to 10 V and set the output resistance to zero ohms.
- d. Record the voltage reading on the external DMM (V1) and the current reading displayed on the front panel of the dc source (I1).
- e. Set the load current to 2.8 A. Record the voltage reading on the external DMM (V2) and the current reading displayed on the front panel of the dc source (I2).
- f. Calculate the Resistance value as follows: 
$$\frac{V2 - V1}{I2 - I1} = R_{low}$$

This is the low output resistance, which should not exceed the limits in the performance test record card for the appropriate model under Low Resistance.

- g. Set the load current back to 0 A. Then set the output resistance of the dc source to 1 ohm.
- h. Record the voltage reading on the external DMM (V3) and the current reading displayed on the front panel of the dc source (I3).
- i. Set the load current to 2.8 A. Record the voltage reading on the external DMM (V4) and the current reading displayed on the front panel of the dc source (I4).
- j. Calculate the Resistance value as follows: 
$$\left| \frac{V4 - V3}{I4 - I3} \right| = R_{high}$$

This is the high output resistance, which should not exceed the limits in the performance test record card for the appropriate model under High Resistance.

## DVM Tests

### DVM Measurement Accuracy (calibration)

This test verifies the DVM measurement accuracy.

- a. Turn off the dc source and connect the external DMM and the external power supply to the DVM inputs as shown in figure B-1e. Connect only the negative output lead of output 1 to the DVM inputs. Then turn on the dc source and select output 1.
- b. Set output 1 to zero volts and the external power supply to 25 volts.
- c. Record the external (3458) DMM reading and the internal DVM reading. The difference should be within the positive limits specified for the DVM in Table A-3.
- d. Set output 1 to 15 V and repeat step c.
- e. Reverse the leads of the external power supply to the DVM inputs. Keep other connections the same.
- f. With output 1 set to 15 V, lower the voltage on the external power supply until the external (3458) DMM reads -4.5 V.
- g. Record the external (3458) DMM reading and the internal DVM reading. The difference should be within the negative limits specified for the DVM in Table A-3.
- h. Set output 1 to zero volts and repeat step g.

## Performance Test Equipment Form

<p><b>Test Facility:</b> _____                  _____                  _____                  Model _____                  Serial No. _____                  Options _____                  Firmware Revision _____</p> <p><b>Special Notes:</b></p>   <p><b>Equipment Used:</b></p> <table style="width: 100%; border-collapse: collapse;"> <thead> <tr> <th style="width: 30%;"></th> <th style="width: 20%;">Model No.</th> <th style="width: 20%;">Trace No.</th> <th style="width: 30%;">Cal. Due Date</th> </tr> </thead> <tbody> <tr> <td>AC Source</td> <td>_____</td> <td>_____</td> <td>_____</td> </tr> <tr> <td>DC Voltmeter</td> <td>_____</td> <td>_____</td> <td>_____</td> </tr> <tr> <td>RMS Voltmeter</td> <td>_____</td> <td>_____</td> <td>_____</td> </tr> <tr> <td>Oscilloscope</td> <td>_____</td> <td>_____</td> <td>_____</td> </tr> <tr> <td>Electronic Load</td> <td>_____</td> <td>_____</td> <td>_____</td> </tr> <tr> <td>Current Shunt</td> <td>_____</td> <td>_____</td> <td>_____</td> </tr> </tbody> </table>		Model No.	Trace No.	Cal. Due Date	AC Source	_____	_____	_____	DC Voltmeter	_____	_____	_____	RMS Voltmeter	_____	_____	_____	Oscilloscope	_____	_____	_____	Electronic Load	_____	_____	_____	Current Shunt	_____	_____	_____	<p>Report Number _____                  Date _____                  Customer _____                  Tested By _____                  Ambient Temperature (C) _____                  Relative Humidity (%) _____                  Nominal Line Frequency _____</p>
	Model No.	Trace No.	Cal. Due Date																										
AC Source	_____	_____	_____																										
DC Voltmeter	_____	_____	_____																										
RMS Voltmeter	_____	_____	_____																										
Oscilloscope	_____	_____	_____																										
Electronic Load	_____	_____	_____																										
Current Shunt	_____	_____	_____																										

## Performance Test Record Form

<b>Model Agilent 66321B/D</b> <b>Model Agilent 66319B/D Output 1</b>	<b>Report No</b> _____	<b>Date</b> _____	
<b>Test Description</b>	<b>Minimum Specification</b>	<b>Results</b>	<b>Maximum Specification</b>
<b>CONSTANT VOLTAGE TESTS</b>			
<b>Voltage Programming and Readback</b>			
Low Voltage (@ 0 V) Vout	- 10 mV	_____	+ 10 mV
Front Panel Display Readback	<b>Vout</b> - 5 mV	_____	<b>Vout</b> + 5 mV
High Voltage (@ Full Scale) Vout	14.9825 V	_____	15.0175 V
Front Panel Display Readback	<b>Vout</b> - 9.5mV	_____	<b>Vout</b> + 9.5 mV
<b>CV Load Effect</b>	- 5.0mV	_____	+ 5.0mV
<b>CV Source Effect</b>	- 0.5mV	_____	+ 0.5 mV
<b>PARD (Ripple and Noise)</b>			
peak-to-peak	N.A.	_____	+ 6 mV
RMS	N.A.	_____	+ 1 mV
<b>Transient Response</b>			
Voltage in 20 $\mu$ s	- 20 mV	_____	+ 20 mV
<b>CONSTANT CURRENT TESTS</b>			
<b>Current Programming and Readback</b>			
Low current (@ 0 A) Iout	- 2.3 mA	_____	+ 2.3 mA
Front Panel Display Readback	<b>Iout</b> - 0.5mA	_____	<b>Iout</b> + 0.5mA
High Current (@ Full Scale) Iout	2.99717 A	_____	3.00283 A
Front Panel Display Readback	<b>Iout</b> - 6.5mA	_____	<b>Iout</b> + 6.5mA
<b>1A Range Current Readback</b>			
Front Panel Display Readback @ 0 A	<b>Iout</b> - 0.2 mA	_____	<b>Iout</b> + 0.2 mA
Front Panel Display Readback @ 1 A	<b>Iout</b> - 1.2mA	_____	<b>Iout</b> + 1.2mA
<b>20 mA Range Current Readback</b>			
Front Panel Display Readback @ 0 A	<b>Iout</b> - 2.5 $\mu$ A	_____	<b>Iout</b> + 2.5 $\mu$ A
Front Panel Display Readback @ + 20 mA	<b>Iout</b> - 22.5 $\mu$ A	_____	<b>Iout</b> + 22.5 $\mu$ A
<b>Current Sink</b>			
Front Panel Display Readback @ - 20 mA	<b>Isink</b> - 22.5 $\mu$ A	_____	<b>Isink</b> + 22.5 $\mu$ A
Front Panel Display Readback @ - 2 A	<b>Isink</b> - 4.5 mA	_____	<b>Isink</b> + 4.5 mA
<b>CC Load Effect</b>	- 0.75mA	_____	+ 0.75mA
<b>CC Source Effect</b>	- 0.75mA	_____	+ 0.75mA
<b>PARD (Current Ripple and Noise)</b>			
RMS	N.A.	_____	+ 2.0 mA
<b>RESISTANCE TESTS</b>			
<b>Low Resistance Readback (0 ohm)</b>	-2 m $\Omega$	_____	+2 m $\Omega$
<b>High Resistance Readback (1 ohm)</b>	0.993 $\Omega$	_____	1.007 $\Omega$



Model 66319B/D Output 2	Report No _____	Date _____	
Test Description	Minimum Specification	Results	Maximum Specification
<b>CONSTANT VOLTAGE TESTS</b>			
<b>Voltage Programming and Readback</b>			
Output 2 Low Voltage @ 0 V	- 40 mV	_____	+ 40 mV
Output 2 Front Panel Display Readback	<b>Vout2</b> - 15 mV	_____	<b>Vout2</b> + 15 mV
Output 2 High Voltage @ Full Scale	11.936 V	_____	12.064 V
Output 2 Front Panel Display Readback	<b>Vout2</b> - 39 mV	_____	<b>Vout2</b> + 39 mV
<b>Load Effect</b>	- 1.6 mV	_____	+ 1.6mV
<b>Source Effect</b>	- 0.4 mV	_____	+ 0.4 mV
<b>PARD (Ripple and Noise)</b>			
Peak-to-Peak	N.A.	_____	+ 6 mV
RMS (with phone capacitance <6 $\mu$ F)	N.A.	_____	+ 1 mV
<b>Transient Response<sup>1</sup></b>			
Time in <400 $\mu$ s	- 20 mV	_____	+ 20 mV
<b>CONSTANT CURRENT TESTS</b>			
<b>Current Programming and Readback</b>			
Output 2 Low Current @ 0 A	- 4.5 mA	_____	+ 4.5 mA
Output 2 High Current @ Full Scale	1.4925 A	_____	1.5075 A
Output 2 Front Panel Display Readback	<b>Iout2</b> - 6 mA	_____	<b>Iout2</b> + 6 mA
<b>Current Sink (-0.032A @ 7.5V) Readback</b>	<b>Isink</b> - 25 mA	_____	<b>Isink</b> + 39 mA
<b>PARD (Current Ripple and Noise)</b>			
RMS	N.A.	_____	+ 2.0 mA
<b>Load Effect</b>	- 0.375 mA	_____	+ 0.375 mA
<b>Source Effect</b>	- 0.25 mA	_____	+ 0.25 mA

<sup>1</sup>Following a 0.75A to 1.5A load change

Model 66319D/66321D DVM Input	Report No _____	Date _____	
Test Description	Minimum Specification	Results	Maximum Specification
<b>DVM VOLTAGE CALIBRATION VERIFICATION</b>			
<b>Positive Voltage Measurement</b>	-15mV	_____	+15mV
<b>Negative Voltage Measurement</b>	-6.8mV	_____	+6.8mV

## Performing the Calibration Procedure

**NOTE:** The calibration procedure can only be performed from the front panel or using the SCPI language commands.



Table B-1 lists the equipment required for calibration. Figure B-1 shows the test setup.

You do not have to do a complete calibration each time. If appropriate, you may calibrate only the voltage or current and proceed to "Saving the Calibration Constants". However, the voltage or current calibration sequence must be performed in its entirety. The following parameters may be calibrated:

- ◆ voltage programming and measurement
- ◆ current programming and measurement
- ◆ 1 A and 0.02A range measurements
- ◆ ac current measurement
- ◆ resistance programming
- ◆ internal DVM

### Front Panel Calibration Menu

The Entry keypad is used for calibration functions.



  Press this key to access the calibration menu.



<b>Display</b>	<b>Command Function</b>
CAL ON <value>	Turns calibration mode on when the correct password value is entered.
CAL OFF	Turns calibration mode off
CAL:LEV <char>	Advance to next step in sequence (P1 or P2).
CAL:DATA <value>	Enter an external calibration measurement.
CAL:VOLT	Begin voltage calibration sequence
CAL:VOLT2	Begin output 2 voltage calibration sequence
CAL:RES	Begin resistance calibration
CAL:VOLT:PROT	Not required
CAL:CURR	Begin high range current calibration sequence
CAL:CURR2	Begin output 2 current calibration sequence
CAL:CURR:MEAS:LOW	Begin 0.02A range current measurement calibration
CAL:CURR:MEAS:R3	Begin 1A range current measurement calibration
CAL:CURR:MEAS:AC	Begin ac current calibration sequence
CAL:DVM	Begin DVM calibration sequence
CAL:SAVE	Saves the calibration constants in non-volatile memory.
CAL:PASS <value>	Set new calibration password.
DATE <char>	Displays the calibration date. (0 if none is supplied)



**Notes:**

value = a numeric value

char = a character string parameter

Use  and  to scroll through the menu commands.

Use  and  to scroll through the menu parameters.

Use  and  to select a digit in a numeric entry field.

## Front Panel Calibration Procedure

These procedures assume you understand how to operate front panel keys (see chapter 5). Make sure the sense terminals are directly jumpered to the output terminals.

### Enable Calibration Mode

Action	Display
1. Reset the unit by selecting <b>Output</b> , scrolling to *RST and pressing <b>Enter</b> .	*RST
2. Press <b>Output On/Off</b> to enable the output.	00.003V 0.0006A
3. To begin calibration press <b>Shift Cal</b> , scroll to CAL ON and press <b>Enter</b> .	CAL ON 0.0
4. Enter the calibration password from Entry keypad and press <b>Enter</b> . If the password is correct the <b>Cal</b> annunciator will come on. If CAL DENIED appears, then an internal switch has been set to prevent the calibration from being changed. If the password is incorrect, an error occurs. If the active password is lost, the calibration function can be recovered by setting an internal switch that defeats password protection (contact the factory for details).	CAL DENIED OUT OF RANGE

### Voltage Programming and Measurement Calibration

Action	Display
5. Connect the external DMM (in voltage mode) directly to output 1. Do not connect the load resistor or current shunt. Select output 1.	
6. Press <b>Shift Cal</b> , scroll to CAL VOLT, and press <b>Enter</b> .	CAL:VOLT
7. Press <b>Shift Cal</b> , scroll to CAL LEV, and press <b>Enter</b> to select the first calibration point.	CAL:LEV P1
8. Press <b>Shift Cal</b> , scroll to CAL DATA, press <b>Enter Number</b> , and enter the voltage value displayed on the DMM. Press <b>Enter</b> .	CAL:DATA 0.00
9. Press <b>Shift Cal</b> , scroll to CAL LEV, use <b>↓</b> to scroll to P2 (the second calibration point), and press <b>Enter</b> .	CAL:LEV P2
10. Press <b>Shift Cal</b> , scroll to CAL DATA, press <b>Enter Number</b> , and enter the second voltage value displayed on the DMM. Press <b>Enter</b> .	CAL:DATA 0.00

### Agilent 66319B/D Output 2 Voltage Programming and Measurement Calibration

Action	Display
11. Connect the external DMM (in voltage mode) directly to output 2. Do not connect the load resistor or current shunt. Select output 2.	
12. Press <b>Shift Cal</b> , scroll to CAL VOLT2, and press <b>Enter</b> .	CAL:VOLT2
13. Press <b>Shift Cal</b> , scroll to CAL LEV, and press <b>Enter</b> to select the first calibration point.	CAL:LEV P1
14. Press <b>Shift Cal</b> , scroll to CAL DATA, press <b>Enter Number</b> , and enter the voltage value displayed on the DMM. Press <b>Enter</b> .	CAL:DATA 0.00
15. Press <b>Shift Cal</b> , scroll to CAL LEV, use <b>↓</b> to scroll to P2 (the second calibration point), and press <b>Enter</b> .	CAL:LEV P2
16. Press <b>Shift Cal</b> , scroll to CAL DATA, press <b>Enter Number</b> , and enter the second voltage value displayed on the DMM. Press <b>Enter</b> .	CAL:DATA 0.00

## B - Performance, Calibration, and Configuration

### Output 1 Current Programming and 3A-Range Measurement Calibration

---

**NOTE:** When performing a 3A-Range current calibration, you must also calibrate the 1A range, the 0.02A range, and the ac current measurement.

---

Action	Display
17. Connect the appropriate current monitor to the output terminals of output 1. Connect the DMM (in voltage mode) across the current shunt. Select output 1.	
18. Press <b>Shift Cal</b> , scroll to CAL CURR, and press <b>Enter</b> .	CAL:CURR
19. Press <b>Shift Cal</b> , scroll to CAL LEV, and press <b>Enter</b> to select the first calibration point.	CAL:LEV P1
20. Press <b>Shift Cal</b> and scroll to CAL DATA. Wait for the DMM reading to stabilize. Then read the DMM and compute the first current value (DMM reading ÷ shunt resistance). Press <b>Enter Number</b> and enter the first current value in amperes. Press <b>Enter</b> .	CAL:DATA 0.00
21. Press <b>Shift Cal</b> , scroll to CAL LEV, use <b>↓</b> to scroll to P2 (the second calibration point), and press <b>Enter</b> .	CAL:LEV P2
22. Press <b>Shift Cal</b> and scroll to CAL DATA. Wait for the DMM reading to stabilize. Then read the DMM and compute the second current value (DMM reading ÷ shunt resistance). Press <b>Enter Number</b> and enter the second current value in amperes. Press <b>Enter</b> .	CAL:DATA 0.00

### 1A-Range Current Measurement Calibration

Action	Display
23. Disconnect all loads from the dc source but leave the sense jumpers in place. <b>Do not connect any equipment to the output until after step #24.</b>	
24. Press <b>Shift Cal</b> , scroll to CAL CURR MEAS R3, and press <b>Enter</b> .	CAL:CURR:MEAS:R3
25. Connect the external DMM (in current mode) directly to the output 1 terminals. The DMM must be capable of measuring up to 1A.	
26. Press <b>Shift Cal</b> , scroll to CAL LEV, and press <b>Enter</b> to select the first calibration point.	CAL:LEV P1
27. Press <b>Shift Cal</b> and scroll to CAL DATA. Wait for the DMM reading to stabilize. Press <b>Enter Number</b> and enter the current reading displayed on the DMM in amperes. Press <b>Enter</b> .	CAL:DATA 0.00

### 0.02A-Range Current Measurement Calibration

Action	Display
28. Disconnect all loads from the dc source but leave the sense jumpers in place. Do not connect any equipment to the output until after step #29.	
29. Press <b>Shift Cal</b> , scroll to CAL CURR MEAS LOW, and press <b>Enter</b> .	CAL:CURR:MEAS:LOW
30. Connect the 800 ohm calibration load resistor to output 1 as shown in figure B-1c. Connect the external DMM (in current mode) in series with the load.	
31. Press <b>Shift Cal</b> , scroll to CAL LEV, and press <b>Enter</b> to select the first calibration point.	CAL:LEV P1
32. Press <b>Shift Cal</b> and scroll to CAL DATA. Wait for the DMM reading to stabilize. Press <b>Enter Number</b> and enter the current reading displayed on the DMM in <i>amperes</i> . Press <b>Enter</b> .	CAL:DATA 0.00

**NOTE:** You must convert the value on the DMM to amperes, otherwise an error will occur.

**AC Current Measurement Calibration**

Action	Display
33. Disconnect all loads from the dc source <b>but leave the sense jumpers in place.</b>	
34. Press <b>Shift Cal</b> and scroll to CAL CURR MEAS AC, and press <b>Enter</b> .	CAL:CURR:MEAS AC
35. Wait for the dc source to compute the ac current calibration constant. The display returns to Meter mode when the calculation is complete.	

**Agilent 66319B/D Output 2 Current Programming Measurement Calibration**

Action	Display
36. Connect the appropriate current monitor to the output terminals of output 2. Connect the DMM (in voltage mode) across the current shunt. Select output 2.	
37. Press <b>Shift Cal</b> , scroll to CAL CURR2, and press <b>Enter</b> .	CAL:CURR2
38. Press <b>Shift Cal</b> , scroll to CAL LEV, and press <b>Enter</b> to select the first calibration point.	CAL:LEV P1
39. Press <b>Shift Cal</b> and scroll to CAL DATA. Wait for the DMM reading to stabilize. Then read the DMM and compute the first current value (DMM reading ÷ shunt resistance). Press <b>Enter Number</b> and enter the first current value in amperes. Press <b>Enter</b> .	CAL:DATA 0.00
40. Press <b>Shift Cal</b> , scroll to CAL LEV, use <b>↓</b> to scroll to P2 (the second calibration point), and press <b>Enter</b> .	CAL:LEV P2
41. Press <b>Shift Cal</b> and scroll to CAL DATA. Wait for the DMM reading to stabilize. Then read the DMM and compute the second current value (DMM reading ÷ shunt resistance). Press <b>Enter Number</b> and enter the second current value in amperes. Press <b>Enter</b> .	CAL:DATA 0.00

**Resistance Calibration**

Action	Display
42. Disconnect all loads from the dc source but <b>leave the sense jumpers in place.</b> Connect an electronic load directly to the output terminals of output 1 as shown in figure B-1a. Connect an external DMM directly to the sense terminals of output 1.	
43. Turn on the electronic load. Program the load to operate in constant current mode and set the load current to 2 amperes.	
44. Press <b>Shift Cal</b> , scroll to CAL RES, and press <b>Enter</b> .	CAL:RES
45. Press <b>Shift Cal</b> , scroll to CAL LEV, and press <b>Enter</b> to select the first calibration point.	CAL:LEV P1
46. Press <b>Shift Cal</b> and scroll to CAL DATA. Wait for the DMM reading to stabilize. Press <b>Enter Number</b> and enter the first voltage value in volts. Press <b>Enter</b> .	CAL:DATA 0.00
47. Press <b>Shift Cal</b> , scroll to CAL LEV, use <b>↓</b> to scroll to P2 (the second calibration point), and press <b>Enter</b> .	CAL:LEV P2
48. Press <b>Shift Cal</b> and scroll to CAL DATA. Wait for the DMM reading to stabilize. Press <b>Enter Number</b> and enter the second voltage value in volts. Press <b>Enter</b> .	CAL:DATA 0.00
49. <b>Turn off and disconnect the electronic load.</b> Then press <b>Shift Cal</b> , scroll to CAL LEV, use <b>↓</b> to scroll to P3 (the third calibration point), and press <b>Enter</b> .	CAL:LEV P3
50. Press <b>Shift Cal</b> and scroll to CAL DATA. Wait for the DMM reading to stabilize. Press <b>Enter Number</b> and enter the third voltage value in volts. Press <b>Enter</b> .	CAL:DATA 0.00

## B - Performance, Calibration, and Configuration

### Agilent 66321D, 66319D DVM Calibration

Action	Display
51. Connect the DVM inputs directly to output 1. Connect the external DMM to the DVM inputs as shown in figure B-1e. Do <b>not</b> connect the Agilent 3478 DMM.	
52. Press <b>Shift Cal</b> , scroll to CAL DVM, and press <b>Enter</b> .	CAL:DVM
53. Press <b>Shift Cal</b> , scroll to CAL LEV, and press <b>Enter</b> to select the first calibration point.	CAL:LEV P1
54. Press <b>Shift Cal</b> , scroll to CAL DATA, press <b>Enter Number</b> , and enter the voltage value displayed on the external DMM. Numbers entered from the external DMM should have an accuracy and resolution of 0.1 mV or better. Press <b>Enter</b> .	CAL:DATA 0.00
55. Reverse the output 1 connections. Move the - lead to the + DVM connector pin, and move the + lead to the - DVM connector pin.	
56. Press <b>Shift Cal</b> , scroll to CAL LEV, use <b>↓</b> to scroll to P2 (the second calibration point), and press <b>Enter</b> .	CAL:LEV P2
57. Press <b>Shift Cal</b> , scroll to CAL DATA, press <b>Enter Number</b> , and enter the second voltage value displayed on the external DMM. Numbers entered from the external DMM should have an accuracy and resolution of 0.1 mV or better.	CAL:DATA -0.00

Because this second value is negative, you must place a minus sign in front of the value. Pressing the **Enter Number** key the second time enters the minus sign. Then press **Enter**.

### Saving the Calibration Constants

---

**WARNING:** Storing calibration constants overwrites the existing ones in non-volatile memory. If you are not sure you want to permanently store the new constants, omit this step. The dc source calibration will then remain unchanged.

---

Action	Display
58. Press <b>Shift Cal</b> , scroll to CAL SAVE, and press <b>Enter</b> .	CAL:SAVE
59. Press <b>Shift Cal</b> , select CAL OFF, and press <b>Enter</b> to exit Calibration mode. *RST and *RCL will also set the calibration state to OFF.	CAL OFF

### Calibration Error Messages

Errors that can occur during calibration are shown in the following table.

**Table B-3. GPIB Calibration Error Messages**

Error	Meaning
401	CAL switch prevents calibration (contact the factory for details).
402	CAL password is incorrect
403	CAL not enabled
404	Computed readback cal constants are incorrect
405	Computed programming cal constants are incorrect
406	Incorrect sequence of calibration commands

## Changing the Calibration Password

The factory default password is 0. You can change the password when the dc source is in calibration mode (which requires you to enter the existing password). Proceed as follows:

Action	Display
1. Begin by pressing <b>Shift Cal</b> and scrolling to the CAL ON command.	CAL ON 0.0
2. Enter the existing password from Entry keypad and press <b>Enter</b>	
3. Press <b>Shift Cal</b> and scroll to the CAL PASS command.	CAL:PASS 0
4. Enter the new password from the keypad. You can use any number with up to six digits and an optional decimal point. If you want the calibration function to operate without requiring any password, change the password to 0 (zero).	

---

**NOTE:** If you want the calibration function to operate without requiring any password, change the password to 0 (zero).

---

If you have forgotten the password, you can set the calibration switch on the A2 Interface board to bypass the password. Refer to the Service Manual for Agilent Model 66111A, 66311A/B/D, 66309B/D (p/n 5964-8176) for information on the location and function of the calibration switch. When you have bypassed the password with the switch, you can enter a new password using the CAL:PASS command. The new password becomes active after CAL:SAVE and CAL:OFF are programmed. Then, with the calibration switches in the normal position, you can turn calibration on using the new password.

## Calibration Over the GPIB

You can calibrate the dc source by using SCPI commands within your controller programming statements. Be sure you are familiar with calibration from the front panel before you calibrate from a controller. Each front panel calibration command has a corresponding SCPI command. When you write your calibration program, perform the calibration procedure in the same order as the front panel procedure documented in this appendix.

The SCPI calibration commands are explained in chapter 8. Calibration error messages that can occur during GPIB calibration are shown in table B-3.

---

## Performing the Configuration Procedure

The configuration procedure lets you customize the power-on/\*RST defaults of the following settings:

- Output compensation mode
- Output coupling
- Output relay mode
- Output OVP setting

You can only customize these default settings from the front panel by first accessing the calibration menu. In this way, any changes to the configuration settings are secured by the calibration password protection feature. All configuration settings can also be returned to the factory state using the configuration procedure.

## B - Performance, Calibration, and Configuration

To access the front panel commands for the configuration function, the calibration state must be enabled. If a calibration password is set, the password must be provided to enable calibration. Once calibration is enabled, the front panel will be in Meter mode. The configuration function can only be invoked while in meter mode. If for some reason the front panel is not in meter mode, press the **Meter** key. To access the configuration menu, you must then simultaneously press the **Local** and the **Recall** keys.

The Configuration function consists of the following menu commands.

Press this key to access the calibration menu.

Simultaneously press these keys to access the configuration menu.

<b>Display</b>	<b>Command Function</b>
CFG EXIT	Exits the configuration menu and returns to meter mode. Also exits calibration mode. Changes not previously saved are lost.
CFG:FACTORY	Returns the *RST state to the factory default settings.
CFG:COMP <char>	Sets the output compensation mode.
CFG:COUP <char>	Sets the output coupling mode.
CFG:RELAY1<char>	Sets the output 1 relay mode (Option 521 units only).
CFG:RELAY2<char>	Sets the output 2 relay mode (Option 521 units only).
CFG:OVP <char>	Sets the overvoltage protection mode.
CFG:SAVE	Stores the current settings in nonvolatile RAM.
CFG:UNDO	Cancels any changes that have been made but not yet saved.

### Notes:

char = a character string parameter

Use  and  to scroll through the menu commands.

Use  and  to scroll through the menu parameters.

Once the configuration function is started, the front panel will remain in the configuration mode. No other functions can be accessed from the keypad. To exit the configuration function, the CFG:EXIT command must be executed. Each configuration command is only executed after the **Enter** key is pressed. An “OKAY” message is displayed to indicate that an action has been taken. When the configuration parameters are changed, they are not immediately stored into non-volatile memory. To store the change into non-volatile memory, the CFG:SAVE command must be executed

Note that the unit is put into the present \*RST state upon entering and exiting the configuration function.



## Error Messages

### Error Number List

This appendix gives the error numbers and descriptions that are returned by the dc source. Error numbers are returned in two ways:

- ◆ Error numbers are displayed on the front panel
- ◆ Error numbers and messages are read back with the `SYSTEM:ERRor?` query. `SYSTEM:ERRor?` returns the error number into a variable and returns two parameters: an NR1 and a string.

The following table lists the errors that are associated with SCPI syntax errors and interface problems. It also lists the device dependent errors. Information inside the brackets is not part of the standard error message, but is included for clarification.

When errors occur, the Standard Event Status register records them in bit 2, 3, 4, or 5 as described in the following table:

**Table C-1. Error Numbers**

<b>Error Number</b>	<b>Error String [Description/Explanation/Examples]</b>
	<b>Command Errors –100 through –199 (sets Standard Event Status Register bit #5)</b>
–100	Command error [generic]
–101	Invalid character
–102	Syntax error [unrecognized command or data type]
–103	Invalid separator
–104	Data type error [e.g., "numeric or string expected, got block data"]
–105	GET not allowed
–108	Parameter not allowed [too many parameters]
–109	Missing parameter [too few parameters]
–112	Program mnemonic too long [maximum 12 characters]
–113	Undefined header [operation not allowed for this device] Check the language setting.
–114	Header suffix out of range [value of numeric suffix is invalid]
–121	Invalid character in number [includes "9" in octal data, etc.]
–123	Numeric overflow [exponent too large; exponent magnitude >32 k]
–124	Too many digits [number too long; more than 255 digits received]
–128	Numeric data not allowed

## C – Error Messages

**Table C-1. Error Numbers (continued)**

-131	Invalid suffix [unrecognized units, or units not appropriate]
-138	Suffix not allowed
-141	Invalid character data [bad character, or unrecognized]
-144	Character data too long
-148	Character data not allowed
-150	String data error
-151	Invalid string data [e.g., END received before close quote]
-158	String data not allowed
-160	Block data error
-161	Invalid block data [e.g., END received before length satisfied]
-168	Block data not allowed
-170	Expression error
-171	Invalid expression
-178	Expression data not allowed
<b>Execution Errors –200 through –299 (sets Standard Event Status Register bit #4)</b>	
-200	Execution error [generic]
-222	Data out of range [e.g., too large for this device]
-223	Too much data [out of memory; block, string, or expression too long]
-224	Illegal parameter value [device-specific]
-225	Out of memory
-270	Macro error
-272	Macro execution error
-273	Illegal macro label
-276	Macro recursion error
-277	Macro redefinition not allowed
<b>System Errors –300 through –399 (sets Standard Event Status Register bit #3)</b>	
-310	System error [generic]
-350	Too many errors [errors beyond 9 lost due to queue overflow]
<b>Query Errors –400 through –499 (sets Standard Event Status Register bit #2)</b>	
-400	Query error [generic]
-410	Query INTERRUPTED [query followed by DAB or GET before response complete]
-420	Query UNTERMINATED [addressed to talk, incomplete programming message received]
-430	Query DEADLOCKED [too many queries in command string]
-440	Query UNTERMINATED [after indefinite response]

**Table C-1. Error Numbers (continued)**

<b>Selftest Errors 0 through 99 (sets Standard Event Status Register bit #3)</b>	
0	No error
1	Non-volatile RAM RD0 section checksum failed
2	Non-volatile RAM CONFIG section checksum failed
3	Non-volatile RAM CAL section checksum failed
4	Non-volatile RAM STATE section checksum failed
5	Non-volatile RST section checksum failed
10	RAM selftest
11	VDAC/IDAC selftest 1
12	VDAC/IDAC selftest 2
13	VDAC/IDAC selftest 3
14	VDAC/IDAC selftest 4
15	OVDAC selftest
80	Digital I/O selftest error
<b>Device-Dependent Errors 100 through 32767 (sets Standard Event Status Register bit #3)</b>	
213	Ingrd receiver buffer overrun
220	Front panel uart overrun
221	Front panel uart framing
222	Front panel uart parity
223	Front panel buffer overrun
224	Front panel timeout
401	CAL switch prevents calibration
402	CAL password is incorrect
403	CAL not enabled
404	Computed readback cal constants are incorrect
405	Computed programming cal constants are incorrect
406	Incorrect sequence of calibration commands
407	CV or CC status is incorrect for this command
601	Too many sweep points
603	CURRENT or VOLTAGE fetch incompatible with last acquisition
604	Measurement overrange
606	Remote front panel communication error



## Example Programs

---

### Pulse Measurements

The following programs illustrate how to make a pulse measurement over the GPIB. The measurement function is set to ACDC, which gives the best results for current waveforms that have ac content. The measurement incorporates 100 readings taken at time intervals of 20 microseconds, for a total measurement time of 2 milliseconds. The trigger point for the pulse measurement occurs at 0.1 amperes on the positive slope of the current pulse. The measurement offset is programmed so that 20 measurement points prior to the trigger are also returned as part of the measurement sample.

Because measurement triggers are initiated by the output pulse, a FETCh command is used to return the measurement data. FETCh commands are also used to return the MAXimum, MINimum, HIGH, and LOW values of the measurement. MEASure commands cannot be used to return data in this example because they always acquire *NEW* measurement data each time they are used.

To produce the output pulses in this example, an electronic load must be connected and programmed to generate 3-ampere pulses with a duty cycle of 100 microseconds at 1000 Hz. The dc source address is 705, and the load address is 706. If required, change these parameters in the appropriate statements.

#### Current Pulse Measurement Using BASIC

```

10      !Rev A.00.00
20      OPTION BASE 1
30      DIM Curr_array(100)
40      !
50      ASSIGN @Ps TO 705
60      ASSIGN @Ld TO 706
80      OUTPUT @Ps;"*RST"                ! Sets supply to default values
90      OUTPUT @Ps;"OUTP ON"            ! Turn on power supply output
100     OUTPUT @Ps;"VOLT 5"             ! Program power supply to 5 volts
110     !
120     OUTPUT @Ld;"CURR:LEVEL 0"       ! Set up electronic load to produce
pulses
130     OUTPUT @Ld;"CURR:TLEVEL 3"
140     !
150     OUTPUT @Ld;"TRAN:FREQ 1000"
160     OUTPUT @Ld;"TRAN:DCYCLE 10"
170     OUTPUT @Ld;"TRAN:MODE CONT"
180     OUTPUT @Ld;"TRAN:STATE ON"
190     !
200     OUTPUT @Ps;"SENS:CURR:DET ACDC" ! Set meter to ACDC
210     OUTPUT @Ps;"SENS:CURR:RANG MAX" ! High Current range
220     OUTPUT @Ps;"TRIG:ACQ:SOUR INT"  ! Set to trigger on pulse
230     OUTPUT @Ps;"SENS:FUNC " "CURR"" ! Acquire current reading
240     OUTPUT @Ps;"TRIG:ACQ:LEV:CURR .1" ! Trigger at 0.1 amps
250     OUTPUT @Ps;"TRIG:ACQ:SLOPE:CURR POS" ! Trigger on positive slope
260     OUTPUT @Ps;"TRIG:ACQ:HYST:CURR .05" ! Set hysteresis of trigger
270     OUTPUT @Ps;"SENS:SWE:TINT 20E-6" ! Set sample time interval to 20us
280     OUTPUT @Ps;"SENS:SWE:POIN 100"  ! Set number of measurement samples
in sweep

```

## D – Example Programs

```
290  OUTPUT 705;"SENS:SWE:OFFS:POIN -20"  ! Number of sample points before
trigger
300  OUTPUT @Ps;"INIT:NAME ACQ"           ! Initiate the trigger system.
310  !                                     Controller now waits for trigger
to occur.
320  OUTPUT @Ps;"FETCH:ARRAY:CURR?"       ! Get the data after measurement
completes.
330  !
340  ENTER @Ps;Curr_array(*)              ! Enters all 100 data points
350  PRINT Curr_array(*)                  ! Print all data points
360  !
370  OUTPUT @Ps;"FETCH:CURR:MAX?"         ! Get more data from previous
measurement.
380  ENTER @Ps;Curr_max
390  PRINT "MAX CURRENT",Curr_max
400  !
410  OUTPUT @Ps;"FETCH:CURR:MIN?"
420  ENTER @Ps;Curr_min
430  PRINT "MIN CURRENT",Curr_min
440  !
450  OUTPUT @Ps;"FETCH:CURR:HIG?"
460  ENTER @Ps;Curr_hi
470  PRINT "HIGH CURRENT",Curr_hi
480  !
490  OUTPUT @Ps;"FETCH:CURR:LOW?"
500  ENTER @Ps;Curr_low
510  PRINT "LOW CURRENT",Curr_low
520  !
530  END
```

When this program runs, it returns 100 measurement data points as well as the MIN, MAX, HIGH, and LOW data in the following format:

```
.030585  .031869  .0344369 .031655  .0320829 .0325109 .0333669 .0340089
.0320825 .031449  .031227  .031441  .0337949 .0327249 .031869  .031655
.0327249 .031013 .0325109 .0333669 3.09751  3.1814  3.14266  3.13667
3.13817  3.13624 .977283  .0667496 .0245932 .0280171 .031013  .031655
.0331529 .0350788 .0348648 .0327249 .031227  .0327249 .031227  .030799
.031869  .0329389 .030371  .031655  .031869  .0329389 .031869  .0322869
.0320829 .0325109 .0333669 .0340089 .0348648 .0327249 .031227  .0327249
.0320829 .030371  .031449  .031227  .031441  .0337949 .031449  .0333669
.031441  .0337949 .030371  .031655  .031869  .0329389 .031869  .0293011
.031441  .0337949 .0327249 .031869  .031655  .031655  .0320829 .031227
.0322969 .031655  .0327249 .0340089 2.97661  3.18632  3.14523  3.13496
3.13453  3.13731  1.32438 .0836549 .0258772 .0284451 .0275891 .0329389
.0329389 .0333669 .0322969 .0333669
MAX CURRENT      3.18632
MIN CURRENT      .0245932
HIGH CURRENT     3.1371
LOW CURRENT      .0314077
```

## Voltage Pulse Measurement Using VISA Library Calls

```

#include <visa.h>
#include <stdio.h> /* for printf */
#include <stdlib.h>

ViStatus main(void)
{
    ViSession defRM, instrumentHandle;
    ViStatus err;
    ViReal64 measvoltage, meascurrent;
    ViReal64 resultDC, resultRMS, resultMIN, resultMAX, resultHIGH, resultLOW;
    ViReal64 voltArray[10];
    ViInt32 i, numReadings ;

    /* initialize the VISA session */
    err = viOpenDefaultRM(&defRM);
    if (err)
    {
        printf("viOpenDefaultRM error, check your hardware connections\n");
        exit (-1);
    }

    /* Open the instrument at address 5 for Communication */
    err = viOpen(defRM, "GPIB0::5::INSTR", VI_NULL, 5000, &instrumentHandle);
    if (err)
    {
        viClose(defRM);
        printf("viOpen error, check the device at address 5\n");
        exit (-1);
    }

    /* Reset the instrument */
    viPrintf(instrumentHandle, "*RST\n");

    /* turn on the output */
    viPrintf(instrumentHandle, "OUTP 1\n");

    /* Set output voltage (2V) and current (1A) levels, turn output on*/
    viPrintf(instrumentHandle, "VOLT %.5lg::CURR %.5lg\n", 2.0, 1.0);

    /* Measure the dc voltage level at the output terminals */
    viQueryf(instrumentHandle, "MEAS:VOLT?\n", "%lf", &measvoltage);

    /* Measure the dc current level at the output terminals */
    viQueryf(instrumentHandle, "MEAS:CURR?\n", "%lf", &meascurrent);

    printf ("Output Voltage = %f; Output Current = %f \n",
            measvoltage,meascurrent);

    /* configure dc source for dynamic measurements */
    /* change sweep parameters */
    viPrintf(instrumentHandle, "SENS:SWE:TINT %.5lg;POIN %ld;OFFS:POIN %ld\n",
            31.2E-6, /* sampling rate = 31.2us */
            256, /* sweep size = 256 points */
            -4); /* pre-trigger offset = 4 points (~125us) */

    /* setup the voltage sensing triggered measurement parameters */
    /* voltage trigger level to 2.75V */
    /* hysteresis band to +/- 0.1V */
    /* positive slope */
    /* trigger count */
    /* acquisition triggered by measurement */

```

## D – Example Programs

```
viPrintf(instrumentHandle, "SENS:FUNC \"VOLT\"\n");
viPrintf(instrumentHandle, "TRIG:ACQ:LEV:VOLT %.5lg\n", 2.75);
viPrintf(instrumentHandle, "TRIG:ACQ:HYST:VOLT %.5lg\n", 0.1);
viPrintf(instrumentHandle, "TRIG:ACQ:SLOP:VOLT POS\n");
viPrintf(instrumentHandle, "TRIG:ACQ:COUN:VOLT %ld\n", 1);
viPrintf(instrumentHandle, "TRIG:ACQ:SOUR INT\n");

/* initiate the acquisition system for measurement trigger */
printf ("Arm acquisition system...\n");
viPrintf(instrumentHandle, "INIT:NAME ACQ\n");

/* must allow time for pre-triggered samples */
printf ("Pre-trigger delay...\n");

/* trigger the acquisition by changing the output voltage level to 5V */
printf ("Trigger acquisition...\n");
viPrintf(instrumentHandle, "VOLT %.5lg\n", 5.0);

/* fetch dynamic measurements from the same measurement data */
viQueryf(instrumentHandle, "FETC:VOLT?\n", "%lf", &resultDC);
viQueryf(instrumentHandle, "FETC:VOLT:ACDC?\n", "%lf", &resultRMS);
viQueryf(instrumentHandle, "FETC:VOLT:MAX?\n", "%lf", &resultMAX);
viQueryf(instrumentHandle, "FETC:VOLT:MIN?\n", "%lf", &resultMIN);
viQueryf(instrumentHandle, "FETC:VOLT:HIGHP?\n", "%lf", &resultHIGH);
viQueryf(instrumentHandle, "FETC:VOLT:LOW?\n", "%lf", &resultLOW);

/* display measurement results */
printf("Dynamic voltage measurements:\n");
printf("dc=%f V\n rms=%f V\n max=%f V\n min=%f V\n high=%f V\n low=%f
V\n",
      resultDC, resultRMS, resultMAX, resultMIN, resultHIGH, resultLOW);

/* fetch first 10 data points from the measurement */
numReadings = 10;
viQueryf(instrumentHandle, "FETC:ARR:VOLT?\n", "%,#lf%*t", &numReadings,
&voltArray[0]);
for (i=0; i<numReadings; i++)
    printf(" Array Data[%d] = %f V\n", i, voltArray[i]);

/* reset sweep parameters for faster measurement */
viPrintf(instrumentHandle, "SENS:SWE:TINT %.5lg;POIN %ld;OFFS:POIN %ld\n",
      15.6E-6, /* sampling rate */
      2048, /* sweep size */
      0); /* pre-trigger points */

/* Measure final dc voltage level at the output terminals */
viQueryf(instrumentHandle, "MEAS:VOLT?\n", "%lf", &measvoltage);

printf (" Output Voltage = %f V\n", measvoltage);

/* close all opened sessions */
viClose(instrumentHandle);
viClose(defRM);

printf ( "PROGRAM COMPLETED \n");

printf("Press Enter key to continue...\n");
getchar();

return VI_SUCCESS ;
}
```



When this program runs, it returns the DC, RMS, MIN, MAX, HIGH, and LOW data in 10 measurement data points in the following format:

```
Output Voltage = 1.999860; Output Current = -0.000043
Arm acquisition system...
Pre-trigger delay...
Trigger acquisition...
Dynamic voltage measurements:
dc = 5.002660 V
rms = 5.002660 V
max = 5.080140 V
min = 1.996970 V
high= 5.002310 V
low = 3.538550 V
Array Data[0] = 2.000360 V
Array Data[1] = 1.999680 V
Array Data[2] = 1.998320 V
Array Data[3] = 1.996970 V
Array Data[4] = 3.214240 V
Array Data[5] = 4.064840 V
Array Data[6] = 4.538600 V
Array Data[7] = 4.923570 V
Array Data[8] = 4.941870 V
Array Data[9] = 5.025240 V
Output Voltage = 5.002450 V
PROGRAM COMPLETED
Press Enter key to continue...
```



## Line Voltage Conversion

---

**WARNING:** *Shock Hazard.* Operating personnel must not remove instrument covers. Component replacement and internal adjustments must be made only by qualified service personnel.

---

### Open the Unit

- ◆ Turn off ac power and disconnect the power cord from the unit.
- ◆ Use a #15 Torx drive and remove the two screws on the bottom of the unit. If your unit has feet, you will need to remove one of the feet to access the screw.
- ◆ Use a #15 Torx drive and loosen the two screws on the rear bezel and remove the bezel.
- ◆ Slide the cover toward the back of the unit and remove it.

### Configure the Power Transformer

- ◆ Locate the ac input wiring harness on the left side of the transformer
- ◆ Use a needle nose pliers and connect the ac input wiring harness according to the information in figure E-1 on the following page.

### Install the Correct Line Fuse

- ◆ Install the correct line fuse. The fuse is located on the bottom pc board directly behind the ac line switch and is labeled F301.  
**For 100/120 Vac operation:** 3.15 AT (time delay); part number 2110-0638  
**For 220/230 Vac operation:** 1.6 AT (time delay); part number 2110-0773
- ◆ Mark the voltage setting that the unit has been set to on the rear panel label.

### Close the Unit

- ◆ Slide the cover over the unit toward the front.
- ◆ Place the bezel on the rear of the unit and tighten the two screws using a #15 Torx drive.
- ◆ Replace the two screws on the bottom of the unit using a #15 Torx drive. Remember to replace the foot if you previously removed it to access the screw.
- ◆ Reconnect the power cord and turn on the unit.

# E – Line Voltage Conversion

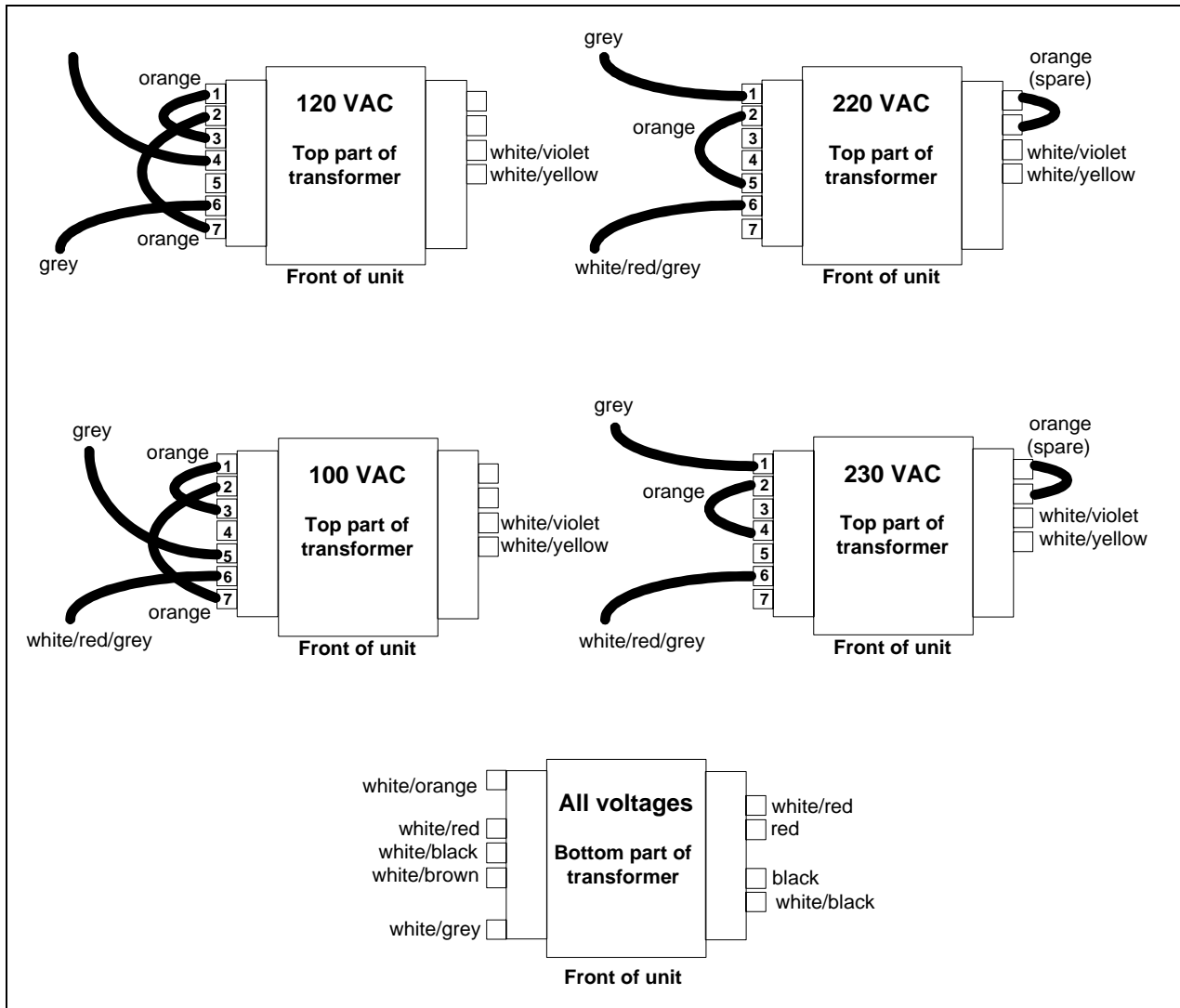

Figure E-1, Power Transformer AC Input Connections

# Index

— —

-- -- -- --, 47, 54, 55, 56

- sense open, 30

—\*—

\*RST, 160

—+—

+ sense open, 30

+/- sense open, 30

+/- terminals, 26

+S/-S terminals, 26

—0—

0 ... 9, 49

—A—

AARD, 65

ABORT, 122

ac line conversion, 171

accessories, 16

ACDC, 105

ACDC current detector, 54, 55, 56

airflow, 25

annunciators

Addr, 44

Cal, 44

CC, 44

CV, 44

Dis, 44

Err, 44

OCP, 44

Prot, 44

Rmt, 44

Shift, 44

SRQ, 44

Unr, 44

average measurements, 73, 77

AWG ratings, 26

—B—

bus, 129

—C—

cables, 16

calibration, 154

ac current, 157

current programming - high range, 156

current programming - low range, 157

current programming - mid range, 156

DVM, 158

enable, 155

equipment, 141

error messages, 159

GPIB, 159

menu, 154

output 2, 157

password, 159

resistance, 158

saving, 159

setup, 142

**voltage measurement**, 155

**voltage programming**, 155

calibration commands

CAL CURR, 94

CAL CURR MEAS AC, 95

CAL CURR MEAS LOWR, 94

CAL CURR MEAS R3, 94

CAL CURR2, 94

CAL DATA, 95

CAL DATE, 95

CAL DVM, 95

CAL PASS, 95

CAL STAT, 96

CAL VOLT PROT, 96

CAL VOLT2, 96

calibration commands, 94

CAL LEV, 95

CAL SAVE, 96

CAL VOLT, 96

calibration verification

DVM, 151

capabilities, 17

capacitance

compensation, 31

HLocal, 31

HRemote, 31

LLocal, 31

LRemote, 31

switching, 31

capacitor discharge limit, 33

CC line regulation, 148

CC load effect, 148

CC load regulation, 148

CC mode, 51, 52

CC noise, 149

CC source effect, 149

character strings, 65

characteristics, 138

checklist, 23

checkout procedure, 39

cleaning, 24

clearing errors, 53

clearing protection, 53

combine commands

common commands, 63

from different subsystems, 63

root specifier, 63

## Index

- command completion, 66
- command summary
  - format, 98
  - border, 98
- common command syntax, 93
- common commands, 117, 121
  - \*CLS, 130
  - \*ESE, 130
  - \*ESR?, 131
  - \*IDN?, 131
  - \*OPC, 131
  - \*OPT?, 132
  - \*PSC, 132
  - \*RCL, 133
  - \*RST, 133
  - \*SAV, 134
  - \*SRE, 134
  - \*STB?, 134
  - \*TRG, 135
  - \*TST, 135
  - \*WAI, 135
- common mode voltage, 34
- compensation, 31
- configuration procedure, 159
- constant current tests, 146
- constant voltage tests, 144
- controller connections, 38
- conventions used in this guide, 61
- conversion, ac line, 171
- CRD, 65
- crowbar circuit, 33
- current, 70
  - maximum, 70
  - measurement range, 75
- current measurement detector, 105
- current measurement range, 54, 55, 56, 105
- current monitoring resistor, 143
- current programming, 146
- current range, 47, 54, 55, 56
- current readback, 147
- current sink, 147, 148
- current sinking, 19
- CV load effect, 144
- CV mode, 19, 51, 52
- CV Noise, 145
- CV source effect, 145

### —D—

- damage, 24
- DC, 105
- DC current detector, 54, 55, 56
- description, 17
- determining cause of interrupt, 86
- device clear, 66
- DFI, 88
- DFI signal, 37
- DIGIO, 57
- digital connector, 24, 37
- digital I/O, 37
  - connections, 38
- digital I/O port, 88
- digital output port, 57

- dimensions, 25
- disabling multiple units, 37
- discrete fault indicator, 88
- display commands, 97, 121
  - DISP, 97
  - DISP CHAN, 97
  - DISP MODE, 97
  - DISP TEXT, 97
- downprogramming, 19
- dry switch, 21, 109
- DVM
  - common mode voltage, 34
  - connections, 34, 36
  - floating voltage measurement, 36
  - measurements, 34

### —E—

- either, 129
- electronic load, 143
- enabling the output, 69
- enter value, 51, 52
- entry keys, 49
  - ←, 49
  - 0 ... 9, 49
  - Backspace, 49
  - Clear Entry, 49
  - Enter Number, 49
- error messages, 41
- error numbers, 161
- errors, 53
- example
  - programs, 165
  - pulse measurement, 165
  - pulse measurement, 167
- external relays, 27

### —F—

- fault indicator
  - discrete, 87
  - remote inhibit, 87
- fetch commands, 73, 74, 77, 98
- FLT, 57, 88
- FLT output, 37
- format commands, 98
  - FORM, 98
  - BORD, 99
- front panel, 43
  - annunciators, 12
  - annunciators, 44
  - buffer size, 54, 55, 56
  - controls, 18
  - controls and indicators, 43
  - immediate actions, 12
  - keys, 44
  - measurements, 54, 55, 56
  - menus, 13
  - time interval, 54, 55, 56
  - using, 11
- function keys, 46
  - ▲, 46
  - Cal, 48

Current, 48  
 immediate action, 46  
 Input, 47  
 Meter, 47  
 OCP, 46  
 Output, 48  
 Output On/Off, 46  
 OV, 48  
 Prot Clear, 46  
 Protect, 48  
 Voltage, 48  
 fuse, 24

## —G—

generating measurement triggers, 79, 80  
 generating triggers, 72  
 GP-IB  
   command library for MS DOS, 59  
   controller programming, 59  
   IEEE Std for standard codes, 59  
   IEEE Std for standard digital interface, 59  
   references, 59  
 GP-IB, 57  
   address, 57  
   address, 61  
   capabilities of the dc source, 61  
   connections, 38  
   interface, 38  
   triggers, 80  
 ground, earth, 16  
 guide, user's, 15

## —H—

Hanning, 74, 107  
 header, 64  
   long form, 64  
   short form, 64  
 High measurements, 76  
 history, 6  
 HLocal, 32, 109  
 hot switch, 21, 109  
 HRemote, 32, 109

## —I—

impedance, 27  
 INH, 57, 87  
 INH input, 37  
 initialization, 69  
 initiate commands, 122  
   INIT CONT NAME, 123  
   INIT CONT SEQ, 123  
   INIT NAME, 122  
   INIT SEQ, 122  
 initiating measurement trigger system, 79  
 initiating output trigger system, 72  
 input  
   connections, 26  
   power, 16  
 inspection, 24  
 instrument commands, 108

INST COUP OUTP STAT, 108  
 internal, 129  
**internal triggers**, 80  
 internally triggered measurements, 78

## —L—

language dictionary, 89  
 language setting, 18  
**latching**, 111  
 lead resistance, 27  
 line fuse, 171  
   replacing, 42  
 line voltage, 26  
 line voltage conversion, 171  
**live**, 111  
 LLocal, 32, 109  
 load line, 19  
 load voltage drops, 27  
 local sensing, 31  
 location, 25  
 low current readback, 147  
 Low measurements, 76  
 LRemote, 32, 109

## —M—

making measurements, 54, 55, 56, 73, 74, 77  
 manuals, 24  
 MAV bit, 86  
 maximum measurements, 76  
 measure commands, 73, 74, 77, 98  
   MEAS ARR CURR?, 99  
   MEAS ARR VOLT?, 99  
   MEAS CURR ACDC?, 100  
   MEAS CURR HIGH?, 101  
   MEAS CURR LOW?, 101  
   MEAS CURR MAX?, 101  
   MEAS CURR MIN?, 102  
   MEAS CURR?, 100  
   MEAS CURR2?, 100  
   MEAS DVM ACDC?, 102  
   MEAS DVM?, 102  
   MEAS VOLT ACDC?, 103  
   MEAS VOLT HIGH?, 103  
   MEAS VOLT LOW?, 104  
   MEAS VOLT MAX?, 104  
   MEAS VOLT MIN?, 104  
   MEAS VOLT?, 102  
   MEAS VOLT2?, 103  
 measurement bandwidth, 47  
 measurement buffer, 47  
 measurement interval, 47  
 measurement ranges, 54, 55, 56  
 measurement samples, 73  
 measurement trigger system model, 78  
 measurements  
   Hanning window, 74  
   Rectangular window, 74  
 message terminator, 64  
   end or identify, 64  
   newline, 64  
 message unit

## Index

- separator, 64
- minimum measurements, 76
- model differences, 17
- monitoring both phases of status transition, 87
- moving among subsystems, 63
- MSS bit, 86
- multiple triggers, 72, 81

### —N—

- negative, 129
- non-volatile memory
  - clearing, 58
  - storing, 45, 48
- numerical data formats, 65

### —O—

- OC, 53
- OCP, 70
- open sense protection, 30
- operation status group, 84
- option 521
  - description, 21
- optional header
  - example, 63
- options, 16
- OT, 53
- output
  - characteristic, 19
  - compensation, 51
  - connections, 26
  - connector, 24
  - control keys, 48
  - current setting, 51, 52
  - enable, 52, 53
  - rating, 19
  - relays, 21, 109
  - resistance, 20, 51
  - voltage setting, 51, 52
- output 2
  - characteristic, 20
  - rating, 20
- output commands, 108
  - OUTP, 108
  - OUTP COMP, 109
  - OUTP DFI, 110
  - OUTP DFI SOUR, 110
  - OUTP PON STAT, 110
  - OUTP PROT CLE, 111
  - OUTP PROT DEL, 111
  - OUTP REL MODE, 109
  - OUTP RI MODE, 111
- output compensation, 31, 48
- output queue, 86
- output trigger system model, 71
- OV, 53
- OVERCURRENT, 41
  - overcurrent protection, 70
- OVERTEMPERATURE, 41
- OVERVOLTAGE, 41
  - overvoltage protection, 33
- OVL, 41, 54, 55, 56

- OVP
  - circuit, 33
  - disable, 33
  - disabling, 33, 48

### —P—

- PARD, 145, 149
- performance
  - equipment, 141
  - resistance programming, 151
  - setup, 142
- performance test form, 151
- performance tests, 143
- PON (power on) bit, 85
- positive, 129
- post-event triggering, 82
- power cord, 24, 26
- power receptacle, 16
- power-on conditions, 83
- power-on defaults, 159
- power-on initialization, 69
- pre-event triggering, 82
- print date, 6
- program examples, 165
- programming, 143
- programming and output values, 143
- programming parameters, 93
- programming status registers, 82
- programming the output, 69
- protection
  - FS, 53
  - OC, 53
  - OT, 53
  - OV, 53
  - RI, 53
- pulse measurement example, 165, 167
- pulse measurement queries, 76

### —Q—

- queries, 63
- query
  - indicator, 64
- query protection, 53
- questionable status group, 85

### —R—

- rack mount kit, 16
- rack mounting, 25
- readback accuracy, 144
- rear panel
  - at a glance, 10
  - connections, 37, 38
- recalling operating states, 58
- Rectangular, 74, 107
- relay mode, 21
- remote inhibit, 87
- REMOTE INHIBIT, 41
- remote programming, 18
- remote sensing
  - load regulation, 29



- stability, 30
  - with external relays, 28
  - with test fixture, 29
- repacking, 24
- resistance, 70
  - negative, 29
  - sense leads, 30
- resistance programming, 20
- returning voltage or current data, 77
- RI, 53, 87
  - signal, 37
- RIDFI, 57
- rms measurements, 75, 77
- root specifier, 64
- RQS bit, 86

—S—

- safety, 5
- safety class, 16
- safety warning, 16
- saving operating states, 58
- SCPI
  - command tree, 62
  - common commands, 62
  - header path, 62
  - multiple commands, 62
  - subsystem commands, 62
- SCPI
  - command completion, 66
  - command syntax, 89
  - conformance, 67
  - data format, 65
  - device clear, 66
  - message structure, 63
  - message types, 63
  - message unit, 63
  - non-conformance, 67
  - program message, 63
  - references, 59
  - response message, 63
  - subsystem commands, 89
  - triggering nomenclature, 71, 78
- SCPI commands
  - at a glance, 14
- selecting measurement trigger source, 79
- selftest errors, 41
- sense commands, 98, 106
  - SENS CURR DET, 105
  - SENS CURR RANG, 105
  - SENS FUNC, 106
  - SENS LEAD STAT?, 106
  - SENS PROT STAT, 106
  - SENS SWE OFFS POIN, 106
  - SENS SWE POIN, 107
  - SENS SWE TINT, 107
  - SENS WIND, 107
- sense open, 30
- servicing operation status, 86
- servicing questionable status events, 86
- setting output trigger system, 71
- setting resistance, 51

- setting voltage/current, 51, 52
- shorting switch, 37
- single triggers, 72, 80
- source commands
  - [SOUR] CURR PROT STAT, 112
  - [SOUR] CURR TRIG, 113
  - [SOUR] CURR2 TRIG, 113
  - [SOUR] DIG DATA, 113
  - [SOUR] DIG FUNC, 114
  - [SOUR] RES, 114
  - [SOUR] RES TRIG, 114
  - [SOUR] VOLT, 115
  - [SOUR] VOLT PROT, 115
  - [SOUR] VOLT PROT STAT, 116
  - [SOUR] VOLT TRIG, 116
  - [SOUR] VOLT2, 115
  - [SOUR] VOLT2 TRIG, 116
- source commands, 108
  - [SOUR] CURR, 112
  - [SOUR] CURR2, 112
- specifications, 137
- SRD, 65
- stability with remote sensing, 30
- standard event status group, 85
- status bit configurations, 84
- status byte register, 85
- status commands, 117
  - STAT OPER COND?, 117
  - STAT OPER ENAB, 118
  - STAT OPER NTR, 118
  - STAT OPER PTR, 118
  - STAT OPER?, 117
  - STAT PRES, 117
  - STAT QUES COND?, 119
  - STAT QUES ENAB, 119
  - STAT QUES NTR, 120
  - STAT QUES PTR, 120
  - STAT QUES?, 119
- status model, 83
- subsystem commands syntax, 90
- suffixes, 65
- support rails, 25
- system commands, 121
  - SYST ERR?, 121
  - SYST LANG, 121
  - SYST VERS?, 121
- system errors, 161
- system keys, 45
  - Address, 45
  - Error, 45
  - Interface, 45
  - Local, 45
  - RCL, 45
  - Save, 45
  - Shift, 45

## —T—

- transient recovery, 145
- transient response, 137
- trigger commands, 122
  - TRIG, 123
  - TRIG ACQ, 124

## Index

TRIG ACQ COUN CURR, 124  
TRIG ACQ COUN DVM, 124  
TRIG ACQ COUN VOLT, 125  
TRIG ACQ HYST CURR, 125  
TRIG ACQ HYST DVM, 126  
TRIG ACQ HYST VOLT, 126  
TRIG ACQ LEV CURR, 127  
TRIG ACQ LEV DVM, 127  
TRIG ACQ LEV VOLT, 128  
TRIG ACQ SLOP CURR, 128  
TRIG ACQ SLOP DVM, 128  
TRIG ACQ SLOP VOLT, 129  
TRIG ACQ SOUR, 129  
TRIG SEQ1 DEF, 130  
TRIG SEQ2, 124  
TRIG SEQ2 COUN CURR, 124  
TRIG SEQ2 COUN DVM, 124  
TRIG SEQ2 COUN VOLT, 125  
TRIG SEQ2 DEF, 130  
TRIG SEQ2 HYST CURR, 125  
TRIG SEQ2 HYST DVM, 126  
TRIG SEQ2 HYST VOLT, 126  
TRIG SEQ2 LEV CURR, 127  
TRIG SEQ2 LEV DVM, 127  
TRIG SEQ2 LEV VOLT, 128  
TRIG SEQ2 SLOP CURR, 128  
TRIG SEQ2 SLOP DVM, 128  
TRIG SEQ2 SLOP VOLT, 129

TRIG SEQ2 SOUR, 129  
TRIG SOUR, 123  
trigger offset, 82  
triggering output changes, 71  
triggers  
    multiple, 72, 81  
    single, 72, 80  
types of SCPI commands, 62

### —U—

UNR annunciator, 20

### —V—

voltage, 69  
    maximum, 70  
voltage programming, 144  
VXIplug&play, 15

### —W—

waiting for measurement results, 81  
warranty, 2  
wire  
    current ratings, 26

## Agilent Sales and Support Office

For more information about Agilent Technologies test and measurement products, applications, services, and for a current sales office listing, visit our web site: <http://www.agilent.com/find/tmdir>

You can also contact one of the following centers and ask for a test and measurement sales representative.

### United States:

Agilent Technologies  
Test and Measurement Call Center  
P.O. Box 4026  
Englewood, CO 80155-4026  
(tel) 1 800 452 4844

### Latin America:

Agilent Technologies  
Latin American Region Headquarters  
5200 Blue Lagoon Drive, Suite #950  
Miami, Florida 33126  
U.S.A.  
(tel) (305) 267 4245  
(fax) (305) 267 4286

### Canada:

Agilent Technologies Canada Inc.  
5150 Spectrum Way  
Mississauga, Ontario  
L4W 5G1  
(tel) 1 877 894 4414

### Australia/New Zealand:

Agilent Technologies Australia Pty Ltd  
347 Burwood Highway  
Forest Hill, Victoria 3131  
(tel) 1-800 629 485 (Australia)  
(fax) (61 3) 9272 0749  
(tel) 0 800 738 378 (New Zealand)  
(fax) (64 4) 802 6881

### Europe:

Agilent Technologies  
Test & Measurement European Marketing Organisation  
P.O. Box 999  
1180 AZ Amstelveen  
The Netherlands  
(tel) (31 20) 547 9999

### Asia Pacific:

Agilent Technologies  
24/F, Cityplaza One, 1111 King's Road,  
Taikoo Shing, Hong Kong  
tel: (852)-3197-7777  
fax: (852)-2506-9284

### Japan:

Agilent Technologies Japan Ltd.  
Measurement Assistance Center  
9-1, Takakura-Cho, Hachioji-Shi,  
Tokyo 192-8510, Japan  
(tel) (81) 426 56 7832  
(fax) (81) 426 56 7840

Technical data is subject to change.

## Manual Updates

The following updates have been made to this manual since its publication.

1/10/01

The 14565 Remote Front Panel has been removed from Table 2-2.

The Maximum current range parameter has been changed from "Max" to "3A" throughout the manual.

Performance testing information has been added to Appendix B.

10/03/01

The Current Sink and Resistance Tests performance procedures have been corrected in Appendix B.

4/22/02

Mains Input Ratings have been corrected in Table A-2. Figure E-1 has been corrected in Appendix E.

5/02/03

Information about the external measurement trigger input has been added to all chapters. This capability is only available on units with firmware revisions A.03.01 and up.

Corrections have also been made to the test record cards in Appendix B for ISO 17025.

2/9/05

The Declaration Page is updated. Further corrections have been made to Appendix B for ISO 17025.

8/2/06

The resistance calibration procedure has been corrected on page 157. Part numbers corrected on page 142.

9/18/08

All references to the RS-232 connector and the Agilent 14575A remote front panel have been removed from this manual. The RS-232 connector and its functionality were removed from the Agilent 66311B/D models starting March, 2008.

5/20/09

A URL has been added to the declarations page to obtain the latest declaration of conformity.

Corrections have been made to Figure 3-10.

The RF field annotation note has been removed from Table A-1.

Information about resetting the calibration password has been added to Appendix B.

8/01/12

Information about -3A range current sink operation has been corrected on pages 148 and 152.