

USER'S GUIDE
Agilent Model 66111A
Fast Transient DC Source
Agilent Model 66311B/D, 66309B/D
Mobile Communications DC Source

NOTE: Refer to page 23 for a brief description of the model differences.



Agilent Technologies

Warranty Information

CERTIFICATION

Agilent Technologies certifies that this product met its published specifications at time of shipment from the factory. Agilent Technologies further certifies that its calibration measurements are traceable to the United States National Bureau of Standards, to the extent allowed by the Bureau's calibration facility, and to the calibration facilities of other International Standards Organization members.

WARRANTY

This Agilent Technologies hardware product is warranted against defects in material and workmanship for a period of one year from date of delivery. Agilent Technologies software and firmware products, which are designated by Agilent Technologies for use with a hardware product and when properly installed on that hardware product, are warranted not to fail to execute their programming instructions due to defects in material and workmanship for a period of 90 days from date of delivery. During the warranty period Agilent Technologies will, at its option, either repair or replace products which prove to be defective. Agilent Technologies does not warrant that the operation for the software firmware, or hardware shall be uninterrupted or error free.

For warranty service, with the exception of warranty options, this product must be returned to a service facility designated by Agilent Technologies. Customer shall prepay shipping charges by (and shall pay all duty and taxes) for products returned to Agilent Technologies for warranty service. Except for products returned to Customer from another country, Agilent Technologies shall pay for return of products to Customer.

Warranty services outside the country of initial purchase are included in Agilent Technologies' product price, only if Customer pays Agilent Technologies international prices (defined as destination local currency price, or U.S. or Geneva Export price).

If Agilent Technologies is unable, within a reasonable time to repair or replace any product to condition as warranted, the Customer shall be entitled to a refund of the purchase price upon return of the product to Agilent Technologies.

LIMITATION OF WARRANTY

The foregoing warranty shall not apply to defects resulting from improper or inadequate maintenance by the Customer, Customer-supplied software or interfacing, unauthorized modification or misuse, operation outside of the environmental specifications for the product, or improper site preparation and maintenance. NO OTHER WARRANTY IS EXPRESSED OR IMPLIED. AGILENT TECHNOLOGIES SPECIFICALLY DISCLAIMS THE IMPLIED WARRANTIES OF MERCHANTABILITY AND FITNESS FOR A PARTICULAR PURPOSE.

EXCLUSIVE REMEDIES

THE REMEDIES PROVIDED HEREIN ARE THE CUSTOMER'S SOLE AND EXCLUSIVE REMEDIES. AGILENT TECHNOLOGIES SHALL NOT BE LIABLE FOR ANY DIRECT, INDIRECT, SPECIAL, INCIDENTAL, OR CONSEQUENTIAL DAMAGES, WHETHER BASED ON CONTRACT, TORT, OR ANY OTHER LEGAL THEORY.

ASSISTANCE

The above statements apply only to the standard product warranty. Warranty options, extended support contacts, product maintenance agreements and customer assistance agreements are also available. Contact your nearest Agilent Technologies Sales and Service office for further information on Agilent Technologies' full line of Support Programs.

Safety Summary

The following general safety precautions must be observed during all phases of operation of this instrument. Failure to comply with these precautions or with specific warnings elsewhere in this manual violates safety standards of design, manufacture, and intended use of the instrument. Agilent Technologies assumes no liability for the customer's failure to comply with these requirements.

GENERAL

This product is a Safety Class 1 instrument (provided with a protective earth terminal). The protective features of this product may be impaired if it is used in a manner not specified in the operation instructions.

Any LEDs used in this product are Class 1 LEDs as per IEC 825-1.

This ISM device complies with Canadian ICES-001. Cet appareil ISM est conforme à la norme NMB-001 du Canada.

ENVIRONMENTAL CONDITIONS

This instrument is intended for indoor use in an installation category II, pollution degree 2 environment. It is designed to operate at a maximum relative humidity of 95% and at altitudes of up to 2000 meters. Refer to the specifications tables for the ac mains voltage requirements and ambient operating temperature range.

BEFORE APPLYING POWER

Verify that the product is set to match the available line voltage, the correct fuse is installed, and all safety precautions are taken. Note the instrument's external markings described under "Safety Symbols".

GROUND THE INSTRUMENT

To minimize shock hazard, the instrument chassis and cover must be connected to an electrical ground. The instrument must be connected to the ac power mains through a grounded power cable, with the ground wire firmly connected to an electrical ground (safety ground) at the power outlet. Any interruption of the protective (grounding) conductor or disconnection of the protective earth terminal will cause a potential shock hazard that could result in personal injury.

ATTENTION: Un circuit de terre continu est essentiel en vue du fonctionnement sécuritaire de l'appareil. Ne jamais mettre l'appareil en marche lorsque le conducteur de mise ... la terre est d,branch,.

FUSES

Only fuses with the required rated current, voltage, and specified type (normal blow, time delay, etc.) should be used. Do not use repaired fuses or short-circuited fuseholders. To do so could cause a shock or fire hazard.

DO NOT OPERATE IN AN EXPLOSIVE ATMOSPHERE

Do not operate the instrument in the presence of flammable gases or fumes.

DO NOT REMOVE THE INSTRUMENT COVER

Operating personnel must not remove instrument covers. Component replacement and internal adjustments must be made only by qualified service personnel.

Instruments that appear damaged or defective should be made inoperative and secured against unintended operation until they can be repaired by qualified service personnel.

SAFETY SYMBOLS



Direct current



Alternating current



Both direct and alternating current



Three-phase alternating current



Earth (ground) terminal



Protective earth (ground) terminal



Frame or chassis terminal



Terminal is at earth potential. Used for measurement and control circuits designed to be operated with one terminal at earth potential.



Terminal for Neutral conductor on permanently installed equipment



Terminal for Line conductor on permanently installed equipment



On (supply)



Off (supply)



Standby (supply). Units with this symbol are not completely disconnected from ac mains when this switch is off. To completely disconnect the unit from ac mains, either disconnect the power cord or have a qualified electrician install an external switch.



In position of a bi-stable push control



Out position of a bi-stable push control



Caution, risk of electric shock



Caution, hot surface



Caution (refer to accompanying documents)

WARNING

The WARNING sign denotes a hazard. It calls attention to a procedure, practice, or the like, which, if not correctly performed or adhered to, could result in personal injury. Do not proceed beyond a WARNING sign until the indicated conditions are fully understood and met.

Caution

The CAUTION sign denotes a hazard. It calls attention to an operating procedure, or the like, which, if not correctly performed or adhered to, could result in damage to or destruction of part or all of the product. Do not proceed beyond a CAUTION sign until the indicated conditions are fully understood and met.



Declaration Page

Manufacturer's Name and Address

Responsible Party

Agilent Technologies, Inc.
550 Clark Drive, Suite 101
Budd Lake, New Jersey 07828
USA

Alternate Manufacturing Site

Agilent Technologies (Malaysia) Sdn. Bhd
Malaysia Manufacturing
Bayan Lepas Free Industrial Zone, PH III
11900 Penang,
Malaysia

Declares under sole responsibility that the product as originally delivered

- Product Names** a) Mobile Communications DC Source
b) System DC Power Supply
- Model Numbers** a) 66332A, 66312A, 66311B, 66311D
66309B, 66309D, 66319B, 66319D, 66321B, 66321D
b) 6631B, 6632B, 6633B, 6634B 6611C
6612C, 6613C, 6614C
- Product Options** This declaration covers all options and customized products based on the above products.

Complies with the essential requirements of the Low Voltage Directive 73/23/EEC and the EMC Directive 89/336/EEC (including 93/68/EEC) and carries the CE Marking accordingly.

EMC Information ISM Group 1 Class A Emissions

As detailed in Electromagnetic Compatibility (EMC), Certificate of Conformance Number
CC/TCF/00/030 based on Technical Construction File (TCF) HPNJ8, dated
Apr. 25, 2000

Assessed by: Celestica Ltd, Appointed Competent Body
Westfields House, West Avenue
Kidsgrove, Stoke-on-Trent
Staffordshire, ST7 1TL
United Kingdom

Safety Information and Conforms to the following safety standards.

- IEC 61010-1:2001 / EN 61010-1:2001
- Canada: CSA C22.2 No. 1010.1:1992
- UL 61010B-1: 2003

This DoC applies to above-listed products placed on the EU market after

January 1, 2004

Date

Bill Darcy/ Regulations Manager

For further information, please contact your local Agilent Technologies sales office, agent or distributor, or
Agilent Technologies Deutschland GmbH, Herrenberger Straße 130, D71034 Böblingen, Germany

Revision: B.00.00

Issue Date: Created on 11/24/2003 3:14 PM

Document No. Eagle.11.24.doc

To obtain the latest Declaration of Conformity, go to <http://regulations.corporate.agilent.com> and click on "Declarations of Conformity."

Acoustic Noise Information

Herstellerbescheinigung

Diese Information steht im Zusammenhang mit den Anforderungen der Maschinenläminformationsverordnung vom 18 Januar 1991.

- * Schalldruckpegel $L_p < 70$ dB(A)
- * Am Arbeitsplatz
- * Normaler Betrieb
- * Nach EN 27779 (Typprüfung).

Manufacturer's Declaration

This statement is provided to comply with the requirements of the German Sound Emission Directive, from 18 January 1991.

- * Sound Pressure $L_p < 70$ dB(A)
- * At Operator Position
- * Normal Operation
- * According to EN 27779 (Type Test).

Printing History

The edition and current revision of this manual are indicated below. Reprints of this manual containing minor corrections and updates may have the same printing date. Revised editions are identified by a new printing date. A revised edition incorporates all new or corrected material since the previous printing date.

Changes to the manual occurring between revisions are covered by change sheets shipped with the manual. In some cases, the manual change applies only to specific instruments. Instructions provided on the change sheet will indicate if a particular change applies only to certain instruments.

This document contains proprietary information protected by copyright. All rights are reserved. No part of this document may be photocopied, reproduced, or translated into another language without the prior consent of Agilent Technologies. The information contained in this document is subject to change without notice.

© Copyright 1999, 2000, 2001, 2005, 2008, 2009 Agilent Technologies Inc.

Edition 1 _____ February, 1999
Update 1 _____ January, 2000
Update 2 _____ June, 2000
Update 3 _____ October, 2001
Update 4 _____ February, 2005
Update 5 _____ September, 2008
Update 6 _____ September, 2009

Table of Contents

Warranty Information	2
Safety Summary	3
Declaration Page	5
Acoustic Noise Information	6
Printing History	6
Table of Contents	7
1 - QUICK REFERENCE	15
The Front Panel - At a Glance	15
The Rear Panel - At a Glance	16
Instrument Configuration	16
Front Panel Number Entry	17
Front Panel Annunciators	18
Immediate Action Keys	18
Front Panel Menus - At a Glance	19
SCPI Programming Commands - At a Glance	20
2 - GENERAL INFORMATION	21
Document Orientation	21
Safety Considerations	22
Options and Accessories	22
Description and Model Differences	23
Common Capabilities	24
Front Panel Controls	24
Remote Programming	24
Output 1 Characteristic	25
Output 2 Characteristic	26
Option 521 Description (Agilent 66309B/D only)	27
3 - INSTALLATION	29
Installation and Operation Checklist	29
Inspection	30
Damage	30
Packaging Material	30
Items Supplied	30
Cleaning	30
Location	30
Bench Operation	31
Rack Mounting	31
Input Connections	31
Connect the Power Cord	31
Output Connections	32
Output 1	32
Output 2	32
Current Ratings	32
Voltage Drops and Lead Resistance	32
Remote Sense Connections	33
Load Regulation and Voltage Drop in the Remote Sense Leads	35
Maintaining Stability while Remote Sensing	35
Open Sense Lead Protection	36
Local Sensing	37
Output Compensation	38
OVP Considerations	39

DVM Connections	39
Measuring Circuits that are Not Powered by the Main Output	40
Measuring Circuits that are Floating with Respect to the Main Output	41
External Protection Connections	42
Digital I/O Connections	43
Computer Connections	43
GPIB Interface	43
RS-232 Interface	44
4 - TURN-ON CHECKOUT	45
Checkout Procedure	45
In Case of Trouble	47
Selftest Error Messages	47
Runtime Error Messages	48
Line Fuse	48
5 - FRONT PANEL OPERATION	49
Introduction	49
Front Panel Description	49
System Keys	51
Function Keys	52
Immediate Action Keys	52
Scrolling Keys	52
Metering Keys	53
Output Control Keys	54
Entry Keys	55
Examples of Front Panel Programming	56
1 - Using the Front Panel Display	56
2 - Setting the Output Voltage, Current, Compensation, and Relay Mode	57
3 - Setting the Output 2 Voltage and Current (Agilent 66309B/D only)	58
4 - Querying and Clearing Output Protection and Errors	59
5 - Making Basic Front Panel Measurements	60
6 - Making Enhanced Front Panel Measurements	61
7 - Making DVM Measurements (Agilent 66311D/66309D only)	62
8 - Programming External Protection and the Digital Port Functions	63
9 - Setting the GPIB Address and Programming Language	63
10 - Storing and Recalling Instrument States	64
6 - INTRODUCTION TO PROGRAMMING	65
External References	65
GPIB References	65
SCPI References	65
VXIplug&play Power Products Instrument Drivers	66
Supported Applications	66
System Requirements	66
Downloading and Installing the Driver	66
Accessing Online Help	67
GPIB Capabilities of the DC Source	67
GPIB Address	67
RS-232 Capabilities of the DC Source	67
RS-232 Data Format	67
RS-232 Flow Control	68
Introduction to SCPI	68
Conventions Used in This Guide	69
Types of SCPI Commands	69
Multiple Commands in a Message	70
Moving Among Subsystems	70

Including Common Commands	70
Using Queries	71
Types of SCPI Messages	71
The Message Unit	71
Headers	71
Query Indicator	72
Message Unit Separator	72
Root Specifier	72
Message Terminator	72
SCPI Data Formats	72
Numerical Data Formats	72
Suffixes and Multipliers	73
Response Data Types	73
SCPI Command Completion	73
Using Device Clear	74
SCPI Conformance Information	74
SCPI Conformed Commands	74
Non-SCPI Commands	74
7 - PROGRAMMING THE DC SOURCE	75
Introduction	75
Programming the Output	75
Power-on Initialization	75
Enabling the Output	75
Output Voltage	76
Output Current	76
Triggering Output Changes	77
SCPI Triggering Nomenclature	77
Output Trigger Model	77
Setting the Voltage or Current Transient Levels	77
Enabling the Output Trigger System	78
Selecting the Output Trigger Source	78
Generating Triggers	78
Making Basic Measurements	79
Average Measurements	79
Controlling Measurement Samples	79
Window Functions	80
Measuring Output 2 Voltage and Current (Agilent 66309B/D only)	80
Making Enhanced Measurements	80
Current Ranges and Measurement Detector	81
RMS Measurements	81
Pulse Measurements	82
Returning All Measurement Data From the Data Buffer	83
Making DVM Measurements	83
Average Measurements	83
RMS Measurements	83
Triggered Measurements	84
SCPI Triggering Nomenclature	84
Measurement Trigger Model	84
Enabling the Measurement Trigger System	85
Selecting the Measurement Trigger Source	85
Selecting the Sensing Function	85
Generating Measurement Triggers	86
Pre-trigger and Post-trigger Data Acquisition	88
Programming the Status Registers	88
Power-On Conditions	89
Operation Status Group	90

Questionable Status Group	91
Standard Event Status Group	91
Status Byte Register	91
Determining the Cause of a Service Interrupt	92
Servicing Operation Status and Questionable Status Events	92
Monitoring Both Phases of a Status Transition	93
Inhibit/Fault Indicator	93
Remote Inhibit (RI)	93
Discrete Fault Indicator (DFI)	94
Using the Inhibit/Fault Port as a Digital I/O	94
8 - LANGUAGE DICTIONARY	95
Introduction	95
Subsystem Commands	95
Common Commands	99
Programming Parameters	99
Calibration Commands	100
CALibrate:CURRent	100
CALibrate:CURRent2	100
CALibrate:CURRent:MEASure:LOWRange	100
CALibrate:CURRent:MEASure:AC	100
CALibrate:DATA	101
CALibrate:DATE	101
CALibrate:DVM	101
CALibrate:LEVel	101
CALibrate:PASSword	101
CALibrate:SAVE	102
CALibrate:STATe	102
CALibrate:VOLTage	102
CALibrate:VOLTage2	102
CALibrate:VOLTage:PROTection	102
Display Commands	103
DISPlay	103
DISPlay:CHANnel	103
DISPlay:MODE	103
DISPlay:TEXT	103
Measurement Commands	104
FORMat	104
FORMat:BORDER	105
MEASure:ARRay:CURRent? FETCh:ARRay:CURRent?	105
MEASure:ARRay:VOLTage? FETCh:ARRay:VOLTage?	105
MEASure:CURRent? FETCh:CURRent?	106
MEASure:CURRent2?	106
MEASure:CURRent:ACDC? FETCh:CURRent:ACDC?	106
MEASure:CURRent:HIGH? FETCh:CURRent:HIGH?	107
MEASure:CURRent:LOW? FETCh:CURRent:LOW?	107
MEASure:CURRent:MAXimum? FETCh:CURRent: MAXimum?	107
MEASure:CURRent:MINimum? FETCh:CURRent:MINimum?	108
MEASure:DVM? FETCh:DVM?	108
MEASure:DVM:ACDC? FETCh:DVM:ACDC?	108
MEASure:VOLTage? FETCh:VOLTage?	108
MEASure:VOLTage2	109
MEASure:VOLTage:ACDC? FETCh:VOLTage:ACDC?	109
MEASure:VOLTage:HIGH? FETCh:VOLTage:HIGH?	109
MEASure:VOLTage:LOW? FETCh:VOLTage:LOW?	110
MEASure:VOLTage:MAXimum? FETCh:VOLTage:MAXimum?	110
MEASure:VOLTage:MINimum? FETCh:VOLTage:MINimum?	110

SENSe:CURRent:DETEctor	111
SENSe:CURRent:RANGe	111
SENSe:FUNCTion	112
SENSe:PROTEction:STATe	112
SENSe:SWEEp:OFFSet:POINts	112
SENSe:SWEEp:POINts	112
SENSe:SWEEp:TINTErval	113
SENSe:WINDow	113
Output Commands	114
INSTrument:COUPlE:OUTPut:STATe	114
OUTPut[1 2]	114
OUTPut[1 2]:RELay:MODE	114
OUTPut:DFI	115
OUTPut:DFI:SOURce	115
OUTPut:PON:STATe	115
OUTPut:PROTEction:CLear	116
OUTPut:PROTEction:DELay	116
OUTPut:RI:MODE	116
OUTPut:TYPE	116
[SOURce:]CURRent	117
[SOURce:]CURRent2	117
[SOURce:]CURRent:PROTEction:STATe	118
[SOURce:]CURRent:TRIGger	118
[SOURce:]CURRent2:TRIGger	118
[SOURce:]DIGital:DATA	119
[SOURce:]DIGital:FUNCTion	119
[SOURce:]VOLTage	119
[SOURce:]VOLTage2	120
[SOURce:]VOLTage:PROTEction	120
[SOURce:]VOLTage:PROTEction:STATe	120
[SOURce:]VOLTage:TRIGger	121
[SOURce:]VOLTage:TRIGger	121
[SOURce:]VOLTage2:TRIGger	121
Status Commands	121
STATus:PRESet	121
STATus:OPERation?	122
STATus:OPERation:CONDition?	122
STATus:OPERation:ENABLE	122
STATus:OPERation:NTR STATus:OPERation:PTR	123
STATus:QUESTionable?	123
STATus:QUESTionable:CONDition?	124
STATus:QUESTionable:ENABLE	124
STATus:QUESTionable:NTR STATus:QUESTionable:PTR	124
System Commands	125
SYSTem:ERRor?	125
SYSTem:LANGuage	125
SYSTem:VERSion?	125
Trigger Commands	126
ABORt	126
INITiate:SEQuence INITiate:NAME	126
INITiate:CONTInuous:SEQuence1 INITiate:CONTInuous:NAME TRANsient	127
TRIGger	127
TRIGger:SOURce	127
TRIGger:SEQuence2 TRIGger:ACQuire	128
TRIGger:SEQuence2:COUNT:CURRent TRIGger:ACQuire:COUNT:CURRent	128
TRIGger:SEQuence2:COUNT:DVM TRIGger:ACQuire:COUNT:DVM	128
TRIGger:SEQuence2:COUNT:VOLTage TRIGger:ACQuire:COUNT:VOLTage	129

TRIGger:SEQuence2:HYSTeresis:CURRent TRIGger:ACQuire:HYSTeresis:CURRent	129
TRIGger:SEQuence2:HYSTeresis:DVM TRIGger:ACQuire:HYSTeresis:DVM	130
TRIGger:SEQuence2:HYSTeresis:VOLTage TRIGger:ACQuire:HYSTeresis:VOLTage	130
TRIGger:SEQuence2:LEVel:CURRent TRIGger:ACQuire:LEVel:CURRent	131
TRIGger:SEQuence2:LEVel:DVM TRIGger:ACQuire:LEVel:DVM	131
TRIGger:SEQuence2:LEVel:VOLTage TRIGger:ACQuire:LEVel:VOLTage	132
TRIGger:SEQuence2:SLOPe:CURRent TRIGger:ACQuire:SLOPe:CURRent	132
TRIGger:SEQuence2:SLOPe:DVM TRIGger:ACQuire:SLOPe:DVM	133
TRIGger:SEQuence2:SLOPe:VOLTage TRIGger:ACQuire:SLOPe:VOLTage	133
TRIGger:SEQuence2:SOURce TRIGger:ACQuire:SOURce	134
TRIGger:SEQuence1:DEFine TRIGger:SEQuence2:DEFine	134
Common Commands	135
*CLS	135
*ESE	135
*ESR?	136
*IDN?	136
*OPC	136
*OPT?	137
*PSC	137
*RCL	137
*RST	138
*SAV	138
*SRE	139
*STB?	139
*TRG	140
*TST?	140
*WAI	140
Additional Commands	141
INSTrument:STATe	141
OUTPut:PROTection:TRIPped?	141
CURRent:LIMit:HIGH?	141
CURRent:LIMit:LOW?	141
CURRent:PROTection:TRIPped?	142
VOLTage:LIMit:HIGH?	142
VOLTage:LIMit:LOW?	142
VOLTage:PROTection:TRIPped?	142
A - SPECIFICATIONS	143
Specifications	143
Supplemental Characteristics	144
B - VERIFICATION AND CALIBRATION	147
Introduction	147
Equipment Required	147
Test Setup	147
Performing the Verification Tests	148
Turn-On Checkout	148
Voltage Programming and Measurement Accuracy	149
Current Programming and Measurement Accuracy	149
DVM Measurement Accuracy	151
Performing the Calibration Procedure	154
Front Panel Calibration Menu	154
Front Panel Calibration Procedure	155
Calibration Error Messages	159
Changing the Calibration Password	159
Calibration Over the GPIB	159

C - ERROR MESSAGES	161
Error Number List	161
D - EXAMPLE PROGRAMS	165
Introduction	165
Assigning the GPIB Address in Programs	165
National Instruments GPIB Driver	165
BASIC	168
Pulse Measurements	169
DFI Programming Example	173
E - LINE VOLTAGE CONVERSION	175
Open the Unit	175
Configure the Power Transformer	175
Install the Correct Line Fuse	175
Close the Unit	175
F - COMPATIBILITY LANGUAGE	177
Introduction	177
INDEX	183



Quick Reference

The Front Panel - At a Glance

1 A 14-character display shows output measurements and programmed values.

2 Annunciators indicate operating modes and status conditions.

3 Rotary control sets voltage, current, and menu parameters.

Use  and  to set the resolution; then adjust the value with the knob.

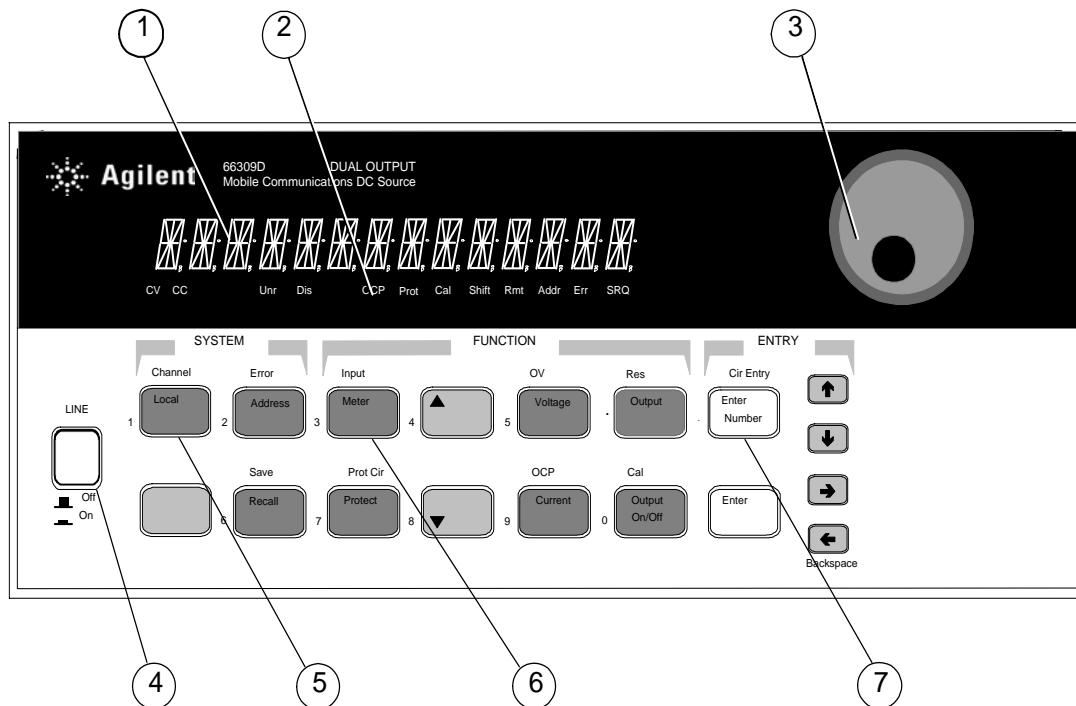



4 Turns the dc source on and off.





5 System keys:

- ◆ return to Local mode
- ◆ select output channel
- ◆ set GPIB address
- ◆ set RS-232 interface
- ◆ display SCPI error codes
- ◆ save and recall instrument states
- ◆ display firmware revision and serial number.

6 Function keys:

- ◆ enable/disable the output
- ◆ select metering functions
- ◆ program voltage and current
- ◆ set and clear protection functions
- ◆  and  scroll through the front panel menu commands.

7 Entry keys:

- ◆ enter values
- ◆ increment or decrement values
- ◆  and  select front panel menu parameters.
- ◆  and  select a digit in the numeric entry field.

The Rear Panel - At a Glance

1 DVM inputs.
Connector plug is removable.

2 GPIB (IEEE-488)
interface connector.

3 Remote front panel
display connector.
RS-232 interface for
Agilent 66111A,
66311B/D only.

4 INH/FLT (remote
INHibit / internal FauLT)
connector. Connector plug
is removable.

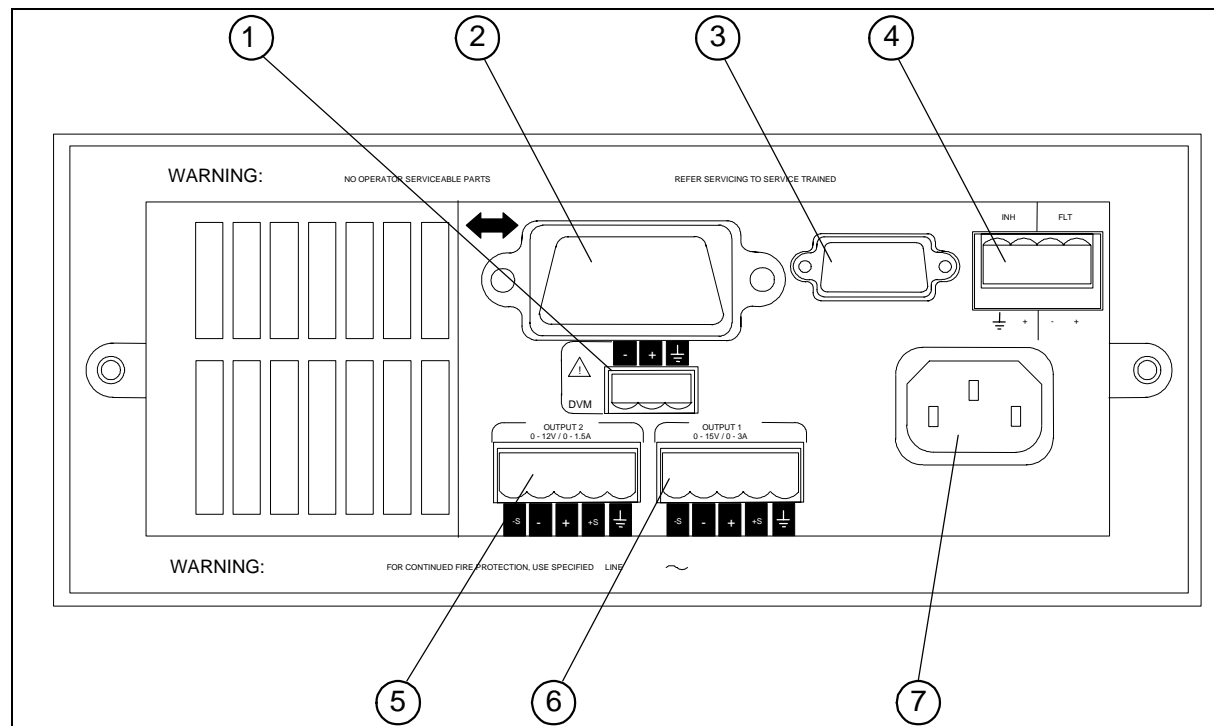

5 Output 2 connector
(Agilent 66309B/D only).
Connector plug is removable.

6 Output 1 connector.
Connector plug is removable.
IMPORTANT: Install this connector with
its supplied sense jumpers before applying
power to the unit.

7 Power cord
connector (IEC 320)

Instrument Configuration

Use the front panel Address key to configure the interface

Refer to “Front Panel Menus - At a Glance”

- ◆ Select either the GPIB or RS-232 interface.
- ◆ Enter the GPIB bus address.
- ◆ Configure the RS-232 baud rate, parity, and flow control.
- ◆ Select either the SCPI or COMPatibility programming language.

Front Panel Number Entry

Enter numbers from the front panel using **one** the following methods:

Use the arrow keys and knob to change voltage or current settings

NOTE: The output must be ON to see the displayed values change in Meter mode. With the output enabled, this method changes the output voltage or current immediately.

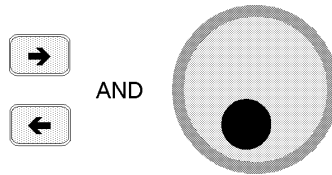

Use the Function keys and knob to change the displayed settings

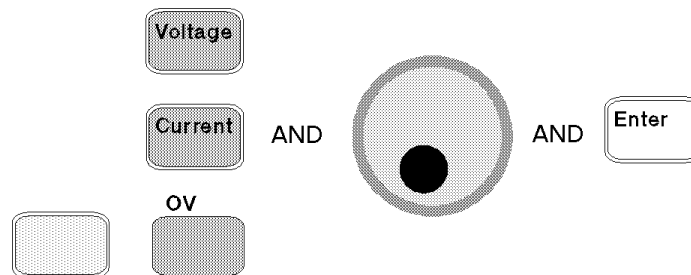

Use the arrow keys to edit individual digits in the displayed setting

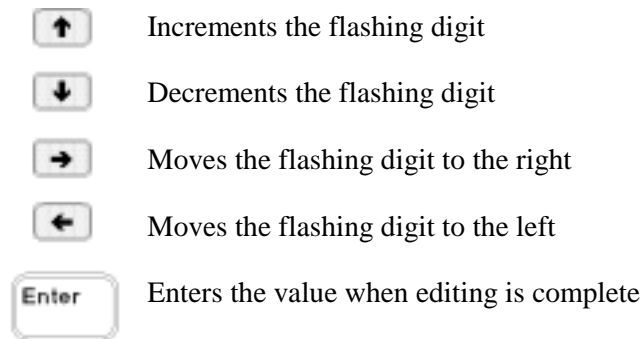

Use the Function keys and Entry keys to enter a new value

NOTE: If you make a mistake, use the Backspace key to delete the number, or press the Meter key to return to meter mode.

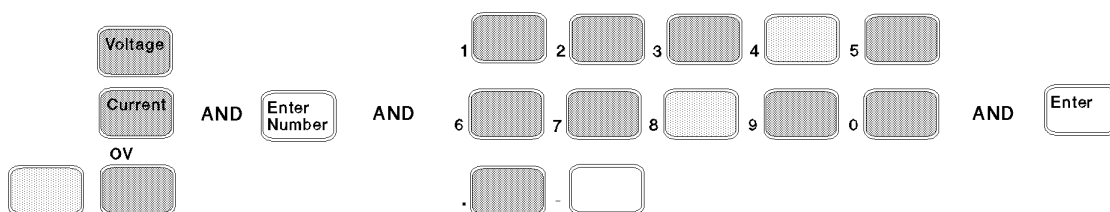







Front Panel Annunciators



CV CC Unr Dis OCP Prot Cal Shift Rmt Addr Err SRQ

CV	Output 1 or output 2 is operating in constant voltage mode.
CC	Output 1 or output 2 is operating in constant current mode.
Unr	Output 1 or output 2 is unregulated.
Dis	The output is OFF. Press the Output On/Off key to turn the output on.
OCP	The over-current protection state is ON. Press the OCP key to turn over-current protection off.
Prot	Indicates that the output has been disabled by one of the protection features. Press the Prot Clear key to clear the protection condition.
Cal	Calibration mode is ON. Scroll to the Cal Off command and press the Enter key to exit the calibration mode.
Shift	The Shift key has been pressed.
Rmt	The remote programming interface (GPIB or RS-232) is active. Press the Local key to return the unit to front panel control.
Addr	The interface is addressed to talk or listen.
Err	There is an error in the SCPI error queue. Press the Error key to view the error code.
SRQ	The interface is requesting service.

Immediate Action Keys

	Toggles the output of the selected output between the ON and OFF states. When coupled, turns both output channels ON or OFF.
	Activates front panel control when the unit is in remote mode (unless a Lockout command is in effect).
 	Resets the protection circuit and allows the unit to return to its last programmed state.
 	A toggle switch that enables or disables overcurrent protection.

Front Panel Menus - At a Glance

Address		<i>ADDRESS 7</i>	Sets the GPIB Address
	▼	<i>INTF GPIB</i>	Selects an interface (GPIB RS232) ¹
	▼	<i>BAUDRATE 300</i>	Selects baud rate (300 600 1200 2400 4800 9600) ¹
	▼	<i>PARITY NONE</i>	Selects message parity (NONE EVEN ODD MARK SPACE) ¹
	▼	<i>FLOW NONE</i>	Selects flow control (XON-XOFF RTS-CTS DTR-DSR NONE) ¹
	▼	<i>LANG SCPI</i>	Selects language (SCPI COMP) ¹
	▼	<i>ROM: A.00.00</i>	Displays the firmware revision of the instrument
	▼	<i>SN: US12345678</i>	Displays the serial number of the instrument
Recall		<i>*RCL 0</i>	Recalls the instrument state
Shift	Save	<i>*SAV 0</i>	Saves the present instrument state
Shift	Error	<i>ERROR 0</i>	Displays the number of errors in the SCPI error queue
Shift	Channel	² <i>5.000V 0.104A</i>	Toggles the display between output 1 and output 2 (output 2 shown)
Meter		¹ <i>12.000V</i> ¹ <i>0.204A</i>	Measures the output voltage and current (output 1 shown)
	▼	¹ <i>12.500V MAX</i>	Measures the peak output voltage ²
	▼	¹ <i>1.000V MIN</i>	Measures the minimum output voltage ²
	▼	¹ <i>12.330V HIGH</i>	Measures the high level of a voltage pulse waveform ²
	▼	¹ <i>0.080V LOW</i>	Measures the low level of a voltage pulse waveform ²
	▼	¹ <i>12.000V RMS</i>	Measures the rms voltage ²
	▼	¹ <i>0.350A MAX</i>	Measures the peak output current ²
	▼	¹ <i>0.050A MIN</i>	Measures the minimum output current ²
	▼	¹ <i>0.400A HIGH</i>	Measures the high level of a current pulse waveform ²
	▼	¹ <i>0.012A LOW</i>	Measures the low level of a current pulse waveform ²
	▼	¹ <i>0.210A RMS</i>	Measures the rms current ²
	▼	¹ <i>12.000V DC:DVM</i>	Measures the dc voltage on the DVM input ³
	▼	¹ <i>12.000V RMS:DVM</i>	Measures the rms voltage on the DVM input ³
Voltage		¹ <i>VOLT 12.000</i>	Sets the voltage of output 1 on all models
		² <i>VOLT 2.000</i>	Sets the voltage of output 2 ⁴
Current		¹ <i>CURR 2.000</i>	Sets the current limit of output 1 on all models
		² <i>CURR 1.000</i>	Sets the current limit of output 2 ⁴
Shift	Res		Not available
Protect		<i>OVERCURRENT</i>	Protection status (example shows overcurrent tripped)
Output		<i>*RST</i>	Places the dc source in the factory-default state
	▼	<i>COUPLING ALL</i>	Couples or decouples output 1 and output 2 (NONE or ALL) ³
	▼	<i>TYPE:CAP LOW</i>	Sets the output capacitance compensation (HIGH, H2, or LOW)
	▼	<i>PON:STATE RST</i>	Select the power-on state command (RST or RCL0)
	▼	<i>PROT:DLY 0.08</i>	Sets the output protection delay in seconds
	▼	<i>RI LATCHING</i>	Sets the remote inhibit mode (LATCHING, LIVE, or OFF)
	▼	<i>DFI OFF</i>	Sets the discrete fault indicator state (ON or OFF)
	▼	<i>DFI:SOUR OFF</i>	Selects the DFI source (QUES, OPER, ESB, RQS, or OFF)
	▼	<i>PORT RIDFI</i>	Sets the output port functions (RIDFI or DIGIO)
	▼	<i>DIGIO 7</i>	Sets and reads the I/O port value (0 through 7)
	▼	<i>SENSE:PROT OFF</i>	Enables or disables the open sense lead detect circuit (ON or OFF)
	▼	¹ <i>REL:MODE DD</i>	Sets the relay mode for Option 521 units (DD, HD, DH, or HH) (output 1 shown)
Shift	OV	<i>VOLT:PROT 22</i>	Sets the overvoltage protection level
	▼	<i>PROT:STAT ON</i>	Enables or disables overvoltage protection (ON or OFF)
Shift	Input	<i>CURR:RANG HIGH</i>	Sets the current range (HIGH, LOW, or AUTO) ²
	▼	<i>CURR:DET ACDC</i>	Sets the current measurement detector (ACDC or DC) ²
	▼	<i>TINT 46.8</i>	Sets the time interval for a front panel measurement in seconds
	▼	<i>POINT 2048</i>	Sets the buffer size for a front panel measurement
Shift	Cal	<i>CAL ON</i>	Accesses calibration menu (See Appendix B).

Use  and  to select parameters (table shows factory defaults). Use **Meter** to exit any menu.

¹Not valid for Model 66309B

²Not valid for Model 66111A

³Only valid for Model 66309B/D

⁴Only valid for Model 66311D/66309D

SCPI Programming Commands - At a Glance

NOTE: Some [optional] commands have been included for clarity. Refer to chapter 8 for a complete description of all programming commands.

<p>ABORT</p> <p>CALibrate</p> <pre>:CURRent [:POSitive] :NEGative :MEASure :LOWRange¹ :AC¹ :CURRent2² :DATA <n> :DATE <date> :DVM³ :LEVel P1 P2 :PASSword <n> :SAVE :STATe <bool> [, <n>] :VOLTage [:DC] :PROtection :VOLTage2²</pre> <p>DISPlay</p> <pre><bool> :CHANnel <channel>² :MODE NORMal TEXT :TEXT <display_string></pre> <p>FORMat</p> <pre>[:DATA] ASCII REAL [,length] :BORDer NORM SWAP</pre> <p>INITiate</p> <pre>:SEQuence[1 2] :NAME TRANSient ACQuire :CONTinuous :SEQuence[1], <bool> :NAME TRANSient, <bool></pre> <p>INSTrument</p> <pre>:COUPling:OUTPut:STATe NONE ALL²</pre> <p>MEASure</p> <pre>:CURRent2 [:DC]?² :VOLTage2 [:DC]?²</pre> <p>MEASure FETCh</p> <pre>:ARRay :CURRent? :VOLTage? [:CURRent] [:DC]? :ACDC?¹ :HIGH?¹ :LOW?¹ :MAX?¹ :MIN?¹ :DVM [:DC]?³ :ACDC?³ :VOLTage [:DC]? :ACDC?¹ :HIGH?¹ :LOW?¹ :MAX?¹ :MIN?¹</pre> <p>OUTPut [1 2]</p> <pre><bool> :DFI <bool> :SOURce QUES OPER ESB RQS OFF :PON :STATe RST RCL0 :PROtection :CLEar :DELay <n> :RELay :MODE DD HD DH HH² :RI :MODE LATCHing LIVE OFF :TYPE [:CAPacitance] HIGH H2 LOW</pre>	<p>SENSe</p> <pre>:CURRent :RANGe <n>¹ :DETector ACDC DC¹ :FUNction "VOLT" "CURR" "DVM" :PROtection :STATe <bool> :SWEEp :OFFSet :POINts <n> :POINts <n> :TINTerval <n> :WINDow :TYPE "HANN" "RECT"</pre> <p>[SOURce:]</p> <pre>CURRent <n> :TRIGgered <n> :PROtection :STATe <bool> CURRent2 <n>² :TRIGgered <n>² DIGital :DATA <n> :FUNction RIDF DIG VOLTage <n> :TRIGgered <n> :PROtection <n> :STATe <bool> VOLTage2 <n>² :TRIGgered <n>²</pre> <p>STATus</p> <pre>:PRESet :OPERation [:EVENT]? :CONDition? :ENABle <n> :NTRansition <n> :PTRansition <n> :QUEStionable [:EVENT]? :CONDition? :ENABle <n> :NTRansition <n> :PTRansition <n></pre> <p>SYSTEM</p> <pre>:ERRor? :LANGuage SCPI COMPatibility :VERSion?</pre> <p>TRIGger</p> <pre>:SEQuence2[:ACQuire [:IMMediate] :COUNT :CURRent <n> :DVM <n>³ :VOLTage <n> :HYSTEResis:CURRent <n> :DVM <n>³ :VOLTage <n> :LEVel :CURRent <n> :DVM <n>³ :VOLTage <n> :SLOPe :CURRent POS NEG EITH :DVM POS NEG EITH³ :VOLTage POS NEG EITH :SOURce BUS INTernal [:SEQuence1] :TRANSient[:IMMediate] :SOURce BUS :SEQuence1 :DEFine TRANSient :SEQuence2 :DEFine ACQuire</pre>
--	--

¹ Not valid for Agilent 66111A

² Only valid for Agilent 66309B/D

³ Only valid for Agilent 66311D/66309D

General Information

Document Orientation

This manual describes the operation of the Agilent Model 66111A Fast Transient, the Agilent Model 66311B/D Mobile Communications, and the Agilent Model 66309B/D Dual Output DC Source. Agilent Models 66311D and 66309D have an additional DVM measurement input on the rear panel. Unless otherwise noted, these models will be referred to by the description "dc source" throughout this manual.

The following Getting Started Map will help you find the information you need to complete the specific task that you want to accomplish. Refer to the table of contents or index of each guide for a complete list of the information contained within.

Getting Started Map

Task	Where to find information
Quick Reference Section	Chapter 1
General information Model differences Capabilities and characteristics	Chapter 2
Installing the unit Line connections Computer connections Load connections	Chapter 3
Checking out the unit Verifying proper operation Using the front panel Calibrating the unit	Chapter 4
Using the front panel Front panel keys Front panel examples	Chapter 5
Using the programming interface GPIB interface RS-232 interface	Chapter 6
Programming the unit using SCPI (and COMPatibility) commands SCPI commands SCPI programming examples SCPI language dictionary	Chapters 7 and 8 for SCPI commands. Appendix D for SCPI examples Appendix F for COMPatibility commands
Installing the VXIplug&play instrument driver NOTE: The driver must be installed on your pc to access the on-line information. Drivers are available on the web at www.agilent.com/find/drivers .	Chapter 6

Safety Considerations

This dc source is a Safety Class 1 instrument, which means it has a protective earth terminal. That terminal must be connected to earth ground through a power source equipped with a ground receptacle. Refer to the Safety Summary page at the beginning of this guide for general safety information. Before installation or operation, check the dc source and review this guide for safety warnings and instructions. Safety warnings for specific procedures are located at appropriate places in the guide.

Options and Accessories

Table 2-1. Options

Option	Description
100	87–106 Vac, 47–63 Hz
220	191–233 Vac, 47–63 Hz
230	207–253 Vac, 47–63 Hz
8ZJ	Delete instrument feet option
004	Output compensation is factory set to High mode for best transient response. (Refer to chapter 3, under "Output Compensation" for more information)
AXS ¹	Rack mount kit for two side-by-side units of equal depth. Consists of: Lock-link kit (p/n 5061-9694) and Flange kit (p/n 5062-3974)
1CM ¹	Rack mount kit for one unit (p/n 5062-3972)
521	Solid state relays to connect and disconnect the output (Models 66309B/D only)
053	Device characterization software for current measurements and display (available for Agilent Model 66311B only)

¹Support rails are required when rack mounting units. Use E3663A support rails for Agilent rack cabinets. If you are using non-Agilent rack cabinets, contact the rack manufacturer to obtain support rails for your cabinet.

Table 2-2. Accessories

Item	Part Number
GPIB cables 1.0 meter (3.3 ft)	Agilent 10833A
2.0 meters (6.6 ft)	Agilent 10833B
4.0 meters (13.2 ft)	Agilent 10833C
0.5 meters (1.6 ft)	Agilent 10833D
Rack mount with slide - for two side-by-side units of different depths	5062-3996; 1494-0015
Rack mount - for two side by side units of different depths	5062-3996
Rack mount with slide - for one unit	5062-3996; 1494-0015; 5062-4022

Description and Model Differences

The Agilent 66111A Fast Transient DC Source is a high performance dc power source that provides peak current sourcing and rapid, basic measurements in a compact, half-rack box. It is designed to simplify the testing of digital wireless communications products. Excellent voltage transient response characteristics prevent test interruptions due to triggering of low voltage phone shutdown. The 15 volt source and 5A peak current capability provides compatibility with a number of communications standards, including: GSM, CDMA, TDMA, PCS, DECT, TERA, PHS, NADC, PHS, and others. Figure 2-1 describes the output characteristic of the dc source.

The Agilent 66311B Mobile Communications DC Source is a high performance dc power source that provides all of the capabilities of the Agilent 66111A plus fast dynamic measurement and analysis of voltage and current waveforms. Dynamic measurement and analysis of current waveforms combined with precision current measurement let you characterize cellular phone current requirements under all operating conditions.

The Agilent 66309B Mobile Communications DC Source includes all of the capabilities of the Agilent 66311B with the addition of a second, electrically-isolated output. Figure 2-2 describes output characteristic of this second output, which is primarily used to provide voltage or current for a charger input on the device under test. The second output has all of the basic programmable features as the main output, with the exception of the waveform measurement capability, the open sense lead detect capability, overvoltage protection, and low current range.

The Agilent 66311D and 66309D Mobile Communications DC Sources also contain an auxiliary DVM, with input terminals located on the rear panel. This provides limited, low voltage dc and ac measurement capability, which can be used to monitor test point voltages on the unit under test as well as on the test fixture. The common mode voltage range is from -4.5 Vdc to $+25$ Vdc relative to the minus terminal of output 1. The DVM is programmable from the front panel of the instrument as well as remotely using SCPI programming commands.

Table 2-3. Model Differences

Item	Agilent 66111A	Agilent 66311B	Agilent 66311D	Agilent 66309B	Agilent 66309D
Waveform measurements	NO	YES	YES	YES ¹	YES ¹
Low range current measurements	NO	YES	YES	YES ¹	YES ¹
ACDC measurement detector	NO	YES	YES	YES ¹	YES ¹
Output compensation	YES	YES	YES	YES ¹	YES ¹
Open sense lead protection	YES	YES	YES	YES ¹	YES ¹
Auxiliary output (output 2)	NO	NO	NO	YES	YES
External DVM input	NO	NO	YES	NO	YES
Adjustable measurement buffer	YES	YES	YES	YES	YES
Compatibility commands	YES	YES	YES	NO	NO
RS-232 interface	YES	YES	YES	NO	NO

¹Applies to the main output (output 1) only.

2 - General Information

Common Capabilities

- ◆ Voltage and current control with 12-bit programming resolution on output 1.
 - 3 ampere current source capability (up to 5 amperes for 7 milliseconds)
- ◆ Extensive measurement capability on output 1
 - dc voltage and current.
 - rms and peak voltage and current.
 - Current measurement capability up to approximately 7.0 amperes
 - 16-bit measurement resolution.
 - Triggered acquisition of digitized current and voltage waveforms (all models except Agilent 66111A)
- ◆ Front panel control with 14-character vacuum fluorescent display, keypad, and rotary control for voltage and current settings.
- ◆ Built-in GPIB interface programming with SCPI command language.
- ◆ Non-volatile state storage and recall with SCPI command language.
- ◆ Over-voltage, over-current, over-temperature, and RI/DFI protection features.
- ◆ Extensive selftest, status reporting, and software calibration.

Front Panel Controls

The front panel has both rotary and keypad controls for setting the output voltage and current. The panel display provides digital readouts of a number of output measurements. Annunciators display the operating status of the dc source. System keys let you perform system functions such as setting the GPIB address and recalling operating states. Front panel Function keys access the dc source function menus. Front panel Entry keys let you select and enter parameter values. Refer to chapter 5 for a complete description of the front panel controls.

Remote Programming

NOTE: When shipped, all dc sources are set to the SCPI programming language. On Agilent 66111A and Agilent 66311B/D units you can change the programming language from SCPI to COMPatibility language. Press the front panel **Address** key, use ▼ to scroll to the LANG command, press ⏴ to select COMP, then press **Enter**. The language setting is saved in non-volatile memory.

The dc source may be remotely programmed via the GPIB bus, and on Agilent 66111A and 66311B/D units, from an RS-232 serial port. GPIB programming is with SCPI commands (Standard Commands for Programmable Instruments), which make dc source programs compatible with those of other GPIB instruments. Dc source status registers allow remote monitoring of a wide variety of dc source operating conditions. A Compatibility language mode is also included on Agilent 66311A and 66311B/D units to make the dc source compatible with the Agilent 6632A, 6633A, and 6634A Series dc power supplies (refer to appendix E). Note that the compatibility features of this unit are limited to the features that were originally available on Agilent 6632A, 6633A, and 6634A units.

Output 1 Characteristic

The dc source's main output (output 1) characteristic is shown in the following figure. The main output of the dc source may be adjusted to any value within the boundaries shown.

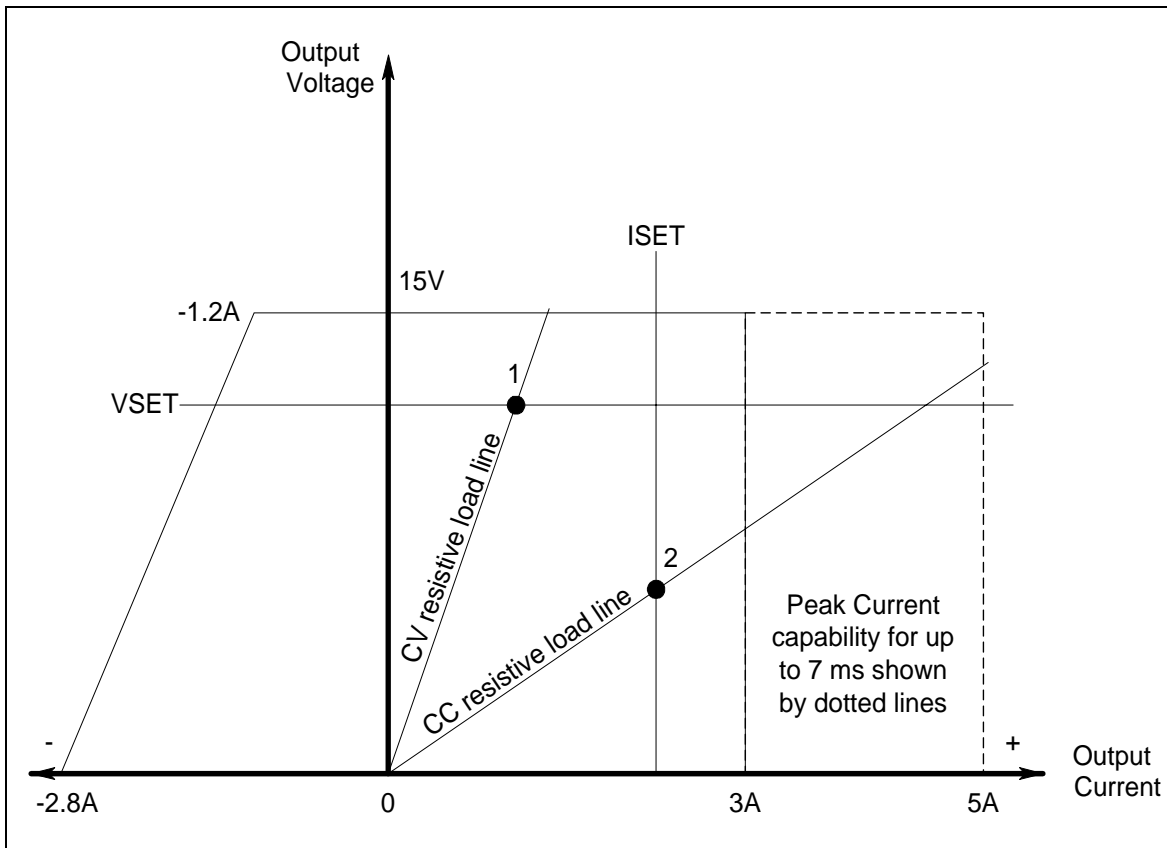

Figure 2-1. Dc Source Output 1 Characteristic

The dc source is capable of providing a constant dc output of 15 volts with up to 3 amperes of current. It is capable of sourcing peak currents of up to 5 amperes -- provided the peak current pulse does not exceed 7 milliseconds, and the *average* current requirement does not exceed 3 amperes. If the unit attempts to draw current for longer than seven milliseconds, the current limit amplifier will limit the current to a maximum of 3.0712 amps. The peak current capability is illustrated by the dotted line in Figure 2-1.

NOTE: To source up to 5 amperes of current for up to 7 milliseconds, **the current limit must be programmed for greater than 3 amperes (up to a maximum of 3.0712 A).**

The dc source can operate in either constant voltage (CV) or constant current (CC) over the rated output voltage and current. Although the dc source can operate in either mode, it is designed as a *constant voltage* source. This means that the unit turns on in constant voltage mode with the output voltage rising to its Vset value. There is no command for constant current operation. The only way to turn the unit on in constant current mode is by placing a short across the output and then enabling or turning the output on.

Note that the dc source cannot be programmed to operate in a specific mode. After initial turn-on, the operating mode of the unit will be determined by the voltage setting, current setting, *and* the load resistance. In figure 2-1, operating point 1 is defined by the load line traversing the positive operating quadrant in the constant voltage region. Operating point 2 is defined by the load line traversing the

2 - General Information

positive operating quadrant in the constant current region.

Figure 2-1 also shows a single range – two quadrant capability. This means that the dc source is capable of sourcing as well as sinking current over the output voltage range from zero volts to the rated voltage. This negative current sinking capability provides fast downprogramming of the output of the dc source. It can also be used to sink current from a battery charger, thus providing battery charger test capability. The negative current is not programmable, and varies linearly from approximately 1.2 amperes at the full rated voltage, to approximately 2.8 amperes at zero output voltage.

NOTE: If you attempt to operate the dc source beyond its output ratings, the output of the unit may become unregulated. This is indicated by the UNR annunciator on the front panel. The output may also become unregulated if the ac line voltage drops below the minimum rating specified in Appendix A.

Output 2 Characteristic

As shown in the following figure, Agilent 66309B/D units have a second output rated at 12 V and 1.5A. The second output has all of the primary programmable features as the main output, with the exception of the waveform measurement capability, the open sense lead detect capability, overvoltage protection, and low current range.

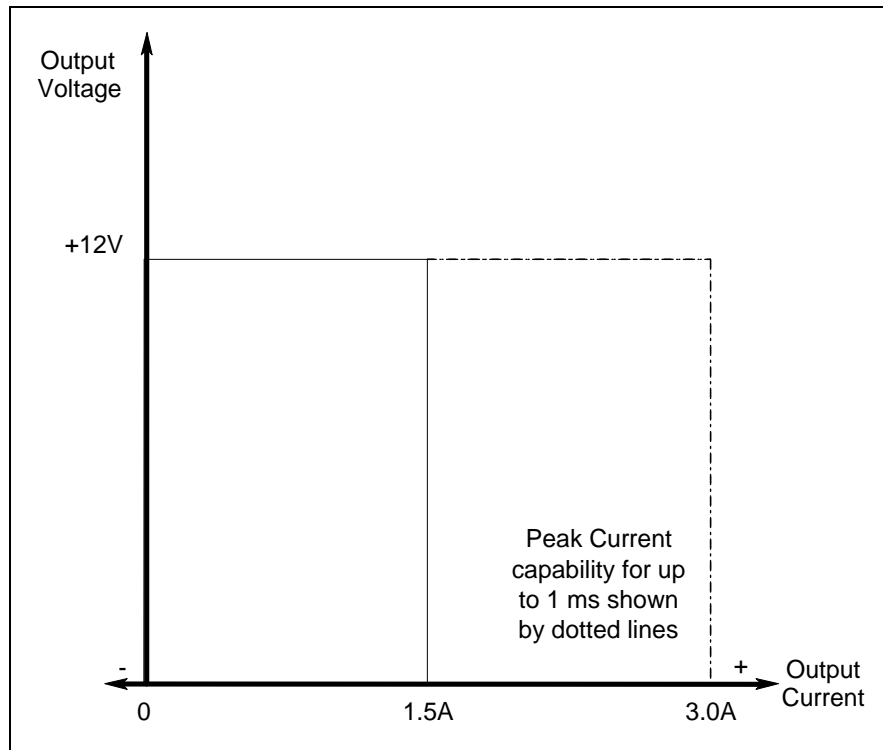

Figure 2-2. Output 2 Characteristic

Tables A-1 through A-3 document the specifications and supplemental characteristics of the Agilent dc sources documented in this manual.

Option 521 Description (Agilent 66309B/D only)

Option 521 consists of the following enhancements to the output capabilities of Agilent models 66309B/66309D:

- ◆ **Solid-state relays to connect and disconnect the output of the dc source.**
The relays are available on the output and sense terminals of outputs 1 and 2. When the solid state relays are open, the output impedance is effectively raised to about 500k ohms for output 1, and about 200k ohms for output 2. Note that the relays open only in response to an Output OFF command.
- ◆ **The ability to either Hot switch or Dry switch the solid state relays.**
With Hot switching, the relays control the on/off characteristics of the voltage at the output terminals. With Dry switching, the power mesh controls the on/off characteristics of the voltage at the output terminals. In general, Hot switching activates the relays when current is flowing through them. Dry switching activates the relays when no current is flowing through them. You can specify different relay options for the Output ON and Output OFF commands. The following table describes the actions that occur based on the relay mode selection in response to the ON or OFF commands.

Table 2-5. Option 521 Relay Modes

Relay Mode	Output ON	Output OFF
Dry (D)	1. Closes the output relay 2. Closes the sense relay 3. Programs the output	1. Downprograms the output 2. Opens the sense relay 3. Opens the output relay
Hot (H)	1. Programs the power mesh 2. Closes the output relay 3. Closes the sense relay	1. Opens the sense relay 2. Opens the output relay 3. Downprograms the power mesh

The relay modes are stored in non-volatile memory. The last selected mode will be restored when the unit is turned on. When shipped from the factory, the relay mode for both output 1 and output 2 is set to Output ON Hot, Output OFF Hot (HH). The *RST command has no effect on the relay mode.

- NOTES:**
- Even with open sense lead detection enabled, the dc source does not check for open sense leads when output 1 is enabled if the Output ON relay mode is set to Hot.
 - On output 1 and output 2, with the Output OFF relay mode set to Hot, any external output capacitors will not be downprogrammed or discharged. This is because the output relay opens prior to the downprogramming of the power mesh.
 - With either output 1 or output 2 disabled, the output voltage readback will not be correct. This is because the sense relay is open, effectively breaking the readback path. The voltage readback will be a small negative number.

Table 2-6. Option 521 Factory Settings

Output Coupling	None (outputs not coupled)
Output Sense Protection	Off
Output Compensation	High
Output 1 Relay Mode	HH
Output 2 Relay Mode	HH

Installation

Installation and Operation Checklist

Check the Output Compensation

Check that the output compensation of the dc source is appropriate for your application. Refer to “Output Compensation” in this chapter.

High mode provides the best transient response and can be used with phones having input capacitances from 5 to 12000 μ F. **Note** that if the last two digits on the front panel display are fluctuating when the phone is in standby, you may want to set the output compensation to Low mode.

Low mode is used when testing phones having input capacitances from 0 to 12000 μ F. Standard dc sources are factory-set to Low mode.

Check the Phone Connections

If you ARE remote sensing, are the + and – sense leads connected ONLY at the test fixture and within 20 inches of the phone contacts? For best performance, the distance from sense lead termination to the phone contacts should be as short as possible. Refer to “Lead Resistance” in this chapter. If your unit has a remote sense switch on the back, make sure it is set to the Remote position (out).

If you are NOT remote sensing, are the sense jumpers installed in the output connector? Ensure that the output connector plug is installed in the unit with its supplied sense jumpers in place. Without sense jumpers, the unit goes into a protect state with the output disabled. If your unit has a remote sense switch on the back, you don't need sense jumpers. Make sure the switch is set to the Local position (in).

Check the Operating Settings and Conditions

Are you able to communicate remotely with the dc source? If not, check that the address is set correctly. Refer to “GPIB Address” in the User's Guide. If your unit has both SCPI and COMP language settings, check that the programming language is set correctly. Refer to “Language setting” in chapter 5.

Is the Prot or Err annunciator on the front panel on? If yes, clear the fault condition before continuing. Refer to “Clearing Protection” in chapter 5.

Is the Overvoltage circuit shutting the unit down? If yes, you can disable the overvoltage circuit. Refer to “Clearing Protection” in chapter 5.

Are the front panel readings unstable? If yes, check that the front panel sampling rate is correct. Also check the setting of the output compensation. Refer to “Front Panel Measurements” in chapter 5 and “Output Compensation” in this chapter.

Additional Agilent 66311/66309 Operating Settings Checks

Are you measuring dynamic output currents? If yes, check that the current detector is set to ACDC. Refer to “Front Panel Measurements” in chapter 5.

Are you measuring output currents under 20 mA? If yes, check that the current range is set to LOW. Refer to “Front Panel Measurements” in chapter 5.

Inspection

Damage

When you receive your dc source, inspect it for any obvious damage that may have occurred during shipment. If there is damage, notify the shipping carrier and the nearest Agilent Sales and Support Office immediately. The list of Agilent Sales and Support Offices is at the back of this guide. Warranty information is printed in the front of this guide.

Packaging Material

Until you have checked out the dc source, save the shipping carton and packing materials in case the unit has to be returned. If you return the dc source for service, attach a tag identifying the model number and the owner. Also include a brief description of the problem.

Items Supplied

The following user-replaceable items are included with your dc source. Some of these items are installed in the unit.

Table 3-1. Items Supplied

Item	Part Number	Description
Power Cord	contact the nearest Agilent Sales and Support Office	A power cord appropriate for your location.
Digital I/O connector	1252-1488	4-terminal digital plug for connecting digital I/O leads. The connector installs in the back of the unit.
Output connector	0360-2604	5-terminal output plug for connecting load and sense leads. This connector installs in the back of the unit.
DVM connector	1252-8670	3-terminal plug for DVM connections (66309B/D)
Sense jumpers	8120-8821	Jumpers that insert into output connector for local sensing. Connect +s to +, and –s to –.
Line Fuse	2110-0638 2110-0773	3.15 AT (time delay) for 100/120 Vac operation 1.6 AT (time delay) for 220/230 Vac operation
Feet	5041-8801	feet for bench mounting
User's Guide	5964-8125	This manual. Contains installation, checkout, front panel, and programming information.

Cleaning

Use a dry cloth or one slightly dampened with water to clean the external case parts. Do not attempt to clean internally.

WARNING: To prevent electric shock, unplug the unit before cleaning.

Location

Figure 3-1 gives the dimensions of your dc source. The dc source must be installed in a location that allows sufficient space at the sides and back of the unit for adequate air circulation (see Bench Operation).

NOTE: This dc source generates magnetic fields that may affect the operation of other instruments. If your instrument is susceptible to operating magnetic fields, do not locate it in the immediate vicinity of the dc source. Typically, at three inches from the dc source, the electromagnetic field is less than 5 gauss. Many CRT's, such as those used in computer displays, are susceptible to magnetic fields much lower than 5 gauss. Check susceptibility before mounting any display near the dc source.

Bench Operation

Do not block the fan exhaust at the rear of the unit.

A fan cools the dc source by drawing air in through the sides and exhausting it out the back. Minimum clearances for bench operation are 1 inch (25 mm) along the sides.

Rack Mounting

The dc source can be mounted in a standard 19-inch rack panel or cabinet. Table 2-1 documents the part numbers for the various rack mounting options that are available for the dc source. Installation instructions are included with each rack mount option.

NOTE: Support rails or an instrument shelf is required when rack mounting units.

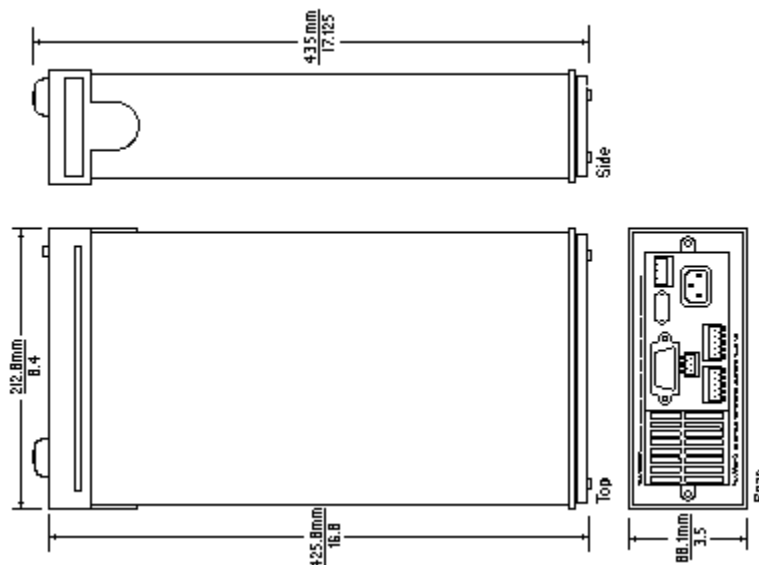

Figure 3-1. Outline Diagram

Input Connections

Connect the Power Cord

Connect the power cord to the IEC 320 connector on the rear of the unit. If the wrong power cord was shipped with your unit, contact your nearest Agilent Sales and Support Office to obtain the correct cord (refer to the list at the back of this guide).

Check the line voltage rating label on the back of the unit to make sure that it agrees with your ac mains voltage. Refer to appendix E if the voltage at your site is different from the voltage indicated on the unit.

Output Connections

Turn the unit off before connecting any wires.

Output 1

The main output connector (output 1) has a termination for the + and – output, the + and – sense terminals, and an earth ground terminal. The 5-pin connector is removable and accepts wires sizes from AWG 22 to AWG 12. Disconnect the mating plug from the unit by pulling it straight back.

IMPORTANT: You must connect the sense terminals on Output 1 for the unit to operate properly. Refer to the section on "Open Sense Lead Protection" in this chapter. Install the connector plug with its supplied sense jumpers *before* applying power to the unit.
You cannot connect outputs in parallel. Instrument operation can become unstable.

Output 2

Agilent 66309B/D units have a second output connector (output 2). It has the same configuration as the main output connector. It has a termination for the + and – output, the + and – sense terminals, and an earth ground terminal. The 5-pin connector is removable and accepts wires sizes from AWG 22 to AWG 12. Disconnect the mating plug from the unit by pulling it straight back. You must connect the sense terminals on Output 2 for the unit to meet its published specifications.

Current Ratings

Fire Hazard To satisfy safety requirements, load wires must be large enough not to overheat when carrying the maximum short-circuit current of the dc source.

The following table lists the characteristics of AWG (American Wire Gage) copper wire.

Table 3-2. Ampacity and Resistance of Stranded Copper Conductors

AWG No.	Maximum Ampacity (in free air)	Resistance (at 20 deg. C)	
		Ω/m	Ω/ft
24	3.52	0.0843	0.0257
22	5.0	0.0531	0.0162
20	8.33	0.0331	0.0101
18	15.4	0.0210	0.00639
16	19.4	0.0132	0.00402
14	31.2	0.0083	0.00252
12	40	0.0052	0.00159

Voltage Drops and Lead Resistance

To optimize the performance and transient response in your test system, please observe the following guidelines:

- ◆ Twist the load leads together and keep them short. The shorter the leads, the better the performance.
- ◆ When remote sensing, twist the sense leads together but do not bundle them in with the load leads.
- ◆ For best performance, keep the total cable length to the load to 20 ft or less when remote sensing. (Note that the unit has been tested with cable lengths of up to 40 feet.)

The load wires must also be of a diameter large enough to avoid excessive voltage drops due to the impedance of the wires. In general, if the wires are heavy enough to carry the maximum short circuit current without overheating, excessive voltage drops will not be a problem.

The maximum allowable value of load lead resistance is 4 ohms total (2 ohms per side). This may be further limited to a lower value, based on peak current loading, by the maximum allowable dc voltage drop of 8 volts total (4 volts per side) as specified for remote sense operation. To illustrate, for up to 2 amps peak, the maximum allowable resistance is 4 ohms total, resulting in a maximum voltage drop of up to 8 volts. For 4 amps peak the maximum allowable resistance is 2 ohms total, again resulting in a maximum allowable voltage drop of up to 8 volts.

In addition to keeping dc resistance low, you also need to minimize the total impedance. For higher slew rate currents (0.2 amps/ μ s) and long wiring lengths (10 to 20 ft.) the inductance can have as much effect as the resistance. To minimize inductance, twist the load leads. The inductance will be on the order of 0.25 μ H/ft if twisted, and 0.4 μ H/ft if untwisted. In addition to lowering the inductance, twisting the leads will reduce noise pick up. If you are using remote sense leads, connect these as a second twisted pair. Do not twist or bundle them with the load leads.

NOTE: The use of relays between the dc source and the phone also increases impedance. Low resistance relays will improve system performance.

Remote Sense Connections

NOTE: You must use remote sensing on both Output 1 and Output 2 for the unit to operate properly and meet its published specifications. If you are **not** using output 1 and the open sense protection feature is turned **ON**, you must jumper the + output 1 pin to its + sense pin, and jumper the - output 1 pin to its - sense pin. Otherwise, the unit will go into a protected state and disable the output (unless open sense protection is turned **OFF**).

Testing has verified stable performance with up to 20 inches of lead length between the sense lead termination and the phone connection (see figure 3-4). However, for optimum performance, connect the sense leads as close as possible to the phone under test. To minimize inductance, connect the sense leads and load leads as separate twisted pairs (see Figure 3-2).

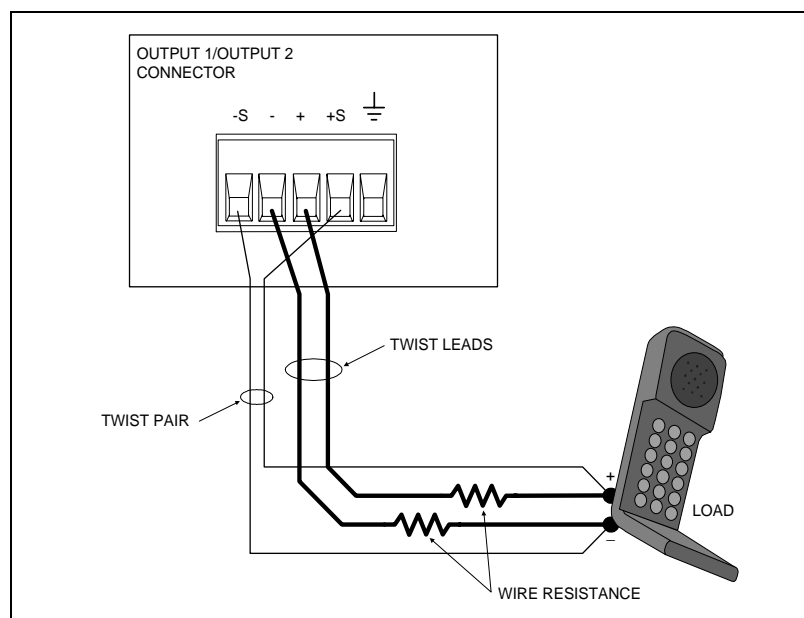

Figure 3-2. Remote Sense Connections

3 - Installation

The sense leads are part of the dc source's feedback path and must be kept at a low resistance (less than several ohms) to maintain optimal performance. Connect the sense leads carefully so that they do not become open-circuited. If the sense leads are left unconnected or become open during operation, the dc source will not regulate the output voltage. See "Open Sense Lead Protection".

Connect the remote sense leads only to the remote sense connections at the output connector and at the location on the test fixture where you want to sense the output voltage. There must not be any continuity from the sense leads to earth ground or from the sense leads to the output leads other than at the test fixture. The open sense detect circuit will check for continuity in the sense leads when the output turned on (from disabled to enabled).

Figure 3-3 shows how to connect remote sense leads and load leads when external disconnect relays are included in the load path.

NOTE: In this arrangement, the output of the unit should be programmed OFF *before* the relays are switched. This is because if the load leads are opened before the sense leads, the overvoltage protection circuit will trip if it is enabled.

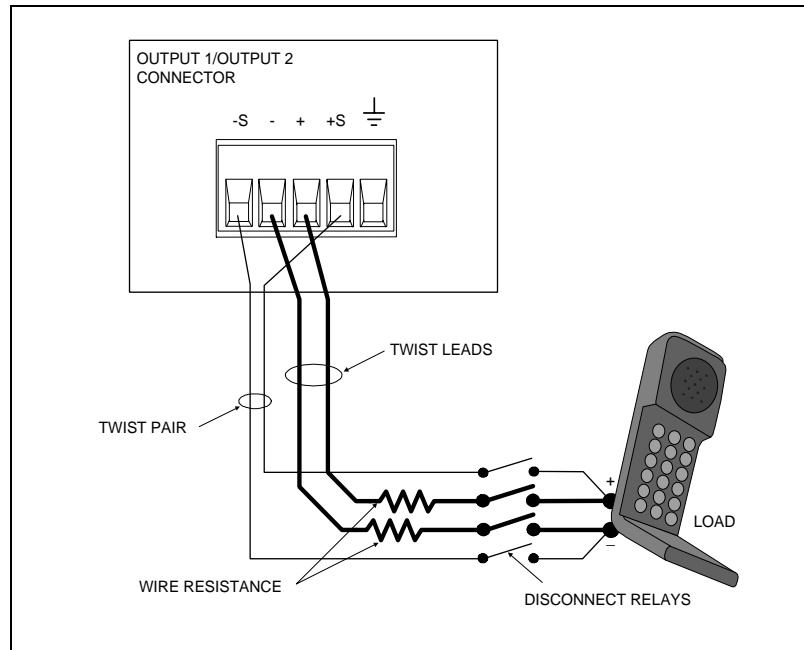

Figure 3-3. Remote Sense Connections with External Relays

Figure 3-4 shows how to connect remote sense leads when using a removable test fixture. Note that in this configuration, the wires in the part of the test fixture where the phone is located must be less than 20 inches in length. This is for stability as well as for the fact that the remote sense leads cannot compensate for the voltage drop in this part of the test fixture.

The overvoltage protection circuit senses voltage at the output terminals, not at the load. Therefore, due to the load lead voltage drop, the voltage measured by the OVP circuit can be significantly higher than the actual voltage at the load. When using remote sensing, you must program the OVP trip voltage high enough to compensate for the voltage drop between the output terminals and the load. Also, if the sum of the programmed voltage and the load-lead drop exceeds the maximum voltage rating of the dc source, this may also trip the OV protection circuit. Refer to OVP considerations for more information.

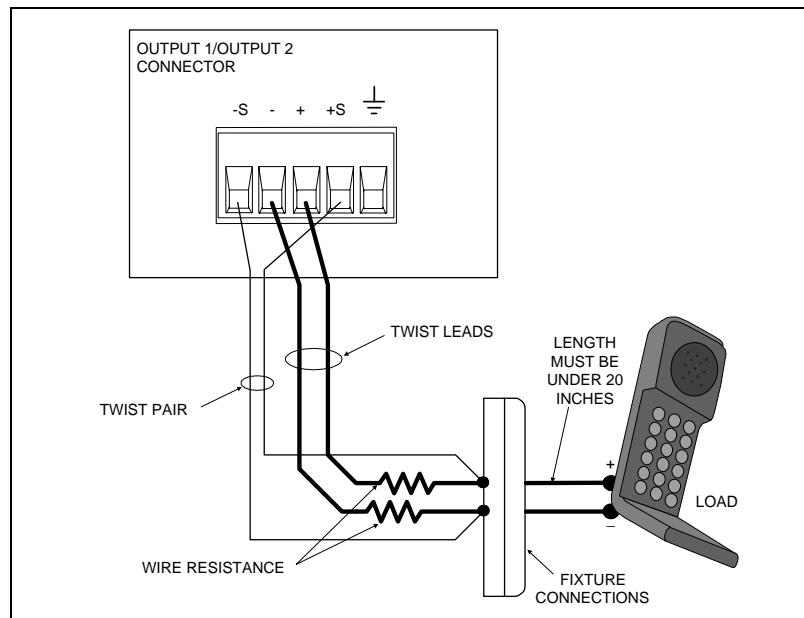

Figure 3-4. Remote Sense Connections with Test Fixture

Load Regulation and Voltage Drop in the Remote Sense Leads

The sense leads are part of the dc source's feedback path and must be kept at a low resistance to maintain optimal performance. One way to accomplish this is to use larger diameter wires for the sense leads (see Table 3-2).

If this is impractical, you can account for the voltage regulation and readback error that will occur when using higher resistance remote sense leads. The voltage load regulation and readback error can be calculated using the following formula:

$$\Delta V = V_{LD+} \left(\frac{R_{S+}}{R_{S+} + 251} \right) + V_{LD-} \left(\frac{R_{S-}}{R_{S-} + 184} \right)$$

where: V_{LD+} and V_{LD-} are the voltage drops in the + and - load leads.
 R_{S+} and R_{S-} are the resistances of the + and - sense leads.

Minimizing the load lead resistance reduces voltage drops V_{LD+} and V_{LD-} . ΔV can be further minimized by decreasing the resistance of the sense leads (R_{S+} and R_{S-}) as much as possible.

Maintaining Stability while Remote Sensing

The remote sense bandwidth and slew rate of standard dc power sources are adequate for compensating for load lead voltage drop for slow to moderate rates of load changes. However, the high pulsed current draw of digital cellular phones presents a challenge to standard dc power sources operating in remote sense mode. Their bandwidth and slew rate are not adequate for dealing with the 0.05 to 0.2 amp/ μ s slew rates imposed by these devices. A large voltage transient occurs at the load, due to the inability of the dc source to keep up with the rate of load change.

The dc source effectively compensates for load lead voltage drops resulting from very high slew rate load current transitions. This keeps the remotely sensed output voltage at a relatively constant level. For 0.05 amp/ μ s to 0.2 amp/ μ s slew rate loading in typical test applications, the transient voltage is reduced more than an order of magnitude over that of other standard dc sources.

Open Sense Lead Protection

The main output (output 1) of the dc source has built-in open sense protection circuitry that detects if there is an open in either the positive or the negative remote sense lead or load lead path. For battery powered devices, undetected open sense connections can cause incorrect battery charger calibration, incorrect test results due to erroneous voltage settings, and low voltage phone shutdown due to a large transient voltage drop.

To enable open sense lead detection from the front panel, press the **Output** key, use **▲** to scroll to SENS:PROT, press **▼** to select **ON**, then press **Enter**. To have the unit turn on with open sense detection enabled, save this state in location 0 and set the power-on state to RCL 0.

When this circuit is enabled, the sense and load leads are checked every time the output transitions from disabled to enabled (off to on). If a lead opens while the output is enabled, this will not be detected immediately by the open sense circuit. However, the output voltage will increase or decrease, depending on which one of the leads is open. Figure 3-5 illustrates the actual output voltage change that occurs with no load lead drop if a lead opens. Turning the output off, then on again, will cause the unit to check the output sense and load leads and determine if a sense lead is open.

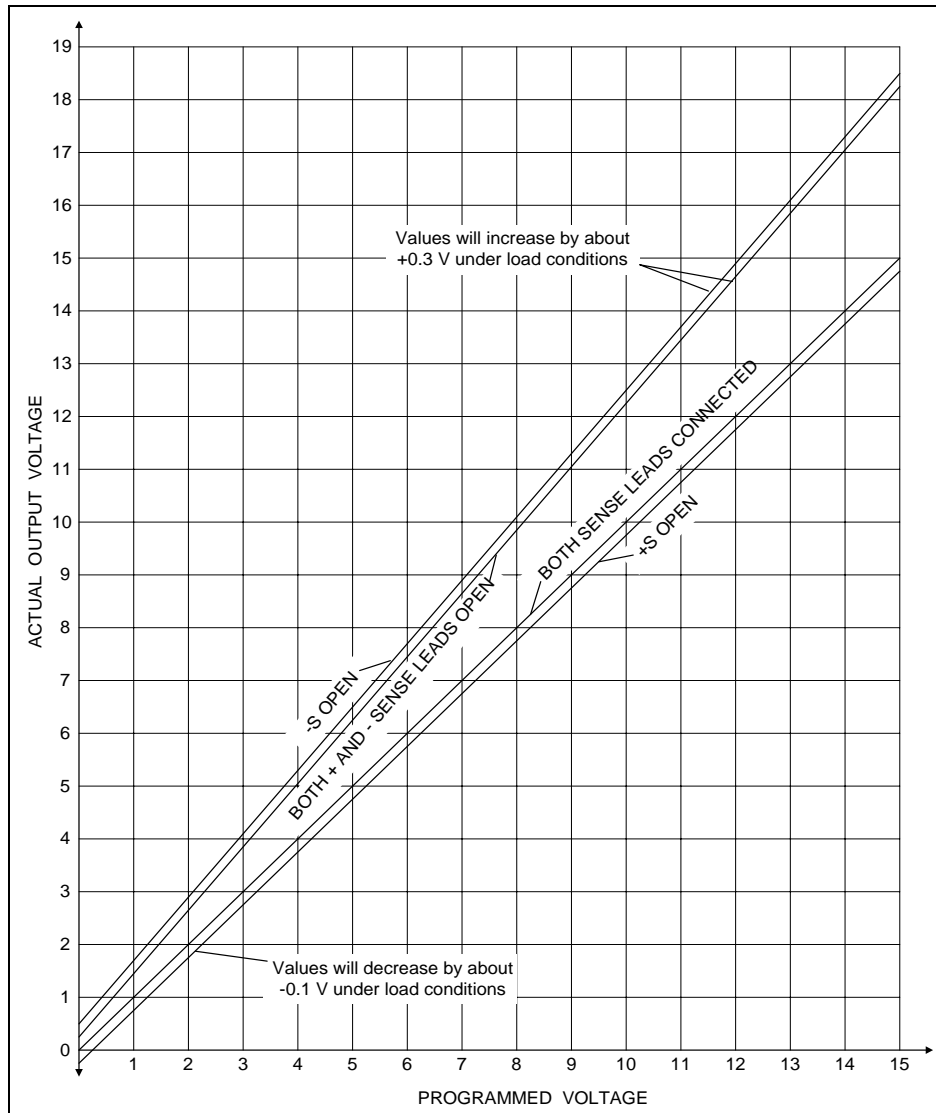

Figure 3-5. Output Voltage vs. Programmed Voltage with Open Sense Condition

If the open sense lead protection circuit detects an open sense lead, the **Prot** annunciator on the front panel turns on and the output turns off. Bit 5 in the Questionable Status Registers is also set (see chapter 7 under "Programming the Status Registers"). On the front panel, press the **Prot** key, and one of the following error messages will be reported on the front panel:

<u>Message</u>	<u>Description</u>
+ sense open	Positive sense or load lead is open
- sense open	Negative sense or load lead is open
+/- sense open	Both positive and negative sense or load leads are open
sense open	Incorrect resistance reading on the sense or load leads. This may be caused by an external power source paralleled with the output, or in rare instances, by the voltage being out of calibration.

The default setting for the open sense lead protection circuit is disabled or **OFF**. This is because applications that apply an external voltage to the output or that use external disconnect relays may interfere with the operation of the open sense detect circuit. If you are using external voltages or relays, you can enable the open sense detect at the beginning of the test procedure. Make sure that the external voltage is disabled and that any relays are in the closed position. Perform the remote sense check by cycling the output off, then on. Then disable the open sense detect circuit and continue using the unit.

Local Sensing

Local sensing is not recommended for optimal performance. You must use the remote sense connections on both the main output (output 1) and on output 2 for the unit to operate properly and meet its published specifications. If you are **not** using remote sensing and the open sense protection feature is **ON**, you must jumper the + output 1 pin to its + sense pin, and jumper the - output 1 pin to its - sense pin. Otherwise, the unit will go into a protected state with the output disabled.

- ◆ Keep load leads as short as possible. Load leads cannot exceed 18 inches (per side) when local sensing.
- ◆ Bundle or twist the leads tightly together to minimize inductance.
- ◆ Jumper the + output 1 pin to its + sense pin, and the - output 1 pin to its - sense pin.

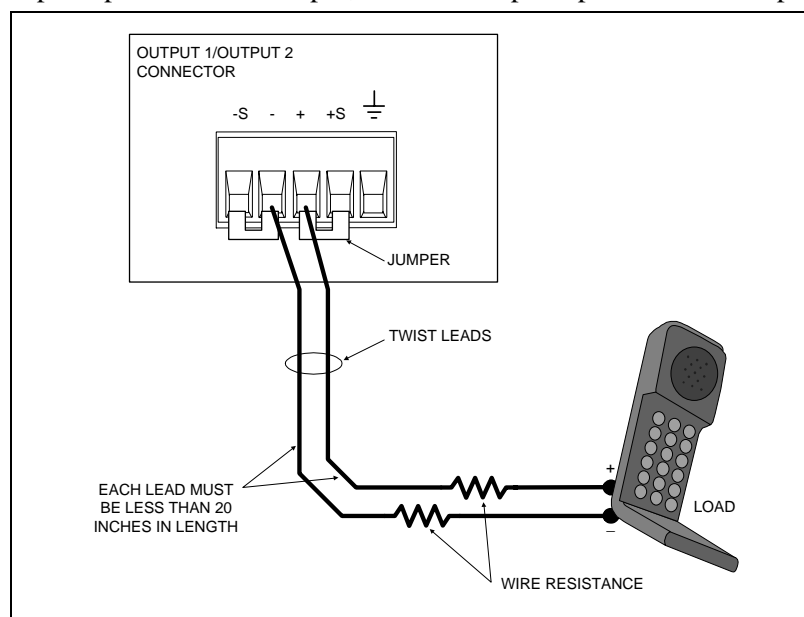

Figure 3-6. Local Sensing

Output Compensation

High bandwidth performance and stability are achieved by using a software-switchable output compensation circuit. This compensation circuit has two bandwidth positions to optimize the response for two different ranges of phone capacitance. The compensation function is set using either the front panel TYPE:CAP command located in the Output menu (see chapter 5), or the OUTput:TYPE[:CAPacitance] SCPI command as explained in chapter 8. The circuit covers the following capacitance ranges:

- ◆ Low Mode: 0 to 12,000 μF
- ◆ High Mode: 5 μF to 12,000 μF
- ◆ H2 Mode: keeps the unit in High mode at all times

The dc source is shipped from the factory with the output compensation set to **Low** Mode. If you do not know the input capacitance of the phone that you are testing, leave the input capacitance set to Low Mode initially. This is because in Low Mode, the output of the dc source will be stable when testing cellular phones that have virtually any input capacitance (from 0 μF to 12,000 μF). Low mode however, has a slower transient response (see appendix A).

The **High** Mode output compensation setting provides faster transient response performance for phones with input capacitances greater than 5 μF . (Most phones have input capacitances greater than 5 μF .) In High mode, operation of the dc source may be momentarily unstable with phones that have input capacitances *less* than 5 μF , or if the output sense leads are not connected. Note that if the dc source senses that there is no load on the output, it will automatically switch from High compensation mode to Low compensation mode.

H2 Mode is an additional compensation mode that guarantees that the dc source stays in High compensation mode at all times. This mode may be the optimal setting in cases where a large capacitor is connected across the phone input and output 1 is sinking current. (H2 mode is not available in earlier dc source units.)

Use the output sense detect circuit to first determine that the sense and load leads are properly connected to the device under test. Then, if you are testing phones in High Mode and want to determine if the input capacitance of your phone is less than 5 μF , perform the following test.

NOTE: It is important that this test is done with the dc source installed in the test system where it will be used, since system stability is also dependent on wiring and the phone impedance.

1. Connect the phone to the dc source and place it in standby mode.
2. Check the last *two* digits of the voltage reading on the front panel of the dc source.
3. If the last two digits are fluctuating, it is an indication that the phone capacitance may be less than 5 μF and the dc source is momentarily unstable.
4. Place the output compensation of the dc source in Low Mode.
5. If the last two digits of the voltage reading are now stable, your phone has an input capacitance less than 5 μF .

OVP Considerations

CAUTION: Disabling the OVP protection circuit may cause excessive output voltages, such as can occur if the remote sense leads are shorted, to damage the equipment under test.

The dc source is shipped from the factory with its overvoltage protection circuit enabled. You can disable the OVP circuit using either the front panel VOLT PROT command located in the OV menu, or the VOLTage:PROTection:STATe SCPI command as explained in chapter 8.

The OVP circuit contains a crowbar SCR, which effectively shorts the output of the dc source whenever the OVP trips. However, if an external current source such as a battery is connected across the output and the OVP is inadvertently triggered, the SCR will continuously sink a large current from the battery, possibly damaging the dc source.

To avoid this, either disable the OVP circuit or program it to its maximum value to prevent it from inadvertently tripping. Additionally, you can connect an external protection diode in series with the output of the dc source. Connect the anode of the diode to the + output terminal.

The OVP circuit's SCR crowbar has also been designed to discharge capacitances up to a specific limit, which is 50,000 μF . If your load capacitance approaches this limit, it is recommended that you do not intentionally trip the OVP and discharge the capacitance through the SCR as part of your normal testing procedure, as this may lead to long-term failure of some components.

DVM Connections

CAUTION: The DVM may be damaged if voltages at the input terminals exceed ± 50 Vdc to ground.

The DVM connector has three pins: plus, minus, and earth ground. The 3-pin connector is removable and accepts wires sizes from AWG 22 to AWG 14. Disconnect the mating plug by pulling it straight back.

The DVM is designed as an auxiliary measurement input that can measure voltages on circuits that are powered by the main output (output 1). Voltage measurements can be made on test points inside the phone under test, or on test points located on the test fixture that is connected to the main output. Figure 3-7 illustrates a common measurement application for the DVM. This example is only provided for illustration; your specific application will vary depending on the type of test and type of phone.

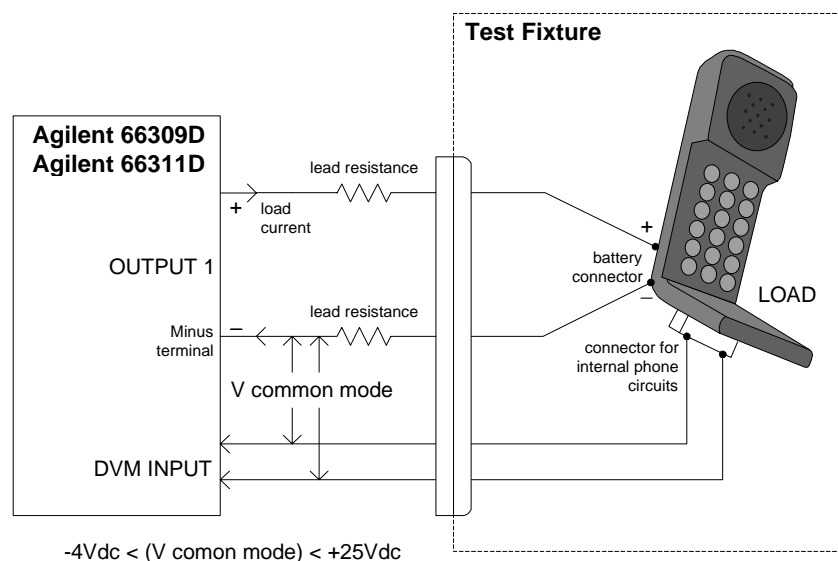

Figure 3-7. DVM Measurement Example

3 - Installation

NOTE: The DVM is not designed to measure voltages that are greater than +25 Vdc or less than -4.5 Vdc with respect to the negative terminal of the main output. The following sections discuss restrictions that apply when using the DVM to measure voltages on circuits that are **not** powered by the main output, or that are floating with respect to the main output.

Measuring Circuits that are Not Powered by the Main Output

To obtain correct voltage measurements, keep the common mode voltage within the specified limits. Common mode voltage is defined as the voltage between either DVM input terminal and the negative terminal of the main output (output 1). The common mode voltage range is from -4.5 Vdc to +25 Vdc. Attempting to measure voltages outside this range may result in incorrect readings due to clipping by the internal DVM measurement circuits.

NOTE: Do not confuse the common mode voltage with the DVM voltage readback. The DVM voltage readback is a differential measurement from one input lead to the other input lead. This quantity may be as high as ± 25 Vdc, depending on the orientation of the input leads.

Because the measurement circuits of the DVM are internally referenced to the minus terminal of the main output, you must observe the following restrictions in order to guarantee accurate DVM measurements (refer to figure 3-8).

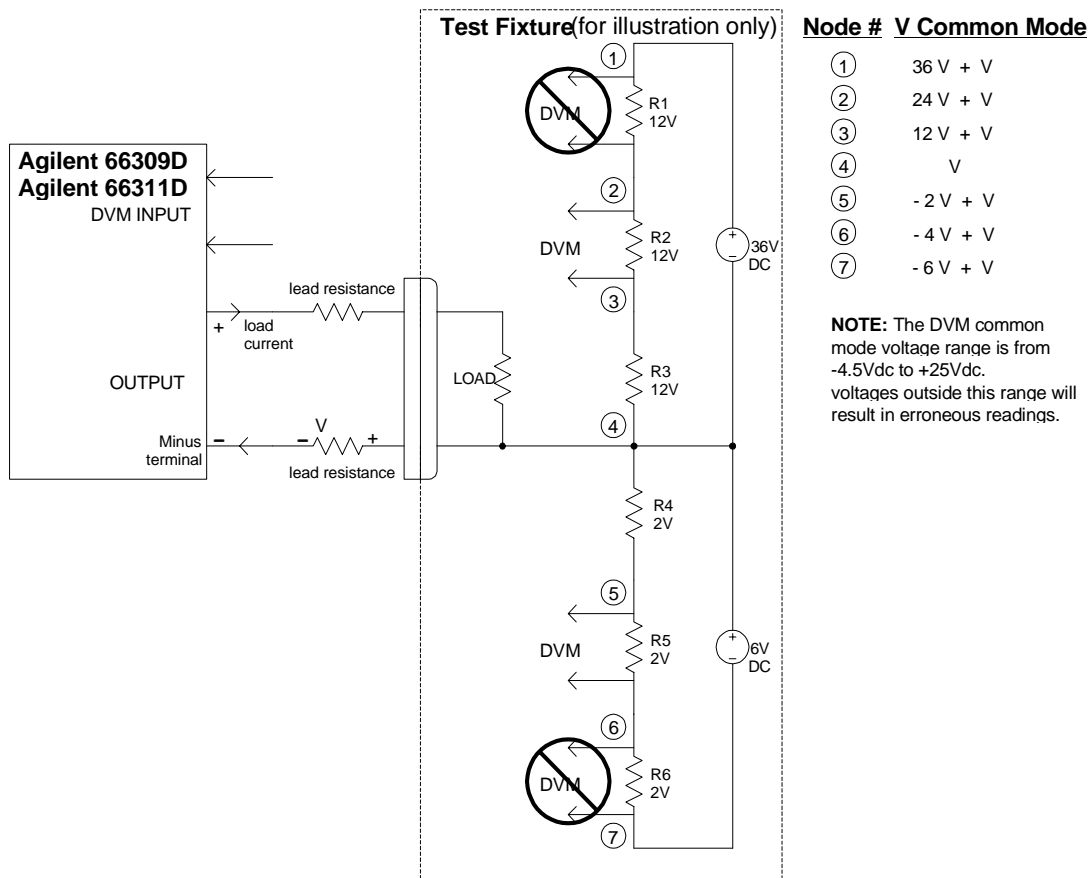

Figure 3-8. Measuring Circuits Not Powered by the Main Output

- ◆ You cannot measure voltages greater than +25 Vdc with respect to the negative terminal of the main output. A situation where this could occur is illustrated by R1 in figure 3-8, which has only a 12 Vdc drop across it but is 36 Vdc + Vlead with respect to the negative terminal of the main output.
- ◆ You cannot measure voltages less than -4.5 Vdc with respect to the negative terminal of the main output. A situation where this could occur is illustrated by R6 in figure 3-8, which has only a -2 Vdc drop across it but is -6 Vdc + Vlead with respect to the negative terminal of the main output.
- ◆ When calculating the common mode voltage between the point that you wish to measure and the negative terminal of the main output, you must also include any voltage drop in the negative load lead. For example, in figure 3-8, if the voltage drop in the negative load lead is 2 V, you would not be able to correctly measure the 12 Vdc drop across R2. This is because when the voltage drop in the load lead is added to the voltage drops across R2 and R3, the resultant voltage is 26 Vdc, which exceeds the +25 Vdc common mode rating of the DVM.

Measuring Circuits that are Floating with Respect to the Main Output

In the example shown in figure 3-9, the common mode voltage between the DVM inputs and the minus terminal of the main output (output 1) includes an undefined floating voltage that may result in incorrect readings due to clipping by the internal DVM measurement circuits. This will occur when the -4.5 Vdc to + 25 Vdc common mode voltage range is exceeded.

The solution to this problem would be to provide a known or controlled common mode voltage by connecting a jumper wire from the floating voltage to be measured to the main output. In this example, the main output is set to 5V, the ac voltage to be measured is approximately 6 Vac (± 8.5 Vpeak), and a jumper wire connects one side of the bias transformer to the + main output terminal. This stabilizes the common mode voltage and offsets it by the output voltage value (5 V). The peak common mode voltage is now:

$$+8.5\text{V} + 5\text{ V} = +13.5\text{ V on the positive side, and}$$

$$-8.5\text{V} + 5\text{ V} = -3.5\text{ V on the negative side;}$$

with both voltages now being within the common mode range of the DVM.

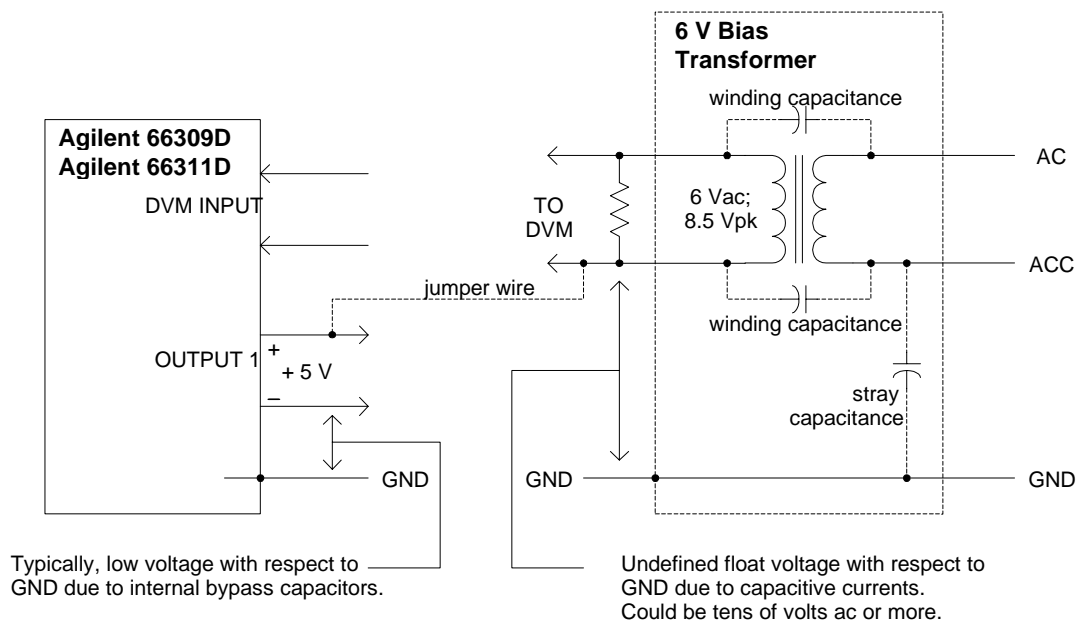

Figure 3-9. Measuring Circuits Floating with Respect to the Main Output

External Protection Connections

This rear panel connector, has a fault output port and an inhibit input port. The fault (FLT) output, also referred to as the DFI (discrete fault indicator) signal in the front panel and SCPI commands, is an open collector circuit that pulls the positive output low with respect to the negative (chassis-referenced) common. The high impedance inhibit (INH) input, also referred to as the RI (remote inhibit) signal in the front panel and SCPI commands, is used to shut down the dc source output whenever the INH + is pulled low with respect to the INH (chassis-referenced) common.

The connector accepts wires sizes from AWG 22 to AWG 12. Disconnect the mating plug to make your wire connections.

NOTE: It is good engineering practice to twist and shield all signal wires to and from the digital connectors. If shielded wire is used, connect only one end of the shield to chassis ground to prevent ground loops.

Figure 3-10 shows how you can connect the FLT/INH circuits of the dc source.

In example A, the INH input connects to a switch that shorts the Inhibit pin (+) to common whenever it is necessary to disable output of the unit. This activates the remote inhibit (RI) circuit, which turns off the dc output. The front panel Prot annunciator comes on and the RI bit is set in the Questionable Status Event register. To re-enable the unit, first open the connection between pins INH + and common and then clear the protection circuit. This can be done either from the front panel or over the GPIB.

In example B, the FLT output of one unit is connected to the INH input of another unit. A fault condition in one of the units will disable all of them without intervention either by the controller or external circuitry. The computer can be notified of the fault via a service request (SRQ) generated by the Questionable Status summary bit. Note that the FLT output can also be used to drive an external relay circuit or signal other devices whenever a user-definable fault occurs.

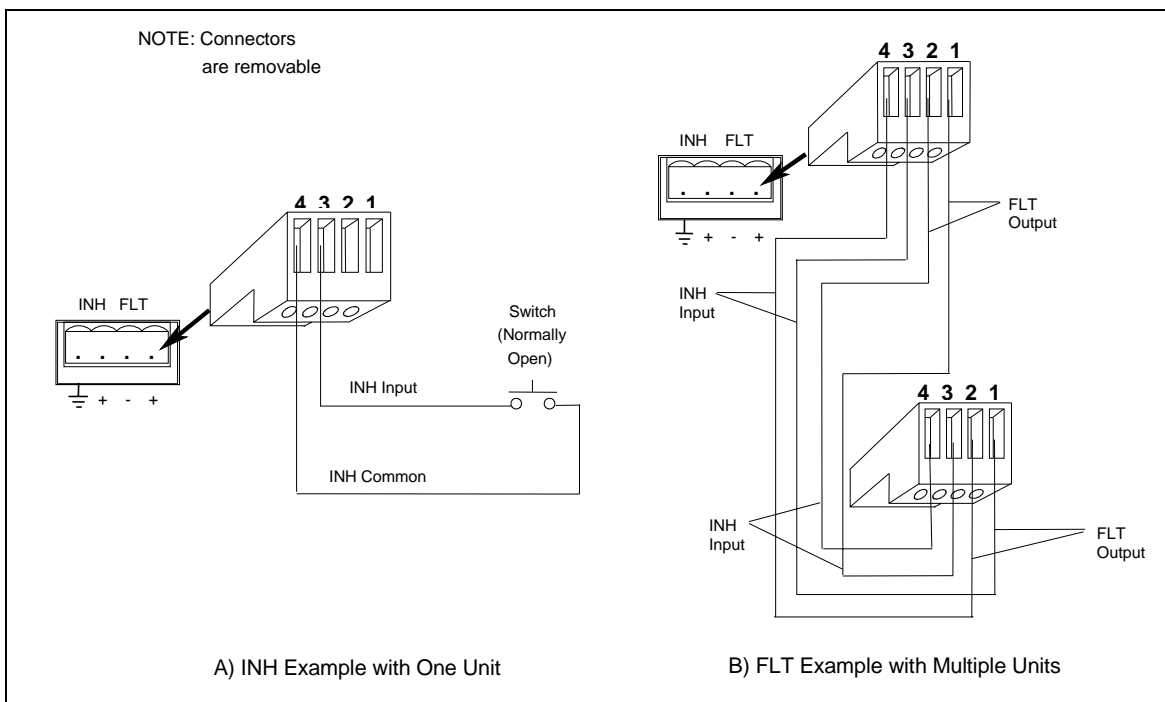

Figure 3-10. FLT/INH Examples

Digital I/O Connections

As shown in Table 3-3 and Figure 3-11, the FLT/INH connector can also be configured as a digital I/O port. Information on programming the digital I/O port is found in chapter 5 and under [SOURCE:]DIGital:DATA and [SOURCE:]DIGital:FUNCTION commands in chapter 8. The electrical characteristics of the digital connector are described in appendix A.

Table 3-3. FLT/INH DIGital I/O Connector

PIN	FAULT/INHIBIT	DIGITAL I/O
1	FLT Output	Output 0
2	FLT Common	Output 1
3	INH Input	Input/Output 2
4	INH Common	Common

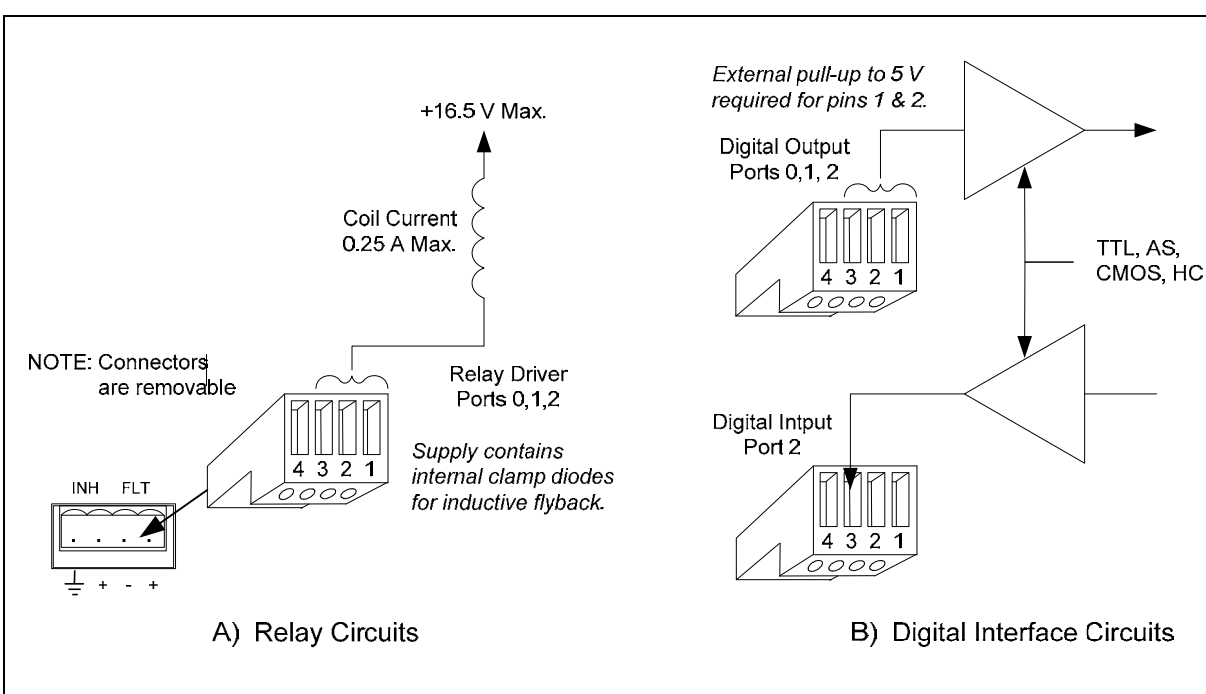

Figure 3-11. Digital I/O Examples

Computer Connections

The dc source can be controlled through an GPIB interface. Agilent 66111A and 66311B/D units can also be controlled through an RS-232 interface.

GPIB Interface

Follow the GPIB card manufacturer's directions for card installation and software driver setup.

Each dc source has its own GPIB bus address, which can be set using the front panel **Address** key as described in chapter 5. GPIB address data is stored in non-volatile memory. The dc source is shipped with its GPIB address set to 5.

3 - Installation

Dc sources may be connected to the GPIB interface in series configuration, star configuration, or a combination of the two, provided the following rules are observed:

- ◆ The total number of devices including the GPIB interface card is no more than 15.
- ◆ The total length of all cables used is no more than 2 meters times the number of devices connected together, up to a maximum of 20 meters. (Refer to table 2-2 for a list of GPIB cables available from Agilent Technologies.)
- ◆ Do not stack more than three connector blocks together on any GPIB connector.
- ◆ Make sure all connectors are fully seated and the lock screws are firmly finger-tightened.

RS-232 Interface

Agilent 66111A and 66311B/D dc sources have an RS-232 programming interface, which is activated by commands located in the front panel **Address** menu. All applicable SCPI and COMPatibility commands are available through RS-232 programming. When the RS-232 interface is selected, the GPIB interface is disabled.

The RS-232 connector is a DB-9, male connector. Adapters are available to connect the dc source to any computer or terminal with a properly configured DB-25 connector (see Table 2-2).

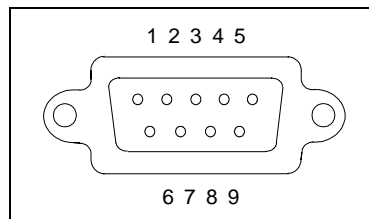

Figure 3-12. RS-232 Connector

Pin	Input/Output	Description
1	-	no connection
2	Input	Receive Data (RxD)
3	Output	Transmit Data (TxD)
4	Output	Data Terminal Ready (DTR)
5	Common	Signal ground
6	Input	Data Set Ready (DSR)
7	Output	Request to Send (RQS)
8	Input	Clear to Send (CTS)
9	-	no connection

Turn-On Checkout

Checkout Procedure

Successful tests in this chapter provide a high degree of confidence that your unit is operating properly. For verification tests, see appendix B. Complete performance tests are given in the Service Guide.

NOTE: To perform the checkout procedure, you will need a wire for shorting the output terminals together.

The following procedure assumes that the unit turns on in the factory-default state. If you need more information about the factory default state, refer to the *RST command in chapter 8. Note that the values shown in the Display column may not exactly match the values that appear on the front panel of the unit.

If you have not already done so, connect the power cord to the unit and plug it in. Connect the output connector to the back of the unit with the sense jumpers installed.

Procedure	Display	Explanation
1. Turn the unit on. The dc source undergoes a self-test when you first turn it on.	***** ADDRESS 5 0.000V 0.0001A	During selftest, all display segments are briefly lit, followed by the GPIB Address. The display then goes into meter mode with the Dis annunciator on, and all others off. In Meter mode the n.nnnV digits indicate the output voltage and the .nnnnA digits indicate the output current. The flashing digit on the display indicates the digit that will be affected if changes are made to the displayed values using the rotary control or the ↑ and ↓ keys. <i>You will only see the changes if the output is ON.</i>

NOTE: Press the Meter key to exit a menu at any time and return to meter mode. If the Err annunciator on the display is on, press the **Shift** key followed by the **Error** key to see the error number. See table 4-1 at the end of this chapter.

2. Check that the fan is on.		You should be able to hear the fan and feel the air coming from the back of the unit.
3. Unplug the output connector from the back of the unit.	-0.224V 0.0000A	The output voltage indicates approximately -0.2 volts because the output sense connections have opened.
4. Press Output , scroll to SENSE:PROT and select ON . Press Enter	SENSE:PROT ON	Enables the open sense detect circuit.
5. Press Output On/Off	-0.224V 0.0000A	The open sense detect circuit disables the output. The Dis annunciator is off, but the Prot annunciator is on.
6. Press Protect	+/- SENSE OPEN	Display indicates the protection condition.

4 - Turn-On Checkout

	Procedure	Display	Explanation
7.	Plug the output connector back into the unit.		Restores the output sense connections. The Prot annunciator is still on.
8.	Press Shift, Prot Clear	NO FAULT	Clears the protection condition. Prot is off; CV is on.
9.	Press Voltage	VOLT 0.000	Display shows the output voltage setting of the unit.
10.	Press Enter Number, <15>, Enter	VOLT <15> 15.003V 0.0001A	Programs the main output to 15 volts. After the value is entered, the display returns to Meter mode. Because the output is enabled, the meter will indicate the actual output voltage.
11.	Press Shift, OV	PROT:LEV 22.00	Display shows the overvoltage protection trip voltage of the unit.
12.	Press Enter Number, <8>, Enter	PROT:LEV <8>	Programs the OVP to 8 volts, which is less than the previously set output voltage.
		0.000V 0.0001A	Because the OVP voltage entered was less than the output voltage, the OVP circuit tripped. The output dropped to zero, CV turned off, and Prot turned on.
13.	Press Shift, OV, Enter Number, <22>, Enter	PROT:LEV <22>	Programs the OVP to a value greater than the output voltage setting of the unit. This prevents the OV circuit from tripping again when the protection condition is cleared.
14.	Press Shift, Prot Clear	15.003V 0.0001A	Clears the protection condition, thus restoring the output of the unit. Prot turns off and CV turns on.
15.	Press Output On/Off	0.000V 0.0000A	Turn the output off.
16.	Connect a jumper wire across the + and - output terminals.		Shorts the output of the unit.
17.	Press Output On/Off.	0.004V 3.0712A	The CC annunciator is on, indicating that the unit is in constant current mode. The unit is sourcing output current at the maximum rating, which is the default output current limit setting.
18.	Press Current, Enter Number, <1>, Enter.	CURR <1>	Programs the output current to 1 ampere.
19.	Press Shift, OCP	0.001V 0.0003A	You enabled the overcurrent protection circuit. The circuit then tripped because the unit was operating in constant current mode. The CC annunciator turns off, and the OCP and Prot annunciators turn on.
20.	Press Shift, OCP	0.001V 0.0003A	You have disabled the overcurrent protection circuit. The OCP annunciator turns off.
21.	Press Shift, Prot Clear	0.004V 0.998A	Restores the output. The Prot annunciator turns off. The CC annunciator turns on.
22.	Turn the unit off and remove the shorting wire from the output terminals.		The next time the unit turns on it will be restored to the *RST or factory default state.

Only perform steps 23 to 33 if you are verifying an Agilent 66309B or 66309D unit.

Procedure	Display	Explanation
23. Turn the unit on. Wait for selftest to complete and press Shift, Channel .	² 0.025V 0.0002A	Shift Channel toggles between channel 1 and channel 2. The left-most digit of the display identifies the output channel that is presently being controlled. It will indicate a "1" for channel 1, or "2" for channel 2.
24. Press Voltage, Enter Number, <12>, Enter .	² VOLT <12>	Programs the output 2 voltage to 12 volts.
25. Press Output On/Off	² 12.005V 0.0002A	Turns the main output and output 2 on. The Dis annunciator is off, but the CV annunciator is on.
26. Press Output On/Off	² 0.000V 0.0000A	Turn all outputs off.
27. Connect a jumper wire across the + and - terminals of output 2.		Shorts output 2 of the unit.
28. Press Output On/Off .	² 0.004V 1.520A	The CC annunciator is on, indicating that output 2 is in constant current mode. Output 2 is sourcing current at its maximum rating, which is the default current limit setting.
29. Press Current, Enter Number, <1>, Enter .	² CURR <1>	Programs the output 2 current to 1 ampere.
30. Press Shift, OCP	² 0.001V 0.0003A	You enabled the overcurrent protection circuit. The circuit then tripped because output 2 was operating in constant current mode. The CC annunciator turns off, and the OCP and Prot annunciators turn on.
31. Press Shift, OCP	² 0.001V 0.0003A	You have disabled the overcurrent protection circuit. The OCP annunciator turns off.
32. Press Shift, Prot Clear	² 0.004V 0.998A	Restores output 2. The Prot annunciator turns off. The CC annunciator turns on.
33. Turn the unit off and remove the shorting wire from the output terminals.		The next time the unit turns on it will be restored to the *RST or factory default state.

In Case of Trouble

Dc source failure may occur during power-on selftest or during operation. In either case, the display may show an error message that indicates the reason for the failure.

Selftest Error Messages

Pressing the **Shift, Error** keys will show the error number. Selftest error messages appear as: ERROR <n> where "n" is a number listed in the following table. If this occurs, turn the power off and then back on to see if the error persists. If the error message persists, the dc source requires service.

4 - Turn-On Checkout

Table 4-1. Power-On Selftest Errors

Error No.	Failed Test
Error 0	No error
Error 1	Non-volatile RAM RD0 section checksum failed
Error 2	Non-volatile RAM CONFIG section checksum failed
Error 3	Non-volatile RAM CAL section checksum failed
Error 4	Non-volatile RAM STATE section checksum failed
Error 5	Non-volatile RST section checksum failed
Error 10	RAM selftest
Error 11 to 14	VDAC/IDAC selftest 1 to 4
Error 15	OVDAC selftest
Error 80	Digital I/O selftest error

Runtime Error Messages

Appendix C lists other error messages that may appear at runtime. Some of these messages will also appear on the front panel when the Prot key is pressed. To clear the error, you must remove the condition that caused the error and then press the Prot Clear key.

Table 4-2. Runtime Error Messages

Error	Description
Overvoltage	an overvoltage condition has occurred
Overcurrent	an overcurrent condition has occurred
Overtemperature	an overtemperature condition has occurred
Remote inhibit	a remote inhibit signal has been applied to the RI input
+ sense open	a positive sense or load lead is open
- sense open	a negative sense or load lead is open
+/- sense open	a positive and negative sense or load lead is open
sense open	incorrect voltage reading on the sense leads, the unit may need to be recalibrated

If the front panel display shows **OVLD**, this indicates that the output voltage or current is beyond the range of the meter readback circuit. If this is the case, check that the setting of the output compensation is correct for the phone you are testing. If the front panel display indicates **-- -- -- -- --**, an GPIB measurement is in progress.

Line Fuse

If the dc source appears "dead" with a blank display and the fan not running, check your ac mains to be certain line voltage is being supplied to the dc source. If the ac mains is normal, the fuse may be defective.

Refer to Appendix E and follow the procedure described in the appendix for accessing and replacing the line fuse located inside the unit. **Do not change any of the line voltage connections.**

NOTE: If the dc source has a defective fuse, replace it only once. If it fails again, the dc source requires service.

Front Panel Operation

Introduction

Here is what you will find in this chapter:

- ◆ a complete description of the front panel controls
- ◆ front panel programming examples

NOTE: The dc source must be in set to Local mode to use the front panel controls. Press the **Local** key on the front panel to put the unit in local mode.

Front Panel Description

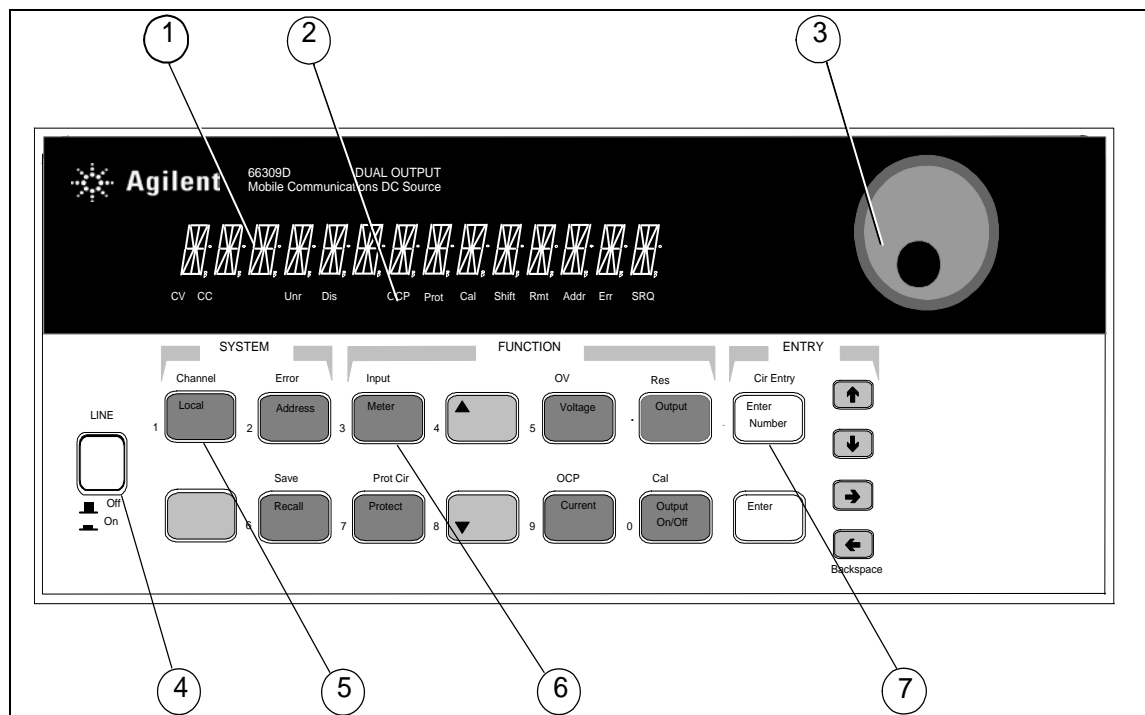

Figure 5-1. Front Panel, Overall View

5 – Front Panel Operation

- ① **Display** 14-character vacuum fluorescent display for showing output measurements and programmed values.
- ② **Annunciators** Annunciators light to indicate operating modes and status conditions:
CV The dc source output is in constant-voltage mode.
CC The dc source output is in constant-current mode.
Unr The dc source output is in an unregulated state.
Dis The dc source output is disabled (off).
OCP The overcurrent protection state is enabled.
Prot One of the dc source's output protection features is activated.
Cal The dc source is in calibration mode.
Shift The Shift key is pressed to access an alternate key function.
Rmt The GPIB interface is in a remote state.
Addr The interface is addressed to talk or to listen.
Err There is a message in the SCPI error queue.
SRQ The interface is requesting service from the controller.
- ③ **Rotary Control** The rotary control lets you set the output voltage or current as well as menu parameters. Press ◀ and ▶ to select the resolution, then adjust the value with the knob.
- ④ **Line** This turns the dc source on or off.
- ⑤ **System Keys** The system keys let you:
Return to Local mode (front panel control)
Set the dc source GPIB address
Selects the remote programming interface
Sets the RS-232 interface communications parameters
Select the output channel on units with more than one output
Display SCPI error codes and clear the error queue
Save and recall up to 4 instrument operating configurations
Select the programming language
- ⑥ **Function Keys** Function access command menus that let you:
Enable or disable the output
Select metering functions
Program output voltage and current
Display the protection status state
Set and clear protection functions
Set the output state at power-on
Calibrate the dc source
Select the output compensation
▲ and ▼ scroll through the front panel menu commands
- ⑦ **Entry Keys** Entry keys let you:
Enter programming values
Increment or decrement programming values
▲ and ▼ select the front panel menu parameters

System Keys

Refer to the examples later in this chapter for more details on the use of these keys.

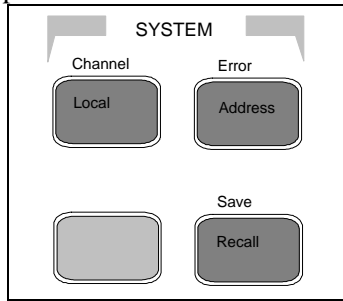

Figure 5-2. System Keys

- This is the blue, unlabeled key, which is also shown as in this guide. Pressing this key accesses the alternate or shifted function of a key (such as **ERROR**). Release the key after you press it. The **Shift** annunciator is lit, indicating that the shifted keys are active.
- Press to change the dc source's selected interface from remote operation to local (front panel) operation. Pressing the key will have no effect if the interface state is already Local, Local-with-Lockout, or Remote-with-Lockout.
- Press to access the address menu. All entries are stored in non-volatile memory.
- | Display | Command Function |
|-----------------|--|
| ADDRESS <value> | Sets the GPIB Address |
| INTF <char> | Selects an interface (GPIB or RS-232 ¹) |
| BAUDRATE <char> | Selects baudrate (300, 600, 1200, 2400, 4800, 9600) ¹ |
| PARITY <char> | Message parity (NONE EVEN ODD MARK SPACE) ¹ |
| FLOW <char> | Flow control (XON-XOFF RTS-CTS DTR-DSR NONE) ¹ |
| LANG <char> | Selects language (SCPI or COMP ¹) |
| ROM <char> | Firmware revision number |
| SN: <char> | Unit serial number |
- Press to place the dc source into a previously stored state. You can recall up to 4 previously stored states (0 through 3).
- Pressing these keys toggles the display between output 1 and output 2.
- | Display | Measurement |
|------------------------------------|---------------------------|
| ¹ <reading>V <reading>A | Measures output channel 1 |
| ² <reading>V <reading>A | Measures output channel 2 |
- Press to display the system error codes stored in the SCPI error queue. This action also clears the queue. If there is no error in the queue, 0 is displayed.
- Press to store an existing dc source state in non-volatile memory. The parameters saved are listed under *SAV as described in chapter 8. You can save up to 4 states (0 through 3).

Notes:

¹ Not valid for Agilent 66309B/D

value = a numeric value char = a character string parameter

Use and to scroll through the command list.

Use and to scroll through the parameter list.

Function Keys

Refer to the examples later in this chapter for more details on the use of these keys.

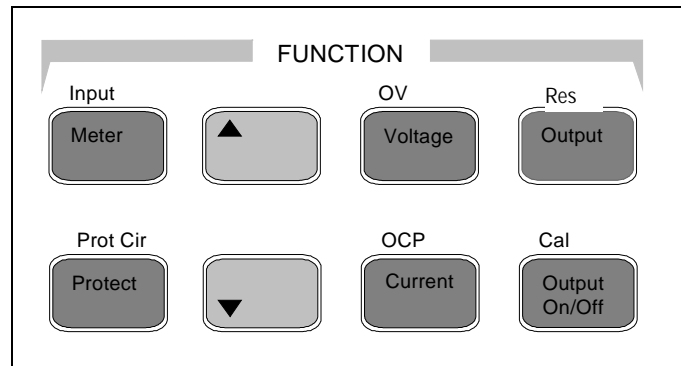

Figure 5-3. Function Keys

Immediate Action Keys

Immediate action keys immediately execute their corresponding function when pressed. Other function keys have commands underneath them that are accessed when the key is pressed.

Output
On/Off

This key toggles the output of the dc source between the on and off states. When coupled, the key affects both output channels. It immediately executes its function as soon as you press it. When off, the dc source output is disabled and the **Dis** annunciator is on.

Shift Prot Cir

Press this key to reset the protection circuit and allow the unit to return to its last programmed state. The condition that caused the protection circuit to become active must be removed prior to pressing this key, or the unit will shut down again and display the **Prot** annunciator again.

Shift OCP

Press this key to toggle between OCP enabled and disabled. If OCP is enabled the output will become disabled if the output mode changes from CV to CC mode. The OCP annunciator indicates the state of OCP.

Scrolling Keys

Scrolling keys let you move through the commands in the presently selected function menu.

▲ ▼

Press ▼ to bring up the next command in the list. Press ▲ to go back to the previous command in the list. Function menus are circular; you can return to the starting position by continuously pressing either key. The following example shows the commands in the Input function menu:

▼ CURR:RANGE <char>
▼ CURR:DET <char>

Metering Keys

Metering keys control the metering functions of the dc source. As set from the factory, all front panel measurements from the main output (output 1), are calculated from a total of 2048 readings taken at a 46.8 microsecond sampling rate. Therefore, the factory default acquisition time for a single front panel measurement is about 100 milliseconds. Refer to “Making Front Panel Measurements” for more information about changing the front panel sampling rate and the number of measurement points.

All front panel measurements from the DVM and from output2 are fixed at 2048 measurement readings taken at a 15.6 microsecond sampling rate.

NOTE: The front panel sample rate and data point settings are separate and independent of the sample rate and data point settings that are programmed over the GPIB interface. When an GPIB measurement is in progress, the front panel display temporarily indicates -- -- -- -- --. Front panel measurements resume when the GPIB measurement completes.

Meter

Press this key to access the meter menu list. Also use this key to exit a menu at any time and return to meter mode.

Display	Measurement
<reading>V <reading>A	Measures output dc voltage and current
<reading>V MAX	Measures peak output voltage ¹
<reading>V MIN	Measures minimum output voltage ¹
<reading>V HIGH	Measures the high level of a voltage waveform ¹
<reading>V LOW	Measures the low level of a voltage waveform ¹
<reading>V RMS	Measures rms voltage ¹
<reading>A MAX	Measures peak output current ¹
<reading>A MIN	Measures minimum output current ¹
<reading>A HIGH	Measures the high level of a current waveform ¹
<reading>A LOW	Measures the low level of a current waveform ¹
<reading>A RMS	Measures rms current ¹
<reading>V DC:DVM	Measures dc voltage on DVM input ²
<reading>V RMS:DVM	Measures rms voltage on DVM input ²

Shift







Input

Press this key to access the following metering functions.

Display	Command Function
CURR:RANGE <char>	Select current range (AUTO LOW HIGH ¹)
CURR:DET <char>	Select current measurement bandwidth (ACDC DC ¹)
TINT <value>	Sets the front panel measurement interval in <i>seconds</i> (15.6 μs to 1 second)
POINTS <char>	Sets the # of points in front panel measurement buffer (1, 2, 4, 8, 16, 32, 64, 128, 256, 512, 1024, 2048)

Notes:

¹not valid for Agilent 66111A
²only valid for Agilent 66311D/66309D
 reading = the returned measurement
 value = a numeric value
 char = a character string parameter

Use  and  to scroll through the menu commands.
 Use  and  to scroll through the menu parameters.
 Use  and  to select a digit in a numeric entry field.

Output Control Keys

Output control keys control the output functions of the dc source.

Voltage

Press this key to access the voltage menu.

Display

Command Function

¹ VOLT <value>

Sets the voltage of output 1 (the main output of all models)

² VOLT <value>

Sets the voltage of output 2 (only applies to Agilent 66309B/D)

Current

Press this key to access the current menu.

Display

Command Function

¹ CURR <value>

Sets the current of output 1 (the main output of all models)

² CURR <value>

Sets the current of output 2 (only applies to Agilent 66309B/D)

Shift

Res

Not available

Output

Press this key to access the output menu list.

Display

Command Function

*RST

Places the dc source in the factory-default state

COUPLING <char>

Couples or decouples output 1 and output 2 (NONE or ALL)¹

TYPE:CAP <char>

Sets the output compensation (HIGH | H2 | LOW)²

PON:STATE <char>

Select the power-on state command (RST | RCL0)²

PROT:DLY <value>

Sets the output protection delay in seconds

RI <char>

Sets the remote inhibit mode (LATCHING | LIVE | OFF)²

DFI <char>

Sets the discrete fault indicator state (ON | OFF)

DFI:SOUR <char>

Selects the DFI source (QUES | OPER | ESB | RQS | OFF)³

PORT <char>

Sets the output port functions (RIDFI or DIGIO)²

DIGIO <char>

Sets and reads the I/O port value (0 through 7)

SENSE:PROT<char>

Enables or disables the open sense lead detect circuit (ON | OFF)

¹REL:MODE <char>

Sets the relay mode for Option 521 units (DD, HD, DH, or HH)

(applies to both outputs; output 1 shown)

Protect

Press this key to display protection status.

Display

Command Function

OVER CURRENT

Status of the protection features (example shows overcurrent)

NO FAULT

Status of the protection features (example shows none tripped)

Shift

OV

Press this key to access the overvoltage protection menu.

Display

Command Function

PROT:STAT <char>

Enables or disables overvoltage protection (ON | OFF)⁴

PROT:LEV <value>

Sets the overvoltage protection level

Shift

Cal

This key accesses the calibration menu (Refer to Appendix B for details).

Notes:

¹only valid for Agilent 66309B/D units with firmware revision A.02.04 and up



²These parameters are stored in non-volatile system memory



³These status summary bits are explained in chapter 7



⁴These parameters are stored in non-volatile state memory

value = a numeric value

char = a character string parameter

Use  and  to scroll through the menu commands.

Use  and  to scroll through the menu parameters.

Use  and  to select a digit in a numeric entry field.

Entry Keys

Refer to the examples later in this chapter for more details on the use of these keys.

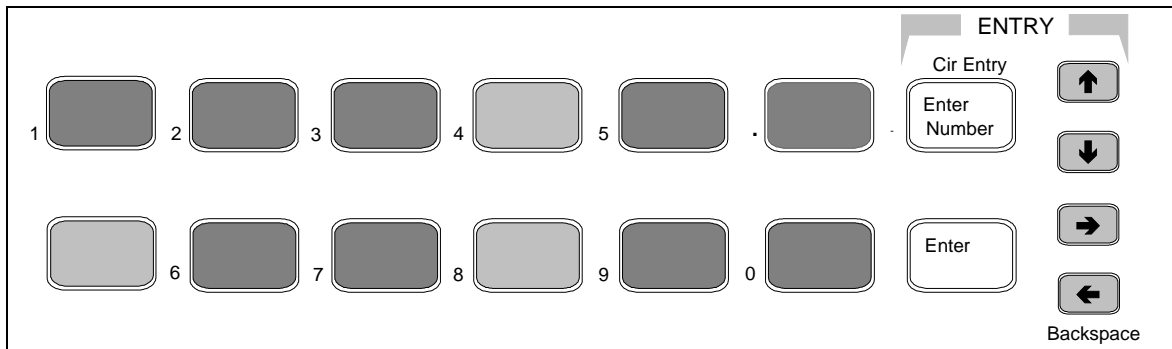

Figure 5-4. Entry Keys



These keys let you scroll through choices in a **parameter** list that apply to a specific command. Parameter lists are circular; you can return to the starting position by continuously pressing either key. If the command has a numeric range, these keys increment or decrement the existing value. In meter mode, these keys can be used to adjust the magnitude of the output voltage or current. Only the flashing digit is changed by these keys. Use the **←** and **→** keys to move the flashing digit.



These keys move the flashing digit in a numeric entry field to the right or left. This lets you increment or decrement a specific digit in the entry field using the **↑** and **↓** keys or the RPG knob.

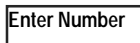

Used only to access a third level key function - the numeric entry keys. These third level function keys are labeled in green.

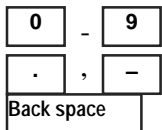

0 through **9** are used for entering numeric values. **.** is the decimal point. **-** is the minus sign. For example, to enter 33.6 press: **Enter Number, 3, 3, ., 6, Enter.**

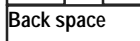

The backspace key deletes the last digit entered from the keypad. This key lets you correct one or more wrong digits before they are entered.



This key aborts a keypad entry by clearing the value. This key is convenient for correcting a wrong value or aborting a value entry. The display then returns to the previously set function.

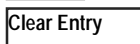

This key executes the entered value or parameter of the presently accessed command. Until you press this key, the parameters you enter with the other Entry keys are displayed but not entered into the dc source. Before pressing **Enter**, you can change or abort anything previously entered into the display. After **Enter** is pressed, the dc source returns to Meter mode.

Examples of Front Panel Programming

You will find these examples on the following pages:

- 1 Using the front panel display
- 2 Setting the output voltage, current, and compensation
- 3 Setting the output 2 voltage and current
- 4 Querying and clearing output protection
- 5 Making basic front panel measurements
- 6 Making enhanced front panel measurements
- 7 Making DVM measurements
- 8 Programming the digital port
- 9 Setting the GPIB address and Programming Language
- 10 Storing and recalling instrument states

1 - Using the Front Panel Display

Selecting an output on Agilent 66309B/D units

Action

Press **Meter** to return the display to Meter mode. Press **Shift Channel** to toggle between channel 1 and channel 2. The left-most digit of the front panel display identifies the output channel that is presently being controlled by the front panel. It will indicate either a "1" for channel 1, or "2" for channel 2.

You can only select an output when the unit is in metering mode. Once an output has been selected, only the menu commands that apply to that output will appear on the display. Output -specific menu commands are identified by a 1 or a 2. Also, the CV, CC, and UNR annunciators apply to the selected channel.

Display

²7.003V 0.004A

Selecting the DVM on Agilent 66311D/66309D units

Action

You must select output 1 to use the DVM. If output 1 is not selected, the DVM's measurement menu is not displayed.

On the Function keypad press **Meter** and press ▼ repeatedly to access the DVM measurement commands. DVM measurement commands are identified by the "DVM" string segment. When accessed, DVM measurement functions are automatically active. Refer to example 3 for more information.

Display

¹ 8.013V 0.003A

¹ <reading>V DC:DVM

Independently Controlling Output 1 and Output 2 on Agilent 66309B/D units (this feature only applies to units that are identified by firmware revision A.02.04 and up)

Action

On the Function keypad, press **OUTPUT**. Scroll to the **COUPLING** command. To uncouple the outputs, use the numeric key to select **NONE**, then press **Enter**.

Display

COUPLING NONE

2 - Setting the Output Voltage, Current, Compensation, and Relay Mode

This example shows you how to set the output voltage and current. It also shows you how to set the compensation circuit for either high or low capacitance cellular phones. Relay mode only applies to Agilent models 66309B/D units that have Option 521 installed. Note that no front panel changes affect the output of the unit unless it has been enabled.

Set the output voltage

Action	Display
1. To enter an approximate value without using the voltage menu: On the Entry keypad, press ← or → to select the 1's digit in the voltage field. Then rotate the front panel RPG knob to obtain 7 V. <i>If the unit is in CC mode, you won't see the output voltage change until the voltage setting is low enough to cause the unit to go into CV mode.</i>	7.003V 0.004A
2. The easiest way to enter an accurate value: On the Function keypad, press Voltage . On the Entry keypad, press Enter Number, 7, Enter .	VOLT 7.000
3. To make minor changes to an existing value: On the Function keypad, press Voltage . On the Entry keypad, press ← or → to select the digit in the numeric field that you wish to change. For example, move the flashing digit to the ones column to change a value in this column. Then, press ↑ to scroll from 7.000 to 8.000. Then press Enter .	VOLT 8.000

Set the output current limit

Action	Display
1. To enter an approximate value without using the current menu: On the Entry keypad, press ← or → to select the tenths digit in the current field. Rotate the front panel RPG knob to obtain 0.4A. <i>If the unit is in CV mode, you will not see the output current change until the current setting is low enough to cause the unit to go into CC mode.</i>	8.003V 0.400A
2. The easiest way to enter an accurate value: On the Function keypad, press Current . On the Entry keypad, press Enter Number, .4, Enter .	CURR 0.400
3. To make minor changes to an existing value: On the Function keypad, press Current . On the Entry keypad, press ← or → to select the digit in the numeric field that you wish to change. For example, move the flashing digit to the tenths column to change a value in this column. Then, press ↑ to scroll from 0.400 to 0.500. Then press Enter .	CURR 0.500

NOTE: To output currents pulses greater than 3 A and up to 5 A peak, you must set the output current limit to greater than 3 amperes (3.0712 amperes max).

Set the output compensation

Action	Display
1. On the Function keypad, press Output . Then press ▼ until you obtain the TYPE:CAP command. Use the ↓ key and select either LOW, HIGH, or H2. Then press Enter . Use HIGH compensation for faster transient response when testing phones with input capacitances greater than 5 μ F, which applies for most phones. In High mode, operation of the dc source may be momentarily unstable when testing phones that have input capacitances under 5 μ F. Use LOW compensation if this occurs. If the dc source senses that there is no load on the output, it will automatically switch from High compensation mode to Low compensation mode. H2 is an additional compensation mode that guarantees that the dc source stays in High compensation mode at all times.	TYPE:CAP HIGH

5 – Front Panel Operation

Setting the relay mode (Agilent 66309B/D with Option 521 only)

Action	Display
1. Use Output ON/OFF to make sure that the output of the selected channel is off. The output must be turned off before any relay settings take effect. If the Dis annunciator is lit, the output is off.	
2. Press Meter to return the display to Meter mode.	
3. Press Shift Channel to select either output channel 1 or output channel 2.	¹ 3.6V 2.04A ² 7.5V 1.04A
4. On the Function keypad, press OUTPUT . Then scroll to the REL:MODE command. Use the ↓ key to select one of the relay modes (DD, DH, HD, or HH) then press Enter . The Output ON mode is specified first, followed by the Output OFF mode. Relay settings cannot be coupled; they must be set separately for each output.	² REL:MODE HH

Enable the output

Action	Display
1. On the Function keypad, press Output On/Off to enable the output. The Dis annunciator will go off, indicating that the voltage is now applied to the output terminals. The A display indicates the actual output current. Note that when the outputs are coupled, this command also enables or disables output 2.	8.003V 0.500A

3 - Setting the Output 2 Voltage and Current (Agilent 66309B/D only)

This example shows you how to set the voltage and current for output 2. Selecting an output was discussed in the previous example. Note that no front panel changes affect the output of the unit unless it has been enabled.

Set the output 2 voltage

Action	Display
1. Press Meter , then Shift, Channel to select output 2. On the Entry keypad, press ← or → to select the 1's digit in the voltage field. Then rotate the front panel RPG knob to obtain 7 V. <i>If the unit is in CC mode, you won't see the output voltage change until the voltage setting is low enough to cause the unit to go into CV mode.</i>	² 7.003V 0.004A
2. An alternate way to enter a value: On the Function keypad, press Voltage . On the Entry keypad, press Enter Number, 7, Enter .	² VOLT 7.000
3. To make minor changes to an existing value: On the Function keypad, press Voltage . On the Entry keypad, press ← or → to select the digit in the numeric field that you wish to change. For example, move the flashing digit to the ones column to change a value in this column. Then, press ↑ on the Entry keypad to scroll from 7.000 to 8.000. Then press Enter .	² VOLT 8.000

Set the output 2 current limit

Action	Display
1. Select output 2 as described in example 1. On the Entry keypad, press ← or → to select the tenths digit in the current field. Rotate the front panel RPG knob to obtain 0.4A. <i>If the unit is in CV mode, you will not see the output current change until the current setting is low enough to cause the unit to go into CC mode.</i>	² 8.003V 0.400A
2. An alternate way to enter a value: On the Function keypad, press Current . On the Entry keypad, press Enter Number, .4, Enter .	² CURR 0.400

- To make minor changes to an existing value: On the Function keypad, press **Current**. ² CURR 0.500
On the Entry keypad, press **←** or **→** to select the digit in the numeric field that you wish to change. For example, move the flashing digit to the tenths column to change a value in this column. Then press **↑** to scroll from 0.400 to 0.500. Then press **Enter**.

NOTE: To draw current pulses greater than 1.5 A and up to 2.5 A peak on output 2, set the output current limit higher than 1.5 amperes (1.52 amperes max). Do not enable OCP, or else make sure that the protection delay setting is longer than the expected current pulse.

Enable the output

Action	Display
1. On the Function keypad, press Output On/Off to enable output 2. The Dis annunciator will go off, indicating that the voltage is now applied to the output terminals. The display indicates the actual output values. Note that when the outputs are coupled, this command also enables or disables output 1.	² 8.003V 0.500A

4 - Querying and Clearing Output Protection and Errors

If an overvoltage, overcurrent, overtemperature or remote inhibit condition occurs, the **Prot** annunciator on the front panel will be on and the dc source will disable its output. If necessary, you can disable the overcurrent or overvoltage protection circuit if its operation interferes with the proper operation of your phone test. Note that if you disable the overvoltage protection, the equipment under test will not be protected from output voltage overshoot conditions. You can also disable the broken sense lead detect circuit if you have an application where an external voltage applied to the output may interfere with the broken sense lead detect circuitry.

Error messages can occur at any time during the operation of the unit. When the **Err** annunciator on the front panel is on it means that either an error has occurred on the GPIB bus, or a selftest error has occurred. Appendix C lists error numbers and descriptions.

Query and clear the dc source overcurrent protection as follows:

Action	Display
1. On the Function keypad, press Protect . In this example, an over current condition has occurred. Refer to Table 4-2 for other protection indicators.	OVERCURRENT
2. On the Function keypad, press Current . This displays the present current limit.	CURR 3.0712
3. To restore normal operation <i>after the cause of the overcurrent condition has been removed</i> , press Shift, Prot Clr . The Prot annunciator then will go off.	
4. To disable overcurrent protection, press Shift, OCP . This key toggles between OCP enabled and disabled. The OCP annunciator is off when OCP is disabled.	

Disable Overvoltage Protection as follows:

1. On the Function keypad, press Shift, OV . Then press ▼ to obtain the PROT:STAT command. Use the ↓ key and select OFF to disable the overvoltage protection function. Then press Enter . To recall this state when the unit turns on, save this state in location 0 and set the power-on state to RCL 0 (see example #10).	PROT:STAT OFF
--	---------------

Query and Clear Errors as follows:

1. On the Function keypad, press Shift, Error . This displays and clears the error in the error queue. Repeatedly press these keys to clear all errors in the queue. If errors persist, your unit may require service.	ERROR 0
---	---------

5 – Making Basic Front Panel Measurements

As shipped from the factory, front panel measurements for the main output (output 1) are calculated from a total of 2048 readings taken at a 46.8 microsecond sampling rate. The unit alternates between voltage and current measurements. Therefore, the data acquisition time for a single front panel voltage or current measurement is about 100 milliseconds. This sampling rate and data acquisition time combined with a built-in windowing function, reduces errors due to sampling a non-integral number of cycles of a waveform for frequencies of 25 Hz or greater. Note that the windowing function is less accurate when measuring output waveforms for frequencies less than 25 Hz, causing the front panel meter to jitter.

There are no trigger controls for front panel measurements. However, you can program both the sampling rate and the number of data points in each front panel measurement using commands in the Input menu. With this flexibility, measurement accuracy can be improved for waveforms with frequencies as low as several Hertz. The sample buffer size may be varied from 1 to 2048 data points in discrete binary values. The sampling rate may be varied from 15.6 microseconds to 1 second. Values are rounded to the nearest 15.6 microsecond interval. Note that the front panel sample interval and buffer size settings are independent of the sample interval and buffer size that you program over the GPIB. This is because you can qualify measurement triggers over the GPIB, which makes the GPIB measurements independent of the front panel measurements. Refer to chapter 8 for more information about GPIB measurements.

To have the unit turn on with the reconfigured buffer size and sampling rate, save this state in location 0 and set the power-on state to RCL 0. Note that front panel measurements parameters for output 2 are not programmable. They are fixed at 2048 data points with a 15.6 microsecond sampling rate.

NOTE: If the front panel display indicates OVLD, the output has exceeded the measurement capability of the instrument. If the front panel display indicates -- -- -- -- -- , an GPIB measurement is in progress.

Use the Meter menu for making front panel measurements:

Action	Display
1. On the Function keypad press Meter to access the following measurement parameters: dc voltage and current	<reading>V <reading>A
2. To change the front panel time interval and buffer size for output waveform measurements, press Shift, Input . Then press ▼ until you obtain the TINT command. Use the Entry keys to enter a value from 15.6 microseconds to 1 second in <i>seconds</i> . Then press Enter .	TINT 0.002
3. Continue by pressing Shift, Input and ▼ until you obtain the POINT command. Press ▼ to select a different buffer size. The choices are: 1, 2, 4, 8, 16, 32, 64, 128, 256, 512, 1024, and 2048. Then press Enter .	POINT 1024

One reason to change the front panel time interval and data points is if the waveform being measured has a period shorter than 3 times the present front panel acquisition time.

6 – Making Enhanced Front Panel Measurements

The following figure illustrates the enhanced measurement capabilities of Agilent Models 66311B/D and 66309B/D for measuring output waveforms. These include peak (max), minimum, high level, and low level measurements as illustrated in the following figure. Rms and dc voltages are calculated from the number of points in the measurement window.

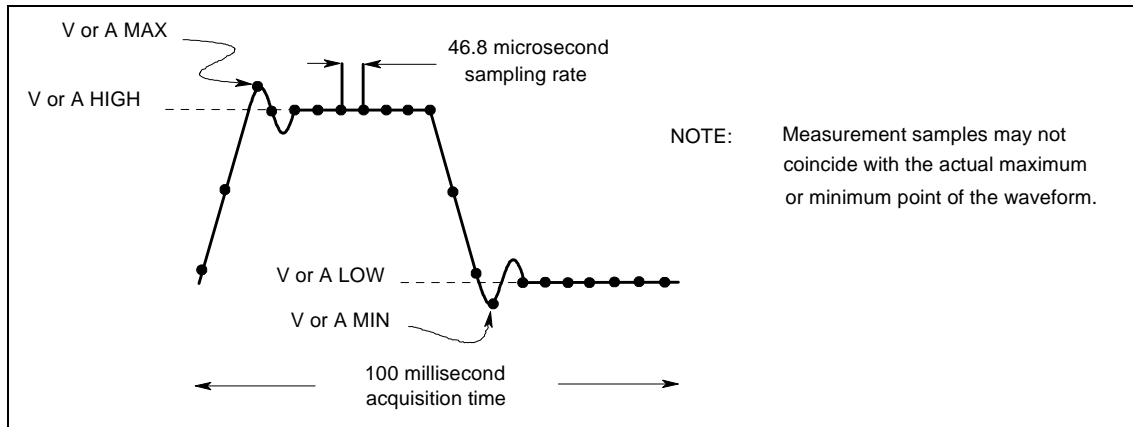

Figure 5-5. Default Front Panel Measurement Parameters

All models except the Agilent 66111A have two current measurement ranges that can be selected in the Input menu. A high current range is available for measuring output currents of up to 7 amperes. A low current range is available for improved resolution when measuring output currents below 20 milliamperes. The low current measurement range is accurate to 0.1% of the reading ± 2.5 microamperes. When the current Range is set to AUTO, the unit automatically selects the range with the best measurement resolution.

NOTE: In the LOW current measurement range, the current detector is fixed at DC. With the current detector in dc, accurate current measurements cannot be made on waveforms with frequency contents over 1 kilohertz.

Use the Meter menu for making front panel measurements:

Action	Display
1. On the Function keypad press Meter and press ▼ repeatedly to access the following measurement parameters:	
◆ dc voltage and current	<reading>V <reading>A
◆ peak voltage ¹	<reading>V MAX
◆ minimum voltage ¹	<reading>V MIN
◆ high level of a voltage pulse waveform ¹	<reading>V HIGH
◆ low level of a voltage pulse waveform ¹	<reading>V LOW
◆ rms voltage ¹	<reading>V RMS
◆ peak current ¹	<reading>A MAX
◆ minimum current ¹	<reading>A MIN
◆ high level of a current pulse waveform ¹	<reading>A HIGH
◆ low level of a current pulse waveform ¹	<reading>A LOW
◆ rms current ¹	<reading>A RMS

¹Not available on Agilent Model 66111A

5 – Front Panel Operation

- To change the front panel time interval and buffer size for output waveform measurements, press **Shift, Input**. Then press ▼ until you obtain the TINT command. Use the Entry keys to enter a value from 15.6 microseconds to 1 second in *seconds*. Then press **Enter**. TINT 0.002
- Continue by pressing **Shift, Input** and ▼ until you obtain the POINT command. Press ↓ to select a different buffer size. The choices are: 1, 2, 4, 8, 16, 32, 64, 128, 256, 512, 1024, and 2048. Then press **Enter**. POINT 1024

One reason to change the front panel time interval and data points is if the waveform being measured has a period shorter than 3 times the present front panel acquisition time.

- For current measurements, press **Shift, Input**. Then press ↓ until you obtain the CURR:RANG AUTO command. Press **Enter** to activate autoranging. Two other selections are also available. Select the HIGH range when measuring currents above 20 mA. Select the LOW range for improved resolution when measuring currents below 20 mA. Note that the LOW range is only appropriate for making dc measurements. CURR:RANG AUTO
- For output waveform measurements, press **Shift, Input**. Then press ▼ until you obtain the CURR:DET command. Check to make sure that the ACDC current detector is selected. This provides the best accuracy for waveform measurements. Only select the DC current detector if you are making dc current measurements and you require a dc measurement offset better than 2mA on the High current measurement range. Press **Enter** to activate any changes. CURR:DET ACDC¹

7 – Making DVM Measurements (Agilent 66311D/66309D only)

The front panel DVM measurement function is only active when Output 1 is selected.

As shipped from the factory, DVM measurements are calculated from a total of 2048 readings taken at a 15.6 microsecond sampling rate. These parameters are fixed. Therefore, the data acquisition time for a single measurement is about 30 milliseconds. This sampling rate and data acquisition time combined with a built-in windowing function reduces errors due to sampling a non-integral number of cycles of a waveform for frequencies of 47 Hz or greater.

NOTE: If the front panel display indicates OVLD, the output has exceeded the measurement capability of the instrument. If the front panel display indicates -- -- -- -- --, a front panel or an GPIB measurement is in progress.

Check that the DVM measurement points are within the DVM measurement capabilities:

The common mode voltage range of the DVM input is –4.5 V to +25 V from either DVM input with respect to the negative output terminal of output 1. The maximum isolation voltage to ground is ±50 Vdc. Refer to chapter 3 under "DVM Connection" for more information on how this affects the DVM's measurement capability.

Use the Meter menu for making DVM measurements:

Action	Display
1. On the Function keypad press Meter and press ▼ repeatedly to access the following DVM measurement parameters:	
◆ dc voltage	¹ <reading>V DC:DVM
◆ rms voltage (ac + dc rms)	¹ <reading>V RMS:DVM

8 - Programming External Protection and the Digital Port Functions

Your dc source is shipped with the output port function set to RIDFI mode. In this mode the port functions as a remote inhibit input with a discrete fault indicator output signal. You can also configure the port to act as a Digital Input/Output device.

To configure the RIDFI mode of the port, proceed as follows:

Action	Display
1. On the Function keypad, press Output .	*RST
2. Scroll through the Output menu by pressing ▼. The PORT command lets you select either the RIDFI or the DIGIO function. Press Enter when done.	PORT RIDFI
3. Scroll to the RI command to configure the Remote INHibit indicator. Use the ▲ and ▼ keys to select either LIVE or LATCHING, either of which enable the RI indicator. Then press Enter . With RI enabled, a low-true on the INH input will disable the output of the unit. LIVE causes the output of the unit to track the state of the INH input. LATCHING latches the output of the unit off in response to the inhibit signal.	RI LIVE RI LATCHING
4. Access the Output menu again and scroll through the menu. The DFI command lets you enable the Discrete Fault Indicator. Use the ▼ key and select ON to enable the FLT output. Then press Enter . With the FLT output enabled, the open-collector logic signal can be used to signal external devices when a fault condition is detected.	DFI ON
5. Scroll to the DFI:SOUR command to select the internal source that drives this signal. Use the ▼ key to select from the RQS or ESB bits, or the Operation or Questionable status registers. Then press Enter . Status summary bits are explained in chapter 7.	DFI:SOUR RQS DFI:SOUR ESB DFI:SOUR OPER DFI:SOUR QUES

To configure the DIGIO mode of the port, proceed as follows:

Action	Display
1. On the Function keypad, press Output .	*RST
2. Scroll through the Output menu by pressing ▼. The PORT command lets you select either the RIDFI or the DIGIO function. Press Enter when done.	PORT DIGIO
3. Scroll to the DIGIO command to set and read the Digital Input/Output Port. Press Enter Number and enter a number from 0 to 7 to program the three bits (0 programs all bits low; 7 programs all bits high). Press Enter when done.	DIGIO 5

9 - Setting the GPIB Address and Programming Language

Your dc source is shipped with the GPIB address set to 5. This address can only be changed from the front panel using the Address menu located under the **Address** key. This menu is also used to select the programming language.

Set the GPIB address as follows:

Action	Display
1. On the System keypad, press Address .	ADDRESS 5
2. Enter the new address. For example, Press Enter Number, 7, Enter .	ADDRESS 7

5 – Front Panel Operation

Set the Language as follows: (not valid for Agilent 66309B/D)

Action	Display
1. On the System keypad, press Address .	ADDRESS 5
2. Scroll through the Address menu by pressing ▼. The LANG command lets you access the programming language.	LANG:SCPI
3. The ▲ and ▼ keys let you select the language. You can select either SCPI or COMPatibility. Press Enter when done. The language setting is saved in non-volatile memory.	

10 - Storing and Recalling Instrument States

You can save up to 4 states (from location 0 to location 3) in non-volatile memory and recall them from the front panel. All programmable settings are saved. This capability is only available when the unit is set to the SCPI programming language.

NOTE: You can program the unit to automatically power-on according to the instrument state that is saved in state 0 as shown in the third example.

Save an instrument state in location 0 as follows:

Action	Display
1. Set the instrument to the state that you want to save.	
2. Save this state to location 0. Press Save, Enter Number, 0, Enter .	*SAV 0

Recall a saved state as follows:

Action	Display
1. Recall the state saved in location 0 by pressing Recall, Enter Number, 0, Enter	*RCL 0

Select the power-on state of the dc source as follows:

Action	Display
1. On the Function keypad, press Output , and scroll through the Output menu until you get to the PON state command.	PON:STATE RST
2. Use the ▲ and ▼ keys to select either RST or RCL0. RST sets the power-on state of the unit as defined by the *RST command. RCL0 sets the power-on state of the unit to the state saved in *RCL location 0. Press Enter when done.	

Clear the non-volatile memory of the dc source as follows:

Action	Display
1. On the Function keypad, press Output, Enter . This returns the unit to the factory-default settings.	*RST
2. Save these settings to location 0. Press Save, Enter Number, 0, Enter .	*SAV 0
3. Repeat step #2 for memory locations 1 through 3.	*SAV 1 *SAV 2 *SAV 3

Introduction to Programming

External References

GPIB References

The most important GPIB documents are your controller programming manuals - BASIC, GPIB Command Library for MS DOS, etc. Refer to these for all non-SCPI commands (for example: Local Lockout).

The following are two formal documents concerning the GPIB interface:

- ◆ *ANSI/IEEE Std. 488.1-1987 IEEE Standard Digital Interface for Programmable Instrumentation.*
Defines the technical details of the GPIB interface. While much of the information is beyond the need of most programmers, it can serve to clarify terms used in this guide and in related documents.
- ◆ *ANSI/IEEE Std. 488.2-1987 IEEE Standard Codes, Formats, Protocols, and Common Commands.*
Recommended as a reference only if you intend to do fairly sophisticated programming. Helpful for finding precise definitions of certain types of SCPI message formats, data types, or common commands.

The above two documents are available from the IEEE (Institute of Electrical and Electronics Engineers), 345 East 47th Street, New York, NY 10017, USA. The WEB address is www.ieee.org.

SCPI References

The following documents will assist you with programming in SCPI:

- ◆ *Standard Commands for Programmable Instruments Volume 1, Syntax and Style*
- ◆ *Standard Commands for Programmable Instruments Volume 2, Command References*
- ◆ *Standard Commands for Programmable Instruments Volume 3, Data Interchange Format*
- ◆ *Standard Commands for Programmable Instruments Volume 4, Instrument Classes*

To obtain a copy of the above documents, contact: Fred Bode, Executive Director, SCPI Consortium, 8380 Hercules Drive, Suite P3, Ls Mesa, CA 91942, USA

VXIplug&play Power Products Instrument Drivers

VXIplug&play instrument drivers for Microsoft Windows 95 and Windows NT are now available on the Web at <http://www.agilent.com/find/drivers>. These instrument drivers provide a high-level programming interface to your Agilent Technologies instrument. VXIplug&play instrument drivers are an alternative to programming your instrument with SCPI command strings. Because the instrument driver's function calls work together on top of the VISA I/O library, a single instrument driver can be used with multiple application environments.

Supported Applications

- Agilent VEE
- Microsoft Visual BASIC
- Microsoft Visual C/C++
- Borland C/C++
- National Instruments LabVIEW
- National Instruments LabWindows/CVI

System Requirements

The VXIplug&play Power Products instrument driver complies with the following:

- Microsoft Windows 95
- Microsoft Windows NT 4.0
- HP VISA revision F.01.02
- National Instruments VISA 1.1

Downloading and Installing the Driver

NOTE: Before installing the VXIplug&play instrument driver, make sure that you have one of the supported applications installed and running on your computer.

1. Access Agilent Technologies' Web site at <http://www.agilent.com/find/drivers>.
2. Select the instrument for which you need the driver.
3. Click on the driver, either Windows 95 or Windows NT, and download the executable file to your pc.
4. Locate the file that you downloaded from the Web. From the **Start** menu select **Run** <path>:\agxxxx.exe - where <path> is the directory path where the file is located, and agxxxx is the instrument driver that you downloaded .
5. Follow the directions on the screen to install the software. The default installation selections will work in most cases. The readme.txt file contains product updates or corrections that are not documented in the on-line help. If you decide to install this file, use any text editor to open and read it.
6. To use the VXIplug&play instrument driver, follow the directions in the VXIplug&play online help under "Introduction to Programming".

Accessing Online Help

A comprehensive online programming reference is provided with the driver. It describes how to get started using the instrument driver with Agilent VEE, LabVIEW, and LabWindows. It includes complete descriptions of all function calls as well as example programs in C/C++ and Visual BASIC.

- To access the online help when you have chosen the default Vxipnp start folder, click on the Start button and select Programs | Vxipnp | Agxxxx Help (32-bit).
- where agxxxx is the instrument driver.

GPIB Capabilities of the DC Source

All dc source functions except for setting the GPIB address are programmable over the GPIB. The IEEE 488.2 capabilities of the dc source are listed in the Specifications Table in Appendix A.

GPIB Address

The dc source operates from an GPIB address that is set from the front panel. To set the GPIB address, press the **Address** key on the front panel and enter the address using the Entry keys. The address can be set from 0 to 30. The GPIB address is stored in non-volatile memory.

ADDRESS <value> Enter a value to set the GPIB Address

RS-232 Capabilities of the DC Source

Agilent 66111A and 66311B/D dc sources provide an RS-232 programming interface, which is activated by commands located under the front panel **Address** key. All SCPI and COMPatibility commands are available through RS-232 programming. When the RS-232 interface is selected, the GPIB interface is disabled.

The EIA RS-232 Standard defines the interconnections between Data Terminal Equipment (DTE) and Data Communications Equipment (DCE). The dc source is designed to be a DTE. It can be connected to another DTE such as a PC COM port through a null modem cable.

NOTE: The RS-232 settings in your program must match the settings specified in the front panel Address menu. Press the front panel **Address** key if you need to change the settings.

RS-232 Data Format

The RS-232 data is a 10-bit word with one start bit and one stop bit. The number of start and stop bits is not programmable. However, the following parity options are selectable using the front panel Address key:

EVEN	Seven data bits with even parity
ODD	Seven data bits with odd parity
MARK	Seven data bits with mark parity (parity is always true)

6 - Introduction to Programming

SPACE Seven data bits with space parity (parity is always false)

NONE Eight data bits without parity

Parity options are stored in non-volatile memory.

Baud Rate

The front panel Address key lets you select one of the following baud rates, which is stored in non-volatile memory:

300 600 1200 2400 4800 9600

RS-232 Flow Control

The RS-232 interface supports several flow control options that are selected using the front panel Address key. For each case, the dc source will send a maximum of five characters after holdoff is asserted by the controller. The dc source is capable of receiving as many as fifteen additional characters after it asserts holdoff.

XON-XOFF A software handshake that uses the ASCII control code DC3 (decimal code 19) to assert hold-off, and control code DC1 (decimal code 17) to release hold-off.

RTS-CTS The dc source asserts its Request to Send (RTS) line to signal hold-off when its input buffer is almost full, and it interprets its Clear to Send (CTS) line as a hold-off signal from the controller.

DTR-DSR The dc source asserts its Data Terminal Ready (DTR) line to signal hold-off when its input buffer is almost full, and it interprets its Data Set Ready (DSR) line as a hold-off signal from the controller.

NONE There is no flow control.

Flow control options are stored in non-volatile memory.

Introduction to SCPI

SCPI (Standard Commands for Programmable Instruments) is a programming language for controlling instrument functions over the GPIB. SCPI is layered on top of the hardware-portion of IEEE 488.2. The same SCPI commands and parameters control the same functions in different classes of instruments. For example, you would use the same DISPLAY command to control the dc source display and the display of a SCPI-compatible multimeter.

Conventions Used in This Guide

Angle brackets	< >	Items within angle brackets are parameter abbreviations. For example, <NR1> indicates a specific form of numerical data.
Vertical bar		Vertical bars separate alternative parameters. For example, NORM TEXT indicates that either "TEXT" or "NORM" can be used as a parameter.
Square Brackets	[]	Items within square brackets are optional. The representation [SOURce:]. VOLTage means that SOURce: may be omitted.
Braces	{ }	Braces indicate parameters that may be repeated zero or more times. It is used especially for showing arrays. The notation <A>{<,B>} shows that parameter "A" must be entered, while parameter "B" may be omitted or may be entered one or more times.
Boldface font		Boldface font is used to emphasize syntax in command definitions. TRIGger:COUNT:CURRENT <NRf> shows command definition.
Computer font		Computer font is used to show program lines in text. TRIGger:COUNT:CURRENT 10 shows a program line.

Types of SCPI Commands

SCPI has two types of commands, common and subsystem.

- ◆ Common commands generally are not related to specific operation but to controlling overall dc source functions, such as reset, status, and synchronization. All common commands consist of a three-letter mnemonic preceded by an asterisk: *RST *IDN? *SRE 8
- ◆ Subsystem commands perform specific dc source functions. They are organized into an inverted tree structure with the "root" at the top. The following figure shows a portion of a subsystem command tree, from which you access the commands located along the various paths. You can see the complete tree in Table 8-1.

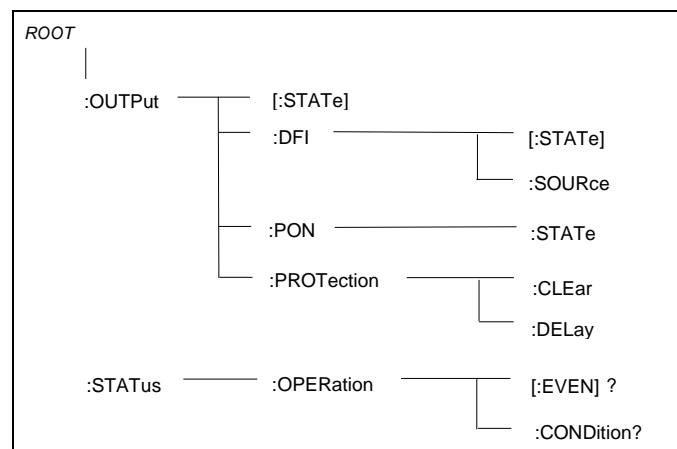

Figure 6-1. Partial Command Tree

Multiple Commands in a Message

Multiple SCPI commands can be combined and sent as a single message with one message terminator. There are two important considerations when sending several commands within a single message:

- ◆ Use a semicolon to separate commands within a message.
- ◆ There is an implied header path that affects how commands are interpreted by the dc source.

The header path can be thought of as a string that gets inserted **before** each command within a message. For the first command in a message, the header path is a null string. For each subsequent command the header path is defined as the characters that make up the headers of the previous command in the message up to and including the last colon separator. An example of a message with two commands is:

```
OUTP:STAT ON;PROT:DEL 2
```

which shows the use of the semicolon separating the two commands, and also illustrates the header path concept. Note that with the second command, the leading header "OUTP" was omitted because after the "OUTP:STAT ON" command, the header path was became defined as "OUTP" and thus the instrument interpreted the second command as:

```
OUTP:PROT:DEL 2
```

In fact, it would have been syntactically incorrect to include the "OUTP" explicitly in the second command, since the result after combining it with the header path would be:

```
OUTP:OUTP:PROT:DEL 2
```

which is incorrect.

Moving Among Subsystems

In order to combine commands from different subsystems, you need to be able to reset the header path to a null string within a message. You do this by beginning the command with a colon (:), which discards any previous header path. For example, you could clear the output protection and check the status of the Operation Condition register in one message by using a root specifier as follows:

```
OUTPut:PROTEction:CLEAr::STATus:OPERation:CONDition?
```

The following message shows how to combine commands from different subsystems as well as within the same subsystem:

```
VOLTage:LEVEl 20;PROTEction 28;;CURREnt:LEVEl 3;PROTEction:STATE ON
```

Note the use of the optional header LEVEl to maintain the correct path within the voltage and current subsystems, and the use of the root specifier to move between subsystems.

Including Common Commands

You can combine common commands with system commands in the same message. Treat the common command as a message unit by separating it with a semicolon (the message unit separator). Common commands *do not affect the header path*; you may insert them anywhere in the message.

```
VOLTage:TRIGgered 17.5::INITialize;*TRG  
OUTPut OFF;*RCL 2;OUTPut ON
```

Using Queries

Observe the following precautions with queries:

- ◆ Set up the proper number of variables for the returned data.
- ◆ Read back all the results of a query before sending another command to the dc source. Otherwise a *Query Interrupted* error will occur and the unreturned data will be lost.

Types of SCPI Messages

There are two types of SCPI messages, program and response.

- ◆ A *program message* consists of one or more properly formatted SCPI commands sent from the controller to the dc source. The message, which may be sent at any time, requests the dc source to perform some action.
- ◆ A *response message* consists of data in a specific SCPI format sent from the dc source to the controller. The dc source sends the message only when commanded by a program message "query."

The following figure illustrates SCPI message structure:

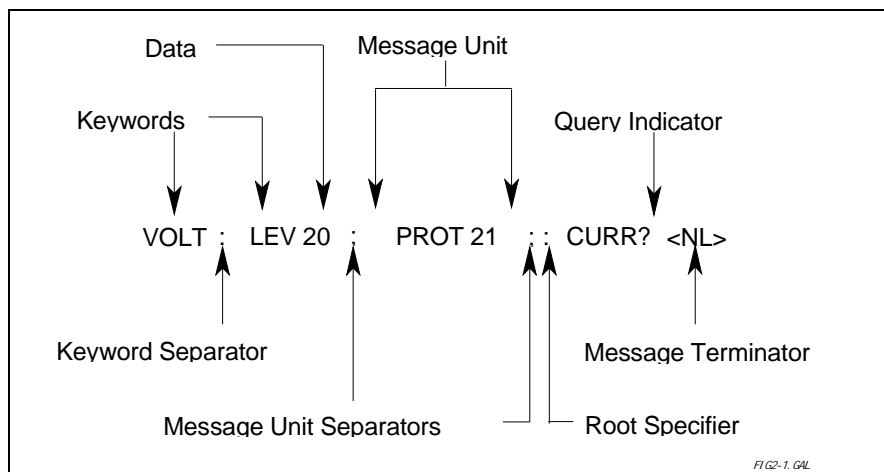

Figure 6-2. Command Message Structure

The Message Unit

The simplest SCPI command is a single message unit consisting of a command header (or keyword) followed by a message terminator. The message unit may include a parameter after the header. The parameter can be numeric or a string.

```
ABORT<NL>
VOLTage 20<NL>
```

Headers

Headers, also referred to as keywords, are instructions recognized by the dc source. Headers may be either in the long form or the short form. In the long form, the header is completely spelled out, such as VOLTAGE, STATUS, and DELAY. In the short form, the header has only the first three or four letters, such as VOLT, STAT, and DEL.

6 - Introduction to Programming

Query Indicator

Following a header with a question mark turns it into a query (VOLTage?, VOLTage:PROTection?). If a query contains a parameter, place the query indicator at the end of the last header.

```
VOLTage:PROTection? MAX
```

Message Unit Separator

When two or more message units are combined into a compound message, separate the units with a semicolon.

```
STATus:OPERation?;QUEStionable?
```

Root Specifier

When it precedes the first header of a message unit, the colon becomes the root specifier. It tells the command parser that this is the root or the top node of the command tree.

Message Terminator

A terminator informs SCPI that it has reached the end of a message. Three permitted messages terminators are:

- ◆ newline (<NL>), which is ASCII decimal 10 or hex 0A.
- ◆ end or identify (<END>)
- ◆ both of the above (<NL><END>).

In the examples of this guide, there is an assumed message terminator at the end of each message.

SCPI Data Formats

All data programmed to or returned from the dc source is ASCII. The data may be numerical or character string.

Numerical Data Formats

<u>Symbol</u>	<u>Response Formats</u>
<NR1>	Digits with an implied decimal point assumed at the right of the least-significant digit. Examples: 273
<NR2>	Digits with an explicit decimal point. Example: .0273
<NR3>	Digits with an explicit decimal point and an exponent. Example: 2.73E+2
<u>Parameter Formats</u>	
<Nrf>	Extended format that includes <NR1>, <NR2> and <NR3>. Examples: 273 273. 2.73E2
<Nrf+>	Expanded decimal format that includes <Nrf> and MIN MAX. Examples: 273 273. 2.73E2 MAX. MIN and MAX are the minimum and maximum limit values that are implicit in the range specification for the parameter.
<Bool>	Boolean Data. Example: 0 1 or ON OFF

Suffixes and Multipliers

<u>Class</u>	<u>Suffix</u>	<u>Unit</u>	<u>Unit with Multiplier</u>
Current	A	ampere	MA (milliampere)
Amplitude	V	volt	MV (millivolt)
Time	S	second	MS (millisecond)
<u>Common Multipliers</u>			
	1E3	K	kilo
	1E-3	M	milli
	1E-6	U	micro

Response Data Types

Character strings returned by query statements may take either of the following forms, depending on the length of the returned string:

- <CRD> Character Response Data. Permits the return of character strings.
- <AARD> Arbitrary ASCII Response Data. Permits the return of unlimited 7-bit ASCII. This data type has an implied message terminator.
- <SRD> String Response Data. Returns string parameters enclosed in double quotes.

SCPI Command Completion

SCPI commands sent to the dc source are processed either sequentially or in parallel. Sequential commands finish execution before a subsequent command begins. Parallel commands allow other commands to begin executing while the parallel command is still executing. Commands that affect trigger actions are among the parallel commands.

The *WAI, *OPC, and *OPC? common commands provide different ways of indicating when all transmitted commands, including any parallel ones, have completed their operations. The syntax and parameters for these commands are described in chapter 8. Some practical considerations for using these commands are as follows:

- *WAI This prevents the dc source from processing subsequent commands until all pending operations are completed.
- *OPC? This places a 1 in the Output Queue when all pending operations have completed. Because it requires your program to read the returned value before executing the next program statement, *OPC? can be used to cause the controller to wait for commands to complete before proceeding with its program.
- *OPC This sets the OPC status bit when all pending operations have completed. Since your program can read this status bit on an interrupt basis, *OPC allows subsequent commands to be executed.

NOTE: The trigger subsystem must be in the Idle state for the status OPC bit to be true. As far as triggers are concerned, OPC is false whenever the trigger subsystem is in the Initiated state.

Using Device Clear

You can send a device clear at any time abort a SCPI command that may be hanging up the GPIB interface. The status registers, the error queue, and all configuration states are left unchanged when a device clear message is received. Device clear performs the following actions:

- ◆ The input and output buffers of the dc source are cleared.
- ◆ The dc source is prepared to accept a new command string.

The following statement shows how to send a device clear over the GPIB interface using *Agilent BASIC*:

```
CLEAR 705      IEEE-488 Device Clear
```

The following statement shows how to send a device clear over the GPIB interface using the GPIB command library for *C* or *QuickBASIC*:

```
IOCLEAR (705)
```

SCPI Conformance Information

SCPI Conformed Commands

The Agilent 66111A, 66311B/D, and 66309B/D conform to SCPI Version 1995.0.

ABOR	OUTP:PROT:DEL	STAT:QUES:ENAB
CAL:DATA	OUTP:PROT:STAT	STAT:QUES:NTR
CAL:STAT	[SOUR]:CURR[:LEV][:IMM][:AMPL]	STAT:QUES:PTR
DISP[:WIND][:STAT]	[SOUR]:CURR[:LEV]:TRIG[:AMPL]	SYST:ERR?
DISP[:WIND]:TEXT[:DATA]	[SOUR]:CURR:PROT:STAT	SYST:LANG
INIT[:IMM]:SEQ NAME	[SOUR]:VOLT[:LEV][:IMM][:AMPL]	SYST:VERS?
INIT:CONT:SEQ NAME	[SOUR]:VOLT[:LEV]:TRIG[:AMPL]	TRIG[:SEQ1 :TRAN][:IMM]
MEAS FETC:ARR:CURR[:DC]?	[SOUR]:VOLT:PROT	TRIG[:SEQ1 :TRAN]:SOUR
MEAS FETC:ARR:VOLT[:DC]?	SENS:CURR[:DC]:RANG[:UPP]	TRIG:SEQ2 ACQ[:IMM]
MEAS FETC[:SCAL]:CURR[:DC]?	SENS:FUNC	TRIG:SEQ2 ACQ:SOUR
MEAS FETC[:SCAL]:CURR:HIGH?	SENS:SWE:OFFS:POIN	TRIG:SEQ:DEF
MEAS FETC[:SCAL]:CURR:LOW?	SENS:SWE:POIN	*CLS
MEAS FETC[:SCAL]:CURR:MAX?	SENS:SWE:TINT	*ESE*ESE?*ESR?
MEAS FETC[:SCAL]:CURR:MIN?	STAT:OPER[:EVEN]?	*IDN?
MEAS FETC[:SCAL]:VOLT[:DC]?	STAT:OPER:COND?	*OPC*OPC?*OPT?
MEAS FETC[:SCAL]:VOLT:HIGH?	STAT:OPER:ENAB	*PSC*PSC?
MEAS FETC[:SCAL]:VOLT:LOW?	STAT:OPER:NTR	*RCL*RST
MEAS FETC[:SCAL]:VOLT:MAX?	STAT:OPER:PTR	*SAV*SRE*STB?
MEAS FETC[:SCAL]:VOLT:MIN?	STAT:PRES	*TRG*TST?
OUTP[:STAT]	STAT:QUES[:EVEN]?	*WAI
OUTP:PROT:CLE	STAT:QUES:COND?	

Non-SCPI Commands

CAL:CURR[:SOUR][:DC][:POS]	OUTP:DFI[:STAT]
CAL:CURR[:SOUR][:DC]:NEG	OUTP:DFI:SOUR
CAL:MEAS[:DC]:LOWR	OUTP:PON:STAT
CAL:MEAS:AC	OUTP:RI:MODE
CAL:LEV	OUTP:TYPE
CAL:PASS	SENS:CURR:DET
CAL:SAVE	[SOUR]:DIG:DATA[:VAL]
CAL:VOLT[:DC]	[SOUR]:DIG:FUNC
CAL:VOLT:PROT	TRIG:SEQ2 ACQ:COUN:CURR :VOLT
DISP[:WIND]:MODE	TRIG:SEQ2 ACQ:HYST:CURR :VOLT
MEAS FETC[:SCAL]:CURR:ACDC?	TRIG:SEQ2 ACQ:LEV:CURR :VOLT
MEAS FETC[:SCAL]:VOLT:ACDC?	TRIG:SEQ2 ACQ:SLOP:CURR :VOLT

Programming the DC Source

Introduction

This chapter contains examples on how to program your dc source. Simple examples show you how to program:

- ◆ output functions such as voltage and current
- ◆ internal and external triggers
- ◆ measurement functions
- ◆ the status and protection functions

NOTE: The examples in this chapter show which commands are used to perform a particular function, but do not show the commands being used in any particular programming environment. Refer to Appendix D for some examples of SCPI commands in a specific programming environment.

Programming the Output

Power-on Initialization

When the dc source is first turned on, it wakes up with the output state set OFF. In this state the output voltage is set to 0. The following commands are given implicitly at power-on:

```
*RST
*CLS
STAT:PRES
*SRE 0
*ESE 0
```

*RST is a convenient way to program all parameters to a known state. Refer to the *RST command in chapter 8 to see how each programmable parameter is set by *RST. Refer to the *PSC command in chapter 8 for more information on the power-on initialization of the *ESE and the *SRE registers.

Enabling the Output

To enable the output, use the command:

```
OUTP ON
```

Note that this command enables *both* outputs on Agilent 66309B/66309D units.

7 - Programming the DC Source

Output Voltage

The output voltage is controlled with the VOLTage command. To set the output voltage to 5 volts, use:

```
VOLT 5 or  
VOLT2 5 for models that have a second output
```

Maximum Voltage

The maximum output voltage that can be programmed can be queried with:

```
VOLT? MAX
```

Overvoltage Protection

The dc source can be programmed to turn off its output if the output voltage exceeds a preset peak voltage limit. As explained in chapter 8, this protection feature is implemented with the following command:

```
VOLT:PROT <n> where <n> is the voltage protection level.
```

NOTE: Use the VOLTage:PROTection:STATe 0 command to disable the overvoltage protection circuit if its operation interferes with the proper operation of your phone test.

Output Current

All models have a programmable current function. The command to program the current is:

```
CURR <n> or  
CURR2 <n> for models that have a second output
```

where <n> is the current limit in amperes.

If the load attempts to draw more current than the programmed limit, the output voltage is reduced to keep the current within the limit.

Maximum Current

The maximum output current that can be programmed can be queried with:

```
CURR? MAX
```

Overcurrent Protection

The dc source can also be programmed to turn off its output if the current limit is reached. As explained in chapter 8, this protection feature is implemented the following command:

```
CURR:PROT:STAT ON | OFF
```

NOTE: Use the OUTPut:PROTection:DELay command to prevent momentary current limit conditions caused by programmed output changes from tripping the overcurrent protection.

Triggering Output Changes

The dc source has two independent trigger systems. One is used for synchronizing output changes, and the other is used for synchronizing measurements. This section describes the output trigger system. The measurement trigger system is described under "Triggering Measurements".

SCPI Triggering Nomenclature

In SCPI terms, trigger systems are called sequences. When more than one trigger system exists, they are differentiated by naming them SEQUENCE1 and SEQUENCE2. SEQUENCE1 is the transient trigger system and SEQUENCE2 is the measurement trigger system. The dc source uses aliases with more descriptive names for these sequences. These aliases can be used instead of the sequence forms.

Sequence Form	Alias
SEQUENCE1	TRANSient
SEQUENCE2	ACQUIRE

Output Trigger Model

Figure 7-1 is a model of the output trigger system. The rectangular boxes represent states. Arrows show the transitions between states. These are labeled with the input or event that causes the transition to occur.

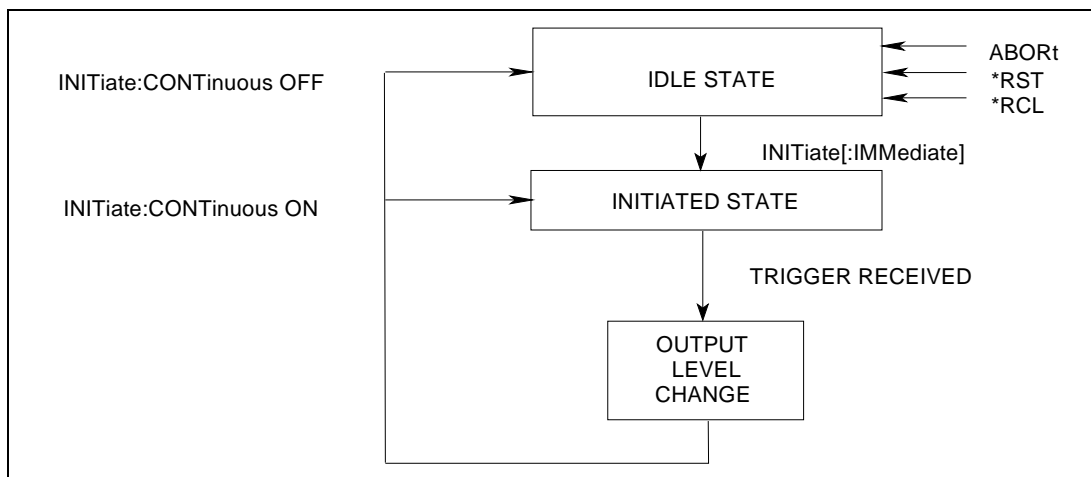

Figure 7-1. Model of Output Trigger System

Setting the Voltage or Current Transient Levels

To program output trigger levels, you must first specify a voltage or current trigger level that the output will go to once a trigger signal is received. Use the following commands to set the output trigger level:

```

VOLT:TRIG <n>
VOLT2:TRIG <n>   for models that have a second output
CURR:TRIG <n>
CURR2:TRIG <n>  for models that have a second output
  
```

NOTE: Until they are programmed, trigger levels will be the same as the corresponding voltage or current levels. For example, if a dc source is powered up and the voltage is programmed to 6, the trigger level is also set to 6. Once you program a trigger level, it will stay at that value until the output is changed by a transient trigger or reprogrammed.

7 - Programming the DC Source

Enabling the Output Trigger System

When the dc source is turned on, the trigger subsystem is in the idle state. In this state, the trigger subsystem is disabled, ignoring all triggers. Sending the following commands at any time returns the trigger system to the idle state:

```
ABOR
*RST
*RCL
```

The INITiate commands move the trigger system from the idle state to the initiated state. This enables the dc source to receive triggers. To initiate for a single triggered action, use:

```
INIT:SEQ1    or
INIT:NAME TRAN
```

After a trigger is received and the action completes, the trigger system will return to the idle state. Thus it will be necessary to enable the system each time a triggered action is desired.

To keep the transient trigger system initiated for multiple triggers without having to send an initiate command for each trigger, use:

```
INIT:CONT:SEQ1 ON    or
INIT:CONT:NAME TRAN, ON
```

Selecting the Output Trigger Source

The only trigger source for output triggers is a command from the bus. Since BUS is the only trigger source, the following command is provided for completeness only:

```
TRIG:SOUR BUS
```

Generating Triggers

Single Trigger

After you have specified the appropriate trigger source, you can generate triggers by sending one of the following commands over the GPIB:

```
TRIG:IMM
*TRG
an IEEE-488 Group Execute Trigger bus command
```

When the trigger system enters the Output Change state upon receipt of a trigger (see figure 7-1), the triggered functions are set to their programmed trigger levels. When the triggered actions are completed, the trigger system returns to the idle state.

Multiple Triggers

When you have programmed INITiate:CONTinuous:SEQuence1 ON as previously discussed, the trigger system does not need to be initiated for each trigger; it responds to the next trigger as soon as it is received. When each triggered action completes, the trigger system returns to the initiated state to wait for the next trigger. INITiate:CONTinuous:SEQuence1 OFF returns the system to single trigger mode.

Making Basic Measurements

All dc sources have excellent output voltage and current measurement capability.

NOTE: There is only one measurement system in the dc source. Therefore, you can perform only **one** measurement function (voltage, current, or DVM) at a time.

All measurements are performed by digitizing the instantaneous output voltage or current for a defined number of samples and sample interval, storing the results in a buffer, and then calculating the measured result. For the main output (output 1), many parameters of the measurement are programmable. These include the number of samples, the time interval between samples, and the method of triggering. Note that there is a tradeoff between these parameters and the speed, accuracy, and stability of the measurement in the presence of noise.

Average Measurements

To measure the average output voltage or current for the main output (output 1), use:

```
MEAS : VOLT?
```

```
MEAS : CURR?
```

Average voltage and current is measured by acquiring a number of readings at the selected time interval, applying the Hanning window function to the readings, and *averaging* the readings. Windowing is a signal conditioning process that reduces the error in average measurements made in the presence of periodic signals such as pulse current waveforms, which are generated when TDMA cellular phones are transmitting. The power-on and *RST sample interval and sweep size settings yield a data acquisition time of 32 milliseconds per measurement.

Ripple rejection is a function of the number of cycles of the ripple frequency contained in the acquisition window. More cycles in the acquisition window results in better ripple rejection. If you increase the data acquisition time for each measurement to 45 microseconds for example, this results in 5.53 cycles in the acquisition window at 60 Hz, for a ripple rejection of about 70 dB.

Controlling Measurement Samples

You can vary both the number of data points in a measurement sample, as well as the time between samples. This is illustrated in Figure 7-2.

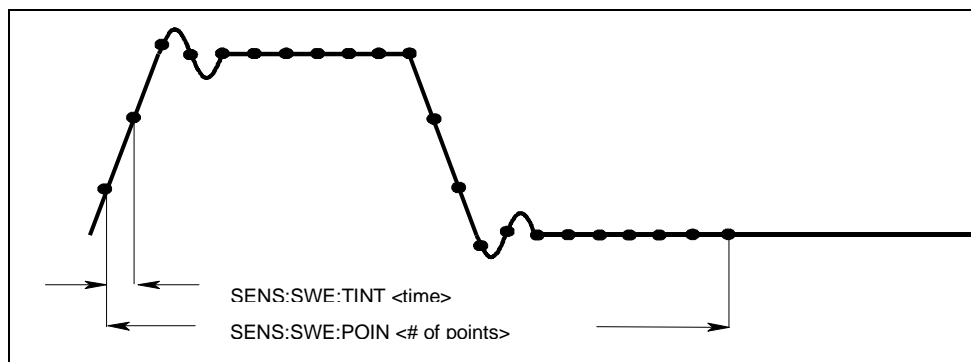

Figure 7-2. Commands that Control Measurement Time

7 - Programming the DC Source

When the instrument is turned on and at *RST, the output voltage or current sampling rate is 15.6 microseconds, and the sweep size is set to 2048 data points. This means that it takes about 32 milliseconds to fill up 2048 data points in the data buffer. Adding a command processing overhead of about 20 milliseconds results in a total measurement time of about 50 milliseconds per measurement. You can vary this data sampling rate with:

```
SENS:SWE:TINT <sample_period>  
SENS:SWE:POIN <points>
```

For example, to set the time interval to 46.8 microseconds per measurement with 1500 samples, use

```
SENS:SWE:TINT 46.8E-6;POIN 1500.
```

Note that reducing the number of sample points increases the speed of the measurement; however, the tradeoff is greater measurement uncertainty in the presence of noise..

Window Functions

The dc source lets you select from two measurement window functions: Hanning and Rectangular. To select a window function, use:

```
SENS:WIND: HANN | RECT
```

As shipped from the factory, the dc source measurement functions use a Hanning window. The Hanning window applies a \cos^4 weighting function to the data in the measurement buffer when computing average and rms measurements. This returns accurate data even if an integral number of waveform cycles are not captured, provided that at least three or more waveform cycles are in the measurement buffer. If there are only one or two waveform cycles, the Hanning window will not give accurate results.

With a Rectangular window, no weighting function is applied to the data in the measurement buffer. However, to use the Rectangular window function to return accurate data for one or more waveform cycles, an integral number of waveform cycles must be captured in the measurement buffer. This means that you must accurately know the waveform period beforehand. In this way you can chose the sample interval and the number of data points so that an integral number of waveform cycles will end up in the measurement buffer.

Measuring Output 2 Voltage and Current (Agilent 66309B/D only)

The measurement parameters for output 2 are not programmable. They are fixed at 2048 data points with a 15.6 microsecond sampling rate using a Hanning window. To measure the average output voltage or current for output 2, use:

```
MEAS:VOLT2?  
MEAS:CURR2?
```

Making Enhanced Measurements

Agilent Models 66311B, 66311D, 66309B, and 66309D have the ability to make several types of voltage or current waveform measurements. These expanded measurement capabilities are particularly useful for loads that draw current in pulses. The SCPI language MEASure and FETCh queries are used to return the various measurement parameters of voltage and current waveforms.

There are two ways to make enhanced measurements:

- ◆ Use the MEASure queries to immediately start acquiring new voltage or current data, and return measurement calculations from this data as soon as the buffer is full. This is the easiest way to make measurements, since it requires no explicit trigger programming. Additional calculations may be obtained from the acquired data using FETCh queries.
- ◆ Use a triggered measurement when the measurement must be synchronized to a signal condition as discussed under “Triggering Measurements”. Then use the FETCh queries to return calculations from the data that was retrieved by the acquisition trigger. This method gives you the flexibility to synchronize the data acquisition with a transition in the output voltage or current. FETCh queries do not trigger the acquisition of new measurement data, but they can be used to return many different calculations from the data that was retrieved by the acquisition trigger. Note that if you acquired voltage data, you can fetch only voltage calculations.

NOTE: For each MEASure query, there exists a corresponding FETCh query. FETCh queries perform the same calculation as MEASure queries, but do **not** acquire new data.

Current Ranges and Measurement Detector

The dc source has two current measurement ranges. The command that controls the ranges is:

```
SENS:CURR:RANG MIN | MAX
```

When the range is set to MIN, the maximum current that can be measured is 20 milliamperes. The crossover value of the high and low ranges is 20 milliamperes.

The dc source also has two measurement detectors. Check that the current detector is set to ACDC when measuring current pulses or other waveforms with a frequency content greater than a few kilohertz.

```
SENS:CURR:DET ACDC
```

Select DC as the measurement detector if you are making only DC current measurements and you require a measurement offset better than 2mA on the High current measurement range. Note that this selection gives inaccurate results on current waveforms that have ac content.

```
SENS:CURR:DET DC
```

RMS Measurements

To read the rms content of a voltage or current waveform, use:

```
MEAS:VOLT:ACDC? or
MEAS:CURR:ACDC?
```

This returns the ac+dc rms measurement.

Making rms or average measurements on ac waveforms for which a non-integral number of cycles of data has been acquired may result in measurement errors due to the last partial cycle of acquired data. The instrument reduces this error by using a Hanning window function when making the measurement. If the measurement readings vary from sample to sample, try increasing the data acquisition time to reduce measurement error.

7 - Programming the DC Source

Pulse Measurements

After pulse data has been acquired, use FETCh queries to return measurement data in the shortest time. FETCh queries do not trigger the acquisition of new measurement data, but return different calculations from the data that was acquired. If you acquired voltage data, you can fetch only voltage measurements; if you acquired current data you can fetch only current measurements, otherwise an error will occur.

The dc source has several measurement queries that return key parameters of pulse waveforms as shown in Figure 7-3.

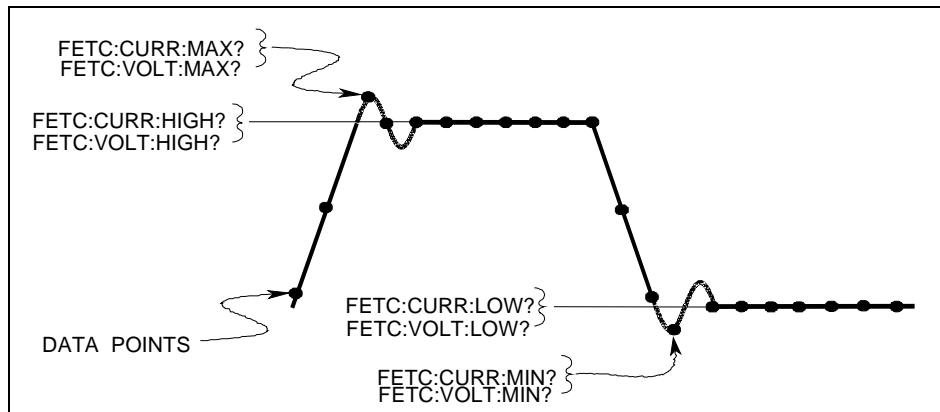

Figure 7-3. Measurement Commands Used to Return Pulse Data

Minimum and Maximum Measurements

To return the maximum or minimum value of a pulse or ac waveform use:

```
FETC:VOLT:MAX? or  
FETC:VOLT:MIN?  
FETC:CURR:MAX? or  
FETC:CURR:MIN?
```

High/Low Measurements

The value of the high level or low level of a pulse can also be measured. High and low level measurements are defined as follows: The instrument first measures the minimum and maximum data points of the pulse waveform. It then generates a histogram of the pulse waveform using 16 bins between the maximum and minimum data points. The bin containing the most data points above the 50% point is the high bin. The bin containing the most data points below the 50% point is the low bin. The average of all the data points in the high bin is returned as the High level. The average of all the data points in the low bin is returned as the Low level. If no high or low bin contains more than 1.25% of the total number of acquired points, then the maximum or minimum value is returned by these queries.

To return the average value of the high bin, use:

```
FETC:CURR:HIGH? or  
FETC:VOLT:HIGH?
```

To return the average value of the low bin, use:

```
FETC:CURR:LOW? or  
FETC:VOLT:LOW?
```

Returning All Measurement Data From the Data Buffer

The MEASure:ARRay and FETCh:ARRay queries return all data values of the instantaneous voltage or current buffer. No weighting function is applied, returning only raw data from the buffer. The commands are:

```
MEAS : ARR : CURR ?
MEAS : ARR : VOLT ?
```

Making DVM Measurements

Agilent Models 66311D and 66309D have a DVM input on the rear panel for making independent voltage measurements. The common mode voltage range of the DVM is -4.5 V to $+25\text{ V}$ from either DVM input with respect to the negative output terminal of output 1. To protect the DVM from damage, keep the maximum isolation voltage to ground at less than $\pm 50\text{ Vdc}$. To obtain correct voltage measurements, keep the common mode voltage within the specified limits. Refer to chapter 3 under "DVM Connection" for more information.

The DVM can only measure average and rms voltage. Its measurement parameters are not programmable. They are fixed at 2048 data points with a 15.6 microsecond sampling rate using a Hanning window. Use the SCPI language MEASure and FETCh queries to return measurements. Note that all triggered measurement functions discussed the next section also apply to DVM measurements.

NOTE: There is only one measurement system in the dc source. Therefore, you can perform only **one** measurement function (voltage, current, or DVM) at a time.

Average Measurements

To measure the average voltage, use:

```
MEAS : DVM : DC ?
```

Average voltage measured by acquiring a number of readings at the selected time interval, applying a Hanning window function to the readings, and *averaging* the readings. Windowing is a signal conditioning process that reduces the error in average measurements made in the presence of periodic signals. The DVM sampling rate and sweep size result in a data acquisition time of 32 milliseconds per measurement. Adding a command processing overhead of about 20 milliseconds results in a total measurement time of about 50 milliseconds per measurement.

RMS Measurements

To measure rms voltage, use:

```
MEAS : DVM : ACDC ?
```

This returns the total rms measurement. If ac and dc are present, the DVM measures the total rms of ac+dc.

Making rms or average measurements on ac waveforms for which a non-integral number of cycles of data has been acquired may result in measurement errors due to the last partial cycle of acquired data. This error is reduced by using a Hanning window function when making the measurement.

Triggered Measurements

Use the measurement trigger system to synchronize the acquisition of measurements with either a BUS or internal trigger. You can trigger voltage and current measurements on the main output (output 1) and on the DVM. An internal trigger synchronizes the acquisition to a signal condition. Use `FETCH` commands to return different calculations from the data acquired by the measurement system. Briefly, to make a triggered measurement:

- 1 Select a sweep interval and sample size
- 2 Set up the trigger levels
- 3 Setting the output 2 voltage and current
- 4 Select the trigger source
- 5 Enable the trigger system
- 6 Fetch the triggered measurements

SCPI Triggering Nomenclature

The dc source uses the following sequence name and alias for the measurement trigger system. The alias can be used instead of the sequence form.

Sequence Form	Alias
SEquence2	ACQuire

Measurement Trigger Model

Figure 7-4 is a model of the measurement trigger system. The rectangular boxes represent states. The arrows show the transitions between states. These are labeled with the input or event that causes the transition to occur.

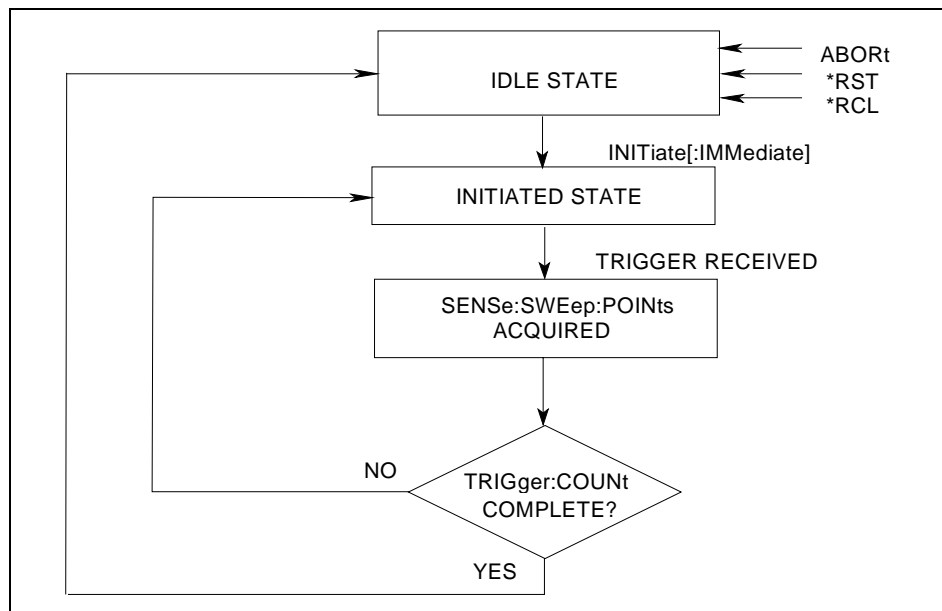

Figure 7-4. Model of Measurement Trigger System

Enabling the Measurement Trigger System

When the dc source is turned on, the trigger system is in the idle state. In this state, the trigger system is disabled and it ignores all triggers. Sending the following commands at any time returns the trigger system to the idle state:

```
ABORt
*RST
*RCL
```

The INITiate commands move the trigger system from the idle state to the initiated state. This enables the measurement system to receive triggers. To initiate the measurement trigger system, use:

```
INIT:SEQ2 or
INIT:NAME ACQ
```

After a trigger is received and the data acquisition completes, the trigger system will return to the idle state (unless multiple triggers are desired). Thus it will be necessary to initiate the system each time a triggered measurement is desired.

NOTE: The measurement trigger system cannot be initiated continuously. However, it can be repeated for a limited number of times as explained under "Multiple triggers".

Selecting the Measurement Trigger Source

The trigger system is waiting for a trigger signal in the initiated state. Before you generate a trigger, you must select a trigger source. The following measurement trigger sources can be selected:

- BUS -** Selects GPIB bus triggers. This synchronizes the measurement to the bus trigger command
- INTernal -** Selects the signal as the measurement trigger. This synchronizes the measurement to the signal condition present at either the main output (output1) terminals or the DVM inputs.

To select GPIB bus triggers, use:

```
TRIG:SEQ2:SOUR BUS or
TRIG:ACQ:SOUR BUS
```

To select internal triggers use:

```
TRIG:SEQ2:SOUR INT or
TRIG:ACQ:SOUR INT
```

Selecting the Sensing Function

There is only one measurement system in the dc source. The measurement system supports voltage measurements at the main output, current measurements at the main output, and DVM input measurements. Before you generate a measurement trigger, you must specify one of the following measurement functions:

```
SENS:FUNC "CURR" or
SENS:FUNC "VOLT" or
SENS:FUNC "DVM"
```

Generating Measurement Triggers

Single Triggers

After you specify the appropriate trigger source and sensing function, generate triggers as follows:

GPIB Triggers Send one of the following commands over the GPIB:
`TRIG:ACQ`
`*TRG`
 an IEEE-488 Group Execute Trigger bus command

Internal Triggers To trigger off of the output signal, you must specify the output level that generates the trigger, the rising or falling edge of the slope, and a hysteresis to qualify trigger conditions. This is illustrated in figure 7-5 for current triggers.

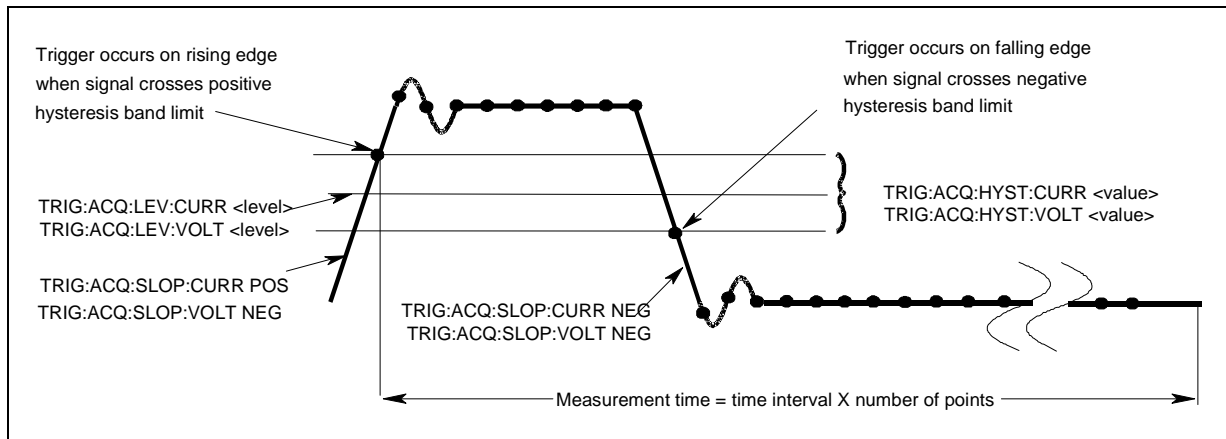

Figure 7-5. Commands Used to Control Measurement Triggers

As shown in figure 7-5, to specify the **current level** that will generate triggers for both positive- and negative-going signals use:

`TRIG:SEQ2:LEV:CURR <value>` or
`TRIG:ACQ:LEV:CURR <value>`

To specify the **slope** on which triggering occurs use the following commands. You can specify a POSitive, a NEGative, or EITHER type of slope.

`TRIG:SEQ2:SLOP:CURR <slope>` or
`TRIG:ACQ:SLOP:CURR <slope>`

To specify a **hysteresis band** to qualify the positive- or negative-going signal use:

`TRIG:SEQ2:HYST:CURR <value>` or
`TRIG:ACQ:HYST:CURR <value>`

NOTE: When using internal triggers, do not INITiate the measurement until after you have specified the slope, level, and hysteresis.

When the acquisition finishes, any of the FETCh queries can be used to return the results. Once the measurement trigger is initiated, if a FETCh query is sent before the data acquisition is triggered or before it is finished, the response data will be delayed until the trigger occurs and the acquisition completes. This may tie up the computer if the trigger condition does not occur immediately.

One way to wait for results without tying up the computer is to use the SCPI command completion commands. For example, you can send the *OPC command after INITIALize, then occasionally poll the OPC status bit in the standard event status register for status completion while doing other tasks. You can also set up an SRQ condition on the OPC status bit going true and do other tasks until the SRQ interrupts.

Multiple Triggers

As shown in Figure 7-6, the dc source also has the ability to set up several measurements in succession. This is accomplished by specifying a trigger count.

NOTE: Multiple triggers can only be programmed for voltage and current measurements on the main output (output 1). Multiple triggers cannot be programmed for DVM measurements.

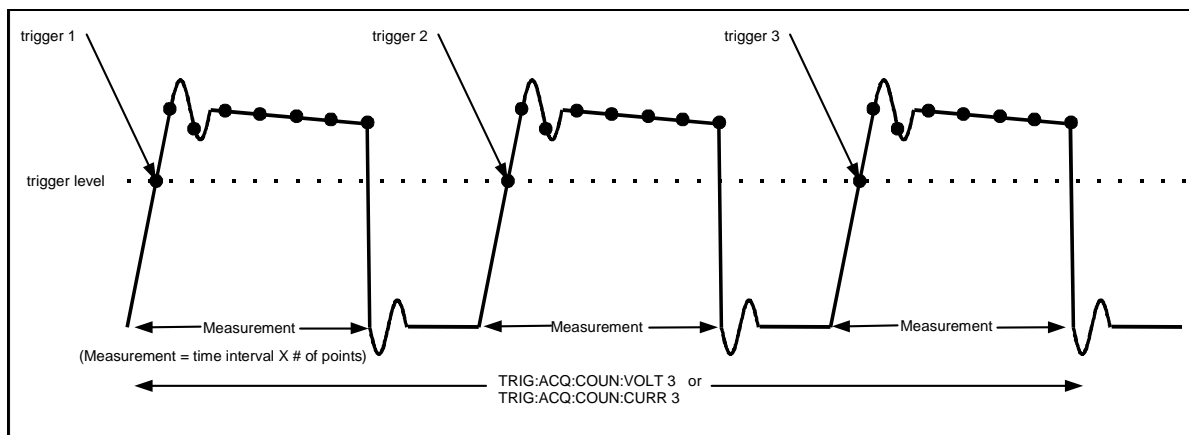

Figure 7-6. Multiple Measurements

To set up the trigger system for a number of sequential acquisitions use:

```
TRIG:ACQ:COUN:CURR <number> or
TRIG:ACQ:COUN:VOLT <number>
```

With this setup, the instrument performs each acquisition sequentially, storing the digitized readings in the internal measurement buffer. It is only necessary to initialize the measurement once at the start; after each completed acquisition the instrument will wait for the next valid trigger condition to start another. When all measurements complete, use FETCh commands to return the data.

By varying the measurement parameters, you can accurately measure specific portions of an output pulse. For example, if you set the measurement time to match the pulse width, you can measure just the high level of a specific number of output pulses. If you increase the measurement time to include the entire waveform, you will return measurement data based on the entire waveform. To calculate the correct time interval for your measurement, simply divide the desired measurement time by the number of points or samples in the measurement.

NOTE: The total number of data points cannot exceed 4096. This means that the count multiplied by the points in each measurement cannot exceed 4096; otherwise an error will occur.

Pre-trigger and Post-trigger Data Acquisition

The measurement system lets you capture data before, after, or at the trigger signal. When a measurement is initiated, the dc source continuously samples the instantaneous signal level of the sensing function. As shown in figure 7-7, you can move the block of data being read into the acquisition buffer with reference to the acquisition trigger. This permits pre-trigger or post-trigger data sampling.

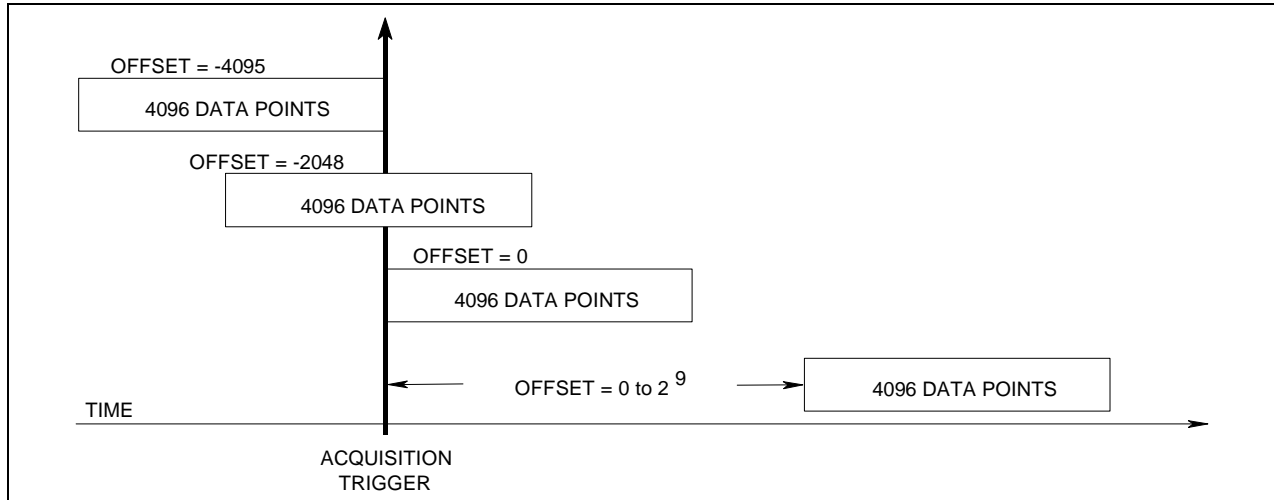

Figure 7-7. Pre-trigger and Post-trigger Acquisition

To offset the beginning of the acquisition buffer relative to the acquisition trigger, use:

```
SENS:SWE:OFFS:POIN <offset>
```

The range for the offset is -4095 to 2,000,000,000 points. As shown in the figure, when the offset is negative, the values at the beginning of the data record represent samples taken prior to the trigger. When the value is 0, all of the values are taken after the trigger. Values greater than zero can be used to program a delay time from the receipt of the trigger until the data points that are entered into the buffer are valid. (Delay time = offset x sample period).

NOTE: If, during a pre-trigger data acquisition, a trigger occurs before the pre-trigger data count is completed, the measurement system ignores this trigger. This will prevent the completion of the measurement if another trigger is not generated.

Programming the Status Registers

Status register programming lets you determine the operating condition of the dc source at any time. For example, you may program the dc source to generate an interrupt (SRQ) when an event such as a current limit occurs. When the interrupt occurs, your program can act on the event in the appropriate fashion.

Figure 7-8 shows the status register structure of the dc source. Table 7-1 defines the status bits. The Standard Event, Status Byte, and Service Request Enable registers and the Output Queue perform standard GPIB functions as defined in the *IEEE 488.2 Standard Digital Interface for Programmable Instrumentation*. The Operation Status and Questionable Status registers implement functions that are specific to the dc source.

Power-On Conditions

Refer to the *RST command description in chapter 8 for the power-on conditions of the status registers.

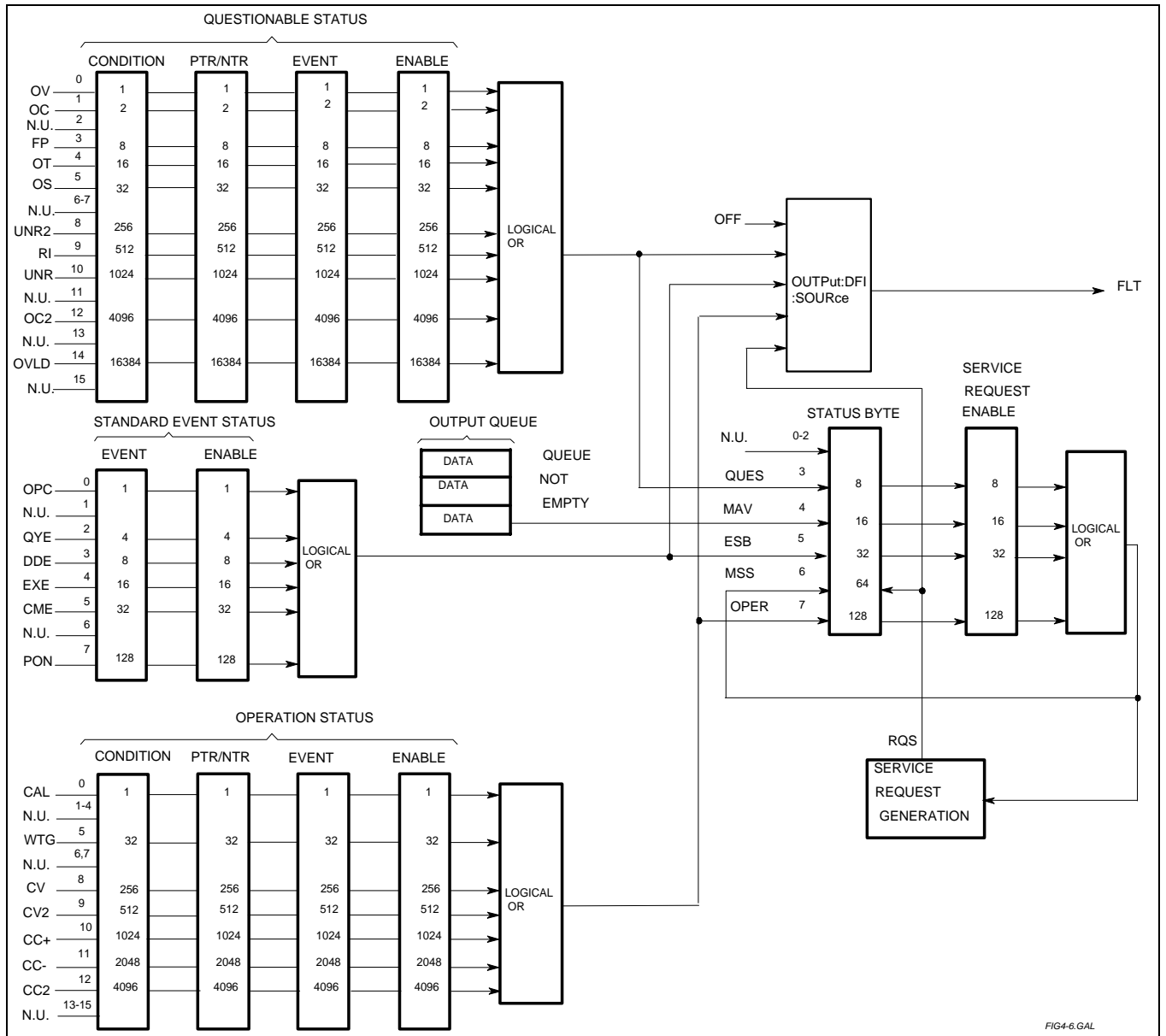

Figure 7-8. DC Source Status Model

7 - Programming the DC Source

Table 7-1. Bit Configurations of Status Registers

Bit	Signal	Meaning
0	CAL	Operation Status Group The dc source is computing new calibration constants
5	WTG	The dc source is waiting for a trigger
8	CV	The dc source is in constant voltage mode
9	CV2	Output 2 is operating in constant voltage mode
10	CC+	The dc source is in constant current mode
11	CC-	The dc source is in negative constant current mode
12	CC2	Output 2 is operating in constant current mode
0	OV	Questionable Status Group The overvoltage protection has tripped
1	OCP	The overcurrent protection has tripped
3	FP	A front panel key has been depressed while in local mode
4	OT	The overtemperature protection has tripped
5	OS	An open sense lead has been detected
8	UNR2	Output 2 is unregulated
9	RI	The remote inhibit state is active
10	UNR	The output is unregulated
12	OC2	Output 2 overcurrent protection has tripped
14	MeasOvld	Current measurement exceeded capability of low range
0	OPC	Standard Event Status Group Operation complete
2	QYE	Query error
3	DDE	Device-dependent error
4	EXE	Execution error
5	CME	Command error
7	PON	Power-on
3	QUES	Status Byte and Service Request Enable Registers Questionable status summary bit
4	MAV	Message Available summary bit
5	ESB	Event Status Summary bit
6	MSS	Master Status Summary bit
	RQS	Request Service bit
7	OPER	Operation status summary bit

Operation Status Group

The Operation Status registers record signals that occur during normal operation. As shown below, the group consists of a Condition, PTR/NTR, Event, and Enable register. The outputs of the Operation Status register group are logically-ORed into the OPERation summary bit (7) of the Status Byte register.

Register	Command	Description
Condition	STAT:OPER:COND?	A register that holds real-time status of the circuits being monitored. It is a read-only register.
PTR Filter	STAT:OPER:PTR <n>	A positive transition filter that functions as described under STAT:OPER:NTR PTR commands in chapter 8. It is a read/write register.
NTR Filter	STAT:OPER:NTR <n>	A negative transition filter that functions as described under STAT:OPER:NTR PTR commands in chapter 8. It is a read/write register.
Event	STAT:OPER:EVEN?	A register that latches any condition that is passed through the PTR or NTR filters. It is a read-only register that is cleared when read.
Enable	STAT:OPER:ENAB <n>	A register that functions as a mask for enabling specific bits from the Event register. It is a read/write register.

Questionable Status Group

The Questionable Status registers record signals that indicate abnormal operation of the dc source. As shown in figure 7-7, the group consists of the same type of registers as the Status Operation group. The outputs of the Questionable Status group are logically-ORed into the QUEStionable summary bit (3) of the Status Byte register.

Register	Command	Description
Condition	STAT:QUES:COND?	A register that holds real-time status of the circuits being monitored. It is a read-only register.
PTR Filter	STAT:QUES:PTR <n>	A positive transition filter that functions as described under STAT:QUES:NTR PTR commands in chapter 8. It is a read/write register.
NTR Filter	STAT:QUES:NTR <n>	A negative transition filter that functions as described under STAT:QUES:NTR PTR commands in chapter 8. It is a read/write register.
Event	STAT:QUES:EVEN?	A register that latches any condition that is passed through the PTR or NTR filters. It is a read-only register that is cleared when read.
Enable	STAT:QUES:ENAB <n>	A register that functions as a mask for enabling specific bits from the Event register. It is a read/write register..

Standard Event Status Group

This group consists of an Event register and an Enable register that are programmed by Common commands. The Standard Event event register latches events relating to instrument communication status (see figure 7-7). It is a read-only register that is cleared when read. The Standard Event enable register functions similarly to the enable registers of the Operation and Questionable status groups.

Command	Action
*ESE	programs specific bits in the Standard Event enable register.
*PSC ON	clears the Standard Event enable register at power-on.
*ESR?	reads and clears the Standard Event event register.

The PON (Power On) Bit

The PON bit in the Standard Event event register is set whenever the dc source is turned on. The most common use for PON is to generate an SRQ at power-on following an unexpected loss of power. To do this, bit 7 of the Standard Event enable register must be set so that a power-on event registers in the ESB (Standard Event Summary Bit), bit 5 of the Service Request Enable register must be set to permit an SRQ to be generated, and *PSC OFF must be sent. The commands to accomplish these conditions are:

```
*PSC OFF
*ESE 128
*SRE 32
```

Status Byte Register

This register summarizes the information from all other status groups as defined in the *IEEE 488.2 Standard Digital Interface for Programmable Instrumentation*. See Table 7-1 for the bit configuration.

Command	Action
*STB?	reads the data in the register but does not clear it (returns MSS in bit 6)
serial poll	clears RQS inside the register and returns it in bit position 6 of the response.

7 - Programming the DC Source

The MSS Bit

This is a real-time (unlatched) summary of all Status Byte register bits that are enabled by the Service Request Enable register. MSS is set whenever the dc source has one or more reasons for requesting service. *STB? reads the MSS in bit position 6 of the response but does not clear any of the bits in the Status Byte register.

The RQS Bit

The RQS bit is a latched version of the MSS bit. Whenever the dc source requests service, it sets the SRQ interrupt line true and latches RQS into bit 6 of the Status Byte register. When the controller does a serial poll, RQS is cleared inside the register and returned in bit position 6 of the response. The remaining bits of the Status Byte register are not disturbed.

The MAV Bit and Output Queue

The Output Queue is a first-in, first-out (FIFO) data register that stores dc source-to-controller messages until the controller reads them. Whenever the queue holds one or more bytes, it sets the MAV bit (4) of the Status Byte register.

Determining the Cause of a Service Interrupt

You can determine the reason for an SRQ by the following actions:

- Step 1 Determine which summary bits are active. Use:
 *STB? or serial poll
- Step 2 Read the corresponding Event register for each summary bit to determine which events caused the summary bit to be set. Use:
 STAT:QUES:EVEN?
 STAT:OPER:EVEN?
 ESR?
 When an Event register is read, it is cleared. This also clears the corresponding summary bit.
- Step 3 Remove the specific condition that caused the event. If this is not possible, the event may be disabled by programming the corresponding bit of the status group Enable register or NTR|PTR filter. A faster way to prevent the interrupt is to disable the service request by programming the appropriate bit of the Service Request Enable register

Servicing Operation Status and Questionable Status Events

This example assumes you want a service request generated whenever the dc source switches to the CC (constant current) operating mode, or whenever the dc source's overvoltage, overcurrent, or overtemperature circuits have tripped. From figure 7-7, note the required path for a condition at bit 10 (CC) of the Operation Status register to set bit 6 (RQS) of the Status Byte register. Also note the required path for Questionable Status conditions at bits 0, 1, and 4 to generate a service request (RQS) at the Status Byte register. The required register programming is as follows:

7 - Programming the DC Source

Discrete Fault Indicator (DFI)

The discrete fault indicator is an open-collector logic signal connected to the rear panel FLT connection that can be used to signal external devices when a fault condition is detected. To select the internal fault source that drives this signal, use:

```
OUTPut:DFI:SOURce QUESTIONable | OPERATION | ESB | RQS | OFF
```

To enable or disable the DFI output, use:

```
OUTPut:DFI:STATE ON | OFF
```

Using the Inhibit/Fault Port as a Digital I/O

You can configure the inhibit/fault port to provide a digital input/output to be used with custom digital interface circuits or relay circuits. As shipped from the factory, the port is shipped for inhibit/fault operation. You can change the configuration of the port to operate as a general-purpose digital input output port with the following command:

```
[SOURce:]DIGital:FUNCTION RIDFi | DIGio
```

The following table shows the pin assignments of the mating plug when used in RI/DFI mode as well as Digital I/O mode. Refer to Table A-2 for the electrical characteristics of the port.

Pin	FAULT/INHIBIT	DIGITAL I/O	Bit Weight
1	FLT Output	OUT 0	0
2	FLT Output	OUT 1	1
3	INH Input	IN/OUT 2	2
4	INH Common	Common	not programmable

To program the digital I/O port use:

```
[SOURce:]DIGital:DATA <data>
```

where the data is an integer from 0 to 7 that sets pins 1 to 3 according to their binary weight. Refer to the DIGital:DATA command for more information.

Language Dictionary

Introduction

This section gives the syntax and parameters for all the IEEE 488.2 SCPI commands and the Common commands used by the dc source. It is assumed that you are familiar with the material in chapter 6, which explains the terms, symbols, and syntactical structures used here and gives an introduction to programming. You should also be familiar with chapter 5, in order to understand how the dc source functions.

The programming examples are simple applications of SCPI commands. Because the SCPI syntax remains the same for all programming languages, the examples given for each command are generic.

Syntax Forms	Syntax definitions use the long form, but only short form headers (or "keywords") appear in the examples. Use the long form to help make your program self-documenting.
Parameters	Most commands require a parameter and all queries will return a parameter. The range for a parameter may vary according to the model of dc source. When this is the case, refer to the Specifications table in the Appendix A.
Related Commands	Where appropriate, related commands or queries are included. These are listed because they are either directly related by function, or because reading about them will clarify or enhance your understanding of the original command or query.
Order of Presentation	The dictionary is organized according to the following functions: calibration, display, measurement, output, status, system, trigger, and common commands. Both the subsystem commands and the common commands that follow are arranged in alphabetical order under each heading.

Subsystem Commands

Subsystem commands are specific to functions. They can be a single command or a group of commands. The groups are comprised of commands that extend one or more levels below the root.

The subsystem command groups are arranged according to function: Calibration, Display, Measurement, Output, Status, System, and Trigger. Commands under each function are grouped alphabetically. Commands followed by a question mark (?) take only the query form. When commands take both the command and query form, this is noted in the syntax descriptions. Table 8-1 lists all of the subsystem commands in alphabetical order.

Table 8-1. Subsystem Commands Syntax

ABORt	Resets the trigger system to the Idle state
CALibrate	
:CURRent	
[:SOURce]	
[:DC] [:POSitive]	Calibrate positive output current and high current measurement range
:MEASure	
[:DC] :LOWRange	Calibrate low current measurement range
:AC	Calibrate ac current measurement circuits
:CURRent2	Calibrate output2 current
:DATE <date>	Sets and reads the calibration date
:DVM	Calibrate DVM voltage readback
:LEVel <level>	Advance to next calibration step (P1 P2)
:PASSword <n>	Set calibration password
:SAVE	Save new cal constants in non-volatile memory
:STATE <bool> [,<n>]	Enable or disable calibration mode
:VOLTag <DC>	Calibrate output voltage and voltage readback
:PROTection	Begin voltage protection calibration sequence
:VOLTag2	Calibrate output2 voltage
DISPlay	
[:WINDow]	
[:STATE] <bool>	Enable/disable front panel display
:CHANnel <n>	Select the output that is displayed (1 2)
:MODE <mode>	Set display mode (NORM TEXT)
:TEXT [:DATA] <string>	Sets the text that is displayed
FORMat	
[:DATA] <type>	Specifies data type and length for all array queries
:BORDER <type>	Specifies byte order for all array queries
INITiate	
[:IMMediate]	
:SEquence<n>	Enable the numbered trigger system sequence (1 2)
:NAME <name>	Enable the named trigger system sequence (TRAN ACQ)
CONTinuous	
:SEquence1, <bool>	Enable continuous output transient triggers
:NAME TRANSient, <bool>	Enable continuous output transient triggers
INSTRument	
:COUPling	
:OUTPut	
:STATE <state>	Couples or decouples output 1 and output 2 (NONE or ALL)
MEASure	
:CURRent2?	Returns the output 2 current measurement
:VOLTag2?	Returns the output 2 voltage measurement
MEASure FETCh	
:ARRay	
:CURRent [:DC]?	Returns the digitized instantaneous current
:VOLTag [:DC]?	Returns the digitized instantaneous voltage
[:SCALar]	
:CURRent [:DC]?	Returns dc current
:ACDC?	Returns the total rms current (ac+dc)
:HIGH?	Returns the HIGH level of a current pulse
:LOW?	Returns the LOW level of a current pulse
:MAX?	Returns maximum current
:MIN?	Returns minimum current

Table 8-1. Subsystem Commands Syntax (continued)

:DVM [:DC]?	Returns DVM dc voltage measurement
:ACDC ?	Returns DVM rms voltage measurement
:VOLTage [:DC]?	Returns dc voltage
:ACDC ?	Returns the total rms voltage (ac+dc)
:HIGH ?	Returns the HIGH level of a voltage pulse
:LOW ?	Returns the LOW level of a voltage pulse
:MAX ?	Returns maximum voltage
:MIN ?	Returns minimum voltage
OUTPut [1 2]	
[:STATe] <bool>	Enables/disables the dc source output
:DFI	
[:STATe] <bool>	Enables/disables the DFI output
:SOURce <source>	Selects event source (QUES OPER ESB RQS OFF)
:PON	
[:STATe] <state>	Set power-on state (*RST RCL0)
:PROTection	
:CLEar	Reset latched protection
:DELay <n>	Delay after programming/before protection
:RELay:	
:MODE <mode>	Specifies the output relay mode (DD, HD, DH, or HH).
:RI	
:MODE <mode>	Sets remote inhibit operating mode (LATC LIVE OFF)
:TYPE [:CAPacitance] <setting>	Sets output capacitor compensation (HIGH H2 LOW)
SENSe	
:CURRent	
[:DC]	
:RANGe [:UPPer] <n>	Selects the high current measurement range
:DETeCTOR <detector>	Selects the current measurement detector (ACDC DC)
:FUNCTion <function>	Configures the measurement sensor ("VOLT" "CURR" "DVM")
:PROTection	
[:STATe] <state>	Enables/disables open sense lead detection
:SWEep	
:OFFSet	
:POINts <n>	Defines the pre/post data capture in the measurement
:POINts <n>	Define the number of data points in the measurement
:TINterval <n>	Sets the digitizer sample spacing
:WINDow [:TYPE] <type>	Sets the measurement window function (HANN RECT)
[SOURce:]	
CURRent	
[:LEVel]	
[:IMMediate][:AMPLitude] <n>	Sets the output current limit
:TRIGgered [:AMPLitude] <n>	Sets the triggered output current limit
:PROTection	
[:STATe] <bool>	Enables/disables current limit protection
CURRent2	
[:LEVel]	
[:IMMediate][:AMPLitude] <n>	Sets the output2 current level
:TRIGgered [:AMPLitude] <n>	Sets the triggered output2 current level
DIGital	
:DATA [:VALue] <n>	Sets and reads the digital control port
:FUNCTion <function>	Configures digital control port (RIDF DIG)
VOLTage	
[:LEVel]	
[:IMMediate][:AMPLitude] <n>	Sets the output voltage level
:TRIGgered [:AMPLitude] <n>	Sets the triggered output voltage level

Table 8-1. Subsystem Commands Syntax (continued)

:PROtEction	
[:LEVEl] <n>	Sets the overvoltage protection threshold
:STATe <bool>	Enables/disables overvoltage protection
VOLTage2	
[:LEVEl]	
[:IMMediate][:AMPLitude] <n>	Sets the output2 voltage level
:TRIGgered [:AMPLitude] <n>	Sets the triggered output2 voltage level
STATus	
:PRESet	Presets all enable and transition registers to power-on
:OPERation	
[:EVENT]?	Returns the value of the event register
:CONDition?	Returns the value of the condition register
:ENABle <n>	Enables specific bits in the Event register
:NTRansition<n>	Sets the Negative transition filter
:PTRansition<n>	Sets the Positive transition filter
:QUEStionable	
[:EVENT]?	Returns the value of the event register
:CONDition?	Returns the value of the condition register
:ENABle <n>	Enables specific bits in the Event register
:NTRansition<n>	Sets the Negative transition filter
:PTRansition<n>	Sets the Positive transition filter
SYSTem	
:ERRor?	Returns the error number and error string
:LANGUage <language>	Sets the programming language (SCPI COMP)
:VERSion?	Returns the SCPI version number
TRIGger	
:SEQuence2 :ACQuire	
[:IMMediate]	Triggers the measurement immediately
:COUNt	
:CURRent <n>	Sets the number of sweeps per current measurement
:DVM <n>	Sets the number of sweeps per DVM measurement
:VOLTage <n>	Sets the number of sweeps per voltage measurement
:HYSTeresis	
:CURRent <n>	Qualifies the trigger when measuring current
:DVM <n>	Qualifies the trigger when making DVM measurements
:VOLTage <n>	Qualifies the trigger when measuring voltage
:LEVEl	
:CURRent <n>	Sets the trigger level for measuring current
:DVM <n>	Sets the trigger level when making DVM measurements
:VOLTage <n>	Sets the trigger level for measuring voltage
:SLOPe	
:CURRent <slope>	Sets the triggered current slope (POS NEG EITH)
:DVM <slope>	Sets the triggered DVM measurement slope (POS NEG EITH)
:VOLTage <slope>	Sets the triggered voltage slope (POS NEG EITH)
:SOURce <source>	Sets the trigger source (BUS INT)
[:SEQuence1 :TRANsient]	
[:IMMediate]	Triggers the output immediately
:SOURce <source>	Sets the trigger source (BUS)
:SEQuence1	
:DEFine TRANsient	Sets or queries the SEQ1 name
:SEQuence2	
:DEFine ACQuire	Sets or queries the SEQ2 name

Common Commands

Common commands begin with an * and consist of three letters (command) or three letters and a ? (query). They are defined by the IEEE 488.2 standard to perform common interface functions. Common commands and queries are categorized under System, Status, or Trigger functions and are listed at the end of the chapter. The dc source responds to the following common commands:

Table 8-2. Common Commands Syntax

*CLS	Clear status
*ESE <n>	Standard event status enable
*ESE?	Return standard event status enable
*ESR?	Return event status register
*IDN?	Return instrument identification
*OPC	Enable "operation complete" bit in ESR
*OPC?	Return a "1" when operation complete
*OPT?	Return option number
*PSC <bool>	Power-on status clear state set/reset
*PSC?	Return power-on status clear state
*RCL <n>	Recall instrument state
*RST	Reset
*SAV <n>	Save instrument state
*SRE <n>	Set service request enable register
*SRE?	Return service request enable register
*STB?	Return status byte
*TRG	Trigger
*TST?	Perform selftest, then return result
*WAI	Hold off bus until all device commands done

Programming Parameters

The following table lists the output programming parameters.

Table 8-3. Output Programming Parameters

Parameter	Value
[SOUR:]CURR[:LEV][:IMM] MAX and [SOUR:]CURR[:LEV]:TRIG MAX	3.0712 A
[SOUR:]CURR2[:LEV][:IMM] MAX and [SOUR:]CURR2[:LEV]:TRIG MAX	1.52 A
*RST Current Value	10% of MAX value
[SOUR:]VOLT[:LEV][:IMM]MAX and [SOUR:]VOLT[:LEV]:TRIG MAX	15.535 V
[SOUR:]VOLT2[:LEV][:IMM]MAX and [SOUR:]VOLT2[:LEV]:TRIG MAX	12.25 V
*RST Voltage Value	0 V
[SOUR:]VOLT:PROT[:LEV] MAX	22 V
*RST OVP Value	MAX
OUTP:PROT:DEL MAX	2,147,483.647
*RST Protection Delay Value	0.08 seconds
SENS:CURR:RANG (not valid for Agilent 66111A)	Low range = 0 – 20 mA High Range = 20 mA – MAX
*RST Current Range	Value MAX

Calibration Commands

Calibration commands let you enable and disable the calibration mode, change the calibration password, calibrate current and voltage programming, and store new calibration constants in nonvolatile memory.

NOTE: If calibration mode has not been enabled with CALibrate:STATe, programming the calibration commands will generate an error. You must also save any changes that you made using CALibrate:SAVE, otherwise all changes will be lost when you exit calibration mode.

CALibrate:CURRENT

This command initiates the calibration of the positive dc output current as well as the high-range current measurement circuit.

Command Syntax	CALibrate:CURRENT[:SOURce][:DC][:POSitive]
Parameters	None
Examples	CAL : STAT 1, ! enable calibration CAL : CURR, ! start current calibration
Related Commands	CAL:CURR:NEG, CAL:LEV, CAL:DATA

CALibrate:CURRENT2

Agilent 66309B/D only

This command initiates the current calibration of output 2.

Command Syntax	CALibrate:CURRENT2
Parameters	None
Examples	CAL : CURR2
Related Commands	CAL:CURR:NEG, CAL:LEV, CAL:DATA

CALibrate:CURRENT:MEASure:LOWRange

Agilent 66311B/D, 66309B/D only

This command initiates the calibration of the low-range current measurement circuit.

Command Syntax	CALibrate:CURRENT:MEASure[:DC]:LOWRange
Parameters	None
Examples	CAL : CURR : MEAS
Related Commands	CAL:CURR

CALibrate:CURRENT:MEASure:AC

Agilent 66311B/D, 66309B/D only

This command initiates the calibration of the high bandwidth (ac) measurement circuit.

Command Syntax	CALibrate:CURRENT:MEASure:AC
Parameters	None
Examples	CAL : CURR : MEAS : AC

CALibrate:DATA

This command enters a calibration value that you obtain by reading an external meter. You must first select a calibration level (with CALibrate:LEVel) for the value being entered.

Command Syntax	CALibrate:DATA<NRf>	
Parameters	<external reading>	
Unit	A (amperes)	
Examples	CAL:DATA 3222.3 MA	CAL:DATA 5.000
Related Commands	CAL:STAT CAL:LEV	

CALibrate:DATE

Use this command to store the date that the unit was last calibrated. You can enter any ASCII string up to 10 characters.

Command Syntax	CALibrate:DATE <date>	
Parameters	<date>	
Examples	CAL:DATE "3/22/99"	CAL:DATE "22.3.99"
Query Syntax	CALibrate:DATE?	
Returned Parameters	<SRD>	

CALibrate:DVM

Agilent 66311D/66309D only

This command initiates the calibration of the DVM.

Command Syntax	CALibrate:DVM
Parameters	None
Examples	CAL:DVM

CALibrate:LEVel

This command selects the next point in the calibration sequence. **P1** is the first calibration point, **P2** is the second calibration point.

Command Syntax	CALibrate:LEVel <point>
Parameters	P1 P2
Examples	CAL:LEV P2

CALibrate:PASSword

This command lets you change the calibration password. A new password is automatically stored in nonvolatile memory and does not have to be stored with CALibrate:SAVE. If the password is set to 0, password protection is removed and the ability to enter the calibration mode is unrestricted.

Command Syntax	CALibrate:PASScode<NRf>
Parameters	<model number> (default)
Examples	CAL:PASS 6812
Related Commands	CAL:SAV

CALibrate:SAVE

This command saves any new calibration constants after a calibration procedure has been completed in nonvolatile memory. If CALibrate:STaTe OFF is programmed without a CALibrate:SAVE, the previous calibration constants are restored..

Command Syntax	CALibrate:SAVE
Parameters	None
Examples	CAL:SAVE
Related Commands	CAL:PASS CAL:STAT

CALibrate:STaTe

This command enables and disables calibration mode. The calibration mode must be enabled before the dc source will accept any other calibration commands.

The first parameter specifies the enabled or disabled state. The second parameter is the password. A password is required if the calibration mode is being enabled and the existing password is not 0. If the password is not entered or is incorrect, an error is generated and the calibration mode remains disabled. The query statement returns only the state, not the password.

NOTE: Whenever the calibration state is changed from enabled to disabled, any new calibration constants are lost unless they have been stored with CALibrate:SAVE.

Command Syntax	CALibrate:STaTe<bool>[,<NRf>]
Parameters	0 1 OFF ON [,<password>]
*RST Value	OFF
Examples	CAL:STAT 1,6812 CAL:STAT OFF
Query Syntax	CALibrate:STaTe?
Returned Parameters	<NR1>
Related Commands	CAL:PASS CAL:SAVE *RST

CALibrate:VOLTagE

This command initiates the calibration of the output voltage and the voltage readback circuit.

Command Syntax	CALibrate:VOLTagE[:DC]
Parameters	None
Examples	CAL:VOLT CAL:VOLT:DC

CALibrate:VOLTagE2**Agilent 66309B/D only**

This command initiates the voltage calibration of output 2.

Command Syntax	CALibrate:VOLTagE2
Parameters	None
Examples	CAL:VOLT2

CALibrate:VOLTagE:PROTection

This command calibrates the overvoltage protection (OV) circuit. The dc source automatically performs the overvoltage calibration, which takes several seconds to complete.

Command Syntax	CALibrate:VOLTagE:PROTection
Parameters	None
Examples	CAL:VOLT:PROT

Display Commands

Display commands control the front panel display of the dc source. Annunciators are not affected.

DISPlay

This command turns the front panel display on or off. When off, the front panel display is blank.

Command Syntax DISPlay[:WINDow][:STATe] <bool>
Parameters 0 | 1 | OFF | ON
***RST Value** ON
Examples DISP ON DISPLAY:STATE ON
Query Syntax DISPlay[:WINDow][STATe]?
Returned Parameters <NR1> 0 or 1

DISPlay:CHANnel

Agilent 66309B/D only

Selects the output channel that will be displayed on the front panel. When output 1 is selected, a small "1" appears in the left-most digit. . When output 2 is selected, a small "2" appears in the left-most digit.

Command Syntax DISPlay:CHANnel <channel>
Parameters 1 | 2
***RST Value** 1
Examples DISPLAY:CHANNEL 2
Query Syntax DISPlay:CHANnel?
Returned Parameters <NR1> 0 or 1

DISPlay:MODE

Switches the display between its normal instrument functions and a mode in which it displays text sent by the user. Text messages are defined with the DISPlay:TEXT command.

Command Syntax DISPlay[:WINDow]:MODE <mode>
Parameters NORMAl | TEXT
***RST Value** NORM
Examples DISP:MODE NORM DISPLAY:MODE TEXT
Query Syntax DISPlay[:WINDow]:MODE?
Returned Parameters <CRD> NORMAL or TEXT

DISPlay:TEXT

This command sends character strings to the display when the display mode is set to TEXT. The character string is case-sensitive and must be enclosed in either single (') or double (") quotes. The display is capable of showing up to 14 characters. Strings exceeding 14 characters will be truncated.

Command Syntax DISPlay[:WINDow]:TEXT [:DATA] <display_string>
Parameters <display string>
***RST Value** " " (null string)
Examples DISP:TEXT "DEFAULT_MODE"
Query Syntax DISPlay[:WINDow]:TEXT?
Returned Parameters <STR> (Last programmed text string)

Measurement Commands

Measurement commands consist of format, measure, and sense commands.

Format commands specify the data formatting of all array queries. You can specify the data type, type length, and byte order.

Measure commands measure the output voltage or current. Measurements are performed by digitizing the instantaneous output voltage or current for a specified number of samples, storing the results in a buffer, and calculating the measured result. Two types of measurement commands are available: MEASure and FETCh. MEASure commands trigger the acquisition of new data before returning the reading. Measurement overflows return a reading of 9.91E+37. FETCh commands return a reading computed from previously acquired data. If you take a voltage measurement, you can fetch only voltage data.

- ◆ Use MEASure when the measurement does not need to be synchronized with any other event.
- ◆ Use FETCh when it is important that the measurement be synchronized with either a trigger or with a particular part of the output waveform.

Sense commands control the current measurement range, the bandwidth detector of the dc source, and the data acquisition sequence.

FORMat

This command selects the data type and the type length for all array queries. Supported types are ASCII and REAL. When ASCII is selected, the response format for these queries is NR3 Numeric Response Data. This format is selected at *RST. The only valid argument for <length> is 0, which means that the dc source selects the number of significant digits to be returned.

When REAL is selected, the array response format is Definite Length Arbitrary Block Response Data. The data within the Arbitrary Block is coded as IEEE single precision floating point, with 4 bytes per value. The second argument to the FORMat:DATA command specifies the number of bits in the returned data. Only the value 32 is permitted in dc source instruments. The byte order within a single value is determined by the FORMat:BORDER command. Definite Length Arbitrary Block Response Data format begins with a header that describes the number of data bytes in the response. The header begins with a pound sign, followed by a single non-zero digit that defines the number of digits in the block length, followed by the digits contained in the block.

For example: The response to the query "MEAS:ARR:CURR:[DC]? 1" which returns 45 numeric values would be as follows: '# '3' '1' '8' '0' <byte1> <byte2> ... <byte180> <newline>

Command Syntax	FORMat[:DATA] <type> [,length]
Parameters	ASCii REAL
*RST Value	ASCii
Examples	FORM REAL
Query Syntax	FORMat?
Returned Parameters	<CRD>
Related Commands	FORM:BORD MEAS:ARR:CURR:DC? MEAS:ARR:VOLT:DC?

FORMat:BORDer

This command selects whether the binary data is transferred in normal or swapped byte order. When NORMal is selected, the first byte sent is the sign bit and seven most significant bits of the exponent, and the last byte sent is the least significant byte of the mantissa. This ordering is generally used in big-endian controllers such as those that use Motorola processors.

When SWAPped is selected, the least significant byte of the mantissa is sent first and the sign bit and seven most significant bits of the exponent are sent last. This ordering is generally used in little-endian controllers such as those that use Intel processors.

Command Syntax	FORMat:BORDer <type>
Parameters	NORMal SWAPped
*RST Value	NORMal
Examples	FORM:BORD SWAP
Query Syntax	FORMat:BORDer?
Returned Parameters	<CRD>
Related Commands	FORM[:DATA] MEAS:ARR:CURR:DC? MEAS:ARR:VOLT:DC

MEASure:ARRay:CURRent?**FETCh:ARRay:CURRent?**

Agilent 66311B/D, 66309B/D only

These queries return an array containing the instantaneous output current in amps. The output voltage or current is digitized whenever a measure command is sent or an acquire trigger occurs. The time interval is set by SENSE:SWEep:TINTerval. The position of the trigger relative to the beginning of the data buffer is determined by SENSE:SWEep:OFFSet. The number of points returned is set by SENSE:SWEep:POINts.

Query Syntax	MEASure:ARRay:CURRent[:DC]? FETCh:ARRay:CURRent[:DC]?
Parameters	None
Examples	MEAS:ARR:CURR? FETC:ARR:CURR?
Returned Parameters	<NR3> [,<NR3>]
Related Commands	SENS:SWE:TINT SENS:SWE:OFFS SENS:SWE:POIN

MEASure:ARRay:VOLTage?**FETCh:ARRay:VOLTage?**

Agilent 66311B/D, 66309B/D only

These queries return an array containing the instantaneous output voltage in volts. The output voltage or current is digitized whenever a measure command is sent or an acquire trigger occurs. The time interval is set by SENSE:SWEep:TINTerval. The position of the trigger relative to the beginning of the data buffer is determined by SENSE:SWEep:OFFSet. The number of points returned is set by SENSE:SWEep:POINts.

Query Syntax	MEASure:ARRay:VOLTage[:DC]? FETCh:ARRay:VOLTage[:DC]?
Parameters	None
Examples	MEAS:ARR:VOLT? FETC:ARR:VOLT?
Returned Parameters	<NR3> [,<NR3>]
Related Commands	SENS:SWE:TINT SENS:SWE:OFFS SENS:SWE:POIN

MEASure:CURRent? FETCh:CURRent?

These queries return the dc output current.

Query Syntax	MEASure[:SCALar]:CURRent[:DC]? FETCh[:SCALar]:CURRent[:DC]?
Parameters	None
Examples	MEAS:CURR? FETC:CURR:DC?
Returned Parameters	<NR3>
Related Commands	MEAS:VOLT?

MEASure:CURRent2?

Agilent 66309B/D only

This query measures the output current at the auxiliary output. Output 2 measurements are calculated from a total of 2048 readings taken at a 15.6 microsecond sampling rate. These parameters are fixed.

Query Syntax	MEASure[:SCALar]:CURRent2[:DC]?
Parameters	None
Examples	MEAS:CURR2? FETC:CURR2:DC?
Returned Parameters	<NR3>
Related Commands	MEAS:VOLT2?

MEASure:CURRent:ACDC? FETCh:CURRent:ACDC?

Agilent 66311B/D, 66309B/D only

These queries return the ac+dc rms output current.

Query Syntax	MEASure[:SCALar]:CURRent:ACDC? FETCh[:SCALar]:CURRent:ACDC?
Parameters	None
Examples	MEAS:CURR:ACDC? FETC:CURR:ACDC?
Returned Parameters	<NR3>
Related Commands	MEAS:VOLT:ACDC?

MEASure:CURRent:HIGH? FETCh:CURRent:HIGH?

Agilent 66311B/D, 66309B/D only

These queries return the High level current of a current pulse waveform. The instrument first measures the minimum and maximum data points of the pulse waveform. It then generates a histogram of the pulse waveform using 16 bins between the maximum and minimum data points. The bin containing the most data points above the 50% point is the high bin. The average of all the data points in the high bin is returned as the High level. If no high bin contains more than 1.25% of the total number of acquired points, then the maximum value is returned by these queries.

Query Syntax	MEASure[:SCALar]:CURRent:HIGH? FETCh[:SCALar]:CURRent:HIGH?
Parameters	None
Examples	MEAS : CURR : HIGH? FETC : CURR : HIGH?
Returned Parameters	<NR3>
Related Commands	MEAS:CURR:LOW? CALC:REF:HIGH

MEASure:CURRent:LOW? FETCh:CURRent:LOW?

Agilent 66311B/D, 66309B/D only

These queries return the Low level current of a current pulse waveform. The instrument first measures the minimum and maximum data points of the pulse waveform. It then generates a histogram of the pulse waveform using 16 bins between the maximum and minimum data points. The bin containing the most data points below the 50% point is the low bin. The average of all the data points in the low bin is returned as the Low level. If no low bin contains more than 1.25% of the total number of acquired points, then the minimum value is returned by these queries.

Query Syntax	MEASure[:SCALar]:CURRent:LOW? FETCh[:SCALar]:CURRent:LOW?
Parameters	None
Examples	MEAS : CURR : LOW? FETC : CURR : LOW?
Returned Parameters	<NR3>
Related Commands	MEAS:CURR:HIGH? CALC:REF:LOW

MEASure:CURRent:MAXimum? FETCh:CURRent: MAXimum?

Agilent 66311B/D, 66309B/D only

These queries return the maximum output current.

Query Syntax	MEASure[:SCALar]:CURRent:MAXimum? FETCh[:SCALar]:CURRent:MAXimum?
Parameters	None
Examples	MEAS : CURR : MAX? FETC : CURR : MAX?
Returned Parameters	<NR3>
Related Commands	MEAS:CURR:MIN?

MEASure:CURRent:MINimum?
FETCh:CURRent:MINimum?

Agilent 66311B/D, 66309B/D only

These queries return the minimum output current.

Query Syntax	MEASure[:SCALar]:CURRent:MINimum? FETCh[:SCALar]:CURRent:MINimum?
Parameters	None
Examples	MEAS : CURR : MIN? FETC : CURR : MIN?
Returned Parameters	<NR3>
Related Commands	MEAS:CURR:MAX?

MEASure:DVM?
FETCh:DVM?

Agilent 66311D/66309D only

These queries measure dc voltage.

Query Syntax	MEASure[:SCALar]:DVM[:DC]? FETCh[:SCALar]:DVM[:DC]?
Parameters	None
Examples	MEAS : DVM : DC? FETC : DVM : DC?
Returned Parameters	<NR3>

MEASure:DVM:ACDC?
FETCh:DVM:ACDC?

Agilent 66311D/66309D only

These queries measure ac+dc (rms) voltage.

Query Syntax	MEASure[:SCALar]:DVM:ACDC? FETCh[:SCALar]:DVM:ACDC?
Parameters	None
Examples	MEAS : DVM : ACDC? FETC : DVM : ACDC?
Returned Parameters	<NR3>

MEASure:VOLTage?
FETCh:VOLTage?

These queries return the dc output voltage.

Query Syntax	MEASure[:SCALar]:VOLTage[:DC]? MEASure[:SCALar]:VOLTage[:DC]?
Parameters	None
Examples	MEAS : VOLT? FETC : VOLT : DC?
Returned Parameters	<NR3>
Related Commands	MEAS:CURR?

MEASure:VOLTage2**Agilent 66309B/D only**

This query measures the output voltage at the auxiliary output. Output 2 measurements are calculated from a total of 2048 readings taken at a 15.6 microsecond sampling rate. These parameters are fixed.

Query Syntax	MEASure[:SCALar]:VOLTage2[:DC]?
Parameters	None
Examples	MEAS:VOLT2? FETC:VOLT2:DC?
Returned Parameters	<NR3>
Related Commands	MEAS:CURR2?

**MEASure:VOLTage:ACDC?
FETCh:VOLTage:ACDC?****Agilent 66311B/D, 66309B/D only**

These queries return the ac+dc rms output voltage.

Query Syntax	MEASure[:SCALar]:VOLTage:ACDC? FETCh[:SCALar]:VOLTage:ACDC?
Parameters	None
Examples	MEAS:VOLT:ACDC? FETC:VOLT:ACDC?
Returned Parameters	<NR3>
Related Commands	MEAS:CURR:ACDC?

**MEASure:VOLTage:HIGH?
FETCh:VOLTage:HIGH?****Agilent 66311B/D, 66309B/D only**

These queries return the High level voltage of a voltage pulse waveform. The instrument first measures the minimum and maximum data points of the pulse waveform. It then generates a histogram of the pulse waveform using 16 bins between the maximum and minimum data points. The bin containing the most data points above the 50% point is the high bin. The average of all the data points in the high bin is returned as the High level. If no high bin contains more than 1.25% of the total number of acquired points, then the maximum value is returned by these queries.

Query Syntax	MEASure[:SCALar]:VOLTage:HIGH? FETCh[:SCALar]:VOLTage:HIGH?
Parameters	None
Examples	MEAS:VOLT:HIGH? FETC:VOLT:HIGH?
Returned Parameters	<NR3>
Related Commands	MEAS:VOLT:LOW? CALC:REF:HIGH

MEASure:VOLTage:LOW? FETCh:VOLTage:LOW?

Agilent 66311B/D, 66309B/D only

These queries return the Low level voltage of a voltage pulse waveform. The instrument first measures the minimum and maximum data points of the pulse waveform. It then generates a histogram of the pulse waveform using 16 bins between the maximum and minimum data points. The bin containing the most data points below the 50% point is the low bin. The average of all the data points in the low bin is returned as the Low level. If no low bin contains more than 1.25% of the total number of acquired points, then the minimum value is returned by these queries.

Query Syntax	MEASure[:SCALar]:VOLTage:LOW? FETCh[:SCALar]:VOLTage:LOW?
Parameters	None
Examples	MEAS : VOLT : LOW? FETC : VOLT : LOW?
Returned Parameters	<NR3>
Related Commands	MEAS:VOLT:HIGH? CALC:REF:LOW

MEASure:VOLTage:MAXimum? FETCh:VOLTage:MAXimum?

Agilent 66311B/D, 66309B/D only

These queries return the maximum output voltage.

Query Syntax	MEASure[:SCALar]:VOLTage:MAXimum? FETCh[:SCALar]:VOLTage:MAXimum?
Parameters	None
Examples	MEAS : VOLT : MAX? FETC : VOLT : MAX?
Returned Parameters	<NR3>
Related Commands	MEAS:VOLT:MIN?

MEASure:VOLTage:MINimum? FETCh:VOLTage:MINimum?

Agilent 66311B/D, 66309B/D only

These queries return the minimum output voltage..

Query Syntax	MEASure[:SCALar]:VOLTage:MINimum? FETCh[:SCALar]:VOLTage:MINimum?
Parameters	None
Examples	MEAS : VOLT : MIN? FETC : VOLT : MIN?
Returned Parameters	<NR3>
Related Commands	MEAS:VOLT:MAX?

SENSe:CURRent:DETEctor**Agilent 66311B/D, 66309B/D only**

This command lets you select the type of detector used for output current measurements. Two choices for detecting current measurements are available:

- ACDC** This is the preferred choice for all dynamic current measurements. When ACDC is selected, the measured output current includes the current that flows in the instrument's output capacitor. It is especially important to use ACDC detection when measuring pulse or other waveforms with frequency contents greater than several kilohertz.
- DC** Select *DC* only if you are making dc current measurements and you require a dc measurement offset accuracy better than 2mA on the High current measurement range. When DC is selected, the component of output current that is supplied by the instrument's output filter is not sensed. Note that this selection gives inaccurate results on current waveforms with frequency contents greater than several kilohertz.

NOTE: This command only applies to the High current measurement range.

Command Syntax	SENSe:CURRent:DETEctor <detector>	
Parameters	ACDC or DC	
*RST Value	ACDC	
Examples	SENS:CURR:DET ACDC	SENS:CURR:DET DC
Query Syntax	SENSe:CURRent:DETEctor?	
Returned Parameters	<CRD>	

SENSe:CURRent:RANGe**Agilent 66311B/D, 66309B/D only**

This command selects the dc current measurement range:

High Range: 0 through MAX (see Table 8-3)

Low Range: 0 through 0.02 A

The High range covers the full current measurement capability of the instrument. The Low range measures currents up to a maximum of 20 mA. This increases the low current measurement sensitivity for greater accuracy and resolution. The value that you program with SENSe:CURRent:RANGe must be the maximum current that you expect to measure. The instrument will select the range that gives the best resolution. The crossover value is 20 mA. When queried, the returned value is the maximum current that can be measured on the range that is presently set.

Command Syntax	SENSe:CURRent[:DC]:RANGe[:UPPer] <NRf+>	
Parameters	0 through MAX (see table 8-3)	
Unit	A (amperes)	
*RST Value	MAX (high range)	
Examples	SENS:CURR:RANG 4.0	
Query Syntax	SENSe:CURRent:RANGe?	
Returned Parameters	<NR3>	

SENSe:FUNction

This command configures the sensing function for triggered measurements. The dc source has up to three measurement sensors as described below. The query returns the function setting.

CURRent Senses the current measurement at the main output (output 1)
DVM Senses the voltage measurement at the DVM inputs (Agilent 66311D/66309D only)
VOLTage Senses the voltage measurement at the main output (output 1)

Command Syntax SENSe:FUNction <function>
Parameters "VOLTage" | "CURRent" | "DVM"
Examples SENS:FUNC "VOLT"
Query Syntax SENSe:FUNction?
Returned Parameters <SRD>

SENSe:PROtection:STATe

This command enables or disables the open sense lead detection. The default setting for this function is disabled. To permanently enable open sense lead detection, program this command on, save this state in location 0 using *SAV 0, and set the output power-on state to recall state 0 (OUTP:PON:STAT RCL 0).

Command Syntax SENSe:PROtection:STATe <bool>
Parameters 0 | OFF | 1 | ON
***RST Value** 0
Examples SENS:PROT:STAT ON
Query Syntax SENSe:PROTect:STATe?
Returned Parameters <NR3>

SENSe:SWEep:OFFSet:POINts

This command defines the offset in a data sweep when an acquire trigger is used. Negative values represent data samples taken prior to the trigger. Positive values represent the delay after the trigger occurs but before the samples are acquired.

Command Syntax SENSe:SWEep:OFFSet:POINts <NRf+>
Parameters -4095 through 2,000,000,000
***RST Value** 0
Examples SENS:SWE:OFFS:POIN -2047
Query Syntax SENSe:SWEep:OFFSet:POINts?
Returned Parameters <NR3>
Related Commands SENS:SWE:TINT SENS:SWE:POIN MEAS:ARR

SENSe:SWEep:POINts

This command defines the number of points in a measurement.

Command Syntax SENSe:SWEep:POINts<NRf+>
Parameters 1 through 4096
***RST Value** 2048
Examples SENS:SWE:POIN 1024
Query Syntax SENSe:SWEep:POINts?
Returned Parameters <NR3>
Related Commands SENS:SWE:TINT SENS:SWE:OFFS MEAS:ARR

SENSe:SWEEp:TINterval

This command defines the time period between samples. The value that you enter for the time interval will be rounded to the nearest 15.6 microsecond increment.

Command Syntax	SENSe:SWEEp:TINterval<NRf+>
Parameters	15.6 microseconds through 31200 seconds
*RST Value	15.6 microseconds
Examples	SENS:SWE:TINT 31.2E-6
Query Syntax	SENSe:SWEEp:TINterval?
Returned Parameters	<NR3>
Related Commands	SENS:SWE:POIN SENS:SWE:OFFS MEAS:ARR

SENSe:WINDow

This command sets the window function that is used in dc and in ac+dc rms measurement calculations. The following functions can be selected:

HANNing	A signal conditioning window that reduces errors in dc and rms measurement calculations in the presence of periodic signals such as line ripple. It also reduces jitter when measuring successive pulse waveforms. The Hanning window multiplies each point in the measurement sample by the function \cos^4 . Do not use the Hanning window when measuring single-shot pulse waveforms.
RECTangular	A window that returns measurement calculations without any signal conditioning. This window may be used for pulse measurements where the exact period of the pulse waveform is known and the measurement interval can be set accordingly using the SENSe:SWEEp:TINterval command.

NOTE: Neither window function alters the instantaneous voltage or current data returned in the measurement array.

Command Syntax	SENSe:WINDow[:TYPE] <type>
Parameters	HANNing RECTangular
*RST Value	HANNing
Examples	SENS:WIND RECT
Query Syntax	SENSe:WINDow[:TYPE]?
Returned Parameters	<CRD>

Output Commands

Output commands consist of instrument, output and source commands.

Instrument commands control the output coupling on Agilent 66309B/D units.

Output commands control the output and digital port functions.

Source commands program the actual voltage, current, and digital port output.

INSTrument:COUPle:OUTPut:STATe

Agilent 66309B/D units with firmware revision A.02.04 and up only

Couples Output 1 and Output 2. When outputs 1 and 2 are coupled, **ALL** OUTPut commands will turn both outputs ON or OFF together. When not coupled, use OUTPut1 or OUTPut2 to turn the specified output ON or OFF individually.

To have the unit turn on with the outputs uncoupled, set the output coupling to NONE, save this state in location 0 and set the power-on state to RCL 0. Note that when an output state is recalled, the outputs are set to the state in which they were in when the state was saved, regardless of the output coupling setting.

Command Syntax	INSTrument:COUPle:OUTPut:STATe <state>
Parameters	ALL NONE
*RST Value	ALL (NONE for units with Option 521)
Examples	INST:COUP:OUTP:STAT ALL
Query Syntax	INSTrument:COUPle:OUTPut:STATe?
Returned Parameters	<CRD>

OUTPut[1 | 2]

This command enables or disables the dc source output. If outputs 1 and 2 are coupled, it affects both the main output and output 2 on Agilent 66309B/D units. If the outputs are not coupled and no output channel is specified, the command applies to the main output. The state of a disabled output is a condition of zero output voltage and a model-dependent minimum source current (see ***RST**).

Command Syntax	OUTPut[1 2][:STATe] <bool>
Parameters	0 OFF 1 ON
*RST Value	0
Examples	OUTP ON
Query Syntax	OUTPut[1 2][:STATe]?
Returned Parameters	<NR1>0 or 1
Related Commands	*RST *RCL *SAV INST:COUP:OUTP:STAT

OUTPut[1 | 2]:RELay:MODE

Agilent 66309B/D units with Option 521 only

Specifies one of the relay modes (DD, DH, HD, or HH). The output must be turned off before any programmed mode settings take effect. Relay settings cannot be coupled; they must be set separately for each output. Relay modes are stored in non-volatile memory and will be restored when the unit is turned on. When shipped from the factory, the relay mode for both output 1 and output 2 is set to HH.

	<u>Output ON</u>	<u>Output OFF</u>
DD	Dry	Dry
DH	Dry	Hot
HD	Hot ¹	Dry
HH	Hot ¹	Hot

¹When the Output ON relay mode is set to Hot, the dc source does not check for open sense leads when the output is turned on or enabled. With Hot output switching, the output is programmed before the sense relays are closed.

Command Syntax	OUTPut[1 2]:RELay:MODE <mode>
Parameters	DD DH HD HH
Examples	OUTP:REL:MODE DH (sets output 1 relay mode DH) OUTP2:REL:MODE HH (sets output 2 relay mode HH)
Query Syntax	OUTPut[1 2]:REL:MODE?
Returned Parameters	<CRD>

CAUTION: Non-volatile memory has a finite maximum number of write cycles. Programs that repeatedly cause write cycles to non-volatile memory can eventually exceed the maximum number of write cycles and cause the memory to fail.

OUTPut:DFI

This command enables or disables the discrete fault indicator (DFI) output from the dc source.

Command Syntax	OUTPut:DFI[:STATe] <bool>
Parameters	0 1 OFF ON
*RST Value	OFF
Examples	OUTP:DFI 1 OUTP:DFI ON
Query Syntax	OUTPut:DFI[:STATe]?
Returned Parameters	0 1
Related Commands	OUTP:DFI:SOUR

OUTPut:DFI:SOURce

This command selects the source for discrete fault indicator (DFI) events. The choices are:

QUESTIONable	selects the Questionable event summary bit (bit 3 of the Status Byte Register)
OPERation	selects the Operation Event summary bit (bit 7 of the Status Byte Register)
ESB	selects the Standard Event summary bit (bit 5 of the Status Byte Register)
RQS	selects the Request Service bit (bit 6 of the Status Byte Register)
OFF	selects no DFI source

Command Syntax	OUTP:DFI:SOUR <source>
Parameters	QUES OPER ESB RQS OFF
*RST Value	OFF
Examples	OUTP:DFI:SOUR OPER
Query Syntax	OUTPut:DFI:SOUR?
Returned Parameters	<CRD>
Related Commands	OUTP:DFI

OUTPut:PON:STATe

This command selects the power-on state of the dc source. This information is saved in non-volatile memory. The following states can be selected:

RST	Sets the power-on state to *RST. Refer to *RST for more information.
RCL0	Sets the power-on state to *RCL 0. Refer to *RCL for more information.

Command Syntax	OUTPut:PON:STATe <state>
Parameters	RST RCL0
Examples	OUTP:PON:STAT RST
Query Syntax	OUTPut:PON:STATe?
Returned Parameters	<CRD>
Related Commands	*RST *RCL

OUTPut:PROTection:CLEAr

This command clears the latch that disables the output when an overvoltage, overcurrent, overtemperature, or remote inhibit status condition is detected. All conditions that generate the fault must be removed before the latch can be cleared. The output is then restored to the state it was in before the fault condition occurred.

Command Syntax	OUTPut:PROTection:CLEAr
Parameters	None
Examples	OUTP:PROT:CLE
Related Commands	OUTP:PROT:DEL *RCL *SAV

OUTPut:PROTection:DELAy

This command sets the time between the programming of an output change that produces a constant current condition (CC) and the recording of that condition by the Operation Status Condition register. The delay prevents the momentary changes in status that can occur during reprogramming from being registered as events by the status subsystem. Since the constant current condition is used to trigger overcurrent protection (OCP), this command also delays OCP. Overvoltage protection is not affected by this command.

Command Syntax	OUTPut:PROTection:DELAy <NRf+>
Parameters	0 to 2,147,483.647
Unit	seconds
*RST Value	0.08 (Normal)
Examples	OUTP:PROT:DEL 75E-1
Query Syntax	OUTPut:PROTection:DELAy?
Returned Parameters	<NR3>
Related Commands	OUTP:PROT:CLE CURR:PROT:STAT *RCL *SAV

OUTPut:RI:MODE

This command selects the mode of operation of the Remote Inhibit protection. The RI mode is stored in non-volatile memory. The following modes can be selected:

- LATChing** causes a TTL low signal on the INH input to disable the output. The only way to clear the latch is by sending OUTPut:PROTection:CLEAR while the INH input is false.
- LIVE** allows the INH input to disable the output in a non-latching manner. In other words, the output follows the state of the INH input. When INH is low true, the output is disabled. When INH is high the output is not affected.
- OFF** the INH input is disabled.

Command Syntax	OUTPut:RI:MODE <mode>
Parameters	LATChing LIVE OFF
Examples	OUTP:RI:MODE LIVE
Query Syntax	OUTPut:RI:MODE?
Returned Parameters	<CRD>
Related Commands	OUTP:PROT:CLE

OUTPut:TYPE

This command programs the output compensation circuit. This circuit compensates the output of the dc source according to the input capacitance of the phone being tested. The circuit covers the following capacitance ranges:

LOW mode: 0 μ F to 12,000 μ F

HIGH mode: 5 μ F to 12,000 μ F

H2 mode: keeps the unit in High mode at all times

The dc source is shipped with the output compensation set LOW mode, which provides stable operation for all types of phones. The HIGH mode setting provides better transient response performance for phones that have input capacitances greater than 5 μ F. In High mode, operation of the dc source will be unstable when connected to phones that have input capacitances less than 5 μ F. Note that if the dc source senses that there is no load on the output, it automatically switches from High mode to Low mode.

H2 is an additional compensation mode that guarantees that the dc source stays in High compensation mode at all times. (Option 004 units are shipped with the compensation set HIGH. *RST is also HIGH.)

NOTE: If you set the output compensation to HIGH mode and you want the unit to power up in HIGH mode, you must first save the desired output settings in non-volatile memory location 0 with the *SAV command. Then program the dc source to power up with the settings stored in memory location 0 with the OUTP:PON:STAT RCL0 command.

Command Syntax OUTPut:TYPE[:CAPacitance] <setting>
Parameters HIGH | LOW | H2
***RST Value** LOW
Examples OUTP:COMP HIGH
Query Syntax OUTPput:TYPE[:CAPacitance]?
Returned Parameters <CRD>

[SOURce:]CURRent

This command sets the immediate current level of the dc source. The immediate level is the current programmed for the output terminals.

Command Syntax [SOURce:]CURRent[:LEVel][:IMMediate][:AMPLitude] <NRf+>
Parameters see Table 8-3
Default Suffix A (amperes)
***RST Value** 10% of MAX
Examples CURR 200 MA CURRENT:LEVEL 200 MA
Query Syntax [SOURce:]CURRent[:LEVel][:IMMediate][:AMPLitude]?
Returned Parameters <NR3>
Related Commands CURR:TRIG

[SOURce:]CURRent2

Agilent 66309B/D only

This command sets the output current level of the auxiliary output.

Command Syntax [SOURce:]CURRent2[:LEVel][:IMMediate][:AMPLitude] <NRf+>
Parameters see Table A-3
Default Suffix A (amperes)
***RST Value** 10% of MAX
Examples CURR2 200 MA CURR2:LEVEL 200 MA
Query Syntax [SOURce:]CURRent2[:LEVel][:IMMediate][:AMPLitude]?
Returned Parameters <NR3>

[SOURce:]CURRent:PROTection:STATe

This command enables or disables the overcurrent protection (OCP) function on all output channels. If the dc source overcurrent protection function is enabled and the dc source goes into constant current operation, then the output is disabled and the Questionable Condition status register OC bit is set (see chapter 7 about programming the status registers). Note that the [SOURce:]CURRent command sets the current limit, which determines when the dc source goes into constant current operation. An overcurrent condition can be cleared with the OUTPut:PROTection:CLEar command after the cause of the condition is removed.

NOTE: Use OUTPut:PROTection:DELAy to prevent momentary current limit conditions caused by programmed output changes from tripping the overcurrent protection.

Command Syntax [SOURce:]CURRent:PROTection:STATe <bool>
Parameters 0 | 1 | OFF | ON
***RST Value** OFF
Examples CURR:PROT:STAT 0 !current protection off
 CURR:PROT:STAT 1 !current protection on
Query Syntax Syntax [SOURce:]CURRent:PROTection:STATe?
Returned Parameters <NR1>0 or 1
Related Commands OUTP:PROT:CLE *RST

[SOURce:]CURRent:TRIGger

This command sets the pending triggered current level of the dc source. The pending triggered level is a stored current value that is transferred to the output terminals when a trigger occurs. In order for a trigger to occur, the trigger subsystem must be initiated (see the INITiate command in the trigger subsystem).

Command Syntax [SOURce:]CURRent[:LEVel]:TRIGgered[:AMPLitude] <NRf+>
Parameters see Table 8-3
Default Suffix A (amperes)
***RST Value** 10% of MAX
Examples CURR:TRIG 1CURRENT:LEVEL:TRIGGERED 1
Query Syntax SOURce:]CURRent[LEVel]:TRIGgered[:AMPLitude]?
Returned Parameters <NR3>
Related Commands INIT CURR

[SOURce:]CURRent2:TRIGger**Agilent 66309B/D only**

This command sets the triggered current level of the auxiliary output. The triggered level is a stored value that is transferred to the output when a trigger occurs. In order for a trigger to occur, the trigger subsystem must be initiated (see the INITiate command).

Command Syntax [SOURce:]CURRent2[:LEVel]:TRIGgered[:AMPLitude] <NRf+>
Parameters see Table A-3
Default Suffix A (amperes)
***RST Value** 10% of MAX
Examples CURR2:TRIG 1 CURR2:LEV:TRIG 1
Query Syntax SOURce:]CURRent2[LEVel]:TRIGgered[:AMPLitude]?
Returned Parameters <NR3>
Related Commands INIT CURR2

[SOURce:]DIGital:DATA

This command programs the digital control port when the port is configured for Digital I/O operation. The port has three signal pins and a digital ground pin. Pins 1 and 2 are output pins controlled by bits 0 and 1. Pin 3 is controlled by bit 2, and can be programmed to serve either as an input or an output. It normally serves as an output. Bit 2 must be programmed high to use pin 3 as an input. Pin 4 is the digital ground. Refer to the following chart for list of the programmable pin settings. The query returns the last programmed value in bits 0 and 1, and the value read at pin 3 in bit 2.

Program Value	Bit Configuration			Pin Setting			
	2	1	0	4	3	2	1
0	0	0	0	GND	Output	Lo	Lo
1	0	0	1	GND	Output	Lo	Hi
2	0	1	0	GND	Output	Hi	Lo
3	0	1	1	GND	Output	Hi	Hi
4	1	0	0	GND	Input	Lo	Lo
5	1	0	1	GND	Input	Lo	Hi
6	1	1	0	GND	Input	Hi	Lo
7	1	1	1	GND	Input	Hi	Hi

Command Syntax [SOURce:]DIGital:DATA[:VALue] <NRf>
Parameters 0 to 7
***RST Value** 0
Examples DIG:DATA 7
Query Syntax [SOURce:]DIGital:DATA?
Returned Parameters <NR1>

[SOURce:]DIGital:FUNcTION

Configures the digital control port. The configuration setting is saved in non-volatile memory.

RIDFi Configures the port for Remote Inhibit/Discrete Fault Interrupt operation

DIGio Configures the port for Digital input/output operation (see DIG:DATA)

Command Syntax [SOURce:]DIGital:FUNcTION <CRD>
Parameters RIDFi | DIGio
Examples DIG:FUNC DIG
Query Syntax [SOURce:]DIGital:FUNc?

Returned Parameters <CRD>

[SOURce:]VOLTage

This command sets the output voltage level of the dc source.

Command Syntax [SOURce:]VOLTage[:LEVel][:IMMediate][:AMPLitude]<NRf+>
Parameters see Table 8-3
Default Suffix V (volts)
***RST Value** 0
Examples VOLT 2.5 !set output voltage to 2.5V
Query Syntax [SOURce:]VOLTage[:LEVel][:IMMediate][:AMPLitude]?

Returned Parameters <NR3>
Related Commands VOLT:TRIG

[SOURce:]VOLTage2**Agilent 66309B/D only**

This command sets the output voltage level of the auxiliary output.

Command Syntax	[SOURce:]VOLTage2[:LEVel][:IMMediate][:AMPLitude]<NRf+>
Parameters	see Table A-3
Default Suffix	V (volts)
*RST Value	0
Examples	VOLT2 500mV !set output2 voltage to 0.5V
Query Syntax	[SOURce:]VOLTage2[:LEVel][:IMMediate][:AMPLitude]?
Returned Parameters	<NR3>

[SOURce:]VOLTage:PROTection

This command sets the overvoltage protection (OVP) level of the dc source. If the output voltage exceeds the OVP level, then the dc source output is disabled and the Questionable Condition status register OV bit is set (see chapter 7 about programming the status registers). An overvoltage condition can be cleared with the OUTP:PROT:CLE command after the condition that caused the OVP trip is removed. The OVP always trips with zero delay and is unaffected by the OUTP:PROT:DEL command. The OVP function can be disabled using the VOLT:PROT:STAT command.

Command Syntax	[SOURce:]VOLTage:PROTection[:LEVel]<NRf+>
Parameters	see Table 8-3
Default Suffix	V (volts)
*RST Value	MAX
Examples	VOLT:PROT 21 !set voltage protect to 21V
Query Syntax	[SOURce:]VOLTage:PROTection[:LEVel]?
Returned Parameters	<NR3>
Related Commands	OUTP:PROT:CLE VOLT:PROT:STAT

[SOURce:]VOLTage:PROTection:STATe

This command enables or disables the overvoltage protection (OVP) function.

CAUTION: Disabling the overvoltage protection function may cause excessive output voltages, such as can occur if remote sense leads are disconnected, to damage the equipment under test.

Command Syntax	[SOURce:]VOLTage:PROTection:STATe <bool>
Parameters	0 1 OFF ON
*RST Value	OFF
Examples	VOLT:PROT:STAT 0 !voltage protection is OFF VOLT:PROT:STAT 1 !voltage protection is ON
Query Syntax	[SOURce:]VOLTage:PROTection:STATe?
Returned Parameters	<NR1>0 or 1
Related Commands	OUTP:PROT:CLE *RST VOLT:PROT

[SOURce:]VOLTage:TRIGger

This command sets the pending triggered voltage level of the dc source. The pending triggered level is a stored voltage value that is transferred to the output terminals when a trigger occurs. In order for a trigger to occur, the trigger subsystem must be initiated (see the INITiate command in the trigger subsystem).

Command Syntax	[SOURce:]VOLTage[:LEVel]:TRIGgered[:AMPLitude] <NRf+>
Parameters	see Table 8-3
Default Suffix	V (volts)
*RST Value	0
Examples	VOLT:TRIG 20 VOLTAGE:LEVEL:TRIGGERED 20
Query Syntax	[SOURce:]VOLTage[:LEVel]:TRIGgered[:AMPLitude]?
Returned Parameters	<NR3>
Related Commands	VOLT *RST

[SOURce:]VOLTage2:TRIGger

Agilent 66309B/D only

This command sets the triggered voltage level of the auxiliary output. The triggered level is a stored value that is transferred to the output when a trigger occurs. In order for a trigger to occur, the trigger subsystem must be initiated (see the INITiate command).

Command Syntax	[SOURce:]VOLTage2[:LEVel]:TRIGgered[:AMPLitude] <NRf+>
Parameters	see Table A-3
Default Suffix	V (volts)
*RST Value	0
Examples	VOLT2:TRIG 20 VOLT2:LEV:TRIG 20
Query Syntax	[SOURce:]VOLTage2[:LEVel]:TRIGgered[:AMPLitude]?
Returned Parameters	<NR3>
Related Commands	VOLT *RST

Status Commands

Status commands program the dc source status registers. The dc source has three groups of status registers; Operation, Questionable, and Standard Event. The Standard Event group is programmed with Common commands as described later in this section. The Operation and Questionable status groups each consist of the Condition, Enable, and Event registers and the NTR and PTR filters. Chapter 7 explains how to read specific register bits and use the information they return.

STATus:PRESet

This command sets all defined bits in the Status Subsystem PTR registers and clears all bits in the subsystem NTR and Enable registers.

Command Syntax	STATus:PRESet
Parameters	None
Examples	STAT:PRES STATUS:PRESET

Table 8-4. Bit Configuration of Operation Status Registers

Bit Position	15-13	12	11	10	9	8	7-6	5	4-1	0
Bit Name	not used	CC2	CC-	CC+	CV2	CV	not used	WTG	not used	CAL
Bit Weight		4096	2048	1024	512	256		32		1

CAL = The dc source is computing new calibration constants.
 WTG = The dc source is waiting for a trigger.
 CV = The dc source is operating in constant voltage mode.
 CV2 = Output 2 is operating in constant voltage mode. (Agilent 66309B/D only)
 CC+ = The dc source is operating in constant current mode.
 CC- = The dc source is operating in negative constant current mode.
 CC2 = Output 2 is operating in constant current mode. (Agilent 66309B/D only)

STATus:OPERation?

This query returns the value of the Operation Event register. The Event register is a read-only register, which holds (latches) all events that are passed by the Operation NTR and/or PTR filter. Reading the Operation Event register clears it.

Query Syntax STATus:OPERtion[:EVENT]?
Parameters None
Returned Parameters <NR1>(Register Value)
Examples STAT:OPER?
Related Commands *CLS STAT:OPER:NTR STAT:OPER:PTR

STATus:OPERation:CONDition?

This query returns the value of the Operation Condition register. That is a read-only register, which holds the real-time (unlatched) operational status of the dc source.

Query Syntax STATus:OPERation:CONDition?
Parameters None
Examples STAT:OPER:COND? STATUS:OPERATION:CONDITION?
Returned Parameters <NR1> (register value)

STATus:OPERation:ENABLE

This command and its query set and read the value of the Operational Enable register. This register is a mask for enabling specific bits from the Operation Event register to set the operation summary bit (OPER) of the Status Byte register. This bit (bit 7) is the logical OR of all the Operational Event register bits that are enabled by the Status Operation Enable register.

Command Syntax STATus:OPERation:ENABLE<NRf>
Parameters 0 to 32767
Preset Value 0
Examples STAT:OPER:ENAB 1312
Query Syntax STATus:OPERation:ENABLE?
Returned Parameters <NR1> (register value)
Related Commands STAT:OPER:EVEN

STATus:OPERation:NTR

STATus:OPERation:PTR

These commands set or read the value of the Operation NTR (Negative-Transition) and PTR (Positive-Transition) registers. These registers serve as polarity filters between the Operation Enable and Operation Event registers to cause the following actions:

- ◆ When a bit in the Operation NTR register is set to 1, then a 1-to-0 transition of the corresponding bit in the Operation Condition register causes that bit in the Operation Event register to be set.
- ◆ When a bit of the Operation PTR register is set to 1, then a 0-to-1 transition of the corresponding bit in the Operation Condition register causes that bit in the Operation Event register to be set.
- ◆ If the same bits in both NTR and PTR registers are set to 1, then any transition of that bit at the Operation Condition register sets the corresponding bit in the Operation Event register.
- ◆ If the same bits in both NTR and PTR registers are set to 0, then no transition of that bit at the Operation Condition register can set the corresponding bit in the Operation Event register.

Command Syntax STATus:OPERtion:NTRansition<NRf>
 STATus:OPERtion:PTRansition<NRf>

Parameters 0 to 32767

Preset Value NTR register = 0; PTR register = 32767

Examples STAT:OPER:NTR 32 STAT:OPER:PTR 1312

Query Syntax STAT:OPER:NTR? STAT:OPER:PTR?

Returned Parameters <NR1> (register value)

Related Commands STAT:OPER:ENAB

Table 8-5. Bit Configuration of Questionable Status Registers

Bit Position	15	14	13	12	11	10	9	8	7-6	5	4	3	2	1	0
Bit Name	not used	Meas Ovld	not used	OC2	not used	UNR	RI	UNR 2	not used	SD	OT	FP	not used	OCP	OV
Bit Weight		16384		4096		1024	512	256		32	16	8		2	1

OV = overvoltage protection has tripped on the main output (output 1)
 OCP = overcurrent protection has tripped on the main output (output 2)
 FP = the front panel "Local" key has been depressed
 OT = overtemperature protection has tripped
 SD = opened sense lead detected
 UNR2 = output 2 is unregulated (Agilent 66309B/D only)
 RI = remote inhibit is active
 UNR = the output is unregulated
 OC2 = output 2 overcurrent protection has tripped (Agilent 66309B/D only)
 Meas Ovld = measurement overload

STATus:QUESTIONable?

This query returns the value of the Questionable Event register. The Event register is a read-only register which holds (latches) all events that are passed by the Questionable NTR and/or PTR filter. Reading the Questionable Event register clears it.

Query Syntax STATus:QUESTIONable[:EVENT]?

Parameters None

Examples STAT:QUES?

Returned Parameters <NR1> (register value)

Related Commands *CLS STAT:QUES:ENAB STAT:QUES:NTR STAT:QUES:PTR

STATus:QUEStionable:CONDition?

This query returns the value of the Questionable Condition register. That is a read-only register, which holds the real-time (unlatched) questionable status of the dc source.

Query Syntax STATus:QUEStionable:CONDition?
Parameters None
Examples STAT:QUES:COND?
Returned Parameters <NR1> (register value)

STATus:QUEStionable:ENABLE

This command and its query set and read the value of the Questionable Enable register. This register is a mask for enabling specific bits from the Questionable Event register to set the questionable summary bit (QUES) of the Status Byte register. This bit (bit 3) is the logical OR of all the Questionable Event register bits that are enabled by the Questionable Status Enable register..

Command Syntax STATus:QUEStionable:ENABLE<NRf>
Parameters 0 to 32767
Preset Value 0
Examples STAT:QUES:ENAB 4098 !enables OC2 and OCP
Query Syntax STATus:QUEStionable:ENABLE?
Returned Parameters <NR1> (register value)
Related Commands STAT:QUES?

STATus:QUEStionable:NTR**STATus:QUEStionable:PTR**

These commands allow you to set or read the value of the Questionable NTR (Negative-Transition) and PTR (Positive-Transition) registers. These registers serve as polarity filters between the Questionable Enable and Questionable Event registers to cause the following actions:

- ◆ When a bit of the Questionable NTR register is set to 1, then a 1-to-0 transition of the corresponding bit of the Questionable Condition register causes that bit in the Questionable Event register to be set.
- ◆ When a bit of the Questionable PTR register is set to 1, then a 0-to-1 transition of the corresponding bit in the Questionable Condition register causes that bit in the Questionable Event register to be set.
- ◆ If the same bits in both NTR and PTR registers are set to 1, then any transition of that bit at the Questionable Condition register sets the corresponding bit in the Questionable Event register.
- ◆ If the same bits in both NTR and PTR registers are set to 0, then no transition of that bit at the Questionable Condition register can set the corresponding bit in the Questionable Event register.

Command Syntax STATus:QUEStionable:NTRansition<NRf>
 STATus:QUEStionable:PTRansition<NRf>
Parameters 0 to 32767
Preset Value NTR register = 0; PTR register = 32767
Examples STAT:QUES:NTR 16
 STATus:QUESTIONABLE:PTR 512
Query Syntax STAT:QUES:NTR?STAT:QUES:PTR?
Returned Parameters <NR1>(Register value)
Related Commands STAT:QUES:ENAB

System Commands

System commands control system functions that are not directly related to output control or measurement functions.

SYSTem:ERRor?

This query returns the next error number followed by its corresponding error message string from the remote programming error queue. The queue is a FIFO (first-in, first-out) buffer that stores errors as they occur. As it is read, each error is removed from the queue. When all errors have been read, the query returns 0,NO ERROR. If more errors are accumulated than the queue can hold, the last error in the queue will be -350,TOO MANY ERRORS (see Appendix C for other error codes).

You can use the front panel Error key to read errors from the queue. Errors generated at the front panel are not put into the queue but appear immediately on the display.

Query Syntax	SYSTem:ERRor?
Parameters	None
Returned Parameters	<NR1> , <SRD>
Examples	SYST:ERR?

SYSTem:LANGuage

This command switches the instrument between its SCPI command language and its compatibility language. The compatibility language is provided for emulation of older dc source systems and is described in Appendix B. Sending the command causes:

- ◆ The selected language to become active and to be stored in nonvolatile memory.
- ◆ The instrument to reset to its power-on state.

If the dc source is shut off, it will resume operation in the last-selected language when power is restored. Note that this command and query can be used regardless of the language that is presently selected.

Command Syntax	SYSTem:LANGuage<string>
Parameters	SCPI COMPatibility
Power-on Value	<i>last selected language</i>
Example	SYST:LANG SCPI
Query Syntax	SYSTem:LANGuage?
Returned Parameters	<CRD>

SYSTem:VERSion?

This query returns the SCPI version number to which the instrument complies. The returned value is of the form YYYY.V, where YYYY represents the year and V is the revision number for that year.

Query Syntax	SYSTem:VERSion?
Parameters	None
Returned Parameters	<NR2>
Examples	SYST:VERS?

Trigger Commands

Trigger commands consist of trigger and initiate commands. They are used to generate output transients and measurement triggers.

Initiate commands initialize the trigger system. **Trigger commands** control the remote triggering of the dc source. Trigger commands (and Initiate commands) are referenced either by name or by number. The correspondence between names and numbers is:

Sequence Number	Sequence Name	Description
1 (the default)	TRANSient	Output transient trigger sequence
2	ACQuire	Measurement acquire trigger sequence

NOTE: Before you generate a measurement trigger, you must specify either a voltage, current , or DVM measurement acquisition using the SENSE:FUNCTION command.

ABORt

This command cancels any trigger actions presently in process. Pending trigger levels are reset to their corresponding immediate values. ABORt also resets the WTG bit in the Operation Condition Status register (see chapter 7 about programming the status registers). If INITiate:CONTinuous ON has been programmed, the trigger subsystem initiates itself immediately after ABORt, thereby setting WTG. ABORt is executed at power turn on and upon execution of *RCL or RST.

Command Syntax	ABORt
Parameters	None
Examples	ABOR
Related Commands	INIT *RST *TRG TRIG

INITiate:SEquence

INITiate:NAME

INITiate commands control the enabling of both output and measurement triggers. When a trigger is enabled, an event on a selected trigger source causes the specified triggering action to occur. If the trigger subsystem is not enabled, all triggers are ignored.

Command Syntax	INITiate[:IMMediate]:SEquence[1 2] INITiate[:IMMediate]:NAME<name>
Parameters	TRANSient ACQuire (for INIT:NAME)
Examples	INIT:SEQ2 INIT:NAME TRAN
Related Commands	ABOR INIT:CONT TRIG TRIG:SEQ:DEF *TRG

INITiate:CONTInuous:SEQuence1

INITiate:CONTInuous:NAME TRANsient

These commands control the output transient trigger system.

1 or ON continuously initiates the output trigger system..

0 or OFF turns off continuous triggering. In this state, the output trigger system must be initiated for each trigger using INITiate:SEQuence.

Command Syntax INITiate:CONTInuous:SEQuence1 <bool>
INITiate:CONTInuous:NAME TRANsient <bool>

Parameters 0 | 1 | OFF | ON

Examples INIT:CONT:SEQ ON INIT:CONT:NAME TRAN, 1

Related Commands ABOR INIT TRIG TRIG:SEQ:DEF *TRG

TRIGger

This command generates a BUS trigger for the output transient trigger system. If the transient trigger system is enabled, the trigger will then:

1. Initiate a pending level change as specified by CURRENT:TRIGger or VOLTage:TRIGger.
2. Clear the WTG bit in the Status Operation Condition register after both transient and acquire trigger sequences have completed. (WTG is the logical-or of both transient and acquire sequences.)
3. If INITiate:CONTInuous ON has been programmed, the trigger subsystem is immediately re-enabled for subsequent triggers. As soon as it is cleared, the WTG bit is again set to 1.

Command Syntax TRIGger[:SEQuence1][:IMMediate]
TRIGger[:TRANsient][:IMMediate]

Parameters None

Examples TRIG TRIG:IMM

Related Commands ABOR CURR:TRIG INIT *TRG VOLT:TRIG

TRIGger:SOURce

This command selects the trigger source for the output transient trigger system. Since BUS is the only trigger source for transient triggers, this command does not need to be used. It is included for completeness only.

BUS GPIB device, *TRG, or <GET> (Group Execute Trigger)

Command Syntax TRIGger[:SEQuence1]:SOURce<source>
TRIGger[:TRANsient]:SOURce<source>

Parameters BUS

***RST Value** BUS

Examples TRIG:SOUR BUS

Query Syntax TRIGger[:SEQuence1]:SOURce?
TRIGger[:TRANsient]:SOURce?

Returned Parameters <CRD>

TRIGger:SEquence2

TRIGger:ACQuire

These commands generate a BUS trigger for the measurement trigger system. When the measurement trigger system is enabled, the measurement trigger causes the dc source to measure either the voltage or current on the main output or the DVM inputs and store the results in a buffer. The SENSE:FUNCTION command selects the signal that will be measured.

Command Syntax	TRIGger:SEquence2[:IMMediate] TRIGger:ACQuire[:IMMediate]
Parameters	None
Examples	TRIG:SEQ2 TRIG:ACQ
Related Commands	TRIG:SOUR TRIG:SEQ2:DEF TRIG:SEQ2:COUN TRIG:SEQ2:LEV:VOLT TRIG:SEQ2:SLOP:CURR SENS:FUNC

TRIGger:SEquence2:COUNt:CURRent

TRIGger:ACQuire:COUNt:CURRent

This command sets up a successive number of triggers for measuring current data. With this command, the trigger system needs to be initialized only once at the start of the acquisition period. After each completed measurement, the instrument waits for the next valid trigger condition to start another measurement. This continues until the count has completed.

Command Syntax	TRIGger:SEquence2:COUNt:CURRent<NRf+> TRIGger:ACQuire:COUNt:CURRent<NRf+>
Parameters	1 to 100
*RST Value	1
Examples	TRIG:SEQ2:COUN:CURR 5 TRIG:ACQ:COUN:CURR 1
Query Syntax	TRIGger:SEquence2:COUNt:CURRent? TRIGger:ACQuire:COUNt:CURRent?
Returned Parameters	<NR3>
Related Commands	TRIG:SEQ2 TRIG:ACQ

TRIGger:SEquence2:COUNt:DVM

TRIGger:ACQuire:COUNt:DVM

Agilent 66311D/66309D only

This command specifies a DVM trigger count. Since the trigger count for DVM measurements cannot be set to any value other than 1, this command does not need to be used. It is included for completeness only.

Command Syntax	TRIGger:SEquence2:COUNt:DVM<NRf+> TRIGger:ACQuire:COUNt:DVM<NRf+>
Parameters	1
*RST Value	1
Examples	TRIG:ACQ:COUN:DVM 1
Query Syntax	TRIGger:SEquence2:COUNt:DVM? TRIGger:ACQuire:COUNt:DVM?
Returned Parameters	<NR3>

TRIGger:SEQuence2:COUnT:VOLTAge

TRIGger:ACQuire:COUnT:VOLTAge

This command sets up a successive number of triggers for measuring voltage data. With this command, the trigger system needs to be initialized only once at the start of the acquisition period. After each completed measurement, the instrument waits for the next valid trigger condition to start another measurement. This continues until the count has completed.

Command Syntax	TRIGger:SEQuence2:COUnT:VOLTAge<NRf+> TRIGger:ACQuire:COUnT:VOLTAge<NRf+>
Parameters	1 to 100
*RST Value	1
Examples	TRIG:SEQ2:COUnT:VOLT 5 TRIG:ACQ:COUnT:VOLT 1
Query Syntax	TRIGger:SEQuence2:COUnT:VOLTAge? TRIGger:ACQuire:COUnT:VOLTAge?
Returned Parameters	<NR3>
Related Commands	TRIG:SEQ2 TRIG:ACQ

TRIGger:SEQuence2:HYSTeresis:CURRent

TRIGger:ACQuire:HYSTeresis:CURRent

This command defines a band around the trigger level through which the signal must pass before an internal measurement can occur. The band limit above and below the trigger level is one half of the hysteresis value added to or subtracted from the trigger level.

For a positive trigger to occur, the excursion of an output waveform in the positive direction must start below the lower hysteresis band limit and pass through the upper hysteresis band limit. For a negative trigger to occur, the excursion of an output waveform in the negative direction must start above the upper hysteresis band limit and pass through the lower hysteresis band limit.

Command Syntax	TRIGger:SEQuence2:HYSTeresis:CURRent<NRf+> TRIGger:ACQuire:HYSTeresis:CURRent<NRf+>
Parameters	0 to MAX (see table 8-3)
Unit	A (amperes)
*RST Value	0
Examples	TRIG:SEQ2:HYST:CURR 0.5 TRIG:ACQ:HYST:CURR 0.5
Query Syntax	TRIGger:SEQuence2:HYSTeresis:CURRent? TRIGger:ACQuire:HYSTeresis:CURRent?
Returned Parameters	<NR3>
Related Commands	TRIG:SEQ2:HYST:VOLT TRIG:SEQ2:LEV:CURR

TRIGger:SEQuence2:HYSTeresis:DVM

TRIGger:ACQuire:HYSTeresis:DVM

Agilent 66311D/66309D only

This command defines a band around the trigger level through which the input signal must pass before a DVM measurement can occur. The band limit above and below the trigger level is one half of the hysteresis value added to or subtracted from the trigger level. For a positive trigger to occur, the excursion of an input signal in the positive direction must start below the lower hysteresis band limit and pass through the upper hysteresis band limit. For a negative trigger to occur, the excursion of an input signal in the negative direction must start above the upper hysteresis band limit and pass through the lower hysteresis band limit.

Command Syntax	TRIGger:SEQuence2:HYSTeresis:DVM<NRf+> TRIGger:ACQuire:HYSTeresis:DVM<NRf+>
Parameters	0 to MAX (see table A-3)
Unit	V (volts)
*RST Value	0
Examples	TRIG:SEQ2:HYST:DVM 0.5 TRIG:ACQ:HYST:DVM 0.5
Query Syntax	TRIGger:SEQuence2:HYSTeresis:DVM? TRIGger:ACQuire:HYSTeresis:DVM?
Returned Parameters	<NR3>
Related Commands	TRIG:SEQ2:LEV:DVM

TRIGger:SEQuence2:HYSTeresis:VOLTage

TRIGger:ACQuire:HYSTeresis:VOLTage

This command defines a band around the trigger level through which the signal must pass before an internal measurement can occur. The band limit above and below the trigger level is one half of the hysteresis value added to or subtracted from the trigger level.

For a positive trigger to occur, the excursion of an output waveform in the positive direction must start below the lower hysteresis band limit and pass through the upper hysteresis band limit. For a negative trigger to occur, the excursion of an output waveform in the negative direction must start above the upper hysteresis band limit and pass through the lower hysteresis band limit.

Command Syntax	TRIGger:SEQuence2:HYSTeresis:VOLTage<NRf+> TRIGger:ACQuire:HYSTeresis:VOLTage<NRf+>
Parameters	0 to MAX (see table 8-3)
Unit	V (volts)
*RST Value	0
Examples	TRIG:SEQ2:HYST:VOLT 2 TRIG:ACQ:HYST:VOLT 2
Query Syntax	TRIGger:SEQuence2:HYSTeresis:VOLTage? TRIGger:ACQuire:HYSTeresis:VOLTage?
Returned Parameters	<NR3>
Related Commands	TRIG:SEQ2:HYST:CURRENTRANGE TRIG:SEQ2:LEV:VOLT

TRIGger:SEQuence2:LEVel:CURRent

TRIGger:ACQuire:LEVel:CURRent

This command sets the trigger level for internally triggered current measurements. A positive current trigger occurs when the current level changes from a value less than the lower hysteresis band limit to a value greater than the upper hysteresis band limit. Similarly, a negative current trigger occurs when the current level changes from a value greater than the upper hysteresis band limit to a value less than the lower hysteresis band limit.

Command Syntax	TRIGger:SEQuence2:LEVel:CURRent<NRf+> TRIGger:ACQuire:LEVel:CURRent<NRf+>
Parameters	0 to MAX (see table 8-3)
Unit	A (amperes)
*RST Value	0
Examples	TRIG:SEQ2:LEV:CURR 5 TRIG:ACQ:LEV:CURR MAX TRIG:ACQ:LEV 2
Query Syntax	TRIGger:SEQuence2:LEVel:CURRent? TRIGger:ACQuire:LEVel:CURRent?
Returned Parameters	<NR3>
Related Commands	TRIG:SEQ2:LEV:VOLT TRIG:SEQ2:HYST:CURR

TRIGger:SEQuence2:LEVel:DVM

TRIGger:ACQuire:LEVel:DVM

Agilent 66311D/66309D only

This command sets the trigger level for DVM measurements. A positive trigger occurs when the input signal changes from a value less than the lower hysteresis band limit to a value greater than the upper hysteresis band limit. Similarly, a negative trigger occurs when the input signal changes from a value greater than the upper hysteresis band limit to a value less than the lower hysteresis band limit.

Command Syntax	TRIGger:SEQuence2:LEVel:DVM<NRf+> TRIGger:ACQuire:LEVel:DVM<NRf+>
Parameters	0 to MAX (see table A-3)
Unit	V (volts)
*RST Value	0
Examples	TRIG:SEQ2:LEV:DVM 5 TRIG:ACQ:LEV:DVM MAX
Query Syntax	TRIGger:SEQuence2:LEVel:DVM? TRIGger:ACQuire:LEVel:DVM?
Returned Parameters	<NR3>
Related Commands	TRIG:SEQ2:HYST:DVM

TRIGger:SEQuence2:LEVel:VOLTage

TRIGger:ACQuire:LEVel:VOLTage

This command sets the trigger level for internally triggered voltage measurements. A positive voltage trigger occurs when the voltage level changes from a value less than the lower hysteresis band limit to a value greater than the upper hysteresis band limit. Similarly, a negative voltage trigger occurs when the voltage level changes from a value greater than the upper hysteresis band limit to a value less than the lower hysteresis band limit.

Command Syntax	TRIGger:SEQuence2:LEVel:VOLTage<NRf+> TRIGger:ACQuire:LEVel:VOLTage<NRf+>
Parameters	0 to MAX (see table 8-3)
Unit	V (volts)
*RST Value	0
Examples	TRIG:SEQ2:LEV:VOLT 5 TRIG:ACQ:LEV:VOLT MAX
Query Syntax	TRIGger:SEQuence2:LEVel:VOLTage? TRIGger:ACQuire:LEVel:VOLTage?
Returned Parameters	<NR3>
Related Commands	TRIG:SEQ2:LEV:CURR TRIG:SEQ2:HYST:VOLT

TRIGger:SEQuence2:SLOPe:CURRent

TRIGger:ACQuire:SLOPe:CURRent

This command sets the slope of an internally triggered current measurement.

POSitive	triggering occurs on the rising edge.
NEGative	triggering occurs on the falling edge.
EITHer	triggering occurs on either edge.

Command Syntax	TRIGger:SEQuence2:SLOPe:CURRent<slope> TRIGger:ACQuire:SLOPe:CURRent<slope>
Parameters	EITHer POSitive NEGative
*RST Value	POSitive
Examples	TRIG:SEQ2:SLOP:CURR POS TRIG:ACQ:SLOP:CURR EITH
Query Syntax	TRIGger:SEQuence2:SLOPe:CURRent? TRIGger:ACQuire:SLOPe:CURRent?
Returned Parameters	<CRD>
Related Commands	TRIG:SEQ2:SLOP:VOLT

TRIGger:SEQuence2:SLOPe:DVM

TRIGger:ACQuire:SLOPe:DVM

Agilent 66311D/66309D only

This command sets the slope of the DVM input signal.

POSitive measurement triggering occurs on the rising edge.

NEGative measurement triggering occurs on the falling edge.

EITHer measurement triggering occurs on either edge.

Command Syntax TRIGger:SEQuence2:SLOPe:DVM<slope>
TRIGger:ACQuire:SLOPe:DVM<slope>

Parameters EITHer | POSitive | NEGative

***RST Value** POSitive

Examples TRIG:SEQ2:SLOP:DVM POS TRIG:ACQ:SLOP:DVM EITH

Query Syntax TRIGger:SEQuence2:SLOPe:DVM?

TRIGger:ACQuire:SLOPe:DVM?

Returned Parameters <CRD>

Related Commands TRIG:SEQ2:LEV:DVM

TRIGger:SEQuence2:SLOPe:VOLTage

TRIGger:ACQuire:SLOPe:VOLTage

This command sets the slope of an internally triggered voltage measurement.

POSitive triggering occurs on the rising edge.

NEGative triggering occurs on the falling edge.

EITHer triggering occurs on either edge.

Command Syntax TRIGger:SEQuence2:SLOPe:VOLTage<slope>
TRIGger:ACQuire:SLOPe:VOLTage<slope>

Parameters EITHer | POSitive | NEGative

***RST Value** POSitive

Examples TRIG:SEQ2:SLOP:VOLT POS TRIG:ACQ:SLOP:VOLT EITH

Query Syntax TRIGger:SEQuence2:SLOPe:VOLTage?

TRIGger:ACQuire:SLOPe:VOLTage?

Returned Parameters <CRD>

Related Commands TRIG:SEQ2:SLOP:CURR

TRIGger:SEQuence2:SOURce

TRIGger:ACQuire:SOURce

These commands select the trigger source for measurement triggers as follows:

BUS GPIB device, *TRG, or <GET> (Group Execute Trigger)
INTernal trigger is generated internally when the measured waveform crosses the trigger level with the selected slope.

Command Syntax TRIGger:SEQuence2:SOURce<source>
 TRIGger:ACQuire:SOURce<source>
Parameters BUS | INTernal
***RST Value** INTernal
Examples TRIG:ACQ:SOUR BUS
Query Syntax TRIGger:SEQuence2:SOURce?
 TRIGger:ACQuire:SOURce?
Returned Parameters <CRD>

TRIGger:SEQuence1:DEFine

TRIGger:SEQuence2:DEFine

These commands define the names that are aliased to trigger sequences 1 and 2. The command accepts only ACQuire for sequence 2 and TRANsient for sequence 1 as predefined names. The query allows the user to query the instrument names aliased to sequences 1 and 2.

Command Syntax TRIGger:SEQuence1:DEFine TRANsient
 TRIGger:SEQuence2:DEFine ACQuire
Parameters TRANsient, ACQuire
Examples SEQ1:DEF ACQ SEQ2:DEF TRAN
Query Syntax TRIGger:SEQuence1:DEFine?
 TRIGger:SEQuence2:DEFine?
Returned Parameters <CRD>
Related Commands TRIG:SEQ2:ACQ TRIG:SEQ1:TRAN

Common Commands

*CLS

This command causes the following actions (see chapter 7 for the descriptions of all registers):

- ◆ Clears the Standard Event Status, Operation Status Event, and Questionable Status Event registers
- ◆ Clears the Status Byte and the Error Queue
- ◆ If *CLS immediately follows a program message terminator (<NL>), then the output queue and the MAV bit are also cleared.

Command Syntax *CLS
Parameters None

*ESE

This command programs the Standard Event Status Enable register bits. The programming determines which events of the Standard Event Status Event register (see *ESR?) are allowed to set the ESB (Event Summary Bit) of the Status Byte register. A "1" in the bit position enables the corresponding event. All of the enabled events of the Standard Event Status Event Register are logically ORed to cause the Event Summary Bit (ESB) of the Status Byte Register to be set. The query reads the Standard Event The query reads the Standard Event Status Enable register.

Table 8-6. Bit Configuration of Standard Event Status Enable Register

Bit Position	7	6	5	4	3	2	1	0
Bit Name	PON	0	CME	EXE	DDE	QUE	0	OPC
Bit Weight	128	64	32	16	8	4	2	1
PON = Power-on has occurred CME = Command error EXE = Execution error				DDE = Device-dependent error QUE = Query error OPC = Operation complete				

Command Syntax *ESE <NRf>
Parameters 0 to 255
Power-On Value (See *PSC)
Examples *ESE 129
Query Syntax *ESE?
Returned Parameters <NR1>(Register value)
Related Commands *ESR? *PSC *STB?

CAUTION: If *PSC is programmed to 0, the *ESE command causes a write cycle to nonvolatile memory. Nonvolatile memory has a finite maximum number of write cycles. Programs that repeatedly cause write cycles to nonvolatile memory can eventually exceed the maximum number of write cycles and cause the memory to fail.

***ESR?**

This query reads the Standard Event Status Event register. Reading the register clears it. The bit configuration is the same as the Standard Event Status Enable register (see *ESE).

Query Syntax *ESR?
Parameters None
Returned Parameters <NR1>(Register binary value)
Related Commands *CLS *ESE *ESE? *OPC

***IDN?**

This query requests the dc source to identify itself. It returns a string composed of four fields separated by commas.

Query Syntax	*IDN?		
Returned Parameters	<AARD>	Field	Information
		Agilent Technologies	Manufacturer
		xxxxxA	model number followed by a letter suffix
		0	zero or the unit's serial number if available
		<A>.xx.xx	Revision levels of firmware.
Example	AGILENT,66312A,0,A.00.01		

***OPC**

This command causes the instrument to set the OPC bit (bit 0) of the Standard Event Status register when the dc source has completed all pending operations. (See *ESE for the bit configuration of the Standard Event Status register.) *Pending operations* are complete when:

- ◆ all commands sent before *OPC have been executed. This includes overlapped commands. Most commands are sequential and are completed before the next command is executed. Overlapped commands are executed in parallel with other commands. Commands that affect output voltage, current or state, relays, and trigger actions are overlapped with subsequent commands sent to the dc source. The *OPC command provides notification that all overlapped commands have been completed.
- ◆ all triggered actions are completed

*OPC does not prevent processing of subsequent commands, but bit 0 will not be set until all pending operations are completed.

*OPC? causes the instrument to place an ASCII "1" in the Output Queue when all pending operations are completed. Unlike *OPC, *OPC? prevents processing of all subsequent commands. It is intended to be used at the end of a command line so that the application program can then monitor the bus for data until it receives the "1" from the dc source Output Queue.

Command Syntax *OPC
Parameters None
Query Syntax *OPC?
Returned Parameters <NR1> 1
Related Commands *OPC *TRIG *WAI

***OPT?**

This query requests the dc source to identify any options that are installed. Options are identified by number. A 0 indicates no options are installed.

Query Syntax *OPT?
Returned Parameters <AARD>

***PSC**

This command controls the automatic clearing at power-on of the Service Request Enable and the Standard Event Status Enable registers. The query returns the current state of *PSC.

***PSC ON | 1** causes these registers to be cleared at power-on. This prevents a PON event from generating SRQ at power-on.

***PSC OFF | 0** causes the contents of the Standard Event Enable and Service Request Enable registers to be saved in nonvolatile memory and recalled at power-on. This allows a PON event to generate SRQ at power-on.

Command Syntax *PSC <Bool>
Parameters 0 | 1 | OFF | ON
Example *PSC 0 *PSC 1
Query Syntax *PSC?
Returned Parameters <NR1>0|1
Related Commands *ESE *SRE

CAUTION: *PSC causes a write cycle to nonvolatile memory. Nonvolatile memory has a finite maximum number of write cycles. Programs that repeatedly cause write cycles to nonvolatile memory can eventually exceed the maximum number of write cycles and cause the memory to fail.

***RCL**

This command restores the dc source to a state that was previously stored in memory with the *SAV command to the specified location. All states are recalled with the following exceptions:

- ◆ the trigger system is set to the Idle state by an implied ABORt command (this cancels any uncompleted trigger actions)
- ◆ the calibration function is disabled by setting CAL:STATe to OFF

NOTE: The device state stored in location 0 is automatically recalled at power turn-on when the OUTPut:PON:STATe is set to RCL 0.

Command Syntax *RCL <NRf>
Parameters 0 | 1 | 2 | 3
Example *RCL 3
Related Commands *PSC *RST *SAV

***RST**

This command resets the dc source to a factory-defined state as defined in the following table. *RST also forces an ABORt command.

Table 8-7. *RST Settings

CAL:STAT	OFF	[SOUR:]CURR2	10% of MAX*
DIG:DATA	0	[SOUR:]CURR2:TRIG	10% of MAX*
DISP:STAT	ON	[SOUR:]CURR:PROT:STAT	OFF
DISP:MODE	NORM	[SOUR:]LIST:COUN	0
DISP:TEXT	“ ”	[SOUR:]VOLT	0
INIT:CONT	OFF	[SOUR:]VOLT:TRIG	0
INST:COUP:OUTP:STAT	ALL	[SOUR:]VOLT2	0
	NONE (option 521 units)	[SOUR:]VOLT2:TRIG	0
OUTP	OFF	[SOUR:]VOLT:PROT	MAX*
OUTP:DFI	OFF	[SOUR:]VOLT:PROT:STAT	ON
OUTP:DFI:SOUR	OFF	TRIG:ACQ:COUN:CURR	1
OUTP:PROT:DEL	.08	TRIG:ACQ:COUN:VOLT	1
OUTP:PROT:STAT	OFF	TRIG:ACQ:HYST:CURR	0
OUTP:TYPE	LOW	TRIG:ACQ:HYST:DVM	0
SENS:CURR:RANG	MAX	TRIG:ACQ:HYST:VOLT	0
SENS:CURR:DET	ACDC (all but 66311A)	TRIG:ACQ:LEV:CURR	0
	DC (66311A only)	TRIG:ACQ:LEV:DVM	0
SENS:FUNC	VOLT	TRIG:ACQ:LEV:VOLT	0
SENS:SWE:OFFS:POIN	0	TRIG:ACQ:SLOP:CURR	POS
SENS:SWE:POIN	2048	TRIG:ACQ:SLOP:DVM	POS
SENS:SWE:TINT	15.6 μ s	TRIG:ACQ:SLOP:VOLT	POS
[SOUR:]CURR	10% of MAX*	TRIG:ACQ:SOUR	INTERNAL
[SOUR:]CURR:TRIG	10% of MAX*	TRIG:TRAN:SOUR	BUS

Command Syntax *RST

Parameters None

Related Commands *PSC *SAV

***SAV**

This command stores the present state of the dc source to the specified location in non-volatile memory. Up to 4 states can be stored. If a particular state is desired at power-on, it should be stored in location 0. It will then be automatically recalled at power turn-on if OUTPut:PON:STATe is set to RCL0. Use *RCL to retrieve instrument states.

Command Syntax *SAV <NRf>

Parameters 0 | 1 | 2 | 3

Example *SAV 3

Related Commands *RCL *RST

CAUTION: *SAV causes a write cycle to nonvolatile memory. Nonvolatile memory has a finite maximum number of write cycles. Programs that repeatedly cause write cycles to nonvolatile memory can eventually exceed the maximum number of write cycles and cause the memory to fail.

***SRE**

This command sets the condition of the Service Request Enable Register. This register determines which bits from the Status Byte Register (see *STB for its bit configuration) are allowed to set the Master Status Summary (MSS) bit and the Request for Service (RQS) summary bit. A 1 in any Service Request Enable Register bit position enables the corresponding Status Byte Register bit and all such enabled bits then are logically ORed to cause Bit 6 of the Status Byte Register to be set.

When the controller conducts a serial poll in response to SRQ, the RQS bit is cleared, but the MSS bit is not. When *SRE is cleared (by programming it with 0), the dc source cannot generate an SRQ to the controller. The query returns the current state of *SRE.

Command Syntax	*SRE <NRf>
Parameters	0 to 255
Power-on Value	see *PSC
Example	*SRE 20
Query Syntax	*SRE?
Returned Parameters	<NR1> (register binary value)
Related Commands	*ESE *ESR *PSC

CAUTION: If *PSC is programmed to 0, the *SRE command causes a write cycle to nonvolatile memory. Nonvolatile memory has a finite maximum number of write cycles. Programs that repeatedly cause write cycles to nonvolatile memory can eventually exceed the maximum number of write cycles and cause the memory to fail.

***STB?**

This query reads the Status Byte register, which contains the status summary bits and the Output Queue MAV bit. Reading the Status Byte register does not clear it. The input summary bits are cleared when the appropriate event registers are read. The MAV bit is cleared at power-on, by *CLS' or when there is no more response data available.

A serial poll also returns the value of the Status Byte register, except that bit 6 returns Request for Service (RQS) instead of Master Status Summary (MSS). A serial poll clears RQS, but not MSS. When MSS is set, it indicates that the dc source has one or more reasons for requesting service.

Table 8-8. Bit Configuration of Status Byte Register

Bit Position	7	6	5	4	3	2	1	0
Bit Name	OPER	MSS (RQS)	ESB	MAV	QUES	0	0	0
Bit Weight	128	64	32	16	8	4	2	1
ESB = Event status byte summary MAV = Message available MSS = Master status summary				OPER = Operation status summary QUES = Questionable status summary RQS = Request for service				

Query Syntax	*STB?
Returned Parameters	<NR1>(Register binary value)

***TRG**

This common command generates a trigger when the trigger subsystem has BUS selected as its source. The command has the same affect as the Group Execute Trigger (<GET>) command.

Command Syntax	*TRG
Parameters	None
Related Commands	ABOR INIT TRIG[:IMM] <GET>

***TST?**

This query causes the dc source to do a self-test and report any errors. 0 indicates that the dc source passed self-test. 1 indicates that one or more tests failed. Selftest errors are written to the error queue (see Appendix C).

Query Syntax	TST?
Returned Parameters	<NR1>

***WAI**

This command instructs the dc source not to process any further commands until all pending operations are completed. "Pending operations" are as defined under the *OPC command. *WAI can be aborted only by sending the dc source an GPIB DCL (Device Clear) command.

Command Syntax	*WAI
Parameters	None
Related Commands	*OPC*OPC?

Additional Commands

The following commands are added to the language dictionary to provide limited Fluke PM2811 Power Supply compatibility. These commands will only work when the SYSTEM LANGUAGE is set to SCPI.

INSTrument:STATe

This command enables or disables the dc source output. The state of a disabled output is a condition of zero output voltage and a model-dependent minimum source current (see *RST).

Command Syntax	INSTrument:STATe <bool>
Parameters	0 OFF 1 ON
*RST Value	0
Examples	INST:STAT 1
Query Syntax	INSTrument[:STATe]?
Returned Parameters	<NR1> 0 or 1
Equivalent SCPI Command	OUTPut[:STATe]

OUTPut:PROTection:TRIPped?

This query reports if any OV (overvoltage), OCP (overcurrent protection), OT (over temperature), or RI (remote inhibit) status bit is set. 0 = bit is not set; 1 = bit is set.

Query Syntax	OUTPut:PROTection:TRIPped?
Returned Parameters	<NR1> 0 or 1
Examples	OUTP:PROT:TRIP?
Equivalent SCPI Command	STATus:QUEStionable:CONDition?

CURRent:LIMit:HIGH?

This query returns the maximum rated current of the instrument.

Query Syntax	[SOURce:]CURRent:LIMit:HIGH?
Returned Parameters	<NRf>
Examples	CURR:LIM:HIGH?
Equivalent SCPI Command	[SOURce:]CURRent? MAX

CURRent:LIMit:LOW?

This query returns the minimum rated current of the instrument.

Query Syntax	[SOURce:]CURRent:LIMit:LOW?
Returned Parameters	<NRf>
Examples	CURR:LIM:LOW?
Equivalent SCPI Command	[SOURce:]CURRent? MIN

CURRent:PROTection:TRIPped?

This query reports if the OCP (overcurrent protection) status bit is set. 0 = bit is not set; 1 = bit is set.

Query Syntax	[SOURce:]CURRent:PROTection:TRIPped?
Returned Parameters	<NR1> 0 or 1
Examples	CURR : PROT : TRIP ?
Equivalent SCPI Command	STATus:QUEStionable:CONDition?

VOLTage:LIMit:HIGH?

This query returns the maximum rated voltage of the instrument.

Query Syntax	[SOURce:]VOLTage:LIMit:HIGH?
Returned Parameters	<NRf>
Examples	VOLT : LIM : HIGH ?
Equivalent SCPI Command	[SOURce:]VOLTage? MAX

VOLTage:LIMit:LOW?

This query returns the minimum rated voltage of the instrument.

Query Syntax	[SOURce:]VOLTage:LIMit:LOW?
Returned Parameters	<NRf>
Examples	VOLT : LIM : LOW ?
Equivalent SCPI Command	[SOURce:]VOLTage? MIN

VOLTage:PROTection:TRIPped?

This query reports if the OV (overvoltage protection) status bit is set. 0 = bit is not set; 1 = bit is set.

Query Syntax	[SOURce:]VOLTage:PROTection:TRIPped?
Returned Parameters	<NR1> 0 or 1
Examples	VOLT : PROT : TRIP ?
Equivalent SCPI Command	STATus:QUEStionable:CONDition?

Specifications

Specifications

Table A-1 lists the specifications of the dc source. Unless otherwise noted, specifications are warranted over the ambient temperature range of 0 to 55 °C. Specifications apply with typical cellular phone capacitive loads from 0 μ F to 12,000 μ F. Sensing is at the rear terminals of the power supply after a 30-minute warm-up period. Sense terminals are externally jumpered to their respective output terminals.

Table A-1. Performance Specifications

Parameter		Agilent 66111A	Agilent 66311B/D; Agilent 66309B/D output 1 only	Agilent 66309B/D output 2 only
Output Ratings	Voltage: Current: Peak Current:	0 – 15 V 0 – 3 A 5 A ¹		0 – 12 V 0 – 1.5 A 2.5 A ²
Programming Accuracy (@ 25°C \pm 5°C)	Voltage: +Current:	0.05% + 10 mV 0.05% + 1.33 mA ³		0.2% + 40 mV 0.2% + 4.5 mA
DC Measurement Accuracy (via GPIB or front panel meters with respect to actual output @ 25°C \pm 5°C)	Voltage: Current: <u>High Current range</u> ⁴ +20 mA to + rated I: –20 mA to – rated I: <u>Low Current range</u> –20 mA to +20 mA:	0.03% + 5 mV see below 0.2% + 9 mA 0.2% + 9 mA NA	0.03% + 5 mV see below 0.2% + 0.5 mA ⁵ 0.2% + 1.1 mA 0.1% + 2.5 μ A	0.2% + 15 mV 0.2% + 3 mA NA NA NA
Ripple and Noise (in the range of 20 Hz to 20 MHz with outputs ungrounded or with either terminal grounded)	Voltage (rms/p-p): Current (rms):	1 mV/6 mV ⁶ 2 mA		1 mV/6 mV ⁶ 2 mA
Load Regulation (change in output voltage or current for any load change within ratings)	Voltage: Current:	2 mV 0.75 mA		1.6 mV 0.375 mA
Line Regulation (change in output voltage or current for any line change within ratings)	Voltage: Current:	0.5 mV 0.75 mA		0.4 mV 0.25 mA
Transient Response Time (for the output voltage to recover to 20 mV <i>below</i> its final setting)		< 35 μ s ⁷		< 400 μ s ⁸

¹ Peak current for up to a 7 millisecond time period. Average current cannot exceed 3 A.

² Peak current for up to a 1 millisecond time period. Average current cannot exceed 1.5 A.

³ 0.05% + 2.3mA when programming between zero and 0.03% of full scale current.

⁴ Agilent 66111A units do not have a low current range, the dc measurement accuracy applies from 0 amperes to the rated current.

⁵ Applies with current detector set to DC. ACDC mode accuracy is 0.2% + 3mA for sourcing and 0.2% + 3.6 mA for sinking.

⁶ Specification is for phone capacitance greater than 6 μ F.

⁷ Applies to the negative portion of the output voltage transient waveform, following a 0.1 A to 1.5 A load current change.

(Applies with unit set to High capacitance compensation range with 5 μ F minimum output load capacitance.)

⁸ Following a 0.75 A to 1.5 A load change.

Supplemental Characteristics

Table A-2 lists the supplemental characteristics, which are not warranted but are descriptions of typical performance determined either by design or type testing.

Table A-2. Supplemental Characteristics

Parameter		Agilent 66111A	Agilent 66311B/D, Agilent 66309B/D output 1 only	Agilent 66309B/D output 2 only
Output Programming Range	Voltage: Current: OVP:	0 – 15.535 V 0 – 3.0712 A 22 V		0 – 12.25 V 0 – 1.52 A NA
Average Programming Resolution	Voltage: Current: OVP:	3.75 mV 0.75 mA 100 mV		14 mV 1.75 mA NA
OVP Accuracy		2.4 % + 240 mV		NA
Average Current Measurement Resolution	High Range: Low Range:	3.5 mA NA	213 μ A 0.6 μ A	55 μ A NA
Maximum Current Measurement		7 A		1.8A
Sink Current		- 2 A @ 7.5 V ¹		- 0.03 A @ 7.5 V
Programming Accuracy Temperature Coefficient (change/C°)	Voltage: Current: OVP:	0.01% + 0.5 mV 0.01% + 15 μ A 0.015% + 4 mV		0.03% + 1.5 mV 0.03% + 0.4 mA NA
Readback Accuracy Temperature Coefficient (change/C°)	Voltage: Current (dc): Current (acdc): Current (low range):	0.01% + 300 μ V 0.02% + 15 μ A NA NA	0.01% + 300 μ V 0.02% + 15 μ A 0.05% + 120 μ A 0.01% + 0.3 μ A	0.02% + 1.5 mV 0.02% + 0.4 mA NA NA
Drift²	Voltage: Current: +	0.01% + 1 mV 0.01% + 30 μ A		0.03% + 3 mV 0.03% + 0.8 mA
Remote Sense Capability (voltage per load lead)		up to 4 V ³		up to 4 V ⁴
Output Voltage Rise Time Output Voltage Fall Time	10% to 90%: 90% to 10%:	< 200 μ s < 200 μ s		< 200 μ s < 35 ms
Output Voltage Settling Time⁵	0 to rated voltage: rated voltage to 0:	0.5 ms 1 ms		NA NA
Dynamic Measurement System⁶	Buffer Length: Sample Rate Range:	NA	0 – 4096 points 15.6 μ s – 31200s	NA

¹The sink current decreases linearly from 2.8A @ 0 V to 1.2 A @ 15 V. Sink current does not track the programmed current.

²Following a 30 minute warm-up, the change in output over 8 hours, under constant ambient, load and line conditions.

³Add 2 mV to the load regulation for each 1 V change in the positive output lead.

⁴Add 3 mV to the load regulation for each 1 V change in the negative output lead.

⁵To settle within 1 LSB or 3.75mV of the final value for Output 1.

⁶For a pulse waveform, the accuracy of any individual data point in the buffer is dependent on the rise time of the pulse. For a current pulse of 1.4A with a rise time constant of 50 μ s, the error in measurement of a single data point during the pulse rise time is typically 10mA.

Table A-2. Supplemental Characteristics (continued)

Parameter		Agilent 66111A Agilent 66311B/D	Agilent 66309B/D
Measurement Time (includes 30 ms ¹ data acquisition time and 20 ms data processing overhead)	voltage or current	50 ms average	
Command Processing Time (time for output to begin to change following receipt of digital data)		4 ms average	
Savable Instrument States (applies only in SCPI mode)		4 (in locations 0 to 3)	
GPIB Interface Capabilities	Language: Interface:	SCPI or COMPatibility ² AH1, C0, DC1, DT1, E1, L4, PP0, RL1, SH1, SR1, T6	
INH/FLT Characteristics	Maximum ratings: FLT Terminals: INH Terminals:	16.5 Vdc between terminals 1 and 2; 3 and 4; and from terminals 1 or 2 to chassis ground Low-level output current = 1.25 mA max. Low-level output voltage = 0.5 V max. Low-level input voltage = 0.8 V max. High-level input voltage = 2 V min. Low-level input current = 1 mA Pulse width = 100 μ s min. Time delay = 4 ms typical	
Digital I/O Characteristics	Maximum ratings: Digital OUT Port 0,1,2 (open collector) Digital IN Port 2: (internal pull-up)	same as INH/FLT Characteristics Output leakage @ 16V = 0.1 mA (ports 0,1) = 12.5 mA (port 2) Output leakage @ 5V = 0.1 mA (ports 0,1) = 0.25 mA (port 2) Low-level output sink current @ 0.5 V = 4 mA Low-level output sink current @ 1 V = 50 mA Low-level input current @ 0.4 V = 1.25 mA High-level input current @ 5 V = 0.25 mA Low-level input voltage = 0.8 V max. High level input voltage = 2.0 V min.	
Isolation to Ground (Maximum from either output terminal to chassis)		50 Vdc	
Mains Input Ratings: (at full load from 47–63 Hz)	100 Vac (87-106 Vac): 115 Vac (104-127 Vac): 220 Vac (191-233 Vac): 230 Vac (207-253 Vac):	1.6 A, 125 W 1.4 A, 125 W 0.8 A, 125 W 0.75A, 125 W	2 A, 170 W 1.7 A, 170 W 0.92 A, 170 W 0.85A, 170 W

¹May be reduced by changing the default conditions of 2048 data points but measurement uncertainty due to noise will increase.²Compatibility language is used to program the Agilent 663xA Series power supplies. Not all Agilent 66111A/66311B capabilities are available when using the Compatibility language. Also, Compatibility language is not available for Agilent 66309B/D units.

A - Specifications

Table A-2. Supplemental Characteristics (continued)

Parameter		All Models
Recommended Calibration Interval	from the date the unit is put into service	1 year
Regulatory Compliance	Listing pending: Certified to: Conforms to: Complies with:	UL 3111-1 CSA 22.2 No. 1010.1 IEC 1010-1, EN 61010-1 EMC directive 89/336/EEC (ISM Group1 Class B)
Dimensions (see figure 3-1)	Height: Width: Depth:	88.1 mm (3.5in.) 212.8 mm (8.4in.) 435 mm (17.125 in.)
Net weight		9.07 kg (20 lbs.)
Shipping weight		11.1 kg (24.5 lbs.)

Table A-3. Agilent 66311D/66309D DVM Specifications and Characteristics

Performance Specifications (warranted from 0 to 55 °C unless otherwise noted)		
DC Readback Accuracy (@ 25°C ±5°C)		0.04% +5 mV
AC+DC rms Readback Accuracy (@ 25°C ±5°C with dc plus a sinewave input > 25mV rms)	60 Hz to 10 kHz: 45-60 Hz and 10-20 kHz:	1% +5 mV ¹ 4 % +5 mV ¹
Common Mode Voltage Range (from either DVM input with respect to the negative output terminal of Output 1)		- 4.5 Vpk to + 25 Vpk
Maximum DC Differential Voltage		± 25 V peak
Maximum AC Differential Voltage (with a sinewave input)		10 V rms ²
Supplemental Characteristics		
Maximum Continuous Input Capability without damage (between input terminals or from either input to chassis ground)		50 V
Input Resistance (from either DVM input with respect to either output terminal of Output 1)		20 MΩ
Input Capacitance (on either input terminal)		< 60 pF
DC Common Mode Rejection Ratio		> 83 dB
Voltage Readback Resolution	Front panel: GPIB:	1 mV < 0.2 mV
Readback Temperature Coefficient (change per °C)		0.002% + 0.2 mV

¹+15 mV for dc plus sinewave input < 25 mV rms.

²To accept 10 Vrms sinewave input, the common mode voltage with respect to the negative terminal of output 1 must be 10 Vdc. This is required to "center" the DVM in its common mode range.

Table A-4. Agilent 66309B/D Option 521 Characteristics

Output Impedance (Output = OFF)	Output 1: Output 2:	500k ohms 200k ohms
Solid State Relay Current rise time (from 10% to 90% of the total output change)	Relay mode =Hot	100 microseconds
Solid State Relay Current fall time (from 10% to 90% of the total output change)	Relay mode =Hot	50 microseconds

Verification and Calibration

Introduction

This appendix includes verification and calibration procedures for the Agilent 66111A Fast Transient DC Source, and the Agilent 66311B/D, 66309B/D Mobile Communications DC Sources. Instructions are given for performing the procedures either from the front panel or from a controller over the GPIB.

The verification procedures do not check all the operating parameters, but verify that the dc source is performing properly. Performance Tests, which check all the specifications of the dc source, are given in the applicable dc source Service Manual.

IMPORTANT: Perform the verification procedures before calibrating your dc source. If the dc source passes the verification procedures, the unit is operating within its calibration limits and does not need to be re-calibrated.

Equipment Required

The equipment listed in the following table, or the equivalent to this equipment, is required for verification and calibration.

Table B-1. Equipment Required

Equipment	Characteristics	Recommended Model
Digital Multimeter	Resolution: 10 nV @ 1 V Readout: 8.5 digits Accuracy: >20 ppm	Agilent 3458A
Current Monitor ¹	15 A (0.1 Ω), ±0.04%, TC=5ppm/°C	Guildline 9230/15
Load Resistor (3 W min. TC=20ppm/°C)	400 Ω (verification.) 800 Ω (calibration)	p/n 0811-0942 p/n 0811-0600
Power Supply	8 V @ 5 A (for current sink verification/calibration) 25 V source (for DVM verification/calibration)	Agilent 6611C or Agilent 6631B Agilent 6631C or Agilent 6633B
GPIB Controller	Full GPIB capabilities (only required if you are calibrating the unit over the GPIB)	HP Series 200/300 or equivalent

¹The 4-terminal current shunt is used to eliminate output current measurement error caused by voltage drops in the load leads and connections. It has special current-monitoring terminals inside the load connection terminals. Connect the voltmeter directly to these current-monitoring terminals.

Test Setup

Figure B-1 shows the setup for the tests. Be certain to use load leads of sufficient wire gauge to carry the full output current (see chapter 3).

B - Verification and Calibration

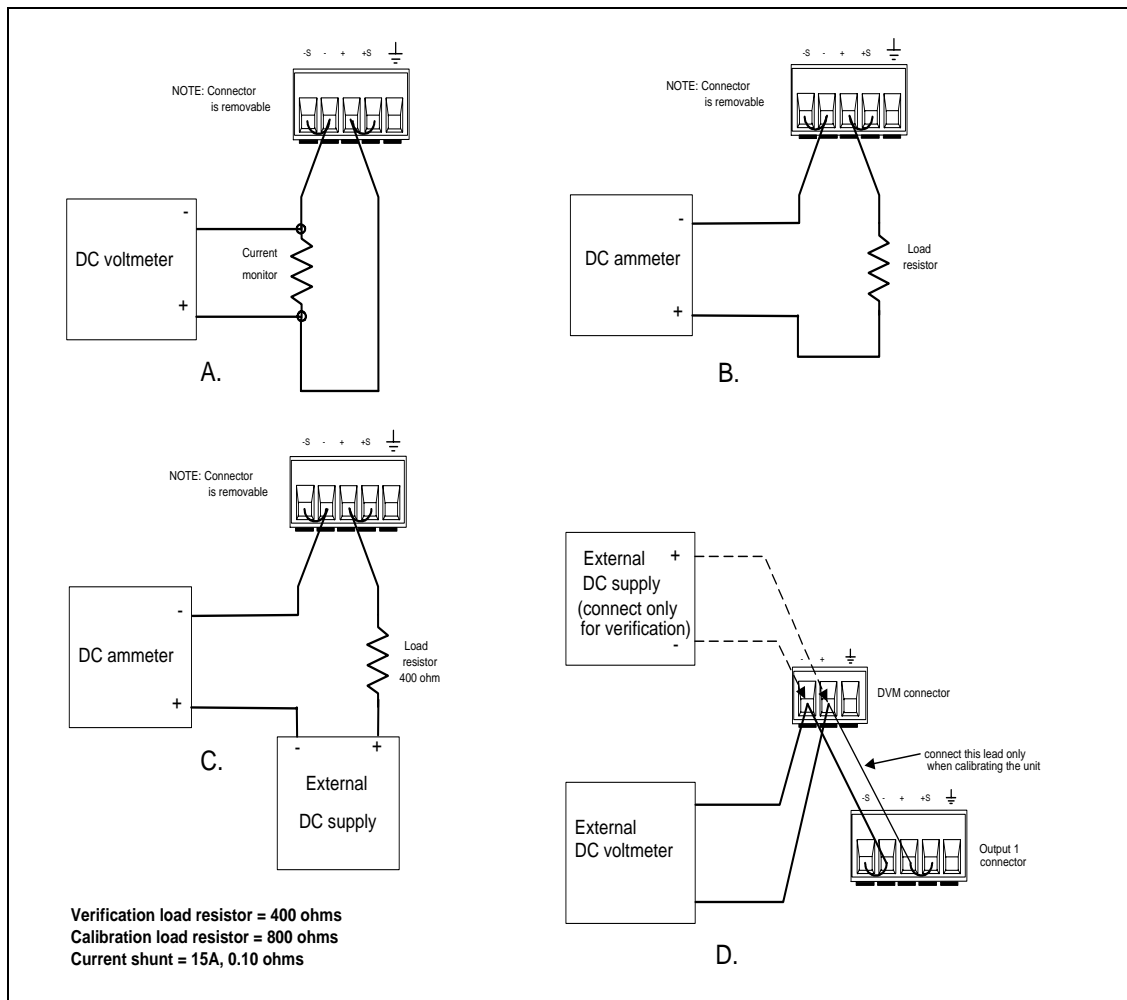

Figure B-1. Verification and Calibration Test Setup

Performing the Verification Tests

The following procedures assume you understand how to operate the dc source from the front panel as explained in chapter 5. Also, when performing the verification tests from an GPIB controller, you may have to consider the relatively slow settling times and slew rates of the dc source as compared to computer and system voltmeters. Suitable WAIT statements can be inserted into the test program to give the dc source time to respond to the test commands.

Perform the following tests for operation verification in the order indicated.

1. Turn-On Checkout
2. Voltage Programming and Measurement Accuracy
3. Current Programming and Measurement Accuracy

Turn-On Checkout

NOTE: The dc source must pass turn-on selftest before you can proceed with the verification tests.

Perform the Turn-On Checkout as directed in chapter 4.

Voltage Programming and Measurement Accuracy

This test verifies the voltage programming, GPIB measurement, and front panel meter functions. Values read back over the GPIB should be the same as those displayed on the front panel. Measure the dc output voltage at the output terminals. **Make sure that the sense terminals are directly jumpered to the output terminals on both outputs 1 and 2.**

Action	Normal Result
1. Turn off the dc source and connect a DMM to the output 1 terminals.	
2. Turn on the dc source with no load on output 1. Select output 1 and set the voltage to 0 V and the current to 3 A. Press Output On/Off to enable the output.	Output voltage near 0 V. Output current near 0 A.
3. Record the voltage reading on the DMM (Vlo) and the voltage reading on the front panel display (Vfpl0).	Readings within low voltage limits (see table B-2, B-3, B-4)
4. Set the output 1 voltage to 15 V.	Output voltage near 15 V.
5. Record the voltage reading on the DMM (Vhi) and the voltage reading on the front panel display (Vfphi).	Readings within high voltage limits (see table B-2, B-3, B-4)
Steps 6-10 apply to Agilent 66309B/D output 2 only	
6. Turn off the dc source and connect a DMM to the output 2 terminals.	
7. Turn on the dc source with no load on output 2. Select output 2 and set the voltage to 0 V and the current to 1.5 A. Press Output On/Off to enable the output.	Output voltage near 0 V. Output current near 0 A.
8. Record the voltage reading on the DMM (V2lo) and the voltage reading on the front panel display (V2fpl0).	Readings within low voltage limits (see table B-4)
9. Set the output 2 voltage to 12 V.	Output voltage near 12 V.
10. Record the voltage reading on the DMM (V2hi) and the voltage reading on the front panel display (V2fphi).	Readings within high voltage limits (see table B-4)

Current Programming and Measurement Accuracy

This test verifies the current programming and measurement. Connect the appropriate current monitor (see table B-1) as shown in figure B-1A.

Current Programming and Measurement (High Range on Agilent 66311B/D, 66309B/D)

Action	Normal Result
1. Turn off the dc source and connect the DMM and current monitor to output 1 as shown in figure B-1A. Then turn on the dc source and select Output 1.	
2. Turn on the dc source, access the Input menu, and set the current sense detector to DC.	CURR:DET DC
3. Set the output 1 voltage to 5 V and the current to 0 A. Press Output On/Off to enable the output.	Output current near 0 A.
4. Divide the voltage drop across the current monitor by its resistance to convert the value to amperes. Record this value (Ilo).	Reading within low current limits (see table B-2, B-3, B-4)
5. Set the output 1 current 3 A.	
6. Divide the voltage drop across the current monitor by its resistance to convert the value to amperes. Record this value (Ihi). Also record the current reading on the front panel display (Ifphi).	Readings within high current limits (see table B-2, B-3, B-4)

B - Verification and Calibration

Steps 7-11 apply to Agilent 66309B/D output 2 only

7. Turn off the dc source and connect the DMM and current monitor to output 2 as shown in figure B-1A. Then turn on the dc source and select Output 2.
8. Set the output 2 voltage to 5 V and the current to 0 A. Press **Output On/Off** to enable the output. Output current near 0 A.
9. Divide the voltage drop across the current monitor by its resistance to convert the value to amperes. Record this value (I2lo). Reading within low current limits (see table B-4)
10. Set the output 2 current 1.5 A.
11. Divide the voltage drop across the current monitor by its resistance to convert the value to amperes. Record this value (I2hi). Also record the current reading on the front panel display (I2fphi). Readings within high current limits (see table B-4)

Low Range Current Measurement (Agilent 66311B/D, 66309B/D output 1 only)

- | Action | Normal Result |
|--|---|
| 12. Turn off and connect output 1 as shown in Figure B-1B using the 400 ohm load resistor. Set the DMM to operate in current mode. | |
| 13. Turn on the dc source, access the Input menu, and set the current range to LOW. | CURR:RANG LOW |
| 14. Set the output 1 voltage to 0 V and the current 3 A. Press Output On/Off to enable the output. | Output current near 0 A. |
| 15. Note the current reading on the DMM (I1rlo). Record the current reading on the front panel display. | Reading within low current measurement (see table B-3, B-4). |
| 16. Set the output 1 voltage to 8 volts. | Output current near +20 mA. |
| 17. Note the current reading on the DMM (I1rhi). Record the current reading on the front panel display. | Reading within high current measurement (see table B-3, B-4). |

Current Sink Measurement

- | Action | Normal Result |
|--|---|
| 18. Turn off the dc source and connect an external supply to output 1 of the unit as shown in figure B-1C using the 400 ohm load resistor. Set the DMM to operate in current mode. | |
| 19. Turn on the dc source, access the Input menu, and set the current range to LOW. | CURR:RANG LOW |
| 20. Access the Input menu and set the current sense detector to DC. | CURR:DET DC |
| 21. Turn on the external supply and program it to 8 volts and 5 A. Program the dc source to 0 V and 1 A. Press Output On/Off to enable the output. | Output current near -20 mA. |
| 22. Note the current reading on the DMM (Isinklo). Record the current reading on the front panel display. | Reading within low current sink measurement (see table B-2, B-3, B-4). |
| 23. Disable the output of the dc source. Short out the 400 ohm load resistor by connecting a jumper across it. Connect the current monitoring resistor across the input of the DMM as previously shown in figure B-1a. Set the DMM to operate in voltage mode. | |
| 24. Access the Input menu and set the current range to HIGH. Set the output 1 voltage to 0 V and the current 3 A. Press Output On/Off to enable the output. | Output current approx. -2 A |
| 25. Divide the voltage drop (DMM reading) across the current monitor by its resistance to convert to amps and record this value (Isinkhi). Record the current reading on the front panel display. | Reading within high current sink measurement (see table B-2, B-3, B-4). |

DVM Measurement Accuracy

This test verifies the DVM measurement accuracy. Connect all equipment as shown in figure B-1D.

Action	Normal Result
1. Turn off the dc source and connect the external DMM and the external power supply to the DVM inputs as shown in figure B-1D. Connect only the negative output lead of output 1 to the DVM inputs. Then turn on the dc source and select Output 1.	
2. Set output 1 to zero volts and the external power supply to 25 volts.	Output voltage near 0 V
3. Record the external (3458) DMM reading (Dvpos) and the internal DVM reading.	Internal DVM reading should be within positive voltage limits. (see Table B-3, B-4).
4. Set output 1 to 15 V and repeat step number 3.	Internal DVM reading should still be within positive voltage limits. (see Table B-3, B-4).
5. Reverse the leads of the external power supply to the DVM inputs. Keep all other connections the same.	Output voltage near 15 V
6. With output 1 set to 15 V, lower the voltage on the external power supply until the external (3458) DMM reads -4.5 V.	Output voltage near 15 V
7. Record the external (3458) DMM reading (Dvneg) and the internal DVM reading.	Internal DVM reading should be within negative voltage limits. (see Table B-3, B-4).
8. Set output 1 to zero volts and repeat step number 7.	Internal DVM reading should still be within negative voltage limits. (see Table B-3, B-4).

B - Verification and Calibration

Table B-2. Verification Test Record for Agilent Model 66111A

Model Agilent 66111A		Report No. _____		Date _____	
Test Description		Minimum Specification	Recorded Results	Maximum Specification	
Voltage Programming and Measurement					
Low Voltage	Vlo	-10 mV	_____mV	+10 mV	
Front Panel measurement	Vfplo	Vlo -5 mV	_____mV	Vlo +5 mV	
High Voltage	Vhi	14.9825 V	_____V	15.0175 V	
Front Panel measurement	Vfphi	Vhi -9.5 mV	_____V	Vhi +9.5 mV	
Current Programming and Measurement					
Low Current	Ilo	-2.3 mA	_____mA	2.3 mA	
High Current	Ihi	2.99717 A	_____A	3.00283 A	
Front Panel measurement	Ifphi	Ihi -15 mA	_____A	Ihi +15 mA	
Current Sink Measurement					
Low Current Sink measurement	Isinklo	Isinklo -22.5 μ A	_____mA	Isinklo +22.5 μ A	
High Current Sink measurement	Isinkhi	Isinklo -13 mA	_____A	Isinklo +13 mA	

Table B-3. Verification Test Record for Agilent Model 66311B/D

Model Agilent _____		Report No. _____		Date _____	
Test Description		Minimum Specification	Recorded Results	Maximum Specification	
Voltage Programming and Measurement					
Low Voltage	Vlo	-10 mV	_____mV	+10 mV	
Front Panel measurement	Vfplo	Vlo -5 mV	_____mV	Vlo +5 mV	
High Voltage	Vhi	14.9825 V	_____V	15.0175 V	
Front Panel measurement	Vfphi	Vhi -9.5 mV	_____V	Vhi +9.5 mV	
Current Programming and Measurement (High Range)					
Low Current	Ilo	-2.3 mA	_____mA	2.3 mA	
High Current	Ihi	2.99717 A	_____A	3.00283 A	
Front Panel measurement	Ifphi	Ihi -6.5 mA	_____A	Ihi +6.5 mA	
Current Measurement (Low Range)					
Low Current measurement	Ilrlo	Ilrlo -2.5 μ A	_____ μ A	Ilrlo +2.5 μ A	
High Current measurement	Ilrhi	Ilrhi -22.5 μ A	_____mA	Ilrhi +22.5 μ A	
Current Sink Measurement					
Low Current Sink measurement	Isinklo	Isinklo -22.5 μ A	_____mA	Isinklo +22.5 μ A	
High Current Sink measurement	Isinkhi	Isinkhi -5.1 mA	_____A	Isinkhi +5.1 mA	
DVM Voltage Measurement (Agilent 66311D only)					
Positive Voltage measurement	Dvpos	Dvpos -15 mV	_____V	Dvpos +15 mV	
Negative Voltage measurement	Dvneg	Dvneg -6.8 mV	_____V	Dvneg +6.8 mV	

Table B-4. Verification Test Record for Agilent Model 66309B/D

Model Agilent _____		Report No. _____		Date _____	
Test Description		Minimum Specification	Recorded Results	Maximum Specification	
Voltage Programming and Measurement					
Low Voltage	Vlo	-10 mV	_____mV	+10 mV	
Front Panel measurement	Vfplo	Vlo -5 mV	_____mV	Vlo +5 mV	
High Voltage	Vhi	14.9825 V	_____V	15.0175 V	
Front Panel measurement	Vfphi	Vhi -9.5 mV	_____V	Vhi +9.5 mV	
Outp 2 Low Voltage	V2lo	-40 mV	_____mV	+40 mV	
Outp 2 Front Panel measurement	V2fplo	V2lo -15 mV	_____mV	V2lo +15 mV	
Outp 2 High Voltage	V2hi	11.936 V	_____V	12.064 V	
Outp 2 Front Panel measurement	V2fphi	V2hi -39 mV	_____V	V2hi +39 mV	
Current Programming and Measurement (High Range)					
Low Current	Ilo	-2.3 mA	_____mA	2.3 mA	
High Current	Ihi	2.99717 A	_____A	3.00283 A	
Front Panel measurement	Ifphi	Ihi -6.5 mA	_____A	Ihi +6.5 mA	
Outp 2 Low Current	I2lo	-4.5 mA	_____mA	4.5 mA	
Outp 2 High Current	I2hi	1.4925 A	_____A	1.5075 A	
Outp 2 Front Panel measurement	I2fphi	I2hi -6 mA	_____A	I2hi +6 mA	
Current Measurement (Low Range)					
Low Current measurement	Ilrlo	Ilrlo -2.5 μ A	_____ μ A	Ilrlo +2.5 μ A	
High Current measurement	Ilrhi	Ilrhi -22.5 μ A	_____mA	Ilrhi +22.5 μ A	
Current Sink Measurement					
Low Current Sink measurement	Isinklo	Isinklo -22.5 μ A	_____mA	Isinklo +22.5 μ A	
High Current Sink measurement	Isinkhi	Isinkhi -5.1 mA	_____A	Isinkhi +5.1 mA	
DVM Voltage Measurement (Agilent 66309D only)					
Positive Voltage measurement	Dvpos	Dvpos -15 mV	_____V	Dvpos +15 mV	
Negative Voltage measurement	Dvneg	Dvneg -6.8 mV	_____V	Dvneg +6.8 mV	

Performing the Calibration Procedure

NOTE: The calibration procedure can only be performed from the front panel or using the SCPI language commands.

Table B-1 lists the equipment required for calibration. Figure B-1 shows the test setup.

You do not have to do a complete calibration each time. If appropriate, you may calibrate only the voltage or current and proceed to "Saving the Calibration Constants". However, the voltage or current calibration sequence must be performed in its entirety. The following parameters may be calibrated:

- ◆ voltage programming and measurement
- ◆ overvoltage protection (OVP)
- ◆ current programming and measurement
- ◆ low range measurement
- ◆ ac current measurement
- ◆ internal DVM

Front Panel Calibration Menu



The Entry keypad is used for calibration functions.



Shift	Cal	Press this key to access the calibration menu.																																
		<table border="0" style="width: 100%;"> <thead> <tr> <th style="text-align: left;">Display</th> <th style="text-align: left;">Command Function</th> </tr> </thead> <tbody> <tr> <td>CAL ON <value></td> <td>Turns calibration mode on when the correct password value is entered.</td> </tr> <tr> <td>CAL OFF</td> <td>Turns calibration mode off</td> </tr> <tr> <td>CAL:LEV <char></td> <td>Advance to next step in sequence (P1 or P2).</td> </tr> <tr> <td>CAL:DATA <value></td> <td>Enter an external calibration measurement.</td> </tr> <tr> <td>CAL:VOLT</td> <td>Begin voltage calibration sequence</td> </tr> <tr> <td>CAL:VOLT2</td> <td>Begin output 2 voltage calibration sequence</td> </tr> <tr> <td>CAL:VOLT:PROT</td> <td>Begin voltage protection calibration</td> </tr> <tr> <td>CAL:CURR</td> <td>Begin high range current calibration sequence</td> </tr> <tr> <td>CAL:CURR2</td> <td>Begin output 2 current calibration sequence</td> </tr> <tr> <td>CAL:CURR:MEAS:LOW</td> <td>Begin low range current measurement calibration¹</td> </tr> <tr> <td>CAL:CURR:MEAS:AC</td> <td>Begin ac current calibration sequence¹</td> </tr> <tr> <td>CAL:DVM</td> <td>Begin DVM calibration sequence</td> </tr> <tr> <td>CAL:SAVE</td> <td>Saves the calibration constants in non-volatile memory.</td> </tr> <tr> <td>CAL:PASS <value></td> <td>Set new calibration password.</td> </tr> <tr> <td>DATE <char></td> <td>Displays the calibration date. (0 if none is supplied)</td> </tr> </tbody> </table>	Display	Command Function	CAL ON <value>	Turns calibration mode on when the correct password value is entered.	CAL OFF	Turns calibration mode off	CAL:LEV <char>	Advance to next step in sequence (P1 or P2).	CAL:DATA <value>	Enter an external calibration measurement.	CAL:VOLT	Begin voltage calibration sequence	CAL:VOLT2	Begin output 2 voltage calibration sequence	CAL:VOLT:PROT	Begin voltage protection calibration	CAL:CURR	Begin high range current calibration sequence	CAL:CURR2	Begin output 2 current calibration sequence	CAL:CURR:MEAS:LOW	Begin low range current measurement calibration ¹	CAL:CURR:MEAS:AC	Begin ac current calibration sequence ¹	CAL:DVM	Begin DVM calibration sequence	CAL:SAVE	Saves the calibration constants in non-volatile memory.	CAL:PASS <value>	Set new calibration password.	DATE <char>	Displays the calibration date. (0 if none is supplied)
Display	Command Function																																	
CAL ON <value>	Turns calibration mode on when the correct password value is entered.																																	
CAL OFF	Turns calibration mode off																																	
CAL:LEV <char>	Advance to next step in sequence (P1 or P2).																																	
CAL:DATA <value>	Enter an external calibration measurement.																																	
CAL:VOLT	Begin voltage calibration sequence																																	
CAL:VOLT2	Begin output 2 voltage calibration sequence																																	
CAL:VOLT:PROT	Begin voltage protection calibration																																	
CAL:CURR	Begin high range current calibration sequence																																	
CAL:CURR2	Begin output 2 current calibration sequence																																	
CAL:CURR:MEAS:LOW	Begin low range current measurement calibration ¹																																	
CAL:CURR:MEAS:AC	Begin ac current calibration sequence ¹																																	
CAL:DVM	Begin DVM calibration sequence																																	
CAL:SAVE	Saves the calibration constants in non-volatile memory.																																	
CAL:PASS <value>	Set new calibration password.																																	
DATE <char>	Displays the calibration date. (0 if none is supplied)																																	



Notes: ¹not valid for Agilent 66111A

value = a numeric value

char = a character string parameter

Use  and  to scroll through the menu commands.

Use  and  to scroll through the menu parameters.

Use  and  to select a digit in a numeric entry field.

Front Panel Calibration Procedure

These procedures assume you understand how to operate front panel keys (see chapter 5). Make sure the sense switch is set to Remote and the sense terminals are directly jumpered to the output terminals. Calibration procedures can only be performed with the dc source set to the SCPI programming language.

Check the Language Setting

Action	Normal Result
1. Turn on the dc source, access the Address menu and scroll to the LANG: command.	LANG: SCPI or LANG:COMP
2. If the language is set to COMPatibility, change it to SCPI and press Enter. If the language is already set to SCPI, just continue with the calibration procedure.	LANG: SCPI

Enable Calibration Mode

Action	Display
3. Reset the unit by selecting Output , scrolling to *RST and pressing Enter .	*RST
4. Press Output On/Off to enable the output.	00.003V 0.0006A
5. To begin calibration press Shift Cal , scroll to CAL ON and press Enter .	CAL ON 0.0
6. Enter the calibration password from Entry keypad and press Enter . If the password is correct the Cal annunciator will come on. If CAL DENIED appears, then an internal switch has been set to prevent the calibration from being changed. (See the Service Manual.) If the password is incorrect, an error occurs. If the active password is lost, the calibration function can be recovered by setting an internal switch that defeats password protection. (See the Service Manual.)	CAL DENIED OUT OF RANGE

Voltage Programming and Measurement Calibration

Action	Display
7. Connect the external DMM (in voltage mode) directly to output 1. Do not connect the load resistor or current shunt. Select output 1.	
8. Press Shift Cal , scroll to CAL VOLT, and press Enter .	CAL:VOLT
9. Press Shift Cal , scroll to CAL LEV, and press Enter to select the first calibration point.	CAL:LEV P1
10. Press Shift Cal , scroll to CAL DATA, press Enter Number , and enter the voltage value displayed on the DMM.	CAL:DATA 0.00
11. Press Shift Cal , scroll to CAL LEV, use ↓ to scroll to P2 (the second calibration point), and press Enter .	CAL:LEV P2
12. Press Shift Cal , scroll to CAL DATA, press Enter Number , and enter the second voltage value displayed on the DMM.	CAL:DATA 0.00

B - Verification and Calibration

Steps 11-16 apply to Agilent 66309B/D output 2 only

- | | | |
|-----|--|---------------|
| 13. | Connect the external DMM (in voltage mode) directly to output 2. Do not connect the load resistor or current shunt. Select output 2. | |
| 14. | Press Shift Cal , scroll to CAL VOLT2, and press Enter . | CAL:VOLT2 |
| 15. | Press Shift Cal , scroll to CAL LEV, and press Enter to select the first calibration point. | CAL:LEV P1 |
| 16. | Press Shift Cal , scroll to CAL DATA, press Enter Number , and enter the voltage value displayed on the DMM. | CAL:DATA 0.00 |
| 17. | Press Shift Cal , scroll to CAL LEV, use ↓ to scroll to P2 (the second calibration point), and press Enter . | CAL:LEV P2 |
| 18. | Press Shift Cal , scroll to CAL DATA, press Enter Number , and enter the second voltage value displayed on the DMM. | CAL:DATA 0.00 |

Overvoltage Protection Calibration

- | Action | Display |
|---|---------------|
| 19. Press Shift Cal , scroll to CAL VOLT PROT, and press Enter . | CAL:VOLT:PROT |
| 20. Wait for the dc source to compute the OVP calibration constant. The display returns to Meter mode when the calculation is complete. | |

Current Programming and High-Range Measurement Calibration

NOTE: When performing a High Range current calibration, you must also calibrate the low range and the ac current measurement.

- | Action | Display |
|---|---------------|
| 21. Connect the appropriate current monitor to output 1 as shown in figure B-1A. Connect the DMM (in voltage mode) across the current shunt. Select output 1. | |
| 22. Press Shift Cal , scroll to CAL CURR, and press Enter . | CAL:CURR |
| 23. Press Shift Cal , scroll to CAL LEV, and press Enter to select the first calibration point. | CAL:LEV P1 |
| 24. Press Shift Cal and scroll to CAL DATA. Wait for the DMM reading to stabilize. Then read the DMM and compute the first current value (DMM reading ÷ shunt resistance). Press Enter Number and enter the first current value in amperes. | CAL:DATA 0.00 |
| 25. Press Shift Cal , scroll to CAL LEV, use ↓ to scroll to P2 (the second calibration point), and press Enter . | CAL:LEV P2 |
| 26. Press Shift Cal and scroll to CAL DATA. Wait for the DMM reading to stabilize. Then read the DMM and compute the second current value (DMM reading ÷ shunt resistance). Press Enter Number and enter the second current value in amperes. | CAL:DATA 0.00 |

Steps 27-32 apply to Agilent 66309B/D output 2 only

- | | | |
|-----|---|---------------|
| 27. | Connect the appropriate current monitor to output 2 as shown in figure B-1A. Connect the DMM (in voltage mode) across the current shunt. Select output 2. | |
| 28. | Press Shift Cal , scroll to CAL CURR2, and press Enter . | CAL:CURR2 |
| 29. | Press Shift Cal , scroll to CAL LEV, and press Enter to select the first calibration point. | CAL:LEV P1 |
| 30. | Press Shift Cal and scroll to CAL DATA. Wait for the DMM reading to stabilize. Then read the DMM and compute the first current value (DMM reading ÷ shunt resistance). Press Enter Number and enter the first current value in amperes. | CAL:DATA 0.00 |
| 31. | Press Shift Cal , scroll to CAL LEV, use ↓ to scroll to P2 (the second calibration point), and press Enter . | CAL:LEV P2 |
| 32. | Press Shift Cal and scroll to CAL DATA. Wait for the DMM reading to stabilize. Then read the DMM and compute the second current value (DMM reading ÷ shunt resistance). Press Enter Number and enter the second current value in amperes. | CAL:DATA 0.00 |

Low-Range Current Measurement Calibration (applies to Agilent 66311B/D, 66309B/D output 1 only)

- | | Action | Display |
|-----|--|-------------------|
| 33. | Disconnect all loads from the dc source but leave the sense jumpers in place. Do not connect any equipment to the output until after step #34. | |
| 34. | Press Shift Cal , scroll to CAL CURR MEAS LOW, and press Enter . | CAL:CURR:MEAS:LOW |
| 35. | Connect the 800 ohm calibration load resistor to output 1 as shown in figure B-1B. Connect the external DMM (in current mode) in series with the load. | |
| 36. | Press Shift Cal , scroll to CAL LEV, and press Enter to select the first calibration point. | CAL:LEV P1 |
| 37. | Press Shift Cal and scroll to CAL DATA. Wait for the DMM reading to stabilize. Press Enter Number and enter the current reading displayed on the DMM in amperes. | CAL:DATA 0.00 |

AC Current Measurement Calibration (applies to Agilent 66311B/D, 66309B/D output 1 only)

- | | Action | Display |
|-----|--|------------------|
| 38. | Disconnect all loads from the dc source but leave the sense jumpers in place . | |
| 39. | Press Shift Cal and scroll to CAL CURR MEAS AC, and press Enter . | CAL:CURR:MEAS AC |
| 40. | Wait for the dc source to compute the ac current calibration constant. The display returns to Meter mode when the calculation is complete. | |

B - Verification and Calibration

DVM Calibration (applies to Agilent 66311D, 66309D only)

Action	Display
41. Connect the DVM inputs directly to output 1. Connect the external DMM to the DVM inputs as shown in figure B-1D. Do not connect the Agilent 3478 DMM.	
42. Press Shift Cal , scroll to CAL DVM, and press Enter .	CAL:DVM
43. Press Shift Cal , scroll to CAL LEV, and press Enter to select the first calibration point.	CAL:LEV P1
44. Press Shift Cal , scroll to CAL DATA, press Enter Number , and enter the voltage value displayed on the external DMM. Numbers entered from the external DMM should have an accuracy and resolution of 0.1 mV or better.	CAL:DATA 0.00
45. Reverse the output 1 connections. Move the - lead to the + DVM connector pin, and move the + lead to the - DVM connector pin.	
46. Press Shift Cal , scroll to CAL LEV, use ↓ to scroll to P2 (the second calibration point), and press Enter .	CAL:LEV P2
47. Press Shift Cal , scroll to CAL DATA, press Enter Number , and enter the second voltage value displayed on the external DMM. Numbers entered from the external DMM should have an accuracy and resolution of 0.1 mV or better. Because this second value is negative, you must place a minus sign in front of the value. Pressing the Enter Number key the second time enters the minus sign.	CAL:DATA -0.00

Saving the Calibration Constants

WARNING: Storing calibration constants overwrites the existing ones in non-volatile memory. If you are not sure you want to permanently store the new constants, omit this step. The dc source calibration will then remain unchanged.

Action	Display
48. Press Shift Cal , scroll to CAL SAVE, and press Enter .	CAL:SAVE
49. Press Shift Cal , select CAL OFF, and press Enter to exit Calibration mode. *RST and *RCL will also set the calibration state to OFF.	CAL OFF

Restore the Language Setting

NOTE: Perform this procedure only if you changed the programming language from COMP to SCPI in the beginning of the calibration procedure.

Action	Normal Result
50. Access the Address menu and scroll to the LANG: command.	LANG: SCPI
51. Change the language from SCPI to COMPAtibility, and press Enter.	LANG: COMP

Calibration Error Messages

Errors that can occur during calibration are shown in the following table.

Table B-3. GPIB Calibration Error Messages

Error	Meaning
401	CAL switch prevents calibration (This is a hardware disable, see the Service Manual.)
402	CAL password is incorrect
403	CAL not enabled
404	Computed readback cal constants are incorrect
405	Computed programming cal constants are incorrect
406	Incorrect sequence of calibration commands

Changing the Calibration Password

The factory default password is 0. You can change the password when the dc source is in calibration mode (which requires you to enter the existing password). Proceed as follows:

Action	Display
1. Begin by pressing Shift Cal and scrolling to the CAL ON command.	CAL ON 0.0
2. Enter the existing password from Entry keypad and press Enter	
3. Press Shift Cal and scroll to the CAL PASS command.	CAL:PASS 0
4. Enter the new password from the keypad. You can use any number with up to six digits and an optional decimal point. If you want the calibration function to operate without requiring any password, change the password to 0 (zero).	

NOTE: If you want the calibration function to operate without requiring any password, change the password to 0 (zero).

Calibration Over the GPIB

You can calibrate the dc source by using SCPI commands within your controller programming statements. Be sure you are familiar with calibration from the front panel before you calibrate from a controller. Each front panel calibration command has a corresponding SCPI command. When you write your calibration program, perform the calibration procedure in the same order as the front panel procedure documented in this appendix.

The SCPI calibration commands are explained in chapter 8. Calibration error messages that can occur during GPIB calibration are shown in table B-3.

Error Messages

Error Number List

This appendix gives the error numbers and descriptions that are returned by the dc source. Error numbers are returned in two ways:

- ◆ Error numbers are displayed on the front panel
- ◆ Error numbers and messages are read back with the `SYSTEM:ERRor?` query. `SYSTEM:ERRor?` returns the error number into a variable and returns two parameters: an NR1 and a string.

The following table lists the errors that are associated with SCPI syntax errors and interface problems. It also lists the device dependent errors. Information inside the brackets is not part of the standard error message, but is included for clarification.

When errors occur, the Standard Event Status register records them in bit 2, 3, 4, or 5 as described in the following table:

Table C-1. Error Numbers

Error Number	Error String [Description/Explanation/Examples]
	Command Errors –100 through –199 (sets Standard Event Status Register bit #5)
–100	Command error [generic]
–101	Invalid character
–102	Syntax error [unrecognized command or data type]
–103	Invalid separator
–104	Data type error [e.g., "numeric or string expected, got block data"]
–105	GET not allowed
–108	Parameter not allowed [too many parameters]
–109	Missing parameter [too few parameters]
–112	Program mnemonic too long [maximum 12 characters]
–113	Undefined header [operation not allowed for this device] Check the language setting.
–114	Header suffix out of range
–121	Invalid character in number [includes "9" in octal data, etc.]
–123	Numeric overflow [exponent too large; exponent magnitude >32 k]
–124	Too many digits [number too long; more than 255 digits received]
–128	Numeric data not allowed

C – Error Messages

Table C-1. Error Numbers (continued)

-131	Invalid suffix [unrecognized units, or units not appropriate]
-138	Suffix not allowed
-141	Invalid character data [bad character, or unrecognized]
-144	Character data too long
-148	Character data not allowed
-150	String data error
-151	Invalid string data [e.g., END received before close quote]
-158	String data not allowed
-160	Block data error
-161	Invalid block data [e.g., END received before length satisfied]
-168	Block data not allowed
-170	Expression error
-171	Invalid expression
-178	Expression data not allowed
Execution Errors –200 through –299 (sets Standard Event Status Register bit #4)	
-200	Execution error [generic]
-222	Data out of range [e.g., too large for this device]
-223	Too much data [out of memory; block, string, or expression too long]
-224	Illegal parameter value [device-specific]
-225	Out of memory
-270	Macro error
-272	Macro execution error
-273	Illegal macro label
-276	Macro recursion error
-277	Macro redefinition not allowed
System Errors –300 through –399 (sets Standard Event Status Register bit #3)	
-310	System error [generic]
-350	Too many errors [errors beyond 9 lost due to queue overflow]
Query Errors –400 through –499 (sets Standard Event Status Register bit #2)	
-400	Query error [generic]
-410	Query INTERRUPTED [query followed by DAB or GET before response complete]
-420	Query UNTERMINATED [addressed to talk, incomplete programming message received]
-430	Query DEADLOCKED [too many queries in command string]
-440	Query UNTERMINATED [after indefinite response]

Table C-1. Error Numbers (continued)

Selftest Errors 0 through 99 (sets Standard Event Status Register bit #3)	
0	No error
1	Non-volatile RAM RD0 section checksum failed
2	Non-volatile RAM CONFIG section checksum failed
3	Non-volatile RAM CAL section checksum failed
4	Non-volatile RAM STATE section checksum failed
5	Non-volatile RST section checksum failed
10	RAM selftest
11	VDAC/IDAC selftest 1
12	VDAC/IDAC selftest 2
13	VDAC/IDAC selftest 3
14	VDAC/IDAC selftest 4
15	OVDAC selftest
80	Digital I/O selftest error
Device-Dependent Errors 100 through 32767 (sets Standard Event Status Register bit #3)	
213	Ingrd receiver buffer overrun
220	Front panel uart overrun
221	Front panel uart framing
222	Front panel uart parity
223	Front panel buffer overrun
224	Front panel timeout
401	CAL switch prevents calibration
402	CAL password is incorrect
403	CAL not enabled
404	Computed readback cal constants are incorrect
405	Computed programming cal constants are incorrect
406	Incorrect sequence of calibration commands
407	CV or CC status is incorrect for this command
601	Too many sweep points
603	CURRENT or VOLTAGE fetch incompatible with last acquisition
604	Measurement overrange

Example Programs

Introduction

The example programs in this section are intended to show how some of the same dc source functions can be programmed to each of the following GPIB interfaces:

1. National Instruments GPIB-PCII Interface/Handler
2. BASIC Language System

Assigning the GPIB Address in Programs

The dc source address cannot be set remotely. It must be set using the front panel Address key. Once the address is set, you can assign it inside programs. The following example is for BASIC and assumes that the GPIB select code is 7, the address is 6, and the dc source is assigned to the variable PS.

```
1070 ASSIGN @PS TO 706      !Agilent BASIC Interface
```

For systems using the National Instruments DOS driver, the address is specified in the software configuration program (IBCONFIG.EXE) and assigned a symbolic name. The address then is referenced only by this name within the application program (see the National Instruments GPIB documentation).

National Instruments GPIB Driver

Your program must include the National Instruments header file DECL.BAS. This contains the initialization code for the interface. Prior to running any applications programs, you must set up the interface with the configuration program (IBCONF.EXE).

Your application program will not include the dc source's symbolic name and GPIB address. These must be specified during configuration (when you run IBCONF.EXE). Note that the primary address range is from 0 to 30. The dc source expects a message termination on EOI or line feed, so set EOI w/last byte of Write. It is also recommended that you set Disable Auto Serial Polling.

All function calls return the status word IBSTA%, which contains a bit (ERR) that is set if the call results in an error. When ERR is set, an appropriate code is placed in variable IBERR%. Be sure to check IBSTA% after every function call. If it is not equal to zero, branch to an error handler that reads IBERR% to extract the specific error.

D – Example Programs

Error Handling

If there is no error-handling code in your program, undetected errors can cause unpredictable results. This includes "hanging up" the controller and forcing you to reset the system. National Instruments drivers have routines for detecting program execution errors. Error detection should be used after every call to a subroutine.

Example 1. National Instruments Interface Example

```
990      '----- Merge DECL.BAS here -----
1000     'DC Source Variable = PS% ; Stand-Alone Address = 706
1005     CODES$=SPACE$(50):MODE$=SPACE$(5):OEVENT$=SPACE$(20)
1010     D$=SPACE$(60):OUTPUT$=SPACE$(40):BDNAME$="PS%"
1015     DIM OUTPUT(2)
1020     '
1025     'Set up dc source interface for DOS driver
1030     CALL IBFIND(BDNAME$,PS%)
1035     IF PS%
1040     CALL IBCLR(PS%)
1045     '
1050     'Program dc source to CV mode with following voltage and current
1055     CODES$ = "VOLTAGE MAX;CURRENT MAX"      :GOSUB 2000
1060     '
1065     'Query dc source outputs and print to screen
1070     CODES$ = "MEASURE:VOLTAGE?;CURRENT?"    :GOSUB 2000    :GOSUB 3000
1075     VOUT = OUTPUT(1)
1080     IOUT = OUTPUT(2)
1085     PRINT"The programmed levels are "VOUT" Volts and "IOUT" Amps"
1090     '
1095     'Program triggered current level to value insufficient to maintain
1100     'supply within its CV operating characteristic
1105     CODES$ = "CURR:TRIG MIN"      :GOSUB 2000
1110     '
1115     'Set operation status mask to detect mode change from CV to CC
1120     CODES$ = "STAT:OPER:ENAB 1024;PTR 1024"  :GOSUB 2000
1125     '
1130     'Enable Status Byte OPER summary bit
1135     CODES$ = "*SRE 128"      :GOSUB 2000
1140     '
1145     'Arm trigger circuit and send trigger to dc source
1150     CODES$ = "INITIATE:SEQUENCE1;TRIGGER"    :GOSUB 2000
1160     'Wait for supply to respond to trigger
1165     FOR I= 1 to 100 :NEXT I
1170     '
1175     'Poll for interrupt caused by change to CC mode and print to screen
1180     SPOL%=0
1185     CALL IBRSP(PS%,SPOL%)
1190     IF (SPOL% AND 128) = 128 THEN POLL = 1 'Set interrupt flag on OPER bit
1195     IF POLL <> 1 THEN GOTO 1230           'No interrupt to service
1200     "CODES$ = "STAT:OPER:EVEN?" :GOSUB 2000 'Query status oper register
1205     CALL IBRD(PS%,OEVENT$)              'Read back event bit
1210     IF IBSTA%
1215     OEVENT=VAL(OEVENT$)
1220     IF (OEVENT AND 1024) = 1024 THEN PRINT "Supply switched to CC mode."
```

Example Programs - D

```

1225 '
1230 'Clear status circuit
1235 CODES$="*CLS" :GOSUB 2000
1240 FOR I=1 TO 50 :NEXT I 'Wait for supply to clear
1245 '
1250 'Disable output and save present state to location 2
1255 CODES$ = "OUTPUT OFF;*SAV 2" :GOSUB 2000
1260 END
1265 '
2000 'Send command to dc source
2005 CALL IBWRT(PS%,CODES$)
2010 IF IBSTAT%
2015 RETURN
1250 'Disable output and save present state to location 2
1255 CODES$ = "OUTPUT OFF;*SAV 2" :GOSUB 2000
1260 END
1265 '
2000 'Send command to dc source
2005 CALL IBWRT(PS%,CODES$)
2010 IF IBSTAT%
2015 RETURN
2020 '
2100 'Error detection routine
2105 PRINT "GPIB error. IBSTAT% = HEX$(IBSTAT%)
2110 PRINT " IBERR% = ";IBERR%" in line ";ERL
2115 STOP
2120 '
3000 'Get data from dc source
3005 CALL IBRD(PS%,OUTPUT$)
3010 IF IBSTA%
3015 I=1 'Parse data string
3020 X=1
3025 C=INSTR(I,OUTPUT$,";")
3030 WHILE C <> 0
3035 D$=MID$(OUTPUT$,I,C-I)
3040 OUTPUT(X)=VAL(D$) 'Get values
3045 I=C+1
3050 C=INSTR(I,OUTPUT$,";")
3055 X=X+1
3060 WEND
3065 D$=RIGHT$(OUTPUT$,LEN(OUTPUT$)-(I-1))
3070 OUTPUT(X)=VAL(D$)
3075 OUTPUT$=SPACE$(40) 'Clear string
3080 RETURN

```

D – Example Programs

BASIC

The BASIC for controllers and BASIC for Windows both provide access to GPIB functions at the operating system level. This makes it unnecessary to have the header files required in front of DOS applications programs. Also, you do not have to be concerned about controller "hangups" as long as your program includes a timeout statement. Because the dc source can be programmed to generate SRQ on errors, your program can use an SRQ service routine for decoding detected errors. The detectable errors are listed in Appendix C.

Example 2. Controller Using BASIC

```
1000 !Dc source at stand-alone address = 706
1010 OPTION BASE 1
1020 DIM Response$(80)
1030 ASSIGN @Ps TO 706
1040 CLEAR SCREEN
1050 !
1060 PRINT "Disconnect any load from output terminals and press CONTINUE..."
1070 PAUSE
1080 !
1090 !Program dc source with following voltage level and current limit
1100 OUTPUT @Ps;"VOLT MAX"
1110 OUTPUT @Ps;"CURR MAX"
1120 OUTPUT @Ps;"OUTP ON"
1130 !
1140 !Query dc source outputs and print to screen
1150 OUTPUT @Ps;"MEAS:VOLT?;CURR?"!Query output levels
1160 ENTER @Ps;Vout,Iout
1170 PRINT "The output levels are ";Vout;" Volts and ";Iout;" Amps"
1180 !
1190 !Program current triggered level to a value insufficient to maintain
1200 !supply within its CV operating characteristic
1210 OUTPUT @Ps;"CURR:TRIG MIN"
1220 !
1230 !Set operation status mask to detect mode change from CV to CC
1240 OUTPUT @Ps;"STAT:OPER:ENAB 1024;PTR 1024"
1250 !
1260 !Enable Status Byte OPER summary bit
1270 OUTPUT @Ps;"*SRE 128"
1280 !
1290 !Arm trigger circuit and send trigger to dc source
1300 OUTPUT @Ps;"INIT:NAME TRAN"
1310 OUTPUT @Ps;"TRIGGER"
1320 !Poll for interrupt caused by change to CC mode and print to screen
1330 PRINT "Connect 1K ohm load and hit CONTINUE..."
1340 PAUSE
1350 Response=SPOLL(@Ps)
1360 IF NOT BIT(Response,7) THEN !No OPER event to report
1370     PRINT "Supply not in CC mode!!!"
1380     GOTO 1320
1390 END IF
1400 OUTPUT @Ps;"STAT:OPER:EVEN?"!Query status operation register
1410 ENTER @Ps;Oevent!Read back event bit
1420 IF BIT(Oevent,10) THEN PRINT "Supply switched to CC mode."
1430 !
1440 !Clear status
1450 OUTPUT @Ps;"*CLS"
1460 !
1470 !Disable output and save present state in location 2
1480 OUTPUT @Ps;"OUTPUT OFF;*SAV 2"
1490 PRINT "Program terminated."
1500 END
```

Pulse Measurements

The following programs illustrate how to make a pulse measurement over the GPIB. The measurement function is set to ACDC, which gives the best results for current waveforms that have ac content. The measurement incorporates 100 readings taken at time intervals of 20 microseconds, for a total measurement time of 2 milliseconds. The trigger point for the pulse measurement occurs at 0.1 amperes on the positive slope of the current pulse. The measurement offset is programmed so that 20 measurement points prior to the trigger are also returned as part of the measurement sample.

Because measurement triggers are initiated by the output pulse, a FETCh command is used to return the measurement data. FETCh commands are also used to return the MAXimum, MINimum, HIGH, and LOW values of the measurement. MEASure commands cannot be used to return data in this example because they always acquire *NEW* measurement data each time they are used.

To produce the output pulses in this example, an electronic load must be connected and programmed to generate 3-ampere pulses with a duty cycle of 100 microseconds at 1000 Hz. The dc source address is 705, and the load address is 706. If required, change these parameters in the appropriate statements.

Example 3. Current Pulse Measurement Using BASIC

```

10    !Rev A.00.00
20    OPTION BASE 1
30    DIM Curr_array(100)
40    !
50    ASSIGN @Ps TO 705
60    ASSIGN @Ld TO 706
80    OUTPUT @Ps;"*RST"                ! Sets supply to default values
90    OUTPUT @Ps;"OUTP ON"            ! Turn on power supply output
100   OUTPUT @Ps;"VOLT 5"            ! Program power supply to 5 volts
110   !
120   OUTPUT @Ld;"CURR:LEVEL 0"       ! Set up electronic load to produce
pulses
130   OUTPUT @Ld;"CURR:TLEVEL 3"
140   !
150   OUTPUT @Ld;"TRAN:FREQ 1000"
160   OUTPUT @Ld;"TRAN:DCYCLE 10"
170   OUTPUT @Ld;"TRAN:MODE CONT"
180   OUTPUT @Ld;"TRAN:STATE ON"
190   !
200   OUTPUT @Ps;"SENS:CURR:DET ACDC" ! Set meter to ACDC
210   OUTPUT @Ps;"SENS:CURR:RANG MAX" ! High Current range
220   OUTPUT @Ps;"TRIG:ACQ:SOUR INT"  ! Set to trigger on pulse
230   OUTPUT @Ps;"SENS:FUNC " "CURR"" ! Acquire current reading
240   OUTPUT @Ps;"TRIG:ACQ:LEV:CURR .1" ! Trigger at 0.1 amps
250   OUTPUT @Ps;"TRIG:ACQ:SLOPE:CURR POS" ! Trigger on positive slope
260   OUTPUT @Ps;"TRIG:ACQ:HYST:CURR .05" ! Set hysteresis of trigger
270   OUTPUT @Ps;"SENS:SWE:TINT 20E-6" ! Set sample time interval to 20us
280   OUTPUT @Ps;"SENS:SWE:POIN 100"  ! Set number of measurement samples
in sweep
290   OUTPUT 705;"SENS:SWE:OFFS:POIN -20" ! Number of sample points before
trigger
300   OUTPUT @Ps;"INIT:NAME ACQ"      ! Initiate the trigger system.
310   !                               Controller now waits for trigger
to occur.
320   OUTPUT @Ps;"FETCH:ARRAY:CURR?"  ! Get the data after measurement
completes.
330   !
340   ENTER @Ps;Curr_array(*)         ! Enters all 100 data points
350   PRINT Curr_array(*)             ! Print all data points

```

D – Example Programs

```
360      !
370      OUTPUT @Ps;"FETCH:CURR:MAX?"           ! Get more data from previous
measurement.
380      ENTER @Ps;Curr_max
390      PRINT "MAX CURRENT",Curr_max
400      !
410      OUTPUT @Ps;"FETCH:CURR:MIN?"
420      ENTER @Ps;Curr_min
430      PRINT "MIN CURRENT",Curr_min
440      !
450      OUTPUT @Ps;"FETCH:CURR:HIG?"
460      ENTER @Ps;Curr_hi
470      PRINT "HIGH CURRENT",Curr_hi
480      !
490      OUTPUT @Ps;"FETCH:CURR:LOW?"
500      ENTER @Ps;Curr_low
510      PRINT "LOW CURRENT",Curr_low
520      !
530      END
```

When this program runs, it returns 100 measurement data points as well as the MIN, MAX, HIGH, and LOW data in the following format:

```
.030585    .031869    .0344369  .031655    .0320829  .0325109  .0333669  .0340089
.0320825  .031449    .031227  .031441    .0337949  .0327249  .031869   .031655
.0327249  .031013    .0325109  .0333669  3.09751   3.1814    3.14266   3.13667
3.13817   3.13624    .977283   .0667496  .0245932  .0280171  .031013   .031655
.0331529  .0350788   .0348648  .0327249  .031227   .0327249  .031227   .030799
.031869   .0329389   .030371   .031655   .031869   .0329389  .031869   .0322869
.0320829  .0325109   .0333669  .0340089  .0348648  .0327249  .031227   .0327249
.0320829  .030371    .031449   .031227   .031441   .0337949  .031449   .0333669
.031441   .0337949   .030371   .031655   .031869   .0329389  .031869   .0293011
.031441   .0337949   .0327249  .031869   .031655   .031655   .0320829  .031227
.0322969  .031655    .0327249  .0340089  2.97661   3.18632   3.14523   3.13496
3.13453   3.13731    1.32438   .0836549  .0258772  .0284451  .0275891  .0329389
.0329389  .0333669   .0322969  .0333669
MAX CURRENT          3.18632
MIN CURRENT          .0245932
HIGH CURRENT         3.1371
LOW CURRENT          .0314077
```

Example 4. Voltage Pulse Measurement Using VISA Library Calls

```
#include <visa.h>
#include <stdio.h> /* for printf */
#include <stdlib.h>

ViStatus main(void)
{
    ViSession defRM, instrumentHandle;
    ViStatus err;
    ViReal64 measvoltage, meascurrent;
    ViReal64 resultDC, resultRMS, resultMIN, resultMAX, resultHIGH, resultLOW;
    ViReal64 voltArray[10];
    ViInt32 i, numReadings ;

    /* initialize the VISA session */
    err = viOpenDefaultRM(&defRM);
    if (err)
```

```

{
    printf("viOpenDefaultRM error, check your hardware connections\n");
    exit (-1);
}

/* Open the instrument at address 5 for Communication */
err = viOpen(defRM, "GPIB0::5::INSTR", VI_NULL, 5000, &instrumentHandle);
if (err)
{
    viClose(defRM);
    printf("viOpen error, check the device at address 5\n");
    exit (-1);
}

/* Reset the instrument */
viPrintf(instrumentHandle, "*RST\n");

/* turn on the output */
viPrintf(instrumentHandle, "OUTP 1\n");

/* Set output voltage (2V) and current (1A) levels, turn output on*/
viPrintf(instrumentHandle, "VOLT %.5lg;CURR %.5lg\n", 2.0, 1.0);

/* Measure the dc voltage level at the output terminals */
viQueryf(instrumentHandle, "MEAS:VOLT?\n", "%lf", &measvoltage);

/* Measure the dc current level at the output terminals */
viQueryf(instrumentHandle, "MEAS:CURR?\n", "%lf", &meascurrent);

printf ("Output Voltage = %f; Output Current = %f \n",
        measvoltage,meascurrent);

/* configure dc source for dynamic measurements */
/* change sweep parameters */
viPrintf(instrumentHandle, "SENS:SWE:TINT %.5lg;POIN %ld;OFFS:POIN %ld\n",
        31.2E-6, /* sampling rate = 31.2us */
        256, /* sweep size = 256 points */
        -4); /* pre-trigger offset = 4 points (~125us) */

/* setup the voltage sensing triggered measurement parameters */
/* voltage trigger level to 2.75V */
/* hysteresis band to +/- 0.1V */
/* positive slope */
/* trigger count */
/* acquisition triggered by measurement */
viPrintf(instrumentHandle, "SENS:FUNC \"VOLT\"\n");
viPrintf(instrumentHandle, "TRIG:ACQ:LEV:VOLT %.5lg\n", 2.75);
viPrintf(instrumentHandle, "TRIG:ACQ:HYST:VOLT %.5lg\n", 0.1);
viPrintf(instrumentHandle, "TRIG:ACQ:SLOP:VOLT POS\n");
viPrintf(instrumentHandle, "TRIG:ACQ:COUN:VOLT %ld\n", 1);
viPrintf(instrumentHandle, "TRIG:ACQ:SOUR INT\n");

/* initiate the acquisition system for measurement trigger */
printf ("Arm acquisition system...\n");
viPrintf(instrumentHandle, "INIT:NAME ACQ\n");

/* must allow time for pre-triggered samples */
printf ("Pre-trigger delay...\n");

/* trigger the acquisition by changing the output voltage level to 5V */
printf ("Trigger acquisition...\n");
viPrintf(instrumentHandle, "VOLT %.5lg\n", 5.0);

```

D – Example Programs

```
/* fetch dynamic measurements from the same measurement data */
viQueryf(instrumentHandle, "FETC:VOLT?\n", "%lf", &resultDC);
viQueryf(instrumentHandle, "FETC:VOLT:ACDC?\n", "%lf", &resultRMS);
viQueryf(instrumentHandle, "FETC:VOLT:MAX?\n", "%lf", &resultMAX);
viQueryf(instrumentHandle, "FETC:VOLT:MIN?\n", "%lf", &resultMIN);
viQueryf(instrumentHandle, "FETC:VOLT:HIG?\n", "%lf", &resultHIGH);
viQueryf(instrumentHandle, "FETC:VOLT:LOW?\n", "%lf", &resultLOW);

/* display measurement results */
printf("Dynamic voltage measurements:\n");
printf("dc=%f V\n rms=%f V\n max=%f V\n min=%f V\n high=%f V\n low=%f
V\n",
    resultDC, resultRMS, resultMAX, resultMIN, resultHIGH, resultLOW);

/* fetch first 10 data points from the measurement */
numReadings = 10;
viQueryf(instrumentHandle, "FETC:ARR:VOLT?\n", "%,#lf%*t", &numReadings,
&voltArray[0]);
for (i=0; i<numReadings; i++)
    printf(" Array Data[%d] = %f V\n", i, voltArray[i]);

/* reset sweep parameters for faster measurement */
viPrintf(instrumentHandle, "SENS:SWE:TINT %.5lg;POIN %ld;OFFS:POIN %ld\n",
    15.6E-6, /* sampling rate */
    2048, /* sweep size */
    0); /* pre-trigger points */

/* Measure final dc voltage level at the output terminals */
viQueryf(instrumentHandle, "MEAS:VOLT?\n", "%lf", &measvoltage);

printf (" Output Voltage = %f V\n", measvoltage);

/* close all opened sessions */
viClose(instrumentHandle);
viClose(defRM);

printf ( "PROGRAM COMPLETED \n");

printf("Press Enter key to continue...\n");
getchar();

return VI_SUCCESS ;
}
```

When this program runs, it returns the DC, RMS, MIN, MAX, HIGH, and LOW data in 10 measurement data points in the following format:

```
Output Voltage = 1.999860; Output Current = -0.000043
Arm acquisition system...
Pre-trigger delay...
Trigger acquisition...
Dynamic voltage measurements:
dc = 5.002660 V
rms = 5.002660 V
max = 5.080140 V
min = 1.996970 V
high= 5.002310 V
low = 3.538550 V
Array Data[0] = 2.000360 V
Array Data[1] = 1.999680 V
Array Data[2] = 1.998320 V
Array Data[3] = 1.996970 V
Array Data[4] = 3.214240 V
Array Data[5] = 4.064840 V
Array Data[6] = 4.538600 V
Array Data[7] = 4.923570 V
Array Data[8] = 4.941870 V
Array Data[9] = 5.025240 V
Output Voltage = 5.002450 V
PROGRAM COMPLETED
Press Enter key to continue...
```

DFI Programming Example

The following program illustrates how to program the DFI port so that it goes low when an OCP condition turns off the output of the unit. To clear an overcurrent condition, the cause of the condition must first be removed and then an OUTPUT:PROTECTION:CLEAR command must be sent. Note that the status event register will not clear the DFI port until the register is read.

Example 5. DFI Example Using BASIC

```
10 !Rev A.00.00
20 ASSIGN @Ps TO 705
30 OUTPUT @Ps;"*RST"           ! Sets supply to default values
40 OUTPUT @Ps;"OUTP ON"       ! Turn on power supply output
50 OUTPUT @Ps;"VOLT 10;CURR .1" ! Program power supply voltage and current
60 !
70 OUTPUT @Ld;"CURR:PROT:STAT ON" ! Turn on overcurrent protection
80 OUTPUT @Ld;"OUTP:DFI:STAT ON" ! Turn on DFI port
90 OUTPUT @Ld;"OUTP:DFI:SOUR QUES" ! Select DFI bit from Questionable status
register
100 OUTPUT @Ld;"STAT:QUES:ENAB 2;PTR 2"! Unmask bit 2 (OCP) on positive
transition
110 !
120 OUTPUT @Ld;"OUTP:PROT:CLE" ! Clears the protection circuit
130 OUTPUT @Ld;"STAT:QUES:EVENT?" ! Clears the Event register and DFI
140 OUTPUT @Ld;EVENT          ! Reads the event and clears the buffer
190 !
```

Line Voltage Conversion

WARNING: *Shock Hazard.* Operating personnel must not remove instrument covers. Component replacement and internal adjustments must be made only by qualified service personnel.

Open the Unit

- ◆ Turn off ac power and disconnect the power cord from the unit.
- ◆ Use a #15 Torx drive and remove the two screws on the bottom of the unit. If your unit has feet, you will need to remove one of the feet to access the screw.
- ◆ Use a #15 Torx drive and loosen the two screws on the rear bezel and remove the bezel.
- ◆ Slide the cover toward the back of the unit and remove it.

Configure the Power Transformer

- ◆ Locate the ac input wiring harness on the left side of the transformer
- ◆ Use a needle nose pliers and connect the ac input wiring harness according to the information in figure E-1 on the following page.

Install the Correct Line Fuse

- ◆ Install the correct line fuse. The fuse is located on the pc board directly behind the ac line switch and is labeled F301.
For 100/120 Vac operation: 3.15 AT (time delay); part number 2110-0638
For 220/230 Vac operation: 1.6 AT (time delay); part number 2110-0773
- ◆ Mark the voltage setting that the unit has been set to on the rear panel label.

Close the Unit

- ◆ Slide the cover over the unit toward the front.
- ◆ Place the bezel on the rear of the unit and tighten the two screws using a #15 Torx drive.

E – Line Voltage Conversion

- ◆ Replace the two screws on the bottom of the unit using a #15 Torx drive. Remember to replace the foot if you previously removed it to access the screw.
- ◆ Reconnect the power cord and turn on the unit.

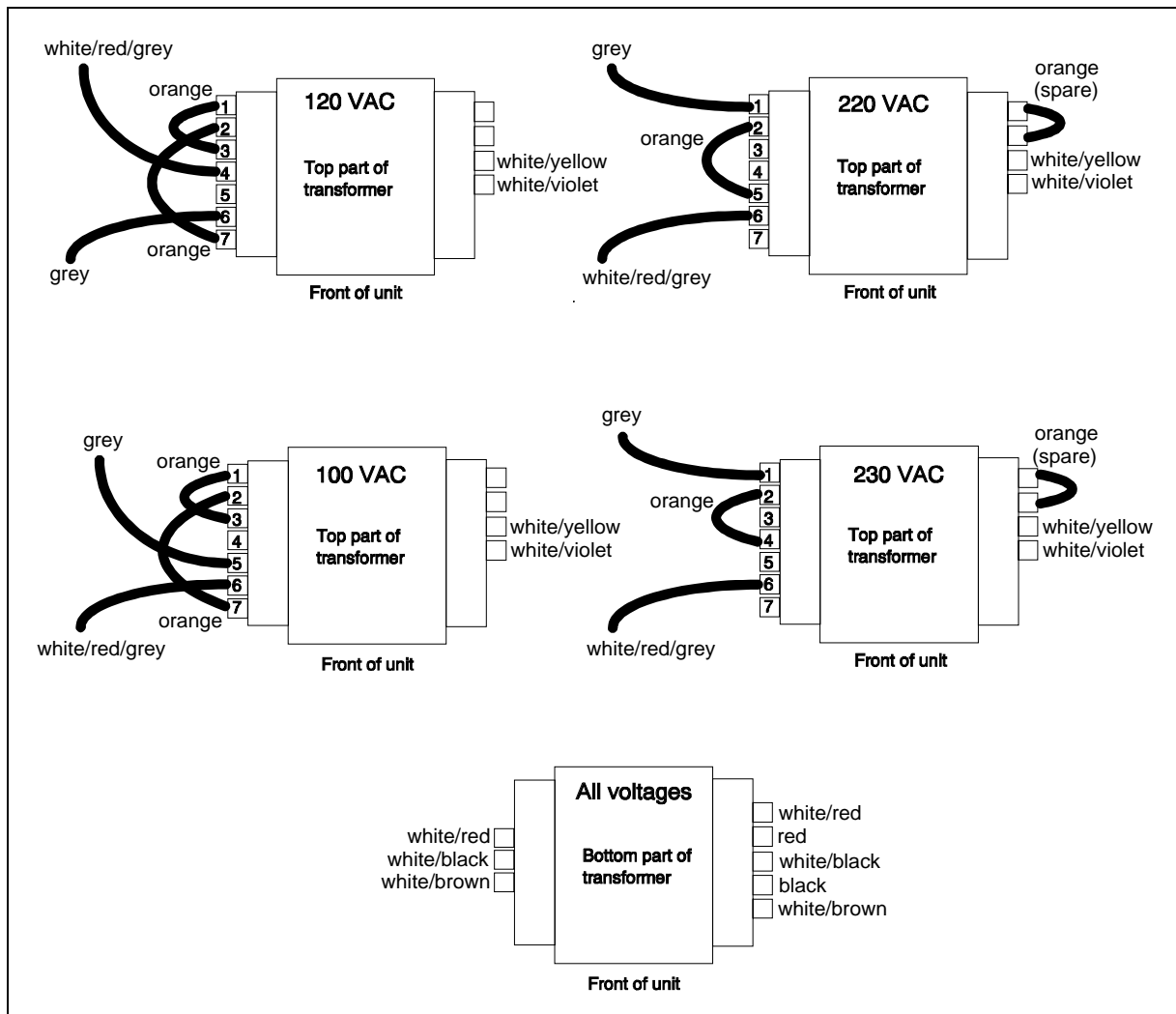

Figure E-1, Power Transformer AC Input Connections

Compatibility Language

Introduction

The Agilent 66111A and 66311B dc sources are programmatically compatible with the HP/Agilent 6632A, 6633A, and 6634A dc power supplies. This means that by using COMPatibility language mode you can program the Agilent 66111A/66311B over the GPIB using COMPatibility commands.

To switch from SCPI commands to COMPatibility commands (and vice versa), use the SYST:LANG command, as documented in chapter 8. The language setting is saved in non-volatile memory.

Table F-2 summarizes the COMPatibility commands. You may need to refer to the HP/Agilent Series 6632A, 6633A, and 6634A Operating Guide (p/n 5957-6360) for complete information on the COMPatibility commands.

The rest of this appendix discusses the COMPatibility language status system, and the COMPatibility language error codes.

NOTE: For complete information on the Compatibility programming language, order the HP/Agilent 6632A/6633A/6634A Operating manual, p/n 5957-6360.

Table F-1. COMPatibility Power-on Settings

Command	Setting	Command	Setting
DC	1 (ON)	POL	1 (normal)
DLY	8 ms (fast) 80 ms (normal)	PON	last stored value
DSP	1 (ON)	RELAY	1 (close)
ISET	0.04 A (66311B) 0.02 A (6632B) 0.008 A (6633B) 0.004 A (6634B)	RLYPON	1 (close)
OCP	OFF	SRQ	0
OUT	1 (ON)	UNMASK	0
OVSET	MAX	VSET	0 V

Table F-2. COMPAtibility Commands

Compatibility Command	Description	Similar SCPI Command
ASTS?	This command reads the contents of the accumulated status register, which stores any bit condition entered in the status register since the accumulated status register was last read, regardless of whether the condition still exists. Data Representation: ZZZZD	STAT:OPER? STAT:QUES? *ESE?
CLR	This command initializes the dc source to the power-on state. It also resets the PON bit in the serial poll register. The command performs the same function as the Device Clear (DCL) interface message.	*RST
DC 0 1	Only applies to units with Relay Option 760. This command enables or disables the output without affecting the state of the output relays. Initial condition: DC 1	OUTP:STAT[:NOR] 0 1 OFF ON
DLY <n>	This command programs the delay time between the programming of an output change that produces a CV, CC, or an UNREG condition, and the recording of that condition by the status registers. This can be used to prevent false triggering of the OverCurrent Protection feature (OCP). Initial delay: 0.08s (Normal); 0.008s (Fast).	OUTP:PROT:DEL
DSP 0 1	This command enables or disables the dc source's front panel display. Initial condition: DSP 1	DISP 0 1 OFF ON
ERR?	This command determines the type of programming error detected by the dc source. A remote programming error sets the ERR bit in the status register, which can be enabled by UNMASK to request service.	SYST:ERR?
FAULT?	This command reads which bits have been set in the fault register. A bit is set in the fault register when the corresponding bit in the status register changes from inactive to active AND the corresponding bit in the mask register has been enabled. The fault register is reset only after it has been read. The decimal equivalent of the total bit weight of all enabled bits is returned. Data Representation: ZZZZD	STAT:OPER? STAT:QUES? *ESE
ID?	This command causes the dc source to report its model number and any options that affect the dc source's output. Data Representation: Agilent663XA	*IDN?
IOUT?	This command measures and returns the actual output current. Data Representation: SD.DDDD	MEAS:CURR?
ISET <n>	This command programs the output current. See Table 8-3 for the programming range of this command. Initial condition: Table F-1	CURR
OCP 0 1	This command enables or disables the dc source's overcurrent protection. If this function is enabled and the dc source goes into CC mode, the output of the dc source is disabled. Initial condition: OCP 0	CURR:PROT:STAT 0 1 OFF ON
OUT 0 1	This command enables or disables the dc source's output. The dc source will be able to implement commands even while the output is disabled. Initial condition: OUT 1	OUTP:STAT 0 1 OFF ON

Table F-2. COMPatibility Commands (continued)

Compatibility Command	Description	Similar SCPI Command
OVSET <n>	This command programs the overvoltage protection. See Table 8-3 for the programming range of this command. Initial condition: MAX	VOLT:PROT
POL 0 1	Only applies to units with Option 760. This command sets the polarity of the output relays to either normal (1) or inverted (0). Initial condition: POL 1	OUTP:REL:POL 0 1
PON 0 1	This command enables (1) or disables (0) SRQ at power-on. Initial condition: last programmed value	PSC 0 1
RELAY 0 1	Only applies to units with Relay Option 760. This command opens (0) or closes (1) the output relays without affecting the programmed output state of the unit. Initial condition: RELAY 1	OUTP:REL 0 1
RLYPON 0 1	Only applies to units with Relay Option 760. This command opens (0) or closes (1) the output relays at power-on without affecting the programmed output state of the unit. Initial condition: RLYPON 1	RCL 0
ROM?	This command returns the ROM version of the dc source. Data Representation: AAA AAA	*IDN?
RST	This command resets the dc source if the output is disabled by the output protection circuits.	OUTP:PROT:CLE
SENS:CURRE:RANG <n>	This command sets the current measurement range of the dc source. See Table 8-3 for the programming range. Initial condition: MAX	SENS:CURRE:RANG
SENS:PROT:STAT 0 1	This command enables/disables the open sense detect feature. Initial condition: 1	SENS:PROT:STAT
SENS:SWE:POIN <n>	This command defines the number of data points in a measurement sweep. Initial condition: 32	SENS:SWE:POIN
SENS:SWE:TINT <n>	This command defines the time period between measurement samples. Initial condition: 15.6 s.	SENS:SWE:TINT
SRQ 0 1	These commands enable or disable the dc source's ability to request service from the controller for fault conditions. UNMASK defines which conditions are defined as faults. Initial condition: SRQ 0	*SRE
STS?	This command reads the contents of the status register, which maintains the present status of the dc source. Data Representation: ZZZZD	STAT:OPER:COND? STAT:QUES:COND? *ESE?
SYST:LANG	This command causes the alternate language to become active and to be stored in nonvolatile memory. In this case, the commands are equivalent. After being shut off, the dc source will resume in the last-selected language when power is restored. The parameter must be either COMP or SCPI.	SYST:LANG

Table F-2. COMPatibility Commands (continued)

Compatibility Command	Description	Similar SCPI Command
TEST?	This command causes the dc source to run selftest and report any detected failures. Data Representation: ZZZZD	*TST?
UNMASK xxx	These commands determine the conditions that will set bits in the fault register, allowing the operator to define the conditions that will be reported as fault. Fault conditions can be enabled by sending the decimal equivalent of the total bit weight of all conditions to be enabled.	STAT:OPER:ENAB STAT:QUES:ENAB *ESE
VOUT?	This command measures and returns the actual output voltage. Data Representation: SZZD.DD; (SZD.DDD for 6634B only)	MEAS:VOLT?
VSET <n>	This command programs the output voltage. See Table 8-3 for the programming range of this command. Initial condition: 0 V	VOLT

A = Alpha

D = Digit

S = Sign (blank for positive and – for negative)

Z = Digit with leading zeros output as spaces

Table F-3. COMPatibility Errors

Error	NumberError String [Description/Explanation/Examples]
ERR 0	No error
ERR 1	EEPROM save failed [Data write to non-volatile memory failed]
ERR 2	Second PON after power-on [More than one PON command received after power-on. Only one is allowed.]
ERR 4	RLYPON sent with no relay option present [A RLYPON command was sent with no relay option present.]
ERR 5	No relay option present [A relay option command was sent with no relay option present.]
ERR 8	Addressed to talk and nothing to say [The unit was addressed to talk without first receiving a query.]
ERR 10	Header expected [A non-alpha character was received when a header was expected.]
ERR 11	Unrecognized header [The string of alpha characters received was not a valid command.]
ERR 20	Number expected [A non-numeric character was received when a number was expected.]
ERR 21	Number Syntax [The numeric character received did not represent a proper number.]
ERR 22	Number out of internal range [The number received was too large or small to be represented in internal format.]
ERR 30	Comma [A comma was not received where one was expected.]
ERR 31	Terminator expected [A valid terminator was not received where one was expected.]
ERR 41	Parameter Out [The number received exceeded the limits for its associated command.]
ERR 42	Voltage Programming Error [The programmed value exceeded the valid voltage limits.]
ERR 43	Current Programming Error [The programmed value exceeded the valid current limits.]
ERR 44	Overvoltage Programming Error [The programmed value exceeded the valid overvoltage limits.]
ERR 45	Delay Programming Error [The programmed value exceeded the valid delay limits.]
ERR 46	Mask Programming Error [The programmed value exceeded the fault mask limits.]
ERR 51	EEPROM Checksum [EEPROM failed, or a new uncalibrated EEPROM was installed.]

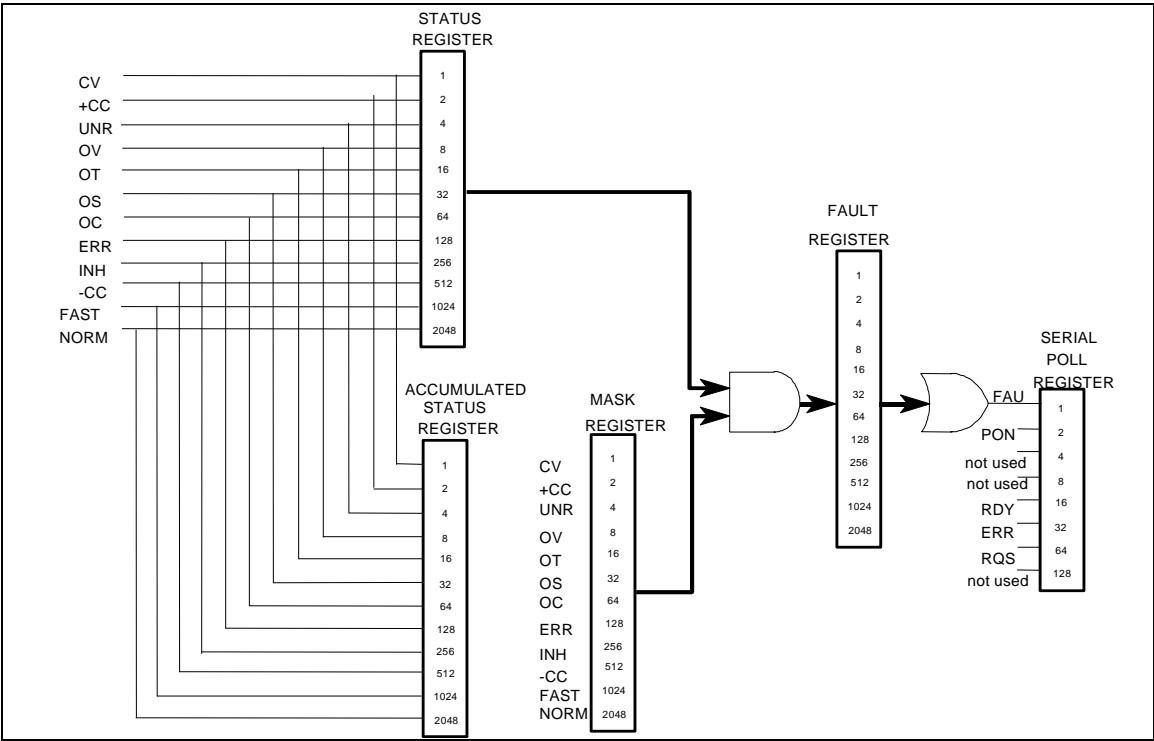

Figure F-1. COMpatibility Status Model

Table F-4. Bit Assignment of Status, Astatus, Fault, & Mask Registers

Bit Position	11	10	9	8	7	6	5	4	3	2	1	0
Bit Name	NORM	FAST	-CC	INH	ERR	OC	OS	OT	OV	UNR	+CC	CV
Bit Weight	2048	1024	512	256	128	64	32	16	8	4	2	1

CV = The unit is operating in constant voltage mode.
 +CC = The unit is operating in constant current mode.
 UNR = The output of the unit is unregulated.
 OV = The overvoltage protection circuit has tripped.
 OT = The over-temperature protection circuit has tripped.
 OC = The overcurrent protection circuit has tripped.
 OS = Open sense lead detected (Agilent 66111A, 66311B/D)
 ERR = A programming error has occurred. Use ERR? to clear.
 -CC = The unit is operating in negative constant current mode.
 INH = The external remote inhibit signal has turned the output off.
 FAST = The output is in Fast operating mode. (Agilent 6632B, 6633B, 6634B only)
 NORM = The output is in Normal operating mode. (Agilent 6632B, 6633B, 6634B only)

Table F-5. Bit Configuration of Serial Poll Register

Bit Position	7	6	5	4	3	2	1	0
Bit Name	not used	RQS	ERR	RDY	not used	not used	PON	FAU
Bit Weight		64	32	16			2	1

RQS = The dc source has generated a service request. Use a serial poll to clear.
 ERR = Same as ERR bit in Status register. Use ERR? to clear.
 RDY = This bit cleared when unit busy processing commands. Set when processing complete.
 PON = A Power-on has occurred. Use CLR to clear.
 FAU = A bit has been set in the Fault register. Use FAULT? to clear.

- —
 - -- -- --, 53, 60, 61, 62
 - sense open, 36
- +—
 - + sense open, 36
 - +/- sense open, 36
 - +/- terminals, 32
 - +S/-S terminals, 32
- 0—
 - 0 ... 9, 55
- A—
 - AARD, 73
 - ABORT, 126
 - ac line conversion, 175
 - accessories, 22
 - ACDC, 111
 - ACDC current detector, 60, 61, 62
 - Agilent BASIC controller example, 168
 - airflow, 31
 - annunciators
 - Addr, 50
 - Cal, 50
 - CC, 50
 - CV, 50
 - Dis, 50
 - Err, 50
 - OCP, 50
 - Prot, 50
 - Rmt, 50
 - Shift, 50
 - SRQ, 50
 - Unr, 50
 - average measurements, 79, 83
 - AWG ratings, 32
- B—
 - bus, 134
- C—
 - cables, 22
 - calibration, 154
 - current programming - high range, 156
 - current programming - low range, 157
 - enable, 155
 - equipment, 147
 - error messages, 159
 - menu, 154
 - OVP, 156, 158
 - password, 159
 - peak current, 157
 - saving, 158
 - setup, 147
 - voltage measurement, 155
 - voltage programming, 155
 - calibration commands
 - CAL CURR, 100
 - CAL CURR MEAS AC, 100
 - CAL CURR MEAS LOWR, 100
 - CAL CURR2, 100
 - CAL DATA, 101
 - CAL DATE, 101
 - CAL DVM, 101
 - CAL PASS, 101
 - CAL STAT, 102
 - CAL VOLT PROT, 102
 - CAL VOLT2, 102
 - calibration commands, 100
 - CAL LEV, 101
 - CAL SAVE, 102
 - CAL VOLT, 102
 - capabilities, 24
 - capacitance
 - compensation, 38
 - High, 38
 - Low, 38
 - switching, 38
 - capacitor discharge limit, 39
 - CC mode, 57, 58
 - character strings, 73
 - characteristics, 144
 - checklist, 29
 - checkout procedure, 45
 - cleaning, 30
 - clearing errors, 59
 - clearing protection, 59
 - combine commands
 - common commands, 70
 - from different subsystems, 70
 - root specifier, 70
 - command completion, 73
 - command summary
 - format, 104
 - border, 104
 - common command syntax, 99
 - common commands, 121, 125
 - *CLS, 135
 - *ESE, 135
 - *ESR?, 136
 - *IDN?, 136
 - *OPC, 136
 - *OPT?, 137
 - *PSC, 137
 - *RCL, 137
 - *RST, 138
 - *SAV, 138
 - *SRE, 139

Index

- *STB?, 139
- *TRG, 140
- *TST, 140
- *WAI, 140
- common mode voltage, 39
- compatibility
 - commands, 178
 - errors, 180
 - Fluke PM2811, 141
 - language, 177
 - power-on settings, 177
 - status model, 181
- controller connections, 43
- conventions used in this guide, 69
- conversion, ac line, 175
- CRD, 73
- crowbar circuit, 39
- current, 76
 - maximum, 76
 - measurement range, 81
- current measurement detector, 111
- current measurement range, 60, 61, 62, 111
- current range, 53, 60, 61, 62
- current sinking, 25
- CV mode, 25, 57, 58

—D—

- damage, 30
- DC**, 111
- DC current detector, 60, 61, 62
- description, 23
- determining cause of interrupt, 92
- device clear, 74
- DFI, 94
- DFI programming example, 173
- DFI signal, 42
- DIGIO, 63
- digital connector, 30, 42
- digital I/O, 42
 - connections, 43
- digital I/O port, 94
- digital output port, 63
- dimensions, 30
- disabling multiple units, 42
- discrete fault indicator, 94
- display commands, 103, 125
 - DISP, 103
 - DISP CHAN, 103
 - DISP MODE, 103
 - DISP TEXT, 103
- downprogramming, 25
- dry switch, 27, 114
- DTR-DSR, 68
- DVM
 - common mode voltage, 39
 - connections, 39, 41
 - floating voltage measurement, 41
 - measurements, 39

—E—

either, 133

- enabling the output, 75
- enter value, 57, 58
- entry keys, 55
 - ←, 55
 - 0 ... 9, 55
 - Backspace, 55
 - Clear Entry, 55
 - Enter Number, 55
- error handling, 166
- error messages, 47
- error numbers, 161
- errors, 59
- example
 - DFI programming, 173
 - IBM controller using National interface, 166
 - programs, 165
 - pulse measurement, 169
 - pulse measurement, 169, 170, 173
- external relays, 33

—F—

- fault indicator
 - discrete, 93
 - remote inhibit, 93
- fetch commands, 79, 80, 83, 104
- FLT, 63, 94
- FLT output, 42
- Fluke PM2811 compatibility, 141
- format commands, 104
 - FORM, 104
 - BORD, 105
- front panel, 49
 - annunciators, 18
 - annunciators, 50
 - buffer size, 60, 61, 62
 - controls, 24
 - controls and indicators, 49
 - immediate actions, 18
 - keys, 50
 - measurements, 60, 61, 62
 - menus, 19
 - time interval, 60, 61, 62
 - using, 17
- function keys, 52
 - ▲, 52
 - Cal, 54
 - Current, 54
 - immediate action, 52
 - Input, 53
 - Meter, 53
 - OCP, 52
 - Output, 54
 - Output On/Off, 52
 - OV, 54
 - Prot Clear, 52
 - Protect, 54
 - Voltage, 54
- fuses, 31

—G—

generating measurement triggers, 85, 86

generating triggers, 78

GP-IB

- command library for MS DOS, 65
- controller programming, 65
- IEEE Std for standard codes, 65
- IEEE Std for standard digital interface, 65
- references, 65

GP-IB, 63

- address, 63
- address, 67
- address in programs, 165
- capabilities of the dc source, 67
- connections, 43
- interface, 43
- triggers, 86

GP-IB address, 24

ground, earth, 22

guide, user's, 21

—H—

Hanning, 80, 113

header, 71

- long form, 71

- short form, 71

High measurements, 82

history, 6

hot switch, 27, 114

—I—

impedance, 33

INH, 63, 93

INH input, 42

initialization, 75

initiate commands, 126

- INIT CONT NAME, 127

- INIT CONT SEQ, 127

- INIT NAME, 126

- INIT SEQ, 126

initiating measurement trigger system, 85

initiating output trigger system, 78

input

- connections, 31

- power, 22

inspection, 30

instrument commands, 114

- INST COUP OUTP STAT, 114

- INST STAT, 141

internal, 134

internal triggers, 86

internally triggered measurements, 84

—L—

language, 177

language dictionary, 95

language setting, 24

latching, 116

lead resistance, 32

line fuse, 30, 175

- replacing, 48

line voltage conversion, 175

live, 116

load line, 25

load voltage drops, 32

local sensing, 37

location, 30

Low measurements, 82

—M—

making measurements, 60, 61, 62, 79, 80, 83

manuals, 30

MAV bit, 92

maximum measurements, 82

measure commands, 79, 80, 83, 104

- MEAS ARR CURR?, 105

- MEAS ARR VOLT?, 105

- MEAS CURR ACDC?, 106

- MEAS CURR HIGH?, 107

- MEAS CURR LOW?, 107

- MEAS CURR MAX?, 107

- MEAS CURR MIN?, 108

- MEAS CURR?, 106

- MEAS CURR2?, 106

- MEAS DVM ACDC?, 108

- MEAS DVM?, 108

- MEAS VOLT ACDC?, 109

- MEAS VOLT HIGH?, 109

- MEAS VOLT LOW?, 110

- MEAS VOLT MAX?, 110

- MEAS VOLT MIN?, 110

- MEAS VOLT?, 108

- MEAS VOLT2?, 109

measurement bandwidth, 53

measurement buffer, 53

measurement interval, 53

measurement ranges, 60, 61, 62

measurement samples, 79

measurement trigger system model, 84

measurements

- Hanning window, 80

- Rectangular window, 80

message terminator, 72

- end or identify, 72

- newline, 72

message unit

- separator, 72

minimum measurements, 82

model differences, 23

monitoring both phases of status transition, 93

moving among subsystems, 70

MSS bit, 92

multiple triggers, 78, 87

—N—

National Instruments GPIB driver, 165

negative, 133

non-volatile memory

- clearing, 64

- storing, 51, 54

numerical data formats, 72

Index

—O—

- OC, 59
- OCP, 76
- open sense protection, 36
- operation status group, 90
- option 521
 - description, 27
- optional header
 - example, 70
- options, 22
- OT, 59
- output
 - characteristic, 25
 - compensation, 57
 - connections, 32
 - connector, 30
 - control keys, 54
 - current setting, 57, 58
 - enable, 58, 59
 - rating, 25
 - relays, 27, 114
 - voltage setting, 57, 58
- output 2
 - characteristic, 26
 - rating, 26
- output commands, 114
 - OUTP, 114
 - OUTP COMP, 116
 - OUTP DFI, 115
 - OUTP DFI SOUR, 115
 - OUTP PON STAT, 115
 - OUTP PROT CLE, 116
 - OUTP PROT DEL, 116
 - OUTP PROT TRIP?, 141
 - OUTP REL MODE, 114
 - OUTP RI MODE, 116
- output compensation, 38, 54
- output queue, 92
- output trigger system model, 77
- OV, 59
- OVERCURRENT, 47
- overcurrent protection, 76
- OVERTEMPERATURE, 47
- OVERVOLTAGE, 47
- OVL, 47, 60, 61, 62
- OVP
 - circuit, 39
 - disable, 39
 - disabling, 39, 54

—P—

- PON (power on) bit, 91
- positive, 133
- post-event triggering, 88
- power cord, 30, 31
- power receptacle, 22
- power-on conditions, 89
- power-on initialization, 75
- pre-event triggering, 88
- print date, 6
- program examples, 165

- programming parameters, 99
- programming status registers, 88
- programming the output, 75
- protection
 - FS, 59
 - OC, 59
 - OT, 59
 - OV, 59
 - RI, 59
- pulse measurement example, 169, 170, 173
- pulse measurement queries, 82

—Q—

- queries, 71
- query
 - indicator, 72
- query protection, 59
- questionable status group, 91

—R—

- rack mount kit, 22
- rack mounting, 31
- rear panel
 - at a glance, 16
 - connections, 42, 43, 44
- recalling operating states, 64
- Rectangular, 80, 112, 113
- relay mode, 27
- remote inhibit, 93
- REMOTE INHIBIT, 47
- remote programming, 24
- remote sensing
 - load regulation, 35
 - OVP considerations, 35
 - stability, 35
 - with external relays, 34
 - with test fixture, 34
- repacking, 30
- resistance
 - sense leads, 36
- returning voltage or current data, 83
- RI, 59, 93
 - signal, 42
- RIDFI, 63
- rms measurements, 81, 83
- root specifier, 72
- RQS bit, 92
- RS-232, 63
 - capabilities of the dc source, 67
 - connections, 44
 - data format, 67
 - flow control, 68
 - interface, 44
- RTS-CTS, 68

—S—

- safety, 5
- safety class, 22
- safety warning, 22

- saving operating states, 64
 - SCPI
 - command tree, 69
 - common commands, 69
 - header path, 70
 - multiple commands, 70
 - subsystem commands, 69
 - SCPI
 - command completion, 73
 - command syntax, 95
 - conformance, 74
 - data format, 72
 - device clear, 74
 - message structure, 71
 - message types, 71
 - message unit, 71
 - non-conformance, 74
 - program message, 71
 - references, 65
 - response message, 71
 - subsystem commands, 95
 - triggering nomenclature, 77, 84
 - SCPI commands
 - at a glance, 20
 - selecting measurement trigger source, 85
 - selftest errors, 47
 - sense commands, 104
 - SENS CURR DET, 111
 - SENS CURR RANG, 111
 - SENS FUNC, 112
 - SENS PROT STAT, 112
 - SENS SWE OFFS POIN, 112
 - SENS SWE POIN, 112
 - SENS SWE TINT, 113
 - SENS WIND, 113
 - sense open, 36
 - servicing operation status, 92
 - servicing questionable status events, 92
 - setting output trigger system, 77
 - setting voltage/current, 57, 58
 - shorting switch, 42
 - single triggers, 78, 86
 - source commands
 - [SOUR] CURR PROT STAT, 118
 - [SOUR] CURR TRIG, 118
 - [SOUR] CURR2 TRIG, 118
 - [SOUR] DIG DATA, 119
 - [SOUR] DIG FUNC, 119
 - [SOUR] VOLT, 119
 - [SOUR] VOLT PROT, 120
 - [SOUR] VOLT PROT STAT, 120
 - [SOUR] VOLT TRIG, 121
 - [SOUR] VOLT2, 120
 - [SOUR] VOLT2 TRIG, 121
 - source commands, 114
 - [SOUR] CURR, 117
 - [SOUR] CURR LIM HIGH?, 141
 - [SOUR] CURR LIM LOW?, 141
 - [SOUR] CURR PROT TRIP?, 142
 - [SOUR] CURR2, 117
 - [SOUR] VOLT LIM HIGH?, 142
 - [SOUR] VOLT LIM LOW?, 142
 - [SOUR] VOLT PROT TRIP?, 142
 - specifications, 143
 - SRD, 73
 - stability with remote sensing, 35
 - standard event status group, 91
 - status bit configurations, 90
 - status byte register, 91
 - status commands, 121
 - STAT OPER COND?, 122
 - STAT OPER ENAB, 122
 - STAT OPER NTR, 123
 - STAT OPER PTR, 123
 - STAT OPER?, 122
 - STAT PRES, 121
 - STAT QUES COND?, 124
 - STAT QUES ENAB, 124
 - STAT QUES NTR, 124
 - STAT QUES PTR, 124
 - STAT QUES?, 123
 - status model, 89
 - subsystem commands syntax, 96
 - suffixes, 73
 - support rails, 31
 - system commands, 125
 - SYST ERR?, 125
 - SYST LANG, 125, 177
 - SYST VERS?, 125
 - system errors, 161
 - system keys, 51
 - Address, 51
 - Error, 51
 - Interface, 51
 - Local, 51
 - RCL, 51
 - Save, 51
 - Shift, 51
- T—
- transient response, 143
 - trigger commands, 126
 - TRIG, 127
 - TRIG ACQ, 128
 - TRIG ACQ COUN CURR, 128
 - TRIG ACQ COUN DVM, 128
 - TRIG ACQ COUN VOLT, 129
 - TRIG ACQ HYST CURR, 129
 - TRIG ACQ HYST DVM, 130
 - TRIG ACQ HYST VOLT, 130
 - TRIG ACQ LEV CURR, 131
 - TRIG ACQ LEV DVM, 131
 - TRIG ACQ LEV VOLT, 132
 - TRIG ACQ SLOP CURR, 132
 - TRIG ACQ SLOP DVM, 133
 - TRIG ACQ SLOP VOLT, 133
 - TRIG ACQ SOUR, 134
 - TRIG SEQ1 DEF, 134
 - TRIG SEQ2, 128
 - TRIG SEQ2 COUN CURR, 128
 - TRIG SEQ2 COUN DVM, 128
 - TRIG SEQ2 COUN VOLT, 129
 - TRIG SEQ2 DEF, 134
 - TRIG SEQ2 HYST CURR, 129
 - TRIG SEQ2 HYST DVM, 130
 - TRIG SEQ2 HYST VOLT, 130

Index

- TRIG SEQ2 LEV CURR, 131
 - TRIG SEQ2 LEV DVM, 131
 - TRIG SEQ2 LEV VOLT, 132
 - TRIG SEQ2 SLOP CURR, 132
 - TRIG SEQ2 SLOP DVM, 133
 - TRIG SEQ2 SLOP VOLT, 133
 - TRIG SEQ2 SOUR, 134
 - TRIG SOUR, 127
 - trigger offset, 88
 - triggering output changes, 77
 - triggers
 - multiple, 78, 87
 - single, 78, 86
 - turn-on checkout, 148
 - TYPE
 - CAP, 54
 - types of SCPI commands, 69
- U—
- UNR annunciator, 26
- V—
- verification
 - current measurement accuracy, 149, 151
 - current programming, 149, 151
 - equipment, 147
 - setup, 147
 - test record, 154
 - voltage measurement accuracy, 149, 155, 158
 - voltage programming, 149, 155, 158
 - voltage, 76
 - maximum, 76
 - voltage deviation with open sense, 36
 - VXIplug&play, 21
- W—
- waiting for measurement results, 87
 - warranty, 2
 - wire
 - current ratings, 32
- X—
- XON-XOFF, 68
- verification

Agilent Sales and Support Office

For more information about Agilent Technologies test and measurement products, applications, services, and for a current sales office listing, visit our web site: <http://www.agilent.com/find/tmdir>

You can also contact one of the following centers and ask for a test and measurement sales representative.

United States:

Agilent Technologies
Test and Measurement Call Center
P.O. Box 4026
Englewood, CO 80155-4026
(tel) 1 800 452 4844

Latin America:

Agilent Technologies
Latin American Region Headquarters
5200 Blue Lagoon Drive, Suite #950
Miami, Florida 33126
U.S.A.
(tel) (305) 267 4245
(fax) (305) 267 4286

Canada:

Agilent Technologies Canada Inc.
5150 Spectrum Way
Mississauga, Ontario
L4W 5G1
(tel) 1 877 894 4414

Australia/New Zealand:

Agilent Technologies Australia Pty Ltd
347 Burwood Highway
Forest Hill, Victoria 3131
(tel) 1-800 629 485 (Australia)
(fax) (61 3) 9272 0749
(tel) 0 800 738 378 (New Zealand)
(fax) (64 4) 802 6881

Europe:

Agilent Technologies
Test & Measurement European Marketing Organisation
P.O. Box 999
1180 AZ Amstelveen
The Netherlands
(tel) (31 20) 547 9999

Asia Pacific:

Agilent Technologies
24/F, Cityplaza One, 1111 King's Road,
Taikoo Shing, Hong Kong
tel: (852)-3197-7777
fax: (852)-2506-9284

Japan:

Agilent Technologies Japan Ltd.
Measurement Assistance Center
9-1, Takakura-Cho, Hachioji-Shi,
Tokyo 192-8510, Japan
(tel) (81) 426 56 7832
(fax) (81) 426 56 7840

Technical data is subject to change.

Manual Updates

The following updates have been made to this manual since its publication.

7/22/99

Additional information about CV mode operation has been added to pages 25 and 26.

The sampling rate for output 2 has been corrected on pages 106 and 109.

The option number referred to under Output Type has been corrected on page 116.

1/7/00

All references to HP have been changed to Agilent. References to HP-IB have been changed to GPIB.

Information about Output Coupling has been added to pages 18, 19, 20, 54, 56 and 96.

A note about magnetic fields has been added to page 31.

Information about installing instrument drivers has been updated on page 64.

The Output command has been updated on page 114.

The INSTRument:COUPle:OUTPut:STATe command has been added to page 114.

3/10/00

H2 mode has been added to the OUTput:TYPE command on pages 19, 20, 37, 38, 54, 57, 97, and 116.

Option 521 has been added to table 2-1 on page 22.

Note 3 has been added to the specifications table on page 143.

Step 6 has been added to the DVM Measurement Accuracy procedure on page 151.

The Negative Voltage measurement values have been corrected on pages 152 and 153.

A note has been added to page 156. Error -114 has been added to page 161.

6/30/00

Information about Option 521 has been added to page 27.

Information about load regulation and voltage drop in the remote sense leads has been added to page 35.

The OUTPut[1 | 2]:RELay:MODE command has been added to pages 19, 20, 54, 58, 97, and 114.

The definition of the Transient Response specification on page 143 has been updated.

Minor corrections have been made to the Programming Resolution, Voltage Rise Time, and Voltage Settling Time characteristics on page 144. Table A-4 has been added to Appendix A.

10/03/01

The Current Sink verification procedure has been corrected in Appendix B.

Program Example 2 has been updated in Appendix D.

2/9/05

The Declaration Page is updated. The test record cards in Appendix B are corrected for ISO 17025.

9/18/08

All references to the RS-232 connector and the Agilent 14575A remote front panel have been removed from this manual. The RS-232 connector and its functionality were removed from the Agilent 66311B/D models starting March, 2008.

9/10/09

A URL has been added to the declarations pages to obtain the latest declaration of conformity.

Corrections have been made to Figure 3-11.

The RF field annotation note has been removed from Table A-1.

The RS-232 connector and its functionality have been added back to Agilent 66311B/D models.

6/13/12

Information about Mains Input Ratings for Model 66311B/D has been updated on page 145.