

# THS3000 Series Oscilloscopes User Manual



077-0607-01

**Tektronix**



**THS3000 Series  
Oscilloscopes  
User Manual**

Copyright © Tektronix. All rights reserved. Licensed software products are owned by Tektronix or its subsidiaries or suppliers, and are protected by national copyright laws and international treaty provisions.

Tektronix products are covered by U.S. and foreign patents, issued and pending. Information in this publication supersedes that in all previously published material. Specifications and price change privileges reserved.

TEKTRONIX and TEK are registered trademarks of Tektronix, Inc.

## **Contacting Tektronix**

Tektronix, Inc.  
14150 SW Karl Braun Drive  
P.O. Box 500  
Beaverton, OR 97077  
USA

For product information, sales, service, and technical support:

- In North America, call 1-800-833-9200.
- Worldwide, visit [www.tektronix.com](http://www.tektronix.com) to find contacts in your area.

## Warranty

Tektronix warrants that this product will be free from defects in materials and workmanship for a period of three (3) years from the date of shipment. If any such product proves defective during this warranty period, Tektronix, at its option, either will repair the defective product without charge for parts and labor, or will provide a replacement in exchange for the defective product. Parts, modules and replacement products used by Tektronix for warranty work may be new or reconditioned to like new performance. All replaced parts, modules and products become the property of Tektronix.

In order to obtain service under this warranty, Customer must notify Tektronix of the defect before the expiration of the warranty period and make suitable arrangements for the performance of service. Customer shall be responsible for packaging and shipping the defective product to the service center designated by Tektronix, with shipping charges prepaid. Tektronix shall pay for the return of the product to Customer if the shipment is to a location within the country in which the Tektronix service center is located. Customer shall be responsible for paying all shipping charges, duties, taxes, and any other charges for products returned to any other locations.

This warranty shall not apply to any defect, failure or damage caused by improper use or improper or inadequate maintenance and care. Tektronix shall not be obligated to furnish service under this warranty a) to repair damage resulting from attempts by personnel other than Tektronix representatives to install, repair or service the product; b) to repair damage resulting from improper use or connection to incompatible equipment; c) to repair any damage or malfunction caused by the use of non-Tektronix supplies; or d) to service a product that has been modified or integrated with other products when the effect of such modification or integration increases the time or difficulty of servicing the product.

THIS WARRANTY IS GIVEN BY TEKTRONIX WITH RESPECT TO THE PRODUCT IN LIEU OF ANY OTHER WARRANTIES, EXPRESS OR IMPLIED. TEKTRONIX AND ITS VENDORS DISCLAIM ANY IMPLIED WARRANTIES OF MERCHANTABILITY OR FITNESS FOR A PARTICULAR PURPOSE. TEKTRONIX' RESPONSIBILITY TO REPAIR OR REPLACE DEFECTIVE PRODUCTS IS THE SOLE AND EXCLUSIVE REMEDY PROVIDED TO THE CUSTOMER FOR BREACH OF THIS WARRANTY. TEKTRONIX AND ITS VENDORS WILL NOT BE LIABLE FOR ANY INDIRECT, SPECIAL, INCIDENTAL, OR CONSEQUENTIAL DAMAGES IRRESPECTIVE OF WHETHER TEKTRONIX OR THE VENDOR HAS ADVANCE NOTICE OF THE POSSIBILITY OF SUCH DAMAGES.

[W4 – 15AUG04]



---

# Table of Contents

General safety summary .....	vi
Preface .....	ix
Where To Find More Information .....	x
Terms Used In This Manual .....	x

## Getting Started

Introduction .....	1-1
Product Description .....	1-1
Front Panel Navigation .....	1-2
Initial Setup .....	1-9
Restore Factory Default Settings .....	1-12
Tilt Stand, Hanging Hook, and Kensington® Lock .....	1-13

## Operating Basics

Operating Basics .....	2-1
Input Connections .....	2-1
About Floating Measurements .....	2-2
Connect Probes and Leads .....	2-4
Select an Input Channel .....	2-12
Adjust the Probe Type Settings .....	2-13
Display an Unknown Signal with Autoset or AutoRange™ .....	2-13
Automatic Measurements .....	2-15
Stop the Display .....	2-18
Average, Persistence, and Glitch Capture .....	2-19
Acquire Waveforms .....	2-22
Pass-Fail Testing .....	2-30

## Functional Overview

Recorder Functions .....	3-1
Plot Measurements Over Time (TrendPlot™) .....	3-1
Record Waveforms In Deep Memory (Scope Roll Mode) .....	3-3
Analyze Waveforms .....	3-6
Use Replay .....	3-6
Use Zoom .....	3-7
Use Cursors .....	3-9

Trigger Functions .....	3-14
Save and Recall .....	3-25
Troubleshooting .....	3-33

## Appendices

Appendix A: Specifications .....	A-1
Introduction .....	A-1
General Specifications .....	A-1
Automatic Measurements .....	A-6
Recorder Specifications .....	A-9
Zoom, Data Log, and Cursors Specifications .....	A-9
Miscellaneous Specifications .....	A-10
Safety Specifications .....	A-13
Probe Specifications .....	A-15
Appendix B: Connect the Instrument to a Computer .....	B-1
USB Ports .....	B-2
Install USB Drivers .....	B-3
Confirm Oscilloscope and PC Communication .....	B-4
Appendix C: Probe Compensation and Compatible Maximum Voltages .....	C-1
Compensate Voltage Probes .....	C-1
Compatible Probe Maximum Voltages .....	C-3
Appendix D: Battery Pack .....	D-1
Save Battery Life .....	D-1
Charge the Batteries .....	D-2
Appendix E: Maintenance and Cleaning .....	E-1
Maintaining the Instrument .....	E-1
Cleaning .....	E-1
Storage .....	E-1

## Index

Index



---

# List of Figures

Figure 1-1: Instrument front panel.....	1-3
Figure 1-2: Rising edge of square wave .....	1-12
Figure 1-3: Tilt stand and location of Kensington® Lock .....	1-13
Figure 1-4: How to use the hanging hook handle.....	1-14
Figure 1-5: How to use the hanging strap handle.....	1-15
Figure 2-1: Top panel input connectors.....	2-1
Figure 2-2: Isolated input architecture .....	2-2
Figure 2-3: Common-reference input architecture.....	2-3
Figure 2-4: Parasitic capacitance between probes, instrument, and environment.....	2-5
Figure 2-5: Parasitic capacitance between analog and digital reference .....	2-6
Figure 2-6: Correct connection of reference leads.....	2-6
Figure 2-7: Wrong connection of reference leads.....	2-7
Figure 2-8: Making voltage probe connections on four channels.....	2-8
Figure 2-9: Voltage probe connection using a ground spring.....	2-9
Figure 2-10: Connections using hook tips and alligator clip grounding.....	2-10
Figure 2-11: Probe tip ground ring .....	2-11
Figure 2-12: Display with Autoset .....	2-14
Figure 2-13: Display with AutoRange™ .....	2-15
Figure 2-14: Hz and V peak-peak as measurements.....	2-17
Figure 2-15: Frozen (stopped) display .....	2-18
Figure 2-16: Live (running) display.....	2-19
Figure 2-17: Using persistence to observe dynamic signals.....	2-21
Figure 2-18: FFT measurement .....	2-27
Figure 3-1: RECORDER REPLAY main menu .....	3-1
Figure 3-2: TrendPlot™ measurement.....	3-2
Figure 3-3: Recording waveforms using Scope Roll Mode .....	3-3
Figure 3-4: Zooming in on a Waveform .....	3-8
Figure 3-5: Voltage measurement with horizontal cursors.....	3-10
Figure 3-6: Time measurement with vertical cursors.....	3-12
Figure 3-7: Risetime measurement using cursors.....	3-13
Figure 3-8: Screen with all trigger information .....	3-17
Figure 3-9: Trigger delay or pretrigger view .....	3-18
Figure 3-10: Making a single shot measurement .....	3-21
Figure 3-11: N-Event triggering .....	3-22
Figure 3-12: Trigger on NTSC video signal field 1.....	3-23
Figure 3-13: Pulse width triggering .....	3-24

Figure A-1: Input voltage versus frequency .....	A-14
Figure A-2: Maximum voltage between oscilloscope references, and between oscilloscope references and earth ground .....	A-14
Figure B-1: Instrument USB connections .....	B-2
Figure C-1: Compensating voltage probes .....	C-2

## List of Tables

Table i: Product documentation .....	x
Table 2-1: Comparison of averaged versus nonaveraged waveforms .....	2-20
Table 2-2: Pixel colors description .....	2-30
Table 3-1: Trigger types .....	3-15
Table 3-2: Internal memory .....	3-25
Table A-1: Record Length (Samples/points per input) .....	A-1
Table A-2: Oscilloscope Inputs .....	A-2
Table A-3: Automatic measurement specifications .....	A-6
Table A-4: Recorder .....	A-9
Table A-5: Zoom, Data Log, and Cursors .....	A-9
Table A-6: Display .....	A-10
Table A-7: Power .....	A-10
Table A-8: Probe Calibration Output Signal .....	A-11
Table A-9: Memory .....	A-11
Table A-10: Interface Ports .....	A-12
Table A-11: Mechanical .....	A-12
Table A-12: Environmental .....	A-12
Table A-13: Safety specifications .....	A-13
Table A-14: THP0301 Voltage Probe .....	A-15
Table C-1: Compatible probe maximum voltages .....	C-3

## General safety summary

Review the following safety precautions to avoid injury and prevent damage to this product or any products connected to it.

To avoid potential hazards, use this product only as specified.

*Only qualified personnel should perform service procedures.*

While using this product, you may need to access other parts of a larger system. Read the safety sections of the other component manuals for warnings and cautions related to operating the system.

### To avoid fire or personal injury

**Use proper power cord.** Use only the power cord specified for this product and certified for the country of use.

**Connect and disconnect properly.** Do not connect or disconnect probes or test leads while they are connected to a voltage source.

**Connect and disconnect properly.** Connect the probe output to the measurement instrument before connecting the probe to the circuit under test. Connect the probe reference lead to the circuit under test before connecting the probe input. Disconnect the probe input and the probe reference lead from the circuit under test before disconnecting the probe from the measurement instrument.

**Observe all terminal ratings.** To avoid fire or shock hazard, observe all ratings and markings on the product. Consult the product manual for further ratings information before making connections to the product.

Do not apply a potential to any terminal, including the common terminal, that exceeds the maximum rating of that terminal.

**Power disconnect.** The power cord disconnects the product from the power source. Do not block the power cord; it must remain accessible to the user at all times.

**Do not operate without covers.** Do not operate this product with covers or panels removed.

**Do not operate with suspected failures.** If you suspect that there is damage to this product, have it inspected by qualified service personnel.

**Avoid exposed circuitry.** Do not touch exposed connections and components when power is present.

**Replace batteries properly.** Replace batteries only with the specified type and rating.

**Use proper AC adapter.** Use only the AC adapter specified for this product.

**Do not operate in wet/damp conditions.**

**Do not operate in an explosive atmosphere.**

**Keep product surfaces clean and dry.**

**Terms in this manual** These terms may appear in this manual:



**WARNING.** *Warning statements identify conditions or practices that could result in injury or loss of life.*



**CAUTION.** *Caution statements identify conditions or practices that could result in damage to this product or other property.*

**Symbols and terms on the product**

These terms may appear on the product:

- DANGER indicates an injury hazard immediately accessible as you read the marking.
- WARNING indicates an injury hazard not immediately accessible as you read the marking.
- CAUTION indicates a hazard to property including the product.

The following symbol(s) may appear on the product:



CAUTION  
Refer to Manual



Double  
Insulated



Earth Terminal



# Preface

This manual contains operating information for the Tektronix THS3024 and THS3014 Handheld Oscilloscopes. It consists of the following chapters:

- The *Getting Started* chapter briefly describes features of the instrument, front panel navigation, button menus, and provides installation instructions and a functional check procedure. (See page 1-1.)
- The *Operating Basics* chapter provides information about operating the front panel, what functions each menu accesses, how to connect to inputs, and using the tilt and security features. (See page 2-1.)
- The *Functional Overview* chapter provides an overview of how the various functions and features of the instrument operate. (See page 3-1.)
- The *Appendix A: Specifications* chapter includes electrical, environmental, physical specifications for the instrument, and certifications and compliances. (See page A-1.)
- The *Appendix B: Connect The Instrument to a Computer* chapter provides procedures for connecting the instrument to a computer and installing USB drivers and OpenChoice™ Desktop software. (See page B-1.)
- The *Appendix C: Probe Calibration and Compatible Maximum Voltages* chapter provides calibration and other probe information. (See page C-1.)
- The *Appendix D: Battery Pack* chapter provides information about how to preserve battery life and charge the battery. (See page D-1.)
- The *Appendix E: Maintenance and Cleaning* chapter describes how to take care of the instrument. (See page E-1.)

## Where To Find More Information

You can find more information about your instrument in the following documents. These documents can be found on the Tektronix Web site at [www.tektronix.com/manuals](http://www.tektronix.com/manuals), on the Product Documentation CD that shipped with your instrument, or both.

**Table i: Product documentation**

To read about	Use these documents
Compliance, safety, standard and optional equipment and accessories, power on and off, battery installation	Installation and Safety Instructions available printed, on the Product Documentation CD that shipped with your instrument, and for download at <a href="http://www.tektronix.com/manuals">www.tektronix.com/manuals</a> .
Operation, configuration, specifications, and instrument capabilities	User manual (this manual) available in English, German, Russian, Korean, Japanese, Simplified Chinese, and Traditional Chinese on the Product Documentation CD that shipped with your instrument and for download at <a href="http://www.tektronix.com/manuals">www.tektronix.com/manuals</a> .
Performance verification procedures	Performance Verification manual available on the Product Documentation CD that shipped with your instrument, and for download at <a href="http://www.tektronix.com/manuals">www.tektronix.com/manuals</a> .
Declassification and security	Declassification and Security Instructions available for download at <a href="http://www.tektronix.com/manuals">www.tektronix.com/manuals</a>

## Terms Used In This Manual

**Isolated, electrically floating.** The terms “isolated” or “electrically floating” are used in this manual to indicate a measurement in which the product input BNC is connected to a voltage different from earth ground.

**Working voltage.** Voltage ratings that are mentioned in the warnings in this manual are given as limits for “working voltage”. They represent V AC RMS (50-60 Hz) for AC sine wave applications and as V DC for DC applications.



---

# Getting Started



---

# Introduction

In addition to a product and feature description, this chapter covers the following topics:

- How to perform a quick functional check, install and compensate passive probes, compensate the signal path, and set the time and date
- How to use the front panel and menu system
- How to identify the instrument controls and connectors

This chapter provides information about instrument setup, menus, and basic functions. This introduction does not cover all of the capabilities of the instrument but gives basic examples to show how to use the menus and perform basic operations.

## Product Description

The Tektronix THS3024 and THS3014 Four Channel Handheld Oscilloscopes are rugged, handheld oscilloscopes ideal for the lab and field.

### General Features

- Four fully isolated input channels
- Volts, Time, Frequency and Watts cursor measurements
- Bright, high contrast QVGA color display
- 7 hour battery operation or external AC/DC adapter power
- 21 automatic measurements
- Comprehensive data logging and analysis capabilities
- USB 2.0 device and host support for exchanging images, waveforms, and settings
- Tektronix OpenChoice® Desktop software for capturing screen images, waveforms, and settings

### Key Features

- Autoset and Autoranging for quick setup and hands-free operation
- 200 MHz bandwidth (3024 model)
- 100 MHz bandwidth (3014 model)
- 5 GS/s maximum sampling rate (3024 model)
- Waveform averaging and enveloping with hardware peak detection
- Advanced pulse and video trigger capability

**Accessories** For a list of standard, optional, and service accessories, please see the Accessories section of the *THS3000 Series Oscilloscopes Installation and Safety Instructions* that shipped with your instrument. You can also find an electronic copy on the Web at [www.tektronix.com/manuals](http://www.tektronix.com/manuals) and on the product documentation CD that was shipped with your instrument.

## Front Panel Navigation

When you press any front panel button, the associated menu, if there is one, will appear on the display screen.

**To select a menu item.** Press one of the four black buttons beneath the menu item you want to select. (See Figure 1-1.)

**To navigate through a submenu.** Use the up, down, right, and left arrow keys to navigate through submenus that may appear.

**To select a submenu item.** Press the **Enter** button.

**To exit a menu.** Press the related button again. For example, if you pressed **Acquire** to access the Acquire menu, press the **Acquire** button again to exit the menu.

**To hide a menu.** Press the **Menu Off** button to hide a menu. Press it again to view the same menu.

**Highlighted white menu items.** A menu item highlighted in white means that item is the current setting.

**Highlighted black menu items.** A menu item highlighted in black means that the selection cursor is on that item.

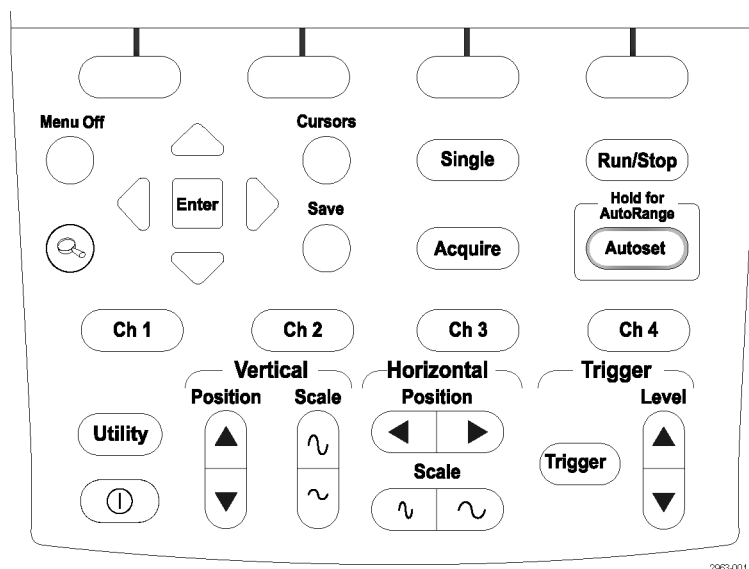

**Figure 1-1: Instrument front panel**

The front panel allows you to configure the instrument, access SW version information, display language options, and instrument functions. In this section of the manual, you can review the menus for each button. The buttons are listed in alphabetical order.

**Acquire** The **Acquire** button provides you access to acquisition parameters, such as measurements, recorder features, and special acquisition modes.



**The MEASURE submenu.** In addition to waveforms, the instrument can also display four measurements (A, B, C, D) which are independently selectable. Each measurement corresponds to any input (Ch 1, Ch 2, Ch 3, and Ch 4) combination, and you can select parameters for each measurement as follows:

For Measurements A-D

- On: Ch1, Ch2, Ch3, Ch4
- V: ac, dc, ac+dc, Peak (Max, Peak-Peak, Min)
- A: ac or dc or ac+dc (100  $\mu$ V/A, 1 mV/A, 10 mV/A, 100 mV/A, 400 mV/A, 1 V/A, 10 V/A, 100 V/A), Phase
- Measurement: Hz, Rise time (cursors), Fall time (cursors), Pulse (width positive, width negative)
- Decibels: Type (dBV, dBm 50  $\Omega$ , dBm 600  $\Omega$ ), On (Vac, Vdc, Vac+dc)

- Duty Cycle: Positive, Negative
- mAs (current): Sensitivity (100  $\mu$ V/A, 1 mV/A, 100 mV/A, 400 mV/A, 1 V/A, 10 V/A, 100 V/A)

**The RECORDER REPLAY submenu.** This submenu provides options for recording measurement data and screen images, and contains the following:

- Trend Plot: Recorder Run/Stop, Options (Time of Day, From Start), View All, Normal, Exit Recorder
- Scope Roll Mode: Recorder Run/Stop, Exit Recorder
- Data Log Replay: Previous, Next, Play, Exit Replay

**The ACQUIRE OPTIONS submenu.** This submenu provides acquisition options and contains the following:

- Glitch: On, Off
- Memory: Short, Long
- Average: Off, On (Average factor: 2, 4, 8, 64; Average: normal, smart)
- Waveform: Normal, Persistence (Off, Short, Medium, Long, Infinite, Display Normal, Display Envelope, Display Dot-join OFF), Mathematics (Function, Source A, Source B), Reference (On, Off, New, Recall, Pass/Fail Testing Off, Pass/Fail Testing Store Fail, Pass/Fail Testing Store Pass)

### Autoset (AutoRange)

Pressing the **Autoset** button results in the automatic setup of all active channels for vertical, horizontal, and trigger systems. Press and hold the Autoset button to activate the **AutoRange** function. This function provides continuous auto setup of vertical, horizontal, and trigger systems that track signal changes. Neither the Autoset function nor the AutoRange function has a dedicated setup menu. You can change Autoset mode from the **Utility>Options>Auto Set Adjust** menu.

### Ch 1 – Ch 4

The **Ch 1** and other channel buttons allow you to set probe input and probe parameters as follows:



**The INPUT 1 menu.** This menu allows you to turn Input 1 On and Off.

**The COUPLING menu.** This menu allows you to set input coupling to DC or AC.

**The PROBE 1 submenu.** This submenu allows you to set the probe type and attenuation or sensitivity as follows:

- Probe Type: Voltage, Current
- Attenuation (Voltage): 1:1, 10:1, 100:1, 1000:1, 20:1, 200:1
- Sensitivity (Current): 100  $\mu\text{V/A}$ , 1  $\text{mV/A}$ , 10  $\text{mV/A}$ , 100  $\text{mV/A}$ , 400  $\text{mV/A}$ , 1  $\text{V/A}$ , 10  $\text{V/A}$ , 100  $\text{V/A}$
- Probe Calibration: Start Yes, Start No

**The INPUT 1 OPTIONS submenu.** This submenu allows you to set the polarity and bandwidth parameters and contains the following:

- Polarity: Normal, Inverted, Variable
- Bandwidth: Full, 20 kHz (HF reject), 20 MHz

**Cursors** The **Cursors** button allows you to view and adjust cursors as follows:



**The CURSOR submenu.** This menu allows you to turn select from the following cursor types:

- I : Single vertical cursor
- II : Two vertical cursors
- = : Two horizontal cursors
- J : Rise time cursor
- L : Fall time cursor

**The MOVE submenu.** Press the arrows keys to move the cursor(s) right, left, up, or down.

**The T, 1/T, mVs, RMS submenu.** This submenu allows you to select the units to view for the distance between the cursors. This menu option is only available when the double vertical cursor is selected:

- T: time
- 1/T: 1/time or frequency
- mVs: Millivolts per second
- RMS: Root mean squared

**The AUTO/MANUAL submenu.** This submenu allows you to set the cursors to auto adjust or manual adjust. This menu is only available when the rise time or fall time cursor is selected.

**The 1, 2, 3, 4, M, OFF submenu.** This submenu allows you to select to which channel to apply the cursor or to turn the cursor off for a selected channel. Each number corresponds to the channel number.

**Enter** Use the **Enter** button to select menu items.

**Level** The **Level** button allows you to adjust the trigger input level.

**Menu Off** The **Menu Off** button allows you to hide any menu from the display. Press the button again to view the same menu.

**Position (horizontal)** Use the **Position** horizontal button to move a waveform left or right along the display grid.

**Position (vertical)** Use the **Position** vertical button to move a waveform up or down along the display grid.

**Run/Stop** Press the **Run/Stop** button to start and stop acquisition. When acquisition is running, the word RUN is displayed in the top right corner of the display screen outlined in green. When acquisition is stopped, the word STOP is displayed in the top right corner of the display screen outlined in red.

**Save** The **Save** button allows you to save, recall, copy, move, rename, and delete screens and setups to internal instrument memory or to the USB device as follows:



**The SAVE menu.** This menu allows you to select what to save where.

- MEMORY: Select from INT (internal instrument memory) or USB (USB memory device).
- Save to INT (or USB): Select to save Screen + Setup or Replay + Setup to internal instrument memory or USB device.

**The RECALL menu.** This menu allows you to recall DATA or SETUP from internal or USB device memory.



**The INT menu.** Select this menu item to capture a screen and setup to internal instrument memory. There is no submenu associated with this menu item.

**The FILE OPTIONS menu.** This menu allows you to do the following:

- MEMORY: Select from INT (internal instrument memory) or USB (USB memory device).
- COPY: Copy the highlighted file from internal memory to USB (or from USB to internal memory).
- MOVE: Move the highlighted file from internal memory to USB (or from USB to internal memory).
- RENAME: Rename the highlighted file.
- DELETE: Delete the highlighted file.
- SELECT ALL: This menu item allows you to select all saved files at once.

**Scale (horizontal)** Use the **Scale** horizontal button to shrink or expand the horizontal scale of the display grid. The value is displayed in the right bottom portion of the display screen.

**Scale (vertical)** Use the **Scale** vertical button to shrink or expand the vertical scale of the display grid for the selected input channel. The value is displayed in the left bottom portion of the display screen.

**Single** Press the **Single** button for a single acquisition. There is no menu associated with this button.

**Trigger** The **Trigger** button allows you to set various trigger parameters. The menu changes as shown here depending on whether trigger is set to automatic (first menu) or manual (second menu). All other menu items remain the same.



**AUTO LEVEL.** (Automatic setting only) Select automatic setting of trigger levels.

**AUTO TRIG.** (Manual setting only) Select from one of four programmed trigger conditions or enable the instrument to generate a trigger if a real trigger does not occur.

**SLOPE.** Select to trigger on the rising edge (**J**), falling edge (**L**), or either (**X**).

**The TRIGGER OPTIONS menu.** This menu allows you to select for the following trigger types and parameters:

- **Automatic Auto Level:** Select from > 15 Hz or > 1 Hz
- **Trigger Conditions:** Update (Auto, Normal, Single Shot), Trigger Filter (Off, Noise Reject, HF Reject), NEvent (Off, On)
- **Video on 1** (channel 1 only): Polarity (Positive, Negative), Signal type (PAL, NTSC, PALPlus, SECAM, Non interlaced)
- **Pulse Width on 1** (channel 1 only): Pulses (positive, negative), Condition (<t, >t, =t ( $\pm 10\%$ ),  $\neq t$  ( $\pm 10\%$ ), Update (On Trigger, Single Shot)

**The FIELD menu.** (Available for Video trigger only) You can select from Field 1 or 2 to trigger either on the first half of the frame (odd, field 1) or on the second half of the frame (even, field 2).

**The ALL LINES menu.** (Available for Video trigger only) Press this menu item to trigger on all line synchronization pulses (horizontal synchronization).

**The LINE NR menu.** (Available for Video trigger only) Press this menu item to enable the **LINE NR** option and use the Vertical Position button to view a specific video line in more detail.

**The WIDTH menu.** (Available for Pulse Width trigger only) Press the Vertical Position button to adjust the pulse width.

**The CONDITION menu.** (Available for Pulse Width trigger only) Press this menu item to select the condition for trigger: >t, <t, or Off.

## Utility

The **Utility** button allows you to access battery options, language options, version and calibration information and display brightness and contrast:



**The OPTIONS menu.** This submenu allows you to set the probe type and attenuation or sensitivity as follows:

- Auto Set Adjust: Search for signals above a specified Hz threshold, Input coupling (Set to DC, Unchanged), Display glitches (Set to On, Unchanged)
- Battery Save Options: Instrument Auto-Off (5 minutes, 30 minutes, Disabled), Display Auto-Off (30 seconds, 5 minutes, Disabled)
- Date Adjust: Year, Month, Day, Format (DD/MM/YY, MM/DD/YY)
- Time Adjust: Hours, Minutes, Seconds
- Factory Default: Select Yes or No

**The LANGUAGE menu.** This submenu allows you to select the language in which you want user messages to be displayed. Choose from English, French, German,

Spanish, Portuguese, Italian, Japanese, Simplified Chinese, Traditional Chinese, Russian, and Korean.

**The VERSION & CAL menu.** This submenu allows you to view instrument information including model and serial number, software version, and calibration date. You can also access information on battery level, status total capacity, time to empty, and battery serial number.

**The CONTRAST and LIGHT menu.** This menu item allows you to adjust display contrast and to dim the display. Use the right or left arrow keys to dim the display. Use the up and down arrow keys to adjust display contrast.

- Zoom** Press the **Zoom** button to zoom in on a specified segment of a waveform. The menu allows you to access the following:
- **GLITCH:** Select on or off.
  - **ZOOM:** Adjust the zoom using the up and down arrow keys.
  - **ZOOM ON/OFF:** Select on or off.

## Initial Setup

The following procedures describe how to power your instrument, turn it on and off, quickly verify that your instrument is powering on and functioning correctly, compensate passive probes using the built-in compensation signal and set the time and date.

- You should perform all initial setup procedures the first time you use the instrument.
- You should perform the probe compensation procedure whenever you attach a passive probe for the first time to any input channel.

- Battery Power** This instrument can be powered by the THSBAT, a 10.8 V custom UL recognized Li-ion battery pack. See the instructions that come with the battery for installation information. You can also find those instructions on the Tektronix Web site at [www.tektronix.com/manuals](http://www.tektronix.com/manuals).

Before using the battery, read the *THS3014 and THS3024 Four Channel Handheld Oscilloscopes Installation and Safety Instructions* that shipped with your instrument for important battery related safety information. This manual can also be found on the Tektronix Web site at [www.tektronix.com/manuals](http://www.tektronix.com/manuals).



**WARNING.** *Fire can cause personal injury and/or property damage. To prevent risk of fire, do not use any battery but the battery Tektronix shipped with this product. Only use the THSBAT battery pack with this product.*

**External Power** This instrument can also be powered externally with an AC power adapter (Tektronix part number 119-7900-00). This instrument can only be safely operated using this particular AC power adapter.

Use the supplied power cord with the adapter. For a list of available power cords, see the *THS3000 Series Oscilloscopes Installation and Safety Instructions* that shipped with your instrument. It can be also be found on the Tektronix Web site at [www.tektronix.com/manuals](http://www.tektronix.com/manuals).

Refer to the *Specifications* section of this manual for additional information on electrical specifications. (See page A-1.)



**WARNING.** *Fire can cause personal injury and/or property damage. To prevent risk of fire, do not use any AC adapter with this product other than the AC adapter provided by Tektronix with this instrument.*

---

- Power-On**
1. If you are using a battery pack, go to step 2. If you are using an external power source, check that the AC power adapter is connected to the instrument and that the adapter is connected to a power cord that is plugged into a properly grounded power outlet.
  2. Press the power button on the instrument front panel and the instrument will turn on. A power plug icon should appear in the upper right portion of the display showing that the instrument is powered from the AC adapter.

- Power-Off**
1. Press the power button on the instrument front panel to turn the instrument off.
  2. To remove power completely, disconnect the AC adapter from the side panel of the instrument (or remove the battery).

## Functional Check

After you have installed the battery or connected external power, perform this quick functional check to verify that your instrument is operating correctly. See the *THS3000 Series Oscilloscopes Installation and Safety Instructions* for battery installation and power information.

Perform this adjustment to match your probe to the input channel. This should be done whenever you attach a passive probe for the first time to any input channel. The calibration consists of a high frequency adjustment and a DC calibration for 10:1 probes and 100:1 probes. You can also read more about probe calibration. (See page C-1, *Probe Compensation and Compatible Maximum Voltages*.)

1. Press the power button on the front panel to turn on the instrument.
2. After a few seconds, you should see a colored trace on the display screen. The color of the trace corresponds to the color of the channel input button on the front panel.
3. Connect a voltage probe to the Ch 1 input BNC on the instrument top panel. The color at the base of each BNC matches the color of the associated channel button and the color of the probe.
4. Attach the probe tip and reference lead to the probe calibration connector located above the USB port on the left side of the instrument.

---

**NOTE.** *Connect the probe tip to the smallest metal connector (on the top) and the reference lead to the larger metal connector (on the bottom).*

---

5. Press the **Ch 1** button to view the menu.
6. Select **PROBE 1** and then use the arrow keys and the **Enter** button to choose the appropriate attenuation from the menu.
7. Return to the **PROBE 1** menu and select **PROBE CAL**.
8. Select **Yes**.
9. You will see the rising edge of a square wave on the display (approximately 500 Hz). This is the signal used to calibrate the probe. (See Figure 1-2.) (See page C-1, *Probe Compensation and Compatible Maximum Voltages*.)

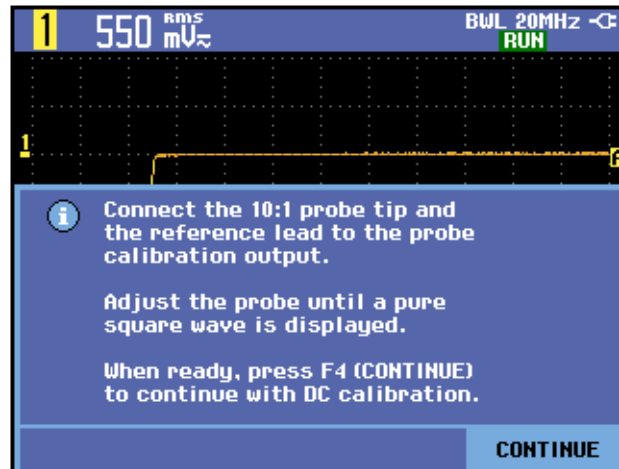

Figure 1-2: Rising edge of square wave

10. Adjust the probe as needed.
11. Select **Continue** and instrument will respond that the calibration is complete and the calibration signal will be removed.
12. Select **Close**.
13. Repeat steps 3 through 12 on all remaining channels.

## Restore Factory Default Settings

To reset the instrument to the factory default settings, do the following:

1. Press the power button on the front panel to turn on the instrument.
2. Press the **Utility** button.
3. Select **Options**.
4. Press the down arrow key and navigate to **Factory Default**.
5. Press the **Enter** button.
6. Select **Yes** when prompted to clear all memories and go back to factory defaults.
7. When the process is complete, the User Options menu will be displayed again. Select **Close** to exit the menu.

## Tilt Stand, Hanging Hook, and Kensington® Lock

**Tilt Stand** This instrument has a built-in tilt stand that folds out and folds back into place when not in use. For benchtop use, pull the portion of the tilt stand nearest to the base of the instrument up and away from the instrument until it locks. (See Figure 1-3.)

**Kensington® Lock** This instrument has a security slot compatible with a Kensington® lock. The Kensington Security Slot along with a locking cable provides physical security against thefts of opportunity. Locking cables are often available at laptop computer accessory dealers and other such stores. (See Figure 1-3.)

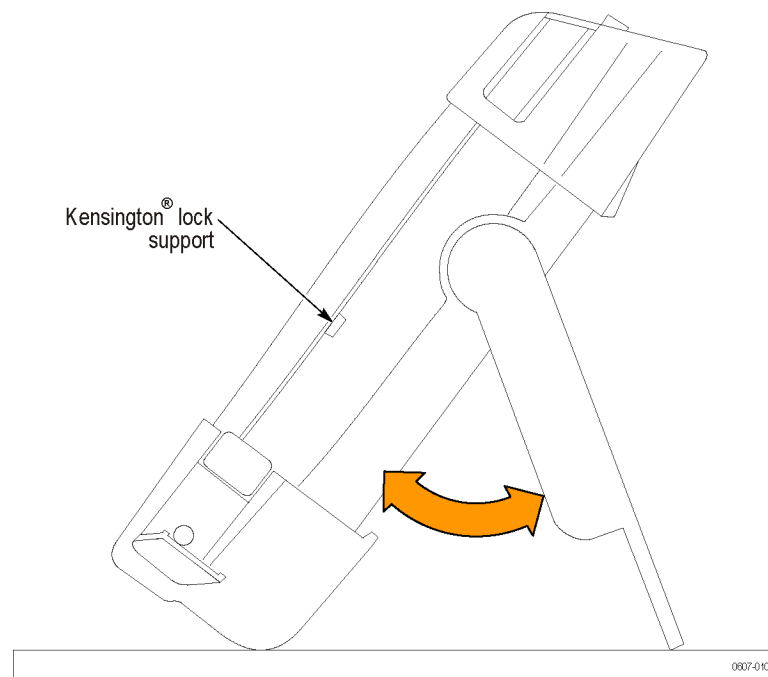

**Figure 1-3: Tilt stand and location of Kensington® Lock**

### Hanging Hook

To hang the instrument from a cabinet door, separation wall, or ladder rung, you can attach a hook handle (optional accessory). To attach the hook handle, close the tilt stand, screw the hook handle into the back of the instrument, and then hang the instrument where needed. (See Figure 1-4.)

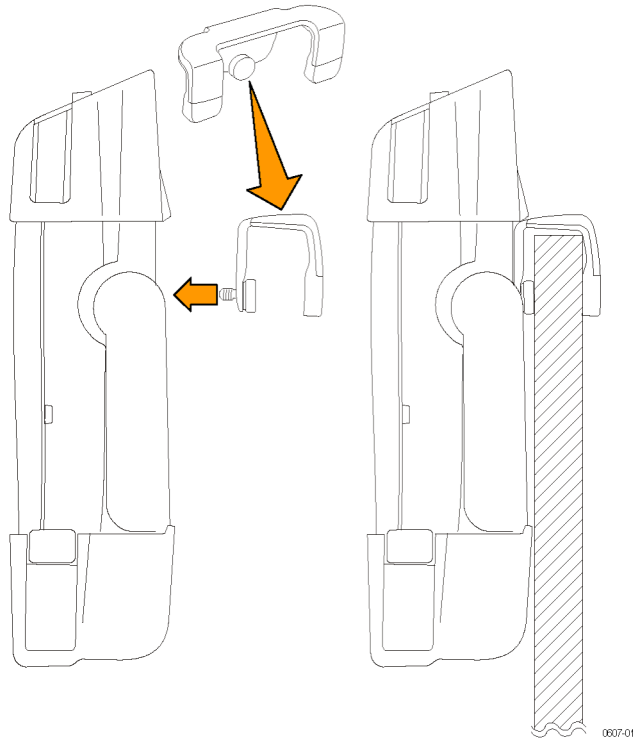
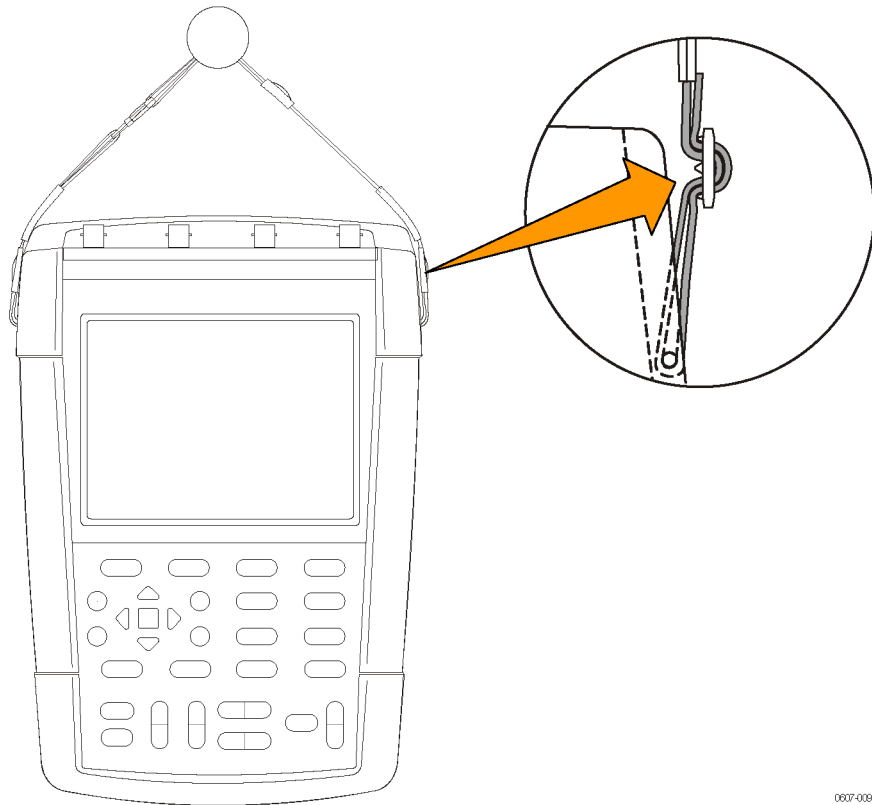

Figure 1-4: How to use the hanging hook handle



**Hanging Strap**

You can also hang the instrument from a door handle or similar object using the hanging strap handle. To attach the hanging strap to the instrument, thread it through the bars on the top right and left sides of the instrument and secure the ends as shown in the following figure. You can now hang the instrument as needed. (See Figure 1-5.)



0007-009

**Figure 1-5: How to use the hanging strap handle**



---

# Operating Basics



# Operating Basics

## Input Connections

The top panel of the instrument has four safety BNC jack signal inputs. The color at the base of each BNC input corresponds to the color of the related channel button on the front panel. Isolated input architecture allows independent floating measurements with each input. (See Figure 2-1.)

---

**NOTE.** Read the important safety information about taking floating measurements. (See page 2-2.)

---

### BNC Connectors

The instrument BNC reference connection is made on the inside of the BNC connector. The black bayonet on the outside of the BNC connectors does not provide electrical contact. For a good connection, make sure your probe or cable connector is pushed on and twist locked. Replace cables or probes that have worn connectors.

### Unterminated BNC Inputs

The black bayonet on the outside of the BNC input connectors does not shield the connector input from unwanted electrical noise from nearby circuits. Connect a 50  $\Omega$  terminator or a BNC shorting plug to the input BNC connector when establishing a “No Signal” baseline condition.

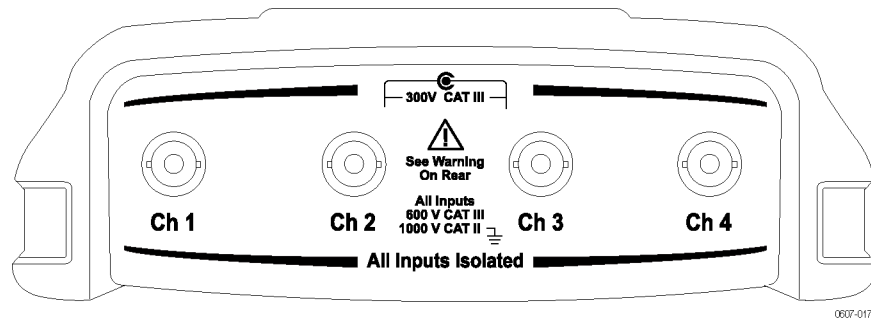

Figure 2-1: Top panel input connectors

## About Floating Measurements

You can use the independently floating isolated inputs to measure signals that are independently floating from each other. The instrument has independently floating isolated inputs. Each input section (1, 2, 3, and 4) has its own signal input and its own reference input. The reference input of each input section is electrically isolated from the reference inputs of the other input sections. (See Figure 2-2.)

The isolated input architecture of this instrument offers the following advantages:

- Simultaneous measurement of independently floating signals.
- Additional safety. Because the commons are not directly connected, the chance of causing a short circuit when measuring multiple signals is greatly reduced.
- Additional safety. When measuring in systems with multiple grounds, the ground currents induced are kept to a minimum.

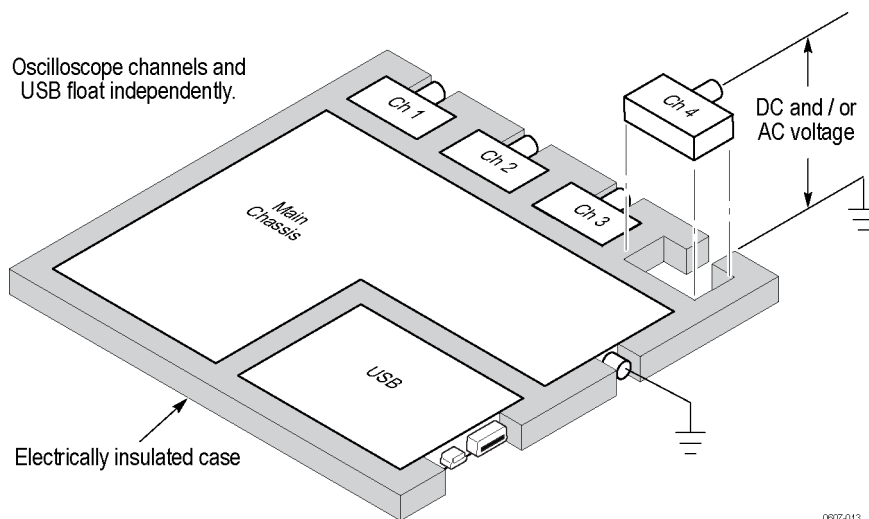

**Figure 2-2: Isolated input architecture**

Many handheld oscilloscope products have the architecture shown below, which shares a common reference for the oscilloscope channels. (See Figure 2-3.) With this architecture, all input signals must have the same voltage reference when you take any multi-channel measurements.

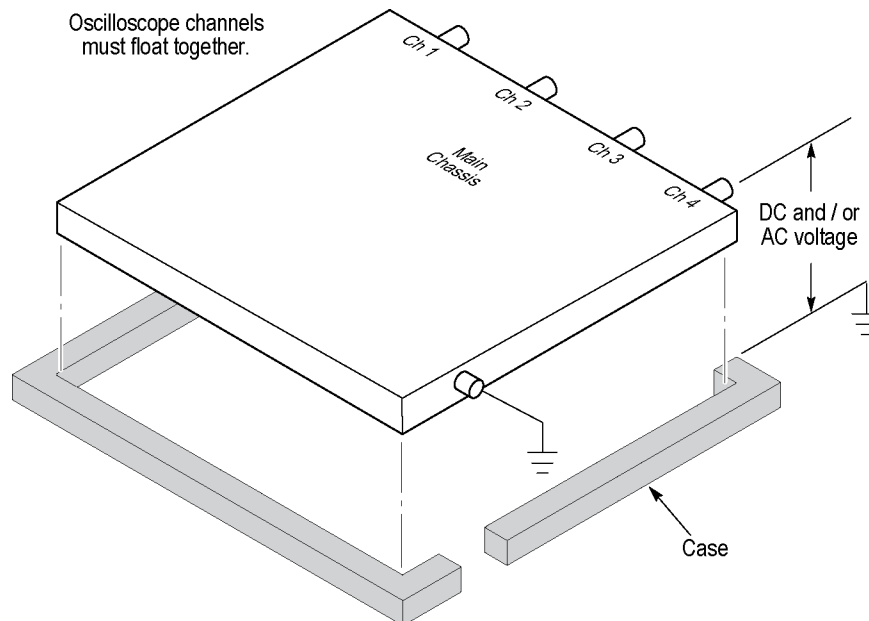

0907-014

**Figure 2-3: Common-reference input architecture**

Most bench-top oscilloscopes share the architecture shown above, but without the insulated case. Without differential preamplifiers or external signal isolators, bench-top oscilloscopes are not suitable for taking floating measurements.

For oscilloscopes with isolated inputs, references are not connected together inside the instrument. Therefore, each reference of the used inputs must be connected to a reference voltage. Independently floating isolated inputs are still coupled by parasitic capacitance. This can occur between the input references and the environment, and between the input references mutually. For this reason, you should connect the references to a system ground or another stable voltage. If the reference of an input is connected to a high speed and/or high voltage signal, you should be aware of parasitic capacitance. (See Figure 2-4 on page 2-5.)

---

**NOTE.** *The input channels are electrically isolated from the USB ports and from the power adapter input.*

---

## Connect Probes and Leads

You can connect voltage probes and test leads to any or all of the BNC connectors. When using voltage probes, match the color of the probe with the color at the base of the BNC connector to make it easy to see which channel you are using at a glance. Following are some examples of how to connect probes and leads.

### Beware of High Voltages



---

**WARNING.** *To prevent electrical shock, do not exceed the measurement or floating voltage ratings for the instrument input BNC connector, probe tip, or probe reference lead.*

---

Understand the voltage ratings for the probes you are using and do not exceed those ratings. The following voltage ratings are important to know and understand:

- The maximum measurement voltage from the probe tip and BNC signal to the probe reference lead
- The maximum floating voltage from the probe reference lead to earth ground
- The maximum measurement voltage from the probe tip and BNC shell to earth ground

These voltage ratings depend on the probe and your application. Refer to the *Specifications* section in this manual for more information. (See page A-15, *Probe Specifications*.)

See the instruction sheet that shipped with your probes for more probe safety information.



---

**WARNING.** *To avoid electric shock, do not use probes that require a ground connection, such as the Tektronix P5200 High Voltage Differential Probe, with the THS3000 Series Oscilloscopes. The P5200 High Voltage Differential Probe requires an instrument with grounded inputs and the TH3000 Series Oscilloscopes have floating inputs (isolated inputs).*

---



### Attach the Reference Leads Correctly

If you are using all four of the instrument channels, you must attach the probe reference lead for each channel directly to your circuit. These attachments are required because the channels are electrically isolated; they do not share a common chassis connection. Use the shortest possible reference lead with each probe to maintain good signal fidelity.

The probe reference lead presents a higher capacitive load to the circuit-under-test than the probe tip. When taking a floating measurement between two nodes of a circuit, attach the probe reference lead to the lowest impedance or least dynamic of the two nodes.

**Parasitic capacitance between probes, instrument, and environment.** Parasitic capacitance can occur between the input references and the environment. For this reason, you should connect the references to a system ground or another stable voltage. If the reference of an input is connected to a high speed and/or high voltage signal, you should be aware of parasitic capacitance. (See Figure 2-4.)

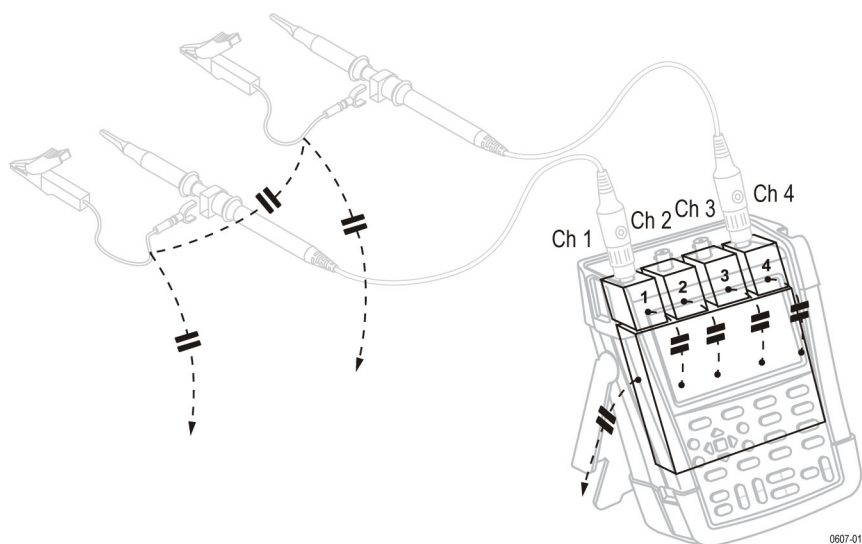
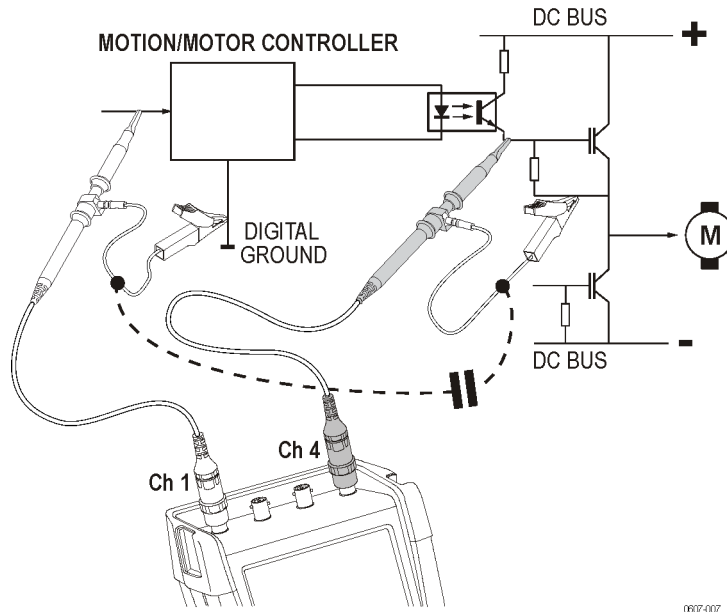

Figure 2-4: Parasitic capacitance between probes, instrument, and environment

**Parasitic capacitance between analog and digital reference.** Parasitic capacitance can occur between the input references mutually. For example, between an analog and digital reference. For this reason, you should connect the references to a system ground or another stable voltage. If the reference of an input is connected to a high speed and/or high voltage signal, you should be aware of parasitic capacitance. (See Figure 2-5.)



0607-007

**Figure 2-5: Parasitic capacitance between analog and digital reference**

This is the correct way to connect reference leads. (See Figure 2-6.)

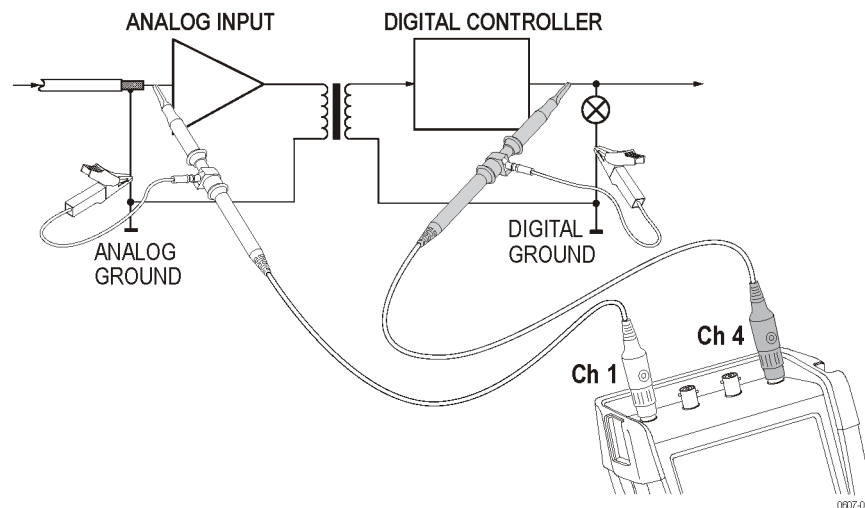

0607-005

**Figure 2-6: Correct connection of reference leads**

This is the wrong way to connect reference leads. Noise that is picked up by reference lead 4 can be transmitted by parasitic capacitance to the analog input amplifier. (See Figure 2-7.)

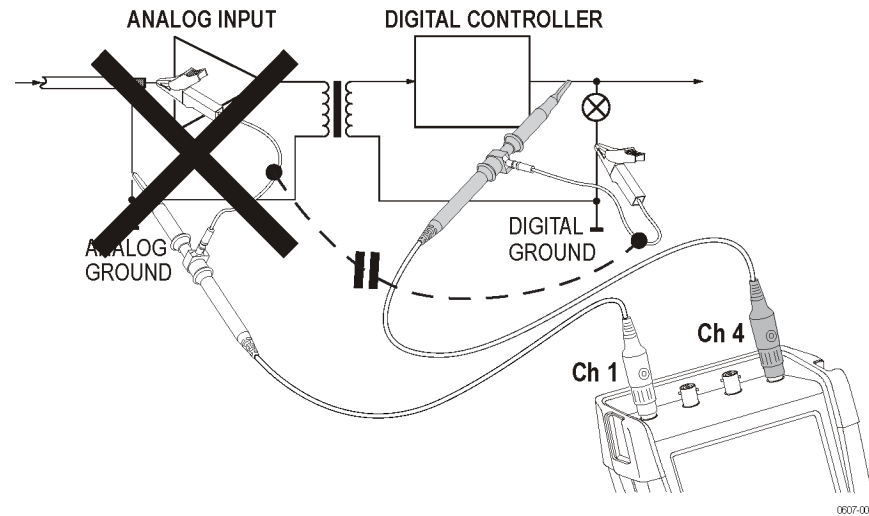
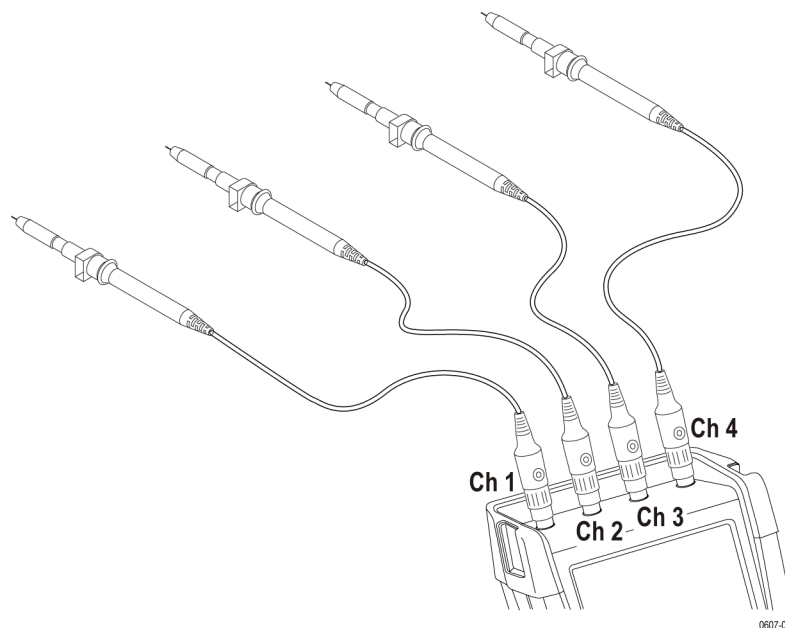

Figure 2-7: Wrong connection of reference leads

### Make Voltage Probe Connections

To make measurements on four channels, connect the yellow voltage probe to the channel 1 input, the blue voltage probe to the channel 2 input, the magenta voltage probe to the channel 3 input, and the green voltage probe to the channel 4 input. Connect the short ground lead of **each** voltage probe to its **own** reference potential. (See Figure 2-8.)



**Figure 2-8: Making voltage probe connections on four channels.**

---

**NOTE.** For an accurate indication of the measured signal, it is necessary to match the probe to the input channel of the instrument. (See page C-1, Probe Compensation and Compatible Maximum Voltages.)

---

## Connections With Probe Accessories

The following images show several different types of probe accessories and their attachments.

**Connection using a ground spring.** The following image shows a voltage probe connection using a ground spring.



**WARNING.** To avoid electrical shock or fire, do not connect the ground spring to voltages higher than 30 Vrms from earth ground.

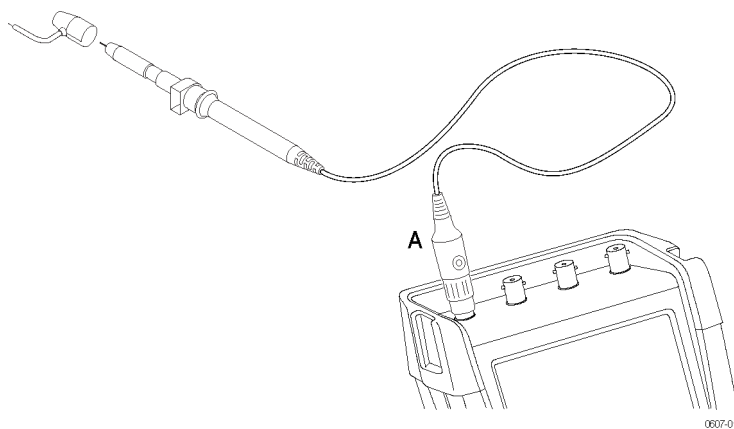

Figure 2-9: Voltage probe connection using a ground spring

**Connections Using Hook Tips and Alligator Clip Grounding.** Connect the probes as shown in the following image, making sure to reapply the insulation sleeve over the probe tip when the hook tip is not in use to avoid electrical shock. (See Figure 2-10.)



**WARNING.** To avoid electrical shock, reapply the insulation sleeve over the probe tip when the hook clip is not used. This also avoids the risk of accidentally interconnecting the reference contact of multiple probes when ground leads are connected. (See Figure 2-8.)

---

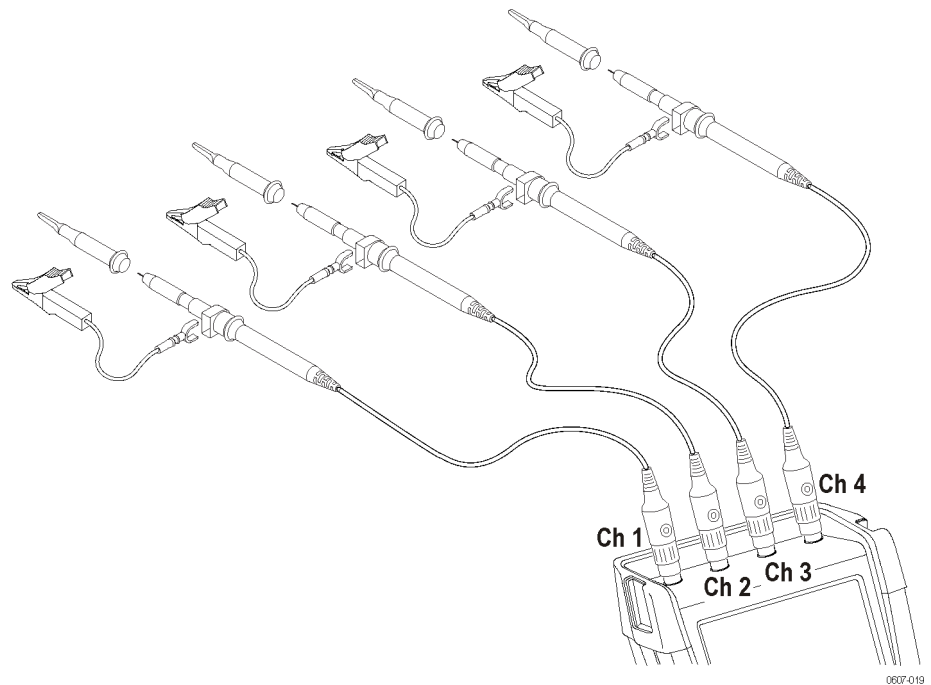

**Figure 2-10: Connections using hook tips and alligator clip grounding**



**WARNING.** To avoid electrical shock use an insulation sleeve if you use the probes without the probe tip or the ground spring.

---

**Connections with a ground lead.** The voltage applied to the reference lead is also present on the ground ring near the probe tip. The ground ring is shown here.



**WARNING.** To avoid electrical shock, always use the insulation sleeve or the probe tip when using the probe reference (ground) lead. The voltage applied to the reference lead is also present on the ground ring near the probe tip. (See Figure 2-11.)

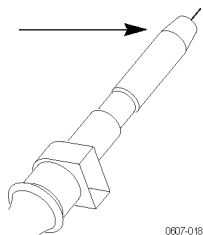

**Figure 2-11: Probe tip ground ring**

## Select an Input Channel

After you have connected probes to the desired inputs, you will want to select an input channel and set the parameters for that channel. To select a channel, do the following:

1. Press one of the channel buttons to display the associated input menu and to turn the input on.
2. Coupling is DC by default. Select AC coupling if you want to observe a small AC signal that rides on a DC signal. When AC coupling is active, the **1~** icon will be visible in the lower left portion of the display screen.

---

**NOTE.** *Autoset can affect how coupling functions. For more information, read about the Autoset feature. (See page 2-13, Display an Unknown Signal with Autoset or AutoRange™.)*

---

3. Press the function button to select **Input Options** and select the desired attenuation and bandwidth settings. Read more about attenuation and bandwidth settings. (See page 2-22, *Acquire Waveforms.*)

### Assign Position and Scale to Multiple Channels

If the channel button is illuminated, the horizontal and vertical **Position** and **Scale** buttons are assigned to the indicated channel.

To assign the **Position** and **Scale** buttons to multiple channels, do the following:

1. Press and hold the **Ch 1** button.
2. Press another one or more channel buttons in sequence.
3. Release the **Ch 1** button.

All pressed buttons are now illuminated. The **Position** and **Scale** buttons now apply to all active channels.

To deactivate this feature, press a single channel button.



## Adjust the Probe Type Settings

To obtain correct measurement results, the instrument probe type settings must correspond to the connected probe types. To select the Channel 1 probe setting, do the following:

1. Press the **Ch 1** button to display the input menu.
2. Select **PROBE 1** from the menu.
3. Select **Voltage** or **Current** from the **Probe Type** submenu.

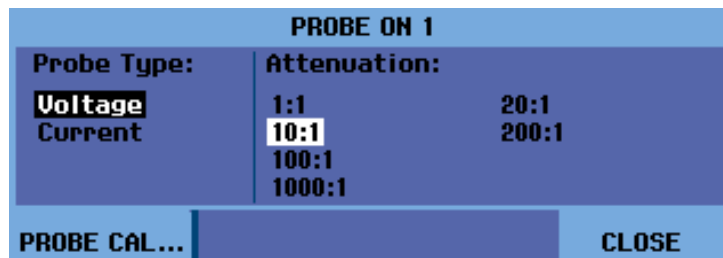

4. Select the attenuation settings (for voltage probes) or the sensitivity settings (for current probes) needed for your application.
5. Press the **Menu Off** button to remove the menu from the display screen.

## Display an Unknown Signal with Autoset or AutoRange™

The Autoset and AutoRange™ features let the instrument display complex, unknown signals automatically. The Autoset function provides a one time setup of the vertical, horizontal and trigger systems of the instrument. The Autoranging function provides continuous auto setup of vertical, horizontal, and trigger systems that track signal changes. When the signal changes, the setup is automatically adjusted to maintain the best display result. This feature is useful for quickly checking several signals.

### Enable Autoset

There are several steps to enabling the Autoset feature. The first involves setting the Autoset parameters as follows:

1. Press the **Utility** button.
2. Select **Options**.
3. Check that the **Auto Set Adjust** menu item is highlighted black, and then press **Enter**.
4. Select the frequency range:

If the frequency range is set to **15 Hz and up**, the Autoset function responds more quickly at this range because the instrument is instructed not to analyze low frequency signal components.

If the frequency range is set to **1 Hz and up**, the instrument is instructed to analyze low frequency components for automatic triggering.

5. Select **Unchanged** or **Set to DC** under **Input coupling**. Selecting the former retains the coupling setting as it is set in the channel button menu of the active input.
6. Select **Unchanged** or **Set to on** under **Display glitches**. Selecting the former retains the glitch setting as it is set in the **Acquire > ACQUIRE OPTIONS** menu.
7. Exit the menu.

---

**NOTE.** *The Autoset option for the signal frequency is similar to the automatic trigger option for the signal frequency. However, the Autoset option determines the behavior of the Autoset function and effects show only when you press the Autoset button.*

---

The second involves enabling Autoset as follows:

1. Press the **Autoset** button. AUTOSSET will appear in the top right portion of the display screen showing you that Autoset is now active.

The waveform identifier (1, 2, 3, or 4) is visible on the right side of the screen. The zero icon (-) beneath the waveform identifier on the left side of the screen identifies the ground level of the waveform. (See Figure 2-12.)

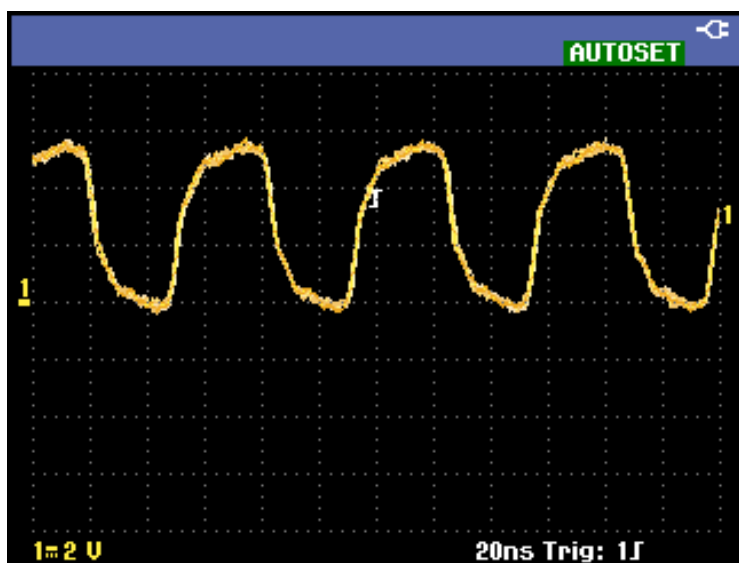

Figure 2-12: Display with Autoset

### Enable AutoRange™

To enable the AutoRange™ feature, press and hold the **Autoset** button until **AUTORANGE** appears in the top right corner of the display screen. The values showing across the bottom of the display screen show range and trigger information.

The waveform identifier (1, 2, 3, or 4) is visible on the right side of the screen. The zero icon (-) beneath the waveform identifier on the left side of the screen identifies the ground level of the waveform. (See Figure 2-13.)

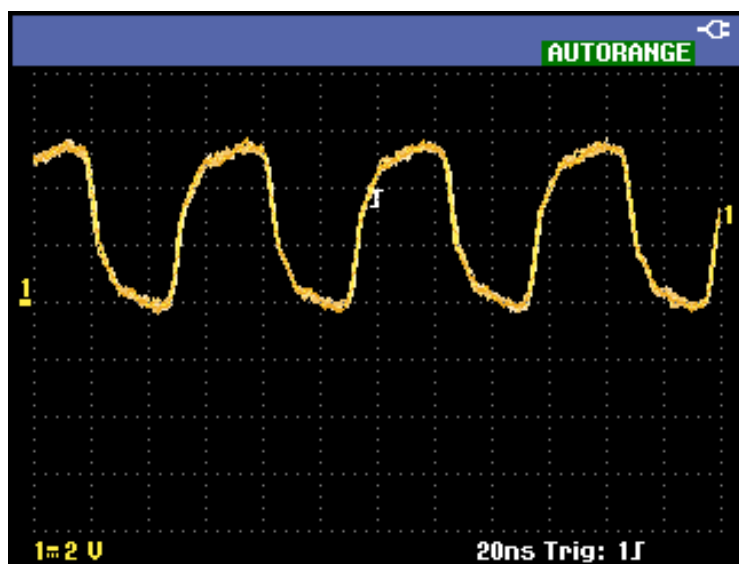

Figure 2-13: Display with AutoRange™

## Automatic Measurements

This instrument offers a wide range of automatic measurements. In addition to the waveforms, the instrument can also display measurements: **MEASURE A**, **B**, **C**, **D**. These measurements are selectable independently and can be done on the channel 1, 2, 3, or 4 input.

### Choose a Frequency Measurement for Channel 1

To choose a frequency measurement for channel 1, do the following:

1. Press the **Ch 1** button to turn the input on.
2. Press the **Acquire** button to view the menu.
3. Select **MEASURE**.

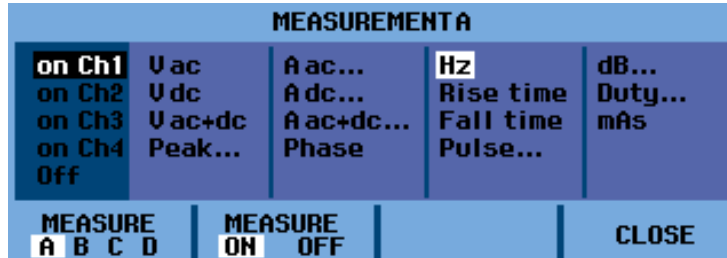

4. Use the function button under **MEASURE A B C D** to select the measure to be displayed. For example, you can select **A**.
5. Use the arrow keys to select **on Ch 1** to assign the measurement to that channel and select the measurement parameters. Select **Hz** for frequency.

### View a Hz and V Peak-Peak Measurement

To choose also a **Peak-Peak** measurement for channel 2 as a second reading, do the following after finishing the previous procedure:

1. Press the **Ch 2** button to turn the input on.
2. Press the **Acquire** button and select **MEASURE**
3. Press the function button to select **MEASURE B**.
4. Select **on Ch2** using the arrow keys and then press the **Enter** button.
5. Select **Peak** using the arrow keys and then press the **Enter** button.
6. Select Peak-Peak.

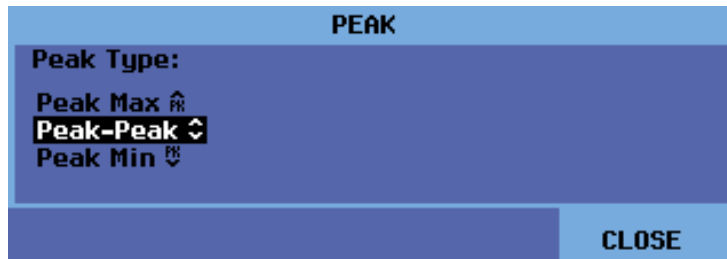

The display now shows two measurements and the top left of the screen shows the Hz measurement. The character size will be reduced when more than two readings are on. (See Figure 2-14.)

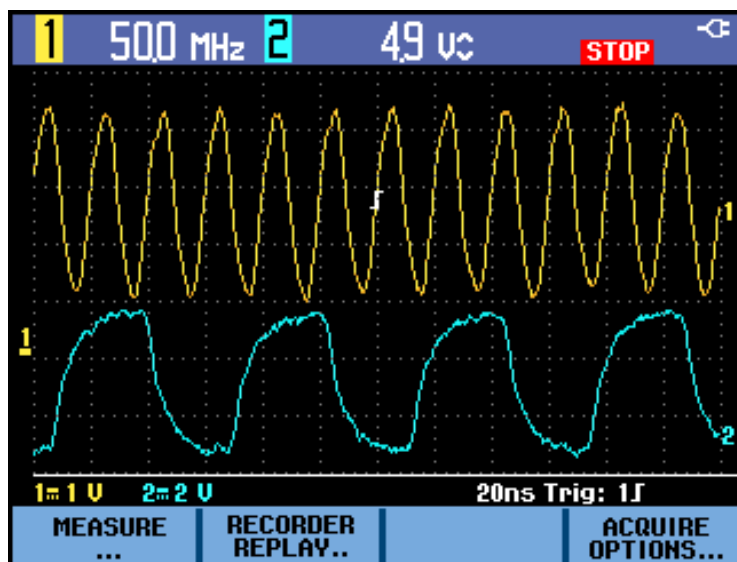

Figure 2-14: Hz and V peak-peak as measurements

**NOTE.** You can set the parameters for all four measurements and assign those to any of the four channels while the MEASURE menu is open.

## Stop the Display

You can freeze the display (all measurements and waveforms) at any time by pressing the **Run/Stop** button until **STOP** appears in red in the top right portion of the display screen and the **Run/Stop** button is illuminated. (See Figure 2-15.)

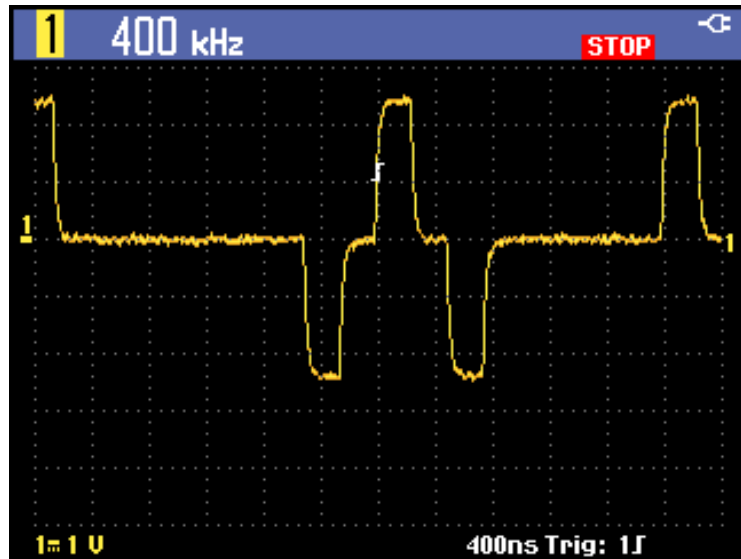

Figure 2-15: Frozen (stopped) display

Press the **Run/Stop** button again to unfreeze the display. **RUN** will appear in green in the top right portion of the display. (See Figure 2-16.)

---

**NOTE.** *RUN* will only appear on the screen if the trigger is set to **MANUAL** from the **Trigger** button menu.

---

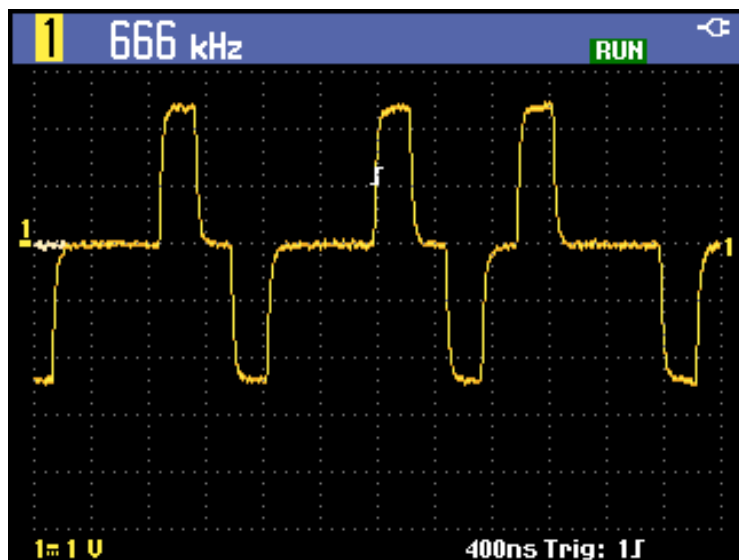

Figure 2-16: Live (running) display

## Average, Persistence, and Glitch Capture

Use the average functions to smooth waveforms by suppressing random or uncorrelated noise in the waveform without loss of bandwidth. Waveform samples with and without smoothing are shown here. (See Table 2-1.)

### Smooth a Waveform With Averaging

To smooth a waveform using averaging, do the following:

1. Press the **Acquire** button.
2. Select **ACQUIRE OPTIONS**.
3. Press the right arrow key to navigate to **Average** and black-highlight **On..**
4. Press the **Enter** button.
5. Select average factor **Average 64**. This averages the outcomes of 64 acquisitions.

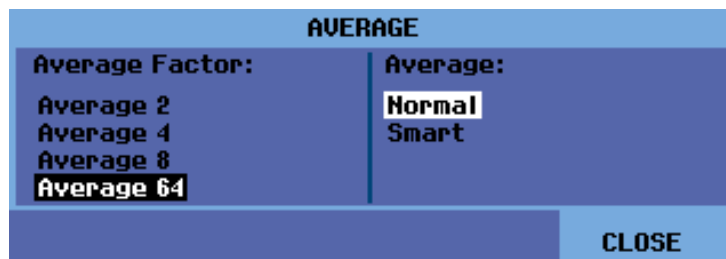

6. Select **Normal** or **Smart** average.

**Normal averaging.** In the normal average mode, occasional deviations in a waveform distort the averaged wave shape, and do not show up on screen clearly. When a signal really changes, for instance when you are probing, it takes some time before the new wave shape is stable.

**Smart averaging.** Smart averaging allows you to quickly probe. Incidental waveform changes, like a line flyback in video, show up on screen instantly.

Table 2-1: Comparison of averaged versus nonaveraged waveforms

Waveform with Averaging

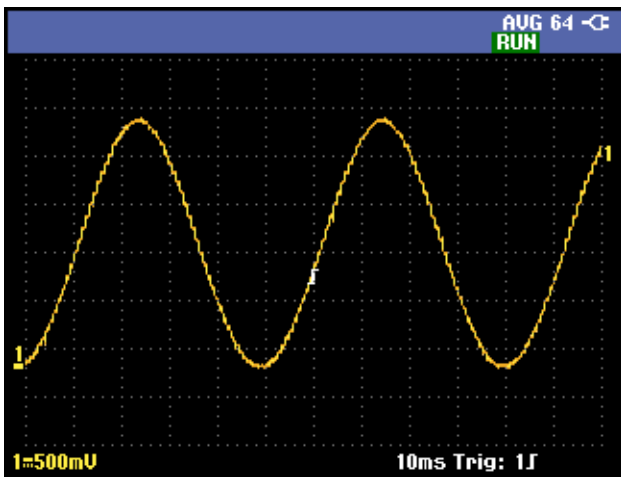

Waveform with no averaging

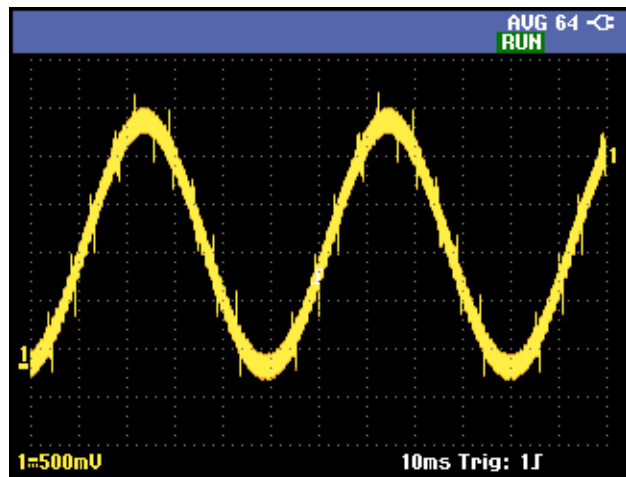

**Use Persistence, Envelope, and Dot-Join to Display Waveforms**

You can use persistence to observe dynamic signals. (See Figure 2-17.)

1. Open the **ACQUIRE OPTIONS** menu.
2. From the **Waveform** submenu, black-highlight **Persistence...** and press the **Enter** button.
3. From the **Digital Persistence and Display** submenus, you can select the following:
  - Select **Short, Medium, Long,** or **Infinite** to observe dynamic waveforms like on an analog oscilloscope.
  - Select **Off** and Display **Envelope** to see the upper and lower boundaries of dynamic waveforms (envelope mode).
  - Select Display **Dot-join OFF** to display measured samples only. Dot join off may be useful when measuring for example modulated signals or video signals.
  - Select Display **Normal** to turn the envelope mode off and the dot-join function on.



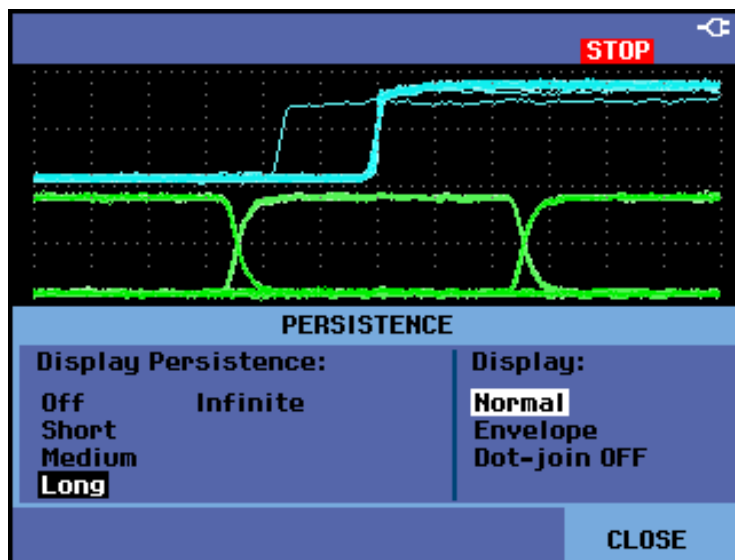

Figure 2-17: Using persistence to observe dynamic signals

**Glitches** To capture glitches on a waveform, do the following:

1. Open the **ACQUIRE OPTIONS** menu.
2. Select **Glitch On**.
3. Press **CLOSE** to exit the menu.

You can use this function to display events (glitches or other asynchronous waveforms) of 8 ns (due to ADC's with 125 MS/s sampling speed) or wider, or you can display HF modulated waveforms.

When you select the 2 mV/div range, glitch detect will automatically be turned off. In the 2 mV/div range, you can manually set glitch detect on.

### Suppress High Frequency Noise

Turning glitch detect off will suppress the high frequency noise on a waveform. Averaging will suppress the noise even more:

1. Open the **ACQUIRE OPTIONS** menu.
2. Select Glitch **Off**.
3. Select Average **On** to open the Average menu
4. Select **Average 8**.

You can read more about averaging and how to use it. (See page 2-19, *Smooth a Waveform With Averaging*.)

**NOTE.** *Glitch capture and average do not affect bandwidth. Further noise suppression is possible with bandwidth limiting filters. (See page 2-24, *Adjust Bandwidth to Smooth Waveforms*.)*

## Acquire Waveforms

Before the instrument can display a signal, the signal must pass through the input channel where it is scaled and digitized. Each channel has a dedicated input amplifier and digitizer. Each channel produces a stream of digital data from which the instrument extracts waveform records. You can set a variety of signal acquisition parameters as described in this section.

### Set Acquisition Speed and Waveform Memory Depth

To set the acquisition speed, do the following:

1. Press the **Acquire** button.
2. Select **ACQUIRE OPTIONS**.
3. Set the **Memory** to one of the following:
  - Short: For faster trace update rate; shortest record length, decreased zoom rate.
  - Long: Maximum waveform detail; 10,000 samples per trace record length, maximum zoom rate, lower trace update rate.

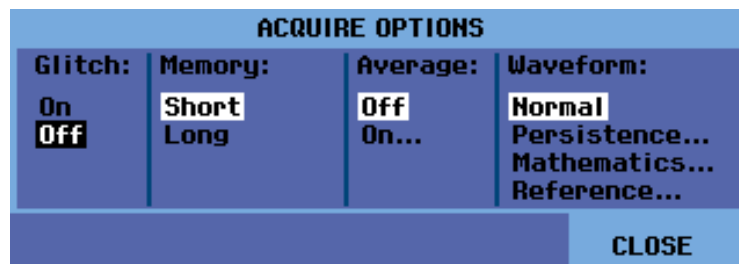

### Reverse the Attenuation of the Displayed Waveform

You may want to reverse the attenuation of a displayed waveform. For example, a negative-going waveform is displayed as a positive-going waveform which may provide a more meaningful view. An inverted display is identified by an inverted trace identifier ( **1** ) at the right of the waveform, and in the status line below the waveform. To invert a waveform, do the following for whichever input channel you are using:

1. Press the desired channel button.
2. Select the **INPUT OPTIONS** submenu.
3. Select **Inverted** for the Attenuator setting.
4. Exit the menu.

### Variable Input Sensitivity

The variable input sensitivity allows you to adjust any input sensitivity continuously. For example, to set the amplitude of a reference signal to exactly 6 divisions.

The input sensitivity of a range can be increased up to 2.5 times, for example between 10 mV/div and 4 mV/div in the 10 mV/div range.

---

**NOTE.** *Variable input sensitivity is not available in the Mathematics functions (+, -, x, and FFT).*

---

To use the variable input sensitivity, do the following for whichever input channel you are using:

1. Press the **Autoset** button. The word **AUTOSET** will appear in the top right portion of the display screen until the autoset is complete.

---

**NOTE.** *The autoset will turn off the variable input sensitivity. You can now select the required input range. Keep in mind that the sensitivity will increase when you start adjusting the variable sensitivity (the displayed trace amplitude will increase).*

---

2. Press the channel button for the desired input to open the input menu.
3. Select **INPUT OPTIONS**.
4. Select **Variable** attenuation.

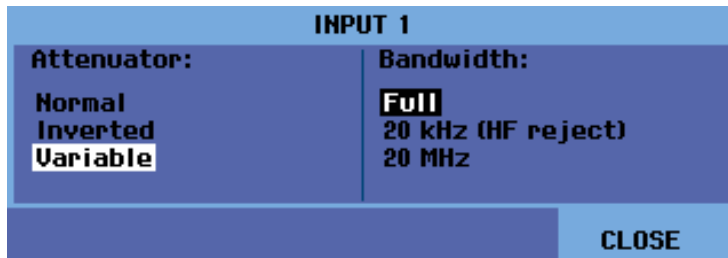

- Exit the menu. You will see the channel number and **Var** in the left bottom portion of the display screen. **1=Var**

---

**NOTE.** Selecting *Variable* will turn off cursors and automatic input ranging. Press the *Vertical Position* buttons to increase or decrease sensitivity.

---

### Adjust Bandwidth to Smooth Waveforms

You can use bandwidth filters to suppress high frequency noise on waveforms by limiting the working bandwidth to 20 kHz or 20 MHz. The application of filters will smooth the displayed waveform. For the same reason, it will also improve triggering on the waveform.

To use the **HF reject** filter on a desired input channel, do the following:

- Press the channel button for the active input to view the menu.
- Select **INPUT OPTIONS**.
- Select the **20 kHz (HF reject)** bandwidth.

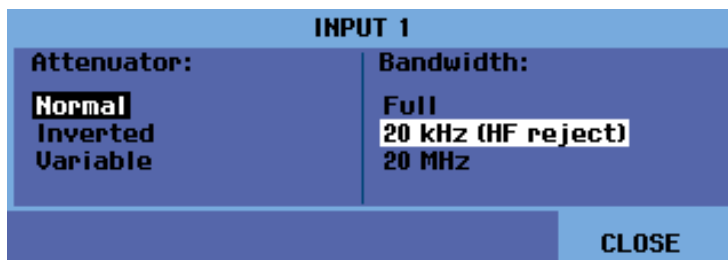

---

**NOTE.** To suppress noise without loss of bandwidth, use the *average function* or *turn off Display Glitches*. (See page 2-19, *Smooth a Waveform With Averaging*.)

---

### Using Mathematics Functions +, -, x, XY-mode

You can add (+), subtract (-), or multiply (x) two waveforms. The instrument will display the mathematical result waveform and the source waveforms.

The XY-mode provides a plot with one input on the vertical axis and the second input on the horizontal axis.

The Mathematics functions perform a point-to-point operation on the involved waveforms.

To use a Mathematics function, do the following:

1. Press the **Acquire** button.
2. Select **ACQUIRE OPTIONS**.
3. Select **Mathematics** from the Waveform options.

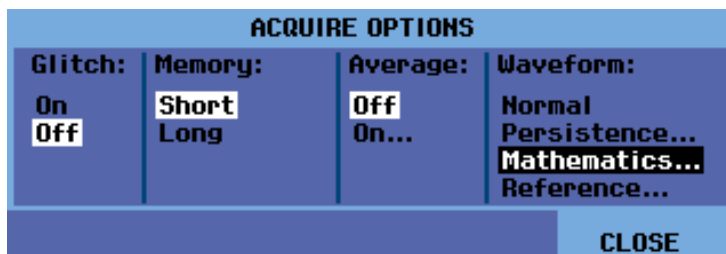

4. Select a function and then a channel for an A and B source.

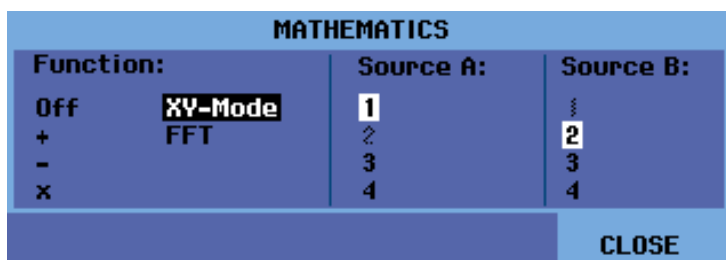

5. Once you have selected the function and sources, a new menu will appear and you should select from the options that menu provides. The menu varies by function as follows:

- +, - :

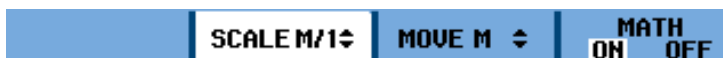

- x:



- XY-Mode:



- FFT:



**NOTE.** The sensitivity range of the mathematical result is equal to the sensitivity range of the least sensitive input divided by the scale factor.

### Using Mathematics Function Spectrum (FFT)

The spectrum function shows the spectral content of the input 1, 2, 3, or 4 waveform(s) in the input trace color. It performs an FFT (Fast Fourier Transform) to transform the amplitude waveform from the time domain into the frequency domain.

To reduce the effect of side-lobes (leakage) it is recommended to use Auto windowing. This will automatically adapt the part of the waveform that is analyzed to a complete number of cycles.

Selecting Hanning, Hamming, or no windowing results in a faster update, but also in more leakage.

Check that the entire waveform amplitude remains on the screen.

To use the FFT function, do the following:

1. Press the **Acquire** button.
2. Select **ACQUIRE OPTIONS**.
3. Select **Mathematics** from the Waveform options.

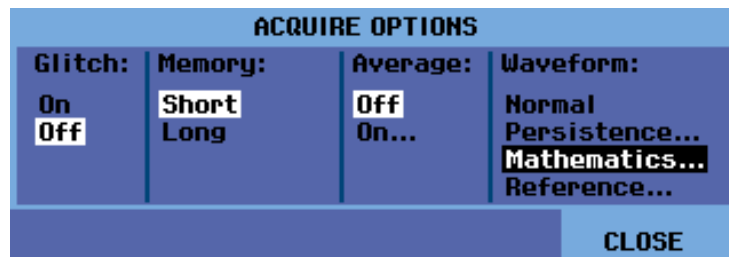

4. Select function **FFT** and then Source channel and a Window type.

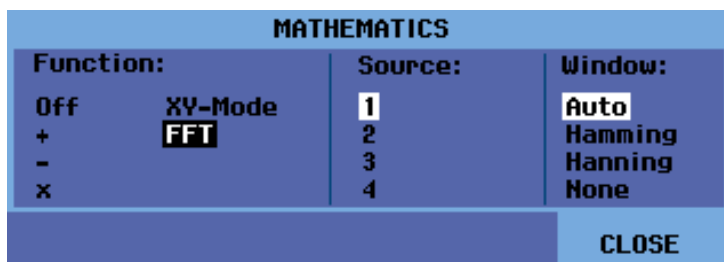

5. Check that **FFT** shows at the top right of the display screen that appears. (See Figure 2-18.)

If **LOW AMPL** shows, a spectrum measurement cannot be done because the waveform amplitude is too low.

If **WRONG TB** shows, the time base setting does not enable the instrument to display an FFT result. It is either too slow, which can result in aliasing, or too fast, which results in less than one signal period on the screen.

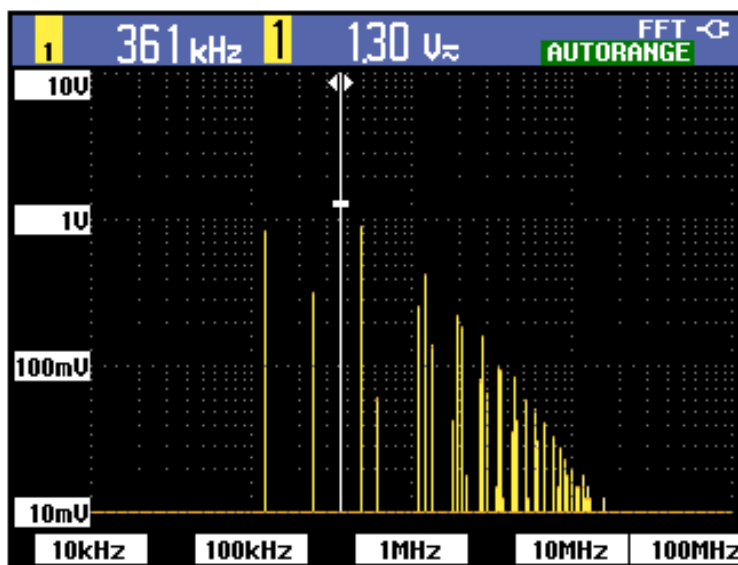
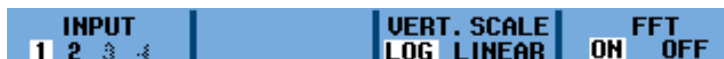

Figure 2-18: FFT measurement

6. Once you have selected the Function, Source, and Window settings, a new menu will appear at the bottom of the display screen.



7. Select the input on which you want to perform the FFT by pressing the function button under the **INPUT** menu item.

8. Set the vertical amplitude scale to logarithmic (**LOG**) or linear (**LINEAR**) by pressing the function button under that menu item.
9. You can turn the FFT display on and off (toggle function) by selecting **ON** or **OFF** under the **FFT** menu item.

### **Compare Waveforms**

You can display a fixed reference waveform with the actual waveform for comparison.

To create a reference waveform and to display it with the actual waveform, do the following:

1. Press the **Acquire** button.
2. Select **ACQUIRE OPTIONS**.



3. Select **Reference** from the Waveform options.

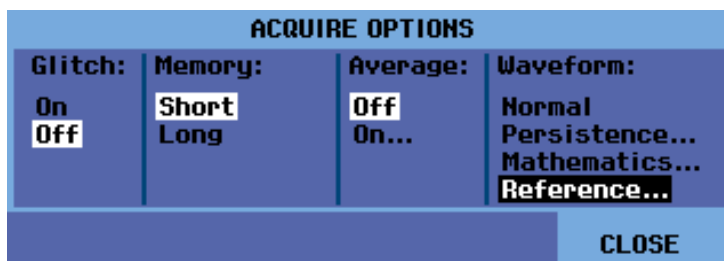

4. Select **On** under Reference to display the reference waveform. The reference waveform can be:
  - the last used reference waveform (if not available, no reference waveform will be shown)
  - the envelope waveform (if the persistence function Envelope is on)

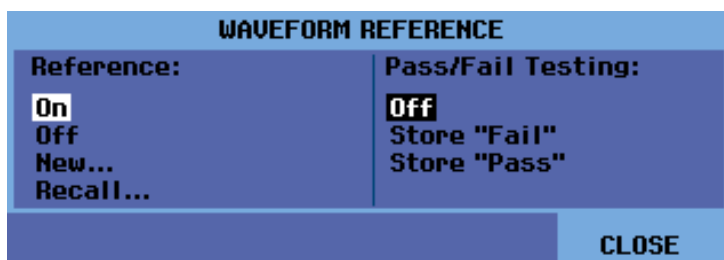

5. Or, select **Recall...** to recall a saved waveform (or waveform envelope) from memory and use it as a reference waveform.
6. Or, select **New...** to open the **NEW REFERENCE** menu and select the width of an additional envelope to be added to the momentary waveform.



7. Press **Enter** to store the momentary waveform and display it permanently for reference. The display screen also shows the actual waveform.

---

**NOTE.** To recall a saved waveform from memory and use it as a reference waveform, read about recalling screens with associated setups. (See page 3-28.)

---

**Reading a reference waveform with an envelope.** Following is an example of a reference waveform with an additional envelope of  $\pm 2$  pixels. 1 vertical pixel

on the display is  $0.04 \times \text{range/div}$ . 1 horizontal pixel on the display is  $0.0333 \times \text{range/div}$ .

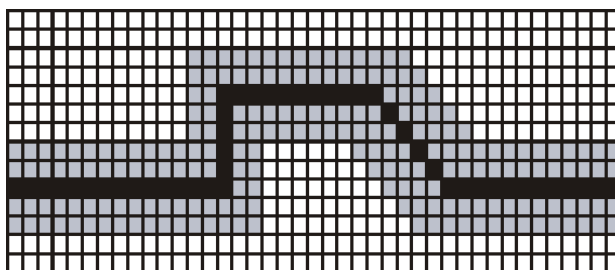

**Table 2-2: Pixel colors description**

Pixel color	Description
black pixels	basic waveform
gray pixels	± 2 pixels envelope

## Pass-Fail Testing

You can use a reference waveform as a test template for the actual waveform. If at least one sample of a waveform is outside the test template, the failed or passed scope screen will be stored. Up to 100 screens can be stored. If the memory is full, the first screen will be deleted in favor of the new screen to be stored.

The most appropriate reference waveform for the Pass Fail test is a waveform envelope.

To use the Pass-Fail function using a waveform envelope, do the following:

1. Display a reference waveform as described in the previous section Comparing Waveforms. (See page 2-28.)
2. From the **Acquire** button **ACQUIRE OPTIONS** menu, select **Reference**.
3. Select one of the following options from the Pass Fail Testing menu:
  - **Store “Fail”**: Each screen with samples outside the reference will be stored.
  - **Store “Pass”**: Each screen with no samples outside the reference will be stored.
  - **Off**: No screens will be stored.

Each time a screen is stored you will hear a beep. You can read more about how to analyze stored screens using replay, zoom, and cursors. (See page 3-6, *Analyze Waveforms*.)

---

# Functional Overview



# Recorder Functions

This chapter provides a step-by-step introduction to the recorder functions of the instrument. The introduction gives examples to show how to use the menus and perform basic operations.

Access the **RECORDER REPLAY..** menu by first pressing the Acquire button. From the **RECORDER REPLAY..** menu, you can now choose from the recorder functions.



Figure 3-1: RECORDER REPLAY main menu

## Plot Measurements Over Time (TrendPlot™)

Use the TrendPlot™ function to plot a graph of measurements as a function of time. When simultaneously plotting two readings, the screen area is split into two sections of four divisions each. When simultaneously plotting three or four readings, the screen area is split into three or four sections of two divisions each.

To start a trend plot, do the following:

1. Make an automatic measurement. The following steps will then plot that information. (See page 2-15, *Automatic Measurements.*)
2. Select **RECORDER REPLAY..** from the **Acquire** button menu.
3. Select **TREND PLOT**.

---

**NOTE.** *If autoranging is not on, you will be asked if you would like to turn it on before plotting. Select **YES** if you expect wide changes to the input signal.*

---

5. Observe that the word **RECORDING** is showing in the right top portion of the display screen. From the menu that appears, you can select a reference (**Time of Day** or **From Start**) from the **OPTIONS..** menu. You can also select to view all data in memory (**VIEW ALL**) or just the twelve most recently recorded divisions (**NORMAL**).



6. Select **STOP** under the **RECORDER** menu item to stop plotting.
7. Observe that the recorded time from start appears at the bottom of the display screen. The present reading appears on the top of the display screen. The

following display shows a trend plot with cursors enabled for measurement. (See Figure 3-2.)

---

**NOTE.** Read more about analyzing waveform using cursors. (See page 3-9.)

---

8. To turn off the TrendPlot™ display, select **EXIT RECORDER**.

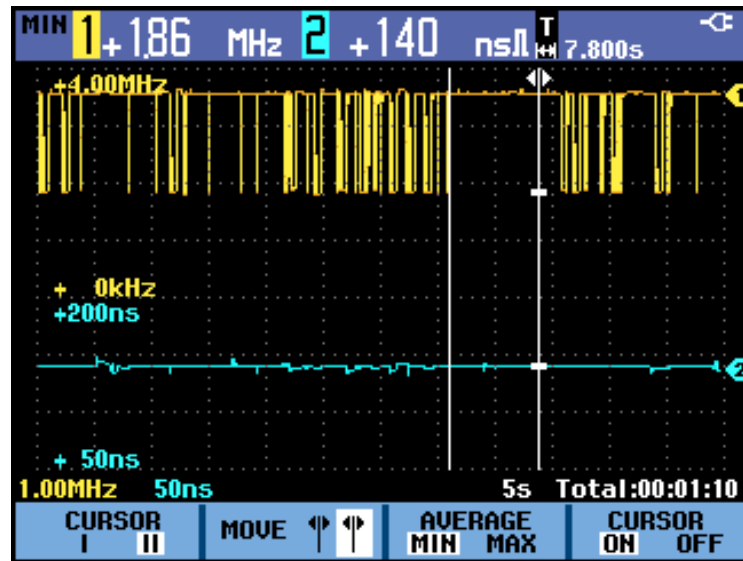

Figure 3-2: TrendPlot™ measurement

The instrument continuously records the digital readings of the measurements and displays these as a graph. The TrendPlot™ graph moves from right to left like a paper chart recorder.

When the instrument is in automatic mode, automatic vertical scaling is used to fit the graph on the screen.

---

**NOTE.** When the recorder memory is full, an automatic compression algorithm is used to compress all samples into half of the memory without loss of transients. The other half of the recorder memory is free again to continue recording.

---

## Record Waveforms In Deep Memory (Scope Roll Mode)

The **SCOPE ROLL MODE** function logs a long waveform of each active input. Use this function to monitor waveforms such as motion control signals or the power-on event of an Uninterruptable Power Supply (UPS). During recording, fast transients are captured. Because of the deep memory, recording can be done for more than one day. This function is similar to the roll mode in many digital sampling oscilloscopes, but has deeper memory and better functionality.

### Start Scope Roll Mode

To record the channel 1 and channel 2 waveform, do the following:

1. Apply signals to the channel 1 and channel 2 inputs.
2. Select **RECORDER REPLAY..** from the **Acquire** button menu.
3. Select **SCOPE ROLL MODE**.
4. The waveform moves across the screen from right to left like on a normal chart recorder. Observe that the screen displays the time from start at the top and the status at the bottom of the screen, which includes the time/div setting and the total timespan that fits the memory. (See Figure 3-3.)
5. Press the function button under the **RECORDER** menu item and select **STOP** to stop recording when you are ready.

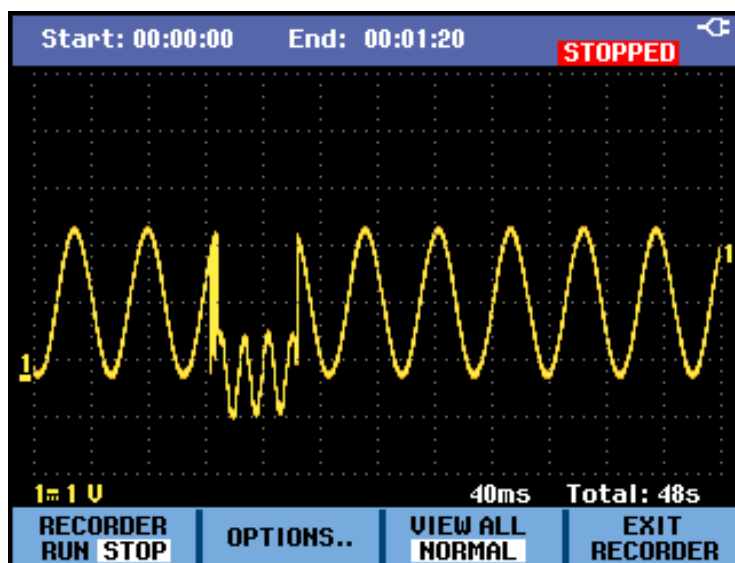

Figure 3-3: Recording waveforms using Scope Roll Mode

### Use Single Sweep Mode

You can use the recorder **Single Sweep** mode to automatically stop recording when the deep memory is full. To activate single sweep mode, do the following:

1. Set up the instrument as in the previous procedure. (See page 3-3, *Start Scope Roll Mode*.)
2. Select **OPTIONS** from the **SCOPE ROLL MODE** menu.
3. Use the right arrow to highlight **Single Sweep** mode and press the **Enter** button.



4. Press the function button under the **RECORDER** menu item and select **RUN** to begin recording in single sweep mode.

### Use Triggering to Start or Stop Scope Roll Mode

To record an electrical event that causes a fault, it might be useful to start or stop recording on a trigger signal:

**Start on trigger** to start recording; recording stops when the deep memory is full.

**Stop on trigger** to stop recording.

**Stop when untriggered** to continue recording if a next trigger comes within 1 division in view all mode.

To set up the instrument to start or stop recording on a trigger signal, do the following:

1. Set up the instrument as in the *Start Scope Roll Mode* procedure. (See page 3-3.)
2. Select **OPTIONS** from the **SCOPE ROLL MODE** menu.
3. Use the right arrow to highlight **on Trigger** mode and press the **Enter** button.
4. Select on of the conditions from the **START SINGLE SWEEP ON TRIGGERING** menu.

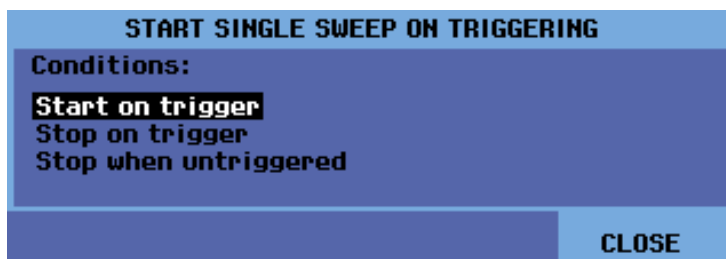



Samples are continuously saved in deep memory during recording. The last twelve recorded divisions are displayed on the screen. Use **View All** to display the full memory contents.

---

**NOTE.** *You can learn more about Single Shot triggering. (See page 3-20.)*

---

## Analyze Waveforms

You can use the Replay, Zoom, and Cursors analysis functions to perform detailed waveform analyses. These functions can be used with one or more of the primary functions: Acquire, TrendPlot™, or Data Log Replay.

It is possible to combine two or three analysis functions. A typical application using these functions is:

- First replay the last screens to find the screen of special interest.
- Then zoom in on the signal event.
- Finally, make measurements using the cursors.

### Use Replay

When you are in acquire mode, the instrument automatically stores the 100 most recent screens. Records are captured and frozen when you press the **Run/Stop** button. You can also use the Replay function to store and view signals even if you did not press **Run/Stop**.

Use the options in the **DATA LOG REPLAY** menu to review stored screens.

#### Replay an Acquired Screen

To review a specific stored screen, do the following:

1. Press the **Acquire** button.
2. Select the **RECORDER REPLAY..** menu option.
3. Select **DATA LOG REPLAY**.



4. Select **Next** or **Previous** to scroll through the stored screens until you find the one you want.



5. Observe that the top portion of the **DATA LOG REPLAY** menu (shown in step 4) displays a replay bar with a screen number and related time stamp. The replay bar represents all 100 stored screens in memory. The  icon represents the picture being displayed on the screen. If the bar is partly white, the memory is not completely filled with 100 screens.

### Replay All Acquired Screens

You can also replay all of the stored screens in sequence, from oldest to newest. To replay all acquired screens, do the following:

1. Press the **Acquire** button.
2. Select the **RECORDER REPLAY..** menu option.
3. Select **DATA LOG REPLAY** to view the replay menu.
4. Select **Play** to start play of all stored screens, from oldest to newest.



---

**NOTE.** Once you have selected to play all screens, the instrument will continue to repeat play until you select **Stop** or **Exit Replay**.

---

5. Select **Stop** when you come to the screen of interest. You can now use the zoom and cursor functions to study the signal in more detail.

### Turn Off the Replay Function

Select **EXIT REPLAY** to turn off the replay function. A warning notice will appear stating that all replay data will be lost. This means you will not be able to return to access the data again without saving it first by pressing the **Save** button. Select **YES**.

### Capturing 100 Trigger Events Automatically

When you use the instrument in triggered mode, 100 trigger event screens are captured. By combining the trigger possibilities with the capability of capturing 100 screens for later replay, you can leave the instrument unattended to capture intermittent signal anomalies. This way you could use Pulse Triggering to trigger and capture 100 intermittent glitches or you could capture 100 UPS startups.

---

**NOTE.** You can read more about triggering and trigger setup. (See page 3-14, *Trigger Functions*.)

---

## Use Zoom

Use the Zoom function to obtain a more detailed view of a waveform. To zoom in on a waveform, do the following:

1. Press the Zoom  button.
2. Press the up and down arrow keys (or horizontal **Scale** key) to enlarge (decrease the time/div) and shrink (increase the time/div) the waveform, respectively. Press the right and left arrow keys (or the horizontal **Position**

key) to move the waveform to the right or left of the screen. The position bar shows the position of the zoomed part in relation to the total waveform.

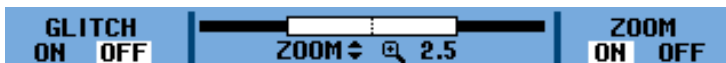

Observe that the bottom of the waveform area displays the zoom ratio, position bar, and time/div. The zoom range depends on the amount of data samples stored in memory. (See Figure 3-4.)

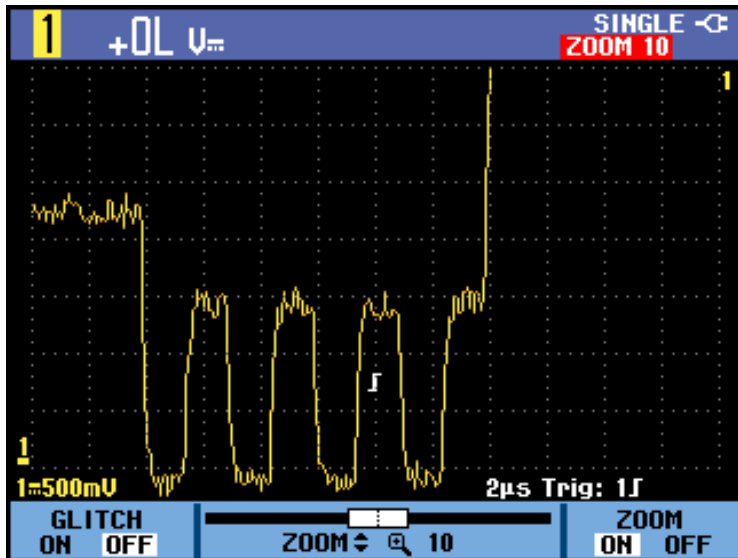

Figure 3-4: Zooming in on a Waveform

---

**NOTE.** To turn off the Zoom function, select **OFF** under the **ZOOM** item of the menu.

---

## Use Cursors

Cursors allow you to make precise digital measurements on waveforms. This can be done on live waveforms, recorded waveforms, and on saved waveforms.

### Use Horizontal Cursors on a Waveform

To use the cursors for a voltage measurement, do the following:

1. Press the **Cursors** button
2. Select the = cursors. The cursor type options are:
  - I : Single vertical cursor
  - II : Two vertical cursors
  - = : Two horizontal cursors
  - J : Rise time cursor
  - L: Fall time cursor
3. Press the function key under the **MOVE** menu item to highlight the upper cursor (if it is not already highlighted).



4. Use the up and down arrow keys to position the upper cursor.
5. Press the function key under the **MOVE** menu item to highlight the lower cursor.
6. Use the up and down arrow keys to position the lower cursor.

---

**NOTE.** *Even when the key labels are not displayed at the bottom of the screen, you still can use the arrow keys. This allows full control of both cursors while having a full screen view.*

---

7. Use the cursors to measure the amplitude, high or low value, or overshoot of the waveform.

This screen shows the voltage difference between the two cursors and the voltage at the cursors. (See Figure 3-5.)

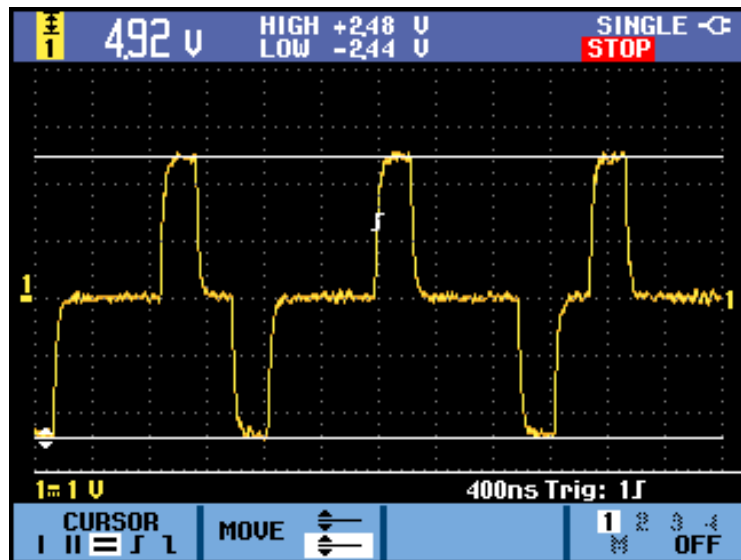

Figure 3-5: Voltage measurement with horizontal cursors

### Use Vertical Cursors on a Waveform

To use the cursors for a time measurement (T, 1/T), for a mVs-mAs-mWs measurement, or for an RMS measurement of the trace section between the cursors, do the following:

1. Press the **Cursors** button
2. Select the **II** cursors. The cursor type options are:
  - **I** : Single vertical cursor
  - **II** : Two vertical cursors
  - **=** : Two horizontal cursors
  - **J** : Rise time cursor
  - **L** : Fall time cursor

3. Select **T** (time) for the measurement type. The measurement type options are:
  - **T**: time
  - **1/T**: 1/time or frequency
  - **mVs**: Millivolts per second

---

**NOTE.** This option varies depending on the probe type you have selected in the channel button **Probe** menu. Other options include **mAs** (milliamperes per second) for current probes, and **mWs** (milliwatts per second) when you are using the Mathematical function **x** and the probe type for one channel is voltage and another channel is current. If you are taking cursor measurements while using mathematical functions **+**, **-**, or **x**, no measurement will be available if the input 1 and 2 measurement units are different. If you are using the mathematical function **FFT**, you must activate cursors from the **Cursor** button menu. You can then turn cursors on and off from the **FFT** menu. You can read more about using the Mathematical functions. (See page 2-24.)

---

- **RMS**: Root mean squared
4. Press the function key under the **MOVE** menu item to highlight the left cursor (if it is not already highlighted).



5. Use the left and right arrow keys to position the left cursor.
6. Press the function key under the **MOVE** menu item to highlight the right cursor.
7. Use the left and right arrow keys to position the right cursor.

---

**NOTE.** Even when the key labels are not displayed at the bottom of the screen, you still can use the arrow keys. This allows full control of both cursors while having a full screen view.

---

8. Use the cursors to measure the time and voltage differences.

This screen shows the time difference between the two cursors and the voltage difference between the two markers. (See Figure 3-6.)

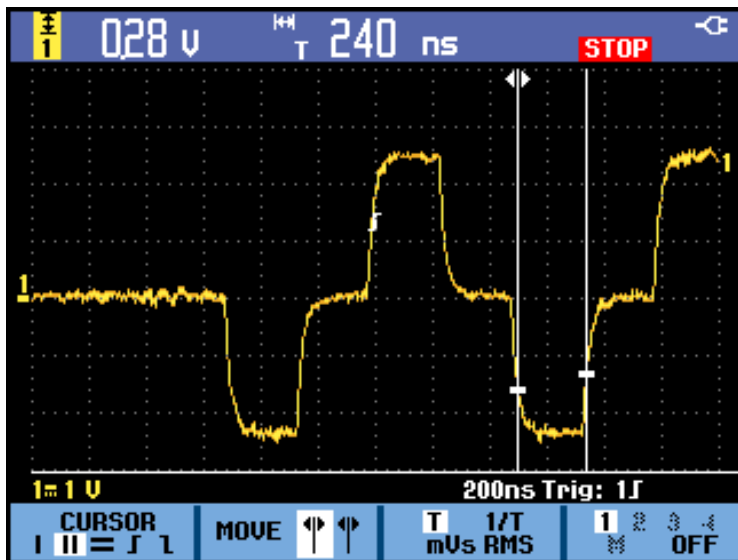

Figure 3-6: Time measurement with vertical cursors

**Use Rise time or Fall time Cursors on a Waveform**

The steps to measure either rise time or fall time are similar. To measure rise time using cursors, do the following:

1. Press the **Cursors** button
2. Select the **J** cursor. The cursor type options are:
  - **I** : Single vertical cursor
  - **II** : Two vertical cursors
  - **=** : Two horizontal cursors
  - **J** : Rise time cursor
  - **L** : Fall time cursor
3. If **MANUAL** is not already highlighted, press the function key under the **AUTO/MANUAL** menu item to highlight **MANUAL**.

---

**NOTE.** Select **AUTO** to automatically complete steps 4 through 7.

---

4. Press the function key under the **MOVE** menu item to highlight the upper cursor (if it is not already highlighted).



5. Use the up and down arrow keys to position the upper cursor to 100% of the trace height. A marker is shown at 90%.



6. Press the function key under the **MOVE** menu item to highlight the lower cursor.
7. Use the up and down arrow keys to position the lower cursor to 0% of the trace height. A marker is shown at 10%.

---

**NOTE.** Even when the key labels are not displayed at the bottom of the screen, you still can use the arrow keys. This allows full control of both cursors while having a full screen view.

---

8. Use the cursors to measure the amplitude, high or low value, or overshoot of the waveform.

This screen shows the risetime measurement from 10%-90% of the trace amplitude. (See Figure 3-7.)

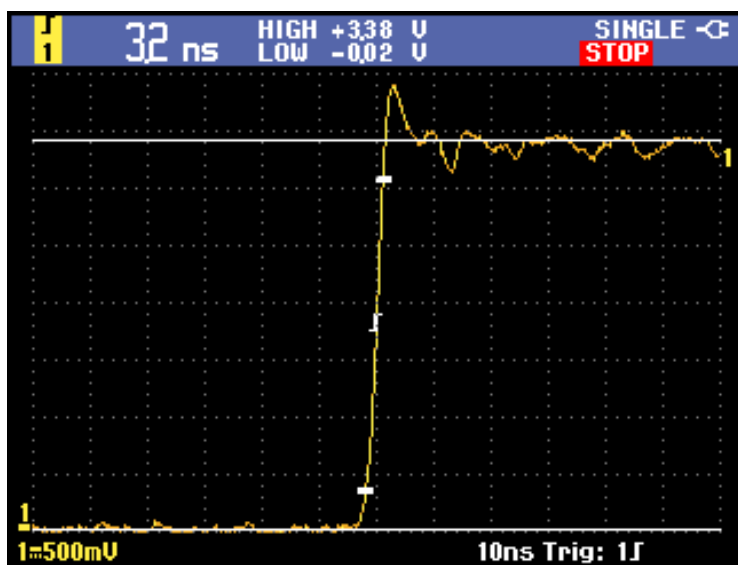

Figure 3-7: Risetime measurement using cursors

# Trigger Functions

**About this Chapter** This chapter provides an introduction to the trigger functions of the instrument. Triggering tells the instrument when to begin displaying the waveform. You can use fully automatic triggering, take control of one or more main trigger functions, or you can use dedicated trigger functions to capture special waveforms.

**Trigger Event** The trigger event establishes the time-reference point in the waveform record. All waveform record data is located in time with respect to that point. The instrument continuously acquires and retains enough sample points to fill the pretrigger portion of the waveform record. That is the part of the waveform that is displayed before, or to the left of, the triggering event on screen. When a trigger event occurs, the instrument is acquiring samples to build the posttrigger portion of the waveform record, that is, the part displayed after or to the right of the trigger event. After a trigger is recognized, the instrument will not accept another trigger until the acquisition is complete.

**Trigger Modes** The trigger mode determines how the instrument behaves in the absence of a trigger event. You can use the following settings for updating the trigger condition by pressing the **Trigger** button and then selecting **TRIGGER OPTIONS** and then **TRIGGER CONDITIONS**.

- **Automatic Auto Level** trigger mode enables the instrument to set the trigger level automatically and track with changes in signal amplitude.
- **Normal** trigger mode enables the instrument to acquire a waveform only when it is triggered. If no trigger occurs, the last waveform record acquired remains on the display. If no last waveform exists, no waveform is displayed.
- **Auto** trigger mode enables the instrument to acquire a waveform even if a trigger does not occur. Auto mode uses a timer that starts when the acquisition is started, and the pretrigger information is obtained. If a trigger event is not detected before the timer times out, the instrument forces a trigger. The length of time it waits for a trigger event depends on the time base setting.

Auto mode, when forcing triggers in the absence of valid triggering events, does not synchronize the waveform on the display. The waveform will appear to move across the screen. If valid triggers occur, the display will become stable.

- **Single Shot** trigger mode allows you to set the instrument to capture (and stop) only one trigger event by pressing the front panel **Single** button. You can also stop single shot triggering by selecting a different trigger mode in the **Trigger > TRIGGER OPTIONS > Trigger Conditions** menu.

Read the Getting Started section for a complete description of the Trigger button menu. (See page 1-2, *Front Panel Navigation*.)

**Trigger Filter** Trigger filtering determines what part of the signal is passed to the trigger circuit. Edge triggering can use both available filter types: Noise Reject and HF Reject.

Following are some typical trigger applications:

- Use the AutoRange™ function to have full automatic triggering and stable display of most waveforms.
- If the signal is unstable or has a very low frequency, you can control the trigger level, slope, and trigger delay for a better view of the signal. (See next section.)
- For dedicated applications, use one of the three manual trigger functions:
- Edge triggering
- Video triggering
- Pulse Width triggering

**Choose a Trigger Type** You can select from the following trigger types:

**Table 3-1: Trigger types**

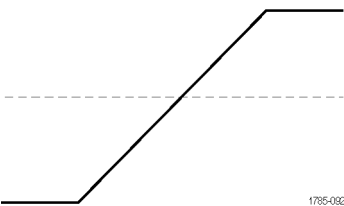
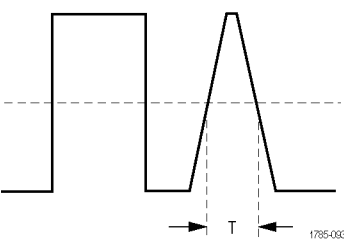
Trigger type	Trigger conditions
<p data-bbox="159 1016 212 1045">Edge</p> 	<p data-bbox="959 1016 1446 1104">Trigger on a rising, falling, or either rising or falling edges, as defined by the slope control. Filter choices are HF Reject and Noise Reject.</p> <p data-bbox="959 1115 1455 1266">Edge triggers are the simplest and most commonly used trigger type, with both analog and digital signals. An edge trigger event occurs when the trigger source passes through a specified voltage level in the specified direction.</p>
<p data-bbox="159 1276 272 1306">Pulse width</p> 	<p data-bbox="959 1276 1446 1398">Trigger on pulses that are less than, greater than, equal to, or not equal to a specified time. You can trigger on positive or negative pulses. Pulse width triggers are primarily used on digital signals.</p>

**Table 3-1: Trigger types (cont.)**

Trigger type	Trigger conditions
Video	<p>Trigger on specified fields or lines of a composite video signal. Only composite signal formats are supported.</p> <p>Trigger on NTSC, PAL, PALPlus, SECAM, or non interlaced signals.</p>
Rise/Fall time	<p>Trigger on rise and fall times. Trigger on pulse edges that traverse between two thresholds at faster or slower rates than the specified time.</p> <p>Specify pulse edges as positive (↑) or negative (↓) or either (X).</p>

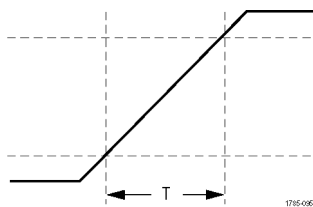
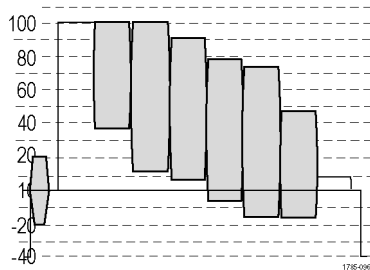

**Set Trigger Level and Slope**

The AutoRange™ function enables hands-off triggering to display complex unknown signals. To manually optimize trigger level and slope, do the following:

1. Press the **Autoset** button to perform an auto set. When the process is complete, **RUN** will appear at the top right of the display screen. This will ensure a stable display of most any signal.
2. Press the **Trigger** button.
3. Select to trigger on either the positive slope or negative slope of the chosen waveform. If you select dual slope triggering (X) the instrument triggers on both the positive slope and negative slope.



4. If **MANUAL** is not already highlighted, press the function key under that menu item to highlight it.
5. Adjust the trigger level using the **Trigger Level** buttons.

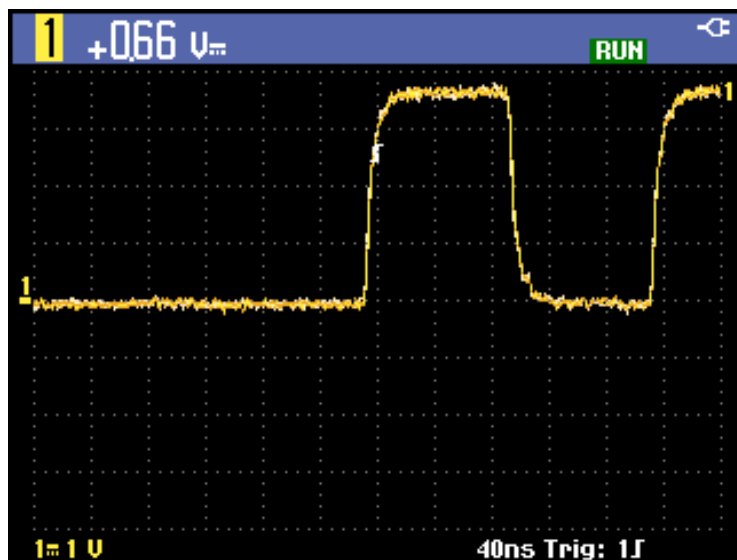

Figure 3-8: Screen with all trigger information

In the following screen, observe the trigger icon  $\lrcorner$  that indicates the trigger position, trigger level, and slope.

At the bottom of the screen the trigger parameters are displayed. For example, **Trig: 1┘** means that channel 1 is used as the trigger source with a positive slope.

When a valid trigger signal is found, the trigger button will be lit and the trigger parameters appear in white.

When no trigger is found, the trigger parameters appear in gray, and the button backlight will be off.

### Set Trigger Delay or Pretrigger

You can begin to display the waveform some time before or after the trigger point is detected using pretrigger (negative delay) or trigger delay, respectively. Initially, you will see a half screen (6 divisions) of negative delay.

**Set trigger delay.** Hold down the horizontal **Position** left button until the trigger icon moves to the new trigger position and changes to include arrows, like this:  $\ll\lrcorner$ . This icon indicates that you have selected a trigger delay. Moving the trigger icon to the right on the display gives you a pretrigger view. This allows you to see what happened before the trigger event, or what caused the trigger.

In case of a trigger delay, the status at the bottom of the display screen will change to include an arrow denoting the delay. For example:

**10ms 1┘ → 9.20ms**

This means that channel 1 is used as the trigger source with a positive slope. The 9.20 ms indicates the (positive) delay between trigger point and waveform display.

When a valid trigger signal is found, the trigger button will be lit and the trigger parameters appear in white.

When no trigger is found, the trigger parameters appear in gray, and the button backlight will be off.

The following image shows an example of a trigger delay of 500 ms (top) and an example of a pretrigger view of 8 divisions (bottom). (See Figure 3-9.)

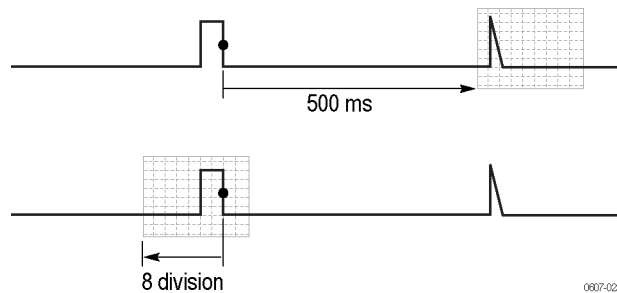
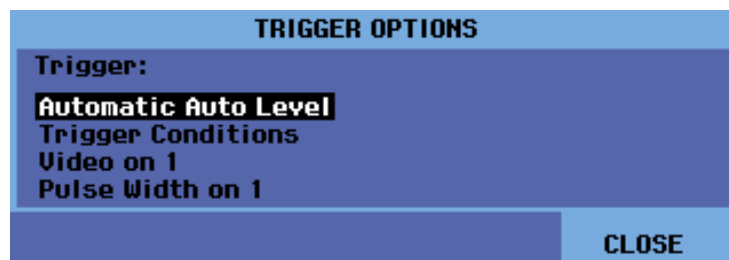

Figure 3-9: Trigger delay or pretrigger view

### Set Automatic Trigger

In the trigger menu, you can change settings for automatic triggering as follows:

1. Press the **Trigger** button.
2. Select **TRIGGER OPTIONS** from the menu.
3. Select **Automatic Auto Level**.



4. Select the trigger threshold: > 15 Hz or > 1 Hz. If the frequency range of the automatic triggering is set to >15 Hz, the Autoset function responds more quickly because the instrument is instructed not to analyze low frequency signal components. However, when you measure frequencies lower than 15 Hz, you need to select > 1 Hz to analyze low frequency components for automatic triggering.

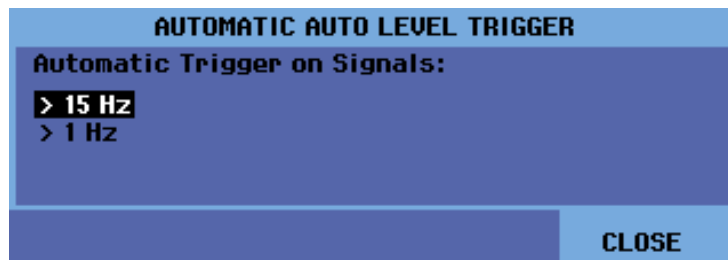

5. Exit the menu.

### Trigger on Edges

If the signal is unstable, complex, or has a very low frequency, use edge triggering to obtain full manual trigger control. To trigger on the rising edge of the **Ch 1** waveform, do the following:

1. Press the **Trigger** button.
2. Select **TRIGGER OPTIONS**.
3. Select **Trigger Conditions**.
4. Select one of the following. In most cases, it is advised to use the **Auto** mode:
  - **Auto**: the instrument will update the screen even if there are no triggers. A trace always appears on the screen.
  - **Normal**: the instrument needs a trigger to display a waveform. Use this mode to update the screen only when valid triggers occur.
  - **Single Shot**: the instrument waits for a trigger. After receiving a trigger, the waveform is displayed and the instrument stops acquisition until the **Single** button or **Run/Stop** button is pressed. The single shot trigger is enabled by pressing the **Single** button or from the **Trigger > TRIGGER OPTIONS > Trigger Conditions** menu.
5. Select **Off** for the Trigger Filter and press the **Enter** button.

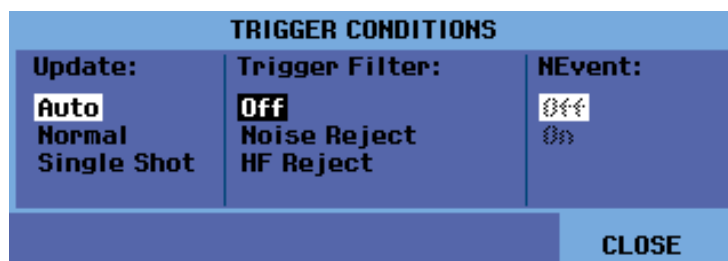

6. The menu that now appears at the bottom of the display screen allows you to select specific edge trigger settings: trigger channel, slope, and level. Adjust these settings as desired.



**Trigger on noisy waveforms.** To reduce jitter on the screen when triggering on noisy waveforms, you can use a trigger filter, as follows:

1. Press the **Trigger** button.
2. Select **TRIGGER OPTIONS**.
3. Select **Trigger Conditions**.
4. Select a trigger filter:
  - **Noise Reject:** an increased trigger gap will be applied
  - **HF Reject:** HF noise on the (internal) trigger signal will be suppressed

***NOTE.** You can also smooth noisy waveforms without changing bandwidth. (See page 2-19, Smooth a Waveform With Averaging.)*

**Single shot trigger.** To make a single shot measurement, do the following:

1. Press the **Trigger** button.
2. Select **TRIGGER OPTIONS**.
3. Select **Trigger Conditions**.

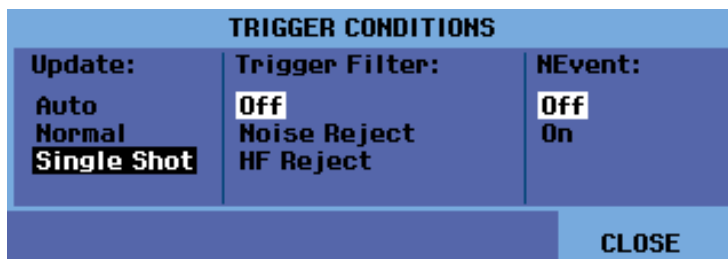

4. Select **Single Shot**. The word **SINGLE** will appear in the top right portion of the display screen indicating that the instrument is waiting for a trigger. As soon as it receives a trigger, the waveform is displayed and the instrument is set to stop. This is indicated by the word **STOP** in the top right portion of the screen. (See Figure 3-10.)
5. Press the **Single** button to set the instrument to trigger again. The word **RUN** will appear in the top right portion of the screen when the instrument is set trigger again.



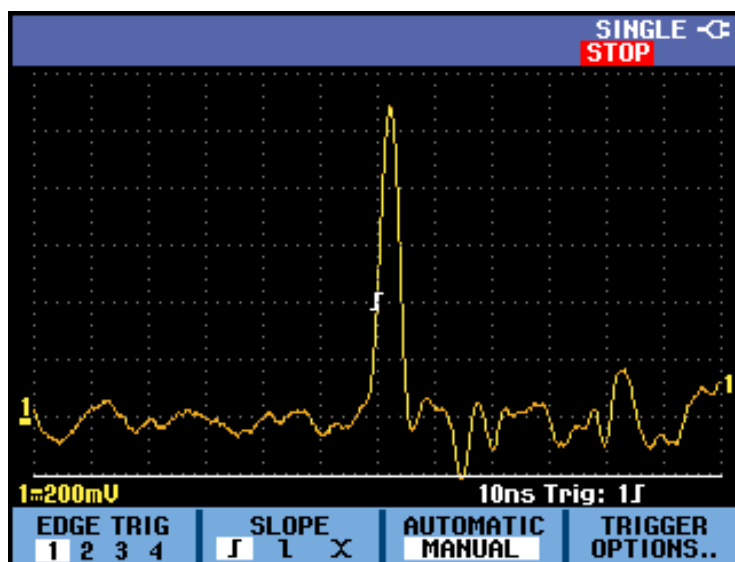

Figure 3-10: Making a single shot measurement

**NOTE.** The instrument stores all single shots in the replay memory. Use the *Replay* function to look at all the stored single shots. (See page 3-6, *Use Replay*.)

**N-Event trigger.** N-Event triggering enables you to create a stable picture of n-event burst waveforms. Each next trigger is generated after the waveform has crossed the trigger level N times in the direction that complies with the selected trigger slope.

To select N-Event triggering, do the following:

1. Press the **Trigger** button.
2. Select **TRIGGER OPTIONS**.
3. Select **Trigger Conditions**.

TRIGGER CONDITIONS		
<b>Update:</b>	<b>Trigger Filter:</b>	<b>NEvent:</b>
Auto	Off	Off
Normal	Noise Reject	On
Single Shot	HF Reject	
		<b>CLOSE</b>

4. Select **Normal** or **Auto** for update, check that the trigger filter is set to **Off**, and then select **On** for the NEvent.

5. Press the function button under the **NEVENT** menu item and then use the right and left arrow keys to select the number of events.



6. Press the **Trigger Level** buttons to adjust the trigger level.

This screen shows an N-Event trigger in which N=3. (See Figure 3-11.)

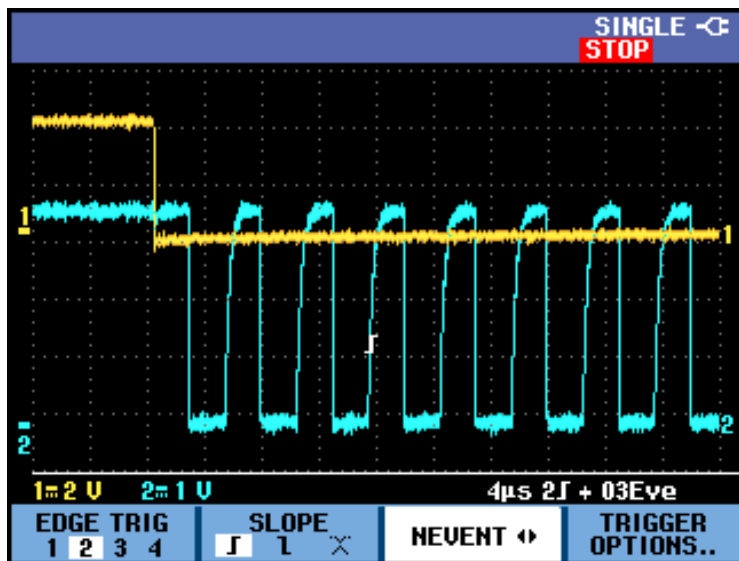

Figure 3-11: N-Event triggering

### Trigger On Video Signals

To trigger on a video signal, first select the standard of the video signal you are going to measure, as follows:

1. Press the **Trigger** button.
2. Select **TRIGGER OPTIONS**.
3. Select **Video on** and press the **Enter** button.
4. Select a video standard, for example **NTSC**, and the polarity. Select positive polarity for video signals with negative going sync pulses. If you select non-interlaced, a scan rate menu will appear.



- Adjust trigger video settings as needed in the menu that appears. For example, to trigger on either the first half of a frame (Field 1, odd) or the second half of a frame (Field 2, even), select that field from the **FIELD** menu and the signal part of that field will be displayed. (See Figure 3-12.)



Select **ALL LINES** to trigger on all line synchronization pulses (horizontal synchronization). The signal of one line is displayed on the screen and the screen is updated with the signal of the next line immediately after the instrument triggers on the horizontal synchronization pulse.

To view a specific video line in more detail, you can select the line number by pressing the function button under the **LINE NR.** menu and then using the up and down arrow keys to select the line number. The signal of the selected line will display on the screen. The screen will be continuously updated with the signal of that line.

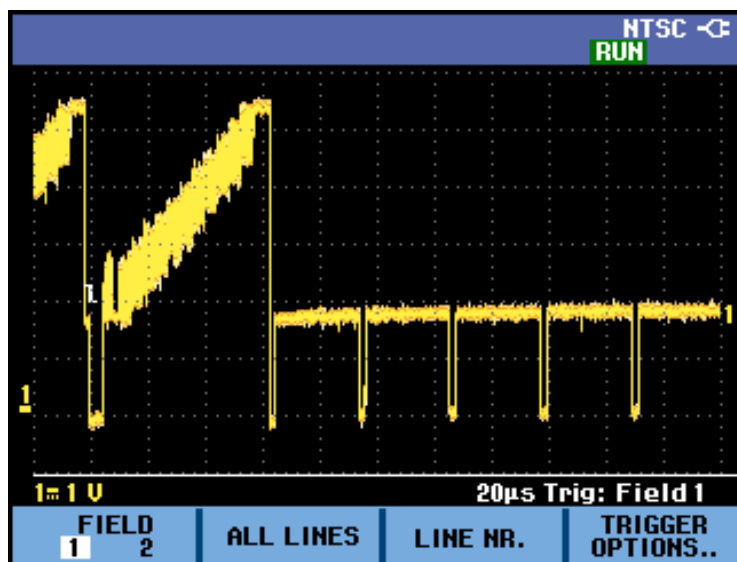

Figure 3-12: Trigger on NTSC video signal field 1

### Trigger On Pulses

Use pulse width triggering to isolate and display specific pulses that you can qualify by time, such as glitches, missing pulses, bursts, or signal dropouts.

**Detect narrow pulses.** To set the instrument to trigger on narrow positive pulses shorter than 5 ms, do the following:

1. Press the **Trigger** button.
2. Select **TRIGGER OPTIONS**.
3. Select **Pulse Width on** and press the **Enter** button.
4. Select the positive pulse icon ( $\Pi$ ).
5. Select the  $=t$  ( $\pm 10\%$ ) condition.
6. Select **On Trigger** for update. The instrument is now prepared to trigger on narrow pulses only. A new menu will appear from which you can further define settings.



In this screen, the pulse width was set to 4.80 μs. All positive pulses equal to 4.80 μs are displayed. (See Figure 3-13.)

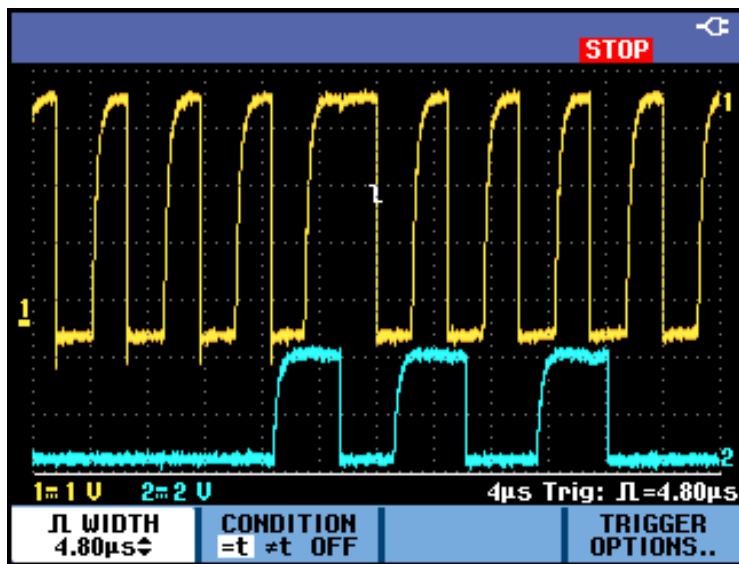

Figure 3-13: Pulse width triggering

---

**NOTE.** The instrument stores all triggered screens in the replay memory. For example, if you set up your triggering for glitches, you can capture 100 glitches with time stamps. Read more in the Replay section. (See page 3-6, Use Replay.)

---

## Save and Recall

The Save and Recall functions, both accessed from the **Save** button menu, allow you to do the following:

- Save screens and setups to internal memory and recall them again from memory. The instrument has 15 ‘screen and setup’ memories, 2 ‘record and setup’ memories, and 1 ‘screen image’ memory. (See Table 3-2.)
- Save and recall up to 256 screens and setups to a USB memory device.
- Name saved screens and setups according to your own preferences.
- Recall screens and recordings to analyze the screen image at a later date.
- Recall a setup to continue a measurement with the recalled operating configuration.

---

**NOTE.** *Saved data are stored in non-volatile Flash memory. Not saved instrument data are stored in RAM memory and will be kept at least 30 seconds when the battery is removed when no power is supplied through the power adapter.*





---

**Table 3-2: Internal memory**

Mode	Memory locations		
	30x	10x	9x
SCOPE ROLL MODE	Setup + 1 screen	Setup + 100 replay screens	
DATA LOG RECORD	—	Setup + record data	Screen image
TREND PLOT	—	Setup + trend plot data	Screen image

In persistence mode the most recently written trace will be saved, not all persistence traces.

In the displayed file list of stored screens and setups the following symbols are used:

-  setup + 1 screen
-  setup + replay screens/record data
-  setup + trendplot data
-  screen image (imageX.bmp)

### Save Screens with Associated Setups

To save a screen + setup, do the following:

1. Press the **Save** button. Once the menu appears, the display screen will be frozen.



2. Select **SAVE...**
3. Select the target memory: **INT** (internal memory) or **USB** (USB device). Observe the number of available and used memory locations.

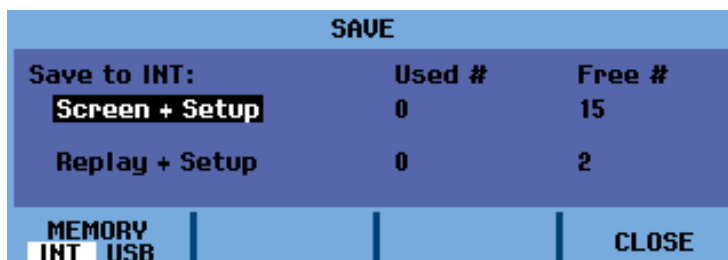

4. Select **Screen + Setup** and press the **Enter** button.
6. Select **EDIT NAME** if you want to rename the file from SCOPE 1.

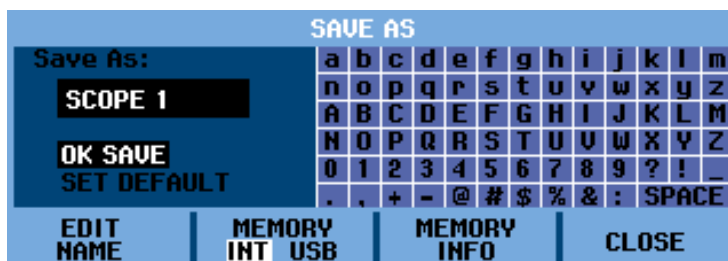

7. Use the arrow keys to select a letter, number, or character. Use the function keys under **PREV #** and **NEXT #** to move the cursor to the next letter in the name to change that letter.

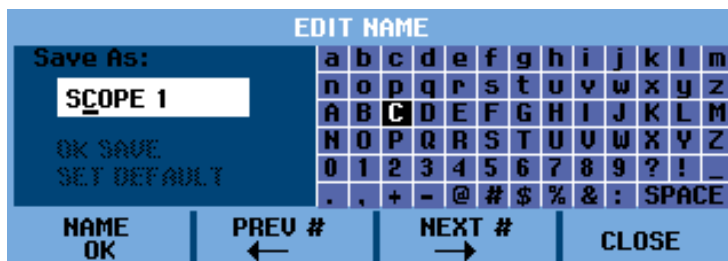

8. Select **NAME OK** to save the new name and return to the previous menu.
9. Observe that the file name and **OK SAVE** are selected (black highlighted). Press the **Enter** button to save the screen + setup.
10. Press the **Run/Stop** button to resume measurements.

**What to do when all memories are in use.** If no free memory locations are available, a message pops up that proposes to you to overwrite the oldest data set. Do one of the following:

- If you do not want to overwrite the oldest data set, press the function 3 button (**NO**).
- If you want to overwrite the oldest data set, press the function 4 button (**YES**).

---

**NOTE.** The **record + setup** memory locations store more than just what is visible on the screen. In TrendPlot or Scope Record mode, the full recording is saved. In scope mode you can save all 100 replay screens in a single **record + setup** memory location. You can see what you can store for the various instrument modes. (See Table 3-2.)

To save a TrendPlot press **STOP** first.

---

### Save Screens in .bmp Format (Print Screen)

1. Press the **Save** button. Once the menu appears, the display screen will be frozen.



2. Press the function 3 button under the camera icon. The file is saved using a fixed name (IMAGE) and a serial number, for example IMAGE004.bmp.

---

**NOTE.** If no free memory locations are available, a message pops up that proposes to you to overwrite the oldest data set. Do one of the following:

If you do not want to overwrite the oldest data set, press the function 3 button (**NO**).

If you want to overwrite the oldest data set, press the function 4 button (**YES**).

---

3. Select **FILE OPTIONS...** to view the saved .bmp file.
4. Press the **Run/Stop** button to resume measurements.

### Delete Screens with Associated Setups

To delete a screen and associated setup, do the following:

1. Press the **Save** button. Once the menu appears, the display screen will be frozen.



2. Select **FILE OPTIONS...**
3. Select the target memory: **INT** (internal memory) or **USB** (USB device).

4. Use the down arrow key to highlight **DELETE**.
5. Press the right arrow to move to the file name list, and then use the down arrow key to highlight the file you want to delete.

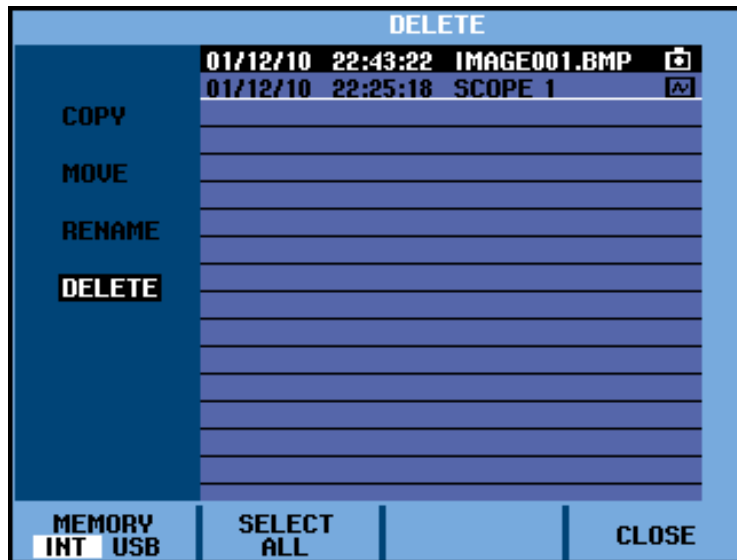

6. Press the **Enter** button.
7. A message will appear asking if you want to delete the selected file. Select **YES** to delete the file. Select **NO** to return to the file list menu.
8. After the item is deleted, the file list menu will be displayed again. Observe that the file you chose to delete is no longer listed. Select **CLOSE** to exit the menu.
9. Press the **Run/Stop** button to resume measurements.

### Recall Screens with Associated Setups

To recall a screen + setup, do the following:

1. Press the **Save** button. Once the menu appears, the display screen will be frozen.



2. Select **RECALL**.
3. Select the target memory: **INT** (internal memory) or **USB** (USB device).



- Use the up or down arrow key to highlight **DATA** and press the **Enter** button.

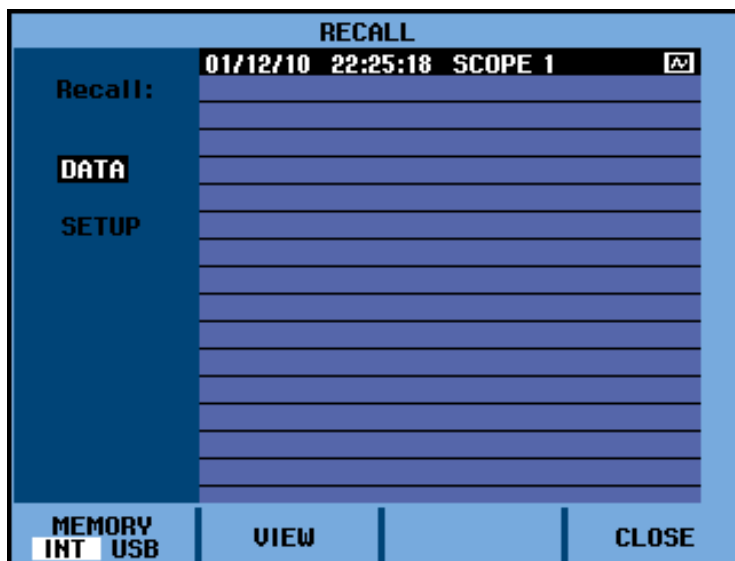

- Press the up and down arrow keys to select the file you want to recall and then select **VIEW**.
- A message will appear asking if you want to continue to view mode, as data on the display screen will be lost. Select **YES** to view the saved file.
- Observe that the recalled waveform is displayed and that **STOP** appears on the screen.
- Press the **Run/Stop** button to exit view mode and resume measurements.

---

**NOTE.** Learn about how to recall a screen as a reference waveform to compare it to measured waveform. (See page 2-28, Compare Waveforms.)

---

### Recall a Setup Configuration

To recall a setup configuration, do the following:

- Press the **Save** button. Once the menu appears, the display screen will be frozen.



- Select **RECALL**.
- Select the target memory: **INT** (internal memory) or **USB** (USB device).
- Use the up or down arrow key to highlight **SETUP** and press the **Enter** button.
- Press the up and down arrow keys to select the file you want to recall and then select **VIEW**.

6. A message will appear asking if you want to continue to view mode, as data on the display screen will be lost. Select **YES** to recall the selected setup.
7. Observe that the recalled setup is displayed and that **STOP** appears on the screen.
8. Press the **Run/Stop** button to exit view mode and resume measurements in the recalled operating configuration.

### View Stored Screens

To scroll through the memories while looking at the stored screens, do the following:

1. Press the **Save** button. Once the menu appears, the display screen will be frozen.



2. Select **RECALL**.
3. Select the target memory: **INT** (internal memory) or **USB** (USB device).
4. Press the **Enter** button.
5. Highlight any file.
6. Select **VIEW**.
7. A message will appear asking if you want to continue to view mode, as data on the display screen will be lost. Select **YES** to view the file and open the viewer menu.



8. Use the up and down arrow keys to scroll through all stored screens.
9. Select the function 3 button to save the screen to internal memory or a USB device (if connected).
10. Press the **Run/Stop** button to exit view mode and resume measurements.

---

**NOTE.** The replay screens of a saved **record + setup** cannot be viewed while the instrument is in **VIEW** mode. Only the screen at the instant of saving can be reviewed in this way. To see all replay screens, recall them from memory using the **RECALL** option. (See page 3-28, Recall Screens with Associated Setups.)

---

### Rename Stored Screens and Setup Files

To rename a stored screen + setup file, do the following:

1. Press the **Save** button. Once the menu appears, the display screen will be frozen.



2. Select **FILE OPTIONS...**
3. Select the target memory: **INT** (internal memory) or **USB** (USB device).
4. Use the down arrow key to highlight **RENAME**.
5. Press the **Enter** button.
6. Use the down arrow key to highlight the file you want to rename, and then press the **Enter** button.

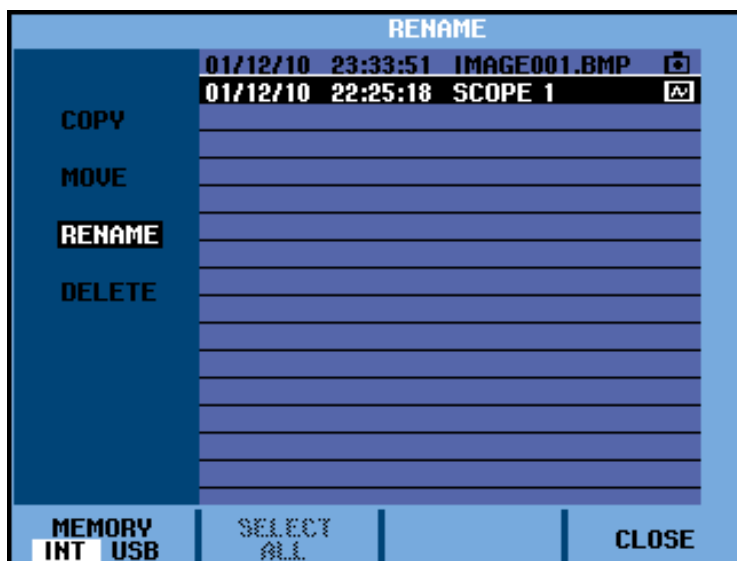

7. Use the arrow keys to select a letter, number, or character. Use the function keys under **PREV #** and **NEXT #** to move the cursor to the next letter in the name to change that letter.



8. Select **NAME OK** to save the new name and return to the previous menu.
9. Press the **Run/Stop** button to exit the **Save** menu and resume measurements.

### Copy or Move Stored Screens and Setup Files

You can copy or move a file from internal memory to a USB device or from a USB device to internal memory by doing the following:

1. Press the **Save** button. Once the menu appears, the display screen will be frozen.



2. Select **FILE OPTIONS...**
3. Select the target memory: **INT** (internal memory) or **USB** (USB device).
4. Use the down arrow key to highlight **COPY** or **MOVE**.

---

**NOTE.** When you select to move a file, a copy of that file will be made and saved to the alternate location and the source file will be deleted. When you select to copy a file, the source file will remain in the same location and a copy will be saved to the alternate location.

---

Press the **Enter** button.

5. Use the down arrow key to highlight the file you want to copy or move, and then press the **Enter** button.

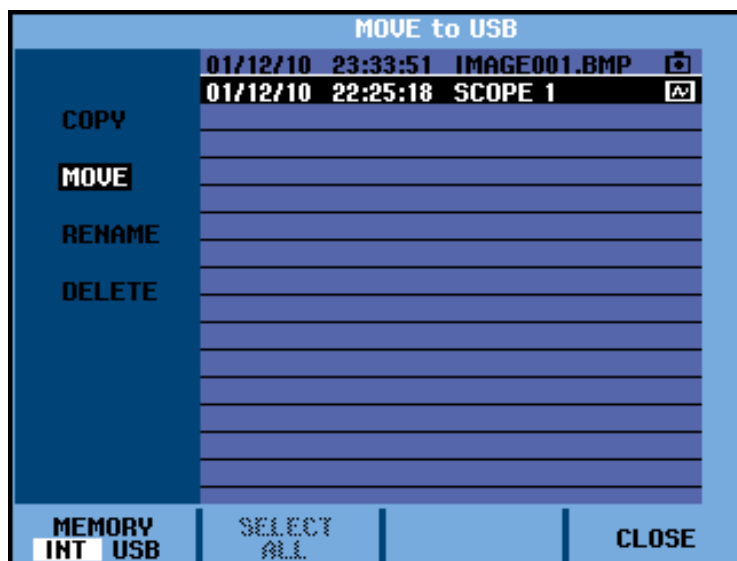

6. When the copy or move process is complete, the menu will reappear and you will see the moved copy is moved or the copied file is now in both memory locations.
7. Press the **Run/Stop** button to exit the **Save** menu and resume measurements.

## Troubleshooting

### What To Do If The Instrument Shuts Down After a Short Time

- The batteries may be empty. Check the battery symbol at the top right of the screen. A  symbol indicates that the batteries are empty and must be charged. Connect the power adapter.
- The instrument is still on but the **Display Auto-OFF** timer is still active. To turn the display on, press any key (this action restarts the **Display Auto-Off** timer), or connect the power adapter. (See page D-1.)
- The **Instrument Auto-OFF** timer is active. Press the power button to turn the instrument on. (See page D-1.)

### What To Do If The Screen Remains Black

- Make sure that the instrument is on (press the power button).
- You might have a problem with the screen contrast. Press the **Utility** button. Now you can use the arrow keys to adjust the contrast.
- The **Display Auto-OFF** timer is active. To turn the display on, press any key (this action restarts the **Display Auto-OFF** timer), or connect the power adapter. (See page D-1.)

### What To Do If The Instrument Cannot Be Turned Off

If the instrument cannot be turned off due to a software problem, do the following:

- Press the power button for at least 5 seconds.

### What To Do If OpenChoice™ Desktop Does Not Recognize The Instrument

- Make sure that the instrument is turned on.
- Make sure that the interface cable is properly connected between the instrument and the PC. Only use the instrument mini-USB port for communication with a computer.
- Make sure that the USB driver was correctly installed. (See page B-3, *Install USB Drivers*.)



---

# Appendices





# Appendix A: Specifications

## Introduction

### Performance Characteristics

Tektronix guarantees the properties expressed in numerical values with the stated tolerance. Specified non-tolerance numerical values indicate those that could be nominally expected from the mean of a range of identical oscilloscopes.

The oscilloscope meets the specified accuracy 30 minutes and two complete acquisitions after power on. Specifications are based on a 1-year calibration cycle.

### Environmental Data

The environmental data in this manual are based on the results of the verification procedures.

### Safety Characteristics

The oscilloscope was designed and tested in accordance with Standards IEC/EN 61010-1:2001 Pollution Degree 2 (According to CE marking), UL 61010-1:2004, CAN/CSA-C22.2 No. 61010-1-04 (including approval), Safety Requirements for Electrical Equipment for Measurement, Control, and Laboratory Use.

This manual contains information and warnings that must be followed by the user to ensure safe operation and to keep the oscilloscope in a safe condition. Use of this equipment in a manner not specified may impair protection provided by the equipment.

## General Specifications

Table A-1: Record Length (Samples/points per input)

Mode	Glitch detect on	Glitch detect off	Maximum sample rate
Short	300 min/max pairs	3k true samples compressed into 1 screen (300 samples per screen)	5 GS/s (THS3024 with 1 channel on) 2.5 GS/s (THS3024 with 1 or 2 channels on, THS3014 with 2 channels on)
Long	300 min/max pairs	10k true samples compressed into 1 screen (use Zoom and Scroll to see waveform details)	1.25 GS/s (All models and 3 or 4 channels on)
Record Roll		30k to 37.5k samples	4x 125 MS/s
Trend Plot		>18k min/max/ average values per measurement	Up to 5 measurements per second

**Table A-2: Oscilloscope Inputs**

Characteristic	Description
<b>Isolated Vertical Inputs (Ch 1, 2, 3, and 4)</b>	
Input coupling	AC, DC
Bandwidth, DC coupled	
THS3024	200 MHz (–3 dB)
THS3014	100 MHz (–3 dB)
Lower frequency limit, AC coupled	
with 10:1 probe	<2 Hz (–3 dB)
direct (1:1)	<5 Hz (–3 dB)
Rise time	
THS3024	1.7 ns
THS3014	3.5 ns
Analog bandwidth limiters	
20 kHz	Upper transition point: 24 kHz ±10%
20 MHz	Upper transition point: 20 MHz ±30%
Polarity	Normal, Inverted, Variable
Sensitivity ranges	
with 10:1 probe	20 mV to 1000 V/div
direct (1:1)	2 mV to 100 V/div
Dynamic range	
DC to 10 MHz	>±8 div
DC to 100 MHz (THS3014)	>±4 div
DC to 200 MHz (THS3014)	>±4 div
Trace positioning range	±4 divisions
Spurious signals	
2 mV/div	<0.75 div pk-pk
5 mV/div	<0.5 div pk-pk
≥50 mV/div	<0.3 div pk-pk
Input impedance and capacitance on BNC	
DC coupled	1 MΩ (±1%)/13.75 pF (±2.25 pF)
AC coupled	3 MΩ (±1%)
Maximum input voltage	
with 10:1 standard probe (THP0301-x), from tip signal to BNC and reference lead	300 V CAT III
direct (1:1), from BNC signal to BNC shell	300 V CAT III
(For detailed specifications, see <i>Safety Specifications</i> . (See page A-13.)	

Table A-2: Oscilloscope Inputs (cont.)

Characteristic	Description
Vertical accuracy	
5 mV/div to 100 V/div	$\pm(2.1\% + 0.04 \text{ range/div})$
2 mV/div	$\pm(2.9\% + 0.08 \text{ range/div})$
Digitizer resolution	8 bits, separate digitizer for each input
Maximum vertical resolution	200 pixels on screen
<b>Horizontal</b>	
Maximum time base speed	1 ns/div
Minimum time base speed (Scope Roll Mode)	2 min/div <4 h/DIV>
Time base accuracy	$\pm(100 \text{ ppm} + 0.04 \text{ div})$
Maximum real time sampling rate	
THS3024	
One channel	up to 5 GS/s
Two channels	up to 2.5 GS/s
Three to four channels	up to 1.25 GS/s
THS3014	
Two channels	up to 2.5 GS/s
Four channels	up to 1.25 GS/s
Record length	see <i>Record Length</i> table (See Table A-1.)
Resolution	300 pixels
Averaging	2, 4, 8, 64
Input delay difference	<0.3 ns
<b>Crosstalk</b>	
Between inputs	
@ DC	-100 dB
@1 MHz	-55 dB
@ channel upper transition point	-40 dB
Between USB and inputs	
@ DC	-100 dB
@ channel upper transition point	-40 dB
Glitch detection	
5 $\mu$ s to 120 s/div	displays glitches as fast as 8 ns
Waveform display	Ch1, Ch2, Ch3, Ch4, Math (+, -, x, X-Y mode, FFT), Normal, Average, Persistence, Reference

Table A-2: Oscilloscope Inputs (cont.)

Characteristic	Description
<b>Trigger and Delay</b>	
Trigger modes	Automatic, Edge, Video, Pulse Width, N-Cycle
Trigger delay	up to +1200 divisions
Pre trigger view	one full screen length
Delay	-12 div to +1200 div
Maximum delay	60 s at 5 s/div
<b>Automatic Auto-Level Trigger</b>	
Source	Ch1, Ch2, Ch3, Ch4
Slope	Positive, Negative, Dual (either positive or negative)
<b>Edge Trigger</b>	
Screen update	Auto, On Trigger, Single Shot
Source	Ch1, Ch2, Ch3, Ch4
Slope	Positive, Negative, Dual (either positive or negative)
Trigger level control range	$\pm 4$ divisions
Vertical trigger level indicator error	$\pm 0.5$ divisions
Horizontal trigger level indicator error	$\pm 1$ sample
Trigger N-cycle range	2–99 cycles
Trigger sensitivity	
DC to 5 MHz at >5 mV/div	0.5 divisions
DC to 5 MHz at 2 mV/div and 5 mV/div	1 division
THS3024	
200 MHz	1 division
250 MHz	2 divisions
THS3014	
100 MHz	1 division
150 MHz	2 divisions
<b>Video Trigger</b>	
Standards	PAL, PAL+, NTSC, SECAM, Non-interlaced
Modes	Lines, Line Select, Field 1 or Field 2
Source	Ch1
Polarity	Positive, Negative
Sensitivity	0.7 division sync level

Table A-2: Oscilloscope Inputs (cont.)

Characteristic	Description
Scan rates	14–22 kHz 19–33 kHz 31–65 kHz
<b>Pulse Width Trigger</b>	
Screen update	On Trigger, Single Shot
Trigger conditions	<T, >T, =T ( $\pm 10\%$ ), $\neq T(\pm 10\%)$
Source	Ch1
Polarity	Positive or negative pulse
Sensitivity	same as edge trigger
Level	same as edge trigger
Pulse time adjustment range	0.01 div. to 655 div. with a minimum of 300 ns (<T) or 500 ns (=T, $\neq T$ ), a maximum of 10 s, and a resolution of 0.01 div. with a minimum of 50 ns
<b>Continuous Auto Set</b>	
Auto-ranging attenuators and time base, automatic AutoRange triggering with automatic source selection.	
Modes	
Normal	15 Hz to maximum bandwidth
Low frequency	1 Hz to maximum bandwidth
Minimum amplitude Ch1, Ch2, Ch3, Ch4	
DC to 1 MHz	10 mV
1 MHz to maximum bandwidth	20 mV
Minimum trigger amplitude	55 mV rms
<b>Automatic Capturing Screens</b>	
Capacity	100 screens
<i>For viewing screens, see Data Log function.</i>	

## Automatic Measurements

The accuracy of all measurements is within  $\pm$  (% of measurement + number of counts) from 18 °C to 28 °C. Add 0.1x (specific accuracy) for each °C below 18 °C or above 28 °C. At least 1.5 waveform periods must be visible on the screen.

**Table A-3: Automatic measurement specifications**

Characteristic	Description
Inputs	1, 2, 3 and 4
DC common mode rejection (CMRR)	>100 dB
AC common mode rejection at 50, 60, or 400 Hz	>60 dB
DC voltage (VDC)	
Maximum voltage	
with 10:1 probe	1000 V
direct (1:1)	300 V
Maximum resolution	
with 10:1 probe	1 mV
direct (1:1)	100 $\mu$ V
Full scale measurement	999 counts
Accuracy at 5 s to 10 $\mu$ s/div	
2 mV/div	$\pm(1.5 \% + 10 \text{ counts})$
5 mV/div to 100 V/div	$\pm(1.5 \% + 5 \text{ counts})$
Normal mode AC rejection at 50 or 60 Hz	>60 dB
AC voltage (VAC)	
Maximum voltage	
with 10:1 probe	1000 V
direct (1:1)	300 V
Maximum resolution	
with 10:1 probe	1 mV
direct (1:1)	100 $\mu$ V
Full scale measurement	999 counts
Accuracy	
DC coupled: DC to 60 Hz	$\pm(1.5 \% + 10 \text{ counts})$
AC coupled, low frequencies	
50 Hz direct (1:1)	$\pm(1.5 \% + 10 \text{ counts})$
60 Hz direct (1:1)	$\pm(1.9 \% + 10 \text{ counts})$

With the 10:1 probe the low frequency roll off point will be lowered to 2 Hz, which improves the AC accuracy for low frequencies. When possible use DC coupling for maximum accuracy

**Table A-3: Automatic measurement specifications (cont.)**

Characteristic	Description
AC coupled, high frequencies	
60 Hz to 20 kHz	$\pm(2.5 \% + 15 \text{ counts})$
20 kHz to 1 MHz	$\pm(5 \% + 20 \text{ counts})$
1 MHz to 25 MHz	$\pm(10 \% + 20 \text{ counts})$
For higher frequencies, the frequency roll off of the instrument starts to affect accuracy.	
Normal mode DC rejection	>50 dB
All accuracies are valid if:	
The waveform amplitude is larger than one division	
At least 1.5 waveform periods are on the screen	
AC+DC voltage (true RMS)	
Maximum voltage	
with 10:1 probe	1000 V
direct (1:1)	300 V
Maximum resolution	
with 10:1 probe	1 mV
direct (1:1)	100 $\mu$ V
Full scale measurement	1100 counts
Accuracy	
DC to 60 Hz	$\pm(1.5 \% + 10 \text{ counts})$
60 Hz to 20 kHz	$\pm(2.5 \% + 15 \text{ counts})$
20 kHz to 1 MHz	$\pm(5 \% + 20 \text{ counts})$
1 MHz to 25 MHz	$\pm(10 \% + 20 \text{ counts})$
For higher frequencies, the frequency roll off of the instrument starts to affect accuracy.	
Current (Amperes)	
With optional current probes	
Ranges	same as VDC, VAC, VAC+DC
Probe sensitivity	100 $\mu$ V/A, 1 mV/A, 10 mV/A, 100 mV/A, 400 mV/A, 1 V/A, 10 V/A, and 100 V/A
Accuracy	same as VDC, VAC, VAC+DC
Frequency (Hz)	
Range	1.000 Hz to full bandwidth
Full scale measurement	999 counts
Accuracy	
1 Hz to full bandwidth	$\pm(0.5 \% + 2 \text{ counts})$ (5 s/div to 10 ns/div and 10 periods on the screen).

**Table A-3: Automatic measurement specifications (cont.)**

Characteristic	Description
<b>Peak</b>	
Modes	Max peak, min peak, or peak-to-peak
Maximum voltage	
with 10:1 probe	1000 V
direct (1:1)	300 V
Maximum resolution	
with 10:1 probe	10 mV
direct (1:1)	1 mV
Full scale measurement	800 counts
Accuracy	
Max peak or min peak	$\pm 0.2$ division
Peak-to-peak	$\pm 0.4$ division
<b>Duty cycle (DUTY)</b>	
Range	4.0 % to 98.0 %
Resolution	0.1 % (when period > 2 div)
Full scale measurement	999 counts (3-digit display)
Accuracy (logic or pulse)	$\pm(0.5 \% + 2 \text{ counts})$
<b>Pulse width (PULSE)</b>	
Resolution (with GLITCH off)	1/100 division
Full scale measurement	999 counts
Accuracy 1 Hz to full bandwidth	$\pm(0.5 \% + 2 \text{ counts})$
<b>Phase (Inputs 1 and 2, 3 and 4)</b>	
Range	-180 to +180 degrees
Resolution	1 degree
Accuracy	
0.1 Hz to 1 MHz	$\pm 2$ degrees
1 MHz to 10 MHz	$\pm 3$ degrees
<b>Decibel (dB)</b>	
dBV	dB relative to one volt
dBm	dB relative to one mW in 50 $\Omega$ or 600 $\Omega$
dB on	VDC, VAC, or VAC+DC
Accuracy	same as VDC, VAC, VAC+DC



## Recorder Specifications

Table A-4: Recorder

Characteristic	Description
<b>TrendPlot (Channel 1, 2, 3, 4)</b>	
Chart recorder mode that plots a graph of min and max values of oscilloscope measurements (four max) over time.	
Measurement speed	>5 measurements/s
Time/div	5 s/div to 30 min/div
Record size (min, max, average)	≥18000 points
Recorded time span	60 min to 22 days
Time reference	time from start, time of day
<b>Scope Roll Mode</b>	
Records oscilloscope waveforms in deep memory while displaying the waveform in Roll mode.	
Source	Input Ch1, Ch2, Ch3, Ch4
Maximum sample speed (5 ms/div to 1 min/div)	4 × 125 MS/s
Glitch capture (5 ms/div to 1 min/div)	8 ns
Glitch capture (2 min/div)	8 ns
Time/div in normal mode	5 ms/div to 2 min/div
Record size	30 k to 37.5 k points per trace
Recorded time span	6 s to 48 hours
Acquisition modes	Single Sweep, Continuous Roll, Start/Stop on Trigger
Time reference	time from start, time of day

## Zoom, Data Log, and Cursors Specifications

Table A-5: Zoom, Data Log, and Cursors

Characteristic	Description
Zoom	Zoom ranges from full record overview to detailed view of individual samples
Data Log	Displays a maximum of 100 captured quad input Scope screens
Data Log modes	Step by Step, Replay as Animation
<b>Cursor measurements</b>	
Cursor modes	single vertical cursor, dual vertical cursors, dual horizontal cursors

Table A-5: Zoom, Data Log, and Cursors (cont.)

Characteristic	Description
Markers	automatic markers at cross points
Measurements	value at cursor 1
	value at cursor 2
	difference between values at cursor 1 and 2
	time between cursors
	RMS between cursors
	Time of Day (Recorder modes)
	Time from Start (Recorder modes)
	Rise Time, fall time
	A × s (current over time between cursors)
	V × s (voltage over time between cursors)
W × s (power over time between cursors using powertrace Ch1xCh2 or Ch3xCh4)	

## Miscellaneous Specifications

Table A-6: Display

Characteristic	Description
View area	126.8 × 88.4 mm (4.99 × 3.48 inches)
Resolution	320 × 240 pixels
Backlight	LED (temperature compensated)
Brightness	
Power adapter	200 cd/m <sup>2</sup>
Battery power	90 cd/m <sup>2</sup>
Display auto-off time (battery saving)	30 seconds, 5 minutes, or disabled

Table A-7: Power

Characteristic	Description
Rechargeable Li-ion battery (THSBAT)	
Operating time	up to 7 hours (low intensity)
Charging time	5 hours
Capacity/voltage	52 Wh / 10.8 V
Lifetime (>80 % capacity)	300× charge/discharge
Allowable ambient temperature during charging	0 to 40 °C (32 to 104 °F)
Auto power-down time (battery saving)	5 min, 30 min, or disabled

**Table A-7: Power (cont.)**

Characteristic	Description
Power adapter 119-7900-xx	Line cord options <ul style="list-style-type: none"> <li>• Option A0 North American line cord</li> <li>• Option A1 European line cord</li> <li>• Option A2 United Kingdom line cord</li> <li>• Option A3 Australian line cord</li> <li>• Option A5 Switzerland line cord</li> <li>• Option A6 Japanese line cord</li> <li>• Option A10 China line cord</li> <li>• Option A11 India line cord</li> <li>• Option E1 Universal Euro &amp; UK</li> </ul>
Line frequency	50 and 60 Hz

**Table A-8: Probe Calibration Output Signal**

Characteristic	Description
Voltage	1.225 V <sub>p-p</sub> ±1.5%
Frequency	500 Hz square wave ±20%
Output impedance	1k Ω
Manual pulse adjustment and automatic DC adjustment with probe check	

**Table A-9: Memory**

Characteristic	Description
Number of oscilloscope memories	30
Each memory can contain four waveforms plus corresponding setups	
Number of recorder memories	10
Each memory can contain:	
<ul style="list-style-type: none"> <li>■ a quad (4 channel) input TrendPlot</li> <li>■ a quad (4 channel) input Scope Record (Roll Mode)</li> <li>■ 100 quad (4 channel) input Scope screens (Replay)</li> </ul>	
Number of Screen Images memory	9
Each memory can contain one screen image	

**Table A-10: Interface Ports**

Port	Description
USB-host port	Directly connects to external flash memory drive for storage of waveform data, measurement results, instrument settings and screen copies.
Mini-USB-B port	Connects to a PC for screen images, settings, and data transfer using OpenChoice™ software.

Note: Remote control and data transfer via the mini-USB port is not possible when saving or recalling data through the USB-host port.

**Table A-11: Mechanical**

Characteristic	Description
Size	265 x 190 x 70 mm (10.5 x 7.5 x 2.8 in)
Weight	2.2 kg (4.8 lbs) including battery

**Table A-12: Environmental**

Characteristic	Description
Environmental	MIL-PRF-28800F, Class 2
Temperature	
Operating	
Battery installed	0 to 40 °C (32 to 104 °F)
No battery installed	0 to 50 °C (32 to 122 °F)
Storage	-20 to +60 °C (-4 to +140 °F)
Humidity (maximum relative)	
Operating	
0 to 10 °C (32 to 50 °F)	noncondensing
10 to 30 °C (50 to 86 °F)	95% (±5%)
30 to 40 °C (86 to 104 °F)	75% (±5%)
40 to 50 °C (104 to 122 °F)	45% (±5%)
Storage	
-20 to +60 °C (-4 to +140 °F)	noncondensing
Altitude	
Operating	3 km (10 000 feet)
Storage	12 km (40 000 feet)
Vibration	
Sinusoidal (operating)	maximum 3 g, according to Per MIL-PRF-28800F, class 2
Random (non operating)	0.03 g <sup>2</sup> /Hz, according to Per MIL-PRF-28800F, class 2
Shock (operating)	maximum 30 g, according to Per MIL-PRF-28800F, class 2
Electromagnetic compatibility (EMC)	

Table A-12: Environmental (cont.)

Characteristic	Description
Emission and immunity	EN 61326-1:2006, EN 61326-2-1:2006
Enclosure protection	IP41, ref: IEC60529

## Safety Specifications

Designed for 1000 V measurement category II, 600 V measurement category III, Pollution Degree 2, per:

- IEC/EN 61010-1: 2001 Pollution Degree 2 (According to CE marking)
- UL 61010-1:2004
- CAN/CSA-C22.2 No. 61010-1-04 (including approval)

Table A-13: Safety specifications

Characteristic	Description
Maximum input voltage	
Using a 10:1 probe (model THP0301)	300 V CAT III
Direct (1:1)	300 V CAT III
Maximum floating voltage	
From any terminal to earth ground	1000 V CAT II 600 V CAT III
Between any terminal	1000 V CAT II 600 V CAT III

**NOTE.** Voltage ratings are given as “working voltage”. They should be read as *Vac-rms* (50-60 Hz) for AC sine wave applications and as *VDC* for DC applications.

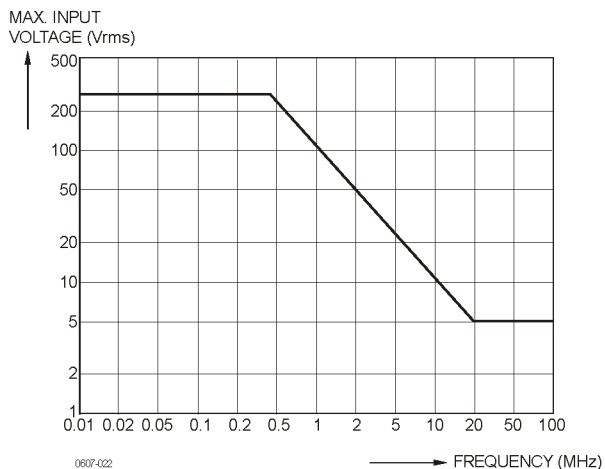

**Figure A-1: Input voltage versus frequency**

**NOTE.** Measurement Category II refers to circuits connected to mains socket outlets and similar points in the mains installation.

Measurement Category III refers to distribution level and fixed installation circuits inside a building.

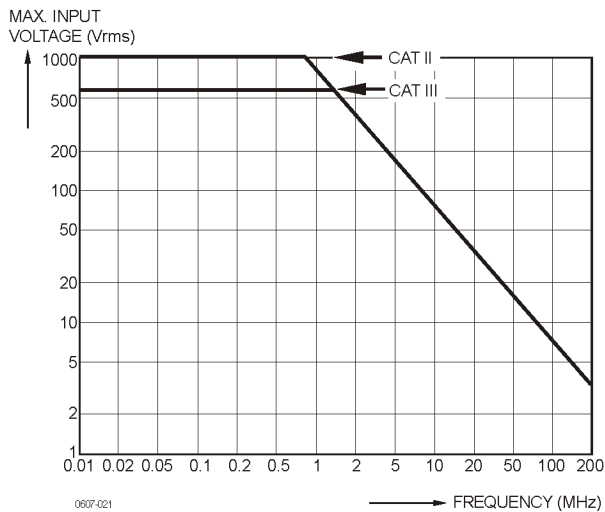

**Figure A-2: Maximum voltage between oscilloscope references, and between oscilloscope references and earth ground**

## Probe Specifications

Table A-14: THP0301 Voltage Probe

Characteristic	Description
Attenuation	10:1
Bandwidth	DC to 300 MHz (-3 dB)
Rise time	0.9 ns
Compensation range	10 pF-22 pF
Maximum tip input voltage	300 V CAT III
Maximum reference lead voltage to ground	300 V CAT III

**NOTE.** For further probe specifications see the instruction sheet supplied with the THP0301 probe set.





---

## Appendix B: Connect the Instrument to a Computer

You can connect your instrument directly to a computer through a USB port and a software application, such as Tektronix OpenChoice® Desktop. Connecting to a PC will allow you to collect screen images and let the PC analyze your data.

Before connecting to a computer, USB drivers need to be loaded onto the computer. The following procedure describes how to install the drivers on a Windows XP computer. Installing on computers with other Windows versions may be different.

Drivers for Windows XP, Vista, and Windows 7 are available from the Windows Driver Distribution Center, and can be downloaded automatically if your computer is connected to the Internet.

The drivers have passed Windows Logo Verification and are signed by Microsoft Windows Hardware Compatibility Publisher. This is required for installation on Windows 7.

---

**NOTE.** *This instrument requires two drivers to be loaded in the following sequence: Tektronix USB driver, then Tektronix USB Serial port.*

---

## USB Ports

The instrument has two USB ports:

- A USB-host port to connect an external USB memory device for data storage.
- A mini-USB-B port which allows you to connect the instrument to a PC or notebook for remote control and data transfer under computer control.

The ports are fully isolated from the input channels and are protected by dust covers when not in use.

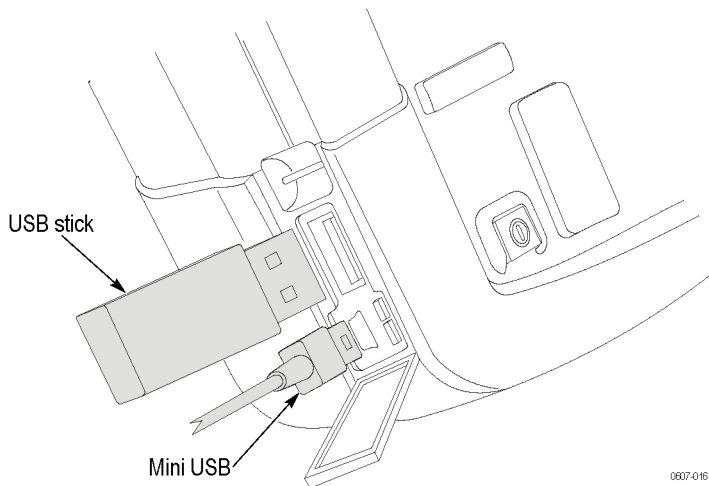
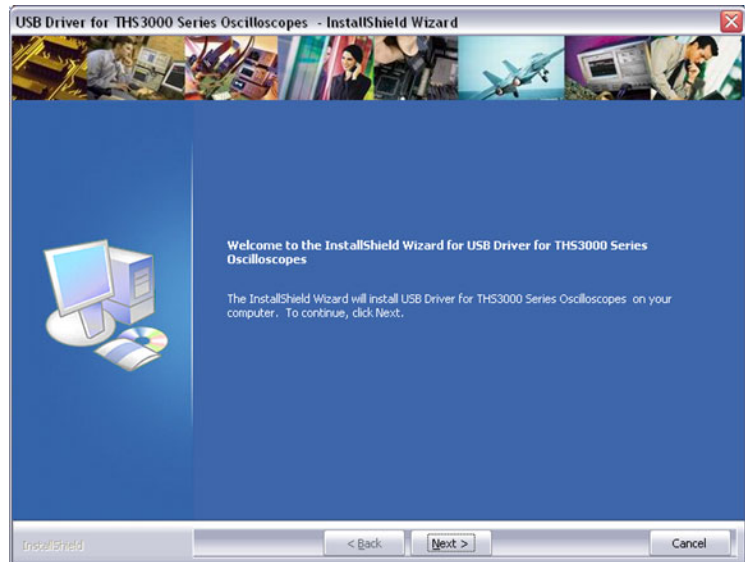

**Figure B-1: Instrument USB connections**

## Install USB Drivers

Two USB drivers must be installed before connecting the oscilloscope to a PC. One driver is for the oscilloscope and the second driver is for the USB serial port on the PC. The oscilloscope does not need to be connected to the PC during the initial USB driver installation.

1. To install the USB drivers, use the Tektronix InstallShield Wizard that is included on the OpenChoice CD provided with the instrument. You can also download the wizard from tek.com at: <http://www.tek.com/support>. In the download section, enter THS3000 and select software from the drop-down list.
2. Unzip the driver file to a user-defined folder.
3. Run the installation application to install the USB drivers on the PC.
4. Check that the PC and oscilloscope communicate properly. (See page B-4, *Confirm Oscilloscope and PC Communication*.)



## Confirm Oscilloscope and PC Communication

- 1 Connect the oscilloscope to the PC with the USB-mini cable that was provided with the oscilloscope.

**NOTE.** The USB cable can be plugged in and out (hot-swapped) when both the computer and the instrument are on. It is not required to power off.

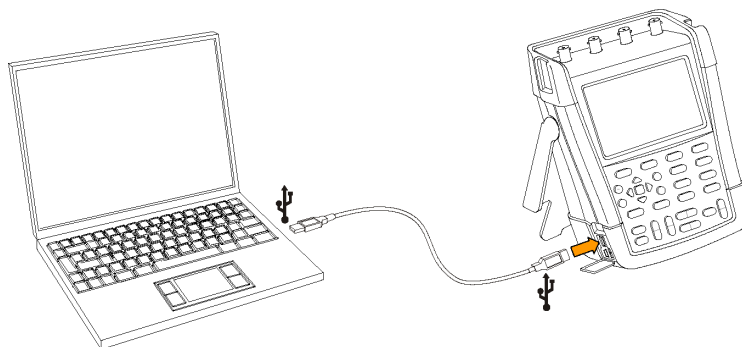

- 2 To check if the drivers are loaded properly, open the Device Manager. (See the Help file of your computer for instructions on how to open the Device Manager for your Windows version.)  
From the Device Manager, click on the + sign to Expand the Ports (COM & LPT) Universal Serial Bus controllers. The Tektronix THS3024 (or 3014) USB Port is listed here.  
Note that the COM port number you see may differ from what is shown in the screen to the right because it is automatically assigned by Windows.

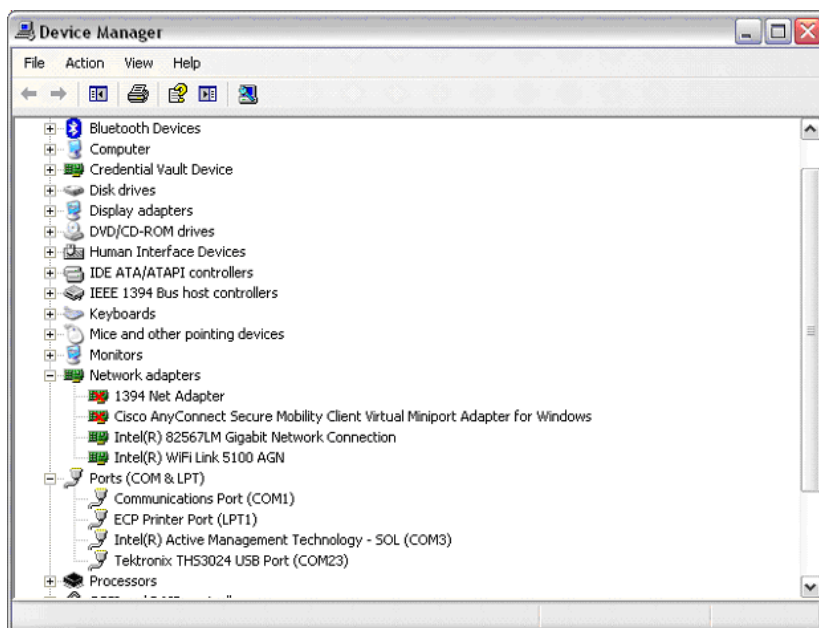

**NOTE.** Sometimes application software may require a different port number (for example in the range Com 1..4). In this situation, the COM port number can be changed manually. To manually assign a different COM port number, right click 'Tektronix THS3024 USB Serial Port COM(23)' and select properties. From the Properties menu, select the Port Settings tab, and click Advanced... to change the port number.

Sometimes other applications installed on the PC automatically occupy the newly created port. In most situations, it is sufficient to unplug the instrument USB cable for a short time and then reconnect the cable.

**Install OpenChoice™  
Desktop**

With OpenChoice™ Desktop software you can upload waveform data, settings, and screen bit maps to your PC or notebook computer for further processing. An OpenChoice™ CD-ROM was shipped with your instrument. To load the software, please insert the CD-ROM into the appropriate drive in your computer and follow the on-screen instructions.

After installing the software, when you first open the application, click on SELECT INSTRUMENT, and then choose ASRLxx::INSTR, which should match the COM number of the port assigned during the USB driver installation.

For more information about OpenChoice™, visit the Tektronix Web site at [www.tektronix.com](http://www.tektronix.com).



---

# Appendix C: Probe Compensation and Compatible Maximum Voltages

## Compensate Voltage Probes

To meet full user specifications, you need to adjust the voltage probes for optimal response. The compensation consists of a high frequency adjustment and a DC compensation for 10:1 probes and 100:1 probes. The probe compensation matches the probe to the input channel. The following procedure explains how to compensate the 10:1 voltage probes.

1. Press the power button on the front panel to turn on the instrument.
2. After a few seconds, a colored trace appears on the display screen. The color of the trace corresponds to the color of the channel input button on the front panel.
3. Connect a 10:1 voltage probe to an input BNC on the instrument top panel. The color at the base of each BNC matches the color of the associated channel button and the color of the probe.
4. Attach the probe tip and reference lead to the probe calibration connector located above the USB port on the left side of the instrument. (See Figure C-1.)

---

**NOTE.** *Connect the probe tip to the smallest metal connector (on the top) and the reference lead to the larger metal connector (on the bottom).*

---

5. Press the appropriate channel button to view the menu.
6. Select **PROBE** and then use the arrow keys and the **Enter** button to choose the **10:1** attenuation from the menu.
7. Return to the **PROBE** menu and select **PROBE CAL**.
8. Select **Yes**.
9. You will see the rising edge of a square wave on the display (approximately 500 Hz). This is the signal used to compensate the probe.
10. Adjust the trimmer in the probe housing until a pure square wave is displayed.

---

**NOTE.** *For instructions to access the trimmer adjustment in the probe housing, see the probe instruction sheet.*

---

11. Select **Continue** and instrument will respond that the compensation is complete and the compensation signal will be removed. Automatic DC compensation is only possible for 10:1 voltage probes.

---

**NOTE.** *During compensation you should not touch the probe.*

---

12. Select **Close**.

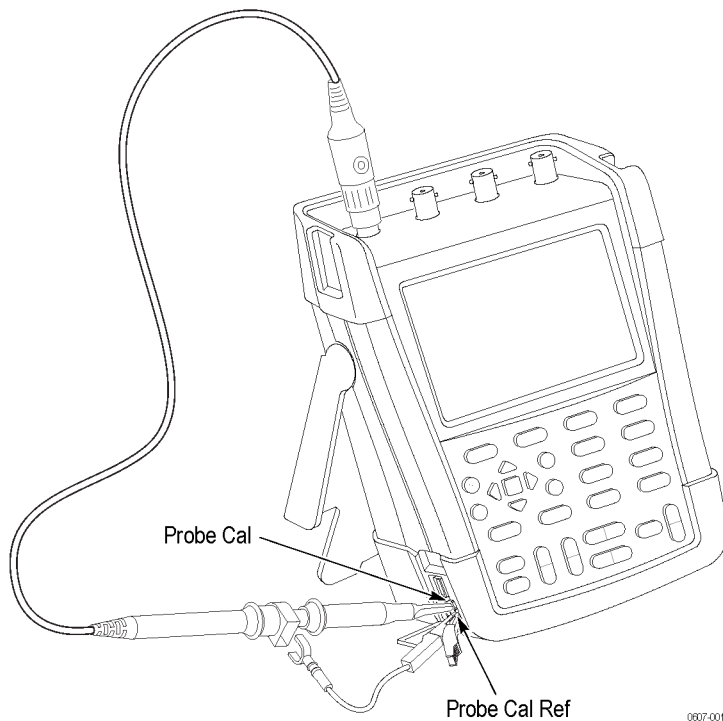

**Figure C-1: Compensating voltage probes**

---

**NOTE.** *When using 100:1 voltage probes, choose 100:1 attenuation to perform an adjustment.*

---



## Compatible Probe Maximum Voltages



**WARNING.** Do not exceed the Measurement Category (CAT), voltage, altitude, or temperature rating of the lowest rated individual component of a product, probe, or accessory.

**Table C-1: Compatible probe maximum voltages**

Passive probes	THP0301 <sup>1</sup>	P5150 <sup>2</sup>	P5122 <sup>1, 5</sup>
Attenuation gain setting	10x	50x	100x
Maximum input voltage <sup>1</sup> between tip (signal) and the reference lead maximum input	300 V RMS CAT III	600 V RMS CAT II	600 V RMS CAT II
Input signal safety rating	300 V RMS CAT III 600 V RMS CAT II	1000 V RMS CAT II	1000 V RMS CAT II
On screen P-P voltage <sup>3 4</sup>	849 V p-p	2828 V p-p	2828 V p-p
On screen RMS voltage <sup>3</sup>	300 V RMS	1000 V RMS	1000 V RMS

<sup>1</sup> Maximum operating altitude is 2000 meters.

<sup>2</sup> The 50X probe is compatible with the THS series, but the vertical system does not allow configuration for 50X readouts.

<sup>3</sup> On screen P-P and RMS voltages are based on an input signal of the maximum safety rating.

<sup>4</sup> On screen P-P Voltages will only be as indicated if the waveform is sinusoidal.

<sup>5</sup> The P5122 may have a warning label stating it can only be used with the TPS2000. There is an exception to this statement: the P5122 can also be used with the THS3000 Series instruments.



# Appendix D: Battery Pack

## Save Battery Life

When operated on the battery, this instrument conserves power by shutting itself down. If you have not pressed a button for at least 30 minutes, the instrument turns itself off automatically.

Automatic power shutdown will not occur if TrendPlot™ or Scope Roll Mode is on, but the backlight will dim. Recording will continue even if the battery is low, and retention of memories is not jeopardized.

To save battery life without automatic power shutdown you can use the display AUTO-off option. The display will be turned off after the selected time (30 seconds or 5 minutes).

---

**NOTE.** *If the power adapter is connected, there is no automatic power shutdown, and the display AUTO-off function is inactive.*

---

### Set the Instrument and Display Auto-Off Timers

The default power shutdown time is 30 minutes. You can set the power shutdown time to 5 minutes as follows:

1. Press the **Utility** button.



2. Select **OPTIONS...**
3. Select **Battery Save Options...**



4. Select **5 minutes** for the Instrument Auto-OFF time.

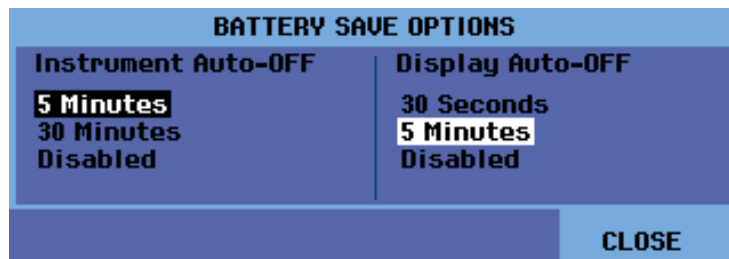

5. You can also adjust the Display Auto-OFF time now.
6. Exit the menu.

The instrument (or display) will be turned off after the selected time is elapsed.







To turn on the display again, do one of the following:

- Press any key. The Display Auto-Off timer starts again and the display will be turned off when the time has elapsed.
- Connect the power adapter; the Auto-Off timer is inactive now.

## Charge the Batteries

At delivery, the Li-ion battery may be empty and must be charged for 5 hours (with the instrument turned off) to reach full charge.

When fully charged, the battery provides up to 7 hours (single channel, time base slower than 1  $\mu\text{s}/\text{div}$ ) of use if the backlight is dimmed. You can dim the backlight in the **Utility > Options > Battery Save Options** menu.

When battery power is used, the battery indicator at the top of the screen informs you about the condition of the batteries. The battery symbols are:      . The symbol  indicates that there are typically five minutes of operating time left.

To charge the batteries and power the instrument, connect the power adapter as shown below. To charge the batteries more quickly, turn off the instrument.

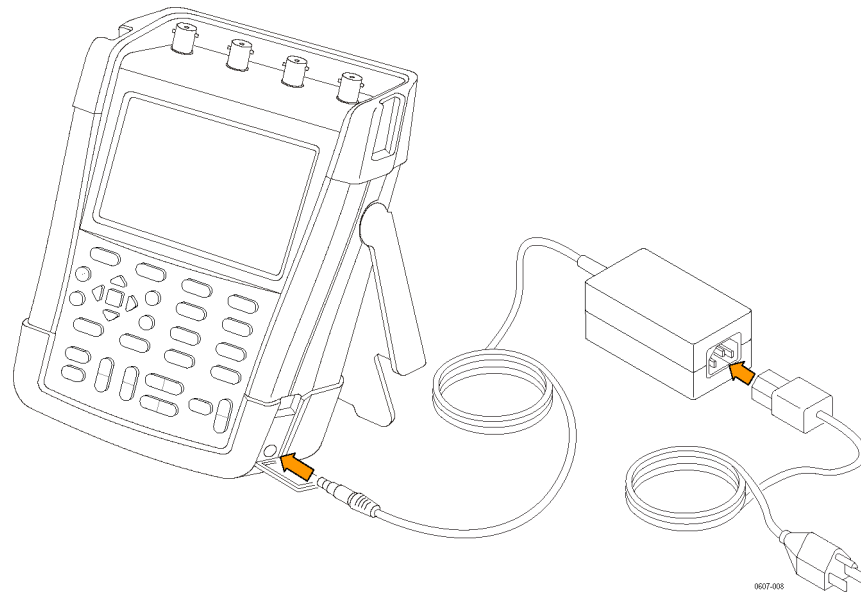

**CAUTION.** To avoid overheating of the batteries during charging, do not exceed the allowable ambient temperature given in the specifications.

**NOTE.** No damage will occur if the power adapter is connected for long periods; for example, during the weekend. The instrument then automatically switches to charge maintenance mode.

Alternatively, you may choose to exchange the battery with a fully charged one, and use the external battery charger (optional accessory).



---

# Appendix E: Maintenance and Cleaning

## Maintaining the Instrument



---

**WARNING.**

- *Have an approved technician repair the product.*
  - *Use only specified replacement parts.*
  - *Before carrying out any maintenance, carefully read the safety information at the beginning of this manual.*
- 

## Cleaning



---

**WARNING.** *Remove the input signals before you clean the instrument.*

---

Clean the instrument with a damp cloth and a mild soap. Do not use abrasives, solvents, or alcohol. These may damage the text on the instrument.

## Storage

If you are storing the instrument for an extended period of time, charge the Li-ion (Lithium-ion) batteries before storing.





---

# Index



# Index

## A

- AC, DC coupling, 2-12, 3-15
- Accessories
  - where to find a list of, 1-2
- Acquire, 1-3
- Adjusting
  - contrast, 1-9
- Auto-off
  - set display to, 1-8
  - set instrument to, 1-8
- AutoRange, 1-4
- Autoset, 1-4
- Averaging
  - normal, 2-20
  - smart, 2-20
  - smooth a waveform
    - with, 2-19

## B

- Battery
  - auto-off timer, D-1
  - automatic instrument shutdown, D-1
  - display auto-off timer, D-1
  - level, 1-9
  - serial number, 1-9
  - status, 1-9
  - time to empty, 1-9
  - total capacity, 1-9
- BNC connectors, 2-1
  - unterminated, 2-1

## Button

- Acquire, 1-3
- Autoset, 1-4
- Ch 1-4, 1-4
- Cursors, 1-5
- Enter, 1-6
- Level, 1-6
- Menu Off, 1-6
- Position horizontal, 1-6
- Position vertical, 1-6
- Run/Stop, 1-6
- Save, 1-6
- Scale horizontal, 1-7
- Scale vertical, 1-7
- Single, 1-7
- Trigger, 1-7
- Utility, 1-8
- Zoom, 1-9

## C

- Calibration date, 1-9
- Channel buttons
  - 1-4, 1-4
- Connect a probe, 2-8
- Contrast
  - adjusting, 1-9
- Copy saved setups and screens, 1-7
- Coupling
  - AC and DC, 2-12, 3-15
- Cursors, 1-5, 3-9
  - analyzing a record, 3-6
  - make a time measurement, 3-10
  - make a voltage measurement, 3-9
  - make an RMS measurement, 3-10

## D

- Date
  - setting, 1-8

## Default settings, 1-12

- Delete saved setups and screens, 1-7
- Dim display screen, 1-9
- Display
  - auto shut-off options, 1-8

## F

- Factory default settings, 1-8, 1-12
- Features
  - list of general, 1-1
  - list of key, 1-1
- Floating measurements, 2-1
- Front panel, 1-2

## G

- Glitch
  - in Acquire > Acquire Options menu, 1-4

## H

- Hanging hook, 1-14
- Hanging strap, 1-15

## I

- Inputs, 2-1, 2-12
  - terminating, 2-1
- Instrument
  - auto shut-off options, 1-8
- Isolated
  - electrically floating, x

## K

- Kensington® lock, 1-13

## L

- Lock
  - Kensington®, 1-13

- M**
- Mathematics
    - in Acquire > Acquire Options
      - > Waveform menu, 1-4
  - Memory
    - viewing files in, 1-7
  - Menu
    - Acquire, 1-3
    - AutoRange, 1-4
    - Autoset, 1-4
    - Ch 1-4, 1-4
    - Cursors, 1-5
    - Save, 1-6
    - Trigger, 1-7
    - Utility, 1-8
  - Move saved setups and screens, 1-7
- O**
- OpenChoice™, B-5
- P**
- Persistence, 2-20
    - in Acquire > Acquire Options
      - > Waveform menu, 1-4
  - Power
    - automatic instrument shutdown, D-1
    - battery, 1-9
    - display auto-off timer, D-1
    - external, 1-10
    - off timer, D-1
  - Probe
    - calibration, 1-11
    - connect a, 2-8
  - Probe accessories
    - alligator clip, 2-10
    - ground spring, 2-9
    - hook clips, 2-10
  - Product description, 1-1
- R**
- Recall, 1-6
  - Recorder
    - changing options, 3-1
    - displaying data, 3-1
    - functions, 3-1
    - menu, 3-1
    - plot measurements, 3-1
    - start or stop using triggering, 3-4
    - TrendPlot™, 3-1
    - using single sweep mode, 3-4
  - Reference
    - in Acquire > Acquire Options
      - > Waveform menu, 1-4
  - Rename
    - screen and setup name, 3-26
- S**
- Safety Summary, vi
  - Save, 1-6
    - edit file name, 3-26
    - screen and setup, 3-26
    - screens as .BMPs, 3-27
    - when all memories are in use, 3-26
  - Security
    - Kensington® lock, 1-13
  - Single sweep mode, 3-4
  - Slope
    - dual, 3-16
    - fall time, 3-16
    - rise time, 3-16
  - Smooth a waveform, 2-19
  - SW version, 1-9
- T**
- Terminating inputs, 2-1
  - Tilt stand, 1-13
- U**
- Utility, 1-8
- W**
- Waveform
    - to smooth a, 2-19
  - Working voltage, x
- Z**
- Zoom
    - analyzing a record, 3-6
    - turn off, 3-8
    - turn on, 3-7
- Time**
- setting, 1-8
- TrendPlot™**
- analyzing a record, 3-6
  - plot measurements, 3-1
- Trigger**
- button, 1-7
  - conditions, 3-15
  - menu, 1-7
  - N-Event, 3-21
  - on edges, 3-15
  - on noisy waveforms, 3-19
  - on pulses, 3-15, 3-23
  - on rise/fall time, 3-16
  - on video frame, 3-23
  - on video lines, 3-23
  - on video signals, 3-16, 3-22
  - single (shot) acquisition, 3-20
  - start or stop recorder using, 3-4
  - type, 3-15