

Programmer Manual



TDS3000, TDS3000B, and TDS3000C Series Digital Phosphor Oscilloscopes

071-0381-03

For the TDS3000C series, this document applies to firmware version 4.00 and above.

For the TDS3000 and the TDS3000B series, this document applies to firmware version 3.00 and above.

www.tektronix.com

Copyright © Tektronix. All rights reserved. Licensed software products are owned by Tektronix or its subsidiaries or suppliers, and are protected by national copyright laws and international treaty provisions.

Tektronix products are covered by U.S. and foreign patents, issued and pending. Information in this publication supercedes that in all previously published material. Specifications and price change privileges reserved.

TEKTRONIX and TEK are registered trademarks of Tektronix, Inc.

WaveAlert, and e*Scope are trademarks of Tektronix, Inc.

Contacting Tektronix

Tektronix, Inc.
14200 SW Karl Braun Drive
P.O. Box 500
Beaverton, OR 97077
USA

For product information, sales, service, and technical support:

- In North America, call 1-800-833-9200.
- Worldwide, visit www.tektronix.com to find contacts in your area.

Table of Contents

Preface

Related Manuals	vii
-----------------------	-----

Getting Started

Overview of the Manual	1-2
Communication Modules	1-4
Installing a Communication Module	1-6
Connector Locations	1-7
Setting Up Ethernet Remote Communications	1-8
Setting Up GPIB Remote Communications	1-18
Setting Up RS-232 Remote Communications	1-21
Comparing GPIB and RS-232	1-26

Command Syntax and Commands

Command and Query Structure	2-1
Clearing the Oscilloscope Output Queue	2-4
Command Entry	2-4
Constructed Mnemonics	2-7
Argument Types	2-8
Command Groups	2-11
Acquisition Commands	2-11
Alias Commands	2-12
Calibration and Diagnostic Commands	2-13
Cursor Commands	2-14
Display Commands	2-16
Ethernet Commands	2-17
File System Commands	2-18
Front Panel Commands	2-18
Hard Copy Commands	2-19
Horizontal Commands	2-19
ITU601 Digital Video Commands (TDS3SDI Only)	2-20
Limit Test Commands (Requires TDS3LIM)	2-21
Mask Commands (TDS3000B Series and TDS3000C Series with TDS3TMT)	2-22
Math Commands	2-27
Measurement Commands	2-28
Miscellaneous Commands	2-30
RS-232 Commands	2-32
Save and Recall Commands	2-32
Status and Error Commands	2-33
Trigger Commands	2-34
Vertical Commands	2-38
Waveform Commands	2-39
Command Descriptions	2-45

Status and Events

Registers	3-1
Queues	3-5
Event Handling Sequence	3-6
Synchronization Methods	3-7
Messages	3-12

Appendices

Appendix A: Character Charts	A-1
Appendix B: Reserved Words	B-1
Appendix C: Interface Specifications	C-1
Appendix D: Factory Initialization Settings	D-1

Glossary and Index

List of Figures

Figure 1-1: Common message elements	1-2
Figure 1-2: Functional groupings and an alphabetical list of commands	1-2
Figure 1-3: Service Requests (SRQs) provide for event (interrupt) driven programs	1-3
Figure 1-4: Communication module connectors	1-5
Figure 1-5: TDS3EM LEDs	1-5
Figure 1-6: Communication module mounting location	1-6
Figure 1-7: Communication module location	1-7
Figure 1-8: The Ethernet Network Settings menu	1-9
Figure 1-9: The Change Instrument Settings screen	1-10
Figure 1-10: The Ethernet Printer Settings window	1-16
Figure 1-11: How to stack GPIB connectors	1-19
Figure 1-12: Typical GPIB network configurations	1-19
Figure 1-13: Selecting the System: I/O menu	1-20
Figure 1-14: The RS-232 connector pin assignments	1-21
Figure 1-15: RS-232 parameter settings	1-22
Figure 2-1: Command Message Elements	2-2
Figure 2-2: Block Argument Example	2-10
Figure 3-1: The Standard Event Status Register (SESR)	3-1
Figure 3-2: The Status Byte Register (SBR)	3-2
Figure 3-3: The Device Event Status Enable Register (DESER) ...	3-3
Figure 3-4: The Event Status Enable Register (ESER)	3-4
Figure 3-5: The Service Request Enable Register (SRER)	3-4
Figure 3-6: Status and event handling process	3-6
Figure 3-7: Command processing without using synchronization ..	3-8
Figure 3-8: Processing sequence with synchronization	3-8

List of Tables

Table 1-1: Communication modules	1-4
Table 1-2: Ethernet Network Settings side menu	1-10
Table 1-3: Ethernet Printer Settings side menu	1-12
Table 1-4: RS-232 adapter cables	1-21
Table 1-5: RS-232 default settings	1-23
Table 1-6: RS-232 troubleshooting	1-25
Table 1-7: Comparison of GPIB and RS-232 interfaces	1-26
Table 2-1: BNF Symbols and Meanings	2-1
Table 2-2: Command Message Elements	2-2
Table 2-3: Comparison of Header Off and On Responses	2-3
Table 2-4: Acquisition commands	2-11
Table 2-5: Alias commands	2-12
Table 2-6: Calibration and diagnostic commands	2-13
Table 2-7: Cursor commands	2-14
Table 2-8: Display commands	2-16
Table 2-9: Ethernet commands	2-17
Table 2-10: File system commands	2-18
Table 2-11: Front panel commands	2-18
Table 2-12: Hard copy commands	2-19
Table 2-13: Horizontal commands	2-19
Table 2-14: ITU601 commands	2-20
Table 2-15: Limit Test commands	2-21
Table 2-16: Mask commands	2-22
Table 2-17: Available TDS3TMT ITU-T G.703 mask standards ..	2-26
Table 2-18: Available TDS3TMT ANSI T1.102 mask standards ..	2-26
Table 2-19: Math commands	2-27
Table 2-20: Measurement commands	2-28
Table 2-21: Miscellaneous commands	2-30
Table 2-22: RS-232 commands	2-32
Table 2-23: Save and Recall commands	2-32
Table 2-24: Status and Error commands	2-33
Table 2-25: Trigger commands	2-34
Table 2-26: Vertical commands	2-38
Table 2-27: Binary data ranges	2-40

Table 2-28: Waveform commands	2-42
Table 2-29: Commands that affect BUSY? response	2-56
Table 2-30: Offset Ranges using a 1x Probe	2-67
Table 2-31: CURVE query error conditions	2-90
Table 2-32: CURVE command error conditions	2-90
Table 2-33: DATA and WFMPre parameter settings	2-94
Table 2-34: XY format pairs	2-104
Table 2-35: XY format pairs	2-113
Table 2-36: FPanel:PRESS arguments	2-135
Table 2-37: Advanced Math expression elements	2-199
Table 2-38: MATH1: commands	2-205
Table 2-39: Commands that Generate an Operation Complete Message	2-240
Table 2-40: HDTV formats	2-292
Table 2-41: Video trigger line range values	2-294
Table 2-42: TRIGger:DELAy commands	2-303
Table 2-43: TRIGger:MAIn commands	2-305
Table 2-44: Additional WFMPre commands	2-326
Table 3-1: SESR bit functions	3-2
Table 3-2: SBR bit functions	3-3
Table 3-3: No event messages	3-12
Table 3-4: Command error messages - CME Bit 5	3-12
Table 3-5: Execution error messages - EXE Bit 4	3-14
Table 3-6: Device error messages - DDE Bit 3	3-17
Table 3-7: System event messages	3-18
Table 3-8: Execution warning messages - EXE Bit 4	3-18
Table 3-9: Internal warning messages	3-19
Table A-1: Character Set	A-1
Table A-2: ASCII & GPIB Code Chart	A-3
Table C-1: Supported standard interface messages	C-2
Table D-1: Factory initialization settings	D-1

Preface

This manual documents the commands for remotely controlling your oscilloscope. With this information, you can write computer programs to perform functions, such as setting the front-panel controls, taking measurements, performing statistical calculations, or exporting data for use in other programs.

Related Manuals

The following documents are available for download from the Manuals Finder Web site at www.tektronix.com:

TDS3000C Series Digital Phosphor Oscilloscopes User Manual. Information about installing and operating your oscilloscope.

TDS3000C Series Digital Phosphor Oscilloscopes Technical Reference. Oscilloscope specifications and a performance verification procedure.

TekVISA Programmer Manual. Description of TekVISA, the Tektronix implementation of the VISA Application Programming Interface (API). TekVISA is industry-compliant software for writing interoperable oscilloscope drivers in a variety of Application Development Environments (ADEs).

TDS3000B Series Digital Phosphor Oscilloscopes User Manual. Information about installing and operating your oscilloscope.

TDS3000B Series Digital Phosphor Oscilloscopes Technical Reference. Oscilloscope specifications and a performance verification procedure.

Getting Started

You can write computer programs that remotely set the oscilloscope front panel controls or that take measurements and read those measurements for further analysis or storage.

To get you started with programming the oscilloscope, this section includes the following:

- *Overview of the Manual* summarizes the type of programming information contained in each major section of this manual (page 1-2).
- *Installing a Communication Module* provides instructions to install one of the optional communication modules (page 1-6).
- *Connector Locations* shows the RS-232 and GPIB connector locations on the back panel of the TDS3000B and TDS3000C oscilloscopes (page 1-7).
- *Setting Up Ethernet Remote Communications* describes setting up for Ethernet 10baseT remote control, including connecting the oscilloscope and setting the appropriate front-panel controls (page 1-8).
- *Setting Up GPIB Remote Communications* describes setting up for GPIB remote control, including connecting the oscilloscope and setting the appropriate front-panel controls (page 1-18).
- *Setting Up RS-232 Remote Communications* describes setting up for RS-232 remote control, including connecting the oscilloscope and setting the appropriate front-panel controls (page 1-21).
- *Comparing GPIB and RS-232* compares the characteristics of the GPIB and RS-232 interfaces (page 1-26).

Overview of the Manual

The information contained in each major section of this manual is described below.

Syntax and Commands

The *Syntax and Commands* chapter describes the structure and content of the messages your program sends to the oscilloscope. Figure 1-1 shows a syntax diagram and command parts as described in the *Command Syntax* subsection.

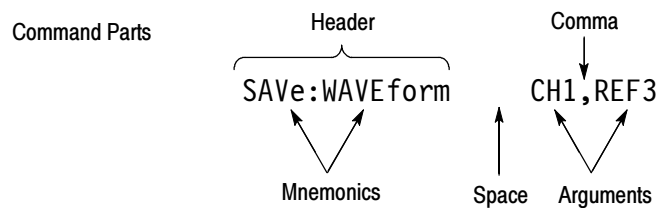

Figure 1-1: Common message elements

Chapter 2 also describes the effect of each command and provides examples of how you might use it. The *Command Groups* section provides a list by functional area. The *Command Descriptions* section arranges commands alphabetically (Figure 1-2).

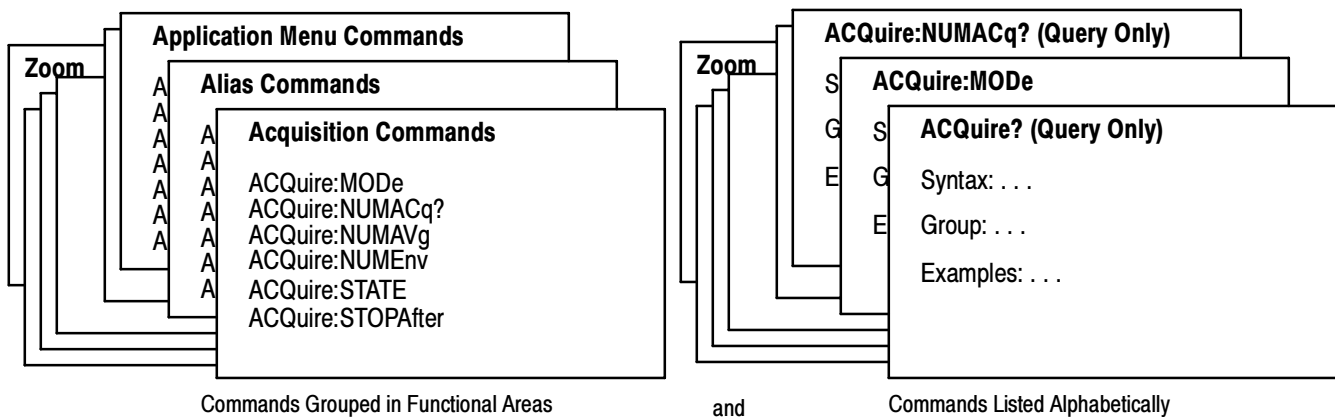

Figure 1-2: Functional groupings and an alphabetical list of commands

Status and Events

Your program may request information from the oscilloscope. The oscilloscope provides information in the form of status and error messages. Figure 1-3 on page 1-3 illustrates the basic operation of this system.

The *Status and Events* chapter starting on page 3-1 describes how to use service requests (SRQs) and various event messages in your programs.

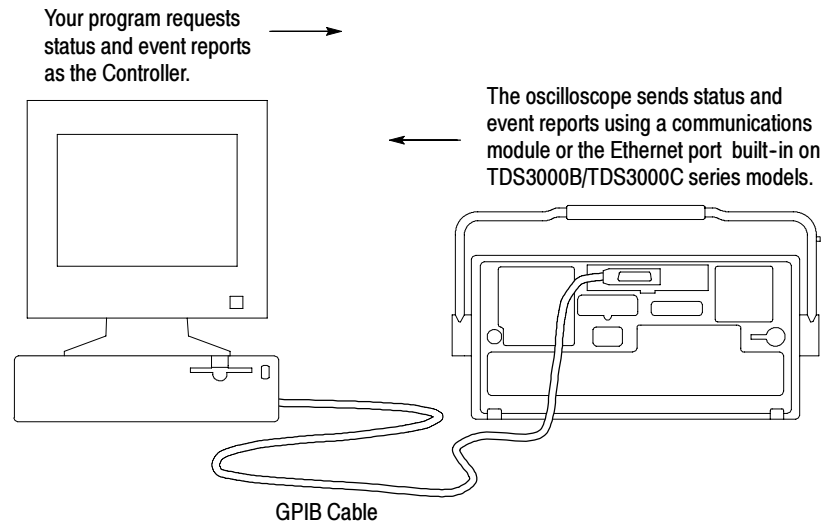

Figure 1-3: Service Requests (SRQs) provide for event (interrupt) driven programs

Communication Modules

Communication modules let you communicate with, or remotely control, your TDS3000, TDS3000B, and TDS3000C Series oscilloscopes.

Table 1-1 lists the available communication modules. Figure 1-4 shows the connector configuration for each module.

Table 1-1: Communication modules

Communication module	Description
TDS3EM	This communication module adds Ethernet 10baseT local area network (LAN) and RS-232 ports to your TDS3000 Series oscilloscope. You can use the Ethernet port for remote programming or printing to a LAN printer. Communication modules are user-installable. All TDS3000B Series and TDS3000C oscilloscopes have a built-in Ethernet port.
TDS3GM	This communication module adds GPIB and RS-232 ports to all TDS3000 oscilloscopes. You can attach a printer to these ports or use them for remote programmability. Communication modules are user-installable.
TDS3VM	This communication module adds VGA and RS-232 ports to all TDS3000 oscilloscopes. You can attach a printer to the RS-232 port or use it for remote programmability. You can attach a monitor to the VGA port to enhance viewing the screen from a distance. Communication modules are user-installable.
TDS3GV	This communication module adds VGA, GPIB, and RS-232 ports to all TDS3000 oscilloscopes. You can attach a printer to these ports or use them for remote programmability. You can attach a monitor to the VGA port to enhance viewing the screen from a distance. Communication modules are user-installable.

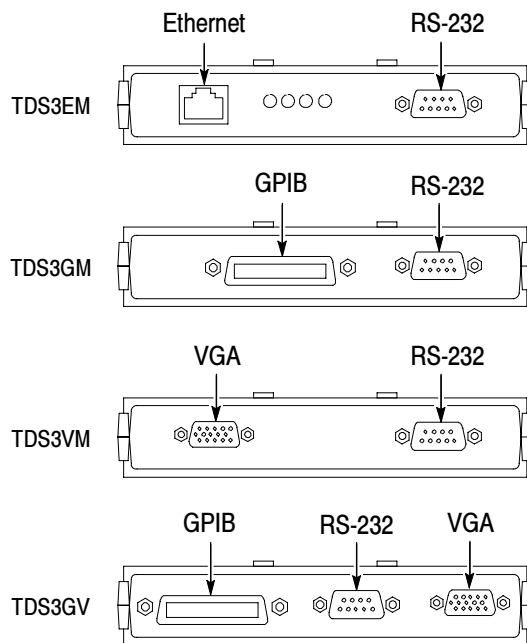
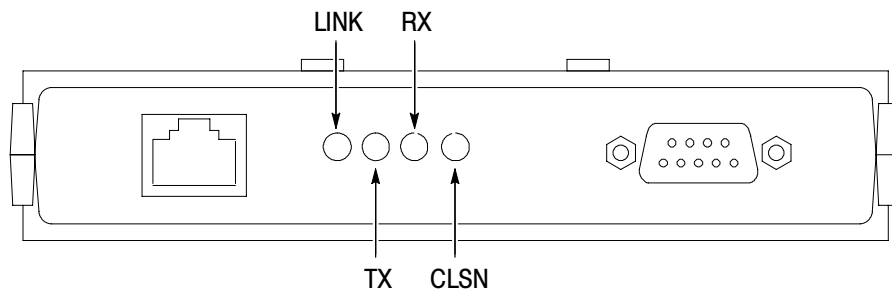

Figure 1-4: Communication module connectors

The TDS3EM Ethernet Communication Module (TDS3000 Series only) has a set of four status LEDs. Figure 1-5 identifies each LED and describes its purpose.



LINK: Indicates Ethernet connection when lit.
 TX: On when oscilloscope is transmitting data.
 RX: On when oscilloscope is receiving data.
 CLSN: On when oscilloscope is attempting to transmit and receive at the same time.

Figure 1-5: TDS3EM LEDs

Installing a Communication Module



CAUTION. To avoid damage to the oscilloscope or communication module, observe all ESD precautions described in the User manual.

NOTE. Do not install a TDS3EM module into a TDS3000B Series or TDS3000C Series oscilloscope. Installing the TDS3EM module will cause both the built-in Ethernet port and the module's Ethernet port to stop functioning.

To install one of the optional communication modules, follow these steps:

1. Turn the oscilloscope power off.
2. Push down on the latching tab to remove the blank cover.
3. Slide the communication module into the compartment until the internal connectors are seated and the latching tab locks.
4. Turn power on. The communication module is now ready for your use.

To remove a communication module, follow these steps:

1. Turn the oscilloscope power off.
2. Push down on the latching tab and then use a small screwdriver to alternately pry out the sides of the communication module.
3. Slide out the communication module and store it in an ESD-shielded bag. Install the blank cover if no other communication module is to be installed.

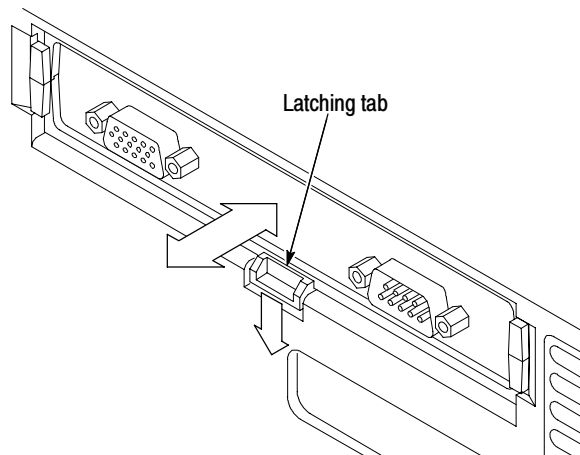

Figure 1-6: Communication module mounting location

Connector Locations

Figure 1-7 shows the location of the installed communication module, as well as the rear-panel connectors. The built-in Ethernet port and External trigger are only available with the TDS3000B and TDS3000C Series models.

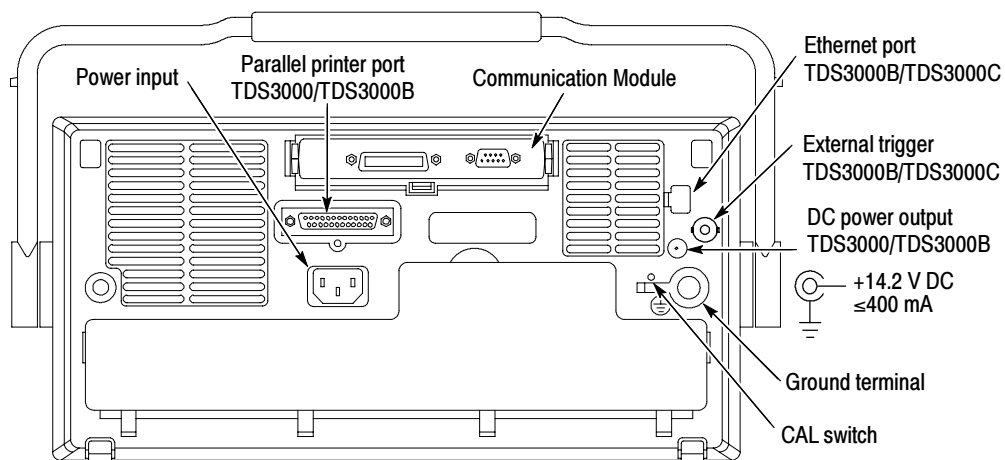

Figure 1-7: Communication module location

Setting Up Ethernet Remote Communications

The following sections describe how to set up the Ethernet communications for network hard copy printing and remote programmability. The Ethernet port requires a straight-through 10BaseT cable with RJ-45 connector. No transceiver is necessary.

Contacting Your Network Administrator

To connect the oscilloscope to the network, you need to obtain information from your network administrator. For your convenience, make two photocopies of the form shown below and send them to your network administrator to fill in. The administrator can then return one copy and keep the other copy for filing.

<p>Ethernet Setup Form for</p> <p>Ethernet Hardware address : : : : :</p> <p>(User: copy this address from the UTILITY > System: I/O > Ethernet Network Settings > Change Instrument Settings screen before sending this form to the network administrator)</p> <p>Type of IP address requested: Dynamic (DHCP/BOOTP) <input type="checkbox"/> Static <input type="checkbox"/></p> <p>(User: See page G-1 of the <i>TDS3000C Series DPO Oscilloscope User Manual</i> for information on dynamic and static IP addresses)</p>	
1	<p>Settings (from network admin.):</p> <p>Instrument Name _____</p> <p>Instrument (IP) Address _____</p> <p>Domain Name: _____</p> <p>DNS IP Address: _____</p> <p>Gateway IP Address: _____</p> <p>Subnet mask _____</p> <p>HTTP Port: _____</p> <p>(User: Enter these values on the UTILITY > I/O > Ethernet Network Settings > Change Instrument Settings screen)</p>
2	<p>Network Administrator: Please provide network information about the following printer:</p> <p>Printer Location: _____</p> <p>Printer Make: _____ Model: _____</p> <p>(User: fill in above printer information before sending form)</p> <p>Printer Network Name: _____</p> <p>Printer Server Name: _____</p> <p>Print Server IP Address: _____</p> <p>(User: Enter above information on the UTILITY > I/O > Ethernet Printer Settings > Add Printer screen.)</p>

The Ethernet Menus

Push the **UTILITY** button, then push the **System** bottom button to select **I/O**. The oscilloscope displays the I/O menu, as shown in Figure 1-8, which contains the Ethernet Network Settings and Ethernet Printer Settings bottom buttons.

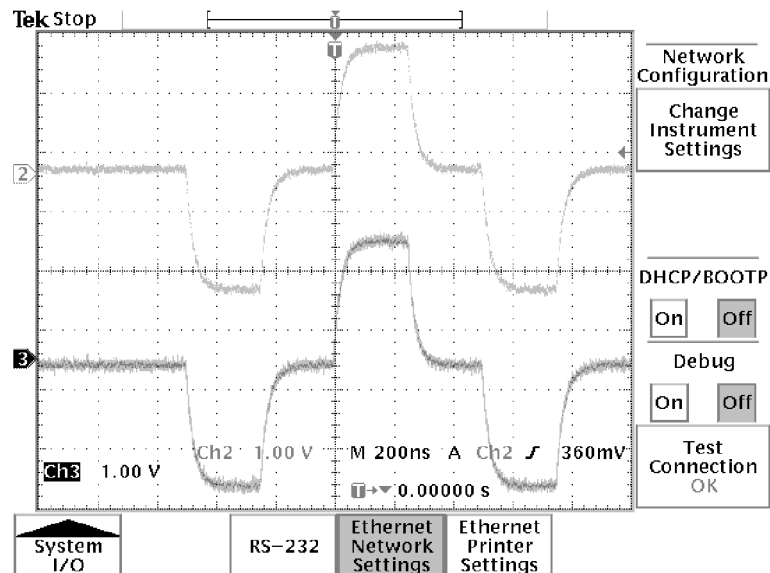

Figure 1-8: The Ethernet Network Settings menu

Ethernet Network Settings Menu. Figure 1-9 shows the Ethernet Change Instrument Settings screen. Table 1-2 describes the Ethernet Network Settings fields. The procedures on page 1-13 (for networks that support DHCP/BOOTP) and 1-14 (for networks that do not support DHCP/BOOTP) describe how to set up the oscilloscope to communicate on your network using the appropriate instrument IP information from your network administrator.

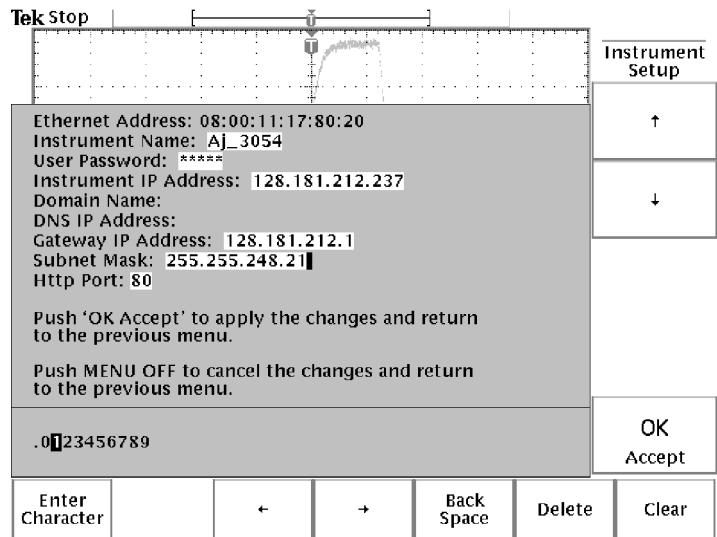

Figure 1-9: The Change Instrument Settings screen

Table 1-2: Ethernet Network Settings side menu

Side	Field/value	Description
Change Instrument Settings	Ethernet Address:	The factory-set Ethernet address for this module or instrument. This field cannot be edited.
	Instrument Name:	An alphanumeric label assigned to the oscilloscope for easier network reference. Check with your network administrator to determine instrument name restrictions and that the instrument name you request does not already exist.
	User Password:	A password that causes the oscilloscope e*Scope web server to prompt for user authentication before allowing ethernet access. Access is permitted for the duration of the network browser session. Leaving this blank allows any browser to access the oscilloscope.

Table 1-2: Ethernet Network Settings side menu (Cont.)

Side	Field/value	Description
Change Instrument Settings (cont.)	Instrument IP Address:	A unique Internet Protocol (IP) address that identifies the oscilloscope. You must enter an IP address in order for the oscilloscope to communicate with the network. Obtain an instrument IP address from your network administrator. If your network supports DCHP/BOOTP protocols, then you can also set DCHP/BOOTP to ON and let the oscilloscope automatically obtain a dynamic IP address from the network. Dynamic IP addresses can change each time the oscilloscope is turned on.
	Domain Name:	The name of the domain to which the oscilloscope is attached. Although not required to communicate with the network, the domain name is used to assist with printer communications. Obtain the domain name (if necessary) from your network administrator.
	DNS IP Address:	The IP address of the domain name system (DNS). Although not required to communicate with the network, the DNS IP address is used to assist with printer communications. Obtain the DNS IP address (if necessary) from your network administrator.
	Gateway IP Address:	Obtain the gateway IP address from your network administrator.
	Subnet Mask:	Obtain the subnet mask value from your network administrator.
	HTTP Port:	The HTTP Port field sets the network http socket value for the oscilloscope. This field lets you set up the oscilloscope as an e*Scope web server on a port other than the default port 80. This is useful for avoiding conflicts with existing web servers that use the same IP address through a router.
DHCP/BOOTP	On Off	Enables or disables Dynamic Host Configuration Protocol (DHCP) and BOOTP support. DHCP is software that automatically assigns IP addresses to devices logging onto the network. Your network administrator can tell you whether DHCP/BOOTP should be on or off.

Table 1-2: Ethernet Network Settings side menu (Cont.)

Side	Field/value	Description
Debug	On Off	Helps in debugging network communications problems by displaying the last 30 characters transmitted and received by the oscilloscope. Only displays information when receiving and responding to remote commands or software such as WaveStar for Oscilloscopes (TDS3000 Series, TDS3000B Series only).
Test Connection		Pushing this button tests the oscilloscope connection to the Ethernet. The oscilloscope effectively “pings” the network to locate itself. While testing, the menu displays Testing... . If the oscilloscope can locate itself on the network, the menu displays OK . If the oscilloscope cannot locate itself, the menu displays No Response .

Table 1-3 describes the Ethernet Printer Settings menu. The procedure on page 1-15 describes how to enter network printer settings. Note that you do not need to be connected to the network to add printer setup information.

Table 1-3: Ethernet Printer Settings side menu

Side	Field/value	Description
Add Printer	Printer Name	The name of a printer queue on the designated print server. Obtain this information from your network administrator.
	Server Name	The name of the server running the printer queue software. ¹ Obtain this information from your network administrator.
	Server IP address	The IP address of the server running the printer queue software. ¹ Obtain this information from your network administrator.
Rename Printer	Selected printer in list	Lets you edit the selected printer’s settings.
Delete Printer	Selected printer in list	Deletes the selected printer information from the oscilloscope.
Confirm Delete	On Off	Enables or disables the oscilloscope from displaying a confirmation window before deleting a printer configuration.

¹ **If you have set the domain name and DNS IP address in the Change Instrument Settings of the Ethernet Network Settings menu, then all you need to enter is either the server name or the server IP address. The DNS server will look up the missing information.**

Setting the Oscilloscope Ethernet Parameters

You need to set two types of Ethernet parameters for the oscilloscope; the oscilloscope IP address and one or more remote printer addresses. The oscilloscope IP address uniquely identifies the oscilloscope to other devices on the network, and is required for the oscilloscope to communicate over the network.

The remote printer addresses enable you to send hard copy printouts to a specified network printer. You can store multiple network printer configurations.

Ethernet Network Settings: DHCP/BOOTP supported. The purpose of a DHCP (Dynamic Host Configuration Protocol) or BOOTP (Boot Protocol) server is to issue an IP address to a network device that requests an address. The IP address enables that device to communicate with the network. This is similar to the personal computer Plug&Play concept.

The following procedure assumes you have installed the TDS3EM Communication Module and cable into a TDS3000 Series oscilloscope.

For TDS3000B and TDS3000C series oscilloscopes, a RJ-45 connector, with 10BaseT cable attached to the oscilloscope Ethernet port, is required.

If your network supports DHCP/BOOTP, perform the following steps:

1. Power on the oscilloscope.
2. Push the **UTILITY** front panel button.
3. Push the **System** screen button to select **I/O**.
4. Push the **Ethernet Network Settings** screen button.
5. Push the **Change Instrument Settings** side button to display the Instrument Setup dialog box.
6. Push the **DHCP/BOOTP** side button to select **On**. The screen displays the clock icon while it is talking with the network to obtain an IP address for the oscilloscope. This step should only take a few moments, but the actual time will vary depending on your network. The clock icon disappears when the task is finished.

To verify that the network assigned an IP address to the oscilloscope, push the Change Instrument Settings side button to display the oscilloscope Ethernet settings. The instrument IP address field should now be filled in.

If the instrument IP address field is blank, then the oscilloscope was not able to obtain an IP address from the network. Contact your network administrator for help.

NOTE. *If the DHCP/BOOTP server assigns a dynamic IP address, then the value in the Instrument IP Address field may be different each time you power on the oscilloscope. This is not a problem if you are mostly sending hard copy to a network printer. However, if you intend to remotely control the oscilloscope, a static IP address is more convenient, as the oscilloscope IP address does not change, making it easier for remote devices to access the oscilloscope.*

Ethernet Network Settings: DHCP/BOOTP Not Supported. If your network does not support DHCP/BOOTP, you must enter the Ethernet settings manually. You can obtain these settings from your network administrator by using the form on page 1-8.

The following procedure presumes that you have installed the TDS3EM Communication Module and cable into a TDS3000 Series oscilloscope. TDS3000B and TDS3000C series oscilloscopes simply require an RJ-45 connector with 10BaseT cable attached to the oscilloscope Ethernet port.

Do these steps to enter the Ethernet parameters:

1. Use the Ethernet network setup form on page 1-8 to request the necessary network information from your network administrator.
2. Power on the oscilloscope.
3. Push the **UTILITY** front panel button.
4. Push the **System** screen button to select **I/O**.
5. Push the **Ethernet Network Settings** screen button.
6. Push the **Change Instrument Settings** side button to display the Instrument Setup dialog box.
7. Push the side menu **↑** and **↓** buttons to select a field to edit.
8. Enter the required information from the Ethernet network setup form into each field:
 - The general purpose knob selects a character in the character list. The list of available characters changes depending on which field is selected.
 - The **Enter Character** button enters the selected character from the character list at the cursor position in the current field. You can also use the **SELECT** button next to the general purpose knob to enter the selected character.
 - The **←** and **→** buttons move the cursor left or right in the current field.

- The **Back Space** button deletes the character to the left of the cursor position in the field.
 - The **Delete** button deletes the character at the cursor position in the field.
 - The **Clear** button deletes all characters from the current field.
9. Push the **OK Accept** side button to apply the field settings. Push the **MENU OFF** button to exit from the menu without applying any changes.
 10. Push the **Test Connection** side menu button to verify that the Ethernet settings are correct and that the oscilloscope can locate itself on the network.
 11. If the oscilloscope does not establish a connection to the network, check that you correctly entered the Ethernet instrument settings, and that you have connected the oscilloscope to the Ethernet connector with an appropriate 10baseT cable. If the settings and cable are correct, contact your network administrator for help.

Ethernet Printer Settings. This procedure presumes that you have successfully established communications with the network by using one of the previous procedures.

Do these steps to add a network printer to the oscilloscope (you can store up to 21 printers in the Ethernet network printer list):

1. Obtain the printer name, server name, and server IP address of the network printer or printers to which you are sending hard copy data.
2. Power on the oscilloscope.
3. Push the **UTILITY** menu button.
4. Push the **System** screen button and select the **I/O System**.
5. Push the **Ethernet Printer Settings** screen button. The oscilloscope displays the Printer Configuration window, as shown in Figure 1-10.
6. Push the **Add Printer** screen button to display the Add Printer dialog box.
7. Push the side menu **↑** and **↓** buttons to select a field to edit.
8. Enter the required information into each field:
 - The general purpose knob selects a character in the character list. The list of available characters changes depending on which field is selected.
 - The **Enter Character** button enters the selected character from the character list. You can also use the **SELECT** button next to the general purpose knob to enter the selected character.
 - The **←** and **→** buttons move the cursor left or right in the current field.

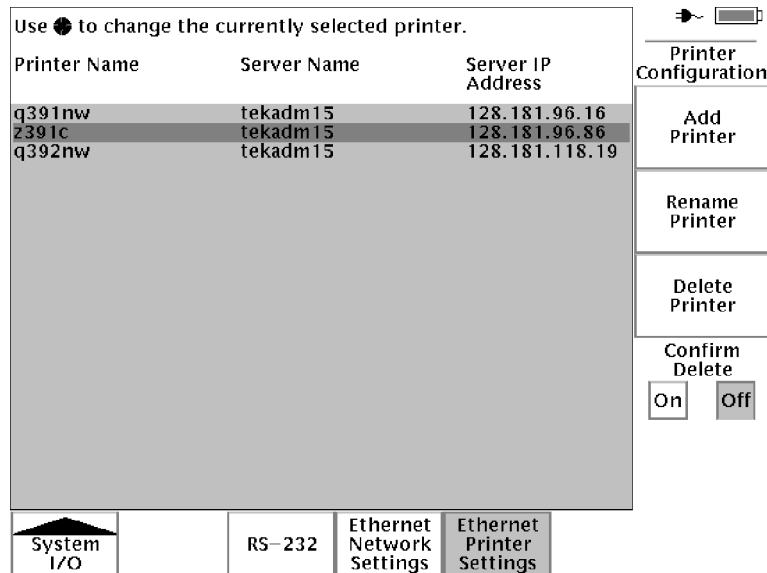

Figure 1-10: The Ethernet Printer Settings window

- The **Back Space** button deletes the character to the left of the cursor position in the field.
 - The **Delete** button deletes the character at the cursor position in the field.
 - The **Clear** button deletes all characters from the current field.
9. Push the **OK Accept** side button to apply the field settings. Push the **MENU OFF** button to exit from the Add Printer menu without applying any changes. You do not need to power cycle the oscilloscope to apply printer settings; you can select and use newly-entered printers immediately.
 10. Select a network printer in the Ethernet printer list. You select a printer by using the general purpose knob to highlight a printer name in the list.
 11. Push the **MENU OFF** button to exit from the System I/O menus.
 12. Push **UTILITY > System: Hard Copy > Port** to verify or set the printer port to Ethernet.
 13. Verify or set the printer format. Verify that the current oscilloscope hard copy format can print on your network printer.
 14. Set Inksaver to **ON** to print the oscilloscope screen as a black on white background image.
 15. Push the **MENU OFF** button to exit from the System Hard Copy menu.

16. Test the network printer by pressing the hard copy button. The printer should print the current screen. If the printer does not print the screen, check the following:
 - Hard copy port is set to Ethernet.
 - Hard copy file format is compatible with the network printer.
 - The printer IP and server information you entered is correct.
 - The network printer is powered on and is online.
17. To print to a different network printer, push UTILITY > System: I/O > Ethernet Printer Settings, and use the general purpose knob to select a network printer. Make sure that you also set/verify the hard copy file format when you change network printers.

Ethernet Error Messages

The following error conditions can occur when you are having network problems. Read the text that follows to help rectify the problem.

Print Server Not Responding. This notifier displays when the oscilloscope attempts to send data to the selected network printer but the network refuses the connection to the network printer. This usually means that the network printer server is offline or the print server IP address is incorrect.

If DNS is available then you can verify the network print server data by entering the printer name and either (but not both) the print server name or the IP address. The DNS protocol will fill in the missing data if the user-supplied data is correct.

If DNS is not available, then contact your network administrator for help.

Printer Not Responding. This notifier displays when the oscilloscope attempts to send data to the selected network printer but the print server is unable to forward the data to the network printer. This usually means that the network printer is offline or the printer name is incorrect. Contact your network administrator to obtain the correct printer queue name.

DNS Server Not responding. This notifier displays when either the Domain information (Domain name or IP address) is not correct, or the print server name or printer server IP address is not validated (via the Domain Name Server).

DNS Protocol

You enable DNS protocol by entering the DNS IP address and the domain name using the Ethernet Network Setup menu. DNS enables the oscilloscope to query the network for either the name of a device with a specified IP address, or the IP address of a named device. DNS fills in missing settings when you enter partial printer configuration information.

Ethernet, VISA, and TekVisa

The VISA standard, developed by the VXI plug & play Systems Alliance, provides a common Input/Output (I/O) library for software developers so that software from different vendors can run on the same platform. All applications that communicate with the Ethernet must use a VISA.

A Tektronix version of VISA, referred to in this document as TekVisa, is available for download from the www.tek.com Web site.

NOTE. *If you are connecting the oscilloscope to a network only to print screen hard copy data, or if you are using e*scope capabilities in a browser, you do not need to install or configure a VISA.*

Setting Up GPIB Remote Communications

The TDS3GM and TDS3GV communication modules have D-type shell GPIB connectors that conform to IEEE Std. 488.1-1987 standards. Attach an IEEE Std 488.1-1987 GPIB cable (available from Tektronix as part number 012-0991-00) to this connector. If needed, you can stack GPIB connectors as shown in Figure 1-11.

GPIB Requirements

Follow these rules when you connect your oscilloscope to a GPIB network:

- Assign a unique device address to each device on the bus. No two devices can share the same device address.
- Do not connect more than 15 devices to any one bus.
- Connect one device for every 2 meters (6 feet) of cable used.
- Do not use more than 20 meters (65 feet) of cable to connect devices.
- Turn on at least two-thirds of the devices on the network while using the network.
- Connect the devices on the network in a star or linear configuration as shown in Figure 1-12 on page 1-19. Do not use loop or parallel configurations.
- Avoid using GPIB address 0. This is typically reserved for controllers.

Appendix C: Interface Specifications gives more information on the GPIB configuration of the oscilloscope. If needed, you can stack GPIB connectors as shown in Figure 1-11.

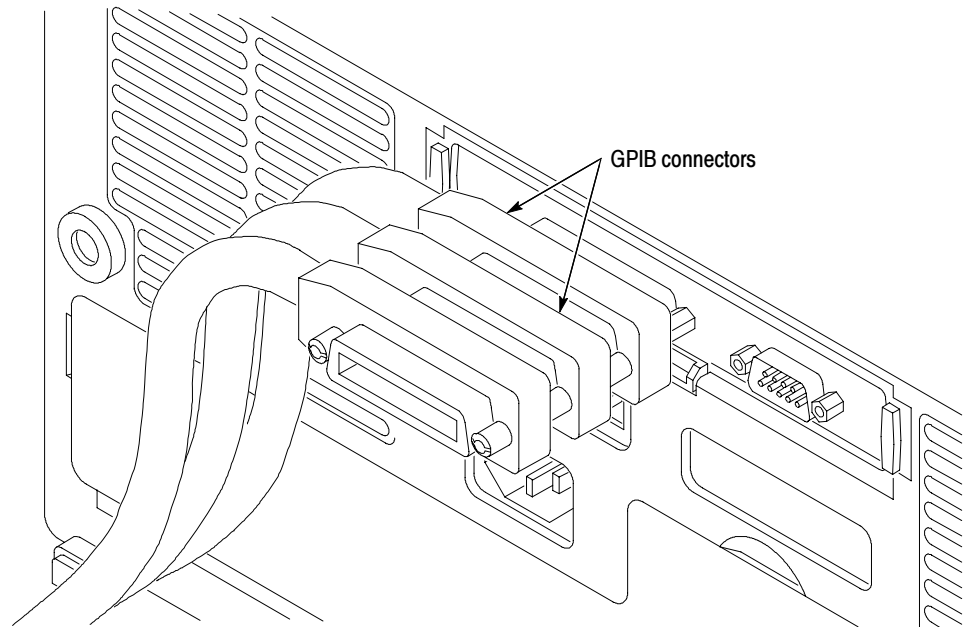

Figure 1-11: How to stack GPIB connectors

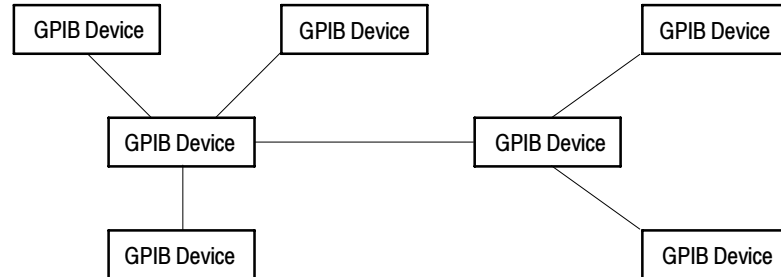

Figure 1-12: Typical GPIB network configurations

Appendix C: Interface Specifications gives more information on the GPIB configuration of the oscilloscope.

Setting the GPIB Parameters

You need to set the GPIB parameters of the oscilloscope to match the configuration of the bus. Once you have set these parameters, you can control the oscilloscope through the GPIB interface.

1. Push the **UTILITY** menu button.
2. Push the **System** screen button and select the **I/O System**. See Figure 1-13.

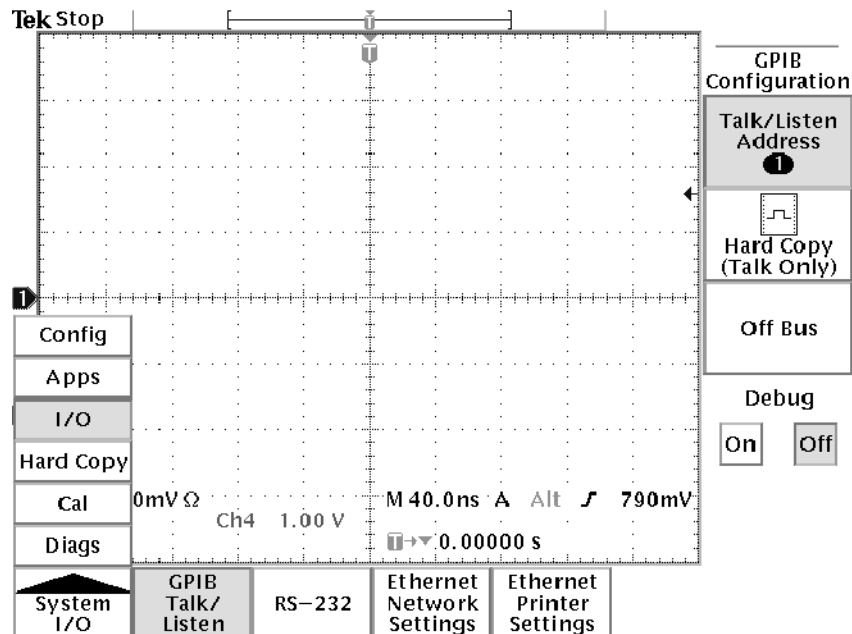



Figure 1-13: Selecting the System: I/O menu

3. Push the **GPIB** screen button.
4. Push the **Talk/Listen Address** screen button and use the general purpose knob to set the **Address**.

The oscilloscope is set up for bidirectional communication with your controller. If you want to isolate the oscilloscope from the bus:

- Push the **Off Bus** screen button. This disables all communication with the controller.

If you want to enter a special mode of operation to communicate directly with non-488.2 hard copy devices:

- Select the **Hard Copy (Talk Only)** screen button, then push the hard copy button  to have the oscilloscope send hard copy information to a printer.

Setting Up RS-232 Remote Communications

All TDS3000, TDS3000B, and TDS3000C Series communication modules have a 9-pin D-type shell RS-232 connector, as shown in Figure 1-4 on page 1-5. The RS-232 interface provides a point-to-point connection between the oscilloscope and equipment such as a computer or terminal. This section tells how to connect and set up the oscilloscope for communication over the RS-232 interface.

Connecting to an RS-232 Device

The RS-232 standard defines two device types: Data Terminal Equipment (DTE) and Data Communications Equipment (DCE). The TDS3000B and TDS3000C series is a DTE device. In standard usage, DTE devices have a male connector, and DCE devices have a female connector. You should use a straight-through female-to-male cable of less than 50 feet for a local DTE-to-DCE connection. Figure 1-14 shows the 9-pin connector with its pin number assignments.

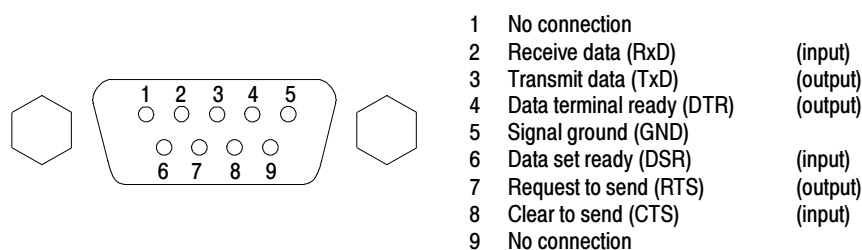

Figure 1-14: The RS-232 connector pin assignments

In terms of the connector and the way the oscilloscope uses the signal lines, the oscilloscope behaves just like a PC/AT COM port. Table 1-4 lists cables you can use to connect the oscilloscope to other devices.

Table 1-4: RS-232 adapter cables

Tektronix part number	Cable type	Use
012-1379-00	9-pin female to 9-pin female, null modem	PC/AT or laptop
012-1380-00	9-pin female to 25-pin female, null modem	Old style PC with 25-pin connector
012-1241-00	9-pin female to 25-pin male, modem	Telephone modem

Follow these guidelines when connecting the oscilloscope to another RS-232 device:

- Do not connect the output line of one DTE device to the output line of another DTE device.
- Connect the signal ground of the oscilloscope to the signal ground of the external device.
- Connect the chassis ground of the oscilloscope to the chassis ground of the external device.

Setting the RS-232 Parameters

To set the RS-232 parameters, do the following steps from the oscilloscope front panel. After these parameters are set, the RS-232 interface is ready to operate.

1. Push the **UTILITY** menu button.
2. Push the **System** screen button to select the **I/O System**.
3. Push the **RS-232** screen button to display the RS-232 parameters (see Figure 1-15).

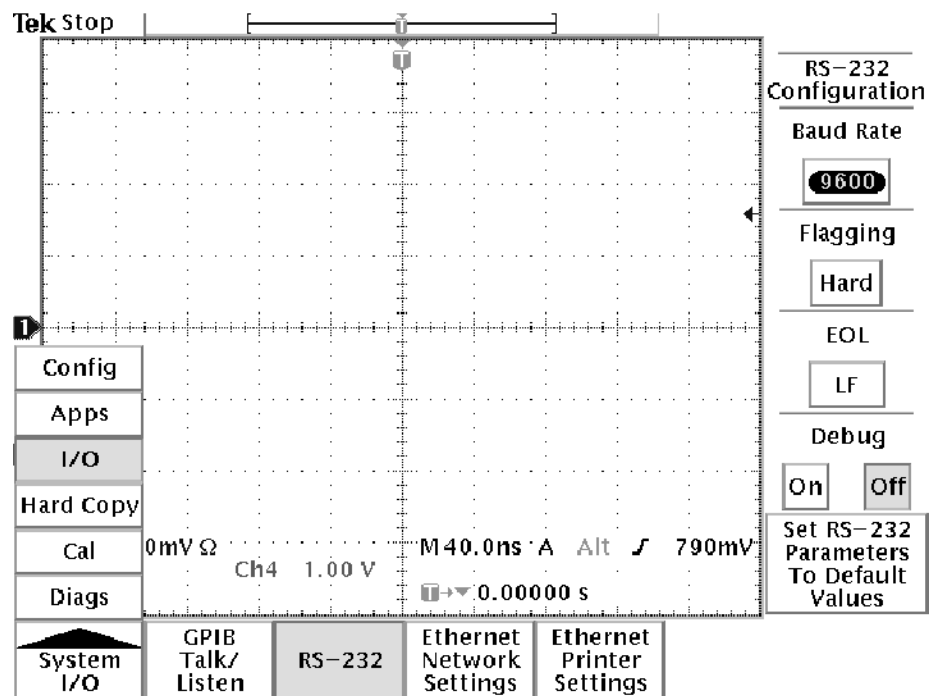

Figure 1-15: RS-232 parameter settings

You can set the following parameters:

- Baud Rate — sets the data transmission rate. You can set rates of 1200, 2400, 4800, 9600, 19200, or 38400 baud.
- Hard Flagging — sets hard flagging (RTS/CTS) on or off. Flagging controls the flow of data between devices.
- Set RS-232 Parameters to Default Values — sets default values for RS-232 parameters (for a list of default settings see Table 1-5 on page 1-23).
- EOL — sets the end of line terminator sent by the oscilloscope. You can set CR, LF, CRLF, or LFCR (for more information on line terminators see page 2-6).

NOTE. You can not set Parity or stop bits or number of bits. Parity = none, Stop bits = 1, number of bits = 8.

4. Push, in turn, each screen button until the desired parameter setting is displayed in the side menu, or push the **Set RS-232 Parameters to Default Values** screen button if the default settings are appropriate. Table 1-5 on page 1-23 lists the default RS-232 settings.

Table 1-5: RS-232 default settings

RS-232 parameter	Default setting
Baud Rate	9600
Hard Flagging	On
EOL	LF

RS-232 Conventions

There are processing conventions that are specific to the RS-232 interface. The next sections discuss the following conventions:

- Transferring binary data
- Processing break signals
- Reporting RS-232 I/O errors
- Checking command status

Transferring Binary Data. When using the RS-232 port to transfer binary data to the oscilloscope, note the following points:

- Using RTS/CTS (hard) flagging guarantees no data loss.
- All eight bits of binary data contain meaningful information. To make sure that all eight bits are received or transmitted, configure the RS-232 device that is connected to the oscilloscope to receive and transmit eight-bit characters (set the RS-232 word length to eight bits).

Processing Break Signals. When the oscilloscope senses a break signal on the RS-232 port, it returns DCL followed by the end of line terminator. Internally, the oscilloscope acts as if it received a GPIB <DCL> command, causing the oscilloscope to flush input and output buffers and then wait for a new command. Break signals do not change oscilloscope settings or stored data and do not interrupt front-panel operation or nonprogrammable functions.

If a break signal is sent in the middle of a character stream, several characters immediately preceding or following the break may be lost. The controller should wait until it receives the DCL and the end of line terminator string before sending more characters.

Reporting RS-232 I/O Errors. Errors are reported when there is a problem with framing, or input buffer overruns. To report errors, the oscilloscope posts an event code (refer to Section 3, *Status and Events* on page 3-1). When an error occurs, the oscilloscope discards all input and output and waits for a new command. A count of these errors since last power on is included in **RS-232 I/O Debug** status.

Push **UTILITY** screen button, select **I/O**, select **RS-232**, then **Debug** menu to enable the debug window to see the RS-232 status, errors data transmitted, and data received.

Use the following statements to help you interpret the status reported in the error log:

- If hard flagging is on and CTS is Low, the oscilloscope will not transmit any data.
- If hard flagging is off, you should ignore the value of CTS since the oscilloscope ignores it.

The RS232 Errors line of the error log lists the number of framing and overrun errors since the last power on.

Checking Command Status. If you want to check the status of each command sent, you can append a *STB? query after every command and read the response string.

RS-232 Troubleshooting

If the oscilloscope and the personal computer or printer have trouble communicating, use the following steps to correct the problem:

1. Verify that you are using the correct RS-232 cable. Determine whether your configuration requires a null-modem connection (where transmit/receive and control lines are switched) or a straight-through RS-232 connection. Refer to Table 1-4 on page 1-21 for information about RS-232 cables.
2. Verify that the RS-232 cable is firmly connected to both the oscilloscope and the correct port on your personal computer or printer. Verify that your printer or the program on the personal computer is using the correct port. Try your program or printer again.
3. Verify that the oscilloscope settings match the settings used by your printer or the program on your personal computer. Start by choosing Set RS-232 Parameters to Defaults (located in the I/O System, RS-232 Configuration menu). Then, change only those menu items that you know need to be changed, such as the baud rate. Try your printer or computer program again.
4. If you are trying to control the oscilloscope using a personal computer or other computer, look at the RS232 Debug menu and examine the RS232 Line status and the Errors. The contents of the Debug menu will not change while you are viewing them. Turn Debug menu off and back on to see any changes in the menu. Use Table 1-6 to troubleshoot your setup.

Table 1-6: RS-232 troubleshooting

Symptom	Possible causes
Your personal computer program tried to send characters to the oscilloscope, but the RS-232 Debug menu last 30 characters received line is empty.	Your RS-232 cable may be wired as a modem instead of a null modem. If you are attempting to use a telephone modem, the cable may be wired as a null modem instead of a modem.
The oscilloscope RS-232 Debug menu displays Framing errors.	<p>There is a baud rate mismatch between the oscilloscope and the personal computer.</p> <p>There is a data bits mismatch between the oscilloscope and the personal computer (The oscilloscope expects 8-bit data).</p> <p>There is a parity mismatch between the oscilloscope and the personal computer. The scope is set to expect no parity.</p>
Transmissions are incomplete, or the oscilloscope does not process all commands from the personal computer.	<p>Flagging is not being used correctly by the oscilloscope or the personal computer or they are using different types of flagging.</p> <p>There is an EOL terminator mismatch between the oscilloscope and the personal computer.</p>

Table 1-6: RS-232 troubleshooting (Cont.)

Symptom	Possible causes
The oscilloscope RS-232 debug menu displays CTS: Low, and the oscilloscope is using hard flagging.	Verify that the RS-232 cable is the recommended cable. Some cables may be wired without the CTS or RTS lines which are used by hard flagging. Verify that the personal computer program is using CTS/RTS hard flagging.
After the personal computer program sends a BREAK, the first message fails.	Verify that the personal computer program is waiting for and reading the DCL and end of line terminator response sent by the oscilloscope.

Comparing GPIB and RS-232

Your system hardware may support both GPIB and RS-232 interfaces. You should select the interface that best meets your requirements. The GPIB interface is an eight-bit parallel bus that provides high-speed data transfer and multiple-instrument control. In contrast, the RS-232 interface is a slower serial data bus for single instrument control, but is easy to connect to low-cost controllers. Table 1-7 provides a more in-depth comparison of the GPIB and RS-232 interfaces.

Table 1-7: Comparison of GPIB and RS-232 interfaces

Operating attribute	GPIB	RS-232
Cable	IEEE-488 Std.	9-wire
Data flow control	Hardware, 3-wire handshake	Flagging: hard (RTS/CTS)
Data format	8-bit parallel	8-bit serial
Interface control	Operator low-level control message	None
Interface messages	Most IEEE-488 Std.	Device clear using a break signal
Interrupts reported	Service requests, status and event code	None, must be polled for status
Message termination (Receive)	Hardware EOL, software LF, or both	Software CR, LF, CRLF, LFCR
Message termination (Transmit)	Hardware EOL, software LF	Software CR, LF, CRLF, LFCR

Table 1-7: Comparison of GPIB and RS-232 interfaces (Cont.)

Operating attribute	GPIB	RS-232
Timing	Asynchronous	Asynchronous
Transmission path length (max)	≤ 2 meters between devices; ≤ 20 meters total cabling for GPIB system	≤ 15 meters
Speed	200kBytes/sec	3.8k Bytes/sec
System environment	Multiple devices (≤ 15)	Single terminal (point-to-point connection)

Command Syntax

You can control the oscilloscope through the GPIB interface using commands and queries. This section describes the syntax these commands and queries use. It also describes the conventions the oscilloscope uses to process them. The next section, entitled *Command Groups*, lists the commands and queries themselves.

You transmit commands to the oscilloscope using the enhanced American Standard Code for Information Interchange (ASCII) character encoding. *Appendix A: Character Charts* on page A-3 contains a chart of the ASCII character set.

This manual describes commands and queries using Backus-Naur Form (BNF) notation and syntax diagrams.

This manual uses the BNF symbols shown in Table 2-1 below:

Table 2-1: BNF Symbols and Meanings

Symbol	Meaning
< >	Defined element
::=	Is defined as
	Exclusive OR
{ }	Group; one element is required
[]	Optional; can be omitted
. . .	Previous element(s) may be repeated
()	Comment

Command and Query Structure

Commands consist of set commands and query commands (usually simply called commands and queries). Commands modify instrument settings or tell the oscilloscope to perform a specific action. Queries cause the oscilloscope to return data and information about its status.

Most commands have both a set form and a query form. The query form of the command differs from the set form by its question mark on the end. For example, the set command ACQUIRE:MODE has a query form ACQUIRE:MODE?. Not all commands have both a set and a query form. Some commands have set only and some have query only.

A command message is a command or query name followed by any information the oscilloscope needs to execute the command or query. Command messages may contain five element types, defined in Table 2-2 and shown in the example in Figure 2-1.

Table 2-2: Command Message Elements

Symbol	Meaning
<Header>	The basic command name. If the header ends with a question mark, the command is a query. The header may begin with a colon (:) character. If the command is concatenated with other commands, the beginning colon is required. Never use the beginning colon with command headers beginning with a star (*).
<Mnemonic>	A header subfunction. Some command headers have only one mnemonic. If a command header has multiple mnemonics, a colon (:) character always separates them from each other.
<Argument>	A quantity, quality, restriction, or limit associated with the header. Some commands have no argument while others have multiple arguments. A <Space> separates arguments from the header. A <Comma> separates arguments from each other.
<Comma>	A single comma between arguments of multiple-argument commands. It may optionally have white space characters before and after the comma.
<Space>	A white space character between command header and argument. It may optionally consist of multiple white space characters.

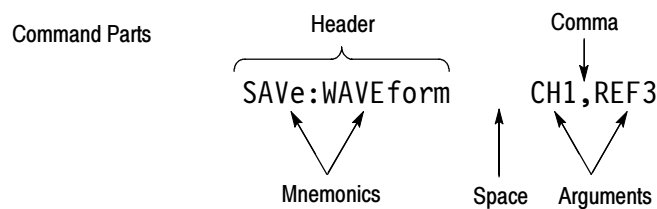

Figure 2-1: Command Message Elements

Commands Commands have the structure:

```
[:]<Header>[<Space><Argument>[<Comma><Argument>]...]
```

A command header consists of one or more mnemonics arranged in a hierarchical or tree structure. The first mnemonic is the base or root of the tree and each subsequent mnemonic is a level or branch off the previous one. Commands at a higher level in the tree may affect those at a lower level. The leading colon (:) always returns you to the base of the command tree.

Queries Queries have the structure:

- [:]<Header>?
- [:]<Header>?[<Space><Argument>[<Comma><Argument>]...]

You can specify a query command at any level within the command tree unless otherwise noted. These branch queries return information about all the mnemonics below the specified branch or level. For example, TRIGger:A:EDGE:SLOpe returns the rising or falling slope for the A edge trigger. TRIGger:A:EDGE? returns the trigger coupling, source, and slope for A edge trigger. TRIGger:A sets the trigger level and returns the current A trigger parameters.

Headers in Query Responses

You can control whether the oscilloscope returns headers as part of the query response. Use the HEADer command to control this feature. If header is on, the query response returns command headers and formats itself as a valid set command. When header is off, the response includes only the values. This may make it easier to parse and extract the information from the response. Table 2-3 shows the difference in responses.

Table 2-3: Comparison of Header Off and On Responses

Query	Header off response	Header on response
ACQuire:NUMAVg?	100	:ACQUIRE:NUMAVG 100
CH1:COUPling?	AC	:CH1:COUPLING AC

NOTE. Responses are always in Upper Case.

Clearing the Oscilloscope Output Queue

You can clear the Output Queue and reset the oscilloscope to accept a new command or query by using the Device Clear (DCL) GPIB interface command.

Command Entry

The following rules apply:

- You can enter commands in upper or lower case.
- You can precede any command with white space characters. White space characters include any combination of the ASCII control characters 00 through 09 and 0B through 20 hexadecimal (0 through 9 and 11 through 32 decimal).
- The oscilloscope ignores commands consisting of any combination of white space characters and line feeds.

Abbreviating Commands

You can abbreviate many oscilloscope commands. Each command listing in the *Commands* section shows the minimum acceptable abbreviations in capitals. For example, you can enter the command `ACQuire:NUMAVg` simply as `ACQ:NUMAV` or `acq:numav`.

NOTE. *Keep in mind that abbreviation rules change over time as new TDS models are introduced. Thus, for the most robust code, use the full spelling. Avoid using the command abbreviations.*

If you use the `HEADer` command to have command headers included as part of query responses, you can further control whether the returned headers are abbreviated or are full-length. The `VERBose` command lets you control this.

Concatenating Commands

You can concatenate any combination of set commands and queries using a semicolon (;). The oscilloscope executes concatenated commands in the order received.

When concatenating commands and queries, you must follow these rules:

1. Separate completely different headers by a semicolon and by the beginning colon on all commands but the first. For example, the commands `TRIGger:MODE NORMAl` and `ACQuire:NUMAVg 10` would be concatenated into a single command:

```
TRIGger:MODE NORMAl;:ACQuire:NUMAVg 10
```

2. If concatenated commands have headers that differ by only the last mnemonic, you can abbreviate the second command and eliminate the beginning colon. For example, you can concatenate the commands ACQUIRE:MODE ENVELOPE and ACQUIRE:NUMAVG 8 into a single command:

```
ACQUIRE:MODE ENVELOPE; NUMAVG 8
```

The longer version works equally well:

```
ACQUIRE:MODE ENVELOPE;;ACQUIRE:NUMAVG 8
```

3. Never precede a star (*) command with a colon:

```
ACQUIRE:MODE ENVELOPE;*TRG
```

Any commands that follow will be processed as if the star command was not there so

```
ACQUIRE:MODE ENVELOPE;*TRG;NUMAVG 8
```

will set the acquisition mode to envelope and set the number of acquisitions for averaging to 10.

4. When you concatenate queries, the responses to all the queries are concatenated into a single response message. For example, if the display graticule is set to Full and the display style is set to dotsonly, the concatenated query

```
DISPLAY:GRATICULE?;STYLE:DOTSONLY?
```

will return either :DISPLAY:GRATICULE FULL;:DISPLAY:STYLE:DOTSONLY 1 if header is on, or FULL;1 if header is off.

5. Set commands and queries may be concatenated in the same message. For example,

```
ACQUIRE:MODE NORMAL;NUMAVG?;STATE?
```

is a valid message that sets the acquisition mode to normal. The message then queries the number of acquisitions for averaging and the acquisition state. Concatenated commands and queries are executed in the order received.

Here are some invalid concatenations:

- DISPLAY:GRAticule FULL;ACQuire:NUMAVg 8
(no colon before ACQuire)
- DISPLAY:GRAticule FULL;:DOTSONLY OFF
(extra colon before DOTsonly — could use DISPLAY:DOTsonly OFF instead)
- DISPLAY:GRAticule FULL;:*TRG
(colon before a star (*) command)
- MATH:HORizontal:SCAl 1.0e-1;HORizontal:POSition 5.0e1
(levels of mnemonics are different—either remove the second use of HORizontal: or place :MATH in from of HORizontal:POSition)

Message Terminators

This manual uses <EOM> (End of message) to represent a message terminator.

Symbol	Meaning
<EOM>	Message terminator

GPIB End of Message Terminators. GPIB EOM terminators can be the END message (EOI asserted concurrently with the last data byte), the ASCII code for line feed (LF) sent as the last data byte, or both. The oscilloscope always terminates messages with LF and EOI. White space is allowed before the terminator; for example, CR LF is acceptable.

RS-232 End of Message Terminators. RS-232 EOM terminators can be a CR (carriage return), LF (line feed), CRLF (carriage return followed by a line feed), or LFCR (line feed followed by a carriage return). When receiving, the oscilloscope accepts all four combinations as valid input message terminators regardless of the currently selected terminator. When a combination of multiple characters is selected (CRLF or LFCR), the oscilloscope interprets the first character as the terminator; the oscilloscope interprets the second character as a null command.

Constructed Mnemonics

Some header mnemonics specify one of a range of mnemonics. For example, a channel mnemonic can be either CH1, CH2, CH3, or CH4. You use these mnemonics in the command just as you do any other mnemonic. For example, there is a CH1:VOLts command, and there is also a CH2:VOLts command. In the command descriptions, this list of choices is abbreviated as CH<x>.

Cursor Position Mnemonics

When cursors are displayed, commands may specify which cursor of the pair to use.

Symbol	Meaning
POSITION<x>	A cursor selector; <x> is either 1 or 2.

Measurement Specifier Mnemonics

Commands can specify which measurement to set or query as a mnemonic in the header. Up to four automated measurements may be displayed with each displayed waveform. The displayed measurements are specified in this way:

Symbol	Meaning
MEAS<x>	A measurement specifier; <x> is either 1 [top], 2, 3, or 4[bottom].

Channel Mnemonics

Commands specify the channel to use as a mnemonic in the header.

Symbol	Meaning
CH<x>	A channel specifier; <x> is either 1, 2, 3, or 4.

Reference Waveform Mnemonics

Commands can specify the reference waveform to use as a mnemonic in the header.

Symbol	Meaning
REF<x>	A reference waveform specifier; <x> is either 1, 2, 3, or 4.

Waveform Mnemonics

In some commands, you can specify a waveform regardless of whether it is a channel waveform, a math waveform, or a reference waveform. Specify such a waveform as follows:

Symbol	Meaning
<wfm>	Can be CH<x>, MATH or REF<x>

Argument Types

The argument of a command may be in one of several forms. The individual descriptions of each command tell which argument types to use with that command.

Numeric Arguments

Many oscilloscope commands require numeric arguments. The syntax shows the format that the oscilloscope returns in response to a query. This is also the preferred format when sending the command to the oscilloscope though any of the formats will be accepted. This manual represents these arguments as follows:

Symbol	Meaning
<NR1>	Signed integer value
<NR2>	Floating point value without an exponent
<NR3>	Floating point value with an exponent

Most numeric arguments will be automatically forced to a valid setting, either by rounding or truncating, when an invalid number is input unless otherwise noted in the command description.

Quoted String Arguments

Some commands accept or return data in the form of a quoted string, which is simply a group of ASCII characters enclosed by a single quote (') or double quote ("). For example:

```
"this is a quoted string"
```

Symbol	Meaning
<QString>	Quoted string of ASCII text

Follow these rules when you use quoted strings:

1. A quoted string can include any character defined in the 7-bit ASCII character set. (See *Appendix A: Character Charts* on page A-3).
2. Use the same type of quote character to open and close the string:

```
"this is a valid string"
```
3. You can mix quotation marks within a string as long as you follow the previous rule:

```
"this is an 'acceptable' string"
```
4. You can include a quote character within a string simply by repeating the quote. For example,

```
"here is a "" mark"
```
5. Strings can have upper or lower case characters.
6. If you use a GPIB network, you cannot terminate a quoted string with the END message before the closing delimiter.
7. A carriage return or line feed imbedded in a quoted string does not terminate the string, but is treated as just another character in the string.
8. The maximum length of a quoted string returned from a query is 1000 characters.

Here are some invalid strings:

- "Invalid string argument"
(quotes are not of the same type)
- "test<EOI>"
(termination character is embedded in the string)

Block Arguments Several oscilloscope commands use a block argument form:

Symbol	Meaning
<NZDig>	A nonzero digit character, in the range 1-9
<Dig>	A digit character, in the range 0-9
<DChar>	A character with the hex equivalent of 00 through FF hexadecimal (0 through 255 decimal)
<Block>	A block of data bytes, defined as: <pre><Block> ::= { #<NZDig><Dig>[<Dig>...] [<DChar>...] #0[<DChar>...]<terminator> }</pre>

<NZDig> specifies the number of <Dig> elements that follow. Taken together, the <Dig> elements form a decimal integer that specifies how many <DChar> elements follow.

Figure 2-2 provides a diagram of block argument use.

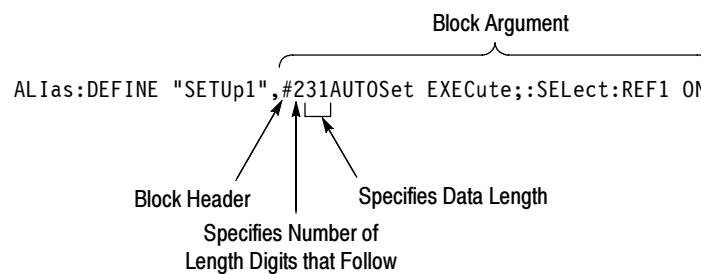

Figure 2-2: Block Argument Example

Command Groups

This section lists TDS3000, TDS3000B, and TDS3000C Series GPIB commands in two ways. It first presents them by functional groups. It then lists them alphabetically. The functional group list starts below. The alphabetical list provides more detail on each command and starts on page 2-45.

The GPIB and RS-232 interfaces conform to Tektronix standard codes and formats except where noted. The GPIB interface also conforms to IEEE Std 488.2-1987 except where noted.

Acquisition Commands

Acquisition commands affect waveform acquisition. These commands control autoset mode, averaging, enveloping, and waveform acquisition. (Persistence controls are in the Display Commands section on page 2-16.) Table 2-4 lists these commands.

Table 2-4: Acquisition commands

Header	Description
ACQuire?	Return acquisition parameters
ACQuire:MODE	Acquisition mode
ACQuire:NUMAcq?	Return # of acquisitions obtained
ACQuire:NUMAVg	Number of acquisitions for average
ACQuire:NUMEnv	Number of acquisitions for envelope
ACQuire:STATE	Start or stop acquisition system
ACQuire:STOPAfter	Acquisition control
AUTOSet	Automatic instrument waveform acquisition setup
WAVEAlert:BEEP (TDS3000B and TDS3000C Series)	Sets or returns the WaveAlert Beep on Anomaly function
WAVEAlert:hard copy (TDS3000B and TDS3000C Series)	Sets or returns the WaveAlert print Hard Copy on Anomaly function
WAVEAlert:SAVEWFM (TDS3000B and TDS3000C Series)	Sets or returns the WaveAlert Save Waveform to memory on Anomaly function
WAVEAlert:SENSitivity (TDS3000B and TDS3000C Series)	Sets or returns the WaveAlert Anomaly sensitivity function

Table 2-4: Acquisition commands (cont.)

Header	Description
WAVEAlert:STATE (TDS3000B and TDS3000C Series)	Sets or returns the WaveAlert testing mode
WAVEAlert:STOPonviolation (TDS3000B and TDS3000C Series)	Sets or returns the Stop on Violation mode
WAVEAlert:TYPE (TDS3000B and TDS3000C Series)	Sets or returns the WaveAlert Highlight Anomaly mode

Alias Commands

Alias commands let you define your own commands as a sequence of standard commands. This is useful when you use the same commands each time you perform a certain task, such as setting up measurements. Table 2-5 lists these commands.

Table 2-5: Alias commands

Header	Description
ALias	Turn the alias state on and off
ALias:CATALOG?	Return a list of aliases
ALias:DEFINE	Create a new alias
ALias:DELEte	Remove an alias
ALias:DELEte:ALL	Remove all aliases
ALias:DELEte:NAME	Remove a named alias
ALias:STATE	Turn the alias state on and off

Calibration and Diagnostic Commands

Calibration and Diagnostic commands let you start the self-calibration and diagnostic routines that are built into the oscilloscope. The diagnostic test operation includes selecting the test sequence, executing the sequence, and viewing the results. Table 2-6 lists these commands.

Table 2-6: Calibration and diagnostic commands

Header	Description
CAL?	Returns status of CALibrate:INTERNa1 and CALibrate:FACTory
*CAL?	Returns status and invokes CALibrate:INTERNa1?
CALibrate:FACTory:ABOrt	Aborts the calibration factory process
CALibrate:FACTory:CONTInue	Instructs the instrument to execute the current factory calibration step
CALibrate:FACTory:NOTIfy:DUE?	Queries if calibration is due
CALibrate:FACTory:NOTIfy:HOURs	Sets and returns hours until calibration is due
CALibrate:FACTory:NOTIfy:YEARs	Sets and returns number of year until calibration is due
CALibrate:FACTory:PREVIous	Instructs the instrument to back up one step to allow the next CALibrate:FACTory:CONTInue command to repeat that step
CALibrate:FACTory:STARt	Begins the factory calibration sequence
CALibrate:FACTory:STATUS?	Returns the factory calibration status value
CALibrate:FACTory:STEPstatus?	Returns the status of the last factory cal step executed. After cal sequence is complete, returns the same status as CALibrate:FACTory:STATUS?
CALibrate:INTERNa1	Executes or queries the state of signal path compensation (SPC)
CALibrate:INTERNa1:STARt	Performs signal path compensation (SPC)
CALibrate:INTERNa1:STATUS?	Return the SPC calibration status value saved in non-volatile memory
DIAG:LOOP:OPTion	Sets the diagnostic loop option
DIAG:LOOP:STOP	Stops diagnostic at the end of the current loop

Table 2-6: Calibration and diagnostic commands (cont.)

Header	Description
DIAG:RESUlt:FLAg?	Returns the PASS or FAIL status from the last FAIL diagnostic test sequence results
DIAG:RESUlt:LOG?	Return diagnostic test sequence results
DIAG:SELEct:ALL	Diagnostics will be run on all subsystems
DIAG:STATE EXECute	Executes all the diagnostics tests that have been selected

Cursor Commands

Cursor commands provide control over cursor (caliper) display and readout. Table 2-7 lists these commands.

Table 2-7: Cursor commands

Header	Description
CURSor?	Query returns all current cursor settings
CURSor:FUNCTion	Sets or returns the cursor type
CURSor:GRATicule?	Returns XY cursor settings
CURSor:GRATicule:SELEct	Selects (makes active) the specified graticule XY cursor
CURSor:GRATicule:XPOSITION<x>	Sets or returns the X position of the specified graticule cursor
CURSor:GRATicule:YPOSITION<x>	Sets or returns the Y position of the specified graticule cursor
CURSor:HBArs?	Returns horizontal bar settings
CURSor:HBArs:DELTA?	Returns vertical distance between horizontal bars
CURSor:HBArs:POSITION<x>	Position a horizontal cursor, relative to ground, typically in volts
CURSor:HBArs:SELEct	Sets which horizontal cursor is active (selected)
CURSor:HBArs:UNITs	Sets or returns measurement units for the horizontal cursors
CURSor:HBArs:USE	Sets measurement scale for the horizontal cursors
CURSor:MODE	Sets cursor tracking mode

Table 2-7: Cursor commands (cont.)

Header	Description
CURSor:VBArs:HDELtA?	Returns the horizontal difference between the two vertical bar cursors
CURSor:VBArs:HPOS<x>?	Returns the value of vertical bar ticks
CURSor:VBArs:POSITION<x>	Sets the horizontal position for both vertical bars
CURSor:VBArs:SElect	Sets which vertical cursor is active (selected)
CURSor:VBArs:UNIts	Sets or returns measurement units for the vertical cursors
CURSor:VBArs:USE	Sets measurement scale for the vertical cursors
CURSor:VBArs:VDELtA?	Returns the value difference between the vertical bar ticks
CURSor:WAVEform:SElect	Selects (makes active) the specified waveform XY cursor
CURSor:XY:PRODDelta?	Returns the value of the XY cursor product delta readout
CURSor:XY:PRODUCT<x>?	Returns the value of the product readout for the specified XY cursor
CURSor:XY:RADIUS<x>?	Returns the XY cursor radius value from the 0,0 origin to the specified XY cursor
CURSor:XY:RATDELtA?	Returns the XY cursor ratio delta value
CURSor:XY:RATIO<x>?	Returns the cursor ratio value for the specified XY cursor
CURSor:XY:RDELtA?	Returns the XY cursor radius delta value for the polar readout.
CURSor:XY:READOUT	Sets or returns the XY cursor readout format
CURSor:XY:RECTX<x>?	Returns the XY cursor X-axis rectangular coordinate value for the specified cursor
CURSor:XY:RECTY<x>?	Returns the XY cursor Y-axis rectangular coordinate value for the specified cursor
CURSor:XY:THDELtA?	Returns the XY cursor polar readout delta theta value
CURSor:XY:THETA<x>?	Returns the polar readout theta value for the specified XY cursor
CURSor:XY:XDELtA?	Returns the difference (delta) between the X-axis values of the two XY cursors
CURSor:XY:YDELtA?	Returns the value of the difference (delta) between the Y-axis values of the two XY cursors

Display Commands

Display commands let you change the graticule style, change the displayed intensities, display messages, and clear the menu. Table 2-8 lists these commands.

Table 2-8: Display commands

Header	Description
CLEARMenu	Clear menus from display
DISplay?	Returns display settings
DISplay:CLOCK	Control the display of the date/time
DISplay:COLor:PALEtte:REGular	Sets current palette to a preset palette
DISplay:FORMat	Sets display format to XY, YT, or Gated XYZ
DISplay:GRAticule	Sets type of graticule that is displayed
DISplay:INTENSITY:BACKLight	Sets backlight intensity settings
DISplay:INTENSITY:WAVEform	Sets waveform brightness
DISplay:PERSistence	Sets variable persistence decay time
DISplay:PERSistence:CLEAR	Resets the persistence time clears the screen of all acquired points
DISplay:STYLE:DOTsonly	Sets dots to on or off
DISplay:XY?	Returns all the XY parameters
DISplay:XY:MODE	Sets the display to YT, triggered XY, or Gated XYZ
DISplay:XY:YChanne1	Specifies the Y channel to be displayed with channel 1
DISplay:XY:YREF	Specifies the Y channel to be displayed with reference 1
DISplay:XY:ZChanne1	Specifies the Z channel to use in gated XYZ mode
DISplay:XY:ZLEVe1	Specifies the Z channel threshold level to enable XY gating in gated XYZ mode
MESSage:BOX	Sets size and location of message window
MESSage:CLEAR	Removes text from the message window
MESSage:SHOW	Displays message text in the message window
MESSage:STATE	Control display of message window

Ethernet Commands

Ethernet commands let you remotely set oscilloscope ethernet settings. Table 2-9 lists these commands. Ethernet commands are available only in the TDS3000B and TDS3000C Series oscilloscopes, or in TDS3000 Series oscilloscopes equipped with an optional TDS3EM Ethernet communications module.

Table 2-9: Ethernet commands

Header	Description
ETHERnet:DCHPBOOTP	Sets or returns DCHP/BOOTP function status
ETHERnet:DNS:IPADdress	Sets or returns the Domain Name Server (DNS) address stored in the oscilloscope
ETHERnet:DOMa inname	Sets or returns the Domain Name Server (DNS) name stored in the oscilloscope
ETHERnet:ENETADdress?	Returns the factory-set ethernet address of the TDS3EM module or oscilloscope
ETHERnet:GATEWay	Sets or returns the Gateway IP address value
ETHERnet:HTTPPORT	Sets or returns the HTTP port value stored in the oscilloscope
ETHERnet:IPADdress	Sets or returns the IP address of the oscilloscope
ETHERnet:NAME	Sets or returns the oscilloscope instrument name
ETHERnet:NETPRInter:ADD	Adds the specified printer to the oscilloscope ethernet printer list
ETHERnet:NETPRInter:DELEte	Deletes the specified printer from the oscilloscope ethernet printer list
ETHERnet:NETPRInter:DELWarn	Enables or disables displaying a warning message when deleting a printer
ETHERnet:NETPRInter:REName	Renames the specified ethernet printer
ETHERnet:NETPRInter:SELEct:ALLInfo?	Returns the selected (active) printer configuration information
ETHERnet:NETPRInter:SELEct:NAME	Sets or returns the identity of the selected (active) ethernet printer
ETHERnet:PASSword	Sets the ethernet password
ETHERnet:PING:EXECUTE	Tests the Ethernet connection
ETHERnet:PING:STATUS?	Returns results of Ethernet connection testing
ETHERnet:SUBNETMASK	Sets or returns the Ethernet subnet mask value

File System Commands

File system commands help you manage the oscilloscopes memory storage device. Table 2-10 lists these commands.

Table 2-10: File system commands

Header	Description
FILESystem?	Returns results of queries
FILESystem:COpy	Copies file to new file
FILESystem:CWD	Sets or returns the current directory
FILESystem:DELEte	Deletes named file or directory
FILESystem:DELWarn	Turns front panel delete confirmation feature on or off
FILESystem:DIR?	Returns a list of files in current directory
FILESystem:FORMat	Formats named drive
FILESystem:FREESpace?	Returns free space on current memory storage device
FILESystem:MKDir	Creates a new directory
FILESystem:OVERWrite	Sets overwrite lock feature on or off
FILESystem:PRInt	Prints file to port
FILESystem:REName	Assigns new name to file
FILESystem:RMDir	Deletes directory and all files in the directory

Front Panel Commands

Front panel commands that let you activate front panel buttons and control knobs. Table 2-11 lists these commands.

Table 2-11: Front panel commands

Header	Description
FPAnel :PRESS	Sets which front panel button to activate
FPAnel :TURN	Sets which front panel control knob to activate

Hard Copy Commands

Hard copy commands let you control the format of hard copy output and the initiation and termination of hard copies. Table 2-12 lists these commands.

Table 2-12: Hard copy commands

Header	Description
HARDCopy	Start or terminate hard copy
HARDCopy:COMPRESSion	Enables/disables hard copy data compression
HARDCopy:FILEName	Selects file to which to write hard copy
HARDCopy:FORMat	Hard copy output format
HARDCopy:INKSaver	Sets oscilloscope to print reduced ink usage hard copy
HARDCopy:LAYout	Hard copy orientation
HARDCopy:PALEtte	Select palette to use when making hard copy
HARDCopy:PORT	Selects hard copy port
HARDCopy:PREVIEW	Displays how the colors will appear

Horizontal Commands

Horizontal commands control the time base of the oscilloscope. You can set the parameters that let you define the time or horizontal axis attributes of a waveform record. Table 2-13 lists these commands.

You may substitute SECdiv for SCALE in the horizontal commands. This provides program compatibility with earlier models of Tektronix oscilloscopes.

Table 2-13: Horizontal commands

Header	Description
HORizontal?	Return horizontal settings
HORizontal:DELay:STATe	Delay the acquisition relative to the trigger event
HORizontal:DELay:TIME	Sets the delay time in seconds
HORizontal:MAIn:SCALE	Main time base time per division
HORizontal:MAIn:SECdiv	Same as HORizontal:MAIn:SCALE
HORizontal:RECOrdlength	Values are 500 or 10000
HORizontal:RESOlution	Sets acquisition resolution to normal or fast trigger

Table 2-13: Horizontal commands (cont.)

Header	Description
HORizontal:SCAlE	Same as HORizontal:MAIn:SCAlE
HORizontal:SECdiv	Same as HORizontal:MAIn:SCAlE
HORizontal:TRIGger:POSition	Time base trigger position
ZOOm:HORizontal:POSition	Values are 0 to 100, in percent of record
ZOOm:HORizontal:SCAlE	Sets or returns the horizontal scale when in zoom
ZOOm:STATE	Activates the zoom function

ITU601 Digital Video Commands

(TDS3SDI Only)

Table 2-14 lists the ITU601 commands available when a TDS3SDI 601 Digital Video application module is installed in a TDS3000B or TDS3000C Series oscilloscope.

Table 2-14: ITU601 commands

Header	Description
ITU601:AUTOSet	Sets the instrument to automatically acquire and display a 601 digital video signal
ITU601:EDH RESEt	Sets the EDH error count to zero
ITU601:EDH:COUNT	Sets or returns the state of the EDH error counter
ITU601:EDH:DETEct?	Returns the state of the EDH detection
ITU601:EDH:NUMERRors?	Returns the number of 601 digital video EDH errors
ITU601:INPUT:FORMat	Sets or returns the digital video signal input format (525 or 625)
ITU601:INPUT:SIGnalstrength?	Returns the digital video signal strength
ITU601:INPUT:STATE?	Returns the input signal state
ITU601:OUTput:FORMat	Sets or returns the format for displaying the digital video signal components.

Limit Test Commands

(Requires TDS3LIM)

The Limit Test commands let you automatically compare each incoming waveform against a template waveform. You set an envelope of limits around a waveform and let the oscilloscope find the waveforms that fall outside those limits. When it finds such a waveform, it can generate a hard copy, emit a beep, save the waveform to memory, stop and wait for your input, or any combination of these actions. Table 2-15 lists the limit test commands, which are only available when a TDS3LIM Limit Test application module is installed in the oscilloscope.

Table 2-15: Limit Test commands

Header	Description
LIMit?	Returns all limit testing parameters
LIMit:BEEP	Beeps when limit exceeded
LIMit:BELL	Same as LIMit:BEEP
LIMit:COMpare:CH<x>	Template to compare waveform to
LIMit:HARDCopy	Prints a hard copy when limit exceeded
LIMit:SAVEWFM	Save waveform to memory storage device
LIMit:STATE	Turn limit testing on or off
LIMit:STOPOnviolation	Sets or returns the stop on violation mode
LIMit:TEMPLate	Template to compare waveform to
LIMit:TEMPLate:DESTination	Reference storage for template waveform
LIMit:TEMPLate:SOURce	Template waveform source
LIMit:TEMPLate:TOLerance:HORIZontal	Template horizontal tolerance
LIMit:TEMPLate:TOLerance:VERTical	Template vertical tolerance

Mask Commands

(TDS3000B Series and TDS3000C Series with TDS3TMT)

The Mask Test commands let you automatically compare each incoming waveform against a template telecommunications mask. When the oscilloscope finds the waveforms that fall outside the mask limits, it can generate a hard copy, emit a beep, stop and wait for your input, or any combination of these actions.

Table 2-16 lists these commands, which are only available when a TDS3TMT Telecom Mask Test application module is installed in the oscilloscope.

Table 2-16: Mask commands

Header	Description
MASK:AUTOFit	Sets or returns the autofit radius setting
MASK:COpy:SOUrce	Sets or returns the mask standard to copy to the User mask when the MASK:COpy:USER command is executed
MASK:COpy:USER	Copies the mask defined by MASK:COpy:SOUrce to the user mask
MASK:COUnT:CH<x>:HITS?	Returns the total hits on all mask segments for the specified channel
MASK:COUnT:FAILURES?	Returns the number of pass/fail tests that have failed
MASK:COUnT:HITS?	Returns the total number of mask hits for all channels on all mask segments
MASK:COUnT:MASK<m>:CH<x>:HITS?	Returns the number of hits for channel <x> in mask segment <m>
MASK:COUnT:MASK<m>:HITS?	Returns the number of hits for all channels in mask segment <m>
MASK:COUnT:STATE	Sets or returns the mask hits count state
MASK:COUnT:TESTS?	Returns the number of pass/fail tests that have occurred when MASK:TEST:REPeat is turned on
MASK:COUnT:TOTa1?	Returns the sum of all hits in all mask segments
MASK:COUnT:VIOLATIONS?	Returns the number of test violations which have occurred in the current pass/fail test
MASK:COUnT:WAVEFORMS?	Returns the number of waveforms which have been acquired and processed during pass/fail testing
MASK:DISPlay	Sets or returns the mask violation detection and display status

Table 2-16: Mask commands (cont.)

Header	Description
MASK:LOCK	Sets or returns the mask lock to waveform mode
MASK:MARGIN:HORizontal	Sets or returns the User mask's horizontal margin percentage
MASK:MARGIN:VERTical	Sets or returns the User mask's vertical margin percentage
MASK:MASK<m> DELEte	Deletes the specified mask segment from the User mask, whether or not the User mask is the current mask
MASK:MASK<m>:COUNT?	Returns the number of hits on the specified mask segment in the current mask
MASK:MASK<m>:NR_Pt?	Returns the number of points that make up the specified mask segment of the currently-displayed mask
MASK:MASK<m>:POINTS	Sets or returns the X-Y user coordinates of all points in the specified mask segment
MASK:MASK<m>:POINTSNorm	Sets or returns the normalized coordinate points of the specified mask segment
MASK:MASK<m>:POINTSPcnt	Sets or returns the points in the specified mask segment, in percentage coordinates
MASK:MASKPRE:AMPli tude	Sets or returns the current mask's nominal pulse amplitude in volts
MASK:MASKPRE:HSCAl e	Sets or returns the nominal timing resolution used to draw the mask, in time/division
MASK:MASKPRE:HTRIGPOS	Sets or returns the nominal trigger position (pulse leading edge) used to draw the mask as a fraction of the display width
MASK:MASKPRE:PATTERNBITS	Sets or returns the number of bits used for serial trigger for the current standard
MASK:MASKPRE:PRESAMPBITS	Sets or returns the number of bits before the (isolated one) pulse leading edge in serial trigger
MASK:MASKPRE:RECOrdlength	Sets or returns the nominal record length for pulse mask testing
MASK:MASKPRE:SERIALTRIG	Sets or returns enabling of serial trigger for the current mask standard
MASK:MASKPRE:TRIGTOSAMP	Sets or returns the time, in seconds, from the (leading edge) trigger position to the pulse bit sampling position

Table 2-16: Mask commands (cont.)

Header	Description
MASK:MASKPRE:VOFFSet	Sets or returns the nominal vertical offset, in volts, used to vertically offset the input channels
MASK:MASKPRE:VPOS	Sets or returns the nominal vertical position, in divisions, used to vertically position the input channels
MASK:MASKPRE:VSCALE	Sets or returns the nominal vertical scale, in volts per division, used to vertically scale the input channels
MASK:MASKPRE:WIDTH	Sets or returns the nominal bit width in seconds
MASK:POLarity	Sets or returns the input waveform polarity pass/fail testing mode
MASK:STANdard	Sets or returns the currently-displayed mask
MASK:STOPOnvIolation	Sets or returns the stop on violation mode
MASK:TEST:BEEP:COMPLetion	Sets or returns the beep on pass/fail test completion mode
MASK:TEST:BEEP:FAILUre	Sets or returns the beep on pass/fail test failure mode
MASK:TEST:DELay	Sets or returns the amount of time to wait after starting pass/fail testing to evaluate waveforms
MASK:TEST:HARDCopy	Sets or returns the hard copy on pass/fail test failure mode
MASK:TEST:REPeat	Sets or returns the repeat pass/fail test on completion mode
MASK:TEST:SAVEWFM	Sets or returns the save waveform to file on failure mode
MASK:TEST:STATE	Sets or returns the state of mask pass/fail testing
MASK:TEST:STATUS?	Returns the mask test pass/fail status
MASK:TEST:THReshold	Sets or returns the maximum number of tested waveforms that are allowed to fail during each pass/fail test
MASK:TEST:WAVEform	Sets or returns the number of waveforms to test during pass/fail testing
MASK:USER:MASK<m> DELEte	Deletes the specified mask segment from the User mask
MASK:USER:MASK<m>:NR_Pt?	Returns the number of points that make up the specified mask segment in the User mask

Table 2-16: Mask commands (cont.)

Header	Description
MASK:USER:MASK<m>:POINTS	Sets or returns the X-Y user coordinates of all points in the specified User mask segment
MASK:USER:MASK<m>:POINTSNorm	Sets or returns the normalized coordinate points of the specified User mask segment
MASK:USER:MASK<m>:POINTSPcnt	Sets or returns the points in the specified User mask segment, in percentage coordinates
MASK:USER:MASKPRE:AMPliTude	Sets or returns the User mask's nominal pulse amplitude in volts
MASK:USER:MASKPRE:HSCAlE	Sets or returns the nominal timing resolution used to draw the User mask, in time/division
MASK:USER:MASKPRE:HTRIGPOS	Sets or returns the nominal trigger position (pulse leading edge), as a fraction of the display width, used to draw the User mask
MASK:USER:MASKPRE:PATTERNBITS	Sets or returns the number of bits used for serial trigger for the User mask standard
MASK:USER:MASKPRE:PRESAMPBITS	Sets or returns the number of bits before the (isolated one) pulse leading edge in User mask
MASK:USER:MASKPRE:RECOrdLength	Sets or returns the nominal record length for User mask
MASK:USER:MASKPRE:SERIALTRIG	Sets or returns enabling of serial trigger for the User mask standard
MASK:USER:MASKPRE:TRIGTOSAMP	Sets or returns the time, in seconds, from the (leading edge) trigger position to the pulse bit sampling position, for the User Mask
MASK:USER:MASKPRE:VOFFSet	Sets or returns the nominal vertical offset, in volts, used to vertically offset the input channels
MASK:USER:MASKPRE:VPOS	Sets or returns the nominal vertical position, in divisions, used to vertically position the input channels
MASK:USER:MASKPRE:VSCAlE	Sets or returns the nominal vertical scale, in volts per division, used to vertically scale the input channels
MASK:USER:MASKPRE:WIDTH	Sets or returns the User mask standard's nominal bit width in seconds
TRIGger:A:COMMunication:STANdard	Sets or returns the current standard A trigger communication trigger settings
TRIGger:MAIn:COMMunication:STANdard	Sets or returns the current standard main trigger communication trigger settings

Table 2- 17: Available TDS3TMT ITU-T G.703 mask standards

Standard	Description
CLOCKCoax	Clock interface coaxial pair 2.048 Mb/s
CLOCKSymmetrical	Clock interface symmetric pair 2.048 Mb/s
DS0Contra	DS-0 data contra-directional 64 kb/s
DS0Double	DS-0 double 64 kb/s
DS0Single	DS-0 single 64 kb/s
DS0Timing	DS-0 timing 64 kb/s
DS1Rate	Old DS1 rate 1.544 Mb/s
G703DS1	G.703 DS1 1.544 Mb/s
DS2RATECoax	DS2 rate coaxial pair 6.312 Mb/s
DS2RATESymmetrical	DS2 rate symmetric pair 6.312 Mb/s
DS3Rate	Old DS3 rate 44.736 Mb/s
G703DS3	G.703 DS3 44.736 Mb/s
E1Coax	E1 coaxial pair 2.048 Mb/s
E1Symmetrical	E1 symmetrical pair 2.048 Mb/s
E2	E2 8.448 Mb/s
E3	E3 34.368 Mb/s
NOne	Turns off mask testing and erases current mask from the screen
RATE32Mbit	32.068 Mb/s

Table 2- 18: Available TDS3TMT ANSI T1.102 mask standards

Standard	Description
DS1	DS1 rate 1.544 Mb/s
DS1A	DS1A 2.048 Mb/s
DS1C	DS1C 3.152 Mb/s
DS2	DS2 6.312 Mb/s
DS3	DS3 44.736 Mb/s
STS1Pulse	STS-1 pulse 51.84 Mb/s
NOne	Turns off mask testing and erases current mask from the screen

Math Commands

Math commands provide access to math function definition. This table also includes TDS3AAM Advanced Analysis application module remote command syntax.

Table 2-19: Math commands

Header	Description
MATH?	Returns definition for the math waveform
MATH:DEFINE	Sets or returns the math waveform definition for the active math operation (as set by MATH:TYPE)
MATH:HORizontal:POSition<NR3>	Sets the math horizontal display position for FFT and dual waveform math with reference sources only
MATH:HORizontal:SCAle<NR3>	Sets the math horizontal display scale for FFT and dual waveform math with reference sources only
MATH:HORizontal:UNIts	Sets or returns the math horizontal measurement units label
MATH:SPECTral:MAG	Sets or returns the FFT waveform vertical scale type (linear or dB)
MATH:SPECTral:WINDow	Sets or returns the FFT window value
MATH:TYPe	Sets or returns the math function (Dual, FFT, DPO, or Advanced)
MATH:VAR<x> (TDS3AAM)	Sets or returns the value of the user-defined variable VAR1 or VAR2
MATH:VERTical:POSition<NR3>	Sets the math waveform display position
MATH:VERTical:SCAle<NR3>	Sets the vertical display scale
MATH:VERTical:UNIts	Sets or returns the math vertical measurement units label
MATH1:DEFINE MATH1:HORizontal:POSition<NR3> MATH1:HORizontal:SCAle MATH1:HORizontal:UNIts MATH1:SPECTral:MAG MATH1:SPECTral:WINDow MATH1:TYPe MATH1:VAR<x> MATH1:VERTical:POSition<NR3> MATH1:VERTical:SCAle<NR3> MATH1:VERTical:UNIts	Same as the equivalent MATH commands

Measurement Commands

Measurement commands control the automated measurement system.

Table 2-20 on page 2-28 lists these commands.

Up to four automated measurements can be displayed on the screen. In the commands, these four measurement readouts are named MEAS<x>, where <x> can be 1, 2, 3, or 4.

In addition to the four displayed measurements, the measurement commands let you specify a fifth measurement, IMMed. The immediate measurement has no front-panel equivalent. Immediate measurements are never displayed, but return the immediate value of the specified measurement. Because they are computed only when needed, immediate measurements slow the waveform update rate less than displayed measurements.

Whether you use displayed or immediate measurements, you use the VALue? query to obtain measurement results.

Measurement commands can set and query measurement parameters. You can assign some parameters, such as waveform sources, differently for each measurement readout. Other parameters, such as reference levels, have only one value, which applies to all measurements.

Table 2-20: Measurement commands

Header	Description
MEASUrement?	Returns all measurement parameters
MEASUrement:CLEARSNapshot	Clears the measurement snapshot screen
MEASUrement:GATing	Sets or returns measurement gating
MEASUrement:IMMed?	Returns immediate measurement parameters
MEASUrement:IMMed:DATA?	Returns measurement result and qualifier
MEASUrement:IMMed:DELay?	Returns information about the immediate delay measurement
MEASUrement:IMMed:DELay:DIREction	Sets the starting point and directions of immediate delay measurement
MEASUrement:IMMed:DELay:EDGE1	Sets or returns the slope of the first edge used for the delay waveform measurement
MEASUrement:IMMed:DELay:EDGE2	Sets or returns the slope of the second edge used for the delay waveform measurement
MEASUrement:IMMed:SOURce	Channel to take measurement from
MEASUrement:IMMed:SOURCE<x>	Sets the source (1 or 2) to be measured
MEASUrement:IMMed:TYPE	The measurement to be taken
MEASUrement:IMMed:UNIts?	Returns measurement units

Table 2-20: Measurement commands (cont.)

Header	Description
MEASUrement:IMMed:VALue?	Returns measurement result
MEASUrement:INDICators?	Returns all measurement indicator parameters
MEASUrement:INDICators:HORZ<x>?	Returns the position of the specified horizontal measurement indicator
MEASUrement:INDICators:STATE	Sets and returns state of visible measurement indicators
MEASUrement:INDICators:NUMHORZ?	Returns the horizontal measurement indicators
MEASUrement:INDICators:NUMVERT?	Returns the vertical measurement indicators
MEASUrement:INDICators:VERT<x>?	Returns the position of the specified vertical measurement indicator
MEASUrement:MEAS<x>?	Returns parameters on measurement
MEASUrement:MEAS<x>COUNT? (TDS3AAM)	Returns parameters on measurement accumulated
MEASUrement:MEAS<x>:DATA?	Returns measurement result and qualifier
MEASUrement:MEAS<x>:DELay?	Returns delay measurement result and qualifier
MEASUrement:MEAS<x>:DELay: DIREction	Sets the starting point and direction to determine the delay measurement
MEASUrement:MEAS<x>:DELay: EDGE<x>	Sets the slope of the edge used for delay measurement
MEASUrement:MEAS<x>:MAXimum? (TDS3AAM)	Returns the maximum value for the specified measurement since last statistical reset
MEASUrement:MEAS<x>:MEAN? (TDS3AAM)	Returns the mean value accumulated for the specified measurement since last statistical reset
MEASUrement:MEAS<x>:MINImum? (TDS3AAM)	Returns the minimum value accumulated for the specified measurement since the last statistical reset
MEASUrement:MEAS<x>:SOURCE	Returns or sets measurement source
MEASUrement:MEAS<x>:SOURCE<x>	Returns or sets the source for the specified measurement
MEASUrement:MEAS<x>:STDev? (TDS3AAM)	Returns or sets standard deviation values accumulated for the specified measurement since the last statistical reset
MEASUrement:MEAS<x>:STATE	Turns measurement display on or off
MEASUrement:MEAS<x>:TYPE	The measurement to be taken
MEASUrement:MEAS<x>:UNIts?	Returns units to use for measurement
MEASUrement:MEAS<x>:VALue?	Returns measurement result

Table 2-20: Measurement commands (cont.)

Header	Description
MEASUrement:MEthod	Method for calculating reference levels
MEASUrement:REFLevel?	Returns reference levels
MEASUrement:REFLevel:ABSolute:HIGH	Sets or returns the high reference level
MEASUrement:REFLevel:ABSolute:LOW	Sets or returns the low reference level
MEASUrement:REFLevel:ABSolute:MID	Sets or returns the mid reference level
MEASUrement:REFLevel:ABSolute:MID2	Sets or returns the mid2 reference level
MEASUrement:REFLevel:MEthod	Specifies reference level used for calculation
MEASUrement:REFLevel:PERCent:HIGH	Sets or returns the percent of the high reference level
MEASUrement:REFLevel:PERCent:LOW	Sets or returns the percent of the low reference level
MEASUrement:REFLevel:PERCent:MID	Sets or returns percent of the mid reference level
MEASUrement:REFLevel:PERCent:MID2	Sets or returns percent of the mid2 reference level
MEASUrement:SNAPShot	Displays measurement snapshot
MEASUrement:STATIstics:MODE (TDS3AAM)	Sets operation and display measurement
MEASUrement:STATIstics:WEIghting (TDS3AAM)	Sets responsiveness of the mean and standard waveform changes

Miscellaneous Commands

Miscellaneous commands do not fit into other categories. Table 2-21 lists these commands.

Several commands and queries are common to all 488.2-1987 devices on the GPIB bus. The 488.2-1987 standard defines them. They begin with a star (*) character.

Table 2-21: Miscellaneous commands

Header	Description
BEL1	Audio alert
DATE	Sets date
*DDT	Define group execute trigger (GET)
FACTory	Similar to *RST

Table 2-21: Miscellaneous commands (cont.)

Header	Description
HDR	Same as HEADER
HEADer	Returns command header with query
LANGuage	Selects language
LOCK	Locks front panel (local lockout)
*LRN?	Returns instrument settings
NEWpass	Changes password for User Protected Data
PASSWord	Access to change User Protected Data
POWER:AC:PRESENT?	Returns a 1 the instrument is powered by AC
POWER:BACKLighT	Sets or returns idle time that must lapse before the backlight turns off
POWER:BATTery:PRESENT?	Returns a 1 if a battery is installed
POWER:BATTery:GASgauge?	Returns remaining charge that is left in the battery. 0 = empty to 15 = full
POWER:SHUTdown	Sets or returns idle time that must lapse before the instrument is powered off
REM	No action; remark only
*RST	Returns most settings to factory default
SET?	Same as *LRN?
TEKSecure	Initialize waveforms and setups
TIME	Sets Time
*TRG	Perform Group Execute Trigger (GET)
*TST?	Self-test
UNLock	Unlock front panel (local lockout)
VERBose	Returns full command name or minimum spellings with query

RS-232 Commands

RS-232 commands allow you to use the serial communications port available with a communication module. Table 2-22 lists these commands.

Table 2-22: RS-232 commands

Header	Description
RS232?	Returns RS-232 parameters
RS232:BAUD	Sets baud rate
RS232:HARDFlagging	Sets hard flagging
RS232:PRESET	Sets RS232 parameters to default values
RS232:TRANsmit:TERMinator	Sets end-of-line terminator

Save and Recall Commands

Save and Recall commands allow you to store and retrieve internal waveforms and settings. When you “save a setup,” you save the settings of the oscilloscope. When you then “recall a setup,” the oscilloscope restores itself to the state it was in when you originally saved that setting. Table 2-23 lists these commands.

Table 2-23: Save and Recall commands

Header	Description
RECALL:MASK (TDS3TMT)	Loads the specified mask file from the disk or flash drive to the User mask
RECALL:SETUp	Recalls saved instrument settings
RECALL:WAVEform	Recalls saved waveform
*RCL	Recalls settings
*SAV	Saves settings
SAVE:MASK (TDS3TMT)	Saves the User mask to a specified file on the disk or flash drive
SAVe:SETUp	Saves instrument settings
SAVe:WAVEform	Saves waveform
SAVe:WAVEform:FILEFormat	Sets or returns file format for saved waveforms

Status and Error Commands

Table 2-24 lists the status and error commands the oscilloscope supports. These commands let you determine the status of the oscilloscope and control events.

Several commands and queries used with the oscilloscope are common to all devices on the GPIB bus. IEEE Std 488.2-1987 defines these commands and queries. They begin with an asterisk (*).

Table 2-24: Status and Error commands

Header	Description
ALLEv?	Returns all events
BUSY?	Returns scope status
*CLS	Clears status
DESE	Device event status enable
*ESE	Event status enable
*ESR?	Returns standard event status register
EVENT?	Returns event code
EVMsg?	Returns event code and message
EVQty?	Returns number of events in queue
ID?	Identification
*IDN?	Returns IEEE-488 instrument identification
*OPC	Operation complete
*PSC	Power-on status clear
*PUD	Queries or sets User Protected Data
*SRE	Service request enable
*STB?	Reads status byte
*WAI	Wait to continue

Trigger Commands

Trigger commands control all aspects of oscilloscope triggering. Table 2-25 lists these commands.

There are two triggers, A and B. Where appropriate, the command set has parallel constructions for each trigger.

You can set the A or B triggers to edge mode. Edge triggering lets you display a waveform at or near the point where the signal passes through a voltage level of your choosing.

The advanced trigger commands are divided into two groups (logic and pulse) in the following tables, but are combined and listed in alphabetical order in the command syntax pages.

This table also includes the TDS3VID Extended Video application module remote command syntax.

Table 2-25: Trigger commands

Header	Description
TRIGger?	Returns parameters
TRIGger:A	Returns the A trigger parameters
TRIGger:A:COMMunication:SOUrce (TDS3TMT)	Sets or returns the signal source on which to trigger
TRIGger:A:COMMunication:STANdard (TDS3TMT)	Sets or returns the communication standard on which to trigger
TRIGger:A:EDGE?	Returns edge trigger parameters
TRIGger:A:EDGE:COUPling	Trigger coupling
TRIGger:A:EDGE:SLOpe	Trigger slope
TRIGger:A:EDGE:SOUrce	Trigger source
TRIGger:A:HOLdoff?	Returns trigger holdoff
TRIGger:A:HOLdoff:TIME	Trigger holdoff
TRIGger:A:HOLdoff:VALue	Trigger holdoff
TRIGger:A:LEVel	Trigger level
TRIGger:A:LOGIC?	Returns the logic trigger settings
TRIGger:A:LOGic:CLAss	Sets or returns the logic trigger class value (pattern or state)
TRIGger:A:LOGic:INPUT<x>: LOGICLeVel	Sets or returns the signal logic level setting of the specified input
TRIGger:A:LOGic:INPUT<x>: SLOpe	Sets or returns the signal slope setting of the specified input

Table 2-25: Trigger commands (cont.)

Header	Description
TRIGger:A:LOGic:INPUT<x>:SOUrce	Sets or returns the signal source for the specified logic trigger input
TRIGger:A:LOGic:INPUT<x>:THReshold	Sets or returns the logic trigger threshold setting of the specified input
TRIGger:A:LOGic:PATtern:DELTATime	Sets or returns the pattern trigger time period value
TRIGger:A:LOGic:PATtern:FUNCTion	Sets or returns the logic function to apply to the pattern trigger inputs
TRIGger:A:LOGic:PATtern:WHEn	Sets or returns the pattern logic condition on which to trigger the oscilloscope
TRIGger:A:LOGic:STATE:WHEn	Sets or returns the state condition on which to trigger the oscilloscope
TRIGger:A:MODE	Trigger mode
TRIGger:A:PULse?	Returns the pulse trigger (width, runt, and slew rate) settings
TRIGger:A:PULse:CLAss	Sets or returns the pulse trigger class value (width, runt, or slew rate)
TRIGger:A:PULse:RUNT?	Returns the runt pulse trigger parameters
TRIGger:A:PULse:RUNT:POLarity	Sets or returns the runt pulse polarity value on which to trigger the oscilloscope
TRIGger:A:PULse:RUNT:THReshold?(TDS3TRG)	Returns the runt pulse trigger upper and lower threshold voltage values
TRIGger:A:PULse:RUNT:THReshold:BOTH	Sets both runt pulse trigger threshold voltage values
TRIGger:A:PULse:RUNT:THReshold:HIGH	Sets or returns the runt pulse trigger high threshold voltage value
TRIGger:A:PULse:RUNT:THReshold:LOW	Sets or returns the runt pulse trigger low threshold voltage value
TRIGger:A:PULse:RUNT:WHEn	Sets or returns the runt pulse width condition on which to trigger the oscilloscope
TRIGger:A:PULse:RUNT: WIDTH	Sets or returns the runt pulse width time period value
TRIGger:A:PULse:SLEWRate?	Returns the slew rate trigger settings
TRIGger:A:PULse:SLEWRate:DELTATime	Sets or returns the time component of the slew rate value
TRIGger:A:PULse:SLEWRate:POLarity	Sets or returns the slew rate slope polarity on which to trigger the oscilloscope
TRIGger:A:PULse:SLEWRate:SLEWrate	Sets or returns the slew rate on which to trigger the oscilloscope

Table 2-25: Trigger commands (cont.)

Header	Description
TRIGger:A:PULse:SLEWRate:THReshold:BOTH	Sets both slew rate threshold voltage values
TRIGger:A:PULse:SLEWRate:THReshold:HIGH	Sets or returns the slew rate high threshold voltage value
TRIGger:A:PULse:SLEWRate:THReshold:LOW	Sets or returns the slew rate low threshold voltage value
TRIGger:A:PULse:SLEWRate:WHEn	Sets or returns the slew rate condition on which to trigger the oscilloscope
TRIGger:A:PULse:SOUrce	Sets or returns the signal source for width, runt, and slew rate triggers
TRIGger:A:PULse:WIDth:POLarity	Sets or returns the pulse width polarity value on which to trigger the oscilloscope
TRIGger:A:PULse:WIDth:WHEn	Sets or returns the pulse width condition on which to trigger the oscilloscope
TRIGger:A:PULse:WIDth:WIDth	Sets or returns the pulse width trigger time period value
TRIGger:A:SETLeve1	Sets the trigger level to 50%
TRIGger:A:TYPe	Sets A trigger to edge, logic, pulse, or, video type
TRIGger:A:VIDeo?	Returns video trigger parameters
TRIGger:A:VIDeo:CUSToM:FORMat (TDS3SDI, TDS3VID)	Sets or queries the custom video signal source format
TRIGger:A:VIDeo:CUSToM:SCAN (TDS3SDI, TDS3VID)	Sets or queries the custom video signal source scan rate on which to trigger
TRIGger:A:VIDeo:FIELD	Sets or queries the field the video trigger detects
TRIGger:A:VIDeo:HDTV:FORMat (TDS3SDI, TDS3VID)	Sets or queries the HDTV signal format on which to trigger
TRIGger:A:VIDeo:HOLdoFF:FIELD (TDS3SDI, TDS3VID)	Sets or queries the number of video fields to hold off before triggering
TRIGger:A:VIDeo:LI NE	Sets or queries the video line number on which to trigger
TRIGger:A:VIDeo:SCAN (TDS3SDI, TDS3VID)	Sets or queries the video signal source scan rate on which to trigger
TRIGger:A:VIDeo:SOUrce	Selects video trigger source
TRIGger:A:VIDeo:STANdard	Selects video trigger standard
TRIGger:A:VIDeo:SYStem	Same as TRIGger:A:VIDeo:SOUrce
TRIGger:B?	Returns the B trigger level

Table 2-25: Trigger commands (cont.)

Header	Description
TRIGger:B:BY	Sets the B trigger to delay by time or events
TRIGger:B:EDGE?	Returns the trigger coupling, source, and the slope of the B trigger
TRIGger:B:EDGE:COUPling	Sets the B trigger coupling
TRIGger:B:EDGE:SLOpe	B trigger slope
TRIGger:B:EDGE:SOURce	B trigger source
TRIGger:B:EVENTS?	Returns the current delayed trigger event parameters
TRIGger:B:EVENTS:COUNT	Delay by events count for the B trigger
TRIGger:B:LEVe1	B trigger level
TRIGger:B:SETLeve1	Sets the trigger level to 50%
TRIGger:B:STATE	Enables/disables the B trigger
TRIGger:B:TIME	Minimum time between A and B trigger
TRIGger:B:TYPe	Sets B trigger to edge, logic, pulse, or, video type
TRIGger:DELaY:EDGE:COUPling TRIGger:DELaY:EDGE:SLOpe TRIGger:DELaY:EDGE:SOURce TRIGger:DELaY:EVENTS:COUNT TRIGger:DELaY:LEVe1 TRIGger:DELaY:SETLeve1 TRIGger:DELaY:STATE TRIGger:DELaY:TIME TRIGger:DELaY:TYPe	Same as the equivalent B trigger commands; for compatibility with earlier oscilloscopes
TRIGger:EXTERna1:PRObe (4-channel TDS3000B and TDS3000C Series oscilloscopes only)	Sets or returns the external input probe factor
TRIGger:EXTERna1:YUNit (4-channel TDS3000B and TDS3000C Series oscilloscopes only)	Sets or returns the external input vertical units
TRIGger:FORCe	Forces a trigger event
TRIGger:STATE?	Returns trigger system status

Vertical Commands

Vertical commands control the display of channels and of main and reference waveforms. Table 2-26 lists these commands.

The `SElect:<wfm>` command also selects the waveform many commands in other command groups use.

You may replace VOLts for SCAle in the vertical commands. This provides program compatibility with earlier models of Tektronix oscilloscopes.

Table 2-26: Vertical commands

Header	Description
CH<x>?	Returns vertical parameters for channel <x>
CH<x>:BANdwidth	Sets or returns the bandwidth for channel <x>
CH<x>:COUPling	Sets or returns the channel coupling for channel <x>
CH<x>:DESKew	Sets or returns the channel deskew time for channel <x>
CH<x>:ID?	Return probe identification for channel <x>
CH<x>:IMPedance	Sets or returns the channel probe impedance for channel <x>
CH<x>:INVert	Sets or returns the channel invert for channel <x>
CH<x>:OFFSet	Sets or returns the channel offset for channel <x>
CH<x>:POSition	Sets or returns the channel position for channel <x>
CH<x>:PROBe	Sets or returns the channel probe attenuation for channel <x>
CH<x>:SCAlE	Sets or returns the channel volts or amps per div for channel <x>
CH<x>:VOLts	Same as CH<x>:SCAlE for channel <x>
CH<x>:YUNIT	Sets or returns the channel vertical units for channel <x>
SElect?	Return selected waveform and state of channels (on/off)
SElect:CONTRol	Set selected waveform
SElect:<wfm>	Turns channels on or off

Waveform Commands

Waveform commands let you transfer waveform data points to and from the oscilloscope. Waveform data points are a collection of values that define a waveform. One data value usually represents one data point in the waveform record. When working with peak detect or envelope waveforms, each data value is either the min or max of a min/max pair. Before you transfer waveform data, you must specify the data format, record length, and waveform source.

Table 2-28 on page 2-42 lists these commands.

Waveform Data Formats

Acquired waveform data uses 9 or more bits to represent each data point. The number of bits used depends on the acquisition mode specified when you acquired the data. Data acquired in SAMple, ENvelope, or PEAKdetect mode uses 9 bits per waveform data point. Data acquired in AVERage mode uses up to 14 bits per point. For more information on the acquisition modes see the ACQUIRE: MODE command on page 2-45.

The DATA:WIDTH command lets you specify the number of bytes per data point when transferring data to and from the oscilloscope. If you specify two bytes for data, the acquired waveform data is left-shifted to be left-justified in the 16-bit (2 byte) data quantity. If you specify one byte for data, the least significant bit(s) are ignored.

The oscilloscope can transfer waveform data in either ASCII or binary format. You specify the format with the DATA:ENCdg command.

ASCII data — is represented by signed integer values. The range of the values depends on the byte width specified. One byte wide data ranges from -128 to 127. Two byte wide data ranges from -32768 to 32767.

Each data value requires two to seven characters. This includes one to five characters to represent the value, another character, if the value is negative, to represent a minus sign, and a comma to separate the data points.

An example ASCII waveform data string may look like this:

```
CURVE<space>-110,-109,-110,-110,-109,-107,-109,-107,
-106,-105,-103,-100,-97,-90,-84,-80
```

Use ASCII to obtain more human readable and easier to format output than binary. However, it may require more bytes to send the same values with ASCII than it does with binary. This may reduce transmission speeds.

Binary data — can be represented by signed integer or positive integer values. The range of the values depends on the byte width specified. When the byte width is one, signed integer data ranges from -128 to 127, and positive integer

values range from 0 to 255. When the byte width is two, the signed integer data ranges from -32768 to 32767, and positive integer values range from 0 to 65,535.

Table 2-27: Binary data ranges

Byte width	Signed integer range	Positive integer range
1	-128 to 127	0 to 255
2	-32,768 to 32,767	0 to 65,535

The defined binary formats also specify the order in which the bytes are transferred. The four binary formats are RIBinary, RPBinary, SRIBinary, and SRPbinary.

RIBinary is signed integer where the most significant byte is transferred first, and RPBinary is positive integer where the most significant byte is transferred first. SRIBinary and SRPbinary correspond to RIBinary and RPBinary respectively but use a swapped byte order where the least significant byte is transferred first. The byte order is ignored when DATA:WIDTH is set to 1.

Waveform Data/Record Lengths

You can transfer multiple points for each waveform record. You can transfer a portion of the waveform or you can transfer the entire record. The DATA:START and DATA:STOP commands let you specify the first and last data points of the waveform record.

The oscilloscope supports 2 waveform record lengths: 500 points and 10,000 points. When transferring data into the oscilloscope, you must first specify the record length of the destination waveform record. This is done with the WFMPre:NR_Pt or WFMPre:REF<x>:NR_Pt commands. Next, specify the first data point within the waveform record. For example, when you set DATA:START to 1, data points will be stored starting with the first point in the record, and when you set DATA:START to 500, data will be stored starting at the 500th point in the record. The oscilloscope will ignore DATA:STOP when reading in data as it will stop reading data when it has no more data to read or when it has reached the specified record length.

When transferring data from the oscilloscope, you must specify the first and last data points in the waveform record. Setting DATA:START to 1 and DATA:STOP to the record length will always return the entire waveform.

Waveform Data Locations and Memory Allocation

The DATA:SOURce command specifies the waveform source when transferring a waveform from the oscilloscope. You can only transfer one waveform at a time.

You can transfer in to the oscilloscope one waveform at a time. Waveforms sent to the oscilloscope are always stored in one of the four reference memory

locations. You can specify the reference memory location with the DATA:DESTINATION command.

Waveform Preamble

Each waveform that you transfer has an associated waveform preamble that contains information such as the horizontal scale, the vertical scale, and other settings in place when the waveform was created. Refer to the WFMPRE commands starting on page 2-314 for more information about the waveform preamble.

Scaling Waveform Data

Once you transfer the waveform data to the controller, you can convert the data points into voltage values for analysis using information from the waveform preamble. The GETWFM (get waveform) program on the disk(s) that come with this manual shows how you can scale data.

Transferring Waveform Data from the oscilloscope

You can transfer waveforms from the oscilloscope to an external controller using the following sequence:

1. Select the waveform source using the DATA:SOURCE command.
2. Specify the waveform data format using DATA:ENCdg.
3. Specify the number of bytes per data point using DATA:WIDTH.
4. Specify the portion of the waveform that you want to transfer using DATA:START and DATA:STOP.
5. Transfer waveform preamble information using the WFMPRE? query.
6. Transfer waveform data from the oscilloscope using the CURVe? query.

Transferring Waveform Data to the oscilloscope

You can transfer waveform data to one of the four reference waveforms in the oscilloscope using the following sequence:

1. Specify the reference waveform using DATA:DESTINATION.
2. Specify the record length of the reference waveform using WFMPRE:NR_Pt.
3. Specify the waveform data format using DATA:ENCdg.
4. Specify the number of bytes per data point using DATA:WIDTH.
5. Specify first data point in the waveform record using DATA:START.
6. Transfer waveform preamble information using WFMPRE.
7. Transfer waveform data to the oscilloscope using CURVe.

Table 2-28: Waveform commands

Header	Description
CURVe	Transfers waveform data to or from the oscilloscope
DATA	Sets or returns the format and location of the waveform data that is transferred with the CURVe command
DATA:DESTination	Sets or returns the destination for waveforms sent to oscilloscope
DATA:ENCdg	Sets or returns the waveform data encoding method
DATA:SOUrce	Sets or returns the source of CURVe? data
DATA:START	Sets or returns the starting point in waveform transfer
DATA:STOP	Sets or returns the ending point in waveform transfer
DATA:TARget	Same as DATA:DESTination
DATA:WIDth	Sets or returns the byte width of waveform points
REF<x>:DATE?	Query waveform save date
REF<x>:HORizontal:POSition<NR3>	Sets or returns the horizontal waveform zoom position
REF<x>:HORizontal:SCAle<NR3>	Sets or returns the horizontal waveform zoom scale
REF<x>:LABel (TDS3AAM)	Sets or returns the user-defined reference waveform label
REF<x>:TIme?	Query waveform save time
REF<x>:VERTical:POSition<NR3>	Sets or returns the vertical waveform position
REF<x>:VERTical:SCAle<NR3>	Sets or returns the vertical waveform scale
WAVFrm?	Query waveform preamble and data
WFMPre?	Query waveform preamble
WFMPre:BIT_Nr	Sets or returns the preamble bit width of waveform points
WFMPre:BN_Fmt	Sets or returns the preamble binary encoding type
WFMPre:BYT_Nr	Sets or returns the preamble byte width of waveform points
WFMPre:BYT_Or	Sets or returns the preamble byte order of waveform points
WFMPre:ENCdg	Sets or returns the preamble encoding method

Table 2-28: Waveform commands (cont.)

Header	Description
WFMPre:NR_Pt	Sets or returns the the number of points in the curve transfer to/from the oscilloscope
WFMPre:PT_Fmt	Sets or returns the format of curve points
WFMPre:PT_Off?	Query trigger offset
WFMPre:WFId?	Query curve identifier
WFMPre:XINcr	Sets or returns the horizontal sampling interval
WFMPre:XUNit	Sets or returns the horizontal units
WFMPre:XZEro	Sets or returns the time of first point in waveform
WFMPre:YMUlt	Sets or returns the vertical scale factor
WFMPre:YOFf	Sets or returns the vertical position
WFMPre:YUNit	Sets or returns the vertical units
WFMPre:YZEro	Sets or returns the offset voltage
WFMPre:<wfm>?	Query waveform preamble
WFMPre:<wfm>:NR_Pt	Set the record length of the destination reference waveform. Query the number of points in the curve transfer from the oscilloscope.
WFMPre:<wfm>:PT_Fmt	Sets or returns the format of curve points
WFMPre:<wfm>:PT_Off?	Query trigger offset
WFMPre:<wfm>:WFId?	Query curve identifier
WFMPre:<wfm>:XINcr	Sets or returns the horizontal sampling interval
WFMPre:<wfm>:XUNit	Sets or returns the horizontal units
WFMPre:<wfm>:XZEro	Sets or returns the time of first points in a waveform
WFMPre:<wfm>:YMUlt	Sets or returns the vertical scale factor
WFMPre:<wfm>:YOFf	Sets or returns the vertical position
WFMPre:<wfm>:YUNit	Sets or returns the vertical units
WFMPre:<wfm>:YZEro	Sets or returns the offset voltage

Command Descriptions

You can use commands to either set instrument features or query instrument values. You can use some commands to do both, some to only set, and some to only query. Commands that are set only are labeled with the words “(Set Only)” next to the command. Commands that are query only are labeled with the words “(Query Only)” next to the command.

This manual shows the minimal command headers, mnemonics, and arguments in upper case. For example, to use the minimal form of the ACQUIRE:MODE command just type ACQ:MOD (or acq:mod).

ACQUIRE? (Query Only)

Returns all the current acquisition parameters.

Group	Acquisition
Syntax	ACQUIRE?
Examples	ACQUIRE? might return the string :ACQUIRE:STOPAFTER RUNSTOP;STATE 1;MODE SAMPLE;NUMENV 8;NUMAVG 16 for the current acquisition parameters.

ACQUIRE:MODE

Sets or queries the acquisition mode of the oscilloscope. This affects all live waveforms. This command is equivalent to setting **Mode** in the **ACQUIRE** menu.

Waveforms are the displayed data point values taken from acquisition intervals. Each acquisition interval represents a time duration set by the horizontal scale (time per division). The oscilloscope sampling system always samples at the maximum rate, and so an acquisition interval may include more than one sample.

The acquisition mode, which you set using this ACQUIRE:MODE command, determines how the final value of the acquisition interval is generated from the many data samples.

Group	Acquisition
--------------	-------------

Syntax ACQUIRE:MODE { SAMPLE | PEAKdetect | AVERAGE | ENVELOPE }

Arguments SAMPLE specifies that the displayed data point value is simply the first sampled value that was taken during the acquisition interval. In sample mode, all waveform data has 9 bits of precision. You can request 16 bit data with a CURVe? query, but the lower-order 7 bits of data will be zero. SAMPLE is the default mode.

PEAKdetect specifies the display of the high-low range of the samples taken from a single waveform acquisition. The high-low range is displayed as a vertical column that extends from the highest to the lowest value sampled during the acquisition interval. PEAKdetect mode can reveal the presence of aliasing or narrow spikes.

AVERAGE specifies averaging mode, where the resulting waveform shows an average of SAMPLE data points from several separate waveform acquisitions. The number of waveform acquisitions that go into making up the average waveform is set or queried using the ACQUIRE:NUMAVg command.

ENVELOPE specifies envelope mode, where the resulting waveform shows the PEAKdetect range of data points from several separate waveform acquisitions. The number of waveform acquisitions that go into making up the envelope waveform is set or queried using the ACQUIRE:NUMENV command.

Examples ACQUIRE:MODE ENVELOPE
sets the acquisition mode to display a waveform that is an envelope of many individual waveform acquisitions.

ACQUIRE:MODE?
might return ENVELOPE.

Related Commands ACQUIRE:NUMAVg, ACQUIRE:NUMENV, CURVe?, DATA:WIDTH

ACQUIRE:NUMACq? (Query Only)

Indicates the number of acquisitions that have taken place since starting acquisition. This value is reset to zero when any Acquisition, Horizontal, or Vertical arguments that affect the waveform are modified. The maximum number of acquisitions that can be counted is $2^{30}-1$. Counting stops when this number is reached. This is the same value that is displayed in the **ACQUIRE** menu.

Group Acquisition

Syntax ACQUIRE:NUMACq?

Examples ACQUIRE:NUMACQ?
might return 350, indicating that 350 acquisitions took place since an ACQUIRE:STATE RUN command was executed.

Related Commands ACQUIRE:STATE

ACQUIRE:NUMAVG

Sets the number of waveform acquisitions that make up an averaged waveform. This is equivalent to setting the **Average** count in the **Acquisition Mode** menu.

Group Acquisition

Syntax ACQUIRE:NUMAVG <NR1>
ACQUIRE:NUMAVG?

Arguments <NR1> is the number of waveform acquisitions to average, from 2 to 512 (must be a power of two).

Examples ACQUIRE:NUMAVG 16
specifies that an averaged waveform will show the result of combining 16 separately acquired waveforms.

ACQUIRE:NUMAVG?
might return 64, indicating that there are 64 acquisitions specified for averaging.

Related Commands ACQUIRE:MODE

ACQUIRE:NUMENV

Sets the number of waveform acquisitions that make up an envelope waveform. This is equivalent to setting the **Envelope** count in the **Acquisition Mode** side menu.

Group Acquisition

Syntax ACQUIRE:NUMENV { <NR1> | INFINITE }
ACQUIRE:NUMENV?

Arguments <NR1> \neq 0 is the number of waveform acquisitions, from 2 to 512 (must be a power of two). The envelope will restart after the specified number of envelopes have been acquired or when the ACQUIRE:STATE RUN command is sent.
INFINITE or <NR1> = 0 or 999999999 specifies continuous enveloping.

NOTE. *If you set the acquisition system to single sequence, envelope mode, and set the number of envelopes to infinity, the oscilloscope will envelope a maximum of 513 acquisitions.*

Returns 999999999 is returned for INFINITE.

Examples ACQUIRE:NUMENV 16
specifies that an enveloped waveform will show the result of combining 16 separately acquired waveforms.
ACQUIRE:NUMENV?
might return 999999999, indicating that acquisitions are acquired infinitely for enveloped waveforms.

Related Commands ACQUIRE:MODE

ACQUIRE:STATE

Sets or returns the acquisition state. This is the equivalent of pressing the front-panel **RUN/STOP** button. If ACQUIRE:STOPAFTER is set to SEQUENCE, other signal events may also stop a waveform acquisition.

Group Acquisition

Syntax ACQUIRE:STATE { OFF | ON | RUN | STOP | <NR1> }
ACQUIRE:STATE?

Arguments	<p>OFF or STOP or <NR1> = 0 stops acquisitions.</p> <p>ON or RUN or <NR1> \neq 0 starts acquisition and display of waveforms. If the command was issued in the middle of an acquisition sequence (for instance averaging or enveloping), RUN restarts the sequence, discarding any data accumulated prior to the STOP. It also resets the number of acquisitions.</p>
Examples	<p>ACQUIRE:STATE RUN starts acquisition of waveform data and resets the number of acquisitions count (NUMACQ) to zero.</p> <p>ACQUIRE:STATE? returns either 0 or 1, depending on whether the acquisition system is running.</p>
Related Commands	ACQUIRE:NUMACQ?, ACQUIRE:STOPAfter

ACQUIRE:STOPAfter

Tells the oscilloscope when to stop taking acquisitions.

Group	Acquisition
Syntax	<p>ACQUIRE:STOPAfter { RUNSTop SEquence }</p> <p>ACQUIRE:STOPAfter?</p>
Arguments	<p>RUNSTop specifies that the run and stop state should be determined by the user pressing the front-panel RUN/STOP button.</p> <p>SEquence specifies “single sequence” operation, where the oscilloscope stops after it has acquired enough waveforms to satisfy the conditions of the acquisition mode. For example, if the acquisition mode is set to sample, and the horizontal scale is set to a speed that allows real-time operation, then the oscilloscope stops acquisition after digitizing a waveform from a single trigger event. However, if the acquisition mode is set to average 128 waveforms, then the oscilloscope stops acquiring data only after all 128 waveforms have been acquired. The ACQUIRE: STATE command and the front-panel RUN/STOP button will also stop acquisition when the oscilloscope is in single sequence mode.</p>

NOTE. *If you set the acquisition system to single sequence, envelope mode, and set the number of envelopes to infinity, the oscilloscope will envelope a maximum of 513 acquisitions.*

Examples ACQUIRE:STOPAFTER RUNSTop
 sets the oscilloscope to stop acquisition when the user presses the front-panel RUN/STOP button.

ACQUIRE:STOPAFTER?
 might return SEQUENCE.

Related Commands ACQUIRE:MODE, ACQUIRE:STATE

Alias

Turns command aliases on or off. This command is identical to the ALIAS:STATE command.

Group Alias

Syntax ALIAS { OFF | ON | <NR1> }
 ALIAS?

Arguments OFF or <NR1> = 0 turns alias expansion off. If a defined alias label is sent when ALIAS is OFF, an execution error (102, "Syntax error: illegal use of alias-alias") will be generated.

ON or <NR1> ≠ 0 turns alias expansion on. When a defined alias is received, the specified command sequence is substituted for the alias and executed.

Examples ALIAS ON
 turns the alias feature on.

ALIAS?
 returns 1 when aliases are on.

ALias:CATALOG? (Query Only)

Returns a list of the currently defined alias labels, separated by commas. If no aliases are defined, the query returns the string "".

Group	Alias
Syntax	ALias:CATALOG?
Returns	<QString>[,<QString>...]
Examples	<p>ALIAS:CATALOG?</p> <p>might return the string "SETUP1", "TESTMENU1", "DEFAULT", showing there are 3 aliases named SETUP1, TESTMENU1, and DEFAULT.</p>

ALias:DEFINE

Assigns a sequence of program messages to an alias label. These messages are then substituted for the alias whenever it is received as a command or query, provided ALias:STATE has been turned ON. The ALias:DEFIne? query returns the definition of a selected alias.

Up to 10 aliases can be defined at one time. Aliases can not be recursive.

Group	Alias
Syntax	<p>ALias:DEFINE <QString><Comma>{ <QString> <Block> }</p> <p>ALias:DEFIne? <QString></p>
Arguments	<p>The first <QString> is the alias label. This label cannot be a command name. Labels must start with a letter, and can contain only letters, numbers, and underscores. The label must be ≤12 characters.</p> <p>The second <QString> or <Block> is a complete sequence of program messages. The messages can contain only valid commands that must be separated by semicolons and must follow all rules for concatenating commands (see page 2-4). The sequence must be ≤256 characters.</p>

NOTE. Attempting to give two aliases the same name causes an execution error. To give a new alias the name of an existing alias, you must first delete the existing alias.

Examples ALIAS:DEFINE "ST1",":RECALL:SETUP 5;:AUTOSET EXECUTE;
:SELECT:CH1 ON"
defines an alias named "ST1" that sets up the oscilloscope using information in setup 5.

ALIAS:DEFINE? "ST1"
might return :ALIAS:DEFINE "ST1",#239:RECALL:SETUP 5;:AUTOSET
EXECUTE;:SELECT:CH1 ON

ALias:DELEte (Set Only)

Removes a specified alias. This command is identical to ALias:DELEte:NAME.

Group Alias

Syntax ALias:DELEte <QString>

Arguments <QString> is the name of the alias you want to remove. Using ALias:DELEte without specifying an alias causes an execution error. <QString> must be an existing alias.

Examples ALIAS:DELETE "SETUP1"
deletes the alias named SETUP1.

ALias:DELEte:ALL (Set Only)

Deletes all existing aliases.

Group Alias

Syntax ALias:DELEte:ALL

Examples ALIAS:DELETE:ALL
deletes all aliases.

ALias:DELEte:NAME (Set Only)

Removes a specified alias. This command is identical to ALias:DELEte.

Group	Alias
Syntax	ALias:DELEte:NAME <QString>
Arguments	<QString> is the name of the alias to remove. Using ALias:DELEte:NAME without specifying an alias causes an execution error. <QString> must be an existing alias.
Examples	ALIAS:DELETE:NAME "STARTUP" deletes the alias named STARTUP.

ALias:STATE

Turns aliases on or off. This command is identical to the ALias command.

Group	Alias
Syntax	ALias:STATE { OFF ON <NR1> } ALias:STATE?
Arguments	OFF or <NR1> = 0 turns alias expansion off. If a defined alias is sent when ALias:STATE is OFF, a command error (102) is generated. ON or <NR1> \neq 0 turns alias expansion on. When a defined alias is received, the specified command sequence is substituted for the alias and executed.
Examples	ALIAS:STATE OFF turns the command alias feature off. ALIAS:STATE? returns 0 when the alias feature is off.

ALLEV? (Query Only)

Causes the oscilloscope to return all events and their messages, and removes the returned events from the Event Queue. The messages are separated by commas. Use the *ESR? query to enable the events to be returned. For a complete discussion of the use of these registers, see page 3-1. This command is similar to repeatedly sending *EVMsg? queries to the instrument.

Group Status and error

Syntax ALLEV?

Returns The event code and message in the following format:

```
<Event Code><Comma><QString>[<Comma><Event Code><Comma>  
<QString>...]
```

```
<QString>::= <Message>;[<Command>]
```

<Command> is the command that caused the error and may be returned when a command error is detected by the oscilloscope. As much of the command will be returned as possible without exceeding the 60 character limit of the <Message> and <Command> strings combined. The command string is right-justified.

Examples ALLEV?
might return the string :ALLEV 2225,"Measurement error, No waveform to measure; ",420,"Query UNTERMINATED; ".

Related Commands *CLS, DESE, *ESE, *ESR?, EVENT?, EVMsg?, EVQty, *SRE, *STB?

AUTOSet (Set Only)

Sets the oscilloscope to automatically adjust its vertical, horizontal, and trigger controls to provide a stable display of the selected waveform. This is equivalent to pressing the front-panel **AUTOSET** button.

Group Acquire

Syntax AUTOSet { EXECute | UNDO | VIDEo | VFields | VLines }

Arguments EXECute sets the oscilloscope to automatically provide a stable display of the active edge-triggered waveform.

UNDO restores the oscilloscope settings to those present prior to the autoset execution.

VIDeo Sets the oscilloscope to display a broadcast-standard video waveform triggered on all lines. The video waveform must be NTSC, PAL, or SECAM-compliant, with a horizontal scan rate from 15 kHz to 20 kHz.

VFields sets the oscilloscope to automatically provide a stable display of the active video waveform, triggered on all fields. TDS3VID, TDS3SDI only.

VLines sets the oscilloscope to automatically provide a stable display of the active video waveform, triggered on all lines. TDS3VID, TDS3SDI only.

Examples AUTOSET EXECUTE
Autosets the oscilloscope to automatically acquire and display an edge-triggered signal.

BELI (Set Only)

Emits an audible tone from the oscilloscope.

Group Miscellaneous

Syntax BEL I

Examples BELL
emits an audible tone from the oscilloscope.

BUSY? (Query Only)

Returns the status of the oscilloscope. This command allows you to synchronize the operation of the oscilloscope with your application program. Synchronization methods are described on page 3-7.

Group Status and error

Syntax BUSY?

Returns <NR1> = 0 means that the oscilloscope is not busy processing an execution-time-intensive command. Execution-time-intensive commands are listed in Table 2-29.

<NR1> = 1 means that the oscilloscope is busy processing one of the commands listed in Table 2-29.

Table 2-29: Commands that affect BUSY? response

Operation	Command
Single sequence acquisition	ACQuire:STATE ON or ACQuire:STATE RUN (when ACQuire:STOPAfter is set to SEQuence)
Automatic scope adjustment	AUTOSet EXECute
Internal self-calibration	*CAL
Hardcopy output	HARDCopy START

Examples BUSY?
might return 1, indicating that the instrument is busy.

Related Commands *OPC, *WAI

CAL? (Query Only)

Returns the internal and factory calibration status and the calibration due status.

Group Calibration and Diagnostic

Syntax CAL?

Returns Internal and factory calibration status and the calibration due status.

Examples CAL?
might return :CALIBRATE:INTERNAL:STATUS PASS;;:CALIBRATE:FACTORY:STATUS PASS;NOTIFY:HOURS 2000;YEARS 1.0E0;DUE 0 to indicate the internal and factory calibration status and the calibration due status.

*CAL? (Query Only)

Runs an internal self-calibration and returns the oscilloscope calibration status.

NOTE. *Disconnect or otherwise remove all input signals prior to starting self-calibration.*

The self-calibration can take several minutes to complete. No other commands are executed until calibration is complete.

Group	Calibration and Diagnostic
Syntax	*CAL?
Returns	<NR1> = 0 indicates that the calibration did not complete successfully. <NR1> ≠ 0 indicates that the calibration completed without errors.
Examples	*CAL? performs an internal self-calibration and might return 1 to indicate that the calibration was successful.

CALibrate:FACTory

This command is the same as CALibrate:FACTory:START.

CALibrate:FACTory:ABOrt (Set Only)

Causes the oscilloscope to abort the factory calibration process, reset to the calibration initialization step, and exit without saving calibration data or status information.

Group	Calibration and Diagnostic
Syntax	CALibrate:FACTory:ABOrt
Examples	CALIBRATE:FACTORY:ABORT aborts the current factory calibration process.

CALibrate:FACTory:CONTInue (Set Only)

Instructs the instrument to execute the current factory calibration step. The calibration step number is incremented on completion of this step, independent of the step pass/fail status. Follow this command with CALibrate:FACTory:STEPstatus? to determine execution status. Use CALibrate:FACTory:PREVious (followed by a CALibrate:FACTory:CONTInue) to repeat a factory calibration step that failed.

If the current step is the last step and the calibration succeeds, new calibration data (and pass status) is saved to non-volatile memory and the oscilloscope returns to normal operation in the same state it was in before beginning factory calibration.

If the current step is the last step and any factory calibration step has failed (without a successful pass for repeated steps), a fail status will be saved to non-volatile memory. Factory calibration data will not be saved to non-volatile memory if the factory status is FAIL.

Group Calibration and Diagnostic

Syntax CALibrate:FACTory:CONTInue

CALibrate:FACTory:NOTIfy:DUE? (Query Only)

Queries if calibration is due.

Group Calibration and Diagnostic

Syntax CALibrate:FACTory:NOTIfy:DUE?

Returns <NR1> = 1 indicates the oscilloscope is due for calibration.
<NR1> = 0 indicates the oscilloscope is not due for calibration.

Examples CALIBRATE:FACTORY:NOTIFY:DUE?
might return :CALIBRATE:FACTORY:NOTIFY:DUE 0 indicating that factory calibration is not due.

CALibrate:FACTory:NOTIfy:HOURS

Sets or returns hours when calibration is due.

Group	Calibration and Diagnostic
Syntax	CALibrate:FACTory:NOTIfy:HOURS { INFIinite <NR1> } CALibrate:FACTory:NOTIfy:HOURS?
Arguments	<NR1> = is the number of hours, 500 to 10000, before the instrument displays a notifier saying that calibration is due. Numbers entered are rounded to the nearest valid number. INFIinite = disables the calibration due notifier display feature.
Examples	CALIBRATE:FACTORY:NOTIFY:HOURS 1500 sets the calibration notification time to 1500 hours. CALIBRATE:FACTORY:NOTIFY:HOURS? might return :CALIBRATE:FACTORY:NOTIFY:HOURS 2000 indicating that the calibration due notifier will be displayed 2000 hours after the last calibration.

CALibrate:FACTory:NOTIfy:YEARS

Sets or returns the number of years when calibration is due.

Group	Calibration and Diagnostic
Syntax	CALibrate:FACTory:NOTIfy:YEARS { INFIinite <NR3> } CALibrate:FACTory:NOTIfy:YEARS?
Arguments	<NR3> = is the number of years, 0.5 to 5, before the instrument displays a notifier saying that calibration is due. Numbers entered are rounded to the nearest valid number. INFIinite = disables this feature.

Examples `CALIBRATE:FACTORY:NOTIFY:YEARS 1.5e0`
sets the calibration due time to 1.5 years.

`CALIBRATE:FACTORY:NOTIFY:YEARS?`
might return `:CALIBRATE:FACTORY:NOTIFY:YEARS 1.5E0` indicating that the calibration due notifier will be displayed 1.5 years after the last calibration.

CALibrate:FACTory:PREVious (Set Only)

This command backs up the calibration steps one step so that the next `CALibrate:FACTory:CONTInue` command will repeat the factory calibration step that just finished. Repeated `CALibrate:FACTory:PREVious` commands can back up as many calibration steps as desired (until step one is reached). The appropriate notifier (with signal source information) is displayed after the factory calibration step is adjusted.

Group Calibration and Diagnostic

Syntax `CALibrate:FACTory:PREVious`

Examples `CALIBRATE:FACTORY:PREVIOUS`
backs up the calibration steps one step.

CALibrate:FACTory:STARt (Set Only)

The factory calibration process consists of a series of steps. This command initializes the factory calibration sequence, but performs no actual signal path characterization.

The calibration process automatically sets up the oscilloscope for each step. Do not send any other commands that change the state of the oscilloscope until the calibration process is complete. Send the `CALibrate:FACTory:CONTInue` command to begin the selected calibration step (after the appropriate signal source is connected). Send `CALibrate:ABOrt` or `*RST` to abort the calibration process.

Group Calibration and Diagnostic

Syntax `CALibrate:FACTory:STARt`

Examples `CALIBRATE:FACTORY:START`
initializes the factory calibration sequence.

CALibrate:FACTory:STATUS? (Query Only)

Returns the factory calibration status value saved in non-volatile memory.

Group Calibration and Diagnostic

Syntax `CALibrate:FACTory:STATUS?`

Examples `CALIBRATE:FACTORY:STATUS?`
might return `:CALIBRATE:FACTORY:STATUS PASS` indicating that factory calibration passed.

CALibrate:FACTory:STEPstatus? (Query Only)

Returns pass during oscilloscope power on without regard to actual calibration status. Returns pass or fail for the factory calibration step that most recently executed when factory calibration is in progress. Use this query to synchronize programmed factory calibration steps.

Group Calibration and Diagnostic

Syntax `CALibrate:FACTory:STEPstatus?`

Examples `CALIBRATE:FACTORY:STEPSTATUS?`
might return `:CALIBRATE:FACTORY:STEPSTATUS FAIL` if the last oscilloscope calibration step did not pass.

CALibrate:INTERNAL (Set Only)

Executes the signal path compensation (SPC) calibration process. The calibration algorithm takes a few minutes to complete. No other command is executed until calibration is complete. The oscilloscope state is saved before SPC execution and restored afterwards. Pass/fail status is saved in nonvolatile memory.

Group Calibration and Diagnostic

Syntax CALibrate:INTERNa1

Examples CALIBRATE:INTERNAL
performs an internal self-calibration (SPC).

Related Commands CALibrate:INTERNa1:START

CALibrate:INTERNAL:START (Set Only)

Performs a signal path compensation (SPC). The calibration algorithm takes a few minutes to complete. No other command is executed until calibration is complete. The oscilloscope state is saved before SPC execution and restored afterwards. Pass/fail status is saved in nonvolatile memory.

Group Calibration and Diagnostic

Syntax CALibrate:INTERNa1:START

Examples CALIBRATE:INTERNAL:START
Starts a signal path compensation (SPC).

Related Commands CALibrate:INTERNa1:STATUS?

CALibrate:INTERNAL:STATUS? (Query Only)

Returns the SPC calibration status value saved in non-volatile memory.

Group Calibration and Diagnostic

Syntax CALibrate:INTERNa1:STATUS?

Returns PASS indicates that the last calibration completed without any errors detected.
FAIL indicates that the last calibration did not complete successfully.
UNCAL indicates that the non-volatile memory has failed.

Examples CALIBRATE:INTERNAL:STATUS?
might return :CALIBRATE:INTERNAL:STATUS UNCAL+ if non-volatile memory has failed.

Related Commands CALibrate:INTERNA1:START

CH<x>? (Query Only)

Returns the vertical parameters of the specified channel. Because CH<x>:SCALE and CH<x>:VOLts are identical, only CH<x>:SCALE is returned.

Group Vertical

Syntax CH<x>?

Examples CH1?
might return the string :CH1:SCALE 10.0E-3;POSITION 0.0E0;
OFFSET 0.0E0;COUPLING DC;BANDWIDTH FULL;DESKEW 0.0E0;
IMPEDANCE MEG;PROBE 1.0E0;YUNIT "V";INVERT 0 for channel 1.

CH<x>:BANdwidth

Sets or queries the bandwidth setting of the specified channel. This is equivalent to setting **Bandwidth** in the **Vertical** menu.

Group Vertical

Syntax CH<x>:BANdwidth { TWEnty | ONEFifty | FULL }
CH<x>:BANdwidth?

Arguments <x> specifies the input channel. Valid values are 1, 2, 3, and 4.

TWEnty sets the channel bandwidth to 20 MHz.

ONEFifty sets the channel bandwidth to 150 MHz. This argument is not available on some models.

FULL sets the channel bandwidth to the full bandwidth of the oscilloscope.

Examples CH2:BANDWIDTH TWENTY
sets the bandwidth of channel 2 to 20 MHz.

CH1:BANDWIDTH?
might return FULL, which indicates that there is no bandwidth limiting on channel 1.

CH<x>:COUPLing

Sets or queries the input attenuator coupling setting of the specified channel. This is equivalent to setting **Coupling** in the **Vertical** menu.

Group Vertical

Syntax CH<x>:COUPLing { AC | DC | GND }
CH<x>:COUPLing?

Arguments <x> specifies the input channel. Valid values are 1, 2, 3, and 4.

AC sets the specified channel to AC coupling. Attempting to set a channel to AC coupling when the channel has an active Level II probe attached, generates a hardware configuration error.

DC sets the specified channel to DC coupling.

GND sets the specified channel to ground. Only a flat ground-level waveform will be displayed.

Examples CH1:COUPLING AC
establishes AC coupling on channel 1.

CH3:COUPLING?
might return DC, indicating that channel 3 is set to DC coupling.

Related Commands CH<x>:IMPedance

CH<x>:DESKew

Sets or queries the horizontal deskew time for this channel. This is equivalent to setting **Deskew** in the **VERTICAL > Probe Setup** menu and entering a value with the general purpose knob. Deskew lets you compensate for time delay differences between input channels caused by signals coming in on cables of different length.

Group	Vertical
Syntax	CH<x>:DESKew <NR3> CH<x>:DESKew?
Arguments	<x> specifies the input channel. Valid values are 1, 2, 3, and 4. <NR3> is the deskew time for this channel. The range is -10.0 ns to +10.0 ns with a resolution of 20 ps. Out of range values are clipped.
Examples	CH1:DESKew? might return "-4.0E-11", indicating that the channel 1 deskew setting is -40.0 ps.

CH<x>:ID? (Query Only)

Returns the probe identification including model name for level II probes.
Returns a null string for non level II probes.

Group	Vertical
Syntax	CH<x>: ID?
Arguments	<x> specifies the input channel. Valid values are 1, 2, 3, and 4.
Examples	CH1: ID? might return "P6243"

CH<x>:IMPedance

Sets or returns the channel probe impedance.

Group Vertical

Syntax CH<x>:IMPedance { FIFty | MEG }
CH<x>:IMPedance?

Arguments <x> specifies the input channel. Valid values are 1, 2, 3, and 4.
FIFty sets the specified channel to 50 Ω impedance.
MEG sets the specified channel to 1 M Ω impedance.

Examples CH1:IMPEDANCE?
might return MEG.

CH<x>:INVert

Sets or returns the specified channel signal invert setting. This command is equivalent to setting **Invert** in the **Vertical** menu.

Group Vertical

Syntax CH<x>:INVert { <NR1> | ON | OFF }
CH<x>:INVert?

Arguments <x> specifies the input channel. Valid values are 1, 2, 3, and 4.
<NR1> = 0 or OFF sets the channel to invert off (normal display).
<NR1> = 1 or ON sets the channel to invert on.

Examples CH<x>:INVERT?
might return 0, indicating that channel 1 is not inverted.

CH<x>:OFFSet

Sets or queries the offset, typically in volts, that is subtracted from the specified input channel before it is acquired. The greater the offset, the lower on the display the waveform appears. This is equivalent to setting **Offset** in the **Vertical** menu.

Group Vertical

Syntax CH<x>:OFFSet <NR3>
CH<x>:OFFSet?

Arguments <x> specifies the input channel. Valid values are 1, 2, 3, and 4.

<NR3> is the specified offset value, typically in volts. The range depends on the vertical scale setting and the probe attenuation factor. The offset ranges for a 1x probe are listed in Table 2-30.

Table 2-30: Offset Ranges using a 1x Probe

CH<x>:SCAlE	OFFSet range
1 mV/div - 9.95 mV/div	±100 mV
10 mV/div - 99.5 mV/div	±1 V
100 mV/div - 995 mV/div	±10 V
1 V/div - 10 V/div	±100 V

Examples CH1:OFFSET 0.5E+00
lowers the channel 1 displayed waveform by 0.5 volts.

CH1:OFFSET?
might return 5.0E-1, indicating that the current channel 1 offset is 0.5 volts.

Related Commands CH<x>:POSition

CH<x>:POSition

Sets or queries the vertical position of the specified channel. The position value is applied to the signal before digitization. This is equivalent to setting **Position** in the **Vertical** menu or adjusting the front-panel Vertical **POSITION** knob.

Group Vertical

Syntax CH<x>:POSition <NR3>
CH<x>:POSition?

Arguments <x> specifies the input channel. Valid values are 1, 2, 3, and 4.
<NR3> is the desired position, in divisions from the center graticule. The range is ± 5 divisions.

Examples CH2:POSITION 1.3E+00
positions the channel 2 input signal 1.3 divisions above the center of the display.
CH1:POSITION?
might return -1.3E+00, indicating that the current position of channel 1 is at -1.3 divisions.

Related Commands CH<x>:OFFSet

CH<x>:PRObe

Sets or returns the gain factor of the probe that is attached to the specified channel.

Group Vertical

Syntax CH<x>:PRObe <NR3>
CH<x>:PRObe?

Arguments <x> specifies the input channel. Valid values are 1, 2, 3, and 4.

<NR3> is the gain factor (output/input) of the probe. If the attached probe has only one legal gain value gain, attempting to set the gain to another value results in a Hardware Configuration error.

Examples CH4:PROBE?
might return 1.0E-1 for a 10x probe.

CH<x>:SCALE

Sets or queries the vertical gain of the specified channel. This is equivalent to setting **Fine Scale** in the **Vertical** menu or adjusting the front-panel **Vertical SCALE** knob.

Group Vertical

Syntax CH<x>:SCALE <NR3>
CH<x>:SCALE?

Arguments <x> specifies the input channel. Valid values are 1, 2, 3, and 4.

<NR3> is the gain, in user units per division. The range is 10 V per division to 1 mV per division when using a 1x, 1 megohm, voltage probe.

Examples CH4:SCALE 1.0E-1
sets the channel 4 gain to 10 units per division.

CH2:SCALE?
might return 1.0E+0, indicating that the current units per division setting of channel 2 is 1 unit per division.

Related Commands CH<x>:VOLts

CH<x>:VOLts

Sets or queries the vertical gain of the specified channel. This command is identical to the CH<x>:SCAlE command and is included for compatibility purposes. Only CH<x>:SCAlE is returned in response to a CH<x>? query.

Group Vertical

Syntax CH<x>:VOLts <NR3>
CH<x>:VOLts?

Arguments <x> specifies the input channel. Valid values are 1, 2, 3, and 4.

<NR3> is the gain, in user units per division. The range is 10 V per division to 1 mV per division when using a 1x, 1 megohm, voltage probe.

Examples CH4:VOLTS 2.00E0
sets the channel 4 gain to 2.00 units per division.

CH2:VOLTS?
might return 1.0E+0, indicating that the current units per division setting of channel 2 is 1 unit per division.

Related Commands CH<x>:SCAlE

CH<x>:YUNit

Sets or returns the units of the specified channel.

Group Vertical

Syntax CH<x>:YUNit <QString>
CH<x>:YUNit?

Arguments <x> specifies the input channel. Valid values are 1, 2, 3, and 4.
 <Qstring> is either “V” for volts or “A” for amps as the units.

Examples CH<x>:YUNIT?
 might return:CH4:YUNIT "V".

CLEARMenu (Set Only)

Clears the current menu from the display. This command is equivalent to pressing the **MENU OFF** button on the front panel.

Group Display

Syntax CLEARMenu

Examples CLEARMENU
 clears the menu from the display.

*CLS (Set Only)

Clears the oscilloscope status data structures.

Group Status and Error

Related Commands DESE, *ESE, *ESR?, EVENT?, EVMsg?, *SRE, *STB?

Syntax *CLS

The *CLS command clears the following:

- the Event Queue
- the Standard Event Status Register (SESR)
- the Status Byte Register (except the MAV bit; see below)

If the *CLS command immediately follows an <E0I>, the Output Queue and MAV bit (Status Byte Register bit 4) are also cleared. MAV indicates information is in the output queue. The device clear (DCL) GPIB control message will clear the output queue and thus MAV. *CLS does not clear the output queue or

MAV. (A complete discussion of these registers and bits, and of event handling in general, begins on page 3-1.)

*CLS can suppress a Service Request that is to be generated by an *OPC. This will happen if a hardcopy output or single sequence acquisition operation is still being processed when the *CLS command is executed.

CURSor? (Query Only)

Returns all current cursor settings for the active cursor.

Group	Cursor
Syntax	CURSor?
Examples	<p>CURSOR?</p> <p>might return :CURSOR:FUNCTION OFF;MODE TRACK;VBARS:UNITS "s";POSITION1 1.20000000E-4;POSITION2 1.60000000E-3;VDELTA 4.56E0;HDELTA 1.48E-3;SELECT CURSOR1;HPOS1 4.84E0;HPOS2 2.8E-1;:CURSOR:HBARS:POSITION1 5.52E0;POSITION2 2.48E0;DELTA 3.04E0;SELECT CURSOR1;UNITS "V" as the current cursor settings.</p>

CURSor:FUNction

Selects or returns the cursor type. Cursors are attached to the selected waveform. WAVEform and GRATICule cursors are only valid in XY or XYZ displays. This command is equivalent to setting **Function** in the **CURSOR** menu.

Group	Cursor
Syntax	<p>CURSor:FUNction { HBArS OFF WAVEform VBArS GRATICule }</p> <p>CURSor:FUNction?</p>
Arguments	<p>HBArS specifies horizontal bar cursors that measure vertical parameters (typically volts).</p> <p>OFF removes the cursors from the display</p> <p>VBArS specifies vertical bar cursors that measure horizontal parameters (typically time).</p>

WAVEform specifies waveform XY cursors.

GRATicule specifies graticule XY cursors. TDS3AAM only.

Examples `CURSOR:FUNCTION VBARS`
selects vertical bar type cursors.

CURSor:GRATicule? (Query Only)

(Available with TDS3AAM)

Returns the current settings for the XY graticule cursors, where XPOSITION1 and YPOSITION1 refers to the reference cursor, and XPOSITION2 and YPOSITION2 refers to the delta cursor.

Group Cursor

Related Commands `CURSor:WAVEform?`

Syntax `CURSor:GRATicule?`

Examples `CURSOR:GRATICULE?`
might return `:CURSOR:GRATICULE:SELECT CURSOR1Y;XPOSITION1 -5.8E-3;
YPOSITION1 -2.0E0;XPOSITION2 2.2E-3;YPOSITION2 3.2E0.`

CURSor:GRATicule:SElect

(Available with TDS3AAM)

Sets (makes active) or returns the specified XY display graticule cursor. This command is equivalent to pressing the SELECT button on the front panel when the Graticule cursors are active.

Group Cursor

Syntax `CURSor:GRATicule:SElect { CURSOR<n>X | CURSOR<n>Y }`
`CURSor:GRATicule:SElect?`

- Arguments** `CURSOR<n>X` specifies the X-axis cursor of the specified graticule cursor, where $n = 1$ for the reference cursor, and $n = 2$ for the delta cursor.
- `CURSOR<n>Y` specifies the Y-axis cursor of the specified graticule cursor, where $n = 1$ for the reference cursor, and $n = 2$ for the delta cursor.
- Examples** `CURSOR:GRATICULE:SELECT CURSOR2X`
 selects the graticule delta X-axis cursor as the active cursor.

CURSOR:GRATICULE:XPOSITION<x>

(Available with TDS3AAM)

Sets or returns the position of the XY graticule cursor's X-axis cursor for the reference or delta cursor.

- Group** Cursor
- Syntax** `CURSOR:GRATICULE:XPOSITION<x> <NR3>`
 `CURSOR:GRATICULE:XPOSITION<x>?`
- Arguments** `<x>` specifies which graticule cursor, where $x = 1$ for the reference cursor and $x = 2$ for the delta cursor.
- `<NR3>` is the X cursor position value.
- Examples** `CURSOR:GRATICULE:XPOSITION1?`
 might return `CURSOR:GRATICULE:XPOSITION1 -1.44E0`

CURSOR:GRATICULE:YPOSITION<x>

(Available with TDS3AAM)

Sets or returns the position of the XY graticule cursor's Y-axis cursor for the reference or delta cursor.

- Group** Cursor
- Syntax** `CURSOR:GRATICULE:YPOSITION<x>`
 `CURSOR:GRATICULE:YPOSITION<x>?`

Arguments <x> specifies which graticule cursor, where x = 1 for the reference cursor and x = 2 for the delta cursor

<NR3> is the Y cursor position value.

Examples CURSOR:GRATICULE:YPOSITION1?
might return CURSOR:GRATICULE:YPOSITION1 2.04E0

CURSOR:HBARs? (Query Only)

Returns the current settings for the horizontal bar cursors.

Group Cursor

Syntax CURSOR:HBARs?

Examples CURSOR:HBARs?
might return :CURSOR:HBARs:POSITION1 0.0E0;POSITION2 0.0E0;DELTA 0.0E0;SELECT CURSOR1;UNITS "V".

CURSOR:HBARs:DELTA? (Query Only)

Returns the vertical difference between the two horizontal bar cursors.

Group Cursor

Syntax CURSOR:HBARs:DELTA?

Returns <NR3> indicates the vertical difference between the two H Bar cursors.

Examples CURSOR:HBARs:DELTA?
might return :CURSOR:HBARs:DELTA 5.08E0 for the difference between the two cursors.

Related Commands CURSOR:HBARs:UNITs?

CURSOR:HBArs:POSITION<x>

Sets or queries the position of the specified horizontal bar cursor relative to ground.

Group Cursor

Syntax CURSOR:HBArs:POSITION<x> <NR3>
CURSOR:HBArs:POSITION<x>?

Arguments <x> specifies the cursor. Valid values are 1 and 2.
<NR3> specifies the cursor position relative to ground, typically in volts.

Examples CURSOR:HBArs:POSITION1 2.0E+1
positions horizontal cursor 2 at 20.0 units, typically volts, relative to ground.
CURSOR:HBArs:POSITION2?
might return :CURSOR:HBArs:POSITION2 0.0E0, indicating that one of the horizontal bar cursors is at 0.0 units, typically volts, relative to ground.

CURSOR:HBArs:SElect

Sets or returns which horizontal bar cursor is active for front-panel control. The active cursor will be displayed as a solid horizontal line and can be moved using the front-panel general purpose knob when cursors are displayed. The unselected cursor will be displayed as a dashed horizontal line. This command is equivalent to pressing the **SELECT** button on the front panel when cursors are displayed.

Group Cursor

Syntax CURSOR:HBArs:SElect { CURSOR1 | CURSOR2 }
CURSOR:HBArs:SElect?

Arguments CURSOR1 selects the first horizontal bar cursor.
CURSOR2 selects the second horizontal bar cursor.

Examples `CURSOR:HBARS:SELECT CURSOR1`
 selects the first horizontal bar cursor as the active cursor.

`CURSOR:HBARS:SELECT?`
 returns `:CURSOR:HBARS:SELECT CURSOR1` when the first cursor is the active cursor.

CURSor:HBArS:UNIts

Sets or queries the measurement units for the horizontal bar cursors.

Group Cursor

Syntax `CURSor:HBArS:UNIts <QString>`
`CURSor:HBArS:UNIts?`

Arguments `<QString>` is V for volts, A for amps, AA for amps², A/V for amps/volts, V/A for volts/amps, VV for volts², W for watts, % for percentage, or IRE when the IRE graticule is selected.

Examples `CURSOR:HBARS:UNITS?`
 returns `:CURSOR:HBARS:UNITS "IRE"` when the horizontal bar cursor units are IRE.

CURSor:HBArS:USE (Set Only)

Sets the horizontal bar cursor measurement scale. This command is only applicable when ratio cursors are on.

Group Cursor

Syntax `CURSor:HBArS:USE { CURrent | FIVEdivs }`

Arguments `<CURrent>` sets the H Bar measurement scale so that 0% is the current position of the lowest H Bar cursor and 100% is the current position of the highest H Bar cursor. Moving the cursors after executing this command does not change the 0% or 100% scale points.

<FIVEdivs> sets H Bar measurement scale so that 5 screen major divisions is 100%, where 0% is -2.5 divisions and 100% is +2.5 divisions from the center horizontal graticule.

Examples `CURSOR:HBARS:USE FIVEdivs`
 sets the H Bar measurement scale so that 5 screen major divisions equals 100%.

Related Commands `CURSOR:HBARS:UNITs`

CURSOR:MODE

Sets or returns the cursor tracking mode,

Group Cursor

Syntax `CURSOR:MODE {INdependent | TRACK }`
`CURSOR:MODE?`

Arguments <INdependent> Sets the cursors to move independently.
 <TRACK> sets the cursors to move together when cursor 1 is selected. Enabling tracking mode automatically selects cursor 1 as the active cursor. If cursor 2 is selected while in tracking mode, only cursor 2 will move.

Examples `CURSOR:MODE TRACK`
 sets the oscilloscope so that both cursors move at the same time.

CURSOR:VBARS:HDELTA? (Query Only)

Returns the horizontal difference between the two vertical bar cursors.

Group Cursor

Syntax `CURSOR:VBARS:HDELTA?`

Returns <NR3> indicates the horizontal difference between the 2 vertical bar cursors. The units are specified by the `CURSOR:HBARS:UNITs?` query.

Examples `CURSOR:VBARS:HDELTA?`
 might return `:CURSOR:VBARS:HDELTA 1.088000000E-3`, indicating the time between the vertical bar cursors is 1.088 milliseconds.

Related Commands `CURSor:VBArS:UNIts`

`CURSor:VBArS:HPOS<x>? (Query Only)`

Returns the horizontal value of the specified vertical bar ticks.

Group Cursor

Syntax `CURSor:VBArS:HPOS<x>?`

Arguments `<x>` specifies the cursor. Valid values are 1 and 2.

Returns `<NR3>` indicates the value of one of the tics. The units are specified by the `CURSor:VBArS:UNIts` command.

Examples `CURSOR:VBARS:HPOS2?`
 might return `:CURSOR:VBARS:HPOS2 1.00E-6`, indicating the value of one vertical bar tick.

Related Commands `CURSor:VBArS:UNIts`

`CURSor:VBArS:POSITION<x>`

Sets or returns a horizontal position of the specified vertical bar cursor. The `CURSor:VBArS:UNIts` command specifies units. The position can appear in units of time (s), or frequency (Hz).

Group Cursor

Syntax `CURSor:VBArS:POSITION<x> <NR3>`
`CURSor:VBArS:POSITION<x>?`

Arguments <x> specifies the cursor. Valid values are 1 and 2.
 <NR3> specifies the cursor position in the units specified by the CURSor:VBArS:UNItS command. The position is relative to the trigger position.

Examples CURSOR:VBARS:POSITION2 9.00E-6
 positions vertical bar cursor 2 at 9 μ s from the trigger.
 CURSOR:VBARS:POSITION1?
 might return :CURSOR:VBARS:POSITION1 1.00E-6, indicating that vertical bar cursor 1 is at 1 μ s.

Related Commands CURSor:VBArS:UNItS, CURSor:VBArS:HPOS?

CURSor:VBArS:SELEct

Selects which vertical bar cursor is active. The active cursor will be displayed as a solid vertical line and can be moved using the front-panel general purpose knob when the CURSOR menu is active. The unselected cursor will be displayed as a dashed vertical line. This command is equivalent to pressing the **SELECT** button on the front panel when the **CURSOR** menu is displayed.

Group Cursor

Syntax CURSor:VBArS:SELEct { CURSOR1 | CURSOR2 }
 CURSor:VBArS:SELEct?

Arguments CURSOR1 specifies the first vertical bar cursor.
 CURSOR2 specifies the second vertical bar cursor.

Examples CURSOR:VBARS:SELECT CURSOR2
 selects the second vertical bar cursor as the active cursor.
 CURSOR:VBARS:SELECT?
 returns :CURSOR:VBARS:SELECT CURSOR1 when the first vertical bar cursor is the active cursor.

CURSor:VBArS:UNIts

Sets or returns the units for the vertical bar cursors. This command is equivalent to setting **Time Units** in the **CURSOR** menu.

Group Cursor

Syntax CURSor:VBArS:UNIts <QString>
CURSor:VBArS:UNIts?

Arguments <QString> is either "s" for seconds, "Hz" for Hertz, "%" for percent, or "degrees" as the unit of measure.

Examples CURSOR:VBARS:UNITS "s"
sets the units for the vertical bar cursors to seconds.

CURSOR:VBARS:UNITS?
returns :CURSOR:VBARS:UNITS "Hz" when the vertical bar cursor units are hertz.

Related Commands CURSor:VBArS:POSITION<x>

CURSor:VBArS:USE (Set Only)

Sets the vertical bar cursor measurement scale. This command only applicable when ratio cursors are on.

Group Cursor

Syntax CURSor:VBArS:USE { CURrent | FIVEdivs }

Arguments <CURrent> sets the V Bar measurement scale so that 0% is the current position of the left-most V Bar cursor and 100% is the current position of the right-most V Bar cursor. Moving the cursors after executing this command does not change the 0% or 100% scale points.

<FIVEdivs> sets V Bar measurement scale so that 5 screen major divisions is 100%, where 0% is -2.5 divisions and 100% is +2.5 divisions from the center vertical graticule.

Examples `CURSOR:VBARS:USE CURRENT`
sets the V Bar measurement scale to use the current cursor positions as 0% and 100% of scale if units are set to %.

Related Commands `CURSOR:VBARS:UNITS`

CURSOR:VBARS:VDELTA? (Query Only)

Returns the vertical difference between the two vertical bar cursor ticks. The units are specified by the `CURSOR:HBARS:UNITS` query.

Group Cursor

Syntax `CURSOR:VBARS:VDELTA?`

Returns <NR3>indicates the horizontal difference between the two vertical bar cursors.

Examples `CURSOR:VBARS:VDELTA?`
might return `:CURSOR:VBARS:VDELTA 1.064E+0`, indicating that the vertical difference between the vertical bar cursors ticks is 1.064 units.

Related Commands `CURSOR:HBARS:UNITS`

CURSOR:WAVEform? (Query Only)

Returns the active (selected) waveform XY cursor.

Group Cursor

Syntax `CURSOR:WAVEform?`

Examples `CURSOR:WAVEform?`
might return `:CURSOR:WAVEFORM:SELECT CURSOR2`.

Related Commands `CURSOR:GRATICule?`

CURSor:WAVEform:SElect

Selects (makes active) or returns the specified XY display waveform cursor. This command is equivalent to pressing the **SELECT** button on the front panel when the XY Waveform cursors are active. Use the CURSor:VBArS commands to position the XY waveform cursors.

Group	Cursor
Syntax	CURSor:WAVEform:SElect { CURSOR1 CURSOR2 } CURSor:WAVEform:SElect?
Arguments	CURSOR1 sets the XY waveform reference cursor as the active cursor. CURSOR2 sets the XY waveform delta cursor as the active cursor.
Examples	CURSOR:WAVEFORM:SELECT CURSOR2 selects the XY waveform delta cursor as the active cursor.

CURSor:XY:PRODDelta? (Query Only)

(Available with TDS3AAM)

Returns the value of the XY cursor product delta readout. XY display mode, XY cursors, and Product readout must be enabled prior to executing this command.

Group	Cursor
Syntax	CURSor:XY:PRODDelta?
Examples	CURSor:XY:PRODDelta? might return CURSor:XY:PRODDelta 2.164E1
Related Commands	CURSor:XY:PRODUCT<x>, CURSor:XY:READOUT, DISPlay:XY:MODE

CURSOR:XY:PRODUCT<x>? (Query Only)*(Available with TDS3AAM)*

Returns the value of the product readout for the specified XY cursor. XY display mode, XY cursors, and Product readout must be enabled prior to executing this command.

Group Cursor

Syntax CURSOR:XY:PRODUCT<x>?

Arguments <x> specifies the XY cursor, where x = 1 for the reference cursor and x = 2 for the delta cursor.

Examples CURSOR:XY:PRODUCT1?
might return CURSOR:XY:PRODUCT1 2.23E2.

Related Commands CURSOR:XY:PRODUCT<x>, CURSOR:XY:READOUT, DISPLAY:XY:MODE

CURSOR:XY:RADIUS<x>? (Query Only)*(Available with TDS3AAM)*

Returns the XY cursor radius value from the 0,0 origin to the specified XY cursor. XY display mode, XY cursors, and Polar readout must be enabled prior to executing this command.

Group Cursor

Syntax CURSOR:XY:RADIUS<x>?

Arguments <x> , where x = 1 for the reference cursor and x = 2 for the delta cursor.

Examples CURSOR:XY:RADIUS?
might return CURSOR:XY:RADIUS1 1.92E0.

Related Commands CURSOR:XY:READOUT, DISPLAY:XY:MODE

CURSor:XY:RATDELta? (Query Only)*(Available with TDS3AAM)*

Returns the XY cursor ratio delta value. XY display mode, XY cursors, and Ratio readout must be enabled prior to executing this command.

Group Cursor

Syntax CURSor:XY:RATDELta?

Examples CURSOR:XY:RATDELTA?
might return CURSOR:XY:RATDELta -6.13E-1.

Related Commands CURSor:XY:READOUT, DISPlay:XY:MODE

CURSor:XY:RATIO<x>? (Query Only)*(Available with TDS3AAM)*

Returns the cursor ratio value for the specified XY cursor. XY display mode, XY cursors, and Ratio readout must be enabled prior to executing this command.

Group Cursor

Syntax CURSor:XY:RATIO<x>?

Arguments <x> , where x = 1 for the reference cursor and x = 2 for the delta cursor.

Examples CURSOR:XY:RATIO2?
might return CURSOR:XY:RATIO2 5.11E-1.

Related Commands CURSor:XY:READOUT, DISPlay:XY:MODE

CURSor:XY:RDELta? (Query Only)

(Available with TDS3AAM)

Returns the XY cursor radius delta value for the polar readout. XY display mode, XY cursors, and Polar readout must be enabled prior to executing this command.

Group Cursor

Syntax CURSor:XY:RDELta?

Examples CURSOR:XY:RDELTA?
might return CURSOR:XY:RDELTA 6.915E0.

Related Commands CURSor:XY:READOUT, DISplay:XY:MODE

CURSor:XY:READOUT

(Available with TDS3AAM)

Sets or returns the XY cursor readout type.

Group Cursor

Syntax CURSor:XY:READOUT { POLARCoord | PRODUct | RATio | RECTangular }
CURSor:XY:READOUT?

Arguments POLARCoord sets the xy cursor readout mode to display position values in polar coordinates.

PRODUct sets the xy cursor readout mode to display position values as the product of the XY cursor positions.

RATio sets the xy cursor readout mode to display position values as the ratio of the X and Y postions.

RECTangular sets the xy cursor readout mode to display position values in rectangular coordinates (distinct X and Y cursor positions).

Examples CURSOR:XY:READOUT?
might return CURSor:XY:READOUT PRODUCT.

CURSor:XY:RECTX<x>? (Query Only)

Returns the XY cursor X-axis rectangular coordinate value for the specified cursor. XY display mode, XY cursors, and Rectangular readout must be enabled prior to executing this command.

Group Cursor

Syntax CURSor:XY:RECTX<x>?

Arguments <x>, where x = 1 for the reference cursor and x = 2 for the delta cursor..

Examples CURSOR:XY:RECTX2?
might return CURSOR:XY:RECTX2 1.72E0

Related Commands CURSor:XY:READOUT, DISplay:XY:MODE

CURSor:XY:RECTY<x>? (Query Only)

Returns the XY cursor Y-axis rectangular coordinate value for the specified cursor. XY display mode, XY cursors, and Rectangular readout must be enabled prior to executing this command.

Group Cursor

Syntax CURSor:XY:RECTY<x>?

Arguments <x>, where x = 1 for the reference cursor and x = 2 for the delta cursor..

Examples CURSOR:XY:RECTY1?
might return CURSOR:XY:RECTY2 -2.76E0

Related Commands CURSor:XY:READOUT, DISplay:XY:MODE

CURSOR:XY:THDELta? (Query Only)*(Available with TDS3AAM)*

Returns the XY cursor polar readout delta theta value. XY display mode, XY cursors, and Polar readout must be enabled prior to executing this command.

Group Cursor

Syntax CURSOR:XY:THDELta?

Examples CURSOR:XY:THDELTA?
might return CURSOR:XY:THDELTA -3.176E1

Related Commands CURSOR:XY:READOUT, DISPLAY:XY:MODE

CURSOR:XY:THETA<x>? (Query Only)*(Available with TDS3AAM)*

Returns the polar readout theta value for the specified XY cursor. XY display mode, XY cursors, and Polar readout must be enabled prior to executing this command.

Group Cursor

Syntax CURSOR:XY:THETA<x>?

Arguments <x>, where x = 1 for the reference cursor and x = 2 for the delta cursor..

Examples CURSOR:XY:THETA2?
might return CURSOR:XY:THETA2 2.71E1

Related Commands CURSOR:XY:READOUT, DISPLAY:XY:MODE

CURSOR:XY:XDELta? (Query Only)

(Available with TDS3AAM)

Returns the difference (delta) between the X-axis values of the two XY cursors. XY display mode, XY cursors, and Rectangular readout must be enabled prior to executing this command.

Group Cursor

Syntax CURSOR:XY:XDELta?

Examples CURSOR:XY:XDELTA?
might return CURSOR:XY:XDELTA 5.88E0

Related Commands CURSOR:XY:READOUT, DISPLAY:XY:MODE

CURSOR:XY:YDELta? (Query Only)

(Available with TDS3AAM)

Returns the value of the difference (delta) between the Y-axis values of the two XY cursors. XY display mode, XY cursors, and Rectangular readout must be enabled prior to executing this command.

Group Cursor

Syntax CURSOR:XY:YDELta?

Examples CURSOR:XY:YDELTA?
might return CURSOR:XY:YDELTA -3.64E0

CURVe

Transfers waveform data to and from the oscilloscope in binary or ASCII format. Formatted and interpreted according to the most recently received or transmitted preamble. Error conditions are shown in Table 2-32.

Table 2-31: CURVe query error conditions

DATA:SOURCE	CURVe? error
A channel which has been turned on but not acquired	No error is generated; the returned data is entirely NULLs
A channel, math, or reference which has not been turned on	Waveform not turned on

Table 2-32: CURVe command error conditions

Condition	CURVe warning/error
More than 10,000 points received	Too many points
Destination waveform is not a reference	Invalid waveform

Each waveform transferred has an associated waveform preamble that contains information such as data format and scale. Refer to the WFMPre? command starting on page 2-314 for information about the waveform preamble. The data format is specified by the DATA:ENCdg and DATA:WIDTH commands.

The CURVe? query sends data from the oscilloscope to an external device. The data source is specified by the DATA:SOURce command. The first and last data points that are transferred are specified by the DATA:STARt and DATA:STOP commands.

The CURVe command sends waveform data from an external device to the oscilloscope. The data is stored in the stored waveform location specified by DATA:DESTination, starting with the data point specified by DATA:STARt. Only one waveform can be transferred at a time. The waveform will only be displayed if the reference waveform is displayed.

A description of the waveform transfer process starts on page 2-39.

The system returns data from the last acquisition if the source is a channel waveform that is being previewed. The data does not reflect the acquisition preview parameters. The user should always follow acquisition parameter changes with a single sequence OPC command prior to CURVe? to ensure the return data reflects the new acquisition parameters.

Group	Waveform
Related Commands	DATA, WFMPre?
Syntax	CURVe { <Block> <asc curve> } CURVe?
Arguments	<p><Block> is the waveform data in binary format. The waveform is formatted as: #<x><yyy><data> where <x> is the number of y bytes. For example, if <yyy> = 500, then <x> = 3. <yyy> is the number of bytes to transfer. If width is 1 then all bytes on the bus are single data points. If width is 2 then all bytes on the bus are 2-byte pairs. Use the DATA:WIDTH command to set the width. <data> is the curve data. See the GETWFM.C or GETWFM.BAS examples in the accompanying disk(s) for more specifics.</p> <p><asc curve> is the waveform data in ASCII format. The format for ASCII data is <NR1>[,<NR1>...] where each <NR1> represents a data point.</p>
Examples	CURVe? might return, for ASCII data: CURVE 0,0,0,0,-1,1,0,-1,0,0,-1,0,0,-1,0,-1, -1,1,0,0,0,-1,0,0,-1,0,1,1,0,-1,0,0,-1,0,0,-1,0,0

DATA

Sets or returns the format and location of the waveform data that is transferred with the CURVe command. Since DATA:DESTINATION and DATA:TARGET are equivalent, only DATA:DESTINATION is returned by the DATA? query.

Group Waveform

Syntax DATA { INIT }
DATA?

Arguments INIT initializes the waveform data parameters to their factory defaults.

Examples DATA?
might return the string :DATA:ENCDG RPBINARY;DESTINATION REF4; SOURCE REF4;START 1;STOP 500;WIDTH 2

Related Commands CURVE, WAVFrm?

DATA:DESTINATION

Sets or returns the reference memory location for storing waveform data that is transferred into the oscilloscope by the CURVe command. This command is identical to the DATA:TARGET command.

Group Waveform

Syntax DATA:DESTINATION REF<x>
DATA:DESTINATION?

Arguments REF<x> (REF1, REF2, REF3 or REF4) is the reference memory location where the waveform will be stored.

This means that you cannot have a channel or math waveform as a destination.

- Examples** DATA:DESTINATION REF3
stores incoming waveform data in reference memory 3.
- DATA:DESTINATION?
might return REF2 as the reference memory location that is currently selected.

DATA:ENCdg

Sets or returns the format of the waveform data. This command is equivalent to setting WFMPre:ENCdg, WFMPre:BN_Fmt, and WFMPre:BYT_Or as shown in Table 2-33. Setting the DATA:ENCdg value causes the corresponding WFMPre values to be updated and vice versa.

Group Waveform

Syntax DATA:ENCdg { ASCIi | RIBinary | RPBinary | SRIBinary | SRPbinary }

DATA:ENCdg?

Arguments ASCIi specifies the ASCII representation of signed integer (RIBinary) data. If this is the value at power-on, the WFMPre values for BN_Fmt, BYT_Or, and ENCdg are set as RP, MSB, and ASC respectively.

RIBinary specifies signed integer data-point representation with the most significant byte transferred first. This format results in the fastest data transfer rate when DATA:WIDTH is set to 2.

The range is -128 to 127 when DATA:WIDTH is 1. Zero is center screen. The range is -32768 to 32767 when DATA:WIDTH is 2. The upper limit is one division above the top of the screen and the lower limit is one division below the bottom of the screen.

RPBinary specifies positive integer data-point representation with the most significant byte transferred first.

The range is 0 to 255 when DATA:WIDTH is 1. Center screen is 127. The range is 0 to 65,535 when DATA:WIDTH is 2. The upper limit is one division above the top of the screen and the lower limit is one division below the bottom of the screen.

SRIBinary is the same as RIBinary except that the byte order is swapped, meaning that the least significant byte is transferred first. This format is useful when transferring data to IBM compatible PCs.

SRPbinary is the same as RPBinary except that the byte order is swapped, meaning that the least significant byte is transferred first. This format is useful when transferring data to IBM compatible PCs.

Table 2-33: DATa and WFMPre parameter settings

DATa:ENCdg Setting	WFMPre settings		
	:ENCdg	:BN_Fmt	:BYT_Or
ASCIi	ASC	N/A	N/A
RIBinary	BIN	RI	MSB
RPBinary	BIN	RP	MSB
SRIBinary	BIN	RI	LSB
SRIBinary	BIN	RP	LSB

Examples DATA:ENCDG RPBINARY sets the data encoding format to be positive integer where the most significant byte is transferred first.

DATA:ENCDG?
might return SRPBINARY for the format of the waveform data.

Related Commands WFMPre:BN_Fmt, WFMPre:BYT_Or, WFMPre:ENCdg

DATa:SOURce

Sets or returns the location of the waveform data that is transferred from the instrument by the CURVe? query. You can transfer one waveform at a time.

Group Waveform

Syntax DATa:SOURce <wfm>
DATa:SOURce?

Arguments <wfm> is the location of the waveform data that will be transferred from the oscilloscope to the controller. Valid values are CH1, CH2, CH3, CH4, MATH, MATH1 (same as MATH), REF1, REF2, REF3, and REF4.

- Examples** DATA:SOURCE REF2
specifies that reference waveform two will be transferred in the next CURVE? query.
- DATA:SOURCE?
might return CH1, indicating that channel 1 is the source for the waveform data that is transferred using a CURVE? query.

DATA:START

Sets or returns the starting data point for waveform transfer. This command allows for the transfer of partial waveforms to and from the oscilloscope.

Group Waveform

Syntax DATA:START <NR1>
DATA:START?

Arguments <NR1> ranges from 1 to the record length, and is the first data point that will be transferred. Data will be transferred from <NR1> to DATA:STOP or the record length, whichever is less. If <NR1> is greater than the record length then no data will be transferred.

When DATA:STOP is less than DATA:START, the values are swapped internally for CURVe?

Examples DATA:START 10
specifies that the waveform transfer will begin with data point 10.

DATA:START?
might return 214 as the first waveform data point that will be transferred.

Related Commands CURVe?, DATA:STOP

DATA:STOP

Sets or returns the last data point that will be transferred when using the CURVe? query. This allows the transfer of partial waveforms to the controller.

When using the CURVe command, the oscilloscope will stop reading data when there is no more data to read or when the specified record length has been reached so this command will be ignored.

Group Waveform

Syntax DATA:STOP <NR1>
 DATA:STOP?

Arguments <NR1> ranges from 1 to the record length, and is the last data point that will be transferred. If <NR1> is greater than the record length then data will be transferred up to the record length. If both DATA:START and DATA:STOP are greater than the record length, an execution error will be reported.

If you always want to transfer complete waveforms, just set DATA:START to 1 and DATA:STOP to the maximum record length.

When DATA:STOP is less than DATA:START, the values are swapped internally for CURVe?

Examples DATA:STOP 9000
 specifies that the waveform transfer will stop at data point 9000.
 DATA:STOP?
 might return 1500 as the last data point that will be transferred.

Related Commands CURVe?, DATA:START

DATA:TARget

Sets or returns the location for storing waveform data transferred to the instrument using the CURVe command. This command is equivalent to the DATA:DESTINATION command and is included for compatibility with older Tektronix instruments.

Group Waveform

Syntax DATA:TARget REF<x>
DATA:TARget?

Arguments <x> specifies reference memory location 1 (REF1) through 4 (REF4).

Examples DATA:TARGET?
might return DATA:TARGET REF2.

Related Commands CURVe

DATA:WIDth

Sets or returns the number of bytes per data point in the waveform transferred using the CURVe command.

Group Waveform

Syntax DATA:WIDth <NR1>
DATA:WIDth?

Arguments <NR1> = 1 specifies that there is 1 byte (8 bits) per point.

<NR1> = 2 specifies that there are 2 bytes (16 bits) per point. This format is useful for AVERage waveforms.

Examples DATA:WIDth 1
sets the data width to 1 byte per data point for CURVe data.

Related Commands CURVe, WFMPre:BIT_Nr, WFMPre:BYT_Nr

DATE

Sets or returns the date that the oscilloscope can display.

Group Miscellaneous

Syntax DATE <QString>
DATE?

Arguments <QString> is a date in the form "yyyy-mm-dd". where mm refers to a two-digit month number from 01 to 12, dd refers to a two-digit day number in the month., and yyyy refers to a four-digit year number. There must a dash (-) after the yyyy and after the mm.

Examples DATE "2000-01-20"
specifies that the date is set to January 20th, 2000.

Related Commands DISplay: CLOCk, TIME

*DDT

Allows the user to specify a command or a list of commands that are executed when the instrument receives a *TRG command or the GET GPIB interface message. *DDT is just a special alias that *TRG uses.

Group Miscellaneous

Syntax *DDT { <Block> | <QString> }
*DDT?

Arguments <Block> or <QString> is a complete sequence of program messages. The messages can contain only valid commands that must be separated by semicolons and must follow all rules for concatenating commands (see page 2-4). The sequence must be ≤255 characters. <Block> format is always returned as a query response.

Examples *DDT #231AUTOSSET EXECUTE;:SELECT:REF1 ON
performs autoset and selects REF1.

Related Commands ALLas:DEFINE, *TRG

DESE

Sets or returns the bits in the Device Event Status Enable Register (DESER). The DESER is the mask that determines whether events are reported to the Standard Event Status Register (SESR), and entered into the Event Queue. For a more detailed discussion of the use of these registers, see page 3-1.

Group Status and Error

Syntax DESE <NR1>
DESE?

Arguments <NR1> is a value in the range from 0 to 255. The binary bits of the DESER are set according to this value. For example, DESE 209 sets the DESER to the binary value 11010001 (that is, the most significant bit in the register is set to 1, the next most significant bit to 1, the next bit to 0, etc.).

The power-on default for DESER is all bits set if *PSC is 1. If *PSC is 0, the DESER maintains its value through a power cycle.

NOTE. Setting the DESER and the ESER to the same value allows only those codes to be entered into the Event Queue and summarized on the ESB bit (bit 5) of the Status Byte Register. Use the *ESE command to set the ESER. A discussion of event handling begins on page 3-1.

Examples DESE 209
sets the DESER to binary 11010001, which enables the PON, URQ, EXE, and OPC bits.

DESE?
might return the string :DESE 186, showing that the DESER contains the binary value 10111010.

Related Commands *CLS, *ESE, *ESR?, EVENT?, EVMsg?, *SRE, *STB?

DIAG:LOOP:OPTion

Sets the diagnostic loop option.

Group Calibration and Diagnostic

Syntax DIAG:LOOP:OPTion {ALWAYS|FAIL|ONFAIL|ONCE}
DIAG:LOOP:OPTion?

Arguments ALWAYS continues looping until diagnostics are stopped via the front panel or by an instrument command.

FAIL causes looping until the first diagnostic failure or until diagnostics are stopped.

ONFAIL causes looping on a specific test group as long as a FAIL status is returned from the test.

ONCE executes diagnostics test sequence once.

Examples DIAG:LOOP:OPTION FAIL
stops the diagnostic loop after the first failure.

DIAG:LOOP:STOP (Set Only)

Stops diagnostic at the end of the current loop.

Group Calibration and Diagnostic

Syntax DIAG:LOOP:STOP

Examples DIAG:LOOP:STOP
stops diagnostic at the end of the current loop.

DIAG:RESULT:FLAG? (Query Only)

Returns the pass/fail status from the last diagnostic test sequence execution. The DIAG:RESULT:LOG? query can be used to determine which test(s) has failed.

Group Calibration and Diagnostic

Syntax DIAG:RESULT:FLAG?

Returns PASS indicating that all of the selected diagnostic tests have passed.
FAIL indicating that at least one of the selected diagnostic tests has failed.

Examples DIAG:RESULT:FLAG?
returns either :DIAG:RESULT:FLAG PASS or FAIL.

Related Commands DIAG:RESULT:LOG?

DIAG:RESULT:LOG? (Query Only)

Returns the internal results log from the last diagnostic test sequence execution. The list contains all modules and module interfaces that were tested along with the pass/fail status of each.

Group Calibration and Diagnostic

Syntax DIAG:RESULT:LOG?

Returns <QString> in the following format:
 <Status>--<Module name>[,<Status>--<Module name>...]

Examples DIAG:RESULT:LOG?
might return :DIAG:RESULT:LOG "pass--CPU,pass--Display,pass--Front Panel,pass--IO,pass--Acquisition,pass--FDD,pass--Application Key,pass--ROM".

Related Commands DIAG:RESULT:FLAG?

DIAG:STATE EXECute (Set Only)

Executes the diagnostic tests that have been specified with the DIAG:SELEct command.

When the test sequence has completed, any of the modules or module interfaces that failed diagnostics are displayed on the screen and stored in an internal log file. The pass/fail status will be returned by the DIAG:RESUlt:FLAg? query, and the internal log will be returned by the DIAG:RESUlt:LOG? query. This command is equivalent to running Extended Diagnostics by selecting **OK Confirm Run Test** when **Execute** is selected in the **UTILITY** menu and **System** is set to **Diags**.

NOTE. *The DIAG:STATE EXECute command can take 30 seconds or more to respond. This command does not return control to the instrument controller until diagnostics are complete.*

Group	Calibration and Diagnostic
Syntax	DIAG:STATE EXECute
Arguments	EXECute runs the diagnostic test sequences specified by the DIAG:SELEct command. When complete, the oscilloscope will return to the state it was in just prior to the test. Pass/fail status of the tests can be returned by executing the DIAG:RESUlt:FLAg? query.
Examples	DIAG:STATE EXECUTE executes all the diagnostic tests that have been selected.

DISplay? (Query Only)

Returns the current display settings.

Group	Display
Syntax	DISplay?
Examples	DISPLAY? returns to the current display settings. might return :DISPLAY:FORMAT YT;STYLE VECTORS;FILTER SINX;PERSIST-

```
ENCE 500.0E-3;GRATICULE FULL;TRIGT 1;INTENSITY:OVERALL 85;
WAVEFORM 70;TEXT 60;CONTRAST 150
```

DISplay:CLOCK

Controls the display of the date and time. This is equivalent to setting **Display Date/Time** in the **UTILITY** menu.

Group	Display
Syntax	DISplay:CLOCK { OFF ON <NR1> } DISplay:CLOCK?
Arguments	<OFF> or <NR1> = 0 removes the clock from the display. <ON> or <NR1> ≠ 0 displays the clock on the display.
Examples	DISPLAY:CLOCK ON sets the display to show the time and date.

DISplay:COLor:PALEtte:REGular

Sets or returns the color palette of displayed waveforms. This command is equivalent to setting Color Palette in the **DISPLAY** menu.

Group	Display
Syntax	DISplay:COLor:PALEtte:REGular { NORMal MONochrome } DISplay:COLor:PALEtte:REGular?
Arguments	<NORMal> selects the factory default color palette. <MONo> selects the monochrome color palette.
Examples	DISPLAY:COLOR:PALETTE:REGULAR? might return :DISPLAY:COLOR:PALETTE:REGULAR NORMAL indicating that Normal is selected.

Related Commands HARDCopy:PALEtte

DISplay:FORMat

Sets or returns the display format. This command is equivalent to setting **XY Display** in the **DISPLAY** menu.

Group Display

Syntax DISplay:FORMat { GATEDxyz | XY | YT | VECtroscope }
 DISplay:FORMat?

Arguments GATEDxyz displays XY signals only when the Z (gating) channel is true. Gated XYZ is similar to analog oscilloscope modulated XYZ mode except that the displayed XY signal is either on or off; there is no intensity modulation. Gated XYZ is useful for showing constellation diagrams.

XY displays the voltage of one waveform against the voltage of another. The sources that make up an XY waveform are predefined and are listed in Table 2-34. Displaying one source causes its corresponding source to be displayed.

Table 2-34: XY format pairs

X-Axis source	Y-Axis source
Ch1	Ch2, Ch3, or Ch4
Ref1	Ref2, Ref3, or Ref4

YT sets the display to a voltage versus time format and is the default display format.

VECtroscope sets the display to a vectorscope format. TDS3VID, TDS3SDI only.

Examples DISPLAY:FORMAT YT
 selects a voltage versus time format for the display.

DISPLAY:FORMAT?
 might return XY for the display format.

Related Commands DISplay:XY:MODE

DISplay:GRAticule

Selects the type of graticule that is displayed. The TDS3VID and TDS3SDI application modules add IRE, mV, and PAL graticules to the standard graticule command, as well as a vectorscope display mode.

Group	Display
Syntax	DISplay:GRAticule { CROSSHair FRaMe FULL GRId IRE MV VECtroscope PAL } DISplay:GRAticule?
Arguments	<p>CROSSHair specifies a frame and cross hairs only.</p> <p>FRaMe specifies just a frame.</p> <p>FULL specifies a frame, a grid, and cross hairs.</p> <p>GRId specifies a frame and grid only.</p> <p>IRE sets the vertical and horizontal scales, and displays a graticule for measuring NTSC-standard video signals. TDS3VID, TDS3SDI only.</p> <p>MV or PAL sets the vertical and horizontal scales, and displays an appropriate graticule for measuring PAL-standard video signals. TDS3VID, TDS3SDI only.</p> <p>VECtroscope displays a vectorscope format screen for measuring NTSC-standard or analog HDTV color difference video signals. TDS3VID, TDS3SDI only.</p>
Examples	<p>DISPLAY:GRATICULE FRAME sets the graticule type to display the frame only.</p> <p>DISPLAY:GRATICULE? returns FULL when all graticule elements (grid, frame, and cross hairs) are selected.</p> <p>DISPLAY:GRATICULE IRE Displays an IRE graticule.</p>

DISplay:INTENSITy:BACKLight

Sets or returns the backlight intensity for the display. This is equivalent to setting **Backlight Intensity** in the **DISPLAY** menu.

- Group** Display
- Syntax** DISplay:INTENSITy:BACKLight { HIGH | MEDium | LOW }
DISplay:INTENSITy:BACKLight?
- Examples** DISPLAY:INTENSITy:BACKLIGHT?
might return :DISPLAY:INTENSITy:BACKLIGHT HIGH

DISplay:INTENSITy:WAVEform

Sets the intensity of the waveforms. This command is equivalent to adjusting the **WAVEFORM INTENSITY** knob.

- Group** Display
- Syntax** DISplay:INTENSITy:WAVEform <NR1>
DISplay:INTENSITy:WAVEform?
- Arguments** <NR1> is the waveform intensity and ranges from 1 to 100 percent.
- Examples** DISPLAY:INTENSITy:WAVEFORM?
might return :DISPLAY:INTENSITy:WAVEFORM 60 as the intensity of the waveforms.

DISplay:PERSiStence

Sets the length of time that data points are displayed. This command is equivalent to changing **Persist Time** in the **Waveform Display** menu.

- Group** Display

Syntax DISplay:PERsistence { <NR3> | INFInite | AUTO | MINImum }
 DISplay:PERsistence?

Arguments <NR3> specifies the time, in seconds, that waveform points are displayed on the screen.

INFInite displays waveform points until a control change resets the acquisition system.

AUTO specifies that the waveform persistence is controlled by the front panel WAVEFORM INTENSITY knob.

MINImum specifies that the waveform persistence is set to the minimum value of 0.0EO.

Examples DISPLAY:PERSISTENCE 3
 specifies that the waveform points are displayed fading for 3 seconds before they completely disappear.

Related Commands DISplay:INTENSITY:WAVEform

DISplay:PERsistence:CLEAR (Set Only)

Resets the persist time countdown and clears the display of all acquired points. This command is equivalent to pressing the **Clear Persistence** button in the **Waveform Display** menu.

Group Display

Syntax DISplay:PERsistence:CLEAR

Examples DISPLAY:PERSISTENCE:CLEAR
 clears the waveform display.

Related Commands DISplay:PERsistence, DISplay:INTENSITY:WAVEform

DISplay:PICTure:AUTOContrast

(Requires TDS3VID or TDS3SDI)

Sets or returns the video picture mode autocontrast setting.

Group Display

Syntax DISplay:PICTure:AUTOContrast { OFF | ON | <NR1> }
DISplay:PICTure:AUTOContrast?

Arguments <OFF> or <NR1> = 0 disables picture autocontrast mode.
<ON> or <NR1> \neq 0 enables picture autocontrast mode.

Examples DISPLAY:PICTURE:AUTOCONTRAST?
might return DISPLAY:PICTURE:AUTOCONTRAST ON, indicating that the video picture autocontrast mode is enabled.

Related Commands DISplay:PICTure:BRiGhtness, DISplay:PICTure:CONTRAst,
DISplay:PICTure:STATE

DISplay:PICTure:BRiGhtness

(Requires TDS3VID or TDS3SDI)

Sets or returns the video picture mode brightness setting.

Group Display

Syntax DISplay:PICTure:BRiGhtness <NR1>
DISplay:PICTure:BRiGhtness?

Arguments <NR1> sets the picture brightness value from 0 to 100. DISplay:PICTure:AUTO-
Contrast must be OFF in order to set the brightness value.

Examples DISPLAY:PICTURE:BRIGHTNESS?
might return DISPLAY:PICTURE:BRIGHTNESS 34, indicating that the video picture brightness setting is 34.

Related Commands DISplay:PICTure:AUTOContrast, DISplay:PICTure:CONTRAsT,
DISplay:PICTure:STATE

DISplay:PICTure:CONTRAsT

(Requires TDS3VID or TDS3SDI)

Sets or returns the video picture mode contrast setting.

Group Display

Syntax DISplay:PICTure:CONTRAsT <NR1>
DISplay:PICTure:CONTRAsT?

Arguments <NR1> sets the picture contrast value from 0 to 100. DISplay:PICTure:AUTOCon-
trast must be OFF in order to set the contrast value.

Examples DISPLAY:PICTURE:CONTRAST?
might return DISPLAY:PICTURE:CONTRAST 45, indicating that the video picture
contrast setting is 45.

Related Commands DISplay:PICTure:AUTOContrast, DISplay:PICTure:BRIGhtness,
DISplay:PICTure:STATE

DISplay:PICTure:STATE

(Requires TDS3VID or TDS3SDI)

Sets or returns the video picture mode setting.

Group Display

Syntax DISplay:PICTure:STATE { OFF | ON | <NR1> }
DISplay:PICTure:STATE?

Arguments <OFF> or <NR1> = 0 disables video picture mode.
<ON> or <NR1> ≠ 0 enables video picture mode.

Examples DISPLAY:PICTURE:STATE?
 might return DISPLAY:PICTURE:STATE ON, indicating that the video picture mode is enabled.

Related Commands DISplay:PICTure:BRiGhtness, DISplay:PICTure:CONTRAst,
 DISplay:PICTure:AUTOContrast

DISplay:STYle:DOTsonly

Selects waveform display style to dots only for XY & YT modes. This command is equivalent to setting **Dots Only** in the **Waveform Display** menu.

Group Display

Syntax DISplay:STYle:DOTsonly { ON | OFF | <NR1> }
 DISplay:STYle:DOTsonly?

Arguments ON or NR1 \geq 1 sets the waveform display style to Dots Only.
 OFF or NR1 \leq 0 sets Dots Only to Off.

Examples DISPLAY:STYLE:DOTSONLY ON
 sets the display to Dots Only.
 DISPLAY:STYLE:DOTSONLY?
 might return :DISPLAY:STYLE:DOTSONLY 1 indicating that the waveform display is set to Dots Only.

DISplay:VECTorscope:STATE

(Requires TDS3VID or TDS3SDI)

Sets or returns the video vectorscope state setting. This is equivalent to turning Vectorscope mode on or off from the front panel.

Group Display

Syntax DISplay:VECTorscope:STATE { ON | OFF | <NR1> }
 DISplay:VECTorscope:STATE?

Arguments	ON or $\text{NR1} \geq 1$ enables the vectorscope display mode. OFF or $\text{NR1} \leq 0$ disables the vectorscope display mode.
Examples	DISPLAY:VECTORSCOPE:STATE? might return :DISPLAY:VECTORSCOPE:STATE 0 indicating that the vectorscope display mode is disabled (off).

DISplay:VECTorscope:TY_SETTING

(Requires TDS3VID or TDS3SDI)

Sets or returns the video vectorscope display type setting state. Note that this does not actually turn on the vectorscope display type, but just sets the type value.

Group	Display
Syntax	DISplay:VECTorscope:TY_SETTING { ONEHundred SEVENTYFive <NR1> } DISplay:VECTorscope:TY_SETTING?
Arguments	ONEHundred or $\text{NR1} \geq 1$ sets the vectorscope display mode to 100%. SEVENTYFive or $\text{NR1} \leq 0$ sets the vectorscope display mode to 75%.
Examples	DISPLAY:VECTORSCOPE:TY_SETTING? might return :DISPLAY:VECTORSCOPE:TY_SETTING 1 indicating that the vectorscope display mode is set to 100%.

DISplay:VECTorscope:TYPE

(Requires TDS3VID or TDS3SDI)

Sets or returns the video vectorscope display type setting.

Group	Display
Syntax	DISplay:VECTorscope:TYPE { ONEHundred SEVENTYFive <NR1> } DISplay:VECTorscope:TYPE?

Arguments ONEHundred or $NR1 \geq 1$ sets the vectorscope display mode to 100% colorbars.
SEVENTYFIVE or $NR1 \leq 0$ sets the vectorscope display mode to 75% colorbars.

Examples DISPLAY:VECTORSCOPE:TYPE?
might return :DISPLAY:VECTORSCOPE:TYPE 1 indicating that the vectorscope display mode is set to 100%.

Display:XY? (Query Only)

Returns all XY and Gated XYZ parameters.

Group Display

Syntax DISplay:XY?

Examples DISPLAY:XY?
might return :DISPLAY:XY:MODE OFF;YCHANNEL OFF;YREF REF2;ZCHANNEL OFF;ZLEVEL 0.0 indicating the XY display is off.

Related Commands DISplay:XY:MODE, DISplay:XY:YChannel

DISplay:XY:MODE

Sets or returns the display mode. This command is equivalent to setting **XY Display** in the **DISPLAY** menu.

Group Display

Syntax DISplay:XY:MODE { OFF | TRIGger | GATEdxyz | VECTorscope }
DISplay:XY:MODE?

Arguments OFF sets the display to a voltage versus time format and is the normal mode.
TRIGger displays the voltage of one waveform against the voltage of another. The sources that make up an XY waveform are predefined and are listed in Table 2-35. Displaying one source causes its corresponding source to be displayed.

Table 2-35: XY format pairs

X-Axis source	Y-Axis source
Ch1	Ch2, Ch3, or Ch4
Ref1	Ref2, Ref3, or Ref4

GATEdxyz displays XY signals only when the Z (gating) channel is true. Gated XYZ is similar to analog oscilloscope modulated XYZ mode except that the displayed XY signal is either on or off; there is no intensity modulation. Gated XYZ is useful for showing constellation diagrams. Use the DISplay:XY:ZChannel and DISplay:XY:ZLEVel commands to specify the Z channel and Z channel threshold level.

VEctroscope sets the display to a video vectorscope display mode. TDS3VID, TDS3SDI only.

Examples

DISPLAY:XY:MODE OFF

Selects a voltage versus time format for the display.

DISPLAY:XY:MODE?

might return :DISPLAY:XY:MODE TRIGGER indicating a triggered XY display format.

Related Commands

DISplay:XY:YChannel, DISplay:XY:YREF, DISplay:XY:ZChannel, DISplay:XY:ZLEVel, DISplay:FORMat

DISplay:XY:YChannel

Specifies the Y channel to be displayed with channel 1 in Triggered XY display mode.

Group

Display

Syntax

DISplay:XY:YChannel { CH2 | CH3 | CH4 | OFF }

DISplay:XY:YChannel?

Arguments

CH2 , CH3, and CH4 specify the channel displayed with channel 1 in Triggered XY Display mode.

OFF sets the Y Channel to off or none which turns off or prevents the CH1 versus CH <x> waveform from being displayed in Triggered XY or prevents it from coming on if Triggered XY is turned on later.

Examples DISPLAY:XY:YCHANNEL CH2
 sets channel 2 to be displayed with channel 1 in Triggered XY mode.

DISPLAY:XY:YCHANNEL?
 might return :DISPLAY:XY:YCHANNEL CH2 indicating that channel 2 will be the Y channel in Triggered XY mode.

Related Commands DISplay:XY:MODe, DISplay:XY:YREF, DISplay:XY?

DISplay:XY:YREF

Specifies the Y channel to be displayed with reference 1 in Triggered XY display mode.

Group Display

Syntax DISplay:XY:YREF { REF2 | REF3 | REF4 | OFF }
 DISplay:XY:YREF?

Arguments REF2 , REF3, and REF4 specify the reference displayed with REF1 in Triggered XY Display mode.

OFF set the Y reference to off which turns off or prevents the REF1 versus REF<x> waveform from being displayed in Triggered XY or prevents it from coming on if Triggered XY is turned on later.

Examples DISPLAY:XY:YREF REF2
 sets REF2 to be displayed with REF1 in Triggered XY mode.

Related Commands DISplay:XY:MODe, DISplay:XY:YCHannel

DISplay:XY:ZCHannel

Specifies the Z channel to use in gated XYZ mode. Gated XYZ is similar to analog oscilloscope modulated XYZ mode except that the displayed XY signal is

either on or off; there is no intensity modulation. Gated XYZ is useful for showing constellation diagrams.

Group	Display
Syntax	DISplay:XY:ZChannel { ? CH2 CH3 CH4 } DISplay:XY:ZChannel?
Arguments	<CH2 - CH4> specifies which channel to use as the Z channel source.
Examples	DISPLAY:XY:ZCHANNEL CH2 sets oscilloscope channel 2 as the Z channel source in gated XYZ mode.

DISplay:XY:ZLEVel

Specifies the Z channel threshold level to enable XY gating in gated XYZ mode.

Group	Display
Syntax	DISplay:XY:ZLEVel <NR3> DISplay:XY:ZLEVel?
Arguments	<NR3> sets the Z channel threshold level. Z-channel signals above the threshold are true and open the XY signal gate; Z-channel signals below the threshold are false and close the XY signal gate. The gating channel is always a high-true logic; to emulate a low-true logic, invert the Z-channel signal.
Examples	DISPLAY:XY:ZLEVEL 1.2E0 sets the Z channel threshold level to 1.2 volts.

*ESE

Sets or returns the bits in the Event Status Enable Register (ESER). The ESER prevents events from being reported to the Status Byte Register (STB). For a more detailed discussion of the use of these registers, see page 3-1.

Group	Status and Error
--------------	------------------

Syntax *ESE <NR1>

*ESE?

Arguments <NR1> is a value in the range from 0 through 255. The binary bits of the ESER are set according to this value.

The power-on default for ESER is 0 if *PSC is 1. If *PSC is 0, the ESER maintains its value through a power cycle.

NOTE. *Setting the DESER and the ESER to the same value allows only those codes to be entered into the Event Queue and summarized on the ESB bit (bit 5) of the Status Byte Register. Use the DESE command to set the DESER. A discussion of event handling begins on page 3-1.*

Examples *ESE 209
sets the ESER to binary 11010001, which enables the PON, URQ, EXE, and OPC bits.

*ESE?
might return the value 186, showing that the ESER contains the binary value 10111010.

Related Commands *CLS, DESE, *ESR?, EVENT?, EVMsg? *SRE, *STB?

*ESR? (Query Only)

Returns the contents of the Standard Event Status Register (SESR). *ESR? also clears the SESR (since reading the SESR clears it). For a more detailed discussion of the use of these registers, see page 3-1.

Group Status and Error

Syntax *ESR?

Example *ESR?
might return the value 213, showing that the SESR contains binary 11010101.

Related Commands ALLEv?, *CLS, DESE, *ESE, EVENT?, EVMsg?, *SRE, *STB?

ETHERnet:DCHPBOOTP

(TDS3000B Series, TDS3000C Series, and TDS3EM Only)

Sets or returns the network initialization search for a DCHP/BOOTP server.

Group	Ethernet
Syntax	ETHERnet:DCHPBOOTP { OFF ON <nr1> } ETHERnet:DCHPBOOTP?
Arguments	ON or nr1 \geq 1 enables the oscilloscope to search the network for a DCHP or BOOTP server in order to automatically assign a dynamic IP address to the oscilloscope.

NOTE. Do not use DCHP/BOOTP searching if your oscilloscope has been assigned a static address on a network. If you set this command to ON, the DCHP/BOOTP search will delete or change your static IP address information.

OFF or nr1 \leq 0 disables the oscilloscope to search the network for a DCHP or BOOTP server.

Example ETHERNET:DCHPBOOTP ON
sets the oscilloscope to search for a DCHP or BOOTP server and assign a dynamic IP address to the oscilloscope.

ETHERnet:DNS:IPADDRESS

(TDS3000B Series, TDS3000C Series, and TDS3EM Only)

Sets or returns the network Domain Name Server (DNS) IP address.

Group	Ethernet
Syntax	ETHERnet:DNS:IPADDRESS <QString> ETHERnet:DNS:IPADDRESS?
Arguments	<QString> is a standard IP address value, enclosed in quotes.

Example ETHERNET:DNS:IPADDRESS "128.196.12.122"
sets the DNS IP address that the oscilloscope uses to communicate with the network.

ETHERnet:DOMainname

(TDS3000B Series, TDS3000C Series, and TDS3EM Only)

Sets or returns the network domain name.

Group Ethernet

Syntax ETHERnet:DOMainname <QString>
ETHERnet:DOMainname?

Arguments <QString> is the network domain name, enclosed in quotes.

Example ETHERNET:DOMAINNAME "Alpha1.Mycorp.com"
sets the domain name that the oscilloscope uses to communicate with the network.

ETHERnet:ENETADDRESS? (Query Only)

(TDS3000B Series, TDS3000C Series, and TDS3EM Only)

Returns the ethernet address value assigned to the TDS3EM Ethernet communication module, or to the TDS3000B and TDS3000C series oscilloscope. This is assigned at the factory and can not be changed.

Group Ethernet

Syntax ETHERnet:ENETADDRESS?

Example ETHERNET:ENETADDRESS?
returns an ethernet address such as "02:00:e3:01:32:03"

ETHERnet:GATEWay

(TDS3000B Series, TDS3000C Series, and TDS3EM Only)

Sets or returns the remote interface gateway IP address.

Group Ethernet

Syntax ETHERnet:GATEWay <QString>
ETHERnet:GATEWay?

Arguments <QString> is a standard IP address value, enclosed in quotes.

Example ETHERNET:GATEWAY "128.143.16.1"
sets the gateway IP address.

ETHERnet:HTTPPORT

(TDS3000B Series, TDS3000C Series, and TDS3EM Only)

Sets or returns the remote interface HTTP port value.

Group Ethernet

Syntax ETHERnet:HTTPPORT <QString>
ETHERnet:HTTPPORT?

Arguments <QString> is an integer port number, enclosed in quotes.

Example ETHERNET:HTTPPORT "45"
sets the HTTP port value to 45.

ETHERnet:IPADDRESS

(TDS3000B Series, TDS3000C Series, and TDS3EM Only)

Sets or returns the IP address assigned to the oscilloscope.

Group Ethernet

Syntax ETHERnet:IPADDRESS <QString>
ETHERnet:IPADDRESS?

Arguments <QString> is a standard IP address value, enclosed in quotes.

Examples ETHERNET:IPADDRESS "123.103.78.90"
sets the oscilloscope's IP address.

ETHERnet:NAME

(TDS3000B Series, TDS3000C Series, and TDS3EM Only)

Sets or returns the network name assigned to the oscilloscope.

Group Ethernet

Syntax ETHERnet:NAME <QString>
ETHERnet:NAME?

Arguments <QString> is the network name assigned to the oscilloscope, enclosed in quotes.

Examples ETHERNET:NAME "labcscope1"
sets the oscilloscope's network name.

ETHERnet:NETPRInter:ADD (Set Only)

(TDS3000B Series, TDS3000C Series, and TDS3EM Only)

Adds the specified printer name and parameters to the oscilloscope ethernet printer list.

Group Ethernet

Syntax ETHERnet:NETPRInter:ADD <QString>

Arguments <QString> is a quoted composite string that contains, in the following order, the network printer name, printer server name, and print server IP address. Each field is delimited by a semicolon (;). The printer name is always required, and either

the server name or server IP address is required. If you do not use all three fields, the missing field delimiter must still be used.

NOTE. *If DNS services are not available, all these fields must be filled in.*

Adding a printer that already exists in the list is equivalent to doing a rename printer operation; the new settings replace the existing printer settings.

- Examples**
- ETHERNET:NETPRINTER:ADD "QMSprt;prtserver1;128.121.33.21"
adds a printer to the oscilloscope printer list.
- ETHERNET:NETPRINTER:ADD "HP600dpi;HPserver;"
adds a printer to the oscilloscope printer list. Note that only the network printer name and print server name are entered, and that the required IP address delimiter is at the end of the string. This example assumes that DNS services are available to supply the printer server IP address.

ETHERnet:NETPRInter:DELEte (Set Only)

(TDS3000B Series, TDS3000C Series, and TDS3EM Only)

Deletes the specified printer from the oscilloscope network printer list.

- Group** Ethernet
- Syntax** ETHERnet:NETPRInter:DELEte <QString>
- Arguments** <QString> is a quoted composite string that contains, in the following order, the network printer name, printer server name, and print server IP address. Each field is delimited by a semicolon (;). The printer name is required, and either the server name or server IP address is required. If you do not use all three fields, you must still use the missing field delimiters.
- Examples** ETHERNET:NETPRINTER:DELETE "QMSprt;prtserver1;128.121.33.21"
deletes the specified printer from the oscilloscope network printer list

ETHERnet:NETPRInter:DELWarn

(TDS3000B Series, TDS3000C Series, and TDS3EM Only)

Sets or returns the oscilloscope on-screen printer delete warning message. No deletion warning message is sent over the network.

Group Ethernet

Syntax ETHERnet:NETPRInter:DELWarn { OFF | ON | <nr1> }
 ETHERnet:NETPRInter:DELWarn?

Arguments OFF turns off delete warning
 ON turns on delete warning
 nr1 is an integer number where nr1 = 0 turns off delete warning, and nr1 ≠ 0 turns on delete warning.

Examples ETHERNET:NETPRINTER:DELWARN 1
 sets the oscilloscope to display a warning message on the oscilloscope screen whenever a front-panel delete printer action occurs.

ETHERnet:NETPRInter:REName (Set Only)

(TDS3000B Series, TDS3000C Series, and TDS3EM Only)

Renames the specified printer name and/or parameters in the oscilloscope ethernet printer list.

Group Ethernet

Syntax ETHERnet:NETPRInter:REName <QString>,<QString>

Arguments <QString> is a quoted composite string that contains, in the following order, the network printer name, printer server name, and print server IP address. Each field is delimited by a semicolon (;). The printer name is always required, and either the server name or server IP address is required. If you do not use all three fields, the missing field delimiter must still be used. The first Qstring is the original printer information, and the second Qstring is the new printer information.

Examples ETHERNET:NETPRINTER:RENAME "QMSprt;prtserver1;128.121.33.21",
"QMScolor;prtserver1;128.121.33.21"
renames the network printer name from QMSprt to QMScolor.

ETHERnet:NETPRInter:SElect:ALLInfo? (Query Only)

(TDS3000B Series, TDS3000C Series, and TDS3EM Only)

Returns a composite string that contains the active (selected) network printer name, printer server name, and print server IP address.

Group Ethernet

Syntax ETHERnet:NETPRInter:SElect:ALLInfo?

Examples ETHERNET:NETPRINTER:SELECT:ALLINFO?
might return "Phaser350;Tekserver;119.23.56.12".

ETHERnet:NETPRInter:SElect:NAME

(TDS3000B Series, TDS3000C Series, and TDS3EM Only)

Sets or returns the network printer to use for hard copy output.

Group Ethernet

Syntax ETHERnet:NETPRInter:SElect:NAME <QString>
ETHERnet:NETPRInter:SElect:NAME?

Arguments <QString> is the network printer name, enclosed in quotes.

Examples ETHERNET:NETPRINTER:SELECT:NAME "TekP360"
sets the oscilloscope to use the network printer named TekP360.

ETHERnet:PASSWord (Set Only)

(TDS3000B Series, TDS3000C Series, and TDS3EM Only)

This command sets the Ethernet access password.

Group Ethernet

Syntax ETHERnet:PASSWord "old","new"

Arguments old is the current password, enclosed in quotes. If there is no current password, enter a null character (two quotes with no character between).

new is a new password, enclosed in quotes.

Examples ETHERNET:PASSWORD "karma2","ZEN53
replaces the current Ethernet password karma2 with the new password ZEN53.

ETHERnet:PING:EXECUTE (Set Only)

(TDS3000B Series, TDS3000C Series, and TDS3EM Only)

This command tests the Ethernet connection by performing a ping operation.

Group Ethernet

Syntax ETHERnet:PING:EXECUTE

Examples ETHERNET:PING:EXECUTE
sets the oscilloscope to execute a ping operation to attempt to identify itself on the Ethernet.

Related Commands ETHERnet:PING:STATUS

ETHERnet:PING:STATUS? (Query Only)

(TDS3000B Series, TDS3000C Series, and TDS3EM Only)

This command returns the last-issued status message from the Ethernet Ping command.

Group	Ethernet
Syntax	ETHERnet:PING:STATUS? { NEVER OK NORESPONSE TRYING }
Arguments	<p>NEVER if ETHERnet:PING:EXECUTE command has never been sent during this power-on session.</p> <p>OK if the most recent ETHERnet:PING:EXECUTE command was successfully sent.</p> <p>NORESPONSE if the ETHERnet:PING:EXECUTE command failed to find the oscilloscope on the network.</p> <p>TRYING the ETHERnet:PING:EXECUTE command is still trying to connect to the network.</p>
Examples	ETHERNET:PING:STATUS? might return NEVER
Related Commands	ETHERnet:PING:EXECUTE

ETHERnet:SUBNETMASK

(TDS3000B Series, TDS3000C Series, and TDS3EM Only)

Sets or returns the remote interface subnet mask value.

Group	Ethernet
Syntax	<p>ETHERnet:SUBNETMASK <QString></p> <p>ETHERnet:SUBNETMASK?</p>
Examples	<p><QString> is the subnet mask value, enclosed in quotes.ETHERNET:SUBNETMASK "255.255.255.0"</p> <p>sets the subnet mask value using standard IP address notation format.</p>

EVENT? (Query Only)

Returns from the Event Queue an event code that provides information about the results of the last *ESR? read. EVENT? also removes the returned value from the Event Queue. A discussion of event handling begins on page 3-1.

Group Status and Error

Related Commands ALLEv?, *CLS, DESE, *ESE, *ESR?, EVMsg?, *SRE, *STB?

Syntax EVENT?

Examples EVENT?
might return the response :EVENT 110, showing that there was an error in a command header.

EVMsg? (Query Only)

Returns from the Event Queue a single event code associated with the results of the last *ESR? read, and returns the event code along with an explanatory message. A more detailed discussion of event handling begins on page 3-1.

Group Status and Error

Syntax EVMsg?

Returns The event code and message in the following format:
`<Event Code><Comma><QString>[<Event Code><Comma><QString>...]
 <QString>:=<Message>;[<Command>]`

where <Command> is the command that caused the error and may be returned when a command error is detected by the oscilloscope. As much of the command will be returned as possible without exceeding the 60 character limit of the <Message> and <Command> strings combined. The command string is right-justified.

Examples EVMSG?
might return the message :EVMSG 110,"Command header error".

Related Commands ALLEv?, *CLS, DESE, *ESE, *ESR?, EVENT?, *SRE, *STB?

EVQty? (Query Only)

Returns the number of event codes that are in the Event Queue. This is useful when using the ALLEv? query since it lets you know exactly how many events will be returned.

Group Status and Error

Syntax EVQty?

Examples EVQTY?
might return :EVQTY 3 as the number of event codes in the Event Queue.

Related Commands ALLEv?, EVENT?, EVMsg?

FACTory (Set Only)

Resets the oscilloscope to its factory default settings (see *Appendix D*). The FACTory command performs an *RST command, resets waveform transmission parameters (DATA:START, DATA:STOP, DATA:WIDTH, and so on), resets events status (PSC, DESE, ESE, SRE), deletes aliases, and resets to HEAD-ER:ON.

Group Miscellaneous

Syntax FACTory

Related Commands *PSC, *RCL, RECAil:SETUp, *RST, *SAV, SAVe:SETUp, TEKSecure

FILESystem? (Query Only)

Returns a composite results to the following queries: FILESystem:CWD?, FILESystem:DELWArn?, FILESystem:OVERWrite?

Group File system

Syntax FILESystem?

Examples FILESYSTEM?
 might return :FILESYSTEM:CWD "fd0:/" ;DELWARN 1;OVERWRITE 1,
 (Confirm Delete on, Overwrite Lock on).

Related Commands FILESystem:CWD?, FILESystem:DELWarn, FILESystem:OVERWrite

FILESystem:COpy (Set Only)

Copies a named file or files to a new file. The new file may be in a totally separate directory than the old file. Also, you can use wild card characters (*.*) to copy multiple files with one command.

Group File system

Syntax FILESystem:COpy { <source file path>,<destination file path> |
 <source directory path>,<destination file path> | <source
 directory path>,<destination directory path> }

Arguments <file path> is a quoted string that defines the file name and path. Input the file path using the form <drive>/<dir>/<filename>. <drive> and one or more <dir>s are optional. If you do not specify them, the oscilloscope will copy the file in the current directory. <filename> stands for a filename of up to 8 characters and can be followed by a period (".") and a 3-character extension. You can also use the inclusive filename *.* in the source file path to copy all files.

<directory path> is a quoted string that defines the directory. Input the directory using the form <drive>/<dir>/<directory name>. <drive> and one or more <dir>s are optional. If you do not specify them, the oscilloscope will copy the directory in the current directory. <directory name> stands for a directory name of up to 8 characters and can be followed by a period (".") and a 3-character extension.

The current directory refers to the name of a directory as returned by the FILESystem:CWD? query.

Examples FILESYSTEM:COpy "TEK00001.SET", "fd0:/TEK00001.SET"
 copies the file named TEK00001.SET on the current drive to a file named
 TEK00001.SET on the drive fd0: in the root directory.

FILESYSTEM:COpy "fd0:/YOURDIR/TEK00001.SET", "fd0:/MYDIR"
copies the file named TEK00001.SET on the fd0: drive and the YOURDIR
directory to the MYDIR directory on the same drive.

```
FILESYSTEM:COPY "YOURDIR", "fd0:/MYDIR"
```

copies the files in the YOURDIR directory in the current directory to the MYDIR directory on the fd0: drive.

FILESystem:CWD

Sets or returns the current working directory (CWD) path. This remote interface working directory is not the same as the working directory used by the oscilloscope menus.

Group	File system
Syntax	FILESystem:CWD <directory path> FILESystem:CWD?
Arguments	<directory path> is a quoted string that defines the directory name and path.
Examples	FILESYSTEM:CWD "fd0:/MYDIR" will define fd0:/MYDIR as the current directory. FILESYSTEM:CWD? might return :FILESYSTEM:CWD "fd0:/MYDIR" if that is the current directory.

FILESystem:DELEte (Set Only)

Deletes a named file.

Group	File system
Syntax	FILESystem:DELEte <file path>
Arguments	<file path> is a quoted string that defines the file name and path. Input the file path using the form <drive>/<dir>/<filename>. <drive> and one or more <dir>s are optional. If you do not specify them, the TDS will delete the file in the current directory. <filename> stands for a filename of up to 8 characters and can be followed by a period (".") and a 3-character extension. You can also use the inclusive filename *.* to delete all files. If <file path> defines a directory, the directory as well as all of the files and subdirectories it contains are deleted.

The current directory refers to the name of a directory as returned by the FILESystem:CWD query.

Examples FILESYSTEM:DELETE "NOT_MINE.SET"
 deletes the file named NOT_MINE.SET in the current directory.

FILESYSTEM:DELETE "*.*"
 deletes all the files in the current directory.

FILESystem:DELWarn

Turns on or off the file-delete warning message. No deletion warning message is returned via the remote interface.

Group File system

Syntax FILESystem:DELWarn { ON | OFF | <NR1> }
 FILESystem:DELWarn?

Arguments ON or <NR1> \neq 0 turns on the front-panel delete warning.
 OFF or <NR1> = 0 turns off the front-panel delete warning.

Examples FILESYSTEM:DELWARN OFF
 disables the front-panel delete warning.

FILESYSTEM:DELWARN?
 might return :FILESYSTEM:DELWARN 0 indicating the front-panel warning is disabled.

FILESystem:DIR (Query Only)

Returns a list of quoted strings. Each string contains the name of a file or directory in the current directory.

The current directory refers to the name of a directory as returned by the FILESystem:CWD query.

Group File system

Syntax FILESystem:DIR?

Examples `FILESYSTEM:DIR?`
returns a list of files and directories in the current directory.

FILESystem:FORMat (Set Only)

Formats a named drive.

Group File system

Syntax `FILESystem:FORMat <drive name>`

Arguments <drive name> is a quoted string that defines the drive to format.

Examples `FILESYSTEM:FORMAT "fd0:"`
formats the media on drive fd0:.

FILESystem:FREEspace (Query Only)

Returns the amount of freespace (in bytes) on the storage drive.

Group File system

Syntax `FILESystem:FREEspace?`

Returns <NR1> is the amount of freespace (in bytes) available on the drive. The oscilloscope returns zero for read-only disks or when no drive is present.

Examples `FILESYSTEM:FREEspace?`
might return 0 as the amount of freespace available if a drive is full.

FILESystem:MKDir (Set Only)

Make a new directory.

Group File system

Syntax `FILESystem:MKDir <directory path>`

Arguments <directory path> is a quoted string that defines the directory. Input the directory using the form <drive>/<dir>/<directory name>. <drive> and one or more <dir>s are optional. If you do not specify them, the oscilloscope will create the directory in the current directory. <directory name> stands for a directory name of up to 8 characters and can be followed by a period (“.”) and a 3-character extension.

The current directory refers to the name of a directory as returned by the FILESystem:CWD query.

Examples FILESYSTEM:MKDIR "NEATPICS"
creates the directory named NEATPICS in the current directory.

FILESystem:OVERWrite

Turns on or off the front panel file-overwrite protection. Turning on file-overwrite protection prevents writing over existing files. Overwrite Lock has no effect on commands received via the remote interface.

Group File system

Syntax FILESystem:OVERWrite { ON | OFF | <NR1> }
FILESystem:OVERWrite?

Arguments ON or <NR1> \neq 0 turns on the file-overwrite protection.
OFF or <NR1> = 0 turns off the file-overwrite protection.

Examples FILESYSTEM:OVERWRITE OFF
lets you overwrite existing files.

FILESYSTEM:OVERWRITE?
might return 1 indicating you cannot overwrite existing files.

FILESystem:PRInt (Set Only)

Prints a named file to the named port.

Group File system

Syntax FILESystem:PRInt <filepath>,{ GPIb | RS232 | CENTronics | ETHERnet}

Arguments <file path> is a quoted string that defines the file name and path. Input the file path using the form <drive>/<dir>/<filename>. <drive> and one or more <dir>s are optional. If you do not specify them, the oscilloscope will print the file in the current directory. <filename> stands for a filename of up to 8 characters and can be followed by a period (".") and a 3-character extension.

The current directory refers to the name of a directory as returned by the FILESystem:CWD command.

GPIb specifies that the hard copy is sent out the GPIB port.

CENTronics specifies that the hard copy is sent out the Centronics port. (This argument is not available on TDS3000C Series instruments.)

RS232 specifies that the hard copy is sent out the RS232 port.

ETHERnet specifies that the hard copy is sent out the Ethernet port.

Examples FILESYSTEM:PRINT "TEK00000.IBM",CENTRONICS
sends the file named TEK00000.IBM out the Centronics port.

FILESystem:REName (Set Only)

Assigns a new name to a file. You can also move a file by specifying the new name in a different directory.

Group File system

Syntax FILESystem:REName <old file path>,<new file path>

Arguments <old file path> is a quoted string that defines the file to rename. Input the file path using the form <drive>/<dir>/<filename>. <drive> and one or more <dir>s are optional. If you do not specify them, the oscilloscope will look for the filename in the current directory.

<new file path> is a quoted string that defines the new name of the file. Input the file path using the form <drive>/<dir>/<filename>. <drive> and one or more <dir>s are optional. If you do not specify them, the oscilloscope will place the newly named file in the current directory.

The current directory refers to the name of a directory as returned by the FILESystem:CWD query.

Examples FILESYSTEM:RENAME "TEK00000.SET", "MYSET.SET"
gives the file named TEK00000.SET the new name of MYSET.SET. The file remains in the current directory.

FILESystem:RMDir (Set Only)

Deletes a named directory.

Group File System

Syntax FILESystem:RMDir <directory path>

Arguments <directory path> is a quoted string that defines the directory. Input the directory using the form <drive>/<dir>/<directory name>. <drive> and one or more <dir>s are optional. If you do not specify them, the oscilloscope will delete the directory in the current directory. <directory name> stands for a directory name of up to 8 characters and can be followed by a period (.) and a 3-character extension.

Examples FILESYSTEM:RMDIR "NEATPICS"
deletes the directory named NEATPICS in the current directory.

FPAnel:PRESS (Set only)

Duplicates the action of pressing a specified front-panel button.

Group Miscellaneous

Syntax FPAnel:PRESS { ACQuire | AUTOSet | BMENU<x> | BTRIG | CH<x> | CLEARMenu | COARSE | CURSor | DELay | DISPlay | FORCETRIG | HARDCopy | MATH | MEASUrement | OFF | QUICKmenu | REF | RMENU<x> | RUNSTop | SAVERecall | SELEct | SETTo50 | SINGLESEQ | TRIGger | UTILITY | VERTical | ZOOm }

Arguments Most of the argument names associate directly with their front panel button. For example, AUTOSet is for the AUTOSSET button. The few commands that do not have obvious associations are listed in Table 2-36.

Table 2-36: FPAnel:PRESS arguments

Argument	Description
ACQuire	Acquire MENU button
BMENU<x>	Screen bottom menu buttons, where <x>=1 for the left-most bottom menu button and <x>=7 for the right-most bottom menu button
CH<x>	Channel select button, where <x>=1 for channel 1, <x>=2 for channel 2, and so on
CLEARMenu	MENU OFF button
MEASUrement	MEASURE button
OFF	Vertical menu waveform channel OFF button
RMENU<x>	Screen side menu buttons, where <x>=1 for the top-most side menu button and <x>=5 for the bottom-most side menu button
TRIGger	Trigger MENU button
VERTical	Vertical MENU button

Examples FPANEL:PRESS AUTOSET
executes the oscilloscope Autoset function.

FPAnel:TURN (Set only)

Duplicates the action of turning a specified front-panel control knob.

Group Miscellaneous

Syntax FPAnel:TURN { [GPKNOB | HORZPOS | HORZSCALE | INTENSITY | TRIGLEVEL | VERTPOS | VERTSCALE] , <n> }

Arguments Most of the argument names associate directly with their front panel knob. For example, GPKNOB is for the general purpose knob, HORZSCALE is for the horizontal scale knob, and so on.

, (comma) separates the control knob argument from the numeric rotation value argument. You do not need a white space between the arguments and the comma.

<n> represents the rotation direction and magnitude of rotation. Negative values represent a counterclockwise knob rotation, and positive values represent a clockwise rotation. The magnitude of <n> specifies the amount of the turn, where <n> = 1 represents turning the knob one unit, <n> = 2 represents turning the knob two units, <n> = 5 represents turning the knob five units, and so on. The range of units depends on which front panel knob is specified.

Examples FPANEL:TURN TRIGLEVEL,10
duplicates turning the front panel Trigger LEVEL knob clockwise by 10 units.

HARDCopy

Sends a copy of the screen display to the port specified by HARDCopy:PORT. The format and layout of the output is specified with the HARDCopy:FORMat and HARDCopy:LAYout commands. This command is equivalent to pressing the front panel **Hard Copy** button (Ⓜ).

The HARDCopy? query returns format, palette, layout, file name, preview, ink saver, compression mode, and port information.

NOTE. This command is NOT IEEE Std 488.2-1987 compatible.

Group Hard copy

Syntax HARDCopy { ABOrt | CLEARSpool | START }
HARDCopy?

Arguments ABOrt terminates the hard copy output in process.
CLEARSpool is equivalent to ABOrt.
START initiates a screen copy that can be stored in a file or redirected to a printing device.

NOTE. Use the *WAI command between HARDCopy START commands to ensure that the first hard copy is complete before starting another.

Examples HARDCOPY ABORT
stops any hard copy output that is in process.

HARDCopy:COMPRESSion

Sets or returns the hard copy compression feature. Setting this command to On causes the oscilloscope to compress hard copy output into gzip-format files (*.gz) prior to sending the file out of the specified hard copy port. .gz files are compatible with GZIP (shareware) or WinZip utilities.

Group Hard copy

Syntax HARDCopy:COMPRESSion [ON | OFF | <nr1>]
HARDCopy:COMPRESSion?

Arguments ON causes the oscilloscope to compress hard copy output files into gzip-format files (*.gz).

NOTE. Hard copy compression is disabled when the output port is set to Centronics.

OFF disables hard copy file compression.

nr1 is an integer number where nr1 = 0 turns off compression, and nr1 ≠ 0 turns on compression.

Examples `HARDCOPY:COMPRESSION ON`
enables hard copy file compression.

HARDCopy:FILENAME

Specifies the file that hard copy data is written to on the next `HARDCOPY START` command. To do multiple hard copies using the `HARDCOPY START` command you must change the `HARDCopy:FILENAME` before each `HARDCOPY START` or the same file will be overwritten each time. `HARDCopy:FILENAME` file names are not checked for syntactical correctness until `HARDCOPY START` is received. (This is a feature that allows you to specify directories that may not exist yet, as long as they are eventually created.)

Group Hard copy

Related Commands `HARDCopy`

Syntax `HARDCopy:FILENAME <file path>`

`HARDCopy:FILENAME?`

`<file path>` specifies that the hard copy is sent to the named file. `<file path>` is a quoted string that defines the file name and path. Input the file path using the form `<drive> <dir>/<filename>`. `<drive>` and one or more `<dir>`s are optional. If you do not specify them, the oscilloscope will write the file to the current directory. `<filename>` stands for a filename of up to 8 characters followed by a period (.) and any 3-character suffix. If a suffix is supplied, it is ignored. The only way to specify the hard copy format is using the `HARDCOPY:FORMAT` command (or set it in the menu). That is, if the hard copy format is TIFF, then the command `HARDCOPY:FILENAME "NEXTFILE.DJ"` does not change the hard copy format to DeskJet. The file that actually gets written is called "NEXTFILE.TIF" and the contents of the file are in TIFF format.

The current directory refers to the name of a directory as returned by the `FILESystem:CWD` query.

Examples `HARDCOPY:FILENAME "TEK.IBM"`
selects `TEK.IBM` as the selected file name to write the hard copy to during the next hard copy.

`HARDCOPY:FILENAME?`

might return `:HARDCOPY:FILENAME "TEK.IBM"` as the selected file name.

HARDCopy:FORMat

Selects the output data format for hardcopies. This is equivalent to setting **Format** in the **UTILITY/Hard Copy** menu.

Group	Hard copy
Syntax	HARDCopy:FORMat { TDS3PRT BMP BMPColor DESKJET DESKJETC EPSColor EPSMono EPSOn INTERLeaf LASERJet PCX PCXcolor RLE THInkjet TIFf DPU3445 BJC80 PNG} HARDCopy:FORMat?
Arguments	<p>TDS3PRT sets the hard copy file format to the TDS3PRT plug-in thermal printer format. (TDS3000B series only.)</p> <p>BMP sets the hard copy file format to Windows monochrome image format.</p> <p>sets the hard copy file format to Windows color image format.</p> <p>DESKJET sets the hard copy file format to HP monochrome ink-jet printer format. (TDS3000B Series and TDS3000C Series only.)</p> <p>DESKJETC sets the hard copy file format to HP color inkjet printer format. (TDS3000B Series and TDS3000C Series only.)</p> <p>EPSColor sets the hard copy file format to Encapsulated PostScript color image format.</p> <p>EPSMono sets the hard copy file format to Encapsulated PostScript monochrome image format.</p> <p>EPSOn sets the hard copy file format to Epson 9-pin and 24-pin dot matrix printer format. (TDS3000B Series and TDS3000C Series only.)</p> <p>INTERLeaf sets the hard copy file format to Interleaf image object format.</p> <p>LASERJet sets the hard copy file format to HP monochrome laser printer format. (TDS3000B Series and TDS3000C Series only.)</p> <p>PCX sets the hard copy file format to PC Paintbrush monochrome image file format.</p> <p>PCXcolor sets the hard copy file format to PC Paintbrush color image file format.</p> <p>RLE sets the hard copy file format to Windows color image file format.</p>

THInkjet sets the hard copy file format to HP monochrome ink-jet printer format. (TDS3000B Series and TDS3000C Series only.)

TIFf sets the hard copy file format to tag image file format.

DPU3445 sets the hard copy file format to Seiko DPU-3445 thermal printer format.

BJC80 sets the hard copy file format to Canon BJC-50, BJC-80 color printer format. (TDS3000B Series and TDS3000C Series only.)

PNG sets the hard copy file format to Portable Network Graphics format.

Examples `HARDCOPY:FORMAT BMPColor`
sets the hard copy output format to color bitmap.

`HARDCOPY:FORMAT?`
might return `:HARDCOPY:FORMAT INTERLEAF` as the hard copy output format.

HARDCopy:INKSaver

Changes hard copy output to print color traces and graticule on a white background while retaining waveform color information (except for channel 1, which prints a dark blue because yellow does not show up well is difficult to see on a white background). This option can significantly reduce print time and quantities of ink required compared with WYSIWYG dark background images. Returns 1 when inksaver is on and 0 when inksaver is turned off.

Group Hard copy:

Syntax `HARDCopy:INKSaver { <NR1> | ON | OFF }`
`HARDCopy:INKSaver?`

Arguments `ON` or `<NR1> ≠ 0` sets the ink saver mode on.
`OFF` or `<NR1> = 0` sets the ink saver mode off.

Examples `HARDCOPY:INKSAVER ON`
will cause subsequent hard copy output and preview commands to display grayscale menus on a white background.

HARDCopy:LAYout

Selects the printing orientation. This is equivalent to setting **Layout** in the **UTILITY > System:Hard Copy > Options** menu.

Group	Hard copy
Syntax	HARDCopy:LAYout { LANDscape PORTRait } HARDCopy:LAYout?
Arguments	LANDscape specifies that the bottom of the hard copy is along the long side of the page. PORTRait specifies that the bottom of the hard copy is along the short side of the page. This is the standard format.
Examples	HARDCOPY:LAYOUT? might return :HARDCOPY:LAYOUT PORTRAIT as the hard copy page-layout format.

HARDCopy:PALEtte

Equivalent to DISplay:COLor:PALEtte:REGular.

Group	Hard copy
Related Commands	HARDCopy, DISplay:COLor:PALEtte:REGular
Syntax	HARDCopy:PALEtte { NORMal MONOchrome } HARDCopy:PALEtte?
Examples	HARDCOPY:PALETTE MONOchrome would change the display to monochrome waveforms, but retain color readouts and menu items.

HARDCopy:PORT

Sets or returns where to send the hard copy data on the next hard copy command (i.e. HARDCOPY START command). This is equivalent to setting **Port** in the **UTILITY > Hard Copy** menu.

Group Hard copy

Related Commands HARDCopy

Syntax HARDCopy:PORT { CENTronics | FILE | GPIb | RS232 | ETHERnet }
 HARDCopy:PORT?

Arguments CENTronics specifies that the hard copy is sent out the Centronics port. (TDS3000 Series and TDS3000B Series only.)

FILE specifies that the hard copy is stored in the file named in the HARDCOPY:FILENAME command.

GPIb specifies that the hard copy is sent out the GPIB port (available with optional TDS3GM and TDS3GV communication modules).

RS232 specifies that the hard copy is sent out the RS232 port (available on optional TDS3VM, TDS3GM, TDS3EM and TDS3GV communication modules).

ETHERnet specifies that the hard copy is sent out the 10baseT Ethernet port. (TDS3000 series requires TDS3EM module.)

Examples HARDCOPY:PORT?
 might return :HARDCOPY:PORT GPIB as the selected hard copy output port.

HARDCopy:PREVIEW

Changes the display screen to simulate hard copy output. The result depends on the current Format, Layout, Palette, and Inksaver selections. It may be monochrome (black and white), grayscale, limited color, or full color.

Group Hard copy:

Syntax HARDCopy:PREVIEW { <NR1> | ON | OFF }
HARDCopy:PREVIEW?

Arguments ON or <NR1> \neq 0 sets the display screen to simulate hard copy output.
OFF or <NR1> = 0 turns off the simulation of hard copy output.

Examples HARDCOPY:PREVIEW ON
will change the display to simulate hard copy output with the current format, layout, palette, and inksaver options.

HDR

This command is identical to the HEADer query and is included for compatibility with older Tektronix instruments.

Group Miscellaneous

Syntax HDR { <NR1> | OFF | ON }
HDR?

HEADer

Sets or returns the Response Header Enable State that sets the oscilloscope to either include or omit headers on query responses. This command does not affect IEEE Std. 488.2-1987 Common Commands (those starting with an asterisk); they never return headers.

Group Miscellaneous

Syntax HEADer { <NR1> | OFF | ON }
HEADer?

Arguments ON or <NR1> \neq 0 sets the Response Header Enable State to true. This causes the oscilloscope to include headers on applicable query responses. You can then use the query response as a command.

OFF or <NR1> = 0 sets the Response Header Enable State to false. This causes the oscilloscope to omit headers on query responses so that only the argument is returned.

Examples HEADER OFF
causes the oscilloscope to omit headers from query responses.

HEADER?
might return :HEADER 1, showing that the Response Header Enable State is true.

Related Commands VERBose

HORizontal? (Query Only)

Returns all oscilloscope horizontal settings. The commands HORizontal:MAIn:SCAle, HORizontal:MAIn:SECdiv, HORizontal:SCAle, and HORizontal:SECdiv are equivalent so HORizontal:MAIn:SCAle is the only value that is returned.

Group Horizontal

Syntax HORizontal?

Examples HORIZONTAL?
might return the string :HORIZONTAL:RESOLUTION LOW;TRIGGER:POSITION 7.6E0;:HORIZONTAL:MAIN:SCALE 1.0E-3;:HORIZONTAL:DELAY:STATE 0;TIME -1.00000000E-3

HORizontal:DELay:STATE

Sets or returns the horizontal delay on or off. Delay off means that the acquisition is positioned relative to the trigger position (HORizontal:TRIGger:POSi-tion). Delay on means that the acquisition is positioned relative to the delay time (HORizontal:DELay:TIME).

Group Horizontal

Syntax	HORizontal:DELay:STATE { ON OFF } HORizontal:DELay:STATE?
Arguments	ON or <NR1> \neq 0 sets the delay on so that the acquisition is positioned relative to the delay time. OFF or <NR1> = 0 sets the delay off so that the acquisition is positioned relative to the trigger position.
Examples	HORIZONTAL:DELAY:STATE ON sets the delay state to on.

HORizontal:DELay:TIME

Sets or returns the delay time between the trigger and the center of the screen. The delay time begins at the trigger location; the acquisition is centered at the end of the delay time.

Group	Horizontal
Syntax	HORizontal:DELay:TIME <NR3> HORizontal:DELay:TIME?
Arguments	<NR3> is the time, in seconds, between the trigger and the center of the screen. It can vary from 100% pretrigger (which means the trigger point is off screen to the right), measured in seconds, to about 50 s (depending on time base setting) post trigger (which means the trigger point is off screen to the left). Delay time is positive when the trigger is located to the left of the center screen.
Examples	HORIZONTAL:DELAY:TIME 2.0E-3 sets the delay time between the trigger and the center of the screen to 2 ms.
Related Commands	HORizontal:DELay:STATE

HORizontal:MAIn:SCAle

Sets the time per division for the main time base. The specified scale value is rounded to a valid scale setting.

Group Horizontal

Syntax HORizontal:MAIn:SCAle <NR3>
HORizontal:MAIn:SCAle?

Arguments <NR3> is the time per division.
The range is 10 s to 1, 2, or 4 ns (depending on model), in a 1-2-4 sequence.

Examples HORIZONTAL:MAIN:SCALE 2E-6
sets the main scale to 2 μ s per division.

Related Commands HORizontal:DELay:TIME, HORizontal:MAIn:SECdiv

HORizontal:MAIn:SECdiv

Sets the time per division for the main time base. This command is identical to the HORizontal:MAIn:SCAle command. It is provided to maintain program compatibility with some older models of Tektronix oscilloscopes.

Group Horizontal

Syntax HORizontal:MAIn:SECdiv <NR3>
HORizontal:MAIn:SECdiv?

Related Commands HORizontal:MAIn:SCAle

HORizontal:RECORDLength

Sets the number of data points that are acquired for each record.

Group Horizontal

Syntax HORizontal:RECORDLength <NR1>
HORizontal:RECORDLength?

Arguments <NR1> is the record length in points. Valid values are 500 and 10000.

Examples HORIZONTAL:RECORDLENGTH 500
specifies that 500 data points will be acquired for each record.
HORIZONTAL:RECORDLENGTH?
might return 10000 as the number of data points per record.

Related Commands HORizontal:RESOLution

HORizontal:RESOLution

Sets the acquisition resolution (record length) to Low or High. This command performs the same function as HORizontal:RECORDLength.

Group Horizontal

Syntax HORizontal:RESOLution { LOW | HIGH }
HORizontal:RESOLution?

Arguments <LOW> sets the horizontal resolution to 500 points.
<HIGH> sets the horizontal resolution to 10,000 points.

Examples HORIZONTAL:RECORDLENGTH?
might return :HORIZONTAL:RESOLUTION HIGH.

Related Commands HORizontal:RECORDLength

HORizontal:SCAle

Sets the time per division for the main time base and is identical to the HORizontal:MAIn:SCAle command. It is provided to maintain program compatibility with some older models of Tektronix oscilloscopes.

Group Horizontal

Syntax HORizontal:SCAle <NR3>
HORizontal:SCAle?

HORizontal:SECdiv

Sets the time per division for the main time base and is identical to the HORizontal:MAIn:SCAle command. It is included here for compatibility purposes.

Group Horizontal

Syntax HORizontal:SECdiv <NR3>
HORizontal:SECdiv?

HORizontal:TRIGger:POSition

Sets or returns the position of the trigger. This is only applied when delay mode is off.

Group Horizontal

Syntax HORizontal:TRIGger:POSition <NR1>
HORizontal:TRIGger:POSition?

Arguments <NR1> is from 0 to 100 % and is the amount of pretrigger information in the waveform.

Examples HORIZONTAL:TRIGGER:POSITION?
might return :HORIZONTAL:TRIGGER:POSITION 50.

ID? (Query Only)

Returns information about the oscilloscope, including the model number, options, application modules, and firmware version.

Group	Status and Error
Syntax	ID?
Returns	The instrument id in the following format: TEK/<model number>,CF:91.1CT,FV:<firmware version number> <option/module>:<version number>
Examples	ID? might return ID TEK/TDS 3054,CF:91.1CT,FV:v1.00 TDS3GM:v1.00 TDS3FFT:v1.00 TDS3TRG:v1.00 TDS3VID:v1.00

*IDN? (Query Only)

Returns the same oscilloscope information as the ID? command except the data is formatted according to Tektronix Codes & Formats.

Group	Status and Error
Syntax	*IDN?
Returns	The instrument id in the following format: TEKTRONIX,<model number>,0,CF:91.1CT FV:<firmware version number> <option/module>:<version number>
Examples	*IDN? might return the response TEKTRONIX,TDS 3054,0,CF:91.1CT FV:v1.00 TDS3GM:v1.00 TDS3FFT:v1.00 TDS3TRG:v1.00 TDS3VID:v1.00
Related Commands	ID?

ITU601:AUTOSet (Set Only)

(TDS3000B and TDS3000C Series with TDS3SDI Only)

Executes the TDS3SDI autoseg function to automatically acquire and display the 601 digital video signal in the specified format.

Group TDS3SDI

Syntax ITU601:AUTOSet { ALLFields | ALLLines | RGB | YC | YPBPR }

Arguments ALLFields sets the oscilloscope to display the 601 digital video signal as a composite signal on channel 1, triggered on all fields.

ALLLines sets the oscilloscope to display the 601 digital video signal as a composite signal on channel 1, triggered on all lines.

RGB sets the oscilloscope to display the 601 digital video signal RGB video information on channels 2, 3, and 4.

YC sets the oscilloscope to display the 601 digital video signal YC video information on channels 3 and 4.

YPBPR sets the oscilloscope to display the 601 digital video signal YPbPr video information on channels 2, 3, and 4.

Examples ITU601:AUTOSET RGB
sets the oscilloscope to display the TDS3SDI 601 digital video signal R, G, and B components.

ITU601:EDH (Set Only)

(TDS3000B and TDS3000C Series with TDS3SDI Only)

Sets the TDS3SDI EDH error counter to zero.

Group TDS3SDI

Syntax ITU601:EDH RESET

Examples ITU601:EDH RESET
resets the TDS3SDI EDH error counter to zero.

ITU601:EDH:COUNT

(TDS3000B and TDS3000C Series with TDS3SDI Only)

Sets or returns the state of the TDS3SDI EDH error counter.

Group	TDS3SDI
Syntax	ITU601:EDH:COUNT { OFF ON <NR1> } ITU601:EDH:COUNT?
Arguments	OFF or <NR1> = 0 disables the EDH error count function. ON or <NR1> = 1 enables the EDH error count function.
Examples	ITU601:EDH:COUNT ON Enables the EDH error count function.

ITU601:EDH:DETECT? (Query Only)

(TDS3000B and TDS3000C Series with TDS3SDI Only)

Returns the state of the TDS3SDI EDH detect CRC mode. Used to indicate if the 601 digital video signal contains CRC data.

Group	TDS3SDI
Syntax	ITU601:EDH:DETECT?
Examples	ITU601:EDH:DETECT? might return the response ITU601:EDH:DETECT ON, indicating that EDH CRC error detection is enabled.

ITU601:EDH:NUMERRors? (Query Only)

(TDS3000B and TDS3000C Series with TDS3SDI Only)

Returns the number of errors stored in the TDS3SDI EDH error counter.

Group	TDS3SDI
Syntax	ITU601:EDH:NUMERRors?
Examples	ITU601:EDH:NUMERRORS? might return the response ITU601:EDH:NUMERRORS 0, indication that the EDH error counter value is zero (no errors).

ITU601:INPUT:FORMat

(TDS3000B and TDS3000C Series with TDS3SDI Only)

Sets or returns the TDS3SDI 601 digital video input signal format.

Group	TDS3SDI
Syntax	ITU601:INPUT:FORMat { AUTO F525 F625 <NR1> } ITU601:INPUT:FORMat?
Arguments	AUTO or <NR1> ≥ 3 sets the oscilloscope to automatically detect and set the input signal format. F525 or <NR1> ≤ 1 sets the oscilloscope to trigger on 525-line 601 digital video signals. F625 or <NR1> = 2 sets the oscilloscope to trigger on 625-line 601 digital video signals.
Examples	ITU601:INPUT:FORMAT AUTO sets the oscilloscope to automatically detect and set the 601 digital video signal input format.

ITU601:INPUT:SIGnalstrength? (Query Only)

(TDS3000B and TDS3000C Series with TDS3SDI Only)

Returns the value of the TDS3SDI input signal strength parameter. The signal strength value is an integer in the range of 0 to 5, where 0 = no signal present and 5 = maximum signal strength.

Group TDS3SDI

Syntax ITU601:INPUT:SIGnalstrength?

Examples ITU601:INPUT:SIGNALSTRENGTH?
might return the response ITU601:INPUT:SIGNALSTRENGTH 1.

ITU601:INPUT:STATE? (Query Only)

(TDS3000B and TDS3000C Series with TDS3SDI Only)

Returns the TDS3SDI input signal state value. Valid return values are MISSING (no 601 digital signal is present), S525 (an S525 601 digital signal is present), and S625 (an S625 601 digital signal is present).

Group TDS3SDI

Syntax ITU601:INPUT:STATE?

Examples ITU601:INPUT:STATE?
might/sets return the response ITU601:INPUT:STATE? MISSING, indicating that there is no 601 digital video signal connected to the TDS3SDI module.

ITU601:OUTput:FORMat

(TDS3000B and TDS3000C Series with TDS3SDI Only)

Sets or returns the TDS3SDI video signal output display format.

Group TDS3SDI

Syntax ITU601:OUTput:FORMat { OFF | GBR | RGB | YC | YPBPR }
ITU601:OUTput:FORMat?

Arguments OFF sets the TDS3SDI module to turn off its signal output.
GBR sets the TDS3SDI module to output GBR color signal information.
RGB sets the TDS3SDI module to output RGB color signal information.
YC sets the TDS3SDI module to output YC color signal information.
YPBPR sets the TDS3SDI module to output YPbPr color signal information.

Examples ITU601:OUTPUT:FORMAT RGB
sets the TDS3SDI module to output the 601 digital video signal information in RGB format.

LANGuage

Sets or returns the user interface display language. This command only affects the oscilloscope displayed language; remote commands and their responses are always in English.

Group Miscellaneous

Syntax LANGuage { ENGLish | FRENch | GERMan | ITALian | PORTUguese | SPANish | RUSSian | JAPANese | KOREan | TRADitionalchinese | SIMPLifiedchinese }
LANGuage?

Examples LANGUAGE?
might return : LANGUAGE ENGLISH

LIMit? (Query Only)*(Requires TDS3LIM)*

Returns all limit testing parameters.

Group	Limit Test
Syntax	LIMit?
Examples	<p>LIMIT?</p> <p>might return:</p> <pre>:LIMIT:BEEP OFF; COMPARE:CH1 REF1;CH2 NONE;CH3 NONE;CH4 NONE; :LIMIT:HARDCOPY OFF;SAVEWFM OFF;STATE OFF;STOPONVIOLATION OFF;TEMPLATE:DESTINATION REF1;SOURCE CH1;TOLERANCE:HORIZONTAL 4.0E-2;VERTICAL 4.0E-2.</pre>

LIMit:BEEP*(Requires TDS3LIM)*

Sets or returns the TDS3LIM beep on error setting. The beep sounds when the waveform data exceeds the limits set in the limit test, if the limit state is on.

Group	Limit Test
Syntax	<pre>LIMit:BEEP { OFF ON <NR1> }</pre> <pre>LIMit:BEEP?</pre>
Arguments	<p>OFF or <NR1> = 0 turns off the beep when any waveform data exceeds the limits set by the limit test.</p> <p>ON or <NR1> \neq 0 turns on the beep.</p>
Examples	<p>LIMIT:BEEP ON</p> <p>specifies that the beep is to sound when any waveform data exceeds the limits specified in the limit test.</p> <p>LIMIT:BEEP?</p> <p>returns either 0 or 1, indicating whether the beep is to sound when any waveform data exceeds the limits specified in the limit test.</p>

LIMit:COMPARE:CH<x>

(Requires TDS3LIM)

Sets or returns the template against which to compare the waveform acquired through the specified channel. The template can be a waveform saved in any of the reference locations REF1 through REF4, or none.

Group Limit Test

Syntax LIMit:COMPARE:CH<x> { NONE | REF<x> }
LIMit:COMPARE:CH<x>?

Arguments Ch<x> is a channel, where <x> is 1, 2, 3, or 4.
NONE turns off limit testing for the specified channel.
REF<x> is a reference waveform, where <x> is 1, 2, 3, or 4.

Examples LIMIT:COMPARE:CH1 REF1
specifies REF1 as the template waveform against which to compare waveforms acquired on CH1.
LIMIT:COMPARE:CH2?
might return LIMIT:COMPARE:CH2 REF4, indicating that waveforms acquired on CH2 will be compared to the limit test template waveform stored in REF4.

Related Commands CURve, LIMit:TEMPLate, LIMit:TEMPLate:DESTination, LIMit:TEMPLate:SOURce, WFMPre

LIMit:HARDCopy

(Requires TDS3LIM)

Sets or returns the TDS3LIM hard copy on error setting. When ON, this command executes a screen hard copy operation when any waveform data exceeds the limits set in the limit test, if the limit state is on. The hard copy operation uses the port, format, and layout settings specified using the HARD-Copy commands.

Group Limit Test

Syntax LIMit:HARDCopy { OFF | ON | <NR1> }

LIMit:HARDCopy?

Arguments ON or <NR1> \neq 0 turns on the hard copy operation when any waveform data exceeds the limits set by the limit test.

OFF or <NR1> = 0 turns off the hard copy operation.

Examples LIMit:HARDCopy ON
specifies that the hard copy operation occurs when any waveform data exceeds the limits specified in the limit test.

LIMit:HARDCopy?
returns either 0 or 1, indicating whether the hard copy operation occurs when any waveform data exceeds the limits specified in the limit test.

Related Commands LIMit:COMPARE:CH<x>, LIMit:STATE, HARDCopy

LIMit:SAVEWFM

(Requires TDS3LIM)

Sets or returns the TDS3LIM save waveform to file on limit test failure setting. When enabled, this command copies waveform data from all active waveforms that have limit test failures to a file on the disk or flash drive. The file format is specified by the SAVE:WAVEform:FILEFormat command. Set the file save format to Internal File Format to minimize file size.

Group Limit Test

Syntax LIMit:SAVEWFM { OFF | ON | <NR1> }

LIMit:SAVEWFM?

Arguments OFF or <NR1> = 0 turns off save waveform to disk or flash drive for limit testing.

ON or <NR1> \neq 0 turns on save waveform to disk or flash drive for limit testing.

Examples LIMit:SAVEWFM ON
specifies that save waveform to disk or flash drive is in effect.

LIMIT:STATE?

returns either 0 or 1, indicating whether save waveform to disk or flash drive is in effect.

Related Commands SAVEWFM, SAVE:WAVEform:FILEFormat

LIMit:STATE

(Requires TDS3LIM)

Turns limit testing on or off, or returns whether limit testing is in effect.

Group Limit Test

Syntax LIMit:STATE { OFF | ON | <NR1> }
LIMit:STATE?

Arguments OFF or <NR1> = 0 turns off limit testing.
ON or <NR1> ≠ 0 turns on limit testing.

Examples LIMIT:STATE ON
specifies that limit testing of waveforms is in effect.

LIMIT:STATE?
returns either 0 or 1, indicating whether limit testing of waveforms is in effect.

Related Commands CURve, LIMit:BEEP, LIMit:COMPARE:CH<x>, LIMit:HARDCopy, LIMit:TEMPLate, WFMPre

LIMit:STOPOnviolation

(Requires TDS3LIM)

Sets or returns the TDS3LIM stop on violation setting. When enabled, this command stops waveform acquisitions on the first occurrence of a limit test violation. LIMit:STATE must be ON for the oscilloscope to detect violations.

Group Limit Test

Syntax	LIMit:STOPOnviolation { OFF ON } LIMit:STOPOnviolation?
Arguments	OFF = 0 turns off the stop on violation. ON \neq 0 turns on the stop on violation.
Examples	LIMIT:STOPOnviolation? might return OFF that indicates the stop on violation is turned off.
Related Commands	MASK:STOPOnviolation

LIMit:TEMPLate (Set Only)

(Requires TDS3LIM)

Uses the values specified by LIMit:TEMPLate:SOUrce, LIMit:TEMPLate:TOLerance:HORIZontal, and LIMit:TEMPLate:TOLerance:VERTical to create a limit test template and store the template in the reference waveform memory location specified in LIMit:TEMPLate:DESTination. You can compare the waveform acquired through the specified channel against this template. The template can be a waveform saved in any of the reference locations REF1 through REF4.

Group	Limit Test
Syntax	LIMit:TEMPLate STORE
Arguments	STORE creates a template with the specified source waveform and tolerances, and stores it in the destination reference waveform to be used in limit testing comparisons.
Examples	LIMIT:TEMPLATE STORE creates a template with the specified source waveform and tolerances, and stores it in the destination reference waveform to be used in limit testing comparisons.
Related Commands	LIMit:TEMPLate:DESTination, LIMit:TEMPLate:SOUrce

LIMit:TEMPLate:DESTination

(Requires TDS3LIM)

Sets or returns the destination reference waveform that the LIMit:TEMPLate STORE command will use.

Group Limit Test

Syntax LIMit:TEMPLate:DESTination REF<x>
LIMit:TEMPLate:DESTination?

Arguments REF<x> specifies the reference waveform destination in which the template waveform is to be stored.

Examples LIMIT:TEMPLATE:DESTINATION REF2
specifies that the template waveform referred to with the LIMit:TEMPLate STORE command is stored as the REF2 waveform.

Related Commands LIMit:COMPARE:CH<x>, LIMit:TEMPLate, LIMit:TEMPLate:SOURce

LIMit:TEMPLate:SOURce

(Requires TDS3LIM)

Sets or returns the source channel, or reference waveform that LIMit:TEMPLate STORE will use in deriving the limit test template waveform.

Group Limit Test

Syntax LIMit:TEMPLate:SOURce { CH<x> | REF<x> }
LIMit:TEMPLate:SOURce?

Arguments CH<x> specifies that the template waveform source is the waveform currently being acquired using the specified channel.

REF<x> specifies that the template waveform source is the waveform currently stored as the specified reference waveform.

Examples `LIMIT:TEMPLATE:SOURCE CH2`
specifies that the template waveform for limit tests is the waveform currently acquired using channel 2.

`LIMIT:TEMPLATE:SOURCE?`
might return `CH2`, specifying that the template waveform source for limit tests is the waveform currently stored as the channel 2 waveform.

Related Commands `LIMit:COMPARE:CH<x>`, `LIMit:TEMPLate`, `LIMit:TEMPLate:DESTination`

LIMit:TEMPLate:TOLerance:HORizontal

(Requires TDS3LIM)

Sets or returns the amount, in units of horizontal divisions, by which the source waveform is varied horizontally when creating the destination template waveform.

Group Limit Test

Syntax `LIMit:TEMPLate:TOLerance:HORizontal <NR3>`
`LIMit:TEMPLate:TOLerance:HORizontal?`

Arguments `<NR3>` is the amount, in horizontal divisions, by which the source waveform is horizontally modified to generate the template that is stored in the destination reference. The range is 0 to 5 divisions.

Examples `LIMIT:TEMPLATE:TOLERANCE:HORIZONTAL 1.0`
specifies that the source waveform is modified horizontally by ± 1.0 horizontal division when generating the template waveform.

`LIMIT:TEMPLATE:TOLERANCE:HORIZONTAL?`
might return `1.0`, specifying that the source waveform is modified horizontally by ± 1.0 horizontal division when generating the template waveform.

Related Commands `LIMit:COMPARE:CH<x>`

LIMit:TEMPLate:TOLerance:VERTical

(Requires TDS3LIM)

Sets or returns the amount, in units of vertical divisions, by which the source waveform is varied vertically when creating the destination waveform.

Group Limit Test

Syntax LIMit:TEMPLate:TOLerance:VERTical <NR3>
LIMit:TEMPLate:TOLerance:VERTical?

Arguments <NR3> is the amount, in vertical divisions, by which the source waveform is varied vertically when creating the test waveform. The range is 0 to 5 divisions.

Examples LIMIT:TEMPLATE:TOLERANCE:VERTICAL 1.0
specifies that the source waveform is vertically varied by ± 1.0 vertical division when creating this test waveform.

LIMIT:TEMPLATE:TOLERANCE:VERTICAL?
might return 1.0, specifying that the source waveform is vertically varied by ± 1.0 vertical division when creating this test waveform.

Related Commands LIMit:COMPARE:CH<x>

LOCK

Sets or returns the front panel lock state. This command lets you disable all front-panel buttons and knobs to prevent manual instrument setting changes while remotely controlling the oscilloscope. There is no front-panel equivalent.

Group Miscellaneous

Syntax LOCK { ALL | NONE }
LOCK?

Arguments ALL disables all front-panel controls.
NONE enables all front-panel controls. This is equivalent to the UNLOCK ALL command.

NOTE. *If the oscilloscope is in the Remote With Lockout State (RWLS), the LOCK NONE command has no effect. For more information, see the ANSI-IEEE Std. 488.1-1987 Standard Digital Interface for Programmable Instrumentation, section 2.8.3 on RL State Descriptions.*

Examples LOCK?
returns NONE when the front-panel controls are enabled by this command.
LOCK ALL
locks the front-panel controls.

Related Commands UNLOCK

***LRN? (Query Only)**

Returns a string listing the oscilloscope settings. You can use this string to return the oscilloscope to the state it was in when you made the *LRN? query.

Group Miscellaneous

Related Commands HEADer, SET?, VERBoSe

Syntax *LRN?

NOTE. The *LRN? query always returns a string including command headers, regardless of the setting of the HEADer command. This is because the returned string is intended to be sent back to the oscilloscope as a command string. The VERBoSe command can still be used normally to specify whether the returned headers should be abbreviated.

Examples

*LRN?

a partial response might look like this:

```
:HEADER 1;:VERBOSE 1;:ALIAS:STATE 1;:ACQUIRE:MODE
SAMPLE;NUMAVG 16;NUMENV 16;STATE 1;STOPAFTER
RUNSTOP;:DISPLAY:COLOR:PALETTE:REGULAR NORMAL;:DISPLAY:STYLE:DOT-
SONLY 0;:DISPLAY:PERSISTENCE 0.0E0;CLOCK 0;GRATICULE
FULL;INTENSITY:WAVEFORM 65;BACKLIGHT HIGH;:DISPLAY:XY:MODE
OFF;YCHANNEL CH2;YREF OFF;:SELECT:CH1 0;CH2 1;CH3 0;CH4 0;MATH
0;REF1 0;REF2 0;REF3 0;REF4 0;CONTROL CH2;:HARDCOPY:FORMAT
PCXCOLOR;PORT FILE;LAYOUT LANDSCAPE;:HORIZONTAL:RESOLUTION
LOW;TRIGGER:POSITION 1.02E1;:HORIZONTAL:MAIN:SCALE
2.0E-4;:HORIZONTAL:DELAY:STATE 0;
```

MASK:AUTOFit**(Requires TDS3TMT)**

Sets or returns the autofit radius setting used for waveform positioning. Autofit does an incremental waveform position redraw to attempt to fit the waveform to a mask. MASK:DISplay must be On to enable Autofit functionality.

Group Mask

Syntax MASK:AUTOFit { <NR1> | OFF }

MASK:AUTOFit?

Arguments <NR1> is an integer number from 0 to 10, where 0 turns the autofit function off, and 1-10 turns the autofit function on and defines the autofit radius. Autofit repositions the waveform in 1-pixel increments to attempt to fit the waveform to a mask. The Autofit radius defines the size of a square search grid radius of $(2 \times \text{radius} + 1) \times (2 \times \text{radius} + 1)$ pixels, centered on the waveform position.

Autofit moves the waveform using a spiral pattern, testing for mask violations at each position. For example, the following table represents a spiral pattern for a radius value of two, where the number in the table represents the order of the waveform moves, and the position of the number represents the position the waveform is offset relative to the starting point (●). A radius of two attempts to fit the waveform in 25 tries (start position plus 24).

9	10	11	12	13
24	1	2	3	14
23	8	●	4	15
22	7	6	5	16
21	20	19	18	17

OFF sets the autofit function off.

Examples MASK:AUTOFIT OFF
turns autofit off.

MASK:COpy:SOUrce

(Requires TDS3TMT)

Sets or returns the mask standard to copy to the User mask when the MASK:COpy:USER command is executed.

Group Mask

Syntax MASK:COpy:SOUrce { CLOCKCoax | CLOCKSymmetrical | DS0Contra
| DS0Double | DS0Single | DS0Timing | DS1C | DS1Rate | DS2
| DS2RATECoax | DS2RATESymmetrical | DS3Rate | E1Coax
| E1Symmetrical | E2 | E3 | G703DS1 | G703DS3 | NONE | RATE32Mbit
| STS1Pulse }

MASK:COpy:SOUrce?

Arguments CLOCKCoax through STS1Pulse are the telecom mask test standards available in TDS3TMT that you can copy to the user mask location.

Examples MASK:COpy:SOURCE E1COAX
sets ITU-T E1 coaxial (2.048 Mb/s) as the mask standard to copy to the user mask location when MASK:COpy:USER is executed.

Related Commands MASK:COpy:USER

MASK:COpy:USER

(Requires TDS3TMT)

Copies the mask defined by MASK:COpy:SOUrce to the user mask.

Group Mask

Syntax MASK:COpy:USER

Examples MASK:COpy:USER
copies the mask defined by MASK:COpy:SOUrce to the user mask.

Related Commands MASK:COpy:SOUrce

MASK:COUNT:CH<x>:HITS? (Query Only)

(Requires TDS3TMT)

Returns the total hits on all mask segments for the specified channel. Hit counting must be turned on (MASK:COUNT:STATE and MASK:DISplay to ON).

Group	Mask
Syntax	MASK:COUNT:CH<x>:HITS?
Arguments	<x> is an integer in the range of 1 to 4 that sets which scope channel to query for mask hits.
Examples	MASK:COUNT:CH2:HITS? might return 138.

MASK:COUNT:FAILURES? (Query Only)

(Requires TDS3TMT)

Returns the number of pass/fail tests that have failed. When MASK:TEST:REPeat is 1, this query returns the number of failed tests, and MASK:COUNT:TESTS? returns the total number of tests.

Group	Mask
Syntax	MASK:COUNT:FAILURES?
Examples	MASK:COUNT:FAILURES? might return 54.
Related Commands	MASK:TEST:REPeat, MASK:COUNT:TESTS?

MASK:COUNT:HITS? (Query Only)

(Requires TDS3TMT)

Returns the total number of mask hits for all channels on all mask segments.

Group Mask

Syntax MASK:COUNT:HITS?

Examples MASK:COUNT:HITS?
might return 564.

Related Commands MASK:COUNT:FAILURES?, MASK:COUNT:CH<c>:HITS?

MASK:COUNT:MASK<m>:CH<x>:HITS? (Query Only)

(Requires TDS3TMT)

Returns the number of hits for channel <x> in mask segment <m>. A mask segment is one of the polygons that make up a mask.

Group Mask

Syntax MASK:COUNT:MASK<m>:CH<x>:HITS?

Arguments <m> is the mask segment number, with a valid range of 1-8.
<x> is the oscilloscope channel, with a valid range of 1-4.

Examples MASK:COUNT:MASK2:CH4:HITS?
might return 14.

Related Commands MASK:COUNT:CH<x>:HITS?, MASK:COUNT:FAILURES?,
MASK:COUNT:HITS?, MASK:COUNT:MASK<m>:HITS?

MASK:COUNT:MASK<m>:HITS? (Query Only)

(Requires TDS3TMT)

Returns the number of hits for all channels in the specified mask segment.

Group Mask

Syntax MASK:COUNT:MASK<m>:HITS?

Arguments <m> is the mask segment number, with a valid range of 1-8.

Examples MASK:COUNT:MASK1:HITS?
might return 124.

Related Commands MASK:COUNT:CH<x>:HITS?, MASK:COUNT:FAILURES?, MASK:COUNT:HITS?
MASK:COUNT:MASK<m>:CH<x>:HITS?

MASK:COUNT:STATE

(Requires TDS3TMT)

Sets or returns the mask hits count state. MASK:DISplay must be ON to enable MASK:COUNT:STATE to count mask violations.

Group Mask

Syntax MASK:COUNT:STATE { OFF | ON | <NR1> }
MASK:COUNT:STATE?

Arguments ON turns on mask hit counting.
OFF turns off mask hit counting.
<NR1> is an integer number where NR1 = 0 turns off mask hit counting, and NR1 ≠ 0 turns on mask hit counting.

Examples MASK:COUNT:STATE ON
turns on mask hit counting.

MASK:COUNT:TESTS? (Query Only)

(Requires TDS3TMT)

Returns the number of pass/fail tests that have occurred when MASK:TEST:REPEAT is turned on.

Group Mask

Syntax MASK:COUNT:TESTS?

Examples MASK:COUNT:TESTS?
might return 50.

Related Commands MASK:COUNT:FAILURES?

MASK:COUNT:TOTAL? (Query Only)

(Requires TDS3TMT)

Returns the sum of all hits in all mask segments. This command is the same as MASK:COUNT:HITS? and is kept for compatibility with other Tektronix oscilloscopes.

Group Mask

Syntax MASK:COUNT:TOTAL?

Examples MASK:COUNT:TOTAL?
might return 560.

Related Commands MASK:COUNT:HITS?

MASK:COUNT:VIOLATIONS? (Query Only)

(Requires TDS3TMT)

Returns the number of test violations which have occurred in the current pass/fail test. A test violation occurs when any part of a channel waveform falls within any mask segment.

Group Mask

Syntax MASK:COUNT:VIOLATIONS?

Examples MASK:COUNT:VIOLATIONS?
might return 560.

Related Commands MASK:COUNT:TESTS?, MASK:COUNT:TOTa1?, MASK:COUNT:WAVEFORMS?

MASK:COUNT:WAVEFORMS? (Query Only)

(Requires TDS3TMT)

Returns the number of waveforms which have been acquired and processed during the current pass/fail test.

Group Mask

Syntax MASK:COUNT:WAVEFORMS?

Examples MASK:COUNT:WAVEFORMS?
might return 1000.

Related Commands MASK:COUNT:TESTS?, MASK:COUNT:TOTa1?, MASK:COUNT:VIOLATIONS?

MASK:DISplay

(Requires TDS3TMT)

Sets or returns the mask violation detection and display status. Enabling detection and display causes waveform points which violate the mask to be displayed in an intensified color so that mask violation points are clearly visible on the display. MASK:DISplay is set to ON if MASK:TEST:STATE, MASK:COUNt:STATE, or MASK:STOPOnviation are set to ON.

Group Mask

Syntax MASK:DISplay { OFF | ON | <NR1> }
MASK:DISplay?

Arguments OFF turns off mask violation detection and display.
ON turns on mask violation detection and display.
<NR1> is an integer number where NR1 = 0 turns off mask violation detection and display, and NR1 ≠ 0 turns on mask violation detection and display.

Examples MASK:COUNT:WAVEFORMS ON
sets the oscilloscope to detect and highlight mask violations.

MASK:LOCK

(Requires TDS3TMT)

Sets or returns the mask lock to waveform mode. Mask lock locks the mask to the waveform such that changes to the horizontal and/or vertical scale settings redraws the mask segments in proportion. This feature allows for expanding horizontal and/or vertical settings to zoom in on waveforms and masks to visually examine violation areas in more detail. You can only use Mask Lock on stopped acquisitions or when pass/fail testing is not running.

Group Mask

Syntax MASK:LOCK { OFF | ON | <NR1> }
MASK:LOCK?

Arguments	OFF turns off mask lock to waveform. ON turns on mask lock to waveform. <NR1> is an integer number where NR1 = 0 turns off mask lock to waveform, and NR1 ≠ 0 turns on mask lock to waveform.
Examples	MASK:LOCK OFF turns off mask lock to waveform.

MASK:MARGIN:VERTical

(Requires TDS3TMT)

Sets or returns the User mask's vertical margin percentage. This command redraws the vertical mask margins by the specified percentage, where the vertical margin percent is the percentage of the User mask's nominal pulse amplitude. This command affects all segments in the User mask. Segment vertical margins move away from the nominal waveform pulse position for positive percentage values, and towards the nominal waveform pulse position for negative percentage values. This command only operates on User (custom) masks.

Group	Mask
Syntax	MASK:MARGIN:VERTical <NR3> MASK:MARGIN:VERTical?
Arguments	<NR3> is a real number that sets the User mask margins as a percentage of the user mask's nominal pulse amplitude.
Examples	MASK:MARGIN:VERTICAL 5 Increases the User mask vertical dimensions by 5%.

MASK:MASK<m> DELEte

(Requires TDS3TMT)

Deletes the specified mask segment from the User mask, whether or not the User mask is the current mask.

Group Mask

Syntax MASK:MASK<m> DELEte

Arguments <m> is an integer number that specifies the User mask segment number to delete from the User mask

Examples MASK:MASK2 DELETE
deletes mask segment 2 from the User mask

MASK:MASK<m>:COUNT? (Query Only)

(Requires TDS3TMT)

Returns the number of hits on the specified mask segment in the current mask. To enable hits counting, set MASK:COUNT:STATE to ON.

Group Mask

Syntax MASK:MASK<m>:COUNT?

Arguments <m> is an integer number that specifies a mask segment number in the current mask.

Examples MASK:MASK1:COUNT
might return MASK:MASK1:COUNT 856.

MASK:MASK<m>:NR_Pt? (Query Only)

(Requires TDS3TMT)

Returns the number of points that make up the specified mask segment of the currently-displayed mask. Each mask point consists of an X-Y pair of coordinates.

Group	Mask
Syntax	MASK:MASK<m>:NR_Pt?
Arguments	<m> is an integer number that specifies a mask segment number in the currently-displayed mask.
Examples	MASK:MASK2:NR_PT? might return MASK:MASK:NR_Pt 5

MASK:MASK<m>:POINTS

(Requires TDS3TMT)

Sets or returns the X-Y coordinates of all points in the specified mask segment referenced to the mask's nominal horizontal and vertical scale. The query form returns point coordinates from the displayed mask. The set form defines new points in the User mask, replacing any existing points in the specified User mask segment.

Group	Mask
Syntax	MASK:MASK<m>:POINTS <NR3>, <NR3> [, <NR3>, <NR3>] MASK:MASK<m>:POINTS?

Arguments <m> specifies the mask segment number in the current mask (query form), or the User mask (set form).

<NR3> refers to the coordinates of one of the vertices in the mask. Each pair of numbers is the horizontal and vertical coordinates of a mask segment vertex. The pairs must be listed in a counterclockwise order. If the vertical or horizontal scale or position is changed after this command and then the query form of this command is issued, then the value returned will not be the same. If just one pair is input then they are ignored and the mask segment is marked as undefined. The default is no points in the mask segment.

Examples MASK:MASK2:POINTS -200e-9, 1.2, 200e-9, 1.2, 0.0, 2.4
defines the points in mask segment 2.

MASK:MASK<m>:POINTSNorm

(Requires TDS3TMT)

Sets or returns the normalized coordinate points of the specified mask segment. Each point is defined as an X-Y pair, where the first value in the pair is the X coordinate, and the second value in the pair is the Y coordinate. Values are normalized values based on the amplitude and pulse width of the current standard.

The query form of this command returns the point coordinates of the specified mask segment of the current mask standard. The set form of this command only affects the User mask, regardless of the current mask standard. Any currently existing points in the User mask segment are deleted.

Group Mask

Syntax MASK:MASK<m>:POINTSNorm <NR3>, <NR3> [, <NR3>, <NR3>]
MASK:MASK<m>:POINTSNorm?

Arguments <NR3> is a floating point number that defines a normalized mask point.

Examples MASK:MASK3:POINTSNORM?
might return -0.66, 0.4, 0.1598, 0.4, -0.25, 0.8

MASK:MASK<m>:POINTSPcnt*(Requires TDS3TMT)*

Sets or returns the points in the specified mask segment, in graticule percentage coordinates. Each point is defined as an X-Y pair, where the first value in the pair is the X coordinate, and the second value in the pair is the Y coordinate. Values are screen-based percentages where 0.0, 0.0 is the upper-left corner of the graticule, and 100.0, 100.0 is the lower-right corner of the graticule.

The query form of this command returns the point coordinates of the specified mask segment of the current mask standard. The set form of this command only affects the User mask, regardless of the current mask standard. Any currently existing points in the User mask segment are deleted.

Group Mask

Syntax MASK:MASK<m>:POINTSPcnt <NR3>, <NR3> [, <NR3>, <NR3>]
 MASK:MASK<m>:POINTSPcnt?

Arguments <m> is the mask segment number.

<NR3> refers to the coordinates of one of the vertexes in the mask. Each pair of NR3 values is the horizontal and vertical coordinates of a mask vertex. The pairs must be listed in counterclockwise order. Resolution of NR3 is to the nearest pixel.

A mask segment cannot horizontally fold back on itself.

To define a User mask segment as an upper segment, the upper mask segment must have a single horizontal line segment on its top edge. Similarly, to define a User mask segment as a lower segment, the lower mask segment must have a single horizontal line segment on its bottom edge.

Examples MASK:MASK3:POINTSPCNT 17.8, 56.5, 57.8, 56.5, 37.8, 31.5
 defines the points in mask segment 3.

MASK:MASKPRE:AMPLitude

(Requires TDS3TMT)

Sets or returns the current mask's nominal pulse amplitude in volts. The query form of this command returns the nominal pulse amplitude of the displayed mask. The set form of this command only affects the User mask, regardless of the current (displayed) mask.

Group Mask

Syntax MASK:MASKPRE:AMPLitude <NR3>
MASK:MASKPRE:AMPLitude?

Arguments <NR3> is a floating-point number that sets the nominal pulse amplitude in volts.

Examples MASK:MASKPRE:AMPLITUDE 2.4
sets the User mask nominal pulse amplitude to 2.4 volts.

Related Commands MASK:MASKPRE:VSCALE

MASK:MASKPRE:HSCALE

(Requires TDS3TMT)

Sets or returns the nominal timing resolution used to draw the mask, in time/division. The query form of this command returns the nominal timing resolution of the displayed mask. The set form of this command only affects the User mask, regardless of the current (displayed) mask.

Group Mask

Syntax MASK:MASKPRE:HSCALE <NR3>
MASK:MASKPRE:HSCALE?

Arguments <NR3> is a floating point number that sets the mask drawing timing resolution.

Examples MASK:MASKPRE:HSCALE 40e-9
sets the nominal timing resolution used to draw the current standard's pulse shape to 40 nanoseconds per division.

Related Commands MASK:MASKPRE:HTRIGPOS

MASK:MASKPRE:HTRIGPOS

(Requires TDS3TMT)

Sets or returns the nominal trigger position (pulse leading edge) used to draw the mask as a fraction of the display width. The query form of this command returns the nominal trigger position of the displayed mask. The set form of this command only affects the User mask, regardless of the current (displayed) mask.

Group Mask

Syntax MASK:MASKPRE:HTRIGPOS <NR3>
MASK:MASKPRE:HTRIGPOS?

Arguments <NR3> is a floating point number in the range of 0 to 1 that sets the trigger point as a fraction of the display width, referenced from the left edge of the graticule.

Examples MASK:MASKPRE:HTRIGPOS 0.6
sets the User mask nominal pulse leading edge position to the 6th horizontal graticule division.

Related Commands MASK:MASKPRE:HSCALE?

MASK:MASKPRE:PATTERNBITS

(Requires TDS3TMT)

Sets or returns the number of bits used for serial trigger for the current standard. For example, DS1 requires six bits; four leading zeros, a one, and a trailing zero. The query form of this command returns the serial bit value of the displayed mask. The set form of this command only affects the User mask, regardless of the current (displayed) mask.

Group Mask

Syntax MASK:MASKPRE:PATTERNBITS <NR1>
MASK:MASKPRE:PATTERNBITS?

Arguments <NR1> is an integer that sets the number of bits.

Examples MASK:MASKPRE:PATTERNBITS 6
sets the User mask number of serial pattern bits to 6.

Related Commands MASK:MASKPRE:PRESAMPBITS
MASK:MASKPRE:SERIALTRIG

MASK:MASKPRE:PRESAMPBITS

(Requires TDS3TMT)

Sets or returns the number of bits before the (isolated one) pulse leading edge in serial trigger pass/fail testing. For example, DS1 has four leading zeros. The query form of this command returns the presample bit value of the displayed mask. The set form of this command only affects the User mask, regardless of the current (displayed) mask.

Group Mask

Syntax MASK:MASKPRE:PRESAMPBITS <NR1>
MASK:MASKPRE:PRESAMPBITS?

Arguments <NR1> is an integer number that sets the number of bits before the trigger pulse.

Examples MASK:MASKPRE:PRESAMPBITS 4
sets the User mask number of bits before the trigger pulse to 4.

Related Commands MASK:MASKPRE:PATTERNBITS
MASK:MASKPRE:SERIALTRIG

MASK:MASKPRE:RECOrdlength

(Requires TDS3TMT)

Sets or returns the nominal record length for pulse mask testing. The query form of this command returns the record length value of the displayed mask. The set form of this command only affects the User mask, regardless of the current (displayed) mask.

Group Mask

Syntax MASK:MASKPRE:RECOrdlength <NR1>
MASK:MASKPRE:RECOrdlength?

Arguments <NR1> is an integer number that sets the record length. All values other than 500 are ignored.

Examples MASK:MASKPRE:RECORDLENGTH 500
sets the User mask record length to 500 points.

MASK:MASKPRE:SERIALTRIG

(Requires TDS3TMT)

Sets or returns enabling of serial trigger pass/fail testing for the current mask standard. The query form of this command returns the serial trigger setting of the displayed mask. The set form of this command only affects the User mask, regardless of the current (displayed) mask.

Group Mask

Syntax MASK:MASKPRE:SERIALTRIG { OFF | ON | <NR1>}
MASK:MASKPRE:SERIALTRIG?

Arguments	OFF disables serial triggering. ON enables serial triggering. <NR1> is an integer number where NR1 = 0 turns off serial triggering, and NR1 ≠ 0 turns on serial triggering.
Examples	MASK:MASKPRE:SERIALTRIG 1 turns on serial triggering for the User mask.
Related Commands	MASK:MASKPRE:PATTERNBITS?, MASK:MASKPRE:PRESAMPBITS

MASK:MASKPRE:TRIGTOSAMP

(Requires TDS3TMT)

Sets or returns the time, in seconds, from the (leading edge) trigger position to the pulse bit sampling position. The query form of this command returns the time value of the displayed mask. The set form of this command only affects the User mask, regardless of the current (displayed) mask.

Group	Mask
Syntax	MASK:MASKPRE:TRIGTOSAMP <NR3> MASK:MASKPRE:TRIGTOSAMP?
Arguments	<NR3> is a floating point number that sets the time to the pulse bit sampling position.
Examples	MASK:MASKPRE:TRIGTOSAMP 162e-9 sets the User mask time from the (leading edge) trigger position to the pulse bit sampling position to 162 nanoseconds.
Related Commands	MASK:MASKPRE:WIDTH

MASK:MASKPRE:VOFFSet

(Requires TDS3TMT)

Sets or returns the nominal vertical offset, in volts, used to vertically offset the input channels. The query form of this command returns the offset value of the displayed mask. The set form of this command only affects the User mask, regardless of the current (displayed) mask.

Group Mask

Syntax MASK:MASKPRE:VOFFSet <NR3>
MASK:MASKPRE:VOFFSet?

Arguments <NR3> is a floating point number that sets the nominal vertical offset in volts.

Examples MASK:MASKPRE:VOFFSET 0.0
sets the User mask nominal vertical offset to 0.0 volts.

Related Commands MASK:MASKPRE:VPOS, MASK:MASKPRE:VSCA1e

MASK:MASKPRE:VPOS

(Requires TDS3TMT)

Sets or returns the nominal vertical position, in divisions, used to vertically position the input channels. The query form of this command returns the vertical position value of the displayed mask. The set form of this command only affects the User mask, regardless of the current (displayed) mask.

Group Mask

Syntax MASK:MASKPRE:VPOS <NR3>
MASK:MASKPRE:VPOS?

Arguments <NR3> is a floating point number that sets the nominal vertical position in divisions.

Examples MASK:MASKPRE:VPOS -0.8
sets the User mask nominal vertical position to -0.8 divisions.

Related Commands MASK:MASKPRE:VOFFSet, MASK:MASKPRE:VPOS, MASK:MASKPRE:VSCALE

MASK:MASKPRE:VSCALE

(Requires TDS3TMT)

Sets or returns the nominal vertical scale, in volts per division, used to vertically scale the input channels. The query form of this command returns the vertical scale value of the displayed mask. The set form of this command only affects the User mask, regardless of the current (displayed) mask.

Group Mask

Syntax MASK:MASKPRE:VSCALE <NR3>
MASK:MASKPRE:VSCALE?

Arguments <NR3> is a floating point number that sets the nominal vertical scale in volts per division.

Examples MASK:MASKPRE:VSCALE 200e-3
sets the User mask nominal vertical scale to 200 millivolts per division.

Related Commands MASK:MASKPRE:VOFFSet, MASK:MASKPRE:VPOS

MASK:MASKPRE:WIDTH

(Requires TDS3TMT)

Sets or returns the nominal bit width in seconds. The query form of this command returns the bit width value of the displayed mask. The set form of this command only affects the User mask, regardless of the current (displayed) mask.

Group Mask

Syntax MASK:MASKPRE:WIDTH <NR3>
MASK:MASKPRE:WIDTH?

Arguments <NR3> is a floating point number that sets the nominal bit width in seconds.

Examples MASK:MASKPRE:WIDTH 648e-9
sets the User mask nominal bit width to 648 nanoseconds (1.544 Mbits/second).

Related Commands MASK:MASKPRE:TRIGTOSAMP

MASK:POLarity

(Requires TDS3TMT)

Sets or returns the input waveform polarity for the pass/fail test. This command only applies when MASK:TEST:STATE is on.

Group Mask

Syntax MASK:POLarity {BOTH | NEGAtive | POSITIVE }
MASK:POLarity?

Arguments BOTH sets the pass/fail test to test both positive and negative waveforms. The oscilloscope tests all positive pulses until 1/2 of the waveforms have been tested. Then the oscilloscope inverts all active channels and performs the remaining tests on negative pulses.

NEGAtive inverts all active channels and performs the pass/fail test on negative pulses.

POSITIVE performs the pass/fail test on positive pulses.

Examples MASK:POLARITY BOTH
sets pass/fail to test both positive (normal) and negative (inverted) waveforms.

Related Commands MASK:TEST:STATE

MASK:STANdard

(Requires TDS3TMT)

Set or returns the currently-displayed mask. To turn mask display off, set the standard to NONE.

Group Mask

Syntax MASK:STANdard { CLOCKCoax | CLOCKSymmetrical | DS0Contra
 | DS0Double | DS0Single | DS0Timing | DS1C | DS1Rate | DS2
 | DS2RATECoax | DS2RATESymmetrical | DS3Rate | E1Coax
 | E1Symmetrical | E2 | E3 | G703DS1 | G703DS3 | NONE | RATE32Mbit
 | STS1Pulse | USERMask }

MASK:STANdard?

Arguments CLOCKCoax through USERMask are the available TDS3TMT masks.

Examples MASK:STANDARD STS1PULSE
 sets the current mask to STS1Pulse.

MASK:STOPOnviolation

(Requires TDS3TMT)

Sets or returns the stop on violation setting. When enabled, this command stops waveform acquisitions on the first occurrence of a waveform violation. MASK:DISplay must be ON for the oscilloscope to detect violations.

Group Mask

Syntax MASK:STOPOnviolation { OFF | ON | <NR1> }
 MASK:STOPOnviolation?

Arguments OFF turns off mask test stop on violation.
 ON stops waveform acquisition on the first occurrence of a mask violation.
 <NR1> is an integer number where NR1 = 0 turns off stop on violation, and NR1 ≠ 0 turns on stop on violation.

Examples MASK:STOPONVIOLATION ON
sets the oscilloscope to stop waveform acquisition on the first occurrence of a waveform violation.

MASK:TEST:BEEP:COMPLetion

(Requires TDS3TMT)

Sets or returns the beep on pass/fail test completion mode. When enabled, this command causes the oscilloscope to emit a tone when the mask pass/fail test status changes to either 'Passed' or 'Failed.'

Group Mask

Syntax MASK:TEST:BEEP:COMPLetion { OFF | ON | <NR1> }
MASK:TEST:BEEP:COMPLetion?

Arguments OFF turns off pass/fail beep on completion.
ON turns on pass/fail beep on completion.
<NR1> is an integer number where NR1 = 0 turns off pass/fail beep on completion, and NR1 ≠ 0 turns on pass/fail beep on completion.

Examples MASK:TEST:BEEP:COMPLETION ON
turns on pass/fail beep on completion.

MASK:TEST:BEEP:FAILUre

(Requires TDS3TMT)

Sets or returns the beep on pass/fail test failure mode. When enabled, this command causes the oscilloscope to emit a tone when the pass/fail status changes to 'Failing.'

Group Mask

Syntax MASK:TEST:BEEP:FAILUre { OFF | ON | <NR1> }
MASK:TEST:BEEP:FAILUre?

- Arguments** OFF turns off pass/fail beep on failure.
ON turns on pass/fail beep on failure.
<NR1> is an integer number where NR1 = 0 turns off pass/fail beep on failure, and NR1 ≠ 0 turns on pass/fail beep on failure.
- Examples** MASK:TEST:BEEP:FAILURE OFF
turns off pass/fail beep on failure.

MASK:TEST:DELay (Requires TDS3TMT)

Sets or returns the amount of time, in seconds, to wait after starting pass/fail testing to evaluate waveforms. This is useful if the test system requires ‘settling’ time prior to evaluating waveforms.

- Group** Mask
- Syntax** MASK:TEST:DELay <NR3>
MASK:TEST:DELay?
- Arguments** <NR3> is a floating point number that specifies the amount of time, in seconds, to delay the start of the pass/fail test.
- Examples** MASK:TEST:DELAY 1
delays waveform evaluation by 1 second after the start of pass/fail testing.

MASK:TEST:HARDCopy (Requires TDS3TMT)

Sets or returns the hard copy on pass/fail test failure mode. When enabled, this command causes the oscilloscope to generate a hard copy, using the current oscilloscope hard copy settings, as soon as the pass/fail testing status changes to ‘Failing.’

NOTE. The oscilloscope generates a hard copy only on the first violation that causes the pass/fail test to fail. To generate a hard copy file for every violation occurrence, set *MASK:TEST:REPeat* to ON and set *MASK:TEST:WAVEform* to 1. Use this technique only when the expected number of violations is small and the violation occurs intermittently.

Group	Mask
Syntax	MASK:TEST:HARDCopy { OFF ON <NR1> } MASK:TEST:HARDCopy?
Arguments	OFF turns off generate hard copy on failure. ON turns on generate hard copy on failure. <NR1> is an integer number where NR1 = 0 turns off generate hard copy on failure, and NR1 ≠ 0 turns on generate hard copy on failure.
Examples	MASK:TEST:HARDCOPY ON turns on generate hard copy on failure.

MASK:TEST:REPeat

(Requires TDS3TMT)

Sets or returns the repeat pass/fail test on completion mode. When enabled, this command repeats the pass/fail test cycle at the completion of the previous test cycle.

Group	Mask
Syntax	MASK:TEST:REPeat { OFF ON <NR1> } MASK:TEST:REPeat?
Arguments	OFF turns off repeat on completion. ON turns on repeat on completion. <NR1> is an integer number where NR1 = 0 turns off repeat on completion, and NR1 ≠ 0 turns on repeat on completion.

Examples `MASK:TEST:REPEAT ON`
causes the oscilloscope to continuously repeat the pass/fail test.

MASK:TEST:SAVEWFM

(Requires TDS3TMT)

Sets or returns the save waveform to file on failure setting. When enabled, this command copies waveform data from all active channels to files when the pass/fail test status changes to 'Failing.' Set the file save format to Internal File Format to minimize file size.

NOTE. *The oscilloscope saves files only on the first violation that causes the pass/fail test to fail. To generate a waveform file for every violation occurrence, set MASK:TEST:REPEAT to ON and set MASK:TEST:WAVEFORM to 1. Use this technique only when the expected number of violations is small and the violation occurs intermittently.*

Group Mask

Syntax `MASK:TEST:SAVEWFM { OFF | ON | <NR1> }`
`MASK:TEST:SAVEWFM?`

Arguments OFF turns off copying all active channel waveforms to files.
ON turns on copying all active channel waveforms to files.
<NR1> is an integer number where NR1 = 0 turns off copying all active channel waveforms to files, and NR1 ≠ 0 turns on copying all active channel waveforms to files.

Examples `MASK:TEST:SAVEWFM ON`
sets the oscilloscope to save the failing waveform data to files.

MASK:TEST:STATE*(Requires TDS3TMT)*

Sets or returns the state of mask pass/fail testing. When enabled, this command resets the pass/fail status information and starts pass/fail mask testing. This command also generates an "Operation Complete" message when pass/fail testing completes. Refer to the BUSY? and *OPC commands in this manual for information on synchronizing a controller with pass/fail testing.

Group	Mask
Syntax	MASK:TEST:STATE { OFF ON <NR1> } MASK:TEST:STATE?
Arguments	OFF turns off mask pass/fail testing. ON turns on mask pass/fail testing. <NR1> is an integer number where NR1 = 0 turns off mask pass/fail testing, and NR1 ≠ 0 turns on mask pass/fail testing.
Examples	MASK:TEST:STATE ON turns on mask pass/fail testing.

MASK:TEST:STATUS? (Query Only)*(Requires TDS3TMT)*

Returns the pass/fail test status. This command returns one of: OFF, DELAY, PASSING, PASSED, FAILING, FAILED, and VIOLATION. OFF occurs before starting a pass/fail test. VIOLATION occurs when acquisitions are stopped due to a mask violation while stop on violations is enabled. DELAY occurs when the oscilloscope is waiting for the specified pre-test delay time to elapse.

Group	Mask
Syntax	MASK:TEST:STATUS?
Examples	MASK:TEST:STATUS? might return MASK:TEST:STATUS PASSING.

MASK:TEST:THReshold

(Requires TDS3TMT)

Sets or returns the maximum number of tested waveforms that are allowed to fail during each pass/fail test before the pass/fail test status changes from PASSING to FAILING.

Group Mask

Syntax MASK:TEST:THReshold <NR1>
MASK:TEST:THReshold?

Arguments <NR1> is an integer number that sets the maximum number of tested waveforms that can fail during each pass/fail test before the test fails.

Examples MASK:TEST:THRESHOLD?
might return MASK:TEST:THReshold 32

MASK:TEST:WAVEform

(Requires TDS3TMT)

Sets or returns the number of waveforms to test during pass/fail testing. If Averaging is on, this is the number of averaged waveforms to test during pass/fail testing.

Group Mask

Syntax MASK:TEST:WAVEform <NR1>
MASK:TEST:WAVEform?

Arguments <NR1> is an integer number that sets the number of tested (sampled or averaged) waveforms to test for each pass/fail test.

Examples MASK:TEST:WAVEFORM?
might return 500.

MASK:USER:MASK<m> DELEte

(Requires TDS3TMT)

Deletes the specified mask segment from the User mask, whether or not the User mask is the current mask.

Group	Mask
Syntax	MASK:USER:MASK<m> DELEte
Arguments	<m> is an integer number that specifies the User mask segment number to delete from the User mask.
Examples	MASK:USER:MASK3 DELETE deletes mask segment three from the User mask.

MASK:USER:MASK<m>:NR_Pt? (Query Only)

(Requires TDS3TMT)

Returns the number of points that make up the specified User mask segment. Each mask point consists of an X-Y pair of coordinates.

Group	Mask
Syntax	MASK:USER:MASK<m>:NR_Pt?
Arguments	<m> is an integer number that specifies a User mask segment number.
Examples	MASK:USER:MASK2:NR_PT? might return MASK:USER:MASK2:NR_Pt 5

MASK:USER:MASK<m>:POINTS

(Requires TDS3TMT)

Sets or returns the X-Y user coordinates of all points in the specified User mask segment. The set form defines new points in the User mask, replacing any existing points in the specified User mask segment.

Group Mask

Syntax MASK:USER:MASK<m>:POINTS <NR3>, <NR3> [, <NR3>, <NR3>]
MASK:USER:MASK<m>:POINTS?

Arguments <m> is an integer that specifies the User mask segment number.

NR3 refers to the coordinates of one of the vertices in the User mask. Each pair of numbers is the horizontal and vertical coordinates of a mask segment vertex. The pairs must be listed in a counterclockwise order. If the vertical or horizontal scale or position is changed after this command and then the query form of this command is issued, then the value returned from the oscilloscope will not be the same. If just one pair is input then they are ignored and the User mask segment is marked as undefined. The default is no points in the User mask segment.

Examples MASK:USER:MASK2:POINTS -2.3e-9, 44e-3, -2.5e-9, 47e-3,
1.2e-9, 40e-3
defines the points in User mask segment 2.

MASK:USER:MASK<m>:POINTSNorm

(Requires TDS3TMT)

The set form of this command only affects the User mask, regardless of the current mask standard. Any currently existing points in the specified User mask segment are deleted.

Group Mask

Syntax MASK:USER:MASK<m>:POINTSNorm <NR3>, <NR3> [, <NR3>, <NR3>]
MASK:USER:MASK<m>:POINTSNorm?

Arguments <m> is an integer number that specifies the User mask segment number.
 <NR3> is a floating point number that defines a normalized User mask point.

Examples MASK:USER:MASK<m>:POINTSNORM?
 might return -0.77, 1.05, -0.5, -0.9, 0.5, 1.0, 1.16, 0.5

MASK:USER:MASK<m>:POINTSPcnt

(Requires TDS3TMT)

Sets or returns the points in the specified User mask segment, in percentage coordinates. Each point is defined as an X-Y pair, where the first value in the pair is the X coordinate, and the second value in the pair is the Y coordinate. Values are screen-based percentages where 0.0, 0.0 is the upper-left corner of the graticule, and 100.0, 100.0 is the lower-right corner of the graticule.

The set form of this command only affects the User mask, regardless of the current mask standard. Any currently existing points in the specified User mask segment are deleted.

Group Mask

Syntax MASK:USER:MASK<m>:POINTSPcnt <NR3>, <NR3> [, <NR3>, <NR3>]
 MASK:USER:MASK<m>:POINTSPcnt?

Arguments <m> is the mask segment number.
 <NR3> refers to the coordinates of one of the vertexes in the mask. Each pair of values is the horizontal and vertical coordinates of a User mask vertex. The pairs must be listed in counterclockwise order. Resolution is to the nearest pixel.
 If just one pair is input then they are ignored and the User mask segment is marked as undefined. The default is no points in the User mask segment.

Examples MASK:USER:MASK3:POINTSPCNT 20.4, 10.5, 97, 10.5, 50, 80
 defines the points in User mask segment 3.

MASK:USER:MASKPRE Commands

(Requires TDS3TMT)

The following commands have the same arguments and functionality as the MASK:MASKPRE commands, except that the MASK:USER:MASKPRE commands only set or return values for the User mask, regardless of the currently-displayed mask standard. Refer to the corresponding MASK:MASKPRE command for command descriptions, syntax and argument information, and examples.

```
MASK:USER:MASKPRE:AMPlitude <NR3>
MASK:USER:MASKPRE:HSCAlE <NR3>
MASK:USER:MASKPRE:HTRIGPOS <NR3>
MASK:USER:MASKPRE:PATTERNBITS <NR1>
MASK:USER:MASKPRE:PRESAMPBITS <NR1>
MASK:USER:MASKPRE:RECOrdlength <NR1>
MASK:USER:MASKPRE:SERIALTRIG { OFF | ON | <NR1>}
MASK:USER:MASKPRE:TRIGTOSAMP <NR3>
MASK:USER:MASKPRE:VOFFSet <NR3>
MASK:USER:MASKPRE:VPOS <NR3>
MASK:USER:MASKPRE:VSCAlE <NR3>
MASK:USER:MASKPRE:WIDth <NR3>
```

MATH? (Query Only)

Returns the definition of the math waveform. The returned data depends on the setting of the MATH:TYPE command

Group Math

Syntax MATH?

Examples

When the math type is Dual, MATH? might return

```
MATH:TYPE DUAL;DEFINE "CH1+CH2";VERTICAL:SCALE 2.0E-1;
POSITION 0.0E0;UNITS "?";:MATH:HORIZONTAL:SCALE 4.0E-4;
POSITION 5.0E1;UNITS "?";:MATH:VAR1 0.0E0;VAR2 0.0E0;SPECTRAL:
MAG DB;WINDOW HANNING.
```

When the math type is FFT, MATH? might return

```
MATH:TYPE FFT;DEFINE "FFT(CH1, HANNING, LOGRMS)";VERTICAL:
SCALE 2.0E1;POSITION 2.0E0;UNITS "?";:MATH:HORIZONTAL:
SCALE 1.25E5;POSITION 5.0E1;UNITS "?";:MATH:VAR1 0.0E0;
VAR2 0.0E0;SPECTRAL:MAG DB;WINDOW HANNING.
```

When the math type is DPO, MATH? might return

```
MATH:TYPE DPO;DEFINE "CH1+CH2";VERTICAL:SCALE 2.0E-1;
POSITION 0.0E0;UNITS "?";:MATH:HORIZONTAL:SCALE 4.0E-4;
POSITION 5.0E1;UNITS "?";:MATH:VAR1 0.0E0;VAR2 0.0E0;SPECTRAL:
MAG DB;WINDOW HANNING.
```

When the math type is Advanced, MATH? might return

```
MATH:TYPE ADVANCED;DEFINE "CH1+CH2*INTG(REF3)";VERTICAL:
SCALE 1.0E-1;POSITION 0.0E0;UNITS "?";:MATH:HORIZONTAL:
SCALE 4.0E-4;POSITION 5.0E1;UNITS "?";:MATH:VAR1 0.0E0;
VAR2 0.0E0;SPECTRAL:MAG DB;WINDOW HANNING.
```

MATH:DEFINE

Sets or returns the current math function as a text string. For TDS3AAM, this command sets or returns the math FFT parameters. For the TDS3AAM, this command also sets or returns the advanced math parameters. This is equivalent to setting the math parameters in the Math menu. The syntax of this command depends on the value of the MATH:TYPE command, as well as which application module is installed in the instrument.

Group Math

Syntax MATH:DEFINE <QString>

Where the syntax for <QString> is:

Dual Wfm Math and DPO Math: "<source><operator><source>"

FFT Math: "FFT (<source>[,<window>,<scaling>])"

Advanced Math: "<expression>"

Dual and DPO Arguments

For the Dual Wfm Math and DPO Math, <QString> contains the expression "<source><operator><source>".

source sets the signal or reference source. Valid choices are: CH1, CH2, CH3, CH4, REF1, REF2, REF3, or REF4. CH3 and CH4 are only available on four-channel instruments.

operator sets the operation to apply to the two waveforms. For Dual Wfm Math, valid operators are + (addition), - (subtraction), * (multiplication), and / (division).

For DPO Math, valid operators are + (addition), - (subtraction), and * (multiplication). There is no division in DPO math.

FFT Arguments

For FFT math, <QString> contains the expression "FFT (<source>[,<window>,<scaling>])".

source sets the signal or reference source from which to generate an FFT waveform. Valid choices are: CH1, CH2, CH3, CH4, REF1, REF2, REF3, or REF4. CH3 and CH4 are only available on four-channel instruments.

window is an optional argument that sets the FFT window algorithm to apply to the source signal. Valid choices are RECTangular, HAMming, HANning, and BLAckmanharris. Each window is a trade-off between frequency resolution and magnitude accuracy. What you want to measure, and your source signal characteristics, help determine which window to use.

scaling is an optional argument that sets the FFT waveform vertical scale type. Valid choices are: LOGrms and LINearrms.

Advanced Math Arguments

For Advanced Math, <QString> contains the expression "<expression>".

expression is a syntactically-correct sequence of valid waveform sources, measurements, mathematical operators, and numeric constants.

Table 2-37: Advanced Math expression elements

Expression	Description
CH1-CH4, REF1-REF4	Specifies a waveform data source.
FFT(, INTG(, DIFF(Executes a Fast Fourier Transform, integration, or differentiation operation on the expression that follows. The FFT operator must be the first (left-most) operator in an expression. All these operations must end with a right parenthesis.
AMPLitude(, AREa(, BURst(, CARea(, CMEan(, CRMs(, DELay(, FALL(, FREQuency(, HIGH(, LOW(, MAXimum(, MEAN(, MINimum(, NDUty(, NOVershoot(, NWldth(, PDUTy(, PERIod(, PHAse(, PK2pk(, POVershoot(, PWldth(, RISE(, RMS(Executes the selected measurement operation on the waveform (active or reference) that follows. All these operations must end with a right parenthesis.
VAR1, VAR2	Adds the user-defined variable to the expression. Refer to the MATH:VAR<x> command.
+, -, *, /	Executes an addition, subtraction, multiplication, or division operation on the following expression. + and - are also unary; use - to negate the expression that follows.
(), ,	Parentheses provide a way to control evaluation order in an expression. The comma is used to separate the "from" and "to" waveforms in Delay and Phase measurement operations.
1-0, ., E	Specifies a numeric value in (optional) scientific notation.

Examples `MATH:TYPE DUAL;:MATH:DEFINE "CH2*REF4"`
 sets the math type to Dual and displays a Dual math waveform that is the product of the channel 1 waveform and the REF4 waveform.

`MATH:TYPE FFT;:MATH:DEFINE "FFT(CH1)"`
 sets the math type to FFT and displays an FFT waveform of the channel 1 waveform, using the current FFT scale and window settings.

`MATH:TYPE FFT;:MATH:DEFINE "FFT(CH3, HAMM, LINEARRMS)"`
 sets the math type to FFT and displays an FFT waveform of the channel 3 waveform, using the Hamming window, with linear rms scaling.

`MATH:DEFINE?`
 might return `MATH:DEFINE "FFT(CH1*CH4) "`

`MATH:TYPE ADVANCED;:MATH:DEFINE "INTG(REF1*CH3)+DELAY(CH1,CH2)"`
 sets the math type to FFT and displays an advanced math waveform that is the integration of the product of REF1 and CH3 plus the result of the delay measurement between channel 1 and 2.

Related Commands `MATH:TYPE`

MATH:HORizontal:POSition

Sets or returns the math horizontal display position for FFT or math waveforms that only have reference waveform source waveforms.

Group Math

Syntax `MATH:HORizontal:POSition <NR3>`
`MATH:HORizontal:POSition?`

Arguments `<NR3>` is the % of the math waveform (divided by 100) that precedes center screen. It can vary from 0.0e0 to 1.0e0.

Examples `MATH:HORIZONTAL:POSITION 1.0e-1`
 sets the horizontal position to 10% pretrigger

MATH:HORizontal:SCALE

Sets or returns the math horizontal display scale for FFT or for dual math waveforms that have source waveforms that are reference waveforms. The

horizontal scale of a dual math waveform with a channel source waveform is set through the `HORizontal:SCALE` command.

Group	Math
Syntax	<code>MATH:HORizontal:SCALE <NR3></code> <code>MATH:HORizontal:SCALE?</code>
Arguments	<code><NR3></code> is the math horizontal scale in seconds.
Examples	<code>MATH:HORIZONTAL:SCALE?</code> might return <code>:MATH:HORIZONTAL:SCALE 2.0E-4</code> indicating that the math horizontal scale is 200 μ s.

MATH:HORizontal:UNITs

Sets or returns the math waveform horizontal measurement unit value.

Group	Math
Syntax	<code>MATH:HORizontal:UNITs <Qstring></code> <code>MATH:HORizontal:UNITs?</code>
Arguments	<code><Qstring></code> is a text label to apply to horizontal units when the horizontal unit is "?" (unknown unit value).
Examples	<code>MATH:HORIZONTAL:UNITs?</code> might return <code>:MATH:HORIZONTAL:UNITs "?"</code> indicating that the math horizontal unit label for unknown values is the default question mark unit.

MATH:SPECTral:MAG

Sets or returns the FFT math waveform vertical display scale.

Group	Math
Syntax	<code>MATH:SPECTral:MAG { DB LINEAR }</code>

MATH:SPECTral:MAG?

Arguments DB sets the FFT vertical scale to dBV RMS.

LINEAR sets the FFT vertical scale to linear RMS.

Examples MATH:SPECTRAL:MAG?
might return :MATH:SPECTral:MAG dB indicating the the FFT vertical scale is set to dB.

MATH:SPECTral:WINDow

Sets or returns the FFT math waveform window algorithm setting.

Group Math

Syntax MATH:SPECTral:WINDow { BLAckmanharris | HAMming | HANning | RECTangular }

MATH:SPECTral:WINDow?

Arguments BLAckmanharris sets the FFT waveform to use the Blackman-Harris window algorithm.

HAMming sets the FFT waveform to use the Hamming window algorithm.

HANning sets the FFT waveform to use the Hanning window algorithm.

RECTangular sets the FFT waveform to use the Rectangular window algorithm.

Examples MATH:SPECTRAL:WINDOW HANNING
sets the FFT math waveform window algorithm to Hanning.

MATH:TYPE

Sets or returns the math waveform mode type.

Group Math

Syntax MATH:TYPE { ADVanced | DPO | DUAL | FFT }

MATH:TYPE?

Arguments ADVanced sets the math waveform mode to advanced math. TDS3AAM only.
 DPO sets the math waveform mode to DPO math. TDS3AAM only.
 DUAL sets the math waveform mode to dual waveform math.
 FFT sets the math waveform mode to FFT math. (TDS3AAM and TDS3FFT, available on TDS3000B Series and TDS3000C Series oscilloscopes.)

Examples MATH:TYPE FFT
 sets the math waveform mode to FFT.

Related Commands MATH:DEFINE

MATH:VAR<x> (Requires TDS3AAM)

Sets or returns the value of the user-defined math variable that can be used as part of an advanced math waveform expression.

Group Math

Syntax MATH:VAR<x> <NR3>
 MATH:VAR<x>?

Arguments <x> specifies which variable to define, where <x> = 1 for VAR1 and <x> = 2 for VAR2.
 <NR3> is a numeric value in scientific notation that sets the value of the specified variable.

Examples MATH:VAR1 1.251E3
 sets the value of VAR1 to 1251.

MATH:VERTical:POStion

Sets or returns the math waveform display position.

Group	Math
Syntax	MATH:VERTical:POSition <NR3> MATH:VERTical:POSition?
Arguments	<NR3> is the math vertical position in divisions from center screen.
Examples	MATH:VERTICAL:POSITION? might return :MATH:VERTICAL:POSITION -3.0E0 indicating the the math waveform is 3 division below center screen.

MATH:VERTical:SCALE

Sets the vertical display scale. This command is equivalent to changing the Vertical **SCALE** knob that controls the waveform zoom factors. The math waveform scale is not affected by this control. The math calculation software automatically determines the optimum vertical scale through examination of input waveform data.

NOTE. *The vertical display scale is reset to the waveform preamble scale, when a vertical scale change to a math source waveform results in a new math autoscale operation. The vertical display scale should be changed only after math source waveform adjustments are complete.*

Group	Math
Syntax	MATH:VERTical:SCALE <NR3> MATH:VERTical:SCALE?
Arguments	<NR3> is the math vertical scale in math waveform vertical units.
Examples	MATH:VERTICAL:SCALE 5.0e0 sets the math vertical scale to 5 math waveform units per division.

MATH:VERTical:UNITs

Sets or returns the math waveform vertical measurement unit value.

Group	Math
Syntax	MATH:HORizontal:UNITs <Qstring> MATH:HORizontal:UNITs?
Arguments	<Qstring> is a text label to apply to vertical units when the vertical unit is “?” (unknown unit value).
Examples	MATH:VERTICAL:UNITs? might return :MATH:VERTICAL:UNITs "joules" indicating that the math vertical unit label for unknown values is joules.

MATH1 Commands

The MATH1 commands listed in Table 2-38 are the same as their associated MATH commands, and are for compatibility with other Tektronix instruments. Refer to the equivalent MATH command for syntax and function information.

Group Math

Table 2-38: MATH1: commands

MATH1:DEFINE	MATH1:HORizontal:POSition	MATH1:HORizontal:SCAle
MATH1:HORizontal:UNITs	MATH1:SPECTral:MAG	MATH1:SPECTral:WINdow
MATH1:TYPe	MATH1:VAR1	MATH1:VAR2
MATH1:VERTical:POSition	MATH1:VERTical:SCAle	MATH1:VERTical:UNITs

MEASUrement? (Query Only)

Returns all measurement values for the last-acquired waveform.

Group Measurement

Syntax MEASUrement?

Example MEASUREMENT?

might return

```
:MEASUREMENT:MEAS1:TYPE FREQUENCY;UNITS "s" COUNT 0;MINIMUM 0.0.0E0;MAXIMUM 0.0.0E0;MEAN 0.0.0E0;STDDEV 0.0.0E0;SOURCE1 CH1;SOURCE2 CH2;DELAY:DIRECTION FORWARDS;EDGE1 RISE1;EDGE2 RISE;;:MEASUREMENT:MEAS1:STATE 0;;:MEASUREMENT:MEAS2:TYPE PERIOD;UNITS "s";COUNT 0;MINIMUM 0.0.0E0;MAXIMUM 0.0.0E0;MEAN 0.0.0E0;STDDEV 0.0.0E0;SOURCE1 CH1;SOURCE2 CH2;DELAY:DIRECTION FORWARDS;EDGE1 RISE;EDGE2 RISE;;:MEASUREMENT:MEAS2:STATE 0;;:MEASUREMENT:MEAS3:TYPE PERIOD;UNITS "s";COUNT 0;MINIMUM 0.0.0E0;MAXIMUM 0.0.0E0;MEAN 0.0.0E0;MEAN 0.0.0E0;STDDEV 0.0.0E0;SOURCE1 CH1;SOURCE2 CH2;DELAY:DIRECTION FORWARDS;EDGE1 RISE;EDGE2 RISE;;:MEASUREMENT:MEAS3:STATE 0;;:MEASUREMENT:MEAS4:TYPE PERIOD;UNITS "s";COUNT 0;MINIMUM 0.0.0E0;MAXIMUM 0.0.0E0;MEAN 0.0.0E0;STDDEV 0.0.0E0;SOURCE1 CH1;SOURCE2 CH2; DELAY:DIRECTION FORWARDS;EDGE1 RISE;EDGE2 RISE;;:MEASUREMENT:MEAS4:STATE 0;;:MEASUREMENT:IMMED:TYPE PERIOD;UNITS "s";SOURCE1 CH1;SOURCE2 CH2;DELAY:DIRECTION FORWARDS;EDGE1 RISE;EDGE2 RISE;;:MEASUREMENT:GATING OFF;INDICATORS:STATE OFF;NUMHORZ 0;NUMVERT 0;HORZ1 0.0.0E0;HORZ2 0.0.0E0;HORZ3 0.0.0E0;HORZ4 0.0.0E0;VERT1 0.0.0E0;VERT2 0.0.0E0;VERT3 0.0.0E0;VERT4 0.0.0E0;;:MEASUREMENT:METHOD AUTO;REFLEVEL:METHOD PERCENT;ABSOLUTE:HIGH 0.0.0E0;LOW 0.0.0E0;MID 0.0.0E0;MID2 0.0.0E0;;:MEASUREMENT:REFLEVEL:PERCENT:HIGH 9:0E1;LOW 1.0E1;MID 5.0E1;MID2 5.0E1;;:MEASUREMENT:STATISTICS:MODE OFF;WEIGHTING 32
```

MEASUrement:CLEARSNAPSHOT

Removes the measurement snapshot display.

Group Measurement

Syntax MEASUrement:CLEARSNAPSHOT

Examples MEASUREMENT:CLEARSNAPSHOT

MEASUrement:GATing

Sets or returns measurement gating.

Group	Measurement
Syntax	MEASUrement:GATing { SCREen CURSor OFF } MEASUrement:GATing?
Arguments	OFF turns off measurement gating. SCREen limits measurements to the portion of the waveform displayed on the screen. CURSor limits measurements to the portion of the waveform between the vertical bar cursors, even if they are off screen.
Examples	MEASUREMENT:GATING SCREEN limits measurements to the portion of the waveform displayed on the screen. MEASUREMENT:GATING? might return MEASUREMENT:GATING CURSOR showing measurements are limited to the portion of the waveform between the vertical bar cursors.

MEASUrement:IMMed? (Query Only)

Returns all immediate measurement setup parameters.

Group	Measurement
Syntax	MEASUrement:IMMed?
Examples	MEASUREMENT:IMMED? might return :MEASUREMENT:IMMED:TYPE PERIOD;UNITS "s";SOURCE1 CH1;SOURCE2 CH2;DELAY:DIRECTION FORWARDS;EDGE1 RISE;EDGE2 RISE

MEASUrement:IMMed:DATa? (Query Only)

Returns the measurement result and qualifier for the immediate measurement specified by the MEASUrement:IMMed:TYPe command. The measurement is taken on the source specified by a MEASUrement:IMMed:SOURCE command. Returns both the measurement result and the status of the result.

Group Measurement

Syntax MEASUrement:IMMed:DATa? <NR3>, <NR1>

Arguments <NR3> is the measurement result.

<NR1> is one of the execution errors shown in Table 3-5 on page 3-14, or it is 0 if there is no error.

Examples MEASUREMENT:IMMED:DATA?
 might return :MEASUREMENT:IMMED:DATA 9.91963315E-4, 0

Related Commands MEASUrement:IMMed:VALue?

MEASUrement:IMMed:DELay? (Query Only)

Returns information about the immediate delay measurement.

Group Measurement

Syntax MEASUrement:IMMed:DELay?

Examples MEASUREMENT:IMMED:DELAY?
 might return :MEASUREMENT:IMMED:DELAY:EDGE1 RISE;EDGE2 RISE;
 DIRECTION FORWARDS

MEASUrement:IMMed:DElay:DIREction

Sets or returns the starting point and direction that determines the delay “to” edge when taking an immediate delay measurement. Use the MEASUrement:IMMed:SOURCE2 command to specify the delay “to” waveform.

Group	Measurement
Syntax	MEASUrement:IMMed:DElay:DIREction {BACKWards FORWards} MEASUrement:IMMed:DElay:DIREction?
Arguments	<p>BACKWards means that the search starts at the end of the waveform and looks for the last rising or falling edge in the waveform. The slope of the edge is specified by MEASUrement:IMMed:DElay:EDGE2.</p> <p>FORWards means that the search starts at the beginning of the waveform and looks for the first rising or falling edge in the waveform. The slope of the edge is specified by MEASUrement:IMMed:DElay:EDGE2.</p>
Examples	<p>MEASUREMENT:IMMED:DELAY:DIRECTION FORWARDS starts searching from the beginning of the waveform record.</p> <p>MEASUREMENT:IMMED:DELAY:DIRECTION? returns either BACKWARDS or FORWARDS.</p>

MEASUrement:IMMed:DElay:EDGE<x>

Sets or returns the slope of the edge that is used for the delay “from” or “to” waveform when taking an immediate delay measurement. The waveform is specified by MEASUrement:IMMed:SOURCE<x>.

Group	Measurement
	MEASUrement:IMMed:SOURCE<x>
Syntax	MEASUrement:IMMed:DElay:EDGE<x> { FALL RISe } MEASUrement:IMMed:DElay:EDGE<x>?

Arguments <x> specifies which waveform to use, where <x> = 1 is the “from” waveform, and <x> = 2 is the “to” waveform.

FALL specifies the falling edge.

RISe specifies the rising edge.

Examples MEASUREMENT:IMMED:DELAY:EDGE1 RISE
specifies that the “from” waveform rising edge be used for the immediate delay measurement.

MEASUREMENT:IMMED:DELAY:EDGE1?
returns either RISE or FALL.

MEASUREMENT:IMMED:SOURCE

Specifies the source to measure “from” when taking an immediate delay measurement or phase measurement. This command is the same as the MEASUREMENT:IMMED:SOURCE1 command.

MEASUREMENT:IMMED:SOURCE<x>

Specifies the source to measure “from” or “to” when taking an immediate delay measurement or phase measurement.

Group Measurement

Syntax MEASUREMENT:IMMED:SOURCE<x> { CH<x> | MATH | MATH1 | REF<x> }
MEASUREMENT:IMMED:SOURCE?

Arguments SOURCE<x> specifies which waveform to use, where <x> = 1 is the “from” waveform, and <x> = 2 is the “to” waveform.

CH<x> is an input channel.

MATH or MATH1 is the math waveform.

REF<x> is a reference waveform.

Examples MEASUREMENT:IMMED:SOURCE1 MATH1
specifies MATH1 as the immediate measurement source.

MEASUREMENT:IMMED:TYPE

Specifies the immediate measurement.

Group Measurement

Syntax MEASUREMENT:IMMED:TYPE { AMPLitude | AREa | BURst | CAREa |
CMEan | CRMs | DELAY | FALL | FREQuency | HIGH | LOW | MAXimum |
MEAN | MINImum | NDuty | NOVershoot | NWidth | PDuty | PERIOD |
PHASE | PK2pk | POVershoot | PWidth | RISE | RMS }

MEASUREMENT:IMMED:TYPE?

Arguments Information on how measurements are derived:.

AMPLitude is the high value minus the low value.

AREa is the area between the curve and ground over the active waveform the high value minus the low value. TDS3AAM only.

BURst is the time from the first MidRef crossing to the last MidRef crossing.

CAREa (cycle area) is the area between the curve and ground over one cycle. TDS3AAM only.

CMEan is the arithmetic mean over one cycle.

CRMs is the true Root Mean Square voltage over one cycle.

DELay is the delay from one waveform's edge event to another. TDS3AAM only.

FALL is the time that it takes for the falling edge of a pulse to fall from a HighRef value to a LowRef value of its final value.

FREQuency is the reciprocal of the period measured in hertz.

HIGH is the 100% reference level.

LOW is the 0% reference level.

MAXimum is the highest amplitude (voltage).

MEAN for general purpose measurements, is the arithmetic mean over the entire waveform. For histogram measurements, it is the average of all acquired points within or on the histogram box.

MINImum is the lowest amplitude (voltage).

NDuty is the ratio of the negative pulse width to the signal period expressed as a percentage.

NOVershoot is the negative overshoot, expressed as:

$$NOVershoot = 100 \times \left(\frac{Low - Minimum}{Amplitude} \right)$$

NWIdth is the distance (time) between MidRef (usually 50%) amplitude points of a negative pulse.

PDUTy is the ratio of the positive pulse width to the signal period expressed as a percentage.

PERIod is the time, in seconds, it takes for one complete signal cycle to happen.

PHAsE is the phase difference from the selected waveform to the designated waveform.

PK2pk is the absolute difference between the maximum and minimum amplitude. It can be used with both general purpose and histogram measurements.

POVershoot is the positive overshoot, expressed as:

$$POVershoot = 100 \times \left(\frac{Maximum - High}{Amplitude} \right)$$

PWIdth is the distance (time) between MidRef (usually 50%) amplitude points of a positive pulse.

RISe is the time that it takes for the leading edge of a pulse to rise from a low reference value to a high reference value of its final value.

RMS is the true Root Mean Square voltage.

Examples

MEASUREMENT:IMMED:TYPE FREQUENCY
 defines the immediate measurement to be a frequency measurement.

MEASUrement:IMMed:UNIts? (Query Only)

Returns the units for the immediate measurement.

Group Measurement

Syntax MEASUrement:IMMed:UNIts?

Returns <QString> returns "V" for volts, "s" for seconds, "Hz" for hertz, "%" for percent, "A" for amps, "W" for watts, for ohms, "dB" for decibels, "?" for unknown, and " " for non-dimensional units. Measurements on math waveforms can return the following units: "V/V", "A/W", "WV", "W/V", "dBV", "dB/V", "V/A", "A/A", "WA", "W/A", "dBA", "dB/A", "VW", "V/W", "AW", "A/W", "WW", "W/W", "dBW", "dB/W", "VdB", "V/dB", "AdB", "A/dB", "WdB", "W/dB", "dBdB", and "dB/dB".

Examples MEASUREMENT:IMMED:UNITS?
might return "s", indicating that the units for the immediate measurement are seconds.

Related Commands MEASUrement:IMMed:TYPe

MEASUrement:IMMed:VALue? (Query Only)

Immediately executes the immediate measurement specified by the MEASUrement:IMMed:TYPe command. The measurement is taken on the source specified by a MEASUrement:IMMed:SOURCE command.

Group Measurement

Syntax MEASUrement:IMMed:VALue?

Returns <NR3>

Related Commands MEASUrement:IMMed:DATA?

MEASUrement:INDICators? (Query Only)

Returns all measurement indicator parameters.

Group Measurement

Syntax MEASUrement:INDICators?

Examples MEASUREMENT:INDICATORS? might return
 :MEASUREMENT:INDICATORS:STATE MEAS1;NUMHORZ 0;NUMVERT 4;HORZ1
 7.5E0;HORZ2 -3.400000095367E0;HORZ3 0.0E0;HORZ4 0.0E0;VERT1
 -6.351123E-6;VERT2 -3.179753E-6;VERT3 -6.40943E-6;VERT4 -6.403E-6

MEASUrement:INDICators:HORIZ<x>? (Query Only)

Returns the position of the specified horizontal measurement indicator <x>, where <x> can be 1, 2, 3, or 4.

Group Measurement

Syntax MEASUrement:INDICators:HORIZ<x>?

Examples MEASUREMENT:INDICATORS:HORIZ1? might return
 :MEASUREMENT:INDICATORS:HORIZ1 -2.0E-3 indicating that horizontal
 indicator1 has a value of -2mV.

MEASUrement:INDICators:NUMHORZ? (Query Only)

Returns the number of horizontal measurement indicators currently being displayed.

Group Measurement

Syntax MEASUrement:INDICators:NUMHORZ?

Examples MEASUREMENT:INDICATORS:NUMHORZ? might return
 :MEASUREMENT:INDICATORS:NUMHORZ 2 indicating that there are currently 2
 horizontal lines drawn on the graticule showing where the measurement
 specified by MEASUrement:INDICators:STATE is being performed.

MEASUREMENT:INDICATORS:NUMVERT? (Query Only)

Returns the number of vertical measurement indicators currently being displayed.

Group Measurement

Syntax MEASUREMENT:INDICATORS:NUMVERT?

Examples MEASUREMENT:INDICATORS:NUMVERT? might return
:MEASUREMENT:INDICATORS:NUMVERT 2 indicating that there are currently 2 vertical lines drawn on the graticule showing where the measurement specified by MEASUREMENT:INDICATORS:STATE is being performed.

MEASUREMENT:INDICATORS:STATE

Set or returns the state of visible measurement indicators. Performs the same operations as the front panel Measurement Indicators menu.

Group Measurement

Syntax MEASUREMENT:INDICATORS:STATE { OFF | MEAS<x>}
MEASUREMENT:INDICATORS:STATE?

Arguments OFF turns off visible measurement indicators.

MEAS<x> turns on the display of visible measurement indicators for measurement <x>, where <x> can be 1, 2, 3, or 4. There must be an active measurement before you can activate an indicator for a specified measurement.

Examples MEASUREMENT:INDICATORS:STATE MEAS2
turns on the display of visible measurement indicators for measurement 2.

MEASUREMENT:INDICATORS:STATE?
might return MEASUREMENT:INDICATORS:STATE OFF indicating that no measurement indicators are active.

MEASUREMENT:INDICATORS:VERT<x>? (Query Only)

Returns the value of the specified vertical measurement indicator <x> from the trigger point, where <x> can be 1, 2, 3, or 4. A negative value means that the indicator is positioned earlier in the waveform record than the trigger point.

Group Measurement

Syntax MEASUREMENT:INDICATORS:VERT<x>?

Examples MEASUREMENT:INDICATORS:VERT2? might return
:MEASUREMENT:INDICATORS:VERT2 -3.724507E-6 indicating that the second measurement indicator is positioned 3.72 μ s before the trigger point.

MEASUREMENT:MEAS<x>? (Query Only)

Returns all measurement parameters for the specified active measurement <x>.

Group Measurement

Syntax MEASUREMENT:MEAS<x>?

Returns Measurement parameters, for the specified measurement.

Examples MEASUREMENT:MEAS3?
might return: :MEASUREMENT:MEAS3:TYPE PERIOD;UNITS "s";COUNT
0;MINIMUM 0.0E0;MAXIMUM 0.0E0;MEAN 0.0E0;STDDEV 0.0E0;SOURCE1
CH1;SOURCE2 CH2;DELAY:DIRECTION FORWARDS;EDGE1 RISE;:MEASURE-
MENT:MEAS3:STATE 0

MEASUREMENT:MEAS<x>:COUNT? (Query Only)

(Requires TDSAAM)

Returns the number of values accumulated for this measurement since the last statistical reset. Some values may have been ignored because they generated an error.

Group Measurement

Syntax	MEASUrement:MEAS<x>:COUNT?
Returns	<NR3>
Examples	MEASUREMENT:MEAS1:COUNT? might return: :MEASU:MEAS1:COUN 3.247000000E+3

MEASUrement:MEAS<x>:DATA? (Query Only)

Returns the measurement result and qualifier for the measurement specified by <x>. Returns both the measurement result and the status of the result.

Group	Measurement
Syntax	MEASUrement:MEAS<x>:DATA? <NR3>, <NR1>
Arguments	<NR3> is the measurement result. <NR1> is one of the execution errors shown in Table 3-5 on page 3-14, or it is 0 if there is no error.
Examples	MEASUREMENT:MEAS1:DATA? might return :MEASUREMENT:MEAS1:DATA 9.91963315E-4, 0
Related Commands	MEASUrement:MEAS<x>:VALue?

MEASUrement:MEAS<x>:DELay? (Query Only)

(Requires TDSAAM)

Returns the delay measurement parameters for the delay measurement specified by <x>.

Group	Measurement
Syntax	MEASUrement:MEAS<x>:DELay?

Examples MEASUREMENT:MEAS3:DELAY?
 might return :MEASUREMENT:MEAS3:DELAY:EDGE1 RISE;
 EDGE2 RISE;DIRECTION FORWARDS.

MEASUREMENT:MEAS<x>:DELAY:DIRECTION

(Requires TDSAAM)

Sets or returns the starting point and direction that determines the delay “to” edge when taking a delay measurement. The waveform is specified by MEASUREMENT:MEAS<X>:SOURCE2. This command is equivalent to setting the direction in the **Delay Edges** and **Direction** side menu items.

Group Measurement

Syntax MEASUREMENT:MEAS<x>:DELAY:DIRECTION { BACKWARDS | FORWARDS }
 MEASUREMENT:MEAS<x>:DELAY:DIRECTION?

Arguments BACKWARDS means that the search starts at the end of the waveform and looks for the last rising or falling edge in the waveform. The slope of the edge is specified by MEASUREMENT:MEAS<x>:DELAY:EDGE2.

FORWARDS means that the search starts at the beginning of the waveform and looks for the first rising or falling edge in the waveform. The slope of the edge is specified by MEASUREMENT:MEAS<x>:DELAY:EDGE2.

Examples MEASUREMENT:MEAS1:DELAY:DIRECTION BACKWARDS
 starts searching from the end of the waveform record.
 MEASUREMENT:MEAS3:DELAY:DIRECTION?
 might return FORWARDS for the search direction.

MEASUREMENT:MEAS<x>:DELAY:EDGE1

Sets or returns the slope of the edge that is used for the delay “from” waveform when taking a delay measurement. The waveform is specified by MEASUREMENT:MEAS<x>:SOURCE1. This command is equivalent to selecting the edges in the **MEASURE > Delay** side menu.

Group Measurement

Syntax MEASUrement:MEAS<x>:DELay:EDGE1 { FALL | RISe }
 MEASUrement:MEAS<x>:DELay:EDGE1?

Arguments FALL specifies the falling edge.
 RISe specifies the rising edge.

Examples MEASUREMENT:MEAS3:DELAY:EDGE1 RISe
 specifies that the rising edge be used for measurement 3.
 MEASUREMENT:MEAS1:DELAY:EDGE1?
 returns either RISe or FALL for measurement 1.

MEASUrement:MEAS<x>:DELay:EDGE2

Sets or returns the slope of the edge that is used for the delay “to” waveform when taking a delay measurement. The waveform is specified by MEASUrement:MEAS<x>:SOURCE2. This command is equivalent to selecting the edges in the **MEASURE > Delay** side menu.

Group Measurement

Syntax MEASUrement:MEAS<x>:DELay:EDGE2 { FALL | RISe }
 MEASUrement:MEAS<x>:DELay:EDGE2?

Arguments FALL specifies the falling edge.
 RISe specifies the rising edge.

Examples MEASUREMENT:MEAS2:DELAY:EDGE2 RISe
 specifies that the rising edge be used for the second delay measurement.
 MEASUREMENT:MEAS2:DELAY:EDGE2?
 might return FALL showing that the falling or negative edge of the waveform is used for the second measurement.

MEASUrement:MEAS<x>:MAXimum? (Query Only)

(Requires TDSAAM)

Returns the maximum value found for the specified measurement since the last statistical reset.

Group Measurement

Syntax MEASUrement:MEAS<x>:MAXimum?

Returns <NR3>

Examples MEASUREMENT:MEAS1:MAXIMUM?
might return: :MEASU:MEAS3:MAX 4.18E-9

MEASUrement:MEAS<x>:MEAN? (Query Only)

(Requires TDSAAM)

Returns the mean value accumulated for the specified measurement since the last statistical reset.

Group Measurement

Syntax MEASUrement:MEAS<x>:MEAN?

Returns <NR3>

Examples MEASUREMENT:MEAS1:MEAN?
might return: :MEASU:MEAS1:MEAN 514.71E-9

MEASUrement:MEAS<x>:MINImum? (Query Only)*(Requires TDSAAM)*

Returns the minimum value found for the specified measurement since the last statistical reset.

Group	Measurement
Syntax	MEASUrement:MEAS<x>:MINImum?
Returns	<NR3>
Examples	MEASUREMENT:MEAS1:MIN? might return: :MEASU:MEAS1:MINI 1.75E-9

MEASUrement:MEAS<x>:SOURCE[1]

Sets or returns the source for all single channel measurements. SOURCE is equivalent to SOURCE1.

Group	Measurement
Syntax	MEASUrement:MEAS<x>:SOUrce { CH<x> MATH[1] REF<x> } MEASUrement:MEAS<x>:SOURCE1 { CH<x> MATH[1] REF<x> } MEASUrement:MEAS<x>:SOUrce? MEASUrement:MEAS<x>:SOURCE1?
Arguments	CH<x> is an input channel. MATH or MATH1 is the math waveform. REF<x> is a reference waveform.
Examples	MEASUREMENT:MEAS2:SOURCE1 MATH1 specifies MATH as the measurement 2 source.

MEASUREMENT:MEAS<x>:SOURCE2

Sets or returns the source to measure “to” when taking a delay measurement or phase measurement. This is equivalent to setting the source in the **Delay from Selected Wfm** side menu or the **Phase from Selected Wfm** side menu.

Group Measurement

Syntax MEASUREMENT:MEAS<x>:SOURCE2 { CH<x> | MATH | REF<x> }
MEASUREMENT:MEAS<x>:SOURCE2?

Arguments CH<x> is an input channel.
MATH is the math waveform.
REF<x> is a reference waveform.

Examples MEASUREMENT:MEAS4:SOURCE2 CH1
sets channel 1 as the delay “to” source when making delay measurements.
MEASUREMENT:MEAS2:SOURCE2?
might return MATH.

MEASUREMENT:MEAS<x>:STATE

Turns the measurement specified by <x> on or off. The source specified by MEASUREMENT:MEAS<x>:SOURCE1 must be active for the measurement to be displayed. The source can be activated using the SELECT:CH<x> command.

Group Measurement

Syntax MEASUREMENT:MEAS<x>:STATE { OFF | ON | <NR1> }
MEASUREMENT:MEAS<x>:STATE?

Arguments OFF or <NR1> = 0 turns the specified measurement off. You can also turn the state off by turning the source off.
ON or <NR1> ≠ 0 turns the specified measurement on.

Examples MEASUREMENT:MEAS1:STATE ON
turns measurement defined as MEAS1 on.

MEASUREMENT:MEAS4:STATE?
returns either 0 or 1, indicating the state of MEAS4.

MEASUREMENT:MEAS<x>:STDdev? (Query Only)

(Requires TDSAAM)

Returns the standard deviation of values accumulated for this measurement since the last statistical reset.

Group Measurement

Syntax MEASUREMENT:MEAS<x>:STDdev?

Returns <NR3>

Examples MEASUREMENT:MEAS1:STDDEV?
might return: :MEASU:MEAS1:STD 21.0E-12

MEASUREMENT:MEAS<x>:TYPE

Sets or returns the measurement type for the measurement specified by MEAS<x>. This is equivalent to selecting the measurement in the **Select Measurement** side menu. To see the measurement value on the display the MEASUREMENT STATE must be set to ON.

Group Measurement

Syntax MEASUREMENT:IMMed:TYPE { AMPLitude | AREa | BURst | CAREa | CMEan | CRMs | DELAY | FALL | FREQuency | HIGH | LOW | MAXimum | MEAN | MINimum | NDuty | NOVershoot | NWIdth | PDuty | PERIOD | PHASE | PK2pk | POVershoot | PWidth | RISE | RMS
MEASUREMENT:MEAS<x>:TYPE?

Arguments Information on how measurements are derived:

AMPLitude is the high value minus the low value.

AREa is the area between the curve and ground over the active waveform the high value minus the low value. TDS3AAM only.

BURSt is the time from the first MidRef crossing to the last MidRef crossing.

CARea (cycle area) is the area between the curve and ground over one cycle. TDS3AAM only.

CMEan is the arithmetic mean over one cycle.

CRMs is the true Root Mean Square voltage over one cycle.

DELAy is the delay from one waveform's edge event to another.

FALL is the time that it takes for the falling edge of a pulse to fall from a HighRef value to a LowRef value of its final value.

FREQuency is the reciprocal of the period measured in hertz.

HIGH is the 100% reference level.

LOW is the 0% reference level.

MAXimum is the highest amplitude (voltage).

MEAN for general purpose measurements, is the arithmetic mean over the entire waveform. For histogram measurements, it is the average of all acquired points within or on the histogram box.

MINimum is the lowest amplitude (voltage).

NDUty is the ratio of the negative pulse width to the signal period expressed as a percentage.

NOVershoot is the negative overshoot, expressed as:

$$NOVershoot = 100 \times \left(\frac{Low - Minimum}{Amplitude} \right)$$

NWIdth is the distance (time) between MidRef (usually 50%) amplitude points of a negative pulse.

PDUty is the ratio of the positive pulse width to the signal period expressed as a percentage.

PERIod is the time, in seconds, it takes for one complete signal cycle to happen.

PHAsE is the phase difference from the selected waveform to the designated waveform.

PK2pk is the absolute difference between the maximum and minimum amplitude. It can be used with both general purpose and histogram measurements.

POVershoot is the positive overshoot, expressed as:

$$POVershoot = 100 \times \left(\frac{(Maximum - High)}{Amplitude} \right)$$

PWIdth is the distance (time) between MidRef (usually 50%) amplitude points of a positive pulse.

RISe is the time that it takes for the leading edge of a pulse to rise from a low reference value to a high reference value of its final value.

RMS is the true Root Mean Square voltage.

Examples MEASUREMENT:MEAS3:TYPE RMS
specifies MEAS3 to calculate the Root Mean Square voltage.

MEASUREMENT:MEAS<x>:UNITS? (Query Only)

Returns the units for the measurement specified by MEASUREMENT:MEAS<x>:TYPE.

Group Measurement

Syntax MEASUREMENT:MEAS<x>:UNITS?

Returns <QString> returns "V" for volts, "s" for seconds, "HZ" for hertz, or "%" for percent. "A" for amps, "W" for watts, "?" for unknown, and " " for non-dimensional units. Measurements on math waveforms can return the following units: "V/V", "A/W", "WV", "W/V", "dBV", "dB/V", "V/A", "A/A", "WA", "W/A", "dBA", "dB/A", "VW", "V/W", "AW", "A/W", "WW", "W/W", "dBW", "dB/W", "VdB", "V/dB", "AdB", "A/dB", "WdB", "W/dB", "dBdB", and "dB/dB".

Examples MEASUREMENT:MEAS3:UNITS?
might return "%", indicating the units for Measurement 3 are percent.

MEASUrement:MEAS<x>:VALue? (Query Only)

Returns the value that has been calculated for the measurement specified by <x>.

NOTE. This value is a display value and is updated on the oscilloscope screen approximately every 1/3 second.

Group Measurement

Syntax MEASUrement:MEAS<x>:VALue?

Examples MEASUREMENT:MEAS1:VALUE?
 might return MEASUREMENT:MEAS1:VALUE 3.742E-6, indicating the measurement value displayed at the time the command was executed.

Related Commands MEASUrement:MEAS<x>:DATA?

MEASUrement:METHOD

Sets or returns the method used to calculate the 0% and 100% reference level. This is equivalent to setting the **High-Low Setup** in the **MEASURE** menu.

Group Measurement

Syntax MEASUrement:METHOD { Auto | HISTogram | MINMax }
 MEASUrement:METHOD?

Arguments HISTogram sets the high and low waveform levels statistically using a histogram algorithm.
 MINMax sets the high and low waveform levels to MAX and MIN, respectively.
 Auto chooses the best method (HISTogram or MINMax) for each dataset.

Examples MEASUREMENT:METHOD HISTOGRAM
specifies that the high and low reference levels are set statistically.

MEASUREMENT:METHOD?
returns :MEASUREMENT:METHOD MINMAX when the reference levels are set to MIN and MAX.

MEASUREMENT:REFLevel? (Query Only)

Returns the reference level method and the reference levels in absolute and percent terms.

Group Measurement

Syntax MEASUREMENT:REFLevel?

Examples MEASUREMENT:REFLEVEL?
might return :MEASUREMENT:REFLEVEL:METHOD PERCENT;ABSOLUTE:HIGH 5.0E0;LOW 0.0E0;MID 2.5E0;MID2 0.0E0;MEASUREMENT:REFLEVEL:PERCENT:HIGH 9.0E1;LOW 1.0E1;MID 5.0E1;MID2 5.0E1.

MEASUREMENT:REFLevel:ABSolute:HIGH

Sets or returns the high reference level, and is the 100% reference level when MEASUREMENT:REFLevel:METHOD is set to ABSolute. This command is equivalent to setting the **Reference Levels** in the **MEASURE** menu.

Group Measurement

Syntax MEASUREMENT:REFLevel:ABSolute:HIGH <NR3>
MEASUREMENT:REFLevel:ABSolute:HIGH?

Arguments <NR3> is the high reference level, in volts. The default is 0.0 V.

Examples MEASUREMENT:REFLEVEL:ABSOLUTE:HIGH 1.71
sets the high reference level to 1.71 Volts.

MEASUREMENT:REFLevel:ABSolute:LOW

Sets or returns the low reference level, and is the 0% reference level when MEASUREMENT:REFLevel:METHOD is set to ABSolute. This command is equivalent to setting the **Reference Levels** in the **MEASURE** menu.

Group Measurement

Syntax MEASUREMENT:REFLevel:ABSolute:LOW <NR3>
MEASUREMENT:REFLevel:ABSolute:LOW?

Arguments <NR3> is the low reference level, in volts. The default is 0.0 V.

Examples MEASUREMENT:REFLEVEL:ABSOLUTE:LOW?
might return :MEASUREMENT:REFLEVEL:ABSOLUTE:LOW 0.0E+0 as the low reference level.

MEASUREMENT:REFLevel:ABSolute:MID

Sets or returns the mid reference level, and is the 50% reference level when MEASUREMENT:REFLevel:METHOD is set to ABSolute. This command is equivalent to setting the **Reference Levels** in the **MEASURE** menu.

Group Measurement

Syntax MEASUREMENT:REFLevel:ABSolute:MID <NR3>
MEASUREMENT:REFLevel:ABSolute:MID?

Arguments <NR3> is the mid reference level, in volts. The default is 0.0 V.

Examples MEASUREMENT:REFLEVEL:ABSOLUTE:MID 2.71
sets the mid reference level to 2.71 Volts.

MEASUREMENT:REFLEVEL:ABSOLUTE:MID2

Sets or returns the mid2 reference level for the “to” waveform when taking a delay measurement, and is the 50% reference level when MEASUREMENT:REFLEVEL:METHOD is set to ABSOLUTE. This command is equivalent to setting the **Reference Levels** in the **MEASURE** menu.

Group	Measurement
Syntax	MEASUREMENT:REFLEVEL:ABSOLUTE:MID2 <NR3> MEASUREMENT:REFLEVEL:ABSOLUTE:MID2?
Arguments	<NR3> is the mid reference level, in volts. The default is 0.0 V.
Examples	MEASUREMENT:REFLEVEL:ABSOLUTE:MID2 0.5 sets the mid reference level for the delay waveform to 0.5 volts.

MEASUREMENT:REFLEVEL:METHOD

Specifies which reference levels are used for measurement calculations. This command is equivalent to setting the **Set Levels** in the **MEASURE > Reference Levels** menu.

Group	Measurement
Syntax	MEASUREMENT:REFLEVEL:METHOD { ABSOLUTE PERCENT } MEASUREMENT:REFLEVEL:METHOD?
Arguments	<p>ABSOLUTE specifies that the reference levels are set explicitly using the MEASUREMENT:REFLEVEL:ABSOLUTE commands. This method is useful when precise values are required. For instance, when designing to published interface specifications such as RS-232-C.</p> <p>PERCENT specifies that the reference levels are calculated as a percent relative to HIGH and LOW. The percentages are defined using the MEASUREMENT:REFLEVEL:PERCENT commands.</p>

Examples MEASUREMENT:REFLEVEL:METHOD ABSOLUTE
specifies that explicit user-defined values are used for the reference levels.

MEASUREMENT:REFLEVEL:METHOD?
returns either ABSOLUTE or PERCENT, indicating the reference levels used.

MEASUREMENT:REFLEVEL:PERCENT:HIGH

Sets or returns the percent, where 100% is equal to HIGH, that is used to calculate the high reference level when MEASUREMENT:REFLEVEL:METHOD is set to PERCENT. This command is equivalent to setting the relevant **Reference Levels** in the **MEASURE** menu.

Group Measurement

Syntax MEASUREMENT:REFLEVEL:PERCENT:HIGH <NR3>
MEASUREMENT:REFLEVEL:PERCENT:HIGH?

Arguments <NR3> ranges from 0 to 100 percent, and is the high reference level.
The default is 90%.

Examples MEASUREMENT:REFLEVEL:PERCENT:HIGH 95
specifies that the high reference level is set to 95% of HIGH.

MEASUREMENT:REFLEVEL:PERCENT:LOW

Sets or returns the percent, where 100% is equal to HIGH, that is used to calculate the low reference level when MEASUREMENT:REFLEVEL:METHOD is set to PERCENT. This command is equivalent to setting the relevant **Reference Levels** in the **MEASURE** menu.

Group Measurement

Syntax MEASUREMENT:REFLEVEL:PERCENT:LOW <NR3>
MEASUREMENT:REFLEVEL:PERCENT:LOW?

Arguments <NR3> ranges from 0 to 100 percent, and is the low reference level.
The default is 10%.

Examples MEASUREMENT:REFLEVEL:PERCENT:LOW?
might return :MEASUREMENT:REFLEVEL:PERCENT:LOW 1.5E1, meaning that the low reference level is 15% of HIGH.

MEASUREMENT:REFLEVEL:PERCENT:MID

Sets or returns the percent, where 100% is equal to HIGH, that is used to calculate the mid reference level when MEASUREMENT:REFLEVEL:METHOd is set to PERCENT. This command is equivalent to setting the relevant **Reference Levels** in the **MEASURE** menu.

Group Measurement

Syntax MEASUREMENT:REFLEVEL:PERCENT:MID <NR3>
MEASUREMENT:REFLEVEL:PERCENT:MID?

Arguments <NR3> ranges from 0 to 100 percent, and is the mid reference level. The default is 50%.

Examples MEASUREMENT:REFLEVEL:PERCENT:MID 60
specifies that the mid reference level is set to 60% of HIGH.

MEASUREMENT:REFLEVEL:PERCENT:MID2

Sets or returns the percent, where 100% is equal to HIGH, that is used to calculate the mid2 reference level for the second waveform specified when taking a delay measurement. This command is equivalent to setting the relevant **Reference Levels** in the **MEASURE** menu.

Group Measurement

Syntax MEASUREMENT:REFLEVEL:PERCENT:MID2 <NR3>
MEASUREMENT:REFLEVEL:PERCENT:MID2?

Arguments <NR3> ranges from 0 to 100 percent, and is the mid reference level. The default is 50%.

Examples MEASUREMENT:REFLEVEL:PERCENT:MID2 40
specifies that the mid reference level is set to 40% of HIGH.

MEASUREMENT:SNAPSHOT (Set Only)

Displays the measurement snapshot list on the oscilloscope screen, which is a list of the immediate values of all available measurements for the active signal.

Group Measurement

Syntax MEASUREMENT:SNAPSHOT

Examples MEASUREMENT:SNAPSHOT

MEASUREMENT:STATISTICS:MODE

(Requires TDSAAM)

Controls the operation and display of measurement statistics.

Group Measurement

Syntax MEASUREMENT:STATISTICS:MODE { OFF | MINMAX | MEANSTDDEV }
MEASUREMENT:STATISTICS:MODE?

Arguments OFF turns measurements off. This is the default value.

MINMAX turns on statistics and displays the min and max statistics.

MEANSTDDEV turns on statistics and displays the mean and standard deviation statistics.

Examples MEASUREMENT:STATISTICS:MODE MINMAX
turns on statistics and displays the min and max statistics.

MEASUREMENT:STATISTICS:WEIGHTING

(Requires TDSAAM)

Controls the responsiveness of mean and standard deviation to waveform changes.

Group	Measurement
Syntax	MEASUREMENT:STATISTICS:WEIGHTING <NR1> MEASUREMENT:STATISTICS:WEIGHTING?
Arguments	<NR1> is the time constant for the mean and standard deviation statistical accumulations.
Examples	MEASUREMENT:STATISTICS:WEIGHTING 4 sets the weighting to 4.

MESSAGE:BOX

Defines the size and position of the message window. This command does not display the window unless MESSAGE:STATE is ON.

Group	Display
Syntax	MESSAGE:BOX <X1>,<Y1>,<X2>,<Y2> MESSAGE:BOX?
Arguments	<X1> and <X2> = 0 to 639, and are pixel positions along the horizontal axis. <X1> defines the left and <X2> defines the right side of the window. <Y1> and <Y2> = 0 to 479, and are pixel positions along the vertical axis. <Y1> defines the top and <Y2> defines the bottom of the window. The reserved height of all characters is 16 pixels so the window must be at least that high to fully display characters.

MESSage:CLEAR

Removes the message text from the message window.

Group Display

Syntax MESSage:CLEAR

Examples MESSAGE:CLEAR
removes the message from the message box.

MESSage:SHOW

Clears the contents of the message window and displays the new message in the window.

Group Display

Syntax MESSage:SHOW <QString>
MESSage:SHOW?

Arguments <QString> is the message and can include any of the characters shown in the TDS Character Chart in Appendix A as well as characters from the Cyrillic, Korean, Japanese, and Chinese character sets. The maximum length of the message is 1000 characters; longer strings are ignored.

The message area is the height and width you have set using the MESSage:BOX command. The length of the message that fits in the message area depends on the contents of the message because the width of characters varies.

If the message exceeds the limits of the message box, either horizontally or vertically, the portion of the message that exceeds the limits will not be displayed. The message string itself is not altered. The entire message can be returned as a query response regardless of what is displayed in the message box.

The message is left-justified, and is displayed on a single line starting with the top most line in the window. A new line character can be embedded in the string to position the message on multiple lines. You can also use white space and tab characters to position the message within a line. Text which does not fit within the message box is truncated. Defining a message box text string erases any previously displayed text within the message box.

You can send a tab by transmitting a tab character (`\t` or `\x09`) followed by two characters representing the most significant eight bits followed by the least significant eight bits of a 16-bit number. The number specifies the pixel column relative to the left margin of the message area. For example, to tab to pixel 13, send TAB (`\t` or `\x09`), NUL (decimal 0), and CR (decimal 13).

For example, using hexadecimal escape sequences, MESSAGE:SHOW `'\x09\x01\x17Hello'` when sent as a command would cause the 'Hello' to be displayed starting at pixel position 279 relative to the left margin set by the MESSAGE:BOX command. If you want to display characters starting at position 279, then $279 = 0x0117$; split the hexadecimal number into two characters `0x01` and `0x17` and send `\x09\x01\x17`.

Special characters which control decoration are two character sequences where the first character is an escape (`0x1b`) and the second character is as follows:

- Bit 7 0
- Bit 6 If set, inverse video is toggled from current state and the following text is displayed in the new inverse state until the state is toggled again. Remaining bits are ignored.
- Bit 5 If set, the color index in the four LSB's (bits 0 through 3) is applied to the foreground or background color depending on the fg/bg bit (bit 4).
- bit 4 If set, color change is applied to the background, otherwise applies to the foreground.
 - bit 0-3 Specifies the color index (0 through 15) to change color to as follows:
 - Index 0 Black (background)
 - Index 1 Yellow (Ch1)
 - Index 2 Cyan (Ch2)
 - Index 3 Magenta (Ch3)
 - Index 4 Green (Ch4)
 - Index 5 Red (math)
 - Index 6 White (reference)
 - Index 7 Orange
 - Index 8 Gray (graticule)
 - Index 9 White (text)

- Index 10 Tek Blue
- Index 11 Bright Blue
- Index 12 undefined
- Index 13 Blue
- Index 14 undefined
- Index 15 Dark Blue

- Bit 4 If set, the foreground color is set to the default foreground color.
- Bit 3 If set, the background color is set to the default background color.
- Bit 2 undefined
- Bit 1 undefined
- Bit 0 undefined

The ESC (escape) character followed by the @ character turns inverse video on or off and can be embedded in the message string. Example: “abcESC@defESC@ghi” specifies the string “abcdefghi” where the “def” portion is displayed in inverse video.

Example: “abcESC#defESC)ESC@ghi” specifies the string “abcdefghi” where the “def” portion appears in the channel 3 color (magenta) and the “ghi” portion appears in the normal text color except it’s in inverse video.

An alternate way to enter characters is octal escape sequences. This consists of a backslash followed by numerals in the standard C language printf fashion.

Another way to enter characters is \xnn where the nn is the hexadecimal value of the character to display.

An advantage of these methods is that any controller program can be used. Another advantage is it’s easy to access characters with the high bit set, that is, those characters with a decimal value greater than 127.

An alternate way to enter certain characters is with a backslash followed by a single character (following “standard” Unix) as follows:

- n newline (carriage return and linefeed)
- \ backslash (\ is required to get a backslash character)
- j Japanese character encoding, the next two characters make one hexadecimal JIS value as explained later
- t horizontal tab; the next 2 characters specify the pixel column to tab to as explained earlier
- u Unicode encoding, the next two characters make one hexadecimal Unicode value as explained later

If a backslash is followed by an undefined special character, the backslash is ignored and the character following it is accepted as is.

NOTE. *The use of any escape codes other than those described above may produce unpredictable results.*

To specify Russian, Chinese, and Korean, use the 16 bit Unicode value characters as shown in the example disk files. For additional information see *The Unicode Standard, Version 2.0*. Only characters used in the oscilloscope are available. Unicode values are represented in a quoted string as “\uxxyy” where xx and yy are both hexadecimal values and xx and yy are concatenated to form a single hexadecimal number. For example, “\u0413” is the Cyrillic capital letter GHE and 0413 is the Unicode value for that character. English and European characters can also be specified using the \u Unicode sequence. In that case xx is simply 00 and yy is the hexadecimal equivalent of the 8 bit character value.

To specify Japanese characters, use the 16 bit Japanese Interchange Standard (JIS X 0208-1983) value. JIS values are represented in a quoted string as “\jxxyy” where xx and yy are both hexadecimal values and xx and yy are concatenated to form a single hexadecimal number.

Supported Unicode and JIS characters are shown in the CHARSETS directory of the disk that accompanies this manual.

Examples

MESSAGE:SHOW "Hello world"

displays "Hello world" in the upper left corner of the box (you can define the box size with the MESSAGE BOX command).

MESSAGE:SHOW "Hello @world@ ... hello"

displays "Hello world ... hello" in the upper left corner of the box and the word "world" is displayed in inverse video. In this example, @ stands for the escape character. The escape character may appear differently for you depending on your controller program.

MESSAGE:SHOW '\x09\x00\xa0\033@Hello World\033@\n\nYou can display messages on your \033*\204\033) oscilloscope\nusing any character or \033\$color\033) used by the\noscilloscope. \033!A \033"few \033%examples \033#follow\033):\n\n\021\027\214\232 \340\341\342\343\344 \u042a\u042e\u042f\u3080\u3084 \u8017\n\n\033*\205\n\033%\206'

displays the message as shown below. "Color" and "A few examples follow" are displayed in green, yellow, cyan, red, and magenta respectively; Tek and Tektronix are also in Tektronix' colors.



MESSage:STATE

Controls the display of the message window.

Group Display

Syntax MESSage:STATE { OFF | ON | <NR1> }
MESSage:STATE?

Arguments <OFF> or <NR1> = 0 removes the message window from the display.
<ON> or <NR1> \neq 0 displays the message window and its contents on the display.

Related Commands MESSage:BOX, MESSage:SHOW

NEWpass (No Query Form)

Changes the password that enables access to password protected data. The PASSWord command must be successfully executed before using this command or an execution error will be generated.

Group Miscellaneous

Syntax NEWpass <QString>

Arguments <QString> is the new password. The password can include up to 10 characters.

Examples NEWPASS "mypassword"
creates a new password for accessing the user protected data.

Related Commands PASSWord, *PUD

*OPC

Generates the operation complete message in the Standard Event Status Register (SESR) when all pending operations finish. The *OPC? query places the ASCII character “1” into the output queue when all pending operations are finished. The *OPC? response is not available to read until all pending operations finish. For a complete discussion of the use of these registers and the output queue, see page 3-1.

Group Status and Error

Syntax *OPC
*OPC?

The *OPC command allows you to synchronize the operation of the oscilloscope with your application program. Synchronization methods are described starting on page 3-7. Table 2-39 shows commands that generate an Operation Complete message.

Table 2-39: Commands that Generate an Operation Complete Message

Operation	Command
Automatic scope adjustment	AUTOSet EXECute
Internal self-calibration	*CAL
Single sequence acquisition	ACQuire:STATE ON or ACQuire:STATE RUN (when ACQuire:STOPAfter is set to SEQuence)
Hardcopy output	HARDCopy STARt

Related Commands BUSY?, *WAI

PASSWord (No Query Form)

Enables the *PUD and NEWpass set commands. Sending PASSWord without any arguments disables these same commands. Once the password is successfully entered, the *PUD and NEWpass commands are enabled until the oscilloscope is powered off, or until the FACTory command, the PASSWord command with no arguments, or the *RST command is issued.

To change the password, you must first enter the valid password with the PASSWord command and then change to your new password with the NEWpass command. Remember that the password is case sensitive.

Group Miscellaneous

Syntax PASSWord
PASSWord <QString>

Arguments <QString> is the password and can include up to 10 characters. The factory default password is "XYZZY" and is always valid.

Examples PASSWORD "XYZZY"
Enables the *PUD and NEWpass set commands.

PASSWORD
Disables the *PUD and NEWpass set commands. You can still use the query version of *PUD.

Related Commands NEWpass, *PUD

*PSC

Sets and queries the power-on status flag that controls the automatic power-on handling of the DESER, SRER, and ESER registers. When *PSC is true, the DESER register is set to 255 and the SRER and ESER registers are set to 0 at power-on. When *PSC is false, the current values in the DESER, SRER, and ESER registers are preserved in nonvolatile memory when power is shut off and are restored at power-on. For a complete discussion of the use of these registers, see page 3-1.

Group Status and Error

Syntax *PSC <NR1>
*PSC?

Arguments <NR1> = 0 sets the power-on status clear flag to false, disables the power-on clear and allows the oscilloscope to possibly assert SRQ after power-on.

<NR1> \neq 0 sets the power-on status clear flag true. Sending *PSC 1 therefore enables the power-on status clear and prevents any SRQ assertion after power-on. Using an out-of-range value causes an execution warning.

Examples *PSC 0
sets the power-on status clear flag to false.

*PSC?
might return the value 1, showing that the power-on status clear flag is set to true.

Related Commands DESE, *ESE, FACtory, *RST, *SRE

POWER:AC:PRESENT? (Query Only)

Indicates if the instrument is being powered by AC or Battery

Group Miscellaneous

Syntax POWER:AC:PRESENT?

Arguments <NR1> = 0 indicates the oscilloscope is being powered by battery.

<NR1> = 1 indicates the oscilloscope is being powered by AC.

Examples POWER:AC:PRESENT?
might return :POWER:AC:PRESENT 1.

Related Commands POWer:BATTery:PRESENT?

POWer:BACKLight

Sets or returns the idle time that must elapse before the backlight is turned off. When the oscilloscope is running on AC power, idle time is ignored.

Group Miscellaneous

Syntax POWer:BACKLight { <NR1> | INFInite }
POWer:BACKLight?

Arguments <NR1> = minutes of idle time before the backlight is turned off. 999999999 is used for infinity, but any value greater than 15 (max timeout) will be rounded to infinity.

INFInite disables the timer meaning the backlight will not turn off automatically.

Examples POWER:BACKLIGHT 5
sets the backlight to turn off after the oscilloscope has been idle for 5 minutes.

Related Commands POWer:SHUTdown

POWer:BATTery:GASgauge? (Query Only)

Indicates the remaining charge left in the battery.

Group Miscellaneous

Syntax POWer:BATTery:GASgauge?

Arguments	<NR1> is a value with a range from 0 to 15 that indicates the remaining charge in the battery; 0 means the battery is fully discharged and 15 means the battery is fully charged
Examples	POWER:BATTERY:GASGAUGE? might return :POWER:BATTERY:GASGAUGE 15.
Related Commands	POWer:BATTERY:PRESENT?

POWer:BATTEry:PRESENT? (Query Only)

Indicates if there is a battery in the instrument.

Group	Miscellaneous
Syntax	POWer:BATTEry:PRESENT?
Arguments	<NR1> = 0 indicates there is no battery in the instrument. <NR1> = 1 indicates there is a battery in the instrument.
Examples	POWER:BATTERY:PRESENT? might return :POWER:BATTERY:PRESENT 0.
Related Commands	POWer:AC:PRESENT?

POWer:SHUTdown

Sets or returns the idle time that must elapse before the oscilloscope is turned off. When the oscilloscope is running on AC power, idle time is ignored.

Group	Miscellaneous
Syntax	POWer:SHUTdown { <NR1> INFInite } POWer:SHUTdown?

- Arguments** <NR1> = the number of minutes of idle time before the oscilloscope is powered off. 999999999 is used for infinity, but any value greater than 15 (max timeout) will be rounded to infinity.
- INFinite disables the timer meaning the oscilloscope will not power off automatically.
- Examples** POWER:SHUTDOWN 5
Instrument will power off after the oscilloscope has been idle for 5 minutes.

***PUD**

Sets or returns a string of Protected User Data. This data is protected by the PASSWord command. You can modify it only by first entering the correct password. The password is not necessary to query the data. This data is displayed in the UTILITY System Config menu. This command accepts European, Russian, and Asian characters; see the MESSAGE:SHOW command for details. Query always returns <Block> type response.

Group Miscellaneous

Syntax *PUD <Block> or <Qstring>
*PUD?

Arguments <Block> is a string containing up to 300 characters.

Examples *PUD #229This instrument belongs to me
stores the string “This instrument belongs to me” in the user protected data area.

*PUD?
might return #221Property of Company X.

Related Commands PASSWord

REBOOT (No Query Form)

Reboots (restarts) the oscilloscope firmware. This is the equivalent of power cycling the oscilloscope.

Group Miscellaneous

Syntax REBOOT

*RCL (No Query Form)

Restores the state of the oscilloscope from a copy of its settings stored in memory. (The settings are stored using the *SAV command.) This command is equivalent to RECALL:SETUp and performs the same function as the Recall Saved Setup item in the SAVE/RECALL menu.

Group Save and Recall

Syntax *RCL <NR1>

Arguments <NR1> is a value in the range from 1 to 10. A value of 1 to 10, specifies a saved setup storage location.

Examples *RCL 3
restores the oscilloscope setup from a copy of the settings stored in setup location 3.

Related Commands FACtory, *LRN?, RECALL:SETUp, *RST, *SAV, SAVE:SETUp

RECALL:MASK

(Requires TDS3TMT)

Loads the specified mask file from the disk or flash drive into the User mask.

Group Save and Recall

Syntax RECALL:MASK <QString>

Arguments <QString> is the path and file name, enclosed in quotes, of the mask file to load from the disk or flash drive into the User mask.

Examples RECALL:MASK "fd0:\custome2.msk"
loads the file custome2.msk from the floppy drive into the User mask.

Related Commands SAVE:MASK <QString>

RECALL:SETUp (No Query Form)

Restores a stored or factory front-panel setup of the oscilloscope. This command is equivalent to selecting **Recall Saved Setup** or **Recall Factory Setup** in the **SAVE/RECALL** menu.

Group Save and Recall

Syntax RECALL:SETUp { FACTory | <NR1> | <file path> }

Arguments FACTory selects the factory setup. Initializes instrument settings to factory defaults, excluding: GPIB, hard copy, RS232 parameters, file instrument setting parameters, calibration notification time, battery off time, backlight time-outs, and user's language.

<NR1> is a value in the range from 1 to 10 and specifies a setup storage location.

<file path> is the name of the file where the setup will be recalled from.

<file path> is a quoted string that defines the file name and path. Input the file path using the form <drive>/<dir>/<filename>. <drive> and one or more <dir>s are optional. If you do not specify them, the oscilloscope will read the file from the current directory. <filename> stands for a filename of up to 8 characters followed by a period (".") and any 3-character extension. Do not use wild card characters.

The current directory refers to the name of a directory as returned by the FILESystem:CWD command.

Examples `RECALL:SETUP FACTORY`
 recalls (and makes current) the front panel setup to the factory defaults.

`RECALL:SETUP 1`
 recalls the front panel setup from setup1.

`RECALL:SETUP "TEK00000.SET"`
 recalls the front panel setup from the file TEK00000.SET in the current directory.

Related Commands `DELEte:SETUp, FACtory, *RCL, *RST, *SAV, SAVe:SETUp`

RECALL:WAVEform (No Query Form)

Recalls a stored waveform into a reference location. This command is similar to selecting From File in the Recall Waveform item in the SAVE/RECALL menu. Only files saved in the internal file format can be recalled; see the `SAVE:WAVEFORM:FILEFORMAT` command.

Group Save and Recall

Syntax `RECALL:WAVEform <file path>,REF<x>`

Arguments `REF<x>` is the location in internal reference memory where the waveform is recalled to.

`<file path>` is a quoted string that defines the file name and path. Input the file path using the form `<drive>/<dir>/<filename>`. `<drive>` and one or more `<dir>`s are optional. If you do not specify them, the oscilloscope will recall the waveform from the current directory. `<filename>` stands for a filename of up to 8 characters followed by a period (".") and any 3-character extension. Do not use wild card characters.

The current directory refers to the name of a directory as returned by the `FILESsystem:CWD` command.

Examples `RECALL:WAVEFORM "TEK00000.ISF",REF1`
 recalls the waveform stored in the file named TEK00000.ISF to reference location 1.

REF<x>:DATE? (Query Only)

Returns reference waveform save date. Saving a waveform to a reference waveform will create a new save date.

Group	Waveform
Syntax	REF<x>:DATE?
Examples	REF4:DATE? might return "09-10-99" in the form mm-dd-yy.

REF<x>:HORizontal:POSition

Sets reference waveform horizontal display position from 0.0 to 100.0. The horizontal display position for a reference waveform is the same for zoom on and off.

Group	Waveform
Syntax	REF<x>:HORizontal:POSition <NR3> REF<x>:HORizontal:POSition?
Arguments	<NR3> is from 0 to 100 and is percent of the waveform that is displayed left of the center graticule
Examples	REF<x>:HORIZONTAL:POSITION? might return REF1:HORIZONTAL:POSITION 5.0E1

REF<x>:HORizontal:SCALE

Sets reference waveform horizontal display scale in horizontal units/div. The horizontal display scale for a reference waveform is the same for zoom on and off.

Group	Waveform
--------------	----------

Syntax REF<x>:HORizontal:SCALE <NR3>
REF<x>:HORizontal:SCALE?

Arguments <NR3> is the time per division. The range is from acquired time/div to (acquired time/div/200) for 10,000 point reference waveforms, and to (acquired time/div/10) for 500 point reference waveforms.

Examples REF1:HORIZONTAL:SCALE?
might return REF1:HORIZONTAL:SCALE 4.0E-4

REF<x>:LABEL

Sets or returns the specified reference waveform label. See MESSAGE:SHOW command for information on how to enter non-English characters.

Group Waveform

Syntax REF<x>:LABEL <Qstring>
REF<x>:LABEL?

Arguments <QString> is a string, enclosed in quotes, that contains the label text.

Examples REF4:LABEL?
might return REF4:LABEL "C1k Wfm 2".

REF<x>:TIME? (Query Only)

Returns reference waveform save time. Saving a waveform to a reference waveform will create a new save time.

Group Waveform

Syntax REF<x>:TIME?

Examples REF<x>:TIME?
might return "16:54:05"

REF<x>:VERTical:POSition

Sets the reference waveform vertical display position in vertical divisions; equivalent to adjusting the Vertical **POSITION** knob when REF<x> is the selected waveform.

Group	Waveform
Syntax	REF<x>:VERTical:POSition <NR3> REF<x>:VERTical:POSition?
Arguments	<NR3> is the reference waveform's display vertical position.
Examples	REF2:VERTICAL:POSITION 1.0 sets the vertical position for the Ref2 waveform to +1 division.

REF<x>:VERTical:SCAle

Sets reference waveform vertical display scale in vertical units/div; equivalent to adjusting the Vertical **SCALE** knob when REF<x> is the selected waveform.

Group	Waveform
Syntax	REF<x>:VERTical:SCAle <NR3> REF<x>:VERTical:SCAle?
Arguments	<NR3> is the reference waveform's display vertical scale.
Examples	REF1:VERTICAL:SCALE 1.0 will display REF1 at 1 V/div

REM (No Query Form)

Specifies a comment. This line is ignored by the instrument.

Group Miscellaneous

Syntax REM <QString>

Arguments <QString> is a string that can have a maximum of 255 characters.

Examples REM "This is a comment"
is ignored by the instrument.

*RST (No Query Form)

*RST returns the instrument settings to the factory defaults (see *Appendix D: Factory Initialization Settings*).

The *RST command does not alter the following:

- The state of the IEEE Std 488.1-1987 interface.
- The selected IEEE Std 488.1-1987 address of the oscilloscope.
- Calibration data that affect device specifications.
- The Output Queue.
- The Service Request Enable Register setting.
- The Standard Event Status Enable Register setting.
- The Power-on status clear flag setting.
- Alias definitions.
- Stored settings.
- The *PUD? response.

Group Status and Error

Related Commands FACtory, *PSC, *RCL, RECALL:SETUp, *SAV, SAVE:SETUp

Syntax *RST

RS232? (Query Only)

Returns the RS232 settings.

Group	RS232
Syntax	RS232?
Arguments	None
Examples	RS232? might return: :RS232:BAUD 38400;TRANSMIT:TERMINATOR LF;HARDFLAGGING:ON.

RS232:BAUD

Sets or returns RS-232 interface transmission speed.

Group	RS232
Syntax	RS232:BAUD <NR1> RS232:BAUD?
Arguments	<NR1> is a rate of 1200, 2400, 4800, 9600, 19200, or 38400 baud.
Examples	RS232:BAUD 9600 sets the transmission rate to 9600 baud.

RS232:HARDFlagging

Sets or returns the input and output hard flagging over the RS-232 port. It uses the RTS (Request To Send) and CTS (Clear To Send) lines to control data transmission. On output, the oscilloscope transmits data only when CTS is asserted. When CTS is not asserted, the oscilloscope stops transmitting data. On input, it asserts RTS until the receive queue is full. Then it unasserts RTS to stop transmission from an external printer. CTS remains unasserted until the receive queue is not full. At that time, CTS is asserted again to restart transmission.

Group RS232

Syntax RS232:HARDFlagging { ON | OFF | <NR1> }
RS232:HARDFlagging?

Arguments <ON> or <NR1> ≠ 0 turn on hardflagging.
<OFF> or <NR1> = 0 turn off hardflagging (RTS always asserted).

Examples RS232:HARDFLAGGING ON
turns on hard flagging.

RS232:PRESet (No Query Form)

Sets RS-232 parameters to default values. The RS232? query will show the new settings

```
RS232:BAUD 9600
RS232:HARDFLAGGING ON
RS232:TRANSMIT:TERMINATOR LF
```

Group Miscellaneous

Syntax RS232:PRESet

Arguments None.

Examples RS232:PRESET
sets RS232 parameters to the default values.

Related Commands RS232?, RS232: BAUD, RS232: HARDFlagging

RS232:TRANsmit:TERMinator

Sets or returns the end-of-line (EOL) terminator. When transmitting, the oscilloscope appends the terminator to the end of each message. When receiving, the oscilloscope accepts all four terminators, regardless of the currently selected terminator. When a combination of multiple characters is selected (CRLF or LFCR), the oscilloscope interprets the first character as the terminator; it treats the second character as a null command.

CR represents an ASCII carriage return character (0x0D) and LF represents an ASCII linefeed character (0x0A).

Group Miscellaneous

Syntax RS232:TRANsmit:TERMinator { CR | LF | CRLf | LFCr }
RS232:TRANsmit:TERMinator?

Arguments <CR> selects the carriage return character as the EOL terminator.
<LF> selects the line feed character as the EOL terminator.
<CRLf> selects the carriage return and line feed characters as the EOL terminator.
<LFCr> selects the line feed and carriage return characters as the EOL terminator.

Examples RS232:TRANSMIT:TERMINATOR CR
sets the carriage return as the EOL terminator.

Related Commands RS232?, RS232: HARDFlagging

*SAV (Set Only)

(Save) stores the state of the oscilloscope into a specified internal setup location. You can later use the *RCL command to restore the oscilloscope to this saved state. This is equivalent to selecting the **Save Current Setup** menu item in the **SAVE/RECALL** menu.

Group Save and Recall

Syntax *SAV <NR1>

Arguments <NR1> is a value in the range from 1 to 10 and specifies a location. Any settings that have been stored previously at this location will be overwritten.

Examples *SAV 2
saves the current settings in internal setup location 2.

Related Commands FACtory, *RCL, RECALL:SETUp, SAVe:SETUp

SAVe:MASK

(Requires TDS3TMT)

Saves the User mask to the specified location on the disk or flash drive.

Group Save and Recall

Syntax SAVe:MASK <QString>

Arguments <QString> is the path and file name, enclosed in quotes, to which to save the User mask data on the disk or flash drive.

Examples SAVe:SETUP "COAX2.MSK"
saves the user mask information to the file COAX2.MSK in the current directory.

SAVe:SETUp (Set Only)

Saves the current front-panel setup into the specified internal setup location or file. This is equivalent to selecting the **Save Current Setup** menu item in the **SAVE/RECALL** menu.

Group Save and Recall

Syntax SAvE:SETUp { <NR1> | <file path> }

Arguments <NR1> is a value in the range from 1 to 10 and specifies a location. Any settings that have been stored previously at this location will be overwritten.

<file path> is a quoted string that defines the file name and path. Input the file path using the form <drive>/<dir>/<filename>. <drive> and one or more <dir>s are optional. If you do not specify them, the oscilloscope will write the file to the current directory. <filename> stands for a filename of up to 8 characters followed by a period (".") and a 3-char extension. We recommend you use ".SET" for the extension to identify files that store setup data.

The current directory refers to the name of a directory as returned by the FILESystem:CWD query.

Examples SAvE:SETUp 5
saves the current front-panel setup in internal setup location 5.

SAvE:SETUp "TEK00000.SET"
saves the current front-panel setup to the file TEK00000.SET in the current directory.

Related Commands RECAIl:SETUp, *RCL, *SAV

SAVe:WAVEform (Set Only)

Stores a waveform in one of four reference memory locations or a file. This command is equivalent to selecting the **Save Waveform** menu item in the **SAVE/RECALL** menu.

Group Save and Recall

Syntax SAvE:WAVEform <wfm>,{ REF<x> | <file path> }

Arguments <wfm> is CH<x>, MATH<x>, or REF<x>, and is the waveform that will be saved.

REF<x> is the location where the waveform will be stored.

<file path> is a quoted string that defines the file name and path. Input the file path using the form <drive>/<dir>/<filename>. <drive> and one or more <dir>s are optional. If you do not specify them, the oscilloscope will write the file to the current directory. <filename> stands for a filename of up to 8 characters followed by a period (".") and the proper 3-character extension. Internal format waveforms use the ".ISF" extension, spreadsheet files use the ".CSV" extension, and Mathcad files use the ".DAT" extension. However, the oscilloscope stores the waveform in the format specified by the SAVE:WAVEFORM:FILEFORMAT command, not the format specified in the suffix.

The current directory refers to the name of a directory as returned by the FILESystem:CWD query.

Examples SAVE:WAVEFORM MATH,REF1
saves the math waveform in reference memory location 2.

SAVE:WAVEFORM MATH1,"TEK00000.ISF"
saves the math1 waveform (which is the same as the MATH waveform) to the file TEK00000.ISF in the current directory.

Related Commands SAVE:WAVEform:FILEFormat

SAVE:WAVEform:FILEFormat

Sets or queries the file format for saved waveforms. Only internal format files can be recalled into the oscilloscope.

Group Save and Recall

Syntax SAVE:WAVEform:FILEFormat { INTERNAL | SPREADSheet | MATHCad }
SAVE:WAVEform:FILEFormat?

Arguments INTERNAL specifies the internal format. Internal format files should have a .ISF extension. The format will be the same as that output from the commands "WFMPRE:ENCDG BINARY;WAVFRM?" (with ASCII waveform preamble information).

SPREADSheet specifies the spreadsheet format. Spreadsheet format files should have a .CSV extension. Each waveform data point consists of two floating point values, an X (typically time) value and a Y (typically amplitude) value. Each XY pair is separated by carriage return (0x0D) and line feed (0x0A) characters. Each value except the last one in the file is followed by a comma (0x2C).

MATHCad specifies the MathCad format. MathCad format files should have a .DAT extension.

If you are writing a MathCad program, you should be aware that the TDS-MathCad file has the following features:

- ASCII format
- First four values contain header information
- First header value holds the oscilloscope waveform record length
- Second header value holds time, in seconds, between samples
- Third header value holds the trigger position (expressed as an index in the data position)
- Fourth header value refers to the fractional trigger position
- Delimiters are carriage returns and line feeds (CRLF)

Examples SAVE:WAVEFORM:FILEFORMAT SPREADSHEET specifies the waveform, when saved, will be stored in a spreadsheet-compatible format.

Related Commands SAVE:WAVEform, RECALL:WAVEform

SElect? (Query Only)

Returns the display status of all waveforms and the selected (control) waveform.

Group Vertical

Syntax SElect?

Examples SELECT?
might return :SELECT:CH1 1;CH2 1;CH3 0;CH4 0;MATH 0;
REF1 0;REF2 0;REF3 0;REF4 0;CONTROL CH1, indicating that channel 1 and 2 are displayed on the screen and channel 1 is the selected (control) waveform.

SElect:CONTROL

Sets or queries the waveform that is currently affected by the cursor and vertical commands.

Group Vertical

Syntax SElect:CONTROL <wfm>
SElect:CONTROL?

Arguments <wfm> is CH<x>, MATH<x>, or REF<x>, and will be the selected waveform.

Returns NONE if all waveforms are off. NONE is ignored on input.
CH<x>, MATH<x>, or REF<x> if it is the waveform affected by the cursor and vertical commands.

Examples SELECT:CONTROL?
might return :SELECT:CONTROL MATH1 indicating MATH1 is the selected waveform.

SElect:<wfm>

Turns the specified waveform ON or OFF. Turning a waveform ON makes it the selected waveform.

Group Vertical

Syntax SElect:<wfm> { OFF | ON }
SElect:<wfm>?

Arguments <wfm> specifies the waveform to display. Valid values are CH1, CH2, CH3, CH4, MATH, MATH1 (same as MATH), REF1, REF2, REF3, and REF4.

OFF or 0 turns off the display of the specified waveform.

ON or 1 turns on the display of the specified waveform. The waveform also becomes the selected waveform.

Examples `SELECT:CH2 ON`
 turns the channel 2 display on and selects channel 2.

`SELECT:REF1?`
 might return `REF1 1` indicating that the REF1 waveform is being displayed.

SET? (Query Only)

Returns a string listing the oscilloscope settings, except for configuration information for the calibration values. You can use this string to return the oscilloscope to the state it was in when you made the SET? query. This command is identical to the *LRN? command.

Group Miscellaneous

Syntax SET?

NOTE. *The SET? query always returns a string with command headers, regardless of the setting of the HEADER command. This is because the returned string is intended to be able to be sent back to the oscilloscope as a command string. The VERBose command can still be used to specify whether the returned headers should be abbreviated or full length.*

Examples SET?
 a partial return string may look like this:
`:HEADER 1;:VERBOSE 1;:ALIAS:STATE 1;:ACQUIRE:MODE
 SAMPLE;NUMAVG 16;NUMENV 16;STATE 1;STOPAFTER
 RUNSTOP;:DISPLAY:COLOR:PALETTE:REGULAR NORMAL;:DISPLAY:STYLE:DOT-
 ONLY 0;:DISPLAY:PERSISTENCE 0.0E0;CLOCK 0;GRATICULE
 FULL;INTENSITY:WAVEFORM 65;BACKLIGHT HIGH;:DISPLAY:XY:MODE
 OFF;YCHANNEL CH2;YREF OFF;:SELECT:CH1 0;CH2 1;CH3 0;CH4 0;MATH
 0;REF1 0;REF2 0;REF3 0;REF4 0;CONTROL CH2;:HARDCOPY:FORMAT
 PCXCOLOR;PORT FILE;LAYOUT LANDSCAPE;:HORIZONTAL:RESOLUTION
 LOW;TRIGGER:POSITION 1.02E1;:HORIZONTAL:MAIN:SCALE
 2.0E-4;:HORIZONTAL:DELAY:STATE 0;`

Related Commands HEADER, *LRN?, VERBose

SETUp<x>:DATE? (Query Only)

Sets or returns the date when the specified instrument setup was saved.

Group Waveform

Syntax SETUp<x>:DATE?

Examples SETUP4:DATE?
might return SETUP4:DATE "04-18-01".

SETUp<x>:LABEL

Sets or returns the specified instrument setup label. See the MESSAge:SHOW command for information on how to enter non-English characters.

Group Waveform

Syntax SETUp<x>:LABEL <Qstring>
SETUp<x>:LABEL?

Arguments <QString> is a string, enclosed in quotes, that contains the label text.

Examples SETUP4:LABEL?
might return REF4:LABEL "Test 2".

SETUp<x>:TIME? (Query Only)

Sets or returns the time that the specified instrument setup was saved.

Group Waveform

Syntax SETUp<x>:TIME?

Examples SETUP2:TIME?
might return SETUP2:TIME "15:24:07".

***SRE**

(Service Request Enable) sets and queries the bits in the Service Request Enable Register (SRER). For a complete discussion of the use of these registers, see page 3-1.

Group Status and Error

Syntax *SRE <NR1>
*SRE?

Arguments <NR1> is a value in the range from 0 to 255. The binary bits of the SRER are set according to this value. Using an out-of-range value causes an execution error. The power-on default for SRER is 0 if *PSC is 1. If *PSC is 0, the SRER Attains its value through a power cycle.

Examples *SRE 48
sets the bits in the SRER to 00110000 binary.

*SRE?
might return a value of 32, showing that the bits in the SRER have the binary value 00100000.

Related Commands *CLS, DESE, *ESE, *ESR?, EVENT?, EVMsg?, FACtory, *PSC, *STB?

***STB? (Query Only)**

(Read Status Byte) query returns the contents of the Status Byte Register (SBR) using the Master Summary Status (MSS) bit. For a complete discussion of the use of these registers, see page 3-1.

Group Status and Error

Syntax *STB?

Returns <NR1>

Examples *STB?
might return the value 96, showing that the SBR contains the binary value 01100000.

Related Commands *CLS, DESE, *ESE, *ESR?, EVENT?, EVMsg?, FACtory, *SRE

SYStem

Sets or returns the UTILITY menu's System menu setting. This command does not display the System menu when executed.

Group Miscellaneous

Syntax SYStem { APPS | CALibrate | CONFIG | DIAg | HARDCopy | IO }
SYStem?

Arguments The arguments correspond to the UTILITY menu System menu items.

Examples SYStem?
might return SYSTEM CONFIG.

TEKSecure

Initializes both waveform and setup memories. This overwrites any previously stored data.

TEKSecure writes zeros in all waveform reference memory, regardless of selected record length, and puts all setups in the factory init state.

TEKSecure then verifies that the waveform and setup memories are in the desired state. It asserts a pass or a fail event on completion.

Group Miscellaneous

Syntax TEKSecure

TIME

Sets or queries the current time

Group Miscellaneous

Syntax TIME <QString>
TIME?

Arguments <QString> is a time in the form "hh:mm:ss".
hh refers to the hour number from 01 to 24.
mm refers to the minute number from 00 to 59.
ss refers to the seconds number from 00 to 59.
There must be a colon after the hh and after the mm.
Use two digits for each of the hh, mm, and ss.

Examples TIME "01:24:00"
sets the time to 01:24 AM.

Related Commands DATE, DISplay: CLOCK

TRIGger

Forces a trigger event to occur, and the TRIGger query returns the current trigger parameters.

Group Trigger

Syntax TRIGger FORCe
TRIGger?

Arguments FORCe creates a trigger event. If TRIGger:STATE is REAdy, the acquisition will complete, otherwise this command will be ignored. This is equivalent to pressing the front-panel **FORCE TRIG** button.

Examples TRIGGER FORCE
 forces a trigger event to occur.

TRIGGER?
 might return :TRIGGER:A:MODE AUTO;TYPE EDGE;HOLDOFF:VALUE
 2.508E-7;;:TRIGGER:A:EDGE:SOURCE CH1;COUPLING DC;SLOPE
 RISE;;:TRIGGER:A:VIDEO:STANDARD NTSC;SOURCE CH1;FIELD
 ALLLINES;;:TRIGGER:A:LEVEL 2.6E-1;;:TRIGGER:B:STATE 0;BY
 TIME;EVENTS:COUNT 1;;:TRIGGER:B:TIME 1.32E-8;TYPE EDGE;LEVEL
 0.0E0;EDGE:SOURCE CH1;COUPLING DC;SLOPE RISE

TRIGger:A? (Query Only)

Returns the current A trigger parameters.

Group Trigger

Syntax TRIGger:A?

Examples TRIGGER:A?
 might return:TRIGGER:A:MODE AUTO;TYPE EDGE;HOLDOFF:TIME
 2.508E-7;;:TRIGGER:A:EDGE:SOURCE CH1; COUPLING DC;SLOPE
 RISE;;:TRIGGER:A:VIDEO:STANDARD NTSC;SOURCE CH1;FIELD ALLLINES;
 :TRIGGER:A:LEVEL 5.5E1

TRIGger:A:COMMunication:SOUrce

(Requires TDS3TMT)

Sets or returns the current mask standard's trigger source. The set mode of this command only applies to the User mask A trigger settings. The query mode of this command returns the current mask A trigger settings.

Group Trigger

Syntax TRIGger:A:COMMunication:SOUrce { ALTernating | CH<x> | EXT |
 EXT10 | LINE | VERTical }

TRIGger:A:COMMunication:Source?

Arguments	<p>ALternating sets the trigger source to alternate between each displayed input channel.</p> <p>CH<x> sets the trigger source to the specified input channel, where <x> is 1, 2, 3, or 4.</p> <p>EXT sets the trigger source to the regular external trigger input connector with a signal input range of -0.8 V to +0.8 V. EXT is not available in 4-channel TDS3000 Series instruments.</p> <p>EXT10 sets the trigger source to the reduced external trigger with a signal input range of -8 V to +8 V. EXT10 is not available in 4-channel TDS3000 Series instruments.</p> <p>LINE sets the trigger source to the AC line frequency.</p>
------------------	--

NOTE. *LINE is not available when the instrument is operating on battery power.*

VERTical sets the trigger source to the lowest numbered displayed channel.

Examples	<p>TRIGger:A:COMMunication:SOUrce CH2 sets the communications A trigger source to oscilloscope channel 2.</p>
-----------------	---

TRIGger:A:COMMunication:STANdard

(Requires TDS3TMT)

Sets or returns the current mask standard's trigger settings. The set mode of this command only applies to the User mask A trigger settings. The query mode of this command returns the current mask A trigger settings.

Group	Trigger
Syntax	<pre>TRIGger:A:COMMunication:STANdard { CLOCKCoax CLOCKSymmetrical DSOContra DSODouble DSOSingle DSOTiming DS1C DS1Rate DS2 DS2RATECoax DS2RATESymmetrical DS3Rate E1Coax E1Symmetrical E2 E3 G703DS1 G703DS3 RATE32Mbit STS1Pulse }</pre> <p>TRIGger:A:COMMunication:STANdard?</p>
Arguments	CLOCKCoax through RATE32Mbit specifies the communication standard trigger settings to apply to the A trigger.

Examples TRIGger:A:COMMunication:STANdard E2
sets the A trigger parameters to those required to test E2 waveforms.

Related Commands TRIGger:MAIn:COMMunication:STANdard

TRIGger:A:EDGE? (Query Only)

Returns the trigger coupling, source, and slope for the A edge trigger.

Group Trigger

Syntax TRIGger:A:EDGE?

Examples TRIGGER:A:EDGE?
might return :TRIGGER:A:EDGE:SOURCE CH1;COUPLING DC;SLOPE RISE

TRIGger:A:EDGE:COUPLing

Sets or queries the type of coupling for the A edge trigger. This is equivalent to setting **Coupling** in the **Trigger** menu.

Group Trigger

Syntax TRIGger:A:EDGE:COUPLing { AC | DC | HFRej | LFRej | NOISErej }
TRIGger:A:EDGE:COUPLing?

Arguments AC selects LFRej trigger coupling. AC coupling is for backward compatibility and will not be returned by a query.

DC selects DC trigger coupling.

HFRej coupling removes the high frequency components of the DC signal.

LFRej coupling removes the low frequency components of the AC signal.

NOISErej selects DC low sensitivity. It requires added signal amplitude for more stable, less false triggering.

Examples TRIGGER:A:EDGE:COUPLING DC
sets the A edge trigger coupling to DC.

TRIGger:A:EDGE:SLOpe

Selects a rising or falling slope for the A edge trigger. This is equivalent to setting **Slope** in the **Trigger** menu.

Group	Trigger
Syntax	TRIGger:A:EDGE:SLOpe { FALL RISE } TRIGger:A:EDGE:SLOpe?
Arguments	FALL specifies to trigger on the falling or negative edge of a signal. RISE specifies to trigger on the rising or positive edge of a signal.
Examples	TRIGGER:A:EDGE:SLOPE RISE sets the A edge trigger to occur on the rising slope.

TRIGger:A:EDGE:SOURce

Sets or queries the source for the A edge trigger. This is equivalent to setting **Source** in the **Trigger** menu.

Group	Trigger
Syntax	TRIGger:A:EDGE:SOURce { EXT EXT10 VERTical CH<x> LINE ALTERNating } TRIGger:A:EDGE:SOURce?
Arguments	EXT sets the trigger source to the regular external trigger input connector with a signal input range of -0.8 V to +0.8 V. EXT is not available in 4 channel TDS3000 Series instruments. EXT10 sets the trigger source to the reduced external trigger with a signal input range of -8 V to +8 V. EXT10 is not available in 4 channel TDS3000 Series instruments. VERTical sets the trigger source to the lowest numbered displayed channel. CH<x> sets the trigger source to the specified input channel, where <x> is 1, 2, 3, or 4.

LINE sets the trigger source to the AC line frequency.

NOTE. *LINE is not available when the instrument is operating on battery power.*

ALternating sets the trigger source to alternate between each displayed input channel.

Examples TRIGGER:A:EDGE:SOURCE LINE
specifies the AC line voltage as the A edge trigger source.

TRIGGER:A:EDGE:SOURCE?
might return :TRIGGER:A:EDGE:SOURCE CH2 for the A edge trigger source.

TRIGger:A:HOLdoff? (Query Only)

Returns the A trigger holdoff time.

Group Trigger

Syntax TRIGger:A:HOLdoff?

Examples TRIGGER:A:HOLDOFF?
might return :TRIGGER:A:HOLDOFF:TIME 2.508E-7.

TRIGger:A:HOLdoff:TIME

Sets or queries the A trigger holdoff time. This is equivalent to setting **Holdoff (Time)** in the **Mode & Holdoff** side menu.

Group Trigger

Syntax TRIGger:A:HOLdoff:TIME <NR3>
TRIGger:A:HOLdoff:TIME?

Examples TRIGGER:A:HOLDOFF:TIME 2.5e-7
to set the holdoff value to 250.8 ns.

TRIGger:A:HOLdoff:VALue

Sets or queries the A trigger holdoff time as a percent of record. This is equivalent to setting **Holdoff (% of record)** in the **Mode & Holdoff** side menu.

Group	Trigger
Syntax	TRIGger:A:HOLdoff:VALue <NR3> TRIGger:A:HOLdoff:VALue?
Arguments	<NR3> from 0 to 100 and is a percent of the holdoff range.
Examples	TRIGGER:A:HOLDOFF:VALUE 50 to set the holdoff value to 50% of record.

TRIGger:A:LEVel

Sets the A trigger level. This command is equivalent to adjusting the front-panel Trigger **LEVEL** knob.

Group	Trigger
Syntax	TRIGger:A:LEVel { ECL TTL <NR3> } TRIGger:A:LEVel?
Arguments	ECL specifies a preset ECL level of -1.3 V. TTL specifies a preset TTL level of 1.4 V. <NR3> is the A trigger level, in volts.
Examples	TRIGGER:A:LEVEL? might return :TRIGGER:A:LEVEL 1.4E0, indicating that the A edge trigger level is set to 1.4 V. TRIGGER:A:LEVEL 0.5 sets the A trigger level to 0.5 V.

TRIGger:A:LOGIc? (Query Only)

Returns the current logic trigger parameters.

Group	Trigger
Syntax	TRIGger:A:LOGIc?
Examples	<pre>TRIGGER:A:LOGIC? might return :TRIGGER:A:LOGIC:INPUT1:SOURCE CH1;LOGICLEVEL LOW;SLOPE RISE;THRESHOLD 1.4000000000;:TRIGGER:A:LOGIC:CLASS PATTERN;PATTERN:FUNCTION AND;DELTATIME 0.0000003168;WHEN TRUE;:TRIGGER:A:LOGIC:STATE:WHEN TRUE</pre>

TRIGger:A:LOGIc:CLAss

Sets or returns the logic trigger class value. This command is equivalent to selecting **Class** in the **Trigger** menu when the **Type** is set to **Logic**.

Group	Trigger
Syntax	<pre>TRIGger:A:LOGIc:CLAss { PATtern STATE } TRIGger:A:LOGIc:CLAss?</pre>
Arguments	<p>PATtern enables pattern triggering, which triggers the oscilloscope when the logic condition (pattern) on two inputs is met.</p> <p>STATE enables state triggering, which triggers the oscilloscope when the specified condition on one channel (state) is met after a second channel (clock) condition is met.</p>
Examples	<pre>TRIGGER:A:LOGIC:CLASS? might return TRIGGER:A:LOGIC:CLASS STATE</pre>

TRIGger:A:LOGIc:INPUT<x>:LOGICLevel

Sets or returns the signal logic of the specified logic trigger input.

Group	Trigger
--------------	---------

Syntax TRIGGER:A:LOGIC:INPUT<x>:LOGICLevel { HIGH | LOW }
 TRIGGER:A:LOGIC:INPUT<x>:LOGICLevel?

Arguments <x> sets the logic trigger input source. Valid values are 1 and 2

HIGH sets the input logic level to high. Defining a signal as high-true means that signal levels above (more positive than) the threshold level are true, and signal levels below (more negative than) the threshold level are false.

LOW sets the input logic level to low. Defining a signal as low-true means that signal levels below (more negative than) the threshold level are true, and signal levels above (more positive than) the threshold level are false.

Examples TRIGGER:A:LOGIC:INPUT2:LOGICLEVEL HIGH
 sets the logic trigger input 2 to high-true logic.

TRIGGER:A:LOGIC:INPUT2:SLOPE

Sets or returns the state logic trigger slope setting for the logic trigger input 2.

Group Trigger

Syntax TRIGGER:A:LOGIC:INPUT2:SLOPE { RISE | FALL }
 TRIGGER:A:LOGIC:INPUT2:SLOPE?

Arguments RISE sets the specified input slope to a rising signal edge.
 FALL sets the specified input slope to a falling signal edge.

Examples TRIGGER:A:LOGIC:INPUT2:SLOPE RISE
 sets input 2 signal slope to rising.

TRIGger:A:LOGic:INPUT<x>:SOUrce

Sets or returns the input signal source for the pattern trigger, which requires two input signal sources.

Group Trigger

Syntax (TDS3000 4-channel) TRIGger:A:LOGic:INPUT<x>:SOUrce { CH<x> }

Syntax (TDS3000 2-channel) TRIGger:A:LOGic:INPUT<x>:SOUrce { CH<x> | EXT | EXT10 }

Syntax (TDS3000B and TDS3000C all models) TRIGger:A:LOGic:INPUT<x>:SOUrce { CH<x> | EXT | EXT10 }

Query Syntax (all) TRIGger:A:LOGic:INPUT<x>:SOUrce?

Arguments x the logic input. Valid values are 1 and 2.

CH<x> sets the oscilloscope logic trigger input signal source to the specified channel, where <x> is 1, 2, 3, or 4.

EXT, EXT10 sets the external trigger channel to the specified input. EXT and EXT10 are not available in TDS3000 Series 4-channel instruments.

Examples TRIGGER:A:LOGIC:INPUT1:SOURCE EXT
sets the logic input 1 source to the external trigger input.

TRIGger:A:LOGic:INPUT<x>:THReshold

Sets or returns the pattern and state logic trigger single threshold voltage value for the specified input.

Group Trigger

Syntax TRIGger:A:LOGic:INPUT<x>:THReshold { <NR3> | ECL | TTL }
TRIGger:A:LOGic:INPUT<x>:THReshold?

Arguments x is the specified logic trigger input. Valid values are 1 and 2.

<NR3> is a floating point value with exponent that sets the threshold voltage value for the specified logic trigger input.

ECL sets the threshold voltage value of the specified input to -1.3 V.

TTL sets the threshold voltage value of the specified input to 1.4 V.

Examples TRIGGER:A:LOGIC:INPUT2:THRESHOLD -1.5E0
sets the threshold voltage of input 2 to -1.5 V.

TRIGger:A:LOGIc:PATtern:DELTATime

Sets or returns the pattern trigger time value. The time value is used as part of the pattern trigger condition to determine if the duration of a logic pattern meets the specified time constraints.

Group Trigger

Syntax TRIGger:A:LOGIc:PATtern:DELTATime <NR3>
TRIGger:A:LOGIc:PATtern:DELTATime?

Arguments <NR3> is a floating point value with exponent that sets the pattern trigger time value. This argument has a range of 39.6E-9 (39.6 ns) to 10.0E0 (10 s), in increments of 13.2 ns. Values that are not an increment of 13.2 ns are rounded to the nearest correct value.

Examples TRIGGER:A:LOGIC:PATTERN:DELTATime 71.28E-8
sets the pattern trigger delta time value to 712.8 ns.

TRIGger:A:LOGIc:PATtern:FUNCTion

Sets or returns the logic function to apply to the pattern trigger inputs.

Group Trigger

Syntax TRIGger:A:LOGIc:PATtern:FUNCTion { AND | NAND | NOR | OR }
 TRIGger:A:LOGIc:PATtern:FUNCTion?

Arguments AND, NAND, NOR, OR set the Boolean logic operation to apply to the logic pattern trigger inputs.

Examples TRIGGER:A:LOGIC:PATTERN:FUNCTION NAND
 sets the pattern trigger logic function to NAND.

TRIGger:A:LOGIc:PATtern:WHEn

Sets or returns the pattern logic condition on which to trigger the oscilloscope.

Group Trigger

Syntax TRIGger:A:LOGIc:PATtern:WHEn { TRUe | FALSe | LESSThan | MOREThan
 | EQUal | NOTEQual }
 TRIGger:A: LOGIc: PATtern: WHEn?

Arguments TRUe triggers the oscilloscope when the pattern becomes true.

FALSe triggers the oscilloscope when the pattern becomes false.

LESSThan triggers the oscilloscope when the input pattern is true for a time period less than the time period specified in TRIGger:A:LOGIc:PATtern:DELTATime.

MOREThan triggers the oscilloscope when the input pattern is true for a time period more (greater) than the time period specified in TRIGger:A:LOGIc:PATtern:DELTATime.

EQUal triggers the oscilloscope when the input pattern is true for a time period equal to the time period specified in TRIGger:A:LOGIc:PATtern:DELTATime, within a $\pm 5\%$ tolerance.

NOTEQual triggers the oscilloscope when the input pattern is true for a time period greater than or less than (not equal to) the time period specified in TRIGger:A:LOGIc:PATtern:DELTATime, within a $\pm 5\%$ tolerance.

Examples TRIGGER:A:LOGIC:PATTERN:WHEN LESSTHAN
sets the oscilloscope to trigger when the pattern is true for a time period less than the pattern trigger delta time setting.

TRIGger:A:LOGIc:STATE:WHEn

Sets or returns the state condition on which to trigger the oscilloscope.

Group Trigger

Syntax TRIGger:A:LOGIc:STATE:WHEn { TRUe | FALSe }
TRIGger:A:LOGIc:STATE:WHEn?

Arguments TRUe triggers the oscilloscope if the state signal is true when the clock signal slope is true.
FALSe triggers the oscilloscope if the state signal is false when the clock signal slope is true.

Examples TRIGGER:A:LOGIC:STATE:WHEN?
might return TRIGGER:A:LOGIC:STATE:WHEN TRUE.

TRIGger:A:MODE

Sets or queries the A trigger mode. This command is equivalent to selecting **Mode & Holdoff** in the **Trigger** menu.

Group Trigger

Syntax TRIGger:A:MODE { AUTO | NORMa1 }
TRIGger:A:MODE?

Arguments AUTO generates a trigger if a trigger is not detected within a specific time period.
NORMa1 waits for a valid trigger event.

Examples TRIGGER:A:MODE AUTO
specifies that a trigger event is automatically generated.

TRIGger:A:PULse? (Query Only)

Returns the pulse trigger parameters.

Group	Trigger
Syntax	TRIGger:A:PULse?
Examples	<pre>TRIGGER:A:PULSE? might return TRIGGER:A:PULSE:CLASS WIDTH;SOURCE CH3;POLARITY EITHER;WIDTH:WHEN MORETHAN;WIDTH 0.0000011880;:TRIG- GER:A:PULSE:RUNT:THRESHOLD:HIGH 0.8000000000;LOW 2.0000000000;:TRIGGER:A:PULSE:RUNT:WHEN LESSTHAN;WIDTH 0.0000011880;:TRIGGER:A:PULSE:SLEWRATE:DELTAIME 0.0000011880;THRESHOLD:HIGH 0.8000000000;LOW 2.0000000000; :TRIGGER:A:PULSE:SLEWRATE:WHEN FASTERTHAN.</pre>

TRIGger:A:PULse:CLass

Sets or returns the pulse trigger class value. This command is equivalent to selecting **Class** in the **Trigger** menu when the trigger **Type** is set to **Pulse**.

Group	Trigger
Syntax	<pre>TRIGger:A:PULse:CLass { WIDTH RUNT SLEWRate } TRIGger:A:PULse:CLass?</pre>
Arguments	<p>WIDTH sets the oscilloscope pulse trigger class to width. The width mode triggers the oscilloscope when the source signal meets specified pulse width constraints.</p> <p>RUNT sets the oscilloscope pulse trigger class to runt. The runt mode triggers the oscilloscope when the source signal meets specified pulse threshold and optional width constraints.</p> <p>SLEWRate sets the oscilloscope pulse trigger class to slew rate. The slew rate mode triggers the oscilloscope when the source signal meets specified slew rate constraints.</p>
Examples	<pre>TRIGGER:A:PULSE:CLASS WIDTH sets the oscilloscope pulse trigger class to width trigger.</pre>

TRIGger:A:PULse:RUNT? (Query Only)

Returns the runt pulse trigger settings.

Group	Trigger
Syntax	TRIGger:A:PULse:RUNT?
Examples	<pre>TRIGGER:A:PULSE:RUNT? might return :TRIGGER:A:PULSE:RUNT:THRESHOLD:HIGH 2.8000000000;LOW 0.7000000000;;:TRIGGER:A:PULSE:RUNT:WHEN LESSTHAN;WIDTH 0.0000011880.</pre>

TRIGger:A:PULse:RUNT:POLarity

Sets or returns the runt-pulse logic trigger signal polarity value.

Group	Trigger
Syntax	<pre>TRIGger:A:RUNT:PULse:POLarity { EITHer POSITIVE NEGAtive } TRIGger:A:RUNT:PULse:POLarity?</pre>
Arguments	<p>EITHer sets the oscilloscope to trigger on either POSITIVE or NEGAtive polarity runt signals.</p> <p>POSITIVE sets the oscilloscope to trigger only on positive-polarity runt pulses.</p> <p>NEGAtive sets the oscilloscope to trigger only on negative-polarity runt pulses.</p>
Examples	<pre>TRIGGER:A:PULSE:POLARITY NEGATIVE</pre> <p>specifies that the oscilloscope only trigger on negative-polarity runt pulses.</p>

TRIGger:A:PULse:RUNT:THReshold? (Query Only)

Returns the runt pulse trigger upper and lower threshold voltage values.

Group	Trigger
Syntax	TRIGger:A:PULse:RUNT:THReshold?

Examples TRIGGER:A:PULSE:RUNT:THRESHOLD?
might return :TRIGGER:A:PULSE:RUNT:THRESHOLD:HIGH 2.00E+0;LOW
800.0E-3.

TRIGger:A:PULse:RUNT:THReshold:BOTh

Sets the value of both runt pulse signal thresholds. This command is equivalent to setting **Set to TTL** or **Set to ECL** in the **Runt Trigger** menu's **Thresholds** side menu item.

Group Trigger

Syntax TRIGger:A:PULse:RUNT:THReshold:BOTh { TTL | ECL }

Arguments TTL sets the upper (high) threshold value to 2.0 V and the lower threshold value to 0.8 V.
ECL sets the upper (high) threshold value to -1.1 V and the lower threshold value to -1.5 V.

Examples TRIGGER:A:PULSE:RUNT:THRESHOLD:BOTH TTL
sets the upper and lower runt pulse trigger threshold voltages to TTL voltage levels.

TRIGger:A:PULse:RUNT:THReshold:HIGH

Sets or returns the runt pulse signal high threshold voltage value. This command is equivalent to setting the threshold in the runt pulse **Thresholds** side menu.

Group Trigger

Syntax TRIGger:A:PULse:RUNT:THReshold:HIGH <NR3>
TRIGger:A:PULse:RUNT:THReshold:HIGH?

Arguments <NR3> is a floating point value with exponent that sets the runt pulse high threshold voltage value.

Examples TRIGGER:A:PULSE:RUNT:THRESHOLD:HIGH 1.8E0
sets the runt pulse high threshold voltage value to 1.8 volts.

TRIGger:A:PULse:RUNT:THReshold:LOW

Sets or returns the runt pulse signal low threshold voltage value. This command is equivalent to setting the threshold in the runt pulse **Thresholds** side menu.

Group	Trigger
Syntax	TRIGger:A:PULse:RUNT:THReshold:LOW <NR3> TRIGger:A:PULse:RUNT:THReshold:LOW?
Arguments	<NR3> is a floating point value with exponent that sets the runt pulse low threshold voltage value.
Examples	TRIGGER:A:PULSE:RUNT:THRESHOLD:LOW -700.0E-3 sets the runt pulse low threshold voltage value to -700 mV.

TRIGger:A:PULse:RUNT:WHEn

Sets or returns the runt pulse width condition on which to trigger the oscilloscope.

Group	Trigger
Syntax	TRIGger:A:PULse:RUNT:WHEn { OCCurs LESSThan MOREThan EQual NOTEQual } TRIGger:A:PULse:RUNT:WHEn?
Arguments	OCCurs triggers the oscilloscope on any runt signal regardless of width. LESSThan triggers the oscilloscope when the runt pulse width is true for a time period less than the time period specified in TRIGger:A:PULse:RUNT:WIDth. MOREThan triggers the oscilloscope when the runt pulse width is true for a time period more (greater) than the time period specified in TRIGger:A:PULse:RUNT:WIDth. EQual triggers the oscilloscope when the runt pulse width is true for a time period equal to the time period specified in TRIGger:A:PULse:RUNT:WIDth, within a $\pm 5\%$ tolerance.

NOTEQual triggers the oscilloscope when the runt pulse width is true for a time period greater than or less than (not equal to) the time period specified in TRIGGER:A:PULSE:RUNT:WIDTH, within a $\pm 5\%$ tolerance.

Examples TRIGGER:A:PULSE:RUNT:WHEN MORETHAN
sets the runt trigger to occur when the oscilloscope detects a runt pulse wider than the specified width.

TRIGGER:A:PULSE:RUNT:WIDTH

Sets or returns the runt pulse width time period value. This command is equivalent to entering a value in the runt pulse trigger menu's **Trigger When** side menu.

Group Trigger

Syntax TRIGGER:A:PULSE:RUNT:WIDTH <NR3>
TRIGGER:A:PULSE:RUNT:WIDTH?

Arguments <NR3> is a floating point value with exponent that sets the runt pulse trigger time value. This argument has a range of 39.6E-9 (39.6 ns) to 10.0E0 (10 s), in increments of 13.2 ns. Values that are not an increment of 13.2 ns are rounded to the nearest correct value.

Examples TRIGGER:A:PULSE:RUNT:WIDTH 15E-6
sets the minimum width of the pulse runt trigger to 15.0084 μ s.

TRIGGER:A:PULSE:SLEWRate? (Query Only)

Returns the slew rate trigger settings.

Group Trigger

Syntax TRIGGER:A:PULSE:SLEWRate?

Examples TRIGGER:A:PULSE:SLEWRate?
might return TRIGGER:A:PULSE:SLEWRate:DELTAIME 0.0000011880;
THRESHOLD:HIGH -0.800000000;LOW -2.000000000;
:TRIGGER:A:PULSE:SLEWRate:WHEN FASTER THAN

TRIGger:A:PULse:SLEWRate:DELTATime

Sets or returns the time component of the slew rate value. The oscilloscope uses the delta time value and the threshold voltage values to calculate the target slew rate $((\text{high threshold voltage} - \text{low threshold voltage}) \div \text{delta time})$.

Group	Trigger
Syntax	TRIGger:A:PULse:SLEWRate:DELTATime <NR3> TRIGger:A:PULse:SLEWRate:DELTATime?
Arguments	<NR3> is a floating point value with exponent that sets the time component of the slew rate value. The argument has a range of 39.6E-9 (39.6 ns) to 10.0E0 (10 s), in increments of 13.2 ns. Values that are not an increment of 13.2 ns are rounded to the nearest correct value.
Examples	TRIGGER:A:PULSE:SLEWRATE:DELTATIME? might return TRIGGER:A:PULSE:SLEWRATE:DELTATIME 0.0000011880

TRIGger:A:PULse:SLEWRate:POLarity

Sets or returns the slew rate logic trigger signal polarity value.

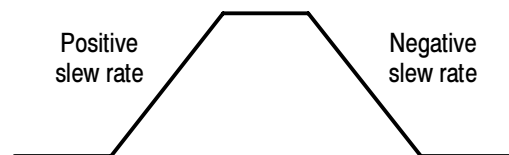

Group	Trigger
Syntax	TRIGger:A:PULse:SLEWRate:POLarity { EITHER POSITIVE NEGATIVE } TRIGger:A:PULse:SLEWRate:POLarity?
Arguments	EITHER sets the oscilloscope to trigger on either POSITIVE or NEGATIVE polarity slew rate signals. POSITIVE sets the oscilloscope to trigger only on positive-polarity slew rate signals.

NEGAtive sets the oscilloscope to trigger only on negative-polarity slew rate signals.

Examples TRIGGER:A:PULSE:SLEWRate:POLARITY NEGATIVE
specifies that the oscilloscope only trigger on negative-polarity pulses or slew rates.

TRIGger:A:PULse:SLEWRate:SLEWRate

Sets or returns the slew rate value in volts per second.

Group Trigger

Syntax TRIGger:A:PULse:SLEWRate:SLEWRate <NR3>
TRIGger:A:PULse:SLEWRate:SLEWRate?

Arguments <NR3> is a floating point value with exponent that sets the slew rate value as volts per second

Examples TRIGger:A:PULse:SLEWRate:SLEWRate?
might return TRIGGER:A:PULSE:SLEWRATE:SLEWRATE 1.547E-3, indicating a slew rate of 1.54 mV/s.

TRIGger:A:PULse:SLEWRate:THReshold:BOTh

Sets the slew rate source signal threshold values.

Group Trigger

Syntax TRIGger:A:PULse:SLEWRate:THReshold:BOTh { TTL | ECL }

Arguments TTL sets the upper threshold to 2.0 V and the lower threshold to 0.8 V.
ECL sets the upper threshold to -1.1 V and the lower threshold to -1.5 V.

Examples TRIGGER:A:PULSE:SLEWRATE:THRESHOLD:BOTH TTL
sets the upper slew rate threshold value to 1.8 V and the lower threshold value to 0.8 V.

TRIGger:A:PULse:SLEWRate:THReshold:HIGH

Sets or returns the slew rate source signal high threshold voltage value.

Group	Trigger
Syntax	TRIGger:A:PULse:SLEWRate:THReshold:HIGH <NR3> TRIGger:A:PULse:SLEWRate:THReshold:HIGH?
Arguments	<NR3> is a floating point value with exponent that sets the slew rate trigger signal high threshold voltage value.
Examples	TRIGGER:A:PULSE:SLEWRATE:THRESHOLD:HIGH 4.1E0 sets the slew rate high threshold voltage value to 4.1 volts.

TRIGger:A:PULse:SLEWRate:THReshold:LOW

Sets or returns the slew rate source signal low threshold voltage value.

Group	Trigger
Syntax	TRIGger:A:PULse:SLEWRate:THReshold:LOW <NR3> TRIGger:A:PULse:SLEWRate:THReshold:LOW?
Arguments	<NR3> is a floating point value with exponent that sets the slew rate trigger signal low threshold voltage value.
Examples	TRIGGER:A:PULSE:SLEWRATE:THRESHOLD:LOW -1.5E0 sets the slew rate low threshold voltage value to -1.5 volts.

TRIGger:A:PULse:SLEWRate:WHEn

Sets or returns the slew rate condition on which to trigger the oscilloscope. The condition is based on the slew rate calculated from the values set by the TRIGger:A:PULse:SLEWRate:DELTAtime and TRIGger:A:PULse:SLEWRate:THReshold commands.

Group Trigger

Syntax TRIGger:A:PULse:SLEWRate:WHEn { FASTERthan | SLOWERthan
| EQUAL | NOTEQUAL }
TRIGger:A:PULse:SLEWRate:WHEn?

Arguments FASTERthan triggers the oscilloscope when the signal slew rate is faster than the calculated slew rate.

SLOWERthan triggers the oscilloscope when the signal slew rate is slower than the calculated slew rate.

EQUAL triggers the oscilloscope when the signal slew rate is equal to the calculated slew rate within a $\pm 5\%$ tolerance.

NOTEQUAL triggers the oscilloscope when the signal slew rate is not equal to the calculated slew rate within a $\pm 5\%$ tolerance.

Examples TRIGGER:A:PULSE:SLEWRATE:WHEN NOTEQUAL
sets the oscilloscope to trigger when the slew rate is not equal to the calculated slew rate.

TRIGger:A:PULse:SOURce

Sets or returns the signal source for width, runt, and slew rate pulse triggers. This command is equivalent to selecting a trigger signal source in the **Source** side menu.

Group Trigger

Syntax	<p>TRIGger:A:PULse:SOUrce { EXT EXT10 VERTical CH<x> LINE ALternating }</p> <p>TRIGger:A:PULse:SOUrce?</p>
Arguments	<p>EXT sets the pulse trigger source to the regular external trigger input connector with a signal input range of -0.8 V to +0.8 V. EXT is not available in four-channel TDS3000 Series instruments.</p> <p>EXT10 sets the pulse trigger source to the reduced external trigger with a signal input range of -8 V to +8 V. EXT10 is not available in four-channel TDS3000 Series instruments.</p> <p>VERTical sets the pulse trigger source to the lowest numbered displayed channel.</p> <p>CH<x> sets the pulse trigger source to the specified input channel, where <x> is 1, 2, 3, or 4.</p> <p>LINE sets the pulse trigger source to the AC line frequency.</p> <hr/> <p>NOTE. <i>LINE is not available when the instrument is operating on battery power.</i></p> <hr/> <p>ALternating sets the pulse trigger source to alternate between each displayed input channel.</p>
Examples	<p>TRIGGER:A:PULSE:SOURCE CH3 sets the pulse trigger signal source to channel 3.</p>

TRIGger:A:PULse:WIDth:POLarity

Sets or returns the pulse-width logic trigger signal polarity value.

Group	Trigger
Syntax	<p>TRIGger:A:PULse:WIDth:POLarity { POSITIVE NEGAtive }</p> <p>TRIGger:A:PULse:WIDth:POLarity?</p>
Arguments	<p>POSITIVE sets the oscilloscope to trigger only on positive-polarity pulses.</p> <p>NEGAtive sets the oscilloscope to trigger only on negative-polarity pulses.</p>

Examples TRIGGER:A:PULSE:WIDTH:POLARITY NEGATIVE
 specifies that the oscilloscope only trigger on negative-polarity pulse signals.

TRIGger:A:PULse:WIDth:WHEn

Sets or returns the pulse width condition on which to trigger the oscilloscope. This is equivalent to selecting the condition in the Pulse Width **Trigger When** side menu.

Group Trigger

Syntax TRIGger:A:PULse:WIDth:WHEn { LESSThan | MOREThan | Equal | NOTEQual }

TRIGger:A:PULse:WIDth:WHEn?

Arguments LESSThan triggers the oscilloscope when the pulse width is true for less than the time period specified in TRIGger:A:PULse:WIDth:WIDth.

MOREThan triggers the oscilloscope when the pulse width is true for more (greater) than the time period specified in TRIGger:A:PULse:WIDth:WIDth.

Equal triggers the oscilloscope when the pulse width is equal to the time period specified in TRIGger:A:PULse:WIDth:WIDth, within a $\pm 5\%$ tolerance.

NOTEQual triggers the oscilloscope when the pulse width is greater than or less than (not equal to) the time period specified in TRIGger:A:PULse:WIDth:WIDth, within a $\pm 5\%$ tolerance.

Examples TRIGGER:A:PULSE:WIDTH:WHEN MORETHAN
 sets the oscilloscope to trigger on pulse width signals that are more (wider) than a specified time period.

TRIGger:A:PULse:WIDth:WIDth

Sets or returns the pulse width trigger time period value.

Group Trigger

Syntax TRIGger:A:PULse:WIDth:WIDth <NR3>

TRIGger:A:PULse:WIDth:WIDth?

Arguments	<NR3> is a floating point value with exponent that sets the pulse width trigger time value. This argument has a range of 39.6E-9 (39.6 ns) to 10.0E0 (10 s), in increments of 13.2 ns. Values that are not an increment of 13.2 ns are rounded to the nearest correct value.
Examples	TRIGGER:A:PULSE:WIDTH:WIDTH? might return TRIGGER:A:PULSE:WIDTH:WHEN MORETHAN;WIDTH 0.0000011880.

TRIGger:A:SETLevel (Set Only)

Sets the trigger level to 50%. This is equivalent to pressing the front-panel **SET TO 50%** button.

Group	Trigger
Syntax	TRIGger:A:SETLevel
Examples	TRIGGER:A:SETLEVEL sets the trigger level midway between MAX and MIN.

TRIGger:A:TYPe

Sets or queries the type of A trigger. This is equivalent to setting **Type** in the **Trigger** menu.

Group	Trigger
Syntax	TRIGger:A:TYPe { EDGE VIDEo COMMunication LOGIc PULse } TRIGger:A:TYPe?

Arguments COMMunication sets the A trigger parameters for communications (mask) testing. TDS3TMT only.

 EDGe sets the oscilloscope to trigger when a signal passes through a single specified voltage level in a specified direction (edge triggering).

 LOGIc sets the oscilloscope to trigger when when the logic condition on two channels is true. (TDS3000 Series with TDS3TRG, TDS3000B Series, TDS3000C Series.)

 PULse sets the oscilloscope to trigger when a signal meets a specified pulse width condition. (TDS3000 Series with TDS3TRG, TDS3000B Series, TDS3000C Series.)

 VIDeo sets the oscilloscope to trigger on video signals.

Examples TRIGGER:A:TYPE?
 might return :TRIGGER:A:TYPE VIDEO indicating that the A trigger type is a video trigger.

TRIGger:A:VIDeo? (Query Only)

Returns the A video trigger parameters.

Group Trigger

Syntax TRIGger:A:VIDeo?

Examples TRIGGER:A:VIDeo?
 might return: :TRIGGER:A:VIDeo:STANDARD NTSC;SOURCE CH1;FIELD ALLLINES;HOLDOFF:FIELD 0.0EO;:TRIGGER:A:VIDeo:LINE 1;SCAN RATE1 as the current A video trigger parameters.

TRIGger:A:VIDeo:CUSTom:FORMat

(Requires TDS3VID or TDS3SDI)

Sets or queries the custom video signal format.

Group Trigger

Syntax TRIGger:A:VIDeo:CUSTom:FORMat { INTERLAcEd | PROGRessive }

TRIGger:A:VIDeo:CUSTom:FORMat?

Arguments INTERLAcEd specifies that the video signal is interlaced.
 PROGRessive specifies that the video signal is progressive.

Examples TRIGGER:A:VIDEO:CUSTOM:FORMAT?
 might return TRIGGER:A:VIDEO:CUSTOM:FORMAT INTERLACED.

TRIGger:A:VIDeo:CUSTom:SCAN

(Requires TDS3VID or TDS3SDI)

Sets or queries the custom video signal scan rate on which to trigger.

Group Trigger

Syntax TRIGger:A:VIDeo:CUSTom:SCAN { RATE1 | RATE2 | RATE3 | RATE4 | RATE5 }
 TRIGger:A:VIDeo:CUSTom:SCAN?

Arguments RATE1 specifies a horizontal scan rate of 15-20 kHz.
 RATE2 specifies a horizontal scan rate of 20-25 kHz.
 RATE3 specifies a horizontal scan rate of 25-35 kHz.
 RATE4 specifies a horizontal scan rate of 35-50 kHz.
 RATE5 specifies a horizontal scan rate of 50-65 kHz.

Examples TRIGGER:A:VIDEO:CUSTOM:SCAN?
 might return TRIGGER:A:VIDEO:CUSTOM:SCAN RATE3.

TRIGger:A:VIDeo:FIELD

Sets or queries the field the video trigger detects.

Group Trigger

Syntax TRIGger:A:VIDeo:FIELD { ODD | EVEN | ALLFields | ALLLines | FIELD1 | FIELD2 | NUMERic }

TRIGger:A:VIDeo:FIELD?

Arguments ODD specifies to trigger on interlaced video odd fields.

EVEN specifies to trigger on interlaced video even fields.

ALLFields specifies to trigger on the interlaced video odd fields.

ALLLines specifies all video lines.

FIELD1 specifies interlaced video field 1. Same as odd.

FIELD2 specifies interlaced video field 2. Same as even.

NUMERic specifies to trigger on the video signal line specified in the TRIGger:A:VIDeo:LINE command. TDS3VID, TDS3SDI only

Examples TRIGGER:A:VIDEO:FIELD1
selects field 1.

TRIGger:A:VIDeo:HDTV:FORMat

(Requires TDS3VID or TDS3SDI)

Sets or queries the analog HDTV video signal format on which to trigger.

Group Trigger

Syntax TRIGger:A:VIDeo:HDTV"FORMat { HD1080I50 | HD1080I60 | HD1080P24 | HD1080P25 | HD1080SF24 | HD480P60 | HD720P60 }

TRIGger:A:VIDeo:HDTV:FORMat?

Arguments Available HDTV formats are:

Table 2-40: HDTV formats

HDTV format	Description
1080I50	1125 Lines (1080 active), 1920 x 1080 pixel, interlaced, 60 fps
1080I60	1125 lines (1080 active), 1920 x 1080 pixel, interlaced, 50 fps
1080P24	1125 lines (1080 active), 1920 x 1080 pixel, progressive, 24 fps

Table 2-40: HDTV formats (cont.)

HDTV format	Description
1080P25	1125 lines (1080 active), 1920 x 1080 pixel, progressive, 25 fps
1080SF24	1125 Lines (1080 active), 1920 x 1080 pixel, progressive (sF), 24 fps
720P60	750 lines (720 active), 1280 x 720 pixel, progressive, 60 fps
480P60	525 lines (480 active), 640 or 704 x 480 pixel, progressive, 60 fps

Examples TRIGGER:A:VIDEO:HDTV:FORMAT?
might return TRIGGER:A:VIDEO:HDTV:FORMAT 1080I60.

TRIGger:A:VIDeo:HOLdoff:FIELD

(Requires TDS3VID or TDS3SDI)

Sets or returns the video trigger field holdoff value.

Group Trigger

Syntax TRIGger:A:VIDeo:HOLdoff:FIELD <NR3>
TRIGger:A:VIDeo:HOLdoff:FIELD?

Arguments <NR3> is a real number from 0.0 to 8, in increments of 0.5, that sets the number of video fields to wait before rearming the video trigger.

Examples TRIGGER:A:VIDEO:HOLDOFF:FIELD 4.5
sets the oscilloscope to wait 4.5 video fields before rearming the video trigger.

TRIGger:A:VIDeo:LINE

Sets or returns the video line number on which to trigger. This is equivalent to selecting the **Line Number** side-menu item in the video **Trigger On** menu. Use the TRIGger:A:VIDeo:FIELD command with the NUMERic argument to actually trigger the oscilloscope on the line specified in the TRIGger:A:VIDeo:LINE command.

Group Trigger

Syntax TRIGger:A:VIDeo:LINE <NR1>
 TRIGger:A:VIDeo:LINE?

Arguments <NR1> is an integer number that sets the video line number on which to trigger. The following table lists the valid choices depending on the active video standard:

Table 2-41: Video trigger line range values

Video standard	Valid line range
525/NTSC	1-525
625/PAL, SECAM	1-625
Custom	1-3000
HDTV: 1080	1-1125
720	1-750
480	1-525

Examples TRIGGER:A:VIDEO:LINE 23
 sets the oscilloscope to trigger on video signal line 23.

TRIGger:A:VIDeo:SCAN

(Requires TDS3VID or TDS3SDI)

Sets or returns the video trigger horizontal line scan rate. This is equivalent to selecting the **Scan Rate** bottom-menu item in the **Custom** video menu.

Group Trigger

Syntax TRIGger:A:VIDeo:SCAN { RATE1 | RATE2 | RATE3 | RATE4 | RATE5 }
 TRIGger:A:VIDeo:SCAN?

Arguments	<p>RATE1 sets the video line scan rate range to 15-20 kHz. This is the standard broadcast rate.</p> <p>RATE2 sets the video line scan rate range to 20-25 kHz.</p> <p>RATE3 sets the video line scan rate range to 25-35 kHz.</p> <p>RATE4 sets the video line scan rate range to 35-50 kHz.</p> <p>RATE5 sets the video line scan rate range to 50-65 kHz.</p>
Examples	<p>TRIGGER:A:VIDEO:SCAN RATE2 sets the video line scan range to 20-25 kHz.</p>

TRIGger:A:VIDeo:SOUrce

Sets or queries the source for the A video trigger. This is equivalent to selecting **Source** in the **Trigger** menu and a desired channel from the side menu.

Group	Trigger
Syntax	<p>TRIGger:A:VIDeo:SOUrce { EXT EXT10 VERTical CH<x> LINE ALTErning }</p> <p>TRIGger:A:VIDeo:SOUrce?</p>
Arguments	<p>EXT sets the video trigger source to the regular external trigger input connector with a signal input range of -0.8 V to +0.8 V. EXT is not available in 4 channel TDS3000 Series instruments.</p> <p>EXT10 sets the video trigger source to the reduced external trigger with a signal input range of -8 V to +8 V. EXT10 is not available in 4 channel TDS3000 Series instruments.</p> <p>VERTical sets the video trigger source to the lowest numbered displayed channel.</p> <p>CH<x> sets the video trigger source to the specified input channel, where <x> is 1, 2, 3, or 4.</p>

LINE sets the video trigger source to the AC line frequency.

NOTE. *LINE is not available when the instrument is operating on battery power.*

ALternating sets the video trigger source to sequentially trigger on each displayed input channel.

Examples TRIGGER:A:VIDEO:SOURCE CH1
selects channel 1 as the source for the A video trigger.

TRIGger:A:VIDeo:STANdard

Sets or queries the video trigger standard. This is equivalent to selecting the standard in the video **Standard** pop-up (525/NTSC, 625/PAL, or SECAM).

Group Trigger

Syntax TRIGger:A:VIDeo:STANdard { NTSc | PAL | SECAM | CUSTom | HDTV | VID875i60 }

TRIGger:A:VIDeo:STANdard?

Arguments NTSc specifies the NTSC 525/59.94/2:1 standard.

PAL specifies the PAL 625/50/2:1 standard.

SECAM specifies the SECAM standard.

CUSTom sets the oscilloscope to use custom video horizontal scan rate parameters as set by TRIGger:A:VIDeo:SCAN. TDS3VID, TDS3SDI only.

HDTV sets the oscilloscope to use HDTV scan rate parameters as set by TRIGger:A:VIDeo:HDTV:FORMat. TDS3VID, TDS3SDI only.

VID875i60 specifies the 875i60 standard. TDS3VID, TDS3SDI only.

Examples TRIGGER:A:VIDEO:STANDARD NTSC
sets the oscilloscope to trigger on NTSC-standard video signals.

TRIGger:A:VIDeo:SYStem

This command is the same as TRIGger:A:VIDeo:STANdard, and is for compatibility with other Tektronix instruments.

TRIGger:B

Sets or returns the current B trigger parameters.

Group	Trigger
Syntax	TRIGger:B SETLevel TRIGger:B?
Arguments	SETLevel sets the B trigger voltage level to 50% of the source peak-to-peak signal.
Examples	TRIGGER:B? might return :TRIGGER:B:STATE 0;BY TIME;EVENTS:COUNT 1;; TRIGGER:B:TIME 1.32E-8;LEVEL 1.0E-3;EDGE:SOURCE CH2; COUPLING DC;SLOPE RISE

TRIGger:B:BY

Sets the B trigger to delay by time or events.

Group	Trigger
Syntax	TRIGger:B:BY { TIME EVENTS } TRIGger:B:BY?
Examples	TRIGGER:B:BY EVENTS sets the B trigger to delay by events.

TRIGger:B:EDGE? (Query Only)

Returns the trigger coupling, source, and slope for the B edge trigger.

Group	Trigger
Syntax	TRIGger:B:EDGE?
Examples	TRIGGER:B:EDGE? might return SOURCE CH1;COUPLING DC;SLOPE RISE

TRIGger:B:EDGE:COUPLing

Sets or queries the type of coupling for the B edge trigger. This is equivalent to setting **Coupling** in the **Trigger** menu.

Group	Trigger
Syntax	TRIGger:B:EDGE:COUPLing { DC HFRej LFRej NOISErej AC } TRIGger:B:EDGE:COUPLing?
Arguments	DC selects DC trigger coupling. AC selects LFRej trigger coupling. AC coupling is for backward compatibility and will not be returned by a query. HFRej coupling removes the high frequency components of the DC signal. LFRej coupling removes the low frequency components of the AC signal. NOISErej selects DC low sensitivity. It requires added signal amplitude for more stable, less false triggering.
Examples	TRIGGER:B:EDGE:COUPLING DC sets the B edge trigger coupling to DC.

TRIGger:B:EDGE:SLOpe

Selects a rising or falling slope for the B edge trigger. This is equivalent to setting **Slope** in the **Trigger** menu.

Group	Trigger
Syntax	TRIGger:B:EDGE:SLOpe { FALL RISE } TRIGger:B:EDGE:SLOpe?
Arguments	FALL specifies to trigger on the falling or negative edge of a signal. RISE specifies to trigger on the rising or positive edge of a signal.
Examples	TRIGGER:B:EDGE:SLOPE RISE sets the B edge trigger to occur on the rising slope.

TRIGger:B:EDGE:SOURce

Sets or queries the source for the B edge trigger. This is equivalent to setting **Source** in the **Trigger** menu.

Group	Trigger
Syntax	TRIGger:B:EDGE:SOURce { LINE CH<x> EXT EXT10 } TRIGger:B:EDGE:SOURce?
Arguments	LINE sets the B trigger source to the AC line frequency. LINE is not available when the instrument is operating on battery power. CH<x> sets the B trigger source to the specified input channel, where <x> is 1, 2, 3, or 4. EXT sets the B trigger source to the regular external trigger input connector with a signal input range of -0.8 V to +0.8 V. EXT is not available in 4-channel TDS3000 Series instruments. EXT10 sets the B trigger source to the reduced external trigger with a signal input range of -8 V to +8 V. EXT10 is not available in 4-channel TDS3000 Series instruments.

Examples TRIGGER:B:EDGE:SOURCE LINE
specifies the AC line voltage as the B edge trigger source.

TRIGGER:B:EDGE:SOURCE?
might return CH2 for the B edge trigger source.

TRIGger:B:EVENTS? (Query Only)

Returns the current delayed trigger event parameter.

Group Trigger

Syntax TRIGger:B:EVENTS? <NR1>

Examples TRIGGER:B:EVENTS?
might return 14 indicating the B trigger occurs on the 14th occurrence of a B trigger event, after the A trigger occurs.

TRIGger:B:EVENTS:COUNT

Sets and returns the number of B trigger events that must occur before the B trigger occurs when TRIGger:DELay:BY is set to EVENTS.

Group Trigger

Syntax TRIGger:B:EVENTS:COUNT <NR1>

Examples TRIGGER:B:EVENTS:COUNT 4
specifies that the B trigger will occur on the fourth B trigger event.

TRIGger:B:LEVel

Sets the B trigger level. This command is equivalent to adjusting the front-panel **TRIGGER LEVEL** knob when the B trigger state is on.

Group	Trigger
Syntax	TRIGger:B:LEVel { ECL TTL <NR3> } TRIGger:B:LEVel?
Arguments	ECL specifies a preset ECL level of -1.3 V. TTL specifies a preset TTL level of 1.4 V. <NR3> is the B trigger level, in volts.
Examples	TRIGGER:B:LEVEL? might return 1.4, indicating that the B edge trigger is set to 1.4 V. TRIGGER:B:LEVEL 0.5 sets the B trigger level to 0.5 V.

TRIGger:B:SETLevel

Set B trigger level to 50%.

Group	Trigger
Syntax	TRIGger:B:SETLevel
Examples	TRIGGER:B:SETLevel sets B trigger level to 50%.

TRIGger:B:STATE

Sets the B trigger level state to on or off.

Group Trigger

Syntax TRIGger:B:STATE { <NR1> | ON | OFF }

Arguments <NR1> 0 = off and 1 = on.

Examples TRIGGER:B:STATE 0
sets B trigger state to off.

TRIGGER:B:STATE?
might return :TRIGGER:B:STATE 0

TRIGger:B:TIME

Sets or queries the B trigger delay time when TRIG:B:BY is set to Time.

Group Trigger

Syntax TRIGger:B:TIME <NR3>
TRIGger:B:TIME?

Arguments <NR3> is the B trigger delay time, in seconds.

Examples TRIGGER:B:TIME?
might return 1.32E-8. indicating the B trigger is armed 13.2 ns after the A trigger occurs.

TRIGger:B:TYPE

Sets or queries the type of B trigger. The only valid type is edge.

Group Trigger

Syntax	TRIGger:B:TYPe { EDGE } TRIGger:B:TYPe?
Arguments	EDGE is a normal trigger. A B trigger event occurs when a signal passes through a specified voltage level in a specified direction and is controlled by the TRIGger:B:EDGE commands.
Examples	TRIGGER:B:TYPE? returns :TRIGGER:B:TYPE EDGE indicating that the B trigger type is a edge trigger.

TRIGger:DELAy Commands

The TRIGger:DELAy commands listed in Table 2-42 have the same function and syntax as the equivalent TRIGger:B commands, and are for compatibility with other Tektronix instruments.

Table 2-42: TRIGger:DELAy commands

TRIGger:DELAy	TRIGger:DELAy:BY
TRIGger:DELAy:EDGE:COUPling	TRIGger:DELAy:EDGE:SLOPe
TRIGger:DELAy:EDGE:SOUrce	TRIGger:DELAy:EVENTS:COUnT
TRIGger:DELAy:LEVel	TRIGger:DELAy:SETLevel
TRIGger:DELAy:STATE	TRIGger:DELAy:TIME
TRIGger:DELAy:TYPe	

TRIGger:EXTERnal:PRObe

(TDS3014B/C, TDS3024B, TDS3034B/C, TDS3044B, TDS3054B/C, TDS3064B Only)

Sets or returns the gain factor value of the external probe connector.

Group	Trigger
Syntax	TRIGger:EXTERnal:PRObe <NR1> TRIGger:EXTERnal:PRObe?

Arguments <NR1> is the gain factor of the probe. TDS3014B/C, TDS3024B, TDS3034B/C, TDS3044B, TDS3054B/C, TDS3064B only, these oscilloscopes do not automatically detect the probe factor of a probe connected to the external trigger connector.

Examples TRIGGER:EXTERNAL:PROBE?
might return TRIGGER:EXTERNAL:PROBE 1.0E1 for a 10x probe.

TRIGger:EXTERnal:YUNit

(TDS3014B/C, TDS3034B/C, TDS3054B/C Only)

Sets or returns the external trigger vertical (Y) units value.

Group Trigger

Syntax TRIGger:EXTERnal:YUNit <qstring>

TRIGger:EXTERnal:YUNit?

Arguments <qstring> is "V" or "A".

Examples TRIGGER:EXTERNAL:YUNIT?
might return:TRIGGER:EXTERNAL:YUNIT "V".

TRIGger:FORCe

If the trigger state is READY, this forces a trigger event. Otherwise it is ignored.

Group Trigger

Syntax TRIGger:FORCe

Examples TRIGGER:FORCE
causes an immediate trigger event if the trigger state is ready.

TRIGger:MAIn Commands

The TRIGger:MAIn commands listed in Table 2-43 have the same syntax and function as the equivalent TRIGger:A commands, and are for compatibility with other Tektronix instruments.

Table 2-43: TRIGger:MAIn commands

TRIGger:MAIn	TRIGger:MAIn:COMMunication:SOUrce
TRIGger:MAIn:COMMunication:STANdard	TRIGger:MAIn:EDGE:COUPling
TRIGger:MAIn:EDGE:SLOpe	TRIGger:MAIn:EDGE:SOUrce
TRIGger:MAIn:HOLdoff:TIME	TRIGger:MAIn:HOLdoff:VALue
TRIGger:MAIn:LEVel	TRIGger:MAIn:LOGic
TRIGger:MAIn:LOGic:INPUT<x>:LOGICLevel	TRIGger:MAIn:INPUT2:SLOpe
TRIGger:MAIn:INPUT<x>:SOUrce	TRIGger:MAIn:INPUT<x>:THReshold
TRIGger:MAIn:LOGic:PATtern:DELTATime	TRIGger:MAIn:LOGic:PATtern:FUNcTion
TRIGger:MAIn:LOGic:PATtern:WHEn	TRIGger:MAIn:LOGic:STATE:WHEn
TRIGger:MAIn:MODE	TRIGger:MAIn:PULse:CLAss
TRIGger:MAIn:PULse:RUNT:POLarity	TRIGger:MAIn:PULse:RUNT:THReshold
TRIGger:MAIn:PULse:RUNT:WHEn	TRIGger:MAIn:PULse:RUNT:WIDth
TRIGger:MAIn:PULse:SLEWRate:DELTATime	TRIGger:MAIn:PULse:SLEWRate:POLarity
TRIGger:MAIn:PULse:SLEWRate:SLEWRate	TRIGger:MAIn:PULse:SLEWRate:THReshold
TRIGger:MAIn:PULse:SLEWRate:WHEn	TRIGger:MAIn:PULse:SOUrce
TRIGger:MAIn:PULse:WIDth:POLarity	TRIGger:MAIn:PULse:WIDth:WHEn
TRIGger:MAIn:PULse:WIDth:WIDth	TRIGger:MAIn:SETLevel
TRIGger:MAIn:TYPE	TRIGger:MAIn:VIDeo:CUSTom:FORMat
TRIGger:MAIn:VIDeo:CUSTom:SCAN	TRIGger:MAIn:VIDeo:FIELD
TRIGger:MAIn:VIDeo:HDTV:FORMat	TRIGger:MAIn:VIDeo:HOLdoff
TRIGger:MAIn:VIDeo:LINE	TRIGger:MAIn:VIDeo:SCAN
TRIGger:MAIn:VIDeo:SOUrce	TRIGger:MAIn:VIDeo:STANdard
TRIGger:MAIn:VIDeo:HDTV:SYStem	TRIGger:MAIn:VIDeo:

TRIGger:STATE? (Query Only)

Returns the current state of the triggering system.

Group Trigger

Syntax TRIGger:STATE?

Returns AUTO indicates that the oscilloscope is in auto mode and acquires data even in the absence of a trigger.

ARMED indicates that the oscilloscope is acquiring pretrigger information. All triggers are ignored when TRIGger:STATE is ARMED.

READY indicates that all pretrigger information has been acquired and the oscilloscope is ready to accept a trigger.

SAVe indicates that acquisition is stopped or that all channels are off.

TRIGger indicates that the oscilloscope has seen a trigger and is acquiring the posttrigger information.

Examples TRIGGER:STATE?
might return ARMED, indicating that pretrigger data is being acquired.

***TRG (Set Only)**

(Trigger) executes commands that are defined by *DDT.

The Group Execute Trigger (GET) interface message has the same effect as the *TRG command.

Group Miscellaneous

Syntax *TRG

Examples *TRG
immediately executes all commands that have been defined by *DDT.

Related Commands Alias commands, *DDT

***TST? (Query Only)**

(Self-Test) Tests the GPIB interface and returns a 0.

Group Miscellaneous

Syntax *TST?

Returns <NR1> and is always 0.

UNLock (Set Only)

Unlocks the front panel. This command is equivalent to LOCK NONE.

NOTE. *If the oscilloscope is in the Remote With Lockout State (RWLS), the UNLOCK command has no effect. For more information see the ANSI-IEEE Std. 488.1-1987 Standard Digital Interface for Programmable Instrumentation, section 2.8.3 on RL State Descriptions.*

Group	Miscellaneous
Syntax	UNLock ALL
Arguments	ALL specifies all front-panel buttons and knobs.
Related Commands	LOCK

VERBose

Sets and queries the Verbose State that controls the length of keywords on query responses. Keywords can be both headers and arguments. This command does not affect IEEE Std 488.2-1987 Common Commands (those starting with an asterisk).

Group	Miscellaneous
Syntax	VERBose { OFF ON <NR1> } VERBose?
Arguments	ON or <NR1> \neq 0 sets the Verbose State true, which returns full-length keywords for applicable setting queries. OFF or <NR1> = 0 sets the Verbose State false, which returns minimum-length keywords for applicable setting queries.

Examples VERBOSE ON
sets the Verbose State true.

VERBOSE?
might return the value 1, showing that the Verbose State is true.

Related Commands HEADer, *LRN?, SET?

*WAI (Set Only)

(Wait) Prevents the oscilloscope from executing further commands or queries until all pending operations finish. This command allows you to synchronize the operation of the oscilloscope with your application program. Synchronization methods are described on page 3-7.

Group Status and Error

Syntax *WAI

Related Commands BUSY?, *OPC

WAVFrm? (Query Only)

Returns WFMPre? and CURVe? data for the waveform specified by the DATA:SOURce command. This command is equivalent to sending WFMPre?; CURVe?. If the waveform specified by the DATA:SOURce command is not displayed, the oscilloscope returns only the waveform transmission parameters (BYT_Nr, BIT_Nr, ENCdg, BN_Fmt, BYT_Or).

The WFMPre response is first, followed by the CURVe response with an intervening semicolon.

Group Waveform

Syntax WAVFrm?

Returns See WFMPre? and CURVe? commands.

Related Commands CURVe, DATA:SOURce, WFMPre?

WAVEAlert:BEEP

(TDS3000B Series and TDS3000C Series)

The beep sounds when a new waveform data varies significantly from the accumulated (DPO) display of previous waveforms.

Group Acquisition

Syntax WAVEAlert:BEEP { OFF | ON | <NR1> }
WAVEAlert:BEEP?

Arguments OFF or <NR1> = 0 turns off the beep when a new waveform is significantly different.
ON or <NR1> \neq 0 turns on the beep.

Returns Either 0 or 1 corresponding to beep OFF or ON.

Examples WAVEALERT:BEEP ON
specifies that the beep is to sound when a new waveform data varies significantly from previous waveforms.
WAVEALERT:BEEP?
returns either 0 or 1, indicating whether the beep is to sound when a new waveform varies significantly from previous waveforms.

WAVEAlert:HARDCopy

(TDS3000B Series and TDS3000C Series)

Executes a hardcopy operation on the waveform when a new waveform data varies significantly from the accumulated (DPO) display of previous waveforms. The hardcopy operation uses the port, and prints in the format and layout, specified using the HARDCopy commands.

Group Acquisition

Syntax WAVEAlert:HARDCopy { OFF | ON | <NR1> }
WAVEAlert:HARDCopy?

- Arguments** ON or <NR1> \neq 0 turns on the hardcopy operation for the waveform when a new waveform is significantly different.
- OFF or <NR1> = 0 turns off the hardcopy operation.
- Examples** WAVEALERT:HARDCOPY ON
specifies that the hardcopy operation occurs when a new waveform data varies significantly from previous waveforms.
- WAVEALERT:HARDCOPY?
returns either 0 or 1, indicating whether the hardcopy operation occurs when a new waveform data varies significantly from previous waveforms.

WAVEAlert:SAVEWFM

(TDS3000B Series and TDS300C Series)

Sets or returns saving WaveAlert anomaly waveforms to file.

- Group** Acquisition
- Syntax** WAVEAlert:SAVEWFM { OFF | ON | <NR1> }
WAVEAlert:SAVEWFM?
- Arguments** OFF or <NR1> = 0 disables saving anomaly waveforms to a file.
- ON or <NR1> \neq 0 enables saving anomaly waveforms to a file.
- Examples** WAVEALERT:SAVEWFM ON
specifies that the oscilloscope save an anomaly waveform to the disk or flash drive.

WAVEAlert:SENSitivity

(TDS3000B Series and TDS3000C Series)

Sets or returns the WaveAlert anomaly detection sensitivity parameter.

Group Acquisition

Syntax WAVEAlert:SENSitivity { <NR1> }
WAVEAlert:SENSitivity?

Arguments <NR1> sets the anomaly sensitivity percentage value, and ranges from 1 to 100.

Examples WAVEAlert:SENSitivity?
might return WAVEAlert:SENSitivity 6.0E1, indicating that sensitivity is set to 60%.

WAVEAlert:STATE

(TDS3000B Series and TDS3000C Series)

Sets or returns the WaveAlert testing state.

Group Acquisition

Syntax WAVEAlert:STATE { OFF | ON | <NR1> }
WAVEAlert:STATE?

Arguments OFF or <NR1> = 0 turns off WaveAlert testing.
ON or <NR1> ≠ 0 turns on WaveAlert testing.

Examples WAVEAlert:STATE ON
specifies that WaveAlert waveform anomaly detection is in effect.
WAVEAlert:STATE?
returns either 0 or 1, indicating whether WaveAlert testing is in effect.

WAVEAlert:STOPOnviolation

(TDS3000B Series and TDS3000C Series)

Sets or returns the WaveAlert stop on violation setting. When enabled, this command stops waveform acquisitions on the first occurrence of a WaveAlert waveform anomaly.

Group	Acquisition
Syntax	WAVEAlert:STOPOnviolation { OFF ON } WAVEAlert:STOPOnviolation?
Arguments	OFF or 0 turns off the stop on violation mode. ON or 1 turns on the stop on violation mode.
Examples	WAVEALERT:STOPONVIOLATION? returns either 0 or 1, indicating whether stop on violation is off or on.

WAVEAlert:TYPe

(TDS3000B Series and TDS3000C Series)

Sets or returns the WaveAlert anomaly waveform highlight type.

Group	Acquisition
Syntax	WAVEAlert:TYPe { ENTire ANOMaly } WAVEAlert:TYPe?
Arguments	ENTire sets the oscilloscope to highlight the entire anomalous waveform. ANOMaly sets the oscilloscope to highlight just that portion of the anomalous waveform that is different than the base waveform.
Examples	WAVEALERT:TYPE? might return WAVEAlert:TYPe ENTire, indicating that the entire anomaly waveform is highlighted.

WFMPre? (Query Only)

Returns waveform transmission and formatting parameters for the waveform specified by the DATA:SOURce command. If the waveform specified by the DATA:SOURce command is not displayed, the oscilloscope returns only the waveform transmission parameters (BYT_Nr, BIT_Nr, ENCDg, BN_Fmt, BYT_Or).

Group Waveform

Syntax WFMPre?

Returns The format of the response is:

```
BYT_Nr <NR1>;BIT_Nr <NR1>;ENCDg { ASC | BIN };  
BN_Fmt { RI | RP };BYT_Or { LSB | MSB };NR_Pt <NR1>;  
WFID <Qstring>;PT_FMT {ENV | Y};XINcr <NR3>;  
PT_Off <NR1>;XZERo <NR3>;XUNit <QString>;YMULT <NR3>; YZero  
<NR3>;YOff <NR3>;YUNit <QString>
```

Example WFMPRE?

might return

```
:WFMPRE:BYT_NR 1;BIT_NR 8;ENCDG ASC;BN_FMT RP;BYT_OR MSB;  
NR_PT 10000;WFID "Ch1, DC coupling, 1.0E-1 V/div, 4.0E-4 s/div,  
10000 points, Sample mode";PT_FMT Y;XINCR 4.0E-7;PT_OFF 0;  
XZERO -2.0E-3;XUNIT "s";YMULT 4.0E-3;YZERO 0.0E0;YOFF 0.0E0;  
YUNIT "V"
```

Related Commands WAVFrm?, WFMPre:<wfm>?

WFMPre:BIT_Nr

Sets or queries the number of bits per waveform point for the waveform to be transferred. Changing the value of WFMPre:BIT_Nr also changes the values of WFMPre:BYT_Nr and DATA:WIDTH.

Group Waveform

Syntax WFMPre:BIT_Nr <NR1>

WFMPre:BIT_Nr?

Arguments <NR1> is either 8 or 16, and is equivalent to `WFMPre:BYT_Nr * 8` and `DATA:WIDTH * 8`.

Examples `WFMPRE:BIT_NR?`
might return 8, indicating that there are 8 bits per waveform point.

Related Commands `DATA:WIDTH`, `WFMPre:BYT_Nr`

WFMPre:BN_Fmt

Sets or queries the format of binary data for the waveform to be transferred. Changing the value of `WFMPre:BN_Fmt` also changes the value of `DATA:ENCdg`.

Group Waveform

Syntax `WFMPre:BN_Fmt { RI | RP }`
`WFMPre:BN_Fmt?`

Arguments RI specifies signed integer data-point representation.
RP specifies positive integer data-point representation.

Examples `WFMPRE:BN_FMT RP`
specifies that the binary waveform data are positive integer data-points.
`WFMPRE:BN_FMT?`
returns either RI or RP as the current waveform data format.

Related Commands `DATA:ENCdg`, `WFMPre:BYT_Or`, `WFMPre:ENCdg`

WFMPre:BYT_Nr

Sets or queries the data width for the waveform to be transferred. This command is equivalent to DATA:WIDTH. Changing WFMPre:BYT_Nr also changes WFMPre:BIT_Nr and DATA:WIDTH.

Group Waveform

Syntax WFMPre:BYT_Nr <NR1>
WFMPre:BYT_Nr?

Arguments <NR1> is an integer in the range of 1 to 2 that sets the number of bytes per point.

Examples WFMPRE:BYT_NR 2
specifies that there are 2 bytes per waveform data point.

Related Commands DATA:WIDTH, WFMPre:BIT_Nr

WFMPre:BYT_Or

Sets or queries which byte of binary waveform data is transmitted first during a waveform data transfer when DATA:WIDTH or WFMPre:BYT_Nr is set to 2, or WFMPre:BIT_Nr is set to 16. Changing WFMPre:BYT_Or changes DATA:ENCdg (if DATA:ENCdg is not ASCII). This specification only has meaning when WFMPre:ENCdg is BIN.

Group Waveform

Syntax WFMPre:BYT_Or { LSB | MSB }
WFMPre:BYT_Or?

Arguments LSB selects the least significant byte to be transmitted first.
MSB selects the most significant byte to be transmitted first.

Examples `WFMPRE:BYT_OR MSB`
 specifies that the most significant byte in the waveform data is transferred first.

`WFMPRE:BYT_OR?`
 returns either MSB or LSB depending on which data byte is transferred first.

Related Commands `DATA:ENCdg`, `WFMPre:BN_Fmt`, `WFMPre:ENCdg`

WFMPre:ENCdg

Sets or queries the type of encoding for waveform data transferred with the `CURVe` command. Changing `WFMPre:ENCdg` also changes `DATA:ENCdg`.

Group Waveform

Syntax `WFMPre:ENCdg { ASC | BIN }`
`WFMPre:ENCdg?`

Arguments `ASC` specifies ASCII curve data.
`BIN` specifies binary curve data.

Examples `WFMPRE:ENCDG ASC`
 specifies that the waveform data is in ASCII format.

`WFMPRE:ENCDG?`
 might return `BIN`, indicating that the waveform data is in binary format.

Related Commands `DATA:ENCdg`, `WFMPre:BYT_Or`, `WFMPre:BN_Fmt`

WFMPre:NR_Pt

The set form of this command sets the record length of the reference waveform specified by DATA:DESTination. Allowable record lengths are 500 and 10000.

The query form of this command returns the number of points that will be returned by the next CURVe query. The number of points is the greater of the absolute value of (DATA:STOP - DATA:START) +1, or the record length of the source waveform specified by DATA:SOUrce. If the source waveform is not on or displayed, the query generates an error and returns event code 2244.

Group Waveform

Syntax WFMPre:NR_Pt { 500 | 10000 }
WFMPre:NR_Pt?

Examples WFMPre:NR_Pt?
returns the number of waveform points in the next CURVE query.

Related Commands DATA:ENCdg, WFMPre:BYT_Or, WFMPre:BN_Fmt

WFMPre:PT_Fmt

The set form of this command sets the format (Y or ENV) of the reference waveform as specified by the DATA:DESTination command.

The query form returns the format of the waveform specified by the DATA:SOUrce command, if that waveform is on or displayed. If the waveform is not displayed, the query form of this command generates an error and returns event code 2244.

Group Waveform

Syntax WFMPre:PT_Fmt { ENV | Y }
WFMPre:PT_Fmt?

Arguments Y specifies a normal waveform where one ASCII or binary data point is transmitted for each point in the waveform record. Only y values are explicitly transmitted. Absolute coordinates are given by:

$$X_n = XZERO + XINcr (n-PT_Off)$$

$$Y_n = YZERO + YMULT (y_n - YOFf)$$

ENV specifies that the oscilloscope transmit the waveform as minimum and maximum point pairs. Peak detect and envelope waveforms use an ENV format. Only y values are explicitly transmitted. Absolute coordinates are given by:

$$X_n = XZERO + XINcr (n-PT_Off)$$

$$Y_{n_{min}} = YZERO + YMULT (y_{n_{min}} - YOFf)$$

$$Y_{n_{max}} = YZERO + YMULT (y_{n_{max}} - YOFf)$$

Examples WFMPRE:PT_FMT Y
sets the waveform data point format to Y.

WFMPRE:PT_FMT?
returns either Y or ENV.

WFMPre:PT_Off

The set form of this command is ignored. The query form always returns a 0, if the waveform specified by DATA:SOURce is on or displayed. If the waveform is not displayed, the query form generates an error and returns event code 2244. This command is listed for compatibility with other Tektronix oscilloscopes.

Group Waveform

Syntax WFMPre:PT_Off
WFMPre:PT_Off?

Arguments Arguments are ignored.

Related Commands WFMPre:<wfm>:PT_Off

WFMPre:WFId? (Query Only)

Returns a descriptive string from the waveform specified in the DATA:SOURce command, if that waveform is on or displayed. If that waveform is not on or displayed, the query fails and the oscilloscope generates an execution error with event code 2244 (waveform requested is not on).

Group Waveform

Syntax WFMPre:WFId?

Arguments None.

Examples

WFMPRE:WFID?
YT waveform:
:WFMPRE:WFID "Ch1, DC coupling, 1.0E-1 V/div, 4.0E-4 s/div, 10000 points, Sample mode"

Non-FFT Math waveform:
:WFMPRE:WFID "Math, DC coupling, 5.0E-2 V/div, 4.0E-4 s/div, 10000 points, Sample mode"

FFT waveform:
:WFMPRE:WFID "Math, DC coupling, 2.0E1 dB/div, 4.0E-3 Hz/div, 10000 points, Sample mode"

Related Commands WFMPre:<wfm>:WFId?

WFMPre:XINcr

The set form of this command specifies the interval (seconds per point for non-FFT, Hertz per point for FFT) between samples of the reference waveform specified by the DATA:DESTination command. The oscilloscope uses this value to calculate the seconds/division or Hertz/division units shown in the status, cursor and measurement readouts when displaying a reference waveform.

The query form returns the interval between samples of the waveform specified by the DATA:SOURce command, if that waveform is on or displayed. If that waveform is not on or displayed, the query fails and the oscilloscope generates an execution error with event code 2244 (waveform requested is not on).

Group Waveform

Syntax WFMPre:XINcr <NR3>
WFMPre:XINcr?

Arguments <NR3> is the sampling interval in seconds or Hertz per point.

Related Commands WFMPre:<wfm>:XINcr

WFMPre:XUNit

The set form of this command is only valid for reference waveforms. The only valid units are “s” and “Hz”. If an attempt is made to set the XUNit to something other than “s” or “Hz”, event 224 (illegal parameter value) is generated. Setting a reference waveform’s XUNit to Hz causes the oscilloscope to display the reference waveform as an FFT waveform.

The query form returns the horizontal units for the waveform specified by DATA:SOURce (“s” for seconds, “Hz” for Hertz). If the waveform specified by DATA:SOURce is not displayed, the query fails and the oscilloscope generates an execution error with event code 2244 (waveform requested is not on).

Group Waveform

Syntax WFMPre:XUNit <qstring>
WFMPre:XUNit?

Arguments <qstring> is “s” or “Hz”.

Related Commands WFMPre:<wfm>:XUNit

WFMPre:XZEro

The set form of this command specifies the position, in XUNits, of the first sample of the reference waveform specified by the DATA:DESTination command.

The query form returns the position of the first sample of the waveform specified by the DATA:SOURce command, if that waveform is on or displayed. If that waveform is not on or displayed, the query fails and the oscilloscope generates an execution error with event code 2244 (waveform requested is not on).

NOTE. *The oscilloscope uses XZEro when calculating cursor readouts.*

Group Waveform

Syntax WFMPre:XZEro <NR3>
WFMPre:XZEro?

Arguments <NR3> is the position, in XUNits, of the first sample in the waveform. If XUNits is “s”, <NR3> is the time of the first sample in this waveform.

Related Commands WFMPre:<wfm>:XZEro

WFMPre:YMUIt

The set form of this command sets the vertical scale factor of the reference waveform specified by the DATA:DESTination command, expressed in YUNits per waveform data point level. For 1 byte waveform data, there are 256 data point levels; for 2 byte waveform data there are 65536 data point levels.

Note that for a given waveform record, both YMUIt and YZEro have to be a consistent set; otherwise vertical cursor readouts and vertical measurements may give incorrect results.

The query form returns the vertical scale factor of the waveform specified by the DATA:SOURce command, if that waveform is on or displayed. If that waveform is not on or displayed, the query fails and the oscilloscope generates an execution error with event code 2244 (waveform requested is not on).

Group Waveform

Syntax WFMPre:YMU1t <NR3>
WFMPre:YMU1t?

Arguments <NR3> is the vertical scale factor, in YUNits (usually volts) per data point level.

Related Commands WFMPre:YUNit

WFMPre:YOFF

YOFF specifies the vertical position of a waveform. YOFF is a value, expressed in waveform data point levels, used to convert waveform record values to YUNit values using the following formula (where dl is data levels; curve_in_dl is a data point from CURVe?):

$$\text{value_in_units} = ((\text{curve_in_dl} - \text{YOFF_in_dl}) * \text{YMULT}) + \text{YZERO_in_units}$$

The set form of this command stores a value for the reference waveform specified by the DATA:DESTination command. This value does not affect how the oscilloscope displays the waveform, but does affect the cursor readouts and vertical measurements.

The query form returns the vertical position of the waveform specified by the DATA:SOUrce command, in data levels, if that waveform is on or displayed. If that waveform is not on or displayed, the query fails and the oscilloscope generates an execution error with event code 2244 (waveform requested is not on).

Group Waveform

Syntax WFMPre:YOFF <NR3>
WFMPre:YOFF?

Arguments <NR3> is a value expressed in waveform data point levels.

WFMPre:YUNit

The set form of this command sets the vertical units for the reference waveform specified by DATA:DESTination.

NOTE. It is possible to set a combination of WFMPre:XUNit and WFMPre:YUNit that is inconsistent (for example, seconds with dB or Hertz with volts). The oscilloscope will not warn you of this condition. The oscilloscope uses WFMPre:XUNit to determine if the waveform is YT or FFT.

The query form returns the vertical units of the waveform specified by the DATA:SOURce command, if that waveform is on or displayed. If that waveform is not on or displayed, the query fails and the oscilloscope generates an execution error with event code 2244 (waveform requested is not on).

Group Waveform

Syntax WFMPre:YUNit <Qstring>
WFMPre:YUNit?

Arguments <qstring> is "V", "VV", "s", "Hz", "%", "div", "S/s", "ohms", "A", "W", "min", "degrees", "?", "AA", "hr", "day", "dB", "B", "/Hz", "IRE", "V/V", "V/A", "VW", "V/W", "VdB", "V/dB", "A/V", "A/A", "AW", "A/W", "AdB", "A/dB", "WV", "W/V", "WA", "W/A", "WW", "W/W", "WdB", "W/dB", "dBV", "dB/V", "dBA", "dB/A", "dBW", "dB/W", "dBdB", or "dB/dB"

Returns <qstring> shown above

Examples WFMPre:YUNit "W"
wfmpre:yunit?
might return: WFMPRE:YUNIT "dB"

Related Commands WFMPre:YUNit, WFMPre:<wfm>:YUNit, WFMPre:YMUlt

WFMPre:YZero

YZero specifies the vertical offset of a waveform. YZero is a value, expressed in YUNits, used to convert waveform record values to YUNit values using the following formula (where dl is data levels; curve_in_dl is a data point from CURVe?):

$$\text{value_in_units} = ((\text{curve_in_dl} - \text{YOFF_in_dl}) * \text{YMULT}) + \text{YZERO_in_units}$$

The set form of this command stores a value for the reference waveform specified by the DATA:DESTINATION command. This value does not affect how the oscilloscope displays the waveform, but does affect the cursor readouts and vertical measurements.

Note that for a given waveform record, both YMULT and YZero have to be a consistent set; otherwise vertical cursor readouts and vertical measurements may give incorrect results.

The query form returns the vertical offset of the waveform specified by the DATA:SOURCE command, in YUNits, if that waveform is on or displayed. If that waveform is not on or displayed, the query fails and the oscilloscope generates an execution error with event code 2244 (waveform requested is not on).

Group Waveform

Syntax WFMPre:YZero <NR3>
WFMPre:YZero?

Arguments <NR3> is a value, expressed in YUNits.

Related Commands WFMPre:<wfm>:YZero

WFMPre—Additional Commands for Compatibility

Table 2-44 lists additional WFMPre commands. The oscilloscope ignores the set form of these commands, and the query form generates event messages 100 and 420. The commands are included for compatibility purposes only.

Table 2- 44: Additional WFMPre commands

Command	Argument	Description
WFMPre:XMUIt	<NR3>	Horizontal (X-axis) scale factor
WFMPre:XOFf	<NR3>	Horizontal (X-axis) offset
WFMPre:ZMUIt	<NR3>	Z-axis scale factor
WFMPre:ZOFf	<NR3>	Z-axis position
WFMPre:ZUNit	<QString>	Z-axis units
WFMPre:ZZEro	<NR3>	Z-axis origin offset

WFMPre:<wfm>? (Query Only)

Returns the waveform formatting data for the waveform specified by <wfm>, if that waveform is on or displayed. If that waveform is not on or displayed, the query fails and the oscilloscope generates event message 420 (Query unterminated) and 2244 (Waveform requested is not on).

NOTE. When querying *WFMPRE:<wfm>:mnemonic* information from the oscilloscope, the value of <wfm> must be *CH1, CH2, MATH, MATH1, REF1, REF2, REF3* or *REF4* for 2 channel models; <wfm> may be *CH3* or *CH4* in addition to the previous set for 4 channel models.

When sending *WFMPRE:<wfm>:mnemonic* information to the oscilloscope, the value of <wfm> must be *REF1, REF2, REF3* or *REF4*. The oscilloscope ignores <wfm> for any value other than *REF1* through *REF4*.

The *WFMPre:<wfm>:mnemonic* commands do not use the values set by the *DATA:SOURce* or *DATA:DESTINATION* commands

Group Waveform

Syntax WFMPre:<wfm>?

Returns The format of the response is:

```
:WFMPre:<wfm>:WFID <Qstring>;PT_FMT { ENV | Y };
NR_Pt <NR1>;XINcr <NR3>;PT_Off <NR1>;XZEro <NR3>;XUNit <QString>;
YMUlt <NR3>;YZEro <NR3>;YOff <NR3>;YUNit <QString>
```

Example WFMPRE:CH1?
might return

```
:WFMPRE:CH1:WFID "Ch1, DC coupling, 1.0E-1 V/div, 4.0E-4 s/div,
10000 points, Sample mode";PT_FMT Y;NR_PT 200;XINCR 4.0E-7;PT OFF
0;XZERO -4.0E-4;XUNIT "s";YMULT 4.0E-3;YZERO 0.0E0;YOFF 5.6E1;YU-
NIT "V"
```

Related Commands WFMPre?

WFMPre:<wfm>:NR_Pt

The set form of this command sets the record length of the reference waveform specified by source/destination waveform. Allowable record lengths are 500 and 10000.

The query form of this command returns the number of points that will be returned by the next CURVe query. The number of points is the greater of the absolute value of (DATA:STOP - DATA:START) +1, or the record length of the source waveform specified by DATA:SOURce. If the source waveform is not on or displayed, the query generates an error and returns event code 2244.

Group Waveform

Syntax WFMPre:<wfm>:NR_Pt { 500 | 10000 }

WFMPre:<wfm>:NR_Pt?

Arguments <wfm> specifies the source or destination waveform; refer to page 2-326 for a description of <wfm>.

10000 sets the record length to 10,000 points.

10000 sets the record length to 10,000 points.

Examples WFMPre:<wfm>:NR_Pt?
returns the number of waveform points in the next CURVE query.

Related Commands DATA:ENCdg, WFMPre:BYT_Or, WFMPre:BN_Fmt

WFMPre:<wfm>:PT_Fmt

Same as WFMPre:PT_Fmt, with the exception that <wfm> specifies the source/destination waveform instead of DATA:SOURCE and DATA:DESTINATION.

WFMPre:<wfm>:PT_Off

Same as WFMPre:PT_Off, with the exception that <wfm> specifies the source/destination waveform instead of DATA:SOURCE and DATA:DESTINATION.

WFMPre:<wfm>:WFId? (Query Only)

Same as WFMPre:WFId, with the exception that <wfm> specifies the source waveform instead of DATA:SOURCE.

WFMPre:<wfm>:XINcr

Same as WFMPre:XINcr, with the exception that <wfm> specifies the source/destination waveform instead of DATA:SOURCE and DATA:DESTINATION.

WFMPre:<wfm>:XUNit

Same as WFMPre:XUNit, with the exception that <wfm> specifies the source/destination waveform instead of DATA:SOURCE and DATA:DESTINATION.

WFMPre:<wfm>:XZEro

Same as WFMPre:XZEro, with the exception that <wfm> specifies the source/destination waveform instead of DATA:SOURCE and DATA:DESTINATION.

WFMPre:<wfm>:YMUlt

Same as WFMPre:YMUlt, with the exception that <wfm> specifies the source/destination waveform instead of DATA:SOURCE and DATA:DESTINATION.

WFMPre:<wfm>:YOFF

Same as WFMPre:YOFF, with the exception that <wfm> specifies the source/destination waveform instead of DATA:SOURCE and DATA:DESTINATION.

WFMPre:<wfm>:YUNit

Same as WFMPre:YUNit, with the exception that <wfm> specifies the source/destination waveform instead of DATA:SOURCE and DATA:DESTINATION.

WFMPre:<wfm>:YZEro

Same as WFMPre:YZEro, with the exception that <wfm> specifies the source/destination waveform instead of DATA:SOURCE and DATA:DESTINATION.

ZOOM:HORizontal:POSition

Sets or queries the horizontal position when in zoom.

Group	Horizontal
Syntax	ZOOM:HORizontal:POSition <NR3> ZOOM:HORizontal:POSition?
Arguments	<NR3> is the horizontal position in percent of record. Position range is from 0% to 100%.
Examples	ZOOM:HORIZONTAL:POSITION? might return :ZOOM:HORIZONTAL:POSITION 5.0E-1

ZOOM:HORIZONTAL:SCALE

Sets or queries the horizontal scale when in zoom.

Group Horizontal

Syntax ZOOM:HORIZONTAL:SCALE <NR3>
ZOOM:HORIZONTAL:SCALE?

Arguments <NR3> is the horizontal scale in seconds.

Examples ZOOM:HORIZONTAL:SCALE
might return :ZOOM:HORIZONTAL:SCALE 1.0E0

ZOOM:STATE

Sets or queries the zoom state mode.

Group Horizontal

Syntax ZOOM:STATE { < NR1> | ON | OFF }
ZOOM:STATE?

Arguments <OFF> or < NR1> = 0 turns off zoom.
<ON> or < NR1> = 1 turns on zoom.

Examples ZOOM:STATE 0
sets the zoom state to off.
ZOOM:STATE?
might return :ZOOM:STATE 0 for the zoom state.

Status and Events

TDS3000B and TDS3000C Series oscilloscopes provide a status and event reporting system for GPIB and RS-232 interfaces. This system informs you of significant events that occur within the oscilloscope.

The oscilloscope status handling system consists of five 8-bit registers and two queues. This section describes these registers and components. It also explains how the event handling system operates.

Registers

The registers in the event handling system fall into two functional groups:

- Status Registers contain information about the status of the oscilloscope. They include the Standard Event Status Register (SESR) and the Status Byte Register (SBR).
- Enable Registers determine whether selected types of events are reported to the Status Registers and the Event Queue. They include the Device Event Status Enable Register (DESER), the Event Status Enable Register (ESER), and the Service Request Enable Register (SRER).

Status Registers

The Standard Event Status Register (SESR) and the Status Byte Register (SBR) record certain types of events that may occur while the oscilloscope is in use. IEEE Std 488.2-1987 defines these registers.

Each bit in a Status Register records a particular type of event, such as an execution error or service request. When an event of a given type occurs, the oscilloscope sets the bit that represents that type of event to a value of one. (You can disable bits so that they ignore events and remain at zero. See the Enable Registers section on page 3-3.) Reading the status registers tells you what types of events have occurred.

The Standard Event Status Register (SESR). The SESR, shown in Figure 3-1, records eight types of events that can occur within the oscilloscope. Use the *ESR? query to read the SESR register. Reading the register clears the bits of the register so that the register can accumulate information about new events.

7	6	5	4	3	2	1	0
PON	URQ	CME	EXE	DDE	QYE	RQC	OPC

Figure 3-1: The Standard Event Status Register (SESR)

Table 3-1: SESR bit functions

Bit	Function
7 (MSB)	PON (Power On). Shows that the oscilloscope was powered on.
6	URQ (User Request). Not used.
5	CME (Command Error). Shows that an error occurred while the oscilloscope was parsing a command or query. Command error messages are listed in Table 3-4 on page 3-12.
4	EXE (Execution Error). Shows that an error occurred while the oscilloscope was executing a command or query. Execution error messages are listed in Table 3-5 on page 3-14.
3	DDE (Device Error). Shows that a device error occurred. Device error messages are listed in Table 3-6 on page 3-17.
2	QYE (Query Error). Shows that either an attempt was made to read the Output Queue when no data was present or pending, or that data in the Output Queue was lost.
1	RQC (Request Control). Not used.
0 (LSB)	OPC (Operation Complete). Shows that the operation is complete. This bit is set when all pending operations complete following an *OPC command.

The Status Byte Register (SBR) — shown in Figure 3-2, records whether output is available in the Output Queue, whether the oscilloscope requests service, and whether the SESR has recorded any events.

Use a Serial Poll (GPIB only) or the *STB? query to read the contents of the SBR. The bits in the SBR are set and cleared depending on the contents of the SESR, the Event Status Enable Register (ESER), and the Output Queue. When you use a Serial Poll to obtain the SBR, bit 6 is the RQS bit. When you use the *STB? query to obtain the SBR, bit 6 is the MSS bit. Reading the SBR does not clear the bits.

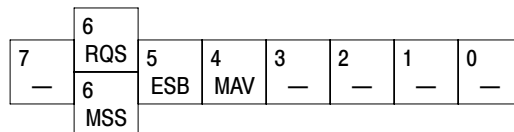

Figure 3-2: The Status Byte Register (SBR)

Table 3-2: SBR bit functions

Bit	Function
7 (MSB)	Not used.
6	RQS (Request Service), obtained from a serial poll. Shows that the oscilloscope requests service from the GPIB controller.
6	MSS (Master Status Summary), obtained from *STB? query. Summarizes the ESB and MAV bits in the SBR.
5	ESB (Event Status Bit). Shows that status is enabled and present in the SESR.
4	MAV (Message Available). Shows that output is available in the Output Queue.
3 - 0	Not used.

Enable Registers

DESER, ESER, and SRER allow you to select which events are reported to the Status Registers and the Event Queue. Each Enable Register acts as a filter to a Status Register (the DESER also acts as a filter to the Event Queue) and can prevent information from being recorded in the register or queue.

Each bit in an Enable Register corresponds to a bit in the Status Register it controls. In order for an event to be reported to its bit in the Status Register, the corresponding bit in the Enable Register must be set to one. If the bit in the Enable Register is set to zero, the event is not recorded.

Various commands set the bits in the Enable Registers. The Enable Registers and the commands used to set them are described below.

The Device Event Status Enable Register (DESER) — is shown in Figure 3-3. This register controls which types of events are reported to the SESR and the Event Queue. The bits in the DESER correspond to those in the SESR, as described earlier.

Use the DESE command to enable and disable the bits in the DESER. Use the DESE? query to read the DESER.

7	6	5	4	3	2	1	0
PON	URQ	CME	EXE	DDE	QYE	RQC	OPC

Figure 3-3: The Device Event Status Enable Register (DESER)

The Event Status Enable Register (ESER) — is shown in Figure 3-4. It controls which types of events are summarized by the Event Status Bit (ESB) in the SBR.

Use the *ESE command to set the bits in the ESER. Use the *ESE? query to read it.

7	6	5	4	3	2	1	0
PON	URQ	CME	EXE	DDE	QYE	RQC	OPC

Figure 3-4: The Event Status Enable Register (ESER)

The Service Request Enable Register (SRER) — is shown in Figure 3-5. It controls which bits in the SBR generate a Service Request (GPIB only) and are summarized by the Master Status Summary (MSS) bit.

Use the *SRE command to set the SRER. Use the *SRE? query to read it. The RQS bit remains set to one until either the Status Byte Register is read with a Serial Poll (GPIB only) or the MSS bit changes back to a zero.

7	6	5	4	3	2	1	0
—	—	ESB	MAV	—	—	—	—

Figure 3-5: The Service Request Enable Register (SRER)

The Enable Registers and the *PSC Command

The *PSC command controls the Enable Registers contents at power-on. Sending *PSC 1 sets the Enable Registers at power on as follows:

- DESER 255 (equivalent to a DESe 255 command)
- ESER 0 (equivalent to an *ESE 0 command)
- SRER 0 (equivalent to an *SRE 0 command)

Sending *PSC 0 lets the Enable Registers maintain their values in non-volatile memory through a power cycle.

NOTE. To enable the PON (Power On) event to generate a Service Request (GPIB only), send *PSC 0, use the DESe and *ESE commands to enable PON in the DESER and ESER, and use the *SRE command to enable bit 5 in the SRER. Subsequent power-on cycles will generate a Service Request (GPIB only).

Queues

The oscilloscope status and event reporting system contains two queues: the Output Queue and the Event Queue.

The Output Queue

The oscilloscope stores query responses in the Output Queue. It empties this queue each time it receives a new command or query message after an <EOM>. The controller must read a query response before it sends the next command (or query) or it will lose responses to earlier queries.



WARNING. When a controller sends a query, an <EOM>, and a second query, the oscilloscope normally clears the first response and outputs the second while reporting a Query Error (QYE bit in the ESER) to indicate the lost response. A fast controller, however, may receive a part or all of the first response as well. To avoid this situation, the controller should always read the response immediately after sending any terminated query message or send a DCL (Device Clear) before sending the second query.

The Event Queue

The Event Queue stores detailed information on up to 40 events. If more than 40 events stack up in the Event Queue, the 40th event is replaced by event code 350, “Too many events.”

Read the Event Queue with the EVENT? query (which returns only the event number), with the EVMSG? query (which returns the event number and a text description of the event), or with the ALLEV? query (which returns all the event numbers along with a description of the event). Reading an event removes it from the queue.

Before reading an event from the Event Queue, you must use the *ESR? query to read the summary of the event from the SESR. This makes the events summarized by the *ESR? read available to the EVENT? and EVMSG? queries, and empties the SESR.

Reading the SESR erases any events that were summarized by previous *ESR? reads but not read from the Event Queue. Events that follow an *ESR? read are put in the Event Queue but are not available until *ESR? is used again.

Event Handling Sequence

Figure 3-6, on page 3-6, shows how to use the status and event handling system. In the explanation that follows, numbers in parentheses refer to numbers in Figure 3-6.

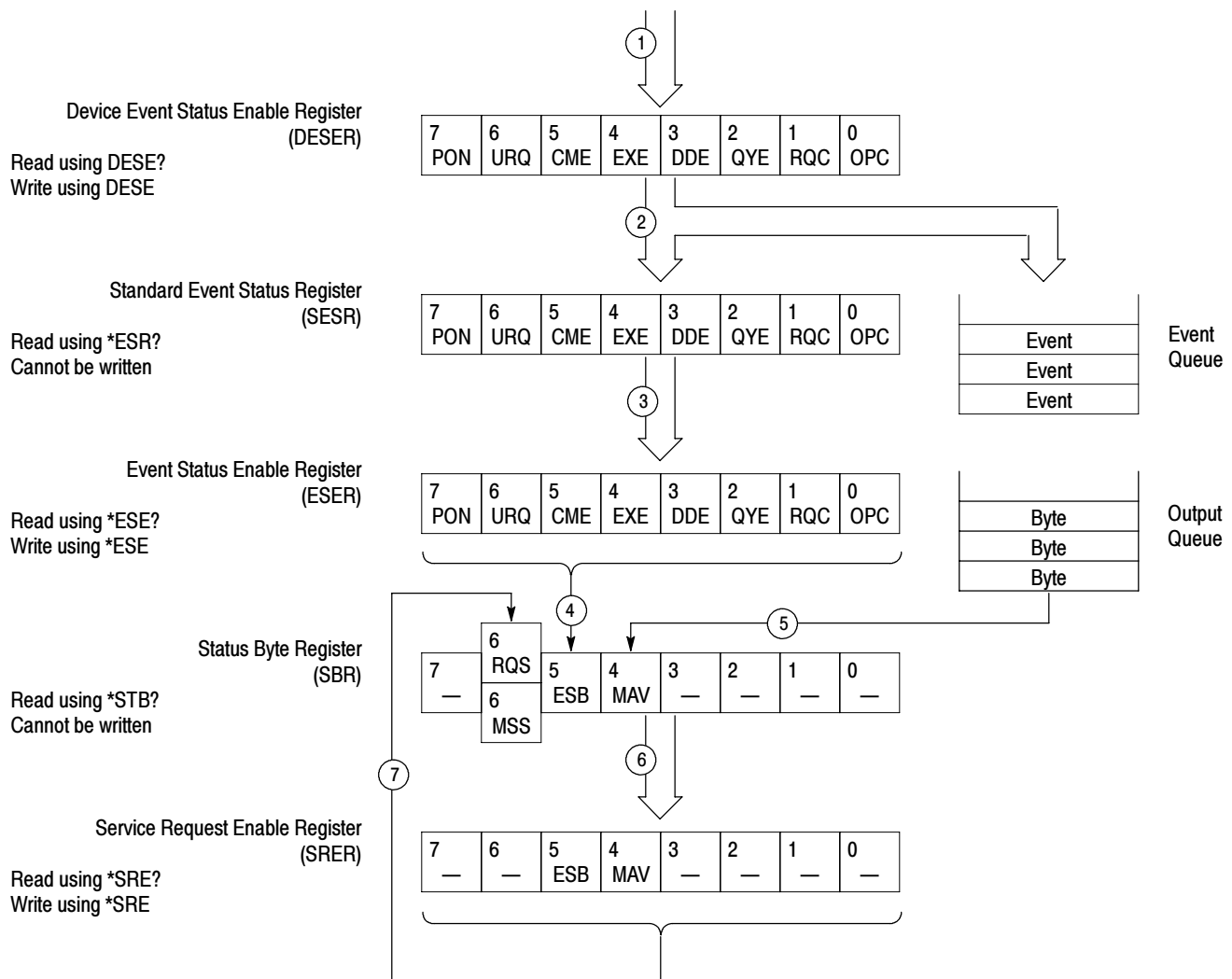

Figure 3-6: Status and event handling process

When an event occurs, a signal is sent to the DESER (1). If that type of event is enabled in the DESER (that is, if the bit for that event type is set to 1), the appropriate bit in the SESR is set to one, and the event is recorded in the Event Queue (2). If the corresponding bit in the ESER is also enabled (3), then the ESB bit in the SBR is set to one (4).

When output is sent to the Output Queue, the MAV bit in the SBR is set to one (5).

When a bit in the SBR is set to one and the corresponding bit in the SRER is enabled (6), the MSS bit in the SBR is set to one and a service request (GPIB only) is generated (7).

Synchronization Methods

Although most remote interface commands are completed almost immediately after being received by the oscilloscope, some commands start a process that requires more time. For example, once a **HARDCOPY START** command is executed it may be a few seconds before the hard copy operation is complete. Rather than remain idle while the operation is in process, the oscilloscope will continue processing other commands. This means that some operations will not be completed in the order that they were sent.

Sometimes the result of an operation depends on the result of an earlier operation. A first operation must complete before the next one gets processed. The oscilloscope status and event reporting system provide ways to do this.

For example, a typical application might involve acquiring a single-sequence waveform and then taking a measurement on the acquired waveform. You could use the following command sequence to do this:

```

REM "Set up single-sequence acquisition"
SELECT:CH1 ON
HORIZONTAL:RECORDLENGTH 500
ACQUIRE:MODE SAMPLE
ACQUIRE:STOPAFTER SEQUENCE
REM "Acquire waveform data"
ACQUIRE:STATE ON
REM "Set up the measurement parameters"
MEASUREMENT:IMMED:TYPE AMPLITUDE
MEASUREMENT:IMMED:SOURCE CH1
REM "Take amplitude measurement on acquired data"
MEASUREMENT:IMMED:VALUE?

```

The acquisition of the waveform requires extended processing time. It may not finish before the oscilloscope takes an amplitude measurement (See Figure 3-7). This can result in an incorrect amplitude value.

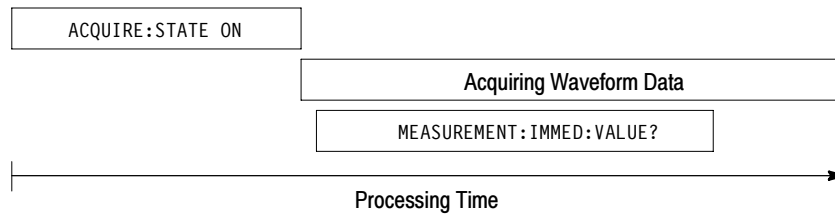

Figure 3-7: Command processing without using synchronization

To ensure the oscilloscope completes waveform acquisition before taking the measurement on the acquired data, you can synchronize the program. Figure 3-8 shows the desired processing sequence.

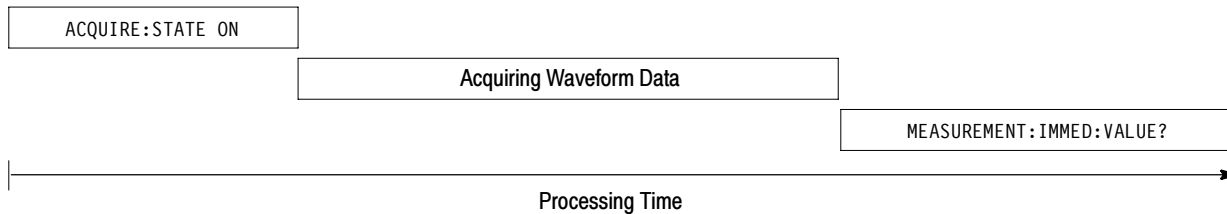

Figure 3-8: Processing sequence with synchronization

You can use four commands to synchronize the operation of the oscilloscope with your application program: `*WAI`, `BUSY?`, `*OPC`, and `*OPC?`.

Using the `*WAI` Command

You can force commands to execute sequentially by using the `*WAI` command. This command forces completion of the previous commands before processing new ones.

The same command sequence using the `*WAI` command for synchronization looks like this:

```

REM "Set up single-sequence acquisition"
SELECT:CH1 ON
HORIZONTAL:RECORDLENGTH 500
ACQUIRE:MODE NORMALSAMPLE
ACQUIRE:STOPAFTER SEQUENCE
REM "Acquire waveform data"
ACQUIRE:STATE ON
REM "Set up the measurement parameters"
MEASUREMENT:IMMED:TYPE AMPLITUDE
MEASUREMENT:IMMED:SOURCE CH1
REM "Wait until the acquisition is complete before taking the measurement"
WAI
    
```



```
REM "Take amplitude measurement on acquired data"
MEASUREMENT:IMMED:VALUE?
```

Though *WAI is one of the easiest ways to achieve synchronization, it is also the most costly. The processing time of the oscilloscope is slowed since it is processing a single command at a time. This time could be spent doing other tasks.

The controller can continue to write commands to the input buffer of the oscilloscope, but the commands will not be processed by the oscilloscope until all operations in process are complete. If the input buffer becomes full, the controller will be unable to write more commands to the buffer. This can cause a time-out.

Using the BUSY Query

The BUSY? query allows you to find out whether the oscilloscope is busy processing a command that has an extended processing time such as single-sequence acquisition.

The same command sequence using the BUSY? query for synchronization looks like this:

```
REM "Set up single-sequence acquisition"
SELECT:CH1 ON
HORIZONTAL:RECORDLENGTH 500
ACQUIRE:MODE NORMALSAMPLE
ACQUIRE:STOPAFTER SEQUENCE
REM "Acquire waveform data"
ACQUIRE:STATE ON
REM "Set up the measurement parameters"
MEASUREMENT:IMMED:TYPE AMPLITUDE
MEASUREMENT:IMMED:SOURCE CH1
REM "Wait until the acquisition is complete before taking the measurement"
While BUSY? keep looping
REM "Take amplitude measurement on acquired data"
MEASUREMENT:IMMED:VALUE?
```

This sequence lets you create your own wait loop rather than using the *WAI command. The BUSY? query helps you avoid time-outs caused by writing too many commands to the input buffer. The controller is still tied up, though, and the repeated BUSY? query will result in more bus traffic.

Using the *OPC Command

If the corresponding status registers are enabled, the *OPC command sets the OPC bit in the Standard Event Status Register (SESR) when an operation is complete. You achieve synchronization by using this command with either a serial poll or service request handler. Use the *OPC command to guarantee all previous commands have been processed and are applied to all dependent waveform operations.

Serial Poll Method (GPIB only). Enable the OPC bit in the Device Event Status Enable Register (DESER) and the Event Status Enable Register (ESER) using the DESE and *ESE commands. When the operation is complete, the OPC bit in the Standard Event Status Register (SESR) will be enabled and the Event Status Bit (ESB) in the Status Byte Register will be enabled.

The same command sequence using the *OPC command for synchronization with serial polling looks like this:

```

REM "Set up single-sequence acquisition"
SELECT:CH1 ON
HORIZONTAL:RECORDLENGTH 500
ACQUIRE:MODE SAMPLE
ACQUIRE:STOPAFTER SEQUENCE
REM "Enable the status registers"
DESE 1
*ESE 1
*SRE 0
REM "Acquire waveform data"
ACQUIRE:STATE ON
REM "Set up the measurement parameters"
MEASUREMENT:IMMED:TYPE AMPLITUDE
MEASUREMENT:IMMED:SOURCE CH1
REM "Wait until the acquisition is complete before taking the measurement"
*OPC
While serial poll = 0, keep looping
REM "Take amplitude measurement on acquired data"
MEASUREMENT:IMMED:VALUE?
    
```

This technique requires less bus traffic than did looping on BUSY?.

Service Request Method (GPIB only). Enable the OPC bit in the Device Event Status Enable Register (DESER) and the Event Status Enable Register (ESER) using the DESE and *ESE commands. You can also enable service requests by setting the ESB bit in the Service Request Enable Register (SRER) using the *SRE command. When the operation is complete, a Service Request will be generated.

The same command sequence using the *OPC command for synchronization looks like this:

```

REM "Set up single-sequence acquisition"
SELECT:CH1 ON
HORIZONTAL:RECORDLENGTH 500
ACQUIRE:MODE SAMPLE
ACQUIRE:STOPAFTER SEQUENCE
REM "Enable the status registers"
DESE 1
*ESE 1
*SRE 32
REM "Acquire waveform data"
ACQUIRE:STATE ON
REM "Set up the measurement parameters"
MEASUREMENT:IMMED:TYPE AMPLITUDE
MEASUREMENT:IMMED:SOURCE CH1
REM "Wait until the acquisition is complete before taking the measurement"
*OPC
Program can now do different tasks such as talk to other
devices. The SRQ, when it comes, interrupts those tasks and
returns control to this task.
REM "Take amplitude measurement on acquired data"
MEASUREMENT:IMMED:VALUE?

```

This technique is more efficient but requires more sophisticated programming.

Using the *OPC? Query

The *OPC? query places a 1 in the Output Queue once an operation is complete. A timeout could occur if you try to read the output queue before there is any data in it.

The same command sequence using the *OPC? query for synchronization looks like this:

```

REM "Set up single-sequence acquisition"
SELECT:CH1 ON
HORIZONTAL:RECORDLENGTH 500
ACQUIRE:MODE SAMPLE
ACQUIRE:STOPAFTER SEQUENCE
REM "Acquire waveform data"
ACQUIRE:STATE ON
REM "Set up the measurement parameters"
MEASUREMENT:IMMED:TYPE AMPLITUDE
MEASUREMENT:IMMED:SOURCE CH1
REM "Wait until the acquisition is complete before taking the measurement"
*OPC?
Wait for read from Output Queue.

```

REM "Take amplitude measurement on acquired data"
 MEASUREMENT:IMMED:VALUE?

This is the simplest approach. It requires no status handling or loops. However, you must set the controller time-out for longer than the acquisition operation.

Messages

Tables 3-3 through 3-9 list all the programming interface messages the oscilloscope generates in response to commands and queries.

For most messages, a secondary message from the oscilloscope gives more detail about the cause of the error or the meaning of the message. This message is part of the message string, and is separated from the main message by a semicolon.

Each message is the result of an event. Each type of event sets a specific bit in the SESR and is controlled by the equivalent bit in the DESER. Thus, each message is associated with a specific SESR bit. In the message tables that follow, the associated SESR bit is specified in the table title, with exceptions noted with the error message text.

Table 3-3 shows the messages when the system has no events or status to report. These have no associated SESR bit.

Table 3-3: No event messages

Code	Message
0	No events to report - queue empty
1	No events to report - new events pending *ESR?

Table 3-4 shows the error messages generated by improper command syntax. Check that the command is properly formed and that it follows the rules in *Command Syntax* starting on page 2-1.

Table 3-4: Command error messages - CME Bit 5

Code	Message
100	Command error
101	Invalid character
102	Syntax error
103	Invalid separator
104	Data type error

Table 3-4: Command error messages - CME Bit 5 (Cont.)

Code	Message
105	GET not allowed
106	Invalid program data separator
108	Parameter not allowed
109	Missing parameter
110	Command header error
111	Header separator error
112	Program mnemonic too long
113	Undefined header
118	Query not allowed
120	Numeric data error
121	Invalid character in number
123	Exponent too large
124	Too many digits
128	Numeric data not allowed
130	Suffix error
131	Invalid suffix
134	Suffix too long
138	Suffix not allowed
140	Character data error
141	Invalid character data
144	Character data too long
148	Character data not allowed
150	String data error
151	Invalid string data
152	String data too long
158	String data not allowed
160	Block data error
161	Invalid block data
168	Block data not allowed
170	Expression error
171	Invalid expression
178	Expression data not allowed
180	Alias error

Table 3-4: Command error messages - CME Bit 5 (Cont.)

Code	Message
181	Invalid outside alias definition
183	Invalid inside alias definition
184	Command in alias requires more/fewer parameters

Table 3-5 lists the execution errors that are detected during execution of a command.

Table 3-5: Execution error messages - EXE Bit 4

Code	Message
200	Execution error
201	Invalid while in local
202	Settings lost due to rtl
210	Trigger error
211	Trigger ignored
212	Arm ignored
220	Parameter error
221	Settings conflict
222	Data out of range
223	Too much data
224	Illegal parameter value
230	Data corrupt or stale
240	Hardware error
241	Hardware missing
242	Hardware configuration error
243	Hardware I/O device error
250	Mass storage error
251	Missing mass storage
252	Missing media
253	Corrupt media
254	Media full
255	Directory full
256	File name not found

Table 3-5: Execution error messages - EXE Bit 4 (Cont.)

Code	Message
257	File name error
258	Media protected
260	Expression error
261	Math error in expression
270	Hard copy error
271	Hard copy device not responding
272	Hard copy is busy
273	Hard copy is aborted
274	Hard copy configuration error
280	Network printer name not found
281	Network printer list full
282	Insufficient network printer information
283	Network printer not responding
284	Network printer server not responding
285	Network printer domain name server not responding
286	No network printers exist
287	Print server not found
2200	Measurement error, Measurement system error
2201	Measurement error, Zero period
2202	Measurement error, No period found
2203	Measurement error, No period, second waveform
2204	Measurement error, Low signal amplitude
2205	Measurement error, Low amplitude, second waveform
2206	Measurement error, Invalid gate
2207	Measurement error, Measurement overflow
2208	Measurement error, Waveform does not cross Mid Ref
2209	Measurement error, No second Mid Ref crossing
2210	Measurement error, No Mid Ref crossing, second waveform
2211	Measurement error, No backwards Mid Ref crossing
2212	Measurement error, No negative crossing
2213	Measurement error, No positive crossing
2214	Measurement error, No crossing
2215	Measurement error, No crossing, second waveform

Table 3-5: Execution error messages - EXE Bit 4 (Cont.)

Code	Message
2216	Measurement error, No crossing, target waveform
2217	Measurement error, Constant waveform
2218	Measurement error, Unused
2219	Measurement error, No valid edge - No arm sample
2220	Measurement error, No valid edge - No arm cross
2221	Measurement error, No valid edge - No trigger cross
2222	Measurement error, No valid edge - No second cross
2223	Measurement error, Waveform mismatch
2224	Measurement error, WAIT calculating
2225	Measurement error, No waveform to measure
2226	Null Waveform
2227	Positive and Negative Clipping
2228	Measurement error, Positive Clipping
2229	Measurement error, Negative Clipping
2230	Measurement error, High Ref < Low Ref
2231	Measurement error, Measurement is not turned on
2232	Measurement error, Frequency out of range
2235	Math error, Invalid math description
2240	Invalid password
2241	Waveform requested is invalid
2242	Data start and stop > record length
2243	Waveform requested is not a data source
2244	Waveform requested is not turned on
2245	Saveref error, Selected channel is turned off
2246	Saveref error, Selected channel data invalid
2248	Saveref error, Source reference data invalid
2260	Calibration error
2270	Alias error
2271	Alias syntax error
2272	Alias execution error
2273	Illegal alias label
2274	Alias parameter error
2275	Alias definition too long

Table 3-5: Execution error messages - EXE Bit 4 (Cont.)

Code	Message
2276	Alias expansion error
2277	Alias redefinition not allowed
2278	Alias header not found
2279	Alias label too long
2280	Alias table full
2285	TekSecure® Pass
2286	TekSecure® Fail
2301	Cursor error, Off-screen
2302	Cursor error, cursors are off
2303	Cursor error, Cursor source waveform is off

Table 3-6 lists the device errors that can occur during oscilloscope operation. These errors may indicate that the oscilloscope needs repair.

Table 3-6: Device error messages - DDE Bit 3

Code	Message
300	Device-specific error
310	System error
311	Memory error
312	PUD memory lost
313	Calibration memory lost
314	Save/recall memory lost
315	Configuration memory lost
316	Password memory lost
350	Queue overflow (does not set DDE bit)
361	Parity error in program message (check parity)
362	Framing error in program message (check baud rate)
363	Input buffer overrun (check flagging)

Table 3-7 lists the system event messages. These messages are generated whenever certain system conditions occur.

Table 3-7: System event messages

Code	Message
400	Query event
401	Power on (PON bit 7 set)
402	Operation complete (OPC bit 0 set)
403	User request (URQ bit 6 set)
404	Power fail (DDE bit 3 set)
405	Request control
410	Query INTERRUPTED (QYE bit 2 set)
420	Query UNTERMINATED (QYE bit 2 set)
430	Query DEADLOCKED (QYE bit 2 set)
440	Query UNTERMINATED after indefinite response (QYE bit 2 set)

Table 3-8 lists warning messages that do not interrupt the flow of command execution. These notify you that you may get unexpected results.

Table 3-8: Execution warning messages - EXE Bit 4

Code	Message
500	Execution warning
510	String data too long, truncated
525	Parameter underrange
526	Parameter overrange
527	Parameter rounded
528	Parameter out of range
530	Data stop > stop, Values swapped internally
531	Data stop > record length, Curve truncated
532	Curve data too long, Curve truncated
540	Measurement warning
541	Measurement warning, Low signal amplitude
542	Measurement warning, Unstable histogram
543	Measurement warning, Low resolution
544	Measurement warning, Uncertain edge

Table 3-8: Execution warning messages - EXE Bit 4 (Cont.)

Code	Message
545	Measurement warning, Invalid in minmax
546	Measurement warning, Need 3 edges
547	Measurement warning, Clipping positive/negative
548	Measurement warning, Clipping positive
549	Measurement warning, Clipping negative

Table 3-9 shows internal errors that indicate an internal fault in the oscilloscope.

Table 3-9: Internal warning messages

Code	Message
600	Internal warning
630	Internal warning, 50 Ω overload

Appendix A: Character Charts

The MESSAGE:SHOW, *PUD, SETUP:LABEL, and REF:LABEL commands can display the characters in Table A-1 and the Chinese, Japanese, Korean, and Russian characters shown in the CHARSETS directory on the disk that accompanied this manual.

Table A-1: Character Set









	0	1	2	3	4	5	6	7
0	NUL 0	 16	space 32	0 48	@ 64	P 80	' 96	p 112
1	 1	Ω 17	! 33	1 49	A 65	Q 81	a 97	q 113
2	↑ 2	Δ 18	” 34	2 50	B 66	R 82	b 98	r 114
3	↓ 3	BW 19	# 35	3 51	C 67	S 83	c 99	s 115
4	← 4	 20	\$ 36	4 52	D 68	T 84	d 100	t 116
5	→ 5	 21	% 37	5 53	E 69	U 85	e 101	u 117
6	 6	 22	& 38	6 54	F 70	V 86	f 102	v 118
7	↩ 7	 23	' 39	7 55	G 71	W 87	g 103	w 119
8	 8	 24	(40	8 56	H 72	X 88	h 104	x 120
9	HT 9	 25) 41	9 57	I 73	Y 89	i 105	y 121
A	LF 10	 26	* 42	: 58	J 74	Z 90	j 106	z 122
B	 11	ESC 27	+ 43	; 59	K 75	[91	k 107	{ 123
C	 12	 28	, 44	< 60	L 76	\ 92	l 108	 124
D	CR 13	 29	— 45	= 61	M 77] 93	m 109	} 125
E	∞ 14	— 30	. 46	> 62	N 78	^ 94	n 110	~ 126
F	— 15	↓ 31	/ 47	? 63	O 79	_ 95	o 111	... 127

Table A-1: Character Set (Cont.)







































	8	9	A	B	C	D	E	F
0	R1 128	U 144	160	o 176	À 192	Ð 208	à 224	 240
1	R2 129	 145	i 161	± 177	Á 193	Ñ 209	á 225	ñ 241
2	R3 130	 146	U 162	 178	Â 194	Ò 210	â 226	ò 242
3	R4 131	 147	▼ 163	 179	Ã 195	Ó 211	ã 227	ó 243
4	Tek 132	 148	 164	 180	Ä 196	Ô 212	ä 228	ô 244
5	Tektronix 133	 149	N _o 165	μ 181	Å 197	Õ 213	å 229	õ 245
6	/ 134	H 150	· 166	 182	Æ 198	Ö 214	æ 230	ö 246
7	 135	L 151	 167	• 183	Ç 199	× 215	ç 231	÷ 247
8	 136	 152	 168	 184	È 200	φ 216	è 232	 248
9	 137	 153	 169	 185	É 201	Ù 217	é 233	ù 249
A	 138	 154	a 170	o 186	Ê 202	Ú 218	ê 234	ú 250
B	 139	 155	 171	 187	Ë 203	Û 219	ë 235	û 251
C	 140	156	 172	 188	Ì 204	Ü 220	ì 236	ü 252
D	 141	157	- 173	 189	Í 205	Ý 221	í 237	ý 253
E	 142	158	 174	 190	Î 206	 222	î 238	 254
F	 143	159	A 175	ç 191	Ï 207	ß 223	ï 239	ÿ 255

Table A-2: ASCII & GPIB Code Chart

B7 B6 B5 BITS B4 B3 B2 B1	0 0 0		0 0 1		0 1 0		0 1 1		1 0 0		1 0 1		1 1 0		1 1 1	
	CONTROL				NUMBERS SYMBOLS				UPPER CASE				LOWER CASE			
0 0 0 0	0 0	NUL 0	20 10	DLE 16	40 20	SP 32	60 30	LA0 48	100 40	TA0 64	120 50	TA16 80	140 60	SA0 96	160 70	SA16 112
0 0 0 1	1 1	GTL SOH 1	21 11	LL0 DC1 17	41 21	LA1 33	61 31	LA17 49	101 41	TA1 65	121 51	TA17 81	141 61	SA1 97	161 71	SA17 113
0 0 1 0	2 2	STX 2	22 12	DC2 18	42 22	” 34	62 32	LA18 50	102 42	TA2 66	122 52	TA18 82	142 62	SA2 98	162 72	SA18 114
0 0 1 1	3 3	ETX 3	23 13	DC3 19	43 23	# 35	63 33	LA19 51	103 43	TA3 67	123 53	TA19 83	143 63	SA3 99	163 73	SA19 115
0 1 0 0	4 4	SDC EOT 4	24 14	DCL DC4 20	44 24	\$ 36	64 34	LA20 52	104 44	TA4 68	124 54	TA20 84	144 64	SA4 100	164 74	SA20 116
0 1 0 1	5 5	PPC ENQ 5	25 15	PPU NAK 21	45 25	% 37	65 35	LA21 53	105 45	TA5 69	125 55	TA21 85	145 65	SA5 101	165 75	SA21 117
0 1 1 0	6 6	ACK 6	26 16	SYN 22	46 26	& 38	66 36	LA22 54	106 46	TA6 70	126 56	TA22 86	146 66	SA6 102	166 76	SA22 118
0 1 1 1	7 7	BEL 7	27 17	ETB 23	47 27	, 39	67 37	LA23 55	107 47	TA7 71	127 57	TA23 87	147 67	SA7 103	167 77	SA23 119
1 0 0 0	8 8	GET BS 8	30 18	SPE CAN 24	50 28	(40	70 38	LA24 56	110 48	TA8 72	130 58	TA24 88	150 68	SA8 104	170 78	SA24 120
1 0 0 1	9 9	TCT HT 9	31 19	SPD EM 25	51 29) 41	71 39	LA25 57	111 49	TA9 73	131 59	TA25 89	151 69	SA9 105	171 79	SA25 121
1 0 1 0	10 A	LF 10	32 1A	SUB 26	52 2A	* 42	72 3A	LA26 58	112 4A	TA10 74	132 5A	TA26 90	152 6A	SA10 106	172 7A	SA26 122
1 0 1 1	11 B	VT 11	33 1B	ESC 27	53 2B	+ 43	73 3B	LA27 59	113 4B	TA11 75	133 5B	TA27 91	153 6B	SA11 107	173 7B	SA27 123
1 1 0 0	12 C	FF 12	34 1C	FS 28	54 2C	, 44	74 3C	LA28 60	114 4C	TA12 76	134 5C	TA28 92	154 6C	SA12 108	174 7C	SA28 124
1 1 0 1	13 D	CR 13	35 1D	GS 29	55 2D	- 45	75 3D	LA29 61	115 4D	TA13 77	135 5D	TA29 93	155 6D	SA13 109	175 7D	SA29 125
1 1 1 0	14 E	SO 14	36 1E	RS 30	56 2E	. 46	76 3E	LA30 62	116 4E	TA14 78	136 5E	TA30 94	156 6E	SA14 110	176 7E	SA30 126
1 1 1 1	15 F	SI 15	37 1F	US 31	57 2F	/ 47	77 3F	UNL 63	117 4F	TA15 79	137 5F	UNT 95	157 6F	SA15 111	177 7F	RUBOUT (DEL) 127
		ADDRESSED COMMANDS		UNIVERSAL COMMANDS		LISTEN ADDRESSES		TALK ADDRESSES		SECONDARY ADDRESSES OR COMMANDS						

KEY

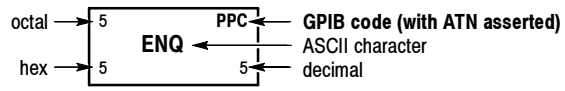

Tektronix

REF: ANSI STD X3.4-1977
IEEE STD 488.1-1987
ISO STD 646-2973

Appendix B: Reserved Words

The following is a list of the reserved words of the digitizing oscilloscope. Do not use these words for aliases. Capital letters identify the required minimum spelling. Hint: Use the full spelling for the most robust code as the minimum spelling rules may change over time and from model to model.

*CAL	ALWAYS	BOTH	CONTROL	DIAG
*CLS	AMPLitude	BOX	COPY	DIR
*DDT	AND	BRIghtness	COUNT	DIREction
*ESE	ANOMaly	BTRIG	COUPling	DISplay
*ESR	APPS	BURst	CPU	DNS
*IDN	AREa	BUSY	CR	DOMainname
*LRN	ASC	BY	CRLf	DOTsonly
*OPC	ASCLi	BYT_Nr	CRMs	DPO
*PSC	ASETup	BYT_Or	CROSSHair	DPU3445
*PUD	AUTO	CALibrate	CURSOr	DS0Contra
*RCL	AUTOContrast	CAREa	CURSOr1	DS0Double
*RST	AUTOFit	CATALOG	CURSOr1X	DS0Single
*SAV	AUTOSet	CENtronics	CURSOr1Y	DS0Timing
*SRE	AVErage	CH1	CURSOr2	DS1
*STB	B	CH2	CURSOr2X	DS1A
*TRG	BACKLight	CH3	CURSOr2Y	DS1C
*TST	BACKWards	CH4	CURVe	DS1Rate
*WAI	BANdwidth	CLAss	CURrent	DS2
A	BATTery	CLEAR	CUSTom	DS2Coax
ABOrt	BAUd	CLEARMenu	CWD	DS2RATECoax
ABSolute	BEEP	CLEARSNapshot	DATE	DS2RATESymmetrical
AC	BELI	CLEARSpool	DATA	DS2Symmetrical
ACQUISition	BIN	CLOCKCoax	DB	DS3
ACQuire	BIT_Nr	CLOCKSymmetrical	DC	DS3Rate
ACTion	BJC80	CLOCK	DEFINE	DUAL
ADC	BLAckmanharris	CMEan	DELEte	DUE
ADD	BMENU1	COARSE	DELTAtime	E1Coax
ADDRes	BMENU2	COLDstart	DELTA	E1Symmetrical
ADVanced	BMENU3	COLor	DELWarn	E2
ALias	BMENU4	COMMunication	DELay	E3
ALL	BMENU5	CPMPARE	DESE	ECL
ALLEv	BMENU6	COMPLetion	DESKJET	EDGE
ALLFields	BMENU7	COMPRESSion	DESKJETColor	EDGE1
ALLInfo	BMP	CONTInue	DESKew	EDGE2
ALLLines	BMPColor	CONFIG	DESTination	EDH
ALTernating	BN_Fmt	CONTRAsT	DHCPBOOTP	EITher

Appendix A: Reserved Words

ENCdg	FLAg	HORZ1	LIMit	MSEtUp
ENET	FLOPPYdisk	HORZ2	LINE	MV
ENETADdress	FORCETRIG	HORZ3	LINEAR	NAME
ENGLish	FORCe	HORZ4	LOCK	NANd
ENTire	FORMat	HORZPOS	LOG	NDUty
ENVelope	FORWards	HORZSCALE	LOGICLevel	NEGAtive
EPSColor	FPAnel	HORizontal	LOGIc	NETPRInter
EPSMono	FRAME	HOST	LOOP	NEWpass
EPSON	FREESpace	HOURS	LOW	NEXT
EQual	FRENch	HPOS1	LSB	NOISErej
ERRLOG	FREQuency	HPOS2	MAG	NONE
ERROR	FULl	HSCALE	MAIn	NOR
ERRORChecking	FUNcTion	HTRIGPOS	MARGIN	NORMAL
ETHERnet	G703DS1	HTTPPORT	MASK	NOTEQual
EVEN	G703DS3	ID	MASK1	NOTIfy
EVENT	GASgauge	IMMed	MASK2	NOVershoot
EVENtS	GATEDxyz	IMPedance	MASK3	NR_Pt
EVMsg	GATEWay	INCRement	MASK4	NTSc
EVQty	GATing	INDEpendent	MASK5	NUMACq
EXECute	GBR	INDICators	MASK6	NUMAVg
EXT	GERMan	INFINite	MASK7	NUMCHan
EXT10	GND	INIT	MASK8	NUMERRors
EXTERnal	GPIb	INKSaver	MASKPRE	NUMERic
F525	GPKNOB	INPUT1	MATH	NUMEnv
F625	GRAticule	INPUT2	MATH1	MUMHORZ
FACTACQ	GRId	INTENSITy	MATHCad	NUMPOWerups
FACTTRIG	HAMming	INTERLAcEd	MAXimum	NUMVERT
FACTVERT	HANning	INTERLeaf	MEAN	NWIdth
FACTory	HARDCopy	INTERNal	MEANSTDdev	OCCurs
FAIL	HARDFlagging	INVert	MEAS1	ODD
FAILURES	HBArs	IO	MEAS2	OFF
FAILUre	HD1080I50	IPADdress	MEAS3	OFFSet
FALL	HD1080I60	IRE	MEAS4	ON
FALSe	HD1080P24	ITALian	MEASUrement	ONCE
FASTERthan	HD1080P25	ITU601	MEDIum	ONEFifty
FCALUPtime	HD1080SF24	JAPANEse	MEG	ONEHundred
FFT	HD480P60	KOREan	MESSage	ONFAIL
FIELD	HD720P60	LABel	METHod	OPTion
FIELD1	HDELta	LANGuage	MID	OR
FIELD2	HDR	LANdscAPE	MID2	OUTput
FIFty	HDTV	LASERJet	MINImum	OVERWrite
FILE	HEADer	LAYout	MINMax	PAL
FILEFormat	HFRej	LESSThan	MKDir	PALEtte
FILEName	HIGH	LEVel	MODE	PASSWord
FILESystem	HISTogram	LF	MONOchrome	PATTERNBITS
FIRST	HITS	LFcr	MOREThan	PATtern
FIVEdivs	HOLDoff	LFRej	MSB	PCX

PCXColor	RATE1	ROM	SNAPShot	TDS3TMT
PDUTy	RATE2	RP	SOUrce	TDS3TRG
PEAKdetect	RATE3	RPBinary	SOURCE1	TDS3UNK
PERCent	RATE32MBIT	RS232	SPANish	TDS3VID
PERIod	RATE4	RUN	SPCACQ	TEKSecure
PERSistence	RATE5	RUNSTop	SPCTRIG	TEMPLate
PHAse	TATIO	RUNT	SPCUPtime	TERMinator
PICTure	RATIO1	RUSSian	SPCVERT	TESTS
PING	RATIO2	SAMple	SPECTral	TESt
PK2pk	RSELta	SAVERecall	SPOOL	THDELta
PNG	READ	SAVEWFM	SPREADSheet	THETA1
POINTS	READOUT	SAVe	SRIbinary	THETA2
POINTSNorm	REBOOT	SCAN	SRPbinary	THInkjet
POINTSPcnt	RECAIl	SCAlE	STANdard	THReshold
POLARCoord	RECOrdlength	SCREen	STARt	TIFf
POLarity	RECTangular	SECAM	STATE	TIME
PORT	RECTX1	SECdiv	STATIstics	TOLerance
PORTRAit	RECTX2	SElect	STATUS	TOTALUPtime
PORTUguese	RECTY1	SEQuence	STATUSMsg	TOTAL
POSITION1	RECTY2	SERIALTRIG	STDdev	TRACk
POSITION2	REF	SET	STEPstatus	TRADitionalchinese
POSITIVe	REF1	SETLevel	STOP	TRANsmit
POSitioN	REF2	SETTo50	STOPAfter	TRIGger
POVershoot	REF3	SETUp	STOPOnviolation	TRIGLEVEL
POWER	REF4	SETUP1	STORe	TRIGTOSAMP
PPORT	REFLevel	SETUP2	STS1Pulse	TRUe
PRESAMPBITS	REGular	SETUP3	STYle	TTL
PRESENT	RELAyexerciser	SETUP4	SUBNETMASK	TURN
PRESET	REM	SETUP5	SYStem	TWEnty
PRESS	REName	SETUP6	TARget	TYPe
PREVIEW	REPeat	SETUP7	TDS3012	UNDO
PREVious	RESet	SETUP8	TDS3012B	UNIts
PRInt	RESOLution	SETUP9	TDS3014	UNLock
PRODDELta	RESTART	SETUP10	TDS3014B	USE
PRODUCT	RESUlt	SEVENTYFive	TDS3032	USER
PRODUCT1	RGB	SHOW	TDS3032B	USERMask
PRODUCT2	RI	SHUTdown	TDS3034	USERNAME
PROGressive	RIBinary	SIGnalstrength	TDS3034B	UTILITY
PRObe	RISe	SIMPlifiedchinese	TDS3052	VALue
PT_Fmt	RLE	SINGLESEQ	TDS3052B	VAR1
PT_Off	RMDir	SLEWRate	TDS3054	VAR2
PULse	RMENU1	SLOT1	TDS3054B	VBArs
PWIdth	RMENU2	SLOT2	TDS3AAM	VDELta
QUICKmenu	RMENU3	SLOT3	TDS3BTA	VECTorscope
RADIUS1	RMENU4	SLOT4	TDS3ENG	VERBose
RADIUS2	RMENU5	SLOWERthan	TDS3FFT	VERT1
RATDELta	RMS	SLOpe	TDS3LIM	VERT2

Appendix A: Reserved Words

VERT3	VOLts	WIDth	XZEro	YREF
VERT4	VPOS	WINDow	Y	YT
VERTPOS	VSCALE	WRITE	YC	YUNit
VERTSCALE	WAVEAlert	XDELta	YCHannel	YZEro
VERTical	WAVEform	XINcr	YDELta	ZCHannel
VFields	WAVEFORMS	XMUit	YEARs	ZLEVel
VGA	WAVFrm	XOFF	YMUit	ZMUit
VIDeo	WEIghting	XPOSITION1	YOFF	ZOFF
VIOLATIONS	WFId	XPOSITION2	YPBPR	ZOOM
VLines	WFMPre	XUNit	YPOSITION1	ZUNit
VOFFSet	WHEn	XY	YPOSOTION2	ZZEro

Appendix C: Interface Specifications

This appendix describes details of the GPIB remote interface of the oscilloscope. Normally, you will not need this information to use the oscilloscope, but the information is useful when connecting to controllers of unusual configuration.

GPIB Function Subsets

The oscilloscope supports many GPIB function subsets, as listed below. Some of the listings describe subsets that the oscilloscope does not support.

- SH1 (Source Handshake). The oscilloscope can transmit multiline messages across the GPIB.
- AH1 (Acceptor Handshake). The oscilloscope can receive multiline messages across the GPIB.
- T5 (Talker). The oscilloscope becomes a talker when its talk address is sent with the ATN (Attention) line asserted. It can send both response data and status information when responding to a serial poll. It ceases to be a talker when the talk address of another device is sent with ATN asserted. The oscilloscope has talk-only capability for hardcopy operation.
- L4 (Listener). The oscilloscope becomes a listener when its listen address is sent with the ATN (Attention) line asserted. The oscilloscope does not have listen-only capability.
- SR1 (Service Request). The oscilloscope asserts an SRQ (Service Request) line to notify the controller when it requires service.
- RL1 (Remote/Local). The oscilloscope responds to both the GTL (Go To Local) and LLO (Local Lock Out) interface messages.
- PP0 (Parallel Poll). The oscilloscope has no parallel poll capability. It does not respond to the following interface messages: PPC, PPD, PPE, and PPU. The oscilloscope does not send out a status message when the ATN (Attention) and EOI (End or Identify) lines are asserted simultaneously.
- DC1 (Device Clear). The oscilloscope responds to the DCL (Device Clear) and, when made a listener, the SDC (Selected Device Clear) interface messages.

- DT1 (Device Trigger). When acting as a listener, the oscilloscope responds to the GET (Group Execute Trigger) interface message.
- C0 (Controller). The oscilloscope cannot control other devices.
- E2 (Electrical). The oscilloscope uses tristate buffers to provide optimal high-speed data transfer.

Interface Messages

Table C-1 shows the standard interface messages supported by the TDS3000, TDS3000B, and TDS3000C Series oscilloscopes.

Table C-1: Supported standard interface messages

Message	GPIB
DCL	Yes
GET	Yes
GTL	Yes
LLO	Yes
PPC	No
PPD	No
PPE	No
PPU	No
SDC	Yes
SPD	Yes
SPE	Yes
TCT	No
UNL	Yes
UNT	Yes
Listen Addresses	Yes
Talk Addresses	Yes

Appendix D: Factory Initialization Settings

The factory initialization settings provide you a known state for the oscilloscope. Factory initialization sets values as shown in Table D-1.

Table D- 1: Factory initialization settings

Control	Changed by Factory Init to
Acquire horizontal resolution	Normal (10,000 points)
Acquire mode	Sample
Acquire number of averages	16
Acquire number of envelopes	16
Acquire run/stop	Run
Acquire single sequence	Off
Channel selection	Channel 1 on, all others off
Coarse	No change
Confirm delete	No change
Cursor function	Off
Cursor H Bar 1 position	10% of graticule height (-3.2 divisions from the center)
Cursor H Bar 2 position	90% of graticule height (+3.2 divisions from the center)
Cursor V Bar 1 position	10% of record length
Cursor V Bar 2 position	90% of record length
Cursor V Bar units	Seconds
Display graticule type	Full
Display backlight	High
Display color palette	Normal
Display persist time	Min
Display style dots only	Off
Display intensity waveform	30
Dual waveform math function	Ch 1 + Ch 2
Edge trigger coupling	DC
Edge trigger level	0.0 V
Edge trigger slope	Rising

Table D-1: Factory initialization settings (Cont.)

Control	Changed by Factory Init to
Edge trigger source	Channel 1
Horizontal delay	On
Horizontal delay time	0 ns
Horizontal trigger position	10%
Horizontal time/div	400 μ s/div
Horizontal zoom	Off
Horizontal zoom position	50%
Horizontal zoom time/div	400 μ s/div
Measure gating	Off (Full Record)
Measure high-low setup	Min-Max
Measure high reference	90% and 0 V (units)
Measure low reference	10% and 0 V (units)
Measure mid reference	50% and 0 V (units)
Overwrite lock	No change
Reference waveforms	No change
Saved setups	No change
Trigger holdoff	250.8 ns
Trigger mode	Auto
Trigger type	Edge
Utility language	No change
Utility date/time display	On
Utility I/O	No change
Utility hard copy	No change
Vertical bandwidth	Full
Vertical coupling	DC 1 M Ω
Vertical invert	Off
Vertical offset	0 V
Vertical position	0 div
Vertical probe setup	Voltage, 10 X, unless there is a probe attached
Vertical volts/div	100 mV/div
Video trigger standard	525/NTSC
Video trigger on	Any line
Waveform file format	No change

Table D- 1: Factory initialization settings (Cont.)

Control	Changed by Factory Init to
XY display	Off
XY Ch1 (x) Versus	Ch 2
XY Ref1 (x) Versus	Off

Glossary

ASCII

Acronym for the American Standard Code for Information Interchange. Controllers transmit commands to the oscilloscope using ASCII character encoding.

Address

A 7-bit code that identifies an instrument on the communication bus. The digitizing oscilloscope must have a unique address for the controller to recognize and transmit commands to it.

Backus-Naur Form (BNF)

A standard notation system for command syntax diagrams. The syntax diagrams in this manual use BNF notation.

Controller

A computer or other device that sends commands to and accepts responses from the digitizing oscilloscope.

EOI

A mnemonic referring to the control line “End or Identify” on the GPIB interface bus. One of the two possible end-of-message terminators.

EOM

A generic acronym referring to the end-of-message terminator. The end-of-message terminator can be either an EOI or the ASCII code for line feed (LF).

Equivalent-time sampling (ET)

A sampling mode in which the oscilloscope acquires signals over many repetitions of the event. The TDS3000, TDS3000B, and TDS3000C series use a type of equivalent time sampling called *random equivalent time sampling*. It utilizes an internal clock that runs asynchronously with respect to the input signal and the signal trigger. The oscilloscope takes samples continuously, independent of the trigger position, and displays them based on the time difference between the sample and the trigger. Although the samples are taken sequentially in time, they are random with respect to the trigger.

Real-time sampling

A sampling mode where the oscilloscope samples fast enough to completely fill a waveform record from a single trigger event. Use real-time sampling to capture single-shot or transient events.

GPIB

Acronym for General Purpose Interface Bus, the common name for the communications interface system defined in IEEE Std 488.

IEEE

Acronym for the Institute for Electrical and Electronic Engineers.

JIS

Japanese Industrial Standard is an encoding scheme which assigns a unique hexadecimal value to each Japanese character.

QuickBASIC

A computer language (distributed by Microsoft) that is based on the Beginner's All-Purpose Symbolic Instruction Code.

QuickC

A computer language (distributed by Microsoft) that is based on C.

RS-232

A serial, full-duplex, asynchronous communication port that follows ANSI/EIA/TIA-562-1989[1], ANSI/EIA/TIA-574-1990[2], and CCITT V.24-1989[3] standards.

TekSecure

A Tektronix custom command that initializes both waveform and setup memories. This overwrites any previously stored data.

Unicode

Unicode Standard is a uniform encoding scheme for written characters and text. This international character code for information processing includes characters for the major scripts of the world, as well as technical symbols in common use. The Unicode Standard is modeled on the ASCII character set, but uses a 16-bit encoding to support full multilingual text.

Index

A

- Abbreviating, command, 2-4
- ACQUIRE?, 2-45
- ACQUIRE:MODE, 2-45
- ACQUIRE:NUMACQ?, 2-46
- ACQUIRE:NUMAVG, 2-47
- ACQUIRE:NUMENV, 2-47
- ACQUIRE:STATE, 2-48
- ACQUIRE:STOPAFTER, 2-49
- Acquisition command group, 2-11
- Acquisition commands
 - ACQUIRE?, 2-45
 - ACQUIRE:MODE, 2-45
 - ACQUIRE:NUMACQ?, 2-46
 - ACQUIRE:NUMAVG, 2-47
 - ACQUIRE:NUMENV, 2-47
 - ACQUIRE:STATE, 2-48
 - ACQUIRE:STOPAFTER, 2-49
 - AUTOSET, 2-54
 - WAVEALERT:BEEP, 2-310
 - WAVEALERT:HARDCOPY, 2-310
 - WAVEALERT:SAVEWFM, 2-311
 - WAVEALERT:SENSITIVITY, 2-312
 - WAVEALERT:STATE, 2-312
 - WAVEALERT:STOPONVIOLATION, 2-313
 - WAVEALERT:TYPE, 2-313
- acquisition run/stop, 2-48
- Address, Definition of, Glossary-1
- ALIAS, 2-50
- Alias command group, 2-12
- Alias commands
 - ALIAS, 2-50
 - ALIAS:CATALOG?, 2-51
 - ALIAS:DEFINE, 2-51
 - ALIAS:DELETE, 2-52
 - ALIAS:DELETE:ALL, 2-52
 - ALIAS:DELETE:NAME, 2-53
 - ALIAS:STATE, 2-53
- ALIAS:CATALOG?, 2-51
- ALIAS:DEFINE, 2-51
- ALIAS:DELETE, 2-52
- ALIAS:DELETE:ALL, 2-52
- ALIAS:DELETE:NAME, 2-53
- ALIAS:STATE, 2-53
- ALLEV?, 2-54
- Argument, command, 2-2
- ASCII, 2-1, Glossary-1
- Audio indicator, 2-55
- AUTOSET, 2-54

B

- Backus-Naur Form, 2-1
 - Definition of, Glossary-1
- BELL, 2-55
- Block, command argument, 2-10
- BNF, Glossary-1
- BNF (Backus Naur form), 2-1
- BUSY?, 2-55

C

- CALIBRATE:FACTORY:ABORT, 2-57
- CALIBRATE:FACTORY:CONTINUE, 2-58
- CALIBRATE:FACTORY:NOTIFY:DUE?, 2-58
- CALIBRATE:FACTORY:NOTIFY:HOURS, 2-59
- CALIBRATE:FACTORY:NOTIFY:YEARS, 2-59
- CALIBRATE:FACTORY:PREVIOUS, 2-60
- CALIBRATE:FACTORY:START, 2-60
- CALIBRATE:FACTORY:STATUS?, 2-61
- CALIBRATE:FACTORY:STEPSTATUS?, 2-61
- CALIBRATE:INTERNAL, 2-61
- CALIBRATE:INTERNAL:START, 2-62
- CALIBRATE:INTERNAL:STATUS?, 2-62
- Calibration and diagnostic command group, 2-13
- Calibration and diagnostic commands
 - *CAL?, 2-57
 - CAL?, 2-56
 - CALIBRATE:FACTORY:ABORT, 2-57
 - CALIBRATE:FACTORY:CONTINUE, 2-58
 - CALIBRATE:FACTORY:NOTIFY:DUE?, 2-58
 - CALIBRATE:FACTORY:NOTIFY:HOURS, 2-59
 - CALIBRATE:FACTORY:NOTIFY:YEARS, 2-59
 - CALIBRATE:FACTORY:PREVIOUS, 2-60
 - CALIBRATE:FACTORY:START, 2-60
 - CALIBRATE:FACTORY:STATUS?, 2-61
 - CALIBRATE:FACTORY:STEPSTATUS?, 2-61
 - CALIBRATE:INTERNAL, 2-61
 - CALIBRATE:INTERNAL:START, 2-62
 - CALIBRATE:INTERNAL:STATUS?, 2-62
 - DIAG:LOOP:OPTION, 2-100
 - DIAG:LOOP:STOP, 2-100
 - DIAG:RESULT:FLAG?, 2-101
 - DIAG:RESULT:LOG?, 2-101
 - DIAG:STATE:EXECUTE, 2-102
- CH<x>?, 2-63
- CH<x>:BANDWIDTH, 2-63
- CH<x>:COUPLING, 2-64
- CH<x>:DESKEW, 2-65

- CH<x>:ID?, 2-65
- CH<x>:IMPEDANCE, 2-66
- CH<x>:INVERT, 2-66
- CH<x>:OFFSET, 2-67
- CH<x>:POSITION, 2-68
- CH<x>:PROBE, 2-68
- CH<x>:SCALE, 2-69
- CH<x>:VOLTS, 2-70
- CH<x>:YUNIT, 2-70
- Channel, command mnemonic, 2-7
- checking RS-232 command status, 1-24
- CH<x>, command mnemonic, 2-7
- Clear Status, 2-71
- CLEARMENU, 2-71
- *CLS, 2-71
- Command
 - Abbreviating, 2-4
 - Argument, 2-2
 - Block argument, 2-10
 - Common, 2-30, 2-33
 - Concatenating, 2-4
 - Header, 2-2
 - Message, 2-2
 - Mnemonic, 2-2
 - Query, 2-1
 - Rules for forming, 2-1
 - Separator, 2-2
 - Set, 2-1
 - Syntax, 2-1
- Command argument
 - Numeric, 2-8
 - Quoted string, 2-9
- Command Descriptions, 1-2
- Command group
 - Acquisition, 2-11
 - Alias Command, 2-12
 - Calibration and diagnostic, 2-13
 - Cursor, 2-14
 - Display, 2-16
 - Ethernet, 2-17
 - File system, 2-18
 - Front panel, 2-18
 - Hard copy, 2-19
 - Horizontal, 2-19
 - ITU601, 2-20
 - Limit test, 2-21
 - Mask, 2-22
 - Math, 2-27
 - Measurement, 2-28
 - Miscellaneous, 2-30
 - RS-232, 2-32
 - Save and recall, 2-32
 - Status and error, 2-33
 - Trigger, 2-34
 - Vertical, 2-38
 - Waveform, 2-39
- Command Groups, 1-2
- Command mnemonic
 - Channel, 2-7
 - CH<x>, 2-7
 - Cursor position, 2-7
 - Measurement specifier, 2-7
 - MEAS<x>, 2-7
 - POSITION<x>, 2-7
 - Reference waveform, 2-7
 - REF<x>, 2-7
 - Waveform, 2-8
 - <wfm>, 2-8
- Command Syntax, 2-1
- Command syntax, BNF (Backus Naur form), 2-1
- Commands, 1-2
 - Parts of, 1-2
- Common command, 2-30, 2-33
- Common GPIB commands
 - *CAL?, 2-57
 - CAL?, 2-56
 - *CLS, 2-71
- communication module installation, 1-6
- communication modules, 1-4
 - description, 1-4
 - installing, 1-6
- compressing hard copy files, 2-137
- Computers, connecting RS-232, 1-21
- Concatenating, command, 2-4
- Connecting to an RS-232 device, 1-21
- Controller, Definition of, Glossary-1
- Cursor command group, 2-14
- Cursor commands
 - CURSOR?, 2-72
 - CURSOR:FUNCTION, 2-72
 - CURSOR:GRATICULE?, 2-73
 - CURSOR:GRATICULE:SELECT, 2-73
 - CURSOR:GRATICULE:XPOSITION<X>, 2-74
 - CURSOR:GRATICULE:YPOSITION<X>, 2-74
 - CURSOR:HBars?, 2-75
 - CURSOR:HBars:DELTA?, 2-75
 - CURSOR:HBars:POSITION<x>, 2-76
 - CURSOR:HBars:SELECT, 2-76
 - CURSOR:HBars:UNITS, 2-77
 - CURSOR:HBars:USE, 2-77
 - CURSOR:MODE, 2-78
 - CURSOR:VBARS:HDELTA?, 2-78
 - CURSOR:VBARS:HPOS<x>?, 2-79
 - CURSOR:VBARS:POSITION<x>, 2-79
 - CURSOR:VBARS:SELECT, 2-80
 - CURSOR:VBARS:UNITS, 2-81

CURSOR:VBARS:USE, 2-81
 CURSOR:VBARS:VDELTA?, 2-82
 CURSOR:WAVEFORM?, 2-82
 CURSOR:WAVEFORM:SELECT, 2-83
 CURSOR:XY:PRODELTA?, 2-83
 CURSOR:XY:PRODUCT<x>?, 2-84
 CURSOR:XY:RADIUS<x>?, 2-84
 CURSOR:XY:RATDELTA?, 2-85
 CURSOR:XY:RATIO<x>?, 2-85
 CURSOR:XY:RDELTA?, 2-86
 CURSOR:XY:READOUT, 2-86
 CURSOR:XY:RECTX<x>?, 2-87
 CURSOR:XY:RECTY<x>?, 2-87
 CURSOR:XY:THDELTA?, 2-88
 CURSOR:XY:THETA<x>?, 2-88
 CURSOR:XY:XDELTA?, 2-89
 CURSOR:XY:YDELTA?, 2-89
 Cursor position, command mnemonic, 2-7
 CURSOR?, 2-72
 CURSOR:FUNCTION, 2-72
 CURSOR:GRATICULE?, 2-73
 CURSOR:GRATICULE:SELECT, 2-73
 CURSOR:GRATICULE:XPOSITION<X>, 2-74
 CURSOR:GRATICULE:YPOSITION<X>, 2-74
 CURSOR:HBARS?, 2-75
 CURSOR:HBARS:DELTA?, 2-75
 CURSOR:HBARS:POSITION<x>, 2-76
 CURSOR:HBARS:SELECT, 2-76
 CURSOR:HBARS:UNITS, 2-77
 CURSOR:HBARS:USE, 2-77
 CURSOR:MODE, 2-78
 CURSOR:VBARS:HDELTA?, 2-78
 CURSOR:VBARS:HPOS<x>?, 2-79
 CURSOR:VBARS:POSITION<x>, 2-79
 CURSOR:VBARS:SELECT, 2-80
 CURSOR:VBARS:UNITS, 2-81
 CURSOR:VBARS:USE, 2-81
 CURSOR:VBARS:VDELTA?, 2-82
 CURSOR:WAVEFORM?, 2-82
 CURSOR:WAVEFORM:SELECT, 2-83
 CURSOR:XY:PRODELTA?, 2-83
 CURSOR:XY:PRODUCT<x>?, 2-84
 CURSOR:XY:RADIUS<x>?, 2-84
 CURSOR:XY:RATDELTA?, 2-85
 CURSOR:XY:RATIO<x>?, 2-85
 CURSOR:XY:RDELTA?, 2-86
 CURSOR:XY:READOUT, 2-86
 CURSOR:XY:RECTX<x>, 2-87
 CURSOR:XY:RECTY<x>?, 2-87
 CURSOR:XY:THDELTA?, 2-88
 CURSOR:XY:THETA<x>?, 2-88
 CURSOR:XY:XDELTA?, 2-89
 CURSOR:XY:YDELTA?, 2-89

CURVE, 2-90

D

DATA, 2-92
 DATA:DESTINATION, 2-92
 DATA:ENCDG, 2-93
 DATA:SOURCE, 2-94
 DATA:START, 2-95
 DATA:STOP, 2-96
 DATA:TARGET, 2-97
 DATA:WIDTH, 2-97
 DATE, 2-98
 DCL, C-2
 *DDT, 2-98
 deleting a specific alias item, 2-52, 2-53
 deleting all aliases, 2-52
 DESE command, 2-99, 3-3
 DESER register, 2-99, 2-242, 3-3
 Device Clear, 2-4, C-2
 DIAG:LOOP:OPTION, 2-100
 DIAG:LOOP:STOP, 2-100
 DIAG:RESULT:FLAG?, 2-101
 DIAG:RESULT:LOG?, 2-101
 DIAG:STATE:EXECUTE, 2-102
 Display command group, 2-16
 Display commands
 CLEARMENU, 2-71
 DISPLAY?, 2-102
 DISPLAY:CLOCK, 2-103
 DISPLAY:COLOR:PALETTE:REGULAR, 2-103
 DISPLAY:FORMAT, 2-104
 DISPLAY:GRATICULE, 2-105
 DISPLAY:INTENSITY:BACKLIGHT, 2-106
 DISPLAY:INTENSITY:WAVEFORM, 2-106
 DISPLAY:PERSISTENCE, 2-106
 DISPLAY:PERSISTENCE:CLEAR, 2-107
 DISPLAY:PICTURE:AUTOCONTRAST, 2-108
 DISPLAY:PICTURE:BRIGHTNESS, 2-108
 DISPLAY:PICTURE:CONTRAST, 2-109
 DISPLAY:PICTURE:STATE, 2-109
 DISPLAY:STYLE:DOTSONLY, 2-110
 DISPLAY:VECTORSCOPE:STATE, 2-110
 DISPLAY:VECTORSCOPE:TY_SETTING, 2-111
 DISPLAY:VECTORSCOPE:TYPE, 2-111
 DISPLAY:XY?, 2-112
 DISPLAY:XY:MODE, 2-112
 DISPLAY:XY:YCHANNEL, 2-113
 DISPLAY:XY:YREF, 2-114
 DISPLAY:XY:ZCHANNEL, 2-114
 DISPLAY:XY:ZLEVEL, 2-115
 displaying data and time. *See* DISPLAY:CLOCK

- MESSAGE:BOX, 2-233
- MESSAGE:CLEAR, 2-234
- MESSAGE:SHOW, 2-234
- MESSAGE:STATE, 2-239
- DISPLAY?, 2-102
- DISPLAY:CLOCK, 2-103
- DISPLAY:COLOR:PALETTE:REGULAR, 2-103
- DISPLAY:FORMAT, 2-104
- DISPLAY:GRATICULE, 2-105
- DISPLAY:INTENSITY:BACKLIGHT, 2-106
- DISPLAY:INTENSITY:WAVEFORM, 2-106
- DISPLAY:PERSISTENCE, 2-106
- DISPLAY:PERSISTENCE:CLEAR, 2-107
- DISPLAY:PICTURE:AUTOCONTRAST, 2-108
- DISPLAY:PICTURE:BRIGHTNESS, 2-108
- DISPLAY:PICTURE:CONTRAST, 2-109
- DISPLAY:PICTURE:STATE, 2-109
- DISPLAY:STYLE:DOTONLY, 2-110
- DISPLAY:VECTORSCOPE:STATE, 2-110
- DISPLAY:VECTORSCOPE:TY_SETTING, 2-111
- DISPLAY:VECTORSCOPE:TYPE, 2-111
- DISPLAY:XY?, 2-112
- DISPLAY:XY:MODE, 2-112
- DISPLAY:XY:YCHANNEL, 2-113
- DISPLAY:XY:YREF, 2-114
- DISPLAY:XY:ZCHANNEL, 2-114
- DISPLAY:XY:ZLEVEL, 2-115

E

- Edge trigger, 2-268, 2-289, 2-298
- End or Identify, Glossary-1
- envelope waveform acquisitions setting, 2-47
- EOI, Glossary-1
- EOM, Glossary-1
- EOM (end of message), 2-6
- Equivalent time sampling, random, Glossary-1
- Error message, programming interface, 3-12
- Error messages, 1-3
 - *ESE, 2-115, 3-3
- ESER register, 2-115, 2-242, 3-3
 - *ESR?, 2-116
 - *ESR? query, 3-1
- Ethernet
 - DNS protocol, 1-17
 - error messages, 1-17
 - network settings, 1-8
 - parameters, 1-13
 - printer settings, 1-15
 - setup menus, 1-9
 - TekVISA, 1-18
 - VISA, 1-18

- Ethernet command group, 2-17
- Ethernet commands
 - ETHERNET:DCHPBOOTP, 2-117
 - ETHERNET:DNS:IPADDRESS, 2-117
 - ETHERNET:DOMAINNAME, 2-118
 - ETHERNET:ENETADDRESS?, 2-118
 - ETHERNET:GATEWAY, 2-119
 - ETHERNET:HTTPPORT, 2-119
 - ETHERNET:IPADDRESS, 2-119
 - ETHERNET:NAME, 2-120
 - ETHERNET:NETPRINTER:ADD, 2-120
 - ETHERNET:NETPRINTER:DELETE, 2-121
 - ETHERNET:NETPRINTER:DELWARN, 2-122
 - ETHERNET:NETPRINTER:RENAME, 2-122
 - ETHERNET:NETPRINTER:SELECT:ALLINFO, 2-123
 - ETHERNET:NETPRINTER:SELECT:NAME, 2-123
 - ETHERNET:PASSWORD, 2-124
 - ETHERNET:PING:EXECUTE, 2-124
 - ETHERNET:PING:STATUS?, 2-124
 - ETHERNET:SUBNETMASK, 2-125
- ETHERNET:DCHPBOOTP, 2-117
- ETHERNET:DNS:IPADDRESS, 2-117
- ETHERNET:DOMAINNAME, 2-118
- ETHERNET:ENETADDRESS?, 2-118
- ETHERNET:GATEWAY, 2-119
- ETHERNET:HTTPPORT, 2-119
- ETHERNET:IPADDRESS, 2-119
- ETHERNET:NAME, 2-120
- ETHERNET:NETPRINTER:ADD, 2-120
- ETHERNET:NETPRINTER:DELETE, 2-121
- ETHERNET:NETPRINTER:DELWARN, 2-122
- ETHERNET:NETPRINTER:RENAME, 2-122
- ETHERNET:NETPRINTER:SELECT:ALLINFO, 2-123
- ETHERNET:NETPRINTER:SELECT:NAME, 2-123
- ETHERNET:PASSWORD, 2-124
- ETHERNET:PING:EXECUTE, 2-124
- ETHERNET:PING:STATUS?, 2-124
- ETHERNET:SUBNETMASK, 2-125
- Event handling, 3-1, 3-6
- Event query, 2-125
- Event queue, 2-125, 3-5
- EVENT?, 2-125
- EVMSG?, 2-126
- EVQTY?, 2-127

F

- FACTORY, 2-127
- Factory initialization settings, *D-1-D-4*

File system command group, 2-18
 File system commands
 FILESYSYEM:COPY, 2-128
 FILESYSYEM:CWD, 2-129
 FILESYSYEM:DELETE, 2-129
 FILESYSYEM:DELWARN, 2-130
 FILESYSYEM:DIR?, 2-130
 FILESYSYEM:FORMAT, 2-131
 FILESYSYEM:FREESPACE, 2-131
 FILESYSYEM:MKDIR, 2-131
 FILESYSYEM:OVERWRITE, 2-132
 FILESYSYEM:PRINT, 2-133
 FILESYSYEM:RENAME, 2-133
 FILESYSYEM:RMDIR, 2-134
 FILESYSTEM?, 2-127
 FILESYSTEM:COPY, 2-128
 FILESYSTEM:CWD, 2-129
 FILESYSTEM:DELETE, 2-129
 FILESYSTEM:DELWARN, 2-130
 FILESYSTEM:DIR, 2-130
 FILESYSTEM:FORMAT, 2-131
 FILESYSTEM:FREESPACE, 2-131
 FILESYSTEM:MKDIR, 2-131
 FILESYSTEM:OVERWRITE, 2-132
 FILESYSTEM:PRINT, 2-133
 FILESYSTEM:RENAME, 2-133
 FILESYSTEM:RMDIR, 2-134
 FPANEL:PRESS, 2-135
 FPANEL:TURN, 2-136
 front panel button control, 2-135
 Front panel command group, 2-18
 front panel knob control, 2-136

G

GET, C-2
 Glitch trigger, 2-278
 Go to local, C-2
 GPIB, Glossary-2
 communication module, 1-4
 comparing GPIB and RS-232, 1-26
 Configurations, 1-18
 Connection rules, 1-18
 EOM (end of message), 2-6
 Function subsets, C-1
 parameters, 1-20
 Group execute trigger, C-2
 GTL, C-2

H

Hard copy command group, 2-19

Hard copy commands
 HARDCOPY, 2-136
 HARDCOPY:COMPRESSION, 2-137
 HARDCOPY:FILENAME, 2-138
 HARDCOPY:FORMAT, 2-139
 HARDCOPY:INKSAVER, 2-140
 HARDCOPY:LAYOUT, 2-141
 HARDCOPY:PALETTE, 2-141
 HARDCOPY:PORT, 2-142
 HARDCOPY:PREVIEW, 2-142
 HARDCOPY, 2-136
 HARDCOPY:COMPRESSION, 2-137
 HARDCOPY:FILENAME, 2-138
 HARDCOPY:FORMAT, 2-139
 HARDCOPY:INKSAVER, 2-140
 HARDCOPY:LAYOUT, 2-141
 HARDCOPY:PALETTE, 2-141
 HARDCOPY:PORT, 2-142
 HARDCOPY:PREVIEW, 2-142
 HDR, 2-143
 HEADER, 2-143
 Header
 Command, 2-2, 2-143
 Included in query response, 2-143, 2-308
 Horizontal command group, 2-19
 Horizontal commands
 HORIZONTAL?, 2-144
 HORIZONTAL:DELAY:STATE, 2-144
 HORIZONTAL:DELAY:TIME, 2-145
 HORIZONTAL:MAIN:SCALE, 2-146
 HORIZONTAL:MAIN:SECDIV, 2-146
 HORIZONTAL:RECORDLENGTH, 2-147
 HORIZONTAL:RESOLUTION, 2-147
 HORIZONTAL:SCALE, 2-148
 HORIZONTAL:SECDIV, 2-148
 HORIZONTAL:TRIGGER:POSITION, 2-148
 ZOOM:HORIZONTAL:POSITION, 2-329
 ZOOM:HORIZONTAL:SCALE, 2-330
 ZOOM:STATE, 2-330
 HORIZONTAL?, 2-144
 HORIZONTAL:DELAY:STATE, 2-144
 HORIZONTAL:DELAY:TIME, 2-145
 HORIZONTAL:MAIN:SCALE, 2-146
 HORIZONTAL:MAIN:SECDIV, 2-146
 HORIZONTAL:RECORDLENGTH, 2-147
 HORIZONTAL:RESOLUTION, 2-147
 HORIZONTAL:SCALE, 2-148
 HORIZONTAL:SECDIV, 2-148
 HORIZONTAL:TRIGGER:POSITION, 2-148

I

ID?, 2-149
*IDN?, 2-149
IEEE, Glossary-2
IEEE Std 488.2 1987, 2-30, 2-33
Interface message, C-2
ITU601 digital video command group, 2-20
ITU601:AUTOSET, 2-150
ITU601:EDH RESET, 2-150
ITU601:EDH:COUNT, 2-151
ITU601:EDH:DETECT?, 2-151
ITU601:EDH:NUMERRORS?, 2-152
ITU601:INPUT:FORMAT, 2-152
ITU601:INPUT:SIGNALSTRENGTH, 2-153
ITU601:INPUT:STATE?, 2-153
ITU601:OUTPUT:FORMAT, 2-154

J

JIS, 2-237, Glossary-2

L

LANGUAGE, 2-154
Limit test command group, 2-21
Limit Test commands
 LIMIT?, 2-155
 LIMIT:BEEP, 2-155
 LIMIT:COMPARE:CH<x>, 2-156
 LIMIT:HARDCOPY, 2-156
 LIMIT:SAVEWFM, 2-157
 LIMIT:STATE, 2-158
 LIMIT:STOPONVIOLATION, 2-158
 LIMIT:TEMPLATE, 2-159
 LIMIT:TEMPLATE:DESTINATION, 2-160
 LIMIT:TEMPLATE:SOURCE, 2-160
 LIMIT:TEMPLATE:TOLERANCE: VERTICAL,
 2-162
 LIMIT:TEMPLATE:TOLERANCE:HORIZONTAL,
 2-161
LIMIT?, 2-155
LIMIT:BEEP, 2-155
LIMIT:COMPARE:CH<X>, 2-156
LIMIT:HARDCOPY, 2-156
LIMIT:SAVEWFM, 2-157
LIMIT:STATE, 2-158
LIMIT:STOPONVIOLATION, 2-158
LIMIT:TEMPLATE, 2-159
LIMIT:TEMPLATE:DESTINATION, 2-160
LIMIT:TEMPLATE:SOURCE, 2-160

LIMIT:TEMPLATE:TOLERANCE: VERTICAL,
 2-162
LIMIT:TEMPLATE:TOLERANCE:HORIZONTAL,
 2-161
LLO, C-2
Local lock out, C-2
LOCK, 2-163
Logic trigger, 2-272, 2-289
*LRN?, 2-164

M

Manual trigger, Simulation with command, 2-307
Mask command group, 2-22
Mask Test commands
 MASK:AUTOFIT, 2-165
 MASK:COPY:SOURCE, 2-166
 MASK:COPY:USER, 2-166
 MASK:COUNT:CH<c>:HITS?, 2-167
 MASK:COUNT:FAILURES?, 2-167
 MASK:COUNT:HITS?, 2-168
 MASK:COUNT:MASK<m>:CH<x>:HITS?, 2-168
 MASK:COUNT:MASK<m>:HITS?, 2-169
 MASK:COUNT:STATE, 2-169
 MASK:COUNT:TESTS?, 2-170
 MASK:COUNT:TOTAL?, 2-170
 MASK:COUNT:VIOLATIONS?, 2-171
 MASK:COUNT:WAVEFORMS?, 2-171
 MASK:DISPLAY, 2-172
 MASK:LOCK, 2-172
 MASK:MARGIN:VERTICAL, 2-173
 MASK:MASK<m>:COUNT?, 2-174
 MASK:MASK<m>:NR_PT?, 2-175
 MASK:MASK<m>:POINTS, 2-175
 MASK:MASK<m>:POINTSNORM, 2-176
 MASK:MASK<m>:POINTSPCNT, 2-177
 MASK:MASK<m>DELETE, 2-174
 MASK:MASKPRE:AMPLITUDE, 2-178
 MASK:MASKPRE:HSCALE, 2-178
 MASK:MASKPRE:HTRIGPOS, 2-179
 MASK:MASKPRE:PATTERNBITS, 2-180
 MASK:MASKPRE:PRESAMPBITS, 2-180
 MASK:MASKPRE:RECORDLENGTH, 2-181
 MASK:MASKPRE:SERIALTRIG, 2-181
 MASK:MASKPRE:TRIGTOSAMP, 2-182
 MASK:MASKPRE:VOFFSET, 2-183
 MASK:MASKPRE:VPOS, 2-183
 MASK:MASKPRE:VSCALE, 2-184
 MASK:MASKPRE:WIDTH, 2-184
 MASK:POLARITY, 2-185
 MASK:STANDARD, 2-186

- MASK:STOPONVIOLATION, 2-186
- MASK:TEST:BEEP:COMPLETION, 2-187
- MASK:TEST:BEEP:FAILURE, 2-187
- MASK:TEST:DELAY, 2-188
- MASK:TEST:HARDCOPY, 2-188
- MASK:TEST:REPEAT, 2-189
- MASK:TEST:SAVEWFM, 2-190
- MASK:TEST:STATE, 2-191
- MASK:TEST:STATUS?, 2-191
- MASK:TEST:THRESHOLD, 2-192
- MASK:TEST:WAVEFORM, 2-192
- MASK:USER:MASK<m> DELETE, 2-193
- MASK:USER:MASK<m>:NR_PT?, 2-193
- MASK:USER:MASK<m>:POINTS, 2-194
- MASK:USER:MASK<m>:POINTSNORM, 2-194
- MASK:USER:MASK<m>:POINTSPCNT, 2-195
- MASK:USER:MASKPRE COMMANDS, 2-196
- MASK:AUTOFIT, 2-165
- MASK:COPY:SOURCE, 2-166
- MASK:COPY:USER, 2-166
- MASK:COUNT:CH<c>HITS?, 2-167
- MASK:COUNT:FAILURES?, 2-167
- MASK:COUNT:HITS?, 2-168
- MASK:COUNT:MASK<m>:CH<x>:HITS?, 2-168
- MASK:COUNT:MASK<m>:HITS?, 2-169
- MASK:COUNT:STATE, 2-169
- MASK:COUNT:TESTS?, 2-170
- MASK:COUNT:TOTAL?, 2-170
- MASK:COUNT:VIOLATIONS?, 2-171
- MASK:COUNT:WAVEFORMS?, 2-171
- MASK:DISPLAY, 2-172
- MASK:LOCK, 2-172
- MASK:MARGIN:VERTICAL, 2-173
- MASK:MASK<m>:POINTS, 2-175
- MASK:MASK<m>:POINTSNORM, 2-176
- MASK:MASK<m>:POINTSPCNT, 2-177
- MASK:MASK<m>COUNT?, 2-174
- MASK:MASK<m>DELETE, 2-174
- MASK:MASK<m>NR_PT?, 2-175
- MASK:MASKPRE:AMPLITUDE, 2-178
- MASK:MASKPRE:HSCALE, 2-178
- MASK:MASKPRE:HTRIGPOS, 2-179
- MASK:MASKPRE:PATTERNBITS, 2-180
- MASK:MASKPRE:PRESAMPBITS, 2-180
- MASK:MASKPRE:RECORDLENGTH, 2-181
- MASK:MASKPRE:SERIALTRIG, 2-181
- MASK:MASKPRE:TRIGTOSAMP, 2-182
- MASK:MASKPRE:VOFFSET, 2-183
- MASK:MASKPRE:VPOS, 2-183
- MASK:MASKPRE:VSCALE, 2-184
- MASK:MASKPRE:WIDTH, 2-184
- MASK:POLARITY, 2-185
- MASK:STANDARD, 2-186
- MASK:STOPONVIOLATION, 2-186
- MASK:TEST:BEEP:COMPLETION, 2-187
- MASK:TEST:BEEP:FAILURE, 2-187
- MASK:TEST:DELAY, 2-188
- MASK:TEST:HARDCOPY, 2-188
- MASK:TEST:REPEAT, 2-189
- MASK:TEST:SAVEWFM, 2-190
- MASK:TEST:STATE, 2-191
- MASK:TEST:STATUS?, 2-191
- MASK:TEST:THRESHOLD, 2-192
- MASK:TEST:WAVEFORM, 2-192
- MASK:USER:MASK<m> DELETE, 2-193
- MASK:USER:MASK<m>:NR_PT?, 2-193
- MASK:USER:MASK<m>:POINTS, 2-194
- MASK:USER:MASK<m>:POINTSNORM, 2-194
- MASK:USER:MASK<m>:POINTSPCNT, 2-195
- MASK:USER:MASKPRE COMMANDS, 2-196
- Math command group, 2-27
- Math commands
 - MATH?, 2-197
 - MATH:DEFINE, 2-198
 - MATH:HORIZONTAL:POSITION, 2-200
 - MATH:HORIZONTAL:SCALE, 2-200
 - MATH:HORIZONTAL:UNITS, 2-201
 - MATH:SPECTRAL:MAG, 2-201
 - MATH:SPECTRAL:WINDOW, 2-202
 - MATH:TYPE, 2-202
 - MATH:VAR<X>, 2-203
 - MATH:VERTICAL POSITION, 2-203
 - MATH:VERTICAL:SCALE, 2-204
 - MATH:VERTICAL:UNITS, 2-205
 - MATH1, 2-205
- MATH?, 2-197
- MATH:DEFINE, 2-198
- MATH:HORIZONTAL:POSITION, 2-200
- MATH:HORIZONTAL:SCALE, 2-200
- MATH:HORIZONTAL:UNITS, 2-201
- MATH:SPECTRAL:MAG, 2-201
- MATH:SPECTRAL:WINDOW, 2-202
- MATH:TYPE, 2-202
- MATH:VAR<X>, 2-203
- MATH:VERTICAL:POSITION, 2-203
- MATH:VERTICAL:SCALE, 2-204
- MATH:VERTICAL:UNITS, 2-205
- MATH1, 2-205
- MEASrement:CLEARSNapshot, 2-206
- Measurement command group, 2-28
- Measurement commands
 - MEASUREMENT?, 2-206
 - MEASUrement:CLEARSNapshot, 2-206
 - MEASUREMENT:GATING, 2-207
 - MEASUREMENT:IMMED?, 2-207
 - MEASUREMENT:IMMED:DATA?, 2-208

- MEASUREMENT:IMMED:DELAY?, 2-208
 MEASUREMENT:IMMED:DELAY:DIRECTION,
 2-209
 MEASUREMENT:IMMED:DELAY:EDGE<x>,
 2-209
 MEASUREMENT:IMMED:SOURCE<x>, 2-210
 MEASUREMENT:IMMED:SOURCE1, 2-210
 MEASUREMENT:IMMED:TYPE, 2-211
 MEASUREMENT:IMMED:UNITS?, 2-213
 MEASUREMENT:IMMED:VALUE?, 2-213
 MEASUREMENT:INDICATORS?, 2-214
 MEASUREMENT:INDICATORS:HORIZ<x>?,
 2-214
 MEASUREMENT:INDICATORS:NUMHORIZ?,
 2-214
 MEASUREMENT:INDICATORS:NUMVERT?,
 2-215
 MEASUREMENT:INDICATORS:STATE, 2-215
 MEASUREMENT:INDICATORS:VERT<X>?,
 2-216
 MEASUREMENT:MEAS<x>?, 2-216
 MEASUREMENT:MEAS<x>: DELAY?, 2-217
 MEASUREMENT:MEAS<x>: DELAY:DI-
 RECTION?, 2-218
 MEASUREMENT:MEAS<x>: DELAY:EDGE1,
 2-218
 MEASUREMENT:MEAS<x>: DELAY:EDGE2,
 2-219
 MEASUREMENT:MEAS<x>: STATE, 2-222
 MEASUREMENT:MEAS<x>: TYPE, 2-223
 MEASUREMENT:MEAS<x>: UNITS?, 2-225
 MEASUREMENT:MEAS<x>: VALUE?, 2-226
 MEASUREMENT:MEAS<x>:COUNT?, 2-216
 MEASUREMENT:MEAS<x>:DATA?, 2-217
 MEASUREMENT:MEAS<x>:MAXIMUM?, 2-220
 MEASUREMENT:MEAS<x>:MEAN?, 2-220
 MEASUREMENT:MEAS<x>:MINIMUM?, 2-221
 MEASUREMENT:MEAS<x>:SOURCE1, 2-221
 MEASUREMENT:MEAS<x>:SOURCE2, 2-222
 MEASUREMENT:MEAS<x>:STDDEV?, 2-223
 MEASUREMENT:METHOD, 2-226
 MEASUREMENT:REFLEVEL?, 2-227
 MEASUREMENT:REFLEVEL:ABSOLUTE:HIGH,
 2-227
 MEASUREMENT:REFLEVEL:ABSOLUTE:LOW,
 2-228
 MEASUREMENT:REFLEVEL:ABSOLUTE:MID,
 2-228
 MEASUREMENT:REFLEVEL:ABSOLUTE:MID2,
 2-229
 MEASUREMENT:REFLEVEL:METHOD, 2-229
 MEASUREMENT:REFLEVEL:PERCENT:HIGH,
 2-230
 MEASUREMENT:REFLEVEL:PERCENT:LOW,
 2-230
 MEASUREMENT:REFLEVEL:PERCENT:MID,
 2-231
 MEASUREMENT:REFLEVEL:PERCENT:MID2,
 2-231
 MEASUREMENT:SNAPSHOT, 2-232
 MEASUREMENT:STATISTICS:MODE, 2-232
 MEASUREMENT:STATISTICS:WEIGHTING,
 2-233
 Measurement specifier, command mnemonic, 2-7
 MEASUREMENT?, 2-206
 MEASUREMENT:GATING, 2-207
 MEASUREMENT:IMMED?, 2-207
 MEASUREMENT:IMMED:DATA?, 2-208
 MEASUREMENT:IMMED:DELAY?, 2-208
 MEASUREMENT:IMMED:DELAY:DIRECTION,
 2-209
 MEASUREMENT:IMMED:DELAY:EDGE<x>, 2-209
 MEASUREMENT:IMMED:SOURCE<x>, 2-210
 MEASUREMENT:IMMED:SOURCE1, 2-210
 MEASUREMENT:IMMED:TYPE, 2-211
 MEASUREMENT:IMMED:UNITS?, 2-213
 MEASUREMENT:IMMED:VALUE?, 2-213
 MEASUREMENT:INDICATORS?, 2-214
 MEASUREMENT:INDICATORS:HORIZ<x>?, 2-214
 MEASUREMENT:INDICATORS:NUMHORIZ?, 2-214
 MEASUREMENT:INDICATORS:NUMVERT?, 2-215
 MEASUREMENT:INDICATORS:STATE, 2-215
 MEASUREMENT:INDICATORS:VERT<X>?, 2-216
 MEASUREMENT:MEAS<x>?, 2-216
 MEASUREMENT:MEAS<x>: DELAY?, 2-217
 MEASUREMENT:MEAS<x>: DELAY:DIRECTION?,
 2-218
 MEASUREMENT:MEAS<x>: DELAY:EDGE1, 2-218
 MEASUREMENT:MEAS<x>: DELAY:EDGE2, 2-219
 MEASUREMENT:MEAS<x>: STATE, 2-222
 MEASUREMENT:MEAS<x>: TYPE, 2-223
 MEASUREMENT:MEAS<x>: UNITS?, 2-225
 MEASUREMENT:MEAS<x>: VALUE?, 2-226
 MEASUREMENT:MEAS<x>:COUNT?, 2-216
 MEASUREMENT:MEAS<x>:DATA?, 2-217
 MEASUREMENT:MEAS<x>:MAXIMUM?, 2-220
 MEASUREMENT:MEAS<x>:MEAN?, 2-220
 MEASUREMENT:MEAS<x>:MINIMUM?, 2-221
 MEASUREMENT:MEAS<x>:SOURCE1, 2-221
 MEASUREMENT:MEAS<x>:SOURCE2, 2-222
 MEASUREMENT:MEAS<x>:STDDEV?, 2-223
 MEASUREMENT:METHOD, 2-226

MEASUREMENT:REFLEVEL?, 2-227
 MEASUREMENT:REFLEVEL:ABSOLUTE:HIG, 2-227
 MEASUREMENT:REFLEVEL:ABSOLUTE:LOW, 2-228
 MEASUREMENT:REFLEVEL:ABSOLUTE:MID, 2-228
 MEASUREMENT:REFLEVEL:ABSOLUTE:MID2, 2-229
 MEASUREMENT:REFLEVEL:METHOD, 2-229
 MEASUREMENT:REFLEVEL:PERCENT:HIG, 2-230
 MEASUREMENT:REFLEVEL:PERCENT:LOW, 2-230
 MEASUREMENT:REFLEVEL:PERCENT:MID, 2-231
 MEASUREMENT:REFLEVEL:PERCENT:MID2, 2-231
 MEASUREMENT:SNAPSHOT, 2-232
 MEASUREMENT:STATISTICS:MODE, 2-232
 MEASUREMENT:STATISTICS:WEIGHTING, 2-233
 MEAS<x>, command mnemonic, 2-7
 Message
 Command, 2-2
 Command terminator, 2-6
 Table of program messages, 3-12
 MESSAGE:BOX, 2-233
 MESSAGE:CLEAR, 2-234
 MESSAGE:SHOW, 2-234
 MESSAGE:STATE, 2-239
 Messages, Status and error, 1-3
 Miscellaneous, LOCK, 2-163
 Miscellaneous command group, 2-30
 Miscellaneous commands
 BELL, 2-55
 DATE, 2-98
 *DDT, 2-98
 FACTORY, 2-127
 FPANEL:PRESS, 2-135
 FPANEL:TURN, 2-136
 HDR, 2-143
 HEADER, 2-143
 LANGUAGE, 2-154
 *LRN?, 2-164
 NEWPASS, 2-239
 PASSWORD, 2-241
 POWER:AC:PRESENT?, 2-242
 POWER:BACKLIGHT, 2-243
 POWER:BATTERY:GASGAUGE?, 2-243
 POWER:BATTERY:PRESENT?, 2-244
 POWER:SHUTDOWN, 2-244
 *PUD, 2-245

REBOOT, 2-246
 REM, 2-252
 SET?, 2-261
 SYSTEM, 2-264
 TEKSECURE, 2-264
 TIME, 2-265
 *TRG, 2-307
 UNLOCK, 2-308
 VERBOSE, 2-308
 Mnemonic, command, 2-2

N

network settings for Ethernet, 1-8
 NEWPASS, 2-239
 Numeric, command argument, 2-8

O

*OPC, 2-240
 Operation complete command, 2-240
 Operation complete wait, 2-309
 Output queue, 3-5

P

Parallel poll, C-2
 Parts of commands, 1-2
 PASSWORD, 2-241
 POSITION<x>, command mnemonic, 2-7
 POWER:AC:PRESENT?, 2-242
 POWER:BACKLIGHT, 2-243
 POWER:BATTERY:GASGAUGE?, 2-243
 POWER:BATTERY:PRESENT?, 2-244
 POWER:SHUTDOWN, 2-244
 Power on status clear command, 2-242
 PPC, C-2
 PPD, C-2
 PPE, C-2
 PPU, C-2
 printing the screen, 2-136
 *PSC, 2-242
 *PSC command, 3-4
 *PUD, 2-245
 Pulse trigger, 2-278, 2-288, 2-289

Q

Query, Header in query response, 2-143, 2-308
 Query command, 2-1

Queue

- Event, 3-5
- Output, 3-5
- QuickBASIC, Glossary-2
- QuickC, Glossary-2
- Quoted string, command argument, 2-9

R

- *RCL, 2-246
- Real-time sampling, Glossary-1
- rear-panel connectors, 1-7
- REBOOT, 2-246
- Recall setting command, 2-246
- RECALL:MASK, 2-246
- RECALL:SETUP, 2-247
- RECALL:WAVEFORM, 2-248
- REF<x>:DATE?, 2-249
- REF<x>:LABEL, 2-250
- REF<x>:VERTICAL:POSITION, 2-251
- REF<x>:VERTICAL:SCALE, 2-251
- REF<x>HORIZONTAL:POSITION, 2-249
- REF<x>HORIZONTAL:SCALE, 2-249
- REF<x>TIME?, 2-250
- Reference waveform, command mnemonic, 2-7
- REF<x>, command mnemonic, 2-7
- Register
 - DESER, 2-99, 2-242, 3-3
 - ESER, 2-115, 2-242, 3-3
 - SBR, 2-263, 3-2
 - SESR, 2-71, 2-116, 2-240, 3-1
 - SRER, 2-242, 2-263, 3-4
- REM, 2-252
- Reset
 - Command, 2-252
 - Factory, 2-127
- resetting the TDS3SDI EDH error counter, 2-150
- RS-232, Glossary-2
- RS-232 command group, 2-32
- RS-232 commands
 - RS232?, 2-253
 - RS232:BAUD, 2-253
 - RS232:HARDFLAGGING, 2-254
 - RS232:PRESET, 2-254
 - RS232:TRANSMIT:TERMINATOR, 2-255
- RS-232, 1-21
 - Adapter cables, 1-21
 - break signals, 1-24
 - command status, 1-24
 - communication module, 1-4
 - Connecting to, 1-21
 - Connector pin assignments, 1-21

- conventions, 1-23
- errors, 1-24
- Setting parameters of, 1-22
- transferring binary data, 1-24
- troubleshooting, 1-25
- RS232?, 2-253
- RS232:BAUD, 2-253
- RS232:HARDFLAGGING, 2-254
- RS232:PRESET, 2-254
- RS232:TRANSMIT:TERMINATOR, 2-255
- *RST, 2-252
- Rules, command forming, 2-1
- run/stop acquisition, 2-48
- Runt trigger, 2-278

S

- *SAV, 2-256
- Save and recall command group, 2-32
- Save and recall commands
 - *RCL, 2-246
 - RECALL:MASK, 2-246
 - RECALL:SETUP, 2-247
 - RECALL:WAVEFORM, 2-248
 - *SAV, 2-256
 - SAVE:MASK, 2-256
 - SAVE:SETUP, 2-257
 - SAVE:WAVEFORM, 2-257
 - SAVE:WAVEFORM:FILEFORMT, 2-258
- Save setting command, 2-256
- SAVE:MASK, 2-256
- SAVE:SETUP, 2-257
- SAVE:WAVEFORM, 2-257
- SAVE:WAVEFORM:FILEFORMT, 2-258
- SBR register, 2-263, 3-2
- SDC, C-2
- SELECT?, 2-259
- SELECT:<wfm>, 2-260
- SELECT:CONTROL, 2-260
- Selected device clear, C-2
- Self test, 2-307
- Separator, command, 2-2
- Serial poll, 3-2
 - Disable, C-2
 - Enable, C-2
- Service request enable command, 2-263
- Service request enable register, 2-263
- Service Requests, 1-3
- SESR register, 2-71, 2-116, 2-240, 3-1
- Set command, 2-1
- SET?, 2-261

Setting

- Command query, 2-164
- Query, 2-164
- Recall command, 2-246
- RS-232 parameters, 1-22
- Save command, 2-256
- setting the user interface language, 2-154
- Setup, communication module install, 1-6
- SETUP<x>:DATE?, 2-262
- SETUP<x>:LABEL, 2-262
- SETUP<x>:TIME?, 2-262
- Slewrates trigger, 2-278
- SPD, C-2
- SPE, C-2
- *SRE command, 2-263, 3-4
- SRER register, 2-242, 2-263, 3-4
- SRQ, 1-3
- Status, 3-1
- Status and error command group, 2-33
- Status and error commands
 - ALLEV?, 2-54
 - BUSY?, 2-55
 - *CLS, 2-71
 - DESE, 2-99, 3-3
 - *ESE, 2-115, 3-3
 - *ESR?, 2-116, 3-1
 - EVENT?, 2-125
 - EVMSG?, 2-126
 - EVQTY?, 2-127
 - FILESYSTEM?, 2-127
 - ID?, 2-149
 - *IDN?, 2-149
 - *OPC, 2-240
 - *PSC, 2-242, 3-4
 - *RST, 2-252
 - *SRE, 2-263, 3-4
 - *STB?, 2-263, 3-2
 - *TST?, 2-307
 - *WAI, 2-309
- Status and Events, 1-3
- *STB?, 2-263
- *STB? query, 3-2
- Syntax
 - BNF (Backus Naur form), 2-1
 - Command, 2-1
- syntax and command description, 1-2
- SYSTEM, 2-264

T

- Table, programming message, 3-12
- TCT, C-2

- TDS3LIM commands, 2-21
- TDS3SDI commands, 2-20
 - ITU601:AUTOSET, 2-150
 - ITU601:EDH RESET, 2-150
 - ITU601:EDH:COUNT, 2-151
 - ITU601:EDH:DETECT?, 2-151
 - ITU601:EDH:NUMERRORS?, 2-152
 - ITU601:INPUT:FORMAT, 2-152
 - ITU601:INPUT:SIGNALSTRENGTH, 2-153
 - ITU601:INPUT:STATE?, 2-153
 - ITU601:OUTPUT:FORMAT, 2-154
- TDS3SDI EDH error counter, 2-150
- TDS3TMT commands, 2-22
- TEKSECURE, 2-264
- TEKSecure, Glossary-2
- Telecom mask test commands, 2-22
- Terminator, command message, 2-6
- TIME, 2-265
- Time base, Manual trigger simulation, 2-307
- *TRG, 2-307
- TRIGGER, 2-265
- Trigger command group, 2-34
- Trigger commands
 - TRIGGER, 2-265
 - TRIGGER:A?, 2-266
 - TRIGGER:A:COMMUNICATION:SOURCE, 2-266
 - TRIGGER:A:COMMUNICATION:STANDARD, 2-267
 - TRIGGER:A:EDGE?, 2-268
 - TRIGGER:A:EDGE:COUPLING, 2-268
 - TRIGGER:A:EDGE:SLOPE, 2-269
 - TRIGGER:A:EDGE:SOURCE, 2-269
 - TRIGGER:A:HOLDOFF?, 2-270
 - TRIGGER:A:HOLDOFF:TIME, 2-270
 - TRIGGER:A:HOLDOFF:VALUE, 2-271
 - TRIGGER:A:LEVEL, 2-271
 - TRIGGER:A:LOGIC?, 2-272
 - TRIGGER:A:LOGIC:CLASS, 2-272
 - TRIGGER:A:LOGIC:INPUT<x>:LOGICLEVEL, 2-272
 - TRIGGER:A:LOGIC:INPUT<x>SOURCE, 2-274
 - TRIGGER:A:LOGIC:INPUT<x>THRESHOLD, 2-274
 - TRIGGER:A:LOGIC:INPUT2:SLOPE, 2-273
 - TRIGGER:A:LOGIC:PATTERN:DELTA TIME, 2-275
 - TRIGGER:A:LOGIC:PATTERN:FUNCTION, 2-275
 - TRIGGER:A:LOGIC:PATTERN:WHEN, 2-276
 - TRIGGER:A:LOGIC:STATE:WHEN, 2-277
 - TRIGGER:A:MODE, 2-277
 - TRIGGER:A:PULSE?, 2-278

- TRIGGER:A:PULSE:CLASS, 2-278
- TRIGGER:A:PULSE:RUNT?, 2-279
- TRIGGER:A:PULSE:RUNT:POLARITY, 2-279
- TRIGGER:A:PULSE:RUNT:THRESHOLD?, 2-279
- TRIGGER:A:PULSE:RUNT:THRESHOLD:BOTH, 2-280
- TRIGGER:A:PULSE:RUNT:THRESHOLD:HIGH, 2-280
- TRIGGER:A:PULSE:RUNT:THRESHOLD:LOW, 2-281
- TRIGGER:A:PULSE:RUNT:WHEN, 2-281
- TRIGGER:A:PULSE:RUNT:WIDTH, 2-282
- TRIGGER:A:PULSE:SLEWRATE?, 2-282
- TRIGGER:A:PULSE:SLEWRATE:DELTATIME, 2-283
- TRIGGER:A:PULSE:SLEWRATE:POLARITY, 2-283
- TRIGGER:A:PULSE:SLEWRATE:SLEWRATE, 2-284
- TRIGGER:A:PULSE:SLEWRATE:THRESHOLD:BOTH, 2-284
- TRIGGER:A:PULSE:SLEWRATE:THRESHOLD:HIGH, 2-285
- TRIGGER:A:PULSE:SLEWRATE:THRESHOLD:LOW, 2-285
- TRIGGER:A:PULSE:SLEWRATE:WHEN, 2-286
- TRIGGER:A:PULSE:SOURCE, 2-286
- TRIGGER:A:PULSE:WIDTH:POLARITY, 2-287
- TRIGGER:A:PULSE:WIDTH:WHEN, 2-288
- TRIGGER:A:PULSE:WIDTH:WIDTH, 2-288
- TRIGGER:A:SETLEVEL, 2-289
- TRIGGER:A:TYPE, 2-289
- TRIGGER:A:VIDEO?, 2-290
- TRIGGER:A:VIDEO:CUSTOM:FORMAT, 2-290
- TRIGGER:A:VIDEO:CUSTOM:SCAN, 2-291
- TRIGGER:A:VIDEO:FIELD, 2-291
- TRIGGER:A:VIDEO:HDTV:FORMAT, 2-292
- TRIGGER:A:VIDEO:HOLDOFF:FIELD, 2-293
- TRIGGER:A:VIDEO:LINE, 2-293
- TRIGGER:A:VIDEO:SCAN, 2-294
- TRIGGER:A:VIDEO:SOURCE, 2-295
- TRIGGER:A:VIDEO:STANDARD, 2-296
- TRIGGER:A:VIDEO:SYSTEM, 2-297
- TRIGGER:B?, 2-297
- TRIGGER:B:BY, 2-297
- TRIGGER:B:EDGE?, 2-298
- TRIGGER:B:EDGE:COUPLING, 2-298
- TRIGGER:B:EDGE:SLOPE, 2-299
- TRIGGER:B:EDGE:SOURCE, 2-299
- TRIGGER:B:EVENTS?, 2-300
- TRIGGER:B:EVENTS:COUNT, 2-300
- TRIGGER:B:LEVEL, 2-301
- TRIGGER:B:SETLEVEL, 2-301
- TRIGGER:B:STATE, 2-302
- TRIGGER:B:TIME, 2-302
- TRIGGER:B:TYPE, 2-302
- TRIGGER:DELAY, 2-303
- TRIGGER:EXTERNAL:PROBE, 2-303
- TRIGGER:EXTERNAL:YUNIT, 2-304
- TRIGGER:FORCE, 2-304
- TRIGGER:MAIN, 2-305
- TRIGGER:STATE?, 2-306
- TRIGGER:A?, 2-266
- TRIGGER:A:COMMUNICATION:SOURCE, 2-266
- TRIGGER:A:COMMUNICATION:STANDARD, 2-267
- TRIGGER:A:EDGE?, 2-268
- TRIGGER:A:EDGE:COUPLING, 2-268
- TRIGGER:A:EDGE:SLOPE, 2-269
- TRIGGER:A:EDGE:SOURCE, 2-269
- TRIGGER:A:HOLDOFF?, 2-270
- TRIGGER:A:HOLDOFF:TIME, 2-270
- TRIGGER:A:HOLDOFF:VALUE, 2-271
- TRIGGER:A:LEVEL, 2-271
- TRIGGER:A:LOGIC?, 2-272
- TRIGGER:A:LOGIC:CLASS, 2-272
- TRIGGER:A:LOGIC:INPUT<x>:SOURCE, 2-274
- TRIGGER:A:LOGIC:INPUT<x>:THRESHOLD, 2-274
- TRIGGER:A:LOGIC:INPUT2:SLOPE, 2-273
- TRIGGER:A:LOGIC:LOGIC:INPUT<x>:LOGICLEVEL, 2-272
- TRIGGER:A:LOGIC:PATTERN:DELTATIME, 2-275
- TRIGGER:A:LOGIC:PATTERN:FUNCTION, 2-275
- TRIGGER:A:LOGIC:PATTERN:WHEN, 2-276
- TRIGGER:A:LOGIC:STATE:WHEN, 2-277
- TRIGGER:A:MODE, 2-277
- TRIGGER:A:PULSE?, 2-278
- TRIGGER:A:PULSE:CLASS, 2-278
- TRIGGER:A:PULSE:RUNT?, 2-279
- TRIGGER:A:PULSE:RUNT:POLARITY, 2-279
- TRIGGER:A:PULSE:RUNT:THRESHOLD?, 2-279
- TRIGGER:A:PULSE:RUNT:THRESHOLD:BOTH, 2-280
- TRIGGER:A:PULSE:RUNT:THRESHOLD:HIGH, 2-280
- TRIGGER:A:PULSE:RUNT:THRESHOLD:LOW, 2-281
- TRIGGER:A:PULSE:RUNT:WHEN, 2-281
- TRIGGER:A:PULSE:RUNT:WIDTH, 2-282
- TRIGGER:A:PULSE:SLEWRATE?, 2-282
- TRIGGER:A:PULSE:SLEWRATE:DELTATIME, 2-283
- TRIGGER:A:PULSE:SLEWRATE:POLARITY, 2-283

TRIGGER:A:PULSE:SLEWRATE:SLEWRATE, 2-284
 TRIGGER:A:PULSE:SLEWRATE:THRESHOLD:BOTH, 2-284
 TRIGGER:A:PULSE:SLEWRATE:THRESHOLD:HIGH, 2-285
 TRIGGER:A:PULSE:SLEWRATE:THRESHOLD:LOW, 2-285
 TRIGGER:A:PULSE:SLEWRATE:WHEN, 2-286
 TRIGGER:A:PULSE:SOURCE, 2-286
 TRIGGER:A:PULSE:WIDTH:POLARITY, 2-287
 TRIGGER:A:PULSE:WIDTH:WHEN, 2-288
 TRIGGER:A:PULSE:WIDTH:WIDTH, 2-288
 TRIGGER:A:SETLEVEL, 2-289
 TRIGGER:A:TYPE, 2-289
 TRIGGER:A:VIDEO?, 2-290
 TRIGGER:A:VIDEO:CUSTOM:FORMAT, 2-290
 TRIGGER:A:VIDEO:CUSTOM:SCAN, 2-291
 TRIGGER:A:VIDEO:FIELD, 2-291
 TRIGGER:A:VIDEO:HDTV:FORMAT, 2-292
 TRIGGER:A:VIDEO:HOLDOFF:FIELD, 2-293
 TRIGGER:A:VIDEO:LINE, 2-293
 TRIGGER:A:VIDEO:SCAN, 2-294
 TRIGGER:A:VIDEO:SOURCE, 2-295
 TRIGGER:A:VIDEO:STANDARD, 2-296
 TRIGGER:A:VIDEO:SYSTEM, 2-297
 TRIGGER:B?, 2-297
 TRIGGER:B:BY, 2-297
 TRIGGER:B:EDGE?, 2-298
 TRIGGER:B:EDGE:COUPLING, 2-298
 TRIGGER:B:EDGE:SLOPE, 2-299
 TRIGGER:B:EDGE:SOURCE, 2-299
 TRIGGER:B:EVENTS?, 2-300
 TRIGGER:B:EVENTS:COUNT, 2-300
 TRIGGER:B:LEVEL, 2-301
 TRIGGER:B:SETLEVEL, 2-301
 TRIGGER:B:STATE, 2-302
 TRIGGER:B:TIME, 2-302
 TRIGGER:B:TYPE, 2-302
 TRIGGER:DELAY, 2-303
 TRIGGER:EXTERNAL:PROBE, 2-303
 TRIGGER:EXTERNAL:YUNIT, 2-304
 TRIGGER:FORCE, 2-304
 TRIGGER:MAIN, 2-305
 TRIGGER:STATE?, 2-306
 *TST? query, 2-307
 turning alias state on or off, 2-53

U

Unicode, 2-237, Glossary-2
 UNL, C-2

Unlisten, C-2
 UNLOCK, 2-308
 UNT, C-2
 Untalk, C-2

V

VERBOSE, 2-308
 Vertical command group, 2-38
 Vertical commands
 CH<x>?, 2-63
 CH<x>:BANDWIDTH, 2-63
 CH<x>:COUPLING, 2-64
 CH<x>:DESKEW, 2-65
 CH<x>:ID?, 2-65
 CH<x>:IMPEDANCE, 2-66
 CH<x>:INVERT, 2-66
 CH<x>:OFFSET, 2-67
 CH<x>:POSITION, 2-68
 CH<x>:PROBE, 2-68
 CH<x>:SCALE, 2-69
 CH<x>:VOLTS, 2-70
 CH<x>:YUNIT, 2-70
 SELECT?, 2-259
 SELECT:<wfm>, 2-260
 SELECT:CONTROL, 2-260
 Video trigger, 2-289, 2-290

W

*WAI, 2-309
 Wait for operation complete, 2-309
 WAVEALERT:BEEP, 2-310
 WAVEALERT:HARDCOPY, 2-310
 WAVEALERT:SAVEWFM, 2-311
 WAVEALERT:SENSITIVITY, 2-312
 WAVEALERT:STATE, 2-312
 WAVEALERT:STOPONVIOLATION, 2-313
 WAVEALERT:TYPE, 2-313
 Waveform, command mnemonic, 2-8
 Waveform command group, 2-39
 Waveform commands
 CURVE, 2-90
 DATA, 2-92
 DATA:DESTINATION, 2-92
 DATA:ENCDG, 2-93
 DATA:SOURCE, 2-94
 DATA:START, 2-95
 DATA:STOP, 2-96
 DATA:TARGET, 2-97
 DATA:WIDTH, 2-97

REF<x>:DATE?, 2-249
REF<x>:HORIZONTAL:POSITION, 2-249
REF<x>:LABEL, 2-250
REF<x>:TIME?, 2-250
REF<x>:VERTICAL:POSITION, 2-251
REF<x>:VERTICAL:SCALE, 2-251
REF<x>HORIZONTAL:SCALE, 2-249
SETUP<x>:DATE?, 2-262
SETUP<x>:LABEL, 2-262
SETUP<x>:TIME?, 2-262
WAVFRM?, 2-309
WFMPRE?, 2-314
WFMPRE:<wfm>?, 2-326
WFMPRE:<wfm>:PT_FMT, 2-328
WFMPRE:<wfm>:PT_OFF, 2-328
WFMPRE:<wfm>:WFID?, 2-328
WFMPRE:<wfm>:XINCR, 2-328
WFMPRE:<wfm>:XUNIT, 2-328
WFMPRE:<wfm>:XZERO, 2-328
WFMPRE:<wfm>:YMULT, 2-329
WFMPRE:<wfm>:YOFF, 2-329
WFMPRE:<wfm>:YUNIT, 2-329
WFMPRE:<wfm>:YZERO, 2-329
WFMPRE:<wfm>NR_PT, 2-327
WFMPRE:BIT_NR, 2-314
WFMPRE:BN_FMT, 2-315
WFMPRE:BYT_NR, 2-316
WFMPRE:BYT_OR, 2-316
WFMPRE:ENCDG, 2-317
WFMPRE:NR_PT, 2-318
WFMPRE:PT_FMT, 2-318
WFMPRE:PT_OFF, 2-319
WFMPRE:WFID, 2-320
WFMPRE:XINCR, 2-320
WFMPRE:XMULT, 2-326
WFMPRE:XOFF, 2-326
WFMPRE:XUNIT, 2-321
WFMPRE:XZERO, 2-322
WFMPRE:YMULT, 2-322
WFMPRE:YOFF, 2-323
WFMPRE:YUNIT, 2-324
WFMPRE:YZERO, 2-325
WFMPRE:ZMULT, 2-326
WFMPRE:ZOFF, 2-326
WFMPRE:ZUNIT, 2-326

WFMPRE:ZZERO, 2-326
WAVFRM?, 2-309
<wfm>, command mnemonic, 2-8
WFMPRE?, 2-314
WFMPRE:<wfm>?, 2-326
WFMPRE:<wfm>:PT_FMT, 2-328
WFMPRE:<wfm>:PT_OFF, 2-328
WFMPRE:<wfm>:WFID?, 2-328
WFMPRE:<wfm>:XINCR, 2-328
WFMPRE:<wfm>:XUNIT, 2-328
WFMPRE:<wfm>:XZERO, 2-328
WFMPRE:<wfm>:YMULT, 2-329
WFMPRE:<wfm>:YOFF, 2-329
WFMPRE:<wfm>:YUNIT, 2-329
WFMPRE:<wfm>:YZERO, 2-329
WFMPRE:<wfm>NR_PT, 2-327
WFMPRE:BIT_NR, 2-314
WFMPRE:BN_FMT, 2-315
WFMPRE:BYT_NR, 2-316
WFMPRE:BYT_OR, 2-316
WFMPRE:ENCDG, 2-317
WFMPRE:NR_PT, 2-318
WFMPRE:PT_FMT, 2-318
WFMPRE:PT_OFF, 2-319
WFMPRE:WFID, 2-320
WFMPRE:XINCR, 2-320
WFMPRE:XMULT, 2-326
WFMPRE:XOFF, 2-326
WFMPRE:XUNIT, 2-321
WFMPRE:XZERO, 2-322
WFMPRE:YMULT, 2-322
WFMPRE:YOFF, 2-323
WFMPRE:YUNIT, 2-324
WFMPRE:YZERO, 2-325
WFMPRE:ZMULT, 2-326
WFMPRE:ZOFF, 2-326
WFMPRE:ZUNIT, 2-326
WFMPRE:ZZERO, 2-326
Width trigger, 2-278, 2-288

Z

ZOOM:HORIZONTAL:POSITION, 2-329
ZOOM:HORIZONTAL:SCALE, 2-330
ZOOM:STATE, 2-330