



**Agilent InfiniiVision
5000/6000/7000
Series Oscilloscopes**

User's Guide



Agilent Technologies

Notices

© Agilent Technologies, Inc. 2000-2011

No part of this manual may be reproduced in any form or by any means (including electronic storage and retrieval or translation into a foreign language) without prior agreement and written consent from Agilent Technologies, Inc. as governed by United States and international copyright laws.

Manual Part Number

54695-97026

Edition

Fifth Edition, March 2011

Print History

54695-97015, June 2009
54695-97018, January 2010
54695-97022, February 2010
54695-97024, June 2010

Printed in Malaysia

Agilent Technologies, Inc.
1900 Garden of the Gods Road
Colorado Springs, CO 80907 USA

A newer version of this manual may be available at

www.agilent.com/find/5000manual
www.agilent.com/find/6000manual
www.agilent.com/find/7000manual

Software Revision

This guide was written for version 6.1 of the Agilent InfiniiVision 5000/6000/7000 Series Oscilloscope software.

Trademark Acknowledgments

Java is a U.S. trademark of Sun Microsystems, Inc.

Sun, Sun Microsystems, and the Sun Logo are trademarks or registered trademarks of Sun Microsystems, Inc. in the U.S. and other countries.

Warranty

The material contained in this document is provided “as is,” and is subject to being changed, without notice, in future editions. Further, to the maximum extent permitted by applicable law, Agilent disclaims all warranties, either express or implied, with regard to this manual and any information contained herein, including but not limited to the implied warranties of merchantability and fitness for a particular purpose. Agilent shall not be liable for errors or for incidental or consequential damages in connection with the furnishing, use, or performance of this document or of any information contained herein. Should Agilent and the user have a separate written agreement with warranty terms covering the material in this document that conflict with these terms, the warranty terms in the separate agreement shall control.

Technology Licenses

The hardware and/or software described in this document are furnished under a license and may be used or copied only in accordance with the terms of such license.

Restricted Rights Legend

If software is for use in the performance of a U.S. Government prime contract or subcontract, Software is delivered and licensed as “Commercial computer software” as defined in DFAR 252.227-7014 (June 1995), or as a “commercial item” as defined in FAR 2.101(a) or as “Restricted computer software” as defined in FAR 52.227-19 (June 1987) or any equivalent agency regulation or contract clause. Use, duplication or disclosure of Software is subject to Agilent Technologies’ standard commercial license terms, and non-DOD Departments and Agencies of the U.S. Government will

receive no greater than Restricted Rights as defined in FAR 52.227-19(c)(1-2) (June 1987). U.S. Government users will receive no greater than Limited Rights as defined in FAR 52.227-14 (June 1987) or DFAR 252.227-7015 (b)(2) (November 1995), as applicable in any technical data.

Product specifications, characteristics, and descriptions in this document are subject to change without notice.

Safety Notices

CAUTION

A **CAUTION** notice denotes a hazard. It calls attention to an operating procedure, practice, or the like that, if not correctly performed or adhered to, could result in damage to the product or loss of important data. Do not proceed beyond a **CAUTION** notice until the indicated conditions are fully understood and met.

WARNING

A **WARNING** notice denotes a hazard. It calls attention to an operating procedure, practice, or the like that, if not correctly performed or adhered to, could result in personal injury or death. Do not proceed beyond a **WARNING** notice until the indicated conditions are fully understood and met.

Book Map

Click the text to jump to a chapter

Navigate to a step in your workflow

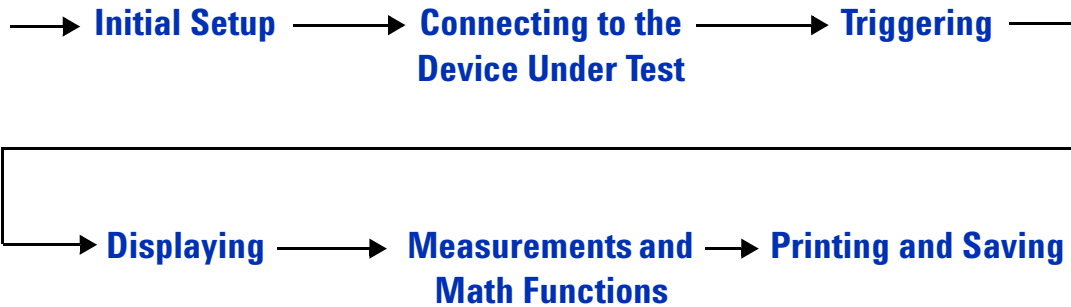

Navigate to a topic

Acquisition Modes

Web Interface

**Serial
Decode/Lister**

Mask Test

**Controls and
Connectors**

Digital Channels

Reference

Index

In This User's Guide...

This guide shows you how to use the InfiniiVision 5000/6000/7000 Series oscilloscopes. It contains the following chapters and topics:

1 Introduction

Model numbers, options, where to find specifications.

2 Initial Setup

Unpacking and setting up your oscilloscope. Using the **Quick Help** system. Using the analog channels, setting up the timebase.

3 Connecting to the Device Under Test

Connect the oscilloscope to the device under test using passive or active probes or 50-ohm BNC cables.

4 Triggering

Trigger modes, trigger settings, and trigger types. Trigger noise rejection, glitch capture.

5 Displaying

Stabilizing and interpreting the display, AutoScale. Using pan and zoom. Adjusting display intensity, using infinite persistence, using labels. XGA video output.

6 Measurements and Math Functions

Automatic time and voltage measurements, FFTs, math functions, measurement statistics, cursor measurements, XY mode horizontal.

7 Printing and Saving

Printing the oscilloscope's display, saving setups and data, and using the file explorer.

8 Acquisition Modes

Run, Stop, and Single acquisitions. Selecting normal, average, peak detect, or high resolution (smoothing) mode. About the Realtime option. Using segmented memory.

9 Web Interface

Setting up the I/O port, establishing LAN connection, using the oscilloscope's web interface.

10 Serial Decode/Lister

Serial decode of I²C, I²S, SPI, CAN, LIN, RS232 (UART), FlexRay, and MIL-STD 1553 serial buses.

11 Mask Test

Using mask test to identify signal excursions beyond set limits.

12 Controls and Connectors

Click on a control or connector to find out how to use it.

13 Digital Channels

Using the digital channels of a mixed-signal oscilloscope (MSO).

14 Reference



Software updates, licenses, Secure Environment mode, Measurement Category, Environmental Conditions, synchronizing the timebases of multiple instruments, cleaning, binary and csv data files, warranty status, Contact Us.

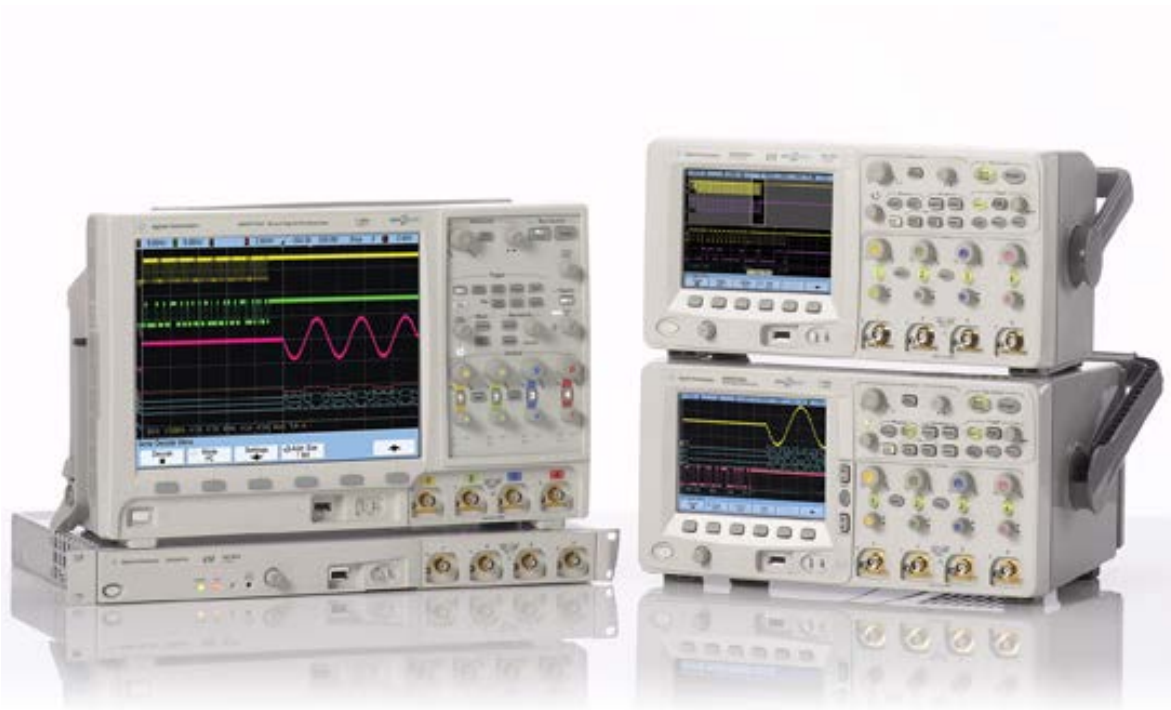

Index





Contents

	Book Map	3
	In This User's Guide...	4
1	Introduction	21
	Models Covered in this Manual	22
	Specifications and Characteristics	23
	Licensed Options	24
	Notes	26
2	Initial Setup	27
	Package Contents	28
	5000 Series Oscilloscope Package Contents	29
	6000A Series Oscilloscope Package Contents	30
	6000A Option BAT Oscilloscope Package Contents	31
	6000L Series Oscilloscope Package Contents	32
	7000A Series Oscilloscope Package Contents	33
	Accessories Available	34
	Tilt the oscilloscope up for easy viewing	36
	To tilt the 5000 Series oscilloscope up for easy viewing	36
	To tilt the 6000 Series oscilloscope up for easy viewing	37
	To tilt the 7000 Series oscilloscope up for easy viewing	38
	To install the optional front panel overlay	40
	5000 Series Overlay	40
	6000 Series Overlay	41
	7000 Series Overlay	42

To mount the oscilloscope in a rack	43
To mount the 5000 or 6000 Series oscilloscope in a rack	43
To mount the 6000L Series oscilloscope in a rack	43
To mount the 7000 Series oscilloscope in a rack	46
Ventilation Requirements	47
5000 and 6000A Series Ventilation Requirements	47
6000L Series Ventilation Requirements	47
7000 Series Ventilation Requirements	47
Power Requirements	48
Power-on the 5000/6000/7000 Series Oscilloscope	49
Power-on the Battery-Powered 6000A Series Oscilloscope	49
 Caution indicator.	50
 AC adapter for battery-powered oscilloscopes	52
Keys, Softkeys, and the Entry Knob	53
Verifying Basic Oscilloscope Operation	54
Quick Help	55
Quick Help Languages	56
Graphical User Interface Languages	56
Quick Help Updates	56
To set the clock	57
To set up the screen saver	58
Using the Analog Channels	59
To set up the Horizontal time base	64
3 Connecting to the Device Under Test	71
Analog Input Impedance (50 Ohm or 1 MOhm)	72

AutoProbe Interface	72
Passive Probes	73
Active Probes	74
Active Probes for 6000 Series 100 MHz Bandwidth Models	75
Connect the Probes to the Oscilloscope	75
 Maximum input voltage at analog inputs	76
 Do not float the oscilloscope chassis	76
Compensating Passive Probes	77
Calibrating Probes	78
Manually Setting the Probe Attenuation Factor	80
Digital Probes	80
4 Triggering	81
Triggering - General Information	83
Trigger Mode and Coupling Menu	84
Auto and Normal Trigger modes	84
Choosing Auto Trigger Mode or Normal Trigger Mode	84
Auto Mode	85
Normal Mode	85
Trigger Level Adjustment	86
Trigger Coupling	87
Trigger Noise Rejection	87
HF Reject	88
LF Reject	89
Noise Rejection	89

Trigger Holdoff	90
Trigger Holdoff Operating Hints	90
To set holdoff	90
External Trigger Input	92
2-Channel Oscilloscope External Trigger Input	92
	
Maximum voltage at 2-channel oscilloscope external trigger input	93
4-Channel Oscilloscope External Trigger Input	94
	
Maximum voltage at 4-channel oscilloscope external trigger input	94
Trigger Output	95
Triggers	95
Source Frequency	95
Source Frequency/8	95
Trigger Types	96
CAN Trigger	98
Duration Trigger	102
< qualifier time set softkey	103
> qualifier time set softkey	103
Edge Trigger	105
FlexRay Setup and Triggering	107
Setup for FlexRay Signals	107
FlexRay Triggering	108
Glitch or Narrow Pulse Capture	112
Using Peak Detect Mode to Find a Glitch	113
I2C Trigger	115
I2S Trigger	121

LIN Trigger	128
MIL-STD 1553 Setup and Triggering	131
Probing MIL-STD 1553 Signals	131
Setup for MIL-STD 1553 Signals	132
MIL-STD 1553 Triggering	133
Nth Edge Burst Trigger	135
Pattern Trigger	137
Hex Bus Pattern Trigger	139
Pulse Width Trigger	140
< qualifier time set softkey	141
> qualifier time set softkey	142
Sequence Trigger	143
Define the “Find” Stage	145
Define the “Trigger on” Stage	146
Define the Optional “Reset on” Stage	147
Adjust the Trigger Level	149
SPI Trigger	150
Assign Oscilloscope Channels to SPI Signals	151
Set Up the Bits in the Serial Data String	155
Resetting All Bits in the Serial Data String to One Value	155
TV Trigger	156
TV Triggering Examples	159
To trigger on a specific line of video	160
To trigger on all sync pulses	161
To trigger on a specific field of the video signal	161
To trigger on all fields of the video signal	162
To trigger on odd or even fields	163
UART/RS232 Trigger	166
USB Trigger	170

5	Displaying	173
	Tips for Displaying Waveforms	174
	Stabilizing the Display	174
	Interpreting the Display	175
	Graphic Symbols in Softkey Menus	176
	AutoScale	177
	How AutoScale works	177
	Undo AutoScale	177
	Enabling Fast Debug AutoScale	178
	Specifying the Channels Displayed After AutoScale	178
	Preserving the Acquisition Mode During AutoScale	178
	Pan and Zoom	179
	Waveform Intensity and Signal Detail	180
	Grid Intensity	181
	Infinite Persistence	182
	Using Labels	183
	Waveform Expansion Reference Point	187
	Vectors (Connect the Dots)	187
	Freeze Display	188
	Antialiasing	189
	XGA Video Output	189
6	Measurements and Math Functions	191
	List of Automatic Measurements	192
	Making Automatic Measurements	193
	Measurement Statistics	194
	Measurement Thresholds	197

Measurement Definitions	199
Time Measurements	199
Delay and Phase Measurements	203
Voltage Measurements	205
Overshoot and Preshoot Measurements	211
Cursor Measurements	214
To make cursor measurements	215
Cursor Examples	217
XY Horizontal Mode	220
Math Functions	224
To use waveform math	224
To perform a math function upon an arithmetic operation	225
Math scale and offset	225
Units	226
Multiply	227
Add or Subtract	228
Differentiate	230
Integrate	232
Square Root	234
FFT Measurement	236
FFT Operation	238
Enabling Precision Measurements and Math	242
7 Printing and Saving	243
Printing the Oscilloscope's Display	244
Quick Print	244
To print the oscilloscope's display	245
Options	245
Palette	246

Saving Oscilloscope Data	247
Selecting a Destination for Your Saved Data	248
Selecting a File Name	249
Saving Waveform Trace and Oscilloscope Setup	250
Display Image and Waveform Data File Formats	250
Choosing Save Settings	251
To save a waveform and/or setup to a USB mass storage device	255
To save a waveform and/or setup to the oscilloscope's internal memory	256
To recall waveform trace and/or oscilloscope setup	256
File Explorer	257
8 Acquisition Modes	261
To start and stop an acquisition	262
To make a single acquisition	264
Acquisition Modes	265
At Slower Sweep Speeds	265
Selecting the Acquisition mode	265
Normal Mode	265
Peak Detect Mode	266
High Resolution Mode	266
Averaging Mode	267
Realtime Sampling Option	269
Segmented Memory	271
Using segmented memory	271
9 Web Interface	275
Setting up the Oscilloscope's LAN Connection	276
To establish a LAN connection	276
To establish a LAN connection (6000L Series)	277
Stand-alone (Point-to-Point) Connection to a PC	278

Accessing the Web Interface	280
Browser Web Control	281
Remote Front Panel	281
Remote Programming	283
Remote Programming with Agilent IO Libraries	284
Get Image	285
Identification Function	286
Instrument Utilities	287
Setting a Password	288
10 Serial Decode/Lister	291
Serial Decode	292
Lister	293
CAN Serial Decode	295
Interpreting CAN Decode	298
CAN Totalizer	299
Interpreting CAN Lister Data	301
FlexRay Serial Decode	302
Interpreting FlexRay Frame Decode	303
FlexRay Totalizer	304
Interpreting FlexRay Lister Data	305
I ² C Serial Decode	306
Interpreting I ² C Decode	308
Interpreting I ² C Lister Data	309
I ² S Serial Decode	310
Interpreting I ² S Decode	312
Interpreting I ² S Lister Data	313

	LIN Serial Decode	314
	Interpreting LIN Decode	317
	Interpreting LIN Lister Data	319
	MIL-STD 1553 Serial Decode	320
	Interpreting MIL-STD 1553 Decode	321
	Viewing MIL-STD 1553 Data in the Lister	322
	SPI Serial Decode	323
	Interpreting SPI Decode	327
	Interpreting SPI Lister Data	328
	UART/RS232 Serial Decode	329
	Interpreting UART/RS232 Decode	333
	UART/RS232 Totalizer	334
	Interpreting UART/RS232 Lister Data	335
11	Mask Test	337
	To create a mask from a “golden” waveform (Automask)	338
	Troubleshooting Mask Setup	339
	Setup Options	340
	Run Until	340
	On Error	340
	Source Lock	341
	Mask Test Trigger Output	342
	Mask Statistics	343
	Reset Statistics	344
	Transparent	344
	To manually modify a mask file	345
	Building a Mask File	348

12 Controls and Connectors 351

Front Panel 352

5000/6000 Series Front Panel (4-channel) 352

5000/6000 Series Front Panel (2-Channel, differences only) 353

6000L Series Front and Rear Panel 354

7000 Series Front Panel (4-Channel) 355

7000 Series Front Panel (2-Channel, differences only) 356

Front Panel Control and Connector Descriptions 357



Do not connect a host computer to the oscilloscope's USB host port 357

Rear Panel 362

5000 Series Rear Panel (4-Channel) 362

5000 Series Rear Panel (2-Channel) 363

6000 Series Rear Panel (4-Channel) 364

6000 Series Rear Panel (2-Channel) 365

6000 Series Option BAT Rear Panel (4-Channel) 366

7000 Series Rear Panel (4-Channel) 367

7000 Series Rear Panel (2-Channel) 368

Rear Panel Control and Connector Descriptions 369

13 Digital Channels 371

To connect the digital probes to the device under test 372



Probe cable for digital channels 372



Acquiring waveforms using the digital channels 375

To display digital channels using AutoScale 376

Example 376

Interpreting the digital waveform display 378

	To change the displayed size of the digital channels	379
	To switch a single channel on or off	379
	To switch all digital channels on or off	379
	To switch groups of channels on or off	379
	To change the logic threshold for digital channels	380
	To reposition a digital channel	380
	To display digital channels as a bus	381
	Digital channel signal fidelity: Probe impedance and grounding	385
	Input Impedance	385
	Probe Grounding	387
	Best Probing Practices	388
	To replace digital probe leads	389
14	Utilities	391
	To restore the oscilloscope to its default configuration	392
	To perform service functions	393
	User Calibration	394
	Self Test	397
15	Reference	399
	About Oscilloscope	400
	Software and Firmware Updates	400
	Installed Licenses	400
	Upgrading to an MSO	401
	Secure Environment Mode Option	402

Measurement Category	403
Measurement Category	403
Measurement Category Definitions	403
Transient Withstand Capability	404
	
Maximum input voltage at analog inputs and 2-channel external trigger input	404
	
Maximum input voltage at digital channels	404
Environmental Conditions	405
Using the 10 MHz reference clock	406
Sample clock and frequency counter accuracy	406
Supplying an external timebase reference	406
To supply a sample clock to the oscilloscope	406
	
Maximum input voltage at 10 MHz REF connector	406
To synchronize the timebase of two or more instruments	408
To clean the oscilloscope	408
Binary Data (.bin) Format	409
Binary Data in MATLAB	409
Binary Header Format	410
Example Program for Reading Binary Data	413
Examples of Binary Files	414
CSV and ASCII XY files	417
Acknowledgements	418
To check warranty and extended services status	418
To return the instrument	419
Contact us	420

Contents



1 Introduction

Models Covered in this Manual **22**
Specifications and Characteristics **23**
Licensed Options **24**
Notes **26**

The Agilent InfiniiVision 5000, 6000, and 7000 Series oscilloscopes deliver powerful features and high performance:

- 100 MHz, 300 MHz, 350 MHz, 500 MHz, and 1 GHz bandwidth models.
- Up to 4 GSa/s sample rate.
- 6.3 inch or 12.1 inch XGA display.
- Powerful triggering including analog HDTV, I²C, I²S, SPI, LIN, CAN, FlexRay, MIL-STD 1553, and USB.
- USB and LAN ports make printing, saving and sharing data easy. GPIB ports on 5000 and 6000 Series models.
- 2-channel and 4-channel Digital Storage Oscilloscope (DSO) models.
- 2+16-channel and 4+16-channel Mixed Signal Oscilloscope (MSO) models.
- An MSO lets you debug your mixed-signal designs using up to four analog signals *and* 16 tightly correlated digital signals simultaneously.
- You can easily upgrade an InfiniiVision 6000 or 7000 Series oscilloscope from a DSO to an MSO and/or add features such as Segmented Memory and Mask Test.



Agilent InfiniiVision oscilloscopes feature MegaZoom III technology:

- Most responsive deep memory.
- High definition color display.
- Largest display in its class (7000 Series, 12.1 inches).
- Fastest waveform update rates, uncompromised.

For more information about InfiniiVision oscilloscopes, see:

www.agilent.com/find/scope

Models Covered in this Manual

5000 SERIES MODEL NUMBERS, BANDWIDTHS, AND SAMPLING RATES

Bandwidth	100 MHz	300 MHz	500 MHz
Maximum Sample Rate	2 GSa/s	2 GSa/s	4 GSa/s
2-Channel DSO	DSO5012A	DSO5032A	DSO5052A
4-Channel DSO	DSO5014A	DSO5034A	DSO5054A

6000 SERIES MODEL NUMBERS, BANDWIDTHS, AND SAMPLING RATES

Bandwidth	100 MHz	300 MHz	500 MHz	1 GHz
Maximum Sample Rate	2 GSa/s	2 GSa/s	4 GSa/s	4 GSa/s
2-Channel + 16 Logic Channels MSO	MSO6012A	MSO6032A	MSO6052A	MSO6102A
4-Channel + 16 Logic Channels MSO	MSO6014A	MSO6034A	MSO6054A	MSO6104A
2-Channel DSO	DSO6012A	DSO6032A	DSO6052A	DSO6102A
4-Channel DSO	DSO6014A, DSO6014L	DSO6034A	DSO6054A, DSO6054L	DSO6104A, DSO6104L

7000 SERIES MODEL NUMBERS, BANDWIDTHS, AND SAMPLING RATES

Bandwidth	100 MHz	350 MHz	500 MHz	1 GHz
Maximum Sample Rate	2 GSa/s	2 GSa/s	4 GSa/s	4 GSa/s
2-Channel + 16 Logic Channels MSO	MS07012A	MS07032A	MS07052A	
4-Channel + 16 Logic Channels MSO	MS07014A	MS07034A	MS07054A	MS07104A
2-Channel DSO	DS07012A	DS07032A	DS07052A	
4-Channel DSO	DS07014A	DS07034A	DS07054A	DS07104A

Specifications and Characteristics

Please see the InfiniiVision oscilloscope data sheets for complete, up-to-date specifications and characteristics. To download a data sheet, please visit:

- www.agilent.com/find/5000
- www.agilent.com/find/6000
- www.agilent.com/find/7000

Then, select the **Library** tab, followed by **Specifications**.

Or, go to the Agilent home page at www.agilent.com and search for **5000, 6000, or 7000 series oscilloscopes data sheet**.

To order a data sheet by phone, please contact your local Agilent office. The complete list is available at: www.agilent.com/find/contactus or on page **page 420**.

Licensed Options

Many of the following licensed options can be easily installed without returning the oscilloscope to a Service Center. Not all options can be installed on all models. See data sheets for details. To see the list of options installed on your oscilloscope, press **[Utility] → Options → Licenses → Show license information**.

UPGRADE OPTIONS

Option	Description	Order
232	RS232/UART serial decode option (for 4 channel or 4+16 channel models only)	Order N5457A after purchase (Option 232 at time of purchase). You can easily install this option yourself.
553	MIL-STD 1553 serial decode option (for 4 channel or 4+16 channel models only)	Order N5469A after purchase (Option 553 at time of purchase). You can easily install this option yourself.
ALT	N5434A FPGA dynamic probe for Altera (MSO recommended)	N5434A with Option 001 (Oscilloscope-locked license) or Option 002 (PC-locked license). Software is installed on an external PC.
AMS	CAN/LIN automotive triggering and decode (for 4 channel or 4+16 channel models only)	Order N5424A after purchase (Option AMS at time of purchase). You can easily install this option yourself.
FPG	N5406A FPGA dynamic probe for Xilinx (MSO recommended)	N5406A with Option 001 (Oscilloscope-locked license) or Option 002 (PC-locked license). Software is installed on an external PC.
FLX	FlexRay trigger and decode (for 4 channel or 4+16 channel models only). Includes mask limit test option (LMT), segmented memory option (SGM), and FlexRay physical layer conformance test application option (FRC)	Order N5432C after purchase (Option FLX at time of purchase). You can easily install this option yourself. FlexRay triggering and decode option.
FRC	FlexRay Physical Layer Conformance Test Application	Order U7244A. Application runs on a PC connected to InfiniiVision oscilloscope.
LMT	Mask Limit Test	Order N5455A after purchase (Option LMT at time of purchase). You can easily install this option yourself.

UPGRADE OPTIONS (CONTINUED)

Option	Description	Order
LSS	I2C/SPI serial decode option (for 4 channel or 4+16 channel models only)	Order N5423A after purchase (Option LSS at time of purchase). You can easily install this option yourself.
MSO	Mixed Signal Oscilloscope (MSO). Upgrade a DSO to an MSO.	Order N2735, N2736A, or N2737A. You can easily install this option yourself. The logic cable kit is supplied with the MSO license.
PWR	U1881A Power Application	Order U1881A. Application runs on PC connected to InfiniiVision oscilloscope. Optional U1880A deskew fixture available.
SEC	Secure Environment Mode	Nonvolatile memory is cleared of all setup and trace settings in compliance with National Industrial Security Program Operation Manual (NISPOM) Chapter 8 requirements. Available at time of purchase only. See also page 402 .
SGM	Segmented Memory	Order N5454A after purchase (Option SGM at time of purchase). You can easily install this option yourself.
SND	I ² S serial decode option (for 4 channel or 4+16 channel models only)	Order N5468A after purchase (Option SND at time of purchase). You can easily install this option yourself.

See also [“Installed Licenses”](#) on page 400.

CALIBRATION OPTION

Option	Order
A6J	ANSI Z540 Compliant Calibration

Notes

Built-in Quick Help

A Quick Help system is built into the oscilloscope. Press and hold any key to display Quick Help. Complete instructions for using the quick help system are given on [page 55](#).

Digital Channels

Because all of the oscilloscopes in the Agilent InfiniiVision Series have analog channels, the analog channel topics in this book apply to all instruments. Whenever a topic discusses the digital channels, that information applies only to Mixed-Signal Oscilloscope (MSO) models or DSO models that have been upgraded to an MSO (available on the 6000 and 7000 Series oscilloscopes).

Abbreviated instructions for pressing a series of keys and softkeys

Instructions for pressing a series of keys are written in an abbreviated manner. Instructions for pressing Key1, then pressing Softkey2, then pressing Softkey3 are abbreviated as follows: Press [**Key1**]→**Softkey2**→**Softkey3**.

The keys may be a front panel [**Key**] or a **Softkey**. Softkeys are the six keys located directly below the oscilloscope display.

Using this book with the 6000L Series oscilloscopes

The 6000L Series oscilloscopes do not have a built-in display or front panel control keys. If you are using a 6000L Series oscilloscope, and this book refers to using front panel controls, you can use the built-in Web control feature described on "[Accessing the Web Interface](#)" on page 280 to complete the instructions.



2 Initial Setup

Package Contents	28
5000 Series Oscilloscope Package Contents	29
6000A Series Oscilloscope Package Contents	30
6000A Option BAT Oscilloscope Package Contents	31
6000L Series Oscilloscope Package Contents	32
7000A Series Oscilloscope Package Contents	33
Accessories Available	34
Tilt the oscilloscope up for easy viewing	36
To install the optional front panel overlay	40
To mount the oscilloscope in a rack	43
Ventilation Requirements	47
Power Requirements	48
Power-on the 5000/6000/7000 Series Oscilloscope	49
Power-on the Battery-Powered 6000A Series Oscilloscope	49
Verifying Basic Oscilloscope Operation	54
Quick Help	55
Graphical User Interface Languages	56
To set the clock	57
To set up the screen saver	58
Keys, Softkeys, and the Entry Knob	53
Using the Analog Channels	59
To set up the Horizontal time base	64

This chapter shows package contents for each oscilloscope model, and explains how to set up the oscilloscope. Information about using the analog channels and setting up the horizontal timebase is given. For an overview of front panel controls see **“Controls and Connectors”** on page 351.



Package Contents

- ✓ Inspect the shipping container for damage.

If your shipping container appears to be damaged, keep the shipping container or cushioning material until you have inspected the contents of the shipment for completeness and have checked the oscilloscope mechanically and electrically.

- ✓ Verify that you received the following items and any optional accessories you may have ordered:

- InfiniiVision Oscilloscope
- Front-panel cover (all models except 6000L Series)
- Power cord (country of origin determines specific type)
- Oscilloscope probes
 - Two probes for 2-channel models
 - Four probes for 4-channel models
- CD-ROM containing:
 - User's Guide
 - Service Guide
 - Programmer's Guide
- Automation-Ready Software CD-ROM
- Accessory pouch (7000 Series only)
- Digital probe kit P/N 54620-68701 (MSO Models only)
- Power Supply P/N 0950-4866 (6000 Option BAT only)
- LAN Crossover Cable 5061-0701 (6000L Series only)
- GPIB cable extender P/N 5183-0803 (6000L Series only)
- 50 ohm feedthrough termination adapter, Qty. 4, P/N 0960-0301 (DSO6014L only)

5000 Series Oscilloscope Package Contents

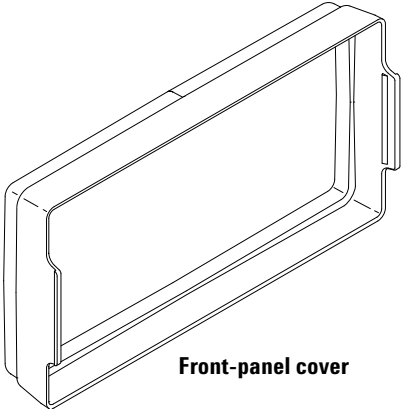

Front-panel cover

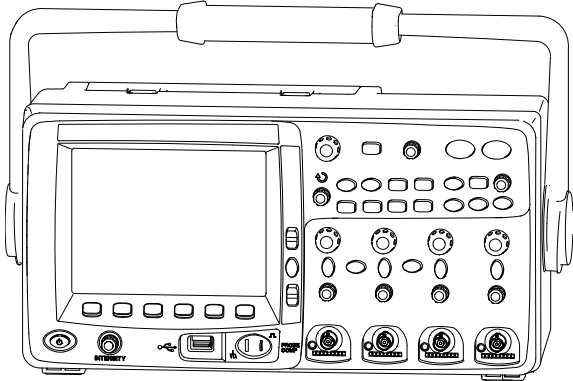

InfiniiVision 5000 Series Oscilloscope

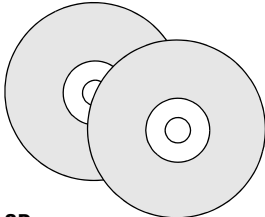

Documentation CD

Automation-Ready CD



Oscilloscope probes
N2863A or 10073C
(Qty 2 or 4)

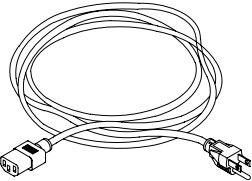

Power cord
(Based on country of origin)

6000A Series Oscilloscope Package Contents

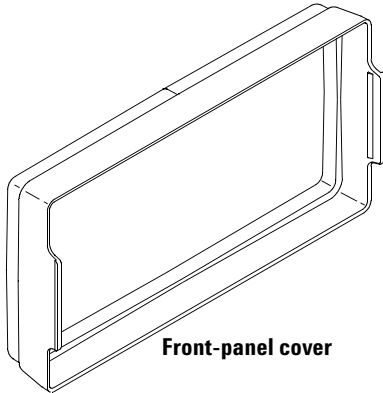

Front-panel cover

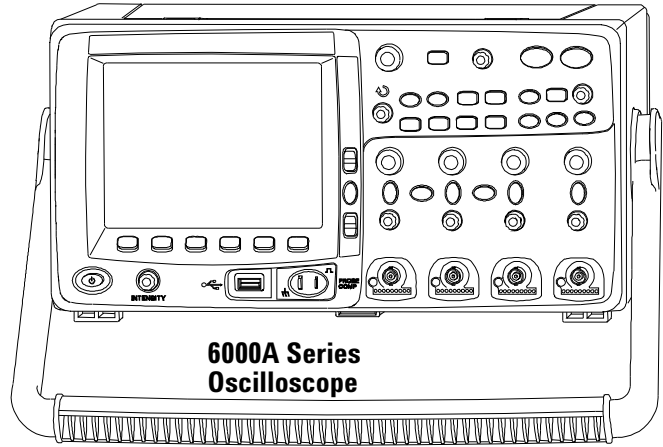

6000A Series
Oscilloscope

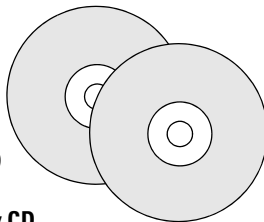

Documentation CD

Automation-Ready CD

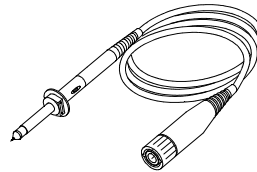

Oscilloscope probes
10073C or 10074C
(Qty 2 or 4)

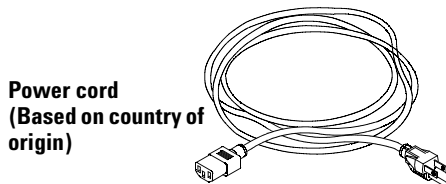

Power cord
(Based on country of
origin)

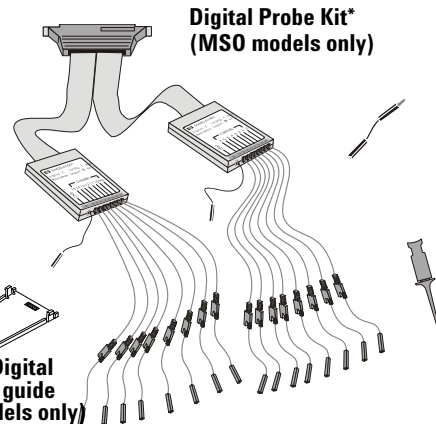

Digital Probe Kit*
(MSO models only)

- *Digital Probe Kit contains:
- 54620-61801 16-channel cable (qty 1)
 - 5959-9334 2-inch probe ground leads (qty 5)
 - 5090-4833 Grabber (qty 20)

Digital probe replacement parts are listed on [page 389](#)

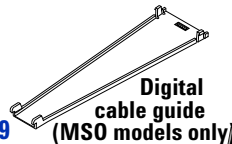

Digital
cable guide
(MSO models only)

6000A Option BAT Oscilloscope Package Contents

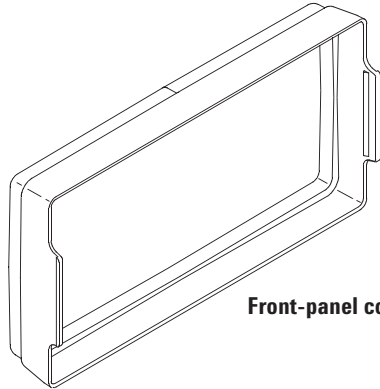

Front-panel cover

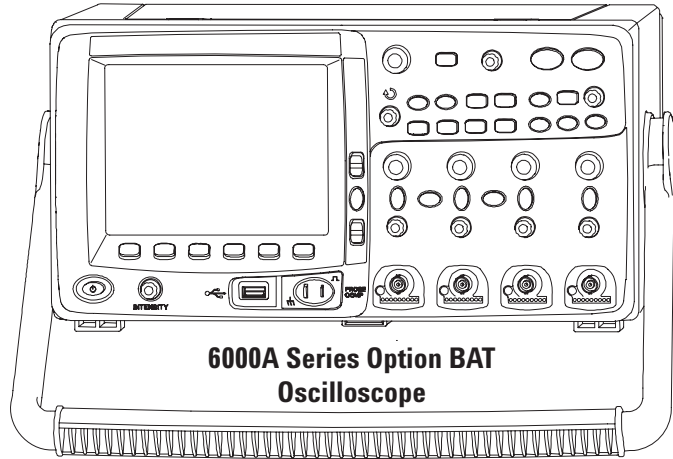

6000A Series Option BAT
Oscilloscope

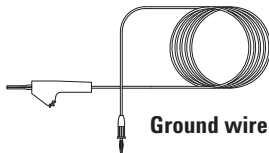

Ground wire

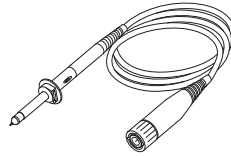

Oscilloscope probes
10073C or 10074C
(Qty 2 or 4)

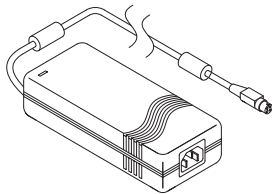

AC/DC power adapter

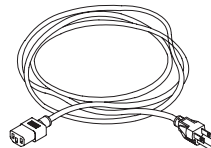

Power cord
(see Power Cords
table)

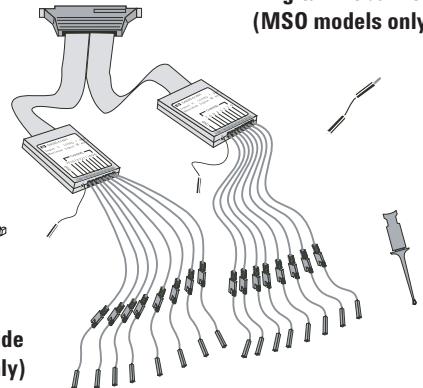

Digital Probe Kit*
(MSO models only)

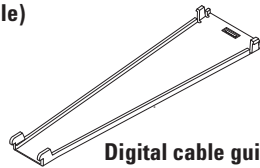

Digital cable guide
(MSO models only)

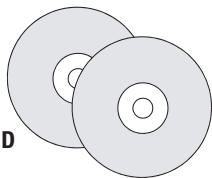

Documentation CD

Automation-Ready CD

*Digital Probe Kit contains:
54620-61801 16-channel cable (qty 1)
5959-9334 2-inch probe ground leads (qty 5)
5090-4833 Grabber (qty 20)

Digital probe replacement parts are listed on [page 389](#)

6000L Series Oscilloscope Package Contents

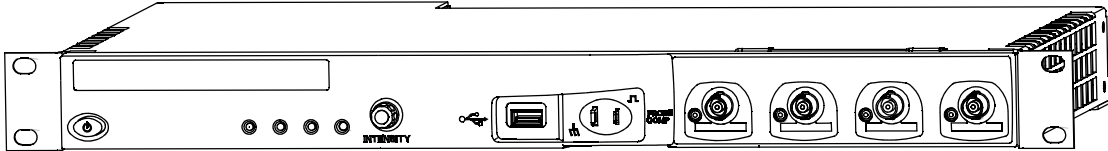

6000L Series Oscilloscope



**50 ohm feedthrough
termination adapter**
P/N 0960-0301, Qty. 4

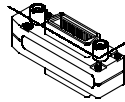

GPIB cable extender
P/N 5183-0803

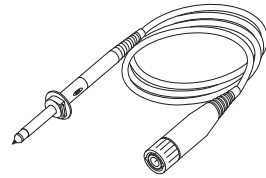

Oscilloscope Probes
10073C or 10074C
Qty. 4

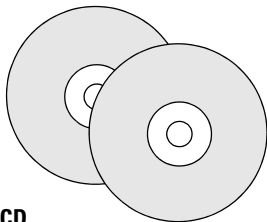

Documentation CD
Automation-Ready CD

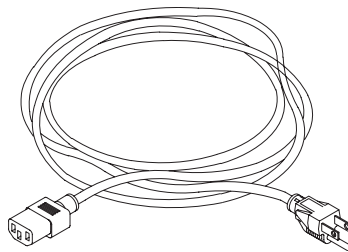

Power cord
(Based on country of
origin)

Rack Mount Kit
(not shown)

7000A Series Oscilloscope Package Contents

Front-panel cover and
accessory pouch
(not shown)

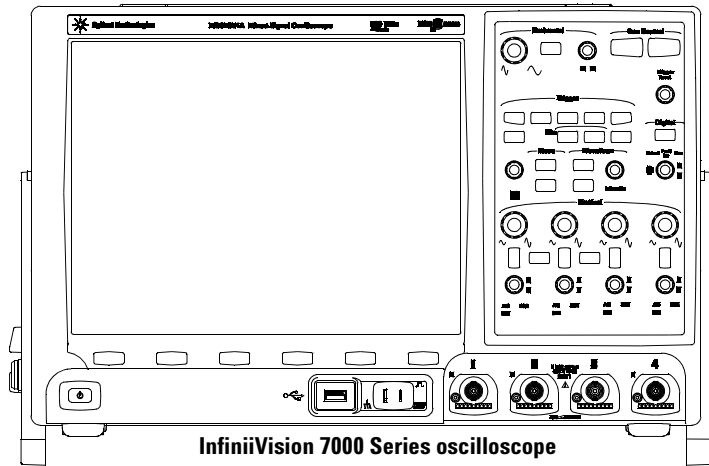

Documentation CD

Automation-Ready CD

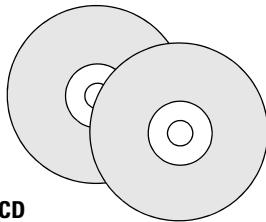

Power cord
(Based on country
of origin)

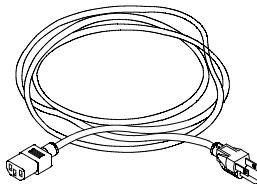

*Digital Probe Kit contains:

- 54620-61801 16-channel cable (qty 1)
- 5959-9334 2-inch probe ground leads (qty 5)
- 5090-4833 Grabber (qty 20)

Digital probe replacement parts are listed on [page 389](#).

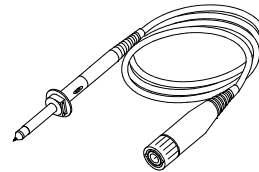

10073C or 1165A
probes
(Qty 2 or 4)

Digital Probe Kit*
(MSO models only)

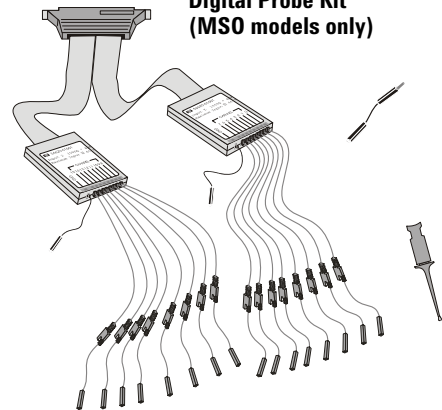

Accessories Available

Model	Description
N2918A	6000/7000 Series Oscilloscope Evaluation Kit
N2916B	5000/6000 Series Oscilloscope Rackmount Kit
N2732A	7000 Series Oscilloscope Rackmount Kit
54684-44101	5000/6000 Front Panel Cover
54913-44101	7000 Front-Panel Cover
various	Front Panel Overlays - see page 40 , page 41 , page 42 .
N2760A	5000 Soft Carrying Case
N2717B	5000 Transit Case
N2733A	7000 Soft Carrying Case
N2734A	Transit Case
1180CZ	Testmobile Oscilloscope Cart for 6000 Series (requires N2919A adapter kit)
N2919A	Testmobile Adapter kit for 6000 Series oscilloscopes
N2605A-097	USB Cable
10833A	GPIB Cable (5000 and 6000 models only)
5061-0701	LAN Crossover Cable
54620-68701	Digital Probe Kit (standard with MSO models)
54684-42301	Digital Probe Cable Guide (cable tray) 6000 models only
01650-61607	Logic Cable and Terminator (use with 40-pin logic analyzer accessories)
0960-0301	50-Ohm Termination Feedthrough (only for 6000 Series 100 MHz models)
10070C	Passive Probe, 1:1 20 MHz, 1.5 m
10074C	Passive Probe, 10:1, 150 MHz, 1.5 m
10073C	Passive Probe, 10:1, 500 MHz, 1.5 m
1165A	Passive Probe, 10:1, 600 MHz, 1.5 m
10076A	Passive Probe, 100:1, 4 kV, 250 MHz
N2863A	Passive Probe, 10:1, 300 MHz, 1.2 m
N2771A	Passive Probe, 1000:1, 30 kV, 50 MHz
N2790A	High-Voltage Differential probe, 50:1 or 500:1 (switchable), 100 MHz
N2786A	2-legged Probe Positioner
N2784A	1-arm Probe Positioner
N2785A	2-arm Probe Positioner
N2880A	InfiniiMax In-line Attenuator kit, pair of 6 dB, 12 dB, and 20 dB attenuators in kit, to be used with InfiniiMax probe amplifiers and heads
N2881A	InfiniiMax DC blocking caps (qty 2), withstand up to 30 V dc, to be used with InfiniiMax probe amplifiers and heads
N2882A	75 ohm-to-50 ohm adapter, dc to 8 GHz bandwidth, 5.7 dB attenuation

Model	Description
W2637A	LPDDR BGA probe, x16, 404 MHz, 100 ohm input impedance
W2638A	LPDDR BGA probe, x32, 404 MHz, 100 ohm input impedance
W2639A	Oscilloscope Adapter Board, 1.5 GHz, 75 ohm input impedance
N5450A	InfiniiMax Extreme Temperature Extension Cables, to be used with InfiniiMax probe amplifiers and heads, 92 cm (36 in)
N2791A	Differential probe, 1 MOhm termination, 10:1 or 100:1 (switchable), 25 MHz
N2792A	Differential probe, 50 Ohm termination, 10:1, 200 MHz, compatible with all InfiniiVision models except 6000 Series 100 MHz models (MSO/DSO601x)
N2793A	Differential probe, 50 Ohm termination, 10:1, 800 MHz, compatible with all InfiniiVision models except 6000 Series 100 MHz models (MSO/DSO601x)
1156A	Active Probe, 1.5 GHz
1144A	Active Probe, 800 MHz (requires 1142A – power supply)
1145A [†]	Active Probe, 750 MHz 2-ch (requires 1142A – power supply)
1130A [†]	For active differential probes: 1.5 GHz InfiniiMax amplifier (requires one or more InfiniiMax probe head – E2675A, E2668A, E2669A).
N2772A	Active Differential Probe, 20 MHz, 1.2 kVDC + peak AC max (requires N2773A power supply)
1141A	Active Differential Probe, 200 MHz, 200 VDC + peak AC max (requires 1142A power supply)
1146A	Current Probe, 100 kHz, 100 A, AC/DC
1147A [†]	Current Probe, 50 MHz, 30 A, AC/DC with AutoProbe interface
N2780A	Current Probe, 2 MHz, 500 A, AC/DC (use with N2779A power supply)
N2781A	Current Probe, 10 MHz, 150 A, AC/DC (use with N2779A power supply)
N2782A	Current Probe, 50 MHz, 30 A, AC/DC (use with N2779A power supply)
N2783A	Current Probe, 100 MHz, 30 A, AC/DC (use with N2779A power supply)
10072A	Fine-Pitch Probe Kit
10075A	0.5 mm IC Clip Kit
10076A	100:1, 4 kV 250 MHz Probe
E2613B	0.5 mm Wedge Probe Adapter, 3-signal, qty 2
E2614A	0.5 mm Wedge Probe Adapter, 8-signal, qty 1
E2615B	0.65 mm Wedge Probe Adapter, 3-signal, qty 2
E2616A	0.65 mm Wedge Probe Adapter, 8-signal, qty 1
E2643A	0.5 mm Wedge Probe Adapter, 16-signal, qty 1
E2644A	0.65 mm Wedge Probe Adapter, 16-signal, qty 1

[†]Indicates a maximum of two of this model probe can be connected to each oscilloscope due to AutoProbe interface current supply limitation. See also “**Passive Probes**” on page 73 and “**Active Probes**” on page 74.

You can find these items at www.agilent.com or at www.parts.agilent.com.

For information on more probes and accessories see “5989-6162EN *Probes and Accessories Selection Guide*” and “5968-8153EN *5000 and 6000 Series Oscilloscope Probes and Accessories Data Sheet*,” available at www.agilent.com.

Tilt the oscilloscope up for easy viewing

The oscilloscope can be tilted up for easier viewing.

To tilt the 5000 Series oscilloscope up for easy viewing

The oscilloscope’s handle affects the tilt. The handle can be locked in one of three positions:

- up, for carrying
- back, so the handle is out of the way
- down, so the oscilloscope can be tilted back for easy viewing when the oscilloscope is on the floor and you are standing above it.

- 1 To rotate the handle, grasp the handle hubs on each side of the instrument and pull the hubs out until they stop.

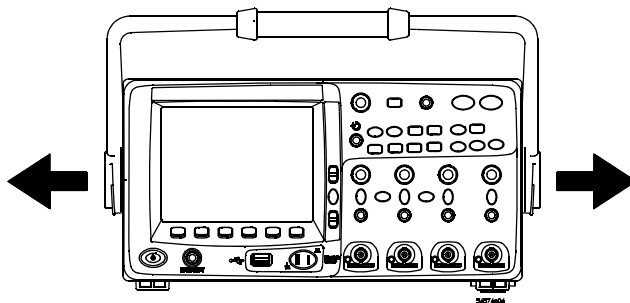

- 2 Without releasing the hubs, rotate the handle to the desired position. Then release the hubs. Continue rotating the handle until it clicks into a set position.

The tilt tabs (underneath the oscilloscope) can be positioned as shown in the center picture below. The handle can be used as a stand when placing the oscilloscope on a floor, as shown in the picture on the right.

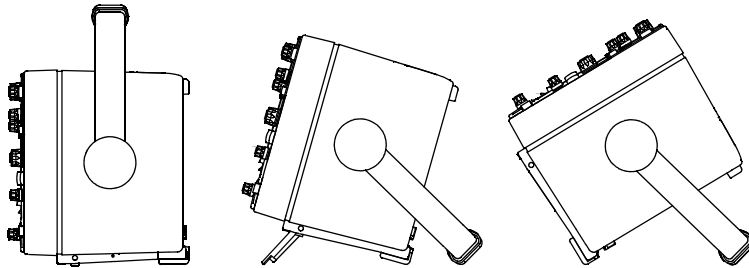

To tilt the 6000 Series oscilloscope up for easy viewing

You can use the oscilloscope's handle for carrying the instrument, or you can use it as a stand to tilt the instrument up for easier viewing of its display.

- 1 Grasp the handle hubs on each side of the instrument and pull the hubs out until they stop.

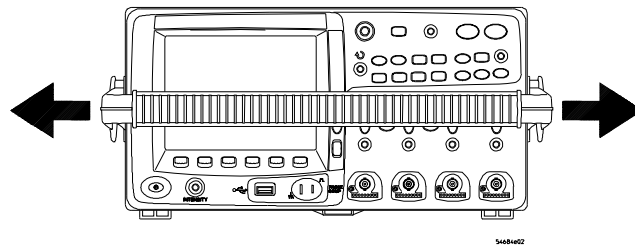

5484e02

2 Initial Setup

- 2 Without releasing the hubs, rotate the handle to the desired position. Then release the hubs. Continue rotating the handle until it clicks into a set position.

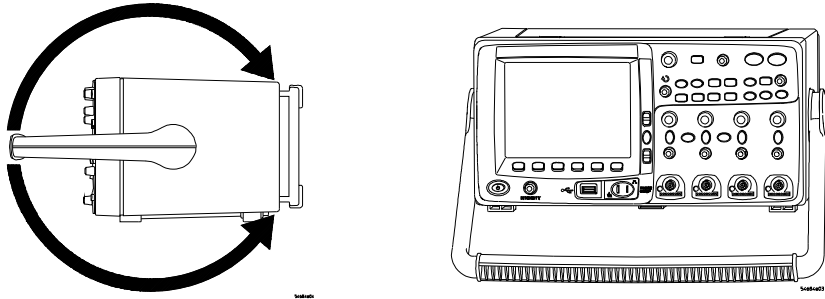

To tilt the 7000 Series oscilloscope up for easy viewing

- 1 Tilt the oscilloscope forward. Rotate the foot down and toward the rear of the oscilloscope. The foot will lock into place.



- 2 Repeat for the other foot.

- 3 Rock the oscilloscope back so that it rests securely on its feet.



To retract the feet

- 1 Tilt the oscilloscope forward. Press the foot release button and rotate the foot up and toward the front of the oscilloscope.
- 2 Repeat for the other foot.

To install the optional front panel overlay

5000 Series Overlay

When Option AB0 (Traditional Chinese localization) or Option AB2 (Simplified Chinese localization) is chosen at time of purchase, front panel overlays with Traditional Chinese or Simplified Chinese text are provided. When Option ABJ (Japanese localization) is ordered, a Japanese front panel overlay is provided.

Remove the protective backing to expose the adhesive, align the label with the top and left edge of the front panel, and press the overlay into place.

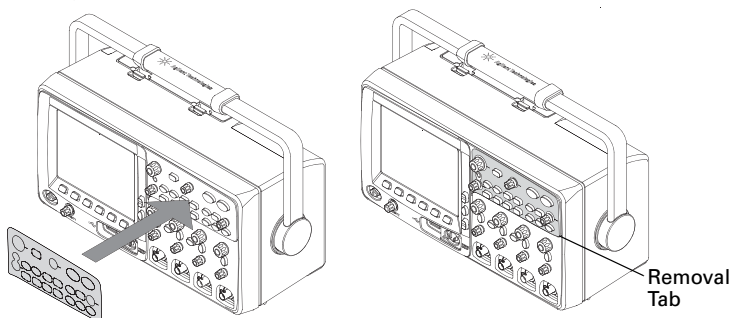

To remove the label, carefully pull it away using the tab at the lower right corner.

The overlays will be available at www.parts.agilent.com using the following part numbers:

Part number	Description
54574-94306	Overlay - Simplified Chinese
54574-94307	Overlay - Traditional Chinese
54574-94308	Overlay - Japanese

6000 Series Overlay

Large label: Remove the protective backing to expose the adhesive, align the label with the top and left edge of the front panel, and press the overlay into place.

Small Label: Remove the protective backing, and affix over existing label. Note: the cut-outs at the top of the label are for indicators on battery operated units.

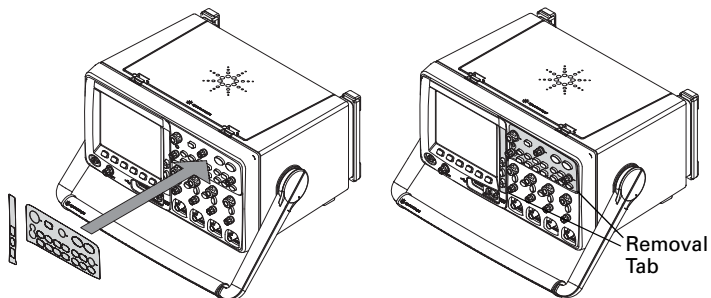

To remove the label, carefully pull it away using the tab at the lower right corner.

The overlays will be available at www.parts.agilent.com using the following part numbers:

Part number	Description
54684-94316	Overlay - Simplified Chinese
54684-94317	Overlay - Traditional Chinese
54684-94318	Overlay - Japanese

7000 Series Overlay

A front panel overlay which labels the controls is available in Simplified Chinese, Traditional Chinese, and Japanese. The overlay is included when the localization option is chosen at time of purchase.

Remove the protective backing to expose the adhesive, align the label with the top and left edge of the front panel, and press the overlay into place.

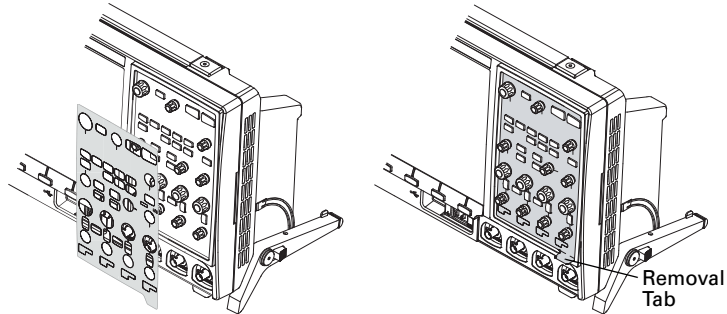

To remove the label, carefully pull it away using the tab at the lower right corner.

The overlays can also be ordered separately at www.parts.agilent.com using the following part numbers:

Part number	Description
54695-94311	2CH Overlay - Simplified Chinese
54695-94312	4CH Overlay - Simplified Chinese
54695-94313	2CH Overlay - Traditional Chinese
54695-94314	4CH Overlay - Traditional Chinese
54695-94315	2CH Overlay - Japanese
54695-94316	4CH Overlay - Japanese

To mount the oscilloscope in a rack

The InfiniiVision oscilloscopes can be mounted in an Electronic Industries Association (EIA) standard 19-inch (487-mm) rack cabinet.

To mount the 5000 or 6000 Series oscilloscope in a rack

To mount the oscilloscope in a rack, purchase and install the N2916B rack mount kit. Instructions are included in the kit. For details search for N2916B at www.agilent.com.

To mount the 6000L Series oscilloscope in a rack

The 6000L Series oscilloscope is supplied with all necessary hardware for installation into a standard EIA 19-inch rack.

RACK MOUNT HARDWARE SUPPLIED

Quantity	Description	Agilent Part Number
2	Front Extender Support	D6104-01201
2	Rear Extender Support	D6104-01202
4	Rear Extender Screw (M3 x 6 mm)	0515-0430
4	Dress Screw (10-32 x 0.0625)	0570-1577
8	Rail Screw (10-32 x 0.375)	2680-0281
12	Clip-nut (10-32)	0590-0804

TOOLS REQUIRED (NOT SUPPLIED)

- #2 Phillips screwdriver
- T20 Torx driver
- T10 Torx driver

2 Initial Setup

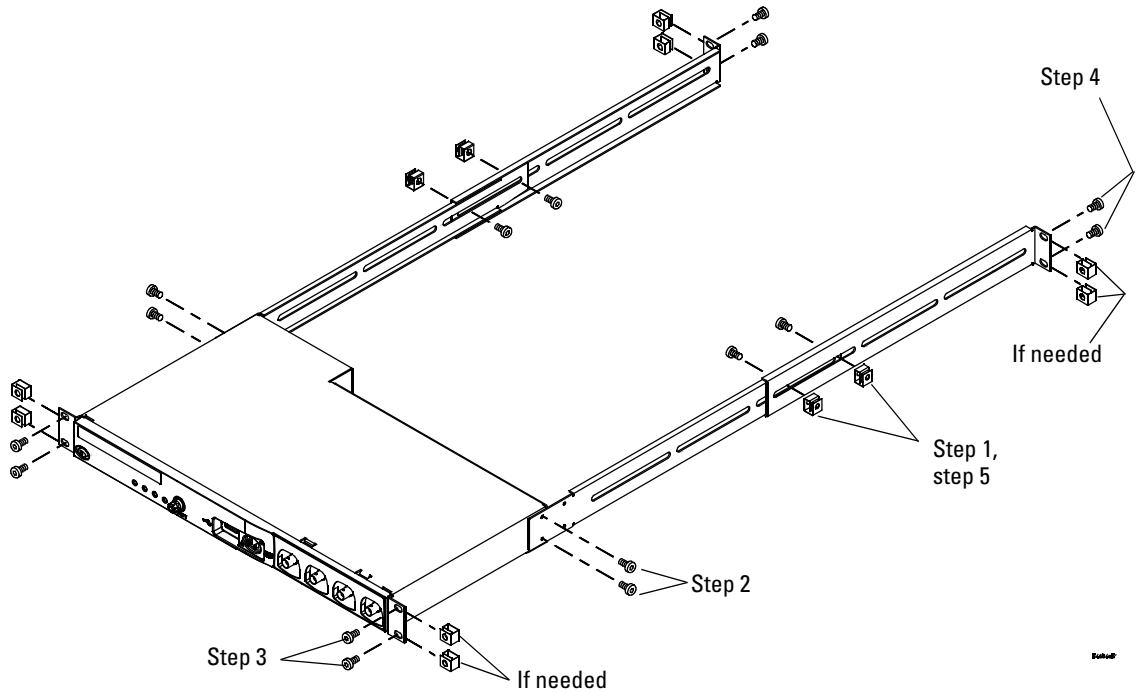

- 1** Loosely attach the Front Extender Supports to the Rear Extender Supports with four (4) clip-nuts and four (4) of the 10-32 x 0.375 Rail Screws. (The screws require a Torx T20 driver.) Choose the correct set of slots in the supports such that their overall length is approximately correct for the depth of your cabinet.
- 2** Fasten the Rack Mount Extenders to the oscilloscope chassis with the four (4) M3 x 6 mm screws, using a Torx T10 driver as follows:

NOTE

The sets of holes in the Rack Mount Extenders are slightly offset. This was done to ensure that the Rack Mount Extenders are attached to the oscilloscope at the correct points so that the oscilloscope's ventilation area is not obscured. The holes in the Rack Mount Extenders will align with the correct holes in the oscilloscope and the screws will go in easily. Do not force the screws into the wrong holes.

- a** Attach a Rack Mount Extender to the left side of the oscilloscope using two (2) of the M3 x 6 mm screws in the *inner* set of holes on the Rack Mount Extender.

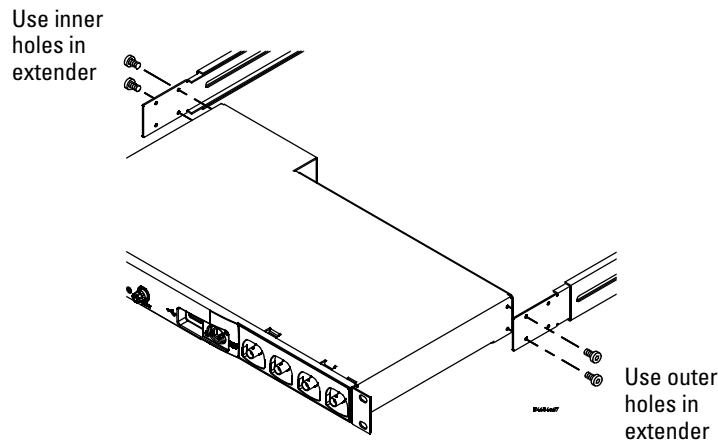

- b** Attach the other Rack Mount Extender to the right side of the oscilloscope using two (2) of the M3 x 6 mm screws in the *outer* set of holes on the rack mount extender.
- 3** Place the instrument in the rack. Install the four (4) 10-32 x 0.625 Dress Screws in the chassis front ears to secure the front of the instrument to the rack. Use the Phillips screwdriver.
- 4** Align the ears in the Rear Mount Extenders with the correct set of holes in the rear of the rack and secure the Rack Mount Extenders to the rack using the four (4) remaining 10-32 x 0.375 Rail Screws. Use the Torx T20 driver.
- 5** Securely attach the Rear Extender Supports to the Front Extender Supports by tightening the four (4) 10-32 x 0.375 Rail Screws screws that you loosely attached in [step 1](#).

2 Initial Setup

6000L Mounting Bracket Dimensions

The following information is provided in case you want to design custom mounting brackets for the 6000L. Dimensions are in mm.

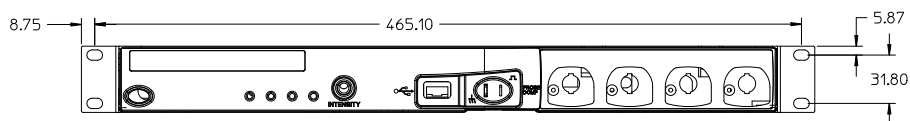
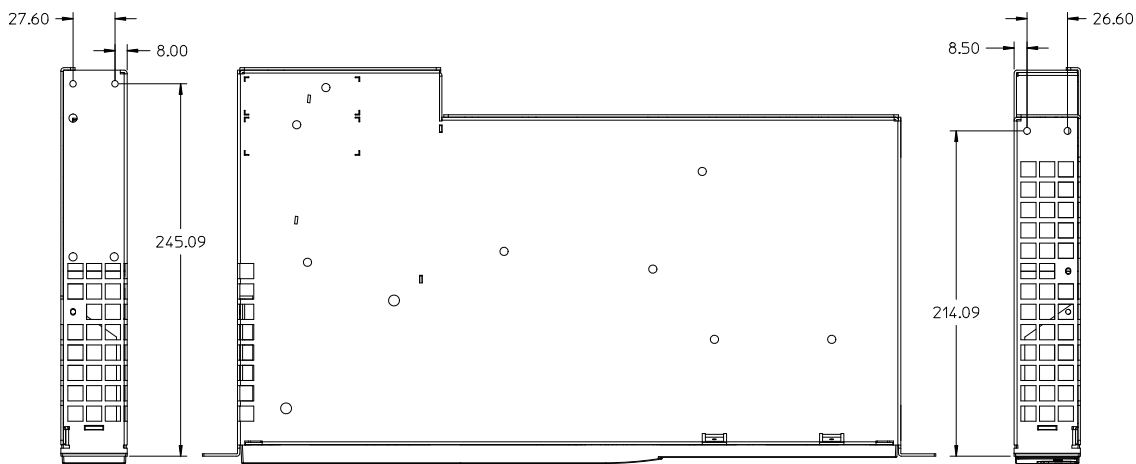

To mount the 7000 Series oscilloscope in a rack

To mount the oscilloscope in a rack, purchase and install the N2732A rack mount kit. Instructions are included in the kit. For details search for N2732A at www.agilent.com.

Ventilation Requirements

The air intake and exhaust areas must be free from obstructions. Unrestricted air flow is required for proper cooling. Always ensure that the air intake and exhaust areas are free from obstructions.

5000 and 6000A Series Ventilation Requirements

The fan draws air in from underneath the oscilloscope and pushes it out behind the oscilloscope.

When using the oscilloscope in a bench-top setting, provide at least 4" (100 mm) clearance behind and above the oscilloscope for proper cooling.

6000L Series Ventilation Requirements

The fan draws air from the left and pushes it out to the right. Ensure the rack in which the oscilloscope is mounted is properly ventilated.

7000 Series Ventilation Requirements

The fan draws air in from the sides of the oscilloscope and pushes it out behind the oscilloscope.

When using the oscilloscope in a bench-top setting, provide at least 2" clearance at the sides and 4" (100 mm) clearance above and behind the oscilloscope for proper cooling.

Power Requirements

5000, 6000A (without Option BAT), and 7000 Line voltage, frequency, and power

~Line 100-120 Vac, 50/60/400 Hz
100-240 Vac, 50/60 Hz
120 W max

6000A with Option BAT

AC power supply/charger line voltage, frequency, and power

~Line 100-240 Vac, 50/60 Hz
120 W max

6000A with Option BAT

DC input voltage and power consumption using N5429A automotive adapter

12 Vdc nominal, (10-18 Vdc)
67-75 W

External ground connection required. See warning on [page 51](#).

6000L Models Line voltage, frequency, and power

~Line 100-240 Vac, 50/60 Hz
80 W max

Power-on the 5000/6000/7000 Series Oscilloscope

- 1 Connect the power cord to the rear of the oscilloscope, then to a suitable AC voltage source. Route the power cord so the oscilloscope's feet and legs do not pinch the cord.

The oscilloscope automatically adjusts for input line voltages in the range 100 to 240 VAC. The line cord provided is matched to the country of origin.

WARNING

Always use a grounded power cord. Do not defeat the power cord ground.

- 2 Press the power switch.

The power switch is located on the lower left corner of the front panel. The oscilloscope will perform a self-test and will be operational in a few seconds.

Power-on the Battery-Powered 6000A Series Oscilloscope

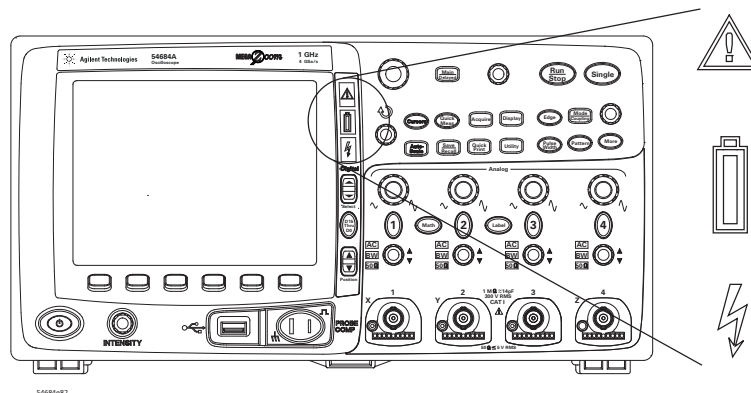

The 6000A Series Option BAT oscilloscopes are battery powered. They have additional LED indicators on the front panel:



Caution indicator. Illuminates (amber) when running on the internal battery. See **“Operating”** below.



Battery power indicator. Turns from green to red when there is 15 to 20 minutes of battery power remaining.



Charging indicator. Illuminates when the battery is charging. Turns off when the battery is fully charged or when the charger is disconnected.

The battery will last approximately 1.75 hours before requiring recharging. Operating time depends on the oscilloscope configuration.

Operating

When operating with the internal battery, the operating temperature should be in the range from -10°C to 50°C , $\leq 80\%$ relative humidity. Low temperatures temporarily reduce battery capacity.

- 1 Make sure battery is charged before use. See **“Charging the Battery”** below.

- 2 Always connect the supplied ground wire from the ground post on the back of the instrument to earth ground (even when connected to an AC or DC adapter for charging/operating the instrument).

WARNING

Maintain oscilloscope ground connection. Do not negate the protective action of the ground connection to the oscilloscope. If the circuit under test has voltages greater than 30 Vrms, the oscilloscope must be grounded through its ground post (on Option BAT models) to prevent electric shock to the user.

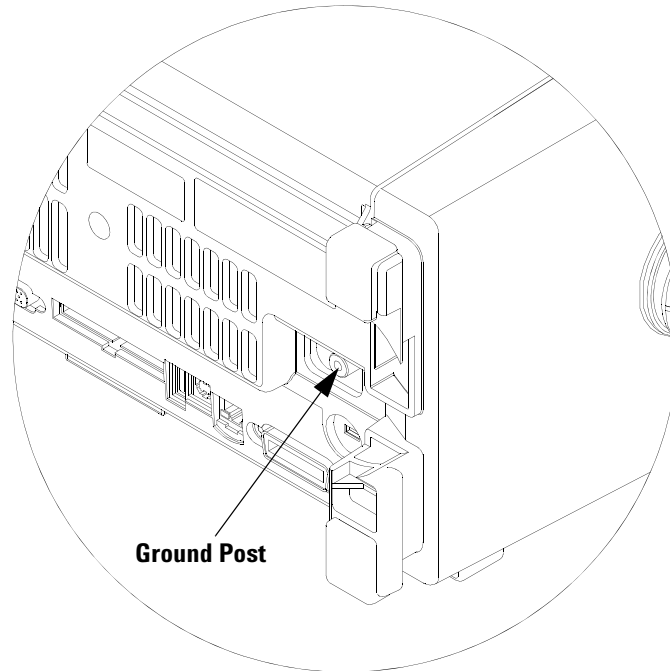

- 3 Press the power switch.

The power switch is located on the lower left corner of the front panel. Some front panel lights will come on and the oscilloscope will be operational in a few seconds.

Charging the Battery

When charging the battery, the operating temperature should be in the range from 0°C to 45°C, ≤ 80% relative humidity.

- 1 Connect the supplied AC adapter to the back of the oscilloscope, and connect the adapter's power cord to a suitable AC voltage source.

CAUTION



AC adapter for battery-powered oscilloscopes: Use only the supplied adapter. Damage to the equipment could result if an improper AC adapter is used.

You can use the oscilloscope while the battery is being charged.

NOTE

If the battery charging indicator does not light

If the battery is extremely discharged, there may not be enough charge for internal circuitry to cause the battery charging indicator LED to light. In this case, it can take up to about 20 minutes of charging before the indicator will light.

Operating with the Automotive Power Adapter Cable

The N5429A 12V DC automotive adapter cable is for charging and operating 6000A Series Option BAT battery-powered oscilloscopes.

- 1 Connect the N5429A adapter cable to the back of the oscilloscope, and connect the other end of the cable to a 12V DC automotive power source.

Battery Replacement

The battery (actually two batteries) can be replaced by a qualified technician. Refer to the service guide for replacement instructions. The service guide is available on the CD that was included with the oscilloscope at time of purchase, and at www.agilent.com/find/6000manual.

Battery Warranty

The battery is warranted for a period of one year from date of purchase.

Keys, Softkeys, and the Entry Knob

On the front panel, “key” refers to any key (button) you can press. “Softkey” specifically refers to the six keys that are directly below the display. The legend for these keys is directly above them, on the display. Their functions change as you navigate through the oscilloscope’s menus.

In this manual, instructions for pressing a series of keys are written in an abbreviated manner. Pressing the **[Utility]** key, then the **Language** softkey, then the **Help** softkey is abbreviated as follows:

Press **[Utility]**→**Language**→**Help**.

Press and hold any key or softkey to view its built-in Quick Help.

When the Entry knob  symbol appears on a softkey, you can use the Entry knob, to select values.

For easy one-handed operation of the 7000 Series oscilloscopes, the Entry knob can be pushed as well as rotated. Rotating the knob moves through selectable items, and pushing the knob implements the selection.

Six softkeys are located below the display. To understand the symbols used in the softkey menus and throughout this guide, see “[Graphic Symbols in Softkey Menus](#)” on page 176.

The Digital Channel Controls are used to select and reposition digital channel waveforms and to display the Digital Channel Menu of MSO model oscilloscopes.

NOTE

The simplest way to set up the oscilloscope is to connect it to the signals of interest and press the **[AutoScale]** key.

To find out how to use a key or connector, see “[Controls and Connectors](#)” on page 351.

Verifying Basic Oscilloscope Operation

If you have a 6000L Series oscilloscope, you need to start a Web control session, as described in [“Accessing the Web Interface”](#) on page 280.

- 1 Press the **[Save/Recall]** key on the front panel, then press the **Default Setup** softkey (**[Save/Recall]**→**Default Setup**). The oscilloscope is now configured to its default settings (configuration details on [page 392](#)).
- 2 Connect an oscilloscope probe from channel 1 to the **Probe Comp** terminal on the front panel.
- 3 Connect the probe’s ground lead to the ground terminal (next to the **Probe Comp** terminal).
- 4 Press **[AutoScale]**.
- 5 You should see a waveform on the oscilloscope’s display similar to this:

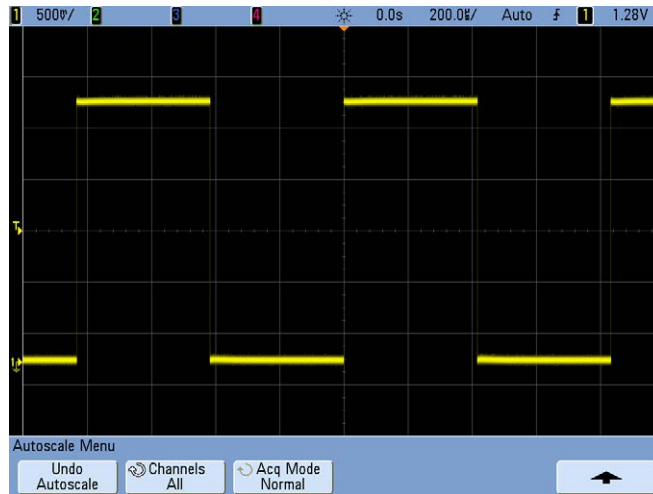

If you see the waveform, but the square wave is not shaped correctly as shown above, perform the procedure [“Compensating Passive Probes”](#) on page 77.

If you do not see the waveform, ensure your power source is adequate, the oscilloscope is powered-on, the power cord is firmly inserted into the oscilloscope receptacle, and the probe is connected securely to the front-panel oscilloscope channel input BNC and to the Probe Comp terminal.

Quick Help

To view Quick Help

- 1 Press and hold the key or softkey for which you would like to view help.

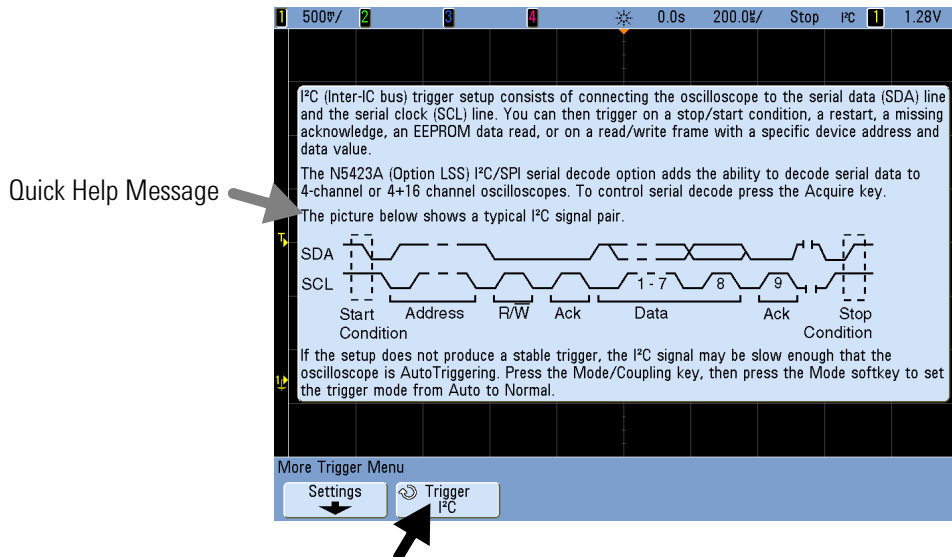

Press and Hold Front Panel Key or Softkey
(or Right-Click Softkey when using Web browser control)

By default, Quick Help remains on the screen until another key is pressed or a knob is turned. You can set Quick Help to close when you release the key. Press the **[Utility]** key, then press the **Language** softkey, then press the **Help Close on Release/Remain on Screen** softkey (**[Utility]**→**Language**→**Help**).

To view Quick Help on 6000L Series oscilloscopes

Start a Web browser control session as described on **“Accessing the Web Interface”** on page 280 and select Remote Front Panel. To view Quick Help information, right-click on the softkey. Help is not available for front panel keys; only softkeys.

Quick Help Languages

To choose a Quick Help language in the oscilloscope:

- 1 Press **[Utility]**, then press the **Language** softkey.
- 2 Repeatedly press and release the **Language** softkey or rotate the Entry knob until the desired language is selected.

Graphical User Interface Languages

When Quick Help is set to one of the following languages, the Graphical User Interface (GUI) will be displayed in the language chosen.

- Simplified Chinese
- Traditional Chinese
- Japanese
- Korean

Quick Help Updates

Updated Quick Help may be made available. To download new Quick Help and GUI language files:

- 1 Direct your web browser to:
www.agilent.com/find/6000sw (for 5000 and 6000 models)
www.agilent.com/find/7000sw (for 7000 models)
- 2 Select **Quick Help Language Support** and follow the directions.

To set the clock

The Clock Menu lets you set the current date and time of day (24-hour format). This time/date stamp will appear on hardcopy prints and directory information on the USB mass storage device.

To set the date and time, or to view the current date and time:

- 1 Press [Utility]→Options→Clock.

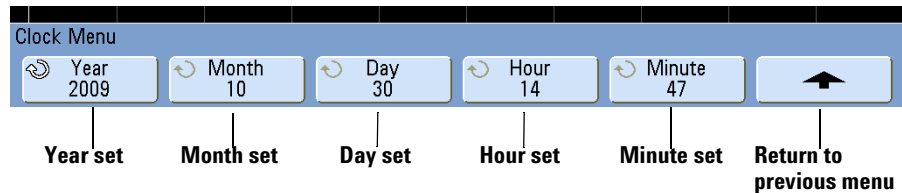

- 2 Press the **Year**, **Month**, **Day**, **Hour** or **Minute** softkey and rotate the Entry knob to set to the desired number.

The hours are shown in the 24-hour format. So 1:00 PM is hour 13.

The real-time clock only allows selection of valid dates. If a day is selected and the month or year is changed so the day is invalid, the day is automatically adjusted.

To set up the screen saver

The oscilloscope can be configured to turn on a display screen saver when the oscilloscope has been idle for a specified length of time.

- 1 Press **[Utility]**→**Options**→**Preferences**→**Screen Saver** to display the Screen Saver Menu.

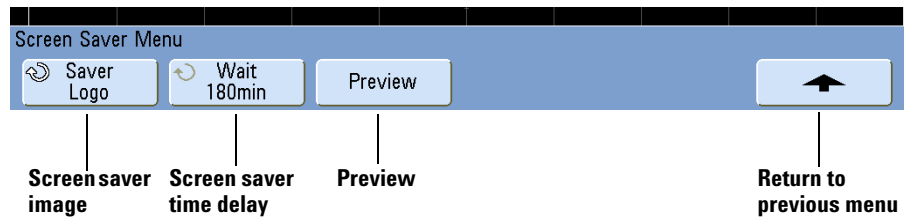

- 2 Press the **Saver** softkey to select the screen saver type.

The screen saver can be set to **Off**, to display any of the images shown in the list, or can display a user-defined text string.

If **User** is selected, press the **Spell** softkey to select the first character of the text string. Use the Entry knob to choose a character. Then press the **Enter** softkey to advance to the next character and repeat the process. The resultant string is displayed in the “**Text =**” line above the softkeys.

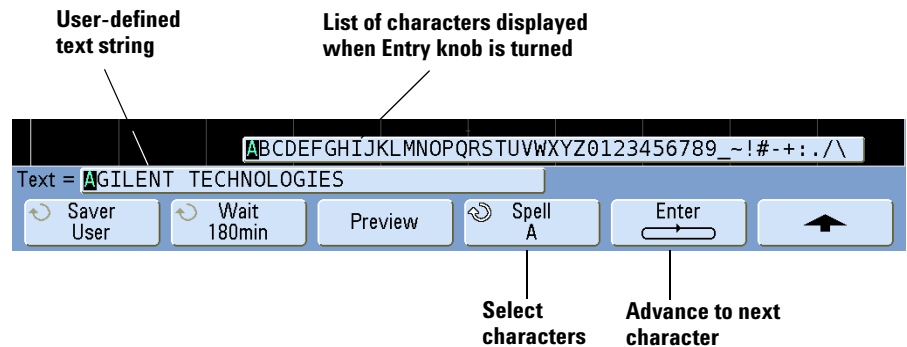

- 3 Turn the Entry knob to select the number of minutes to wait before the selected screen saver activates.

When you turn the Entry knob, the number of minutes is displayed in the **Wait** softkey. The default time is 180 minutes (3 hours).

- 4 Press the **Preview** softkey to preview the screen saver you have selected with the **Saver** softkey.
- 5 To view the normal display after the screen saver has started, press any key or turn any knob.

Using the Analog Channels

- 1 Connect the oscilloscope probes for channels 1 and 2 to the Probe Comp output on the front panel of the instrument.
- 2 Press the [1] key in the Analog section of the oscilloscope's front panel to display the Channel 1 Menu.

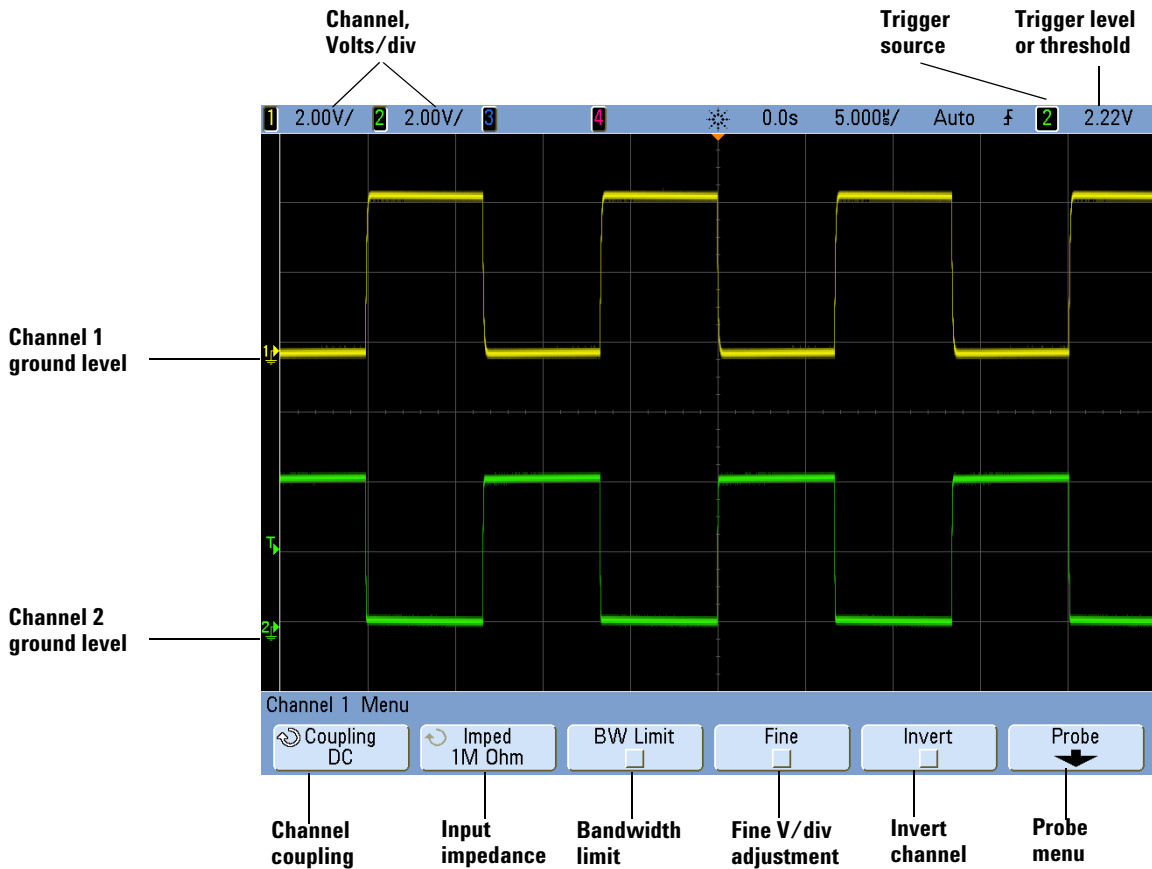

Pressing an analog channel key displays the channel's menu and turns the display of the channel on or off. The channel is displayed when the key is illuminated.

Turning channels off

You must be viewing the menu for a channel before you can turn it off. For example, if channel 1 and channel 2 are turned on and the menu for channel 2 is being displayed, to turn channel 1 off, press **[1]** to display channel 1 menu, then press **[1]** again to turn channel 1 off.

Vertical sensitivity Turn the large knob above the channel key marked $\sim \nabla$ to set the sensitivity (volts/division) for the channel. The vertical sensitivity knob changes the analog channel sensitivity in a 1-2-5 step sequence (with a 1:1 probe attached). The analog channel Volts/Div value is displayed in the status line.

Fine Press the **Fine** softkey to turn on fine control V/div adjustment (vernier) for the selected channel. When Fine is selected, you can change the channel's vertical sensitivity in smaller increments. The channel sensitivity remains fully calibrated when Fine is on. The V/div value is displayed in the status line at the top of the display.

When Fine is turned off, turning the volts/division knob changes the channel sensitivity in a 1-2-5 step sequence.

Vertical expansion The default mode for expanding the signal when you turn the volts/division knob is vertical expansion about the ground level of the channel. To set the expansion mode to expand about the center of the screen instead, press **Expand** in the User Preferences Menu (**[Utility]**→**Options**→**Preferences**) and select **Center**.

Ground level The ground level of the signal for each displayed analog channel is identified by the position of the ∇ icon at the far-left side of the display.

Vertical position Turn the small vertical position knob (\blacklozenge) to move the channel's waveform up or down on the display. The voltage value momentarily displayed in the upper right portion of the display represents the voltage difference between the vertical center of the display and the ground level (∇) icon. It also represents the voltage at the vertical center of the display if vertical expansion is set to expand about ground.

Channel Coupling and Input Impedance Selection

Measurement Hints

If the channel is DC coupled, you can quickly measure the DC component of the signal by simply noting its distance from the ground symbol.

If the channel is AC coupled, the DC component of the signal is removed, allowing you to use greater sensitivity to display the AC component of the signal.

- 3 Press the channel's on/off key, then press the **Coupling** softkey to select the input channel coupling.

Coupling changes the channel's input coupling to either **AC** (alternating current) or **DC** (direct current). AC coupling places a 3.5 Hz high-pass filter in series with the input waveform that removes any DC offset voltage from the waveform. When **AC** is selected, "AC" is illuminated on the front panel next to the channel position knob (◆).

- DC coupling is useful for viewing waveforms as low as 0 Hz that do not have large DC offsets.
- AC coupling is useful for viewing waveforms with large DC offsets. When AC coupling is chosen, you cannot select 50Ω mode. This is done to prevent damage to the oscilloscope.

Note that Channel Coupling is independent of Trigger Coupling. To change trigger coupling see [page 87](#).

- 4 Press the **Imped** (impedance) softkey.

NOTE

When you connect an AutoProbe, self-sensing probe, or a compatible InfiniiMax probe, the oscilloscope will automatically configure the oscilloscope to the correct impedance.

The analog channel input impedance can be set to either **1M Ohm** or **50 Ohm** by pressing the **Imped** softkey.

- **50 Ohm** mode matches 50-ohm cables commonly used in making high frequency measurements, and 50-ohm active probes. This impedance matching gives you the most accurate measurements since reflections are minimized along the signal path. When **50 Ohm** is selected, "50Ω" is illuminated on the front panel next to the channel position knob. The oscilloscope automatically switches to **1 M Ohm** mode to prevent possible damage if AC coupling is selected.

- **1M Ohm** mode is for use with many passive probes and for general-purpose measurements. The higher impedance minimizes the loading effect of the oscilloscope on the device under test.

5 Press the **BW Limit** softkey to turn on bandwidth limiting.

Pressing the **BW Limit** softkey turns the bandwidth limit on or off for the selected channel. When bandwidth limit is on, the maximum bandwidth for the channel is approximately 25 MHz. For waveforms with frequencies below this, turning bandwidth limit on removes unwanted high frequency noise from the waveform. The bandwidth limit also limits the trigger signal path of any channel that has **BW Limit** turned on.

When **BW Limit** is selected, “BW” is illuminated on the front panel next to the channel position knob (◆).

6 Press the **Invert** softkey to invert the selected channel.

When Invert is selected, the voltage values of the displayed waveform are inverted. Invert affects how a channel is displayed, but does not affect triggering. If the oscilloscope is set to trigger on a rising edge, it remains set to trigger on a same edge (triggers at the same point on the waveform) after the channel is inverted.

Inverting a channel will also change the result of any function selected in the Waveform Math Menu or any measurement.

7 Press the **Probe** softkey to display the Channel Probe Menu.

This menu lets you select additional probe parameters such as attenuation factor and units of measurement for the connected probe.

Probe calibration not needed, not available when this softkey is ghosted.

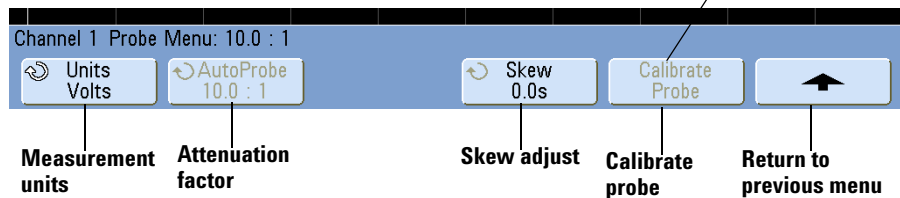

- **Probe Units** — Press the **Units** softkey to select the proper measurement unit for the connected probe. Select **Volts** for a voltage probe and select **Amps** for a current probe. Channel sensitivity, trigger level, measurement results, and math functions will reflect the measurement units you have selected.

- **Probe Attenuation Factor**— This is set automatically if the oscilloscope can identify the connected probe. See “**AutoProbe Interface**” on page 72 and “**Manually Setting the Probe Attenuation Factor**” on page 80.
- **Skew** — When measuring time intervals in the ns range, small differences in cable length can affect the measurement. Use **Skew** to remove cable-delay errors between any two channels.

Probe the same point with both probes, then press **Skew** and turn the Entry knob to enter the amount of skew between channels. Each analog channel can be adjusted ± 100 ns in 10 ps increments for a total of 200 ns difference.

The skew setting is not affected by pressing [**Save/Recall**]→**Default Setup** or by pressing [**Auto Scale**].

- **Calibrate Probe** — See “**Calibrating Probes**” on page 78.

To set up the Horizontal time base

- 1 Press the **[Menu/Zoom]** key (or **[Main/Delayed]** key on some oscilloscopes) in the Horizontal section of the front panel.

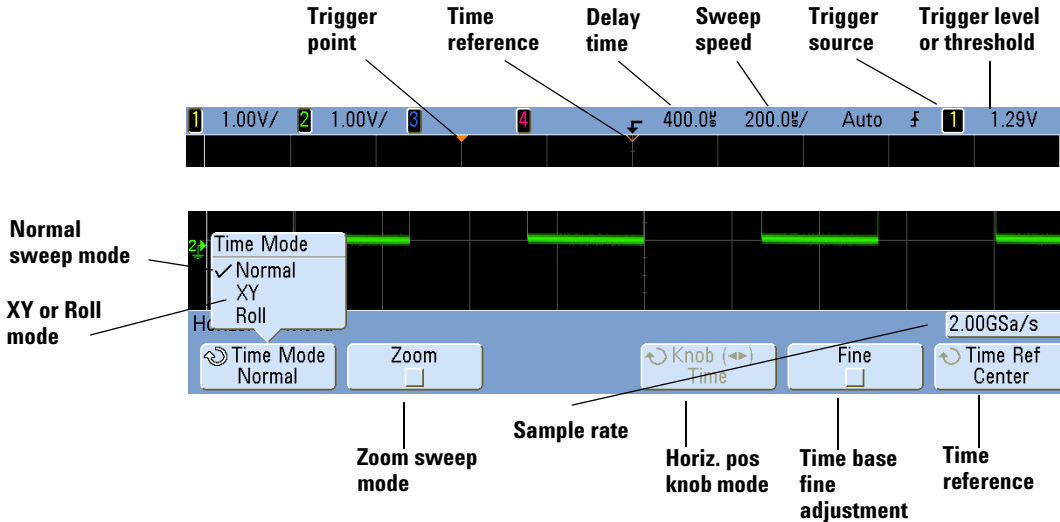

The Horizontal Menu lets you select the horizontal mode (Normal, Zoom, XY, or Roll), and set the time base fine adjustment and time reference.

The current sample rate is displayed above the **Fine** and **Time Ref** softkeys.

Normal mode

- 1 Press the **Normal** softkey to select Normal horizontal mode.

Normal horizontal mode is the normal viewing mode for the oscilloscope. When the oscilloscope is stopped, you can use the Horizontal knobs to pan and zoom the waveform.

- 2 Turn the large knob (time/division) in the Horizontal section and notice the change it makes to the status line.

When the oscilloscope is running in Normal mode, use the large Horizontal knob marked \sim to change sweep speed and use the small knob marked \blacktriangleleft to set the delay time (horizontal position). When the oscilloscope is stopped, use these knobs to pan and zoom your waveform. The sweep speed (seconds/division) value is displayed in the status line.

3 Press the **Fine** softkey to turn on the time base fine adjustment.

The **Fine** softkey lets you change the sweep speed in smaller increments with the time/division knob. The sweep speed remains fully calibrated when Fine is on. The value is displayed in the status line at the top of the display.

When Fine is turned off, the Horizontal sweep speed knob changes the time base sweep speed in a 1-2-5 step sequence.

4 Note the setting of the **Time Ref** (time reference) softkey.

Time reference is the reference point on the display for delay time (horizontal position). The time reference can be set to one major division from the left or right edge, or to the center of the display.

A small hollow triangle (∇) at the top of the display grid marks the position of the time reference. When delay time is set to zero, the trigger point indicator (\blacktriangledown) overlays the time reference indicator.

Turning the Horizontal sweep speed knob will expand or contract the waveform about the time reference point (∇). Turning the Horizontal position ($\blacktriangleleft\blacktriangleright$) knob in Normal mode will move the trigger point indicator (\blacktriangledown) to the left or right of the time reference point (∇).

The time reference position sets the initial position of the trigger event within acquisition memory and on the display, with delay set to 0. The delay setting sets the specific location of the trigger event with respect to the time reference position. The time reference setting affects the Zoom sweep as described in the following ways:

- When the horizontal mode is set to Normal, the delay knob positions the normal sweep relative to the trigger. This delay is a fixed number. Changing this delay value does not affect the sweep speed.
- When the horizontal mode is set to Zoom, the delay knob controls the position of the zoom sweep window inside the normal sweep display. This delay value is independent of sampling interval and sweep speed. Changing this delay value does not effect the position of the normal window.

5 Turn the delay knob ($\blacktriangleleft\blacktriangleright$) and notice that its value is displayed in the status line.

The delay knob moves the normal sweep horizontally, and it pauses at 0.00 s, mimicking a mechanical detent. Changing the delay time moves the sweep horizontally and indicates how far the trigger point (solid inverted triangle) is from the time reference point (hollow inverted triangle ∇). These reference points are indicated along the top of the display grid. The previous figure shows the trigger point with the

delay time set to 400 μs . The delay time number tells you how far the time reference point is located from the trigger point. When delay time is set to zero, the delay time indicator overlays the time reference indicator.

All events displayed left of the trigger point happened before the trigger occurred, and these events are called pre-trigger information. You will find this feature very useful because you can now see the events that led up to the trigger point. Everything to the right of the trigger point is called post-trigger information. The amount of delay range (pre-trigger and post-trigger information) available depends on the sweep speed selected and memory depth.

Zoom mode

Zoom, formerly called Delayed sweep mode, is a horizontally expanded version of normal display. When Zoom is selected, the display divides in half and the Zoom mode  icon is displayed in the middle of the line at the top of the display. The top half of the display shows the normal sweep and the bottom half displays the Zoom sweep.

The Zoom window is a magnified portion of the normal sweep. You can use Zoom to locate and horizontally expand part of the normal sweep for a more detailed (higher-resolution) analysis of signals.

The following steps show you how to use Zoom.

- 1 Connect a signal to the oscilloscope and obtain a stable display.
- 2 Press the **[Menu/Zoom]** key (or **[Main/Delayed]** key on some oscilloscopes).
- 3 Press the **Zoom** softkey.

To change the sweep speed for the Zoom window, turn the horizontal sweep speed control knob. As you turn the knob, the sweep speed is highlighted in the status line above the waveform display area.

The area of the normal display that is expanded is outlined with a box and the rest of the normal display is lightened. The box shows the portion of the normal sweep that is expanded in the lower half. The Horizontal Sweep Speed controls the size of the box and the Horizontal Position (delay time) control sets the left-to-right position of the zoom sweep. The delay value, which is the time being displayed relative to the trigger point) is momentarily displayed in the upper-right portion of the display when the delay time () knob is turned. Negative delay values indicate you're looking at a portion of the waveform before the trigger event, and positive values indicate you're looking at the waveform after the trigger event.

To change the sweep speed for the normal sweep window, press the **Normal** softkey, then turn the sweep speed knob.

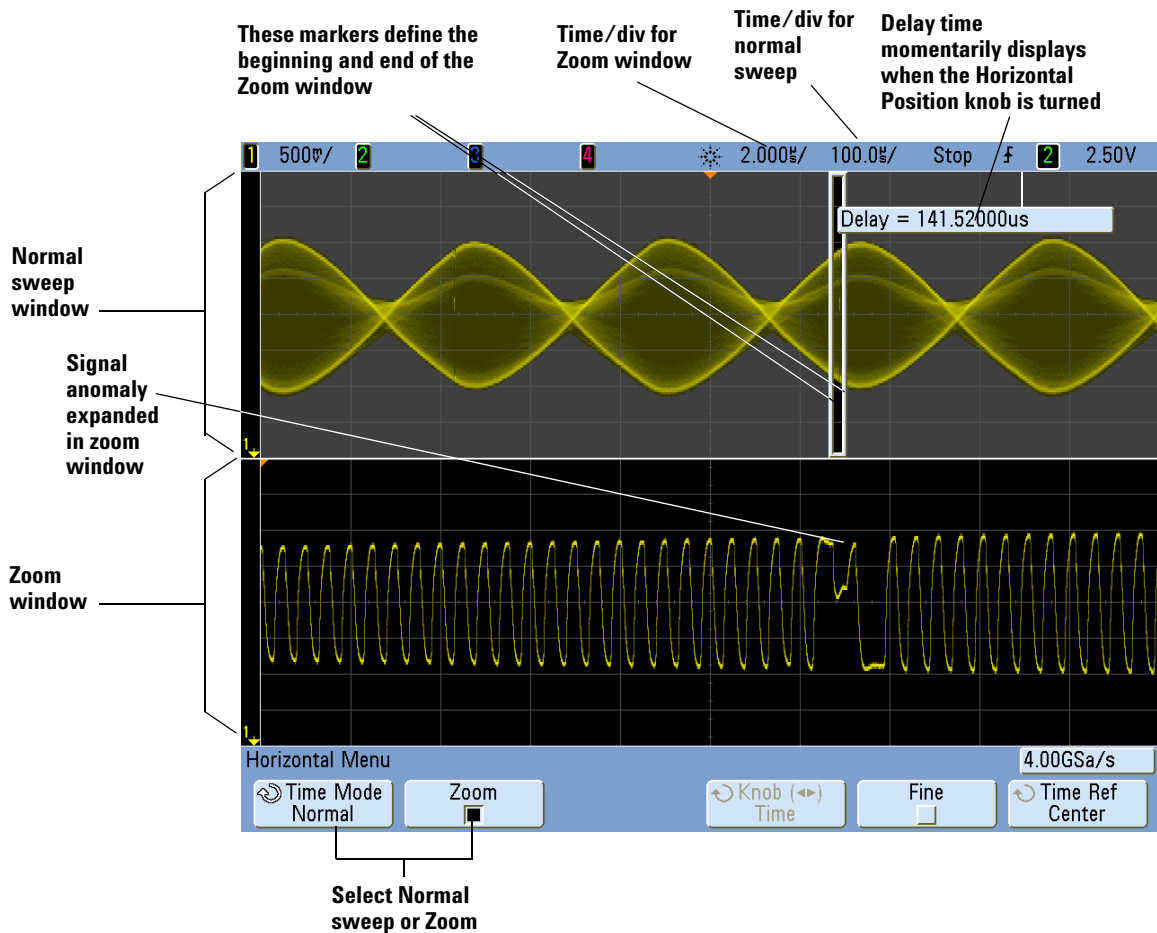

When the horizontal mode is set to Normal, the horizontal position control (delay control) positions the normal sweep relative to the trigger. This delay is a fixed number. Changing this delay value does not affect the sweep speed. When the horizontal mode is set to Zoom, the delay controls the position of the zoom sweep window inside the normal sweep display. This delay value is independent of sampling interval and sweep speed.

To change the sweep speed for the normal sweep window, press the **Normal** softkey, then turn the sweep speed knob.

To specify the measurement window for Zoom mode When the zoomed time base is displayed, you can specify whether the upper, Main window or the lower, Zoom window is used as the measurement window.

- 1 Press **[Utility] > Options > Preferences > More**.
- 2 Press **Window** to select from these measurement window options:
 - **Auto Select** – The measurement is attempted in the lower, Zoom window; if it cannot be made there, the upper, Main window is used.
 - **Main** – The measurement window is the upper, Main window.
 - **Zoom** – The measurement window is the lower, Zoom window.

For information about using zoom mode for measurements, refer to [Chapter 6](#), “Measurements and Math Functions,” starting on page 191.

Roll mode

- Press the **[Menu/Zoom]** key (or **[Main/Delayed]** key on some oscilloscopes), then press the **XY** or **Roll** softkey to select “Roll”.
- Roll mode causes the waveform to move slowly across the screen from right to left. It only operates on time base settings of 500 ms/div and slower. If the current time base setting is faster than the 500 ms/div limit, it will be set to 500 ms/div when Roll mode is entered.
- In Normal horizontal mode, signal events occurring before the trigger are plotted to the left of the trigger point (t) and signal events after the trigger plotted to the right of the trigger point.
- In Roll mode there is no trigger. The fixed reference point on the screen is the right edge of the screen and refers to the current moment in time. Events that have occurred are scrolled to the left of the reference point. Since there is no trigger, no pre-trigger information is available.

If you would like to pause the display in Roll mode press the **[Single]** key. To clear the display and restart an acquisition in Roll mode, press the **[Single]** key again.

Use Roll mode on low-frequency waveforms to yield a display much like a strip chart recorder. It allows the waveform to roll across the display.

XY mode

XY mode changes the display from a volts-versus-time display to a volts-versus-volts display. The time base is turned off. Channel 1 amplitude is plotted on the X-axis and Channel 2 amplitude is plotted on the Y-axis.

You can use XY mode to compare frequency and phase relationships between two signals. XY mode can also be used with transducers to display strain versus displacement, flow versus pressure, volts versus current, or voltage versus frequency.

Use the cursors to make measurements on XY mode waveforms.

For more information about using XY mode for measurements, refer to [“XY Horizontal Mode”](#) on page 220.

Z-Axis Input in XY Display Mode (Blanking)

When you select the XY display mode, the time base is turned off. Channel 1 is the X-axis input, channel 2 is the Y-axis input, and channel 4 (or the External trigger on 2-channel models) is the Z-axis input. If you only want to see portions of the Y versus X display, use the Z-axis input. Z-axis turns the trace on and off (analog oscilloscopes called this Z-axis blanking because it turned the beam on and off). When Z is low (<1.4 V), Y versus X is displayed; when Z is high (>1.4 V), the trace is turned off.

Knob softkey

The “Knob ◀▶” softkey is used in conjunction with Segmented Memory. You can set the Horizontal Position knob to adjust the horizontal position or move between segments. See [“Segmented Memory”](#) on page 271.

2 Initial Setup



3 Connecting to the Device Under Test

Analog Input Impedance (50 Ohm or 1 MOhm)	72
AutoProbe Interface	72
Passive Probes	73
Active Probes	74
Active Probes for 6000 Series 100 MHz Bandwidth Models	75
Connect the Probes to the Oscilloscope	75
Compensating Passive Probes	77
Calibrating Probes	78
Manually Setting the Probe Attenuation Factor	80
Digital Probes	80

This chapter explains how to connect the oscilloscope to your device under test (DUT) using probes.



Analog Input Impedance (50 Ohm or 1 MOhm)

The input impedance of most InfiniiVision oscilloscope analog channels can be set to either 50 Ω or 1 M Ω . (The input impedance of 6000 Series 100 MHz bandwidth models is fixed at 1 M Ω .) The 50 Ω mode matches 50 Ω cables and many active probes commonly used in making high frequency measurements. This impedance matching gives you the most accurate measurements because reflections are minimized along the signal path. The 1 M Ω impedance is commonly required for use with most passive probes.

If you would like to connect to the oscilloscope using 50 ohm BNC cables instead, select the 50 ohm input impedance mode.

For instructions on setting the input impedance, see “[Channel Coupling and Input Impedance Selection](#)” on page 61.

For more information on probing, visit www.agilent.com/find/scope_probes

Information about selecting a probe can be found in document number 5989-6162EN: *Agilent Oscilloscope Probes and Accessories Selection Guide*, available at www.agilent.com.

AutoProbe Interface

The AutoProbe interface uses a series of contacts directly below the channel’s BNC connector to transfer information between the oscilloscope and the probe. When you connect a compatible probe to the oscilloscope, the AutoProbe interface determines the type of probe and sets the oscilloscope’s parameters (units, offset, attenuation, coupling, and impedance) accordingly.

Passive Probes

All InfiniiVision oscilloscopes recognize passive probes such as the 10073C, 10074C and 1165A. These probes have a pin on their connector that connects to the ring around the oscilloscope's BNC connector. Therefore, the oscilloscope will automatically set the attenuation factor for recognized Agilent passive probes.

Passive probes that do not have a pin that connects to the ring around the BNC connector will not be recognized by the oscilloscope, and you must set the probe attenuation factor manually. See [page 80](#).

The following passive probes can be used with the InfiniiVision oscilloscopes. Any combination of passive probes can be used.

PASSIVE PROBES

Passive Probes	Quantity Supported
1165A Passive probe, 10:1, 600 MHz, 1.5 m	4
10070C Passive probe, 1:1 20 MHz, 1.5 m	4
10073C Passive probe, 10:1, 500 MHz, 1.5 m	4
10074C Passive probe, 10:1, 150 MHz, 1.5 m	4
10076A Passive probe, 100:1, 4 kV, 250 MHz	4
N2863A Passive probe, 10:1, 300 MHz, 1.2 m	4

Active Probes

Most Agilent active probes are compatible with the AutoProbe interface. Active probes that do not have their own external power supply require substantial power from the AutoProbe interface. “Quantity Supported” indicates the maximum number of each type of active probe that can be connected to the oscilloscope. If too much current is drawn from the AutoProbe interface, an error message will be displayed, indicating that you must momentarily disconnect all probes to reset the AutoProbe interface, then connect only the supported quantity of active probes.

ACTIVE PROBES

Active Probes	Quantity Supported
1130A 1.5 GHz InfiniiMax amplifier, requires one or more InfiniiMax probe heads: E2675A, E2668A, E2669A	2
1131A InfiniiMax 3.5 GHz Probe	2
1132A InfiniiMax 5 GHz Probe	2
1134A InfiniiMax 7 GHz Probe	2
1141A Differential Probe, 200 MHz, with 1142A power supply	4
1144A Active Probe, 800 MHz, with 1142A power supply	4
1145A 2-Channel, 750 MHz Active Probe, with 1142A power supply	2
1147A 50 MHz/15A AC/DC Current Probe	2
1156A 1.5 GHz Active Probe	4
1157A 2.5 GHz Active Probe	4
1158A 4 GHz Active Probe	4
N2772A Differential Probe, 20 MHz, with N2773A power supply	4
N2774A (obsolete, replaced by N2782A) with N2775A power supply	4
N2782A 50 MHz/30Arms AC/DC Current Probe, with N2779A power supply	4

Active Probes for 6000 Series 100 MHz Bandwidth Models

The following active probes use their own power supply. Therefore, they can be used on all 6000 Series oscilloscopes, including the 100 MHz bandwidth models.

Many active probes have a 50 Ω output impedance. The input impedance of 6000 Series 100 MHz bandwidth models is fixed at 1 M Ω . When connecting these probes to 6000 Series 100 MHz bandwidth models, a 50 Ω feedthrough terminator (such as Agilent part number 0960-0301 is required).

ACTIVE PROBES FOR ALL 6000 SERIES OSCILLOSCOPES

Active Probes	Quantity Supported
1141A with 1142A power supply	4
1144A with 1142A power supply	4
1145A with 1142A power supply	2
N2772A with N2773A power supply	4
N2774A with N2775A power supply	4

Connect the Probes to the Oscilloscope

- 1 Connect the oscilloscope probe to an oscilloscope channel BNC connector.
- 2 Connect the probe's retractable hook tip to the point of interest on the circuit or device under test. Be sure to connect the probe ground lead to a ground point on the circuit.

3 Connecting to the Device Under Test

CAUTION



Maximum input voltage at analog inputs:

CAT I 300 Vrms, 400 Vpk; transient overvoltage 1.6 kVpk

CAT II 100 Vrms, 400 Vpk

50 Ω input: 5 Vrms

Input protection is enabled in 50 Ω mode and the 50 Ω load will disconnect if greater than 5 Vrms is detected. However the inputs could still be damaged, depending on the time constant of the signal. The 50 Ω input protection only functions when the oscilloscope is powered on.

1 M ohm input, 100 MHz models:

For steady-state sinusoidal waveforms derate at 20 dB/decade above 200 kHz to a minimum of 10 Vpk

1 M ohm input, 350 MHz, 500 MHz, 1 GHz models:

For steady-state sinusoidal waveforms derate at 20 dB/decade above 57 kHz to a minimum of 5 Vpk

With N2863A 10:1 probe: CAT I 600 V, CAT II 300 V (DC + peak AC)

With 10073C or 10074C 10:1 probe: CAT I 500 Vpk, CAT II 400 Vpk

CAUTION



Do not float the oscilloscope chassis: Defeating the ground connection and “floating” the oscilloscope chassis will probably result in inaccurate measurements and may also cause equipment damage. The probe ground lead is connected to the oscilloscope chassis and the ground wire in the power cord. If you need to measure between two live points, use a differential probe with sufficient dynamic range.

WARNING

Do not negate the protective action of the ground connection to the oscilloscope. The oscilloscope must remain grounded through its power cord or, on Option BAT models, through its ground post. Defeating the ground creates an electric shock hazard.

Compensating Passive Probes

Each oscilloscope passive probe must be compensated to match the input characteristics of the oscilloscope channel to which it is connected. A poorly compensated probe can introduce significant measurement errors.

- 1 Perform the procedure “**Verifying Basic Oscilloscope Operation**” on page 54.
- 2 Use a nonmetallic tool (supplied with the probe) to adjust the trimmer capacitor on the probe for the flattest pulse possible. The trimmer capacitor is located on the probe BNC connector.

Perfectly compensated

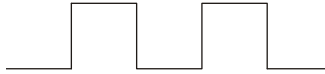

Over compensated



Under compensated



- 3 Connect probes to all other oscilloscope channels (channel 2 of a 2-channel oscilloscope, or channels 2, 3, and 4 of a 4-channel oscilloscope). Repeat the procedure for each channel.

Calibrating Probes

Some probes, such as the 10073C, 10074C, and 1165A passive probes, do not require calibration. When one of these probes is connected, the **Calibrate Probe** softkey in the Channel Probe Menu is grayed-out (displayed in faint text).

However, for certain active probes, such as InfiniiMax probes, the oscilloscope can accurately calibrate its analog channels for the probe. When you connect a probe that can be calibrated, the **Calibrate Probe** softkey in the Channel Probe Menu becomes active. To calibrate one of these probes:

- 1 First, plug your probe into one of the oscilloscope channels.

This could be, for example, an InfiniiMax probe amplifier/probe head with attenuators attached.

- 2 Connect the probe to the Probe Comp terminal, and the probe ground to the Probe Comp ground terminal.

NOTE

When calibrating a differential probe, connect the positive lead to the Probe Comp terminal and the negative lead to the Probe Comp ground terminal. You may need to connect an alligator clip to the ground lug to allow a differential probe to span between the Probe Comp test point and ground. A good ground connection ensures the most accurate probe calibration.

- 3 Press the Channel on/off key to turn the channel on (if the channel is off).
- 4 In the Channel Menu, press the **Probe** softkey.
- 5 In the Channel Probe Menu, the second softkey from the left is for specifying your probe head (and attenuation). Repeatedly press this softkey until the probe head selection matches the attenuator you are using.

The choices are:

- 10:1 single-ended browser (no attenuator)
- 10:1 differential browser (no attenuator)
- 10:1 (+6 dB Atten) single-ended browser
- 10:1 (+6 dB Atten) differential browser
- 10:1 (+12 dB Atten) single-ended browser
- 10:1 (+12 dB Atten) differential browser

- 10:1 (+20 dB Atten) single-ended browser
- 10:1 (+20 dB Atten) differential browser

6 Press the **Calibrate Probe** softkey and follow the instructions on the display.

For more information on InfiniiMax probes and accessories, see the probe's *User's Guide*.

Manually Setting the Probe Attenuation Factor

The probe attenuation factor must be set properly for accurate measurement results.

If you connect a probe that is not automatically identified by the oscilloscope, you can manually set the attenuation factor as follows:

- 1 Press the channel key.
- 2 Press the **Probe** softkey until you have selected how you want to specify the attenuation factor, choosing either **Ratio** or **Decibels**.
- 3 Turn the Entry knob  to set the attenuation factor for the connected probe.

When measuring voltage values, the attenuation factor can be set from 0.1:1 to 1000:1 in a 1-2-5 sequence.

When measuring current values with a current probe, the attenuation factor can be set from 10 V/A to 0.001 V/A.

When specifying the attenuation factor in decibels, you can select values from -20 dB to 60 dB.

If Amps is chosen as the units and a manual attenuation factor is chosen, then the units as well as the attenuation factor are displayed above the Probe softkey.

Units and Attenuation Factor



Digital Probes

Please see [“To connect the digital probes to the device under test”](#) on page 372 for information about digital probing.

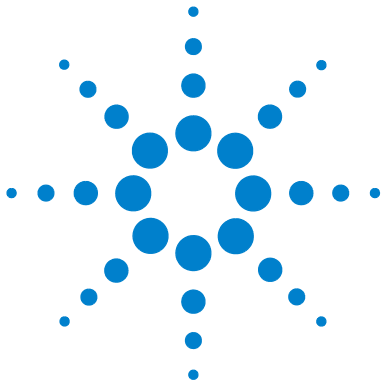

4 Triggering

Triggering - General Information	83
Trigger Mode and Coupling Menu	84
Auto and Normal Trigger modes	84
Trigger Level Adjustment	86
Trigger Coupling	87
Trigger Noise Rejection	87
Trigger Holdoff	90
External Trigger Input	92
Trigger Output	95
Trigger Types	96
CAN Trigger	98
Duration Trigger	102
Edge Trigger	105
FlexRay Setup and Triggering	107
Glitch or Narrow Pulse Capture	112
I2C Trigger	115
I2S Trigger	121
LIN Trigger	128
MIL-STD 1553 Setup and Triggering	131
Nth Edge Burst Trigger	135
Pattern Trigger	137
Pulse Width Trigger	140
Sequence Trigger	143
SPI Trigger	150
TV Trigger	156
UART/RS232 Trigger	166
USB Trigger	170



4 Triggering

This chapter provides instructions for setting up triggers for various signal types. Setups can be saved if desired (see [“Saving Oscilloscope Data”](#) on page 247).

The easiest way to trigger on a waveform is to use AutoScale. Simply press the **[AutoScale]** key and the oscilloscope will attempt to trigger on the waveform using a simple Edge Trigger type. For AutoScale details see [“AutoScale”](#) on page 177.

Complex waveforms may require specific trigger setups as described in this chapter.

Triggering - General Information

A triggered waveform is one in which the oscilloscope begins tracing (displaying) the waveform, from the left side of the display to the right, each time a particular trigger condition is met. This provides stable display of periodic signals such as sine waves and square waves, as well as nonperiodic signals such as serial data streams.

The figure below shows the conceptual representation of acquisition memory. You can think of the trigger event as dividing acquisition memory into a pre-trigger and post-trigger buffer. The position of the trigger event in acquisition memory is defined by the time reference point and the delay (horizontal position) setting (see [page 64](#)).

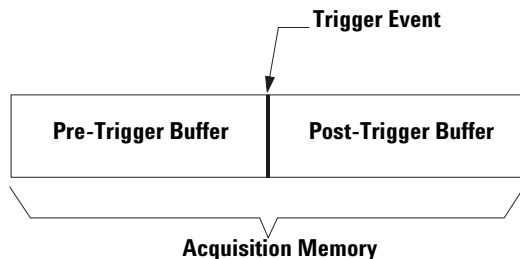

Agilent InfiniiVision oscilloscopes provide a full set of features to help automate your measurement tasks. MegaZoom technology lets you capture and examine triggered or untriggered waveforms. You can:

- Modify the way the oscilloscope acquires data.
- Set up simple or complex trigger conditions as needed, to capture only the sequence of events you want to examine.

NOTE

Adding options such as the Low Speed Serial (LSS) or Automotive Serial (AMS) serial decode feature to the oscilloscope will add more trigger features to the relevant trigger types (I²C and SPI, or CAN and LIN). Adding option FRS (FlexRay serial decode) will add the FlexRay triggers.

- See also: [“Segmented Memory”](#) on page 271

Trigger Mode and Coupling Menu

- Press the **[Mode/Coupling]** key in the Trigger section of the front panel.

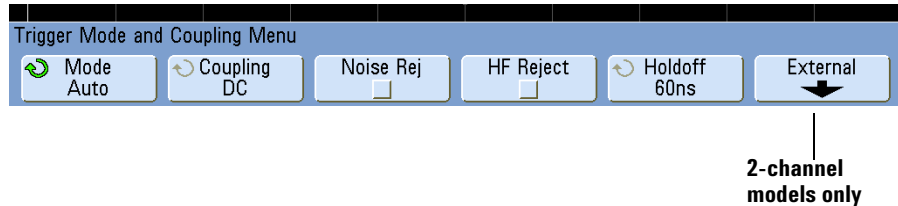

Auto and Normal Trigger modes

Choosing Auto Trigger Mode or Normal Trigger Mode

If you press **[Run]** when the oscilloscope is in Normal trigger mode, a trigger must be detected before an acquisition can complete. No waveform will be displayed unless the trigger condition is met.

In Auto trigger mode, the oscilloscope automatically triggers and captures waveforms when you press **[Run]**.

In many cases, a triggered display is not needed to check signal levels or activity. For these applications, use Auto trigger mode (which is the default setting). If you only want to acquire specific events as specified by the trigger settings, use Normal trigger mode.

In some cases, such as when triggering on a slow serial signal (for example, I²C, SPI, CAN, LIN, etc.) it may be necessary to select the Normal trigger mode to stabilize the display by preventing the oscilloscope from Auto-triggering.

You can select the trigger mode by pressing the **[Mode/Coupling]** key, then the **Mode** softkey.

- 1 Press the **[Mode/Coupling]** key.
- 2 Press the **Mode** softkey, then select **Normal** or **Auto**.
 - **Normal** — displays a waveform when the trigger conditions are met, otherwise the oscilloscope does not trigger and the display is not updated.
 - **Auto** — is the same as Normal mode, except it forces the oscilloscope to trigger if the trigger conditions are not met.

Auto Mode

Use the auto trigger modes for signals other than low-repetitive-rate signals and for unknown signal levels. To display a DC signal, you must use auto trigger mode since there are no edges on which to trigger.

When you select [**Run**], the oscilloscope operates by first filling the pre-trigger buffer. It starts searching for a trigger after the pre-trigger buffer is filled, and continues to flow data through this buffer while it searches for the trigger. While searching for the trigger, the oscilloscope overflows the pre-trigger buffer; the first data put into the buffer is the first pushed out (FIFO). When a trigger is found, the pre-trigger buffer will contain the events that occurred just before the trigger. If no trigger is found, the oscilloscope generates a trigger and displays the data as though a trigger had occurred. In this case, the background of the **Auto** indicator at the top of the display will flash, and the **Auto** indicator will change to **Auto?** indicating that the oscilloscope is forcing triggers.

When you press the [**Single**] key, the oscilloscope will fill pre-trigger buffer memory, and continue flowing data through the pre-trigger buffer until the auto trigger overrides the searching and forces a trigger. At the end of the trace, the oscilloscope will stop and display the results.

Normal Mode

Use Normal trigger mode for low repetitive-rate signals or when Auto trigger is not required.

In Normal mode the oscilloscope must fill the pre-trigger buffer with data before it will begin searching for a trigger event. The trigger mode indicator on the status line flashes **Trig'd?** to indicate the oscilloscope is filling the pre-trigger buffer. While searching for the trigger, the oscilloscope overflows the pre-trigger buffer; the first data put into the buffer is the first pushed out (FIFO).

When the trigger event is found, the oscilloscope will fill the post-trigger buffer and display the acquisition memory. The trigger mode indicator on the status line indicates **Trig'd** (not flashing). If the acquisition was initiated by [**Run/Stop**], the process repeats. If the acquisition was initiated by pressing [**Single**], then the acquisition stops and you can Pan and Zoom the waveform.

In either Auto or Normal mode, the trigger may be missed completely under certain conditions. This is because the oscilloscope will not recognize a trigger event until the pre-trigger buffer is full. Suppose you set the Time/Div knob to a slow sweep speed, such as 500 ms/div. If the trigger condition occurs before the oscilloscope has filled the

4 Triggering

pre-trigger buffer, the trigger will not be found. If you use Normal mode and wait for the trigger condition indicator to flash before causing the action in the circuit, the oscilloscope will always find the trigger condition.

Some measurements you want to make will require you to take some action in the device under test to cause the trigger event. Usually, these are single-shot acquisitions, where you will use the **[Single]** key.

Trigger Level Adjustment

You can adjust the trigger level for a selected analog channel by turning the Trigger Level knob. The position of the trigger level for the analog channel is indicated by the trigger level icon **T▶** (if the analog channel is on) at the far left side of the display when DC coupling is selected. The value of the analog channel trigger level is displayed in the upper-right corner of the display.

The trigger level for a selected digital channel is set using the threshold menu in the Digital Channel Menu. Press the **[D15-D0]** key on the front panel, then press the **Thresholds** softkey to set the threshold level (TTL, CMOS, ECL, or user defined) for the selected digital channel group. The threshold value is displayed in the upper-right corner of the display.

The line trigger level is not adjustable. This trigger is synchronized with the power line supplied to the oscilloscope.

Trigger Coupling

- 1 Press the **[Mode/Coupling]** key.
- 2 Press the **Coupling** softkey, then select **DC**, **AC**, or **LF Reject** coupling.
 - **DC** coupling allows DC and AC signals into the trigger path.
 - **AC** coupling places a 10 Hz high-pass filter in the trigger path removing any DC offset voltage from the trigger waveform. The high-pass filter in the External Trigger input path is 3.5 Hz for all models. Use AC coupling to get a stable edge trigger when your waveform has a large DC offset.
 - **LF (low frequency) Reject** coupling places a 50 kHz high-pass filter in series with the trigger waveform. Low frequency reject removes any unwanted low frequency components from a trigger waveform, such as power line frequencies, that can interfere with proper triggering. Use this coupling to get a stable edge trigger when your waveform has low frequency noise.
 - **TV** coupling is normally grayed-out, but is automatically selected when TV trigger is enabled in the Trigger More Menu.

Note that Trigger Coupling is independent of Channel Coupling. To change Channel Coupling see [page 61](#).

Trigger Noise Rejection

If the signal you are probing is noisy, you can set up the oscilloscope to reduce the noise on the displayed waveform. First, stabilize the displayed waveform by removing the noise from the trigger path. Second, reduce the noise on the displayed waveform.

- 1 Connect a signal to the oscilloscope and obtain a stable display.
- 2 Remove the noise from the trigger path by turning on high-frequency rejection (**HF Reject**), low-frequency rejection (**LF Reject**), or **Noise Rejection**.
- 3 Use **Averaging Mode** to reduce noise on the displayed waveform.

HF Reject

HF Reject adds a 50 kHz low-pass filter in the trigger path to remove high frequency components from the trigger waveform. You can use HF Reject to remove high-frequency noise, such as AM or FM broadcast stations or noise from fast system clocks, from the trigger path.

- 1 Press **[Mode/Coupling]**→**HF Reject**.

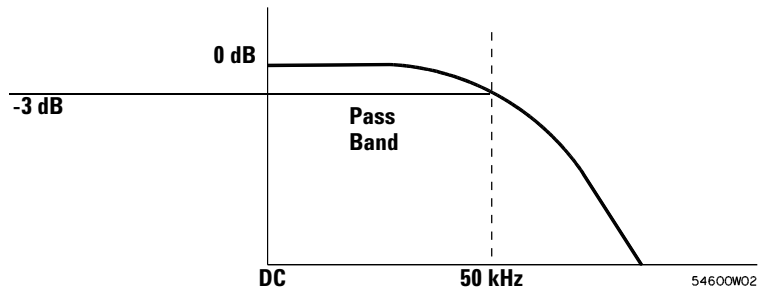

LF Reject

Low-frequency reject (LF reject) adds a high-pass filter with the 3-dB point at 50 kHz. LF reject removes low-frequency signals, such as power line noise, from the trigger path.

- 1 Press **[Mode/Coupling]**→**Coupling**→**LF Reject**.

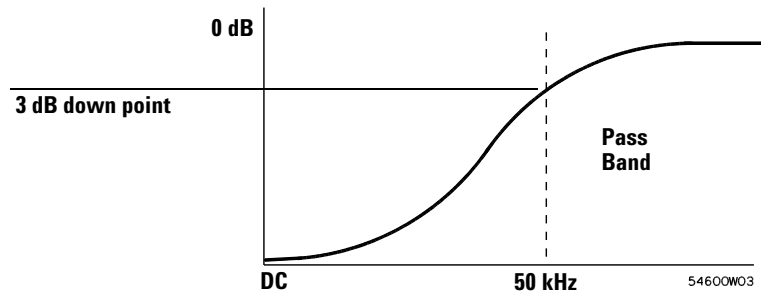

Noise Rejection

Noise Rej adds additional hysteresis to the trigger circuitry. By increasing the trigger hysteresis band, you reduce the possibility of triggering on noise. However, this also decreases the trigger sensitivity so that a slightly larger signal is required to trigger the oscilloscope.

- 1 Press **[Mode/Coupling]**→**HF Reject**.

Trigger Holdoff

Trigger Holdoff Operating Hints

Holdoff keeps a trigger from occurring until after a certain amount of time has passed since the last trigger. This feature is valuable when a waveform crosses the trigger level multiple times during one period of the waveform.

Without holdoff, the oscilloscope could trigger on each of the crossings, producing a confusing waveform. With holdoff set correctly, the oscilloscope always triggers on the same crossing. The correct holdoff setting is typically slightly less than one period. Set the holdoff to this time to generate a unique trigger point. This action works even though many waveform periods pass between triggers, because the holdoff circuit operates on the input signal continuously.

Changing the time base settings does not affect the holdoff number. In contrast, the holdoff in analog oscilloscopes is a function of the time base setting, making it necessary to readjust the holdoff each time you change the time base setting.

With Agilent's MegaZoom technology, you can press **[Stop]**, then pan and zoom through the data to find where it repeats. Measure this time using the cursors, then set the holdoff.

To set holdoff

- 1 Press the **[Mode/Coupling]** key; then press the **Holdoff** softkey.
- 2 Turn the Entry knob  to increase or decrease the trigger holdoff time shown.

Holdoff sets the amount of time that the oscilloscope waits before re-arming the trigger circuitry. Use Holdoff to stabilize the display of complex waveforms.

To get a stable trigger on the pulse burst shown below, set the holdoff time to be >200 ns but <600 ns.

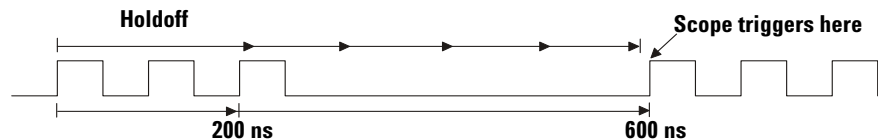

By setting the Holdoff, you can synchronize triggers. The oscilloscope will trigger on one edge of the waveform, and ignore further edges until the holdoff time expires. The oscilloscope will then re-arm the trigger circuit to search for the next edge trigger. This allows the oscilloscope to trigger on a repeating pattern in a waveform.

External Trigger Input

The External Trigger input can be used as a source in several of the trigger types.

On 2-channel oscilloscopes, the external trigger BNC input is on the front panel and is labeled **Ext Trigger**.

On 4-channel oscilloscopes, the external trigger BNC input is on the rear panel and is labeled **Ext Trig**.

2-Channel Oscilloscope External Trigger Input

External Trigger Probe Settings

You can set external trigger probe parameters as described below.

- 1 Press the **[Mode/Coupling]** key in the Trigger section of the front panel.

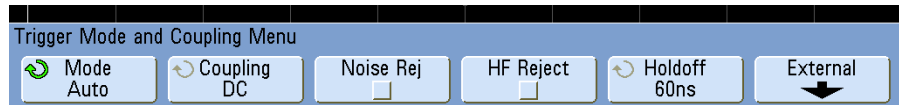

- 2 Press the **External** softkey to display the External Trigger Menu.



Probe Attenuation Turn the Entry knob to set the attenuation factor displayed in the **Probe** softkey for the connected probe. The attenuation factor can be set from 0.1:1 to 1000:1 in a 1-2-5 sequence.

When you connect an AutoProbe self-sensing probe, the oscilloscope will automatically configure your probe to the correct attenuation factor.

The probe correction factor must be set properly for measurements to be made correctly.

Range The input voltage range can be set to 1.0 Volts or 8.0 Volts. When in current mode, the range is fixed at 1.0 Amps. Range is automatically scaled according to the probe's attenuation factor.

CAUTION

Maximum voltage at 2-channel oscilloscope external trigger input:

CAT I 300 Vrms, 400 Vpk; transient overvoltage 1.6 kVpk

CAT II 100 Vrms, 400 Vpk

50 Ω input: 5 Vrms

Input protection is enabled in 50 Ω mode and the 50 Ω load will disconnect if greater than 5 Vrms is detected. However the inputs could still be damaged, depending on the time constant of the signal. The 50 Ω input protection only functions when the oscilloscope is powered on.

1 M ohm input, 100 MHz models:

For steady-state sinusoidal waveforms derate at 20 dB/decade above 200 kHz to a minimum of 10 Vpk

1 M ohm input, 350 MHz, 500 MHz, 1 GHz models:

For steady-state sinusoidal waveforms derate at 20 dB/decade above 57 kHz to a minimum of 5 Vpk

With N2863A 10:1 probe: CAT I 600 V, CAT II 300 V (DC + peak AC)

With 10073C or 10074C 10:1 probe: CAT I 500 Vpk, CAT II 400 Vpk

Input Impedance The 2-channel oscilloscopes have selectable external trigger input impedance. The impedance can be set to either **1M Ohm** or **50 Ohm** by pressing the **Imped** softkey.

- **50 Ohm** — matches 50-ohm cables commonly used in making high frequency measurements. This impedance matching gives you the most accurate measurements since reflections are minimized along the signal path.
- **1M Ohm** — is for use with many passive probes and for general-purpose measurements. The higher impedance minimizes the loading effect of the oscilloscope on the device under test.

Probe Units Press the **Units** softkey to select the proper measurement unit for the connected probe. Select **Volts** for a voltage probe and select **Amps** for a current probe. Measurement results, channel sensitivity, and trigger level will reflect the measurement units you have selected.

4-Channel Oscilloscope External Trigger Input

Input Impedance The external trigger input impedance for the 4-channel oscilloscope is approximately 2.14 k Ω .

Input Voltage The input voltage sensitivity is 500 mV, from DC to 500 MHz. The input voltage range is ± 15 V.

CAUTION



Maximum voltage at 4-channel oscilloscope external trigger input: 15 Vrms. Do not exceed 15 Vrms at rear panel External Trigger input or damage to the oscilloscope may occur.

There are no range or units settings for the External Trigger input of the 4-channel oscilloscope.

Trigger Output

You can select one of the following signals to be output at the TRIG OUT connector on the rear panel of the oscilloscope:

- Triggers
- Source frequency
- Source frequency/8
- Mask test pass/fail (see [“Mask Test Trigger Output”](#) on page 342.)

Triggers

This is the default selection. In this mode, a rising edge is output each time the oscilloscope triggers. This rising edge is delayed 17 ns from the oscilloscope’s trigger point. The output level is 0-5 V into an open circuit, and 0-2.5 V into 50 Ω .

Source Frequency

This mode is only available when the oscilloscope is set to positive or negative edge trigger on a front-panel source (analog channel or the external input of a 2-channel oscilloscope). In this mode, the TRIG OUT BNC is connected to the output of the trigger comparator. The output level is 0-580 mV into an open circuit, and 0-290 mV into 50 Ω . The maximum frequency output is 350 MHz due to the bandwidth limitation of the TRIG OUT BNC amplifier. This selection is useful for driving an external frequency counter.

Source Frequency/8

This selection produces the same signal as described in Source frequency except the output frequency is one-eighth of the trigger comparator output frequency. This mode is useful when your input signal is faster than 350 MHz.

The Trigger Out connector also provides the User Cal signal. See [“User Calibration”](#) on page 394.

Trigger Types

The oscilloscope lets you synchronize the display to the actions of the device under test by defining a trigger condition. You can use any input channel or the **External Trigger Input** BNC as the source for most trigger types.

MegaZoom Technology Simplifies Triggering

With the built-in MegaZoom technology, you can simply AutoScale the waveforms, then stop the oscilloscope to capture a waveform. You can then pan and zoom through the data using the Horizontal and Vertical knobs to find a stable trigger point. AutoScale often produces a triggered display.

The following trigger types are presented in this chapter:

- CAN Trigger **98**
- Duration Trigger **102**
- Edge Trigger **105**
- FlexRay Setup and Triggering **107**
- Glitch or Narrow Pulse Capture **112**
- I2C Trigger **115**
- I2S Trigger **121**
- LIN Trigger **128**
- MIL-STD 1553 Setup and Triggering **131**
- Nth Edge Burst Trigger **135**
- Pattern Trigger **137**
- Pulse Width Trigger **140**
- Sequence Trigger **143**
- SPI Trigger **150**
- TV Trigger **156**
- UART/RS232 Trigger **166**
- USB Trigger **170**

Changes to the trigger specification are applied when you make them. If the oscilloscope is stopped when you change a trigger specification, the oscilloscope will use the new specification when you press **[Run/Stop]** or **[Single]**. If the oscilloscope is running when you change a triggering specification, it uses the new trigger definition when it starts the next acquisition.

CAN Trigger

The Controller Area Network (CAN) trigger allows triggering on CAN version 2.0A and 2.0B signals. Setup consists of connecting the oscilloscope to a CAN signal, using the Signals Menu to specify the signal source, baud rate, and sample point, and using the Settings Menu to specify the event to trigger upon.

If the AMS license is not installed on the oscilloscope, you can still trigger on the Start of Frame (SOF) bit of a CAN data frame. If the N5424A CAN/LIN Automotive Triggering and Decode option (license AMS) is installed on your oscilloscope, the following additional CAN trigger types will also be available: Remote Frame ID (RTR), Data Frame ID (~RTR), Remote or Data Frame ID, Data Frame ID and Data, Error Frame, All Errors, Acknowledge Error, and Overload Frame.

A CAN message frame in CAN_L signal type is shown below:

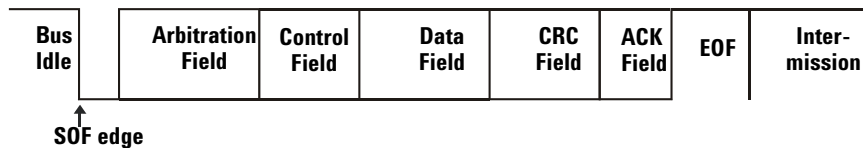

- 1 Press [**Save/Recall**]→**Default Setup**.
- 2 Press the [**Label**] key to switch labels on.
- 3 Turn on the analog or digital channel that you will be using for the CAN signal.
- 4 Press the [**More**] key in the Trigger section of the front panel, rotate the Entry knob until **CAN** is displayed in the **Trigger** softkey.

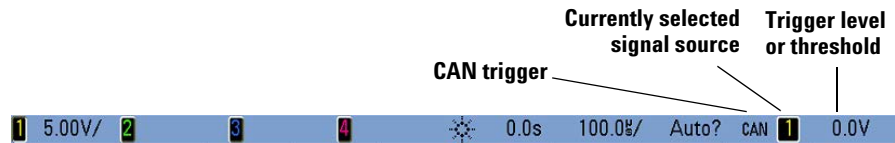

5 Press the **Settings** softkey to display CAN Trigger Menu.



6 Repeatedly press and release the **Trigger:** softkey or rotate the Entry knob to select the trigger condition.

- **SOF - Start of Frame** — The oscilloscope triggers at the start of a frame.
- **Remote Frame ID (RTR)** — The oscilloscope triggers on remote frames with the specified ID. Press the **Bits** softkey to select the ID.

NOTE

For details about using the CAN Bits Menu softkeys, press and hold the softkey in question to display the built-in help.

- **Data Frame ID (~RTR)** - The oscilloscope will trigger on data frames matching the specified ID. Press the **Bits** softkey to select the ID.
- **Remote or Data Frame ID** - The oscilloscope will trigger on remote or data frames matching the specified ID. Press the **Bits** softkey to select the ID.
- **Data Frame ID and Data** - The oscilloscope will trigger on data frames matching the specified ID and data. Press the **Bits** softkey to select the ID and set up the number of data bytes and values.
- **Error Frame** - The oscilloscope will trigger on CAN active error frames.
- **All Errors** - The oscilloscope will trigger when any form error or active error is encountered.
- **Acknowledge Error** - The oscilloscope will trigger when the acknowledge bit is recessive (high).
- **Overload Frame** - The oscilloscope will trigger on CAN overload frames.

- 7 Press the **Signals** softkey to enter the CAN Signals Menu.

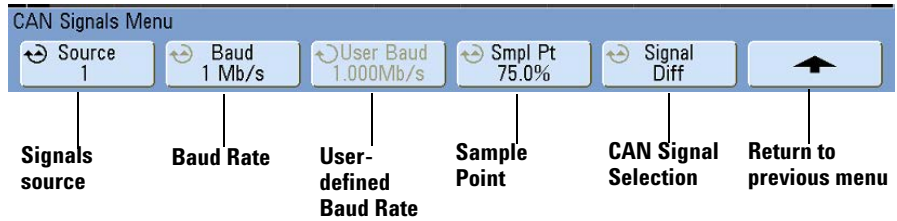

- 8 Press the **Source** softkey to select the channel connected to the CAN signal line.

As you repeatedly press the **Source** softkey (or rotate the Entry knob), the **CAN** label for the source channel is automatically set and the channel you select is shown in the upper-right corner of the display next to “**CAN**”.

If you have connected one of the oscilloscope’s analog source channels to the CAN signal: Adjust the trigger level for the selected analog channel to the middle of the waveform by turning the Trigger Level knob.

If you have connected one of the oscilloscope’s digital source channels to the CAN signal (this applies to MSO model oscilloscopes only): Press the [**D15-D0**] key and select **Thresholds** to set an appropriate threshold level for digital channels.

The value of the trigger level or digital threshold is displayed in the upper-right corner of the display.

- 9 Press the **Signal** softkey and select the type and polarity of the CAN signal. This also automatically sets the channel label for the source channel.

- **CAN_H** — The actual CAN_H differential bus

Dominant low signals:

- **CAN_L** — The actual CAN_L differential bus signal
- **Rx** — The Receive signal from the CAN bus transceiver
- **Tx** — The Transmit signal from the CAN bus transceiver
- **Differential** — The CAN differential bus signals connected to an analog source channel using a differential probe. Connect the probe’s positive lead to the dominant-low CAN signal (CAN_L) and connect the negative lead to the dominant-high CAN signal (CAN_H).

- 10 Repeatedly press and release the **Baud** softkey to set the CAN signal baud rate to match your CAN bus signal.

The CAN baud rate can be set to:

10 kb/s	50 kb/s	100 kb/s	500 kb/s
20 kb/s	62.5 kb/s	125 kb/s	800 kb/s
33.3 kb/s	83.3 kb/s	250 kb/s	1 Mb/s
User Defined			

The default baud rate is 1 Mb/s.

If the desired baud rate is not shown in the table, select User Defined. You can set the CAN baud rate from 10.0 kb/s to 1.000 Mb/s in increments of 100 b/s. Press the **User Baud** softkey and rotate the Entry knob to make your selection.

- 11** Repeatedly press and release the **Smpl Pt** softkey to select the point between phase segments 1 and 2 where the state of the bus is measured. This controls the point within the bit's time where the bit value is captured.

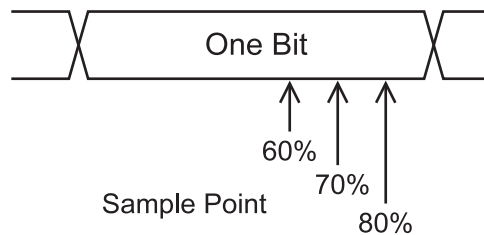

You can use the **Zoom** mode for easier navigation of the decoded data.

NOTE

If the setup does not produce a stable trigger, the CAN signal may be slow enough that the oscilloscope is AutoTriggering. Press the **[Mode/Coupling]** key, then press the **Mode** softkey to set the trigger mode from **Auto** to **Normal**.

NOTE

To display CAN serial decode, see [page 295](#).

Duration Trigger

Duration trigger lets you define a pattern, then trigger on a specified time duration of this logical AND combination of the channels.

- 1 Press the **[More]** key in the Trigger section of the front panel, rotate the Entry knob until **Duration** is displayed in the **Trigger** softkey, then press the **Settings** softkey to display the Duration Trigger Menu.

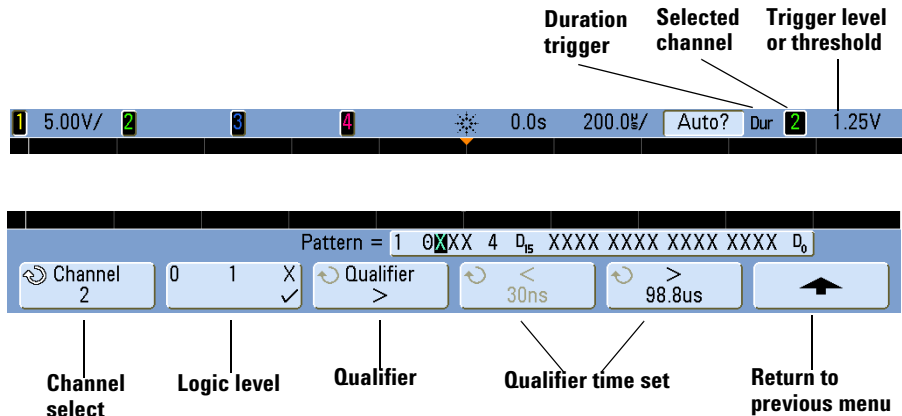

- 2 For each analog or digital channel you want to include in the desired pattern, press the **Channel** softkey to select the channel.

This is the channel source for the H, L, or X condition. As you press the **Channel** softkey (or rotate the Entry knob), the channel you select is highlighted in the **Pattern =** line directly above the softkeys and in the upper-right corner of the display next to “Dur”. External trigger may also be specified as a channel in the pattern when using the 2-channel and 4-channel oscilloscopes.

Adjust the trigger level for the selected analog channel by turning the Trigger Level knob. Press the **[D15-D0]** key and select **Thresholds** to set the threshold level for digital channels. The value of the trigger level or digital threshold is displayed in the upper-right corner of the display.

- 3 For each channel you select, press the logic level softkey to set the condition for that channel in the pattern.
 - **1** sets the pattern to 1 (high) on the selected channel. A high is a voltage level that is greater than the channel's trigger level or threshold level.
 - **0** sets the pattern to 0 (low) on the selected channel. A low is a voltage level that is less than the channel's trigger level or threshold level.

- **X** sets the pattern to don't care on the selected channel. Any channel set to don't care is ignored and is not used as part of the pattern. If all channels in the pattern are set to don't care, the oscilloscope will not trigger.

4 Press the **Qualifier** softkey to set the time duration qualifier for the pattern.

The time qualifier can set the oscilloscope to trigger on a channel pattern whose time duration is:

- less than a time value (<)
- greater than a time value (>)
- greater than a time value, but with timeout (**Timeout**). A trigger will be forced at the timeout value, rather than occurring when the pattern is exited.
- within a range of time values (><)
- outside a range of time values (<>)

The time values for the selected qualifier are set using the qualifier time set softkeys (< and >) and the Entry knob.

5 Select a qualifier time set softkey (< or >), then rotate the Entry knob to set the duration qualifier time.

< qualifier time set softkey

- When the less than (<) qualifier is selected, the Entry knob sets the oscilloscope to trigger on a pattern duration less than the time value displayed on the softkey.
- When the within time range (><) qualifier is selected, the Entry knob sets the upper time range value.
- When the out of time range (<>) qualifier is selected, the Entry knob sets the lower time range value.

> qualifier time set softkey

- When the greater than (>) qualifier is selected, the Entry knob sets the oscilloscope to trigger on a pattern duration greater than the time value displayed on the softkey.
- When the within time range (><) qualifier is selected, the Entry knob sets the lower time range value.
- When the out of time range (<>) qualifier is selected, the Entry knob sets the upper time range value.
- When **Timeout** qualifier is selected, the Entry knob sets the timeout value.

4 Triggering

When the duration trigger occurs

The timer starts on the last edge that makes the pattern (logical AND) true. The trigger will occur on the first edge that makes the pattern false if the time qualifier criteria of the pattern has been met, except in Timeout mode. In Timeout, the trigger occurs when the timeout value is reached while the pattern is true.

Edge Trigger

The Edge trigger type identifies a trigger by looking for a specified edge (slope) and voltage level on a waveform. You can define the trigger source and slope in this menu. The slope can be set to rising edge or falling edge, and can be set to alternating edges or either edge on all sources except Line. The trigger type, source, and level are displayed in the upper-right corner of the display.

- 1 Press the **[Edge]** key in the Trigger section of the front panel to display the Edge Trigger Menu.

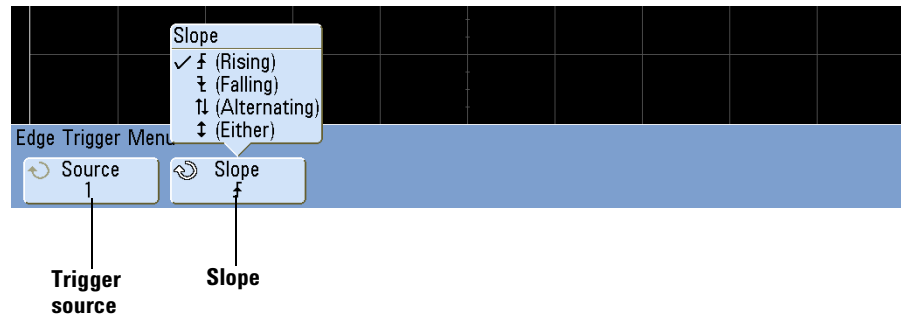
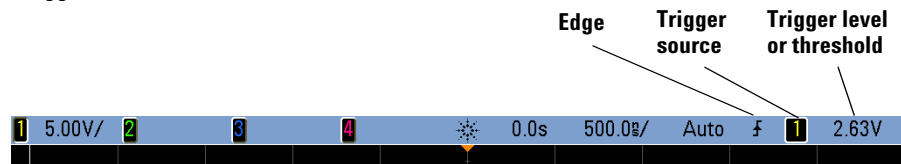

- 2 Press the **Slope** softkey and select rising edge, falling edge, alternating edges, or either edge. The selected slope is displayed in the upper-right corner of the display.

NOTE

Alternating edge mode is useful when you want to trigger on both edges of a clock (for example, DDR signals). Either edge mode is useful when you want to trigger on any activity of a selected source. All modes operate up to the bandwidth of the oscilloscope except Either edge mode, which has a limitation. Either edge mode will trigger on Constant Wave signals up to 100 MHz, but can trigger on isolated pulses down to $1/(2 \times \text{oscilloscope's bandwidth})$.

- 3 Select the trigger source.

4 Triggering

You can select analog channel 1 or 2, Ext, or Line as the trigger source on any Agilent InfiniiVision oscilloscope. The trigger source can also be set to channel 3 and 4 on the 4-channel oscilloscopes, or digital channels D15 through D0 on the mixed-signal oscilloscopes. You can choose a channel that is turned off (not displayed) as the source for the edge trigger.

The selected trigger source is indicated in the upper-right corner of the display next to the slope symbol:

1 through **4** = analog channels

D0 through **D15** = digital channels

E = External trigger

L = Line trigger

FlexRay Setup and Triggering

The N5432C FlexRay triggering and decode option (Option FLX) requires a four-channel InfiniiVision Series oscilloscope.

Option FLX lets you:

- Trigger on FlexRay bus frames, error conditions, or events.
- Display decoded FlexRay bus data.

Setup for FlexRay Signals

To set up the oscilloscope to capture a FlexRay signal, use the **Signals** softkey which appears in the Trigger Menu or the **Settings** softkey which appears in the Serial Decode Menu:

- 1 In the front panel Trigger section, press **[More]**.
- 2 In the More Trigger Menu, press **Trigger**; then, select the **FlexRay** trigger type.



- 3 Press **Settings**.
- 4 In the FlexRay Trigger Menu, press **Signals**.



- 5 In the FlexRay Signals Menu, press **Source** and select the analog channel that is probing the FlexRay signal.



- 6 Press **Baud** and select the baud rate of the FlexRay signal being probed.
- 7 Press **Bus** and select the bus type of the FlexRay signal being probed.

4 Triggering

It is important to specify the correct bus because this setting affects CRC error detection.

- 8 Press **Auto Setup** to perform the following actions:
 - Set the selected source channel's impedance to 50 Ohms.
 - Set the selected source channel's probe attenuation to 10:1.
 - Set the trigger level (on the selected source channel) to -300 mV.
 - Turns on trigger Noise Reject.
 - Turns on Serial Decode.
 - Sets the trigger type to FlexRay.

FlexRay Triggering

To set up the oscilloscope to capture a FlexRay signal, see "[Setup for MIL-STD 1553 Signals](#)" on page 132.

After you have set up the oscilloscope to capture a FlexRay signal, you can then set up triggers on frames, errors, or events.

NOTE

To display FlexRay serial decode, see "[FlexRay Serial Decode](#)" on page 302.

Triggering on FlexRay Frames

- 1 In the front panel Trigger section, press **[More]**.
- 2 In the More Trigger Menu, press **Trigger**; then, select the **FlexRay** trigger type.



- 3 Press **Settings**.
- 4 In the FlexRay Trigger Menu, press **Trigger**; then, select **Frame**.



- 5 Press the **Frames** softkey to access the FlexRay Frame Trigger Menu.

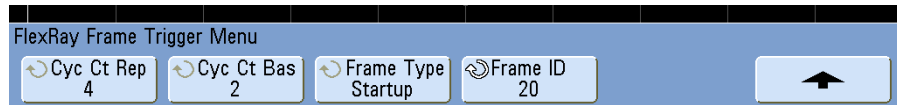

- 6 Press the **Frame ID** softkey, and use the Entry knob to select the frame ID value from **All** or **1** to **2047**.
- 7 Press the **Frame Type** softkey to select the frame type:
- **All Frames**
 - **Startup Frames**
 - **NULL Frames**
 - **Sync Frames**
 - **Normal Frames**
 - **NOT Startup Frames**
 - **NOT NULL Frames**
 - **NOT Sync Frames**
- 8 Press the **Cyc Ct Rep** softkey, and use the Entry knob to select the cycle count repetition factor (**2, 4, 8, 16, 32, or 64, or All**).
- 9 Press the **Cyc Ct Bas** softkey, and use the Entry knob to select the cycle count base factor from **0** through the **Cyc Ct Rep** factor minus 1.

For example, with a base factor of 1 and a repetition factor of 16, the oscilloscope triggers on cycles 1, 17, 33, 49, and 65.

To trigger on a particular cycle, set the Cycle Repetition factor to 64 and use the cycle base factor to choose a cycle.

To trigger all (any) cycles, set the Cycle Repetition factor to **All**. The scope will trigger on any and all cycles.

NOTE

Because specific FlexRay frames may occur infrequently, it may be helpful to set the oscilloscope to Normal trigger mode instead of Auto trigger mode. This prevents the oscilloscope from Auto triggering while waiting for a particular frame and cycle combination.

Triggering on FlexRay Errors

- 1 In the front panel Trigger section, press **[More]**.
- 2 In the More Trigger Menu, press **Trigger**; then, select the **FlexRay** trigger type.



- 3 Press **Settings**.
- 4 In the FlexRay Trigger Menu, press **Trigger**; then, select **Error**.



- 5 Press the **Errors** softkey; then, select the error type:
 - **All Errors**
 - **Header CRC Error** — cyclic redundancy check error in the header.
 - **Frame CRC Error** — cyclic redundancy check error in the frame.

NOTE

Since FlexRay errors occur infrequently it may be helpful to set the oscilloscope to Normal trigger mode instead of Auto trigger mode. This prevents the oscilloscope from Auto triggering while waiting for an error to occur. You may need to adjust trigger holdoff to see a particular error when multiple errors exist.

Triggering on FlexRay Events

- 1 In the front panel Trigger section, press **[More]**.
- 2 In the More Trigger Menu, press **Trigger**; then, select the **FlexRay** trigger type.

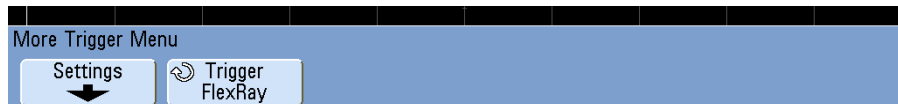

- 3 Press **Settings**.

- 4 In the FlexRay Trigger Menu, press **Trigger**; then, select **Event**.

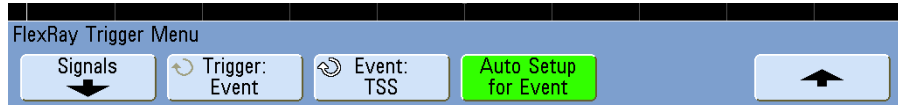

- 5 Press **Event**; then, select the event type:
- **Wake-up**
 - **TSS - Transmission Start Sequence**
 - **BSS - ByteStart Sequence**
 - **FES/DTS - Frame End or Dynamic Trailing Sequence**
- 6 Press **Auto Setup for Event**.

This automatically configures oscilloscope settings (as shown on the display) for the selected event trigger.

Glitch or Narrow Pulse Capture

A glitch is a rapid change in the waveform that is usually narrow as compared to the waveform. Peak detect mode can be used to more easily view glitches or narrow pulses. In peak detect mode, narrow glitches and sharp edges are displayed more brightly than when in Normal acquire mode, making them easier to see.

To characterize the glitch, use the cursors or the automatic measurement capabilities of the oscilloscope.

15 NS NARROW PULSE, 20 MS/DIV, NORMAL MODE

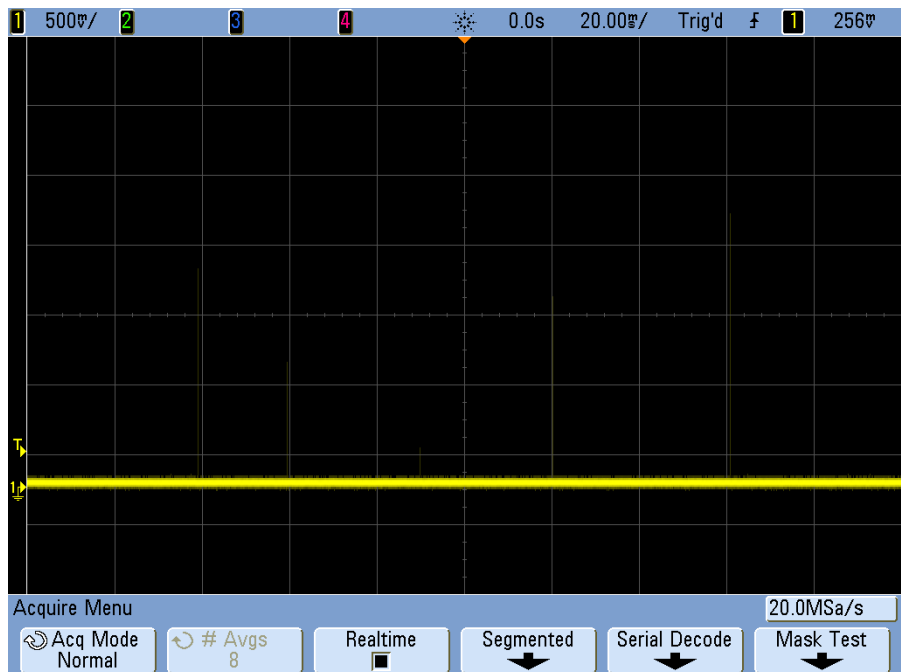

15 ns Narrow Pulse, 20 ms/div, Peak Detect Mode

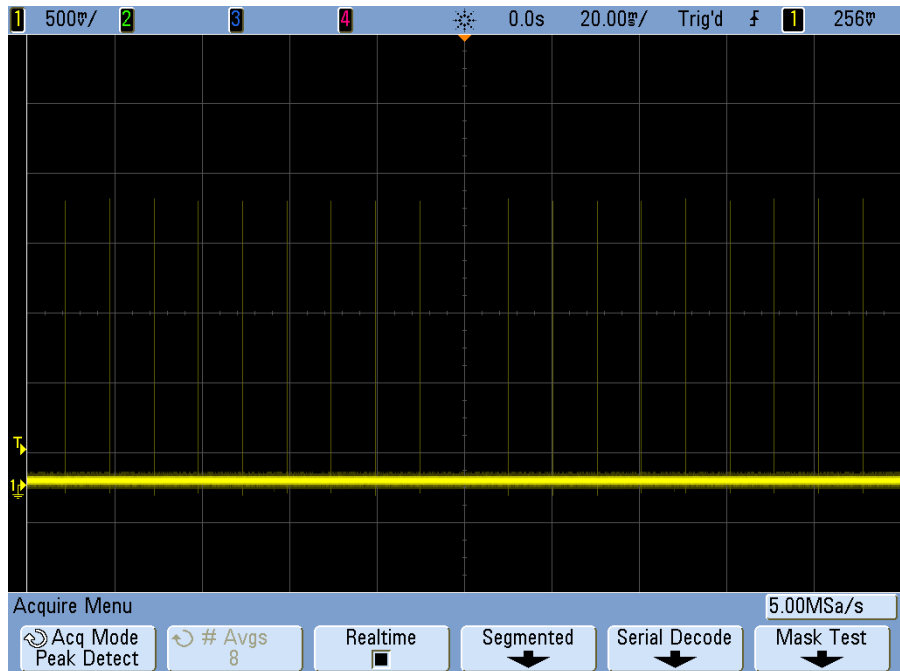

Using Peak Detect Mode to Find a Glitch

- 1 Connect a signal to the oscilloscope and obtain a stable display.
- 2 To find the glitch, press the **[Acquire]** key, then, press the **Acq Mode** softkey until **Peak Detect** is selected.
- 3 Press the **[Display]** key then press the ∞ **Persist** (infinite persistence) softkey.

Infinite persistence updates the display with new acquisitions but does not erase previous acquisitions. New sample points are shown at normal intensity while previous acquisitions are displayed in gray at lower intensity. Waveform persistence is not kept beyond the display area boundary.

Press the **Clear Display** softkey to erase previously acquired points. The display will accumulate points until ∞ **Persist** is turned off.

4 Triggering

- 4 Characterize the glitch with Zoom mode:
 - a Press the **[Menu/Zoom]** key (or **[Main/Delayed]** key on some oscilloscopes), then press the **Zoom** softkey.
 - b To obtain a better resolution of the glitch, expand the time base.

Use the horizontal position knob (◀▶) to pan through the waveform to set the expanded portion of the normal sweep around the glitch.

I²C Trigger

An I²C (Inter-IC bus) trigger setup consists of connecting the oscilloscope to the serial data (SDA) line and the serial clock (SCL) line, then triggering on a stop/start condition, a restart, a missing acknowledge, an EEPROM data read, or on a read/write frame with a specific device address and data value.

- 1 Press **[Save/Recall]**→**Default Setup**.
- 2 Press the **[Label]** key to switch labels on.
- 3 Turn on any analog or digital channels that you will be using for the I²C signals.
- 4 Press the **[More]** key in the Trigger section of the front panel, rotate the Entry knob until **I²C** is displayed in the **Trigger** softkey, then press the **Settings** softkey to display the I²C Trigger Menu.

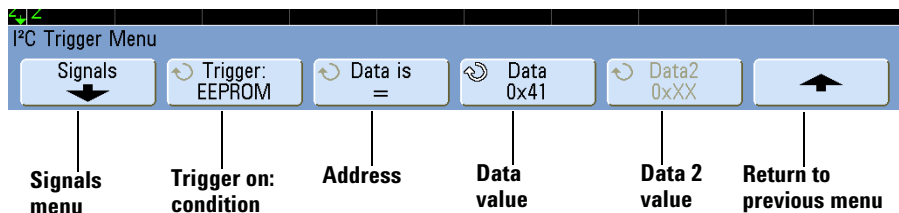
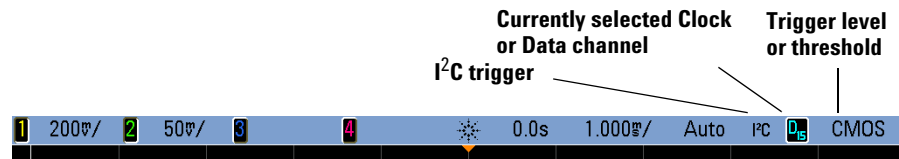

- 5 Press the **Signals** softkey to display the I²C Signals Menu.

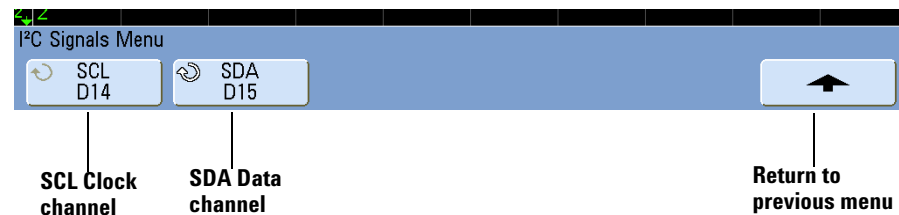

- 6 Connect an oscilloscope channel to the SCL (serial clock) line in the device under test, then set the **SCL** clock channel softkey to that channel.

As you press the **SCL** softkey (or rotate the Entry knob), the **SCL** label for the source channel is automatically set and the channel you select is shown in the upper-right corner of the display next to “**I²C**”.

- 7 Set the trigger levels for the SCL and SDA signals to the middle of the signals:
 - If your I²C signals are connected to analog channels, press the **SCL** softkey and rotate the **Trigger Level** knob, then press the **SDA** softkey and rotate the **Trigger Level** knob.
 - If your I²C signals are connected to digital channels (this applies to MSO model oscilloscopes only), press the [**D15-D0**] key and the **Thresholds** softkey to access the threshold level setting softkeys and set the thresholds to the approximate middle of the signals.
- 8 Choose 7-bit or 8-bit address size. Use 8-bit address size to include the R/W bit as part of the address value, or choose 7-bit address size to exclude the R/W bit from the address value.
- 9 Connect an oscilloscope channel to the SDA (serial data) line in the device under test, then set the **SDA** data channel softkey to that channel.
- 10 As you press the **SDA** softkey (or rotate the Entry knob), the **SDA** label for the source channel is automatically set and the channel you select is shown in the upper-right corner of the display next to “**I²C**”.

Adjust the trigger level for the selected analog channel by turning the Trigger Level knob. Press the [**D15-D0**] key and select **Thresholds** to set the threshold level for digital channels. The value of the trigger level or digital threshold is displayed in the upper-right corner of the display.

Data needs to be stable during the whole high clock cycle or it will be interpreted as a start or stop condition (data transitioning while the clock is high).

- 11 Return to the previous menu; then, press the **Trigger:** softkey to select one of the following I²C trigger conditions:
 - **Start Condition** — The oscilloscope triggers when SDA data transitions from high to low while the SCL clock is high. For triggering purposes (including frame triggers), a restart is treated as a start condition.

- **Stop Condition** — The oscilloscope triggers when data (SDA) transitions from low to high while the clock (SCL) is high.

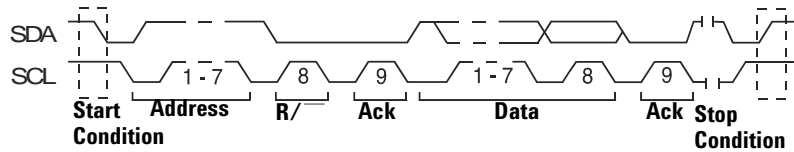

- **Missing Acknowledge** — The oscilloscope triggers when SDA data is high during any Ack SCL clock bit.
- **Address with no Ack** — The oscilloscope triggers when the acknowledge of the selected address field is false. The R/W bit is ignored.
- **Restart** — The oscilloscope triggers when another start condition occurs before a stop condition.
- **EEPROM Data Read** — The trigger looks for EEPROM control byte value 1010xxx on the SDA line, followed by a Read bit and an Ack bit. It then looks for the data value and qualifier set by the **Data** softkey and the **Data is** softkey. When this event occurs, the oscilloscope will trigger on the clock edge for the Ack bit after the data byte. This data byte does not need to occur directly after the control byte.

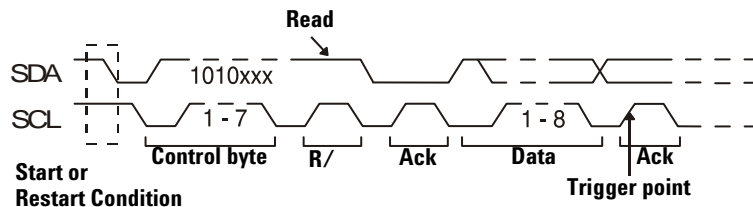

4 Triggering

- **Frame (Start: Addr7: Read: Ack: Data) or Frame (Start: Addr7: Write: Ack: Data)** — The oscilloscope triggers on a read or write frame in 7-bit addressing mode on the 17th clock edge if all bits in the pattern match. For triggering purposes, a restart is treated as a start condition.

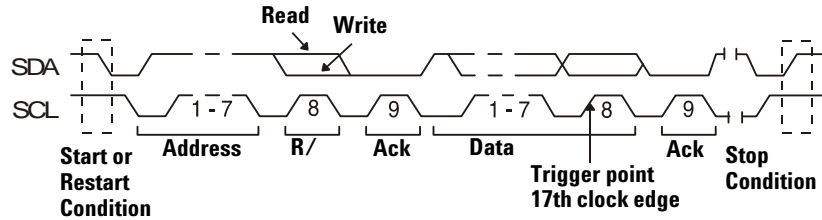

- **Frame (Start: Addr7: Read: Ack: Data: Ack: Data2) or Frame (Start: Addr7: Write: Ack: Data: Ack: Data2)** — The oscilloscope triggers on a read or write frame in 7-bit addressing mode on the 26th clock edge if all bits in the pattern match. For triggering purposes, a restart is treated as a start condition.

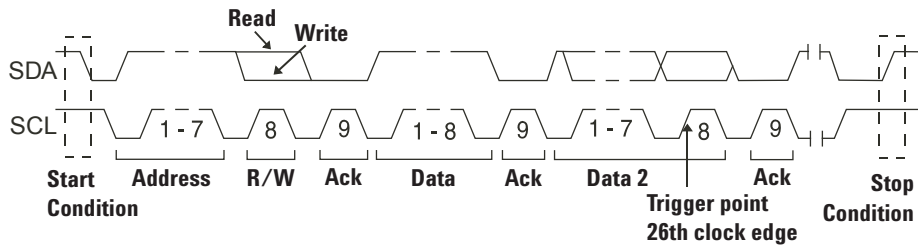

- **10-bit Write** — The oscilloscope triggers on a 10-bit write frame on the 26th clock edge if all bits in the pattern match. The frame is in the format:
Frame (Start: Address byte 1: Write: Address byte 2: Ack: Data)

For triggering purposes, a restart is treated as a start condition.

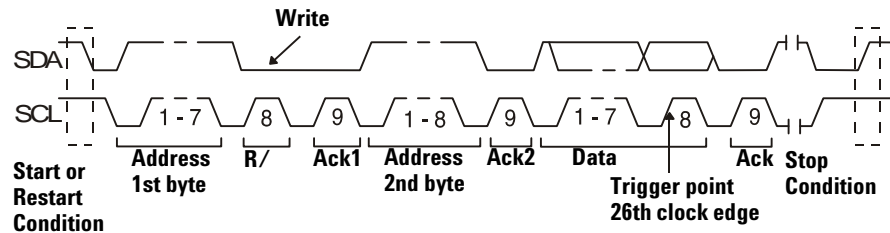

12 If you have set the oscilloscope to trigger on an EEPROM Data Read condition:

Press the **Data is** softkey to set the oscilloscope to trigger when data is = (equal to), \neq (not equal to), < (less than), or > (greater than) the data value set in the **Data** softkey.

The oscilloscope will trigger on the clock edge for the Ack bit after the trigger event is found. This data byte does not need to occur directly after the control byte. The oscilloscope will trigger on any data byte that meets the criteria defined by the **Data is** and **Data** softkeys during a current address read or a random read or a sequential read cycle.

13 If you have set the oscilloscope to trigger on a 7-bit address read or write frame condition or a 10-bit write frame condition:

a Press the **Address** softkey and turn the Entry knob to select the 7-bit or 10-bit device address.

You can select from an address range of 0x00 to 0x7F (7-bit) or 0x3FF (10-bit) hexadecimal. When triggering on a read/write frame, the oscilloscope will trigger after the start, address, read/write, acknowledge, and data events occur.

If don't care is selected (0xXX or 0xXXX) for the address, the address will be ignored. The trigger will always occur on the 17th clock for 7-bit addressing or 26th clock for 10-bit addressing.

b Press the **Data** value softkey and turn the Entry knob to select the 8-bit data pattern on which to trigger.

You can select a data value in the range of 0x00 to 0xFF (hexadecimal). The oscilloscope will trigger after the start, address, read/write, acknowledge, and data events occur.

4 Triggering

If don't care (0xXX) is selected for data, the data will be ignored. The trigger will always occur on the 17th clock for 7-bit addressing or 26th clock for 10-bit addressing.

- c If you have selected a three-byte trigger, press the **Data2** value softkey and turn the Entry knob to select the 8-bit data pattern on which to trigger.

NOTE

To display I²C serial decode, see [page 310](#).

I²S Trigger

The N5468A (Option SND) I²S trigger and serial decode option adds the ability to decode serial data to 4-channel or 4+16 channel oscilloscopes. To control serial decode press the **[Acquire]** key.

An I²S (Inter-IC Sound or Integrated Interchip Sound) trigger setup consists of connecting the oscilloscope to the serial clock, word select, and serial data lines and then triggering on a data value.

- 1 Press **[Save/Recall]**→**Default Setup**.
- 2 Press the **[Label]** key to switch labels on.
- 3 Turn on any analog or digital channels that you will be using for the I²S signals.
- 4 Press the **[More]** key in the Trigger section of the front panel. Rotate the Entry knob until **I²S** is displayed in the **Trigger** softkey.
- 5 Press the **Settings** softkey to display the I²S Trigger Menu.

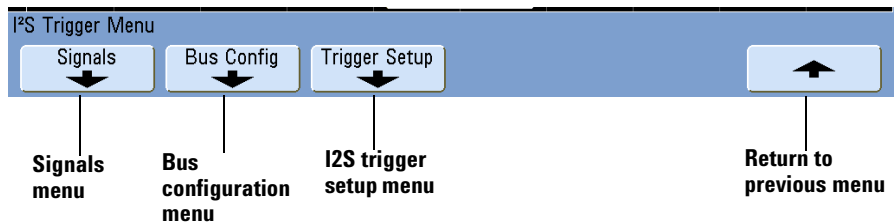
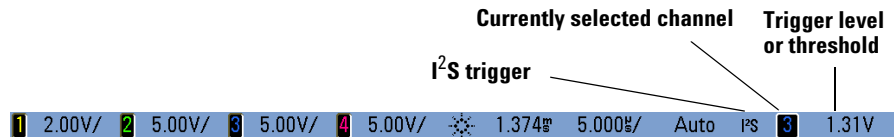

4 Triggering

- Press the **Signals** softkey to display the I²S Signals Menu. A diagram appears showing WS, SCLK, and SDATA signals for the currently specified bus configuration.

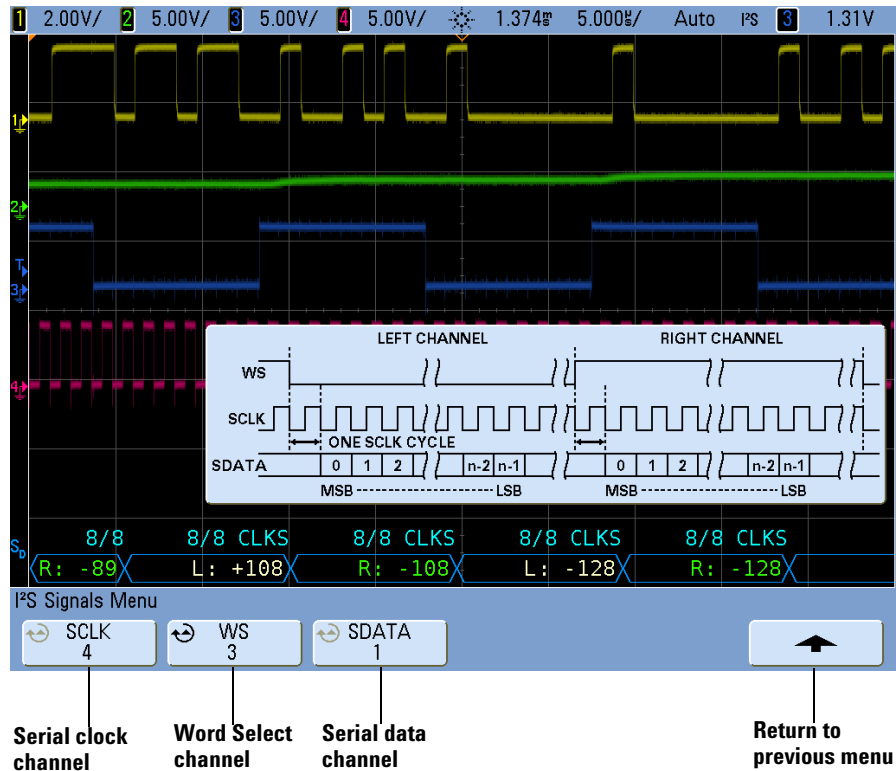

- Connect an oscilloscope channel to the SCLK (serial clock) line in the device under test. (If the channel is not already switched on, switch it on now, and return to this menu by pressing **[More]**→**Settings**→**Signals**.)

Rotate the Entry knob to set the **SCLK** clock channel softkey to the SCLK channel.

As you rotate the Entry knob the **SCLK** label for the source channel is automatically set and the channel you select is shown in the upper-right corner of the display next to “I²S”.

- Connect an oscilloscope channel to the WS (word select) line in the device under test, switch the channel on, then set the **WS** channel softkey to that channel.
- Connect an oscilloscope channel to the SDATA (serial data) line in the device under test, switch the channel on, then set the **SDATA** channel softkey to that channel.

10 Set the trigger levels for the SCLK, WS, and SDATA signals to the middle of the signals:

- If your I²S signals are connected to analog channels, press the **SCLK** softkey and rotate the **Trigger Level** knob (not the Entry knob). Repeat for the **WS** and **SDATA** softkeys.
- If your I²S signals are connected to digital channels (on MSO model oscilloscopes only), press the **[D15-D0]** key and the **Thresholds** softkey to access the threshold level setting softkeys and set the thresholds to the approximate middle of the signals. For details see [“To change the logic threshold for digital channels”](#) on page 380.

11 Press **[More]**→**Settings**→**Bus Config**. The I²S Bus Configuration Menu is displayed, along with a diagram showing WS, SCLK, and SDATA signals for the currently specified bus configuration.

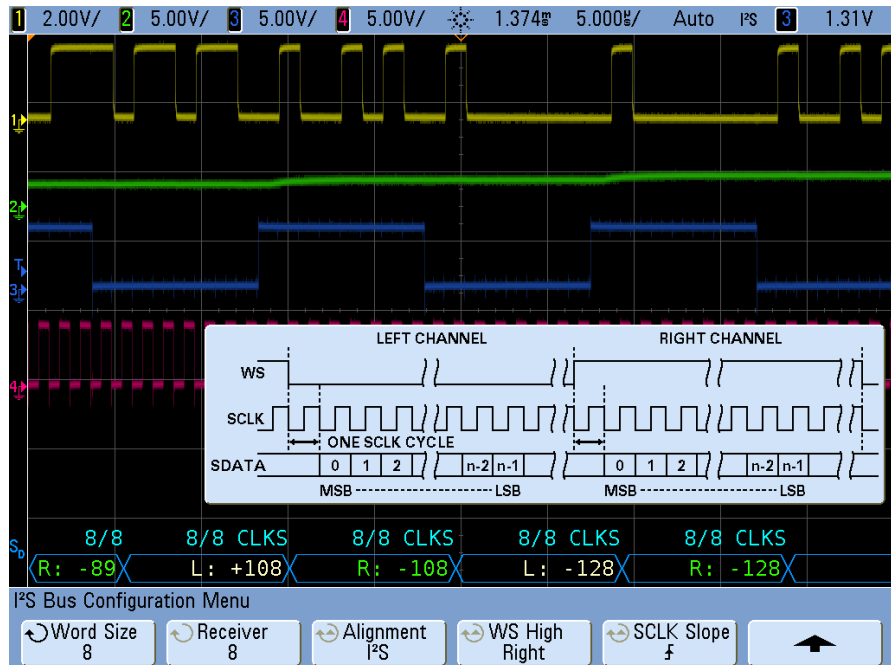

12 Press the **Word Size** softkey. Rotate the Entry knob to match the transmitter word size of the device under test (from 4 to 32 bits).

13 Press the **Receiver** softkey. Rotate the Entry knob to match the receiver word size of the device under test (from 4 to 32 bits).

- 14 Press the **Alignment** softkey and rotate the Entry knob to select the desired alignment of the data signal (SDATA). The on-screen diagram changes with your selection.

Standard Alignment: MSB of data for each sample is sent first, LSB is sent last. The MSB appears on the SDATA line one bit clock after the edge of the WS transition.

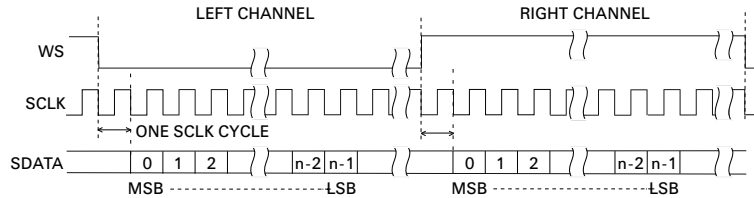

Left-Justified: Data transmission (MSB first) begins at the edge of the WS transition (without the one-bit delay that Standard format employs).

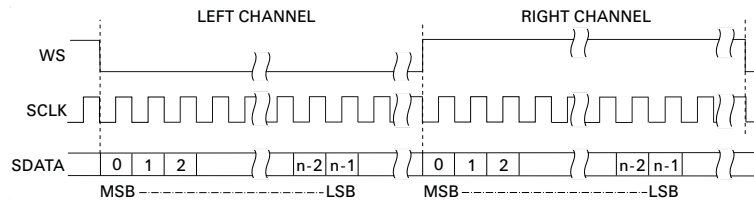

Right-Justified: Data transmission (MSB first) is right-justified to the transition of WS.

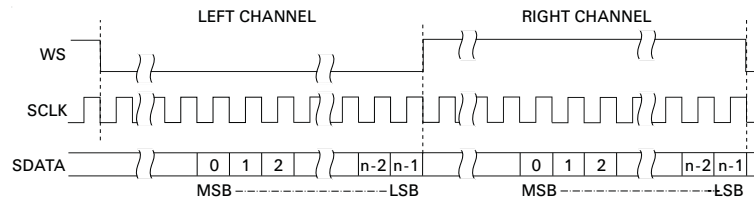

15 Press the **WS Low** softkey to select whether WS Low indicates Left or Right channel data. The on-screen diagram changes with your selection.

WS Low = Left Channel: Left-channel data corresponds to WS=low; right-channel data corresponds to WS=high. WS Low=Left is the oscilloscope's default WS setting.

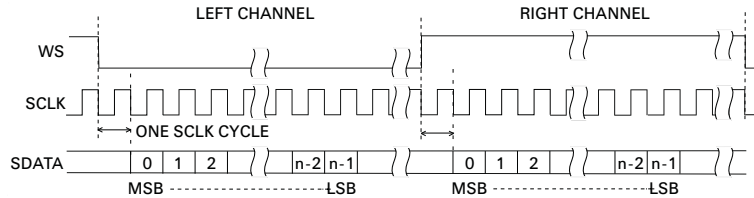

WS Low = Right Channel: Right-channel data corresponds to WS=low; left-channel data corresponds to WS=high.

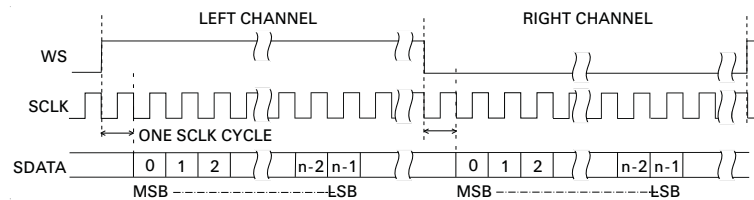

16 Press the **SCLK Slope** softkey to select the SCLK edge on which data is clocked in your device under test: either rising or falling. The on-screen diagram changes with your selection.

17 Press the up arrow softkey.

18 Press the **Trigger Setup** softkey.

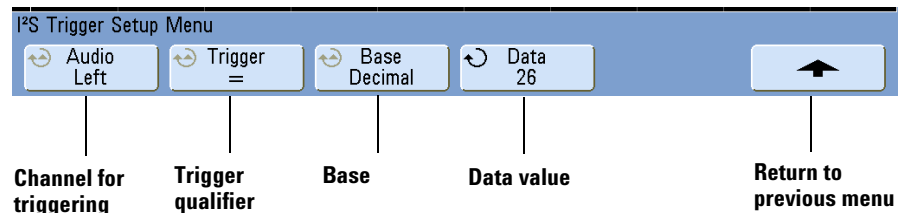

19 Press the **Audio** softkey and rotate the Entry knob to choose to trigger on **Left** channel events, **Right** channel events, or events that occur on **Either** channel.

20 Press the **Trigger** softkey and choose a qualifier:

- **Equal** — triggers on the specified audio channel's data word when it equals the specified word.
- **Not equal** — triggers on any word other than the specified word.
- **Less than** — triggers when the channel's data word is less than the specified value.
- **Greater than** — triggers when the channel's data word is greater than the specified value.
- **In Range** — enter upper and lower values to specify the range in which to trigger.
- **Out of Range** — enter upper and lower values to specify range in which trigger will not occur.
- **Increasing value** — triggers when the data value is increasing over time and the specified value is met or exceeded. Use the **Trigger** softkey in this menu to set the data value that must be reached. Use the **Armed** softkey to set the value to which the data value must fall before the trigger circuit is re-armed (ready to trigger again). The Armed control reduces triggers due to noise.

This trigger condition is best understood when the digital data transferred over the I²S bus is considered in terms of representing an analog waveform. The figure below shows a plot of sample data transmitted over an I²S bus for one channel. In this example, the oscilloscope will trigger at the 2 points shown since there are two instances in which the data increases from a value below (or at) the "Armed" value to a value greater than (or equal to) the specified "Trigger" value.

If you select an "Armed" value that is equal to or greater than the "Trigger" value, the "Trigger" value will be increased so that it is always greater than the "Armed" value.

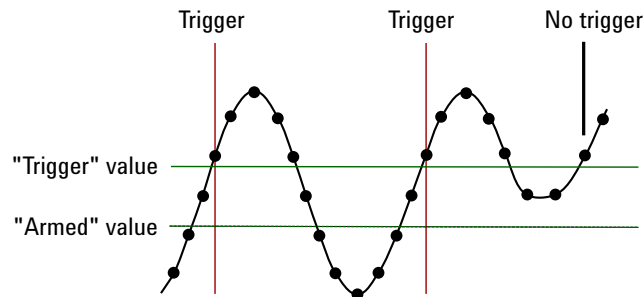

- **Decreasing value** — similar to the description above except the trigger occurs on a decreasing data word value, and the “Armed” value is the value to which the data must rise in order to re-arm the trigger.

21 Press the **Base** softkey and select a number base for entering data values:

- **Binary (2’s complement).**

When Binary is selected, the **Bits** softkey appears. This softkey opens the I²S Bits Menu for entering data values.

When the trigger qualifier requires a pair of values (as with In Range, Out of Range, Increasing value, or Decreasing value), the first softkey in the I²S Bits Menu lets you select which value of the pair.

In the I²S Bits Menu, press the **Bit** softkey and rotate the Entry knob to select each bit; then, use the **0 1 X** softkey to set each bit value to zero, one, or don’t care. You can use the **Set all Bits** softkey to set all bits to the value chosen on the **0 1 X** softkey.

- **Signed decimal.**

When Decimal is selected, the softkey(s) to the right let you enter decimal values with the Entry knob. These softkeys can be **Data**, **<**, **>**, or **Threshold** depending on the selected trigger qualifier.

22 If the setup does not produce a stable trigger, the I²S signal may be slow enough that the oscilloscope is AutoTriggering. Press the **[Mode/Coupling]** key, then press the **Mode** softkey to set the trigger mode from **Auto** to **Normal**.

NOTE

To display I²S serial decode, see [page 310](#).

LIN Trigger

LIN (Local Interconnect Network) trigger setup consists of connecting the oscilloscope to a serial LIN signal.

LIN triggering will trigger on the rising edge at the Sync Break exit of the LIN single-wire bus signal that marks the beginning of the message frame. If the N5424A CAN/LIN Automotive Triggering and Decode option is installed on your oscilloscope, the Frame ID and Frame ID and Data trigger types are also available.

A LIN signal message frame is shown below:

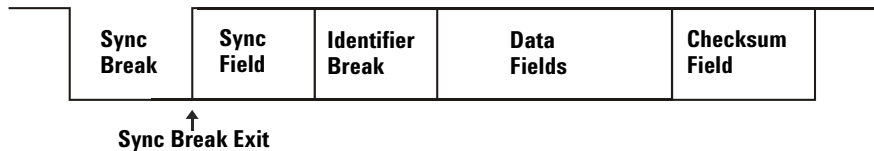

- 1 Press **[Save/Recall]**→**Default Setup**.
- 2 Turn on the analog or digital channel that you will be using for the LIN signal.
- 3 Press the **[More]** key in the Trigger section of the front panel, and rotate the Entry knob until **LIN** is displayed in the **Trigger** softkey.



- 4 Press the **Settings** softkey to display the LIN Trigger Menu.

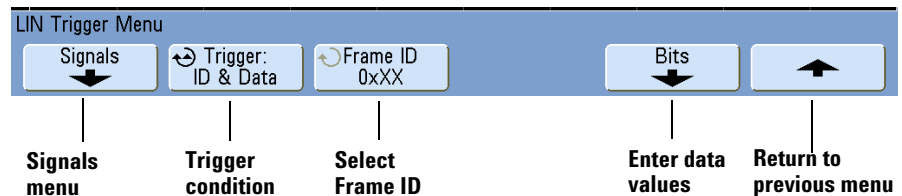

- 5 Press the **Signals** softkey. The LIN Signals Menu will be displayed.

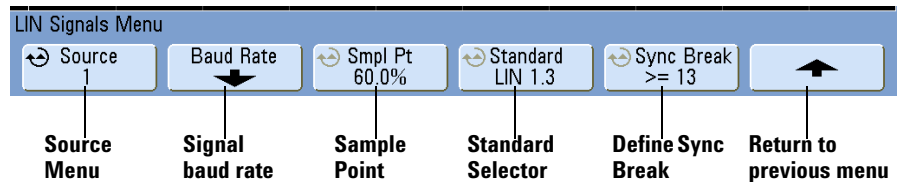

- 6 Press the **Source** softkey to select the channel connected to the LIN signal line.

If you have connected one of the oscilloscope's analog source channels to the LIN signal: Adjust the trigger level for the selected analog channel to the middle of the waveform by turning the Trigger Level knob.

If you have connected one of the oscilloscope's digital source channels to the LIN signal (this applies to MSO model oscilloscopes only): Press the **[D15-D0]** key and select **Thresholds** to set an appropriate threshold level for digital channels.

The value of the trigger level or digital threshold is displayed in the upper-right corner of the display.

- 7 Press the **Baud** softkey to set the LIN signal baud rate to match your LIN bus signal.

The LIN baud rate can be set to 2400 b/s, 9600 b/s, 10.4 kb/s, 19.2 kb/s, 115.2 kb/s, 625 kb/s, or User Defined. The default baud rate is 2400 b/s.

If the desired baud rate is not shown in the list, select User Defined. You can set the LIN baud rate from 2.4 kb/s to 625 kb/s in increments of 100 b/s. Press the User Baud softkey and rotate the Entry knob to make your selection.

- 8 Press the **Smpl Pt** softkey to select the sample point at which the oscilloscope will sample the bit value.

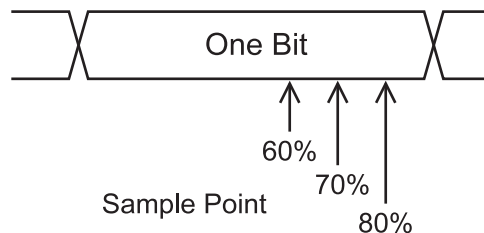

- 9 Press the **Standard** softkey to select the LIN standard you are measuring (LIN 1.3 or LIN 2.0).

10 Press the **Sync Break** softkey and select the minimum number of clocks that define a sync break in your LIN signal.

11 Press the up-arrow softkey to return to the LIN Trigger Menu.

12 Press the **Trigger:** softkey and choose the type of trigger:

- **Sync** (Sync Break) — The oscilloscope triggers on the rising edge at the Sync Break exit of the LIN single-wire bus signal that marks the beginning the message frame.
- **ID** (Frame ID) — The oscilloscope triggers when a frame with an ID equal to the selected value is detected. Use the **Entry** knob to select the value for the Frame ID.
- **ID & Data** (Frame ID and Data) — The oscilloscope triggers when a frame with an ID and data equal to the selected values is detected. When triggering on a frame ID and data:
 - To select the frame ID value, press the **Frame ID** softkey, and use the **Entry** knob.

Note that you can enter a “don’t care” value for the frame ID and trigger on data values only.

- To set up the number of data bytes and enter their values (in hexadecimal or binary), press the **Bits** softkey to open the LIN Bits Menu.

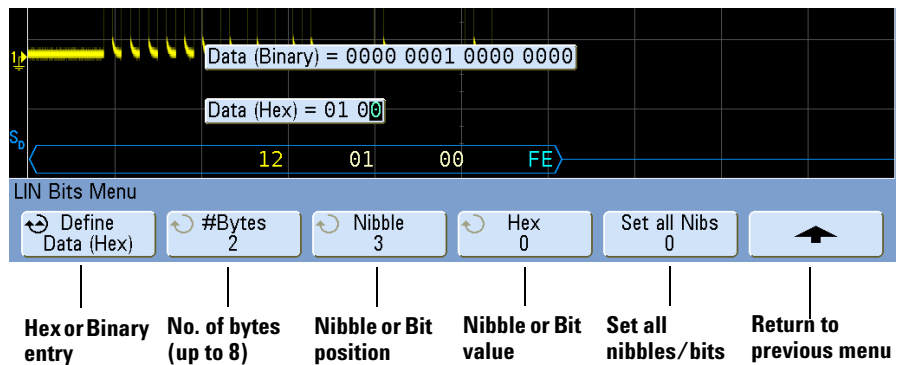

NOTE

For details about using the LIN Bits Menu softkeys, press and hold the softkey in question to display the built-in help.

NOTE

For LIN decode information see [page 314](#).

MIL-STD 1553 Setup and Triggering

The N5469A MIL-STD 1553 triggering and decode option (Option 553) requires a four-channel InfiniiVision Series oscilloscope.

The MIL-STD 1553 triggering and decode solution supports bi-phase MIL-STD 1553 signaling, the standard 1553 Manchester II encoding, data rate of 1 Mb/s, and word length of 20 bits.

Probing MIL-STD 1553 Signals

The MIL-STD 1553 differential bus must be probed with a differential active probe.

Agilent recommends the N2791A 25 MHz differential active probe.

Output of the differential probe must be fed, via a BNC tee and two equal-length BNC cables, into two channels of the oscilloscope. This way, the oscilloscope can perform dual threshold triggering (using upper and lower thresholds).



This N2791A differential probe works well because it is designed for 1 MOhm impedance oscilloscope inputs.

If you use a different differential probe that is designed for 50 Ohm impedance oscilloscope inputs, be sure to set only one of the oscilloscope channel input impedances to 50 Ohms (because the two input channel's impedances are seen in parallel).

Setup for MIL-STD 1553 Signals

To set up the oscilloscope for MIL-STD 1553 signals:

- 1 In the front panel Trigger section, press **[More]**.
- 2 In the More Trigger Menu, press **Trigger**; then, select the **MIL-1553** trigger type.



- 3 Press **Settings**.
- 4 In the MIL-STD-1553 Trigger Settings Menu:

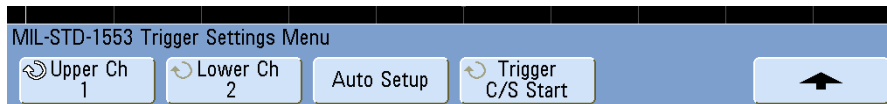

- **Upper Ch** — selects the channel used for the upper threshold. Because defined pairs of channels are used for upper and lower thresholds (either channels 1 and 2, or channels 3 and 4), this softkey also selects the channel for the lower threshold.
- **Lower Ch** — shows the channel selected for lower thresholds.
- **Auto Setup** — performs these actions:
 - Copies the Upper Threshold Channel position and volts/div settings to the Lower Threshold Channel.
 - Sets both the Upper Threshold Channel and the Lower Threshold Channel probe attenuation to 10:1.
 - Sets the Upper Threshold Channel trigger level to 500 mV and the Lower Threshold Channel trigger level to -500 mV.
 - Turns off trigger noise reject.
 - Turns on Serial Decode.
 - Sets the trigger type to MIL-1553.

These softkeys appear in both the Trigger Menu and the Serial Decode Menu.

MIL-STD 1553 Triggering

To set up the oscilloscope to capture MIL-STD 1553 signals, see “[Setup for MIL-STD 1553 Signals](#)” on page 132.

To set up a MIL-STD 1553 trigger:

- 1 In the front panel Trigger section, press **[More]**.
- 2 In the More Trigger Menu, press **Trigger**; then, select the **MIL-1553** trigger type.



- 3 Press **Settings**.
- 4 In the MIL-STD-1553 Trigger Settings Menu, press **Trigger**; then, select from these options:

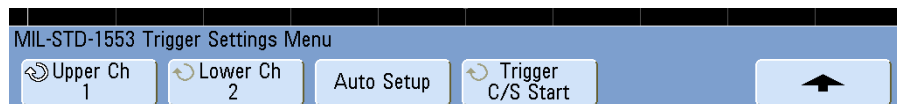

- **Data Word Start** – triggers on the start of a Data word (at the end of a valid Data Sync pulse).
- **Data Word Stop** – triggers on the end of a Data word.
- **Command/Status Word Start** – triggers on the start of Command/Status word (at the end of a valid C/S Sync pulse).
- **Command/Status Word Stop** – triggers on the end of a Command/Status word.
- **Remote Terminal Address** – triggers if the RTA of the Command/Status word matches the specified value.

When this option is selected, the **RTA** softkey appears and lets you select the hex Remote Terminal Address value to trigger on. If you select 0xXX (don't cares), the oscilloscope will trigger on any RTA.

- **Remote Terminal Address + 11 Bits** – triggers if the RTA and the remaining 11 bits match the specified criteria.

When this option is selected, the **RTA + Bits** softkey appears and opens the MIL-STD-1553 RTA + 11 Bits Menu. In this menu:

- The **RTA** softkey lets you select the hex Remote Terminal Address value.

4 Triggering

- The **Bit Time** softkey lets you select the bit time position.
- The **0 1 X** softkey lets you set the bit time position value as a 1, 0, or X (don't care).
- **Parity Error** – triggers if the (odd) parity bit is incorrect for the data in the word.
- **Manchester Error** – triggers if a Manchester encoding error is detected.
- **Sync Error** – triggers if an invalid Sync pulse is found.

NOTE

To display MIL-STD-1553 serial decode, see [“MIL-STD 1553 Serial Decode”](#) on page 320.

Nth Edge Burst Trigger

The Nth Edge Burst trigger lets you trigger on the Nth edge of a burst that occurs after an idle time.



Nth Edge Burst trigger set up consists of selecting the source, the slope of the edge, the idle time, and the number of the edge:

- 1 Press the **[More]** key in the Trigger section of the front panel, rotate the Entry knob until **Nth Edge Burst** is displayed in the **Trigger** softkey.
- 2 Press the **Settings** softkey to display the Nth Edge Burst Trigger Menu.

4 Triggering

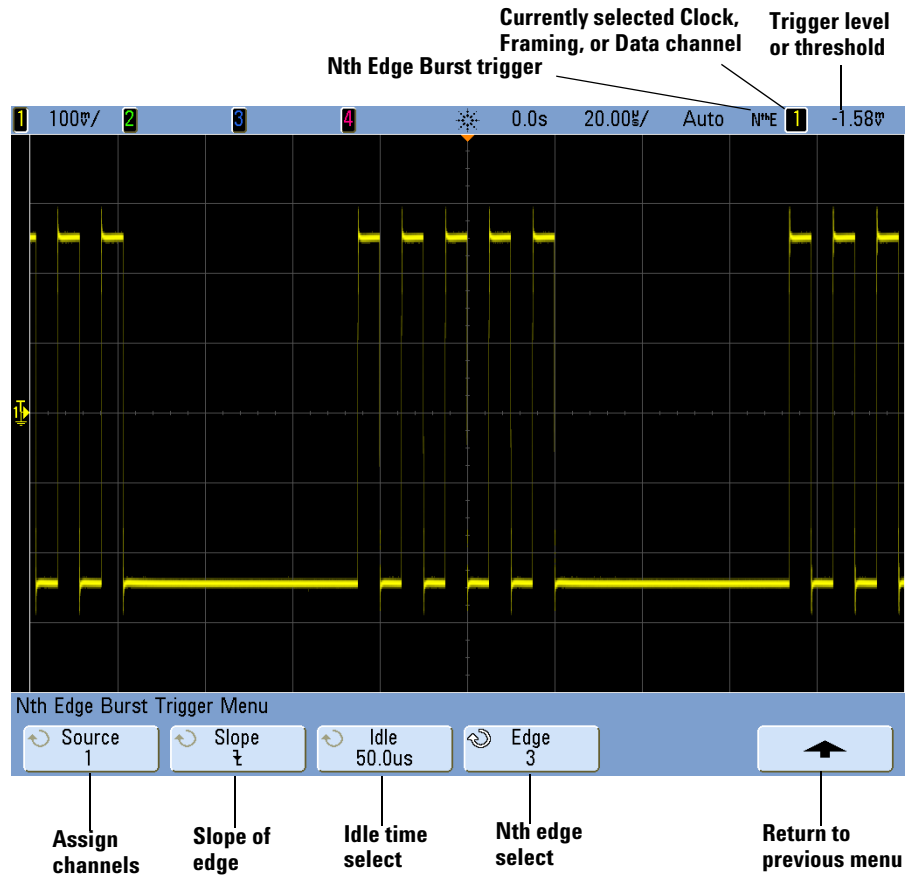

- 3 Press the **Slope** softkey to specify the slope of the edge.
- 4 Press the **Idle** softkey; then, turn the Entry knob to specify the idle time.
- 5 Press the **Edge** softkey; then, turn the Entry knob to which edge to trigger on.

Pattern Trigger

The Pattern trigger identifies a trigger condition by looking for a specified pattern. This pattern is a logical AND combination of the channels. Each channel can have a value of 0 (low), 1 (high), or don't care (X). A rising or falling edge can be specified for one channel included in the pattern. You can also trigger on a hex bus value as described on [page 139](#).

- 1 Press the **[Pattern]** key in the Trigger section of the front panel to display the PatternTrigger Menu.

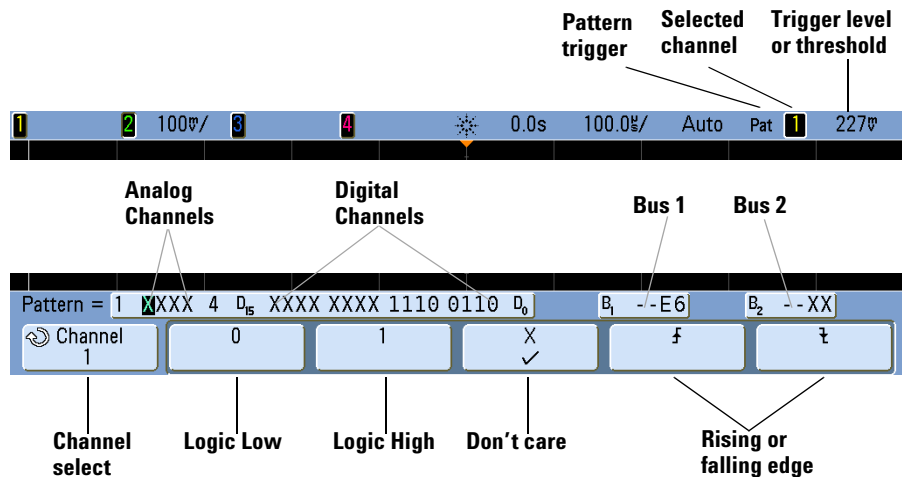



- 2 For each analog or digital channel you want to include in the desired pattern, press the **Channel** softkey to select the channel.

This is the channel source for the 0, 1, X, or edge condition. As you press the **Channel** softkey (or rotate the Entry knob), the channel you select is highlighted in the **Pattern =** line directly above the softkeys and in the upper-right corner of the display next to "Pat". External trigger may also be specified as a channel in the pattern when using the 2-channel and 4-channel oscilloscopes.

Adjust the trigger level for the selected analog channel by turning the Trigger Level knob. Press the **[D15-D0]** key and select **Thresholds** to set the threshold level for digital channels. The value of the trigger level or digital threshold is displayed in the upper-right corner of the display.

- 3 For each channel you select, press one of the condition softkeys to set the condition for that channel in the pattern.

4 Triggering

- **0** sets the pattern to zero (low) on the selected channel. A low is a voltage level that is less than the channel's trigger level or threshold level.
- **1** sets the pattern to 1 (high) on the selected channel. A high is a voltage level that is greater than the channel's trigger level or threshold level.
- **X** sets the pattern to don't care on the selected channel. Any channel set to don't care is ignored and is not used as part of the pattern. However, if all channels in the pattern are set to don't care, the oscilloscope will not trigger.
- The rising edge () or falling edge () softkey sets the pattern to an edge on the selected channel. Only one rising or falling edge can be specified in the pattern. When an edge is specified, the oscilloscope will trigger at the edge specified if the pattern set for the other channels is true.

If no edge is specified, the oscilloscope will trigger on the last edge that makes the pattern true.

Specifying an Edge in a Pattern

You are allowed to specify only one rising or falling edge term in the pattern. If you define an edge term, then select a different channel in the pattern and define another edge term, the previous edge definition is changed to a don't care.

Hex Bus Pattern Trigger

You can specify a bus value on which to trigger. To do this, first define the bus. See [“To display digital channels as a bus”](#) on page 381 for details. You can trigger on a bus value whether you are displaying the bus or not.

To trigger on a bus value:

- 1 Press the **[Pattern]** key on the front panel.
- 2 Press the **Channel** softkey and rotate the Entry knob to select **Bus1** or **Bus2**.
- 3 Press the **Digit** softkey and rotate the Entry knob to select a digit of the selected bus.
- 4 Press the **Hex** softkey and rotate the Entry knob to select a value for the digit.

NOTE

If a digit is made up of less than four bits, then the value of the digit will be limited to the value that can be created by the selected bits.

- 5 You can use the **Set all Digits** softkey to set all digits to a particular value.

When a hex bus digit contains one or more don't care (X) bits and one or more bit with a value or 0 or 1, the “\$” sign will be displayed for the digit.

For information regarding digital bus display when Pattern triggering see [“Bus values are displayed when using Pattern trigger”](#) on page 384.

Pulse Width Trigger

Pulse Width (glitch) triggering sets the oscilloscope to trigger on a positive or negative pulse of a specified width. If you want to trigger on a specific timeout value, use **Duration** trigger in the Trigger More Menu (see “**Duration Trigger**” on page 102).

- 1 Press the [**Pulse Width**] key in the Trigger section of the front panel to display the Pulse Width Trigger Menu.

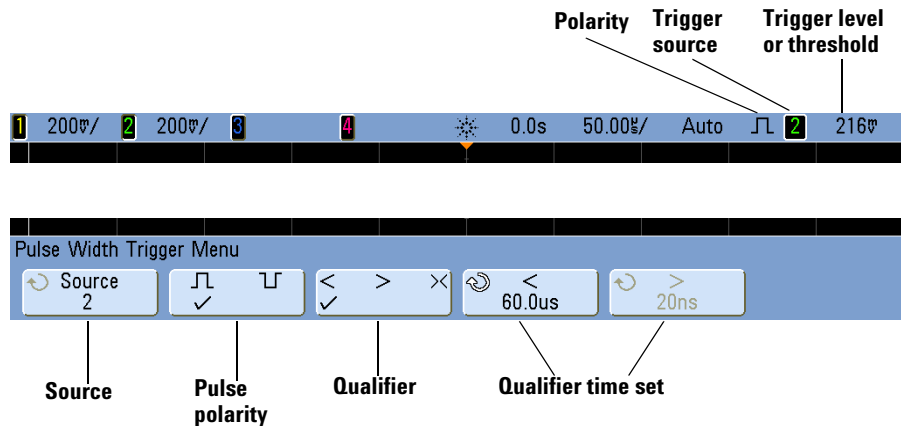

- 2 Press the **Source** softkey (or rotate the Entry knob) to select a channel source for the trigger.

The channel you select is shown in the upper-right corner of the display next to the polarity symbol.

The source can be any analog or digital channel available on your oscilloscope. External trigger may also be specified as a source when using a 2-channel oscilloscope.

Adjust the trigger level for the selected analog channel by turning the Trigger Level knob. Press the [**D15-D0**] key and select **Thresholds** to set the threshold level for digital channels. The value of the trigger level or digital threshold is displayed in the upper-right corner of the display.

- 3 Press the pulse polarity softkey to select positive () or negative () polarity for the pulse width you want to capture.

The selected pulse polarity is displayed in the upper-right corner of the display. A positive pulse is higher than the current trigger level or threshold and a negative pulse is lower than the current trigger level or threshold.

When triggering on a positive pulse, the trigger will occur on the high to low transition of the pulse if the qualifying condition is true. When triggering on a negative pulse, the trigger will occur on the low to high transition of the pulse if the qualifying condition is true.

4 Press the qualifier softkey (< > ><) to select the time qualifier.

The Qualifier softkey can set the oscilloscope to trigger on a pulse width that is:

- less than a time value (<).

For example, for a positive pulse, if you set $t < 10$ ns:



- greater than a time value (>).

For example, for a positive pulse, if you set $t > 10$ ns:



- within a range of time values (><).

For example, for a positive pulse, if you set $t > 10$ ns and $t < 15$ ns:

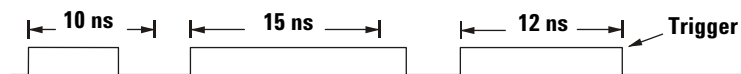

5 Select the qualifier time set softkey (< or >), then rotate the Entry knob to set the pulse width qualifier time.

The qualifiers can be set as follows:

- 2 ns to 10 s for > or < qualifier (5 ns to 10 s for 350 MHz bandwidth models)
- 10 ns to 10 s for >< qualifier, with minimum difference of 5 ns between upper and lower settings

< qualifier time set softkey

- When the less than (<) qualifier is selected, the Entry knob sets the oscilloscope to trigger on a pulse width less than the time value displayed on the softkey.

4 Triggering

- When the time range (><) qualifier is selected, the Entry knob sets the upper time range value.

> qualifier time set softkey

- When the greater than (>) qualifier is selected, the Entry knob sets the oscilloscope to trigger on a pulse width greater than the time value displayed on the softkey.
- When the time range (><) qualifier is selected, the Entry knob sets the lower time range value.

Sequence Trigger

Sequence trigger lets you trigger the oscilloscope after finding a sequence of events. Defining a sequence trigger requires three steps:

1 Define an event to find before you search for the trigger.

The “find” event can be a pattern, an edge from a single channel, or the combination of a pattern and a channel edge.

2 Define the trigger event.

The “trigger on” event can be a pattern, an edge from a single channel, the combination of a pattern and a channel edge, or the nth occurrence of an edge from a single channel.

3 Set an optional reset event.

If you choose to define a “reset” event, the event can be a pattern, an edge from a single channel, the combination of a pattern and a channel edge, or a timeout value.

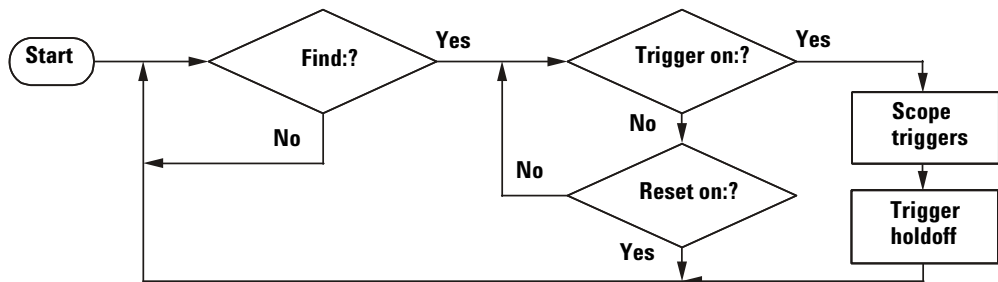

Figure 1 Sequence Trigger Flowchart

To access the sequence trigger settings, press the **[More]** key in the Trigger section of the front panel, rotate the Entry knob until **Sequence** is displayed in the **Trigger** softkey, then press the **Settings** softkey to display Sequence Trigger Menu.

4 Triggering

Sequence trigger **Selected channel** **Trigger level or threshold**

Sequence stage definitions

Term definitions

Sequence Stages

First, find: Pattern 1 Entered

Then, trigger on: Edge 2

Reset on: No Reset

P1: 1	01XX	4	D ₁₅	XXXX	XXXX	XXXX	XXXX	D ₀
P2: 1	10XX	4	D ₁₅	XXXX	XXXX	XXXX	XXXX	D ₀
E1: 1	XXXX	4	D ₁₅	XXXX	XXXX	XXXX	XXXX	D ₀
E2: 1	XfXX	4	D ₁₅	XXXX	XXXX	XXXX	XXXX	D ₀

N = 1
Timeout = 100ns

Sequence Trigger Menu

Channel 2 Stage Find Find: P1 Enter Term Pattern 1 0 1 X ↑

Channel select **Stage select** **Find, Trigger on, or Reset condition** **Select term** **Define term** **Return to previous menu**

As you set stage, term, and channel definitions for the sequence trigger, these settings will be shown in the waveform area of the display.

Define the “Find” Stage

- 1 Press the **Stage** softkey and select **Find**:

Find: is the first stage in the trigger sequence. When you select the **Stage Find** softkey, the next softkey to the right will display **Find**: and give you a list of the terms you can define for the Find stage. The Find stage can be set to one of the following conditions:

- **Pattern 1 Entered** — A pattern is entered on the last edge that makes the pattern true (logical AND).
- **Pattern 1 Exited** — A pattern is exited on the first edge that makes the pattern false (logical NAND).
- **Edge 1**
- **Pattern 1 and Edge 1**

- 2 Press the **Find**: softkey and select the Find stage condition.

- 3 To define the term(s) used in the Find stage, press the **Term** softkey and select the pattern and/or edge term displayed in the **Find**: softkey.

- 4 If you select a pattern term, each channel in the pattern must be set to a **1** (high), **0** (low), or **X** (don't care).

- a Press the **Channel** softkey (or rotate the Entry knob) to select the channel.

As you select a channel, the channel is highlighted in the selected pattern list shown in the waveform area and is also shown in the upper-right corner of the display next to “**seq**”

- b Press the **0 1 X** softkey to set a level for the channel.

- **1** sets the pattern to high on the selected channel. A high is a voltage level that is greater than the channel's trigger level or threshold level.
- **0** sets the pattern to low on the selected channel. A low is a voltage level that is less than the channel's trigger level or threshold level.
- **X** sets the pattern to don't care on the selected channel. Any channel set to don't care is ignored and is not used as part of the pattern. If all channels in the pattern are set to don't care, the oscilloscope will not trigger.

Adjust the trigger level for the selected analog channel by turning the Trigger Level knob. Press the [**D15-D0**] key and select **Thresholds** to set the threshold level for digital channels. The value of the trigger level or digital threshold is displayed in the upper-right corner of the display.

- c Repeat for all channels in the pattern.

- 5 If you select an edge term, one channel must be set to a rising edge or a falling edge. All other channel edges will be set to don't care (X).
 - a Press the **Channel** softkey (or rotate the Entry knob) to select the channel.

As you select a channel, the channel is highlighted in the selected pattern list shown in the waveform area.
 - b Then press the **↕ X** softkey to select rising edge or falling edge. All other channels will be defaulted to don't care (X).

If you want to reassign an edge to a different channel, repeat the above step. The value of the original channel edge will be defaulted to X (don't care).

If the term(s) used in the "Find:" Sequence Stage condition are set to "don't care," the oscilloscope will not trigger. At least one term in the stage must be set to a value other than X (don't care).

Define the "Trigger on" Stage

- 1 Press the **Stage** softkey and select **Trigger on:**.

Trigger on: is the next stage in the trigger sequence. When you select the **Stage Trigger on:** softkey, the next softkey to the right will display **Trigger:** and give you a list of the terms you can define for the Trigger on: stage. The Trigger on: stage can be set to one of the following conditions:

- **Pattern 2 Entered** — A pattern is entered on the last edge that makes the pattern true (logical AND).
- **Pattern 2 Exited** — A pattern is exited on the first edge that makes the pattern false (logical NAND).
- **Edge 2**
- **Pattern 2 and Edge 2**
- **Nth Edge 2**
- **Nth Edge 2 (no re-find)**

- 2 Press the **Trigger:** softkey and select a stage to trigger on.
- 3 To define the term(s) used in the Trigger on: stage, press the **Term** softkey and select the pattern or edge term displayed in the **Trigger:** softkey.

- 4** If you select a pattern term, each channel in the pattern must be set to a **1** (high), **0** (low), or **X** (don't care).
- Press the **Channel** softkey (or rotate the Entry knob) to select the channel.
 - Press the **0 1 X** softkey to set a level for the channel.
 - Repeat for all channels in the pattern.
- 5** If you select an edge term, one channel must be set to a rising edge or a falling edge. All other channel edges will be set to don't care (X).
- Press the **Channel** softkey (or rotate the Entry knob) to select the channel.

The channel you select is shown in the upper-right corner of the display next to "Seq".
 - Then press the **↕ ↘ X** softkey to select rising edge or falling edge. All other channel edges will be defaulted to don't care.
- 6** When you set a Trigger on: condition to trigger on Edge 2, you can also select which occurrence of Edge 2 to trigger on.
- Make sure **Nth Edge 2** or **Nth Edge 2 (no re-find)** is selected in the **Trigger:** softkey.

When **Nth Edge 2** is selected, if the Find event occurs again before the Count (N) event is satisfied, Count (N) will be reset to zero.

When **Nth Edge 2 (no re-find)** is selected, if the Find event occurs again before the Count (N) event is satisfied, the Count (N) is not reset to zero.
 - Press the **Term** softkey and select **Count (N)**.
 - Press the **N** softkey, then turn the Entry knob to set the number of edges to wait before triggering.

N can be set from 1 to 10,000.

If the term(s) used in the "Trigger on:" Sequence Stage condition are set to "don't care," the oscilloscope will not trigger. At least one term in the stage must be set to a value other than X (don't care).

Define the Optional "Reset on" Stage

- Press the **Stage** softkey and select **Reset on:**.

Reset on: is the last stage in the trigger sequence. When you select the **Stage Reset on:** softkey, the next softkey to the right will display **Reset:** and give you a list of the terms you can define for the Reset on: stage. The Reset on: stage can be set to one of the following conditions:

- **No Reset** — Resets on the find condition.
- **Pattern 1 (or 2) Entered** — A pattern is entered on the last edge that makes the pattern true (logical AND).
- **Pattern 1 (or 2) Exited** — A pattern is exited on the first edge that makes the pattern false (logic NAND).
- **Edge 1 (or 2)**
- **Pattern 1 and Edge 1**
- **Timeout**

Terms that are grayed-out are not valid in the reset stage.

- 2 Press the **Reset:** softkey and select a term to reset on.
- 3 Press the **Term** softkey and select the pattern, edge, or timeout term displayed in the **Reset:** softkey.
- 4 If you select **No Reset**, no reset stage will be defined.
- 5 If you select a pattern term, each channel in the pattern must be set to a **H** (high), **L** (low), or **X** (don't care).
 - a Press the **Channel** softkey (or rotate the Entry knob) to select the channel.
 - b Press the **0 1 X** softkey to set a level for the channel.
 - c Repeat for all channels in the pattern.
- 6 If you select an edge term, one channel must be set to a rising edge or a falling edge. All other channel edges will be set to don't care (X).
 - a Press the **Channel** softkey (or rotate the Entry knob) to select the channel.
 - b Then press the **↕ ↘ X** softkey to select rising edge or falling edge. All other channel edges will be defaulted to don't care.
- 7 If you select the **Timeout** term, you will need to set a timeout value.
 - a Press the **Term** softkey and select **Timeout**.
 - b Press the **Timeout** softkey, then turn the Entry knob to set the timeout value.

Timeout can be set from 10 ns to 10 seconds. The timer starts when the Find condition has been met. If the timer is running and another Find condition occurs, the timer will restart from time zero.

Adjust the Trigger Level

- For analog channels, adjust the trigger level for the selected analog channel by turning the Trigger Level knob.
- To set the threshold level for digital channels, press the **[D15-D0]** key and select **Thresholds**.

The value of the trigger level or digital threshold is displayed in the upper-right corner of the display.

SPI Trigger

Serial Peripheral Interface (SPI) trigger setup consists of connecting the oscilloscope to a clock, data, and framing signal. You can then trigger on a data pattern that occurs at the start of a frame. The serial data string can be specified to be from 4 to 32 bits long.

When you press the **Settings** softkey, a graphic will be displayed showing the current state of the frame signal, clock slope, number of data bits, and data bit values. Press the **Signals** softkey in the Settings Menu to see the current source channels for the clock, data, and frame signals.

- 1 Press [**Save/Recall**]→**Default Setup**.
- 2 Press the [**Label**] key to switch labels on.
- 3 Turn on any analog or digital channels that you will be using for the SPI signals.
- 4 Press the [**More**] key in the Trigger section of the front panel, rotate the Entry knob until **SPI** is displayed in the **Trigger** softkey, then press the **Settings** softkey to display the SPI Trigger Menu.

Currently selected Clock, Framing, or Data channel

Trigger level or threshold

SPI trigger

Graphic showing current state of the SPI trigger setup

Data string values

~CS

CLK

DATA

Trigger Point

Bit 0

Bit 1

Bit N-1

Bit N

Data: 0000 0010 0000 1000

SPI Trigger Menu

Signals

#Bits 16

Bit 12

0 1 X

Set all Bits 1

Assign channels

data bits in string

Data bit select

Data bit value

Set all data bits to value

Return to previous menu

Assign Oscilloscope Channels to SPI Signals

This explains how to assign oscilloscope channels to the SPI clock, data, and frame signals.

- 5 Press the **Signals** softkey to access SPI trigger settings for clock source and slope, data source, and frame type and source.

SPI Signals Menu

Clock D11

f t

Data D10

Frame by ~CS

~CS D13

Clock channel

Clock slope

Data channel

Frame by condition

Frame channel

Return to previous menu

4 Triggering

- 6 Press the **Clock** softkey or turn the Entry knob to select the channel connected to the SPI serial clock line.

As you press the **Clock** softkey (or rotate the Entry knob), the **CLK** label for the source channel is automatically set and the channel you select is shown in the upper-right corner of the display next to “**SPI**”.

If you have connected one of the oscilloscope’s analog source channels to the Clock signal: Adjust the trigger level for the selected analog channel to the middle of the waveform by turning the Trigger Level knob.

If you have connected one of the oscilloscope’s digital source channels to the Clock signal (this applies to MSO model oscilloscopes only): Press the [**D15-D0**] key and select **Thresholds** to set an appropriate threshold level for digital channels.

- 7 Press the slope softkey () to select rising edge or falling edge for the selected Clock source.

This determines which clock edge the oscilloscope will use to latch the serial data. When you press the slope softkey, the graphic shown on the display changes to show the current state of the clock signal.



- 8 Press the **Data** softkey or turn the Entry knob to select the channel that is connected to the SPI serial data line. (If the channel you selected is off, switch it on.)

As you press the **Data** softkey (or rotate the Entry knob), the **DATA** label for the source channel is automatically set and the channel you select is shown in the upper-right corner of the display next to “SPI”.

If you have connected one of the oscilloscope’s analog source channels to the Data signal: Adjust the trigger level for the selected analog channel to the middle of the waveform by turning the Trigger Level knob.

If you have connected one of the oscilloscope’s digital source channels to the Data signal (this applies to MSO model oscilloscopes only): Press the [**D15-D0**] key and select **Thresholds** to set an appropriate threshold level for digital channels.

- 9 Press the **Frame by** softkey to select a framing signal that the oscilloscope will use for determining which clock edge is the first clock edge in the serial stream.

You can set the oscilloscope to trigger during a high chip select (**CS**), a low chip select (**~CS**), or after a **Timeout** period during which the clock signal has been idle.

- If the framing signal is set to **CS** (or **~CS**), the first clock edge as defined, rising or falling, seen after the **CS** (or **~CS**) signal transitions from low to high (or high to low) is the first clock in the serial stream.

Chip Select — Press the **CS** or **~CS** softkey or turn the Entry knob to select the channel that is connected to the SPI frame line. The label (**~CS** or **CS**) for the source channel is automatically set. The data pattern and the clock transition must occur during the time when the framing signal is valid. The framing signal must be valid for the entire data pattern.

As you press the **CS** or **~CS** softkey (or rotate the Entry knob), the **CS** or **~CS** label for the source channel is automatically set and the channel you select is shown in the upper-right corner of the display next to “**SPI**”. When you press the **Frame by** softkey, the graphic shown on the previous page changes to show timeout selection or the current state of the chip select signal.

If you have connected one of the oscilloscope’s analog source channels to the Chip Select signal: Adjust the trigger level for the selected analog channel to the middle of the waveform by turning the Trigger Level knob.

If you have connected one of the oscilloscope’s digital source channels to the Chip Select signal (this applies to MSO model oscilloscopes only): Press the **[D15-D0]** key and select **Thresholds** to set an appropriate threshold level for digital channels.

- If the framing signal is set to **Timeout**, the oscilloscope generates its own internal framing signal after it sees inactivity on the serial clock line.

Clock Timeout — Select **Clock Timeout** in the **Frame by** softkey, then select the **Timeout** softkey and turn the Entry knob to set the minimum time that the Clock signal must be idle (not transitioning) before the oscilloscope will search for the Data pattern on which to trigger. When you press the **Frame by** softkey, the graphic shown on the previous page changes to show timeout selection or the current state of the chip select signal.

The Timeout value can be set anywhere from 100 ns to 10 s.

- 10** Press the up-arrow softkey to return to the previous menu.

Set Up the Bits in the Serial Data String

This explains how to set up the number of bits in the serial data string and set values for those data bits

- 1 Press the **#Bits** softkey, and turn the Entry knob to set the number of bits (**#Bits**) in the serial data string. The number of bits in the string can be set anywhere from 4 bits to 32 bits. The data values for the serial string are displayed in the Data string in the waveform area.
- 2 Turn the Entry knob to select a specific data bit in the serial string as shown in the **Bit** softkey.

As you rotate the Entry knob, the bit is highlighted in the Data string shown in the waveform area.

- 3 Press the **0 1 X** softkey to set the bit selected in the **Bit** softkey to **0** (low), **1** (high), or **X** (don't care).

Repeat steps 2 and 3 to assign values for all bits.

Resetting All Bits in the Serial Data String to One Value

To reset all of the bit values in the serial data string to one value (0, 1, or X):

- 1 Press the **0 1 X** softkey to select your reset bit value.
- 2 Press the **Set all Bits** softkey to reset the data string to the selected value.

NOTE

For SPI decode information see [page 323](#).

TV Trigger

TV triggering can be used to capture the complicated waveforms of most standard and high-definition analog video signals. The trigger circuitry detects the vertical and horizontal interval of the waveform and produces triggers based on the TV trigger settings you have selected.

The oscilloscope's MegaZoom III technology gives you bright, easily viewed displays of any part of the video waveform. Analysis of video waveforms is simplified by the oscilloscope's ability to trigger on any selected line of the video signal.

NOTE

It is important, when using a 10:1 passive probe, that the probe is correctly compensated. The oscilloscope is sensitive to this and will not trigger if the probe is not properly compensated, especially for progressive formats.

- 1 Press the **[More]** key in the Trigger section of the front panel. If **TV** is not selected, rotate the Entry knob until **TV** is displayed in the **Trigger** softkey, then press the **Settings** softkey to display TV Trigger Menu.

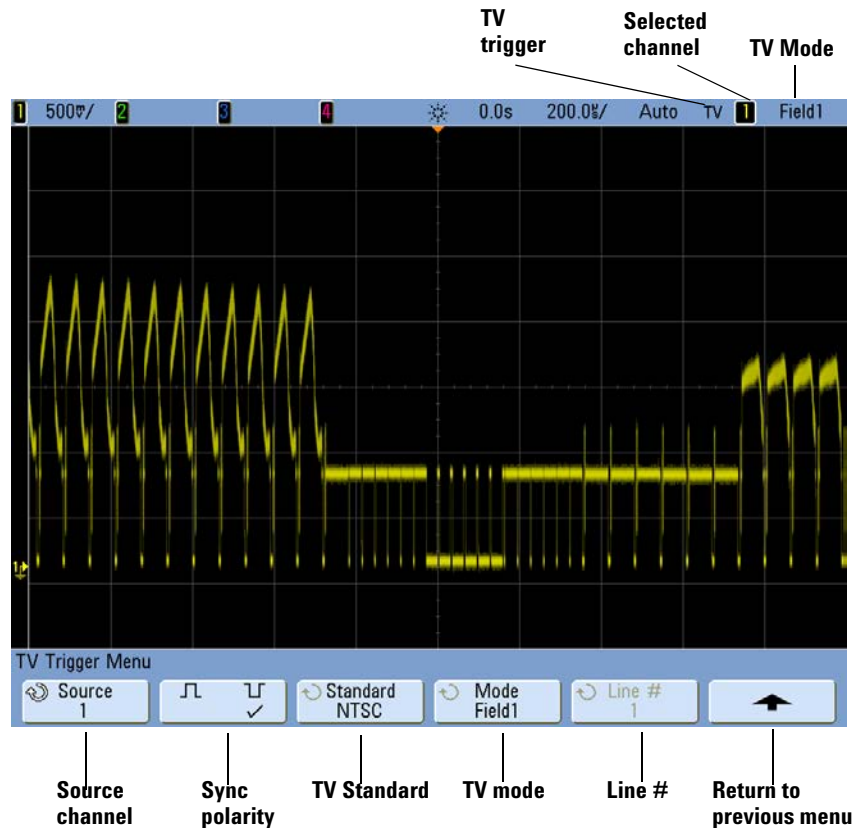

- 2 Press the **Source** softkey and select any analog channel as the TV trigger source.

The selected trigger source is displayed in the upper-right corner of the display. Turning the Trigger **Level** knob does not change the trigger level because the trigger level is automatically set to the sync pulse. Trigger coupling is automatically set to **TV** in the Trigger Mode and Coupling Menu.

Provide Correct Matching
 Many TV signals are produced from 75 Ω sources. To provide correct matching to these sources, a 75 Ω terminator (such as an Agilent 11094B) should be connected to the oscilloscope input.

- 3 Press the sync polarity softkey to set the TV trigger to either positive (\lrcorner) or negative (\ulcorner) sync polarity.

4 Press the **Standard** softkey to set the TV standard.

The oscilloscope supports triggering on the following television (TV) and video standards.

Standard	Type	Sync Pulse
NTSC	Interlaced	Bi-level
PAL	Interlaced	Bi-level
PAL-M	Interlaced	Bi-level
SECAM	Interlaced	Bi-level
Generic	Interlaced/Progressive	Bi-level/Tri-level
EDTV 480p/60	Progressive	Bi-level
HDTV 720p/60	Progressive	Tri-level
HDTV 1080p/24	Progressive	Tri-level
HDTV 1080p/25	Progressive	Tri-level
HDTV 1080p/50	Progressive	Tri-level
HDTV 1080p/60	Progressive	Tri-level
HDTV 1080i/50	Interlaced	Tri-level
HDTV 1080i/60	Interlaced	Tri-level

5 Press the **Mode** softkey to select the portion of the video signal that you would like to trigger on.

The TV trigger modes available are:

- **Field1** and **Field2** — Trigger on the rising edge of the first serration pulse of field 1 or field 2 (interlaced standards only).
- **All Fields** — Trigger on the rising edge of the first pulse in the vertical sync interval (not available in Generic mode).
- **All Lines** — Trigger on all horizontal sync pulses.
- **Line** — Trigger on the selected line # (EDTV and HDTV standards only).
- **Line: Field1** and **Line:Field2** — Trigger on the selected line # in field 1 or field 2 (interlaced standards only except 1080i).
- **Line: Alternate** — Alternately trigger on the selected line # in field 1 and field 2 (NTSC, PAL, PAL-M, and SECAM only).
- **Vertical** — Trigger on the rising edge of the first serration pulse or approximately 70 μ s after the start of vertical sync, whichever occurs first (only available in Generic mode).
- **Count: Vertical** — Counts falling edges of sync pulses; triggers on the selected count number (only available in Generic mode).

- 6** If you select a line # mode, press the **Line #** softkey, then rotate the Entry knob to select the line number on which you want to trigger.
- 7** When using the Generic standard and you select a line # mode or **Count:Vertical**, press the **Count #** softkey and rotate the Entry knob to select the desired count number.

Listed below are the line (or count) numbers per field for each non-HDTV/EDTV video standard.

Video standard	Field 1	Field 2	Alt Field
NTSC	1 to 263	1 to 262	1 to 262
PAL	1 to 313	314 to 625	1 to 312
PAL-M	1 to 263	264 to 525	1 to 262
SECAM	1 to 313	314 to 625	1 to 312
Generic	1 to 1024	1 to 1024	1 to 1024 (vertical)

Line numbers for each EDTV/HDTV video standard

EDTV 480p/60	1 to 525
HDTV 720p/60	1 to 750
HDTV 1080p/24	1 to 1125
HDTV 1080p/25	1 to 1125
HDTV 1080i/50	1 to 1125
HDTV 1080i/60	1 to 1125

Line Number Represents Count

In **Generic** mode, the line number represents the number of a count instead of a real line number. This is reflected in the label in the softkey changing from **Line** to **Count**. In the **Mode** softkey selections, **Line:Field 1**, **Line:Field 2** and **Count:Vertical** are used to indicate where the counting starts. For an interlaced video signal, the counting starts from the rising edge of the first vertical serration pulse of Field 1 and/or Field 2. For a non-interlaced video signal, the counting starts after the rising edge of the vertical sync pulse.

TV Triggering Examples

The following are exercises to familiarize you with TV triggering. These exercises use the NTSC video standard.

To trigger on a specific line of video

TV triggering requires greater than 1/2 division of sync amplitude with any analog channel as the trigger source. Turning the trigger **Level** knob in TV trigger does not change the trigger level because the trigger level is automatically set to the sync pulse tips.

One example of triggering on a specific line of video is looking at the vertical interval test signals (VITS), which are typically in line 18. Another example is closed captioning, which is typically in line 21.

- 1 Press the Trigger [**More**] key, then press the **TV** softkey.
- 2 Press the **Settings** softkey, then press the **Standard** softkey to select the appropriate TV standard (NTSC).
- 3 Press the **Mode** softkey and select the TV field of the line you want to trigger on. You can choose **Line:Field1**, **Line:Field2**, or **Line:Alternate**.
- 4 Press the **Line #** softkey and select the number of the line you want to examine.

Alternate Triggering

If **Line:Alternate** is selected, the oscilloscope will alternately trigger on the selected line number in Field 1 and Field 2. This is a quick way to compare the Field 1 VITS and Field 2 VITS or to check for the correct insertion of the half line at the end of Field 1.

EXAMPLE: TRIGGERING ON LINE 136

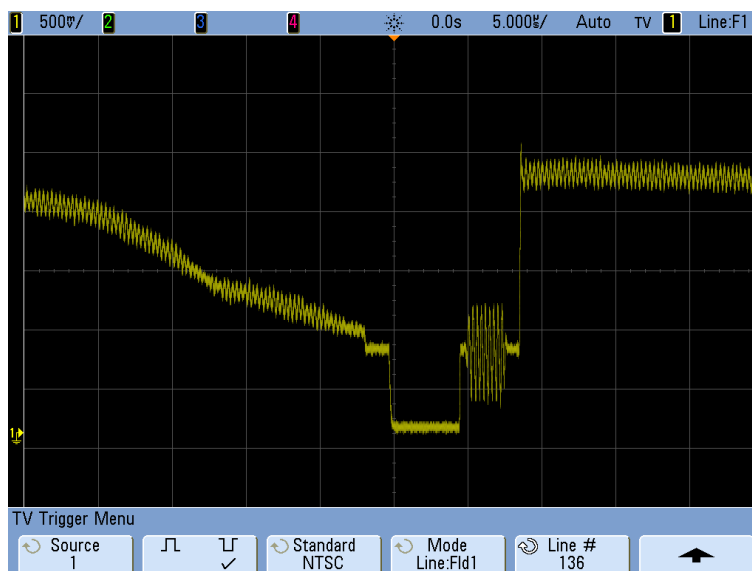

To trigger on all sync pulses

To quickly find maximum video levels, you could trigger on all sync pulses. When **All Lines** is selected as the TV trigger mode, the oscilloscope will trigger on all horizontal sync pulses.

- 1 Press the Trigger [**More**] key, then press the **TV** softkey.
- 2 Press the **Settings** softkey, then press the **Standard** softkey to select the appropriate TV standard.
- 3 Press the **Mode** softkey and select **All Lines**.

TRIGGERING ON ALL LINES

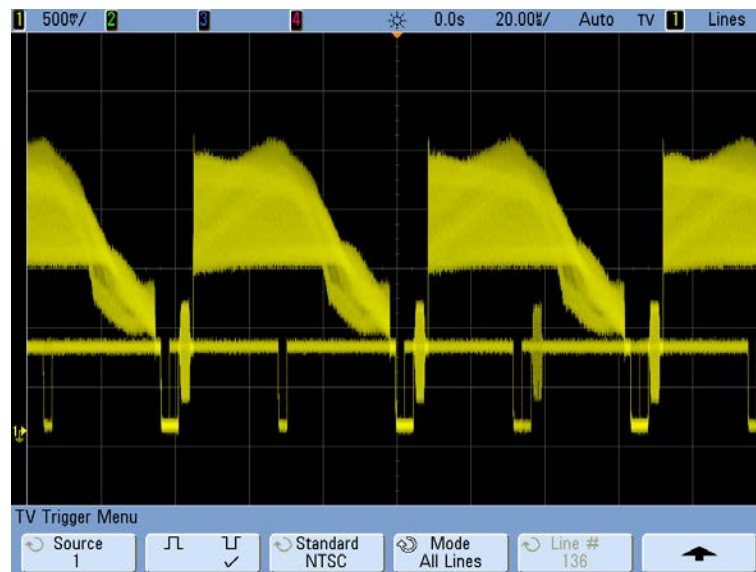

To trigger on a specific field of the video signal

To examine the components of a video signal, trigger on either Field 1 or Field 2 (available for interleaved standards). When a specific field is selected, the oscilloscope triggers on the rising edge of the first serration pulse in the vertical sync interval in the specified field (1 or 2).

- 1 Press the Trigger [**More**] key, then press the **TV** softkey.
- 2 Press the **Settings** softkey, then press the **Standard** softkey to select the appropriate TV standard.

- 3 Press the **Mode** softkey and select **Field1** or **Field2**.

TRIGGERING ON FIELD 1

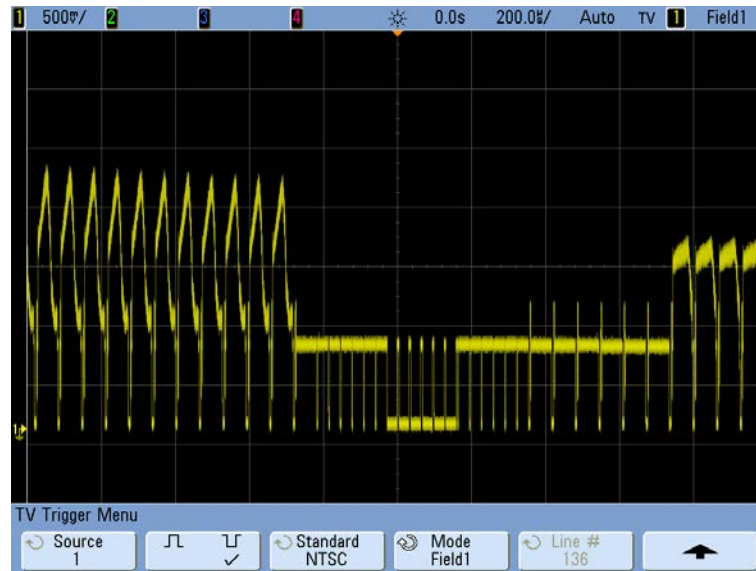

To trigger on all fields of the video signal

To quickly and easily view transitions between fields, or to find the amplitude differences between the fields, use the All Fields trigger mode.

- 1 Press the Trigger [**More**] key, then press the **TV** softkey.
- 2 Press the **Settings** softkey, then press the **Standard** softkey to select the appropriate TV standard.
- 3 Press the **Mode** softkey and select **All Fields**.

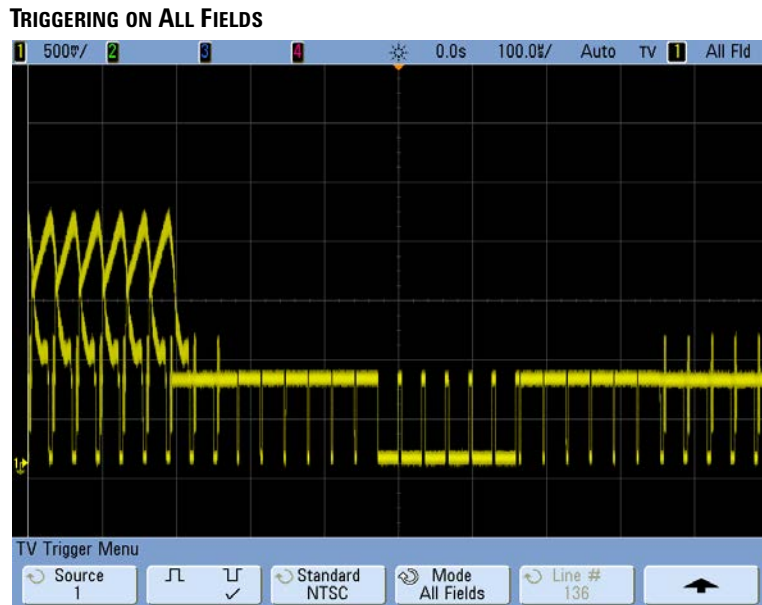

To trigger on odd or even fields

To check the envelope of your video signals, or to measure worst case distortion, trigger on the odd or even fields. When Field 1 is selected, the oscilloscope triggers on color fields 1 or 3. When Field 2 is selected, the oscilloscope triggers on color fields 2 or 4.

- 1 Press the Trigger [**More**] key, then press the **TV** softkey.
- 2 Press the **Settings** softkey, then press the **Standard** softkey to select the appropriate TV standard.
- 3 Press the **Mode** softkey and select **Field1** or **Field2**.

The trigger circuits look for the position of the start of Vertical Sync to determine the field. But this definition of field does not take into consideration the phase of the reference subcarrier. When Field 1 is selected, the trigger system will find any field where the vertical sync starts on Line 4. In the case of NTSC video, the oscilloscope will trigger on color field 1 alternating with color field 3 (see the following figure). This setup can be used to measure the envelope of the reference burst.

4 Triggering

TRIGGERING ON COLOR FIELD 1 ALTERNATING WITH COLOR FIELD 3

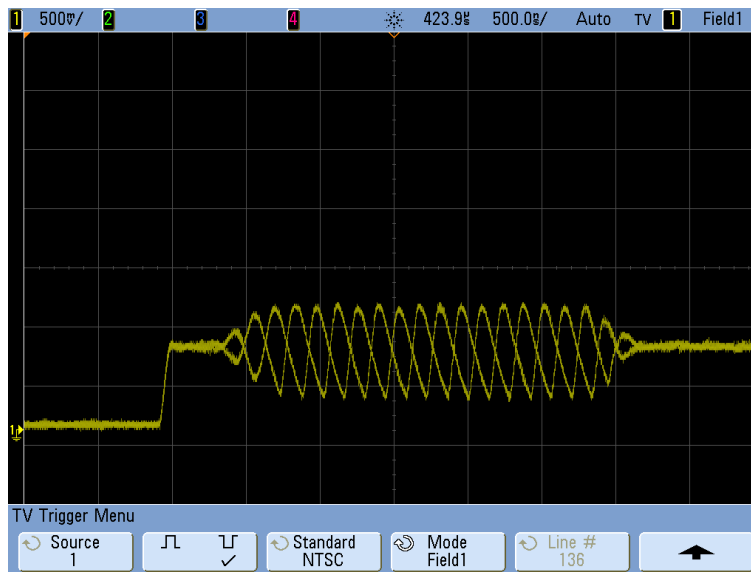

If a more detailed analysis is required, then only one color field should be selected to be the trigger. You can do this by using the **TV Holdoff** softkey in the trigger More Trigger Menu when the trigger type is set to **TV**. Press the **TV Holdoff** softkey and use the Entry knob to adjust the holdoff in half-field increments until the oscilloscope triggers on only one phase of the color burst.

A quick way to synchronize to the other phase is to briefly disconnect the signal and then reconnect it. Repeat until the correct phase is displayed.

When holdoff is adjusted using the **TV Holdoff** softkey and the Entry knob, the corresponding holdoff time will be displayed in the Trigger Mode and Coupling Menu.

HALF-FIELD HOLDOFF TIME

Standard	Time
NTSC	8.35 ms
PAL	10 ms
PAL-M	10 ms
SECAM	10 ms
Generic	8.35 ms
EDTV 480p/60	8.35 ms
HDTV 720p/60	8.35 ms
HDTV 1080p/24	20.835 ms
HDTV 1080p/25	20 ms
HDTV 1080i/50	10 ms
HDTV 1080i/60	8.35 ms

USING TV HOLDOFF TO SYNCHRONIZE TO COLOR FIELD 1 OR 3 (FIELD 1 MODE)

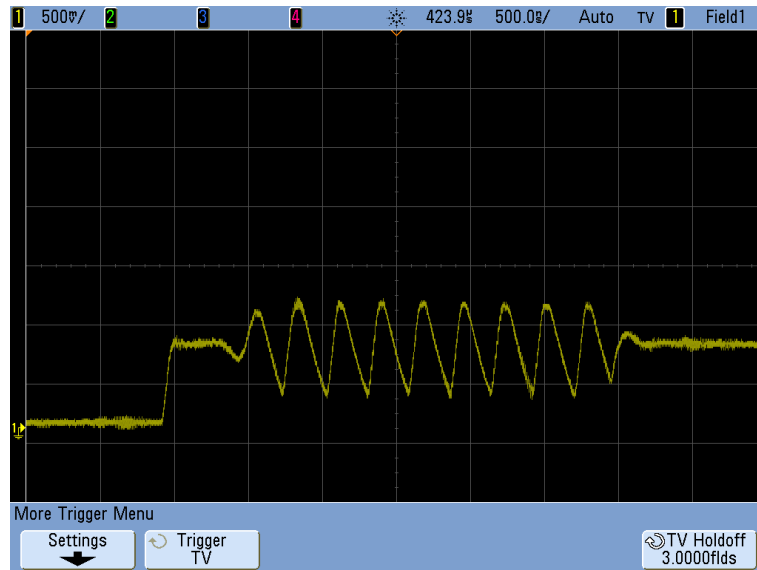

UART/RS232 Trigger

To trigger on a UART (Universal Asynchronous Receiver/Transmitter) signal connect the oscilloscope to the Rx and Tx lines and set up a trigger condition. RS232 (Recommended Standard 232) is one example of a UART protocol.

- 1 Press **[Save/Recall]**→**Default Setup**.
- 2 Press the **[Label]** key to switch labels on.
- 3 Turn on any analog or digital channels that you will be using for the UART/RS232 signals.
- 4 Press the **[More]** key in the Trigger section of the front panel. Rotate the Entry knob until **UART/RS232** is displayed in the **Trigger** softkey
- 5 Press the **Settings** softkey to display the UART/RS232 Trigger Menu.

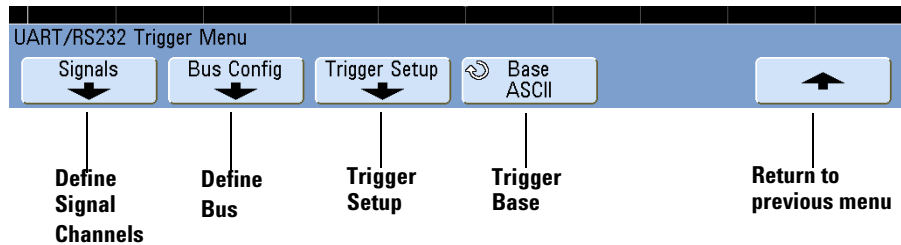
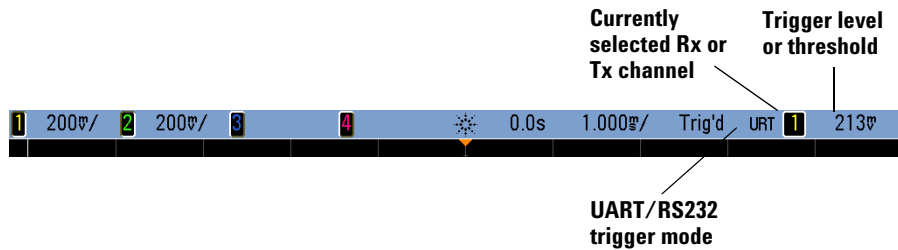

- 6 Press the **Signals** softkey to display the UART/RS232 Signals Menu.

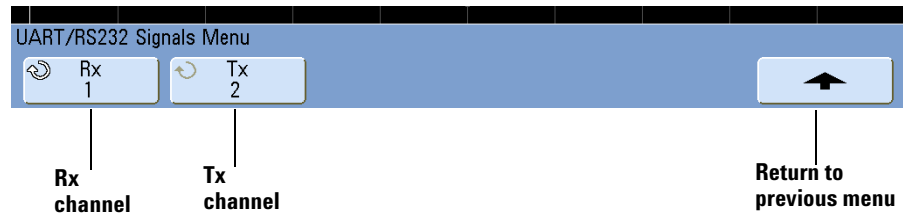

- 7 Connect an oscilloscope channel to the Rx signal in the device under test, then press the **Rx** softkey and rotate the Entry knob to select the channel.

As you press the **Rx** softkey (or rotate the Entry knob), the channel you select is shown in the upper-right corner of the display next to “**URT**”.

- 8 Make sure the trigger or threshold levels are set to the middle of the signal:
- For analog channels, turn the Trigger Level knob.
 - For digital channels, press the **[D15-D0]** key and the **Thresholds** softkey to access the threshold level setting softkeys.

The value of the trigger level or digital threshold is displayed in the upper-right corner of the display.

- 9 Repeat these steps for the Tx signal.
- 10 Press the **[More]** key, then the **Settings** softkey to return to the UART/RS232 Trigger Menu.
- 11 Press the **Bus Config** softkey and set the following parameters.

- a #Bits:** Set the number of bits in the UART/RS232 words to match your device under test (selectable from 5-9 bits).
- b Parity:** Choose odd, even, or none, based on your device under test.
- c Baud:** Press the **Baud Rate** softkey, then press the **Baud** softkey and select a baud rate to match the signal in your device under test. If the desired baud rate is not listed, select **User Defined** on the Baud softkey, then select the desired baud rate using the **User Baud** softkey. You can set the UART baud rate from 1.2 kb/s to 3.0000 Mb/s in increments of 100 b/s.
- d Polarity:** Select idle low or idle high to match your device under test’s state when at idle. For RS232 select idle low.
- e Bit Order:** Select whether the most significant bit (MSB) or the least significant bit (LSB) is presented after the start bit in the signal from your device under test. For RS232 select LSB.

- 12** Press the up arrow softkey to return to the previous menu.
- 13** Press the **Base** softkey to select Hex or ASCII as the base displayed on the Data softkey in the UART/RS232 Trigger Setup Menu. Note that the setting of this softkey does not affect the selected base of the decode display.
- 14** Press the **Trigger Setup** softkey and set up the desired trigger condition:
- **Rx Start Bit** — The oscilloscope triggers when a start bit occurs on Rx.
 - **Rx Stop Bit** — Triggers when a stop bit occurs on Rx. The trigger will occur on the first stop bit. This is done automatically whether the device under test uses 1, 1.5, or 2 stop bits. You do not need to specify the number of stop bits used by the device Under test.
 - **Rx Data** — Triggers on a data byte that you specify. For use when the device under test data words are from 5 to 8 bits in length (no 9th (alert) bit).
 - **Rx 1:Data** — For use when the device under test data words are 9 bits in length including the alert bit (the 9th bit). Triggers only when the 9th (alert) bit is 1. The specified data byte applies to the least significant 8 bits (excludes the 9th (alert) bit).
 - **Rx 0:Data** — For use when the device under test data words are 9 bits in length including the alert bit (the 9th bit). Triggers only when the 9th (alert) bit is 0. The specified data byte applies to the least significant 8 bits (excludes the 9th (alert) bit).
 - **Rx X:Data** — For use when the device under test data words are 9 bits in length including the alert bit (the 9th bit). Triggers on a data byte that you specify regardless of the value of the 9th (alert) bit. The specified data byte applies to the least significant 8 bits (excludes the 9th (alert) bit).
 - Similar choices are available for Tx.
 - **Rx or Tx Parity Error** — Triggers on a parity error based on the parity you have set in the Bus Configuration Menu.
- 15** If you choose a trigger condition that includes “**Data**” in its description (for example: **Rx Data**) then press the **Data is** softkey and choose an equality qualifier. You can choose equal to, not equal to, less than, or greater than a specific data value.
- 16** Use the **Data** softkey to choose the data value for your trigger comparison. This works in conjunction with the **Data is** softkey.
- 17** Optional: The **Burst** softkey lets you trigger on the Nth frame (1-4096) after an idle time you select. All trigger conditions must be met for the trigger to occur.

- 18** If **Burst** is selected, an idle time (1 μ s to 10 s) can be specified so that the oscilloscope will look for a trigger condition only after the idle time has past. Press the **Idle** softkey and rotate the Entry knob to set an idle time.
- 19** Remember to set the trigger mode to Normal (press **[Mode/Coupling]** \rightarrow **Mode** \rightarrow **Normal**) to prevent Auto Triggering.

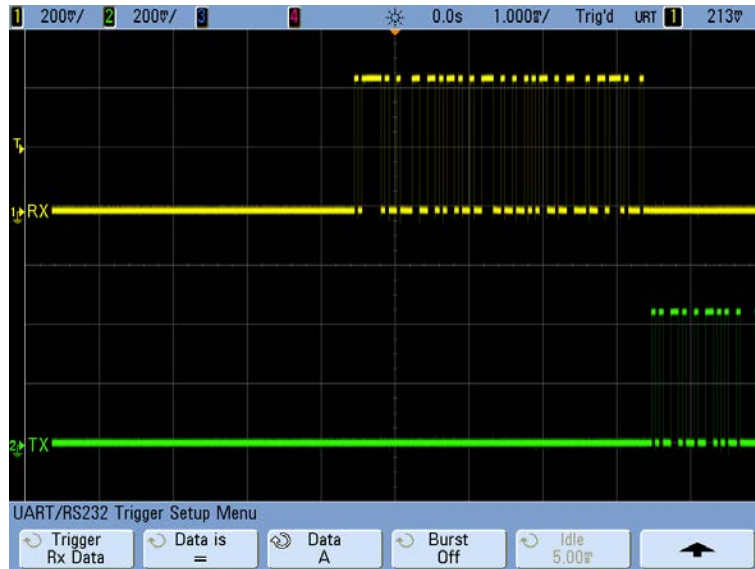
**NOTE**

To display UART/RS232 serial decode, see [page 329](#).

USB Trigger

USB trigger will trigger on a Start of Packet (SOP), End of Packet (EOP) signal, Reset Complete (RC), Enter Suspend (Suspend), or Exit Suspend (Exit Sus) on the differential USB data lines (D+ and D-). USB Low Speed and Full Speed are supported by this trigger.

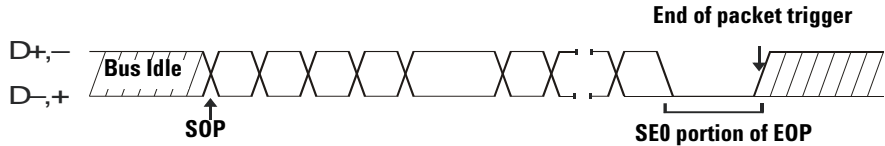

- 1 Press **[Save/Recall]** → **Default Setup**.
- 2 Press the **[Label]** key to switch labels on.
- 3 Turn on any analog or digital channels that you will be using for the USB signals.
- 4 Press the **[More]** key in the Trigger section of the front panel, rotate the Entry knob until **USB** is displayed in the **Trigger** softkey, then press the **Settings** softkey to display USB Trigger Menu.

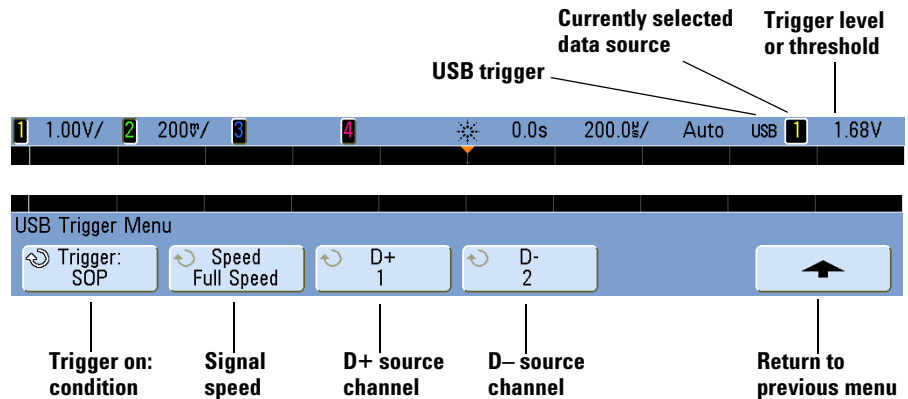

- 5 Press the **Speed** softkey to select the speed of the transaction being probed.
You may select Low Speed (1.5 Mb/s) or Full Speed (12 Mb/s).
- 6 Press the **D+** and **D-** softkeys to select the channel connected to the USB signal D+ and D- lines. The **D+** and **D-** labels for the source channels are automatically set.

As you press the **D+** or **D-** softkey (or rotate the Entry knob), the **D+** and **D-** label for the source channel is automatically set and the channel you select is shown in the upper-right corner of the display next to “USB”.

If you have connected the oscilloscope’s analog source channels to the D+ and D- signals: Adjust the trigger level for each connected analog channel to the middle of the waveform by pressing the **D+** or **D-** softkey, then turning the Trigger Level knob.

If you have connected the oscilloscope’s digital source channels to the D+ and D- signals (this applies to MSO model oscilloscopes only): Press the **[D15-D0]** key and select **Thresholds** to set an appropriate threshold level for the digital channels.

The value of the trigger level or digital threshold is displayed in the upper-right corner of the display.

7 Press the **Trigger:** softkey to select where the USB trigger will occur:

- **SOP** (Start of Packet) — triggers at the Sync bit at the beginning of the packet.
- **EOP** (End of Packet) — triggers at the end of the SE0 portion of the EOP.
- **RC** (Reset Complete) — triggers when SE0 is > 10 ms.
- **Suspend** (Enter Suspend) — triggers when the bus is idle > 3 ms.
- **Exit Sus** (Exit Suspend) — triggers when exiting an idle state > 10 ms. This is used to see the suspend/resume transition.

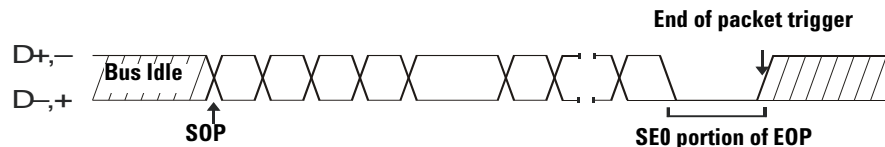

4 Triggering



5 Displaying

Tips for Displaying Waveforms	174
Stabilizing the Display	174
Interpreting the Display	175
Graphic Symbols in Softkey Menus	176
AutoScale	177
Pan and Zoom	179
Waveform Intensity and Signal Detail	180
Grid Intensity	181
Infinite Persistence	182
Using Labels	183
Waveform Expansion Reference Point	187
Vectors (Connect the Dots)	187
Freeze Display	188
Antialiasing	189
XGA Video Output	189

The topics in this chapter pertain to aspects of displaying waveforms.

- See Also**
- **“Acquisition Modes”** on page 261.
 - **“XY Horizontal Mode”** on page 220.
 - **“Printing the Oscilloscope’s Display”** on page 244.



Tips for Displaying Waveforms

The easiest way to display waveforms is to connect the probes to the signals and press **[AutoScale]**.

When selecting a particular trigger type, it is helpful to consider whether to use Auto or Normal trigger mode. See **“Auto and Normal Trigger modes”** on page 84.

Stabilizing the Display

If you are acquiring a slow signal from a serial bus or another signal that arrives in bursts, the oscilloscope may Auto-trigger between signal bursts, which will cause the display to appear unstable. You can solve this problem by selecting the Normal trigger mode. See **“Auto and Normal Trigger modes”** on page 84.

If the acquired signal is noisy, there are several steps you can take to stabilize its display. To reduce the random noise displayed when triggering on a noisy signal, see **“Trigger Noise Rejection”** on page 87.

Interpreting the Display

The oscilloscope display contains acquired waveforms, setup information, measurement results, and the softkey definitions.

INTERPRETING THE DISPLAY

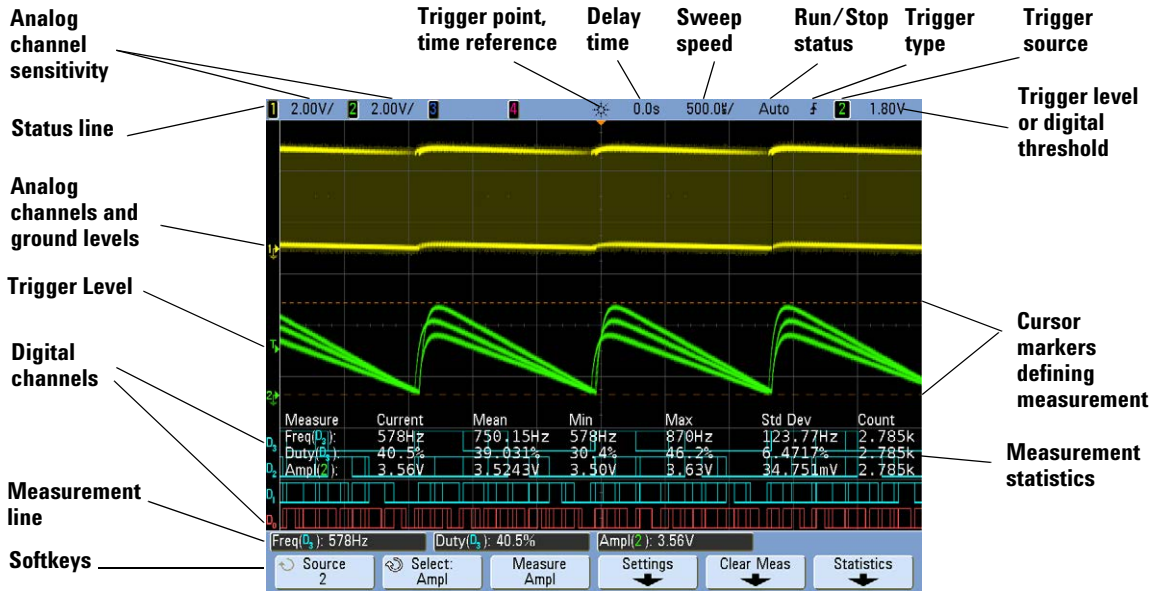

Status line The top line of the display contains vertical, horizontal, and trigger setup information.

Display area The display area contains the waveform acquisitions, channel identifiers, and analog trigger and ground level indicators. Each analog channel's information appears in a different color.



Measurement line This line normally contains automatic measurement and cursor results, but can also display advanced trigger setup data and menu information.

Softkeys The softkeys let you set up additional parameters for the selected mode or menu.

Graphic Symbols in Softkey Menus

Softkeys are the six keys directly below the display. They are called Softkeys because software determines the function assigned to each key in any given menu.

The following graphic symbols appear in the oscilloscope's softkey menus. The softkey menus appear at the bottom of the display, just above the six softkeys.

 Rotate the Entry knob to adjust the parameter. The Entry knob is located on the front panel. The  symbol below the knob is illuminated when this control is active.

 Rotate the Entry knob to select an item. Push the Entry knob or press the softkey to activate the item or close the menu.

 Press the softkey to display a pop-up menu. Press the softkey or rotate and push the Entry knob to make an item active.

 Option is selected but not active.

 Option is selected and active.

 Feature is on. Press the softkey again to turn the feature off.

 Feature is off. Press the softkey again to turn the feature on.

 Press the softkey to view the menu.

 Press the softkey to return to the previous menu.

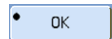
 A dot on a softkey indicates that the action specified in the dialog will be performed when the Entry knob is pushed (7000 Series only).

AutoScale

Press the [**AutoScale**] key to quickly display the input signals.

How AutoScale works

AutoScale automatically configures the oscilloscope to best display the input signals by analyzing any waveforms present at each channel and at the external trigger input. This includes the digital channels on MSO models.

AutoScale finds, turns on, and scales any channel with a repetitive waveform that has a frequency of at least 50 Hz, a duty cycle greater than 0.5%, and an amplitude of at least 10 mV peak-to-peak. Any channels that do not meet these requirements are turned off.

The trigger source is selected by looking for the first valid waveform starting with external trigger, then continuing with the highest number analog channel down to the lowest number analog channel, and finally (if the oscilloscope is an MSO) the highest number digital channel.

During AutoScale, the delay is set to 0.0 seconds, the sweep speed setting is a function of the input signal (about 2 periods of the triggered signal on the screen), and the triggering mode is set to Edge. Vectors remain in the state they were before the AutoScale.

Undo AutoScale

Press the **Undo AutoScale** softkey to return the oscilloscope to the settings that existed before you pressed the [**AutoScale**] key.

This is useful if you have unintentionally pressed the [**AutoScale**] key or do not like the settings AutoScale has selected and want to return to your previous settings.

Enabling Fast Debug AutoScale

The Fast Debug option changes the behavior of [**AutoScale**] to let you make quick visual comparisons to determine whether the signal being probed is a DC voltage, ground, or an active AC signal. Channel coupling is maintained for easy viewing of oscillating signals.

- 1 Press [**Utility**] > **Options** > **Preferences** > **AutoScale**.
- 2 In the AutoScale Preferences Menu, press **Fast Debug** to enable or disable the option.

Specifying the Channels Displayed After AutoScale

The **Channels** softkey selection determines which channels will be displayed on subsequent AutoScales.

- **All Channels** — The next time you press [**AutoScale**], all channels that meet the requirements of AutoScale will be displayed.
- **Only Displayed Channels** — The next time you press [**AutoScale**], only the channels that are turned on will be examined for signal activity. This is useful if you only want to view specific active channels after pressing [**AutoScale**].

Preserving the Acquisition Mode During AutoScale

The acquisition mode is normally switched to Normal when AutoScale is performed. AutoScale can be set to leave the acquisition mode unchanged if you prefer this option.

Choose Normal to make the oscilloscope switch to Normal acquisition mode whenever the [**AutoScale**] key is pressed. This is the default mode.

Choose Preserve to make the oscilloscope remain in the acquisition mode you have chosen when the [**AutoScale**] key is pressed.

Pan and Zoom

The ability to pan (move horizontally) and zoom (expand or compress horizontally) an acquired waveform is important because of the additional insight it can reveal about the captured waveform. This additional insight is often gained from seeing the waveform at different levels of abstraction. You may want to view both the big picture and the specific little picture details.

The ability to examine waveform detail after the waveform has been acquired is a benefit generally associated with digital oscilloscopes. Often this is simply the ability to freeze the display for the purpose of measuring with cursors or printing the screen. Some digital oscilloscopes go one step further by including the ability to further examine the signal details after acquiring them by panning and zooming through the waveform.

There is no limit imposed on the zoom ratio between the sweep speed used to acquire the data and the sweep speed used to view the data. There is, however, a useful limit. This useful limit is somewhat a function of the signal you are analyzing.

In normal display mode, with vectors (connect-the-dots) off, you can zoom in to the point where there are no samples on the screen. Obviously, this is far beyond the useful limit. Likewise, with vectors on, you can see the linear interpolation between the points, but again, this is of very limited value.

Zoom

The screen will still contain a relatively good display if you zoom in horizontally by a factor of 1000 and zoom in vertically by a factor of 10 to display the information from where it was acquired. Remember that you can only make automatic measurements on displayed data.

To pan and zoom a waveform

You can pan across and zoom-in on a waveform even when the acquisition system is stopped.

- 1 Press the **[Run/Stop]** key or the **[Single]** key and allow the oscilloscope to acquire the waveform and stop. The **[Run/Stop]** key is illuminated red when the oscilloscope is stopped.
- 2 Turn the horizontal sweep speed knob marked $\sim \wedge \sim$ to zoom horizontally and turn the volts/division knob marked $\sim \vee \sim$ to zoom vertically.

The ∇ symbol at the top of the display indicates the time reference point where the zoom-in/zoom-out is referenced.

5 Displaying

- 3 Turn the Horizontal Position (Delay Time) knob (◀▶) to pan horizontally and turn the channel's vertical position knob (⬆️) to pan vertically.

The stopped display may contain several triggers worth of information, but only the last trigger acquisition is available for pan and zoom.

Waveform Intensity and Signal Detail

The **Intensity** knob lets you adjust the displayed waveforms to account for various signal characteristics, such as fast sweep speeds and low trigger rates. Increasing the intensity lets you see the maximum amount of noise and infrequently occurring events. Reducing the intensity can expose more detail in complex signals as shown in the following figures. The intensity knob does not affect the digital channels.

Amplitude Modulation with Noise Shown at 100% Intensity

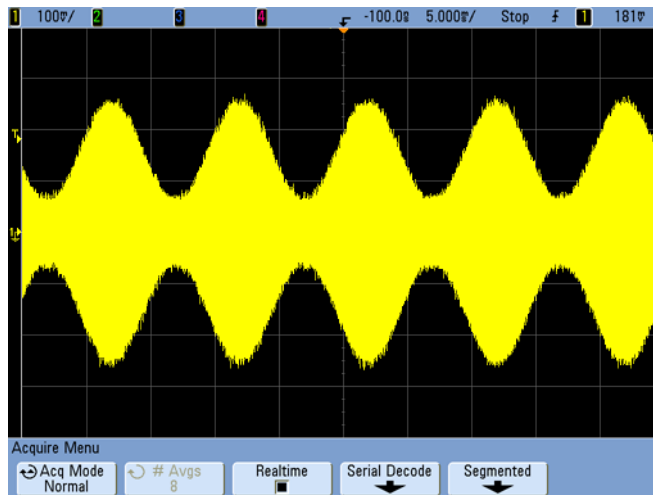

Amplitude Modulation with Noise Shown at 40% Intensity

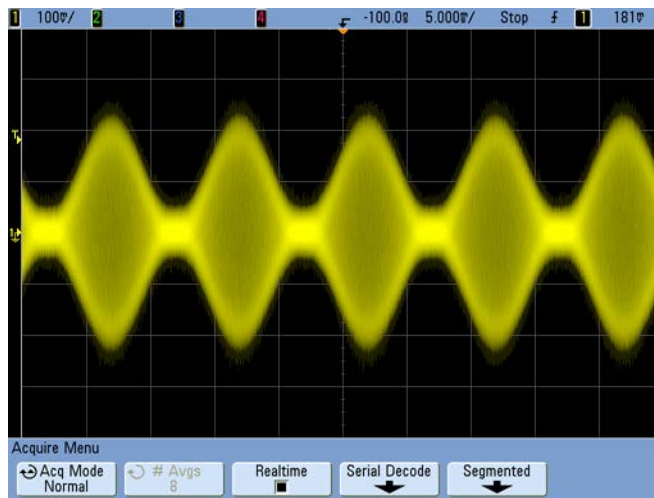

Grid Intensity

To adjust the grid (graticule) intensity, press **[Display]**→**Grid** and use the Entry knob  to adjust the intensity.

To adjust the display grid (graticule) intensity

- 1 Press the **[Display]** key.
- 2 Turn the Entry knob  to change the intensity of the displayed grid. The intensity level is shown in the **Grid** softkey and is adjustable from 0 to 100%.

Each major vertical division in the grid corresponds to the vertical sensitivity shown in the status line at the top of the display.

Each major horizontal division in the grid corresponds to the sweep speed time shown in the status line at the top of the display.

Infinite Persistence

With infinite persistence, the oscilloscope updates the display with new acquisitions, but does not erase the results of previous acquisitions. All previous acquisitions are displayed in gray with reduced intensity. New acquisitions are shown in their normal color with normal intensity. Waveform persistence is kept only for the current display area; you cannot pan and zoom the infinite persistence display.

Use infinite persistence to measure noise and jitter, to see the worst-case extremes of varying waveforms, to look for timing violations, or to capture events that occur infrequently.

To use infinite persistence to display multiple repetitive events

- 1 Connect a signal to the oscilloscope.
- 2 Press the **[Display]** key.



- 3 Press **∞ Persist** to turn on infinite persistence. The display will begin accumulating multiple acquisitions.
- 4 Press the **Clear Display** softkey to erase previous acquisitions. The oscilloscope will start to accumulate acquisitions again.
- 5 Turn off infinite persistence, then press the **Clear Display** softkey to return the oscilloscope to the normal display mode.

Accumulating multiple acquisitions

Turning off infinite persistence does not clear the display. This allows you to accumulate multiple acquisitions, stop acquisitions, and then compare future acquisitions to the stored waveforms. The display is cleared if you press the **Clear Display** softkey or if you press the **[AutoScale]** key.

See also **“Glitch or Narrow Pulse Capture”** on page 112.

Using Labels

You can define labels and assign them to each analog input channel, or you can turn labels off to increase the waveform display area. Labels can also be applied to digital channels on MSO models.

To turn the label display on or off

- 1 Press the **[Label]** key on the front panel.

This turns on display labels for the analog and digital channels. When the **[Label]** key is illuminated, the labels for displayed channels are displayed at the left edge of the displayed traces. The figure below shows an example of the default labels assigned when you turn the label display on. The channel labels default to their channel number.

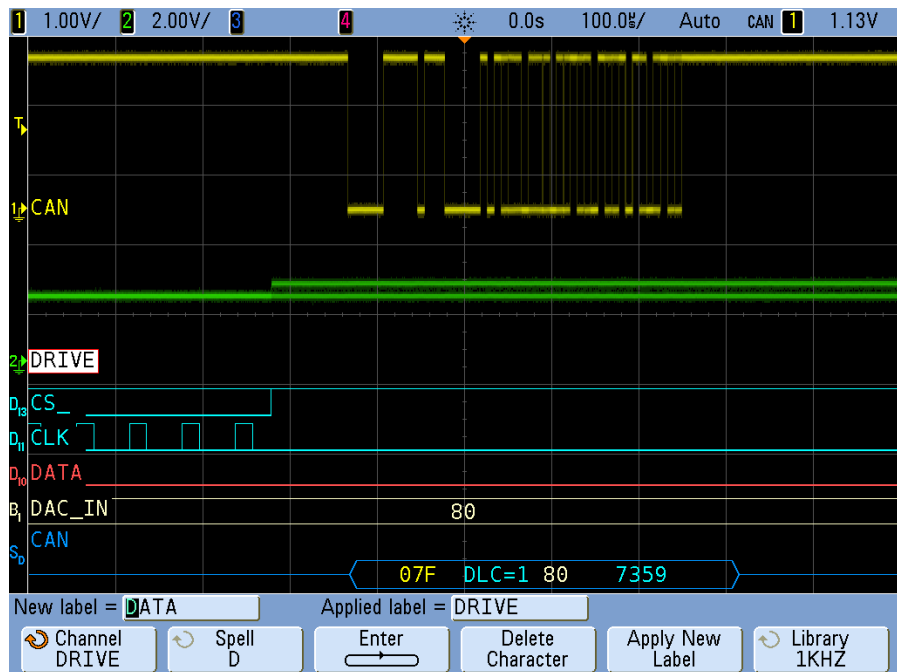

- 2 To turn the labels off, press the **[Label]** key until it is not illuminated.

To assign a predefined label to a channel

- 1 Press the **[Label]** key.
- 2 Press the **Channel** softkey, then turn the Entry knob or successively press the **Channel** softkey to select a channel for label assignment.

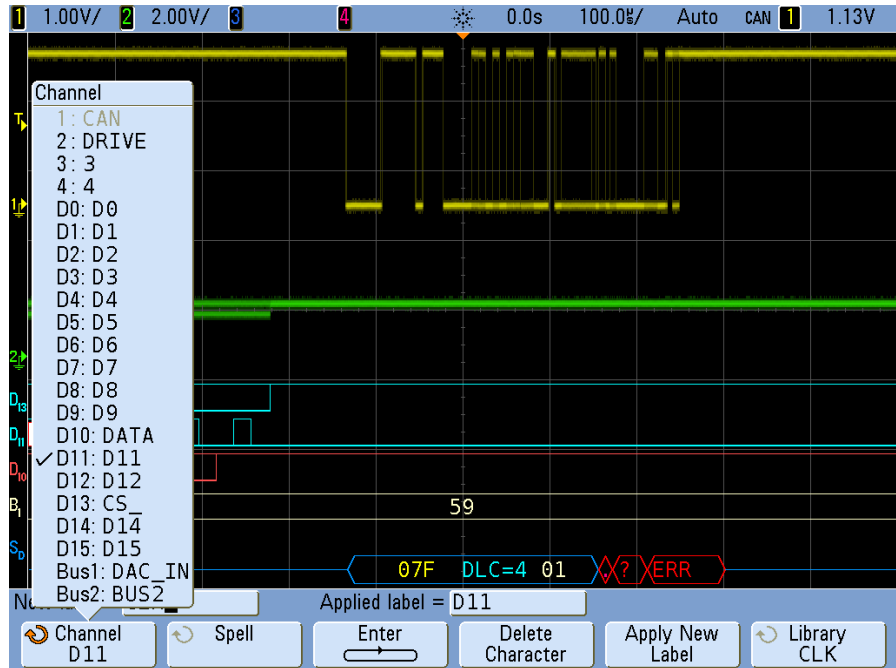

The figure above shows the list of channels and their default labels. The channel does not have to be turned on to have a label assigned to it.

- 3 Press the **Library** softkey, then turn the Entry knob or successively press the **Library** softkey to select a predefined label from the library.
- 4 Press the **Apply New Label** softkey to assign the label to your selected channel.
- 5 Repeat the above procedure for each predefined label you want to assign to a channel.

To define a new label

- 1 Press the **[Label]** key.
- 2 Press the **Channel** softkey, then turn the Entry knob or successively press the softkey to select a channel for label assignment.

The channel does not have to be turned on to have a label assigned to it. If the channel is turned on, its current label will be highlighted.

- 3 Press the **Spell** softkey, then turn the Entry knob to select the first character in the new label.

Turning the Entry knob selects a character to enter into the highlighted position shown in the “**New label =**” line above the softkeys and in the **Spell** softkey. Labels can be up to ten characters in length.

- 4 Press the **Enter** softkey to enter the selected character and to go to the next character position.

You may position the highlight on any character in the label name by successively pressing the **Enter** softkey.

- 5 To delete a character from the label, press the **Enter** softkey until the letter you want to delete is highlighted, then press the **Delete Character** softkey.
- 6 When you are done entering characters for the label, press the **Apply New Label** softkey to assign the label to the selected channel.

When you define a new label, it is added to the nonvolatile label list.

Label Assignment Auto-Increment

When you assign a label ending in a digit, such as ADDR0 or DATA0, the oscilloscope automatically increments the digit and displays the modified label in the “New label” field after you press the **Apply New Label** softkey. Therefore, you only need to select a new channel and press the **Apply New Label** softkey again to assign the label to the channel. Only the original label is saved in the label list. This feature makes it easier to assign successive labels to numbered control lines and data bus lines.

To load a list of labels from a text file you create

It may be convenient to create a list of labels using a text editor, then load the label list into the oscilloscope. This lets you type on a keyboard rather than edit the label list using the oscilloscope’s controls.

You can create a list of up to 75 labels and load it into the oscilloscope. Labels are added to the beginning of the list. If more than 75 labels are loaded, only the first 75 are stored.

To load labels from a text file into the oscilloscope:

- 1 Use a text editor to create each label. Each label can be up to ten characters in length. Separate each label with a line feed.
- 2 Name the file `labellist.txt` and save it on a USB mass storage device such as a thumb drive.
- 3 Load the list into the oscilloscope using the File Explorer (press **[Utility]**→ **File Explorer**).

Label List Management

When you press the **Library** softkey, you will see a list of the last 75 labels used. The list does not save duplicate labels. Labels can end in any number of trailing digits. As long as the base string is the same as an existing label in the library, the new label will not be put in the library. For example, if label `A0` is in the library and you make a new label called `A12345`, the new label is not added to the library.

When you save a new user-defined label, the new label will replace the oldest label in the list. Oldest is defined as the longest time since the label was last assigned to a channel. Any time you assign any label to a channel, that label will move to the newest in the list. Thus, after you use the label list for a while, your labels will predominate, making it easier to customize the instrument display for your needs.

When you reset the label library list (see next topic), all of your custom labels will be deleted, and the label list will be returned to its factory configuration.

To reset the label library to the factory default

- 1 Press **[Utility]**→**Options**→**Preferences**→**More**.

NOTE

Pressing the **Default Library** softkey will remove all user-defined labels from the library and set the labels back to the factory default. Once deleted, these user-defined labels cannot be recovered.

- 2 Press the **Default Library** softkey.

This will delete all user-defined labels from the library and set the labels in the library back to the factory default. However, this does not default the labels currently assigned to the channels (those labels that appear in the waveform area).

Defaulting labels without erasing the default library.

Selecting **Default Setup** in the Save/Recall Menu will set all channel labels back to the default labels but does not erase the list of user-defined labels in the library.

Waveform Expansion Reference Point

To set the waveform expansion reference point, press **[Utility]→Options→Preferences→Expand** and select **Ground** or **Center**.

When you change a channel's volts/division setting, the waveform display can be set to expand (or compress) about the signal ground level or the center of the display.

Expand About Ground The displayed waveform will expand about the position of the channel's ground. This is the default setting. The ground level of the signal is identified by the position of the ground level () icon at the far-left side of the display. The ground level will not move when you adjust the vertical sensitivity (volts/division) control.

If the ground level is off screen, the waveform will expand about the top or bottom edge of the screen based on where the ground is off screen.

Expand About Center The displayed waveform will expand about the center of the display.

Vectors (Connect the Dots)

Agilent InfiniiVision oscilloscopes are designed to operate optimally with vectors on. This mode produces the most insightful waveforms for most situations.

When enabled, **Vectors** draws a line between consecutive waveform data points.

- Vectors give an analog look to a digitized waveform.
- Vectors allow you to see steep edges on waveforms, such as square waves.
- Vectors allow subtle detail of complex waveforms to be viewed, much like an analog oscilloscope trace, even when the detail is just a small number of pixels in size.

The oscilloscope turns vectors on whenever the acquisition system stops. Digital channels on the mixed-signal oscilloscope are not affected by the Display Menu. They are always displayed with vectors on. They also only contain one trigger worth of information.

Using Vectors (Display Menu)

One of the most fundamental choices you must make about your display is whether to draw vectors (connect the dots) between the samples, or simply let the samples fill in the waveform. To some degree, this is a matter of personal preference, but it also depends on the waveform.

- You will probably operate the oscilloscope most often with vectors on. Complex analog signals like video and modulated signals show analog-like intensity information with vectors on.
- Turn vectors off when highly complex or multivalued waveforms are displayed. Turning vectors off may aid the display of multivalued waveforms such as eye diagrams.
- Having vectors on does not slow down the display rate.

Freeze Display

To freeze the display without stopping running acquisitions:

- 1 Press the **[Display]** key.
- 2 Press the **Freeze Display** softkey.

To un-freeze the display, press **Freeze Display** again.

Many activities, such as adjusting the trigger level, adjusting vertical or horizontal settings, or saving data will un-freeze the display.

Manual cursors can be used on the frozen display.

Antialiasing

At slower sweep speeds, the sample rate is reduced and a proprietary display algorithm is used to minimize the likelihood of aliasing.

By default, Antialiasing is enabled. You should leave Antialiasing enabled unless there is a specific reason to switch it off.

If you need to switch Antialiasing off, press [**Utility**]→**Options**→**Preferences** and press the **Antialiasing** softkey to switch the feature off. The displayed waveforms will be more susceptible to aliasing.

XGA Video Output

A standard XGA video output connector is provided on the rear panel. You can connect a monitor to provide a larger display, or to provide a display at a viewing position away from the oscilloscope.

The oscilloscope's built-in display will remain on even when an external display is connected.

For optimal video quality and performance we recommend you use a shielded video cable with ferrite cores.



6 Measurements and Math Functions

List of Automatic Measurements	192
Making Automatic Measurements	193
Measurement Statistics	194
Measurement Thresholds	197
Measurement Definitions	199
Time Measurements	199
Delay and Phase Measurements	203
Voltage Measurements	205
Overshoot and Preshoot Measurements	211
Cursor Measurements	214
XY Horizontal Mode	220
Math Functions	224
Multiply	227
Add or Subtract	228
Differentiate	230
Integrate	232
Square Root	234
FFT Measurement	236
Enabling Precision Measurements and Math	242

See Also **[“To specify the measurement window for Zoom mode”](#)** on page 68.



List of Automatic Measurements

You can press the [Quick Meas] key and select an automatic measurement. Follow the link or go to the page for details.

Time Measurements

- “Counter” on page 199.
- “Duty Cycle” on page 200.
- “Frequency” on page 200.
- “Period” on page 201.
- “Rise Time” on page 201.
- “Fall Time” on page 201.
- “+ Width” on page 202.
- “– Width” on page 202.
- “X at Max Y” on page 202.
- “X at Min Y” on page 202.

Phase and Delay

- “Phase” on page 204.
- “Delay” on page 203.

Voltage Measurements

- “Average” on page 207.
- “Amplitude” on page 206.
- “Base” on page 207.
- “Extinction Ratio” on page 207.
- “Maximum” on page 207.
- “Minimum” on page 207.
- “Peak-Peak” on page 208.
- “Ratio” on page 208.
- “RMS” on page 208.
- “Std Deviation” on page 208.
- “Top” on page 210.

Preshoot and Overshoot

- “Preshoot” on page 211.
- “Overshoot” on page 212.

Making Automatic Measurements

[Quick Meas] makes automatic measurements on a channel or any running math function. Some measurements can only be made on analog source channels (see list on [page 194](#)). The results of the last four selected measurements are displayed above the softkeys, or in the display area when certain menus are selected. **[Quick Meas]** also makes measurements on stopped waveforms when you are panning and zooming.

Cursors are turned on to show the portion of the waveform being measured for the most recently selected measurement (right-most on the measurement line).

- 1 Press the **[Quick Meas]** key to display the Measurement Menu.

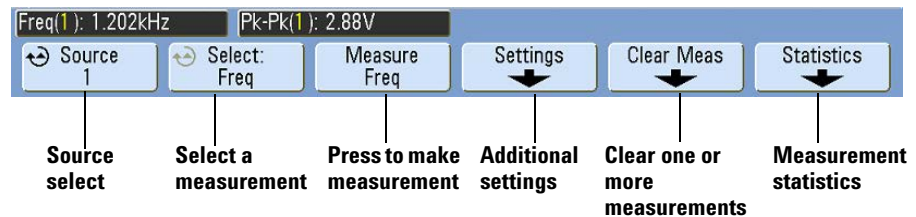

- 2 Press the **Source** softkey to select the channel or running math function to be measured.

Only channels or math functions that are displayed are available for measurements. If you choose an invalid source channel for a measurement, the measurement will default to the nearest in the list that makes the source valid.

If a portion of the waveform required for a measurement is not displayed or does not display enough resolution to make the measurement, the result will display “No Edges”, “Clipped”, “Low Signal”, “< value”, or “> value”, or a similar message to indicate that the measurement may not be reliable.

- 3 Press the **Select** softkey then rotate the Entry knob to select a measurement to be made.



- 4 The **Settings** softkey will be available to make additional measurement settings on some measurements.
- 5 Press the **Measure** softkey to make the measurement. (By default, measurement statistics are displayed. See [page 194](#).)
- 6 To turn off Quick Meas, press the **[Quick Meas]** key again. The key will no longer be illuminated and the measurements will be erased from the display.
- 7 To stop making one or more measurements, press the **Clear Meas** softkey and choose the measurement to clear, or press **Clear All**.

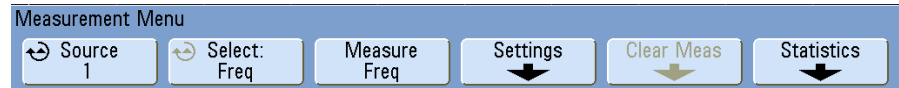

After all measurements have been cleared, when **[Quick Meas]** is pressed again, the default measurements will be Frequency and Peak-Peak.

Measurements available only on analog channels

The following measurements can only be made on analog source channels: rise time, fall time, X at max Y, X at min Y, phase, delay, average, amplitude, base, maximum, minimum, peak-to-peak, ratio, rms, std. deviation, and top.

Measurement Statistics

Press the **[Quick Meas]** key to enter the Measurement Menu. By default, statistics are displayed, and frequency and voltage are measured on channel 1.

Select the measurements you desire for the channels you are using (see [page 192](#)).

From the Measurement Menu, press the **Statistics** softkey to enter the Statistics Menu.



Statistics

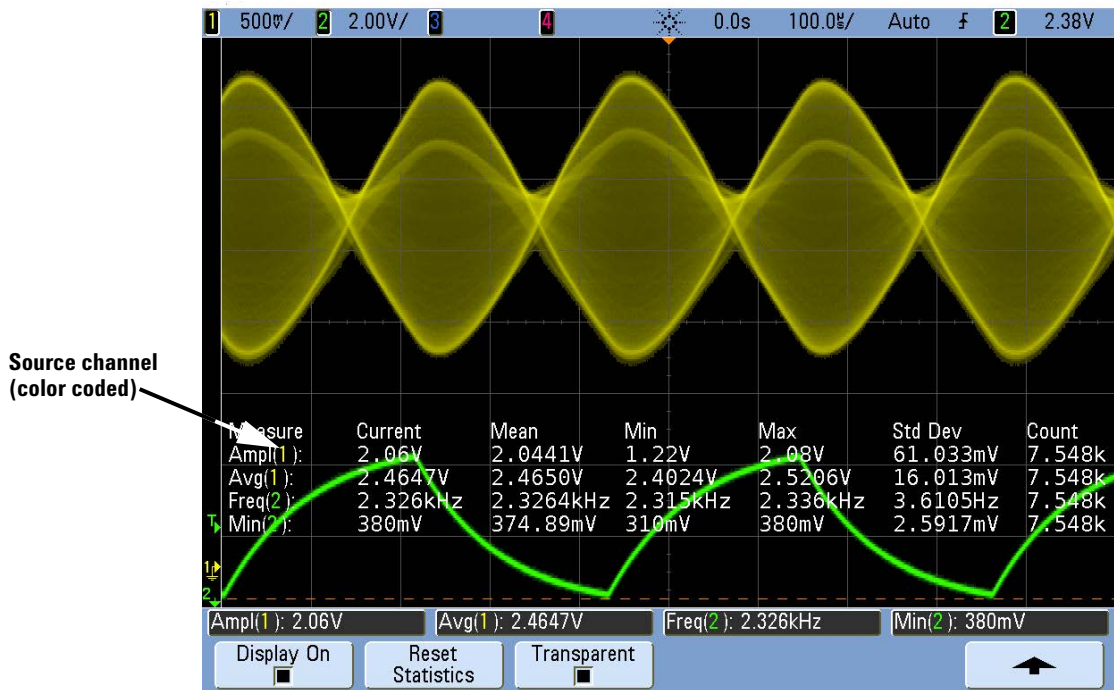

The following statistics are shown: Name of the measurement, current measured value, mean, minimum measured value, maximum measured value, standard deviation, and the number of times the measurement has been made (count). Statistics are based on the total number of captured waveforms (count).

The standard deviation shown in Statistics is calculated using the same formula used for calculating the standard deviation Quick Measurement. The formula is shown in the section titled “**Std Deviation**” on page 208.

The source channel of the measurement is shown in parenthesis after the measurement name. For example: “**Freq(1)**” indicates a frequency measurement on channel 1.

You can switch the statistics **Display On** or **Display Off**. Statistics continue to accumulate even when the statistics display is off.

When you navigate away from the Measurements Menu, the statistics display will no longer be displayed, but statistical data collection will continue. Return to the Measurements Menu to see the data again.

To reset the statistics measurements, press the **Reset Statistics** softkey. This resets all statistics and begins recording statistical data again.

Each time a new measurement (for example: frequency, period, or amplitude) is added the statistics are reset and accumulation of statistical data begins again.

When the **[Single]** key is pressed, statistics are reset and a single measurement is done (count = 1). Successive **[Single]** acquisitions accumulate statistical data (and the count is incremented).

Press the **Transparent** softkey to disable the Transparent mode. This shows statistics with a gray background. Press the **Transparent** softkey again to enable Transparent mode. This writes measurement values, statistics, and cursor values on the screen without a background. This controls the display of statistics in both Quick Meas and the optional Mask test feature.

The **Increment Statistics** softkey only appears when the acquisition is stopped and the optional segmented memory feature is off. Press the **[Single]** or **[Run/Stop]** key to stop the acquisition. You can use the horizontal position control (in the Horizontal control section of the front panel) to pan through the waveform. Active measurements will stay on screen, allowing you to measure various aspects of the captured waveforms. Press **Increment Statistics** to add the currently measured waveform to the collected statistical data.

The **Analyze Segments** softkey only appears when the acquisition is stopped and the optional segmented memory feature is on. After an acquisition has completed (and the oscilloscope is stopped), you can press the **Analyze Segments** softkey to accumulate measurement statistics for the acquired segments.

You can also turn on infinite persistence (in the Display Menu) and press the **Analyze Segments** softkey to create an infinite persistence display.

Measurement Thresholds

Setting measurement thresholds defines the vertical levels where measurements will be taken on an analog channel or math waveform.

Changing default thresholds may change measurement results

The default lower, middle, and upper threshold values are 10%, 50%, and 90% of the value between Top and Base. Changing these threshold definitions from the default values may change the returned measurement results for Average, Delay, Duty Cycle, Fall Time, Frequency, Overshoot, Period, Phase, Preshoot, Rise Time, +Width, and -Width.

- 1 From the Quick Meas Menu, press the **Settings** softkey, then press the **Thresholds** softkey to set analog channel measurement thresholds.
- 2 Press the **Source** softkey to select the analog channel or math waveform source for which you want to change measurement thresholds. Each analog channel and the math waveform can be assigned unique threshold values.

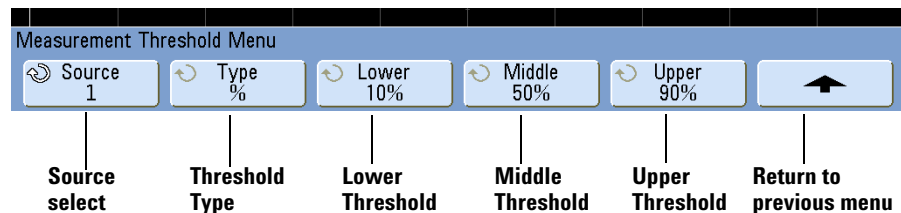

- 3 Press the **Type** softkey to set the measurement threshold to % (percentage of Top and Base value) or to **Absolute** (absolute value.)
 - Percentage thresholds can be set from 5% to 95%.
 - The units for absolute threshold for each channel is set in the channel probe menu.
 - When the **Source** is set to **Math: f(t)**, the threshold **Type** can only be set to **Percent**.

Absolute threshold hints

- Absolute thresholds are dependent on channel scaling, probe attenuation, and probe units. Always set these values first before setting absolute thresholds.
- The minimum and maximum threshold values are limited to on-screen values.
- If any of the absolute threshold values are above or below the minimum or maximum waveform values, the measurement may not be valid.

- 4 Press the **Lower** softkey, then turn the Entry knob to set the lower measurement threshold value.

Increasing the lower value beyond the set middle value will automatically increase the middle value to be more than the lower value. The default lower threshold is 10% or 800 mV.

If threshold **Type** is set to %, the lower threshold value can be set from 5% to 93%.

- 5 Press the **Middle** softkey, then turn the Entry knob to set the middle measurement threshold value.

The middle value is bounded by the values set for lower and upper thresholds. The default middle threshold is 50% or 1.20 V.

- If threshold **Type** is set to %, the middle threshold value can be set from 6% to 94%.

- 6 Press the **Upper** softkey, then turn the Entry knob to set the upper measurement threshold value.

Decreasing the upper value below the set middle value will automatically decrease the middle value to be less than the upper value. The default upper threshold is 90% or 1.50 V.

- If threshold **Type** is set to %, the upper threshold value can be set from 7% to 95%.

Measurement Definitions

Time Measurements

FFT measurements

When you make an **X at Max Y** or **X at Min Y** measurement on a math FFT function, the resultant units will be in Hertz. No other time related automatic measurement can be made on the FFT math function. Use the cursors to make other measurements on FFT.

The default lower, middle, and upper measurement thresholds are 10%, 50%, and 90% between Top and Base values. See **“Measurement Thresholds”** on page 197 for other percentage threshold and absolute value threshold settings.

The following figure shows time measurement points.

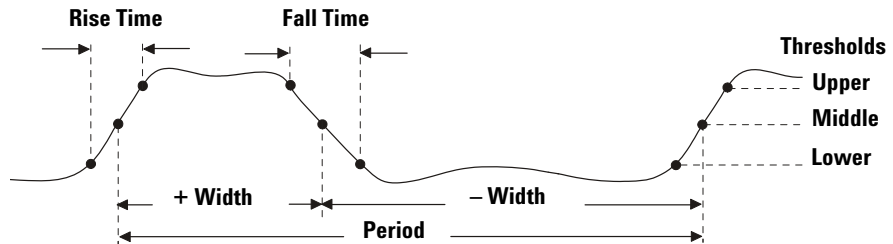

Digital channel time measurements

Automatic time measurements **Delay**, **Fall Time**, **Phase**, **Rise Time**, **X at Max Y**, and **X at Min Y**, and are not valid for digital channels on mixed-signal oscilloscopes.

Counter

The InfiniiVision 7000 Series oscilloscopes have an integrated hardware frequency counter which counts the number of cycles that occur within a period of time (known as the *gate time*) to measure the frequency of a signal.

The gate time for the Counter measurement is automatically adjusted to be 100 ms or twice the current time window, whichever is longer, up to 1 second.

The Counter can measure frequencies up to the bandwidth of the oscilloscope. The minimum frequency supported is $1/(2 \times \text{gate time})$.

The measured frequency is normally displayed in 5 digits, but can be displayed in 8 digits when an external 10 MHz frequency reference is provided at the 10 MHz REF rear panel BNC and the gate time is 1 second (50 ms/div sweep speed or greater). See (“[To supply a sample clock to the oscilloscope](#)” on page 406.)

The hardware counter uses the trigger comparator output. Therefore, the counted channel’s trigger level (or threshold for digital channels) must be set correctly. The Y cursor shows the threshold level used in the measurement.

Any channel except Math can be selected as the source.

Only one Counter measurement can be displayed at a time.

Duty Cycle

The duty cycle of a repetitive pulse train is the ratio of the positive pulse width to the period, expressed as a percentage. The X cursors show the time period being measured. The Y cursor shows the middle threshold point.

$$\text{Duty cycle} = \frac{\text{+ Width}}{\text{Period}} \times 100$$

Frequency

Frequency is defined as 1/Period. Period is defined as the time between the middle threshold crossings of two consecutive, like-polarity edges. A middle threshold crossing must also travel through the lower and upper threshold levels which eliminates runt pulses. The X cursors show what portion of the waveform is being measured. The Y cursor shows the middle threshold point.

To isolate an event for frequency measurement The following figure shows how to use Zoom mode to isolate an event for a frequency measurement. If the measurement is not possible in the Zoom mode, then the normal time base is used. If the waveform is clipped, it may not be possible to make the measurement.

ISOLATING AN EVENT FOR FREQUENCY MEASUREMENT

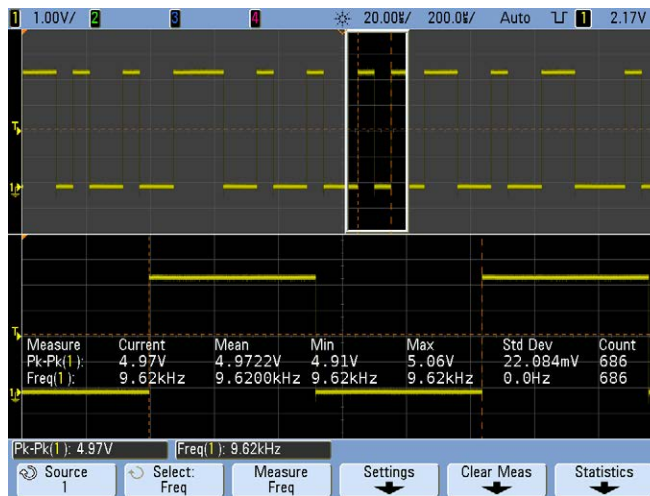

Period

Period is the time period of the complete waveform cycle. The time is measured between the middle threshold points of two consecutive, like-polarity edges. A middle threshold crossing must also travel through the lower and upper threshold levels which eliminates runt pulses. The X cursors show what portion of the waveform is being measured. The Y cursor shows the middle threshold point.

Fall Time

The fall time of a signal is the time difference between the crossing of the upper threshold and the crossing of the lower threshold for a negative-going edge. The X cursor shows the edge being measured. For maximum measurement accuracy, set the sweep speed as fast as possible while leaving the complete falling edge of the waveform on the display. The Y cursors show the lower and upper threshold points.

Rise Time

The rise time of a signal is the time difference between the crossing of the lower threshold and the crossing of the upper threshold for a positive-going edge. The X cursor shows the edge being measured. For maximum measurement accuracy, set the sweep speed as fast as possible while leaving the complete rising edge of the waveform on the display. The Y cursors show the lower and upper threshold points.

+ Width

+ Width is the time from the middle threshold of the rising edge to the middle threshold of the next falling edge. The X cursors show the pulse being measured. The Y cursor shows the middle threshold point.

– Width

– Width is the time from the middle threshold of the falling edge to the middle threshold of the next rising edge. The X cursors show the pulse being measured. The Y cursor shows the middle threshold point.

X at Max Y

X at Max Y is the X axis value (usually time) at the first displayed occurrence of the waveform Maximum, starting from the left-side of the display. For periodic signals, the position of the maximum may vary throughout the waveform. The X cursor shows where the current X at Max Y value is being measured.

To measure the peak of an FFT:

- 1 Select **FFT** as the Operator in the Waveform Math Menu.
- 2 Choose **Math: f(t)** as the source in the Quick Meas Menu.
- 3 Choose **Maximum** and **X at Max Y** measurements.

Maximum units are in dB and **X at Max Y** units are in Hertz for FFT.

X at Min Y

X at Min Y is the X axis value (usually time) at the first displayed occurrence of the waveform Minimum, starting from the left-side of the display. For periodic signals, the position of the minimum may vary throughout the waveform. The X cursor shows where the current X at Min Y value is being measured.

Delay and Phase Measurements

Digital channel measurements

Automatic measurements **Phase**, and **Delay** are not valid for digital channels on the mixed-signal oscilloscope or for the math FFT function. The two sources defined in the phase and delay measurement must be turned on.

Delay

Delay measures the time difference from the selected edge on source 1 and the selected edge on source 2 closest to the trigger reference point at the middle threshold points on the waveforms. Negative delay values indicate that the selected edge of source 1 occurred after the selected edge of source 2.

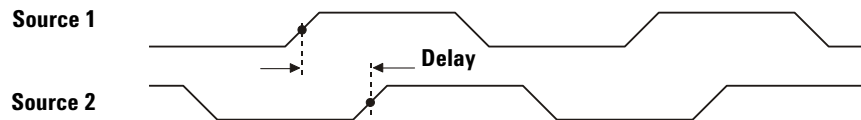

- 1 Press the **[Quick Meas]**→**Select** and select **Delay**. Press the **Settings** softkey to select the source channels and slope for the delay measurement.

The default Delay settings measure from the rising edge of channel 1 to the rising edge of channel 2.

- 2 Press the **Measure Delay** softkey to make the measurement.

The example below shows a delay measurement between the rising edge of channel 1 and the rising edge of channel 2.

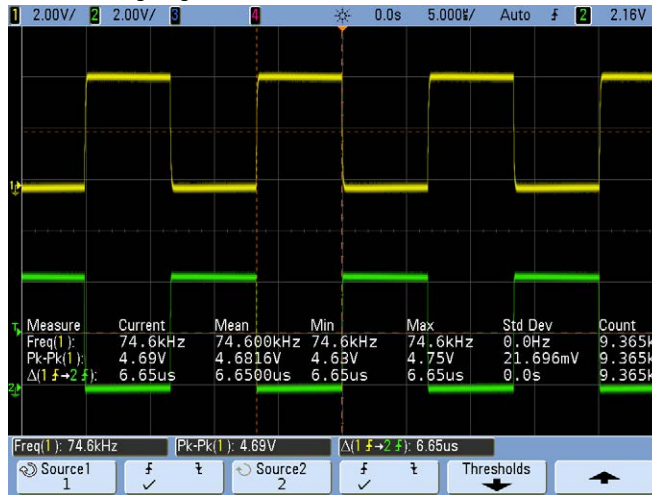

Phase

Phase is the calculated phase shift from source 1 to source 2, expressed in degrees. Negative phase shift values indicate that the rising edge of source 1 occurred after the rising edge of source 2.

$$\text{Phase} = \frac{\text{Delay}}{\text{Source 1 Period}} \times 360$$

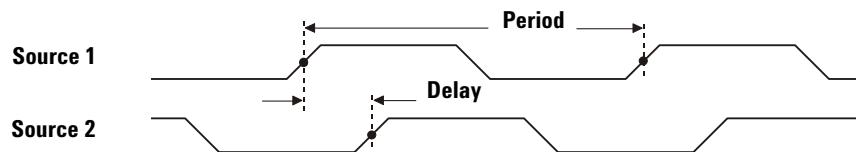

- 1 Press the **Settings** softkey to select the source 1 and source 2 channels for the phase measurement.

The default Phase settings measure from channel 1 to channel 2.

The example below shows a phase measurement between the channel 1 and the math d/dt function on channel 1.

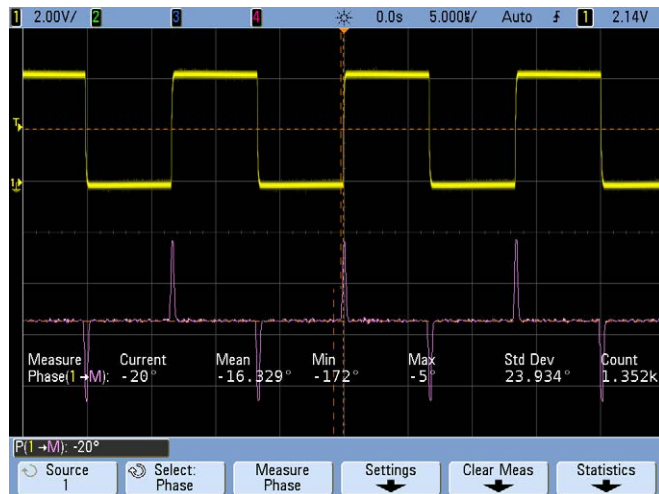

Voltage Measurements

Measurement units for each input channel can be set to Volts or Amps using the channel **Probe Units** softkey. A scale unit of **U** (undefined) will be displayed for math function 1-2 and for d/dt, and $\int dt$ when 1-2 or 1+2 is the selected source if channel 1 and channel 2 are set to dissimilar units in the channel **Probe Units** softkey.

Math Measurements and Units

Only Peak-Peak, Maximum, Minimum, Average, X at Min Y, and X at Max Y automatic measurements may be made on a math FFT function. See “Making time measurements automatically” for the FFT X at Max Y and X at Min Y measurement. Use the cursors to make other measurements on FFT. All voltage measurements may be made on other math functions. The resultant units are:

- FFT: dB* (decibels)
- 1 * 2: V², A² or W (Volt-Amp)
- 1 – 2: V (Volts) or A (Amps)
- d/dt: V/s or A/s (V/second A/second)
- ∫ dt: Vs or As (V-seconds or A-seconds)

* When the FFT source is channel 1, 2, 3, or 4, FFT units will be displayed in dBV when channel units is set to Volts and channel impedance is set to 1 MΩ. FFT units will be displayed in dBm when channel units is set to Volts and channel impedance is set to 50Ω. FFT units will be displayed as dB for all other FFT sources or when a source channel’s units has been set to Amps.

The following figure shows the voltage measurement points.

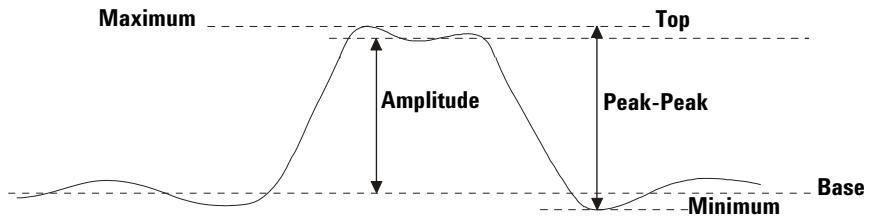

Digital channel voltage measurements

Automatic voltage measurements are not valid on digital channels on the mixed-signal oscilloscope.

Amplitude

The Amplitude of a waveform is the difference between its Top and Base values. The Y cursors show the values being measured.

Average

Average is the sum of the waveform samples divided by the number of samples.

$$\text{Average} = \frac{\sum x_i}{n}$$

where x_i = value at i th point being measured
 n = number of points in measurement interval

Which samples are measured depends on the **Interval** setting:

- **N Cycles** — the average value is measured on an integral number of periods of the displayed signal. If less than three edges are present, the measurement shows “No edges”.
- **Full Screen** — the average value is measured on all displayed data points.
- **Auto** — the measurement attempts to compute a value using the **N Cycles** interval. If less than three edges are present, the measurement is computed using the **Full Screen** interval.

The X cursors show what portion of the displayed waveform is being measured.

Base

The Base of a waveform is the mode (most common value) of the lower part of the waveform, or if the mode is not well defined, the base is the same as Minimum. The Y cursor shows the value being measured.

Extinction Ratio

The extinction ratio is the ratio of the "logic one" level amplitude (V top) to the "logic zero" level amplitude (V base), in dB. That is, the extinction ratio is: $10 \log(V_{\text{top}}/V_{\text{base}})$.

Maximum

Maximum is the highest value in the waveform display. The Y cursor shows the value being measured.

Minimum

Minimum is the lowest value in the waveform display. The Y cursor shows the value being measured.

Peak-Peak

The peak-to-peak value is the difference between Maximum and Minimum values. The Y cursors show the values being measured.

Ratio

The Ratio measurement displays the ratio of the AC RMS voltages of two sources, expressed in dB. Press the **Settings** softkey to select the source channels for the measurement.

RMS

RMS (DC) is the root-mean-square value of the waveform.

$$\text{RMS (dc)} = \sqrt{\frac{\sum_{i=1}^n x_i^2}{n}}$$

where x_i = value at i th point being measured
 n = number of points in measurement interval

Which samples are measured depends on the **Interval** setting:

- **N Cycles** — the RMS (DC) value is measured on an integral number of periods of the displayed signal. If less than three edges are present, the measurement shows “No edges”.
- **Full Screen** — the RMS (DC) value is measured on all displayed data points.
- **Auto** — the measurement attempts to compute a value using the **N Cycles** interval. If less than three edges are present, the measurement is computed using the **Full Screen** interval.

The X cursors show what interval of the waveform is being measured.

Std Deviation

The Std Deviation measurement shows the standard deviation of the displayed voltage values. It is an RMS measurement across the full screen with the DC component removed. It is useful, for example, for measuring power supply noise.

The standard deviation of a measurement is the amount that a measurement varies from the mean value. The Mean value of a measurement is the statistical average of the measurement.

The following figure graphically shows the mean and standard deviation. Standard deviation is represented by the Greek letter sigma: σ . For a Gaussian distribution, two sigma ($\pm 1\sigma$) from the mean, is where 68.3 percent of the measurement results reside. Six sigma ($\pm 3\sigma$) from is where 99.7 percent of the measurement results reside.

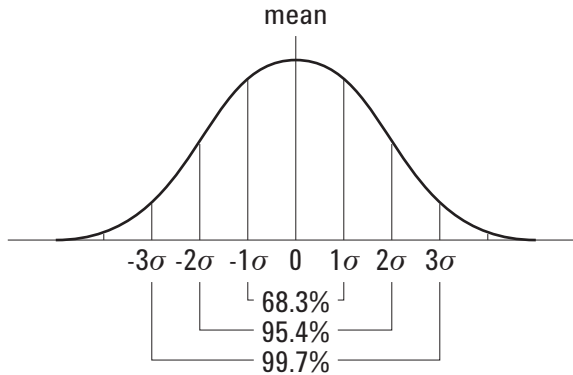

The mean is calculated as follows:

$$\bar{x} = \frac{\sum_{i=1}^N x_i}{N}$$

where:

\bar{x} = the mean.

N = the number of measurements taken.

x_i = the i^{th} measurement result.

The standard deviation is calculated as follows:

$$\sigma = \sqrt{\frac{\sum_{i=1}^N (x_i - \bar{x})^2}{N-1}}$$

6 Measurements and Math Functions

where:

σ = the standard deviation.

N = the number of measurements taken.

x_i = the i^{th} measurement result.

\bar{x} = the mean.

Top

The Top of a waveform is the mode (most common value) of the upper part of the waveform, or if the mode is not well defined, the top is the same as Maximum. The Y cursor shows the value being measured.

To isolate a pulse for Top measurement The following figure shows how to use Zoom mode to isolate a pulse for a Top measurement.

ISOLATING AREA FOR TOP MEASUREMENT

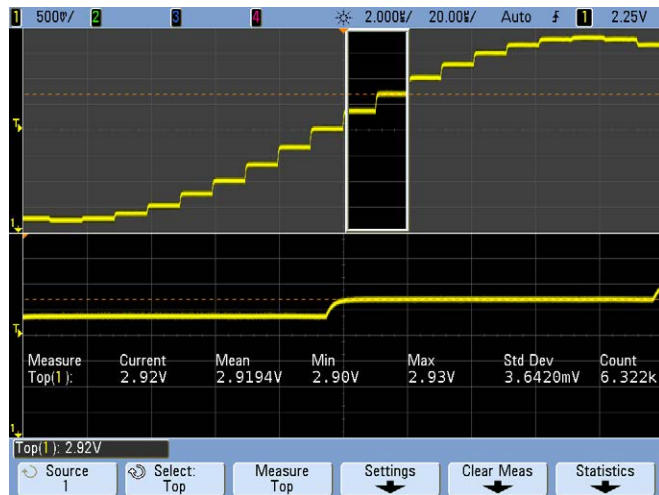

Overshoot and Preshoot Measurements

Digital channel time measurements

Automatic measurements **Preshoot** and **Overshoot** are not valid measurements for the math FFT function or for digital channels on the mixed-signal oscilloscope.

Preshoot

Preshoot is distortion that precedes a major edge transition expressed as a percentage of Amplitude. The X cursors show which edge is being measured (edge closest to the trigger reference point).

$$\text{Rising edge preshoot} = \frac{\text{Base} - \text{D local Minimum}}{\text{Amplitude}} \times 100$$

$$\text{Falling edge preshoot} = \frac{\text{local Maximum} - \text{D Top}}{\text{Amplitude}} \times 100$$

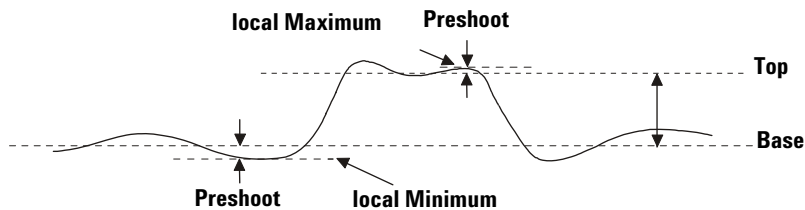

Overshoot

Overshoot is distortion that follows a major edge transition expressed as a percentage of Amplitude. The X cursors show which edge is being measured (edge closest to the trigger reference point).

$$\text{Rising edge overshoot} = \frac{\text{local Maximum} - \text{D Top}}{\text{Amplitude}} \times 100$$

$$\text{Falling edge overshoot} = \frac{\text{Base} - \text{D local Minimum}}{\text{Amplitude}} \times 100$$

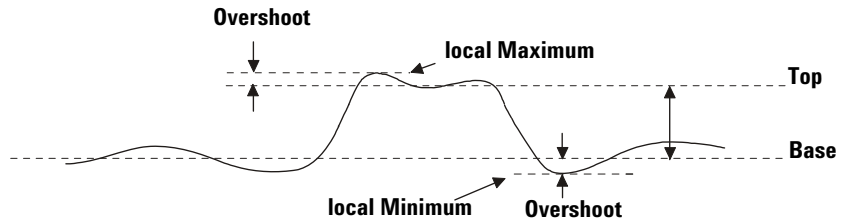

AUTOMATIC OVERSHOOT MEASUREMENT

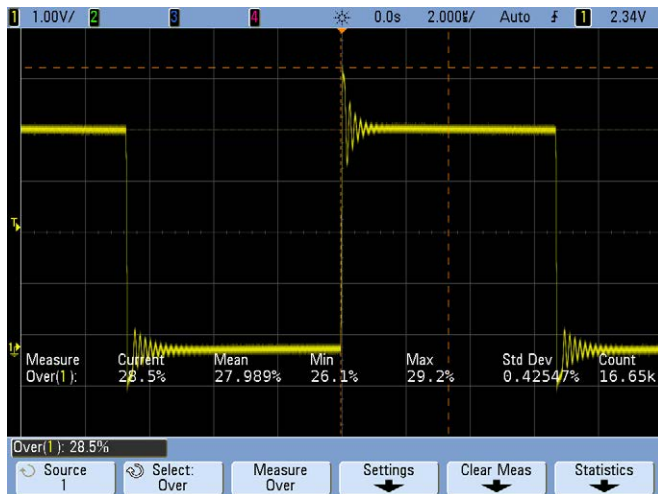

Post Acquisition Processing

In addition to changing display parameters after the acquisition, you can perform all of the measurements and math functions after the acquisition. Measurements and math functions will be recalculated as you pan and zoom and turn channels on and off. As you zoom in and out on a signal using the horizontal sweep speed knob and vertical volts/division knob, you affect the resolution of the display. Because measurements and math functions are performed on displayed data, you affect the resolution of functions and measurements.

Cursor Measurements

Cursors are horizontal and vertical markers that indicate X-axis values (usually time) and Y-axis values (usually voltage) on a selected waveform source. You can use cursors to make custom voltage or time measurements on oscilloscope signals, and timing measurements on digital channels. Cursor information is displayed on the line above the softkeys.

Cursors are not always limited to the visible display. If you set a cursor, then pan and zoom the waveform until the cursor is off screen, its value will not be changed. It will still be there when you return to its original location.

X cursors are vertical dashed lines that adjust horizontally and normally indicate time relative to the trigger point. When used with the FFT math function as a source, the X cursors indicate frequency.

The X1 cursor (short-dashed vertical line) and X2 cursor (long-dashed-vertical line) adjust horizontally and indicate time relative to the trigger point for all sources except math FFT (frequency is indicated).

In XY horizontal mode, the X cursors display channel 1 values (Volts or Amps).

The cursor values for the selected waveform source are displayed within the X1 and X2 softkeys.

The difference between X1 and X2 (ΔX) and $1/\Delta X$ are displayed on the dedicated line above the softkeys or in the display area when some menus are selected.

Y cursors are horizontal dashed lines that adjust vertically and normally indicate Volts or Amps, dependent on the channel **Probe Units** setting. When math functions are used as a source, the measurement units correspond to that math function.

The Y1 cursor (short-dashed horizontal line) and Y2 cursor (long-dashed horizontal line) adjust vertically and indicate values relative to the waveform's ground point, except math FFT where the values are relative to 0 dB.

In XY horizontal mode, the Y cursors display channel 2 values (Volts or Amps).

The cursor values for the selected waveform source are displayed within the Y1 and Y2 softkeys.

The difference between Y1 and Y2 (ΔY) is displayed on the dedicated line above the softkeys or in the display area when some menus are selected.

To make cursor measurements

NOTE

If you intend to make cursor measurements on a trace that you recall from memory, be sure to recall both setup and trace. See **“To recall waveform trace and/or oscilloscope setup”** on page 256.

- 1 Connect a signal to the oscilloscope and obtain a stable display.
- 2 Press the **[Cursors]** key. The key will illuminate, indicating that cursors are “on”. (Press the key again when you want to turn cursors off.)
- 3 In the Cursors Menu, press **Mode**; then, select the desired mode:
 - **Manual** — ΔX , $1/\Delta X$, and ΔY values are displayed. ΔX is the difference between the X1 and X2 cursors and ΔY is the difference between the Y1 and Y2 cursors.

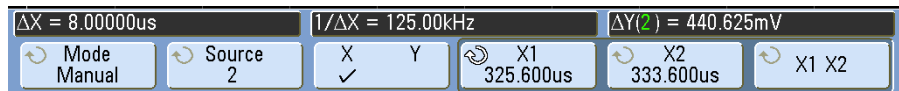

- **Track Waveform** — As you move a marker horizontally, the vertical amplitude of the waveform is tracked and measured. At the bottom of the display, the time and voltage positions are shown for the markers. The vertical (Y) and horizontal (X) differences between the markers are shown as ΔX and ΔY values.
- **Binary** — Logic levels of displayed waveforms at the current X1 and X2 cursor positions are displayed above the softkeys in binary. The display is color coded to match the color of the related channel’s waveform.

Cursor X1 values for analog channels 1 through 4

Cursor X1 values for digital channels D15 Through D0

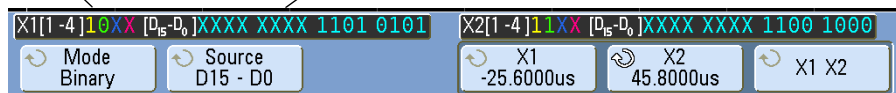

- **Hex** — Logic levels of displayed waveforms at the current X1 and X2 cursor positions are displayed above the softkeys in hexadecimal.

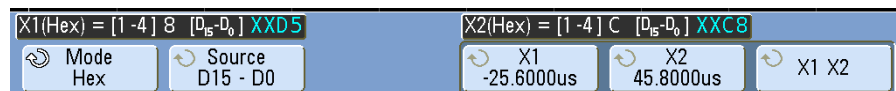

Manual and **Track Waveform** modes can be used on waveforms that are displayed on the analog input channels (including math functions).

Binary and **Hex** modes apply to digital signals (of MSO oscilloscope models).

In **Hex** and **Binary** modes, a level can be displayed as 1 (higher than trigger level), 0 (lower than trigger level), indeterminate state (\updownarrow), or X (don't care).

In **Binary** mode, X is displayed if the channel is turned off.

In **Hex** mode, the channel is interpreted as a 0 if turned off.

- 4 Press **Source** (or **X1 Source**, **X2 Source** in the **Track Waveform** mode); then, select the input source for cursor values.
- 5 In the **Manual** mode, press **X Y** to select between X and Y cursors for adjustment.
- 6 Adjust the cursor(s) by pressing one of these softkeys:
 - **X1** — adjust horizontally and normally measure time.
 - **X2** — adjust horizontally and normally measure time.
 - **X1 X2** — adjusts both cursors at the same time, while the delta value remains the same. This can be useful, for example, for checking pulse width variations in a pulse train.
 - **Y1** — adjust vertically and normally measure voltage.
 - **Y2** — adjust vertically and normally measure voltage.
 - **Y1 Y2** — adjusts both cursors at the same time, while the delta value remains the same.

Then, turn the Entry knob.

The cursor currently assigned to the Entry knob displays brighter than the other cursors.

NOTE

After adjusting the **X1**, **X2**, **X1 X2**, **Y1**, **Y2**, or **Y1 Y2** controls, you can press the Entry knob to adjust the next control.

Cursor Examples

CURSORS USED TO MEASURE PULSE WIDTHS OTHER THAN MIDDLE THRESHOLD POINTS

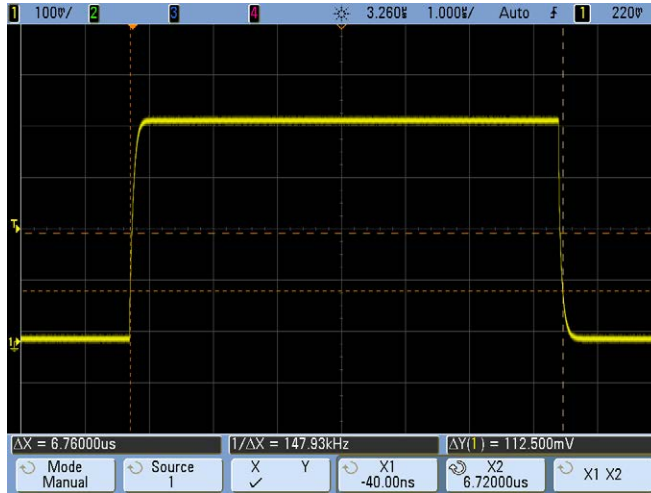

CURSORS MEASURE FREQUENCY OF PULSE RINGING



6 Measurements and Math Functions

Expand the display with Zoom mode, then characterize the event of interest with the cursors.

CURSORS TRACK ZOOM SWEEP



Put the **X1** cursor on one side of a pulse and the **X2** cursor on the other side of the pulse.

MEASURING PULSE WIDTH WITH CURSORS

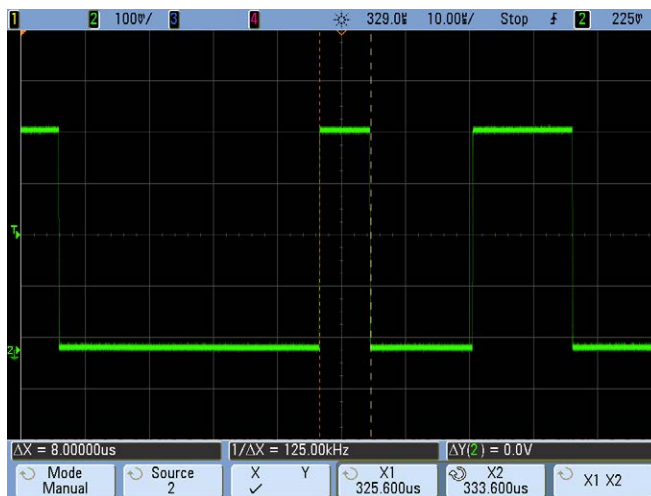

Press the **X1 X2** softkey and move the cursors together to check for pulse width variations in a pulse train.

MOVING THE CURSORS TOGETHER TO CHECK PULSE WIDTH VARIATIONS

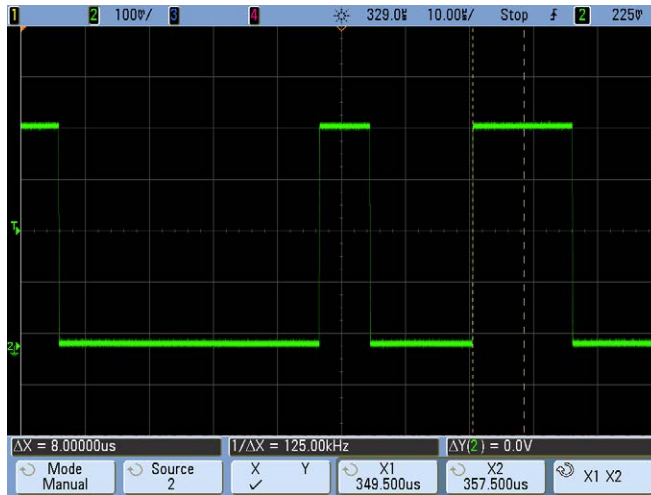

XY Horizontal Mode

The XY horizontal mode converts the oscilloscope from a volts-versus-time display to a volts-versus-volts display using two input channels. Channel 1 is the X-axis input, channel 2 is the Y-axis input. You can use various transducers so the display could show strain versus displacement, flow versus pressure, volts versus current, or voltage versus frequency. This exercise shows a common use of the XY display mode by measuring the phase difference between two signals of the same frequency with the Lissajous method.

- 1 Connect a sine wave signal to channel 1, and a sine wave signal of the same frequency but out of phase to channel 2.
- 2 Press the **[AutoScale]** key, press the **[Menu/Zoom]** key (or **[Main/Delayed]** key on some oscilloscopes), then press the **XY** or **Roll** softkey to select "XY".
- 3 Center the signal on the display with the channel 1 and 2 position (↕) knobs. Use the channel 1 and 2 volts/div knobs and the channel 1 and 2 **Fine** softkeys to expand the signal for convenient viewing.

The phase difference angle (θ) can be calculated using the following formula (assuming the amplitude is the same on both channels):

$$\sin \theta = \frac{A}{B} \text{ or } \frac{C}{D}$$

EXAMPLE OF CENTERING A SIGNAL ON THE DISPLAY

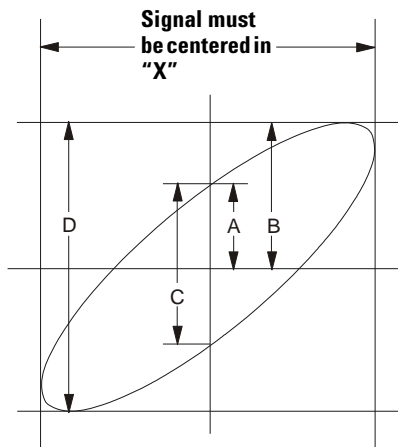

SIGNAL CENTERED ON THE DISPLAY

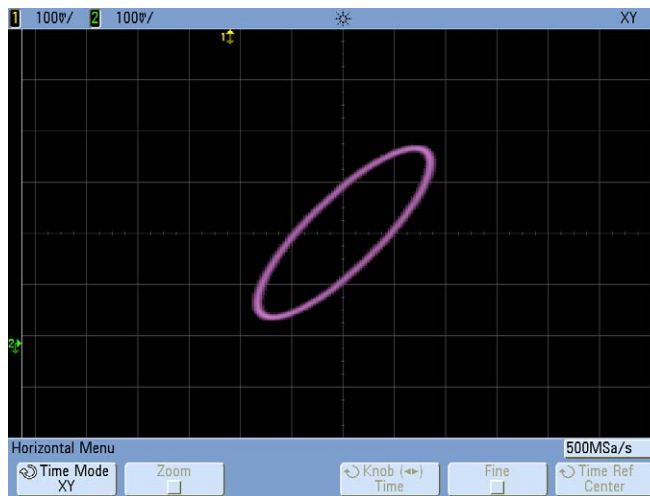

4 Press the [**Cursors**] key.

5 Set the Y2 cursor to the top of the signal, and set Y1 to the bottom of the signal.

Note the ΔY value at the bottom of the display. In this example, we are using the Y cursors, but you could have used the X cursors instead.

CURSORS SET ON DISPLAYED SIGNAL

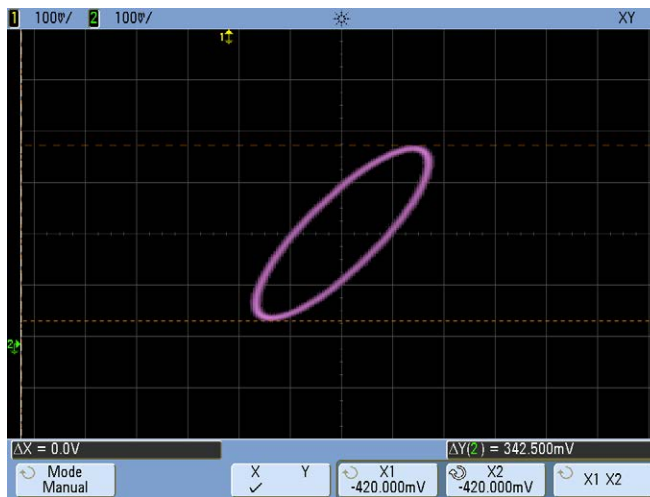

- 6 Move the Y1 and Y2 cursors to the intersection of the signal and the Y axis. Again, note the ΔY value.

CURSORS SET TO CENTER OF SIGNAL

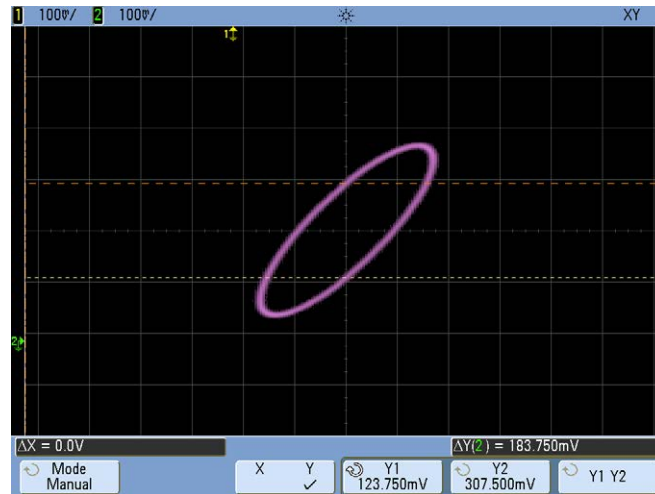

- 7 Calculate the phase difference using the formula below.

$$\sin \theta = \frac{\text{second } \Delta Y}{\text{first } \Delta Y} = \frac{1.031}{1.688} ; \theta = 37.65 \text{ degrees of phase shift}$$

Z-Axis Input in XY Display Mode (Blanking)

When you select the XY display mode, the time base is turned off. Channel 1 is the X-axis input, channel 2 is the Y-axis input, and channel 4 (or the External trigger on 2-channel models) is the Z-axis input. If you only want to see portions of the Y versus X display, use the Z-axis input. Z-axis turns the trace on and off (analog oscilloscopes called this Z-axis blanking because it turned the beam on and off). When Z is low (<1.4 V), Y versus X is displayed; when Z is high (>1.4 V), the trace is turned off.

SIGNALS ARE 90 OUT OF PHASE

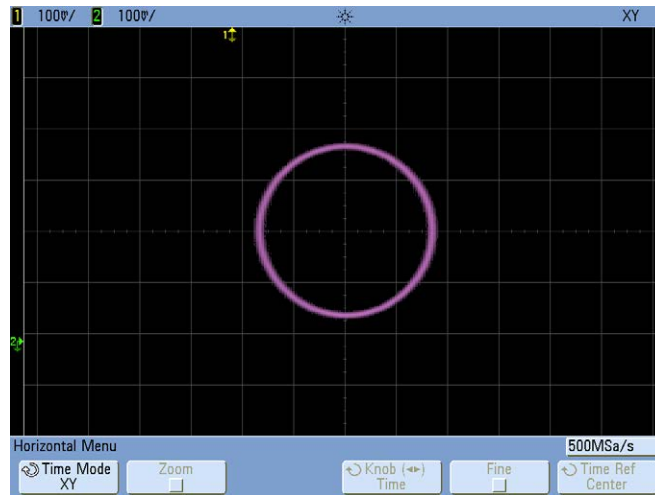

SIGNALS ARE IN PHASE

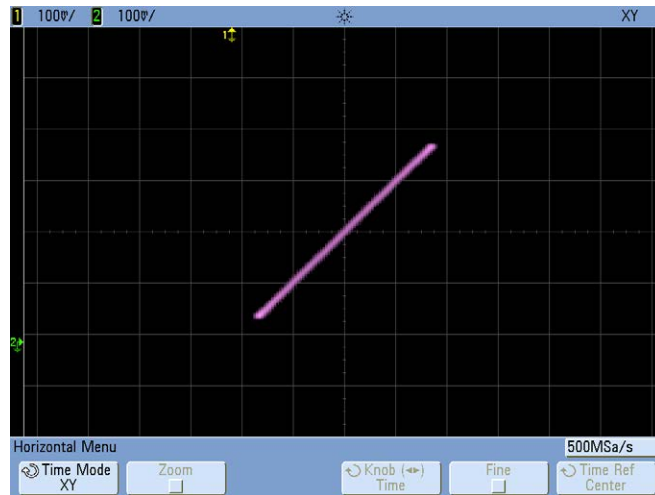

Math Functions

Math functions can be performed on analog channels. The resulting math waveform is displayed in light purple.

You can use a math function on a channel even if you choose not to display the channel on-screen.

You can:

- Perform an arithmetic operation (add, subtract, or multiply) on channels 1 and 2 or on channels 3 and 4.
- Perform a function (differentiate, integrate, FFT, or square root) on the signal acquired on an analog channel.
- Perform a function on the result of an arithmetic operation.

To use waveform math

- 1 Press the **[Math]** key on the front panel to display the Waveform Math Menu.

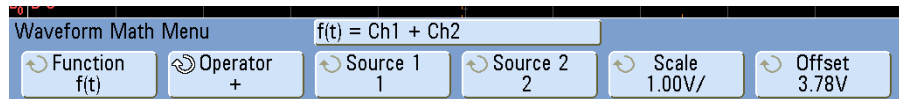

- 2 If **f(t)** is not already shown on the **Function** softkey, press the **Function** softkey and select **f(t): Displayed**.
- 3 Use the **Operator** softkey to select an operator.
- 4 Use the **Source 1** softkey to select the analog channel on which to perform math. You can rotate the Entry knob or repetitively press the **Source 1** softkey to make your selection. If you choose a function (differentiate, integrate, FFT, or square root) the result is displayed.
- 5 If you select an arithmetic operator, use the **Source 2** softkey to select the second source for the arithmetic operation. The result is displayed.
- 6 Use the **Scale** and **Offset** softkeys to re-size and re-position the math waveform.

To perform a math function upon an arithmetic operation

To perform a function (differentiate, integrate, FFT, or square root) on an arithmetic operation (add, subtract, or multiply):

- 1 Press the **Function** softkey and select **g(t): Internal**.
- 2 Use the **Operator, Source 1, and Source 2** softkeys to set up an arithmetic operation.
- 3 Press the **Function** softkey and select **f(t): Displayed**.
- 4 Use the **Operator** softkey to select a function (differential, integral, FFT, or square root).
- 5 Press the **Source 1** softkey and select **g(t)** as the source. Note that **g(t)** is only available when you select a function in the previous step.

Math Operating Hints

If the analog channel or math function is clipped (not fully displayed on screen) the resulting displayed math function will also be clipped.

Once the function is displayed, the analog channel(s) may be turned off for better viewing of the math waveform.

The vertical scaling and offset of each math function can be adjusted for ease of viewing and measurement considerations.

The math function waveform can be measured using **[Cursors]** and/or **[Quick Meas]**.

Math scale and offset

Any math function may be manually scaled by pressing the **Scale** or **Offset** softkeys and adjusting the value.

Math Scale and Offset are Set Automatically

Any time the currently displayed math function definition is changed, the function is automatically scaled for optimum vertical scale and offset. If you manually set scale and offset for a function, select a new function, then select the original function, the original function will be automatically rescaled.

- 1 In the Waveform Math Menu, press the **Scale** or **Offset** softkeys to set your own scale factors (units/division) or offset (units) for the selected math function. The **Function** softkey must be set to **f(t): Displayed** in order to set scale and offset.
- 2 Press the **Scale** or **Offset** softkey, then turn the Entry knob to rescale or change the offset value for your math function.

Units

Units for each input channel can be set to Volts or Amps using the **Units** softkey in the channel's Probe Menu. Scale and offset units are:

Math function	Units
add or subtract	V or A
multiply	V^2 , A^2 , or W (Volt-Amp)
d/dt	V/s or A/s (V/second or A/second)
$\int dt$	Vs or As (V-seconds or A-seconds)
FFT	dB* (decibels)
$\sqrt{\text{ (square root)}}$	$V^{1/2}$, $A^{1/2}$, or $W^{1/2}$ (Volt-Amp)

* When the FFT source is channel 1, 2, 3 or 4, FFT units will be displayed in dBV when channel units is set to Volts and channel impedance is set to 1 M Ω . FFT units will be displayed in dBm when channel units is set to Volts and channel impedance is set to 50 Ω . FFT units will be displayed as dB for all other FFT sources or when a source channel's units has been set to Amps.

A scale unit of **U** (undefined) will be displayed for math functions when two source channels are used and they are set to dissimilar units and the combination of units cannot be resolved.

Multiply

When you select the multiply math function, the voltage values of the channel chosen in **Source 1** are multiplied point by point by the voltage values of the channel chosen in **Source 2**, and the result is displayed. Multiply is useful for seeing power relationships when one of the channels is proportional to the current.

Example: Multiply channel 1 by channel 2

- **Scale** — lets you set your own vertical scale factors for multiply expressed as V^2/div (Volts-squared/division), A^2/div (Amps-squared/division), or W/div (Watts/division or Volt-Amps/division). Units are set in the channel Probe Menu. Press the **Scale** softkey, then turn the Entry knob to rescale the math waveform.
- **Offset** — lets you set your own offset for the multiply math function. The offset value is in V^2 (Volts-squared), A^2 (Amps-squared), or W (Watts) and is represented by the center horizontal grid line of the display. Press the **Offset** softkey, then turn the Entry knob to change the offset for the math waveform.

EXAMPLE OF MULTIPLY

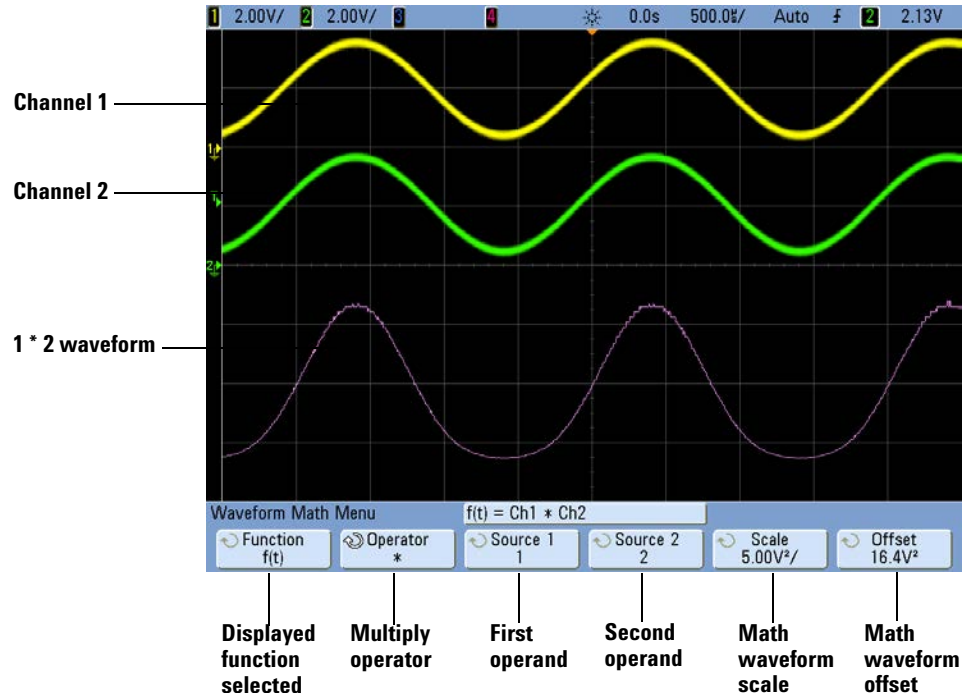

Add or Subtract

When you select add or subtract, the **Source 1** and **Source 2** channel voltage values are added or subtracted point by point, and the result is displayed.

You can use subtract to make a differential measurement or to compare two waveforms. If your waveforms' DC offsets are larger than the dynamic range of the oscilloscope's input channels you will need to use a differential probe instead.

Example: Subtract channel 2 from channel 1

- **Scale** — lets you set your own vertical scale factors for subtract, expressed as V/div (Volts/division) or A/div (Amps/division). Press the **Scale** softkey, then turn the Entry knob to rescale. Units are set in the channel Probe Menu.
- **Offset** — lets you set your own offset for the math function. The offset value is in Volts or Amps and is represented by the center horizontal grid line of the display. Press the **Offset** softkey, then turn the Entry knob to change the offset of the math waveform.

A scale unit of **U** (undefined) will be displayed for scale and offset if the two source channels are set to dissimilar units. Units are set using the channel's **Probe Units** softkey.

EXAMPLE OF SUBTRACT

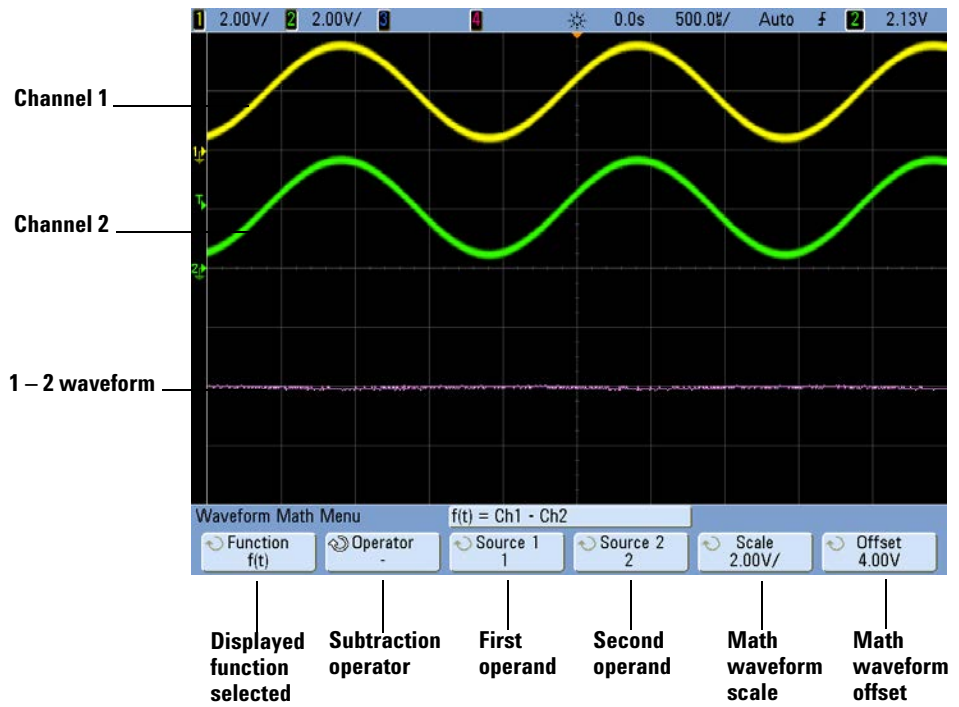

Differentiate

d/dt (differentiate) calculates the discrete time derivative of the selected source. You can use differentiate to measure the instantaneous slope of a waveform. For example, the slew rate of an operational amplifier may be measured using the differentiate function.

Because differentiation is very sensitive to noise, it is helpful to set acquisition mode to **Averaging** in the Acquire Menu.

d/dt plots the derivative of the selected source using the “average slope estimate at 4 points” formula. The equation is:

$$d_i = \frac{y_{i+4} + 2y_{i+2} - 2y_{i-2} - y_{i-4}}{8\Delta t}$$

Where

d = differential waveform

y = channel 1, 2, 3, or 4, or g(t) (internal arithmetic operation) data points

i = data point index

Δt = point-to-point time difference

- 1 Press the **[Math]** key, press the **Function** softkey and select **f(t)**, press the **Operator** softkey and select **d/dt**. Press the **Source**, **Scale**, or **Offset** softkeys if you want to change the source, scaling, or offset for the differentiate function.
 - **Source** — selects the source for d/dt. (See [page 225](#) for information about using **g(t)** as the source.)
 - **Scale** — lets you set your own vertical scale factors for d/dt expressed in units/second/division, where units can be V (Volts), A (Amps), or W (Watts). Units are set in the channel Probe Menu. Press the **Scale** softkey, then turn the Entry knob to rescale d/dt.
 - **Offset** — lets you set your own offset for the dV/dt math function. The offset value is in units/second where units can be V (Volts), A (Amps), or W (Watts) and is represented by the center horizontal grid line of the display. Press the **Offset** softkey, then turn the Entry knob to change the offset for d/dt.

A scale unit of **U** (undefined) will be displayed for scale and offset if the two source channels are set to dissimilar units. Units are set using the channel's **Probe Units** softkey.

EXAMPLE OF DIFFERENTIATE FUNCTION

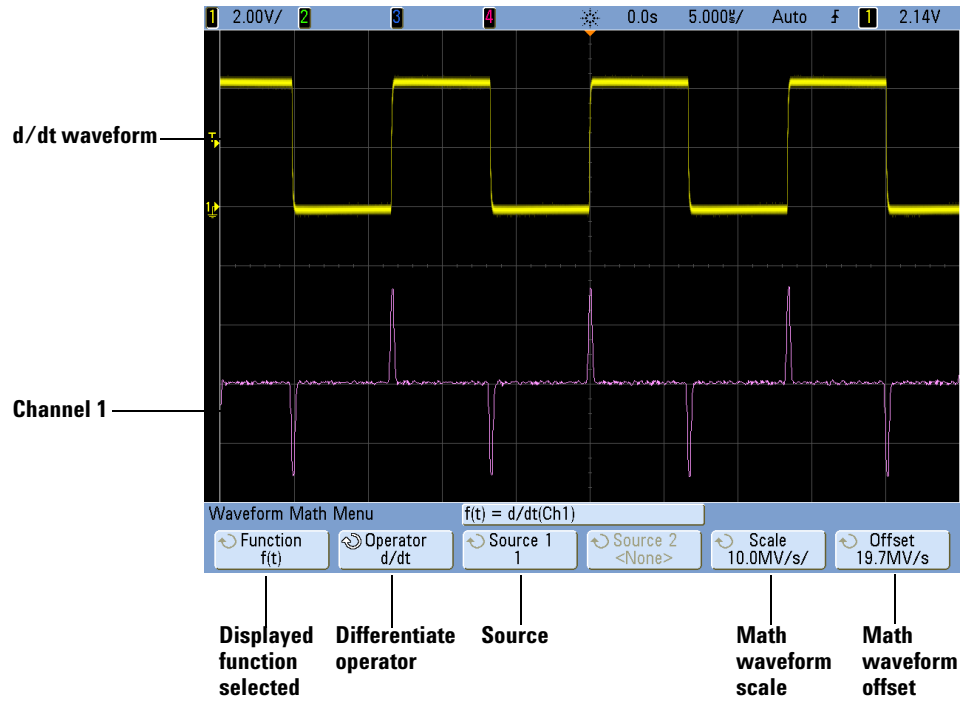

Integrate

$\int dt$ (integrate) calculates the integral of the selected source. You can use integrate to calculate the energy of a pulse in volt-seconds or measure the area under a waveform.

$\int dt$ plots the integral of the source using the “Trapezoidal Rule”. The equation is:

$$I_n = c_0 + \Delta t \sum_{i=0}^n y_i$$

Where

I = integrated waveform

Δt = point-to-point time difference

y = channel 1, 2, 3, or 4, or $g(t)$ (internal arithmetic operation)

c_0 = arbitrary constant

i = data point index

- 1 Press the **[Math]** key, press the **Function** softkey and select **f(t)**, press the **Operator** softkey and select $\int dt$. Press the **Source**, **Scale**, or **Offset** softkeys if you want to change the source, scaling, or offset for the differentiate function.
 - **Source** — selects the source for $\int dt$. (See [page 225](#) for information about using **g(t)** as the source.)
 - **Scale** — lets you set your own vertical scale factors for $\int dt$ expressed in unit-seconds/division, where units can be V (Volts), A (Amps), or W (Watts). Units are set in the channel Probe Menu. Press the **Scale** softkey, then turn the Entry knob to rescale $\int dt$.
 - **Offset** — lets you set your own offset for the $\int Vdt$ math function. The offset value is in unit-seconds where units can be V (Volts), A (Amps), or W (Watts) and is represented by the center horizontal grid line of the display. Press the **Offset** softkey, then turn the Entry knob to change the offset for $\int dt$. The integrate calculation is relative to the source signal’s offset. The following examples illustrate the effects of signal offset.

INTEGRATE AND SIGNAL OFFSET

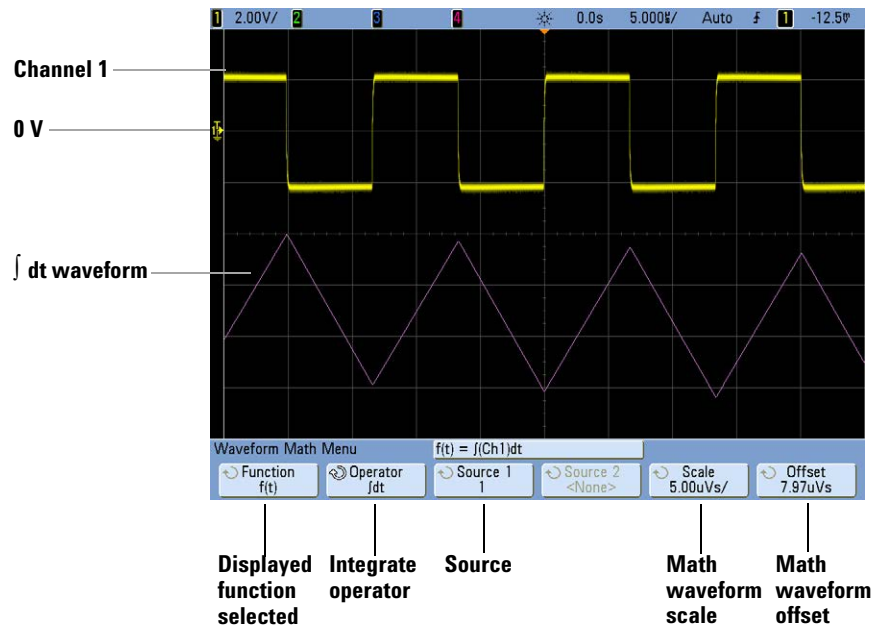
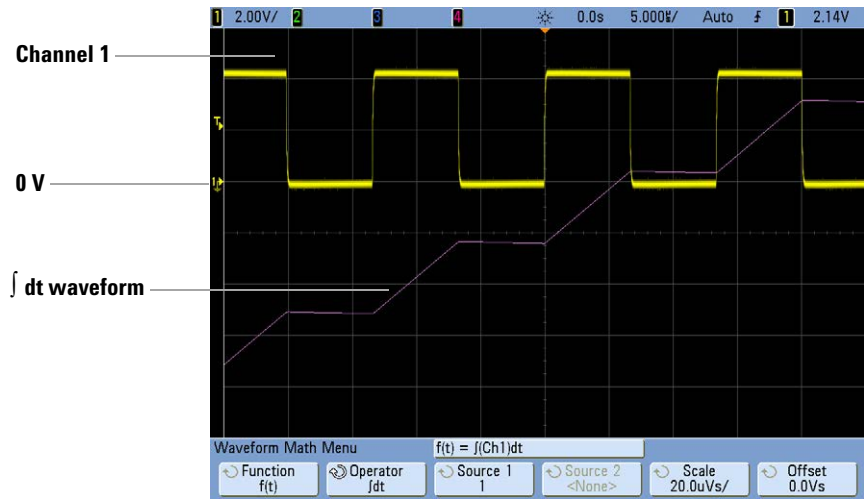

Square Root

Square root ($\sqrt{\quad}$) calculates the square root of the selected source.

- 1 Press the **[Math]** key, press the **Function** softkey and select **f(t)**, press the **Operator** softkey and select $\sqrt{\quad}$ (square root). Press the **Source 1**, **Scale**, or **Offset** softkeys if you want to change the source, scaling, or offset for the square root function.
 - **Source 1** — selects the source for $\sqrt{\quad}$ (square root). (See [page 225](#) for information about using **g(t)** as the source.)
 - **Scale** — lets you set your own vertical scale factors for $\sqrt{\quad}$ (square root) expressed as $V^{1/2}/\text{div}$ (Volts-square-root/division), $A^{1/2}/\text{div}$ (Amps-square-root/division), or $W^{1/2}/\text{div}$ (Watts-square-root/division or Volt-Amps-square-root/division). Units are set in the channel Probe Menu. Press the **Scale** softkey, then turn the Entry knob to rescale $\sqrt{\quad}$ (square root).
 - **Offset** — lets you set your own offset for the multiply math function. The offset value is in $V^{1/2}$ (Volts-square-root), $A^{1/2}$ (Amps-square-root), or $W^{1/2}$ (Watts-square-root) and is represented by the center horizontal grid line of the display. Press the **Offset** softkey, then turn the Entry knob to change the offset for $\sqrt{\quad}$ (square root).

A scale unit of **U** (undefined) will be displayed for scale and offset if the two source channels are set to dissimilar units. Units are set using the channel's **Probe Units** softkey.

EXAMPLE OF $\sqrt{\text{ (SQUARE ROOT)}}$.

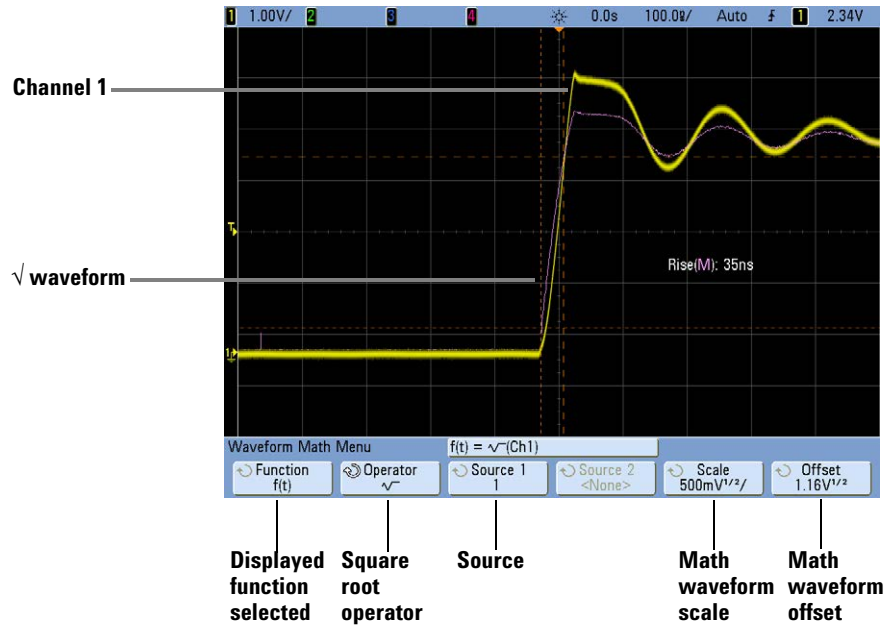

FFT Measurement

FFT is used to compute the fast Fourier transform using analog input channels or an arithmetic operation $g(t)$. FFT takes the digitized time record of the specified source and transforms it to the frequency domain. When the FFT function is selected, the FFT spectrum is plotted on the oscilloscope display as magnitude in dBV versus frequency. The readout for the horizontal axis changes from time to frequency (Hertz) and the vertical readout changes from volts to dB.

Use the FFT function to find crosstalk problems, to find distortion problems in analog waveforms caused by amplifier non-linearity, or for adjusting analog filters.

FFT Units

0 dBV is the amplitude of a 1 V_{rms} sinusoid. When the FFT source is channel 1 or channel 2 (or channel 3 or 4 on 4-channel models), FFT units will be displayed in dBV when channel units is set to Volts and channel impedance is set to 1 M Ω .

FFT units will be displayed in dBm when channel units is set to Volts and channel impedance is set to 50 Ω .

FFT units will be displayed as dB for all other FFT sources or when a source channel's units has been set to Amps.

DC Value

The FFT computation produces a DC value that is incorrect. It does not take the offset at center screen into account. The DC value is not corrected in order to accurately represent frequency components near DC.

Aliasing

When using FFTs, it is important to be aware of frequency aliasing. This requires that the operator have some knowledge as to what the frequency domain should contain, and also consider the sampling rate, frequency span, and oscilloscope vertical bandwidth when making FFT measurements. The FFT sample rate is displayed directly above the softkeys when the FFT Menu is displayed.

Aliasing happens when there are frequency components in the signal higher than half the sample rate. Since the FFT spectrum is limited by this frequency, any higher components are displayed at a lower (aliased) frequency.

The following figure illustrates aliasing. This is the spectrum of a 990 Hz square wave, which has many harmonics. The FFT sample rate is set to 100 kSa/s, and the oscilloscope displays the spectrum. The displayed waveform shows the components of the input signal above the Nyquist frequency to be mirrored (aliased) on the display and reflected off the right edge.

ALIASING

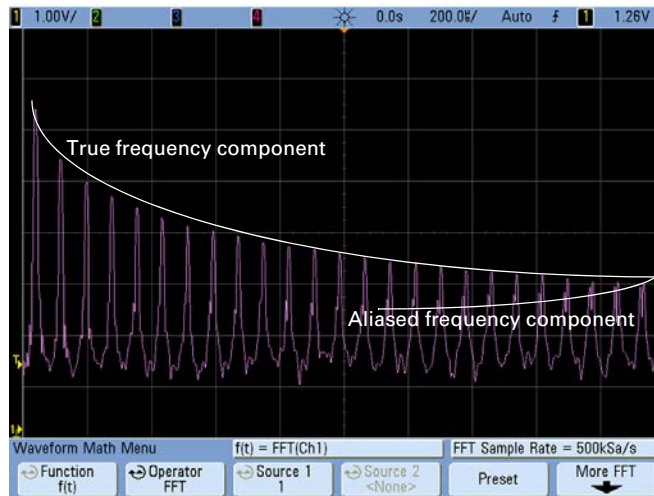

Since the frequency span goes from ≈ 0 to the Nyquist frequency, the best way to prevent aliasing is to make sure that the frequency span is greater than the frequencies of significant energy present in the input signal.

Spectral Leakage

The FFT operation assumes that the time record repeats. Unless there is an integral number of cycles of the sampled waveform in the record, a discontinuity is created at the end of the record. This is referred to as leakage. In order to minimize spectral leakage, windows that approach zero smoothly at the beginning and end of the signal are employed as filters to the FFT. The FFT Menu provides four windows: Hanning, flattop, rectangular, and Blackman-Harris. For more information on leakage, see Agilent Application Note 243, “The Fundamentals of Signal Analysis” at <http://cp.literature.agilent.com/litweb/pdf/5952-8898E.pdf>.

FFT Operation

- 1 Press the **[Math]** key, press the **Function** softkey and select **f(t)**, press the **Operator** softkey and select **FFT**.

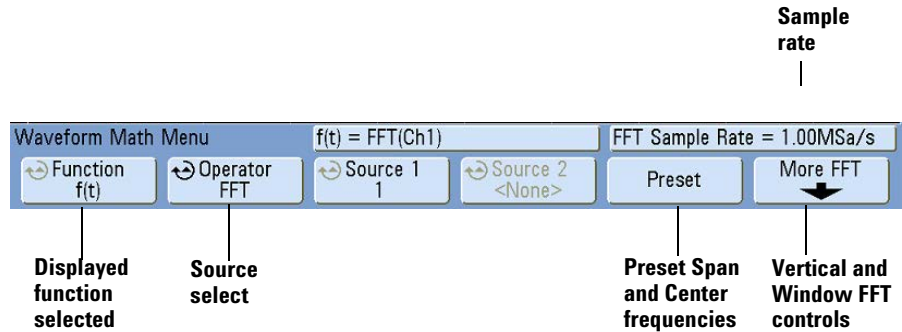

- **Source 1** — selects the source for the FFT. (See [page 225](#) for information about using **g(t)** as the source.)
 - **Preset** — sets the frequency Span and Center to values that will cause the entire available spectrum to be displayed. The maximum available frequency is half the effective FFT sample rate, which is a function of the time per division setting. The current FFT sample rate is displayed above the softkeys.
 - **More FFT** — displays the More FFT Settings Menu.
- 2 Press the More FFT softkey to display additional FFT settings.

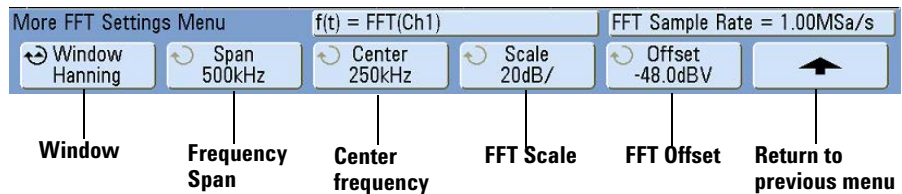

- **Window** — selects a window to apply to your FFT input signal:
 - **Hanning** — window for making accurate frequency measurements or for resolving two frequencies that are close together.
 - **Flat Top** — window for making accurate amplitude measurements of frequency peaks.

- **Rectangular** — good frequency resolution and amplitude accuracy, but use only where there will be no leakage effects. Use on self-windowing waveforms such as pseudo-random noise, impulses, sine bursts, and decaying sinusoids.
- **Blackman Harris** — window reduces time resolution compared to a rectangular window, but improves the capacity to detect smaller impulses due to lower secondary lobes.
- **Span** — sets the overall width of the FFT spectrum that you see on the display (left to right). Divide span by 10 to calculate the number of Hertz per division. It is possible to set Span above the maximum available frequency, in which case the displayed spectrum will not take up the whole screen. Press the **Span** softkey, then turn the Entry knob to set the desired frequency span of the display.
- **Center** — sets the FFT spectrum frequency represented at the center vertical grid line of the display. It is possible to set the Center to values below half the span or above the maximum available frequency, in which case the displayed spectrum will not take up the whole screen. Press the **Center** softkey, then turn the Entry knob to set the desired center frequency of the display.
- **Scale** — lets you set your own vertical scale factors for FFT expressed in dB/div (decibels/division). Press the **Scale** softkey, then turn the Entry knob to rescale your math function.
- **Offset** — lets you set your own offset for the FFT. The offset value is in dB and is represented by the center horizontal grid line of the display. Press the **Offset** softkey, then turn the Entry knob to change the offset of your math function.

Scale and offset considerations

If you do not manually change the FFT scale or offset settings, when you turn the horizontal sweep speed knob, the span and center frequency settings will automatically change to allow optimum viewing of the full spectrum. If you do manually set scale or offset, turning the sweep speed knob will not change the span or center frequency settings, allowing you see better detail around a specific frequency. Pressing the FFT **Preset** softkey will automatically rescale the waveform and span and center will again automatically track the horizontal sweep speed setting.

- 3 To make cursors measurements, press the [**Cursors**] key and set the **Source** softkey to **Math: f(t)**.

Use the X1 and X2 cursors to measure frequency values and difference between two frequency values (ΔX). Use the Y1 and Y2 cursors to measure amplitude in dB and difference in amplitude (ΔY).

- 4 To make other measurements, press the [**Quick Meas**] key and set the **Source** softkey to **Math: f(t)**.

You can make peak-to-peak, maximum, minimum, and average dB measurements on the FFT waveform. You can also find the frequency value at the first occurrence of the waveform maximum by using the X at Max Y measurement.

The following FFT spectrum was obtained by connecting the front panel Probe Comp signal (approximately 1.2 kHz square wave) to channel 1. Set sweep speed to 5 ms/div, vertical sensitivity to 500 mV/div, Units/div to 10 dBV, Offset to -34.0 dBV, Center frequency to 5.00 kHz, frequency Span to 10.0 kHz, and window to Hanning.

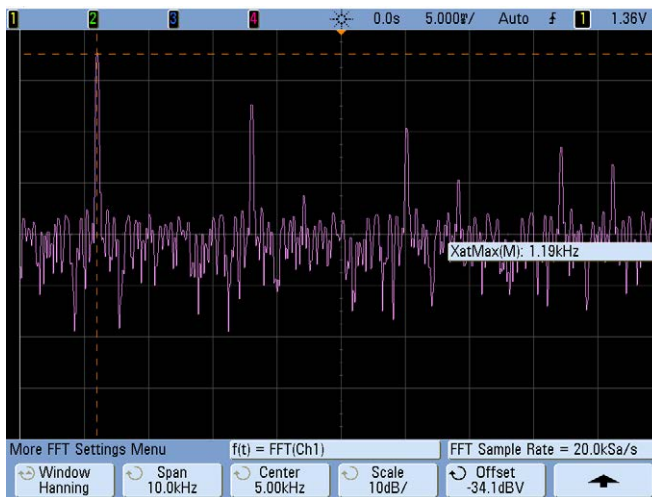

FFT Measurement Hints

The number of points acquired for the FFT record is 1000 and when frequency span is at maximum, all points are displayed. Once the FFT spectrum is displayed, the frequency span and center frequency controls are used much like the controls of a spectrum analyzer to examine the frequency of interest in greater detail. Place the desired part of the waveform at the center of the screen and decrease frequency span to increase the display resolution. As frequency span is decreased, the number of points shown is reduced, and the display is magnified.

While the FFT spectrum is displayed, use the **[Math]** and **[Cursors]** keys to switch between measurement functions and frequency domain controls in FFT Menu.

Decreasing the effective sampling rate by selecting a slower sweep speed will increase the low frequency resolution of the FFT display and also increase the chance that an alias will be displayed. The resolution of the FFT is the effective sample rate divided by the

number of points in the FFT. The actual resolution of the display will not be this fine as the shape of the window will be the actual limiting factor in the FFTs ability to resolve two closely spaced frequencies. A good way to test the ability of the FFT to resolve two closely spaced frequencies is to examine the sidebands of an amplitude modulated sine wave.

For the best vertical accuracy on peak measurements:

- Make sure the probe attenuation is set correctly. The probe attenuation is set from the Channel Menu if the operand is a channel.
- Set the source sensitivity so that the input signal is near full screen, but not clipped.
- Use the Flat Top window.
- Set the FFT sensitivity to a sensitive range, such as 2 dB/division.

For best frequency accuracy on peaks:

- Use the Hanning window.
- Use Cursors to place an X cursor on the frequency of interest.
- Adjust frequency span for better cursor placement.
- Return to the Cursors Menu to fine tune the X cursor.

For more information on the use of FFTs please refer to Agilent Application Note 243, "The Fundamentals of Signal Analysis" at

<http://cp.literature.agilent.com/litweb/pdf/5952-8898E.pdf>. Additional information can be obtained from Chapter 4 of the book "Spectrum and Network Measurements" by Robert A. Witte.

Enabling Precision Measurements and Math

Normally, after pressing **[Save/Recall] > Default Setup**, the oscilloscope performs measurements and generates math waveforms using a 1000-point (maximum) measurement record. This measurement record is purposely small in order to provide high waveform update rates and minimal “dead time” between acquisitions to improve the probability of capturing infrequent events.

However, at the expense of waveform update rate, you can enable precision measurements and math waveforms that use a 128K-point (maximum) record. This mode gives you better resolution on measurements and math waveforms (including FFT).

To enable precision measurements and math:

- 1 Press **[Utility] > Options**.
- 2 In the User Options Menu, select **Precision** to enable precision measurements and math waveforms.



Precision measurements and math are disabled in the same way, or you can disable them by pressing **[Save/Recall] > Default Setup**.



7 Printing and Saving

Printing the Oscilloscope's Display **244**

Quick Print **244**

To print the oscilloscope's display **245**

Options **245**

Palette **246**

Saving Oscilloscope Data **247**

Selecting a Destination for Your Saved Data **248**

Selecting a File Name **249**

Saving Waveform Trace and Oscilloscope Setup **250**

Display Image and Waveform Data File Formats **250**

Choosing Save Settings **251**

To save a waveform and/or setup to a USB mass storage device **255**

To save a waveform and/or setup to the oscilloscope's internal
memory **256**

To recall waveform trace and/or oscilloscope setup **256**

File Explorer **257**



Printing the Oscilloscope's Display

You can print the complete display, including the status line and softkeys, to a USB printer.

The Print Configuration Menu is displayed when you press the **[Print]** key. The print option softkeys and the **Press to Print** softkey are ghosted (not available) until a printer is connected.

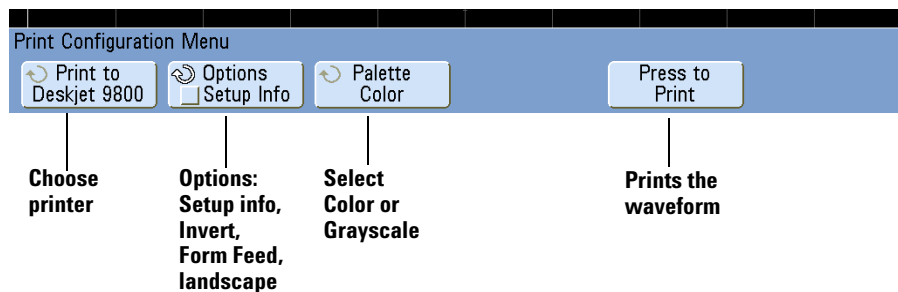

Quick Print

On earlier oscilloscopes the **[Print]** key was labeled **[Quick Print]** and the oscilloscope attempted to print or save as soon as the key was pressed.

On newer oscilloscopes the key is labeled **[Print]**, and by default, when it is pressed the Print Configuration Menu is displayed.

Now you can select whether pressing the key displays the Print Configuration Menu or performs a Quick Print.

To choose Print or Quick Print functionality:

- 1 Press **[Save/Recall]**.
- 2 Press the **Quick Print** softkey to set Quick Print on or off.

When Quick Print is enabled, a Save function is performed immediately when the **[Print]** (or **[Quick Print]**) key is pressed. The save parameters must be set up in the Save/Recall Menu (see [page 247](#)) before pressing **[Print]**.

To print the oscilloscope's display

- 1 Connect a USB printer to either the USB port on the front panel or the rectangular USB host port on the rear panel.

For the most up-to-date listing of printers that are compatible with the InfiniiVision 5000/6000/7000 Series oscilloscopes, please visit www.agilent.com/find/InfiniiVision-printers.

- 2 Press the **[Print]** key on the front panel.
- 3 Press the **Press to Print** softkey.

You can stop printing by pressing the **Cancel Print** softkey.

NOTE

The oscilloscope will print the last menu visited before you pressed the **[Print]** key. Therefore, if you have measurements (Amplitude, Frequency, etc.) showing on the display before you select **[Print]**, the measurements will be shown on the printout.

To print the display showing the Print Configuration Menu at the bottom, press the **[Print]** key twice, then press the **Press to Print** softkey.

Options

Press the **Options** softkey to change the following options:

- **Setup Information** — Select to print oscilloscope setup information on your printout, including vertical, horizontal, trigger, acquisition, math, and display settings.
- **Invert Graticule Colors** — The **Invert Graticule Colors** option can be used to reduce the amount of black ink it takes to print oscilloscope images by changing the black background to white. **Invert Graticule Colors** is the default mode.



Graticule Not Inverted

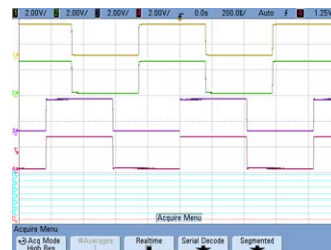

Graticule Inverted

- **Form Feed** — The **Form Feed** option can be selected to send a form feed command to the printer after the waveform is printed and before the setup information is printed. Switch **Form Feed** off if you want setup information printed on the same sheet of paper with the waveform. This option only has an effect when the **Setup Information** option is selected. Also, if the amount of setup information will not fit on the same page with the waveform, it will be printed on a new page regardless of the **Form Feed** setting.
- **Landscape** — Choose **Landscape** mode to print horizontally on the page instead of vertically (portrait mode).

Palette

Press the **Palette** softkey to change the following options.

- **Color** — When **Color** printing is selected, the traces are printed in color.
- **Grayscale** — When **Grayscale** printing is selected, the traces are printed in shades of gray rather than in color.

Saving Oscilloscope Data

Here are a few points about saving oscilloscope data:

- You can save a waveform trace and recall it later. The recalled trace appears in cyan (blue).
- You can save oscilloscope setup parameters and recall them later. The setup file stores settings such as horizontal timebase, vertical sensitivity, trigger mode, trigger level, measurements, cursors, and math functions. This lets you easily and consistently set up the oscilloscope to make a particular measurement.
- There is a distinction between print and save: print always refers to printing the display to a printer. Save means saving data to a USB mass storage device or the oscilloscope's internal memory.

The following table shows types of data and where the data can be saved.

SAVING OSCILLOSCOPE DATA

Type of Data	Can be saved to:	
	USB device	Oscilloscope's internal memory
Oscilloscope setup and waveform trace	Yes	Yes*
Display image and waveform data files (BMP, PNG, CSV, ASCII XY, ALB, BIN)	Yes	No

*If Secure Environment Mode option is installed then data is prevented from being stored in the oscilloscope's internal memory.

NOTE

You can also save the oscilloscope's display image using a web browser. See "[Get Image](#)" on page 285 for details.

Selecting a Destination for Your Saved Data

Press [**Save/Recall**]→**Save** to access the Save Menu and select a destination for saving your data.

Press to go/Location/Save to softkey (Using the oscilloscope's File Explorer)

The second softkey from the left in the Save Menu is the file explorer softkey.

If no USB mass storage device is connected to the oscilloscope, you will only be able to save Trace and Setup files to the oscilloscope's internal memory. You will not be able to save display image files or waveform data files as described on [page 250](#) unless a USB mass storage device is connected.

Rotate the Entry knob to align the selection arrow with “**C:**” and push the Entry knob to select it. Then rotate and push the Entry knob to select the “**setups**” directory, then select a file (**intern_n**) to be overwritten.

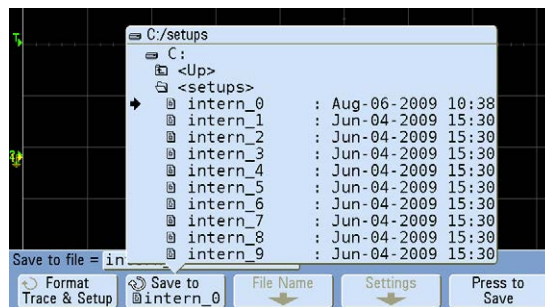

NOTE

The File Explorer in the Save and Recall Menus can be used to save the following file types: oscilloscope setup, waveform trace, display image and waveform data. It can be used to recall oscilloscope setup and waveform trace files.

The **File Explorer** in the Utility Menu can be used for loading files into the oscilloscope or deleting files.

If one or more USB mass storage devices are connected to the oscilloscope, you can navigate to the USB device using the same method. The following display image shows an image ready to be saved to a subfolder called “Rise time” on a USB mass storage device. Push the Entry knob to save the image.

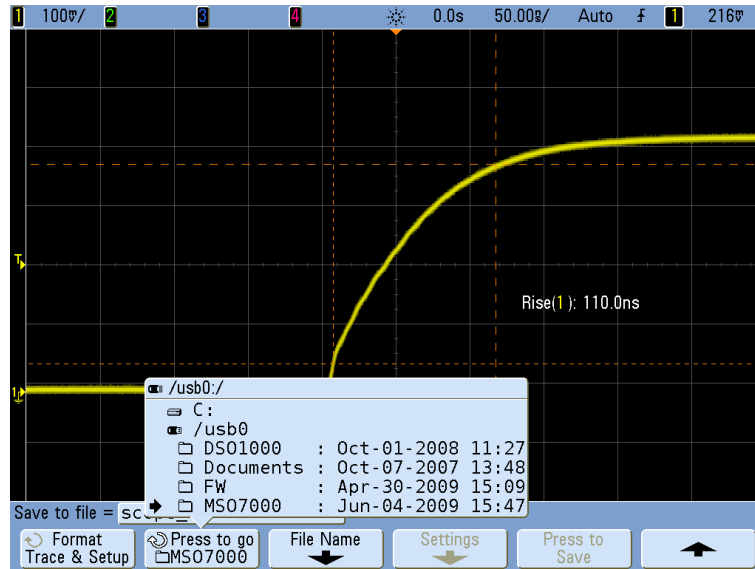

Selecting a File Name

Overwriting a file

You can choose to overwrite an existing file name by browsing to that file and selecting it, then choosing **Press to Save**.

Creating a new file name

- 1 Press the **File Name** softkey in the Save Menu. (You must have a USB mass storage device connected to the oscilloscope for this softkey to be active.)
- 2 Repeatedly turn and push the Entry knob to select letters and numbers for the new file name. Or, you can press the **Spell** softkey and press the **Enter** softkey to create the new file name.
- 3 You can press the **Enter** softkey or the Entry knob to move the cursor forward within the file name.

- 4 You can press the **Delete Character** softkey to delete the current character and shift the rest of the characters to the left.
- 5 When you select the **Auto Increment** option, the oscilloscope will add a numeric suffix to your file name, and increment the number with each successive save. It will truncate characters as necessary when the file name length is at maximum and more digits are required for the numeric portion of the file name.
- 6 Press the **Press to Save** softkey to save the file.

Saving Waveform Trace and Oscilloscope Setup

When the **Trace & Setup** option is selected from the **Format** softkey, both waveform trace and oscilloscope setup are saved to the USB mass storage device or the oscilloscope's internal memory. After saving, you can choose to recall the trace, the setup, or both.

The trace is saved with the file extension TIF and the setup is saved with the extension SCP. These extensions can be seen using the File Explorer, but they do not appear when using the file browser in the Recall Menu. When using Mask Testing, the mask data file is saved also. Its extension is MSK.

Display Image and Waveform Data File Formats

Display image and waveform data files can be saved on a USB mass storage device, but they cannot be saved to the oscilloscope's internal memory.

Press [**Save/Recall**]→**Save**→**Format** to select a format.

You can save the display image in the following file formats:

- **BMP (8-bit) image file** — The screen image is converted to a smaller, lower resolution bitmap file of the complete screen (including the status line and softkeys).
- **BMP (24-bit) image file** — This is a larger, high-resolution bitmap file of the complete screen.
- **PNG (24-bit) image file** — This is an image file that uses lossless compression. Files are much smaller than the BMP format.

You can save waveform data in the following formats:

- **CSV data file** — This creates a file of comma-separated variable values of all displayed channels and math waveforms. This format is suitable for spreadsheet analysis. Serial decode Lister data is also saved in CSV format. (See also [page 417](#).)

- **ASCII XY data file**— This creates a file of comma-separated variables for each displayed channel (including serial decode waveforms). If the oscilloscope acquisition is stopped, then data records greater than 1000 points can be written. This format is also suitable for spreadsheets.
- **BIN data file** — This creates a binary file with a header, and data in the form of time and voltage pairs. This file is much smaller than the ASCII XY data file. If the oscilloscope acquisition is stopped, then data records greater than 1000 points can be written. (See also [page 409](#).)
- **ALB data file** — This creates a file in an Agilent proprietary format which can be read by Agilent logic analyzers. You can use Agilent’s B4610A Data import tool for offline viewing and analysis.
- **Mask test data file** — This creates a mask file in an Agilent proprietary format which can be read by Agilent InfiniiVision oscilloscopes. A mask data file includes certain setup information, but not all setup information. To save all setup information including the mask data file, choose “Trace and Setup” format instead. (See also [“Mask Test”](#) on page 337.)

Choosing Save Settings

Press [**Save/Recall**]→**Save**→**Settings** to change the following options. A USB mass storage device (such as a thumb drive) must be connected to the oscilloscope.

These settings are not applicable when the format “Trace&Setup” is selected.

Setup Info

Select **Setup Info** if you want the oscilloscope setup information to be included. Oscilloscope setup information includes vertical, horizontal, trigger, acquisition, math, and display settings. The setup information will be sent to a separate file with a TXT extension.

Invert Graticule Colors

This setting is applicable when you have chosen BMP or PNG using the **Format** softkey.

The **Invert Graticule Colors** option can be used to reduce the amount of black ink it takes to print oscilloscope images by changing the black background to white. **Invert Graticule Colors** is the default mode. **Invert Graticule Colors** is available when the BMP and PNG formats are selected.



Graticule Not Inverted



Graticule Inverted

Palette

Press the **Palette** softkey to change the following options. The Palette options are available when the BMP and PNG formats are selected.

- **Color** — When **Color** printing is selected, the traces are printed in color. Color printing is not applicable to CSV format.
- **Grayscale** — When **Grayscale** printing is selected, the traces are printed in shades of gray rather than in color. Grayscale printing is not applicable to CSV format.

Length Control

The **Length** softkey is available when the CSV, ASCII XY, BIN, or ALB formats are selected. **Length** sets the number of data points that will be output to the file. **Length** can be set to 100, 250, 500, or 1000 when the acquisition is running, or more when the acquisition is stopped. (CSV length is limited to 1000 points.) It is important to save enough points to represent the captured data accurately. Press the [**Single**] key to obtain the maximum record length.

The maximum available record length depends on whether one or two channels are active (turned on) per channel pair (channel pairs are channels 1 and 2 and channels 3 and 4), whether digital channels are on or off, and the horizontal timebase setting (how much data is shown on screen).

Only displayed data points are output (except when you are using segmented memory and the **Save Segment** control is set to **All** segments). Therefore, adjust the Horizontal controls to display the data you want to save.

The length control has no effect on the amount of Serial Decode data saved; all serial decode data will be output.

The Length control will perform a “1 of n” decimation of the data when necessary. For example: if the **Length** is set to 1000, and you are displaying a record that is 5000 data points in length, four of each five data points will be decimated, creating an output file 1000 data points in length. However, if serial decode is on, no decimation will occur.

For more information see [“Minimum and Maximum Values in CSV Files”](#) on page 417.

Save Segment

When using the optional segmented memory feature you can choose to save either the currently displayed segment or all acquired segments in memory. (See also [page 274](#).)

Press [**Save/Recall**]→**Save**→**Format** (choose CSV, ASCII XY, or BIN)→

Settings→**Save Seg** to make your selection. Set the Length control appropriately (see Length Control, above).

Segmented memory save formats

Segmented memory data can be saved as a screen capture (in BMP or PNG format) or in CSV, ASCII XY, or BIN (data file format). The Save Segment setting is relevant to data file formats, not screen capture formats.

When saving waveform capture at maximum memory depth, you can expect the following approximate save times:

CSV	2 hours
ASCII XY	30 minutes
BIN	3 minutes

The primary difference between CSV format and ASCII XY data format is that in CSV all data are presented as columns in a single spreadsheet file, whereas in ASCII XY the data are presented in separate files for channel 1, channel 2, channel 3, channel 4, digital channels 0-7, digital channels 8-15, and math waveforms.

For more information, see:

- [“Binary Data \(.bin\) Format”](#) on page 409
- [“CSV and ASCII XY files”](#) on page 417

Format (ALB data file format settings in Save Menu)

You can acquire data from the oscilloscope in ALB format, then analyze it offline (on a PC) using the Agilent *B4610A Data Import Tool for Offline Viewing and Analysis*. See Agilent publication number 5989-7834EN at www.Agilent.com.

When you choose any ALB format other than Default, waveforms from the analog channels (if displayed) are also digitized and displayed as digital waveforms. The analog channel's trigger level determines the point at which the voltage is considered a logic 1 or 0.

Available ALB serial formats include:

- Default
- CAN
- I2C
- LIN
- UART/RS232
- SPI (2 Wire Serial)
- SPI (3 Wire Serial)
- SPI (4 Wire Serial)

To select a serial format for the ALB data file:

- 1 Press **[Save/Recall]**→**Save**.
- 2 Press **Format** and select ALB.
- 3 Press **Settings**.
- 4 Press **Format** and select the format for the ALB data file.

If you connect your serial bus signals to the oscilloscope as shown in the following table, the labels in the analysis software will be correct. If you do not, then you will have to re-map the signals in the analysis software.

RECOMMENDED SIGNAL MAPPING

Label	Signal	Scope Channel	Maps to Logic Analyzer Channel
TxRS232	Tx	Ch1	D0
RxRS232	Rx	Ch2	D1
I2C	Data	Ch1	D0
I2C	Clk	Ch2	D1
SPI2 (2-wire)	Clk	Ch1	D0
SPI2	Data	Ch2	D1
SPI3 (3-wire)	~Chip Select	Ch1	D0
SPI3	Clk	Ch2	D1
SPI3	Data	Ch3	D2
SPI4 (4-wire)	~Chip Select	Ch1	D0
SPI4	Clk	Ch2	D1
SPI4	DataIn	Ch3	D2
SPI4	DataOut	Ch4	D3
CAN	Data	Ch1	D0
LIN	Data	Ch1	D0

To save a waveform and/or setup to a USB mass storage device

- 1 Insert a USB mass storage device into the front or rear USB device port.
- 2 Press the [**Save/Recall**] key.
- 3 Press the **Save** softkey. The proposed file name will be shown in the “**Save to file**” prompt above the **Save** softkey. (If you want to change the file name, press the **File Name** softkey. See “**Creating a new file name**” on page 249 for details.)
- 4 Choose a file format using the **Format** softkey. For file format information see “**Display Image and Waveform Data File Formats**” on page 250.
- 5 Press the **Press to Save** softkey.

NOTE

When saving display image files, the oscilloscope will save an image using the last menu you visited before pressing the **[Print]** key. Therefore, if you have measurements (Amplitude, Frequency, etc.) showing on the display before you select Save, the measurements will be shown in the display image file.

To save an image of the display showing the Save/Recall Menu at the bottom, press the **[Save/Recall]** key twice, then press the **Press to Save** softkey.

To save a waveform and/or setup to the oscilloscope's internal memory

- 1 Press the **[Save/Recall]** key.
- 2 Press the **Save** softkey.
- 3 Press the **Format** softkey and choose **Trace and Setup**.
- 4 Press the **Save to** softkey. Then rotate the **Entry** knob to navigate to the "C:\setups" directory, then choose one of the files to overwrite (intern_0 through intern_9). You can push the **Entry** knob to make your directory and file selections.
- 5 Press the **Press to Save** softkey or select the file using the Entry knob and then press the Entry knob.

To recall waveform trace and/or oscilloscope setup

A recalled trace is typically used for a quick comparison of measurement results. For example, you might save a trace of a waveform to use as a reference, then make a similar measurement on a test system and then recall the saved trace to observe any differences.

- 1 Press the **[Save/Recall]** key.
- 2 Press the **Recall** softkey. The Recall Menu will be displayed.
- 3 Press the **Recall:** softkey in the Recall Menu and choose **Setup, Trace, or Trace and Setup**.
- 4 Press the second softkey from the left and navigate to the oscilloscope's internal memory location or the USB mass storage device that holds the saved trace and/or setup. See "**File Explorer**" (below) for more information.
- 5 Press the **Press to Recall** softkey.

File Explorer

The File Explorer lets you navigate the file system. Using the File Explorer you can save, recall, load, and delete files.

File system The user-accessible file system consists of ten internal memory locations, plus external USB mass storage devices you connect to the USB device ports on the oscilloscope.

Internal memory The ten internal nonvolatile memory locations are located on the oscilloscope at C:\setups and are named intern_0 through intern_9. You can save waveform trace and oscilloscope setup in each of the ten internal memory locations, but you cannot save display image files or waveform data files in the oscilloscope's internal memory. The latter must be stored on USB mass storage devices.

USB mass storage devices Most USB mass storage devices are compatible with the oscilloscope. However, certain devices may be incompatible, and may not be able to be read or written to.

When the USB mass storage device is connected to the oscilloscope's front or rear USB host port, a small four-color circle icon may be displayed briefly as the USB device is read.

You do not need to "eject" the USB mass storage device before removing it. Simply ensure that any file operation you've initiated is done, and remove the USB drive from the oscilloscope's host port.

Do not connect USB devices that identify themselves as hardware type "CD" because these devices are not compatible with the InfiniiVision 7000 Series oscilloscopes.

If two USB mass storage devices are connected to the oscilloscope, the first one is designated "USB0" and the second one is designated "USB5," not "USB1." This numbering method is normal; it is inherent in the USB driver.

A file that has been deleted from the USB mass storage device cannot be recovered by the oscilloscope.

NOTE

Regarding USB Ports:

The USB port on the front panel, and the USB port on the rear panel labeled “HOST” are USB Series A receptacles. These are the receptacles to which you can connect USB mass storage devices and printers.

The square receptacle on the rear panel labeled “DEVICE” is provided for controlling the oscilloscope over USB. See the *Programmer’s Guide* for more information. To access these documents online, direct your web browser to:

- www.agilent.com/find/5000manual
- www.agilent.com/find/6000manual
- www.agilent.com/find/7000manual

System software System software files can be loaded into the oscilloscope. These software updates can be downloaded from:

- www.agilent.com/find/5000sw
- www.agilent.com/find/6000sw
- www.agilent.com/find/7000sw

See “**Software and Firmware Updates**” on page 400 for more information.

To use the file explorer

Files can be loaded and deleted using the file explorer.

You can create directories on a USB mass storage device using your PC or other instrument. You can navigate to any directory on the USB device by rotating and pushing the Entry knob.

- 1 Connect a USB mass storage device with the files to be loaded or deleted to the USB port on the front or the rear of the oscilloscope. A small four-color circle icon may be displayed as the USB device is read.
- 2 Press [**Utility**]→**File Explorer**.
- 3 Turn and push the Entry knob to select the desired file on the USB mass storage device. This softkey will be labeled **Press to go** when pointing at a directory that can be selected, **Location** when pointing to a directory that is currently selected, and **Selected** when pointing to a file that can be loaded or deleted. Pressing the Entry knob will initiate the selected activity.

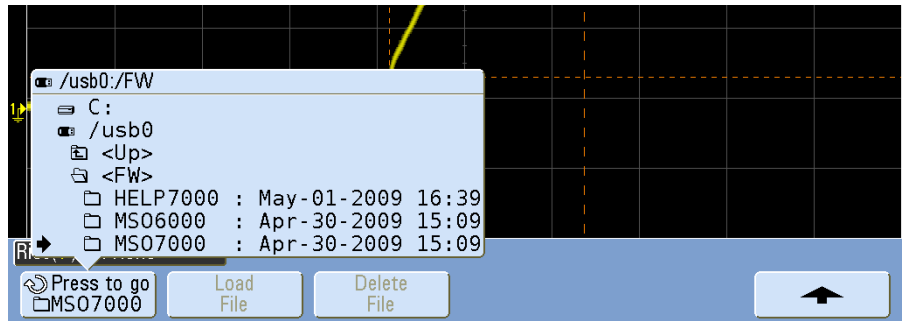

Navigate using Entry knob, select using this key or push Entry knob

Load selected file

Delete selected file

Return to previous menu

7 Printing and Saving



8 Acquisition Modes

To start and stop an acquisition [262](#)

To make a single acquisition [264](#)

Acquisition Modes [265](#)

Normal Mode [265](#)

Peak Detect Mode [266](#)

High Resolution Mode [266](#)

Averaging Mode [267](#)

Realtime Sampling Option [269](#)

Segmented Memory [271](#)

This chapter describes various acquisition modes.

- See Also**
- **“Mask Test”** on page 337.
 - **“Glitch or Narrow Pulse Capture”** on page 112.



To start and stop an acquisition

- When you press the **[Run/Stop]** key, it illuminates in green and the oscilloscope is in run mode.

The oscilloscope examines the input voltage at each probe, and updates the display whenever the trigger conditions are met. Trigger processing and screen update rate are optimized based on the oscilloscope settings. The oscilloscope displays multiple acquisitions of the same signal similar to the way an analog oscilloscope displays waveforms.

- When you press the **[Run/Stop]** key again, it illuminates in red, and the oscilloscope is stopped.

“Stop” is displayed in the trigger mode position in the status line at the top of the display. You can pan and zoom the stored waveform by turning the horizontal and vertical control knobs.

When the oscilloscope is running and you press the **[Run/Stop]** key, it will flash until the current acquisition is completed. If the acquisition completes immediately, the **[Run/Stop]** key will not flash.

At slower sweep speeds, you may not want to wait for the acquisition to finish. Just press **[Run/Stop]** again. The acquisition will stop immediately and a partial waveform will be displayed.

You can display the results of multiple acquisitions using infinite persistence. See [“Infinite Persistence”](#) on page 182.

Memory Depth/Record Length**[Run/Stop] versus [Single]**

When the oscilloscope is running, the trigger processing and update rate are optimized over the memory depth.

Single

Single acquisitions always use the maximum memory available—at least twice as much memory as acquisitions captured in Run mode—and the oscilloscope stores at least twice as many samples. At slow sweep speeds, the oscilloscope operates at a higher sample rate when Single is used to capture an acquisition due to the increased memory available. To acquire data with the longest possible record length, press the **[Single]** key.

Running

When running, versus taking a single acquisition, the memory is divided in half. This allows the acquisition system to acquire one record while processing the previous acquisition, dramatically improving the number of waveforms per second processed by the oscilloscope. While running, maximizing the rate at which waveforms are drawn on the display provides the best representation of your input signal.

To make a single acquisition

When you press the **[Single]** key it illuminates in yellow and the oscilloscope starts the acquisition system, searching for the trigger condition. When the trigger condition is met, the captured waveform is displayed, the **[Single]** key is extinguished and the **[Run/Stop]** key illuminates in red.

- Use the **[Single]** key to view single-shot events without subsequent waveform data overwriting the display.

Use **[Single]** when you want the maximum sample rate and the maximum memory depth for pan and zoom. (See **“Pan and Zoom”** on page 179)

- 1 Set the trigger mode to Normal (see **“Auto and Normal Trigger modes”** on page 84 for instructions).

This keeps the oscilloscope from automatically triggering immediately.

- 2 If you are triggering on analog channel events, turn the Trigger Level knob to the trigger threshold to a level that your waveform will cross.
- 3 To begin a single acquisition, press the **[Single]** key.

When you press **[Single]**, the display is cleared, the trigger circuitry is armed, the **[Single]** key is illuminated yellow, and the oscilloscope will wait until a trigger condition occurs before it displays a waveform.

When the oscilloscope triggers, the single acquisition is displayed and the oscilloscope is stopped (the **[Run/Stop]** key is illuminated in red).

- 4 To acquire another waveform, press **[Single]** again.

Auto Single

Auto-trigger will generate a trigger for you if one is not found in the predetermined time (about 40 ms) after you press **[Single]**. If you want to make a single acquisition and you are not particularly interested in triggering the acquisition (for example, if you are probing a DC level), set the trigger mode to Auto (see [page 84](#)) and press the **[Single]** key. If a trigger condition occurs, it will be used; if a trigger doesn't happen, an untriggered acquisition will be taken.

Acquisition Modes

The InfiniiVision oscilloscopes have the following acquisition modes:

- **Normal** — for most waveforms (with normal decimating at slower sweep speeds, no averaging).
- **Peak Detect** — for displaying narrow pulses that occur infrequently (at slower sweep speeds).
- **Averaging** — for reducing noise and increasing resolution (at all sweep speeds, without bandwidth or rise time degradation).
- **High Resolution** — for reducing random noise (at slower sweep speeds).

Realtime sampling (where the oscilloscope produces the waveform display from samples collected during one trigger event) can be turned off or on in the Normal, Peak Detect, and High Resolution modes.

(For information on the XY horizontal mode see [“XY Horizontal Mode”](#) on page 220.)

At Slower Sweep Speeds

At slower sweep speeds, the sample rate drops because the acquisition time increases and the oscilloscope's digitizer is sampling faster than is required to fill memory.

For example, suppose an oscilloscope's digitizer has a sample period of 1 ns (maximum sample rate of 1 GSa/s) and a 1 M memory depth. At that rate, memory is filled in 1 ms. If the acquisition time is 100 ms (10 ms/div), only 1 of every 100 samples is needed to fill memory.

Selecting the Acquisition mode

To select the acquisition mode press the **[Acquire]** key on the front panel.

Normal Mode

In Normal mode at slower sweep speeds, extra samples are decimated (in other words, some are thrown away). This mode yields the best display for most waveforms.

Peak Detect Mode

In Peak Detect mode at slower sweep speeds, minimum and maximum samples are kept in order to capture infrequent and narrow events (at the expense of exaggerating any noise). This mode displays all pulses that are at least as wide as the sample period (see [Table 1](#)).

Table 1 InfiniiVision Series Oscilloscope Bandwidths, Maximum Sample Rates, and Sample Periods

Bandwidth	Maximum Sample Rate	A sample is taken every (sample period)
100 MHz	2 GSa/s	500 ps
350 MHz	2 GSa/s	500 ps
500 MHz	4 GSa/s	250 ps
1 GHz	4 GSa/s	250 ps

See also [“Glitch or Narrow Pulse Capture”](#) on page 112.

High Resolution Mode

In High Resolution mode, at slower sweep speeds extra samples are averaged in order to reduce random noise, produce a smoother trace on the screen, and effectively increase vertical resolution.

High Resolution mode averages sequential sample points within the same acquisition. An extra bit of vertical resolution is produced for every factor of 4 averages. The number of extra bits of vertical resolution is dependent on the time per division setting (sweep speed) of the scope.

The slower the sweep speed, the greater the number of samples that are averaged together for each display point.

High Resolution mode can be used on both single-shot and repetitive signals and it does not slow waveform update because the computation is done in the MegaZoom custom ASIC. High Resolution mode limits the oscilloscope's real-time bandwidth because it effectively acts like a low-pass filter.

2 GSa/s Sample Rate	4 GSa/s Sample Rate	Bits of resolution
≤ 50 ns/div	≤ 50 ns/div	8
200 ns/div	100 ns/div	9
1 us/div	500 ns/div	10
5 us/div	2 us/div	11
≥ 20 us/div	≥ 10 us/div	12

Averaging Mode

The Averaging mode lets you average multiple acquisitions together to reduce noise and increase vertical resolution (at all sweep speeds). Averaging requires a stable trigger.

The number of averages can be set from 2 to 65536 in powers-of-2 increments.

A higher number of averages reduces noise more and increases vertical resolution.

# Avgs	Bits of resolution
2	8
4	9
16	10
64	11
≥ 256	12

The higher the number of averages, the slower the displayed waveform responds to waveform changes. You must compromise between how quickly the waveform responds to changes and how much you want to reduce the displayed noise on the signal.

To use the Averaging mode

- 1 Press the [**Acquire**] key, then press the **Acq Mode** softkey until the Averaging mode is selected.
- 2 Press the **#Avgs** softkey and turn the Entry knob to set the number of averages that best eliminates the noise from the displayed waveform. The number of acquisitions being averaged is displayed in the **# Avgs** softkey.

8 Acquisition Modes

RANDOM NOISE ON THE DISPLAYED WAVEFORM

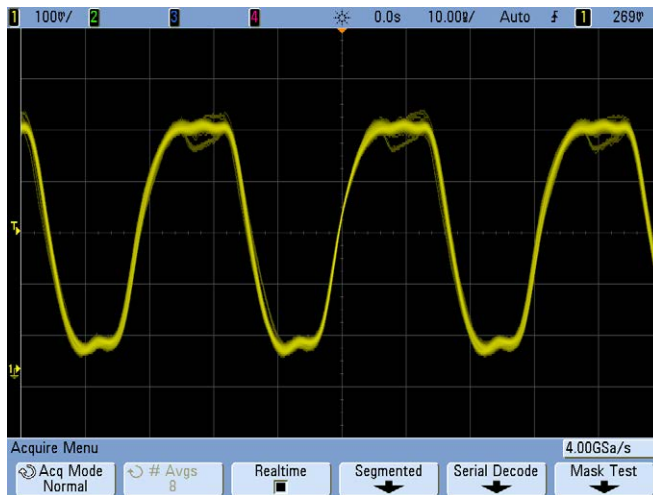

128 AVERAGES USED TO REDUCE RANDOM NOISE

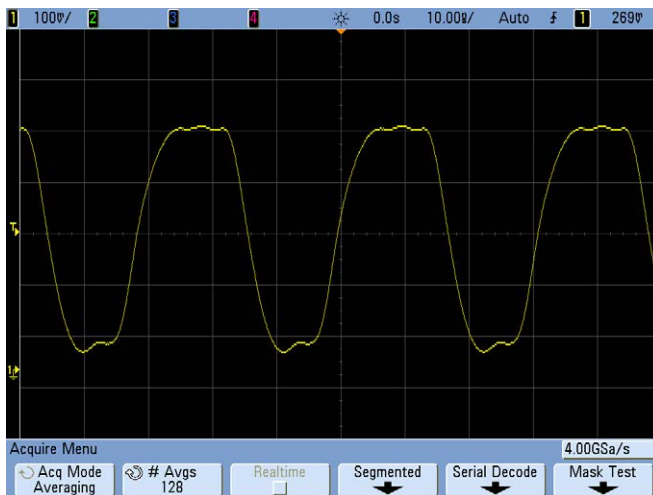

See also **“Trigger Noise Rejection”** on page 87

Realtime Sampling Option

Realtime sampling specifies that the oscilloscope produce the waveform display from samples collected during one trigger event (that is, one acquisition).

Use Realtime sampling to capture infrequent triggers, unstable triggers, or complex changing waveforms, such as eye diagrams.

Realtime sampling can be turned on in **Normal**, **Peak Detect**, or **High Resolution** acquisition modes. It cannot be turned on when the acquisition mode is **Averaging**.

When Realtime sampling is on (as in the default setup):

- When less than 1000 samples can be collected in the time spanned by the screen, a sophisticated reconstruction filter is used to fill in and enhance the waveform display.
- If you press the **[Stop]** key, and pan and zoom through the waveform using the Horizontal and Vertical controls, only the last trigger's acquisition will be displayed.

When Realtime sampling is off:

- The oscilloscope produces the waveform display from samples collected from multiple acquisitions. In this case, the reconstruction filter is not used.

Realtime Sampling and Oscilloscope Bandwidth

To accurately reproduce a sampled waveform, the sample rate should be at least four times the highest frequency component of the waveform. If not, it is possible for the reconstructed waveform to be distorted or aliased. Aliasing is most commonly seen as jitter on fast edges.

The maximum sample rate for 350 MHz bandwidth oscilloscopes is 2 GSa/s.

The maximum sample rate for 1 GHz and 500 MHz bandwidth oscilloscopes is 4 GSa/s for a single channel in a channel pair. Channels 1 and 2 constitute a channel pair, and channels 3 and 4 constitute another channel pair. For example, the sample rate of a 4-channel oscilloscope is 4 GSa/s when channels 1 and 3, 1 and 4, 2 and 3, or 2 and 4 are on.

Whenever both channels in a channel pair are on, the sample rate for all channels is halved. For example, when channels 1, 2, and 3 are on, the sample rate for all channels is 2 GSa/s.

When Realtime sampling is on, the bandwidth of the oscilloscope is limited because the bandwidth of the reconstruction filter is set to $f_s/4$. For example, a 610x oscilloscope with channels 1 and 2 on has a bandwidth of 500 MHz when Realtime sampling on and 1 GHz when Realtime sampling is off.

8 Acquisition Modes

To see the sample rate, press the [**Acquire**] key on the front panel. The sample rate is displayed in the line just above the softkeys.

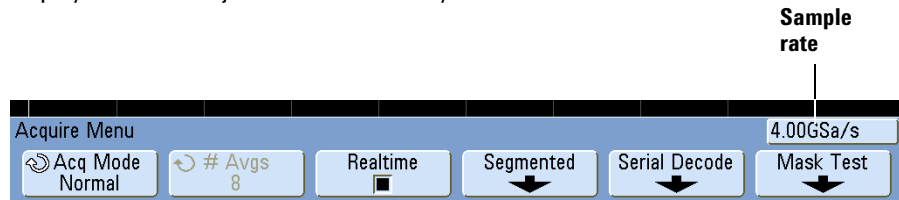

Segmented Memory

You can purchase the oscilloscope with the segmented memory option factory-installed (Option SGM) or you can easily install it yourself (order model number N5454A “Segmented Memory”).

When capturing multiple infrequent trigger events it is advantageous to divide the oscilloscope’s memory into segments. This lets you capture signal activity without capturing long periods of signal “dead time.”

Each segment is complete with all analog channel, digital channel (on MSO models), and serial decode data.

When using Segmented memory, use the Analyze Segments feature (see [“Measurements, statistics, and infinite persistence”](#) on page 273) to show infinite persistence across all acquired segments. See also [“Infinite Persistence”](#) on page 182 for details.

Using segmented memory

- 1 Set up a trigger condition. (See [“Triggering”](#) on page 81 for details.)
- 2 Press the **[Acquire]** key in the Waveform section of the front panel.
- 3 Press the **Segmented** softkey to access the Segmented Memory Menu.
- 4 In the Segmented Memory Menu, press the **Segmented** softkey to enable segmented memory acquisitions.
- 5 Press the **# of Segs** softkey and rotate the Entry knob to select the number of segments into which you would like to divide the oscilloscope’s memory. Memory can be divided into as few as two segments and as many as 2000 segments.
- 6 Press the **[Run]** key or the **[Single]** key.

The oscilloscope will run and fill a memory segment for each trigger event. When the oscilloscope is busy acquiring multiple segments, the progress is displayed in the upper right area of the display. The oscilloscope will continue to trigger until memory is filled, then the oscilloscope will stop.

8 Acquisition Modes

If the signal you are measuring has more than about 1 s of “dead time” (inactivity), consider selecting **Normal** trigger mode to prevent AutoTriggering. Press the **[Mode/Coupling]** key, then press the **Mode** softkey and select **Normal**.

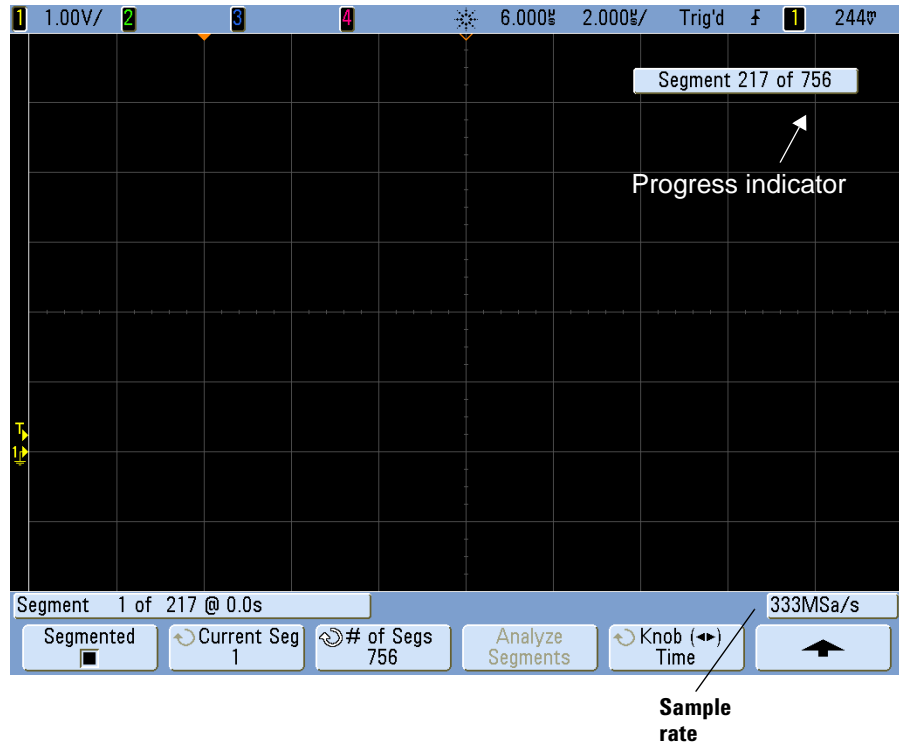

Navigating segments

Press the **Current Seg** softkey and turn the Entry knob to display to the desired segment along with a time tag indicating the time from the first trigger event.

You can also press the **Knob** softkey to toggle between **Current Segment** and **Time**. When **Current Segment** is selected, the Horizontal position control knob moves the display to the desired segment. When **Time** is selected, the Horizontal position control knob moves the display horizontally just as it does when Segmented Memory mode is not selected. The **Knob** softkey also appears in the Horizontal Menu so you can make the same adjustments there.

Measurements, statistics, and infinite persistence

To perform measurements and view statistical information, press [**Quick Meas**] and set up your desired measurements. (See “**List of Automatic Measurements**” on page 192.) Then press **Analyze Segments**. Statistical data will be accumulated for the measurements you have chosen.

The **Analyze Segments** softkey only appears when the acquisition is stopped and the optional segmented memory feature is on.

You can also turn on infinite persistence (in the Display Menu) and press the **Analyze Segments** softkey to create an infinite persistence display.

Re-arm time

After each segment fills, the oscilloscope re-arms and is ready to trigger in about 8 μs . Remember though, for example: if the horizontal time per division control is set to 5 $\mu\text{s}/\text{div}$, and the Time Reference is set to **Center**, it will take at least 50 μs to fill all ten divisions and re-arm. (That’s 25 μs to capture pre-trigger data and 25 μs to capture post-trigger data.)

8 Acquisition Modes

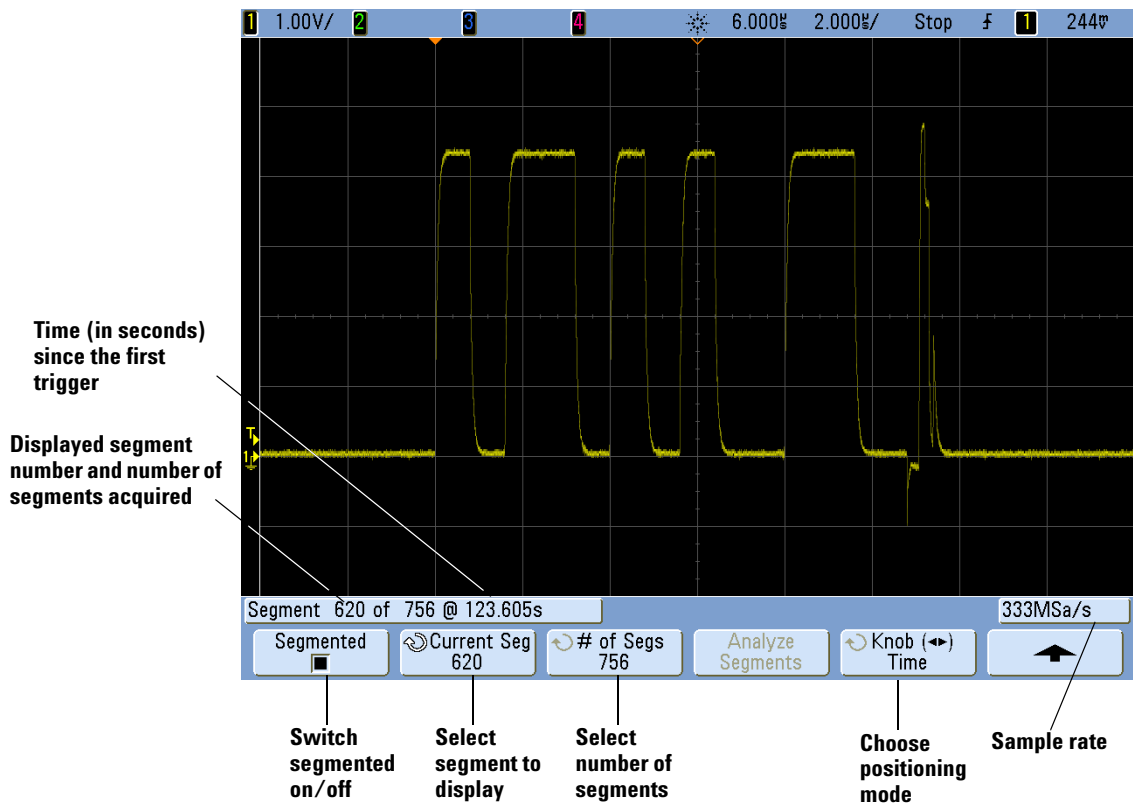

Saving data from segmented memory

You can save either the currently displayed segment (**Save Segment - Current**), or all segments (**Save Segment - All**) in the following data formats: CSV, ASCII XY, and BIN. Be sure to set the Length control to capture enough points to accurately represent the captured data. When the oscilloscope is busy saving multiple segments, progress is displayed in the upper right area of the display.

To select the current segment or all segments, press **[Save/Recall]→Save→Settings→Save Seg**. A USB storage device must be connected to the oscilloscope to enable this Save option. You can also save the screen image in BMP or PNG formats. For more information see **“Save Segment”** on page 253.

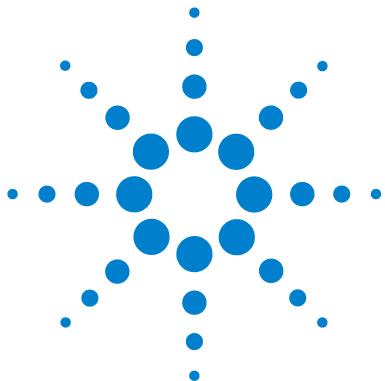

9 Web Interface

Setting up the Oscilloscope's LAN Connection	276
Accessing the Web Interface	280
Browser Web Control	281
Get Image	285
Identification Function	286
Instrument Utilities	287
Setting a Password	288

The Agilent InfiniiVision oscilloscopes have a LAN interface and a built-in web server; these let you use a Java™-enabled web browser remotely to:

- View information about the oscilloscope like its model number, serial number, host name, IP address, and VISA (address) connect string.
- Control the oscilloscope using the Remote Front Panel.
- Send SCPI (Standard Commands for Programmable Instrumentation) remote programming commands via the SCPI Commands applet window.
- Get screen images and save or print them from the browser.
- Activate the Identification function to identify a particular instrument by causing a message to be displayed or a front panel light to blink.
- View installed options, view firmware versions and install firmware upgrade files, and view calibration status (via the Instrument Utilities page).
- View and modify the oscilloscope's network configuration and status information.

The web interface for InfiniiVision oscilloscope also provides help for each of its pages.



Microsoft Internet Explorer is the recommended Web browser for communication and control of the oscilloscope. Other Web browsers may work but are not guaranteed to work with the oscilloscope. The Web browser must be Java-enabled with Sun Microsystems™ Java Plug-in.

Before you can use the web interface, you must place the oscilloscope on the network and set up its LAN connection.

Setting up the Oscilloscope's LAN Connection

Before you can use the web interface, you must place the oscilloscope on the network and set up its LAN connection.

NOTE

Once you connect the oscilloscope to a LAN it is a good practice to limit access to the oscilloscope by setting a password. By default, the oscilloscope is not password protected. See [page 288](#) to set a password.

NOTE

Any time you modify the oscilloscope's hostname it will break the connection between the oscilloscope and the LAN. You will need to re-establish communication to the oscilloscope using the new hostname.

To establish a LAN connection

To connect to the network using DHCP or AutoIP

- 1 Connect the oscilloscope to the local area network (LAN) by inserting the LAN cable into the "LAN" port on the rear panel of the oscilloscope. In a few moments the oscilloscope will connect to the network automatically.
 - a If the oscilloscope does not automatically connect to the network, press **[Utility]→I/O→LAN Reset**. In a few moments the oscilloscope will connect to the network.
 - b If desired you can enable NetBIOS. Press **[Utility]→I/O→Control** to access the option.
 - c When using DHCP you can select DynamicDNS if desired. Press **[Utility]→I/O→Control** to access the option.

To connect to the network using Manual mode

- 1 Get the oscilloscope's network parameters (hostname, domain, IP address, subnet mask, gateway IP, DNS IP, etc.) from your network administrator.
- 2 Connect the oscilloscope to the local area network (LAN) by inserting the LAN cable into the "LAN" port on the rear panel of the oscilloscope.
- 3 On the oscilloscope, ensure the controller interface is enabled:
 - a Press **[Utility]→I/O→Control**.
 - b Ensure that LAN is selected. If not, use the Entry knob to point to "LAN" and then push the Entry knob.
- 4 Configure the oscilloscope's LAN interface:
 - a Press the **LAN Settings** softkey.
 - b Press the **Config** softkey to deselect DHCP and AutoIP.
 - c Press the **Addresses** softkey.
 - d Use the **Modify** softkey (and the other softkeys and the Entry knob) to enter the IP Address, Subnet Mask, Gateway IP, and DNS IP values. When you are done, press the return (up arrow) softkey.
 - e Press the **Domain** softkey. Use the **Modify** softkey (and the other softkeys and the Entry knob) to enter the Host name and the Domain name. When you are done, press the return (up arrow) softkey.
 - f Press the **Apply** softkey.

To establish a LAN connection (6000L Series)

- 1 Connect a cable from your site Local Area Network (LAN) to the LAN port on the rear panel of the oscilloscope.
- 2 Turn on the oscilloscope power.
- 3 When the LAN indicator illuminates green, the LAN is connected as configured.

This may take a few minutes.

The oscilloscope will attempt to connect to the LAN using DHCP, AutoIP, then Manual, in that order (when enabled).

DHCP allows a network DHCP server to assign an address. If a DHCP server is not present, the oscilloscope moves on to AutoIP.

These connection methods can be enabled or disabled later using the Configure Network tab in the web interface.

- 4 Open a web browser and enter the oscilloscope's hostname in the address field. The oscilloscope's Web page will be displayed.

Hostname

If you do not know the oscilloscope's hostname you can reset the hostname as follows:

- 1 Press and release the **Reset** button (see [page 354](#)) on the front panel of the 6000L Series oscilloscope. This will reset the hostname to that which is printed on the label near the oscilloscope's power cord connection. The following LAN parameters will be reset:
 - Hostname
 - IP address
 - Domain name
 - VISA address
 - Password (see [page 288](#).)

Stand-alone (Point-to-Point) Connection to a PC

The following procedure describes how to establish a point-to-point (stand alone) connection to the oscilloscope. This is useful if you want to control the oscilloscope using a laptop computer or a stand-alone computer.

- 1 Connect your PC to the oscilloscope using a cross-over LAN cable such as Agilent part number 5061-0701, available on the web at www.parts.agilent.com.
- 2 Turn on the oscilloscope power. Wait until the LAN connection is configured:
 - Press **[Utility]→I/O** and wait until the LAN status shows "configured".
 - On 6000L Series oscilloscopes, the LAN indicator illuminates green when the LAN connection is configured.

This may take a few minutes.

DHCP servers are not typically present on PCs; in this case, the oscilloscope moves on to AutoIP. AutoIP uses a subnet mask of 255.255.0.0. The oscilloscope's IP address will be in the range 169.254.x.x where the x's are negotiated with the PC on the AutoIP network. Generally, the oscilloscope will end up at 169.254.254.254; however, this could be different depending on negotiation during AutoIP.

After the LAN connection is configured, you can find the oscilloscope's IP address and use it to access the instrument's Web interface:

- On an oscilloscope that has a display, you can find the IP address assigned to the oscilloscope in the **[Utility]→I/O** screen.
- On a 6000L Series oscilloscope without a display, you can use the Agilent Connection Expert to find the oscilloscope's IP address.

To find a 6000L Series oscilloscope's IP address using Agilent Connection Expert

The Agilent Connection Expert is part of the Agilent IO Libraries Suite software that comes on the *Automation Ready CD-ROM* provided with the oscilloscope.

- 1** Install the Agilent I/O Libraries Suite from the CD that was supplied with the oscilloscope. If you do not have the CD, you can download the I/O Libraries Suite from www.agilent.com/find/iolib.
- 2** Start the Agilent Connection Expert application from the Agilent I/O Libraries Suite program group.
- 3** When the Agilent Connection Expert application is displayed, select **Refresh All**.
- 4** Right-click **LAN** and select **Add Instrument**.
- 5** In the Add Instrument window, the LAN line should be highlighted; select **OK**.
- 6** In the LAN Instrument window, select **Find Instruments....**
- 7** In the Search for instruments on the LAN window, **LAN** and **Look up hostnames** should be checked.
- 8** Select the **Find Now** key. (NOTE: It may take up to three minutes before the instrument is found. If the instrument is not found the first time, wait about one minute and try again.)
- 9** When the instrument is found, select **OK** and **OK** to close the Add Instrument windows.

Now, you can see the oscilloscope's IP address in the Agilent Connection Expert and use it to access the instrument's Web interface.

Accessing the Web Interface

To access the oscilloscope's web interface:

- 1 Connect the oscilloscope to your LAN (see [page 276](#)) or establish a point-to-point connection (see [page 278](#)). It is possible to use a point-to-point connection, but using a normal LAN connection is the preferred method.
- 2 Type the oscilloscope's hostname or IP address in the web browser.

The oscilloscope's web interface Welcome Page is displayed.

Agilent Technologies Oscilloscope

Another web-enabled instrument from Agilent Technologies

Welcome Page

Browser Web Control

Get Image

Instrument Utilities

Configure Network

Network Status

Print Page

Help with this Page

Welcome to your
Web-Enabled Oscilloscope

LXI

Information about this Web-Enabled Instrument

Instrument	DSO7104A Oscilloscope
Serial Number	MY47250008
Description	Agilent DSO7104A (MY47250008)
Hostname	
IP Address	130.29.71.212
VISA TCP/IP Connect String	TCPIP0:130.29.71.212::INSTR

Advanced Information Identification: off on

Use the navigation bar on the left to access your Oscilloscope and related information.

© Agilent Technologies, Inc. 2006

Browser Web Control

The web interface's Browser Web Control page gives you access to the Remote Front Panel and the SCPI Command window applet for Remote Programming.

NOTE

If Java is not installed on your PC, you will be prompted to install the Sun Microsystems Java Plug-in. This plug-in must be installed on the controlling PC for the web interface's Remote Front Panel or Remote Programming operations.

Remote Front Panel

To operate the oscilloscope using the web interface's Remote Front Panel:

- 1 Access the oscilloscope's web interface (see ["Accessing the Web Interface"](#) on page 280).
- 2 When the oscilloscope's web interface is displayed, select **Browser Web Control**, then select **Remote Front Panel**. After a few seconds the Remote Front Panel appears.
- 3 Use the Main Menu and the Function Keys to control the oscilloscope. To view Quick Help, right-click on a softkey.

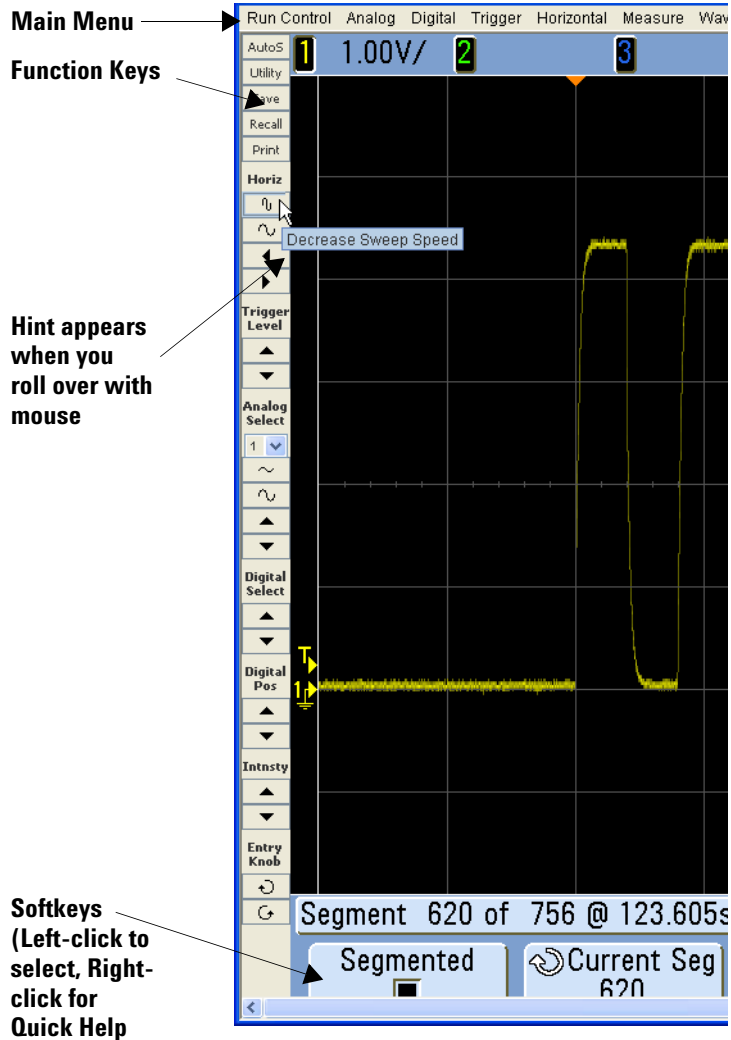

Scrolling and Monitor Resolution

When using a monitor resolution of 1024 x 768 or less on the remote computer, you need to scroll to access the full remote front panel. To display the remote front panel without scroll bars, use a monitor resolution greater than 1024 x 768 on your computer's display.

Remote Programming

To send remote programming commands to the oscilloscope via the SCPI Commands applet window:

- 1 Access the oscilloscope's web interface (see **"Accessing the Web Interface"** on page 280).
- 2 When the oscilloscope's web interface is displayed, select **Browser Web Control**, then select **Remote Programming**.
- 3 On the Remote Programming page, click **SCPI Commands...**

The SCPI Commands applet window appears.

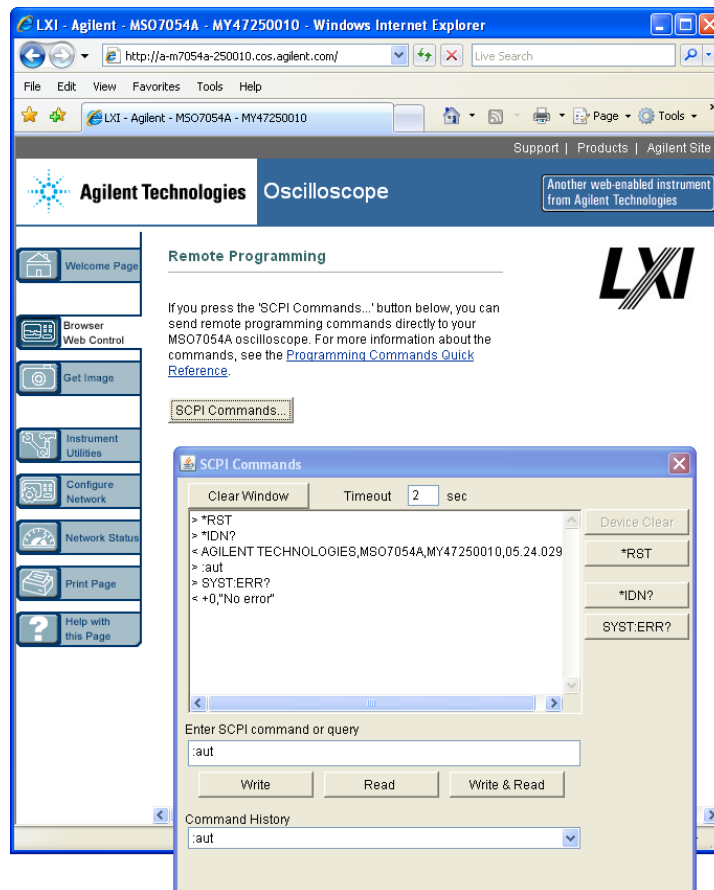

If you get the “Unable to connect to the instrument. You may need to set the instrument’s controller type to LAN.” message:

- a On the oscilloscope’s front panel, press **[Utility]**→**I/O**.
- b In the I/O Menu, press **Control**.
- c Use the Entry knob to point to LAN; then, press **Control** again to enable the LAN controller type.

Multiple controller types may be enabled.

Remote Programming with Agilent IO Libraries

While the SCPI Commands applet window lets you enter and remote programming commands, remote programming for automated test and data acquisition is typically done using the Agilent IO Libraries, which are separate from the instrument’s web interface.

The Agilent IO Libraries let a controller PC communicate with Agilent InfiniiVision oscilloscopes via their LAN, USB, or, in the case of the 5000/6000 Series oscilloscopes, GPIB interfaces.

The *Automation Ready CD* provided with the oscilloscope contains the Agilent IO Libraries Suite connectivity software to enable communication over these interfaces. Refer to the instructions provided on the CD-ROM to install this software on your PC. If you do not have the *Automation Ready CD* you can download the Agilent IO Libraries Suite from www.agilent.com/find/iolib.

Information about controlling the oscilloscope through remote commands is contained in the *Programmer’s Guide*, which is included on the documentation CD supplied with this oscilloscope. You can also access this document on the Agilent web site.

For more information about connecting to the oscilloscope, refer to the *Agilent Technologies USB/LAN/GPIB Interfaces Connectivity Guide*. For a printable electronic copy of the Connectivity Guide, direct your Web browser to www.agilent.com and search for Connectivity Guide.

Get Image

To save (or print) the oscilloscope's display from the web interface:

- 1 Access the oscilloscope's web interface (see "[Accessing the Web Interface](#)" on page 280).
- 2 When the oscilloscope's web interface is displayed, select the **Get Image** tab from the left side of the Welcome screen. After a delay of several seconds, the oscilloscope's screen image will be displayed.
- 3 Right-click on the image and select "**Save Picture As...**" (or "**Print Picture...**").
- 4 Select a storage location for the image file and click **Save**.

Identification Function

The Identification web interface feature is useful when trying to locate a specific instrument in a rack of equipment.

- 1 Access the oscilloscope's web interface (see "[Accessing the Web Interface](#)" on page 280).
- 2 When the oscilloscope's web interface Welcome Page is displayed, select the Identification **on** radio button.

An "Identify" message is displayed on the oscilloscope; you can either select Identification **off** or press the **OK** softkey on the oscilloscope to continue.

On 6000L Series oscilloscopes, the LAN indicator on the front of the instrument will flash green to identify the oscilloscope until you select Identification **off**.

The screenshot shows the Agilent Technologies Oscilloscope web interface. The header includes the Agilent logo and the text "Oscilloscope" and "Another web-enabled instrument from Agilent Technologies". The main content area displays "Welcome to your Web-Enabled Oscilloscope" and "Information about this Web-Enabled Instrument". A table lists instrument details:

Instrument	DSO7104A Oscilloscope
Serial Number	MY47250008
Description	Agilent DSO7104A (MY47250008)
Hostname	
IP Address	130.29.71.212
VISA TCP/IP Connect String	TCPIP0::130.29.71.212::INSTR

Below the table, the "Advanced Information" section shows the "Identification" status as "off" (selected) with radio buttons for "off" and "on". An arrow points to the "on" radio button. A note below reads: "Use the navigation bar on the left to access your Oscilloscope and related information." The footer includes "© Agilent Technologies, Inc. 2006".

Identification Option

Instrument Utilities

The Instrument Utilities page of the web interface lets you:

- View installed options.
- View firmware versions.
- Install firmware upgrade files.
- View calibration status.

You can select these capabilities via a drop-down menu.

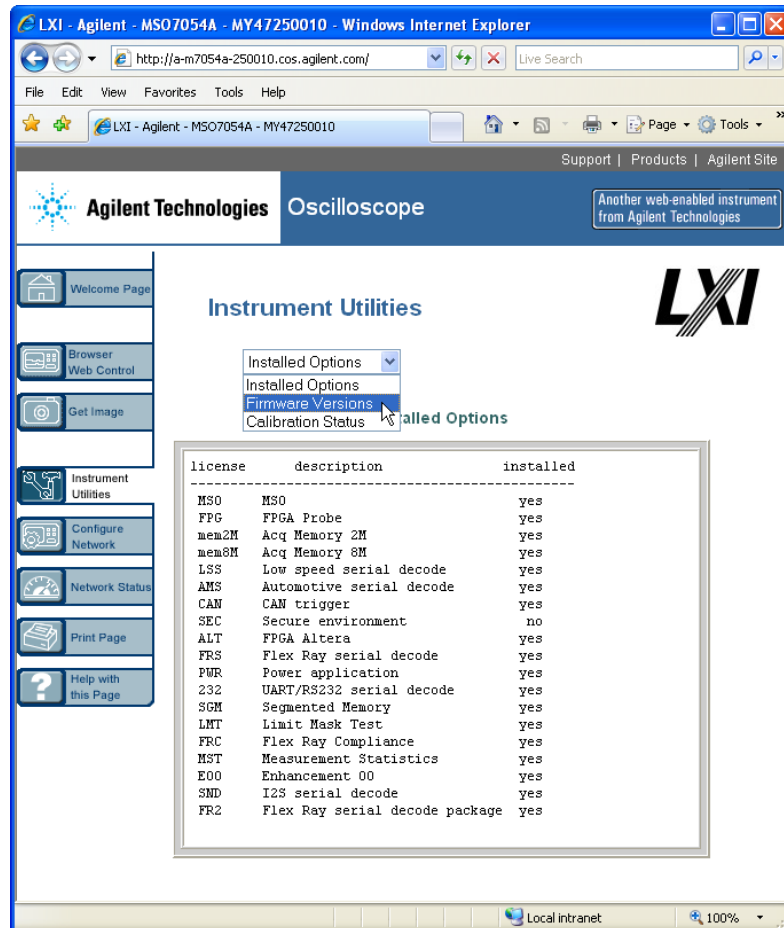

The screenshot shows the LXI web interface in Internet Explorer. The page title is "Instrument Utilities". A dropdown menu is open, showing "Installed Options", "Firmware Versions" (highlighted), and "Calibration Status". Below the menu is a table with the following data:

license	description	installed
MS0	MS0	yes
FPG	FPGA Probe	yes
mem2M	Acq Memory 2M	yes
mem8M	Acq Memory 8M	yes
LSS	Low speed serial decode	yes
AMS	Automotive serial decode	yes
CAN	CAN trigger	yes
SEC	Secure environment	no
ALT	FPGA Altera	yes
FRS	Flex Ray serial decode	yes
PWR	Power application	yes
232	UART/RS232 serial decode	yes
SGH	Segmented Memory	yes
LMT	Limit Mask Test	yes
FRC	Flex Ray Compliance	yes
MST	Measurement Statistics	yes
E00	Enhancement 00	yes
SND	I2S serial decode	yes
FR2	Flex Ray serial decode package	yes

Setting a Password

Whenever you connect the oscilloscope to a LAN, it is good practice to set a password. The password prevents someone from remotely accessing the oscilloscope via a Web browser and changing parameters. Remote users can still view the Welcome screen, view network status, etc., but they can't operate the instrument or change its setup without the password.

To set a password:

- 1 Access the oscilloscope's web interface (see ["Accessing the Web Interface"](#) on page 280).
- 2 When the oscilloscope's web interface is displayed, select the Configure Network tab from the instrument's Welcome page.
- 3 Click the **Modify Configuration** button.

The screenshot shows the Agilent Technologies Oscilloscope web interface. The left sidebar contains the following menu items: Welcome Page, Browser Web Control, Get Image, Instrument Utilities, **Configure Network** (highlighted with an arrow labeled 'Step 1'), Network Status, Print Page, and Help with this Page. The main content area is titled 'Current Network Configuration' and features a 'Modify Configuration' button (highlighted with an arrow labeled 'Step 2'). Below the button is a table of network parameters.

Parameter	Currently in use
Configuration mode	DHCP
Dynamic DNS	OFF
NetBIOS	OFF
IP Address	192.168.0.4
Subnet Mask	255.255.255.0
Default Gateway	192.168.0.1
DHCP Server	192.168.0.1
DNS Server	130.29.64.128, 192.168.0.1, 205.171.3.65
Hostname	
Domain	
LAN KeepAlive Timeout	1800
Media Sense	ON
GPIB Control	ON
GPIB Address	7
USB Control	ON
LAN Control	OFF

4 Enter your desired password, and click **Apply Changes**.

Parameter	Configured Value	Edit Configuration
IP Settings may be configured using the following:		
DHCP	ON	<input type="radio"/> OFF <input checked="" type="radio"/> ON
Automatic IP	OFF	<input checked="" type="radio"/> OFF <input type="radio"/> ON
Manual	ON	<input type="radio"/> OFF <input checked="" type="radio"/> ON
IP Settings to use in manual mode:		
IP Address	130.29.65.165	<input type="text" value="130.29.65.165"/>
Subnet Mask	255.255.248.0	<input type="text" value="255.255.248.0"/>
Default Gateway	130.29.64.1	<input type="text" value="130.29.64.1"/>
Domain name and name service settings:		
DNS Server	130.29.64.128	<input type="text" value="130.29.64.128"/>
Hostname	DSO7104A	<input type="text" value="DSO7104A"/>
Domain	cos.agilent.com	<input type="text" value="cos.agilent.com"/>
Dynamic DNS	OFF	<input checked="" type="radio"/> OFF <input type="radio"/> ON
NetBIOS	OFF	<input checked="" type="radio"/> OFF <input type="radio"/> ON
Other settings:		
KeepAlive Timeout (sec)	1800	<input type="text" value="1800"/>
Description	Agilent DSO7104A (MY47250008)	<input type="text" value="Agilent DSO7104A (MY47250008)"/>
Password		<input type="password"/> ← Step 3
GPIB Control	ON	<input type="radio"/> OFF <input checked="" type="radio"/> ON
GPIB Address	7	<input type="text" value="7"/>
USB Control	ON	<input type="radio"/> OFF <input checked="" type="radio"/> ON
LAN Control	OFF	<input checked="" type="radio"/> OFF <input type="radio"/> ON

When accessing the password protected oscilloscope, the user name is the IP address of the oscilloscope.

To reset the password

Do one of these things to reset the password:

- Using the keys on the front panel of the oscilloscope, press **[Utility]→I/O→LAN Reset**
- On 6000L Series oscilloscopes, press the LAN RESET button on the front panel.

or

- Using the web browser select the **Configure Network** tab, select **Modify Configuration**, erase the Password, and select **Apply Changes**.



10 Serial Decode/Lister

Serial Decode	292
Lister	293
CAN Serial Decode	295
FlexRay Serial Decode	302
I ² C Serial Decode	306
I ² S Serial Decode	310
LIN Serial Decode	314
MIL-STD 1553 Serial Decode	320
SPI Serial Decode	323
UART/RS232 Serial Decode	329

Triggering on Serial Data

In some cases, such as when triggering on a slow serial signal (for example, I²C, SPI, CAN, LIN, etc.) it may be necessary to switch from the Auto trigger mode to the Normal trigger mode to prevent the oscilloscope from Auto-triggering and stabilize the display. You can select the trigger mode by pressing the **[Mode/Coupling]** key, then the **Mode** softkey.

Also, the trigger level must be set appropriately for each analog channel.



Serial Decode

Agilent's hardware accelerated serial decode options can be installed when the oscilloscope is manufactured, or added later. The following serial decode licenses are available:

- The N5424A (Option AMS) license provides the ability to decode CAN (Controller Area Network) and LIN (Local Interconnect Network) serial buses. Requires a 4-channel oscilloscope.

Adding the Automotive Serial (AMS) serial decode license will add more CAN and LIN trigger types to the trigger menu. See [page 98](#) or [page 128](#) for details.

- The N5432A (Option FRS) license provides the ability to trigger on and decode FlexRay automotive serial buses. See [page 108](#) for FlexRay triggering information. Requires a 4-channel MSO oscilloscope.
- The N5423A (Option LSS) license provides the ability to decode I²C (Inter-IC) and SPI (Serial Peripheral Interface) serial buses. Requires a 4-channel oscilloscope.
- The N5468A (Option SND) license provides the ability to decode I²S (Inter-IC Sound or Integrated Interchip Sound) serial buses. Requires a 4-channel oscilloscope.
- The N5457A (Option 232) license provides the ability to decode many UART (Universal Asynchronous Receiver/Transmitter) protocols including RS232 (Recommended Standard 232). Requires a 4-channel oscilloscope.

To determine whether these licenses are installed on your oscilloscope press the **[Utility]** key, then press the **Options** softkey, the **Licenses** softkey, and the **Show license information** softkey.

To order serial decode licenses, go to www.agilent.com and search for the product number (for example, N5432A) or contact your local Agilent Technologies representative (see www.agilent.com/find/contactus).

Lister

Lister is a powerful tool for investigating protocol failures. You can use Lister to view large amounts of packet level serial data in a tabular format, including time tags and specific decoded values. After pressing the **[Single]** key, you can rotate the Entry knob to select an event and press the **Zoom to Selection** softkey to jump to the event.

To use the Lister:

- 1 Set up trigger and decode on the serial data signals to be analyzed. Instructions for triggering on serial protocols are in **"Triggering"** on page 81. Instructions for setting up serial decode are in this chapter (starting with **"CAN Serial Decode"** on page 295).
- 2 Press **[Acquire]**→**Serial Decode**→**Lister**.
- 3 Press **Lister Display** to enable the display.

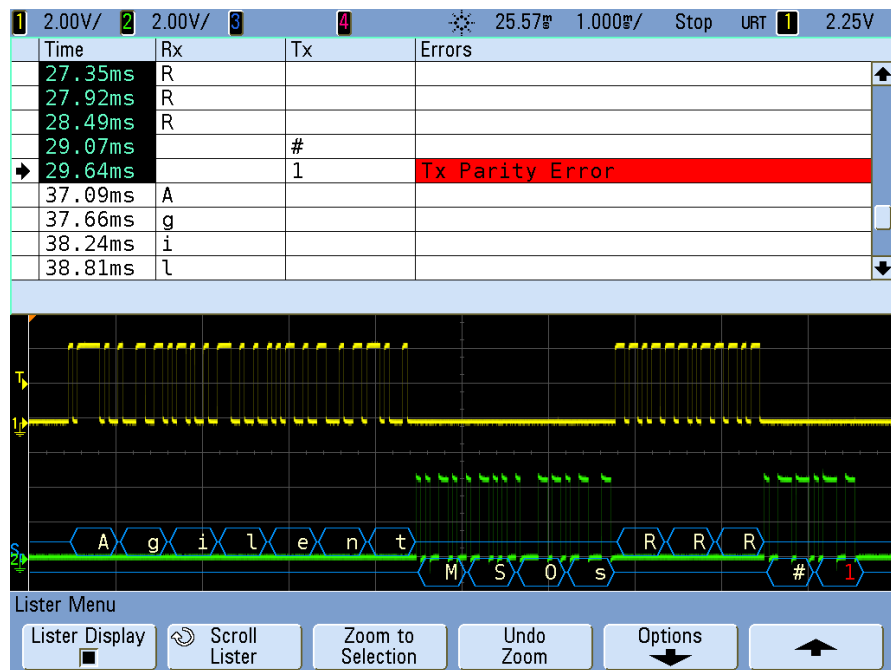

Before you can select a row or navigate through the Lister data, oscilloscope acquisitions must be stopped.

- 4 Press the **[Single]** key (in the Run Control group on the front panel) to stop the acquisition.

Pressing **[Single]** instead of **[Stop]** fills the maximum memory depth.

When zoomed out and viewing a large number of packets, the Lister may not be able to display information for all packets. However, when you press the **[Single]** key the Lister will contain all on-screen serial decode information.

- 5 Press the **Scroll Lister** softkey and use the Entry knob to scroll through the data.

Time tags in the Time column indicate the event time relative to the trigger point. The time tags of events that are shown in the waveform display area are displayed with a dark background.

- 6 Press the **Zoom to Selection** softkey (or push the Entry knob on 7000 Series oscilloscopes) to center the waveform display at the time associated with the selected Lister row and automatically set the horizontal scale setting.
- 7 Press the **Undo Zoom** softkey to return to the horizontal scale and delay settings before the last **Zoom to Selection**.
- 8 Press the **Options** softkey to open the Lister Options Menu. In this menu, you can:
 - Enable or disable the **Track Time** option. When enabled, as you select different Lister rows (using the Entry knob while acquisitions are stopped), the horizontal delay changes to the Time of the selected row.

CAN Serial Decode

NOTE

For CAN triggering set up see [page 98](#).

- 1 Connect the CAN signal to one of the oscilloscope's input channels.
- 2 Set up the trigger mode as described in **"Triggering"** on page 81. You can use CAN trigger or another trigger type.
- 3 Select the CAN serial decode mode:
 - a Press the **[Acquire]** key.
 - b Press the **Serial Decode** softkey.

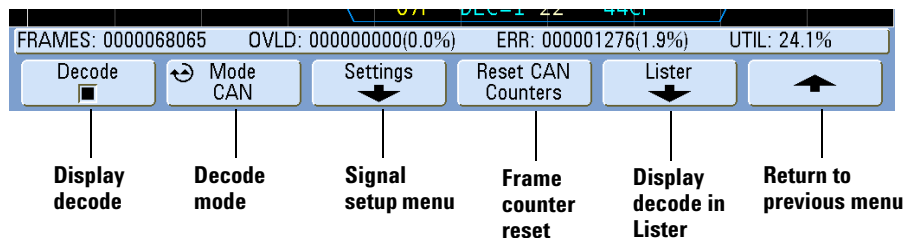

- c In the Serial Decode Menu, press the **Mode** softkey.
- d Use the Entry knob (or repeatedly press and release the **Mode** softkey) to select the **CAN** serial decode mode.

- 4 Specify the CAN signal:
 - a Press the **Settings** softkey to access the CAN Signals Menu.

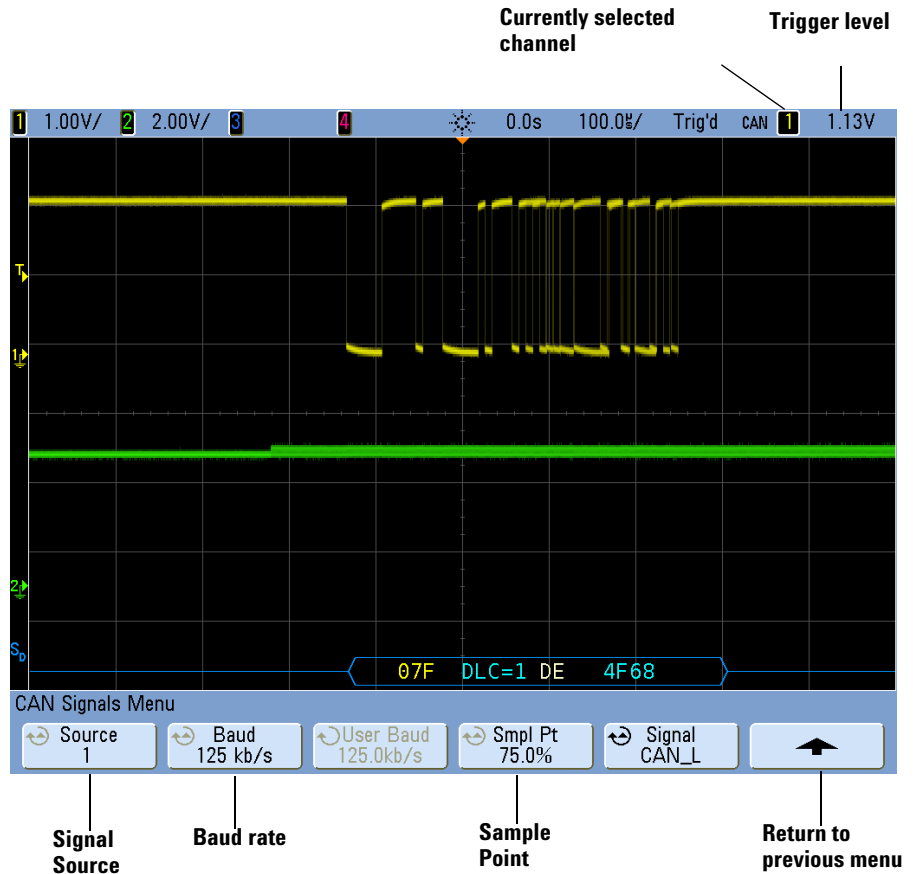

- 5 Press the **Source** softkey, and use the Entry knob to select the channel for the CAN signal.

If you have connected one of the oscilloscope's analog source channels to the CAN signal: Adjust the trigger level for the selected analog channel to the middle of the waveform by turning the Trigger Level knob.

If you have connected one of the oscilloscope's digital source channels to the CAN signal (this applies to MSO model oscilloscopes only): Press the **[D15-D0]** key and select **Thresholds** to set an appropriate threshold level for digital channels.

The value of the trigger level or digital threshold is displayed in the upper-right corner of the display.

- 6** Repeatedly press and release the **Baud** softkey to set the CAN signal baud rate to match your CAN bus signal.

The CAN baud rate can be set to:

10 kb/s	50 kb/s	100 kb/s	500 kb/s
20 kb/s	62.5 kb/s	125 kb/s	800 kb/s
33.3 kb/s	83.3 kb/s	250 kb/s	1 Mb/s
User Defined			

The default baud rate is 1 Mb/s

If the desired baud rate is not shown in the table, select User Defined. You can set the CAN baud rate from 10.0 kb/s to 1.000 Mb/s in increments of 100 b/s. Press the **User Baud** softkey and rotate the Entry knob to make your selection.

- 7** Repeatedly press and release the **Smpl Pt** softkey to select the point between phase segments 1 and 2 where the state of the bus is measured. This controls the point within the bit's time where the bit value is captured.

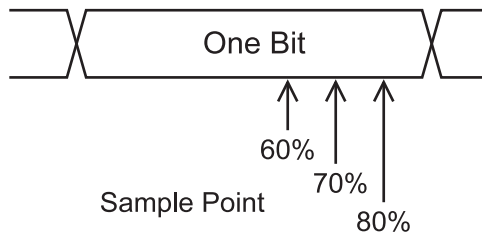

- 8** Set the trigger level.
- For analog channels, turn the Trigger Level knob.
 - For digital channels, press the **[D15-D0]** key and the **Thresholds** softkey to access the threshold level setting softkeys.

NOTE

Changing the Source settings in the Serial Decode setup also changes them in the Trigger setup.

- 9** Return to the previous menu by pressing the up-arrow softkey.

10 If the decode line does not appear on the display, press the **Decode** softkey to turn it on.

11 If the oscilloscope is stopped, press the **[Run/Stop]** key to acquire and decode data.

NOTE

If the setup does not produce a stable trigger, the CAN signal may be slow enough that the oscilloscope is AutoTriggering. Press the **[Mode/Coupling]** key, then press the **Mode** softkey to set the trigger mode from **Auto** to **Normal**.

You can use the **Zoom** horizontal sweep mode for easier navigation of the decoded data.

Interpreting CAN Decode

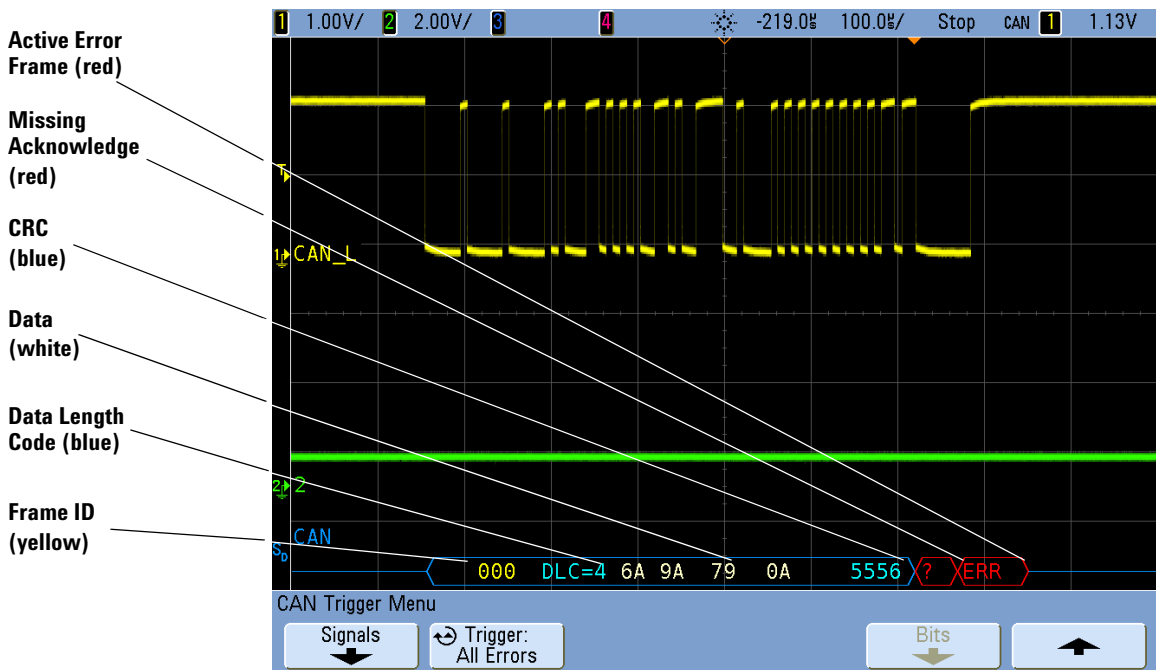

- Frame ID appears in hex digits in yellow. Frames of 11 or 29 bits are automatically detected.
- Remote frame (RMT) appears in green.

- Data length code (DLC) appears in blue for data frames and green for remote frames.
- Data bytes appear in hex digits in white for data frames.
- Cyclic redundancy check (CRC) appears in hex digits in blue when valid, or in red to indicate that the oscilloscope's hardware decode calculated a CRC that is different from the incoming CRC data stream.
- Angled waveforms show an active bus (inside a packet/frame).
- Mid-level blue lines show an idle bus.
- Decoded text is truncated at the end of the associated frame when there is insufficient space within frame boundaries.
- Red dots in the decode line indicate that there is data that is not being displayed. Scroll or expand the horizontal scale to view the information.
- Aliased bus values (undersampled or indeterminate) are drawn in red.
- Unknown bus values (undefined or error conditions) are drawn in red with a "?" label.
- Flagged error frames are drawn in red with an "ERR" label.

CAN Totalizer

The CAN totalizer provides a direct measure of bus quality and efficiency. The CAN totalizer measures total CAN frames, flagged error frames, overload frames, and bus utilization.

The totalizer is always running (counting frames and calculating percentages) and is displayed whenever CAN decode is displayed. The totalizer counts even when the oscilloscope is stopped (not acquiring data). Pressing the **[Run/Stop]** key does not affect the totalizer. When an overflow condition occurs, the counter displays **OVERFLOW**. The counters can be reset to zero by pressing the **Reset CAN Counters** softkey.

Types of Frames

- *Active error frames* are CAN frames in which a CAN node recognizes an error condition during a data or remote frame and issues an active error flag.
- A *partial frame* occurs when the oscilloscope detects any error condition during a frame that is not followed by an active error flag. Partial frames are not counted.

Counters

- The FRAMES counter gives the total number of completed remote, data, overload, and active error frames.
- The OVLD counter gives the total number of completed overload frames and their percentage of the total number of frames.
- The ERR counter gives the total number of completed active error frames and their percentage of the total number of frames.
- The UTIL (bus load) indicator measures the percentage of time the bus is active. The calculation is done on 330 ms periods, approximately every 400 ms.

Example: If a data frame contains an active error flag, both the FRAMES counter and the ERR counter will be incremented. If a data frame contains an error that is not an active error it is considered a partial frame and no counters are incremented.

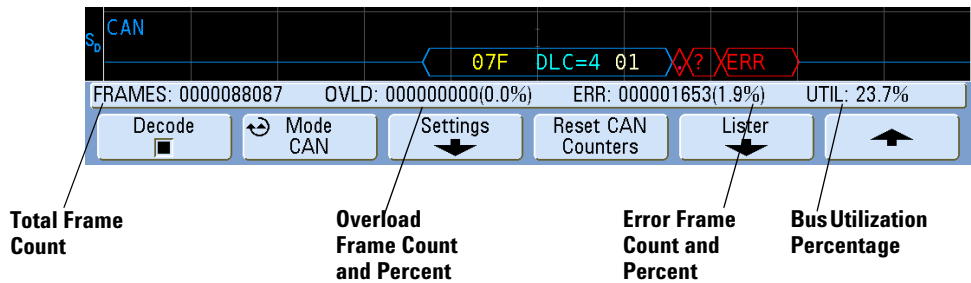

Interpreting CAN Lister Data

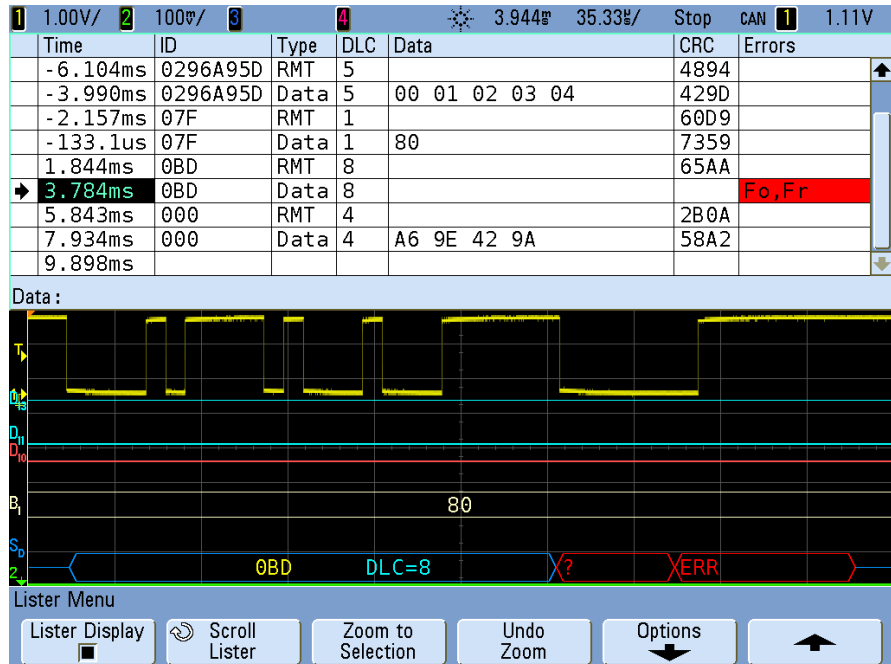

In addition to the standard Time column, the CAN Lister contains these columns:

- ID — frame ID.
- Type — frame type (RMT remote frame, Data, etc.).
- DLC — data length code.
- Data — data bytes.
- CRC — cyclic redundancy check.
- Errors — highlighted in red. Errors can be Acknowledge (Ack, A), Form (Fo), or Frame (Fr). Different kinds of errors can be combined like "Fo,Fr" in the above example.

FlexRay Serial Decode

To set up the oscilloscope to capture FlexRay signals, see “[Setup for FlexRay Signals](#)” on page 107.

NOTE

While decoding FlexRay data, you can use FlexRay trigger or another trigger type, such as duration, I²C, Nth edge burst, sequence, SPI, or USB.

When the oscilloscope is in FlexRay trigger mode, only FlexRay decode is available.

NOTE

For FlexRay triggering setup see “[FlexRay Triggering](#)” on page 108.

To set up FlexRay serial decode:

- 1 Select the FlexRay serial decode mode:
 - a Press the [**Acquire**] key.
 - b Press the **Serial Decode** softkey.

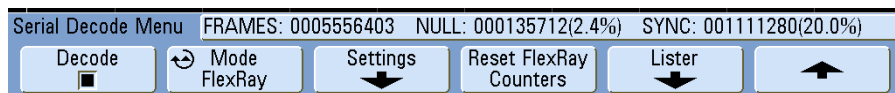

- c In the Serial Decode Menu, press the **Mode** softkey.
 - d Use the Entry knob (or repeatedly press and release the **Mode** softkey) to select the **FlexRay** serial decode mode.
- 2 If the decode line does not appear on the display, press the [**Serial**] key to turn it on.
- 3 If the oscilloscope is stopped, press the [**Run/Stop**] key to acquire and decode data.

You can use the **Zoom** horizontal sweep mode for easier navigation of the decoded data.

Interpreting FlexRay Frame Decode

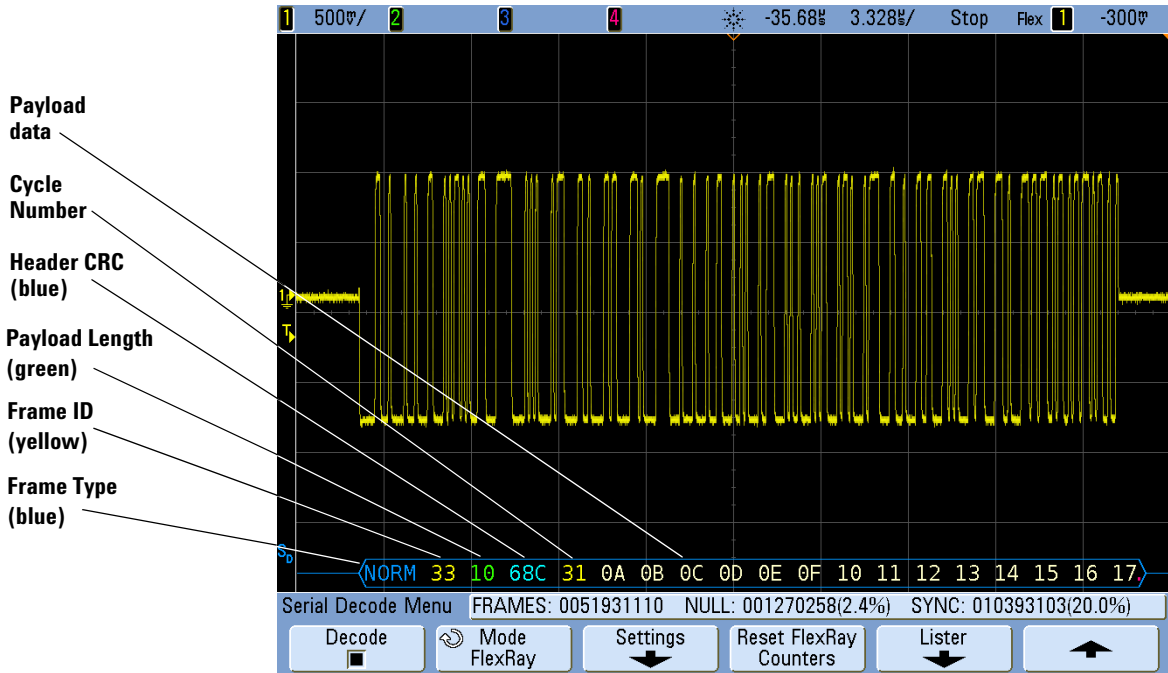

The FlexRay decode display shows frame decoding.

- Frame type (NORM, SYNC, SUP, NULL in blue).
- Frame ID (decimal digits in yellow).
- Payload-length (decimal number of words in green).
- Header CRC (hex digits in blue plus red HCRC error message if invalid).
- Cycle number (decimal digits in yellow).
- Data bytes (HEX digits in white).
- Frame CRC (hex digits in blue plus red FCRC error message if invalid).
- Frame/coding errors (specific error symbol in red).

FlexRay Totalizer

The FlexRay totalizer consists of counters that provide a direct measure of bus quality and efficiency. The totalizer appears on screen whenever FlexRay Decode is ON in the Serial Decode Menu.

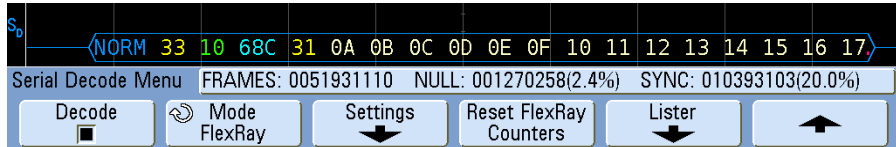

- The FRAMES counter gives a real-time count of all captured frames.
- The NULL counter gives the number and percentage of null frames.
- The SYNC counter gives the number and percentage of sync frames.

The totalizer runs, counting frames and calculating percentages, even when the oscilloscope is stopped (not acquiring data).

When an overflow condition occurs, the counter displays **OVERFLOW**.

The counters can be reset to zero by pressing the **Reset FlexRay Counters** softkey.

Interpreting FlexRay Lister Data

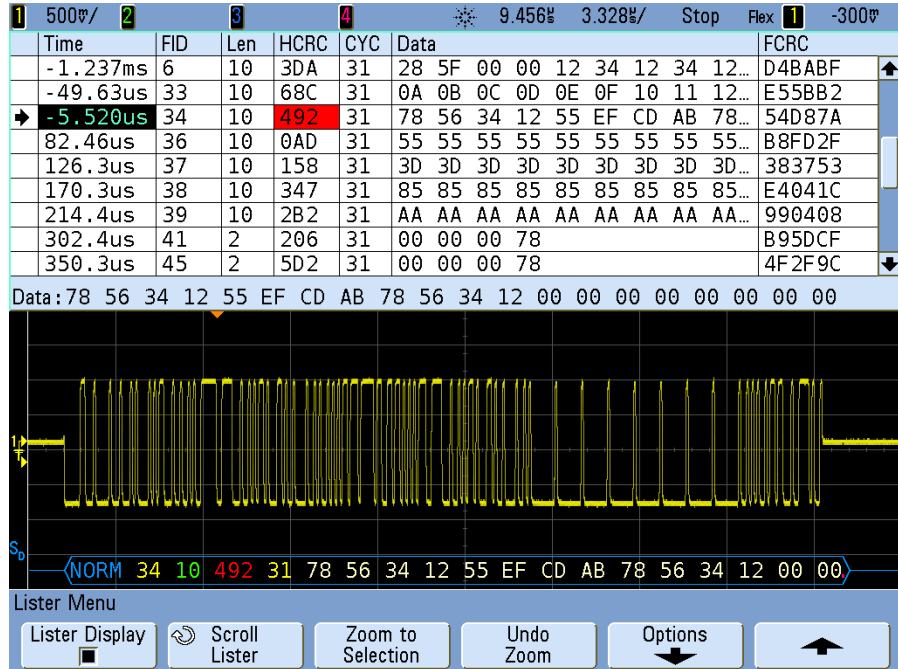

In addition to the standard Time column, the FlexRay Lister contains these columns:

- FID — frame ID.
- Len — payload length.
- HCRC — header CRC.
- CYC — cycle number.
- Data.
- FCRC — frame CRC.
- Frames with errors are highlighted in red.

I²C Serial Decode

NOTE

Because of oscilloscope hardware resource limitations, you cannot decode I²C data while LIN triggering is selected.

NOTE

For I²C triggering setup see [page 121](#).

- 1 Select the I²C serial decode mode:
 - a Press the **[Acquire]** key.
 - b Press the **Serial Decode** softkey.

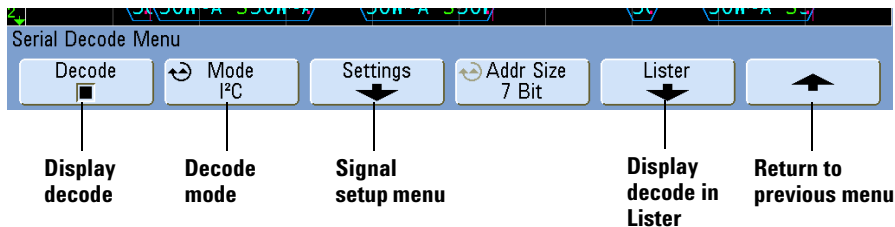

- c In the Serial Decode Menu, press the **Mode** softkey.
 - d Use the Entry knob (or repeatedly press and release the **Mode** softkey) to select the **I²C** serial decode mode.
- 2 Specify the I²C signals:

NOTE

If you have already set up an I²C trigger, the signals have already been specified, and you have set the analog trigger level for each analog channel, you can continue on with [step 3](#).

Changing I²C signals in the Serial Decode setup also changes them in the Trigger setup.

- a Press the **Settings** softkey to access the I²C Signals Menu.

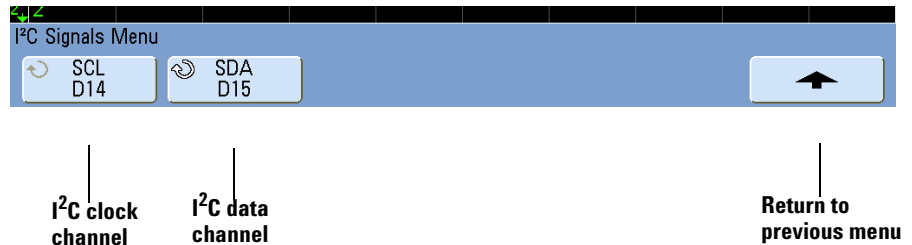

- b Press the **SCL** softkey, and use the Entry knob to select the channel probing the clock signal.
- c Press the **SDA** softkey, and use the Entry knob to select the channel probing the data signal.
- 3 Set the trigger levels for the SCL and SDA signals to the middle of the signals:
 - If your I²C signals are connected to analog channels, press the **SCL** softkey and rotate the **Trigger Level** knob, then press the **SDA** softkey and rotate the **Trigger Level** knob.
 - If your I²C signals are connected to digital channels, press the **[D15-D0]** key and the **Thresholds** softkey to access the threshold level setting softkeys and set the thresholds to the approximate middle of the signals.
- 4 If the decode line does not appear on the display, press the up-arrow softkey to return to the previous menu, then press the **Decode** softkey to turn it on.
- 5 If the oscilloscope is stopped, press the **[Run/Stop]** key to acquire and decode data.

NOTE

If the setup does not produce a stable trigger, the I²C signal may be slow enough that the oscilloscope is AutoTriggering. Press the **[Mode/Coupling]** key, then press the **Mode** softkey to set the trigger mode from **Auto** to **Normal**.

You can use the **Zoom** horizontal sweep mode for easier navigation of the acquired data.

Interpreting I²C Decode

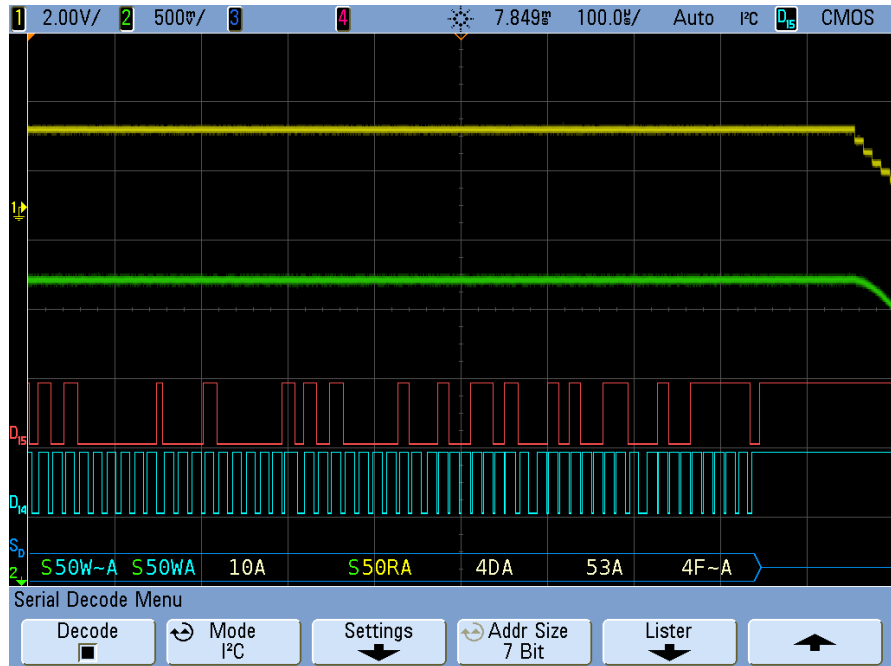

- Angled waveforms show an active bus (inside a packet/frame).
- Mid-level blue lines show an idle bus.
- In the decoded hexadecimal data:
 - Address values appear at the start of a frame.
 - Write addresses appear in light-blue along with the “W” character.
 - Read addresses appear in yellow along with the “R” character.
 - Restart addresses appear in green along with the “S” character.
 - Data values appear in white.
 - “A” indicates Ack (low), “~A” indicates No Ack (high).
 - Decoded text is truncated at the end of the associated frame when there is insufficient space within frame boundaries.
- Red dots in the decode line indicate that more data can be displayed. Scroll or expand the horizontal scale to view the data.

- Aliased bus values (undersampled or indeterminate) are drawn in red.
- Unknown bus values (undefined or error conditions) are drawn in red.

Interpreting I²C Lister Data

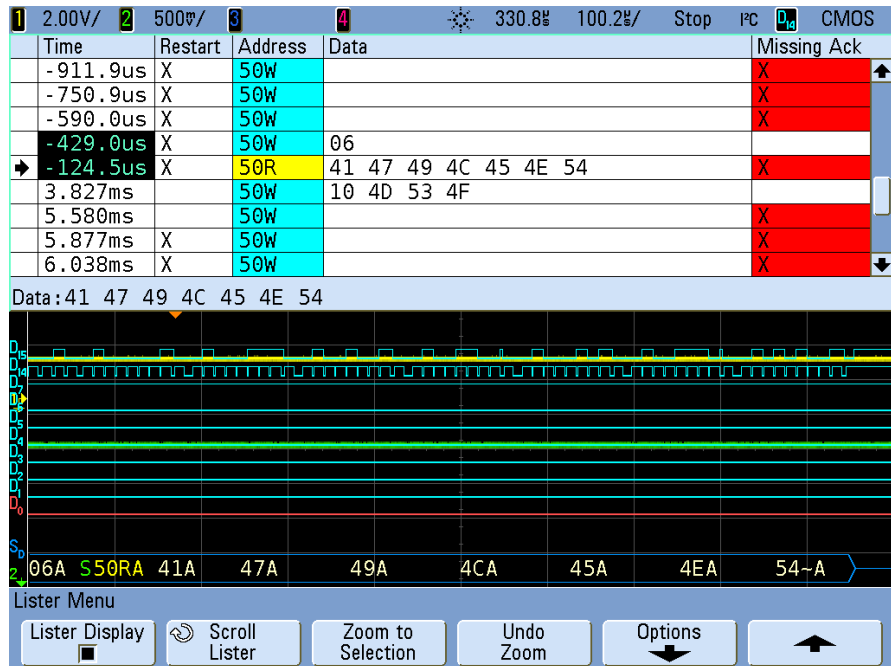

In addition to the standard Time column, the I²C Lister contains these columns:

- Restart — indicated with an “X”.
- Address — colored blue for writes, yellow for reads.
- Data — data bytes.
- Missing Ack — highlighted in red, error if it has an “X”.

I²S Serial Decode

NOTE

When triggering is set to CAN, LIN, Flexray, or UART/RS232 mode, decoding in I²S is not allowed. When triggering in I²C or SPI modes, or any non-serial trigger mode, I²S is available for decoding. When I²S is selected as the trigger mode, only I²S decode is available.

NOTE

For I²S triggering setup see [page 121](#).

- 1 Select the I²S serial decode mode:
 - a Press the **[Acquire]** key.
 - b Press the **Serial Decode** softkey.

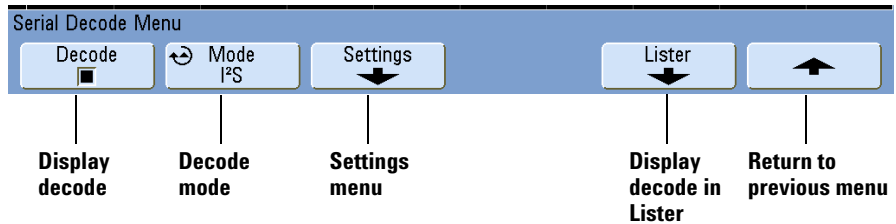

- c Press the **Decode** softkey to enable the serial decode waveform.
 - d In the Serial Decode Menu, press the **Mode** softkey.
 - e Use the Entry knob (or repeatedly press and release the **Mode** softkey) to select the I²S serial decode mode.

- 2 Press the **Settings** softkey to open the I²S Settings Menu.

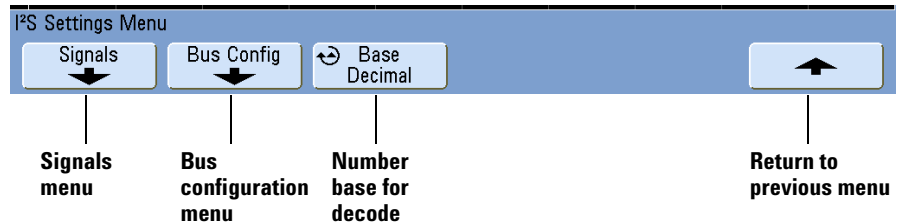

- a Press the **Signals** softkey to open the I²S Signals Menu. This menu is where you select the oscilloscope channels that probe the serial clock, Word Select, and serial data lines. It is the same menu you use when setting up I²S triggers. For more information about the options in this menu, see [step 6](#) on [page 122](#).
 - b Press the **Bus Config** softkey to open the I²S Bus Configuration Menu. This menu is where you identify the device under test's I²S bus setup. It is the same menu you use when setting up I²S triggers. For more information about the options in this menu, see [step 11](#) on [page 123](#).
 - c Press the **Base** softkey to select the number base in which to display decoded data.
- 3 If the decode waveform does not appear on the display, press the up-arrow softkey to return to the previous menu, then press the **Decode** softkey to turn it on.
 - 4 If the oscilloscope is stopped, press the **[Run/Stop]** key to acquire and decode data.

NOTE

If the setup does not produce a stable trigger, the I²S signal may be slow enough that the oscilloscope is AutoTriggering. Press the **[Mode/Coupling]** key, then press the **Mode** softkey to set the trigger mode from **Auto** to **Normal**.

You can use the **Zoom** horizontal sweep mode for easier navigation of the acquired data.

Interpreting I²S Decode

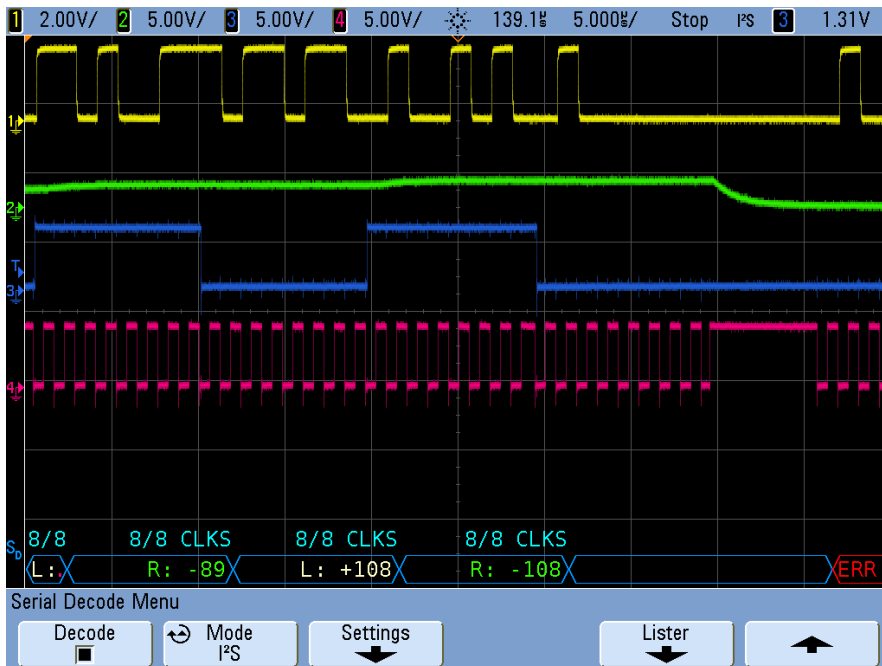

- Angled waveforms show an active bus (inside a packet/frame).
- Mid-level blue lines show an idle bus.
- In the decoded data:
 - Right channel data values appear in green along with the “R:” characters.
 - Left channel data values appear in white along with the “L:” characters.
 - Decoded text is truncated at the end of the associated frame when there is insufficient space within frame boundaries.
- Red dots in the decode line indicate that more data can be displayed. Scroll or expand the horizontal scale to view the data.
- Aliased bus values (undersampled or indeterminate) are drawn in red.
- Unknown bus values (undefined or error conditions) are drawn in red.

NOTE

When the receiver word size is greater than the transmit word size, the decoder fills the least significant bits with zeros and the decoded value does not match the trigger value.

Interpreting I²S Lister Data

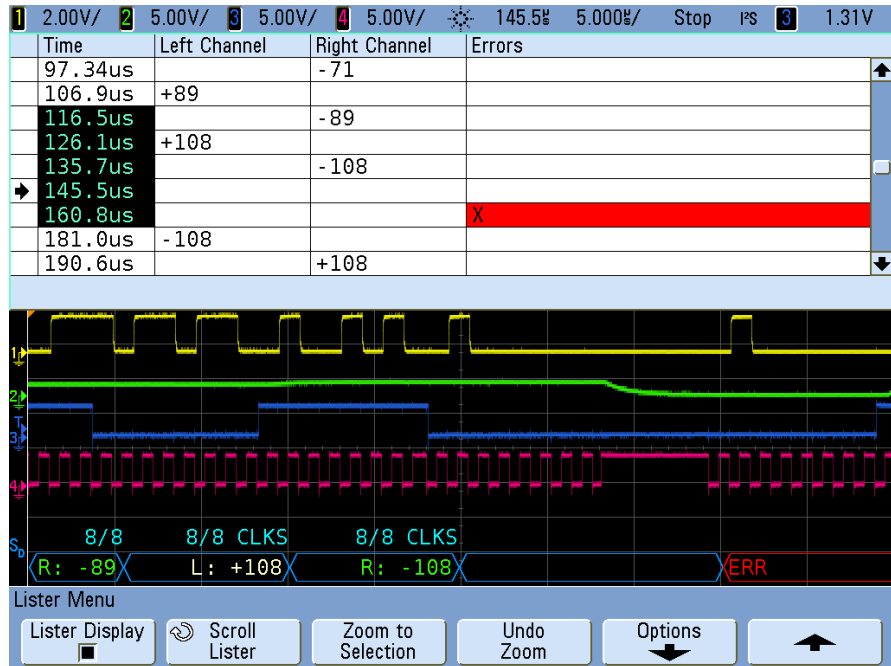

In addition to the standard Time column, the I²S Lister contains these columns:

- Left Channel — displays the left channel data.
- Right Channel — displays the right channel data.
- Errors — highlighted in red and marked with an “X”.

LIN Serial Decode

NOTE

For LIN triggering setup see [page 128](#).

- 1 Select the LIN serial decode mode:
 - a Press the **[Acquire]** key.
 - b Press the **Serial Decode** softkey.

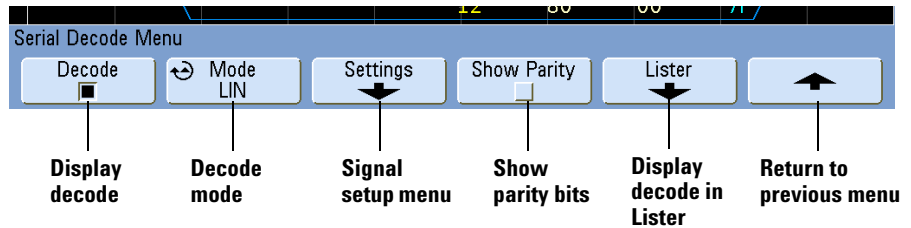

- c In the Serial Decode Menu, press the **Mode** softkey.
 - d Use the Entry knob (or repeatedly press and release the **Mode** softkey) to select the **LIN** serial decode mode.
- 2 Choose whether to include the parity bits in the identifier field.
 - a If you want to mask the upper two parity bits, ensure that the box under the **Show Parity** softkey is not selected.
 - b If you want to include the parity bits in the identifier field, ensure that the box under the **Show Parity** softkey is selected.

3 Specify the LIN signal:

- a Press the **Settings** softkey to access the LIN Signals Menu.

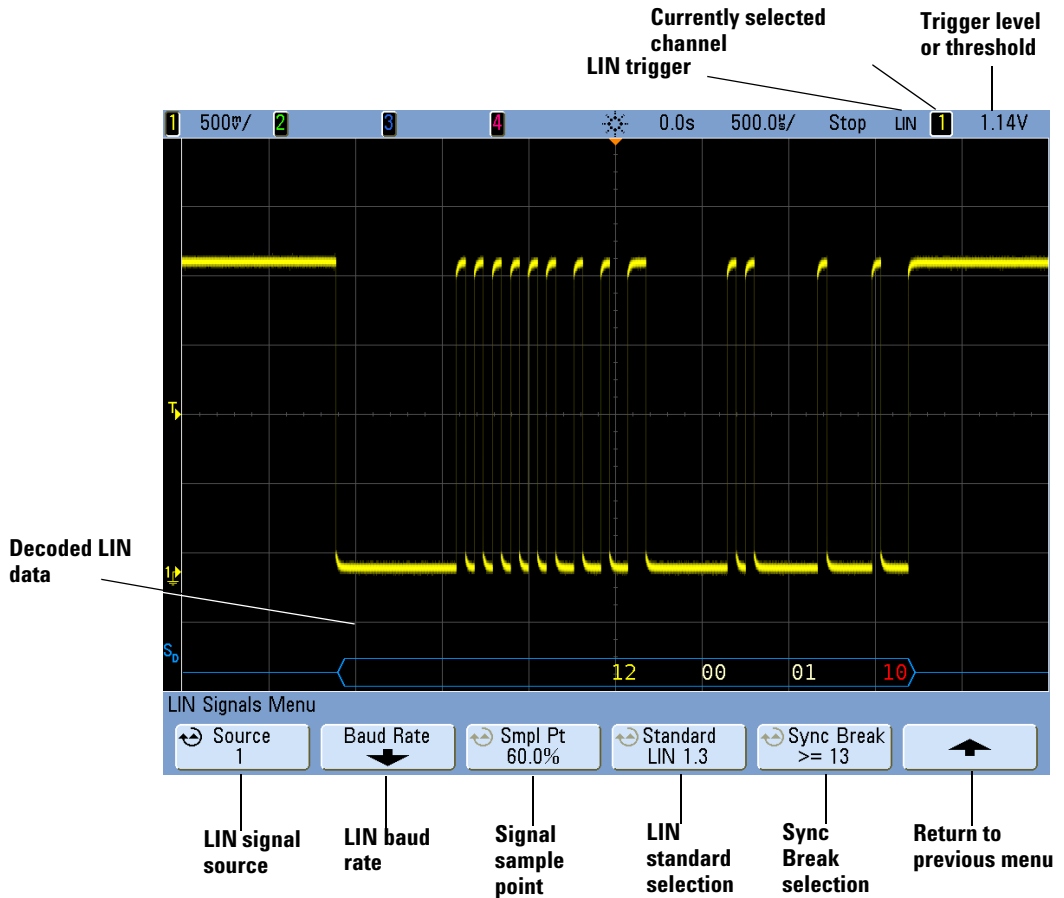

- b Press the **Source** softkey, and use the Entry knob to select the channel probing the LIN signal.
- c Press the **Baud** softkey and rotate the Entry knob to set the LIN signal baud rate to match your LIN bus signal.

The LIN baud rate can be set to 2400 b/s, 9600 b/s, 10.4 kb/s, 19.2 kb/s, 115.2 kb/s, 625 kb/s, or User Defined. The default baud rate is 2400 b/s.

If the desired baud rate is not shown in the list, select **User Defined**. You can set the LIN baud rate from 2.4 kb/s to 625 kb/s in increments of 100 b/s. Press the **User Baud** softkey and rotate the Entry knob to make your selection.

- d Repeatedly press and release the **Smpl Pt** softkey to select the sample point. This controls the point within the bit's time where the bit value is captured.

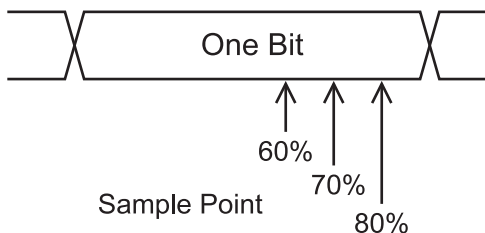

- e Repeatedly press and release the **Standard** softkey to select the LIN standard (LIN 1.3 or LIN 2.0) of the measured signal. For LIN 1.2 signals, use the LIN 1.3 setting. The LIN 1.3 setting assumes the signal follows the "Table of Valid ID Values" as shown in section A.2 of the LIN Specification dated December 12, 2002. If your signal does not comply with the table, use the LIN 2.0 setting.
 - f Repeatedly press and release the **Sync Break** softkey to define the minimum number of clocks that define a Sync Break.
- 4 Set the trigger or threshold levels to the middle of the LIN signal.

If you have connected one of the oscilloscope's analog source channels to the LIN signal: Adjust the trigger level for the selected analog channel to the middle of the waveform by turning the Trigger Level knob.

If you have connected one of the oscilloscope's digital source channels to the LIN signal (this applies to MSO model oscilloscopes only): Press the **[D15-D0]** key and select **Thresholds** to set an appropriate threshold level for digital channels.

The value of the trigger level or digital threshold is displayed in the upper-right corner of the display.

NOTE

Changing the Trigger settings in the Serial Decode setup also changes them in the Trigger setup.

- g If the decode line does not appear on the display, press the up-arrow softkey to return to the previous menu, then press the **Decode** softkey.

5 If the oscilloscope is stopped, press the **[Run/Stop]** key to acquire and decode data.

NOTE

If the setup does not produce a stable trigger, the LIN signal may be slow enough that the oscilloscope is AutoTriggering. Press the **[Mode/Coupling]** key, then press the **Mode** softkey to set the trigger mode from **Auto** to **Normal**.

You can use the **Zoom** horizontal sweep mode for easier navigation of the decoded data.

Interpreting LIN Decode

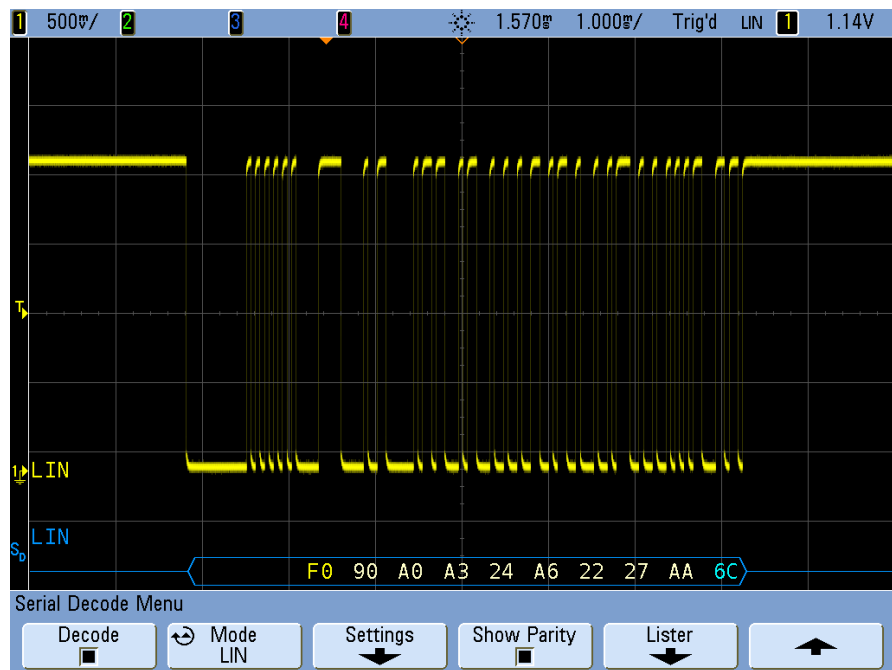

- Angled waveforms show an active bus (inside a packet/frame).
- Mid-level blue lines show an idle bus (LIN 1.3 only).
- The hexadecimal ID and parity bits (if enabled) appear in yellow. If a parity error is detected the hexadecimal ID and parity bits (if enabled) appear in red.
- Decoded hexadecimal data values appear in white.

- For LIN 1.3, the checksum appears in blue if correct, or red if incorrect. The checksum always appears in white for LIN 2.0.
- Decoded text is truncated at the end of the associated frame when there is insufficient space within frame boundaries.
- Red dots in the decode line indicate that there is data that is not being displayed. Scroll or expand the horizontal scale to view the information.
- Unknown bus values (undefined or error conditions) are drawn in red.
- If there is an error in the synch field, SYNC will appear in red.
- If the header exceeds the length specified in the standard, THM will appear red.
- If the total frame count exceeds the length specified in the standard, TFM will appear red (LIN 1.3 only).
- For LIN 1.3 a wakeup signal is indicated by WAKE in blue. If the wakeup signal is not followed by a valid wakeup delimiter a wakeup error is detected and displayed as WUP in red.

Interpreting LIN Lister Data

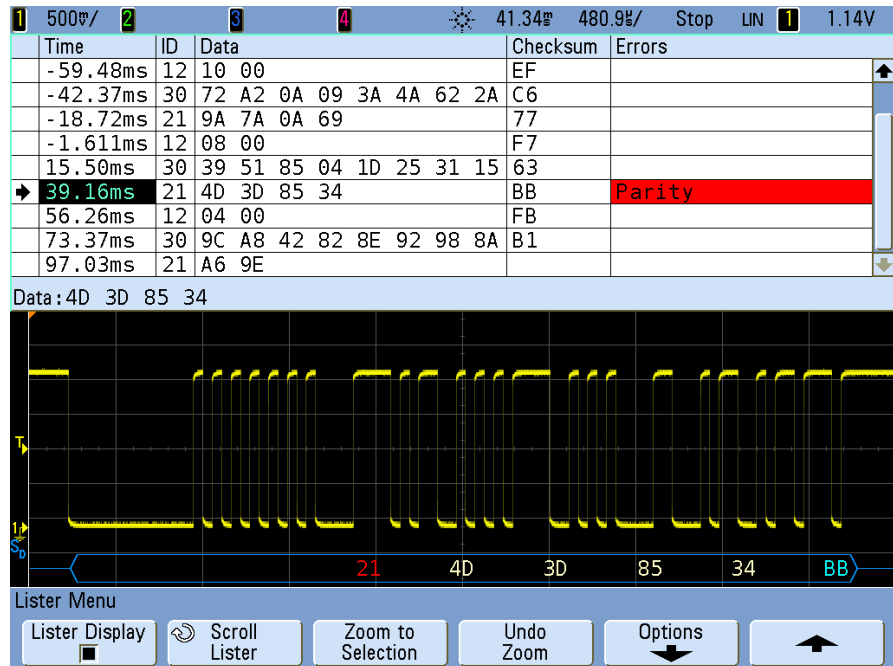

In addition to the standard Time column, the LIN Lister contains these columns:

- ID — frame ID.
- Data — (LIN 1.3 only) data bytes.
- Checksum — (LIN 1.3 only).
- Data and Checksum — (LIN 2.0 only).
- Errors — highlighted in red.

MIL-STD 1553 Serial Decode

To probe MIL-STD 1553 signals, see [“Probing MIL-STD 1553 Signals”](#) on page 131.

To set up the oscilloscope to capture MIL-STD 1553 signals, see [“Setup for MIL-STD 1553 Signals”](#) on page 132.

NOTE

Before you can select serial decode of MIL-STD 1553 signals, the trigger type must be set to MIL-STD-1553 or one of the non-serial triggering modes. See [“MIL-STD 1553 Triggering”](#) on page 133.

When MIL-STD-1553 is selected as the trigger mode, only MIL-STD-1553 decode is available.

To set up MIL-STD 1553 serial decode:

- 1 Select the MIL-STD 1553 serial decode mode:
 - a Press the **[Acquire]** key.
 - b Press the **Serial Decode** softkey.
 - c In the Serial Decode Menu, press the **Mode** softkey.
 - d Use the Entry knob (or repeatedly press and release the **Mode** softkey) to select the **MIL-1553** serial decode mode.



- 2 Press **Settings**.
- 3 In the MIL-STD-1553 Settings Menu, use the **Base** softkey to select between hexadecimal and binary display of the decoded data.

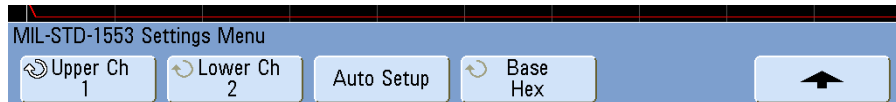

The base setting is used for the display of the remote terminal address and the data, in both the decode line and in the Lister.

You can use the **Zoom** horizontal sweep mode for easier navigation of the acquired data.

Interpreting MIL-STD 1553 Decode

To display serial decode information, you must press **Run** or **Single** after switching on serial decode.

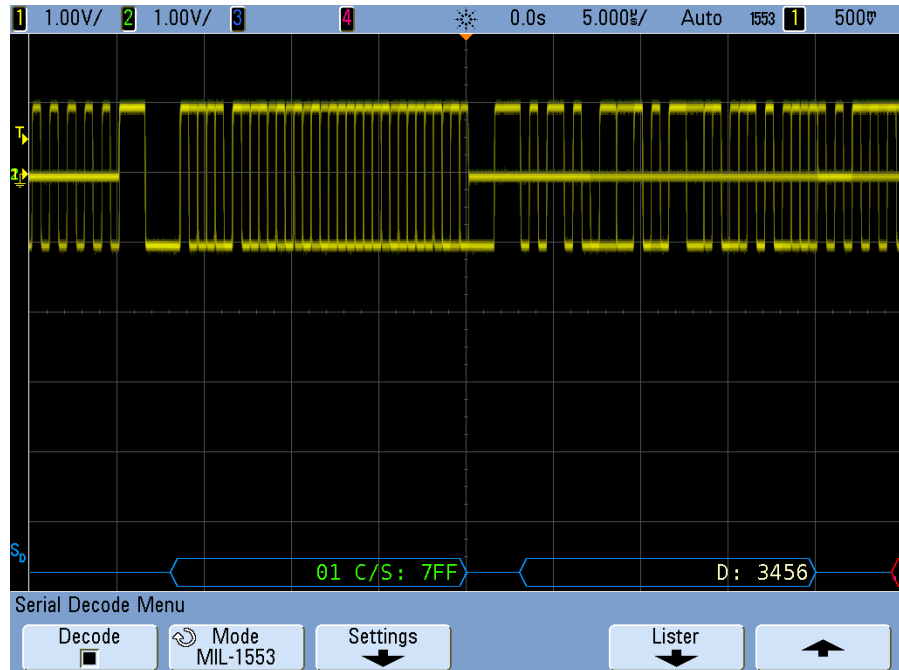

The MIL-STD 1553 decode display is color coded as follows:

- Command and Status decoded data is colored green, with the Remote Terminal Address (5 bits of data) being displayed first, then the text "C/S:", followed by the value of the remaining 11 bits of a Command/Status word.
- Data word decoded data is colored white, preceded by the text "D:".
- Command/Status or Data words with a Parity error have the decode text displayed in red instead of green or white.
- SYNC errors are displayed with the word "SYNC" within red angle brackets.
- Manchester encoding errors are displayed with the word "MANCH" within blue angle brackets (blue instead of red because a valid Sync pulse started the word).

Viewing MIL-STD 1553 Data in the Lister

- 1 In the Serial Decode Menu (when serial decode is being displayed), press **Lister**.
- 2 In the Lister Menu, press **Lister Display** to turn it on.

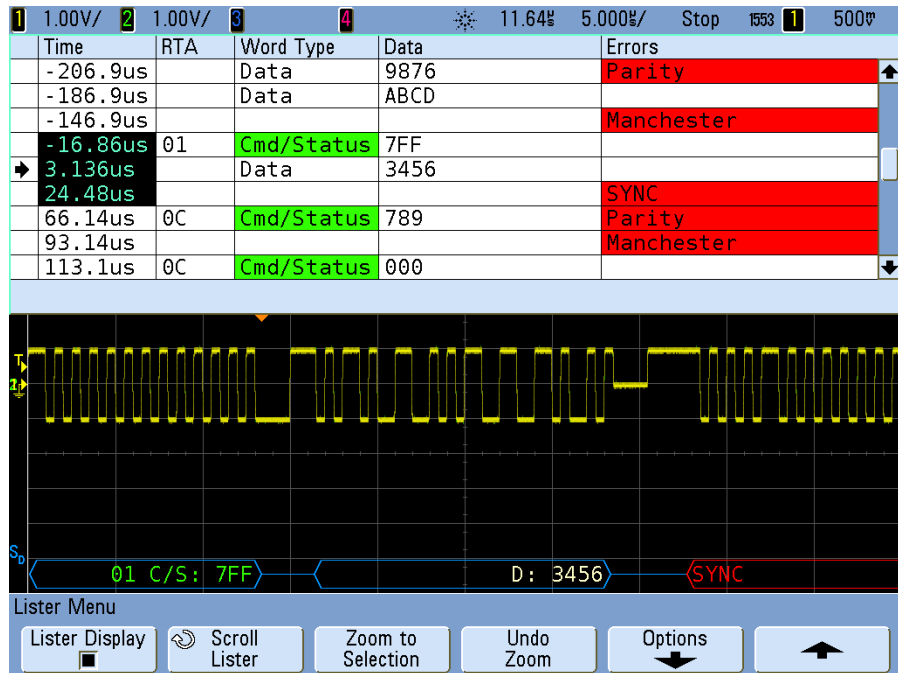

In addition to the standard Time column, the MIL-STD 1553 Lister contains these columns:

- RTA – displays the Remote Terminal Address for Command/Status words, nothing for Data words.
- Word Type – “Cmd/Status” for Command/Status words, “Data” for Data words. For Command/Status words the background color is green to match the decode text color.
- Data – the 11 bits after the RTA for Command/Status words, or the 16 bits of a Data word.
- Errors – “Sync”, “Parity”, or “Manchester” errors as appropriate. The background color is red to indicate an error.

For more information on using the Lister display, see **“Lister”** on page 293.

SPI Serial Decode

NOTE

Because of oscilloscope hardware resource limitations, you cannot decode SPI data while CAN or LIN triggering is selected.

NOTE

For SPI triggering setup see [page 150](#).

- 1 Select the SPI serial decode mode:
 - a Press the **[Acquire]** key.
 - b Press the **Serial Decode** softkey.

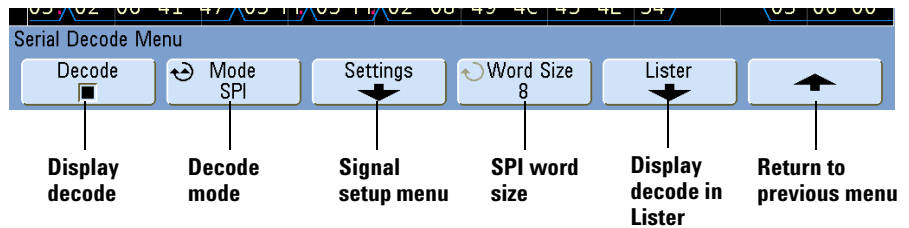

- c In the Serial Decode Menu, press the **Mode** softkey.
 - d Use the Entry knob (or repeatedly press and release the **Mode** softkey) to select the **SPI** serial decode mode.

10 Serial Decode/Lister

2 Specify the SPI signals:

NOTE

If you have already set up an SPI trigger, the signals and their trigger or threshold levels have already been specified, and you can continue on with [step 3](#).

Changing SPI signals in the Serial Decode setup also changes them in the Trigger setup.

- a** Press the **Settings** softkey to access the SPI Settings Menu.



- b** Press the **Signals** softkey to access the SPI Signals Menu.

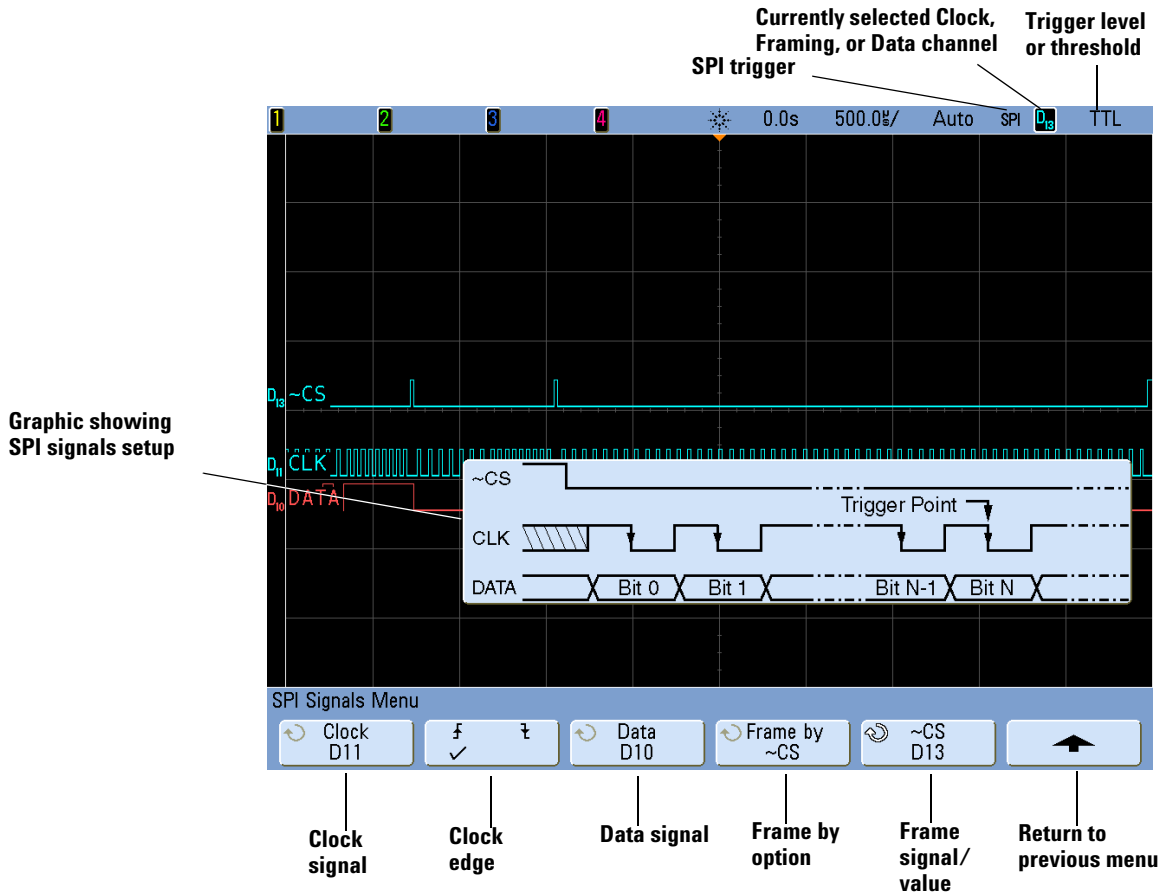

- c Press the **Clock** softkey, and use the Entry knob to select the channel probing the clock signal.
- d If you have connected one of the oscilloscope's analog source channels to the Clock signal: Adjust the trigger level for the selected analog channel to the middle of the waveform by turning the Trigger Level knob.

If you have connected one of the oscilloscope's digital source channels to the Clock signal (this applies to MSO model oscilloscopes only): Press the **[D15-D0]** key and select **Thresholds** to set an appropriate threshold level for digital channels.

- e** Press the rising or falling edge softkey to specify the edge that the clock occurs on.
- f** Press the **Data** softkey, and use the Entry knob to select the channel probing the data signal.
- g** If you have connected one of the oscilloscope's analog source channels to the Data signal: Adjust the trigger level for the selected analog channel to the middle of the waveform by turning the Trigger Level knob.

If you have connected one of the oscilloscope's digital source channels to the Data signal (this applies to MSO model oscilloscopes only): Press the **[D15-D0]** key and select **Thresholds** to set an appropriate threshold level for digital channels.

- h** Repeatedly press and release the **Frame by** softkey to select the method used to identify frames:
 - **~CS - Not Chip Select** — an active low chip select signal.
 - **CS - Chip Select** — an active high chip select signal.
 - **Clock Timeout** — clock idle for a period of time.
- i** If you chose framing by chip select or not chip select, press the **CS** or **~CS** softkey, and use the Entry knob to select the channel probing the chip select signal.

If you have connected one of the oscilloscope's analog source channels to the Chip Select signal: Adjust the trigger level for the selected analog channel to the middle of the waveform by turning the Trigger Level knob.

If you have connected one of the oscilloscope's digital source channels to the Chip Select signal (this applies to MSO model oscilloscopes only): Press the **[D15-D0]** key and select **Thresholds** to set an appropriate threshold level for digital channels.

- j** If you chose framing by clock timeout, press the **Timeout** softkey and use the Entry knob to specify the idle time.
- 3** Press the up-arrow softkey to return to the previous menu. Press the **Word Size** softkey, and use the Entry knob to select the number of bits in a word.
 - 4** If the decode line does not appear on the display, press the **Decode** softkey to turn it on.
 - 5** If the oscilloscope is stopped, press the **[Run/Stop]** key to acquire and decode data.

NOTE

If the setup does not produce a stable trigger, the SPI signal may be slow enough that the oscilloscope is AutoTriggering. Press the **[Mode/Coupling]** key, then press the **Mode** softkey to set the trigger mode from **Auto** to **Normal**.

You can use the **Zoom** horizontal sweep mode for easier navigation of the acquired data.

Interpreting SPI Decode

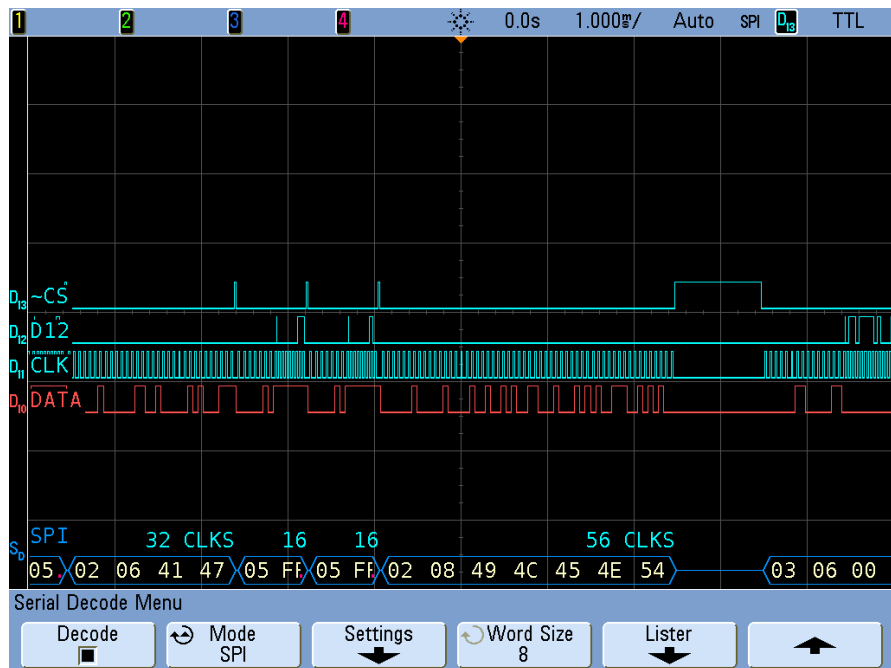

- Angled waveforms show an active bus (inside a packet/frame).
- Mid-level blue lines show an idle bus.
- The number of clocks in a frame appears in light-blue above the frame, to the right.
- Decoded hexadecimal data values appear in white.
- Decoded text is truncated at the end of the associated frame when there is insufficient space within frame boundaries.

10 Serial Decode/Lister

- Red dots in the decode line indicate that there is data that is not being displayed. Scroll or expand the horizontal scale to view the information.
- Aliased bus values (undersampled or indeterminate) are drawn in red.
- Unknown bus values (undefined or error conditions) are drawn in red.

Interpreting SPI Lister Data

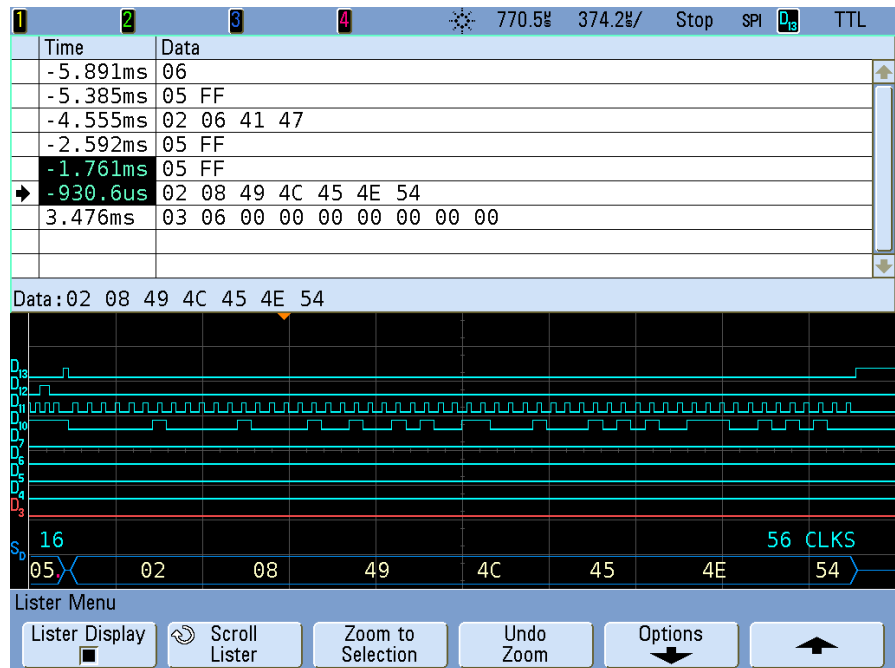

In addition to the standard Time column, the SPI Lister contains these columns:

- Data — data bytes (MISO or MOSI).

UART/RS232 Serial Decode

NOTE

Because of oscilloscope hardware resource limitations, you cannot decode UART/RS232 data while CAN, LIN, or FlexRay triggering is selected.

NOTE

For UART/RS232 triggering setup see [page 166](#).

1 Select the UART/RS232 serial decode mode:

- a Press the **[Acquire]** key.
- b Press the **Serial Decode** softkey.

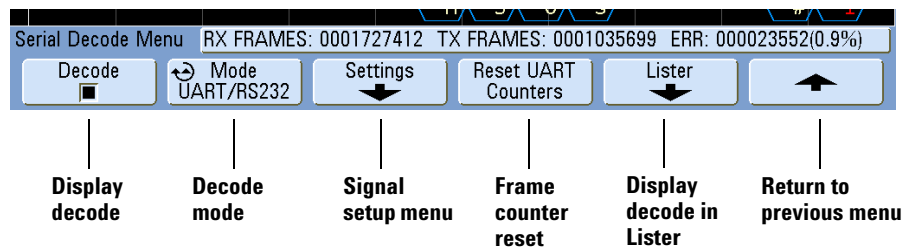

- c In the Serial Decode Menu, press the **Mode** softkey.
- d Use the Entry knob (or repeatedly press and release the **Mode** softkey) to select the **UART/RS232** serial decode mode if it is not already selected.

NOTE

Changing UART/RS232 signals in the Serial Decode setup also changes them in the Trigger setup.

- 2 Specify the UART/RS232 signals:
 - a Press the **Settings** softkey to access the UART/RS232 decode settings menu.

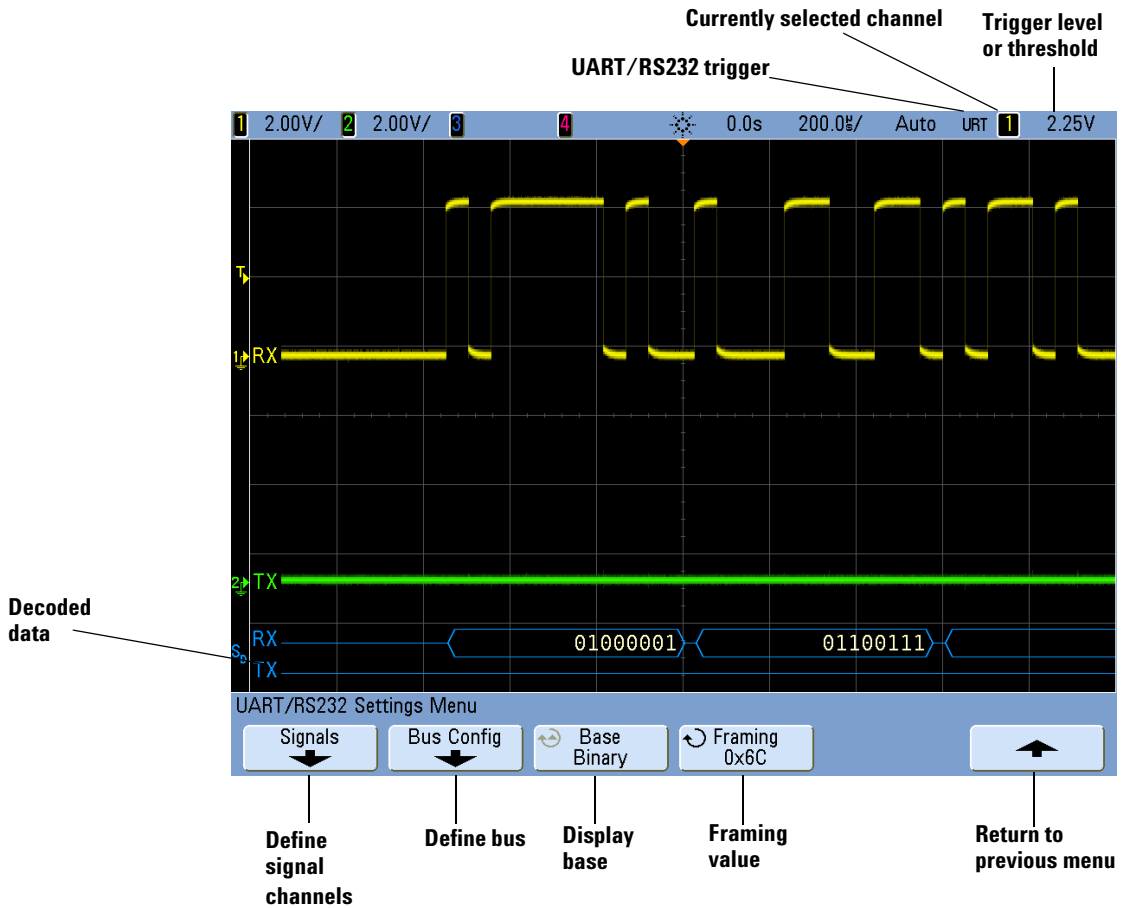

- b** Press the **Signals** softkey, and select the oscilloscope channels that you have connected to the Rx and Tx signals. Set the trigger levels. See **“UART/RS232 Trigger”** on page 166 for detailed instructions.
- 3** Press the “Return to previous menu” (up arrow) softkey.

NOTE

Changing the Bus Configuration settings in the Serial Decode setup also changes them in the Trigger setup.

- 4** Press the **Bus Config** softkey.
 - a #Bits:** Set the number of bits in the UART/RS232 words to match your device under test (selectable from 5-9 bits).
 - b Parity:** Choose odd, even, or none, based on your device under test.
 - c Baud:** Select the baud rate to match the signal in your device under test.
 - d Polarity:** Select idle low or idle high to match your device under test’s state when at idle. For RS232 select idle low.
 - e Bit Order:** Select whether the most significant bit (MSB) or the least significant bit (LSB) is presented after the start bit in the signal from your device under test. For RS232 select LSB.

NOTE

In the decode display the most significant bit is always displayed on the left regardless of how Bit Order is set.

- 5** Press the “Return to previous menu” (up arrow) softkey.
- 6** Press the **Base** softkey to select the base (hex, binary, or ASCII) in which decoded words are displayed.
 - When displaying words in ASCII, the 7-bit ASCII format is used. Valid ASCII characters are between 0x00 and 0x7F. To display in ASCII you must select at least 7 bits in the Bus Configuration. If ASCII is selected and the data exceeds 0x7F, the data is displayed in hex.
 - When **#Bits** is set to 9, the 9th (alert) bit is displayed directly to the left of the ASCII value (which is derived from the lower 8 bits).
- 7** Optional: Press the **Framing** softkey and select a value. In the decode display the chosen value will be displayed in light blue. However, if a parity error occurs the data will be displayed in red.

10 Serial Decode/Lister

- 8** Make sure the trigger or threshold levels are set to the middle of the signals:
 - For analog channels, turn the Trigger Level knob.
 - For digital channels, press the **[D15-D0]** key and the **Thresholds** softkey to access the threshold level setting softkeys.
- 9** If the decode line does not appear on the display, press the up arrow softkey to return to the previous menu, then press the **Decode** softkey to turn on serial decode.
- 10** If the oscilloscope is stopped, press the **[Run/Stop]** key to acquire and decode data.

NOTE

If the setup does not produce a stable trigger, the UART/RS232 signal may be slow enough that the oscilloscope is AutoTriggering. Press the **[Mode/Coupling]** key, then press the **Mode** softkey to set the trigger mode from **Auto** to **Normal**.

You can use the **Zoom** horizontal sweep mode for easier navigation of the acquired data.

Interpreting UART/RS232 Decode

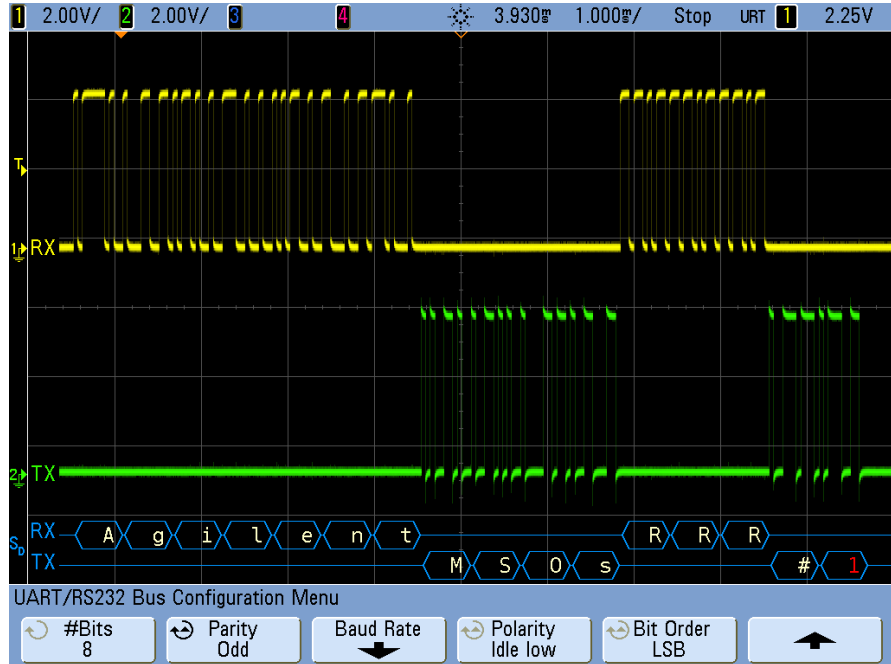

- Angled waveforms show an active bus (inside a packet/frame).
- Mid-level blue lines show an idle bus.
- When using 5-8 bit formats, the decoded data is displayed in white (in binary, hex, or ASCII).
- When using the 9 bit format, all data words are displayed in green, including the 9th bit. The 9th bit is displayed on the left.
- When a data word value is selected for framing, it is displayed in light blue. When using 9-bit data words, the 9th bit will also be displayed in light blue.
- Decoded text is truncated at the end of the associated frame when there is insufficient space within frame boundaries.
- When the horizontal scale setting does not permit the display of all available decoded data, red dots will appear in the decoded bus to mark the location of hidden data. Expand the horizontal scale to allow the data to display.
- An unknown (undefined) bus is shown in red.

- A parity error will cause the associated data word to be shown in red, which includes the 5-8 data bits and the optional 9th bit.

UART/RS232 Totalizer

The UART/RS232 totalizer consists of counters that provide a direct measure of bus quality and efficiency. The totalizer appears on screen whenever UART/RS232 Decode is ON in the Serial Decode Menu.

The totalizer is running, counting frames and calculating the percentage of error frames, even when the oscilloscope is stopped (not acquiring data).

The ERR (error) counter is a count of Rx and Tx frames with parity errors. The TX FRAMES and RX FRAMES counts include both normal frames and frames with parity errors. When an overflow condition occurs, the counter displays **OVERFLOW**.

The counters can be reset to zero by pressing the **Reset UART Counters** softkey.

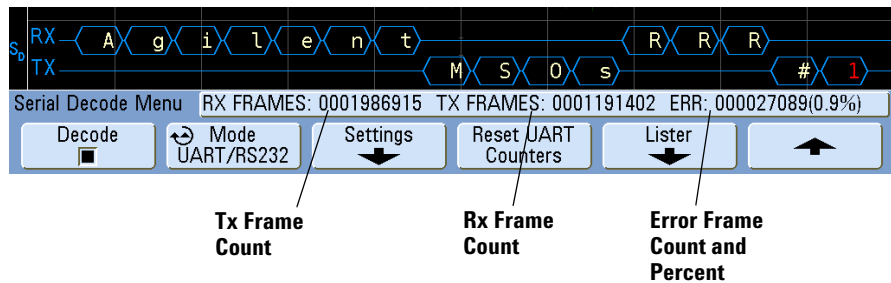

Interpreting UART/RS232 Lister Data

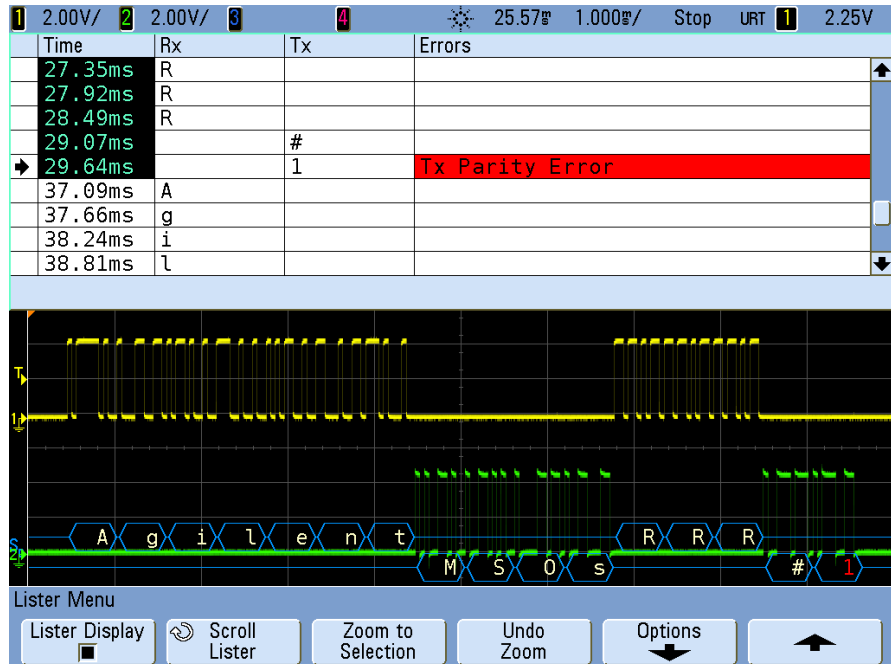

In addition to the standard Time column, the UART/RS232 Lister contains these columns:

- Rx — receive data.
- Tx — transmit data.
- Errors — highlighted in red, Parity Error or Unknown Error.

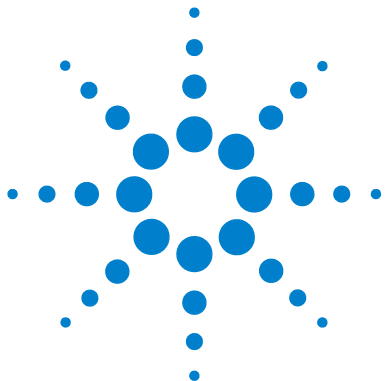

11 Mask Test

To create a mask from a “golden” waveform (Automask) **338**

Setup Options **340**

Mask Statistics **343**

To manually modify a mask file **345**

Building a Mask File **348**

One way to verify a waveform's compliance to a particular set of parameters is to use mask testing. A mask defines a region of the oscilloscope's display in which the waveform must remain in order to comply with chosen parameters. Compliance to the mask is verified point-by-point across the display. Mask test operates on displayed analog channels; it does not operate on channels that are not displayed.

To enable mask test order option LMT at time of oscilloscope purchase, or order N5455A as a stand-alone item after oscilloscope purchase.



To create a mask from a “golden” waveform (Automask)

A golden waveform meets all chosen parameters, and it is the waveform to which all others will be compared.

- 1 Configure the oscilloscope to display the golden waveform.
- 2 Press the **[Acquire]** key.
- 3 Press the **Mask Test** softkey (in the Acquire Menu) to enter the Mask Test Menu.

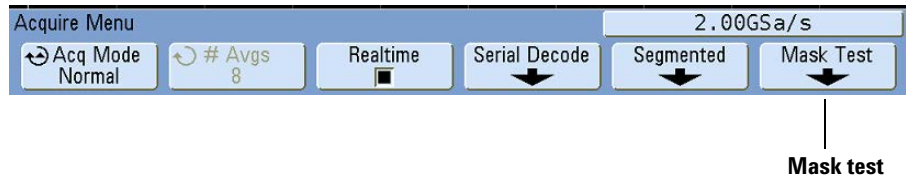

- 4 Press the **Automask** softkey.

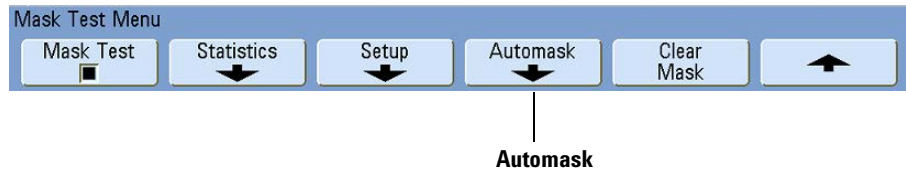

- 5 Press the **Source** softkey and ensure the analog channel from which to create the mask is selected.
- 6 Adjust the mask's horizontal tolerance ($\pm Y$) and vertical tolerance ($\pm X$). These are adjustable in graticule divisions or in absolute units (volts or seconds), selectable using the **Units** softkey.

- 7 Press the **Create Mask** softkey. The mask is created and testing begins. Whenever the **Create Mask** softkey is pressed the old mask is erased and a new mask is created.

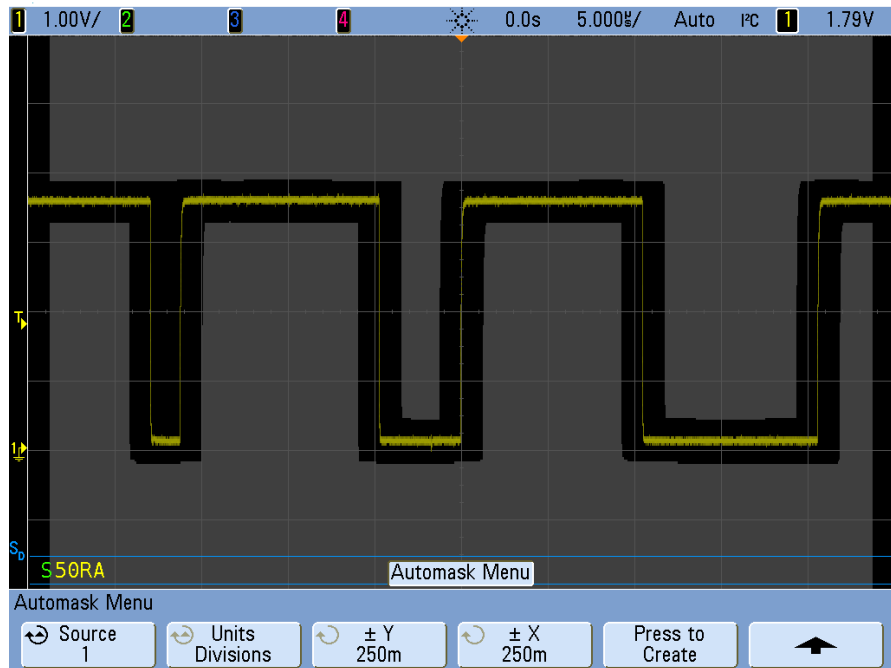

- 8 To clear the mask and switch off mask testing, press the up arrow softkey to return to the Mask Test Menu, then press the **Clear Mask** softkey.

If infinite persistence display mode (see **"Infinite Persistence"** on page 182) is "on" when mask test is enabled, it stays on. If infinite persistence is "off" when mask test is enabled, it is switched on when mask test is switched on, then infinite persistence is switched off when mask test is switched off.

Troubleshooting Mask Setup

If you press **Create Mask** and the mask appears to cover the entire screen, check the $\pm Y$ and $\pm X$ settings in the Automask Menu. If these are set to zero the resulting mask will be extremely tight around the waveform.

If you press **Create Mask** and it appears that no mask was created, check the $\pm Y$ and $\pm X$ settings. They may be set so large that the mask is not visible.

Setup Options

Run Until

The Run Until softkey lets you specify a condition on which to terminate testing.

Forever The oscilloscope runs continuously. However, if an error occurs the action specified using the **On Error** softkey will occur.

Minimum # of Tests Choose this option and then use the **# of Tests** softkey to select the number of times the oscilloscope will trigger, display the waveform(s), and compare them to the mask. The oscilloscope will stop after the specified number of tests have been completed. The specified minimum number of tests may be exceeded. If an error occurs the action specified using the **On Error** softkey will occur. The actual number of tests completed is displayed above the softkeys.

Minimum Time Choose this option and then use the **Test Time** softkey to select how long the oscilloscope will run. When the selected time has passed the oscilloscope will stop. The specified time may be exceeded. If an error occurs the action specified using the **On Error** softkey will occur. The actual test time is displayed above the softkeys.

Minimum Sigma Choose this option and then use the Sigma softkey to select a minimum sigma. The mask test runs until enough waveforms are tested to achieve a minimum test sigma. (If an error occurs the oscilloscope will perform the action specified by the **On Error** softkey.) Note that this is a test sigma (the max achievable process sigma, assuming no defects, for a certain number of tested waveforms) as opposed to a process sigma (which is tied to the amount of failures per test). The sigma value may exceed the selected value when a small sigma value is chosen. The actual sigma is displayed.

On Error

The **On Error** setting specifies the action to take when the input waveform does not conform to the mask. This setting supersedes the **Run Until** setting.

Stop The oscilloscope will stop when the first error is detected (on the first waveform that does not conform to the mask). This setting supersedes the **Minimum # of Tests** and **Minimum Time** settings.

Save The oscilloscope will save the screen image based on the settings you have chosen. See **“Saving Oscilloscope Data”** on page 247.

Print The oscilloscope will print the waveform display when the first error is detected. This option is only available when a printer is connected as described in **“To print the oscilloscope’s display”** on page 245.

Measure Measurements and measurement statistics run only on waveforms that contain a mask violation and are not affected by passing waveforms. This mode is not available when the acquisition mode is set to Averaging.

Note that you can choose to Print or Save, but you cannot select both.

Source Lock

When you turn on Source Lock using the **Source Lock** softkey, the mask is redrawn to match the source whenever you move the waveform. For example, if you change the horizontal timebase or the vertical gain the mask is redrawn with the new settings.

When you turn off Source Lock, the mask is not redrawn when horizontal or vertical settings are changed.

If you change the Source channel, the mask is not erased. It is re-scaled to the vertical gain and offset settings of the channel to which it is assigned. To create a new mask for the selected source channel, press the up arrow softkey, then press **Automask**, then press **Create Mask**.

The Source softkey in the Mask Setup Menu is the same as the Source softkey in the Automask Menu.

Mask Test Trigger Output

The oscilloscope's trigger output (located on the rear panel) can be activated by mask test results.

Press **[Utility]**→**Options**→**Rear Panel**→**Trig Out** and select **Mask**. Use the **Mask Out** softkey to select the desired mode.

Run mode	Mask Out setting	Trigger Output (rear panel)
Single	Pass	A pulse is produced if the mask test passed.
Single	Fail	A pulse is produced if the mask test failed.
Run	Pass	A pulse is produced if all mask tests have passed
Run	Fail	A pulse is produced if any mask test has failed

The Pass/fail status is evaluated periodically. When the evaluation of the testing period results in a pulse output, the trigger output pulses high (+ 5 V). Otherwise, the trigger output remains at low (0 V).

Mask Statistics

From the Mask Test Menu, press the **Statistics** softkey to enter the Mask Statistics Menu.

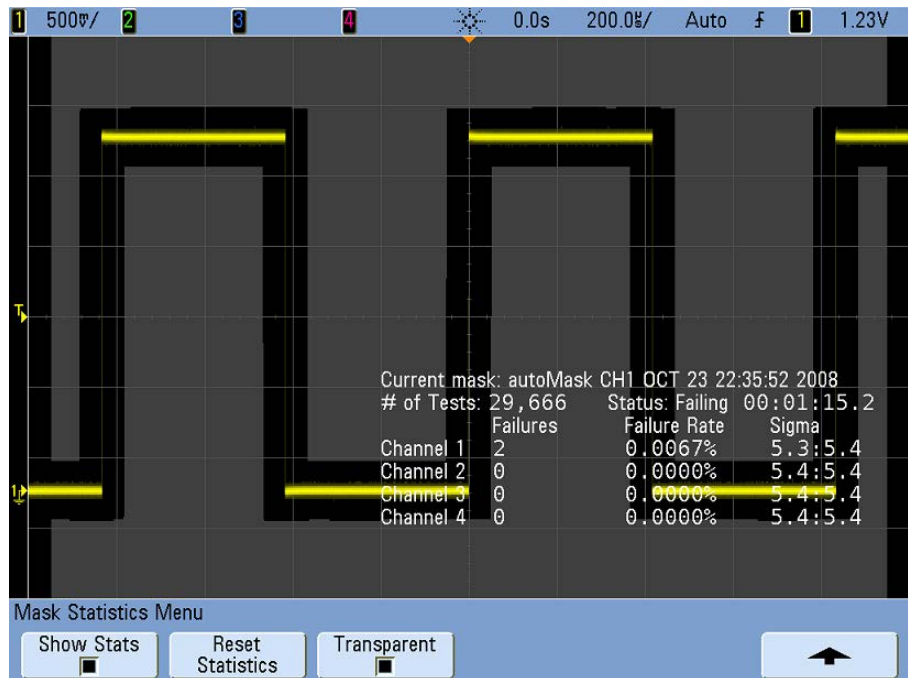

When you enable **Show Statistics** the following information is displayed:

- Current mask, name of mask, Channel number, date and time.
- # of Tests (total number of mask tests executed).
- Status (Passing, Failing, or Untested).
- Accumulated test time (in hours, minutes, seconds, and tenths of seconds).

And for each analog channel:

- Number of failures (acquisitions in which the signal excursion went beyond the mask).
- Failure rate (percentage of failures).
- Sigma (the ratio of process sigma to maximum achievable sigma, based on number of waveforms tested).

Reset Statistics

Press this softkey to reset the statistics counters to zero.

Note that statistics are also reset when:

- Mask Test is switched on after being switched off.
- Clear Mask softkey is pressed.
- An Automask is created.

Additionally, the accumulated time counter is reset whenever the oscilloscope is run after the acquisition was stopped.

Transparent

Enable Transparent mode to write measurement values and statistics on the screen without a background. Disable the Transparent mode to show them with a light blue background. This controls the display of statistics for both Quick Meas and the optional Mask test feature.

To manually modify a mask file

You can manually modify a mask file that you created using the Automask function.

- 1 Follow the steps 1-7 in **“To create a mask from a “golden” waveform (Automask)”** on page 338. Do not clear the mask after creating it.
- 2 Attach a USB mass storage device to the oscilloscope.
- 3 Press the **[Save/Recall]** key.
- 4 Press the **Save** softkey.
- 5 Press the **Format** softkey and select **Mask**.
- 6 Press the second softkey and select a destination folder on your USB mass storage device.
- 7 Press the **Press to Save** softkey. This creates an ASCII text file that describes the mask.
- 8 Remove the USB mass storage device and connect it to a PC.
- 9 Open the .msk file you created using a text editor (such as Wordpad).
- 10 Edit, save, and close the file.

The mask file contains the following sections:

- Mask File Identifier.
- Mask Title.
- Mask Violation Regions.
- Oscilloscope Setup Information.

Mask File Identifier

The Mask File Identifier is MASK_FILE_548XX.

Mask Title

The Mask Title is a string of ASCII characters.

Example: autoMask CH1 OCT 03 09:40:26 2008

When a mask file contains the keyword “autoMask” in the title, the edge of the mask is passing by definition. Otherwise, the edge of the mask is defined as a failure.

Mask Violation Regions

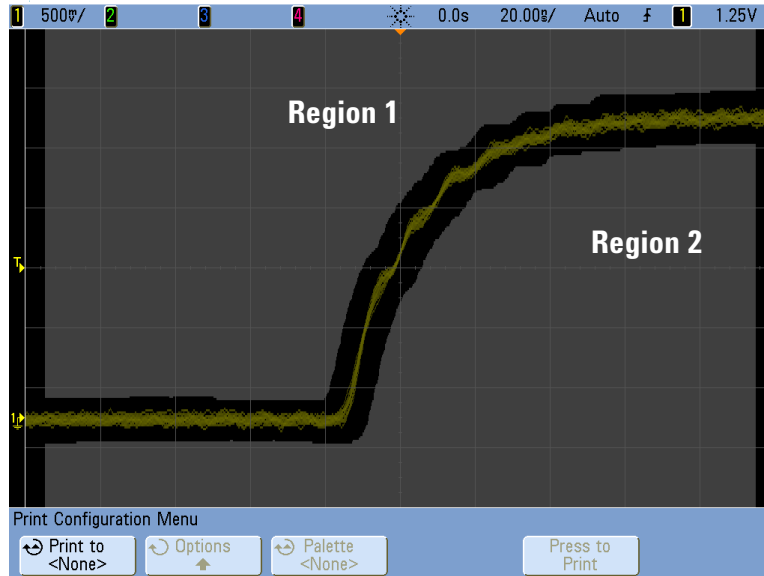

Up to 8 regions can be defined for a mask. They can be numbered 1-8. They can appear in any order in the .msk file. The numbering of the regions must go from top to bottom, left to right. The lowest numbered region

An Automask file contains two special regions: the region “glued” to the top of the display, and the region that is “glued” to the bottom. The top region is indicated by y-values of “MAX” for the first and last points. The bottom region is indicated by y-values of “MIN” for the first and last points.

The top region must be the lowest numbered region in the file. The bottom region must be the highest numbered region in the file.

Region number 1 is the top mask region. The vertices in Region 1 describe points along a line; that line is the bottom edge of the top portion of the mask.

Similarly, the vertices in Region 2 describe the line that forms the top of the bottom part of the mask.

The vertices in a mask file are normalized. There are four parameters that define how values are normalized:

- X1

- ΔX
- $Y1$
- $Y2$

These four parameters are defined in the Oscilloscope Setup portion of the mask file.

The Y-values (normally voltage) are normalized in the file using the following equation:

$$Y_{\text{norm}} = (Y - Y1) / \Delta Y$$

where $\Delta Y = Y2 - Y1$

To convert the normalized Y-values in the mask file to voltage:

$$Y = (Y_{\text{norm}} * \Delta Y) + Y1$$

where $\Delta Y = Y2 - Y1$

The X-values (normally time) are normalized in the file using the following equation:

$$X_{\text{norm}} = (X - X1) / \Delta X$$

To convert the normalized X-values to time:

$$X = (X_{\text{norm}} * \Delta X) + X1$$

Oscilloscope Setup Information

The keywords “setup” and “end_setup” (appearing alone on a line) define the beginning and end of the oscilloscope setup region of the mask file. The oscilloscope setup information contains remote programming language commands that the oscilloscope executes when the mask file is loaded.

Any legal remote programming command can be entered in this section.

The mask scaling controls how the normalized vectors are interpreted. This in turn controls how the mask is drawn on the display. The remote programming commands that control mask scaling are:

```
:MTES:SCAL:BIND 0
```

```
:MTES:SCAL:X1 -400.000E-06
```

```
:MTES:SCAL:XDEL +800.000E-06
```

```
:MTES:SCAL:Y1 +359.000E-03
```

```
:MTES:SCAL:Y2 +2.35900E+00
```

Building a Mask File

The following mask uses all eight regions. The most difficult part of creating a mask file is normalizing the X and Y values from the time and voltage values. This example shows an easy way to convert voltage and time to normalized X and Y values in the mask file.

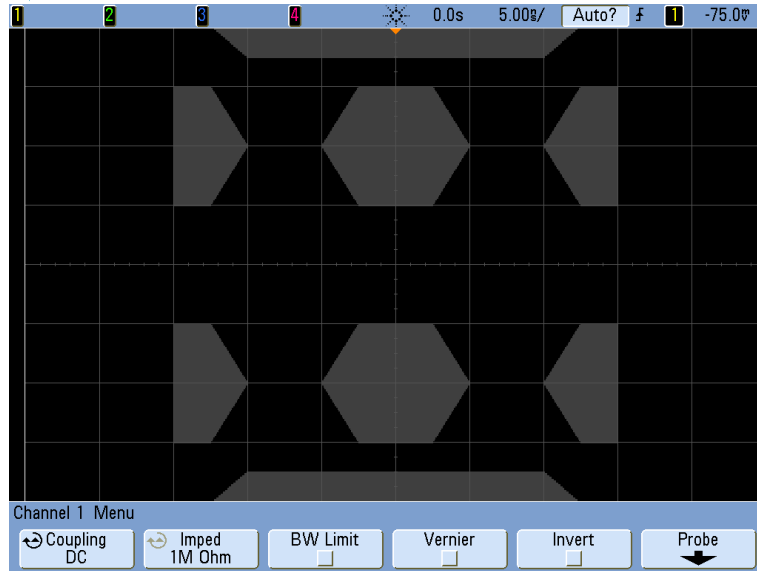

The following mask file produced the mask shown above:

MASK_FILE_548XX

"All Regions"

```

/* Region Number */ 1
/* Number of vertices */ 4
-12.50, MAX
-10.00, 1.750
10.00, 1.750
12.50, MAX

/* Region Number */ 2
/* Number of vertices */ 5
-10.00, 1.000
-12.50, 0.500
-15.00, 0.500
-15.00, 1.500

```

-12.50, 1.500

**/* Region Number */ 3
 /* Number of vertices */ 6
 -05.00, 1.000
 -02.50, 0.500
 02.50, 0.500
 05.00, 1.000
 02.50, 1.500
 -02.50, 1.500**

**/* Region Number */ 4
 /* Number of vertices */ 5
 10.00, 1.000
 12.50, 0.500
 15.00, 0.500
 15.00, 1.500
 12.50, 1.500**

**/* Region Number */ 5
 /* Number of vertices */ 5
 -10.00, -1.000
 -12.50, -0.500
 -15.00, -0.500
 -15.00, -1.500
 -12.50, -1.500**

**/* Region Number */ 6
 /* Number of vertices */ 6
 -05.00, -1.000
 -02.50, -0.500
 02.50, -0.500
 05.00, -1.000
 02.50, -1.500
 -02.50, -1.500**

**/* Region Number */ 7
 /* Number of vertices */ 5
 10.00, -1.000
 12.50, -0.500
 15.00, -0.500
 15.00, -1.500
 12.50, -1.500**

/* Region Number */ 8

```

/* Number of vertices */ 4
-12.50, MIN
-10.00, -1.750
10.00, -1.750
12.50, MIN

setup
:MTES:ENAB 1
:CHAN1:RANG +4.00E+00;OFFS +0.0E+00;COUP DC;IMP ONEM;DISP 1;BWL 0;INV 0
:CHAN1:LAB "1";UNIT VOLT;PROB +1.0E+00;PROB:SKEW +0.0E+00;STYP SING
:CHAN2:RANG +16.0E+00;OFFS +1.62400E+00;COUP DC;IMP FIFT;DISP 0;BWL 0;INV 0
:CHAN2:LAB "2";UNIT VOLT;PROB +1.0E+00;PROB:SKEW +0.0E+00;STYP SING
:CHAN3:RANG +40.0E+00;OFFS +0.0E+00;COUP DC;IMP ONEM;DISP 0;BWL 0;INV 0
:CHAN3:LAB "3";UNIT VOLT;PROB +1.0E+00;PROB:SKEW +0.0E+00;STYP SING
:CHAN4:RANG +40.0E+00;OFFS +0.0E+00;COUP DC;IMP ONEM;DISP 0;BWL 0;INV 0
:CHAN4:LAB "4";UNIT VOLT;PROB +1.0E+00;PROB:SKEW +0.0E+00;STYP SING
:EXT:BWL 0;IMP ONEM;RANG +5E+00;UNIT VOLT;PROB +1.0E+00;PROB:STYP SING
:TIM:MODE MAIN;REF CENT;MAIN:RANG +50.00E-09;POS +0.0E+00
:TRIG:MODE EDGE;SWE AUTO;NREJ 0;HFR 0;HOLD +60E-09
:TRIG:EDGE SOUR CHAN1;LEV -75.00E-03;SLOP POS;REJ OFF;COUP DC
:ACQ:MODE RTIM;TYPE NORM;COMP 100;COUNT 8;SEGM:COUN 2
:DISP:LAB 0;CONN 1;PERS MIN;SOUR PMEM1
:HARD:APR "";AREA SCR;FACT 0;FFE 0;INKS 1;PAL NONE;LAY PORT
:SAVE:FIL "mask_0"
:SAVE:IMAG:AREA GRAT;FACT 0;FORM NONE;INKS 0;PAL COL
:SAVE:WAV:FORM NONE
:MTES:SOUR CHAN1;ENAB 1;LOCK 1
:MTES:AMAS:SOUR CHAN1;UNIT DIV;XDEL +3.00000000E-001;YDEL +2.00000000E-001
:MTES:SCAL:BIND 0;X1 +0.0E+00;XDEL +1.0000E-09;Y1 +0.0E+00;Y2 +1.00000E+00
:MTES:RMOD FOR;RMOD:TIME +1E+00;WAV 1000;SIGM +6.0E+00
:MTES:RMOD:FACT:STOP 0;PRIN 0;SAVE 0
end_setup

```

How is mask testing done?

InfiniiVision oscilloscopes start mask testing by creating a database that is 256 x 1000 for the waveform viewing area. Each location in the array is designated as either a violation or a pass area. Each time a data point from a waveform occurs in a violation area a failure is logged. Every active analog channel is tested against the mask database for each acquisition. Over 2 billion failures can be logged per-channel. The number of acquisitions tested is also logged and displayed as “# of Tests”.

The mask file allows greater resolution than the 256 X 1000 database. Some quantization of data occurs to reduce the mask file data for display on-screen.



12 Controls and Connectors

Front Panel [352](#)

- 5000/6000 Series Front Panel (4-channel) [352](#)
- 5000/6000 Series Front Panel (2-Channel, differences only) [353](#)
- 6000L Series Front and Rear Panel [354](#)
- 7000 Series Front Panel (4-Channel) [355](#)
- 7000 Series Front Panel (2-Channel, differences only) [356](#)
- Front Panel Control and Connector Descriptions [357](#)

Rear Panel [362](#)

- 5000 Series Rear Panel (4-Channel) [362](#)
- 5000 Series Rear Panel (2-Channel) [363](#)
- 6000 Series Rear Panel (4-Channel) [364](#)
- 6000 Series Rear Panel (2-Channel) [365](#)
- 6000 Series Option BAT Rear Panel (4-Channel) [366](#)
- 6000L Series Front and Rear Panel [354](#)
- 7000 Series Rear Panel (4-Channel) [367](#)
- 7000 Series Rear Panel (2-Channel) [368](#)
- Rear Panel Control and Connector Descriptions [369](#)



Front Panel

5000/6000 Series Front Panel (4-channel)

Click the text for the item's description and operation information. Printed manual: refer to numbered descriptions on the following pages.

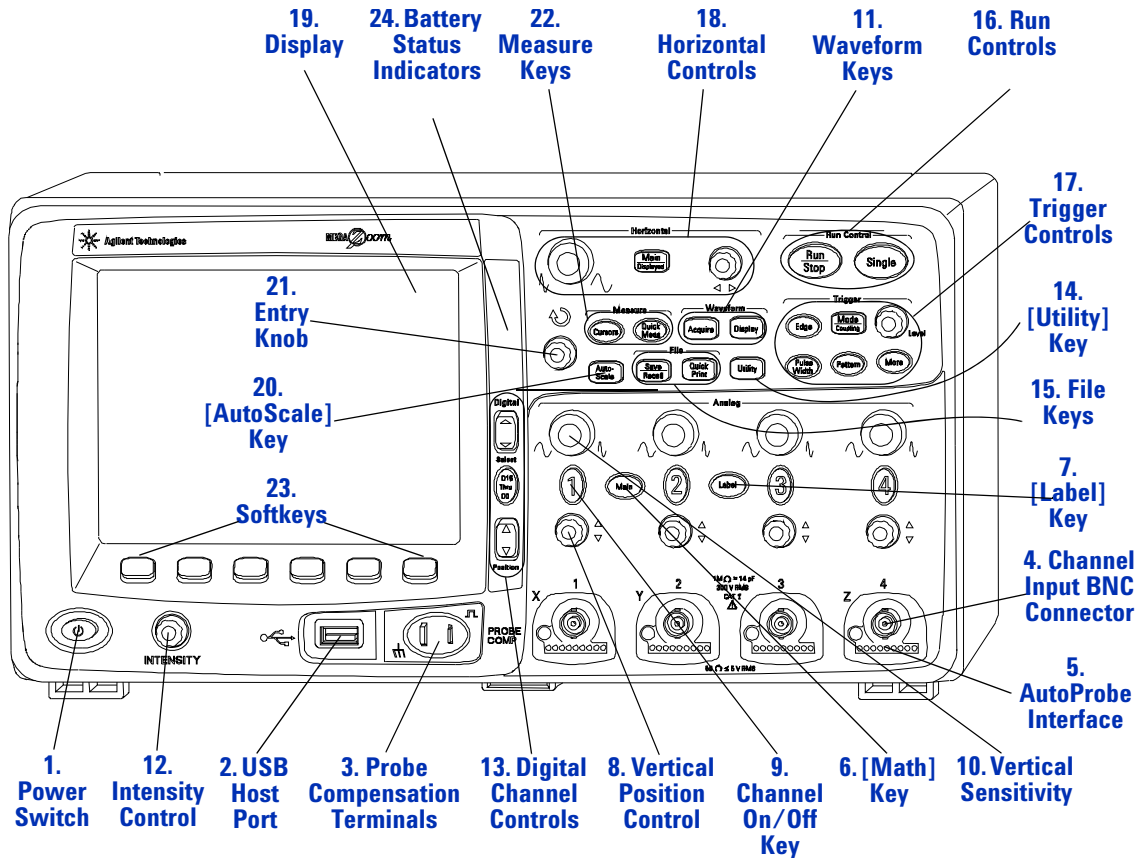

5000/6000 Series Front Panel (2-Channel, differences only)

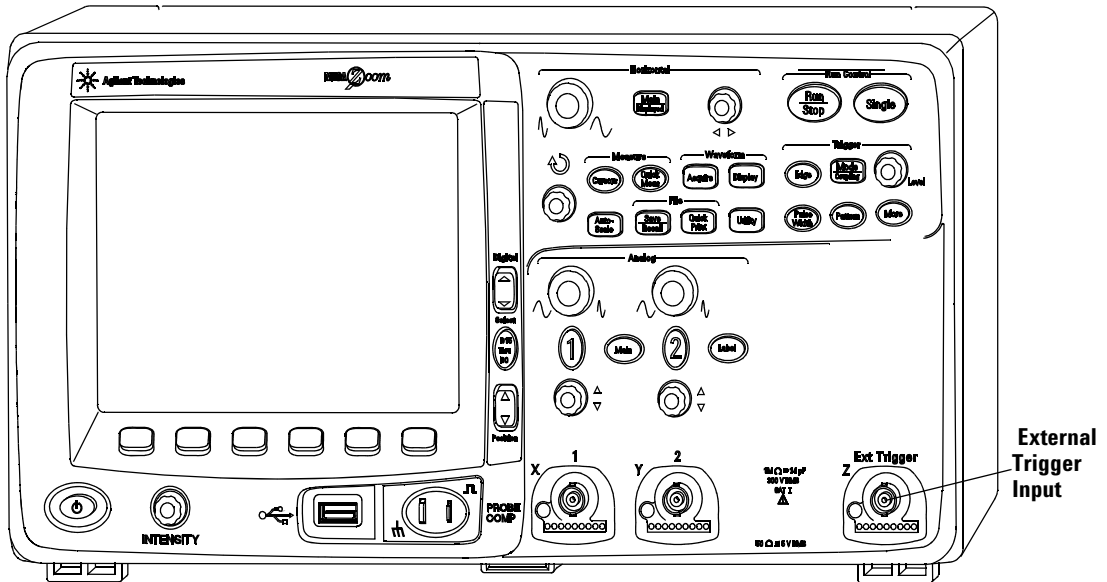

The differences between the front panel of the 4-channel oscilloscopes and the 2-channel oscilloscopes are:

- The 2-channel oscilloscope has two sets of channel controls
- The 2-channel oscilloscope's external trigger input is on the front panel instead of the rear panel. Some trigger features differ. See **“External Trigger Input”** on page 92.

6000L Series Front and Rear Panel

Click the text for the item's description and operation information. Printed manual: refer to numbered descriptions on the following pages.

FRONT PANEL

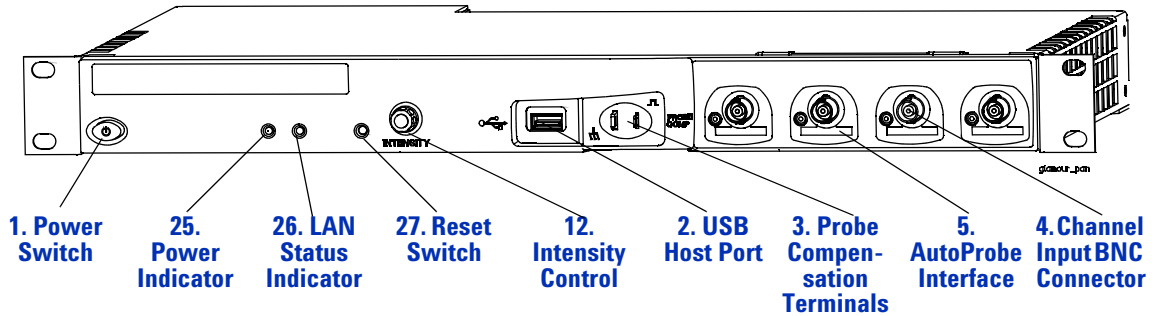

REAR PANEL

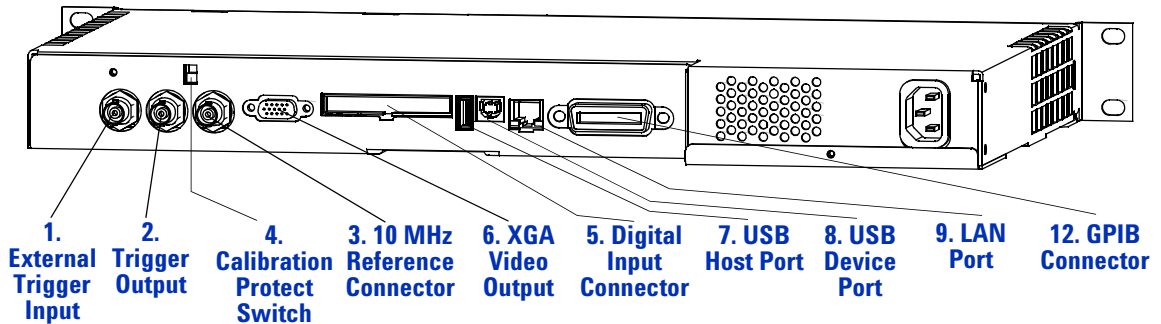

7000 Series Front Panel (4-Channel)

Click the text for the item's description and operation information. Printed manual: refer to numbered descriptions on the following pages.

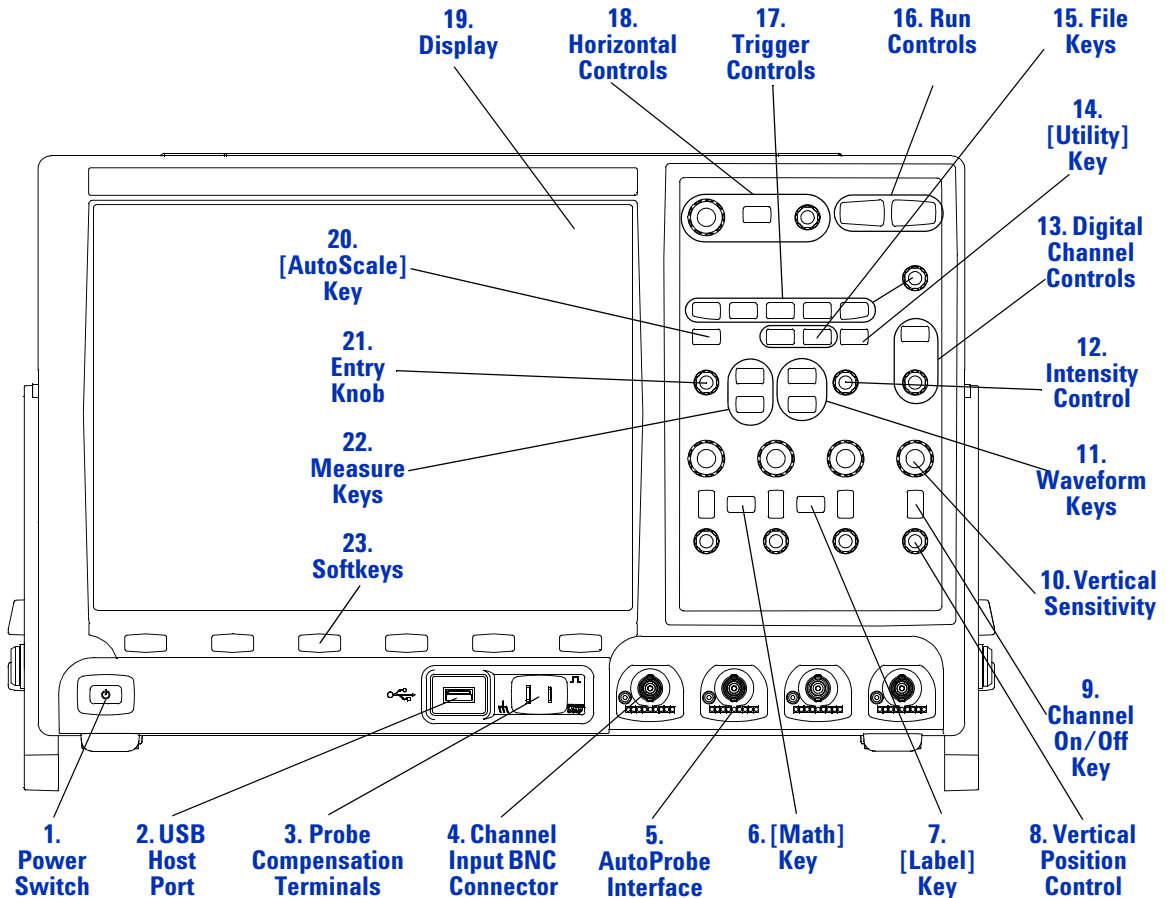

7000 Series Front Panel (2-Channel, differences only)

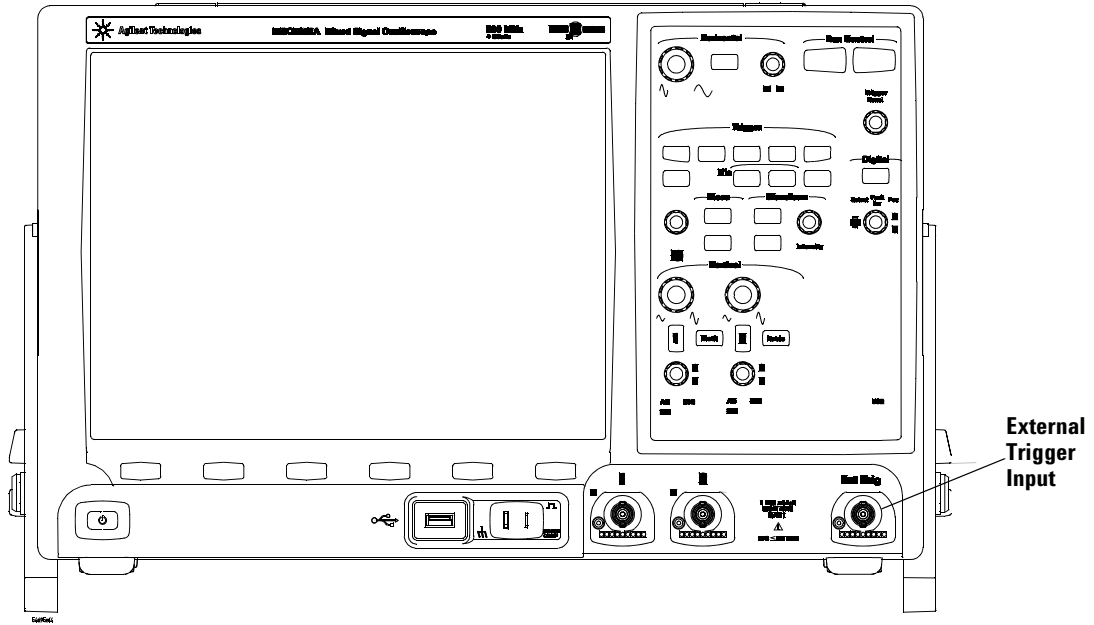

The differences between the front panel of the 4-channel oscilloscopes and the 2-channel oscilloscopes are:

- The 2-channel oscilloscope has two sets of channel controls
- The 2-channel oscilloscope's external trigger input is on the front panel instead of the rear panel. Some trigger features differ. See **"External Trigger Input"** on page 92.

Front Panel Control and Connector Descriptions

1. Power Switch Press once to switch power on; press again to switch power off. See [page 49](#).

2. USB Host Port This port is for connecting USB mass storage devices or printers to the oscilloscope.

Connect a USB compliant mass storage device (flash drive, disk drive, etc.) to store or recall oscilloscope setup files or waveforms.

To print, connect a USB compliant printer. For more information about printing see [“To print the oscilloscope’s display”](#) on page 245.

You can also use the USB port to update the oscilloscope’s system software when updates are available.

You do not need to take special precautions before removing the USB mass storage device from the oscilloscope (you do not need to “eject” it). Simply unplug the USB mass storage device from the oscilloscope when the file operation is complete.

For more information about saving to a USB mass storage device see [“Saving Oscilloscope Data”](#) on page 247.

CAUTION

Do not connect a host computer to the oscilloscope’s USB host port: use the device port. A host computer sees the oscilloscope as a device, so connect the host computer to the oscilloscope’s device port (on the rear panel). See [“Web Interface”](#) on page 275.

3. Probe Compensation Terminals Use the signal at this terminal to match a probe’s input capacitance to the oscilloscope channel to which it is connected. See [page 77](#).

4. Channel Input BNC Connector Attach the oscilloscope probe or BNC cable to the BNC connector. This is the channel’s input connector.

5. AutoProbe Interface When you connect a probe to the oscilloscope, the AutoProbe Interface attempts to determine the type of probe and set its parameters in the Probe Menu accordingly. On all models except 100 MHz 6000 Series. See [“AutoProbe Interface”](#) on page 72.

6. [Math] Key The [Math] key provides access to add, subtract, multiply, differentiate, integrate, FFT (Fast Fourier Transform) and square root functions. See “[Measurements and Math Functions](#)” on page 191.

7. [Label] Key Press this key to access the Label Menu, which lets you enter labels to identify each trace on the oscilloscope display. See “[Using Labels](#)” on page 183.

8. Vertical Position Control Use this knob to change the channel’s vertical position on the display. There is one Vertical Position control for each channel. See “[Using the Analog Channels](#)” on page 59.

9. Channel On/Off Key Use this key to switch the channel on or off, or to access the channel’s menu in the softkeys. There is one Channel On/Off key for each channel. See “[Using the Analog Channels](#)” on page 59.

10. Vertical Sensitivity There is one knob marked $\sim \vee$ for each channel. Use these knobs to change the vertical sensitivity (gain) of each channel. See “[Using the Analog Channels](#)” on page 59.

11. Waveform Keys The [Acquire] key lets you set the oscilloscope to acquire in Normal, Peak Detect, Averaging, or High Resolution modes (see “[Acquisition Modes](#)” on page 265), and lets you turn Realtime sampling off or on (see [page 269](#)). The [Display] key lets you access the menu where you can select infinite persistence (see [page 182](#)), switch vectors on or off (see [page 187](#)), and adjust the display grid (graticule) intensity (see [page 181](#)).

12. Intensity Control Rotate clockwise to increase analog waveform intensity; counterclockwise to decrease. You can vary the intensity control to bring out signal detail, much like an analog oscilloscope. Digital channel waveform intensity is not adjustable. More details about using the Intensity control to view signal detail are on [page 180](#).

13. Digital Channel Controls These controls switch the digital channels on and off, and can be used to select a digital channel for repositioning on the display.

Press the [D15-D0] key to turn on the digital channels (the [D15-D0] key will illuminate). There are two indicators above the Digital Channel Control Knob: **Select** and **Pos** (Position). When **Select** is illuminated, rotate the knob to select a digital trace. The selected trace will change from blue to red. Push the Digital Channel Control Knob to toggle from **Select** to **Pos**. Rotate the knob and press it again to re-position the digital trace.

If a trace is repositioned over an existing trace the indicator at the left edge of the trace will change from **D_{nn}** designation (where nn is a one or two digit channel number from 0 to 15) to **D***. The “*” indicates that two channels are overlaid.

You can rotate the knob to select an overlaid channel, then press the knob to position it just as you would any other channel.

For more information on digital channels see [Chapter 13](#), “Digital Channels,” starting on page 371.

14. [Utility] Key Press this key to access the Utility Menu, which lets you configure the oscilloscope’s I/O settings, use the file explorer, set preferences, access the service menu, and choose other options.

15. File Keys Press the **[Save/Recall]** key to save or recall a waveform or setup, or to access the Default Setup function, which restores many settings to their factory configuration (details on [“To restore the oscilloscope to its default configuration”](#) on page 392). The **[Print]** key opens the Print Configuration Menu so you can print the displayed waveforms. See [“Saving Oscilloscope Data”](#) on page 247 and [“Printing the Oscilloscope’s Display”](#) on page 244.

16. Run Controls Press **[Run/Stop]** to make the oscilloscope begin looking for a trigger. The **[Run/Stop]** key will illuminate in green. If the trigger mode is set to “Normal,” the display will not update until a trigger is found. If the trigger mode is set to “Auto,” the oscilloscope looks for a trigger, and if none is found, it will automatically trigger, and the display will immediately show the input signals. In this case, the **Auto** indicator at the top of the display will change to **Auto?** and the background will flash, indicating that the oscilloscope is forcing triggers.

Press **[Run/Stop]** again to stop acquiring data. The key will illuminate in red. Now you can pan across and zoom-in on the acquired data.

Press **[Single]** to make a single acquisition of data. The key will illuminate in yellow until the oscilloscope triggers. See [“To start and stop an acquisition”](#) on page 262.

17. Trigger Controls These controls determine how the oscilloscope triggers to capture data. See [Chapter 4](#), “Triggering,” starting on page 81.

18. Horizontal Controls

Horizontal Sweep Speed Control Turn the knob in the Horizontal section that is marked  to adjust the sweep speed. The symbols under the knob indicate that this control has the effect of spreading out or zooming in on the waveform using the horizontal scale. The horizontal sweep speed control changes the time per horizontal division on the display. For more information see [“To set up the Horizontal time base”](#) on page 64.

Horizontal Position Control Turn the knob marked  to pan through the waveform data horizontally. You can see the captured waveform before the trigger (turn the knob clockwise) or after the trigger (turn the knob counterclockwise). If you pan through the waveform when the oscilloscope is stopped (not in Run mode) then you are looking at the waveform data from the last acquisition taken. See [“To set up the Horizontal time base”](#) on page 64.

Horizontal [Menu/Zoom] Key (or [Main/Delayed] Key on some oscilloscopes)

Press this key to access the menu where you can split the oscilloscope display into Normal and Zoom sections, and where you can select XY and Roll modes. You can also select horizontal time/division fine adjustment and select the trigger time reference point on this menu. See [“To set up the Horizontal time base”](#) on page 64.

19. Display The display shows captured waveforms using a different color for each channel. For more information about display modes see [Chapter 5](#), “Displaying,” starting on page 173. Signal detail is displayed using 256 levels of intensity. For more information about viewing signal detail see [“Waveform Intensity and Signal Detail”](#) on page 180.

20. [AutoScale] Key When you press the **[AutoScale]** key the oscilloscope will quickly determine which channels have activity, and it will turn these channels on and scale them to display the input signals. See [“AutoScale”](#) on page 177

21. Entry Knob The entry knob is used to select items from menus and to change values. Its function changes based upon which menu is displayed. Note that the curved arrow symbol  above the entry knob illuminates whenever the entry knob can be used to select a value. Rotate and push the entry knob to select among the choices that are shown on the softkeys. More information about the Entry knob is on [page 53](#).

22. Measure Keys Press the [**Cursors**] key to turn on cursors that you can use for making measurements. Press the [**Quick Meas**] key to access a set of predefined measurements. See **Chapter 6**, “Measurements and Math Functions,” starting on page 191.

23. Softkeys The functions of these keys change based upon the menus shown on the display directly above the keys.

24. Battery Status Indicators These indicators appear only on 6000A models with option BAT (battery power). See “**Power-on the Battery-Powered 6000A Series Oscilloscope**” on page 49 for important operation and safety information.

25. Power Indicator (6000L models only.) Illuminates green when power is on.

26. LAN Status Indicator (6000L models only.) This indicator illuminates green when a LAN connection has been detected and is connected as configured. The LAN status indicator illuminates red when the following LAN faults occur:

- failure to acquire a valid IP address
- detection of a duplicate IP address
- failure to renew an already acquired DHCP lease

The LAN status indicator flashes green when the identify function is activated (see “**Identification Function**” on page 286).

27. Reset Switch (6000L models only.) When power is on, press and release this recessed pushbutton to default LAN parameters.

Rear Panel

5000 Series Rear Panel (4-Channel)

Click the text for the item's description and operation information. Printed manual: refer to numbered descriptions on the following pages.

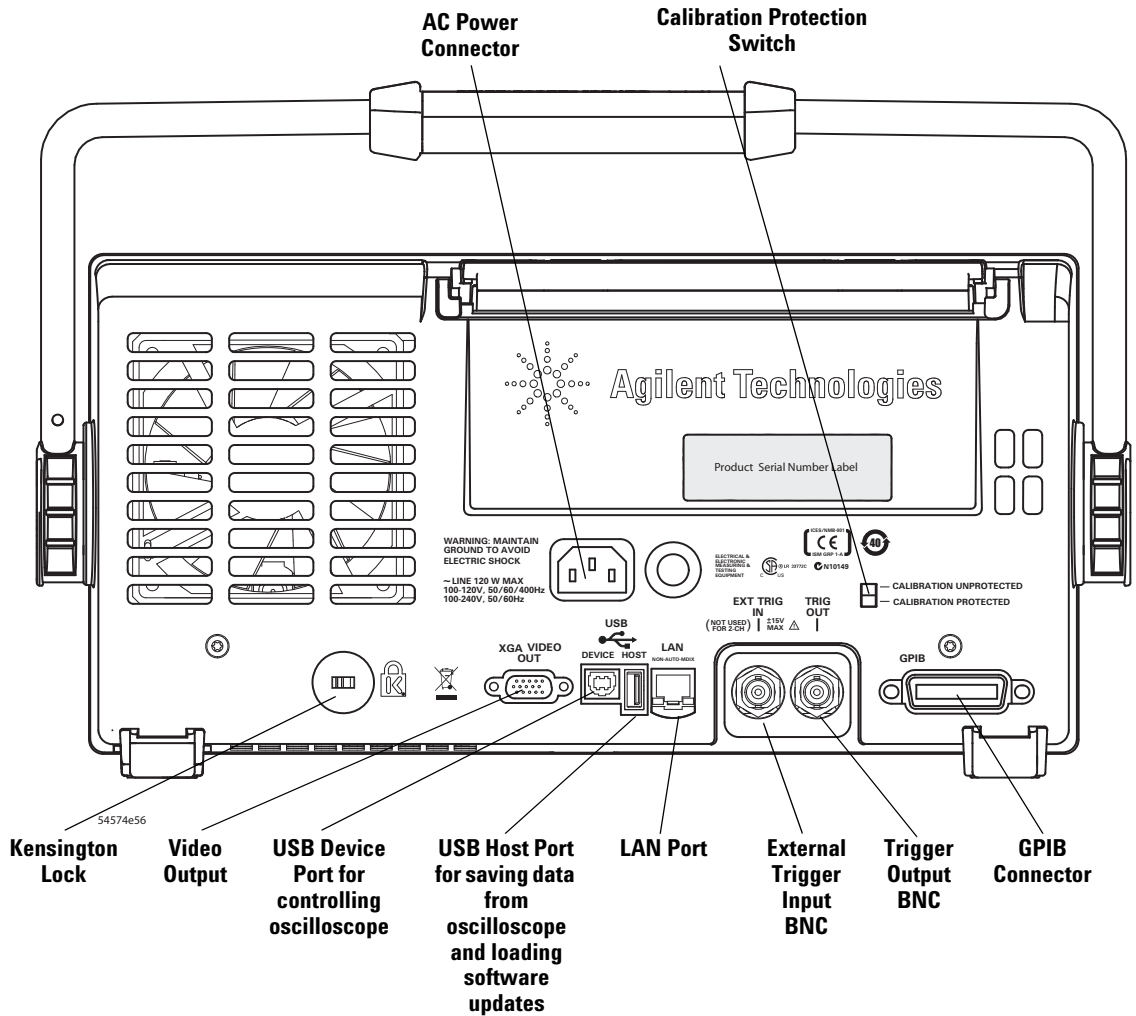

5000 Series Rear Panel (2-Channel)

The 2-channel model rear panel is the same as the 4-channel model rear panel shown on [page 366](#), except on 2-channel models, the external trigger input is on the front panel instead of the rear panel.

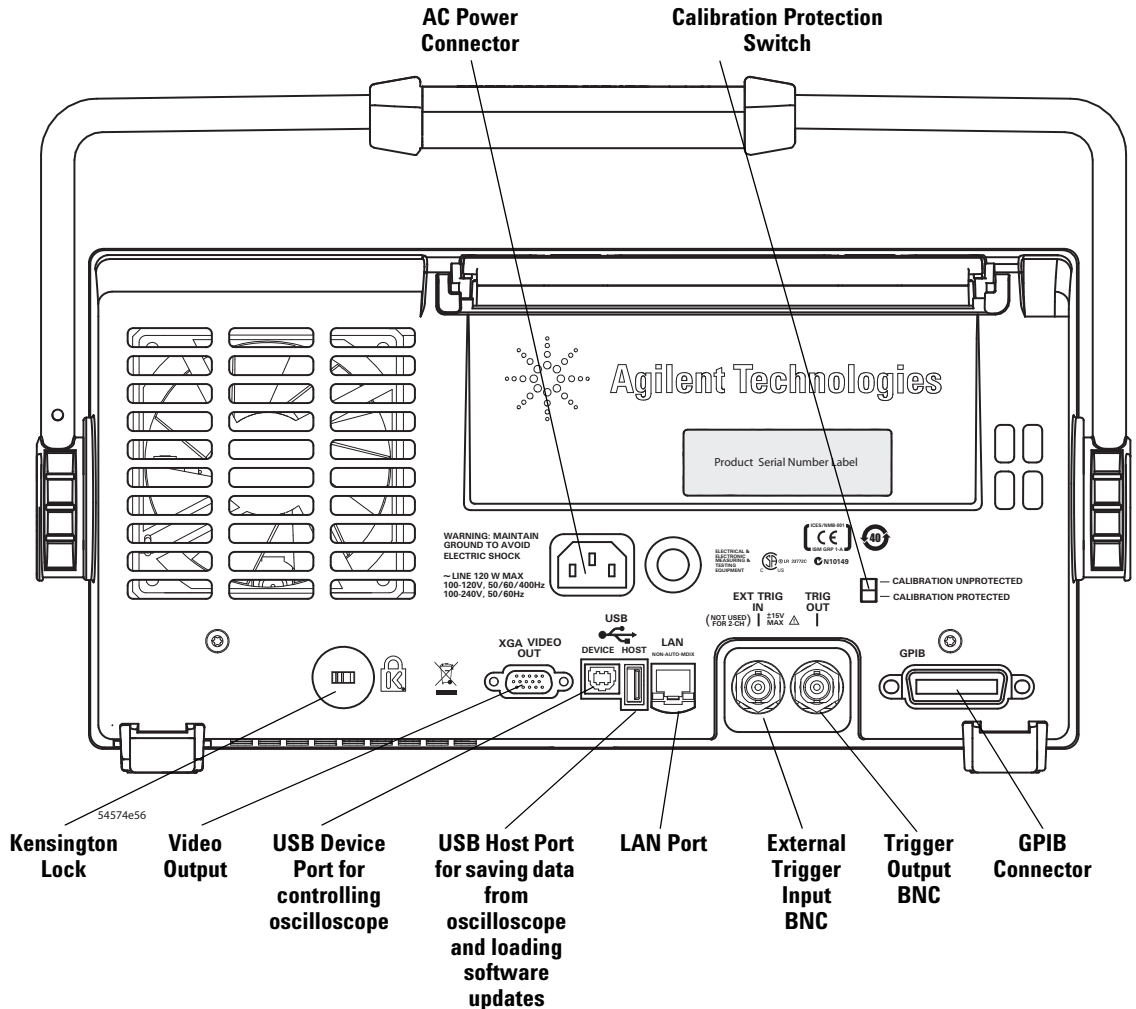

6000 Series Rear Panel (4-Channel)

Click the text for the item's description and operation information. Printed manual: refer to numbered descriptions on the following pages.

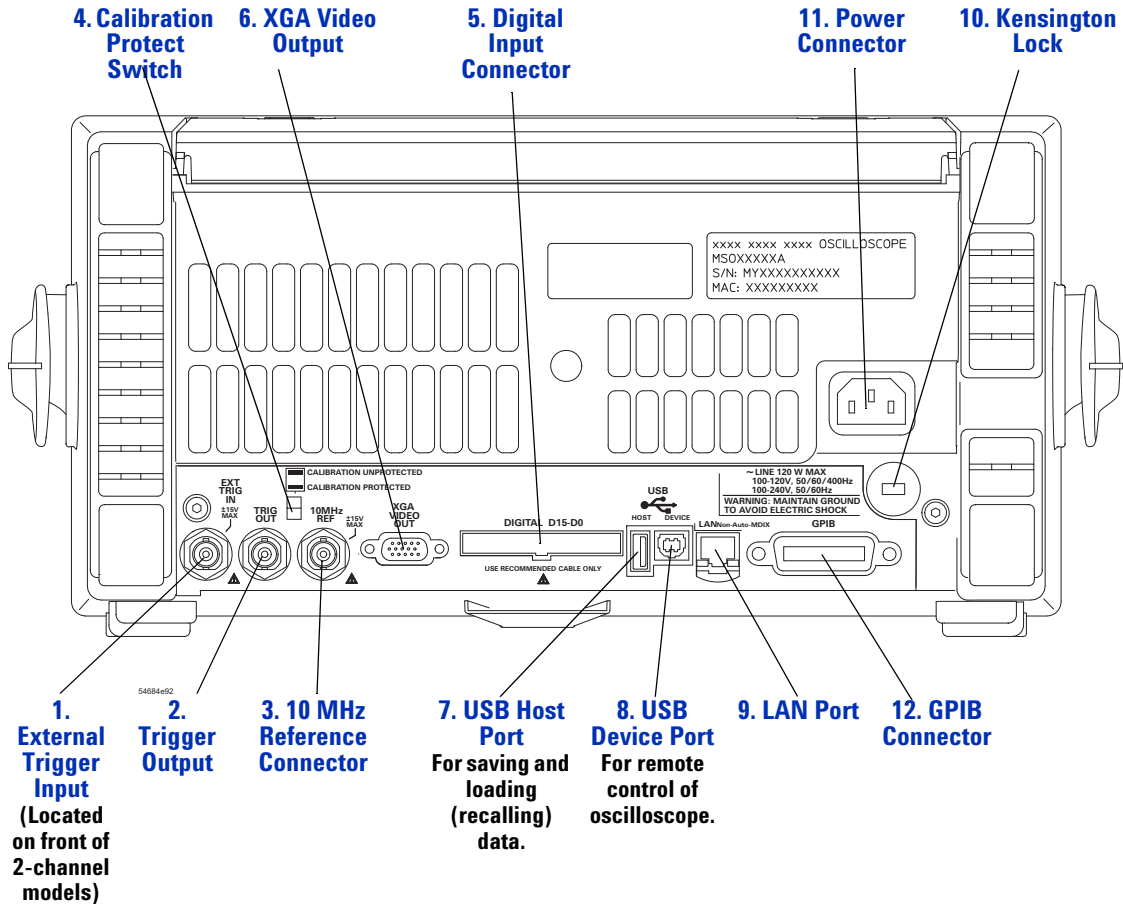

6000 Series Rear Panel (2-Channel)

The 2-channel model rear panel is the same as the 4-channel model rear panel shown on [page 366](#), except on 2-channel models, the external trigger input is on the front panel instead of the rear panel.

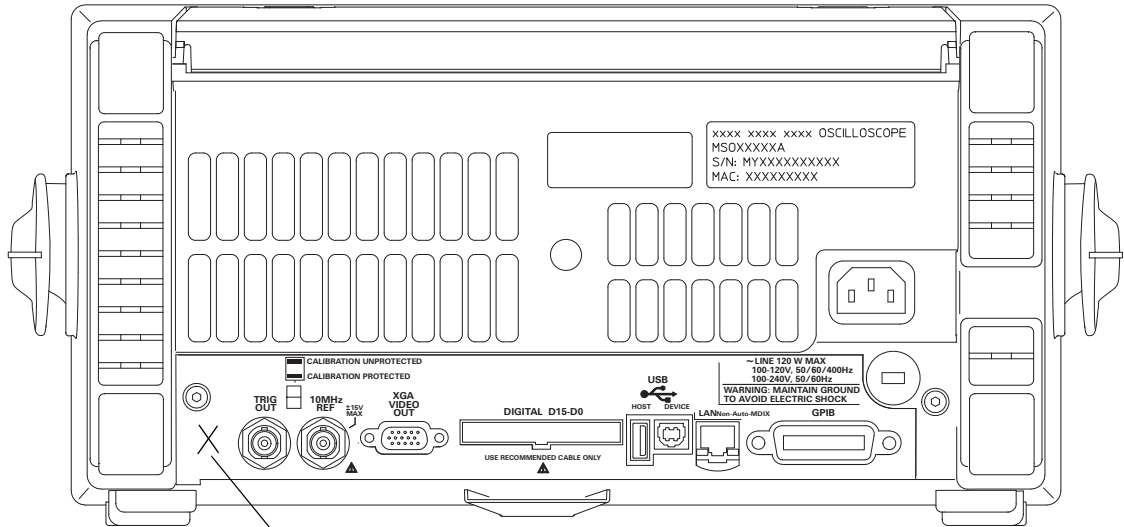

External Trigger Input
BNC is on front panel

54684e93

6000 Series Option BAT Rear Panel (4-Channel)

Click the text for the item's description and operation information. Printed manual: refer to numbered descriptions on the following pages.

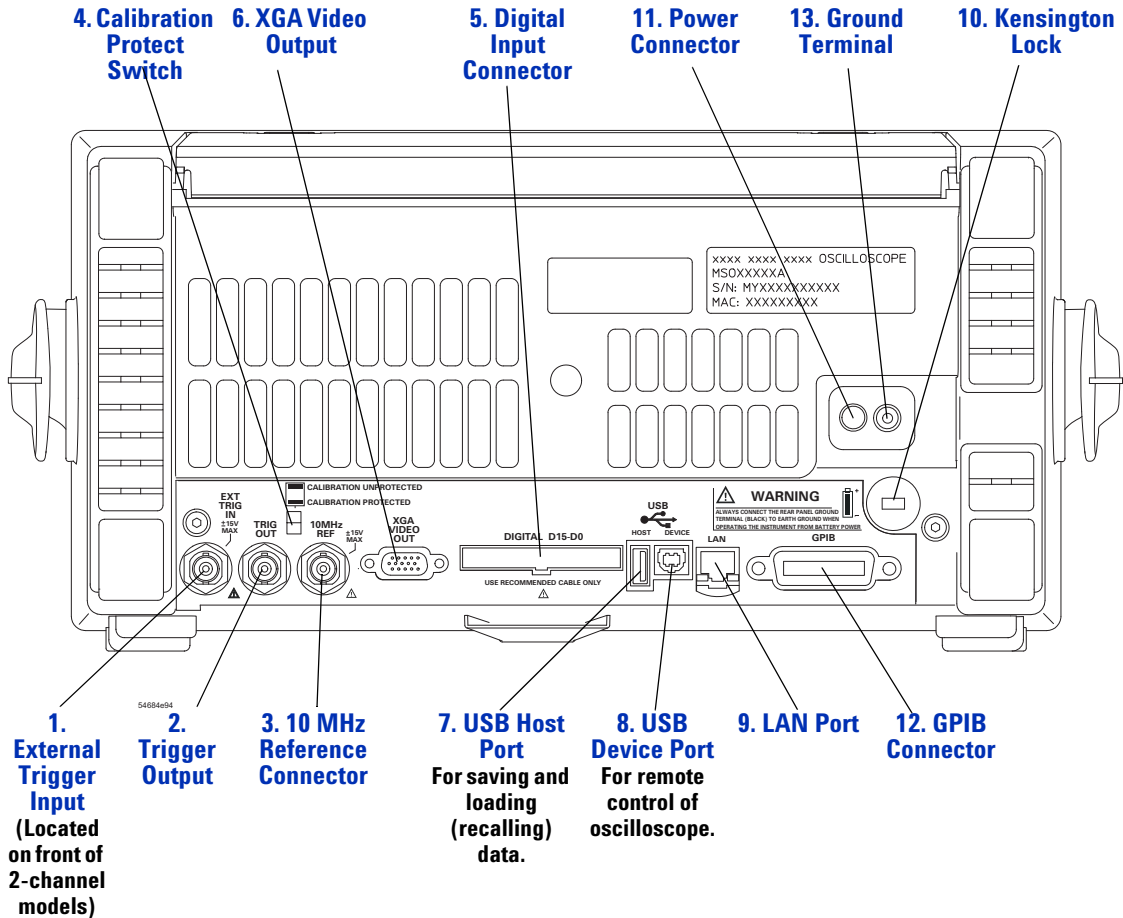

7000 Series Rear Panel (4-Channel)

Click the text for the item's description and operation information. Printed manual: refer to numbered descriptions on the following pages.

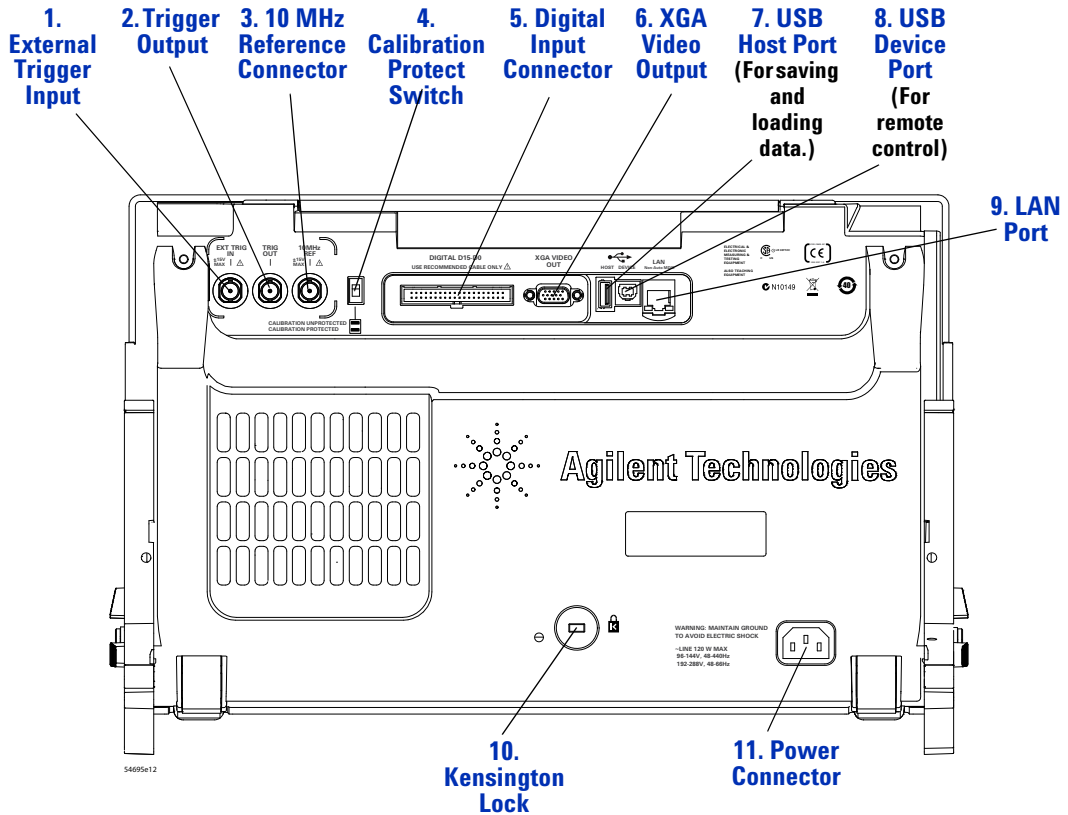

7000 Series Rear Panel (2-Channel)

The 2-channel model rear panel is the same as the 4-channel model rear panel shown on [page 366](#), except on 2-channel models, the external trigger input is on the front panel instead of the rear panel.

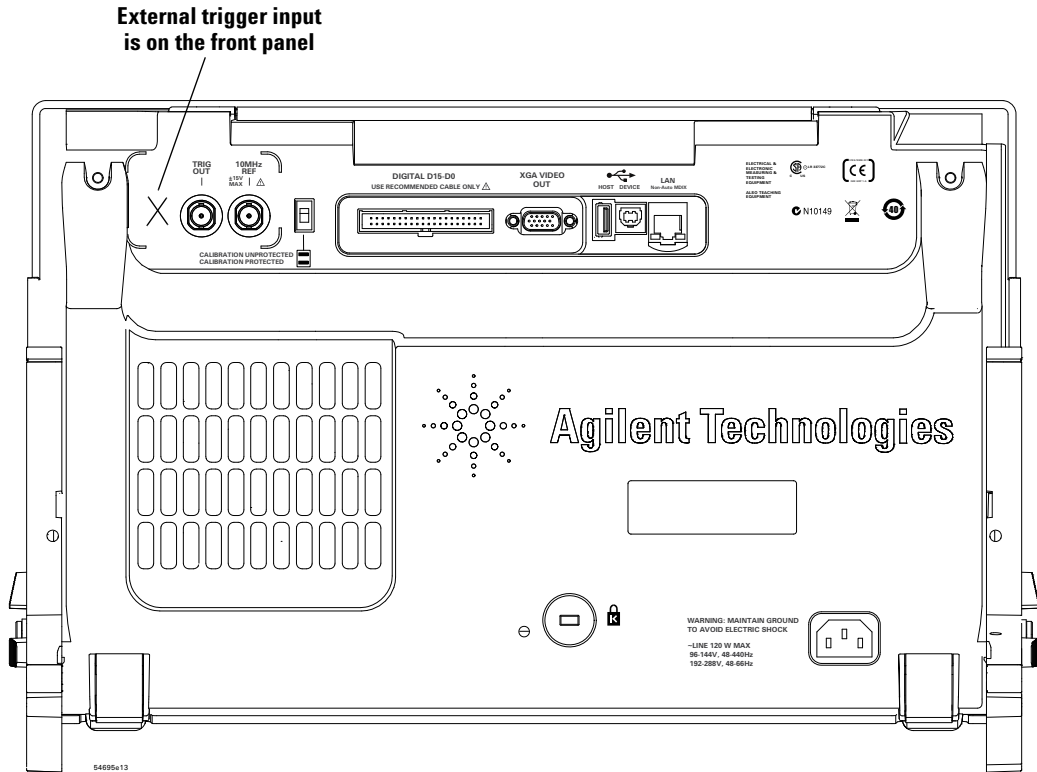

Rear Panel Control and Connector Descriptions

- 1. External Trigger Input** See [“External Trigger Input”](#) on page 92 for an explanation of this feature.
- 2. Trigger Output** See [“Trigger Output”](#) on page 95.
- 3. 10 MHz Reference Connector** See [“Using the 10 MHz reference clock”](#) on page 406.
- 4. Calibration Protect Switch** See [“User Calibration”](#) on page 394.
- 5. Digital Input Connector** Connect the digital probe cable to this connector (MSO models only).
- 6. XGA Video Output** This video output is always active. You can connect an external monitor to this connector.
- 7. USB Host Port** This port functions identically to the USB host port on the front panel. USB Host Port is used for saving data from the oscilloscope and loading software updates. See also [page 357](#).
- 8. USB Device Port** This port is for connecting the oscilloscope to a host PC. You can issue remote commands from a host PC to the oscilloscope via the USB device port. See [“Remote Programming with Agilent IO Libraries”](#) on page 284.
- 9. LAN Port** You can communicate with the oscilloscope and use the Remote Front Panel feature using the LAN port. See [“Web Interface”](#) on page 275 and [“Accessing the Web Interface”](#) on page 280.
- 10. Kensington Lock** This is where you can attach a Kensington lock for securing the instrument.
- 11. Power Connector** Attach the power cord here, or on 6000A Option BAT models attach power connector from 0950-4866 power supply.
- 12. GPIB Connector** This port is for controlling the oscilloscope via GPIB. You can issue remote commands from a host computer and retrieve data from the oscilloscope. See [“Remote Programming with Agilent IO Libraries”](#) on page 284.

12 Controls and Connectors

13. Ground Terminal Option BAT oscilloscopes: Connect the oscilloscope to earth ground using this terminal. Maintain oscilloscope ground connection. Do not negate the protective action of the ground connection to the oscilloscope. If the device under test has voltages greater than 30 Vrms, the oscilloscope must be grounded through its ground terminal to prevent electric shock to the user or damage to the oscilloscope.



13 Digital Channels

- To connect the digital probes to the device under test [372](#)
- Acquiring waveforms using the digital channels [375](#)
- To display digital channels using AutoScale [376](#)
- Interpreting the digital waveform display [378](#)
- To switch all digital channels on or off [379](#)
- To switch groups of channels on or off [379](#)
- To switch a single channel on or off [379](#)
- To change the displayed size of the digital channels [379](#)
- To reposition a digital channel [380](#)
- To change the logic threshold for digital channels [380](#)
- To display digital channels as a bus [381](#)
- Digital channel signal fidelity: Probe impedance and grounding [385](#)
- To replace digital probe leads [389](#)

This chapter describes how to use the digital channels of a Mixed-Signal Oscilloscope (MSO).



To connect the digital probes to the device under test

The digital channels are enabled on MSO6000/7000 models and DSO6000/7000 models which have the MSO upgrade license installed.

- 1 If necessary, turn off the power supply to the device under test.

Turning off power to the device under test would only prevent damage that might occur if you accidentally short two lines together while connecting probes. You can leave the oscilloscope powered on because no voltage appears at the probes.

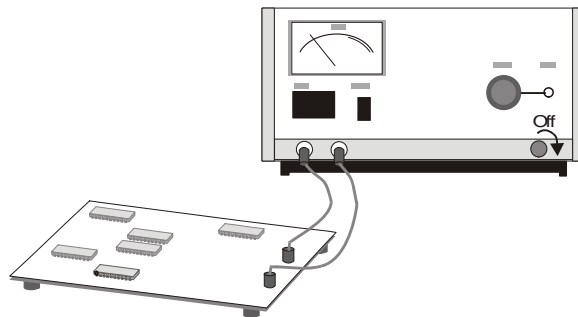

- 2 Connect the digital probe cable to the D15 - D0 connector on the rear panel of the mixed-signal oscilloscope. The digital probe cable is indexed so you can connect it only one way. You do not need to power-off the oscilloscope.

CAUTION



Probe cable for digital channels: Use only the Agilent part number 54620-68701 digital probe kit supplied with the mixed-signal oscilloscope.

- 3 Route the cable under the oscilloscope and bring it out in front.

- 4 Connect the ground lead on each set of channels (each pod), using a probe grabber. The ground lead improves signal fidelity to the oscilloscope, ensuring accurate measurements.

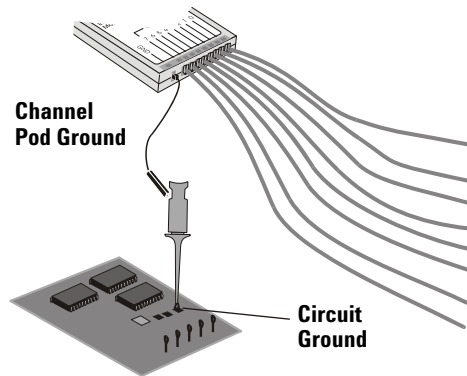

- 5 Connect a grabber to one of the probe leads. (Other probe leads are omitted from the figure for clarity.)

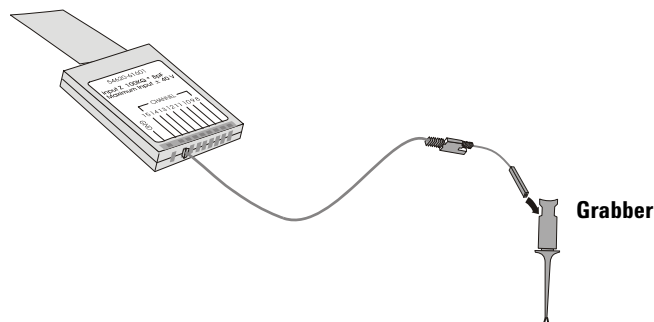

13 Digital Channels

- 6 Connect the grabber to a node in the circuit you want to test.

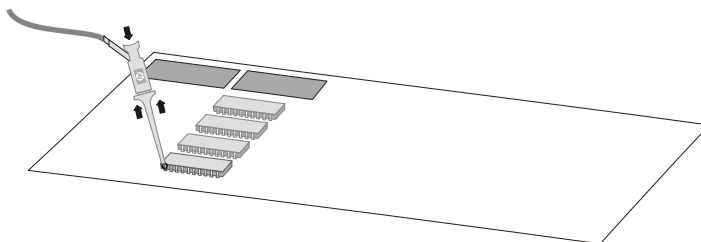

- 7 For high-speed signals, connect a ground lead to the probe lead, connect a grabber to the ground lead, and attach the grabber to ground in the device under test.

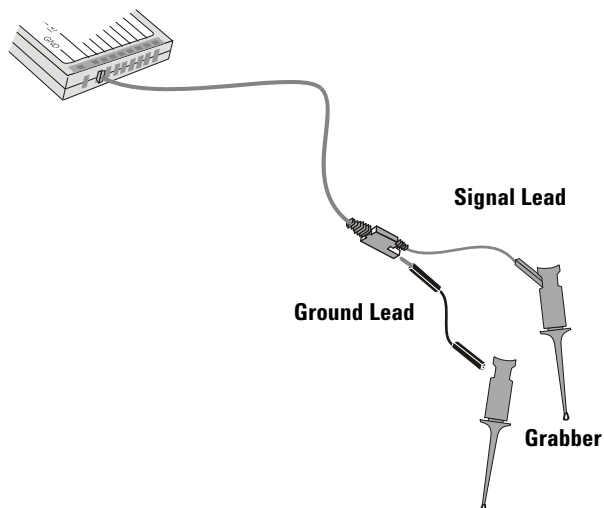

- 8 Repeat steps 3 through 6 until you have connected all points of interest.

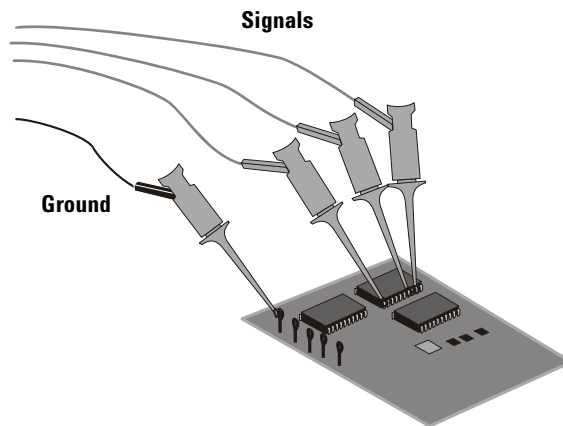

Acquiring waveforms using the digital channels

When you press **[Run/Stop]** or **[Single]** to run the oscilloscope, the oscilloscope examines the input voltage at each input probe. When the trigger conditions are met the oscilloscope triggers and displays the acquisition.

For digital channels, each time the oscilloscope takes a sample it compares the input voltage to the logic threshold. If the voltage is above the threshold, the oscilloscope stores a 1 in sample memory; otherwise, it stores a 0.

To display digital channels using AutoScale

When signals are connected to the digital channels, AutoScale quickly configures and displays the digital channels.

- To configure the instrument quickly, press the **[AutoScale]** key.

Any digital channel with an active signal will be displayed. Any digital channels without active signals will be turned off.

- To undo the effects of AutoScale, press the **Undo AutoScale** softkey before pressing any other key.

This is useful if you have unintentionally pressed the **[AutoScale]** key or do not like the settings AutoScale has selected. This will return the oscilloscope to its previous settings.

For information about how AutoScale works, see [page 177](#).

To set the instrument to the factory-default configuration, press the **[Save/Recall]** key, then press the **Default Setup** softkey.

Example

Install probe clips on channels 0 and 1 of the digital probe cable. Connect the probes for digital channels 0 and 1 to the Probe Comp output on the front panel of the instrument. Be sure to connect the ground lead to the ground lug beside the Probe Comp output. Set

the instrument to the factory default configuration by pressing the **[Save/Recall]** key, then the **Default Setup** softkey. Then press the **[AutoScale]** key. You should see a display similar to the following.

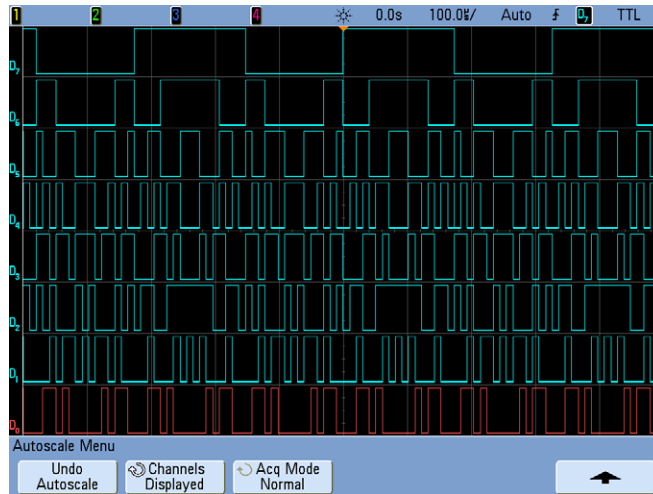
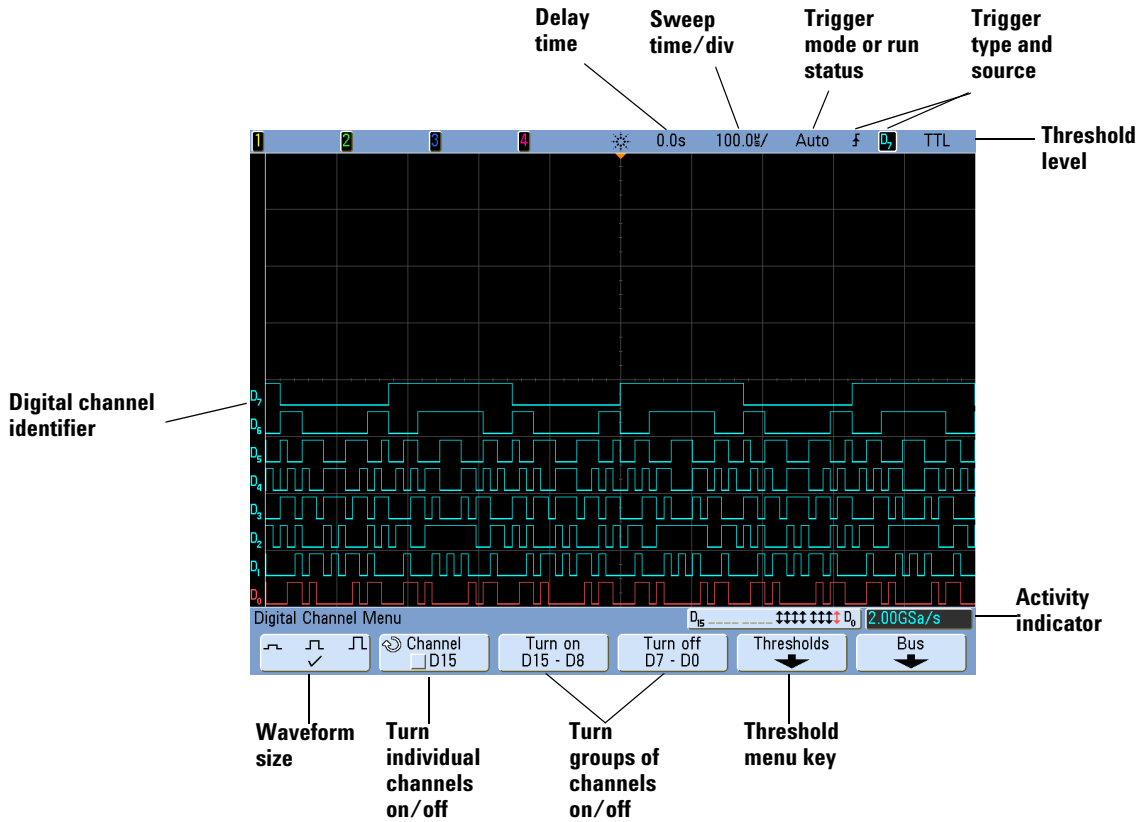

Figure 2 AutoScale of digital channels 0 through 7 (MSO models only)

Interpreting the digital waveform display



The following figure shows a typical display with digital channels.



Activity indicator

When any digital channels are turned on, an activity indicator is displayed in the status line at the bottom of the display. A digital channel can be always high (■), always low (■), or actively toggling logic states (↑↓). Any channel that is turned off will be grayed out in the activity indicator.

To change the displayed size of the digital channels

- 1 Press the [D15-D0] key.
- 2 Press the size (  ) softkey to select how the digital channels are displayed.

The sizing control lets you spread out or compress the digital traces vertically on the display for more convenient viewing.

To switch a single channel on or off

- 1 With the Digital Channel Menu displayed, rotate the Entry knob to select the desired channel from the popup menu.
- 2 Press the softkey that is directly below the popup menu to switch the selected channel on or off.

To switch all digital channels on or off

- 1 Press the [D15-D0] key to switch the display of the digital channels on or off. The Digital Channel Menu will be displayed above the softkeys.

The digital channels are displayed when this key is illuminated.

If you want to switch the digital channels off, and the Digital Channel Menu is not already displayed, you will have to push the [D15-D0] key twice to switch the digital channels off. The first push displays the Digital Channel Menu, and the second push switches the channels off.

To switch groups of channels on or off

- 1 Press the [D15-D0] key on the front panel if the Digital Channel Menu is not already displayed.
- 2 Press the **Turn off** (or **Turn on**) softkey for the **D15 - D8** group or the **D7 - D0** group.

Each time you press the softkey, the softkey's mode toggles between **Turn on** and **Turn off**.

To change the logic threshold for digital channels

- 1 Press the **[D15-D0]** key so that the Digital Channel Menu is displayed.
- 2 Press the **Thresholds** softkey
- 3 Press the **D15 - D8** or **D7 - D0** softkey, then select a logic family preset or select **User** to define your own threshold.

Logic family	Threshold Voltage
TTL	+1.4 V
CMOS	+2.5 V
ECL	-1.3 V
User	Variable from -8 V to +8 V

The threshold you set applies to all channels within the selected D15 Thru D8 or D7 Thru D0 group. Each of the two channel groups can be set to a different threshold if desired.

Values greater than the set threshold are high (1) and values less than the set threshold are low (0).

If the **Thresholds** softkey is set to **User**, press the **User** softkey for the channel group, then turn the Entry knob to set the logic threshold. There is one **User** softkey for each group of channels.

To reposition a digital channel

Press the **[D15-D0]** key to turn on the digital channels (the **[D15-D0]** key will illuminate).

On 6000 Series oscilloscopes: To select a waveform, press up or down on the **[Select]** key in the Digital controls. The selected waveform is highlighted in red. To position the selected waveform, press up or down on the **[Position]** key.

On 7000 Series oscilloscopes: To select a waveform, push the knob in the Digital controls until the **Select** indicator is lit; then, turn the knob. The selected waveform is highlighted in red. To position the selected waveform, push the knob until the **Pos** indicator is lit; then, turn the knob.

If a trace is repositioned over an existing trace the indicator at the left edge of the trace will change from **D_{nn}** designation (where nn is a one or two digit channel number from 0 to 15) to **D***. The “*” indicates that two channels are overlaid.

To display digital channels as a bus

Digital channels may be grouped and displayed as a bus, with each bus value displayed at the bottom of the display in hex or binary. You can create up to two buses. To configure and display each bus, press the **[D15-D0]** key on the front panel. Then press the **Bus** softkey.

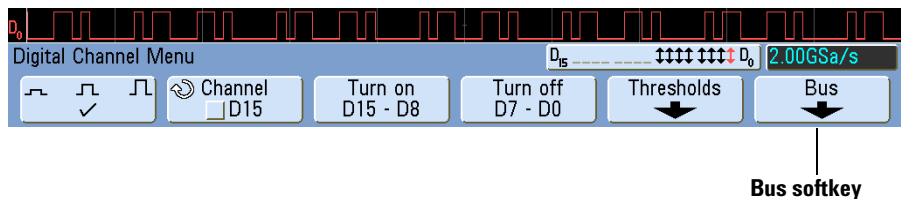

Next, select a bus. Rotate the Entry knob, then press the Entry knob or the **Bus1/Bus2** softkey to switch it on.

Use the second softkey from the left and the Entry knob to select individual channels to be included in the bus. You can rotate the Entry knob and push the softkey to select channels. You can also press the **Select/Deselect D15-D8** and **Select/Deselect D7-D0** softkeys to include or exclude groups of eight channels in each bus.

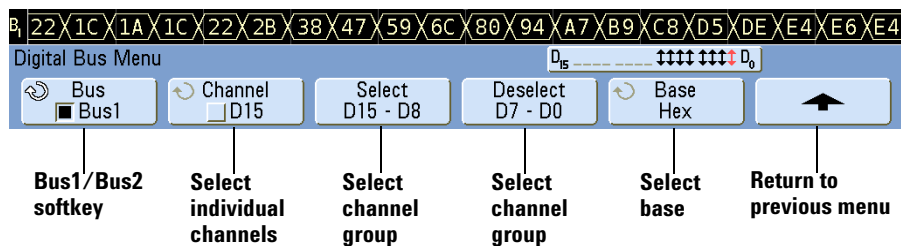

If the bus display is blank, completely white, or if the display includes “...”, you need to expand the horizontal scale to allow space for the data to be shown, or use the cursors to display the values (see [page 382](#)).

The **Base** softkey lets you choose to display the bus values in hex or binary.

13 Digital Channels

The buses are shown at the bottom of the display.

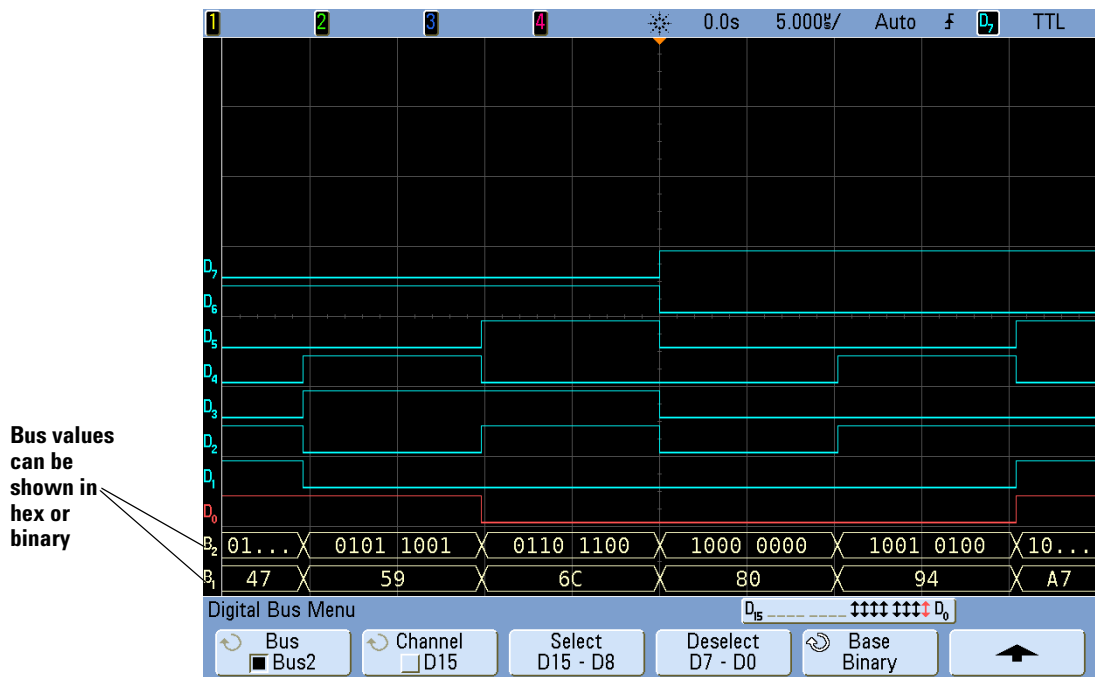

Using cursors to read bus values

To read the digital bus value at any point using the cursors:

- 1 Turn on Cursors (by pressing the [**Cursors**] key on the front panel)
- 2 Press the cursor **Mode** softkey and change the mode to **Hex** or **Binary**.
- 3 Press the **Source** softkey and select **Bus1** or **Bus2**.

- Use the Entry knob and the **X1** and **X2** softkeys to position the cursors where you want to read the bus values.

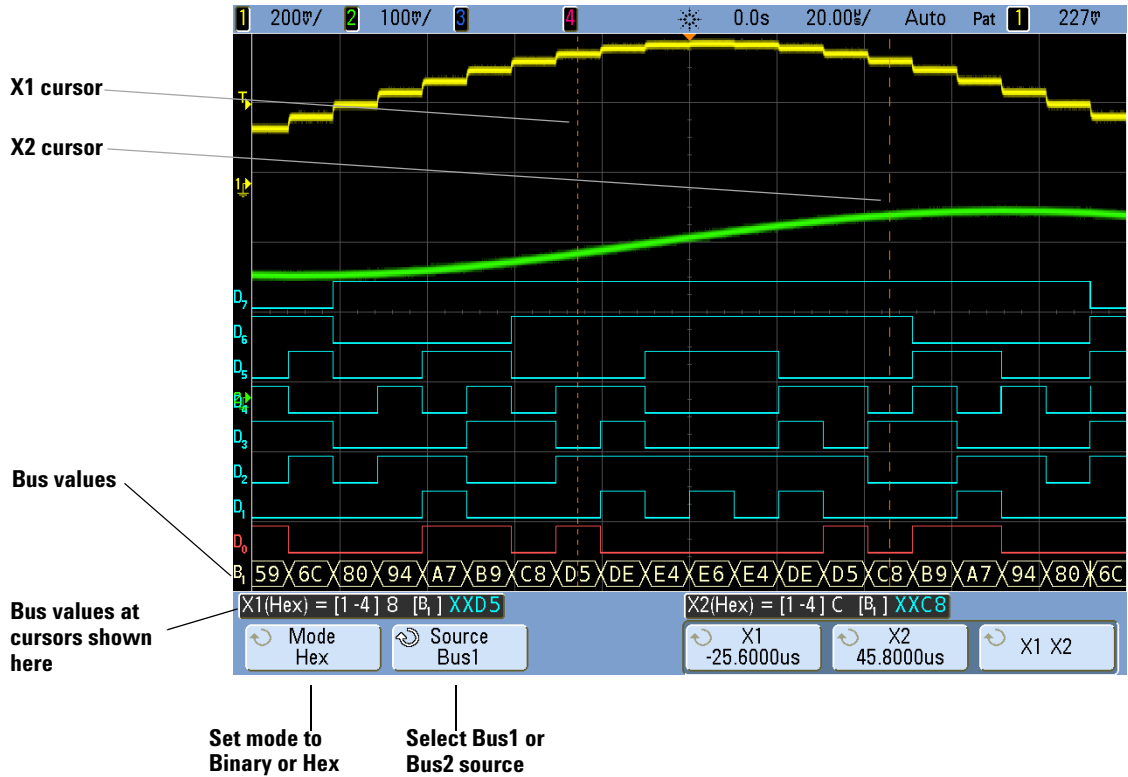

When you press the **[D15-D0]** key to display the Digital Channel Menu, the digital activity indicator is shown where the cursor values were and the bus values at the cursors are displayed in the graticule.

Bus values are displayed when using Pattern trigger

The bus values are also displayed when using the Pattern trigger function. Press the [Pattern] key on the front panel to display the Pattern Trigger Menu and the bus values will be displayed on the right, above the softkeys.

The dollar sign (\$) will be displayed in the bus value when the bus value cannot be displayed as a hex value. This occurs when one or more “don’t cares” (X) are combined with low (0) and high (1) logic levels in the pattern specification, or when a transition indicator (rising edge (⬆) or falling edge (⬇)) are included in the pattern specification. A byte that consists of all don’t cares (X) will be displayed in the bus as a don’t care (X).

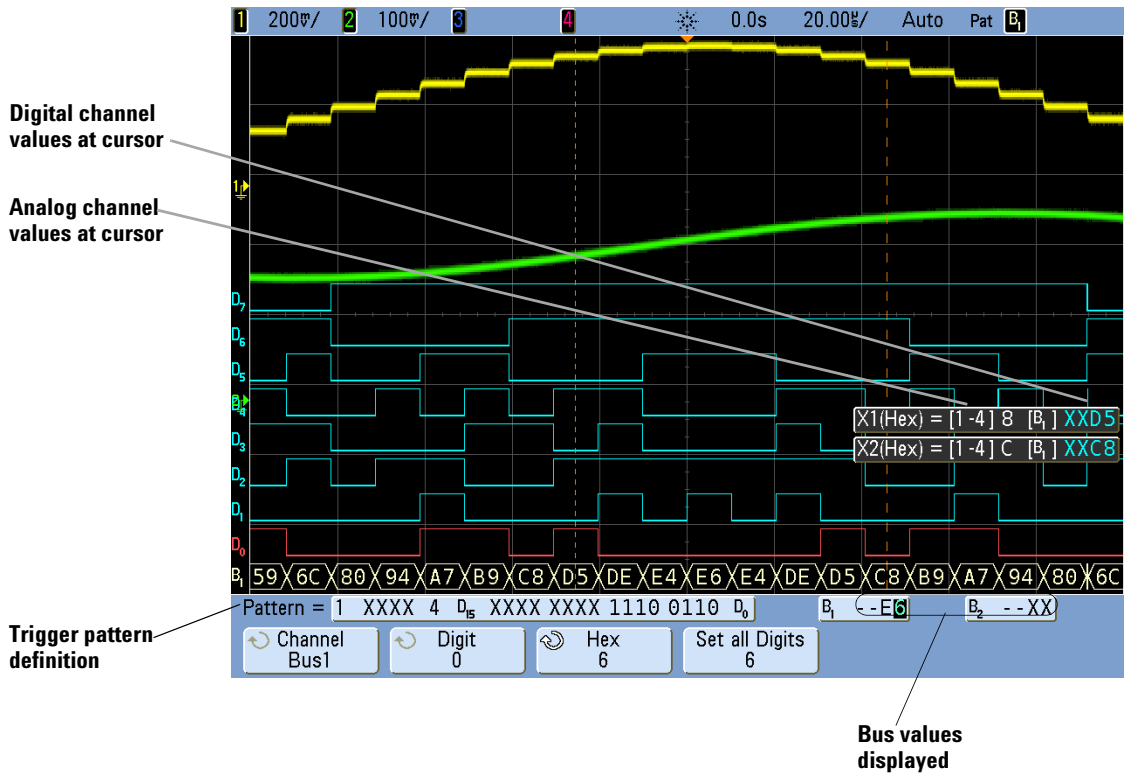

See page 137 for more information on Pattern triggering.

Digital channel signal fidelity: Probe impedance and grounding

When using the mixed-signal oscilloscope you may encounter problems that are related to probing. These problems fall into two categories: probe loading and probe grounding. Probe loading problems generally affect the device under test, while probe grounding problems affect the accuracy of the data to the measurement instrument. The design of the probes minimizes the first problem, while the second is easily addressed by good probing practices.

Input Impedance

The logic probes are passive probes, which offer high input impedance and high bandwidths. They usually provide some attenuation of the signal to the oscilloscope, typically 20 dB.

Passive probe input impedance is generally specified in terms of a parallel capacitance and resistance. The resistance is the sum of the tip resistor value and the input resistance of the test instrument (see the following figure). The capacitance is the series combination of the tip compensating capacitor and the cable, plus instrument capacitance in parallel with the stray tip capacitance to ground. While this results in an input impedance specification that is an accurate model for DC and low frequencies, the high-frequency model of the probe input is more useful (see the following figure). This high-frequency model takes into account pure tip capacitance to ground as well as series tip resistance, and the cable's characteristic impedance (Z_0).

DC AND LOW-FREQUENCY PROBE EQUIVALENT CIRCUIT

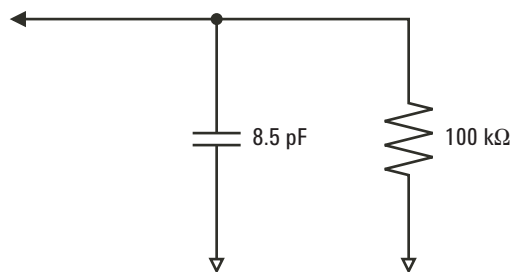

HIGH-FREQUENCY PROBE EQUIVALENT CIRCUIT

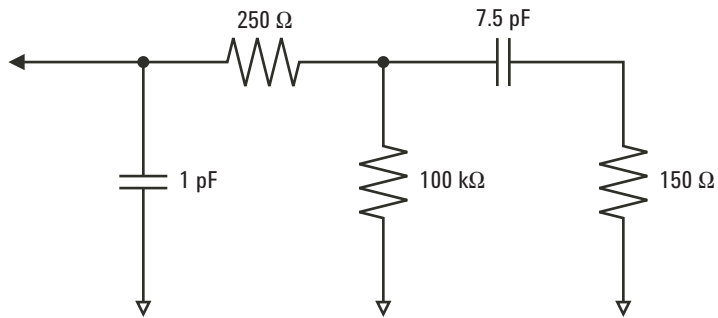

The impedance plots for the two models are shown in these figures. By comparing the two plots, you can see that both the series tip resistor and the cable's characteristic impedance extend the input impedance significantly. The stray tip capacitance, which is generally small (1 pF), sets the final break point on the impedance chart.

IMPEDANCE VERSUS FREQUENCY FOR BOTH PROBE CIRCUIT MODELS

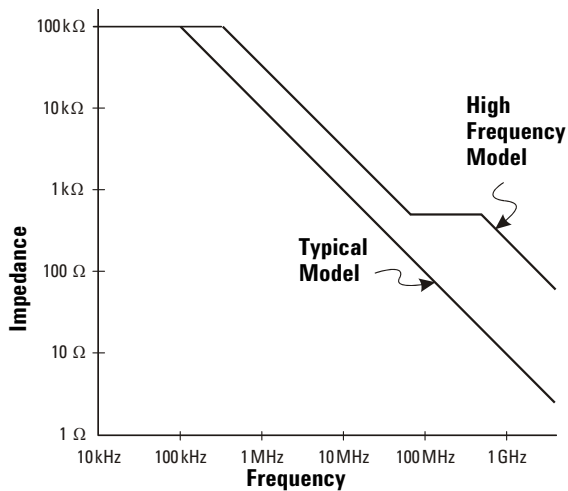

The logic probes are represented by the high-frequency circuit model shown above. They are designed to provide as much series tip resistance as possible. Stray tip capacitance to ground is minimized by the proper mechanical design of the probe tip assembly. This provides the maximum input impedance at high frequencies.

Probe Grounding

A probe ground is the low-impedance path for current to return to the source from the probe. Increased length in this path will, at high frequencies, create large common mode voltages at the probe input. The voltage generated behaves as if this path were an inductor according to the equation:

$$V = L \frac{di}{dt}$$

Increasing the ground inductance (L), increasing the current (di) or decreasing the transition time (dt), will all result in increasing the voltage (V). When this voltage exceeds the threshold voltage defined in the oscilloscope, a false data measurement will occur.

Sharing one probe ground with many probes forces all the current that flows into each probe to return through the same common ground inductance of the probe whose ground return is used. The result is increased current (di) in the above equation, and, depending on the transition time (dt), the common mode voltage may increase to a level that causes false data generation.

Common Mode Input Voltage Model

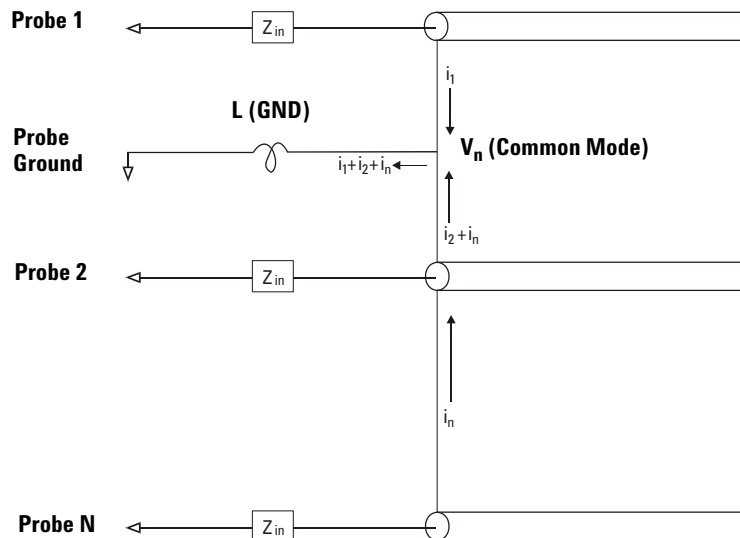

In addition to the common mode voltage, longer ground returns also degrade the pulse fidelity of the probe system. Rise time is increased, and ringing, due to the undamped LC circuit at the input of the probe, is also increased. Because the digital channels display

reconstructed waveforms, they do not show ringing and perturbations. You will not find ground problems through examination of the waveform display. In fact, it is likely you will discover the problem through random glitches or inconsistent data measurements. Use the analog channels to view ringing and perturbations.

Best Probing Practices

Because of the variables L , di , and dt , you may be unsure how much margin is available in your measurement setup. The following are guidelines for good probing practices:

- The ground lead from each digital channel group (D15–D8 and D7–D0) should be attached to the ground of the device under test if any channel within the group is being used for data capture.
- When capturing data in a noisy environment, every third digital channel probe's ground should be used in addition to the channel group's ground.
- High-speed timing measurements (rise time < 3 ns) should make use of each digital channel probe's own ground.

When designing a high-speed digital system, you should consider designing dedicated test ports that interface directly to the instrument's probe system. This will ease measurement setup and ensure a repeatable method for obtaining test data. The 01650-61607 16-channel logic probe and termination adapter is designed to make it easy to connect to industry-standard, 20-pin board connectors. This probe consists of a 2 m logic analyzer probe cable and a 01650-63203 termination adapter that provides the proper RC networks in a very convenient package. Three 20-pin, low-profile, straight board connectors are included. Additional board connectors can be ordered from Agilent Technologies.

To replace digital probe leads

If you need to remove a probe lead from the cable, insert a paper clip or other small pointed object into the side of the cable assembly, and push to release the latch while pulling out the probe lead.

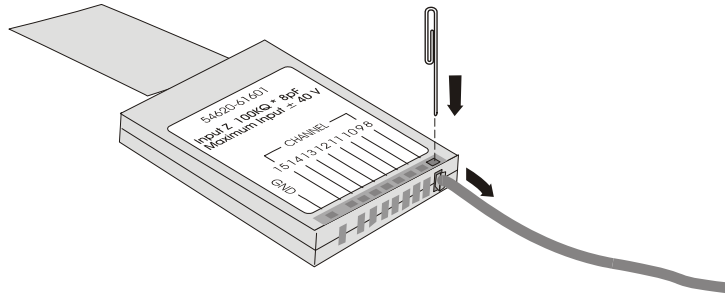

DIGITAL PROBE REPLACEMENT PARTS

Part Number	Description
54620-68701	Digital probe kit
5959-9333	Replacement probe leads (qty 5)
5959-9335	Replacement 2-inch probe ground lead (qty 5)
01650-94309	Package of probe labels
54620-61801	16-channel cable (qty 1)
5090-4833	Grabbers (qty 20)

For other replacement parts, consult the *InfiniiVision Oscilloscope Service Guides*.

13 Digital Channels



14 Utilities

To restore the oscilloscope to its default configuration **392**

To perform service functions **393**

User Calibration **394**

Self Test **397**

This chapter explains oscilloscope utilities.



To restore the oscilloscope to its default configuration

- Press the [**Save/Recall**] key, then press the **Default Setup** softkey.

The default configuration returns the oscilloscope to its default settings. This places the oscilloscope in a known operating condition. The major default settings are:

Horizontal normal mode, 100 μ s/div scale, 0 s delay, center time reference.

Vertical (Analog) Channel 1 on, 5 V/div scale, DC coupling, 0 V position, 1 M Ω impedance, probe factor to 1.0 if an AutoProbe probe is not connected to the channel.

Trigger Edge trigger, Auto sweep mode, 0 V level, channel 1 source, DC coupling, rising edge slope, 60 ns holdoff time.

Display Vectors on, 33% grid intensity, infinite persistence off.

Other Acquire mode normal, [**Run/Stop**] to Run, cursors and measurements off.

Labels All custom labels that you have created in the Label Library are preserved (not erased), but all channel labels will be set to their original names.

To perform service functions

- Press the **[Utility]→Service** to display the Service Menu.

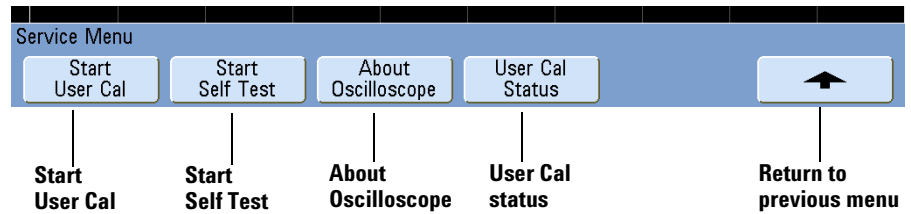

The Service Menu lets you:

- Perform User Calibration on the oscilloscope.
- View User Calibration status.
- Perform instrument Self Test.
- View information about your oscilloscope model number, code revision information, and User Calibration status.

User Calibration

Perform user-calibration:

- Each year or after 2000 hours of operation.
- If the ambient temperature is $>10^{\circ}\text{C}$ from the calibration temperature.
- If you want to maximize the measurement accuracy.

The amount of use, environmental conditions, and experience with other instruments help determine if you need shorter User Cal intervals.

User Cal performs an internal self-alignment routine to optimize the signal path in the oscilloscope. The routine uses internally generated signals to optimize circuits that affect channel sensitivity, offset, and trigger parameters. Disconnect all inputs and allow the oscilloscope to warm up before performing this procedure.

Performing User Cal will invalidate your Certificate of Calibration. If NIST (National Institute of Standards and Technology) traceability is required, perform the Performance Verification procedure in the *Agilent InfiniiVision Oscilloscopes Service Guide* using traceable sources.

To perform User Cal

- 1 Set the rear-panel CALIBRATION switch to UNPROTECTED.
- 2 Connect short (12 inch maximum) equal length cables to each analog channel's BNC connector on the front of the oscilloscope. You will need two equal-length cables for a 2-channel oscilloscope or four equal-length cables for a 4-channel oscilloscope.

Use 50Ω RG58AU or equivalent BNC cables when performing User Cal.

For a 2-channel oscilloscope, connect a BNC tee to the equal length cables. Then connect a BNC(f)-to-BNC(f) (also called a barrel connector) to the tee as shown below.

USER CALIBRATION CABLE FOR 2-CHANNEL OSCILLOSCOPE

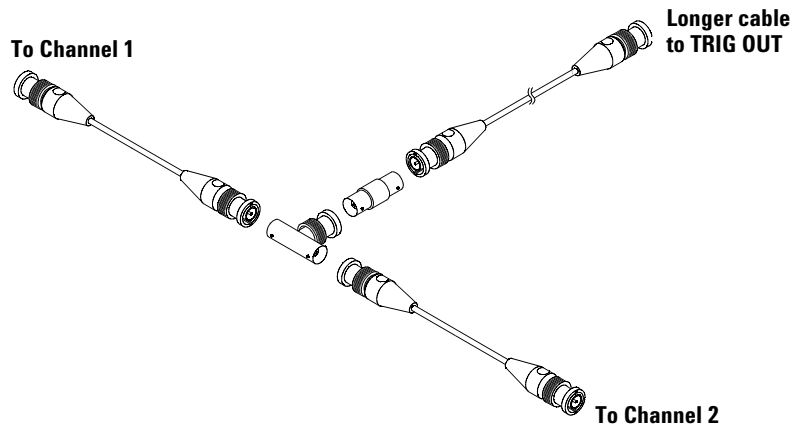

For a 4-channel oscilloscope, connect BNC tees to the equal-length cables as shown below. Then connect a BNC(f)-to-BNC(f) (barrel connector) to the tee as shown below.

USER CALIBRATION CABLE FOR 4-CHANNEL OSCILLOSCOPE

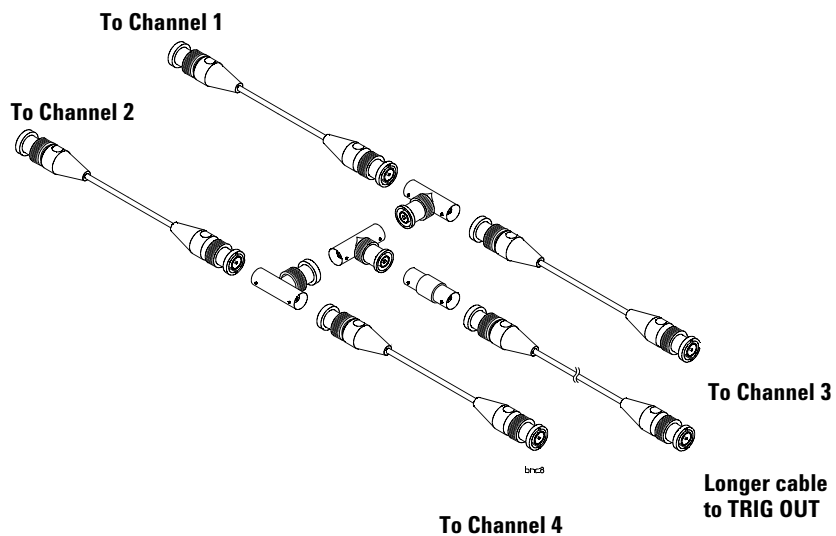

- 3 Connect a BNC cable (40 inches maximum) from the TRIG OUT connector on the rear panel to the BNC barrel connector.
- 4 Press the **[Utility]** key, then press the **Service** softkey.
- 5 Begin the Self Cal by pressing the **Start User Cal** softkey.
- 6 When the User Cal is completed, set the rear-panel CALIBRATION switch to PROTECTED.

User Cal Status

Pressing **[Utility]**→**Service**→**User Cal Status** displays the summary results of the previous User Cal, and the status of probe calibrations for probes that can be calibrated. Note that passive probes do not need to be calibrated, but InfiniiMax probes can be calibrated. For more information about calibrating probes see [page 78](#).

Results:

User Cal date:

Change in temperature since last User Cal:

Failure:

Comments:

Probe Cal Status:

Self Test

Pressing **[Utility]**→**Service**→**Start Self Test** performs a series of internal procedures to verify that the oscilloscope is operating properly.

It is recommended you run Self Test:

- after experiencing abnormal operation.
- for additional information to better describe an oscilloscope failure.
- to verify proper operation after the oscilloscope has been repaired.

Successfully passing Self Test does not guarantee 100% of the oscilloscope's functionality. Self Test is designed to provide an 80% confidence level that the oscilloscope is operating properly.



15 Reference

About Oscilloscope	400
Software and Firmware Updates	400
Installed Licenses	400
Upgrading to an MSO	401
Secure Environment Mode Option	402
Measurement Category	403
Environmental Conditions	405
Using the 10 MHz reference clock	406
To supply a sample clock to the oscilloscope	406
To synchronize the timebase of two or more instruments	408
To clean the oscilloscope	408
Binary Data (.bin) Format	409
CSV and ASCII XY files	417
Acknowledgements	418
To check warranty and extended services status	418
To return the instrument	419
Contact us	420



About Oscilloscope

Press **[Utility]→Service→About Oscilloscope** to display information about your oscilloscope model number, serial number, software version, boot version, graphics version, and installed licenses.

Software and Firmware Updates

From time to time Agilent Technologies releases software and firmware updates for its products. To search for firmware updates for your oscilloscope, direct your web browser to www.agilent.com/find/7000sw.

To view the currently installed software and firmware press **[Utility]→Service→About Oscilloscope**.

Installed Licenses

This line in the About This Oscilloscope dialog contains information about the licenses that have been installed on the oscilloscope. For example, it can show:

- **232** — UART (Universal Asynchronous Receiver/Transmitter) and RS232 (Recommended Standard 232) trigger and decode. This license provides trigger and decode capability for many UART protocols including RS232.
- **553** — MIL-STD 1553 trigger and decode. This license provides trigger and serial decode capability for MIL-STD 1553 buses.
- **ALT** — Altera FPGA Dynamic Probe. This license provides internal FPGA visibility and quick instrument setup.
- **AMS** — Automotive Serial Decode. This license provides serial decode of CAN and LIN buses.
- **FPG** — Xilinx FPGA Dynamic Probe. This license provides internal FPGA visibility and quick instrument setup.
- **FLX** — FlexRay trigger and decode (for 4 channel or 4+16 channel models only). Includes mask limit test option (LMT), segmented memory option (SGM), and FlexRay physical layer conformance test application option (FRC).
- **FRC** — FlexRay Physical Layer Conformance Test Application.
- **LMT** — Mask Limit Test. This license lets you create a mask and test waveforms to determine whether they comply to the mask.

- **LSS** — Low Speed Serial Decode. This license provides serial decode of I²C and SPI buses.
- **mem8M** — Memory Upgrade. This license is always provided with 7000 Series oscilloscopes. It shows the total memory depth (8 Mpts interleaved).
- **MSO** — Mixed Signal Oscilloscope. This license adds 16 digital channels. You do not have to install any hardware. A digital probe cable is provided for connection to your device under test.
- **PWR** — This license lets your oscilloscope communicate with software running on a PC for characterizing power devices.
- **SEC** — Secure Environment mode. This license prevents oscilloscope setup and trace information from being stored in the oscilloscope's internal memory.
- **SGM** — Segmented memory. This license lets you capture infrequent or burst signals with great resolution by eliminating the capture of your signal's "dead time."
- **SND** — I²S serial decode option (for 4 channel or 4+16 channel models only).

Upgrading to an MSO

A license can be installed to activate the digital channels of an oscilloscope that was not originally ordered as a mixed-signal oscilloscope (MSO). A mixed signal oscilloscope has analog channels plus 16 time-correlated digital timing channels.

To view the currently installed licenses press [**Utility**]→**Options**→**Licenses**→**Show license information**.

For information about upgrading your oscilloscope through licensing, contact your local Agilent Technologies representative or see www.agilent.com/find/7000.

Secure Environment Mode Option

Secure environment mode is compliant to National Industrial Security Program Operating Manual (NISPOM) Chapter 8 requirements.

Secure environment mode is called option SEC.

When secure environment mode is installed, trace and setup data are stored to internal volatile memory (rather than internal non-volatile memory). Oscilloscope setup, waveform, and trace data are erased when the power is shut off. This ensures that any setup, waveform, and trace data will not be visible to the next user upon power-up. The clock and LAN settings (and GPIB settings on 5000/6000 Series oscilloscopes) are not discarded upon power-down.

To permanently store data, you can save it to an external device through one of the oscilloscope's USB ports.

Once installed, secure environment mode cannot be disabled.

When installed, the secure environment mode license will appear as SEC in the Installed Licenses line of the "About Oscilloscope" display. To access the About Oscilloscope display, press the **[Utility]** key, then press the **Service** softkey, then press the **About Oscilloscope** softkey.

Measurement Category

Measurement Category

The InfiniiVision oscilloscopes are intended to be used for measurements in Measurement Category I.

WARNING

Use this instrument only for measurements within its specified measurement category.

Measurement Category Definitions

Measurement category I is for measurements performed on circuits not directly connected to MAINS. Examples are measurements on circuits not derived from MAINS, and specially protected (internal) MAINS derived circuits. In the latter case, transient stresses are variable; for that reason, the transient withstand capability of the equipment is made known to the user.

Measurement category II is for measurements performed on circuits directly connected to the low voltage installation. Examples are measurements on household appliances, portable tools and similar equipment.

Measurement category III is for measurements performed in the building installation. Examples are measurements on distribution boards, circuit-breakers, wiring, including cables, bus-bars, junction boxes, switches, socket-outlets in the fixed installation, and equipment for industrial use and some other equipment, for example, stationary motors with permanent connection to the fixed installation.

Measurement category IV is for measurements performed at the source of the low-voltage installation. Examples are electricity meters and measurements on primary overcurrent protection devices and ripple control units.

Transient Withstand Capability

CAUTION



Maximum input voltage at analog inputs and 2-channel external trigger input:

CAT I 300 Vrms, 400 Vpk; transient overvoltage 1.6 kVpk

CAT II 100 Vrms, 400 Vpk

50 Ω input: 5 Vrms

Input protection is enabled in 50 Ω mode and the 50 Ω load will disconnect if greater than 5 Vrms is detected. However the inputs could still be damaged, depending on the time constant of the signal. The 50 Ω input protection only functions when the oscilloscope is powered on.

1 M ohm input, 100 MHz models:

For steady-state sinusoidal waveforms derate at 20 dB/decade above 200 kHz to a minimum of 10 Vpk

1 M ohm input, 350 MHz, 500 MHz, 1 GHz models:

For steady-state sinusoidal waveforms derate at 20 dB/decade above 57 kHz to a minimum of 5 Vpk

With N2863A 10:1 probe: CAT I 600 V, CAT II 300 V (DC + peak AC)

With 10073C or 10074C 10:1 probe: CAT I 500 Vpk, CAT II 400 Vpk

CAUTION



Maximum input voltage at digital channels: ± 40 V peak CAT I; transient overvoltage 800 Vpk

Environmental Conditions

Environment Indoor use only.

Ambient temperature Operating $-10\text{ }^{\circ}\text{C}$ to $+55\text{ }^{\circ}\text{C}$;
non-operating $-40\text{ }^{\circ}\text{C}$ to $+70\text{ }^{\circ}\text{C}$

Humidity Operating 95% RH at $40\text{ }^{\circ}\text{C}$ for 24 hr; non-operating 90% RH at $65\text{ }^{\circ}\text{C}$ for 24 hr

Altitude Operating to 4,570 m (15,000 ft); non-operating to 15,244 m (50,000 ft)

Overvoltage Category This product is intended to be powered by MAINS that comply to Overvoltage Category II, which is typical of cord-and-plug connected equipment.

Pollution Degree The InfiniiVision scilloscopes may be operated in environments of Pollution Degree 2 (or Pollution Degree 1).

Pollution Degree Definitions Pollution Degree 1: No pollution or only dry, non-conductive pollution occurs. The pollution has no influence. Example: A clean room or climate controlled office environment.

Pollution Degree 2. Normally only dry non-conductive pollution occurs. Occasionally a temporary conductivity caused by condensation may occur. Example: General indoor environment.

Pollution Degree 3: Conductive pollution occurs, or dry, non-conductive pollution occurs which becomes conductive due to condensation which is expected. Example: Sheltered outdoor environment.

Using the 10 MHz reference clock

The **10 MHz REF** BNC connector on the rear panel is provided so you can:

- Supply a more accurate sample clock signal to the oscilloscope, or
- Synchronize the timebase of two or more instruments.

Sample clock and frequency counter accuracy

The oscilloscope's timebase uses a built-in reference that has an accuracy of 15 ppm. This is sufficient for most uses. However, if you are looking at a window that is very narrow compared to the selected delay (for example, looking at a 15 ns pulse with the delay set to 1 ms), significant error can be introduced.

Using the built-in sample clock, the oscilloscope's hardware frequency counter is a 5-digit counter.

Supplying an external timebase reference

When you supply an external timebase reference, the hardware frequency counter is automatically changed to an 8-digit counter. In this case, the frequency counter (**[Quick Meas]**→**Select**→**Counter**) is as accurate as the external clock.

For more information on the hardware frequency counter, see "**Counter**" on page 199.

To supply a sample clock to the oscilloscope

- 1 Connect a 10 MHz square or sine wave to the BNC connector labeled **10 MHz REF**. The amplitude must be between 180 mV and 1 V, with an offset of between 0 V and 2 V.

CAUTION



Maximum input voltage at 10 MHz REF connector: Do not apply more than ± 15 V at the 10 MHz REF BNC connector on the rear panel or damage to the instrument may occur.

- 2 Press **[Utility]**→**Options**→**Rear Panel**→**Ref Signal**.
- 3 Use the Entry Knob and the **Ref Signal** softkey to select **10 MHz input**.

A black locked padlock icon will appear at the top of the display.

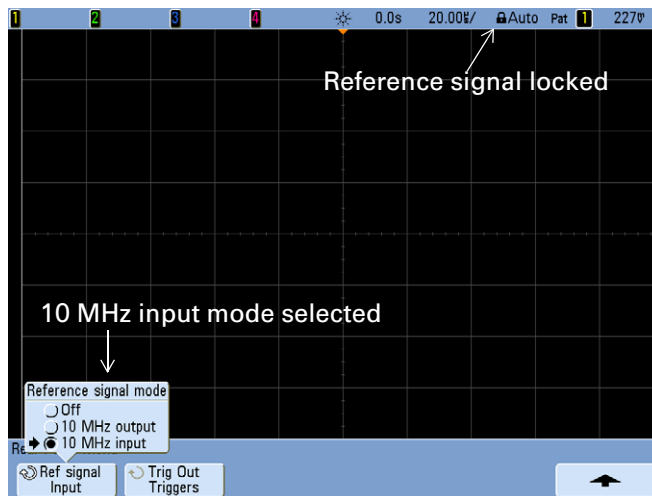

If the externally supplied sample clock varies greater than 0.5% from 10 MHz a soft unlock will occur. The oscilloscope will continue to acquire data but the lock symbol in the upper right part of the display will become a red unlocked padlock icon.

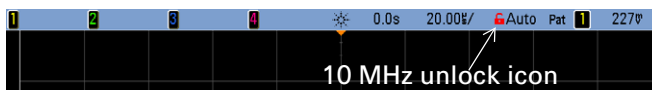

If the externally supplied sample clock signal is lost, a hard unlock will occur. The lock symbol in the upper right part of the display will become a red unlocked padlock icon and the oscilloscope will stop acquiring data. The oscilloscope will resume sampling when the externally supplied sample clock becomes stable again.

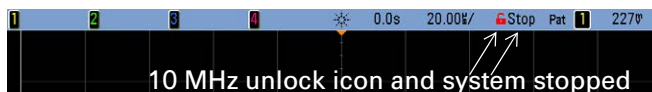

To synchronize the timebase of two or more instruments

The oscilloscope can output its 10 MHz system clock for the purpose of synchronization with other instruments.

- 1 Connect a BNC cable to the BNC connector labeled **10 MHz REF** on the rear panel of the oscilloscope.
- 2 Connect the other end of the BNC cable to the instrument(s) that will accept the 10 MHz reference signal. Put a 50 Ω termination at the input to the other instrument to terminate the signal.
- 3 Press **[Utility]→Options→Rear Panel→Ref Signal**.
- 4 Use the Entry Knob and the **Ref Signal** softkey to select **10 MHz output**.

The oscilloscope will output its 10 MHz reference signal at TTL levels.

To clean the oscilloscope

- 1 Remove power from the instrument.
- 2 Clean the external surfaces of the oscilloscope with a soft cloth dampened with a mixture of mild detergent and water.
- 3 Make sure that the instrument is completely dry before reconnecting it to a power source.

Binary Data (.bin) Format

The binary data format stores waveform data in binary format and provides data headers that describe that data.

Because the data is in binary format, the size of the file is approximately 5 times smaller than the ASCII XY format.

If more than one source is on, all displayed sources will be saved, except math functions.

When using segmented memory, each segment is treated as a separate waveform. All segments for a channel are saved, then all segments of the next (higher numbered) channel are saved. This continues until all displayed channels are saved.

When the oscilloscope is in the Peak Detect acquisition mode, the minimum and maximum value waveform data points are saved to the file in separate waveform buffers. The minimum value data points are saved first; then, the maximum value data points are saved.

BIN data - using segmented memory

When saving all segments, each segment has its own waveform header (see [page 410](#)).

In BIN file format, data are presented as follows:

- Channel 1 data (all segments)
- Channel 2 data (all segments)
- Channel 3 data (all segments)
- Channel 4 data (all segments)
- Digital channel data (all segments)
- Math waveform data (all segments)

When not saving all segments, the number of waveforms is equivalent to the number of active channels (including math and digital channels, with up to seven waveform for each digital pod). When saving all segments the number of waveforms is equal to the number of active channels multiplied by the number of segments acquired.

Binary Data in MATLAB

Binary data from an InfiniiVision oscilloscope can be imported to The MathWorks MATLAB®. You can download the appropriate MATLAB functions from the Agilent Technologies web site at www.agilent.com/find/7000sw.

Agilent provides the .m files, which need to be copied into the work directory for MATLAB. The default work directory is C:\MATLAB7\work.

Binary Header Format

File Header

There is only one file header in a binary file. The file header consists of the following information.

Cookie Two byte characters, AG, that indicate the file is in the Agilent Binary Data file format.

Version Two bytes that represent the file version.

File Size A 32-bit integer that is the number of bytes that are in the file.

Number of Waveforms A 32-bit integer that is the number of waveforms that are stored in the file.

Waveform Header

It is possible to store more than one waveform in the file, and each waveform stored will have a waveform header. When using segmented memory, each segment is treated as a separate waveform. The waveform header contains information about the type of waveform data that is stored following the waveform data header.

Header Size A 32-bit integer that is the number of bytes in the header.

Waveform Type A 32-bit integer that is the type of waveform stored in the file:

- 0 = Unknown.
- 1 = Normal.
- 2 = Peak Detect.
- 3 = Average.
- 4 = Not used in InfiniiVision oscilloscopes.
- 5 = Not used in InfiniiVision oscilloscopes.
- 6 = Logic.

Number of Waveform Buffers A 32-bit integer that is the number of waveform buffers required to read the data.

Points A 32-bit integer that is the number of waveform points in the data.

Count A 32-bit integer that is the number of hits at each time bucket in the waveform record when the waveform was created using an acquisition mode like averaging. For example, when averaging, a count of four would mean every waveform data point in the waveform record has been averaged at least four times. The default value is 0.

X Display Range A 32-bit float that is the X-axis duration of the waveform that is displayed. For time domain waveforms, it is the duration of time across the display. If the value is zero then no data has been acquired.

X Display Origin A 64-bit double that is the X-axis value at the left edge of the display. For time domain waveforms, it is the time at the start of the display. This value is treated as a double precision 64-bit floating point number. If the value is zero then no data has been acquired.

X Increment A 64-bit double that is the duration between data points on the X axis. For time domain waveforms, this is the time between points. If the value is zero then no data has been acquired.

X Origin A 64-bit double that is the X-axis value of the first data point in the data record. For time domain waveforms, it is the time of the first point. This value is treated as a double precision 64-bit floating point number. If the value is zero then no data has been acquired.

X Units A 32-bit integer that identifies the unit of measure for X values in the acquired data:

- 0 = Unknown.
- 1 = Volts.
- 2 = Seconds.
- 3 = Constant.
- 4 = Amps.
- 5 = dB.
- 6 = Hz.

Y Units A 32-bit integer that identifies the unit of measure for Y values in the acquired data. The possible values are listed above under “X Units”.

Date A 16-byte character array, left blank in InfiniiVision oscilloscopes.

Time A 16-byte character array, left blank in the InfiniiVision oscilloscopes.

Frame A 24 byte character array that is the model number and serial number of the oscilloscope in the format of: MODEL#:SERIAL#.

Waveform Label A 16 byte character array that contains the label assigned to the waveform.

Time Tags A 64-bit double, only used when saving multiple segments (requires segmented memory option). This is the time (in seconds) since the first trigger.

Segment Index A 32-bit unsigned integer. This is the segment number. Only used when saving multiple segments.

Waveform Data Header

A waveform may have more than one data set. Each waveform data set will have a waveform data header. The waveform data header consists of information about the waveform data set. This header is stored immediately before the data set.

Waveform Data Header Size A 32-bit integer that is the size of the waveform data header.

Buffer Type A 16-bit short that is the type of waveform data stored in the file:

- 0 = Unknown data.
- 1 = Normal 32-bit float data.
- 2 = Maximum float data.
- 3 = Minimum float data.
- 4 = Not used in InfiniiVision oscilloscopes.
- 5 = Not used in InfiniiVision oscilloscopes.
- 6 = Digital unsigned 8-bit char data (for digital channels).

Bytes Per Point A 16-bit short that is the number of bytes per data point.

Buffer Size A 32-bit integer that is the size of the buffer required to hold the data points.

Example Program for Reading Binary Data

To find an example program for reading binary data, direct your web browser to www.agilent.com/find/7000sw, and select “Example Program for Reading Binary Data”.

Examples of Binary Files

Single Acquisition Multiple Analog Channels

The following picture shows a binary file of a single acquisition with multiple analog channels.

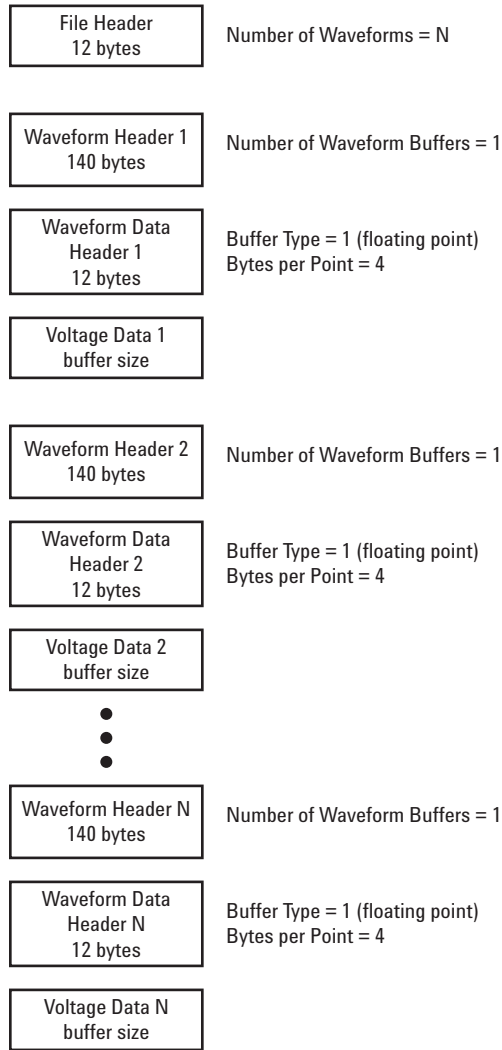

Single Acquisition All Pods Logic Channels

The following picture shows a binary file of a single acquisition with all pods for the logic channels saved.

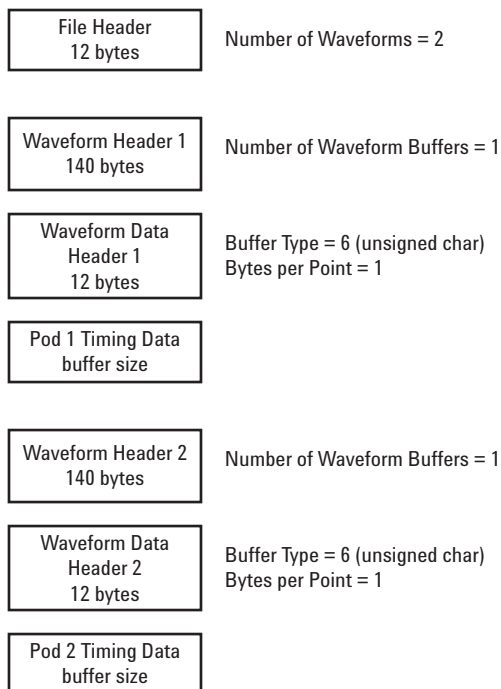

15 Reference

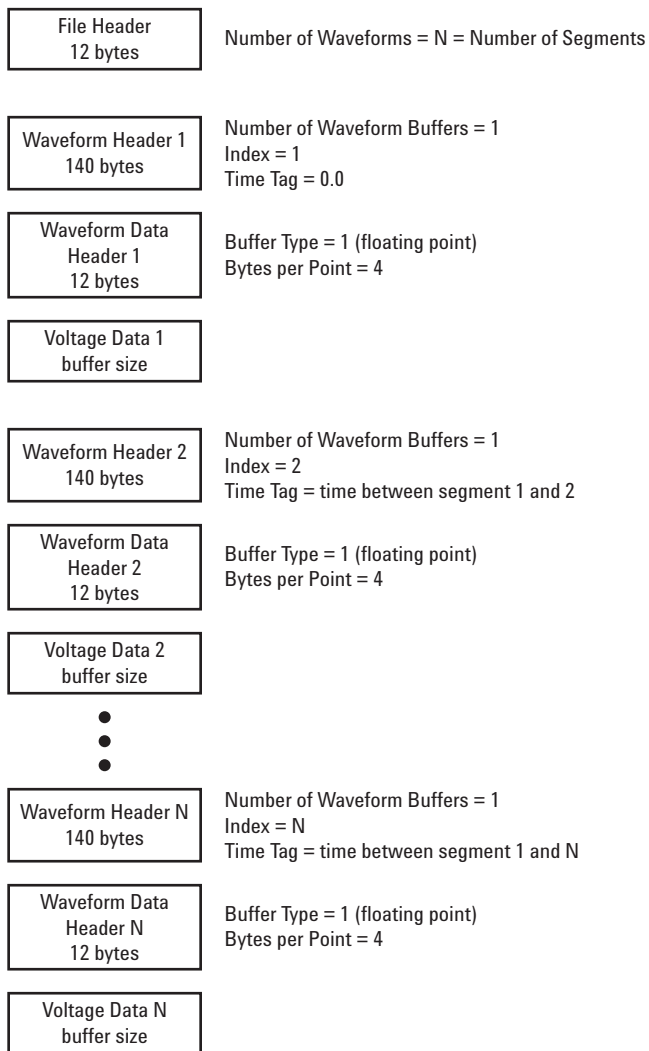

CSV and ASCII XY files

CSV and ASCII XY file structure

In CSV or ASCII XY format the **Length** control selects the number of points per segment. All segments are contained in the CSV file or in each ASCII XY data file.

For example: If the Length control is set to 1000 points, there will be 1000 points (rows in the spreadsheet) per segment. When saving all segments there are three header rows, so the data for the first segment starts at row 4. The second segment's data starts at row 1004. The time column shows the time since the trigger on the first segment. The top row shows the selected number of points per segment.

BIN files are a more efficient data transfer format than CSV or ASCII XY. Use this file format for fastest data transfer.

Minimum and Maximum Values in CSV Files

If you are running a Quick Measurement Minimum or Maximum measurement, the minimum and maximum values shown in the Quick Measurement display may not appear in the CSV file.

Explanation:

When the oscilloscope's sample rate is 4 GSa/s, a sample will be taken every 250 ps. If the sweep speed is set to 100 ns/div, there will be 1000 ns of data displayed (because there are ten divisions across the screen). To find the total number of samples the oscilloscope will take:

$$1000ns \times 4Gsa/s = 4000samples$$

For measurement data, the oscilloscope will decimate the 4000 points to 1000 points that will fit on the display. This decimation will not lose track of the min and max values at each of the 1000 horizontal data points, and min and max values will be displayed on screen. However, the oversampled data is also processed to provide a best-estimate value at each of the 1000 horizontal points. The data in the CSV file will be the best-estimate value at each of the 1000 horizontal points. Therefore, the min and max values may not appear in the CSV file.

This occurs when oversampling occurs
(10 * seconds per division * maximum sample rate > 1000).

Acknowledgements

RealVNC is licensed under the GNU General Public License. Copyright (C) 2002-2005 RealVNC Ltd. All Rights Reserved.

This is free software; you can redistribute it and/or modify it under the terms of the GNU General Public License as published by the Free Software Foundation; either version 2 of the License, or (at your option) any later version.

This software is distributed in the hope that it will be useful, but WITHOUT ANY WARRANTY; without even the implied warranty of MERCHANTABILITY or FITNESS FOR A PARTICULAR PURPOSE. See the GNU General Public License for more details. The license is located on the Agilent InfiniiVision Oscilloscopes Documentation CD-ROM.

RealVNC source code can be obtained from RealVNC or by contacting Agilent. Agilent will charge for the cost of physically performing the source distribution.

To check warranty and extended services status

To learn the warranty status of your oscilloscope:

- 1 Point your web browser to: www.agilent.com/find/warrantystatus
- 2 Enter your product's model number and serial number. The system will search for the warranty status of your product and display the results. If the system cannot find your product's warranty status, select **Contact Us** and speak with an Agilent Technologies representative.

To return the instrument

Before shipping the oscilloscope to Agilent Technologies, contact your nearest Agilent Technologies sales or service office for additional details. Information on contacting Agilent Technologies can be found at www.agilent.com/find/contactus.

1 Write the following information on a tag and attach it to the oscilloscope.

- Name and address of owner
- Model number
- Serial number
- Description of service required or failure indication

2 Remove accessories from the oscilloscope.

Only return accessories to Agilent Technologies if they are associated with the failure symptoms.

3 Package the oscilloscope.

You can use the original shipping container, or provide your own materials sufficient to protect the instrument during shipping.

4 Seal the shipping container securely, and mark it FRAGILE.

Contact us

Americas

Canada (877) 894-4414
Latin America 305 269 7500
United States (800) 829-4444

Asia Pacific

Australia 1 800 629 485
China 800 810 0189
Hong Kong 800 938 693
India 1 800 112 929
Japan 81 426 56 7832
Korea 080 769 0800
Malaysia 1 800 888 848
Singapore 1 800 375 8100
Taiwan 0800 047 866
Thailand 1 800 226 008

Europe

Austria 0820 87 44 11
Belgium 32 (0) 2 404 93 40
Denmark 45 70 13 15 15
Finland 358 (0) 10 855 2100
France 0825 010 700
Germany 01805 24 6333*
*0.14€/minute
Ireland 1890 924 204
Italy 39 02 92 60 8484
Netherlands 31 (0) 20 547 2111
Spain 34 (91) 631 3300
Sweden 0200-88 22 55
Switzerland (French)
44 (21) 8113811 (Opt 2)
Switzerland (German)
0800 80 53 53 (Opt 1)
United Kingdom 44 (0) 7004 666666

Other European countries:

www.agilent.com/find/contactus

Index

Symbols

- (-)Width measurement, 202
- (+)Width measurement, 202

Numerics

- 1 M ohm input impedance, 61
- 10 MHz reference clock, 406
- 1-2 math function, 228
- 232 Option, 24, 400
- 50 ohm input impedance, 61
- 553 Option, 400

A

- About Oscilloscope, 400
- AC adapter, 52
- AC channel coupling, 61
- accessories, 28, 34, 36
- acquire, 261, 267
- acquisition mode, 265
 - averaging, 267
 - high resolution, 266
 - normal, 265
 - peak detect, 266
- acquisition modes, 261
- acquisition option
 - realtime, 269
- active probes, 74
- active serial bus, 299, 308, 312, 317, 327, 333
- activity indicator, 378
- adding digital channels license, 401
- addition math function, 228
- address with no ack condition, I2C trigger, 117
- Addresses softkey, 277

- adjust the feet, 36
- aliasing, FFT, 236
- ALT Option, 24, 400
- Amplitude measurement, 206
- AMS Option, 24, 400
- analog channel
 - probe attenuation, 63
 - setup, 59
- analog filters, adjusting, 236
- analyze segments, 196, 273
- ASCII file format, 251
- attenuation, probe, 63, 92
- attenuators, 78
- Auto Increment, 250
- Auto trigger indicator, 85, 359
- auto trigger mode, 84, 85
- Auto? trigger indicator, 85
- AutoIP, 276
- automatic measurements, 192, 193
- automatic setup, 376
- AutoProbe, 61, 357
 - external trigger, 92
- AutoScale
 - acquisition mode, 178
 - channels, 178
 - digital channels, 376
 - fast debug, 178
 - undo, 177
- AutoScale key, 360
- auto-single, 264
- Average measurement, 207
- averaging acquire mode, 265, 267

B

- bandwidth limit, 62
- bandwidth, oscilloscope, 269

- Base measurement, 207
- BAT option, 49
- battery
 - charging, 52
 - life, 50
 - power indicator, 50
 - replacement, 52
 - warranty, 52
- battery indicators, 361
- BIN file format, 251
- binary data (.bin), 409
- binary data file examples, 414
- binary data in MATLAB, 409
- binary data, example program for reading, 413
- bits, SPI trigger, 155
- Blackman Harris FFT, 239
- blanking, 69, 222
- BMP file format, 250
- boot version, 400
- brackets, 6000L, 46
- brightness of waveforms, 358
- Browser Web Control, 281, 283
- built-in help system, 55
- burst
 - capture signal bursts, 271
- bus display mode, 381
- buttons
 - 5000/6000 Series, 352, 353
 - 6000L Series, 354
 - 7000 Series, 355, 356

C

- calibrate probe, 63
- calibration, 394

Index

- calibration protect switch
 - 5000 Series, 362
 - 6000 Series, 364
 - 6000-BAT Series, 364, 366
 - 7000 Series, 367
 - calibration status, 287
 - CAN decode
 - source channels, 297
 - CAN frame counter, 299
 - CAN serial decode, 295, 302
 - CAN Signals Menu, 296
 - CAN totalizer, 299
 - CAN trigger, 98
 - CAN trigger types, additional, 98
 - capture signal bursts, 271
 - caution indicator, 50
 - Center, FFT, 239
 - channel
 - analog, 59
 - bandwidth limit, 62
 - coupling, 61
 - fine adjustment, 60
 - invert, 62
 - on/off keys, 358
 - position, 60
 - probe units, 62
 - skew, 63
 - vertical sensitivity, 60
 - channel labels, 183
 - channel pair, 269
 - characteristics, 23
 - charging indicator, 50, 52
 - Chinese GUI, 56
 - choosing values, 53
 - cleaning, 408
 - clear display, 113, 182
 - clock, 57
 - CMOS threshold, 380
 - comparison of measurement results, 256
 - compensate probes, 357
 - compensating your probe, 77
 - Config softkey, 277
 - connect probes
 - digital, 372
 - connect the dots, 187
 - connection
 - to a PC, 278
 - connectors
 - 5000 Series, 362, 363
 - 6000 Series, 364, 365
 - 6000-BAT Series, 364, 366
 - 7000 Series, 367, 368
 - controls
 - 5000/6000 Series, 352, 353
 - 6000L Series, 354
 - 7000 Series, 355, 356
 - conventions
 - in softkey menus, 176
 - Counter measurement, 199
 - counter, CAN frame, 299
 - counter, FlexRay frame, 304
 - counter, UART/RS232 frame, 334
 - coupling, channel, 61
 - crossover cable, 28
 - crosstalk problems, 236
 - CSV file format, 250
 - cursor measurements, 214
 - cursors
 - binary, 215
 - hex, 215
 - manual, 215
 - track waveform, 215
- ## D
- D*, 359, 381
 - d/dt math function, 230
 - damage, shipping, 28
 - data sheet, 23
 - DC channel coupling, 61
 - dead time (re-arm), 273
 - default configuration, 392
 - default label library, 186
 - default setup, 392
 - delay knob, 65
 - Delay measurement, 203
 - delay measurements, 192
 - delay time indicator, 65
 - delayed, 95
 - delayed mode, 66
 - delayed sweep, 66
 - delete character, 250
 - delete file, 257
 - DHCP, 276
 - differentiate math function, 230
 - Digit softkey, 139
 - digital bus mode, 381
 - digital channel controls, 358
 - digital channel menu, 379
 - digital channels, 26, 379
 - AutoScale, 376
 - enabling, 401
 - logic threshold, 380
 - probing, 385
 - size, 379
 - digital display, interpreting, 378
 - digital probes, 372, 385
 - impedance, 385
 - dimensions, 6000L, 46
 - display, 175, 360
 - area, 175
 - clear, 182
 - infinite persistence, 182
 - interpreting, 175
 - measurement line, 175
 - signal detail, 180
 - softkeys, 175
 - status line, 175
 - vectors, 188
 - display multiple acquisitions, 262
 - distortion problems, 236
 - DNS IP, 277
 - domain, 277
 - Domain softkey, 277
 - DSO, 21
 - duration trigger, 102
 - Duty cycle measurement, 200
- ## E
- ECL threshold, 380
 - edge triggering, 105

EEPROM data read, I2C trigger, 117
 energy of a pulse, 232
 Entry knob, 53, 176, 360
 event table, 293
 expand about, 60, 187
 expand about center, 187
 expand about ground, 187
 exporting waveform, 247
 external memory device, 357
 external timebase, 406
 external trigger, 92

- input impedance, 93, 94
- probe attenuation, 92
- probe settings, 92
- probe units, 93

 Extinction Ratio measurement, 207
 eye diagrams, 269

F

f(t), 225
 factory default configuration, 392
 Fall time measurement, 201
 feet, 36
 FFT measurements, 236
 FFT window, 238
 file

- save, recall, load, 257

 file browser, save to, 248
 file explorer, 248, 257

- using, 258

 file format

- ASCII, 251
- BIN, 251
- BMP, 250
- CSV, 250
- PNG, 250

 file keys, 359
 file name, new, 249
 fine adjustment, channel, 60
 fine adjustment, sweep speed, 65
 firmware updates, 400
 firmware upgrade files, 287
 firmware version information, 275

firmware versions, 287
 flash drive, 357
 Flat top window, 238
 FlexRay frame counter, 304
 FlexRay serial decode, 302
 FlexRay totalizer, 304
 FlexRay trigger, 108
 FLX Option, 400
 FPG Option, 24, 400
 FR2 Option, 400
 frame mode

- segmented memory, 271

 frame trigger, I2C, 118
 Frequency measurement, 200
 front panel

- 5000/6000 Series, 352, 353
- 6000L Series, 354
- 7000 Series, 355, 356
- language overlay, 40

 front panel keys, 53
 FRS Option, 24

G

g(t), 225
 gateway IP, 277
 glitch capture, 112
 glitch trigger, 140
 golden waveform test, 337
 grabber, 373, 374
 graphic symbols in menus, 176
 graphical user interface languages, 56
 graphics version, 400
 graticule intensity, 181
 grid intensity, 181
 ground level, 60
 ground post, 51
 ground wire, 51

H

Hanning window, 238
 HDTV trigger, 156
 help system, built-in, 55

hex bus trigger, 139
 Hex softkey, 139
 HF Reject, 87, 88
 high-frequency noise rejection, 88
 high-resolution mode, 265, 266
 holdoff, 90
 horizontal controls, 64
 horizontal fine adjustment, 65
 horizontal Menu/Zoom key, 360
 horizontal position control, 360
 horizontal sweep speed control, 360
 horizontal time/div control, 360
 host name, 275, 277

I

I2C serial decode, 302, 306
 I2C Signals Menu, 307
 I2C trigger, 115
 I2S serial decode, 310, 320
 I2S trigger, 121, 133
 idle serial bus, 299, 308, 312, 317, 327, 333
 Imped softkey, 61
 impedance

- digital probes, 385
- external trigger, 94

 increment statistics, 196
 indeterminate state, 216
 indicator

- LAN status, 361

 indicators, battery-powered oscilloscopes, 49
 infinite persistence, 112, 182, 262
 infrequent triggers, 269
 input impedance

- channel input, 61
- external trigger, 94

 installed licenses, 400
 installed options, 287
 instantaneous slope of a waveform, 230
 Instrument Utilities web page, 287
 Integrate math function, 232
 intensity control, 180, 358

Index

invert, [62](#)
invert graticule colors, [251](#)
IP address, [275, 277](#)

J

Japanese GUI, [56](#)

K

keys, [53](#)
 5000/6000 Series, [352, 353](#)
 6000L Series, [354](#)
 7000 Series, [355, 356](#)
Knob softkey, [69](#)
knobs
 5000/6000 Series, [352, 353](#)
 6000L Series, [354](#)
 7000 Series, [355, 356](#)
Korean GUI, [56](#)

L

label key, [358](#)
label list, [186](#)
label list, loading from text file, [185](#)
labels, [183](#)
 auto-increment, [185](#)
 default library, [186](#)
LAN connection, [276, 277](#)
LAN reset, [278](#)
LAN Settings softkey, [277](#)
LAN status indicator, [361](#)
landscape mode, [246](#)
language, Quick Help, [56](#)
languages
 graphical user interface, [56](#)
length control, [252](#)
length softkey, [252](#)
LF Reject, [87, 89](#)
library, labels, [184](#)
licenses, [24, 400, 401](#)
LIN serial decode, [314](#)
LIN Signals Menu, [315](#)
LIN trigger, [128](#)

line power, [48](#)
Lister, [293](#)
LMT Option, [24, 400](#)
load file, [257](#)
localized front panel overlay, [40](#)
Location, [248](#)
logic threshold, [380](#)
low-frequency noise rejection, [89](#)
LSS license, [400](#)
LSS Option, [24, 401](#)

M

Main/Delayed key, [64, 66, 68, 114, 220](#)
mask test, [337](#)
 trigger output, [342](#)
mask testing, [337](#)
math
 1*2, [227](#)
 1-2, [228](#)
 addition, [228](#)
 differentiate, [230](#)
 FFT, [236](#)
 functions, [224](#)
 functions on arithmetic operations, [225](#)
 integrate, [232](#)
 measurements, [206](#)
 multiply, [227](#)
 offset, [225](#)
 scale, [225](#)
 subtract, [228](#)
 units, [225, 226](#)
 using waveform math, [224](#)
math key, [358](#)
MATLAB binary data, [409](#)
Maximum measurement, [207](#)
maximum sample rate, [269](#)
measure keys, [361](#)
measurement category
 definitions, [403](#)
measurement definitions, [199](#)
measurement line, [175](#)
measurement statistics, [194](#)
measurement thresholds, [197](#)

measurement window, zoomed time
 base, [68](#)
measurements, [243](#)
 automatic, [193](#)
 delay, [192](#)
 overshoot, [193](#)
 phase, [192](#)
 preshoot, [193](#)
 time, [192](#)
 voltage, [192](#)
MegaZoom III, [22](#)
mem2M license, [400](#)
mem8M, [401](#)
mem8M license, [400](#)
memory depth, [263](#)
memory, segmented, [271](#)
Menu/Zoom key, [360](#)
MIL-STD 1553 license, [400](#)
MIL-STD 1553, probing signals, [131](#)
Minimum measurement, [207](#)
missing acknowledge condition, I2C
 trigger, [117](#)
Mode/Coupling key, trigger, [84](#)
model number, [275, 400](#)
Modify softkey, [277](#)
mounting 6000L, [46](#)
MSO, [21](#)
MSO feature upgrade, [401](#)
MSO license, [400](#)
MSO Option, [24, 401](#)
MST Option, [24](#)
Multiply math function, [227](#)

N

N2791A 25 MHz differential active
 probe, [131](#)
N5429A 12V DC automotive adapter
 cable, [52](#)
navigate files, [257](#)
network
 connecting to, [276](#)
network configuration parameters, [275](#)
network status information, [275](#)

- new label, 184
 - noise
 - high-frequency, 88, 89
 - low-frequency, 89
 - noise rejection, 89
 - normal acquire mode, 265
 - normal horizontal mode, 64
 - normal mode, 265
 - Normal trigger mode, 84, 85, 359
 - Nth Edge 2, 147
 - Nth Edge 2 (no re-find), 147
 - Nth edge burst trigger, 135
 - Nth edge burst triggering, 135
- O**
- option SEC, 402
 - options, print, 245
 - output
 - trigger, 95
 - overlay, localized, 40
 - Overshoot measurement, 212
 - overshoot measurements, 193
 - overvoltage category, 405
- P**
- palette, 252
 - pan and zoom, 179
 - parts, replacement, 389
 - passive probes, 73
 - password
 - reset, 289
 - set, 288
 - pattern
 - duration trigger, 102
 - pattern trigger, 137
 - SPI trigger, 155
 - pattern trigger, 137
 - PC connection, 278
 - peak detect acquisition mode, 112
 - peak detect mode, 265, 266
 - Peak-peak measurement, 208
 - Period measurement, 201
 - persistence, infinite, 262
 - Phase measurement, 204
 - phase measurements, 192
 - PNG file format, 250
 - point-to-point connection, 278
 - pollution degree, 405
 - definitions, 405
 - position digital channels, 358, 380
 - position knob, 358, 380
 - position, analog, 60
 - post-processing, 213
 - power consumption, 48
 - power requirements, 48
 - power supply, 369
 - power switch, 49, 51, 357
 - power-on, 49
 - predefined labels, 184
 - Preset, FFT, 238
 - Preshoot measurement, 211
 - preshoot measurements, 193
 - Press to go, 248
 - print, 244
 - landscape, 246
 - Quick Print, 244
 - print options, 245
 - print screen, 244
 - printer
 - USB, 244, 245, 357
 - printers
 - supported, 245
 - printing the display, 244
 - probe
 - AutoProbe interface, 357
 - calibrate, 63
 - probe attenuation, 63, 92
 - probe compensation, 357
 - probe head, 78
 - probe units, 62, 93
- Q**
- qualifier, 141
 - Quick Help, 55
 - updates, 56
 - Quick Help language, 56
 - Quick Meas, 192
 - quick meas, 192
 - Quick Meas key, 193
 - Quick Print, 244
- R**
- random noise, 87
 - ratio measurement, 208
 - realtime acquisition option, 269
 - Realtime sampling and bandwidth, 269
 - rear panel
 - 10 MHz reference, 406
 - 5000 Series, 362, 363
 - 6000 Series, 364, 365
 - 6000-BAT Series, 364
 - 6000-BATSeries, 366
 - 7000 Series, 367, 368
 - re-arm time, 273
 - recall waveform, 256
 - recall waveform and setup, 256
 - record length, 263
 - Rectangular window, 239
 - reference clock, 10 MHz, 406
 - reference point, waveform, 187
 - Remote Front Panel, 281, 283

Index

replacement parts, 389
reset LAN, 278
restart condition, I2C trigger, 117
return instrument for service, 419
Rise time measurement, 201
RMS measurement, 208
roll mode, 68
RS232 trigger, 166
run controls, 359
Run/Stop key, 262
runt pulses, 201

S

safety warning, 76
sample clock, 10 MHz, 406
sample rate, 22, 23, 266, 269
 current rate displayed, 64
save
 browse to destination, 248
 execution time, 253
 settings, 251
save file, 257
save segment, 253
Save to, 248
save trace
 to scope memory, 256
 to USB, 255
save waveform
 to scope memory, 256
 to USB, 255
saver, screen, 58
saving
 serial decode data, 251
saving data, 247
SCL, I2C trigger, 115
SCLK, I2S trigger, 122
screen saver, 58
SDA, 115
SDA, I2C trigger, 116
SEC Option, 24, 401
SEC, option, 402
secure environment mode, 402
segmented memory, 271
 re-arm time, 273
 save time, 253
 saving segments, 253
 statistical data, 273
select digital channels, 358, 380
select knob, 358, 380
selecting
 values, 53
Self Test, service, 397
sequence trigger, 143
serial clock, I2C trigger, 115
serial clock, I2S trigger, 122
serial data, 115
serial data, I2C trigger, 116
serial decode, 253
 saving data, 251
serial number, 275, 400
service functions, 393
Set all Digits softkey, 139
setup, automatic, 376
setup, default, 392
SGM, 271
SGM Option, 24, 401
shipping damage, 28
shipping precautions, 419
Sigma, minimum, 340
single acquisition, 264, 359
Single key, 264
size, 379
skew, analog channel, 63
slope trigger, 105
SND Option, 24
softkeys, 26, 53, 175, 361
software updates, 400
software version, 400
source frequency, 95
Span, FFT, 239
specifications, 23
spectral leakage, FFT, 237
SPI serial decode, 323
SPI Signals Menu, 324, 330
SPI trigger, 150

square root, 234
stage, sequence, 145
stand-alone connection, 278
start acquisition, 262, 359
start condition, I2C, 116
statistics
 increment, 196
 mask test, 343
 measurement, 194
 using segmented memory, 273
status line, 175
status, User Cal, 396
Std Deviation measurement, 208
stop acquisition, 262, 359
stop condition, I2C, 117
subnet mask, 277
Subtract math function, 228
sweep speed fine adjustment, 65
symbols
 in softkey menus, 176
sync polarity, TV trigger, 157
synchronize scopes with reference
 clock, 406

T

template, front panel, 40
test, mask, 337
threshold
 analog channel measurements, 197
 digital channels, 380
thumb drive, 357
tilt for viewing, 36
time
 re-arm, 273
time measurements, 192, 199
time reference indicator, 65
time reference point, 65
time, save execution, 253
timebase, 64
timebase, external, 406
Top measurement, 210
totalizer, CAN, 299
totalizer, FlexRay, 304

- totalizer, UART/rs232, [334](#)
 - trace
 - save to scope memory, [256](#)
 - save to USB, [255](#)
 - tracking cursors, [215](#)
 - transient withstand capability, [404](#)
 - Trig'd trigger indicator, [85](#)
 - Trig'd? trigger indicator, [85](#)
 - trigger
 - coupling, [87](#)
 - definition, [83](#)
 - external, [92](#)
 - general information, [83](#)
 - holdoff, [90](#)
 - list of trigger types, [96](#)
 - mode - auto or normal, [84](#)
 - mode/coupling, [84](#)
 - source, [105](#)
 - trigger controls, [359](#)
 - trigger indicator
 - Auto, [85](#)
 - Auto?, [85](#)
 - Trig'd, [85](#)
 - Trig'd?, [85](#)
 - trigger level, [86](#)
 - trigger mode
 - auto, [84, 85](#)
 - normal, [84, 85](#)
 - Trigger Out connector, [95](#)
 - trigger output, [95](#)
 - mask test, [342](#)
 - trigger type
 - CAN, [98](#)
 - duration, [102](#)
 - edge, [105](#)
 - FlexRay, [108](#)
 - glitch, [140](#)
 - HDTV, TV, [156](#)
 - hex bus, [139](#)
 - I2C, [115](#)
 - I2S, [121, 133](#)
 - LIN, [128](#)
 - Nth edge burst, [135](#)
 - pattern, [137](#)
 - pulse width, [140](#)
 - RS232, [166](#)
 - sequence, [143](#)
 - slope, [105](#)
 - SPI, [150](#)
 - UART, [166](#)
 - USB, [170](#)
 - triggers, [95](#)
 - TTL threshold, [380](#)
 - turn channel on, [358](#)
 - TV trigger, [156](#)
- ## U
- UART totalizer, [334](#)
 - UART trigger, [166](#)
 - UART/RS232 frame counter, [334](#)
 - UART/RS232 license, [400](#)
 - UART/RS232 serial decode, [302, 329](#)
 - units, math, [225, 226](#)
 - units, probe, [62, 93](#)
 - unstable triggers, [269](#)
 - updating software and firmware, [400](#)
 - upgrade files, [287](#)
 - upgrade options, [24](#)
 - upgrading the oscilloscope, [401](#)
 - upload new firmware, [275](#)
- ## V
- values, choosing, [53](#)
 - vectors, [187, 188](#)
 - ventilation requirements, [47](#)
 - vertical expansion, [60](#)
 - vertical position, [60](#)
 - vertical position control, [358](#)
 - vertical sensitivity, [60, 358](#)
 - viewing signals, [180](#)
 - viewing, tilt the instrument, [36](#)
 - VISA connect string, [275](#)
 - voltage measurements, [192, 205](#)
- ## W
- warranted specifications, [23](#)
 - warranty, [418](#)
 - battery, [52](#)

Index

waveform

- cursor tracking, [215](#)
- intensity, [180](#)
- keys, [358](#)
- printing, [244](#)
- recall, [256](#)
- reference point, [187](#)
- save options, [251](#)
- save to scope memory, [256](#)
- save to USB, [255](#)
- saving and exporting, [247](#)

Width - measurement, [202](#)

Width + measurement, [202](#)

Window, FFT, [238](#)

www, [258](#)

X

X at Max Y measurement, [202](#)

X at Max Y on FFT, [199](#)

X at Min Y measurement, [202](#)

X at Min Y on FFT, [199](#)

XY mode, [69](#), [220](#)

Z

Z-axis blanking, [69](#), [222](#)

zoom and pan, [179](#)

Zoom mode, [66](#)

zoomed time base measurement
window, [68](#)