

# MSO3000 and DPO3000 Series Digital Phosphor Oscilloscopes User Manual



  
071-2656-02

**Tektronix**



**MSO3000 and DPO3000 Series  
Digital Phosphor Oscilloscopes  
User Manual**

Copyright © Tektronix. All rights reserved. Licensed software products are owned by Tektronix or its subsidiaries or suppliers, and are protected by national copyright laws and international treaty provisions.

Tektronix products are covered by U.S. and foreign patents, issued and pending. Information in this publication supersedes that in all previously published material. Specifications and price change privileges reserved.

TEKTRONIX and TEK are registered trademarks of Tektronix, Inc.

e\*Scope, OpenChoice, TekVPI, and Wave Inspector are registered trademarks of Tektronix, Inc.

MagniVu, iView, and TekSecure are trademarks of Tektronix, Inc.

PictBridge is a registered trademark of the Standard of Camera & Imaging Products Association CIPA DC-001-2003 Digital Photo Solutions for Imaging Devices.

## Contacting Tektronix

Tektronix, Inc.  
14150 SW Karl Braun Drive  
P.O. Box 500  
Beaverton, OR 97077  
USA

For product information, sales, service, and technical support:

- In North America, call 1-800-833-9200.
- Worldwide, visit [www.tektronix.com](http://www.tektronix.com) to find contacts in your area.

## Warranty

Tektronix warrants that the product will be free from defects in materials and workmanship for a period of three (3) years from the date of original purchase from an authorized Tektronix distributor. If the product proves defective during this warranty period, Tektronix, at its option, either will repair the defective product without charge for parts and labor, or will provide a replacement in exchange for the defective product. Batteries are excluded from this warranty. Parts, modules and replacement products used by Tektronix for warranty work may be new or reconditioned to like new performance. All replaced parts, modules and products become the property of Tektronix.

In order to obtain service under this warranty, Customer must notify Tektronix of the defect before the expiration of the warranty period and make suitable arrangements for the performance of service. Customer shall be responsible for packaging and shipping the defective product to the service center designated by Tektronix, shipping charges prepaid, and with a copy of customer proof of purchase. Tektronix shall pay for the return of the product to Customer if the shipment is to a location within the country in which the Tektronix service center is located. Customer shall be responsible for paying all shipping charges, duties, taxes, and any other charges for products returned to any other locations.

This warranty shall not apply to any defect, failure or damage caused by improper use or improper or inadequate maintenance and care. Tektronix shall not be obligated to furnish service under this warranty a) to repair damage resulting from attempts by personnel other than Tektronix representatives to install, repair or service the product; b) to repair damage resulting from improper use or connection to incompatible equipment; c) to repair any damage or malfunction caused by the use of non-Tektronix supplies; or d) to service a product that has been modified or integrated with other products when the effect of such modification or integration increases the time or difficulty of servicing the product.

THIS WARRANTY IS GIVEN BY TEKTRONIX WITH RESPECT TO THE PRODUCT IN LIEU OF ANY OTHER WARRANTIES, EXPRESS OR IMPLIED. TEKTRONIX AND ITS VENDORS DISCLAIM ANY IMPLIED WARRANTIES OF MERCHANTABILITY OR FITNESS FOR A PARTICULAR PURPOSE. TEKTRONIX' RESPONSIBILITY TO REPAIR OR REPLACE DEFECTIVE PRODUCTS IS THE SOLE AND EXCLUSIVE REMEDY PROVIDED TO THE CUSTOMER FOR BREACH OF THIS WARRANTY. TEKTRONIX AND ITS VENDORS WILL NOT BE LIABLE FOR ANY INDIRECT, SPECIAL, INCIDENTAL, OR CONSEQUENTIAL DAMAGES IRRESPECTIVE OF WHETHER TEKTRONIX OR THE VENDOR HAS ADVANCE NOTICE OF THE POSSIBILITY OF SUCH DAMAGES.

[W16 – 15AUG04]

## Warranty

Tektronix warrants that this product will be free from defects in materials and workmanship for a period of one (1) year from the date of shipment. If any such product proves defective during this warranty period, Tektronix, at its option, either will repair the defective product without charge for parts and labor, or will provide a replacement in exchange for the defective product. Parts, modules and replacement products used by Tektronix for warranty work may be new or reconditioned to like new performance. All replaced parts, modules and products become the property of Tektronix.

In order to obtain service under this warranty, Customer must notify Tektronix of the defect before the expiration of the warranty period and make suitable arrangements for the performance of service. Customer shall be responsible for packaging and shipping the defective product to the service center designated by Tektronix, with shipping charges prepaid. Tektronix shall pay for the return of the product to Customer if the shipment is to a location within the country in which the Tektronix service center is located. Customer shall be responsible for paying all shipping charges, duties, taxes, and any other charges for products returned to any other locations.

This warranty shall not apply to any defect, failure or damage caused by improper use or improper or inadequate maintenance and care. Tektronix shall not be obligated to furnish service under this warranty a) to repair damage resulting from attempts by personnel other than Tektronix representatives to install, repair or service the product; b) to repair damage resulting from improper use or connection to incompatible equipment; c) to repair any damage or malfunction caused by the use of non-Tektronix supplies; or d) to service a product that has been modified or integrated with other products when the effect of such modification or integration increases the time or difficulty of servicing the product.

THIS WARRANTY IS GIVEN BY TEKTRONIX WITH RESPECT TO THE PRODUCT IN LIEU OF ANY OTHER WARRANTIES, EXPRESS OR IMPLIED. TEKTRONIX AND ITS VENDORS DISCLAIM ANY IMPLIED WARRANTIES OF MERCHANTABILITY OR FITNESS FOR A PARTICULAR PURPOSE. TEKTRONIX' RESPONSIBILITY TO REPAIR OR REPLACE DEFECTIVE PRODUCTS IS THE SOLE AND EXCLUSIVE REMEDY PROVIDED TO THE CUSTOMER FOR BREACH OF THIS WARRANTY. TEKTRONIX AND ITS VENDORS WILL NOT BE LIABLE FOR ANY INDIRECT, SPECIAL, INCIDENTAL, OR CONSEQUENTIAL DAMAGES IRRESPECTIVE OF WHETHER TEKTRONIX OR THE VENDOR HAS ADVANCE NOTICE OF THE POSSIBILITY OF SUCH DAMAGES.

[W2 – 15AUG04]

## Warranty

Tektronix warrants that the product will be free from defects in materials and workmanship for a period of one (1) year from the date of original purchase from an authorized Tektronix distributor. If the product proves defective during this warranty period, Tektronix, at its option, either will repair the defective product without charge for parts and labor, or will provide a replacement in exchange for the defective product. Batteries are excluded from this warranty. Parts, modules and replacement products used by Tektronix for warranty work may be new or reconditioned to like new performance. All replaced parts, modules and products become the property of Tektronix.

In order to obtain service under this warranty, Customer must notify Tektronix of the defect before the expiration of the warranty period and make suitable arrangements for the performance of service. Customer shall be responsible for packaging and shipping the defective product to the service center designated by Tektronix, shipping charges prepaid, and with a copy of customer proof of purchase. Tektronix shall pay for the return of the product to Customer if the shipment is to a location within the country in which the Tektronix service center is located. Customer shall be responsible for paying all shipping charges, duties, taxes, and any other charges for products returned to any other locations.

This warranty shall not apply to any defect, failure or damage caused by improper use or improper or inadequate maintenance and care. Tektronix shall not be obligated to furnish service under this warranty a) to repair damage resulting from attempts by personnel other than Tektronix representatives to install, repair or service the product; b) to repair damage resulting from improper use or connection to incompatible equipment; c) to repair any damage or malfunction caused by the use of non-Tektronix supplies; or d) to service a product that has been modified or integrated with other products when the effect of such modification or integration increases the time or difficulty of servicing the product.

THIS WARRANTY IS GIVEN BY TEKTRONIX WITH RESPECT TO THE PRODUCT IN LIEU OF ANY OTHER WARRANTIES, EXPRESS OR IMPLIED. TEKTRONIX AND ITS VENDORS DISCLAIM ANY IMPLIED WARRANTIES OF MERCHANTABILITY OR FITNESS FOR A PARTICULAR PURPOSE. TEKTRONIX' RESPONSIBILITY TO REPAIR OR REPLACE DEFECTIVE PRODUCTS IS THE SOLE AND EXCLUSIVE REMEDY PROVIDED TO THE CUSTOMER FOR BREACH OF THIS WARRANTY. TEKTRONIX AND ITS VENDORS WILL NOT BE LIABLE FOR ANY INDIRECT, SPECIAL, INCIDENTAL, OR CONSEQUENTIAL DAMAGES IRRESPECTIVE OF WHETHER TEKTRONIX OR THE VENDOR HAS ADVANCE NOTICE OF THE POSSIBILITY OF SUCH DAMAGES.

[W15 – 15AUG04]





# Table of Contents

General Safety Summary .....	v
Compliance Information .....	vii
EMC Compliance .....	vii
Safety Compliance .....	ix
Environmental Considerations .....	xi
Preface .....	xii
Key Features .....	xiii
Conventions Used in This Manual .....	xiv
Installation .....	1
Before Installation .....	1
Operating Considerations .....	5
Connecting Probes .....	8
Securing the Oscilloscope .....	9
Powering On the Oscilloscope .....	9
Powering Off the Oscilloscope .....	10
Functional Check .....	10
Compensating a Passive Voltage Probe .....	12
Application Module Free Trial .....	12
Installing an Application Module .....	13
Upgrading Bandwidth .....	13
Changing the User Interface Language .....	15
Changing the Date and Time .....	16
Changing the Font Appearance .....	17
Signal Path Compensation .....	19
Upgrading Firmware .....	20
Connecting Your Oscilloscope to a Computer .....	24
Connecting a USB Keyboard to Your Oscilloscope .....	28
Get Acquainted with the Instrument .....	29
Front-Panel Menus and Controls .....	29
Front-Panel Connectors .....	41
Side Panel Connector .....	42
Rear-Panel Connectors .....	42
Acquire the Signal .....	44
Setting Up Analog Channels .....	44
Using the Default Setup .....	47
Using Autoset .....	48
Acquisition Concepts .....	49
How the Analog Acquisition Modes Work .....	50
Changing the Acquisition Mode, Record Length, and Delay Time .....	51
Using Roll Mode .....	53
Setting Up a Serial or Parallel Bus .....	54
Setting Up Digital Channels .....	66

When and Why to Turn On MagniVu .....	68
Using MagniVu .....	68
Trigger Setup .....	70
Triggering Concepts .....	70
Choosing a Trigger Type .....	73
Selecting Triggers .....	74
Triggering on Buses .....	76
Checking Trigger Settings .....	81
Using Sequence Trigger, A (Main) and B (Delayed) .....	81
Starting and Stopping an Acquisition .....	83
Display Waveform Data .....	84
Adding and Removing a Waveform .....	84
Setting the Display Style and Persistence .....	84
Setting Waveform Intensity .....	88
Scaling and Positioning a Waveform .....	89
Setting Input Parameters .....	90
Positioning and Labeling Bus Signals .....	94
Positioning, Scaling, and Grouping Digital Channels .....	95
Viewing Digital Channels .....	97
Annotating the Screen .....	97
Viewing the Trigger Frequency .....	98
Analyze Waveform Data .....	100
Taking Automatic Measurements .....	100
Selecting Automatic Measurements .....	101
Customizing an Automatic Measurement .....	104
Taking Manual Measurements with Cursors .....	108
Using Math Waveforms .....	112
Using FFT .....	113
Using Advanced Math .....	115
Using Reference Waveforms .....	116
Using Wave Inspector to Manage Long Record Length Waveforms .....	118
Analyzing Power .....	123
Save and Recall Information .....	124
Saving a Screen Image .....	126
Saving and Recalling Waveform Data .....	127
Saving and Recalling Setups .....	129
Saving with One Button Push .....	130
Managing Drive, Directories, and Files .....	131
Printing a Hard Copy .....	132
Erasing Oscilloscope Memory .....	137
Using Application Modules .....	139
Application Examples .....	140
Taking Simple Measurements .....	140
Analyzing Signal Detail .....	147
Triggering on a Video Signal .....	151

---

Capturing a Single-Shot Signal .....	154
Correlating Data with a TLA Logic Analyzer .....	157
Tracking Down Bus Anomalies .....	159
Troubleshooting an RS-232 Bus .....	161
Troubleshooting Circuits Using Parallel Buses .....	163
Appendix: Warranted Specifications .....	165
Index	



# General Safety Summary

Review the following safety precautions to avoid injury and prevent damage to this product or any products connected to it.

To avoid potential hazards, use this product only as specified.

*Only qualified personnel should perform service procedures.*

## To Avoid Fire or Personal Injury

**Use proper power cord.** Use only the power cord specified for this product and certified for the country of use.

**Connect and disconnect properly.** Do not connect or disconnect probes or test leads while they are connected to a voltage source.

**Connect and disconnect properly.** De-energize the circuit under test before connecting or disconnecting the current probe.

**Ground the product.** This product is grounded through the grounding conductor of the power cord. To avoid electric shock, the grounding conductor must be connected to earth ground. Before making connections to the input or output terminals of the product, ensure that the product is properly grounded.

**Observe all terminal ratings.** To avoid fire or shock hazard, observe all ratings and markings on the product. Consult the product manual for further ratings information before making connections to the product.

Connect the probe reference lead to earth ground only.

Do not apply a potential to any terminal, including the common terminal, that exceeds the maximum rating of that terminal.

**Power disconnect.** The power cord disconnects the product from the power source. Do not block the power cord; it must remain accessible to the user at all times.

**Do not operate without covers.** Do not operate this product with covers or panels removed.

**Do not operate with suspected failures.** If you suspect that there is damage to this product, have it inspected by qualified service personnel.

**Avoid exposed circuitry.** Do not touch exposed connections and components when power is present.

**Do not operate in wet/damp conditions.**

**Do not operate in an explosive atmosphere.**

**Keep product surfaces clean and dry.**

**Provide proper ventilation.** Refer to the manual's installation instructions for details on installing the product so it has proper ventilation.

## Terms in This Manual

These terms may appear in this manual:



---

**WARNING.** *Warning statements identify conditions or practices that could result in injury or loss of life.*

---



---

**CAUTION.** *Caution statements identify conditions or practices that could result in damage to this product or other property.*

---

## Symbols and Terms on the Product

These terms may appear on the product:

- DANGER indicates an injury hazard immediately accessible as you read the marking.
- WARNING indicates an injury hazard not immediately accessible as you read the marking.
- CAUTION indicates a hazard to property including the product.

The following symbol(s) may appear on the product:



# Compliance Information

This section lists the EMC (electromagnetic compliance), safety, and environmental standards with which the instrument complies.

## EMC Compliance

### EC Declaration of Conformity – EMC

Meets intent of Directive 2004/108/EC for Electromagnetic Compatibility. Compliance was demonstrated to the following specifications as listed in the Official Journal of the European Communities:

**EN 61326-1:2006, EN 61326-2-1:2006.** EMC requirements for electrical equipment for measurement, control, and laboratory use. <sup>1 2 3 4</sup>

- CISPR 11:2003. Radiated and conducted emissions, Group 1, Class A
- IEC 61000-4-2:2001. Electrostatic discharge immunity
- IEC 61000-4-3:2002. RF electromagnetic field immunity <sup>5</sup>
- IEC 61000-4-4:2004. Electrical fast transient/burst immunity
- IEC 61000-4-5:2001. Power line surge immunity
- IEC 61000-4-6:2003. Conducted RF immunity <sup>6</sup>
- IEC 61000-4-11:2004. Voltage dips and interruptions immunity <sup>7</sup>

**EN 61000-3-2:2006.** AC power line harmonic emissions

**EN 61000-3-3:1995.** Voltage changes, fluctuations, and flicker

### European Contact.

Tektronix UK, Ltd.  
Western Peninsula  
Western Road  
Bracknell, RG12 1RF  
United Kingdom

- <sup>1</sup> This product is intended for use in nonresidential areas only. Use in residential areas may cause electromagnetic interference.
- <sup>2</sup> Emissions which exceed the levels required by this standard may occur when this equipment is connected to a test object.
- <sup>3</sup> To ensure compliance with the EMC standards listed here, high quality shielded interface cables should be used.
- <sup>4</sup> Instrument rebooting may be experienced where the EUT takes longer than 10 seconds to recover from the IEC 61000-4-11 transient immunity test.
- <sup>5</sup> The increase in trace noise while subjected to the test field (3 V/m over the frequency range 80 MHz to 1 GHz, 1.4 GHz to 2.0 GHz, and 1 V/m from 2.0 GHz to 2.7 GHz, with 80% amplitude modulation at 1 kHz) is not to exceed 1 major division of induced noise in the channel at 20 mV/div, sample mode, 100 us/div. (IEC 61000-4-3).
- <sup>6</sup> The increase in trace noise while subjected to the injected test signal (3 V rms over the frequency range of 150 kHz to 80 MHz, with 80% amplitude modulation at 1 kHz) is not to exceed 1 major division of induced noise in the channel at 20 mV/div, sample mode, 100 us/div (IEC 61000-4-6).
- <sup>7</sup> Performance Criterion C applied at the 70%/25 cycle Voltage-Dip and the 0%/250 cycle Voltage-Interruption test levels (IEC 61000-4-11).

### **Australia / New Zealand Declaration of Conformity – EMC**

Complies with the EMC provision of the Radiocommunications Act per the following standard, in accordance with ACMA:

- CISPR 11:2003. Radiated and Conducted Emissions, Group 1, Class A, in accordance with EN 61326-1:2006 and EN 61326-2-1:2006.



## Safety Compliance

### EC Declaration of Conformity – Low Voltage

Compliance was demonstrated to the following specification as listed in the Official Journal of the European Communities:

Low Voltage Directive 2006/95/EC.

- EN 61010-1: 2001. Safety requirements for electrical equipment for measurement control and laboratory use.

### U.S. Nationally Recognized Testing Laboratory Listing

- UL 61010-1:2004, 2<sup>nd</sup> Edition. Standard for electrical measuring and test equipment.

### Canadian Certification

- CAN/CSA-C22.2 No. 61010-1:2004. Safety requirements for electrical equipment for measurement, control, and laboratory use. Part 1.

### Additional Compliances

- IEC 61010-1: 2001. Safety requirements for electrical equipment for measurement, control, and laboratory use.

### Equipment Type

Test and measuring equipment.

### Safety Class

Class 1 – grounded product.

### Pollution Degree Description

A measure of the contaminants that could occur in the environment around and within a product. Typically the internal environment inside a product is considered to be the same as the external. Products should be used only in the environment for which they are rated.

- Pollution Degree 1. No pollution or only dry, nonconductive pollution occurs. Products in this category are generally encapsulated, hermetically sealed, or located in clean rooms.
- Pollution Degree 2. Normally only dry, nonconductive pollution occurs. Occasionally a temporary conductivity that is caused by condensation must be expected. This location is a typical office/home environment. Temporary condensation occurs only when the product is out of service.
- Pollution Degree 3. Conductive pollution, or dry, nonconductive pollution that becomes conductive due to condensation. These are sheltered locations where neither temperature nor humidity is controlled. The area is protected from direct sunshine, rain, or direct wind.
- Pollution Degree 4. Pollution that generates persistent conductivity through conductive dust, rain, or snow. Typical outdoor locations.

## Pollution Degree

Pollution Degree 2 (as defined in IEC 61010-1). Note: Rated for indoor use only.

## Installation (Overvoltage) Category Descriptions

Terminals on this product may have different installation (overvoltage) category designations. The installation categories are:

- Measurement Category IV. For measurements performed at the source of low-voltage installation.
- Measurement Category III. For measurements performed in the building installation.
- Measurement Category II. For measurements performed on circuits directly connected to the low-voltage installation.
- Measurement Category I. For measurements performed on circuits not directly connected to MAINS.

## Overvoltage Category

Overvoltage Category II (as defined in IEC 61010-1).

## Environmental Considerations

This section provides information about the environmental impact of the product.

### Product End-of-Life Handling

Observe the following guidelines when recycling an instrument or component:

**Equipment Recycling.** Production of this equipment required the extraction and use of natural resources. The equipment may contain substances that could be harmful to the environment or human health if improperly handled at the product's end of life. In order to avoid release of such substances into the environment and to reduce the use of natural resources, we encourage you to recycle this product in an appropriate system that will ensure that most of the materials are reused or recycled appropriately.



This symbol indicates that this product complies with the applicable European Union requirements according to Directives 2002/96/EC and 2006/66/EC on waste electrical and electronic equipment (WEEE) and batteries. For information about recycling options, check the Support/Service section of the Tektronix Web site ([www.tektronix.com](http://www.tektronix.com)).

**Mercury Notification.** This product uses an LCD backlight lamp that contains mercury. Disposal may be regulated due to environmental considerations. Please contact your local authorities or, within the United States, refer to the E-cycling Central Web page ([www.eiae.org](http://www.eiae.org)) for disposal or recycling information.

### Restriction of Hazardous Substances

This product has been classified as Monitoring and Control equipment, and is outside the scope of the 2002/95/EC RoHS Directive.

## Preface

This manual describes the installation and operation of the following oscilloscopes:

MSO3054	MSO3034	MSO3032	MSO3014
MSO3012	DPO3054	DPO3052	DPO3034
DPO3032	DPO3014	DPO3012	

## Key Features

MSO3000 and DPO3000 Series instruments can help you verify, debug, and characterize electronic designs. Key features include:

- 500 MHz, 300 MHz, and 100 MHz bandwidths – models with 100 MHz or 300 MHz bandwidths can be upgraded up to 500 MHz
- 2 channel and 4 channel models
- Sample rates up to 2.5 GS/s on all analog channels
- 5 M points record length on all channels
- 50,000 waveforms/second display rate
- Bus triggering and analysis (with the appropriate application module and model oscilloscope) for I<sup>2</sup>C, SPI, MIL-STD-1553, CAN, LIN, FlexRay, RS-232, RS-422, RS-485, UART, I<sup>2</sup>S, Left Justified (LJ), Right Justified (RJ), TDM
- Power analysis application module (optional)
- Wave Inspector controls for managing long record lengths, with zoom and pan, play and pause, search and mark
- 229 mm (9 inch), with 800 x 480 resolution, WVGA color display
- Small and lightweight, at 127 mm (5 inches) deep and 4.1 kg (9 pounds)
- USB available for quick and easy storage
- Direct printing to any PictBridge-compatible printer
- Built-in Ethernet port
- USB 2.0 device port for direct PC control of the oscilloscope using USBTMC protocol
- OpenChoice documentation and analysis software
- NI LabVIEW SignalExpress™ Tektronix Edition productivity and analysis software
- Remote viewing and control with e\*Scope
- Remote control with VISA connectivity
- TekVPI Versatile Probe Interface supports active, differential, and current probes for automatic scaling and units

MSO3000 Series Mixed Signal Oscilloscopes also offer:

- MagniVu 121.2 ps resolution
- Parallel bus triggering and analysis
- 16 digital channels
- Easy connection to your device-under-test through the convenient design of the P6316 digital probe

## Conventions Used in This Manual

The following icons are used throughout this manual.

Sequence Step



front-panel power



Connect power

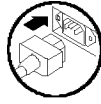

Network

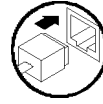

USB

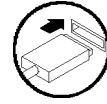

# Installation

## Before Installation

Unpack the oscilloscope and check that you received all items listed as standard accessories. The following pages list recommended accessories and probes, instrument options, and upgrades. Check the Tektronix Web site ([www.tektronix.com](http://www.tektronix.com)) for the most current information.

### Standard Accessories

Accessory	Description	Tektronix part number
<i>MSO3000 and DPO3000 Series Oscilloscopes User Manual</i>	English (Option L0)	071-2656-XX
	French (Option L1)	071-2657-XX
	Italian (Option L2)	071-2658-XX
	German (Option L3)	071-2659-XX
	Spanish (Option L4)	071-2660-XX
	Japanese (Option L5)	071-2661-XX
	Portuguese (Option L6)	071-2662-XX
	Simple Chinese (Option L7)	071-2663-XX
	Traditional Chinese (Option L8)	071-2664-XX
	Korean (Option L9)	071-2665-XX
Russian (Option L10)	071-2666-XX	
<i>MSO3000 and DPO3000 Series Oscilloscopes Documentation Browser CD</i>	Electronic versions of documents, including the Programmer Manual and the Technical Reference	063-4104-xx
<i>NI LabVIEW SignalExpress Tektronix Edition and Tektronix OpenChoice Desktop CD</i>	Productivity, analysis, and documentation software	063-3967-XX
Calibration certificate documenting traceability to national metrology institute(s), and ISO9001 quality system registration		--
Front-panel Overlay	French (Option L1)	335-1917-00
	Italian (Option L2)	335-1918-00
	German (Option L3)	335-1919-00
	Spanish (Option L4)	335-1920-00
	Japanese (Option L5)	335-1921-00
	Portuguese (Option L6)	335-1922-00
	Simplified Chinese (Option L7)	335-1923-00
	Traditional Chinese (option L8)	335-1924-00
	Korean (Option L9)	335-1925-00
	Russian (Option L10)	335-1926-00
For MSO3000 and DPO3000 series: Analog Probes	One, 500 MHz, 10X passive probe per channel	P6139B

**Standard Accessories (cont.)**

<b>Accessory</b>	<b>Description</b>	<b>Tektronix part number</b>
Front Cover	Hard plastic cover to help protect the instrument	200-5052-00
Power Cord	North America (Option A0)	161-0348-00
	Universal Euro (Option A1)	161-0343-00
	United Kingdom (Option A2)	161-0344-00
	Australia (Option A3)	161-0346-00
	Switzerland (Option A5)	161-0347-00
	Japan (Option A6)	161-0342-00
	China (Option A10)	161-0341-00
	India (Option A11)	161-0349-00
	No power cord or AC adapter (Option A99)	--
Accessories Pouch	Pouch that attaches to the handle for carrying probes and other accessories	016-2008-00
For MSO3000 series: Digital probe	One, 16-channel digital probe	P6316



## Optional Accessories

Accessory	Description	Tektronix part number
Aerospace serial triggering and analysis application module	This module enables triggering on MIL-STD-1553 serial buses. Also, it provides digital views of the signal, bus views, bus decoding, search tools, and decode tables with time stamp information.	DPO3AERO
Audio serial triggering and analysis application module	The audio serial triggering and analysis module enables triggering on I <sup>2</sup> S, Left Justified (LJ), Right Justified (RJ), and TDM buses.	DPO3AUDIO
Automotive serial triggering and analysis application module	The automotive serial triggering and analysis module enables triggering on packet level information on CAN and LIN serial buses, as well as digital views of the signal, bus views, bus decoding, search tools, and packet decode tables with timestamp information.	DPO3AUTO
Computer triggering and analysis application module	The computer triggering and analysis module enables triggering on RS-232, RS-422, RS-485 and UART serial buses, search tools, bus views, bus decoding in hex, binary, and ASCII, and decode tables with timestamp information.	DPO3COMP
Embedded serial triggering and analysis application module	The embedded serial triggering and analysis module enables triggering on packet level information on I <sup>2</sup> C and SPI serial buses, as well as digital views of the signal, bus views, bus decoding, search tools, and packet decode tables with timestamp information.	DPO3EMBD
FlexRay serial triggering and analysis application module	This module enables triggering on packet level information in FlexRay buses, as well as digital views of the signal, bus views, packet decoding, search tools, packet decode tables with time stamp information.	DPO3FLEX
Power analysis application module	The power analysis module supports measurements of power quality, switching loss, harmonics, ripple, modulation, safe operating area, and slew rate.	DPO3PWR
Extended video application module	The extended video module enables triggering on a variety of standard HDTV signals, as well as on custom (non-standard) bi-level and tri-level video signals with 3 to 4,000 lines.	DPO3VID
Bandwidth fixed license upgrade options	These products enable you to upgrade the bandwidth of a 100MHz or 300MHz instrument up to 500MHz when your project requirements demand higher performance.	DPO3BW1T32 DPO3BW1T52 DPO3BW1T34 DPO3BW1T54 DPO3BW3T52 DPO3BW3T54
TPA-BNC	TekVPI to TekProbe II BNC Adapter	TPA-BNC

**Optional Accessories (cont.)**

<b>Accessory</b>	<b>Description</b>	<b>Tektronix part number</b>
TEK-USB-488 Adapter	GPIB to USB Adapter	TEK-USB-488
Rackmount kit	Adds rackmount brackets	RMD3000
Soft transit case	Case for carrying instrument	ACD4000
Hard transit case	Traveling case, which requires use of the soft transit case (ACD4000)	HCTEK4321
MSO3000 and DPO3000 Series Oscilloscopes Service manual	Service information on MSO3000 and DPO3000 Series oscilloscopes	071-2667-XX
MSO3000 and DPO3000 Series Oscilloscopes Application Module Installation Manual	Manual	071-2524-XX
DPO3PWR and DPO4PWR Power Measurement Module User Manual	English (Option L0)	071-2631-XX
	French (Option L1)	077-0235-XX
	Italian (Option L2)	077-0236-XX
	German (Option L3)	077-0237-XX
	Spanish (Option L4)	077-0238-XX
	Japanese (Option L5)	077-0239-XX
	Portuguese (Option L6)	077-0240-XX
	Simple Chinese (Option L7)	077-0241-XX
	Traditional Chinese (Option L8)	077-0242-XX
	Korean (Option L9)	077-0243-XX
Russian (Option L10)	077-0244-XX	
MSO3000 and DPO3000 Series Oscilloscopes Declassification and Security Instructions	Describes how to sanitize or remove memory devices from the Tektronix MSO3000 and DPO3000 oscilloscopes	077-0307-XX

The MSO3000 and DPO3000 Series oscilloscopes work with multiple optional probes. (See page 8, *Connecting Probes*.) Check the Tektronix Web site ([www.tektronix.com](http://www.tektronix.com)) for the most current information.

**Related Documentation**

MSO3000 and DPO3000 Series Oscilloscopes Programmer Manual	Describes commands for remote control of the oscilloscope. Available electronically on the Documentation Browser CD or for download from <a href="http://www.tektronix.com/manuals">www.tektronix.com/manuals</a>	077-0301-XX
MSO3000 and DPO3000 Series Oscilloscopes Technical Reference Manual	Describes the oscilloscope specifications and performance verification procedure. Available electronically on the Documentation Browser CD or for download from <a href="http://www.tektronix.com/manuals">www.tektronix.com/manuals</a>	077-0300-XX

## Operating Considerations

### MSO3000 and DPO3000 Series Oscilloscopes

Power Supply Input Voltage: 100 V to 240 V  $\pm$  10%

Power Supply Input Power Frequency:  
50/60 Hz at 100 V to 240 V  
400 Hz  $\pm$  10% at 115 V

Power Consumption: 120 W maximum

Weight: 4.2 kg (9.2 lbs), standalone instrument

Height, including feet but not handle:  
203.2 mm (8 in)

Width, 416.6 mm (16.4 in)

Depth, 147.4 mm (5.8 in)

Clearance: 51 mm (2 in)

Temperature:

Operating: 0 °C to +50 °C (+32 °F to +122 °F)

Nonoperating: -40 °C to +71 °C (-40 °F to +160 °F)

Humidity:

Operating: 5% to 95% relative humidity (RH) at up to +30 °C

Operating: 5% to 45% relative humidity (RH) above +30 °C up to +50 °C, non-condensing, and as limited by a Maximum Wet-Bulb Temperature of +38 °C (derates relative humidity to 45 % RH at +50 °C)

Non-operating: 5% to 95% Relative Humidity (RH) at up to +30 °C

Non-operating: 5% to 45% Relative Humidity (RH) above +30 °C up to +50 °C, non-condensing, and as limited by a Maximum Wet-Bulb Temperature of +38 °C (derates relative humidity to 27% RH at 60 C)

Altitude:

Operating: 3,000 m (9,843 ft)

Nonoperating Altitude: 12,000 m (39,370 ft)

Random Vibration:

Operating: 0.31  $G_{RMS}$ , 5 – 500 Hz, 10 minutes per axis, 3 axes (30 minutes total)

Non-operating: 2.46  $G_{RMS}$ , 5 – 500 Hz, 10 minutes per axis, 3 axes (30 minutes total)

Pollution Degree: 2, Indoor use only

Acquisition System: 1 M $\Omega$

The maximum input voltage: At front-panel connector, 300 V $_{RMS}$ , Installation Category II; for measurements performed on circuits directly connected to the low-voltage installation.



MSO3000 series



DPO3000 series

Acquisition System: 50  $\Omega$  and 75  $\Omega$

The maximum input voltage: 5 V<sub>RMS</sub> with a peak at  $\pm 20$  V. For Installation Category I measurements. Not for connection to Installation Category II, III, or IV circuits.

Acquisition System: Digital Inputs

The maximum input voltage at the input for the digital probe is +30 V to -20 V peak.

Aux In: 1 M $\Omega$

The maximum input voltage: At the front-panel connector, 300 V<sub>RMS</sub>, Installation Category II; for measurements performed on circuits directly connected to the low-voltage installation.



**CAUTION.** To ensure proper cooling, keep the sides and rear of the instrument clear of obstructions.

---

Total Probe Power:

If the total probe power requirements exceed the available power from the oscilloscope, connect the external AC adapter (Tektronix part number 119-7465-XX) to the rear-panel Probe Power connector.

Maximum Probe Power Available Per Channel (3 or 5 TekVPI Interfaces):

5 V  $\pm$  5%, 50 mA max., 250 mW max.

12 V  $\pm$  10%, 2 A max., 24 W max.

## P6139B Passive Probe

Maximum tip input voltage: 300 V<sub>RMS</sub> CAT II and DC

Temperature:

Operating: -15 °C to +65 °C ( +5 °F to +149 °F)

Nonoperating: -62 °C to +85 °C ( -80 °F to +185 °F)

Altitude:

Operating: 3.0 km (10,000 ft) maximum

Nonoperating: 15 km (50,000 ft) maximum

Humidity:

Operating: 5% to 95% relative humidity (%RH) up to +30 °C, 5% to 75% RH above +30 °C up to +65 °C. Noncondensing.

Non-operating: 5% to 45% RH above +65 °C up to +85 °C. Noncondensing.

## MSO3000 Series Oscilloscope with a P6316 Digital Probe

Threshold Accuracy:  $\pm(100 \text{ mV} + 3\% \text{ of threshold})$

Threshold Range: +25 V to -15 V.

Maximum nondestructive input signal to probe: +30 V to -20 V

Minimum signal swing: 500 mV<sub>peak-to-peak</sub>

Input resistance: 101 K $\Omega$

Input capacitance: 8.0 pF typical

Temperature:

Operating: 0 °C to +50 °C (+32 °F to +122 °F)

Nonoperating: -40 °C to +71 °C (-40 °F to +160 °F)

Altitude:

Operating: 3,000 m (9,843 ft) maximum

Nonoperating: 12,000 m (39,370 ft) maximum

Pollution Degree: 2, Indoor use only

Humidity:

5% to 95% relative humidity

## Cleaning

Inspect the oscilloscope and probes as often as operating conditions require. To clean the exterior surface, perform the following steps:

1. Remove loose dust on the outside of the oscilloscope and probes with a lint-free cloth. Use care to avoid scratching the clear glass display filter.
2. Use a soft cloth dampened with water to clean the oscilloscope. Use an aqueous solution of 75% isopropyl alcohol for more efficient cleaning.



**CAUTION.** Avoid getting moisture inside the unit during external cleaning. Use only enough cleaning solution to dampen the cloth or swab.

---



**CAUTION.** To avoid damage to the surface of the oscilloscope or probes, do not use any abrasive or chemical cleaning agents.

---

## Connecting Probes

The oscilloscope supports probes with the following:

### 1. Tektronix Versatile Probe Interface (TekVPI)

These probes support two-way communication with the oscilloscope through on-screen menus and remotely through programmable support. The remote control is useful in applications like ATE where you want the system to preset probe parameters.

### 2. Tektronix Versatile Probe Interface (TekVPI) for Passive Probes

These probes build upon the functionality of the TekVPI interface. Each probe is matched with the corresponding oscilloscope channel, allowing the oscilloscope to optimize the signal input path. This provides AC compensation across the frequency band.

### 3. TPA-BNC Adapter

The TPA-BNC Adapter allows you to use TEKPROBE II probe capabilities, such as providing probe power, and passing scaling and unit information to the oscilloscope.

### 4. BNC Interfaces

Some of these use TEKPROBE capabilities to pass the waveform signal and scaling to the oscilloscope. Some only pass the signal and there is no other communication.

### 5. Digital Probe Interface (MSO3000 Series only)

The P6316 probe provides 16 channels of digital (on or off state) information.

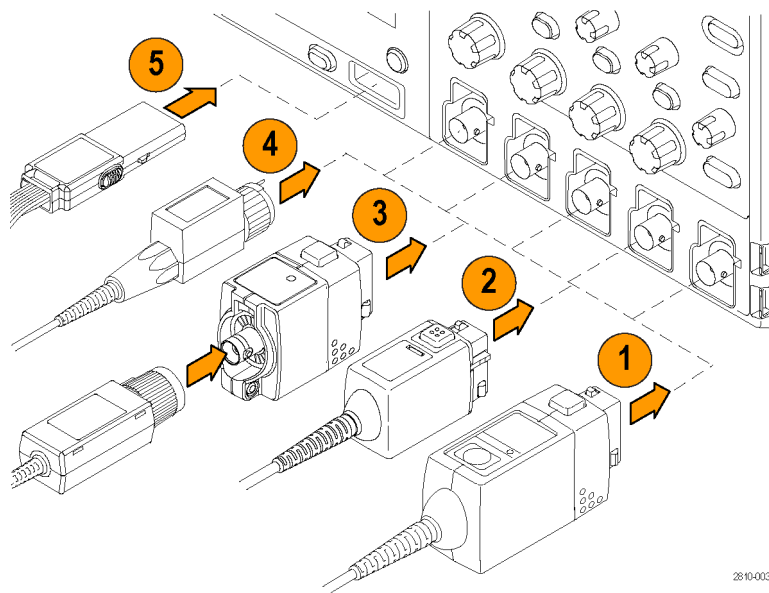

2810-003

For more information on the many probes available for use with MSO3000 and DPO3000 Series oscilloscopes, refer to [www.tektronix.com](http://www.tektronix.com).

## Securing the Oscilloscope

1. Use a standard laptop computer style security lock to secure your oscilloscope to your location.

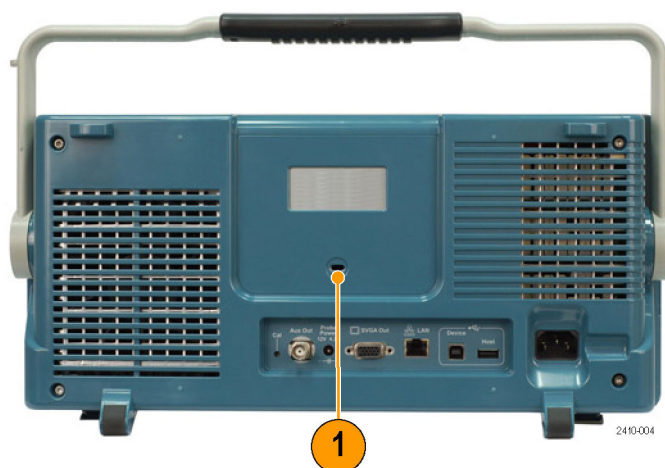

## Powering On the Oscilloscope

### Ground the Oscilloscope and Yourself

Before pushing the power switch, connect the oscilloscope to an electrically neutral reference point, such as earth ground. Do this by plugging the three-pronged power cord into an outlet grounded to earth ground.

Grounding the oscilloscope is necessary for safety and to take accurate measurements. The oscilloscope needs to share the same ground as any circuits that you are testing.

If you are working with static sensitive components, ground yourself. Static electricity that builds up on your body can damage static-sensitive components. Wearing a grounding strap safely sends static charges on your body to earth ground.

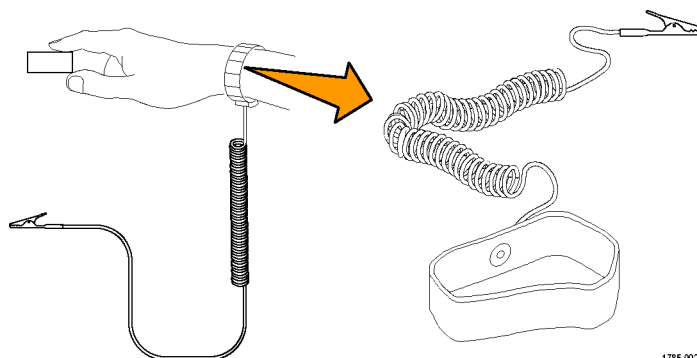

To connect the power cord and power on the oscilloscope:

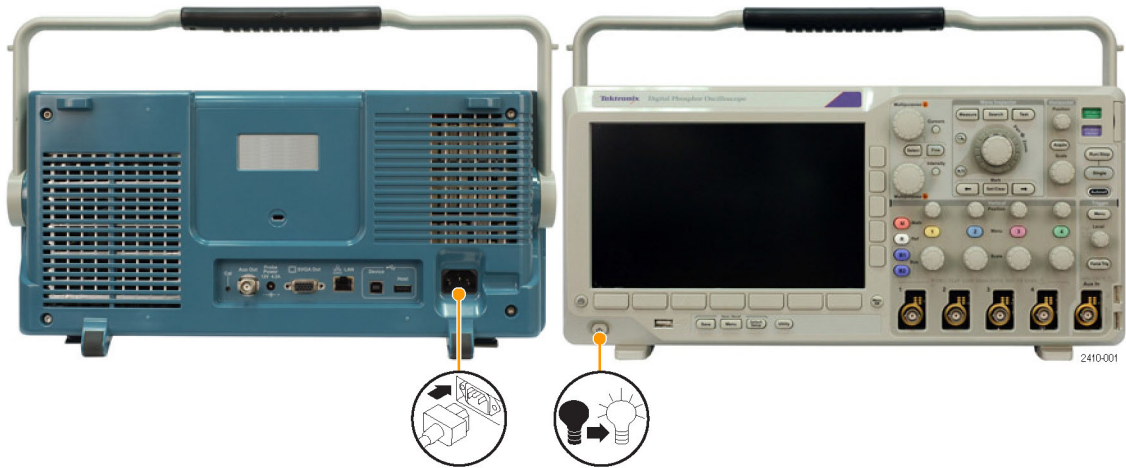

## Powering Off the Oscilloscope

To power off the oscilloscope and remove the power cord:



## Functional Check

Perform this quick functional check to verify that your oscilloscope is operating correctly.

1. Connect the oscilloscope power cable as described in *Powering On the Oscilloscope*. (See page 9.)



2. Power on the oscilloscope.



3. Connect the probe connector to oscilloscope channel 1 and the probe tip and reference lead to the **PROBE COMP** terminals on the oscilloscope front-panel.



4. Push **Default Setup**.



5. Push **Autoset**. The screen should now display a square wave, approximately 2.5 V at 1 kHz.

If the signal appears but is misshapen, perform the procedures for compensating the probe. (See page 12, *Compensating a Passive Voltage Probe*.)

If no signal appears, rerun the procedure. If this does not remedy the situation, have the instrument serviced by qualified service personnel.

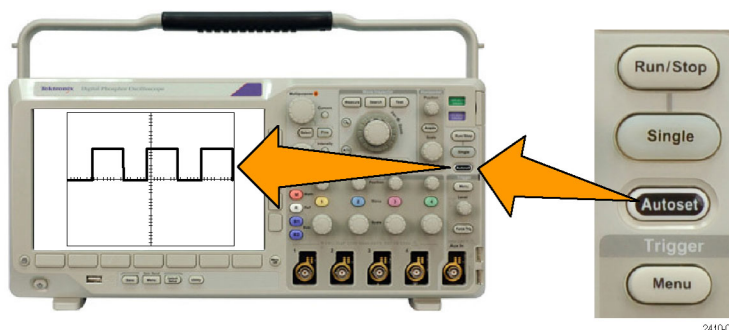

## Compensating a Passive Voltage Probe

Whenever you attach a passive voltage probe for the first time to any input channel, compensate the probe to match it to the corresponding oscilloscope input channel.

To properly compensate your passive probe:

1. Follow the steps for the functional check. (See page 10, *Functional Check*.)
2. Check the shape of the displayed waveform to determine if your probe is properly compensated.
3. If necessary, adjust your probe. Repeat as needed.

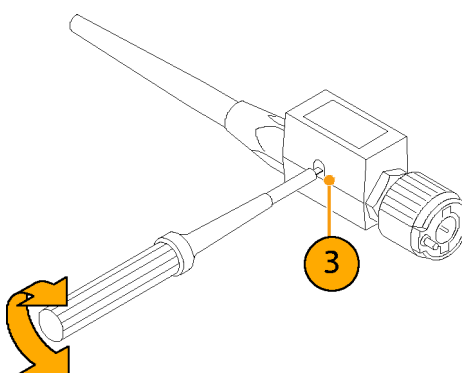

1785-140

### Quick Tips

Use the shortest possible ground lead and signal path to minimize probe-induced ringing and distortion on the measured signal.

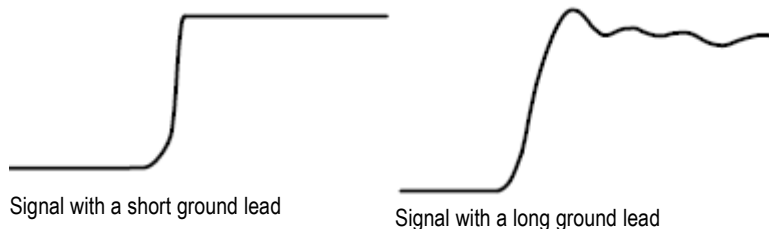

## Application Module Free Trial

A 30-day free trial is available for all application module licenses not installed in your oscilloscope. The trial period begins when you power on the oscilloscope for the first time.

After 30 days, you must purchase the module if you want to continue using the application. To see the date when your free trial period expires, push **Utility** the front-panel, push **Utility Page** on the lower menu, use multipurpose knob **a** to select **Config**, and push **About** on the lower menu.

## Installing an Application Module



**CAUTION.** To avoid damage to the oscilloscope or application module, observe ESD (electrostatic discharge) precautions. (See page 9, Powering On the Oscilloscope.)

Turn off the oscilloscope power while removing or adding an application module.

(See page 10, Powering Off the Oscilloscope.)

Optional application module packages extend the capability of your oscilloscope.

You can physically install up to four application modules at one time. Application modules go into the two slots with windows in the upper right corner of the front-panel. Two additional slots are directly behind the two that you can see. To use these slots, install the module with the label facing away from you.

Each module has a license, which you can optionally transfer between your application modules and oscilloscope. You can keep each license in the module, which will allow you to move the module from one instrument to another.

Alternatively, you can move the license from the module to the oscilloscope. This approach will allow you to store the module separately from the oscilloscope for safe keeping. This approach will also allow you to use more than four applications on your oscilloscope simultaneously.

To transfer a license from a module to your oscilloscope or from your oscilloscope to a module:

1. Turn off the power to the oscilloscope. Insert the application modules in the oscilloscope. Turn on the power.
2. Push **Utility** on the front-panel. If needed, push **Utility Page** on the lower menu and turn multipurpose knob **a** to select **Config**. Push **Manage Modules and Options** on the lower menu, and then push **License Type** on the side menu until “Modules” is selected. The licenses contained in the oscilloscope will be listed in the size menu. Push the button next to the appropriate license to transfer. You may transfer up to four licenses at one time.
3. After you turn off the power to the oscilloscope, you can remove the physical application module from the oscilloscope.

Refer to the *MSO3000 and DPO3000 Series Oscilloscopes Application Module Installation Manual* that came with your application module for instructions on installing and testing an application module.

**NOTE.** If you transfer a license from a module to an oscilloscope, the module will not work on another oscilloscope until you transfer the license back from the oscilloscope to the module. Consider putting the physical module in an envelope or other storage with a label with the date, the module name, and the model and serial number of the oscilloscope, which holds the license. This will help prevent trouble later if someone finds the module, installs it in some other oscilloscope, and wonders why it does not work.

## Upgrading Bandwidth

You may increase the bandwidth of a 100MHz or 300MHz instrument up to 500MHz when your project requirements demand higher performance by purchasing an upgrade.

Available bandwidth upgrade products are:

- DPO3BW1T32 - upgrades bandwidth from 100 MHz to 300 MHz for 2 channel models
- DPO3BW1T52 - upgrades bandwidth from 100 MHz to 500 MHz for 2 channel models
- DPO3BW3T52 - upgrades bandwidth from 300 MHz to 500 MHz for 2 channel models

- DPO3BW1T34 - upgrades bandwidth from 100 MHz to 300 MHz for 4 channel models
- DPO3BW1T54 - upgrades bandwidth from 100 MHz to 500 MHz for 4 channel models
- DPO3BW3T54 - upgrades bandwidth from 300 MHz to 500 MHz for 4 channel models

To enable the upgrade, you will need to order a bandwidth upgrade product. Then, depending upon the serial number of your instrument, you will either need to send your instrument to a Tektronix service center, or install an option key on your instrument (see below).

To determine the serial number of your instrument, push **Utility**, and then push **About**. The serial number is located on the resulting screen.

- If the serial number of your instrument starts with C01, you will need to send your instrument to a Tektronix service center to enable the bandwidth upgrade. Arrangements for the service upgrade are made at the time an order is placed.
- If the serial number of your instrument starts with C02, you may upgrade the bandwidth by installing a fixed license option key on your instrument.

To upgrade bandwidth by installing an option key on your instrument,

1. Once you have placed an order for the appropriate bandwidth upgrade product, you should receive an **Option Key Certificate** with the option key number.

2. Push **Utility**.



3. On the lower menu, push **Utility Page** and select **Config**.



4. Push **Manage Modules & Options**.



5. On the side menu, push **License Type** until **Options** is highlighted.

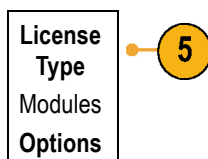

6. Push **Install Option**.



7. Enter the Option Key number using multipurpose knob **a** and push **Enter Character** on the lower menu. Alternatively, you may use a USB keyboard.

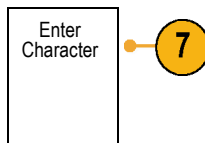

8. Push **OK Accept** on the side menu. Following a successful installation of the option key, a message will be displayed indicating that you must power cycle the oscilloscope to enable the new features.

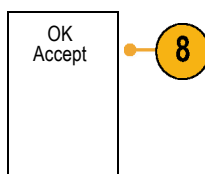

9. Power cycle the oscilloscope.

10. To verify that the bandwidth has been upgraded, push **Utility**, and then push **About** on the lower menu. The bandwidth information should be towards the top of this screen.

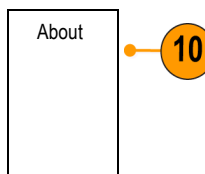

## Changing the User Interface Language

To change the language of the oscilloscope user interface, and to change the front-panel button labels through the use of an overlay:

1. Push **Utility**.



2. Push **Utility Page**.



3. Turn multipurpose knob **a** and select **Config**.

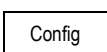

4. Push **Language** from the resulting lower menu.

Utility Page Config	Language English	Set Date & Time	TekSecure Erase Memory	About	Manage Modules & Options	
------------------------	---------------------	-----------------	------------------------------	-------	--------------------------------	--



5. Turn multipurpose knob **a** and select the desired language. Choose among: English, French, German, Italian, Spanish, Brazilian Portuguese, Russian, Japanese, Korean, Simplified Chinese, and Traditional Chinese.
6. If you choose to use English, be sure that the plastic front-panel overlay is removed. If you choose a language other than English, place the plastic overlay for the language that you desire over the front-panel to display labels in that language.

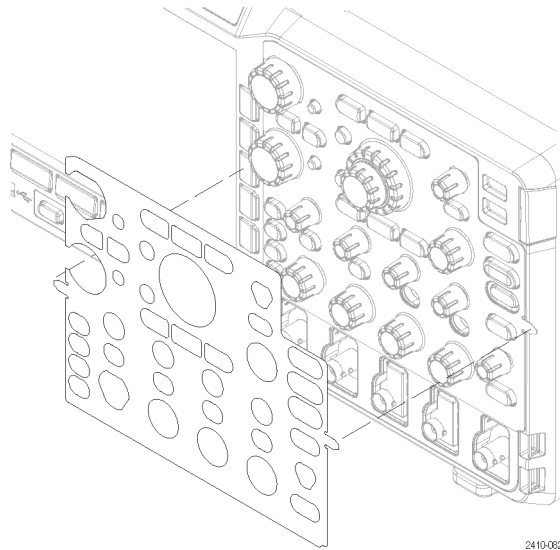

2410-082

## Changing the Date and Time

To set the internal clock with the current date and time:

1. Push **Utility**.



2410-017

2. Push **Utility Page**.



3. Turn multipurpose knob **a** and select **Config**.

Config

4. Push **Set Date & Time**.

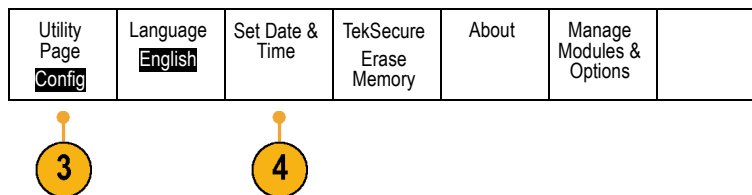

5. Push the side menu buttons and turn both multipurpose knobs (**a** and **b**) to set the time and date values.

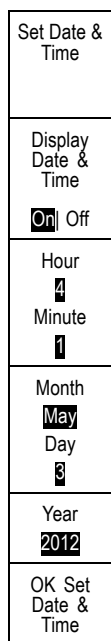

6. Push **OK Set Date & Time**.

## Changing the Font Appearance

**NOTE.** The font appearance can only be changed for the following languages: English, French, Spanish, Italian, Portuguese and German.

To change the font appearance:

1. Push **Utility**.



2. Push **Utility Page**.



3. Turn multipurpose knob **a** and select **Display**.



4. Push **Font**.

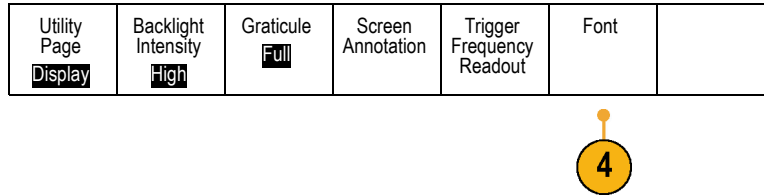

5. On the side menu, push **Regular** or **Bold**.

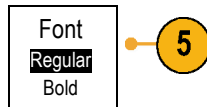



## Signal Path Compensation

Signal Path Compensation (SPC) corrects for DC inaccuracies caused by temperature variations and/or long-term drift. Run the compensation whenever the ambient temperature has changed by more than 10 °C (18 °F) or once a week if you use vertical settings of 5 mV/division or less. Failure to do so may result in the instrument not meeting warranted performance levels at those volts/div settings.

To compensate the signal path:

1. Warm up the oscilloscope for at least 20 minutes. Remove all input signals (probes and cables) from channel inputs. Input signals with AC components adversely affect SPC.



2. Push **Utility**.



3. Push **Utility Page**.

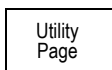

4. Turn multipurpose knob **a** and select **Calibration**.

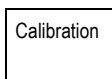

5. Push **Signal Path** on the lower menu.

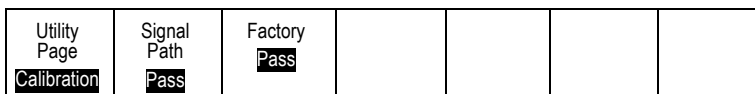

6. Push **OK Compensate Signal Paths** from the resulting side menu.

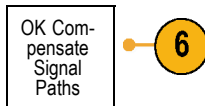

The calibration will take approximately 10 minutes to complete.

7. After calibration, verify that the status indicator on the lower menu displays **Pass**.



If it does not, then recalibrate the instrument or have the instrument serviced by qualified service personnel.



Service personnel use the factory calibration functions to calibrate the internal voltage references of the oscilloscope using external sources. Refer to your Tektronix field office or representative for assistance with factory calibration.

---

**NOTE.** *Signal Path Compensation does not include calibration to the probe tip. (See page 12, Compensating a Passive Voltage Probe.)*

---

## Upgrading Firmware

To upgrade the firmware of the oscilloscope:

1. Open up a Web browser and go to [www.tektronix.com/software](http://www.tektronix.com/software). Proceed to the software finder. Download the latest firmware for your oscilloscope on your PC.

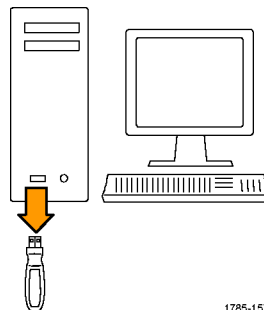

1785-157

Unzip the files and copy the firmware.img file into the root folder of a USB flash drive.

2. Power off your oscilloscope.



3. Insert the USB flash drive into the front-panel USB port on your oscilloscope.



4. Power on the oscilloscope. The instrument automatically recognizes the replacement firmware and installs it.

If the instrument does not install the firmware, rerun the procedure. If the problem continues, try a different model of USB flash drive. Finally, if needed, contact qualified service personnel.

**NOTE.** Do not power off the oscilloscope or remove the USB flash drive until the oscilloscope finishes installing the firmware.



5. Power off the oscilloscope and remove the USB flash drive.



6. Power on the oscilloscope.



7. Push **Utility**.



8. Push **Utility Page**.



9. Turn multipurpose knob **a** and select **Config**.

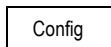

10. Push **About**. The oscilloscope displays the firmware version number.

Utility Page Config	Language English	Set Date & Time	TekSecure Erase Memory	About	Manage Modules & Options	
------------------------	---------------------	-----------------	---------------------------	-------	--------------------------	--

11. Confirm that the version number matches that of the new firmware.



## Connecting Your Oscilloscope to a Computer

Connect your oscilloscope directly to a remote computer to let the PC analyze your data, collect screen images, or to control your oscilloscope. (See page 126, *Saving a Screen Image*.) (See page 127, *Saving and Recalling Waveform Data*.)

Two ways to connect your oscilloscope to a computer are through the VISA drivers and the e\*Scope Web-enabled tools. Use VISA to communicate with your oscilloscope from your computer through a software application. Use e\*Scope to communicate with your oscilloscope through a Web browser.

### Using VISA

VISA lets you use your MS-Windows computer to acquire data from your oscilloscope for use in an analysis package that runs on your PC, such as Microsoft Excel, National Instruments LabVIEW, or a program of your own creation. You can use a common communications connection, such as USB, Ethernet, or GPIB, to connect the computer to the oscilloscope.

To set up VISA communications between your oscilloscope and a computer:

1. Load the VISA drivers on your computer.  
You will find the drivers on the appropriate CD that comes with your oscilloscope or at the Tektronix software finder Web page ([www.tektronix.com/software](http://www.tektronix.com/software)).
2. Connect the oscilloscope to your computer with the appropriate USB or Ethernet cable.

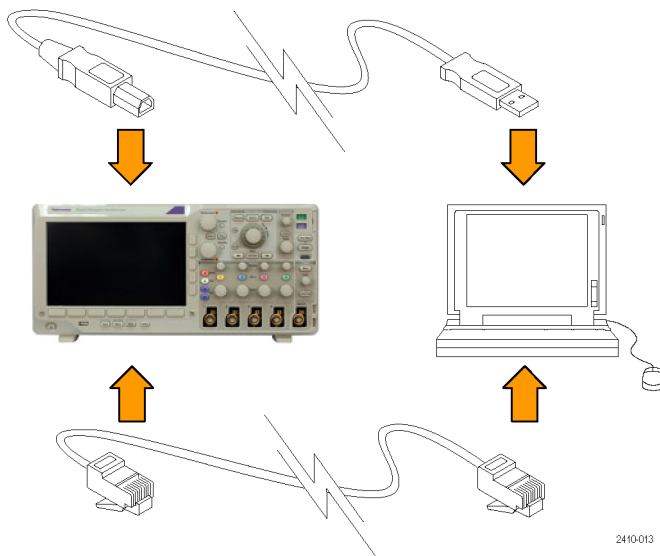

To communicate between the oscilloscope and a GPIB system, connect the oscilloscope to the TEK-USB-488 GPIB-to-USB Adapter with a USB cable. Then connect the adapter to your GPIB system with a GPIB cable. Cycle the power on the oscilloscope.

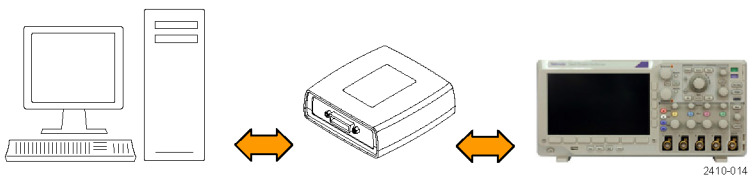

3. Push **Utility**.



4. Push **Utility Page**.

Utility Page



5. Turn multipurpose knob **a** and select **I/O**.

I/O

6. If you are using USB, the system sets itself up automatically for you, if USB is enabled.

Utility Page I/O	USB Computer	Ethernet Network Settings	Socket Server	GPIB 1		
---------------------	-----------------	---------------------------	---------------	-----------	--	--

Check **USB** on the lower menu to be sure that USB is enabled. If it is not enabled, push **USB**. Then push **Connect to Computer** on the side menu.



7. To use Ethernet, push **Ethernet Network Settings**.

On the side menu, if you are on a DHCP Ethernet network and using a through cable, set DHCP to **On**. If you are using a cross-over cable, set it to **Off** and set a hard coded TCP/IP address.

Change Instrument Settings
DHCP/BOOTP On Off
Test Connection

8. If you want to change socket server parameters, push **Socket Server** and enter new values through the resulting side menu.

9. If you are using GPIB, push **GPIB**. Enter the GPIB address on the side menu, using multipurpose knob **a**.

Talk/Listen Address  
a 1



This will set the GPIB address on an attached TEK-USB-488 Adapter.

10. Run your application software on your computer.



### Quick Tips

- The CD that is shipped with your oscilloscope includes a variety of Windows-based software tools designed to ensure efficient connectivity between your oscilloscope and your computer. There are toolbars that speed connectivity with Microsoft Excel and Word. There is also a standalone acquisition program called the OpenChoice Desktop.
- The rear-panel USB 2.0 device port is the correct USB port for computer connectivity. Use the rear- and front-panel USB 2.0 host ports to connect your oscilloscope to USB flash drives and printers. Use the USB Device port to connect your oscilloscope to a PC or a PictBridge printer.

USB Host port



USB Device port



### Using e\*Scope

With e\*Scope, you can access any Internet-connected MSO3000 or DPO3000 Series oscilloscope from a Web browser on your computer. No matter where you are, your oscilloscope is as close as the nearest browser.

To set up e\*Scope communications between your oscilloscope and a Web browser running on a remote computer:

1. Connect the oscilloscope to your computer network with the appropriate Ethernet cable.

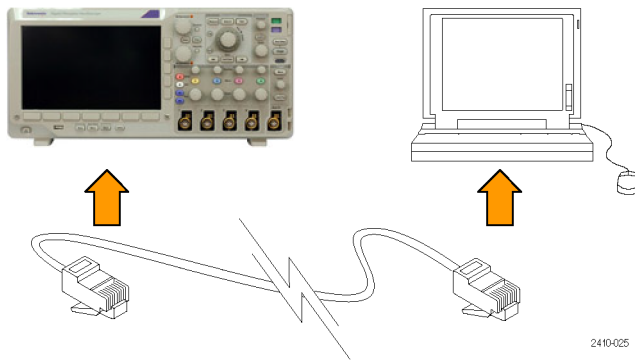

2. Push **Utility**.





3. Push **Utility Page**.

Utility Page
--------------



4. Turn multipurpose knob **a** and select **I/O**.

I/O
-----

5. Push **Ethernet Network Settings**.

Utility Page I/O	USB Computer	Ethernet Network Settings	Socket Server	GPIB 1		
---------------------	-----------------	---------------------------	---------------	-----------	--	--



6. On the side menu, if you are on a DHCP Ethernet network and using dynamic addressing, set DHCP to **On**. If you are using static addressing, set it to **Off**.

Push **Change Instrument Settings**. If you are using DHCP, note the Ethernet address and instrument name. If you are using Static addressing, enter the Ethernet address you will be using.

Change Instrument Settings
DHCP/BOOTP <input checked="" type="checkbox"/> On <input type="checkbox"/> Off
Test Connection



**NOTE.** Depending on the type and speed of network to which your DPO3000 Series oscilloscope is connected, you may not see the DHCP/BOOTP field update instantaneously after pressing the DHCP/BOOTP button. It may take a few seconds to update.

7. Start your browser on your remote computer. In the browser address line, enter the IP address or, if DHCP is set to **On** in the oscilloscope, simply enter the instrument name.

8. You should now see the e\*Scope screen showing the oscilloscope display, on your Web browser.

If e\*Scope does not work, rerun the procedure. If it still does not work, contact qualified service personnel.

## Connecting a USB Keyboard to Your Oscilloscope

You can connect a US-style USB keyboard to a USB Host port on the rear or front-panel of the oscilloscope. The oscilloscope will detect the keyboard, even if it is plugged in while the oscilloscope is powered on.

You can use the keyboard to quickly create names or labels. You can bring up the Label menu using the lower label button of the Channel or Bus menus. Use the arrow keys on the keyboard to move the insertion point, and then type in a name or label. Labeling channels and buses makes the information on the screen easier to identify.

# Get Acquainted with the Instrument

## Front-Panel Menus and Controls

The front-panel has buttons and controls for the functions that you use most often. Use the menu buttons to access more specialized functions.

### Using the Menu System

To use the menu system:

1. Push a front-panel menu button to display the menu that you want to use.

**NOTE.** The **B1** and **B2** buttons support up to two different serial or parallel buses.



2410-025

2. Push a lower menu button to select an item. If a pop-out menu appears, turn multipurpose knob **a** to select the desired choice. If a pop-up menu appears, press the button again to select the desired choice.

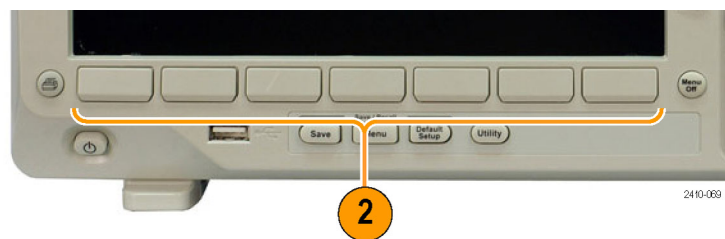

2410-026

3. Push a side menu button to select an item.  
If the menu item contains more than one choice, push the side menu button repeatedly to cycle through the choices.  
If a pop-out menu appears, turn multipurpose knob **a** to select the desired choice.



4. To remove a side menu, push the lower menu button again or push **Menu Off**.



5. Certain menu choices require you to set a numeric value to complete the setup. Use the upper and lower multipurpose knobs **a** and **b** to adjust values.
6. Push **Fine** to turn off or on the ability to make smaller adjustments.



### Using the Menu Buttons

Use the menu buttons to perform many functions in the oscilloscope.

1. **Measure.** Push to perform automated measurements on waveforms or to configure cursors.
2. **Search.** Push to search through an acquisition for user-defined events/criteria.
3. **Test.** Push to activate advanced or application-specific testing features.
4. **Acquire.** Push to set the acquisition mode and adjust the record length.
5. **Autoset.** Push to perform an automatic setup of oscilloscope settings.

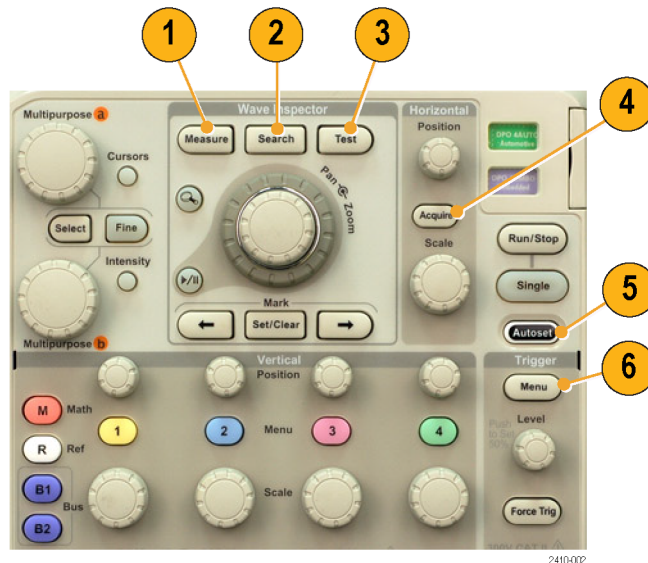

6. **Trigger Menu.** Push to specify trigger settings.
7. **Utility.** Push to activate the system utility functions, such as selecting a language or setting the date/time.

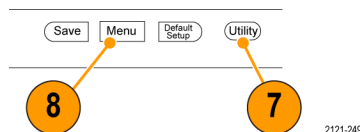

8. **Save / Recall Menu.** Push to save and recall setups, waveforms, and screen images to internal memory or a USB flash drive.
9. **Channel 1,2,3, or 4 Menu.** Push to set vertical parameters for input waveforms and to display or remove the corresponding waveform from the display.



10. **B1 or B2.** Push to define and display a bus if you have the appropriate module application keys.
  - The DPO3AERO module supports MIL-STD-1553 buses.
  - The DPO3AUTO module supports CAN and LIN buses.
  - The DPO3EMBD module supports I<sup>2</sup>C and SPI.
  - The DPO3FLEX module supports FlexRay buses.
  - The DPO3COMP module supports RS-232, RS-422, RS-485, and UART buses.
  - The DPO3AUDIO module supports I<sup>2</sup>S, Left Justified (LJ), Right Justified (RJ), and TDM buses.

Also, push **B1** or **B2** to display or remove the corresponding bus from the display.



11. **R.** Push to manage reference waveforms, including the display or removal of each reference waveform from the display.
12. **M.** Push to manage the math waveform, including the display or removal of the math waveform from the display.

## Using Other Controls

These buttons and knobs control waveforms, cursors, and other data input.

1. Turn the upper multipurpose knob **a**, when activated, to move a cursor, to set a numerical parameter value for a menu item, or to select from a pop-out list of choices. Push **Fine** to toggle between coarse and fine adjustment.

Screen icons tell you when **a** or **b** are active.

2. **Cursors**. Push once to activate the two vertical cursors. Push again to turn on the two vertical and two horizontal cursors. Push again to turn off all cursors.

When the cursors are on, you can turn the multipurpose knobs to control their position.

3. **Select**. Push to activate special functions.

For example, when using the two vertical cursors (and no horizontal ones are visible), you can push this button to link or unlink the cursors. When the two vertical and two horizontal cursors are both visible, you can push this button to make either the vertical cursors or the horizontal cursors active.

You can also use the **Select** button with the file system operations.

4. **Fine**. Push to toggle between making coarse and fine adjustments with the vertical and horizontal position knobs, the trigger level knob, and many operations of multipurpose knobs **a** and **b**.

5. Waveform **Intensity**. Push to enable multipurpose knob **a** to control waveform display intensity and knob **b** to control graticule intensity.

6. Turn the lower multipurpose knob **b**, when activated, to move a cursor or set a numerical parameter value for a menu item. Push **Fine** to make adjustments more slowly.

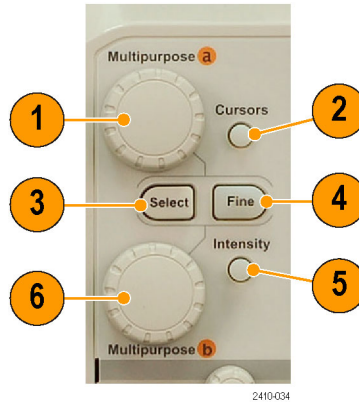

- 7. **Zoom** button. Push to activate zoom mode.
- 8. **Pan** (outer knob). Turn to scroll the zoom window through the acquired waveform.
- 9. **Zoom** (inner knob). Turn to control the zoom factor. Turning it clockwise zooms in further. Turning it counterclockwise zooms out.

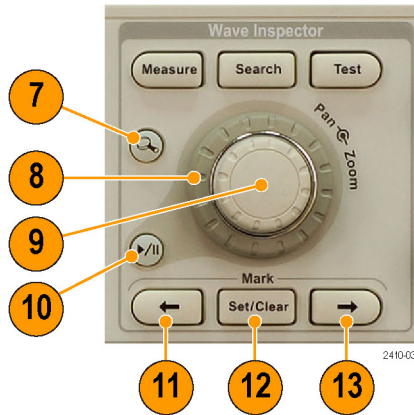

- 10. **Play-pause** button. Push to start or stop the automatic panning of a waveform. Control the speed and direction with the pan knob.
- 11. ← **Prev.** Push to jump to the previous waveform mark.
- 12. **Set/Clear Mark.** Push to establish or delete a waveform mark.
- 13. → **Next.** Push to jump to the next waveform mark.

- 14. **Horizontal Position.** Turn to adjust the trigger point location relative to the acquired waveforms. Push **Fine** to make smaller adjustments.
- 15. **Horizontal Scale.** Turn to adjust the horizontal scale (time/division).

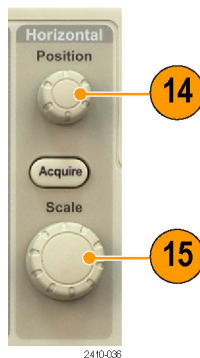



- 16. **Run/Stop.** Push to start or stop acquisitions.
- 17. **Single.** Push to make a single acquisition.
- 18. **Autoset.** Push to automatically set the vertical, horizontal, and trigger controls for a usable, stable display.
- 19. **Trigger Level.** Turn to adjust the trigger level.  
Push this button to set the trigger level to the midpoint of the waveform.

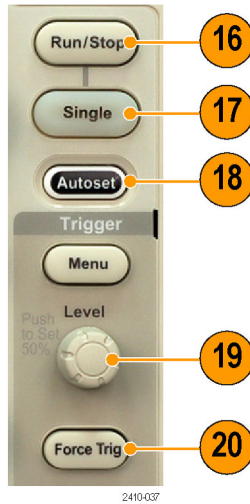

- 20. **Force Trig.** Push to force an immediate trigger event.

- 21. **Vertical Position.** Turn to adjust the vertical position of the corresponding waveform. Push **Fine** to make smaller adjustments.
- 22. **1, 2, 3, 4.** Push to display or remove the corresponding waveform from the display and access the vertical menu.

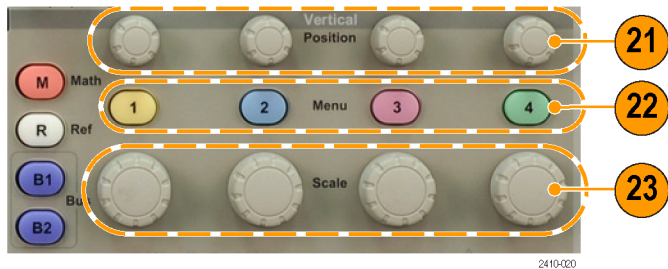

- 23. **Vertical Scale.** Turn to adjust the vertical scale factor of the corresponding waveform (volts/division).

- 24. **Print.** Push to print a screen image using the printer selected in the Utility menu. (See page 132, *Printing a Hard Copy.*)
- 25. **Power switch.** Push to power on or off the instrument.

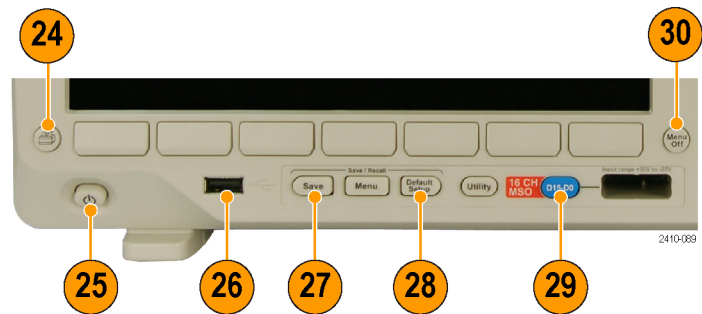

- 26. USB 2.0 host port.** Insert a USB cable here to connect peripherals to the oscilloscope, such as a keyboard, a printer, or a flash drive. There is one more USB 2.0 host port on the rear panel.
- 27. Save.** Push to perform an immediate save operation. The save operation uses the current save parameters, as defined in the Save / Recall menu.
- 28. Default Setup.** Push to perform an immediate restore of the oscilloscope to the default settings.
- 29. D15 - D0.** Push to display or remove the digital channels from the display, and to access the digital channel setup menu (MSO3000 Series only).

- 30. Menu Off.** Push to clear a displayed menu from the screen.

## Identifying Items in the Display

The items shown to the right may appear in the display. Not all of these items are visible at any given time. Some readouts move outside the graticule area when menus are turned off.

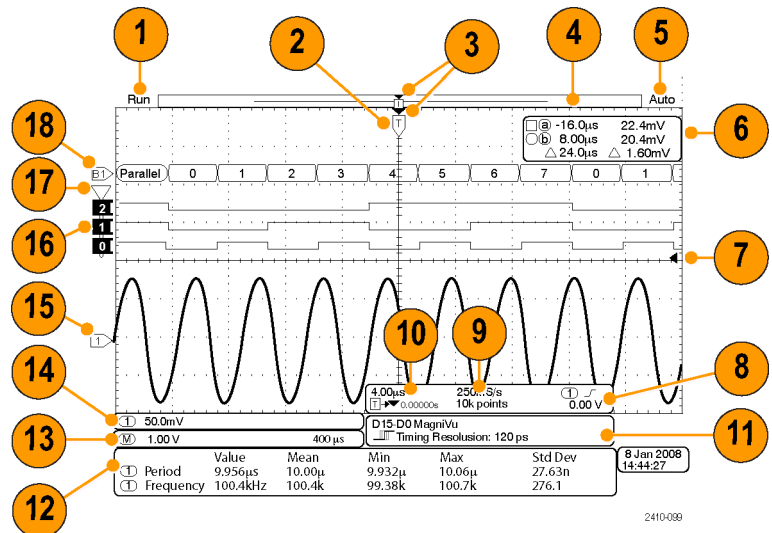

- The acquisition readout shows when an acquisition is running, stopped, or when acquisition preview is in effect. Icons are:
  - Run: Acquisitions enabled
  - Stop: Acquisitions not enabled
  - Roll: In roll mode (40 ms/div or slower)
  - PreVu: In this state, the oscilloscope is stopped or between triggers. You can change the horizontal or vertical position or scale to see approximately what the next acquisition will look like.

- The trigger position icon shows the trigger position in the acquisition.

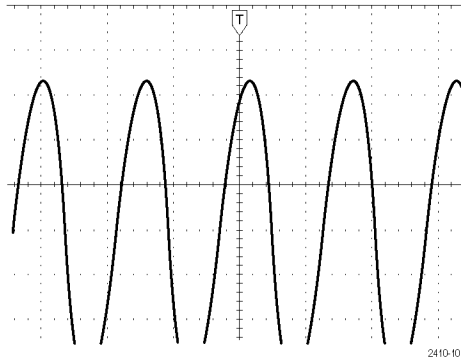

- The expansion point icon (an orange triangle) shows the point that the horizontal scale expands and compresses around.

To make the expansion point the same as the trigger point, push **Acquire** and set the lower menu **Delay** item to **Off**.

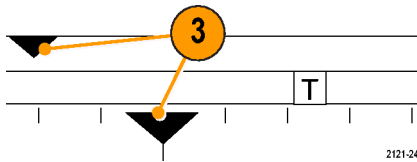

- The waveform record view shows the trigger location relative to the waveform record. The line color corresponds to the selected waveform color.

The brackets show the part of the record currently displayed on the screen.

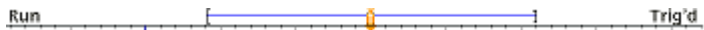

- The trigger status readout shows trigger status. Status conditions are:

- PrTrig: Acquiring pretrigger data
- Trig?: Waiting for trigger
- Trig'd: Triggered
- Auto: Acquiring untriggered data

- The cursor readout shows time, amplitude, and delta ( $\Delta$ ) values for each cursor.

For FFT measurements, it shows frequency and magnitude.

For serial buses, the readout shows the decoded values.

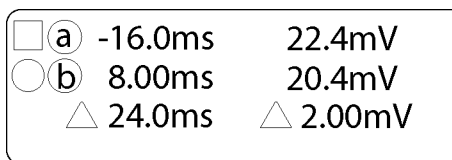

1785-134

(See page 108, *Taking Manual Measurements with Cursors.*)

7. The trigger level icon shows the trigger level on the waveform. The icon color corresponds to the trigger source color.

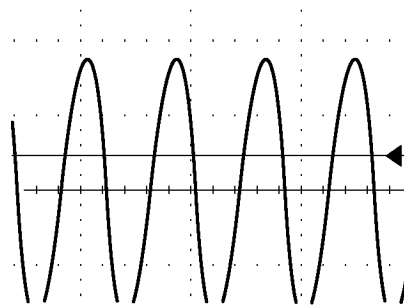

1785-143

8. The trigger readout shows the trigger source, slope, and level. The trigger readouts for other trigger types show other parameters.

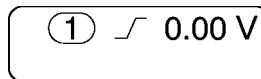

1785-135

9. The top line of the record length/sampling rate readout shows the sampling rate (adjust with the **Horizontal Scale** knob). The bottom line shows the record length (adjust with the **Acquire** menu).

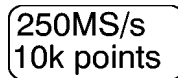

1785-137

10. The horizontal position/scale readout shows on the top line the horizontal scale (adjust with the **Horizontal Scale** knob).

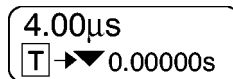

1785-136

With **Delay Mode** on, the bottom line shows the time from the T symbol to the expansion point icon (adjust with the **Horizontal Position** knob).

Use horizontal position to insert added delay between when the trigger occurs and when you actually capture the data. Insert a negative time to capture more pretrigger information.

With **Delay Mode** off, the bottom line shows the time location of the trigger within the acquisition, as a percentage.

11. The Timing Resolution readout shows the resolution of the digital channel timing.

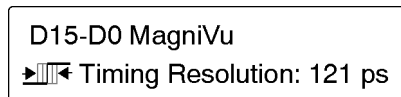



2121-008

Timing resolution is the time between samples. It is the reciprocal of the digital sample rate.

When the MagniVu control is on, "MagniVu" appears in the readout.

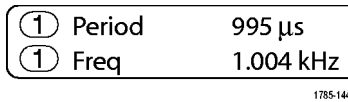
12. Measurement readouts show the selected measurements. You can select up to four measurements to display at one time.



A  symbol appears instead of the expected numerical measurement if a vertical clipping condition exists. Part of the waveform is outside the range of the digitizer. The digitizer range extends one division above and one division below the screen. To obtain a proper numerical measurement, turn the vertical scale and position knobs to bring all of the waveform within the range of the digitizer.

13. The auxiliary waveform readouts show the vertical and horizontal scale factors of the math and reference waveforms.

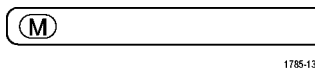

14. The channel readout shows the channel scale factor (per division), coupling, invert, and bandwidth status. Adjust with the **Vertical Scale** knob and the channel 1, 2, 3, or 4 menus.

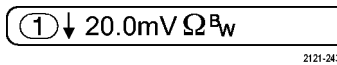

15. For analog channels, the waveform baseline indicator shows the zero-volt level of a waveform (ignoring the effect of offset). The icon colors correspond to the waveform colors.

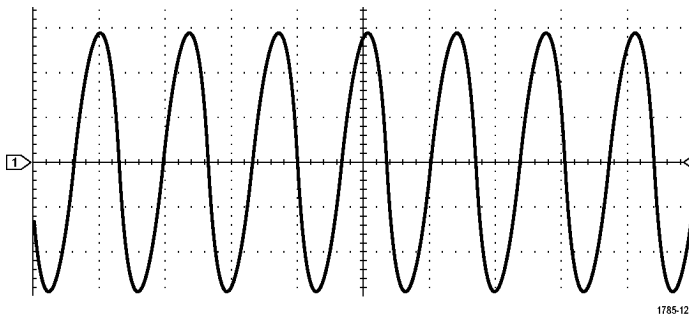

16. For digital channels (MSO3000 Series only), the baseline indicators point to the high and low levels. The indicator colors match the color code used on the physical probe channels. The D0 indicator is black, the D1 indicator is brown, the D2 indicator is red, and so on.

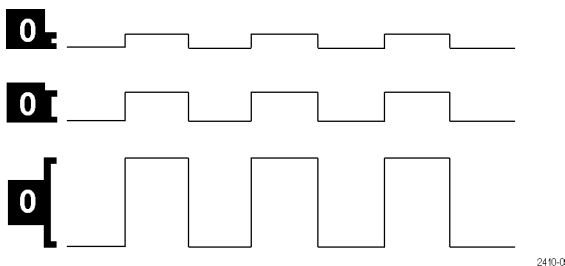

- The group icon indicates when digital channels are grouped (MSO3000 Series only).

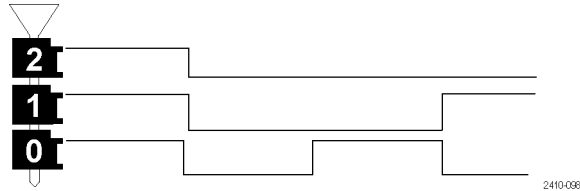

- The bus display shows decoded packet level information for serial buses or for parallel buses (MSO3000 Series only). The bus indicator shows the bus number and bus type.

## Front-Panel Connectors

- Input Range +30 V to -20 V connector for the P6316 digital probe on MSO3000 models only.
- Channel 1, 2, (3, 4). Channel inputs with the TekVPI Versatile Probe Interface.
- Aux In.** Trigger level range is adjustable from +8 V to -8 V. The maximum input voltage is 450V peak, 300V RMS. Input resistance is  $1\text{ M}\Omega \pm 1\%$  in parallel with  $11.5\text{ pF} \pm 2\text{ pF}$ .
- PROBE COMP.** Square wave signal source to compensate probes. Output voltage: 0 - 2.5V, amplitude  $\pm 1\%$  behind  $1\text{ k}\Omega \pm 2\%$ . Frequency: approximately 1 kHz.
- Ground.
- Application Module Slots.

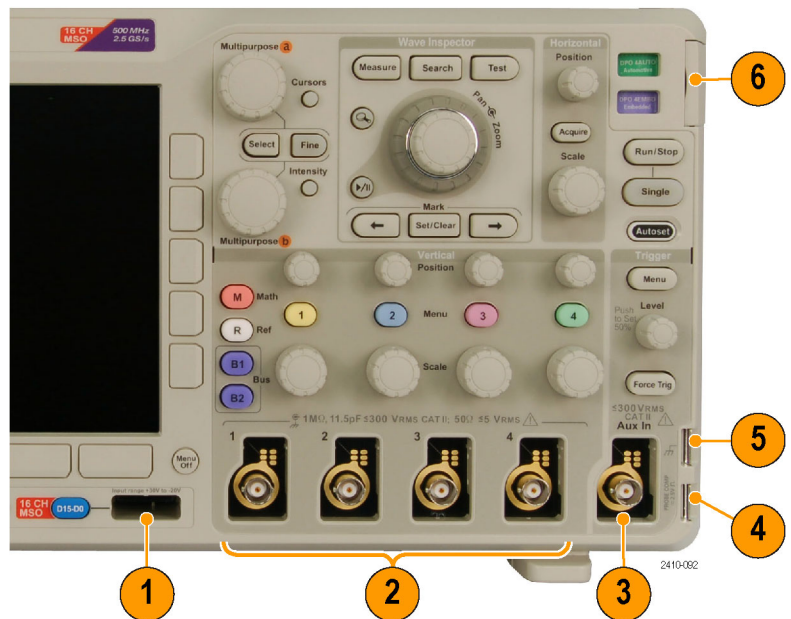

## Side Panel Connector

1. Ground strap connector. This is a receptacle for a grounding strap.



## Rear-Panel Connectors

1. **Cal.** This is for use by authorized service personnel only.
2. **Aux Out.** Use this output to synchronize other test equipment with your oscilloscope. A LOW to HIGH transition indicates that the trigger occurred. The logic level for Vout (HI) is  $\geq 3.25\text{V}$  open circuit;  $\geq 2.2\text{ V}$  into a  $50\Omega$  load to ground. The logic level for Vout (LO) is  $\leq 0.4\text{ V}$  into a load of  $\leq 4\text{ mA}$ ;  $\leq 0.2\text{ V}$  into a  $50\Omega$  load to ground.
3. **Probe Power.** Use this port to provide auxiliary power for TekVPI probes, when needed.
4. **Video Out.** Use the Video Out port (DB-15 female connector) to show the oscilloscope display on an external monitor or projector.
5. **LAN.** Use the LAN (Ethernet) port (RJ-45 connector) to connect the oscilloscope to a 10/100 Base-T local area network.

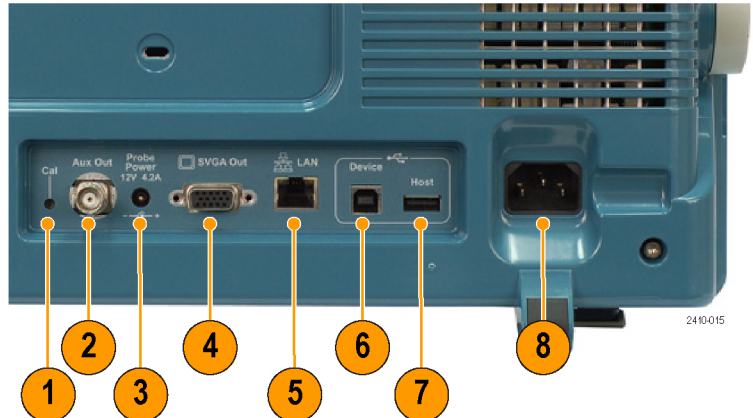



- 6. Device.** Use the USB 2.0 High speed device port to control the oscilloscope through USBTMC or GPIB with a TEK-USB-488 Adapter. The USBTMC protocol allows USB devices to communicate using IEEE488 style messages. This lets you run your GPIB software applications on USB hardware. Also, use the USB port to connect a PictBridge-compatible printer to the oscilloscope.
- 7. Host.** Use the USB 2.0 Full speed host ports (one on the rear-panel and one on the front) to take advantage of USB flash drives, keyboards, and printers.
- 8. Power input.** Attach to an AC power line with integral safety ground. (See page 5, *Operating Considerations.*)

# Acquire the Signal

This section describes concepts of and procedures for setting up the oscilloscope to acquire the signal as you want it to.

## Setting Up Analog Channels

Use front-panel buttons and knobs to set up your instrument to acquire signals using the analog channels.

1. Connect the P6139B or TekVPI probe to the input signal source.

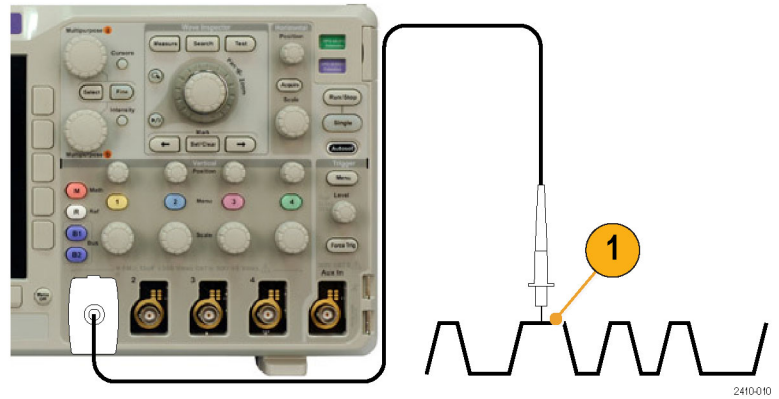

2410-010

2. Select the input channel by pushing the front-panel buttons.

**NOTE.** If you are using a probe that does not supply probe encoding, set the attenuation (probe factor) on the oscilloscope vertical menu for the channel to match the probe.

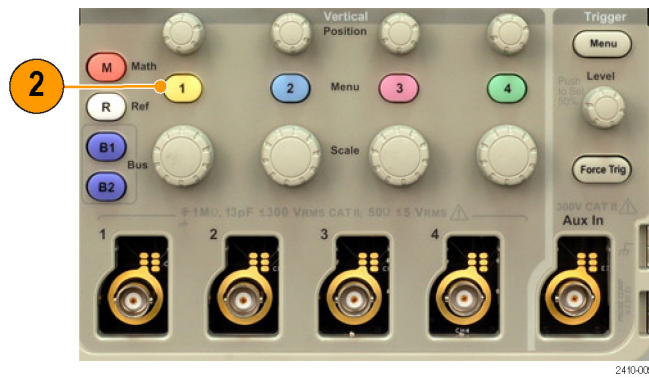

2410-008

3. Push **Default Setup**.



2410-007

4. Push **Autoset**.



2410-008

5. Push the desired channel button. Then adjust the vertical position and scale.

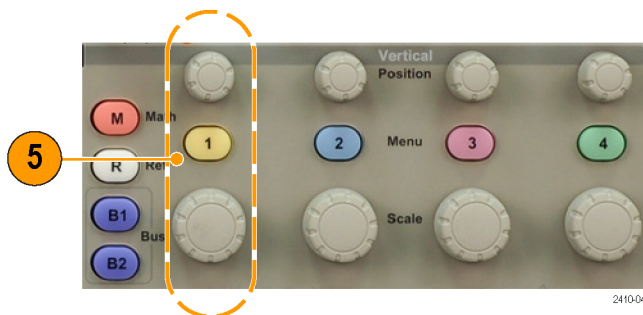

6. Adjust the horizontal position and scale.  
 The horizontal position determines the number of pretrigger and posttrigger samples.  
 The horizontal scale determines the size of the acquisition window relative to the waveform. You can scale the window to contain a waveform edge, a cycle, several cycles, or thousands of cycles.

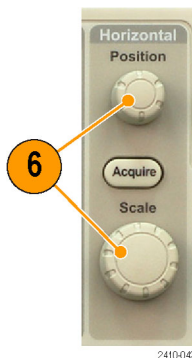

### Quick Tip

- Use the zoom feature to see multiple cycles of your signal in the upper part of the display, and a single cycle in the lower part of the display. (See page 118, *Using Wave Inspector to Manage Long Record Length Waveforms.*)

### Labeling Channels and Buses

You can add a label to the channels and buses shown on the display for easy identification. The label is placed on the waveform baseline indicator in the left side of the screen. The label can have up to 32 characters.

To label a channel or bus, follow these steps:

1. Push a front-panel button for an input channel or a bus.

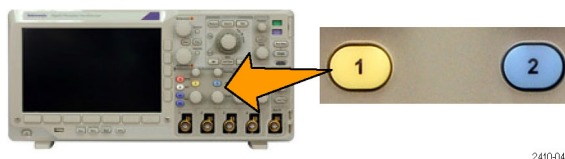

2. Push **Label** on the lower menu to create a label, such as for channel 1 or B1.

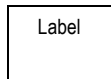

3. Push **Select Preset Label** to view a list of labels.



4. Turn multipurpose knob **b** to scroll through the list to find a suitable label. You can edit the label after you insert it if necessary.



5. Push **Insert Preset Label** to add the label.



If you are using a USB keyboard, use the arrow keys to position the insertion point and edit the inserted label, or type in a new label. (See page 28, *Connecting a USB Keyboard to Your Oscilloscope.*)

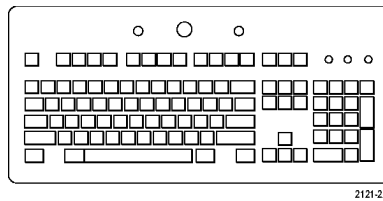

6. If you do not have a USB keyboard connected, push the side and lower menu arrow keys to position the insertion point.

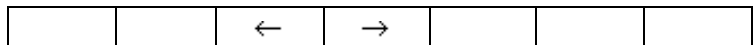
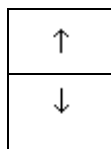

- Turn multipurpose knob **a** to scroll through the list of letters, numbers, and other characters to find the character in the name that you want to enter.



ABCDEFGHIJKLMNOPQRSTUVWXYZ  
 abcdefghijklmnopqrstuvwxyz  
 0123456789\_+=!@#%&\*( )[]{}<>/~"':,;?`

- Push **Select** or **Enter Character** to let the oscilloscope know that you have picked the proper character to use.



You can use the lower menu to edit the label as needed.

Enter Character		←	→	Back Space	Delete	Clear
-----------------	--	---	---	------------	--------	-------

- Continue scrolling and pushing **Select** until you have entered all the desired characters. For another label, push the side and lower menu arrow keys to reposition the insertion point.

- Push **Display Labels** and select **On** to see the label.

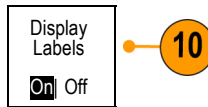

## Using the Default Setup

To return the oscilloscope to its default settings:

- Push **Default Setup**.



- If you change your mind, push **Undo Default Setup** to undo the last default setup.

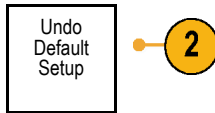

## Using Autoset

Autoset adjusts the instrument (acquisition, horizontal, trigger, and vertical controls) such that it displays four or five waveform cycles for analog channels with the trigger near the midlevel, and ten cycles for digital channels.

Autoset works with both the analog and digital channels.

- Connect the analog probe, and then select the input channel. (See page 44, *Setting Up Analog Channels*.)



Connect the digital probe and select the input channel. (See page 66, *Setting Up Digital Channels*.)



- Push **Autoset** to execute an Autoset.



- If desired, push **Undo Autoset** to undo the last Autoset.



You can also disable the Autoset function if you want to set up a waveform manually. To disable or enable the Autoset function:

- Push and hold **Autoset**.



- Push and hold **Menu Off**.



3. Release **Menu Off**, and then release **Autoset**.

4. Select the desired side menu setting.

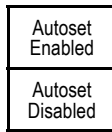

### Quick Tips

- To position the waveform appropriately, Autoset may change the vertical position. Autoset always sets vertical offset to 0 V.
- If you use Autoset when no channels are displayed, the instrument turns on channel one (1) and scales it.
- If you use Autoset and the oscilloscope detects a video signal, the oscilloscope automatically sets the trigger type to video and makes other adjustments to display a stable video signal.

## Acquisition Concepts

Before a signal can be displayed, it must pass through the input channel where it is scaled and digitized. Each channel has a dedicated input amplifier and digitizer. Each channel produces a stream of digital data from which the instrument extracts waveform records.

### Sampling Process

Acquisition is the process of sampling an analog signal, converting it into digital data, and assembling it into a waveform record, which is then stored in acquisition memory.

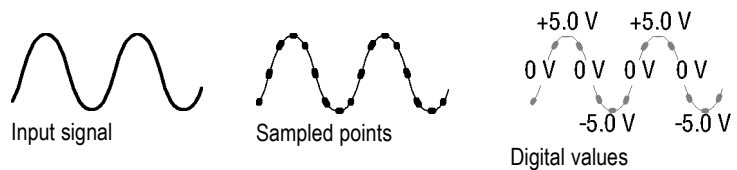

### Real-Time Sampling

MSO3000 and DPO3000 Series oscilloscopes use real-time sampling. In real-time sampling, the instrument digitizes all of the points it acquires using a single trigger event.

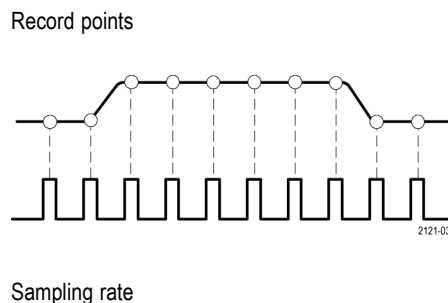

## Waveform Record

The instrument builds the waveform record through use of the following parameters:

- **Sample interval:** The time between recorded sample points. Adjust this by turning the **Horizontal Scale** knob or changing the record length with the menu buttons.
- **Record length:** The number of samples required to fill a waveform record. Set this by pushing **Acquire** and using the resulting lower and side menus.
- **Trigger point:** The zero time reference in a waveform record. It is shown on the screen by an orange T.
- **Horizontal position:** When **Delay Mode** is on, this is the time from the trigger point to the expansion point. Adjust this by turning the **Horizontal Position** knob. Use a positive time to acquire the record after the trigger point. Use a negative time to acquire it before the trigger point.
- **Expansion point:** The point that the horizontal scale expands and contracts around. It is shown by an orange triangle.

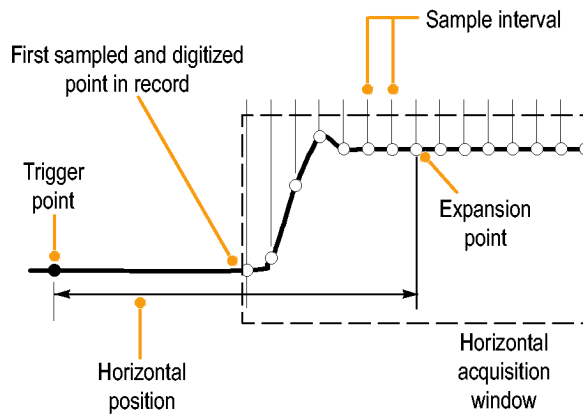

1785-109

## How the Analog Acquisition Modes Work

**Sample** mode retains the first sampled point from each acquisition interval. Sample is the default mode.

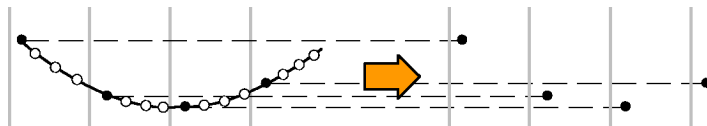

1785-128

**Peak Detect** mode uses the highest and lowest of all the samples contained in two consecutive acquisition intervals. This mode only works with real-time, noninterpolated sampling and is useful for catching high frequency glitches.

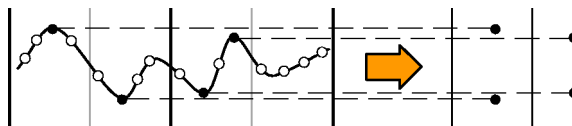

1785-129



**Hi Res** mode calculates the average of all the samples for each acquisition interval. This mode only works with real-time, noninterpolated sampling. Hi-Res provides a higher-resolution, lower bandwidth waveform.

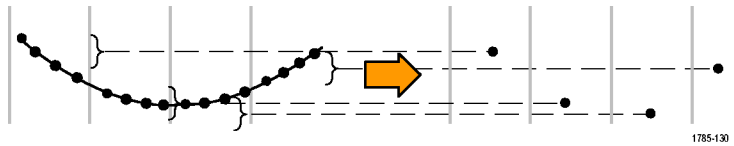

**Envelope** mode finds the highest and lowest record points over all acquisitions. Envelope uses Peak Detect for each individual acquisition.

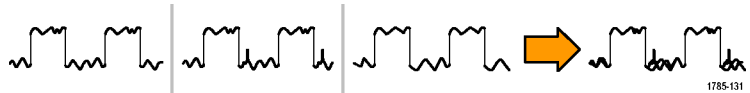

**Average** mode calculates the average value for each record point over a user-specified number of acquisitions. Average uses Sample mode for each individual acquisition. Use average mode to reduce random noise.



## Changing the Acquisition Mode, Record Length, and Delay Time

Use this procedure to change the acquisition mode.

1. Push **Acquire**.



2. Push **Mode**.

Mode <b>Sample</b>	Record Length <b>10k</b>	Delay On <b>Off</b>	Set Horiz. Position to 10%	Waveform Display	XY Display <b>Off</b>
-----------------------	-----------------------------	------------------------	-------------------------------	------------------	--------------------------



- Then choose the acquisition mode on the side menu. You can choose from: Sample, Peak Detect, Hi Res, Envelope, or Average.

**NOTE.** Peak Detect and Hi Res modes take advantage of sample points that the oscilloscope would have discarded at lower sweep speeds. Therefore, these modes only work when the current sample rate is less than the maximum possible sample rate. As soon as the oscilloscope starts to acquire at the maximum sample rate, then the Peak Detect, Hi Res and Sample modes all look the same. You can control the sample rate by setting the Horizontal scale and the Record Length.

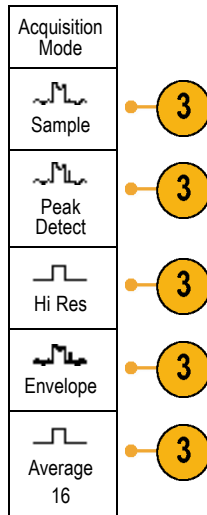

- If you chose **Average**, turn multipurpose knob **a** to set the number of waveforms to average over.



2410-045

- Push **Record Length**.

- Push the record length button on the side menu.

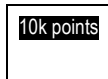

Choose among: 1000, 10 k, 100 k, 1 M, and 5 M points.

7. Push **Delay** on the lower menu to select **On** when you want to delay the acquisition relative to the trigger event.

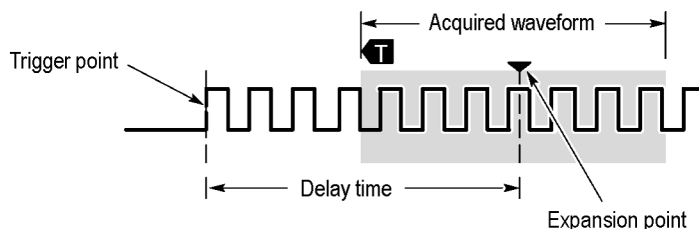

With **Delay** set to **On**, turn the **Horizontal Position** knob counterclockwise to increase the delay. The trigger point will move to the left and ultimately outside of the acquired waveform. Then you can adjust the **Horizontal Scale** knob to acquire more detail around the area of interest at the center of the screen.

When this delay is on, the trigger point separates from the horizontal expansion point. The horizontal expansion point stays at the center of the screen. The trigger point can move off the screen. When this happens, the trigger marker turns to point in the direction of the trigger point.

Use the delay feature when you want to acquire waveform detail that is separated from the trigger event by a significant interval of time. For example, you can trigger on a sync pulse that occurs once every 10 ms and then look at high-speed signal characteristics that occur 6 ms after the sync pulse.

When the delay feature is set to **Off**, the expansion point is tied to the trigger point so that scale changes are centered around the trigger point.

## Using Roll Mode

Roll mode gives a display similar to a strip chart recorder for low-frequency signals. Roll mode lets you see acquired data points without waiting for the acquisition of a complete waveform record.

Roll mode is enabled when the trigger mode is auto and the horizontal scale is set to 40 ms/div or slower.

### Quick Tips

- Switching to Envelope or Average acquisition mode, using math waveforms, turning on a bus, or switching to Normal trigger will disable Roll mode.
- Roll mode is disabled when you set the horizontal scale to 20 ms per division or faster.
- Push **Run/Stop** to halt Roll mode.



## Setting Up a Serial or Parallel Bus

Your oscilloscope can decode and trigger on signal events or conditions that occur on:

Bus type	With this setup
Parallel	MSO3000 oscilloscope
I <sup>2</sup> C and SPI	DPO3EMBD application module. MSO3000 or DPO3000 oscilloscope
RS-232, RS-422, RS-485, and UART	DPO3COMP application module. MSO3000 or DPO3000 oscilloscope
MIL-STD-1553	DPO3AERO application module. MSO3000 or DPO3000 oscilloscope
CAN and LIN	DPO3AUTO application module. MSO3000 or DPO3000 oscilloscope
FlexRay	DPO3FLEX application module. MSO3000 or DPO3000 oscilloscope
Audio buses (I <sup>2</sup> S, Left Justified (LJ), Right Justified (RJ), and TDM)	DPO3AUDIO application module. MSO3000 or DPO3000 oscilloscope

(See page 12, *Application Module Free Trial*.)

### Using Buses in Two Steps

To quickly use serial bus triggering:

1. Push **B1** or **B2** and enter parameters of the bus on which to trigger.

You can separately use **B1** and **B2** to view two different buses.



2. Push Trigger **Menu** and enter trigger parameters. (See page 73, *Choosing a Trigger Type*.)

You can display bus information without triggering on the bus signal.



### Setting Up Bus Parameters

---

**NOTE.** For all serial bus sources, use any combination of channels 1 through 4, and D15 through D0.

---

To trigger on serial or parallel bus conditions, refer to Triggering on Buses. (See page 76, *Triggering on Buses*.)

To set up bus parameters:

1. Push **B1** or **B2** to bring up the lower menu bus choices.



2. Push **Bus**. Turn multipurpose knob **a** to scroll through the list of bus types and select the desired bus: Parallel (MSO3000 Series only), I<sup>2</sup>C, SPI, RS-232, MIL-STD-1553, CAN, LIN, FlexRay, or Audio.

The actual menu items shown will depend on your model oscilloscope and the application modules installed.

B1 Parallel	Define Inputs	Thresholds		B1 Label I <sup>2</sup> C	Bus Display	Event Table
----------------	---------------	------------	--	------------------------------	-------------	-------------



3. Push **Define Inputs**. The choices depend on the selected bus.

Use the side menu to define parameters for the inputs, such as specific signals to an analog or digital channel.

If you select **Parallel**, push the side menu button to enable or disable **Clocked Data**.

Push the side menu button to select the **Clock Edge** on which to clock data: rising edge, falling edge, or both edges.

Turn multipurpose knob **a** to select the **Number of Data Bits** in the parallel bus.

Turn multipurpose knob **a** to select the desired bit to define.

Turn multipurpose knob **b** to select the desired analog or digital channel as the source for the bit.

Define Inputs
Clocked Data Yes <b>No</b>
Clock Edge 
Number of Data Bits <b>(a) 16</b>
Define Bits <b>(a) Bit 15</b> (b) D15

4. Push **Thresholds**.

You can set the threshold for all channels in the serial bus from a list of preset values. The preset values vary, depending on the bus type.

Bus I <sup>2</sup> C	Define Inputs	Thresholds		B1 Label I <sup>2</sup> C	Bus Display	Event Table
-------------------------	---------------	------------	--	------------------------------	-------------	-------------



Alternately, you can set the threshold to a specific value for the signals that make up the serial bus. To do so, push **Select** on the side menu and turn multipurpose knob **a** to select a Bit or a Channel number (Signal name).



2319-046

Then, turn multipurpose knob **b** to define the voltage level above which the oscilloscope treats the signal as a logic high and below which as a logic low.



2319-046

- Optionally, push **B1 Label** to edit the label for the bus. (See page 45, *Labeling Channels and Buses.*)

Bus <b>I2C</b>	Define Inputs	Thresholds	Include R/W in address <b>No</b>	B1 Label <b>I2C</b>	Bus Display	Event Table
-------------------	---------------	------------	-------------------------------------	------------------------	-------------	-------------



- Push **Bus Display** and use the side menu to define how to display the parallel or serial bus.

Depending on the bus, use the side menu or the knobs to set the number format.

<b>Hex</b>
Binary
ASCII

7. Push **Event Table** and select **On** to display a list of bus packets with timestamps.

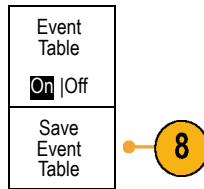

For a clocked parallel bus, the table lists the value of the bus at each clock edge. For an unclocked parallel bus, the table lists the value of the bus whenever any one of its bits changes.

The Event Table lists different data types, depending on the bus type.

8. Push **Save Event Table** to save the event table data in a .csv (spreadsheet) format on the currently selected storage device.

This example of an Event Table is from an RS-232 bus.

RS-232 event tables display one line for each 7- or 8-bit byte when Packets are set to Off.

RS-232 event tables display one line for each packet when Packets are set to On.

Other buses display one word, frame, or packet per row, depending on the bus type.

Tektronix		version v1.2f	
Bus Definition: RS232			
Time	Tx	Rx	
-4.77E-02	E		
-4.44E-02	n		
-4.10E-02	g		
-3.75E-02	i		
-3.41E-02	n		
-3.08E-02	e		
-2.73E-02	e		
-2.39E-02	r		
-2.06E-02	i		
-1.71E-02	n		
-1.37E-02	g		
-1.03E-02	.		
-6.92E-03	SP		
-3.49E-03	P		
-5.38E-05	o		
3.28E-03	r		
6.71E-03	t		
1.69E-02	l		
2.02E-02	a		
2.43E-02	n		
2.82E-02	d		
3.16E-02			

2319-085

- Push **B1** or **B2** and turn multipurpose knob **a** to move the bus display up or down on the screen.

## I<sup>2</sup>C Bus

To acquire data from an I<sup>2</sup>C bus, you need to also set up these items:

- If you select **I<sup>2</sup>C**, push **Define Inputs** and the appropriate side menu choices.

B1 <b>I<sup>2</sup>C</b>	Define Inputs	Thresholds	Include R/W in Address <b>No</b>	B1 Label I <sup>2</sup> C	Bus Display	Event Table
-----------------------------	---------------	------------	-------------------------------------	---------------------------	-------------	-------------

You can assign the predefined **SCLK Input** or **SDA Input** to the channel connected to the signal.



- Push **Include R/W in Address** and then push the desired side menu button.  
This control determines how the oscilloscope shows the I<sup>2</sup>C addresses in bus decode traces, cursor readouts, Event Table listings, and trigger settings.

If you select **Yes**, the oscilloscope displays 7-bit addresses as eight bits, where the eighth bit (LSB) is the R/W bit. It displays 10-bit addresses as 11 bits where the third bit is the R/W bit.

If you select **No**, the oscilloscope displays 7-bit addresses as seven bits, and 10-bit addresses as ten bits.

In the physical layer of the I<sup>2</sup>C protocol, 10 bit I<sup>2</sup>C addresses are preceded by the five bit code, 11110. The oscilloscope does not include these five bits in address readouts.

## SPI Bus

To acquire data from an SPI bus, you need to also set up these items:

- If you selected **SPI**, push **Define Inputs** and the appropriate side menu choices.

Bus <b>SPI</b>	Define Inputs	Thresholds	Configure	B1 Label SPI	Bus Display	Event Table
-------------------	---------------	------------	-----------	--------------	-------------	-------------

You can set the **Framing** to SS (Slave Select) or to Idle Time.

You can assign the predefined **SCLK**, **SS**, **MOSI**, or **MISO** signals to any channel.



- Push **Configure** and the desired side menu choices.



3. Push **SCLK** to set the edge of the signal to match the SPI bus being acquired.
4. Set the level of the SS, MOSI, and MISO signals to match the SPI bus.

Active High means that a signal is considered active when the signal is greater than the threshold value.

Active Low means that the signal is considered active when the signal is lower than the threshold value.

SCLK 	<b>3</b>
SS Active High Active Low	<b>4</b>
MOSI Active High Active Low	
MISO Active High Active Low	
-more- 1 Of 2	

5. Use multipurpose knob **a** to set the number of bits of the SPI Word Size.
6. Push either side menu button to set the bit order of the SPI bus.

Word Size <b>(a) 8 bits</b>	<b>5</b>
Bit Order MS First	<b>6</b>
Bit Order LS First	

## RS-232 Bus

To acquire data from a RS-232 bus, you need to also set up these items:

1. If you selected **RS-232**, push **Configure** and the desired side menu choices.

Use the side menu to configure the bus.  
Use Normal polarity for RS-232 signals and Inverted polarity for RS-422, RS-485, and UART buses.

Bus <b>RS-232</b>	Define Inputs	Thresholds	Configure <b>9600-8-N</b>	B1 Label RS-232	Bus Display	Event Table
----------------------	---------------	------------	------------------------------	--------------------	-------------	-------------



2. Push **Bit Rate**, and turn multipurpose knob **a** to select the appropriate bit rate.
3. Push **Data Bits** and select the number to match the bus.
4. Push **Parity** and turn multipurpose knob **a** to match the polarity used by the bus as None, Odd, or Even.
5. Push **Packets** and select On or Off.
6. Turn multipurpose knob **a** to select an end-of-packet character.

Bit Rate 9600 bps	2
Data Bits 7   8	3
Parity (a) None	4
Packets On   Off	5
End of Packet 0A (Linefeed)	6

RS-232 decoding displays a stream of bytes. You can organize the stream into packets with an end-of-packet character

If you defined an end-of-packet character to use for RS-232 decoding, the stream of bytes will be displayed as packets.

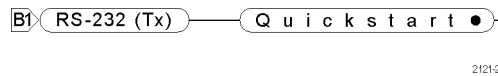

2121-233

When decoding an RS-232 bus in ASCII mode, a large dot indicates that the value represents a character outside the printable ASCII range.

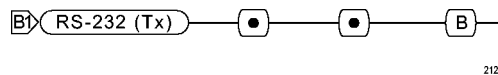

2121-232

## MIL-STD-1553 Bus

To acquire data from a MIL-STD-1553 bus, you need to also set up these items:

1. If you selected **MIL-STD-1553**, push **Define Inputs** and the appropriate side menu choices.

Bus	Define Inputs	Thresholds	RT	B1 Label	Bus Display	Event Table
MIL-STD-1553		786mV 22.00 V	13.3 $\mu$ s 4.00 $\mu$ s	1553		

1

2. Turn multipurpose knob **a** to select the channel connected to the MIL-STD-1553 bus source.

MIL-STD-1553 Input (a) 1	2
-----------------------------	---

- 3. Push either **Polarity Normal** or **Polarity Inverted** on the size menu to match the bus being acquired.
- 4. Push **Thresholds** to set the **Channel Thresholds** or choose a **Preset** value. Turn multipurpose knob **a** to set the high threshold level. Turn multipurpose knob **b** to set the low threshold level.

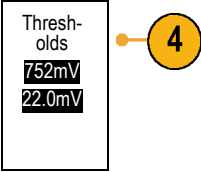

- 5. Push **RT** to set the **Response Time**. Turn multipurpose knob **a** to set the maximum level. Turn multipurpose knob **b** to set the minimum level.

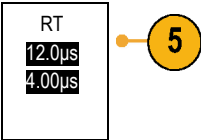

### CAN Bus

To acquire data from a CAN bus, you need to also set up these items:

- 1. If you selected **CAN**, push **Define Inputs** and the appropriate side menu choices.

Bus <b>CAN</b>	Define Inputs	Thresholds	Bit Rate <b>500 Kbps</b>	B1 Label CAN	Bus Display	Event Table
-------------------	---------------	------------	-----------------------------	-----------------	-------------	-------------



- 2. Turn multipurpose knob **a** to select the channel connected to the CAN bus source.
- 3. Turn multipurpose knob **a** to select the type of CAN signal: CAN\_H, CAN\_L, Rx, Tx, or Differential.
- 4. Turn multipurpose knob **a** to set the **Sample Point** from 5% to 95% of the position within the bit period or the unit interval.

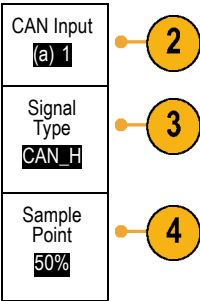

5. Push **Bit Rate** and turn multipurpose knob **a** to select from the list of predefined bit rates.

Alternately, you can set the bit rate to a specific value. To do so, select **Custom**, and then turn multipurpose knob **b** to set the bit rate from 10,000 to 1,000,000.

Bus <b>CAN</b>	Define Inputs	Thresholds	Bit Rate <b>500 Kbps</b>	B1 Label CAN	Bus Display	Event Table
-------------------	---------------	------------	-----------------------------	-----------------	-------------	-------------



## LIN Bus

To acquire data from a LIN bus, you need to also set up these items:

1. If you selected **LIN**, push **Define Inputs** and the appropriate side menu choices.

Bus <b>LIN</b>	Define Inputs	Thresholds	Configure	B1 Label LIN	Bus Display	Event Table
-------------------	---------------	------------	-----------	-----------------	-------------	-------------



2. Turn multipurpose knob **a** to select the channel connected to the LIN bus source.
3. Turn multipurpose knob **a** to set the **Sample Point** from 5% to 95% of the position within the bit period or the unit interval.
4. Select the **Polarity** to match the LIN bus being acquired.

LIN Input <b>(a) 1</b>	<b>2</b>
Sample Point <b>50%</b>	<b>3</b>
Polarity Normal (High=1)	<b>4</b>
Polarity Inverted (High=0)	

5. Push **Configure** and the appropriate side menu choices.

Bus <b>LIN</b>	Define Inputs	Thresholds	Configure	B1 Label LIN	Bus Display	Event Table
-------------------	---------------	------------	-----------	-----------------	-------------	-------------



6. Push **Bit Rate**, and turn multipurpose knob **a** to select from the list of predefined bit rates. Alternately, you can set the bit rate to a specific value. To do so, select **Custom**, and then turn multipurpose knob **b** to set the bit rate from 800 bps to 100,000 bps.
7. Push **LIN Standard**, and turn multipurpose knob **a** to select the appropriate standard.
8. Push **Include Parity Bits with Id** to select whether or not to include parity bits.

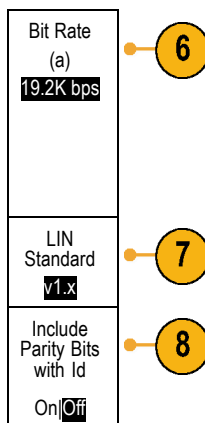

## FlexRay Bus

To acquire data from a FlexRay bus, you need to also set up these items:

1. If you selected **FlexRay**, push **Define Inputs** and the appropriate side menu choices.

Bus FlexRay	Define Inputs	Thresholds 786 mV 22.0 mV	Bit Rate 10000000	B1 Label FlexRay	Bus Display	Event Table
----------------	---------------	---------------------------------	----------------------	---------------------	-------------	-------------

1

2. Turn multipurpose knob **a** to select the channel connected to the FlexRay bus source.

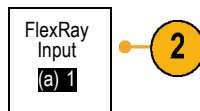

3. Push the appropriate side menu buttons for **FlexRay Channel Type** and **Polarity**.

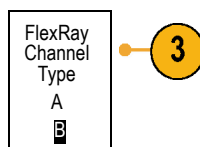

4. Push **Thresholds** to set the **Channel Thresholds**. Turn multipurpose knob **a** to set the high threshold level. Turn multipurpose knob **b** to set the low threshold level.

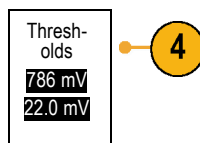

5. Push **Bit Rate** and turn multipurpose knob **a** to select from the list of predefined bit rates.

Bus FlexRay	Define Inputs	Thresholds 786mV 22.00 V	Bit Rate 1000000	B1 Label FlexRay	Bus Display	Event Table
----------------	------------------	--------------------------------	---------------------	---------------------	----------------	----------------

Alternately, you can set the bit rate to a specific value. To do so, select **Custom**, and then turn multipurpose knob **b** to set the bit rate from 1,000,000 to 10,000,000 b/s.



## Audio Bus

To acquire data from an audio bus, you need to also set up these items:

1. If you selected **Audio**, push **Define Input** and the desired side menu choices.

Bus Audio	Define Inputs	Thresholds	Configure	B1 Label RS-232	Bus Display	Event Table
--------------	------------------	------------	-----------	--------------------	----------------	----------------



2. Push **Type**, and turn multipurpose knob **a** to select the type of audio bus data configuration on which to trigger.
  3. Select **I2S** to trigger on the standard Inter-IC Sound, or Integrated Interchip Sound, electrical serial bus interface standard stereo format.
  4. Select **Left Justified** to trigger on an I2S stream where there is no bit clock delay and the data starts right on the edge of the word select clock.
  5. Select **Right Justified** to trigger on an I2S stream where the data lines up with the right edge of the word select clock.
  6. Select **TDM** to trigger on time-division multiplexing.
7. Push **Configure**, and the appropriate side menu buttons to further set up I2S triggering.

Audio Bus Type
I2S
Left Justified (LJ)
Right Justified (RJ)
TDM

### Physical Layer Bus Activity

Oscilloscope waveform traces from analog channels 1 to 4, digital channels D15 to D0, and the traces you see when you choose to display a bus always show the physical layer bus activity. In the physical layer display, bits that were transmitted earlier are to the left, and bits that were transmitted later are to the right.

- I2C, and CAN buses transmit the MSB (most significant bit) first
- SPI buses do not specify a bit order
- RS-232 and LIN buses transmit the LSB (least significant bit) first

---

**NOTE.** The oscilloscope displays the decode traces and event tables for all buses with the MSB on the left and LSB on the right.

---

For example, an RS-232 signal (after the start bit) might be high, high, high, low, high, low, low, and high. Since the RS-232 protocol uses high for zero and low for one, this value would be 0001 0110.

Since the decode displays the MSB first, the oscilloscope reverses the order of the bits and displays 0110 1000. If the bus display is set to hex, the value displays as 68. If the bus display is set to ASCII, the value displays as h.

## Setting Up Digital Channels

Use front-panel buttons and knobs to set up your instrument to acquire signals using the digital channels.

1. Connect the P6316 16-channel digital probe to the input signal source.

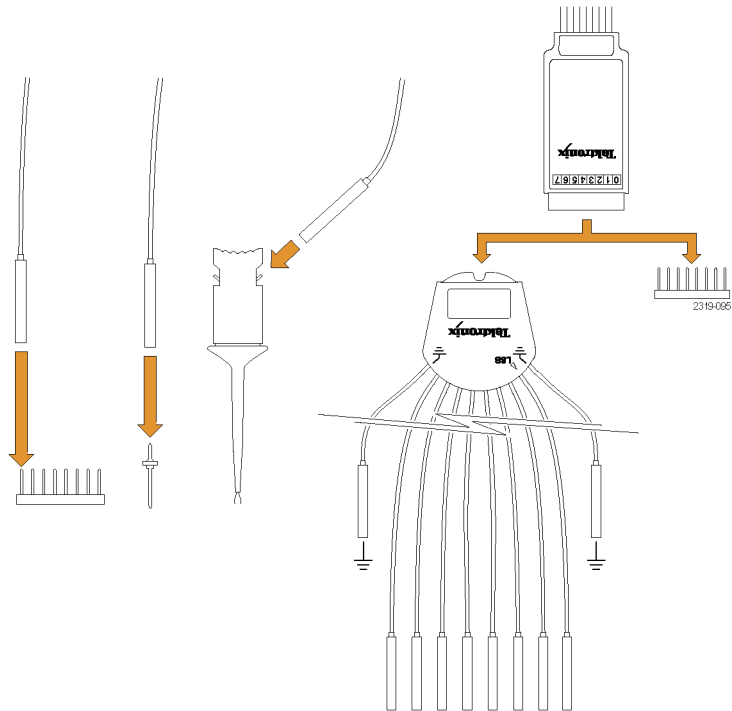

2. Connect the ground lead or leads to the circuit ground.  
You can connect one or two of the common ground leads for each group of 8 channels (wires).
3. If needed, connect the appropriate grabber for each probe to the probe tip.
4. Connect each channel to the desired circuit test point.
5. Push **D15 - D0** on the front-panel to display the menu.



6. Push **D15 - D0** on the lower menu to access the D15 - D0 On or Off menu.

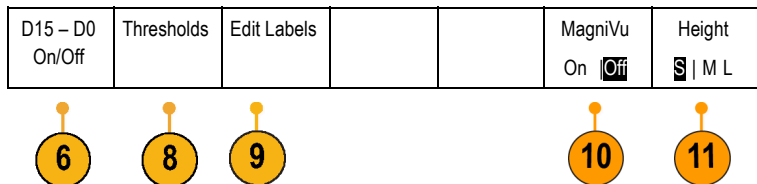



7. Turn multipurpose knob **a** to scroll through the list of digital channels. Turn multipurpose knob **b** to position the selected channel.

As you position channels close to each other on the display, the oscilloscope groups the channels, and adds the group to the pop-up list. You can select the group from the list to move all the channels in the group instead of individual channels.

8. Push **Thresholds** on the lower menu. You can assign a different threshold value to each pod.
9. Push **Edit Labels** on the lower menu and create the label. You can create labels through the front-panel or with an optional USB keyboard. (See page 45, *Labeling Channels and Buses*.)
10. Push **MagniVu** on the lower menu to increase the timing resolution.

11. Push **Height** on the lower menu repeatedly to set the signal height. You only need to do this once to set the height for all of the digital channels.

### Quick Tip

- Use the zoom feature to see multiple cycles of the signal in the upper part, and a single cycle in the lower part of the display. (See page 118, *Using Wave Inspector to Manage Long Record Length Waveforms.*)
- When setting up the digital probe, the first set of eight leads (pins 7 to 0) on the digital probe is marked Group 1 on the lead box. The second set (pins 15 to 8) is marked Group 2.
- Digital channels store a high or low state for each sample. The threshold that separates a high from a low state can be set for all the channels in Group 1 or in Group 2 of the digital probe. The threshold can not be set for individual channels.

## When and Why to Turn On MagniVu

For MSO3000 Series only, MagniVu allows you to have higher resolution to accurately determine edge placement. This helps you to make precise timing measurements on digital edges. You can see up to 16 times more detail than with normal digital channel sampling.

The MagniVu record is acquired in parallel with the main digital acquisition and is available at any time, running or stopped. MagniVu provides an ultra high resolution view of your data sampled at a maximum resolution of 121.2 ps for 10,000 points centered around the trigger.

---

**NOTE.** *MagniVu centers itself around the trigger point. If you turn MagniVu on while using a large record length and you are looking somewhere other than the trigger point, then the digital signal may be off screen. In most of these cases, you can find the digital record by looking for the digital signal in the upper overview and panning accordingly.*

---

---

**NOTE.** *You should turn on MagniVu when light gray shading is displayed to indicate the uncertainty of the edge position. If the shading is not displayed, you do not need to use MagniVu. (See page 97, *Viewing Digital Channels.*)*

---

## Using MagniVu

1. Push **D15 – D0**.



2. Push **MagniVu** and select **On**.

D15 – D0 On/Off	Thresholds	Label			MagniVu On <input checked="" type="checkbox"/>	Height <input checked="" type="checkbox"/>   M L
--------------------	------------	-------	--	--	---	---

### Quick Tips

- If you think you need more timing resolution, turn on MagniVu to increase the resolution.
- MagniVu is always acquired. If the oscilloscope is in a stopped state, you can turn on MagniVu and still get the resolution without taking another acquisition.
- The serial bus features do not use data acquired in MagniVu mode.

# Trigger Setup

This section contains concepts and procedures for setting up the oscilloscope to trigger on your signal.

## Triggering Concepts

### Trigger Event

The trigger event establishes the time-reference point in the waveform record. All waveform record data is located in time with respect to that point. The instrument continuously acquires and retains enough sample points to fill the pretrigger portion of the waveform record. That is the part of the waveform that is displayed before, or to the left of, the triggering event on screen. When a trigger event occurs, the instrument starts acquiring samples to build the posttrigger portion of the waveform record, that is, the part displayed after or to the right of the trigger event. After a trigger is recognized, the instrument will not accept another trigger until the acquisition is complete and the holdoff time has expired.

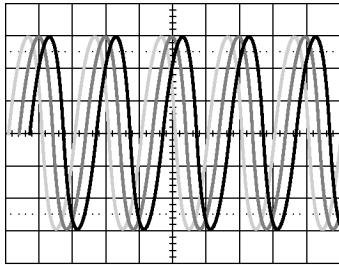

1785-087a

Untriggered display

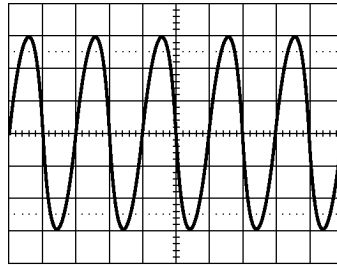

1785-087b

Triggered display

### Trigger Modes

The trigger mode determines how the instrument behaves in the absence of a trigger event:

- Normal trigger mode enables the instrument to acquire a waveform only when it is triggered. If no trigger occurs, the last waveform record acquired remains on the display. If no last waveform exists, no waveform is displayed.
- Auto trigger mode enables the instrument to acquire a waveform even if a trigger does not occur. Auto mode uses a timer that starts when the acquisition is started, and the pretrigger information is obtained. If a trigger event is not detected before the timer times out, the instrument forces a trigger. The length of time it waits for a trigger event depends on the time base setting.

Auto mode, when forcing triggers in the absence of valid triggering events, does not synchronize the waveform on the display. The waveform will appear to roll across the screen. If valid triggers occur, the display will become stable.

You can also force the instrument to trigger by pushing **Force Trig** on the front-panel.

## Trigger Holdoff

Adjust holdoff to obtain stable triggering when the instrument is triggering on undesired trigger events.

Trigger holdoff can help stabilize triggering, since the oscilloscope does not recognize new triggers during the holdoff time. When the instrument recognizes a trigger event, it disables the trigger system until acquisition is complete. In addition, the trigger system remains disabled during the holdoff period that follows each acquisition.

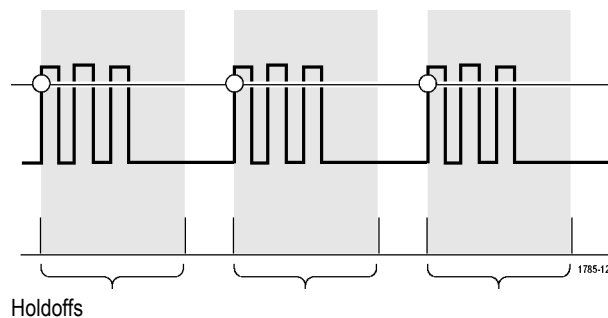

## Trigger Coupling

Trigger coupling determines what part of the signal is passed to the trigger circuit. Edge triggering can use all available coupling types: DC, AC, Low Frequency Rejection, High Frequency Rejection, and Noise Rejection. Sequence (B) triggering does not provide AC coupling. Other trigger types use DC coupling only.

## Horizontal Position

When **Delay Mode** is on, use horizontal position to acquire waveform detail in a region that is separated from the trigger location by a significant interval of time.

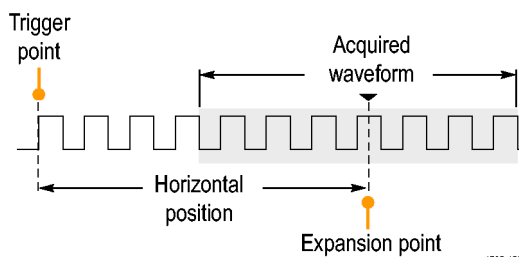

1. Adjust the position (delay) time by rotating the **Horizontal Position** knob.
2. Turn horizontal **SCALE** to acquire the detail that you need around the position (delay) expansion point.

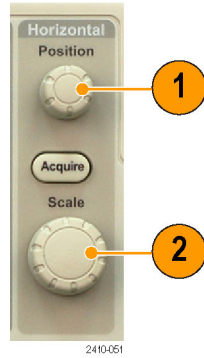

The part of the record that occurs before the trigger is the pretrigger portion. The part that occurs after the trigger is the posttrigger portion. Pretrigger data can help you troubleshoot. For example, to find the cause of an unwanted glitch in your test circuit, you can trigger on the glitch and make the pretrigger period large enough to capture data before the glitch. By analyzing what happens before the glitch, you may uncover information that helps you find the source of the glitch. Alternatively, to see what is happening in your system as a result of the trigger event, make the posttrigger period large enough to capture data after the trigger.

### Slope and Level

The slope control determines whether the instrument finds the trigger point on the rising or the falling edge of a signal.

The level control determines where on that edge the trigger point occurs.

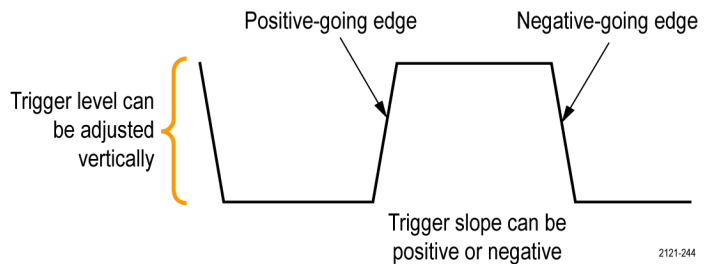

The oscilloscope provides a long horizontal bar or bars across the graticule to temporarily show the trigger level.

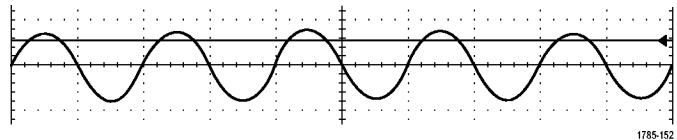

1. Turn the front-panel Trigger **Level** knob to adjust the trigger level without going to a menu.

Push the knob to quickly set the trigger level to the midpoint of the waveform.



## Choosing a Trigger Type

To select a trigger:

1. Push Trigger **Menu**.



2. Push **Type** to bring up the **Trigger Type** side menu.

**NOTE.** The bus trigger in the MSO3000 Series works on parallel buses even without an application module. Using the bus trigger on other buses requires use of the DPO3AERO, DPO3AUDIO, DPO3AUTO, DPO3EMBD, DPO3COMP, or DPO3FLEX application module.

Trigger Type
Sequence (B Trigger)
Pulse Width
Timeout
Runt
Logic
Setup & Hold
Rise/Fall Time
Video
Bus

3. Turn multipurpose knob **a** to select the desired trigger type.

4. Complete the trigger setup using the lower menu controls displayed for the trigger type. The controls to set up the trigger vary depending on the trigger type.

Type <b>Edge</b>	Source <b>1</b>	Coupling <b>DC</b>	Slope 	Level <b>100 mV</b>		Mode <b>Auto</b> & Holdoff
<b>2</b>	<b>4</b>	<b>4</b>	<b>4</b>	<b>4</b>		

## Selecting Triggers

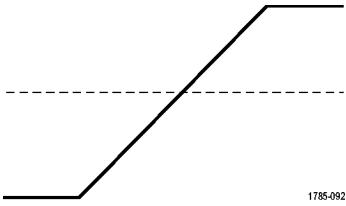
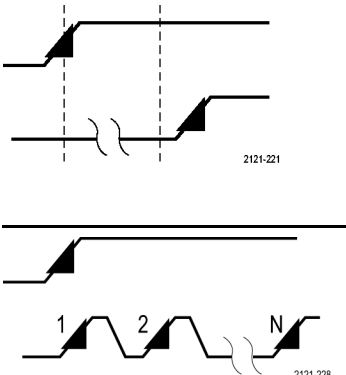
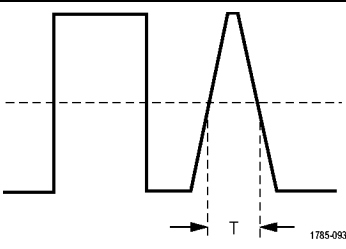
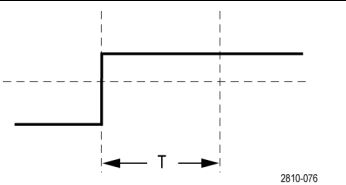
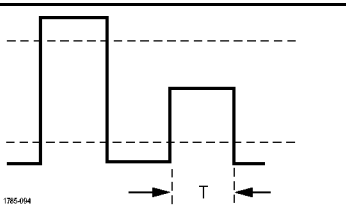
Trigger Type	Trigger Conditions
<p>Edge</p> 	<p>Trigger on a rising or falling edge, as defined by the slope control. Coupling choices are DC, AC, LF Reject, HF Reject, and Noise Reject.</p> <p>Edge triggers are the simplest and most commonly used trigger type, with both analog and digital signals. An edge trigger event occurs when the trigger source passes through a specified voltage level in the specified direction.</p>
<p>Sequence (B Trigger)</p> 	<p>Combine an edge A Event (Main) trigger with the B Event (Delayed) trigger to capture more complex signals. (See page 81, <i>Using Sequence Trigger, A (Main) and B (Delayed).</i>)</p> <p><b>Time.</b> After the A Event occurs, the trigger system waits the specified amount of time, and then looks for the B Event before triggering and displaying the waveform.</p> <p><b>Events.</b> After the A Event occurs, the trigger system looks for a specified number of B Events before triggering and displaying the waveform.</p>
<p>Pulse Width</p> 	<p>Trigger on pulses that are less than, greater than, equal to, not equal to, a specified time. Additionally, you can trigger when a pulse width is within or outside a range of two different specified times. You can also trigger on positive or negative pulses. Pulse width triggers are primarily used on digital signals.</p>
<p>Timeout</p> 	<p>Trigger when no pulse is detected within a specified time.</p>
<p>Runt</p> 	<p>Trigger on a pulse amplitude that crosses one threshold but fails to cross a second threshold before recrossing the first. You can detect positive or negative (or either) runts, or only those wider than, less than, greater than, equal to, or not equal to a specified width. Runt triggers are primarily used on digital signals.</p>



## Trigger Type

Logic

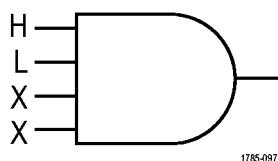

## Trigger Conditions

Trigger when all channels transition to the specified state. Use multipurpose knob **a** to select a channel. Push the appropriate side menu button to set that channel's state to **High (H)**, **Low (L)**, or **Don't Care (X)**.

Use **Clock** on the side menu to enable clocked (state) triggering. You can have at most a single clock channel. Push **Clock Edge** on the lower menu to change the polarity of the clock edge. Turn off clocked triggering and return to unclocked (pattern) triggering by selecting the clock channel and setting it to high, low, or don't care.

For unclocked triggering, by default, triggering occurs when the selected condition goes true. You can also select triggering when the condition goes false, or time-qualified triggering.

You can use up to 20 channels for a logic trigger (4 analog and 16 digital) with MSO3000 Series oscilloscopes.

**NOTE.** Optimum Logic trigger performance is achieved by using only analog channels or only digital channels.

Setup and Hold

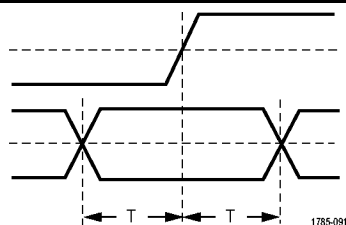

Trigger when a logic data input changes state inside of the setup or hold time relative to a clock edge.

Setup is the amount of time that data should be stable and not change before a clock edge occurs. Hold is the time that data should be stable and not change after a clock edge occurs.

MSO3000 Series oscilloscopes are capable of multiple channel Setup and Hold triggering, and can monitor the state of an entire bus for setup and hold violations. You can use up to 20 channels for a Setup and Hold trigger (4 analog and 16 digital) with MSO3000 Series oscilloscopes.

Use **Clock** on the side menu to select the clock channel. Use **Select** control, **Data**, and **Not used** to select one or more channels you want to monitor for setup and hold violations.

**NOTE.** Optimum Setup and Hold trigger performance is achieved by using only analog channels or only digital channels.

Rise/Fall Time

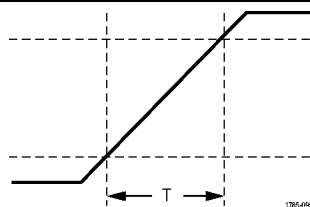

Trigger on rise and fall times. Trigger on pulse edges that traverse between two thresholds at faster or slower rates than the specified time. Specify pulse edges as positive, negative, or either.

**Trigger Type**

Video

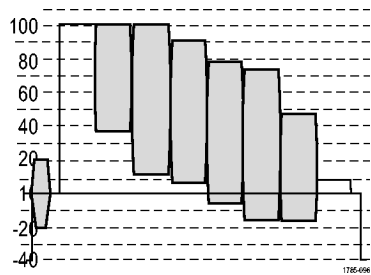

**Trigger Conditions**

Trigger on specified fields or lines of a composite video signal. Only composite signal formats are supported. Trigger on NTSC, PAL, or SECAM. Works with Macrovision signals. With the DPO3VID module, trigger on a variety of HDTV video standard signals, as well as custom (non-standard) bilevel and trilevel video signals with 3 to 4,000 lines.

Bus

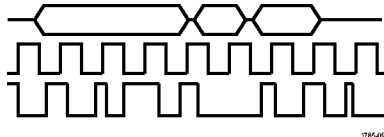

Trigger on various bus conditions. Parallel requires an MSO3000 Series oscilloscope. I<sup>2</sup>C and SPI requires a DPO3EMBD module. RS-232, RS-422, RS-485, and UART require a DPO3COMP module. MIL-STD-1553 requires a DPO3AERO module. CAN and LIN requires a DPO3AUTO module. FlexRay requires a DPO3FLEX module. I<sup>2</sup>S, Left Justified (LJ), Right Justified (RJ), and TDM require a DPO3AUDIO module. (See page 12, *Application Module Free Trial*.)

**Triggering on Buses**

You can use your oscilloscope to trigger on I<sup>2</sup>C, SPI, RS-232, RS-422, RS-485, UART, MIL-STD-1553, CAN, LIN, FlexRay, I<sup>2</sup>S, Left Justified (LJ), Right Justified (RJ), and TDM buses, if you have the appropriate DPO3AERO, DPO3AUDIO, DPO3AUTO, DPO3COMP, DPO3EMBD, or DPO3FLEX application module installed. The MSO3000 Series can trigger on parallel buses without an application module. The oscilloscope can display both physical layer (as analog waveforms) and protocol level information (as symbolic waveforms).

To set up the bus trigger:

1. If you have not already defined your bus using **B1** and **B2** on the front-panel, do so now. (See page 54, *Setting Up a Serial or Parallel Bus*.)



2. Push **Trigger Menu**.



3. Push **Type**.

Type <b>Bus</b>	Source Bus <b>B1 (I2C)</b>	Trigger On <b>Address</b>	Address <b>07F</b>		Direction <b>Write</b>	Mode <b>Auto</b> & Holdoff
--------------------	-------------------------------	------------------------------	-----------------------	--	---------------------------	----------------------------------

4. Turn multipurpose knob **a** to scroll through the trigger type side menu until you select **Bus**.



5. Push **Source Bus** and turn multipurpose knob **a** to scroll through the source bus side menu until you select the bus that you want to trigger on.

B1 (I2C)
B2 (CAN)

6. Push **Trigger On** and select the desired trigger on feature from the side menu.

## Parallel Bus Trigger

You can trigger on a binary or hex data value. Push **Data** on the lower menu and enter the parameters of interest with multipurpose knobs **a** and **b**.

## I2C Bus Trigger

If you are using the I2C bus trigger, you can trigger on **Start**, **Repeated Start**, **Stop**, **Missing Ack**, **Address**, **Data**, or **Address/Data**.

If you are setting up an I2C trigger and have made a **Trigger On** selection of **Address** or **Address/Data**, push **Address** on the lower menu to access the I2C Address side menu.

Push **Addressing Mode** on the side menu and select **7 bit** or **10 bit**. Push **Address** on the side menu. Enter the address parameters of interest with multipurpose knobs **a** and **b**.

Then push **Direction** on the lower menu and select the direction of interest: **Read**, **Write**, or **Read or Write**.

If you have made a **Trigger On** selection of **Data** or **Address/Data**, push **Data** on the lower menu to access the I2C Data side menu.

Push **Number of Bytes** and enter the number of bytes using multipurpose knob **a**.

Push **Addressing Mode** on the side menu and select **7 bit** or **10 bit**. Push **Data** on the side menu. Enter the data parameters of interest with multipurpose knobs **a** and **b**.

For more information on the I2C address formats, refer to item 2 under *Setting Up Bus Parameters*.

## SPI Bus Trigger

If you are using the SPI bus trigger, you can trigger on **SS Active**, **MOSI**, **MISO**, or **MOSI & MISO**.

If you are setting up an SPI trigger and have made a **Trigger On** selection of **MOSI** or **MISO**, push **Data** on the lower menu, push **MOSI** (or **MISO**) on the side menu, and enter the data parameters of interest with multipurpose knobs **a** and **b**.

Then push **Number of Bytes** and enter the number of bytes using multipurpose knob **a**.

If you select **MOSI & MISO**, push **Data** on the lower menu and enter the parameters of interest on the side menus.

## RS-232 Bus Trigger

If you are using the RS-232 bus trigger, you can trigger on **Tx Start Bit**, **Rx Start Bit**, **Tx End of Packet**, **Rx End of Packet**, **Tx Data**, or **Rx Data**.

If you are setting up an RS-232 trigger and have made a **Trigger On** selection of **Tx Data** or **Rx Data**, push **Data** on the lower menu.

Push **Number of Bytes** and enter the number of bytes with multipurpose knob **a**.

Push **Data** on the side menu, and enter the parameters of interest with multipurpose knobs **a** and **b**.

## MIL-STD-1553 Bus Trigger

You can trigger on **Sync**, **Command**, **Status**, **Data**, **Time (RT/IMG)**, or **Error**.

If you are setting up a MIL-STD-1553 trigger and have made a **Trigger On** selection of **Command**, push **RT Address** on the lower menu to enter specific values of **RT Address** to trigger on. Push **Command Word Details** on the lower menu to enter the **T/R bit** value, **Subaddress/Mode** value, **Word Count/Mode Code** value, and **Parity** value.

If you are setting up a MIL-STD-1553 trigger and have made a **Trigger On** selection of **Status**, push **RT-Address** on the lower menu to enter specific values of **RT Address** to trigger on. Push **Status Word Bits** on the lower menu to enter values for **Message Error (bit 9)**, **Instr. (bit 10)**, **Service Req. (bit 11)**, **BCR (bit 15)**, **Busy (bit 16)**, **Subsystem Flag (bit 17)**, **DBCA (bit 18)**, **Terminal Flag (bit 19)** and **Parity**.

If you are setting up a MIL-STD-1553 trigger and have made a **Trigger On** selection of **Data**, push **Data** on the lower menu to enter specific **Data** values, and the **Parity** value.

If you are setting up a MIL-STD-1553 trigger and have made a **Trigger On** selection of **Time (RT/IMG)**, push **Trigger When** on the lower menu to set the trigger condition. Push **Times** on the lower menu to set the **Maximum** and **Minimum** times.

If you are setting up a MIL-STD-1553 trigger and have made a **Trigger On** selection of **Error**, push **Error Type** on the lower menu to select the type of error to trigger on.

## CAN Bus Trigger

If you are using the CAN bus trigger, you can trigger on **Start of Frame**, **Type of Frame**, **Identifier**, **Data**, **Id & Data**, **End of Frame**, and **Missing Ack**.

If you are setting up a CAN trigger and have made a **Trigger On** selection of **Type of Frame**, push **Frame Type** on the lower menu, and select Data Frame, Remote Frame, Error Frame, or Overload Frame.

If you have made a **Trigger On** selection of **Identifier**, push **Identifier** on the lower menu, and select a **Format**. Then push **Identifier** on the side menu, and enter a binary or hex value with multipurpose knobs **a** and **b**.

Push **Direction** on the lower menu and select the direction of interest: **Read**, **Write**, or **Read or Write**.

If you have made a **Trigger On** selection of **Data**. Push **Data** on the lower menu and enter the parameters of interest with multipurpose knobs **a** and **b**.

## LIN Bus Trigger

If you are using the LIN bus trigger, you can trigger on **Sync, Identifier, Data, Id & Data, Wakeup Frame, Sleep Frame, or Error**.

If you are setting up an LIN trigger and have made a **Trigger On** selection of **Identifier, Data, or Identifier & Data**, push **Identifier** or **Data** on the lower menu and enter the parameters of interest on the resulting side menu.

If you have made a **Trigger On** selection of **Error**, push **Error Type** on the lower menu and enter the parameters of interest on the resulting side menu.

## FlexRay Bus Trigger

You can trigger on **Start of Frame, Type of Frame, Identifier, Cycle Count, Header Fields, Data, Id & Data, End of Frame** or **Error**.

## Audio Bus Trigger

If you are using the I<sup>2</sup>S, LJ, and RJ bus, you can trigger on **Word Select**, or **Data**.

If you are using the TDM bus, you can trigger on **Frame Sync**, or **Data**.

## I<sup>2</sup>C, SPI, CAN, and LIN, and FlexRay Bus Trigger Data Matching

**Rolling window byte matching for I<sup>2</sup>C, SPI, and FlexRay.** To use a rolling window to trigger on data, you define the number of bytes to match. Then the oscilloscope uses a rolling window to find any match within a packet, with the window rolling one byte at a time.

For example, if the number of bytes is one, the oscilloscope will attempt to match the first byte, second byte, third, and so on within the packet.

If the number of bytes is two, the oscilloscope will try to match any two consecutive bytes, such as one and two, two and three, three and four, and so on. If the oscilloscope finds a match, it will trigger.

With FlexRay, obtain a rolling window match by setting the **Byte Offset** in the Data menu to **Don't care**.

**Specific byte matching (non-rolling window matching for a specific position in the packet) for I<sup>2</sup>C, SPI, CAN, LIN, and FlexRay.** You can trigger on a specific byte for I<sup>2</sup>C, SPI, CAN, LIN, and FlexRay in several ways:

- For I<sup>2</sup>C and SPI, enter the number of bytes to match the number of bytes in the signal. Then use don't cares (X) to mask the bytes that you are not interested in.
- For I<sup>2</sup>C, push **Trigger On** on the lower menu to trigger on **Address/Data**. Push **Address**. On the side menu, push **Address**, and rotate multipurpose knobs **a** and **b** as needed. Set the address to don't cares (X) if you want to mask the address. The data will be matched starting at the first byte without using a rolling window.
- For CAN and LIN, triggering occurs when the user-selected data input matches the data and qualifier in the signal starting at the first byte. Set the number of bytes to match the number of bytes of interest. Use the data qualifier to perform: =, !=, <, >, >=, and <= operations. Triggering on identifier and data always matches the identifier and data selected by the user, with the data starting at the first byte. No rolling window is used.
- For FlexRay, triggering occurs when the user-selected data input matches the data and qualifier in the signal starting at the byte offset. Set the number of bytes to match the number of bytes of interest. Use the data qualifier to perform: =, !=, <, >, >=, and <= operations. Triggering on identifier and data always matches the identifier and data selected by the user, with the data starting at the first byte. No rolling window is used.

## Data Value Matching

You can trigger on a specific data value for RS-232 bytes. If you defined an end-of-packet character to use for RS-232 bus decoding, you can use the same end-of-packet character as a data value for trigger data matching. To do so, choose the Tx End of Packet or the Rx End of Packet character as the Trigger On selection.

You can also trigger on a specific data value for other buses.

## Parallel Bus Trigger Data Matching

Optimum parallel bus trigger performance is achieved by using only analog channels or only digital channels (MSO3000 Series only).

## Checking Trigger Settings

To quickly determine the settings of some key trigger parameters, check the Trigger readout at the bottom of the display. The readouts differ for edge and the advanced triggers.

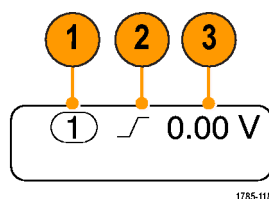

Edge trigger readout

1. Trigger source = channel 1.
2. Trigger slope = rising.
3. Trigger level = 0.00 V.

## Using Sequence Trigger, A (Main) and B (Delayed)

Combine an edge A Event (Main) trigger with the B Event (Delayed) trigger to capture more complex signals. After the A Event occurs, the trigger system looks for the B Event before triggering and displaying the waveform.

A and B triggers can (and typically do) have separate sources.

Use the Edge trigger menu to set up the A trigger first. Then, to use the B trigger:

1. Push Trigger **Menu**.



2. Push **Type**.
3. Turn multipurpose knob **a** to select a trigger type of **Sequence (B Trigger)**.  
This brings up the Sequence (B Trigger) menu.

4. Push **B Trigger After A**.

Type Sequence (B Trigger)	Source 1	Coupling DC	Slope 	Level 0.00 V	B Trigger After A Time	Mode Auto & Holdoff
---------------------------------	-------------	----------------	-----------	-----------------	------------------------------	---------------------------



Push a side menu button to select sequencing the B trigger after the A as Time or as Events.

Time (a) 8 ns
B Events 1
Set to Minimum

5. Set the other Sequence Trigger parameters on the related side and lower menus.

### B Trigger After Delay Time

The A trigger arms the instrument. Posttrigger acquisition starts on the first B edge after the trigger delay time.

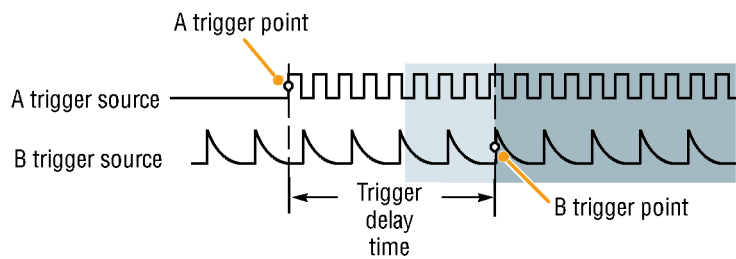

### Trigger on B Events

The A trigger arms the instrument. Posttrigger acquisition starts on the nth B event.

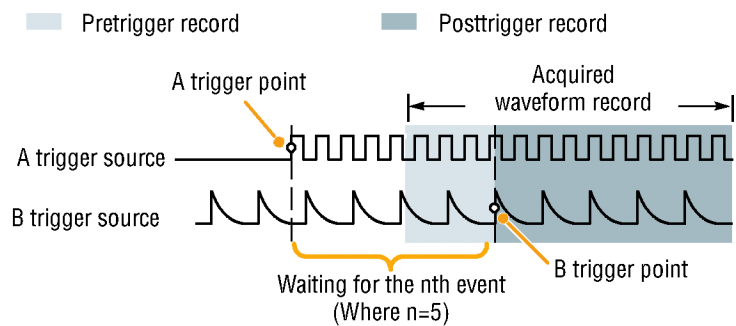

### Quick Tips

- B-trigger delay time and horizontal position are independent functions. When you establish a trigger condition using either the A trigger alone or the A and B triggers together, you can also use the horizontal position control to delay the acquisition by an additional amount.
- When using the B trigger, the A and B trigger types can only be Edge.



## Starting and Stopping an Acquisition

After you have defined the acquisition and trigger parameters, start the acquisition with **Run/Stop** or **Single**.

- Push **Run/Stop** to start acquisitions.  
The oscilloscope acquires repeatedly until you push the button again to stop the acquisition.
- Push **Single** to take a single acquisition.  
Single sets the trigger mode to **Normal** for the single acquisition.



2410053

# Display Waveform Data

This section contains concepts and procedures for displaying the acquired waveform.

## Adding and Removing a Waveform

- To add or remove a waveform from the display, push the corresponding front-panel channel button or the D15-D0 button.

You can use the channel as a trigger source whether or not it is displayed.

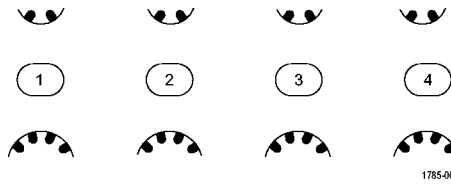

## Setting the Display Style and Persistence

- To set the display style, push **Acquire**.



- Push **Waveform Display**.

Mode Sample	Record Length 10K	Delay On Off	Set Horiz. Position to 10%	Waveform Display	XY Display On	
----------------	----------------------	-----------------	-------------------------------	------------------	------------------	--



3. Push **Dots Only** on the side menu. Dots on will display the waveform record points as dots on the screen. Dots off connects the dots with vectors.
4. Push **Persist Time**, and turn multipurpose knob **a** to have waveform data remain on screen for a user-specified amount of time.
5. Push **Set to Auto** to have the oscilloscope automatically determine a persistence time for you.
6. Push **Clear Persistence** to reset the persistence information.
7. To display the amplitude from one waveform against the amplitude from another, push **XY Display**. Then push **Triggered XY** on the side menu.

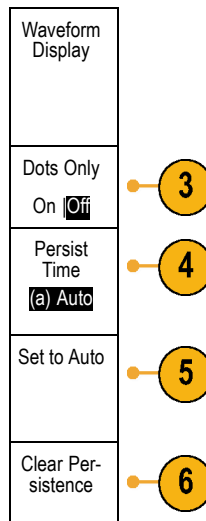

A data point from the first waveform specifies the horizontal location while the corresponding data point from the second waveform specifies the vertical location for each displayed point.

## Quick Tips

- Variable persistence accumulates record points for a specified time interval. Each record point decays independently according to the time interval. Use variable persistence for displaying infrequently appearing signal anomalies, such as glitches.
- Infinite persistence continuously accumulates record points until you change one of the acquisition display settings. Use infinite persistence for displaying unique signal anomalies, such as glitches.
- The XY Display mode graphs the data in fixed pairs of waveforms against one another. You can use CH1 versus CH2, and REF1 versus REF2. On four-channel models, you can also use CH3 versus CH4, and REF3 versus REF4.
- When the XY Display is on, an upper window appears that displays data versus time.

## Setting the Graticule Style

1. To set the graticule style, push **Utility**.



2. Push **Utility Page**.

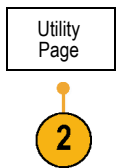

3. Turn multipurpose knob **a** and select **Display**.



4. Push **Graticule** on the lower menu.

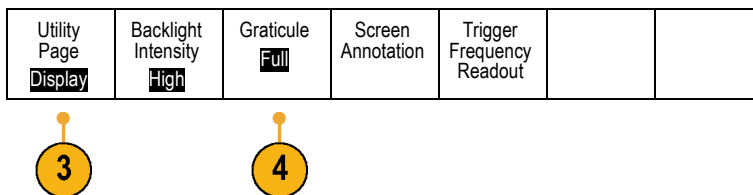

5. Select the desired style on the resulting side menu.

The **Frame** graticule provides a clean screen on which you can most easily read automatic measurement results and other screen text.

The **Full** graticule can help you make cursor measurements on hard copies.

The **Grid**, **Solid**, and **Cross Hair** graticules provide compromises between **Frame** and **Full**.



2410-074

### Quick Tips

- You can display IRE and mV graticules. To do this, set the trigger type to video and set the vertical scale to 143 mV/division. (The 143 mV/division selection is available in the coarse vertical scale settings for the channel when you set the trigger type to video.) The oscilloscope will automatically display the IRE graticule for NTSC signals, and the mV graticule for other video signals (PAL, SECAM, HDTV, and custom).

### Setting the LCD Backlight

1. Push **Utility**.



2410-017

2. Push **Utility Page** on the lower menu.

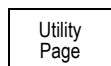

3. Turn multipurpose knob **a** and select **Display**.



4. Push **Backlight Intensity**.

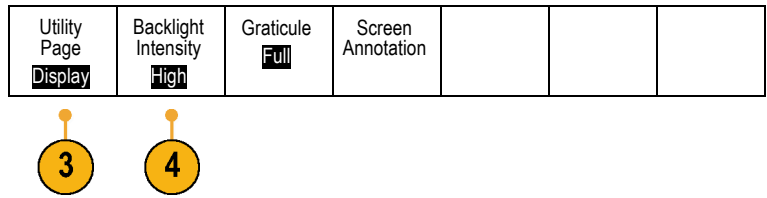

5. Select the intensity level on the resulting side menu. Choices are: **High, Medium, and Low**.

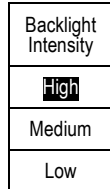

## Setting Waveform Intensity

1. Push **Intensity** on the front-panel.



This will bring up the intensity readout on the display.

- a) Waveform Intensity: 35%
  - b) Graticule Intensity: 75%
- 2121-245

2. Rotate multipurpose knob **a** to select the desired waveform intensity.



3. Rotate multipurpose knob **b** to select the desired intensity for the graticule.
4. Push **Intensity** again to clear the intensity readout from the display.



## Scaling and Positioning a Waveform

Use the horizontal controls to adjust the time base, adjust the trigger point, and to examine waveform details more closely. You can also use the Wave Inspector Pan and Zoom controls to adjust the display of waveforms. (See page 118, *Using Wave Inspector to Manage Long Record Length Waveforms.*)

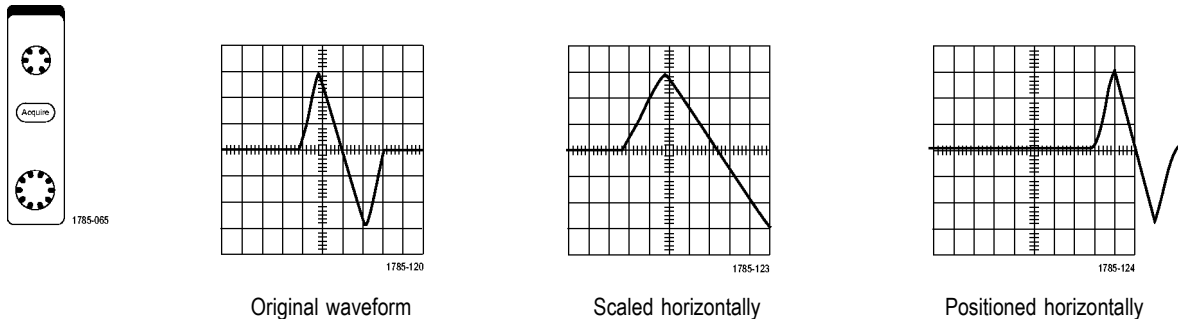

Use the vertical controls to select waveforms, adjust the waveform vertical position and scale, and set input parameters. Push a channel menu button (1, 2, 3, or 4) as many times as needed and the associated menu items to select, add, or remove a waveform.

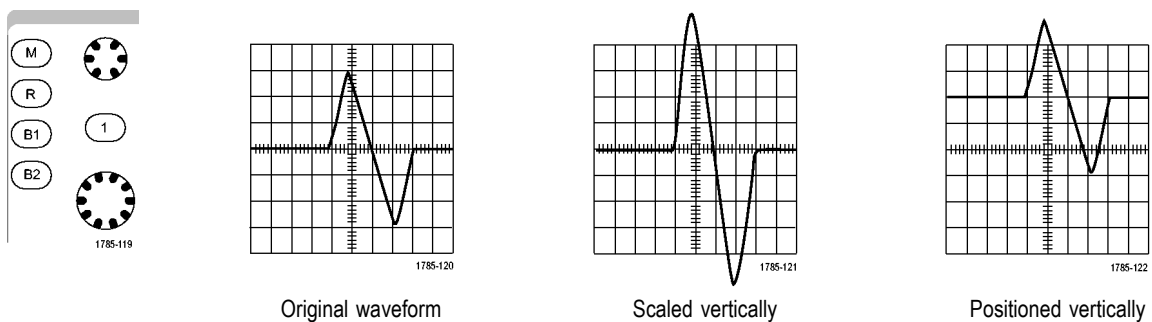

### Quick Tips

- **Preview.** If you change the Position or Scale controls when the acquisition is stopped or when it is waiting for the next trigger, the oscilloscope rescales and repositions the relevant waveforms in response to the new control settings. It simulates what you will see when you next push **RUN**. The oscilloscope uses the new settings for the next acquisition.

You may see a clipped waveform if the original acquisition went off the screen.

The math waveform, cursors, and automatic measurements remain active and valid when using preview.

## Setting Input Parameters

Use the vertical controls to select waveforms, adjust the waveform vertical position and scale, and set input parameters.

1. Push a channel menu button **1**, **2**, **3**, or **4** to bring up the vertical menu for the designated waveform. The vertical menu only affects the selected waveform.

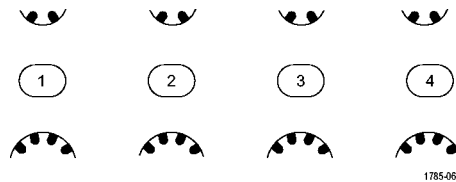

Pushing a channel button will also select or cancel that waveform selection.

2. Push **Coupling** repeatedly to select the coupling to use.  
Use DC coupling to pass both AC and DC components.

Use AC coupling to block the DC component and show only the AC signal.

Use Ground (GND) to display the reference potential.

Coupling DC AC 	Impedance 1MΩ 75Ω 50Ω	Invert On Off	Bandwidth Full	(1) Label	More	
-----------------------	-----------------------------	------------------	-------------------	-----------	------	--



3. Push **Impedance** repeatedly to select the input impedance to use.  
Set the input impedance (termination) to 50 Ω, 75 Ω, or 1 MΩ if using DC or Gnd coupling. Input impedance is automatically set to 1 MΩ when using AC coupling.  
For more information on input impedance, see **Quick Tips**. (See page 93, *Quick Tips*.)
4. Push **Invert** to invert the signal.  
Select **Off** for normal operation and **On** to invert the polarity of the signal in the preamplifier.



5. Push **Bandwidth**, and select the desired bandwidth on the resulting side menu.  
 The set choices are: Full and 20 MHz.  
 Additional choices may appear, depending on the probe that you use.  
 Select **Full** to set the bandwidth to the full oscilloscope bandwidth.  
 Select **20 MHz** to set the bandwidth to 20 MHz.
6. Push **Label** to create a label for the channel.  
 (See page 45, *Labeling Channels and Buses*.)
7. Push **More** to access additional side menus.

8. Select **Fine Scale** to enable multipurpose knob **a** to make fine vertical scale adjustments.

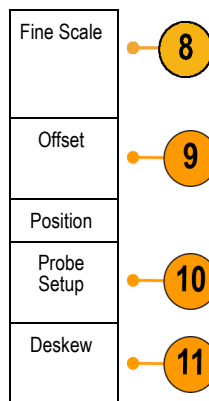

9. Select **Offset** to enable multipurpose knob **a** to make vertical offset adjustments.  
 On the side menu, choose **Set to 0 V** to set the vertical offset to 0 V.  
 For more information on offset, see **Quick Tips**. (See page 93, *Quick Tips*.)

10. Select **Probe Setup** to define probe parameters.

On the resulting side menu:

- Select **Voltage** or **Current** to set the probe type for probes that do not have the TekProbe Level 1, TekProbe II (requires a TPA-BNC adapter) or TekVPI interface.
- For probes that do not have a Tek interface, when **Probe Type** is set to **Voltage**, use multipurpose knob **a** to set the **Attenuation** to match the probe.
- For probes that do not have a Tek interface, when **Probe Type** is set to **Current**, use multipurpose knob **a** to set the Amps/Volts ratio (**Attenuation**) to match the probe.
- If you are measuring current by probing the voltage drop across a resistor, set **Measure Current** to **Yes**. Push **A/V** on the side menu and turn multipurpose knob **a** to set the Amps/Volts or Volts/Amps ratio of your setup. For example, if you are measuring the drop across a  $2\ \Omega$  resistor, set the V/A ratio to 2.

11. Select **Deskew** to make display and measurement adjustments for probes that have differing propagation delays. This is especially important when using a current probe in conjunction with a voltage probe.

For best results, use a deskew fixture, such as the Tektronix 067-1686-xx.

If you do not have a deskew fixture, you can use the controls in the Deskew menu to set the oscilloscope's deskew parameters to recommended values, based on the normal propagation delay of each probe. The oscilloscope automatically loads the nominal propagation delay values of TekVPI and TekProbe II (requires use of a TPA-BNC adapter) probes. For other common probes, first push **Select** on the side menu, and select the channel to which the probe is attached. Then push **Probe Model** on the side menu, and select the probe model. If your probe is not in the list, set the probe model to **Other**, and push **Propagation Delay** on the side menu and dial in its propagation delay with multipurpose knob a.

To display the recommended deskew values calculated by the oscilloscope, set **Show rec. deskews** on the side menu to **Yes**.

To set the deskew value of each channel to the recommended value, push **Set all deskews to recommended value** on the lower menu.

## Quick Tips

- **Using Probes with the TekProbe II and TekVPI Interfaces.** When you attach a probe with the TekProbe II or the TekVPI interface, the oscilloscope sets the channel sensitivity, coupling, and termination resistance automatically to match the probe requirements. Tek Probe II probes require use of the TPA-BNC Adapter.
- **The Difference Between Vertical Position and Offset.** Adjust the vertical position to place the waveforms where you want to see them. The waveform baseline indicators indicate the zero Volts (or Amps) level for each waveform. If you adjust the channel's Vertical Scale, the waveform expands or contracts around the waveform's baseline indicator.

When you use the Channel<x>> **More > Offset > Vertical Offset** control to move a waveform, the baseline indicator no longer represents zero. Instead, it represents the level of the offset. If you adjust the channel's Vertical Scale, the waveform expands or contracts around the waveform's baseline indicator.

- **50 and 75  $\Omega$  Protection.** If you select 50  $\Omega$  or 75  $\Omega$  termination, the maximum vertical scale factor is limited to 1 V/div, except that with a 10X probe the scale factor is 10 V. If you apply excessive input voltage, the oscilloscope automatically switches to 1 M $\Omega$  termination to protect the internal 50  $\Omega$  or 75  $\Omega$  termination. For more details, refer to the specifications in the *DPO3000 Series Oscilloscopes Technical Reference*.

## Positioning and Labeling Bus Signals

**Positioning bus signals.** Push the appropriate front-panel bus button and turn multipurpose knob **a** to adjust the vertical position of the selected bus. (See page 54, *Setting Up a Serial or Parallel Bus.*)

1. Push the appropriate front-panel bus button to select that bus.



2. Turn multipurpose knob **a** to adjust the vertical position of the selected bus.



**Labeling bus signals.** To label a bus, do the following steps:

1. Push the appropriate front-panel bus button.

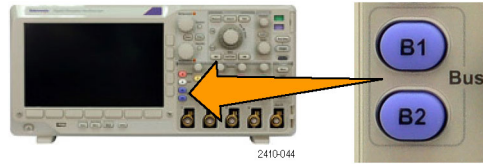

2. Push **Label**.  
(See page 45, *Labeling Channels and Buses*.)

Bus (B1) <b>I2C</b>	Define Inputs	Thresholds	Include R/W in address <b>No</b>	(B1) Label <b>I2C</b>	Bus Display	Event Table
------------------------	---------------	------------	-------------------------------------	--------------------------	-------------	-------------



## Positioning, Scaling, and Grouping Digital Channels

1. Push **D15–D0** on the front-panel.



2. Push **D15–D0** on the lower menu.

D15 – D0 On/Off	Thresholds	Edit Labels			MagniVu On <b>Off</b>	Height <b>S</b>   M L
--------------------	------------	-------------	--	--	--------------------------	--------------------------



3. Push **Select** on the side menu.

Select <b>(a) D0</b> (b) 1.08 div
Display <b>On</b>   Off
Turn on D7–D0
Turn on D15–D8



- Turn multipurpose knob **a** to select the channel to move.

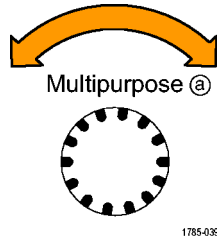

- Turn multipurpose knob **b** to move the selected channel.

**NOTE.** The display of the channel (or group) only moves after you stop rotating the knob.

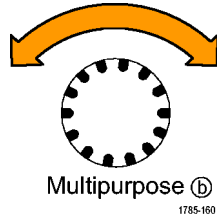

- To change the scale (height) of the digital channels, push **Height** on the lower menu.

**NOTE.** The **S** (Small) selection will display each waveform at 0.2 divisions tall. The **M** (Medium) selection will display each waveform at 0.5 divisions tall. The **L** (Large) selection will display each waveform at 1 division tall. **L** only works if there is enough room in the display to display the waveforms. You can display up to 8**L** waveforms at one time.

- You can label individual digital channels for easier identification. (See page 45, *Labeling Channels and Buses.*)

- To group some or all of the digital channels together, move the channels right next to each other. All the channels that are next to each other automatically form a group.

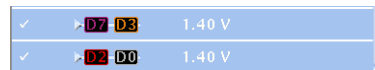

You can see the groups by pressing **Select** on the side menu and turning multipurpose knob **a**.

When a group is selected, turn multipurpose knob **b** to move the whole group.

## Viewing Digital Channels

The various ways of displaying data from the digital channels help you analyze the signals. Digital channels store a high or low state for each sample.

Logic high levels are displayed in green. Logic low levels are displayed in blue. When a single transition occurs during the time represented by one pixel column, the transition (edge) is displayed in gray.

When multiple transitions occur during the time represented by one pixel column, the transition (edge) is displayed in white.

When the display shows a white edge, indicating multiple transitions, you may be able to zoom in and see the individual edges.

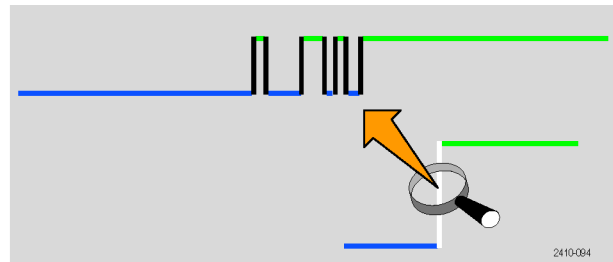

When the oscilloscope is zoomed in so far that there is more than one pixel column per sample, the uncertainty of the edge position is indicated by light gray shading.

**NOTE.** When the light gray shading is displayed, use MagniVu. The MagniVu readout appears when MagniVu is being used.

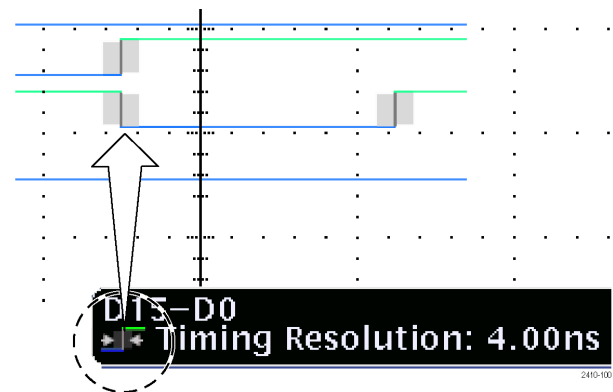

## Annotating the Screen

You can add your own text to the screen by doing the following:

1. Push **Utility**.



2. Push **Utility Page**.



- Turn multipurpose knob **a** and select **Display**.



- Push **Screen Annotation** on the resulting lower menu.

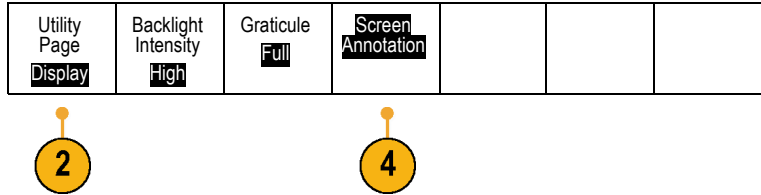

- Push **Display Annotation** to select **On** on the side menu.

The annotation window now appears.  
Position it by turning multipurpose knobs **a** and **b**.

- Push **Edit Annotation** on the side menu
- Turn multipurpose knob **a** to scroll through the list of letters, numbers, and other characters to select each desired character. Alternatively, use a US-style USB keyboard to type in characters. (See page 28, *Connecting a USB Keyboard to Your Oscilloscope*.)

To reposition the text, push **Position** on the side menu and turn multipurpose knobs **a** and **b**, as desired.

## Viewing the Trigger Frequency

You can display a readout of trigger frequency. It counts all of the triggerable events, whether the oscilloscope triggered on them or not, and displays the number of times per second that they occur. To display this readout, do the following:

- Push **Utility**.



- Push **Utility Page**.





- Turn multipurpose knob **a** and select **Display**.



- Push **Trigger Frequency Readout** from the resulting lower menu.

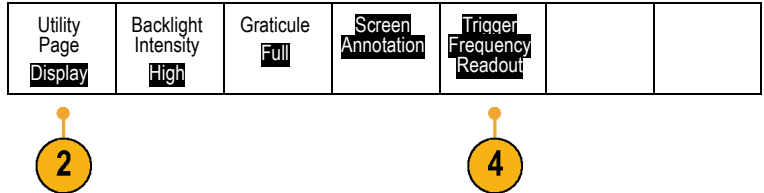

- Push **On** on the side menu.

The trigger frequency now appears in the Trigger readout, towards the lower right of the display.

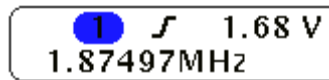

# Analyze Waveform Data

After having properly set up the acquisition, triggering, and display of your desired waveform, you can then analyze the results. Select from features such as cursors, automatic measurements, statistics, math, and FFT.

## Taking Automatic Measurements

To take an automatic measurement:

1. Push **Measure**.



2. Push **Add Measurement**.



3. Turn multipurpose knob **a** to select the specific measurement. If needed, then turn multipurpose knob **b** to select the channel to measure on.



4. To remove a measurement, push **Remove Measurement**, turn multipurpose knob **a** to select the specific measurement, and push **OK Remove Measurement** on the side menu.







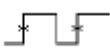

### Quick Tips

- To remove all measurements, select **Remove All Measurements**.
- A  symbol appears instead of the expected numerical measurement if a vertical clipping condition exists. Part of the waveform is above or below the display. To obtain a proper numerical measurement, turn the vertical scale and position knobs to make all of the waveform appear in the display.

## Selecting Automatic Measurements

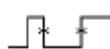
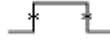
The following tables list each automatic measurement by category: time or amplitude. (See page 100, *Taking Automatic Measurements*.)

### Time Measurements

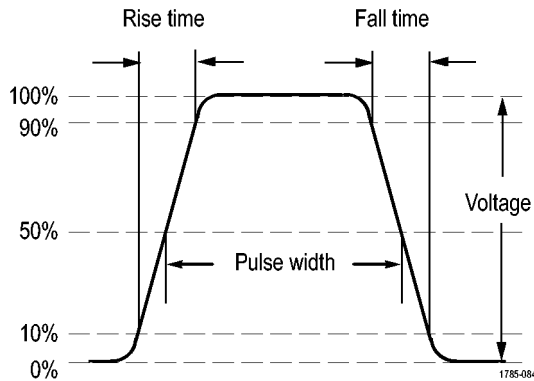

Measurement		Description
Period		The time required to complete the first cycle in a waveform or gated region. Period is the reciprocal of frequency and is measured in seconds.
Frequency		The first cycle in a waveform or gated region. Frequency is the reciprocal of the period; it is measured in hertz (Hz) where one Hz is one cycle per second.
Delay		The time between the mid reference (default 50%) amplitude point of two different waveforms. See also <i>Phase</i> .
Rise Time		The time required for the leading edge of the first pulse in the waveform or gated region to rise from the low reference value (default = 10%) to the high reference value (default = 90%) of the final value.
Fall Time		The time required for the falling edge of the first pulse in the waveform or gated region to fall from the high reference value (default = 90%) to the low reference value (default = 10%) of the final value.
Positive Duty Cycle		The ratio of the positive pulse width to the signal period expressed as a percentage. The duty cycle is measured on the first cycle in the waveform or gated region.
Negative Duty Cycle		The ratio of the negative pulse width to the signal period expressed as a percentage. The duty cycle is measured on the first cycle in the waveform or gated region.
Positive Pulse Width		The distance (time) between the mid reference (default 50%) amplitude points of a positive pulse. The measurement is made on the first pulse in the waveform or gated region.
Negative Pulse Width		The distance (time) between the mid reference (default 50%) amplitude points of a negative pulse. The measurement is made on the first pulse in the waveform or gated region.
Burst Width		The duration of a burst (a series of transient events) and is measured over the entire waveform or gated region.
Phase		The amount of time that one waveform leads or lags another waveform, expressed in degrees where 360° makes up one waveform cycle. See also <i>Delay</i> .



### Amplitude Measurements

Measurement	Description
Positive Overshoot	This is measured over the entire waveform or gated region and is expressed as: Positive Overshoot = (Maximum – High) / Amplitude x 100%.
Negative Overshoot	This is measured over the entire waveform or gated region and is expressed as: Negative Overshoot = (Low – Minimum) / Amplitude x 100%.
Pk-Pk	The absolute difference between the maximum and minimum amplitude in the entire waveform or gated region.
Amplitude	The high value less the low value measured over the entire waveform or gated region.
High	This value is used as 100% whenever high reference, mid reference, or low reference values are needed, such as in fall time or rise time measurements. Calculate using either the min/max or histogram method. The min/max method uses the maximum value found. The histogram method uses the most common value found above the midpoint. This value is measured over the entire waveform or gated region.
Low	This value is used as 0% whenever high reference, mid reference, or low reference values are needed, such as in fall time or rise time measurements. Calculate using either the min/max or histogram method. The min/max method uses the minimum value found. The histogram method uses the most common value found below the midpoint. This value is measured over the entire waveform or gated region.
Max	The most positive peak voltage. Max is measured over the entire waveform or gated region.
Min	The most negative peak voltage. Min is measured over the entire waveform or gated region.
Mean	The arithmetic mean over the entire waveform or gated region.
Cycle Mean	The arithmetic mean over the first cycle in the waveform or the first cycle in the gated region.





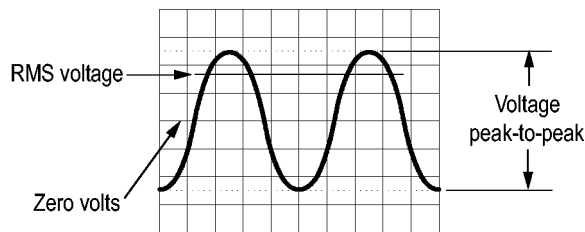

## Amplitude Measurements (cont.)

Measurement		Description
RMS		The true Root Mean Square voltage over the entire waveform or gated region.
Cycle RMS		The true Root Mean Square voltage over the first cycle in the waveform or the first cycle in the gated region.



1785-083

## Miscellaneous Measurements

Measurement		Description
Rising Edge Count		The number of positive transitions from the low reference value to the high reference value in the waveform or gated region.
Falling Edge Count		The number of negative transitions from the high reference value to the low reference value in the waveform or gated region.
Positive Pulse Count		The number of positive pulses that rise above the mid reference crossing in the waveform or gated region.
Negative Pulse Count		The number of negative pulses that fall below the mid reference crossing in the waveform or gated region.
Area		Area measurement is a voltage over time measurement. It returns the area over the entire waveform or gated region in volt-seconds. Area measured above ground is positive; area measured below ground is negative.
Cycle Area		A voltage over time measurement. The measurement is the area over the first cycle in the waveform or the first cycle in the gated region expressed in volt-seconds. The area above the common reference point is positive, and the area below the common reference point is negative.

## Customizing an Automatic Measurement

You can customize automatic measurements by using gating, modifying measurement statistics, adjusting the measurement reference levels, or taking a snapshot.

### Gating

Gating confines the measurement to a certain portion of a waveform. To use:

1. Push **Measure**.



2. Push **More** as many times as needed to select **Gating** from the resulting pop-up menu.

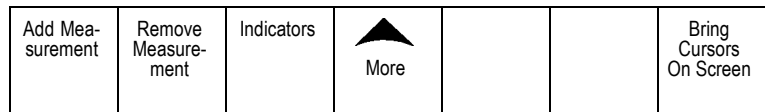

3. Position the gates using the side menu options.

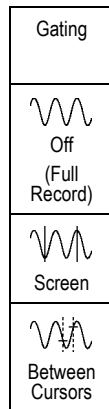

## Statistics

Statistics characterize the stability of measurements. To adjust statistics:

1. Push **Measure**.



2. Push **More** as many times as needed to select **Statistics** from the resulting pop-up menu.

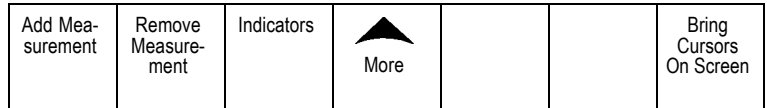

3. Push the side menu options. These include whether to turn statistics on or off and how many samples to use for mean and standard deviation calculations.

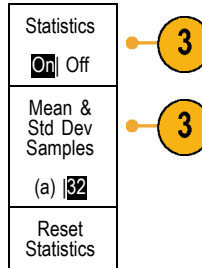

## Snapshot

To see all the single-sourced measurements at one moment in time:

1. Push **Measure**.



2. Push **Add Measurement** on the lower menu.



3. Turn multipurpose knob **a** to select the desired **Source** channel.



4. Turn multipurpose knob **b** to select the **Measurement Type** of Snapshot.



5. Push **OK Snapshot All Measurements**.

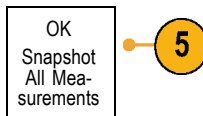



6. View results.

Snapshot on 1

Period	: 312.2µs	Freq	: 3.203kHz
+Width	: 103.7µs	-Width	: 208.5µs
Burst W	: 936.5µs		
Rise	: 1.452µs	Fall	: 1.144µs
+Duty	: 33.23%	-Duty	: 66.77 %
+Over	: 7.143%	-Over	: 7.143 %
High	: 9.200 V	Low	: -7.600 V
Max	: 10.40 V	Min	: -8.800 V
Amplitude	: 16.80 V	Pk-Pk	: 19.20 V
Mean	: -5.396 V	CycleMean	: -5.396 V
RMS	: 7.769 V	CycleRMS	: 8.206 V
Area	: -21.58mVs	CycleArea	: -654.6µVs
+Edges	5	-Edges	4
+Pulses	4	-Pulses	4

Reference Levels

Reference levels determine how time-related measurements are taken. For example, they are used in calculating rise and fall times.

1. Push **Measure**.



2. Push **More** as many times as needed to select **Reference Levels** from the resulting pop-up menu.

Add Measurement	Remove Measurement	Indicators	▲ More		Bring Cursors On Screen	Configure Cursors
-----------------	--------------------	------------	-----------	--	-------------------------	-------------------



- Set the levels using the side menu.

Use High and Low reference to calculate rise and fall times.

Use Mid reference primarily for measurements between edges, such as pulse widths.

Reference Levels
Set Levels in % <b>Units</b>
High Ref <b>(a) 90.0 %</b>
Mid Ref <b>50.0 %</b> <b>50.0 %</b>
Low Ref <b>10.0 %</b>
Set to Defaults

## Taking Manual Measurements with Cursors

Cursors are on-screen markers that you position in the waveform display to take manual measurements on acquired data. They appear as horizontal and/or as vertical lines. To use cursors:

- Push **Cursors** to turn cursors on. A second push turns cursors off. You can also push and hold **Cursors** to display the cursor menu.



**NOTE.** To keep the cursors on but remove the cursor readout from the display, push **Menu Off** until the cursor readout disappears. You will still be able to move the cursors using the multipurpose knobs. To restore the cursor readout display, push the **Menu Off** again.

In the example, two vertical cursors appear on the selected screen waveform. As you turn multipurpose knob **a**, you move one cursor to the right or left. As you turn knob **b**, you move the other cursor.

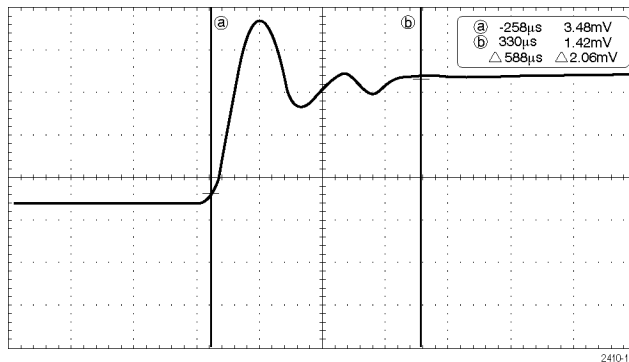

2. With cursors on, push **Select**.

This turns the cursor linking on and off. If linking is on, turning multipurpose knob **a** moves the two cursors together. Turning multipurpose knob **b** adjusts the time between the cursors.



3. Push **Fine** to toggle between a coarse and a fine adjustment for multipurpose knobs **a** and **b**.

Pushing **Fine** also changes the sensitivity of other knobs as well.



4. Push and hold **Cursors** to display the cursor menu.



5. Push **Cursors** on the lower menu to set the cursors to **Screen**.

In screen mode, two horizontal bars and two vertical bars span the graticule.

Cursors	Source	Bars	Linked	Bring	Cursor	
Waveform	Auto	Horizontal	On/Off	Cursors	Units	
Screen		Vertical		On Screen		

6. Turn multipurpose knobs **a** and **b** to move the pair of horizontal cursors.



7. Push **Select**.

This makes the horizontal cursors active and the vertical ones inactive. Now, as you turn the multipurpose knobs, the horizontal cursors will move.

Push **Select** again to make the vertical cursors active again.



- View the cursor and the cursor readout.

**NOTE.** On digital channels, you can take timing measurements with cursors, but not amplitude measurements.

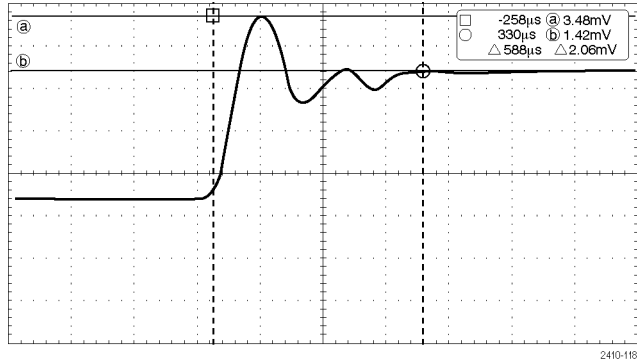

- Display multiple waveforms on the screen by pushing one or more of the channel 1 through 4 buttons or, if you are using an MSO3000B, by pushing **D15 – D0**.

- Push and hold **Cursors** to display the cursor menu again.



- Push **Source** on the lower menu. A pop-up menu will appear. The default menu selection of **Auto** will cause the cursors to take measurements on the selected (last used) waveform.

- Turn multipurpose knob **a** to choose a channel to measure other than the one pointed to by **Auto**.

- Push **Menu Off** to remove the pop-up menu.



14. Turn multipurpose knob **a** and take cursor measurements on the alternate waveform.

## Using Cursor Readouts

Cursor readouts supply textual and numeric information relating to the current cursor positions.

Readouts appear in the upper right corner of the graticule. If Zoom is on, the readout appears in the upper right corner of the zoom window.

When a bus is selected, the readout shows the decoded bus data in the format you have selected, hexadecimal, binary, decimal, or ASCII (depending on the selected standard). The data value of that point is displayed in the cursor readout.

$\Delta$  Readout:

The  $\Delta$  readouts indicate the difference between the cursor positions.

a Readout:

Indicates that the value is controlled by multipurpose knob **a**.

b Readout:

Indicates that the value is controlled by multipurpose knob **b**.

The horizontal cursor lines on the display measure the vertical parameters, typically voltage.

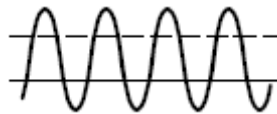

The vertical cursor lines on the display measure horizontal parameters, typically time.



<input type="checkbox"/> a	-16.0ms	22.4mV
<input type="radio"/> b	8.00ms	20.4mV
<input type="checkbox"/>	$\Delta$ 24.0ms	$\Delta$ 2.00mV

1785-134

The square and circle shapes in the readout map to the multipurpose knobs when both vertical and horizontal cursors are present.

## Using XY Cursors

When the XY Display mode is on, the cursor readouts will appear to the right of the graticule. They include rectangular, polar, product, and ratio readouts.

## Using Math Waveforms

Create math waveforms to support the analysis of your channel and reference waveforms. By combining and transforming source waveforms and other data into math waveforms, you can derive the data view that your application requires.

**NOTE.** Math waveforms are not available for use with serial buses.

Use the following procedure for executing simple (+, -, x, ÷) math operations on two waveforms:

1. Push **Math**.



2. Push **Dual Wfm Math**.

Dual Wfm Math	FFT	Advanced Math		(M) Label		
---------------	-----	---------------	--	-----------	--	--



3. On the side menu, set the sources to either channel 1, 2, 3, 4, or reference waveforms **R1**, **R2**, **R3**, or **R4**. Choose the +, -, x, or ÷ operators.
4. For example, you might calculate power by multiplying a voltage waveform and a current waveform.

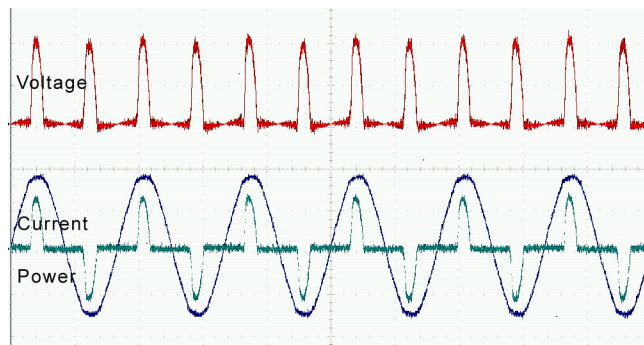

### Quick Tips

- Math waveforms can be created from channel or reference waveforms or a combination of them.
- Measurements can be taken on math waveforms in the same way as on channel waveforms.
- Math waveforms derive their horizontal scale and position from the sources in their math expressions. Adjusting these controls for the source waveforms also adjusts the math waveform.
- You can zoom in on math waveforms using the inner knob of the Pan-Zoom control. Use the outer knob for positioning the zoomed area. (See page 118, *Using Wave Inspector to Manage Long Record Length Waveforms.*)

## Using FFT

An FFT breaks down signals into component frequencies, which the oscilloscope uses to display a graph of the frequency domain of a signal, as opposed to the oscilloscope's standard time domain graph. You can match these frequencies with known system frequencies, such as system clocks, oscillators, or power supplies.

1. Push **Math**.



2. Push **FFT**.



3. Push **FFT Source** on the side menu, if needed, and turn multipurpose knob **a** to select the source to use. Choices are: channels 1, 2, 3, 4, reference waveforms R1, R2, R3, and R4.

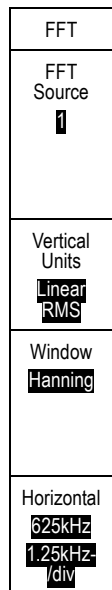

4. Push **Vertical Scale** on the side menu repeatedly to select either Linear RMS or dBV RMS.



5. Push **Window** on the side menu repeatedly to select the desired window.

Window choices are: Rectangular, Hamming, Hanning, and Blackman-Harris.



6. Push **Horizontal** on the side menu to activate multipurpose knobs **a** and **b** to pan and zoom the FFT display.



7. The FFT will appear on the display.

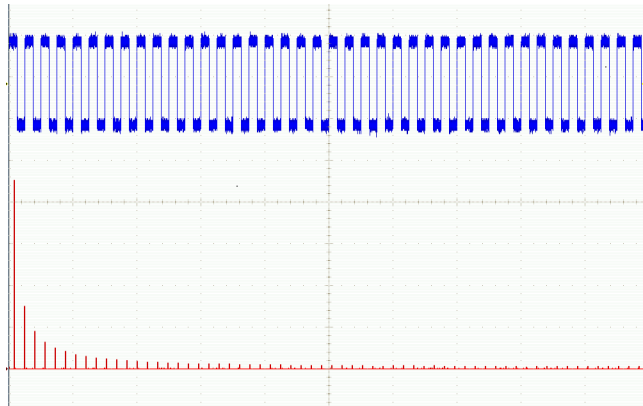

### Quick Tips

- Use short record lengths for faster instrument response.
- Use long record lengths to lower the noise relative to the signal and increase the frequency resolution.
- If desired, use the zoom feature along with the horizontal **Position** and **Scale** controls to magnify and position the FFT waveform.
- Use the default dBV RMS scale to see a detailed view of multiple frequencies, even if they have very different amplitudes. Use the linear RMS scale to see an overall view of how all frequencies compare to each other.
- The FFT feature provides four windows. Each is a trade-off between frequency resolution and magnitude accuracy. What you want to measure and your source signal characteristics help determine which window to use. Use the following guidelines to select the best window.

#### Description

#### Window

##### Rectangular

This is the best type of window for resolving frequencies that are very close to the same value but worst for accurately measuring the amplitude of those frequencies. It is the best type for measuring the frequency spectrum of nonrepetitive signals and measuring frequency components near DC.

Use Rectangular for measuring transients or bursts where the signal level before and after the event are nearly equal. Also, use this window for equal-amplitude sine waves with frequencies that are very close and for broadband random noise with a relatively slow varying spectrum.

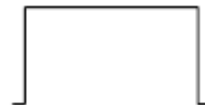

##### Hamming

This is a very good window for resolving frequencies that are very close to the same value with somewhat improved amplitude accuracy over the rectangular window. It has a slightly better frequency resolution than the Hanning.

Use Hamming for measuring sine, periodic, and narrow band random noise. This window works on transients or bursts where the signal levels before and after the event are significantly different.





**Description****Window****Hanning**

This is a very good window for measuring amplitude accuracy but less so for resolving frequencies.

Use Hanning for measuring sine, periodic, and narrow band random noise. This window works on transients or bursts where the signal levels before and after the event are significantly different.

**Blackman-Harris:**

This is the best window for measuring the amplitude of frequencies but worst at resolving frequencies.

Use Blackman-Harris for measuring predominantly single frequency waveforms to look for higher order harmonics.



## Using Advanced Math

The advanced math feature lets you create a custom math waveform expression that can incorporate active and reference waveforms, measurements, and/or numeric constants. To use this feature:

1. Push **Math**.

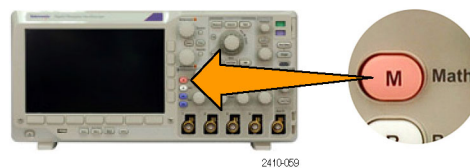

2. Push **Advanced Math**.

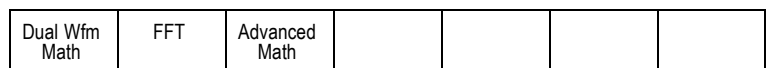

3. Use the side menu to create custom expressions.
4. Push **Edit Expression** and use the multipurpose knobs and the resulting lower menu buttons to create an expression. When done, push **OK Accept** on the side menu.

For example, to use **Edit Expression** to take the integral of a square wave:

1. Push **Clear** on the lower menu.
2. Turn multipurpose knob **a** to select **Intg(**.
3. Push **Enter Selection**.
4. Turn multipurpose knob **a** to select channel **1**.
5. Push **Enter Selection**.
6. Turn multipurpose knob **a** to select **)**.
7. Push **OK Accept**.

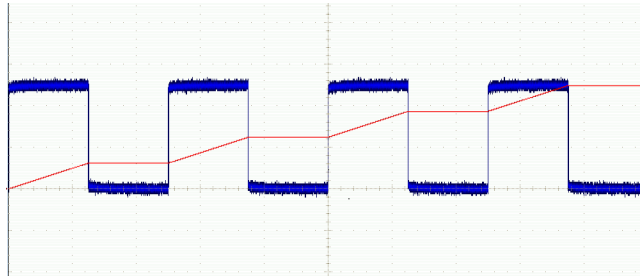

## Using Reference Waveforms

Create a reference waveform to store a waveform. For example, you might do this to set up a standard against which to compare other waveforms. To use the reference waveforms:

---

**NOTE.** 5 M reference waveforms are volatile and not saved when the oscilloscope power is turned off. To keep these waveforms, save them to external storage.

---

1. Push **Ref R**. This brings up the lower reference menu.

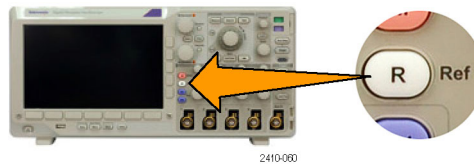

2. Use the resulting lower menu selections to display or select a reference waveform.

(R1) <input checked="" type="checkbox"/> On 3-May-07	(R2) <input type="checkbox"/> Off	(R3) <input type="checkbox"/> Off	(R4) <input type="checkbox"/> Off			
2	2	2	2			

3. Use the side menu and the multipurpose knobs to adjust the vertical and horizontal settings of the reference waveform.

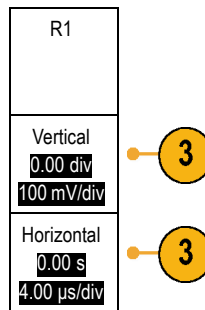

### Quick Tips

- **Selecting and Displaying Reference Waveforms.** You can display all the reference waveforms at the same time. Push the appropriate screen button to select a particular reference waveform.
- **Removing Reference Waveforms from the Display.** To remove a reference waveform from the display, push **R** on the front-panel to access the lower menu. Then push the associated button on the lower menu to turn it off.
- **Scaling and Positioning a Reference Waveform.** You can position and scale a reference waveform independently from all other displayed waveforms. Select the reference waveform and then adjust it with a multipurpose knob. You can do this whether acquisition is running or not.

If a reference waveform is selected, scaling and repositioning of the reference waveform operates the same way whether zoom is turned on or off.

- **Saving 5 M Reference Waveforms.** 5 M reference waveforms are volatile and not saved when the oscilloscope power is turned off. To keep these waveforms, save them to external storage.

## Using Wave Inspector to Manage Long Record Length Waveforms

The Wave Inspector controls (zoom/pan, play/pause, marks, search) help you to efficiently work with long record length waveforms. To magnify a waveform horizontally, turn the Zoom knob. To scroll through a zoomed waveform, turn the Pan knob.

The Pan-Zoom Control consists of:

1. An outer pan knob
2. An inner zoom knob

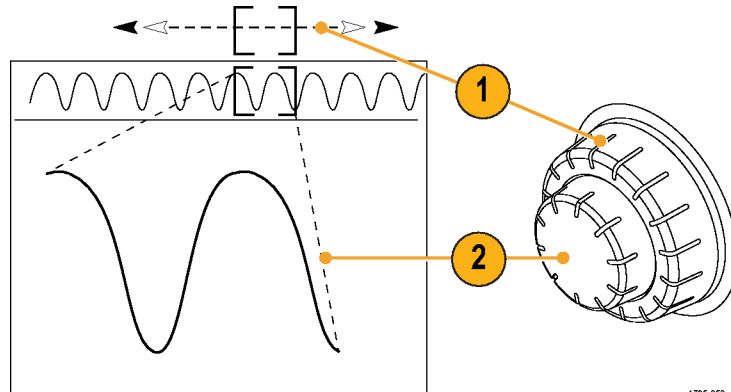

1785-053

### Zooming a Waveform

To use zoom:

1. Rotate the inner knob on the Pan-Zoom control clockwise to zoom in on a selected portion of the waveform. Rotate the knob counterclockwise to zoom back out.

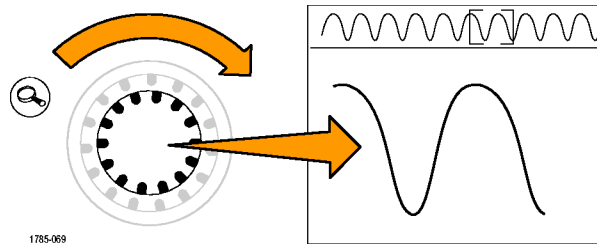

1785-069

2. Alternatively, enable or disable the zoom mode by pushing the zoom button.

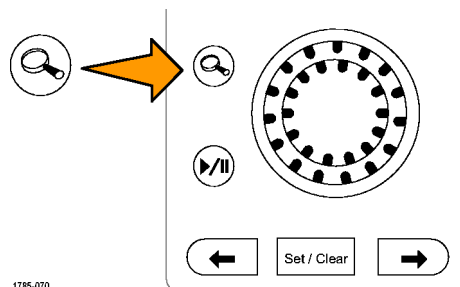

1785-070

3. Examine the zoomed view of the waveform that appears on the larger, lower portion of the display. The upper portion of the display will show the position and size of the zoomed portion in the waveform, within the context of the overall record.

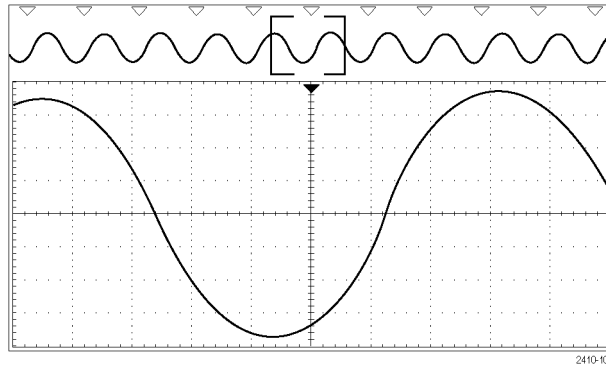

### Panning a Waveform

While the zoom feature is on, you can use the pan feature to quickly scroll through the waveform. To use pan:

1. Rotate the pan (outer) knob of the pan-zoom controls to pan the waveform.  
Turn the knob clockwise to pan forward. Turn it counterclockwise to pan backwards. The further you turn the knob, the faster the zoom window pans.

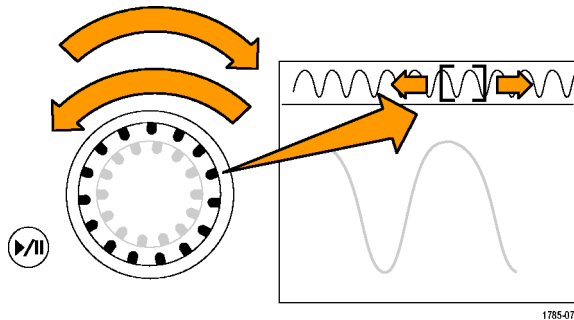

### Playing and Pausing a Waveform

Use the play-pause feature to automatically pan through a waveform record. To use it:

1. Enable the play-pause mode by pushing the play-pause button.
2. Adjust the play speed by turning the pan (outer) knob further. The further you turn it, the faster it goes.

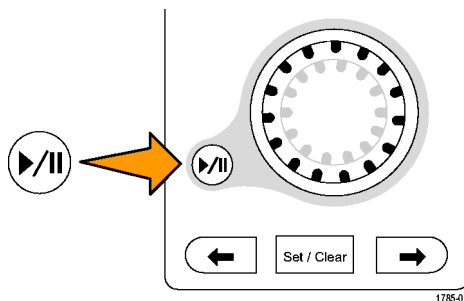

3. Change the play direction by reversing the direction that you are turning the pan knob.
4. During play, up to a point, the more you turn the ring, the faster the waveform accelerates. If you rotate the ring as far as it can go, the play speed does not change, but the zoom box quickly moves in that direction. Use this maximum rotation feature to replay a portion of the waveform that you just saw and want to see again.
5. Pause the play-pause feature by pushing the play-pause button again.

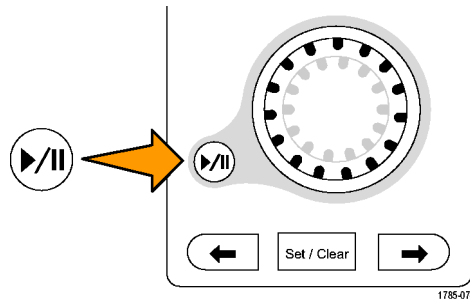

## Searching and Marking Waveforms

You can mark locations of interest in the acquired waveform. These marks help you limit your analysis to particular regions of the waveform. You can mark areas of the waveform automatically, if they meet some special criteria, or you can manually mark each item of interest. You can use arrow keys to jump from mark to mark (area of interest to area of interest). You can automatically search and mark many of the same parameters that you can trigger on.

Search marks provide a way to mark a waveform region for reference. You can set marks automatically with search criteria. You can search for and mark regions with particular edges, pulse widths, runts, logic states, rise/fall times, setup and hold, and bus search types.

To manually set and clear (delete) marks:

1. Move (the zoom box) to the area on the waveform where you want to set (or clear) a search mark by turning the pan (outer) knob.  
Push the next (→) or previous (←) arrow button to jump to an existing mark.
2. Push **Set/Clear**.  
If no search mark is at the screen center, the oscilloscope will add one.
3. Investigate your waveform by moving from search mark to search mark. Use the next (→) or previous (←) arrow button to jump from one marked location to another, without adjusting any other controls.
4. Delete a mark. Push the next (→) or previous (←) arrow button to jump to the mark you want to clear. To remove the current, center-positioned mark, push **Set/Clear**. It works on both manually and automatically created marks.

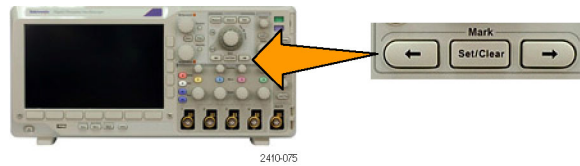

To automatically set and clear (delete) search marks:

1. Push **Search**.



2. Select the search type desired on the lower menu.

The search menu is similar to the trigger menu.

Search Off	Search Type Edge	Source 1	Slope ↓			Threshold 0.00V
---------------	---------------------	-------------	------------	--	--	--------------------



3. From the side menu, turn on the search.

4. On the screen, hollow triangles show the location of automatic marks and solid triangles show the custom (user-defined) locations. These appear on both normal and zoomed waveform views.
5. You can quickly investigate your waveform by moving from search mark to search mark with the next (→) and previous (←) arrow buttons. No other adjustments are needed.

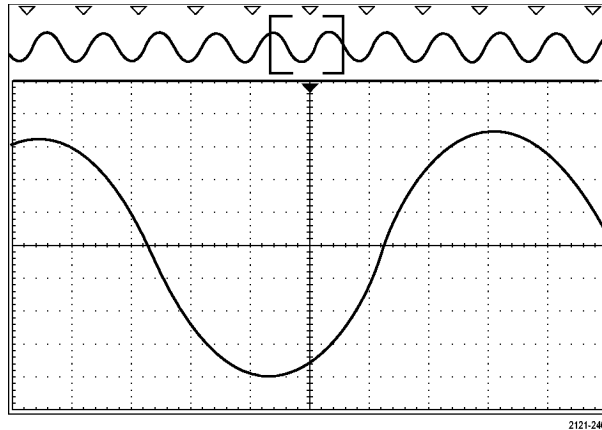

**Quick Tips.**

- You can copy trigger settings to search for other locations in your acquired waveform that meet the trigger conditions.
- You can also copy search settings to your trigger.
- Custom (User) marks are saved with the waveform when the waveform is saved and when the setup is saved.
- Automatic search marks are not saved with the waveform when the waveform is saved. However, you can easily recapture them by reusing the search function.
- The search criteria are saved in the saved setup.

The Wave Inspector includes the following search capabilities:

Search	Description
Edge	Searches for edges (rising or falling) with a user-specified threshold level.
Pulse Width	Searches for positive or negative pulse widths that are >, <, =, or ≠ a user specified pulse width, or are inside or outside of a range.
Timeout	Searches for situations when no pulse is detected within a specified time.
Runt	Searches for positive or negative pulses that cross one amplitude threshold but fail to cross a second threshold before crossing the first again. Search for all runt pulses or only those with a duration >, <, =, or ≠ a user specified time.
Logic	Search for a logic pattern (AND, OR, NAND, or NOR) across multiple waveforms with each input set to either High, Low, or Don't Care. Search for when the event goes true, goes false, or stays valid for >, <, =, or ≠ a user specified time. Additionally, you can define one of the inputs as a clock for synchronous (state) searches.
Setup & Hold	Search for violations of user specified Setup and Hold times.



Search	Description
Rise/Fall Time	Search for rising and/or falling edges that are $>$ , $<$ , $=$ , or $\neq$ a user specified time.
Bus	<p>Parallel: Search for a binary or hex value (MSO3000 Series only).</p> <p>I<sup>2</sup>C: Search for Start, Repeated Start, Stop, Missing Ack, Address, Data, or Address and Data.</p> <p>SPI: Search for SS Active, MOSI, MISO, or MOSI &amp; MISO</p> <p>RS-232, RS-422, RS-485, UART: Search for Tx Start Bit, Rx Start Bit, Tx End of Packet, Rx End of Packet, Tx Data, Rx Data, Tx Parity Error, Rx Parity Error.</p> <p>CAN: Search for Start of Frame, Type of Frame (Data, Remote, Error, Overload), Identifier (standard or extended), Data, Identifier and Data, End of Frame, or Missing Ack, Bit Stuffing Error</p> <p>LIN: Search for Synch, Identifier, Data, ID &amp; Data, Wakeup Frame, Sleep Frame, Error</p> <p>FlexRay: Search for Start of Frame, Type of Frame, Identifier, Cycle Count, Header Fields, Data, ID &amp; Data, End of Frame, Error</p> <p>I<sup>2</sup>S, LF, RJ: Search for Word Select or Data.</p> <p>TDM: Search for Frame Sync or Data.</p> <p>MIL-STD-1553: Search for Sync, Command, Status, Data, Time (RT/IMG), Error</p>

## Analyzing Power

Acquire, measure, and analyze power signals with the DPO3PWR Power Analysis Module. To use this application:

1. Push **Test**.



2. Push **Analysis**.

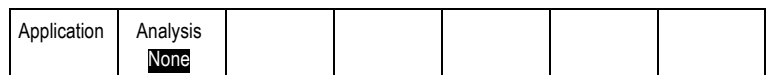

3. Use the side menu to select the desired analysis function.  
Choose among power quality, switching loss, harmonics, ripple, modulation, and safe operating area, and deskew.

## Save and Recall Information

The oscilloscope provides permanent storage for setups, waveforms, and screen images. Use the internal storage of the oscilloscope to save setup files and reference waveform data.

Use external USB flash drives, to save setups, waveforms, and screen images. Use the external storage to carry data to remote computers for further analysis and for archiving.

**External file structure.** If you are saving information to external storage, select the appropriate menu (such as the **To File** side menu to save setups and waveforms) and turn multipurpose knob **a** to scroll through the external file structure.

- E: is the USB flash drive plugged into the USB port on the front of the oscilloscope
- F: is the USB flash drive plugged into the USB port on the rear of the oscilloscope

Use multipurpose knob **a** to scroll through the list of files. Use **Select** on the front-panel to open and close folders.

**Naming your file.** The oscilloscope gives all files it creates a default name in the following format:

- tekXXXXX.set for setup files where XXXXX is an integer from 00000 to 99999
- tekXXXXX.png, tekXXXXX.bmp, or tekXXXXX.tif for image files
- tekXXXXYYY.csv for spreadsheet files or tekXXXXYYY.isf for internal format files

For waveforms, the XXXX is an integer from 0000 to 9999. The YYY is the channel of the waveform, and can be one of the following:

- CH1, CH2, CH3, or CH4 for the analog channels
- D00, D01, D02, D03, and so on through D15 for the digital channels
- MTH for a math waveform
- RF1, RF2, RF3, or RF4 for reference memory waveforms
- ALL for a single spreadsheet file containing multiple channels when you select Save All Waveforms

---

**NOTE.** Only analog channels and waveforms derived from analog channels (such as math and reference) can be saved to an ISF file. When saving all channels in ISF format, a group of files will be saved. Each will have the same value for XXXX, but the YYY values will be set to the different channels that were turned on when the Save All Waveforms was performed.

---

For example, the first time you save a file, that file is named tek00000. The next time you save the same type of file, the file will be named tek00001.

**Editing file, directory, reference waveform, or instrument setup names.** Give files descriptive names that you can recognize at a later date. To edit file names, directory names, reference waveform and instrument setup labels:

1. Push **Save / Recall Menu**.



2. Push **Save Screen Image**, **Save Waveform**, or **Save Setup**.

Save Screen Image	Save Waveform	Save Setup	Recall Waveform	Recall Setup	Assign <b>Save</b> to <b>Setup</b>	File Utilities
-------------------	---------------	------------	-----------------	--------------	------------------------------------	----------------



3. For waveform or setup files, enter the file manager by pushing the side menu **To File** item.

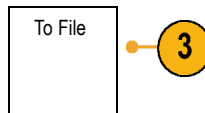

4. Turn multipurpose knob **a** to scroll through the file structure. (See page 124, *External file structure*.)



2410-045

5. Push **Select** to open or close file folders.



2410-047

6. Push **Edit File Name**.  
Edit the file name the same way you edit labels for channels. (See page 45, *Labeling Channels and Buses*.)

7. Push **Menu Off** to cancel the save operation, or push an **OK Save** side menu item to complete the operation.



2410-028



## Saving a Screen Image

A screen image consists of a graphical image of the oscilloscope screen. This is different from waveform data, which consists of numeric values for each point in the waveform. To save a screen image:

1. Push **Save / Recall Menu**.  
Do not yet push the **Save** button.



2. Push **Save Screen Image** on the lower menu.

Save Screen Image	Save Waveform	Save Setup	Recall Waveform	Recall Setup	Assign <b>Save</b> to Setup	File Utilities
-------------------	---------------	------------	-----------------	--------------	-----------------------------	----------------



3. On the side menu, push **File Format** repeatedly to select among: .tif, .bmp, and .png formats.
4. Push **Orientation** to select between saving the image in a landscape (horizontal) and a portrait (vertical) orientation.
5. Push **Ink Saver** to turn the **Ink Saver** mode on or off. When on, this mode provides a white background.
6. Push **Edit File Name** to create a custom name for the screen image file. Skip this step to use a default name.
7. Push **OK Save Screen Image** to write the image to the selected media.

Save Screen Image	
File Format [.png]	3
Orientation [Landscape/Portrait icons]	4
Ink Saver On [Off]	5
Edit File Name	6
OK Save Screen Image	7

For information on printing screen images of waveforms, go to *Printing a Hard Copy*. (See page 132, *Printing a Hard Copy*.)

## Saving and Recalling Waveform Data

Waveform data consists of the numeric values for each point in the waveform. It copies the data, as opposed to a graphical image of the screen. To save the current waveform data or to recall previously stored waveform data:

1. Push **Save / Recall Menu**.

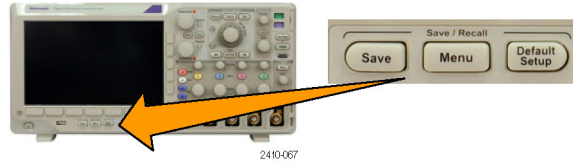

2. Push **Save Waveform** or **Recall Waveform** on the lower menu.

Save Screen Image	Save Waveform	Save Setup	Recall Waveform	Recall Setup	Assign <b>Save</b> to <b>Waveform</b>	File Utilities
-------------------	---------------	------------	-----------------	--------------	---------------------------------------	----------------

**NOTE.** The oscilloscope can save digital waveforms to .csv files, not reference memories. The oscilloscope cannot recall digital waveforms.



3. Select one waveform or all waveforms.
4. From the resulting side menu, select the location to save the waveform data to or to recall it from.

Save the information externally to a file on a USB flash drive. Alternatively, save the information internally to one of the two reference memory files on 2-channel model or one of the four reference files on 4-channel model oscilloscopes.

5. Push **File Details** to save to a USB flash drive.



This brings up the file manager screen. Use it to navigate to the desired drive and folder, and optionally to specify the file name. Skip this step to use the default name and location.

**Saving a waveform to file.** When you push **File Details** on the side menu, the oscilloscope changes the side menu contents. The following table describes these side menu items for saving data to a mass storage file.

Side menu button	Description
Internal File Format (.ISF)	Sets the oscilloscope to save waveform data from analog channels (and math and reference waveforms derived from analog channels), in internal waveform save file (.isf) format. This format is the fastest to write and creates the smallest-sized file. Use this format if you intend to recall a waveform to reference memory for viewing or measuring.  The oscilloscope cannot save digital waveforms in an .isf file format.
Spreadsheet File Format (.CSV)	Sets the oscilloscope to save waveform data as a comma-separated data file compatible with popular spreadsheet programs. This file can also be recalled to reference memory.

**Saving an analog waveform to reference memory.** To save an analog waveform to nonvolatile memory inside the oscilloscope, select the waveform that you want to save, push **Save Waveform**, and then select one of the reference waveform locations. Four-channel models have four reference locations. Two-channel models have two reference locations.

Saved waveforms contain only the most recent acquisition. Gray-scale information, if any, is not saved.

---

**NOTE.** 5 M reference waveforms are volatile and not saved when the oscilloscope power is turned off. To keep these waveforms, save them to external storage.

---

### Displaying a Reference Waveform

To display a waveform stored in nonvolatile memory:

1. Push **Ref R**.

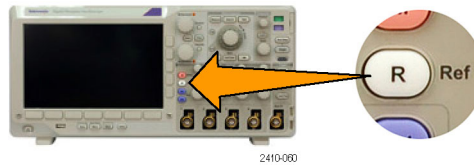

2. Push **R1, R2, R3, or R4**.

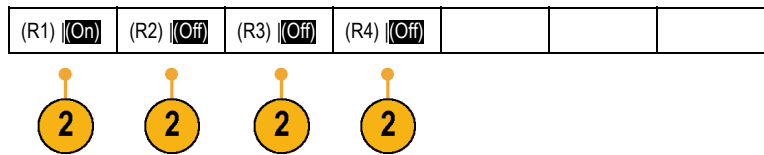

**Removing a reference waveform from the display.** To remove a reference waveform from the display:

1. Push **Ref R**.

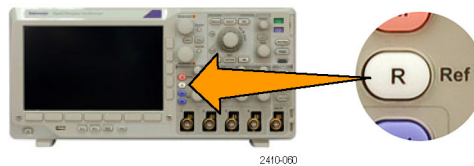

2. Push **R1, R2, R3, or R4** on the lower menu to remove the reference waveform from the display.

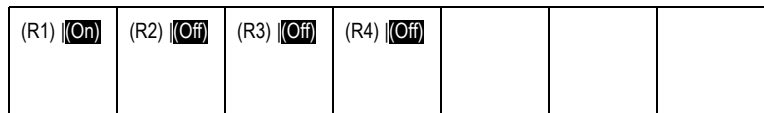

The reference waveform is still in nonvolatile memory and can be displayed again.

## Saving and Recalling Setups

Setup information includes acquisition information, such as vertical, horizontal, trigger, cursor, and measurement information. It does not include communications information, such as GPIB addresses. To save the setup information:

1. Push **Save / Recall Menu**.

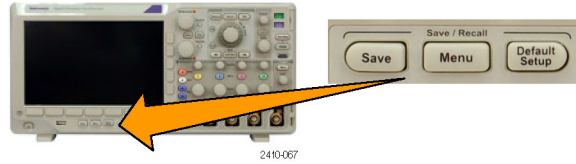

2. Push **Save Setup** or **Recall Setup** on the lower menu.

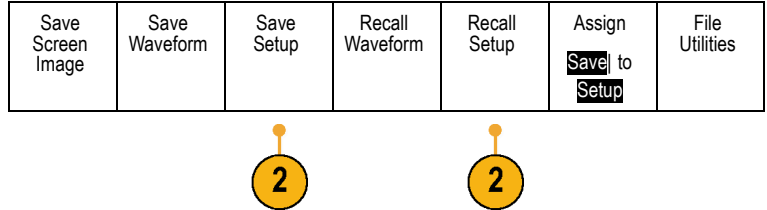

3. From the resulting side menu, select the location to save the setup to or to recall it from.

To save setup information to one of the ten internal setup memories in the oscilloscope, push the appropriate side menu button.

To save setup information to a USB file, push **To File**.

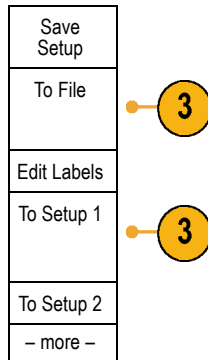

4. If you are saving information to a USB flash drive, turn multipurpose knob **a** to scroll through the file structure. (See page 124, *External file structure*.)



Push **Select** to open or close file folders.



Push **Menu Off** to cancel the save operation, or select a **Save to Selected File** item on the side menu to complete the operation.



5. Save the file.

Save to Selected File
-----------------------

### Quick Tips

- **Recalling the Default Setup.** Push **Default Setup** on the front-panel to initialize the oscilloscope to a known setup. (See page 47, *Using the Default Setup.*)

## Saving with One Button Push

After you have defined the save/recall parameters with the Save/Recall Menu button and menu, you can save files with a single push of the **Save** button. For example, if you have defined the save operation to save waveform data to a USB drive, then each push of the **Save** button will save current waveform data to the defined USB drive.

1. To define the Save button behavior, push **Save/Recall Menu**.



2. Push **Assign Save to** button.

Save Screen Image	Save Waveform	Save Setup	Recall Waveform	Recall Setup	Assign Save to Setup	File Utilities
-------------------	---------------	------------	-----------------	--------------	----------------------	----------------



3. Push the action to assign to the **Save** button.

Assign Save to
Screen Image
Waveform
Setup



4. From now on, when you push **Save** the oscilloscope will perform the action that you just specified rather than requiring you to navigate through the menus each time.



## Managing Drive, Directories, and Files

You can manage drives, directories, and files from the oscilloscope user interface.

1. Push **Save/Recall Menu**.

2. Push **File Utilities**

Save Screen Image	Save Waveform	Save Setup	Recall Waveform	Recall Setup	Assign Save   to Setup	File Utilities
-------------------------	------------------	---------------	--------------------	-----------------	------------------------------	-------------------

2

Select the desired file operation from the side menus. You can:

- Create a new folder
- Delete a highlighted directory or file
- Copy a highlighted drive, directory, or file
- Paste a previously copied drive, directory, or file
- Rename a highlighted drive, directory, or file
- Format a highlighted drive

## Printing a Hard Copy

To print an image of what appears on the oscilloscope screen, do the following procedure.

### Connect a Printer to Your Oscilloscope

Connect a non-PictBridge printer to a USB port on the rear or front-panel of the oscilloscope. Alternatively, connect a PictBridge printer to the USB device port on the rear panel or hook up a networked printer through the Ethernet port.

### Set Up Print Parameters

To set up the oscilloscope to print hard copies:

1. Push **Utility**.



2. Push **Utility Page**.

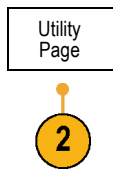

3. Turn multipurpose knob **a** and select **Print Setup**.

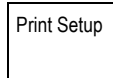

4. Push **Select Printer** if you are changing the default printer.

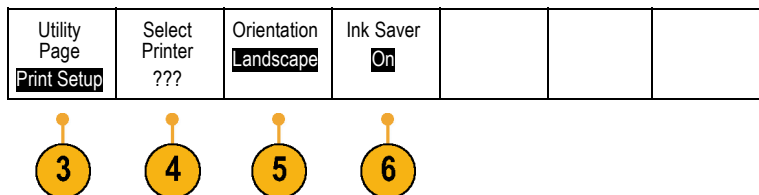

Turn multipurpose knob **a** to scroll through the list of available printers.

Push **Select** to choose the desired printer.

To add a non-PictBridge USB printer to the list, plug the printer into a USB host port.

The oscilloscope will automatically recognize most printers.

To set up a PictBridge USB printer, refer to the next topic.

To add an Ethernet printer to the list, refer to that topic. (See page 135, *Printing Over Ethernet*.)

5. Select the image orientation (portrait or landscape).

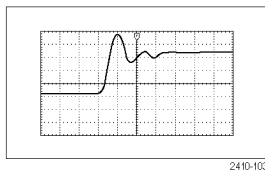

Landscape

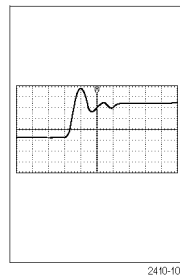

Portrait

6. Choose **Ink Saver On** or **Off**.  
The **On** selection will print out a copy with a clear (white) background.

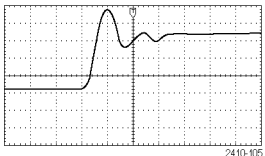

Ink Saver on

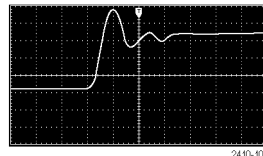

Ink Saver off

## Printing to a PictBridge Printer

To set up the oscilloscope to print to a PictBridge printer:

1. Push **Utility**.



2. Push **Utility Page**.

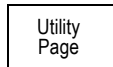

3. Turn multipurpose knob **a** and select **I/O**.



4. Push **USB**.

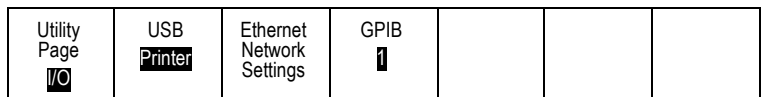

5. Push **Connect to PictBridge Printer**.

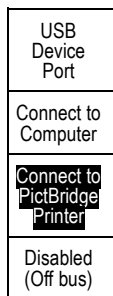

To add an Ethernet printer to the list, refer to that topic. (See page 135, *Printing Over Ethernet*.)

## Printing Over Ethernet

To set up the oscilloscope to print over Ethernet:

1. Connect an Ethernet cable to the rear-panel Ethernet port.

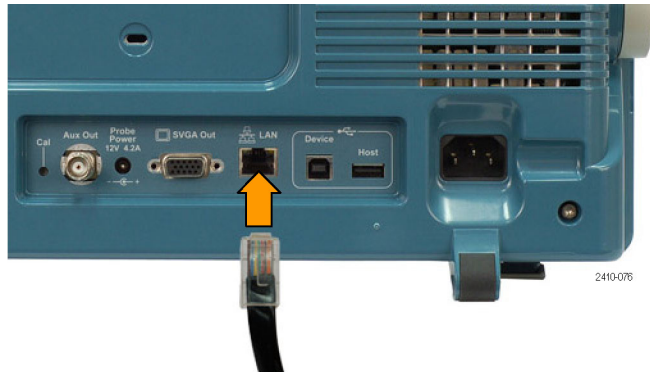

2. Push **Utility**.



3. Push **Utility Page**.



4. Turn multipurpose knob **a** and select **Print Setup**.

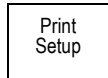

5. Push **Select Printer**.

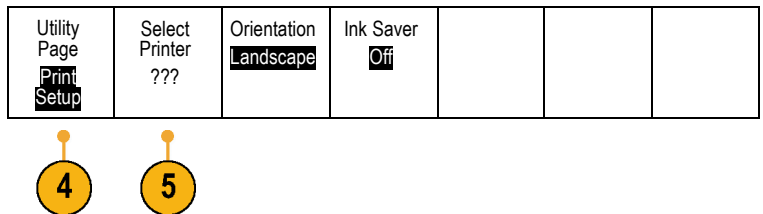

6. Push **Add Network Printer**.

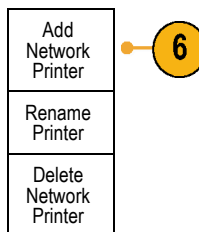

- Turn multipurpose knob **a** to scroll through the list of letters, numbers, and other characters to find the first character in the printer name that you want to enter.  
If you are using a USB keyboard, use the arrow keys to position the insertion point and type in the printer name. (See page 28, *Connecting a USB Keyboard to Your Oscilloscope.*)



ABCDEFGHIJKLMNOPQRSTUVWXYZ  
 abcdefghijklmnopqrstuvwxyz  
 0123456789\_ =+!@#%&\*( )[]{}<>/~"|\;,:.?

- Push **Select** or **Enter Character** to let the oscilloscope know that you have picked the proper character to use.



You can use the lower menu to edit the name, as needed.

Enter Character		←	→	Back Space	Delete	Clear
-----------------	--	---	---	------------	--------	-------

- Continue scrolling and pushing **Select** until you have entered all the desired characters.

- Push the down arrow key to move the character cursor down a row to the **Server Name** field.

- Turn multipurpose knob **a** and push **Select** or **Enter Character** as often as needed to enter the name.

- If desired, push the down arrow key to move the character cursor down a row to the **Server IP Address:** field.

Add Printer
↑
↓
OK Accept

- Turn multipurpose knob **a** and push **Select** or **Enter Character** as often as needed to enter the name.

- When done, push **OK Accept**.

---

**NOTE.** If you have multiple printers connected to the oscilloscope at the same time, the oscilloscope will print to the printer listed in the *Utility > Utility Page > Print Setup > Select Printer* menu item.

---

## Printing with One Button Push

Once you have connected a printer to your oscilloscope and set up print parameters, you can print current screen images with a single push of a button:

Push the printer icon button in the lower left corner of the front-panel.



## Erasing Oscilloscope Memory

You can erase all setup and waveform information saved in the nonvolatile oscilloscope memory with the TekSecure function. If you have acquired confidential data on your oscilloscope, you may want to execute the TekSecure function before you return the oscilloscope to general use. The TekSecure function:

- Replaces all waveforms in all reference memories with null values
- Replaces the current front-panel setup and all stored setups with the default setup
- Displays a confirmation or warning message, depending on whether the verification is successful or unsuccessful

To use TekSecure:

1. Push **Utility**.



2. Push **Utility Page**.

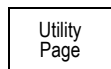

3. Turn multipurpose knob **a** and select **Config**.

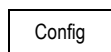

4. Push **TekSecure Erase Memory**.

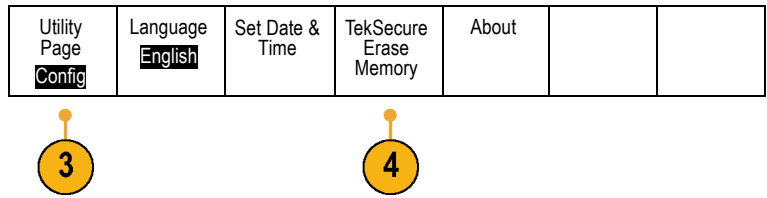

5. Push **OK Erase Setup and Ref Memory** on the side menu.

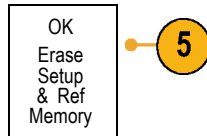

To cancel the procedure, push **Menu Off**.



6. Power off the oscilloscope, and then power it back on to complete the process.





## Using Application Modules

Optional application module packages extend the capability of your oscilloscope. (See page 12, *Application Module Free Trial*.) You can install up to four application modules at one time. (See page 13, *Installing an Application Module*.)

Refer to the *MSO3000 and DPO3000 Series Oscilloscopes Application Module Installation Manual* that came with your application module for instructions on installing and testing an application module. Some modules are described in the following list. Additional modules may be available. Contact your Tektronix representative or visit our Web site at [www.tektronix.com](http://www.tektronix.com) for more information. Also, refer to *Contacting Tektronix* at the beginning of the manual.

- The **DPO4AERO Aerospace Serial Triggering and Analysis Module** adds triggering on MIL-STD-1553 buses, as well as analytical tools to help you efficiently analyze your serial bus. These include digital views of the signal, bus views, packet decoding, search tools, and event tables with timestamp information.
- The **DPO3AUDIO Audio Serial Triggering and Analysis Module** adds triggering on I<sup>2</sup>S, Left Justified (LJ), Right Justified (RJ), and TDM buses, as well as analytical tools to help you efficiently analyze your serial bus. These include digital views of the signal, bus views, packet decoding, search tools, and event tables with timestamp information.
- The **DPO3AUTO Automotive Serial Triggering and Analysis Module** adds triggering on packet level information in serial buses used in automotive designs (CAN and LIN), as well as analytical tools to help you efficiently analyze your serial bus. These include digital views of the signal, bus views, packet decoding, search tools, and event tables with timestamp information.
- The **DPO3COMP Computer Serial Triggering and Analysis Module** adds triggering on byte or packet level information in RS-232, RS-422, RS-485, and UART buses, and analytical tools to help you efficiently analyze your serial bus. These include digital views of the signal, bus views, packet decoding, search tools, and event tables with timestamp information.
- The **DPO3EMBD Embedded Serial Triggering and Analysis Module** adds triggering on packet level information in serial buses used in embedded designs (I<sup>2</sup>C and SPI), as well as analytical tools to help you efficiently analyze your serial bus. These include digital views of the signal, bus views, packet decoding, search tools, and event tables with timestamp information.
- The **DPO4FLEX Serial Triggering and Analysis Module** offers FlexRay serial bus support, as well as analytical tools to help you efficiently analyze your serial bus. These include digital views of the signal, bus views, packet decoding, search tools, and event tables with timestamp information.
- The **DPO3PWR Power Analysis Module** adds measurements of power quality, switching loss, harmonics, ripple, modulation, safe operating area, and slew rate.
- The **DPO3VID Extended Video Module** adds triggering on a variety of standard HDTV signals, as well as on custom (non-standard) bilevel and trilevel video signals with 3 to 4,000 lines.

# Application Examples

This section contains ways to use your instrument in both common and advanced troubleshooting tasks.

## Taking Simple Measurements

If you need to see a signal in a circuit, but you do not know the signal amplitude or frequency, connect the probe from channel 1 of the oscilloscope to the signal. Then display the signal and measure its frequency and peak-to-peak amplitude.

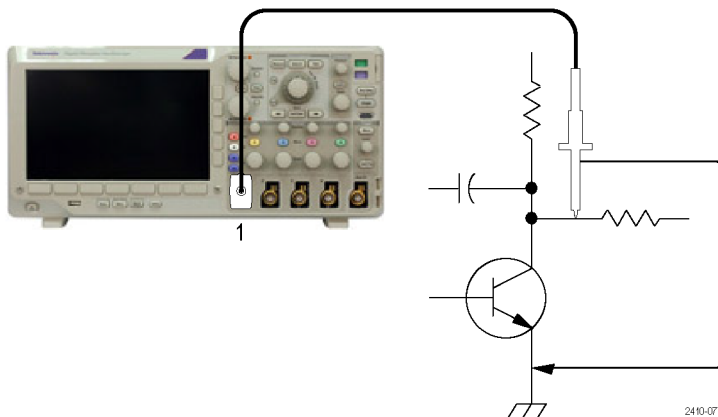

## Using Autoset

To quickly display a signal:

1. Push **Autoset**.



The oscilloscope sets vertical, horizontal, and trigger controls automatically. You can manually adjust any of these controls if you need to optimize the display of the waveform.

When you are using more than one channel, the autoset function sets the vertical controls for each channel and uses the lowest-numbered active channel to set the horizontal and trigger controls.

## Selecting Automatic Measurements

The oscilloscope can take automatic measurements of most displayed signals. To measure signal frequency and peak-to-peak amplitude:

1. Push **Measure**.



2. Push **Add Measurement**.

Add Measurement	Remove Measurement	Indicators	More			Bring Cursors On Screen
-----------------	--------------------	------------	------	--	--	-------------------------

2

3. If needed, on the side menu, push **Source** and turn multipurpose knob **a** to select the channel from which you want to measure. Turn multipurpose knob **b** to select the **Frequency** measurement. Push **OK Add Measurement** on the side menu. Repeat this process to select the **Peak-to-peak** measurement, and again push **OK Add Measurement**.



4. Push **Menu Off**.



- Observe that the measurements appear on the screen and update as the signal changes.

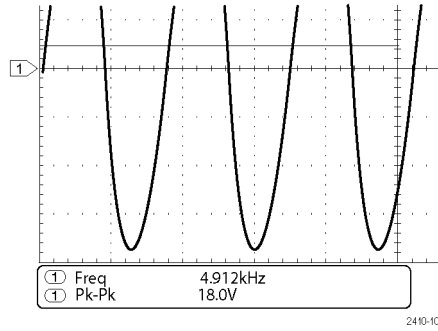

## Measuring Two Signals

In this example, you are testing a piece of equipment and need to measure the gain of its audio amplifier. You have an audio generator that can inject a test signal at the amplifier input. Connect two oscilloscope channels to the amplifier input and output as shown. Measure both signal levels and use these measurements to calculate the gain.

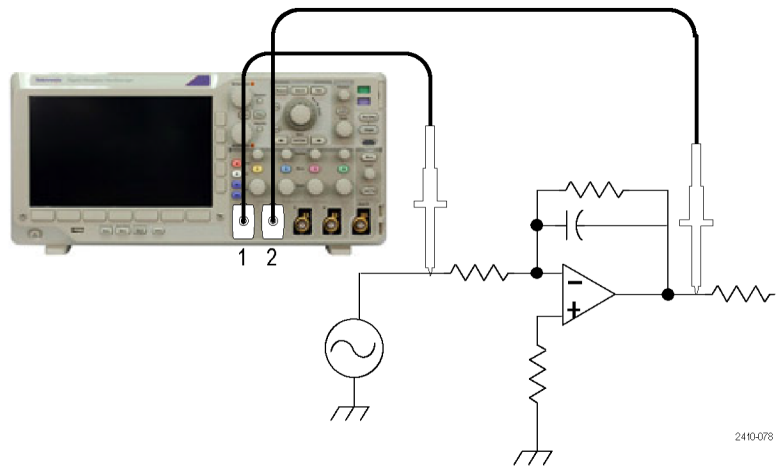

To display the signals connected to channels 1 and 2:

1. Push channel **1** and channel **2** to activate both channels.



2. Push **Autoset**.



To select measurements for the two channels:

1. Push **Measure** to see the measurement menu.



2. Push **Add Measurement**.



3. If needed, on the side menu, push **Source** and turn multipurpose knob **a** to select channel **1**. Turn multipurpose knob **b** to select the **Amplitude** measurement. Push **OK Add Measurement** on the side menu. Repeat this process to select channel **2** and again push **OK Add Measurement** on the side menu.



4. Calculate the amplifier gain using the following equations:  
 $Gain = (output\ amplitude \div input\ amplitude)$   
 $= (3.155\ V \div 130.0\ mV) = 24.27$   
 $Gain\ (dB) = 20 \times \log(24.27) = 27.7\ dB$

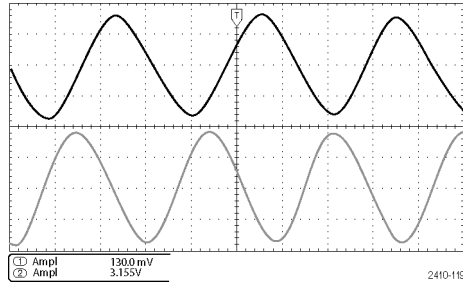

### Customizing Your Measurements

In this example, you want to verify that the incoming signal to digital equipment meets its specifications. Specifically, the transition time from a low logic level (0.8 V) to a high logic level (2.0 V) must be 10 ns or less.

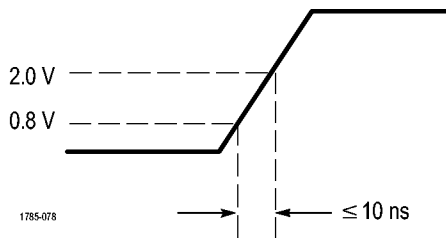

To select the Rise Time measurement:

1. Push **Measure**.



2. Push **Add Measurement**.



3. If needed, on the side menu, push **Source** and turn multipurpose knob **a** to select the channel from which you want to measure. Turn multipurpose knob **b** to select the **Rise Time** measurement. Push **OK Add Measurement** on the side menu.



4. Push **More** repeatedly until you select **Reference Levels** from the pop-up menu.

5. Push **Set Levels in** to select **units**.
6. Push **High Ref** and turn multipurpose knob **a** to enter 2.00 V. If needed, push **Fine** to change the sensitivity of the multipurpose knob.
7. Push **Low Ref** and turn multipurpose knob **a** to enter 800 mV. If needed, push **Fine** to change the sensitivity of the multipurpose knob.

Reference Levels
Set Levels in %  Units
High Ref (a) 2.00 V
Mid Ref
Low Ref (a) 800 mV

Rise time is typically measured between the 10% and 90% amplitude levels of a signal. These are the default reference levels that the oscilloscope uses for rise time measurements. However, in this example, you need to measure the time that the signal takes to pass between the 0.8 V and 2.0 V levels.

You can customize the rise time measurement to measure the signal transition time between any two reference levels. You can set each of these reference levels to a specific percent of the signal amplitude or to a specific level in vertical units (such as volts or amperes).

**Measuring specific events.** Next you want to see the pulses in the incoming digital signal, but the pulse widths vary so it is hard to establish a stable trigger. To look at a snapshot of the digital signal, do this step:

1. Push **Single** to capture a single acquisition. This assumes that the oscilloscope will trigger with the current settings.



Now you want to measure the width of each displayed pulse. You can use measurement gating to select a specific pulse to measure. To measure the second pulse:

2. Push **Measure**.





3. Push **Add Measurement**.



4. If needed, on the side menu, push **Source** and turn multipurpose knob **a** to select the channel from which you want to measure. Turn multipurpose knob **b** to select the **Positive Pulse Width** measurement. Push **OK Add Measurement** on the side menu.



5. Push **More** repeatedly until you select **Gating** from the pop-up menu.

6. Select **Between Cursors** on the side menu to choose measurement gating using cursors.

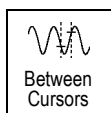

7. Place one cursor to the left and one cursor to the right of the second pulse.
8. View the resulting width measurement (160 ms) for the second pulse.

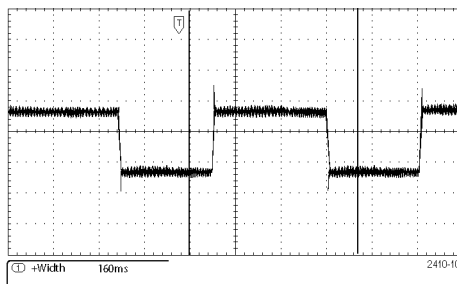

## Analyzing Signal Detail

In this example, you have a noisy signal displayed on the oscilloscope, and you need to know more about it. You suspect that the signal contains much more detail than you can currently see in the display.

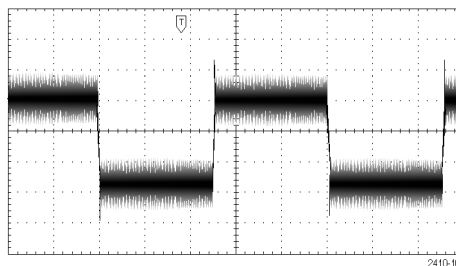

## Looking at a Noisy Signal

The signal appears noisy. You suspect that noise is causing problems in your circuit. To better analyze the noise:

1. Push **Acquire**.



2. Push **Mode** on the lower menu.

Mode Sample	Record Length 10K	Delay On Off	Set Horiz. Position to 10%	Waveform Display	XY Display Off	
----------------	----------------------	-----------------	----------------------------------	---------------------	-------------------	--



3. Push **Peak Detect** on the side menu.

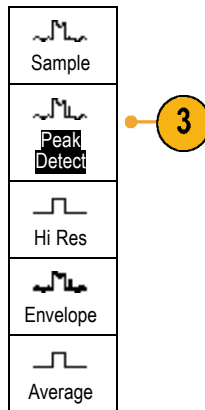

4. Push **Intensity** and turn multipurpose knob **a** to see the noise more easily.



5. View the results on the display. Peak detect emphasizes noise spikes and glitches in your signal as narrow as 1 ns, even when the time base is set to a slow setting.

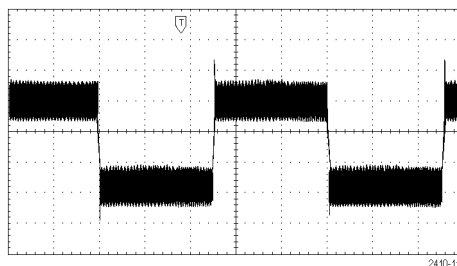

Peak-detect and the other acquisition modes are explained earlier in this manual. (See page 49, *Acquisition Concepts*.)

## Separating the Signal from Noise

Now you want to analyze the signal shape and ignore the noise. To reduce random noise in the oscilloscope display:

1. Push **Acquire**.



2. Push **Mode**.

Mode Sample	Record Length 10K	Delay On Off	Set Horiz. Position to 10%	Waveform Display	XY Display Off	
----------------	----------------------	-----------------	----------------------------------	---------------------	-------------------	--



3. Push **Average** on the side menu.



Averaging reduces random noise and makes it easier to see detail in a signal. In the example to the right, a ring shows on the rising and falling edges of the signal when the noise is removed.

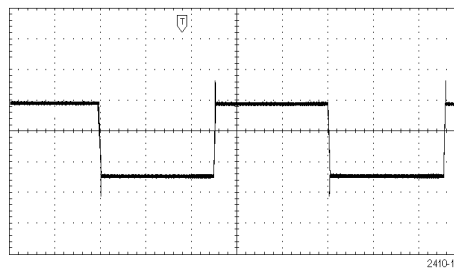

## Taking Cursor Measurements

You can use the cursors to take quick measurements on a waveform. To measure the ring frequency at the rising edge of the signal:

1. Push channel 1 to select the channel 1 signal.



2. Push and hold **Cursors** to turn on cursors and display the Cursor menu.



3. Push **Linked** to set Linked to **Off**.
4. Push **Bring Cursors On Screen**.
5. Push **Cursor Units**.

Cursors Waveform Screen	Source Auto	Bars Horizontal Vertical	Linked On Off	Bring Cursors On Screen	Cursor Units	
			3	4	5	

6. Push **Vertical Bar Units** on the side menu, if this choice is not already selected. Turn multipurpose knob **a** to select **Hz (1/s)** as the unit of measurement.



7. Push **Menu Off** to assign cursor control to the multipurpose knobs.



8. Place one cursor on the first peak of the ring using multipurpose knob **a**.



- Place the other cursor on the next peak of the ring using multipurpose knob **b**.



- The cursor  $\Delta$  readout shows the measured ring frequency is 227 kHz.

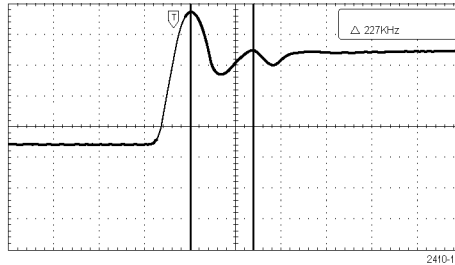

## Triggering on a Video Signal

The oscilloscope supports triggering on NTSC, SECAM, and PAL signals.

In this example, you are testing the video circuit in a piece of medical equipment and need to display the video output signal. The video output is an NTSC standard signal. Use the video signal to obtain a stable display.

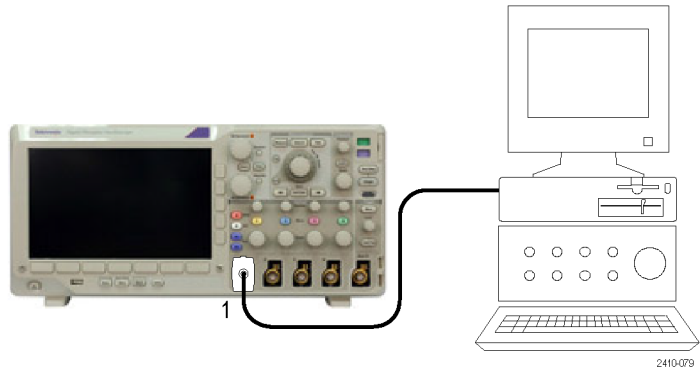

To trigger on the video fields:

- Push Trigger **Menu**.



2. Push **Type**.

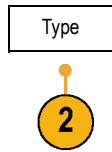

3. Turn multipurpose knob **a** to scroll through the trigger type side menu until you select **Video**.



4. Push **Video Standard**, and turn multipurpose knob **a** to scroll through the standards until you select **525/NTSC**.

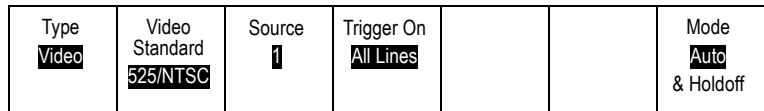

5. Push **Trigger On**.



6. Select **Odd Fields**.



If the signal had been noninterlaced, you could choose to trigger on **All Fields**.

7. Turn the **Horizontal Scale** knob to see a complete field across the screen.

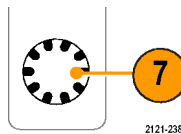

8. View results.

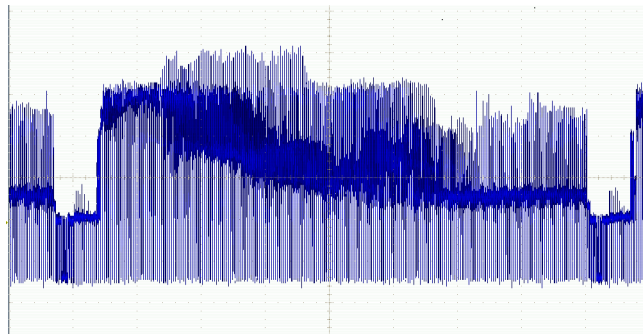

## Triggering on Lines

**Triggering on Lines.** To look at the video lines in the field:

1. Push **Trigger Menu**.



2. Push **Type**.

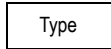

3. Turn multipurpose knob **a** to scroll through the trigger type side menu until you select **Video**.



Type <b>Video</b>	Video Standard <b>525/NTSC</b>	Source <b>1</b>	Trigger On <b>All Lines</b>			Mode <b>Auto</b> & Holdoff
----------------------	-----------------------------------	--------------------	--------------------------------	--	--	----------------------------------

4. Push **Trigger On**.



5. Select **All Lines**.

To trigger on a specific line, select **Line Number**, and use multipurpose knob **a** to select the line number.

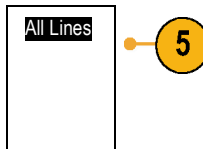

6. Adjust **Horizontal Scale** to see a complete video line across the screen.

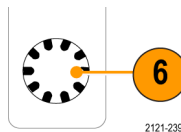

7. Observe the results.

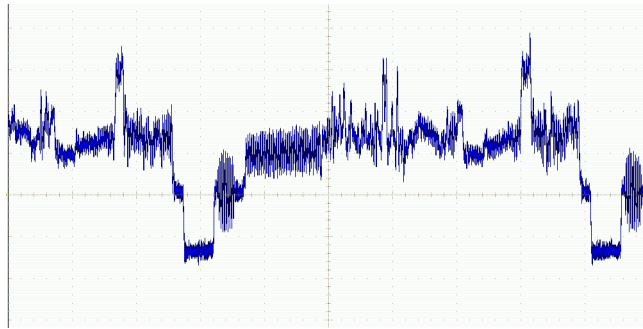

## Capturing a Single-Shot Signal

In this example, the reliability of a reed relay in a piece of equipment has been poor, and you need to investigate the problem. You suspect that the relay contacts arc when the relay opens. The fastest you can open and close the relay is about once per minute, so you need to capture the voltage across the relay as a single-shot acquisition.

To set up for a single-shot acquisition:

1. Adjust the **Vertical Scale** and **Horizontal Scale** to appropriate ranges for the signal you expect to see.

2. Push **Acquire**.



3. Push **Mode**.

4. Select **Sample**.

5. Push Trigger **Menu**.



6. Push **Slope** and .

7. Turn the **Trigger Level** knob to adjust the trigger level to a voltage midway between the open and closed voltages of the relay.



8. Push **Single** (single sequence).



When the relay opens, the oscilloscope triggers and captures the event.

The **Single** sequence button disables auto triggering so that only a valid triggered signal is acquired.

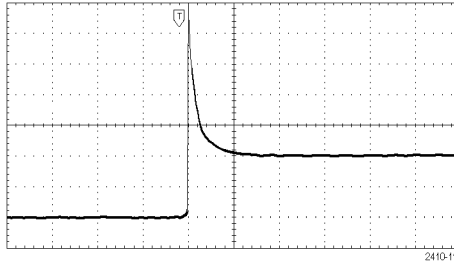

### Optimizing the Acquisition

The initial acquisition shows the relay contact beginning to open at the trigger point. This is followed by large spikes that indicate contact bounce and inductance in the circuit. The inductance can cause contact arcing and premature relay failure.

Before you take the next acquisition, you can adjust the vertical and horizontal controls to give you a preview of how the next acquisition might appear. As you adjust these controls, the current acquisition is repositioned, expanded, or compressed. This preview is useful to optimize the settings before the next single-shot event is captured.

When the next acquisition is captured with the new vertical and horizontal settings, you can see more detail about the relay contact opening. You can now see that the contact bounces several times as it opens.

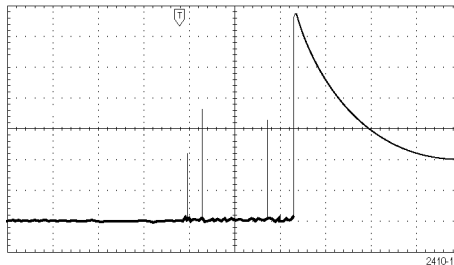

### Using the Horizontal Zoom Function

To take a close look at a particular point on the acquired waveform, use the horizontal zoom function. To look closely at the point where the relay contact first begins to open:

1. Turn the **Zoom** knob.

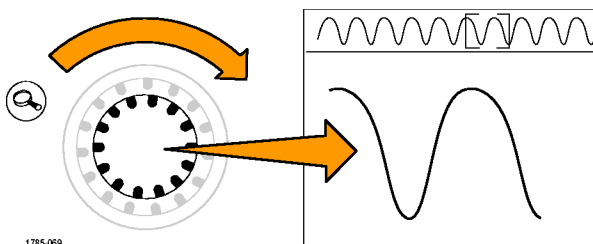

2. Turn the **Pan** knob to place the center of the zoom box close to where the relay contact begins to open.
3. Turn the **Zoom** knob to magnify the waveform in the zoom window.

The ragged waveform and the inductive load in the circuit suggest that the relay contact may be arcing as it opens.

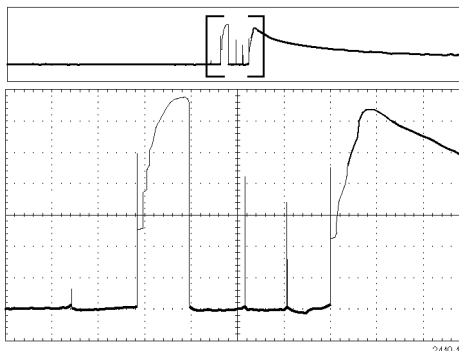

## Correlating Data with a TLA Logic Analyzer

To troubleshoot designs with fast clock edges and data rates, it helps to view analog characteristics of digital signals in relation to complex digital events in the circuit. You can do that with iView, which lets you transfer analog waveforms from the oscilloscope to the logic analyzer display. You can then view time-correlated analog and digital signals side by-side, and use this to pinpoint sources of glitches and other problems.

The iView External Oscilloscope Cable Kit allows you to connect your logic analyzer to a Tektronix oscilloscope. This enables communication between the two instruments. The Add External Oscilloscope wizard, which is available from the TLA application System menu, guides you through the process of connecting the iView cable between your logic analyzer and oscilloscope.

The TLA also provides a setup window to assist you in verifying, changing, and testing the oscilloscope settings. Before acquiring and displaying a waveform, you must establish a connection between your Tektronix logic analyzer and oscilloscope using the Add External Oscilloscope wizard.

To do this:

1. Select **Add iView External Oscilloscope** from the logic analyzer System menu.

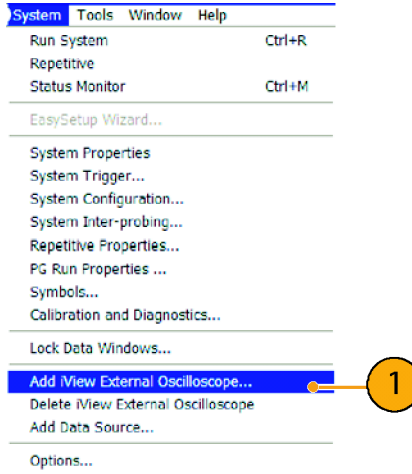

2. Select your model of oscilloscope.
3. Follow the on-screen instructions, and then click **Next**.
4. See your Tektronix Logic Analyzer documentation for more information on correlating data between your Tektronix oscilloscope and logic analyzer.

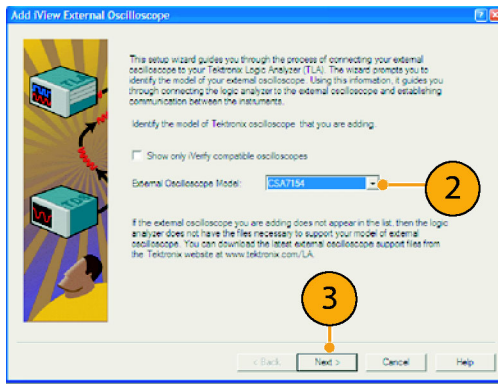

## Tracking Down Bus Anomalies

In this example, you are testing your new I<sup>2</sup>C circuit. Something is not working. You tell the master IC to send a message to the slave IC. Then you expect to receive data back and an LED to light. The light never goes on. Where in the ten or so commands that were sent out did the problem occur? Once you locate the problem location, how do you determine what went wrong?

You can use your oscilloscope, with its serial triggering and long-record length management features, to track down the problem in both the physical layer and in the protocol layer of the bus.

### Basic Strategy

First, you will display and acquire the bus signal by setting up the bus parameters and trigger. Then, you will search through each packet with the search/mark functions.

---

**NOTE.** Triggering on I<sup>2</sup>C, SPI, CAN, LIN, FlexRay, RS-232, RS-422, RS-485, UART, MIL-STD-1553, I<sup>2</sup>S, Left Justified, Right Justified, and TDM bus signals requires use of an appropriate DPO3AERO, DPO3EMBD, DPO3AUTO, DPO3COMP, DPO3AUDIO, or DPO3FLEX Serial Triggering and Analysis Module. Triggering on Parallel bus signals requires use of an MSO3000 Series oscilloscope.

---

1. Connect the channel 1 probe to the clock line.
2. Connect the channel 2 probe to the data line.

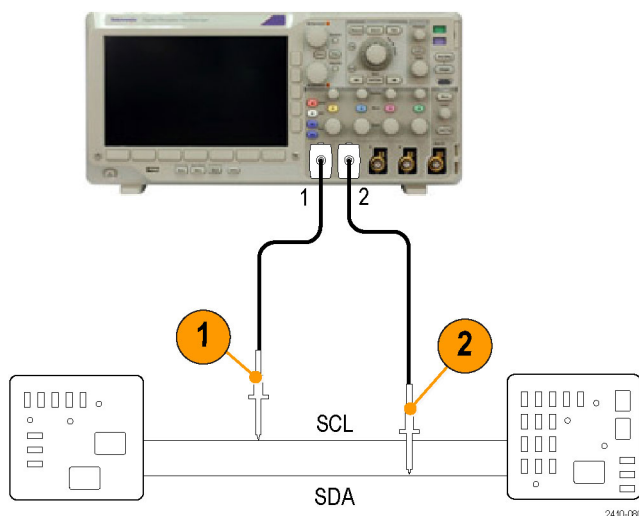

3. Push **Autoset**.



4. Push **B1** and enter the parameters of your I<sup>2</sup>C bus in the resulting screen menus.



5. Push **Trigger Menu**.

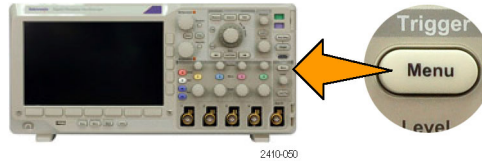

6. Push **Type** to select **Bus**. Enter trigger parameters in the resulting screen menus.

Type <b>Bus</b>	Source Bus <b>B1 (I2C)</b>	Trigger On <b>Address</b>	Address <b>07F</b>		Direction <b>Read</b>	Mode <b>Auto</b> & Holdoff
--------------------	----------------------------------	------------------------------	-----------------------	--	--------------------------	----------------------------------



7. Analyze the physical layer. For example, you can use the cursors for manual measurements. (See page 108, *Taking Manual Measurements with Cursors*.) You can also use the automated measurements. (See page 100, *Taking Automatic Measurements*.)



8. Push **Search**. Set **Search** to **On**. Enter a search type, source, and other parameters as relevant on the lower menu and associated side menus. (See page 118, *Using Wave Inspector to Manage Long Record Length Waveforms*.)



9. Jump ahead to the next search point by pushing the right arrow key. Push it again and again until you see all the events. Jump back with the left arrow key. Do you have all the packets that you expected to have? If not, at least you have narrowed your search down to the last packet sent.

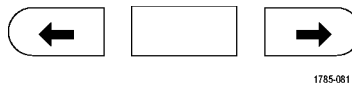

10. Analyze the decoded packets in the protocol layer. Did you send the data bytes in the correct order? Did you use the correct address?

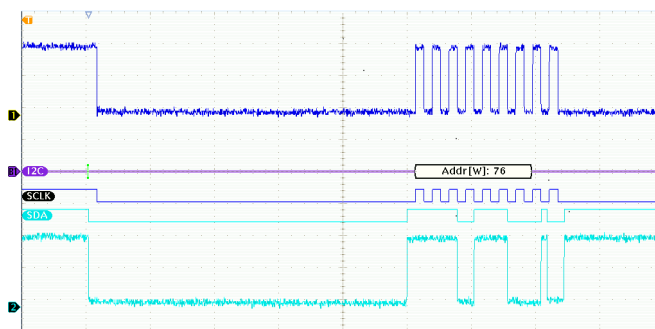

## Troubleshooting an RS-232 Bus

In this example, you are looking at analog characteristics of a digital signal in a digital circuit. You are doing this to analyze the signal integrity of a signal. For example, you might be testing RS-232 bus signals.

### Basic Strategy

First, you will display and acquire the digital signal. Then, you will look at both the analog and digital representations of the signal. Finally, you will search through each RS-232 byte with the search/mark functions.

**NOTE.** Triggering on RS-232 bus signals requires use of the DPO3COMP Serial Triggering and Analysis Module. (See page 12, Application Module Free Trial.)

1. Connect the desired analog probe tip to the desired test point.

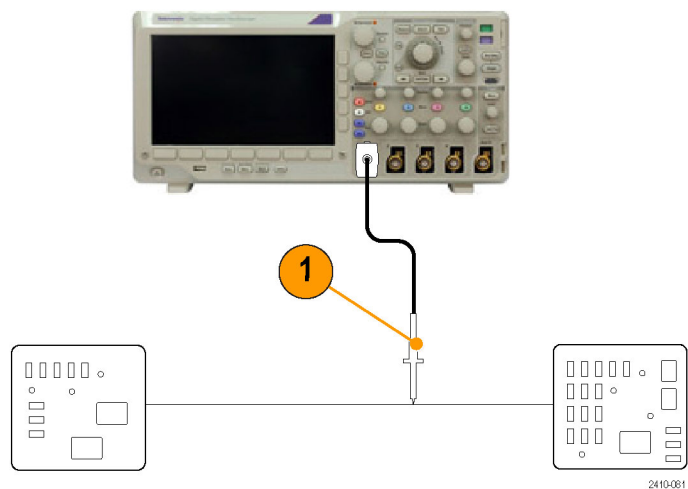

2. Push **Default Setup**.



3. Push **Autoset**.



4. Push **B1**.

5. Push **Bus B1** on the lower menu, use multipurpose knob **a** to select **RS-232**, and enter the parameters of the bus in the resulting screen menus.



6. Push **Bus Display** on the lower menu, push **Bus and Waveforms** on the side menu, and then push **ASCII** on the side menu.
7. Turn the Horizontal Scale knob to adjust the timebase.  
As you increase the time per division, you will see more data appear in the Bus display.
8. Push **Trigger Menu**. Select the **Bus** trigger type. Define what type of condition to trigger on, such as the Tx Start Bit.



9. Push **Search**, then push **Search** on the lower menu, and then select **On** on the side menu.



10. Push **Search Type**. Use multipurpose knob **a** to select **Bus**. Push **Search For** and select the desired search, such as for the Tx Start Bit.
11. Push the Previous and Next Mark buttons to navigate through the record.
12. Push Zoom and Pan to see the areas of interest and analyze the results.

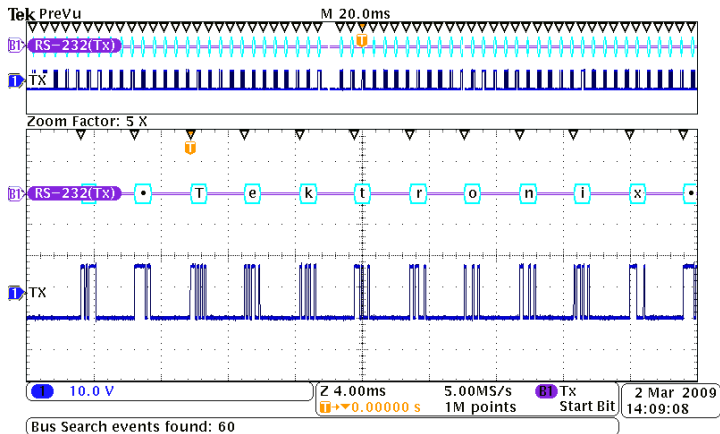



## Troubleshooting Circuits Using Parallel Buses

In this example, you are monitoring a parallel bus with your oscilloscope. You can use your MSO3000 Series oscilloscope with its 16 digital channels to analyze the bus. The MSO3000 Series will not only let you see the on-off status of the signals, but will also decode the parallel bus signals for you.

### Basic Strategy

First, you will display and acquire the digital signals. Then, you will search through the data with the search/mark functions.

---

**NOTE.** The MSO3000 Series oscilloscopes support triggering and decoding on Parallel bus signals.

---

1. Connect the desired digital probe tips to the desired test points. For simplicity, this example connects to a 7-bit counter.

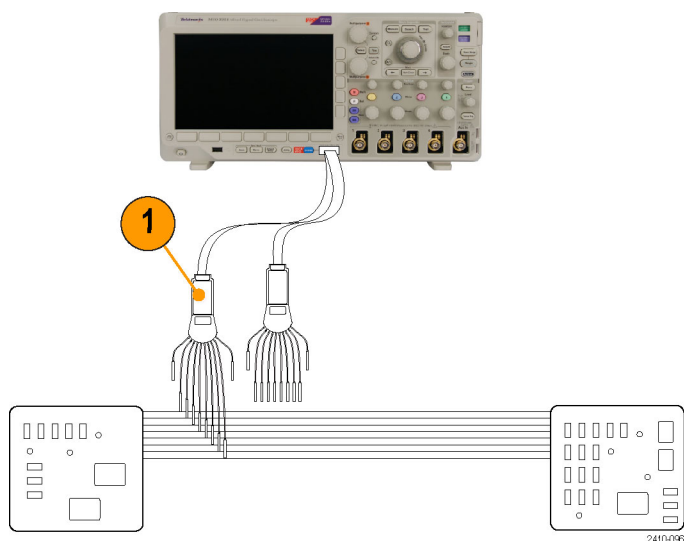

2. Push **Default Setup**. Then push the channel **1** button to remove the waveform from the display.



3. Push **D15-D0**.



4. On the lower menu, push **D15-D0 On/Off** and then on the side menu, push **Turn On D7-D0** to display the digital waveforms. To turn off a channel, use multipurpose knob **a** to select the channel and push **Display** on the side menu to select **Off**.

5. Push **Autoset**.



6. Push **B1**, and select Parallel as the bus type. On the lower menu, push **Define Inputs** and enter the parameters for your bus for Clocked Data, Clock Edge, the Number of Bits, and Define Bits.



7. Turn the Horizontal Scale knob to adjust the timebase.  
As you increase the time per division, you will see more data appear in the Bus display.

8. Push **Trigger Menu**. Push **Type**, select **Bus**, and enter the parameters of the trigger, such as the Source Bus and Data. Define the Mode and Holdoff as desired.



9. Push **Search** on the front-panel, push **Search** on the lower menu, and select **On** on the side menu.



10. Push **Search Type**. Use the multipurpose knob **a** to select **Bus** and then push **Data**. Use the multipurpose knobs **a** and **b** to define the data value.

11. Push **Previous** and **Next Mark** to navigate through the record.

12. Push **Zoom**, and **Pan** to the areas of interest to analyze the results.

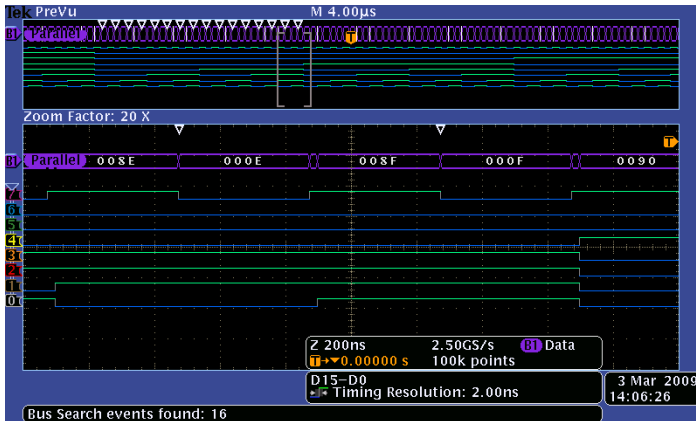

## Appendix: Warranted Specifications

Analog bandwidth, 50 $\Omega$		The limits stated below are for ambient temperature of $\leq 30$ $^{\circ}\text{C}$ and the bandwidth selection set to FULL. Reduce the upper bandwidth frequency by 1% for each $^{\circ}\text{C}$ above 30 $^{\circ}\text{C}$ .			
Instrument	Bandwidth	10 mV/div to 1 V/div	5 mV/div to 9.98 mV/div	2mV/div to 4.98mV/div	1 mV/div to 1.99 mV/div
MSO/DPO 3054	500 MHz	DC to 500 MHz	DC to 400 MHz	DC to 250 MHz	DC to 150 MHz
DPO 3052	500 MHz	DC to 500 MHz	DC to 400 MHz	DC to 250 MHz	DC to 150 MHz
MSO/DPO 3034	500 MHz	DC to 500 MHz	DC to 400 MHz	DC to 250 MHz	DC to 150 MHz
	300 MHz		DC to 300 MHz	DC to 250 MHz	DC to 150 MHz
MSO/DPO 3032	500 MHz	DC to 500 MHz	DC to 400 MHz	DC to 250 MHz	DC to 150 MHz
	300 MHz		DC to 300 MHz	DC to 250 MHz	DC to 150 MHz
MSO/DPO 3014	500 MHz	DC to 500 MHz	DC to 400 MHz	DC to 250 MHz	DC to 150 MHz
	300 MHz		DC to 300 MHz	DC to 250 MHz	DC to 150 MHz
	100 MHz				DC to 100 MHz
MSO/DPO 3012	500 MHz	DC to 500 MHz	DC to 400 MHz	DC to 250 MHz	DC to 150 MHz
	300 MHz		DC to 300 MHz	DC to 250 MHz	DC to 150 MHz
	100 MHz				DC to 100 MHz
Input impedance, DC coupled	1 M $\Omega$ :	$\pm 1\%$ in parallel with 11.5 pF $\pm 2$ pF			
	75 $\Omega$ :	$\pm 1\%$ VSWR $\leq 1.3:1$ from DC to 60 MHz, typical			
	50 $\Omega$ :	$\pm 1\%$			
	For 500MHz bandwidth models: VSWR $\leq 1.5:1$ from DC to 500 MHz, typical				
	For 300MHz bandwidth models: VSWR $\leq 1.5:1$ from DC to 350 MHz, typical				
	For 100MHz bandwidth models: VSWR $\leq 1.5:1$ from DC to 100 MHz, typical				
DC Balance	0.2 div with the input DC-50 $\Omega$ coupled and 50 $\Omega$ terminated 0.2 div with the input DC-75 $\Omega$ coupled and 75 $\Omega$ terminated 0.25 div at 2 mV/div with the input DC-50 $\Omega$ coupled and 50 $\Omega$ terminated 0.25 div at 2 mV/div with the input DC-75 $\Omega$ coupled and 75 $\Omega$ terminated 0.5 div at 1 mV/div with the input DC-50 $\Omega$ coupled and 50 $\Omega$ terminated 0.5 div at 1 mV/div with the input DC-75 $\Omega$ coupled and 75 $\Omega$ terminated 0.2 div with the input DC-1 M $\Omega$ coupled and 50 $\Omega$ terminated 0.3 div at 1 mV/div with the input DC-1 M $\Omega$ coupled and 50 $\Omega$ terminated				
DC Gain accuracy	$\pm 2.5\%$ for Coarse setting of 1 mV/div, derated at 0.100%/ $^{\circ}\text{C}$ above 30 $^{\circ}\text{C}$ $\pm 2.0\%$ for Coarse setting of 2 mV/div, derated at 0.100%/ $^{\circ}\text{C}$ above 30 $^{\circ}\text{C}$ $\pm 1.5\%$ for Coarse settings o. 5 mV/div and above, derated at 0.100%/ $^{\circ}\text{C}$ above 30 $^{\circ}\text{C}$ $\pm 3.0\%$ for all Fine V/div settings, derated at 0.100%/ $^{\circ}\text{C}$ above 30 $^{\circ}\text{C}$				

Offset accuracy	$\pm[0.005 \times   \text{offset} - \text{position}   + \text{DC Balance}]$ <b>NOTE.</b> Both the position and constant offset term must be converted to volts by multiplying by the appropriate volts/div term.		
Long-term sample rate and delay time accuracy	±10 ppm over any ≥ 1 ms time interval		
Auxiliary output (AUX OUT)	LOW TRUE; LOW to HIGH transition indicates that the trigger occurred. The logic levels are given in the following table:		
	Characteristic	Limits	
	Vout (HI)	≥ 3.25 V open circuit; ≥ 2.2 V into a 50 Ω load to ground	
	Vout (LO)	≤ 0.4 V into a load of ≤ 4 mA; ≤0.3 V into a 50 Ω load to ground	
Random Noise, Sample acquisition mode	Bandwidth of Instrument	Bandwidth Selection	RMS Noise
	500MHz	Full bandwidth	<(170 μV + 8% of Volts/div Setting)
		150 MHz bandwidth limit	<(90 μV + 6% of Volts/div Setting)
		20 MHz bandwidth limit	<(25 μV + 6% of Volts/div Setting)
	300MHz	Full bandwidth	<(140 μV + 6% of Volts/div Setting)
		150 MHz bandwidth limit	<(80 μV + 6% of Volts/div Setting)
		20 MHz bandwidth limit	<(30 μV + 5% of Volts/div Setting)
	100MHz	Full bandwidth	<(100 μV + 6% of Volts/div Setting)
		20 MHz bandwidth limit	<(100 μV + 6% of Volts/div Setting)
	Delta Time Measurement Accuracy	<p>The formula to calculate delta-time measurement accuracy (DTA) for a given instrument setting and input signal is given below (assumes insignificant signal content above Nyquist)</p> <p>SR<sub>1</sub> = Slew Rate (1<sup>st</sup> Edge) around the 1<sup>st</sup> point in the measurement</p> <p>SR<sub>2</sub> = Slew Rate (2<sup>nd</sup> Edge) around the 2<sup>nd</sup> point in the measurement</p> <p>N = input-referred noise (volts<sub>rms</sub>, Refer to the Random Noise, Sample acquisition mode specification)</p> <p>t<sub>sr</sub> = 1/ (Sample Rate)</p> <p>TBA = timebase accuracy (Refer to the Long-term sample rate and delay time accuracy specification)</p> <p>t<sub>p</sub> = delta-time measurement duration (sec)</p> <p>RD = (Record Length) / (Sample Rate)</p> $DTA_{PP} = \pm 5 \times \sqrt{2 \left( \frac{N}{SR_1} \right)^2 + 2 \left( \frac{N}{SR_2} \right)^2 + (5 ps + 1 E^{-6} \times RD)^2 + 2t_{sr} + TBA \times t_p}$ $DTA_{RMS} = \sqrt{2 \left( \frac{N}{SR_1} \right)^2 + 2 \left( \frac{N}{SR_2} \right)^2 + (5 ps + 1 E^{-6} \times RD)^2 + \left( \frac{2t_{sr}}{\sqrt{12}} \right) + TBA \times t_p}$	

Assumes that error due to aliasing is insignificant.

The term under the square-root sign is the stability, and is due to TIE (Time Interval Error). The errors due to this term occur throughout a single-shot measurement. The second term is due to both the absolute center-frequency accuracy and the center-frequency stability of the timebase and varies between multiple single-shot measurements over the observation interval (the amount of time from the first single-shot measurement to the final single-shot measurement).



# Index

## Symbols and Numbers

50  $\Omega$  protection, 93

## A

About, 23  
 Accessories, 1  
 Acquire button, 31, 51, 84, 148, 149  
 Acquisition  
   input channels and digitizers, 49  
   modes defined, 50  
   readout, 37  
   sampling, 49  
 Adapter  
   TEK-USB-488, 4  
   TPA-BNC, 3, 8  
 Adding waveform, 84  
 Advanced math, 115  
 Altitude  
   MSO3000 and DPO3000, 5  
   P6139B, 6  
   P6316, 7  
 Amplitude measurement, 102  
 Annotating the screen, 97  
 Application modules, 13, 139  
   30-day free trial, 12  
   DPO3AUDIO, 3, 54  
   DPO3AUTO, 3, 54  
   DPO3COMP, 3, 54  
   DPO3EMBD, 3, 54  
   DPO3PWR, 3, 123  
   DPO3VID, 3, 76  
 Area measurement, 103  
 Attenuation, 92  
 Audio, 54  
 Auto trigger mode, 70  
 Autoset, 48, 140  
   Video, 49  
 Autoset button, 11, 31, 35, 44, 48, 140  
 Autoset disable, 48  
 Autoset undo, 48  
 Aux In connector, 41  
 Aux Out connector, 42  
 Auxiliary readout, 40  
 Average acquisition mode, 51

## B

B trigger, 82  
 B1 / B2 button, 54, 55, 76  
 Backlight intensity, 88  
 Bandwidth, xiii, 91  
 Baseline indicators, 40  
 Before Installation, 1  
 Blackman-Harris FFT window, 115  
 Blue lines, 97  
 BNC interface, 8  
 Burst Width measurement, 101  
 Bus  
   button, 54, 55, 76  
   display, 41, 56  
   menu, 32, 55  
   positioning and labeling, 94  
   setup, 55  
 Bus and Waveforms display, 65  
 Bus trigger, defined, 76  
 Buses, 54, 76  
   cursor readout, 111

## Button

Acquire, 31, 51, 84, 148, 149  
 Autoset, 11, 31, 35, 44, 48, 140  
 B1 / B2, 32, 54, 76  
 B1 / B2 bus, 55  
 bus, 54, 55, 76  
 Cal, 42  
 Channel, 32  
 Cursors, 33, 108  
 D15 - D0, 36, 68  
 Default Setup, 36, 44, 47  
 Fine, 31, 33, 34, 35  
 Force Trig, 35, 70  
 hard copy, 35, 137  
 Intensity, 88  
 M, 32, 112, 113  
 Math, 32, 112, 113  
 Measure, 31, 100, 105, 141, 143, 145, 146  
 Menu Off, 37, 141  
 Next, 34  
 Play-pause, 34, 119  
 Previous, 34  
 Print, 35  
 printer, 137  
 Ref, 32, 116, 128  
 Run/Stop, 35, 53, 83  
 Save / Recall, 32, 36, 126  
 Search, 31, 121  
 Select, 33  
 Set / Clear Mark, 34, 121  
 Set to 50%, 35, 72  
 Single, 35, 83, 146, 155  
 Test, 31, 123  
 Trigger, 31  
 Trigger level, 35  
 Trigger menu, 73, 151  
 Utility, 15, 16, 19, 31, 85, 87, 97, 98, 132  
 Vertical, 32  
 Zoom, 34  
 byte matching, 80

## C

Cal button, 42  
 Calibration, 19, 20  
 Calibration certificate, 1  
 CAN, 32, 54, 76

- CAN trigger, 78
  - Changing the Font Appearance, 17
  - Channel button, 32
  - Channel readout, 40
  - Channel vertical menu, 90
  - Cleaning, 7
  - Clearance, MSO3000 and DPO3000, 5
  - Communications, 24, 26
  - Compensate probe, 12
  - Compensate signal path, 19
  - Confidential data, 137
  - Connecting a USB keyboard, 28
  - Connecting to a PC, 24
  - Connectivity, 1, 24, 26
  - Connector
    - Aux Out, 42
    - Probe Power, 42
    - Video port, 42
  - Connectors
    - front-panel, 41
    - rear-panel, 42
    - side panel, 42
  - Controls, 29
  - Coupling, 90
  - Coupling, trigger, 71
  - Cover, front, 2
  - Cross Hair graticule style, 87
  - CSV format, 127
  - Cursor readout, 38, 111
  - Cursors, 108
    - button, 33, 108
    - linking, 109
    - measurements, 108
    - menu, 108
    - XY, 111
  - Cycle Area measurement, 103
  - Cycle Mean measurement, 102
  - Cycle RMS measurement, 103
- D**
- D15 - D0 button, 36, 68
  - Data value matching, 80
  - Date and time, changing, 16
  - Default Setup, 47, 130
    - button, 36, 44, 47
    - menu, 36
    - Undo, 48
  - Delay measurement, 101
  - Delay time, 53
  - Delayed trigger, 81
  - Depth, MSO3000 and DPO3000, 5
  - Deskew, 92
  - Digital channels, 97
    - Baseline indicators, 40
    - Group icon, 41
    - scaling, positioning, grouping, and labeling, 95
    - setup, 66
  - Digital probe interface, 8
  - Disable Autoset, 48
  - Display
    - information, 37
    - persistence, 84
    - style, 84
    - XY, 85
  - Displaying, reference waveforms, 128
  - DPO3AERO, 139
  - DPO3AUDIO, 3, 54, 139
  - DPO3AUTO, 3, 54, 139
  - DPO3COMP, 3, 54, 139
  - DPO3EMBD, 3, 54, 139
  - DPO3PWR, 3, 123, 139
  - DPO3VID, 3, 76, 139
  - Drivers, 24, 26
  - Dual waveform math, 112
- E**
- e\*Scope, 26
  - Edge trigger, defined, 74
  - Edges
    - Fuzzy, 97
    - White, 97
  - Envelope acquisition mode, 51
  - Erase setup and ref memory, 137
  - Ethernet, xiii, 25, 26, 27
    - port, 42
    - printing, 135
  - Event Table, 57
  - Excel, 24
  - Expansion point, 50
  - Expansion point icon, 38
- F**
- Factory calibration, 20
  - Fall Time measurement, 101
  - Falling Edge Count measurement, 103
- FFT**
- Blackman-Harris, 115
  - controls, 113
  - Hamming, 114
  - Hanning, 115
  - Rectangular, 114
- File format, 126
    - Internal File Format (ISF), 127
    - Spreadsheet file format (.CSV), 127
  - File names, 124
  - File system, 124, 127
  - Fine, 33
  - Fine button, 31, 33, 34, 35
  - Firmware upgrade, 20
  - Firmware version, 23
  - firmware.img file, 20
  - Flash drives, 26
  - FlexRay
    - trigger, 79
  - Font appearance, 17
  - Force Trig button, 35, 70
  - Frame graticule style, 87
  - Frequency measurement, 101
  - Frequency, Source
    - MSO3000 and DPO3000, 5
  - Front cover, 2
    - front-panel, 29
  - Front-panel connectors, 41
  - Front-panel overlay, 16
  - Full graticule style, 87
  - Functional check, 10
  - Fuzzy edges, 97
- G**
- Gating, 104
  - GPIO, 24, 43
  - GPIO address, 25
  - Graticule
    - Cross Hair, 87
    - Frame, 87
    - Full, 87
    - Grid, 87
    - intensity, 88
    - IRE, 87
    - mV, 87
    - Solid, 87
    - styles, 85
  - Green lines, 97
  - Grid graticule style, 87
  - Ground, 9
  - Ground lead, 12



Ground strap, 9  
 Ground strap connector, 42  
 Ground yourself to discharge static, 9  
 Group icon, 41  
 Grouping channels, 67  
   digital, 95

## H

Hamming FFT window, 114  
 Hanning FFT window, 115  
 Hard copy, 132  
 Hard copy button, 35  
 Height, MSO3000 and DPO3000, 5  
 Hi Res acquisition mode, 51  
 High measurement, 102  
 High-low indicators, 40  
 Holdoff, trigger, 71  
 Horizontal delay, 71  
 Horizontal lines  
   Green and blue, 97  
 Horizontal position, 34, 50, 71, 72, 89, 114, 157  
   and math waveforms, 112  
   defined, 45  
   readout, 39  
 Horizontal scale, 34, 89, 114, 152, 153, 154, 157  
   and math waveforms, 112  
   defined, 45  
   readout, 39

How to  
   compensate a voltage probe, 12  
   compensate the signal path, 19  
   connect probes and adapters, 8  
   connect to a computer, 24  
   erase memory, 137  
   label channels and buses, 45  
   manage long record length waveforms, 118  
   perform a functional check, 10  
   power off the oscilloscope, 10  
   power on the oscilloscope, 9  
   print a hard copy, 132  
   recall setups, 129  
   recall waveforms, 126  
   save screen images, 126  
   save setups, 129  
   save waveforms, 126  
   search through and add marks to waveforms, 120  
   select a trigger, 74  
   select automatic measurements, 101  
   setup analog channels, 44  
   setup bus parameters, 55  
   setup digital channels, 66  
   setup input parameters, 90  
   setup VISA communications, 24  
   take automatic measurements, 100  
   take manual measurements with cursors, 108  
   trigger on buses, 76  
   upgrade the firmware, 20  
   use a sequential trigger, 81  
   use e\*Scope, 26  
   use MagniVu, 68  
   use Wave Inspector, 118  
 Humidity  
   MSO3000 and DPO3000, 5  
   P6139B, 6  
   P6316, 7

## I

I2C, 32, 54, 76  
   trigger, 77  
 I2S, 32, 76  
   trigger, 79

## Icon

  Expansion point, 38  
   Trigger level, 39  
   Trigger position, 38  
 Image orientation, 126, 133  
 Impedance, 90  
 Indicator, waveform baseline, 40  
 Infinite persistence, 85  
 Ink Saver, 126, 133  
 Inner knob, 34, 112  
 Input capacitance, P6316, 7  
 Input resistance, P6316, 7  
 Intensity button, 88  
 Internal File Format (ISF), 127  
 Invert, 90  
 IRE graticule, 87  
 ISF format, 127

## K

Keyboard, USB, 28  
 Knob  
   inner, 34, 112  
   Multipurpose, 17, 31, 33, 51, 127, 150, 151  
   outer, 34  
   pan, 34, 119, 121  
   Trigger level, 72  
   Vertical menu, 35  
   Vertical position, 35, 45  
   Vertical scale, 35, 45  
   zoom, 34, 112, 118

## L

Label bus, 94  
 LabView, 24  
 LAN port, 42  
 Landscape, 126, 133  
 Language  
   change, 15  
   overlay, 16  
 Left Justified, 76  
   trigger, 79  
 Left Justified (LJ), 32  
 Level, trigger, 72  
 LIN, 32, 54, 76  
   trigger, 78  
 Lock, standard laptop, 9  
 Logic trigger, defined, 75  
 Long record length, 159  
   management, 118  
 Low measurement, 102

**M**

M button, 32, 112, 113  
MagniVu, xiii, 68  
MagniVu readout, 39  
Main trigger, 81  
Mark, 120  
Math  
    Advanced, 115  
    button, 32, 112, 113  
    Dual waveform, 112  
    FFT, 113  
    menu, 32  
    waveforms, 112  
Max measurement, 102  
Maximum nondestructive input  
    signal, P6316, 6  
Maximum signal swing, P6316, 6  
Mean measurement, 102  
Measure button, 31, 100, 105, 141,  
    143, 145, 146  
Measurement menu, 31  
Measurements  
    automatic, 100  
    cursor, 108  
    defined, 101  
    reference levels, 107  
    snapshot, 105  
    statistics, 105  
Memory, erasure of, 137  
Menu, 29  
    Bus, 32, 55  
    buttons, 31  
    Cursors, 108  
    Default Setup, 36  
    Math, 32  
    Measurement, 31  
    Reference, 32, 116, 117  
    Save / Recall, 32, 36, 126  
    Trigger, 31, 73, 81, 151  
    Utility, 15, 16, 31, 35, 85, 97,  
        98, 132  
    Vertical, 32, 90  
Menu Off button, 37, 141  
MIL-STD-1553  
    trigger, 78  
Min measurement, 102  
Mode, roll, 53  
Multiple transition detection, 97  
Multipurpose knob, 31, 33, 51, 127,  
    150, 151  
mV graticule, 87

**N**

Negative Duty Cycle  
    measurement, 101  
Negative Overshoot  
    measurement, 102  
Negative Pulse Count  
    measurement, 103  
Negative Pulse Width  
    measurement, 101  
Network printing, 135  
Next button, 34  
NI SignalExpress Tektronix Edition  
    software, xiii  
Normal trigger mode, 70

**O**

Offset and position, 93  
Offset vertical, 91  
OpenChoice, xiii, 1  
Operating specifications, 5  
Option key, 13  
Orientation of the image, 126, 133  
Outer knob, 34  
Overlay, 16

**P**

P6139B probe, 1  
P6316 probe, 2, 68  
P6316 probe ground leads, 66  
Pan, 118, 119  
    knob, 34, 119, 121  
Parallel bus, xiii, 54  
Parallel bus anomalies, 163  
Pause, 119  
Peak detect acquisition mode, 50  
Period measurement, 101  
Persistence  
    display, 84  
    infinite, 85  
    variable, 85  
Phase measurement, 101  
Physical layer bus activity, 65  
PictBridge, xiii, 26, 43  
    printing, 134  
Pk-Pk measurement, 102  
Play, 119  
Play-pause button, 34, 119  
Play-pause mode, 119  
Pollution Degree  
    MSO3000 and DPO3000, 5  
    P6316, 7  
Portrait, 126, 133  
Position  
    bus, 94  
    digital channels, 95  
    Horizontal, 71, 72, 89, 114, 157  
    Vertical, 89  
Position and offset, 93  
Positive Duty Cycle  
    measurement, 101  
Positive Overshoot  
    measurement, 102  
Positive Pulse Count  
    measurement, 103  
Positive Pulse Width  
    measurement, 101  
Posttrigger, 70, 72  
Power  
    cord, 2  
    input, 43  
    off, 10  
    removing, 10  
    supply, 9  
    switch, 35  
Power consumption, MSO3000 and  
    DPO3000, 5  
Predefined math expressions, 112  
Pretrigger, 70, 72  
Previous button, 34  
Print, 132  
    Ethernet, 135  
    hard copy, 132  
    PictBridge, 134  
Print button, 35  
Probe Comp, 11  
PROBE COMP connector, 41  
Probe compensation, 12  
Probe connector  
    analog, 41  
    logic, 41  
Probe Power connector, 42  
Probes  
    BNC, 8  
    connecting, 8  
    digital, 8  
    ground lead, 12  
    P6139B, 1  
    P6316, 2  
    TEK-USB-488 Adapter, 4  
    TekVPI, 8  
    TPA-BNC Adapter, 3, 8  
Pulse Width trigger, defined, 74

**R**

Rackmount, 4  
 Readout  
   Acquisition, 37  
   Auxiliary, 40  
   Channel, 40  
   Cursor, 38, 111  
   Horizontal position/scale, 39  
   MagniVu, 39  
   Record length/sampling rate, 39  
   Timing resolution, 39  
   Trigger, 39, 81  
   Trigger frequency, 98  
   Trigger status, 38  
 Real-time sampling, 49  
 Rear-panel connectors, 42  
 Recalling  
   setups, 129  
   waveforms, 126  
 Record length, xiii, 50  
 Record length/sampling rate readout, 39  
 Rectangular FFT window, 114  
 Ref button, 32, 116, 128  
 Ref R, 128  
 Reference levels, 107  
 Reference menu, 32, 116, 117  
 Reference waveforms, 116  
   displaying, 128  
   removing, 117, 128  
   saving, 128  
   saving 5 M waveforms, 117  
 Removing reference waveforms, 117, 128  
 Removing waveform, 84  
 Right Justified, 76  
   trigger, 79  
 Right Justified (RJ), 32  
 Rise Time measurement, 101  
 Rise/Fall trigger, defined, 75  
 Rising Edge Count measurement, 103  
 RMS measurement, 103  
 Roll mode, 53  
 Rolling window data matching, 80

RS-232, 32, 54, 76  
   bus example, 161  
   cursor readout, 111  
   decoding, 65  
   trigger, 78  
 RS-422, 32  
 RS-485, 32  
 Run/Stop button, 35, 53, 83  
 Runt trigger, defined, 74

**S**

Safety Summary, v  
 Sample acquisition mode, 50  
 Sample interval, 50  
 Sample rates, xiii  
 Sampling process, defined, 49  
 Sampling, real-time, 49  
 Save / Recall menu, 32, 36, 126  
 Save / Recall Menu button, 32  
 Save / Recall Save button, 36, 126  
 Saving  
   reference waveforms, 128  
   screen images, 126  
   setups, 129  
   waveforms, 126  
 Saving and recalling Information, 124  
 Scale  
   digital channels, 95  
   Horizontal, 34, 89, 114, 152, 153, 154, 157  
   Vertical, 89, 154  
 Screen annotations, 97  
 Search, 120  
 Search / Mark, 159  
 Search button, 31, 121  
 Securing memory, 137  
 Security lock, 9  
 Select button, 33  
 Sequence (B Trigger), defined, 74  
 Sequential triggering, 81  
 Serial bus, 54, 159  
 Serial bus trigger, 76  
 Serial buses trigger, 77  
 Serial number, 14  
 Set / Clear Mark button, 34, 121  
 Set to 50% button, 35, 72

**Setup**

  default, 36, 44, 47, 130  
 Setup and Hold trigger, defined, 75  
 Side panel connector, 42  
 Signal path compensation, 19  
 Single button, 35, 83, 146, 155  
 Single sequence, 53, 83  
 Slope, trigger, 72  
 Snapshot, 105  
 Software drivers, 24, 26  
 Software, optional, 139  
 Solid graticule style, 87  
 SPC, 19  
 Specifications  
   operating, 5  
   power supply, 9  
 SPI, 32, 54, 76  
 SPI trigger, 77  
 Spreadsheet file format (.CSV), 127  
 Start an acquisition, 83  
 Statistics, 105  
 Stop an acquisition, 83  
 SVGA Out, 42  
 Switch, power, 35

**T**

Table, Event, 57  
 TDM, 32, 76  
   trigger, 79  
 TEK-USB-488 Adapter, 4, 24, 25, 43  
 TekSecure, 137  
 TekVPI, 8  
 Temperature  
   MSO3000 and DPO3000, 5  
   P6139B, 6  
   P6316, 7  
 Termination, 90  
 Test button, 31, 123  
 Threshold accuracy, P6316, 6  
 Threshold range, P6316, 6  
 Timeout trigger, defined, 74  
 Timing resolution readout, 39  
 TPA-BNC Adapter, 3, 8  
 Transit case, 4  
 Transition trigger, defined, 75

## Trigger

- B trigger after delay time, 82
- Bus, defined, 76
- buses, 76
- byte matching, 80
- CAN bus, 78
- concepts, 70
- coupling, 71
- data matching on a rolling window, 80
- delayed, 81
- Edge, defined, 74
- event, defined, 70
- FlexRay bus, 79
- forcing, 70
- Frequency readout, 98
- holdoff, 71
- I2C bus, 77
- I2S bus, 79
- Left Justified, 79
- level, 72
- level button, 35
- level icon, 39
- level knob, 72
- LIN bus, 78
- Logic, defined, 75
- MIL-STD-1553 bus, 78
- modes, 70, 73
- parallel bus data matching, 80
- parallel buses, 54
- point, 50
- position icon, 38
- posttrigger, 70, 72
- pretrigger, 70, 72
- Pulse Width, defined, 74
- readout, 39, 81
- Right Justified, 79
- Rise/Fall, defined, 75
- RS-232 bus, 78
- Runt, defined, 74
- Sequence (B Trigger), defined, 74
- sequential, 81
- serial buses, 54, 77, 159
- Setup and Hold, defined, 75
- slope, 72
- SPI bus, 77
- status readout, 38
- TDM bus, 79
- Timeout, defined, 74
- Trigger on B events, 82
- video lines, 153
- Video, defined, 76

- Trigger menu, 31, 73, 81, 151
  - button, 73, 151
- Trigger modes
  - Auto, 70
  - Normal, 70
- Trigger types, defined, 74
- Triggering on Buses, 76

## U

- Undo
  - Autoset, 48
  - Default Setup, 48
- Upgrading bandwidth, 13
- Upgrading firmware, 20
- USB, xiii, 24, 25, 26, 32, 124, 132
  - device port, 43
  - host ports, 36, 43
  - keyboard, 28
- USBTMC, 43
- User marks, 120
- Utility button, 15, 16, 19, 31, 85, 87, 97, 98, 132
- Utility menu, 15, 16, 31, 35, 85, 97, 98

## V

- Variable persistence, 85
- Versatile Probe Interface, 8
- Version, firmware, 23
- Vertical
  - button, 32
  - menu, 32, 90
  - Menu knob, 35
  - offset, 93
  - Offset, 91
  - position, 89
  - position and autoset, 49
  - position and offset, 93
  - Position knob, 35, 45
  - scale, 89, 154
  - Scale knob, 35, 45
- Vibration, MSO3000 and DPO3000, 5
- Video
  - Autoset, 49
  - fields, 151
  - lines, 153
  - port, 42
  - projector, 42
  - trigger, 151
- Video trigger, defined, 76

## View

- digital channels, 97
- waveform record, 38
- VISA, 24
- Voltage, Input
  - P6139B, 6
- Voltage, Source
  - MSO3000 and DPO3000, 5

## W

- Wave Inspector, xiii, 118
- Waveform
  - adding, 84
  - display style, 84
  - intensity, 88
  - pan, 118, 119
  - pause, 119
  - play, 119
  - play-pause, 119
  - record defined, 50
  - removing, 84
  - search and mark, 120
  - user marks, 120
  - zoom, 118
- Waveform baseline indicator, 40
- Waveform record, 50
- Waveform record view, 38
- Weight
  - MSO3000 and DPO3000, 5
- White edges, 97
- Width
  - MSO3000 and DPO3000, 5

**X**

- XY
  - cursors, 111
  - display, 85

## Z

- Zoom, 118
  - button, 34
  - graticule size, 119
  - Horizontal, 156
  - knob, 34, 118