

**MDO4000 Series
Mixed Domain Oscilloscopes
User Manual**



**MDO4000 Series
Mixed Domain Oscilloscopes
User Manual**

Revision A

www.tektronix.com

071-2913-02

Tektronix

Copyright © Tektronix. All rights reserved. Licensed software products are owned by Tektronix or its subsidiaries or suppliers, and are protected by national copyright laws and international treaty provisions.

Tektronix products are covered by U.S. and foreign patents, issued and pending. Information in this publication supersedes that in all previously published material. Specifications and price change privileges reserved.

TEKTRONIX and TEK are registered trademarks of Tektronix, Inc.

e*Scope, iView, OpenChoice, TekSecure, and TekVPI are registered trademarks of Tektronix, Inc.

MagniVu and Wave Inspector are trademarks of Tektronix, Inc.

PictBridge is a registered trademark of the Standard of Camera & Imaging Products Association CIPA DC-001-2003 Digital Photo Solutions for Imaging Devices.

Contacting Tektronix

Tektronix, Inc.
14150 SW Karl Braun Drive
P.O. Box 500
Beaverton, OR 97077
USA

For product information, sales, service, and technical support:

- In North America, call 1-800-833-9200.
- Worldwide, visit www.tektronix.com to find contacts in your area.

Warranty

Tektronix warrants that the product will be free from defects in materials and workmanship for a period of three (3) years from the date of original purchase from an authorized Tektronix distributor. If the product proves defective during this warranty period, Tektronix, at its option, either will repair the defective product without charge for parts and labor, or will provide a replacement in exchange for the defective product. Batteries are excluded from this warranty. Parts, modules and replacement products used by Tektronix for warranty work may be new or reconditioned to like new performance. All replaced parts, modules and products become the property of Tektronix.

In order to obtain service under this warranty, Customer must notify Tektronix of the defect before the expiration of the warranty period and make suitable arrangements for the performance of service. Customer shall be responsible for packaging and shipping the defective product to the service center designated by Tektronix, shipping charges prepaid, and with a copy of customer proof of purchase. Tektronix shall pay for the return of the product to Customer if the shipment is to a location within the country in which the Tektronix service center is located. Customer shall be responsible for paying all shipping charges, duties, taxes, and any other charges for products returned to any other locations.

This warranty shall not apply to any defect, failure or damage caused by improper use or improper or inadequate maintenance and care. Tektronix shall not be obligated to furnish service under this warranty a) to repair damage resulting from attempts by personnel other than Tektronix representatives to install, repair or service the product; b) to repair damage resulting from improper use or connection to incompatible equipment; c) to repair any damage or malfunction caused by the use of non-Tektronix supplies; or d) to service a product that has been modified or integrated with other products when the effect of such modification or integration increases the time or difficulty of servicing the product.

THIS WARRANTY IS GIVEN BY TEKTRONIX WITH RESPECT TO THE PRODUCT IN LIEU OF ANY OTHER WARRANTIES, EXPRESS OR IMPLIED. TEKTRONIX AND ITS VENDORS DISCLAIM ANY IMPLIED WARRANTIES OF MERCHANTABILITY OR FITNESS FOR A PARTICULAR PURPOSE. TEKTRONIX' RESPONSIBILITY TO REPAIR OR REPLACE DEFECTIVE PRODUCTS IS THE SOLE AND EXCLUSIVE REMEDY PROVIDED TO THE CUSTOMER FOR BREACH OF THIS WARRANTY. TEKTRONIX AND ITS VENDORS WILL NOT BE LIABLE FOR ANY INDIRECT, SPECIAL, INCIDENTAL, OR CONSEQUENTIAL DAMAGES IRRESPECTIVE OF WHETHER TEKTRONIX OR THE VENDOR HAS ADVANCE NOTICE OF THE POSSIBILITY OF SUCH DAMAGES.

[W16 – 15AUG04]

Warranty

Tektronix warrants that the product will be free from defects in materials and workmanship for a period of one (1) year from the date of original purchase from an authorized Tektronix distributor. If the product proves defective during this warranty period, Tektronix, at its option, either will repair the defective product without charge for parts and labor, or will provide a replacement in exchange for the defective product. Batteries are excluded from this warranty. Parts, modules and replacement products used by Tektronix for warranty work may be new or reconditioned to like new performance. All replaced parts, modules and products become the property of Tektronix.

In order to obtain service under this warranty, Customer must notify Tektronix of the defect before the expiration of the warranty period and make suitable arrangements for the performance of service. Customer shall be responsible for packaging and shipping the defective product to the service center designated by Tektronix, shipping charges prepaid, and with a copy of customer proof of purchase. Tektronix shall pay for the return of the product to Customer if the shipment is to a location within the country in which the Tektronix service center is located. Customer shall be responsible for paying all shipping charges, duties, taxes, and any other charges for products returned to any other locations.

This warranty shall not apply to any defect, failure or damage caused by improper use or improper or inadequate maintenance and care. Tektronix shall not be obligated to furnish service under this warranty a) to repair damage resulting from attempts by personnel other than Tektronix representatives to install, repair or service the product; b) to repair damage resulting from improper use or connection to incompatible equipment; c) to repair any damage or malfunction caused by the use of non-Tektronix supplies; or d) to service a product that has been modified or integrated with other products when the effect of such modification or integration increases the time or difficulty of servicing the product.

THIS WARRANTY IS GIVEN BY TEKTRONIX WITH RESPECT TO THE PRODUCT IN LIEU OF ANY OTHER WARRANTIES, EXPRESS OR IMPLIED. TEKTRONIX AND ITS VENDORS DISCLAIM ANY IMPLIED WARRANTIES OF MERCHANTABILITY OR FITNESS FOR A PARTICULAR PURPOSE. TEKTRONIX' RESPONSIBILITY TO REPAIR OR REPLACE DEFECTIVE PRODUCTS IS THE SOLE AND EXCLUSIVE REMEDY PROVIDED TO THE CUSTOMER FOR BREACH OF THIS WARRANTY. TEKTRONIX AND ITS VENDORS WILL NOT BE LIABLE FOR ANY INDIRECT, SPECIAL, INCIDENTAL, OR CONSEQUENTIAL DAMAGES IRRESPECTIVE OF WHETHER TEKTRONIX OR THE VENDOR HAS ADVANCE NOTICE OF THE POSSIBILITY OF SUCH DAMAGES.

[W15 – 15AUG04]

Table of Contents

General safety summary	v
Compliance Information	vii
EMC Compliance	vii
Safety Compliance	viii
Environmental Considerations	ix
Preface	xi
Key Features	xi
Conventions Used in This Manual	xii
Installation	1
Before Installation	1
Operating Considerations	6
Operating Positions	8
Connecting Probes	9
Securing the Oscilloscope	10
Powering on the Oscilloscope	11
Powering off the Oscilloscope	12
Functional Check	12
Compensating a TPP0500 or TPP1000 Passive Voltage Probe	13
Compensating a non-TPP0500 or non-TPP1000 Passive Voltage Probe	15
Application Module Free Trial	16
Installing an Application Module	16
Changing the Language of the User Interface or Keyboard	17
Changing the Date and Time	18
Signal Path Compensation	20
Upgrading Firmware	22
Connecting Your Oscilloscope to a Computer	25
Connecting a USB Keyboard to Your Oscilloscope	33
Get Acquainted with the Instrument	34
Front Panel Menus and Controls	34
Front Panel Connectors	47
Side-Panel Connector	47
Rear-Panel Connectors	48
Acquire the Signal	50
Setting Up Analog Channels	50
Using the Default Setup	53
Using Autoset	54
Acquisition Concepts	55
How the Analog Acquisition Modes Work	57
Changing the Acquisition Mode, Record Length, and Delay Time	57
Using Roll Mode	59
Setting Up a Serial or Parallel Bus	60
Setting Up Digital Channels	72

When and Why to Turn On MagniVu	74
Using MagniVu	74
Setting Up the RF Inputs	75
Trigger Setup	80
Triggering Concepts	80
Choosing a Trigger Type	83
Selecting Triggers	84
Triggering on Buses	86
Checking Trigger Settings	90
Using Sequence Trigger (A (Main) and B (Delayed))	91
Starting and Stopping an Acquisition	93
Triggering on the RF Input	93
Display Waveform or Trace Data	96
Adding and Removing a Waveform	96
Setting the Display Style and Persistence	96
Setting Waveform Intensity	100
Scaling and Positioning a Waveform	101
Setting Input Parameters	102
Positioning and Labeling Bus Signals	106
Positioning, Scaling, and Grouping Digital Channels	106
Viewing Digital Channels	108
Annotating the Screen	108
Viewing the Trigger Frequency	109
Displaying the Frequency Domain Menu	110
Analyze Waveform or Trace Data	117
Using Markers in the Frequency Domain	117
Taking Automatic Measurements in the Frequency Domain	120
Taking Automatic Measurements in the Time Domain	121
Selecting Automatic Measurements in the Time Domain	122
Customizing an Automatic Measurement in the Time Domain	125
Taking Manual Measurements with Cursors	129
Setting Up a Histogram	133
Using Math Waveforms	136
Using FFT	137
Using Advanced Math	140
Using Spectrum Math	141
Using Reference Waveforms and Traces	142
Using Wave Inspector to Manage Long Record Length Waveforms	144
Auto-magnify	149
Time-Correlated Multi-Domain Display	150
Limit and Mask Testing	154
Analyzing Power	158
Save and Recall Information	160
Saving a Screen Image	162
Saving and Recalling Waveform and Trace Data	163

Saving and Recalling Setups	166
Saving with One Button Push	168
Managing Drives, Directories, and Files	169
Mounting a Network Drive	169
Printing a Hard Copy	170
Erasing Oscilloscope Memory	176
Using Application Modules	178
Appendix A: MDO4000 Specifications	180
Appendix B: TPP0500 and TPP1000 500 MHz and 1 GHz 10X Passive Probes Information	184
Operating Information	184
Connecting the Probe to the Oscilloscope	184
Compensating the Probe with MDO4000 Series Oscilloscopes	184
Standard Accessories	184
Optional Accessories	186
Replacing the Probe Tip	186
Specifications	187
Performance Graphs	187
Safety Summary	189
Appendix C: P6616 General-Purpose Logic Probe Information	191
Product Description	191
Connecting the Probe to the Oscilloscope	191
Connecting the Probe to Your Circuit	192
Functional Check	192
Typical Application	193
Accessories	193
Specifications	194
Safety Summary	195
Safety Terms and Symbols in This Manual	195
Index	

General safety summary

Review the following safety precautions to avoid injury and prevent damage to this product or any products connected to it.

To avoid potential hazards, use this product only as specified.

Only qualified personnel should perform service procedures.

To avoid fire or personal injury

Use proper power cord. Use only the power cord specified for this product and certified for the country of use.

Connect and disconnect properly. Do not connect or disconnect probes or test leads while they are connected to a voltage source.

Connect and disconnect properly. De-energize the circuit under test before connecting or disconnecting the current probe.

Ground the product. This product is grounded through the grounding conductor of the power cord. To avoid electric shock, the grounding conductor must be connected to earth ground. Before making connections to the input or output terminals of the product, ensure that the product is properly grounded.

Observe all terminal ratings. To avoid fire or shock hazard, observe all ratings and markings on the product. Consult the product manual for further ratings information before making connections to the product.

Connect the probe reference lead to earth ground only.

Do not apply a potential to any terminal, including the common terminal, that exceeds the maximum rating of that terminal.

Power disconnect. The power cord disconnects the product from the power source. Do not block the power cord; it must remain accessible to the user at all times.

Do not operate without covers. Do not operate this product with covers or panels removed.

Do not operate with suspected failures. If you suspect that there is damage to this product, have it inspected by qualified service personnel.

Avoid exposed circuitry. Do not touch exposed connections and components when power is present.

Do not operate in wet/damp conditions.

Do not operate in an explosive atmosphere.

Keep product surfaces clean and dry.

Provide proper ventilation. Refer to the manual's installation instructions for details on installing the product so it has proper ventilation.

Terms in this manual

These terms may appear in this manual:



WARNING. *Warning statements identify conditions or practices that could result in injury or loss of life.*



CAUTION. *Caution statements identify conditions or practices that could result in damage to this product or other property.*

Symbols and terms on the product

These terms may appear on the product:

- DANGER indicates an injury hazard immediately accessible as you read the marking.
- WARNING indicates an injury hazard not immediately accessible as you read the marking.
- CAUTION indicates a hazard to property including the product.

The following symbol(s) may appear on the product:



Compliance Information

This section lists the EMC (electromagnetic compliance), safety, and environmental standards with which the instrument complies.

EMC Compliance

EC Declaration of Conformity – EMC

Meets intent of Directive 2004/108/EC for Electromagnetic Compatibility. Compliance was demonstrated to the following specifications as listed in the Official Journal of the European Communities:

EN 61326-1:2006, EN 61326-2-1:2006. EMC requirements for electrical equipment for measurement, control, and laboratory use.^{1 2 3 4}

- CISPR 11:2003. Radiated and conducted emissions, Group 1, Class A
- IEC 61000-4-2:2001. Electrostatic discharge immunity
- IEC 61000-4-3:2002. RF electromagnetic field immunity⁵
- IEC 61000-4-4:2004. Electrical fast transient/burst immunity
- IEC 61000-4-5:2001. Power line surge immunity
- IEC 61000-4-6:2003. Conducted RF immunity⁶
- IEC 61000-4-11:2004. Voltage dips and interruptions immunity⁷

EN 61000-3-2:2006. AC power line harmonic emissions

EN 61000-3-3:1995. Voltage changes, fluctuations, and flicker

European contact.

Tektronix UK, Ltd.
Western Peninsula
Western Road
Bracknell, RG12 1RF
United Kingdom

- ¹ This product is intended for use in nonresidential areas only. Use in residential areas may cause electromagnetic interference.
- ² Emissions which exceed the levels required by this standard may occur when this equipment is connected to a test object.
- ³ To ensure compliance with the EMC standards listed here, high quality shielded interface cables should be used.
- ⁴ Instrument rebooting may be experienced where the EUT takes longer than 10 seconds to recover from a transient immunity test.
- ⁵ The instrument will exhibit ≤ 4.0 division waveform displacement and ≤ 8.0 division increase in peak-to-peak noise when subjected to radiated interference per IEC 61000-4-3.
- ⁶ The instrument will exhibit ≤ 1.0 division waveform displacement and ≤ 2.0 division increase in peak-to-peak noise when subjected to conducted interference per IEC 61000-4-6.
- ⁷ Performance Criterion C applied at the 70%/25 cycle Voltage-Dip and the 0%/250 cycle Voltage-Interruption test levels (IEC 61000-4-11).

Australia / New Zealand Declaration of Conformity – EMC

Complies with the EMC provision of the Radiocommunications Act per the following standard, in accordance with ACMA:

- CISPR 11:2003. Radiated and Conducted Emissions, Group 1, Class A, in accordance with EN 61326-1:2006 and EN 61326-2-1:2006.

Australia / New Zealand contact.

Baker & McKenzie
Level 27, AMP Centre
50 Bridge Street
Sydney NSW 2000, Australia

Safety Compliance

EC Declaration of Conformity – Low Voltage

Compliance was demonstrated to the following specification as listed in the Official Journal of the European Communities:

Low Voltage Directive 2006/95/EC.

- EN 61010-1: 2001. Safety requirements for electrical equipment for measurement control and laboratory use.

U.S. Nationally Recognized Testing Laboratory Listing

- UL 61010-1:2004, 2nd Edition. Standard for electrical measuring and test equipment.

Canadian Certification

- CAN/CSA-C22.2 No. 61010-1:2004. Safety requirements for electrical equipment for measurement, control, and laboratory use. Part 1.

Additional Compliances

- IEC 61010-1: 2001. Safety requirements for electrical equipment for measurement, control, and laboratory use.

Equipment Type

Test and measuring equipment.

Safety Class

Class 1 – grounded product.

Pollution Degree Description

A measure of the contaminants that could occur in the environment around and within a product. Typically the internal environment inside a product is considered to be the same as the external. Products should be used only in the environment for which they are rated.

- Pollution Degree 1. No pollution or only dry, nonconductive pollution occurs. Products in this category are generally encapsulated, hermetically sealed, or located in clean rooms.
- Pollution Degree 2. Normally only dry, nonconductive pollution occurs. Occasionally a temporary conductivity that is caused by condensation must be expected. This location is a typical office/home environment. Temporary condensation occurs only when the product is out of service.
- Pollution Degree 3. Conductive pollution, or dry, nonconductive pollution that becomes conductive due to condensation. These are sheltered locations where neither temperature nor humidity is controlled. The area is protected from direct sunshine, rain, or direct wind.
- Pollution Degree 4. Pollution that generates persistent conductivity through conductive dust, rain, or snow. Typical outdoor locations.

Pollution Degree

Pollution Degree 2 (as defined in IEC 61010-1). Note: Rated for indoor use only.

Installation (Overvoltage) Category Descriptions

Terminals on this product may have different installation (overvoltage) category designations. The installation categories are:

- Measurement Category IV. For measurements performed at the source of low-voltage installation.
- Measurement Category III. For measurements performed in the building installation.
- Measurement Category II. For measurements performed on circuits directly connected to the low-voltage installation.
- Measurement Category I. For measurements performed on circuits not directly connected to MAINS.

Overvoltage Category

Overvoltage Category II (as defined in IEC 61010-1).

Environmental Considerations

This section provides information about the environmental impact of the product.

Product End-of-Life Handling

Observe the following guidelines when recycling an instrument or component:

Equipment recycling. Production of this equipment required the extraction and use of natural resources. The equipment may contain substances that could be harmful to the environment or human health if improperly handled at the product's end of life. In

order to avoid release of such substances into the environment and to reduce the use of natural resources, we encourage you to recycle this product in an appropriate system that will ensure that most of the materials are reused or recycled appropriately.



This symbol indicates that this product complies with the applicable European Union requirements according to Directives 2002/96/EC and 2006/66/EC on waste electrical and electronic equipment (WEEE) and batteries. For information about recycling options, check the Support/Service section of the Tektronix Web site (www.tektronix.com).

Restriction of Hazardous Substances

This product has been classified as Monitoring and Control equipment, and is outside the scope of the 2002/95/EC RoHS Directive.

Preface

This manual describes the installation and operation of the following oscilloscopes:

Model	MDO4104-6	MDO4104-3	MDO4054-6	MDO4054-3	MDO4034-3	MDO4014-3
Bandwidth	1 GHz	1 GHz	500 MHz	500 MHz	350 MHz	100 MHz
Analog Channels	4	4	4	4	4	4
Digital Channels	16	16	16	16	16	16
RF Channels	1	1	1	1	1	1
Sample Rate (1 ch)	5 GS/s	5 GS/s	2.5 GS/s	2.5 GS/s	2.5 GS/s	2.5 GS/s
Sample Rate (2 ch)	5 GS/s	5 GS/s	2.5 GS/s	2.5 GS/s	2.5 GS/s	2.5 GS/s
Sample Rate (4 ch)	2.5 GS/s	2.5 GS/s	2.5 GS/s	2.5 GS/s	2.5 GS/s	2.5 GS/s
Record Length (1 ch)	20M	20M	20M	20M	20M	20M
Record Length (2 ch)	20M	20M	20M	20M	20M	20M
Record Length (4 ch)	20M	20M	20M	20M	20M	20M
RF Frequency	6 GHz	3 GHz	6 GHz	3 GHz	3 GHz	3 GHz

Key Features

MDO4000 Mixed Domain Oscilloscopes provide time-correlated acquisition of analog, digital, and RF signals in a single instrument. They can help you verify, debug, and characterize electronic designs by providing views and measurements in both the time and frequency domains simultaneously. Key features include:

- A dedicated RF input channel for frequency domain measurements
- 16 digital channels and four analog channels for time domain measurements
- Time-correlated acquisition of analog, digital, and RF signals in a single instrument
- The ability to independently set acquisition parameters on the time and frequency domain channels
- Models are available with bandwidths from 100 MHz to 1 GHz
- Sample rates of either 2.5 or 5 GS/s on all analog channels depending on the model
- 20 M points record length on all channels
- >50,000 waveforms/second maximum waveform capture rate
- Advanced triggering and analysis: I²C, SPI, USB 2.0, CAN, LIN, FlexRay, RS-232, RS-422, RS-485, UART, I²S, Left Justified (LJ), Right Justified (RJ), TDM, Ethernet, MIL-STD-1553 (with the appropriate application module), and Parallel
- Power analysis, and limit and mask testing application modules (optional)

Conventions Used in This Manual

The following icons are used throughout this manual.

Sequence Step



Front panel power



Connect power

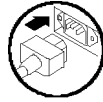

Network

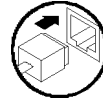

USB

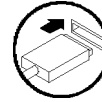

Installation

Before Installation

Unpack the oscilloscope and check that you received all items listed as standard accessories. The following pages list recommended accessories and probes, instrument options, and upgrades. Check the Tektronix Web site (www.tektronix.com) for the most current information.

Standard accessories

Accessory	Description	Tektronix part number
<i>MDO4000 Series Oscilloscopes User Manual</i>	English (Option L0)	071-2913-XX
	French (Option L1)	071-2914-XX
	Italian (Option L2)	071-2915-XX
	German (Option L3)	071-2916-XX
	Spanish (Option L4)	071-2917-XX
	Japanese (Option L5)	071-2918-XX
	Portuguese (Option L6)	071-2919-XX
	Simplified Chinese (Option L7)	071-2920-XX
	Traditional Chinese (Option L8)	071-2921-XX
	Korean (Option L9)	071-2922-XX
Russian (Option L10)	071-2923-XX	
<i>MDO4000 Series Oscilloscopes Documentation Browser CD</i>	Electronic versions of documents, including the Programmer Manual and the Technical Reference.	063-4367-XX
<i>NI LabVIEW SignalExpress™, Tektronix Edition and Tektronix OpenChoice Desktop CD</i>	Productivity, analysis, and documentation software	063-3967-XX
Calibration certificate documenting traceability to national metrology institute(s), and ISO9001 quality system registration.		--
Front Panel Overlay	French (Option L1)	335-2376-XX
	Italian (Option L2)	335-2377-XX
	German (Option L3)	335-2378-XX
	Spanish (Option L4)	335-2379-XX
	Japanese (Option L5)	335-2380-XX
	Portuguese (Option L6)	335-2381-XX
	Simplified Chinese (Option L7)	335-2382-XX
	Traditional Chinese (Option L8)	335-2383-XX
	Korean (Option L9)	335-2384-XX
	Russian (Option L10)	335-2385-XX

Standard accessories (cont.)

Accessory	Description	Tektronix part number
Probes	For 100, 350 and 500 MHz models, one 500 MHz, 10X passive probe per channel	TPP0500
	For 1 GHz models, one 1 GHz, 10X passive probe per channel	TPP1000
Adapter	N Male to BNC Female	103-0045-00
Front Cover	Hard plastic cover to help protect the instrument	200-5130-00
Power Cord	North America (Option A0)	161-0348-00
	Universal Euro (Option A1)	161-0343-00
	United Kingdom (Option A2)	161-0344-00
	Australia (Option A3)	161-0346-00
	Switzerland (Option A5)	161-0347-00
	Japan (Option A6)	161-0342-00
	China (Option A10)	161-0341-00
	India (Option A11)	161-0349-00
	Brazil (Option A12)	161-0356-00
	No power cord or AC adapter (Option A99)	--
Logic probe	One, 16-channel logic probe, with accessories	P6616
Probe and accessory pouch	Bag to hold probes and related accessories	016-2030-XX

Optional accessories

Accessory	Description	Tektronix part number
Aerospace serial triggering and analysis application module	This module enables triggering on MIL-STD-1553 serial buses. Also, it provides digital views of the signal, bus views, bus decoding, search tools, and decode tables with time stamp information.	DPO4AERO
Audio serial triggering and analysis application module	This module enables triggering on I ² S, Left Justified (LJ), Right Justified (RJ), and TDM audio buses. Also, it provides digital views of the signal, bus views, packet decoding, search tools, and packet decode tables with time stamp information	DPO4AUDIO
Automotive serial triggering and analysis application module	This module enables triggering on packet level information on CAN and LIN serial buses. Also, it provides a digital view of the signal, bus view, packet decoding, search tools, and a packet decode table with time stamp information.	DPO4AUTO

Optional accessories (cont.)

Accessory	Description	Tektronix part number
FlexRay, CAN, and LIN serial triggering and analysis application module	This module enables triggering on packet level information in FlexRay, CAN, and LIN buses. Also, it provides digital views of the signal, bus views, packet decoding, search tools, packet decode tables with time stamp information and eye diagram analysis software.	DPO4AUTOMAX
Computer triggering and analysis application module	This module enables triggering on RS-232, RS-422, RS-485 and UART serial buses. Also, it provides digital views of the signal, bus views, packet decoding, search tools, and packet decode tables with time stamp information.	DPO4COMP
Embedded serial triggering and analysis application module	This module enables triggering on packet level information on I ² C and SPI serial buses. Also, it provides digital views of the signal, bus views, packet decoding, search tools, and packet decode tables with time stamp information.	DPO4EMBD
Ethernet serial triggering and analysis application module	This module enables triggering on 10BASE-T and 100BASE-TX buses. Also, it provides search tools, bus views, and decode tables with time stamp information. <i>NOTE. ≥350 MHz bandwidth models are recommended for 100BASE-TX.</i>	DPO4ENET
Limit and mask test application module	This module supports limit testing and testing on telecom standard masks or custom masks. <i>NOTE. ≥350 MHz bandwidth models are recommended for Telecomm standards >55 Mb/s. 1 GHz bandwidth models are recommended for high-speed (HS) USB.</i>	DPO4LMT
Power analysis application module	This module supports measurements of power quality, switching loss, harmonics, ripple, modulation, safe operating area, and slew rate (dV/dt and dI/dt).	DPO4PWR
Universal Serial Bus triggering and analysis application module	This module enables triggering on packet level information on USB 2.0 serial buses. Also, it provides digital views of the signal, bus views, bus decoding data in hex, binary, and ASCII, search tools, and packet decode tables with time stamp information. <i>NOTE. 1 GHz bandwidth models are required for high-speed (HS) USB.</i>	DPO4USB

Optional accessories (cont.)

Accessory	Description	Tektronix part number
Extended video application module	This module enables triggering on a variety of standard HDTV signals, as well as on custom (non-standard) bilevel and trilevel video signals with 3 to 4,000 lines.	DPO4VID
Advanced RF triggering application module	This module enables triggering with RF power as the source for Pulse Width, Timeout, Runt, Logic, and Sequence triggers	MDO4TRIG
NEX-HD2HEADER	Adapter that routes the channels from a Mictor connector to 0.1 inch header pins	NEX-HD2HEADER
TEK-USB-488 Adapter	GPIB to USB Adapter	TEK-USB-488
Rackmount kit	Adds rackmount brackets	RMD5000
Soft transit case	Case for carrying instrument	ACD4000B
Hard transit case	Traveling case, which requires use of the soft transit case (ACD4000B)	HCTEK54
MSO4000B, DPO4000B, and MDO4000 Series Oscilloscopes Programmer Manual	Describes commands for remote control of the oscilloscope. Available electronically on the Documentation Browser CD or for download from www.tektronix.com/manuals .	077-0510-XX
MDO4000 Series Oscilloscopes Technical Reference Manual	Describes the oscilloscope specifications and performance verification procedure. Available electronically on the Documentation Browser CD or for download from www.tektronix.com/manuals .	077-0583-XX
MDO4000 Series Oscilloscopes Service Manual	Service information on MDO4000 Series oscilloscopes	077-0585-XX

Optional accessories (cont.)

Accessory	Description	Tektronix part number
MSO4000B, DPO4000B, and MDO4000 Series Application Module Installation Instructions	Describes how to install application modules on your oscilloscope	071-2136-XX
DPO3PWR and DPO4PWR Power Measurement Module User Manual	English (Option L0)	071-2631-XX
	French (Option L1)	077-0235-XX
	Italian (Option L2)	077-0236-XX
	German (Option L3)	077-0237-XX
	Spanish (Option L4)	077-0238-XX
	Japanese (Option L5)	077-0239-XX
	Portuguese (Option L6)	077-0240-XX
	Simplified Chinese (Option L7)	077-0241-XX
	Traditional Chinese (Option L8)	077-0242-XX
	Korean (Option L9)	077-0243-XX
Russian (Option L10)	077-0244-XX	
MDO4000 Series Oscilloscopes Declassification and Security Instructions	Describes how to sanitize or remove memory devices from the Tektronix MD4000Series oscilloscopes.	077-0584-00
TekVPI Probes	Visit the Oscilloscope Probe and Accessory Selector Tool on the Tektronix website at www.tektronix.com . <i>NOTE. A subset of TekVPI probes can be used on the RF input as well. These probes require the use of the TPA-N-VPI adapter listed below.</i>	
TPA-N-VPI adapter	Adapter from N connection (RF input) to TekVPI probe.	TPA-N-VPI
TPA-BNC adapter	TekVPI to TekProbe II BNC Adapter	TPA-BNC

The MDO4000 Series oscilloscopes support a multitude of optional probes. (See page 9, *Connecting Probes*.) Visit the Oscilloscope Probe and Accessory Selector Tool on the Tektronix Web site (www.tektronix.com) for the most up to date information.

Operating Considerations

MDO4000 Series Oscilloscopes

Operating Line Frequency and Voltage Range

Volts	Hz
100-240	50-60
115	400

Mains input voltage range: 100 V - 240 V

Maximum Power Consumption: 225 W

Weight:

5.0 kg (11.0 lbs), standalone instrument, without front cover

Height, feet folded in, handle folded down:
229 mm (9.0 in)

Width, from handle hub to handle hub: 439 mm
(17.3 in)

Depth, from back of feet to front of knobs: 147 mm
(5.8 in)

Depth, from back of feet to front of front cover: 155 mm
(6.1 in)

Temperature:

Operating: +0 °C to +50 °C (+32 °F to 122 °F)

Non-operating: -20 °C to +60 °C (-4 °F to 140 °F)

Humidity:

Operating: High: 40 °C to 50 °C (104 °F to 122 °F),
10% to 60% RH

Operating: Low: 0 °C to 40 °C (32 °F to 104 °F), 10
to 90% RH

Non-operating: High: 40 °C to 60 °C (104 °F to
140 °F), 5 to 60% RH

Non-operating: Low: 0 °C to 40 °C (32 °F to 104 °F),
5 to 90% RH

Altitude:

Operating: 3,000 m (about 9,843 ft)

Non-operating Altitude: 12,000 m (39,370 ft)

Pollution Degree: 2, Indoor use only

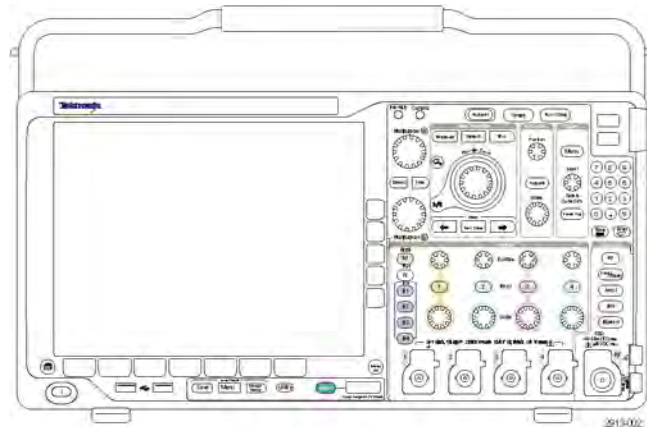

MDO4000 Series

Acquisition System: 1 M Ω

The maximum input voltage at the BNC, 300 V_{RMS}. Installation Category II.

Derate at 20 dB/decade between 4.5 MHz and 45 MHz.

Derate at 14 dB/decade between 45 MHz and 450 MHz.

Above 450 MHz, 5 V_{RMS}.

Acquisition System: 50 Ω

The maximum input voltage at the BNC: 5 V_{RMS}, with peaks $\leq \pm 20$ V (DF $\leq 6.25\%$)

P6616: Digital Probe Inputs

The absolute maximum input voltage: ± 42 V_{Peak}.

Dedicated RF Input:

The maximum operating voltage: ± 40 V_{DC}.



CAUTION. To ensure proper cooling, keep the sides and rear of the instrument clear of obstructions. Ventilation clearance should be at least 51 mm (2 in) on the left side, when looking at the front of the instrument, and on the rear of the instrument

Find more information on MDO4000 Series oscilloscope specifications in Appendix A. (See page 180, *Appendix A: MDO4000 Specifications.*)

Find information on TPP0500/TPP1000 probes in Appendix B. (See page 184, *Appendix B: TPP0500 and TPP1000 500 MHz and 1 GHz 10X Passive Probes Information.*)

Find information on P6616 probes in Appendix C. (See page 191, *Appendix C: P6616 General-Purpose Logic Probe Information.*)

Cleaning

Inspect the oscilloscope and probes as often as operating conditions require. To clean the exterior surface, perform the following steps:

1. Remove loose dust on the outside of the oscilloscope and probes with a lint-free cloth. Use care to avoid scratching the display.
2. Use a soft cloth dampened with water to clean the oscilloscope. Use an aqueous solution of 75% isopropyl alcohol for more efficient cleaning.



CAUTION. Avoid getting moisture inside the unit during external cleaning. Use only enough cleaning solution to dampen the cloth or swab.



CAUTION. To avoid damage to the surface of the oscilloscope or probes, do not use any abrasive or chemical cleaning agents.

Operating Positions

Use the handle and front flip feet to place the oscilloscope in a convenient operating position. When the feet are extended, always have the handle in a down position.

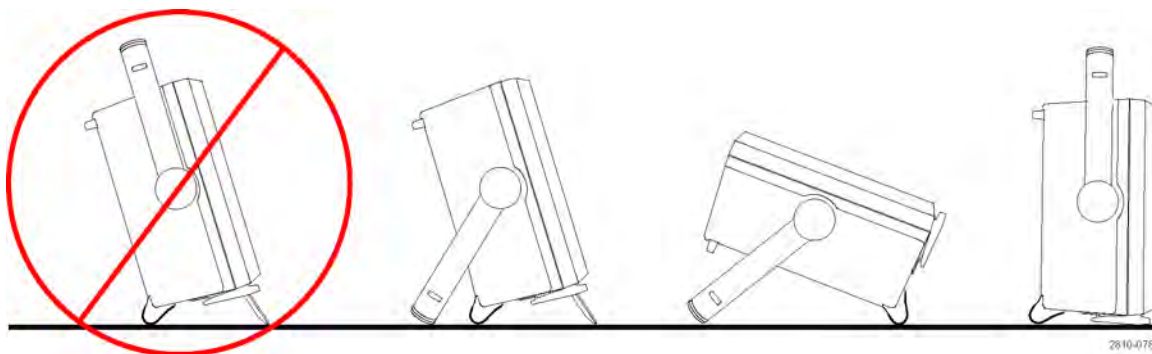

Connecting Probes

The oscilloscope supports probes with the following:

1. Tektronix Versatile Probe Interface (TekVPI)

These probes support two-way communication with the oscilloscope through on-screen menus and remotely through programmable support. The remote control is useful in applications like ATE where you want the system to preset probe parameters.
2. Tektronix Versatile Probe Interface (TekVPI) for Passive Probes

These probes build upon the functionality of the TekVPI interface. Each probe is matched with its corresponding oscilloscope channel, allowing the oscilloscope to optimize the signal input path. This provides AC compensation across the frequency band.
3. TPA-BNC Adapter

The TPA-BNC Adapter allows you to use TEKPROBE II probe capabilities, such as providing probe power, and passing scaling and unit information to the oscilloscope.
4. BNC Interfaces

Some of these use TEKPROBE capabilities to pass the waveform signal and scaling to the oscilloscope. Some only pass the signal and there is no other communication.
5. Logic Probe Interface

The P6616 probe provides 16 channels of digital (on or off state) information.
6. The TPA-N-VPI Adapter allows you to use TekVPI probes in the RF input.

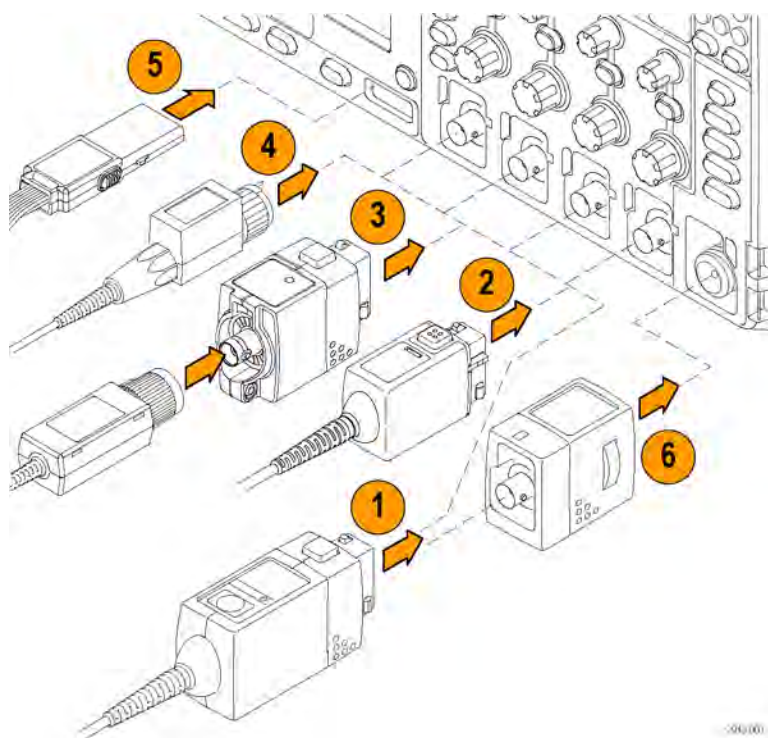

For more information on the many probes available for use with MDO4000 Series oscilloscopes, visit the Oscilloscope Probe and Accessory Selector Tool on the Tektronix website at www.tektronix.com.

Securing the Oscilloscope

1. Use a standard laptop computer style security lock to secure your oscilloscope to your location.

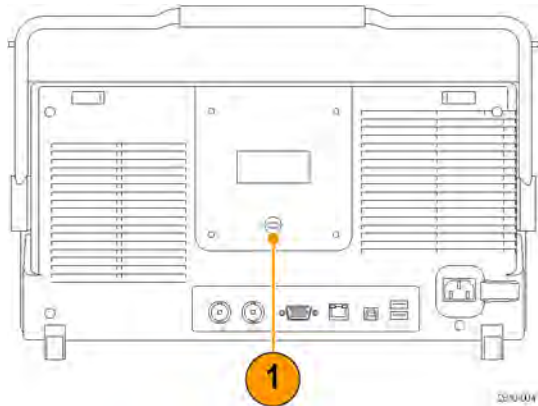

Powering on the Oscilloscope

Ground the Oscilloscope and Yourself

To power on the instrument, connect the power cord that was provided with the instrument to the power connector on the rear panel. Connect the power cord to a properly grounded electrical outlet. To power off the instrument, remove the power cord from the instrument.

Grounding the oscilloscope is necessary for safety and to take accurate measurements. The oscilloscope needs to share the same ground as any circuits that you are testing.

If you are working with static sensitive components, ground yourself. Static electricity that builds up on your body can damage static-sensitive components. Wearing a grounding strap safely sends static charges on your body to earth ground.

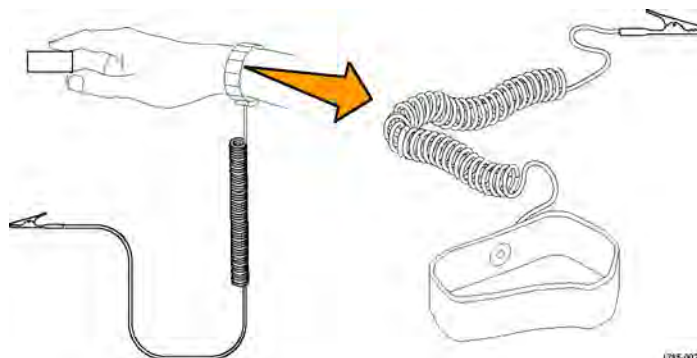

1785-002

To connect the power cord and power on the oscilloscope:

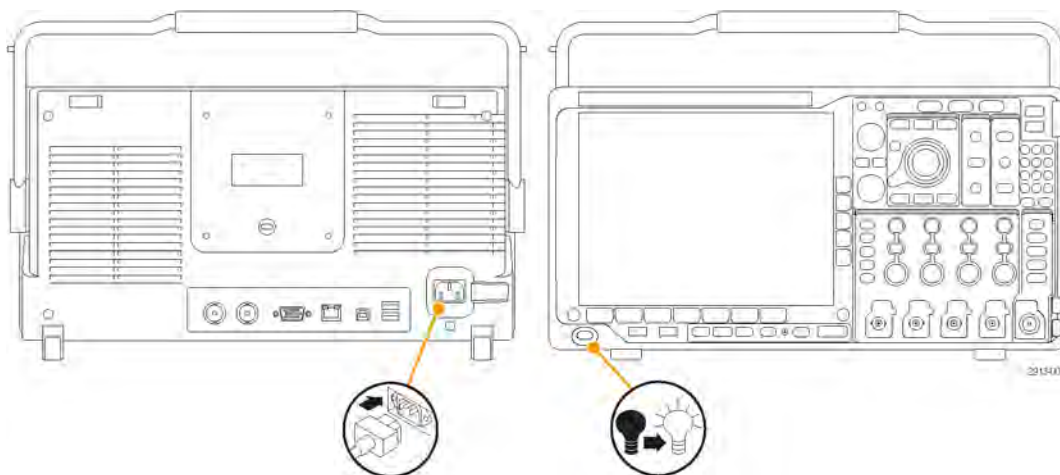

22151004

Powering off the Oscilloscope

To power off the oscilloscope and remove the power cord:

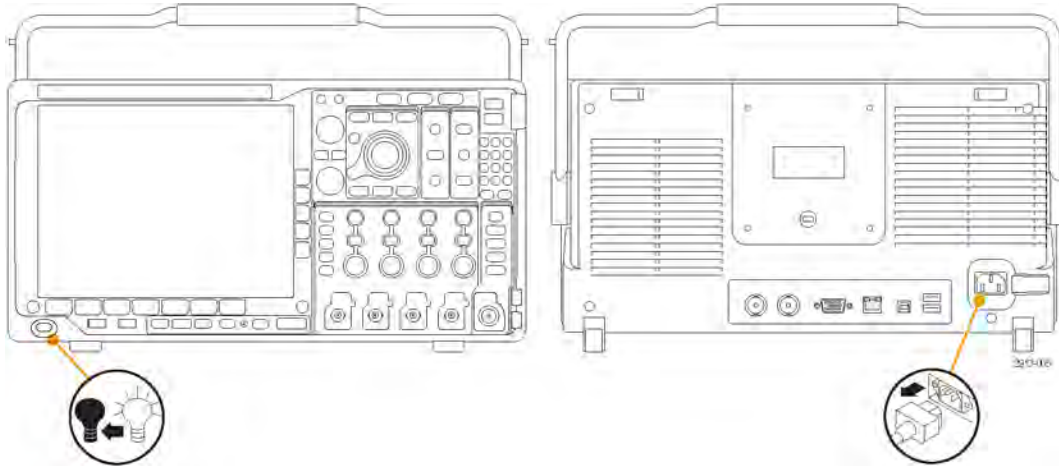

Functional Check

Perform this quick functional check to verify that your oscilloscope is operating correctly.

1. Connect the oscilloscope power cable as described in *Powering On the Oscilloscope*. (See page 11.)
2. Power on the oscilloscope.

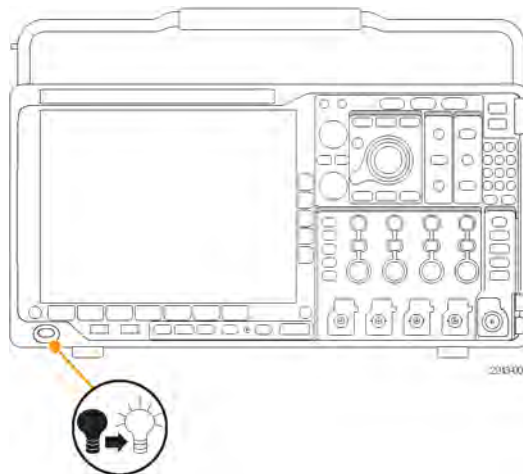

3. Connect the probe connector to oscilloscope channel 1 and the probe tip and reference lead to the **PROBE COMP** terminals on the oscilloscope front panel.

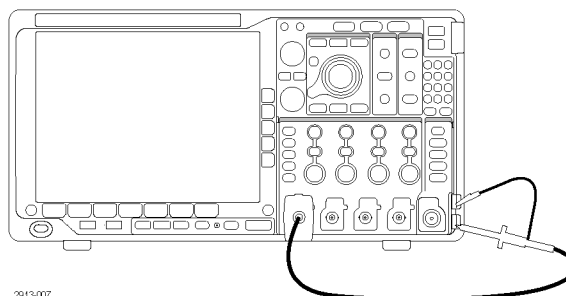

4. Push **Default Setup**.

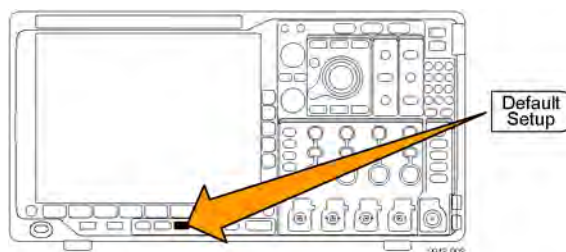

5. Push **Autoset**. The screen should now display a square wave, approximately 2.5 V at 1 kHz.

If the signal appears but is misshapen, perform the procedures for compensating the probe. (See page 15, *Compensating a non-TPP0500 or non-TPP1000 Passive Voltage Probe*.)

If no signal appears, rerun the procedure. If this does not remedy the situation, have the instrument serviced by qualified service personnel.

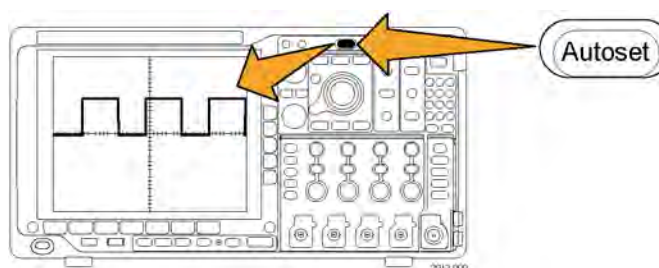

Compensating a TPP0500 or TPP1000 Passive Voltage Probe

The MDO4000 Series oscilloscopes can automatically compensate TPP0500 and TPP1000 probes. This eliminates the need for manual probe compensation, as is typically performed with other probes.

Each compensation generates values for a specific probe and channel combination. If you want to use the probe on another channel and desire to compensate the new probe-channel pair, you must run a new set of compensation steps for that new combination.

1. Connect the oscilloscope power cable. (See page 11, *Powering on the Oscilloscope*.)
2. Power on the oscilloscope.

3. Connect the probe connector to the oscilloscope channel, and the probe tip and reference lead to the **PROBE COMP** terminals on the oscilloscope front panel.

NOTE. Connect only one probe at a time to the probe comp terminals.

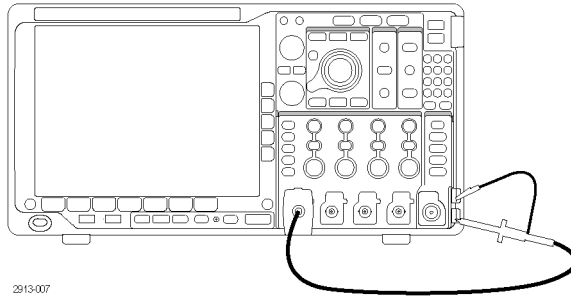

2913-007

4. Push a front panel button for an input channel connected to the probe you wish to compensate. (1, 2, 3, or 4)



5. Notice on the lower menu that the oscilloscope has automatically set the probe termination value

Coupling DC AC	Termination set by TPP1000	Invert On Off	Bandwidth Full	Label		▲ More
-------------------	-------------------------------	------------------	-------------------	-------	--	-----------



6. Push **More** repeatedly to select **Probe Setup** from the resulting pop-up menu.

7. Notice that the compensation status starts as **Default**.

8. Push **Compensate probe** and follow the instructions that appear on the display.

TPP1000 Probe Setup	
SN: 000001 Atten: 10X	
Compensation Status Default	7
Compensate probe for 1	8
Measure Current Yes No	

When compensating TPP0500/TPP1000 probes on the MDO4000 Series oscilloscopes:

- Each compensation generates values for a specific probe and channel combination. If you want to use the probe on another channel and desire to compensate the new probe-channel pair, you must run a new set of compensation steps.
- Each channel can store compensation values for 10 individual probes. If you try to compensate an 11th probe on a channel, the oscilloscope will delete the values for the least recently used probe and add the values for the new probe.
- The oscilloscope will assign default compensation values to a TPP0500 or TPP1000 probe connected to the **Aux In** channel.

NOTE. A factory calibration will delete all stored compensation values

NOTE. A probe compensation failure is most likely due to intermittent connection of the probe tip or ground connection during the probe compensation operation. If a failure occurs, the oscilloscope will re-use the old probe compensation values, if they existed prior to the failed probe compensation operation.

Compensating a non-TPP0500 or non-TPP1000 Passive Voltage Probe

Whenever you attach a passive voltage probe for the first time to any input channel, compensate the probe to match it to the corresponding oscilloscope input channel.

If you are interested in using the automatic probe compensation procedure described above for the TPP0500 and TPP1000 probes (See page 13, *Compensating a TPP0500 or TPP1000 Passive Voltage Probe*.) on a non-TPP0500/TPP1000 Tektronix passive probe, check the instruction manual for your probe to see if it qualifies. Otherwise, to properly compensate your passive probe:

1. Follow the steps for the functional check. (See page 12, *Functional Check*.)

2. Check the shape of the displayed waveform to determine if your probe is properly compensated.
3. If necessary, adjust your probe. Repeat as needed.

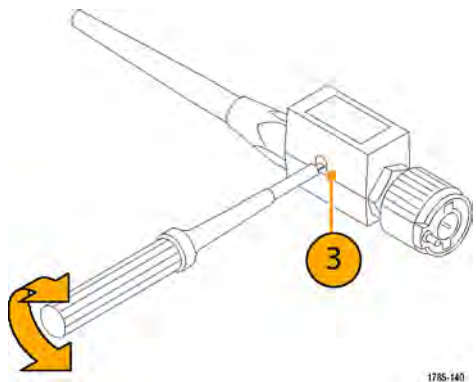

Quick Tips

Use the shortest possible ground lead and signal path to minimize probe-induced ringing and distortion on the measured signal.

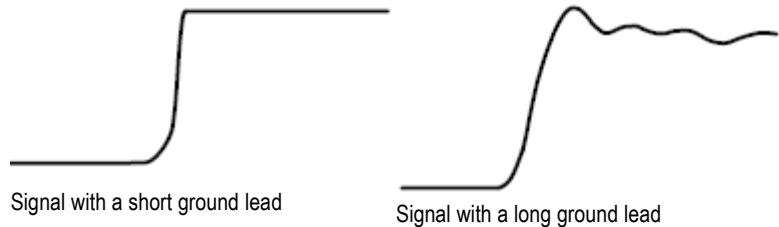

Application Module Free Trial

A 30-day free trial is available for all application module licenses not installed in your oscilloscope. The trial period begins when you power on the oscilloscope for the first time.

After 30 days, you must purchase the module if you want to continue using the application. To see the date when your free trial period expires, push **Utility** on the front panel, push **Utility Page** on the lower menu, use multipurpose knob **a** to select **Config**, and push **About** on the lower menu.

Installing an Application Module



CAUTION. To avoid damage to the oscilloscope or application module, observe ESD (electrostatic discharge) precautions. (See page 11, Powering on the Oscilloscope.)

Turn off the oscilloscope power while removing or adding an application module.

(See page 12, Powering off the Oscilloscope.)

Optional application module packages extend the capability of your oscilloscope.

You can physically install up to four application modules at one time. Application modules go into the two slots with windows in the upper right corner of the front panel. Two additional slots are directly behind the two that you can see. To use these slots, install the module with the label facing away from you.

Some of the modules have licenses which allow you to transfer the license between your application modules and the oscilloscope. You can keep each license in the module, which will allow you to move the module from one instrument to another. Alternatively, you can move the license from the module to the oscilloscope. This approach will allow you to store the module separately from the oscilloscope for safe keeping. This approach will also allow you to use more than four applications on your oscilloscope simultaneously. To transfer a license from a module to your oscilloscope or from your oscilloscope to a module:

1. Turn off the power to the oscilloscope. Insert the application modules into the oscilloscope. Turn on the power.
2. Push **Utility** on the front panel. If needed, push **Utility Page** on the lower menu and turn multipurpose knob **a** to select **Config**. Push **Manage Modules and Options** on the lower menu, and then push **License Type** on the side menu until “Modules” is selected. The licenses contained in the oscilloscope will be listed in the side menu. Push the button next to the appropriate license to transfer. You may transfer up to four licenses at one time.
3. After you turn off the power to the oscilloscope, you can remove the physical application module from the oscilloscope.

Refer to the *MSO4000B, DPO4000B, and MDO4000 Series Oscilloscopes Application Module Installation Manual* that came with your application module for instructions on installing and testing an application module.

NOTE. If you transfer a license from a module to an oscilloscope, the module will not work on another oscilloscope until you transfer the license back from the oscilloscope to the module. Consider putting the physical module in an envelope or other storage with a label recording the date, module name, model and serial number of the oscilloscope which holds the license. This will help prevent confusion later if someone finds the module, installs it in some other oscilloscope, and wonders why it does not work.

Changing the Language of the User Interface or Keyboard

To change the language of the oscilloscope user interface or keyboard, and to change the front panel button labels through the use of an overlay:

1. Push **Utility**.

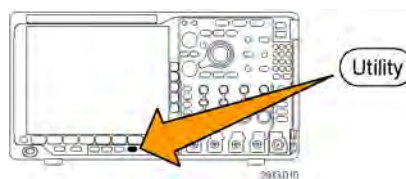

2. Push **Utility Page**.



3. Turn multipurpose knob **a** and select **Config**.

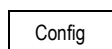

4. Push **Language** from the resulting lower menu.

Utility Page Config	Language	Set Date & Time	TekSecure Erase Memory	About	Manage Modules & Options	
------------------------	----------	-----------------	------------------------------	-------	--------------------------------	--



5. Push **Menus** from the resulting side menu and turn multipurpose knob **a** to select the desired language for the user interface.
6. Push **USB Keyboard** from the resulting side menu and turn multipurpose knob **a** to select the desired language version of keyboard to use.

Language	
Menus (a) English	5
USB Keyboard English	6

7. If you choose to use an English user interface, be sure that the plastic front panel overlay is removed.
If you choose a language other than English, place the plastic overlay for the language that you desire over the front panel to display labels in that language.

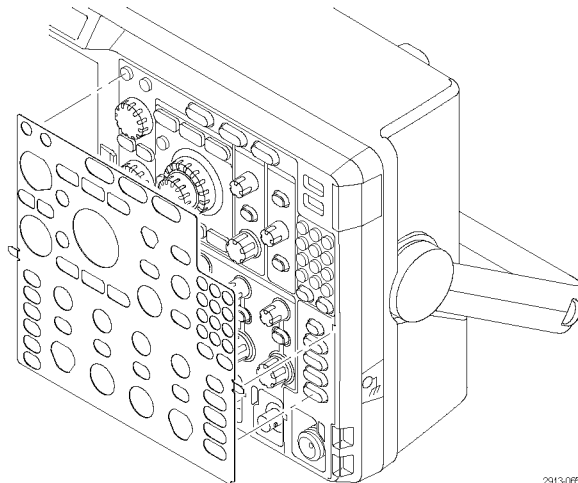

2913-005

Changing the Date and Time

To set the internal clock with the current date and time:

1. Push **Utility**.

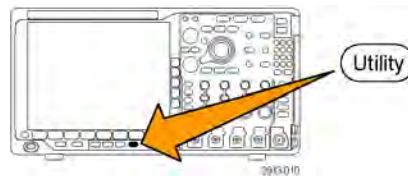

2. Push **Utility Page**.



3. Turn multipurpose knob **a** and select **Config**.

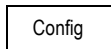

4. Push **Set Date & Time**.

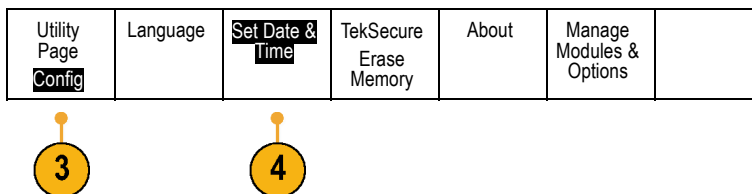

5. Push the side menu buttons and turn both multipurpose knobs (**a** and **b**) to set the time and date values.

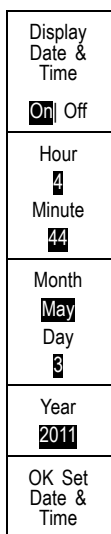

6. Push **OK Set Date & Time**.

Signal Path Compensation

Signal Path Compensation (SPC) corrects for DC inaccuracies caused by temperature variations and/or long-term drift. Run the compensation whenever the ambient temperature has changed by more than 10 °C (18 °F) or once a week if you use vertical settings of 5 mV/division or less. Failure to do so may result in the instrument not meeting warranted performance levels at those volts/div settings.

Signal Path Compensation for Time and Frequency Domains

To compensate the signal path:

1. Warm up the oscilloscope for at least 20 minutes. Remove all input signals (probes and cables) from channel inputs. Input signals with AC components adversely affect SPC.

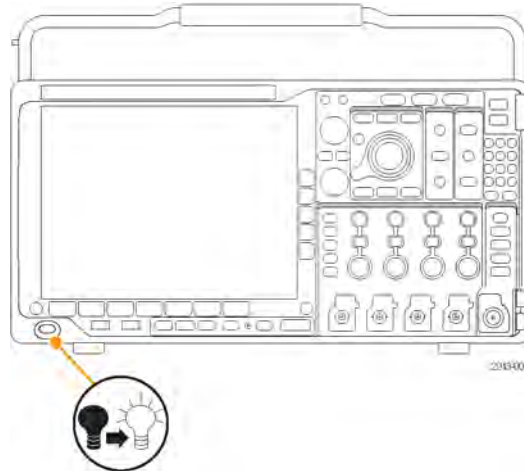

2. Push **Utility**.

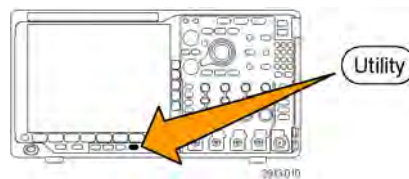

3. Push **Utility Page**.



4. Turn multipurpose knob **a** and select **Calibration**.

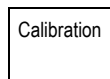

5. Push **Signal Path** on the lower menu.

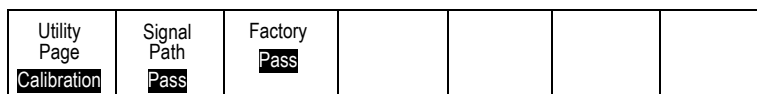

6. Push **OK Compensate Signal Paths** on the resulting side menu.

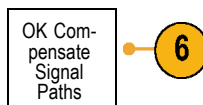

The calibration will take approximately 10 minutes to complete.

7. After calibration, verify that the status indicator on the lower menu displays **Pass**.



If it does not, then recalibrate the instrument or have the instrument serviced by qualified service personnel.

Service personnel use the factory calibration functions to calibrate the internal voltage references of the oscilloscope using external sources. Contact your Tektronix field office or representative for assistance with factory calibration.

NOTE. Signal Path Compensation does not include calibration to the probe tip. (See page 15, Compensating a non-TPP0500 or non-TPP1000 Passive Voltage Probe.)

Signal Path Compensation for Frequency Domain Only

The signal path compensation (SPC) described above runs on both the time and the frequency domain inputs. If you only want to compensate the RF input, you can save time by running SPC only on the RF input and skipping the time domain part. You can do this as follows:

1. As with the time and frequency calibration, warm up the oscilloscope for at least 20 minutes. Remove all input signals (probes and cables) from the RF input.
2. Push **RF** to bring up the Frequency Domain menu.

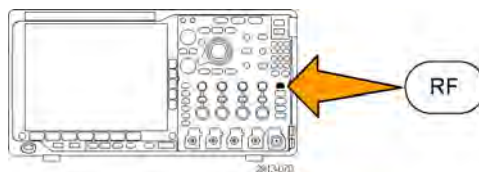

3. Push **More** to select **Compensate Signal Path**.
4. On the resulting side menu, push **OK**. **Compensate RF Signal Path**.

Spectrum Traces	RF Versus Time Traces	Spectrogram On	Spectrum Triggered	Detection Method Auto	Edit Labels	▲ More
-----------------	-----------------------	--------------------------	--------------------	---------------------------------	-------------	-----------



Upgrading Firmware

To upgrade the firmware of the oscilloscope:

1. Open up a Web browser and go to www.tektronix.com/software/downloads. Proceed to the software finder. Download the latest firmware for your oscilloscope on your PC.

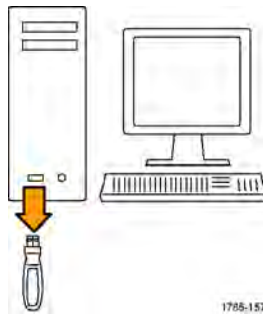

Unzip the files and copy the firmware.img file into the root folder of a USB flash drive or USB hard drive.

2. Power off your oscilloscope.

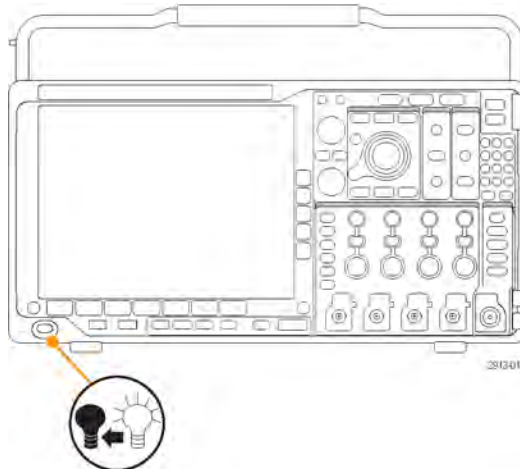

3. Insert the USB flash or hard drive into the USB port on the front panel of your oscilloscope.

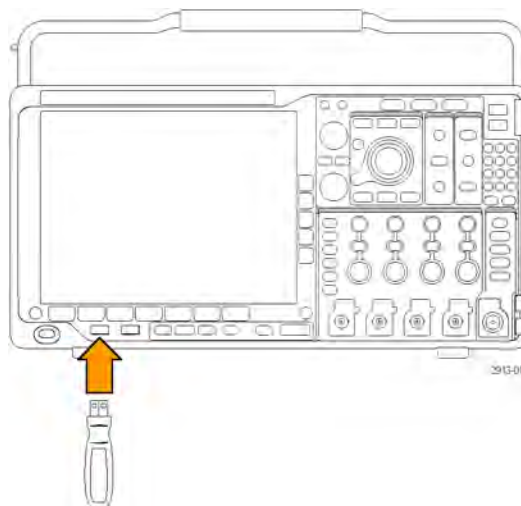

4. Power on the oscilloscope. The instrument automatically recognizes the replacement firmware and installs it.

If the instrument does not install the firmware, rerun the procedure. If the problem continues, try a different model of USB flash or hard drive. Finally, if needed, contact qualified service personnel.

NOTE. Do not power off the oscilloscope or remove the USB drive until the oscilloscope finishes installing the firmware.

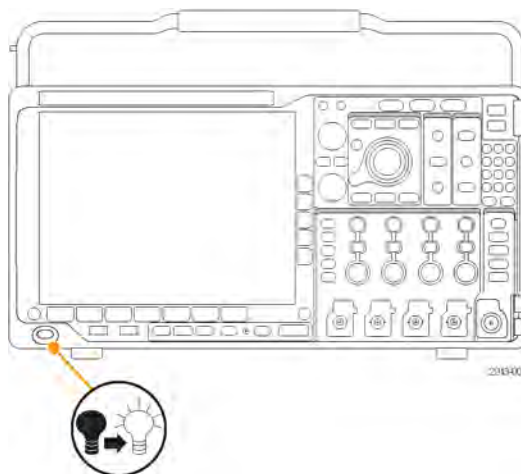

5. Power off the oscilloscope and remove the USB flash or hard drive.

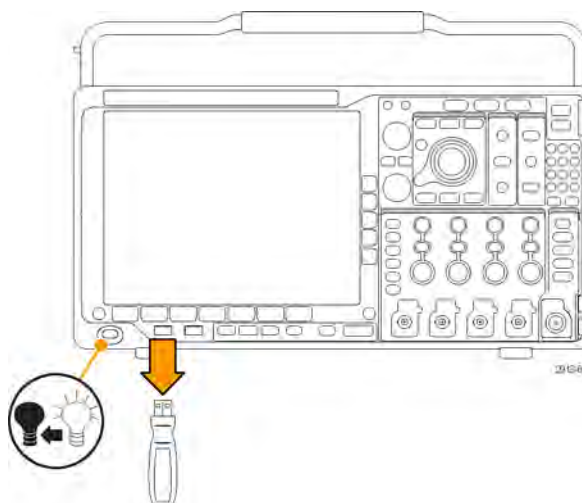

- Power on the oscilloscope.

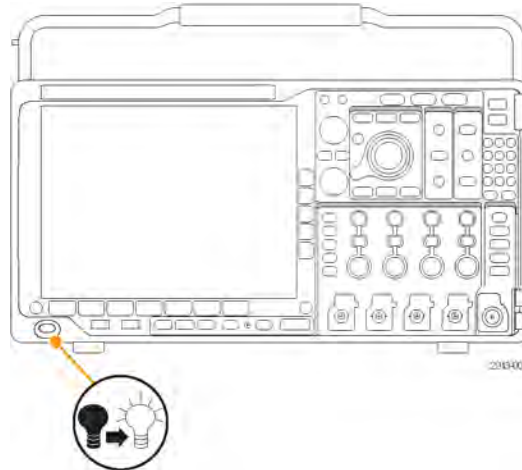

- Push **Utility**.

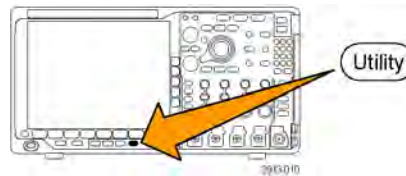

- Push **Utility Page**.



- Turn multipurpose knob **a** and select **Config**.

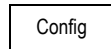

- Push **About**. The oscilloscope displays the firmware version number.

Utility Page	Language	Set Date & Time	TekSecure Erase Memory	About	Manage Modules & Options	
Config						

- Confirm that the version number matches that of the new firmware.



Connecting Your Oscilloscope to a Computer

Connect your oscilloscope directly to a computer to let the PC analyze your data, collect screen images, or to control your oscilloscope. (See page 162, *Saving a Screen Image*.) (See page 163, *Saving and Recalling Waveform and Trace Data*.)

Three ways to connect your oscilloscope to a computer are through the VISA drivers, the e*Scope Web-enabled tools, and a socket server. Use VISA to communicate with your oscilloscope from your computer through a software application, such as Tektronix OpenChoice Desktop®. Use e*Scope to communicate with your oscilloscope through a Web browser, such as Microsoft Internet Explorer.

Using VISA

VISA lets you use your MS-Windows computer to acquire data from your oscilloscope for use in an analysis package that runs on your PC, such as Microsoft Excel, National Instruments LabVIEW, Tektronix OpenChoice Desktop software, or a program of your own creation. You can use a common communications connection, such as USB, Ethernet, or GPIB, to connect the computer to the oscilloscope.

To set up VISA communications between your oscilloscope and a computer:

1. Load the VISA drivers on your computer.
Also, load your application, such as OpenChoice Desktop.
You will find the drivers and OpenChoice Desktop software on the appropriate CD that comes with your oscilloscope or at the Tektronix software finder Web page (www.tektronix.com).
2. Connect the oscilloscope to your computer with the appropriate USB or Ethernet cable.

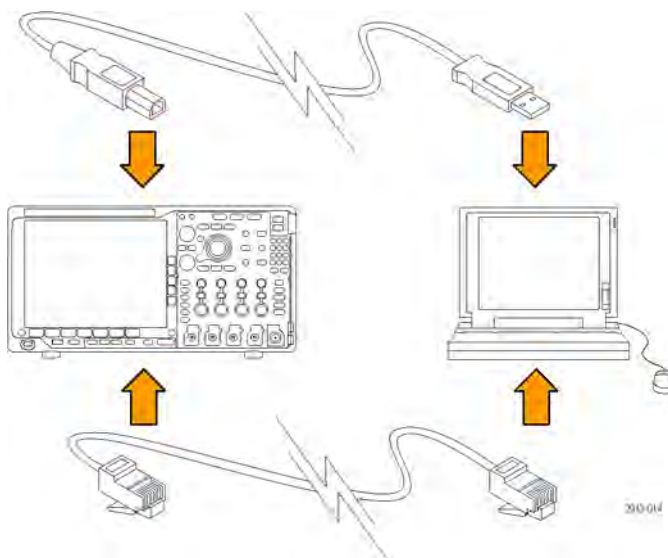

To communicate between the oscilloscope and a GPIB system, connect the oscilloscope to the TEK-USB-488 GPIB-to-USB Adapter with a USB cable. Then connect the adapter to your GPIB system with a GPIB cable. Cycle the power on the oscilloscope.



3. Push **Utility**.

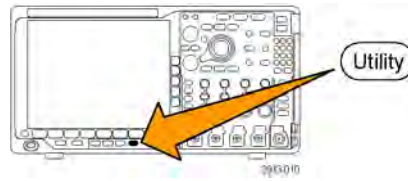

4. Push **Utility Page**.



5. Turn multipurpose knob **a** and select **I/O**.

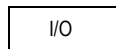

6. If you are using USB, the system sets itself up automatically for you, if USB is enabled.

Utility Page I/O	USB Computer	Ethernet & LXI	Network Configuration Automatic	Socket Server	GPIB 1	
---------------------	-----------------	----------------	------------------------------------	---------------	-----------	--

Check **USB** on the lower menu to be sure that USB is enabled. If it is not enabled, push **USB**. Then push **Connect to Computer** on the side menu.



7. To use Ethernet, push **Ethernet & LXI** on the lower menu.

Use the side menu buttons to adjust your network settings, as needed. For more information, see the e*Scope setup information below.

8. If you want to change socket server parameters, push **Socket Server** and enter new values through the resulting side menu.

9. If you are using GPIB, push **GPIB**. Enter the GPIB address on the side menu, using multipurpose knob **a**.

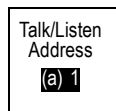

This will set the GPIB address on an attached TEK-USB-488 Adapter.

10. Run your application software on your computer.

Quick Tips

- Your oscilloscope shipped with a CD that contains a variety of Windows-based software tools for efficient connectivity between your oscilloscope and your computer. These include toolbars that speed connectivity with Microsoft Excel and Word. There are also two standalone acquisition programs called NI LabVIEW SignalExpress™, Tektronix Edition and Tektronix OpenChoice Desktop.
- The rear-panel USB 2.0 device port is the correct USB port for computer connectivity. Use the rear and front panel USB 2.0 host ports to connect your oscilloscope to USB flash drives. Use the USB Device port to connect your oscilloscope to a PC or a PictBridge printer.

USB Host port



USB Device port



Using the LXI Web Page and e*Scope

With e*Scope, you can access any Internet-connected MDO4000 Series oscilloscope from a web browser on your computer.

To set up e*Scope communications between your oscilloscope and a Web browser running on a remote computer:

1. Connect the oscilloscope to your computer network with an appropriate Ethernet cable.

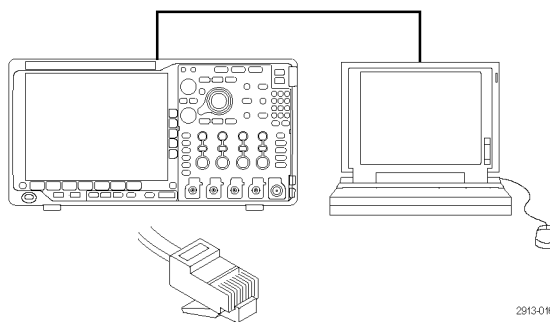

2. Push **Utility**.

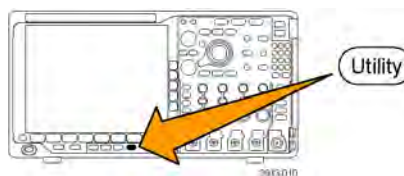

3. Push **Utility Page**.



4. Turn multipurpose knob **a** and select **I/O**.

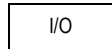

5. Push **Ethernet & LXI**.

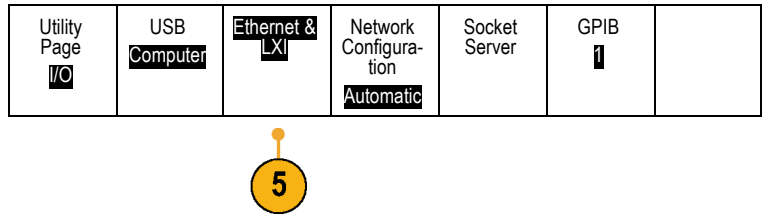

6. View the top item on the side menu to determine the condition of the LAN. An indicator turns green for good status and red if the device detects a fault.



7. Push **LAN Settings** to display the network parameters configured on your oscilloscope.



8. Push **LAN Reset** to restore the LAN defaults to your oscilloscope.



9. Push **Test Connection** to check if your oscilloscope can find an attached network.



10. Push **more** to see another page of side menu items.

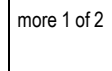

11. Push **Change Names** to change the name of the oscilloscope, the network domain, or the service name.
12. Push **Change Ethernet & LXI Password** to change the name of the password.
13. Push **Change e*Scope Password** to use the LXI password to also protect your oscilloscope from changes made to LAN settings from a Web browser.

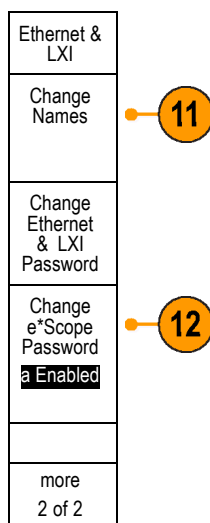

14. Start your browser on your remote computer. In the browser address line, enter the host name, a dot, and the domain name together. Alternatively, just enter the IP address of the instrument. Either way, you should then see the LXI Welcome page on your Web browser on your computer screen.
15. Click "Network Configuration" to view and edit the network configuration settings. If you are using a password and changing your settings, you need to know that the default user name is "ixiuser".

- For e*Scope, click the Instrument Control (e*Scope) link on the left side of the LXI Welcome page. You should then see a new tab (or window) open in your browser with e*Scope running.

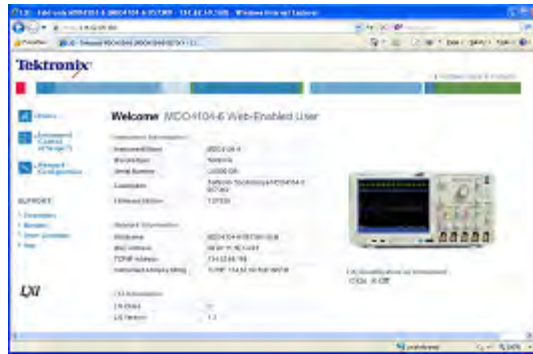

Using a Socket Server

A socket server provides two-way communication over an Internet Protocol-based computer network. You can use your oscilloscope's socket server feature to let your oscilloscope communicate with a remote-terminal device or computer.

To set up and use a socket server between your oscilloscope and a remote terminal or computer:

- Connect the oscilloscope to your computer network using an appropriate Ethernet cable.

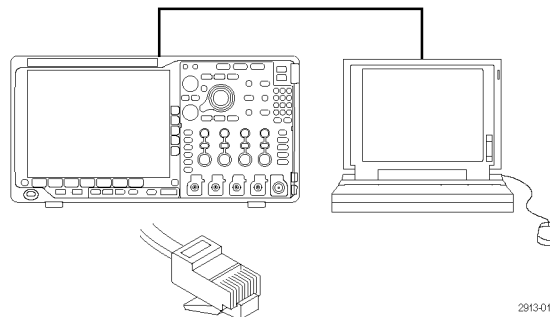

2913-016

2. Push **Utility**.

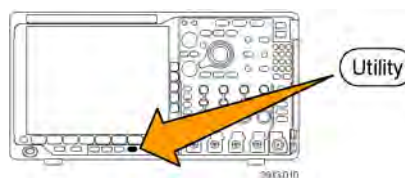

3. Push **Utility Page**.

Utility Page



4. Turn multipurpose knob **a** and select **I/O**.

I/O

5. Push **Socket Server**.

Utility Page I/O	USB Computer	Ethernet & LXI	Network Configura- tion Manual	Socket Server	GPIO 1	
---------------------	-----------------	-------------------	---	------------------	-----------	--



6. On the resulting Socket Server side menu, push the top entry to highlight **Enabled**.
7. Choose whether the protocol should be **None** or **Terminal**.
A communication session run by a human at a keyboard typically uses a terminal protocol. An automated session might handle its own communications without such protocol from the oscilloscope.
8. If required, change the port number by rotating multipurpose knob **a**.
9. If required, press **OK** to set the new port number.

Socket Server
Enabled Disabled
Protocol None Terminal
Current Port 4000
Select Port (a) 4000
OK Set Port

- After you have set up the socket server parameters, the computer is now ready to communicate with the oscilloscope. If you are running an MS Windows PC, you could run its default client Telnet, which has a command interface. One way to do this is by typing "Telnet" in the Run window. The Telnet window will open on the PC.

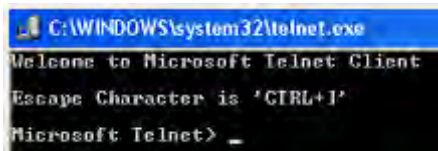

NOTE. On MS Windows 7, you must first enable Telnet in order for Telnet to work.

- Start a terminal session between your computer and your oscilloscope by typing in an open command with the oscilloscope's LAN address and port #.

You can obtain the LAN address by pushing the **Ethernet & LXI** lower menu button and the resulting **LAN Settings** side menu button to view the resulting Ethernet and LXI Settings screen. You can obtain the port # by pushing **Socket Server** on the lower menu and viewing **Current Port** on the side menu.

For example, if the oscilloscope IP address was 123.45.67.89 and the port # was the default of 4000, you could open a session by writing into the MS Windows Telnet screen: o 123.45.67.89 4000.

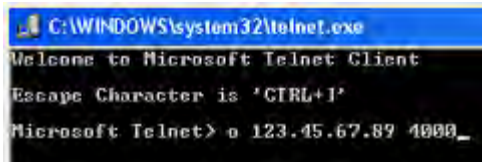

The oscilloscope will send a help screen to the computer when it has finished connecting.

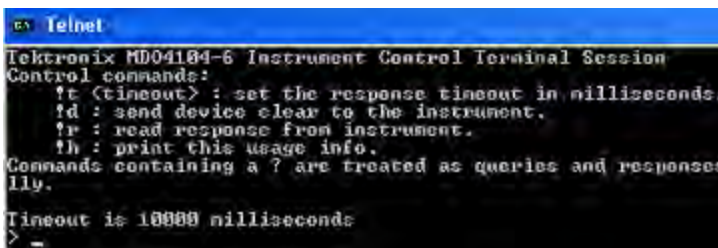

12. You can now type in a standard query, such as, `*idn?`

The Telnet session window will respond by displaying a character string describing your instrument.

You can type in more queries and view more results using this Telnet session window. You can find the syntax for relevant commands, queries and related status codes in the MSO4000B, DPO4000B, and MDO4000 Series Programmer Manual.

NOTE. Do not use the computer's backspace key during an MS Windows Telnet session with the oscilloscope.

Connecting a USB Keyboard to Your Oscilloscope

You can connect a USB keyboard to a USB Host port on the rear or front panel of the oscilloscope. The oscilloscope will detect the keyboard, even if it is plugged in while the oscilloscope is powered on.

You can use the keyboard to quickly create names or labels. You can bring up the **Label** button on the lower menu by pushing a Channel or Bus button. Use the arrow keys on the keyboard to move the insertion point, and then type in a name or label. Labeling channels and buses makes the information on the screen easier to identify.

To choose whether to use a keyboard with a United States (US) key layout or one with an alternative layout:

1. Push **Utility**.
2. Push **Utility Page**.
3. Turn multipurpose knob **a** and select **Config**.
4. Push **Language** on the lower menu.
5. Push **USB Keyboard** on the side menu.
6. Turn multipurpose knob **a** and select the desired keyboard layout style from the resulting menu.

Utility Page Config	Language	Set Date & Time	TekSecure Erase Memory	About	Manage Modules & Options	
-------------------------------	----------	-----------------	------------------------------	-------	--------------------------	--



Get Acquainted with the Instrument

Front Panel Menus and Controls

The front panel has buttons and controls for the functions that you use most often. Use the menu buttons to access more specialized functions.

Overview

1. Frequency domain display
2. Time domain display
3. Traditional oscilloscope front panel controls
4. 10-digit keypad
5. Dedicated spectral analysis controls
6. Dedicated RF input with N-connector

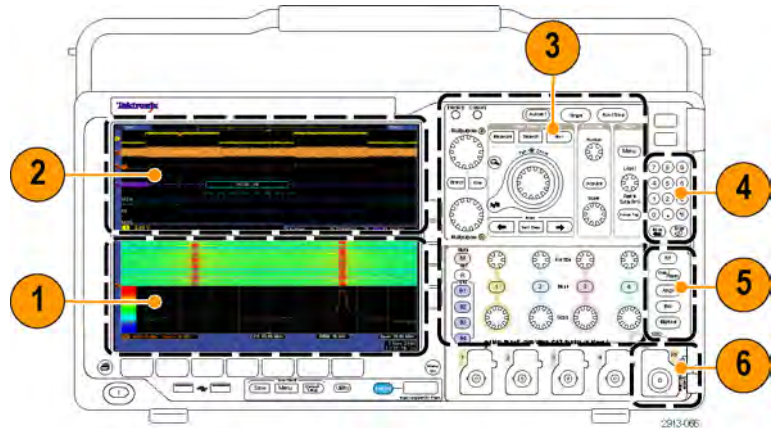

Using the Menu System

To use the menu system:

1. Push a front panel menu button to display the menu that you want to use.

NOTE. The **B1** through **B4** buttons support up to four different serial or parallel buses.

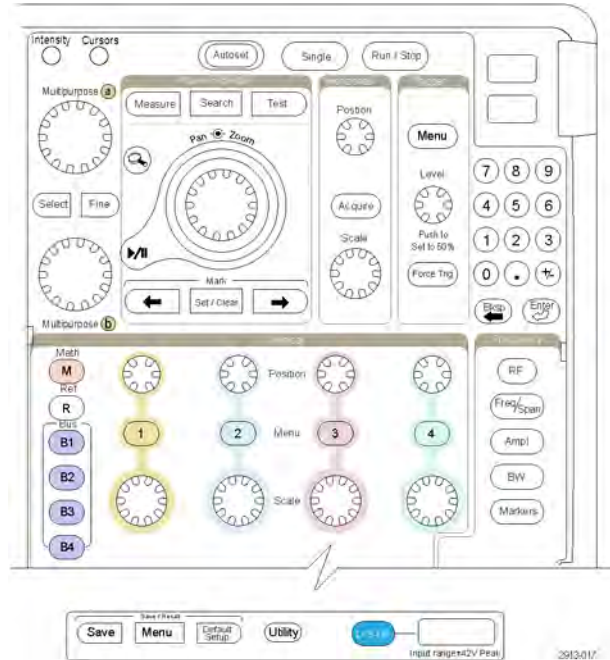

2. Push a lower menu button. If a pop-out menu appears, turn multipurpose knob **a** to select the desired choice. If a pop-up menu appears, push the button again to select the desired choice.

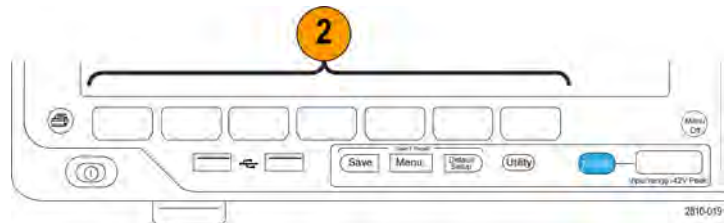

3. Push a side menu button.
If the menu item contains more than one choice, push the side button repeatedly to cycle through the choices.
If a pop-out menu appears, turn multipurpose knob **a** to select the desired choice.



- To remove a sidel menu, push the lower button again or push **Menu Off**.

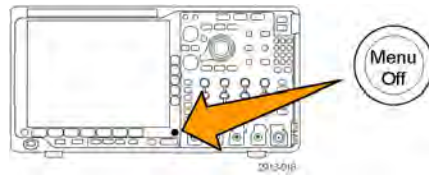

- Certain menu choices require you to set a numeric value to complete the setup. Use the upper and lower multipurpose knobs **a** and **b** to adjust values.
- Push **Fine** to turn off or on the ability to make smaller adjustments.

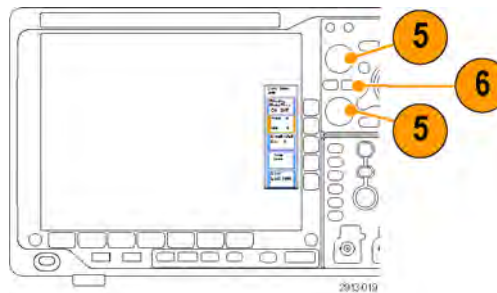

Using the Menu Buttons

Use the menu buttons to perform many functions in the oscilloscope.

- Measure.** Push to perform automated measurements on waveforms.
- Search.** Push to perform an automated search through an acquisition for user-defined events/criteria.
- Autoset.** Push to perform an automatic setup of oscilloscope settings.
- Test.** Push to activate advanced or application-specific testing features.
- Acquire.** Push to set the acquisition mode and adjust the record length.

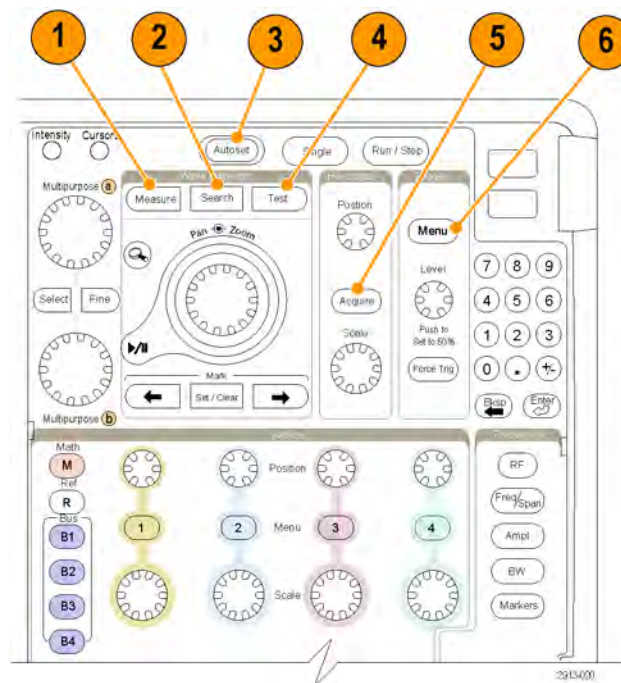

- Trigger Menu.** Push to specify trigger settings.

7. **Utility.** Push to activate the system utility functions, such as selecting a language or setting the date/time.

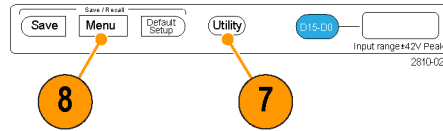

8. **Save / Recall Menu.** Push to save and recall setups, waveforms, and screen images to internal memory, a USB flash drive, or a mounted network drive.

9. **Channel 1,2,3, or 4 Menu.** Push to set vertical parameters for input waveforms and to display or remove the corresponding waveform from the display.

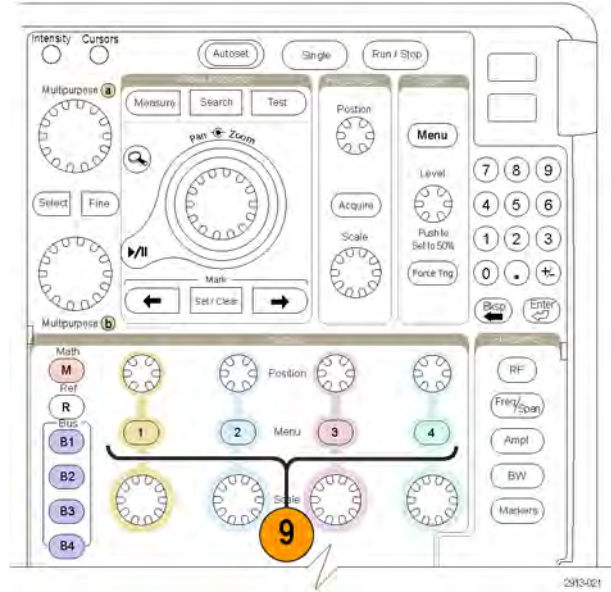

10. **B1, B2, B3, or B4.** Push to define and display a bus if you have the appropriate module application keys.

- DPO4AERO supports MIL-STD-1553 buses.
- DPO4AUTO supports CAN and LIN buses.
- DPO4AUTOMAX supports CAN, LIN, and FlexRay buses.
- DPO4EMBD supports I²C and SPI buses.
- DPO4ENET supports Ethernet buses.
- DPO4USB supports USB 2.0 buses.
- DPO4COMP supports RS-232, RS-422, RS-485, and UART buses.
- DPO4AUDIO supports I²S, Left Justified (LJ), Right Justified (RJ), and TDM buses.

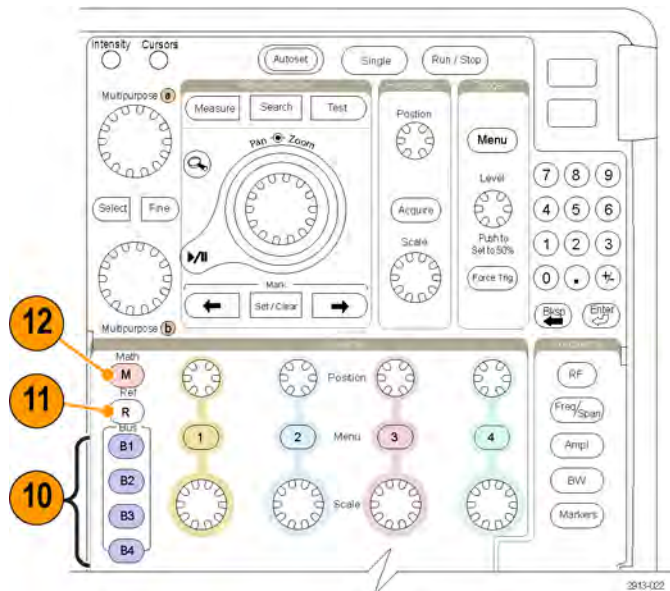

Also, push the **B1**, **B2**, **B3**, or **B4** button to display or remove the corresponding bus from the display.

11. **R**. Push to manage reference waveforms and traces, including the display or removal of each reference waveform or trace from the display.
12. **M**. Push to manage the math waveform or trace, including the display or removal of the math waveform or trace from the display.

Using Spectral Analysis Controls

These buttons configure the acquisition and display of the RF input.

1. **RF**. Push to bring up the frequency domain display and menu.
2. **Freq/Span**. Push to specify the portion of the spectrum to view on the display. Set the center frequency and the span – or set the start and stop frequency.
3. **Ampl**. Push to set the reference level.
4. **B/W**. Push to define the resolution bandwidth.
5. **Markers**. Push to set automatic or manual markers.



Using Other Controls

These buttons and knobs control waveforms, cursors, and other data input.

1. **Waveform Intensity.** Push to enable multipurpose knob **a** to control waveform display intensity and knob **b** to control graticule intensity.

2. **Cursors.** Push once to turn the cursors on. When the cursors are on, you can turn the multipurpose knobs to control their position. Push again to turn them off.

Push and hold to show the cursor menu and configure the cursors. Push **Menu Off** when done to return control of the cursors to the multipurpose knobs.

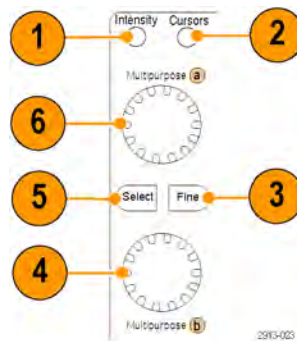

3. **Fine.** Push to toggle between making coarse and fine adjustments with the vertical and horizontal position knobs, the trigger level knob, and many operations of multipurpose knobs **a** and **b**.

4. Turn the lower multipurpose knob **b**, when activated, to move a cursor or set a numerical parameter value for a menu item. Push **Fine** to make adjustments more slowly.

5. **Select.** Push to activate special functions.

For example, when using the two vertical cursors (and no horizontal ones are visible), you can push this button to link or unlink the cursors. When the two vertical and two horizontal cursors are both visible, you can push this button to make either the vertical cursors or the horizontal cursors active.

You also can use the **Select** button with the file system operations.

6. Turn the upper multipurpose knob **a**, when activated, to move a cursor, to set a numerical parameter value for a menu item, or to select from a pop-out list of choices. Push the **Fine** button to toggle between coarse and fine adjustment. Screen icons tell you when **a** or **b** are active.

- 7. **Zoom** button. Push to activate zoom mode.
- 8. **Pan** (outer knob). Turn to scroll the zoom window through the acquired waveform.
- 9. **Zoom** (inner knob). Turn to control the zoom factor. Turning it clockwise zooms in further. Turning it counterclockwise zooms out.

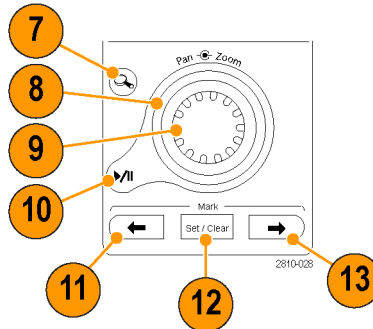

- 10. **Play-pause** button. Push to start or stop the automatic panning of a waveform. Control the speed and direction with the pan knob.
- 11. ← **Prev**. Push to jump to the previous waveform mark.
- 12. **Set/Clear Mark**. Push to establish or delete a waveform mark.
- 13. → **Next**. Push to jump to the next waveform mark.

- 14. **Horizontal Position**. Turn to adjust the trigger point location relative to the acquired waveforms. Push **Fine** to make smaller adjustments.
- 15. **Horizontal Scale**. Turn to adjust the horizontal scale (time/division).

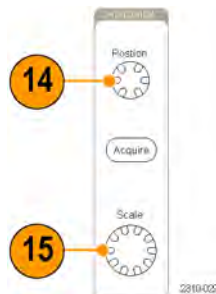

16. Run/Stop. Push to start or stop acquisitions.

17. Single. Push to make a single acquisition.

18. Autoset. Push to automatically set the vertical, horizontal, and trigger controls for a usable, stable display.

19. Trigger Level. Turn to adjust the trigger level. Push to set the trigger level to the midpoint of the waveform.

20. Force Trig. Push to force an immediate trigger event.

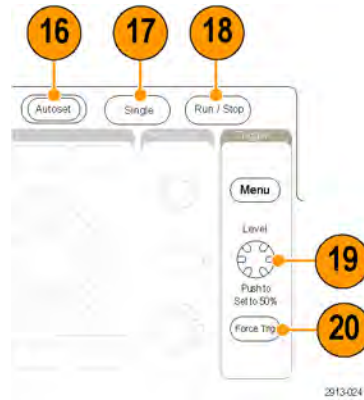

21. Vertical Position. Turn to adjust the vertical position of the corresponding waveform. Push **Fine** to make smaller adjustments.

22. 1, 2, 3, 4. Push to display or remove the corresponding waveform from the display and access the vertical menu.

23. Vertical Scale. Turn to adjust the vertical scale factor of the corresponding waveform (volts/division).

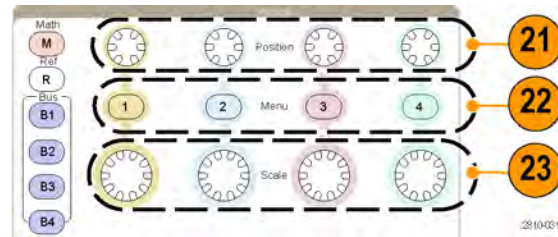

24. Print. Push to print a screen image using the printer selected in the Utility menu. (See page 170, *Printing a Hard Copy.*)

25. Power switch. Push to power on or off the instrument.

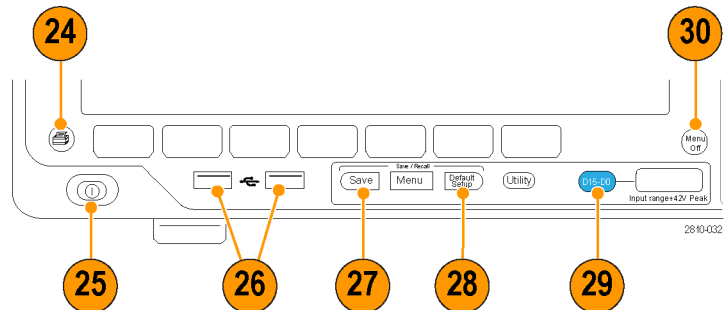

26. USB 2.0 host ports. Insert a USB cable here to connect peripherals to the oscilloscope, such as a keyboard, a printer, or a flash drive. There are two more USB 2.0 host ports on the rear panel.

- 27. **Save.** Push to perform an immediate save operation. The save operation uses the current save parameters, as defined in the Save / Recall menu.
- 28. **Default Setup.** Push to perform an immediate restore of the oscilloscope to the default settings.
- 29. **D15 - D0.** Push to display or remove the digital channels from the display, and to access the digital channel setup menu.
- 30. **Menu Off.** Push to clear a displayed menu from the screen.

Identifying Items in the Time Domain Display

The items shown to the right may appear in the display. Not all of these items are visible at any given time. Some readouts move outside the graticule area when menus are turned off.

- 1. The acquisition readout shows when an acquisition is running, stopped, or when acquisition preview is in effect.

The readout may show:

- Run: Acquisitions enabled
- Stop: Acquisitions not enabled
- Roll: In roll mode (40 ms/div or slower)
- PreVu: In this state, the oscilloscope is stopped or between triggers. You can change the horizontal or vertical position or scale to see approximately what the next acquisition will look like.
- A/B: When using average acquisition mode, B shows the total number of acquisitions to be averaged (you set this using the Acquisition Mode side menu), and A shows the current progress towards this total number.

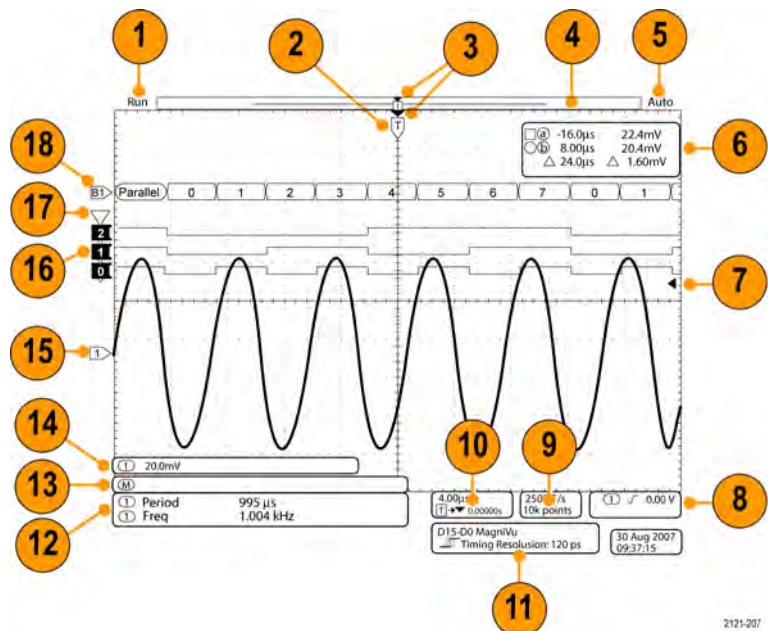

2. The trigger position icon shows the trigger position in the acquisition.

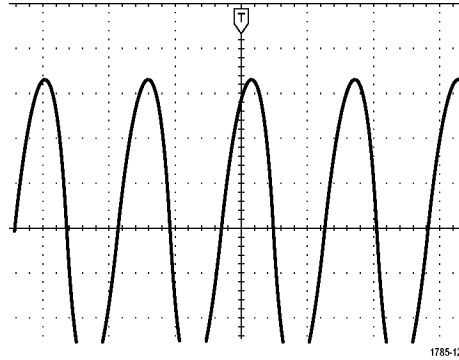

3. The expansion point icon (an orange triangle) shows the point that the horizontal scale expands and compresses around.

To make the expansion point the same as the trigger point, push **Acquire** and set the lower menu **Delay** item to **Off**.

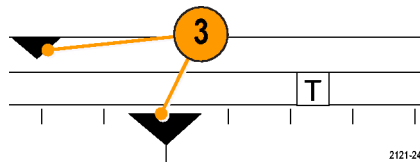

4. The waveform record view shows the trigger location relative to the waveform record. The line color corresponds to the selected waveform color.

The brackets show the part of the record currently displayed on the screen.



5. The trigger status readout shows trigger status. Status conditions are:

- PrTrig: Acquiring pretrigger data
- Trig?: Waiting for trigger
- Trig'd: Triggered
- Auto: Acquiring untriggered data

6. The cursor readout shows time, amplitude, and delta (Δ) values for each cursor.

For FFT measurements, it shows frequency and magnitude.

For serial and parallel buses, the readout shows the decoded values.

(See page 129, *Taking Manual Measurements with Cursors.*)

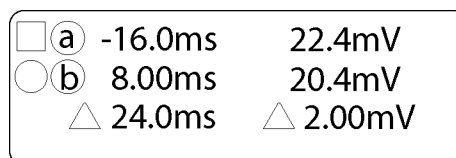

7. The trigger level icon shows the trigger level on the waveform. The icon color corresponds to the trigger source color.

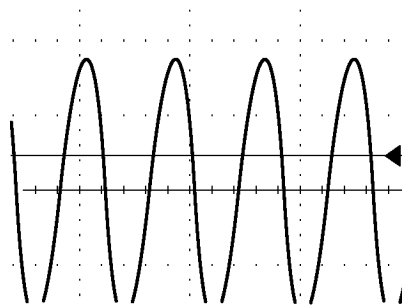

1785-143

8. The trigger readout shows the trigger source, slope, and level. The trigger readouts for other trigger types show other parameters.

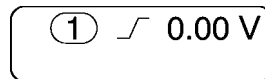

1785-135

9. The top line of the record length/sampling rate readout shows the sampling rate. You can adjust it with the **Horizontal Scale** knob. The bottom line shows the record length. You can adjust it by pushing **Acquire** and **Record Length** on the lower menu.

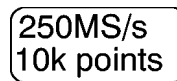

1785-137

10. The horizontal position/scale readout shows on the top line the horizontal scale (adjust with the **Horizontal Scale** knob).

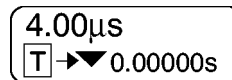

1785-136

With **Delay Mode** on, the bottom line shows the time from the T symbol to the expansion point icon (adjust with the **Horizontal Position** knob).

Use horizontal position to insert added delay between when the trigger occurs and when you actually capture the data. Insert a negative time to capture more pretrigger information.

With **Delay Mode** off, the bottom line shows the time location of the trigger within the acquisition, as a percentage.

11. The Timing Resolution readout shows the timing resolution of the digital channels.

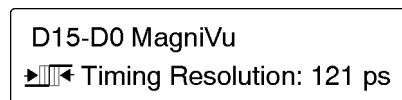

2121-208

Timing resolution is the time between samples. It is the reciprocal of the digital sample rate.

When the MagniVu control is on, "MagniVu" appears in the readout.

12. Measurement readouts show the selected measurements. You can select up to eight measurements to display at one time.

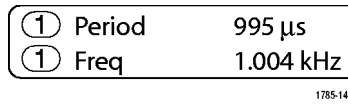

A symbol appears instead of the expected numerical measurement if a vertical clipping condition exists. Part of the waveform is above or below the display. To obtain a proper numerical measurement, turn the vertical scale and position knobs to make all of the waveform appear in the display.

13. The auxiliary waveform readouts show the vertical and horizontal scale factors of the math and reference waveforms.

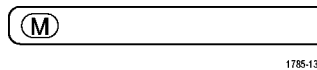

14. The channel readout shows the channel scale factor (per division), coupling, invert, and bandwidth status. Adjust with the **Vertical Scale** knob and in the channel 1, 2, 3, or 4 menus.

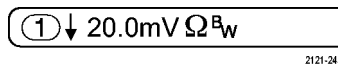

15. For analog channels, the waveform baseline indicator shows the zero-volt level of a waveform, assuming you have not used any offset. The icon colors correspond to the waveform colors.

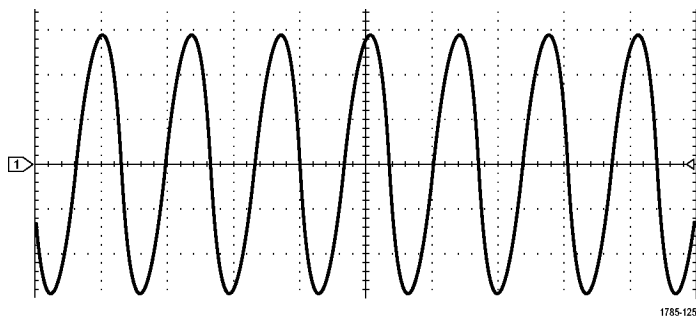

16. For digital channels, the baseline indicators point to the high and low levels. The indicator colors follow the color code used on resistors. The D0 indicator is black, the D1 indicator is brown, the D2 indicator is red, and so on.

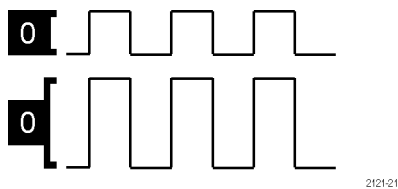

17. The group icon indicates when digital channels are grouped.

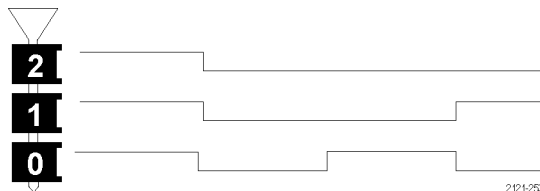

18. The bus display shows decoded packet level information for serial buses or for parallel buses. The bus indicator shows the bus number and bus type.

Identifying Items in the Frequency Domain Display

Activate the frequency domain display by pressing the front panel RF button.

1. Vertical graticule labels
2. Start frequency
3. Reference level
4. Vertical scale
5. Center frequency
6. Span and resolution
7. RF Menu
8. Stop frequency

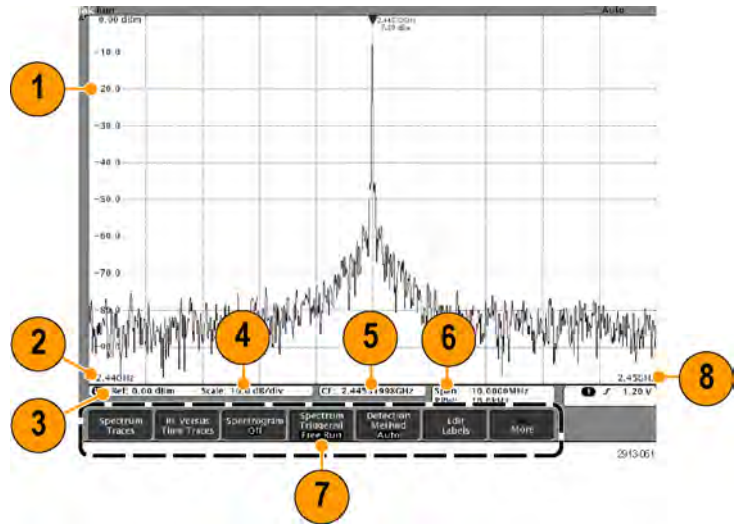

Front Panel Connectors

1. Logic Probe Connector
2. Channel 1, 2, 3, 4. Channel inputs with TekVPI Versatile Probe Interface.
3. RF Input Connector.
4. **PROBE COMP.** Square wave signal source to compensate or calibrate probes. Output voltage: 0 – 2.5 V, amplitude $\pm 1\%$ behind $1\text{ k}\Omega \pm 2\%$. Frequency: 1 kHz.
5. Ground.
6. Application Module Slots.

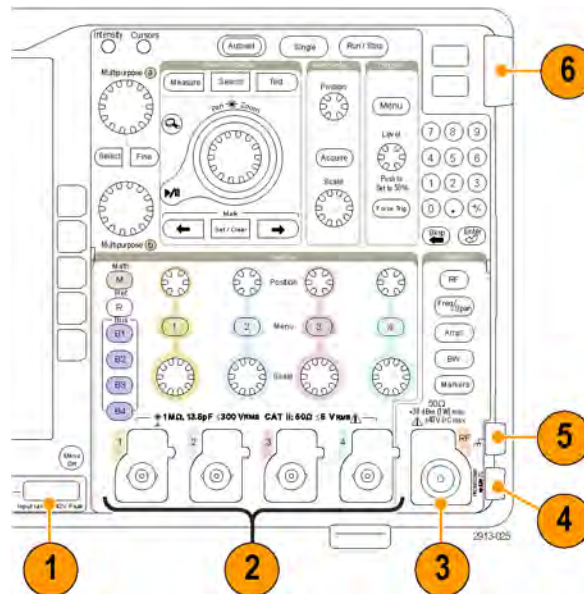

Side-Panel Connector

1. Ground strap connector. This is a receptacle for a grounding strap.

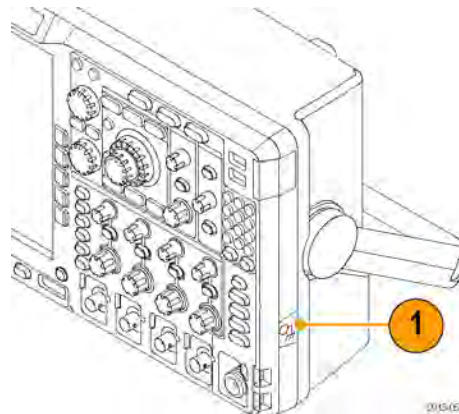

Rear-Panel Connectors

1. **Auxiliary Output.** Use this output to generate a signal on a main trigger pulse, as a 10 MHz reference signal, or to output a signal when other events happen, such as mask-limit test events.

To use this to synchronize other test equipment with your oscilloscope, push **Utility** on the front panel, push **Utility Page** on the lower menu, and select **External Signals** with multipurpose knob **a**. Push **AUX OUT** on the lower menu and **Main Trigger** on the resulting side menu.

A LOW to HIGH transition indicates that the trigger occurred. The logic level for Vout (HI) is ≥ 2.5 V open circuit; ≥ 1.0 V into a 50 Ω load to ground. The logic level for Vout (LO) is ≤ 0.7 V into a load of ≤ 4 mA; ≤ 0.25 V into a 50 Ω load to ground.

2. **EXT REF IN.** You can connect an external clock to this connector. To enable this connector, push **Utility** on the front panel, push **Utility Page** on the lower menu, and select **External Signals** with multipurpose knob **a**. Push **Reference Source** on the lower menu and **EXT REF IN** on the resulting side menu.
3. **XGA Out.** Use the XGA Video port (DB-15 female connector) to show the oscilloscope display on an external monitor or projector.
4. **LAN.** Use the LAN (Ethernet) port (RJ-45 connector) to connect the oscilloscope to a 10/100 Base-T local area network.
MDO4000 models are LXI Class C version 1.3 compliant.

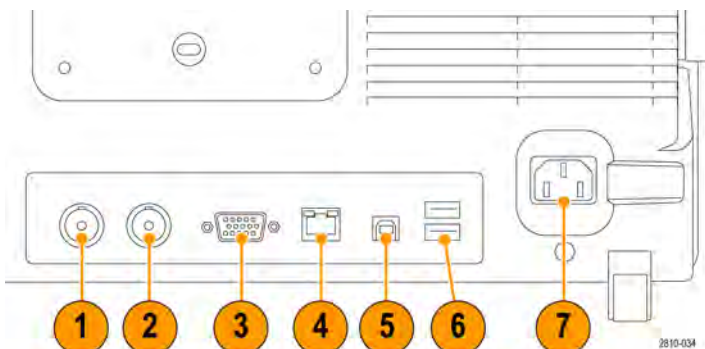

- 5. Device.** Use the USB 2.0 High speed device port to control the oscilloscope through USBTMC or GPIB with a TEK-USB-488 Adapter. The USBTMC protocol allows USB devices to communicate using IEEE488 style messages. This lets you run your GPIB software applications on USB hardware. Also, use the USB port to connect a PictBridge-compatible printer to the oscilloscope.

NOTE. *For high speed operation, the cable connected from the USB 2.0 Device port to the host computer must meet the USB 2.0 specification for high speed operation when connected to a high speed host controller.*

- 6. Host.** Use the USB 2.0 high speed host ports (two on the rear-panel and two on the front) to take advantage of USB flash drives and printers.
- 7. Power input.** Attach to an AC power line with integral safety ground. (See page 6, *Operating Considerations.*)

Acquire the Signal

This section describes concepts of and procedures for setting up the oscilloscope to acquire the signal as you want it to.

Setting Up Analog Channels

Use front panel buttons and knobs to set up your instrument to acquire signals using the analog channels.

1. Connect the TPP0500/TPP1000 or VPI probe to the input signal source.

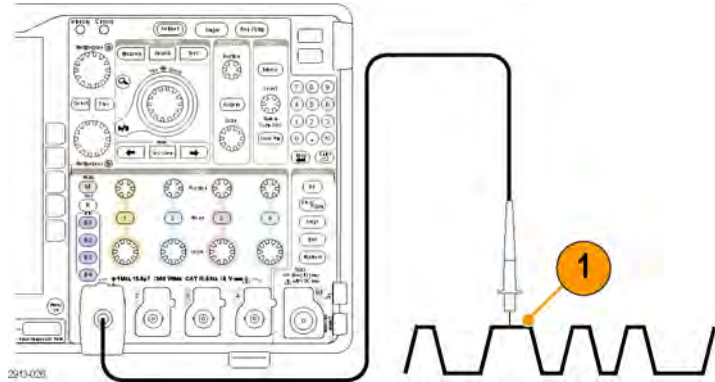

2. Select the input channel by pushing the front panel buttons.

NOTE. If you are using a probe that does not supply probe encoding, set the attenuation (probe factor) on the oscilloscope vertical menu for the channel to match the probe.

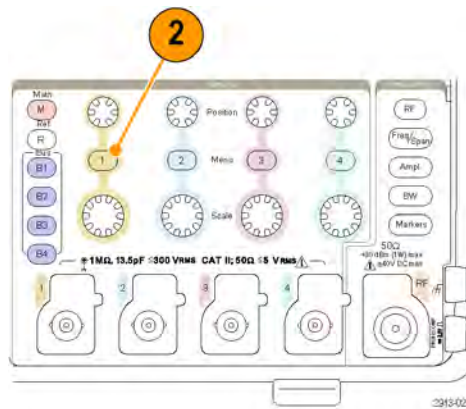

3. Push **Default Setup**.

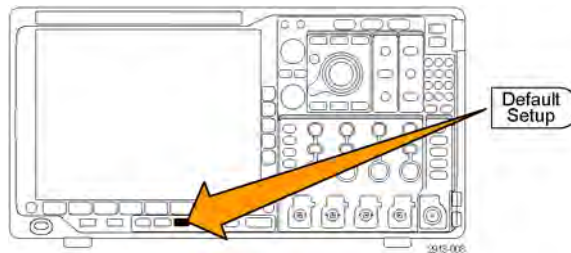

4. Push **Autoset**.

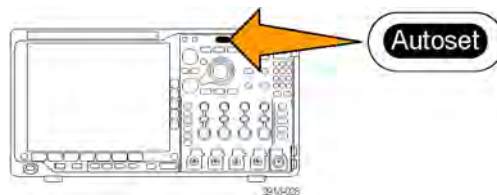

5. Push the desired channel button. Then adjust the vertical position and scale.

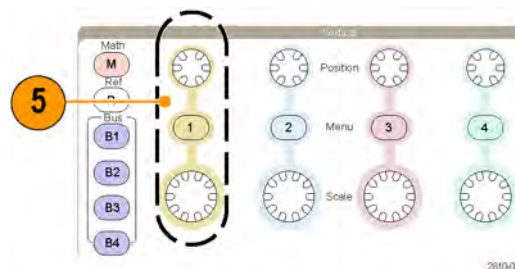

6. Adjust the horizontal position and scale.
The horizontal position determines the number of pretrigger and posttrigger samples.
The horizontal scale determines the size of the acquisition window relative to the waveform. You can scale the window to contain a waveform edge, a cycle, several cycles, or thousands of cycles.

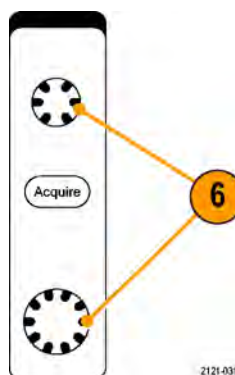

Quick Tip

- Use the zoom feature to see multiple cycles of your signal in the upper part, and a single cycle in the lower part of the display. (See page 144, *Using Wave Inspector to Manage Long Record Length Waveforms.*)

Labeling Channels and Buses

You can add a label to the channels and buses shown on the display for easy identification. The label is placed on the waveform baseline indicator in the left side of the screen. The label can have up to 32 characters.

To label a channel, push a channel input button for an analog channel.

1. Push a front panel button for an input channel or a bus.





2. Push a lower menu button to create a label, such as for channel 1 or B1.

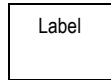

3. Push **Choose Preset Label** to view a list of labels.

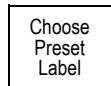

4. Turn multipurpose knob **b** to scroll through the list to find a suitable label. You can edit the label after you insert it if necessary.

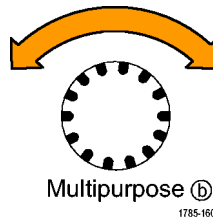

5. Push **Insert Preset Label** to add the label.



If you are using a USB keyboard, use the arrow keys to position the insertion point and edit the inserted label, or type in a new label. (See page 33, *Connecting a USB Keyboard to Your Oscilloscope.*)

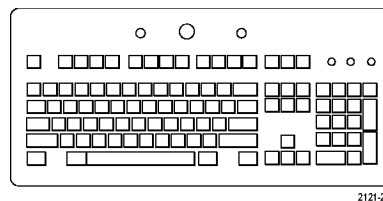

6. If you do not have a USB keyboard connected, push the side and lower menu arrow keys to position the insertion point.

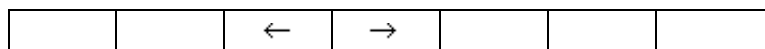
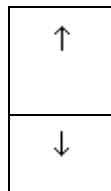

- 7. Turn multipurpose knob **a** to scroll through the list of letters, numbers, and other characters to find the character in the name that you want to enter.

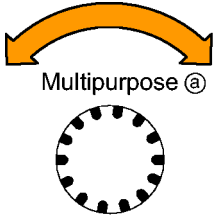

1785-039

ABCDEFGHIJKLMNOPQRSTUVWXYZ
 abcdefghijklmnopqrstuvwxyz
 0123456789_ =+!@#%&*()[]{}<>/~"'\:;.,?`

- 8. Push **Select** or **Enter Character** to let the oscilloscope know that you have picked the proper character to use.



You can use the lower menu buttons to edit the label as needed.

Enter Character		←	→	Back Space	Delete	Clear
-----------------	--	---	---	------------	--------	-------

- 9. Continue scrolling and pushing **Select** until you have entered all the desired characters. For another label, push the side and lower menu arrow keys to reposition the insertion point.

- 10. Push **Display Labels** and select **On** to see the label.

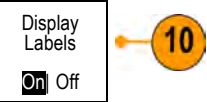

Using the Default Setup

To return the oscilloscope to its default settings:

- 1. Push **Default Setup**.

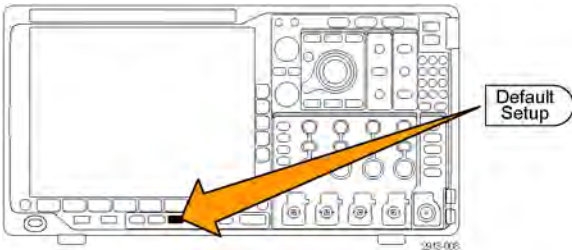

2. If you change your mind, push **Undo Default Setup** to undo the last default setup.

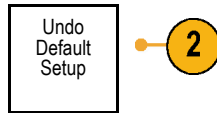

Using Autoset

Autoset adjusts the instrument (acquisition, horizontal, trigger, and vertical controls) such that it displays four or five waveform cycles for analog channels with the trigger near the midlevel, and ten cycles for digital channels.

Autoset works with both the analog and digital channels.

1. To autoset an analog channel, connect the analog probe, and then select the input channel. (See page 50, *Setting Up Analog Channels*.)



To autoset a digital channel, connect the logic probe and select the input channel. (See page 72, *Setting Up Digital Channels*.)

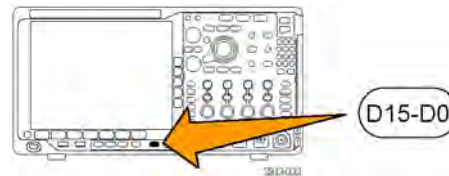

2. Push **Autoset** to execute an Autoset.

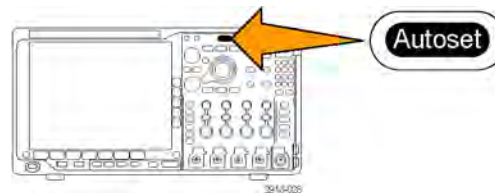

3. If desired, push **Undo Autoset** to undo the last Autoset.



You can also disable the Autoset function. To disable or enable the Autoset function:

1. Push and hold **Autoset**.

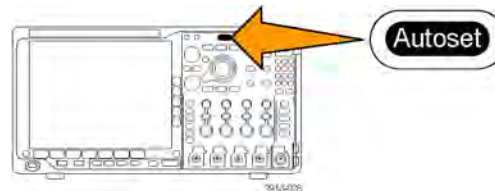

2. Push and hold **Menu Off**.



3. Release **Menu Off**, and then release **Autoset**.

4. Select the desired setting using the side menu.

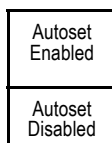

Quick Tips

- To position the waveform appropriately, Autoset may change the vertical position. Autoset always sets vertical offset to 0 V.
- If you use Autoset when no channels are displayed, the instrument turns on channel 1 and scales it.
- If you use Autoset and the oscilloscope detects a video signal, the oscilloscope automatically sets the trigger type to video and makes other adjustments to display a stable video signal.

Acquisition Concepts

Before a signal can be displayed, it must pass through the input channel where it is scaled and digitized. Each channel has a dedicated input amplifier and digitizer. Each channel produces a stream of digital data from which the instrument extracts waveform records.

Sampling Process

Acquisition is the process of sampling an analog signal, converting it into digital data, and assembling it into a waveform record, which is then stored in acquisition memory.

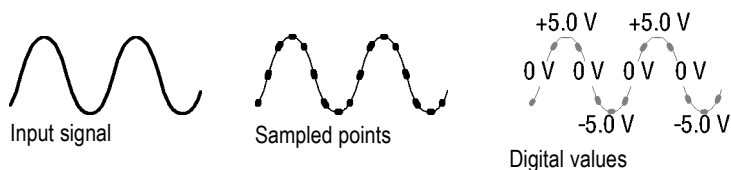

Real-Time Sampling

MDO4000 Series oscilloscopes use real-time sampling. In real-time sampling, the instrument digitizes all of the points it acquires using a single trigger event.

Record points

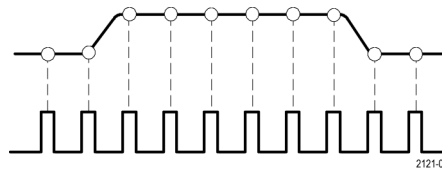

Sampling rate

Waveform Record

The instrument builds the waveform record through use of the following parameters:

- **Sample interval:** The time between recorded sample points. Adjust this by turning the **Horizontal Scale** knob or pushing **Acquire** and changing the record length in the Acquire menu.
- **Record length:** The number of samples required to fill a waveform record. Set this by pushing the **Acquire** button and using the lower and side menus.
- **Trigger point:** The zero time reference in a waveform record. It is shown on the screen by an orange T.
- **Horizontal position:** When **Delay Mode** is on, this is the time from the trigger point to the expansion point. Adjust this by turning the **Horizontal Position** knob. Use a positive time to acquire the record after the trigger point. Use a negative time to acquire it before the trigger point.
- **Expansion point:** The point that the horizontal scale expands and contracts around. It is shown by an orange triangle.

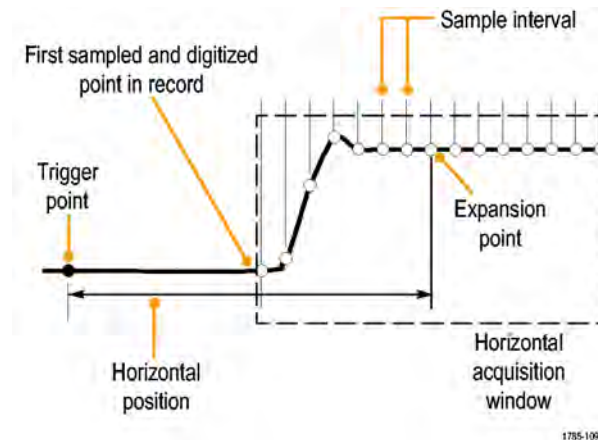

1785-109

How the Analog Acquisition Modes Work

Sample mode retains the first sampled point from each acquisition interval. Sample is the default mode.

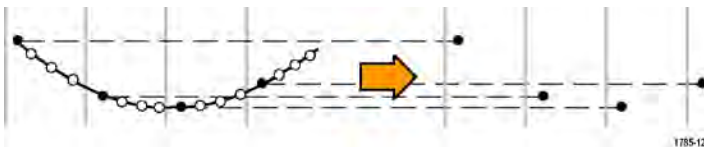

Peak Detect mode uses the highest and lowest of all the samples contained in two consecutive acquisition intervals. This mode only works with real-time, noninterpolated sampling and is useful for catching high frequency glitches.

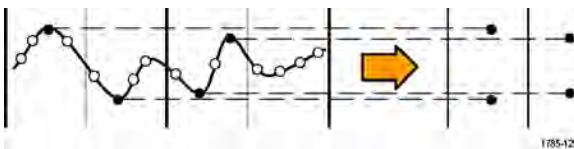

Hi Res mode calculates the average of all the samples for each acquisition interval. This mode also only works with real-time, noninterpolated sampling. Hi-Res provides a higher-resolution, lower-bandwidth waveform.

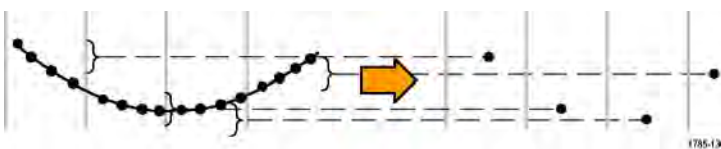

Envelope mode finds the highest and lowest record points over all acquisitions. Envelope uses Peak Detect for each individual acquisition.

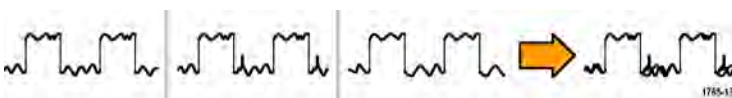

Average mode calculates the average value for each record point over a user-specified number of acquisitions. Average uses Sample mode for each individual acquisition. Use average mode to reduce random noise.



Changing the Acquisition Mode, Record Length, and Delay Time

Use this procedure to change the acquisition mode.

1. Push **Acquire**.

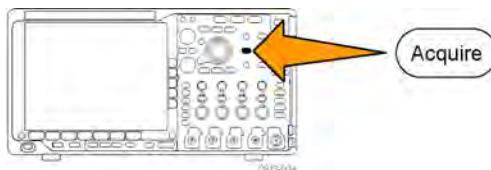

2. Push **Mode**.





Mode Sample	Record Length 10k	Delay On Off	Set Horiz. Position to 10%	Waveform Display	XY Display Off	
----------------	----------------------	-----------------	----------------------------------	---------------------	-------------------	--

●
2

●
5

●
7

3. Then choose the acquisition mode from the side menu. You can choose from: Sample, Peak Detect, Hi Res, Envelope, or Average.

Acquisition Mode	
 Sample	● 3
 Peak Detect	● 3
Hi Res	
 Envelope	● 3
 Average 16	● 3

NOTE. Peak Detect and Hi Res modes take advantage of sample points that the oscilloscope would have discarded at lower sweep speeds. Therefore, these modes only work when the current sample rate is less than the maximum possible sample rate. As soon as the oscilloscope starts to acquire at the maximum sample rate, then the Peak Detect, Hi Res and Sample modes all look the same. You can control the sample rate by setting the Horizontal scale and the Record Length.

4. If you chose **Average**, turn multipurpose knob **a** to set the number of waveforms to average over.

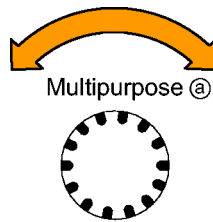

1785-039

5. Push **Record Length**.
6. Scroll through the available choices. Choose among 1000, 10 k, 100 k, 1 M, 10 M, and 20 M points.

7. Push **Delay** on the lower menu to select **On** when you want to delay the acquisition relative to the trigger event.

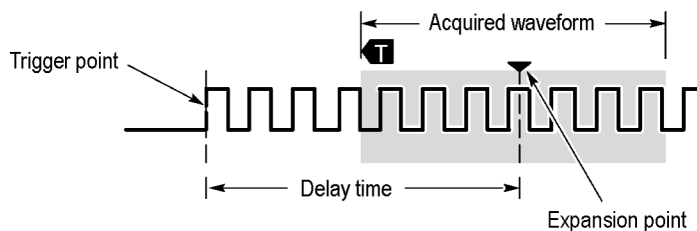

With **Delay** set to **On**, turn the **Horizontal Position** knob counterclockwise to increase the delay. The trigger point will move to the left and ultimately outside of the acquired waveform. Then you can adjust the **Horizontal Scale** knob to acquire more detail around the area of interest at the center of the screen.

When this delay is on, the trigger point separates from the horizontal expansion point. The horizontal expansion point stays at the center of the screen. The trigger point can move off the screen. When this happens, the trigger marker turns to point in the direction of the trigger point.

Use the delay feature when you want to acquire waveform detail that is separated from the trigger event by a significant interval of time. For example, you can trigger on a sync pulse that occurs once every 10 ms and then look at high-speed signal characteristics that occur 6 ms after the sync pulse.

When the delay feature is set to **Off**, the expansion point is tied to the trigger point so that scale changes are centered around the trigger point.

Using Roll Mode

Roll mode gives a display similar to a strip chart recorder for low-frequency signals. Roll mode lets you see acquired data points without waiting for the acquisition of a complete waveform record.

Roll mode is enabled when the trigger mode is auto and the horizontal scale is set to 40 ms/div or slower.

Quick Tips

- Switching to Envelope or Average acquisition mode, using digital channels, using math waveforms, turning on a bus, or switching to Normal trigger will disable Roll mode.
- Roll mode is disabled when you set the horizontal scale to 20 ms per division or faster.
- Push **Run/Stop** to halt Roll mode.



Setting Up a Serial or Parallel Bus

Your oscilloscope can decode and trigger on signal events or conditions that occur on:

Bus type	With this hardware
Audio (I ² S, Left Justified (LJ), Right Justified (RJ), and TDM)	DPO4AUDIO application module
CAN and LIN	DPO4AUTO or DPO4AUTOMAX application module
Ethernet	DPO4ENET application module <i>NOTE. ≥350 MHz bandwidth models are recommended for 100BASE-TX.</i>
FlexRay	DPO4AUTOMAX application module
I ² C and SPI	DPO4EMBD application module
MIL-STD-1553	DPO4AERO application module
Parallel	MDO4000 Series oscilloscope
RS-232, RS-422, RS-485, and UART	DPO4COMP application module
USB 2.0	DPO4USB application module <i>NOTE. 1 GHz bandwidth models are required for high-speed (HS) USB.</i>

(See page 16, *Application Module Free Trial*.)

Using Buses in Two Steps

To quickly use serial bus triggering:

1. Push **B1**, **B2**, **B3**, or **B4** and enter parameters of the bus on which to trigger. You can separately assign a different bus to each of the **B1**, **B2**, **B3**, and **B4** buttons.

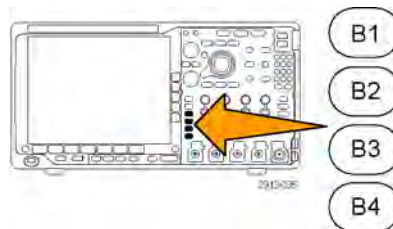

2. Push Trigger **Menu** and enter trigger parameters. (See page 83, *Choosing a Trigger Type*.)
You can display bus information without triggering on the bus signal.



Setting Up Bus Parameters

NOTE. For most bus sources, you may use any combination of channels 1 through 4, and D15 through D0. With some buses, you may also use Ref 1 through 4 and Math as sources for protocol decode.

To trigger on serial or parallel bus conditions, refer to Triggering on Buses. (See page 86, *Triggering on Buses*.)

To set up bus parameters:

1. Push **B1**, **B2**, **B3**, or **B4** to bring up the lower bus menu.

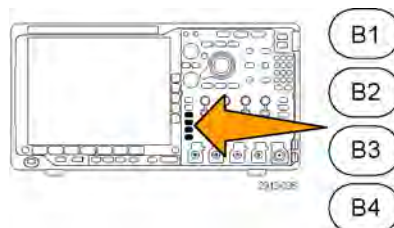

2. Push **Bus**. Turn multipurpose knob **a** to scroll through the list of bus types and select the desired bus: Parallel, I²C, SPI, RS-232, CAN, LIN, FlexRay, Audio, USB, Ethernet, or MIL-STD-1553.

The actual menu items shown will depend on your model oscilloscope and the application modules installed.

Bus B1 Parallel	Define Inputs	Thresholds		B1 Label Parallel	Bus Display	Event Table
--------------------	---------------	------------	--	----------------------	-------------	-------------



3. Push **Define Inputs**. The choices depend on the selected bus.

Use the side menu buttons to define parameters for the inputs, such as specific signals to an analog or digital channel.

If you select **Parallel**, push the side menu button to enable or disable **Clocked Data**.

Push the side menu button to select the **Clock Edge** on which to clock data: rising edge, falling edge, or both edges.

Turn multipurpose knob **a** to select the **Number of Data Bits** in the parallel bus.

Turn multipurpose knob **a** to select the desired bit to define.

Turn multipurpose knob **b** to select the desired analog or digital channel as the source for the bit.

Define Inputs
Clocked Data Yes No
Clock Edge / \ / \
Number of Data Bits (a) 16
Define Bits (a) Bit 15 (b) D15

4. Push **Thresholds**.

Bus B1 Parallel	Define Inputs	Thresholds		B1 Label Parallel	Bus Display	Event Table
--------------------	---------------	------------	--	----------------------	-------------	-------------

You can set the threshold for all channels in the parallel or serial bus from a list of preset values. The preset values vary, depending on the bus type.



Alternatively, you can set the threshold to a specific value for the signals that make up the parallel or serial bus. To do so, push **Select** on the side menu and turn multipurpose knob **a** to select a Bit or a Channel number (Signal name).



2319-045

Then, turn multipurpose knob **b** to define the voltage level above which the oscilloscope treats the signal as a logic high and below which as a logic low.



2319-045

NOTE. Some buses use two thresholds per channel.

5. Optionally, push **B1 Label** to edit the label for the bus. (See page 51, *Labeling Channels and Buses*.)

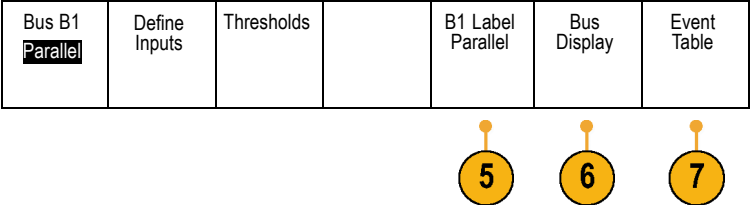

6. Push **Bus Display** and use the side menu to define how to display the parallel or serial bus.

Depending on the bus, use the side menu or the knobs to set the number format.

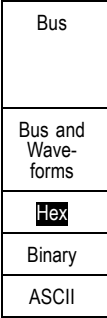

7. Push **Event Table** and select **On** to display a list of bus packets with timestamps.

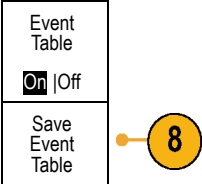

For a clocked parallel bus, the table lists the value of the bus at each clock edge. For an unclocked parallel bus, the table lists the value of the bus whenever any one of its bits changes.

The Event Table lists bytes, words, or packets, depending on the bus type.

8. Push **Save Event Table** to save the event table data in a .csv (spreadsheet) format on the currently selected storage device.

This example of an Event Table is from an RS-232 bus.

RS-232 event tables display one line for each 7- or 8-bit byte when Packets are set to Off.

RS-232 event tables display one line for each packet when Packets are set to On.

Other buses display one word, frame, or packet per row, depending on the bus type.

Tektronix		version v1.2f	
Bus Definition: RS232			
Time	Tx	Rx	
-4.77E-02	E		
-4.44E-02	n		
-4.10E-02	g		
-3.75E-02	i		
-3.41E-02	n		
-3.08E-02	e		
-2.73E-02	e		
-2.39E-02	r		
-2.06E-02	i		
-1.71E-02	n		
-1.37E-02	g		
-1.03E-02	,		
-6.92E-03	SP		
-3.49E-03	P		
-5.38E-05	o		
3.28E-03	r		
6.71E-03	t		
1.69E-02	l		
2.02E-02	a		
2.43E-02	n		
2.82E-02	d		
3.16E-02			

9. Push **B1**, **B2**, **B3**, or **B4** and turn multipurpose knob **a** to move the bus display up or down on the screen.

I²C Bus

To acquire data from an I²C bus, you need to also set up these items:

1. If you select **I²C**, push **Define Inputs** and the appropriate side menu choices.

Bus B1 I²C	Define Inputs	Thresholds	Include R/W in Address No	B1 Label I ² C	Bus Display	Event Table
---------------------------------	---------------	------------	-------------------------------------	---------------------------	-------------	-------------

You can assign the predefined **SCLK Input** or **SDA Input** to the channel connected to the signal.



2. Push **Include R/W in Address** and then push the desired side button.

This control determines how the oscilloscope shows the I²C addresses in bus decode traces, cursor readouts, Event Table listings, and trigger settings.

If you select **Yes**, the oscilloscope displays 7-bit addresses as eight bits, where the eighth bit (LSB) is the R/W bit. It displays 10-bit addresses as 11 bits where the third bit is the R/W bit.

If you select **No**, the oscilloscope displays 7-bit addresses as seven bits, and 10-bit addresses as ten bits.

In the physical layer of the I²C protocol, 10 bit I²C addresses are preceded by the five bit code, 11110. The oscilloscope does not include these five bits in address readouts.

SPI Bus

To acquire data from an SPI bus, you need to also set up these items:

- 1. If you selected **SPI**, push **Define Inputs** and the appropriate side menu choices.

You can set the **Framing** to SS (Slave Select) or to Idle Time.

You can assign the predefined **SCLK**, **SS**, **MOSI**, or **MISO** signals to any channel.

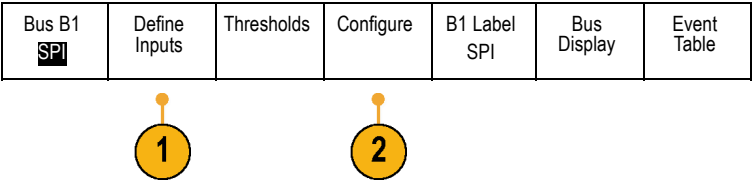

- 2. Push **Configure** and the desired side menu choices.

- 3. Push **SCLK** to set the edge of the signal to match the SPI bus being acquired.

- 4. Set the level of the SS, MOSI, and MISO signals to match the SPI bus.

Active High means that a signal is considered active when the signal is greater than the threshold value.

Active Low means that the signal is considered active when the signal is lower than the threshold value.

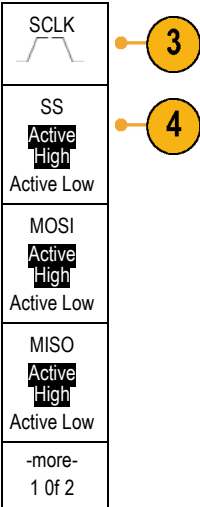

5. Use multipurpose knob **a** to set the number of bits of the SPI Word Size.
6. Push either side menu button to set the bit order of the SPI bus.

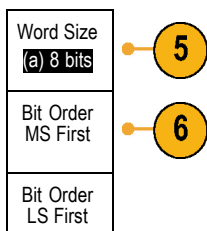

RS-232 Bus

To acquire data from a RS-232 bus, you need to also set up these items:

1. If you selected **RS-232**, push **Configure** and the desired side menu choices.

Use the side menu to configure the bus.
Use Normal polarity for RS-232 signals and Inverted polarity for RS-422, RS-485, and UART buses.

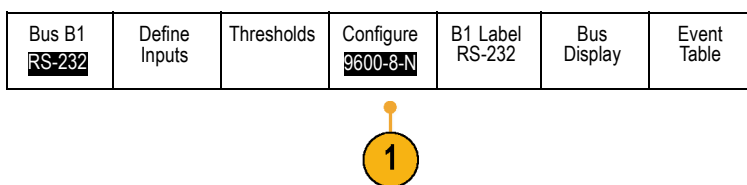

2. Push **Bit Rate**, and turn multipurpose knob **a** to select the appropriate bit rate.
3. Push **Data Bits** and select the number to match the bus.
4. Push **Parity** and turn multipurpose knob **a** to match the polarity used by the bus as None, Odd, or Even.
5. Push **Packets** and select On or Off.
6. Turn multipurpose knob **a** to select an end-of-packet character.

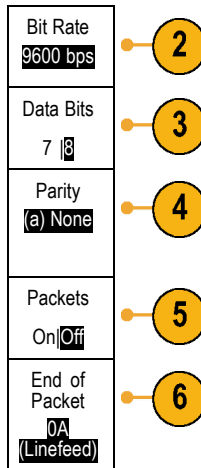

RS-232 decoding displays a stream of bytes. You can organize the stream into packets with an end-of-packet character

If you defined an end-of-packet character to use for RS-232 decoding, the stream of bytes will be displayed as packets.

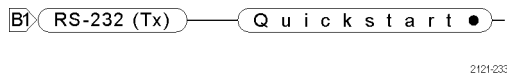

When decoding an RS-232 bus in ASCII mode, a large dot indicates that the value represents a character outside the printable ASCII range.

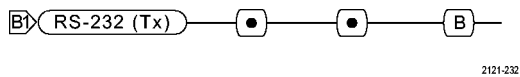

CAN Bus

To acquire data from a CAN bus, you need to also set up these items:

1. If you selected **CAN**, push **Define Inputs** and the appropriate side menu choices.

Bus B1	Define Inputs	Thresholds	Bit Rate	B1 Label	Bus Display	Event Table
CAN			500 Kbps	CAN		



2. Turn multipurpose knob **a** to select the channel connected to the CAN bus source.
3. Turn multipurpose knob **a** to select the type of CAN signal: CAN_H, CAN_L, Rx, Tx, or Differential.
4. Turn multipurpose knob **a** to set the **Sample Point** from 5% to 95% of the position within the bit period or the unit interval.

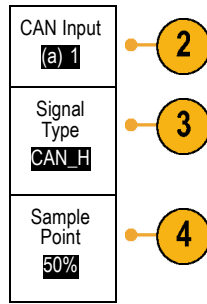

5. Push **Bit Rate** and turn multipurpose knob **a** to select from the list of predefined bit rates.

Alternatively, you can set the bit rate to a specific value. To do so, select **Custom**, and then turn multipurpose knob **b** to set the bit rate from 10,000 to 1,000,000.

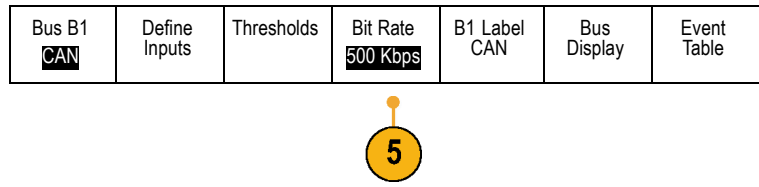

LIN Bus

To acquire data from a LIN bus, you need to also set up these items:

1. If you selected **LIN**, push **Define Inputs** and the appropriate side menu choices.

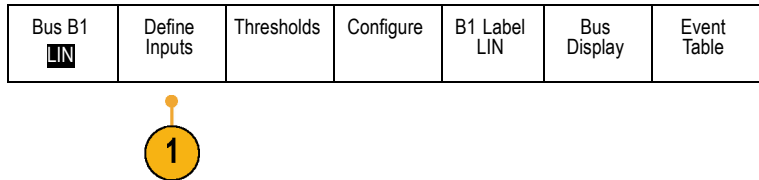

2. Turn multipurpose knob **a** to select the channel connected to the LIN bus source.
3. Turn multipurpose knob **a** to set the **Sample Point** from 5% to 95% of the position within the bit period or the unit interval.
4. Select the **Polarity** to match the LIN bus being acquired.

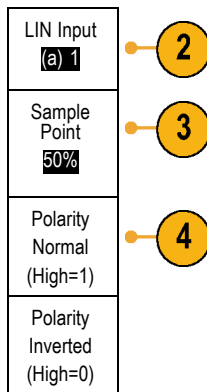

5. Push **Configure** and the appropriate side menu choices.

Bus B1 LIN	Define Inputs	Thresholds	Configure	B1 Label LIN	Bus Display	Event Table
----------------------	---------------	------------	-----------	-----------------	-------------	-------------



6. Push **Bit Rate**, and turn multipurpose knob **a** to select from the list of predefined bit rates. Alternatively, you can set the bit rate to a specific value. To do so, select **Custom**, and then turn multipurpose knob **b** to set the bit rate from 800 bps to 100,000 bps.
7. Push **LIN Standard**, and turn multipurpose knob **a** to select the appropriate standard.
8. Push **Include Parity Bits with Id** to select whether or not to include parity bits.

Bit Rate (a) 19.2K bps
LIN Standard v1.x
Include Parity Bits with Id On Off



Audio Bus

To acquire data from an Audio bus, you need to also set up these items:

1. If you selected **Audio**, push **Define Inputs** and the desired side menu choices.

Bus B1 Audio	Define Inputs	Thresholds	Configure	B1 Label RS-232	Bus Display	Event Table
------------------------	---------------	------------	-----------	--------------------	-------------	-------------



2. Push **Type**, and turn multipurpose knob **a** to select the type of audio bus data configuration on which to trigger.
3. Select **I2S** to trigger on the standard Inter-IC Sound, or Integrated Interchip Sound, electrical serial bus interface standard stereo format.
4. Select **Left Justified** to trigger on an I2S stream where there is no bit clock delay and the data starts right on the edge of the word select clock.
5. Select **Right Justified** to trigger on an I2S stream where the data lines up with the right edge of the word select clock.
6. Select **TDM** to trigger on time-division multiplexing.

7. Push **Configure**, and the appropriate buttons on the side menu to further set up I2S triggering.

Audio Bus Type
I2S
Left Justified (LJ)
Right Justified (RJ)
TDM

USB Bus

To acquire data from a USB bus, you need to also set up these items:

1. If you selected **USB**, push **Define Inputs** to set the USB bus speed and probe type.

Bus B1 USB	Define Inputs Full Speed	Thresholds		B1 Label USB	Bus Display	Event Table
----------------------	------------------------------------	------------	--	------------------------	-------------	-------------



2. The Thresholds, Label, Bus Display, and Event Table menus operate similarly to the other serial buses.

Ethernet

To acquire data from an Ethernet bus, you need to also set up these items:

1. If you selected **Ethernet**, push **Define Inputs** and the desired side menu choices.

Bus (B1) Ethernet	Define Inputs 100B- ASE-TX	Thresholds	IPv4 Yes No	(B1) Label Ethernet	Bus Display	Event Table
	1		3			

2. The Thresholds, Bus Display, and Event Table menus operate similarly to the other serial buses.
3. Push **IPv4** to decide whether or not to decode and trigger on Internet Protocol version 4 signals.

MIL-STD 1553

To acquire data from a MIL-STD 1553 bus, you need to also set up these items:

Bus B1 MIL-1553	Define Inputs	Thresholds 800 mV 0.00 V	RT 12.0µS 4.00µS	B1 Label 1553	Bus Display	Event Table
	1	2	3	2	2	2

1. Push **Define Inputs** and use multipurpose knob **a** to select the desired side menu choices. Select the polarity desired to match the MIL-STD-1553 bus being acquired.
2. The **Thresholds**, **Label**, **Bus Display**, and **Event Table** menu items operate similarly to how they work on other serial bus menus.
3. Push **RT** if you wish to change the Response Time (RT) maximum and minimum default values.

Physical Layer Bus Activity

Oscilloscope waveform traces from analog channels 1 to 4, digital channels D15 to D0, Math waveforms, and the traces you see when you choose to display a bus always show the physical layer bus activity. In the physical layer display, bits that were transmitted earlier are to the left, and bits that were transmitted later are to the right.

- I2C, and CAN buses transmit the MSB (most significant bit) first
- SPI buses do not specify a bit order
- RS-232 and LIN buses transmit the LSB (least significant bit) first

NOTE. The oscilloscope displays the decode traces and event tables for all buses with the MSB on the left and LSB on the right.

For example, an RS-232 signal (after the start bit) might be high, high, high, low, high, low, low, and high. Since the RS-232 protocol uses high for zero and low for one, this value would be 0001 0110.

Since the decode displays the MSB first, the oscilloscope reverses the order of the bits and displays 0110 1000. If the bus display is set to hex, the value displays as 68. If the bus display is set to ASCII, the value displays as h.

Setting Up Digital Channels

Use front panel buttons and knobs to set up your instrument to acquire signals using the digital channels.

1. Connect the P6616 16-channel logic probe to the input signal source.

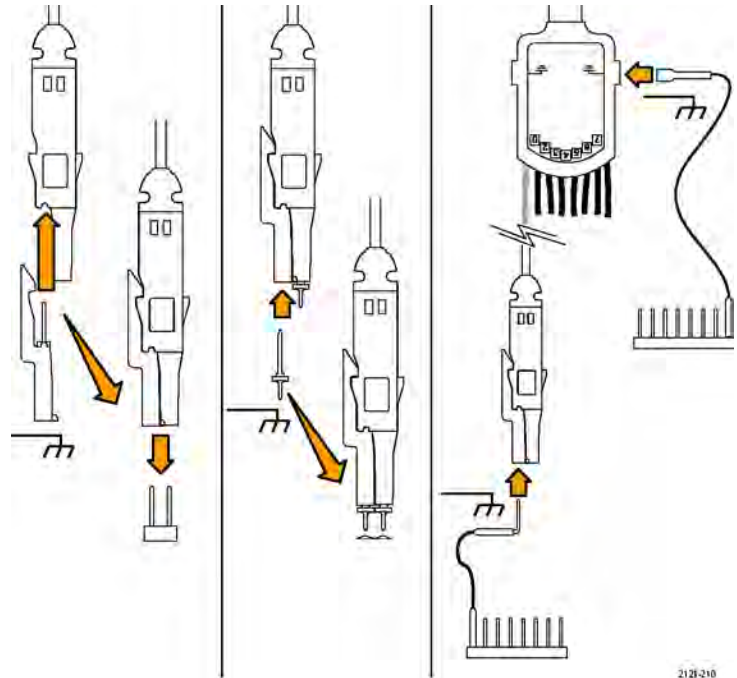

2. Connect the ground lead or leads to the circuit ground.
You can connect a separate lead for each channel or a common ground lead for each group of 8 wires.
3. If needed, connect the appropriate grabber for each probe to the probe tip.
4. Connect each probe to the desired circuit test point.
5. Push **D15 - D0** on the front panel to display the menu.

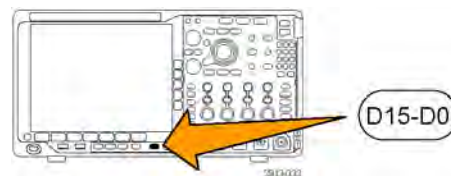

6. Push **D15 - D0** on the lower menu to access the D15 - D0 On or Off menu.

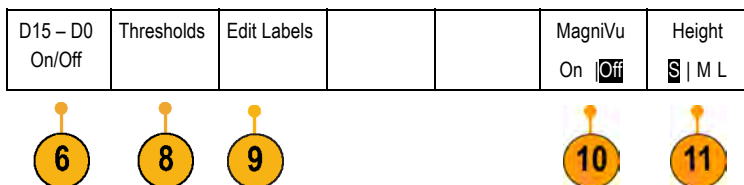

7. Turn multipurpose knob **a** to scroll through the list of digital channels. Turn multipurpose knob **b** to position the selected channel.
- As you position channels close to each other on the display, the oscilloscope groups the channels, and adds the group to the pop-up list. You can select the group from the list to move all the channels in the group instead of individual channels.
8. Push **Thresholds** on the lower menu. You can assign a different threshold value to each channel.
9. Push **Edit Labels** on the lower menu and create the label. You can create labels through the front panel or with an optional USB keyboard. (See page 51, *Labeling Channels and Buses*.)
10. Push **MagniVu** on the lower menu to increase the timing resolution. (See page 74, *When and Why to Turn On MagniVu*.)
11. Push **Height** on the lower menu repeatedly to set the signal height. You only need to do this once to set the height for all of the digital channels.

Quick Tip

- Use the zoom feature to see multiple cycles of the signal in the upper part, and a single cycle in the lower part of the display. (See page 144, *Using Wave Inspector to Manage Long Record Length Waveforms*.)
- When setting up the logic probe, the first set of eight leads (pins 7 to 0) on the logic probe are marked GROUP 1 on the lead box. The second set (pins 15 to 8) is marked GROUP 2.
- The lead for the first channel in each group is colored blue for easy identification while you connect the logic probe to the device under test. The other leads are gray.
- Digital channels store a high or low state for each sample. The threshold that separates high from low can be set separately for each channel.

When and Why to Turn On MagniVu

Tektronix MagniVu acquisition technology allows you to have higher timing resolution so that you can more accurately determine edge placement and make more precise timing measurements on digital edges. Using MagniVu, you can see up to 32 times more detail than you can using normal digital channel sampling.

The MagniVu record is acquired in parallel to the main digital acquisition and is available at any time, running or stopped. MagniVu provides an ultra high resolution view of your data sampled at a maximum resolution of 60.6 ps for 10,000 points centered around the trigger.

NOTE. MagniVu centers itself around the trigger point. If you turn MagniVu on while using a large record length and you are looking somewhere other than the trigger point, then the digital signal may be off screen. In most of these cases, you can find the digital record by looking for the digital signal in the upper overview and panning accordingly.

NOTE. You should turn on MagniVu when light gray shading is displayed to indicate the uncertainty of the edge position. If the shading is not displayed, you do not need to use MagniVu. (See page 108, Viewing Digital Channels.)

Using MagniVu

1. Push **D15 – D0**.

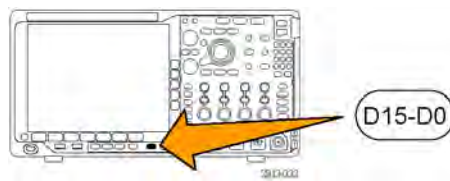

2. Push **MagniVu** and select **On**.

D15 – D0 On/Off	Thresholds	Label			MagniVu On <input checked="" type="radio"/> Off	Height S M L
--------------------	------------	-------	--	--	--	-------------------

Quick Tips

- If you think you need more timing resolution, turn on MagniVu to increase the resolution.
- MagniVu is always acquired. If the oscilloscope is in a stopped state, you can turn on MagniVu and still get the resolution without taking another acquisition.
- The serial bus features do not use data acquired in MagniVu mode.

Setting Up the RF Inputs

Frequency and Span Parameters

1. The center frequency is a precise frequency at the center of the display. In many applications, it is a carrier frequency.
2. The span is the range of frequencies you can observe around the center frequency.

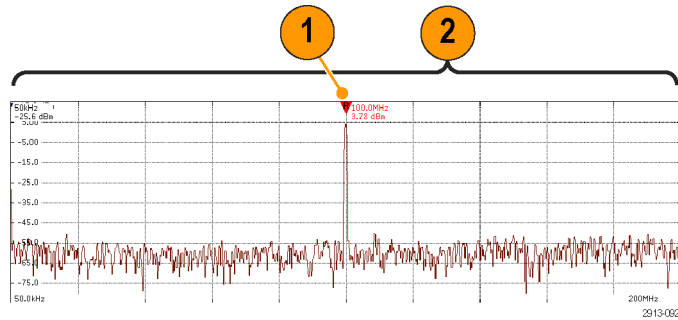

To define the center frequency and the span:

1. Push **Freq/Span** on the front panel.

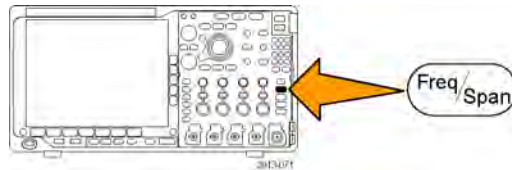

2. Push **Center Frequency** on the side menu and use either the multipurpose knob **a** or the oscilloscope keypad to enter the desired center frequency. If you use the keypad, you can also use the resulting side menu choices to enter units.
3. Push **Span** and use either multipurpose knob **b** or the keypad to enter the desired span. If you use the keypad, you can also use the resulting side menu choices to enter units.
4. Push **Start** to set the lowest frequency to capture.
5. Push **Stop** to set the highest frequency to capture.
6. Push ** To Center** to move the frequency identified by the reference marker to the center frequency.

Frequency & Span
Center Frequency (a) 2.24 GHz
Span (a) 3.00 GHz
Start 7.36 MHz
Stop 3.74 GHz
 To Center

Reference Level

1. Push **Ampl** to bring up the side menu for adjusting RF amplitude settings.

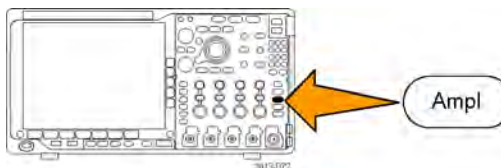

- 2. Push **Ref Level** and rotate multipurpose knob **a** to set the approximate maximum power level, as shown by the baseline indicator at the top of the frequency graticule.
- 3. Push **Vertical** and rotate multipurpose knob **a** to adjust the vertical position. You will move the baseline indicator up or down. This is useful if you want to move signals onto the visible display.
Rotate multipurpose knob **b** to adjust the vertical scale.
- 4. Push **Vertical Units** and rotate multipurpose knob **a** to define the vertical units of measure for the frequency domain. Choices are: dBm, dBμW, dBmV, dBμV, dBmA, and dBμA. This is useful if your application requires a different unit of measurement than that being currently displayed.
- 5. Push **Auto Level** to direct the oscilloscope to automatically calculate and set the reference level for you.

Amplitude
Ref Level (a) -25.0 dBm
Vertical 420 mdiv 20.0 dB/div
Vertical Units dBm
Auto Level

Resolution Bandwidth

The resolution bandwidth (RBW) determines the level to which the oscilloscope can resolve individual frequencies in the frequency domain. For example, if the test signal contains two carriers separated by 1 kHz, you will not be able to discriminate between them unless the RBW is less than 1 kHz.

The views below both show the same signal. The difference between them is their RBW.

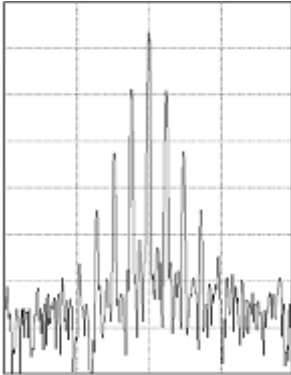

Lower (narrower) RBWs take longer to process, but have finer frequency resolution and a lower noise floor.

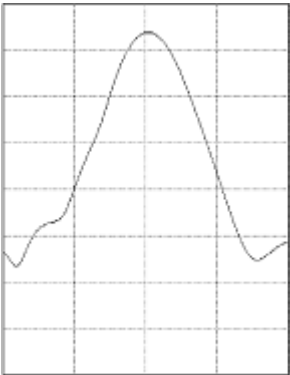

Higher (wider) RBWs take less time to process, but have less frequency resolution and a higher noise floor.

1. Push **BW** to bring up the resolution bandwidth side menu. This allows you to set the smallest frequency difference that the instrument can discern in the frequency axis.

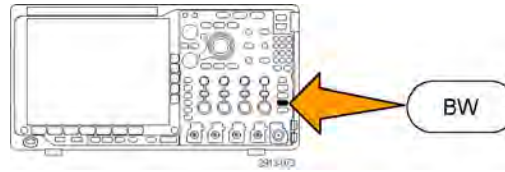

2. Push **RBW Mode** to select either **Auto** or **Manual**.

Auto sets the resolution bandwidth automatically as you change the span. The default behavior is $RBW = \text{Span}/1000$.

Manual allows you to set your own resolution bandwidth.

3. To manually adjust the RBW, push **RBW** and turn multipurpose knob **a**.

4. Push **Span : RBW** and turn multipurpose knob **a** to set the span/RBW ratio.

This ratio is used when the **RBW Mode** is set to **Auto**. The default is 1000:1 but you can set it to other values in a 1-2-5 sequence (e.g. 1000, 20000, 50000).

5. Push **Window** and turn multipurpose knob **a** to choose which FFT window type to use.

The choices are: Kaiser, Rectangular, Hamming, Hanning, Blackman-Harris, or Flat-Top.

Bandwidth
RBW Mode Auto Manual
RBW (a) 600 kHz (Auto)
Span : RBW 1000 : 1
Window Kaiser

The RF bandwidth FFT feature provides six windows. Each offers a trade-off between frequency resolution and magnitude accuracy. The choice of which window to use depends upon what you want to measure and your source's signal characteristics. Use the following guidelines to select the best window:

Description

Window

Kaiser

The frequency resolution when using the Kaiser window is fair; the spectral leakage and amplitude accuracy are both good.

The Kaiser window is best used when frequencies are very close to the same value but have widely differing amplitudes (the side lobe level and shape factor are closest to the traditional Gaussian RBW). This window is also good for random signals.



Description**Window****Rectangular**

The frequency resolution when using the Rectangular (a.k.a. boxcar or none) window is very good, the spectral leakage is high, and amplitude accuracy is poor.

Use the Rectangular window for measuring transients or bursts where the signal levels before and after the event are nearly equal. Also, use this window for equal-amplitude sine waves with frequencies that are very close together, and for broadband random noise with a relatively slow varying spectrum. This window is the best type for measuring the frequency spectrum of non-repetitive signals, and measuring frequency components near DC.

**Hamming**

The frequency resolution when using the Hamming window is good (slightly better than Hanning), the spectral leakage is moderate, and amplitude accuracy is fair.

Use the Hamming window for measuring sine, periodic, and narrow band random noise. This window works well on transients or bursts where the signal levels before and after the event are significantly different.

**Hanning**

The frequency resolution when using the Hanning (a.k.a. Hann) window is good, the spectral leakage is low and amplitude accuracy is fair.

Use the Hanning window for measuring sine, periodic, and narrow band random noise. This window works well on transients or bursts where the signal levels before and after the event are significantly different.

**Blackman-Harris**

The frequency resolution when using the Blackman-Harris window is poor, the spectral leakage is very low and amplitude accuracy is good.

Use the Blackman-Harris window for measuring predominantly single frequency waveforms to look for higher order harmonics, or several moderately or widely spaced sinusoidal signals.

**Flat-Top**

The frequency resolution when using a Flat-Top window is poor, the spectral leakage is low and amplitude accuracy is very good.

Use the Flat-Top window for making accurate amplitude measurements of moderately or widely spaced sinusoidal signals.



Trigger Setup

This section contains concepts and procedures for setting up the oscilloscope to trigger on your signal.

Triggering Concepts

Trigger Event

The trigger event establishes the time-reference point in the waveform record. All waveform record data is located in time with respect to that point. The instrument continuously acquires and retains enough sample points to fill the pretrigger portion of the waveform record. That is the part of the waveform that is displayed before, or to the left of, the triggering event on screen. When a trigger event occurs, the instrument starts acquiring samples to build the posttrigger portion of the waveform record, that is, the part displayed after or to the right of the trigger event. After a trigger is recognized, the instrument will not accept another trigger until the acquisition is complete and the holdoff time has expired.

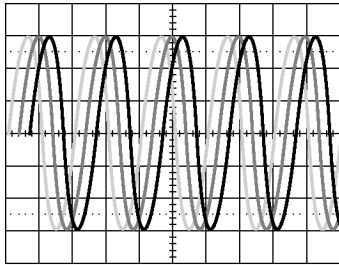

Untriggered display

1785-087a

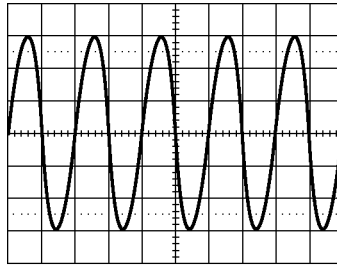

Triggered display

1785-087b

Trigger Modes

The trigger mode determines how the instrument behaves in the absence of a trigger event:

- Normal trigger mode enables the instrument to acquire a waveform only when it is triggered. If no trigger occurs, the last waveform record acquired remains on the display. If no last waveform exists, no waveform is displayed.
- Auto trigger mode enables the instrument to acquire a waveform even if a trigger does not occur. Auto mode uses a timer that starts when the acquisition is started, and the pretrigger information is obtained. If a trigger event is not detected before the timer times out, the instrument forces a trigger. The length of time it waits for a trigger event depends on the time base setting.

Auto mode, when forcing triggers in the absence of valid triggering events, does not synchronize the waveform on the display. The waveform will appear to roll across the screen. If valid triggers occur, the display will become stable.

You can also force the instrument to trigger by pushing the front panel **Force Trig** button.

Trigger Holdoff

Adjust holdoff to obtain stable triggering when the instrument is triggering on undesired trigger events.

Trigger holdoff can help stabilize triggering, since the oscilloscope does not recognize new triggers during the holdoff time. When the instrument recognizes a trigger event, it disables the trigger system until acquisition is complete. In addition, the trigger system remains disabled during the holdoff period that follows each acquisition.

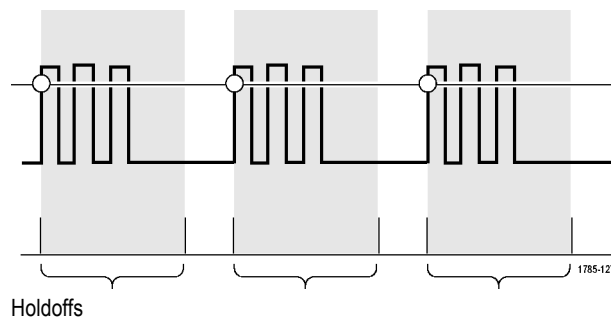

Trigger Coupling

Trigger coupling determines what part of the signal is passed to the trigger circuit. Edge and Sequence triggering can use all available coupling types: DC, AC, Low Frequency Rejection, High Frequency Rejection, and Noise Rejection. All other trigger types use DC coupling only.

Horizontal Position

When **Delay Mode** is on, use horizontal position to acquire waveform detail in a region that is separated from the trigger location by a significant interval of time.

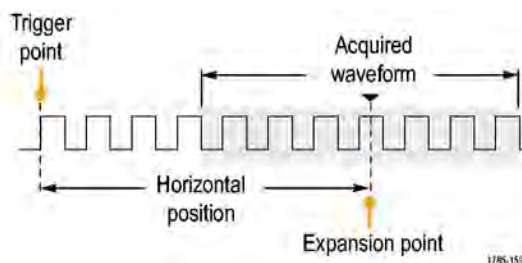

1. Adjust the position (delay) time by rotating the **Horizontal Position** knob.
2. Turn horizontal **SCALE** to acquire the detail that you need around the position (delay) expansion point.

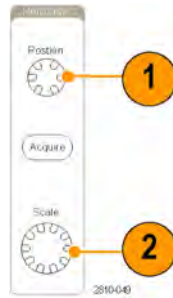

The part of the record that occurs before the trigger is the pretrigger portion. The part that occurs after the trigger is the posttrigger portion. Pretrigger data can help you troubleshoot. For example, to find the cause of an unwanted glitch in your test circuit, you can trigger on the glitch and make the pretrigger period large enough to capture data before the glitch. By analyzing what happens before the glitch, you may uncover information that helps you find the source of the glitch. Alternatively, to see what is happening in your system as a result of the trigger event, make the posttrigger period large enough to capture data after the trigger.

Slope and Level

The slope control determines whether the instrument finds the trigger point on the rising or the falling edge of a signal.

The level control determines where on that edge the trigger point occurs.

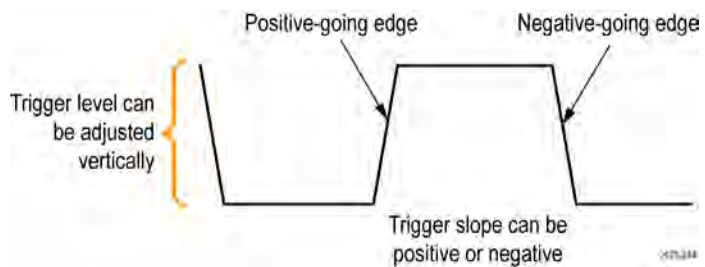

The oscilloscope provides a long horizontal bar or bars across the graticule to temporarily show the trigger level.

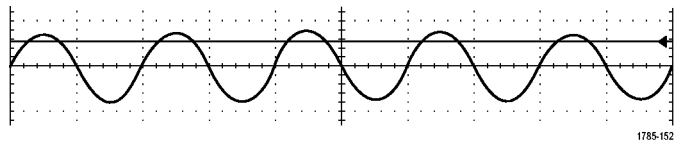

1. Turn the front panel Trigger **Level** knob to adjust the trigger level without going to a menu.
2. Push the front panel Trigger **Level** knob to quickly set the trigger level to the midpoint of the waveform.



Choosing a Trigger Type

To select a trigger:

1. Push Trigger **Menu**.

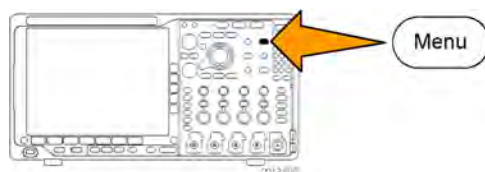

2. Push **Type** to bring up the **Trigger Type** side menu.

NOTE. The bus trigger in the MDO4000 Series works on parallel buses even without an application module. Using the bus trigger on other buses requires use of a DPO4AERO, DPO4AUDIO, DPO4AUTO, DPO4AUTOMAX, DPO4COMP, DPO4EMBD, DPO4ENET, or DPO4USB application module.

Trigger Type
Sequence (B Trigger)
Pulse Width
Timeout
Runt
Logic
Setup & Hold
Rise/Fall Time
Video
Bus

3. Turn multipurpose knob **a** to select the desired trigger type.

4. Complete the trigger setup using the lower menu controls displayed for the trigger type. The controls to set up the trigger vary depending on the trigger type.

Type Edge	Source 1	Coupling DC	Slope 	Level 100 mV		Mode Auto & Holdoff
---------------------	--------------------	-----------------------	-----------	------------------------	--	----------------------------------



Selecting Triggers

Trigger Type

Edge

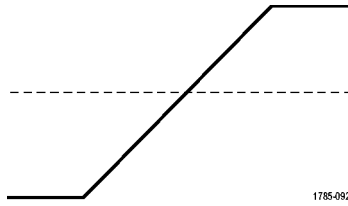

Trigger Conditions

Trigger on a rising or falling edge, as defined by the slope control. Coupling choices are DC, LF Reject, HF Reject, and Noise Reject.

Edge triggers are the simplest and most commonly used trigger type, with both analog and digital signals. An edge trigger event occurs when the trigger source passes through a specified voltage level in the specified direction.

Sequence
(B Trigger)

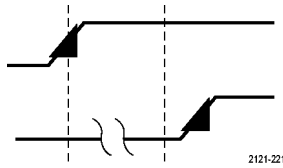

Combine an edge A Event (Main) trigger with the B Event (Delayed) trigger to capture more complex signals. (See page 91, *Using Sequence Trigger (A (Main) and B (Delayed))*.)

Time. After the A Event occurs, the trigger system waits the specified amount of time, and then looks for the B Event before triggering and displaying the waveform.

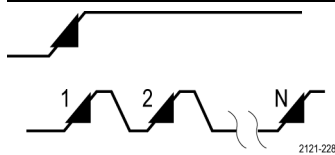

Events. After the A Event occurs, the trigger system looks for a specified number of B Events before triggering and displaying the waveform.

Pulse Width

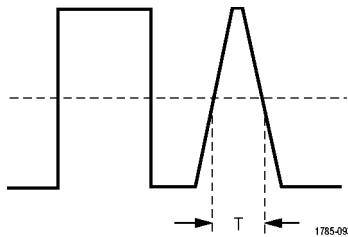

Trigger on pulses that are less than, greater than, equal to, or not equal to a specified time. Additionally, you can trigger when a pulse width is within or outside a range of two different specified times. You can trigger on positive or negative pulses. Pulse width triggers are primarily used on digital signals.

Timeout

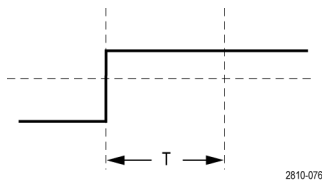

Trigger when no pulse is detected within a specified time. The signal stays above or below (or either above or below) a set value for a set amount of time.

Runt

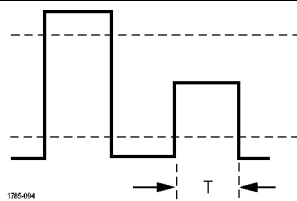

Trigger on a pulse amplitude that crosses one threshold but fails to cross a second threshold before recrossing the first. You can detect positive or negative (or either) runts, or only those wider than, less than, greater than, equal to, or not equal to a specified width. Runt triggers are primarily used on digital signals.

Trigger Type

Logic

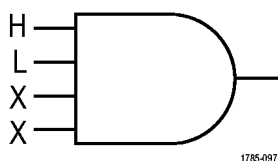

Trigger Conditions

Trigger when all channels transition to the specified state. Use multipurpose knob **a** to select a channel. Push the appropriate button on the side menu to set that channel's state to **High (H)**, **Low (L)**, or **Don't Care (X)**.

Push **Clock** on the side menu to enable clocked (state) triggering. You can have at most a single clock channel. Push **Clock Edge** on the lower menu to change the polarity of the clock edge. Turn off clocked triggering and return to unclocked (pattern) triggering by selecting the clock channel and setting it to high, low, or don't care.

For unclocked triggering, by default, triggering occurs when the selected condition goes true. You can also select triggering when the condition goes false, or time-qualified triggering.

You can use up to 21 channels for a Logic trigger (4 analog, 16 digital, and 1 RF).

NOTE. To use the RF input in a Logic trigger, you must first install the MDO4TRIG application module.

NOTE. Optimum Logic trigger performance is achieved by using only analog channels or only digital channels.

Setup and Hold

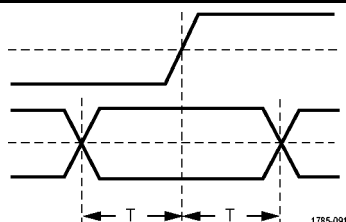

Trigger when a logic data input changes state inside of the setup or hold time relative to a clock edge.

Setup is the amount of time that data should be stable and not change before a clock edge occurs. Hold is the time that data should be stable and not change after a clock edge occurs.

MDO4000 Series oscilloscopes are capable of multiple channel Setup and Hold triggering, and can monitor the state of an entire bus for setup and hold violations. You can use up to 20 channels for a Setup and Hold trigger (4 analog and 16 digital).

Push **Clock** on the side menu to select the clock channel. Push the **Select** control, **Data**, and **Not used** buttons to select one or more channels you want to monitor for setup and hold violations.

NOTE. Optimum Setup and Hold trigger performance is achieved by using only analog channels or only digital channels.

Rise/Fall Time

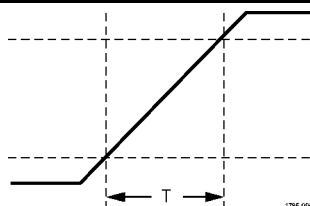

Trigger on rise and fall times. Trigger on pulse edges that traverse between two thresholds at faster or slower rates than the specified time. Specify pulse edges as positive or negative or either.

Trigger Type

Video

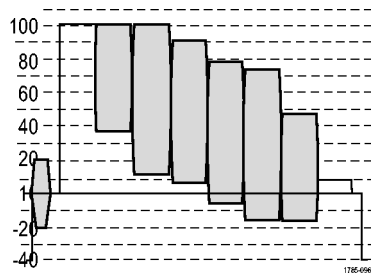

Trigger Conditions

Trigger on specified fields or lines of a composite video signal. Only composite signal formats are supported. Trigger on NTSC, PAL, or SECAM. Works with Macrovision signals. With the DPO4VID module, trigger on a variety of HDTV video standard signals, as well as custom (non-standard) bilevel and trilevel video signals with 3 to 4,000 lines.

Bus

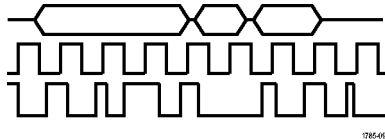

Trigger on various bus conditions. I²C requires a DPO4EMBD module. SPI requires a DPO4EMBD module. CAN requires a DPO4AUTO or DPO4AUTOMAX module. RS-232, RS-422, RS-485, and UART require a DPO4COMP module. LIN requires either a DPO4AUTO or a DPO4AUTOMAX module. FlexRay requires a DPO4AUTOMAX module. Audio requires a DPO4AUDIO module. USB requires a DPO4USB module. Ethernet requires a DPO4ENET module. MIL-STD-1553 requires a DPO4AERO module. (See page 16, *Application Module Free Trial*.)

Triggering on Buses

You can use your oscilloscope to trigger on multiple data buses, if you have the appropriate application module installed. The MDO4000 Series can trigger on parallel buses without an application module. The oscilloscope can display both the physical layer (as analog waveforms) and the protocol level information (as digital and symbolic waveforms).

To set up the bus trigger:

1. If you have not already defined your bus using the front panel **B1**, **B2**, **B3**, or **B4** buttons, do so now. (See page 60, *Setting Up a Serial or Parallel Bus*.)

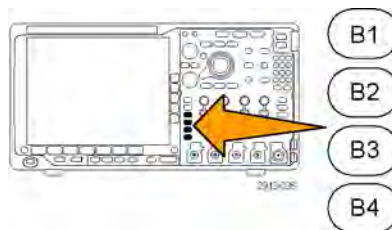

2. Push Trigger **Menu**.

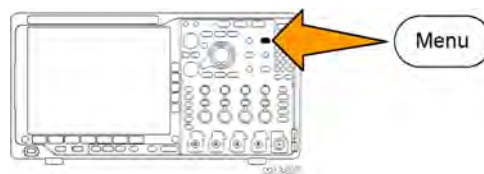

3. Push **Type**.

Type Bus	Source Bus B1 (I2C)	Trigger On Address	Address 07F		Direction Write	Mode Auto & Holdoff
--------------------	-------------------------------	------------------------------	-----------------------	--	---------------------------	-----------------------------------

4. Turn multipurpose knob **a** to scroll through the trigger type side menu until you select **Bus**.



5. Push **Source Bus** and use the Source Bus side menu to select the bus that you want to trigger on.
6. Push **Trigger On** and select the desired trigger on feature from the side menu.

Parallel Bus Trigger

You can trigger on a binary or hex data value. Push **Data** on the lower menu and enter the parameters of interest with multipurpose knobs **a** and **b**.

I2C Bus Trigger

You can trigger on **Start**, **Repeated Start**, **Stop**, **Missing Ack**, **Address**, **Data**, or **Address/Data**.

If you are setting up an I2C trigger and have made a **Trigger On** selection of **Address** or **Address/Data**, push **Address** on the lower menu to access the I2C Address side menu.

Push **Addressing Mode** on the side menu and select **7 bit** or **10 bit**. Push **Address** on the side menu. Enter the address parameters of interest with multipurpose knobs **a** and **b**.

Then push **Direction** on the lower menu and select the direction of interest: **Read**, **Write**, or **Read or Write**.

If you have made a **Trigger On** selection of **Data** or **Address/Data**, push **Data** on the lower menu to access the I2C Data side menu.

Push **Number of Bytes** and enter the number of bytes with multipurpose knob **a**.

Push **Addressing Mode** on the side menu and select **7-bit** or **10-bit**. Push **Data** on the side menu. Enter the data parameters of interest with multipurpose knobs **a** and **b**.

For more information on the I2C address formats, refer to item 2 under *Setting Up Bus Parameters*.

SPI Bus Trigger

You can trigger on **SS Active**, **MOSI**, **MISO**, or **MOSI & MISO**.

If you are setting up an SPI trigger and have made a **Trigger On** selection of **MOSI** or **MISO**, push **Data** on the lower menu, push **MOSI** or **MISO** on the side menu, and enter the data parameters of interest using multipurpose knobs **a** and **b**.

Then push **Number of Bytes** and enter the number of bytes with multipurpose knob **a**.

If you select **MOSI & MISO**, push **Data** on the lower menu and enter the parameters of interest in the side menus.

RS-232 Bus Trigger

You can trigger on **Tx Start Bit**, **Rx Start Bit**, **Tx End of Packet**, **Rx End of Packet**, **Tx Data**, or **Rx Data**.

If you are setting up an RS-232 trigger and have made a **Trigger On** selection of **Tx Data** or **Rx Data**, push **Data** on the lower menu.

Push **Number of Bytes** and enter the number of bytes with multipurpose knob **a**.

Push **Data** on the side menu, and enter the parameters of interest with multipurpose knobs **a** and **b**.

CAN Bus Trigger

You can trigger on **Start of Frame**, **Type of Frame**, **Identifier**, **Data**, **Id & Data**, **End of Frame**, and **Missing Ack**.

If you are setting up a CAN trigger and have made a **Trigger On** selection of **Type of Frame**, push **Frame Type** on the lower menu, and select **Data Frame**, **Remote Frame**, **Error Frame**, or **Overload Frame**.

If you have made a **Trigger On** selection of **Identifier**, push **Identifier** on the lower menu and select a **Format**. Then push **Identifier** on the side menu, and enter a binary or hex value with multipurpose knobs **a** and **b**.

Push **Direction** on the lower menu and select the direction of interest: **Read**, **Write**, or **Read or Write**.

If you have made a **Trigger On** selection of **Data**, push **Data** on the lower menu and enter the parameters of interest.

LIN Bus Trigger

You can trigger on **Sync**, **Identifier**, **Data**, **Id & Data**, **Wakeup Frame**, **Sleep Frame**, or **Error**.

If you are setting up an LIN trigger and have made a **Trigger On** selection of **Identifier**, **Data**, or **Identifier & Data**, push **Identifier** or **Data** on the lower menu and enter the parameters of interest on the resulting side menu.

If you have made a **Trigger On** selection of **Error**, push **Error Type** on the lower menu and enter the parameters of interest on the side menu.

FlexRay Bus Trigger

You can trigger on **Start of Frame**, **Type of Frame**, **Identifier**, **Cycle Count**, **Header Fields**, **Data**, **Id & Data**, **End of Frame** or **Error**.

Audio Bus Trigger

If you are using an **I2C**, Left Justified (**LJ**), or Right Justified (**RJ**) audio bus, you can trigger on **Word Select** or **Data**.

If you are using an **TDM** audio bus, you can trigger on **Frame Sync** or **Data**.

USB Bus Trigger

You can trigger on **Sync**, **Reset**, **Suspend**, **Resume**, **End of Packet**, **Token (Address) Packet**, **Data Packet**, **Handshake Packet**, **Special Packet**, or **Error**.

NOTE. For triggering on a high speed USB bus (480 MB/s), use an oscilloscope with 350 MHz or higher bandwidth.

Ethernet Bus Trigger

You can trigger on **Start Frame Delimiter**, **MAC Addresses**, **MAC Length/Type**, **TCP/IPv4 Client Data**, **End of Packet**, **Idle**, or an **FCS (CRC) Error**. If you turn on **Q-(VLAN) Tagging**, you can also trigger on **MAC Q-Tag Control Information**.

MIL-STD-1553 Bus Trigger

You can trigger on **Sync**, **Command**, **Status**, **Data**, **Time (RT/IMG)**, or **Error**.

If you are setting up a MIL-STD-1553 trigger and have made a **Trigger On** selection of **Command**, push **RT Address** on the lower menu to enter specific values of **RT Address** to trigger on. Push **Command Word Details** on the lower menu to enter the **T/R bit** value, **Subaddress/Mode** value, **Word Count/Mode Code** value, and **Parity** value.

If you are setting up a MIL-STD-1553 trigger and have made a **Trigger On** selection of **Status**, push **RT-Address** on the lower menu to enter specific values of **RT Address** to trigger on. Push **Status Word Bits** on the lower menu to enter values for **Message Error (bit 9)**, **Instr. (bit 10)**, **Service Req. (bit 11)**, **BCR (bit 15)**, **Busy (bit 16)**, **Subsystem Flag (bit 17)**, **DBCA (bit 18)**, **Terminal Flag (bit 19)** and **Parity**.

If you are setting up a MIL-STD-1553 trigger and have made a **Trigger On** selection of **Data**, push **Data** on the lower menu to enter specific **Data** values, and the **Parity** value.

If you are setting up a MIL-STD-1553 trigger and have made a **Trigger On** selection of **Time (RT/IMG)**, push **Trigger When** on the lower menu to set the trigger condition. Push **Times** on the lower menu to set the **Maximum** and **Minimum** times.

If you are setting up a MIL-STD-1553 trigger and have made a **Trigger On** selection of **Error**, push **Error Type** on the lower menu to select the type of error to trigger on.

I²C, SPI, USB, Ethernet, CAN, LIN, and FlexRay Bus Trigger Data Matching

Rolling window byte matching for I²C, SPI, USB, and FlexRay. To use a rolling window to trigger on data, you define the number of bytes to match. Then the oscilloscope uses a rolling window to find any match within a packet, with the window rolling one byte at a time.

For example, if the number of bytes is one, the oscilloscope will attempt to match the first byte, second byte, third, and so on within the packet.

If the number of bytes is two, the oscilloscope will try to match any two consecutive bytes, such as one and two, two and three, three and four, and so on. If the oscilloscope finds a match, it will trigger.

With FlexRay, USB, or Ethernet, obtain a rolling window match by setting the **Byte Offset** in the Data menu to **Don't care**.

Specific byte matching (non-rolling window matching for a specific position in the packet) for I²C, SPI, USB, CAN, and FlexRay.

You can trigger on a specific byte for I²C, SPI, CAN, and FlexRay in several ways:

- For I²C and SPI, enter the number of bytes to match the number of bytes in the signal. Then use don't cares (X) to mask the bytes that you are not interested in.
- For I²C, push **Trigger On** on the lower menu to trigger on **Address/Data**. Push **Address**. On the side menu, push **Address**, and rotate multipurpose knobs **a** and **b** as needed. Set the address to don't cares (X) if you want to mask the address. The data will be matched starting at the first byte without using a rolling window.
- For USB, triggering occurs when the user-selected data input matches the data and qualifier in the signal starting at the byte offset. Set the number of bytes to match the number of bytes of interest. Use the data qualifier to perform: =, !=, <, >, >=, and <= operations.
- For CAN, triggering occurs when the user-selected data input matches the data and qualifier in the signal starting at the first byte. Set the number of bytes to match the number of bytes of interest. Use the data qualifier to perform: =, !=, <, >, >=, and <= operations. Triggering on identifier and data always matches the identifier and data selected by the user, with the data starting at the first byte. No rolling window is used.
- For FlexRay and Ethernet, triggering occurs when the user-selected data input matches the data and qualifier in the signal starting at the byte offset. Set the number of bytes to match the number of bytes of interest. Use the data qualifier to perform: =, !=, <, >, >=, and <= operations. Triggering on identifier and data always matches the identifier and data selected by the user, with the data starting at the first byte. No rolling window is used.

Data Value Matching

You can trigger on a specific data value for RS-232 bytes. If you defined an end-of-packet character to use for RS-232 bus decoding, you can use the same end-of-packet character as a data value for trigger data matching. To do so, choose the Tx End of Packet or the Rx End of Packet character as the Trigger On selection.

You can also trigger on a specific data value for other buses.

Parallel Bus Trigger Data Matching

Optimum parallel bus trigger performance is achieved by using only analog channels or only digital channels.

Checking Trigger Settings

To quickly determine the settings of some key trigger parameters, check the Trigger readout at the bottom of the display. The readouts differ for edge and the advanced triggers.

1. Trigger source = channel 1.
2. Trigger slope = rising.
3. Trigger level = 0.00 V.

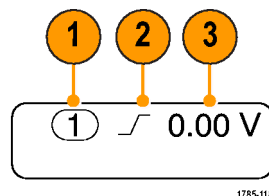

Edge trigger readout

Using Sequence Trigger (A (Main) and B (Delayed))

Combine an edge A Event (Main) trigger with the B Event (Delayed) trigger to capture more complex signals. After the A Event occurs, the trigger system looks for the B Event before triggering and displaying the waveform.

A and B triggers can (and typically do) have separate sources.

Use the Edge trigger menu to set up the A trigger first. Then, to use the B trigger:

1. Push Trigger **Menu**.

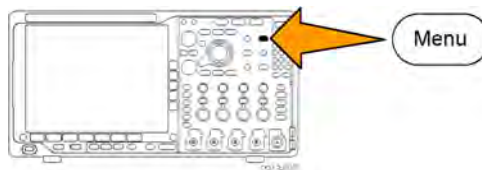

2. Push **Type**.
3. Turn multipurpose knob **a** to select a trigger type of **Sequence (B Trigger)**.
This brings up the Sequence (B Trigger) menu.

4. Push **B Trigger After A**.

Type	Source	Coupling	Slope	Level	B Trigger After A	Mode
Sequence (B Trigger)	1	DC		0.00 V	Time	Auto & Holdoff



Select the method for sequencing the B trigger after the A by pushing a side menu button.

Time (a) 8 ns
B Events 1
Set to Minimum

5. Set the other Sequence Trigger parameters in the related side and lower menus.

B Trigger After Delay Time

The A trigger arms the instrument. Posttrigger acquisition starts on the first B edge after the trigger delay time.

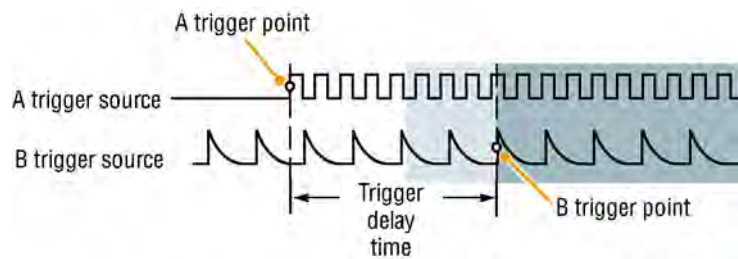

Trigger on B Events

The A trigger arms the instrument. Posttrigger acquisition starts on the nth B event.

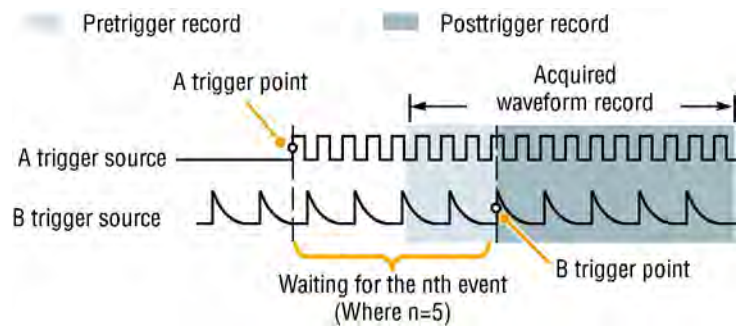

Quick Tips

- B-trigger delay time and horizontal position are independent functions. When you establish a trigger condition using either the A trigger alone or the A and B triggers together, you can also use the horizontal position control to delay the acquisition by an additional amount.
- When using the B trigger, the A and B trigger types can only be Edge.

Starting and Stopping an Acquisition

After you have defined the acquisition and trigger parameters, start the acquisition with **Run/Stop** or **Single**.

- Push **Run/Stop** to start acquisitions. The oscilloscope acquires repeatedly until you push the button again to stop the acquisition.
- Push **Single** to take a single acquisition. Single sets the trigger mode to **Normal** for the single acquisition.
- If any RF trace and any other analog or digital waveform are active, then pressing **Run/Stop** to stop acquisitions will cause the oscilloscope to wait for one more trigger event before stopping. While waiting for the trigger event, the **Run/Stop** button will turn yellow and the **Single** button will turn green. Once the acquisition occurs, the **Run/Stop** button will turn red and the **Single** button will become unlit.

If the Trigger Mode is set to Auto and another trigger event does not occur within the Auto trigger timeout period then an acquisition will be made and the instrument will stop.

If the Trigger mode is set to Normal, the oscilloscope will continue waiting for a trigger event to occur as long as necessary

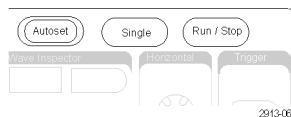

Triggering on the RF Input

Overview

With the MDO4000, a single event triggers all of the analog, digital, and RF acquisitions, regardless of whether that event came from an analog, digital, or RF input.

The MDO4000 allows you to trigger at the precise time that a frequency domain event of interest occurs. This is because the triggered acquisition system is fully integrated with both the RF and the time domain channels. A single trigger event coordinates the acquisitions from both the time and frequency domains.

What's more, the MDO4000 allows you to trigger on a change in the power envelope of the RF input. The RF power being triggered on is the total power acquired within the band, not just the current span.

NOTE. The MDO4000 acquisition system uses one of three frequency bands to acquire RF data depending on where you set Center Frequency and Span. The bands are: 50 kHz to 3.75 GHz, 2.75 GHz to 4.5 GHz, and 3.5 GHz to 6.0 GHz.

The MDO4000 Series provides RF Power as a source for Edge triggering. This enables your oscilloscope to trigger as the RF power envelope passes through a specific power level. To do this, set the oscilloscope to trigger on a rising edge in order to trigger on events where the RF turns on. Conversely, set it to trigger on a falling edge in order to trigger on events where the RF turns off.

With the MDO4TRIG application module installed, the MD4000 also provides RF Power as a source for Pulse Width, Timeout, Runt, Logic, and Sequence triggers.

Limitations

By understanding how the RF Power trigger works and its limitations, you can use it appropriately.

The RF Power trigger drives one input of a comparator with an RF logarithmic power detector. The trigger level provides the reference to the other comparator input in dBm. Since neither the output of the power detector nor of the comparator can be directly observed, it is important to recognize how this trigger works. For example, a continuous or swept sine wave will cause the power detector to output a DC voltage proportional to the sine wave power. Since there is no change in the power level, the RF Power trigger does not provide a trigger. To get a trigger, there must be a change in the detected power level. A signal such as a burst or amplitude modulated sine wave will cause the power detector to produce a varying output that can be edge triggered.

The RF power detector is relatively slow compared to an analog channel trigger. The power detector can take up to 2 μ s to respond to changes in the RF power level. In the plot at the right, the RF channel is driven with a 100 MHz sine wave with a 500 cycle burst, for a burst duration of 5 μ s. As a result, the RF power threshold will impact the amount of trigger delay and the apparent width of the pulse. For example, when the trigger level is at -10 dBm, the amount of delay will be approximately 500 ns. The pulse width will also appear to be only 4.5 μ s, even though the input burst length is 5 μ s.

RF Power Detector Response to 100 MHz 500 Cycle Sine Wave Burst

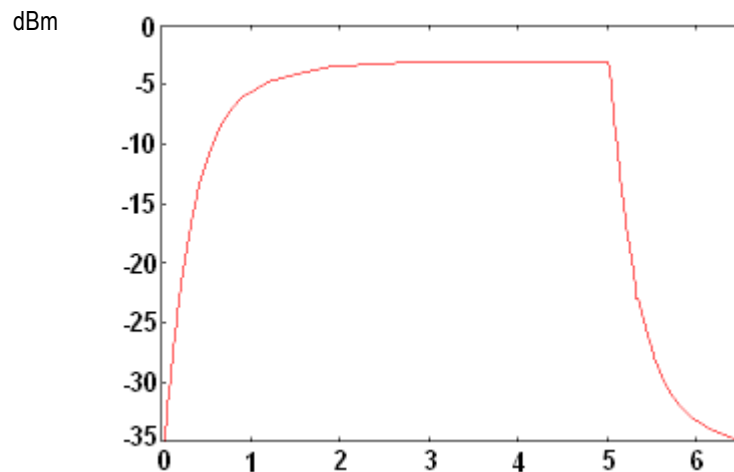

In the figure to the right, with a -35 dBm trigger level, there is minimal delay between the start of the burst and the trigger. The RF amplitude versus time trace shown in the time domain graticule illustrates the profile of this RF burst.

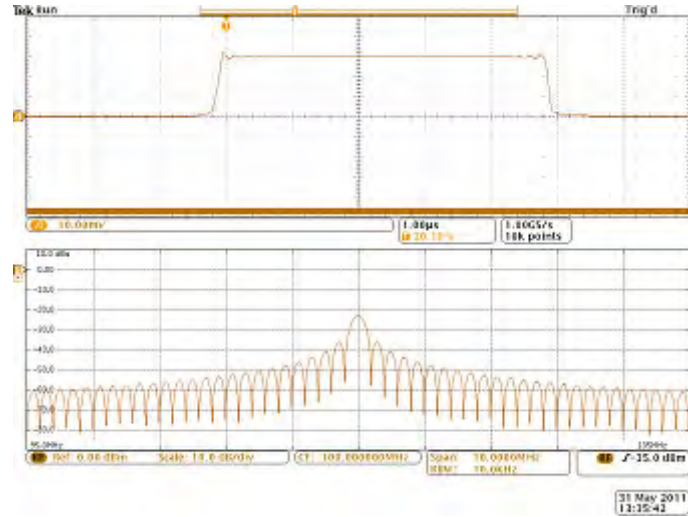

In the figure to the right, the edge trigger power level is now raised to -10 dBm. The trigger indication is now delayed approximately 500 ns from the start of the burst. This is due to the power detector response discussed previously.

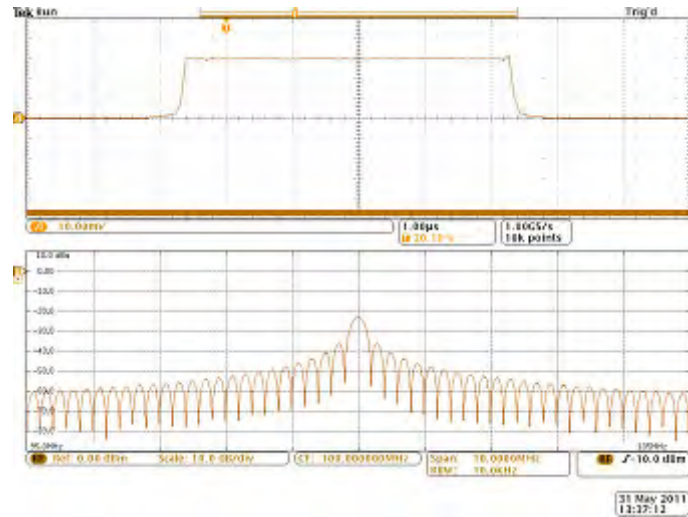

Display Waveform or Trace Data

This section contains concepts and procedures for displaying the acquired waveform or trace.

Adding and Removing a Waveform

1. To add or remove a waveform from the display, push the corresponding front panel channel button or the D15-D0 button.

You can use the channel as a trigger source whether or not it is displayed.

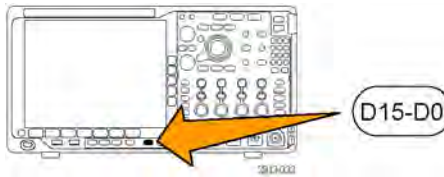
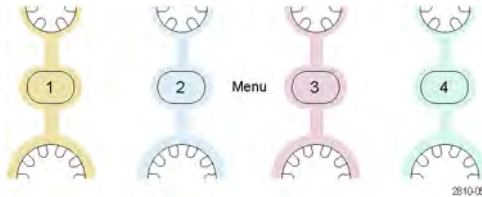

Setting the Display Style and Persistence

1. To set the display style, push **Acquire**.



2. Push **Waveform Display**.

Mode Sample	Record Length 10k	Delay On Off	Set Horiz. Position to 10%	Waveform Display	XY Display On	
-----------------------	-----------------------------	------------------------	-------------------------------	------------------	-------------------------	--



3. Push **Dots Only On Off** on the side menu. Dots on will display the waveform record points as dots on the screen. Dots off connects the dots with vectors.
4. Push **Persistence to Off** to display the display persistence.
5. Push **Persist Time**, and turn multipurpose knob **a** to have waveform data remain on screen for a user-specified amount of time.
6. Push **Set to Auto** to have the oscilloscope automatically determine a persistence time for you.
7. Push **Clear Persistence** to reset the persistence information.

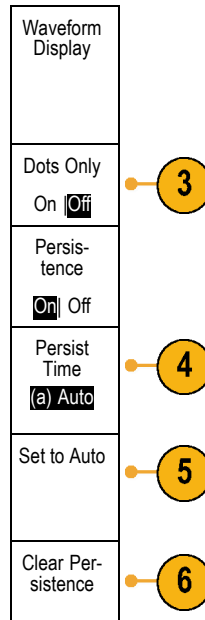

8. To display the amplitude from one waveform against the amplitude from another, push **XY Display**. Then push **Triggered XY** from the side menu.

A data point from the first waveform specifies the horizontal location while the corresponding data point from the second waveform specifies the vertical location for each displayed point.

Quick Tips

- Variable persistence accumulates record points for a specified time interval. Each record point decays independently according to the time interval. Use variable persistence for displaying infrequently appearing signal anomalies, such as glitches.
- Infinite persistence continuously accumulates record points until you change one of the acquisition display settings. Use infinite persistence for displaying unique signal anomalies, such as glitches.
- The XY Display mode graphs the data in fixed pairs of waveforms against one another.
- When the XY Display is on, an upper window appears that displays data versus time.

Setting the Graticule Style

1. To set the graticule style, push **Utility**.

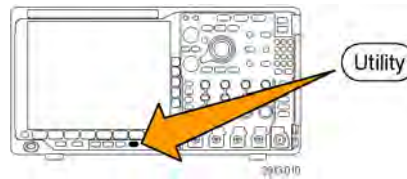

2. Push **Utility Page**.



3. Turn multipurpose knob **a** and select **Display**.



4. Push **Graticule** on the lower menu.

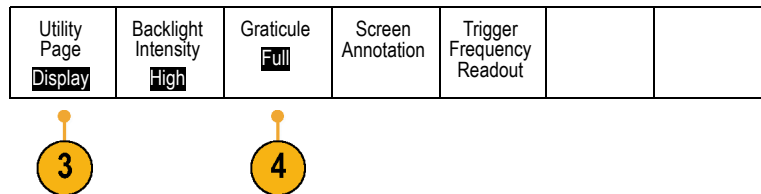

5. Select the desired style on the side menu.

The **Frame** graticule provides a clean screen on which you can most easily read automatic measurement results and other screen text.

The **Full** graticule can help you make cursor measurements on hard copies.

The **Grid**, **Solid**, and **Cross Hair** graticules provide compromises between **Frame** and **Full**.

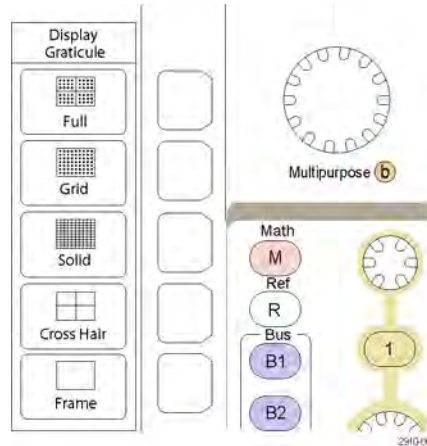

Quick Tips

- You can display IRE and mV graticules. To do this, set the trigger type to video and set the vertical scale to 114 mV/division. (The 114 mV/division selection is available in the fine vertical scale settings for the channel when you set the trigger type to video.) The oscilloscope will automatically display the IRE graticule for NTSC signals, and the mV graticule for other video signals (PAL, SECAM, HDTV, and custom).

Setting the LCD Backlight

1. Push **Utility**.

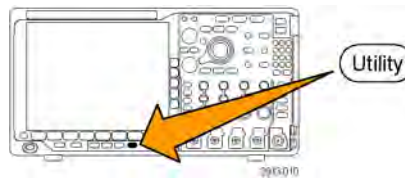

2. Push **Utility Page**.



3. Turn multipurpose knob **a** and select **Display**.



4. Push **Backlight Intensity**.

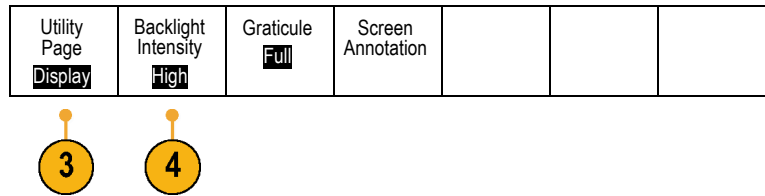

5. Select the intensity level on the side menu. Choices are: **High**, **Medium**, and **Low**.

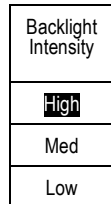

Setting Waveform Intensity

1. Push **Intensity** on the front panel.



This will bring up the intensity readout on the display.

- a Waveform Intensity: 35%
- b Graticule Intensity: 75%

2. Rotate multipurpose knob **a** to select the desired waveform intensity.

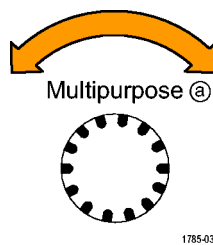

3. Rotate multipurpose knob **b** to select the desired intensity for the graticule.

4. Push **Intensity** again to clear the intensity readout from the display.

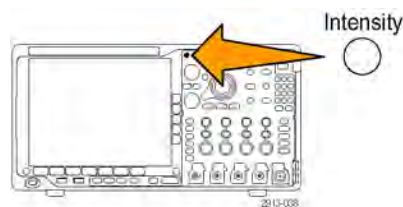

Scaling and Positioning a Waveform

Use the horizontal controls to adjust the time base, adjust the trigger point, and to examine waveform details more closely. You can also use the Wave Inspector Pan and Zoom controls to adjust the display of waveforms. (See page 144, *Using Wave Inspector to Manage Long Record Length Waveforms.*)

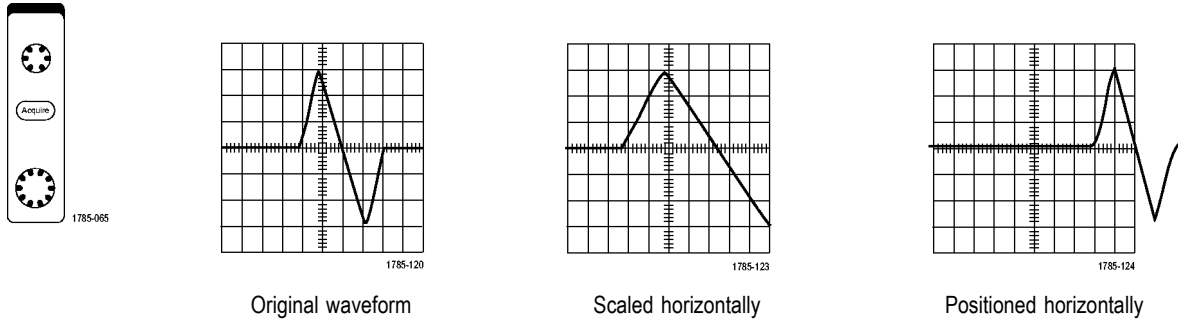

Use the vertical controls to select waveforms, adjust the waveform vertical position and scale, and set input parameters. Push a channel menu button (1, 2, 3, or 4), button as many times as needed and the associated menu items to select, add, or remove a waveform.

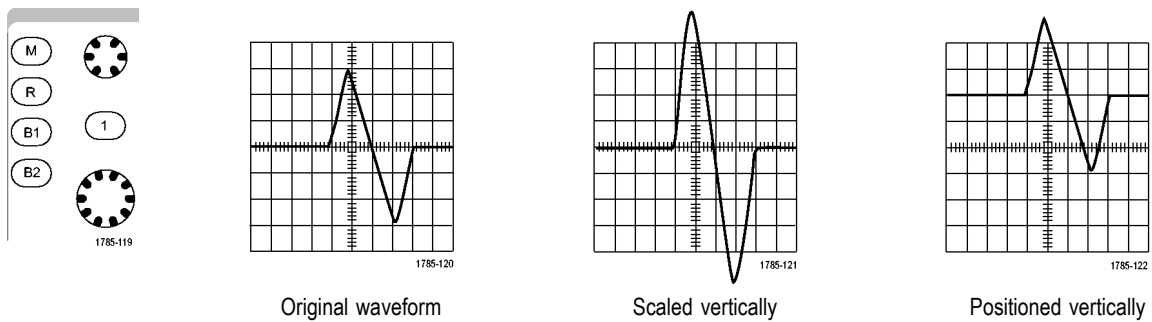

Quick Tips

- **Preview.** If you change the Position or Scale controls when the acquisition is stopped or when it is waiting for the next trigger, the oscilloscope rescales and repositions the relevant waveforms in response to the new control settings. It simulates what you will see when you next push the **RUN** button. The oscilloscope uses the new settings for the next acquisition.

You may see a clipped waveform if the original acquisition went off the screen.

The math waveform, cursors, and automatic measurements remain active and valid when using preview.

Setting Input Parameters

Use the vertical controls to select waveforms, adjust the waveform vertical position and scale, and set input parameters.

1. Push a channel menu button **1**, **2**, **3**, or **4** to bring up the vertical menu for the designated waveform. The vertical menu only affects the selected waveform.

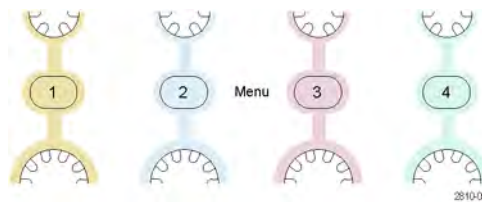

Pushing a channel button will also select or cancel that waveform selection.

2. Push **Coupling** repeatedly to select the coupling to use.

Use DC coupling to pass both AC and DC components.

Use AC coupling to block the DC component and show only the AC signal.

Coupling DC AC	Termination 1MΩ 50Ω	Invert On Off	Bandwidth Full	(1) Label		More
---------------------	--------------------------	--------------------	-------------------	-----------	--	------



3. Push **Termination** repeatedly to select the input impedance to use.

Set the input impedance (termination) to 50 Ω or 1 MΩ if using DC coupling. Input impedance is automatically set to 1 MΩ when using AC coupling.

For more information on input impedance, see **Quick Tips**. (See page 105, *Quick Tips*.)

4. Push **Invert** to invert the signal.

Select **Off** for normal operation and **On** to invert the polarity of the signal in the preamplifier.

5. Push **Bandwidth**, and select the desired bandwidth on the side menu.

The set choices are: Full, 250 MHz, and 20 MHz. Additional choices may appear, depending on the probe that you use.

Select **Full** to set the bandwidth to the full oscilloscope bandwidth.

Select **250 MHz** to set the bandwidth to 250 MHz.

Select **20 MHz** to set the bandwidth to 20 MHz.

NOTE. 100 MHz model oscilloscopes do not include a 250 MHz option on the menu.

6. Push **Label** to create a label for the channel. (See page 51, *Labeling Channels and Buses*.)
7. For some types of probes, you can push this button to instruct the oscilloscope to perform an AC calibration on the entire signal path from the probe tip to the specific oscilloscope channel. This can result in a flatter frequency response over the entire frequency range.
8. Push **More** to access additional side menus.

9. Select **Fine Scale** to enable multipurpose knob **a** to make fine vertical scale adjustments.

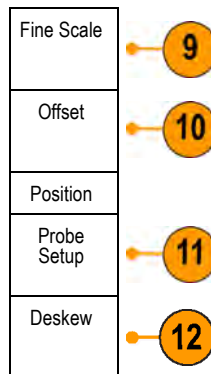

10. Select **Offset** to enable multipurpose knob **a** to make vertical offset adjustments.

Push **Set to 0 V** on the side menu to set the vertical offset to 0 V.

For more information on offset, see **Quick Tips**. (See page 105, *Quick Tips*.)

11. Select **Probe Setup** to define probe parameters.

On the side menu:

- Select **Voltage** or **Current** to set the probe type for probes that do not have a TekProbe Level 1, TekProbe II (requires a TPA-BNC adapter) or TekVPI interface.
- For probes that do not have a Tek interface, when **Probe Type** is set to **Voltage**, use multipurpose knob **a** to set **Attenuation** to match the probe
- For probes that do not have a Tek interface, when **Probe Type** is set to **Current**, use multipurpose knob **a** to set the Amps/Volts ratio (Attenuation) to match the probe.
- If you are measuring current by probing the voltage drop across a resistor, set **Measure Current** to **Yes**. Push **A/V** ratio on the side menu and turn multipurpose knob **a** to set the Amps/Volts or Volts/Amp ratio of your setup. For example, if you are measuring the drop across a $2\ \Omega$ resistor, set the V/A ratio to 2.

12. Select **Deskew** to make display and measurement adjustments for probes that have differing propagation delays. This is especially important when using a current probe in conjunction with a voltage probe.
For best results, use a deskew fixture, such as the Tektronix 067-1686-xx.

If you do not have a deskew fixture, you can use the controls in the Deskew menu to set the oscilloscope's deskew parameters to recommended values, based on the nominal propagation delay of each probe. The oscilloscope automatically loads the nominal propagation delay values of TekVPI and TekProbe II (requires use of a TPA-BNC adaptor) probes. For other common probes, first push **Select** on the side menu, and select the channel to which the probe is attached. Then push **Probe Model** on the side menu, and select the probe model. If your probe is not in the list, set probe model to **Other**, and push **Propagation Delay** on the side menu and dial in its propagation delay with multipurpose knob **a**.

To display the recommended deskew values calculated by the oscilloscope, set **Show rec. deskews** on the side menu to **Yes**.

To set the deskew values of each channel to the recommended values, push **Set all deskews to recommended values** on the side menu.

Quick Tips

- **Using Probes with the TekProbe II and TekVPI Interfaces.** When you attach a probe with the TekProbe II or the TekVPI interface, the oscilloscope sets the channel sensitivity, coupling, and termination resistance automatically to match the probe requirements. Tek Probe II probes require use of the TPA-BNC Adapter.
- **The Difference Between Vertical Position and Offset.** Adjust the vertical position to place the waveforms where you want to see them. The waveform baseline indicators indicate the zero Volts (or Amps) level for each waveform. If you adjust the channel's Vertical Scale, the waveform expands or contracts around the waveform's baseline indicator.

When you use the Channel<x> > **More** >**Offset** > **Vertical Offset** control to move a waveform, the baseline indicator no longer represents zero. Instead, it represents the level of the offset. If you adjust the channel's Vertical Scale, the waveform expands or contracts around the waveform's baseline indicator.

- **50 Ω Protection.** If you select 50 Ω termination, the maximum vertical scale factor is limited to 1 V/div, except that with a 10X probe the scale factor is 10 V. If you apply excessive input voltage, the oscilloscope automatically switches to 1 M Ω termination to protect the internal 50 Ω termination. For more details, refer to the specifications in the *MDO4000 Series Oscilloscopes Technical Reference*.

Positioning and Labeling Bus Signals

Positioning bus signals. Push the appropriate front panel bus button and turn multipurpose knob **a** to adjust the vertical position of the selected bus. (See page 60, *Setting Up a Serial or Parallel Bus.*)

1. Push the appropriate front panel bus button to select that bus.

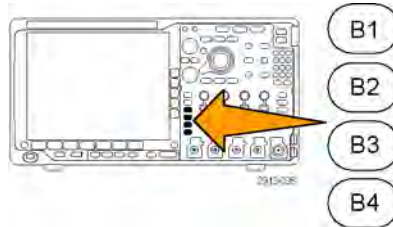

2. Turn multipurpose knob **a** to adjust the vertical position of the selected bus.

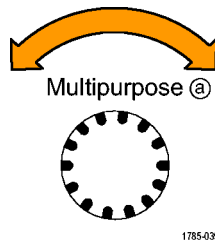

Labeling bus signals. To label a bus, do the following steps:

1. Push the appropriate front panel bus button.

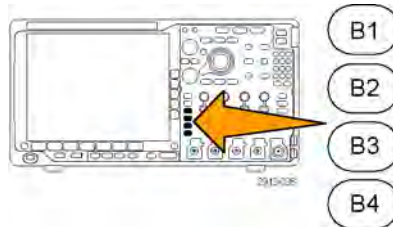

2. Push **Label**.
(See page 51, *Labeling Channels and Buses.*)

Bus (B1) Parallel	Define Inputs	Thresholds		(B1) Label Parallel	Bus Display	Event Table
----------------------	------------------	------------	--	------------------------	----------------	----------------



Positioning, Scaling, and Grouping Digital Channels

1. Push the front panel **D15-D0** button.

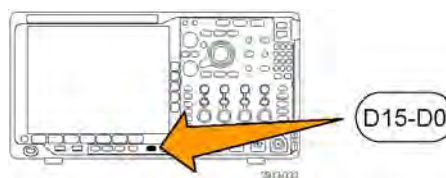

2. Push **D15–D0** on the lower menu.

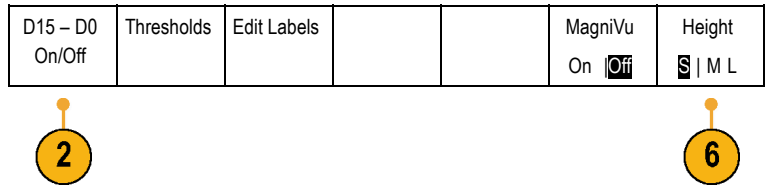

3. Push **Select** on the side menu.

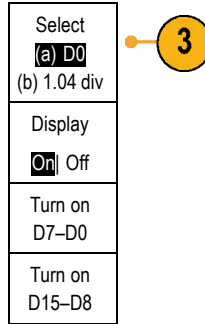

4. Turn multipurpose knob **a** to select the channel to move.

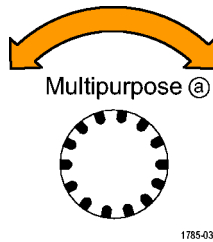

5. Turn multipurpose knob **b** to move the selected channel.

NOTE. The display of the channel (or group) only moves after you stop rotating the knob.

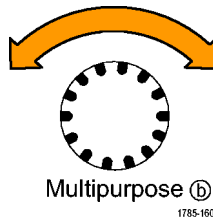

6. To change the scale (height) of the digital channels, push **Height** on the lower menu.

NOTE. The **S** (Small) selection will display each waveform at 0.2 divisions tall. The **M** (Medium) selection will display each waveform at 0.5 divisions tall. The **L** (Large) selection will display each waveform at 1 division tall. **L** only works if there is enough room in the display to display the waveforms. You can display up to 10 **L** waveforms at one time.

7. You can label individual digital channels for easier identification. (See page 51, *Labeling Channels and Buses*.)

- To group some or all of the digital channels together, move the channels right next to each other. All the channels that are next to each other automatically form a group.

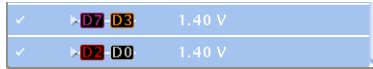

You can see the groups by pushing **Select** on the side menu and turning multipurpose knob **a**.

When a group is selected, turn multipurpose knob **b** to move the whole group.

Viewing Digital Channels

The various ways of displaying data from the digital channels help you analyze the signals. Digital channels store a high or low state for each sample.

Logic high levels are displayed in green. Logic low levels are displayed in blue. When a single transition occurs during the time represented by one pixel column, the transition (edge) is displayed in gray.

When multiple transitions occur during the time represented by one pixel column, the transition (edge) is displayed in white.

When the display shows a white edge, indicating multiple transitions, you may be able to zoom in and see the individual edges.

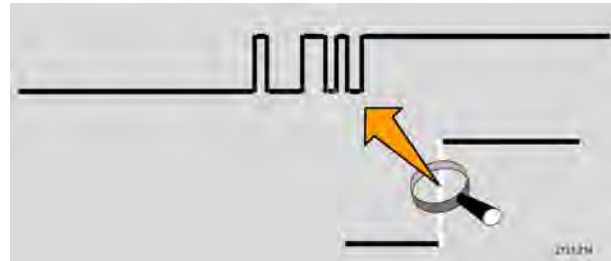

When you are zoomed in so far that there is more than one pixel column per sample, the uncertainty of the edge position is indicated by light gray shading.



NOTE. When the light gray shading is displayed, use *MagniVu*.

Annotating the Screen

You can add your own text to the screen by doing the following:

- Push **Utility**.

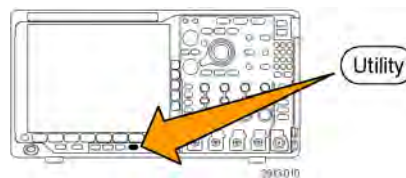

2. Push **Utility Page**.



3. Turn multipurpose knob **a** and select **Display**.

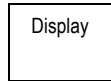

4. Push **Screen Annotation** on the resulting lower menu.

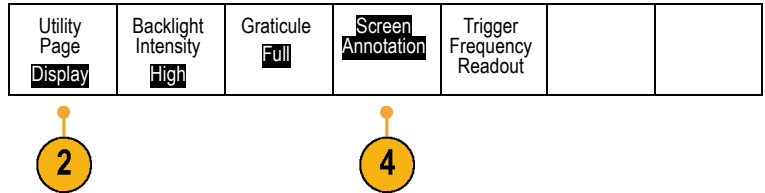

5. Push **Display Annotation** to select **On** on the side menu.
The annotation window now appears. Position it by turning multipurpose knobs **a** and **b**.
6. Push **Edit Annotation** on the side menu
7. Turn multipurpose knob **a** to scroll through the list of letters, numbers, and other characters to select each desired character.
Alternatively, use a USB keyboard to type in characters. (See page 33, *Connecting a USB Keyboard to Your Oscilloscope*.)

To reposition the annotated text, push **Position** on the side menu and turn multipurpose knobs **a** and **b**, as desired.

Viewing the Trigger Frequency

You can display a readout of trigger frequency. It counts all of the triggerable events, whether the oscilloscope triggered on them or not, and displays the number of times per second that they occur. To display this readout, do the following:

1. Push **Utility**.

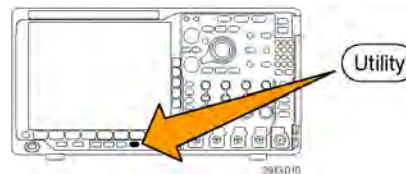

2. Push **Utility Page**.



3. Turn multipurpose knob **a** and select **Display**.



4. Push **Trigger Frequency Readout** from the resulting lower menu.

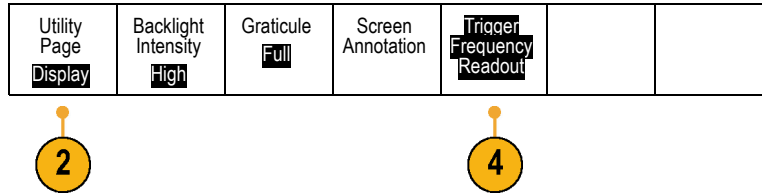

5. Push **On** on the side menu.

The trigger frequency now appears in the Trigger readout, toward the lower right of the display.

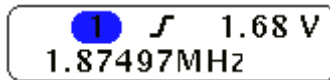

Displaying the Frequency Domain Menu

1. Push **RF** to bring up the frequency domain menu.

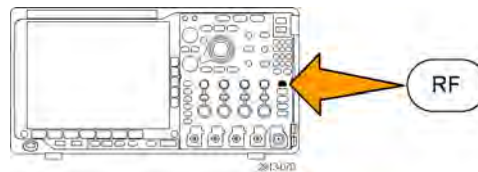

2. Push **Spectrum Traces** to bring up the side menu of four different spectrum trace types that the MDO4000 can display.

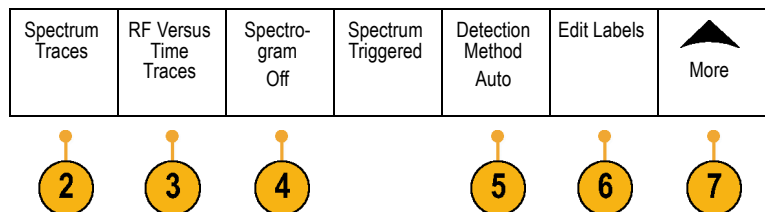

3. Push **RF Versus Time Traces** to bring up the side menu of three different RF versus time traces that the MDO4000 can display.
4. Push **Spectrogram** to bring up a side menu to enable and configure the spectrogram display.
5. Push **Detection Method** to bring up a side menu of ways to reduce the FFT output to the 1,000 pixel wide display.

6. Push **Edit Label** to label the RF and RF versus time traces.
7. Push **More** to choose between side menus to compensate the RF signal path or to configure the RF input probe.

Trace Types

The frequency domain window supports four spectrum traces. You may turn each of these traces on and off independently. You can display all or some of them simultaneously.

1. Push **Spectrum Traces** from the RF Menu to bring up the related side menu.

2. Set **Normal** to **On** to display the normal trace.
3. Set **Average** to **On** to display the average trace. Turn multipurpose knob **a** to set the number of waveforms to include in each average.
4. Set **Max Hold** to **On** to display the max hold trace.
5. Set **Min Hold** to **On** to display the min hold trace.

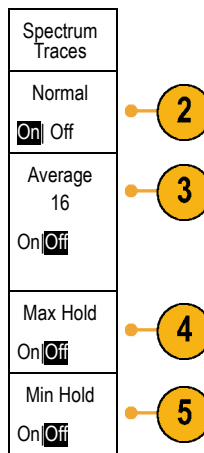

The figure to the right illustrates the different trace types.

1. Normal trace: Each acquisition is discarded as new data is acquired.
2. Max hold trace: The maximum data values are accumulated over multiple acquisitions of the Normal trace.
3. Min hold trace: The minimum data values are accumulated over multiple acquisitions of the Normal trace.
4. Average trace: Data from the Normal trace is averaged over multiple acquisitions. This is true power averaging, which occurs before the log conversion. Each power of 2 averaging reduces the displayed noise by 3 dB.

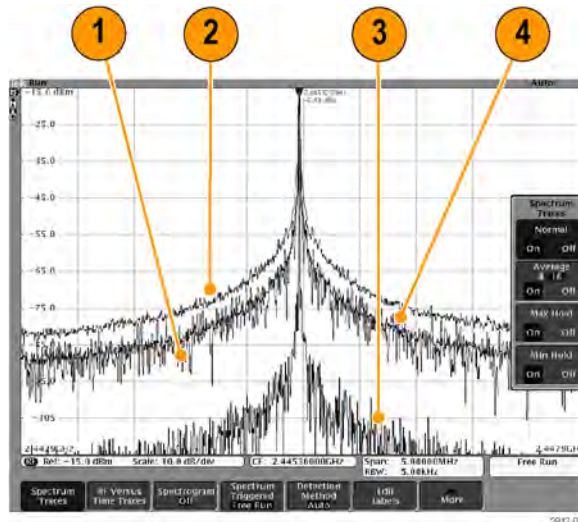

The figure to the right shows the frequency domain window's trace indicator.

1. An **RF** trace indicator is placed at the Reference Level.
2. A capital **M** appears if the maximum trace is turned on.
3. A capital **A** appears if the average trace is turned on.
4. A capital **N** appears if the normal trace is turned on.
5. The small **m** appears if the minimum trace is turned on.

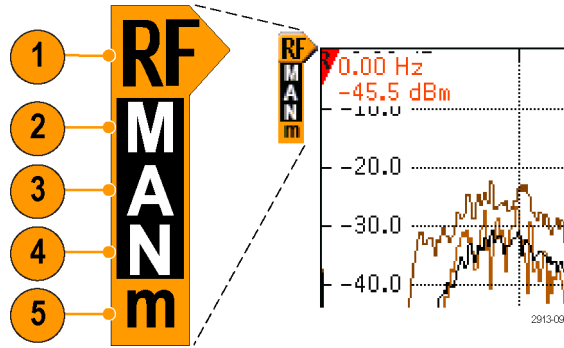

Orange highlighting indicates the currently selected trace. In the figure to the right, the small **m**, which stands for the minimum trace, is highlighted. This indicates that the minimum trace is currently selected.

Detection Types

The MDO4000 calculates FFTs with a 1,000 to ~2,000,000 point output, depending on the acquisition settings. It then reduces that FFT output into a 1,000 pixel-wide display. This means that approximately 1 to 2,000 FFT points get compressed into each pixel column. The MDO4000 gives you several choices as to how this compression is done. The choices are: +peak, sample, average, and -peak. The figure below illustrates how these detection methods work in a 5:1 compression, where five points are reduced to each pixel column.

1. FFT points

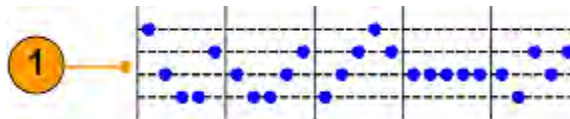

2. Decimation



3. +Peak: Uses the highest amplitude point in each interval.



4. Sample: Uses the first point in each interval.



- 5. Average: Averages all points in each interval.



- 6. -Peak: Uses the lowest amplitude point in each interval.



RF Time Domain Traces

The time domain window can also display three RF time domain traces, in addition to the usual analog and digital waveforms. You may turn each of these traces on or off independently, and display all or some of them simultaneously. To use these traces:

- 1. Push **RF Versus Time Traces** from the RF Menu to bring up the related side menu.

- 2. Set **Amplitude** to **On** to display the amplitude versus time trace.

- 3. Set **Frequency** to **On** to display the frequency versus time trace.

- 4. Set **Phase** to **On** to display the phase versus time trace.

- 5. Set **Freq/Phase Squelch** to **On** to use the squelch feature.

- 6. Push **Squelch Threshold** and rotate multipurpose knob **a** to set the threshold for the squelch feature.

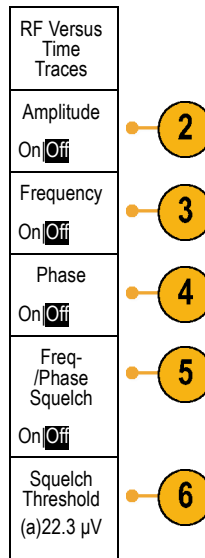

The trace options are:

The trace options are:

1. The Amplitude versus Time trace: The instantaneous amplitude of the input, after band-pass filtering, to the current frequency range, as defined by the center frequency and span settings.
2. The Frequency versus Time trace: The instantaneous frequency of the input, relative to the center frequency. The vertical axis displays frequency, relative to the center frequency.
3. The Phase versus Time trace: The instantaneous phase of the input, relative to the center frequency. The vertical axis is phase, with wrapping at roughly +/- 180°.

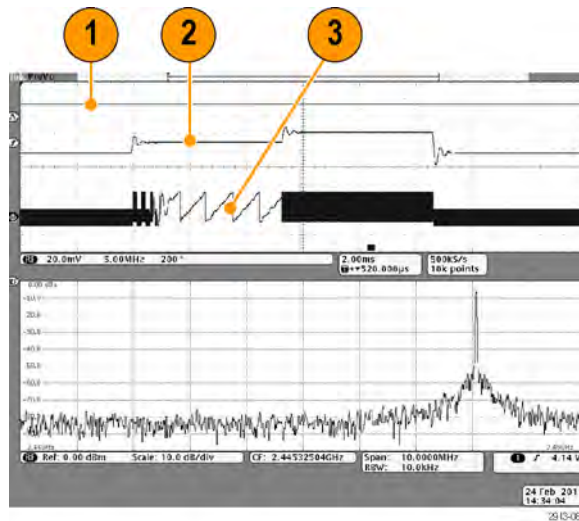

All of these traces are derived from the time-domain IQ data acquired for the RF channel. They are time correlated with other analog and digital channels and represent a continuous time domain data stream.

The frequency versus time waveform handle (baseline indicator) indicates the center frequency. When the trace is above the waveform handle, it is above the center frequency. When the trace is below the waveform handle, it is below the center frequency.

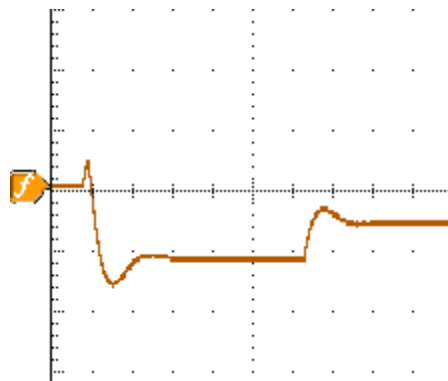

Use squelch to suppress (not display) the phase and frequency information when the amplitude of the RF input is below a user-specified value. This keeps both the frequency versus time and the phase versus time traces from displaying broad bands of noise when there is no signal present on the RF input.

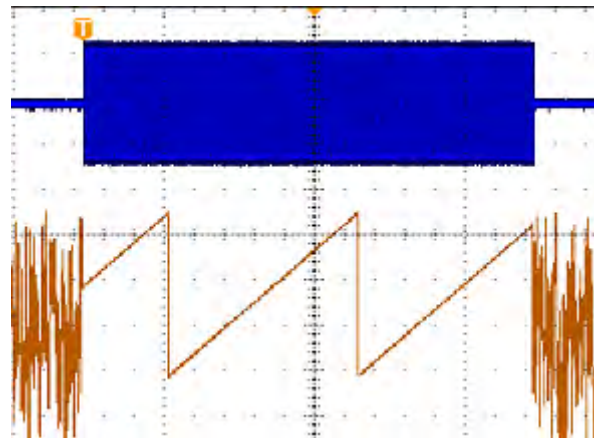

Squelch off

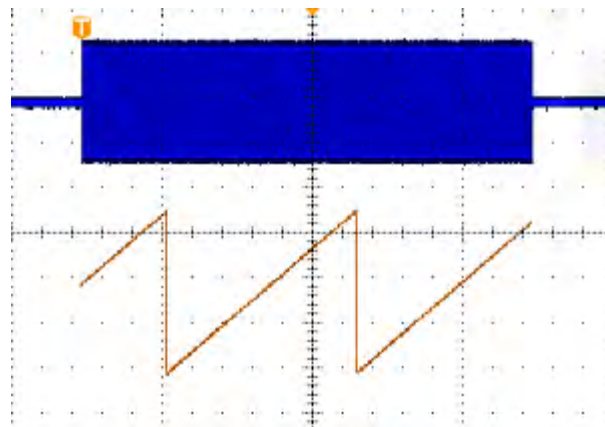

Squelch on

Spectrogram Display

The spectrogram display is particularly useful for monitoring slowly-changing RF phenomena. The x-axis represents frequency, just like the typical spectrum display. The y-axis represents time. Color indicates amplitude.

Spectrogram slices are generated by taking each spectrum and flipping it on its edge so that it is one pixel row tall, and then assigning colors to each pixel based on the amplitude at that frequency with the cold colors of blue and green representing low amplitude, and the hotter colors of yellow and red indicating higher amplitude. Each new acquisition adds another slice at the bottom of the spectrogram, and the history moves up one row.

When acquisitions are stopped, you can navigate through the history of the spectrogram by pressing the side menu slice control and turning multipurpose knob **a**. When acquisitions are stopped and the spectrogram is displayed, the spectrogram slice trace is displayed as the Normal spectrum trace.

To use the spectrogram feature, push **Spectrogram** from the RF Menu to bring up the related side menu.

1. Push **Display** to **On** to start the spectrogram.
2. To review each spectrum captured in the spectrogram, push **Run / Stop** to stop acquiring RF acquisitions. Rotate multipurpose knob **a**.

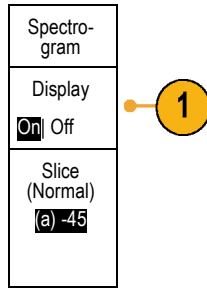

Spectrogram Triggered and Free Run

When the MDO4000 displays just the frequency domain (and not the time domain), you can choose whether the spectrum should be triggered using the trigger defined in the Trigger menu, or should be in a free run mode. When you select the free run mode, the MDO4000 acquires spectrums as fast as possible.

To use the spectrogram triggered and free run feature, push **Spectrom** from the RF Menu to toggle between **Triggered** and **Free Run**. Remember that this only works when the MDO4000 displays just the frequency domain (and not the time domain).

1. When the oscilloscope displays both the time and frequency domains, the spectrum shown is always triggered.



2. When only the frequency domain is displayed, you can select either trigger or free run mode. In free run mode, the oscilloscope acquires spectrums as fast as possible.

To display only the frequency domain, turn off all time domain waveforms, including channels 2 - 4, digital channels 0 - 15, buses, time domain math waveforms, time domain reference waveforms, and any RF versus time traces.

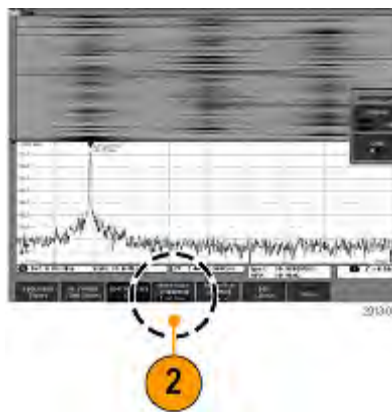

Analyze Waveform or Trace Data

After having properly set up the acquisition, triggering, and display of your desired waveform or trace, you can analyze the results. Select from features such as cursors, automatic measurements, statistics, waveform histograms, math, and FFT.

Using Markers in the Frequency Domain

1. Push **Markers**. This brings up the **Markers** side menu.

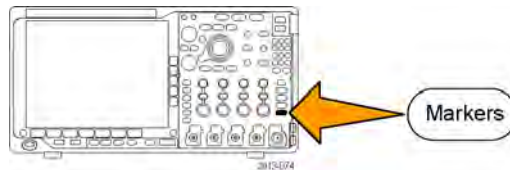

2. Push **Peak Markers** and turn multipurpose knob **a** to select how many peaks to label on the display.

NOTE. This is the maximum number of peaks that will be marked. If there are more peaks that meet the threshold and excursion criteria than the specified number of Peak Markers identified in this control, then only the specified number of highest amplitude peaks will be marked.

3. Push  **To Center** to set the center frequency to the frequency indicated by the Reference Marker. The Reference Marker is automatically placed on the highest amplitude peak.
4. Push **Threshold** and turn multipurpose knob **a** to define the threshold of the peak markers. Turn multipurpose knob **b** to define their excursion value.
5. Push **Manual Markers** to activate manual markers. Use manual markers to measure non-peak areas of interest in the spectrum.
6. Push **Readout** to choose between Absolute and Delta readouts. Delta readouts are relative to the Reference Marker.

Markers
Peak Markers (a) 5
<input checked="" type="checkbox"/> On <input type="checkbox"/> Off
 To Center
Threshold -50.0 dBm
Excursion 30.0 dB
Manual Markers On <input type="checkbox"/> Off <input checked="" type="checkbox"/>
Readout Absolute Delta

Automatic Peak Markers

Automatic peak markers are on by default and assist with quickly identifying the frequency and amplitude of peaks in the spectrum.

1. The Reference Marker is placed on the highest amplitude peak. It is marked with a red R in a triangle.
2. The automatic markers indicate frequency and amplitude.
3. Absolute readouts show the actual frequency and amplitude of the automatic markers.
4. Delta readouts show the frequency and amplitude of the automatic markers relative to the reference marker.

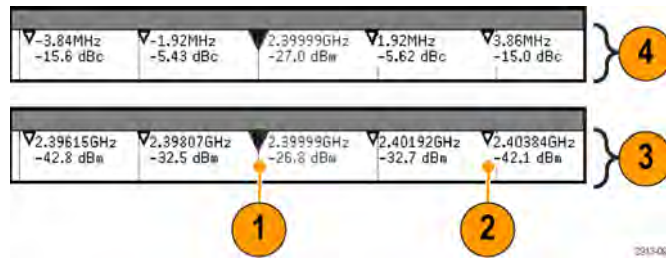

In the screen shot shown below, a marker has been placed on each of the obvious peaks in the display. The Reference Marker is the highest peak. It is marked with the red R in a triangle, and its readout is shown in red text.

1. Reference marker
2. Automatic markers

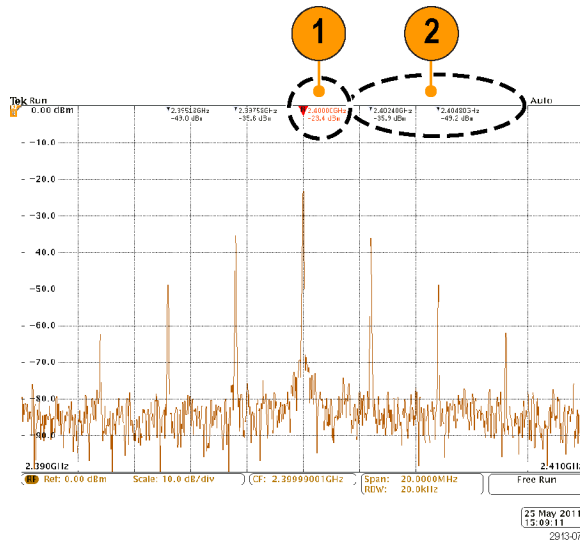

Use **Threshold** and **Excursion** to define which peaks are marked.

The threshold is a minimum amplitude that a signal must cross to be a valid peak. If the threshold is lower, more peaks will tend to qualify to have markers. If the threshold is higher, fewer peaks tend to qualify to have markers.

The excursion is how far a signal needs to fall in amplitude between marked peaks to be another valid peak. If the excursion is low, more peaks will tend to qualify to have associated markers. If the excursion is high, fewer peaks will tend to qualify to have associated markers.

Each automatic marker has a readout associated with it. These can be absolute or delta readouts. An absolute marker readout shows the actual frequency and amplitude of the associated marker. A delta marker readout shows the frequency and amplitude differences from the Reference Marker. The Reference Marker's readout indicates absolute frequency and amplitude, regardless of the readout type.

Manual Markers

Two manual markers are provided for you to measure non-peak areas of the spectrum and to measure Noise Density and Phase Noise. When the manual markers are turned on, the Reference Marker is no longer automatically attached to the highest amplitude peak. It is now assigned to multipurpose knob **a** and can be moved to any location you desire. This enables easy measurement of any part of the spectrum as well as delta measurements to any part of the spectrum. This also lets you measure non-peak spectral content of interest. The readouts for manual markers indicate frequency and amplitude, just like automatic marker readouts.

As with automatic peak marker readouts, the manual marker readouts can show either absolute or delta values.

1. One manual marker is controlled by multipurpose knob **a**.
2. The other manual marker is controlled by multipurpose knob **b**.

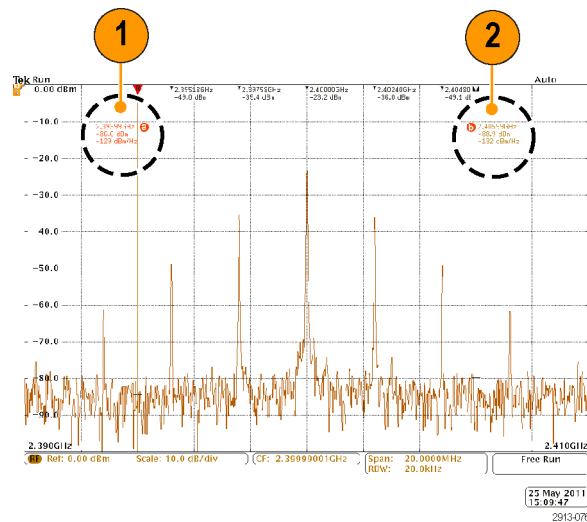

3. Delta readouts for frequency and amplitude are shown at the top of the display.
4. The third line of the manual marker **a** always shows the noise density (dBm/Hz).
5. The third line of manual marker **b** always shows noise density when you choose absolute markers. It shows phase noise when you choose delta markers (dBc/Hz).

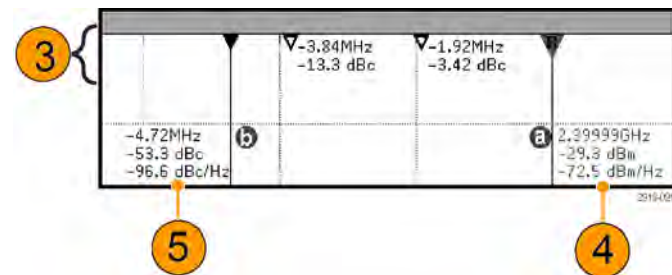

Taking Automatic Measurements in the Frequency Domain

To take an automatic measurement in the frequency domain:

1. Push **Measure**.



2. Push **Domain** to select **Frequency**.

Domain Time	Select Measure- ment					
Frequency	None					

3. Push **Select Measurement**.



4. Choose the measurement of interest from the side menu.

Channel power: The total power within the bandwidth, defined by the Channel Width.

Adjacent channel power ratio: The power in the main channel and the ratio of channel power to main power, for the upper and lower halves of each adjacent channel.

Occupied bandwidth: The bandwidth that contains the specified % of power within the analysis bandwidth.

Select Measure- ment
None
Channel Power
Adjacent Channel Power Ratio
Occupied Bandwidth

As you select each frequency measurement, on screen help will appear to explain the purpose of that measurement. A **Configure** item will appear on the lower menu. After you press **Configure** and set the measurement parameters in the resulting side menu, the oscilloscope will automatically set the span. When the RF measurements are on, the Auto detection method will set all frequency domain traces to the **Average** detection method. This provides optimal measurement accuracy.

Taking Automatic Measurements in the Time Domain

To take an automatic measurement in the time domain:

1. Push **Measure**.



2. Push **Domain** to select **Time** domain measurements.

Domain Time Frequency	Add Mea- surement	Remove Mea- surement	Indicators	Waveform His- tograms	 More	Bring Cursors on Screen
------------------------------------	----------------------	-------------------------	------------	-----------------------------	---	-------------------------------



3. Push **Add Measurement**.
4. Turn multipurpose knob **b** to select the specific measurement. If needed, then turn multipurpose knob **a** to select the channel to measure on.

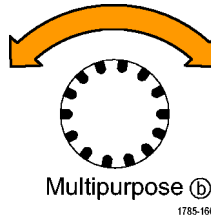

5. To remove a measurement, push **Remove Measurement**, turn multipurpose knob **a** to select the specific measurement, and push **OK Remove Measurement** on the side menu.







Quick Tips

- To remove all measurements, select **Remove All Measurements**.
- A  symbol appears instead of the expected numerical measurement if a vertical clipping condition exists. Part of the waveform is above or below the display. To obtain a proper numerical measurement, turn the vertical scale and position knobs to make all of the waveform appear in the display.
- If the oscilloscope displays a **Low Resolution** message, increase the record length of the acquisition so that the oscilloscope has more points from which to calculate the measurement.

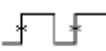
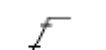
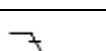
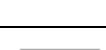
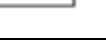
Selecting Automatic Measurements in the Time Domain

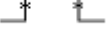
The following tables list each automatic measurement by category: time or amplitude. (See page 121, *Taking Automatic Measurements in the Time Domain.*)

Time measurements

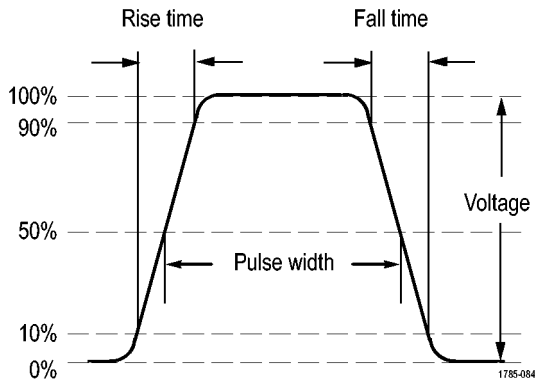

Measurement		Description
Frequency		The first cycle in a waveform or gated region. Frequency is the reciprocal of the period; it is measured in hertz (Hz) where one Hz is one cycle per second.
Period		The time required to complete the first cycle in a waveform or gated region. Period is the reciprocal of frequency and is measured in seconds.
Rise Time		The time required for the leading edge of the first pulse in the waveform or gated region to rise from the low reference value (default = 10%) to the high reference value (default = 90%) of the final value.
Fall Time		The time required for the falling edge of the first pulse in the waveform or gated region to fall from the high reference value (default = 90%) to the low reference value (default = 10%) of the final value.
Delay		The time between the mid reference (default 50%) amplitude point of two different waveforms. See also <i>Phase</i> .
Phase		The amount of time that one waveform leads or lags another waveform, expressed in degrees where 360° makes up one waveform cycle. See also <i>Delay</i> .
Positive Pulse Width		The distance (time) between the mid reference (default 50%) amplitude points of a positive pulse. The measurement is made on the first pulse in the waveform or gated region.
Negative Pulse Width		The distance (time) between the mid reference (default 50%) amplitude points of a negative pulse. The measurement is made on the first pulse in the waveform or gated region.
Positive Duty Cycle		The ratio of the positive pulse width to the signal period expressed as a percentage. The duty cycle is measured on the first cycle in the waveform or gated region.
Negative Duty Cycle		The ratio of the negative pulse width to the signal period expressed as a percentage. The duty cycle is measured on the first cycle in the waveform or gated region.
Burst Width		The duration of a burst (a series of transient events) and is measured over the entire waveform or gated region.



Amplitude measurements

Measurement		Description
Peak-to-Peak		The absolute difference between the maximum and minimum amplitude in the entire waveform or gated region.
Amplitude		The high value less the low value measured over the entire waveform or gated region.
Max		The most positive peak voltage. Max is measured over the entire waveform or gated region.
Min		The most negative peak voltage. Min is measured over the entire waveform or gated region.
High		This value is used as 100% whenever high reference, mid reference, or low reference values are needed, such as in fall time or rise time measurements. Calculate using either the min/max or histogram method. The min/max method uses the maximum value found. The histogram method uses the most common value found above the midpoint. This value is measured over the entire waveform or gated region.
Low		This value is used as 0% whenever high reference, mid reference, or low reference values are needed, such as in fall time or rise time measurements. Calculate using either the min/max or histogram method. The min/max method uses the minimum value found. The histogram method uses the most common value found below the midpoint. This value is measured over the entire waveform or gated region.
Positive Overshoot		This is measured over the entire waveform or gated region and is expressed as: Positive Overshoot = $(\text{Maximum} - \text{High}) / \text{Amplitude} \times 100\%$.
Negative Overshoot		This is measured over the entire waveform or gated region and is expressed as: Negative Overshoot = $(\text{Low} - \text{Minimum}) / \text{Amplitude} \times 100\%$.
Mean		The arithmetic mean over the entire waveform or gated region.
Cycle Mean		The arithmetic mean over the first cycle in the waveform or the first cycle in the gated region.





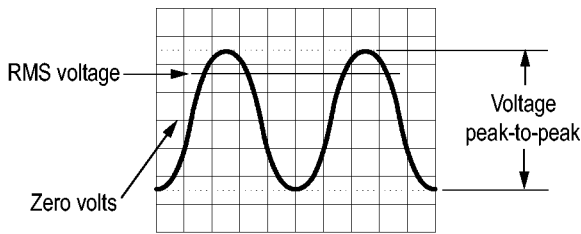

Amplitude measurements (cont.)

Measurement		Description
RMS		The true Root Mean Square voltage over the entire waveform or gated region.
Cycle RMS		The true Root Mean Square voltage over the first cycle in the waveform or the first cycle in the gated region.



1785-083

Miscellaneous measurements

Measurement		Description
Positive Pulse Count		The number of positive pulses that rise above the mid reference crossing in the waveform or gated region.
Negative Pulse Count		The number of negative pulses that fall below the mid reference crossing in the waveform or gated region.
Rising Edge Count		The number of positive transitions from the low reference value to the high reference value in the waveform or gated region.
Falling Edge Count		The number of negative transitions from the high reference value to the low reference value in the waveform or gated region.
Area		Area measurement is a voltage over time measurement. It returns the area over the entire waveform or gated region in volt-seconds. Area measured above ground is positive; area measured below ground is negative.
Cycle Area		A voltage over time measurement. The measurement is the area over the first cycle in the waveform or the first cycle in the gated region expressed in volt-seconds. The area above the common reference point is positive, and the area below the common reference point is negative.

Histogram measurements

Measurement	Description
Waveform Count	Displays the number of waveforms that contributed to the histogram.
Hits in Box	Displays the number of samples within the histogram box or on its boundaries.
Peak Hits	Displays the number of samples in the bin that contains the most hits.
Median	Displays the middle histogram data value, where half of all histogram data points are less than this value and half are greater than this value.

Histogram measurements (cont.)

Measurement	Description
Peak-to-peak	Displays the peak-to-peak value of the histogram. Vertical histograms display the voltage of the highest nonzero bin minus the voltage of the lowest nonzero bin. Horizontal histograms display the time of the rightmost nonzero bin minus the time of the leftmost nonzero bin.
Histogram Max	Displays the voltage of the highest nonzero bin in vertical histograms or the time of the rightmost nonzero bin in horizontal histograms.
Histogram Min	Displays the voltage of the lowest nonzero bin in vertical histograms or the time of the leftmost nonzero bin in horizontal histograms.
Histogram Mean	Measures the average of all histogram data points within or on the histogram box.
Standard Deviation	Measures the standard deviation (Root Mean Square (RMS) deviation) of all histogram data points within or on the histogram box.
Sigma1	Displays the percentage of the hits in the histogram that are within one standard deviation of the histogram mean.
Sigma2	Displays the percentage of the hits in the histogram that are within two standard deviations of the histogram mean.
Sigma3	Displays the percentage of the hits in the histogram that are within three standard deviations of the histogram mean.

Customizing an Automatic Measurement in the Time Domain

You can customize automatic measurements by using gating, modifying measurement statistics, adjusting the measurement reference levels, or taking a snapshot.

Gating

Gating confines the measurement to a certain portion of a waveform. To use:



1. Push **Measure**.

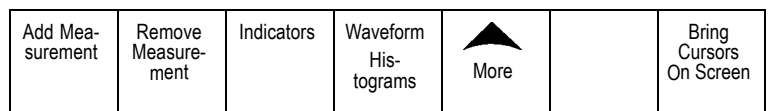

2. Push **More** as many times as needed to select **Gating** from the resulting pop-up menu.



- Position the gates using the side menu options.

Gating
 Off (Full Record)
 Screen
 Between Cursors

Statistics

Statistics characterize the stability of measurements. To adjust statistics:

- Push **Measure**.



- Push **More** as many times as needed to select **Statistics** from the resulting pop-up menu.

Add Measurement	Remove Measurement	Indicators	Waveform Histograms	 More	Bring Cursors On Screen
-----------------	--------------------	------------	---------------------	---	-------------------------



3. Push the side menu options. These include whether to turn statistics on or off and how many samples to use for mean and standard deviation calculations.

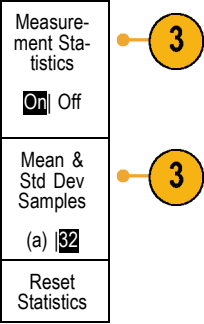

Snapshot

To see all the single-sourced measurements at one moment in time:

1. Push **Measure**.



2. Push **Add Measurement**.

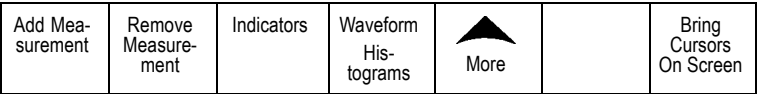

3. Turn multipurpose knob **a** to select the desired **Source** channel.

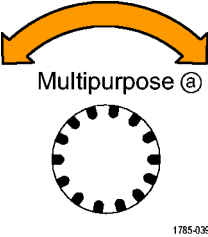

4. Turn multipurpose knob **b** to select the **Measurement Type of Snapshot**.

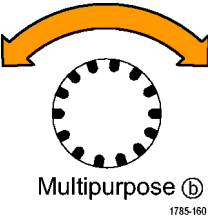

5. Push **OK Snapshot All Measurements.**

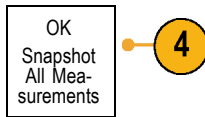

6. View results.

Snapshot on 1

Period	: 312.2µs	Freq	: 3.203 kHz
+Width	: 103.7µs	-Width	: 208.5µs
Burst W	: 936.5µs		
Rise	: 1.452µs	Fall	: 1.144µs
+Duty	: 33.23%	-Duty	: 66.77 %
+Over	: 7.143%	-Over	: 7.143 %
High	: 9.200 V	Low	: -7.600 V
Max	: 10.40 V	Min	: -8.800 V
Ampl	: 16.80 V	Pk-Pk	: 19.20 V
Mean	: -5.396 V	CycleMean	: -5.396 V
RMS	: 7.769 V	CycleRMS	: 8.206 V
Area	: -21.58 mVs	CycleArea	: -654.6µVs
+Edges	: 1	-Edges	: 0
+Pulses	: 2	-Pulses	: 2

Reference Levels

Reference levels determine how time-related measurements are taken. For example, they are used in calculating rise and fall times.

1. Push **Measure**.



2. Push **More** as many times as needed to select **Reference Levels** from the resulting pop-up menu.

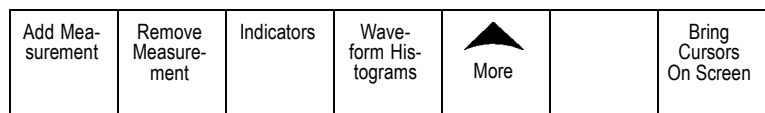

3. Set the levels using the side menu.

Use High and Low reference to calculate rise and fall times.

Use Mid reference primarily for measurements between edges such as pulse widths.

Reference Levels
Set Levels in % [Units]
High Ref (a) 90.0 %
Mid Ref 50.0 % 50.0 %
Low Ref 10.0 %
- Set to Defaults

Taking Manual Measurements with Cursors

Cursors are on-screen markers that you position in the waveform display to take manual measurements on acquired data. They appear as horizontal and/or as vertical lines. To use cursors on analog or digital channels:

1. Push **Cursors** to turn cursors on.

NOTE. A second push turns cursors off. You can also push and hold **Cursors** to display the cursor menu.

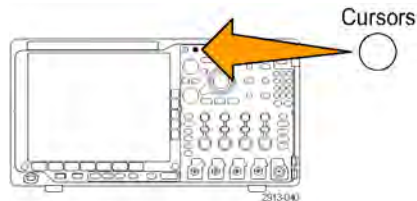

In this example, two vertical cursors appear on the selected waveform. As you turn multipurpose knob **a**, you move one cursor to the right or left. As you turn knob **b**, you move the other cursor.

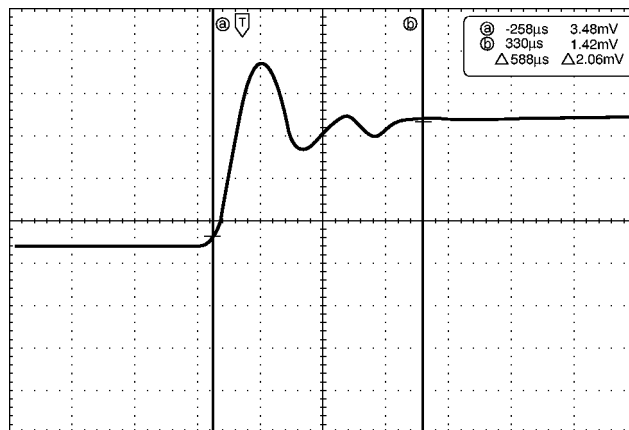

1785-146

- With cursors on, push **Select**.

This turns the cursor linking on and off. If linking is on, turning multipurpose knob **a** moves the two cursors together. Turning multipurpose knob **b** adjusts the time between the cursors.



- Push **Fine** to toggle between a coarse and a fine adjustment for multipurpose knobs **a** and **b**.

Pushing **Fine** also changes the sensitivity of other knobs as well.



- Push and hold **Cursors** to display the cursor menu.

- Push **Cursors** on the lower menu to set the cursors to **Screen**.

In screen mode, two horizontal bars and two vertical bars span the graticule.

Cursors Waveform Screen	Source Selected Waveform	Bars Horizontal Vertical	Linked On Off	Bring Cursors On Screen	Cursor Units	
--------------------------------------	---------------------------------------	--------------------------------	-------------------------	-------------------------------	-----------------	--



- Turn multipurpose knobs **a** and **b** to move the pair of horizontal cursors.

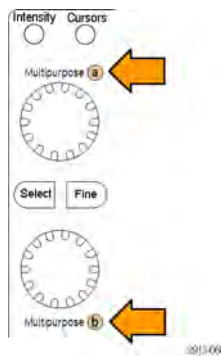

- Push **Select**.

This makes the vertical cursors active and the horizontal cursors inactive. Now, as you turn the multipurpose knobs, the vertical cursors will move.

Push **Select** to make the horizontal cursors active again.

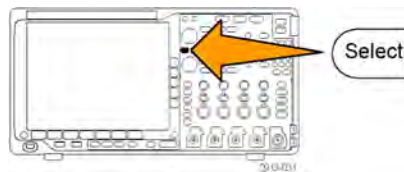

8. View the cursor and the cursor readout.

NOTE. On digital channels, you can take timing measurements with cursors, but not amplitude measurements.

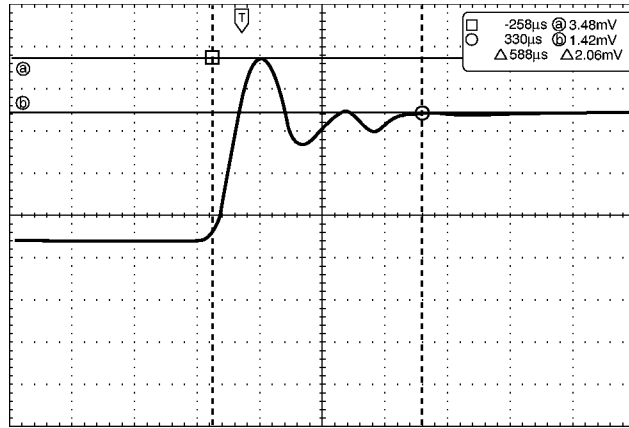

1785-147

9. Display multiple waveforms on the screen by pushing one or more of the channel 1 through 4 buttons or by pushing the **D15 – D0** button.
10. Push and hold **Cursors** to display the cursor menu again.

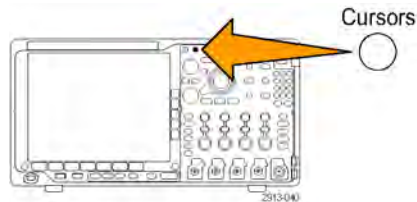

11. Push **Source** on the lower menu.

A pop-up menu will appear. The default menu selection of **Selected Waveform** will cause the cursors to take measurements on the selected (last used) waveform.
12. Turn multipurpose knob **a** to choose a channel to measure other than the one pointed to by **Selected Waveform**.
13. Push **Menu Off** to remove the pop-up menu.
14. Turn multipurpose knob **a** and take cursor measurements on the alternate waveform.



15. Push **Cursors** again. This turns off the cursors. The screen no longer displays the cursors and the cursor readout.

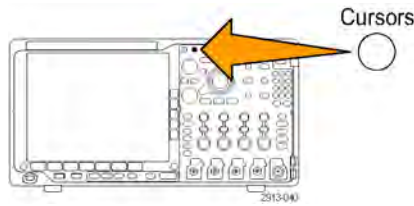

Using Cursor Readouts

Cursor readouts supply textual and numeric information relating to the current cursor positions. The oscilloscope always shows the readouts when the cursors are turned on.

Readouts appear in the upper right corner of the graticule. If Zoom is on, the readout appears in the upper right corner of the zoom window.

When a bus is selected, the readout shows the decoded bus data in the format you have selected from the choices in the bus menu. When a digital channel is selected, the cursors show the values of all displayed digital channels.

NOTE. When serial or parallel buses are selected, the data value at that point is displayed in the cursor readout.

Δ Readout:

The Δ readouts indicate the difference between the cursor positions.

<input type="checkbox"/> a	-16.0μs	22.4mV
<input type="radio"/> b	8.00μs	20.4mV
<input type="checkbox"/> Δ	24.0μs	Δ 1.60mV

1785-134

a Readout:

Indicates that the value is controlled by multipurpose knob **a**.

b Readout:

Indicates that the value is controlled by multipurpose knob **b**.

The horizontal cursor lines on the display measure the vertical parameters, typically voltage.

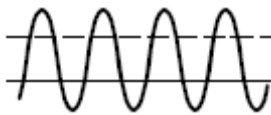

The vertical cursor lines on the display measure horizontal parameters, typically time.



The square and circle shapes in the readout map to the multipurpose knobs when both vertical and horizontal cursors are present.

Using XY Cursors

When the XY Display mode is on, the cursor readouts will appear to the right of the lower graticule (XY). They will include rectangular, polar, product, and ratio readouts. The oscilloscope will display vertical-bar waveform cursors in the upper graticule (YT).

Setting Up a Histogram

You can display a vertical (voltage) or horizontal (time) histogram. Use histogram measurements to get statistical measurement data for a section of a waveform along one axis. The sources for a histogram can be any of the four analog channels, a math waveform, or any of the four reference waveforms.

To Display a Histogram

1. Set up the oscilloscope to show the waveform on which to measure the histogram. Use **Autoset** if appropriate.

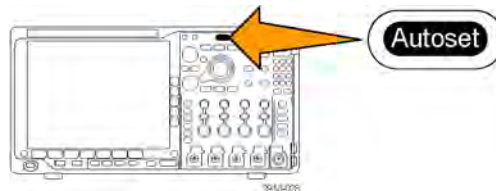

2. Push **Measure**.



3. Push **Waveform Histograms** on the lower menu.

Add Measurement	Remove Measurement	Indicators	Waveform Histograms	More	Bring Cursors On Screen
-----------------	--------------------	------------	---------------------	------	-------------------------

3

4. Push the top button on the side menu to select the waveform axis for which you want to show the histogram values: **Vertical** or **Horizontal**.

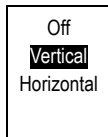

5. Push **Source** on the side menu and use multipurpose knob **a** to select the channel for which to display histogram measurements.

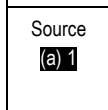

6. Push **Horiz. Limits** on the side menu and use the multipurpose knobs **a** and **b** to set the **L** (left) and **R** (right) boundaries of the histogram box.

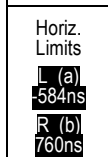

7. Push **Vert. Limits** on the side menu and use the multipurpose knobs **a** and **b** to set the **T** (top) and **B** (bottom) boundaries of the histogram box.

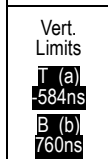

8. Push **- more - 1 of 2**.

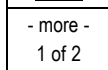

9. Push **Display** on the side menu and select **Linear** or **Log**.

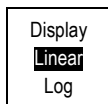

To Add Measurements on Histogram Data

1. Push **Add Measurement** on the lower menu to add measurements on the histogram data.

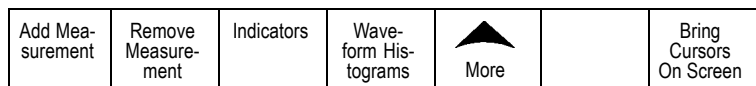

2. Push **Source** on the side menu and turn multipurpose knob **a** to select **H** for histogram measurements.

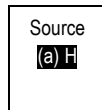

3. Push **Measurement Type** on the side menu and turn multipurpose knob **b** to select a histogram measurement.

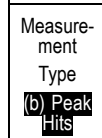

- 4. Push **OK Add Measurement** on the side menu to add the measurement to the measurement readout list.



To Reset Histogram Measurements and Statistics

To reset the histogram measurements and statistics, follow these steps:

- 1. Push **Waveform Histograms** on the lower menu.



- 2. Push **- more - 1 of 2** on the side menu.

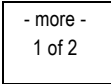

- 3. Push **Reset Histogram Counts** on the side menu.



- 4. Push **More** on the side menu.

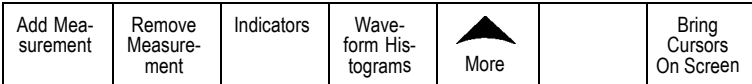

5. Push **Reset Statistics** on the side menu.

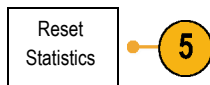

You can view the histogram at the top (for horizontal histograms) or the left edge (for vertical histograms) of the graticule.

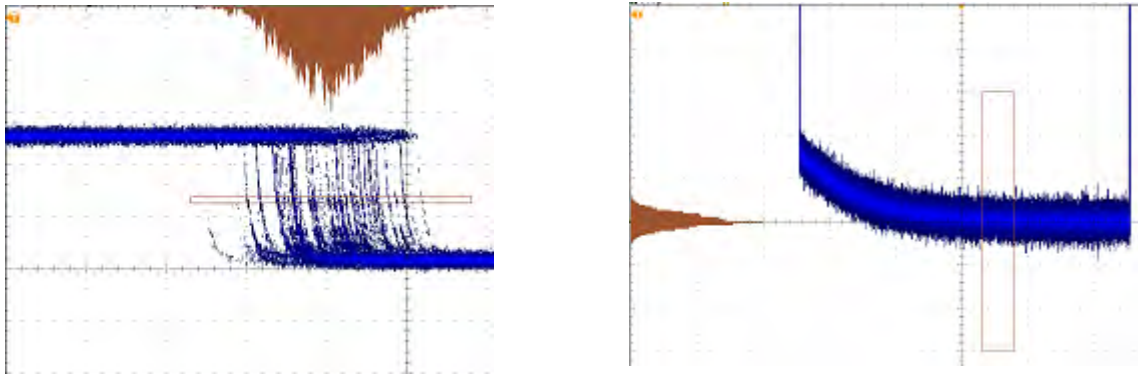

Quick Tips

- Use horizontal histograms to measure signal jitter.
- Use vertical histograms to measure signal noise.

Using Math Waveforms

Create math waveforms to support the analysis of your channel and reference waveforms. By combining and transforming source waveforms and other data into math waveforms, you can derive the data view that your application requires.

NOTE. *Math waveforms are not available for use with serial buses.*

Use the following procedure for executing simple (+, -, *, ÷) math operations on two waveforms:

1. Push **Math**.

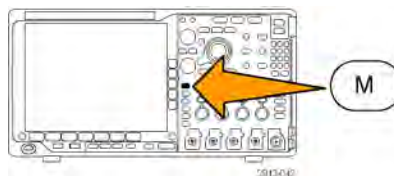

2. Push **Dual Wfm Math**.

Dual Wfm Math	FFT	Advanced Math	Spectrum Math	(M) Label		
---------------	-----	---------------	---------------	-----------	--	--



3. On the side menu, set the sources to either channel **1, 2, 3, 4**, or reference waveforms **R1, 2, 3**, or **4**. Choose the **+**, **-**, **x**, or **÷** operators.
4. For example, you might calculate power by multiplying a voltage waveform and a current waveform.

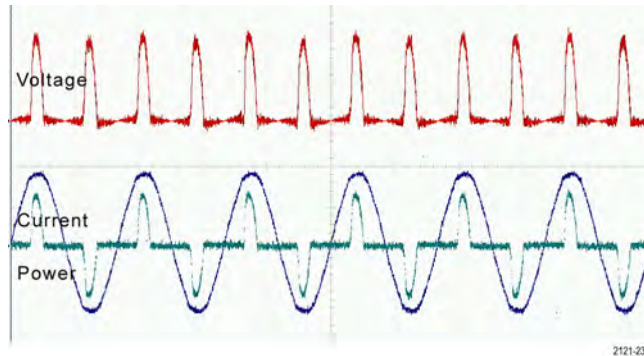

Quick Tips

- Math waveforms can be created from channel or reference waveforms or a combination of them.
- Measurements can be taken on math waveforms in the same way as on channel waveforms.
- Math waveforms derive their horizontal scale and position from the sources in their math expressions. Adjusting these controls for the source waveforms also adjusts the math waveform.
- You can zoom in on math waveforms using the inner knob of the Pan-Zoom control. Use the outer knob for positioning the zoomed area. (See page 144, *Using Wave Inspector to Manage Long Record Length Waveforms*.)

Using FFT

An FFT function breaks down signals into component frequencies, which the oscilloscope uses to display a graph of the frequency domain of a signal, as opposed to the oscilloscope's standard time domain graph. You can match these frequencies with known system frequencies, such as system clocks, oscillators, or power supplies.

1. Push **Math**.



2. Push **FFT**.

Dual Wfm Math	FFT	Advanced Math	Spectrum Math	(M) Label		
---------------	------------	---------------	---------------	-----------	--	--



3. Push **FFT Source** on the side menu, if needed, and turn multipurpose knob **a** to select the source to use. Choices are: channels 1, 2, 3, 4, reference waveforms 1, 2, 3, and 4.
4. Push **Vertical Scale** on the side menu repeatedly to select either Linear RMS or dBV RMS.
5. Push **Window** on the side menu repeatedly to select the desired window. Window choices are: Rectangular, Hamming, Hanning, and Blackman-Harris.
6. Push **Horizontal** on the side menu to activate multipurpose knobs **a** and **b** to pan and zoom the FFT display.

FFT	
FFT Source	1
Vertical Units	Linear RMS
Window	Hanning
Horizontal	625kHz 1.25kHz/div



7. The FFT will appear on the display.

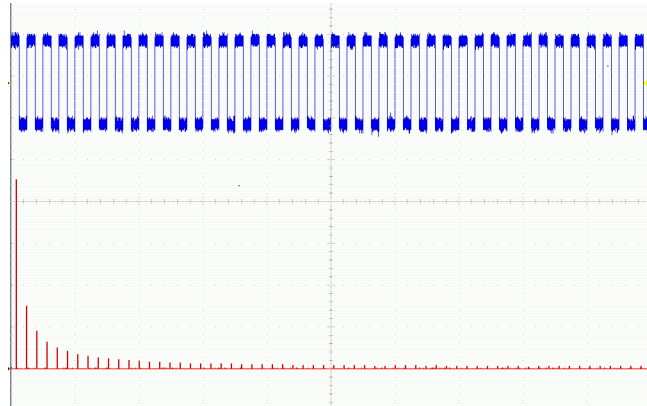

Quick Tips

- Use short record lengths for faster instrument response.
- Use long record lengths to lower the noise relative to the signal and increase the frequency resolution.
- If desired, use the zoom feature along with the horizontal **Position** and **Scale** controls to magnify and position the FFT waveform.
- Use the default dBV RMS scale to see a detailed view of multiple frequencies, even if they have very different amplitudes. Use the linear RMS scale to see an overall view of how all frequencies compare to each other.
- The math FFT feature provides four windows. Each offers a trade-off between frequency resolution and magnitude accuracy. The choice of which window to use depends upon what you want to measure and your source's signal characteristics. Use the following guidelines to select the best window:

Description

Window

Rectangular

The frequency resolution when using the Rectangular (a.k.a. boxcar or none) window is very good, the spectral leakage is high, and amplitude accuracy is poor.

Use the Rectangular window for measuring transients or bursts where the signal levels before and after the event are nearly equal. Also, use this window for equal-amplitude sine waves with frequencies that are very close together, and for broadband random noise with a relatively slow varying spectrum. This window is the best type for measuring the frequency spectrum of non-repetitive signals, and measuring frequency components near DC.

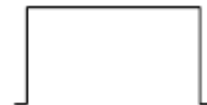

Hamming

The frequency resolution when using the Hamming window is good (slightly better than Hanning), the spectral leakage is moderate, and amplitude accuracy is fair.

Use the Hamming window for measuring sine, periodic, and narrow band random noise. This window works well on transients or bursts where the signal levels before and after the event are significantly different.



Description

Window

Hanning

The frequency resolution when using the Hanning (a.k.a. Hann) window is good, the spectral leakage is low and amplitude accuracy is fair.

Use the Hanning window for measuring sine, periodic, and narrow band random noise. This window works well on transients or bursts where the signal levels before and after the event are significantly different.



Blackman-Harris

The frequency resolution when using the Blackman-Harris window is poor, the spectral leakage is very low and amplitude accuracy is good.

Use the Blackman-Harris window for measuring predominantly single frequency waveforms to look for higher order harmonics, or several moderately or widely spaced sinusoidal signals.



Using Advanced Math

The advanced math feature lets you create a custom math waveform expression that can incorporate active and reference waveforms, measurements, and/or numeric constants. To use this feature:

1. Push **Math**.

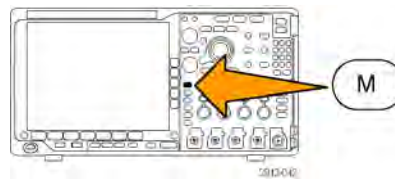

2. Push **Advanced Math**.

Dual Wfm Math	FFT	Advanced Math	Spectrum Math		(M) Label	
---------------	-----	----------------------	---------------	--	-----------	--



3. Use the side menu buttons to create custom expressions.

4. Push **Edit Expression** and use the multipurpose knobs and the resulting lower menu buttons to create an expression. When done, push **OK Accept**.

For example, to use **Edit Expression** to take the integral of a square wave:

1. Push **Clear** on the lower menu.
2. Turn multipurpose knob **a** to select **Intg(**.
3. Push **Enter Selection**.
4. Turn multipurpose knob **a** to select channel **1**.
5. Push **Enter Selection**.
6. Turn multipurpose knob **a** to select **)**.
7. Push **OK Accept**.

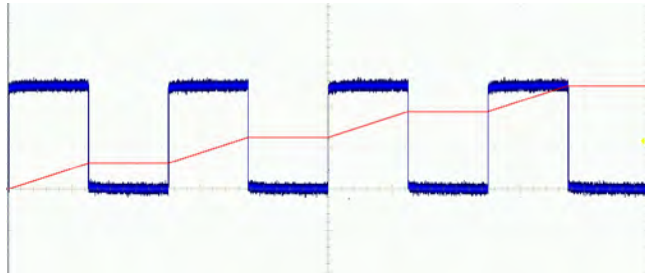

Using Spectrum Math

The spectrum math feature lets you create a math waveform by adding or subtracting frequency traces.

1. Push **Math**.

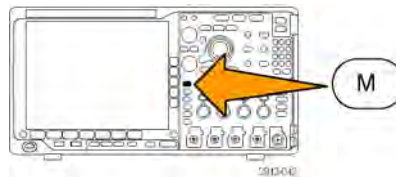

2. Push **Spectrum Math**.

Dual Wfm Math	FFT	Advanced Math	Spectrum Math		(M) Label	
---------------	-----	---------------	----------------------	--	-----------	--

Use the side menu choices to construct your desired math trace.



3. Push **1st Source** and select the RF normal trace (**RF:N**), RF average trace (**RF:A**), RF maximum trace (**RF:M**), the RF minimum trace (**RF:m**), or any of the reference memories with frequency domain information.
4. Choose + or - as the operator.
5. Choose the second source from the provided options.

The math waveform will appear on the display as a red trace.

6. Push **Label** from the lower menu and use the resulting side menu choices to give your math trace an appropriate label.

NOTE. The oscilloscope will only complete the calculation if the units of measure of the source waveforms, when combined, make logical sense.

Using Reference Waveforms and Traces

Create and store a reference waveform or trace. For example, you might do this to set up a standard against which to compare other waveforms. To use the reference waveforms or traces:

NOTE. 10 M and 20 M reference waveforms are volatile and not saved when the oscilloscope power is turned off. To keep these waveforms, save them to external storage.

1. Push **Ref R**. This brings up the lower reference menu.



2. Use the resulting lower menu selections to display or select a reference waveform or trace.

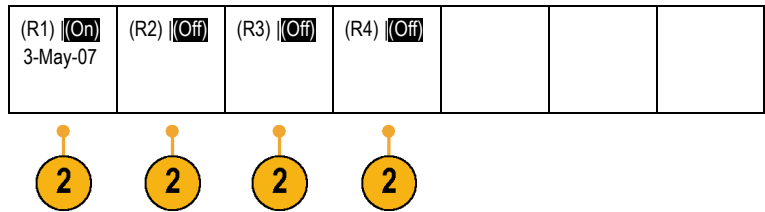

3. Push **Vertical** on the side menu and use the multipurpose knobs to adjust the vertical settings of the reference waveform or trace.
4. Push **Horizontal** on the side menu and use the multipurpose knobs to adjust the horizontal settings of the reference waveform or trace.
5. Push **Edit Label** and use the resulting menus to define labels to display with the reference waveforms and traces.
6. Push **Ref Details** to read information about the selected reference. Use this to determine whether the reference is an analog waveform or an RF trace.
7. Push **Save to File** to store reference information in external storage.

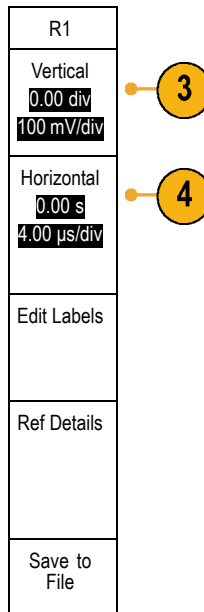

Quick Tips

- **Selecting and Displaying Reference Waveforms.** You can display all the reference waveforms at the same time. Push the appropriate screen button to select a particular reference waveform.
- **Removing Reference Waveforms from the Display.** To remove a reference waveform from the display, push **R** on the front panel to access the lower menu. Then push the associated lower menu to turn it off.
- **Scaling and Positioning a Reference Waveform.** You can position and scale a reference waveform independently from all other displayed waveforms. Select the reference waveform and then adjust it with a multipurpose knob. You can do this whether acquisition is running or not.

If a reference waveform is selected, scaling and repositioning of the reference waveform operates the same way whether zoom is turned on or off.

- **Saving 10 M and 20 M Reference Waveforms.** 10 M and 20 M reference waveforms are volatile and not saved when the oscilloscope power is turned off. To keep these waveforms, save them to external storage.

Using Wave Inspector to Manage Long Record Length Waveforms

The Wave Inspector controls (zoom/pan, play/pause, marks, search) help you to efficiently work with long record length waveforms. To magnify a waveform horizontally, turn the Zoom knob. To scroll through a zoomed waveform, turn the Pan knob.

The Pan-Zoom Control consists of:

1. An outer pan knob
2. An inner zoom knob

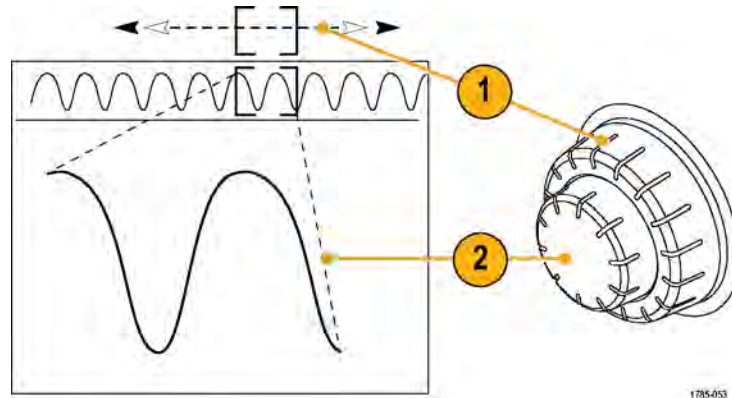

1785-053

Zooming a Waveform

To use zoom:

1. Rotate the inner knob on the Pan-Zoom control clockwise to zoom in on a selected portion of the waveform. Rotate the knob counterclockwise to zoom back out.

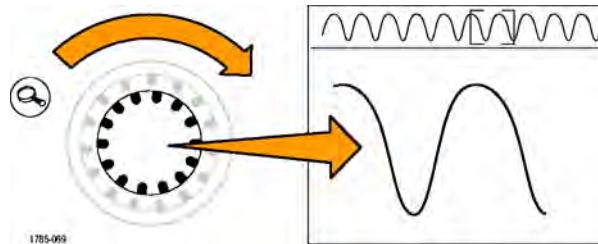

1785-069

2. Alternatively, enable or disable the zoom mode by pushing the zoom button.

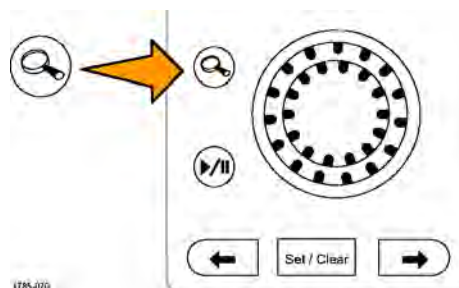

1785-070

3. Examine the zoomed view of the waveform that appears on the larger, lower portion of the display. The upper portion of the display will show the position and size of the zoomed portion in the waveform, within the context of the overall record.

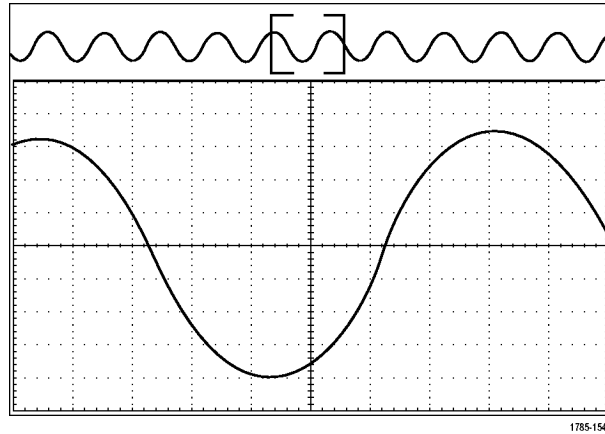

Panning a Waveform

While the zoom feature is on, you can use the pan feature to quickly scroll through the waveform. To use pan:

1. Rotate the pan (outer) knob of the pan-zoom controls to pan the waveform.
Turn the knob clockwise to pan forward. Turn it counterclockwise to pan backwards. The further you turn the knob, the faster the zoom window pans.

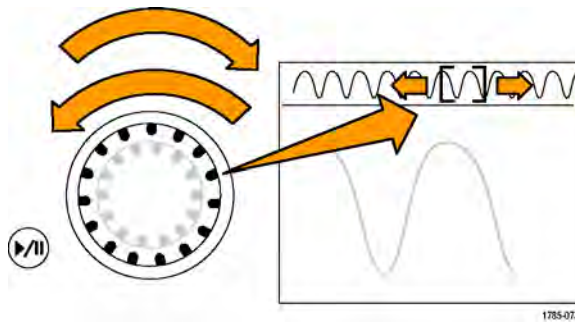

Playing and Pausing a Waveform

Use the play-pause feature to automatically pan through a waveform record. To use it:

1. Enable the play-pause mode by pushing the play-pause button.
2. Adjust the play speed by turning the pan (outer) knob further. The further you turn it, the faster it goes.

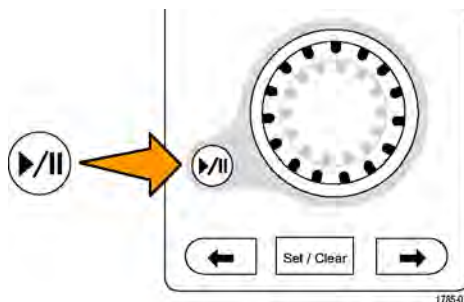

3. Change the play direction by reversing the direction that you are turning the pan knob.
4. During play, up to a point, the more you turn the ring, the faster the waveform accelerates. If you rotate the ring as far as it can go, the play speed does not change, but the zoom box quickly moves in that direction. Use this maximum rotation feature to replay a portion of the waveform that you just saw and want to see again.
5. Pause the play-pause feature by pushing the play-pause button again.

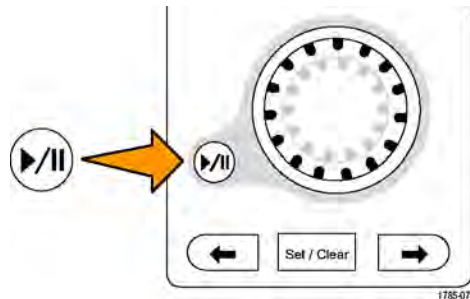

Searching and Marking Waveforms

You can mark locations of interest in the acquired waveform. These marks help you limit your analysis to particular regions of the waveform. You can mark areas of the waveform automatically, if they meet some special criteria, or you can manually mark each item of interest. You can use arrow keys to jump from mark to mark (area of interest to area of interest). You can automatically search and mark many of the same parameters that you can trigger on.

Search marks provide a way to mark a waveform region for reference. You can set marks automatically with search criteria. You can search for and mark regions with particular edges, pulse widths, runts, logic states, rise/fall times, setup and hold, and bus search types.

To manually set and clear (delete) marks:

1. Move (the zoom box) to the area on the waveform where you want to set (or clear) a search mark by turning the pan (outer) knob.
Push the next (→) or previous (←) arrow button to jump to an existing mark.

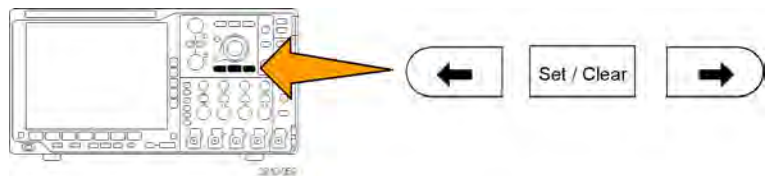

2. Push **Set/Clear**.
If no search mark is at the screen center, the oscilloscope will add one.

- Investigate your waveform by moving from search mark to search mark. Use the next (→) or previous (←) arrow button to jump from one marked location to another, without adjusting any other controls.
- Delete a mark. Push the next (→) or previous (←) arrow button to jump to the mark you want to clear. To remove the current, center-positioned mark, push **Set/Clear**. It works on both manually and automatically created marks.

To automatically set and clear (delete) search marks:

- Push **Search**.



- Select the search type desired from the lower menu.



The search menu is similar to the trigger menu.



- From the side menu, turn on the search.
- On the screen, hollow triangles show the location of automatic marks and solid triangles show the custom (user-defined) locations. These appear on both normal and zoomed waveform views.
- You can quickly investigate your waveform by moving from search mark to search mark with the next (→) and previous (←) arrow buttons. No other adjustments are needed.

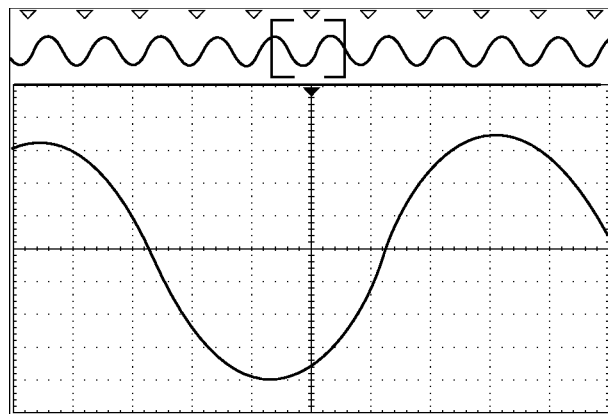

2121-240

Quick tips.

- You can copy trigger settings to search for other locations in your acquired waveform that meet the trigger conditions.
- You can also copy search settings to your trigger.

- Custom (User) marks are saved with the waveform when the waveform is saved and when the setup is saved.
- Automatic search marks are not saved with the waveform when the waveform is saved. However, you can easily recapture them by reusing the search function.
- The search criteria are saved in the saved setup.

The Wave Inspector includes the following search capabilities:

Search	Description
Edge	Searches for edges (rising or falling) with a user-specified threshold level.
Pulse Width	Searches for positive or negative pulse widths that are >, <, =, or ≠ a user specified pulse width, or are inside or outside of a range.
Timeout	Searches for the lack of a pulse. The signal stays above or below (or either above or below) a set value for a set amount of time.
Runt	Searches for positive or negative pulses that cross one amplitude threshold but fail to cross a second threshold before crossing the first again. Search for all runt pulses or only those with a duration >, <, =, or ≠ a user specified time.
Logic	Search for a logic pattern (AND, OR, NAND, or NOR) across multiple waveforms with each input set to either High, Low, or Don't Care. Search for when the event goes true, goes false, or stays valid for >, <, =, or ≠ a user specified time. Additionally, you can define one of the inputs as a clock for synchronous (state) searches.
Setup & Hold	Search for violations of user specified Setup and Hold times.
Rise/Fall Time	Search for rising and/or falling edges that are >, <, =, or ≠ a user specified time.
Bus	Parallel: Search for a binary or hex value. I ² C: Search for Start, Repeated Start, Stop, Missing Ack, Address, Data, or Address and Data. SPI: Search for SS Active, MOSI, MISO, or MOSI & MISO RS-232, RS-422, RS-485, UART: Search for Tx Start Bit, Rx Start Bit, Tx End of Packet, Rx End of Packet, Tx Data, Rx Data, Tx Parity Error, Rx Parity Error. CAN: Search for Start of Frame, Type of Frame (Data, Remote, Error, Overload), Identifier (standard or extended), Data, Identifier and Data, End of Frame, or Missing Ack, Bit Stuffing Error LIN: Search for Synch, Identifier, Data, ID & Data, Wakeup Frame, Sleep Frame, Error FlexRay: Search for Start of Frame, Type of Frame, Identifier, Cycle Count, Header Fields, Data, ID & Data, End of Frame, Error Audio: Search for Word Select or Data USB: Search for Sync, Reset, Suspend, Resume, End of Packet, Token (Address) Packet, Data Packet, Handshake Packet, Special Packet, or Error Ethernet: Search for Start of Frame, MAC Addresses, MAC Length/Type, MAC Client Data, End of Packet, Idle, FCS (CRC) Error. If Q-(VLAN) Tagging is turned on, you can also search for Q-Tag Control Information. MIL-STD-1553: Search for Sync, Command, Status, Data, Time (RT/IMG), Error

Auto-magnify

As you adjust the horizontal scale control to faster time/division settings, the MDO4000 Series automatically increases the sample rate to keep acquiring the same record length in the shorter period of time. Eventually though, the MDO4000 Series hits its maximum sample rate. Once the instrument is at its fastest sample rate, further changes to faster timebase settings cause the oscilloscope to operate in Auto-magnify mode, where the oscilloscope shows the faster desired time/division setting and continues to acquire the desired record length. The result is that the oscilloscope cannot show all of the acquired points within the desired time/division setting.

Instead, the oscilloscope shows you only a portion of the entire record in the time-domain graticule. This feature provides you with a way to magnify a portion of the record without having to use the smaller zoom screen display. This feature gives you the maximum benefit of the sample rate / record length combination in your oscilloscope. With Auto-magnify, you have access to the full record length at the maximum sample rate.

NOTE. Auto-magnify only comes on when the zoom feature is turned off.

1. The entire acquisition is indicated by the horizontal bar in the upper display.
2. The portion of the acquisition shown in the time domain graticule is shown within the part of the upper display defined by the brackets.

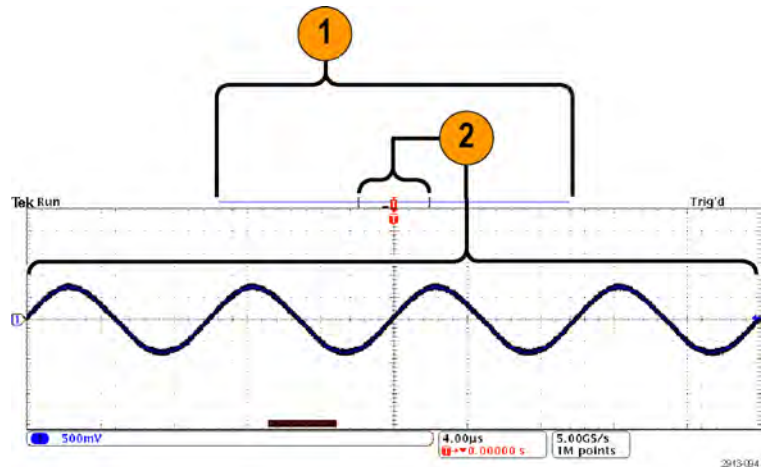

NOTE. If you are using the frequency domain and auto-magnify features at the same time, and if you move the spectrum time outside of the portion of the acquisition shown in the graticule, then the orange bar in the time-domain display showing the spectrum time will disappear, as will any activity in the frequency domain display.

Time-Correlated Multi-Domain Display

A single trigger event coordinates acquisition across all analog, digital, and RF channels. This enables a time-correlated view of both the time and frequency domain signals in a single instrument.

1. **Spectrum Time:** This is the position in time used to calculate the spectrum shown in the frequency domain graticule. An orange bar at the bottom of the time domain display indicates the Spectrum Time. The orange bar is also shown in the acquisition overview at the top of the display.
2. **Analog Time:** This is the amount of time acquired in the time domain graticule. It is controlled by the Horizontal Scale knob.

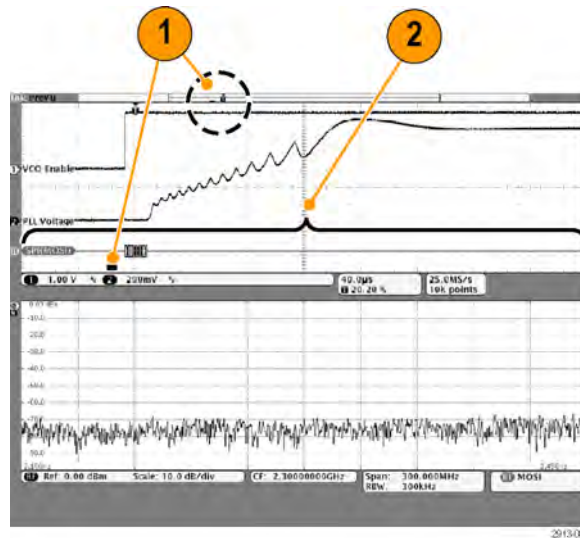

3. **RF Acquisition time:** This is the amount of time acquired by the RF system. At mid-to-fast time base settings, it equals analog time. At slower time base settings, it can be less than analog time. In the figure to the right, it is shown by a pair of brackets around the spectrum time.

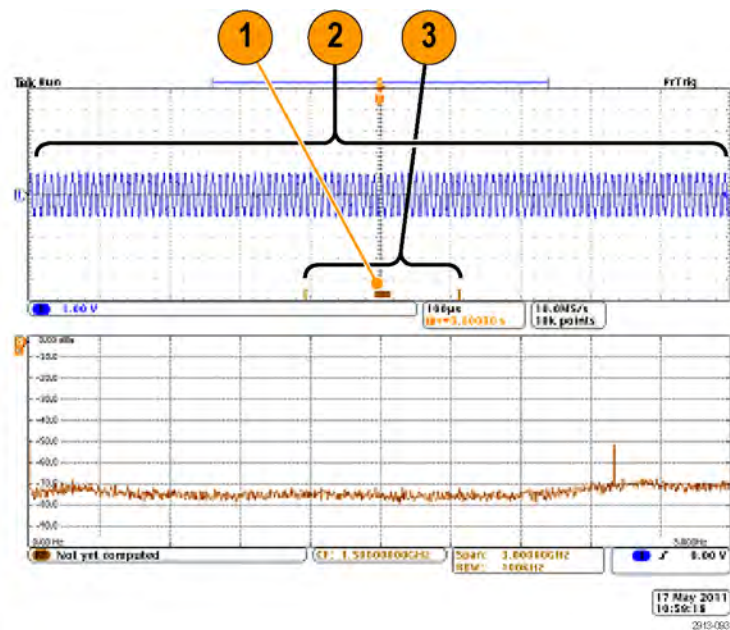

Panning Spectrum Time Through Analog Time

One of the most powerful features of the MDO4000 series is its ability to move spectrum time through analog time. This allows you to see how the spectrum changes over time and how it changes relative to other analog signals, digital signals, or serial/parallel bus commands.

Move spectrum time through analog time by rotating the Wave Inspector pan (outer) knob.

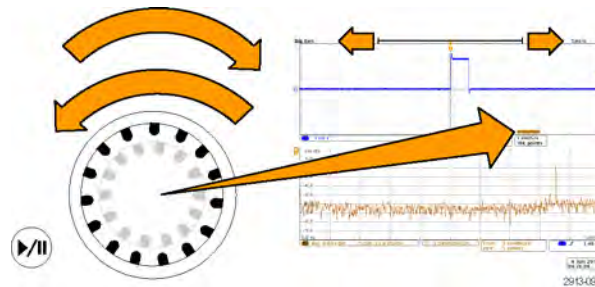

When the oscilloscope is acquiring data (running) and you are rotating the pan control, you can move spectrum time and RF acquisition time simultaneously. The operation works as if you were dragging the RF acquisition time along with the spectrum time.

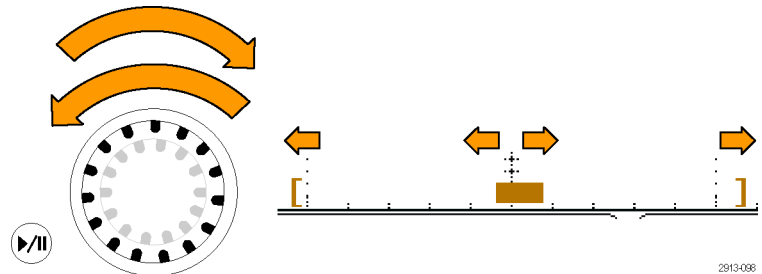

When you rotate the pan knob clockwise, you move the RF acquisition time and spectrum time to the right of the display. When the right side of the RF acquisition time reaches the far right side of the screen, you cannot move RF acquisition time any further to the right.

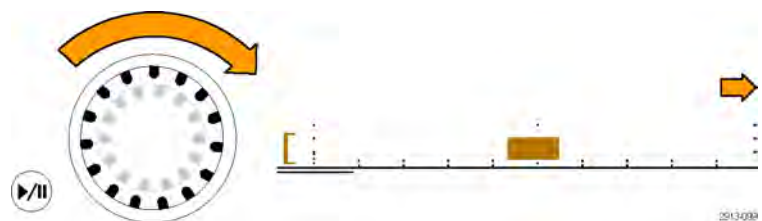

You can, however, keep moving the spectrum time further to the right until it reaches the right side of the RF acquisition time/analog time.

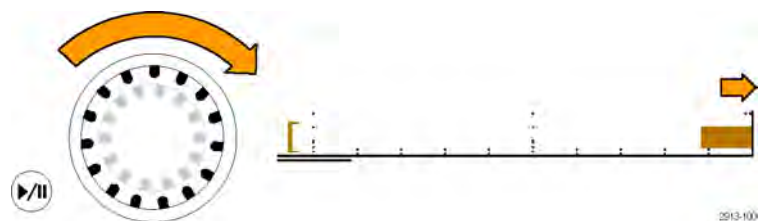

If you then turn pan counter-clockwise, the spectrum time goes back to the middle of the RF acquisition time.

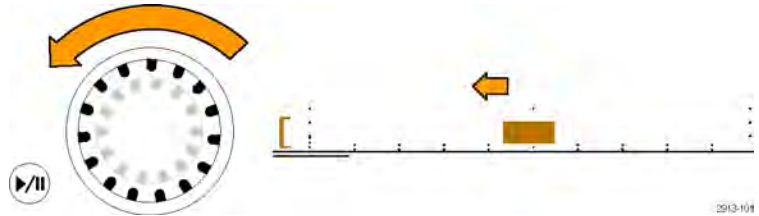

Keep rotating the pan control counter-clockwise and move the RF acquisition time and spectrum time together toward the left of the display. When the right side of the RF acquisition time reaches the trigger indicator shown at the top of the display, you cannot move the RF acquisition time any further to the left even if you keep rotating the pan knob. The RF acquisition time must stay attached to the trigger.

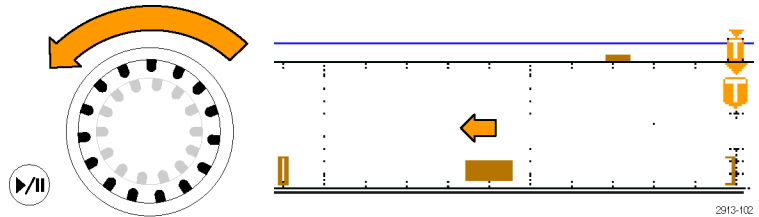

If you keep rotating the pan control counter-clockwise, the spectrum time will keep moving left within the RF acquisition time until it reaches the left end of the RF acquisition time.

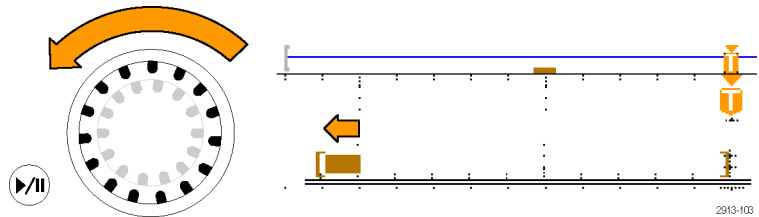

When the oscilloscope is not acquiring data (stopped), the RF acquisition time is fixed on the display. Turning the pan control clockwise or counter-clockwise will not move the RF acquisition time. Turning the pan control will, however, move the spectrum time within the RF acquisition time.

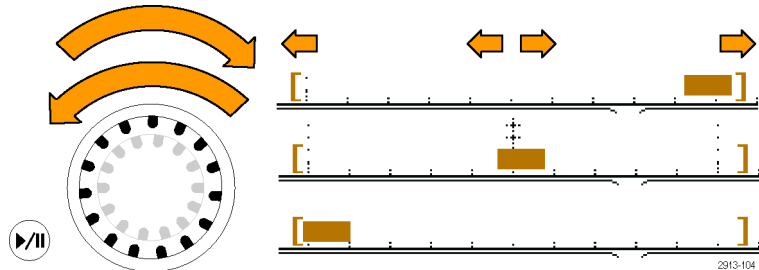

Zooming in on Spectrum Time and Analog Time

1. Rotate the zoom (inner) knob of the pan-zoom control or push the front panel zoom button to turn on the zoom control
2. Rotate the zoom control to enlarge or shrink the displayed time domain data.

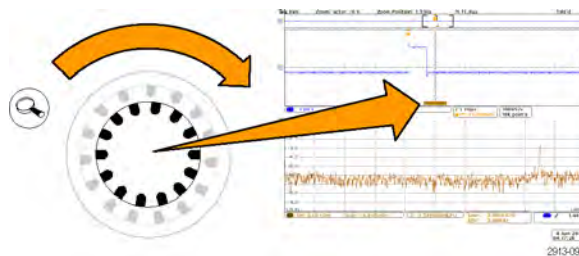

You can use the zoom controls to look more closely into analog time and the time correlated multi-domain display.

With zoom on, the oscilloscope centers spectrum time in the center of the zoomed view of the time domain window. The orange spectrum time bar stays anchored to the middle of the zoom view of the time domain window.

Special Case: When Spectrum Time is Outside the RF Acquisition Time

When in zoom mode, if you rotate the pan knob until the zoom box moves outside of the RF acquisition time, the spectrum time bar turns gray, and the spectrum trace in the frequency domain display disappears. If you then rotate the pan control until the zoom box moves back into the RF acquisition time, the spectrum time bar returns to orange.

1. The zoomed-in portion of the analog time is shown by brackets. In the figure to the right, this time is outside of the RF acquisition time.
2. The RF acquisition time is shown by a pair of vertical brackets.
3. The spectrum time indicator turns gray when there is no RF data to display, as in the figure to the right. It will turn back to orange if you move the spectrum time so that it occurs inside the RF acquisition time.

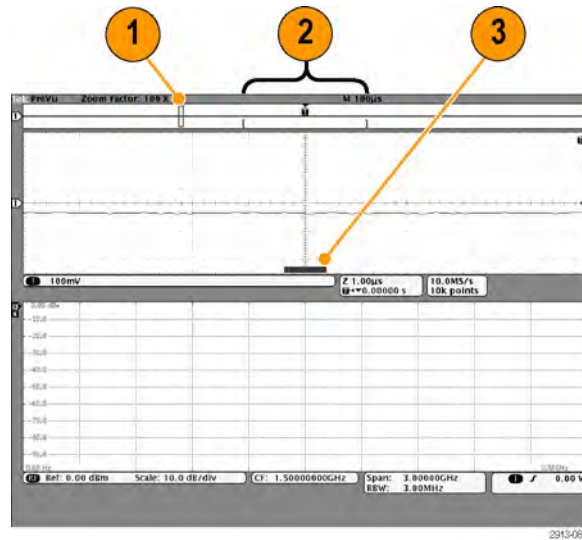

Limit and Mask Testing

Monitor an active input signal against a mask and output pass or fail results by judging whether the input signal is within the bounds of the mask. To set up and run a limit or mask test, do the following:

1. Select or create the mask.
2. Set up the test.
3. Run the test and view the results.

NOTE. ≥ 350 MHz bandwidth models are recommended for Telecomm standards >55 Mb/s.

1 GHz bandwidth models are recommended for high-speed (HS) USB.

Create or Select the Mask

The three mask types you can create or select are: limit test, standard, and custom.

Create a limit test mask.

1. Push the front panel **Default Setup** button.

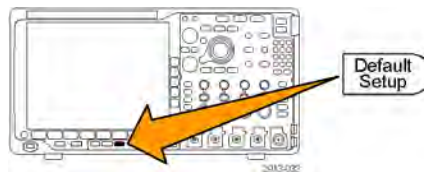

2. Connect your probe from your oscilloscope to the mask source.

3. Push the front panel **Autoset** button.

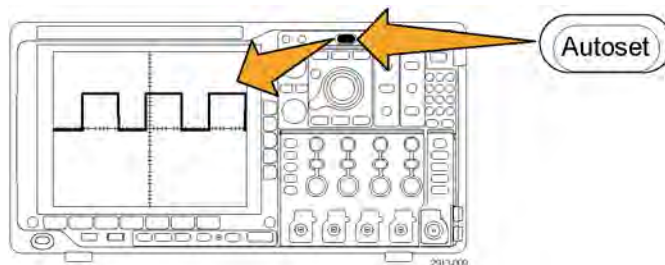

4. Push the front panel **Test** button.

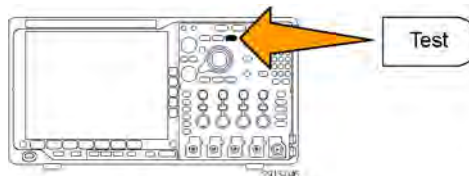

5. Push **Application** on the lower menu. Turn multipurpose knob **a** to select **Limit/Mask Test** from the menu.
6. Push **Select Mask** on the lower menu and, from the resulting side menu, select **Limit Test**.

7. Push **Create Limit Mask** on the lower menu.
8. On the resulting side menu, push **Source Channel** and turn multipurpose knob **a** to choose the waveform to use as the template for the limit test.
9. Push **Horizontal \pm Limit** to set the mask horizontal limits. The units are referenced to graticule divisions, where one major division contains 1,000 milli-divisions (mdiv).
10. Push **Vertical \pm Limit** to set the mask vertical limits. The units are referenced to graticule divisions, where one major division contains 1,000 millidivisions (mdov).
11. Push **OK Create Limit Mask** to make the mask in the oscilloscope.

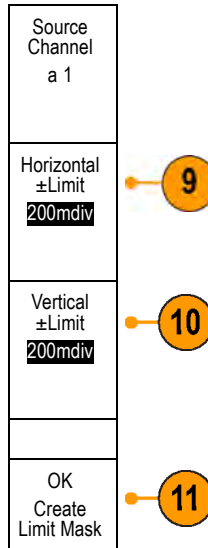

Select a standard mask.

1. Push **Test** on the front panel.
2. Push **Application** on the lower menu. Turn multipurpose knob **a** to select **Limit/Mask Test** from the menu.
3. Push **Select Mask** on the lower menu and, from the resulting side menu, select **Standard**.
4. Push **Select Standard** on the lower menu.
5. Use the resulting side menu buttons to select the desired standard to use.
6. Push **OK Apply Standard** on the side menu.

Create a custom mask. There are three ways to create a custom mask. You can edit a standard mask, load a mask from a text file, or create a mask via a remote interface.

Create a custom mask by editing a standard mask.

1. Push **Test** on the front panel.
2. Push **Application** on the lower menu. Turn multipurpose knob **a** to select **Limit/Mask Test** from the menu.
3. Push **Select Mask** on the lower menu and, from the resulting side menu, select **Standard**.

4. Push **Select Standard** on the lower menu.
5. Use the resulting side menu to select the desired standard to use.
6. Push **OK Apply Standard** on the side menu.
7. Push **Set Up Mask** on the lower menu.
8. Push **Copy Active Mask to Custom** from the resulting side menu.
9. Push **Edit Custom Mask** on the lower menu.
10. Turn multipurpose knob **a** to adjust the custom mask **Vertical Margin**, as shown in the resulting side menu. A positive value will spread the upper and lower mask segments apart. A negative value will bring the upper and lower segments together.

NOTE. For more on editing capabilities, see the "Create a custom mask from a text file" section or the "Create a mask via a remote interface" section.

Create a custom mask from a text file.

1. Push the front panel **Test** button.
2. Push **Application** on the lower menu. Turn multipurpose knob **a** to select **Limit/Mask Test** from the menu.
3. Push **Set Up Mask** on the lower menu.
4. From the resulting side menu, push **Recall Mask from File**.

Your mask text file should have an ".msk" file name extension and use the following format:

```
:REM "Initialize the custom mask"  
:MASK:CUSTOM INIT  
:REM "Mask Setup Information"  
:MASK:USER:LABEL "Custom Mask of STS-1"  
:MASK:USER:AMPLITUDE 1.0000  
:MASK:USER:VSCALE 200.0000E-3  
:MASK:USER:VPOS -2.5000  
:MASK:USER:VOFFSET 0.0E+0  
:MASK:USER:HSCALE 4.0000E-9  
:MASK:USER:HTRIGPOS 318.1000E-3  
:MASK:USER:WIDTH 29.5500E-9  
:MASK:USER:RECORDLENGTH 1000  
:MASK:USER:TRIGTOSAMP 7.2750E-9
```

```

:REM "Mask Points are Defined in Volts and Seconds"
:REM "Points in a segment must be defined in counter clockwise order"
:REM "A single point at 0,0 indicates an empty segment"
:MASK:USER:SEG1:POINTS -7.5000E-9,1.5000,-7.5000E-9,100.0000E-3,-5.1656E-
9,100.0000E-3,-1.3536E-9,500.0000E-3,-1.3536E-9,1.2000,7.2750E-9,1.1000,15.9036E-
9,1.2000,15.9036E-9,500.0000E-3,19.7156E-9,100.0000E-3,22.0500E-9,100.0000E-
3,22.0500E-9,1.5000
:MASK:USER:SEG2:POINTS -7.5000E-9,-500.0000E-3,22.0500E-9,-500.0000E-3,22.0500E-9,-
100.0000E-3,13.4214E-9,-200.0000E-3,13.4214E-9,500.0000E-3,11.6780E-9,800.0000E-
3,7.2750E-9,900.0000E-3,2.8720E-9,800.0000E-3,1.1286E-9,500.0000E-3,1.1286E-9,-
200.0000E-3,-7.5000E-9,-100.0000E-3
:MASK:USER:SEG3:POINTS 0.0E+0,0.0E+0
:MASK:USER:SEG4:POINTS 0.0E+0,0.0E+0
:MASK:USER:SEG5:POINTS 0.0E+0,0.0E+0
:MASK:USER:SEG6:POINTS 0.0E+0,0.0E+0
:MASK:USER:SEG7:POINTS 0.0E+0,0.0E+0
:MASK:USER:SEG8:POINTS 0.0E+0,0.0E+0

```

Create a custom mask via a remote interface. To use remote interface commands to create and edit a mask, see the MSO4000B, DPO4000B, and MDO4000 Series Oscilloscope Programmer Manual.

Set Up the Test

To set up the limit or mask test, connect the test source to the oscilloscope. For a limit test, set the test source horizontal and vertical settings to the same values that were used to create the limit test mask. Push **Set Up Test** on the lower menu and set the following:

Setting	Description
Source Channel	Select the channel to be tested
Violation Threshold	Set the number of violations that can occur before a test status is considered failed.
Stop After Waveform	Set the test to stop after a set number of waveforms.
Stop After Time	Set the test to stop after a set amount of time elapses.
Select Action on Failure	Set how the oscilloscope responds to test failure. You can set multiple actions. These are: Stop acquisition Save waveform to file Save screen image to file Print screen image Aux out pulse Set a remote interface service request (SRQ)
Select Action on Test Completion	Set how the oscilloscope will respond to test completion. You can set multiple actions. They are: Aux out pulse Set a remote interface service request (SRQ)
Pre-Test Delay	Set a delay before starting a test.

Setting	Description
Repeat Test	Set On for the test to repeat when it has run the minimum number of waveforms or the minimum amount of time. Set Off for the test to run a single time and not repeat.
Mask Polarity	Set the mask polarity to use during the test. When Both is selected, the test will run with Normal polarity for about half of the expected number of waveforms or amount of time and then will run with Inverted polarity for the remained of the test.

Run the Test and View the Results

1. Push **Run Test** on the lower menu to start and stop the test.
2. Push **Show Results** on the lower menu and use the resulting side menu to select whether to show basic or more detailed results. You can also reset the results.



Quick Tips

- Use Average acquisition mode to create a smoother, cleaner limit test mask.
- If you want to re-use the mask later, save it to a file by selecting **Set Up Mask** from the lower menu and **Save Mask to File** from the resulting side menu.
- To simplify the setup of the test source, save the oscilloscope setup so that later you can quickly reload the settings to correctly display the test source for limit testing.
- Have the mask automatically re-scale with the source channel setting changes by selecting **Set Up Mask** on the lower menu and **Lock to Source** as **On** on the resulting side menu.
- The math waveform is not available when using mask testing.

Analyzing Power

Acquire, measure, and analyze power signals with the DPO4PWR Power Analysis Module. To use this application:

1. Push **Test**.



2. Turn multipurpose knob **a** to select **Power Analysis**.

3. Push **Analysis**.

Applica- tion	Analysis None					
------------------	------------------	--	--	--	--	--



4. Use the side menu buttons to select the desired analysis function.
Choose among power quality, switching loss, harmonics, ripple, modulation, and safe operating area, and deskew. See the *DPO3PWR and DPO4PWR Power Analysis Modules User Manual* for more information.

Save and Recall Information

The oscilloscope provides permanent storage for setups, waveforms, and screen images. Use the internal storage of the oscilloscope to save setup files and reference waveform data.

Use external storage, such as USB drives or network drives, to save setups, waveforms, and screen images. Use the external storage to carry data to remote computers for further analysis and for archiving.

External file structure. If you are saving information to external storage, select the appropriate menu (such as the **To File** side menu to save setups and waveforms) and turn multipurpose knob **a** to scroll through the external file structure.

- E: is the USB memory device plugged into the first (left) USB port on the front of the oscilloscope
- F: is the USB memory device plugged into the second (right) USB port on the front of the oscilloscope
- G: and H: are the USB memory devices plugged into the USB ports on the rear of the oscilloscope
- I through Z are network storage locations

Use multipurpose knob **a** to scroll through the list of files. Push **Select** on the front panel to open and close folders.

Naming your file.

The oscilloscope gives all files it creates a default name in the following format:

- tekXXXXX.set for setup files where XXXXX is an integer from 00000 to 99999
- tekXXXXX.png, tekXXXXX.bmp, or tekXXXXX.tif for image files
- tekXXXXYYY.csv for spreadsheet files or tekXXXXYYY.isf for internal format files

For waveforms, the XXXX is an integer from 0000 to 9999. The YYY is the channel of the waveform, and can be one of the following:

- CH1, CH2, CH3, or CH4 for the analog channels
- D00, D01, D02, D03, and so on through D15 for the digital channels
- MTH for a math waveform
- RF1, RF2, RF3, or RF4 for reference memory waveforms
- ALL for a single spreadsheet file containing multiple channels when you select Save All Waveforms

For RF traces, XXXX is an integer from 0000 to 9999. The YYY defines the trace and can be one of the following:

- NRM for a normal trace
- AVG for an average trace
- MAX for a maximum hold trace
- MIN for a minimum hold trace
- AVT for an amplitude versus time trace
- FVT for a frequency versus time trace

- PVT for a phase versus time trace
- TIQ for a baseband I & Q file

NOTE. Analog, digital, and RF waveforms and traces and those waveforms and traces derived from them (such as math and reference) can be saved to an ISF file. When saving all channels in ISF format, a group of files will be saved. Each will have the same value for XXXX, but the YYY values will be set to the different channels that were turned on when the Save All Waveforms operation was performed.

The XXXX value will automatically increment each time you save a file of the same type. For example, the first time you save a file, that file is named tek00000. The next time you save the same type of file, the file will be named tek00001.

Editing file, directory, reference waveform, or instrument setup names. Give files descriptive names that you can recognize at a later date. To edit file names, directory names, reference waveform and instrument setup labels:

1. Push **Save / Recall Menu**.

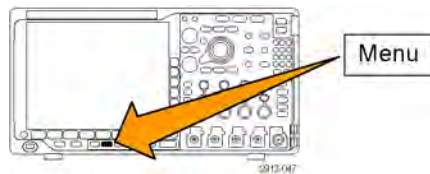

2. Push **Save Screen Image, Save Waveform, or Save Setup**.

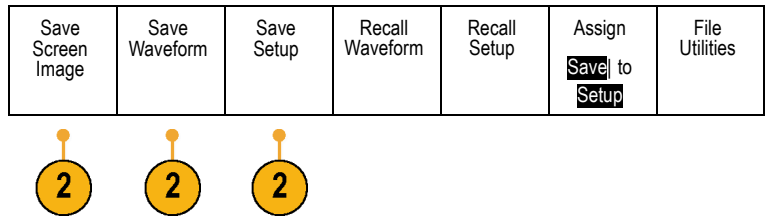

3. For waveform or setup files, enter the file manager by pushing the appropriate side menu button.

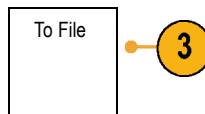

4. Turn multipurpose knob **a** to scroll through the file structure. (See page 160, *External file structure*.)

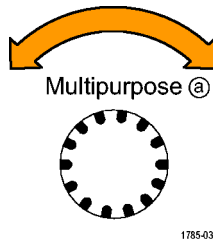

5. Push **Select** to open or close file folders.



6. Push **Edit File Name**.
Edit the file name the same way you edit labels for channels. (See page 51, *Labeling Channels and Buses*.)
7. Push the **Menu Off** button to cancel the save operation, or push **OK Save** on the side menu to complete the operation.

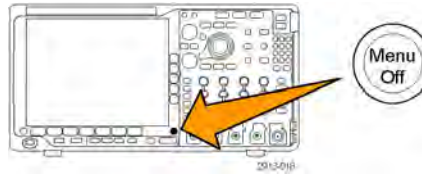

Saving a Screen Image

A screen image consists of a graphical image of the oscilloscope screen. This is different from waveform data, which consists of numeric values for each point in the waveform. To save a screen image:

1. Push **Save / Recall Menu**.
Do not yet push the **Save** button.

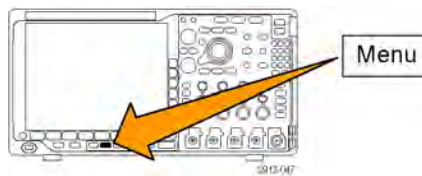

2. Push **Save Screen Image** on the lower menu.

Save Screen Image	Save Waveform	Save Setup	Recall Waveform	Recall Setup	Assign Save to Setup	File Utilities
-------------------	---------------	------------	-----------------	--------------	----------------------------	----------------



3. Push **File Format** on the side menu to select among: .tif, .bmp, and .png formats.
4. Push **Orientation** to select between saving the image in a landscape (horizontal) and a portrait (vertical) orientation.
5. Push **Ink Saver** to turn the **Ink Saver** mode on or off. When on, this mode provides a white background.
6. Push **Edit File Name** to create a custom name for the screen image file. Skip this step to use a default name.
7. Push **OK Save Screen Image** to write the image to the selected media.

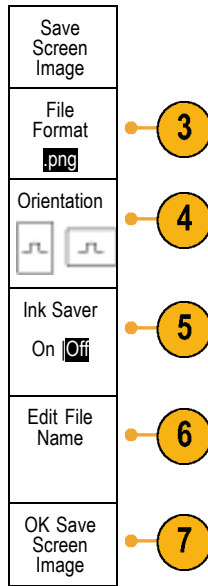

For information on printing screen images of waveforms, go to *Printing a Hard Copy*. (See page 170, *Printing a Hard Copy*.)

Saving and Recalling Waveform and Trace Data

Waveform and trace data consists of the numeric values for each point in the waveform or trace. It copies the data, as opposed to a graphical image of the screen. To save the current waveform or trace data or to recall previously stored waveform or trace data:

1. Push **Save / Recall Menu**.

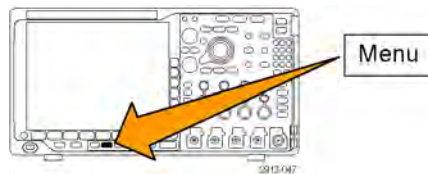

2. Push **Save Waveform** or **Recall Waveform** on the lower menu.

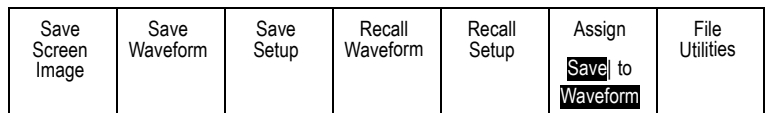

NOTE. The oscilloscope can save digital waveforms to .csv files, not reference memories. The oscilloscope cannot recall digital waveforms.

NOTE. The oscilloscope can save, but not recall, RF acquisitions as .TIQ files. You can use .TIQ files with Tektronix SignalVu Vector Signal Analysis software.

3. Rotate multipurpose knob **a** and, on the side menu, select one of the displayed waveforms or traces. Alternatively, select **All Displayed Waveforms**.

When saving RF trace data, you can select to save it as either the standard display data or as baseband I and Q data (.TIQ files). Use the I and Q data with Tektronix SignalVu Vector Signal Analysis software.

4. Rotate multipurpose knob **b** and select the location to save the waveform or trace data to or to recall it from.

Save the information externally to a file on a USB drive or mounted network drive. Alternatively, save the information internally to one of the four reference files.

5. Push **File Details** to save to a USB or network drive.



This brings up the file manager screen. Use it to navigate to the desired drive and folder, and optionally to specify the file name. Skip this step to use the default name and location.

Saving a waveform to file. When you push **File Details** on the side menu, the oscilloscope changes the side menu contents. The following table describes these side menu items for saving data to a mass storage file.

Side menu button	Description
Instrument Specific File Format (.ISF)	Sets the oscilloscope to save data from analog, digital, or RF channels (and math and reference waveforms derived, where possible, from those channels), in Instrument Specific Format (.isf) format. This format is the fastest to write. It also creates the smallest-sized file. Use this format if you intend to recall an analog waveform or RF trace to reference memory for viewing or measuring.
Spreadsheet file format (.csv)	Sets the oscilloscope to save data as a comma-separated data file that is compatible with popular spreadsheet programs. Analog and RF data stored in this file format can also be recalled to reference memory.

Saving a waveform or trace to reference memory. To save a waveform or trace to nonvolatile memory inside the oscilloscope, push the **Save Waveform** screen button, select the waveform that you want to save, and then select one of the four reference waveform locations.

Saved waveforms contain only the most recent acquisition. Gray-scale information, if any, is not saved.

NOTE. 10 M and 20 M reference waveforms are volatile and not saved when the oscilloscope power is turned off. To keep these waveforms, save them to external storage.

Displaying a reference waveform. To display a waveform stored in nonvolatile memory:

1. Push **Ref R**.



2. Push **R1**, **R2**, **R3**, or **R4**.

If you push the side menu **Ref Details**, you can read whether the reference holds analog waveform or RF trace information.

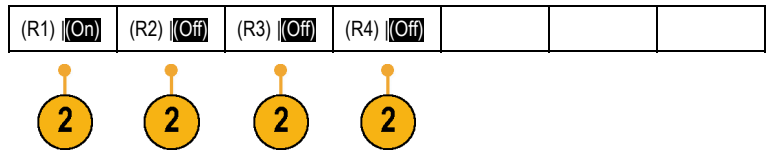

Removing a reference waveform from the display. To remove a reference waveform from the display:

1. Push **Ref R**.



2. Push **R1**, **R2**, **R3**, or **R4** on the lower menu to remove the reference waveform or trace from the display.

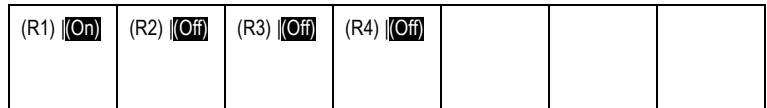

The reference waveform is still in nonvolatile memory and can be displayed again with another push of the button.

NOTE. 10 M and 20 M reference waveforms are volatile and not saved when the oscilloscope power is turned off. To keep these waveforms, save them to external storage.

Saving and Recalling Setups

Setup information includes acquisition information, such as vertical, horizontal, trigger, cursor, and measurement information. It does not include communications information, such as GPIB addresses. To save the setup information:

1. Push **Save / Recall Menu**.

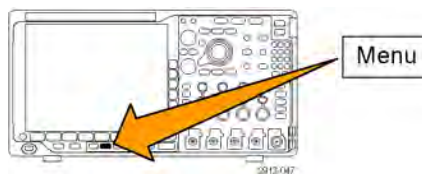

2. Push **Save Setup** or **Recall Setup** on the lower menu.

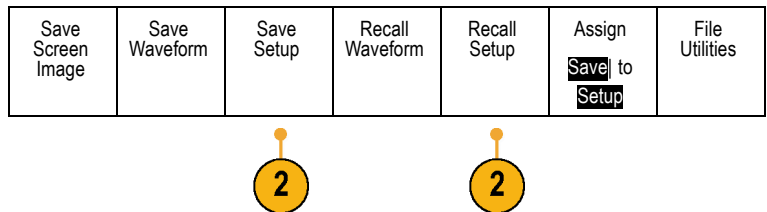

- From the resulting side menu, select the location to save the setup to or to recall it from.

To save setup information to one of the ten internal setup memories in the oscilloscope, push the appropriate side menu button.

To save setup information to a USB or network drive, push the **To File** button.

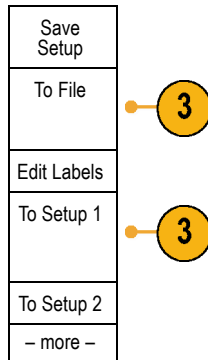

- If you are saving information to a USB or network drive, turn multipurpose knob **a** to scroll through the file structure. (See page 160, *External file structure*.)

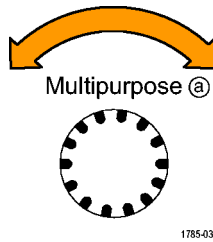

1785-039

Push **Select** to open or close file folders.



Push the **Menu Off** button to cancel the save operation, or push **Save to Selected File** on the side menu to complete the operation.



5. Save the file.

Save to Selected File

Quick Tips

- **Recalling the Default Setup.** Push **Default Setup** on the front panel to initialize the oscilloscope to a known setup. (See page 53, *Using the Default Setup.*)

Saving with One Button Push

After you have defined the save/recall parameters with the Save/Recall Menu button and menu, you can save files with a single push of the **Save** button. For example, if you have defined the save operation to save waveform data to a USB flash drive, then each push of the **Save** button will save current waveform data to the defined USB flash drive.

1. To define the Save button behavior, push **Save/Recall Menu**.

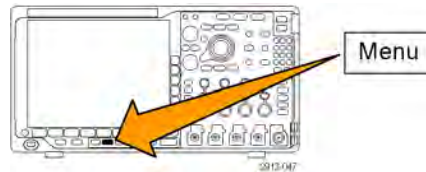

2. Push **Assign Save to ...**

Save Screen Image	Save Waveform	Save Setup	Recall Waveform	Recall Setup	Assign Save to Setup	File Utilities
-------------------	---------------	------------	-----------------	--------------	----------------------	----------------

2

3. Push the side menu button corresponding to the items or items you wish to save when you push the **Save** button.

Assign Save to
Screen Image
Waveform
Setup
Image, Waveform, and Setup

4. From now on, when you push **Save** the oscilloscope will perform the action that you just specified rather than requiring you to navigate through the menus each time.

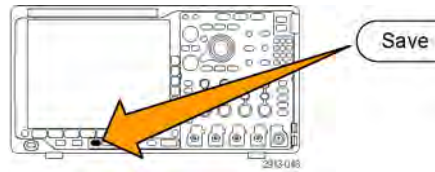

Managing Drives, Directories, and Files

You can manage drives, directories, and files from the oscilloscope user interface.

1. Push **Save/Recall Menu**.

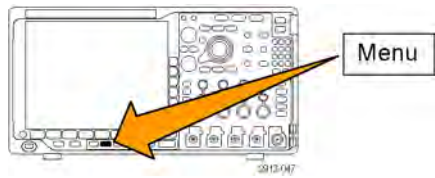

2. Push **File Utilities**.

Save Screen Image	Save Waveform	Save Setup	Recall Waveform	Recall Setup	Assign Save to Setup	File Utilities
-------------------------	------------------	---------------	--------------------	-----------------	------------------------------------	-------------------

Select the desired file operation from the side menus. You can:

- Create a new folder
- Delete a highlighted directory, or file
- Copy a highlighted drive, directory or file
- Paste a previously copied drive, directory, or file
- Mount or unmount a networked drive
- Rename a highlighted drive, directory, or file
- Format a highlighted drive

2

Mounting a Network Drive

Mount a network storage device, such as a PC or a file server, to save setups, waveforms, and screen images directly to the drive or to recall waveforms or setups from the drive.

To save to or recall files from a network drive, you must first connect your oscilloscope to the network (See page 25, *Connecting Your Oscilloscope to a Computer*).

NOTE. Consult your network administrator for information related to your network.

After the network connection has been established, do the following:

1. Push **Save/Recall Menu** on the front panel.
2. Push **File Utilities** on the lower menu and, from the resulting side menu, select – **more – 1 of 2**. Then select **Mount**.
3. From the resulting side menu, set the following:

Setting	Description
Drive Letter	Select from I: to Z:
Server Name or IP Address	Use a USB keyboard or the on-screen interface to enter the server name or IP address.
Path	Use a USB keyboard or the on-screen interface to enter the shared file path. For example, to mount an MS Windows PC directory named "C:\Example", enter "C\$\Example". The dollar sign enables sharing. No colon is needed.
User Name	If necessary, use a USB keyboard or the on-screen interface to enter the user name.
User Password	If necessary, use a USB keyboard or the on-screen interface to enter the user password. The oscilloscope only displays "*"s as you type the password. They are erased from the screen after OK Accept is pushed.

NOTE. Ensure that file sharing is enabled for the network location.

4. Push **OK Accept**.

NOTE. To unmount a network drive, push **Save/Recall Menu** on the front panel, push **File Utilities** on the lower menu, push – **more – 1 of 2** on the side menu, and **Unmount** items.

NOTE. Any network locations that were mounted when the oscilloscope was powered down will be automatically remounted when the oscilloscope is powered up. Unmount any network location that you do not want to automatically remount on power up.

Printing a Hard Copy

To print an image of what appears on the oscilloscope screen, do the following procedure.

Connect a Printer to Your Oscilloscope

Connect a non-PictBridge printer to a USB port on the rear or front panel of the oscilloscope. Alternatively, connect a PictBridge printer to the USB device port on the rear panel, or hook up a networked printer through the Ethernet port.

NOTE. Refer to the www.tektronix.com/printer_setup Web page for a list of compatible printers.

Set Up Print Parameters

To set up the oscilloscope to print hard copies:

1. Push **Utility**.

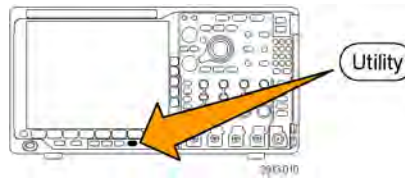

2. Push **Utility Page**.



3. Turn multipurpose knob **a** and select **Print Setup**.



4. Push **Select Printer** if you are changing the default printer.

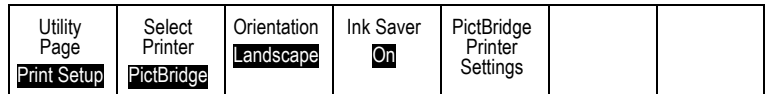

Turn multipurpose knob **a** to scroll through the list of available printers.

Push **Select** to choose the desired printer.

To add a non-PictBridge USB printer to the list, plug the printer into a USB host port. The oscilloscope will automatically recognize most printers.

To set up a PictBridge USB printer, refer to the next topic.

To add an Ethernet printer to the list, refer to that topic. (See page 173, *Printing Over Ethernet*.)

5. Select the image orientation (portrait or landscape).

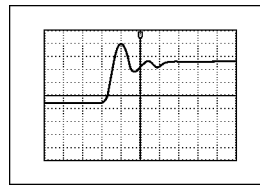

Landscape



Portrait

- Choose **Ink Saver On** or **Off**.
The **On** selection will print out a copy with a clear (white) background.

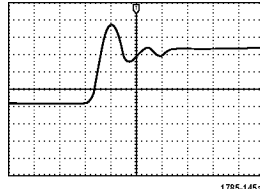

Ink Saver on

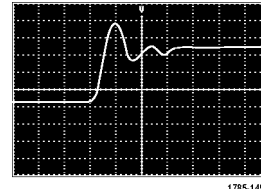

Ink Saver off

Printing to a PictBridge Printer

To set up the oscilloscope to print to a PictBridge printer:

- Push **Utility**.

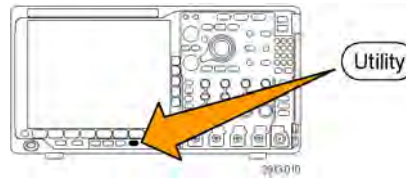

- Push **Utility Page**.



- Turn multipurpose knob **a** and select **I/O**.



- Push **USB**.

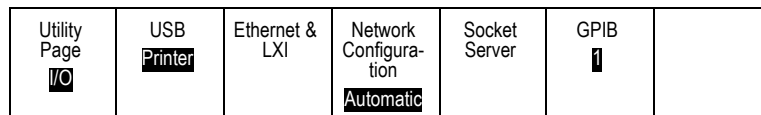

5. Push **Connect to PictBridge Printer**.

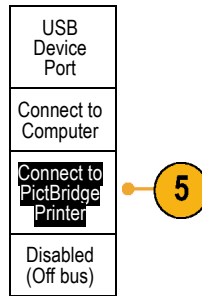

Printing Over Ethernet

To set up the oscilloscope to print over Ethernet:

1. Connect an Ethernet cable to the rear-panel Ethernet port.

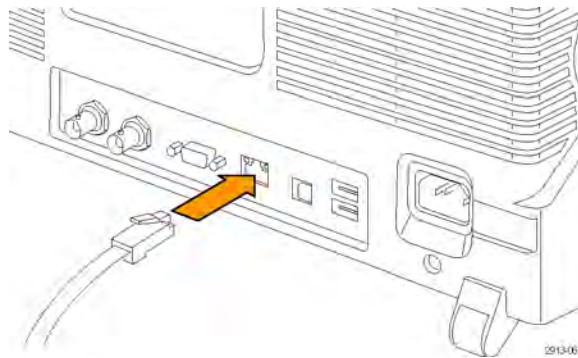

2. Push **Utility**.

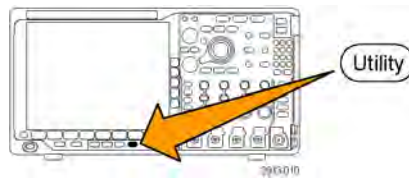

3. Push **Utility Page**.



4. Turn multipurpose knob **a** and select **Print Setup**.

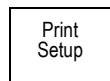

5. Push **Select Printer**.

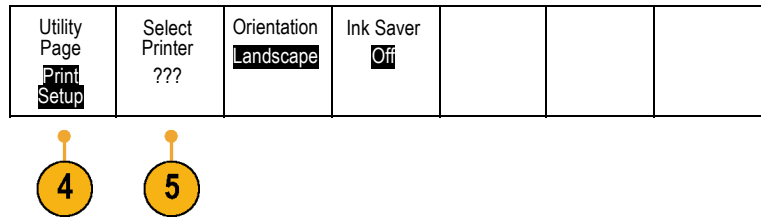

6. Push **Add Network Printer**.

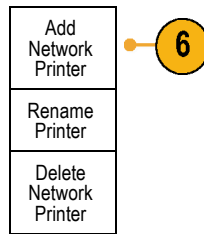

7. Turn multipurpose knob **a** to scroll through the list of letters, numbers, and other characters to find the first character in the printer name that you want to enter.

If you are using a USB keyboard, use the arrow keys to position the insertion point and type in the printer name. (See page 33, *Connecting a USB Keyboard to Your Oscilloscope.*)

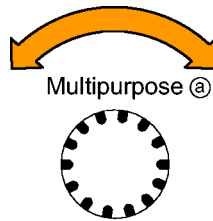

1785-039
 ABCDEFGHIJKLMNOPQRSTUVWXYZ
 abcdefghijklmnopqrstuvwxyz
 0123456789_+~!@#%&*()[]{}</>/~"'\|:;.,?>

8. Push **Select** or **Enter Character** to let the oscilloscope know that you have picked the proper character to use.



You can use the lower menu buttons to edit the name, as needed.

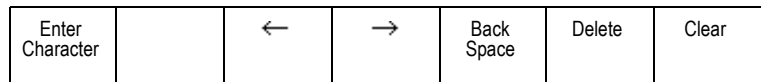

9. Continue scrolling and pushing **Select** until you have entered all the desired characters.

10. Push the down arrow key to move the character cursor down a row to the **Server Name** field.
11. Turn multipurpose knob **a** and push **Select** or **Enter Character** as often as needed to enter the name.
12. If desired, push the down arrow key to move the character cursor down a row to the **Server IP Address:** field.

Add Printer
↑
↓
OK Accept

13. Turn multipurpose knob **a** and push **Select** or **Enter Character** as often as needed to enter the name.
14. When done, push **OK Accept**.

NOTE. *If you have multiple printers connected to the oscilloscope at the same time, the oscilloscope will print to the printer listed in the Utility> Utility Page> Print Setup> Select Printer menu item.*

Printing with One Button Push

Once you have connected a printer to your oscilloscope and set up print parameters, you can print current screen images with a single push of a button:

Push the printer icon button in the lower left corner of the front panel.

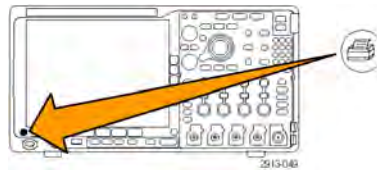

Erasing Oscilloscope Memory

You can erase all setup and waveform information saved in the nonvolatile oscilloscope memory with the TekSecure function. If you have acquired confidential data on your oscilloscope, you may want to execute the TekSecure function before you return the oscilloscope to general use. The TekSecure function:

- Replaces all waveforms in all reference memories with null values
- Replaces the current front panel setup and all stored setups with the default setup
- Displays a confirmation or warning message, depending on whether the verification is successful or unsuccessful

To use TekSecure:

1. Push **Utility**.

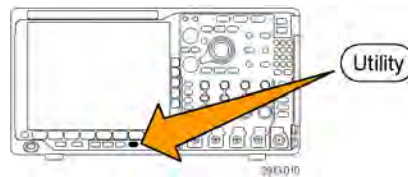

2. Push **Utility Page**.



3. Turn multipurpose knob **a** and select **Config**.

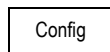

4. Push **TekSecure Erase Memory**.

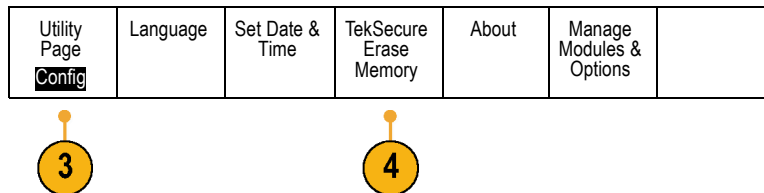

5. Push **OK Erase Setup and Ref Memory** on the side menu.

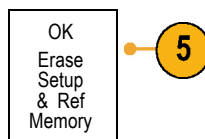

To cancel the procedure, push **Menu Off**.

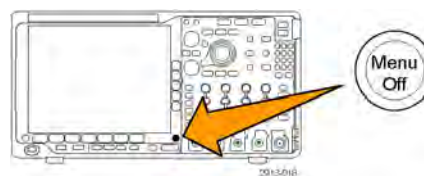

6. Power off the oscilloscope, and then power it back on to complete the process.

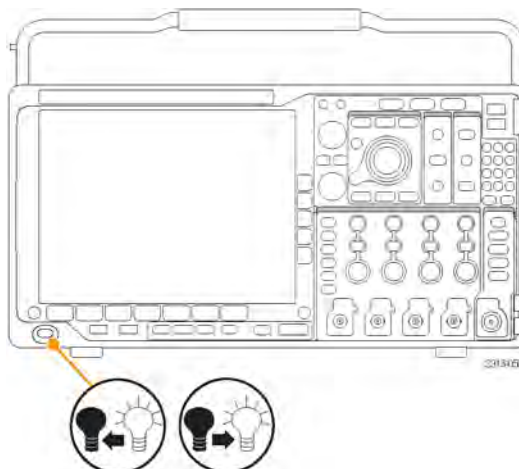

Using Application Modules

Optional application module packages extend the capability of your oscilloscope. (See page 16, *Application Module Free Trial.*) (See page 16, *Installing an Application Module.*)

Refer to the *MSO4000B, DPO4000B, and MDO4000 Series Application Module Installation Instructions* that came with your application module for instructions on installing and testing an application module. Some modules are described in the following list. Additional modules may be available. Contact your Tektronix representative or visit our Web site at www.tektronix.com for more information. Also, refer to *Contacting Tektronix* at the beginning of the manual.

- The **DPO4AERO Aerospace Serial Triggering and Analysis Module** adds triggering and analysis on MIL-STD-1553 buses.
- The **DPO4AUDIO Audio Serial Triggering and Analysis Module** adds triggering and analysis on I²S, Left Justified (LJ), Right Justified (RJ), and TDM buses.
- The **DPO4AUTO Automotive Serial Triggering and Analysis Module** adds triggering and analysis on packet level information in serial buses used in automotive designs (CAN and LIN), as well as analytical tools to help you efficiently analyze your serial bus. These include digital views of the signal, bus views, packet decoding, search tools, and event tables with timestamp information.
- The **DPO4AUTOMAX FlexRay, CAN, and LIN Serial Triggering and Analysis Module** offers the features of the DPO4AUTO Module plus FlexRay serial bus support.
- The **DPO4COMP Computer Serial Triggering and Analysis Module** adds triggering and analysis on byte or packet level information in RS-232, RS-422, RS-485, and UART buses, and analytical tools to help you efficiently analyze your serial bus. These include digital views of the signal, bus views, packet decoding, search tools, and event tables with timestamp information.
- The **DPO4EMBD Embedded Serial Triggering and Analysis Module** adds triggering and analysis on packet level information in serial buses used in embedded designs (I²C and SPI), as well as analytical tools to help you efficiently analyze your serial bus. These include digital views of the signal, bus views, packet decoding, search tools, and event tables with timestamp information.
- The **DPO4ENET Serial Triggering and Analysis Module** adds triggering and analysis on 10BASE-T and 100BASE-TX bus signals.

NOTE. ≥ 350 MHz bandwidth models are recommended for 100BASE-TX.

- The **DPO4LMT Limit and Mask Test Module** adds testing acquired waveforms against a comparison waveform with user-defined horizontal and vertical limits or against telecom standard masks or custom masks.

NOTE. ≥ 350 MHz bandwidth models are recommended for Telecomm standards > 55 Mb/s.

1 GHz bandwidth models are recommended for high-speed (HS) USB.

- The **DPO4PWR Power Analysis Module** adds measurements of power quality, switching loss, harmonics, ripple, modulation, safe operating area, and slew rate (dV/dt and dI/dt).

- The **DPO4USB USB 2.0 Serial Triggering and Analysis Module** adds triggering and analysis on USB low-speed, full-speed, and high-speed buses.

NOTE. 1 GHz bandwidth models are required for high-speed (HS) USB.

- The **DPO4VID Extended Video Module** adds triggering on a variety of standard HDTV signals, as well as on custom (non-standard) bilevel and trilevel video signals with 3 to 4,000 lines.
- The **MDO4TRIG Advanced RF Triggering Module** enables triggering with RF power as a source for Pulse Width, Timeout, Runt, Logic, and Sequence triggers.

Appendix A: MDO4000 Specifications

You can find a more complete list of MDO4000 product specifications in the *MDO4000 Series Oscilloscopes Technical Reference*.

These are the new user manual specifications

Table 1: Analog channel input and vertical specifications

Characteristic	Description		
✓ Input Impedance, DC coupled	1 MΩ		
	1 MΩ ±1%		
	50 Ω		
	50 Ω ±1%		
	MDO4104-3, MDO4104-6	VSWR ≤ 1.5:1 from DC to 1 GHz, typical	
✓ Input Capacitance, 1 MΩ DC coupled, typical	MDO4054-3, MDO4054-6	VSWR ≤ 1.5:1 from DC to 500 MHz, typical	
	MDO4034-3	VSWR ≤ 1.5:1 from DC to 350 MHz, typical	
	MDO4014-3	VSWR ≤ 1.5:1 from DC to 100 MHz, typical	
✓ DC Balance	0.1 div with DC-50 Ω oscilloscope input impedance (50 Ω BNC terminated) 0.2 div at 1 mV/div with DC-50 Ω oscilloscope input impedance (50 Ω BNC terminated) 0.2 div with DC-1 MΩ oscilloscope input impedance (50 Ω BNC terminated)		
✓ DC Gain Accuracy	<i>For 1 MΩ, 50Ω path (checked direct) and for 250 KΩ path (checked indirect):</i> For 50 Ω path: ± 2.0%, derated at 0.100%/°C above 30 °C, 1 mV/Div setting ± 1.5%, derated at 0.100%/°C above 30 °C ± 3.0% variable gain, derated at 0.100%/°C above 30 °C		
✓ Offset Accuracy	± [0.005 × offset – position + DC Balance] Both the position and constant offset term must be converted to volts by multiplying by the appropriate volts/div term.		
✓ Analog Bandwidth, 50 Ω, DC coupled	The limits stated below are for ambient temperature of ≤30 °C (86 °F) and the bandwidth selection set to Full. Reduce the upper bandwidth frequency by 1% for each °C above 30 °C.		
	<i>Instrument</i>	<i>Volts/Div setting</i>	
	MDO4104-3, MDO4104-6	5 mV/div – 1 V/div	DC to 1.00 GHz
		2 mV/div – 4.98 mV/div	DC to 350 MHz
		1 mV/div – 1.99 mV/div	DC to 175 MHz
	MDO4054-3, MDO4054-6	5 mV/div – 1 V/div	DC to 500 MHz
		2 mV/div – 4.98 mV/div	DC to 350 MHz
		1 mV/div – 1.99 mV/div	DC to 175 MHz
	MDO4034-3	2 mV/div – 1 V/div	DC to 350 MHz
		1 mV/div – 1.99 mV/div	DC to 175 MHz
	MDO4014-3	1 mV/div – 1 V/div	DC to 100 MHz

Table 1: Analog channel input and vertical specifications (cont.)

Characteristic	Description			
✓ Analog Bandwidth, 1 M Ω , DC coupled, typical	The limits stated below are for ambient temperature of ≤ 30 °C (86 °F) and the bandwidth selection set to FULL. Reduce the upper bandwidth frequency by 1% for each °C above 30 °C.			
		<i>Instrument</i>	<i>Volts/Div setting</i>	<i>Bandwidth</i>
		MDO4104-3, MDO4104-6 (TPP1000 probe)	50 mV/div – 100 V/div	DC to 1000 MHz
			20 mV/div – 49.8 mV/div	DC to 350 MHz
			10 mV/div – 19.99 mV/div	DC to 175 MHz
		MDO4054-3, MDO4054-6 (TPP0500 probe)	50 mV/div – 100 V/div	DC to 500 MHz
			20 mV/div – 49.89 mV/div	DC to 350 MHz
			10 mV/div – 19.9 mV/div	DC to 175 MHz
		MDO4034-3 (TPP0500 probe)	20 mV/div – 100 V/div	DC to 350 MHz
			10 mV/div – 19.9 mV/div	DC to 175 MHz
	MDO4014-3 (TPP0500 probe)	10 mV/div – 100 V/div	DC to 100 MHz	
✓ Random Noise, Sample Acquisition Mode	<i>Instrument</i>	<i>Bandwidth selection</i>	<i>RMS noise (mV)</i>	
			1 M Ω	50 Ω
	MDO4104-3, MDO4104-6	Full Bandwidth	$\leq (300 \mu\text{V} + 8.0\% \text{ of Volts/div setting})$	$\leq (75 \mu\text{V} + 6.0\% \text{ of Volts/div setting})$
		250 MHz bandwidth limit	$\leq (100 \mu\text{V} + 5.0\% \text{ of Volts/div setting})$	$\leq (50 \mu\text{V} + 4.0\% \text{ of Volts/div setting})$
		20 MHz bandwidth limit	$\leq (100 \mu\text{V} + 5.0\% \text{ of Volts/div setting})$	$\leq (50 \mu\text{V} + 4.0\% \text{ of Volts/div setting})$
	MDO4054-3, MDO4054-6, MDO4034-3,	Full Bandwidth	$\leq (130 \mu\text{V} + 8.0\% \text{ of Volts/div setting})$	$\leq (130 \mu\text{V} + 8.0\% \text{ of Volts/div setting})$
		250 MHz bandwidth limit	$\leq (100 \mu\text{V} + 6.0\% \text{ of Volts/div setting})$	$\leq (100 \mu\text{V} + 6.0\% \text{ of Volts/div setting})$
		20 MHz bandwidth limit	$\leq (100 \mu\text{V} + 4.0\% \text{ of Volts/div setting})$	$\leq (100 \mu\text{V} + 4.0\% \text{ of Volts/div setting})$
	MDO4014-3	Full Bandwidth	$\leq (130 \mu\text{V} + 8.0\% \text{ of Volts/div setting})$	$\leq (130 \mu\text{V} + 8.0\% \text{ of Volts/div setting})$
		20 MHz bandwidth limit	$\leq (100 \mu\text{V} + 4.0\% \text{ of Volts/div setting})$	$\leq (100 \mu\text{V} + 4.0\% \text{ of Volts/div setting})$

Table 2: Horizontal and acquisition system specifications

Characteristic	Description
✓ Long-term sample rate and delay time accuracy	±5 ppm over any ≥1 ms time interval
✓ Delta-time measurement accuracy	<p>The formula to calculate the delta-time measurement accuracy (DTA) for a given instrument setting and input signal is given below (assumes insignificant signal content above Nyquist and insignificant error due to aliasing):</p> <p>SR₁ = slew rate around 1st point in measurement (1st edge) SR₂ = slew rate around 2nd point in measurement (2nd edge) N = input-referred noise (V_{RMS}) TBA = time base accuracy (5 ppm) t_p = delta-time measurement duration (sec) RD = (record length)/(sample rate) t_{sr} = 1/(sample rate) assume edge shape that results from Gaussian filter response</p> $DTA_{pk-pk} = \pm 5 \times \sqrt{2 \left[\frac{N}{SR_1} \right]^2 + 2 \left[\frac{N}{SR_2} \right]^2 + (3ps + 1 \times 10^{-7} \times RD)^2 + 2t_{sr} + TBA \times t_p}$ <hr/> $DTA_{rms} = \sqrt{2 \left[\frac{N}{SR_1} \right]^2 + 2 \left[\frac{N}{SR_2} \right]^2 + (3ps + 1 \times 10^{-7} \times RD)^2 + \left(\frac{2 \times t_{sr}}{\sqrt{12}} \right)^2 + TBA \times t_p}$ <p>The term under the square-root sign is the stability and is due to TIE (Time Interval Error). The errors due to this term occur throughout a single-shot measurement. The second term is due to both the absolute center-frequency accuracy and the center-frequency stability of the time base and varies between multiple single-shot measurements over the observation interval (the amount of time from the first single-shot measurement to the final single-shot measurement).</p>

Table 3: Digital acquisition specifications, MDO4000 series

Characteristic	Description
✓ Threshold Accuracy	±(100 mV + 3% of threshold setting after calibration) Requires valid SPC.

Table 4: RF Channel Characteristics

Characteristic	Description
✓ Phase Noise	10 kHz: < -90 dBc/Hz 100 kHz: < -95 dBc/Hz 1 MHz: < -113 dBc/Hz
✓ Display Average Noise Level (DANL)	MDO4104-6 and MDO4054-6 50 kHz to 5 MHz: < -130 dBm/Hz 5 MHz to 3 GHz: < -148 dBm/Hz 3 GHz to 6 GHz: < -140 dBm/Hz
	MDO4104-3, MDO4054-3, MDO4034-3, and MDO4014-3 50 kHz to 5 MHz: < -130 dBm/Hz 5 MHz to 3 GHz: < -148 dBm/Hz
✓ Level Measurement Uncertainty	< ±1 dB, < ±0.5 dB (typical), 18 – 28°C temperature range < ±1.5 dB, temperature ambient > 28°C or temperature ambient < 18 °C temperature range
✓ 3rd Order Intermodulation Distorsion	< -60 dBc
✓ Residual Spurious Response	< -78 dBm
✓ Crosstalk to RF Channel from Analog Channels	< -68 dB from reference level (< 1 GHz oscilloscope input frequencies) < -48 dB from reference level (1 GHz to 2 GHz oscilloscope input frequencies)

Table 5: Input/Output port specifications

Characteristic	Description						
✓ Auxiliary output (AUX OUT)	Selectable output: Main Trigger Out, Event, or Reference Clock Out. Trigger Out: A HIGH to LOW transition indicates that the trigger occurred. Reference Clock Out: Outputs the 10 MHz Reference Clock. Event Out: A HIGH to LOW transition indicates that the event occurred. <i>The logic levels are given in the following table:</i>						
	<table border="1"> <thead> <tr> <th>Characteristic</th> <th>Limits</th> </tr> </thead> <tbody> <tr> <td>Vout (HI)</td> <td>≥2.5 V open circuit ≥1.0 V into a 50 Ω load to ground</td> </tr> <tr> <td>Vout (LO)</td> <td>≤0.7 V into a load of ≤4 mA ≤0.25 V into a 50 Ω load to ground</td> </tr> </tbody> </table>	Characteristic	Limits	Vout (HI)	≥2.5 V open circuit ≥1.0 V into a 50 Ω load to ground	Vout (LO)	≤0.7 V into a load of ≤4 mA ≤0.25 V into a 50 Ω load to ground
Characteristic	Limits						
Vout (HI)	≥2.5 V open circuit ≥1.0 V into a 50 Ω load to ground						
Vout (LO)	≤0.7 V into a load of ≤4 mA ≤0.25 V into a 50 Ω load to ground						

Table 6: External Reference Input

Characteristic	Description
✓ External Reference Input frequency variation tolerance, typical	9.9 MHz to 10.1 MHz
✓ External Reference Input Sensitivity, typical	V_{in} 1.5 V _{p-p} for input frequencies between 9.9 MHz and 10.1 MHz

Appendix B: TPP0500 and TPP1000 500 MHz and 1 GHz 10X Passive Probes Information

Operating Information

The TPP0500 and TPP1000 10X Passive Probes are compact passive probes with 10X attenuation that are designed for use with Tektronix MDO4000 Series oscilloscopes.

The probes have no user- or Tektronix-serviceable parts.

Connecting the Probe to the Oscilloscope

Connect the probe as shown in the illustrations below.

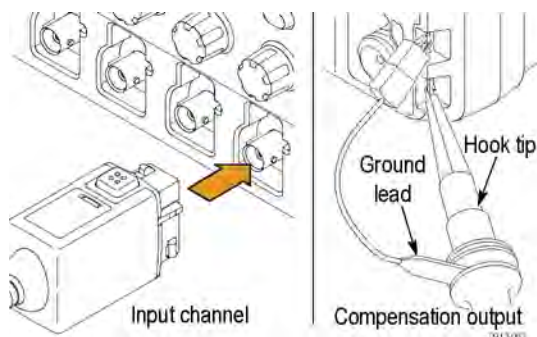

Compensating the Probe with MDO4000 Series Oscilloscopes

For information on compensating the probe, refer to the related section earlier in this manual.

(See page 13, *Compensating a TPP0500 or TPP1000 Passive Voltage Probe.*)



Standard Accessories

The standard accessories included with the probe are shown below.

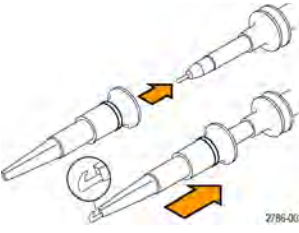
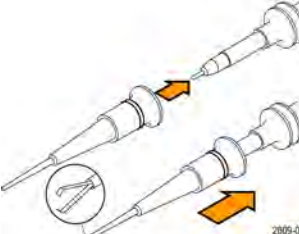
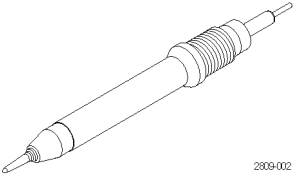
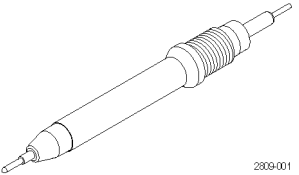
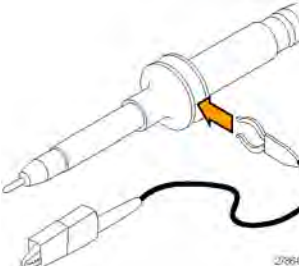

WARNING. To avoid electric shock when using the probe or accessories, keep fingers behind the finger guard of probe body and accessories.

To reduce risk of shock, when using the probe on floating measurements, ensure the reference lead accessories are fully mated before connecting the probe to the circuit under test.

Item	Description
	<p>Hook tip</p> <p>Press the hook tip onto the probe tip and then clamp the hook onto the circuit</p> <p>Reorder Tektronix part number 013-0362-XX</p>
	<p>Micro Hook tip</p> <p>Use this tip to access test points in tight spaces. Press the hook tip onto the probe tip and then clamp the hook onto the circuit</p> <p>Reorder Tektronix part number 013-0363-XX</p>
	<p>Rigid tip</p> <p>This tip is pre-installed on the probe.</p> <p>Reorder Tektronix part number 206-0610-XX</p>
	<p>Pogo tip</p> <p>This spring-loaded tip allows compliant testing of circuit boards. The probe tip retracts slightly when pressure is applied to it and then springs back into place.</p> <p>Reorder Tektronix part number 206-0611-XX</p>
	<p>Ground lead, with alligator clip</p> <p>Secure the lead to the probe head ground and then to your circuit ground.</p> <p>Reorder Tektronix part number 196-3521-XX</p>
	<p>Ground springs</p> <p>Attach the spring to the ground band on the probe tip to take measurements on test points that have ground connections nearby (<0.75 in, std; 0.375 in, short).</p> <p>Reorder Tektronix part numbers: 016-2028-XX (long, 2 ea.) 016-2034-XX (short, 2 ea.)</p>

Optional Accessories

The following accessories can be ordered for your probe.

Accessory	Tektronix part number
Ground Lead, Clip-on, 6 in	196-3198-xx
Ground Lead, Alligator, 12 in	196-3512-xx
MicroCKT Test Tip	206-0569-xx
Circuit Board Test Point/PCB Adapter	016-2016-xx
Compact Probe Tip Ckt Board Test Point	131-4210-xx
Wire, spool, 32 AWG	020-3045-xx

Replacing the Probe Tip

Order Tektronix part number 206-0610-xx for rigid tip replacement, or order part number 206-0611-xx for pogo pin replacement.

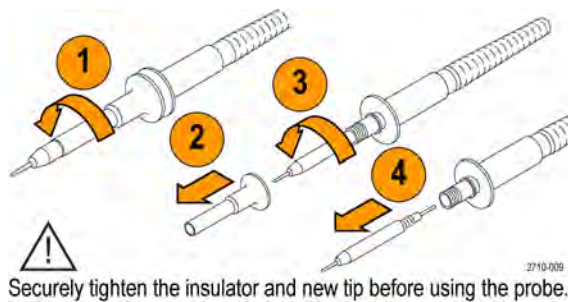

Specifications

Table 7: Electrical and mechanical specifications

Characteristic	TPP0500	TPP1000
Bandwidth (-3 dB)	500 MHz	1 GHz
System rise time (typical)	<350 ps	<700 ps
System input capacitance	Rigid tip: 3.9 pF ±0.3 pf Pogo pin tip: 5.1 pf ±0.5 pf	
System attenuation accuracy	10:1 ±2.2%	
Probe series resistance @DC	9.75 MΩ ±0.5%	
System input resistance @DC	10 MΩ ±2%	
Propagation delay	~5.67 ns	
Maximum input voltage	300 V _{RMS} CAT II	
Cable length	1.3 m, ±3 cm	

Performance Graphs

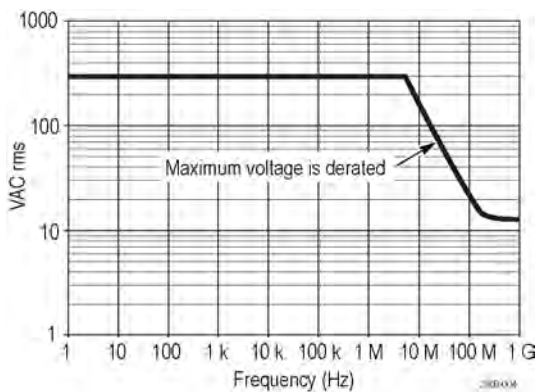
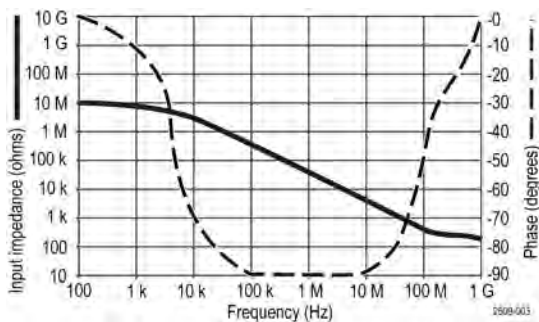

Refer to the reference lead derating curve above when making floating measurements.

Table 8: Environmental specifications

Characteristics	Description
Temperature	
Operating	-15 °C to +65 °C (+5 °F to +149 °F)
Nonoperating	-62 °C to +85 °C (-80 °F to +185 °F)
Humidity	
Operating	5% to 95% relative humidity @ up to 30 °C
Nonoperating	5% to 45% relative humidity @30 °C up to 50 °C
Altitude	
Operating	4.6 km (15,000 ft) maximum
Nonoperating	12.2 km (40,000 ft) maximum

Table 9: Certifications and compliances

Characteristics	Description								
EC Declaration of Conformity	Compliance was demonstrated to the following specification as listed in the Official Journal of the European Communities: Low Voltage Directive 2006/95/EC: EN61010-031: 2002								
Measurement Category Descriptions	<table border="1"> <thead> <tr> <th>Category</th> <th>Examples of Products in this Category</th> </tr> </thead> <tbody> <tr> <td>CAT III</td> <td>Distribution-level mains, fixed installation</td> </tr> <tr> <td>CAT II</td> <td>Local-level mains, appliances, portable equipment</td> </tr> <tr> <td>CAT I</td> <td>Circuits not directly connected to mains.</td> </tr> </tbody> </table>	Category	Examples of Products in this Category	CAT III	Distribution-level mains, fixed installation	CAT II	Local-level mains, appliances, portable equipment	CAT I	Circuits not directly connected to mains.
Category	Examples of Products in this Category								
CAT III	Distribution-level mains, fixed installation								
CAT II	Local-level mains, appliances, portable equipment								
CAT I	Circuits not directly connected to mains.								
Pollution Degree 2	Do not operate in environments where conductive pollutants may be present (as defined in IEC 61010-1). Rated for indoor use only.								
Additional Safety Standards	UL61010B-1, First Edition & UL61010B-2-031, First Edition. CAN/CSA-C22.2 No. 1010.1-92, & CAN/CSA-C22.2 No. 1010.2.031-94 IEC61010-031:2002								



Equipment Recycling. This product complies with the European Union’s requirements according to Directive 2002/96/EC on waste electrical and electronic equipment (WEEE). For more information about recycling options, check the Support/Service section of the Tektronix Web site (www.tektronix.com).

Safety Summary

Review the following safety precautions to avoid injury and prevent damage to this product or any products connected to it. To avoid potential hazards, use this product only as specified. Using the probe or accessories in a manner not specified could result in a shock or fire hazard.

To Avoid Fire or Personal Injury

Ground-Referenced Oscilloscope Use. Do not float the reference lead of this probe when using with ground referenced oscilloscopes (for example, DPO, MSO, and TDS series oscilloscopes). The reference lead must be connected to earth potential (0 V).

Connect and Disconnect Properly. Connect the probe output to the measurement instrument before connecting the probe to the circuit under test. Disconnect the probe input and the probe reference lead from the circuit under test before disconnecting the probe from the measurement instrument.

Avoid Electric Shock. To avoid injury or loss of life, do not connect or disconnect probes or test leads while they are connected to a voltage source.

Observe All Terminal Ratings. To avoid fire or shock hazard, observe all ratings and markings on the product. Consult the product manual for further ratings information before making connections to the product.

Avoid Electric Shock. When using probe accessories, never exceed the lowest rating of the probe or its accessory, whichever is less, including the measurement category and voltage rating.

Avoid Electric Overload. To avoid injury or fire hazard, do not apply potential to any input, including the reference inputs, that varies from ground by more than the maximum rating for that input.

Avoid Exposed Circuitry and Do not Operate Without Covers. Do not touch exposed connections and components when power is present.

Inspect The Probe And Accessories. Before each use, inspect probe and accessories for damage (cuts, tears, defects in the probe body, accessories, cable jacket, etc.). Do not use if damaged.

Do Not Operate in Wet/Damp Conditions.

Do Not Operate in an Explosive Atmosphere.

Keep Product Surfaces Clean and Dry.

Safety Terms and Symbols Terms in This Manual.

These terms may appear in this manual:



WARNING. Warning statements identify conditions or practices that could result in injury or loss of life.



CAUTION. Caution statements identify conditions or practices that could result in damage to this product or other property.

Symbols on the Product. These symbols may appear on the product:



CAUTION
Refer to Manual

Appendix C: P6616 General-Purpose Logic Probe Information

Product Description

The P6616 general-purpose logic probe connects the Tektronix MDO4000 Series of mixed-signal oscilloscopes to digital buses and signals on your target system. The probe contains 16 data channels split between two lead sets (GROUP 1 and GROUP 2).

The first lead in each set is identified by blue insulation, and the remaining seven leads are gray. All leads include a ground connection at the tip. You can connect the probe leads separately to the target system, or group the leads together using the probe tip holders.



Connecting the Probe to the Oscilloscope

Connect the probe as shown in the illustration below.

1. Insert the probe label-side up into the connector on the oscilloscope.
2. To remove the probe, squeeze the buttons on the side and pull out the probe.

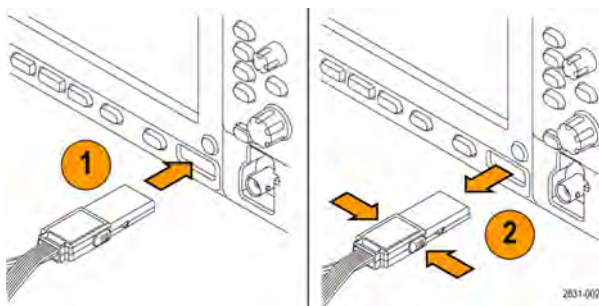

Connecting the Probe to Your Circuit

Attach the probe to the circuit using the appropriate connectors and adapters. Select the best method for your needs, and then proceed to Setting up the Probe.

To set and view the digital channel parameters, do the following:

Push the **D15–D0** button.

The parameters listed below can be set on each digital channel:

- Threshold voltage and vertical position (the default threshold setting is 1.4 V)
- Signal height and position (set once for all 16 channels)
- Channel label

To set and view bus characteristics, do the following:

Push the **B1** to **B4** buttons.

The setup screens allow you to set and view various bus characteristics.

For buses such as SPI and I²C, you must have the appropriate application module. (See page 60, *Setting Up a Serial or Parallel Bus*.)

Functional Check

Logic activity immediately displays on all connected, active channels. If you do not see an active signal:

1. Push the **Trigger** button.
2. Select Edge for trigger type.
3. Select the channel that you are setting up as the source.
4. Push the **Autoset** button.

If you do not see an active signal, try another probe channel (or analog probe) to verify circuit activity at the test point.

Typical Application

1. Use the P6616 probe to view digital signals on a system bus.
2. Use an analog probe, such as the TPP0500 or TPP1000 passive probe, to view analog waveform information.

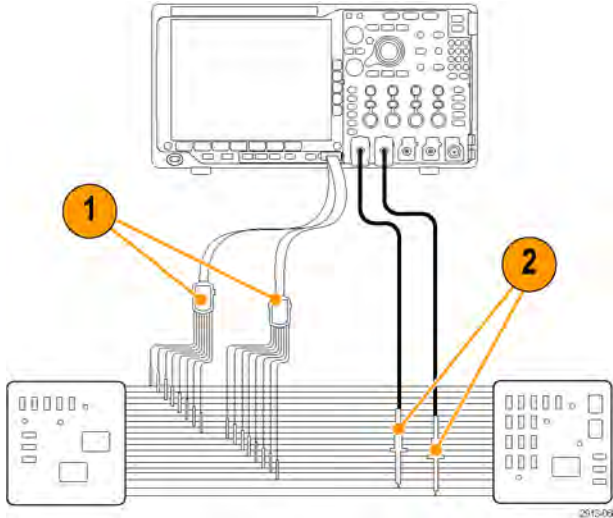

Accessories

The following standard accessories ship with the probe and are shown in the illustration on the following page.

Item	Description	Quantity	Part number
–	Logic probe accessory kit	Item 1–6	020-2662-XX
1	Extension ground tip	1 set of 20	020-2711-XX
2	Probe tip	1 set of 10	131-5638-11
3	IC grabber	1 set of 20	020-2733-XX
4	Probe tip holder	2 ea	352-1115-XX
5	8" Ground lead	1 set of 2	020-2713-XX
6	3" Ground lead	1 set of 8	020-2712-XX
	Instructions ¹	1 ea	071-2831-XX

¹ Instructions are included with the probe, but not in the accessory kit. The instructions can be downloaded at www.tektronix.com/manuals.

These optional accessories can be ordered for your probe:

Description	Part number
P6960 Probe D-MAX Footprint to Square Pin Header Adapter	NEX-P6960PIN

Specifications

Table 10: Electrical and mechanical specifications

Characteristic	Description
Input channels	16 digital
Input resistance	100 k Ω \pm 1.0%
Input capacitance	3.0 pF
Input signal swing	
Minimum	400 mV p-p
Maximum	30 V p-p, \leq 200 MHz (centered around the DC threshold voltage) at the probe tip 10 V p-p, \geq 200 MHz (centered around the DC threshold voltage) at the probe tip
Maximum nondestructive input signal	\pm 42 V
User defined threshold range	\pm 40 V
Minimum detectable pulse width	1 ns
Digital channel-to-digital channel skew	200 ps
Probe length	1.3 m (4.27 ft)
Maximum input toggle rate	500 MHz

Table 11: Environmental specifications

Characteristic	Description
Temperature	
Operating	0 °C to +50 °C (+32 °F to +122 °F)
Non-operating	-55 °C to +75 °C (-67 °F to +167 °F)
Humidity	
Operating	5% to 95% relative humidity
Non-operating	10% to 95% relative humidity
Altitude	
Operating	4.6 km (15,092 ft) maximum
Non-operating	15 km (50,000 ft) maximum



Equipment Recycling. This product complies with the European Union's requirements according to Directive 2002/96/EC on waste electrical and electronic equipment (WEEE). For more information about recycling options, check the Support/Service section of the Tektronix Web site (www.tektronix.com).

Safety Summary

To avoid potential hazards, use this probe only as specified.

Connect and Disconnect Properly. Connect the probe output to the measurement instrument before connecting the probe to the circuit under test. Disconnect the probe input and the probe ground from the circuit under test before disconnecting the probe from the measurement instrument.

Observe All Terminal Ratings. To avoid fire or shock hazard, observe all ratings and markings on the product. Consult the product manual for further ratings information before making connections to the product.

Do not Operate Without Covers. Do not touch exposed connections and components when power is present.

Avoid Exposed Circuitry. Do not touch exposed connections and components when power is present.

Do Not Operate With Suspected Failures. If you suspect there is damage to this product, have it inspected by qualified service personnel.

Do Not Operate in Wet/Damp Conditions. Do Not Operate in an Explosive Atmosphere.

Keep Product Surfaces Clean and Dry.

Safety Terms and Symbols in This Manual.

These terms may appear in this manual:



WARNING. Warning statements identify conditions or practices that could result in injury or loss of life.



CAUTION. Caution statements identify conditions or practices that could result in damage to this product or other property.

Symbols on the Product. This symbol may appear on the product:



Index

Symbols and Numbers

50 Ω protection, 105

A

About, 24
 Accessories, 1
 ACD4000B, 4
 Acquire button, 36, 57, 96
 Acquisition
 input channels and digitizers, 55
 modes defined, 57
 readout, 42
 sampling, 55
 Adapter
 TEK-USB-488, 4
 TPA-BNC, 5, 9
 TPA-N-VPI, 5, 9
 Adding waveform, 96
 Adjacent channel power ratio measurement, 120
 Advanced math, 140
 Altitude, 6
 Ampl button, 38, 76
 Amplitude measurement, 123
 Amplitude versus time trace, 113
 Analog time, 150
 spectrum time, 151
 Annotating the screen, 108
 Application modules, 16, 178
 30-day free trial, 16
 DPO4AERO, 2, 60
 DPO4AUDIO, 2, 60
 DPO4AUTO, 2, 60
 DPO4AUTOMAX, 3, 60
 DPO4COMP, 3, 60
 DPO4EMBD, 3, 60
 DPO4ENET, 3, 60
 DPO4LMT, 3
 DPO4PWR, 3, 60
 DPO4USB, 3, 60
 DPO4VID, 4, 86
 license transfers, 16
 MDO4TRIG, 4, 94
 Area measurement, 124

Audio
 bus trigger, 88
 Auto Level, 77
 Auto trigger mode, 80
 Auto-magnify mode, 149
 Autoset, 54
 Video, 55
 Autoset button, 13, 36, 41, 51, 54
 Autoset disable, 54
 Autoset undo, 54
 Auxiliary Output (AUX OUT), 48
 Auxiliary readout, 45
 Average acquisition mode, 57
 Average detection type, 113
 Average trace, 111

B

B trigger, 92
 B/W button, 38
 B1 / B2 / B3 / B4, 60, 61, 86
 Backlight intensity, 100
 Bandwidth, xi, 103
 resolution, 77
 Baseline indicator, 77
 Frequency versus time, 114
 Baseline indicators, 45
 Before Installation, 1
 Blackman-Harris FFT window, 79, 140
 Blue lines, 108
 BNC interface, 9
 Burst Width measurement, 122
 Bus
 button, 60, 61, 86
 display, 46, 63
 menu, 37, 61
 positioning and labeling, 106
 setup, 61
 Bus and Waveforms display
 show physical layer bus activity, 71
 Bus trigger, defined, 86
 Buses, 60, 86
 cursor readout, 132

Button

Acquire, 36, 57, 96
 Ampl, 38, 76
 Autoset, 13, 36, 41, 51, 54
 B/W, 38
 B1 / B2 / B3 / B4, 37, 60, 61, 86
 bus, 60, 61, 86
 BW, 78
 Channel, 37
 Cursors, 39, 129
 D15 - D0, 42, 74
 Default Setup, 42, 50, 53
 Fine, 36, 39, 40, 41
 Force Trig, 41, 80
 Freq/Span, 38, 75
 hard copy, 41, 175
 Intensity, 39, 100
 M, 38, 136, 137
 Markers, 38
 Math, 38, 136, 137
 Measure, 36, 121, 126, 127
 Menu Off, 42
 Next, 40
 Play-pause, 40, 145
 Previous, 40
 Print, 41
 printer, 175
 Ref, 38, 142, 165
 RF, 21, 38, 46, 110
 Run/Stop, 41, 59, 93
 Save / Recall, 37, 42, 162
 Search, 36, 147
 Select, 39
 Set / Clear Mark, 40, 146
 Set to 50%, 41, 82
 Single, 41, 93
 Span, 76
 Test, 36
 Trigger, 36
 Trigger level, 41
 Trigger menu, 83
 Utility, 17, 18, 20, 37, 98, 99, 108, 109, 171
 Vertical, 37
 Zoom, 40
 BW button, 78
 byte matching, 90

C

Calibration, 20, 21
 Calibration certificate, 1
 CAN, 37, 60, 86
 bus trigger, 88
 Case
 hard transit, 4
 soft transit, 4
 Center frequency, 76
 Channel
 button, 37
 readout, 45
 vertical menu, 102
 Channel power measurement, 120
 Cleaning, 8
 Clearance, 7
 Communications, 25, 27, 30
 Compensate
 non-TPP500 or non-TPP1000
 probe, 15
 signal path, 20
 TPP500 or TPP1000 probe, 13
 Confidential data, 176
 Connecting
 a USB keyboard, 33
 to a PC, 25
 Your oscilloscope, 25
 Connectivity, 1, 25, 27, 30
 Connectors
 front panel, 47
 rear-panel, 48
 side-panel, 47
 Controls, 34
 Copy a drive, directory, or file, 169
 Coupling, 102
 Coupling, trigger, 81
 Cover, front, 2
 Create new folder, 169
 Cross Hair graticule style, 99
 Cursor readout, 43, 132
 Cursors, 129
 button, 39, 129
 linking, 130
 measurements, 129
 menu, 129
 XY, 133
 Cycle Area measurement, 124
 Cycle Mean measurement, 123
 Cycle RMS measurement, 124

D

D15 - D0 button, 42, 74

Date and time, changing, 18
 Default Setup, 53, 168
 button, 42, 50, 53
 menu, 42
 Undo, 54
 Delay measurement, 122
 Delay time, 59
 Delayed trigger, 91
 Delete directory or file, 169
 Depth, 6
 Deskew, 104
 Detection types, 112
 dl/dt, 3
 Digital channels, 108
 Baseline indicators, 45
 Group icon, 45
 scaling, positioning, grouping,
 and labeling, 106
 setup, 72
 Disable AutoSet, 54
 Display
 frequency domain, 34, 46
 information, 42
 persistence, 96
 style, 96
 time domain, 34
 time-correlated multi-
 domain, 150
 XY, 98
 Displaying, reference
 waveforms, 165
 DPO4AERO, 2, 60, 178
 DPO4AUDIO, 2, 60, 178
 DPO4AUTO, 2, 60, 178
 DPO4AUTOMAX, 3, 60, 178
 DPO4COMP, 3, 60, 178
 DPO4EMBD, 3, 60, 178
 DPO4ENET, 3, 60, 178
 DPO4LMT, 3, 154, 178
 DPO4PWR, 3, 60, 178
 DPO4USB, 3, 60, 179
 DPO4VID, 4, 86, 179
 Drivers, 25, 27
 Dual waveform math, 136
 dV/dt, 3

E

e*Scope, 27
 Edge trigger, defined, 84
 Edges
 Fuzzy, 108
 White, 108

Envelope acquisition mode, 57
 Erase setup and ref memory, 176
 Ethernet, 26, 27, 28, 37, 60, 86
 bus trigger, 89
 port, 48
 printing, 173
 Event Table, 63
 Excel, 25, 27
 Excursion, 118
 Expansion point, 56
 Expansion point icon, 43
 EXT REF IN, 48

F

Factory calibration, 21
 Fall Time measurement, 122
 Falling Edge Count
 measurement, 124
 FFT
 Blackman-Harris, 79, 140
 controls, 137
 Flat-Top, 79
 Hamming, 79, 139
 Hanning, 79, 140
 Kaiser, 78
 Rectangular, 79, 139
 File format, 163
 Instrument Specific File Format
 (ISF), 165
 TIQ, 163
 File names, 160
 File system, 160, 165
 Fine, 39
 Fine button, 36, 39, 40, 41
 Firmware
 upgrade, 22
 version, 24
 firmware.img file, 22
 Flash drive, 27
 Flat-Top FFT window, 79
 FlexRay, 37, 60, 86
 bus trigger, 88
 Force Trig button, 41, 80
 Format a drive, 169
 Frame graticule style, 99
 Free run spectrogram, 116
 Freq/Span button, 38, 75
 Frequency Domain
 menu, 38
 Frequency domain display, 34, 46

- Frequency domain markers, 117
 - automatic, 118
 - manual, 119
- Frequency Domain menu, 21
- Frequency measurement, 122
- Frequency versus time
 - baseline indicator, 114
- Frequency versus time trace, 113
- Frequency, center, 76
- Front cover, 2
- Front panel, 34
- front panel connectors, 47
- front panel overlay, 18
- Full graticule style, 99
- Functional check, 12
- Fuzzy edges, 108

G

- Gating, 125
- GPIO, 25, 49
- GPIO address, 26
- Graticule
 - Cross Hair, 99
 - Frame, 99
 - Full, 99
 - Grid, 99
 - intensity, 100
 - IRE, 99
 - mV, 99
 - Solid, 99
 - styles, 98
- Green lines, 108
- Grid graticule style, 99
- Ground, 11
 - lead, 16
 - strap, 11
 - strap connector, 47
- Ground yourself to discharge
 - static, 11
- Group icon, 45
- Grouping channels, 73
 - digital, 106

H

- Hamming FFT window, 79, 139
- Hanning FFT window, 79, 140
- Hard copy, 170
- Hard copy button, 41
- HCTEK54 transit hard case, 4
- Height, 6
- Hi Res acquisition mode, 57

- High measurement, 123
- High-low indicators, 45
- Histogram (waveform)
 - reset the count, 135
 - setup, 133
- Histogram measurements, 124
- Hits in Box measurement, 124
- Holdoff, trigger, 81
- Horizontal delay, 81
- Horizontal lines
 - Green and blue, 108
- Horizontal position, 40, 56, 81, 82, 101, 139
 - and math waveforms, 137
 - defined, 51
 - readout, 44
- Horizontal scale, 40, 101, 139
 - and math waveforms, 137
 - defined, 51
 - readout, 44

How to

- calibrate a TPP0500 or TPP1000 voltage probe, 13
- compensate a non-TPP0500 or non-TPP1000 voltage probe, 15
- compensate the signal path, 20
- connect probes and adapters, 9
- connect to a computer, 25
- erase memory, 176
- label channels and buses, 51
- manage long record length waveforms, 144
- perform a functional check, 12
- power off the oscilloscope, 12
- power on the oscilloscope, 11
- print a hard copy, 170
- recall setups, 166
- recall waveforms, 162
- save screen images, 162
- save setups, 166
- save waveforms, 162
- search through and add marks to waveforms, 146
- select a trigger, 84
- select automatic measurements, 122
- setup a waveform histogram, 133
- setup analog channels, 50
- setup bus parameters, 61
- setup digital channels, 72
- setup input parameters, 102
- setup VISA communications, 25
- take an automatic measurement in the frequency domain, 120
- take an automatic measurement in the time domain, 121
- take manual measurements with cursors, 129
- trigger on buses, 86
- upgrade the firmware, 22
- use a sequential trigger, 91
- use a socket server, 30
- use e*Scope, 27
- use MagniVu, 74
- use Wave Inspector, 144

Humidity, 6

- I**
- I2C, 37, 60, 86
 - I2S, 37, 60, 86
 - Icon
 - Expansion point, 43
 - Trigger level, 44
 - Trigger position, 43
 - Image orientation, 163, 171
 - Impedance, 102
 - Indicator
 - baseline, 77
 - trace, 112
 - Indicator, waveform baseline, 45
 - Infinite persistence, 98
 - Ink Saver, 163, 172
 - Inner knob, 40, 137
 - Instrument Specific File Format (ISF), 165
 - Intensity
 - button, 39
 - Intensity button, 100
 - Invert, 102
 - IRE graticule, 99
 - ISF format, 165
- K**
- Kaiser FFT window, 78
 - Keyboard
 - Connection, 33
 - Key layout style, 33
 - language, 17
 - Keypad, 34
 - Knob
 - inner, 40, 137
 - Multipurpose, 19, 36, 39, 40, 58, 165
 - outer, 40
 - pan, 40, 145, 146
 - Trigger level, 82
 - Vertical menu, 41
 - Vertical position, 41, 51
 - Vertical scale, 41, 51
 - zoom, 40, 137, 144
- L**
- Label bus, 106
 - LabVIEW SignalExpress, 25, 27
 - LAN port, 48
 - Landscape, 163, 171
 - Language
 - change, 17
 - overlay, 18
 - Left Justified (LJ), 37, 60, 86
 - Level, trigger, 82
 - License transfers for application modules, 16
 - Limit testing, 154
 - LIN, 37, 60, 86
 - bus trigger, 88
 - Linked cursors, 130
 - Lock, standard laptop, 10
 - Logic probe, 2
 - Logic probe interface, 9
 - Logic trigger, defined, 85
 - Long record length management, 144
 - Low measurement, 123
 - Low resolution message, 121
 - LXI, 28
 - LXI Class C, 48
- M**
- M button, 38, 136, 137
 - MagniVu, 74
 - MagniVu readout, 44
 - Main trigger, 91
 - Mark, 146
 - Markers, 117, 118
 - threshold and excursion, 118
 - Markers button, 38
 - Mask testing, 154
 - Math
 - Advanced, 140
 - button, 38, 136, 137
 - Dual waveform, 136
 - FFT, 137
 - menu, 38
 - spectrum, 141
 - waveforms, 136
 - Max hold trace, 111
 - Max measurement, 123, 125
 - MDO4TRIG, 4, 94, 179
 - Mean measurement, 123, 125
 - Measure button, 36, 121, 126, 127
 - Measurement
 - adjacent channel power ratio, 120
 - channel power, 120
 - occupied bandwidth, 120
 - Measurement menu, 36
 - Measurements
 - automatic, 121
 - cursor, 129
 - defined, 122
 - frequency domain, 120
 - histogram, 124
 - reference levels, 128
 - snapshot, 127
 - statistics, 126
 - Mediam measurement, 124
 - Memory, erasure of, 176
 - Menu, 34
 - Bus, 37, 61
 - buttons, 36
 - Cursors, 129
 - Default Setup, 42
 - Frequency Domain, 38
 - Math, 38
 - Measurement, 36
 - Reference, 38, 143
 - Save / Recall, 37, 42, 162
 - Trigger, 36, 83, 91
 - Utility, 17, 19, 37, 41, 98, 109, 110, 171
 - Vertical, 37, 102
 - Menu Off button, 42
 - Menus
 - Frequency Domain, 21
 - Microsoft
 - Excel, 27
 - Word, 27
 - MIL-STD-1553, 37, 60, 86
 - bus trigger, 89
 - data value matching, 90
 - Min hold trace, 111
 - Min measurement, 123, 125
 - Mode, roll, 59
 - Mount or unmount a networked drive, 169
 - Multiple transition detection, 108
 - Multipurpose knob, 36, 39, 40, 58, 165
 - mV graticule, 99
- N**
- N-connector RF input, 34
 - Negative Duty Cycle measurement, 122
 - Negative Overshoot measurement, 123
 - Negative Pulse Count measurement, 124

- Negative Pulse Width measurement, 122
 - Network printing, 173
 - Networked drives, mounting and unmounting, 169
 - NEX-HD2HEADER, 4
 - Next button, 40
 - NI LabVIEW SignalExpress, 1
 - Normal trace, 111
 - Normal trigger mode, 80
- O**
- Occupied bandwidth measurement, 120
 - Offset and position, 105
 - Offset vertical, 103
 - OpenChoice, 1
 - OpenChoice Desktop, 25, 27
 - Operating specifications, 6
 - Orientation of the image, 163, 171
 - Outer knob, 40
 - Overlay, 18
- P**
- P6616, 8, 73
 - probe ground leads, 72
 - P6616 logic probe, 2
 - Pan, 144, 145
 - knob, 40, 145, 146
 - Panning
 - spectrum time through analog time, 151
 - Parallel bus, 60, 86
 - trigger, 86, 87
 - Pause, 145
 - Peak detect acquisition mode, 57
 - +Peak detection type, 112
 - Peak detection type, 113
 - Peak Hits measurement, 124
 - Peak-to-peak measurement, 125
 - Peak-to-Peak measurement, 123
 - Period measurement, 122
 - Persistence
 - display, 96
 - infinite, 98
 - variable, 98
 - Phase measurement, 122
 - Phase versus time
 - trace, 113
 - Physical layer bus activity, 71
 - PictBridge, 27, 49, 170
 - Play, 145
 - Play-pause
 - button, 40, 145
 - mode, 145
 - Pollution Degree, 6
 - Portrait, 163, 171
 - Position
 - bus, 106
 - digital channels, 106
 - Horizontal, 81, 82, 101, 139
 - Vertical, 101
 - Position and offset, 105
 - Positive Duty Cycle measurement, 122
 - Positive Overshoot measurement, 123
 - Positive Pulse Count measurement, 124
 - Positive Pulse Width measurement, 122
 - Posttrigger, 80, 82
 - Pouch, probe and accessory, 2
 - Power
 - cord, 2
 - input, 49
 - off, 12
 - removing, 12
 - supply, 11
 - switch, 41
 - Power consumption, 6
 - Predefined math expressions, 136
 - Pretrigger, 80, 82
 - Previous button, 40
 - Print, 171
 - Ethernet, 173
 - hard copy, 170
 - Print button, 41
 - Probe
 - accessory, 2
 - logic, 2
 - Probe Comp, 13, 14
 - PROBE COMP connector, 47
 - Probe compensation
 - non-TPP0500 or non-TPP1000, 15
 - TPP0500 or TPP1000, 13
 - Probe connector
 - analog, 47
 - logic, 47
- Probes
- BNC, 9
 - connecting, 9
 - ground lead, 16
 - logic, 9
 - P6616, 191
 - TEK-USB-488 Adapter, 4
 - TekVPI, 5, 9
 - TPA-BNC Adapter, 5, 9
 - TPP0500, 2, 184
 - TPP1000, 2, 184
- Pulse Width trigger, defined, 84
- R**
- Rackmount, 4
 - RBW, 77
 - Readout
 - Acquisition, 42
 - Auxiliary, 45
 - Channel, 45
 - Cursor, 43, 132
 - Horizontal position/scale, 44
 - MagniVu, 44
 - Record length/sampling rate, 44
 - Timing resolution, 44
 - Trigger, 44, 90
 - Trigger frequency, 109
 - Trigger status, 43
 - Real-time sampling, 56
 - Rear-panel connectors, 48
 - Recalling
 - setups, 166
 - waveforms, 162
 - Record length, xi, 56
 - Record length/sampling rate readout, 44
 - Rectangular FFT window, 79, 139
 - Ref button, 38, 142, 165
 - Ref R, 165
 - Reference level, 112
 - Reference levels, 128
 - Reference menu, 38, 143
 - Reference waveforms, 142
 - displaying, 165
 - removing, 143, 166
 - saving, 165
 - saving 10 M and 20 M waveforms, 143
 - Removing reference waveforms, 143, 166
 - Removing waveform, 96

- Rename a drive, directory, or file, 169
 - Resolution bandwidth, 77
 - RF Acquisition time, 150
 - RF button, 21, 38, 46, 110
 - RF input connector, 34, 47
 - RF power trigger, 93
 - RF time domain traces, 113
 - RF versus time trace, 113
 - Right Justified (RJ), 37, 60, 86
 - Rise Time measurement, 122
 - Rise/Fall trigger, defined, 85
 - Rising Edge Count measurement, 124
 - RMS measurement, 124
 - Roll mode, 59
 - Rolling window data matching, 89
 - RS-232, 37, 60, 86
 - bus trigger, 88
 - cursor readout, 132
 - data value matching, 90
 - decoding, 67
 - RS-422, 37, 60
 - RS-485, 37, 60
 - Run/Stop button, 41, 59, 93
 - Runt trigger, defined, 84
- S**
- Safety Summary, v
 - Sample acquisition mode, 57
 - Sample detection type, 112
 - Sample interval, 56
 - Sample rates, xi
 - Sampling process, defined, 55
 - Sampling, real-time, 56
 - Save / Recall menu, 37, 42, 162
 - Save / Recall Menu button, 37
 - Save / Recall Save button, 42, 162
 - Saving
 - reference waveforms, 165
 - screen images, 162
 - setups, 166
 - waveforms, 162
 - Saving and recalling Information, 160
 - Scale
 - digital channels, 106
 - Horizontal, 40, 101, 139
 - Vertical, 101
 - Screen annotations, 108
 - Search, 146
 - Search button, 36, 147
 - Securing memory, 176
 - Security lock, 10
 - Select button, 39
 - Selecting a keyboard key layout style, 33
 - Sequence (B Trigger), defined, 84
 - Sequential triggering, 91
 - Serial bus, 60
 - trigger, 86
 - Set / Clear Mark button, 40, 146
 - Set to 50% button, 41, 82
 - Setup
 - default, 42, 50, 53, 168
 - Setup and Hold trigger, defined, 85
 - Side panel connector, 47
 - Sigma1 measurement, 125
 - Sigma2 measurement, 125
 - Sigma3 measurement, 125
 - Signal path compensation, 20
 - Frequency domain, 21
 - Time and frequency domains, 20
 - Single button, 41, 93
 - Single sequence, 59, 93
 - Slew rate, 3
 - Slope, trigger, 82
 - Snapshot, 127
 - Socket server, 30
 - Socket Server, 26
 - Software drivers, 25, 27
 - Software, optional, 178
 - Solid graticule style, 99
 - Span button, 76
 - SPC, 20
 - Specifications
 - operating, 6
 - power supply, 11
 - Spectrogram
 - display, 115
 - triggered and free run, 116
 - Spectrum Math, 141
 - Spectrum time, 150
 - analog time, 151
 - outside the RF acquisition time, 153
 - Spectrum traces, 111
 - SPI, 37, 60, 86
 - SPI bus trigger, 87
 - Squelch, 113, 115
 - Standard Deviation measurement, 125
 - Start an acquisition, 93
 - Statistics, 126
 - Stop an acquisition, 93
 - Switch, power, 41
- T**
- Table, Event, 63
 - TDM, 37, 60, 86
 - TEK-USB-488 Adapter, 4, 25, 26, 49
 - TekSecure, 176
 - TekVPI, 9
 - TekVPI Probes, 5
 - Telnet, 32
 - Temperature, 6
 - Termination, 102
 - Test button, 36
 - Threshold, 118
 - Time domain display, 34
 - Time-correlated multi-domain display, 150
 - Timeout trigger, defined, 84
 - Timing resolution readout, 44
 - TIQ files, 163
 - TPA-BNC Adapter, 5, 9
 - TPA-N-VPI Adapter, 5, 9
 - TPP0500 or TPP1000 compensation, 13
 - TPP0500 probe, 2
 - TPP0500, TPP1000, 8
 - TPP1000 probe, 2
 - Trace
 - amplitude versus time, 113
 - average, 111
 - frequency versus time, 113
 - indicator, 112
 - max hold, 111
 - min hold, 111
 - normal, 111
 - phase versus time, 113
 - RF time domain, 113
 - RF versus time, 113
 - Transit case
 - hard, 4
 - soft, 4
 - Transition trigger, defined, 85
 - Trigger
 - Audio bus, 88
 - B trigger after delay time, 92
 - Bus, defined, 86
 - buses, 86
 - byte matching, 90
 - Can bus, 88
 - concepts, 80

- coupling, 81
- data matching on a rolling window, 89
- delayed, 91
- Edge, defined, 84
- Ethernet bus, 89
- event, defined, 80
- FlexRay bus, 88
- forcing, 80
- Frequency readout, 109
- holdoff, 81
- level, 82
- level button, 41
- level icon, 44
- level knob, 82
- LIN bus, 88
- Logic, defined, 85
- MIL-STD-1553 bus, 89
- MIL-STD-1553 data value matching, 90
- modes, 80, 83
- Parallel bus, 87
- parallel bus data matching, 90
- parallel buses, 60
- point, 56
- position icon, 43
- posttrigger, 80, 82
- pretrigger, 80, 82
- Pulse Width, defined, 84
- readout, 44, 90
- RF power, 93
- Rise/Fall, defined, 85
- RS-232 bus, 88
- RS-232 data value matching, 90
- Runt, defined, 84
- Sequence (B Trigger), defined, 84
- sequential, 91
- serial buses, 60
- Setup and Hold, defined, 85
- slope, 82
- SPI bus, 87
- status readout, 43
- Timeout, defined, 84
- Trigger on B events, 92
- USB bus, 88
- Video, defined, 86

- Trigger menu, 36, 83, 91
 - button, 83
- Trigger modes
 - Auto, 80
 - Normal, 80
- Trigger types, defined, 84
- Triggered spectrogram, 116
- Triggering on Buses, 86

U

- UART, 37, 60
- Undo
 - Autoset, 54
 - Default Setup, 54
- Upgrading firmware, 22
- USB, 60, 86, 160, 170
 - bus trigger, 88
 - device port, 49
 - flash drive, 27
 - host ports, 41, 49
- USBTMC, 49
- User interface language, 17
- User marks, 146
- Utility button, 17, 18, 20, 37, 98, 99, 108, 109, 171
- Utility menu, 17, 19, 37, 41, 98, 109, 110

V

- Variable persistence, 98
- Ventilation, 7
- Versatile Probe Interface, 9
- Version, firmware, 24
- Vertical
 - button, 37
 - menu, 37, 102
 - Menu knob, 41
 - offset, 105
 - Offset, 103
 - position, 101
 - position and autoset, 55
 - position and offset, 105
 - Position knob, 41, 51
 - scale, 101
 - Scale knob, 41, 51

- Video
 - Autoset, 55
 - port, 48
- Video trigger, defined, 86
- View
 - digital channels, 108
 - waveform record, 43
- VISA, 25

W

- Wave Inspector, 144
- Waveform
 - adding, 96
 - display style, 96
 - histogram measurements, 124
 - intensity, 100
 - pan, 144, 145
 - pause, 145
 - play, 145
 - play-pause, 145
 - record defined, 56
 - removing, 96
 - search and mark, 146
 - user marks, 146
 - zoom, 144
- Waveform baseline indicator, 45
- Waveform Count measurement, 124
- Waveform record, 56
- Waveform record view, 43
- Weight, 6
- White edges, 108
- Width, 6
- Word, 27

X

- XY
 - cursors, 133
 - display, 98

Z

- Zoom, 144
 - button, 40
 - graticule size, 145
 - knob, 40, 144