

# **Agilent InfiniiVision 7000B Series Oscilloscopes**

## **User's Guide**



**Agilent Technologies**

# Notices

© Agilent Technologies, Inc. 2000-2010

No part of this manual may be reproduced in any form or by any means (including electronic storage and retrieval or translation into a foreign language) without prior agreement and written consent from Agilent Technologies, Inc. as governed by United States and international copyright laws.

## Manual Part Number

54695-97025

## Edition

Third Edition, June 2010

Printed in Malaysia

Agilent Technologies, Inc.  
1900 Garden of the Gods Rd.  
Colorado Springs, CO 80907 USA

## Software Revision

This guide was written for version 6.1 of the Agilent InfiniiVision 7000B Series Oscilloscope software.

## Trademark Acknowledgments

Java is a U.S. trademark of Sun Microsystems, Inc.

Sun, Sun Microsystems, and the Sun Logo are trademarks or registered trademarks of Sun Microsystems, Inc. in the U.S. and other countries.

## Warranty

**The material contained in this document is provided “as is,” and is subject to being changed, without notice, in future editions. Further, to the maximum extent permitted by applicable law, Agilent disclaims all warranties, either express or implied, with regard to this manual and any information contained herein, including but not limited to the implied warranties of merchantability and fitness for a particular purpose. Agilent shall not be liable for errors or for incidental or consequential damages in connection with the furnishing, use, or performance of this document or of any information contained herein. Should Agilent and the user have a separate written agreement with warranty terms covering the material in this document that conflict with these terms, the warranty terms in the separate agreement shall control.**

## Technology Licenses

The hardware and/or software described in this document are furnished under a license and may be used or copied only in accordance with the terms of such license.

## Restricted Rights Legend

U.S. Government Restricted Rights. Software and technical data rights granted to the federal government include only those rights customarily provided to end user customers. Agilent provides this customary commercial license in Software and technical data pursuant to FAR 12.211 (Technical Data) and 12.212 (Computer Software) and, for the Department of Defense, DFARS 252.227-7015 (Technical Data - Commercial Items) and DFARS 227.7202-3 (Rights in Commercial Computer Software or Computer Software Documentation).

## Safety Notices

### CAUTION

A **CAUTION** notice denotes a hazard. It calls attention to an operating procedure, practice, or the like that, if not correctly performed or adhered to, could result in damage to the product or loss of important data. Do not proceed beyond a **CAUTION** notice until the indicated conditions are fully understood and met.

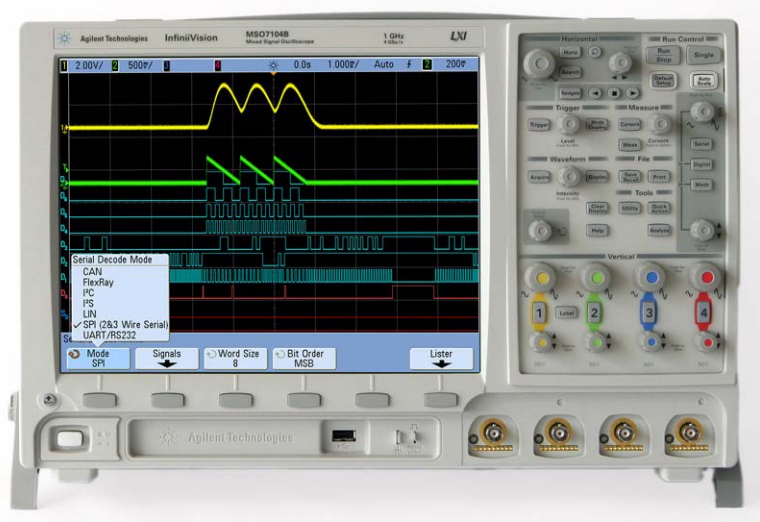
---

### WARNING

A **WARNING** notice denotes a hazard. It calls attention to an operating procedure, practice, or the like that, if not correctly performed or adhered to, could result in personal injury or death. Do not proceed beyond a **WARNING** notice until the indicated conditions are fully understood and met.

---

## InfiniiVision 7000B Series Oscilloscopes—At a Glance



The Agilent InfiniiVision 7000B Series oscilloscopes deliver powerful features and high performance:

- 100 MHz, 350 MHz, 500 MHz, and 1 GHz bandwidth models.
- Up to 4 GSa/s sample rate.
- 12.1 inch XGA display.
- Powerful triggering including analog HDTV and USB. Options for CAN, FlexRay, I<sup>2</sup>C, I<sup>2</sup>S, LIN, MIL-STD 1553, SPI, and UART/RS232.
- USB and LAN ports make printing, saving and sharing data easy.
- 2-channel and 4-channel Digital Storage Oscilloscope (DSO) models.
- 2+16-channel and 4+16-channel Mixed Signal Oscilloscope (MSO) models.
- An MSO lets you debug your mixed-signal designs using up to four analog signals *and* 16 tightly correlated digital signals simultaneously.

- You can easily upgrade an InfiniiVision 7000B Series oscilloscope from a DSO to an MSO and/or add features such as Segmented Memory and Mask Test.
- A Quick Help system is built into the oscilloscope. Press and hold any key to display Quick Help. Complete instructions for using the quick help system are given on [page 49](#).

Agilent InfiniiVision oscilloscopes feature MegaZoom III technology:

- Most responsive deep memory.
- High definition color display.
- Largest display in its class (12.1 inches).
- Fastest waveform update rates, uncompromised.

For more information about InfiniiVision oscilloscopes, see: [www.agilent.com/find/scope](http://www.agilent.com/find/scope)

**Table 17000B Series Model Numbers, Bandwidths, and Sampling Rates**

<b>Bandwidth</b>	<b>100 MHz</b>	<b>350 MHz</b>	<b>500 MHz</b>	<b>1 GHz</b>
<b>Maximum Sample Rate</b>	<b>2 GSa/s</b>	<b>2 GSa/s</b>	<b>4 GSa/s</b>	<b>4 GSa/s</b>
2-Channel + 16 Logic Channels MSO	MS07012B	MS07032B	MS07052B	
4-Channel + 16 Logic Channels MSO	MS07014B	MS07034B	MS07054B	MS07104B
2-Channel DSO	DS07012B	DS07032B	DS07052B	
4-Channel DSO	DS07014B	DS07034B	DS07054B	DS07104B

# In This Guide

This guide shows you how to use the InfiniiVision 7000B Series oscilloscopes. It contains these chapters:

- 1 Getting Started**
- 2 Probing the Device Under Test**
- 3 Displaying Waveforms**
- 4 Triggering**
- 5 Measurements and Math Functions**
- 6 Saving, Recalling, and Printing**
- 7 Acquisition Modes**
- 8 Web Interface**
- 9 Serial Decode/Lister**
- 10 CAN/LIN Triggering and Serial Decode**
- 11 I2C/SPI Triggering and Serial Decode**
- 12 I2S Triggering and Serial Decode**
- 13 FlexRay Triggering and Serial Decode**
- 14 MIL-STD 1553 Triggering and Serial Decode**
- 15 UART/RS232 Triggering and Serial Decode**
- 16 Analyzing Data**
- 17 Digital Channels**

## 18 Oscilloscope Utility Settings

## 19 Reference

## Index

### NOTE

#### Digital Channels

Because all of the oscilloscopes in the Agilent InfiniiVision Series have analog channels, the analog channel topics in this book apply to all instruments. Whenever a topic discusses the digital channels, that information applies only to Mixed-Signal Oscilloscope (MSO) models or DSO models that have been upgraded to an MSO.

---

### NOTE

#### Abbreviated instructions for pressing a series of keys and softkeys


Instructions for pressing a series of keys are written in an abbreviated manner. Instructions for pressing Key1, then pressing Softkey2, then pressing Softkey3 are abbreviated as follows:

Press **[Key1] > Softkey2 > Softkey3**.



The keys may be a front panel **[Key]** or a **Softkey**. Softkeys are the six keys located directly below the oscilloscope display.

---

# Contents

<b>Figures</b>	21
<b>Tables</b>	23
<b>1 Getting Started</b>	25
Inspect the Package Contents	26
Tilt the Oscilloscope for Easy Viewing	28
Power-On the Oscilloscope	29
Power Requirements	29
Ventilation Requirements	29
To mount the oscilloscope in a rack	29
To power-on the oscilloscope	30
Recall the Default Oscilloscope Setup	31
Input a Waveform and AutoScale	32
How AutoScale works	33
Become Familiar with Oscilloscope Controls and Connectors	34
Front Panel Controls and Connectors (4-Channel)	35
Front Panel Controls and Connectors (2-Channel, differences only)	36
Front Panel Control and Connector Descriptions	37
	
Do not connect a host computer to the oscilloscope's USB host port	37
Rear Panel (4-Channel)	42
Rear Panel (2-Channel)	43
Rear Panel Connector Descriptions	44
Front Panel Overlays for Different Languages	45
Using the Oscilloscope Softkey Menu	46

## Contents



Become Familiar with the Oscilloscope Display	48
Access the Built-In Quick Help	49
To view Quick Help	49
To select the Quick Help language	50
To get the latest Quick Help	50
<b>2 Probing the Device Under Test</b>	<b>51</b>
Analog Input Impedance (50 Ohm or 1 MOhm)	52
AutoProbe Interface	52
Passive Probes	53
Active Probes	53
Connect the Probes to the Oscilloscope	55
 Maximum input voltage at analog inputs	55
 Do not float the oscilloscope chassis	55
Compensating Passive Probes	56
Calibrating Probes	57
Manually Setting the Probe Attenuation Factor	59
Digital Probes	60



<b>3</b>	<b>Displaying Waveforms</b>	<b>61</b>
	Using the Horizontal Controls	62
	To adjust the horizontal (time/div) scale	63
	To adjust the horizontal delay (position)	63
	Panning and Zooming Single or Stopped Acquisitions	64
	To change the horizontal time mode (Normal, XY, or Roll)	65
	To display the zoomed time base	71
	To change the horizontal scale knob's coarse/fine adjustment setting	73
	To position the time reference (left, center, right)	74
	To navigate the time base	74
	Using the Vertical Controls	77
	To turn waveforms on or off (channel or math)	78
	To adjust the vertical scale	78
	To adjust the vertical position	78
	To specify channel coupling	79
	To specify channel input impedance	79
	To specify bandwidth limiting	80
	To change the vertical scale knob's coarse/fine adjustment setting	81
	To invert a waveform	81
	Setting Analog Channel Probe Options	82
	To specify the channel units	82
	To specify the probe attenuation	82
	To specify the probe skew	83
	To calibrate a probe	83
	Changing the Display Settings	84
	To adjust waveform intensity	84
	To set or clear infinite persistence	85
	To clear the display	86
	To adjust the grid brightness	86
	To display waveforms as vectors or dots	87
	To freeze the display	87

Using Labels	89
To turn the label display on or off	89
To assign a predefined label to a channel	90
To define a new label	91
To load a list of labels from a text file you create	92
To reset the label library to the factory default	93

## 4 Triggering 95

Triggering - General Information	97
Trigger Mode and Coupling Menu	98
Auto and Normal Trigger modes	99
Choosing Auto Trigger Mode or Normal Trigger Mode	99
Auto Mode	100
Normal Mode	100
Trigger Level Adjustment	102
Trigger Coupling	103
Trigger Noise Rejection	104
HF Reject	105
LF Reject	105
Noise Rejection	106
Trigger Holdoff	107
Trigger Holdoff Operating Hints	107
To set holdoff	107
External Trigger Input	109
2-Channel Oscilloscope External Trigger Input	109
 Maximum voltage at 2-channel oscilloscope external trigger input	110
4-Channel Oscilloscope External Trigger Input	111
 Maximum voltage at 4-channel oscilloscope external trigger input	111

Trigger Types	112
Duration Trigger	114
< qualifier time set softkey	115
> qualifier time set softkey	116
Edge Trigger	117
Glitch or Narrow Pulse Capture	119
Using Peak Detect Mode to Find a Glitch	121
Nth Edge Burst Trigger	123
Pattern Trigger	125
Hex Bus Pattern Trigger	126
Pulse Width Trigger	128
< qualifier time set softkey	130
> qualifier time set softkey	130
Sequence Trigger	131
Define the “Find” Stage	132
Define the “Trigger on” Stage	134
Define the Optional “Reset on” Stage	136
Adjust the Trigger Level	137
TV Trigger	138
TV Triggering Examples	142
To trigger on a specific line of video	142
To trigger on all sync pulses	144
To trigger on a specific field of the video signal	145
To trigger on all fields of the video signal	146
To trigger on odd or even fields	147
USB Trigger	150
<b>5 Measurements and Math Functions</b>	<b>153</b>
List of Automatic Measurements	154

## Contents

Making Automatic Measurements	156
Measurement Statistics	157
Measurement Thresholds	160
Measurement Definitions	162
Time Measurements	162
Delay and Phase Measurements	166
Voltage Measurements	169
Overshoot and Preshoot Measurements	174
Cursor Measurements	177
To make cursor measurements	178
Cursor Examples	180
Math Functions	183
To use waveform math	183
To perform a math function upon an arithmetic operation	184
Math scale and offset	184
Units	185
Multiply	187
Add or Subtract	189
Differentiate	191
Integrate	193
Square Root	195
FFT Measurement	197
FFT Operation	199

<b>6</b>	<b>Saving, Recalling, and Printing</b>	<b>205</b>
	Saving and Recalling Data	206
	Selecting a Destination for Your Saved Data	206
	Selecting a File Name	208
	Saving Waveform Trace and Oscilloscope Setup	209
	Display Image and Waveform Data File Formats	210
	Choosing Save Settings	211
	To save a waveform and/or setup to a USB mass storage device	215
	To save a waveform and/or setup to the oscilloscope's internal memory	216
	To recall waveform trace and/or oscilloscope setup	216
	File Explorer	217
	Printing Screens	220
	To print the oscilloscope's display	220
	Options	221
	Palette	221
<b>7</b>	<b>Acquisition Modes</b>	<b>223</b>
	Starting, Stopping, and Single Acquisitions (Run Control)	224
	To start and stop an acquisition	224
	To make a single acquisition	225
	Acquisition Modes	227
	At Slower Sweep Speeds	227
	Selecting the Acquisition mode	227
	Normal Mode	227
	Peak Detect Mode	228
	High Resolution Mode	228
	Averaging Mode	229
	Realtime Sampling Option	232
	Segmented Memory	234
	Using segmented memory	234


<b>8</b>	<b>Web Interface</b>	<b>239</b>
	Setting up the Oscilloscope's LAN Connection	241
	To establish a LAN connection	241
	Stand-alone (Point-to-Point) Connection to a PC	242
	Accessing the Web Interface	244
	Browser Web Control	245
	Remote Front Panel	245
	Remote Programming	247
	Remote Programming with Agilent IO Libraries	249
	Get Image	250
	Identification Function	251
	Instrument Utilities	252
	Setting a Password	253
<b>9</b>	<b>Serial Decode/Lister</b>	<b>255</b>
	Serial Decode	256
	Lister	257
	Searching Lister Data	259
<b>10</b>	<b>CAN/LIN Triggering and Serial Decode</b>	<b>261</b>
	Setup for CAN Signals	262
	CAN Triggering	264
	CAN Serial Decode	266
	Interpreting CAN Decode	267
	CAN Totalizer	268
	Interpreting CAN Lister Data	269
	Searching for CAN Data in the Lister	270
	Setup for LIN Signals	272


LIN Triggering	274
LIN Serial Decode	276
Interpreting LIN Decode	277
Interpreting LIN Lister Data	278
Searching for LIN Data in the Lister	279
<b>11 I<sup>2</sup>C/SPI Triggering and Serial Decode</b>	<b>281</b>
Setup for I <sup>2</sup> C Signals	282
I <sup>2</sup> C Triggering	284
I <sup>2</sup> C Serial Decode	288
Interpreting I <sup>2</sup> C Decode	289
Interpreting I <sup>2</sup> C Lister Data	290
Searching for I <sup>2</sup> C Data in the Lister	291
Setup for SPI Signals	292
SPI Triggering	295
SPI Serial Decode	297
Interpreting SPI Decode	298
Interpreting SPI Lister Data	299
Searching for SPI Data in the Lister	300
<b>12 I<sup>2</sup>S Triggering and Serial Decode</b>	<b>301</b>
Setup for I <sup>2</sup> S Signals	302
I <sup>2</sup> S Triggering	306
I <sup>2</sup> S Serial Decode	309
Interpreting I <sup>2</sup> S Decode	310
Interpreting I <sup>2</sup> S Lister Data	311
Searching for I <sup>2</sup> S Data in the Lister	312
<b>13 FlexRay Triggering and Serial Decode</b>	<b>313</b>
Setup for FlexRay Signals	314



## Contents

FlexRay Triggering	315
Triggering on FlexRay Frames	315
Triggering on FlexRay Errors	316
Triggering on FlexRay Events	317
FlexRay Serial Decode	318
Interpreting FlexRay Frame Decode	319
FlexRay Totalizer	320
Interpreting FlexRay Lister Data	321
Searching for FlexRay Data in the Lister	322
<b>14 MIL-STD 1553 Triggering and Serial Decode</b>	<b>323</b>
Probing MIL-STD 1553 Signals	324
Setup for MIL-STD 1553 Signals	325
MIL-STD 1553 Triggering	326
MIL-STD 1553 Serial Decode	327
Interpreting MIL-STD 1553 Decode	328
Viewing MIL-STD 1553 Data in the Lister	329
Searching for MIL-STD 1553 Data in the Lister	330
<b>15 UART/RS232 Triggering and Serial Decode</b>	<b>333</b>
Setup for UART/RS232 Signals	334
UART/RS232 Triggering	335
UART/RS232 Serial Decode	338
Interpreting UART/RS232 Decode	339
UART/RS232 Totalizer	340
Interpreting UART/RS232 Lister Data	341
Searching for UART/RS232 Data in the Lister	342



- 16 Analyzing Data 343**
  - Performing Mask Tests 344
    - To create a mask from a “golden” waveform (Automask) 344
    - Setup Options 346
    - Mask Test Trigger Output 348
    - Mask Statistics 348
    - To manually modify a mask file 350
    - Building a Mask File 353
  - Enabling Precision Measurements and Math 357
  
- 17 Digital Channels 359**
  - To connect the digital probes to the device under test 360
  -  Probe cable for digital channels 360
  - Acquiring waveforms using the digital channels 363
  - To display digital channels using AutoScale 364
    - Example 364
  - Interpreting the digital waveform display 366
  - To change the displayed size of the digital channels 367
  - To switch a single channel on or off 367
  - To switch all digital channels on or off 367
  - To switch groups of channels on or off 368
  - To change the logic threshold for digital channels 368
  - To reposition a digital channel 369
  - To display digital channels as a bus 369

Digital channel signal fidelity: Probe impedance and grounding	374
Input Impedance	374
Probe Grounding	376
Best Probing Practices	378
To replace digital probe leads	379
<b>18 Oscilloscope Utility Settings</b>	<b>381</b>
Configuring the [Quick Action] Key	382
Setting Oscilloscope Preferences	383
To choose "expand about" center or ground	383
To disable/enable antialiasing	383
To set up the screen saver	384
To set AutoScale preferences	385
To disable/enable transparent backgrounds	386
To load the default label library	386
To specify the measurement window for Zoom mode	386
Setting Rear Panel Options	388
To set the reference signal mode	388
 Maximum input voltage at 10 MHz REF connector	389
To set the trigger out source	391
Setting the Oscilloscope's Clock	392
Entering Licenses and Displaying License Information	393
To enter licenses	393
To display license information	393
Licensed Options Available	393
Other Options Available	395
Upgrading to an MSO	396
Secure Environment Mode Option	396

Performing Service Tasks	397
To display oscilloscope information	397
To perform user calibration	397
To display the user calibration status	400
To perform self test	401
To clean the oscilloscope	401
To check warranty and extended services status	402
To return the instrument	402
To contact Agilent	403
<b>19 Reference</b>	<b>405</b>
Specifications and Characteristics	406
Accessories Available	407
Software and Firmware Updates	410
Measurement Category	411
Measurement Category	411
Measurement Category Definitions	411
Transient Withstand Capability	412
 Maximum input voltage at analog inputs and 2-channel external trigger input	412
 Maximum input voltage at digital channels	412
Environmental Conditions	413
Binary Data (.bin) Format	414
Binary Data in MATLAB	415
Binary Header Format	415
Example Program for Reading Binary Data	418
Examples of Binary Files	418
CSV and ASCII XY files	422

## Contents

Acknowledgements 423

**Index** 425

## Figures

- Figure 1. Interpreting the oscilloscope display 48
- Figure 2. Example of centering a signal on the display 67
- Figure 3. Signal centered on the display 67
- Figure 4. Cursors set on displayed signal 68
- Figure 5. Cursors set to center of signal 69
- Figure 6. Signals are 90 out of phase 70
- Figure 7. Signals are in phase 71
- Figure 8. Amplitude Modulation Shown at 100% Intensity 84
- Figure 9. Amplitude Modulation Shown at 40% Intensity 85
- Figure 10. 15 ns Narrow Pulse, 20 ms/div, Normal Mode 120
- Figure 11. 15 ns Narrow Pulse, 20 ms/div, Peak Detect Mode 121
- Figure 12. Sequence Trigger Flowchart 131
- Figure 13. Example: Triggering on Line 136 143
- Figure 14. Triggering on All Lines 144
- Figure 15. Triggering on Field 1 145
- Figure 16. Triggering on All Fields 146
- Figure 17. Triggering on Color Field 1 Alternating with Color Field 3 148
- Figure 18. Using TV Holdoff to Synchronize to Color Field 1 or 3 (Field 1 mode) 149
- Figure 19. Isolating an event for Frequency measurement 164
- Figure 20. Isolating area for Top measurement 174
- Figure 21. Automatic Overshoot measurement 176
- Figure 22. Cursors used to measure pulse widths other than middle threshold points 180
- Figure 23. Cursors measure frequency of pulse ringing 181
- Figure 24. Cursors track Zoom sweep 181
- Figure 25. Measuring pulse width with cursors 182
- Figure 26. Moving the cursors together to check pulse width variations 182

## Figures

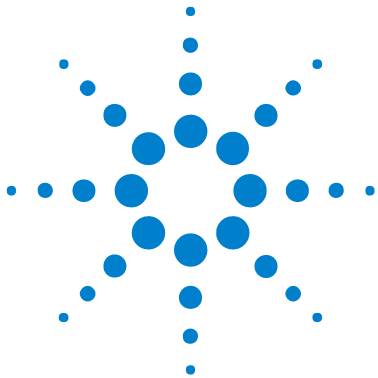
Figure 27. Example of Multiply	188
Figure 28. Example of Subtract	190
Figure 29. Example of Differentiate Function	192
Figure 30. Integrate and Signal Offset	194
Figure 31. Example of $\sqrt{\quad}$ (Square Root)	196
Figure 32. Aliasing	198
Figure 33. Random noise on the displayed waveform	231
Figure 34. 128 Averages used to reduce random noise	231
Figure 35. AutoScale of digital channels 0 to 3 (MSO models only)	365
Figure 36. DC and Low-Frequency Probe Equivalent Circuit	375
Figure 37. High-Frequency Probe Equivalent Circuit	375
Figure 38. Impedance versus Frequency for Both Probe Circuit Models	376
Figure 39. Common Mode Input Voltage Model	377
Figure 40. User Calibration cable for 2-channel oscilloscope	399
Figure 41. User Calibration cable for 4-channel oscilloscope	400

## Tables

Table 1. 7000B Series Model Numbers, Bandwidths, and Sampling Rates	4
Table 1. Default Configuration Settings	31
Table 2. Passive Probes	53
Table 3. Active Probes	54
Table 4. Half-field holdoff time	149
Table 5. Saving Oscilloscope Data	206
Table 6. Recommended Signal Mapping	215
Table 7. InfiniiVision Series Oscilloscope Bandwidths, Maximum Sample Rates, and Sample Periods	228
Table 8. Digital Probe Replacement Parts	379
Table 9. Licensed Options Available	394
Table 10. Calibration Option	395
Table 11. Accessories Available for 7000B Series Oscilloscopes	407

## Tables





# 1 Getting Started

Inspect the Package Contents	26
Tilt the Oscilloscope for Easy Viewing	28
Power-On the Oscilloscope	29
Recall the Default Oscilloscope Setup	31
Input a Waveform and AutoScale	32
Become Familiar with Oscilloscope Controls and Connectors	34
Become Familiar with the Oscilloscope Display	48
Access the Built-In Quick Help	49

This chapter describes the steps you take when using the oscilloscope for the first time.

**See Also** • [“Setting Oscilloscope Preferences”](#) on page 383.



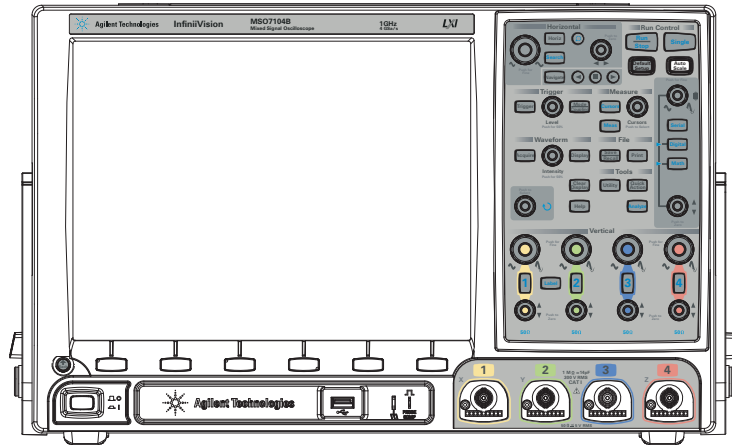
## Inspect the Package Contents

- ✓ Inspect the shipping container for damage.

If your shipping container appears to be damaged, keep the shipping container or cushioning material until you have inspected the contents of the shipment for completeness and have checked the oscilloscope mechanically and electrically.

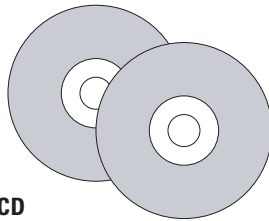
- ✓ Verify that you received the following items and any optional accessories you may have ordered:
  - InfiniiVision Oscilloscope
  - Front-panel cover
  - Power cord (country of origin determines specific type)
  - Oscilloscope probes:
    - Two probes for 2-channel models
    - Four probes for 4-channel models
  - CD-ROM containing:
    - User's Guide
    - Service Guide
    - Programmer's Guide
  - Automation-Ready Software CD-ROM
  - Accessory pouch
  - Digital probe kit P/N 54620-68701 (MSO Models only)

Front-panel cover and accessory pouch (not shown)



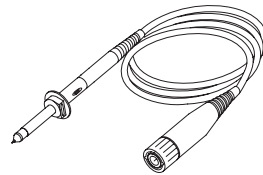
InfiniVision 7000B Series oscilloscope

Documentation CD

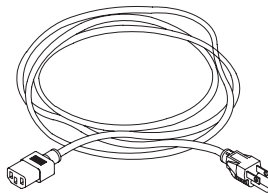


Automation-Ready CD

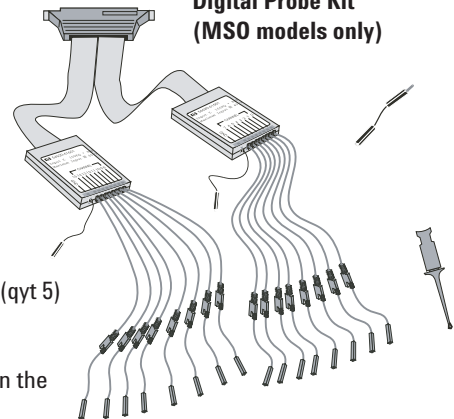
10073C or 1165A probes (Qty 2 or 4)



Power cord (Based on country of origin)



Digital Probe Kit\* (MSO models only)



\*Digital Probe Kit contains:  
 54620-61801 16-channel cable (qyt 1)  
 5959-9334 2-inch probe ground leads (qyt 5)  
 5090-4833 Grabber (qyt 20)

Digital probe replacement parts are listed in the "Digital Channels" chapter.

See Also • ["Accessories Available"](#) on page 407.

## Tilt the Oscilloscope for Easy Viewing

The oscilloscope can be tilted up for easier viewing.

- 1 Tilt the oscilloscope forward. Rotate the foot down and toward the rear of the oscilloscope. The foot will lock into place.



- 2 Repeat for the other foot.
- 3 Rock the oscilloscope back so that it rests securely on its feet.



To retract the feet:

- 1 Tilt the oscilloscope forward. Press the foot release button and rotate the foot up and toward the front of the oscilloscope.
- 2 Repeat for the other foot.

# Power-On the Oscilloscope

## Power Requirements

Line voltage, frequency, and power:

- ~Line 100-120 Vac, 50/60/400 Hz
- 100-240 Vac, 50/60 Hz
- 120 W max

## Ventilation Requirements

The air intake and exhaust areas must be free from obstructions. Unrestricted air flow is required for proper cooling. Always ensure that the air intake and exhaust areas are free from obstructions.

The fan draws air in from the sides of the oscilloscope and pushes it out behind the oscilloscope.

When using the oscilloscope in a bench-top setting, provide at least 2" clearance at the sides and 4" (100 mm) clearance above and behind the oscilloscope for proper cooling.

## To mount the oscilloscope in a rack

The InfiniiVision 7000B series oscilloscopes can be mounted in an Electronic Industries Association (EIA) standard 19-inch (487-mm) rack cabinet.

To mount the oscilloscope in a rack, purchase and install the N2732A rack mount kit. Instructions are included in the kit. For details search for N2732A at [www.agilent.com](http://www.agilent.com).

## To power-on the oscilloscope

- 1 Connect the power cord to the rear of the oscilloscope, then to a suitable AC voltage source. Route the power cord so the oscilloscope's feet and legs do not pinch the cord.

The oscilloscope automatically adjusts for input line voltages in the range 100 to 240 VAC. The line cord provided is matched to the country of origin.

### **WARNING**

**Always use a grounded power cord. Do not defeat the power cord ground.**

---

- 2 Press the power switch.

The power switch is located on the lower left corner of the front panel. The oscilloscope will perform a self-test and will be operational in a few seconds.

## Recall the Default Oscilloscope Setup

To recall the default oscilloscope setup:

- Press **[Default Setup]**.

The default setup restores the oscilloscope's default settings. This places the oscilloscope in a known operating condition. The major default settings are:

**Table 1** Default Configuration Settings

<b>Horizontal</b>	Normal mode, 100 $\mu$ s/div scale, 0 s delay, center time reference.
<b>Vertical (Analog)</b>	Channel 1 on, 5 V/div scale, DC coupling, 0 V position, 1 M $\Omega$ impedance, probe factor to 1.0 if an AutoProbe probe is not connected to the channel.
<b>Trigger</b>	Edge trigger, Auto sweep mode, 0 V level, channel 1 source, DC coupling, rising edge slope, 60 ns holdoff time.
<b>Display</b>	Vectors on, 33% grid intensity, infinite persistence off.
<b>Other</b>	Acquire mode normal, <b>[Run/Stop]</b> to Run, cursors and measurements off.
<b>Labels</b>	All custom labels that you have created in the Label Library are preserved (not erased), but all channel labels will be set to their original names.

## Input a Waveform and AutoScale

Use [**AutoScale**] to automatically configure the oscilloscope to best display the input signals.

- 1 Connect an oscilloscope probe from channel 1 to the **Probe Comp** terminal on the front panel.
- 2 Connect the probe's ground lead to the ground terminal (next to the **Probe Comp** terminal).
- 3 Press [**AutoScale**].
- 4 If you want to return to the oscilloscope settings that existed before, press **Undo AutoScale**.
- 5 If you want to change the channels autoscaled or preserve the acquisition mode during autoscale, press **Channels** or **Acq Mode**.

These are the same softkeys that appear in the AutoScale Preferences Menu. See “[To set AutoScale preferences](#)” on page 385.

- 6 You should see a waveform on the oscilloscope's display similar to this:



If you see the waveform, but the square wave is not shaped correctly as shown above, perform the procedure “[Compensating Passive Probes](#)” on page 56.



If you do not see the waveform, ensure your power source is adequate, the oscilloscope is powered-on, the power cord is firmly inserted into the oscilloscope receptacle, and the probe is connected securely to the front-panel oscilloscope channel input BNC and to the Probe Comp terminal.

## How AutoScale works

AutoScale analyzes any waveforms present at each channel and at the external trigger input. This includes the digital channels on MSO models.

AutoScale finds, turns on, and scales any channel with a repetitive waveform that has a frequency of at least 50 Hz, a duty cycle greater than 0.5%, and an amplitude of at least 10 mV peak-to-peak. Any channels that do not meet these requirements are turned off.

The trigger source is selected by looking for the first valid waveform starting with external trigger, then continuing with the highest number analog channel down to the lowest number analog channel, and finally (if the oscilloscope is an MSO) the highest number digital channel.

During AutoScale, the delay is set to 0.0 seconds, the sweep speed setting is a function of the input signal (about 2 periods of the triggered signal on the screen), and the triggering mode is set to Edge. Vectors remain in the state they were before the AutoScale.


## Become Familiar with Oscilloscope Controls and Connectors

On the front panel, “key” refers to any key (button) you can press. “Softkey” specifically refers to the six keys that are directly below the display. The legend for these keys is directly above them, on the display. Their functions change as you navigate through the oscilloscope’s menus.

In this manual, instructions for pressing a series of keys are written in an abbreviated manner. Pressing the **[Help]** key, then the **Language** softkey, then the **Help** softkey is abbreviated as follows:

Press **[Help] > Language > Help**.

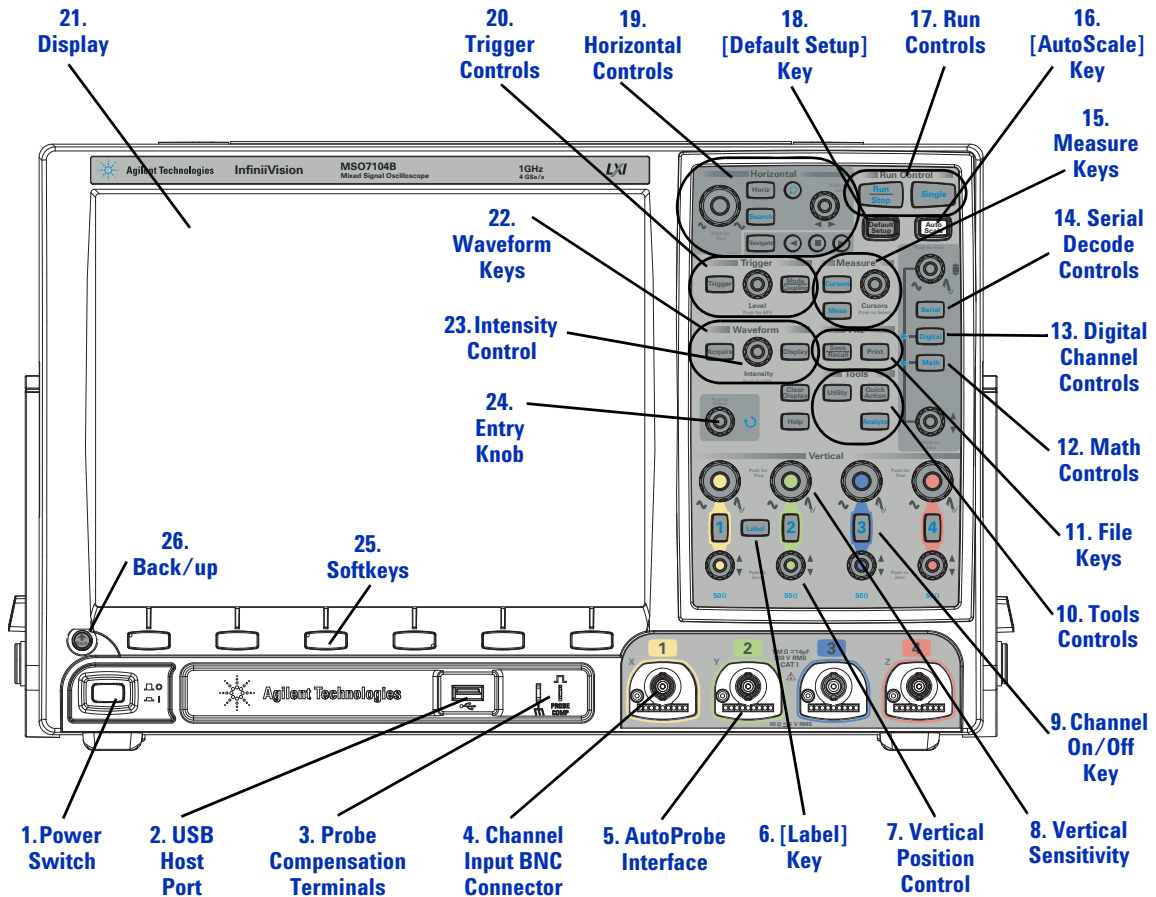
Press and hold any key or softkey to view its built-in Quick Help.

When the Entry knob  symbol appears on a softkey, you can use the Entry knob, to select values.

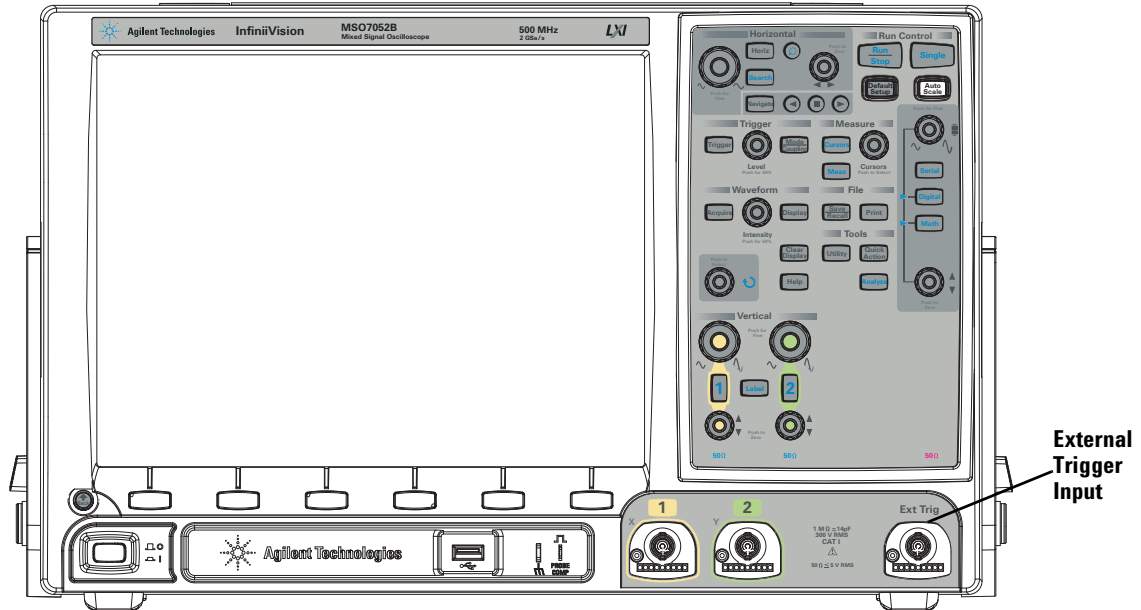
For easy one-handed operation of the 7000B Series oscilloscopes, the Entry knob can be pushed as well as rotated. Rotating the knob moves through selectable items, and pushing the knob makes the selection.

## Front Panel Controls and Connectors (4-Channel)

For the following figure, refer to numbered descriptions in “Front Panel Control and Connector Descriptions” on page 37.



## Front Panel Controls and Connectors (2-Channel, differences only)



The differences between the front panel of the 4-channel oscilloscopes and the 2-channel oscilloscopes are:

- The 2-channel oscilloscope has two sets of channel controls
- The 2-channel oscilloscope's external trigger input is on the front panel instead of the rear panel. Some trigger features differ. See [“External Trigger Input”](#) on page 109.

## Front Panel Control and Connector Descriptions

**1. Power Switch** Press once to switch power on; press again to switch power off. See [page 29](#).

**2. USB Host Port** This port is for connecting USB mass storage devices or printers to the oscilloscope.

Connect a USB compliant mass storage device (flash drive, disk drive, etc.) to store or recall oscilloscope setup files or waveforms.

To print, connect a USB compliant printer. For more information about printing see [“To print the oscilloscope’s display”](#) on page 220.

You can also use the USB port to update the oscilloscope’s system software when updates are available.

You do not need to take special precautions before removing the USB mass storage device from the oscilloscope (you do not need to “eject” it). Simply unplug the USB mass storage device from the oscilloscope when the file operation is complete.

For more information about saving to a USB mass storage device see [“Saving and Recalling Data”](#) on page 206.

### CAUTION



#### **Do not connect a host computer to the oscilloscope’s USB host port**

Use the device port. A host computer sees the oscilloscope as a device, so connect the host computer to the oscilloscope’s device port (on the rear panel). See [“Web Interface”](#) on page 239.

---

**3. Probe Compensation Terminals** Use the signal at this terminal to match a probe’s input capacitance to the oscilloscope channel to which it is connected. See [page 56](#).

**4. Channel Input BNC Connector** Attach the oscilloscope probe or BNC cable to the BNC connector. This is the channel’s input connector.

**5. AutoProbe Interface** When you connect a probe to the oscilloscope, the AutoProbe Interface attempts to determine the type of probe and set its parameters in the Probe Menu accordingly. See [“AutoProbe Interface”](#) on page 52.

**6. [Label] Key** Press this key to access the Label Menu, which lets you enter labels to identify each trace on the oscilloscope display. See [“Using Labels”](#) on page 89.

**7. Vertical Position Control** Use this knob to change the channel’s vertical position on the display. There is one Vertical Position control for each channel. See [“Using the Vertical Controls”](#) on page 77.

**8. Vertical Sensitivity** There is one knob marked  $\sim \updownarrow$  for each channel. Use these knobs to change the vertical sensitivity (gain) of each channel. See [“Using the Vertical Controls”](#) on page 77.

**9. Channel On/Off Key** Use this key to switch the channel on or off, or to access the channel’s menu in the softkeys. There is one Channel On/Off key for each channel. See [“Using the Vertical Controls”](#) on page 77.

**10. Tools Controls** Press this key to access the Utility Menu, which lets you configure the oscilloscope’s I/O settings, use the file explorer, set preferences, access the service menu, and choose other options.

**11. File Keys** Press the [**Save/Recall**] key to save or recall a waveform or setup. The [**Print**] key opens the Print Configuration Menu so you can print the displayed waveforms. See [“Saving and Recalling Data”](#) on page 206 and [“Printing Screens”](#) on page 220.

**12. Math Controls** The [**Math**] key provides access to add, subtract, multiply, differentiate, integrate, FFT (Fast Fourier Transform) and square root functions. See [“Measurements and Math Functions”](#) on page 153.

**13. Digital Channel Controls** These controls switch the digital channels on and off, and can be used to select a digital channel for repositioning on the display.

Press the [**Digital**] key to turn on the digital channels (the [**Digital**] key will illuminate as well as the arrow to the left).

When the arrow to the left of the **[Digital]** key is illuminated, the upper knob selects (and highlights in red) individual digital channels, and the lower knob positions the selected digital channel.

If a trace is repositioned over an existing trace the indicator at the left edge of the trace will change from **D<sub>nn</sub>** designation (where nn is a one or two digit channel number from 0 to 15) to **D\***. The “\*” indicates that two channels are overlaid.

You can rotate the upper knob to select an overlaid channel, then rotate the lower knob to position it just as you would any other channel.

For more information on digital channels see [Chapter 17](#), “Digital Channels,” starting on page 359.

**14. Serial Decode Controls** These **[Serial]** key is used to enable serial decode. The upper and lower knob are not used with serial decode.

For more information on serial decode, see [Chapter 9](#), “Serial Decode/Listener,” starting on page 255.

**15. Measure Keys** Press the **[Cursors]** key to turn on cursors that you can use for making measurements. Press the **[Meas]** key to access a set of predefined measurements. See [Chapter 5](#), “Measurements and Math Functions,” starting on page 153.

**16. [AutoScale] Key** When you press the **[AutoScale]** key. the oscilloscope will quickly determine which channels have activity, and it will turn these channels on and scale them to display the input signals. See [“Input a Waveform and AutoScale”](#) on page 32.


**17. Run Controls** Press **[Run/Stop]** to make the oscilloscope begin looking for a trigger. The **[Run/Stop]** key will illuminate in green. If the trigger mode is set to “Normal,” the display will not update until a trigger is found. If the trigger mode is set to “Auto,” the oscilloscope looks for a trigger, and if none is found, it will automatically trigger, and the display will immediately show the input signals. In this case, the **Auto** indicator at the top of the display will change to **Auto?** and the background will flash, indicating that the oscilloscope is forcing triggers.


Press **[Run/Stop]** again to stop acquiring data. The key will illuminate in red. Now you can pan across and zoom-in on the acquired data.


Press [**Single**] to make a single acquisition of data. The key will illuminate in yellow until the oscilloscope triggers. See [“To start and stop an acquisition”](#) on page 224.

**18. [Default Setup] Key** Press this key to return to the factory default configuration (details on [“Performing Service Tasks”](#) on page 397).

### 19. Horizontal Controls

**Horizontal Sweep Speed Control** Turn the knob in the Horizontal section that is marked  to adjust the sweep speed. The symbols under the knob indicate that this control has the effect of spreading out or zooming in on the waveform using the horizontal scale. The horizontal sweep speed control changes the time per horizontal division on the display. For more information see [“Using the Horizontal Controls”](#) on page 62.

**Horizontal Position Control** Turn the knob marked  to pan through the waveform data horizontally. You can see the captured waveform before the trigger (turn the knob clockwise) or after the trigger (turn the knob counterclockwise). If you pan through the waveform when the oscilloscope is stopped (not in Run mode) then you are looking at the waveform data from the last acquisition taken. See [“Using the Horizontal Controls”](#) on page 62.

**Horizontal [Zoom] Key** Press the  zoom key to access the menu where you can split the oscilloscope display into Normal and Zoom sections, and where you can select XY and Roll modes. You can also select horizontal time/division vernier and select the trigger time reference point on this menu. See [“Using the Horizontal Controls”](#) on page 62.

**Horizontal [Search] Key** When serial decode is enabled, you can use the [**Search**] key to find and place marks on rows in the Lister. See [“Searching Lister Data”](#) on page 259.

**Horizontal [Navigate] Key and Controls** Press this key to navigate through captured data, marks in the serial decode Lister, or segmented memory acquisitions. See [“To navigate the time base”](#) on page 74.


**20. Trigger Controls** These controls determine how the oscilloscope triggers to capture data. See [Chapter 4](#), “Triggering,” starting on page 95.





**21. Display** The display shows captured waveforms using a different color for each channel. For more information about display modes see [Chapter 3](#), “Displaying Waveforms,” starting on page 61. Signal detail is displayed using 256 levels of intensity. For more information about viewing signal detail see “[To adjust waveform intensity](#)” on page 84.

**22. Waveform Keys** The [**Acquire**] key lets you set the oscilloscope to acquire in Normal, Peak Detect, Averaging, or High Resolution modes (see “[Acquisition Modes](#)” on page 227), and lets you turn Realtime sampling off or on (see [page 232](#)). The [**Display**] key lets you access the menu where you can select infinite persistence (see [page 85](#)), switch vectors on or off (see [page 87](#)), and adjust the display grid (graticule) intensity (see [page 86](#)).

**23. Intensity Control** Rotate clockwise to increase analog waveform intensity; counterclockwise to decrease. You can vary the intensity control to bring out signal detail, much like an analog oscilloscope. Digital channel waveform intensity is not adjustable. More details about using the Intensity control to view signal detail are on [page 84](#).

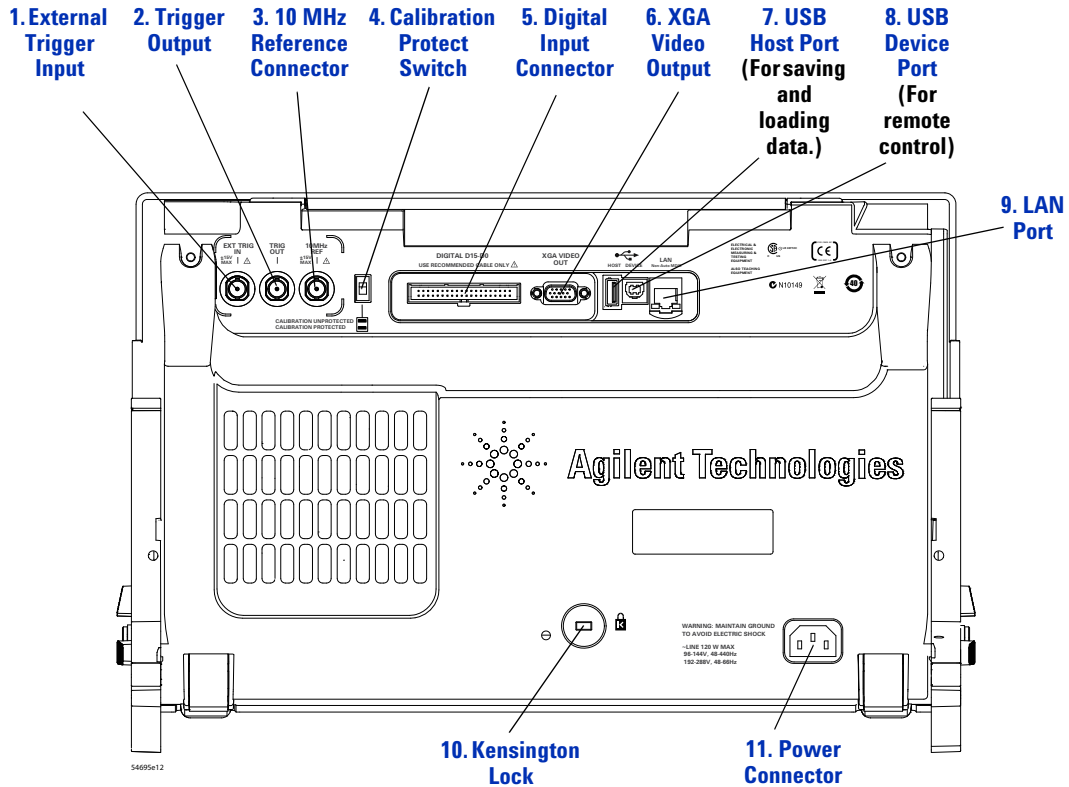
**24. Entry Knob** The entry knob is used to select items from menus and to change values. Its function changes based upon which menu is displayed. Note that the curved arrow symbol  above the entry knob illuminates whenever the entry knob can be used to select a value. Rotate and push the entry knob to select among the choices that are shown on the softkeys. More information about the Entry knob is on [page 34](#).

**25. Softkeys** The functions of these keys change based upon the menus shown on the display directly above the keys.

**26. Back/up** The  back/up key moves up in the softkey menu hierarchy. At the top of the hierarchy, the  back/up key turns the menus off, and oscilloscope information is shown instead.

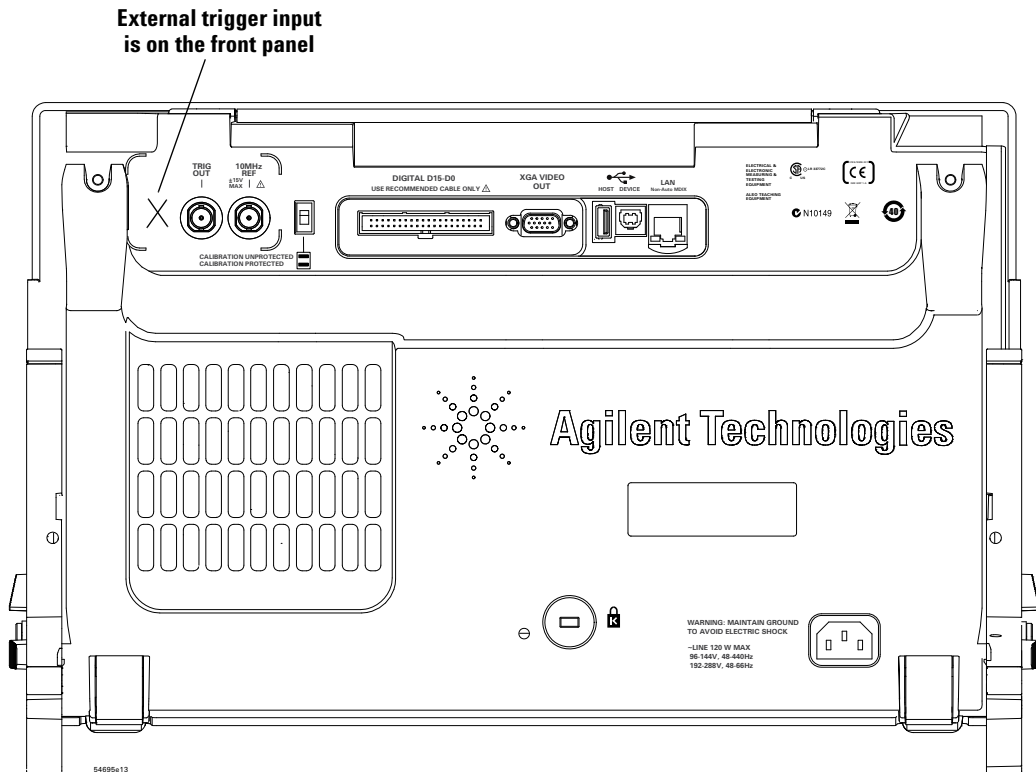
## Rear Panel (4-Channel)

Click the text for the item's description and operation information. Printed manual: refer to numbered descriptions on the following pages.



## Rear Panel (2-Channel)

The 2-channel model rear panel is the same as the 4-channel model rear panel shown on [page 42](#), except on 2-channel models, the external trigger input is on the front panel instead of the rear panel.



## Rear Panel Connector Descriptions

- 1. External Trigger Input** See [“External Trigger Input”](#) on page 109 for an explanation of this feature.
- 2. Trigger Output** See [“Trigger Types”](#) on page 112.
- 3. 10 MHz Reference Connector** See [“To set the reference signal mode”](#) on page 388.
- 4. Calibration Protect Switch** See [“To perform user calibration”](#) on page 397.
- 5. Digital Input Connector** Connect the digital probe cable to this connector (MSO models only).
- 6. XGA Video Output** A standard XGA video output connector is provided on the rear panel.  
  
You can connect an external monitor to provide a larger display or to provide a display at a viewing position away from the oscilloscope.  
  
The oscilloscope’s built-in display remains on even when an external display is connected. The video output connector is always active.  
  
For optimal video quality and performance, we recommend you use a shielded video cable with ferrite cores.
- 7. USB Host Port** This port functions identically to the USB host port on the front panel. USB Host Port is used for saving data from the oscilloscope and loading software updates. See also [page 37](#).
- 8. USB Device Port** This port is for connecting the oscilloscope to a host PC. You can issue remote commands from a host PC to the oscilloscope via the USB device port. See [“Remote Programming with Agilent IO Libraries”](#) on page 249.
- 9. LAN Port** You can communicate with the oscilloscope and use the Remote Front Panel feature using the LAN port. See [“Web Interface”](#) on page 239 and [“Accessing the Web Interface”](#) on page 244.

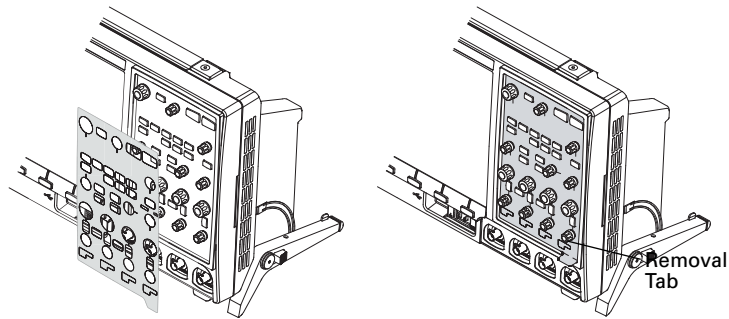
**10. Kensington Lock** This is where you can attach a Kensington lock for securing the instrument.

**11. Power Connector** Attach the power cord here.

## Front Panel Overlays for Different Languages

A front panel overlay which labels the controls is available in Simplified Chinese, Traditional Chinese, and Japanese. The overlay is included when the localization option is chosen at time of purchase.

Remove the protective backing to expose the adhesive, align the label with the top and left edge of the front panel, and press the overlay into place.



To remove the label, carefully pull it away using the tab at the lower right corner.

The overlays can also be ordered separately at [www.parts.agilent.com](http://www.parts.agilent.com) using the following part numbers:


Part number	Description
54695-94323	2CH Overlay - Simplified Chinese
54695-94324	4CH Overlay - Simplified Chinese
54695-94325	2CH Overlay - Traditional Chinese
54695-94326	4CH Overlay - Traditional Chinese
54695-94327	2CH Overlay - Japanese
54695-94328	4CH Overlay - Japanese

## Using the Oscilloscope Softkey Menus

Softkeys are the six keys directly below the display. They are called softkeys because software determines the function assigned to each key in any given menu.

The following graphic symbols appear in the oscilloscope's softkey menus. The softkey menus appear at the bottom of the display, just above the six softkeys.



Rotate the Entry knob to adjust the parameter. The Entry knob is located on the front panel. The  symbol below the knob is illuminated when this control is active.



Rotate the Entry knob to select an item. Push the Entry knob or press the softkey to activate the item or close the menu.



Press the softkey to display a pop-up menu. Press the softkey or rotate and push the Entry knob to make an item active.



Option is selected but not active.



Option is selected and active.




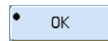
Feature is on. Press the softkey again to turn the feature off.



Feature is off. Press the softkey again to turn the feature on.



Press the softkey to view the menu. Press the  back/up key to return to the previous menu.



A dot on a softkey indicates that the action specified in the dialog will be performed when the Entry knob is pushed.

## Become Familiar with the Oscilloscope Display

The oscilloscope display contains acquired waveforms, setup information, measurement results, and the softkey definitions.

**Figure 1** Interpreting the oscilloscope display



**Status line** The top line of the display contains vertical, horizontal, and trigger setup information.

**Display area** The display area contains the waveform acquisitions, channel identifiers, and analog trigger and ground level indicators. Each analog channel's information appears in a different color.

**Measurement line** This line normally contains automatic measurement and cursor results, but can also display advanced trigger setup data and menu information.

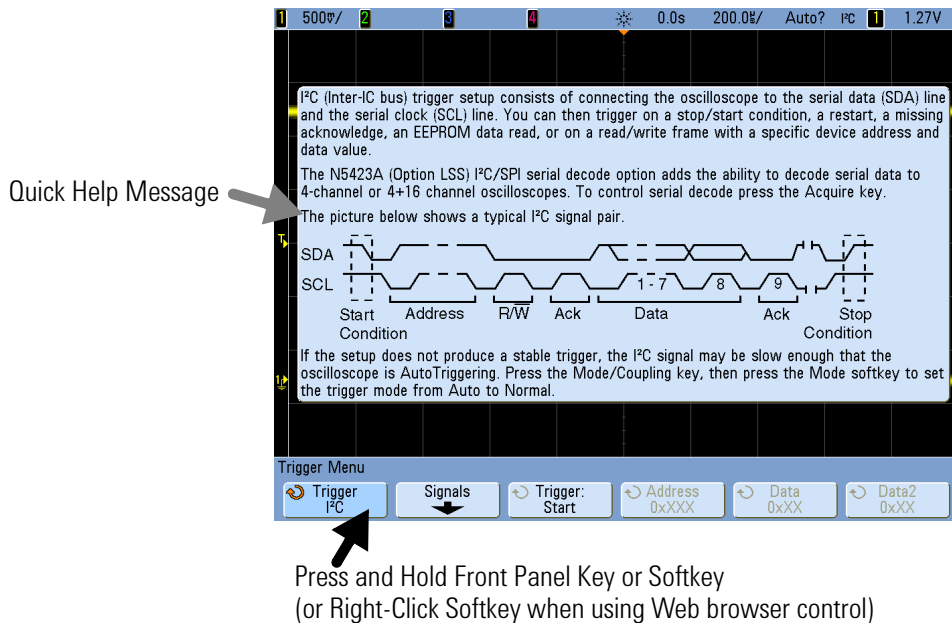
**Softkeys** The softkeys let you set up additional parameters for the selected mode or menu.



## Access the Built-In Quick Help

### To view Quick Help

- 1 Press and *hold* the key or softkey for which you would like to view help.



By default, Quick Help remains on the screen until another key is pressed or a knob is turned. You can set Quick Help to close when you release the key. Press the **[Help]** key, then press the **Language** softkey, then press the **Help** softkey and select either **Close on Release** or **Remain on Screen ([Help] > Language > Help)**.

## To select the Quick Help language

To choose a Quick Help language in the oscilloscope:

- 1 Press [**Help**], then press the **Language** softkey.
- 2 Repeatedly press and release the **Language** softkey or rotate the Entry knob until the desired language is selected.

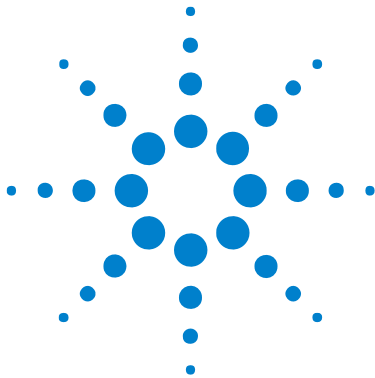
When Quick Help is set to one of the following languages, the Graphical User Interface (GUI) is displayed in the language chosen.

- Simplified Chinese
- Traditional Chinese
- Japanese
- Korean

## To get the latest Quick Help

Updated Quick Help content may be downloaded and installed on the oscilloscope just like firmware updates. To download new Quick Help and GUI language files:

- 1 Direct your web browser to: [www.agilent.com/find/7000sw](http://www.agilent.com/find/7000sw)
- 2 Select **Quick Help Language Support** and follow the directions.



## 2 Probing the Device Under Test

Analog Input Impedance (50 Ohm or 1 MOhm)	52
AutoProbe Interface	52
Passive Probes	53
Active Probes	53
Connect the Probes to the Oscilloscope	55
Compensating Passive Probes	56
Calibrating Probes	57
Manually Setting the Probe Attenuation Factor	59
Digital Probes	60

This chapter explains how to connect the oscilloscope to your device under test (DUT) using probes.



## Analog Input Impedance (50 Ohm or 1 MOhm)

The input impedance of most InfiniiVision oscilloscope analog channels can be set to either 50  $\Omega$  or 1 M $\Omega$ . The 50  $\Omega$  mode matches 50  $\Omega$  cables and many active probes commonly used in making high frequency measurements. This impedance matching gives you the most accurate measurements because reflections are minimized along the signal path. The 1 M $\Omega$  impedance is commonly required for use with most passive probes.

If you would like to connect to the oscilloscope using 50 ohm BNC cables instead, select the 50 ohm input impedance mode.

For instructions on setting the input impedance, see “[To specify channel input impedance](#)” on page 79.

For more information on probing, visit [www.agilent.com/find/scope\\_probes](http://www.agilent.com/find/scope_probes)

Information about selecting a probe can be found in document number [5989-6162EN](#): *Agilent Oscilloscope Probes and Accessories Selection Guide*, available at [www.agilent.com](http://www.agilent.com).

## AutoProbe Interface

The AutoProbe interface uses a series of contacts directly below the channel’s BNC connector to transfer information between the oscilloscope and the probe. When you connect a compatible probe to the oscilloscope, the AutoProbe interface determines the type of probe and sets the oscilloscope’s parameters (units, offset, attenuation, coupling, and impedance) accordingly.

## Passive Probes

All InfiniiVision oscilloscopes recognize passive probes such as the 10073C, 10074C and 1165A. These probes have a pin on their connector that connects to the ring around the oscilloscope's BNC connector. Therefore, the oscilloscope will automatically set the attenuation factor for recognized Agilent passive probes.

Passive probes that do not have a pin that connects to the ring around the BNC connector will not be recognized by the oscilloscope, and you must set the probe attenuation factor manually. See [page 59](#).

The following passive probes can be used with the InfiniiVision oscilloscopes. Any combination of passive probes can be used.

**Table 2** Passive Probes

Passive Probes	Quantity Supported
1165A Passive probe, 10:1, 600 MHz, 1.5 m	4
10070C Passive probe, 1:1 20 MHz, 1.5 m	4
10073C Passive probe, 10:1, 500 MHz, 1.5 m	4
10074C Passive probe, 10:1, 150 MHz, 1.5 m	4
10076A Passive probe, 100:1, 4 kV, 250 MHz	4
N2863A Passive probe, 10:1, 300 MHz, 1.2 m	4

## Active Probes

Most Agilent active probes are compatible with the AutoProbe interface. Active probes that do not have their own external power supply require substantial power from the AutoProbe interface. “Quantity Supported” indicates the maximum number of each type of active probe that can be connected to the oscilloscope. If too much current is drawn from the AutoProbe interface, an error message will be displayed, indicating that you must momentarily disconnect all probes to reset the AutoProbe interface, then connect only the supported quantity of active probes.

**Table 3** Active Probes

Active Probes	Quantity Supported
1130A 1.5 GHz InfiniiMax amplifier, requires one or more InfiniiMax probe heads: E2675A, E2668A, E2669A	2
1131A InfiniiMax 3.5 GHz Probe	2
1132A InfiniiMax 5 GHz Probe	2
1134A InfiniiMax 7 GHz Probe	2
1141A Differential Probe, 200 MHz, with 1142A power supply	4
1144A Active Probe, 800 MHz, with 1142A power supply	4
1145A 2-Channel, 750 MHz Active Probe, with 1142A power supply	2
1147A 50 MHz/15A AC/DC Current Probe	2
1156A 1.5 GHz Active Probe	4
1157A 2.5 GHz Active Probe	4
1158A 4 GHz Active Probe	4
N2772A Differential Probe, 20 MHz, with N2773A power supply	4
N2774A (obsolete, replaced by N2782A) with N2775A power supply	4
N2782A 50 MHz/30Arms AC/DC Current Probe, with N2779A power supply	4

## Connect the Probes to the Oscilloscope

- 1 Connect the oscilloscope probe to an oscilloscope channel BNC connector.
- 2 Connect the probe's retractable hook tip to the point of interest on the circuit or device under test. Be sure to connect the probe ground lead to a ground point on the circuit.

### CAUTION



#### Maximum input voltage at analog inputs

CAT I 300 Vrms, 400 Vpk; transient overvoltage 1.6 kVpk

CAT II 100 Vrms, 400 Vpk

50 $\Omega$  input: 5 Vrms

Input protection is enabled in 50  $\Omega$  mode and the 50  $\Omega$  load will disconnect if greater than 5 Vrms is detected. However the inputs could still be damaged, depending on the time constant of the signal. The 50  $\Omega$  input protection only functions when the oscilloscope is powered on.

1 M ohm input, 100 MHz models:

For steady-state sinusoidal waveforms derate at 20 dB/decade above 200 kHz to a minimum of 10 Vpk

1 M ohm input, 350 MHz, 500 MHz, 1 GHz models:

For steady-state sinusoidal waveforms derate at 20 dB/decade above 57 kHz to a minimum of 5 Vpk

With N2863A 10:1 probe: CAT I 600 V, CAT II 300 V (DC + peak AC)

With 10073C or 10074C 10:1 probe: CAT I 500 Vpk, CAT II 400 Vpk

### CAUTION



#### Do not float the oscilloscope chassis

Defeating the ground connection and "floating" the oscilloscope chassis will probably result in inaccurate measurements and may also cause equipment damage. The probe ground lead is connected to the oscilloscope chassis and the ground wire in the power cord. If you need to measure between two live points, use a differential probe with sufficient dynamic range.

### WARNING

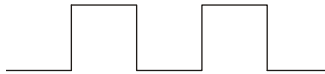
Do not negate the protective action of the ground connection to the oscilloscope. The oscilloscope must remain grounded through its power cord. Defeating the ground creates an electric shock hazard.

## Compensating Passive Probes

Each oscilloscope passive probe must be compensated to match the input characteristics of the oscilloscope channel to which it is connected. A poorly compensated probe can introduce significant measurement errors.

- 1 Perform the procedure “[Input a Waveform and AutoScale](#)” on page 32.
- 2 Use a nonmetallic tool (supplied with the probe) to adjust the trimmer capacitor on the probe for the flattest pulse possible. The trimmer capacitor is located on the probe BNC connector.

Perfectly compensated



Over compensated



Under compensated



- 3 Connect probes to all other oscilloscope channels (channel 2 of a 2-channel oscilloscope, or channels 2, 3, and 4 of a 4-channel oscilloscope). Repeat the procedure for each channel.



## Calibrating Probes

Some probes, such as the 10073C, 10074C, and 1165A passive probes, do not require calibration. When one of these probes is connected, the **Calibrate Probe** softkey in the Channel Probe Menu is grayed-out (displayed in faint text).

However, for certain active probes, such as InfiniiMax probes, the oscilloscope can accurately calibrate its analog channels for the probe. When you connect a probe that can be calibrated, the **Calibrate Probe** softkey in the Channel Probe Menu becomes active. To calibrate one of these probes:

- 1 First, plug your probe into one of the oscilloscope channels.  
This could be, for example, an InfiniiMax probe amplifier/probe head with attenuators attached.
- 2 Connect the probe to the Probe Comp terminal, and the probe ground to the Probe Comp ground terminal.

### NOTE

When calibrating a differential probe, connect the positive lead to the Probe Comp terminal and the negative lead to the Probe Comp ground terminal. You may need to connect an alligator clip to the ground lug to allow a differential probe to span between the Probe Comp test point and ground. A good ground connection ensures the most accurate probe calibration.

- 3 Press the Channel on/off key to turn the channel on (if the channel is off).
- 4 In the Channel Menu, press the **Probe** softkey.
- 5 In the Channel Probe Menu, the second softkey from the left is for specifying your probe head (and attenuation). Repeatedly press this softkey until the probe head selection matches the attenuator you are using.

## 2 Probing the Device Under Test

The choices are:

- 10:1 single-ended browser (no attenuator)
- 10:1 differential browser (no attenuator)
- 10:1 (+6 dB Atten) single-ended browser
- 10:1 (+6 dB Atten) differential browser
- 10:1 (+12 dB Atten) single-ended browser
- 10:1 (+12 dB Atten) differential browser
- 10:1 (+20 dB Atten) single-ended browser
- 10:1 (+20 dB Atten) differential browser


**6** Press the **Calibrate Probe** softkey and follow the instructions on the display.

For more information on InfiniiMax probes and accessories, see the probe's *User's Guide*.

## Manually Setting the Probe Attenuation Factor

The probe attenuation factor must be set properly for accurate measurement results.

If you connect a probe that is not automatically identified by the oscilloscope, you can manually set the attenuation factor as follows:

- 1 Press the channel key.
- 2 Press the **Probe** softkey until you have selected how you want to specify the attenuation factor, choosing either **Ratio** or **Decibels**.
- 3 Turn the Entry knob  to set the attenuation factor for the connected probe.

When measuring voltage values, the attenuation factor can be set from 0.1:1 to 1000:1 in a 1-2-5 sequence.

When measuring current values with a current probe, the attenuation factor can be set from 10 V/A to 0.001 V/A.

When specifying the attenuation factor in decibels, you can select values from -20 dB to 60 dB.

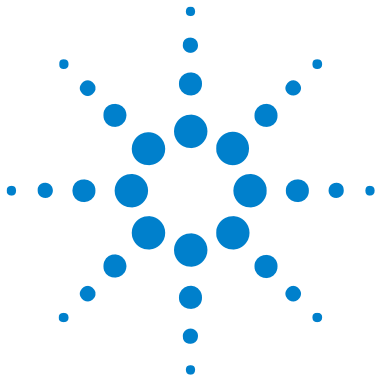
If Amps is chosen as the units and a manual attenuation factor is chosen, then the units as well as the attenuation factor are displayed above the Probe softkey.

### Units and Attenuation Factor



## Digital Probes

Please see [“To connect the digital probes to the device under test”](#) on page 360 for information about digital probing.



## 3 Displaying Waveforms

- Using the Horizontal Controls 62
- Using the Vertical Controls 77
- Setting Analog Channel Probe Options 82
- Changing the Display Settings 84
- Using Labels 89

This chapter describes using the horizontal controls, the vertical controls, the **[Display]** key and menu options, and labels when displaying waveforms.


The easiest way to adjust the horizontal and vertical scale and display waveforms is to connect the probes to the signals and press **[AutoScale]**. See “[Input a Waveform and AutoScale](#)” on page 32.

- See Also**
- “[Triggering](#)” on page 95 for topics related to stabilizing waveforms on the display.
  - “[Acquisition Modes](#)” on page 223 for topics related to detecting peak values of waveforms, averaging waveforms, and capturing high-resolution waveforms.
  - “[Printing Screens](#)” on page 220.
  - “[Setting Oscilloscope Preferences](#)” on page 383.

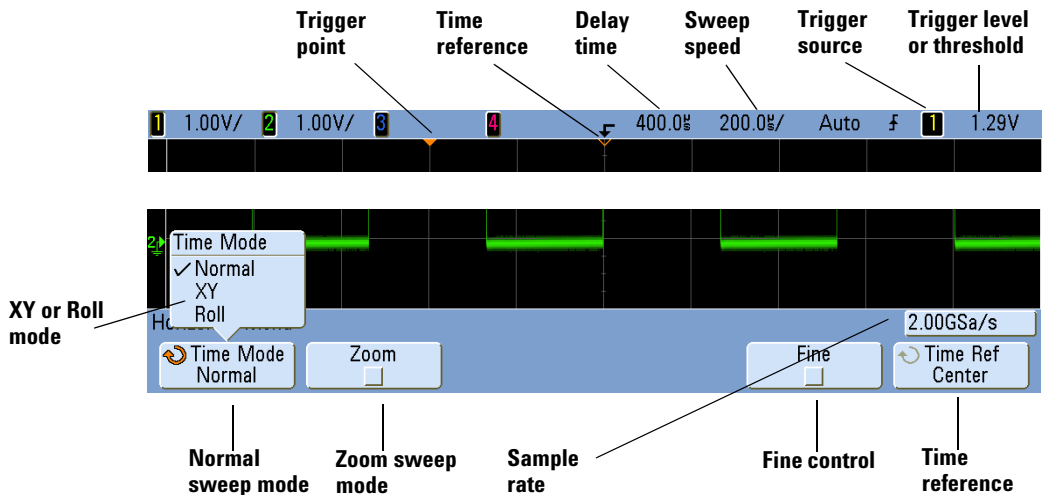


## Using the Horizontal Controls

The horizontal controls include:

- The horizontal scale and position knobs.
- The **[Horiz]** key for accessing the Horizontal Menu.
- The  zoom key for quickly enabling/disabling the split-screen zoom display.
- The **[Search]** key for marking events in the serial decode Lister. See “Searching Lister Data” on page 259.
- The **[Navigate]** keys for navigating time, marked events in the serial decode Lister, and segmented memory acquisitions.

The following figure shows the Horizontal Menu which appears after pressing the **[Horiz]** key.



The Horizontal Menu lets you select the time mode (Normal, XY, or Roll), enable Zoom, set the time base fine control (vernier), and specify the time reference.

The current sample rate is displayed above the **Fine** and **Time Ref** softkeys.

## To adjust the horizontal (time/div) scale

- 1 Turn the large horizontal scale (sweep speed) knob marked  $\nabla \sim$  to change the horizontal time/div setting.

Notice how the time/div information in the status line changes.

The  $\nabla$  symbol at the top of the display indicates the time reference point.

Note that the horizontal scale knob has a different purpose in the Zoom display. See “[To display the zoomed time base](#)” on page 71.

The horizontal scale knob works (in the Normal time mode) while acquisitions are running or when they are stopped. When running, adjusting the horizontal scale knob changes the sample rate. When stopped, adjusting the horizontal scale knob lets you zoom into acquired data. See “[Panning and Zooming Single or Stopped Acquisitions](#)” on page 64.

## To adjust the horizontal delay (position)

- 1 Turn the horizontal delay (position) knob ( $\blacktriangleleft \blacktriangleright$ ).

Notice that the delay value is displayed in the status line.

The delay knob moves the normal sweep horizontally, and it pauses at 0.00 s, mimicking a mechanical detent.

Changing the delay time moves the sweep horizontally and indicates how far the trigger point (solid inverted triangle) is from the time reference point (hollow inverted triangle  $\nabla$ ). These reference points are indicated along the top of the display grid.

The previous figure shows the trigger point with the delay time set to 400  $\mu$ s. The delay time number tells you how far the time reference point is located from the trigger point. When delay time is set to zero, the delay time indicator overlays the time reference indicator.

All events displayed left of the trigger point happened before the trigger occurred. These events are called pre-trigger information, and they show events that led up to the trigger point.

Everything to the right of the trigger point is called post-trigger information. The amount of delay range (pre-trigger and post-trigger information) available depends on the sweep speed selected and memory depth.

Note that the horizontal position knob has a different purpose in the Zoom display. See [“To display the zoomed time base”](#) on page 71.

The horizontal position knob works (in the Normal time mode) while acquisitions are running or when they are stopped. When running, adjusting the horizontal scale knob changes the sample rate. When stopped, adjusting the horizontal scale knob lets you zoom into acquired data. See [“Panning and Zooming Single or Stopped Acquisitions”](#) on page 64.

## Panning and Zooming Single or Stopped Acquisitions

When the oscilloscope is stopped, use the horizontal scale and position knobs to pan and zoom your waveform. The stopped display may contain several acquisitions worth of information, but only the last acquisition is available for pan and zoom.

The ability to pan (move horizontally) and scale (expand or compress horizontally) an acquired waveform is important because of the additional insight it can reveal about the captured waveform. This additional insight is often gained from seeing the waveform at different levels of abstraction. You may want to view both the big picture and the specific little picture details.

The ability to examine waveform detail after the waveform has been acquired is a benefit generally associated with digital oscilloscopes. Often this is simply the ability to freeze the display for the purpose of measuring with cursors or printing the screen. Some digital oscilloscopes go one step further by including the ability to further examine the signal details after acquiring them by panning through the waveform and changing the horizontal scale.

There is no limit imposed on the scaling ratio between the sweep speed used to acquire the data and the sweep speed used to view the data. There is, however, a useful limit. This useful limit is somewhat a function of the signal you are analyzing.



In normal display mode, with vectors (connect-the-dots) off, you can scale in to the point where there are no samples on the screen. Obviously, this is far beyond the useful limit. Likewise, with vectors on, you can see the linear interpolation between the points, but again, this is of very limited value.

## NOTE

### Zooming into stopped acquisitions

The screen will still contain a relatively good display if you zoom-in horizontally by a factor of 1000 and zoom-in vertically by a factor of 10 to display the information from where it was acquired. Remember that you can only make automatic measurements on displayed data.

## To change the horizontal time mode (Normal, XY, or Roll)

1 Press [**Horiz**].

2 In the Horizontal Menu, press **Time Mode**; then, select:

- **Normal** – the normal viewing mode for the oscilloscope.

In the Normal time mode, signal events occurring before the trigger are plotted to the left of the trigger point (t) and signal events after the trigger plotted to the right of the trigger point.

- **XY** – XY mode changes the display from a volts-versus-time display to a volts-versus-volts display. The time base is turned off. Channel 1 amplitude is plotted on the X-axis and Channel 2 amplitude is plotted on the Y-axis.

You can use XY mode to compare frequency and phase relationships between two signals. XY mode can also be used with transducers to display strain versus displacement, flow versus pressure, volts versus current, or voltage versus frequency.

Use the cursors to make measurements on XY mode waveforms.

For more information about using XY mode for measurements, refer to “[XY Time Mode](#)” on page 66.

- **Roll** – causes the waveform to move slowly across the screen from right to left. It only operates on time base settings of 500 ms/div and slower. If the current time base setting is faster than the 500 ms/div limit, it will be set to 500 ms/div when Roll mode is entered.

In Roll mode there is no trigger. The fixed reference point on the screen is the right edge of the screen and refers to the current moment in time. Events that have occurred are scrolled to the left of the reference point. Since there is no trigger, no pre-trigger information is available.

If you would like to pause the display in Roll mode press the [**Single**] key. To clear the display and restart an acquisition in Roll mode, press the [**Single**] key again.

Use Roll mode on low-frequency waveforms to yield a display much like a strip chart recorder. It allows the waveform to roll across the display.

#### XY Time Mode

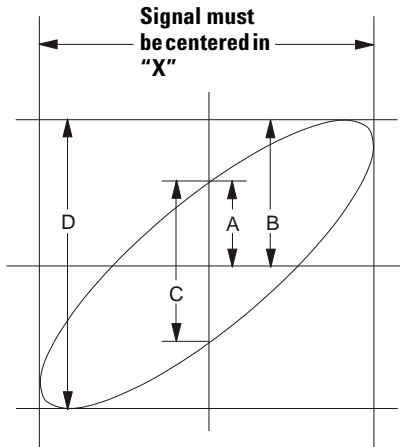
The XY time mode converts the oscilloscope from a volts-versus-time display to a volts-versus-volts display using two input channels. Channel 1 is the X-axis input, channel 2 is the Y-axis input. You can use various transducers so the display could show strain versus displacement, flow versus pressure, volts versus current, or voltage versus frequency. This exercise shows a common use of the XY display mode by measuring the phase difference between two signals of the same frequency with the Lissajous method.

- 1 Connect a sine wave signal to channel 1, and a sine wave signal of the same frequency but out of phase to channel 2.
- 2 Press the [**AutoScale**] key, press the [**Horiz**] key; then, press **Time Mode** and select “XY”.
- 3 Center the signal on the display with the channel 1 and 2 position (◆) knobs. Use the channel 1 and 2 volts/div knobs and the channel 1 and 2 **Fine** softkeys to expand the signal for convenient viewing.

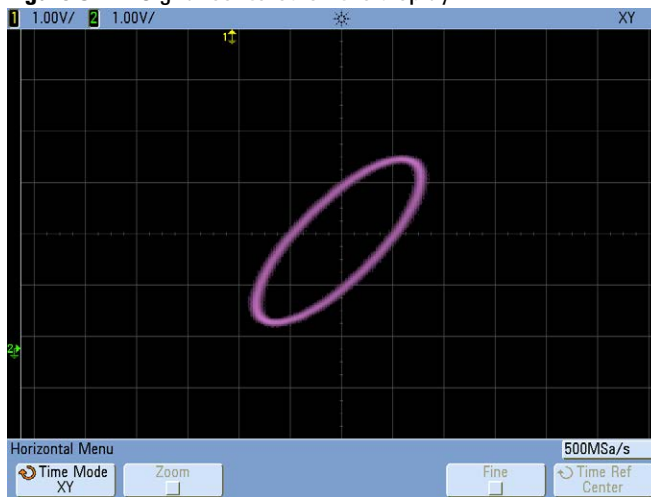
The phase difference angle ( $\theta$ ) can be calculated using the following formula (assuming the amplitude is the same on both channels):

$$\sin \theta = \frac{A}{B} \text{ or } \frac{C}{D}$$

**Figure 2** Example of centering a signal on the display



**Figure 3** Signal centered on the display



- 4 Press the [Cursors] key.
- 5 Set the Y2 cursor to the top of the signal, and set Y1 to the bottom of the signal.

### 3 Displaying Waveforms

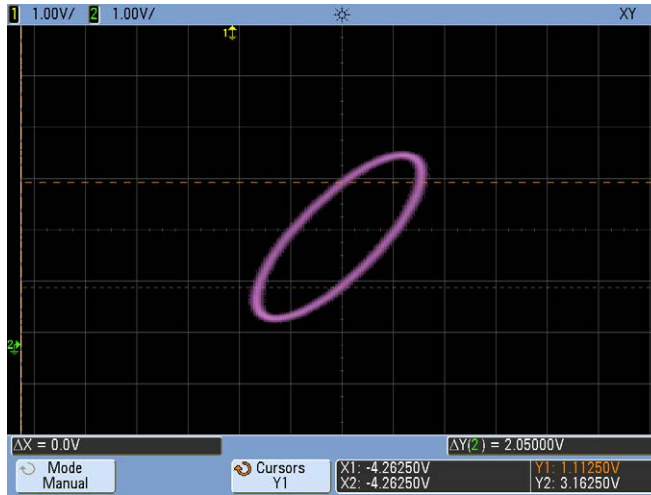
Note the  $\Delta Y$  value at the bottom of the display. In this example, we are using the Y cursors, but you could have used the X cursors instead.

**Figure 4** Cursors set on displayed signal



- 6 Move the Y1 and Y2 cursors to the intersection of the signal and the Y axis. Again, note the  $\Delta Y$  value.

**Figure 5** Cursors set to center of signal



- 7 Calculate the phase difference using the formula below.

$$\sin \theta = \frac{\text{second } \Delta Y}{\text{first } \Delta Y} = \frac{1.031}{1.688} ; \theta = 37.65 \text{ degrees of phase shift}$$

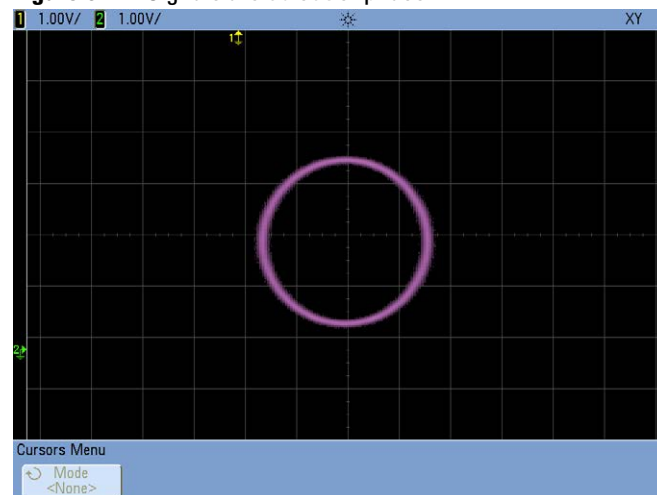
### 3 Displaying Waveforms

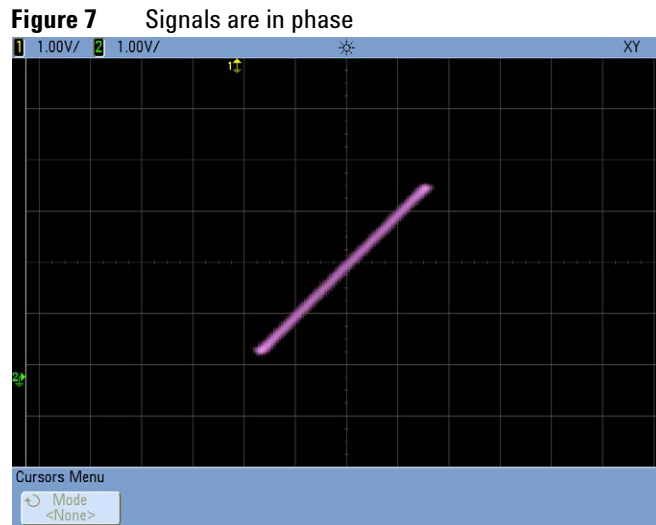
#### NOTE

#### Z-Axis Input in XY Display Mode (Blanking)


When you select the XY display mode, the time base is turned off. Channel 1 is the X-axis input, channel 2 is the Y-axis input, and channel 4 (or the External trigger on 2-channel models) is the Z-axis input. If you only want to see portions of the Y versus X display, use the Z-axis input. Z-axis turns the trace on and off (analog oscilloscopes called this Z-axis blanking because it turned the beam on and off). When Z is low (<1.4 V), Y versus X is displayed; when Z is high (>1.4 V), the trace is turned off.

**Figure 6** Signals are 90 out of phase






## To display the zoomed time base

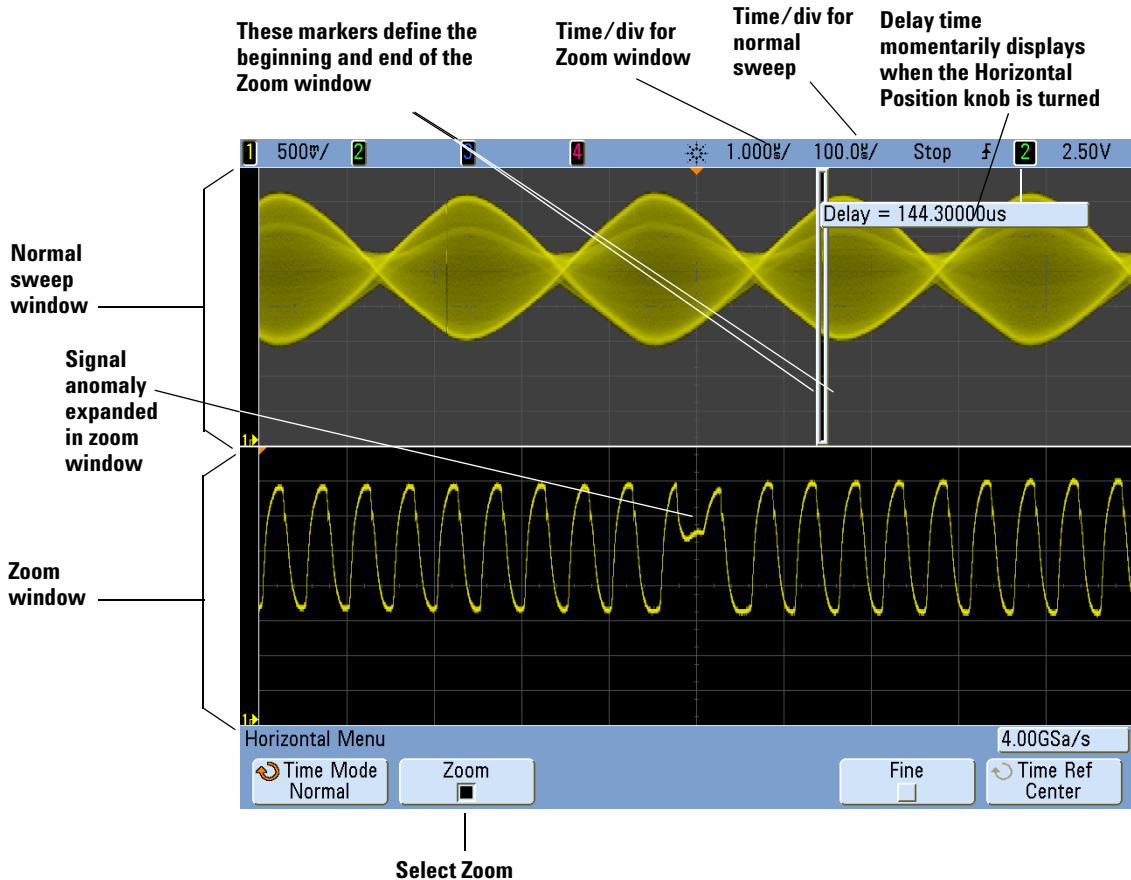
Zoom, formerly called Delayed sweep mode, is a horizontally expanded version of normal display. When Zoom is selected, the display divides in half and the Zoom mode  icon is displayed in the middle of the line at the top of the display. The top half of the display shows the normal sweep and the bottom half displays the Zoom sweep.

The Zoom window is a magnified portion of the normal sweep. You can use Zoom to locate and horizontally expand part of the normal sweep for a more detailed (higher-resolution) analysis of signals.

### 3 Displaying Waveforms

To turn on (or off) Zoom:

- 1 Press the  zoom key (or press the [Horiz] key and then the **Zoom** softkey).



The area of the normal display that is expanded is outlined with a box and the rest of the normal display is lightened. The box shows the portion of the normal sweep that is expanded in the lower half.

To change the sweep speed for the Zoom window, turn the horizontal scale (sweep speed) knob. As you turn the knob, the sweep speed is highlighted in the status line above the waveform display area. The Horizontal scale (sweep speed) knob controls the size of the box.



The Horizontal position (delay time) knob sets the left-to-right position of the zoom sweep. The delay value, which is the time displayed relative to the trigger point) is momentarily displayed in the upper-right portion of the display when the delay time (◀▶) knob is turned.

Negative delay values indicate you're looking at a portion of the waveform before the trigger event, and positive values indicate you're looking at the waveform after the trigger event.

To change the sweep speed for the normal sweep window, turn off Zoom; then, turn the horizontal scale (sweep speed) knob.

For information about using zoom mode for measurements, refer to [Chapter 5](#), "Measurements and Math Functions," starting on page 153.

**See Also** ["To specify the measurement window for Zoom mode"](#) on page 386.

## To change the horizontal scale knob's coarse/fine adjustment setting

- 1 Push the horizontal scale knob (or press [**Horiz**] > **Fine**) to toggle between fine and coarse adjustment of the horizontal scale.

The **Fine** softkey lets you change the sweep speed in smaller increments with the time/division knob.

The sweep speed remains fully calibrated when Fine is on.

The horizontal time/div scale value is displayed in the status line at the top of the display.

When **Fine** is turned off, the Horizontal sweep speed knob changes the time base sweep speed in a 1-2-5 step sequence.

## To position the time reference (left, center, right)

Time reference is the reference point on the display for delay time (horizontal position).

1 Press [**Horiz**].

2 In the Horizontal Menu, press **Time Ref**; then, select:

- **Left** – the time reference is set to one major division from the left edge of the display.
- **Center** – the time reference is set to the center of the display.
- **Right** – the time reference is set to one major division from the right edge of the display.

A small hollow triangle ( $\nabla$ ) at the top of the display grid marks the position of the time reference. When delay time is set to zero, the trigger point indicator ( $\blacktriangledown$ ) overlays the time reference indicator.

The time reference position sets the initial position of the trigger event within acquisition memory and on the display, with delay set to 0.

Turning the Horizontal scale (sweep speed) knob expands or contracts the waveform about the time reference point ( $\nabla$ ). See [“To adjust the horizontal \(time/div\) scale”](#) on page 63.

Turning the Horizontal position ( $\blacktriangleleft\blacktriangleright$ ) knob in Normal mode (not Zoom) moves the trigger point indicator ( $\blacktriangledown$ ) to the left or right of the time reference point ( $\nabla$ ). See [“To adjust the horizontal delay \(position\)”](#) on page 63.

## To navigate the time base

You can use the [**Navigate**] key and controls to navigate through captured data, marks in the serial decode Lister, or segmented memory acquisitions.

### To navigate time

When acquisitions are stopped, you can use the navigation controls to play through the captured data.

1 Press [**Navigate**].

2 In the Navigate Menu, press **Navigate**; then, select **Time**.

- 3 Press the ◀ ◼ ▶ navigation keys to play backward, stop, or play forward in time. You can press the ◀ or ▶ keys multiple times to speed up the playback. There are three speed levels.

### To navigate marks in the Lister

When acquisitions are stopped and serial decode is enabled, you can use the navigation controls to go to marks in the Lister (set using the [Search] key and menu).

- 1 Press [Navigate].
- 2 In the Navigate Menu, press **Navigate**; then, select **Search**.
- 3 Press the ◀ ▶ back and forward keys to go to the previous or next mark.
- 4 Press the ◼ stop key to set or clear a mark.

The **Auto zoom** softkey specifies whether the waveform display is automatically zoomed to fit the marked row as you navigate.

Pressing the **Scroll Lister** softkey lets you use the Entry knob to scroll through data rows in the Lister display.

### To navigate segments

When the segmented memory acquisition is enabled and acquisitions are stopped, you can use the navigation controls to play through the acquired segments.

- 1 Press [Navigate].
- 2 In the Navigate Menu, press **Navigate**; then, select **Segments**.
- 3 Press **Play Mode**; then, select:

- **Manual** – to play through segments manually.

In the Manual play mode:

- Press the ◀ ▶ back and forward keys to go to the previous or next segment.
- Press the ◀◀ softkey to go to the first segment.
- Press the ▶▶ softkey to go to the last segment.

### 3 Displaying Waveforms

- **Auto** – to play through segments in an automated fashion.

In the Auto play mode:

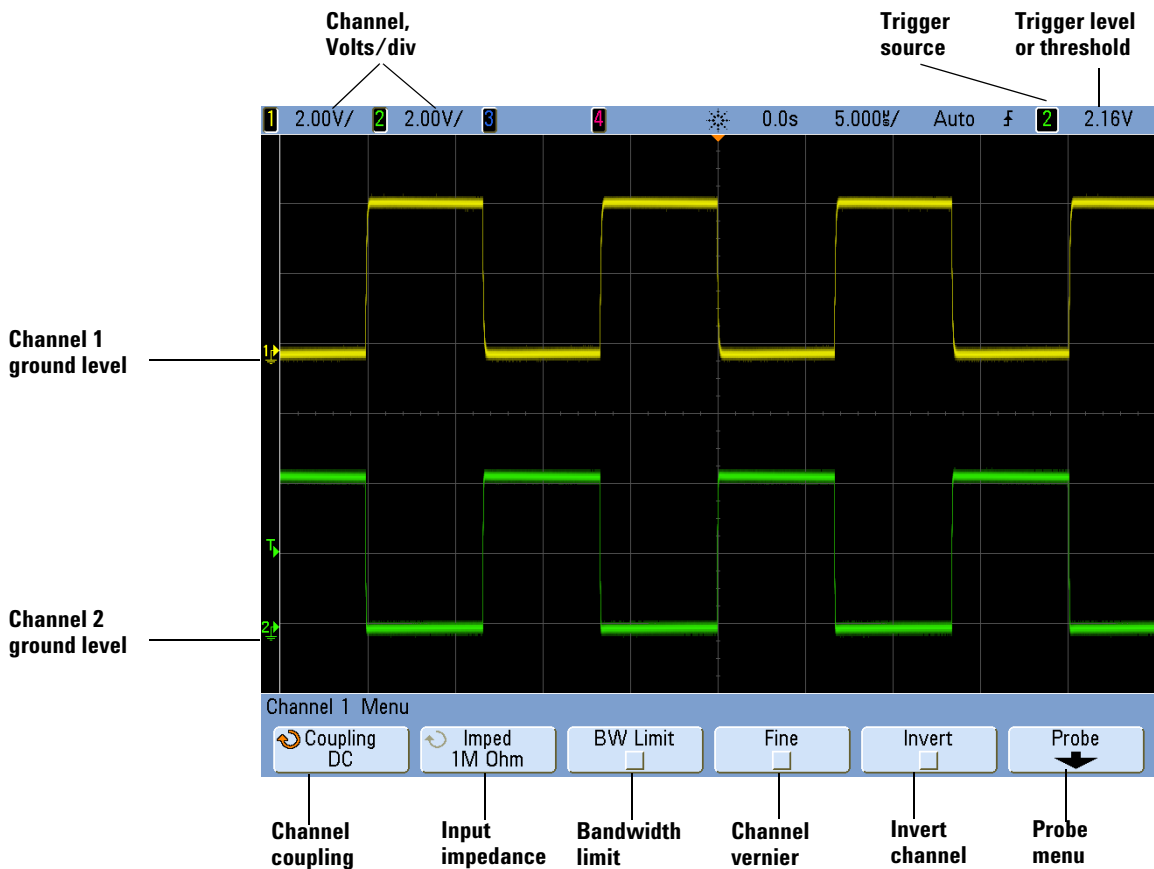
- Press the ◀◼▶ navigation keys to play backward, stop, or play forward in time. You can press the ◀ or ▶ keys multiple times to speed up the playback. There are three speed levels.


## Using the Vertical Controls

The vertical controls include:

- The vertical scale and position knobs for each analog channel.
- The channel keys for turning a channel on or off and accessing the channel's softkey menu.

The following figure shows the Channel 1 Menu that appears after pressing the [1] channel key.



The ground level of the signal for each displayed analog channel is identified by the position of the  icon at the far-left side of the display.

## To turn waveforms on or off (channel or math)

- 1 Press an analog channel key turn the channel on or off (and to display the channel's menu).

When a channel is on, its key is illuminated.

### NOTE

#### Turning channels off

You must be viewing the menu for a channel before you can turn it off. For example, if channel 1 and channel 2 are turned on and the menu for channel 2 is being displayed, to turn channel 1 off, press [1] to display channel 1 menu, then press [1] again to turn channel 1 off.

## To adjust the vertical scale

- 1 Turn the large knob above the channel key marked  $\sim \nabla$  to set the vertical scale (volts/division) for the channel.

The vertical scale knob changes the analog channel scale in a 1-2-5 step sequence (with a 1:1 probe attached) unless fine adjustment is enabled (see [“To change the vertical scale knob's coarse/fine adjustment setting”](#) on page 81).

The analog channel Volts/Div value is displayed in the status line.

The default mode for expanding the signal when you turn the volts/division knob is vertical expansion about the ground level of the channel; however, you can change this to expand about the center of the display. See [“To choose "expand about" center or ground”](#) on page 383.

## To adjust the vertical position

- 1 Turn the small vertical position knob ( $\blacklozenge$ ) to move the channel's waveform up or down on the display.

The voltage value momentarily displayed in the upper right portion of the display represents the voltage difference between the vertical center of the display and the ground level ( $\nabla$ ) icon. It also represents the

voltage at the vertical center of the display if vertical expansion is set to expand about ground (see “To choose “expand about” center or ground” on page 383).

## To specify channel coupling

Coupling changes the channel's input coupling to either **AC** (alternating current) or **DC** (direct current).

### NOTE

#### Measurement Hints

If the channel is DC coupled, you can quickly measure the DC component of the signal by simply noting its distance from the ground symbol.

If the channel is AC coupled, the DC component of the signal is removed, allowing you to use greater sensitivity to display the AC component of the signal.

- 1 Press the desired channel key.
- 2 In the Channel Menu, press the **Coupling** softkey to select the input channel coupling:
  - **DC** – DC coupling is useful for viewing waveforms as low as 0 Hz that do not have large DC offsets.
  - **AC** – AC coupling is useful for viewing waveforms with large DC offsets. When AC coupling is chosen, you cannot select 50Ω mode. This is done to prevent damage to the oscilloscope.

AC coupling places a 3.5 Hz high-pass filter in series with the input waveform that removes any DC offset voltage from the waveform.

Note that Channel Coupling is independent of Trigger Coupling. To change trigger coupling see [page 103](#).

## To specify channel input impedance

The analog channel input impedance can be set to either **1M Ohm** or **50 Ohm**.

#### NOTE

When you connect an AutoProbe, self-sensing probe, or a compatible InfiniiMax probe, the oscilloscope will automatically configure the oscilloscope to the correct impedance.

---

- 1 Press the desired channel key.
- 2 In the Channel Menu, press **Imped** (impedance); then, select:
  - **50 Ohm** – matches 50-ohm cables commonly used in making high frequency measurements, and 50-ohm active probes. This impedance matching gives you the most accurate measurements since reflections are minimized along the signal path. When **50 Ohm** is selected, “50Ω” is illuminated on the front panel next to the channel position knob. The oscilloscope automatically switches to **1 M Ohm** mode to prevent possible damage if AC coupling is selected.
  - **1M Ohm** – is for use with many passive probes and for general-purpose measurements. The higher impedance minimizes the loading effect of the oscilloscope on the device under test.

## To specify bandwidth limiting

- 1 Press the desired channel key.
- 2 In the Channel Menu, press the **BW Limit** softkey to enable or disable bandwidth limiting.

When bandwidth limit is on, the maximum bandwidth for the channel is approximately 25 MHz. For waveforms with frequencies below this, turning bandwidth limit on removes unwanted high frequency noise from the waveform. The bandwidth limit also limits the trigger signal path of any channel that has **BW Limit** turned on.



## To change the vertical scale knob's coarse/fine adjustment setting

- 1 Push the channel's vertical scale knob (or press the channel key and then the **Fine** softkey in the Channel Menu) to toggle between fine and coarse adjustment of the vertical scale.

When **Fine** adjustment is selected, you can change the channel's vertical sensitivity in smaller increments. The channel sensitivity remains fully calibrated when **Fine** is on.

The vertical scale value is displayed in the status line at the top of the display.

When **Fine** is turned off, turning the volts/division knob changes the channel sensitivity in a 1-2-5 step sequence.

## To invert a waveform

- 1 Press the desired channel key.
- 2 In the Channel Menu, press the **Invert** softkey to invert the selected channel.

When **Invert** is selected, the voltage values of the displayed waveform are inverted.

Invert affects how a channel is displayed, but does not affect triggering. If the oscilloscope is set to trigger on a rising edge, it remains set to trigger on a same edge (triggers at the same point on the waveform) after the channel is inverted.

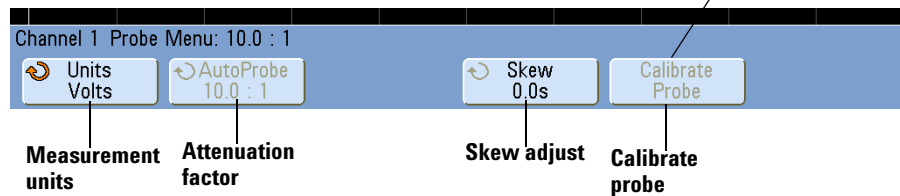
Inverting a channel will also change the result of any function selected in the Waveform Math Menu or any measurement.

## Setting Analog Channel Probe Options

- 1 Press the probe's associated channel key.
- 2 In the Channel Menu, press the **Probe** softkey to display the Channel Probe Menu.

This menu lets you select additional probe parameters such as attenuation factor and units of measurement for the connected probe.

**Probe calibration not needed, not available when this softkey is ghosted.**



### To specify the channel units

- 1 Press the probe's associated channel key.
- 2 In the Channel Menu, press **Probe**.
- 3 In the Channel Probe Menu, press **Units**; then, select:
  - **Volts** – for a voltage probe.
  - **Amps** – for a current probe.

Channel sensitivity, trigger level, measurement results, and math functions will reflect the measurement units you have selected.

### To specify the probe attenuation

This is set automatically if the oscilloscope can identify the connected probe. See “[AutoProbe Interface](#)” on page 52 and “[Manually Setting the Probe Attenuation Factor](#)” on page 59.

## To specify the probe skew

When measuring time intervals in the ns range, small differences in cable length can affect the measurement. Use **Skew** to remove cable-delay errors between any two channels.

- 1 Probe the same point with both probes.
- 2 Press one of the probes associated channel key.
- 3 In the Channel Menu, press **Probe**.
- 4 In the Channel Probe Menu, press **Skew**; then, select the desired skew value.

Each analog channel can be adjusted  $\pm 100$  ns in 10 ps increments for a total of 200 ns difference.

The skew setting is not affected by recalling the [**Default Setup**] or by pressing [**Auto Scale**].

## To calibrate a probe

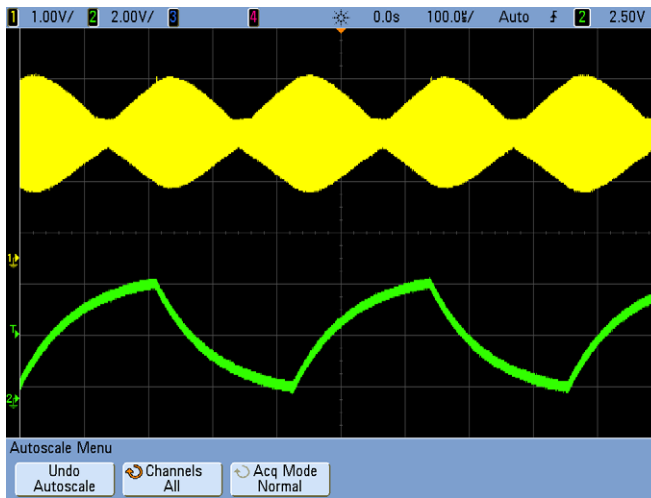
See “[Calibrating Probes](#)” on page 57.

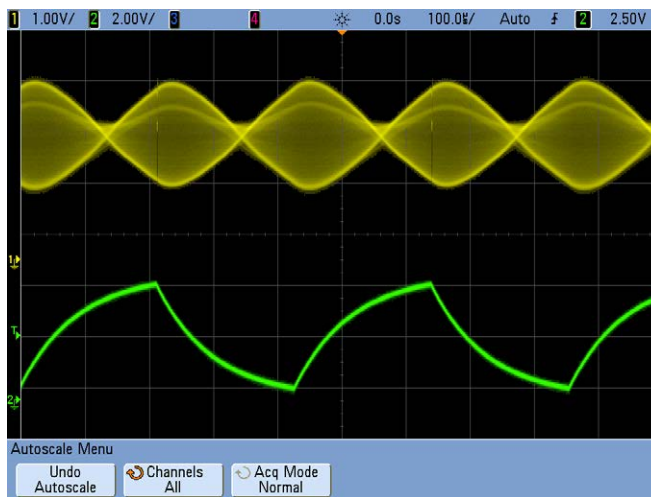
## Changing the Display Settings

### To adjust waveform intensity

The **Intensity** knob lets you adjust the displayed waveforms to account for various signal characteristics, such as fast sweep speeds and low trigger rates. Increasing the intensity lets you see the maximum amount of noise and infrequently occurring events. Reducing the intensity can expose more detail in complex signals as shown in the following figures. The intensity knob does not affect the digital channels.

**Figure 8** Amplitude Modulation Shown at 100% Intensity



**Figure 9** Amplitude Modulation Shown at 40% Intensity


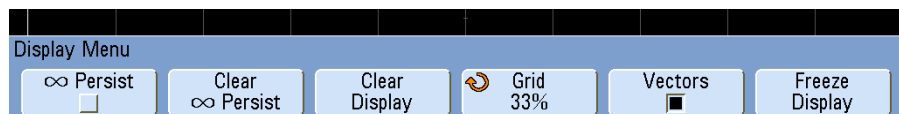
## To set or clear infinite persistence

With infinite persistence, the oscilloscope updates the display with new acquisitions, but does not erase the results of previous acquisitions. All previous acquisitions are displayed in gray with reduced intensity. New acquisitions are shown in their normal color with normal intensity. Waveform persistence is kept only for the current display area; you cannot pan and zoom the infinite persistence display.

Use infinite persistence to measure noise and jitter, to see the worst-case extremes of varying waveforms, to look for timing violations, or to capture events that occur infrequently.

To use infinite persistence to display multiple repetitive events:

- 1 Connect a signal to the oscilloscope.
- 2 Press the **[Display]** key.



- 3 Press  $\infty$  **Persist** to turn on infinite persistence. The display will begin accumulating multiple acquisitions.
- 4 Press the **Clear**  $\infty$  **Persist** softkey to erase previous acquisitions. The oscilloscope will start to accumulate acquisitions again.
- 5 To return the oscilloscope to the normal display mode, turn off infinite persistence; then, press the **Clear**  $\infty$  **Persist** softkey.

### NOTE

#### Accumulating multiple acquisitions

Turning off infinite persistence does not clear the display. This allows you to accumulate multiple acquisitions, stop acquisitions, and then compare future acquisitions to the stored waveforms. The display is cleared if you press the **Clear Display** softkey or if you press the **[AutoScale]** key.

---


See also “[Glitch or Narrow Pulse Capture](#)” on page 119.

## To clear the display

- 1 Press **[Clear Display]** (or press **[Display] > Clear Display**).

## To adjust the grid brightness

To adjust the display grid (graticule) brightness:

- 1 Press **[Display]**.
- 2 Press **Grid**; then, turn the Entry knob  to change the intensity of the displayed grid.

The intensity level is shown in the **Grid** softkey and is adjustable from 0 to 100%.

Each major vertical division in the grid corresponds to the vertical sensitivity shown in the status line at the top of the display.

Each major horizontal division in the grid corresponds to the sweep speed time shown in the status line at the top of the display.

## To display waveforms as vectors or dots

Agilent InfiniiVision oscilloscopes are designed to operate optimally with vectors (connect the dots) on. This mode produces the most insightful waveforms for most situations.

To disable or enable vectors:

**1** Press **[Display]**.

**2** Press **Vectors**.

When enabled, **Vectors** draws a line between consecutive waveform data points.

- Vectors give an analog look to a digitized waveform. Complex analog signals like video and modulated signals show analog-like intensity information with vectors on.
- Vectors allow you to see steep edges on waveforms, such as square waves.
- Vectors allow subtle detail of complex waveforms to be viewed, much like an analog oscilloscope trace, even when the detail is just a small number of pixels in size.

You may want to turn vectors off when highly complex or multivalued waveforms are displayed. Turning vectors off may aid the display of multivalued waveforms such as eye diagrams.

Having vectors on does not slow down the display rate.

The oscilloscope turns vectors on whenever the acquisition system stops.

Digital channels on a mixed-signal oscilloscope are not affected by the Display Menu. They are always displayed with vectors on. They also only contain one acquisition worth of information.

## To freeze the display

To freeze the display without stopping running acquisitions:

**1** Press the **[Display]** key.

**2** Press the **Freeze Display** softkey.

To un-freeze the display, press **Freeze Display** again.

### **3 Displaying Waveforms**

Many activities, such as adjusting the trigger level, adjusting vertical or horizontal settings, or saving data will un-freeze the display.

Manual cursors can be used on the frozen display.



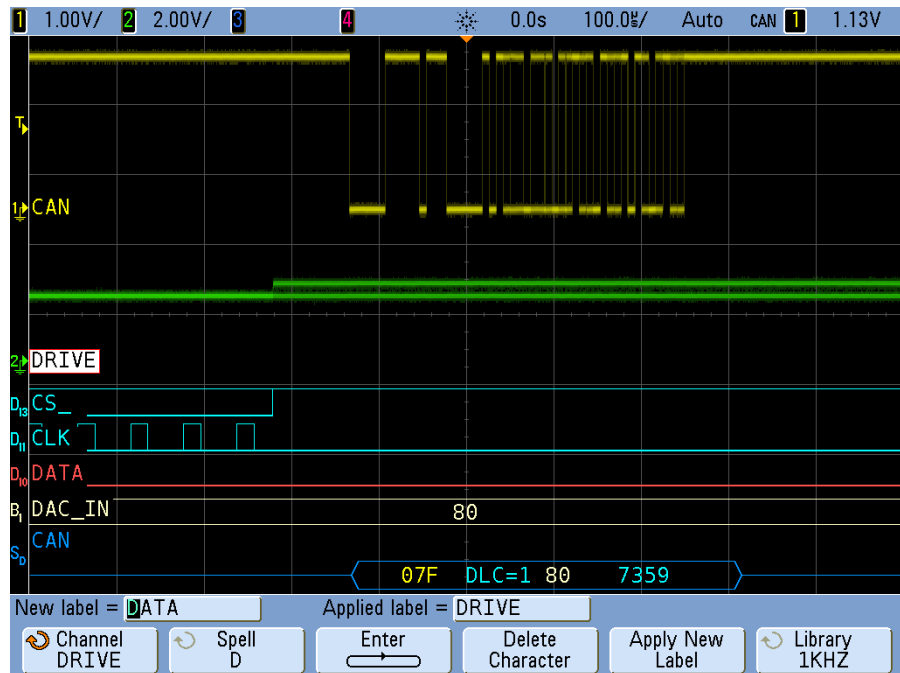
## Using Labels

You can define labels and assign them to each analog input channel, or you can turn labels off to increase the waveform display area. Labels can also be applied to digital channels on MSO models.

### To turn the label display on or off

- 1 Press the [Label] key on the front panel.

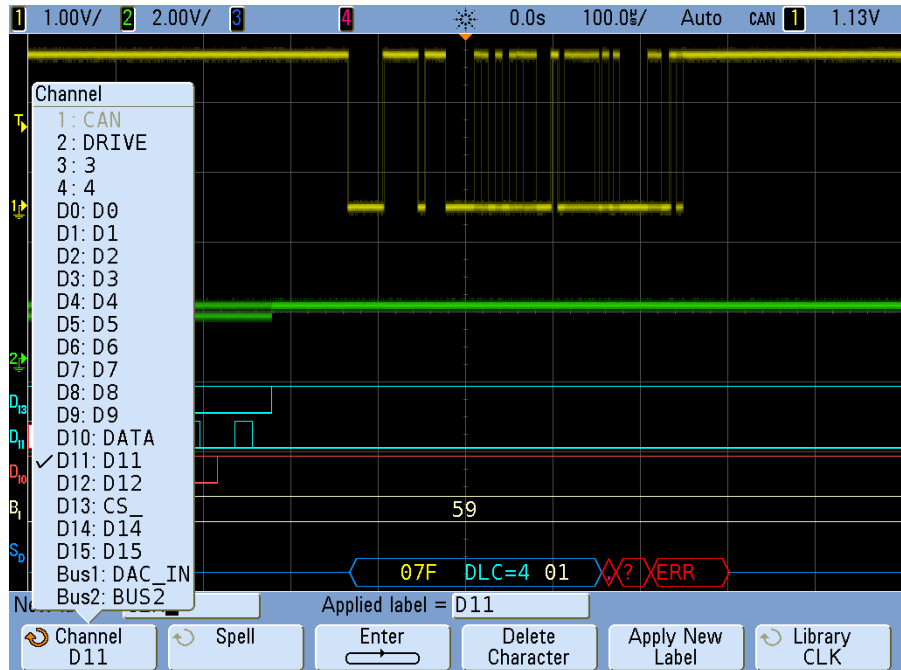
This turns on display labels for the analog and digital channels. When the [Label] key is illuminated, the labels for displayed channels are displayed at the left edge of the displayed traces. The figure below shows an example of the default labels assigned when you turn the label display on. The channel labels default to their channel number.



- 2 To turn the labels off, press the [Label] key until it is not illuminated.

## To assign a predefined label to a channel

- 1 Press the **[Label]** key.
- 2 Press the **Channel** softkey, then turn the Entry knob or successively press the **Channel** softkey to select a channel for label assignment.



The figure above shows the list of channels and their default labels. The channel does not have to be turned on to have a label assigned to it.

- 3 Press the **Library** softkey, then turn the Entry knob or successively press the **Library** softkey to select a predefined label from the library.
- 4 Press the **Apply New Label** softkey to assign the label to your selected channel.
- 5 Repeat the above procedure for each predefined label you want to assign to a channel.

## To define a new label

- 1 Press the **[Label]** key.
- 2 Press the **Channel** softkey, then turn the Entry knob or successively press the softkey to select a channel for label assignment.  
The channel does not have to be turned on to have a label assigned to it. If the channel is turned on, its current label will be highlighted.
- 3 Press the **Spell** softkey, then turn the Entry knob to select the first character in the new label.  
Turning the Entry knob selects a character to enter into the highlighted position shown in the “**New label =**” line above the softkeys and in the **Spell** softkey. Labels can be up to ten characters in length.
- 4 Press the **Enter** softkey to enter the selected character and to go to the next character position.  
You may position the highlight on any character in the label name by successively pressing the **Enter** softkey.
- 5 To delete a character from the label, press the **Enter** softkey until the letter you want to delete is highlighted, then press the **Delete Character** softkey.
- 6 When you are done entering characters for the label, press the **Apply New Label** softkey to assign the label to the selected channel.

When you define a new label, it is added to the nonvolatile label list.

### Label Assignment Auto-Increment

When you assign a label ending in a digit, such as ADDR0 or DATA0, the oscilloscope automatically increments the digit and displays the modified label in the “New label” field after you press the **Apply New Label** softkey. Therefore, you only need to select a new channel and press the **Apply New Label** softkey again to assign the label to the channel. Only the original label is saved in the label list. This feature makes it easier to assign successive labels to numbered control lines and data bus lines.

## To load a list of labels from a text file you create

It may be convenient to create a list of labels using a text editor, then load the label list into the oscilloscope. This lets you type on a keyboard rather than edit the label list using the oscilloscope's controls.

You can create a list of up to 75 labels and load it into the oscilloscope. Labels are added to the beginning of the list. If more than 75 labels are loaded, only the first 75 are stored.

To load labels from a text file into the oscilloscope:

- 1 Use a text editor to create each label. Each label can be up to ten characters in length. Separate each label with a line feed.
- 2 Name the file `labellist.txt` and save it on a USB mass storage device such as a thumb drive.
- 3 Load the list into the oscilloscope using the File Explorer (press **[Utility]** > **File Explorer**).

### NOTE

#### Label List Management

When you press the **Library** softkey, you will see a list of the last 75 labels used. The list does not save duplicate labels. Labels can end in any number of trailing digits. As long as the base string is the same as an existing label in the library, the new label will not be put in the library. For example, if label `A0` is in the library and you make a new label called `A12345`, the new label is not added to the library.

When you save a new user-defined label, the new label will replace the oldest label in the list. Oldest is defined as the longest time since the label was last assigned to a channel. Any time you assign any label to a channel, that label will move to the newest in the list. Thus, after you use the label list for a while, your labels will predominate, making it easier to customize the instrument display for your needs.

When you reset the label library list (see next topic), all of your custom labels will be deleted, and the label list will be returned to its factory configuration.

## To reset the label library to the factory default

- 1 Press **[Utility] > Options > Preferences > More**.

### NOTE

Pressing the Default Library softkey will remove all user-defined labels from the library and set the labels back to the factory default. Once deleted, these user-defined labels cannot be recovered.

---

- 2 Press the **Default Library** softkey.

This will delete all user-defined labels from the library and set the labels in the library back to the factory default. However, this does not default the labels currently assigned to the channels (those labels that appear in the waveform area).

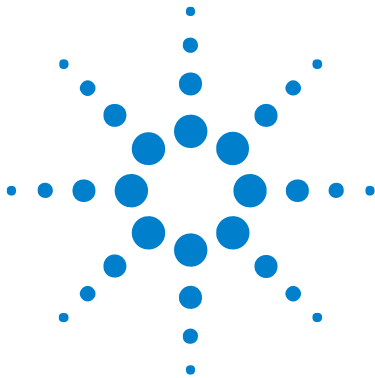
### NOTE

#### **Defaulting labels without erasing the default library.**

Pressing **[Default Setup]** sets all channel labels back to the default labels but does not erase the list of user-defined labels in the library.

---

### **3 Displaying Waveforms**



## 4 Triggering

Triggering - General Information	97
Trigger Mode and Coupling Menu	98
Auto and Normal Trigger modes	99
Trigger Level Adjustment	102
Trigger Coupling	103
Trigger Noise Rejection	104
Trigger Holdoff	107
External Trigger Input	109
Trigger Types	112
Trigger Types	112
Duration Trigger	114
Edge Trigger	117
Glitch or Narrow Pulse Capture	119
Nth Edge Burst Trigger	123
Pattern Trigger	125
Pulse Width Trigger	128
Sequence Trigger	131
TV Trigger	138
USB Trigger	150

This chapter provides instructions for setting up triggers for various signal types. Setups can be saved if desired (see “[Saving and Recalling Data](#)” on page 206).

The easiest way to trigger on a waveform is to use AutoScale. Simply press the **[AutoScale]** key and the oscilloscope will attempt to trigger on the waveform using a simple Edge Trigger type. For AutoScale details see “[Input a Waveform and AutoScale](#)” on page 32.



## 4 Triggering

Complex waveforms may require specific trigger setups as described in this chapter.

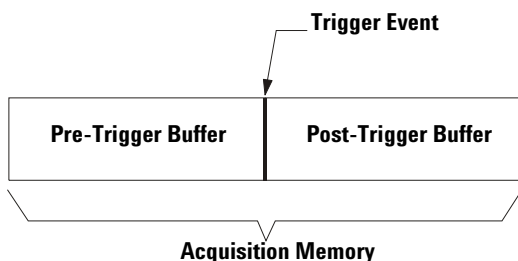
- See Also**
- “[CAN Triggering](#)” on page 264 if you have Option AMS (N5424A).
  - “[FlexRay Triggering](#)” on page 315 if you have Option FLX (N5432C).
  - “[I2C Triggering](#)” on page 284 if you have Option LSS (N5423A).
  - “[I2S Triggering](#)” on page 306 if you have Option SND (N5468A).
  - “[LIN Triggering](#)” on page 274 if you have Option AMS (N5424A).
  - “[MIL-STD 1553 Triggering](#)” on page 326 if you have Option 553 (N5469A).
  - “[SPI Triggering](#)” on page 295 if you have Option LSS (N5423A).
  - “[UART/RS232 Triggering](#)” on page 335 if you have Option 232 (N5457A).



## Triggering - General Information

A triggered waveform is one in which the oscilloscope begins tracing (displaying) the waveform, from the left side of the display to the right, each time a particular trigger condition is met. This provides stable display of periodic signals such as sine waves and square waves, as well as nonperiodic signals such as serial data streams.

The figure below shows the conceptual representation of acquisition memory. You can think of the trigger event as dividing acquisition memory into a pre-trigger and post-trigger buffer. The position of the trigger event in acquisition memory is defined by the time reference point and the delay (horizontal position) setting (see [page 63](#)).



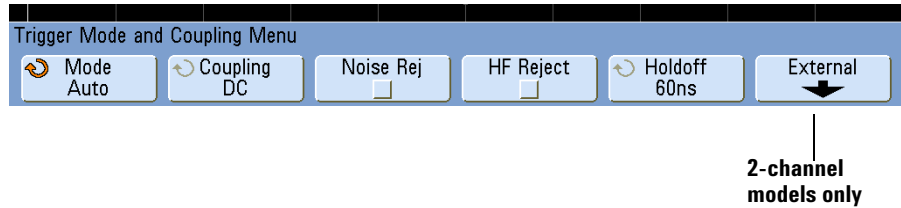
Agilent InfiniiVision oscilloscopes provide a full set of features to help automate your measurement tasks. MegaZoom technology lets you capture and examine triggered or untriggered waveforms. You can:

- Modify the way the oscilloscope acquires data.
- Set up simple or complex trigger conditions as needed, to capture only the sequence of events you want to examine.

**See Also** • [“Segmented Memory”](#) on page 234.

## Trigger Mode and Coupling Menu

- Press the [**Mode/Coupling**] key in the Trigger section of the front panel.



## Auto and Normal Trigger modes

If you are acquiring a slow signal from a serial bus or another signal that arrives in bursts, the oscilloscope may Auto-trigger between signal bursts, which will cause the display to appear unstable. You can solve this problem by selecting the Normal trigger mode.

### Choosing Auto Trigger Mode or Normal Trigger Mode

If you press **[Run]** when the oscilloscope is in Normal trigger mode, a trigger must be detected before an acquisition can complete. No waveform will be displayed unless the trigger condition is met.

In Auto trigger mode, the oscilloscope automatically triggers and captures waveforms when you press **[Run]**.

In many cases, a triggered display is not needed to check signal levels or activity. For these applications, use Auto trigger mode (which is the default setting). If you only want to acquire specific events as specified by the trigger settings, use Normal trigger mode.

In some cases, such as when triggering on a slow serial signal (for example, I<sup>2</sup>C, SPI, CAN, LIN, etc.) it may be necessary to select the Normal trigger mode to stabilize the display by preventing the oscilloscope from Auto-triggering.

You can select the trigger mode by pressing the **[Mode/Coupling]** key, then the **Mode** softkey.

**1** Press the **[Mode/Coupling]** key.

**2** Press the **Mode** softkey, then select **Normal** or **Auto**.

- **Normal** – displays a waveform when the trigger conditions are met, otherwise the oscilloscope does not trigger and the display is not updated.
- **Auto** – is the same as Normal mode, except it forces the oscilloscope to trigger if the trigger conditions are not met.

### Auto Mode

Use the auto trigger modes for signals other than low-repetitive-rate signals and for unknown signal levels. To display a DC signal, you must use auto trigger mode since there are no edges on which to trigger.

When you select **[Run]**, the oscilloscope operates by first filling the pre-trigger buffer. It starts searching for a trigger after the pre-trigger buffer is filled, and continues to flow data through this buffer while it searches for the trigger. While searching for the trigger, the oscilloscope overflows the pre-trigger buffer; the first data put into the buffer is the first pushed out (FIFO). When a trigger is found, the pre-trigger buffer will contain the events that occurred just before the trigger. If no trigger is found, the oscilloscope generates a trigger and displays the data as though a trigger had occurred. In this case, the background of the **Auto** indicator at the top of the display will flash, and the **Auto** indicator will change to **Auto?** indicating that the oscilloscope is forcing triggers.

When you press the **[Single]** key, the oscilloscope will fill pre-trigger buffer memory, and continue flowing data through the pre-trigger buffer until the auto trigger overrides the searching and forces a trigger. At the end of the trace, the oscilloscope will stop and display the results.

### Normal Mode

Use Normal trigger mode for low repetitive-rate signals or when Auto trigger is not required.

In Normal mode the oscilloscope must fill the pre-trigger buffer with data before it will begin searching for a trigger event. The trigger mode indicator on the status line flashes **Trig'd?** to indicate the oscilloscope is filling the pre-trigger buffer. While searching for the trigger, the oscilloscope overflows the pre-trigger buffer; the first data put into the buffer is the first pushed out (FIFO).

When the trigger event is found, the oscilloscope will fill the post-trigger buffer and display the acquisition memory. The trigger mode indicator on the status line indicates **Trig'd** (not flashing). If the acquisition was initiated by **[Run/Stop]**, the process repeats. If the acquisition was initiated by pressing **[Single]**, then the acquisition stops and you can Pan and Zoom the waveform.

In either Auto or Normal mode, the trigger may be missed completely under certain conditions. This is because the oscilloscope will not recognize a trigger event until the pre-trigger buffer is full. Suppose you set the Time/Div knob to a slow sweep speed, such as 500 ms/div. If the trigger condition occurs before the oscilloscope has filled the pre-trigger buffer, the trigger will not be found. If you use Normal mode and wait for the trigger condition indicator to flash before causing the action in the circuit, the oscilloscope will always find the trigger condition.

Some measurements you want to make will require you to take some action in the device under test to cause the trigger event. Usually, these are single-shot acquisitions, where you will use the **[Single]** key.

### Trigger Level Adjustment

You can adjust the trigger level for a selected analog channel by turning the Trigger Level knob. The position of the trigger level for the analog channel is indicated by the trigger level icon  $\mathbf{T}\blacktriangleright$  (if the analog channel is on) at the far left side of the display when DC coupling is selected. The value of the analog channel trigger level is displayed in the upper-right corner of the display.

The trigger level for a selected digital channel is set using the threshold menu in the Digital Channel Menu. Press the **[Digital]** key on the front panel, then press the **Thresholds** softkey to set the threshold level (TTL, CMOS, ECL, or user defined) for the selected digital channel group. The threshold value is displayed in the upper-right corner of the display.

The line trigger level is not adjustable. This trigger is synchronized with the power line supplied to the oscilloscope.

## Trigger Coupling

- 1 Press the [**Mode/Coupling**] key.
- 2 Press the **Coupling** softkey, then select **DC**, **AC**, or **LF Reject** coupling.
  - **DC** coupling allows DC and AC signals into the trigger path.
  - **AC** coupling places a 10 Hz high-pass filter in the trigger path removing any DC offset voltage from the trigger waveform. The high-pass filter in the External Trigger input path is 3.5 Hz for all models. Use AC coupling to get a stable edge trigger when your waveform has a large DC offset.
  - **LF** (low frequency) **Reject** coupling places a 50 kHz high-pass filter in series with the trigger waveform. Low frequency reject removes any unwanted low frequency components from a trigger waveform, such as power line frequencies, that can interfere with proper triggering. Use this coupling to get a stable edge trigger when your waveform has low frequency noise.
  - **TV** coupling is normally grayed-out, but is automatically selected when TV trigger is enabled in the Trigger Menu.

Note that Trigger Coupling is independent of Channel Coupling. To change Channel Coupling see [page 79](#).

## **Trigger Noise Rejection**

If the signal you are probing is noisy, you can set up the oscilloscope to reduce the noise on the displayed waveform. First, stabilize the displayed waveform by removing the noise from the trigger path. Second, reduce the noise on the displayed waveform.

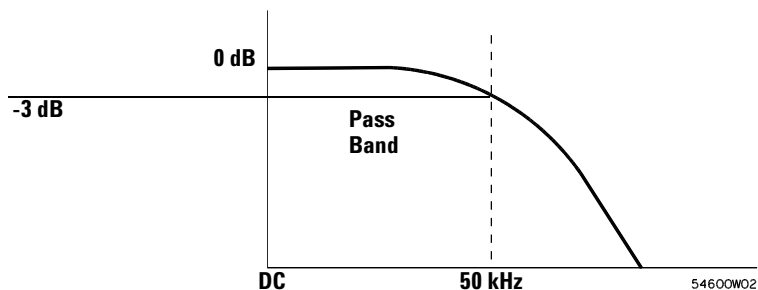
- 1** Connect a signal to the oscilloscope and obtain a stable display.
- 2** Remove the noise from the trigger path by turning on high-frequency rejection ([HF Reject](#)), low-frequency rejection ([LF Reject](#)), or [Noise Rejection](#).
- 3** Use [Averaging Mode](#) to reduce noise on the displayed waveform.



## HF Reject

HF Reject adds a 50 kHz low-pass filter in the trigger path to remove high frequency components from the trigger waveform. You can use HF Reject to remove high-frequency noise, such as AM or FM broadcast stations or noise from fast system clocks, from the trigger path.

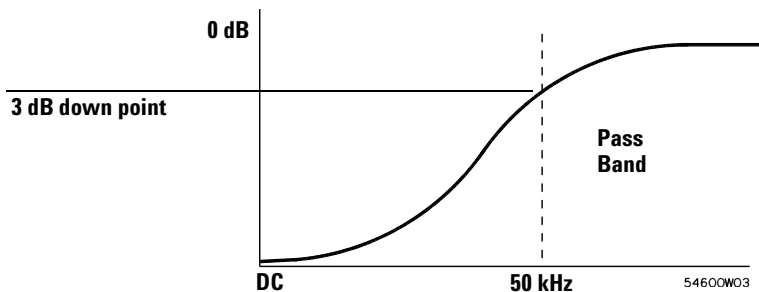
- 1 Press **[Mode/Coupling] > HF Reject**.



## LF Reject

Low-frequency reject (LF reject) adds a high-pass filter with the 3-dB point at 50 kHz. LF reject removes low-frequency signals, such as power line noise, from the trigger path.

- 1 Press **[Mode/Coupling] > Coupling > LF Reject**.



## **Noise Rejection**

Noise Rej adds additional hysteresis to the trigger circuitry. By increasing the trigger hysteresis band, you reduce the possibility of triggering on noise. However, this also decreases the trigger sensitivity so that a slightly larger signal is required to trigger the oscilloscope.

**1** Press **[Mode/Coupling] > HF Reject**.

# Trigger Holdoff

## Trigger Holdoff Operating Hints


Holdoff keeps a trigger from occurring until after a certain amount of time has passed since the last trigger. This feature is valuable when a waveform crosses the trigger level multiple times during one period of the waveform.

Without holdoff, the oscilloscope could trigger on each of the crossings, producing a confusing waveform. With holdoff set correctly, the oscilloscope always triggers on the same crossing. The correct holdoff setting is typically slightly less than one period. Set the holdoff to this time to generate a unique trigger point. This action works even though many waveform periods pass between triggers, because the holdoff circuit operates on the input signal continuously.

Changing the time base settings does not affect the holdoff number. In contrast, the holdoff in analog oscilloscopes is a function of the time base setting, making it necessary to readjust the holdoff each time you change the time base setting.

With Agilent's MegaZoom technology, you can press **[Stop]**, then pan and zoom through the data to find where it repeats. Measure this time using the cursors, then set the holdoff.

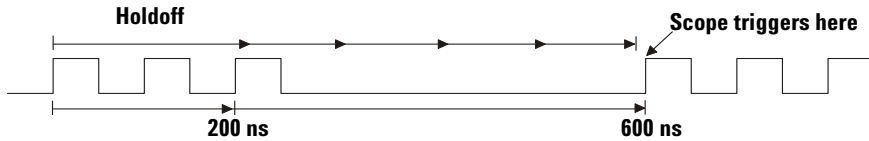
## To set holdoff

- 1 Press the **[Mode/Coupling]** key; then, press the **Holdoff** softkey.
- 2 Turn the Entry knob  to increase or decrease the trigger holdoff time shown.

Holdoff sets the amount of time that the oscilloscope waits before re-arming the trigger circuitry. Use Holdoff to stabilize the display of complex waveforms.

## 4 Triggering

To get a stable trigger on the pulse burst shown below, set the holdoff time to be  $>200$  ns but  $<600$  ns.



By setting the Holdoff, you can synchronize triggers. The oscilloscope will trigger on one edge of the waveform, and ignore further edges until the holdoff time expires. The oscilloscope will then re-arm the trigger circuit to search for the next edge trigger. This allows the oscilloscope to trigger on a repeating pattern in a waveform.

## External Trigger Input

The External Trigger input can be used as a source in several of the trigger types.

On 2-channel oscilloscopes, the external trigger BNC input is on the front panel and is labeled **Ext Trigger**.

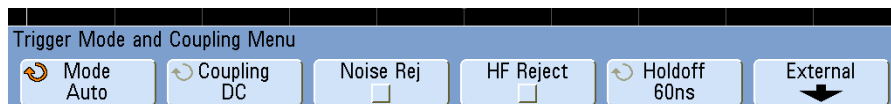
On 4-channel oscilloscopes, the external trigger BNC input is on the rear panel and is labeled **Ext Trig**.

## 2-Channel Oscilloscope External Trigger Input

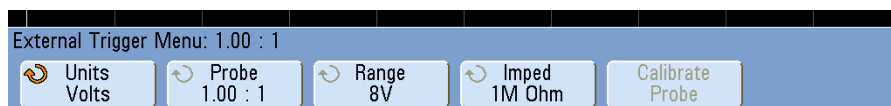
### External Trigger Probe Settings

You can set external trigger probe parameters as described below.

- 1 Press the **[Mode/Coupling]** key in the Trigger section of the front panel.



- 2 Press the **External** softkey to display the External Trigger Menu.



**Probe Attenuation** Turn the Entry knob to set the attenuation factor displayed in the **Probe** softkey for the connected probe. The attenuation factor can be set from 0.1:1 to 1000:1 in a 1-2-5 sequence.

When you connect an AutoProbe self-sensing probe, the oscilloscope will automatically configure your probe to the correct attenuation factor.

The probe correction factor must be set properly for measurements to be made correctly.

**Range** The input voltage range can be set to 1.0 Volts or 8.0 Volts. When in current mode, the range is fixed at 1.0 Amps. Range is automatically scaled according to the probe's attenuation factor.

### CAUTION



#### Maximum voltage at 2-channel oscilloscope external trigger input

CAT I 300 Vrms, 400 Vpk; transient overvoltage 1.6 kVpk

CAT II 100 Vrms, 400 Vpk

50 $\Omega$  input: 5 Vrms

Input protection is enabled in 50  $\Omega$  mode and the 50  $\Omega$  load will disconnect if greater than 5 Vrms is detected. However the inputs could still be damaged, depending on the time constant of the signal. The 50  $\Omega$  input protection only functions when the oscilloscope is powered on.

1 M ohm input, 100 MHz models:

For steady-state sinusoidal waveforms derate at 20 dB/decade above 200 kHz to a minimum of 10 Vpk

1 M ohm input, 350 MHz, 500 MHz, 1 GHz models:

For steady-state sinusoidal waveforms derate at 20 dB/decade above 57 kHz to a minimum of 5 Vpk

With N2863A 10:1 probe: CAT I 600 V, CAT II 300 V (DC + peak AC)

With 10073C or 10074C 10:1 probe: CAT I 500 Vpk, CAT II 400 Vpk

---

**Input Impedance** The 2-channel oscilloscopes have selectable external trigger input impedance. The impedance can be set to either **1M Ohm** or **50 Ohm** by pressing the **Imped** softkey.

- **50 Ohm** – matches 50-ohm cables commonly used in making high frequency measurements. This impedance matching gives you the most accurate measurements since reflections are minimized along the signal path.
- **1M Ohm** – is for use with many passive probes and for general-purpose measurements. The higher impedance minimizes the loading effect of the oscilloscope on the device under test.

**Probe Units** Press the **Units** softkey to select the proper measurement unit for the connected probe. Select **Volts** for a voltage probe and select **Amps** for a current probe. Measurement results, channel sensitivity, and trigger level will reflect the measurement units you have selected.

## 4-Channel Oscilloscope External Trigger Input

**Input Impedance** The external trigger input impedance for the 4-channel oscilloscope is approximately 2.14 k $\Omega$ .

**Input Voltage** The input voltage sensitivity is 500 mV, from DC to 500 MHz. The input voltage range is  $\pm 15$  V.

### CAUTION



#### **Maximum voltage at 4-channel oscilloscope external trigger input**

15 Vrms. Do not exceed 15 Vrms at rear panel External Trigger input or damage to the oscilloscope may occur.

---

There are no range or units settings for the External Trigger input of the 4-channel oscilloscope.

# Trigger Types

The oscilloscope lets you synchronize the display to the actions of the device under test by defining a trigger condition. You can use any input channel or the [External Trigger Input](#) BNC as the source for most trigger types.

### NOTE

#### MegaZoom Technology Simplifies Triggering

With the built-in MegaZoom technology, you can simply AutoScale the waveforms, then stop the oscilloscope to capture a waveform. You can then pan and zoom through the data using the Horizontal and Vertical knobs to find a stable trigger point. AutoScale often produces a triggered display.

---

The following trigger types are described in this chapter:

- [Duration Trigger](#) 114
- [Edge Trigger](#) 117
- [Glitch or Narrow Pulse Capture](#) 119
- [Nth Edge Burst Trigger](#) 123
- [Pattern Trigger](#) 125
- [Pulse Width Trigger](#) 128
- [Sequence Trigger](#) 131
- [TV Trigger](#) 138
- [USB Trigger](#) 150

Changes to the trigger specification are applied when you make them. If the oscilloscope is stopped when you change a trigger specification, the oscilloscope will use the new specification when you press **[Run/Stop]** or **[Single]**. If the oscilloscope is running when you change a triggering specification, it uses the new trigger definition when it starts the next acquisition.

- See Also**
- [“CAN Triggering”](#) on page 264 if you have Option AMS (N5424A).
  - [“FlexRay Triggering”](#) on page 315 if you have Option FLX (N5432C).
  - [“I2C Triggering”](#) on page 284 if you have Option LSS (N5423A).
  - [“I2S Triggering”](#) on page 306 if you have Option SND (N5468A).

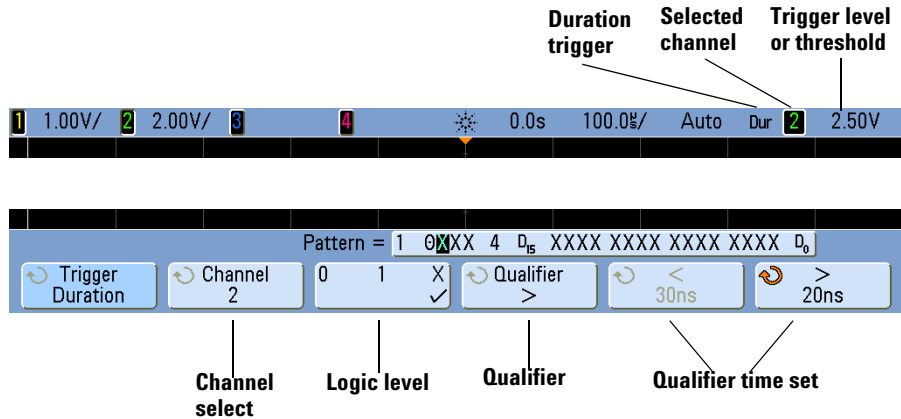


- “LIN Triggering” on page 274 if you have Option AMS (N5424A).
- “MIL-STD 1553 Triggering” on page 326 if you have Option 553 (N5469A).
- “SPI Triggering” on page 295 if you have Option LSS (N5423A).
- “UART/RS232 Triggering” on page 335 if you have Option 232 (N5457A).

## Duration Trigger

Duration trigger lets you define a pattern, then trigger on a specified time duration of this logical AND combination of the channels.

- 1 Press the **[Trigger]** key in the Trigger section of the front panel, rotate the Entry knob until **Duration** is displayed in the **Trigger** softkey.



- 2 For each analog or digital channel you want to include in the desired pattern, press the **Channel** softkey to select the channel.

This is the channel source for the H, L, or X condition. As you press the **Channel** softkey (or rotate the Entry knob), the channel you select is highlighted in the **Pattern =** line directly above the softkeys and in the upper-right corner of the display next to “Dur”. External trigger may also be specified as a channel in the pattern when using the 2-channel and 4-channel oscilloscopes.

Adjust the trigger level for the selected analog channel by turning the Trigger Level knob. Press the **[Digital]** key and select **Thresholds** to set the threshold level for digital channels. The value of the trigger level or digital threshold is displayed in the upper-right corner of the display.

- 3 For each channel you select, press the logic level softkey to set the condition for that channel in the pattern.
  - **1** sets the pattern to 1 (high) on the selected channel. A high is a voltage level that is greater than the channel's trigger level or threshold level.

- **0** sets the pattern to 0 (low) on the selected channel. A low is a voltage level that is less than the channel's trigger level or threshold level.
  - **X** sets the pattern to don't care on the selected channel. Any channel set to don't care is ignored and is not used as part of the pattern. If all channels in the pattern are set to don't care, the oscilloscope will not trigger.
- 4** Press the **Qualifier** softkey to set the time duration qualifier for the pattern.
- The time qualifier can set the oscilloscope to trigger on a channel pattern whose time duration is:
- less than a time value (<)
  - greater than a time value (>)
  - greater than a time value, but with timeout (**Timeout**). A trigger will be forced at the timeout value, rather than occurring when the pattern is exited.
  - within a range of time values (><)
  - outside a range of time values (<>)
- The time values for the selected qualifier are set using the qualifier time set softkeys (< and >) and the Entry knob.
- 5** Select a qualifier time set softkey (< or >), then rotate the Entry knob to set the duration qualifier time.

### < qualifier time set softkey

- When the less than (<) qualifier is selected, the Entry knob sets the oscilloscope to trigger on a pattern duration less than the time value displayed on the softkey.
- When the within time range (><) qualifier is selected, the Entry knob sets the upper time range value.
- When the out of time range (<>) qualifier is selected, the Entry knob sets the lower time range value.

### > qualifier time set softkey

- When the greater than (>) qualifier is selected, the Entry knob sets the oscilloscope to trigger on a pattern duration greater than the time value displayed on the softkey.
- When the within time range (><) qualifier is selected, the Entry knob sets the lower time range value.
- When the out of time range (<>) qualifier is selected, the Entry knob sets the upper time range value.
- When **Timeout** qualifier is selected, the Entry knob sets the timeout value.

#### NOTE

#### When the duration trigger occurs

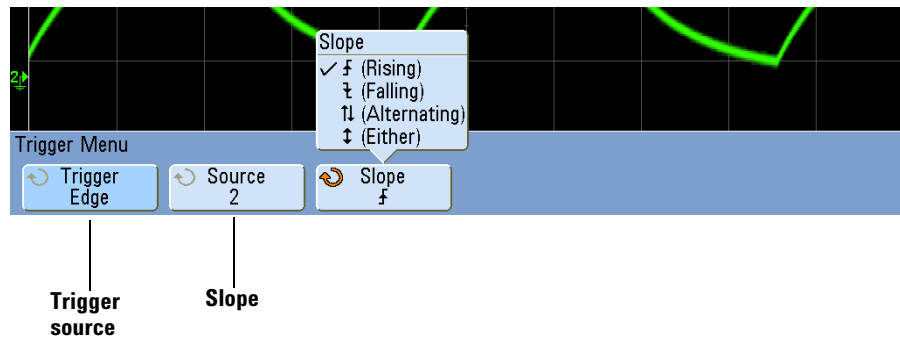
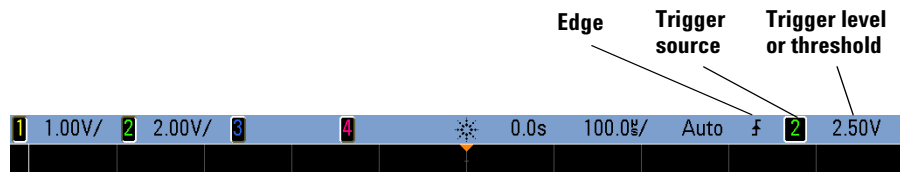
The timer starts on the last edge that makes the pattern (logical AND) true. The trigger will occur on the first edge that makes the pattern false if the time qualifier criteria of the pattern has been met, except in Timeout mode. In Timeout, the trigger occurs when the timeout value is reached while the pattern is true.

---

## Edge Trigger

The Edge trigger type identifies a trigger by looking for a specified edge (slope) and voltage level on a waveform. You can define the trigger source and slope in this menu. The slope can be set to rising edge or falling edge, and can be set to alternating edges or either edge on all sources except Line. The trigger type, source, and level are displayed in the upper-right corner of the display.

- 1 Press the **[Edge]** key in the Trigger section of the front panel to display the Edge Trigger Menu.



- 2 Press the **Slope** softkey and select rising edge, falling edge, alternating edges, or either edge. The selected slope is displayed in the upper-right corner of the display.

### NOTE

Alternating edge mode is useful when you want to trigger on both edges of a clock (for example, DDR signals). Either edge mode is useful when you want to trigger on any activity of a selected source. All modes operate up to the bandwidth of the oscilloscope except Either edge mode, which has a limitation. Either edge mode will trigger on Constant Wave signals up to 100 MHz, but can trigger on isolated pulses down to  $1/2 \times$  oscilloscope's bandwidth).

### 3 Select the trigger source.

You can select analog channel 1 or 2, Ext, or Line as the trigger source on any Agilent InfiniiVision oscilloscope. The trigger source can also be set to channel 3 and 4 on the 4-channel oscilloscopes, or digital channels D15 through D0 on the mixed-signal oscilloscopes. You can choose a channel that is turned off (not displayed) as the source for the edge trigger.

The selected trigger source is indicated in the upper-right corner of the display next to the slope symbol:

**1** through **4** = analog channels

**D0** through **D15** = digital channels

**E** = External trigger

**L** = Line trigger

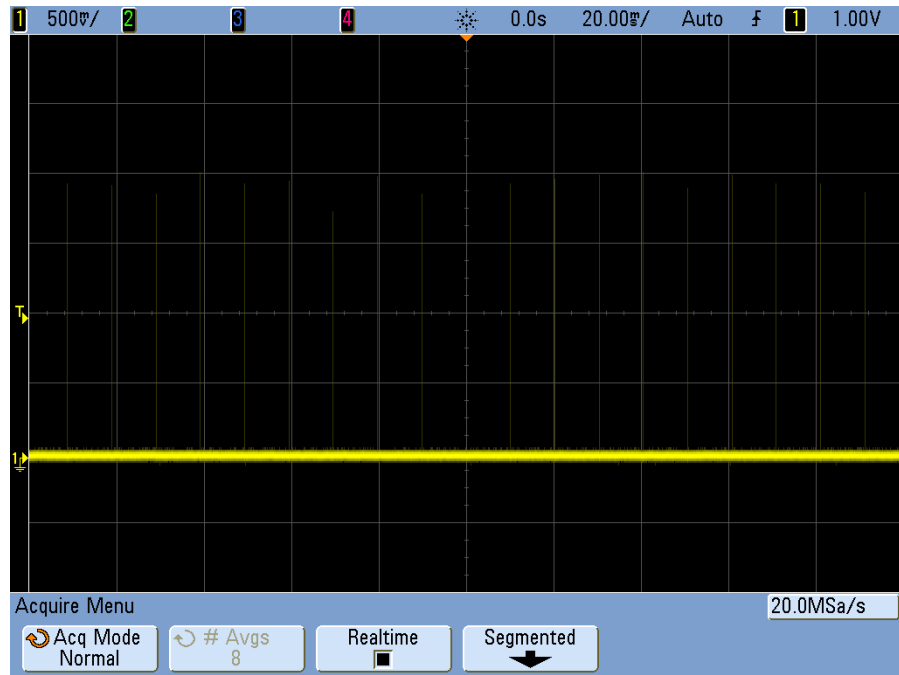
## Glitch or Narrow Pulse Capture

A glitch is a rapid change in the waveform that is usually narrow as compared to the waveform. Peak detect mode can be used to more easily view glitches or narrow pulses. In peak detect mode, narrow glitches and sharp edges are displayed more brightly than when in Normal acquire mode, making them easier to see.

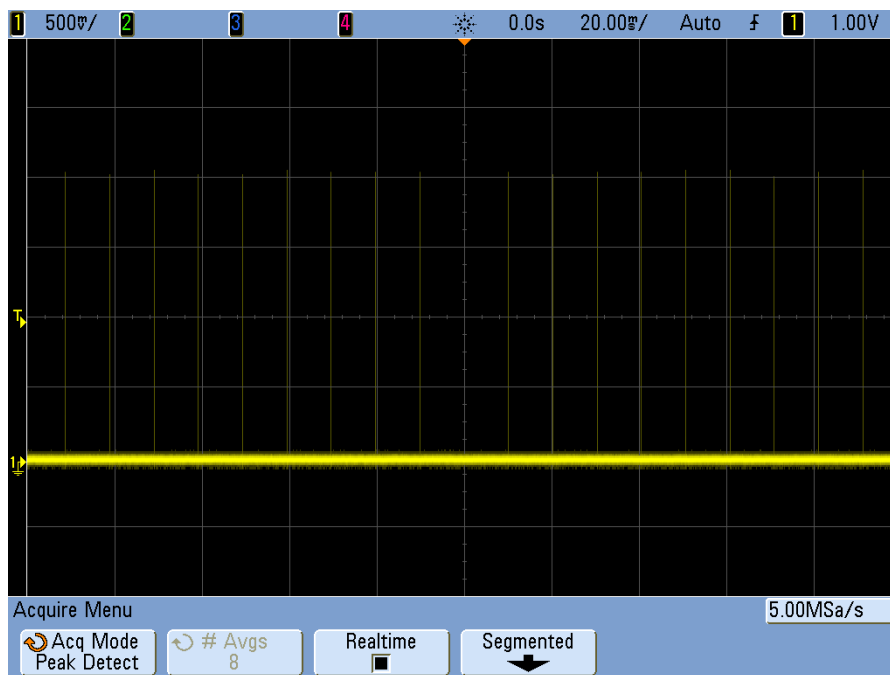
## 4 Triggering

To characterize the glitch, use the cursors or the automatic measurement capabilities of the oscilloscope.

**Figure 10** 15 ns Narrow Pulse, 20 ms/div, Normal Mode





**Figure 11** 15 ns Narrow Pulse, 20 ms/div, Peak Detect Mode


## Using Peak Detect Mode to Find a Glitch


- 1 Connect a signal to the oscilloscope and obtain a stable display.
- 2 To find the glitch, press the **[Acquire]** key, then, press the **Acq Mode** softkey until **Peak Detect** is selected.
- 3 Press the **[Display]** key then press the  $\infty$  **Persist** (infinite persistence) softkey.

Infinite persistence updates the display with new acquisitions but does not erase previous acquisitions. New sample points are shown at normal intensity while previous acquisitions are displayed in gray at lower intensity. Waveform persistence is not kept beyond the display area boundary.

## 4 Triggering

Press the **Clear Display** softkey to erase previously acquired points. The display will accumulate points until  $\infty$  **Persist** is turned off.

- 4 Characterize the glitch with Zoom mode:
  - a Press the  zoom key (or press the **[Horiz]** key and then the **Zoom** softkey).
  - b To obtain a better resolution of the glitch, expand the time base.

Use the horizontal position knob () to pan through the waveform to set the expanded portion of the normal sweep around the glitch.

## Nth Edge Burst Trigger

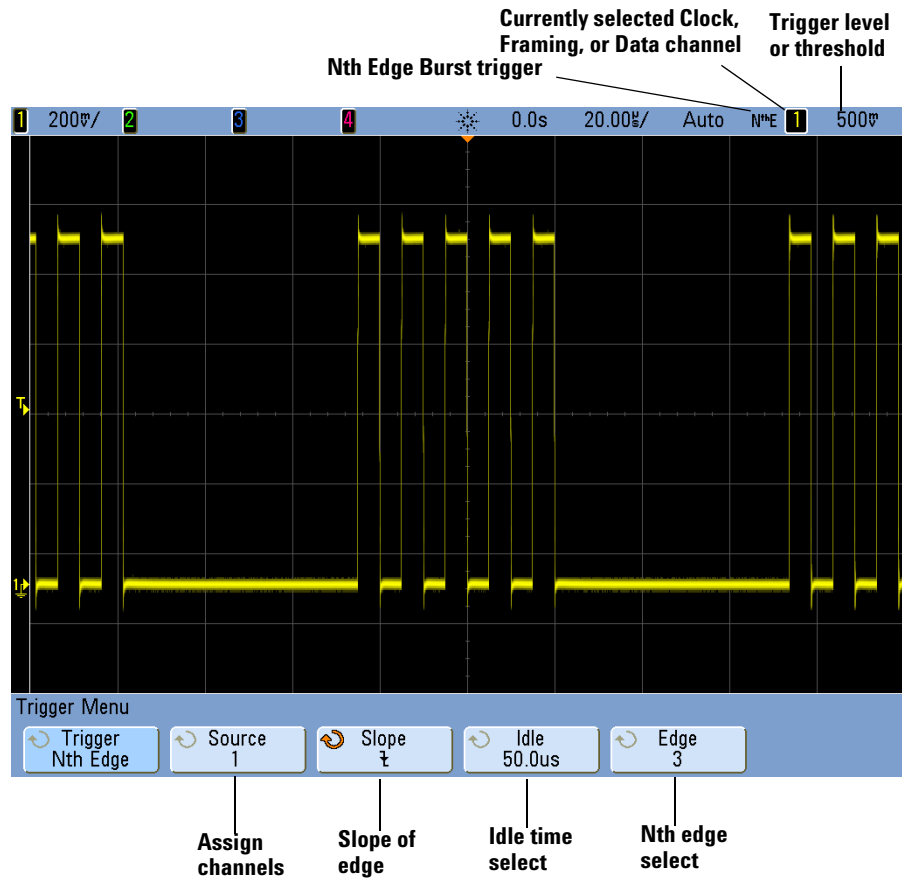
The Nth Edge Burst trigger lets you trigger on the Nth edge of a burst that occurs after an idle time.



## 4 Triggering

Nth Edge Burst trigger set up consists of selecting the source, the slope of the edge, the idle time, and the number of the edge:

- 1 Press the **[Trigger]** key in the Trigger section of the front panel, rotate the Entry knob until **Nth Edge Burst** is displayed in the **Trigger** softkey.

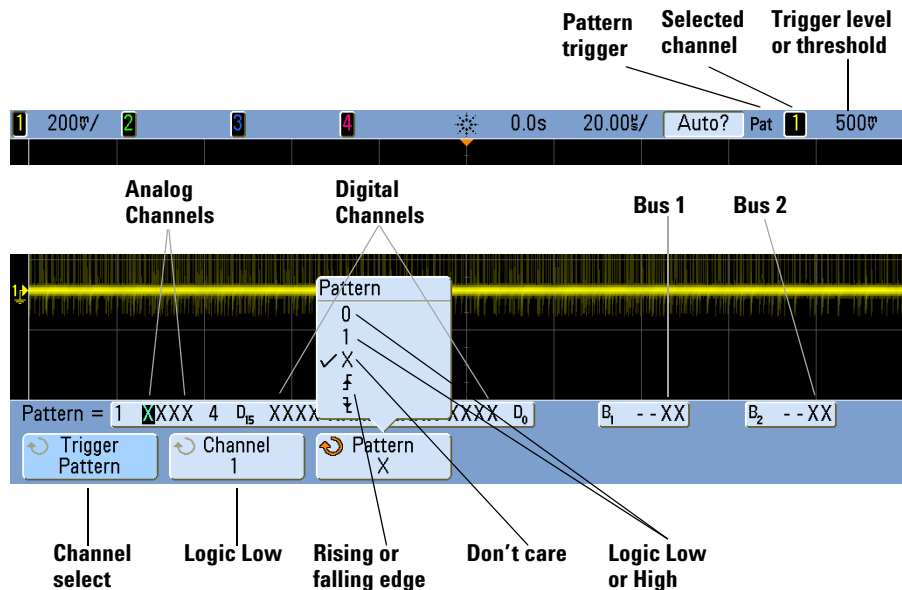


- 2 Press the **Slope** softkey to specify the slope of the edge.
- 3 Press the **Idle** softkey; then, turn the Entry knob to specify the idle time.
- 4 Press the **Edge** softkey; then, turn the Entry knob to which edge to trigger on.

# Pattern Trigger

The Pattern trigger identifies a trigger condition by looking for a specified pattern. This pattern is a logical AND combination of the channels. Each channel can have a value of 0 (low), 1 (high), or don't care (X). A rising or falling edge can be specified for one channel included in the pattern. You can also trigger on a hex bus value as described on [page 126](#).

- 1 Press the **[Pattern]** key in the Trigger section of the front panel to display the PatternTrigger Menu.





- 2 For each analog or digital channel you want to include in the desired pattern, press the **Channel** softkey to select the channel.

This is the channel source for the 0, 1, X, or edge condition. As you press the **Channel** softkey (or rotate the Entry knob), the channel you select is highlighted in the **Pattern =** line directly above the softkeys and in the upper-right corner of the display next to “Pat”. External trigger may also be specified as a channel in the pattern when using the 2-channel and 4-channel oscilloscopes.

Adjust the trigger level for the selected analog channel by turning the Trigger Level knob. Press the **[Digital]** key and select **Thresholds** to set the threshold level for digital channels. The value of the trigger level or digital threshold is displayed in the upper-right corner of the display.

**3** For each channel you select, press one of the condition softkeys to set the condition for that channel in the pattern.

- **0** sets the pattern to zero (low) on the selected channel. A low is a voltage level that is less than the channel's trigger level or threshold level.
- **1** sets the pattern to 1 (high) on the selected channel. A high is a voltage level that is greater than the channel's trigger level or threshold level.
- **X** sets the pattern to don't care on the selected channel. Any channel set to don't care is ignored and is not used as part of the pattern. However, if all channels in the pattern are set to don't care, the oscilloscope will not trigger.
- The rising edge () or falling edge () softkey sets the pattern to an edge on the selected channel. Only one rising or falling edge can be specified in the pattern. When an edge is specified, the oscilloscope will trigger at the edge specified if the pattern set for the other channels is true.

If no edge is specified, the oscilloscope will trigger on the last edge that makes the pattern true.

### NOTE

#### Specifying an Edge in a Pattern

You are allowed to specify only one rising or falling edge term in the pattern. If you define an edge term, then select a different channel in the pattern and define another edge term, the previous edge definition is changed to a don't care.

## Hex Bus Pattern Trigger

You can specify a bus value on which to trigger. To do this, first define the bus. See [“To display digital channels as a bus”](#) on page 369 for details. You can trigger on a bus value whether you are displaying the bus or not.

To trigger on a bus value:

- 1 Press the **[Pattern]** key on the front panel.
- 2 Press the **Channel** softkey and rotate the Entry knob to select **Bus1** or **Bus2**.
- 3 Press the **Digit** softkey and rotate the Entry knob to select a digit of the selected bus.
- 4 Press the **Hex** softkey and rotate the Entry knob to select a value for the digit.

**NOTE**

If a digit is made up of less than four bits, then the value of the digit will be limited to the value that can be created by the selected bits.

- 5 You can use the **Set all Digits** softkey to set all digits to a particular value.

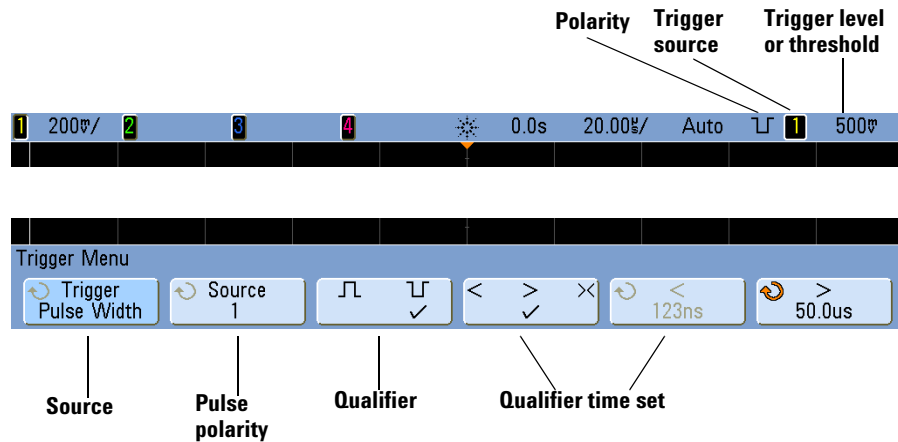
When a hex bus digit contains one or more don't care (X) bits and one or more bit with a value of 0 or 1, the "\$" sign will be displayed for the digit.

For information regarding digital bus display when Pattern triggering see ["Bus values are displayed when using Pattern trigger"](#) on page 373.

## Pulse Width Trigger

Pulse Width (glitch) triggering sets the oscilloscope to trigger on a positive or negative pulse of a specified width. If you want to trigger on a specific timeout value, use **Duration** trigger in the Trigger Menu (see “[Duration Trigger](#)” on page 114).

- 1 Press the [**Pulse Width**] key in the Trigger section of the front panel to display the Pulse Width Trigger Menu.



- 2 Press the **Source** softkey (or rotate the Entry knob) to select a channel source for the trigger.

The channel you select is shown in the upper-right corner of the display next to the polarity symbol.

The source can be any analog or digital channel available on your oscilloscope. External trigger may also be specified as a source when using a 2-channel oscilloscope.

Adjust the trigger level for the selected analog channel by turning the Trigger Level knob. Press the [**Digital**] key and select **Thresholds** to set the threshold level for digital channels. The value of the trigger level or digital threshold is displayed in the upper-right corner of the display.

- 3 Press the pulse polarity softkey to select positive ( $\square$ ) or negative ( $\square$ ) polarity for the pulse width you want to capture.



The selected pulse polarity is displayed in the upper-right corner of the display. A positive pulse is higher than the current trigger level or threshold and a negative pulse is lower than the current trigger level or threshold.

When triggering on a positive pulse, the trigger will occur on the high to low transition of the pulse if the qualifying condition is true. When triggering on a negative pulse, the trigger will occur on the low to high transition of the pulse if the qualifying condition is true.

**4** Press the qualifier softkey (< > ><) to select the time qualifier.

The Qualifier softkey can set the oscilloscope to trigger on a pulse width that is:

- less than a time value (<).

For example, for a positive pulse, if you set  $t < 10$  ns:



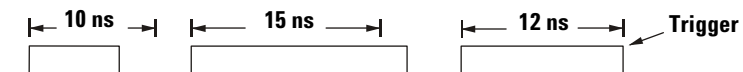
- greater than a time value (>).

For example, for a positive pulse, if you set  $t > 10$  ns:



- within a range of time values (><).

For example, for a positive pulse, if you set  $t > 10$  ns and  $t < 15$  ns:



**5** Select the qualifier time set softkey (< or >), then rotate the Entry knob to set the pulse width qualifier time.

The qualifiers can be set as follows:

- 2 ns to 10 s for > or < qualifier (5 ns to 10 s for 350 MHz bandwidth models)
- 10 ns to 10 s for >< qualifier, with minimum difference of 5 ns between upper and lower settings

### **< qualifier time set softkey**

- When the less than (<) qualifier is selected, the Entry knob sets the oscilloscope to trigger on a pulse width less than the time value displayed on the softkey.
- When the time range (><) qualifier is selected, the Entry knob sets the upper time range value.

### **> qualifier time set softkey**

- When the greater than (>) qualifier is selected, the Entry knob sets the oscilloscope to trigger on a pulse width greater than the time value displayed on the softkey.
- When the time range (><) qualifier is selected, the Entry knob sets the lower time range value.

## Sequence Trigger

Sequence trigger lets you trigger the oscilloscope after finding a sequence of events. Defining a sequence trigger requires three steps:

- 1 Define an event to find before you search for the trigger.

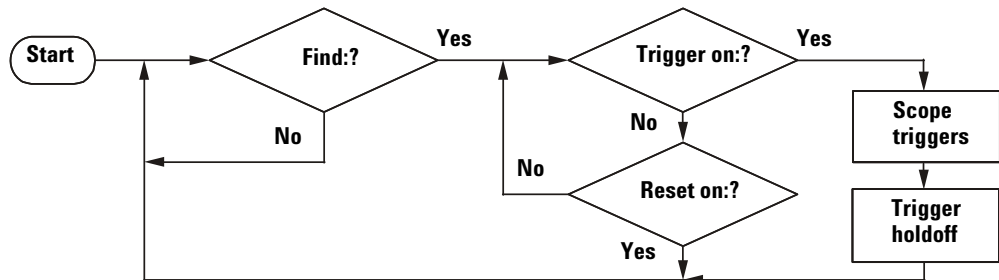
The “find” event can be a pattern, an edge from a single channel, or the combination of a pattern and a channel edge.

- 2 Define the trigger event.

The “trigger on” event can be a pattern, an edge from a single channel, the combination of a pattern and a channel edge, or the nth occurrence of an edge from a single channel.

- 3 Set an optional reset event.

If you choose to define a “reset” event, the event can be a pattern, an edge from a single channel, the combination of a pattern and a channel edge, or a timeout value.



**Figure 12** Sequence Trigger Flowchart

To access the sequence trigger settings, press the **[Trigger]** key in the Trigger section of the front panel, rotate the Entry knob until **Sequence** is displayed in the **Trigger** softkey.

## 4 Triggering

Sequence trigger Selected channel Trigger level or threshold

Sequence stage definitions

Term definitions

Sequence Stages

First, find: Pattern 1 Entered

Then, trigger on: Edge 2

Reset on: No Reset

P1: 1 0XXX 4 D<sub>IS</sub> XXXX XXXX XXXX XXXX D<sub>0</sub>

P2: 1 1XXX 4 D<sub>IS</sub> XXXX XXXX XXXX XXXX D<sub>0</sub>

E1: 1 XXXX 4 D<sub>IS</sub> XXXX XXXX XXXX XXXX D<sub>0</sub>

E2: 1 1XXX 4 D<sub>IS</sub> XXXX XXXX XXXX XXXX D<sub>0</sub>

N = 1

Timeout = 100ns

Trigger Menu

Trigger Sequence Channel 1 Stage Find Find: P1 Enter Term Pattern 1 0 1 X

Channel select Stage select Find, Trigger on, or Reset condition Select term Define term

As you set stage, term, and channel definitions for the sequence trigger, these settings will be shown in the waveform area of the display.

### Define the “Find” Stage

- 1 Press the **Stage** softkey and select **Find:**.

**Find:** is the first stage in the trigger sequence. When you select the **Stage Find** softkey, the next softkey to the right will display **Find:** and give you a list of the terms you can define for the Find stage. The Find stage can be set to one of the following conditions:

- **Pattern 1 Entered** — A pattern is entered on the last edge that makes the pattern true (logical AND).
  - **Pattern 1 Exited** — A pattern is exited on the first edge that makes the pattern false (logical NAND).
  - **Edge 1**
  - **Pattern 1 and Edge 1**
- 2 Press the **Find:** softkey and select the Find stage condition.
  - 3 To define the term(s) used in the Find stage, press the **Term** softkey and select the pattern and/or edge term displayed in the **Find:** softkey.
  - 4 If you select a pattern term, each channel in the pattern must be set to a **1** (high), **0** (low), or **X** (don't care).
    - a Press the **Channel** softkey (or rotate the Entry knob) to select the channel.

As you select a channel, the channel is highlighted in the selected pattern list shown in the waveform area and is also shown in the upper-right corner of the display next to “**seq**”

- b Press the **0 1 X** softkey to set a level for the channel.
  - **1** sets the pattern to high on the selected channel. A high is a voltage level that is greater than the channel's trigger level or threshold level.
  - **0** sets the pattern to low on the selected channel. A low is a voltage level that is less than the channel's trigger level or threshold level.
  - **X** sets the pattern to don't care on the selected channel. Any channel set to don't care is ignored and is not used as part of the pattern. If all channels in the pattern are set to don't care, the oscilloscope will not trigger.

Adjust the trigger level for the selected analog channel by turning the Trigger Level knob. Press the [**Digital**] key and select **Thresholds** to set the threshold level for digital channels. The value of the trigger level or digital threshold is displayed in the upper-right corner of the display.

- c Repeat for all channels in the pattern.

- 5 If you select an edge term, one channel must be set to a rising edge or a falling edge. All other channel edges will be set to don't care (X).
  - a Press the **Channel** softkey (or rotate the Entry knob) to select the channel.

As you select a channel, the channel is highlighted in the selected pattern list shown in the waveform area.
  - b Then press the **↕ X** softkey to select rising edge or falling edge. All other channels will be defaulted to don't care (X).

If you want to reassign an edge to a different channel, repeat the above step. The value of the original channel edge will be defaulted to **X** (don't care).

### NOTE

If the term(s) used in the "Find:" Sequence Stage condition are set to "don't care," the oscilloscope will not trigger. At least one term in the stage must be set to a value other than X (don't care).

## Define the "Trigger on" Stage

- 1 Press the **Stage** softkey and select **Trigger on:**.

Trigger on: is the next stage in the trigger sequence. When you select the **Stage Trigger on:** softkey, the next softkey to the right will display **Trigger:** and give you a list of the terms you can define for the Trigger on: stage. The Trigger on: stage can be set to one of the following conditions:

- **Pattern 2 Entered** – A pattern is entered on the last edge that makes the pattern true (logical AND).
  - **Pattern 2 Exited** – A pattern is exited on the first edge that makes the pattern false (logical NAND).
  - **Edge 2**
  - **Pattern 2 and Edge 2**
  - **Nth Edge 2**
  - **Nth Edge 2 (no re-find)**
- 2 Press the **Trigger:** softkey and select a stage to trigger on.

- 3 To define the term(s) used in the Trigger on: stage, press the **Term** softkey and select the pattern or edge term displayed in the **Trigger:** softkey.
- 4 If you select a pattern term, each channel in the pattern must be set to a **1** (high), **0** (low), or **X** (don't care).
  - a Press the **Channel** softkey (or rotate the Entry knob) to select the channel.
  - b Press the **0 1 X** softkey to set a level for the channel.
  - c Repeat for all channels in the pattern.
- 5 If you select an edge term, one channel must be set to a rising edge or a falling edge. All other channel edges will be set to don't care (X).
  - a Press the **Channel** softkey (or rotate the Entry knob) to select the channel.  
The channel you select is shown in the upper-right corner of the display next to "Seq".
  - b Then press the **↕ ↘ X** softkey to select rising edge or falling edge. All other channel edges will be defaulted to don't care.
- 6 When you set a Trigger on: condition to trigger on Edge 2, you can also select which occurrence of Edge 2 to trigger on.
  - a Make sure **Nth Edge 2** or **Nth Edge 2 (no re-find)** is selected in the **Trigger:** softkey.  
When **Nth Edge 2** is selected, if the Find event occurs again before the Count (N) event is satisfied, Count (N) will be reset to zero.  
When **Nth Edge 2 (no re-find)** is selected, if the Find event occurs again before the Count (N) event is satisfied, the Count (N) is not reset to zero.
  - b Press the **Term** softkey and select **Count (N)**.
  - c Press the **N** softkey, then turn the Entry knob to set the number of edges to wait before triggering.  
**N** can be set from 1 to 10,000.

**NOTE**

If the term(s) used in the "Trigger on:" Sequence Stage condition are set to "don't care," the oscilloscope will not trigger. At least one term in the stage must be set to a value other than X (don't care).

## Define the Optional “Reset on” Stage

- 1 Press the **Stage** softkey and select **Reset on:**.

Reset on: is the last stage in the trigger sequence. When you select the **Stage Reset on:** softkey, the next softkey to the right will display **Reset:** and give you a list of the terms you can define for the Reset on: stage. The Reset on: stage can be set to one of the following conditions:

- **No Reset** – Resets on the find condition.
- **Pattern 1 (or 2) Entered** – A pattern is entered on the last edge that makes the pattern true (logical AND).
- **Pattern 1 (or 2) Exited** – A pattern is exited on the first edge that makes the pattern false (logic NAND).
- **Edge 1 (or 2)**
- **Pattern 1 and Edge 1**
- **Timeout**

Terms that are grayed-out are not valid in the reset stage.

- 2 Press the **Reset:** softkey and select a term to reset on.
- 3 Press the **Term** softkey and select the pattern, edge, or timeout term displayed in the **Reset:** softkey.
- 4 If you select **No Reset**, no reset stage will be defined.
- 5 If you select a pattern term, each channel in the pattern must be set to a **H** (high), **L** (low), or **X** (don't care).
  - a Press the **Channel** softkey (or rotate the Entry knob) to select the channel.
  - b Press the **0 1 X** softkey to set a level for the channel.
  - c Repeat for all channels in the pattern.
- 6 If you select an edge term, one channel must be set to a rising edge or a falling edge. All other channel edges will be set to don't care (**X**).
  - a Press the **Channel** softkey (or rotate the Entry knob) to select the channel.
  - b Then press the **↕ ↘ X** softkey to select rising edge or falling edge. All other channel edges will be defaulted to don't care.



7 If you select the **Timeout** term, you will need to set a timeout value.

- a Press the **Term** softkey and select **Timeout**.
- b Press the **Timeout** softkey, then turn the Entry knob to set the timeout value.

Timeout can be set from 10 ns to 10 seconds. The timer starts when the Find condition has been met. If the timer is running and another Find condition occurs, the timer will restart from time zero.

## Adjust the Trigger Level

- For analog channels, adjust the trigger level for the selected analog channel by turning the Trigger Level knob.
- To set the threshold level for digital channels, press the **[Digital]** key and select **Thresholds**.

The value of the trigger level or digital threshold is displayed in the upper-right corner of the display.

# TV Trigger

TV triggering can be used to capture the complicated waveforms of most standard and high-definition analog video signals. The trigger circuitry detects the vertical and horizontal interval of the waveform and produces triggers based on the TV trigger settings you have selected.

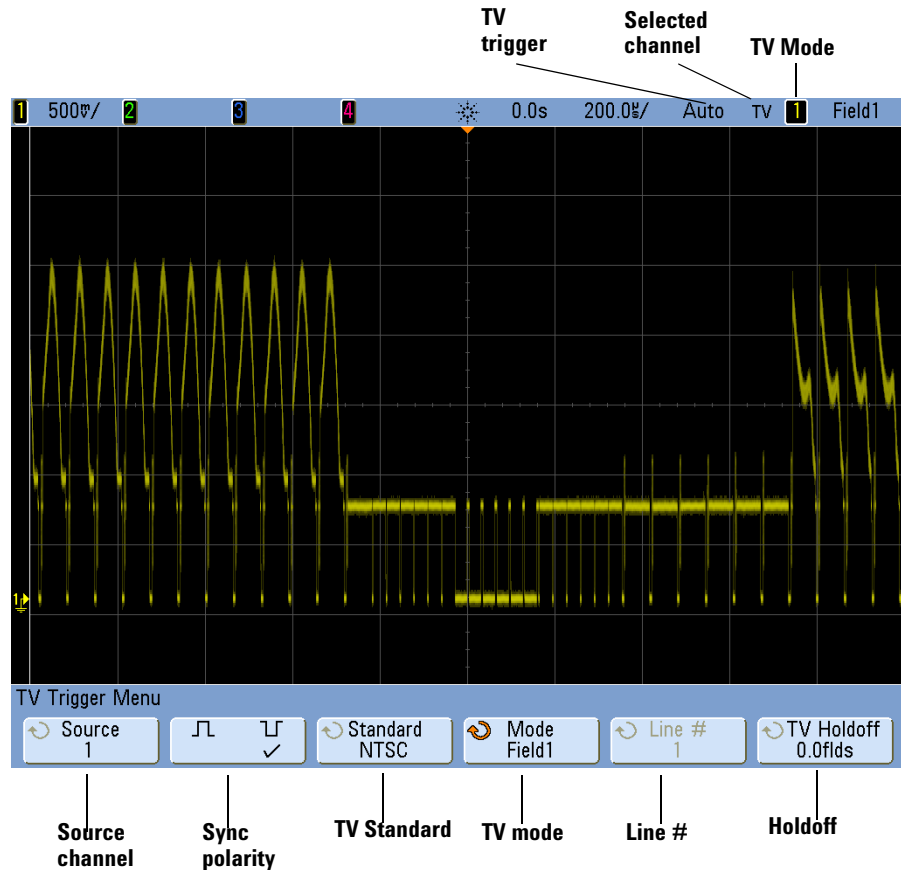
The oscilloscope's MegaZoom III technology gives you bright, easily viewed displays of any part of the video waveform. Analysis of video waveforms is simplified by the oscilloscope's ability to trigger on any selected line of the video signal.

### NOTE

It is important, when using a 10:1 passive probe, that the probe is correctly compensated. The oscilloscope is sensitive to this and will not trigger if the probe is not properly compensated, especially for progressive formats.

---

- 1 Press the **[Trigger]** key in the Trigger section of the front panel. If **TV** is not selected, rotate the Entry knob until **TV** is displayed in the **Trigger** softkey, then press the **Settings** softkey to display TV Trigger Menu.





- 2 Press the **Source** softkey and select any analog channel as the TV trigger source.

The selected trigger source is displayed in the upper-right corner of the display. Turning the Trigger **Level** knob does not change the trigger level because the trigger level is automatically set to the sync pulse. Trigger coupling is automatically set to **TV** in the Trigger Mode and Coupling Menu.

**NOTE****Provide Correct Matching**

Many TV signals are produced from 75  $\Omega$  sources. To provide correct matching to these sources, a 75  $\Omega$  terminator (such as an Agilent 11094B) should be connected to the oscilloscope input.

- 3 Press the sync polarity softkey to set the TV trigger to either positive () or negative () sync polarity.

- 4 Press the **Standard** softkey to set the TV standard.

The oscilloscope supports triggering on the following television (TV) and video standards.

Standard	Type	Sync Pulse
NTSC	Interlaced	Bi-level
PAL	Interlaced	Bi-level
PAL-M	Interlaced	Bi-level
SECAM	Interlaced	Bi-level
Generic	Interlaced/Progressive	Bi-level/Tri-level
EDTV 480p/60	Progressive	Bi-level
HDTV 720p/60	Progressive	Tri-level
HDTV 1080p/24	Progressive	Tri-level
HDTV 1080p/25	Progressive	Tri-level
HDTV 1080p/50	Progressive	Tri-level
HDTV 1080p/60	Progressive	Tri-level
HDTV 1080i/50	Interlaced	Tri-level
HDTV 1080i/60	Interlaced	Tri-level

- 5 Press the **Mode** softkey to select the portion of the video signal that you would like to trigger on.

The TV trigger modes available are:

- **Field1** and **Field2** – Trigger on the rising edge of the first serration pulse of field 1 or field 2 (interlaced standards only).
- **All Fields** – Trigger on the rising edge of the first pulse in the vertical sync interval (not available in Generic mode).
- **All Lines** – Trigger on all horizontal sync pulses.
- **Line** – Trigger on the selected line # (EDTV and HDTV standards only).

- **Line: Field1** and **Line:Field2** – Trigger on the selected line # in field 1 or field 2 (interlaced standards only except 1080i).
  - **Line: Alternate** – Alternately trigger on the selected line # in field 1 and field 2 (NTSC, PAL, PAL-M, and SECAM only).
  - **Vertical** – Trigger on the rising edge of the first serration pulse or approximately 70  $\mu$ s after the start of vertical sync, whichever occurs first (only available in Generic mode).
  - **Count: Vertical** – Counts falling edges of sync pulses; triggers on the selected count number (only available in Generic mode).
- 6** If you select a line # mode, press the **Line #** softkey, then rotate the Entry knob to select the line number on which you want to trigger.
- 7** When using the Generic standard and you select a line # mode or **Count:Vertical**, press the **Count #** softkey and rotate the Entry knob to select the desired count number.

Listed below are the line (or count) numbers per field for each non-HDTV/EDTV video standard.

Video standard	Field 1	Field 2	Alt Field
NTSC	1 to 263	1 to 262	1 to 262
PAL	1 to 313	314 to 625	1 to 312
PAL-M	1 to 263	264 to 525	1 to 262
SECAM	1 to 313	314 to 625	1 to 312
Generic	1 to 1024	1 to 1024	1 to 1024 (vertical)

Line numbers for each EDTV/HDTV video standard

EDTV 480p/60	1 to 525
HDTV 720p/60	1 to 750
HDTV 1080p/24	1 to 1125
HDTV 1080p/25	1 to 1125
HDTV 1080i/50	1 to 1125
HDTV 1080i/60	1 to 1125

### NOTE

#### Line Number Represents Count

In **Generic** mode, the line number represents the number of a count instead of a real line number. This is reflected in the label in the softkey changing from **Line** to **Count**. In the **Mode** softkey selections, **Line:Field 1**, **Line:Field 2** and **Count:Vertical** are used to indicate where the counting starts. For an interlaced video signal, the counting starts from the rising edge of the first vertical serration pulse of Field 1 and/or Field 2. For a non-interlaced video signal, the counting starts after the rising edge of the vertical sync pulse.

---

## TV Triggering Examples

The following are exercises to familiarize you with TV triggering. These exercises use the NTSC video standard.

### To trigger on a specific line of video

TV triggering requires greater than 1/2 division of sync amplitude with any analog channel as the trigger source. Turning the trigger **Level** knob in TV trigger does not change the trigger level because the trigger level is automatically set to the sync pulse tips.

One example of triggering on a specific line of video is looking at the vertical interval test signals (VITS), which are typically in line 18. Another example is closed captioning, which is typically in line 21.

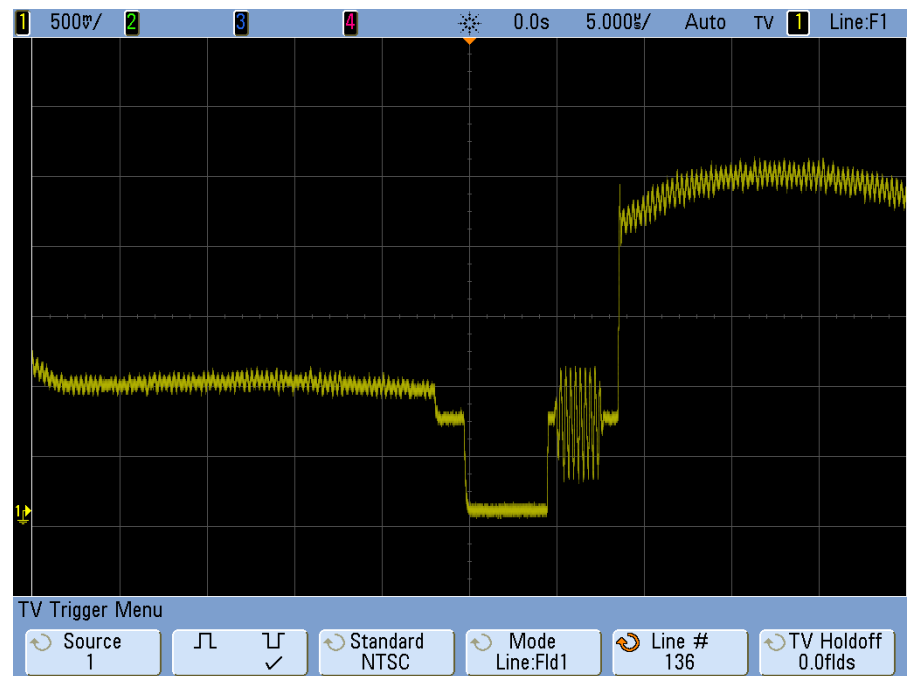
- 1 Press the **[Trigger]** key; then, select **TV**.
- 2 Press the **Settings** softkey, then press the **Standard** softkey to select the appropriate TV standard (NTSC).
- 3 Press the **Mode** softkey and select the TV field of the line you want to trigger on. You can choose **Line:Field1**, **Line:Field2**, or **Line:Alternate**.
- 4 Press the **Line #** softkey and select the number of the line you want to examine.

## NOTE

**Alternate Triggering**

If **Line:Alternate** is selected, the oscilloscope will alternately trigger on the selected line number in Field 1 and Field 2. This is a quick way to compare the Field 1 VITS and Field 2 VITS or to check for the correct insertion of the half line at the end of Field 1.

**Figure 13** Example: Triggering on Line 136

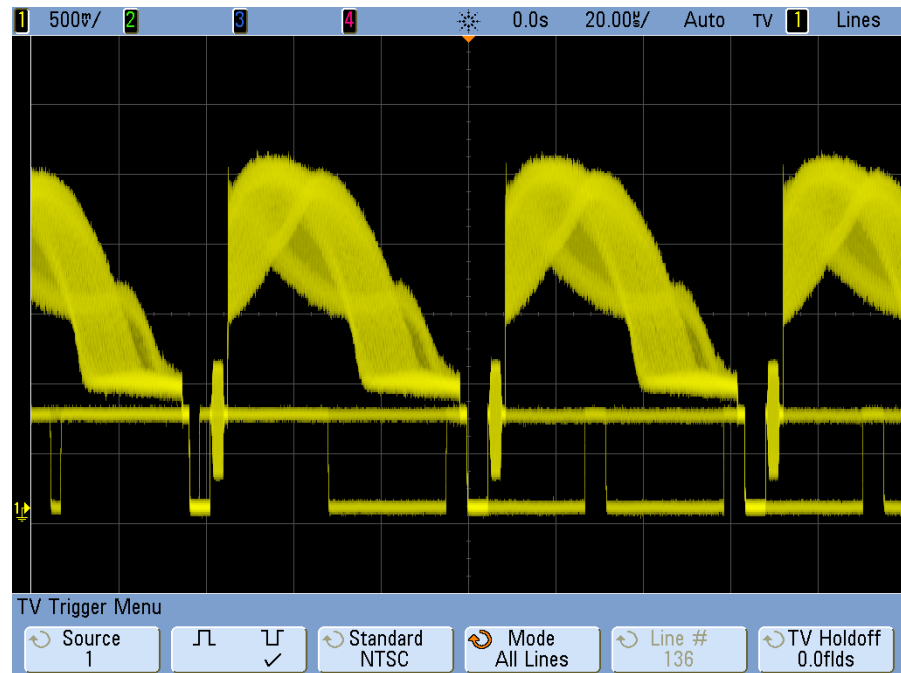


### To trigger on all sync pulses

To quickly find maximum video levels, you could trigger on all sync pulses. When **All Lines** is selected as the TV trigger mode, the oscilloscope will trigger on all horizontal sync pulses.

- 1 Press the **[Trigger]** key; then, select **TV**.
- 2 Press the **Settings** softkey, then press the **Standard** softkey to select the appropriate TV standard.
- 3 Press the **Mode** softkey and select **All Lines**.

**Figure 14** Triggering on All Lines



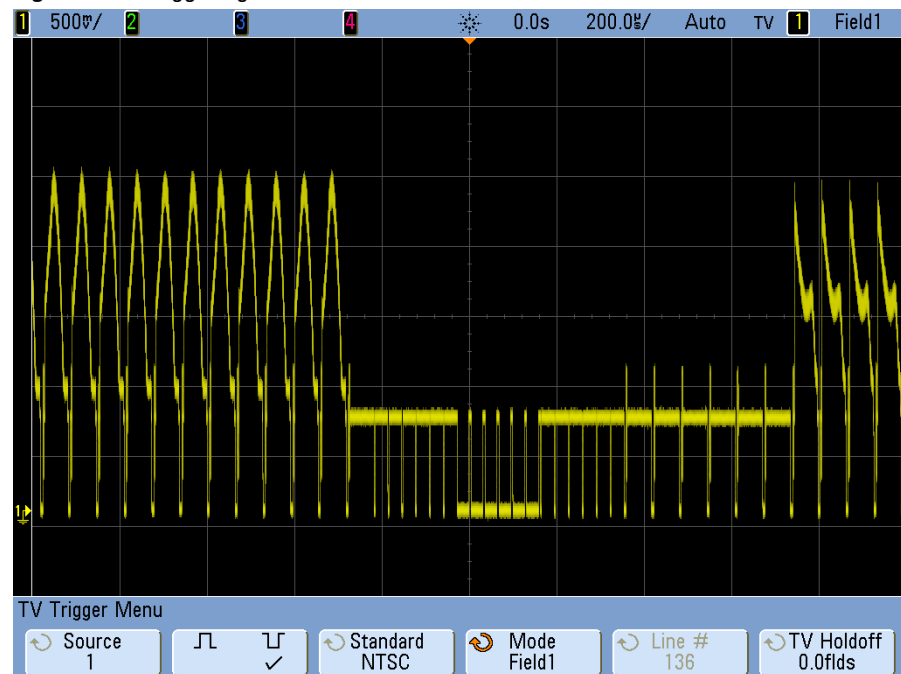


## To trigger on a specific field of the video signal

To examine the components of a video signal, trigger on either Field 1 or Field 2 (available for interleaved standards). When a specific field is selected, the oscilloscope triggers on the rising edge of the first serration pulse in the vertical sync interval in the specified field (1 or 2).

- 1 Press the **[Trigger]** key; then, select **TV**.
- 2 Press the **Settings** softkey, then press the **Standard** softkey to select the appropriate TV standard.
- 3 Press the **Mode** softkey and select **Field1** or **Field2**.

**Figure 15** Triggering on Field 1

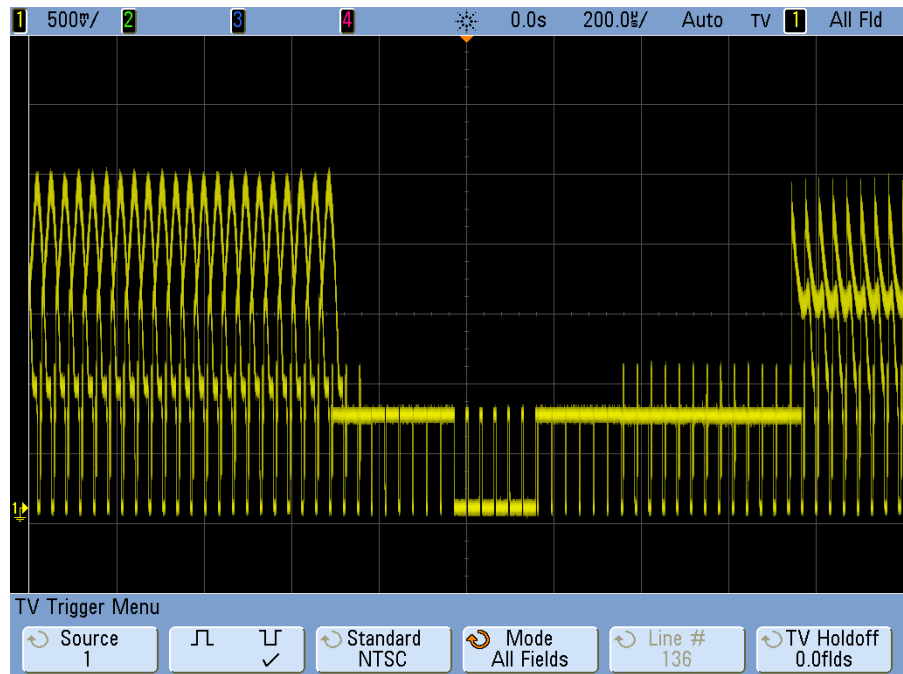


## To trigger on all fields of the video signal

To quickly and easily view transitions between fields, or to find the amplitude differences between the fields, use the All Fields trigger mode.

- 1 Press the **[Trigger]** key; then, select **TV**.
- 2 Press the **Settings** softkey, then press the **Standard** softkey to select the appropriate TV standard.
- 3 Press the **Mode** softkey and select **All Fields**.

**Figure 16** Triggering on All Fields



## To trigger on odd or even fields

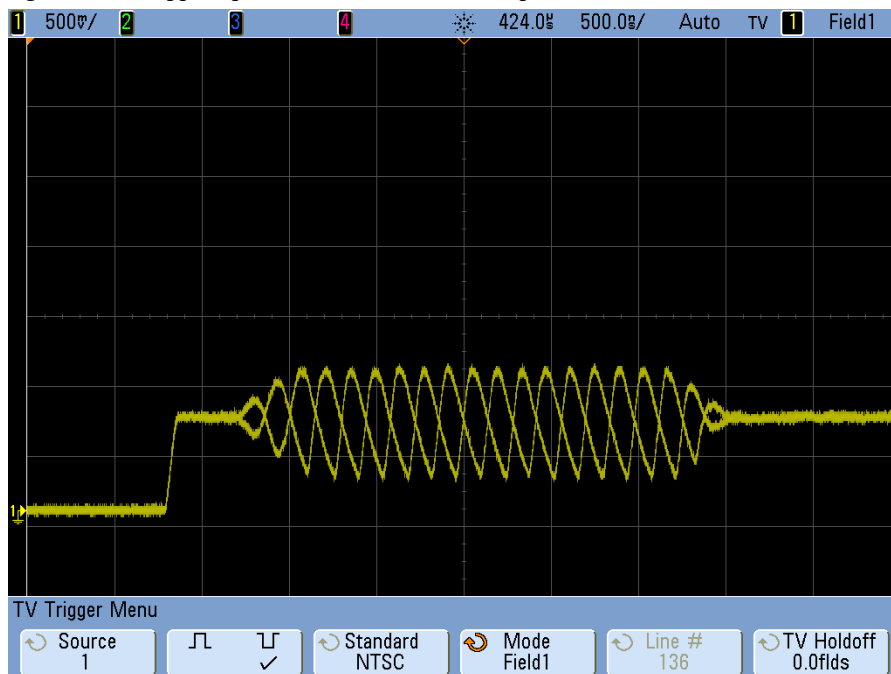
To check the envelope of your video signals, or to measure worst case distortion, trigger on the odd or even fields. When Field 1 is selected, the oscilloscope triggers on color fields 1 or 3. When Field 2 is selected, the oscilloscope triggers on color fields 2 or 4.

- 1 Press the **[Trigger]** key; then, select **TV**.
- 2 Press the **Settings** softkey, then press the **Standard** softkey to select the appropriate TV standard.
- 3 Press the **Mode** softkey and select **Field1** or **Field2**.

The trigger circuits look for the position of the start of Vertical Sync to determine the field. But this definition of field does not take into consideration the phase of the reference subcarrier. When Field 1 is selected, the trigger system will find any field where the vertical sync

starts on Line 4. In the case of NTSC video, the oscilloscope will trigger on color field 1 alternating with color field 3 (see the following figure). This setup can be used to measure the envelope of the reference burst.

**Figure 17** Triggering on Color Field 1 Alternating with Color Field 3



If a more detailed analysis is required, then only one color field should be selected to be the trigger. You can do this by using the **TV Holdoff** softkey in the TV Trigger Menu. Press the **TV Holdoff** softkey and use the Entry knob to adjust the holdoff in half-field increments until the oscilloscope triggers on only one phase of the color burst.

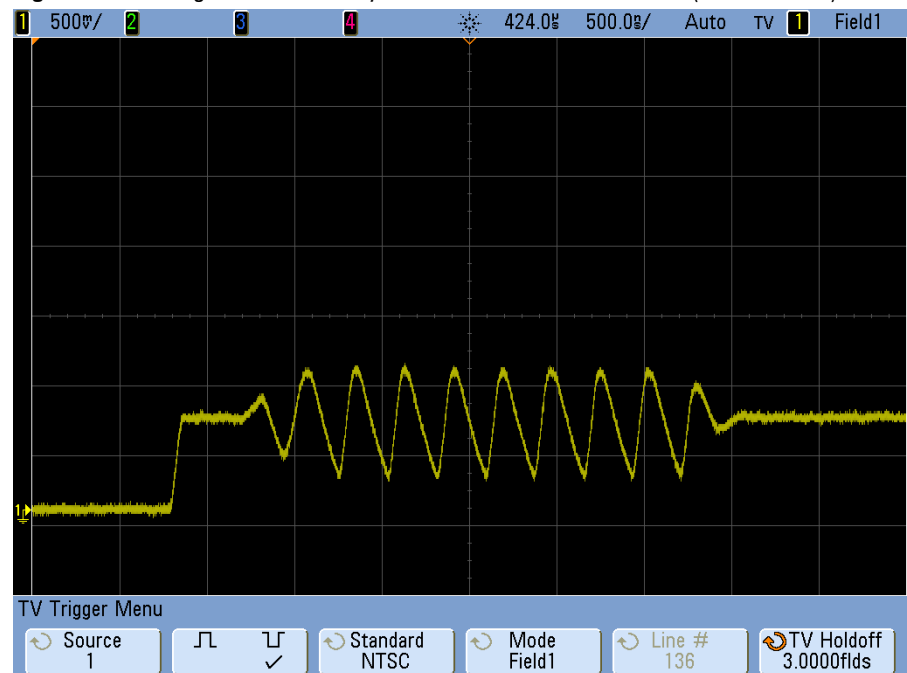
A quick way to synchronize to the other phase is to briefly disconnect the signal and then reconnect it. Repeat until the correct phase is displayed.

When holdoff is adjusted using the **TV Holdoff** softkey and the Entry knob, the corresponding holdoff time will be displayed in the Trigger Mode and Coupling Menu.

**Table 4** Half-field holdoff time

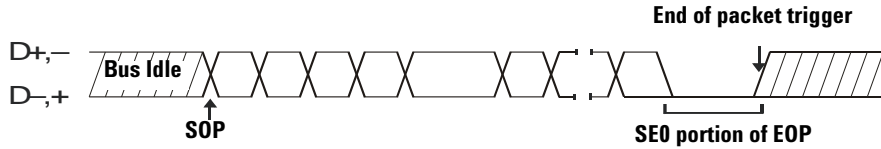
Standard	Time
NTSC	8.35 ms
PAL	10 ms
PAL-M	10 ms
SECAM	10 ms
Generic	8.35 ms
EDTV 480p/60	8.35 ms
HDTV 720p/60	8.35 ms
HDTV 1080p/24	20.835 ms
HDTV 1080p/25	20 ms
HDTV 1080i/50	10 ms
HDTV 1080i/60	8.35 ms

**Figure 18** Using TV Holdoff to Synchronize to Color Field 1 or 3 (Field 1 mode)

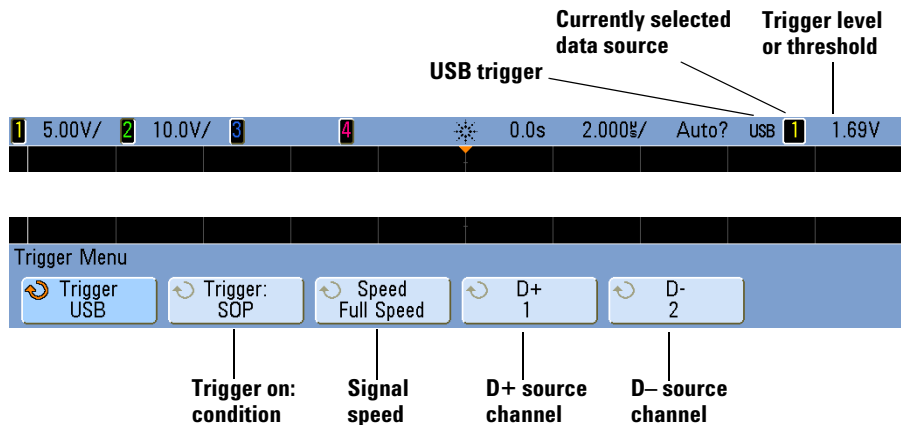


# USB Trigger

USB trigger will trigger on a Start of Packet (SOP), End of Packet (EOP) signal, Reset Complete (RC), Enter Suspend (Suspend), or Exit Suspend (Exit Sus) on the differential USB data lines (D+ and D-). USB Low Speed and Full Speed are supported by this trigger.



- 1 Press [**Default Setup**].
- 2 Press the [**Label**] key to switch labels on.
- 3 Turn on any analog or digital channels that you will be using for the USB signals.
- 4 Press the [**Trigger**] key in the Trigger section of the front panel, rotate the Entry knob until **USB** is displayed in the **Trigger** softkey.



- 5 Press the **Speed** softkey to select the speed of the transaction being probed.  
You may select Low Speed (1.5 Mb/s) or Full Speed (12 Mb/s).

- 6 Press the **D+** and **D-** softkeys to select the channel connected to the USB signal D+ and D- lines. The **D+** and **D-** labels for the source channels are automatically set.

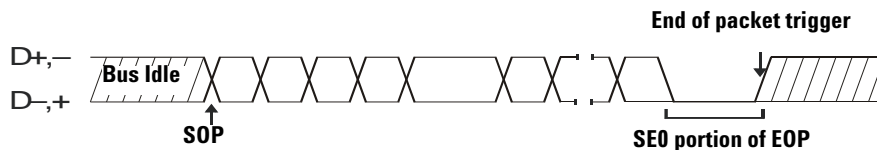
As you press the **D+** or **D-** softkey (or rotate the Entry knob), the **D+** and **D-** label for the source channel is automatically set and the channel you select is shown in the upper-right corner of the display next to “USB”.

If you have connected the oscilloscope’s analog source channels to the D+ and D- signals: Adjust the trigger level for each connected analog channel to the middle of the waveform by pressing the **D+** or **D-** softkey, then turning the Trigger Level knob.

If you have connected the oscilloscope’s digital source channels to the D+ and D- signals (this applies to MSO model oscilloscopes only): Press the **[Digital]** key and select **Thresholds** to set an appropriate threshold level for the digital channels.

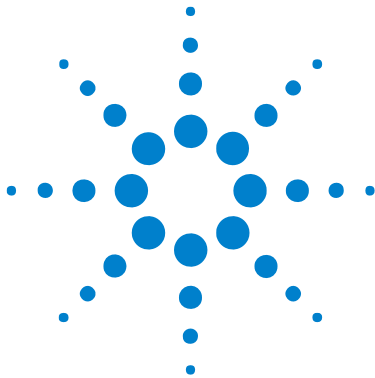
The value of the trigger level or digital threshold is displayed in the upper-right corner of the display.

- 7 Press the **Trigger:** softkey to select where the USB trigger will occur:
- **SOP** (Start of Packet) – triggers at the Sync bit at the beginning of the packet.
  - **EOP** (End of Packet) – triggers at the end of the SE0 portion of the EOP.
  - **RC** (Reset Complete) – triggers when SE0 is > 10 ms.
  - **Suspend** (Enter Suspend) – triggers when the bus is idle > 3 ms.
  - **Exit Sus** (Exit Suspend) – triggers when exiting an idle state > 10 ms. This is used to see the suspend/resume transition.



## 4 Triggering





## 5 Measurements and Math Functions

List of Automatic Measurements	154
Making Automatic Measurements	156
Measurement Definitions	162
Cursor Measurements	177
Math Functions	183
Multiply	187
Add or Subtract	189
Differentiate	191
Integrate	193
Square Root	195
FFT Measurement	197

- See Also**
- “Enabling Precision Measurements and Math” on page 357.
  - “To specify the measurement window for Zoom mode” on page 386.



## List of Automatic Measurements

You can press the **[Meas]** key and select an automatic measurement. Follow the link or go to the page for details.

### Time Measurements

- [“Counter”](#) on page 162.
- [“Duty Cycle”](#) on page 163.
- [“Frequency”](#) on page 163.
- [“Period”](#) on page 164.
- [“Rise Time”](#) on page 165.
- [“Fall Time”](#) on page 165.
- [“+ Width”](#) on page 165.
- [“- Width”](#) on page 165.
- [“X at Max Y”](#) on page 165.
- [“X at Min Y”](#) on page 166.

### Phase and Delay

- [“Phase”](#) on page 167.
- [“Delay”](#) on page 166.

### Voltage Measurements

- [“Average”](#) on page 170.
- [“Amplitude”](#) on page 170.
- [“Base”](#) on page 170.
- [“Extinction Ratio”](#) on page 171.
- [“Maximum”](#) on page 171.
- [“Minimum”](#) on page 171.
- [“Peak-Peak”](#) on page 171.
- [“Ratio”](#) on page 171.
- [“RMS”](#) on page 171.
- [“Std Deviation”](#) on page 172.

- [“Top”](#) on page 173.

**Preshoot and Overshoot**

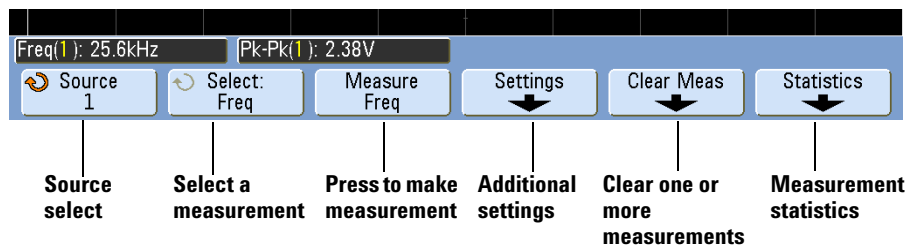
- [“Preshoot”](#) on page 175.
- [“Overshoot”](#) on page 175.

## Making Automatic Measurements

[Meas] makes automatic measurements on a channel or any running math function. Some measurements can only be made on analog source channels (see list on [page 157](#)). The results of the last four selected measurements are displayed above the softkeys, or in the display area when certain menus are selected. [Meas] also makes measurements on stopped waveforms when you are panning and zooming.

Cursors are turned on to show the portion of the waveform being measured for the most recently selected measurement (right-most on the measurement line).

- 1 Press the [Meas] key to display the Measurement Menu.

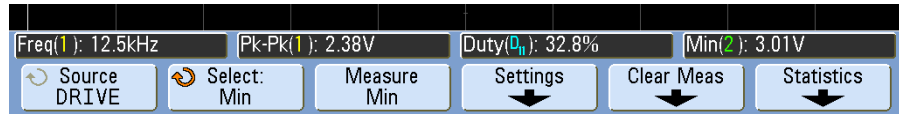


- 2 Press the **Source** softkey to select the channel or running math function to be measured.

Only channels or math functions that are displayed are available for measurements. If you choose an invalid source channel for a measurement, the measurement will default to the nearest in the list that makes the source valid.

If a portion of the waveform required for a measurement is not displayed or does not display enough resolution to make the measurement, the result will display “No Edges”, “Clipped”, “Low Signal”, “< value”, or “> value”, or a similar message to indicate that the measurement may not be reliable.

- 3 Press the **Select** softkey then rotate the Entry knob to select a measurement to be made.



- 4 The **Settings** softkey will be available to make additional measurement settings on some measurements.
- 5 Press the **Measure** softkey to make the measurement. (By default, measurement statistics are displayed. See [page 157](#).)
- 6 To turn off measurements, press the **[Meas]** key again. The key will no longer be illuminated and the measurements will be erased from the display.
- 7 To stop making one or more measurements, press the **Clear Meas** softkey and choose the measurement to clear, or press **Clear All**.



After all measurements have been cleared, when **[Meas]** is pressed again, the default measurements will be Frequency and Peak-Peak.

### Measurements available only on analog channels

The following measurements can only be made on analog source channels: rise time, fall time, X at max Y, X at min Y, phase, delay, average, amplitude, base, maximum, minimum, peak-to-peak, ratio, rms, std. deviation, and top.

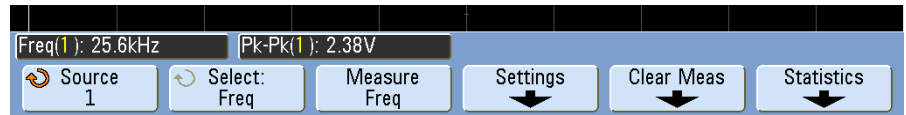
## Measurement Statistics

Press the **[Meas]** key to enter the Measurement Menu. By default, statistics are displayed, and frequency and voltage are measured on channel 1.

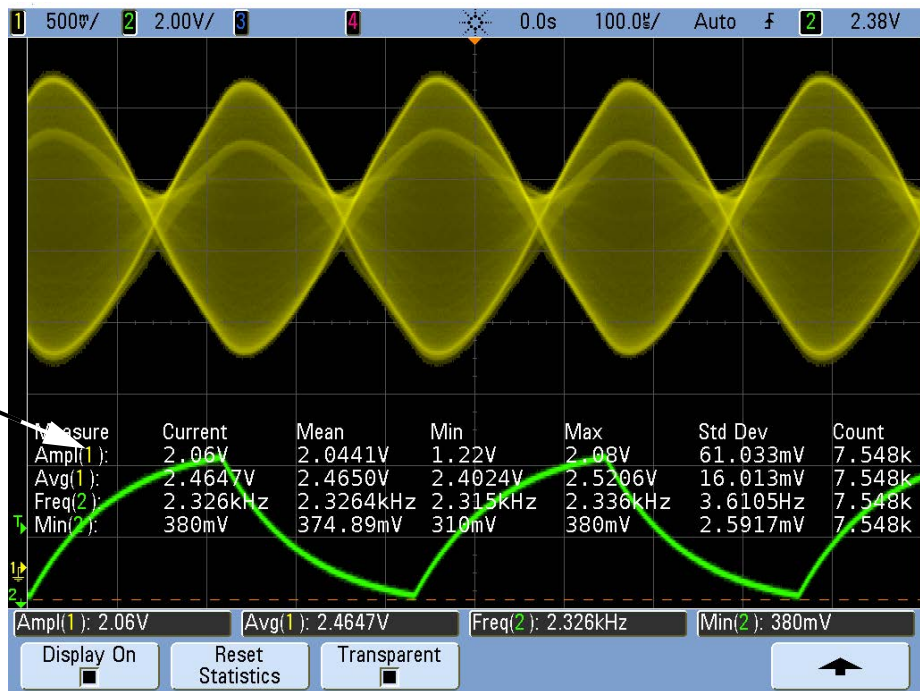
Select the measurements you desire for the channels you are using (see [page 154](#)).

## 5 Measurements and Math Functions

From the Measurement Menu, press the **Statistics** softkey to enter the Statistics Menu.



Source channel  
(color coded)



The following statistics are shown: Name of the measurement, current measured value, mean, minimum measured value, maximum measured value, standard deviation, and the number of times the measurement has been made (count). Statistics are based on the total number of captured waveforms (count).

The standard deviation shown in Statistics is calculated using the same formula used for calculating the standard deviation measurement. The formula is shown in the section titled “Std Deviation” on page 172.

The source channel of the measurement is shown in parenthesis after the measurement name. For example: "**Freq(1)**" indicates a frequency measurement on channel 1.

You can switch the statistics **Display On** or **Display Off**. Statistics continue to accumulate even when the statistics display is off.

When you navigate away from the Measurements Menu, the statistics display will no longer be displayed, but statistical data collection will continue. Return to the Measurements Menu to see the data again.

To reset the statistics measurements, press the **Reset Statistics** softkey. This resets all statistics and begins recording statistical data again.

Each time a new measurement (for example: frequency, period, or amplitude) is added the statistics are reset and accumulation of statistical data begins again.

When the **[Single]** key is pressed, statistics are reset and a single measurement is done (count = 1). Successive **[Single]** acquisitions accumulate statistical data ( and the count is incremented).

Press the **Transparent** softkey to disable the Transparent mode. This shows statistics with a gray background. Press the **Transparent** softkey again to enable Transparent mode. This writes measurement values, statistics, and cursor values on the screen without a background. This controls the display of statistics in both measurements and the optional Mask test feature.

The **Increment Statistics** softkey only appears when the acquisition is stopped and the optional segmented memory feature is off. Press the **[Single]** or **[Run/Stop]** key to stop the acquisition. You can use the horizontal position control (in the Horizontal control section of the front panel) to pan through the waveform. Active measurements will stay on screen, allowing you to measure various aspects of the captured waveforms. Press **Increment Statistics** to add the currently measured waveform to the collected statistical data.

The **Analyze Segments** softkey only appears when the acquisition is stopped and the optional segmented memory feature is on. After an acquisition has completed (and the oscilloscope is stopped), you can press the **Analyze Segments** softkey to accumulate measurement statistics for the acquired segments.

You can also turn on infinite persistence (in the Display Menu) and press the **Analyze Segments** softkey to create an infinite persistence display.

## Measurement Thresholds

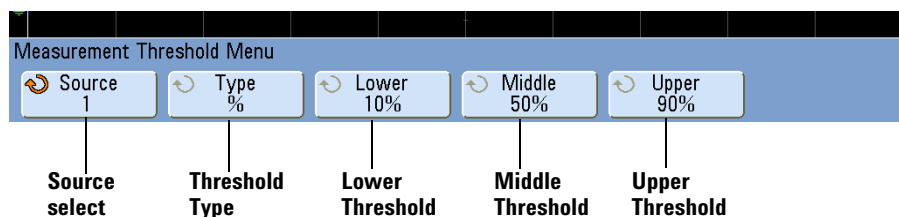
Setting measurement thresholds defines the vertical levels where measurements will be taken on an analog channel or math waveform.

### NOTE

#### Changing default thresholds may change measurement results

The default lower, middle, and upper threshold values are 10%, 50%, and 90% of the value between Top and Base. Changing these threshold definitions from the default values may change the returned measurement results for Average, Delay, Duty Cycle, Fall Time, Frequency, Overshoot, Period, Phase, Preshoot, Rise Time, +Width, and -Width.

- 1 From the Measurement Menu, press the **Settings** softkey, then press the **Thresholds** softkey to set analog channel measurement thresholds.
- 2 Press the **Source** softkey to select the analog channel or math waveform source for which you want to change measurement thresholds. Each analog channel and the math waveform can be assigned unique threshold values.



- 3 Press the **Type** softkey to set the measurement threshold to % (percentage of Top and Base value) or to **Absolute** (absolute value.)
  - Percentage thresholds can be set from 5% to 95%.



- The units for absolute threshold for each channel is set in the channel probe menu.
- When the **Source** is set to **Math: f(t)**, the threshold **Type** can only be set to **Percent**.

**NOTE****Absolute threshold hints**

- Absolute thresholds are dependent on channel scaling, probe attenuation, and probe units. Always set these values first before setting absolute thresholds.
- The minimum and maximum threshold values are limited to on-screen values.
- If any of the absolute threshold values are above or below the minimum or maximum waveform values, the measurement may not be valid.

- 4 Press the **Lower** softkey, then turn the Entry knob to set the lower measurement threshold value.

Increasing the lower value beyond the set middle value will automatically increase the middle value to be more than the lower value. The default lower threshold is 10% or 800 mV.

If threshold **Type** is set to %, the lower threshold value can be set from 5% to 93%.

- 5 Press the **Middle** softkey, then turn the Entry knob to set the middle measurement threshold value.

The middle value is bounded by the values set for lower and upper thresholds. The default middle threshold is 50% or 1.20 V.

- If threshold **Type** is set to %, the middle threshold value can be set from 6% to 94%.

- 6 Press the **Upper** softkey, then turn the Entry knob to set the upper measurement threshold value.

Decreasing the upper value below the set middle value will automatically decrease the middle value to be less than the upper value. The default upper threshold is 90% or 1.50 V.

- If threshold **Type** is set to %, the upper threshold value can be set from 7% to 95%.

## Measurement Definitions

### Time Measurements

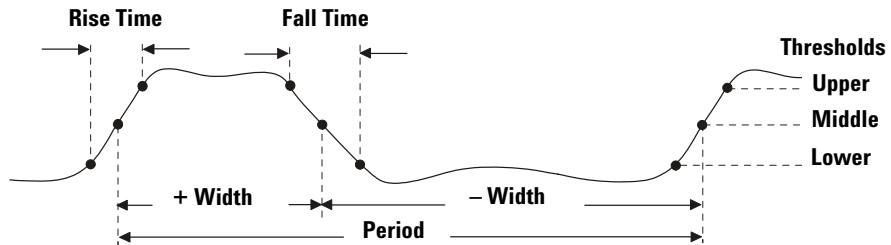
#### NOTE

#### FFT measurements

When you make an **X at Max Y** or **X at Min Y** measurement on a math FFT function, the resultant units will be in Hertz. No other time related automatic measurement can be made on the FFT math function. Use the cursors to make other measurements on FFT.

The default lower, middle, and upper measurement thresholds are 10%, 50%, and 90% between Top and Base values. See [“Measurement Thresholds”](#) on page 160 for other percentage threshold and absolute value threshold settings.

The following figure shows time measurement points.



#### NOTE

#### Digital channel time measurements

Automatic time measurements **Delay**, **Fall Time**, **Phase**, **Rise Time**, **X at Max Y**, and **X at Min Y**, and are not valid for digital channels on mixed-signal oscilloscopes.

#### Counter

The InfiniiVision 7000B Series oscilloscopes have an integrated hardware frequency counter which counts the number of cycles that occur within a period of time (known as the *gate time*) to measure the frequency of a signal.

The gate time for the Counter measurement is automatically adjusted to be 100 ms or twice the current time window, whichever is longer, up to 1 second.

The Counter can measure frequencies up to the bandwidth of the oscilloscope. The minimum frequency supported is  $1/(2 \times \text{gate time})$ .

The measured frequency is normally displayed in 5 digits, but can be displayed in 8 digits when an external 10 MHz frequency reference is provided at the 10 MHz REF rear panel BNC and the gate time is 1 second (50 ms/div sweep speed or greater). See ([“To set the reference signal mode”](#) on page 388.)

The hardware counter uses the trigger comparator output. Therefore, the counted channel's trigger level (or threshold for digital channels) must be set correctly. The Y cursor shows the threshold level used in the measurement.

Any channel except Math can be selected as the source.

Only one Counter measurement can be displayed at a time.

### **Duty Cycle**

The duty cycle of a repetitive pulse train is the ratio of the positive pulse width to the period, expressed as a percentage. The X cursors show the time period being measured. The Y cursor shows the middle threshold point.

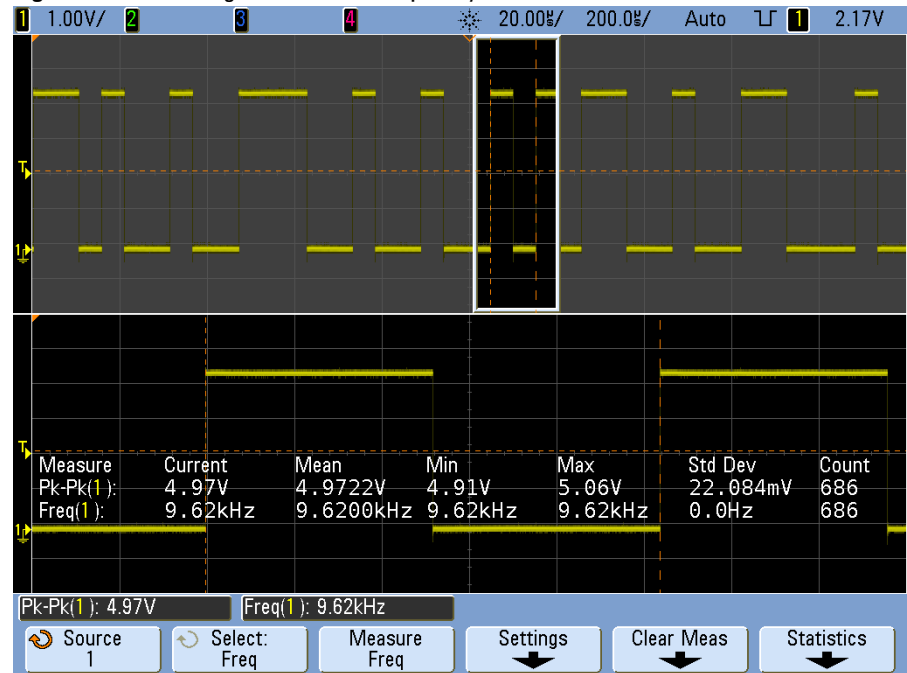
$$\text{Duty cycle} = \frac{+ \text{Width}}{\text{Period}} \times 100$$

### **Frequency**

Frequency is defined as  $1/\text{Period}$ . Period is defined as the time between the middle threshold crossings of two consecutive, like-polarity edges. A middle threshold crossing must also travel through the lower and upper threshold levels which eliminates runt pulses. The X cursors show what portion of the waveform is being measured. The Y cursor shows the middle threshold point.

**To isolate an event for frequency measurement** The following figure shows how to use Zoom mode to isolate an event for a frequency measurement. If the measurement is not possible in the Zoom mode, then the normal time base is used. If the waveform is clipped, it may not be possible to make the measurement.

**Figure 19** Isolating an event for Frequency measurement



## Period

Period is the time period of the complete waveform cycle. The time is measured between the middle threshold points of two consecutive, like-polarity edges. A middle threshold crossing must also travel through the lower and upper threshold levels which eliminates runt pulses. The X cursors show what portion of the waveform is being measured. The Y cursor shows the middle threshold point.

### Fall Time

The fall time of a signal is the time difference between the crossing of the upper threshold and the crossing of the lower threshold for a negative-going edge. The X cursor shows the edge being measured. For maximum measurement accuracy, set the sweep speed as fast as possible while leaving the complete falling edge of the waveform on the display. The Y cursors show the lower and upper threshold points.

### Rise Time

The rise time of a signal is the time difference between the crossing of the lower threshold and the crossing of the upper threshold for a positive-going edge. The X cursor shows the edge being measured. For maximum measurement accuracy, set the sweep speed as fast as possible while leaving the complete rising edge of the waveform on the display. The Y cursors show the lower and upper threshold points.

### + Width

+ Width is the time from the middle threshold of the rising edge to the middle threshold of the next falling edge. The X cursors show the pulse being measured. The Y cursor shows the middle threshold point.

### – Width

– Width is the time from the middle threshold of the falling edge to the middle threshold of the next rising edge. The X cursors show the pulse being measured. The Y cursor shows the middle threshold point.

### X at Max Y

X at Max Y is the X axis value (usually time) at the first displayed occurrence of the waveform Maximum, starting from the left-side of the display. For periodic signals, the position of the maximum may vary throughout the waveform. The X cursor shows where the current X at Max Y value is being measured.

To measure the peak of an FFT:

- 1 Select **FFT** as the Operator in the Waveform Math Menu.
- 2 Choose **Math: f(t)** as the source in the Measurement Menu.
- 3 Choose **Maximum** and **X at Max Y** measurements.

**Maximum** units are in dB and **X at Max Y** units are in Hertz for FFT.

### X at Min Y

X at Min Y is the X axis value (usually time) at the first displayed occurrence of the waveform Minimum, starting from the left-side of the display. For periodic signals, the position of the minimum may vary throughout the waveform. The X cursor shows where the current X at Min Y value is being measured.

## Delay and Phase Measurements

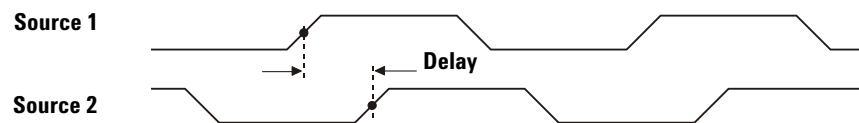
### NOTE

#### Digital channel measurements

Automatic measurements **Phase**, and **Delay** are not valid for digital channels on the mixed-signal oscilloscope or for the math FFT function. The two sources defined in the phase and delay measurement must be turned on.

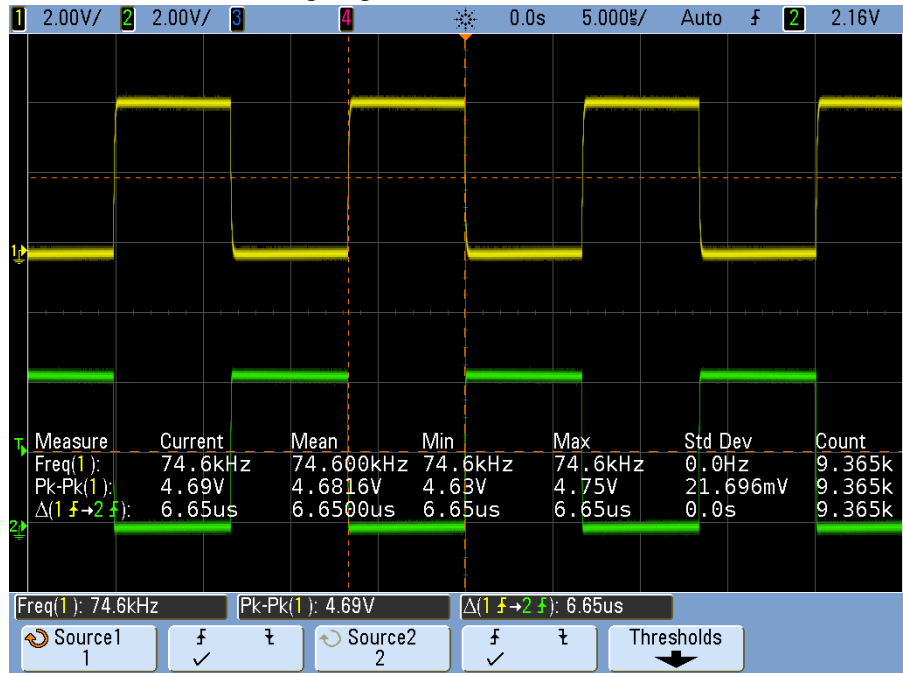
### Delay

Delay measures the time difference from the selected edge on source 1 and the selected edge on source 2 closest to the trigger reference point at the middle threshold points on the waveforms. Negative delay values indicate that the selected edge of source 1 occurred after the selected edge of source 2.



- 1 Press the **[Meas] > Select** and select **Delay**. Press the **Settings** softkey to select the source channels and slope for the delay measurement.  
The default Delay settings measure from the rising edge of channel 1 to the rising edge of channel 2.
- 2 Press the **Measure Delay** softkey to make the measurement.

The example below shows a delay measurement between the rising edge of channel 1 and the rising edge of channel 2.

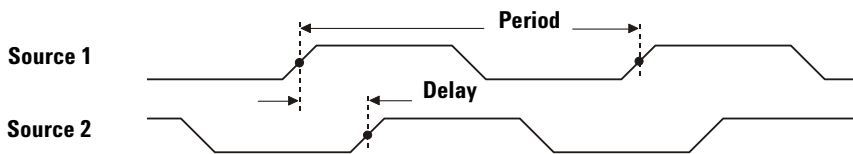


## Phase

Phase is the calculated phase shift from source 1 to source 2, expressed in degrees. Negative phase shift values indicate that the rising edge of source 1 occurred after the rising edge of source 2.

$$\text{Phase} = \frac{\text{Delay}}{\text{Source 1 Period}} \times 360$$

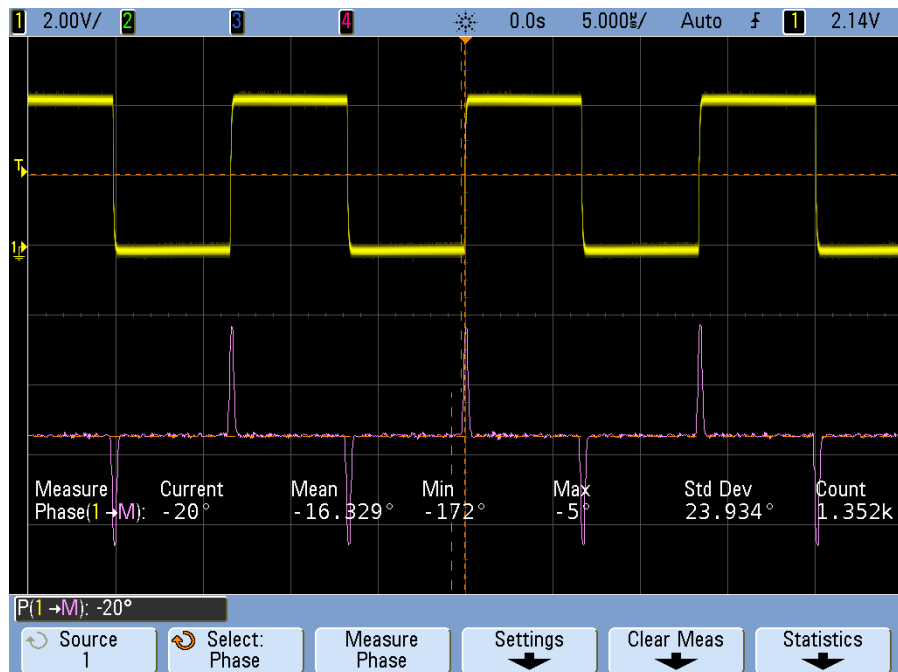
## 5 Measurements and Math Functions



- 1 Press the **Settings** softkey to select the source 1 and source 2 channels for the phase measurement.

The default Phase settings measure from channel 1 to channel 2.

The example below shows a phase measurement between the channel 1 and the math d/dt function on channel 1.





## Voltage Measurements

Measurement units for each input channel can be set to Volts or Amps using the channel **Probe Units** softkey. A scale unit of **U** (undefined) will be displayed for math function 1-2 and for  $d/dt$ , and  $\int dt$  when 1-2 or 1+2 is the selected source if channel 1 and channel 2 are set to dissimilar units in the channel **Probe Units** softkey.

### NOTE

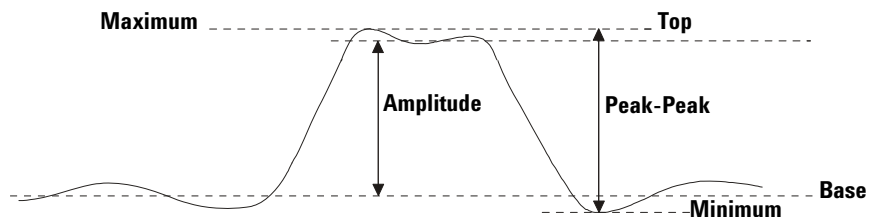
#### Math Measurements and Units

Only Peak-Peak, Maximum, Minimum, Average, X at Min Y, and X at Max Y automatic measurements may be made on a math FFT function. See “Making time measurements automatically” for the FFT X at Max Y and X at Min Y measurement. Use the cursors to make other measurements on FFT. All voltage measurements may be made on other math functions. The resultant units are:

- FFT — dB\* (decibels)
- $1 * 2$  —  $V^2$ ,  $A^2$  or W (Volt-Amp)
- $1 - 2$  — V (Volts) or A (Amps)
- $d/dt$  — V/s or A/s (V/second A/second)
- $\int dt$  — Vs or As (V-seconds or A-seconds)

\* When the FFT source is channel 1, 2, 3, or 4, FFT units will be displayed in dBV when channel units is set to Volts and channel impedance is set to  $1 M\Omega$ . FFT units will be displayed in dBm when channel units is set to Volts and channel impedance is set to  $50\Omega$ . FFT units will be displayed as dB for all other FFT sources or when a source channel's units has been set to Amps.

The following figure shows the voltage measurement points.



**NOTE****Digital channel voltage measurements**

Automatic voltage measurements are not valid on digital channels on the mixed-signal oscilloscope.

**Amplitude**

The Amplitude of a waveform is the difference between its Top and Base values. The Y cursors show the values being measured.

**Average**

Average is the sum of the waveform samples divided by the number of samples.

$$\text{Average} = \frac{\sum x_i}{n} \quad \begin{array}{l} \text{where } x_i = \text{value at } i\text{th point being measured} \\ n = \text{number of points in measurement interval} \end{array}$$

Which samples are measured depends on the **Interval** setting:

- **N Cycles** – the average value is measured on an integral number of periods of the displayed signal. If less than three edges are present, the measurement shows “No edges”.
- **Full Screen** – the average value is measured on all displayed data points.
- **Auto** – the measurement attempts to compute a value using the **N Cycles** interval. If less than three edges are present, the measurement is computed using the **Full Screen** interval.

The X cursors show what portion of the displayed waveform is being measured.

**Base**

The Base of a waveform is the mode (most common value) of the lower part of the waveform, or if the mode is not well defined, the base is the same as Minimum. The Y cursor shows the value being measured.

### Extinction Ratio

The extinction ratio is the ratio of the "logic one" level amplitude (V top) to the "logic zero" level amplitude (V base), in dB. That is, the extinction ratio is:  $10 \log(V_{\text{top}}/V_{\text{base}})$ .

### Maximum

Maximum is the highest value in the waveform display. The Y cursor shows the value being measured.

### Minimum

Minimum is the lowest value in the waveform display. The Y cursor shows the value being measured.

### Peak-Peak

The peak-to-peak value is the difference between Maximum and Minimum values. The Y cursors show the values being measured.

### Ratio

The Ratio measurement displays the ratio of the AC RMS voltages of two sources, expressed in dB. Press the **Settings** softkey to select the source channels for the measurement.

### RMS

RMS (DC) is the root-mean-square value of the waveform.

$$\text{RMS (dc)} = \sqrt{\frac{\sum_{i=1}^n x_i^2}{n}}$$

where  $x_i$  = value at  $i$ th point being measured  
 $n$  = number of points in measurement interval

Which samples are measured depends on the **Interval** setting:

- **N Cycles** – the RMS (DC) value is measured on an integral number of periods of the displayed signal. If less than three edges are present, the measurement shows “No edges”.
- **Full Screen** – the RMS (DC) value is measured on all displayed data points.
- **Auto** – the measurement attempts to compute a value using the **N Cycles** interval. If less than three edges are present, the measurement is computed using the **Full Screen** interval.

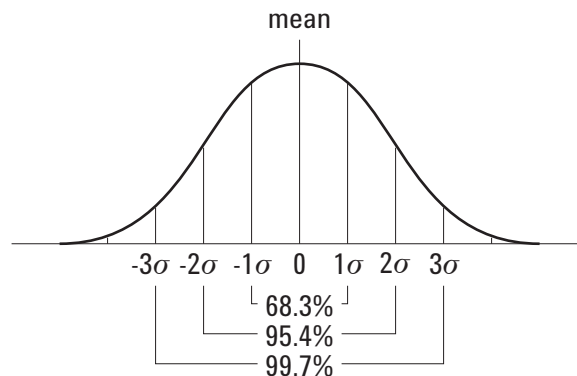
The X cursors show what interval of the waveform is being measured.

### Std Deviation

The Std Deviation measurement shows the standard deviation of the displayed voltage values. It is an RMS measurement across the full screen with the DC component removed. It is useful, for example, for measuring power supply noise.

The standard deviation of a measurement is the amount that a measurement varies from the mean value. The Mean value of a measurement is the statistical average of the measurement.

The following figure graphically shows the mean and standard deviation. Standard deviation is represented by the Greek letter sigma:  $\sigma$ . For a Gaussian distribution, two sigma ( $\pm 1\sigma$ ) from the mean, is where 68.3 percent of the measurement results reside. Six sigma ( $\pm 3\sigma$ ) from is where 99.7 percent of the measurement results reside.



The mean is calculated as follows:

$$\bar{x} = \frac{\sum_{i=1}^N x_i}{N}$$

where:

- $\bar{x}$  = the mean.
- N = the number of measurements taken.
- $x_i$  = the  $i^{\text{th}}$  measurement result.

The standard deviation is calculated as follows:

$$\sigma = \sqrt{\frac{\sum_{i=1}^N (x_i - \bar{x})^2}{N - 1}}$$

where:

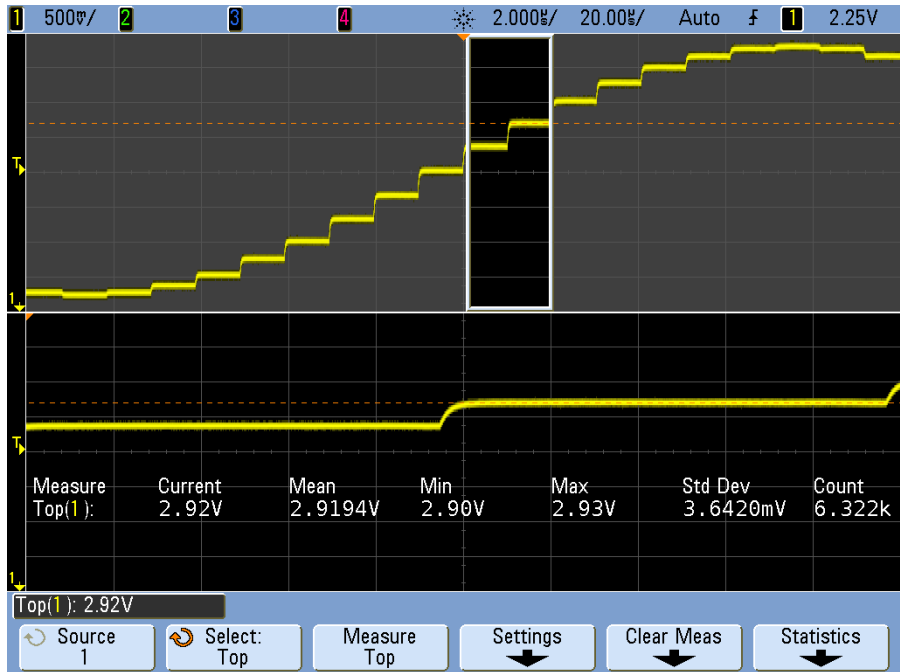
- $\sigma$  = the standard deviation.
- N = the number of measurements taken.
- $x_i$  = the  $i^{\text{th}}$  measurement result.
- $\bar{x}$  = the mean.

## Top

The Top of a waveform is the mode (most common value) of the upper part of the waveform, or if the mode is not well defined, the top is the same as Maximum. The Y cursor shows the value being measured.

**To isolate a pulse for Top measurement** The following figure shows how to use Zoom mode to isolate a pulse for a **Top** measurement.

**Figure 20** Isolating area for Top measurement



## Overshoot and Preshoot Measurements

### NOTE

#### Digital channel time measurements

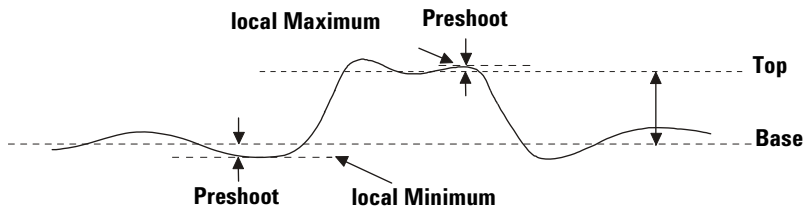
Automatic measurements **Preshoot** and **Overshoot** are not valid measurements for the math FFT function or for digital channels on the mixed-signal oscilloscope.

### Preshoot

Preshoot is distortion that precedes a major edge transition expressed as a percentage of Amplitude. The X cursors show which edge is being measured (edge closest to the trigger reference point).

$$\text{Rising edge preshoot} = \frac{\text{Base} - \text{D local Minimum}}{\text{Amplitude}} \times 100$$

$$\text{Falling edge preshoot} = \frac{\text{local Maximum} - \text{D Top}}{\text{Amplitude}} \times 100$$

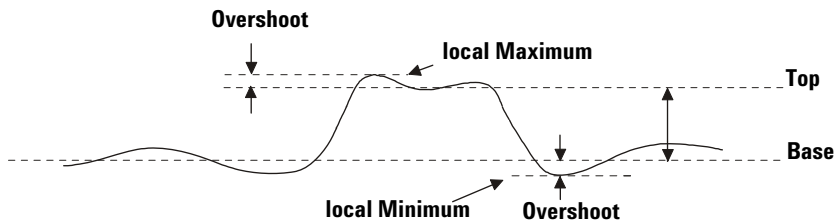


### Overshoot

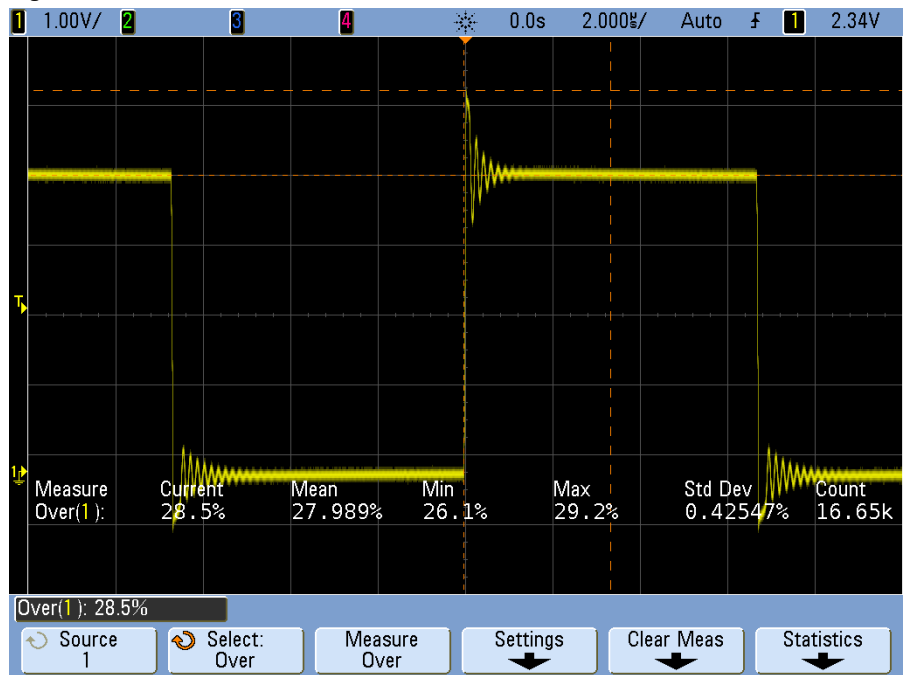
Overshoot is distortion that follows a major edge transition expressed as a percentage of Amplitude. The X cursors show which edge is being measured (edge closest to the trigger reference point).

$$\text{Rising edge overshoot} = \frac{\text{local Maximum} - \text{D Top}}{\text{Amplitude}} \times 100$$

$$\text{Falling edge overshoot} = \frac{\text{Base} - \text{D local Minimum}}{\text{Amplitude}} \times 100$$



**Figure 21** Automatic Overshoot measurement



**NOTE**

**Post Acquisition Processing**

In addition to changing display parameters after the acquisition, you can perform all of the measurements and math functions after the acquisition. Measurements and math functions will be recalculated as you pan and zoom and turn channels on and off. As you zoom in and out on a signal using the horizontal sweep speed knob and vertical volts/division knob, you affect the resolution of the display. Because measurements and math functions are performed on displayed data, you affect the resolution of functions and measurements.



## Cursor Measurements

Cursors are horizontal and vertical markers that indicate X-axis values (usually time) and Y-axis values (usually voltage) on a selected waveform source. You can use cursors to make custom voltage or time measurements on oscilloscope signals, and timing measurements on digital channels. Cursor information is displayed on the line above the softkeys and in the softkey menu area.

Cursors are not always limited to the visible display. If you set a cursor, then pan and zoom the waveform until the cursor is off screen, its value will not be changed. It will still be there when you return to its original location.

X cursors are vertical dashed lines that adjust horizontally and normally indicate time relative to the trigger point. When used with the FFT math function as a source, the X cursors indicate frequency.

The X1 cursor (short-dashed vertical line) and X2 cursor (long-dashed vertical line) adjust horizontally and indicate time relative to the trigger point for all sources except math FFT (where frequency is indicated).

In XY horizontal mode, the X cursors display channel 1 values (Volts or Amps).

The X1 and X2 cursor values for the selected waveform source are displayed in the softkey menu area.

The difference between X1 and X2 ( $\Delta X$ ) and  $1/\Delta X$  are displayed on the dedicated line above the softkeys or in the display area when some menus are selected.

Y cursors are horizontal dashed lines that adjust vertically and normally indicate Volts or Amps, dependent on the channel **Probe Units** setting. When math functions are used as a source, the measurement units correspond to that math function.

The Y1 cursor (short-dashed horizontal line) and Y2 cursor (long-dashed horizontal line) adjust vertically and indicate values relative to the waveform's ground point, except math FFT where the values are relative to 0 dB.

In XY horizontal mode, the Y cursors display channel 2 values (Volts or Amps).

When active, the Y1 and Y2 cursor values for the selected waveform source are displayed in the softkey menu area.

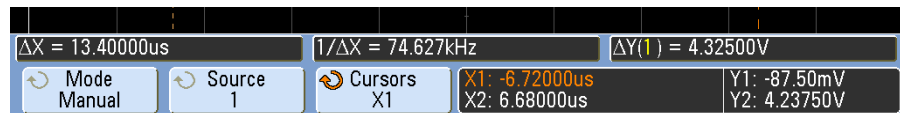
The difference between Y1 and Y2 ( $\Delta Y$ ) is displayed on the dedicated line above the softkeys or in the display area when some menus are selected.

## To make cursor measurements

### NOTE

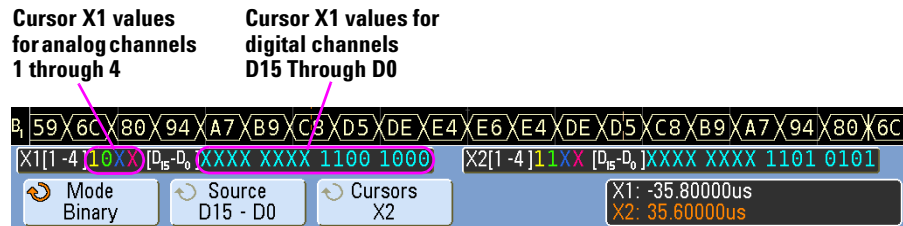
If you intend to make cursor measurements on a trace that you recall from memory, be sure to recall both setup and trace. See [“To recall waveform trace and/or oscilloscope setup”](#) on page 216.

- 1 Connect a signal to the oscilloscope and obtain a stable display.
- 2 Press the **[Cursors]** key. The key will illuminate, indicating that cursors are “on”. (Press the key again when you want to turn cursors off.)
- 3 In the Cursors Menu, press **Mode**; then, select the desired mode:
  - **Manual** –  $\Delta X$ ,  $1/\Delta X$ , and  $\Delta Y$  values are displayed.  $\Delta X$  is the difference between the X1 and X2 cursors and  $\Delta Y$  is the difference between the Y1 and Y2 cursors.

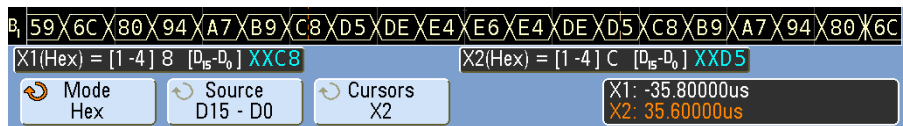


- **Track Waveform** – As you move a marker horizontally, the vertical amplitude of the waveform is tracked and measured. At the bottom of the display, the time and voltage positions are shown for the markers. The vertical (Y) and horizontal (X) differences between the markers are shown as  $\Delta X$  and  $\Delta Y$  values.

- **Binary** – Logic levels of displayed waveforms at the current X1 and X2 cursor positions are displayed above the softkeys in binary. The display is color coded to match the color of the related channel's waveform.



- **Hex** – Logic levels of displayed waveforms at the current X1 and X2 cursor positions are displayed above the softkeys in hexadecimal.



**Manual** and **Track Waveform** modes can be used on waveforms that are displayed on the analog input channels (including math functions).

**Binary** and **Hex** modes apply to digital signals (of MSO oscilloscope models).

In **Hex** and **Binary** modes, a level can be displayed as 1 (higher than trigger level), 0 (lower than trigger level), indeterminate state ( $\updownarrow$ ), or X (don't care).

In **Binary** mode, X is displayed if the channel is turned off.

In **Hex** mode, the channel is interpreted as 0 if turned off.

- 4 Press **Source** (or **X1 Source**, **X2 Source** in the **Track Waveform** mode); then, select the input source for cursor values.
- 5 Select the cursor(s) to be adjusted:
  - Press the **Cursors** softkey; then, turn the Entry knob.

Or:

  - Push the Cursors knob; then, turn the Cursors knob. To finalize your selection, either push the Cursors knob again or wait a couple seconds for the popup menu to disappear.

## 5 Measurements and Math Functions

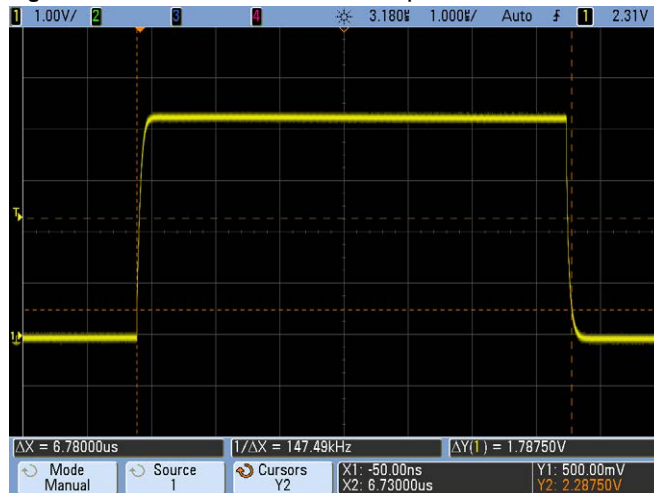
The **X1 X2 linked** and **Y1 Y2 linked** selections let you adjust both cursors at the same time, while the delta value remains the same. This can be useful, for example, for checking pulse width variations in a pulse train.

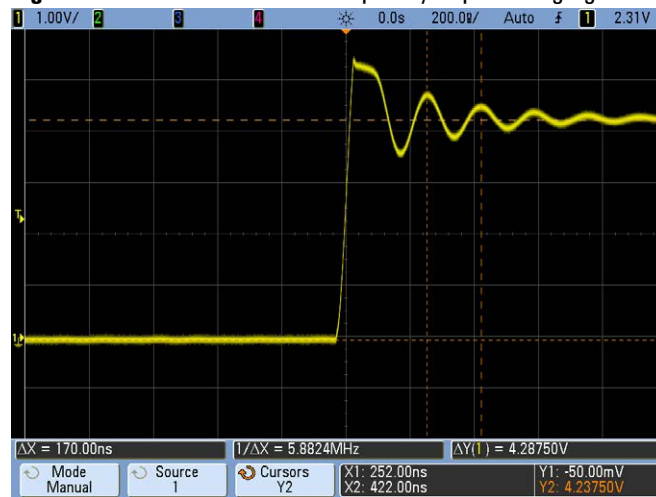
The currently selected cursor(s) display brighter than the other cursors.

- 6 Adjust the selected cursor(s) by turning the Cursors knob.

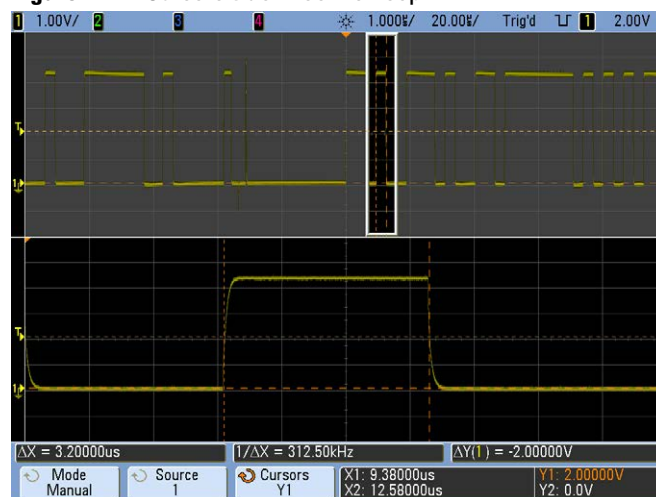
## Cursor Examples

**Figure 22** Cursors used to measure pulse widths other than middle threshold points



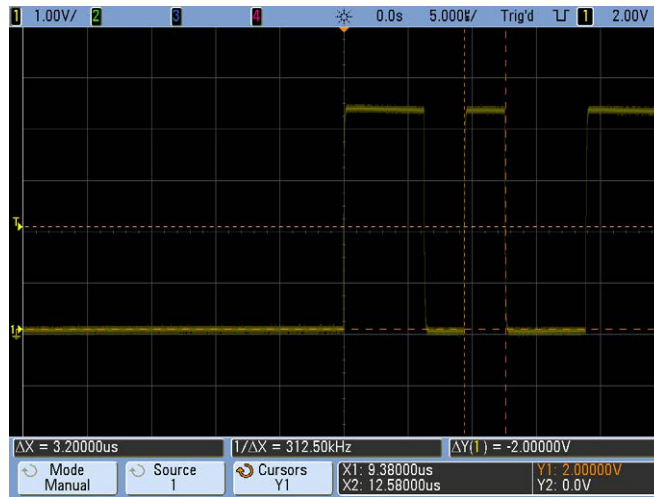
**Figure 23** Cursors measure frequency of pulse ringing

Expand the display with Zoom mode, then characterize the event of interest with the cursors.

**Figure 24** Cursors track Zoom sweep

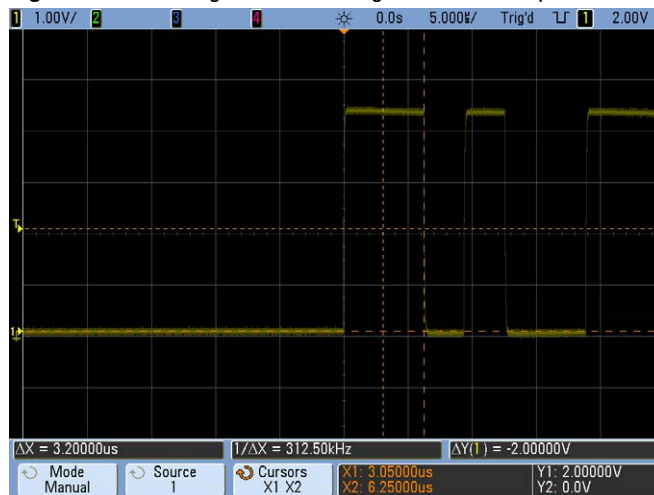
Put the **X1** cursor on one side of a pulse and the **X2** cursor on the other side of the pulse.

**Figure 25** Measuring pulse width with cursors



Press the **X1 X2 linked** softkey and move the cursors together to check for pulse width variations in a pulse train.

**Figure 26** Moving the cursors together to check pulse width variations



## Math Functions

Math functions can be performed on analog channels. The resulting math waveform is displayed in light purple.

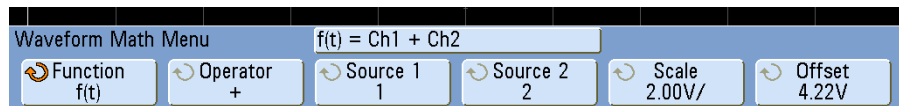
You can use a math function on a channel even if you choose not to display the channel on-screen.

You can:

- Perform an arithmetic operation (add, subtract, or multiply) on channels 1 and 2 *or* on channels 3 and 4.
- Perform a function (differentiate, integrate, FFT, or square root) on the signal acquired on an analog channel.
- Perform a function on the result of an arithmetic operation.

### To use waveform math

- 1 Press the [**Math**] key on the front panel to display the Waveform Math Menu.



- 2 If **f(t)** is not already shown on the **Function** softkey, press the **Function** softkey and select **f(t): Displayed**.
- 3 Use the **Operator** softkey to select an operator.
- 4 Use the **Source 1** softkey to select the analog channel on which to perform math. You can rotate the Entry knob or repetitively press the **Source 1** softkey to make your selection. If you choose a function (differentiate, integrate, FFT, or square root) the result is displayed.
- 5 If you select an arithmetic operator, use the **Source 2** softkey to select the second source for the arithmetic operation. The result is displayed.
- 6 Use the multiplexed scale and position knobs, or the **Scale** and **Offset** softkeys, to re-size and re-position the math waveform.

## To perform a math function upon an arithmetic operation

To perform a function (differentiate, integrate, FFT, or square root) on an arithmetic operation (add, subtract, or multiply):

- 1 Press the **Function** softkey and select **g(t): Internal**.
- 2 Use the **Operator, Source 1, and Source 2** softkeys to set up an arithmetic operation.
- 3 Press the **Function** softkey and select **f(t): Displayed**.
- 4 Use the **Operator** softkey to select a function (differential, integral, FFT, or square root).
- 5 Press the **Source 1** softkey and select **g(t)** as the source. Note that **g(t)** is only available when you select a function in the previous step.

### NOTE

#### Math Operating Hints

If the analog channel or math function is clipped (not fully displayed on screen) the resulting displayed math function will also be clipped.

Once the function is displayed, the analog channel(s) may be turned off for better viewing of the math waveform.

The vertical scaling and offset of each math function can be adjusted for ease of viewing and measurement considerations.

The math function waveform can be measured using [**Cursors**] and/or [**Meas**].

## Math scale and offset

Any math function may be manually scaled by pressing the **Scale** or **Offset** softkeys and adjusting the value.



**NOTE****Math Scale and Offset are Set Automatically**

Any time the currently displayed math function definition is changed, the function is automatically scaled for optimum vertical scale and offset. If you manually set scale and offset for a function, select a new function, then select the original function, the original function will be automatically rescaled.

- 1 In the Waveform Math Menu, press the **Scale** or **Offset** softkeys to set your own scale factors (units/division) or offset (units) for the selected math function. The **Function** softkey must be set to **f(t): Displayed** in order to set scale and offset.
- 2 Press the **Scale** or **Offset** softkey, then turn the Entry knob to rescale or change the offset value for your math function.

## Units

Units for each input channel can be set to Volts or Amps using the **Units** softkey in the channel's Probe Menu. Scale and offset units are:

Math function	Units
add or subtract	V or A
multiply	$V^2$ , $A^2$ , or W (Volt-Amp)
d/dt	V/s or A/s (V/second or A/second)
$\int dt$	Vs or As (V-seconds or A-seconds)
FFT	dB* (decibels)
$\sqrt{\quad}$ (square root)	$V^{1/2}$ , $A^{1/2}$ , or $W^{1/2}$ (Volt-Amp)

\* When the FFT source is channel 1, 2, 3 or 4, FFT units will be displayed in dBV when channel units is set to Volts and channel impedance is set to 1 M $\Omega$ . FFT units will be displayed in dBm when channel units is set to Volts and channel impedance is set to 50 $\Omega$ . FFT units will be displayed as dB for all other FFT sources or when a source channel's units has been set to Amps.

## 5 Measurements and Math Functions

A scale unit of **U** (undefined) will be displayed for math functions when two source channels are used and they are set to dissimilar units and the combination of units cannot be resolved.

## Multiply

When you select the multiply math function, the voltage values of the channel chosen in **Source 1** are multiplied point by point by the voltage values of the channel chosen in **Source 2**, and the result is displayed. Multiply is useful for seeing power relationships when one of the channels is proportional to the current.

Example: Multiply channel 1 by channel 2

- **Scale** – lets you set your own vertical scale factors for multiply expressed as  $V^2/\text{div}$  (Volts-squared/division),  $A^2/\text{div}$  (Amps-squared/division), or  $W/\text{div}$  (Watts/division or Volt-Amps/division). Units are set in the channel Probe Menu. Press the **Scale** softkey, then turn the Entry knob to rescale the math waveform.
- **Offset** – lets you set your own offset for the multiply math function. The offset value is in  $V^2$  (Volts-squared),  $A^2$  (Amps-squared), or  $W$  (Watts) and is represented by the center horizontal grid line of the display. Press the **Offset** softkey, then turn the Entry knob to change the offset for the math waveform.

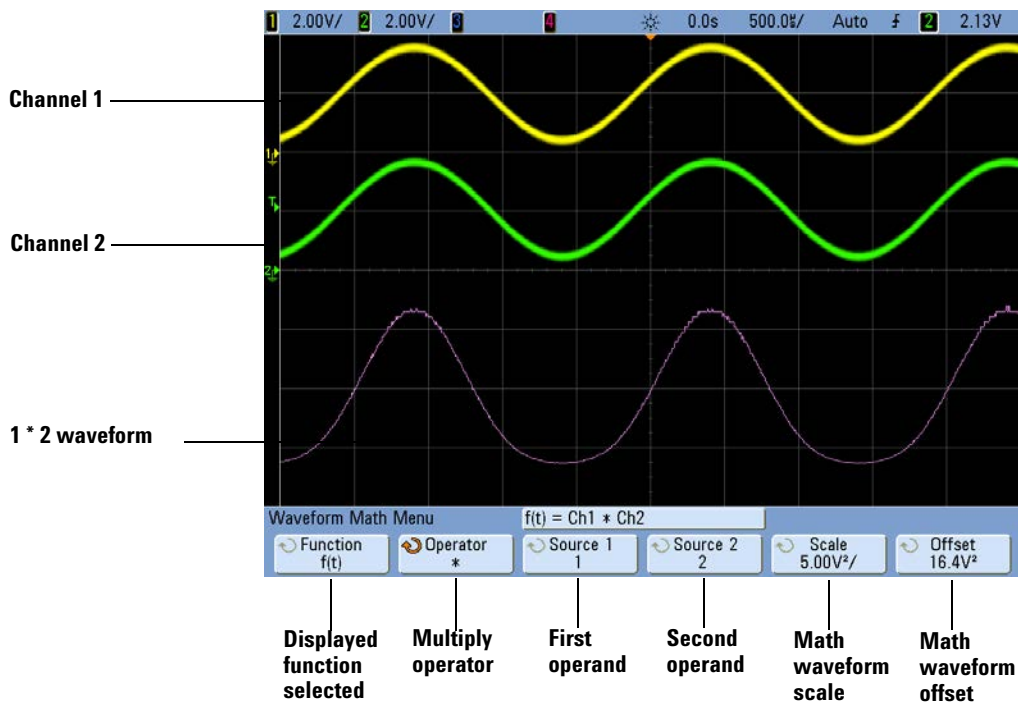


Figure 27 Example of Multiply

## Add or Subtract

When you select add or subtract, the **Source 1** and **Source 2** channel voltage values are added or subtracted point by point, and the result is displayed.

You can use subtract to make a differential measurement or to compare two waveforms. If your waveforms' DC offsets are larger than the dynamic range of the oscilloscope's input channels you will need to use a differential probe instead.

Example: Subtract channel 2 from channel 1

- **Scale** – lets you set your own vertical scale factors for subtract, expressed as V/div (Volts/division) or A/div (Amps/division). Press the **Scale** softkey, then turn the Entry knob to rescale. Units are set in the channel Probe Menu.
- **Offset** – lets you set your own offset for the math function. The offset value is in Volts or Amps and is represented by the center horizontal grid line of the display. Press the **Offset** softkey, then turn the Entry knob to change the offset of the math waveform.
- A scale unit of **U** (undefined) will be displayed for scale and offset if the two source channels are set to dissimilar units. Units are set using the channel's **Probe Units** softkey.

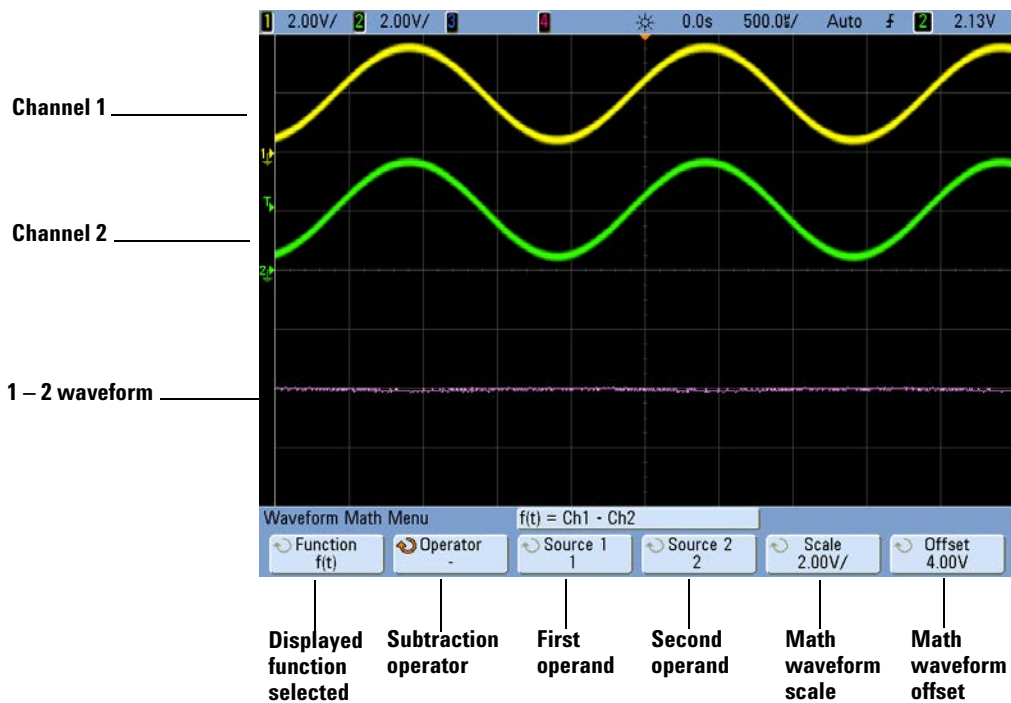


Figure 28 Example of Subtract

## Differentiate

**d/dt** (differentiate) calculates the discrete time derivative of the selected source. You can use differentiate to measure the instantaneous slope of a waveform. For example, the slew rate of an operational amplifier may be measured using the differentiate function.

Because differentiation is very sensitive to noise, it is helpful to set acquisition mode to **Averaging** in the Acquire Menu.

**d/dt** plots the derivative of the selected source using the “average slope estimate at 4 points” formula. The equation is:

$$d_i = \frac{y_{i+4} + 2y_{i+2} - 2y_{i-2} - y_{i-4}}{8\Delta t}$$

Where

d = differential waveform

y = channel 1, 2, 3, or 4, or g(t) (internal arithmetic operation) data points

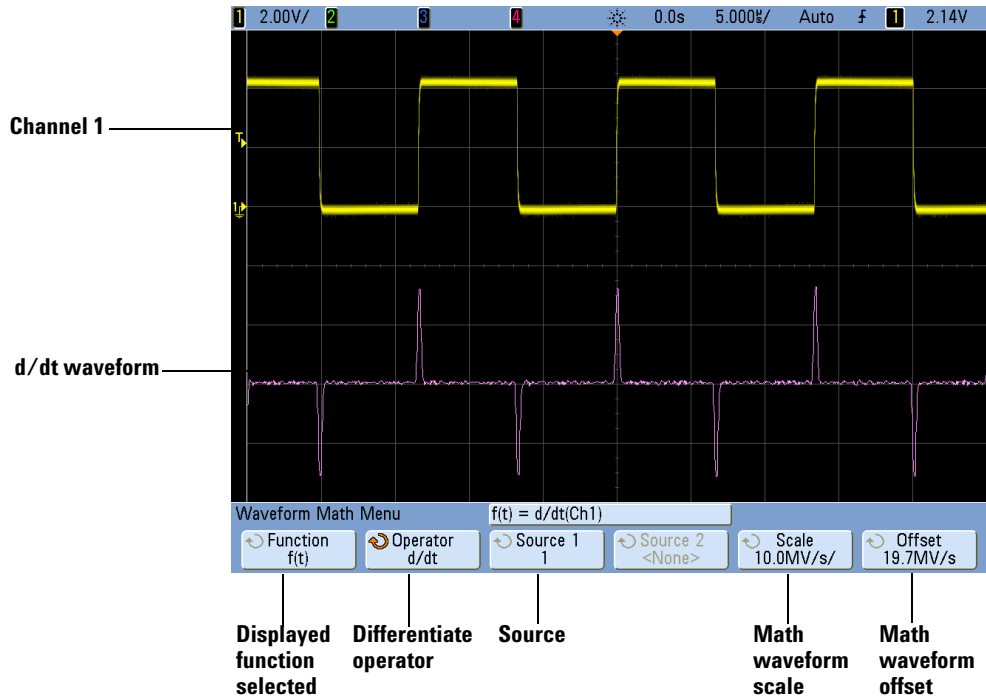
i = data point index

$\Delta t$  = point-to-point time difference

- 1 Press the **[Math]** key, press the **Function** softkey and select **f(t)**, press the **Operator** softkey and select **d/dt**. Press the **Source**, **Scale**, or **Offset** softkeys if you want to change the source, scaling, or offset for the differentiate function.
  - **Source** – selects the source for d/dt. (See [page 184](#) for information about using **g(t)** as the source.)
  - **Scale** – lets you set your own vertical scale factors for d/dt expressed in units/second/division, where units can be V (Volts), A (Amps), or W (Watts). Units are set in the channel Probe Menu. Press the **Scale** softkey, then turn the Entry knob to rescale d/dt.
  - **Offset** –lets you set your own offset for the dV/dt math function. The offset value is in units/second where units can be V (Volts), A (Amps), or W (Watts) and is represented by the center horizontal grid line of the display. Press the **Offset** softkey, then turn the Entry knob to change the offset for d/dt.

## 5 Measurements and Math Functions

A scale unit of **U** (undefined) will be displayed for scale and offset if the two source channels are set to dissimilar units. Units are set using the channel's **Probe Units** softkey.



**Figure 29** Example of Differentiate Function



# Integrate

$\int dt$  (integrate) calculates the integral of the selected source. You can use integrate to calculate the energy of a pulse in volt-seconds or measure the area under a waveform.

$\int dt$  plots the integral of the source using the “Trapezoidal Rule”. The equation is:

$$I_n = c_o + \Delta t \sum_{i=0}^n y_i$$

Where

I = integrated waveform

$\Delta t$  = point-to-point time difference

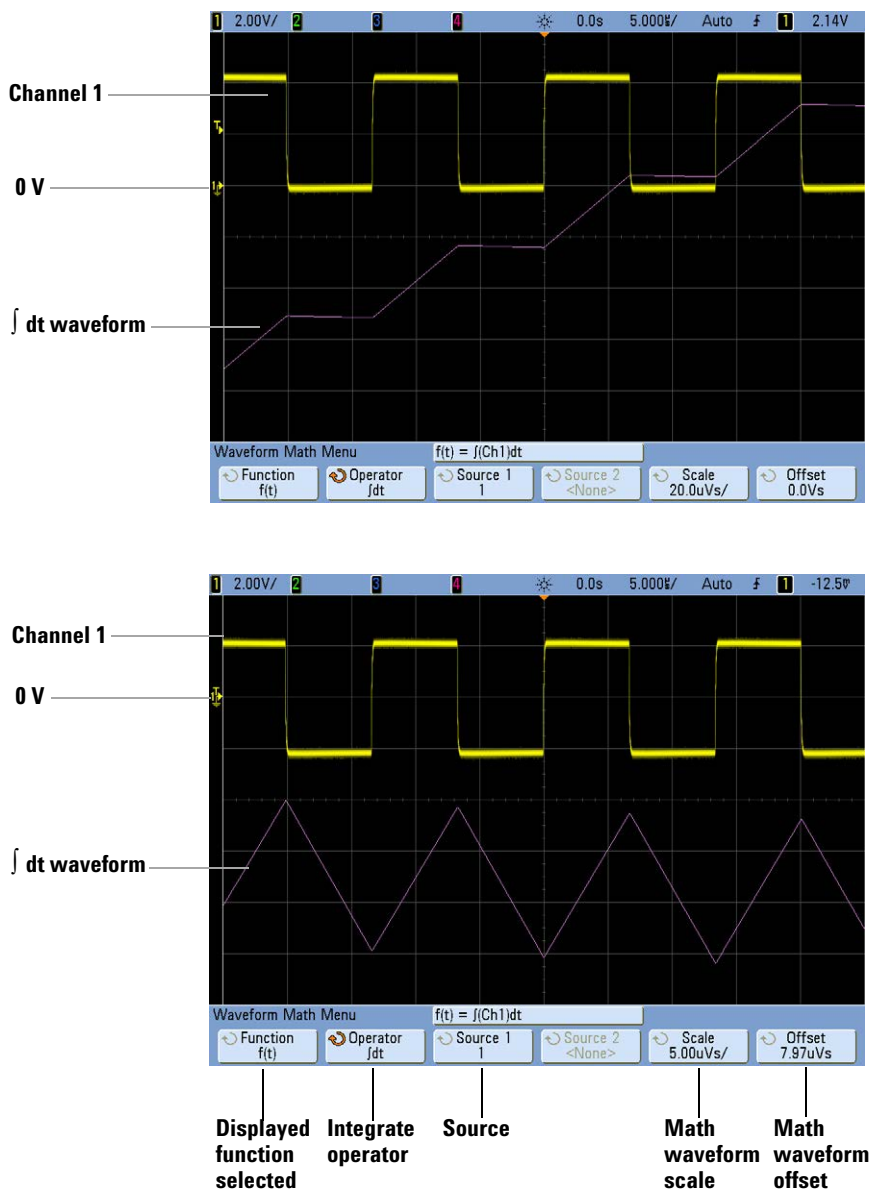
y = channel 1, 2, 3, or 4, or g(t) (internal arithmetic operation)

$c_o$  = arbitrary constant

i = data point index

- 1 Press the **[Math]** key, press the **Function** softkey and select **f(t)**, press the **Operator** softkey and select  $\int dt$ . Press the **Source**, **Scale**, or **Offset** softkeys if you want to change the source, scaling, or offset for the differentiate function.
  - **Source** – selects the source for  $\int dt$ . (See [page 184](#) for information about using **g(t)** as the source.)
  - **Scale** – lets you set your own vertical scale factors for  $\int dt$  expressed in unit-seconds/division, where units can be V (Volts), A (Amps), or W (Watts). Units are set in the channel Probe Menu. Press the **Scale** softkey, then turn the Entry knob to rescale  $\int dt$ .
  - **Offset** – lets you set your own offset for the  $\int Vdt$  math function. The offset value is in unit-seconds where units can be V (Volts), A (Amps), or W (Watts) and is represented by the center horizontal grid line of the display. Press the **Offset** softkey, then turn the Entry knob to change the offset for  $\int dt$ . The integrate calculation is relative to the source signal’s offset. The following examples illustrate the effects of signal offset.

## 5 Measurements and Math Functions



**Figure 30** Integrate and Signal Offset

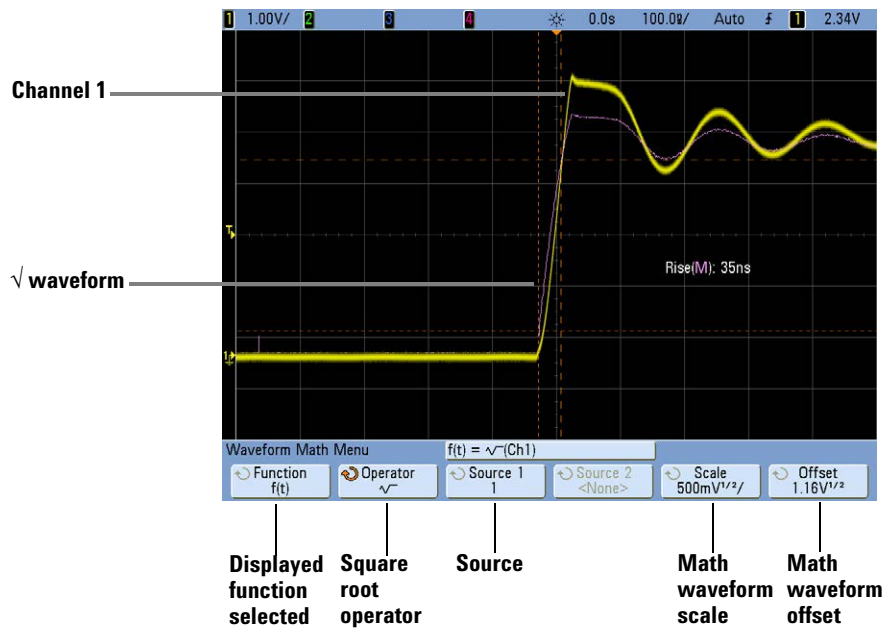
## Square Root

Square root ( $\sqrt{\quad}$ ) calculates the square root of the selected source.

- 1 Press the **[Math]** key, press the **Function** softkey and select **f(t)**, press the **Operator** softkey and select  $\sqrt{\quad}$  (square root). Press the **Source 1**, **Scale**, or **Offset** softkeys if you want to change the source, scaling, or offset for the square root function.
  - **Source 1** – selects the source for  $\sqrt{\quad}$  (square root). (See [page 184](#) for information about using **g(t)** as the source.)
  - **Scale** – lets you set your own vertical scale factors for  $\sqrt{\quad}$  (square root) expressed as  $V^{1/2}/\text{div}$  (Volts-square-root/division),  $A^{1/2}/\text{div}$  (Amps-square-root/division), or  $W^{1/2}/\text{div}$  (Watts-square-root/division or Volt-Amps-square-root/division). Units are set in the channel Probe Menu. Press the **Scale** softkey, then turn the Entry knob to rescale  $\sqrt{\quad}$  (square root).
  - **Offset** – lets you set your own offset for the multiply math function. The offset value is in  $V^{1/2}$  (Volts-square-root),  $A^{1/2}$  (Amps-square-root), or  $W^{1/2}$  (Watts-square-root) and is represented by the center horizontal grid line of the display. Press the **Offset** softkey, then turn the Entry knob to change the offset for  $\sqrt{\quad}$  (square root).

A scale unit of **U** (undefined) will be displayed for scale and offset if the two source channels are set to dissimilar units. Units are set using the channel's **Probe Units** softkey.

## 5 Measurements and Math Functions



**Figure 31** Example of  $\sqrt{\phantom{x}}$  (Square Root)

## FFT Measurement

FFT is used to compute the fast Fourier transform using analog input channels or an arithmetic operation  $g(t)$ . FFT takes the digitized time record of the specified source and transforms it to the frequency domain. When the FFT function is selected, the FFT spectrum is plotted on the oscilloscope display as magnitude in dBV versus frequency. The readout for the horizontal axis changes from time to frequency (Hertz) and the vertical readout changes from volts to dB.

Use the FFT function to find crosstalk problems, to find distortion problems in analog waveforms caused by amplifier non-linearity, or for adjusting analog filters.

### FFT Units

0 dBV is the amplitude of a 1 V<sub>rms</sub> sinusoid. When the FFT source is channel 1 or channel 2 (or channel 3 or 4 on 4-channel models), FFT units will be displayed in dBV when channel units is set to Volts and channel impedance is set to 1 M $\Omega$ .

FFT units will be displayed in dBm when channel units is set to Volts and channel impedance is set to 50 $\Omega$ .

FFT units will be displayed as dB for all other FFT sources or when a source channel's units has been set to Amps.

### DC Value

The FFT computation produces a DC value that is incorrect. It does not take the offset at center screen into account. The DC value is not corrected in order to accurately represent frequency components near DC.

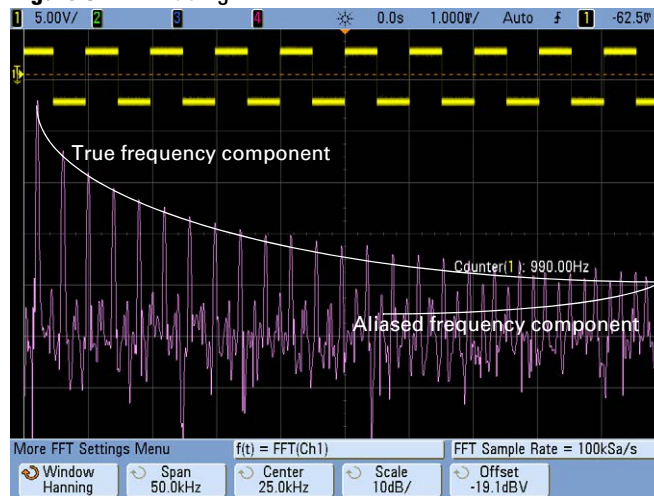
### Aliasing

When using FFTs, it is important to be aware of frequency aliasing. This requires that the operator have some knowledge as to what the frequency domain should contain, and also consider the sampling rate, frequency span, and oscilloscope vertical bandwidth when making FFT measurements. The FFT sample rate is displayed directly above the softkeys when the FFT Menu is displayed.

Aliasing happens when there are frequency components in the signal higher than half the sample rate. Since the FFT spectrum is limited by this frequency, any higher components are displayed at a lower (aliased) frequency.

The following figure illustrates aliasing. This is the spectrum of a 990 Hz square wave, which has many harmonics. The FFT sample rate is set to 100 kSa/s, and the oscilloscope displays the spectrum. The displayed waveform shows the components of the input signal above the Nyquist frequency to be mirrored (aliased) on the display and reflected off the right edge.

**Figure 32** Aliasing



Since the frequency span goes from  $\approx 0$  to the Nyquist frequency, the best way to prevent aliasing is to make sure that the frequency span is greater than the frequencies of significant energy present in the input signal.

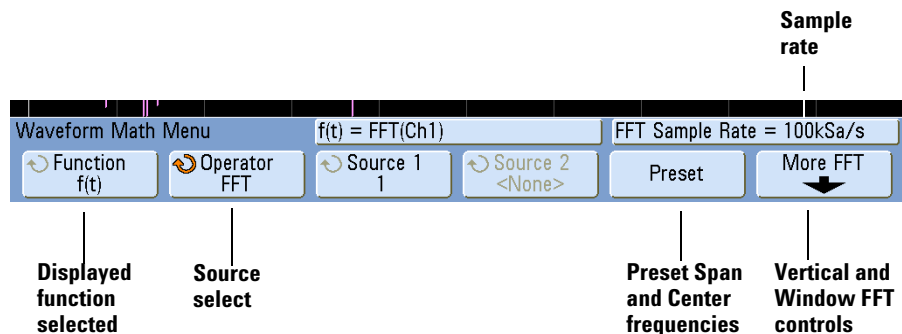
### Spectral Leakage

The FFT operation assumes that the time record repeats. Unless there is an integral number of cycles of the sampled waveform in the record, a discontinuity is created at the end of the record. This is referred to as leakage. In order to minimize spectral leakage, windows that approach zero smoothly at the beginning and end of the signal are employed as filters to the FFT. The FFT Menu provides four windows: Hanning, flattop,

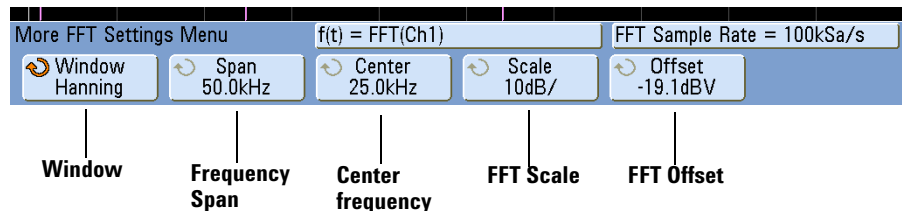
rectangular, and Blackman-Harris. For more information on leakage, see Agilent Application Note 243, “The Fundamentals of Signal Analysis” at <http://cp.literature.agilent.com/litweb/pdf/5952-8898E.pdf>.

## FFT Operation

- 1 Press the **[Math]** key, press the **Function** softkey and select **f(t)**, press the **Operator** softkey and select **FFT**.



- **Source 1** – selects the source for the FFT. (See [page 184](#) for information about using **g(t)** as the source.)
  - **Preset** – sets the frequency Span and Center to values that will cause the entire available spectrum to be displayed. The maximum available frequency is half the effective FFT sample rate, which is a function of the time per division setting. The current FFT sample rate is displayed above the softkeys.
  - **More FFT** – displays the More FFT Settings Menu.
- 2 Press the More FFT softkey to display additional FFT settings.



- **Window** – selects a window to apply to your FFT input signal:

- **Hanning** – window for making accurate frequency measurements or for resolving two frequencies that are close together.
- **Flat Top** – window for making accurate amplitude measurements of frequency peaks.
- **Rectangular** – good frequency resolution and amplitude accuracy, but use only where there will be no leakage effects. Use on self-windowing waveforms such as pseudo-random noise, impulses, sine bursts, and decaying sinusoids.
- **Blackman Harris** – window reduces time resolution compared to a rectangular window, but improves the capacity to detect smaller impulses due to lower secondary lobes.
- **Span** – sets the overall width of the FFT spectrum that you see on the display (left to right). Divide span by 10 to calculate the number of Hertz per division. It is possible to set Span above the maximum available frequency, in which case the displayed spectrum will not take up the whole screen. Press the **Span** softkey, then turn the Entry knob to set the desired frequency span of the display.
- **Center** – sets the FFT spectrum frequency represented at the center vertical grid line of the display. It is possible to set the Center to values below half the span or above the maximum available frequency, in which case the displayed spectrum will not take up the whole screen. Press the **Center** softkey, then turn the Entry knob to set the desired center frequency of the display.
- **Scale** – lets you set your own vertical scale factors for FFT expressed in dB/div (decibels/division). Press the **Scale** softkey, then turn the Entry knob to rescale your math function.
- **Offset** – lets you set your own offset for the FFT. The offset value is in dB and is represented by the center horizontal grid line of the display. Press the **Offset** softkey, then turn the Entry knob to change the offset of your math function.



**NOTE****Scale and offset considerations**

If you do not manually change the FFT scale or offset settings, when you turn the horizontal sweep speed knob, the span and center frequency settings will automatically change to allow optimum viewing of the full spectrum. If you do manually set scale or offset, turning the sweep speed knob will not change the span or center frequency settings, allowing you see better detail around a specific frequency. Pressing the FFT **Preset** softkey will automatically rescale the waveform and span and center will again automatically track the horizontal sweep speed setting.

- 3 To make cursors measurements, press the [**Cursors**] key and set the **Source** softkey to **Math: f(t)**.

Use the X1 and X2 cursors to measure frequency values and difference between two frequency values ( $\Delta X$ ). Use the Y1 and Y2 cursors to measure amplitude in dB and difference in amplitude ( $\Delta Y$ ).

- 4 To make other measurements, press the [**Meas**] key and set the **Source** softkey to **Math: f(t)**.

You can make peak-to-peak, maximum, minimum, and average dB measurements on the FFT waveform. You can also find the frequency value at the first occurrence of the waveform maximum by using the X at Max Y measurement.

The following FFT spectrum was obtained by connecting the front panel Probe Comp signal (approximately 1.2 kHz square wave) to channel 1. Set sweep speed to 5 ms/div, vertical sensitivity to 500 mV/div, Units/div to 10 dBV, Offset to -34.0 dBV, Center frequency to 5.00 kHz, frequency Span to 10.0 kHz, and window to Hanning.



### FFT Measurement Hints

The number of points acquired for the FFT record is 1000 and when frequency span is at maximum, all points are displayed. Once the FFT spectrum is displayed, the frequency span and center frequency controls are used much like the controls of a spectrum analyzer to examine the frequency of interest in greater detail. Place the desired part of the waveform at the center of the screen and decrease frequency span to increase the display resolution. As frequency span is decreased, the number of points shown is reduced, and the display is magnified.

While the FFT spectrum is displayed, use the **[Math]** and **[Cursors]** keys to switch between measurement functions and frequency domain controls in FFT Menu.

Decreasing the effective sampling rate by selecting a slower sweep speed will increase the low frequency resolution of the FFT display and also increase the chance that an alias will be displayed. The resolution of the FFT is the effective sample rate divided by the number of points in the FFT. The actual resolution of the display will not be this fine as the shape of the window will be the actual limiting factor in the FFT's ability to resolve two closely spaced frequencies. A good way to test the ability of the FFT to resolve two closely spaced frequencies is to examine the sidebands of an amplitude modulated sine wave.

For the best vertical accuracy on peak measurements:

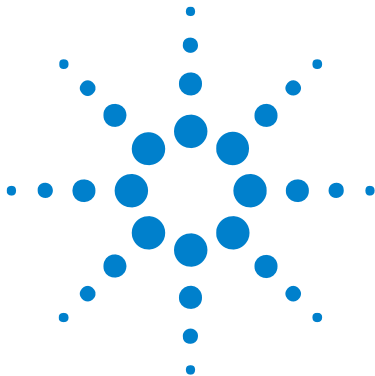
- Make sure the probe attenuation is set correctly. The probe attenuation is set from the Channel Menu if the operand is a channel.
- Set the source sensitivity so that the input signal is near full screen, but not clipped.
- Use the Flat Top window.
- Set the FFT sensitivity to a sensitive range, such as 2 dB/division.

For best frequency accuracy on peaks:

- Use the Hanning window.
- Use Cursors to place an X cursor on the frequency of interest.
- Adjust frequency span for better cursor placement.
- Return to the Cursors Menu to fine tune the X cursor.

For more information on the use of FFTs please refer to Agilent Application Note 243, "The Fundamentals of Signal Analysis" at <http://cp.literature.agilent.com/litweb/pdf/5952-8898E.pdf>. Additional information can be obtained from Chapter 4 of the book "Spectrum and Network Measurements" by Robert A. Witte.





## 6 Saving, Recalling, and Printing

Saving and Recalling Data [206](#)

Printing Screens [220](#)



## Saving and Recalling Data

Here are a few points about saving oscilloscope data:

- You can save a waveform trace and recall it later. The recalled trace appears in cyan (blue).
- You can save oscilloscope setup parameters and recall them later. The setup file stores settings such as horizontal timebase, vertical sensitivity, trigger mode, trigger level, measurements, cursors, and math functions. This lets you easily and consistently set up the oscilloscope to make a particular measurement.
- There is a distinction between print and save: print always refers to printing the display to a printer. Save means saving data to a USB mass storage device or the oscilloscope's internal memory.

The following table shows types of data and where the data can be saved.

**Table 5** Saving Oscilloscope Data

Type of Data	Can be saved to:	
	USB device	Oscilloscope's internal memory
Oscilloscope setup and waveform trace	Yes	Yes*
Display image and waveform data files (BMP, PNG, CSV, ASCII XY, ALB, BIN)	Yes	No
*If Secure Environment Mode option is installed then data is prevented from being stored in the oscilloscope's internal memory.		

### NOTE

You can also save the oscilloscope's display image using a web browser. See "[Get Image](#)" on page 250 for details.

## Selecting a Destination for Your Saved Data

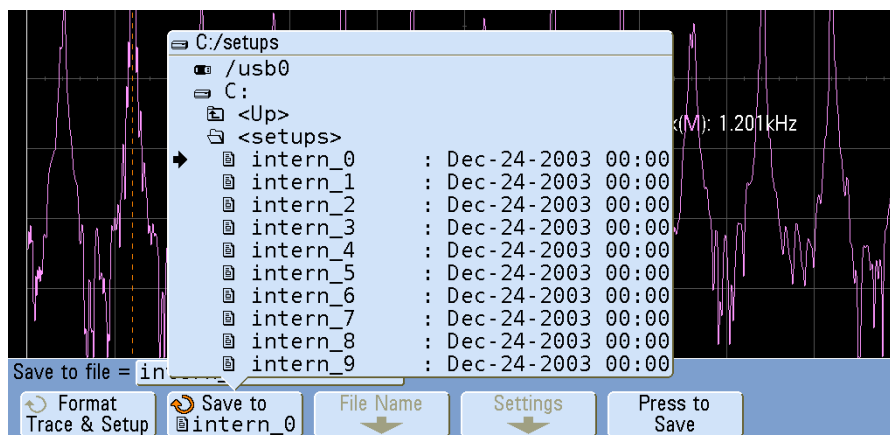
Press [**Save/Recall**] > **Save** to access the Save Menu and select a destination for saving your data.

**Press to go/Location/Save to softkey (Using the oscilloscope's File Explorer)**

The second softkey from the left in the Save Menu is the file explorer softkey.

If no USB mass storage device is connected to the oscilloscope, you will only be able to save Trace and Setup files to the oscilloscope's internal memory. You will not be able to save display image files or waveform data files as described on [page 210](#) unless a USB mass storage device is connected.

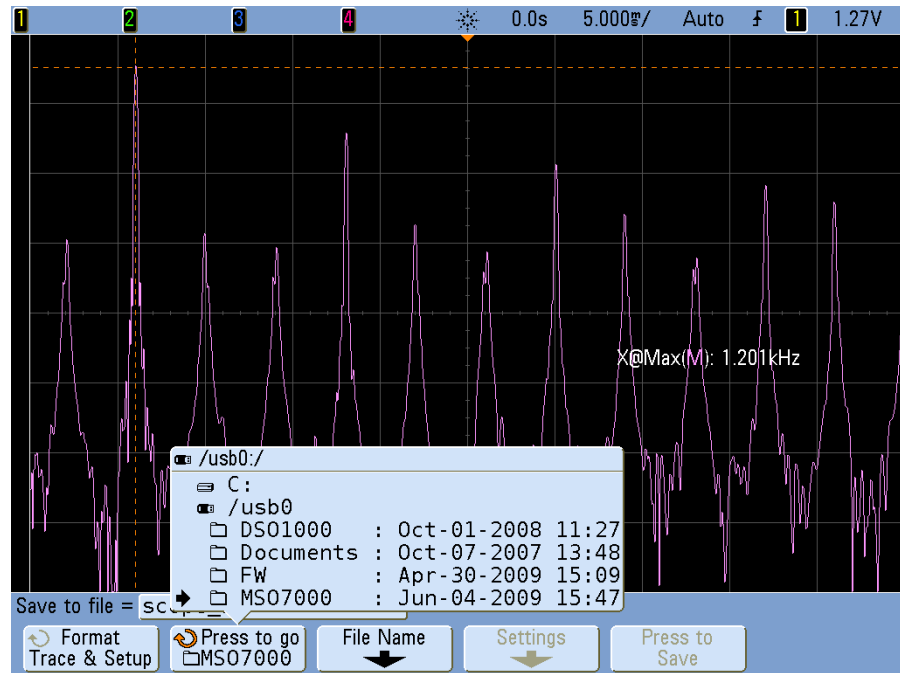
Rotate the Entry knob to align the selection arrow with “C:” and push the Entry knob to select it. Then rotate and push the Entry knob to select the “setups” directory, then select a file (**intern\_n**) to be overwritten.

**NOTE**

The File Explorer in the Save and Recall Menus can be used to save the following file types: oscilloscope setup, waveform trace, display image and waveform data. It can be used to recall oscilloscope setup and waveform trace files.

The **File Explorer** in the Utility Menu can be used for loading files into the oscilloscope or deleting files.

If one or more USB mass storage devices are connected to the oscilloscope, you can navigate to the USB device using the same method. The following display image shows an image ready to be saved to a subfolder called “MSO7000” on a USB mass storage device. Push the Entry knob to save the image.



## Selecting a File Name

### Overwriting a file

You can choose to overwrite an existing file name by browsing to that file and selecting it, then choosing **Press to Save**.



### Creating a new file name

- 1 Press the **File Name** softkey in the Save Menu. (You must have a USB mass storage device connected to the oscilloscope for this softkey to be active.)
- 2 Repeatedly turn and push the Entry knob to select letters and numbers for the new file name. Or, you can press the **Spell** softkey and press the **Enter** softkey to create the new file name.
- 3 You can press the **Enter** softkey or the Entry knob to move the cursor forward within the file name.
- 4 You can press the **Delete Character** softkey to delete the current character and shift the rest of the characters to the left.
- 5 When you select the **Auto Increment** option, the oscilloscope will add a numeric suffix to your file name, and increment the number with each successive save. It will truncate characters as necessary when the file name length is at maximum and more digits are required for the numeric portion of the file name.
- 6 Press the **Press to Save** softkey to save the file.

## Saving Waveform Trace and Oscilloscope Setup

When the **Trace & Setup** option is selected from the **Format** softkey, both waveform trace and oscilloscope setup are saved to the USB mass storage device or the oscilloscope's internal memory. After saving, you can choose to recall the trace, the setup, or both.

The trace is saved with the file extension TIF and the setup is saved with the extension SCP. These extensions can be seen using the File Explorer, but they do not appear when using the file browser in the Recall Menu. When using Mask Testing, the mask data file is saved also. Its extension is MSK.

## Display Image and Waveform Data File Formats

Display image and waveform data files can be saved on a USB mass storage device, but they cannot be saved to the oscilloscope's internal memory.

Press [**Save/Recall**] > **Save** > **Format** to select a format.

You can save the display image in the following file formats:

- **BMP (8-bit) image file** – The screen image is converted to a smaller, lower resolution bitmap file of the complete screen (including the status line and softkeys).
- **BMP (24-bit) image file** – This is a larger, high-resolution bitmap file of the complete screen.
- **PNG (24-bit) image file** – This is an image file that uses lossless compression. Files are much smaller than the BMP format.

You can save waveform data in the following formats:

- **CSV data file** – This creates a file of comma-separated variable values of all displayed channels and math waveforms. This format is suitable for spreadsheet analysis. Serial decode Lister data is also saved in CSV format. (See also [page 422](#).)
- **ASCII XY data file**– This creates a file of comma-separated variables for each displayed channel (including serial decode waveforms). If the oscilloscope acquisition is stopped, then data records greater than 1000 points can be written. This format is also suitable for spreadsheets.
- **BIN data file** – This creates a binary file with a header, and data in the form of time and voltage pairs. This file is much smaller than the ASCII XY data file. If the oscilloscope acquisition is stopped, then data records greater than 1000 points can be written. (See also [page 414](#).)
- **ALB data file** – This creates a file in an Agilent proprietary format which can be read by Agilent logic analyzers. You can use Agilent's B4610A Data import tool for offline viewing and analysis.
- **Mask test data file** – This creates a mask file in an Agilent proprietary format which can be read by Agilent InfiniiVision oscilloscopes. A mask data file includes certain setup information, but not all setup information. To save all setup information including the mask data file, choose "Trace and Setup" format instead. (See also "[Analyzing Data](#)" on [page 343](#).)

## Choosing Save Settings

Press [**Save/Recall**] > **Save** > **Settings** to change the following options. A USB mass storage device (such as a thumb drive) must be connected to the oscilloscope.

These settings are not applicable when the format “Trace&Setup” is selected.

### Setup Info

Select **Setup Info** if you want the oscilloscope setup information to be included. Oscilloscope setup information includes vertical, horizontal, trigger, acquisition, math, and display settings. The setup information will be sent to a separate file with a TXT extension.

### Invert Graticule Colors

This setting is applicable when you have chosen BMP or PNG using the **Format** softkey.

The **Invert Graticule Colors** option can be used to reduce the amount of black ink it takes to print oscilloscope images by changing the black background to white. **Invert Graticule Colors** is the default mode. **Invert Graticule Colors** is available when the BMP and PNG formats are selected.



**Graticule Not Inverted**



**Graticule Inverted**

### Palette

Press the **Palette** softkey to change the following options. The Palette options are available when the BMP and PNG formats are selected.

- **Color** – When **Color** printing is selected, the traces are printed in color. Color printing is not applicable to CSV format.

- **Grayscale** – When **Grayscale** printing is selected, the traces are printed in shades of gray rather than in color. Grayscale printing is not applicable to CSV format.

### Length Control

The **Length** softkey is available when the CSV, ASCII XY, BIN, or ALB formats are selected. **Length** sets the number of data points that will be output to the file. **Length** can be set to 100, 250, 500, or 1000 when the acquisition is running, or more when the acquisition is stopped. (CSV length is limited to 1000 points.) It is important to save enough points to represent the captured data accurately. Press the [**Single**] key to obtain the maximum record length.

The maximum available record length depends on whether one or two channels are active (turned on) per channel pair (channel pairs are channels 1 and 2 and channels 3 and 4), whether digital channels are on or off, and the horizontal timebase setting (how much data is shown on screen).

Only displayed data points are output (except when you are using segmented memory and the **Save Segment** control is set to **All** segments). Therefore, adjust the Horizontal controls to display the data you want to save.

The length control has no effect on the amount of Serial Decode data saved; all serial decode data will be output.

The Length control will perform a “1 of n” decimation of the data when necessary. For example: if the **Length** is set to 1000, and you are displaying a record that is 5000 data points in length, four of each five data points will be decimated, creating an output file 1000 data points in length. However, if serial decode is on, no decimation will occur.

For more information see [“Minimum and Maximum Values in CSV Files”](#) on page 422.

### Save Segment

When using the optional segmented memory feature you can choose to save either the currently displayed segment or all acquired segments in memory. (See also [page 237](#).)

Press [**Save/Recall**] > **Save** > **Format** (choose CSV, ASCII XY, or BIN) > **Settings** > **Save Seg** to make your selection. Set the Length control appropriately (see Length Control, above).

### Segmented memory save formats

Segmented memory data can be saved as a screen capture (in BMP or PNG format) or in CSV, ASCII XY, or BIN (data file format). The Save Segment setting is relevant to data file formats, not screen capture formats.

When saving waveform capture at maximum memory depth, you can expect the following approximate save times:

CSV	2 hours
ASCII XY	30 minutes
BIN	3 minutes

The primary difference between CSV format and ASCII XY data format is that in CSV all data are presented as columns in a single spreadsheet file, whereas in ASCII XY the data are presented in separate files for channel 1, channel 2, channel 3, channel 4, digital channels 0-7, digital channels 8-15, and math waveforms.

For more information, see:

- “Binary Data (.bin) Format” on page 414
- “CSV and ASCII XY files” on page 422

### Format (ALB data file format settings in Save Menu)

You can acquire data from the oscilloscope in ALB format, then analyze it offline (on a PC) using the Agilent *B4610A Data Import Tool for Offline Viewing and Analysis*. See Agilent publication number 5989-7834EN at [www.agilent.com](http://www.agilent.com).

When you choose any ALB format other than Default, waveforms from the analog channels (if displayed) are also digitized and displayed as digital waveforms. The analog channel’s trigger level determines the point at which the voltage is considered a logic 1 or 0.

Available ALB serial formats include:

- Default
- CAN
- I2C
- LIN
- UART/RS232
- SPI (2 Wire Serial)
- SPI (3 Wire Serial)
- SPI (4 Wire Serial)

To select a serial format for the ALB data file:

- 1** Press **[Save/Recall] > Save**.
- 2** Press **Format** and select ALB.
- 3** Press **Settings**.
- 4** Press **Format** and select the format for the ALB data file.

If you connect your serial bus signals to the oscilloscope as shown in the following table, the labels in the analysis software will be correct. If you do not, then you will have to re-map the signals in the analysis software.

**Table 6** Recommended Signal Mapping

Label	Signal	Scope Channel	Maps to Logic Analyzer Channel
TxRS232	Tx	Ch1	D0
RxRS232	Rx	Ch2	D1
I2C	Data	Ch1	D0
I2C	Clk	Ch2	D1
SPI2 (2-wire)	Clk	Ch1	D0
SPI2	Data	Ch2	D1
SPI3 (3-wire)	~Chip Select	Ch1	D0
SPI3	Clk	Ch2	D1
SPI3	Data	Ch3	D2
SPI4 (4-wire)	~Chip Select	Ch1	D0
SPI4	Clk	Ch2	D1
SPI4	DataIn	Ch3	D2
SPI4	DataOut	Ch4	D3
CAN	Data	Ch1	D0
LIN	Data	Ch1	D0

## To save a waveform and/or setup to a USB mass storage device

- 1 Insert a USB mass storage device into the front or rear USB device port.
- 2 Press the **[Save/Recall]** key.
- 3 Press the **Save** softkey. The proposed file name will be shown in the “**Save to file**” prompt above the **Save** softkey. (If you want to change the file name, press the **File Name** softkey. See “[Creating a new file name](#)” on page 209 for details.)

- 4 Choose a file format using the **Format** softkey. For file format information see “[Display Image and Waveform Data File Formats](#)” on page 210.
- 5 Press the **Press to Save** softkey.

### NOTE

When saving display image files, the oscilloscope will save an image using the last menu you visited before pressing the **[Print]** key. Therefore, if you have measurements (Amplitude, Frequency, etc.) showing on the display before you select Save, the measurements will be shown in the display image file.

To save an image of the display showing the Save/Recall Menu at the bottom, press the **[Save/Recall]** key twice, then press the **Press to Save** softkey.

## To save a waveform and/or setup to the oscilloscope’s internal memory

- 1 Press the **[Save/Recall]** key.
- 2 Press the **Save** softkey.
- 3 Press the **Format** softkey and choose **Trace and Setup**.
- 4 Press the **Save to** softkey. Then rotate the **Entry** knob to navigate to the “C:\setups” directory, then choose one of the files to overwrite (intern\_0 through intern\_9). You can push the **Entry** knob to make your directory and file selections.
- 5 Press the **Press to Save** softkey or select the file using the Entry knob and then press the Entry knob.

## To recall waveform trace and/or oscilloscope setup

A recalled trace is typically used for a quick comparison of measurement results. For example, you might save a trace of a waveform to use as a reference, then make a similar measurement on a test system and then recall the saved trace to observe any differences.

- 1 Press the **[Save/Recall]** key.
- 2 Press the **Recall** softkey. The Recall Menu will be displayed.



- 3 Press the **Recall** softkey in the Recall Menu and choose **Setup, Trace, or Trace and Setup**.
- 4 Press the second softkey from the left and navigate to the oscilloscope's internal memory location or the USB mass storage device that holds the saved trace and/or setup. See “[File Explorer](#)” (below) for more information.
- 5 Press the **Press to Recall** softkey.

## File Explorer

The File Explorer lets you navigate the file system. Using the File Explorer you can save, recall, load, and delete files.

**File system** The user-accessible file system consists of ten internal memory locations, plus external USB mass storage devices you connect to the USB device ports on the oscilloscope.

**Internal memory** The ten internal nonvolatile memory locations are located on the oscilloscope at C:\setups and are named intern\_0 through intern\_9. You can save waveform trace and oscilloscope setup in each of the ten internal memory locations, but you cannot save display image files or waveform data files in the oscilloscope's internal memory. The latter must be stored on USB mass storage devices.

**USB mass storage devices** Most USB mass storage devices are compatible with the oscilloscope. However, certain devices may be incompatible, and may not be able to be read or written to.

When the USB mass storage device is connected to the oscilloscope's front or rear USB host port, a small four-color circle icon may be displayed briefly as the USB device is read.

You do not need to “eject” the USB mass storage device before removing it. Simply ensure that any file operation you've initiated is done, and remove the USB drive from the oscilloscope's host port.

Do not connect USB devices that identify themselves as hardware type “CD” because these devices are not compatible with the InfiniiVision 7000B Series oscilloscopes.

If two USB mass storage devices are connected to the oscilloscope, the first one is designated “USB0” and the second one is designated “USB5,” not “USB1.” This numbering method is normal; it is inherent in the USB driver.

A file that has been deleted from the USB mass storage device cannot be recovered by the oscilloscope.

### NOTE

Regarding USB Ports:

The USB port on the front panel, and the USB port on the rear panel labeled “HOST” are USB Series A receptacles. These are the receptacles to which you can connect USB mass storage devices and printers.

The square receptacle on the rear panel labeled “DEVICE” is provided for controlling the oscilloscope over USB. See the *Programmer’s Guide* for more information. To access the *Programmer’s Guide* online, direct your web browser to:

- [www.agilent.com/find/7000manual](http://www.agilent.com/find/7000manual)

---

**System software** System software files can be loaded into the oscilloscope. These software updates can be downloaded from:

- [www.agilent.com/find/7000sw](http://www.agilent.com/find/7000sw)

See “Software and Firmware Updates” on page 410 for more information.

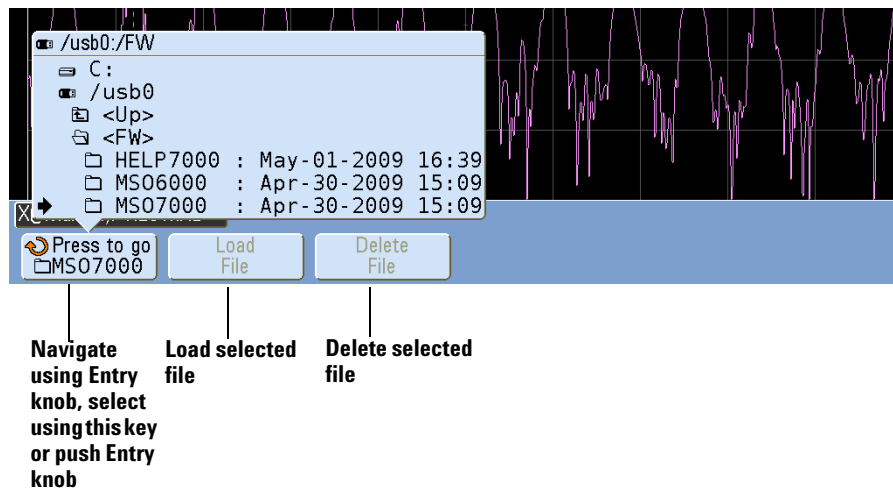
### To use the file explorer

Files can be loaded and deleted using the file explorer.

You can create directories on a USB mass storage device using your PC or other instrument. You can navigate to any directory on the USB device by rotating and pushing the Entry knob.

- 1 Connect a USB mass storage device with the files to be loaded or deleted to the USB port on the front or the rear of the oscilloscope. A small four-color circle icon may be displayed as the USB device is read.
- 2 Press **[Utility] > File Explorer**.
- 3 Turn and push the Entry knob to select the desired file on the USB mass storage device. This softkey will be labeled **Press to go** when pointing at a directory that can be selected, **Location** when pointing to a directory that is currently selected, and **Selected** when pointing to a file

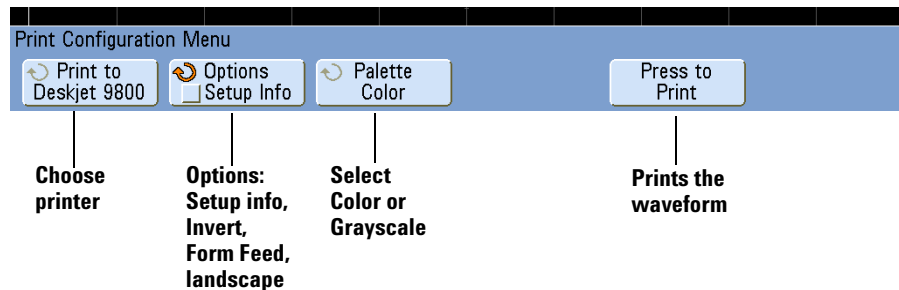
that can be loaded or deleted. Pressing the Entry knob will initiate the selected activity.



## Printing Screens

You can print the complete display, including the status line and softkeys, to a USB printer.

The Print Configuration Menu is displayed when you press the **[Print]** key. The print option softkeys and the **Press to Print** softkey are ghosted (not available) until a printer is connected.



### To print the oscilloscope's display

- 1 Connect a USB printer to either the USB port on the front panel or the rectangular USB host port on the rear panel.  
For the most up-to-date listing of printers that are compatible with the InfiniiVision oscilloscopes, please visit [www.agilent.com/find/InfiniiVision-printers](http://www.agilent.com/find/InfiniiVision-printers).
- 2 Press the **[Print]** key on the front panel.
- 3 Press the **Press to Print** softkey.

You can stop printing by pressing the **Cancel Print** softkey.

#### NOTE

The oscilloscope will print the last menu visited before you pressed the **[Print]** key. Therefore, if you have measurements (Amplitude, Frequency, etc.) showing on the display before you select **[Print]**, the measurements will be shown on the printout.

To print the display showing the Print Configuration Menu at the bottom, press the **[Print]** key twice, then press the **Press to Print** softkey.

## Options

Press the **Options** softkey to change the following options:

- **Setup Information** – Select to print oscilloscope setup information on your printout, including vertical, horizontal, trigger, acquisition, math, and display settings.
- **Invert Graticule Colors** – The **Invert Graticule Colors** option can be used to reduce the amount of black ink it takes to print oscilloscope images by changing the black background to white. **Invert Graticule Colors** is the default mode.



**Graticule Not Inverted**



**Graticule Inverted**

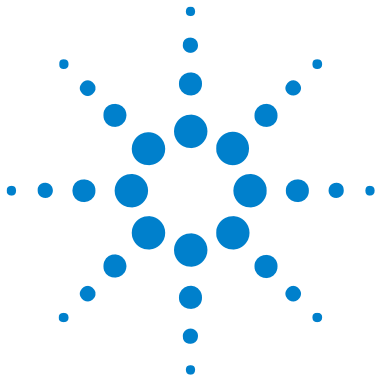
- **Form Feed** – The **Form Feed** option can be selected to send a form feed command to the printer after the waveform is printed and before the setup information is printed. Switch **Form Feed** off if you want setup information printed on the same sheet of paper with the waveform. This option only has an effect when the **Setup Information** option is selected. Also, if the amount of setup information will not fit on the same page with the waveform, it will be printed on a new page regardless of the **Form Feed** setting.
- **Landscape** – Choose **Landscape** mode to print horizontally on the page instead of vertically (portrait mode).

## Palette

Press the **Palette** softkey to change the following options.

- **Color** – When **Color** printing is selected, the traces are printed in color.
- **Grayscale** – When **Grayscale** printing is selected, the traces are printed in shades of gray rather than in color.





## 7 Acquisition Modes

Starting, Stopping, and Single Acquisitions (Run Control) [224](#)  
Acquisition Modes [227](#)  
Segmented Memory [234](#)

This chapter describes various acquisition modes.

- See Also**
- [“Analyzing Data”](#) on page 343.
  - [“Glitch or Narrow Pulse Capture”](#) on page 119.



## Starting, Stopping, and Single Acquisitions (Run Control)

### To start and stop an acquisition

- When you press the **[Run/Stop]** key, it illuminates in green and the oscilloscope is in run mode.

The oscilloscope examines the input voltage at each probe, and updates the display whenever the trigger conditions are met. Trigger processing and screen update rate are optimized based on the oscilloscope settings. The oscilloscope displays multiple acquisitions of the same signal similar to the way an analog oscilloscope displays waveforms.

- When you press the **[Run/Stop]** key again, it illuminates in red, and the oscilloscope is stopped.

“Stop” is displayed in the trigger mode position in the status line at the top of the display. You can pan and zoom the stored waveform by turning the horizontal and vertical control knobs.

When the oscilloscope is running and you press the **[Run/Stop]** key, it will flash until the current acquisition is completed. If the acquisition completes immediately, the **[Run/Stop]** key will not flash.

At slower sweep speeds, you may not want to wait for the acquisition to finish. Just press **[Run/Stop]** again. The acquisition will stop immediately and a partial waveform will be displayed.

You can display the results of multiple acquisitions using infinite persistence. See [“To set or clear infinite persistence”](#) on page 85.



## NOTE

**Memory Depth/Record Length**

**[Run/Stop] versus [Single]** — When the oscilloscope is running, the trigger processing and update rate are optimized over the memory depth.

**Single** — Single acquisitions always use the maximum memory available—at least twice as much memory as acquisitions captured in Run mode—and the oscilloscope stores at least twice as many samples. At slow sweep speeds, the oscilloscope operates at a higher sample rate when Single is used to capture an acquisition due to the increased memory available. To acquire data with the longest possible record length, press the **[Single]** key.

**Running** — When running, versus taking a single acquisition, the memory is divided in half. This allows the acquisition system to acquire one record while processing the previous acquisition, dramatically improving the number of waveforms per second processed by the oscilloscope. While running, maximizing the rate at which waveforms are drawn on the display provides the best representation of your input signal.

## To make a single acquisition

When you press the **[Single]** key it illuminates in yellow and the oscilloscope starts the acquisition system, searching for the trigger condition. When the trigger condition is met, the captured waveform is displayed, the **[Single]** key is extinguished and the **[Run/Stop]** key illuminates in red.

- Use the **[Single]** key to view single-shot events without subsequent waveform data overwriting the display.

Use **[Single]** when you want the maximum sample rate and the maximum memory depth for pan and zoom. (See “[Panning and Zooming Single or Stopped Acquisitions](#)” on page 64)

- 1 Set the trigger mode to Normal (see “[Auto and Normal Trigger modes](#)” on page 99 for instructions).

This keeps the oscilloscope from automatically triggering immediately.

- 2 If you are triggering on analog channel events, turn the Trigger Level knob to the trigger threshold to a level that your waveform will cross.
- 3 To begin a single acquisition, press the **[Single]** key.

When you press **[Single]**, the display is cleared, the trigger circuitry is armed, the **[Single]** key is illuminated yellow, and the oscilloscope will wait until a trigger condition occurs before it displays a waveform.

When the oscilloscope triggers, the single acquisition is displayed and the oscilloscope is stopped (the **[Run/Stop]** key is illuminated in red).

**4** To acquire another waveform, press **[Single]** again.

### **Auto Single**

Auto-trigger will generate a trigger for you if one is not found in the predetermined time (about 40 ms) after you press **[Single]**. If you want to make a single acquisition and you are not particularly interested in triggering the acquisition (for example, if you are probing a DC level), set the trigger mode to Auto (see [page 99](#)) and press the **[Single]** key. If a trigger condition occurs, it will be used; if a trigger doesn't happen, an untriggered acquisition will be taken.

## Acquisition Modes

The InfiniiVision oscilloscopes have the following acquisition modes:

- **Normal** – for most waveforms (with normal decimating at slower sweep speeds, no averaging).
- **Peak Detect** – for displaying narrow pulses that occur infrequently (at slower sweep speeds).
- **Averaging** – for reducing noise and increasing resolution (at all sweep speeds, without bandwidth or rise time degradation).
- **High Resolution** – for reducing random noise (at slower sweep speeds).

**Realtime** sampling (where the oscilloscope produces the waveform display from samples collected during one trigger event) can be turned off or on in the Normal, Peak Detect, and High Resolution modes.

(For information on the XY horizontal mode see “[XY Time Mode](#)” on page 66.)

### At Slower Sweep Speeds

At slower sweep speeds, the sample rate drops because the acquisition time increases and the oscilloscope’s digitizer is sampling faster than is required to fill memory.

For example, suppose an oscilloscope’s digitizer has a sample period of 1 ns (maximum sample rate of 1 GSa/s) and a 1 M memory depth. At that rate, memory is filled in 1 ms. If the acquisition time is 100 ms (10 ms/div), only 1 of every 100 samples is needed to fill memory.

### Selecting the Acquisition mode

To select the acquisition mode press the [**Acquire**] key on the front panel.

### Normal Mode

In Normal mode at slower sweep speeds, extra samples are decimated (in other words, some are thrown away). This mode yields the best display for most waveforms.

## Peak Detect Mode

In Peak Detect mode at slower sweep speeds, minimum and maximum samples are kept in order to capture infrequent and narrow events (at the expense of exaggerating any noise). This mode displays all pulses that are at least as wide as the sample period (see [Table 7](#)).

**Table 7** InfiniiVision Series Oscilloscope Bandwidths, Maximum Sample Rates, and Sample Periods

Bandwidth	Maximum Sample Rate	A sample is taken every (sample period)
100 MHz	2 GSa/s	500 ps
350 MHz	2 GSa/s	500 ps
500 MHz	4 GSa/s	250 ps
1 GHz	4 GSa/s	250 ps

See also “[Glitch or Narrow Pulse Capture](#)” on page 119.

## High Resolution Mode

In High Resolution mode, at slower sweep speeds extra samples are averaged in order to reduce random noise, produce a smoother trace on the screen, and effectively increase vertical resolution.

High Resolution mode averages sequential sample points within the same acquisition. An extra bit of vertical resolution is produced for every factor of 4 averages. The number of extra bits of vertical resolution is dependent on the time per division setting (sweep speed) of the scope.

The slower the sweep speed, the greater the number of samples that are averaged together for each display point.

High Resolution mode can be used on both single-shot and repetitive signals and it does not slow waveform update because the computation is done in the MegaZoom custom ASIC. High Resolution mode limits the oscilloscope's real-time bandwidth because it effectively acts like a low-pass filter.

<b>2 GSa/s Sample Rate</b>	<b>4 GSa/s Sample Rate</b>	<b>Bits of resolution</b>
≤ 50 ns/div	≤ 50 ns/div	8
200 ns/div	100 ns/div	9
1 us/div	500 ns/div	10
5 us/div	2 us/div	11
≥ 20 us/div	≥ 10 us/div	12

## Averaging Mode

The Averaging mode lets you average multiple acquisitions together to reduce noise and increase vertical resolution (at all sweep speeds). Averaging requires a stable trigger.

The number of averages can be set from 2 to 65536 in powers-of-2 increments.

A higher number of averages reduces noise more and increases vertical resolution.

<b># Avgs</b>	<b>Bits of resolution</b>
2	8
4	9
16	10
64	11
≥ 256	12

The higher the number of averages, the slower the displayed waveform responds to waveform changes. You must compromise between how quickly the waveform responds to changes and how much you want to reduce the displayed noise on the signal.

### To use the Averaging mode

- 1 Press the **[Acquire]** key, then press the **Acq Mode** softkey until the Averaging mode is selected.
- 2 Press the **#Avgs** softkey and turn the Entry knob to set the number of averages that best eliminates the noise from the displayed waveform.

The number of acquisitions being averaged is displayed in the **# Avgs** softkey.

**Figure 33** Random noise on the displayed waveform



**Figure 34** 128 Averages used to reduce random noise



See also “Trigger Noise Rejection” on page 104

### Realtime Sampling Option

Realtime sampling specifies that the oscilloscope produce the waveform display from samples collected during one trigger event (that is, one acquisition).

Use Realtime sampling to capture infrequent triggers, unstable triggers, or complex changing waveforms, such as eye diagrams.

Realtime sampling can be turned on in **Normal**, **Peak Detect**, or **High Resolution** acquisition modes. It cannot be turned on when the acquisition mode is **Averaging**.

When Realtime sampling is on (as in the default setup):

- When less than 1000 samples can be collected in the time spanned by the screen, a sophisticated reconstruction filter is used to fill in and enhance the waveform display.
- If you press the **[Stop]** key, and pan and zoom through the waveform using the Horizontal and Vertical controls, only the last trigger's acquisition will be displayed.

When Realtime sampling is off:

- The oscilloscope produces the waveform display from samples collected from multiple acquisitions. In this case, the reconstruction filter is not used.

### Realtime Sampling and Oscilloscope Bandwidth

To accurately reproduce a sampled waveform, the sample rate should be at least four times the highest frequency component of the waveform. If not, it is possible for the reconstructed waveform to be distorted or aliased. Aliasing is most commonly seen as jitter on fast edges.

The maximum sample rate for 350 MHz bandwidth oscilloscopes is 2 GSa/s.

The maximum sample rate for 1 GHz and 500 MHz bandwidth oscilloscopes is 4 GSa/s for a single channel in a channel pair. Channels 1 and 2 constitute a channel pair, and channels 3 and 4 constitute another channel pair. For example, the sample rate of a 4-channel oscilloscope is 4 GSa/s when channels 1 and 3, 1 and 4, 2 and 3, or 2 and 4 are on.



Whenever both channels in a channel pair are on, the sample rate for all channels is halved. For example, when channels 1, 2, and 3 are on, the sample rate for all channels is 2 GSa/s.

When Realtime sampling is on, the bandwidth of the oscilloscope is limited because the bandwidth of the reconstruction filter is set to  $f_s/4$ . For example, a 710x oscilloscope with channels 1 and 2 on has a bandwidth of 500 MHz when Realtime sampling on and 1 GHz when Realtime sampling is off.

To see the sample rate, press the **[Horiz]** key on the front panel. The sample rate is displayed in the line just above the softkeys.



## Segmented Memory

You can purchase the oscilloscope with the segmented memory option factory-installed (Option SGM) or you can easily install it yourself (order model number N5454A “Segmented Memory”).

When capturing multiple infrequent trigger events it is advantageous to divide the oscilloscope’s memory into segments. This lets you capture signal activity without capturing long periods of signal “dead time.”

Each segment is complete with all analog channel, digital channel (on MSO models), and serial decode data.

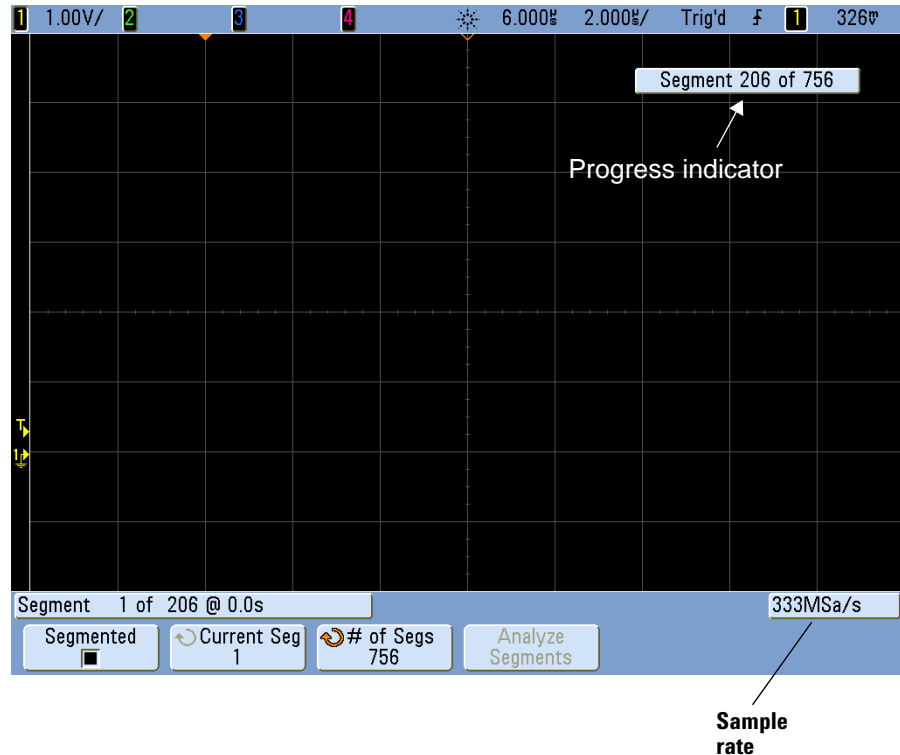
When using Segmented memory, use the Analyze Segments feature (see [“Measurements, statistics, and infinite persistence”](#) on page 236) to show infinite persistence across all acquired segments. See also [“To set or clear infinite persistence”](#) on page 85 for details.

### Using segmented memory

- 1 Set up a trigger condition. (See [“Triggering”](#) on page 95 for details.)
- 2 Press the **[Acquire]** key in the Waveform section of the front panel.
- 3 Press the **Segmented** softkey to access the Segmented Memory Menu.
- 4 In the Segmented Memory Menu, press the **Segmented** softkey to enable segmented memory acquisitions.
- 5 Press the **# of Segs** softkey and rotate the Entry knob to select the number of segments into which you would like to divide the oscilloscope’s memory. Memory can be divided into as few as two segments and as many as 2000 segments.
- 6 Press the **[Run]** key or the **[Single]** key.

The oscilloscope will run and fill a memory segment for each trigger event. When the oscilloscope is busy acquiring multiple segments, the progress is displayed in the upper right area of the display. The oscilloscope will continue to trigger until memory is filled, then the oscilloscope will stop.

If the signal you are measuring has more than about 1 s of “dead time” (inactivity), consider selecting **Normal** trigger mode to prevent AutoTriggering. Press the [**Mode/Coupling**] key, then press the **Mode** softkey and select **Normal**.



### Navigating segments

Press the **Current Seg** softkey and turn the Entry knob to display to the desired segment along with a time tag indicating the time from the first trigger event.

You can also press the **Knob** softkey to toggle between **Current Segment** and **Time**. When **Current Segment** is selected, the Horizontal position control knob moves the display to the desired segment. When **Time** is selected, the Horizontal position control knob moves the display horizontally just as it

does when Segmented Memory mode is not selected. The **Knob** softkey also appears in the Horizontal Menu so you can make the same adjustments there.

### Measurements, statistics, and infinite persistence

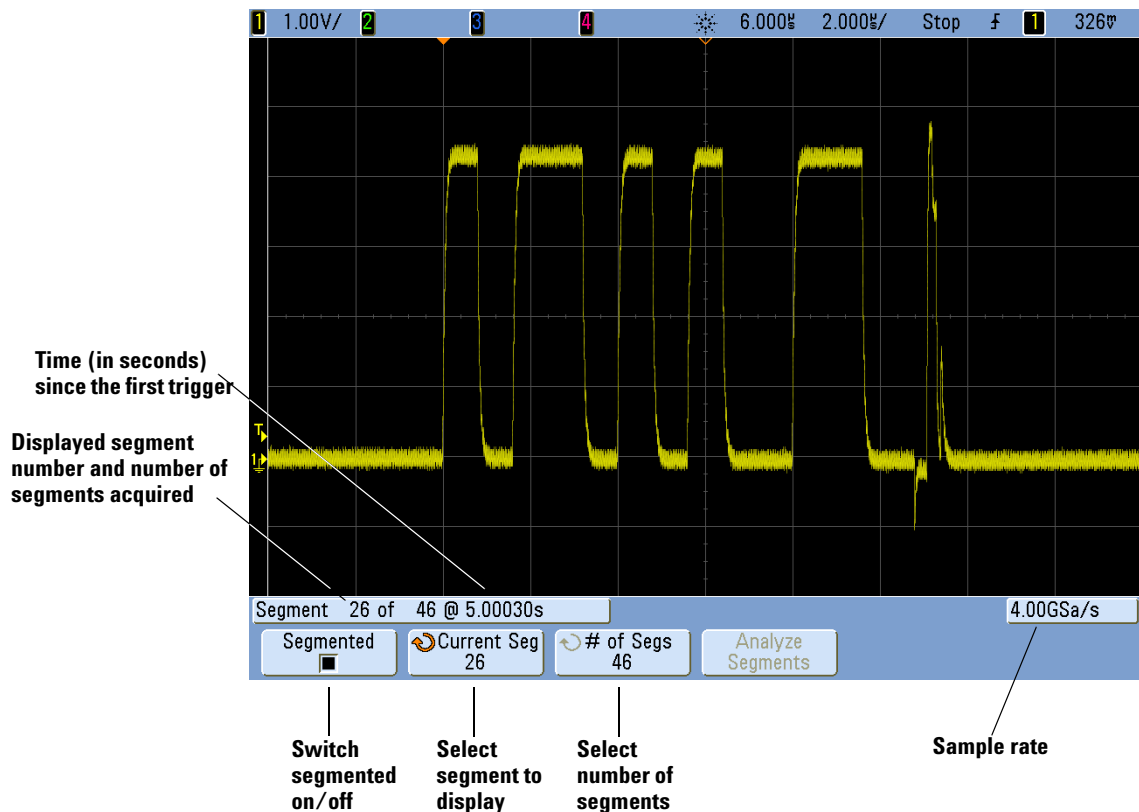
To perform measurements and view statistical information, press [**Meas**] and set up your desired measurements. (See “[List of Automatic Measurements](#)” on page 154.) Then press **Analyze Segments**. Statistical data will be accumulated for the measurements you have chosen.

The **Analyze Segments** softkey only appears when the acquisition is stopped and the optional segmented memory feature is on.

You can also turn on infinite persistence (in the Display Menu) and press the **Analyze Segments** softkey to create an infinite persistence display.

### Re-arm time

After each segment fills, the oscilloscope re-arms and is ready to trigger in about 8  $\mu\text{s}$ . Remember though, for example: if the horizontal time per division control is set to 5  $\mu\text{s}/\text{div}$ , and the Time Reference is set to **Center**, it will take at least 50  $\mu\text{s}$  to fill all ten divisions and re-arm. (That’s 25  $\mu\text{s}$  to capture pre-trigger data and 25  $\mu\text{s}$  to capture post-trigger data.)

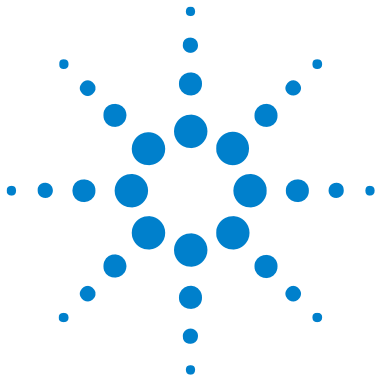


### Saving data from segmented memory

You can save either the currently displayed segment (**Save Segment - Current**), or all segments (**Save Segment - All**) in the following data formats: CSV, ASCII XY, and BIN. Be sure to set the Length control to capture enough points to accurately represent the captured data. When the oscilloscope is busy saving multiple segments, progress is displayed in the upper right area of the display.

To select the current segment or all segments, press **[Save/Recall] > Save > Settings > Save Seg**. A USB storage device must be connected to the oscilloscope to enable this Save option. You can also save the screen image in BMP or PNG formats. For more information see [“Save Segment”](#) on page 212.





## 8 Web Interface

Setting up the Oscilloscope's LAN Connection	241
Accessing the Web Interface	244
Browser Web Control	245
Get Image	250
Identification Function	251
Instrument Utilities	252
Setting a Password	253

The Agilent InfiniiVision oscilloscopes have a LAN interface and a built-in web server; these let you use a Java™-enabled web browser remotely to:

- View information about the oscilloscope like its model number, serial number, host name, IP address, and VISA (address) connect string.
- Control the oscilloscope using the Remote Front Panel.
- Send SCPI (Standard Commands for Programmable Instrumentation) remote programming commands via the SCPI Commands applet window.
- Get screen images and save or print them from the browser.
- Activate the Identification function to identify a particular instrument by causing a message to be displayed or a front panel light to blink.
- View installed options, view firmware versions and install firmware upgrade files, and view calibration status (via the Instrument Utilities page).
- View and modify the oscilloscope's network configuration and status information.

The web interface for InfiniiVision oscilloscope also provides help for each of its pages.



Microsoft Internet Explorer is the recommended Web browser for communication and control of the oscilloscope. Other Web browsers may work but are not guaranteed to work with the oscilloscope. The Web browser must be Java-enabled with Sun Microsystems™ Java Plug-in.

Before you can use the web interface, you must place the oscilloscope on the network and set up its LAN connection.



## Setting up the Oscilloscope's LAN Connection

Before you can use the web interface, you must place the oscilloscope on the network and set up its LAN connection.

### NOTE

When you connect the oscilloscope to a LAN it is a good practice to limit access to the oscilloscope by setting a password. By default, the oscilloscope is not password protected. See [page 253](#) to set a password.

---

### NOTE

Any time you modify the oscilloscope's hostname it will break the connection between the oscilloscope and the LAN. You will need to re-establish communication to the oscilloscope using the new hostname.

---

## To establish a LAN connection

### To connect to the network using DHCP or AutoIP

- 1 Connect the oscilloscope to the local area network (LAN) by inserting the LAN cable into the "LAN" port on the rear panel of the oscilloscope. In a few moments the oscilloscope will connect to the network automatically.
  - a If the oscilloscope does not automatically connect to the network, press **[Utility] > I/O > LAN Reset**. In a few moments the oscilloscope will connect to the network.
  - b If desired you can enable NetBIOS. Press **[Utility] > I/O > Control** to access the option.
  - c When using DHCP you can select DynamicDNS if desired. Press **[Utility] > I/O > Control** to access the option.

### To connect to the network using Manual mode

- 1 Get the oscilloscope's network parameters (hostname, domain, IP address, subnet mask, gateway IP, DNS IP, etc.) from your network administrator.
- 2 Connect the oscilloscope to the local area network (LAN) by inserting the LAN cable into the "LAN" port on the rear panel of the oscilloscope.
- 3 On the oscilloscope, ensure the controller interface is enabled:
  - a Press **[Utility] > I/O > Control**.
  - b Ensure that LAN is selected. If not, use the Entry knob to point to "LAN" and then push the Entry knob.
- 4 Configure the oscilloscope's LAN interface:
  - a Press the **LAN Settings** softkey.
  - b Press the **Config** softkey to deselect DHCP and AutoIP.
  - c Press the **Addresses** softkey.
  - d Use the **Modify** softkey (and the other softkeys and the Entry knob) to enter the IP Address, Subnet Mask, Gateway IP, and DNS IP values. When you are done, go back up in the menu hierarchy.
  - e Press the **Domain** softkey. Use the **Modify** softkey (and the other softkeys and the Entry knob) to enter the Host name and the Domain name. When you are done, go back up in the menu hierarchy.
  - f Press the **Apply** softkey.

## Stand-alone (Point-to-Point) Connection to a PC

The following procedure describes how to establish a point-to-point (stand alone) connection to the oscilloscope. This is useful if you want to control the oscilloscope using a laptop computer or a stand-alone computer.

- 1 Connect your PC to the oscilloscope using a cross-over LAN cable such as Agilent part number 5061-0701, available on the web at [www.parts.agilent.com](http://www.parts.agilent.com).
- 2 Turn on the oscilloscope power. Wait until the LAN connection is configured:

- Press **[Utility] > I/O** and wait until the LAN status shows “configured”. This may take a few minutes.

Now the instrument is connected and the instrument’s Web interface may be used.

## Accessing the Web Interface

To access the oscilloscope's web interface:

- 1 Connect the oscilloscope to your LAN (see [page 241](#)) or establish a point-to-point connection (see [page 242](#)). It is possible to use a point-to-point connection, but using a normal LAN connection is the preferred method.
- 2 Type the oscilloscope's hostname or IP address in the web browser. The oscilloscope's web interface Welcome Page is displayed.

Support | Products | Agilent Site

Agilent Technologies Oscilloscope

Another web-enabled instrument from Agilent Technologies

Welcome Page

Welcome to your  
**Web-Enabled Oscilloscope**  
**MSO7104B**

Information about this Web-Enabled Instrument

Instrument	MSO7104B Oscilloscope
Serial Number	MY49250013
Description	Agilent MSO7104B (MY49250013)
Hostname	a-m7104b-250013.cos.agilent.com
IP Address	130.29.111.5
VISA TCP/IP Connect String	TCPIP0::a-m7104b-250013::INSTR

**Advanced information**      Identification:  off  on

Use the navigation bar on the left to access your Oscilloscope and related information.

© Agilent Technologies, Inc. 2006-2010

## Browser Web Control

The web interface's Browser Web Control page gives you access to the Remote Front Panel and the SCPI Command window applet for Remote Programming.

### NOTE

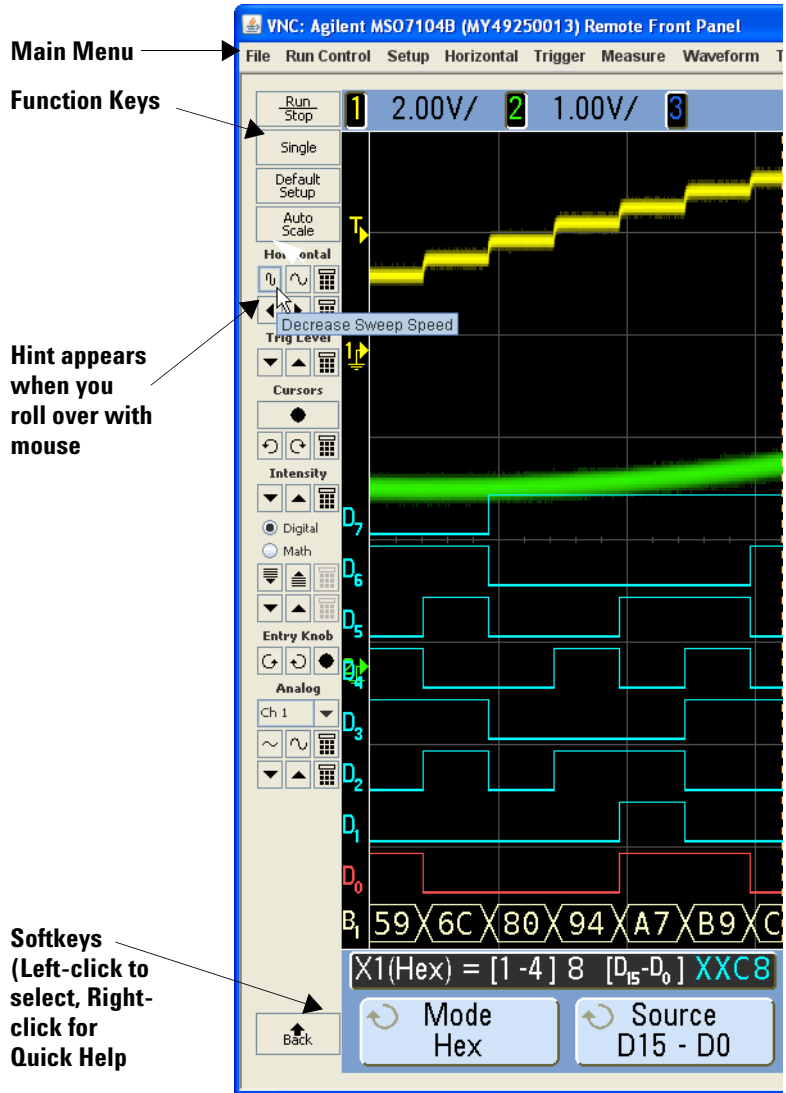
If Java is not installed on your PC, you will be prompted to install the Sun Microsystems Java Plug-in. This plug-in must be installed on the controlling PC for the web interface's Remote Front Panel or Remote Programming operations.

---

## Remote Front Panel

To operate the oscilloscope using the web interface's Remote Front Panel:

- 1 Access the oscilloscope's web interface (see [“Accessing the Web Interface”](#) on page 244).
- 2 When the oscilloscope's web interface is displayed, select **Browser Web Control**, then select **Remote Front Panel**. After a few seconds the Remote Front Panel appears.
- 3 Use the Main Menu and the Function Keys to control the oscilloscope. To view Quick Help, right-click on a softkey.



### Scrolling and Monitor Resolution

When using a monitor resolution of 1024 x 768 or less on the remote computer, you need to scroll to access the full remote front panel. To display the remote front panel without scroll bars, use a monitor resolution greater than 1024 x 768 on your computer's display.

## Remote Programming

To send remote programming commands to the oscilloscope via the SCPI Commands applet window:

- 1 Access the oscilloscope's web interface (see [“Accessing the Web Interface”](#) on page 244).
- 2 When the oscilloscope's web interface is displayed, select **Browser Web Control**, then select **Remote Programming**.
- 3 On the Remote Programming page, click **SCPI Commands....**  
The SCPI Commands applet window appears.

**Agilent Technologies Oscilloscope**

**Remote Programming**

If you press the 'SCPI Commands...' button below, you can send remote programming commands directly to your MSO7104B oscilloscope. For more information about the commands, see the [Programming Commands Quick Reference](#).

SCPI Commands...

**SCPI Commands**

Clear Window    Timeout 2 sec

```
> *RST
> *IDN?
< AGILENT TECHNOLOGIES,MSO7104B,MY49250013,05.29.03C
> :aut
> SYST:ERR?
< -222,"Data out of range"
> SYST:ERR?
< +0,"No error"
```

Device Clear

\*RST

\*IDN?

SYST:ERR?

Enter SCPI command or query

:aut

Write    Read    Write & Read

Command History

:aut

If you get the “Unable to connect to the instrument. You may need to set the instrument’s controller type to LAN.” message:

- a On the oscilloscope’s front panel, press **[Utility] > I/O**.
- b In the I/O Menu, press **Control**.
- c Use the Entry knob to point to LAN; then, press **Control** again to enable the LAN controller type.

Multiple controller types may be enabled.



## Remote Programming with Agilent IO Libraries

While the SCPI Commands applet window lets you enter and remote programming commands, remote programming for automated test and data acquisition is typically done using the Agilent IO Libraries, which are separate from the instrument's web interface.

The Agilent IO Libraries let a controller PC communicate with Agilent InfiniiVision oscilloscopes via their LAN or USB interfaces.

The *Automation Ready CD* provided with the oscilloscope contains the Agilent IO Libraries Suite connectivity software to enable communication over these interfaces. Refer to the instructions provided on the CD-ROM to install this software on your PC. If you do not have the *Automation Ready CD* you can download the Agilent IO Libraries Suite from [www.agilent.com/find/iolib](http://www.agilent.com/find/iolib).

Information about controlling the oscilloscope through remote commands is contained in the *Programmer's Guide*, which is included on the documentation CD supplied with this oscilloscope. You can also access this document on the Agilent web site.

For more information about connecting to the oscilloscope, refer to the *Agilent Technologies USB/LAN/GPIB Interfaces Connectivity Guide*. For a printable electronic copy of the Connectivity Guide, direct your Web browser to [www.agilent.com](http://www.agilent.com) and search for Connectivity Guide.

## Get Image

To save (or print) the oscilloscope's display from the web interface:

- 1 Access the oscilloscope's web interface (see [“Accessing the Web Interface”](#) on page 244).
- 2 When the oscilloscope's web interface is displayed, select the **Get Image** tab from the left side of the Welcome screen. After a delay of several seconds, the oscilloscope's screen image will be displayed.
- 3 Right-click on the image and select **“Save Picture As...”** (or **“Print Picture...”**).
- 4 Select a storage location for the image file and click **Save**.

## Identification Function

The Identification web interface feature is useful when trying to locate a specific instrument in a rack of equipment.

- 1 Access the oscilloscope's web interface (see “[Accessing the Web Interface](#)” on page 244).
- 2 When the oscilloscope's web interface Welcome Page is displayed, select the Identification **on** radio button.

An “Identify” message is displayed on the oscilloscope; you can either select Identification **off** or press the **OK** softkey on the oscilloscope to continue.

The screenshot shows the web interface for an Agilent MSO7104B Oscilloscope. The page has a blue header with the Agilent Technologies logo and the word "Oscilloscope". A navigation sidebar on the left includes links for Welcome Page, Browser Web Control, Get Image, Instrument Utilities, Configure Network, Network Status, Print Page, and Help with this Page. The main content area displays "Welcome to your Web-Enabled Oscilloscope MSO7104B" and a table of instrument information. Below the table, there is an "Advanced information" section with a radio button for "Identification" set to "off". An arrow points to the "on" radio button, labeled "Identification Option".

Support | Products | Agilent Site

Agilent Technologies Oscilloscope

Another web-enabled instrument from Agilent Technologies

Welcome to your  
Web-Enabled Oscilloscope  
MSO7104B

Information about this Web-Enabled Instrument

Instrument	MSO7104B Oscilloscope
Serial Number	MY49250013
Description	Agilent MSO7104B (MY49250013)
Hostname	a-m7104b-250013.cos.agilent.com
IP Address	130.29.111.5
VISA TCP/IP Connect String	TCPIP0::a-m7104b-250013::INSTR

Advanced information Identification:  off  on

Use the navigation bar on the left to access your Oscilloscope and related information.

© Agilent Technologies, Inc. 2006-2010

Identification Option

## Instrument Utilities

The Instrument Utilities page of the web interface lets you:

- View installed options.
- View firmware versions.
- Install firmware upgrade files.
- View calibration status.

You can select these capabilities via a drop-down menu.

The screenshot shows the Agilent Technologies Oscilloscope web interface. The main header includes the Agilent logo and the text "Oscilloscope". A left-hand navigation menu contains several buttons: Welcome Page, Browser Web Control, Get Image, Instrument Utilities (highlighted), Configure Network, Network Status, Print Page, and Help with this Page. The main content area is titled "Instrument Utilities" and features a dropdown menu with the following options: "Installed Options" (selected), "Firmware Versions", and "Calibration Status". Below the dropdown is a table with the following data:

license	description	installed
MSO	MSO	yes
FPG	FPGA Probe	yes
mem2M	Acq Memory 2M	yes
mem8M	Acq Memory 8M	yes
LSS	Low speed serial decode	yes
AMS	Automotive serial decode	yes
CAN	CAN trigger	yes
SEC	Secure environment	no
ALI	FPGA Altera	yes
PWR	Power application	yes
232	UART/RS232 serial decode	yes
SGM	Segmented Memory	yes
LMT	Limit Mask Test	yes
FRC	Flex Ray Compliance	yes
MST	Measurement Statistics	yes
E00	Enhancement 00	yes
SND	I2S serial decode	yes
FLX	Flex Ray serial decode package	yes
553	MIL-STD-1553 serial decode	yes

## Setting a Password

Whenever you connect the oscilloscope to a LAN, it is good practice to set a password. The password prevents someone from remotely accessing the oscilloscope via a Web browser and changing parameters. Remote users can still view the Welcome screen, view network status, etc., but they can't operate the instrument or change its setup without the password.

To set a password:

- 1 Access the oscilloscope's web interface (see [“Accessing the Web Interface”](#) on page 244).
- 2 When the oscilloscope's web interface is displayed, select the Configure Network tab from the instrument's Welcome page.
- 3 Click the **Modify Configuration** button.

The screenshot shows the Agilent Oscilloscope web interface. The left sidebar contains navigation tabs: Welcome Page, Browser Web Control, Get Image, Instrument Utilities, **Configure Network** (highlighted by Step 1), Network Status, Print Page, and Help with this Page. The main content area is titled 'Current Network Configuration' and features a 'Modify Configuration' button (highlighted by Step 2) and a table of network parameters.

Parameter	Currently in use
Configuration mode	DHCP
Dynamic DNS	ON
NetBIOS	ON
IP Address	130.29.111.5
Subnet Mask	255.255.252.0
Default Gateway	130.29.108.1
DHCP Server	130.29.64.128
DNS Server	130.29.108.128, 130.29.64.128
Hostname	a-m7104b-250013
Domain	cos.agilent.com
LAN KeepAlive Timeout	1800
Media Sense	ON
GPiB Control	OFF
GPiB Address	7
USB Control	OFF
LAN Control	ON

4 Enter your desired password, and click **Apply Changes**.

The screenshot shows the 'Configure Network' page of the Agilent Oscilloscope web interface. The page has a navigation sidebar on the left and a main configuration area. At the top of the main area are buttons for 'Undo Changes', 'Factory Defaults', and 'Apply Changes'. Below these is a table with three columns: 'Parameter', 'Configured Value', and 'Edit Configuration'. The table is divided into several sections: 'IP Settings may be configured using the following:', 'IP Settings to use in manual mode:', 'Domain name and name service settings:', and 'Other settings:'. The 'Password' field in the 'Other settings' section is highlighted with a black arrow and labeled 'Step 3'.

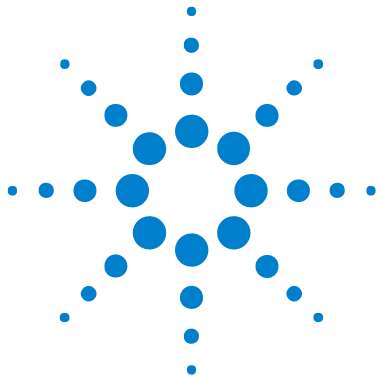
Parameter	Configured Value	Edit Configuration
<b>IP Settings may be configured using the following:</b>		
DHCP	ON	<input type="radio"/> OFF <input checked="" type="radio"/> ON
Automatic IP	ON	<input type="radio"/> OFF <input checked="" type="radio"/> ON
Manual	OFF	<input checked="" type="radio"/> OFF <input type="radio"/> ON
<b>IP Settings to use in manual mode:</b>		
IP Address	169.254.254.254	<input type="text" value="169.254.254.254"/>
Subnet Mask	255.255.248.0	<input type="text" value="255.255.248.0"/>
Default Gateway	169.254.254.254	<input type="text" value="169.254.254.254"/>
<b>Domain name and name service settings:</b>		
DNS Server	0.0.0.0	<input type="text" value="0.0.0.0"/>
Hostname	a-m7104b-250013	<input type="text" value="a-m7104b-250013"/>
Domain		<input type="text"/>
Dynamic DNS	ON	<input type="radio"/> OFF <input checked="" type="radio"/> ON
NetBIOS	ON	<input type="radio"/> OFF <input checked="" type="radio"/> ON
<b>Other settings:</b>		
KeepAlive Timeout (sec)	1800	<input type="text" value="1800"/>
Description	Agilent MSO7104B (MY49250013)	<input type="text" value="Agilent MSO7104B (MY49250013)"/>
Password		<input type="password"/>
GPIB Control	OFF	<input checked="" type="radio"/> OFF <input type="radio"/> ON
GPIB Address	7	<input type="text" value="7"/>
USB Control	OFF	<input checked="" type="radio"/> OFF <input type="radio"/> ON
LAN Control	ON	<input type="radio"/> OFF <input checked="" type="radio"/> ON

When accessing the password protected oscilloscope, the user name is the IP address of the oscilloscope.

### To reset the password

Do one of these things to reset the password:

- Using the keys on the front panel of the oscilloscope, press **[Utility] > I/O > LAN Reset**
- Using the web browser select the **Configure Network** tab, select **Modify Configuration**, erase the Password, and select **Apply Changes**.



## 9 Serial Decode/Lister

Serial Decode [256](#)

Lister [257](#)

Searching Lister Data [259](#)

### Triggering on Serial Data

In some cases, such as when triggering on a slow serial signal (for example, I<sup>2</sup>C, SPI, CAN, LIN, etc.) it may be necessary to switch from the Auto trigger mode to the Normal trigger mode to prevent the oscilloscope from Auto-triggering and stabilize the display. You can select the trigger mode by pressing the **[Mode/Coupling]** key, then the **Mode** softkey.

Also, the trigger level must be set appropriately for each analog channel.



## Serial Decode

Agilent's hardware accelerated serial decode options can be installed when the oscilloscope is manufactured, or added later. The following serial decode licenses are available:

- The N5424A (Option AMS) license provides the ability to decode CAN (Controller Area Network) and LIN (Local Interconnect Network) serial buses. Requires a 4-channel oscilloscope. See:
  - “[CAN Serial Decode](#)” on page 266.
  - “[LIN Serial Decode](#)” on page 276.
- The N5432C (Option FLX) license provides the ability to trigger on and decode FlexRay automotive serial buses. Requires a 4-channel oscilloscope. See “[FlexRay Serial Decode](#)” on page 318.
- The N5423A (Option LSS) license provides the ability to decode I<sup>2</sup>C (Inter-IC) and SPI (Serial Peripheral Interface) serial buses. Requires a 4-channel oscilloscope. See:
  - “[I<sup>2</sup>C Serial Decode](#)” on page 288.
  - “[SPI Serial Decode](#)” on page 297.
- The N5468A (Option SND) license provides the ability to decode I<sup>2</sup>S (Inter-IC Sound or Integrated Interchip Sound) serial buses. Requires a 4-channel oscilloscope. See “[I<sup>2</sup>S Serial Decode](#)” on page 309.
- The N5469A (Option 553) license provides the ability to decode MIL-STD 1553 serial buses. Requires a 4-channel oscilloscope. See “[MIL-STD 1553 Serial Decode](#)” on page 327.
- The N5457A (Option 232) license provides the ability to decode many UART (Universal Asynchronous Receiver/Transmitter) protocols including RS232 (Recommended Standard 232). Requires a 4-channel oscilloscope. See “[UART/RS232 Serial Decode](#)” on page 338.

To determine whether these licenses are installed on your oscilloscope, see “[To display license information](#)” on page 393.

To order serial decode licenses, go to [www.agilent.com](http://www.agilent.com) and search for the product number (for example, N5424A) or contact your local Agilent Technologies representative (see [www.agilent.com/find/contactus](http://www.agilent.com/find/contactus)).

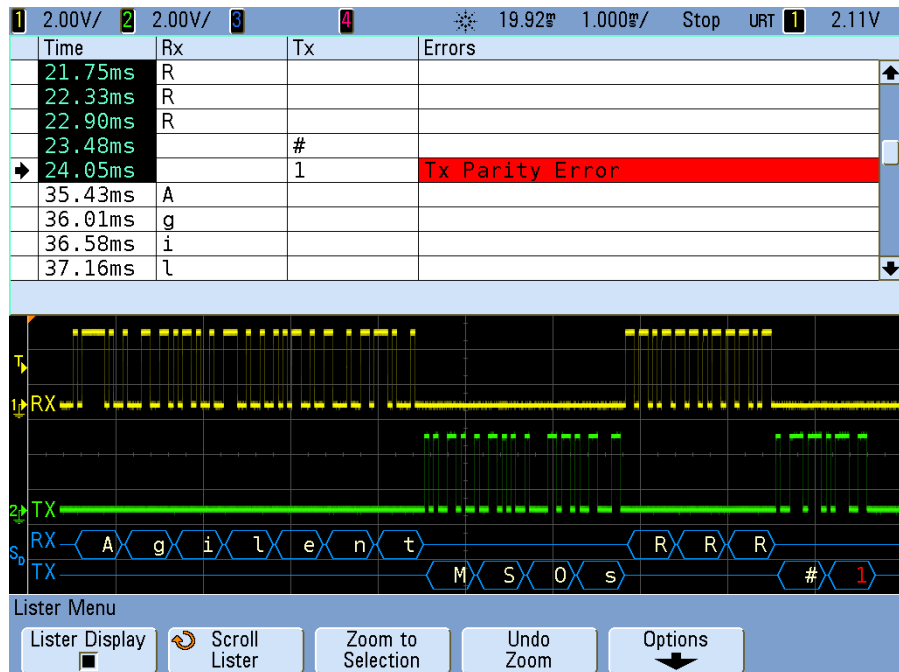


## Lister

Lister is a powerful tool for investigating protocol failures. You can use Lister to view large amounts of packet level serial data in a tabular format, including time tags and specific decoded values. After pressing the **[Single]** key, you can rotate the Entry knob to select an event and press the **Zoom to Selection** softkey to jump to the event.

To use the Lister:

- 1 Set up trigger and decode on the serial data signals to be analyzed.
- 2 Press **[Serial] > Lister**.
- 3 Press **Lister Display** to enable the display.



Before you can select a row or navigate through the Lister data, oscilloscope acquisitions must be stopped.

- 4 Press the **[Single]** key (in the Run Control group on the front panel) to stop the acquisition.

Pressing **[Single]** instead of **[Stop]** fills the maximum memory depth.

When zoomed out and viewing a large number of packets, the Lister may not be able to display information for all packets. However, when you press the **[Single]** key the Lister will contain all on-screen serial decode information.

- 5 Press the **Scroll Lister** softkey and use the Entry knob to scroll through the data.

Time tags in the Time column indicate the event time relative to the trigger point. The time tags of events that are shown in the waveform display area are displayed with a dark background.

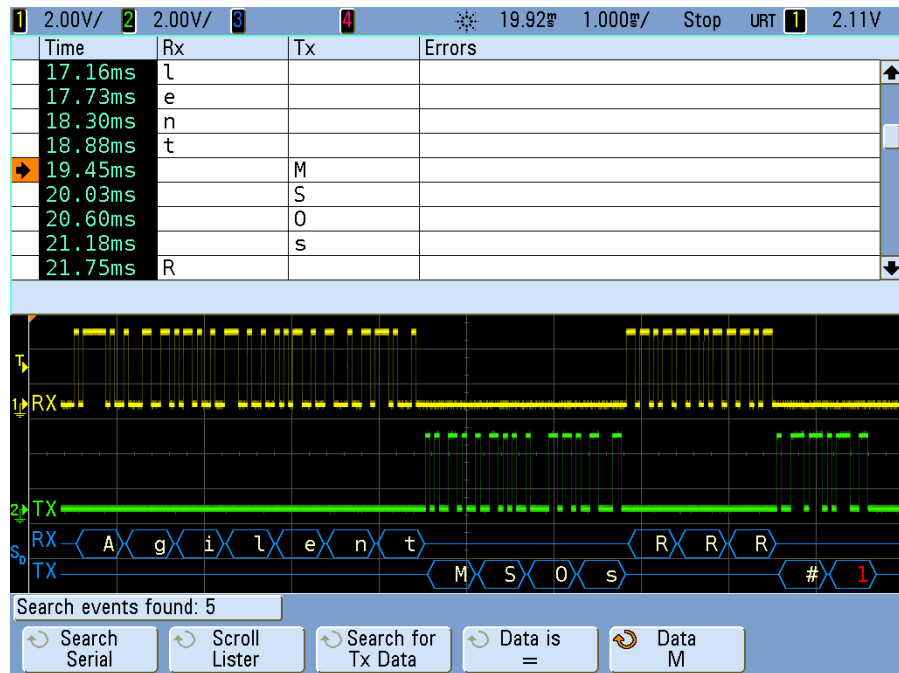
- 6 Press the **Zoom to Selection** softkey (or push the Entry knob) to center the waveform display at the time associated with the selected Lister row and automatically set the horizontal scale setting.
- 7 Press the **Undo Zoom** softkey to return to the horizontal scale and delay settings before the last **Zoom to Selection**.
- 8 Press the **Options** softkey to open the Lister Options Menu. In this menu, you can:
  - Enable or disable the **Track Time** option. When enabled, as you select different Lister rows (using the Entry knob while acquisitions are stopped), the horizontal delay changes to the Time of the selected row.

## Searching Lister Data

When serial decode is enabled, you can use the [**Search**] key to find and place marks on rows in the Lister.

The **Search for** softkey lets you specify events to find. It is similar to specifying protocol triggers.

Events found are marked in orange in the far left Lister column. The total number of events found is displayed above the softkeys.



Each serial decode option lets you find protocol-specific headers, data, errors, etc. See:

- “[Searching for CAN Data in the Lister](#)” on page 270 if you have Option AMS (N5424A).
- “[Searching for FlexRay Data in the Lister](#)” on page 322 if you have Option FLX (N5432C).

- [“Searching for I2C Data in the Lister”](#) on page 291 if you have Option LSS (N5423A).
- [“Searching for I2S Data in the Lister”](#) on page 312 if you have Option SND (N5468A).
- [“Searching for LIN Data in the Lister”](#) on page 279 if you have Option AMS (N5424A).
- [“Searching for MIL-STD 1553 Data in the Lister”](#) on page 330 if you have Option 553 (N5469A).
- [“Searching for SPI Data in the Lister”](#) on page 300 if you have Option LSS (N5423A).
- [“Searching for UART/RS232 Data in the Lister”](#) on page 342 if you have Option 232 (N5457A).



## 10 CAN/LIN Triggering and Serial Decode

Setup for CAN Signals [262](#)

CAN Triggering [264](#)

CAN Serial Decode [266](#)

Setup for LIN Signals [272](#)

LIN Triggering [274](#)

LIN Serial Decode [276](#)

The N5424A CAN/LIN triggering and decode option (Option AMS) requires a four-channel InfiniiVision Series oscilloscope.

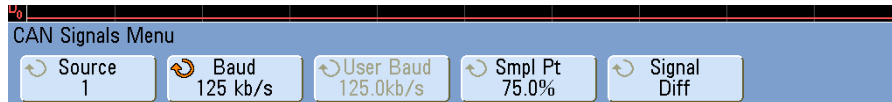


## Setup for CAN Signals

Setup consists of connecting the oscilloscope to a CAN signal, using the Signals Menu to specify the signal source, baud rate, and sample point.

To set up the oscilloscope to capture CAN signals, use the **Signals** softkey which appears in both the Trigger Menu and the Serial Decode Menu:

- 1 Press [**Label**] to turn on labels.
- 2 Press [**Trigger**]; then, select the **CAN** trigger type.
- 3 Press the **Signals** softkey to open the CAN Signals Menu.



- 4 Press **Source**; then, select the channel for the CAN signal.  
The **CAN** label for the source channel is automatically set, and the channel you select is shown in the upper-right corner of the display next to “**CAN**”.
- 5 Set the trigger level.
  - For analog channels, turn the Trigger Level knob.
  - For digital channels, press the [**Digital**] key and the **Thresholds** softkey to access the threshold level setting softkeys.

The value of the trigger level or digital threshold is displayed in the upper-right corner of the display.
- 6 Press the **Signal** softkey and select the type and polarity of the CAN signal. This also automatically sets the channel label for the source channel.
  - **CAN\_H** – The actual CAN\_H differential bus

Dominant low signals:

  - **CAN\_L** – The actual CAN\_L differential bus signal
  - **Rx** – The Receive signal from the CAN bus transceiver
  - **Tx** – The Transmit signal from the CAN bus transceiver

- **Differential** – The CAN differential bus signals connected to an analog source channel using a differential probe. Connect the probe's positive lead to the dominant-low CAN signal (CAN\_L) and connect the negative lead to the dominant-high CAN signal (CAN\_H).

7 Repeatedly press and release the **Baud** softkey to set the CAN signal baud rate to match your CAN bus signal.

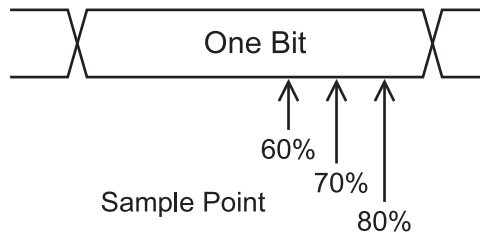
The CAN baud rate can be set to:

10 kb/s	50 kb/s	100 kb/s	500 kb/s
20 kb/s	62.5 kb/s	125 kb/s	800 kb/s
33.3 kb/s	83.3 kb/s	250 kb/s	1 Mb/s
User Defined			

The default baud rate is 1 Mb/s

If the desired baud rate is not shown in the table, select User Defined. You can set the CAN baud rate from 10.0 kb/s to 1.000 Mb/s in increments of 100 b/s. Press the **User Baud** softkey and rotate the Entry knob to make your selection.

8 Repeatedly press and release the **Smpl Pt** softkey to select the point between phase segments 1 and 2 where the state of the bus is measured. This controls the point within the bit's time where the bit value is captured.



## CAN Triggering

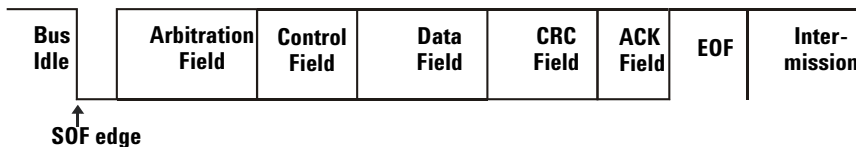
To set up the oscilloscope to capture a CAN signal, see “[Setup for CAN Signals](#)” on page 262.

The Controller Area Network (CAN) trigger allows triggering on CAN version 2.0A and 2.0B signals.

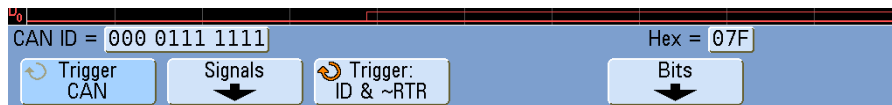
After setting up the oscilloscope to capture a CAN signal, use the **Trigger** softkey in the the Trigger Menu to specify the event to trigger on.

If the AMS license is not installed on the oscilloscope, you can still trigger on the Start of Frame (SOF) bit of a CAN data frame. If the N5424A CAN/LIN Automotive Triggering and Decode option (license AMS) is installed on your oscilloscope, the following additional CAN trigger types will also be available: Remote Frame ID (RTR), Data Frame ID (~RTR), Remote or Data Frame ID, Data Frame ID and Data, Error Frame, All Errors, Acknowledge Error, and Overload Frame.

A CAN message frame in CAN\_L signal type is shown below:



- 1 Press [**Trigger**]; then, select the **CAN** trigger type.
- 2 Repeatedly press and release the **Trigger**: softkey or rotate the Entry knob to select the trigger condition.



- **SOF - Start of Frame** – The oscilloscope triggers at the start of a frame.
- **Remote Frame ID (RTR)** – The oscilloscope triggers on remote frames with the specified ID. Press the **Bits** softkey to select the ID.



**NOTE**

For details about using the CAN Bits Menu softkeys, press and hold the softkey in question to display the built-in help.

---

- **Data Frame ID (~RTR)** - The oscilloscope will trigger on data frames matching the specified ID. Press the **Bits** softkey to select the ID.
- **Remote or Data Frame ID** - The oscilloscope will trigger on remote or data frames matching the specified ID. Press the **Bits** softkey to select the ID.
- **Data Frame ID and Data** - The oscilloscope will trigger on data frames matching the specified ID and data. Press the **Bits** softkey to select the ID and set up the number of data bytes and values.
- **Error Frame** - The oscilloscope will trigger on CAN active error frames.
- **All Errors** - The oscilloscope will trigger when any form error or active error is encountered.
- **Acknowledge Error** - The oscilloscope will trigger when the acknowledge bit is recessive (high).
- **Overload Frame** - The oscilloscope will trigger on CAN overload frames.

You can use the **Zoom** mode for easier navigation of the decoded data.

**NOTE**

If the setup does not produce a stable trigger, the CAN signal may be slow enough that the oscilloscope is AutoTriggering. Press the [**Mode/Coupling**] key, then press the **Mode** softkey to set the trigger mode from **Auto** to **Normal**.

---

**NOTE**

To display CAN serial decode, see “[CAN Serial Decode](#)” on page 266.

---

## CAN Serial Decode

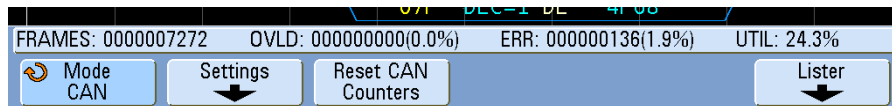
To set up the oscilloscope to capture CAN signals, see “Setup for CAN Signals” on page 262.

### NOTE

For CAN triggering set up see “CAN Triggering” on page 264.

To set up CAN serial decode:

- 1 Press [**Serial**]; then, select the **CAN** serial decode mode.



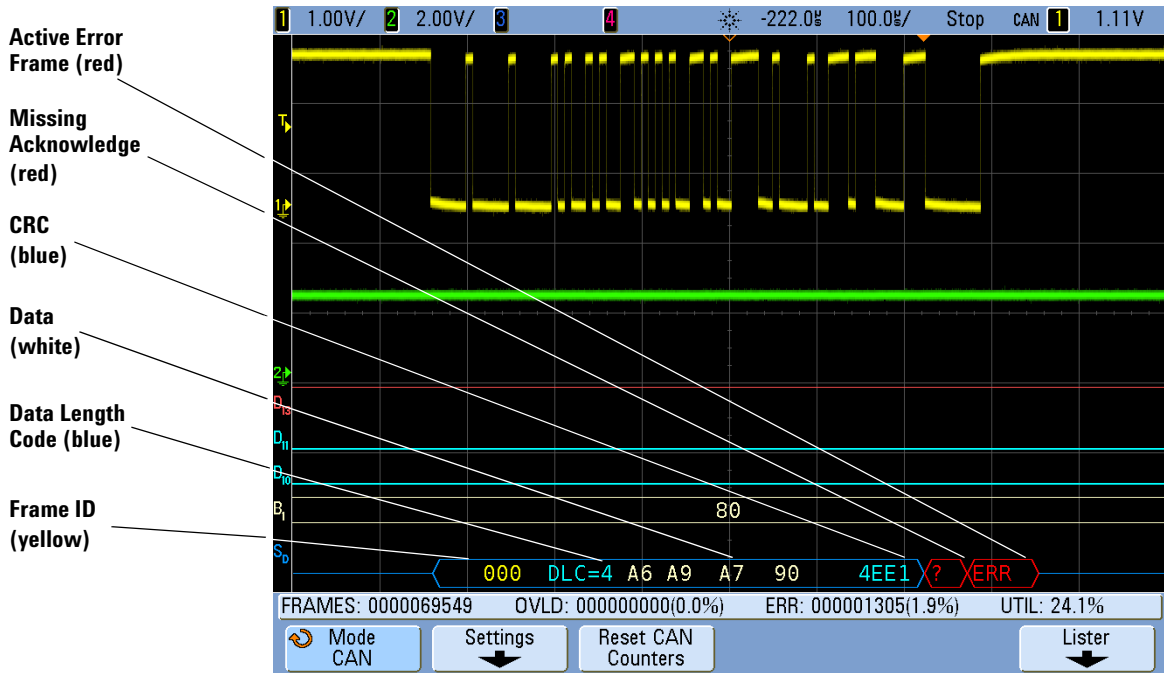
- 2 If the decode line does not appear on the display, press the [**Serial**] key to turn it on.
- 3 If the oscilloscope is stopped, press the [**Run/Stop**] key to acquire and decode data.

### NOTE

If the setup does not produce a stable trigger, the CAN signal may be slow enough that the oscilloscope is AutoTriggering. Press the [**Mode/Coupling**] key, then press the **Mode** softkey to set the trigger mode from **Auto** to **Normal**.

You can use the **Zoom** horizontal sweep mode for easier navigation of the decoded data.

## Interpreting CAN Decode

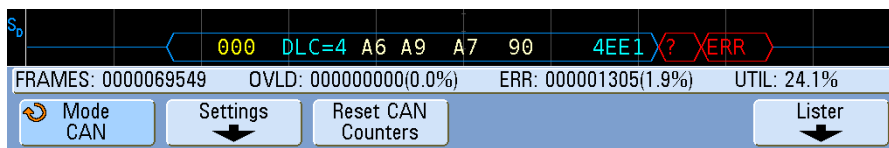


- Frame ID appears in hex digits in yellow. Frames of 11 or 29 bits are automatically detected.
- Remote frame (RMT) appears in green.
- Data length code (DLC) appears in blue for data frames and green for remote frames.
- Data bytes appear in hex digits in white for data frames.
- Cyclic redundancy check (CRC) appears in hex digits in blue when valid, or in red to indicate that the oscilloscope's hardware decode calculated a CRC that is different from the incoming CRC data stream.
- Angled waveforms show an active bus (inside a packet/frame).
- Mid-level blue lines show an idle bus.
- Decoded text is truncated at the end of the associated frame when there is insufficient space within frame boundaries.

- Red dots in the decode line indicate that there is data that is not being displayed. Scroll or expand the horizontal scale to view the information.
- Aliased bus values (undersampled or indeterminate) are drawn in red.
- Unknown bus values (undefined or error conditions) are drawn in red with a “?” label.
- Flagged error frames are drawn in red with an “ERR” label.

### CAN Totalizer

The CAN totalizer provides a direct measure of bus quality and efficiency. The CAN totalizer measures total CAN frames, flagged error frames, overload frames, and bus utilization.



The totalizer is always running (counting frames and calculating percentages) and is displayed whenever CAN decode is displayed. The totalizer counts even when the oscilloscope is stopped (not acquiring data). Pressing the **[Run/Stop]** key does not affect the totalizer. When an overflow condition occurs, the counter displays **OVERFLOW**. The counters can be reset to zero by pressing the **Reset CAN Counters** softkey.

### Types of Frames

- *Active error frames* are CAN frames in which a CAN node recognizes an error condition during a data or remote frame and issues an active error flag.
- A *partial frame* occurs when the oscilloscope detects any error condition during a frame that is not followed by an active error flag. Partial frames are not counted.

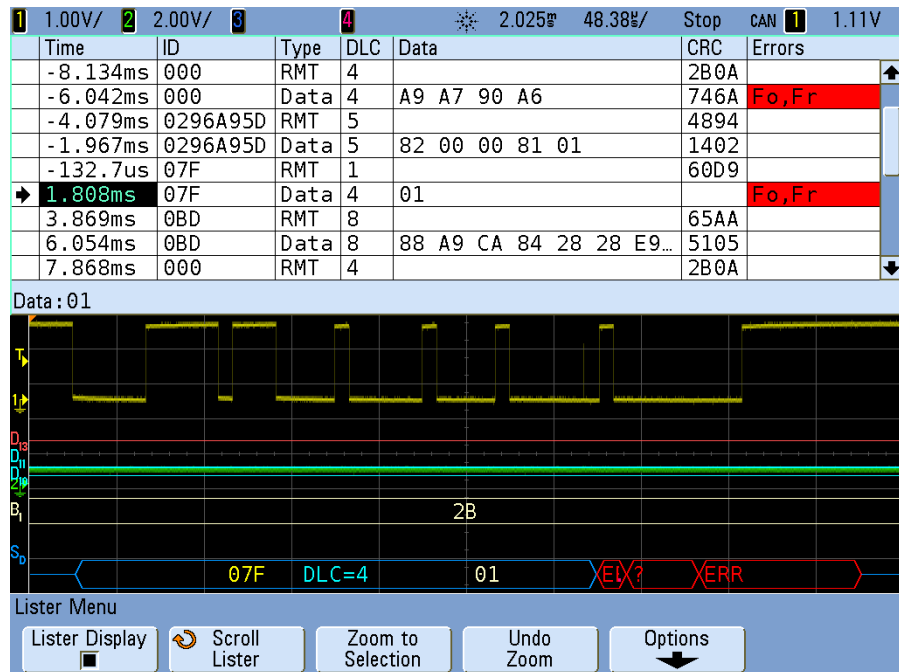
### Counters

- The FRAMES counter gives the total number of completed remote, data, overload, and active error frames.

- The OVLD counter gives the total number of completed overload frames and their percentage of the total number of frames.
- The ERR counter gives the total number of completed active error frames and their percentage of the total number of frames.
- The UTIL (bus load) indicator measures the percentage of time the bus is active. The calculation is done on 330 ms periods, approximately every 400 ms.

Example: If a data frame contains an active error flag, both the FRAMES counter and the ERR counter will be incremented. If a data frame contains an error that is not an active error it is considered a partial frame and no counters are incremented.

## Interpreting CAN Lister Data



In addition to the standard Time column, the CAN Lister contains these columns:

- ID – frame ID.
- Type – frame type (RMT remote frame, Data, etc.).
- DLC – data length code.
- Data – data bytes.
- CRC – cyclic redundancy check.
- Errors – highlighted in red. Errors can be Acknowledge (Ack, A), Form (Fo), or Frame (Fr). Different kinds of errors can be combined like “Fo,Fr” in the above example.

### Searching for CAN Data in the Lister

The oscilloscope’s search capability lets you search for (and mark) certain types of CAN data in the Lister. You can use the **[Navigate]** key and controls to navigate through the marked rows.

- 1 With CAN selected as the serial decode mode, press **[Search]**.
- 2 In the Search Menu, press **Search for**; then, select from these options:
  - **Remote Frame ID (RTR)** – Finds remote frames with the specified ID. Press the Bits softkey to enter the ID.
  - **Data Frame ID (~RTR)** – Finds data frames matching the specified ID. Press the Bits softkey to enter the ID.
  - **Remote or Data Frame ID** – Finds remote or data frames matching the specified ID. Press the Bits softkey to select the ID.
  - **Data Frame ID and Data** – Finds data frames matching the specified ID and data. Press the Bits softkey to set the ID length, ID value, number of data bytes, and data value.
  - **Error Frame** – Finds CAN active error frames.
  - **All Errors** – Finds any form error or active error.
  - **Overload Frame** – Finds CAN overload frames.

For more information on searching data, see [“Searching Lister Data”](#) on page 259.

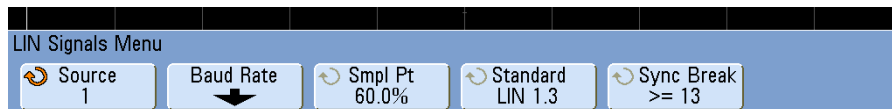
For more information on using the **[Navigate]** key and controls, see [“To navigate the time base”](#) on page 74.

## Setup for LIN Signals

LIN (Local Interconnect Network) trigger setup consists of connecting the oscilloscope to a serial LIN signal.

To set up the oscilloscope to capture LIN signals, use the **Signals** softkey which appears in both the Trigger Menu and the Serial Decode Menu:

- 1 Press [**Label**] to turn on labels.
- 2 Press [**Trigger**]; then, select the **LIN** trigger type.
- 3 Press the **Signals** softkey. The LIN Signals Menu will be displayed.



- 4 Press the **Source** softkey to select the channel connected to the LIN signal line.
- 5 Set the trigger or threshold levels to the middle of the LIN signal.  
If you have connected one of the oscilloscope's analog source channels to the LIN signal, adjust the trigger level for the selected analog channel to the middle of the waveform by turning the Trigger Level knob.  
If you have connected one of the oscilloscope's digital source channels to the LIN signal (this applies to MSO model oscilloscopes only), press the [**Digital**] key and select **Thresholds** to set an appropriate threshold level for digital channels.

The value of the trigger level or digital threshold is displayed in the upper-right corner of the display.

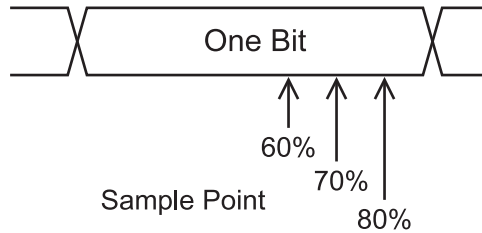
- 6 Press the **Baud** softkey to set the LIN signal baud rate to match your LIN bus signal.

The LIN baud rate can be set to 2400 b/s, 9600 b/s, 10.4 kb/s, 19.2 kb/s, 115.2 kb/s, 625 kb/s, or User Defined. The default baud rate is 2400 b/s.

If the desired baud rate is not shown in the list, select **User Defined**. You can set the LIN baud rate from 2.4 kb/s to 625 kb/s in increments of 100 b/s. Press the **User Baud** softkey and rotate the Entry knob to make your selection.



- 7 Press the **Smpl Pt** softkey to select the sample point at which the oscilloscope will sample the bit value.



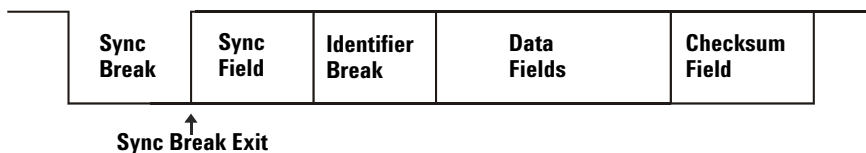
- 8 Press the **Standard** softkey to select the LIN standard you are measuring (LIN 1.3 or LIN 2.0).  
For LIN 1.2 signals, use the LIN 1.3 setting. The LIN 1.3 setting assumes the signal follows the “Table of Valid ID Values” as shown in section A.2 of the LIN Specification dated December 12, 2002. If your signal does not comply with the table, use the LIN 2.0 setting.
- 9 Press the **Sync Break** softkey and select the minimum number of clocks that define a sync break in your LIN signal.

## LIN Triggering

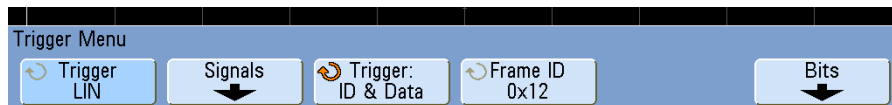
To set up the oscilloscope to capture a LIN signal, see “[Setup for LIN Signals](#)” on page 272.

LIN triggering will trigger on the rising edge at the Sync Break exit of the LIN single-wire bus signal that marks the beginning of the message frame. If the N5424A CAN/LIN Automotive Triggering and Decode option is installed on your oscilloscope, the Frame ID and Frame ID and Data trigger types are also available.

A LIN signal message frame is shown below:



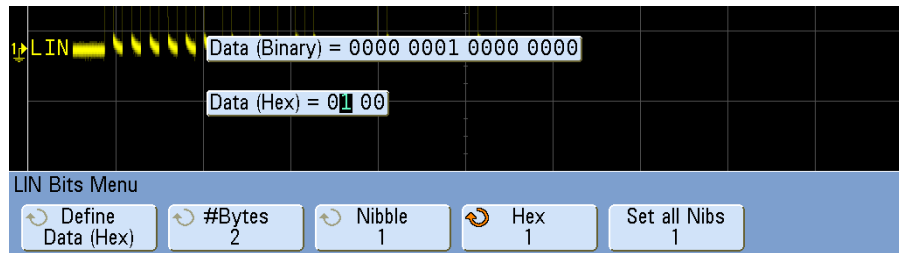
- 1 Press [**Trigger**]; then, select the **LIN** trigger type.
- 2 Repeatedly press and release the **Trigger:** softkey or rotate the Entry knob to select the trigger condition.



- 3 Press the **Trigger:** softkey and choose the type of trigger:
  - **Sync** (Sync Break) – The oscilloscope triggers on the rising edge at the Sync Break exit of the LIN single-wire bus signal that marks the beginning of the message frame.
  - **ID** (Frame ID) – The oscilloscope triggers when a frame with an ID equal to the selected value is detected. Use the **Entry** knob to select the value for the Frame ID.
  - **ID & Data** (Frame ID and Data) – The oscilloscope triggers when a frame with an ID and data equal to the selected values is detected. When triggering on a frame ID and data:
    - To select the frame ID value, press the **Frame ID** softkey, and use the **Entry** knob.

Note that you can enter a “don’t care” value for the frame ID and trigger on data values only.

- To set up the number of data bytes and enter their values (in hexadecimal or binary), press the **Bits** softkey to open the LIN Bits Menu.



#### NOTE

For details about using the LIN Bits Menu softkeys, press and hold the softkey in question to display the built-in help.

#### NOTE

For LIN decode information see “[LIN Serial Decode](#)” on page 276.

## LIN Serial Decode

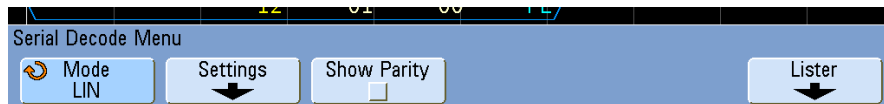
To set up the oscilloscope to capture CAN signals, see “Setup for LIN Signals” on page 272.

### NOTE

For LIN triggering setup see “LIN Triggering” on page 274.

To set up LIN serial decode:

- 1 Press [**Serial**]; then, select the **LIN** serial decode mode.



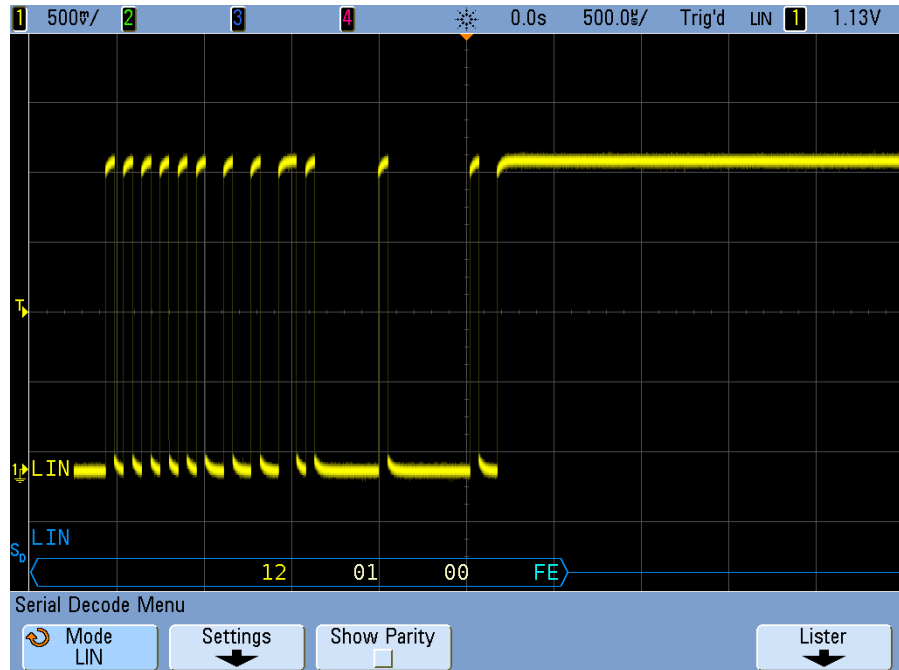
- 2 Choose whether to include the parity bits in the identifier field.
  - a If you want to mask the upper two parity bits, ensure that the box under the **Show Parity** softkey is not selected.
  - b If you want to include the parity bits in the identifier field, ensure that the box under the **Show Parity** softkey is selected.
- 3 If the decode line does not appear on the display, press the [**Serial**] key to turn it on.
- 4 If the oscilloscope is stopped, press the [**Run/Stop**] key to acquire and decode data.

### NOTE

If the setup does not produce a stable trigger, the LIN signal may be slow enough that the oscilloscope is AutoTriggering. Press the [**Mode/Coupling**] key, then press the **Mode** softkey to set the trigger mode from **Auto** to **Normal**.

You can use the **Zoom** horizontal sweep mode for easier navigation of the decoded data.

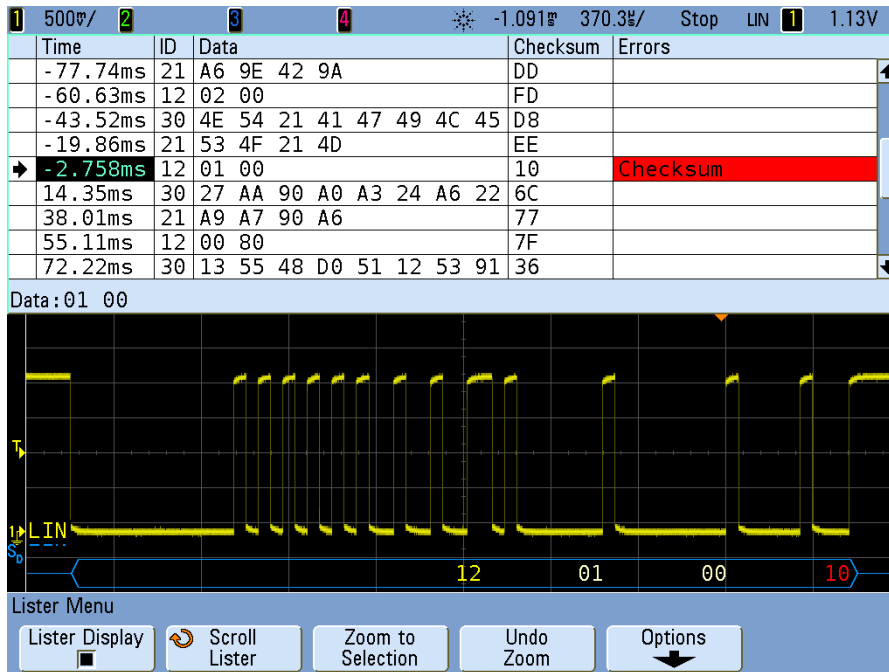
## Interpreting LIN Decode



- Angled waveforms show an active bus (inside a packet/frame).
- Mid-level blue lines show an idle bus (LIN 1.3 only).
- The hexadecimal ID and parity bits (if enabled) appear in yellow. If a parity error is detected the hexadecimal ID and parity bits (if enabled) appear in red.
- Decoded hexadecimal data values appear in white.
- For LIN 1.3, the checksum appears in blue if correct, or red if incorrect. The checksum always appears in white for LIN 2.0.
- Decoded text is truncated at the end of the associated frame when there is insufficient space within frame boundaries.
- Red dots in the decode line indicate that there is data that is not being displayed. Scroll or expand the horizontal scale to view the information.
- Unknown bus values (undefined or error conditions) are drawn in red.
- If there is an error in the synch field, SYNC will appear in red.

- If the header exceeds the length specified in the standard, THM will appear red.
- If the total frame count exceeds the length specified in the standard, TFM will appear red (LIN 1.3 only).
- For LIN 1.3 a wakeup signal is indicated by WAKE in blue. If the wakeup signal is not followed by a valid wakeup delimiter a wakeup error is detected and displayed as WUP in red.

## Interpreting LIN Lister Data



In addition to the standard Time column, the LIN Lister contains these columns:

- ID – frame ID.
- Data – (LIN 1.3 only) data bytes.
- Checksum – (LIN 1.3 only).

- Data and Checksum – (LIN 2.0 only).
- Errors – highlighted in red.

## Searching for LIN Data in the Lister

The oscilloscope's search capability lets you search for (and mark) certain types of LIN data in the Lister. You can use the **[Navigate]** key and controls to navigate through the marked rows.

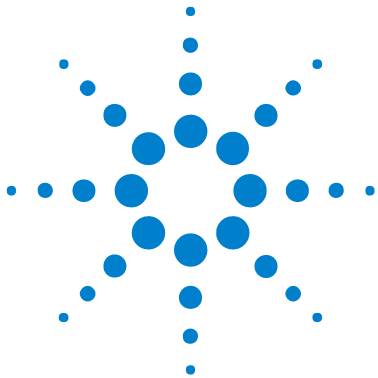
- 1 With LIN selected as the serial decode mode, press **[Search]**.
- 2 In the Search Menu, press **Search for**; then, select from these options:
  - **ID** – Finds frames with the specified ID. Press the Frame ID softkey to select the ID.
  - **ID & Data** – Finds frames with the specified ID and data. Press the Frame ID softkey to select the ID. Press the Bits softkey to enter the data value.
  - **Errors** – Finds all errors.

For more information on searching data, see “[Searching Lister Data](#)” on page 259.

For more information on using the **[Navigate]** key and controls, see “[To navigate the time base](#)” on page 74.







# 11

## I<sup>2</sup>C/SPI Triggering and Serial Decode

Setup for I2C Signals [282](#)

I2C Triggering [284](#)

I2C Serial Decode [288](#)

Setup for SPI Signals [292](#)

SPI Triggering [295](#)

SPI Serial Decode [297](#)

The N5423A I<sup>2</sup>C/SPI triggering and decode option (Option LSS) requires a four-channel InfiniiVision Series oscilloscope.



## Setup for I<sup>2</sup>C Signals

An I<sup>2</sup>C (Inter-IC bus) trigger setup consists of connecting the oscilloscope to the serial data (SDA) line and the serial clock (SCL) line.

To set up the oscilloscope to capture I<sup>2</sup>C signals, use the **Signals** softkey which appears in the Trigger Menu or the **Settings** softkey which appears in the Serial Decode Menu:

- 1 Press [**Label**] to turn on labels.
- 2 Press [**Trigger**]; then, select the **I<sup>2</sup>C** trigger type.
- 3 Press the **Signals** softkey to display the I<sup>2</sup>C Signals Menu.



- 4 Connect an oscilloscope channel to the SCL (serial clock) line in the device under test, then set the **SCL** clock channel softkey to that channel.

As you press the **SCL** softkey (or rotate the Entry knob), the **SCL** label for the source channel is automatically set and the channel you select is shown in the upper-right corner of the display next to “I<sup>2</sup>C”.

- 5 Connect an oscilloscope channel to the SDA (serial data) line in the device under test, then set the **SDA** data channel softkey to that channel.

As you press the **SDA** softkey (or rotate the Entry knob), the **SDA** label for the source channel is automatically set and the channel you select is shown in the upper-right corner of the display next to “I<sup>2</sup>C”.

- 6 Set the trigger levels for the SCL and SDA signals to the middle of the signals:
  - If your I<sup>2</sup>C signals are connected to analog channels, press the **SCL** softkey and rotate the **Trigger Level** knob, then press the **SDA** softkey and rotate the **Trigger Level** knob.
  - If your I<sup>2</sup>C signals are connected to digital channels (this applies to MSO model oscilloscopes only), press the [**Digital**] key and the **Thresholds** softkey to access the threshold level setting softkeys and set the thresholds to the approximate middle of the signals.

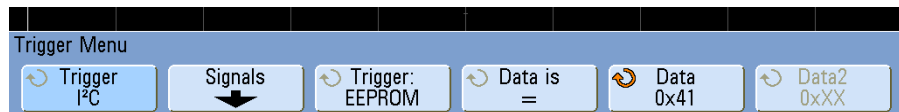
Data must be stable during the whole high clock cycle or it will be interpreted as a start or stop condition (data transitioning while the clock is high).

## I<sup>2</sup>C Triggering

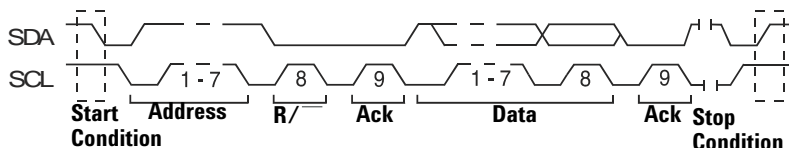
To set up the oscilloscope to capture I<sup>2</sup>C signals, see “Setup for I2C Signals” on page 282.

After the oscilloscope has been set up to capture I<sup>2</sup>C signals, you can trigger on a stop/start condition, a restart, a missing acknowledge, an EEPROM data read, or on a read/write frame with a specific device address and data value.

- 1 Press [**Trigger**]; then, select the **I<sup>2</sup>C** trigger type.
- 2 Repeatedly press and release the **Trigger**: softkey or rotate the Entry knob to select the trigger condition.

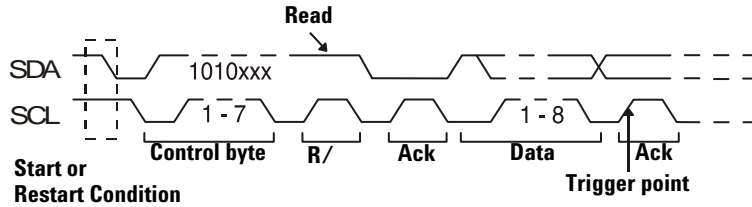


- **Start Condition** – The oscilloscope triggers when SDA data transitions from high to low while the SCL clock is high. For triggering purposes (including frame triggers), a restart is treated as a start condition.
- **Stop Condition** – The oscilloscope triggers when data (SDA) transitions from low to high while the clock (SCL) is high.

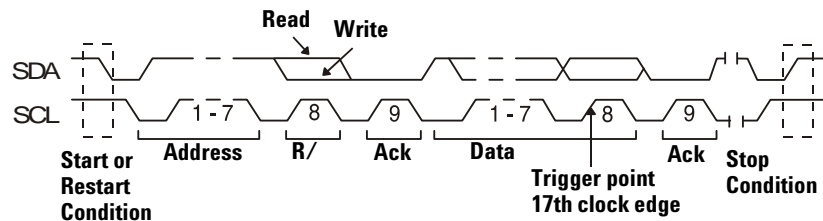


- **Missing Acknowledge** – The oscilloscope triggers when SDA data is high during any Ack SCL clock bit.
- **Address with no Ack** – The oscilloscope triggers when the acknowledge of the selected address field is false. The R/W bit is ignored.
- **Restart** – The oscilloscope triggers when another start condition occurs before a stop condition.

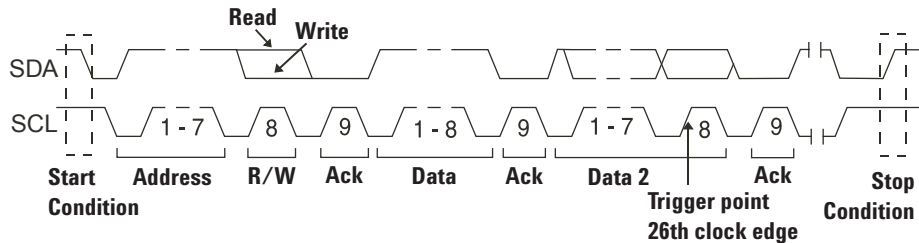
- **EEPROM Data Read** – The trigger looks for EEPROM control byte value 1010xxx on the SDA line, followed by a Read bit and an Ack bit. It then looks for the data value and qualifier set by the **Data** softkey and the **Data is** softkey. When this event occurs, the oscilloscope will trigger on the clock edge for the Ack bit after the data byte. This data byte does not need to occur directly after the control byte.



- **Frame (Start: Addr7: Read: Ack: Data) or Frame (Start: Addr7: Write: Ack: Data)** – The oscilloscope triggers on a read or write frame in 7-bit addressing mode on the 17th clock edge if all bits in the pattern match. For triggering purposes, a restart is treated as a start condition.



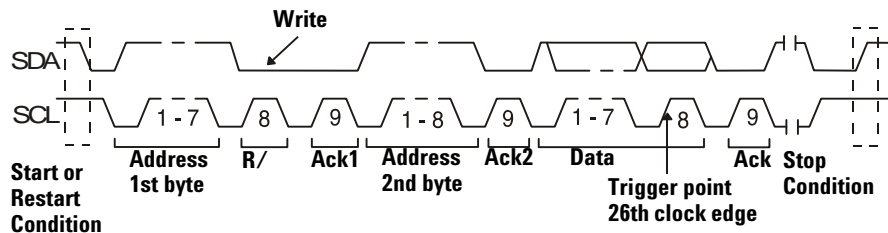
- **Frame (Start: Addr7: Read: Ack: Data: Ack: Data2) or Frame (Start: Addr7: Write: Ack: Data: Ack: Data2)** – The oscilloscope triggers on a read or write frame in 7-bit addressing mode on the 26th clock edge if all bits in the pattern match. For triggering purposes, a restart is treated as a start condition.



- **10-bit Write** – The oscilloscope triggers on a 10-bit write frame on the 26th clock edge if all bits in the pattern match. The frame is in the format:

Frame (Start: Address byte 1: Write: Address byte 2: Ack: Data)

For triggering purposes, a restart is treated as a start condition.



- 3 If you have set the oscilloscope to trigger on an EEPROM Data Read condition:

Press the **Data is** softkey to set the oscilloscope to trigger when data is = (equal to), ≠ (not equal to), < (less than), or > (greater than) the data value set in the **Data** softkey.

The oscilloscope will trigger on the clock edge for the Ack bit after the trigger event is found. This data byte does not need to occur directly after the control byte. The oscilloscope will trigger on any data byte that meets the criteria defined by the **Data is** and **Data** softkeys during a current address read or a random read or a sequential read cycle.

- 4 If you have set the oscilloscope to trigger on a 7-bit address read or write frame condition or a 10-bit write frame condition:
  - a Press the **Address** softkey and turn the Entry knob to select the 7-bit or 10-bit device address.
 

You can select from an address range of 0x00 to 0x7F (7-bit) or 0x3FF (10-bit) hexadecimal. When triggering on a read/write frame, the oscilloscope will trigger after the start, address, read/write, acknowledge, and data events occur.

If don't care is selected (0xXX or 0XXXX) for the address, the address will be ignored. The trigger will always occur on the 17th clock for 7-bit addressing or 26th clock for 10-bit addressing.
  - b Press the **Data** value softkey and turn the Entry knob to select the 8-bit data pattern on which to trigger.
 

You can select a data value in the range of 0x00 to 0xFF (hexadecimal). The oscilloscope will trigger after the start, address, read/write, acknowledge, and data events occur.

If don't care (0xXX) is selected for data, the data will be ignored. The trigger will always occur on the 17th clock for 7-bit addressing or 26th clock for 10-bit addressing.
  - c If you have selected a three-byte trigger, press the **Data2** value softkey and turn the Entry knob to select the 8-bit data pattern on which to trigger.

#### NOTE

To display I<sup>2</sup>C serial decode, see “I<sup>2</sup>C Serial Decode” on page 288.

## I<sup>2</sup>C Serial Decode

To set up the oscilloscope to capture I<sup>2</sup>C signals, see “[Setup for I2C Signals](#)” on page 282.

### NOTE

Because of oscilloscope hardware resource limitations, you cannot decode I<sup>2</sup>C data while LIN triggering is selected.

### NOTE

For I<sup>2</sup>C triggering setup see “[I2C Triggering](#)” on page 284.

To set up I<sup>2</sup>C serial decode:

- 1 Press [**Serial**]; then, select the **I<sup>2</sup>C** serial decode mode.



- 2 Choose 7-bit or 8-bit address size. Use 8-bit address size to include the R/W bit as part of the address value, or choose 7-bit address size to exclude the R/W bit from the address value.
- 3 If the decode line does not appear on the display, press the [**Serial**] key to turn it on.
- 4 If the oscilloscope is stopped, press the [**Run/Stop**] key to acquire and decode data.

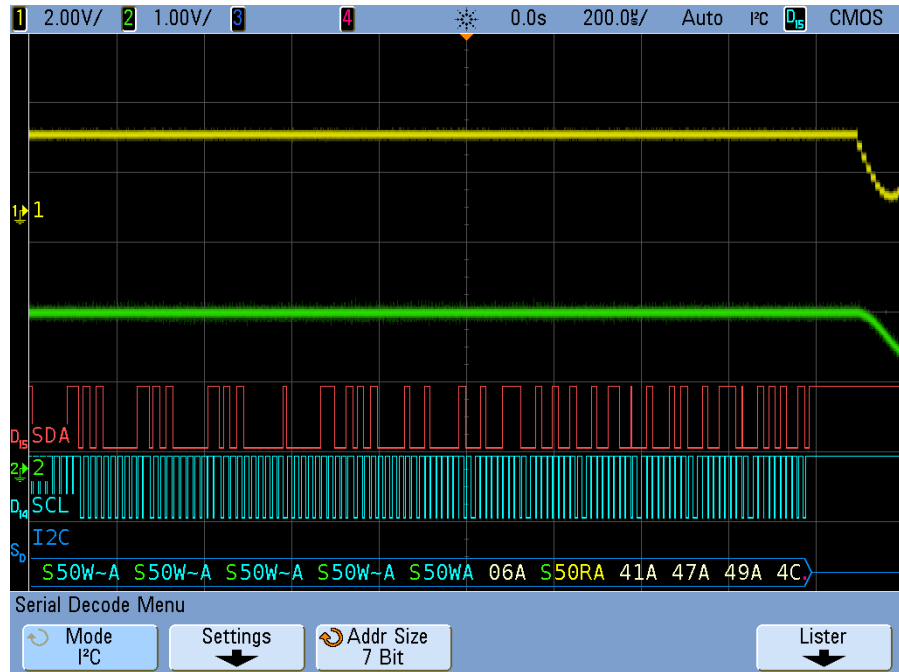
### NOTE

If the setup does not produce a stable trigger, the I<sup>2</sup>C signal may be slow enough that the oscilloscope is AutoTriggering. Press the [**Mode/Coupling**] key, then press the **Mode** softkey to set the trigger mode from **Auto** to **Normal**.

You can use the **Zoom** horizontal sweep mode for easier navigation of the acquired data.



## Interpreting I<sup>2</sup>C Decode

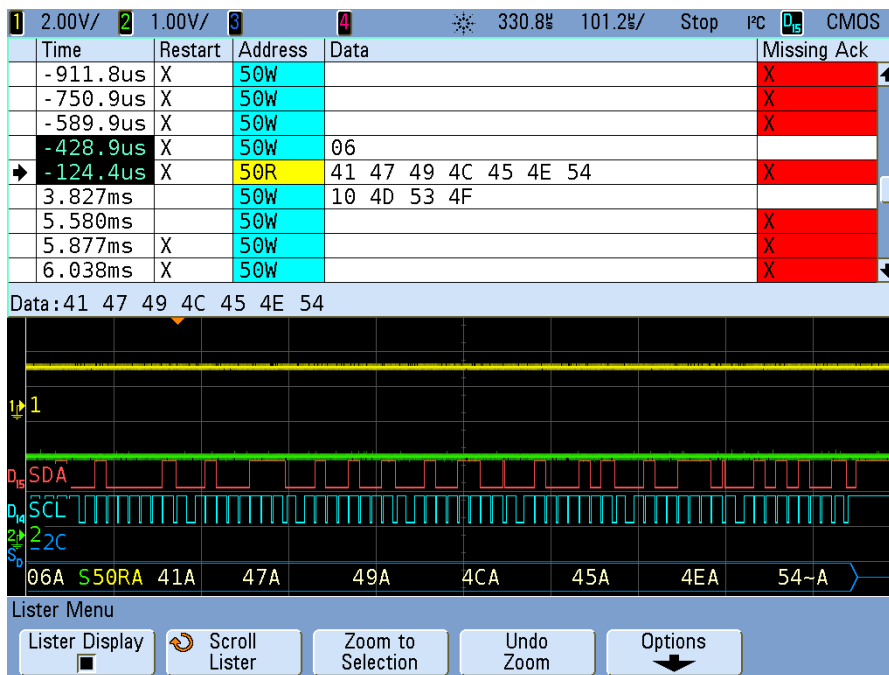


- Angled waveforms show an active bus (inside a packet/frame).
- Mid-level blue lines show an idle bus.
- In the decoded hexadecimal data:
  - Address values appear at the start of a frame.
  - Write addresses appear in light-blue along with the “W” character.
  - Read addresses appear in yellow along with the “R” character.
  - Restart addresses appear in green along with the “S” character.
  - Data values appear in white.
  - “A” indicates Ack (low), “~A” indicates No Ack (high).
  - Decoded text is truncated at the end of the associated frame when there is insufficient space within frame boundaries.
- Red dots in the decode line indicate that more data can be displayed. Scroll or expand the horizontal scale to view the data.

## 11 I<sup>2</sup>C/SPI Triggering and Serial Decode

- Aliased bus values (undersampled or indeterminate) are drawn in red.
- Unknown bus values (undefined or error conditions) are drawn in red.

### Interpreting I<sup>2</sup>C Lister Data



In addition to the standard Time column, the I<sup>2</sup>C Lister contains these columns:

- Restart – indicated with an “X”.
- Address – colored blue for writes, yellow for reads.
- Data – data bytes.
- Missing Ack – highlighted in red, error if it has an “X”.

## Searching for I<sup>2</sup>C Data in the Lister

The oscilloscope's search capability lets you search for (and mark) certain types of I<sup>2</sup>C data in the Lister. You can use the **[Navigate]** key and controls to navigate through the marked rows.

- 1 With I<sup>2</sup>C selected as the serial decode mode, press **[Search]**.
- 2 In the Search Menu, press **Search for**; then, select from these options:
  - **Missing Acknowledge** – finds SDA data is high during any Ack SCL clock bit.
  - **Address with no Ack** – finds when the acknowledge of the selected address field is false. The R/W bit is ignored.
  - **Restart** – finds when another start condition occurs before a stop condition.
  - **EEPROM Data Read** – finds EEPROM control byte value 1010xxx on the SDA line, followed by a Read bit and an Ack bit. It then looks for the data value and qualifier set by the Data is softkey and the Data softkeys.
  - **Frame(Start:Address7:Read:Ack:Data)** – finds a read frame on the 17th clock edge if all bits in the pattern match.
  - **Frame(Start:Address7:Write:Ack:Data)** – finds a write frame on the 17th clock edge if all bits in the pattern match.
  - **Frame(Start:Address7:Read:Ack:Data:Ack:Data2)** – finds a read frame on the 26th clock edge if all bits in the pattern match.
  - **Frame(Start:Address7:Write:Ack:Data:Ack:Data2)** – finds a write frame on the 26th clock edge if all bits in the pattern match.

For more information on searching data, see [“Searching Lister Data”](#) on page 259.

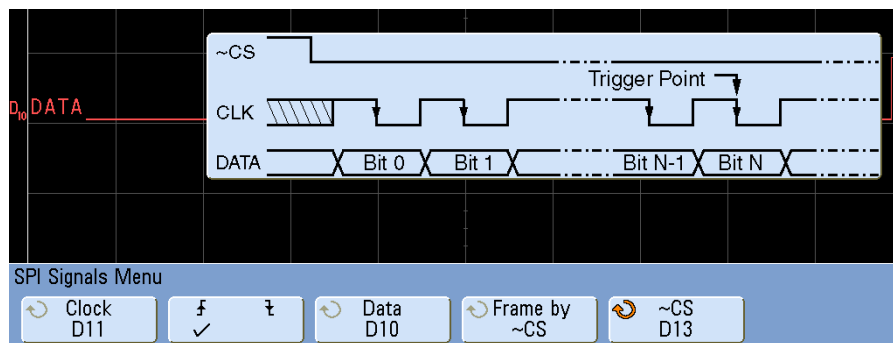
For more information on using the **[Navigate]** key and controls, see [“To navigate the time base”](#) on page 74.

## Setup for SPI Signals

Serial Peripheral Interface (SPI) trigger setup consists of connecting the oscilloscope to a clock, data, and framing signal.

To set up the oscilloscope to capture SPI signals, use the **Signals** softkey which appears in both the Trigger Menu and the Serial Decode Menu:

- 1 Press [**Label**] to turn on labels.
- 2 Press [**Trigger**]; then, select the **SPI** trigger type.
- 3 Press the **Signals** softkey. The SPI Signals Menu will be displayed.



- 4 Press the **Clock** softkey or turn the Entry knob to select the channel connected to the SPI serial clock line.  
As you press the **Clock** softkey (or rotate the Entry knob), the **CLK** label for the source channel is automatically set and the channel you select is shown in the upper-right corner of the display next to “SPI”.
- 5 Press the slope softkey (↕ ↘) to select rising edge or falling edge for the selected Clock source.  
This determines which clock edge the oscilloscope will use to latch the serial data. When you press the slope softkey, the graphic shown on the display changes to show the current state of the clock signal.
- 6 Press the **Data** softkey or turn the Entry knob to select the channel that is connected to the SPI serial data line. (If the channel you selected is off, switch it on.)

As you press the **Data** softkey (or rotate the Entry knob), the **DATA** label for the source channel is automatically set and the channel you select is shown in the upper-right corner of the display next to “SPI”.

- 7 Press the **Frame by** softkey to select a framing signal that the oscilloscope will use for determining which clock edge is the first clock edge in the serial stream.

You can set the oscilloscope to trigger during a high chip select (**CS**), a low chip select (**~CS**), or after a **Timeout** period during which the clock signal has been idle.

- If the framing signal is set to **CS** (or **~CS**), the first clock edge as defined, rising or falling, seen after the **CS** (or **~CS**) signal transitions from low to high (or high to low) is the first clock in the serial stream.

**Chip Select** – Press the **CS** or **~CS** softkey or turn the Entry knob to select the channel that is connected to the SPI frame line. The label (**~CS** or **CS**) for the source channel is automatically set. The data pattern and the clock transition must occur during the time when the framing signal is valid. The framing signal must be valid for the entire data pattern.

As you press the **CS** or **~CS** softkey (or rotate the Entry knob), the **CS** or **~CS** label for the source channel is automatically set and the channel you select is shown in the upper-right corner of the display next to “**SPI**”. When you press the **Frame by** softkey, the graphic shown on the previous page changes to show timeout selection or the current state of the chip select signal.

- If the framing signal is set to **Timeout**, the oscilloscope generates its own internal framing signal after it sees inactivity on the serial clock line.

**Clock Timeout** – Select **Clock Timeout** in the **Frame by** softkey, then select the **Timeout** softkey and turn the Entry knob to set the minimum time that the Clock signal must be idle (not transitioning) before the oscilloscope will search for the Data pattern on which to trigger. When you press the **Frame by** softkey, the graphic shown on the previous page changes to show timeout selection or the current state of the chip select signal.

The Timeout value can be set anywhere from 100 ns to 10 s.

- 8 Set the trigger levels for the Clock, Data, and (if used) CS signals to the middle of the signals:
- If your SPI signals are connected to analog channels, press the **Clock** softkey and rotate the **Trigger Level** knob. Repeat for the **Data**, **~CS**, or **CS** signals.

## 11 I<sup>2</sup>C/SPI Triggering and Serial Decode

- If your SPI signals are connected to digital channels (this applies to MSO model oscilloscopes only), press the **[Digital]** key and the **Thresholds** softkey to access the threshold level setting softkeys and set the thresholds to the approximate middle of the signals.

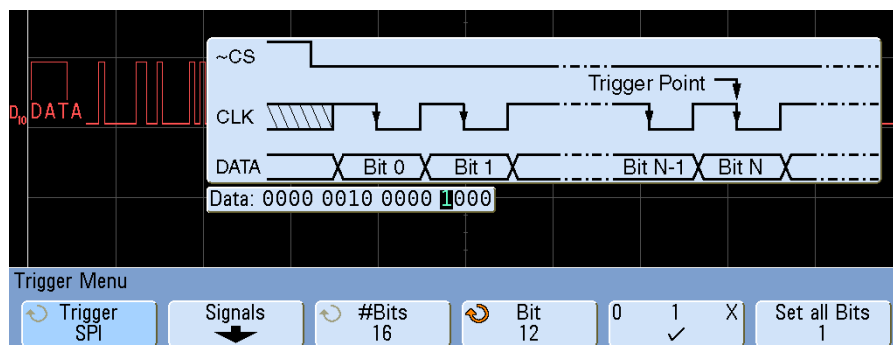
## SPI Triggering

To set up the oscilloscope to capture SPI signals, see “Setup for SPI Signals” on page 292.

After the oscilloscope has been set up to capture SPI signals, you can then trigger on a data pattern that occurs at the start of a frame. The serial data string can be specified to be from 4 to 32 bits long.

When you select the SPI trigger type, a graphic will be displayed showing the current state of the frame signal, clock slope, number of data bits, and data bit values. Press the **Signals** softkey in the Settings Menu to see the current source channels for the clock, data, and frame signals.

- 1 Press [**Trigger**]; then, select the **SPI** trigger type.
- 2 Repeatedly press and release the **Trigger:** softkey or rotate the Entry knob to select the trigger condition.



- 3 Press the **#Bits** softkey, and turn the Entry knob to set the number of bits (**#Bits**) in the serial data string. The number of bits in the string can be set anywhere from 4 bits to 32 bits. The data values for the serial string are displayed in the Data string in the waveform area.
- 4 Turn the Entry knob to select a specific data bit in the serial string as shown in the **Bit** softkey.
 

As you rotate the Entry knob, the bit is highlighted in the Data string shown in the waveform area.
- 5 Press the **0 1 X** softkey to set the bit selected in the **Bit** softkey to **0** (low), **1** (high), or **X** (don't care).
 

Repeat the last two steps to assign values for all bits.

## 11 I<sup>2</sup>C/SPI Triggering and Serial Decode

To reset all of the bit values in the serial data string to one value (0, 1, or X):

- 1 Press the **0 1 X** softkey to select your reset bit value.
- 2 Press the **Set all Bits** softkey to reset the data string to the selected value.

### NOTE

For SPI decode information see [“SPI Serial Decode”](#) on page 297.

---



## SPI Serial Decode

To set up the oscilloscope to capture SPI signals, see “[Setup for SPI Signals](#)” on page 292.

### NOTE

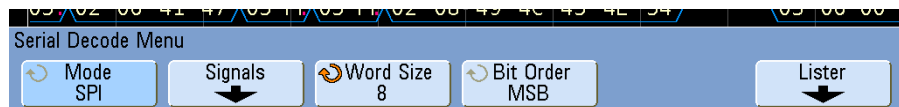
Because of oscilloscope hardware resource limitations, you cannot decode SPI data while CAN or LIN triggering is selected.

### NOTE

For SPI triggering setup see “[SPI Triggering](#)” on page 295.

To set up SPI serial decode:

- 1 Press [**Serial**]; then, select the **SPI** serial decode mode.



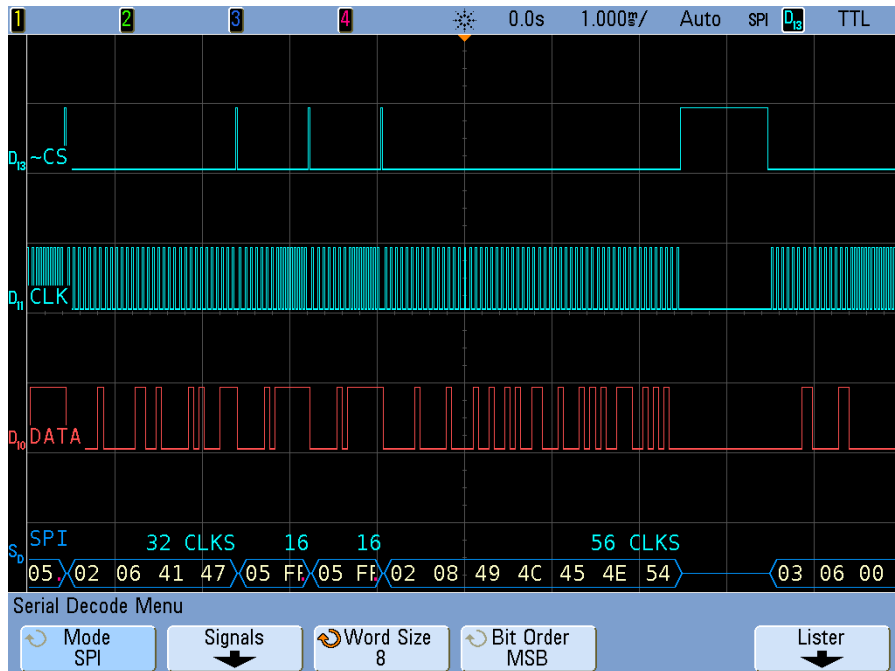
- 2 Press the **Word Size** softkey, and use the Entry knob to select the number of bits in a word.
- 3 Press **Bit Order** to select the bit order, most significant bit first (MSB) or least significant bit first (LSB), used when displaying data in the serial decode waveform and in the Lister.
- 4 If the decode line does not appear on the display, press the [**Serial**] key to turn it on.
- 5 If the oscilloscope is stopped, press the [**Run/Stop**] key to acquire and decode data.

### NOTE

If the setup does not produce a stable trigger, the SPI signal may be slow enough that the oscilloscope is AutoTriggering. Press the [**Mode/Coupling**] key, then press the **Mode** softkey to set the trigger mode from **Auto** to **Normal**.

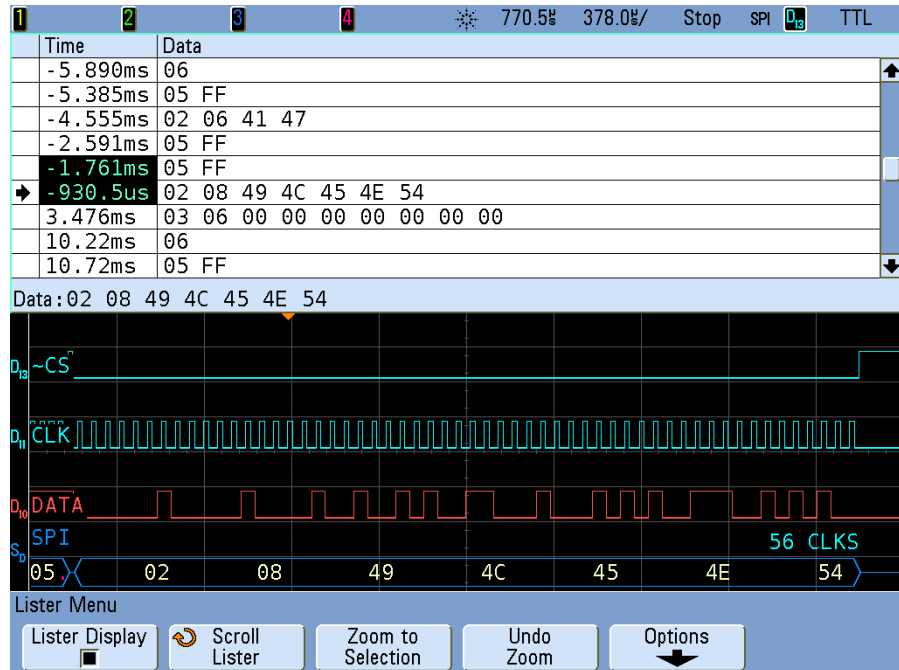
You can use the **Zoom** horizontal sweep mode for easier navigation of the acquired data.

## Interpreting SPI Decode



- Angled waveforms show an active bus (inside a packet/frame).
- Mid-level blue lines show an idle bus.
- The number of clocks in a frame appears in light-blue above the frame, to the right.
- Decoded hexadecimal data values appear in white.
- Decoded text is truncated at the end of the associated frame when there is insufficient space within frame boundaries.
- Red dots in the decode line indicate that there is data that is not being displayed. Scroll or expand the horizontal scale to view the information.
- Aliased bus values (undersampled or indeterminate) are drawn in red.
- Unknown bus values (undefined or error conditions) are drawn in red.

## Interpreting SPI Lister Data



In addition to the standard Time column, the SPI Lister contains these columns:

- Data – data bytes (MISO or MOSI).

## Searching for SPI Data in the Lister

The oscilloscope's search capability lets you search for (and mark) certain types of SPI data in the Lister. You can use the **[Navigate]** key and controls to navigate through the marked rows.

- 1 With SPI selected as the serial decode mode, press **[Search]**.
- 2 In the Search Menu, use the **Words** softkey to specify the number of words in the data value; then, use the remaining softkeys to enter the hex digit values.

For more information on searching data, see [“Searching Lister Data”](#) on page 259.

For more information on using the **[Navigate]** key and controls, see [“To navigate the time base”](#) on page 74.



## 12 I<sup>2</sup>S Triggering and Serial Decode

Setup for I2S Signals 302

I2S Triggering 306

I2S Serial Decode 309

The N5468A I<sup>2</sup>S audio triggering and decode option (Option SND) requires a four-channel InfiniiVision Series oscilloscope.



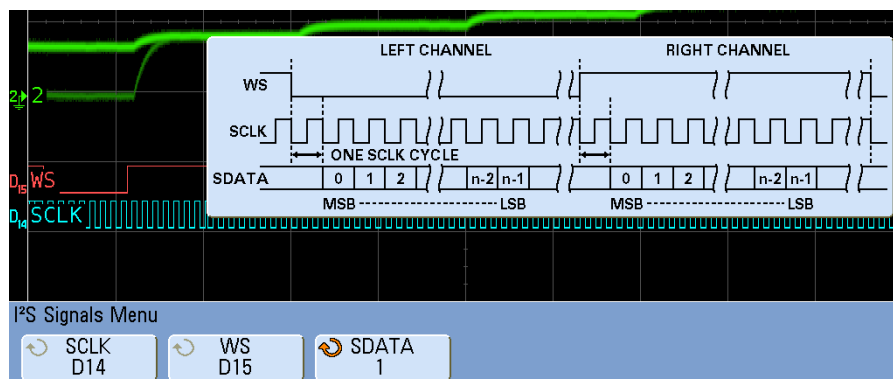
## Setup for I<sup>2</sup>S Signals

An I<sup>2</sup>S (Inter-IC Sound or Integrated Interchip Sound) trigger setup consists of connecting the oscilloscope to the serial clock, word select, and serial data lines.

To set up the oscilloscope to capture I<sup>2</sup>S signals, use the **Signals** and **Bus Config** softkeys which appear in both the Trigger Menu and the Serial Decode Menu:

- 1 Press [**Label**] to turn on labels.
- 2 Press [**Trigger**]; then, select the **I<sup>2</sup>S** trigger type.
- 3 Press **Signals** to open the I<sup>2</sup>S Signals Menu.

A diagram appears showing WS, SCLK, and SDATA signals for the currently specified bus configuration.



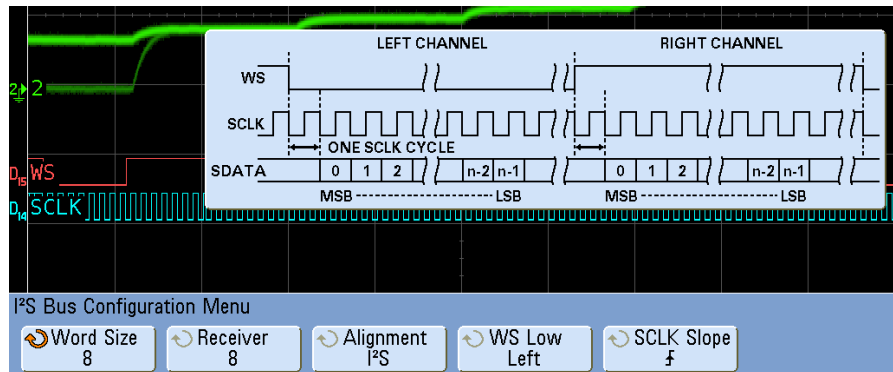
- 4 Connect an oscilloscope channel to the SCLK (serial clock) line in the device under test. (If the channel is not already switched on, switch it on now, and return to this menu by pressing [**Trigger**] > **Signals**.)

Rotate the Entry knob to set the **SCLK** clock channel softkey to the SCLK channel.

As you rotate the Entry knob the **SCLK** label for the source channel is automatically set and the channel you select is shown in the upper-right corner of the display next to “I<sup>2</sup>S”.

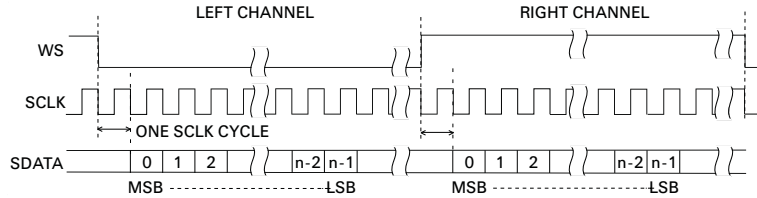
- 5 Connect an oscilloscope channel to the WS (word select) line in the device under test, switch the channel on, then set the **WS** channel softkey to that channel.

- 6 Connect an oscilloscope channel to the SDATA (serial data) line in the device under test, switch the channel on, then set the **SDATA** channel softkey to that channel.
- 7 Set the trigger levels for the SCLK, WS, and SDATA signals to the middle of the signals:
  - If your I<sup>2</sup>S signals are connected to analog channels, press the **SCLK** softkey and rotate the **Trigger Level** knob (not the Entry knob). Repeat for the **WS** and **SDATA** softkeys.
  - If your I<sup>2</sup>S signals are connected to digital channels (on MSO model oscilloscopes only), press the **[Digital]** key and the **Thresholds** softkey to access the threshold level setting softkeys and set the thresholds to the approximate middle of the signals. For details see [“To change the logic threshold for digital channels”](#) on page 368.
- 8 Press **[Trigger] > Bus Config**. The I<sup>2</sup>S Bus Configuration Menu is displayed, along with a diagram showing WS, SCLK, and SDATA signals for the currently specified bus configuration.

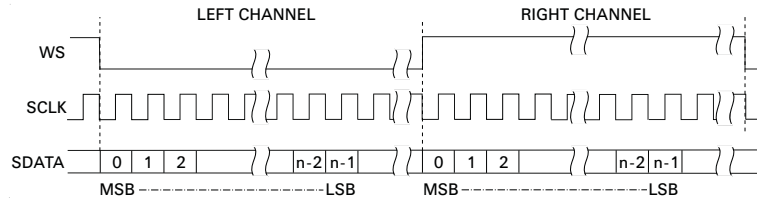


- 9 Press the **Word Size** softkey. Rotate the Entry knob to match the transmitter word size of the device under test (from 4 to 32 bits).
- 10 Press the **Receiver** softkey. Rotate the Entry knob to match the receiver word size of the device under test (from 4 to 32 bits).
- 11 Press the **Alignment** softkey and rotate the Entry knob to select the desired alignment of the data signal (SDATA). The on-screen diagram changes with your selection.

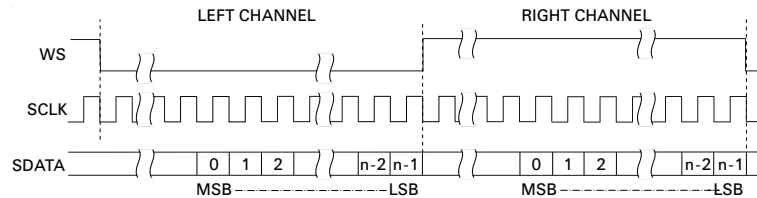
**Standard Alignment:** MSB of data for each sample is sent first, LSB is sent last. The MSB appears on the SDATA line one bit clock after the edge of the WS transition.



**Left-Justified:** Data transmission (MSB first) begins at the edge of the WS transition (without the one-bit delay that Standard format employs).



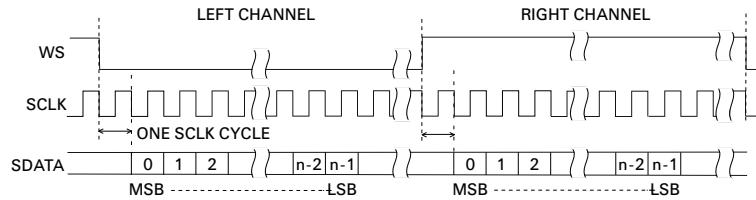
**Right-Justified:** Data transmission (MSB first) is right-justified to the transition of WS.



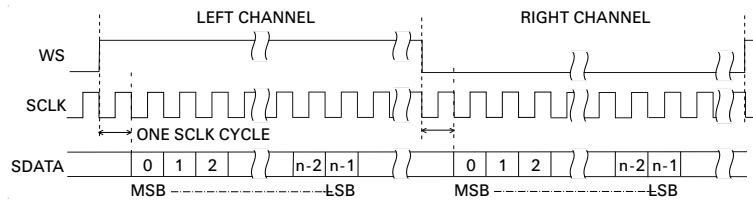
**12** Press the **WS Low** softkey to select whether WS Low indicates Left or Right channel data. The on-screen diagram changes with your selection.



**WS Low = Left Channel:** Left-channel data corresponds to WS=low; right-channel data corresponds to WS=high. WS Low=Left is the oscilloscope's default WS setting.



**WS Low = Right Channel:** Right-channel data corresponds to WS=low; left-channel data corresponds to WS=high.



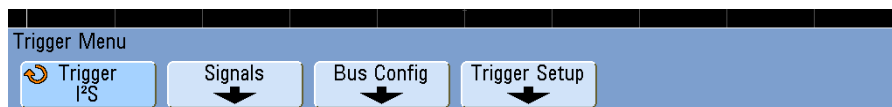
- 13** Press the **SCLK Slope** softkey to select the SCLK edge on which data is clocked in your device under test: either rising or falling. The on-screen diagram changes with your selection.

## I<sup>2</sup>S Triggering

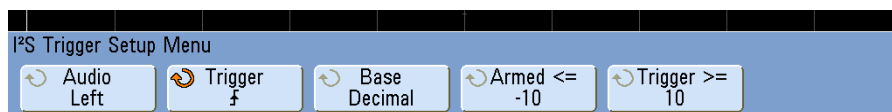
To set up the oscilloscope to capture I<sup>2</sup>S signals, see “[Setup for I2S Signals](#)” on page 302.

After you have set up the oscilloscope to capture I<sup>2</sup>S signals, you can then trigger on a data value.

- 1 Press [**Trigger**]; then, select the **I<sup>2</sup>S** trigger type.



- 2 Press **Trigger Setup** to open the I<sup>2</sup>S Trigger Setup Menu.

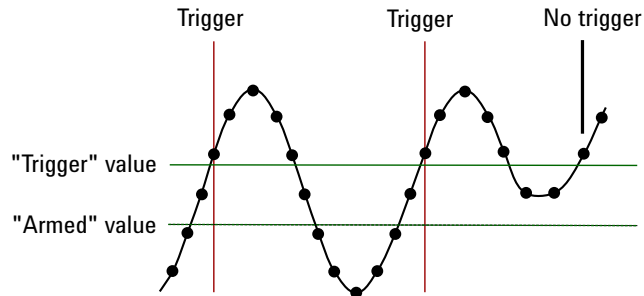


- 3 Press the **Audio** softkey and rotate the Entry knob to choose to trigger on **Left** channel events, **Right** channel events, or events that occur on **Either** channel.
- 4 Press the **Trigger** softkey and choose a qualifier:
  - **Equal** – triggers on the specified audio channel’s data word when it equals the specified word.
  - **Not equal** – triggers on any word other than the specified word.
  - **Less than** – triggers when the channel’s data word is less than the specified value.
  - **Greater than** – triggers when the channel’s data word is greater than the specified value.
  - **In Range** – enter upper and lower values to specify the range in which to trigger.
  - **Out of Range** – enter upper and lower values to specify range in which trigger will not occur.

- **Increasing value** – triggers when the data value is increasing over time and the specified value is met or exceeded. Use the **Trigger** softkey in this menu to set the data value that must be reached. Use the **Armed** softkey to set the value to which the data value must fall before the trigger circuit is re-armed (ready to trigger again). The Armed control reduces triggers due to noise.

This trigger condition is best understood when the digital data transferred over the I<sup>2</sup>S bus is considered in terms of representing an analog waveform. The figure below shows a plot of sample data transmitted over an I<sup>2</sup>S bus for one channel. In this example, the oscilloscope will trigger at the 2 points shown since there are two instances in which the data increases from a value below (or at) the “Armed” value to a value greater than (or equal to) the specified “Trigger” value.

If you select an “Armed” value that is equal to or greater than the “Trigger” value, the “Trigger” value will be increased so that it is always greater than the “Armed” value.



- **Decreasing value** – similar to the description above except the trigger occurs on a decreasing data word value, and the “Armed” value is the value to which the data must rise in order to re-arm the trigger.
- 5 Press the **Base** softkey and select a number base for entering data values:
- **Binary (2's complement).**

When Binary is selected, the **Bits** softkey appears. This softkey opens the I<sup>2</sup>S Bits Menu for entering data values.

When the trigger qualifier requires a pair of values (as with In Range, Out of Range, Increasing value, or Decreasing value), the first softkey in the I<sup>2</sup>S Bits Menu lets you select which value of the pair.

In the I<sup>2</sup>S Bits Menu, press the **Bit** softkey and rotate the Entry knob to select each bit; then, use the **0 1 X** softkey to set each bit value to zero, one, or don't care. You can use the **Set all Bits** softkey to set all bits to the value chosen on the **0 1 X** softkey.

- **Signed decimal.**

When Decimal is selected, the softkey(s) to the right let you enter decimal values with the Entry knob. These softkeys can be **Data**, **<**, **>**, or **Threshold** depending on the selected trigger qualifier.

- 6 If the setup does not produce a stable trigger, the I<sup>2</sup>S signal may be slow enough that the oscilloscope is AutoTriggering. Press the **[Mode/Coupling]** key, then press the **Mode** softkey to set the trigger mode from **Auto** to **Normal**.

### NOTE

To display I<sup>2</sup>S serial decode, see “[I2S Serial Decode](#)” on page 309.

## I<sup>2</sup>S Serial Decode

To set up the oscilloscope to capture I<sup>2</sup>S signals, see “[Setup for I2S Signals](#)” on page 302.

### NOTE

When triggering is set to CAN, LIN, Flexray, or UART/RS232 mode, decoding in I<sup>2</sup>S is not allowed. When triggering in I<sup>2</sup>C or SPI modes, or any non-serial trigger mode, I<sup>2</sup>S is available for decoding. When I<sup>2</sup>S is selected as the trigger mode, only I<sup>2</sup>S decode is available.

### NOTE

For I<sup>2</sup>S triggering setup see “[I2S Triggering](#)” on page 306.

To set up I<sup>2</sup>S serial decode:

- 1 Press [**Serial**]; then, select the **I<sup>2</sup>S** serial decode mode.



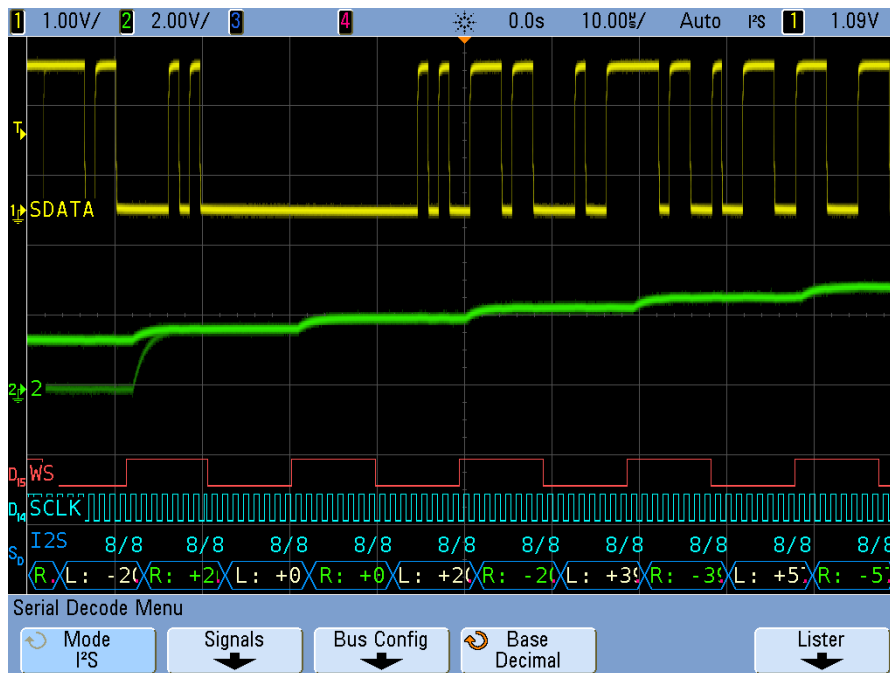
- 2 Press the **Base** softkey to select the number base in which to display decoded data.
- 3 If the decode line does not appear on the display, press the [**Serial**] key to turn it on.
- 4 If the oscilloscope is stopped, press the [**Run/Stop**] key to acquire and decode data.

### NOTE

If the setup does not produce a stable trigger, the I2S signal may be slow enough that the oscilloscope is AutoTriggering. Press the [**Mode/Coupling**] key, then press the **Mode** softkey to set the trigger mode from **Auto** to **Normal**.

You can use the **Zoom** horizontal sweep mode for easier navigation of the acquired data.

## Interpreting I<sup>2</sup>S Decode

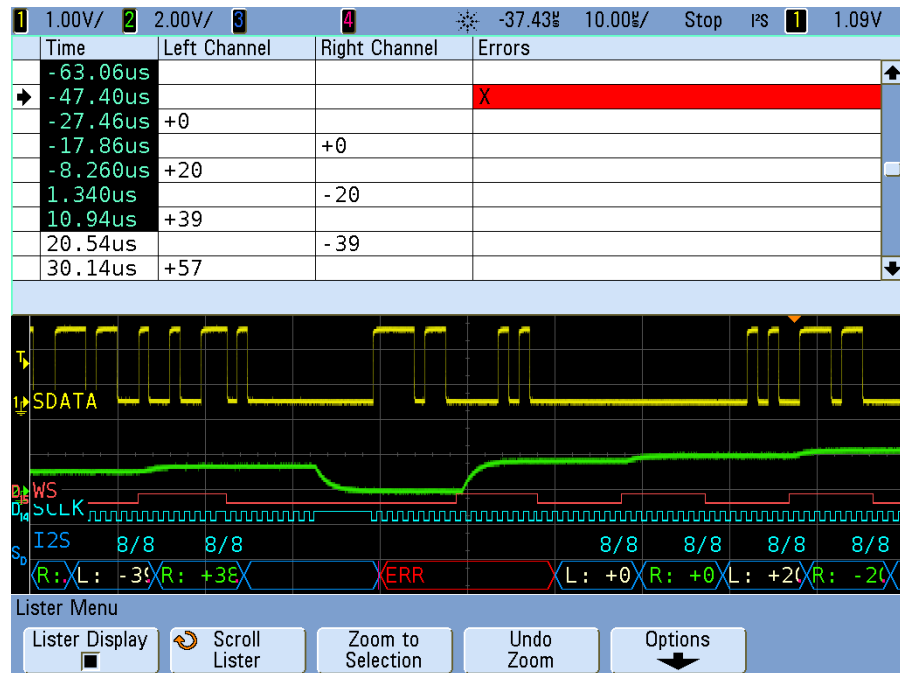


- Angled waveforms show an active bus (inside a packet/frame).
- Mid-level blue lines show an idle bus.
- In the decoded data:
  - Right channel data values appear in green along with the “R:” characters.
  - Left channel data values appear in white along with the “L:” characters.
  - Decoded text is truncated at the end of the associated frame when there is insufficient space within frame boundaries.
- Red dots in the decode line indicate that more data can be displayed. Scroll or expand the horizontal scale to view the data.
- Aliased bus values (undersampled or indeterminate) are drawn in red.
- Unknown bus values (undefined or error conditions) are drawn in red.

**NOTE**

When the receiver word size is greater than the transmit word size, the decoder fills the least significant bits with zeros and the decoded value does not match the trigger value.

## Interpreting I<sup>2</sup>S Lister Data



In addition to the standard Time column, the I<sup>2</sup>S Lister contains these columns:

- Left Channel – displays the left channel data.
- Right Channel – displays the right channel data.
- Errors – highlighted in red and marked with an “X”.

## Searching for I<sup>2</sup>S Data in the Lister

The oscilloscope's search capability lets you search for (and mark) certain types of I<sup>2</sup>S data in the Lister. You can use the **[Navigate]** key and controls to navigate through the marked rows.

1 With I<sup>2</sup>S selected as the serial decode mode, press **[Search]**.

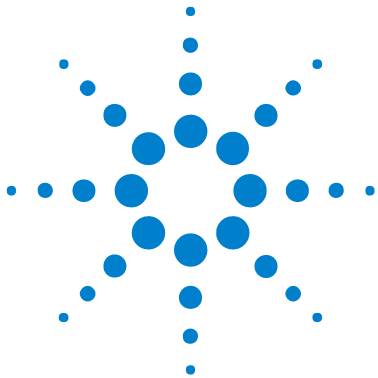
2 In the Search Menu, press **Search for**; then, select from these options:

- **= (Equal)** – finds the specified audio channel's data word when it equals the specified word.
- **!= (Not Equal)** – finds any word other than the specified word.
- **< (Less than)** – finds when the channel's data word is less than the specified value.
- **> (Greater than)** – finds when the channel's data word is greater than the specified value.
- **>< (In Range)** – enter upper and lower values to specify the range to find.
- **<> (Out of Range)** – enter upper and lower values to specify range not to find.
- **Errors** – finds all errors.

For more information on searching data, see [“Searching Lister Data”](#) on page 259.

For more information on using the **[Navigate]** key and controls, see [“To navigate the time base”](#) on page 74.





## 13 FlexRay Triggering and Serial Decode

Setup for FlexRay Signals 314

FlexRay Triggering 315

FlexRay Serial Decode 318

The N5432C FlexRay triggering and decode option (Option FLX) requires a four-channel InfiniiVision Series oscilloscope.

Option FLX lets you:

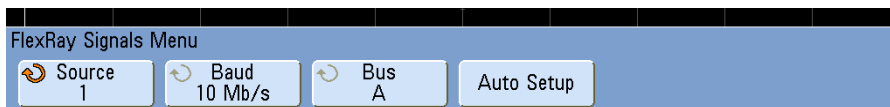
- Trigger on FlexRay bus frames, error conditions, or events.
- Display decoded FlexRay bus data.



## Setup for FlexRay Signals

To set up the oscilloscope to capture a FlexRay signal, use the **Signals** softkey which appears in the Trigger Menu or the **Settings** softkey which appears in the Serial Decode Menu:

- 1 Press [**Trigger**]; then, select the **FlexRay** trigger type.
- 2 Press **Signals** to open the FlexRay Signals Menu.



- 3 Press **Source** and select the analog channel that is probing the FlexRay signal.
- 4 Press **Baud** and select the baud rate of the FlexRay signal being probed.
- 5 Press **Bus** and select the bus type of the FlexRay signal being probed.

It is important to specify the correct bus because this setting affects CRC error detection.

- 6 Press **Auto Setup** to perform the following actions:
  - Set the selected source channel's impedance to 50 Ohms.
  - Set the selected source channel's probe attenuation to 10:1.
  - Set the trigger level (on the selected source channel) to -300 mV.
  - Turns on trigger Noise Reject.
  - Turns on Serial Decode.
  - Sets the trigger type to FlexRay.

## FlexRay Triggering

To set up the oscilloscope to capture a FlexRay signal, see “[Setup for FlexRay Signals](#)” on page 314.

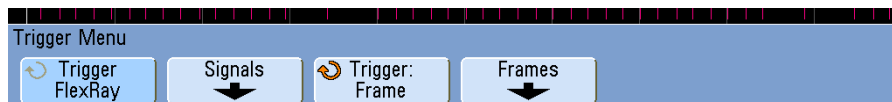
After you have set up the oscilloscope to capture a FlexRay signal, you can then set up triggers on frames, errors, or events.

### NOTE

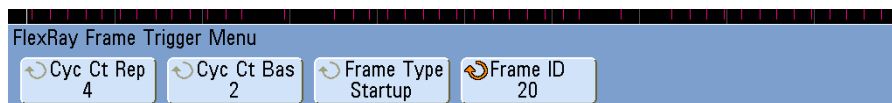
To display FlexRay serial decode, see “[FlexRay Serial Decode](#)” on page 318.

### Triggering on FlexRay Frames

- 1 Press [**Trigger**]; then, select the **FlexRay** trigger type.
- 2 In the Trigger Menu press **Trigger**; then, select **Frame**.



- 3 Press the **Frames** softkey to access the FlexRay Frame Trigger Menu.



- 4 Press the **Frame ID** softkey, and use the Entry knob to select the frame ID value from **All** or **1** to **2047**.
- 5 Press the **Frame Type** softkey to select the frame type:
  - **All Frames**
  - **Startup Frames**
  - **NULL Frames**
  - **Sync Frames**
  - **Normal Frames**
  - **NOT Startup Frames**
  - **NOT NULL Frames**

- **NOT Sync Frames**

**6** Press the **Cyc Ct Rep** softkey, and use the Entry knob to select the cycle count repetition factor (**2**, **4**, **8**, **16**, **32**, or **64**, or **All**).

**7** Press the **Cyc Ct Bas** softkey, and use the Entry knob to select the cycle count base factor from **0** through the **Cyc Ct Rep** factor minus 1.

For example, with a base factor of 1 and a repetition factor of 16, the oscilloscope triggers on cycles 1, 17, 33, 49, and 65.

To trigger on a particular cycle, set the Cycle Repetition factor to 64 and use the cycle base factor to choose a cycle.

To trigger all (any) cycles, set the Cycle Repetition factor to **All**. The scope will trigger on any and all cycles.

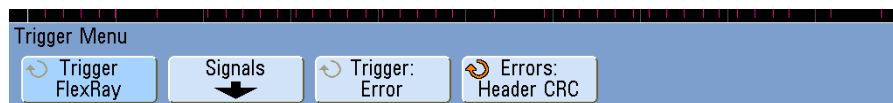
### NOTE

Because specific FlexRay frames may occur infrequently, it may be helpful to set the oscilloscope to Normal trigger mode instead of Auto trigger mode. This prevents the oscilloscope from Auto triggering while waiting for a particular frame and cycle combination.

## Triggering on FlexRay Errors

**1** Press [**Trigger**]; then, select the **FlexRay** trigger type.

**2** In the Trigger Menu press **Trigger**; then, select **Error**.



**3** Press the **Errors** softkey; then, select the error type:

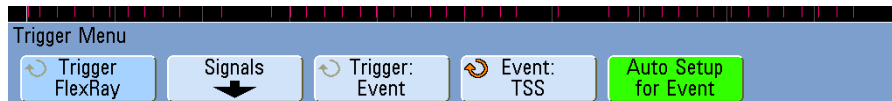
- **All Errors**
- **Header CRC Error** – cyclic redundancy check error in the header.
- **Frame CRC Error** – cyclic redundancy check error in the frame.

### NOTE

Since FlexRay errors occur infrequently it may be helpful to set the oscilloscope to Normal trigger mode instead of Auto trigger mode. This prevents the oscilloscope from Auto triggering while waiting for an error to occur. You may need to adjust trigger holdoff to see a particular error when multiple errors exist.

## Triggering on FlexRay Events

- 1 Press [**Trigger**]; then, select the **FlexRay** trigger type.
- 2 In the Trigger Menu press **Trigger**; then, select **Event**.



- 3 Press **Event**; then, select the event type:
  - **Wake-up**
  - **TSS - Transmission Start Sequence**
  - **BSS - ByteStart Sequence**
  - **FES/DTS - Frame End or Dynamic Trailing Sequence**
- 4 Press **Auto Setup for Event**.

This automatically configures oscilloscope settings (as shown on the display) for the selected event trigger.

## FlexRay Serial Decode

To set up the oscilloscope to capture FlexRay signals, see “[Setup for FlexRay Signals](#)” on page 314.

### NOTE

While decoding FlexRay data, you can use FlexRay trigger or another trigger type, such as duration, I<sup>2</sup>C, Nth edge burst, sequence, SPI, or USB.

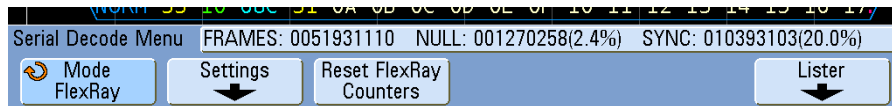
When the oscilloscope is in FlexRay trigger mode, only FlexRay decode is available.

### NOTE

For FlexRay triggering setup see “[FlexRay Triggering](#)” on page 315.

To set up FlexRay serial decode:

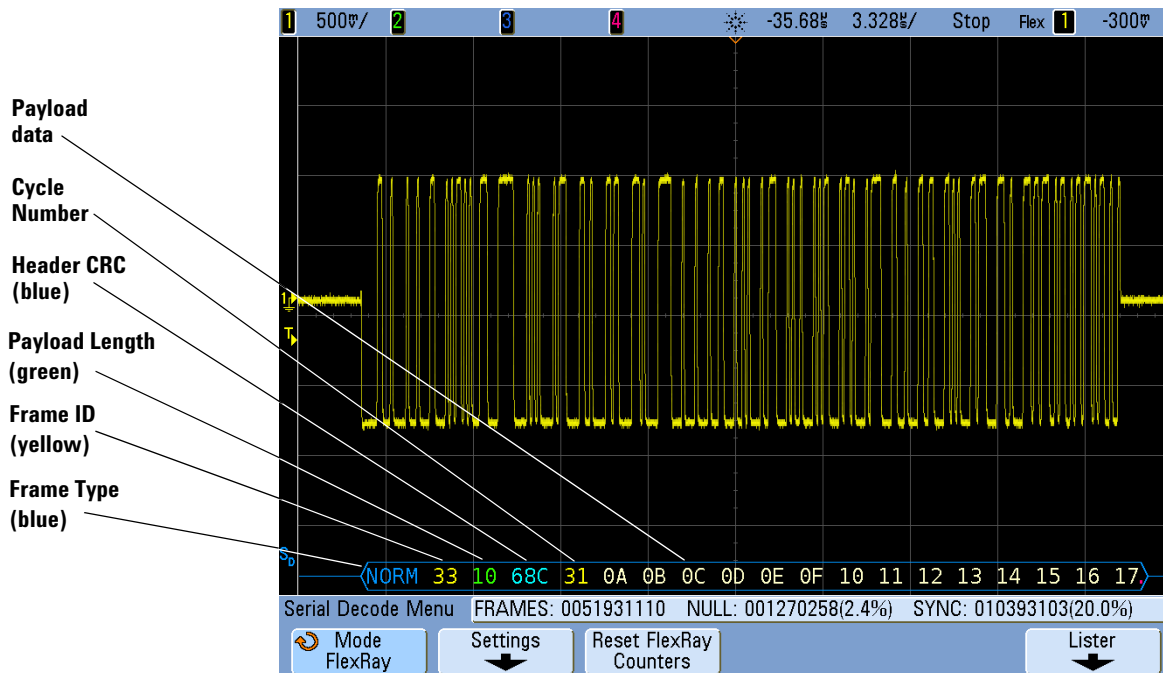
- 1 Press [**Serial**]; then, select the **FlexRay** serial decode mode.



- 2 If the decode line does not appear on the display, press the [**Serial**] key to turn it on.
- 3 If the oscilloscope is stopped, press the [**Run/Stop**] key to acquire and decode data.

You can use the **Zoom** horizontal sweep mode for easier navigation of the decoded data.

## Interpreting FlexRay Frame Decode

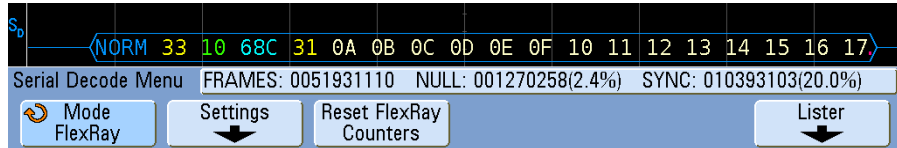


The FlexRay decode display shows frame decoding.

- Frame type (NORM, SYNC, SUP, NULL in blue).
- Frame ID (decimal digits in yellow).
- Payload-length (decimal number of words in green).
- Header CRC (hex digits in blue plus red HCRC error message if invalid).
- Cycle number (decimal digits in yellow).
- Data bytes (HEX digits in white).
- Frame CRC (hex digits in blue plus red FCRC error message if invalid).
- Frame/coding errors (specific error symbol in red).

## FlexRay Totalizer

The FlexRay totalizer consists of counters that provide a direct measure of bus quality and efficiency. The totalizer appears on screen whenever FlexRay Decode is ON in the Serial Decode Menu.



- The FRAMES counter gives a real-time count of all captured frames.
- The NULL counter gives the number and percentage of null frames.
- The SYNC counter gives the number and percentage of sync frames.

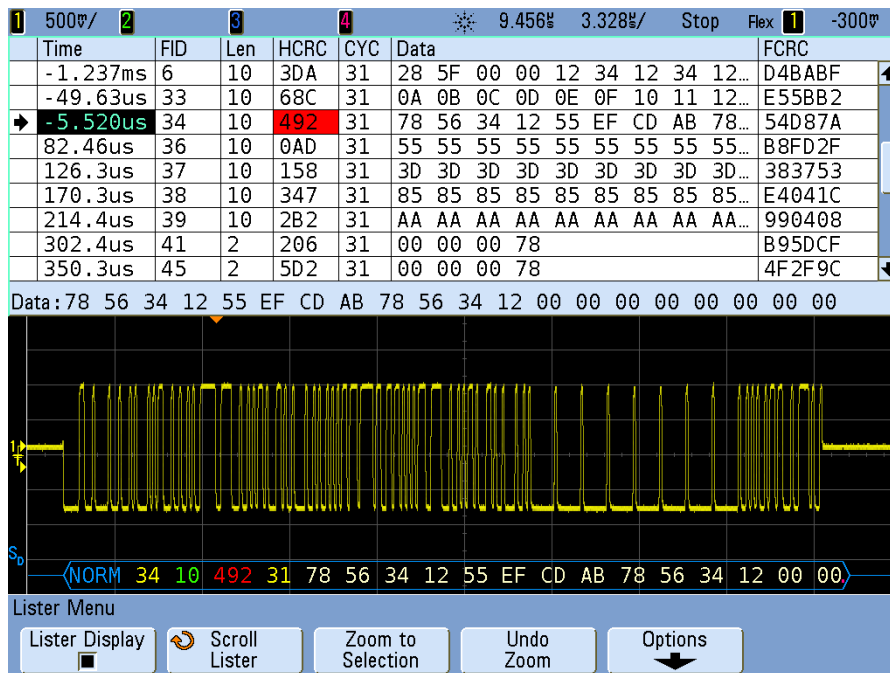
The totalizer runs, counting frames and calculating percentages, even when the oscilloscope is stopped (not acquiring data).

When an overflow condition occurs, the counter displays **OVERFLOW**.

The counters can be reset to zero by pressing the **Reset FlexRay Counters** softkey.



## Interpreting FlexRay Lister Data



In addition to the standard Time column, the FlexRay Lister contains these columns:

- FID – frame ID.
- Len – payload length.
- HCRC – header CRC.
- CYC – cycle number.
- Data.
- FCRC – frame CRC.
- Frames with errors are highlighted in red.

## Searching for FlexRay Data in the Lister

The oscilloscope's search capability lets you search for (and mark) certain types of FlexRay data in the Lister. You can use the **[Navigate]** key and controls to navigate through the marked rows.

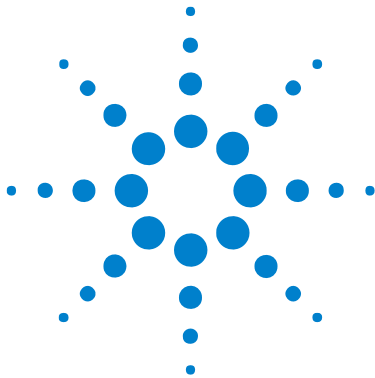
1 With FlexRay selected as the serial decode mode, press **[Search]**.

2 In the Search Menu, press **Search for**; then, select from these options:

- **Frame ID** – Finds frames with the specified ID. Press the **Frame ID** softkey to select the ID.
- **Cycle number (+ Frame ID)** – Finds frames with the specified cycle number and ID. Press the **Frame ID** softkey to select the ID. Press the **Cycle #** softkey to select the number.
- **Data (+ Frame ID + Cycle number)** – Finds frames with the specified data, cycle number, and frame ID. Press the **Frame ID** softkey to select the ID. Press the **Cycle #** softkey to select the number. Press the **Data** softkey to open a menu where you can enter the data value.
- **Header CRC Error** – Finds cyclic redundancy check errors in headers.
- **Frame CRC Error** – Finds cyclic redundancy check errors in frames.
- **All Errors** – Finds all errors.

For more information on searching data, see [“Searching Lister Data”](#) on page 259.

For more information on using the **[Navigate]** key and controls, see [“To navigate the time base”](#) on page 74.



## 14 MIL-STD 1553 Triggering and Serial Decode

Probing MIL-STD 1553 Signals	324
Setup for MIL-STD 1553 Signals	325
MIL-STD 1553 Triggering	326
MIL-STD 1553 Serial Decode	327

The N5469A MIL-STD 1553 triggering and decode option (Option 553) requires a four-channel InfiniiVision Series oscilloscope.

The MIL-STD 1553 triggering and decode solution supports bi-phase MIL-STD 1553 signaling, the standard 1553 Manchester II encoding, data rate of 1 Mb/s, and word length of 20 bits.



## Probing MIL-STD 1553 Signals

The MIL-STD 1553 differential bus must be probed with a differential active probe.

Agilent recommends the N2791A 25 MHz differential active probe.

Output of the differential probe must be fed, via a BNC tee and two equal-length BNC cables, into two channels of the oscilloscope. This way, the oscilloscope can perform dual threshold triggering (using upper and lower thresholds).

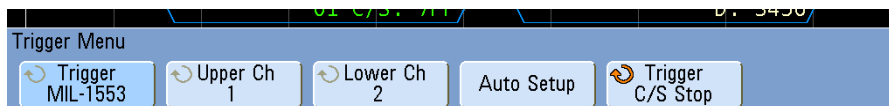


This N2791A differential probe works well because it is designed for 1 MOhm impedance oscilloscope inputs.

If you use a different differential probe that is designed for 50 Ohm impedance oscilloscope inputs, be sure to set only one of the oscilloscope channel input impedances to 50 Ohms (because the two input channel's impedances are seen in parallel).

## Setup for MIL-STD 1553 Signals

To set up the oscilloscope for MIL-STD 1553 signals, these softkeys appear in both the Trigger Menu and the Serial Decode Menu:



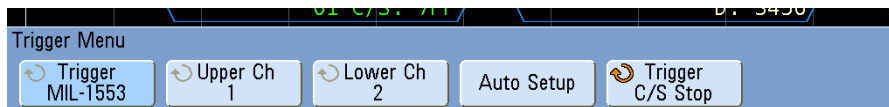
- **Upper Ch** – selects the channel used for the upper threshold. Because defined pairs of channels are used for upper and lower thresholds (either channels 1 and 2, or channels 3 and 4), this softkey also selects the channel for the lower threshold.
- **Lower Ch** – shows the channel selected for lower thresholds.
- **Auto Setup** – performs these actions:
  - Copies the Upper Threshold Channel position and volts/div settings to the Lower Threshold Channel.
  - Sets both the Upper Threshold Channel and the Lower Threshold Channel probe attenuation to 10:1.
  - Sets the Upper Threshold Channel trigger level to 500 mV and the Lower Threshold Channel trigger level to -500 mV.
  - Turns off trigger noise reject.
  - Turns on Serial Decode.
  - Sets the trigger type to MIL-1553.

## MIL-STD 1553 Triggering

To set up the oscilloscope to capture MIL-STD 1553 signals, see “Setup for MIL-STD 1553 Signals” on page 325.

To set up a MIL-STD 1553 trigger:

- 1 Press [**Trigger**]; then, select the **MIL-STD-1553** trigger type.



- 2 In the Trigger Menu, press the **Trigger** softkey on the right side; then, select from these options:
  - **Data Word Start** – triggers on the start of a Data word (at the end of a valid Data Sync pulse).
  - **Data Word Stop** – triggers on the end of a Data word.
  - **Command/Status Word Start** – triggers on the start of Command/Status word (at the end of a valid C/S Sync pulse).
  - **Command/Status Word Stop** – triggers on the end of a Command/Status word.
  - **Remote Terminal Address** – triggers if the RTA of the Command/Status word matches the specified value.

When this option is selected, the **RTA** softkey appears and lets you select the hex Remote Terminal Address value to trigger on. If you select 0xXX (don't care), the oscilloscope will trigger on any RTA.

- **Remote Terminal Address + 11 Bits** – triggers if the RTA and the remaining 11 bits match the specified criteria.

When this option is selected, the **RTA + Bits** softkey appears and opens the MIL-STD-1553 RTA + 11 Bits Menu. In this menu:

- The **RTA** softkey lets you select the hex Remote Terminal Address value.
- The **Bit Time** softkey lets you select the bit time position.
- The **0 1 X** softkey lets you set the bit time position value as a 1, 0, or X (don't care).

- **Parity Error** – triggers if the (odd) parity bit is incorrect for the data in the word.
- **Manchester Error** – triggers if a Manchester encoding error is detected.
- **Sync Error** – triggers if an invalid Sync pulse is found.

**NOTE**

To display MIL-STD-1553 serial decode, see “[MIL-STD 1553 Serial Decode](#)” on page 327.

## MIL-STD 1553 Serial Decode

To set up the oscilloscope to capture MIL-STD 1553 signals, see “[Setup for MIL-STD 1553 Signals](#)” on page 325.

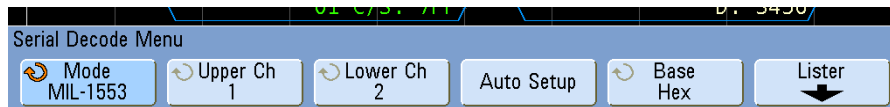
**NOTE**

Before you can select serial decode of MIL-STD 1553 signals, the trigger type must be set to MIL-STD-1553 or one of the non-serial triggering modes. See “[MIL-STD 1553 Triggering](#)” on page 326.

When MIL-STD-1553 is selected as the trigger mode, only MIL-STD-1553 decode is available.

To set up MIL-STD 1553 serial decode:

- 1 Press [**Serial**]; then, select the **MIL-STD-1553** serial decode mode.



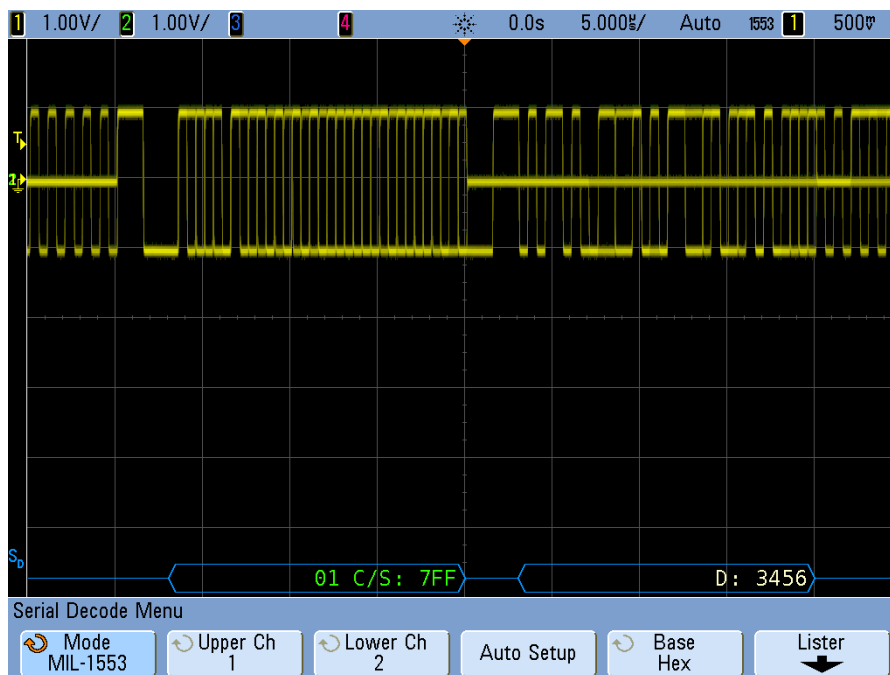
- 2 Use the **Base** softkey to select between hexadecimal and binary display of the decoded data.

The base setting is used for the display of the remote terminal address and the data, in both the decode line and in the Lister.

You can use the **Zoom** horizontal sweep mode for easier navigation of the acquired data.

## Interpreting MIL-STD 1553 Decode

To display serial decode information, you must press **Run** or **Single** after switching on serial decode.



The MIL-STD 1553 decode display is color coded as follows:

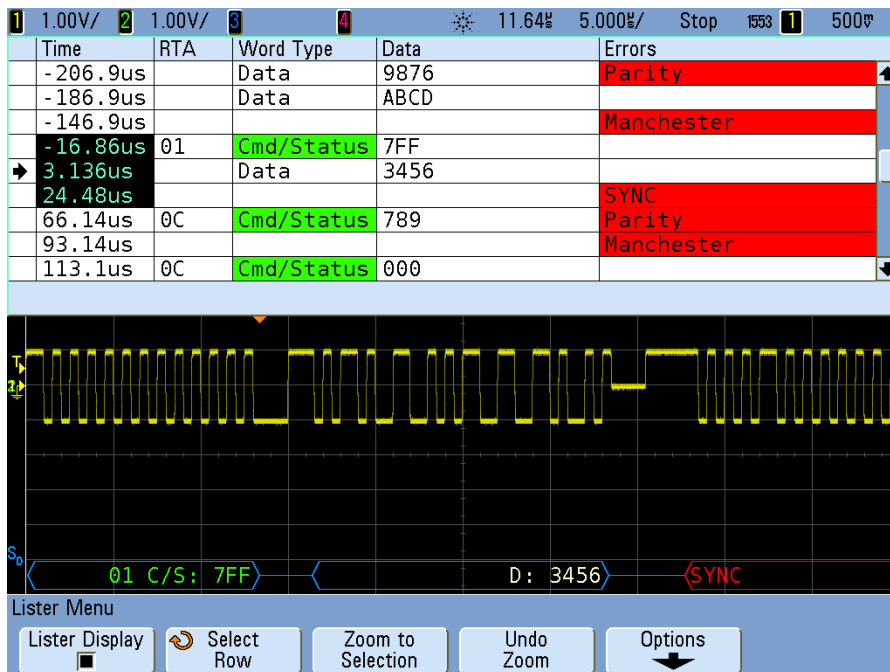
- Command and Status decoded data is colored green, with the Remote Terminal Address (5 bits of data) being displayed first, then the text "C/S:", followed by the value of the remaining 11 bits of a Command/Status word.
- Data word decoded data is colored white, preceded by the text "D:".
- Command/Status or Data words with a Parity error have the decode text displayed in red instead of green or white.
- SYNC errors are displayed with the word "SYNC" within red angle brackets.



- Manchester encoding errors are displayed with the word "MANCH" within blue angle brackets (blue instead of red because a valid Sync pulse started the word).

## Viewing MIL-STD 1553 Data in the Lister

- In the Serial Decode Menu (when serial decode is being displayed), press **Lister**.
- In the Lister Menu, press **Lister Display** to turn it on.



In addition to the standard Time column, the MIL-STD 1553 Lister contains these columns:

- RTA – displays the Remote Terminal Address for Command/Status words, nothing for Data words.

- **Word Type** – “Cmd/Status” for Command/Status words, “Data” for Data words. For Command/Status words the background color is green to match the decode text color.
- **Data** – the 11 bits after the RTA for Command/Status words, or the 16 bits of a Data word.
- **Errors** – “Sync”, “Parity”, or “Manchester” errors as appropriate. The background color is red to indicate an error.

For more information on using the Lister display, see “[Lister](#)” on page 257.

### Searching for MIL-STD 1553 Data in the Lister

The oscilloscope’s search capability lets you search for (and mark) certain types of MIL-STD 1553 data in the Lister. You can use the **[Navigate]** key and controls to navigate through the marked rows.

**1** With MIL-STD-1553 selected as the serial decode mode, press **[Search]**.

**2** In the Search Menu, press **Search for**; then, select from these options:

- **Data Word Start** – finds the start of a Data word (at the end of a valid Data Sync pulse).
- **Command/Status Word Start** – finds the start of Command/Status word (at the end of a valid C/S Sync pulse).
- **Remote Terminal Address** – finds the Command/Status word whose RTA matches the specified value. The value is specified in hex.

When this option is selected, the **RTA** softkey activates and lets you select the hex Remote Terminal Address value to find.

- **Remote Terminal Address + 11 Bits** – finds the RTA and the remaining 11 bits that match the specified criteria.

When this option is selected, these softkeys let you select the Remote Terminal Address and 11 bit time values:

- The **RTA** softkey lets you select the hex Remote Terminal Address value.
- The **Bit Time** softkey lets you select the bit time position.
- The **0 1** softkey lets you set the bit time position value as a 1 or 0.

- **Parity Error** – finds (odd) parity bits that are incorrect for the data in the word.
- **Sync Error** – finds invalid Sync pulses.
- **Manchester Error** – finds Manchester encoding errors.

For more information on searching data, see [“Searching Lister Data”](#) on page 259.

For more information on using the **[Navigate]** key and controls, see [“To navigate the time base”](#) on page 74.





## 15 UART/RS232 Triggering and Serial Decode

Setup for UART/RS232 Signals [334](#)

UART/RS232 Triggering [335](#)

UART/RS232 Serial Decode [338](#)

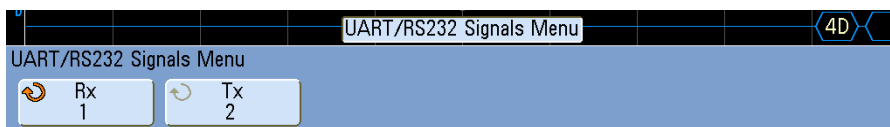
The N5457A UART/RS232 triggering and decode option (Option 232) requires a four-channel InfiniiVision Series oscilloscope.



## Setup for UART/RS232 Signals

To set up the oscilloscope to capture UART/RS232 signals, use the **Signals** and **Bus Config** softkeys which appear in both the Trigger Menu and the Serial Decode Menu:

- 1 Press [**Label**] to turn on labels.
- 2 Press [**Trigger**]; then, select the **UART/RS232** trigger type.
- 3 Press **Signals** to open the UART/RS232 Signals Menu.



- 4 Connect an oscilloscope channel to the Rx signal in the device under test, then press the **Rx** softkey and rotate the Entry knob to select the channel.

As you press the **Rx** softkey (or rotate the Entry knob), the channel you select is shown in the upper-right corner of the display next to “**URT**”.

- 5 Make sure the trigger or threshold levels are set to the middle of the signal:
  - For analog channels, turn the Trigger Level knob.
  - For digital channels, press the [**Digital**] key and the **Thresholds** softkey to access the threshold level setting softkeys.

The value of the trigger level or digital threshold is displayed in the upper-right corner of the display.

- 6 Repeat these steps for the Tx signal.
- 7 Press the [**Menu Up**] key to return to the Trigger Menu.
- 8 Press **Bus Config** to open the UART/RS232 Bus Configuration Menu.



Set the following parameters.

- a #Bits:** Set the number of bits in the UART/RS232 words to match your device under test (selectable from 5-9 bits).
- b Parity:** Choose odd, even, or none, based on your device under test.
- c Baud:** Press the **Baud Rate** softkey, then press the **Baud** softkey and select a baud rate to match the signal in your device under test. If the desired baud rate is not listed, select **User Defined** on the Baud softkey, then select the desired baud rate using the **User Baud** softkey. You can set the UART baud rate from 1.2 kb/s to 3.0000 Mb/s in increments of 100 b/s.
- d Polarity:** Select idle low or idle high to match your device under test's state when at idle. For RS232 select idle low.
- e Bit Order:** Select whether the most significant bit (MSB) or the least significant bit (LSB) is presented after the start bit in the signal from your device under test. For RS232 select LSB.

#### NOTE

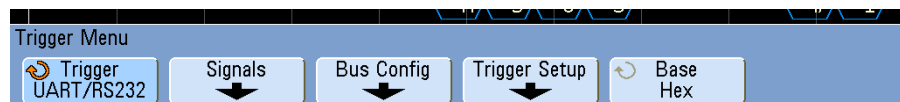
In the serial decode display, the most significant bit is always displayed on the left regardless of how Bit Order is set.

## UART/RS232 Triggering

To set up the oscilloscope to capture UART/RS-232 signals, see “[Setup for UART/RS232 Signals](#)” on page 334.

To trigger on a UART (Universal Asynchronous Receiver/Transmitter) signal connect the oscilloscope to the Rx and Tx lines and set up a trigger condition. RS232 (Recommended Standard 232) is one example of a UART protocol.

- 1 Press [**Trigger**]; then, select the **UART/RS232** trigger type.



- 2 Press the **Base** softkey to select Hex or ASCII as the base displayed on the Data softkey in the UART/RS232 Trigger Setup Menu.

Note that the setting of this softkey does not affect the selected base of the decode display.

- 3 Press the **Trigger Setup** softkey and set up the desired trigger condition:
  - **Rx Start Bit** – The oscilloscope triggers when a start bit occurs on Rx.
  - **Rx Stop Bit** – Triggers when a stop bit occurs on Rx. The trigger will occur on the first stop bit. This is done automatically whether the device under test uses 1, 1.5, or 2 stop bits. You do not need to specify the number of stop bits used by the device Under test.
  - **Rx Data** – Triggers on a data byte that you specify. For use when the device under test data words are from 5 to 8 bits in length (no 9th (alert) bit).
  - **Rx 1:Data** – For use when the device under test data words are 9 bits in length including the alert bit (the 9th bit). Triggers only when the 9th (alert) bit is 1. The specified data byte applies to the least significant 8 bits (excludes the 9th (alert) bit).
  - **Rx 0:Data** – For use when the device under test data words are 9 bits in length including the alert bit (the 9th bit). Triggers only when the 9th (alert) bit is 0. The specified data byte applies to the least significant 8 bits (excludes the 9th (alert) bit).
  - **Rx X:Data** – For use when the device under test data words are 9 bits in length including the alert bit (the 9th bit). Triggers on a data byte that you specify regardless of the value of the 9th (alert) bit. The specified data byte applies to the least significant 8 bits (excludes the 9th (alert) bit).
  - Similar choices are available for Tx.
  - **Rx or Tx Parity Error** – Triggers on a parity error based on the parity you have set in the Bus Configuration Menu.
- 4 If you choose a trigger condition that includes “**Data**” in its description (for example: **Rx Data**), then press the **Data is** softkey, and choose an equality qualifier. You can choose equal to, not equal to, less than, or greater than a specific data value.
- 5 Use the **Data** softkey to choose the data value for your trigger comparison. This works in conjunction with the **Data is** softkey.
- 6 Optional: The **Burst** softkey lets you trigger on the Nth frame (1-4096) after an idle time you select. All trigger conditions must be met for the trigger to occur.



- 7 If **Burst** is selected, an idle time (1  $\mu$ s to 10 s) can be specified so that the oscilloscope will look for a trigger condition only after the idle time has past. Press the **Idle** softkey and rotate the Entry knob to set an idle time.
- 8 Remember to set the trigger mode to Normal (press [**Mode/Coupling**] > **Mode** > **Normal**) to prevent Auto Triggering.

**NOTE**

To display UART/RS232 serial decode, see “[UART/RS232 Serial Decode](#)” on page 338.

## UART/RS232 Serial Decode

To set up the oscilloscope to capture UART/RS232 signals, see “[Setup for UART/RS232 Signals](#)” on page 334.

### NOTE

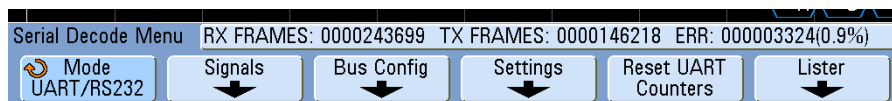
Because of oscilloscope hardware resource limitations, you cannot decode UART/RS232 data while CAN, LIN, or FlexRay triggering is selected.

### NOTE

For UART/RS232 triggering setup see “[UART/RS232 Triggering](#)” on page 335.

To set up UART/RS232 serial decode:

- 1 Press [**Serial**]; then, select the **UART/RS232** serial decode mode.



- 2 Press **Settings**.
- 3 In the UART/RS232 Settings Menu, press the **Base** softkey to select the base (hex, binary, or ASCII) in which decoded words are displayed.



- When displaying words in ASCII, the 7-bit ASCII format is used. Valid ASCII characters are between 0x00 and 0x7F. To display in ASCII you must select at least 7 bits in the Bus Configuration. If ASCII is selected and the data exceeds 0x7F, the data is displayed in hex.
  - When **#Bits** is set to 9 in the UART/RS232 Bus Configuration Menu, the 9th (alert) bit is displayed directly to the left of the ASCII value (which is derived from the lower 8 bits).
- 4 Optional: Press the **Framing** softkey and select a value. In the decode display the chosen value will be displayed in light blue. However, if a parity error occurs the data will be displayed in red.

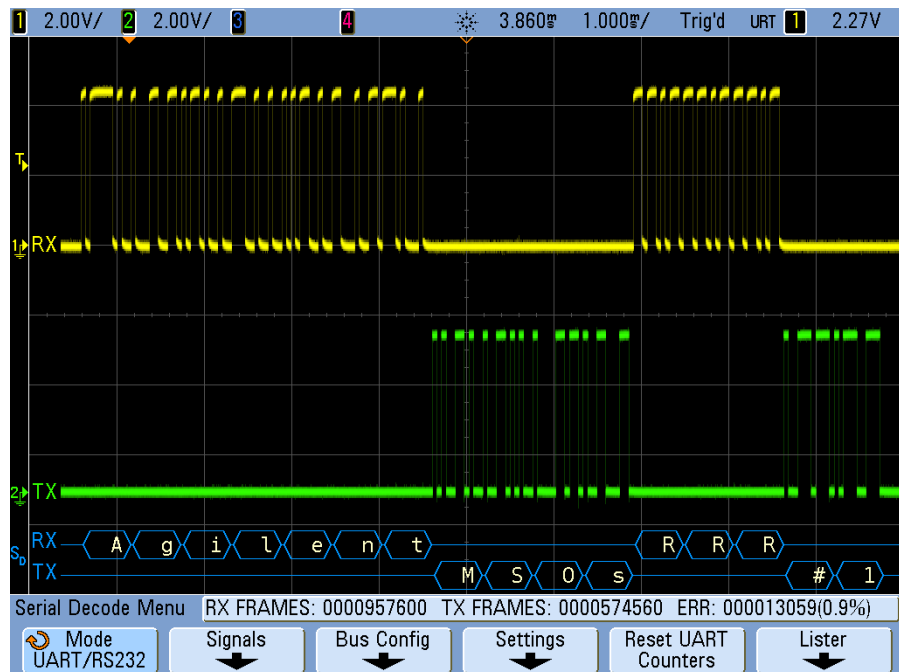
- 5 If the decode line does not appear on the display, press the **[Serial]** key to turn it on.
- 6 If the oscilloscope is stopped, press the **[Run/Stop]** key to acquire and decode data.

**NOTE**

If the setup does not produce a stable trigger, the UART/RS232 signal may be slow enough that the oscilloscope is AutoTriggering. Press the **[Mode/Coupling]** key; then, press the **Mode** softkey to set the trigger mode from **Auto** to **Normal**.

You can use the **Zoom** horizontal sweep mode for easier navigation of the acquired data.

## Interpreting UART/RS232 Decode

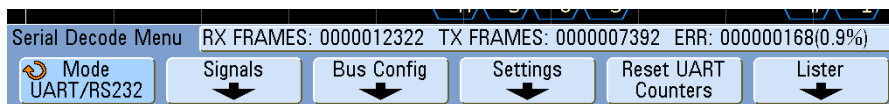


- Angled waveforms show an active bus (inside a packet/frame).

- Mid-level blue lines show an idle bus.
- When using 5-8 bit formats, the decoded data is displayed in white (in binary, hex, or ASCII).
- When using the 9 bit format, all data words are displayed in green, including the 9th bit. The 9th bit is displayed on the left.
- When a data word value is selected for framing, it is displayed in light blue. When using 9-bit data words, the 9th bit will also be displayed in light blue.
- Decoded text is truncated at the end of the associated frame when there is insufficient space within frame boundaries.
- When the horizontal scale setting does not permit the display of all available decoded data, red dots will appear in the decoded bus to mark the location of hidden data. Expand the horizontal scale to allow the data to display.
- An unknown (undefined) bus is shown in red.
- A parity error will cause the associated data word to be shown in red, which includes the 5-8 data bits and the optional 9th bit.

## UART/RS232 Totalizer

The UART/RS232 totalizer consists of counters that provide a direct measure of bus quality and efficiency. The totalizer appears on screen whenever UART/RS232 Decode is ON in the Serial Decode Menu.

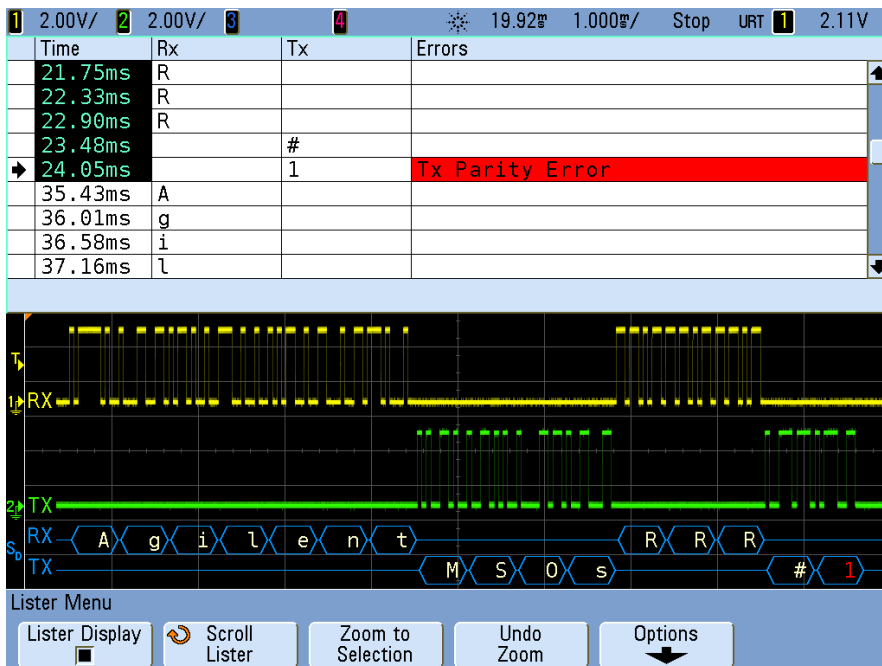


The totalizer is running, counting frames and calculating the percentage of error frames, even when the oscilloscope is stopped (not acquiring data).

The ERR (error) counter is a count of Rx and Tx frames with parity errors. The TX FRAMES and RX FRAMES counts include both normal frames and frames with parity errors. When an overflow condition occurs, the counter displays **OVERFLOW**.

The counters can be reset to zero by pressing the **Reset UART Counters** softkey.

## Interpreting UART/RS232 Lister Data



In addition to the standard Time column, the UART/RS232 Lister contains these columns:

- Rx – receive data.
- Tx – transmit data.
- Errors – highlighted in red, Parity Error or Unknown Error.

## Searching for UART/RS232 Data in the Lister

The oscilloscope's search capability lets you search for (and mark) certain types of UART/RS232 data in the Lister. You can use the **[Navigate]** key and controls to navigate through the marked rows.

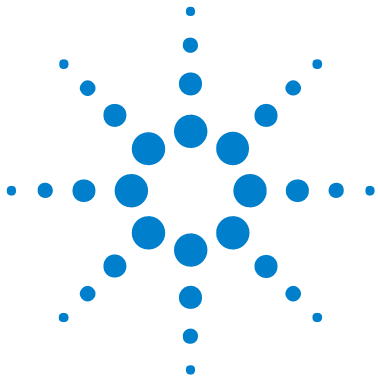
**1** With UART/RS232 selected as the serial decode mode, press **[Search]**.

**2** In the Search Menu, press **Search for**; then, select from these options:

- **Rx Data** – Finds a data byte that you specify. For use when the DUT data words are from 5 to 8 bits in length (no 9th (alert) bit).
- **Rx 1:Data** – For use when the DUT data words are 9 bits in length including the alert bit (the 9th bit). Finds only when the 9th (alert) bit is 1. The specified data byte applies to the least significant 8 bits (excludes the 9th (alert) bit)
- **Rx 0:Data** – For use when the DUT data words are 9 bits in length including the alert bit (the 9th bit). Finds only when the 9th (alert) bit is 0. The specified data byte applies to the least significant 8 bits (excludes the 9th (alert) bit).
- **Rx X:Data** – For use when the DUT data words are 9 bits in length including the alert bit (the 9th bit). Finds a data byte that you specify regardless of the value of the 9th (alert) bit. The specified data byte applies to the least significant 8 bits (excludes the 9th (alert) bit).
- Similar choices are available for Tx.
- **Rx or Tx Parity Error** – Finds a parity error based on the parity you have set in the Bus Configuration Menu.
- **Rx or Tx Any Error** – Finds any error.

For more information on searching data, see [“Searching Lister Data”](#) on page 259.

For more information on using the **[Navigate]** key and controls, see [“To navigate the time base”](#) on page 74.



## 16 Analyzing Data

Performing Mask Tests [344](#)

Enabling Precision Measurements and Math [357](#)

The oscilloscope's **[Analyze]** key gives you access to these features:

- Mask testing if you have Option LMT (N5455A) installed.
- Precision measurements and waveform math.



## Performing Mask Tests

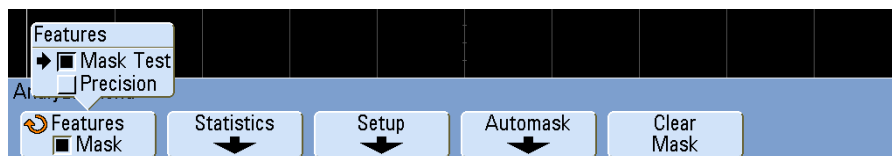
One way to verify a waveform's compliance to a particular set of parameters is to use mask testing. A mask defines a region of the oscilloscope's display in which the waveform must remain in order to comply with chosen parameters. Compliance to the mask is verified point-by-point across the display. Mask test operates on displayed analog channels; it does not operate on channels that are not displayed.

To enable mask test order option LMT at time of oscilloscope purchase, or order N5455A as a stand-alone item after oscilloscope purchase.

### To create a mask from a “golden” waveform (Automask)

A golden waveform meets all chosen parameters, and it is the waveform to which all others will be compared.

- 1 Configure the oscilloscope to display the golden waveform.
- 2 Press the **[Analyze]** key.
- 3 Press **Features**; then, select **Mask Test**.
- 4 Press **Features** again to enable mask testing.



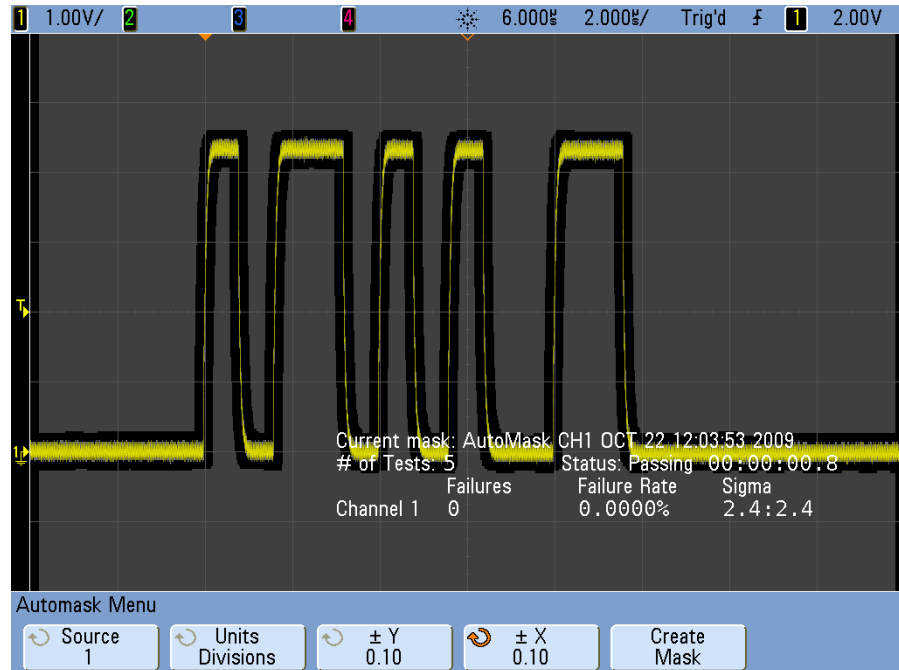
- 5 Press **Automask**.
- 6 In the Automask Menu, press the **Source** softkey and ensure the analog channel from which to create the mask is selected.



- 7 Adjust the mask's horizontal tolerance ( $\pm Y$ ) and vertical tolerance ( $\pm X$ ). These are adjustable in graticule divisions or in absolute units (volts or seconds), selectable using the **Units** softkey.



- 8 Press the **Create Mask** softkey. The mask is created and testing begins. Whenever the **Create Mask** softkey is pressed the old mask is erased and a new mask is created.



- 9 To clear the mask and switch off mask testing, go back up in the menu hierarchy to return to the Mask Test Menu, then press the **Clear Mask** softkey.

If infinite persistence display mode (see [“To set or clear infinite persistence”](#) on page 85) is “on” when mask test is enabled, it stays on. If infinite persistence is “off” when mask test is enabled, it is switched on when mask test is switched on, then infinite persistence is switched off when mask test is switched off.

### Troubleshooting Mask Setup

If you press **Create Mask** and the mask appears to cover the entire screen, check the  $\pm Y$  and  $\pm X$  settings in the Automask Menu. If these are set to zero the resulting mask will be extremely tight around the waveform.

If you press **Create Mask** and it appears that no mask was created, check the  $\pm Y$  and  $\pm X$  settings. They may be set so large that the mask is not visible.

## Setup Options

### Run Until

The Run Until softkey lets you specify a condition on which to terminate testing.

**Forever** The oscilloscope runs continuously. However, if an error occurs the action specified using the **On Error** softkey will occur.

**Minimum # of Tests** Choose this option and then use the **# of Tests** softkey to select the number of times the oscilloscope will trigger, display the waveform(s), and compare them to the mask. The oscilloscope will stop after the specified number of tests have been completed. The specified minimum number of tests may be exceeded. If an error occurs the action specified using the **On Error** softkey will occur. The actual number of tests completed is displayed above the softkeys.

**Minimum Time** Choose this option and then use the **Test Time** softkey to select how long the oscilloscope will run. When the selected time has passed the oscilloscope will stop. The specified time may be exceeded. If an error occurs the action specified using the **On Error** softkey will occur. The actual test time is displayed above the softkeys.

**Minimum Sigma** Choose this option and then use the Sigma softkey to select a minimum sigma. The mask test runs until enough waveforms are tested to achieve a minimum test sigma. (If an error occurs the oscilloscope will perform the action specified by the **On Error** softkey.) Note that this is a test sigma (the max achievable process sigma, assuming no defects, for a certain number of tested waveforms) as opposed to a process sigma (which is tied to the amount of failures per test). The sigma value may exceed the selected value when a small sigma value is chosen. The actual sigma is displayed.

## On Error

The **On Error** setting specifies the action to take when the input waveform does not conform to the mask. This setting supersedes the **Run Until** setting.

**Stop** The oscilloscope will stop when the first error is detected (on the first waveform that does not conform to the mask). This setting supersedes the **Minimum # of Tests** and **Minimum Time** settings.

**Save** The oscilloscope will save the screen image based on the settings you have chosen. See [“Saving and Recalling Data”](#) on page 206.

**Print** The oscilloscope will print the waveform display when the first error is detected. This option is only available when a printer is connected as described in [“To print the oscilloscope’s display”](#) on page 220.

**Measure** Measurements and measurement statistics run only on waveforms that contain a mask violation and are not affected by passing waveforms. This mode is not available when the acquisition mode is set to Averaging.

Note that you can choose to Print or Save, but you cannot select both.

## Source Lock

When you turn on Source Lock using the **Source Lock** softkey, the mask is redrawn to match the source whenever you move the waveform. For example, if you change the horizontal timebase or the vertical gain the mask is redrawn with the new settings.

When you turn off Source Lock, the mask is not redrawn when horizontal or vertical settings are changed.

If you change the Source channel, the mask is not erased. It is re-scaled to the vertical gain and offset settings of the channel to which it is assigned. To create a new mask for the selected source channel, go back up in the menu hierarchy; then, press **Automask**, and press **Create Mask**.

The Source softkey in the Mask Setup Menu is the same as the Source softkey in the Automask Menu.

## Mask Test Trigger Output

The oscilloscope's trigger output (located on the rear panel) can be activated by mask test results.

Press **[Utility] > Options > Rear Panel > Trig Out** and select **Mask**. Use the **Mask Out** softkey to select the desired mode.

Run mode	Mask Out setting	Trigger Output (rear panel)
Single	Pass	A pulse is produced if the mask test passed.
Single	Fail	A pulse is produced if the mask test failed.
Run	Pass	A pulse is produced if all mask tests have passed
Run	Fail	A pulse is produced if any mask test has failed

The Pass/fail status is evaluated periodically. When the evaluation of the testing period results in a pulse output, the trigger output pulses high (+ 5 V). Otherwise, the trigger output remains at low (0 V).

## Mask Statistics

From the Mask Test Menu, press the **Statistics** softkey to enter the Mask Statistics Menu.



When you enable **Show Statistics** the following information is displayed:

- Current mask, name of mask, Channel number, date and time.
- # of Tests (total number of mask tests executed).
- Status (Passing, Failing, or Untested).
- Accumulated test time (in hours, minutes, seconds, and tenths of seconds).

And for each analog channel:

- Number of failures (acquisitions in which the signal excursion went beyond the mask).
- Failure rate (percentage of failures).
- Sigma (the ratio of process sigma to maximum achievable sigma, based on number of waveforms tested).

### Reset Statistics

Press this softkey to reset the statistics counters to zero.

Note that statistics are also reset when:

- Mask Test is switched on after being switched off.
- Clear Mask softkey is pressed.
- An Automask is created.

Additionally, the accumulated time counter is reset whenever the oscilloscope is run after the acquisition was stopped.

### Transparent

Enable Transparent mode to write measurement values and statistics on the screen without a background. Disable the Transparent mode to show them with a light blue background. This controls the display of statistics for both measurements and the optional Mask test feature.

## To manually modify a mask file

You can manually modify a mask file that you created using the Automask function.

- 1 Follow the steps 1-7 in [“To create a mask from a “golden” waveform \(Automask\)”](#) on page 344. Do not clear the mask after creating it.
- 2 Attach a USB mass storage device to the oscilloscope.
- 3 Press the **[Save/Recall]** key.
- 4 Press the **Save** softkey.
- 5 Press the **Format** softkey and select **Mask**.
- 6 Press the second softkey and select a destination folder on your USB mass storage device.
- 7 Press the **Press to Save** softkey. This creates an ASCII text file that describes the mask.
- 8 Remove the USB mass storage device and connect it to a PC.
- 9 Open the .msk file you created using a text editor (such as Wordpad).
- 10 Edit, save, and close the file.

The mask file contains the following sections:

- Mask File Identifier.

- Mask Title.
- Mask Violation Regions.
- Oscilloscope Setup Information.

### Mask File Identifier

The Mask File Identifier is MASK\_FILE\_548XX.

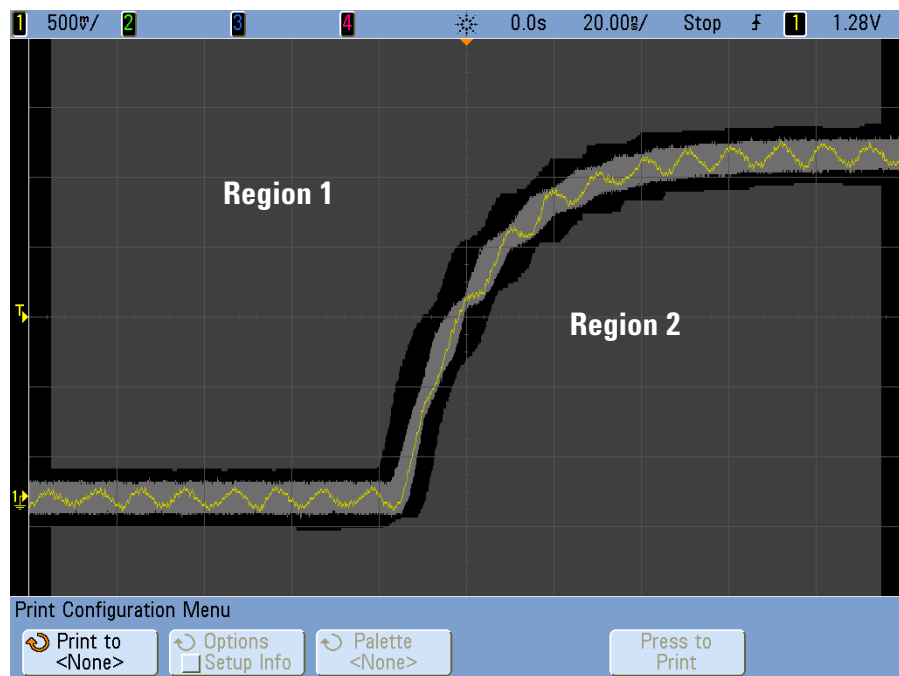
### Mask Title

The Mask Title is a string of ASCII characters.

Example: autoMask CH1 OCT 03 09:40:26 2008

When a mask file contains the keyword “autoMask” in the title, the edge of the mask is passing by definition. Otherwise, the edge of the mask is defined as a failure.

### Mask Violation Regions



Up to 8 regions can be defined for a mask. They can be numbered 1-8. They can appear in any order in the .msk file. The numbering of the regions must go from top to bottom, left to right.

An Automask file contains two special regions: the region “glued” to the top of the display, and the region that is “glued” to the bottom. The top region is indicated by y-values of “MAX” for the first and last points. The bottom region is indicated by y-values of “MIN” for the first and last points.

The top region must be the lowest numbered region in the file. The bottom region must be the highest numbered region in the file.

Region number 1 is the top mask region. The vertices in Region 1 describe points along a line; that line is the bottom edge of the top portion of the mask.

Similarly, the vertices in Region 2 describe the line that forms the top of the bottom part of the mask.

The vertices in a mask file are normalized. There are four parameters that define how values are normalized:

- X1
- $\Delta X$
- Y1
- Y2

These four parameters are defined in the Oscilloscope Setup portion of the mask file.

The Y-values (normally voltage) are normalized in the file using the following equation:

$$Y_{\text{norm}} = (Y - Y1)/\Delta Y$$

$$\text{where } \Delta Y = Y2 - Y1$$

To convert the normalized Y-values in the mask file to voltage:

$$Y = (Y_{\text{norm}} * \Delta Y) + Y1$$

$$\text{where } \Delta Y = Y2 - Y1$$

The X-values (normally time) are normalized in the file using the following equation:



$$X_{\text{norm}} = (X - X1)/\Delta X$$

To convert the normalized X-values to time:

$$X = (X_{\text{norm}} * \Delta X) + X1$$

### Oscilloscope Setup Information

The keywords “setup” and “end\_setup” (appearing alone on a line) define the beginning and end of the oscilloscope setup region of the mask file. The oscilloscope setup information contains remote programming language commands that the oscilloscope executes when the mask file is loaded.

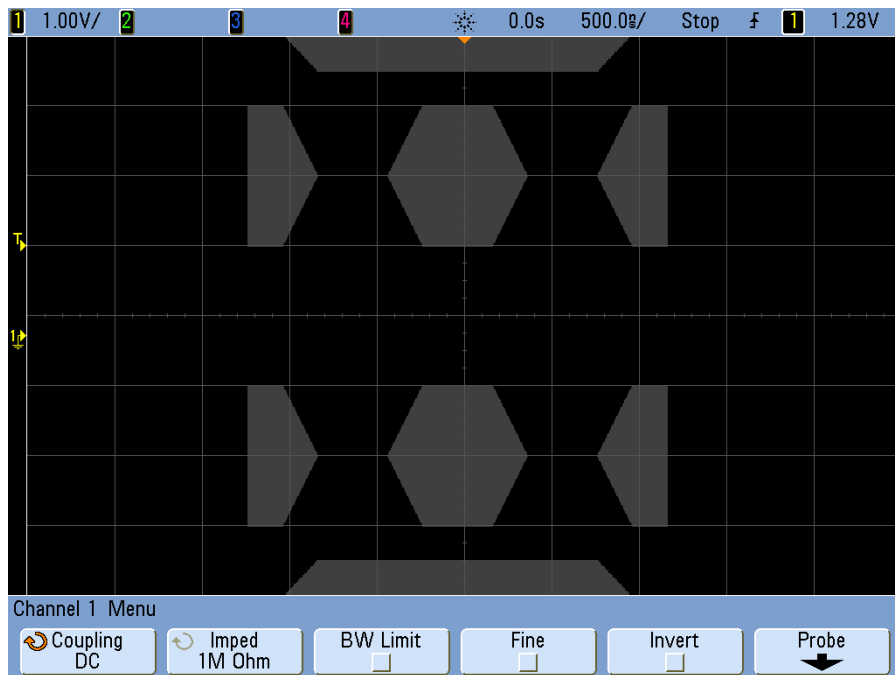
Any legal remote programming command can be entered in this section.

The mask scaling controls how the normalized vectors are interpreted. This in turn controls how the mask is drawn on the display. The remote programming commands that control mask scaling are:

```
:MTES:SCAL:BIND 0
:MTES:SCAL:X1 -400.000E-06
:MTES:SCAL:XDEL +800.000E-06
:MTES:SCAL:Y1 +359.000E-03
:MTES:SCAL:Y2 +2.35900E+00
```

## Building a Mask File

The following mask uses all eight mask regions. The most difficult part of creating a mask file is normalizing the X and Y values from the time and voltage values. This example shows an easy way to convert voltage and time to normalized X and Y values in the mask file.



The following mask file produced the mask shown above:

```
MASK_FILE_548XX
```

```
"All Regions"
```

```
/* Region Number */ 1
/* Number of vertices */ 4
  -12.50,    MAX
  -10.00,   1.750
   10.00,   1.750
  12.50,    MAX

/* Region Number */ 2
/* Number of vertices */ 5
  -10.00,   1.000
  -12.50,   0.500
  -15.00,   0.500
  -15.00,   1.500
  -12.50,   1.500
```

```
/* Region Number */ 3
/* Number of vertices */ 6
  -05.00,  1.000
  -02.50,  0.500
   02.50,  0.500
   05.00,  1.000
   02.50,  1.500
  -02.50,  1.500

/* Region Number */ 4
/* Number of vertices */ 5
   10.00,  1.000
   12.50,  0.500
   15.00,  0.500
   15.00,  1.500
   12.50,  1.500

/* Region Number */ 5
/* Number of vertices */ 5
  -10.00, -1.000
  -12.50, -0.500
  -15.00, -0.500
  -15.00, -1.500
  -12.50, -1.500

/* Region Number */ 6
/* Number of vertices */ 6
  -05.00, -1.000
  -02.50, -0.500
   02.50, -0.500
   05.00, -1.000
   02.50, -1.500
  -02.50, -1.500

/* Region Number */ 7
/* Number of vertices */ 5
   10.00, -1.000
   12.50, -0.500
   15.00, -0.500
   15.00, -1.500
   12.50, -1.500

/* Region Number */ 8
/* Number of vertices */ 4
  -12.50,   MIN
```

```

-10.00, -1.750
 10.00, -1.750
 12.50,   MIN

```

```

setup
:MTES:ENAB 1
:CHAN1:RANG +4.00E+00;OFFS +0.0E+00;COUP DC;IMP ONEM;DISP 1;BWL 0;INV 0
:CHAN1:LAB "1";UNIT VOLT;PROB +1.0E+00;PROB:SKEW +0.0E+00;STYP SING
:CHAN2:RANG +16.0E+00;OFFS +1.62400E+00;COUP DC;IMP FIFT;DISP 0;BWL 0;INV 0
:CHAN2:LAB "2";UNIT VOLT;PROB +1.0E+00;PROB:SKEW +0.0E+00;STYP SING
:CHAN3:RANG +40.0E+00;OFFS +0.0E+00;COUP DC;IMP ONEM;DISP 0;BWL 0;INV 0
:CHAN3:LAB "3";UNIT VOLT;PROB +1.0E+00;PROB:SKEW +0.0E+00;STYP SING
:CHAN4:RANG +40.0E+00;OFFS +0.0E+00;COUP DC;IMP ONEM;DISP 0;BWL 0;INV 0
:CHAN4:LAB "4";UNIT VOLT;PROB +1.0E+00;PROB:SKEW +0.0E+00;STYP SING
:EXT:BWL 0;IMP ONEM;RANG +5E+00;UNIT VOLT;PROB +1.0E+00;PROB:STYP SING
:TIM:MODE MAIN;REF CENT;MAIN:RANG +50.00E-09;POS +0.0E+00
:TRIG:MODE EDGE;SWE AUTO;NREJ 0;HFR 0;HOLD +60E-09
:TRIG:EDGE:SOUR CHAN1;LEV -75.00E-03;SLOP POS;REJ OFF;COUP DC
:ACQ:MODE RTIM;TYPE NORM;COMP 100;COUNT 8;SEGM:COUN 2
:DISP:LAB 0;CONN 1;PERS MIN;SOUR PMEM1
:HARD:APR "";AREA SCR;FACT 0;FFE 0;INKS 1;PAL NONE;LAY PORT
:SAVE:FIL "mask_0"
:SAVE:IMAG:AREA GRAT;FACT 0;FORM NONE;INKS 0;PAL COL
:SAVE:WAV:FORM NONE
:MTES:SOUR CHAN1;ENAB 1;LOCK 1
:MTES:AMAS:SOUR CHAN1;UNIT DIV;XDEL +3.00000000E-001;YDEL +2.00000000E-001
:MTES:SCAL:BIND 0;X1 +0.0E+00;XDEL +1.0000E-09;Y1 +0.0E+00;Y2 +1.00000E+00
:MTES:RMOD FOR;RMOD:TIME +1E+00;WAV 1000;SIGM +6.0E+00
:MTES:RMOD:FACT:STOP 0;PRIN 0;SAVE 0
end_setup

```

## How is mask testing done?

InfiniiVision oscilloscopes start mask testing by creating a database that is 256 x 1000 for the waveform viewing area. Each location in the array is designated as either a violation or a pass area. Each time a data point from a waveform occurs in a violation area a failure is logged. Every active analog channel is tested against the mask database for each acquisition. Over 2 billion failures can be logged per-channel. The number of acquisitions tested is also logged and displayed as “# of Tests”.

The mask file allows greater resolution than the 256 X 1000 database. Some quantization of data occurs to reduce the mask file data for display on-screen.

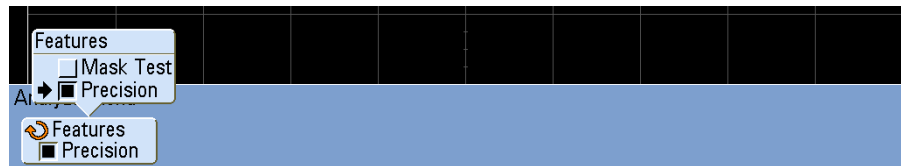
## Enabling Precision Measurements and Math

Normally, after pressing [**Default Setup**], the oscilloscope performs measurements and generates math waveforms using a 1000-point (maximum) measurement record. This measurement record is purposely small in order to provide high waveform update rates and minimal “dead time” between acquisitions to improve the probability of capturing infrequent events.

However, at the expense of waveform update rate, you can enable precision measurements and math waveforms that use a 128K-point (maximum) record. This mode gives you better resolution on measurements and math waveforms (including FFT).

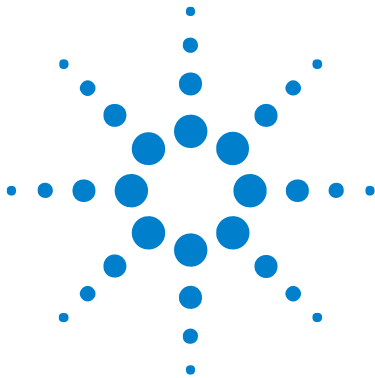
To enable precision measurements and math:

- 1 Press the [**Analyze**] key.
- 2 Press **Features**; then, select **Precision**.
- 3 Press **Features** again to enable precision measurements and math waveforms.



Precision measurements and math are disabled in the same way, or you can disable them by pressing the [**Default Setup**] key.





## 17 Digital Channels

- To connect the digital probes to the device under test [360](#)
- Acquiring waveforms using the digital channels [363](#)
- To display digital channels using AutoScale [364](#)
- Interpreting the digital waveform display [366](#)
- To switch all digital channels on or off [367](#)
- To switch groups of channels on or off [368](#)
- To switch a single channel on or off [367](#)
- To change the displayed size of the digital channels [367](#)
- To reposition a digital channel [369](#)
- To change the logic threshold for digital channels [368](#)
- To display digital channels as a bus [369](#)
- Digital channel signal fidelity: Probe impedance and grounding [374](#)
- To replace digital probe leads [379](#)

This chapter describes how to use the digital channels of a Mixed-Signal Oscilloscope (MSO).

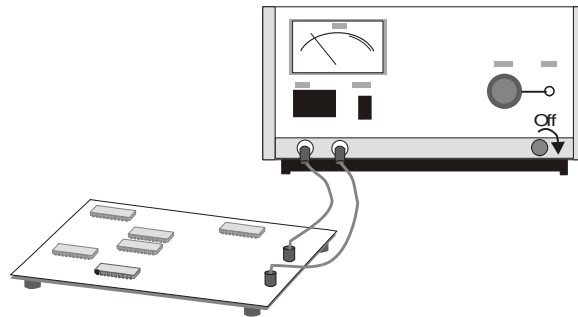


## To connect the digital probes to the device under test

The digital channels are enabled on MSO7000B Series models and DSO7000B Series models which have the MSO upgrade license installed.

- 1 If necessary, turn off the power supply to the device under test.

Turning off power to the device under test would only prevent damage that might occur if you accidentally short two lines together while connecting probes. You can leave the oscilloscope powered on because no voltage appears at the probes.



- 2 Connect the digital probe cable to the D15 - D0 connector on the rear panel of the mixed-signal oscilloscope. The digital probe cable is indexed so you can connect it only one way. You do not need to power-off the oscilloscope.

### CAUTION



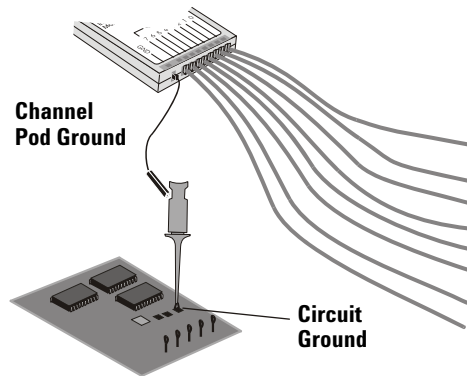
#### Probe cable for digital channels

Use only the Agilent part number 54620-68701 digital probe kit supplied with the mixed-signal oscilloscope.

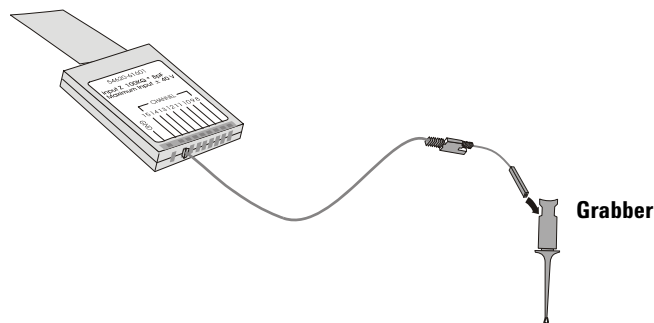
- 3 Route the cable under the oscilloscope and bring it out in front.



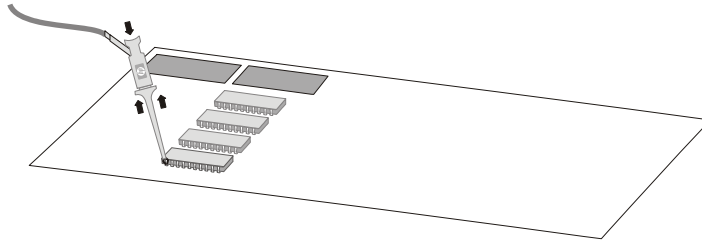
- 4 Connect the ground lead on each set of channels (each pod), using a probe grabber. The ground lead improves signal fidelity to the oscilloscope, ensuring accurate measurements.



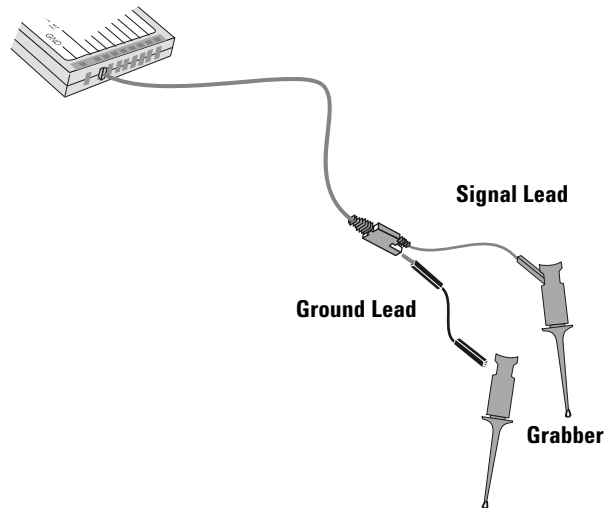
- 5 Connect a grabber to one of the probe leads. (Other probe leads are omitted from the figure for clarity.)



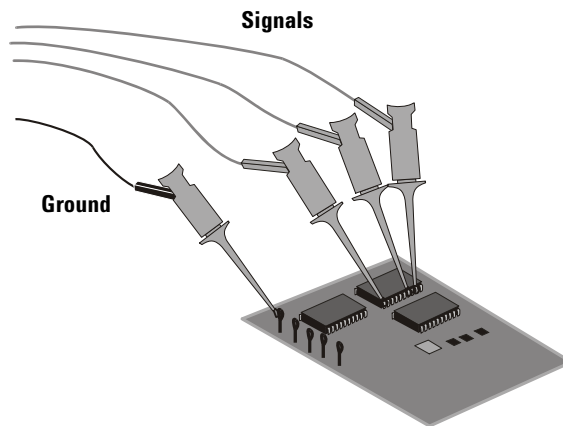
- 6 Connect the grabber to a node in the circuit you want to test.



- 7 For high-speed signals, connect a ground lead to the probe lead, connect a grabber to the ground lead, and attach the grabber to ground in the device under test.



- 8 Repeat steps 3 through 6 until you have connected all points of interest.



## Acquiring waveforms using the digital channels

When you press **[Run/Stop]** or **[Single]** to run the oscilloscope, the oscilloscope examines the input voltage at each input probe. When the trigger conditions are met the oscilloscope triggers and displays the acquisition.

For digital channels, each time the oscilloscope takes a sample it compares the input voltage to the logic threshold. If the voltage is above the threshold, the oscilloscope stores a 1 in sample memory; otherwise, it stores a 0.

## To display digital channels using AutoScale

When signals are connected to the digital channels, AutoScale quickly configures and displays the digital channels.

- To configure the instrument quickly, press the **[AutoScale]** key.  
Any digital channel with an active signal will be displayed. Any digital channels without active signals will be turned off.
- To undo the effects of AutoScale, press the **Undo AutoScale** softkey before pressing any other key.

This is useful if you have unintentionally pressed the **[AutoScale]** key or do not like the settings AutoScale has selected. This will return the oscilloscope to its previous settings.

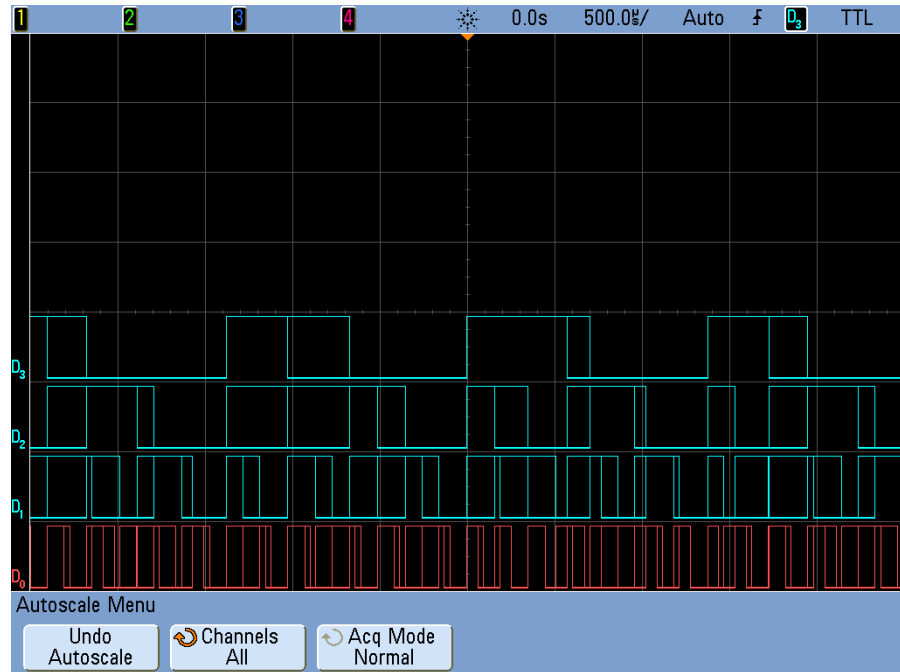
For information about how AutoScale works, see [page 33](#).

To set the instrument to the factory-default configuration, press the **[Default Setup]** key.

### Example

Install probe clips on channels 0 and 1 of the digital probe cable. Connect the probes for digital channels 0 and 1 to the Probe Comp output on the front panel of the instrument. Be sure to connect the ground lead to the

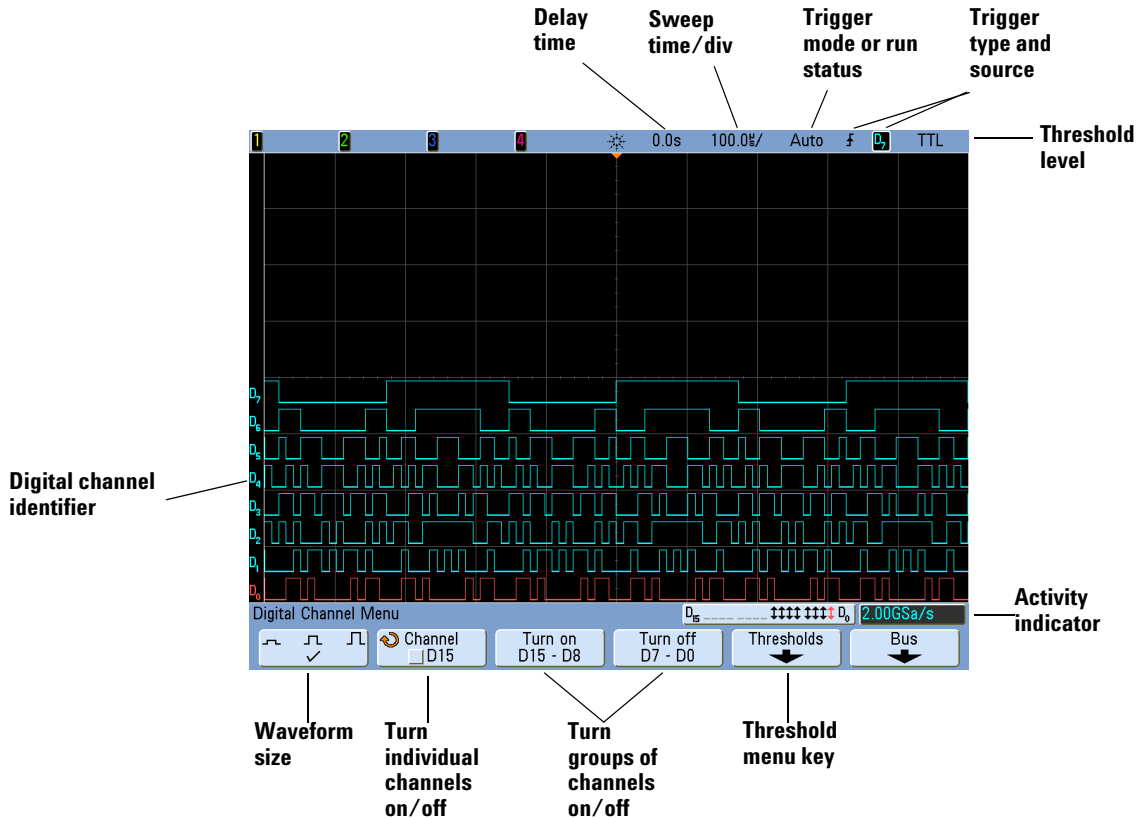
ground lug beside the Probe Comp output. Set the instrument to the factory default configuration by pressing the **[Default Setup]** key. Then press the **[AutoScale]** key. You should see a display similar to the following.



**Figure 35** AutoScale of digital channels 0 to 3 (MSO models only)

## Interpreting the digital waveform display




The following figure shows a typical display with digital channels.



### Activity indicator

When any digital channels are turned on, an activity indicator is displayed in the status line at the bottom of the display. A digital channel can be always high (■), always low (■), or actively toggling logic states (↑↓). Any channel that is turned off will be grayed out in the activity indicator.

## To change the displayed size of the digital channels

- 1 Press the **[Digital]** key.
- 2 Press the size (    ) softkey to select how the digital channels are displayed.

The sizing control lets you spread out or compress the digital traces vertically on the display for more convenient viewing.

## To switch a single channel on or off

- 1 With the Digital Channel Menu displayed, rotate the Entry knob to select the desired channel from the popup menu.
- 2 Press the softkey that is directly below the popup menu to switch the selected channel on or off.

## To switch all digital channels on or off

- 1 Press the **[Digital]** key to switch the display of the digital channels on or off. The Digital Channel Menu will be displayed above the softkeys.  
The digital channels are displayed when this key is illuminated.  
If you want to switch the digital channels off, and the Digital Channel Menu is not already displayed, you will have to push the **[Digital]** key twice to switch the digital channels off. The first push displays the Digital Channel Menu, and the second push switches the channels off.

## To switch groups of channels on or off

- 1 Press the [**Digital**] key on the front panel if the Digital Channel Menu is not already displayed.
- 2 Press the **Turn off** (or **Turn on**) softkey for the **D15 - D8** group or the **D7 - D0** group.

Each time you press the softkey, the softkey's mode toggles between **Turn on** and **Turn off**.

## To change the logic threshold for digital channels

- 1 Press the [**Digital**] key so that the Digital Channel Menu is displayed.
- 2 Press the **Thresholds** softkey
- 3 Press the **D15 - D8** or **D7 - D0** softkey, then select a logic family preset or select **User** to define your own threshold.

Logic family	Threshold Voltage
TTL	+1.4 V
CMOS	+2.5 V
ECL	-1.3 V
User	Variable from -8 V to +8 V

The threshold you set applies to all channels within the selected D15 Thru D8 or D7 Thru D0 group. Each of the two channel groups can be set to a different threshold if desired.

Values greater than the set threshold are high (1) and values less than the set threshold are low (0).

If the **Thresholds** softkey is set to **User**, press the **User** softkey for the channel group, then turn the Entry knob to set the logic threshold. There is one **User** softkey for each group of channels.



## To reposition a digital channel

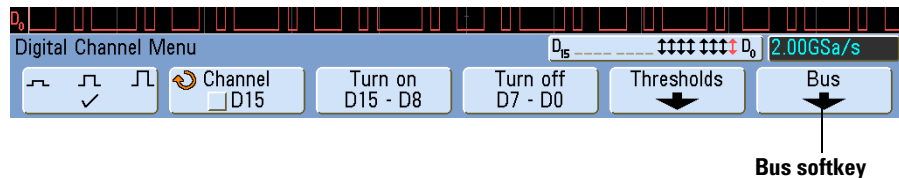
Press the [**Digital**] key to turn on the digital channels (the [**Digital**] key will illuminate).

To select a waveform, push the knob in the Digital controls until the **Select** indicator is lit; then, turn the knob. The selected waveform is highlighted in red. To position the selected waveform, push the knob until the **Pos** indicator is lit; then, turn the knob.

If a trace is repositioned over an existing trace the indicator at the left edge of the trace will change from **D<sub>nn</sub>** designation (where nn is a one or two digit channel number from 0 to 15) to **D\***. The “\*” indicates that two channels are overlaid.

## To display digital channels as a bus

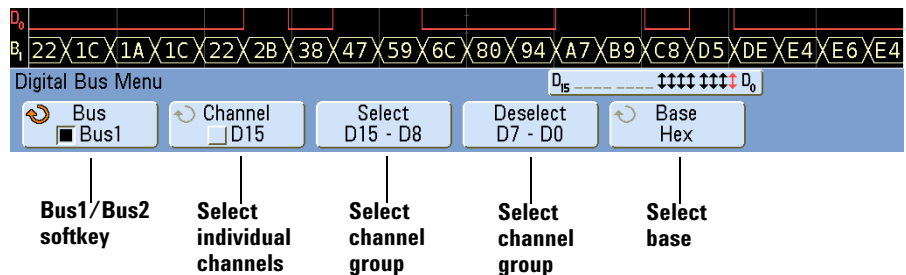
Digital channels may be grouped and displayed as a bus, with each bus value displayed at the bottom of the display in hex or binary. You can create up to two buses. To configure and display each bus, press the [**Digital**] key on the front panel. Then press the **Bus** softkey.



Next, select a bus. Rotate the Entry knob, then press the Entry knob or the **Bus1/Bus2** softkey to switch it on.

## 17 Digital Channels

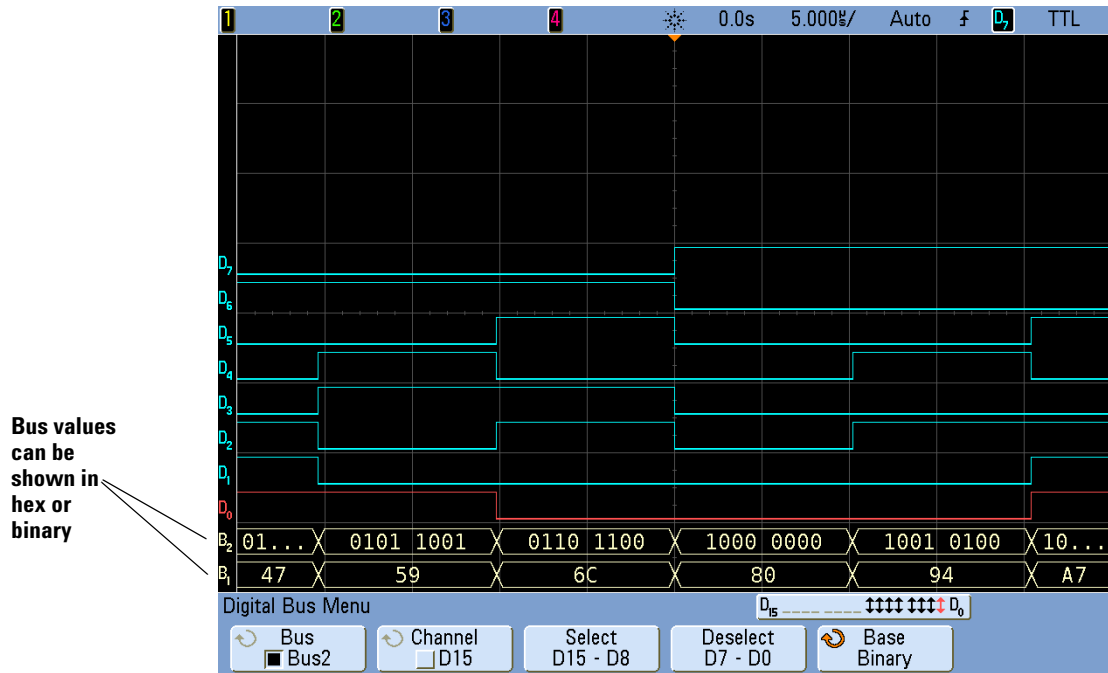
Use the second softkey from the left and the Entry knob to select individual channels to be included in the bus. You can rotate the Entry knob and push the softkey to select channels. You can also press the **Select/Deselect D15-D8** and **Select/Deselect D7-D0** softkeys to include or exclude groups of eight channels in each bus.



If the bus display is blank, completely white, or if the display includes "...", you need to expand the horizontal scale to allow space for the data to be shown, or use the cursors to display the values (see [page 371](#)).

The **Base** softkey lets you choose to display the bus values in hex or binary.

The buses are shown at the bottom of the display.



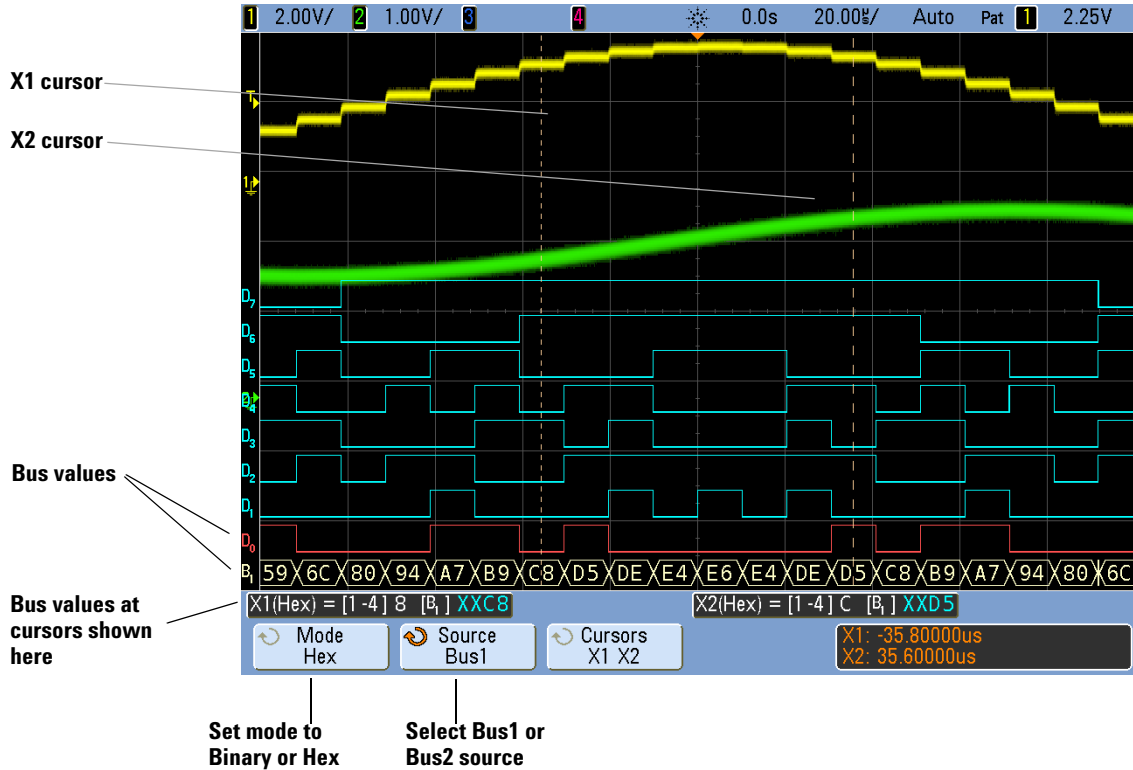
### Using cursors to read bus values

To read the digital bus value at any point using the cursors:

- 1 Turn on Cursors (by pressing the **[Cursors]** key on the front panel)
- 2 Press the cursor **Mode** softkey and change the mode to **Hex** or **Binary**.
- 3 Press the **Source** softkey and select **Bus1** or **Bus2**.

## 17 Digital Channels

- 4 Use the Entry knob and the **X1** and **X2** softkeys to position the cursors where you want to read the bus values.

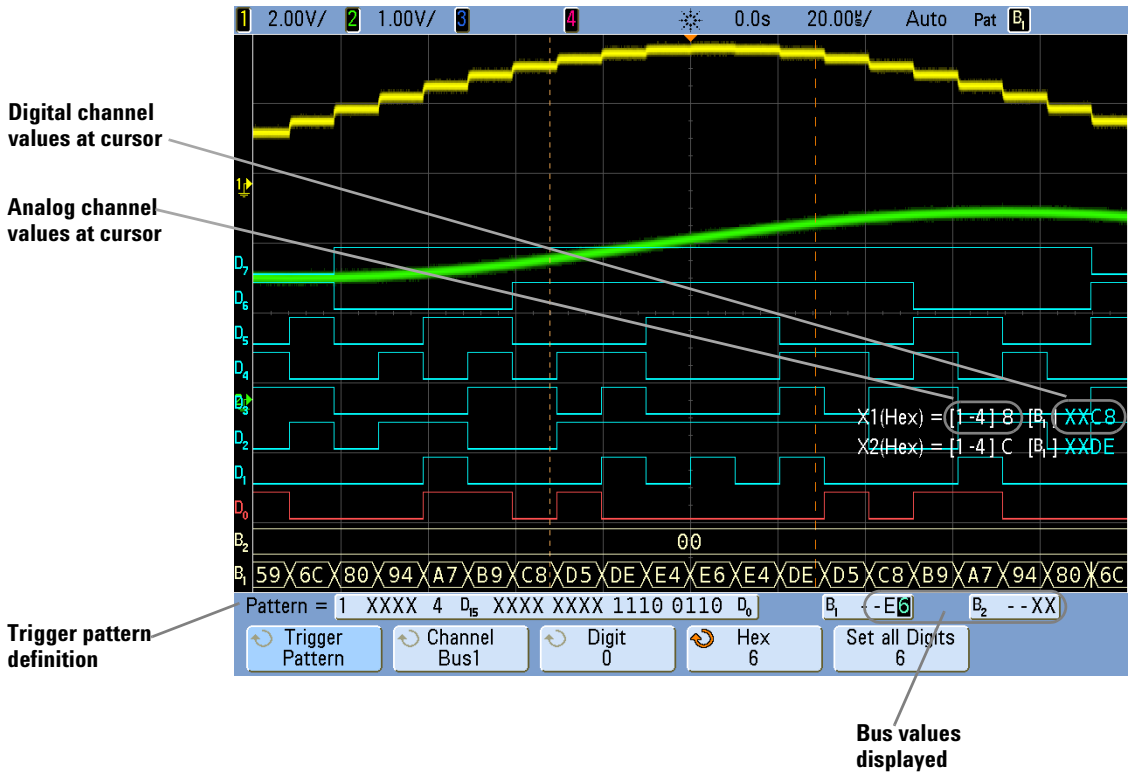


When you press the **[Digital]** key to display the Digital Channel Menu, the digital activity indicator is shown where the cursor values were and the bus values at the cursors are displayed in the graticule.

### Bus values are displayed when using Pattern trigger

The bus values are also displayed when using the Pattern trigger function. Press the **[Pattern]** key on the front panel to display the Pattern Trigger Menu and the bus values will be displayed on the right, above the softkeys.

The dollar sign (\$) will be displayed in the bus value when the bus value cannot be displayed as a hex value. This occurs when one or more “don’t cares” (X) are combined with low (0) and high (1) logic levels in the pattern specification, or when a transition indicator (rising edge ( $\uparrow$ ) or falling edge ( $\downarrow$ )) are included in the pattern specification. A byte that consists of all don’t cares (X) will be displayed in the bus as a don’t care (X).



See [page 125](#) for more information on Pattern triggering.

## Digital channel signal fidelity: Probe impedance and grounding

When using the mixed-signal oscilloscope you may encounter problems that are related to probing. These problems fall into two categories: probe loading and probe grounding. Probe loading problems generally affect the device under test, while probe grounding problems affect the accuracy of the data to the measurement instrument. The design of the probes minimizes the first problem, while the second is easily addressed by good probing practices.

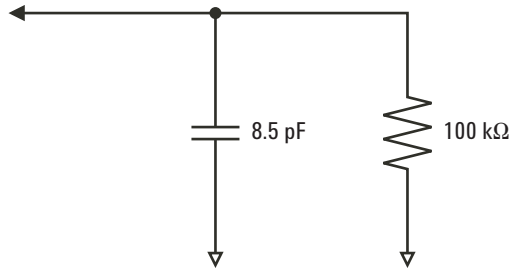
### Input Impedance

The logic probes are passive probes, which offer high input impedance and high bandwidths. They usually provide some attenuation of the signal to the oscilloscope, typically 20 dB.

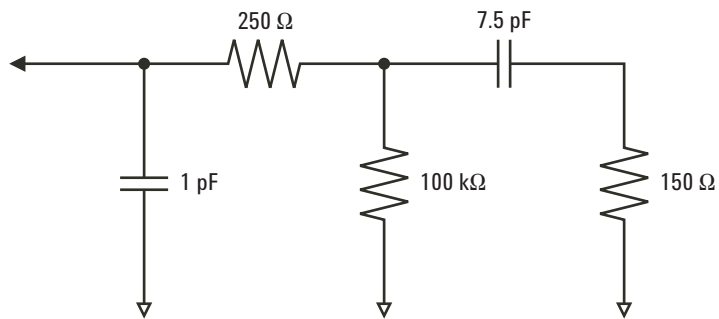
Passive probe input impedance is generally specified in terms of a parallel capacitance and resistance. The resistance is the sum of the tip resistor value and the input resistance of the test instrument (see the following figure). The capacitance is the series combination of the tip compensating capacitor and the cable, plus instrument capacitance in parallel with the stray tip capacitance to ground. While this results in an input impedance specification that is an accurate model for DC and low frequencies, the high-frequency model of the probe input is more useful (see the following

figure). This high-frequency model takes into account pure tip capacitance to ground as well as series tip resistance, and the cable's characteristic impedance ( $Z_0$ ).

**Figure 36** DC and Low-Frequency Probe Equivalent Circuit

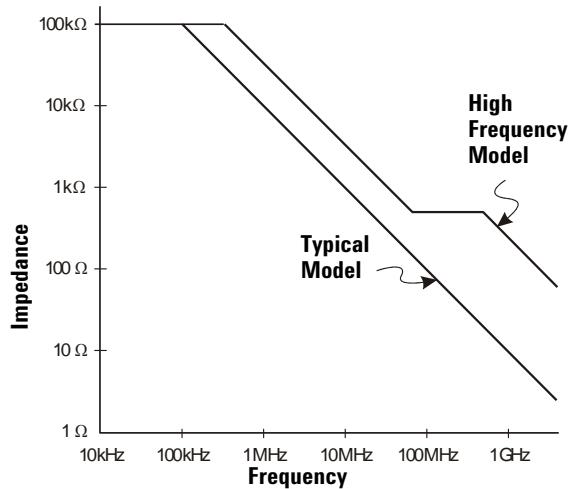


**Figure 37** High-Frequency Probe Equivalent Circuit



The impedance plots for the two models are shown in these figures. By comparing the two plots, you can see that both the series tip resistor and the cable's characteristic impedance extend the input impedance significantly. The stray tip capacitance, which is generally small (1 pF), sets the final break point on the impedance chart.

**Figure 38** Impedance versus Frequency for Both Probe Circuit Models



The logic probes are represented by the high-frequency circuit model shown above. They are designed to provide as much series tip resistance as possible. Stray tip capacitance to ground is minimized by the proper mechanical design of the probe tip assembly. This provides the maximum input impedance at high frequencies.

## Probe Grounding

A probe ground is the low-impedance path for current to return to the source from the probe. Increased length in this path will, at high frequencies, create large common mode voltages at the probe input. The voltage generated behaves as if this path were an inductor according to the equation:

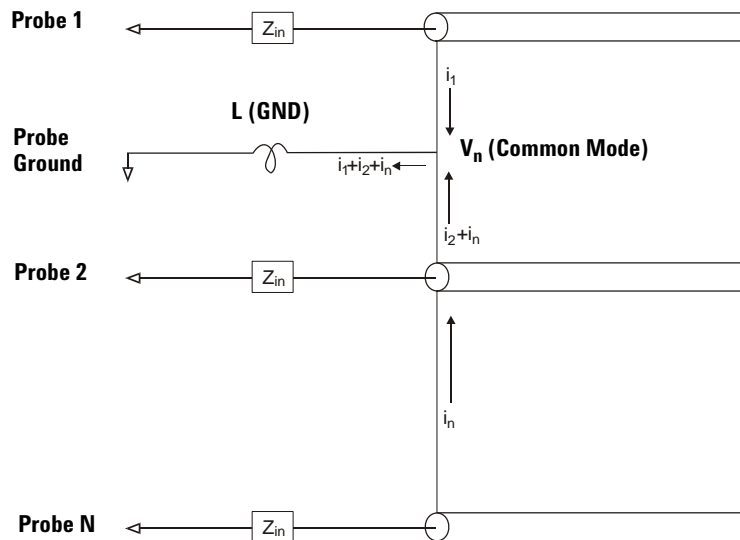
$$V = L \frac{di}{dt}$$



Increasing the ground inductance ( $L$ ), increasing the current ( $di$ ) or decreasing the transition time ( $dt$ ), will all result in increasing the voltage ( $V$ ). When this voltage exceeds the threshold voltage defined in the oscilloscope, a false data measurement will occur.

Sharing one probe ground with many probes forces all the current that flows into each probe to return through the same common ground inductance of the probe whose ground return is used. The result is increased current ( $di$ ) in the above equation, and, depending on the transition time ( $dt$ ), the common mode voltage may increase to a level that causes false data generation.

**Figure 39** Common Mode Input Voltage Model



In addition to the common mode voltage, longer ground returns also degrade the pulse fidelity of the probe system. Rise time is increased, and ringing, due to the undamped LC circuit at the input of the probe, is also increased. Because the digital channels display reconstructed waveforms, they do not show ringing and perturbations. You will not find ground problems through examination of the waveform display. In fact, it is likely you will discover the problem through random glitches or inconsistent data measurements. Use the analog channels to view ringing and perturbations.

## Best Probing Practices

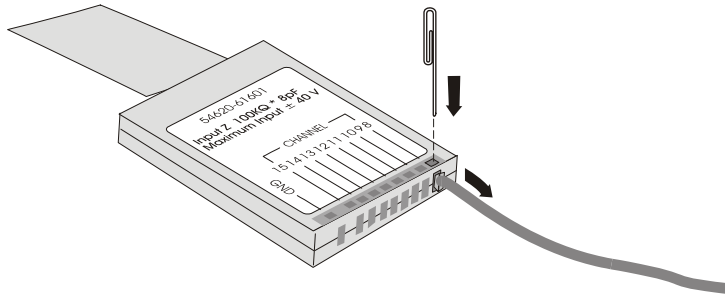
Because of the variables  $L$ ,  $di$ , and  $dt$ , you may be unsure how much margin is available in your measurement setup. The following are guidelines for good probing practices:

- The ground lead from each digital channel group (D15–D8 and D7–D0) should be attached to the ground of the device under test if any channel within the group is being used for data capture.
- When capturing data in a noisy environment, every third digital channel probe's ground should be used in addition to the channel group's ground.
- High-speed timing measurements (rise time  $< 3$  ns) should make use of each digital channel probe's own ground.

When designing a high-speed digital system, you should consider designing dedicated test ports that interface directly to the instrument's probe system. This will ease measurement setup and ensure a repeatable method for obtaining test data. The 01650-61607 16-channel logic probe and termination adapter is designed to make it easy to connect to industry-standard, 20-pin board connectors. This probe consists of a 2 m logic analyzer probe cable and a 01650-63203 termination adapter that provides the proper RC networks in a very convenient package. Three 20-pin, low-profile, straight board connectors are included. Additional board connectors can be ordered from Agilent Technologies.

## To replace digital probe leads

If you need to remove a probe lead from the cable, insert a paper clip or other small pointed object into the side of the cable assembly, and push to release the latch while pulling out the probe lead.



**Table 8** Digital Probe Replacement Parts

Part Number	Description
54620-68701	Digital probe kit
5959-9333	Replacement probe leads (qty 5)
5959-9335	Replacement 2-inch probe ground lead (qty 5)
01650-94309	Package of probe labels
54620-61801	16-channel cable (qty 1)
5090-4833	Grabbers (qty 20)

For other replacement parts, consult the *InfiniiVision Oscilloscope Service Guides*.





## 18 Oscilloscope Utility Settings

Configuring the [Quick Action] Key	382
Setting Oscilloscope Preferences	383
Setting Rear Panel Options	388
Setting the Oscilloscope's Clock	392
Entering Licenses and Displaying License Information	393
Performing Service Tasks	397

This chapter explains oscilloscope utilities.



## Configuring the [Quick Action] Key

The [Quick Action] key lets you perform common, repetitive actions by pressing a single key.

To configure the [Quick Action] key:

- 1 Press [Utility] > **Quick Action** > **Action**; then, select the action that should be performed:
  - **Off** – disables the [Quick Action] key.
  - **Quick Print** – prints the current screen image. Press **Settings** to set up the printing options. See “[Printing Screens](#)” on page 220.
  - **Quick Save** – saves setups, screen images, or data. Press **Settings** to set up the save options. See “[Saving and Recalling Data](#)” on page 206.
  - **Quick Recall** – recalls setups, traces, or masks. Press **Settings** to set up the recall options. See “[Saving and Recalling Data](#)” on page 206.
  - **Quick Freeze Display** – freezes the display without stopping acquisitions. For more information, see “[To freeze the display](#)” on page 87.

Once the [Quick Action] key is configured, you simply press it to perform the selected action.

## Setting Oscilloscope Preferences

The User Preferences Menu (under **[Utility] > Options > Preferences**) lets you specify preferences like the vertical expansion reference, antialiasing, screen saver, autoscale options, transparent backgrounds, or loading the default label library.

### To choose "expand about" center or ground

When you change a channel's volts/division setting, the waveform display can be set to expand (or compress) about the signal ground level or the center of the display.

To set the waveform expansion reference point:

1 Press **[Utility] > Options > Preferences > Expand** and select:

- **Ground** – The displayed waveform will expand about the position of the channel's ground. This is the default setting.

The ground level of the signal is identified by the position of the ground level (⚡) icon at the far-left side of the display.

The ground level will not move when you adjust the vertical sensitivity (volts/division) control.

If the ground level is off screen, the waveform will expand about the top or bottom edge of the screen based on where the ground is off screen.

- **Center** – The displayed waveform will expand about the center of the display.

### To disable/enable antialiasing

At slower sweep speeds, the sample rate is reduced and a proprietary display algorithm is used to minimize the likelihood of aliasing.

By default, Antialiasing is enabled. You should leave Antialiasing enabled unless there is a specific reason to switch it off.

If you need to switch Antialiasing off, press **[Utility] > Options > Preferences** and press the **Antialiasing** softkey to switch the feature off. The displayed waveforms will be more susceptible to aliasing.

## To set up the screen saver

The oscilloscope can be configured to turn on a display screen saver when the oscilloscope has been idle for a specified length of time.

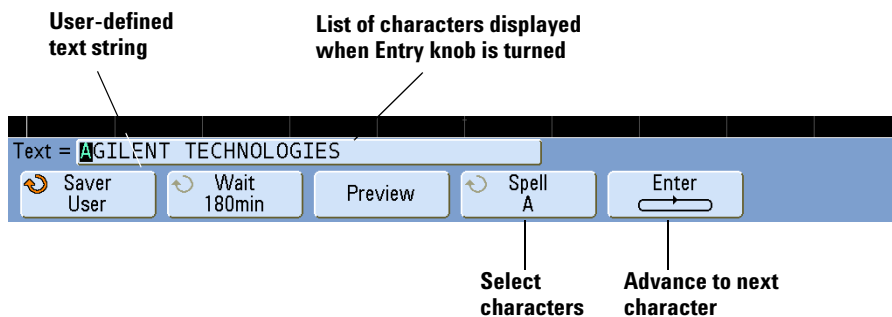
- 1 Press **[Utility] > Options > Preferences > Screen Saver** to display the Screen Saver Menu.



- 2 Press the **Saver** softkey to select the screen saver type.

The screen saver can be set to **Off**, to display any of the images shown in the list, or can display a user-defined text string.

If **User** is selected, press the **Spell** softkey to select the first character of the text string. Use the Entry knob to choose a character. Then press the **Enter** softkey to advance to the next character and repeat the process. The resultant string is displayed in the “Text =” line above the softkeys.



- 3 Turn the Entry knob to select the number of minutes to wait before the selected screen saver activates.

When you turn the Entry knob, the number of minutes is displayed in the **Wait** softkey. The default time is 180 minutes (3 hours).



- 4 Press the **Preview** softkey to preview the screen saver you have selected with the **Saver** softkey.
- 5 To view the normal display after the screen saver has started, press any key or turn any knob.

## To set AutoScale preferences

There are preference settings for which channels are used and whether the acquisition mode should be changed when the [**AutoScale**] key is pressed.

### To enable Fast Debug autoscale

The Fast Debug option changes the behavior of [**AutoScale**] to let you make quick visual comparisons to determine whether the signal being probed is a DC voltage, ground, or an active AC signal. Channel coupling is maintained for easy viewing of oscillating signals.

- 1 Press [**Utility**] > **Options** > **Preferences** > **AutoScale**.
- 2 In the AutoScale Preferences Menu, press **Fast Debug** to enable or disable the option.

### To specified the channels to be autoscaled

Normally, [**AutoScale**] checks all input channels when performing the automated setup. However, you can tell it to check only the displayed channels.

- 1 Press [**Utility**] > **Options** > **Preferences** > **AutoScale**.
- 2 In the AutoScale Preferences Menu, press **Channels**; then select:
  - **All Channels** – The next time you press [**AutoScale**], all channels that meet the requirements of AutoScale will be displayed.
  - **Only Displayed Channels** – The next time you press [**AutoScale**], only the channels that are turned on will be examined for signal activity. This is useful if you only want to view specific active channels after pressing [**AutoScale**].

### To preserve the acquisition mode during autoscale

The acquisition mode is normally switched to Normal when **[AutoScale]** is performed. However, you can tell it to leave the acquisition mode unchanged.

- 1 Press **[Utility] > Options > Preferences > AutoScale**.
- 2 In the AutoScale Preferences Menu, press **Acq Mode**; then select:
  - **Normal** – to make the oscilloscope switch to Normal acquisition mode whenever the **[AutoScale]** key is pressed. This is the default mode.
  - **Preserve** – to make the oscilloscope remain in the acquisition mode you have chosen when the **[AutoScale]** key is pressed.

### To disable/enable transparent backgrounds

There is a preference setting for whether measurements, statistics, and other text displays have transparent or solid backgrounds.

- 1 Press **[Utility] > Options > Preferences > More**.
- 2 Press **Transparent** to toggle between transparent and solid text display backgrounds.

### To load the default label library

See [“To reset the label library to the factory default”](#) on page 93.

### To specify the measurement window for Zoom mode

When the zoomed time base is displayed, you can specify whether the upper, Main window or the lower, Zoom window is used as the measurement window.

- 1 Press **[Utility] > Options > Preferences > More**.
- 2 Press **Window** to select from these measurement window options:
  - **Auto Select** – The measurement is attempted in the lower, Zoom window; if it cannot be made there, the upper, Main window is used.

- **Main** – The measurement window is the upper, Main window.
- **Zoom** – The measurement window is the lower, Zoom window.

## Setting Rear Panel Options

The rear panel options you can set are:

- The function of the 10 MHz REF connector.
- The source of the TRIG OUT signal.

### To set the reference signal mode

The **10 MHz REF** BNC connector on the rear panel is provided so you can:

- Supply a more accurate sample clock signal to the oscilloscope, or
- Synchronize the timebase of two or more instruments.

#### Sample clock and frequency counter accuracy

The oscilloscope's timebase uses a built-in reference that has an accuracy of 15 ppm. This is sufficient for most uses. However, if you are looking at a window that is very narrow compared to the selected delay (for example, looking at a 15 ns pulse with the delay set to 1 ms), significant error can be introduced.

Using the built-in sample clock, the oscilloscope's hardware frequency counter is a 5-digit counter.

#### Supplying an external timebase reference

When you supply an external timebase reference, the hardware frequency counter is automatically changed to an 8-digit counter. In this case, the frequency counter (**[Meas] > Select > Counter**) is as accurate as the external clock.

For more information on the hardware frequency counter, see [“Counter”](#) on page 162.

### To supply a sample clock to the oscilloscope

- 1 Connect a 10 MHz square or sine wave to the BNC connector labeled **10 MHz REF**. The amplitude must be between 180 mV and 1 V, with an offset of between 0 V and 2 V.

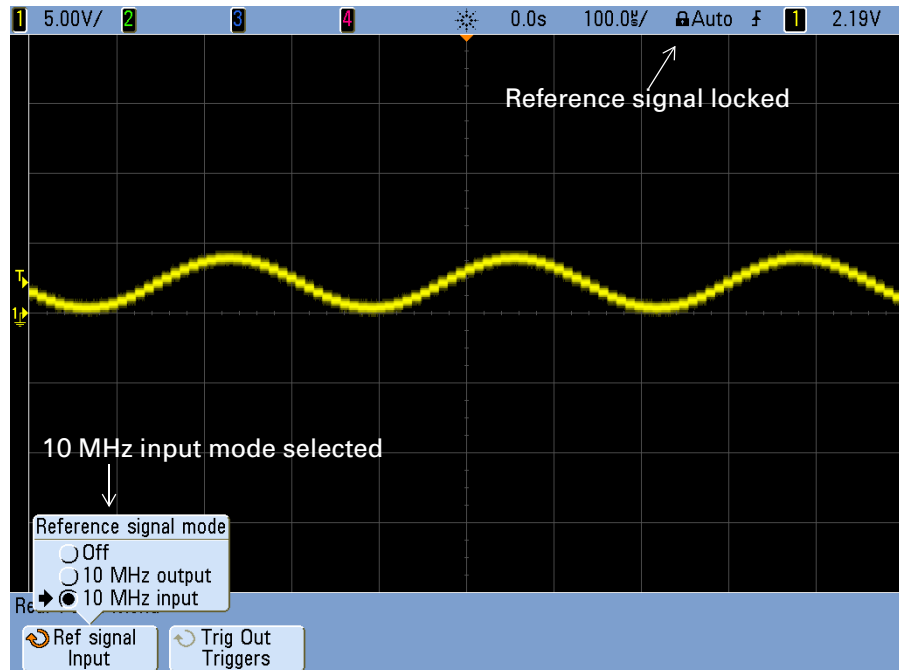
## CAUTION



### Maximum input voltage at 10 MHz REF connector

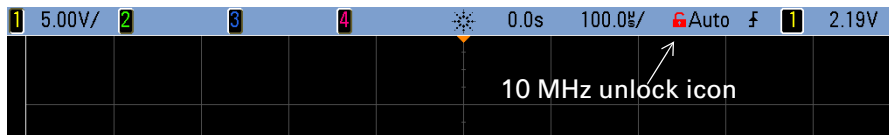
Do not apply more than  $\pm 15$  V at the 10 MHz REF BNC connector on the rear panel or damage to the instrument may occur.

- 2 Press **[Utility] > Options > Rear Panel > Ref Signal**.
- 3 Use the Entry Knob and the **Ref Signal** softkey to select **10 MHz input**. A black locked padlock icon will appear at the top of the display.

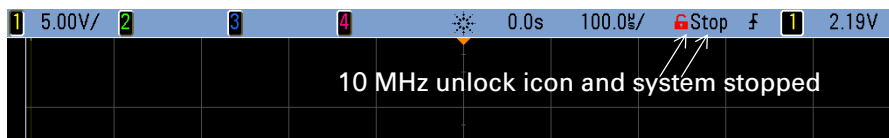


## 18 Oscilloscope Utility Settings

If the externally supplied sample clock varies greater than 0.5% from 10 MHz a soft unlock will occur. The oscilloscope will continue to acquire data but the lock symbol in the upper right part of the display will become a red unlocked padlock icon.



If the externally supplied sample clock signal is lost, a hard unlock will occur. The lock symbol in the upper right part of the display will become a red unlocked padlock icon and the oscilloscope will stop acquiring data. The oscilloscope will resume sampling when the externally supplied sample clock becomes stable again.



### To synchronize the timebase of two or more instruments

The oscilloscope can output its 10 MHz system clock for the purpose of synchronization with other instruments.

- 1 Connect a BNC cable to the BNC connector labeled **10 MHz REF** on the rear panel of the oscilloscope.
- 2 Connect the other end of the BNC cable to the instrument(s) that will accept the 10 MHz reference signal. Put a 50  $\Omega$  termination at the input to the other instrument to terminate the signal.
- 3 Press **[Utility] > Options > Rear Panel > Ref Signal**.
- 4 Use the Entry Knob and the **Ref Signal** softkey to select **10 MHz output**.

The oscilloscope will output its 10 MHz reference signal at TTL levels.

## To set the trigger out source

You can select one of the following signals to be output at the TRIG OUT connector on the rear panel of the oscilloscope:

- Triggers
- Source frequency
- Source frequency/8
- Mask test pass/fail (see [“Mask Test Trigger Output”](#) on page 348.)

### Triggers

This is the default selection. In this mode, a rising edge is output each time the oscilloscope triggers. This rising edge is delayed 17 ns from the oscilloscope's trigger point. The output level is 0-5 V into an open circuit, and 0-2.5 V into 50  $\Omega$ .

### Source Frequency

This mode is only available when the oscilloscope is set to positive or negative edge trigger on a front-panel source (analog channel or the external input of a 2-channel oscilloscope). In this mode, the TRIG OUT BNC is connected to the output of the trigger comparator. The output level is 0-580 mV into an open circuit, and 0-290 mV into 50  $\Omega$ . The maximum frequency output is 350 MHz due to the bandwidth limitation of the TRIG OUT BNC amplifier. This selection is useful for driving an external frequency counter.

### Source Frequency/8

This selection produces the same signal as described in Source frequency except the output frequency is one-eighth of the trigger comparator output frequency. This mode is useful when your input signal is faster than 350 MHz.

The Trigger Out connector also provides the User Cal signal. See [“To perform user calibration”](#) on page 397.

## Setting the Oscilloscope's Clock

The Clock Menu lets you set the current date and time of day (24-hour format). This time/date stamp will appear on hardcopy prints and directory information on the USB mass storage device.

To set the date and time, or to view the current date and time:

- 1 Press **[Utility] > Options > Clock**.



- 2 Press the **Year, Month, Day, Hour** or **Minute** softkey and rotate the Entry knob to set to the desired number.

The hours are shown in the 24-hour format. So 1:00 PM is hour 13.

The real-time clock only allows selection of valid dates. If a day is selected and the month or year is changed so the day is invalid, the day is automatically adjusted.



## Entering Licenses and Displaying License Information

The options settings under the [Utility] key let you enter license strings and display license information.

### To enter licenses

- 1 Press [Utility] > Options > Licenses.
- 2 In the Licenses Menu, press **Spell**; then select the desired character.
- 3 Press **Enter**; then, select the next character using the **Spell** softkey.
- 4 When the complete license string has been entered, press **Apply**.

### To display license information

- 1 Press [Utility] > Options > Licenses > Show license information.

The license information includes:

- Instrument ID.
- Serial number.
- Installed licenses string.

### Licensed Options Available

Many of the following licensed options can be easily installed without returning the oscilloscope to a Service Center. Not all options can be installed on all models. See data sheets for details.

## 18 Oscilloscope Utility Settings

**Table 9** Licensed Options Available

Option	Description	After purchase model number, notes
<b>232</b>	RS232/UART serial decode option (for 4 channel or 4+16 channel models only) Provides trigger and decode capability for many UART (Universal Asynchronous Receiver/Transmitter) protocols including RS232 (Recommended Standard 232).	Order N5457A. You can easily install this option yourself.
<b>553</b>	MIL-STD 1553 triggering and decode option (for 4 channel or 4+16 channel models only)	Order N5469A. You can easily install this option yourself.
<b>ALT</b>	N5434A FPGA dynamic probe for Altera (MSO recommended) Provides internal FPGA visibility and quick instrument setup.	N5434A with Option 001 (Oscilloscope-locked license) or Option 002 (PC-locked license). Software is installed on an external PC.
<b>AMS</b>	Automotive Serial Decode. Provides serial decode of CAN and LIN buses (for 4 channel or 4+16 channel models only)	Order N5424A. You can easily install this option yourself.
<b>FPG</b>	N5406A FPGA dynamic probe for Xilinx (MSO recommended) Provides internal FPGA visibility and quick instrument setup.	N5406A with Option 001 (Oscilloscope-locked license) or Option 002 (PC-locked license). Software is installed on an external PC.
<b>FLX</b>	FlexRay triggering and decode (for 4 channel or 4+16 channel models only). Includes mask limit test option (LMT), segmented memory option (SGM), and FlexRay physical layer conformance test application option (FRC).	Order N5432C. You can easily install this option yourself.
<b>FRC</b>	FlexRay Physical Layer Conformance Test Application.	Order U7244A. Application runs on a PC connected to InfiniiVision oscilloscope.
<b>LMT</b>	Mask Limit Test Lets you create a mask and test waveforms to determine whether they comply to the mask.	Order N5455A. You can easily install this option yourself.
<b>LSS</b>	Low Speed Serial Decode. Provides serial decode of I <sup>2</sup> C and SPI buses (for 4 channel or 4+16 channel models only)	Order N5423A. You can easily install this option yourself.

**Table 9** Licensed Options Available (continued)

Option	Description	After purchase model number, notes
<b>mem8M</b>	Memory Upgrade. Is always provided with 7000B Series oscilloscopes. It shows the total memory depth (8 Mpts interleaved).	N/A
<b>MSO</b>	Mixed Signal Oscilloscope (MSO). Upgrade a DSO to an MSO. Adds 16 digital channels. You do not have to install any hardware.	Order N2735, N2736A, or N2737A. You can easily install this option yourself. The digital probe cable kit is supplied with the MSO license.
<b>PWR</b>	U1881A Power Application. Lets your oscilloscope communicate with software running on a PC for characterizing power devices.	Order U1881A. Application runs on PC connected to InfiniiVision oscilloscope. Optional U1880A deskew fixture available.
<b>SEC</b>	Secure Environment Mode. Nonvolatile memory is cleared of all setup and trace settings in compliance with National Industrial Security Program Operation Manual (NISPOM) Chapter 8 requirements.	Available at time of purchase only. See also <a href="#">page 396</a> .
<b>SGM</b>	Segmented Memory. Lets you capture infrequent or burst signals with great resolution by eliminating the capture of your signal's "dead time".	Order N5454A. You can easily install this option yourself.
<b>SND</b>	I <sup>2</sup> S serial decode option (for 4 channel or 4+16 channel models only)	Order N5468A. You can easily install this option yourself.

## Other Options Available

**Table 10** Calibration Option

Option	Order
A6J	ANSI Z540 Compliant Calibration

## Upgrading to an MSO

A license can be installed to activate the digital channels of an oscilloscope that was not originally ordered as a mixed-signal oscilloscope (MSO). A mixed signal oscilloscope has analog channels plus 16 time-correlated digital timing channels.

To view the currently installed licenses press **[Utility] > Options > Licenses > Show license information**.

For information about upgrading your oscilloscope through licensing, contact your local Agilent Technologies representative or see [www.agilent.com/find/7000](http://www.agilent.com/find/7000).

## Secure Environment Mode Option

Secure environment mode is compliant to National Industrial Security Program Operating Manual (NISPOM) Chapter 8 requirements.

Secure environment mode is called option SEC.

When secure environment mode is installed, trace and setup data are stored to internal volatile memory (rather than internal non-volatile memory). Oscilloscope setup, waveform, and trace data are erased when the power is shut off. This ensures that any setup, waveform, and trace data will not be visible to the next user upon power-up. The clock and LAN settings are not discarded upon power-down.

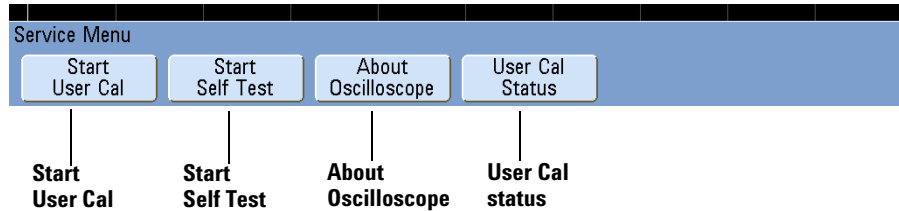
To permanently store data, you can save it to an external device through one of the oscilloscope's USB ports.

Once installed, secure environment mode cannot be disabled.

When installed, the secure environment mode license will appear as SEC in the Installed Licenses line of the "About Oscilloscope" display. To access the About Oscilloscope display, press the **[Utility]** key, then press the **Service** softkey, then press the **About Oscilloscope** softkey.

## Performing Service Tasks

- Press the **[Utility] > Service** to display the Service Menu.



The Service Menu lets you:

- Perform User Calibration on the oscilloscope.
- View User Calibration status.
- Perform instrument Self Test.
- View information about your oscilloscope model number, code revision information, and User Calibration status.

### To display oscilloscope information

Press **[Utility] > Service > About Oscilloscope** to display information about your oscilloscope:

- Model number.
- serial number.
- Software version.
- Boot version.
- Graphics version.
- Installed licenses. See also [“Entering Licenses and Displaying License Information”](#) on page 393.

### To perform user calibration

Perform user-calibration:

- Each year or after 2000 hours of operation.
- If the ambient temperature is  $>10^{\circ}$  C from the calibration temperature.
- If you want to maximize the measurement accuracy.

The amount of use, environmental conditions, and experience with other instruments help determine if you need shorter User Cal intervals.

User Cal performs an internal self-alignment routine to optimize the signal path in the oscilloscope. The routine uses internally generated signals to optimize circuits that affect channel sensitivity, offset, and trigger parameters. Disconnect all inputs and allow the oscilloscope to warm up before performing this procedure.

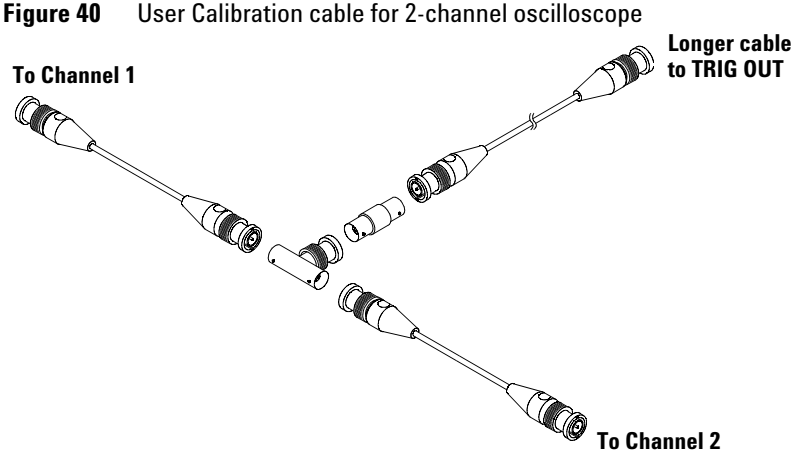
Performing User Cal will invalidate your Certificate of Calibration. If NIST (National Institute of Standards and Technology) traceability is required, perform the Performance Verification procedure in the *Agilent InfiniiVision Oscilloscopes Service Guide* using traceable sources.

To perform user calibration:

- 1** Set the rear-panel CALIBRATION switch to UNPROTECTED.
- 2** Connect short (12 inch maximum) equal length cables to each analog channel's BNC connector on the front of the oscilloscope. You will need two equal-length cables for a 2-channel oscilloscope or four equal-length cables for a 4-channel oscilloscope.

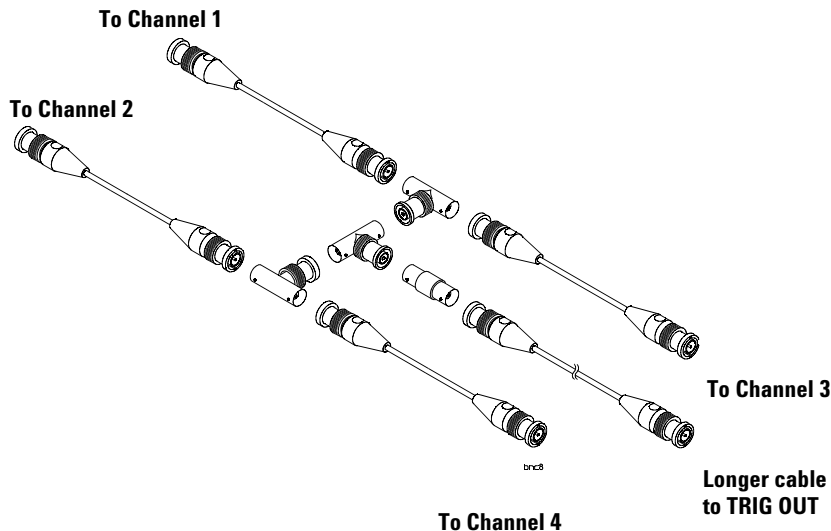
Use 50 $\Omega$  RG58AU or equivalent BNC cables when performing User Cal.

For a 2-channel oscilloscope, connect a BNC tee to the equal length cables. Then connect a BNC(f)-to-BNC(f) (also called a barrel connector) to the tee as shown below.



For a 4-channel oscilloscope, connect BNC tees to the equal-length cables as shown below. Then connect a BNC(f)-to-BNC(f) (barrel connector) to the tee as shown below.

**Figure 41** User Calibration cable for 4-channel oscilloscope



- 3 Connect a BNC cable (40 inches maximum) from the TRIG OUT connector on the rear panel to the BNC barrel connector.
- 4 Press the **[Utility]** key, then press the **Service** softkey.
- 5 Begin the Self Cal by pressing the **Start User Cal** softkey.
- 6 When the User Cal is completed, set the rear-panel CALIBRATION switch to PROTECTED.

### To display the user calibration status

Pressing **[Utility] > Service > User Cal Status** displays the summary results of the previous User Cal, and the status of probe calibrations for probes that can be calibrated. Note that passive probes do not need to be calibrated, but InfiniiMax probes can be calibrated. For more information about calibrating probes see [page 57](#).



**Results:**  
**User Cal date:**  
**Change in temperature since last User Cal:**  
**Failure:**  
**Comments:**  
**Probe Cal Status:**

## To perform self test

Pressing **[Utility] > Service > Start Self Test** performs a series of internal procedures to verify that the oscilloscope is operating properly.

It is recommended you run Self Test:

- after experiencing abnormal operation.
- for additional information to better describe an oscilloscope failure.
- to verify proper operation after the oscilloscope has been repaired.

Successfully passing Self Test does not guarantee 100% of the oscilloscope's functionality. Self Test is designed to provide an 80% confidence level that the oscilloscope is operating properly.

## To clean the oscilloscope

- 1 Remove power from the instrument.
- 2 Clean the external surfaces of the oscilloscope with a soft cloth dampened with a mixture of mild detergent and water.
- 3 Make sure that the instrument is completely dry before reconnecting it to a power source.

## To check warranty and extended services status

To learn the warranty status of your oscilloscope:

- 1 Point your web browser to: [www.agilent.com/find/warrantystatus](http://www.agilent.com/find/warrantystatus)
- 2 Enter your product's model number and serial number. The system will search for the warranty status of your product and display the results. If the system cannot find your product's warranty status, select **Contact Us** and speak with an Agilent Technologies representative.

## To return the instrument

Before shipping the oscilloscope to Agilent Technologies, contact your nearest Agilent Technologies sales or service office for additional details. Information on contacting Agilent Technologies can be found at [www.agilent.com/find/contactus](http://www.agilent.com/find/contactus).

- 1 Write the following information on a tag and attach it to the oscilloscope.
  - Name and address of owner
  - Model number
  - Serial number
  - Description of service required or failure indication
- 2 Remove accessories from the oscilloscope.

Only return accessories to Agilent Technologies if they are associated with the failure symptoms.
- 3 Package the oscilloscope.

You can use the original shipping container, or provide your own materials sufficient to protect the instrument during shipping.
- 4 Seal the shipping container securely, and mark it FRAGILE.

## To contact Agilent

### Americas

Canada (877) 894-4414

Latin America 305 269 7500

United States (800) 829-4444

### Asia Pacific

Australia 1 800 629 485

China 800 810 0189

Hong Kong 800 938 693

India 1 800 112 929

Japan 81 426 56 7832

Korea 080 769 0800

Malaysia 1 800 888 848

Singapore 1 800 375 8100

Taiwan 0800 047 866

Thailand 1 800 226 008

### Europe

Austria 0820 87 44 11

Belgium 32 (0) 2 404 93 40

Denmark 45 70 13 15 15

Finland 358 (0) 10 855 2100

France 0825 010 700

Germany 01805 24 6333\*

\*0.14€/minute

Ireland 1890 924 204

Italy 39 02 92 60 8484

Netherlands 31 (0) 20 547 2111

Spain 34 (91) 631 3300

Sweden 0200-88 22 55

Switzerland (French)

44 (21) 8113811 (Opt 2)

Switzerland (German)

0800 80 53 53 (Opt 1)

United Kingdom 44 (0) 7004 666666

Other European countries:

[www.agilent.com/find/contactus](http://www.agilent.com/find/contactus)





## 19 Reference

Specifications and Characteristics	406
Accessories Available	407
Software and Firmware Updates	410
Measurement Category	411
Environmental Conditions	413
Binary Data (.bin) Format	414
CSV and ASCII XY files	422
Acknowledgements	423



## Specifications and Characteristics

Please see the InfiniiVision oscilloscope data sheets for complete, up-to-date specifications and characteristics. To download a data sheet, please visit:

- [www.agilent.com/find/7000](http://www.agilent.com/find/7000)

Then, select the **Library** tab, followed by **Specifications**.

Or, go to the Agilent home page at [www.agilent.com](http://www.agilent.com) and search for **7000 series oscilloscopes data sheet**.

To order a data sheet by phone, please contact your local Agilent office. The complete list is available at: [www.agilent.com/find/contactus](http://www.agilent.com/find/contactus) or on [page 403](#).

## Accessories Available

**Table 11** Accessories Available for 7000B Series Oscilloscopes

Model	Description
N2918A	6000/7000B Series Oscilloscope Evaluation Kit
N2732A	7000 Series Oscilloscope Rackmount Kit
54913-44101	7000 Front-Panel Cover
various	Front Panel Overlays - see <a href="#">page 45</a> .
N2733A	7000 Soft Carrying Case
N2734A	Transit Case
N2605A-097	USB Cable
5061-0701	LAN Crossover Cable
54620-68701	Digital Probe Kit (standard with MSO models)
01650-61607	Logic Cable and Terminator (use with 40-pin logic analyzer accessories)
10070C	Passive Probe, 1:1 20 MHz, 1.5 m
10074C	Passive Probe, 10:1, 150 MHz, 1.5 m
10073C	Passive Probe, 10:1, 500 MHz, 1.5 m
1165A	Passive Probe, 10:1, 600 MHz, 1.5 m
10076A	Passive Probe, 100:1, 4 kV, 250 MHz
N2863A	Passive Probe, 10:1, 300 MHz, 1.2 m
N2771A	Passive Probe, 1000:1, 30 kV, 50 MHz
N2790A	High-Voltage Differential probe, 50:1 or 500:1 (switchable), 100 MHz
N2786A	2-legged Probe Positioner
N2784A	1-arm Probe Positioner
N2785A	2-arm Probe Positioner
N2880A	InfiniiMax In-line Attenuator kit, pair of 6 dB, 12 dB, and 20 dB attenuators in kit, to be used with InfiniiMax probe amplifiers and heads

**Table 11** Accessories Available for 7000B Series Oscilloscopes (continued)

<b>Model</b>	<b>Description</b>
N2881A	InfiniiMax DC blocking caps (qty 2), withstand up to 30 V DC, to be used with InfiniiMax probe amplifiers and heads
N2882A	75 ohm-to-50 ohm adapter, DC to 8 GHz bandwidth, 5.7 dB attenuation
W2637A	LPDDR BGA probe, x16, 404 MHz, 100 ohm input impedance
W2638A	LPDDR BGA probe, x32, 404 MHz, 100 ohm input impedance
W2639A	Oscilloscope Adapter Board, 1.5 GHz, 75 ohm input impedance
N5450A	InfiniiMax Extreme Temperature Extension Cables, to be used with InfiniiMax probe amplifiers and heads, 92 cm (36 in)
N2791A	Differential probe, 1 MOhm termination, 10:1 or 100:1 (switchable), 25 MHz
N2792A	Differential probe, 50 Ohm termination, 10:1, 200 MHz, compatible with all InfiniiVision 7000B Series models
N2793A	Differential probe, 50 Ohm termination, 10:1, 800 MHz, compatible with all InfiniiVision 7000B Series models
1156A	Active Probe, 1.5 GHz
1144A	Active Probe, 800 MHz (requires 1142A – power supply)
1145A <sup>†</sup>	Active Probe, 750 MHz 2-ch (requires 1142A – power supply)
1130A <sup>†</sup>	For active differential probes: 1.5 GHz InfiniiMax amplifier (requires one or more InfiniiMax probe head – E2675A, E2668A, E2669A).
N2772A	Active Differential Probe, 20 MHz, 1.2 kVDC + peak AC max (requires N2773A power supply)
1141A	Active Differential Probe, 200 MHz, 200 VDC + peak AC max (requires 1142A power supply)
1146A	Current Probe, 100 kHz, 100 A, AC/DC
1147A <sup>†</sup>	Current Probe, 50 MHz, 30 A, AC/DC with AutoProbe interface
N2780A	Current Probe, 2 MHz, 500 A, AC/DC (use with N2779A power supply)
N2781A	Current Probe, 10 MHz, 150 A, AC/DC (use with N2779A power supply)
N2782A	Current Probe, 50 MHz, 30 A, AC/DC (use with N2779A power supply)
N2783A	Current Probe, 100 MHz, 30 A, AC/DC (use with N2779A power supply)



**Table 11** Accessories Available for 7000B Series Oscilloscopes (continued)

<b>Model</b>	<b>Description</b>
10072A	Fine-Pitch Probe Kit
10075A	0.5 mm IC Clip Kit
10076A	100:1, 4 kV 250 MHz Probe
E2613B	0.5 mm Wedge Probe Adapter, 3-signal, qty 2
E2614A	0.5 mm Wedge Probe Adapter, 8-signal, qty 1
E2615B	0.65 mm Wedge Probe Adapter, 3-signal, qty 2
E2616A	0.65 mm Wedge Probe Adapter, 8-signal, qty 1
E2643A	0.5 mm Wedge Probe Adapter, 16-signal, qty 1
E2644A	0.65 mm Wedge Probe Adapter, 16-signal, qty 1

<sup>†</sup>Indicates a maximum of two of this model probe can be connected to each oscilloscope due to AutoProbe interface current supply limitation. See also “[Passive Probes](#)” on page 53 and “[Active Probes](#)” on page 53.

You can find these items at [www.agilent.com](http://www.agilent.com) or at [www.parts.agilent.com](http://www.parts.agilent.com).

For information on more probes and accessories see “[5989-6162EN Probes and Accessories Selection Guide](#)” and “[5968-8153EN 5000, 6000, and 7000 Series InfiniiVision Oscilloscope Probes and Accessories Data Sheet](#),” available at [www.agilent.com](http://www.agilent.com).

## Software and Firmware Updates

From time to time Agilent Technologies releases software and firmware updates for its products. To search for firmware updates for your oscilloscope, direct your web browser to [www.agilent.com/find/7000sw](http://www.agilent.com/find/7000sw).

To view the currently installed software and firmware press **[Utility] > Service > About Oscilloscope**.

# Measurement Category

## Measurement Category

The InfiniiVision oscilloscopes are intended to be used for measurements in Measurement Category I.

**WARNING**

**Use this instrument only for measurements within its specified measurement category.**

---

## Measurement Category Definitions

Measurement category I is for measurements performed on circuits not directly connected to MAINS. Examples are measurements on circuits not derived from MAINS, and specially protected (internal) MAINS derived circuits. In the latter case, transient stresses are variable; for that reason, the transient withstand capability of the equipment is made known to the user.

Measurement category II is for measurements performed on circuits directly connected to the low voltage installation. Examples are measurements on household appliances, portable tools and similar equipment.

Measurement category III is for measurements performed in the building installation. Examples are measurements on distribution boards, circuit-breakers, wiring, including cables, bus-bars, junction boxes, switches, socket-outlets in the fixed installation, and equipment for industrial use and some other equipment, for example, stationary motors with permanent connection to the fixed installation.

Measurement category IV is for measurements performed at the source of the low-voltage installation. Examples are electricity meters and measurements on primary overcurrent protection devices and ripple control units.

## Transient Withstand Capability

### CAUTION



#### Maximum input voltage at analog inputs and 2-channel external trigger input

CAT I 300 Vrms, 400 Vpk; transient overvoltage 1.6 kVpk

CAT II 100 Vrms, 400 Vpk

50 $\Omega$  input: 5 Vrms

Input protection is enabled in 50  $\Omega$  mode and the 50  $\Omega$  load will disconnect if greater than 5 Vrms is detected. However the inputs could still be damaged, depending on the time constant of the signal. The 50  $\Omega$  input protection only functions when the oscilloscope is powered on.

1 M ohm input, 100 MHz models:

For steady-state sinusoidal waveforms derate at 20 dB/decade above 200 kHz to a minimum of 10 Vpk

1 M ohm input, 350 MHz, 500 MHz, 1 GHz models:

For steady-state sinusoidal waveforms derate at 20 dB/decade above 57 kHz to a minimum of 5 Vpk

With N2863A 10:1 probe: CAT I 600 V, CAT II 300 V (DC + peak AC)

With 10073C or 10074C 10:1 probe: CAT I 500 Vpk, CAT II 400 Vpk

---

### CAUTION



#### Maximum input voltage at digital channels

$\pm$ 40 V peak CAT I; transient overvoltage 800 Vpk

---

## Environmental Conditions

**Environment** Indoor use only.

**Ambient temperature** Operating  $-10\text{ }^{\circ}\text{C}$  to  $+55\text{ }^{\circ}\text{C}$ ;  
non-operating  $-40\text{ }^{\circ}\text{C}$  to  $+70\text{ }^{\circ}\text{C}$

**Humidity** Operating 95% RH at  $40\text{ }^{\circ}\text{C}$  for 24 hr; non-operating 90% RH at  $65\text{ }^{\circ}\text{C}$  for 24 hr

**Altitude** Operating to 4,570 m (15,000 ft); non-operating to 15,244 m (50,000 ft)

**Overvoltage Category** This product is intended to be powered by MAINS that comply to Overvoltage Category II, which is typical of cord-and-plug connected equipment.

**Pollution Degree** The InfiniiVision scilloscopes may be operated in environments of Pollution Degree 2 (or Pollution Degree 1).

**Pollution Degree Definitions** Pollution Degree 1: No pollution or only dry, non-conductive pollution occurs. The pollution has no influence. Example: A clean room or climate controlled office environment.

Pollution Degree 2. Normally only dry non-conductive pollution occurs. Occasionally a temporary conductivity caused by condensation may occur. Example: General indoor environment.

Pollution Degree 3: Conductive pollution occurs, or dry, non-conductive pollution occurs which becomes conductive due to condensation which is expected. Example: Sheltered outdoor environment.

## Binary Data (.bin) Format

The binary data format stores waveform data in binary format and provides data headers that describe that data.

Because the data is in binary format, the size of the file is approximately 5 times smaller than the ASCII XY format.

If more than one source is on, all displayed sources will be saved, except math functions.

When using segmented memory, each segment is treated as a separate waveform. All segments for a channel are saved, then all segments of the next (higher numbered) channel are saved. This continues until all displayed channels are saved.

When the oscilloscope is in the Peak Detect acquisition mode, the minimum and maximum value waveform data points are saved to the file in separate waveform buffers. The minimum value data points are saved first; then, the maximum value data points are saved.

### **BIN data - using segmented memory**

When saving all segments, each segment has its own waveform header (see [page 415](#)).

In BIN file format, data are presented as follows:

- Channel 1 data (all segments)
- Channel 2 data (all segments)
- Channel 3 data (all segments)
- Channel 4 data (all segments)
- Digital channel data (all segments)
- Math waveform data (all segments)

When not saving all segments, the number of waveforms is equivalent to the number of active channels (including math and digital channels, with up to seven waveform for each digital pod). When saving all segments the number of waveforms is equal to the number of active channels multiplied by the number of segments acquired.

## Binary Data in MATLAB

Binary data from an InfiniiVision oscilloscope can be imported to The MathWorks MATLAB®. You can download the appropriate MATLAB functions from the Agilent Technologies web site at [www.agilent.com/find/7000sw](http://www.agilent.com/find/7000sw).

Agilent provides the .m files, which need to be copied into the work directory for MATLAB. The default work directory is C:\MATLAB7\work.

## Binary Header Format

### File Header

There is only one file header in a binary file. The file header consists of the following information.

**Cookie** Two byte characters, AG, that indicate the file is in the Agilent Binary Data file format.

**Version** Two bytes that represent the file version.

**File Size** A 32-bit integer that is the number of bytes that are in the file.

**Number of Waveforms** A 32-bit integer that is the number of waveforms that are stored in the file.

### Waveform Header

It is possible to store more than one waveform in the file, and each waveform stored will have a waveform header. When using segmented memory, each segment is treated as a separate waveform. The waveform header contains information about the type of waveform data that is stored following the waveform data header.

**Header Size** A 32-bit integer that is the number of bytes in the header.

**Waveform Type** A 32-bit integer that is the type of waveform stored in the file:

- 0 = Unknown.
- 1 = Normal.
- 2 = Peak Detect.
- 3 = Average.
- 4 = Not used in InfiniiVision oscilloscopes.
- 5 = Not used in InfiniiVision oscilloscopes.
- 6 = Logic.

**Number of Waveform Buffers** A 32-bit integer that is the number of waveform buffers required to read the data.

**Points** A 32-bit integer that is the number of waveform points in the data.

**Count** A 32-bit integer that is the number of hits at each time bucket in the waveform record when the waveform was created using an acquisition mode like averaging. For example, when averaging, a count of four would mean every waveform data point in the waveform record has been averaged at least four times. The default value is 0.

**X Display Range** A 32-bit float that is the X-axis duration of the waveform that is displayed. For time domain waveforms, it is the duration of time across the display. If the value is zero then no data has been acquired.

**X Display Origin** A 64-bit double that is the X-axis value at the left edge of the display. For time domain waveforms, it is the time at the start of the display. This value is treated as a double precision 64-bit floating point number. If the value is zero then no data has been acquired.

**X Increment** A 64-bit double that is the duration between data points on the X axis. For time domain waveforms, this is the time between points. If the value is zero then no data has been acquired.

**X Origin** A 64-bit double that is the X-axis value of the first data point in the data record. For time domain waveforms, it is the time of the first point. This value is treated as a double precision 64-bit floating point number. If the value is zero then no data has been acquired.



**X Units** A 32-bit integer that identifies the unit of measure for X values in the acquired data:

- 0 = Unknown.
- 1 = Volts.
- 2 = Seconds.
- 3 = Constant.
- 4 = Amps.
- 5 = dB.
- 6 = Hz.

**Y Units** A 32-bit integer that identifies the unit of measure for Y values in the acquired data. The possible values are listed above under “X Units”.

**Date** A 16-byte character array, left blank in InfiniiVision oscilloscopes.

**Time** A 16-byte character array, left blank in the InfiniiVision oscilloscopes.

**Frame** A 24 byte character array that is the model number and serial number of the oscilloscope in the format of: MODEL#:SERIAL#.

**Waveform Label** A 16 byte character array that contains the label assigned to the waveform.

**Time Tags** A 64-bit double, only used when saving multiple segments (requires segmented memory option). This is the time (in seconds) since the first trigger.

**Segment Index** A 32-bit unsigned integer. This is the segment number. Only used when saving multiple segments.

### Waveform Data Header

A waveform may have more than one data set. Each waveform data set will have a waveform data header. The waveform data header consists of information about the waveform data set. This header is stored immediately before the data set.

**Waveform Data Header Size** A 32-bit integer that is the size of the waveform data header.

**Buffer Type** A 16-bit short that is the type of waveform data stored in the file:

- 0 = Unknown data.
- 1 = Normal 32-bit float data.
- 2 = Maximum float data.
- 3 = Minimum float data.
- 4 = Not used in InfiniiVision oscilloscopes.
- 5 = Not used in InfiniiVision oscilloscopes.
- 6 = Digital unsigned 8-bit char data (for digital channels).

**Bytes Per Point** A 16-bit short that is the number of bytes per data point.

**Buffer Size** A 32-bit integer that is the size of the buffer required to hold the data points.

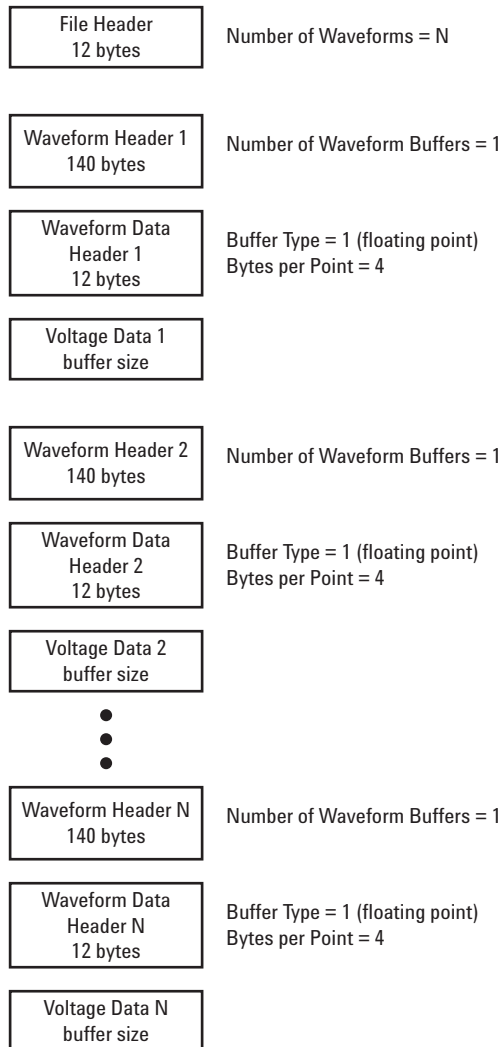
## Example Program for Reading Binary Data

To find an example program for reading binary data, direct your web browser to [www.agilent.com/find/7000sw](http://www.agilent.com/find/7000sw), and select “Example Program for Reading Binary Data”.

## Examples of Binary Files

### Single Acquisition Multiple Analog Channels

The following picture shows a binary file of a single acquisition with multiple analog channels.

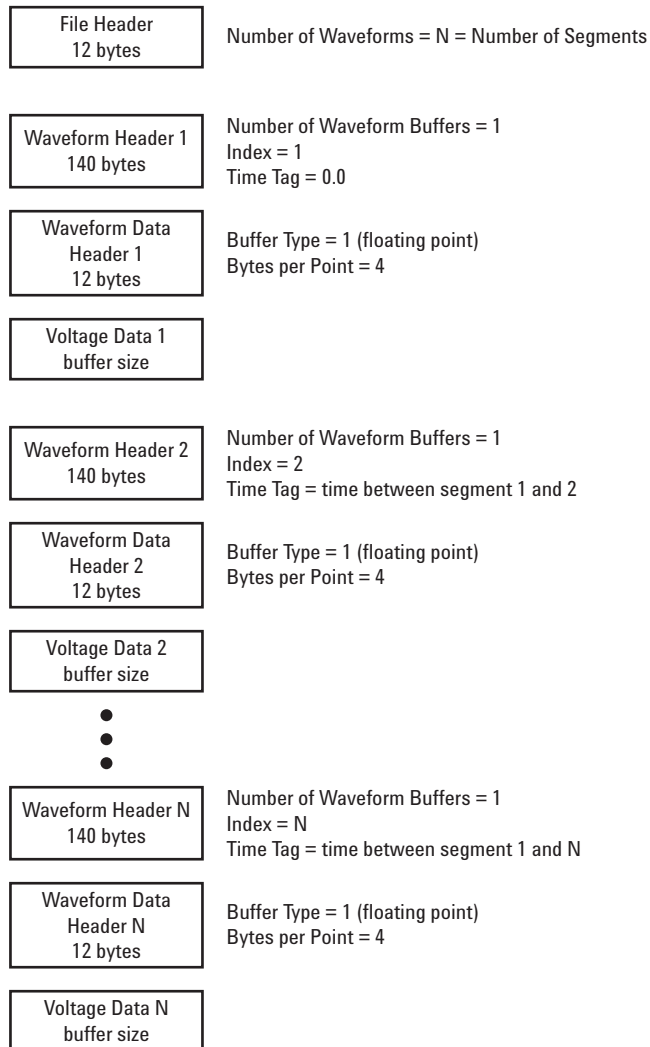


### Single Acquisition All Pods Logic Channels

The following picture shows a binary file of a single acquisition with all pods for the logic channels saved.

## 19 Reference

File Header 12 bytes	Number of Waveforms = 2
Waveform Header 1 140 bytes	Number of Waveform Buffers = 1
Waveform Data Header 1 12 bytes	Buffer Type = 6 (unsigned char) Bytes per Point = 1
Pod 1 Timing Data buffer size	
Waveform Header 2 140 bytes	Number of Waveform Buffers = 1
Waveform Data Header 2 12 bytes	Buffer Type = 6 (unsigned char) Bytes per Point = 1
Pod 2 Timing Data buffer size	



## CSV and ASCII XY files

### CSV and ASCII XY file structure

In CSV or ASCII XY format the **Length** control selects the number of points per segment. All segments are contained in the CSV file or in each ASCII XY data file.

For example: If the Length control is set to 1000 points, there will be 1000 points (rows in the spreadsheet) per segment. When saving all segments there are three header rows, so the data for the first segment starts at row 4. The second segment's data starts at row 1004. The time column shows the time since the trigger on the first segment. The top row shows the selected number of points per segment.

BIN files are a more efficient data transfer format than CSV or ASCII XY. Use this file format for fastest data transfer.

### Minimum and Maximum Values in CSV Files

If you are running a Minimum or Maximum measurement, the minimum and maximum values shown in the measurement display may not appear in the CSV file.

Explanation:

When the oscilloscope's sample rate is 4 GSa/s, a sample will be taken every 250 ps. If the sweep speed is set to 100 ns/div, there will be 1000 ns of data displayed (because there are ten divisions across the screen). To find the total number of samples the oscilloscope will take:

$$1000ns \times 4Gsa/s = 4000samples$$

For measurement data, the oscilloscope will decimate the 4000 points to 1000 points that will fit on the display. This decimation will not lose track of the min and max values at each of the 1000 horizontal data points, and min and max values will be displayed on screen. However, the oversampled data is also processed to provide a best-estimate value at each of the 1000 horizontal points. The data in the CSV file will be the best-estimate value at each of the 1000 horizontal points. Therefore, the min and max values may not appear in the CSV file.

This occurs when oversampling occurs  
(10 \* seconds per division \* maximum sample rate > 1000).

## Acknowledgements

RealVNC is licensed under the GNU General Public License. Copyright (C) 2002-2005 RealVNC Ltd. All Rights Reserved.

This is free software; you can redistribute it and/or modify it under the terms of the GNU General Public License as published by the Free Software Foundation; either version 2 of the License, or (at your option) any later version.

This software is distributed in the hope that it will be useful, but WITHOUT ANY WARRANTY; without even the implied warranty of MERCHANTABILITY or FITNESS FOR A PARTICULAR PURPOSE. See the GNU General Public License for more details. The license is located on the Agilent InfiniiVision Oscilloscopes Documentation CD-ROM.

RealVNC source code can be obtained from RealVNC or by contacting Agilent. Agilent will charge for the cost of physically performing the source distribution.





# Index

## Symbols

- (-)Width measurement, 165
- (+)Width measurement, 165

## Numerics

- 1 M ohm input impedance, 80
- 10 MHz reference clock, 388
- 1-2 math function, 189
- 232 Option, 393, 394
- 50 ohm input impedance, 80
- 553 Option, 394

## A

- About Oscilloscope, 397
- AC channel coupling, 79
- accessories, 26, 407, 409
- acquire, 223, 230
- acquisition mode, 227
  - averaging, 229, 230
  - high resolution, 228
  - normal, 227
  - peak detect, 228
- acquisition modes, 223
- acquisition option
  - realtime, 232
- active probes, 53
- active serial bus, 267, 277, 289, 298, 310, 339
- activity indicator, 366
- adding digital channels license, 396
- addition math function, 189
- address with no ack condition, I2C trigger, 284
- Addresses softkey, 242
- adjust the feet, 28

- aliasing, FFT, 197
- ALT Option, 393, 394
- Amplitude measurement, 170
- AMS Option, 393, 394
- analog channel
  - probe attenuation, 82
  - setup, 77
- analog filters, adjusting, 197
- analyze segments, 160, 236
- ASCII file format, 210
- attenuation, probe, 82, 109
- attenuators, 57
- Auto Increment, 209
- Auto trigger indicator, 39, 100
- auto trigger mode, 99, 100
- Auto? trigger indicator, 100
- AutoIP, 241
- automatic measurements, 154, 156
- automatic setup, 364
- AutoProbe, 38, 80
  - external trigger, 109
- AutoScale
  - acquisition mode, 386
  - channels, 385
  - digital channels, 364
  - fast debug, 385
  - undo, 32
- AutoScale key, 39, 40
- AutoScale preferences, 385
- auto-single, 226
- Average measurement, 170
- averaging acquire mode, 227, 229, 230

## B

- bandwidth limit, 80
- bandwidth, oscilloscope, 232

- Base measurement, 170
- BIN file format, 210
- binary data (.bin), 414
- binary data file examples, 418
- binary data in MATLAB, 415
- binary data, example program for reading, 418
- bits, SPI trigger, 295
- Blackman Harris FFT, 200
- blanking, 70
- BMP file format, 210
- boot version, 397
- brightness of waveforms, 41
- Browser Web Control, 245, 247
- built-in help system, 49
- burst
  - capture signal bursts, 234
- bus display mode, 369
- buttons
  - 7000 Series, 35, 36

## C

- calibrate probe, 83
- calibration, 397
- calibration protect switch
  - 7000 Series, 42
- calibration status, 252
- CAN decode
  - source channels, 262
- CAN frame counter, 268
- CAN serial decode, 318
- CAN totalizer, 268
- CAN trigger, 264
- CAN trigger types, additional, 264
- capture signal bursts, 234
- Center, FFT, 200

## Index

- channel
  - analog, 77
  - bandwidth limit, 80
  - coupling, 79
  - invert, 81
  - on/off keys, 38
  - position, 78
  - probe units, 82, 83
  - skew, 83
  - vernier, 81
  - vertical sensitivity, 78
- channel labels, 89
- channel pair, 232
- characteristics, 406
- Chinese GUI, 50
- choosing values, 34
- cleaning, 401
- clear display, 122
- clear infinite persistence, 86
- clock, 392
- CMOS threshold, 368
- comparison of measurement results, 216
- compensate probes, 37
- compensating your probe, 56
- Config softkey, 242
- connect probes
  - digital, 360
- connect the dots, 87
- connection
  - to a PC, 242
- connectors
  - 7000 Series, 42, 43
- controls
  - 7000 Series, 35, 36
- conventions
  - in softkey menus, 46
- Counter measurement, 162
- counter, CAN frame, 268
- counter, FlexRay frame, 320
- counter, UART/RS232 frame, 340
- coupling, channel, 79
- crosstalk problems, 197
- CSV file format, 210
- cursor measurements, 177
- cursors
  - binary, 179
  - hex, 179
  - manual, 178
  - track waveform, 178
- D**
- D\*, 39, 369
- d/dt math function, 191
- damage, shipping, 26
- data sheet, 406
- DC channel coupling, 79
- dead time (re-arm), 236
- default configuration, 31
- default label library, 93
- default setup, 31
- delay knob, 63
- Delay measurement, 166
- delay measurements, 154
- delay time indicator, 74
- delayed, 391
- delayed sweep, 71
- delete character, 209
- delete file, 217
- DHCP, 241
- differentiate math function, 191
- Digit softkey, 127
- digital bus mode, 369
- digital channel controls, 38
- digital channel menu, 367
- digital channels, 6, 367
  - AutoScale, 364
  - enabling, 396
  - logic threshold, 368
  - probing, 374
  - size, 367
- digital display, interpreting, 366
- digital probes, 360, 374
  - impedance, 374
- display, 41, 48
  - area, 48
  - infinite persistence, 85
  - interpreting, 48
  - measurement line, 48
  - signal detail, 84
  - softkeys, 48
  - status line, 48
  - vectors, 87
- display multiple acquisitions, 224
- distortion problems, 197
- DNS IP, 242
- domain, 242
- Domain softkey, 242
- DSO, 3
- duration trigger, 114
- Duty cycle measurement, 163
- E**
- ECL threshold, 368
- edge triggering, 117
- EEPROM data read, I2C trigger, 285
- energy of a pulse, 193
- Entry knob, 34, 41, 46
- event table, 257
- expand about, 78, 383
- expand about center, 383
- expand about ground, 383
- exporting waveform, 206
- external memory device, 37
- external timebase, 388
- external trigger, 109
  - input impedance, 110, 111
  - probe attenuation, 109
  - probe settings, 109
  - probe units, 110
- Extinction Ratio measurement, 171
- eye diagrams, 232
- F**
- f(t), 184
- factory default configuration, 31

- Fall time measurement, 165
  - feet, 28
  - FFT measurements, 197
  - FFT window, 199
  - file
    - save, recall, load, 217
  - file browser, save to, 206
  - file explorer, 207, 217
    - using, 218
  - file format
    - ASCII, 210
    - BIN, 210
    - BMP, 210
    - CSV, 210
    - PNG, 210
  - file keys, 38
  - file name, new, 209
  - fine adjustment, sweep speed, 73
  - firmware updates, 410
  - firmware upgrade files, 252
  - firmware version information, 239
  - firmware versions, 252
  - flash drive, 37
  - Flat top window, 200
  - FlexRay frame counter, 320
  - FlexRay serial decode, 318
  - FlexRay totalizer, 320
  - FlexRay trigger, 315
  - FLX Option, 394
  - FPG Option, 393, 394
  - FR2 Option, 394
  - frame mode
    - segmented memory, 234
  - frame trigger, I2C, 285, 286
  - freeze display, 382
    - Quick Freeze Display, 382
  - Frequency measurement, 163
  - frequency requirements, power source, 29
  - front panel
    - 7000 Series, 35, 36
    - language overlay, 45
  - front panel keys, 46
  - FRS Option, 393
- G**
- g(t), 184
  - gateway IP, 242
  - glitch capture, 119
  - glitch trigger, 128
  - golden waveform test, 344
  - grabber, 361, 362
  - graphic symbols in menus, 46
  - graphical user interface languages, 50
  - graphics version, 397
  - graticule intensity, 86
  - grid intensity, 86
  - ground level, 77
- H**
- Hanning window, 200
  - HDTV trigger, 138
  - help system, built-in, 49
  - hex bus trigger, 126
  - Hex softkey, 127
  - HF Reject, 104, 105
  - high-frequency noise rejection, 105
  - high-resolution mode, 227, 228
  - holdoff, 107
  - Horiz key, 62, 66, 72, 122
  - horizontal controls, 65
  - horizontal Navigate key, 40
  - horizontal position control, 40
  - horizontal scale fine adjustment, 73
  - horizontal Search key, 40
  - horizontal sweep speed control, 40
  - horizontal time/div control, 40
  - horizontal Zoom key, 40
  - host name, 239, 242
- I**
- I2C serial decode, 309, 318
  - I2C trigger, 284
  - I2S serial decode, 309, 327
  - I2S trigger, 306, 326
  - idle serial bus, 267, 277, 289, 298, 310, 340
- Imped softkey, 80
  - impedance
    - digital probes, 374
    - external trigger, 111
  - increment statistics, 159
  - indeterminate state, 179
  - infinite persistence, 85, 119, 224
    - clearing, 86
  - infrequent triggers, 232
  - input impedance
    - channel input, 80
    - external trigger, 111
  - installed licenses, 393, 397
  - installed options, 252
  - instantaneous slope of a waveform, 191
  - instrument ID, 393
  - Instrument Utilities web page, 252
  - Integrate math function, 193
  - intensity control, 41, 84
  - invert, 81
  - invert graticule colors, 211
  - IP address, 239, 242
- J**
- Japanese GUI, 50
- K**
- keys, 46
    - 7000 Series, 35, 36
  - knobs
    - 7000 Series, 35, 36
  - Korean GUI, 50
- L**
- label key, 38
  - label list, 92
  - label list, loading from text file, 92
  - labels, 89
    - auto-increment, 91
    - default library, 93
  - LAN connection, 241
  - LAN Settings softkey, 242

## Index

landscape mode, 221  
language, Quick Help, 50  
languages  
    graphical user interface, 50  
length control, 212  
length softkey, 212  
LF Reject, 104, 105  
library, labels, 90  
licenses, 393, 396  
LIN serial decode, 276  
LIN trigger, 274  
line power, 29  
line voltage, 29  
Lister, 257  
LMT Option, 393, 394  
load file, 217  
localized front panel overlay, 45  
Location, 207  
logic threshold, 368  
low-frequency noise rejection, 105  
LSS Option, 393, 394

## M

mask test, 344  
    trigger output, 348  
mask testing, 344  
math  
    1\*2, 187  
    1-2, 189  
    addition, 189  
    differentiate, 191  
    FFT, 197  
    functions, 183  
    functions on arithmetic operations, 184  
    integrate, 193  
    measurements, 169  
    multiply, 187  
    offset, 185  
    scale, 185  
    subtract, 189  
    units, 185  
    using waveform math, 183  
math key, 38

MATLAB binary data, 415  
Maximum measurement, 171  
maximum sample rate, 232  
Meas key, 154, 156  
measure keys, 39  
measurement category  
    definitions, 411  
measurement definitions, 162  
measurement line, 48  
measurement statistics, 157  
measurement thresholds, 160  
measurement window, zoomed time  
    base, 386  
measurements, 154, 205  
    automatic, 156  
    delay, 154  
    overshoot, 155  
    phase, 154  
    preshoot, 155  
    time, 154  
    voltage, 154  
MegaZoom III, 4  
mem8M, 395  
memory depth, 225  
memory, segmented, 234  
menu up, 41  
MIL-STD 1553 license, 394  
MIL-STD 1553, probing signals, 324  
Minimum measurement, 171  
missing acknowledge condition, I2C  
    trigger, 284  
Mode/Coupling key, trigger, 98  
model number, 239, 397  
Modify softkey, 242  
MSO, 3  
MSO feature upgrade, 396  
MSO Option, 393, 395  
MST Option, 393  
Multiply math function, 187

## N

N2791A 25 MHz differential active  
    probe, 324

navigate files, 217  
Navigate key, 40  
network  
    connecting to, 241  
network configuration parameters, 239  
network status information, 239  
new label, 91  
noise  
    high-frequency, 105, 106  
    low-frequency, 105  
noise rejection, 106  
normal acquire mode, 227  
normal mode, 227  
Normal trigger mode, 39, 99, 100  
Nth Edge 2, 135  
Nth Edge 2 (no re-find), 135  
Nth edge burst trigger, 123  
Nth edge burst triggering, 123

## O

option SEC, 396  
options, print, 221  
output  
    trigger, 391  
overlay, localized, 45  
Overshoot measurement, 175  
overshoot measurements, 155  
overvoltage category, 413

## P

palette, 211  
pan and zoom, 63  
parts, replacement, 379  
passive probes, 53  
password  
    reset, 254  
    set, 253  
pattern  
    duration trigger, 114  
    pattern trigger, 125  
    SPI trigger, 295  
pattern trigger, 125

- PC connection, 242
  - peak detect acquisition mode, 119
  - peak detect mode, 227, 228
  - Peak-peak measurement, 171
  - Period measurement, 164
  - persistence, infinite, 224
  - Phase measurement, 167
  - phase measurements, 154
  - PNG file format, 210
  - point-to-point connection, 242
  - pollution degree, 413
    - definitions, 413
  - position digital channels, 369
  - position knob, 369
  - position, analog, 78
  - post-processing, 176
  - power consumption, 29
  - power requirements, 29
  - power supply, 45
  - power switch, 30, 37
  - power-on, 29
  - predefined labels, 90
  - Preset, FFT, 199
  - Preshoot measurement, 175
  - preshoot measurements, 155
  - Press to go, 207
  - print, 382
    - landscape, 221
    - Quick Print, 382
  - print options, 221
  - print screen, 220
  - printer
    - USB, 37, 220
  - printers
    - supported, 220
  - printing the display, 220
  - probe
    - AutoProbe interface, 38
      - calibrate, 83
    - probe attenuation, 82, 109
    - probe compensation, 37
    - probe head, 57
    - probe units, 82, 110
  - probes, 407, 409
    - active, 53
    - compensating, 56
    - connecting to o-scope, 55
    - digital, 360
    - passive, 53
  - pulse polarity, 128
  - pulse width trigger, 128
  - Push to Position, 369
  - Push to Select, 369
  - PWR Option, 395
- Q**
- qualifier, 129
  - Quick Action key, 382
  - Quick Freeze Display, 382
  - Quick Help, 49
    - updates, 50
  - Quick Help language, 50
  - Quick Print, 382
  - Quick Recall, 382
  - Quick Save, 382
- R**
- random noise, 104
  - ratio measurement, 171
  - realtime acquisition option, 232
  - Realtime sampling and bandwidth, 233
  - rear panel
    - 10 MHz reference, 388
    - 7000 Series, 42, 43
  - re-arm time, 236
  - recall, 382
    - Quick Recall, 382
  - recall waveform, 216
  - recall waveform and setup, 216
  - record length, 225
  - Rectangular window, 200
  - reference clock, 10 MHz, 388
  - reference point, waveform, 383
  - Remote Front Panel, 245, 247
  - replacement parts, 379
  - restart condition, I2C trigger, 284
  - return instrument for service, 402
  - Rise time measurement, 165
  - RMS measurement, 171
  - roll mode, 65
  - RS232 trigger, 335
  - run controls, 39
  - Run/Stop key, 224
  - runt pulses, 164
- S**
- safety warning, 56
  - sample clock, 10 MHz, 388
  - sample rate, 4, 228, 232
    - current rate displayed, 62
  - save, 382
    - browse to destination, 206
    - execution time, 213
    - Quick Save, 382
    - settings, 211
  - save file, 217
  - save segment, 212
  - Save to, 207
  - save trace
    - to scope memory, 216
    - to USB, 215
  - save waveform
    - to scope memory, 216
    - to USB, 215
  - saver, screen, 384
  - saving
    - serial decode data, 210
  - saving data, 206
  - SCL, I2C trigger, 282
  - SCLK, I2S trigger, 302
  - screen saver, 384
  - SDA, 282
  - SDA, I2C trigger, 282
  - Search key, 40
  - SEC Option, 393, 395
  - SEC, option, 396
  - secure environment mode, 396

## Index

- segmented memory, 234
    - re-arm time, 236
    - save time, 213
    - saving segments, 212
    - statistical data, 236
  - select digital channels, 369
  - select knob, 369
  - selecting
    - values, 34
  - Self Test, service, 401
  - sequence trigger, 131
  - serial clock, I2C trigger, 282
  - serial clock, I2S trigger, 302
  - serial data, 282
  - serial data, I2C trigger, 282
  - serial decode, 212
    - saving data, 210
  - serial decode controls, 39
  - serial number, 239, 393, 397
  - service functions, 397
  - Set all Digits softkey, 127
  - setup, automatic, 364
  - setup, default, 31
  - SGM, 234
  - SGM Option, 393, 395
  - shipping damage, 26
  - shipping precautions, 402
  - Sigma, minimum, 346
  - single acquisition, 39, 225
  - Single key, 225
  - size, 367
  - skew, analog channel, 83
  - slope trigger, 117
  - SND Option, 393
  - softkeys, 6, 41, 46, 48
  - software updates, 410
  - software version, 397
  - source frequency, 391
  - Span, FFT, 200
  - specifications, 406
  - spectral leakage, FFT, 198
  - SPI trigger, 295
  - square root, 195
  - stage, sequence, 132
  - stand-alone connection, 242
  - start acquisition, 39, 224
  - start condition, I2C, 284
  - statistics
    - increment, 159
    - mask test, 348
    - measurement, 157
    - using segmented memory, 236
  - status line, 48
  - status, User Cal, 400
  - Std Deviation measurement, 172
  - stop acquisition, 39, 224
  - stop condition, I2C, 284
  - subnet mask, 242
  - Subtract math function, 189
  - sweep speed fine adjustment, 73
  - symbols
    - in softkey menus, 46
  - sync polarity, TV trigger, 140
  - synchronize scopes with reference clock, 388
- ## T
- template, front panel, 45
  - test, mask, 344
  - threshold
    - analog channel measurements, 160
    - digital channels, 368
  - thumb drive, 37
  - tilt for viewing, 28
  - time
    - re-arm, 236
  - time measurements, 154, 162
  - time reference indicator, 74
  - time, save execution, 213
  - timebase, 65
  - timebase, external, 388
  - Top measurement, 173
  - totalizer, CAN, 268
  - totalizer, FlexRay, 320
  - totalizer, UART/rs232, 340
  - trace
    - save to scope memory, 216
    - save to USB, 215
  - tracking cursors, 178
  - transient withstand capability, 412
  - Trig'd trigger indicator, 100
  - Trig'd? trigger indicator, 100
  - trigger
    - coupling, 103
    - definition, 97
    - external, 109
    - general information, 97
    - holdoff, 107
    - list of trigger types, 112
    - mode - auto or normal, 99
    - mode/coupling, 98
    - source, 118
  - trigger controls, 40
  - trigger indicator
    - Auto, 100
    - Auto?, 100
    - Trig'd, 100
    - Trig'd?, 100
  - trigger level, 102
  - trigger mode
    - auto, 99, 100
    - normal, 99, 100
  - Trigger Out connector, 391
  - trigger output, 391
    - mask test, 348

- trigger type
    - CAN, 264
    - duration, 114
    - edge, 117
    - FlexRay, 315
    - glitch, 128
    - HDTV, TV, 138
    - hex bus, 126
    - I2C, 284
    - I2S, 306, 326
    - LIN, 274
    - Nth edge burst, 123
    - pattern, 125
    - pulse width, 128
    - RS232, 335
    - sequence, 131
    - slope, 117
    - SPI, 295
    - UART, 335
    - USB, 150
  - triggers, 391
  - TTL threshold, 368
  - turn channel on, 38
  - TV trigger, 138
- U**
- UART totalizer, 340
  - UART trigger, 335
  - UART/RS232 frame counter, 340
  - UART/RS232 license, 394
  - UART/RS232 serial decode, 266, 276, 288, 297, 309, 318, 338
  - units, math, 185
  - units, probe, 82, 110
  - unstable triggers, 232
  - updating software and firmware, 410
  - upgrade files, 252
  - upgrade options, 393
  - upgrading the oscilloscope, 396
  - upload new firmware, 239
- USB**
- CD device, 217
  - device port, 220
  - eject device, 37
  - flash drive, 37
  - ports, 37
  - printer, 220
  - storage device numbering, 218
  - trigger type, 150
- USB0, 218
- USB5, 218
- user cal, 397
- user calibration, 397
- User-defined threshold, 368
- utilities, 381
- utility key, 38

**V**

- values, choosing, 34
- vectors, 87
- ventilation requirements, 29
- vernier, channel, 81
- vertical expansion, 78
- vertical position, 78
- vertical position control, 38
- vertical sensitivity, 38, 78
- viewing signals, 84
- viewing, tilt the instrument, 28
- VISA connect string, 239
- voltage measurements, 154, 169

**W**

- warranted specifications, 406
- warranty, 402

- waveform
  - cursor tracking, 178
  - intensity, 84
  - keys, 41
  - printing, 220
  - recall, 216
  - reference point, 383
  - save options, 211
  - save to scope memory, 216
  - save to USB, 215
  - saving and exporting, 206
- Width - measurement, 165
- Width + measurement, 165
- Window, FFT, 199
- www, 218

**X**

- X at Max Y measurement, 165
- X at Max Y on FFT, 162
- X at Min Y measurement, 166
- X at Min Y on FFT, 162
- XY mode, 65, 66

**Z**

- Z-axis blanking, 70
- zoom and pan, 63
- Zoom key, 40
- zoomed time base measurement window, 386

