

**MSO7000C/DX Series Mixed Signal Oscilloscopes  
DPO7000C/DX Series Digital Phosphor Oscilloscopes  
DPO7000C Series Digital Phosphor Oscilloscopes  
MSO5000B and DPO5000B Series Oscilloscopes  
User Manual**



071-2980-04

**Tektronix**



**MSO70000C/DX Series Mixed Signal Oscilloscopes  
DPO70000C/DX Series Digital Phosphor Oscilloscopes  
DPO7000C Series Digital Phosphor Oscilloscopes  
MSO5000B and DPO5000B Series Oscilloscopes  
User Manual**

This document supports firmware version 6.8

[www.tektronix.com](http://www.tektronix.com)

071-2980-04

**Tektronix**

Copyright © Tektronix. All rights reserved. Licensed software products are owned by Tektronix or its subsidiaries or suppliers, and are protected by national copyright laws and international treaty provisions.

Tektronix products are covered by U.S. and foreign patents, issued and pending. Information in this publication supersedes that in all previously published material. Specifications and price change privileges reserved.

TEKTRONIX and TEK are registered trademarks of Tektronix, Inc.

TekScope, TekConnect, Wave Inspector, and TekLink are registered trademarks of Tektronix, Inc.

FastFrame, OpenChoice, iCapture, MyScope, MultiView Zoom, SignalVu, TekExpress, TriMode, TekSecure, TekProbe, TekVPI, TekVISA, MagniVu, DPX, and PinPoint are trademarks of Tektronix, Inc.

## **Contacting Tektronix**

Tektronix, Inc.  
14150 SW Karl Braun Drive  
P.O. Box 500  
Beaverton, OR 97077  
USA

For product information, sales, service, and technical support:

- In North America, call 1-800-833-9200.
- Worldwide, visit [www.tektronix.com](http://www.tektronix.com) to find contacts in your area.

## Warranty

Tektronix warrants that this product will be free from defects in materials and workmanship for a period of one (1) year from the date of shipment. If any such product proves defective during this warranty period, Tektronix, at its option, either will repair the defective product without charge for parts and labor, or will provide a replacement in exchange for the defective product. Parts, modules and replacement products used by Tektronix for warranty work may be new or reconditioned to like new performance. All replaced parts, modules and products become the property of Tektronix.

In order to obtain service under this warranty, Customer must notify Tektronix of the defect before the expiration of the warranty period and make suitable arrangements for the performance of service. Customer shall be responsible for packaging and shipping the defective product to the service center designated by Tektronix, with shipping charges prepaid. Tektronix shall pay for the return of the product to Customer if the shipment is to a location within the country in which the Tektronix service center is located. Customer shall be responsible for paying all shipping charges, duties, taxes, and any other charges for products returned to any other locations.

This warranty shall not apply to any defect, failure or damage caused by improper use or improper or inadequate maintenance and care. Tektronix shall not be obligated to furnish service under this warranty a) to repair damage resulting from attempts by personnel other than Tektronix representatives to install, repair or service the product; b) to repair damage resulting from improper use or connection to incompatible equipment; c) to repair any damage or malfunction caused by the use of non-Tektronix supplies; or d) to service a product that has been modified or integrated with other products when the effect of such modification or integration increases the time or difficulty of servicing the product.

THIS WARRANTY IS GIVEN BY TEKTRONIX WITH RESPECT TO THE PRODUCT IN LIEU OF ANY OTHER WARRANTIES, EXPRESS OR IMPLIED. TEKTRONIX AND ITS VENDORS DISCLAIM ANY IMPLIED WARRANTIES OF MERCHANTABILITY OR FITNESS FOR A PARTICULAR PURPOSE. TEKTRONIX' RESPONSIBILITY TO REPAIR OR REPLACE DEFECTIVE PRODUCTS IS THE SOLE AND EXCLUSIVE REMEDY PROVIDED TO THE CUSTOMER FOR BREACH OF THIS WARRANTY. TEKTRONIX AND ITS VENDORS WILL NOT BE LIABLE FOR ANY INDIRECT, SPECIAL, INCIDENTAL, OR CONSEQUENTIAL DAMAGES IRRESPECTIVE OF WHETHER TEKTRONIX OR THE VENDOR HAS ADVANCE NOTICE OF THE POSSIBILITY OF SUCH DAMAGES.

[W2 – 15AUG04]



# Table of Contents

Important safety information .....	v
General safety summary .....	v
Service safety summary .....	vii
Terms in this manual .....	viii
Symbols and terms on the product .....	viii
Compliance information .....	ix
EMC compliance .....	ix
Safety compliance .....	x
Environmental considerations .....	xiii
Preface .....	xiv
Key features .....	xiv
Documentation .....	xvi
Conventions used in this manual .....	xvi
Install your instrument .....	1
Standard accessories .....	1
Operating requirements .....	3
Preventing ESD .....	6
Powering on the instrument .....	7
Powering off the instrument .....	9
Removing the power .....	10
Securing the oscilloscope .....	11
Connecting to a network .....	11
Adding a second monitor .....	12
Operating system restore .....	15
Installing the MSO5000B and DPO5000B hard drive .....	16
Getting acquainted with your instrument .....	17
Front panel .....	17
Side and rear panels .....	20
Interface and display .....	23
Control panel .....	25
Accessing online help .....	28
Accessing menus and control windows .....	29
Inspect your instrument .....	30
Verify internal diagnostics pass .....	30
Acquisition .....	31
Signal path compensation .....	31
Setting up analog signal input .....	33
Using Default Setup .....	35
Using Autoset .....	36
Probe compensation and deskew .....	37
Acquisition concepts .....	37
How the acquisition modes work .....	40

Enable enhanced effective number of bits .....	41
Changing the acquisition mode .....	42
Starting and stopping an acquisition .....	43
Selecting the horizontal mode .....	43
Using FastAcq .....	46
Using DSP enhanced bandwidth .....	47
Setting the Termination Voltage .....	49
Using Roll Mode .....	50
Setting up digital signal input .....	51
Setting up digital channels .....	52
Setting up a bus .....	53
When and why to turn on MagniVu .....	60
Using MagniVu .....	60
Viewing analog characteristics of digital waveforms .....	61
Using FastFrame mode .....	63
Using FastFrame frame finder .....	66
Pinpoint triggers .....	68
Triggering concepts .....	68
Choosing a trigger type .....	70
Trigger selections .....	72
Checking trigger status .....	74
Using a (Main) and b (Delayed) triggers .....	75
Triggering with B-Event Scan .....	78
Triggering on a parallel bus .....	80
Triggering on a serial bus .....	83
Triggering using Visual Triggers (Visual Triggering) .....	84
Setting up Action on Event .....	86
Sending E-Mail on Trigger .....	87
Setting up E-Mail on Event .....	88
Using horizontal delay .....	90
Display a waveform .....	91
Setting the Display Style .....	91
Setting the Display Persistence .....	92
Setting the Display Format .....	93
Selecting the Waveform Interpolation .....	94
Adding Screen Text .....	95
Setting the Graticule Style .....	96
Setting the Trigger Level Marker .....	97
Displaying the Date and Time .....	97
Using the Color Palettes .....	98
Setting reference waveform colors .....	99
Setting Math Waveform Colors .....	99
Using MultiView Zoom .....	99
Zooming in multiple areas .....	101
Lock and Scroll zoomed waveforms .....	103



Hide waveforms in the zoomed window .....	104
Using Wave Inspector to manage long record length waveforms .....	105
Searching and marking waveforms .....	107
Using a visual search .....	115
Analyzing waveforms .....	116
Taking automatic measurements .....	116
Automated measurement selections .....	118
Customizing an automatic measurement .....	121
Taking cursor measurements .....	125
Setting up a histogram .....	127
Using math waveforms .....	129
Using Spectral Analysis .....	132
Using the Serial Error Detector .....	135
Using mask testing .....	141
Using limit testing .....	144
MyScope .....	146
Creating a new MyScope control window .....	146
Using MyScope control windows .....	150
Saving and recalling information .....	152
Saving screen captures .....	152
Saving waveforms .....	153
Recalling waveforms .....	155
Saving digital waveforms .....	156
Saving instrument setups .....	157
Recalling instrument setups .....	158
Saving measurements .....	159
Saving user masks .....	160
Saving histogram data .....	161
Saving timestamps .....	162
Copying your results to the clipboard .....	163
Printing a hard copy .....	165
Run application software .....	166
Application examples .....	168
Capturing intermittent anomalies .....	168
Using the extended desktop and OpenChoice architecture for efficient documentation .....	171
Triggering on buses .....	173
Triggering on a video signal .....	175
Correlating data between a Tektronix oscilloscope and logic analyzer .....	177
Appendix A .....	178
Cleaning .....	178
Appendix B .....	179
Obtaining the latest oscilloscope application and version releases .....	179
Appendix C .....	180
TPP0500 and TPP1000 500 MHz and 1 GHz 10X passive probes instructions .....	180
Operating information .....	180

Connecting the probe to the oscilloscope .....	180
Compensating the probe .....	181
Standard accessories .....	181
Optional accessories .....	183
Replacing the probe tip .....	183
Specifications .....	183
Performance graphs .....	184
Safety summary .....	185
Appendix D .....	187
P6616 General-Purpose Logic Probe instructions .....	187
Product description .....	187
Connecting the probe to the oscilloscope .....	188
Connecting the probe to your circuit .....	189
Functional check .....	189
Typical application .....	190
Accessories .....	190
Specifications .....	191
Safety summary .....	192
Safety terms and symbols in this manual .....	192
Contacting Tektronix .....	193
Warranty information .....	193
Index	

# Important safety information

This manual contains information and warnings that must be followed by the user for safe operation and to keep the product in a safe condition.

To safely perform service on this product, additional information is provided at the end of this section. (See page vii, *Service safety summary*.)

## General safety summary

Use the product only as specified. Review the following safety precautions to avoid injury and prevent damage to this product or any products connected to it. Carefully read all instructions. Retain these instructions for future reference.

Comply with local and national safety codes.

For correct and safe operation of the product, it is essential that you follow generally accepted safety procedures in addition to the safety precautions specified in this manual.

The product is designed to be used by trained personnel only.

Only qualified personnel who are aware of the hazards involved should remove the cover for repair, maintenance, or adjustment.

Before use, always check the product with a known source to be sure it is operating correctly.

This product is not intended for detection of hazardous voltages.

Use personal protective equipment to prevent shock and arc blast injury where hazardous live conductors are exposed.

While using this product, you may need to access other parts of a larger system. Read the safety sections of the other component manuals for warnings and cautions related to operating the system.

When incorporating this equipment into a system, the safety of that system is the responsibility of the assembler of the system.

### To avoid fire or personal injury

**Use proper power cord.** Use only the power cord specified for this product and certified for the country of use.

Do not use the provided power cord for other products.

**Ground the product.** This product is grounded through the grounding conductor of the power cord. To avoid electric shock, the grounding conductor must be connected to earth ground. Before making connections to the input or output terminals of the product, make sure that the product is properly grounded.

**Power disconnect.** The power cord disconnects the product from the power source. See instructions for the location. Do not position the equipment so that it is difficult to operate the power cord; it must remain accessible to the user at all times to allow for quick disconnection if needed.

**Connect and disconnect properly.** Do not connect or disconnect probes or test leads while they are connected to a voltage source.

Use only insulated voltage probes, test leads, and adapters supplied with the product, or indicated by Tektronix to be suitable for the product.

**Observe all terminal ratings.** To avoid fire or shock hazard, observe all ratings and markings on the product. Consult the product manual for further ratings information before making connections to the product. Do not exceed the Measurement Category (CAT) rating and voltage or current rating of the lowest rated individual component of a product, probe, or accessory. Use caution when using 1:1 test leads because the probe tip voltage is directly transmitted to the product.

Do not apply a potential to any terminal, including the common terminal, that exceeds the maximum rating of that terminal.

Do not float the common terminal above the rated voltage for that terminal.

For MSO/DPO70K and DPO7K instruments, the measuring terminals on this product are not rated for connection to mains or Category II, III, or IV circuits.

**Do not operate without covers.** Do not operate this product with covers or panels removed, or with the case open. Hazardous voltage exposure is possible.

**Avoid exposed circuitry.** Do not touch exposed connections and components when power is present.

**Do not operate with suspected failures.** If you suspect that there is damage to this product, have it inspected by qualified service personnel.

Disable the product if it is damaged. Do not use the product if it is damaged or operates incorrectly. If in doubt about safety of the product, turn it off and disconnect the power cord. Clearly mark the product to prevent its further operation.

Before use, inspect voltage probes, test leads, and accessories for mechanical damage and replace when damaged. Do not use probes or test leads if they are damaged, if there is exposed metal, or if a wear indicator shows.

Examine the exterior of the product before you use it. Look for cracks or missing pieces.

Use only specified replacement parts.

**Do not operate in wet/damp conditions.** Be aware that condensation may occur if a unit is moved from a cold to a warm environment.

**Do not operate in an explosive atmosphere.**

**Keep product surfaces clean and dry.** Remove the input signals before you clean the product.

**Provide proper ventilation.** Refer to the installation instructions in the manual for details on installing the product so it has proper ventilation.

Slots and openings are provided for ventilation and should never be covered or otherwise obstructed. Do not push objects into any of the openings.

**Provide a safe working environment.** Always place the product in a location convenient for viewing the display and indicators.

Avoid improper or prolonged use of keyboards, pointers, and button pads. Improper or prolonged keyboard or pointer use may result in serious injury.

Be sure your work area meets applicable ergonomic standards. Consult with an ergonomics professional to avoid stress injuries.

Use care when lifting and carrying the product. This product is provided with handles for lifting and carrying.



---

**WARNING.** *The product is heavy. To reduce the risk of personal injury or damage to the device get help when lifting or carrying the product.*

*Use the secondary grip for repositioning/lifting on the bench top. To avoid injury by dropping the instrument, use the primary handle when you carry the instrument.*

---

Use only the Tektronix rackmount hardware specified for this product.

## Service safety summary

The *Service safety summary* section contains additional information required to safely perform service on the product. Only qualified personnel should perform service procedures. Read this *Service safety summary* and the *General safety summary* before performing any service procedures.

**To avoid electric shock.** Do not touch exposed connections.

**Do not service alone.** Do not perform internal service or adjustments of this product unless another person capable of rendering first aid and resuscitation is present.

**Disconnect power.** To avoid electric shock, switch off the product power and disconnect the power cord from the mains power before removing any covers or panels, or opening the case for servicing.

**Use care when servicing with power on.** Dangerous voltages or currents may exist in this product. Disconnect power, remove battery (if applicable), and disconnect test leads before removing protective panels, soldering, or replacing components.

**Verify safety after repair.** Always recheck ground continuity and mains dielectric strength after performing a repair.

## Terms in this manual

These terms may appear in this manual:



---

**WARNING.** Warning statements identify conditions or practices that could result in injury or loss of life.

---



---

**CAUTION.** Caution statements identify conditions or practices that could result in damage to this product or other property.

---

## Symbols and terms on the product

These terms may appear on the product:

- DANGER indicates an injury hazard immediately accessible as you read the marking.
- WARNING indicates an injury hazard not immediately accessible as you read the marking.
- CAUTION indicates a hazard to property including the product.



When this symbol is marked on the product, be sure to consult the manual to find out the nature of the potential hazards and any actions which have to be taken to avoid them. (This symbol may also be used to refer the user to ratings in the manual.)

The following symbol(s) may appear on the product:



CAUTION  
Refer to Manual



Protective Ground  
(Earth) Terminal



Earth Terminal



Chassis Ground



Standby



WARNING  
High Voltage

## Compliance information

This section lists the EMC (electromagnetic compliance), safety, and environmental standards with which the instrument complies.

### EMC compliance

#### EC Declaration of Conformity – EMC

Meets intent of Directive 2004/108/EC for Electromagnetic Compatibility. Compliance was demonstrated to the following specifications as listed in the Official Journal of the European Communities:

**EN 61326-1:2006, EN 61326-2-1:2006.** EMC requirements for electrical equipment for measurement, control, and laboratory use.<sup>1 2 3</sup>

- CISPR 11:2003. Radiated and conducted emissions, Group 1, Class A
- IEC 61000-4-2:2001. Electrostatic discharge immunity
- IEC 61000-4-3:2002. RF electromagnetic field immunity<sup>4</sup>
- IEC 61000-4-4:2004. Electrical fast transient/burst immunity
- IEC 61000-4-5:2001. Power line surge immunity
- IEC 61000-4-6:2003. Conducted RF immunity<sup>4</sup>
- IEC 61000-4-11:2004. Voltage dips and interruptions immunity

**EN 61000-3-2:2006.** AC power line harmonic emissions

**EN 61000-3-3:1995.** Voltage changes, fluctuations, and flicker

#### European contact.

Tektronix UK, Ltd.  
Western Peninsula  
Western Road  
Bracknell, RG12 1RF  
United Kingdom

- <sup>1</sup> This product is intended for use in nonresidential areas only. Use in residential areas may cause electromagnetic interference.
- <sup>2</sup> Emissions which exceed the levels required by this standard may occur when this equipment is connected to a test object.
- <sup>3</sup> If interconnect cables are used, they must be low-EMI shielded cables such as the following Tektronix part numbers or their equivalents: 012-0991-01, 012-0991-02 or 012-0991-03 GPIB Cable; 012-1213-00 (or CA part number 0294-9) RS-232 Cable; 012-1214-00 Centronics Cable; or LCOM part number CTL3VGAMM-5 VGA Cable. Use an 012-0482-00 cable for the Ref Out connector.
- <sup>4</sup> The performance criterion for when the oscilloscope is subjected to the continuously present electromagnetic phenomenon: MSO70000C/DX, DPO70000C/DX, and DPO7000: 10 mV/division to 1 V/division: ≤0.4 division waveform displacement or ≤0.8 division increase in peak-to-peak noise. MSO5000B and DPO5000B: ≤4.0 division waveform displacement or ≤8.0 division increase in peak-to-peak noise.

#### Australia / New Zealand Declaration of Conformity – EMC

Complies with the EMC provision of the Radiocommunications Act per the following standard, in accordance with ACMA:

- CISPR 11:2003. Radiated and Conducted Emissions, Group 1, Class A, in accordance with EN 61326-1:2006 and EN 61326-2-1:2006.

#### **Australia / New Zealand contact.**

Baker & McKenzie  
Level 27, AMP Centre  
50 Bridge Street  
Sydney NSW 2000, Australia

## **Safety compliance**

This section lists the safety standards with which the product complies and other safety compliance information.

### **EU declaration of conformity – low voltage**

Compliance was demonstrated to the following specification as listed in the Official Journal of the European Union:

Low Voltage Directive 2006/95/EC.

- EN 61010-1. Safety Requirements for Electrical Equipment for Measurement, Control, and Laboratory Use – Part 1: General Requirements.
- EN 61010-2-030. Safety Requirements for Electrical Equipment for Measurement, Control, and Laboratory Use – Part 2-030: Particular requirements for testing and measuring circuits.

### **U.S. nationally recognized testing laboratory listing**

- UL 61010-1. Safety Requirements for Electrical Equipment for Measurement, Control, and Laboratory Use – Part 1: General Requirements.
- UL 61010-2-030. Safety Requirements for Electrical Equipment for Measurement, Control, and Laboratory Use – Part 2-030: Particular requirements for testing and measuring circuits.

### **Canadian certification**

- CAN/CSA-C22.2 No. 61010-1. Safety Requirements for Electrical Equipment for Measurement, Control, and Laboratory Use – Part 1: General Requirements.
- CAN/CSA-C22.2 No. 61010-2-030. Safety Requirements for Electrical Equipment for Measurement, Control, and Laboratory Use – Part 2-030: Particular requirements for testing and measuring circuits.

### **Additional compliances**

- IEC 61010-1. Safety Requirements for Electrical Equipment for Measurement, Control, and Laboratory Use – Part 1: General Requirements.
- IEC 61010-2-030. Safety Requirements for Electrical Equipment for Measurement, Control, and Laboratory Use – Part 2-030: Particular requirements for testing and measuring circuits.



## Equipment type

Test and measuring equipment.

## Safety class

Class 1 – grounded product.

## Pollution degree descriptions

A measure of the contaminants that could occur in the environment around and within a product. Typically the internal environment inside a product is considered to be the same as the external. Products should be used only in the environment for which they are rated.

- Pollution degree 1. No pollution or only dry, nonconductive pollution occurs. Products in this category are generally encapsulated, hermetically sealed, or located in clean rooms.
- Pollution degree 2. Normally only dry, nonconductive pollution occurs. Occasionally a temporary conductivity that is caused by condensation must be expected. This location is a typical office/home environment. Temporary condensation occurs only when the product is out of service.
- Pollution degree 3. Conductive pollution, or dry, nonconductive pollution that becomes conductive due to condensation. These are sheltered locations where neither temperature nor humidity is controlled. The area is protected from direct sunshine, rain, or direct wind.
- Pollution degree 4. Pollution that generates persistent conductivity through conductive dust, rain, or snow. Typical outdoor locations.

## Pollution degree rating

Pollution degree 2 (as defined in IEC 61010-1). Rated for indoor, dry location use only.

## IP rating

IP20 (as defined in IEC 60529).

## Measurement and overvoltage category descriptions

Measurement terminals on this product may be rated for measuring mains voltages from one or more of the following categories (see specific ratings marked on the product and in the manual).

- Category II. Circuits directly connected to the building wiring at utilization points (socket outlets and similar points).
- Category III. In the building wiring and distribution system.
- Category IV. At the source of the electrical supply to the building.

---

**NOTE.** Only mains power supply circuits have an overvoltage category rating. Only measurement circuits have a measurement category rating. Other circuits within the product do not have either rating.

---

### **Mains overvoltage category rating**

Overvoltage category II (as defined in IEC 61010-1).

## Environmental considerations

This section provides information about the environmental impact of the product.

### Product end-of-life handling

Observe the following guidelines when recycling an instrument or component:

**Equipment recycling.** Production of this equipment required the extraction and use of natural resources. The equipment may contain substances that could be harmful to the environment or human health if improperly handled at the product's end of life. To avoid release of such substances into the environment and to reduce the use of natural resources, we encourage you to recycle this product in an appropriate system that will ensure that most of the materials are reused or recycled appropriately.



This symbol indicates that this product complies with the applicable European Union requirements according to Directives 2002/96/EC and 2006/66/EC on waste electrical and electronic equipment (WEEE) and batteries. For information about recycling options, check the Support/Service section of the Tektronix Web site ([www.tektronix.com](http://www.tektronix.com)).

**Mercury notification.** This product uses an LCD backlight lamp that contains mercury. Disposal may be regulated due to environmental considerations. Please contact your local authorities or, within the United States, refer to the E-cycling Central Web page ([www.eiae.org](http://www.eiae.org)) for disposal or recycling information <sup>1</sup>.

<sup>1</sup> This notification does not apply to MSO5000B and DPO5000B instruments. MSO5000B and DPO5000B instruments use an LED backlight that does not contain mercury.

**Perchlorate materials.** This product contains one or more type CR lithium batteries. According to the state of California, CR lithium batteries are classified as perchlorate materials and require special handling. See [www.dtsc.ca.gov/hazardouswaste/perchlorate](http://www.dtsc.ca.gov/hazardouswaste/perchlorate) for additional information.

### Restriction of hazardous substances

This product is classified as an industrial monitoring and control instrument, and is not required to comply with the substance restrictions of the recast RoHS Directive 2011/65/EU until July 22, 2017.

## Preface

This manual describes the installation and operation of MSO/DPO7000DX Series, MSO/DPO7000C Series, DPO7000C Series, and MSO/DPO5000B Series instruments. Basic operations and concepts are presented in this manual. For more detailed information see the online help on your instrument. The following instruments are supported by this manual:

- MSO73304DX and DPO73304DX
- MSO72504DX and DPO72504DX
- MSO72304DX and DPO72304DX
- MSO72004C and DPO72004C
- MSO71604C and DPO71604C
- MSO71254C and DPO71254C
- MSO70804C, and DPO70804C
- MSO70604C and DPO70604C
- MSO70404C and DPO70404C
- DPO7354C
- DPO7254C
- DPO7104C
- DPO7054C
- MSO5204B and DPO5204B
- MSO5104B and DPO5104B
- MSO5054B and DPO5054B
- MSO5034B and DPO5034B

## Key features

MSO7000C/DX, DPO7000DX, DPO7000C, DPO7000C, MSO5000B, and DPO5000B Series instruments can help you verify, debug, and characterize electronic designs. Key features include:

- 33 GHz bandwidth and 50 GS/s on 4 analog channels and 100 GS/s real time sampling rate on 2 analog channels, MSO73304DX and DPO73304DX
- 25 GHz bandwidth and 50 GS/s on 4 analog channels and 100 GS/s real time sampling rate on 2 analog channels, MSO72504DX and DPO72504DX
- 23 GHz bandwidth and 50 GS/s on 4 analog channels and 100 GS/s real time sampling rate on 2 analog channels, MSO72304DX and DPO72304DX
- 20 GHz bandwidth and 50 GS/s on 4 analog channels and 100 GS/s real time sampling rate on 2 analog channels, MSO72004C and DPO72004C
- 16 GHz bandwidth and 50 GS/s on 4 analog channels and 100 GS/s real time sampling rate on 2 analog channels, MSO71604C and DPO71604C

- 12.5 GHz bandwidth and 50 GS/s on 4 analog channels and 100 GS/s real time sampling rate on 2 analog channels, MSO71254C and DPO71254C
- 8 GHz bandwidth and 25 GS/s real time sampling rate on 4 analog channels, MSO70804C and DPO70804C
- 6 GHz bandwidth and 25 GS/s real time sampling rate on 4 analog channels, MSO70604C and DPO70604C
- 4 GHz bandwidth and 25 GS/s real time sampling rate on 4 analog channels, MSO70404C and DPO70404C
- 3.5 GHz bandwidth and 10 GS/s real time sampling rate on all channels, 40 GS/s on 1 channel, DPO7354C
- 2.5 GHz bandwidth and 10 GS/s real time sampling rate on all channels, 40 GS/s on 1 channel, DPO7254C
- 1 GHz bandwidth and 5 GS/s (10 GS/s optional) real time sampling rate on all channels, 20 GS/s (40 GS/s optional) on 1 channel, DPO7104C
- 500 MHz bandwidth and 5 GS/s real time sampling rate on all channels, 20 GS/s on 1 channel, DPO7054C
- 2 GHz bandwidth and 10 GS/s real time sampling rate on 2 analog channels, MSO5204B and DPO5204B
- 1 GHz bandwidth and 10 GS/s real time sampling rate on 2 analog channels, MSO5104B and DPO5104B
- 500 MHz bandwidth and 5 GS/s real time sampling rate on all analog channels, MSO5054B and DPO5054B
- 350 MHz bandwidth and 5 GS/s real time sampling rate on all analog channels, MSO5034B and DPO5034B
- Enhanced Bandwidth capability that, when enabled, applies Digital Signal Processing (DSP) filters that can extend the bandwidth and flatten the passband. Enhanced Bandwidth provides a matched response across enabled channels when they are at maximum sample rate. You can limit the bandwidth down to 500 MHz to optimize the signal to noise ratio. Enhanced bandwidth is extended to the probe tip for some high performance probes and tips.
- Record lengths up to 500,000,000 samples, depending on model and option
- Up to 1.0% DC vertical gain accuracy, depending on model
- Four analog input channels (each with 8-bit resolution when not in Hi-Res mode), auxiliary trigger input and output
- Sixteen digital channels available on MSO70000C/DX and MSO5000B Series instruments with an additional clock channel available on the MSO70000C/DX
- iCapture allows analyzing the analog characteristics of the digital channels on MSO70000C/DX Series instruments
- Sample, envelope, peak-detect, high-resolution, waveform database, average, and FastAcq acquisition modes
- Full programmability, with an extensive GPIB-command set and a message-based interface
- PinPoint triggering with flexible A and B trigger events and logic qualified triggers available on MSO70000C/DX, DPO70000C/DX, and DPO7000C
- Complete set of triggers available on MSO5000B and DPO5000B Series instruments
- Selectable trigger position correction to more accurately place the trigger and reduce jitter
- Serial triggering on industry standards, serial pattern triggering, and pattern lock triggering are available on some models or options.
- Trigger on digital channels on MSO70000C/DX and MSO5000B Series instruments
- Visual triggering, an intuitive method of triggering based on shapes in the instrument display, optional on some models
- Powerful built-in measurement capability, including histograms, automatic measurements, eye pattern measurements and measurement statistics

- Mathematically combine waveforms to create waveforms that support your data-analysis task. Use arbitrary filters in math equations. Use spectral analysis to analyze waveforms in the frequency domain.
- A large 12.1 inch (307.3 mm) [10.4 inch (264 mm) MSO5000B and DPO5000B] high resolution XGA color display that supports color grading of waveform data to show sample density. Display 10 divisions both horizontally and vertically.
- Wave Inspector controls for managing long record length, with zoom and pan, play and pause, and search and mark available on MSO5000B and DPO5000B
- MagniVu 60.6 ps resolution, high-speed digital sampling rate on MSO5000B
- MultiView Zoom to view and compare up to four zoom areas at a time. Lock and manually or automatically scroll up to four zoom areas. You can control the visibility of waveforms inside the zoom window
- Automatically search and mark events of interest on your waveform
- Automatic DDR analysis using the DDR Memory Technology Analysis option
- Customizable MyScope control windows
- Ability to control sample rate and record length separately from horizontal scale
- An intuitive, graphical user interface (UI), with online help that is built in and available on screen
- Internal, removable disk storage
- Wide array of probing solutions



## Documentation

Review the following for the location of different types of information available for this product.

To read about	Use these documents
Installation and Operation (overviews)	User Manual. Provides general operating information.
In-Depth Operation and User Interface Help	Online Help. Provides detailed instructions for using instrument functions. Access online help from the Help button or Help menu for information on controls and elements on screen. (See page 28, <i>Accessing online help</i> .)
Programmer Commands	Programmer guide (on the documentation browser or available on-line at <a href="http://www.tektronix.com/manuals">www.tektronix.com/manuals</a> ). Includes the syntax of the GPIB commands.
Service Information	Service manual (on the documentation browser or available on-line at <a href="http://www.tektronix.com/manuals">www.tektronix.com/manuals</a> ).

## Conventions used in this manual

The following icons are used throughout this manual.

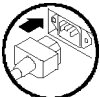
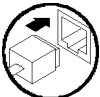
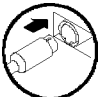
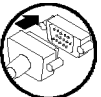
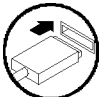
Sequence Step	Front panel power	Connect power	Network	PS-2	SVGA	USB
						

# Install your instrument

Unpack the instrument and check that you received all items listed as Standard Accessories. Recommended accessories, probes, instrument options, and upgrades are listed in the online help. Check the Tektronix Web site ([www.tektronix.com](http://www.tektronix.com)) for the most current information.

## Standard accessories

Accessory	Tektronix part number
MSO70000C/DX, DPO70000C/DX, DPO7000C, MSO5000B, and DPO5000B Series Digital Phosphor Oscilloscopes User Manual	071-2980-xx
High Performance Oscilloscopes Best Practices User Manual, MSO70000C/DX, DPO70000C/DX, and DPO7000C series	071-2989-xx
Online Help (part of the product software)	—
Performance Verification (on the documentation browser)	077-0063-xx
Programmer Online Guide (on the documentation browser)	077-0010-xx
NIST, Z540-1, and ISO9000 Calibration Certificate	—
One TekConnect adapter, MSO/DPO70000C/DX models only	TCA-BNC
Four TekConnect adapters, MSO/DPO70000C models only	TCA-292MM
Four TekConnect adapters, MSO/DPO73304DX, MSO/DPO72504DX, and MSO/DPO72304DX models only	TCA-292D
One passive probe per channel, DPO7354C, DPO7254C, DPO7104C, and DPO7054C	P6139B
One 16-channel digital probe with accessory kit, MSO5000B models only	P6616
One passive probe per channel, MSO5204B, MSO5104B, DPO5204B, and DPO5104B	TPP1000
One passive probe per channel, MSO5054B, MSO5034B, DPO5054B, and DPO5034B	TPP0500/B
Touchscreen stylus, MSO5000B and DPO5000B	119-6107-xx
Keyboard, MSO/DPO70000C/DX models only	119-7083-xx
Mouse, optical	119-7054-xx
DVI to VGA adapter, MSO70000C, DPO70000C, and DPO7000C series	887-4187-00
Front Cover, MSO5000B and DPO5000B	200-5130-xx
All other models	200-4963-xx
Wrist Strap, MSO/DPO70000C/DX models only	006-3415-05
Accessory Pouch	
MSO/DPO70000C/DX models	016-1441-xx
DPO7000C models	016-1966-xx
MSO5000B and DPO5000B models	016-2029-xx

<b>Accessory</b>		<b>Tektronix part number</b>			
One 17-channel digital probe with accessory kit, MSO70000DX models only		P6717A			
<b>Accessory</b>		<b>Tektronix part number</b>			
Power Cord	One of the following:	MSO5000B and DPO5000 B models	DPO7000C models	MSO70000C-/DX, DPO70000 C/DX models	
	North America (Option A0)	161-0348-00	161-0104-00	161-0213-00	
	Universal Euro (Option A1)	161-0343-00	161-0104-06	161-0209-00	
	United Kingdom (Option A2)	161-0344-00	161-0104-07	161-0210-00	
	Australia (Option A3)	161-0346-00	161-0104-14	161-0211-01	
	North America 240 V (Option A4)	—	161-0104-08	—	
	Switzerland (Option A5)	161-0347-00	161-0167-00	161-0212-00	
	Japan (Option A6)	161-0342-00	161-A005-00	161-0213-00	
					Notice: Do not use the provided power cord for other products.
	China (Option A10)	161-0341-00	161-0306-00	161-0352-00	
	India (Option A11)	161-0349-00	161-0324-00	161-0325-00	
	Brazil (Option A12)	161-0356-00	161-0356-00	161-0358-00	
	No power cord or AC adapter (Option A99)	—	—	—	



## Operating requirements

### MSO/DPO7000DX, MSO/DPO7000C, and DPO7000C

- Place the instrument on a cart or bench. The instrument should rest on its bottom or rear feet. An optional rack mounting kit is available. Observe the following clearance requirements and dimensions:

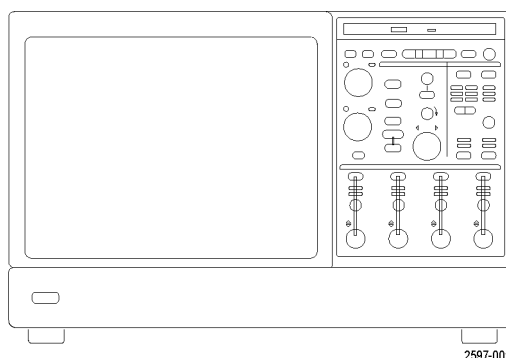

	<b>DPO7000C Models:</b>	<b>MSO/DPO7000C/DX Models:</b>
■ Top:	0 in (0 mm)	0 in (0 mm)
■ Left and right side:	0 in (0 mm) on right side 3 in (76 mm) on left side	3 in (76 mm)
■ Bottom:	0 in (0 mm) standing on feet, flip stands down	0 in (0 mm) standing on feet, flip stands down
■ Rear:	0 in (0 mm) on rear feet	0 in (0 mm) on rear feet
2. Width:	17.96 inches (456 mm)	17.75 inches (451 mm)
3. Height:	10.9 inches (277 mm)	11.48 inches (292 mm)
4. Before operating the instrument, verify the ambient temperature:	5 °C to +45 °C (+41 °F to +113 °F)	5 °C to +45 °C (+41 °F to +113 °F)
5. Verify the operating humidity:	8% to 80% relative humidity with a maximum wet-bulb temperature of +29 °C (+84 °F) at or below +45 °C (+113 °F), noncondensing Upper limit derated to 30% relative humidity at +45 °C (+113 °F)	8% to 80% relative humidity at up to +32 °C (+90 °F) 5% to 45% relative humidity above +32 °C (+90 °F) up to +45 °C (+113 °F), noncondensing, and is limited by a maximum wet-bulb temperature of +29.4 °C (+85 °F) (derate relative humidity to 32% at +45 °C (+113 °F))
6. Verify the operating altitude:	DPO7000C models: 3,000 m (9,843 feet)	MSO/DPO7000C/DX models: 3,000 m (9,843 feet), derate maximum operating temperature by 1 °C per 300 meters (984.25 feet) above 1500 meters (4921.25 feet) altitude.

7. Maximum input voltage, DPO7000C models:

- 50  $\Omega$
- 1 M $\Omega$

5 V<sub>RMS</sub>, with no impulse allowed, with peaks  $\leq \pm 24$  V.  
 150 V, derate at 20 dB/decade to 9 V<sub>RMS</sub> above 200 kHz. The maximum input voltage at the BNC, between center conductor and ground is 400 V peak. The RMS voltage is limited to <150 V for arbitrary waveshapes including DC. The maximum pulse width for impulses with peaks over 150 V is 50  $\mu$ s. Example: At 0 V to 400 V peak, rectangular wave, the duty factor is 14%. The maximum transient withstand voltage is  $\pm 800$  V peak.

Maximum input voltage, 4 GHz to 20 GHz models:

- 50  $\Omega$

<1 V<sub>RMS</sub> for <1 V/FS settings and < 5.5 V<sub>RMS</sub> for  $\geq 1$  V/FS settings.

Maximum input voltage, > 20 GHz models:

- 50  $\Omega$

$\leq 1.2$  V/FS settings:  
 $\pm 1.5$  V relative to the termination bias (30 mA maximum).  
 $\pm 5$  V absolute maximum input.  
 >1.2 V/FS settings:  
 10 V at 25 °C derated to 8.4 V at 45 °C (limited by attenuator).

Maximum nondestructive input voltage to logic probes, MSO7000C/DX Series:

$\pm 15$  V



**CAUTION.** For proper cooling, keep the bottom and sides of the instrument clear of obstructions.

### MSO5000B and DPO5000B

1. Place the instrument on a cart or bench. The instrument should rest on its bottom or rear feet. An optional rack mounting kit is available. Observe the following clearance requirements and dimensions:

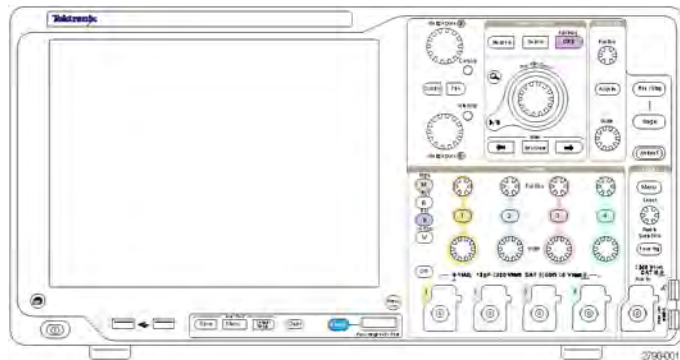

- Rear: 2 in (50.8 mm)
  - Left side: 2 in (50.8 mm)
2. Width: 17.3 inches (439 mm)
  3. Height: 9.2 inches (233 mm) including feet  
 10.7 inches (272 mm) including vertical handle and feet
  4. Before operating the instrument, verify the ambient temperature: 5 °C to +50 °C (+41 °F to +131 °F)

- 
5. Verify the operating humidity: High: 40 °C to 50 °C (104 °F to 122 °F), 10% to 60% relative humidity  
Low: 0 °C to 40 °C (32 °F to 104 °F), 10% to 90% relative humidity
6. Verify the operating altitude: 3,000 m (9,843 feet)
7. Maximum input voltage:
- 50  $\Omega$  input impedance 5 V<sub>RMS</sub>, with peaks  $\leq \pm 20$  V (DF  $\leq 6.25\%$ ).
- 1 M $\Omega$  input impedance 300 V<sub>RMS</sub>, CAT II, with peaks  $\leq \pm 425$  V at the BNC.  
For <100 mV/div derate at 20 dB/decade above 100 kHz to 30 V<sub>RMS</sub> at 1 MHz, 10 dB/decade above 1 MHz.  
For  $\geq 100$  mV/div derate at 20 dB/decade above 3 MHz to 30 V<sub>RMS</sub> at 30 MHz, 10 dB/decade above 30 MHz.
- Maximum nondestructive input voltage to logic probes:  $\pm 42$  V



**CAUTION.** For proper cooling, keep the back and left side of the instrument clear of obstructions.

---

## Preventing ESD



**CAUTION.** A direct electrostatic discharge can damage the instrument input. To learn how to avoid this damage, read the following information.

Electrostatic discharge (ESD) is a concern when handling any electronic equipment. The instrument is designed with robust ESD protection, however it is still possible that large discharges of static electricity directly into the signal input may damage the instrument. To avoid damage to the instrument, use the following techniques to prevent electrostatic discharge to the instrument.

1. Discharge the static voltage from your body by wearing a grounded antistatic wrist strap while connecting and disconnecting cables and TekConnect adapters. The instrument provides a front panel connection for this purpose.

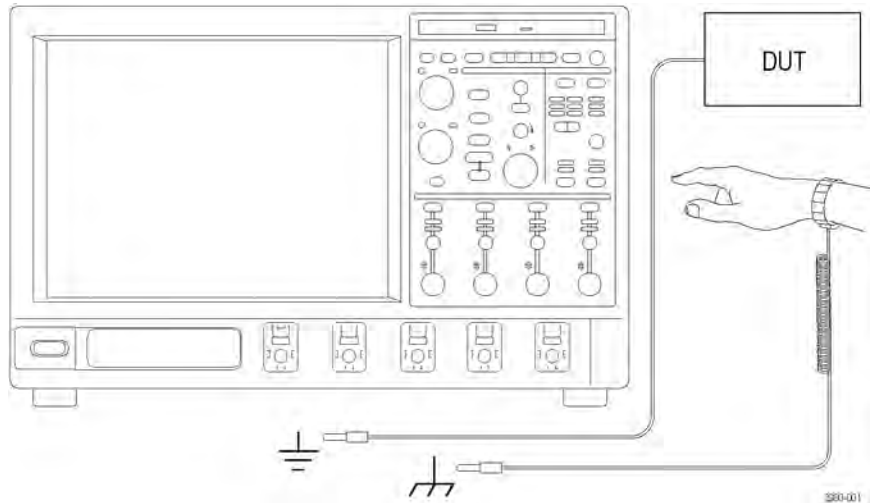

2. A cable that is left unconnected on a bench can develop a large static charge. Discharge the static voltage from all cables before connecting them to the instrument or device under test by momentarily grounding the center conductor of the cable, or by connecting a 50  $\Omega$  termination to one end, before attaching the cable to the instrument.

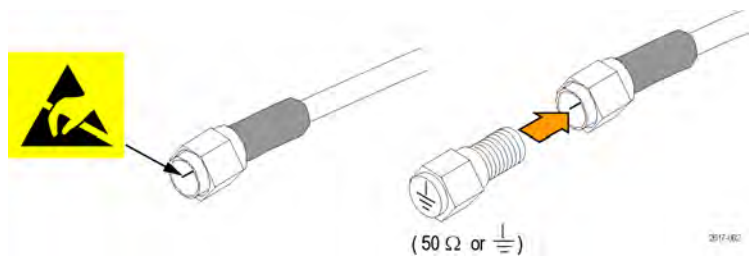

## Powering on the instrument

### Power supply requirements

Source voltage and frequency	Power consumption
MSO70000C/DX and DPO70000C/DX Series: 100–240 V <sub>RMS</sub> ±10%, 50–60 Hz or 115 V <sub>RMS</sub> ±10%, 400 Hz. CAT II	≤1100 VA
DPO7000C Series: 100–240 V <sub>RMS</sub> ±10%, 47–63 Hz or 115 V <sub>RMS</sub> ±10%, 400 Hz	550 Watts maximum
MSO5000B and DPO5000B Series: 100–240 V <sub>RMS</sub> ±10% 50–60 Hz 115 V 440 Hz	275 Watts maximum

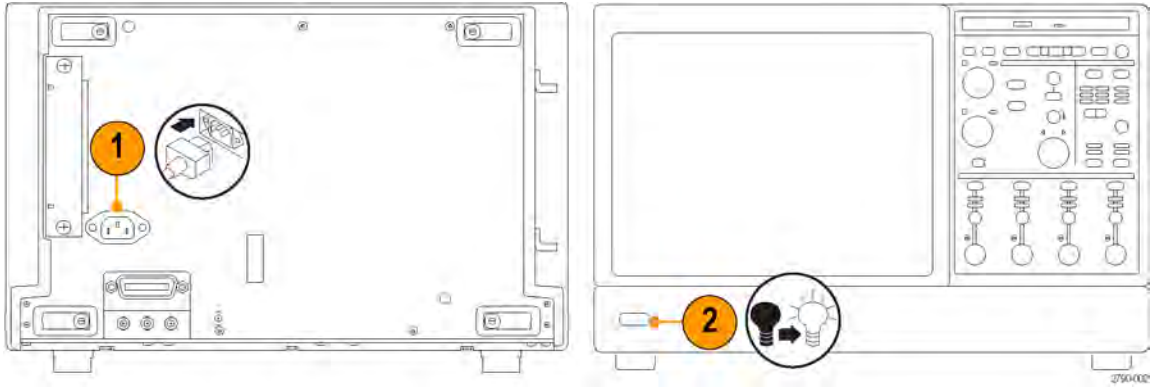

DPO7000C Series

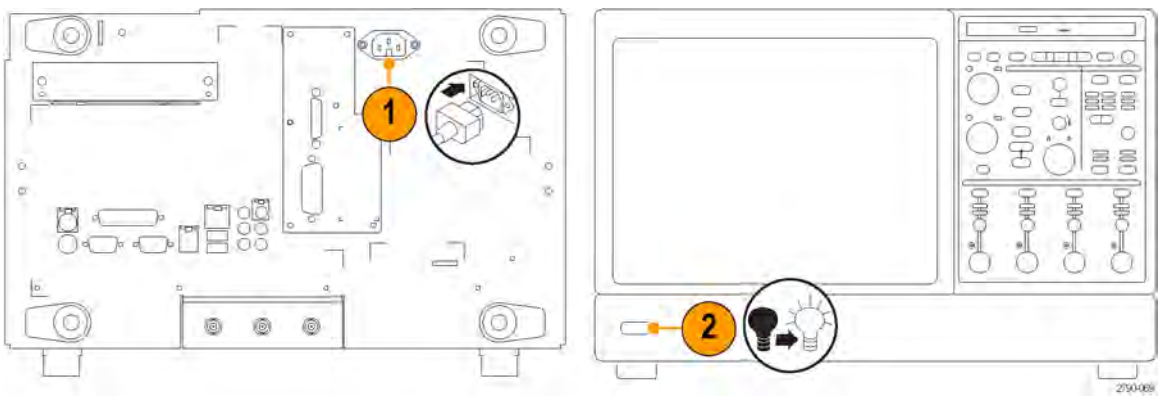

MSO/DPO70000DX and MSO/DPO70000C Series

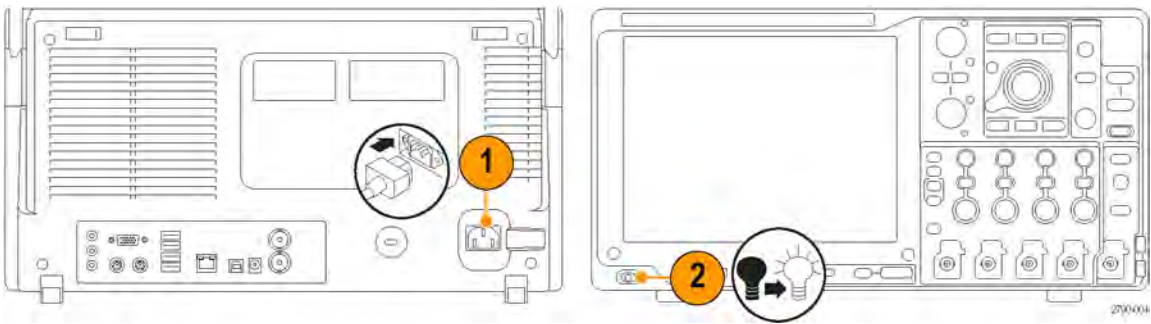

MSO5000B and DPO5000B Series

## Powering off the instrument

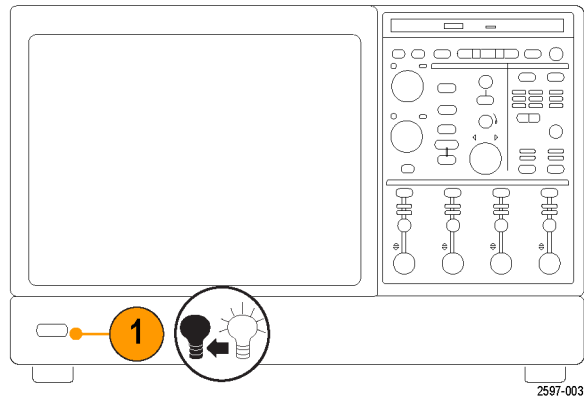

MSO/DPO70000DX, MSO/DPO70000C, and DPO7000C Series

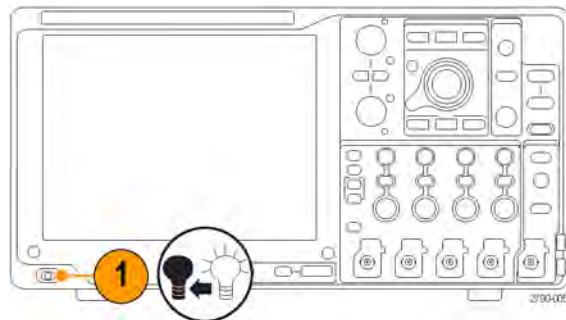

MSO5000B and DPO5000B Series

## Removing the power



DPO7000C Series

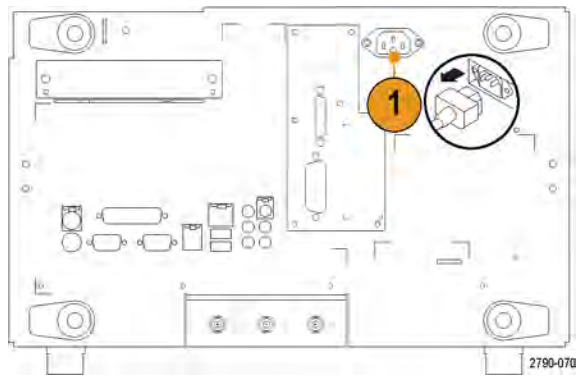

MSO/DPO70000DX and MSO/DPO70000C Series

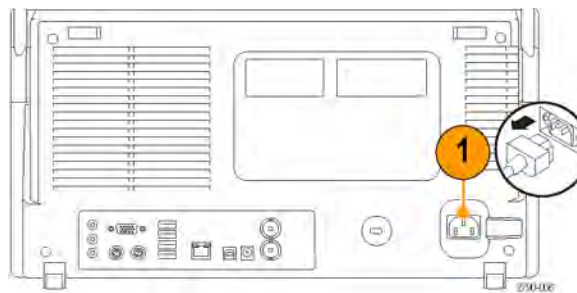

MSO5000B and DPO5000B Series



## Securing the oscilloscope

1. Use a standard laptop computer-style security lock to secure your oscilloscope to your location.

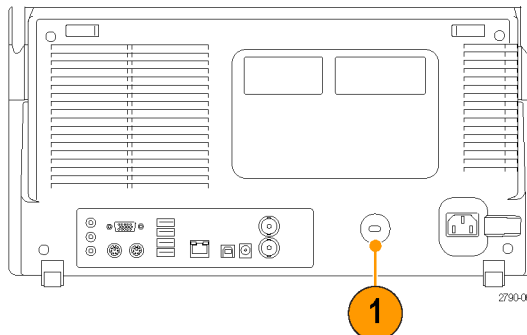

MSO5000B and DPO5000B Series

## Connecting to a network

Connect your instrument to a network for printing, file sharing, internet access, and other functions. Consult with your network administrator and use the standard Windows utilities to configure the instrument for your network.

Use the Remote Desktop Connection of Windows to control and view the instrument remotely.

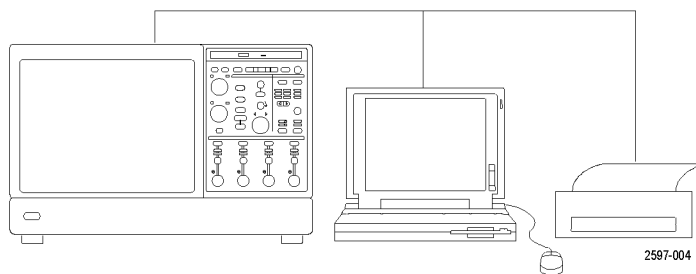

## Adding a second monitor

You can operate the instrument while using Windows and installed applications on an external monitor. Follow the procedure below to set up a dual monitor configuration.

### MSO/DPO7000DX and MSO/DPO7000C Series

1. Turn power off.
2. Connect second monitor. If using a VGA monitor with an MSO/DPO7000C, use a DVI to VGA adapter.
3. Connect keyboard.
4. Connect mouse.
5. Turn instrument power on.
6. Turn monitor power on.

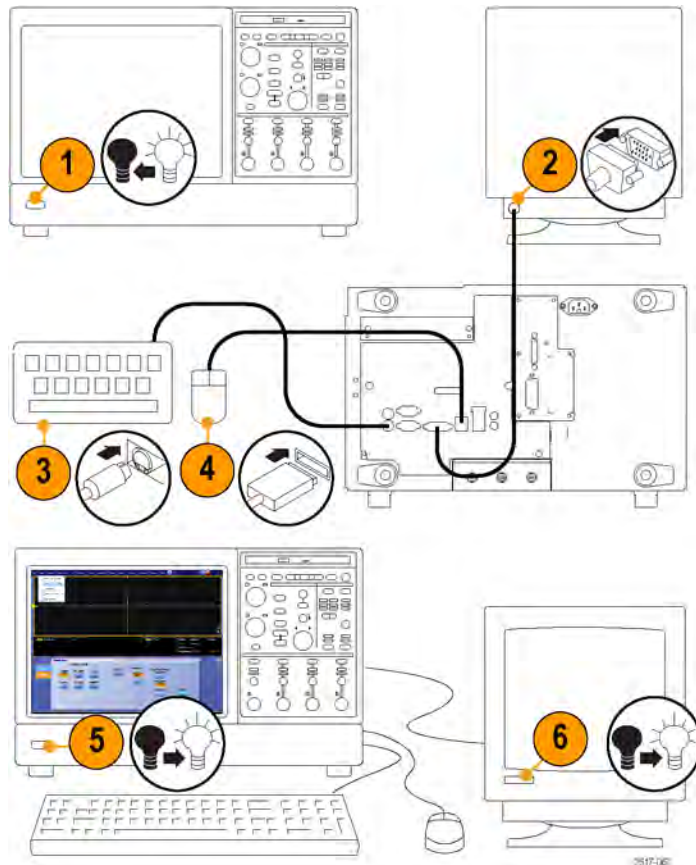

MSO/DPO7000DX and MSO/DPO7000C Series

## DPO7000C models

1. Turn off power.
2. Connect second monitor.
3. Connect keyboard.
4. Connect mouse.
5. Turn on instrument power.
6. Turn on monitor power.

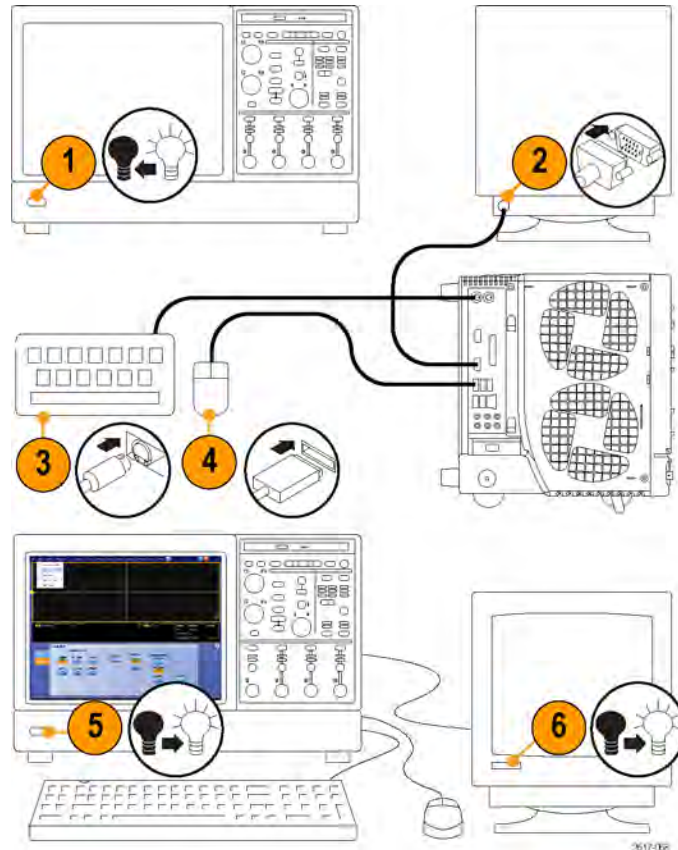

DPO7000C Series

### MSO5000B and DPO5000B models

1. Turn off power.
2. Connect second monitor.

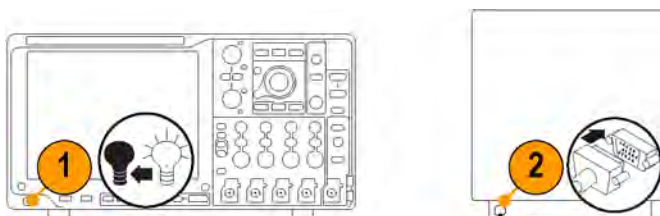

3. Connect keyboard.
4. Connect mouse.

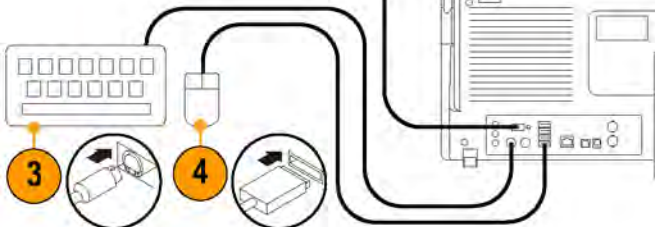

5. Turn on instrument power.
6. Turn on monitor power.

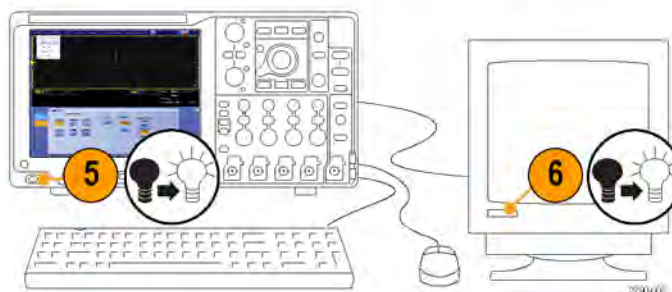

MSO5000B and DPO5000B models

## Operating system restore

If your instrument shipped with an operating system restore DVD and you need to restore the operating system, you can use the procedure that came with the DVD.

The instrument contains an operating system restore file on a separate partition of the hard drive.

The preferred method to restore the instrument operating system is to use the hard disk restore file.



---

**CAUTION.** *Using the restore process reformats the hard drive and reinstalls the operating system. All saved data is lost. If possible, save important files to external media before performing a system restore.*

---

1. Restart the instrument. During the boot-up process you will see the following message at the top of the screen: Starting Acronis Loader... press F5 for Acronis Startup Recovery Manager

---

**NOTE.** *To successfully complete the system restore, you must use the Windows version of the Acronis software. Using a generic MAC keyboard starts the DOS version of the Acronis software. Do not use a MAC keyboard.*

---

2. Repeatedly press the F5 key until the Acronis True Image Tool opens. There is a 15-second time period from when the message appears until the instrument proceeds with the normal instrument startup. If the instrument does not open the Acronis application, power off the instrument, then power on the instrument and try again.
3. Click Restore.
4. In the Confirmation dialog box, click Yes to restore the instrument operating system, or No to exit the restore process. The restore process takes approximately 30 minutes; the actual time depends on the instrument configuration.

## Installing the MSO5000B and DPO5000B hard drive



**CAUTION.** Inserting the hard drive assembly upside down could damage the instrument.

1. Verify that the instrument is off.
2. Insert the hard drive into the instrument with the drive assembly chassis facing up.
3. Secure the drive assembly using the thumb screw.
4. Install the cover.

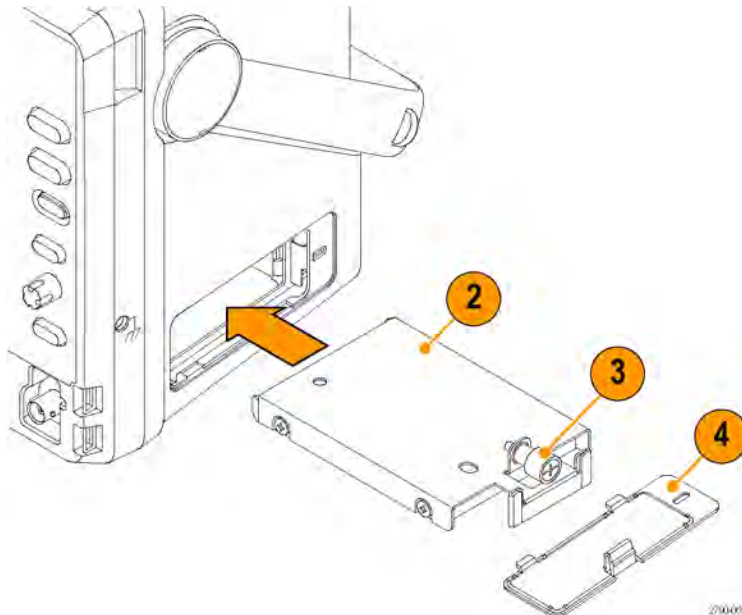

# Getting acquainted with your instrument

## Front panel

MSO/DPO70000DX, MSO/DPO70000C, and DPO7000C

1. DVD/CD-RW drive
2. Front panel controls

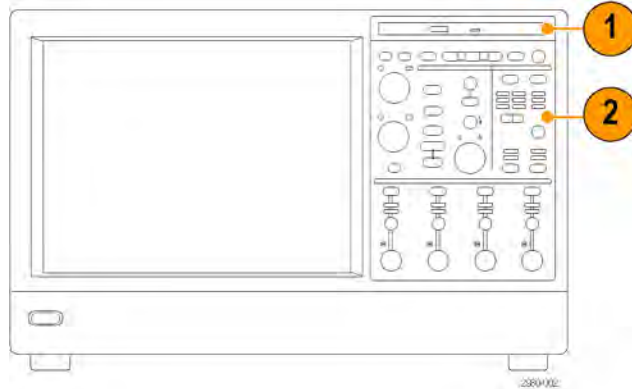

- 3. USB port
- 4. Ground terminal
- 5. Recovered data output (not available on DPO7104C and DPO7054C)
- 6. Recovered clock output (not available on DPO7104C and DPO7054C)
- 7. Probe compensation output
- 8. Probe calibration output
- 9. Channel 1–4 input
- 10. Auxiliary Trigger input
- 11. Fast Edge output
- 12. DC Probe Cal output
- 13. Logic probe input
- 14. Ground terminal through a 1 MΩ resistor

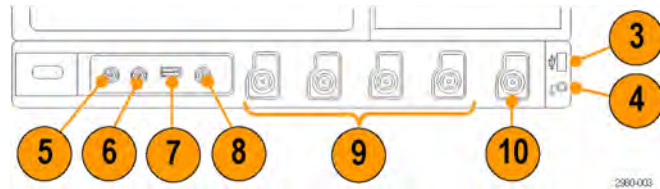

DPO7000C Series

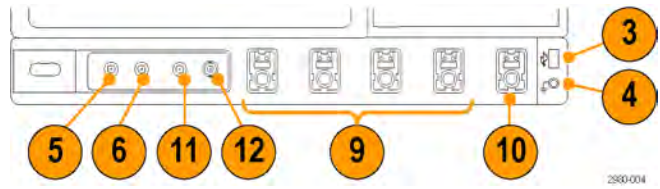

DPO70000C Series

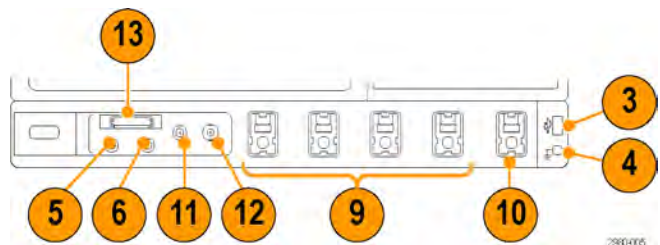

MSO70000C Series

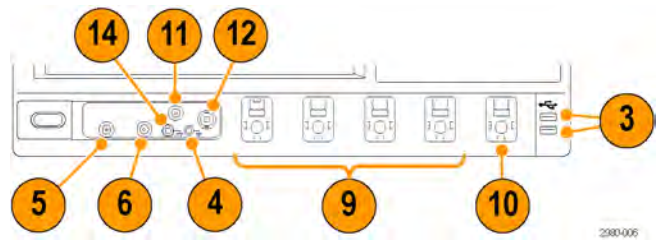

DPO70000DX Series

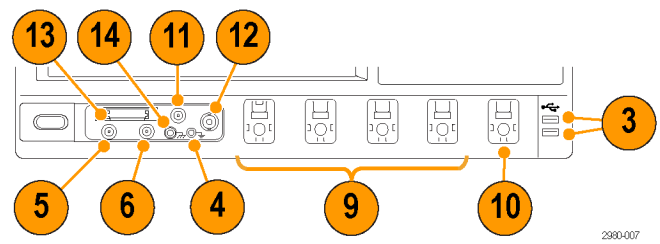

MSO70000DX Series



### MSO5000B and DPO5000B Series

1. Front panel controls
2. Ground terminal
3. Probe compensation output
4. Auxiliary Trigger input
5. Channel 1–4 inputs
6. Logic probe input
7. USB ports

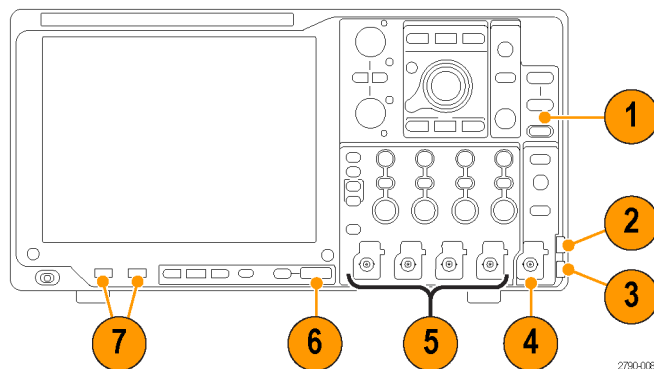

MSO5000B and DPO5000B Series

2790-008

## Side and rear panels

### MSO/DPO70000DX and MSO/DPO70000C

1. Removable hard disk drive
2. PS-2 connector for mouse
3. USB host ports
4. Passive eSATA Port
5. RJ-45 LAN connector to connect to network
6. TekLink connector
7. GPIB port to connect to controller
8. Line Out connector for speaker

---

**NOTE.** Some instruments may have additional audio connectors.

---

9. Mic connector for microphone
10. DVI-D Video port
11. COM 1 and COM 2 serial ports
12. PS-2 connector for keyboard
13. Auxiliary output
14. Reference output
15. External reference input
16. VGA port

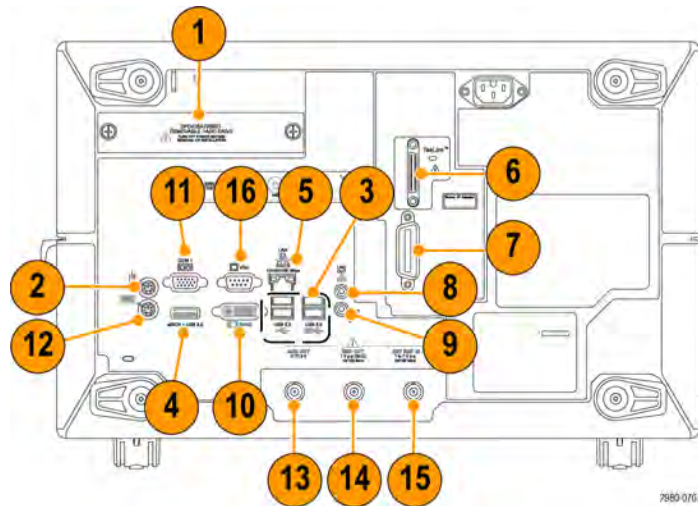

MSO/DPO70000DX and MSO/DPO70000C Series

**DPO7000C**

1. PS-2 connector for keyboard
2. PS-2 connector for mouse
3. RJ-45 LAN connector to connect to network
4. Line Out connector for speaker
5. Mic connector for microphone
6. USB host ports
7. DVI-1 Video port
8. COM 1 and COM 2 serial ports
9. Printer connection
10. Oscilloscope Only XGA Out video port to connect a monitor
11. Removable hard disk drive
12. GPIB port to connect to controller
13. Auxiliary output
14. Channel 3 output
15. External reference input

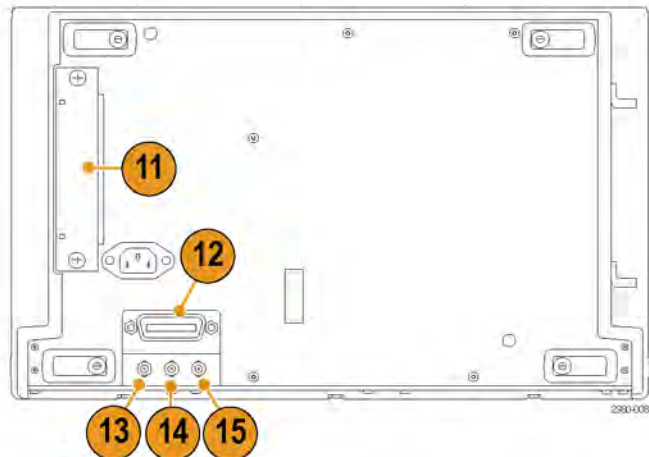
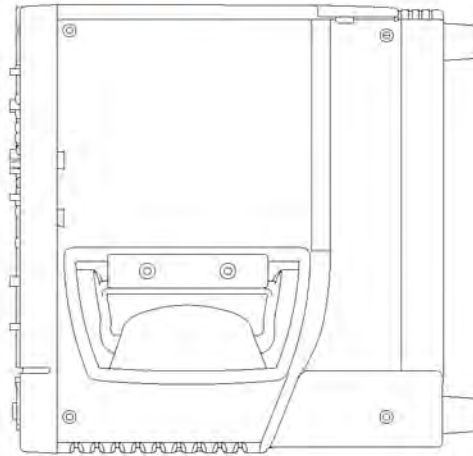
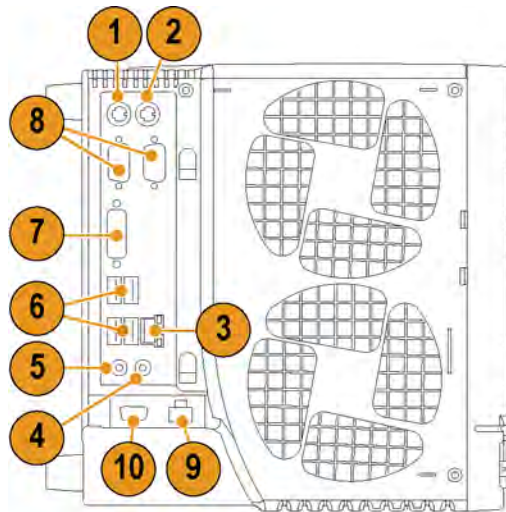

DPO7000C Series

### MSO5000B and DPO5000B

1. Line In connector
2. Line Out connector for speaker
3. Mic connector for microphone
4. Video port to connect a monitor
5. PS-2 connector for keyboard
6. PS-2 connector for mouse
7. USB host ports
8. RJ-45 LAN connector to connect to network
9. USB Device port
10. Probe Power input, use 119-7465-xx power supply
11. External reference input
12. Auxiliary output
13. Security lock input
14. AC Power input
15. Removable hard disk drive cover
16. Ground connection

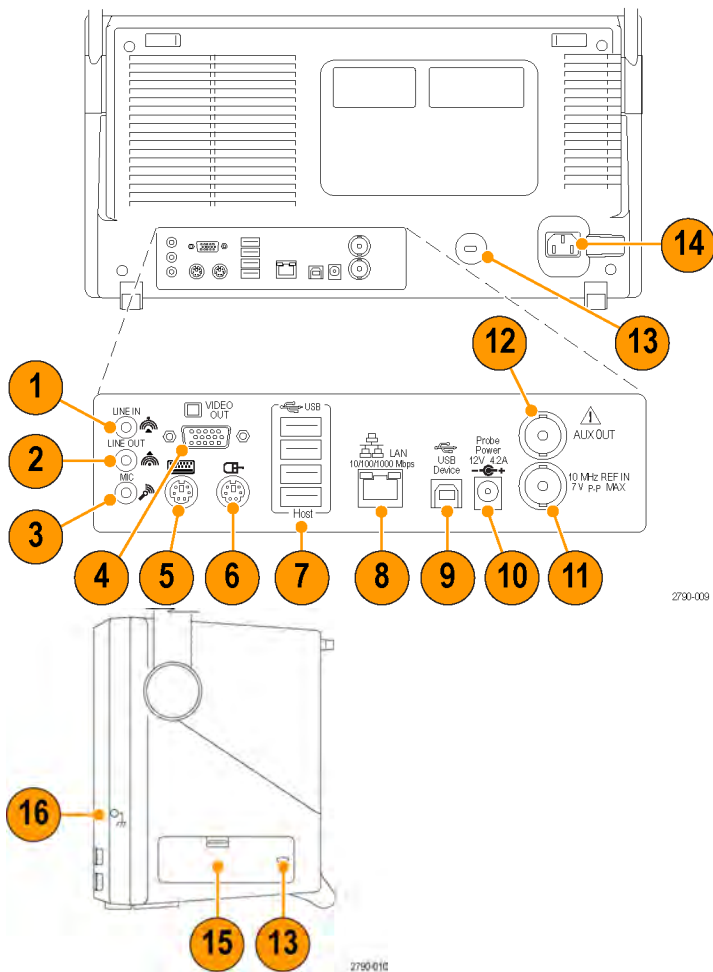

MSO5000B and DPO5000B Series

To use PS-2 devices, they must be plugged in before you power on the instrument. PS-2 devices must not be hot swapped.

## Interface and display

The menu bar mode provides access to commands that control all of the instrument features and functions. The toolbar mode provides access to the most common features.

- 1. Menu Bar:** Access to data I/O, printing, online help, and instrument functions
- 2. Buttons/Menu:** Click to toggle between toolbar and menu bar modes and to customize your toolbar
- 3. Multipurpose Knob Readouts:** Adjust and display parameters controlled by the multipurpose knobs
- 4. Display:** Live, reference, math, digital, and bus waveforms display here, with cursors
- 5. Waveform Handle:** Click and drag to change vertical position of a waveform or bus. Click the handle and change the position and scale using the multipurpose knobs.
- 6. Controls Status:** Quick reference to vertical selections, scale, offset, and parameters
- 7. Readouts:** Display cursor and measurement readouts in this area. Measurements are selectable from the menu bar or toolbar. If a control window is displayed, some combinations of readouts move to the graticule area.

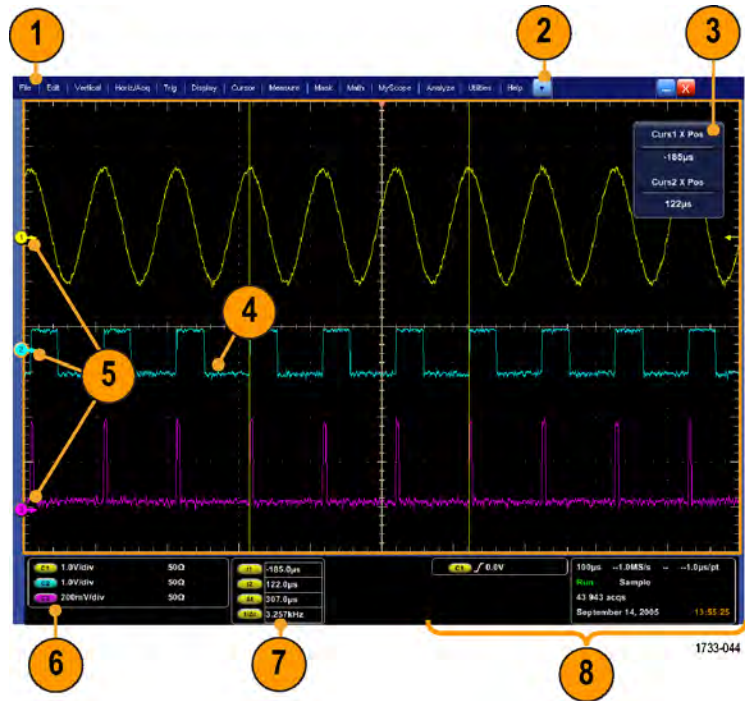

**WARNING.** If there is vertical clipping, there may be a dangerous voltage on the probe tip, but the readout will indicate a low voltage. A  symbol appears in the measurement readout if a vertical clipping condition exists. Automatic amplitude-related measurements where the signal is vertically clipped produce inaccurate results. Clipping also causes inaccurate amplitude values in waveforms that are stored or exported for use in other programs. If a math waveform is clipped, it will not affect amplitude measurements on that math waveform.

- 8. Status:** Display of acquisition status, mode, and number of acquisitions; trigger status; date; time; and quick reference to record length and horizontal parameters

1. **Buttons/Menu:** Click to toggle between toolbar and menu bar modes and to customize the toolbar
2. Drag cursors to measure waveforms on screen
3. Drag the position icons to reposition a waveform
4. Click the icon to assign the multipurpose knobs to waveform vertical position and scale
5. Drag across the waveform area to create a box for zooming, enabling/disabling histograms, gating measurements, and adding and controlling visual trigger areas
6. Drag icon to change the trigger level

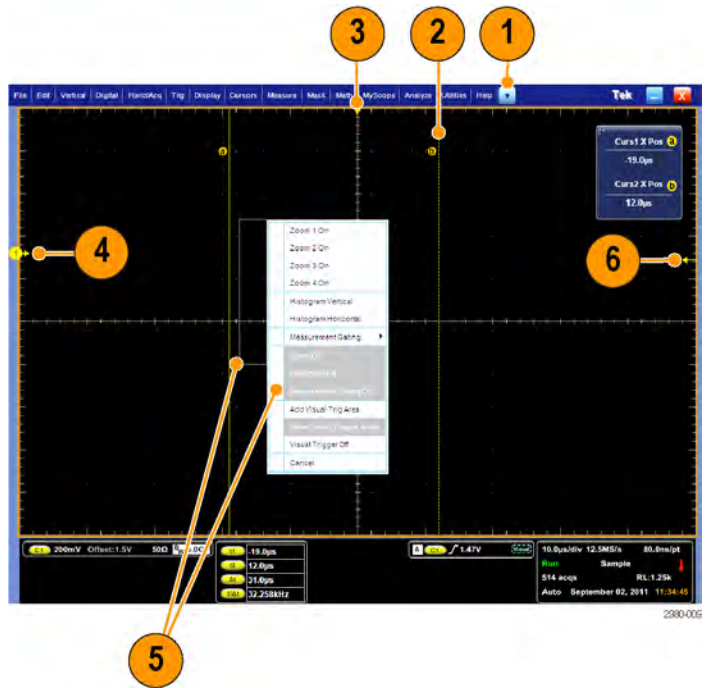

## Control panel

### MSO/DPO7000DX, MSO/DPO7000C, and DPO7000C

1. Push to automatically set up the vertical, horizontal, and trigger controls based on selected channels.
  2. Push to return settings to default values.
  3. Push to make a hard copy or save a screen capture.
  4. Push to turn on MultiView Zoom and add a magnified graticule to the display.
  5. Horizontally scale, position, delay, and set record length (resolution) of all waveforms.
  6. Use to start and stop acquisition, start a single acquisition sequence, clear data, or start fast acquisitions.
  7. Use to set the trigger parameters. Push Advanced to display additional trigger functions. The Arm, Ready, and Trig'D lights show the acquisition status.
  8. Turn to adjust waveform intensity.
  9. Turn to adjust parameters selected from the screen interface. Push to toggle between normal and fine adjustment.
  10. Push to turn cursors on or off.
  11. Use to search and mark waveforms.
  12. Push to turn the touch screen on and off.
  13. Turn channel displays on and off. Vertically scale, position, or offset the waveform. Toggle between position and offset.
- On MSO7000 Series instruments, turn on digital channels using the Digital > Digital Setup menu. (See page 51, *Setting up digital signal input.*)

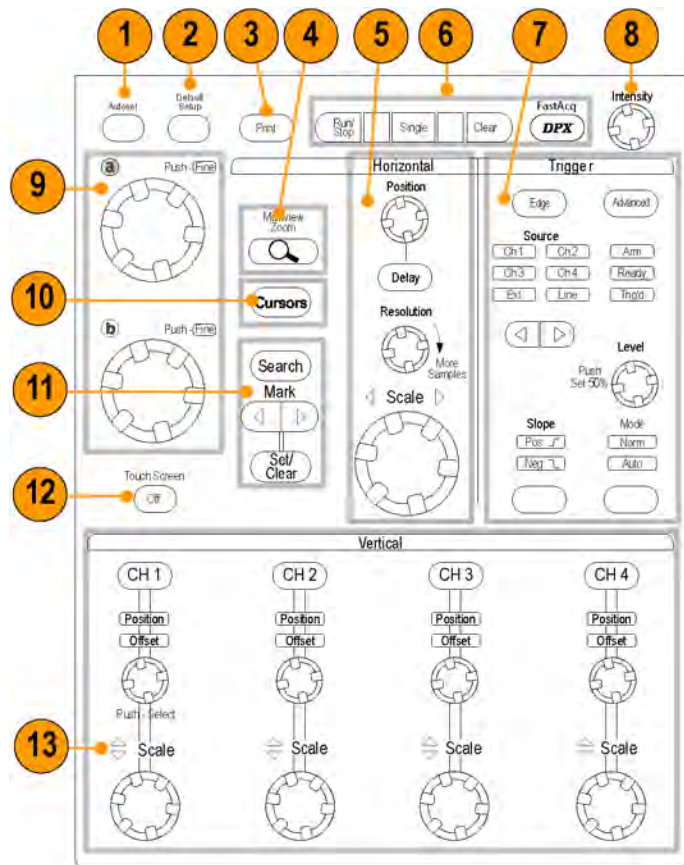

2597-006

## MSO5000B and DPO5000B

1. Turn to adjust parameters selected from the screen interface. Push **Fine** to select fine adjustment, push **Coarse** to select coarse adjustment.
2. Push to turn cursors on or off.
3. Push to adjust waveform intensity using a Multipurpose knob.
4. Push to turn on MultiView Zoom and add a magnified graticule to the display.
5. Push to perform automated measurements, search through an acquisition for user-defined events/criteria, or start or stop fast acquisitions.
6. Horizontally scale, position, and set the horizontal and acquisition parameters of all waveforms.
7. Turn the inner zoom knob to control the zoom factor. Turn the outer pan knob to scroll the zoom window through the acquired waveform. Push the play-pause button to start or stop the automatic panning of a waveform. Control the speed and direction with the pan knob.
8. Use to start and stop acquisition or start a single acquisition sequence.
9. Use to search and mark waveforms, to establish or delete a waveform mark, or to jump to the previous or next waveform mark.
10. Push to automatically set up the vertical, horizontal, and trigger controls based on selected channels.
11. Use to set the trigger parameters. Push Menu to display additional trigger functions.

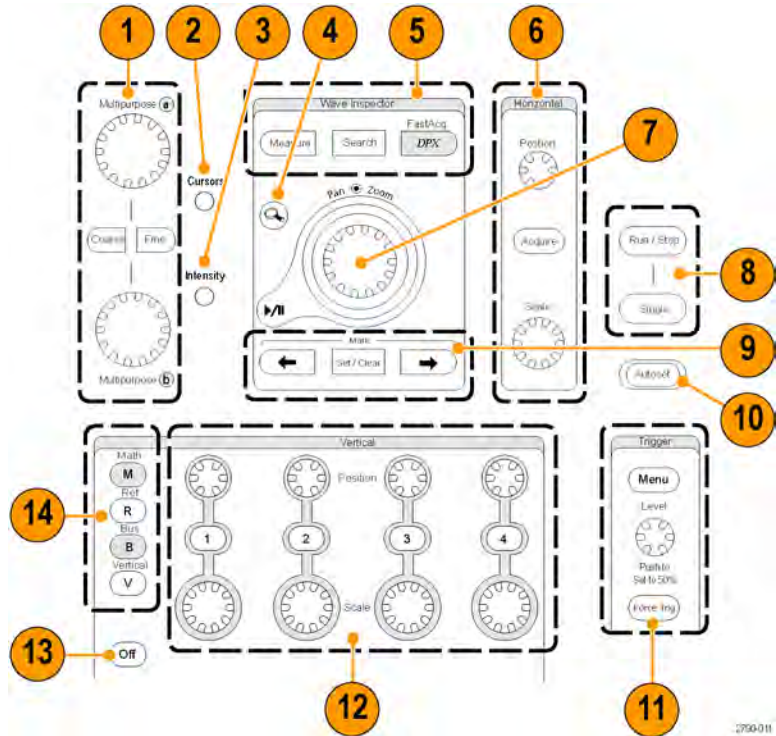



12. Turn channel displays on and off.  
Vertically scale or position the waveform.  
On MSO5000B Series instruments, turn on digital channels by pushing the D15–D0 button or using the Digital > Digital Setup menu. (See page 51, *Setting up digital signal input.*)
13. Push to turn the touch screen on and off.
14. Push to display the math, reference, bus, or vertical setup menus.
15. Push to turn off a displayed menu.
16. Push to access the digital setup menu (MSO5000B Series only).
17. Push to clear data.
18. Push to return settings to default values.
19. Push to save and recall setups, waveforms, and screen images.
20. Push to make a hard copy or save a screen capture.

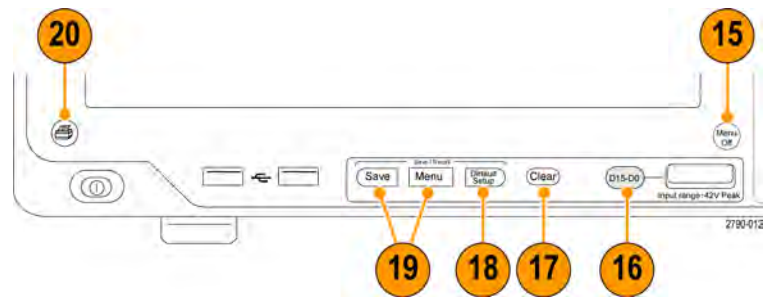

## Accessing online help

In-depth information is available in the online help on all the features of your instrument.

To access context-sensitive help on the active window, select **Help > Help on Window...** or press **F1**.

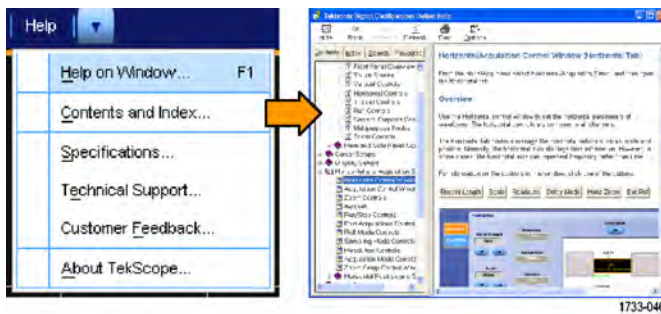

1733-046

1. To access any topic in the help system, select **Help > Contents and Index...**

2. Use the Contents, Index, Search, or Favorites tab to select the topic, and then click **Display**.

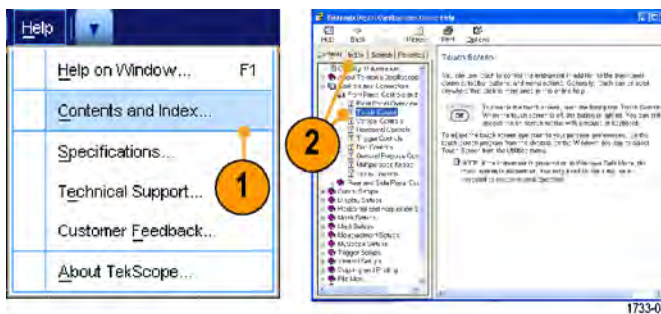

1733-047

To navigate within the help system:

- Click a button in a help window to navigate between the Overview and specific topics.
- Click the **Minimize** button in the help window to move help out of the way so you can operate the instrument.
- Click **Alt** and **Tab** to see the last help topic again.

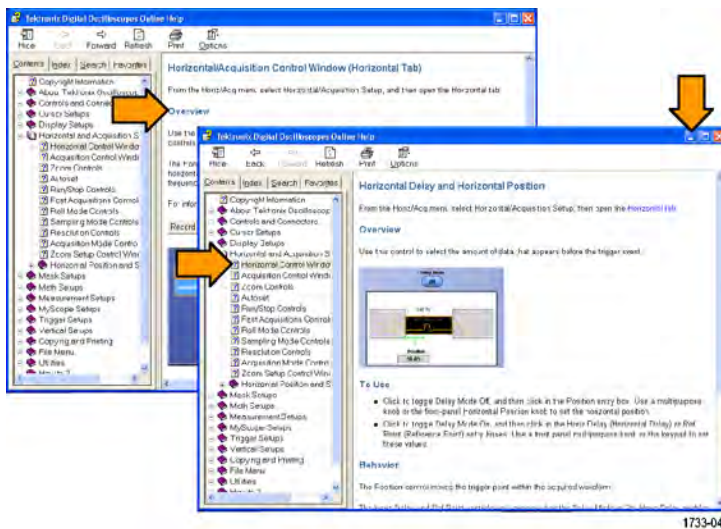

1733-048

## Accessing menus and control windows

Access menus and control windows using the following techniques:

- Click a menu, and then select a command.

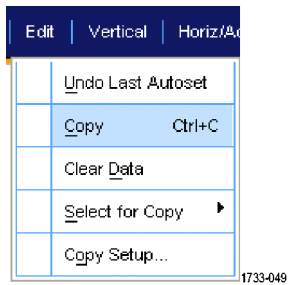

1733-049

- For a shortcut menu, right-click anywhere in the graticule or on an object. The shortcut menu is context sensitive and varies with the area or object where you right-clicked. Some examples are shown in the figure at right.

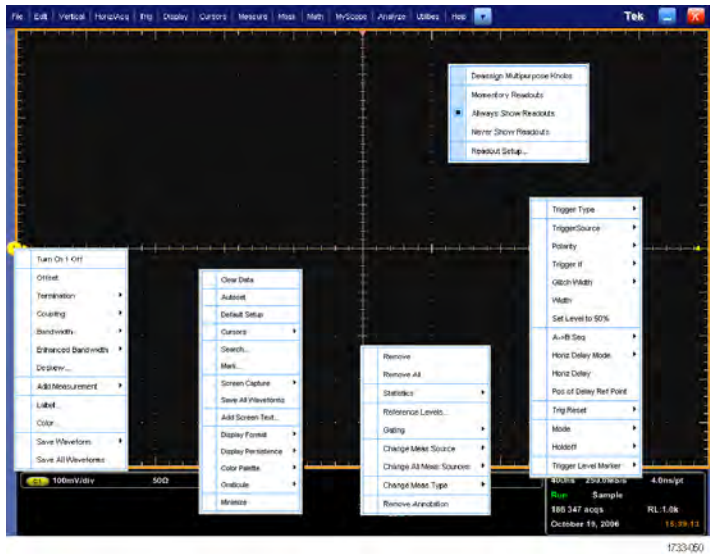

1733-050

- In the toolbar mode, click a button to quickly access a setup control window. (See page 23.)



1733-052

# Inspect your instrument

Use the following procedures to verify the functionality of your instrument.

## Verify internal diagnostics pass

1. Power on the instrument.
2. Select Instrument Diagnostics....

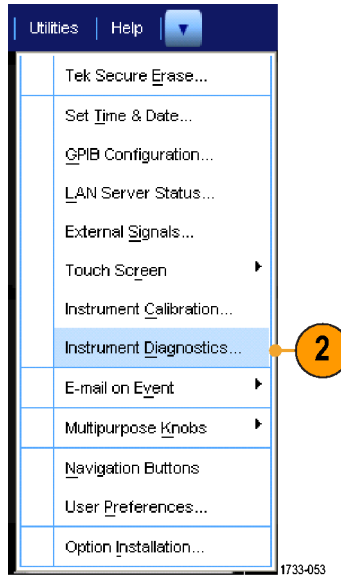

3. Click Run. The test results appear in the diagnostics control window.
4. Verify that all tests pass. If diagnostic failures occur, contact your local Tektronix service personnel.

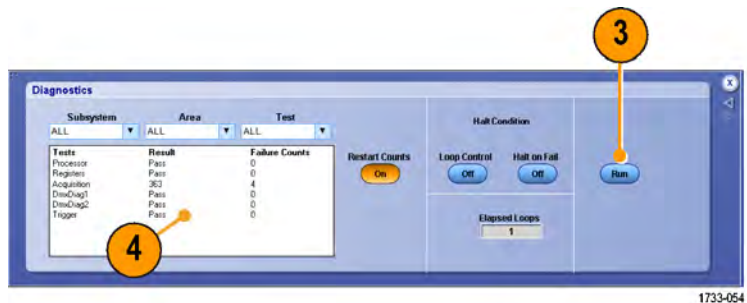

# Acquisition

This section contains concepts of and procedures for using the acquisition system.

## Signal path compensation

Use this procedure if the temperature has changed more than 5 °C (9 °F) since the last signal path compensation (SPC). Perform the signal path compensation regularly to ensure that your measurements have the highest level of accuracy. Tektronix considers it a best practice to run SPC when using the instrument to measure signals with higher sensitivity (10 mV/div and lower) settings regardless of temperature shift or time since it was last run. Failure to do so may result in the instrument not meeting warranted performance levels.

1. Prerequisites: instrument powered on for 20 minutes, and all input signals removed.
2. Select **Instrument Calibration**.

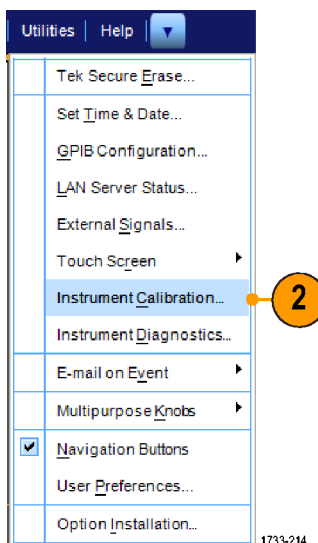

3. When the Temperature Status changes to Ready, click Run SPC to start the calibration. Calibration may take 10 to 15 minutes.

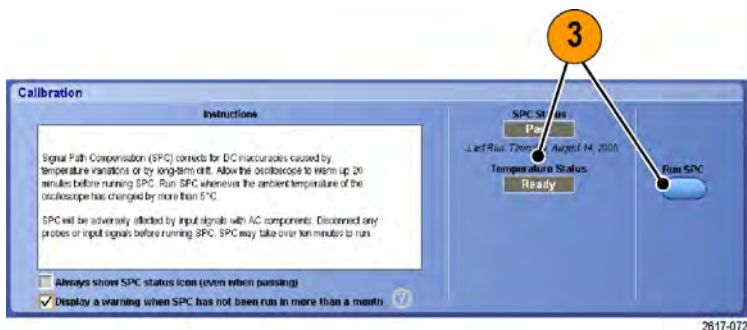

- If the instrument does not pass, recalibrate the instrument, or have the instrument serviced by qualified service personnel.

**NOTE.** To always show the SPC status icon or display a warning when SPC has not been run in more than a month, click the corresponding check box.

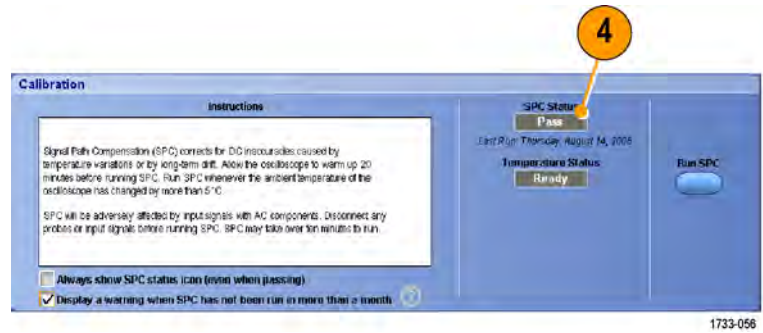

- If the SPC needed icon is red, perform a signal path compensation.

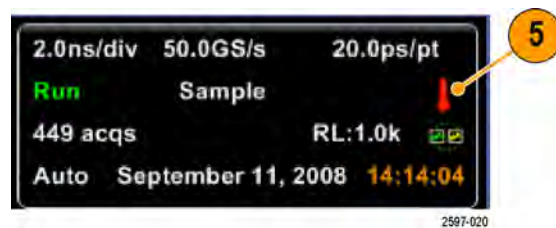

## Setting up analog signal input

Use front-panel buttons to set up your instrument to acquire the signal.

1. Connect the probe to the input signal source.



**CAUTION.** To prevent damage to the instrument, always wear an antistatic wrist strap when making connections to the instrument and observe the maximum input voltage ratings for input connectors.

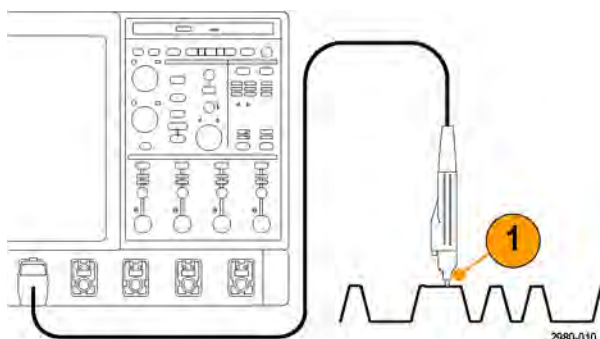

MSO/DPO7000DX and MSO/DPO70000C Series

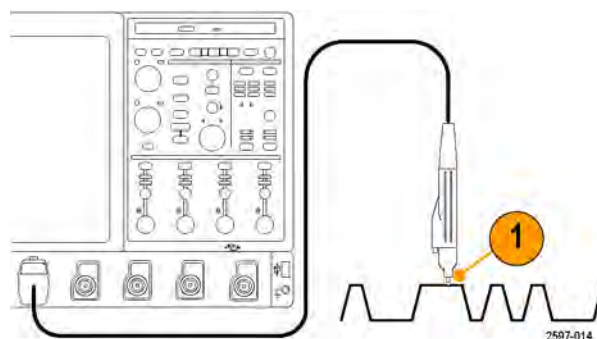

DPO7000C Series

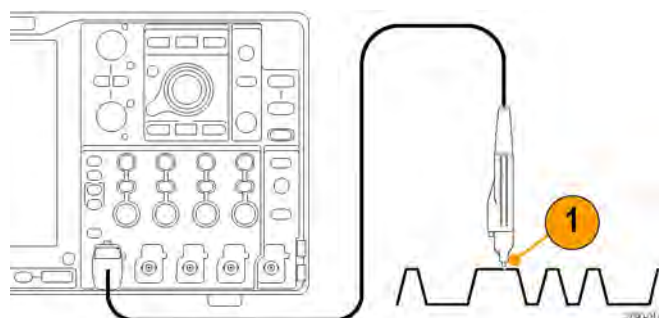

MSO5000B and DPO5000B Series

2. Select the input channel by pushing the front-panel buttons to toggle the channels on and off.

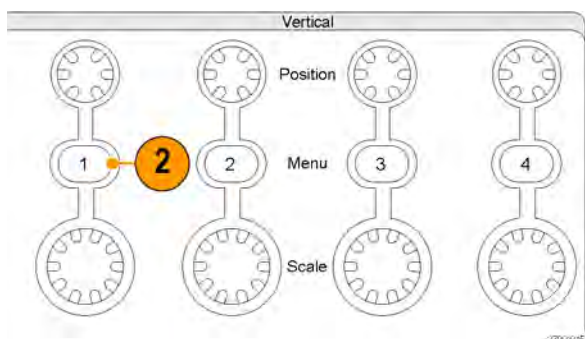

MSO5000B and DPO5000B Series

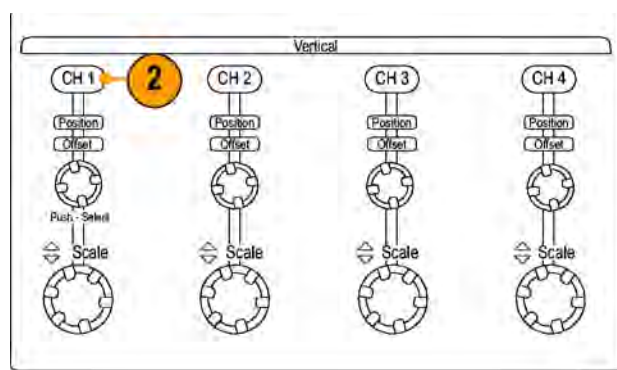

MSO/DPO7000DX, MSO/DPO70000C, and DPO7000C Series

3. Push **Autoset**.
4. Adjust the vertical position, scale, and offset using the front-panel knobs.

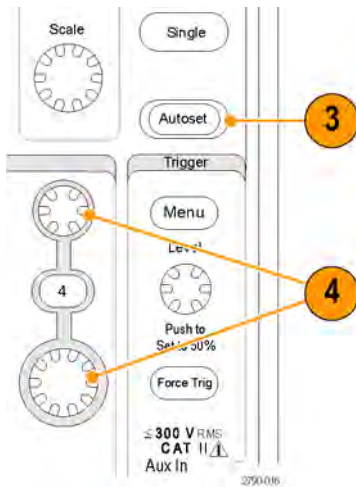

MSO5000B and DPO5000B Series

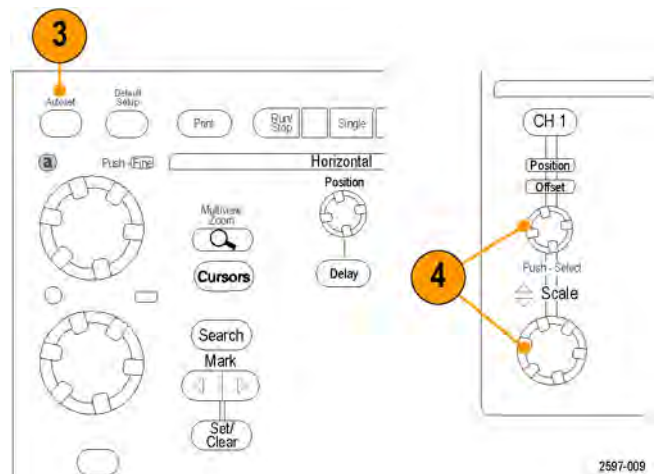

MSO/DPO70000DX, MSO/DPO70000C, and DPO7000C Series

5. Adjust the horizontal position and scale using the front-panel knobs.  
The horizontal position determines the number of pretrigger and posttrigger samples.

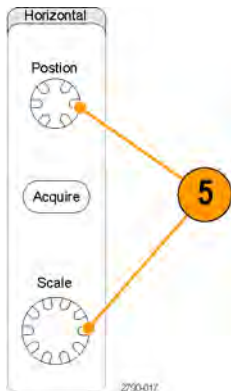

MSO5000B and DPO5000B Series

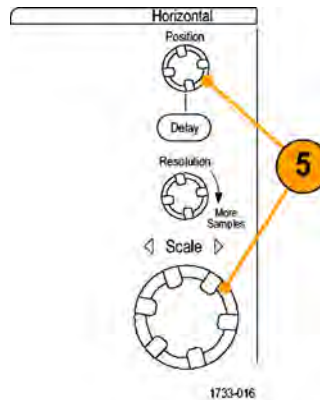

MSO/DPO70000DX, MSO/DPO70000C, and DPO7000C Series



## Using Default Setup

1. To quickly return to the factory default settings, push **DEFAULT SETUP**.

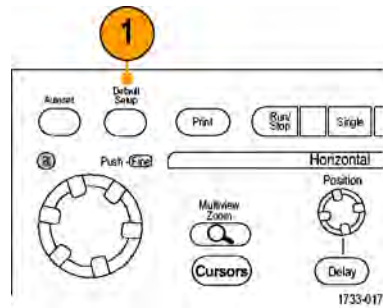

MSO/DPO70000DX, MSO/DPO70000C, and DPO7000C Series

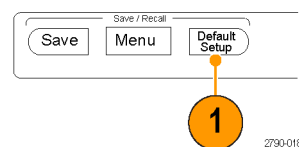

MSO5000B and DPO5000B Series

## Using Autose

Use Autose to quickly and automatically set up the instrument (acquisition, horizontal, trigger, and vertical) based on the characteristics of the input signal. Autose makes adjustments to the signal such that the waveform displays two or three cycles with the trigger level near the midlevel.

1. Connect the probe, and then select the input channel. (See page 33, *Setting up analog signal input.*)
2. Push the **AUTOSET** button to execute an Autose.

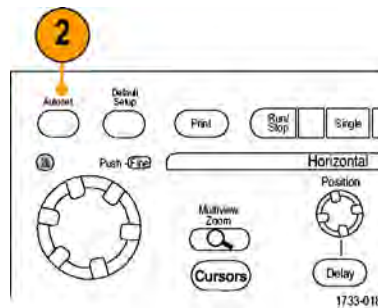

MSO/DPO70000DX, MSO/DPO70000C, and DPO7000C Series

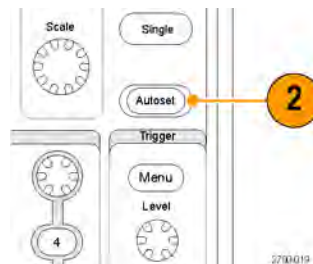

MSO5000B and DPO5000B Series

3. Click **Undo** to undo the last Autose. Parameters that are not affected by Autose retain their settings.

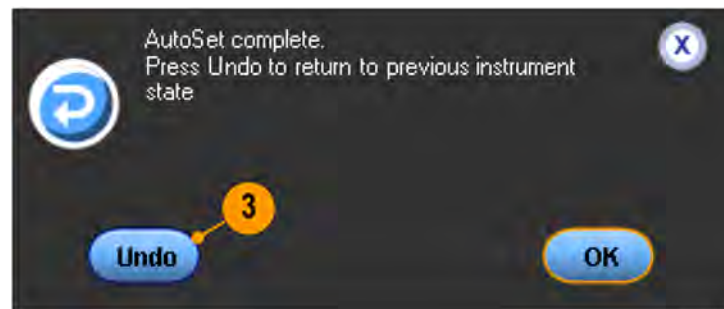

1733-058

### Quick tips

- Autose automatically sets up the analog channels.
- On instruments with iCapture, autose automatically sets up the iCapture channels.

- To position the waveform appropriately, Autoset may change the vertical position. Autoset may also adjust vertical offset.
- If you use Autoset when one or more channels are displayed, the instrument selects the lowest numbered channel for horizontal scaling and triggering. You can individually control the vertical scaling of each channel.
- If you use Autoset when no channels are displayed, the instrument turns on channel one (Ch 1) and scales it.
- Close Autoset Undo control window by clicking the X. After Autoset Undo closes, you can still undo the last Autoset by selecting the Undo Last Autoset command from the Edit menu.
- Stop the Autoset Undo control window from opening automatically by changing the User Preferences in the Utilities menu.

## Probe compensation and deskew

To optimize measurement accuracy, see the instrument online help to perform the following procedures:

- Compensate passive probes
- Compensate active probes
- Deskew input channels

## Acquisition concepts

### Acquisition hardware

Before a signal is displayed, it must pass through the input channel where it is scaled and digitized. Each channel has a dedicated input amplifier and digitizer. Each channel produces a stream of digital data from which the instrument extracts waveform records.

### Sampling process

Acquisition is the process of sampling an analog signal, converting it into digital data, and assembling it into a waveform record, which is then stored in acquisition memory.

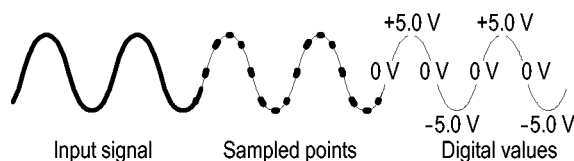

### Real-Time sampling

In real-time sampling, the instrument digitizes all of the points it acquires using one trigger event. Use real-time sampling to capture single-shot or transient events.

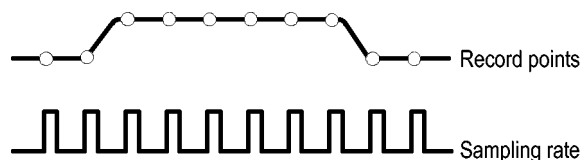

## Interpolated Real-Time sampling

In interpolated real-time sampling, the instrument digitizes all of the points it acquires using one trigger event. If the instrument cannot acquire enough samples for a complete waveform at the maximum real-time sample rate, it interpolates. Use interpolated real-time sampling to capture single-shot or transient events.

## Equivalent-Time sampling

The instrument uses equivalent-time sampling to extend its sample rate beyond its real-time maximum sampling rate. Equivalent-time sampling is only used if Equivalent Time is selected and the time base is set to a sampling rate that is too fast to create a waveform record using real-time sampling.

The instrument makes multiple acquisitions of a repetitive waveform to obtain the sample density required for one complete waveform record. Thus, equivalent time sampling should only be used with repetitive signals.

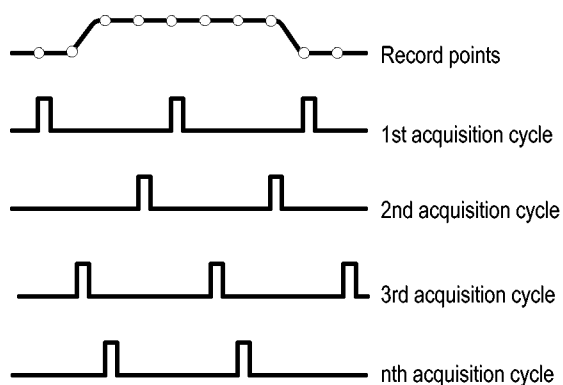

## Waveform record

The instrument builds the waveform record through use of the following parameters:

- **Sample interval:** The time between sample points.
- **Record length:** The number of samples required to fill a waveform record.
- **Trigger point:** The zero time reference in a waveform record.
- **Horizontal position:** When horizontal delay is off, the horizontal position is a percentage of the waveform record between 0 and 99.9 percent. The trigger point and the horizontal reference are at the same time in the waveform record. For example, if the horizontal position is 50 percent, then the trigger point is in the middle of the waveform record. When horizontal delay is on, the time from the trigger point to the horizontal reference is the horizontal delay.

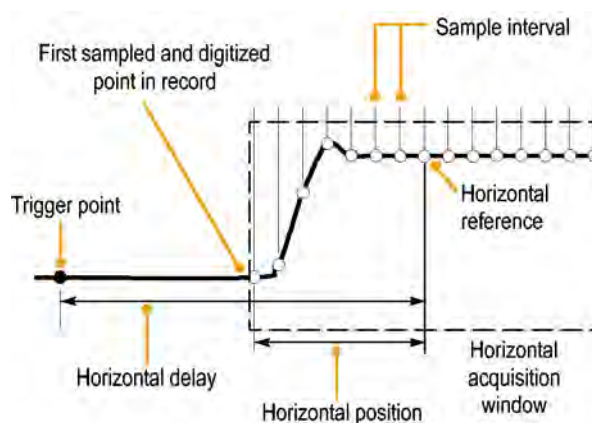

## Interpolation

Your instrument can interpolate between the samples it acquires when it does not have all of the actual samples it needs to fill the waveform record. Linear interpolation computes record points between actual acquired samples by using a straight line fit.

Sin(x)/x interpolation computes record points using a curve fit between the actual values acquired. Sin(x)/x interpolation is the default interpolation mode because it requires fewer actual sample points than linear interpolation to accurately represent the waveform.

## How the acquisition modes work

**Sample** mode retains the first sampled point from each acquisition interval. Sample is the default mode.

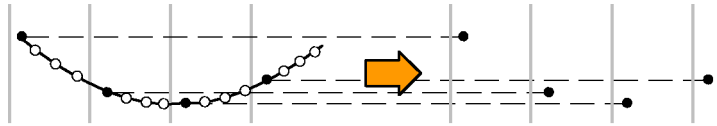

**Peak Detect** mode uses the highest and lowest of all the samples contained in two consecutive acquisition intervals. This mode only works with real-time, noninterpolated sampling and is useful for catching high frequency glitches.

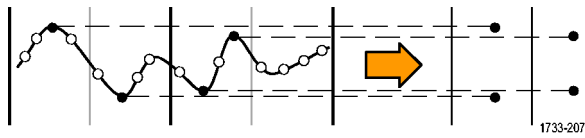

**Hi Res** calculates the average of all the samples for each acquisition interval. Hi-Res provides a higher-resolution, lower-bandwidth waveform.

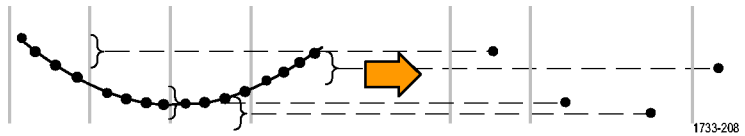

**Envelope** mode finds the highest and lowest record points over many acquisitions. Envelope uses Peak Detect for each individual acquisition.



**Average** mode calculates the average value for each record point over many acquisitions. Average uses Sample mode for each individual acquisition. Use average mode to reduce random noise.

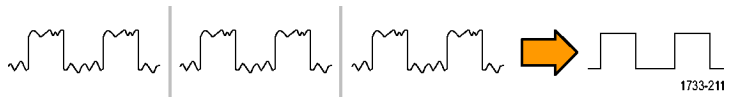

**Waveform Database** mode is a three-dimensional accumulation of source waveform data over several acquisitions. In addition to amplitude and timing information, the database includes a count of the number of times a specific waveform point (time and amplitude) was acquired.



## Enable enhanced effective number of bits

Use this control, in the Acquisition tab, to turn the Enhanced Effective Number of Bits (ENOB) on or off to optimize waveform detail. This control is only available on MSO/DPO7000DX models.

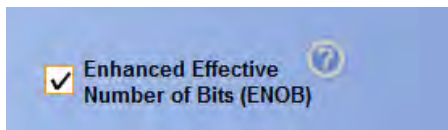

1. Click the **Enhanced Effective Number of Bits** check box to turn ENOB On or Off. You will find this control in the Acquisitions tab of the Horizontal/Acquisition control window.

Enhanced Effective Number of Bits enables interleave correction DSP that improves the effective number of bits. This control is only available in some instrument models. This control is not available in Hi Res mode.

When Enhanced Effective Number of Bits is enabled, EB+ is displayed in the horizontal/acquisition readout.

## Changing the acquisition mode

Use this procedure to change the acquisition mode.

1. Select **Horiz/Acq > Acquisition Mode**.
2. To select an acquisition mode, do one of the following:
  - Select an acquisition mode directly from the menu.
  - Click **Mode...**, and then select an acquisition mode.



3. For Average or Envelope acquisition modes, click the **# of Wfms** control, and then set the number of waveforms with the multipurpose knob. For WfmDB mode, click the **Samples** control, and then set the number of samples with the multipurpose knob.



### Quick tip

- Click the keypad icon to set the number of waveforms or samples.



## Starting and stopping an acquisition

After the channels that you want to acquire are selected, use the following procedure.

1. Push the front-panel **RUN/STOP** button to start the acquisition.
2. Push the **RUN/STOP** button again to stop the acquisition.
3. To take a single acquisition, push the **Single** button.

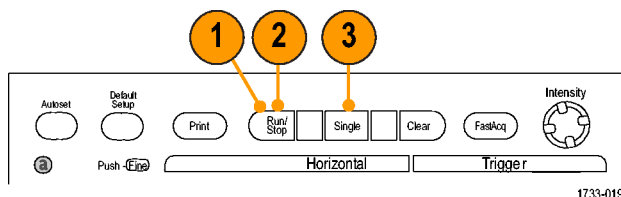

MSO/DPO70000DX, MSO/DPO70000C, and DPO7000C Series

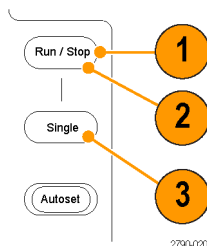

MSO5000B and DPO5000B Series

## Selecting the horizontal mode

Your instrument has three horizontal modes. Automatic is the default mode. Select the horizontal mode that works best for your test setup.

To set the horizontal mode, select **Horiz/Acq** > **Horizontal/Acquisition Setup** to display the horizontal control window. Choose one of the modes described below.



In Automatic mode you can set the Scale and Sample Rate. Record length is a dependent variable. If changing the scale would cause the record length to exceed the Record Length Limit, the sample rate is decreased to the next available setting.

If the sampling mode is real time and the sample rate is at the real time limit, attempting to increase the sample rate has no effect.

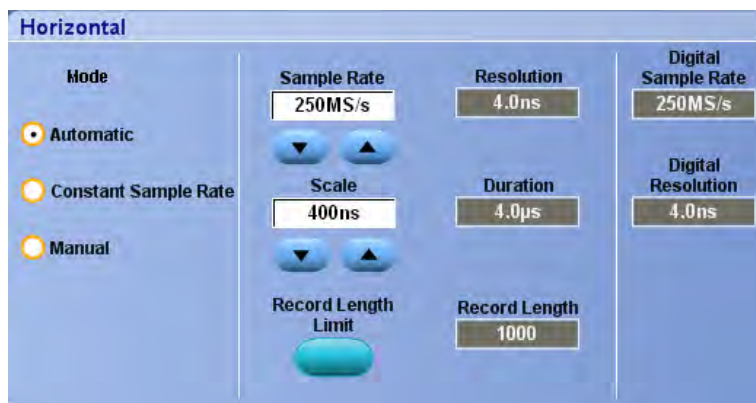

To set the Record Length Limit, click **Record Length Limit** and set the limit using the buttons or keypad. The default maximum limit depends on your instrument model and record length option.

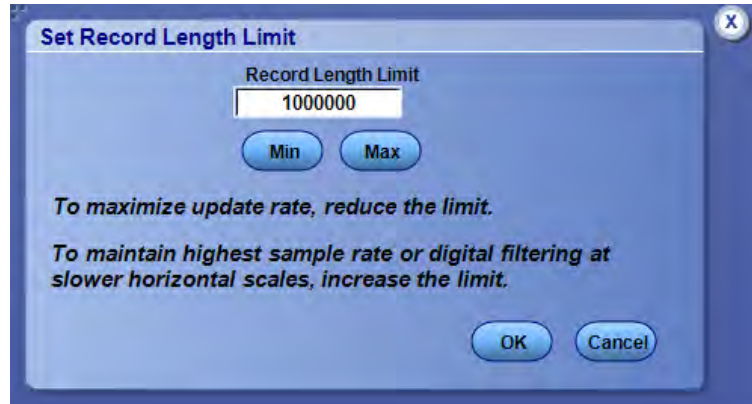

In Constant Sample Rate mode you can set the Sample Rate and Scale. The default sample rate ensures bandwidth filter operation. Record length is a dependent variable. The maximum record length depends on your instrument model and record length option.

The front-panel resolution knob changes the sample rate in both automatic and constant sample rate modes.

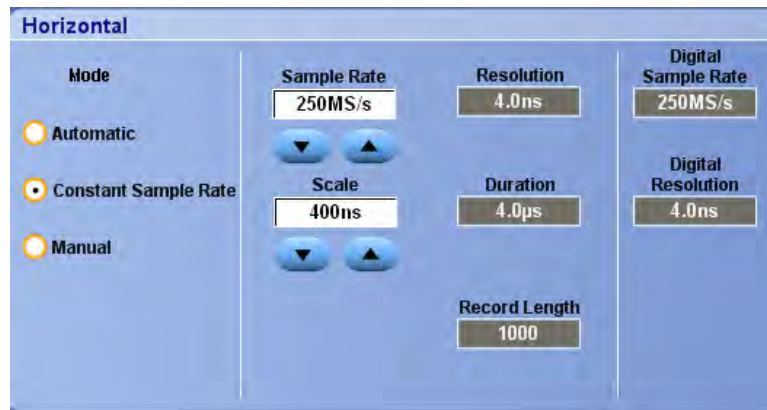

In Manual mode you can set the Sample Rate and Record Length. Horizontal Scale is a dependent variable calculated from the sample rate and record length.

The Horizontal Scale knob changes record length in manual mode.



All three modes interact with sample rate, scale, and record length as shown. The horizontal line is the maximum real-time sample rate. Each staircase shows that as you increase the scale, the sample rate must decrease when either the maximum record length or the record length limit you set is reached. Manual mode uses the maximum record length.

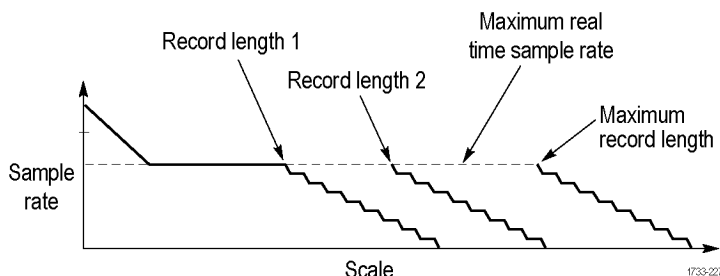

Automatic and Constant Sample Rate modes are identical. However, Constant Sample Rate mode keeps the sample rate constant at a rate that guarantees bandwidth enhancement filters are used.

**Quick tips**

- Digital sample rate and resolution are dependent variables, and are controlled by the analog sample rate selection.

## Using FastAcq

Fast acquisition mode reduces the dead time between waveform acquisitions, enabling the capture and display of transient events such as glitches or runt pulses. Fast acquisition mode can also display waveform phenomena at an intensity that reflects their rate-of-occurrence.

### 1. Push **FastAcq**.

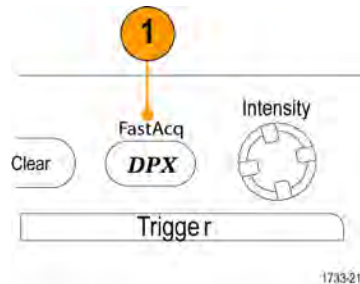

MSO/DPO70000DX, MSO/DPO70000C, and DPO7000C Series

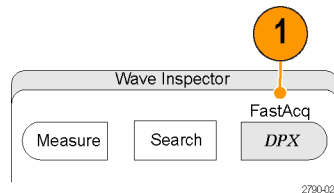

MSO5000B and DPO5000B Series

### 2. Find glitches, transients, or other random events.

When you have identified an anomaly, set the trigger system up to look for it. (See page 168, *Capturing intermittent anomalies*.)

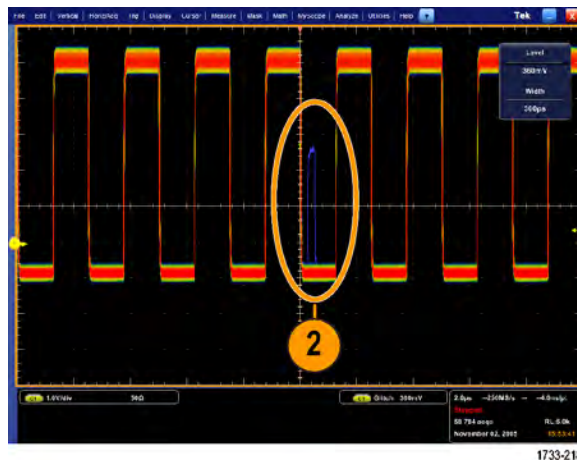

### Quick tips

- Digital channels and buses are not available in FastAcq mode.
- To optimize for capturing details or rare events, select **Horiz/Acq > Horizontal/Acquisition Setup > Acquisition > Fast Acq**, and then select Optimize For **Capturing Details** or **Capturing rare events**.

## Using DSP enhanced bandwidth

If your instrument has the enhanced bandwidth feature, use the DSP (digital signal processing) enhanced bandwidth for more accurate rise time measurements, to extend the bandwidth, and flatten the passband at the full sample rate. The enhanced bandwidth provides a matched response across enabled channels so you can perform channel-to-channel comparison and differential measurements.

1. Push **AUTOSET** to set the horizontal, vertical, and trigger controls or set the controls manually.

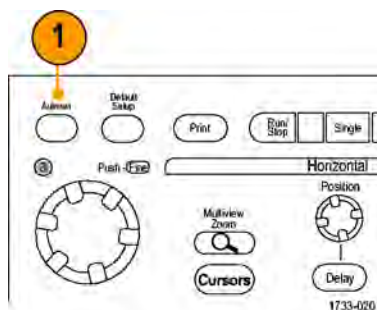

MSO/DPO70000DX, MSO/DPO70000C, and DPO7000C Series

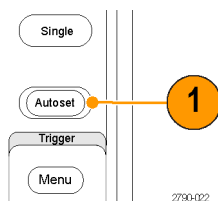

MSO5000B and DPO5000B Series

2. Select **Vertical > Bandwidth Enhanced...**

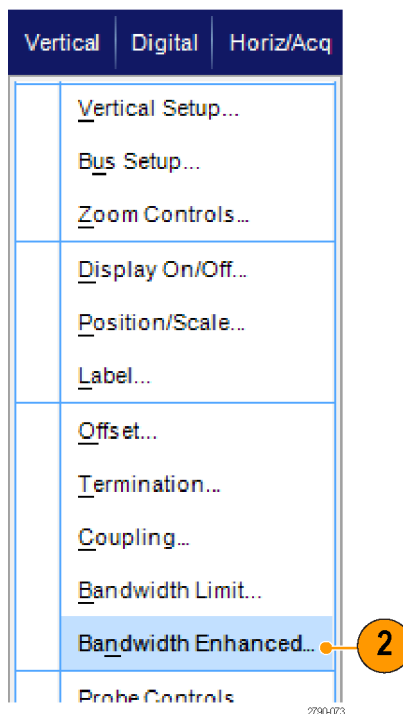

- Click **Digital Filters (DSP) Enabled** to turn the enhanced bandwidth on. You must set the sample rate correctly to enable DSP.
- To force a constant sample rate that enables DSP filters, check **Force Constant Sample Rate**.

**NOTE.** *If not already set, selecting Constant Sample rate sets the horizontal mode to constant sample rate, sets the sample rate to allow DSP, and selects a DSP bandwidth.*

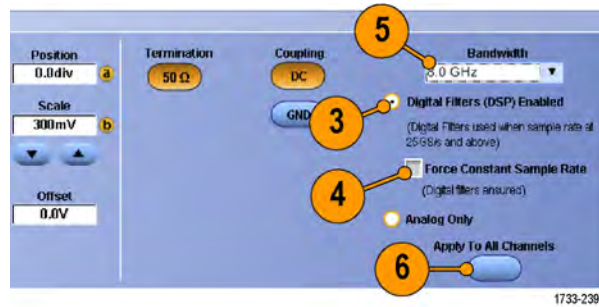

- Select the desired bandwidth from the **Bandwidth** list.  
The available bandwidth selections depend on your instrument, probe, and probe tip.  
Selecting Analog Only selects a hardware (HW) bandwidth.
- To apply your selections to all channels, check **Apply To All Channels**.  
When different probing makes it impossible for the instrument to set all channels the same, the instrument sets each channel to the closest bandwidth value possible.

The bandwidth indicator appears in the vertical readout when the enhanced bandwidth is turned on.



### Quick tips

- Right click the waveform handle to display a menu where you can select the channel bandwidth and other bandwidth enhanced settings.
- The DSP enhanced bandwidth occurs at maximum sample rate.
- Use the DSP enhanced bandwidth when your signals have rise times less than 50 ps.
- Select Analog Only for higher waveform throughput, overdriven signals, and when you prefer to use your own DSP post-processing.
- You can limit the instrument bandwidth by selecting Vertical > Bandwidth Limit and then selecting the bandwidth.

## Setting the Termination Voltage

Termination voltage adjustment is only available on MSO/DPO70000DX models.

Oscilloscope inputs have traditionally been terminated to ground. The signals being measured often are not ground referenced. Pulling signals to ground can impair measurement results or potentially damage the DUT.

The instrument delivers a variable termination voltage up to  $\pm 3.4$  volts to the device under test (DUT), and supports a large offset range. This allows you to adjust the oscilloscope to mirror the conditions and behavior of the DUT, and measure high-speed signals in an environment similar to the one in which they operate.

Using the combination of termination voltage and offset to center the oscilloscope reference point in the operating range of the DUT maximizes the available dynamic range and minimizes the noise of the measurement system.

To set the termination voltage of a channel, do these steps:

1. Select **Vertical > Vertical Setup**.

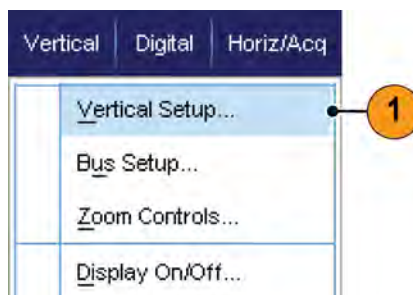

2. Click in the Termination Voltage field. Set the termination voltage using the keypad or multipurpose knobs.

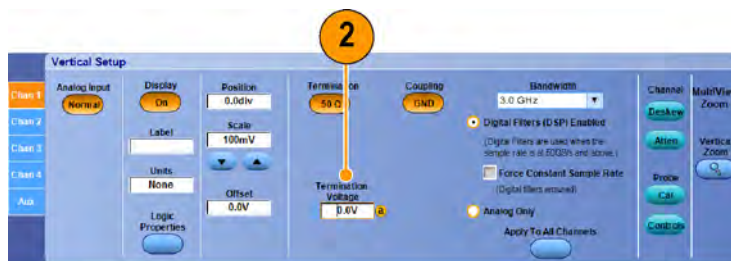

2980-024

## Using Roll Mode

Roll mode gives a display similar to a strip chart recorder for low-frequency signals. Roll mode displays acquired data points without waiting for the acquisition of a complete waveform record.

1. Select **Horiz/Acq > Horizontal/Acquisition Setup....**

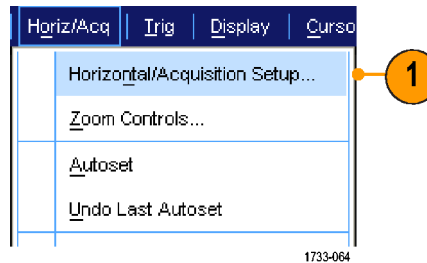

2. If not selected, click the **Acquisition** tab. Click **Auto** to turn on Roll mode.

**NOTE.** Roll mode requires *Sample, Peak Detect, or Hi Res acquisition mode.*

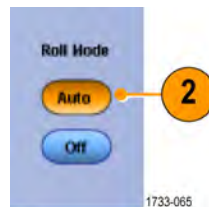

3. To stop acquisitions in Roll mode:

- If you are not in Single Sequence, push **RUN/STOP** to stop Roll mode.
- If you are in Single Sequence, Roll mode acquisitions stop automatically when a complete record is acquired.

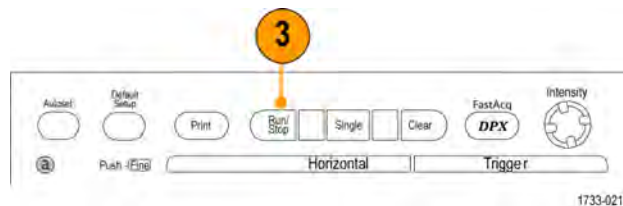

MSO/DPO70000DX, MSO/DPO70000C, and DPO7000C Series

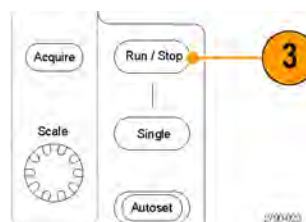

MSO5000B and DPO5000B Series

### Quick tips

- Switching to Envelope, Average, or WfmDB acquisition mode will turn off Roll mode.
- Roll mode is disabled when you set the horizontal scale to 50 ms per division or faster.



## Setting up digital signal input

Use Digital setup menus to set up the digital channels to acquire signals. Digital channels are available only on MSO7000C/DX and MSO5000B Series instruments, DPO5000B Series instruments with option MSOE installed, and DPO7000DX instruments with option MSOU installed.

1. Connect the logic probe to the instrument.
2. Connect the probe to the input signal sources.



**CAUTION.** To prevent damage to the instrument always wear an antistatic wrist strap when making connections to the instrument and observe the maximum input voltage ratings for input connectors.

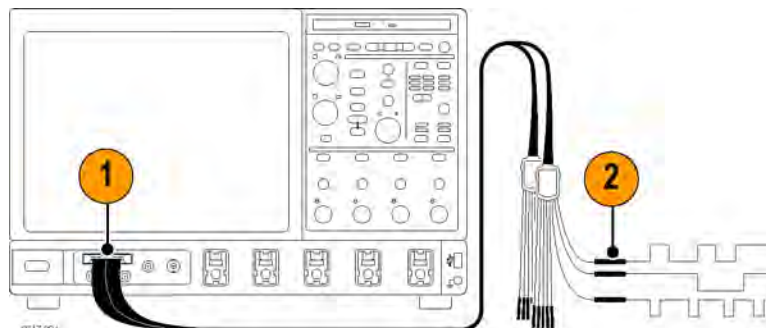

MSO7000C/DX and DPO7000DX Series

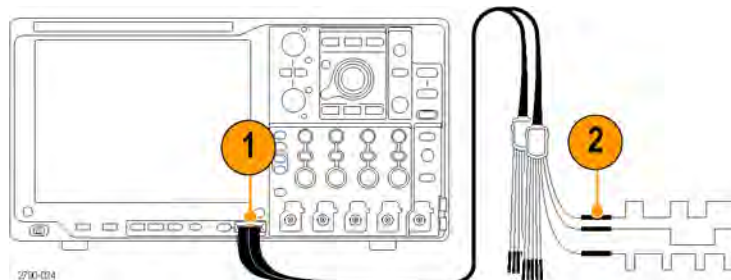

MSO5000B and DPO5000B Series

3. Set up digital channels and buses using the Digital menus.

(See page 52, *Setting up digital channels.*)  
and (See page 53, *Setting up a bus.*)



## Setting up digital channels

You can set a digital channel threshold, size, position and label on MSO7000C/DX and MSO5000B Series instruments, DPO5000B Series instruments with option MSOE installed, and DPO7000DX instruments with option MSOU installed.

1. Select **Digital > Digital Setup**.



2. Select the **D7 - D0** or **D15 - D8** tab for the digital channels you want to set up.
3. Click a digital channel button to toggle the display of the digital channel on or off.

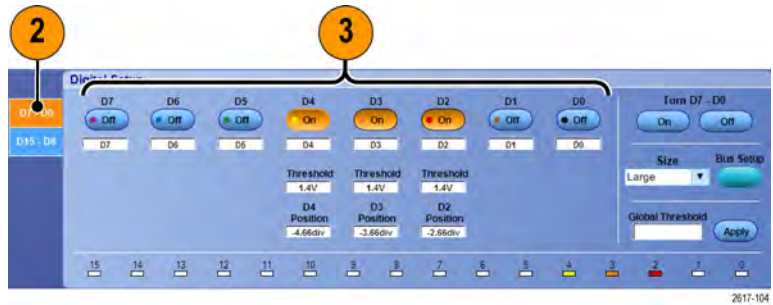

4. Click **Threshold** or **Position** and adjust them using the keyboard or multipurpose knobs. Or, set the threshold of all 16 channels by entering a Global Threshold value and clicking **Apply**.

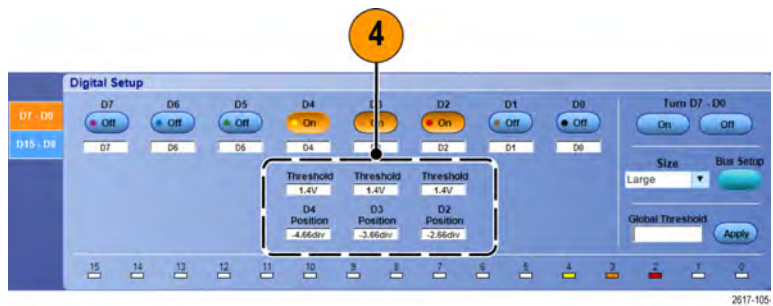

- To change the displayed vertical size of all digital channels, click Size and select the display size from the list.

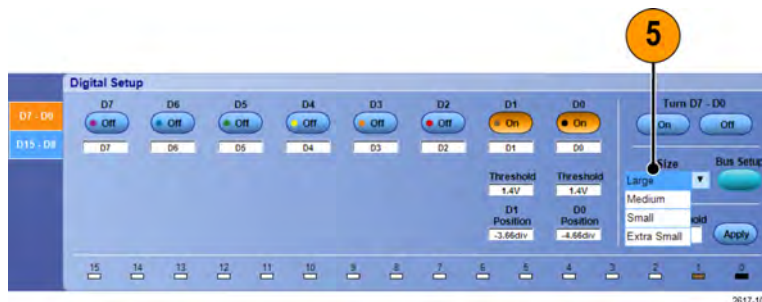

- To change a digital channel label, click the label and enter a new label using the keyboard.

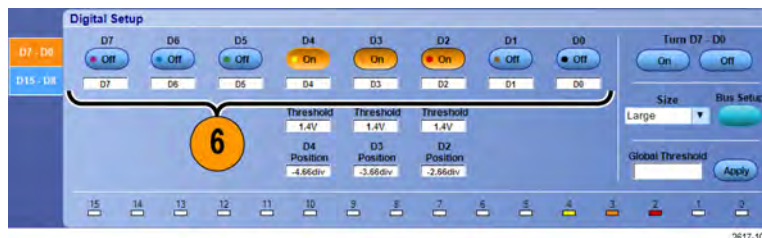

## Setting up a bus

You can set up serial (optional) and parallel buses.

- Select **Vertical > Bus Setup** or, on some instruments, **Digital > Bus Setup**.

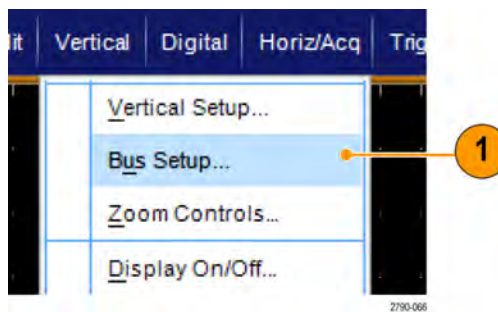

- Select the **Config** tab.



3. Scroll to, and then select the bus to set up.
4. To toggle the display of the bus on or off, click the **Bus** button.

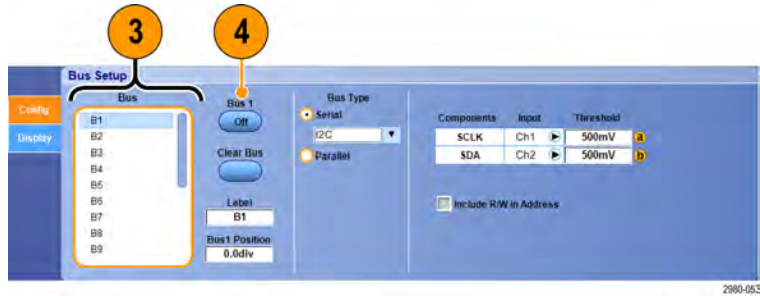

5. To change the default label of the bus, click **Label** and enter a new label using the keyboard.
6. To change the displayed position of the bus, click **Bus Position** and use the keyboard or multipurpose knob to enter a new bus position.



7. To select the bus type, click Bus Type **Serial** or **Parallel**.

You can set up each bus type.  
 (See page 55, *Set up a serial bus.*) or (See page 56, *Set up a parallel bus.*)

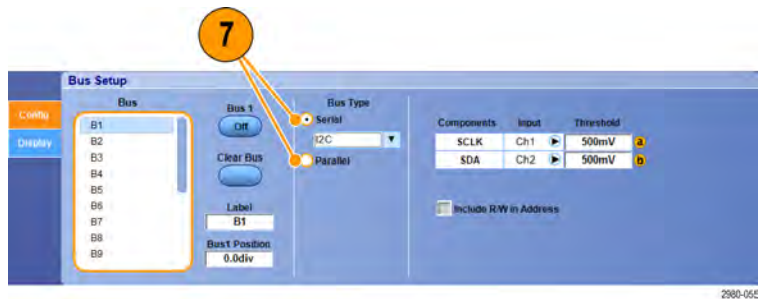

### Quick tips

- Position a bus or waveform by clicking on the bus or waveform handle and dragging the handle to the desired position.

## Set up a serial bus

You can set serial (optional) bus parameters. You can use digital channels in bus definitions on MSO Series instruments only.

1. To set up a serial bus, select Bus Type **Serial** and select the type of serial bus from the drop-down list. Each bus type has its own collection of parameters that you set up. Set up other bus types as appropriate for the selected bus.

See the online help for additional help setting up a bus.

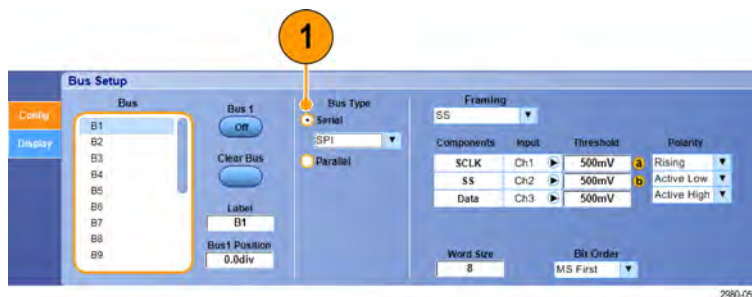

2. To select the input for the displayed components of the bus, click the component **Input** and select from the displayed list.

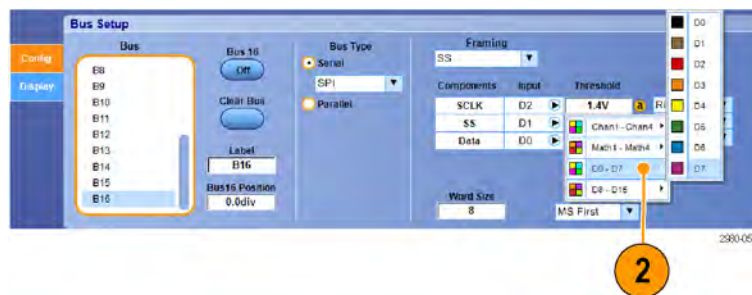

3. To set an input threshold, double click Threshold and enter the threshold using the keypad.

**NOTE.** To set thresholds independently when they are currently shared, go to **Trig > A Event (Main) Trigger Setup** and change **Settings to Independent**.

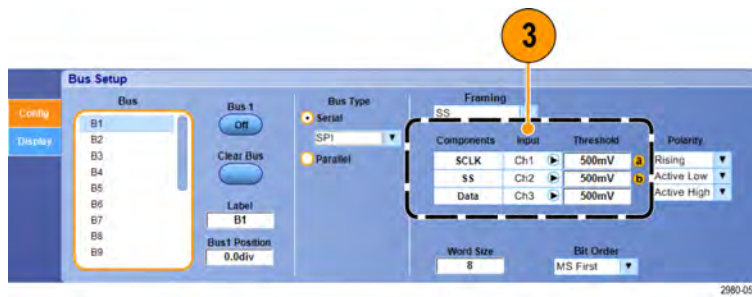

4. To select the polarity for the displayed components of the bus, click the component **Polarity** and select from the displayed list.

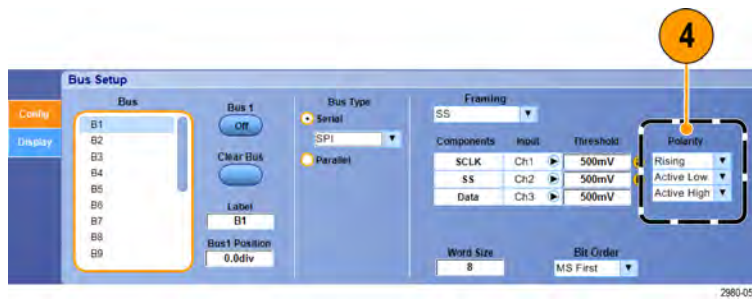

## Quick tips

- To use a custom serial decoder, see the online help.

## Set up a parallel bus

You can set parallel bus parameters. You can use digital channels in bus definitions on MSO Series instruments only.

1. To set up a parallel bus, select Bus Type **Parallel**.

See the online help for additional help setting up a bus.

2. To add sources to the bus, click the Add Sources **Select** button.

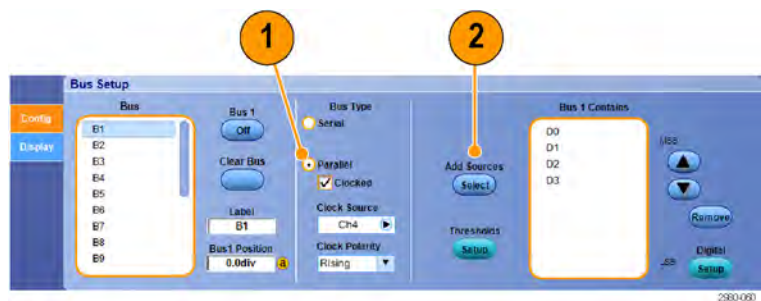

3. Click the button for each channel you want in the bus. The order of the parallel bus is determined by the order in which you select the channels. Digital channels are available as sources only on MSO Series instruments.

4. Click the **OK** button.

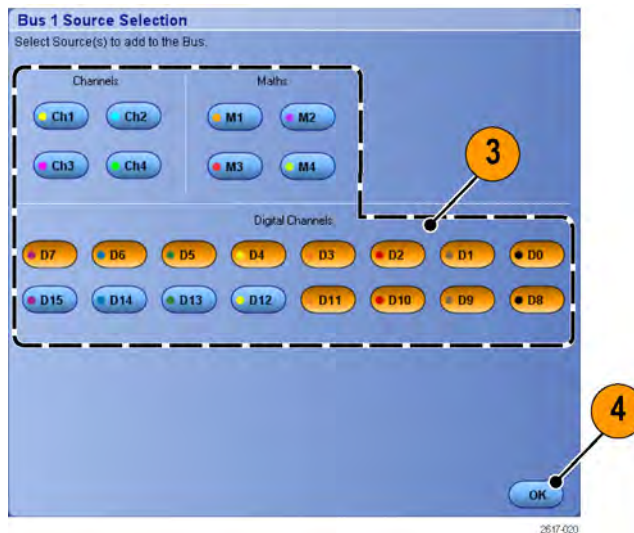

5. To move a channel within the bus, scroll to and select the channel you want to move, and then click the up or down arrow buttons.
6. To remove a channel within the bus, scroll to and select the channel you want to remove, and then click the **Remove** button.
7. To set channel thresholds, click the Thresholds **Setup** button.
8. For each threshold you want to set, double click the channel Threshold, and enter the threshold using the keypad or multipurpose knobs.
9. When the desired thresholds have been set, click the **OK** button.
10. To set all channels to the same threshold, double click **Digital Threshold** and use the keypad to enter a threshold. Then click **Apply**.
11. On MSO70000C/DX instruments, to set the clock source and polarity, double click the item and select from the displayed list. To set the clock level, double click the Clock Level, and enter the level using the keypad or multipurpose knobs.

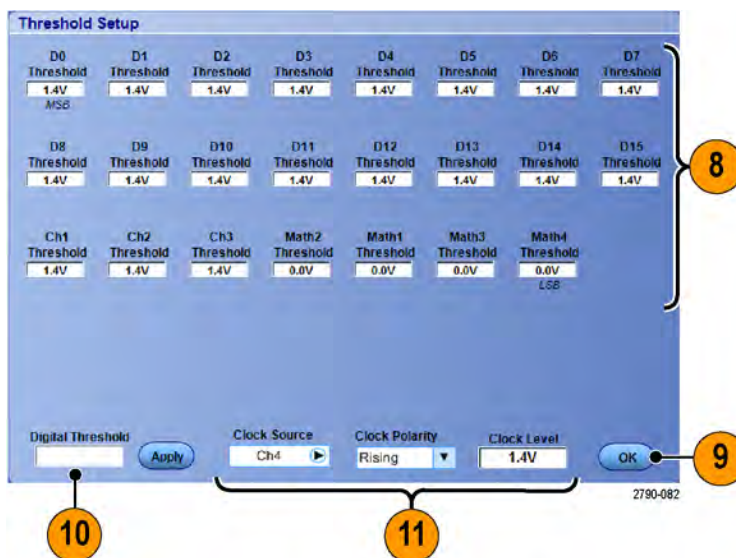
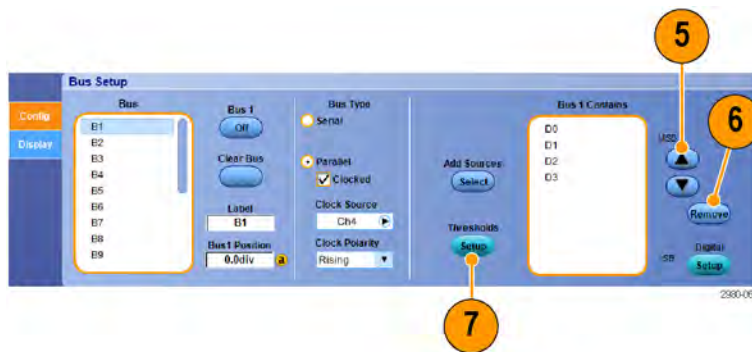

## Set up bus display

You can set the bus style and decoding. You can use digital channels in bus definitions on MSO Series instruments only.

1. Select **Digital > Bus Setup**.



2. Select the **Display** tab.
3. To select the bus, scroll to display the bus, and then select the bus.
4. Select the decoding from the bus decoding list.

See the online help for information on the Results Table.



5. Click a + box to expand (display additional) the views, or click a - box to collapse (remove) views.

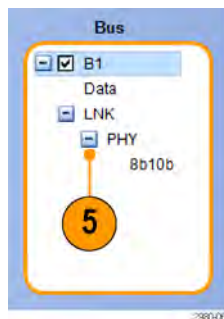



6. Bus views may also be added or removed from the display by clicking on the + box or - box in the display. Available views may include Transaction/transport, link/framing/packets, physical/bytes/symbols, and bit level.

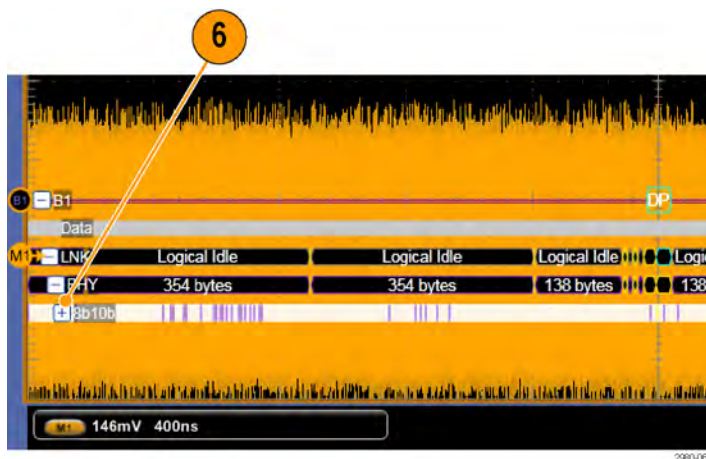

7. If using a symbol table, check **Use Symbol File**. Click **Browse** and browse to the symbol table file.

For some buses other settings are available. Set the other settings as appropriate for your bus.

See the online help for additional help setting up a bus.

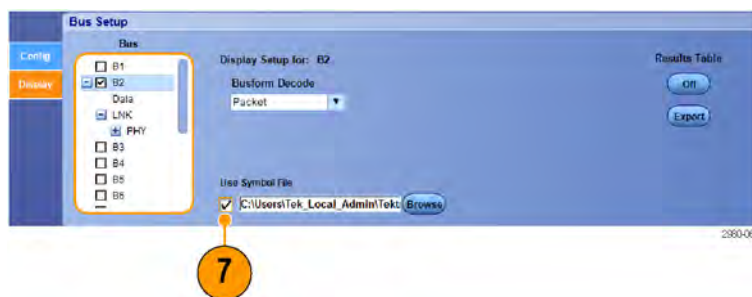

## When and why to turn on MagniVu

For the MSO5000B Series, MagniVu gives you higher resolution to accurately determine edge placement. This helps you make precise timing measurements on digital edges. You can see up to 32 times more detail than with normal digital channel sampling.

The MagniVu record is acquired in parallel to the main digital acquisition and is available at any time, running or stopped. MagniVu provides an ultra high resolution view of your data sampled at a maximum resolution of 60.6 ps for 10,000 points centered around the trigger.

---

**NOTE.** *MagniVu centers itself around the trigger point. If you turn MagniVu on while using a large record length and you are looking somewhere other than the trigger point, then the digital signal may be off screen. In most of these cases, you can find the digital record by looking for the digital signal in the upper overview and panning accordingly.*

---

## Using MagniVu

1. Push **D15 – D0**.

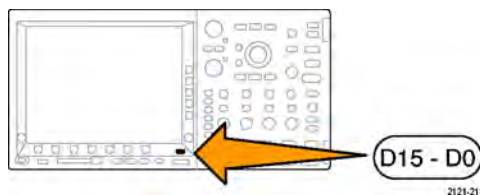

2. Select **Digital > MagniVu** to toggle MagniVu On.

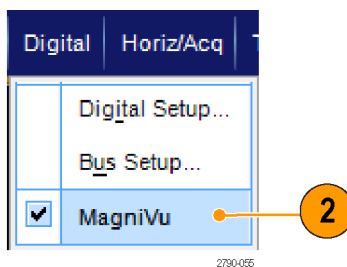

### Quick tips

- If you think you need more timing resolution, turn on MagniVu to increase the resolution.
- MagniVu is always acquired. If the oscilloscope is in a stopped state, turn on MagniVu and still get the resolution without taking another acquisition.

## Viewing analog characteristics of digital waveforms

iCapture allows you to view the analog characteristics of digital channel signals. Additional measurement capabilities are available while viewing the analog characteristics of a waveform. iCapture is available on MSO70000C/DX Series instruments and on DPO70000DX instruments with option MSOU installed..

1. Select **Vertical > Vertical Setup**.

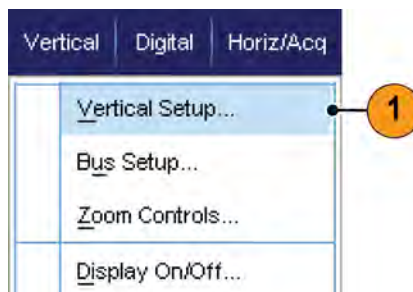

2. Press the Digital Input **iCapture** button.



3. Click **Digital Source** and select a digital channel to send through the analog input.



- To set channel thresholds used when converting an analog waveform to digital format for inclusion in a bus, click the **Logic Properties** button.

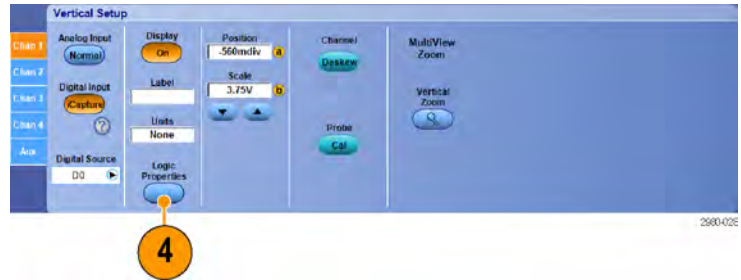

- To choose whether to share threshold settings or have independent threshold settings, click **Channel Settings** and select **Shared** or **Independent** from the list.
- For each threshold you want to set, click the channel threshold. Set the threshold using the keypad or multipurpose knobs.
- When the required thresholds have been set, click the **OK** button.

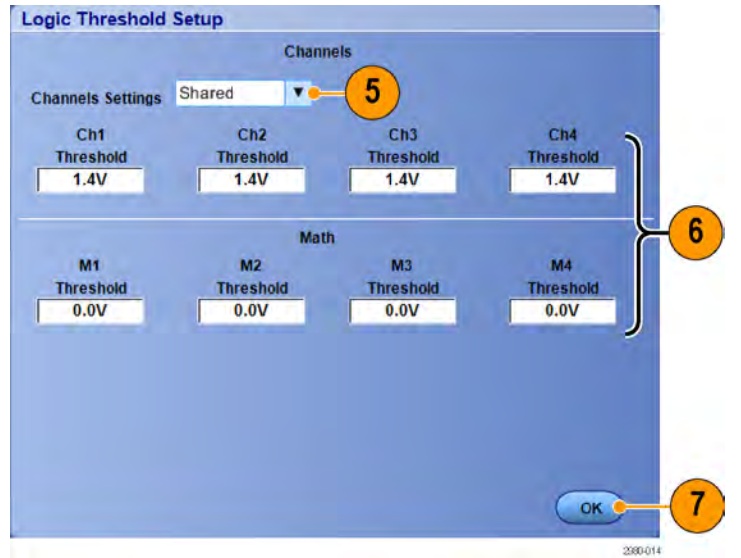

### Quick tips

- If using iCapture on an MSO70000DX, you can select the digital source as the trigger signal. The MSO70000C continues to trigger on the analog channel even though that channel is selected for iCapture of a digital channel.

## Using FastFrame mode

FastFrame allows you to capture many trigger events as single records in a larger record, and then view and measure each record individually. Time Stamps display the absolute trigger time for a specific frame and the relative time between triggers of two specified frames.

1. Push **AUTOSET** to set the horizontal, vertical, and trigger controls or set the controls manually.

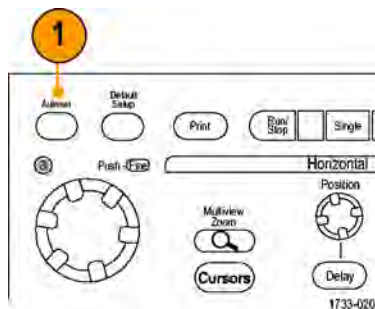

MSO/DPO70000DX, MSO/DPO70000C, and DPO7000C Series

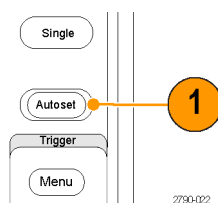

MSO5000B and DPO5000B Series

2. Select **Horiz/Acq > FastFrame Setup...**

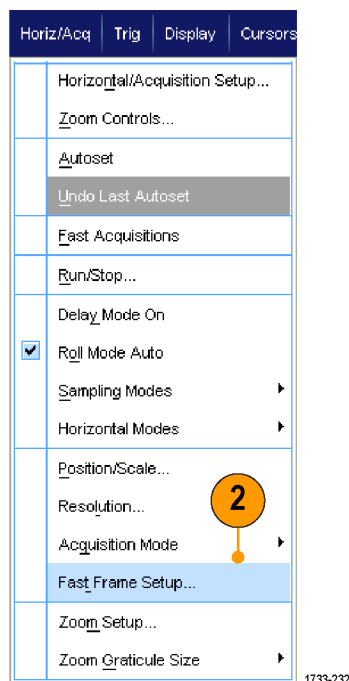

3. Push FastFrame to toggle it On.
4. Select **Frame Size** and **# of Events Frames**. Then use the multipurpose knobs to set each one. Number of frames represents the number of trigger events that are captured. Frame size is the number of samples that are stored with each trigger event (or frame). The number of frames is reduced if there is insufficient memory to store all the records. The shorter the frame length, the more frames you can acquire.

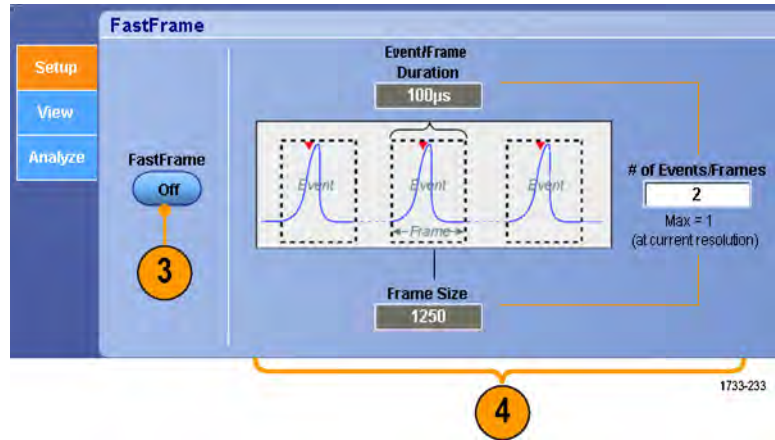

5. Use the Frame Viewing controls to select the frame that you want to view.
6. To view multiple frames superimposed over each other, select Overlay.

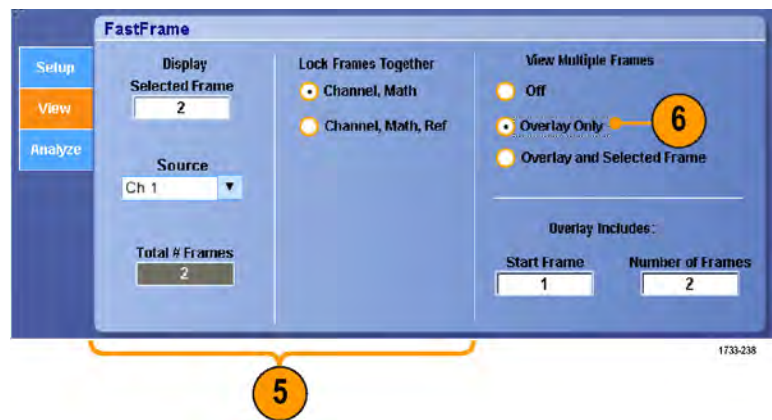

7. Use the Time Stamps controls to select the source for, and frame number of, the reference frame. The reference frame is the starting point when measuring the relative time between two frames.

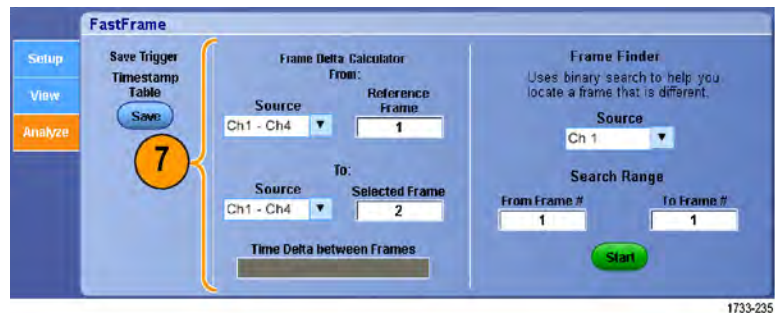

### Quick tips

- Digital channels and buses are not available in FastFrame mode.
- Use FastFrame when you want to preserve the data associated with each trigger event for further analysis or visual inspections.
- Use FastFrame when you want to capture multiple events that have long dead times between them that are of no interest to you.

- Multiple frames are best viewed with the Normal, Green, or Gray color palettes because the dark blue selected frame may be hard to distinguish if you use Temp or Spectral.
- If you select an Average Summary Frame, you can set Math functions (Averaging) to apply to All Frames or have it apply to Only the Summary Frame. If the summary data is of primary interest, selecting Summary Frame Only can substantially improve system throughput.

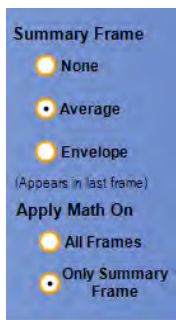

## Using FastFrame frame finder

Frame finder allows you to find a FastFrame frame that is different from other frames.

1. Select the source of the FastFrame frames.
2. Set the Search Range by entering the **From Frame #** and the **To Frame #**.

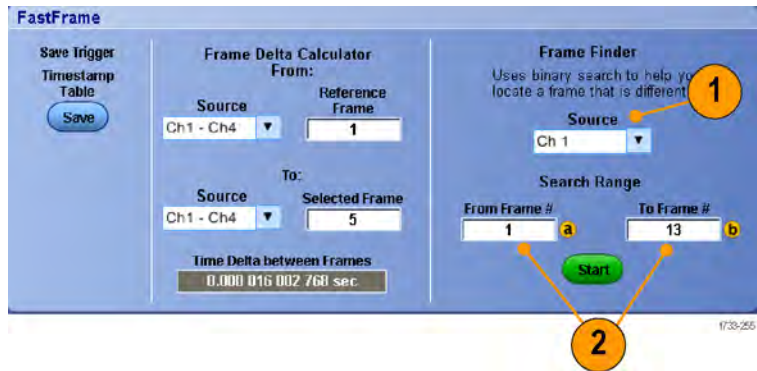

3. Push **Run/Stop** to stop acquisitions.

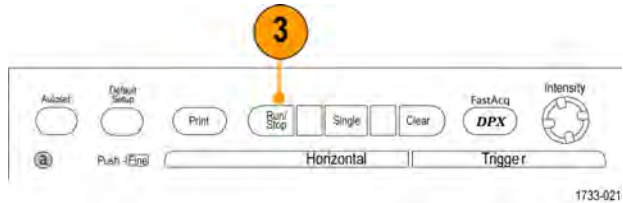

MSO/DPO7000DX, MSO/DPO7000C, and DPO7000C Series

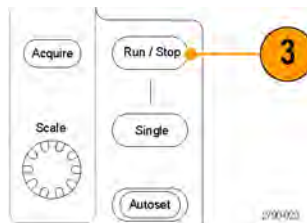

MSO5000B and DPO5000B Series

4. Push **Start** to start the search.

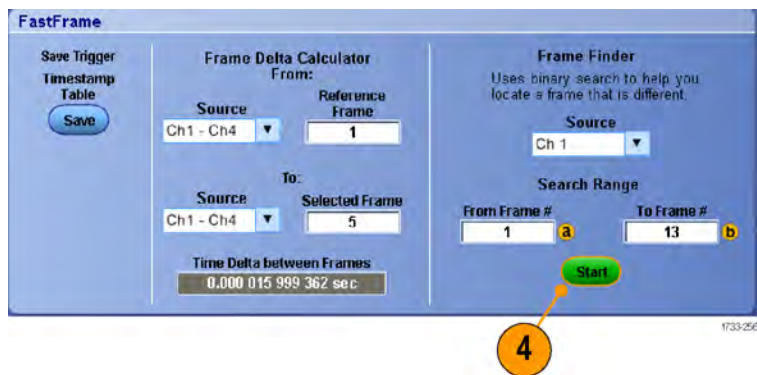



Frame Finder searches for and displays a different frame.

5. If the anomaly you are looking for is not in the displayed frame, push **No**. Frame Finder searches for another different frame.
6. If the anomaly you are looking for is in the displayed frame, push **Yes**.
7. If you are done searching, push **Stop**.

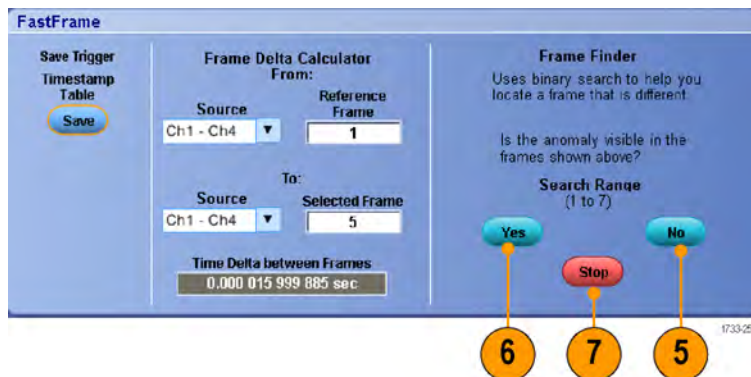

8. Push Run/Stop to restart acquisitions.

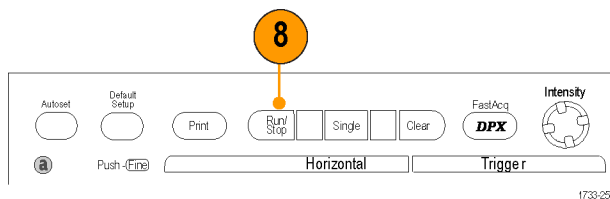

MSO/DPO7000DX, MSO/DPO7000C, and DPO7000C Series

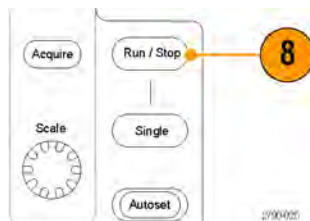

MSO5000B and DPO5000B Series

## Pinpoint triggers

The Pinpoint trigger system comes with advanced trigger types that are usable on both A and B triggers, and it can reset the trigger sequence if the B event does not occur after a specific number of events or a specific time. Pinpoint triggers support capture of events based on the most complex trigger event or sequence of trigger events.

Only a portion of the Pinpoint trigger functionality is available on MSO5000B and DPO5000B instruments.

This section contains concepts and procedures for using the trigger system.

## Triggering concepts

### Trigger event

The trigger event establishes the time-zero point in the waveform record. All waveform record data are located in time with respect to that point. The instrument continuously acquires and retains enough sample points to fill the pretrigger part of the waveform record. When a trigger event occurs, the instrument starts acquiring samples to build the posttrigger part of the waveform record (displayed after, or to the right of, the trigger event). Once a trigger is recognized, the instrument will not accept another trigger until the acquisition is complete and the holdoff time has expired.

### Trigger modes

The trigger mode determines how the instrument behaves in the absence of a trigger event:

- Normal trigger mode enables the instrument to acquire a waveform only when it is triggered. If no trigger occurs, the last waveform record acquired remains on the display. If no last waveform exists, no waveform is displayed.
- Auto trigger mode enables the instrument to acquire a waveform even if a trigger does not occur. Auto mode uses a timer that starts after a trigger event occurs. If another trigger event is not detected before the timer times out, the instrument forces a trigger. The length of time it waits for a trigger event depends on the time base setting.

Auto mode, when forcing triggers in the absence of valid triggering events, does not synchronize the waveform on the display. The waveform will appear to roll across the screen. If valid triggers occur, the display will become stable.

In edge-trigger mode, force the instrument to trigger by pushing the Force Trigger button on the Trigger Setup control window.

Select the trigger mode in the Trig > Mode menu. For more information, see the instrument online help.

### Trigger holdoff

Trigger holdoff can help stabilize triggering, by extending the period in which further trigger recognition is suppressed after initiating an acquisition. Such an extension can help the system skip over the remaining events of a recurring burst of events, and thus always trigger on the first event in each burst. Adjust holdoff to obtain stable triggering when the instrument is triggering on undesired trigger events.

Set the trigger holdoff in the Trig > Holdoff menu. For more information, see the instrument online help.

## Trigger coupling

Trigger coupling determines what part of the signal is passed to the trigger circuit. Edge triggering can use all available coupling types: AC, DC, Low Frequency Rejection, High Frequency Rejection, and Noise Rejection. All other trigger types use DC coupling only. Your instrument may not offer all coupling types.

Select the trigger coupling in the Trig > A Event (Main) Trigger Setup menu. For more information, see the instrument online help.

## Horizontal position

Horizontal position defines where the trigger occurs on the waveform record. It lets you choose how much the instrument acquires before and after the trigger event. The part of the record that occurs before the trigger is the pretrigger part. The part that occurs after the trigger is the posttrigger part.

Pretrigger data is valuable when troubleshooting. For example, if you are trying to find the cause of an unwanted glitch in your test circuit, trigger on the glitch and make the pretrigger period large enough to capture data before the glitch. By analyzing what happens before the glitch, you may uncover information that helps you find the source of the glitch. Alternatively, to see what is happening in your system as a result of the trigger event, make the posttrigger period large enough to capture data after the trigger.

## Slope and level

The slope control determines whether the instrument finds the trigger point on the rising or the falling edge of a signal. The level control determines where on that edge the trigger point occurs.

## Delayed trigger system

You can trigger with the A (Main) trigger system alone or combine the A (Main) trigger with the B (Delayed) trigger to trigger on sequential events. When using sequential triggering, the A trigger event arms the trigger system, and the B trigger event triggers the instrument when the B trigger conditions are met. A and B triggers can (and typically do) have separate sources. The B trigger condition is based on a time delay or a specified number of events. (See page 75, *Using a (Main) and b (Delayed) triggers.*)

## Choosing a trigger type

Your instrument allows you to modify basic trigger parameters from the front panel or set up more advanced triggers in the Trigger Setup control window.

**NOTE.** Some trigger type selections are not available on some instruments.

1. Select Trig > Edge Setup.



2. Set the source, slope, coupling, and mode using the setup menu.

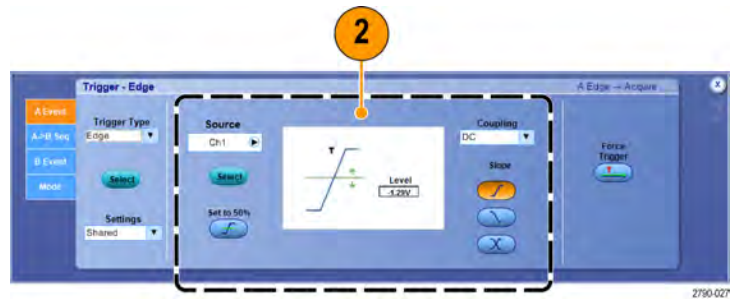

- To select one of the other trigger types, select a trigger type directly from the Trig menu.

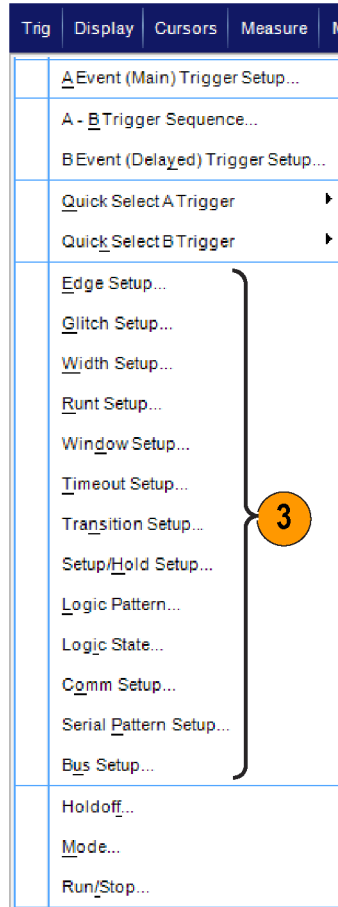





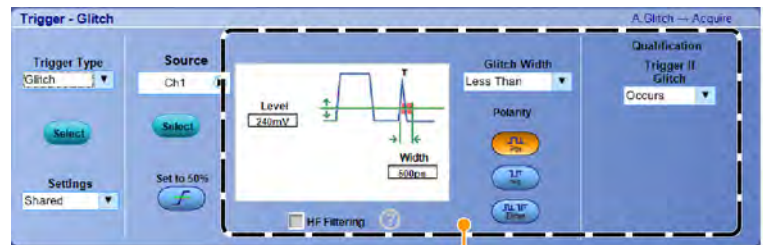





2700-074





- Complete the trigger setup using the controls displayed for the trigger type. The controls to set up the trigger vary depending on the trigger type, instrument model, and options.



2700-064

## Trigger selections

Trigger Type		Trigger Conditions
Edge		Trigger on a rising or falling edge, as defined by the slope control. Coupling choices are DC, AC, LF Reject, HF Reject, and Noise Reject.
Glitch		Trigger on a pulse narrower (or wider) than the specified width or ignore glitches narrower (or wider) than the specified width.
Width		Trigger on pulses that are inside or outside a specified time range. Can trigger on positive or negative pulses.
Runt		Trigger on a pulse amplitude that crosses one threshold but fails to cross a second threshold before recrossing the first. Can detect positive or negative runts, or only those wider than a specified width. These pulses can also be qualified by the logical state of other channels.
Window		Trigger when the input signal rises above an upper threshold level or falls below a lower threshold level. Trigger the instrument as the signal is entering or leaving the threshold window. Qualify the trigger event in terms of time by using the Trigger When Wider option, or by the logical state of other channels using the Trigger When Logic option.
Timeout		Trigger when no pulse is detected within a specified time.
Transition		Trigger on pulse edges that traverse between two thresholds at faster or slower rates than the specified time. The pulse edges can be positive or negative.
Serial		<p>Trigger on 64-bit NRZ serial pattern at data rates up to 1.25Gb/s and 4 8b/10b symbols at data rates up to 6.25Gb/s (MSO70000C/DX and DPO70000C/DX only). Requires option ST1G (DPO7000C) or ST6G (MSO70000C/DX and DPO70000C/DX). Includes clock recovery. Push the Push to Set 50% control to reinitialize clock recovery.</p> <p>Pattern Lock automatically finds and locks on a long repeating pseudo-random bit sequence (PRBS). This lock means that the instrument knows the bit length of the pseudo-random bit sequence and can predict when the cycle repeats. Pattern Lock enables the instrument to take samples at specific locations in a data pattern with outstanding time base accuracy.</p>
Pattern		<p>Trigger when logic inputs cause the selected function to become True or False. You can also specify that the logic conditions must be satisfied for a specific amount of time before triggering.</p> <p>Not recommended with iCapture inputs if using more than one source or an external trigger.</p>
State		<p>Trigger when all of the logic inputs to the selected logic function cause the function to be True or False when the clock input changes state.</p> <p>Not recommended with iCapture inputs if using more than one source or an external trigger.</p>
Setup/ Hold		<p>Trigger when a logic input changes state inside the setup and hold times relative to the clock. The mode triggers on a setup and hold violation.</p> <p>Not recommended with iCapture inputs if using more than one source or an external trigger.</p>

Trigger Type	Trigger Conditions	
Comm		<p>Trigger with mask testing on communications codes and standards (analog channels only). The controls work together to define the parameters for the trigger event (available with Option MTM or MTH on some instruments). This mode includes clock recovery. Push the Push to Set 50% knob to reinitialize clock recovery.</p>
Bus		<p>Trigger on components (such as a specified address) of a bus that you define. With some instruments and options, trigger types include parallel, SPI, RS-232, USB, and I<sup>2</sup>C triggers.</p> <p>Not recommended with iCapture inputs if using more than one source or an external trigger.</p>
Video		<p>Trigger on specified fields or lines of a composite video signal (DPO7000C, MSO5000B, and DPO5000B Series only). Only composite signal formats are supported.</p>
CAN		<p>Trigger on CAN Bus signals.</p> <p>Not recommended with iCapture inputs if using more than one source or an external trigger.</p>

## Checking trigger status

Check the trigger status from the status lights on the front panel or from the readout.

Check the ARM, READY, and TRIG'D front-panel controls to determine the trigger status.

- If TRIG'D is on, the instrument has recognized a valid trigger and is filling the posttrigger part of the waveform.
- If READY is on, the instrument can accept, and is waiting for, a valid trigger to occur. Pretrigger data has been acquired.
- If ARM is on, the trigger circuitry is filling the pretrigger part of the waveform record.
- If both TRIG'D and READY are on, a valid A event trigger has been recognized and the instrument is waiting for a delayed trigger. When a delayed trigger is recognized, the posttrigger part of the delayed waveform will fill.
- If ARM, TRIG'D, and READY are off, acquisitions have stopped.

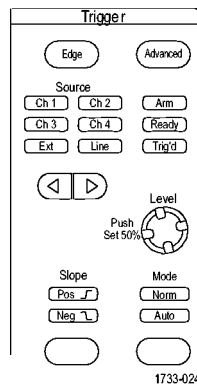

MSO/DPO7000DX, MSO/DPO7000C, DPO7000C Series

To quickly determine the settings of some key trigger parameters, check the Trigger readout at the bottom of the display. The readouts differ for edge and the advanced triggers:

1. A trigger source = Ch1
2. Trigger slope = rising edge
3. Trigger level
4. Time base
5. Check the ARM, READY, and TRIG'D readout to determine the trigger status.
6. Check the Auto/Normal readout to determine the trigger mode.

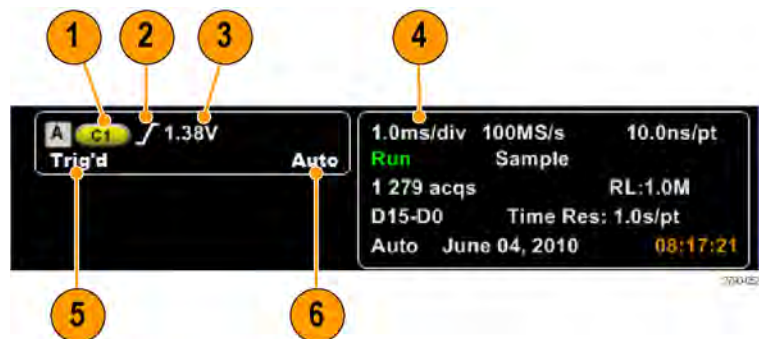



## Using a (Main) and b (Delayed) triggers

You can use the A Event (Main) trigger for simple signals or combine it with the B Event (Delayed) trigger to capture more complex signals. After the A Event occurs, the trigger system looks for the B Event before triggering and displaying the waveform.

### A trigger

1. Select Trig > A Event (Main) Trigger Setup...

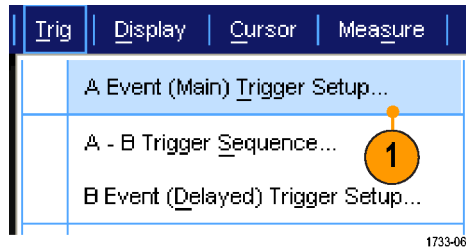

2. Set the A trigger type and source in the A Event tab.

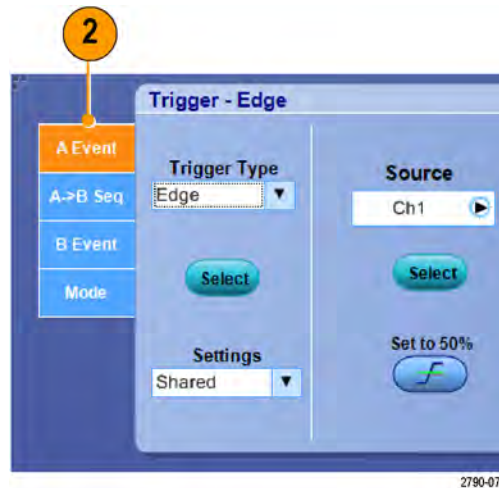

### B trigger (Delayed)

#### NOTE.

3. Choose a function in the A → B Seq tab.
4. Set the trigger delay time or the number of B events.

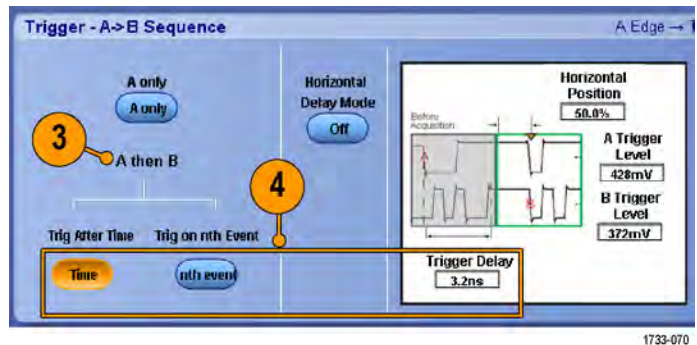

- Set the B trigger characteristics in the B Event (Delayed) tab.

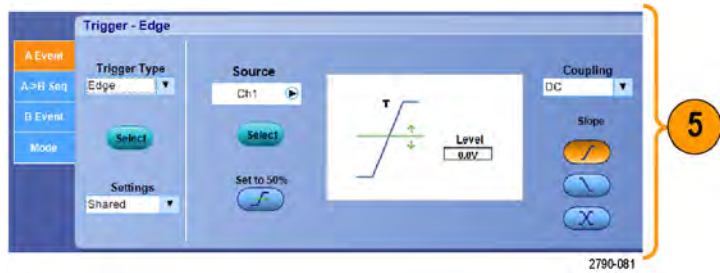

- Select **Normal** Trigger Mode and **Auto** Holdoff in the Mode tab.

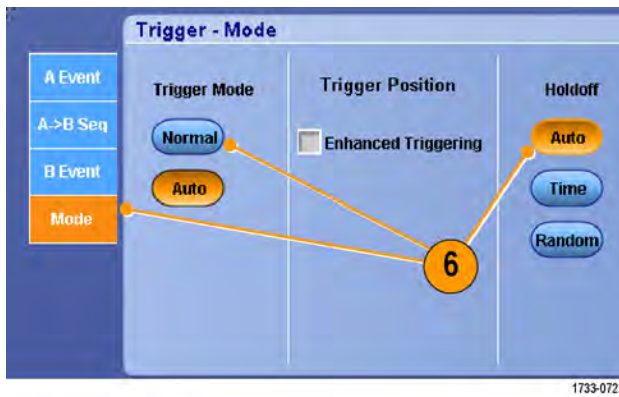

### Trigger on B Event

The A trigger arms the instrument. Posttrigger acquisition starts on the nth B event.

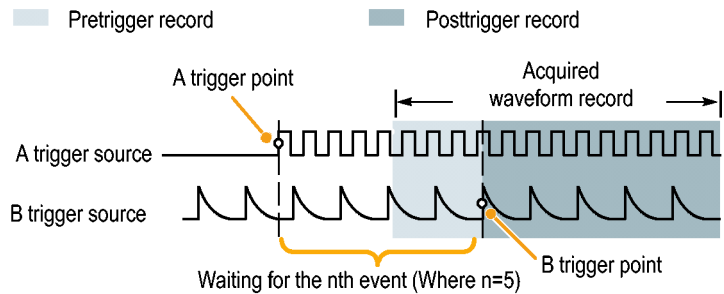

### B Trigger After Delay Time

The A trigger arms the instrument. Posttrigger acquisition starts on the first B edge after the trigger delay time.

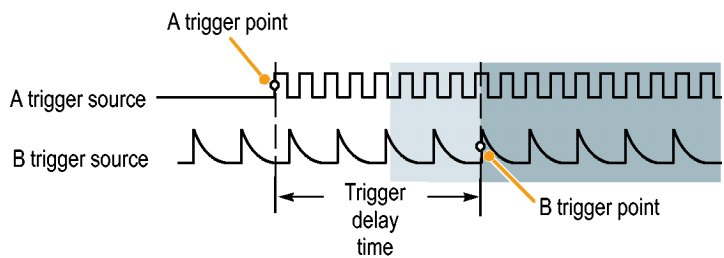

## Triggering with Reset

You can specify a condition to reset the trigger system if it occurs before the B trigger event. When the reset event occurs, the trigger system stops waiting for the B event and returns to waiting for the A event.

Triggering with reset is not available on MSO5000B and DPO5000B instruments.

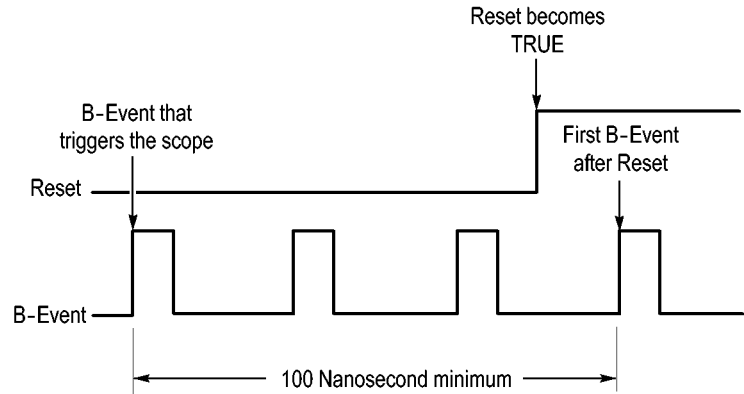

## Quick tips

- B-trigger delay time and horizontal delay time are independent functions. When you establish a trigger condition using either the A trigger alone or the A and B triggers together, you can also use horizontal delay to delay the acquisition by an additional amount.

## Correcting trigger position

Trigger position correction corrects for differences in the data path and the trigger path to more accurately place the trigger on the displayed waveform. Trigger position correction can also use averaging to more accurately place the trigger on noisy signals. To more accurately place edge triggers on the display, perform the following procedure.

1. To more accurately place the trigger on the display, check **Enhanced Triggering**. To more accurately place the trigger on noisy signals, also check **Optimized for Noisy Signals**.

The **Optimized for Noisy Signals** selection is only available if **Enhanced Triggering** is selected.

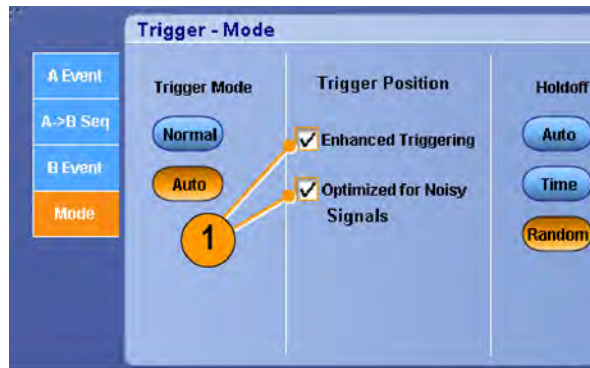

1733-259

## Triggering with B-Event Scan

Use A->B Sequence B-Event Scan to create overlapped eye diagrams synchronized or initiated by an A trigger event.

B-Event Scan is not available on MSO5000B and DPO5000B instruments.

Trig on nth Event captures the nth B-Event that occurs after the A-Event for all acquisitions. B-Event Scan automatically advances the B-Event value to capture different portions of the signal.

1. Set the A trigger type and source in the A Event tab.

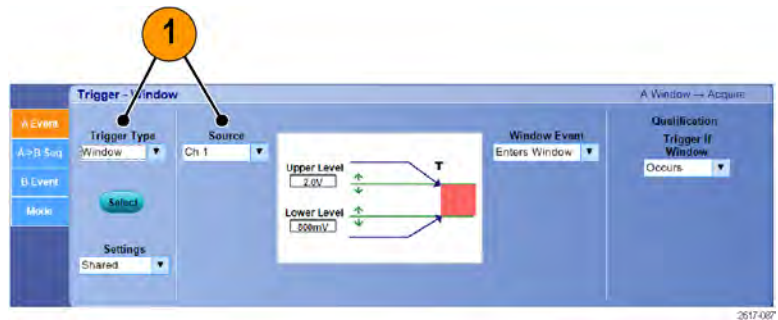

2. Set the B trigger type and source in the B Event tab.

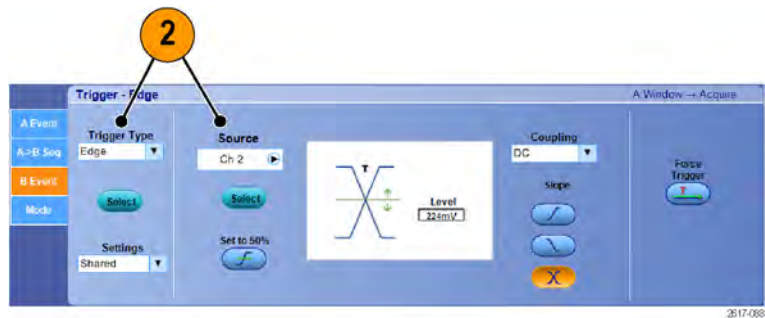

3. To more accurately place the trigger on the display, check **Enhanced Triggering**. To more accurately place the trigger on noisy signals, also check **Optimized for Noisy Signals**.

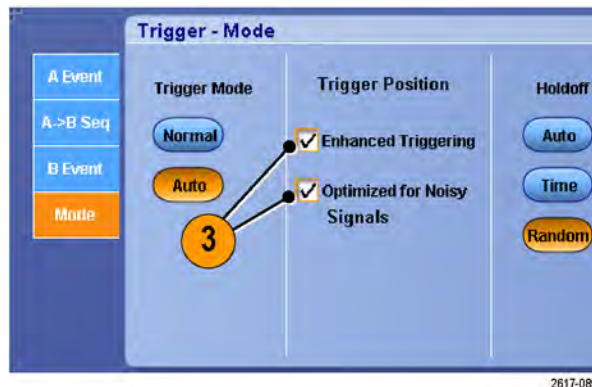

4. Select Trig on nth Event and B Event Scan in the A>B Seq tab.
5. To display the B Event Scan Setup window, press B Event Scan > Setup.

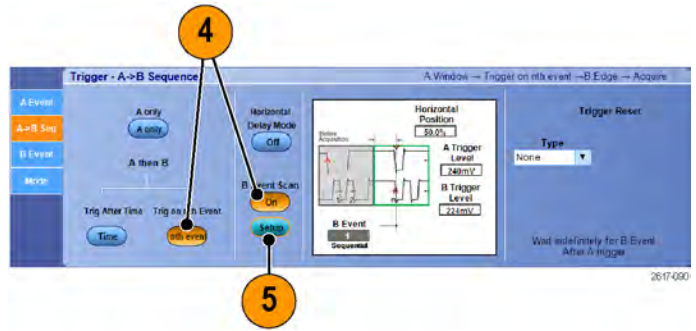

6. Set the B Event start value.
7. Set the B Event ending value.
8. Set the number of acquisitions before the B Event value is incremented.

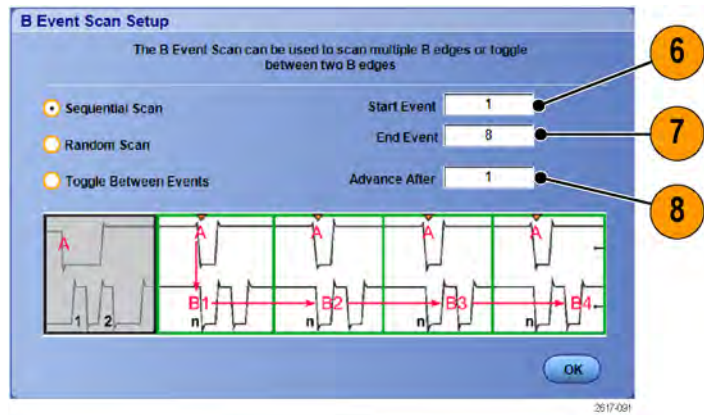

9. Select the method that the B Event value is incremented after the selected number of acquisitions occur:

**Sequential Scan** increments by 1 until the End Event is reached. When the End Event is reached, the B Event value is reset to the Start Event value and the process starts over.

**Random Scan** sets the B Event value to a random value between the Start Event and the End Event for each set of Advance After acquisitions.

**Toggle Between Events** toggles the B Event value between the Start Event and the End Event for each set of Advance After acquisitions.

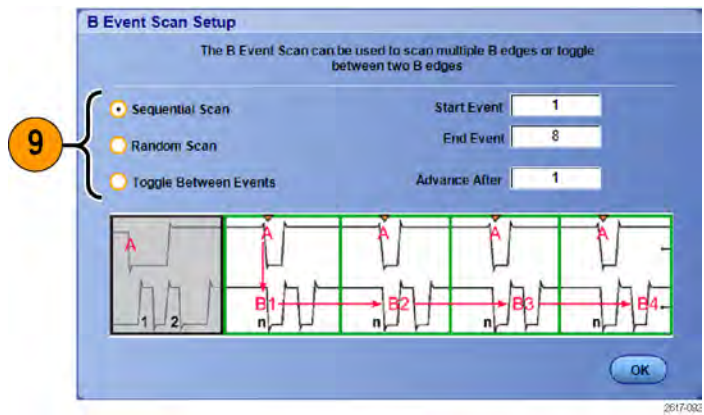

- In this example, a DDR3 DQS signal is on Ch 1 and the DQ signal is on Ch 2. The instrument is in Run Mode with Display Mode set to Infinite Persistence. The instrument trigger setup was as follows:

A-Event Window trigger on Ch 1 to detect the DDR3 DQS Write condition.

B-Event Edge trigger on Either slope on Ch 1 to trigger on the DQS (clock) edges.

A->B Sequence set to Trig on the nth Event.

B Scan Enabled with Start Event = 1, End Event = 8, and Mode = Sequential.

The data eyes are formed by the DQ signal on Ch 2.

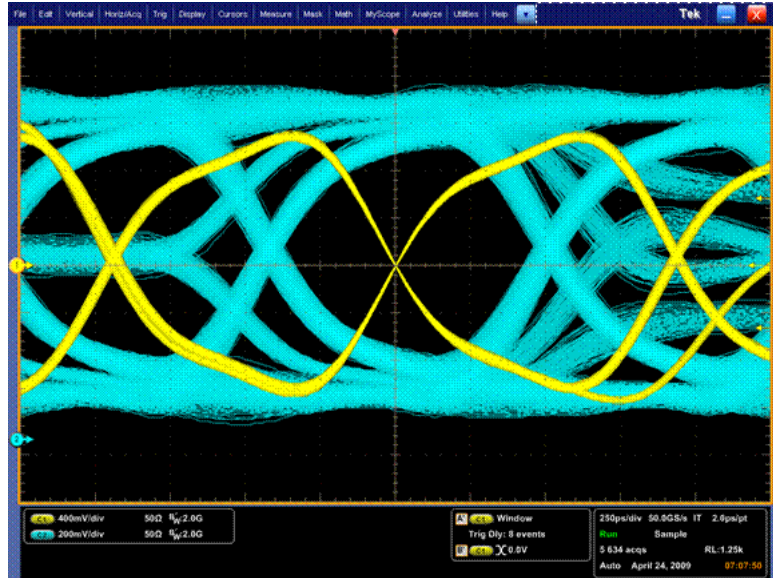

## Triggering on a parallel bus

Locate problems by triggering on a parallel bus. MSO instruments can use digital channels as components of a parallel bus.

- Set up a parallel bus. (See page 53, *Setting up a bus*.) Select **Trig > A Event (Main) Trigger Setup...**

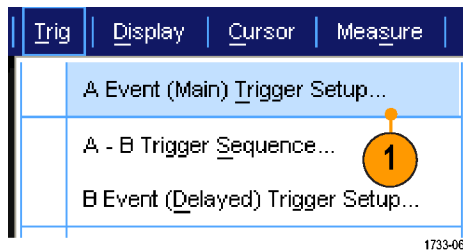

- Select the A Event tab.

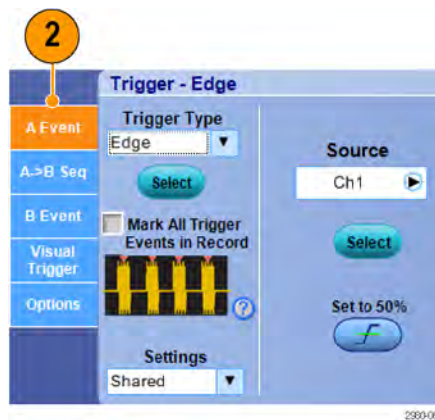

3. Select the **Bus** Trigger Type.

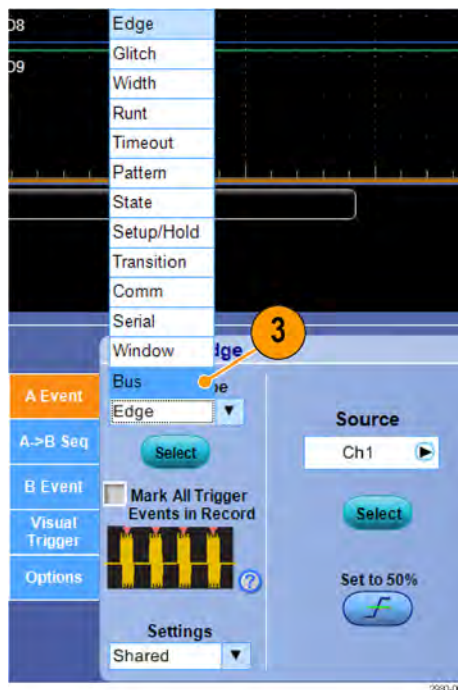

4. Select the bus to trigger on.

**NOTE.** Clocked buses will only appear in the drop down list if the clock source is set to Ch4.

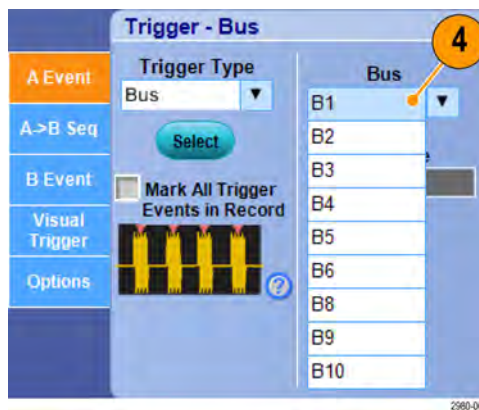

5. Click an Edit button and set the pattern and format that you want to trigger on.

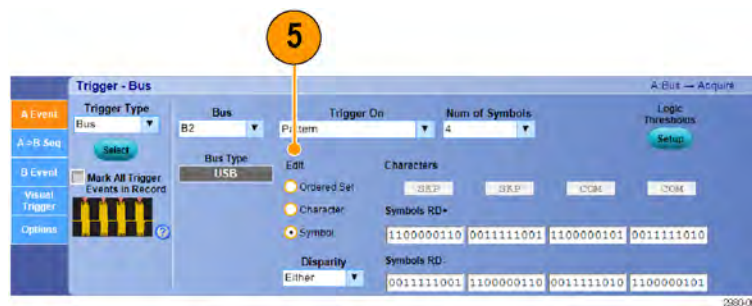

6. Select the data format.
7. Set the pattern to trigger on using the keypad.

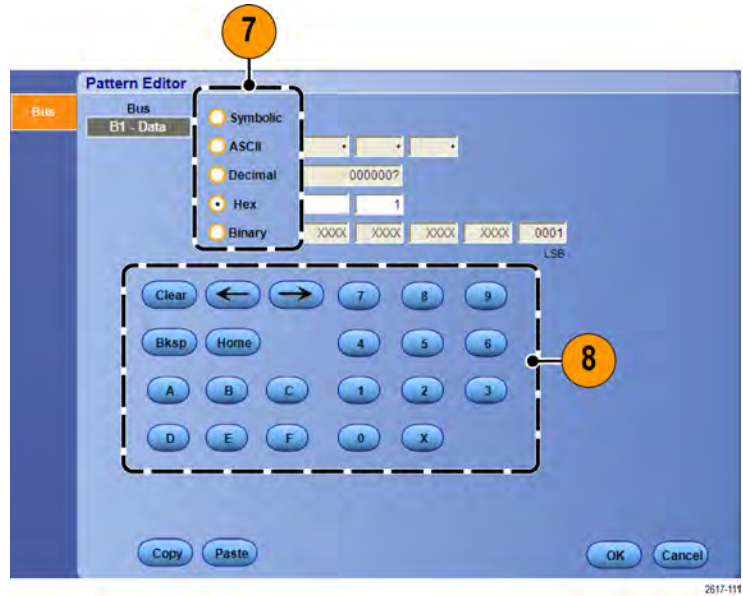

8. Analyze your waveforms.

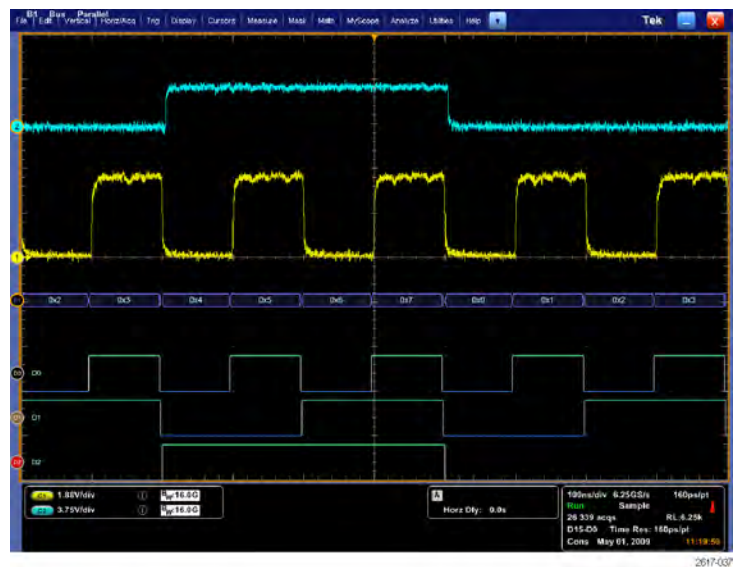



## Triggering on a serial bus

Locate problems by triggering on a serial bus. Serial buses are available on MSO/DPO70000DX, MSO/DPO70000C, DPO7000C, MSO5000B, and DPO5000B Series instruments. Digital channels can be used in bus definitions on MSO instruments.

Set up a serial bus. (See page 53, *Setting up a bus*.)

1. Select **Trig > A Event (Main) Trigger Setup...**



2. Select the A Event tab.

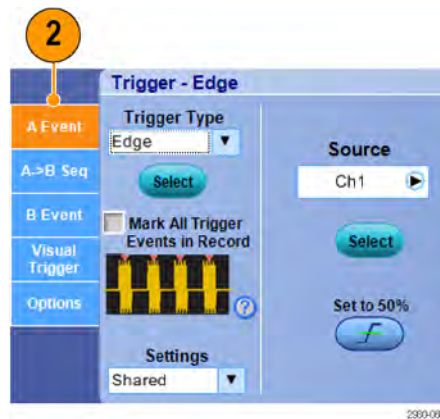

3. Select the Bus Trigger Type.

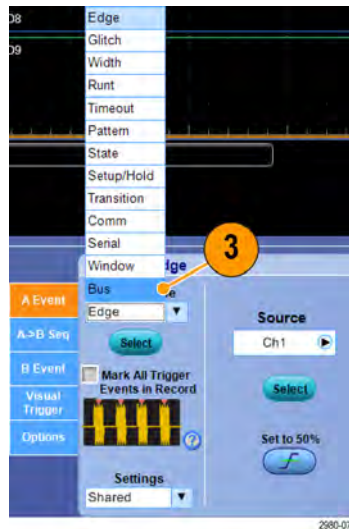

4. Select the bus.

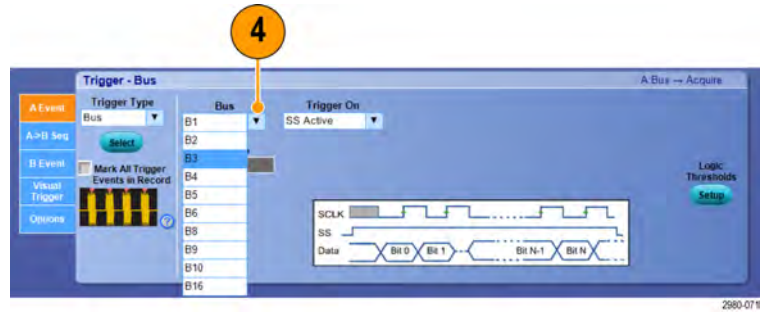

5. Select the bus signal to trigger on.
6. Depending on your Trigger On choice and your bus type, make the required selections for the bus.  
See the online help for additional help setting up a bus.

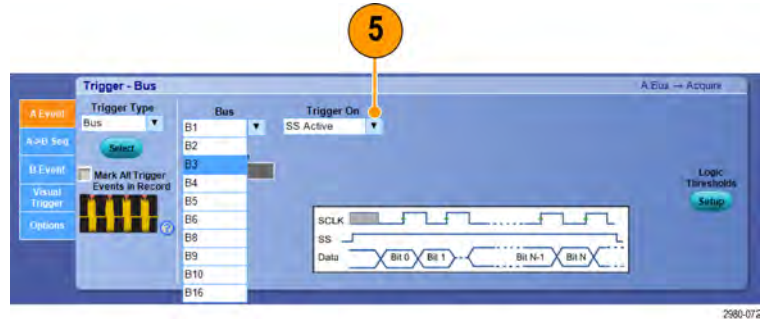

## Triggering using Visual Triggers (Visual Triggering)

Visual triggering allows you to create trigger conditions directly on the display screen. (Visual Triggers are available as an option on some models.)

1. Create a visual trigger area by left clicking and dragging a box on the display. Then select Add Visual Trig Area from the menu.

**NOTE.** This same menu allows you to hide or show all visual trigger areas and toggle visual triggering on and off.

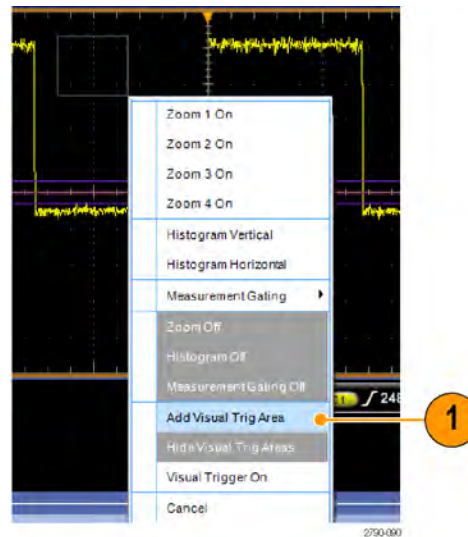

- Click the area to enable its handles. Click and drag the area to move it to a new location. Click and drag one of the area handles to resize the area vertically, horizontally, or both.

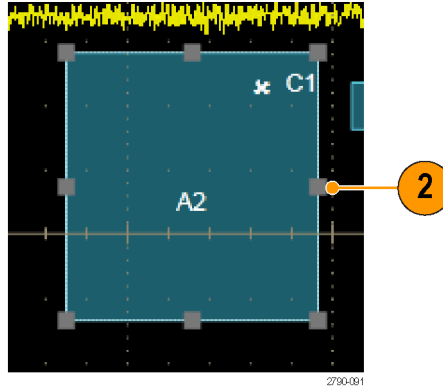

- Right click in the visual trigger area and select Visual Trigger Area from the menu.

Use the visual trigger menus to edit the trigger area and set conditions for the visual trigger.

Refer to online help for detailed information about creating and editing visual triggers.

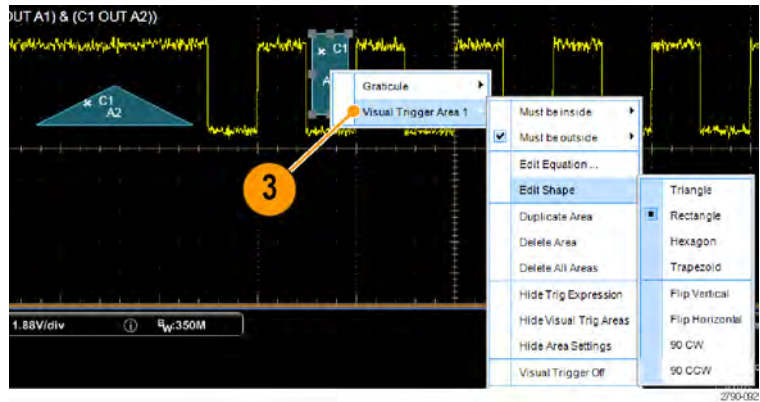

- From the Trig menu, select Visual Trigger Setup, then double click the Visual Trigger equation.

Refer to online help for detailed information about using the Qualification Expression Editor.

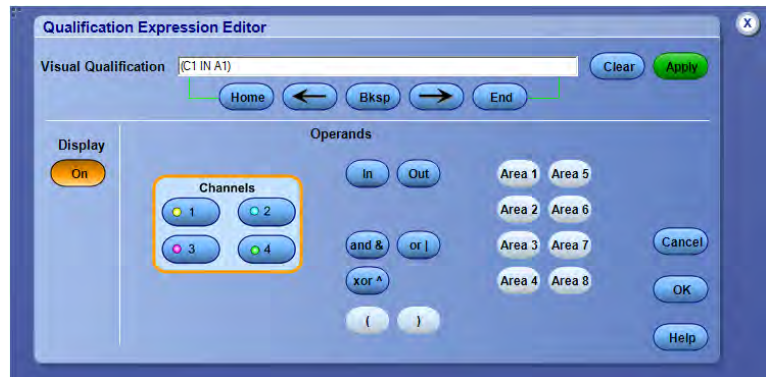

## Setting up Action on Event

Action on Event allows configure the oscilloscope to save a variety of files when a defined event takes place, such as a trigger events, mask test failures, and limit test failures.

1. Select **File > Action on Event**.
2. Select the event to use.
3. Select the action to take when the event occurs. Select Save, Send E-mail, or both.

Use the Setup button (next to Save) to display the Save on Event Setup display screen.

Use the Setup button (next to Send E-mail) to display the Send E-mail Setup display screen. (See page 88, *Setting up E-Mail on Event*.)

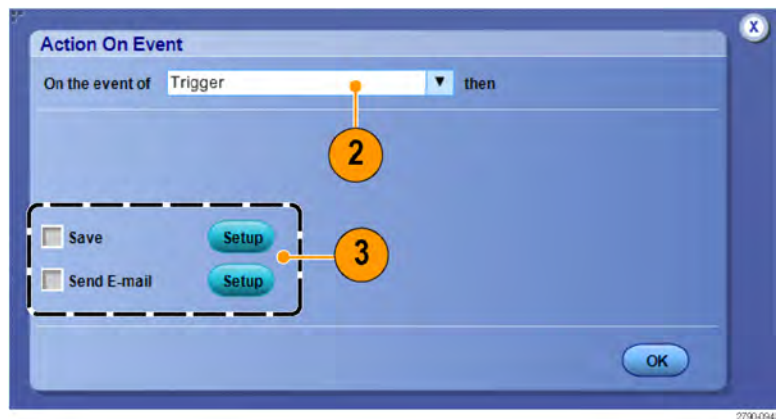
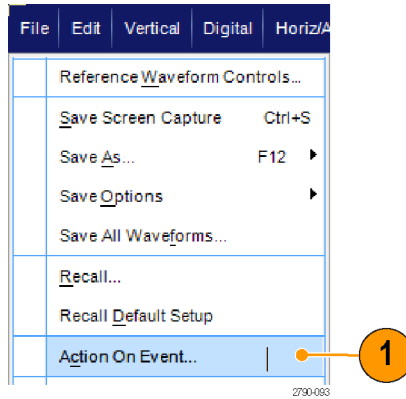

4. Enter the location to save the files.
5. Select the event that initiates a save.
6. Select what type of files to save on the event.
7. Set the file naming convention to use.
8. Set the number of events to save.

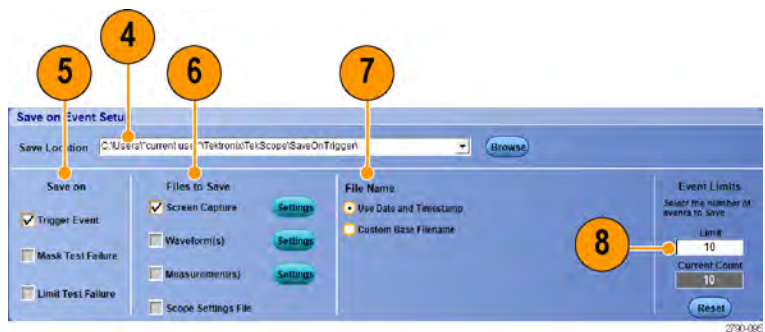

## Sending E-Mail on Trigger

You must configure e-mail on event before performing the following procedure. (See page 88, *Setting up E-Mail on Event*.)

1. Select **Trig > A Event (Main) Trigger Setup...**
2. Select the **Mode** tab.
3. Under E-mail on Trigger, click **On**, and then click **Setup**. (See page 88, *Setting up E-Mail on Event*.)

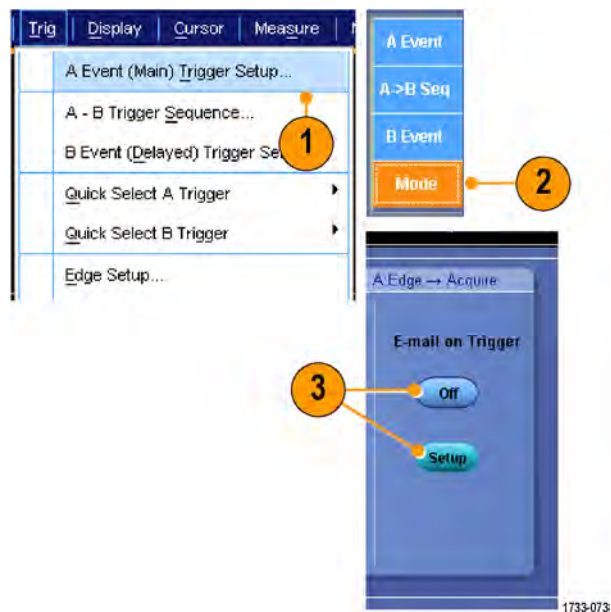

## Setting up E-Mail on Event

1. Select **Utilities > E-mail on Event > Setup....**

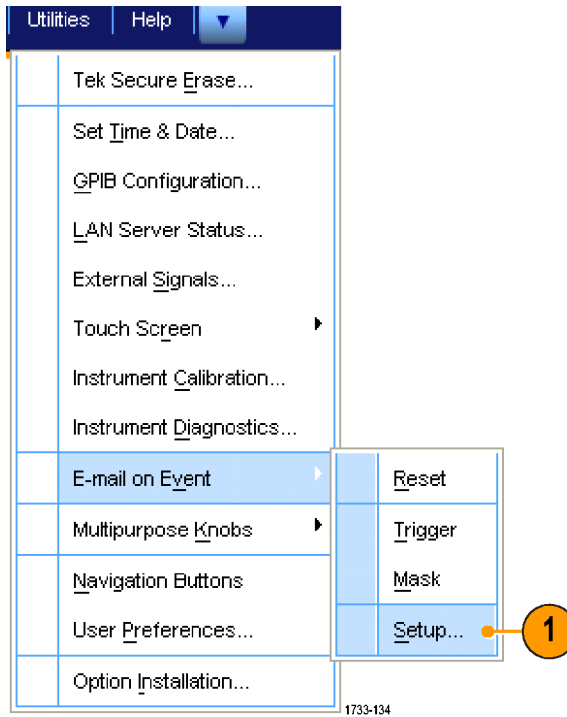

2. Enter recipients' e-mail address(es). Separate multiple entries with commas. There is a limit of 252 characters in the e-mail address box.

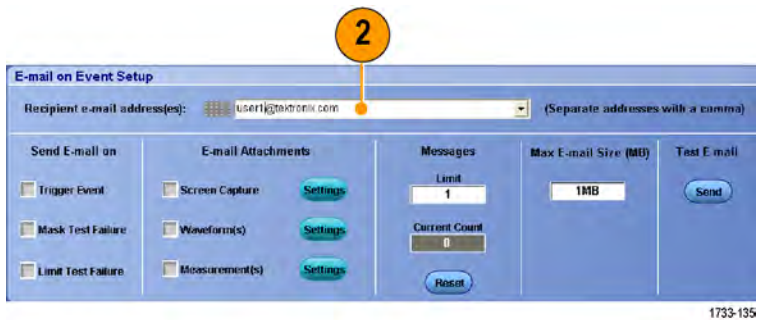

3. Click **Config**, and then enter the SMTP Server Address. Contact your network administrator for the correct address.

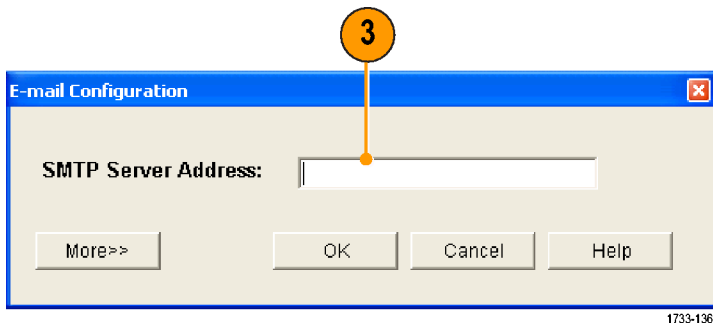

4. Select the event(s) for which you want to send an e-mail.
5. To include attachments, select the type of attachment, and then click **Settings** to specify the format.

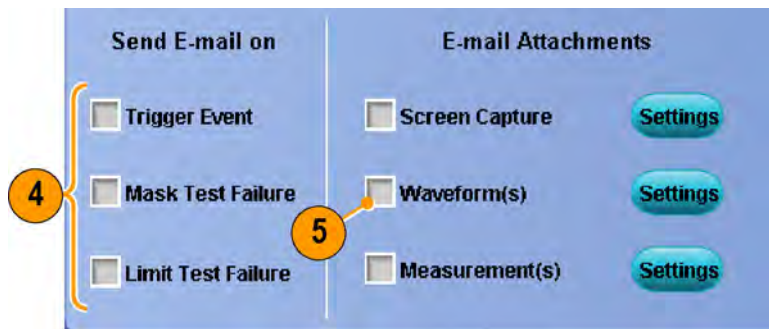

1733-137

6. Set the maximum message limit and e-mail size. When the maximum message limit is reached, you must click **Reset** to send more e-mails on event.
7. To verify that you have set up the e-mail addresses correctly, send a test-mail by clicking **Send**.
8. If necessary, click **Config** to access the e-mail configuration dialog box and adjust the configuration.

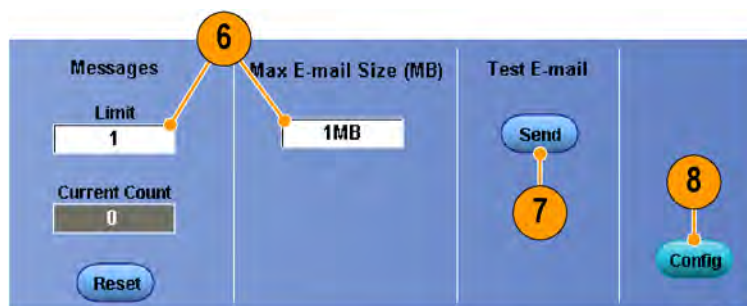

1733-138

## Using horizontal delay

Use horizontal delay to acquire waveform detail in a region that is separated from the trigger location by a significant interval of time.

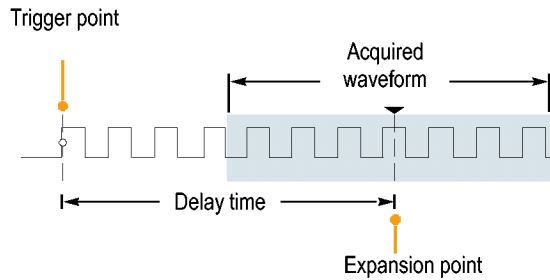

1. Select **Horiz/Acq > Horizontal/Acquisition Setup**.

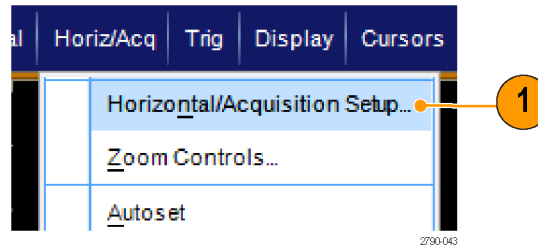

2. Push the **Delay Mode** button to toggle delay mode on.

3. Adjust the delay time with the horizontal **POSITION** control, or enter the delay time in the control window.

4. Adjust the horizontal **SCALE** to acquire the detail that you need.

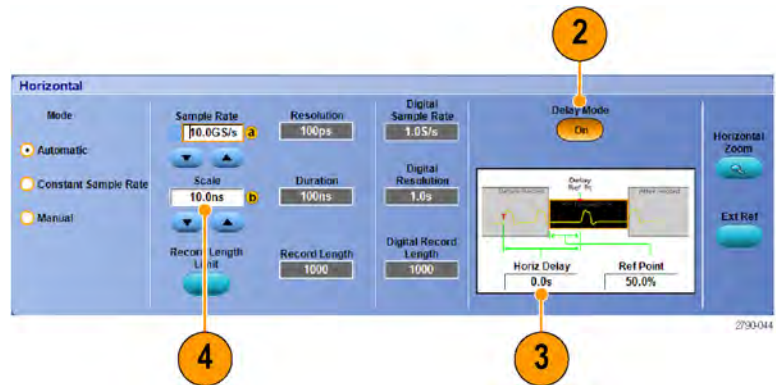

### Quick tips

- Use MultiView Zoom and Horizontal Delay together to magnify a delayed acquisition.
- Toggle Horizontal Delay on and off to quickly compare signal details at two different areas of interest, one near the trigger location and the other centered at the delay time.



# Display a waveform

This section contains concepts and procedures for displaying a waveform. Detailed information is available in the online help.

## Setting the Display Style

To set the display style select **Display > Display Style**, and then select one of the following styles:



Displays waveforms with lines drawn between record points.



1733-075

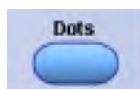

Displays waveform record points as dots on the screen.



1733-076



Displays the actual samples. Interpolated points are not displayed.



1733-077

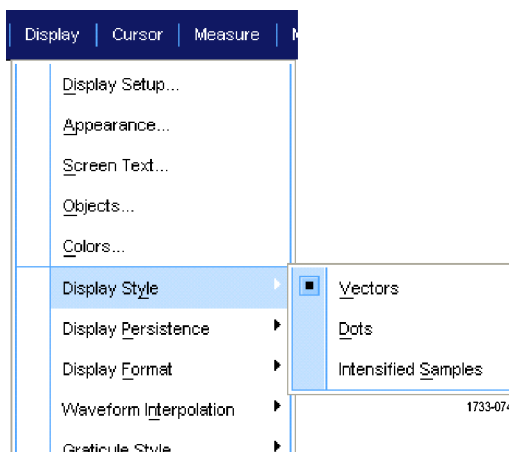

## Setting the Display Persistence

Select **Display > Display Persistence**, and then select the type of persistence.

- No persistence shows record points for the current acquisition only. Each new waveform record replaces the previously acquired record for a channel.
- Infinite persistence continuously accumulates record points until you change one of the acquisition display settings. Use for displaying points that may occur outside the normal acquisition envelope.
- Variable persistence accumulates record points for a specified time interval. Each record point decays independently according to the time interval.
- Reset persistence clears the persistence.

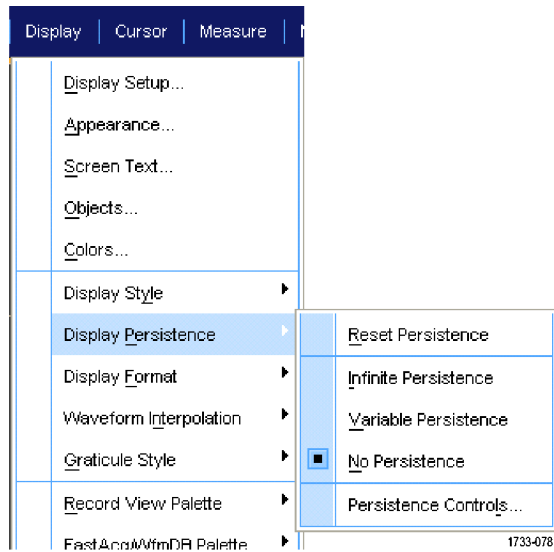

1. To set the variable persistence time, select **Display > Display Persistence > Persistence Controls....**
2. Click **Variable, Persist Time**, and then use the multipurpose knobs to set the persistence time.

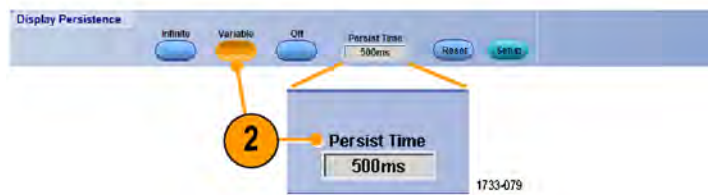
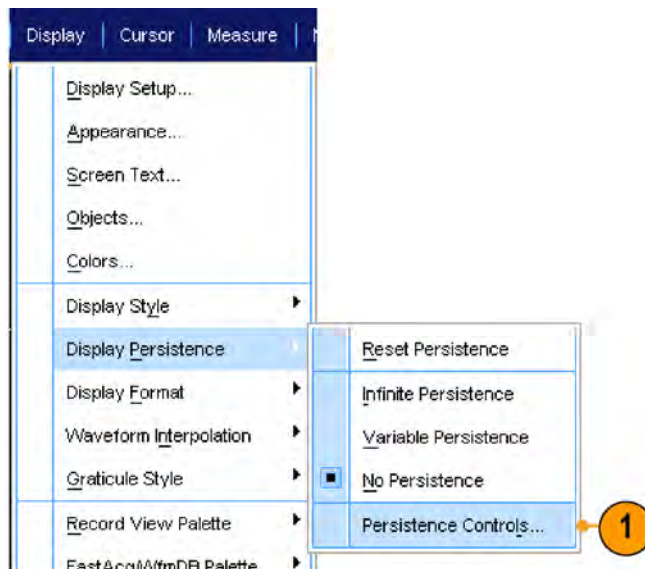

## Setting the Display Format

The instrument can display waveforms in two different formats. Choose the format that best suits your needs.

Select **Display > Display Format**.

- Select **YT** format to show a signal amplitude as it varies over time.
- Select **XY** format to compare the amplitude of waveform records point by point:  
The following channels are compared:  
Ch 1 (X) and Ch 2 (Y),  
Ch 3 (X) and Ch 4 (Y),  
Ref 1 (X) and Ref 2 (Y),  
Ref 3 (X) and Ref 4 (Y)
- Select **XYZ** format to compare the voltage levels of the Ch 1 (X) and Ch 2 (Y) waveform records point by point as in XY format. The displayed waveform intensity is modulated by the Ch 3 (Z) waveform record. XYZ format is triggered. A -5 division signal (including position and offset) on Ch 3 produces a blank screen; a +5 division signal produces full intensity.

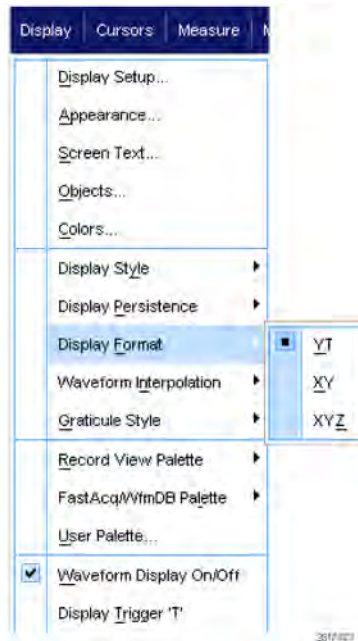

### Quick tips

- XY format is particularly useful for studying phase relationships such as Lissajous Patterns.
- XY format is a dot-only display, although it can have persistence. The Vector style selection has no effect when you select XY format.

## Selecting the Waveform Interpolation

Select **Display > Waveform Interpolation**, and then select one of the following:

- Sin(X)/X interpolation computes record points using a curve fit between the actual samples acquired.
- Linear interpolation computes record points between actual acquired samples by using a straight line fit.

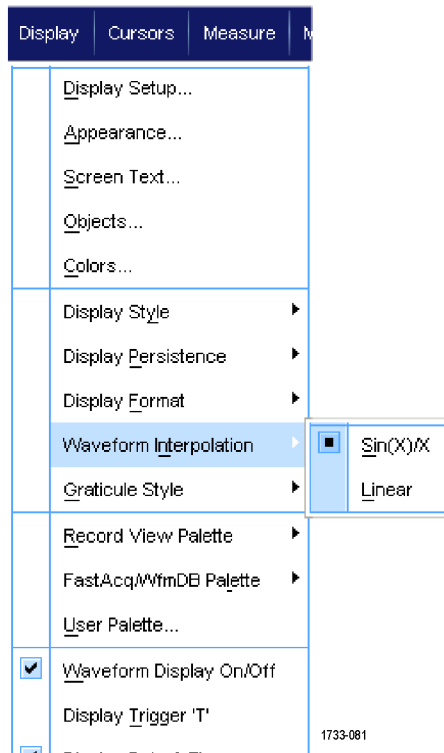

### Quick tips

- Sin(X)/X interpolation is the default interpolation mode. It requires fewer actual sample points than linear interpolation to accurately represent the waveform.

## Adding Screen Text

1. Select **Display > Screen Text**.

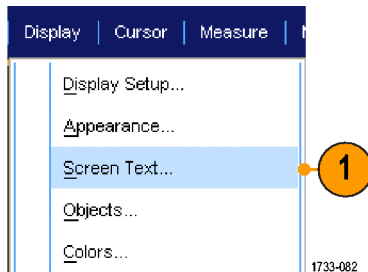

2. Enter up to eight independent lines of text.
3. Click **Text Off** or **On** to turn the text display on and off.
4. Click **Font** or **Color** to select the font and color of the screen text.
5. Click **Controls** to open the Text Properties control window for positioning of the text on the display.
6. Click **Clear** to erase the entire text of the selected line.

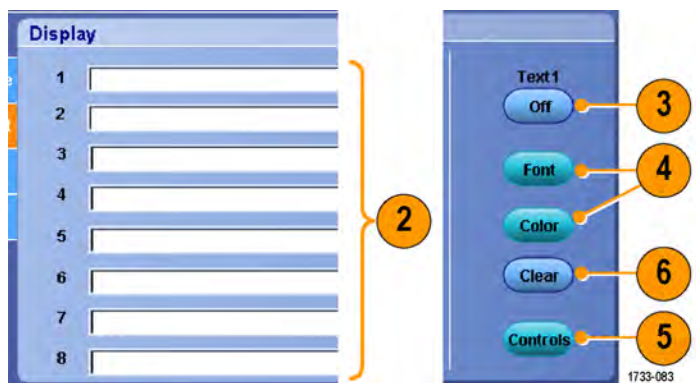

### Quick tips

- Click and drag screen text to reposition it on the screen.
- You can also label waveforms and buses. (See page 52, *Setting up digital channels*.) (See page 53, *Setting up a bus*.)

## Setting the Graticule Style

To set the graticule style, select **Display > Graticule Style**, and then select one of the following styles:



Use for quick estimate of waveform parameters.



Use for full-screen measurements with cursors and automatic readouts when cross-hairs are not needed.



Use for making quick estimates of waveforms while leaving more room for automatic readouts and other data.



Use with automatic readouts and other screen text when display features are not needed.



Use for NTSC video signals.



Use for video signals other than NTSC.



Solid is similar to Full, but the grid, cross hairs, and frame are drawn using solid lines.

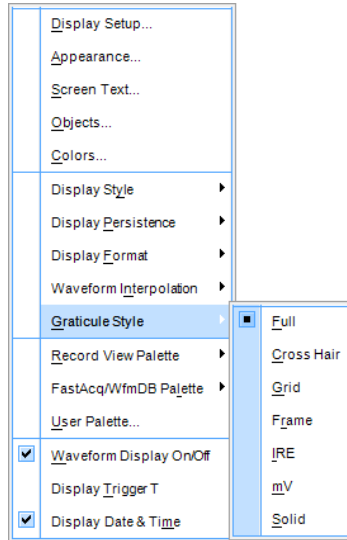

## Setting the Trigger Level Marker

1. Select **Display > Objects...**
2. Select one of the following:
  - **Short** displays a short arrow on the side of the graticule.
  - **Long** displays a horizontal line across the graticule.
  - **Off** turns off the trigger level marker.

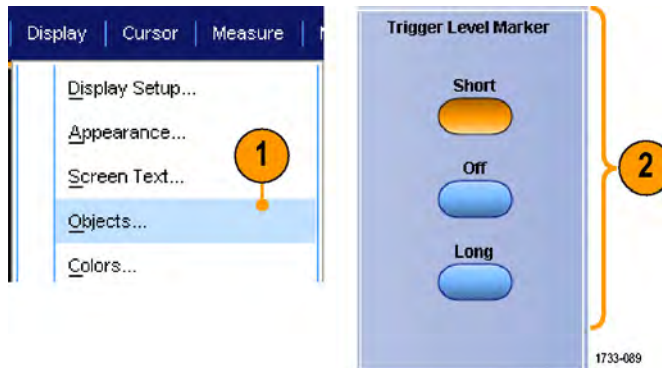

## Displaying the Date and Time

1. Select **Display > Objects...**
2. Toggle the display of the date and time on the graticule. Use the Utilities menu to set the date and time.

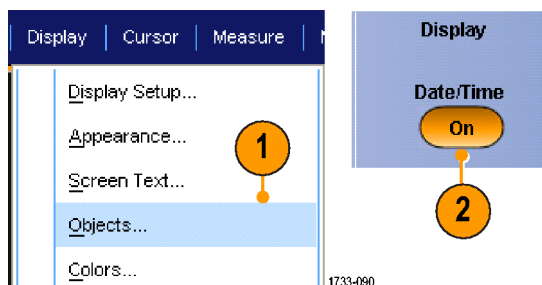

## Using the Color Palettes

Select **Display > Record View Palette** or **FastAcq/WfmDB Palette**, and then select one of the following color schemes for the waveform and graticule:

- Normal displays hues and lightness levels for best overall viewing. The color of each channel waveform matches the color of the corresponding front-panel vertical knob.
- Temperature Grading displays areas of the waveform with the highest sample density in red shades. The areas of lowest sample density appear in blue shades.
- Monochrome Green displays areas of the waveform with the highest sample density in lighter green shades. The areas of lowest sample density appear in darker green shades. It most closely resembles analog oscilloscope displays.
- Spectral Grading displays areas of the waveform with the highest sample density in blue shades. The areas of lowest sample density appear in red shades.
- Monochrome Gray displays areas of the waveform with the highest sample density in lighter gray shades. The areas of lowest sample density appear in darker gray shades.
- User displays the waveform in a user-defined color.

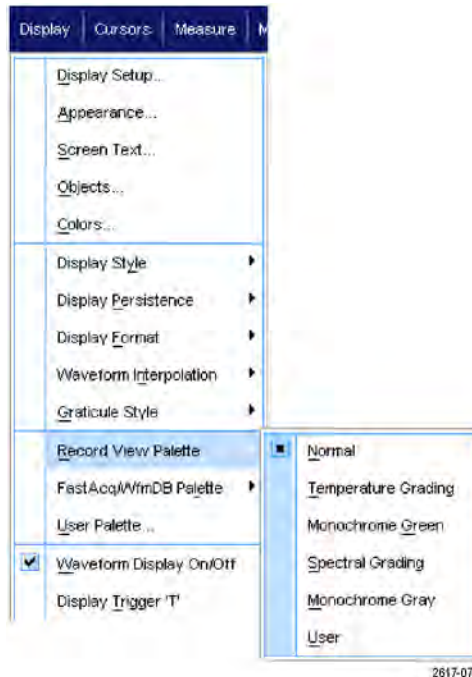

2617-076

### Quick tips

- Choose one of the color grading palettes in the **Display > Colors** control window to see different sample densities represented in different colors.
- There are two color palettes, one for Record View and one for FastAcq/WfmDB.



## Setting reference waveform colors

Select **Display > Colors...**, and then select one of the following:

- Default uses the default system color for reference waveforms.
- Inherit uses the same color for the reference waveform as the original waveform.

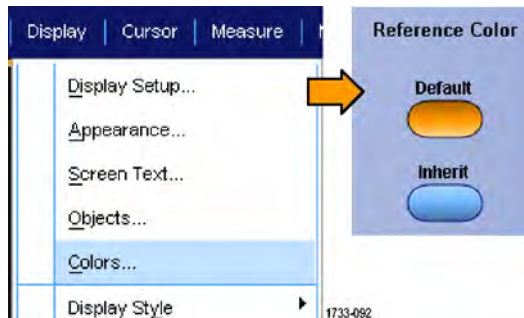

## Setting Math Waveform Colors

Select **Display > Colors...**, and then select one of the following:

- Default uses the default system color for math waveforms.
- Inherit uses the same color for the math waveform as the lowest numbered channel waveform the math function is based on.

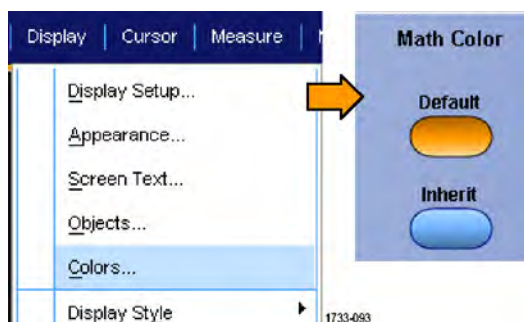

### Quick tips

- The default color for math and reference waveforms are different for each waveform.

## Using MultiView Zoom

Use the MultiView Zoom function to magnify a waveform vertically, horizontally, or in both dimensions. Zoomed waveforms can also be aligned, locked, and automatically scrolled. Scale and Position affect only the display, not the actual waveform data.

1. If **MultiView Zoom** is off, push **MultiView Zoom** to split the screen and add a zoom graticule.



2. Push **HORIZ** or **VERT** to select which axis to magnify in the zoom graticule. Use the multipurpose knobs to adjust scale and position of the magnified waveform.

In this example the main graticule is the top half of the graticule and the zoomed graticule is the bottom half of the graticule.

**NOTE.** You can hide or display zoomed waveforms by pressing **Show/Hide Waveforms** and then checking which zoomed waveforms to display.



3. To adjust the zoom graticule size, select Zoom Graticule Size from either the Vertical or Horiz/Acq menus.
4. If **MultiView Zoom** is on but the readouts are not attached to the zoom controls, press the **MultiView Zoom** button to attach the readouts to the zoom controls. Press the **MultiView Zoom** button again to turn zoom off.

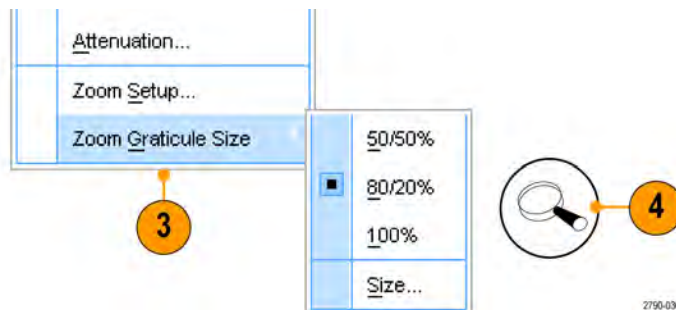

### Quick tips

- Use the Zoom Setup menu to change the graticule size of the zoomed waveform.
- Use Wave Inspector to manage long record length waveforms. (See page 105, *Using Wave Inspector to manage long record length waveforms.*)

## Zooming in multiple areas

When you want to view and compare multiple areas of one record at the same time, use the following procedure.

1. Click and drag a box around the area of the waveform that you want to zoom.
2. Select **Zoom 1 On**.

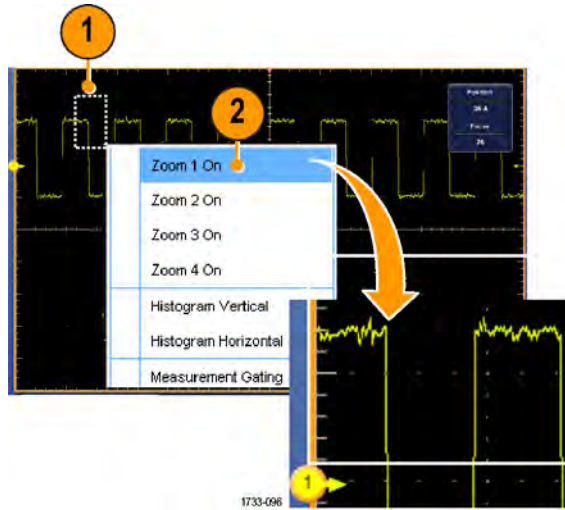

3. Click and drag a box around another area of the waveform that you want to zoom, and then select **Zoom 2 On**.

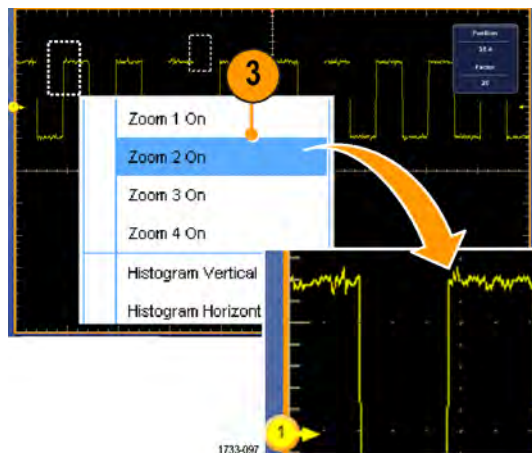

4. To adjust the zoomed area horizontally, click the horizontal marker below the Zoom box to select the zoomed area.
5. Use the multipurpose knobs to adjust the horizontal position and factor of the selected zoom area.

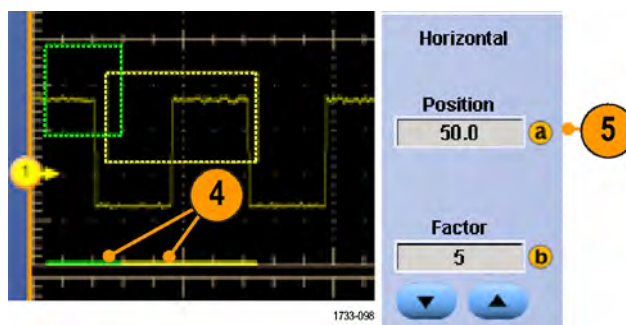

6. To adjust the zoomed area vertically, select **Vertical > Zoom Setup...**, click a vertical field, and then use the multipurpose knobs to adjust the Vertical Position and Factor.

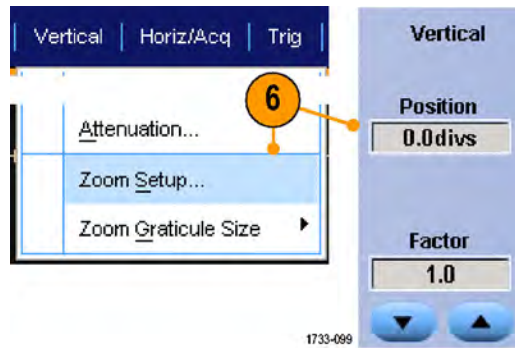

### Quick tips

- To clear the zoom area, click **Position Factor Reset** from the Zoom Setup control window.
- Turn each zoom display on and off from the Zoom Setup control window.
- Push the **MultiView Zoom** button once or twice to toggle all zoom displays on and off.
- To reposition the zoomed area horizontally, click and drag the horizontal marker at the bottom of the zoom box.
- Use Wave Inspector to manage long record length waveforms. (See page 105, *Using Wave Inspector to manage long record length waveforms.*)

## Lock and Scroll zoomed waveforms

1. To use Lock and Scroll select **Zoom Setup...** from either the Vertical or Horiz/Acq menu, and then select the **Lock and Scroll** tab.

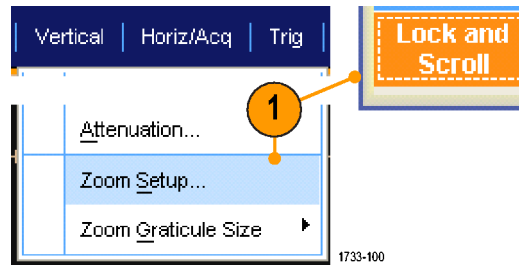

2. To scroll a single zoomed area, select a **Zoom 1-4** check box, and then click an Auto Scroll button.

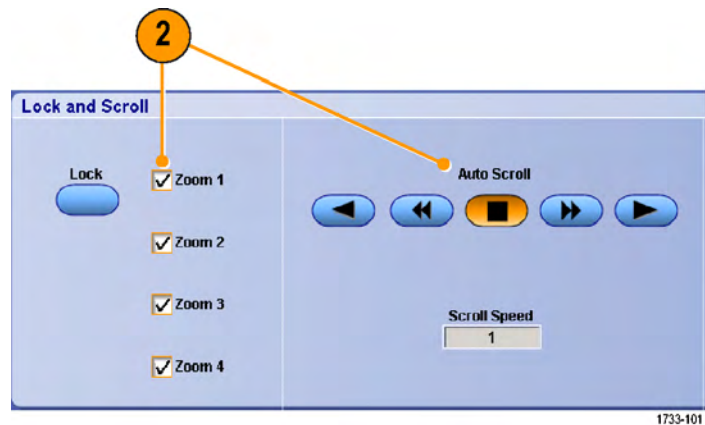

3. To scroll multiple zoomed areas simultaneously, click **Lock**, and then select the **Zoom 1-4** check boxes that you want to scroll through.  
Locking the zoomed areas locks in their relative horizontal position. Changing the horizontal position of one locked and zoomed area changes them all.

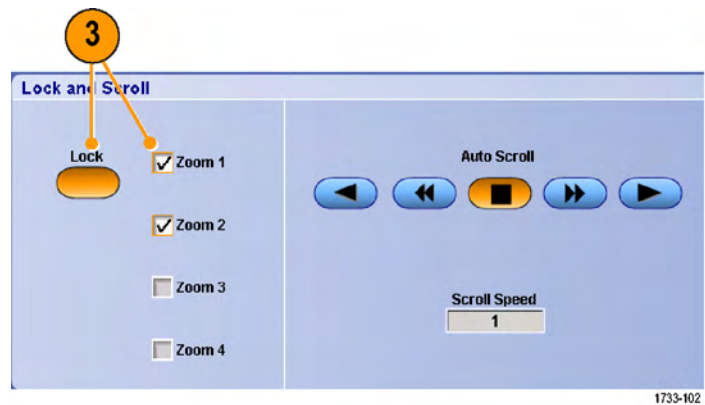

### Quick tips

- When multiple zoom areas are selected but not locked, the zoom area with the highest number will autoscroll, while the other zoom areas remain stationary.

## Hide waveforms in the zoomed window

1. To hide or view waveforms, select **Zoom Setup...** from either the Vertical or Horiz/Acq menu.
2. Select a **Zoom** tab, and then press **Show/Hide Waveforms**.

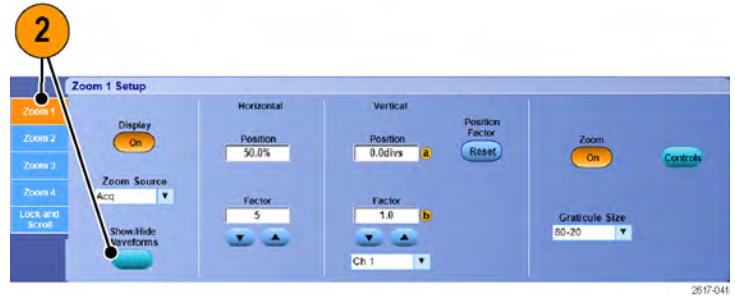
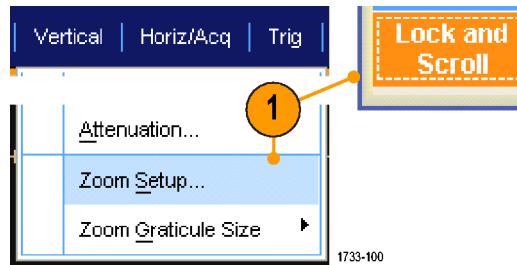

3. Select the zoomed area that contains the waveform you want to show or hide.
4. Uncheck the channel, math, reference, or digital waveform you want to hide. Digital channels are only available on MSO Series instruments.

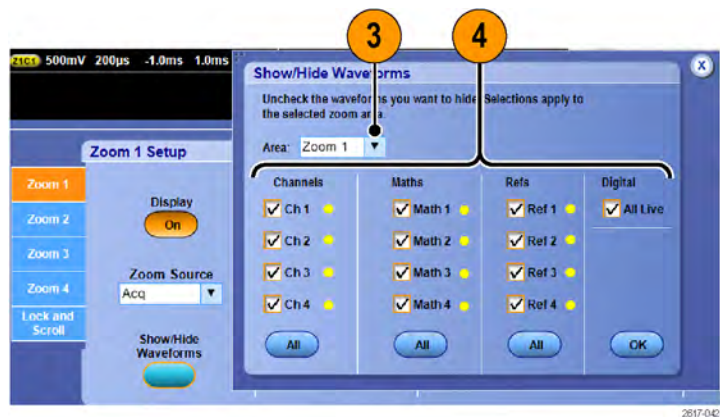

## Using Wave Inspector to manage long record length waveforms

The Wave Inspector controls (Pan/Zoom, play/pause, Mark, Search) help you to efficiently work with long record length waveforms. To magnify a waveform horizontally, turn the Zoom knob. To scroll through a zoomed waveform, turn the Pan knob.

Wave inspector is available on MSO5000B and DPO5000B Series instruments.

The Pan-Zoom Control consists of:

1. An outer pan knob
2. An inner zoom knob

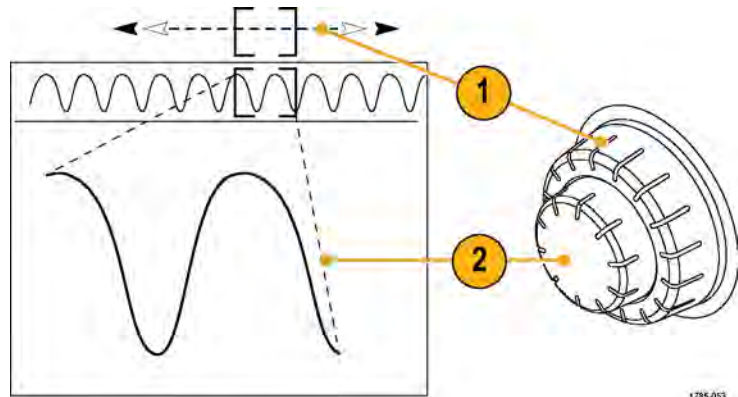

### Zooming a waveform

To use zoom:

1. Rotate the inner knob on the Pan-Zoom control clockwise to zoom in on a selected part of the waveform. Rotate the knob counterclockwise to zoom back out.

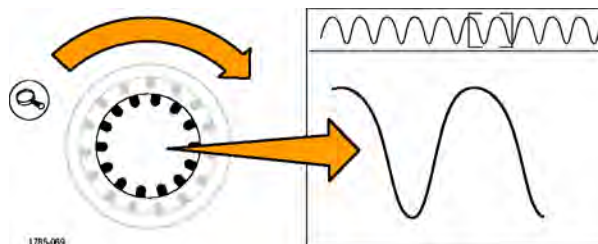

2. Alternatively, enable or disable the zoom mode by pushing the zoom button once or twice.

(See page 99, *Using MultiView Zoom.*)

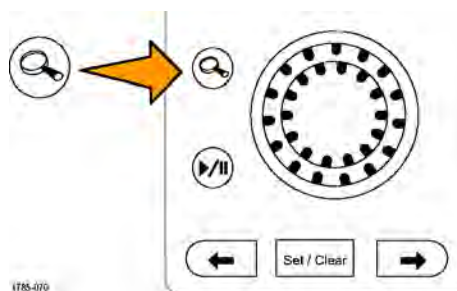

3. Examine the zoomed view of the waveform that appears on the larger, lower part of the display. The upper part of the display will show the position and size of the zoomed part in the waveform, within the context of the overall record.

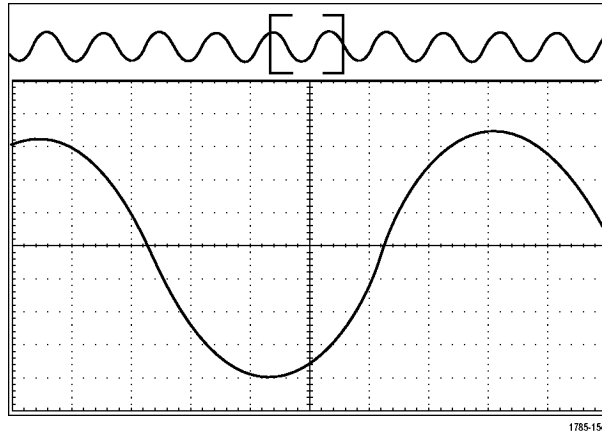

1785-154

### Panning a waveform

While the zoom feature is on, use the pan feature to quickly scroll through the waveform. To use pan:

1. Rotate the pan (outer) knob of the pan-zoom controls to pan the waveform.  
Turn the knob clockwise to pan forward. Turn it counterclockwise to pan backward. The further you turn the knob, the faster the zoom window pans.

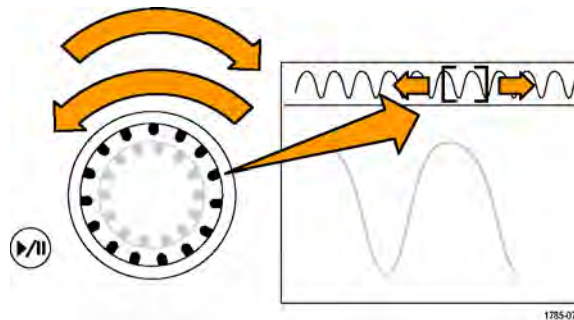

1785-073

### Playing and pausing a waveform

Use the play-pause feature to automatically pan through a waveform record. To use it:

1. Enable the play-pause mode by pushing the play-pause button.
2. Adjust the play speed by turning the pan (outer) knob further. The further you turn it, the faster it goes.

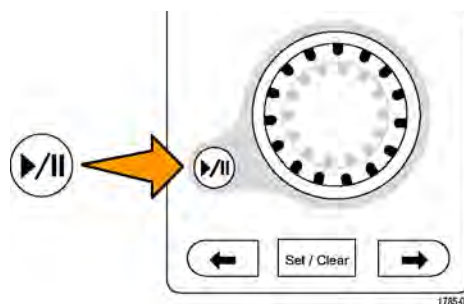

1785-074



3. Change the play direction by reversing the direction that you are turning the pan knob.
4. During play, up to a point, the more you turn the outer knob, the faster the waveform accelerates. If you rotate the outer knob as far as it can go, the play speed does not change, but the zoom box quickly moves in that direction. Use this maximum rotation feature to replay a part of the waveform that you just saw and want to see again.
5. Pause the play-pause feature by pushing the play-pause button again.

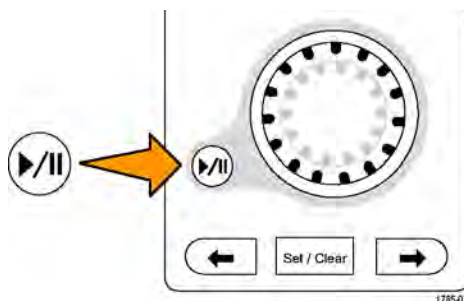

## Searching and marking waveforms

You can mark locations of interest in the acquired waveform. These marks help you limit your analysis to particular regions of the waveform. You can mark areas of the waveform automatically, if they meet some special criteria, or you can manually mark each item of interest. You can jump from mark to mark (area of interest to area of interest). You can automatically search and mark many of the same parameters that you can trigger on. Many search parameters do not have the time limits as triggers. You can search on math and reference waveforms. You can find all of the acquired events of a certain type.

Search marks provide a way to mark a waveform region for reference. Set marks automatically with search criteria. Search for and mark regions with particular edges, pulse widths, runts, logic states, rise/fall times, setup and hold violations, and bus search types.

Search and Mark do not support digital waveforms.

**To manually set and clear (delete) marks:**

1. Turn on **Multiview Zoom**. Zoom 1 is used with marks.  
(See page 99, *Using MultiView Zoom*.)

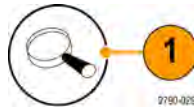

2. Select **Analyze > Search**.

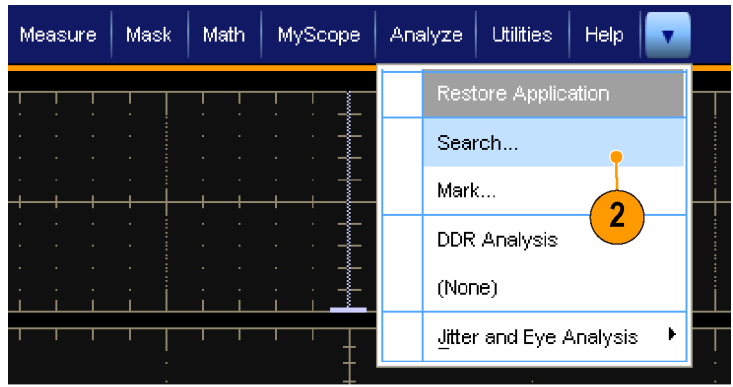

3. Move (the zoom box) to the area on the waveform where you want to set (or clear) a search mark by turning a multipurpose knob.  
Push the Next (→) or Prev (←) arrow button to jump to an existing mark.

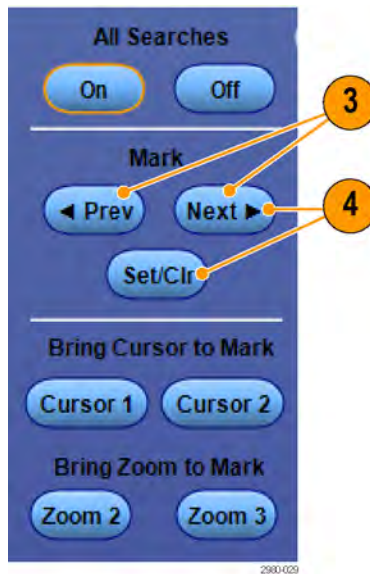

4. Push **Set Clr** or the front panel **Set/Clear** button.  
If no search mark is at the screen center, the instrument will add one.  
When a mark is created, the horizontal zoom factor is saved. When you use Next or Prev to move between marks, the zoom factor is restored.

- Investigate your waveform by moving from search mark to search mark. Use the Next (→) or Prev (←) arrow button to jump from one marked location to another, without adjusting any other controls.
- Delete a mark. Push the Next (→) or Prev (←) arrow button to jump to the mark you want to clear. To remove the center-positioned mark, push the **Set Clr** or the front panel **Set/Clear** button. It works on both manually and automatically created marks.

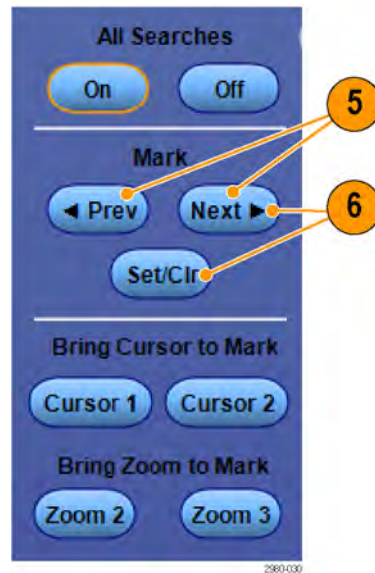

**To automatically set and clear (delete) search marks:**

1. Push **Search** or select **Analyze > Search**.

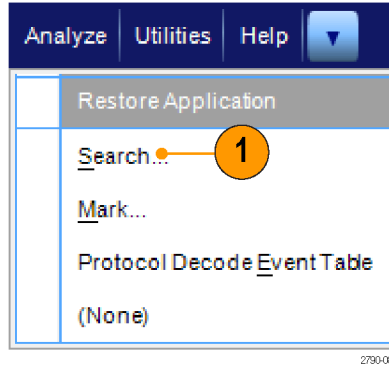

2. Select the desired search type from the menu.  
The search menu is similar to the trigger menu.  
Serial bus searches are optional.

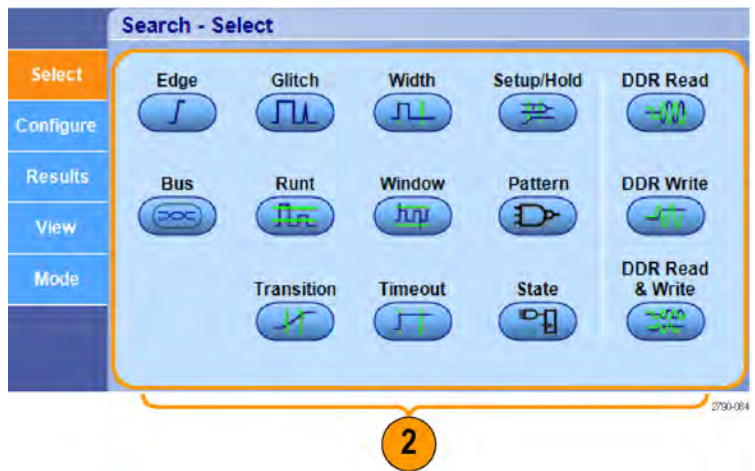

3. Set up your search from the Configure tab. To copy the trigger setup or a search setup, press Settings Copy.
4. From the Copy Settings window, select where to copy the settings from and where to copy the settings to. Press Copy and then Close.

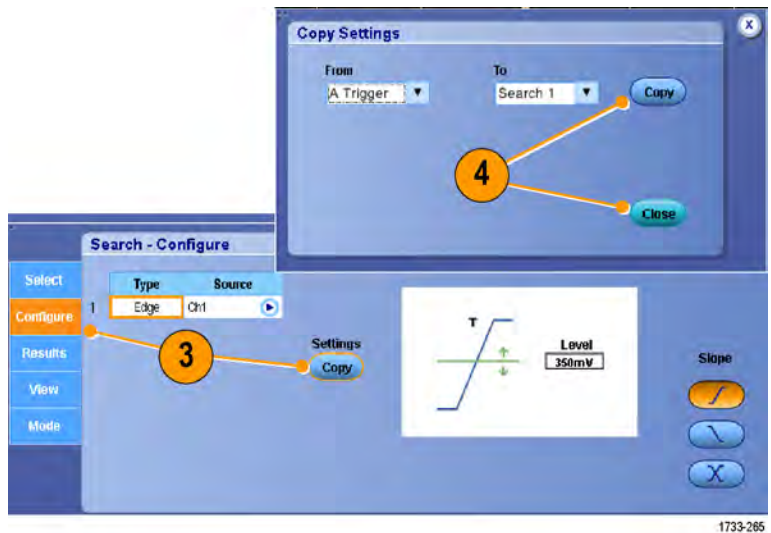

- To modify the current search setup, adjust the displayed controls. Displayed controls vary depending on the selected search.

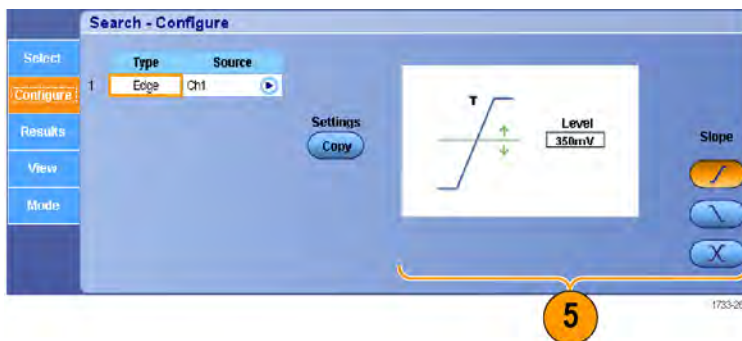

- If not already on, press **All Searches** to toggle search to on.

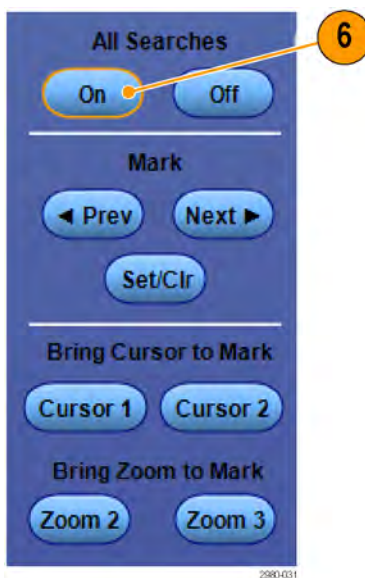

- On the screen, triangles show the location of automatic marks and triangles with a white outline show the custom (user-defined) locations. These appear on both normal and zoomed waveform views.

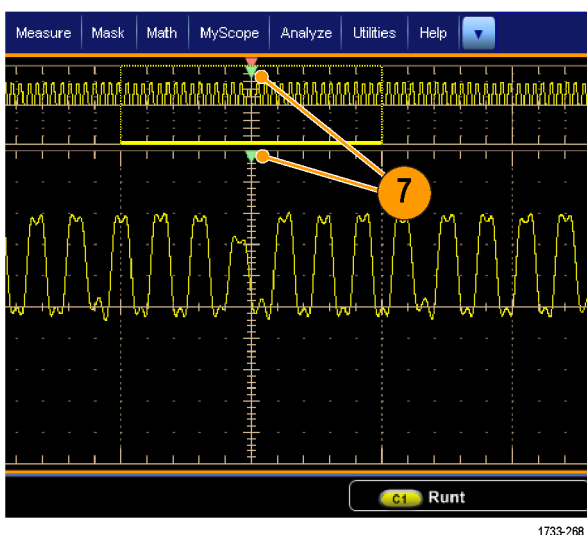

- Quickly investigate your waveform by moving from mark to mark with the Next (→) or Prev (←) arrow button. No other adjustments are needed.

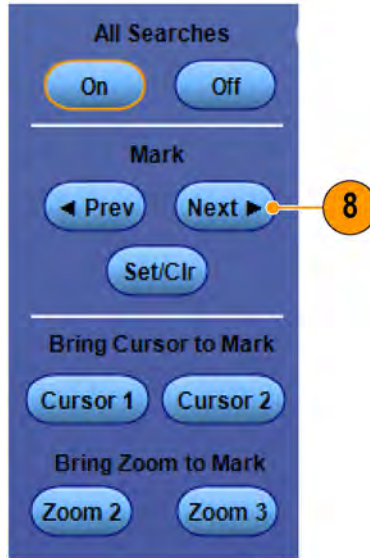

2980-032

- To toggle between the display of search events counts or Marks time, select the **Results** tab and press **View Count**.
- To clear all marks from the table, press All Marks **Clear**.
- To export the Mark Table to a file, press All Marks **Export**.

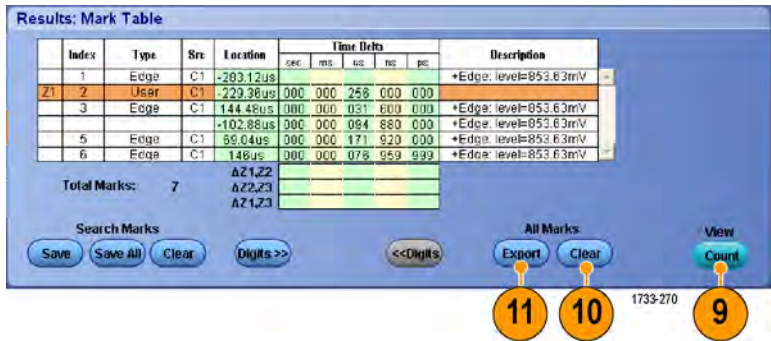

1733-270

- To convert a mark or all marks to user marks, press Search Marks **Save** or **Save All**.
- To remove the currently highlighted row from the Mark Table, press Search Marks **Clear**.
- To toggle between showing mark locations in engineering notation or in high precision form, press **Digits**.

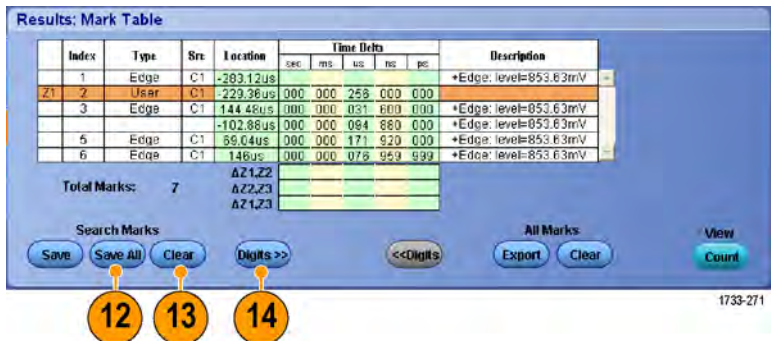

1733-271

15. To toggle the display of mark triangles on and off, select the **View** tab and press **Show Marks**.



16. To stop acquisitions if a match is found, select the **Mode** tab and check **Stop Acquisition if event found**.

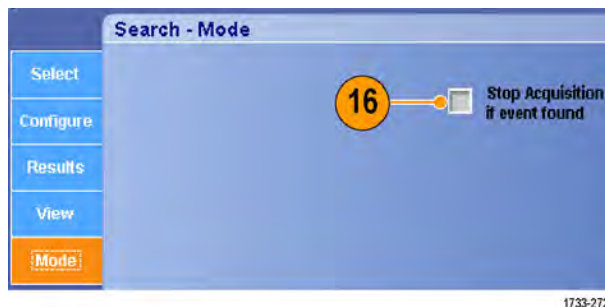

### Quick tips

- Search is performed only on acquired data. Set up the instrument to acquire the data you are searching for.
- Set the sample rate so the search event is discernible. You can search for a glitch that is wider than a couple of sample intervals.
- You can copy trigger settings to search for other locations in your acquired waveform that meet the trigger conditions. You can copy search settings to your trigger.
- Edge search marks are created without zoom factors. Other search types create marks with an appropriate zoom factor.
- Pressing Bring Zoom to Mark **Zoom 2** or **Zoom 3** displays the corresponding zoom view with the same zoom parameters as Zoom 1.
- Custom (User) marks are saved with the waveform when the waveform is saved and when the setup is saved.
- Automatic search marks are not saved with the waveform when the waveform is saved. However, the search criteria are saved in the saved setup, so you can easily recapture the marks by reusing the search function.

Search includes the following search capabilities:

Search	Description
Edge	Searches for edges (rising or falling) with a user-specified threshold level.
Glitch	Searches for pulses narrower (or wider) than the specified width, or ignores glitches narrower (or wider) than the specified width.
Width	Searches for positive or negative pulse widths that are $>$ , $<$ , $=$ , or $\neq$ a user-specified pulse width.
Setup & Hold	Search for violations of user-specified setup and hold times.

Search	Description
Runt	Searches for positive or negative pulses that cross one amplitude threshold but fail to cross a second threshold before crossing the first again. Search for all runt pulses or only those with a duration $>$ , $<$ , $=$ , or $\neq$ a user-specified time.
Window	Searches for a signal that is entering or leaving the threshold window. Qualify the search in terms of time by using the When Wider option, or by the logical state of other channels using the When Logic option.
Pattern	Search for a logic pattern (AND, OR, NAND, or NOR) across multiple waveforms with each input set to either High, Low, or Don't Care. Search for when the event goes true, goes false, or stays valid for $>$ , $<$ , $=$ , or $\neq$ a user-specified time. Additionally, you must define one of the inputs as a clock for synchronous (state) searches.
Transition	Search for rising and/or falling edges that are $>$ , $<$ , $=$ , or $\neq$ a user-specified time.
Timeout	Searches for no pulse in a specified time.
State	Searches for when all of the logic inputs to the selected logic function cause the function to be True or False when the clock input changes state.
DDR Read	Searches for DDR read pulses. Requires option DDRA.
DDR Write	Searches for DDR write pulses. Requires option DDRA.
DDR Read and Write	Searches for DDR read and write pulses. Requires option DDRA.
Bus	<p>Parallel: Search for a binary or hex value.</p> <p>I<sup>2</sup>C: Search for Start, Repeated Start, Stop, Missing Ack, Address, Data, or Address and Data.</p> <p>SPI: Search for SS Active, MOSI, MISO, or MOSI &amp; MISO.</p> <p>CAN: Search for Start of Frame, Type of Frame (Data, Remote, Error, Overload), Identifier (standard or extended), Data, Identifier and Data, End of Frame, or Missing Ack, Bit Stuffing Error.</p> <p>RS-232, RS-422, RS-485, UART: Search for Tx Start Bit, Rx Start Bit, Tx End of Packet, Rx End of Packet, Tx Data, Rx Data, Tx Parity Error, Rx Parity Error.</p> <p>LIN: Search for Sync, Identifier, Data, ID &amp; Data, Wakeup Frame, Sleep Frame, Error.</p> <p>FlexRay: Search for Start of Frame, Type of Frame, Identifier, Cycle Count, Header Fields, Data, ID &amp; Data, End of Frame, Error.</p> <p>Ethernet: search for Start of Frame, MAC Addresses, Q-Tag Control Information, MAC Length/Type/Data, IPv4Header, TCP Header, TCP/IPv4 Client Data, End of Packet, and FCS Error.</p> <p>PCIe: search for Pattern, Character/Symbol, Long Ordered Set Error, and Any Control Character.</p> <p>8b/10b: search for Pattern, Character/Symbol, Error, and Any Control Character.</p> <p>MIPI: search for Stop, Start/End of Transmission, Bus Turn Around, Escape Mode, Warning, Error, and Short/Long Packet.</p> <p>MIL-STD-1553: search for Sync, Command/Status Word, Data, RT/IMG Time, and Error.</p> <p>Custom: search using your custom decoder.</p> <p>USB: Search for Sync, Reset, Suspend, Resume, End of Packet, Token (Address) Packet, Data Packet, Handshake Packet, Special Packet, Error, Pattern, Character/Symbol, Long Ordered Set, Packets, LFPS, or Any Control Character.</p>



## Using a visual search

A visual search is performed with the same settings as the main trigger. The results of a visual search are displayed as marks with a color distinct from those of an Analyze search. Do the following steps to set up a visual search.

1. Set up pinpoint triggers. (See page 70, *Choosing a trigger type*.)
2. Set up a visual trigger. (See page 84, *Triggering using Visual Triggers (Visual Triggering)*.)
3. Click **Mark All Trigger Events in Record**.

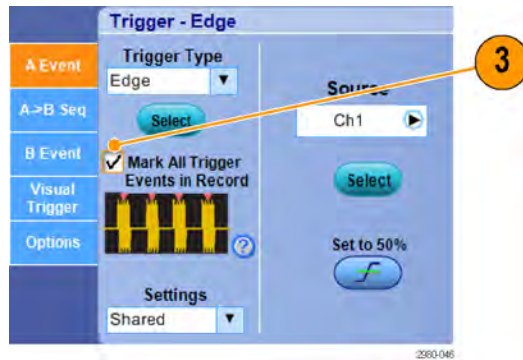

4. Visual Trigger areas are displayed in blue.
5. Visual Search areas are displayed in green.

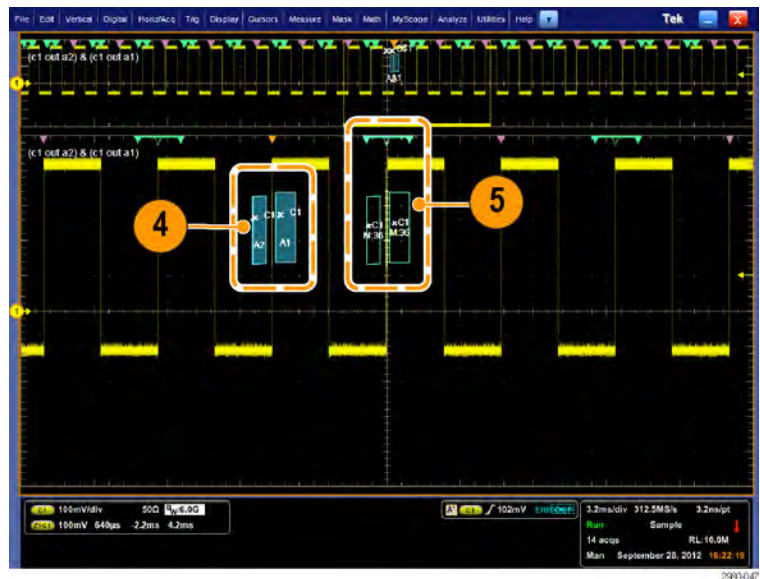

6. Only the active visual search area is displayed. Press the **Mark Next** and the **Mark Prev** buttons to move the active mark to other visual search areas.

Use the other Analyze Search control windows to control or view the results of the Visual Search.



# Analyzing waveforms

Your instrument features cursors, automatic measurements, statistics, histograms, math, spectral analysis, and advanced pass/fail tests to help you to analyze waveforms. This section contains concepts and procedures for analyzing waveforms. Detailed information is available in the online help.

## Taking automatic measurements

1. Select **Measure > Measurement Setup...**

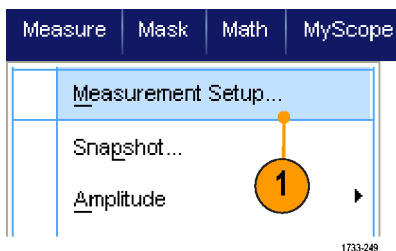

2. Select the channel, math or reference waveform that you want to measure.
3. Using the tabs, select measurements in five different categories.

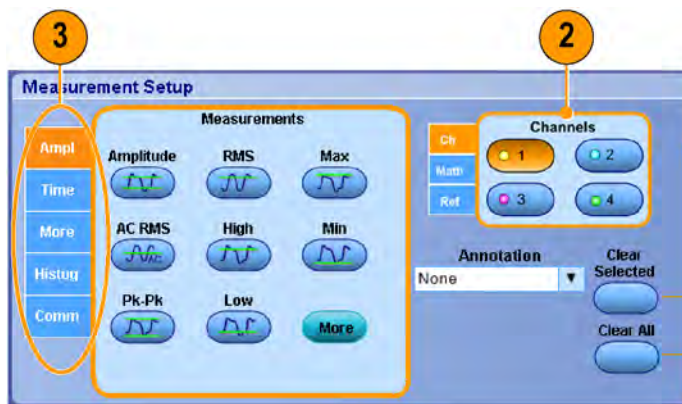

4. To remove all measurements, click **Clear All**.
5. To remove multiple measurements, click and drag to select the measurements, and then click **Clear Selected**.

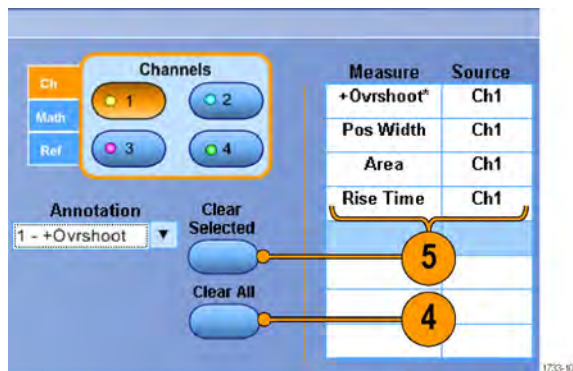

You can also choose a measurement for the selected waveform directly in the Measure menu. (See page 118, *Automated measurement selections*.)

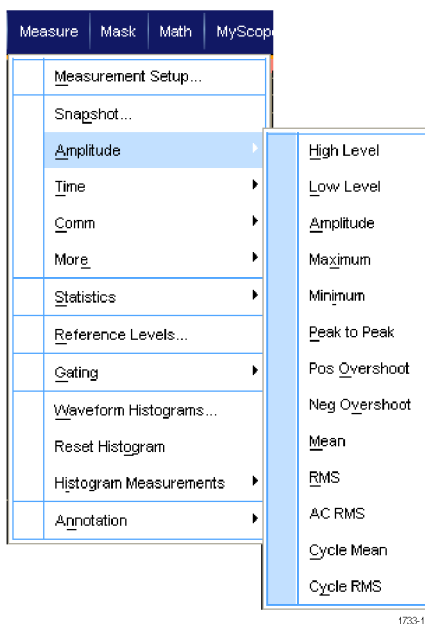

### Quick tips

- Automatic measurements are available for digital channel waveforms by using DPOJET. Only measurements appropriate to digital waveforms are available. On MSO7000C/DX instruments you can take a measurement of a digital channel waveform by first sending the digital channel to an analog channel using iCapture. (See page 61, *Viewing analog characteristics of digital waveforms*.)
- In roll mode, measurements are not available until after you stop the acquisition.



**WARNING.** If there is vertical clipping, there may be a dangerous voltage on the probe tip, but the readout will indicate a low voltage. A  symbol appears in the measurement readout if a vertical clipping condition exists. Automatic amplitude-related measurements where the signal is vertically clipped produce inaccurate results. Clipping also causes inaccurate amplitude values in waveforms that are stored or exported for use in other programs. If a math waveform is clipped, it will not affect amplitude measurements on that math waveform.

## Automated measurement selections

The following tables list each automated measurement by category: amplitude, time, histogram, communication, or more. (See page 116, *Taking automatic measurements.*)

### Amplitude measurements

Measurement	Description
Amplitude	The high value less the low value measured over the entire waveform or gated region.
High	This value is used as 100% whenever high reference, mid reference, or low reference values are needed, such as in fall time or rise time measurements. It is calculated using either the min/max or histogram method. The min/max method uses the maximum value found. The histogram method uses the most common value found above the midpoint. This value is measured over the entire waveform or gated region.
Low	This value is used as 0% whenever high reference, mid reference, or low reference values are needed, such as in fall time or rise time measurements. It is calculated using either the min/max or histogram method. The min/max method uses the minimum value found. The histogram method uses the most common value found below the midpoint. This value is measured over the entire waveform or gated region.
RMS	The true Root Mean Square voltage over the entire waveform or gated region.
AC RMS	The true Root Mean Square voltage over the measurement region.
Max	The most positive peak voltage. Max is measured over the entire waveform or gated region.
Min	The most negative peak voltage. Min is measured over the entire waveform or gated region.
Pk-Pk	The absolute difference between the maximum and minimum amplitude in the entire waveform or gated region.
Cycle RMS	The true Root Mean Square voltage over the first cycle in the waveform or the first cycle in the gated region.
+Overshoot	This is measured over the entire waveform or gated region and is expressed as: Positive Overshoot = ((Maximum - High) / Amplitude) x 100%.
-Overshoot	This is measured over the entire waveform or gated region and is expressed as: Negative Overshoot = ((Low - Minimum) / Amplitude) x 100%.
Mean	The arithmetic mean over the entire waveform or gated region.
Cycle Mean	The arithmetic mean over the first cycle in the waveform or the first cycle in the gated region.

### Time measurements

Measurement	Description
Rise Time	The time required for the leading edge of the first pulse in the waveform or gated region to rise from the low reference value (default = 10%) to the high reference value (default = 90%) of the final value.
Fall Time	The time required for the falling edge of the first pulse in the waveform or gated region to fall from the high reference value (default = 90%) to the low reference value (default = 10%) of the final value.
Pos Width	The distance (time) between the mid reference (default 50%) amplitude points of a positive pulse. The measurement is made on the first pulse in the waveform or gated region.
Neg Width	The distance (time) between the mid reference (default 50%) amplitude points of a negative pulse. The measurement is made on the first pulse in the waveform or gated region.
+ Duty Cyc	The ratio of the positive pulse width to the signal period expressed as a percentage. The duty cycle is measured on the first cycle in the waveform or gated region.

**Time measurements (cont.)**

Measurement	Description
- Duty Cyc	The ratio of the negative pulse width to the signal period expressed as a percentage. The duty cycle is measured on the first cycle in the waveform or gated region.
Period	The time required to complete the first cycle in a waveform or gated region. Period is the reciprocal of frequency and is measured in seconds.
Freq	The frequency of the first cycle in a waveform or gated region. Frequency is the reciprocal of the period; it is measured in Hertz (Hz) where one Hz is one cycle per second.
Delay	The time between the mid reference (default 50%) amplitude point of two different waveforms.

**More measurements**

Measurement	Description
Area	The area over the entire waveform or gated region in volt-seconds. Area measured above ground is positive; area measured below ground is negative.
Cycle Area	The area over the first cycle in the waveform or the first cycle in the gated region expressed in volt-seconds. The area above the common reference point is positive while the area below the common reference point is negative.
Phase	The amount of time that one waveform leads or lags another waveform, expressed in degrees where 360° contains one waveform cycle.
Burst Width	The duration of a burst (a series of transient events) and is measured over the entire waveform or gated region.

**Histogram measurements**

Measurement	Description
Wfm Ct	Displays the number of waveforms that have contributed to the histogram.
Hits in Box	Displays the number of points in or on the histogram box.
Peak Hits	Displays the number of points in the largest bin of the histogram.
Median	Displays the middle point of the histogram box. Half of all acquired points within or on the histogram box are less than this value and half are greater than this value.
Max	Displays the voltage of the highest nonzero bin in vertical histograms or the time of the rightmost nonzero bin in the horizontal histograms.
Min	Displays the voltage of the lowest nonzero bin in vertical histograms or the time of the leftmost nonzero bin in the horizontal histograms.
Pk-Pk	Displays the peak-to-peak value of the histogram. Vertical histograms display the voltage of the highest nonzero bin minus the voltage of the lowest nonzero bin. Horizontal histograms display the time of the rightmost nonzero bin minus the time of the leftmost nonzero bin.
Mean	Measures the average of all acquired points within or on the histogram box.
Std Dev	Measures the standard deviation (Root Mean Square (RMS) deviation) of all acquired points within or on the histogram box.
Mean $\pm$ 1 Std Dev	Displays the percentage of points in the histogram that are within one standard deviation of the histogram mean.

**Histogram measurements (cont.)**

<b>Measurement</b>	<b>Description</b>
Mean $\pm 2$ Std Dev	Displays the percentage of points in the histogram that are within two standard deviations of the histogram mean.
Mean $\pm 3$ Std Dev	Displays the percentage of points in the histogram that are within three standard deviations of the histogram mean.

**Communication measurements**

<b>Measurement</b>	<b>Description</b>
Ext Ratio	The ratio of eye top to base. This measurement only works for waveform database or a reference waveform saved in waveform database mode.
Ext Ratio %	The ratio of eye top to base expressed as a percentage. This measurement only works for waveform database or a reference waveform saved in waveform database mode.
Ext Ratio (dB)	The ratio of eye top to base expressed in decibels. This measurement only works for waveform database or a reference waveform saved in waveform database mode.
Eye Height	The measurement of the eye height in volts.
Eye Width	The measurement of eye width in seconds.
Eye Top	The top value used in the extinction ratio measurements.
Eye Base	The base value used in the extinction ratio measurements.
Crossing %	The eye crossing point expressed as a percentage of eye height.
Jitter P-P	The peak-to-peak value for the edge jitter in the current horizontal units.
Jitter RMS	The RMS value of the edge jitter in the current horizontal units.
Jitter 6 Sigma	Six times the RMS value of the edge jitter in the current horizontal units.
Noise P-P	The peak-to-peak value of the noise of the top or base of the signal as specified by you.
Noise RMS	The RMS value of the noise of the top or base of the signal as specified by you.
S/N Ratio	The ratio of the signal amplitude to the noise of the top or base of the signal as specified by you.
Cyc Distortion	The peak-to-peak time variation of the first eye crossing measured at the Mid Ref as a percent of the eye period.
Q-Factor	The ratio of eye size to noise.

## Customizing an automatic measurement

Customize automatic measurements by using gating, modifying measurement statistics, or adjusting the measurement reference levels.

### Gating

Use Gating to confine the measurement to a certain part of a waveform.

1. Select **Measure > Gating > Gating ...**
2. Position the gates by doing one of the following:
  - Click **Cursor** to set the gated area to the area between the cursors.
  - Click **Zoom (1-4)** to set the gated area to the Zoom (1-4) graticule.

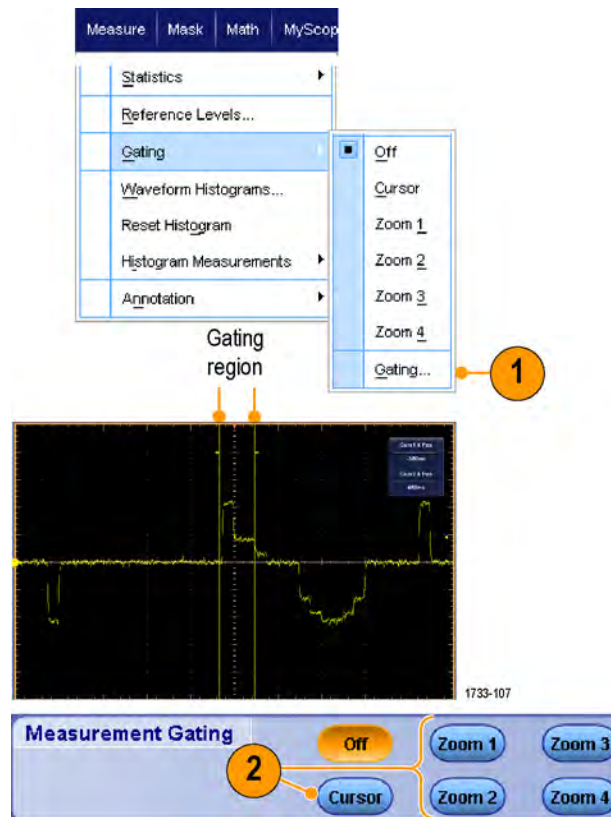

## Statistics

Statistics turn on automatically with measurements. Statistics characterize the stability of the measurement.

1. To change the statistics that are displayed, select **Measure > Statistics**, and then select **Mean** or **All**. (All includes min, max, mean, standard deviation, and population.)
2. To remove statistics select **Off**.

**NOTE.** Placing the cursor over a measurement displays a higher resolution version of the measurement.

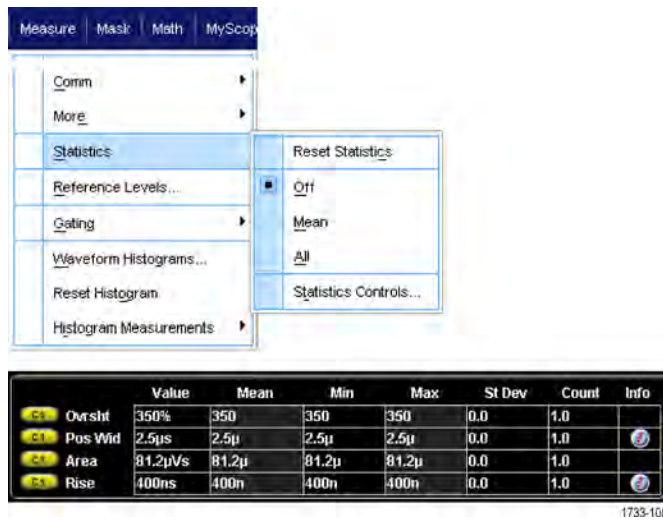

1733-108

## Snapshot

To see a one-time view of all valid measurements, select **Measure > Snapshot**.

**NOTE.** If the setup for a measurement is invalid, the results of that measurement is displayed as 3 question marks.

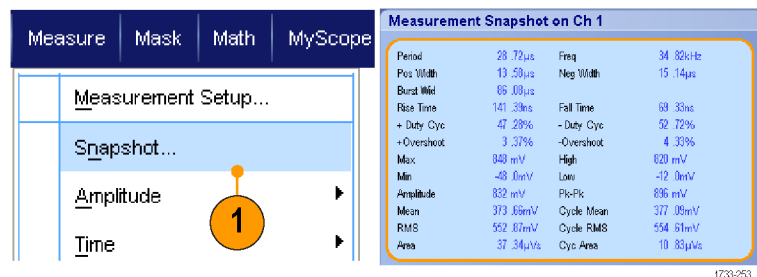

1733-253

To select between taking a snapshot of general measurements or communications measurements, select General or Comm.

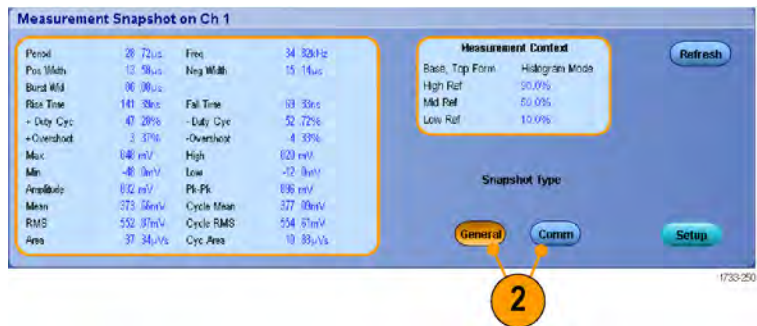

1733-250



## Annotate measurements

1. To annotate measurements, select **Annotation** from the Measurements setup control window. From the drop down list, select the measurement to annotate.

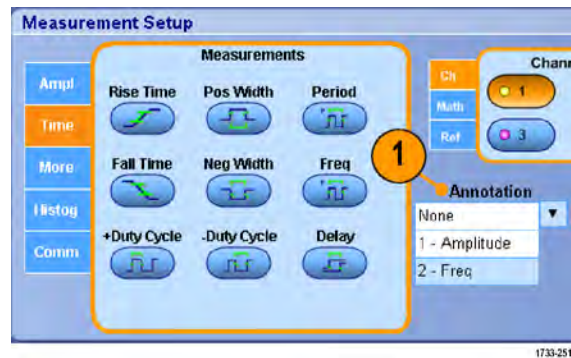

2. To select the amount of measurement annotation detail, select **Measure > Annotation > Standard** or **Detailed**.

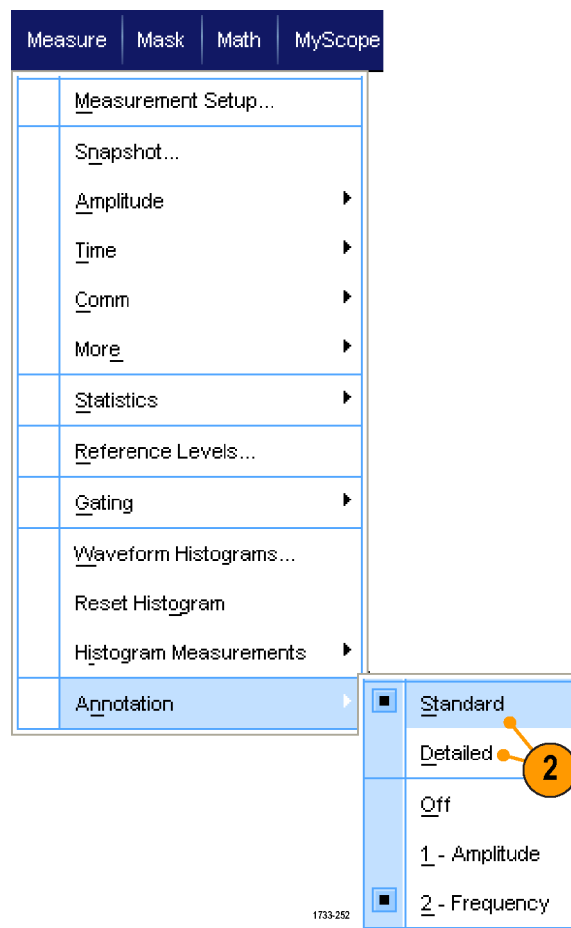

## Reference Levels

Reference levels determine how time-related measurements are taken.

1. Select **Measure > Reference Levels...**
2. Adjust the measurement reference levels to different relative or absolute values.
  - High and Low references are used to calculate rise and fall times. The default High reference is 90% and Low reference is 10%.
  - Mid reference is primarily used for measurements between edges such as pulse widths. The default level is 50%.
  - Mid2 reference is used on the second waveform specified in delay or phase measurements. The default level is 50%.

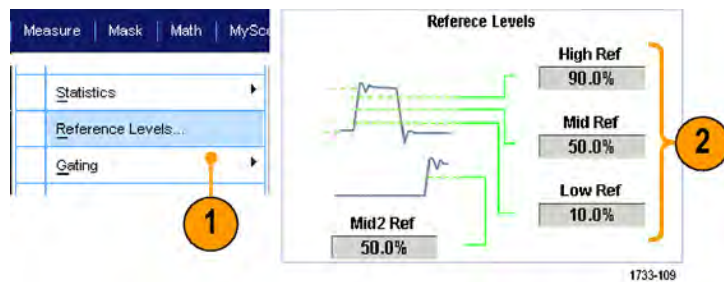

## Quick tips

- To ensure accurate noise values, be sure to go to the Reference Levels Setup menu and set the signal type to Eye when measuring an Eye signal.

## Taking cursor measurements

Use cursors to take manual measurements on acquired data.

### 1. Push **Cursors**.

**NOTE.** If cursors are on but the multipurpose knob readouts are not attached to the Position controls, press the Cursors button to attach the controls to the readouts. Press the Cursors button again to turn cursors off.

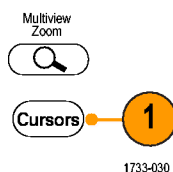

MSO/DPO70000DX, MSO/DPO70000C, and DPO7000C Series

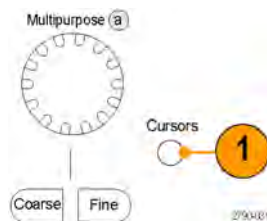

MSO5000B and DPO5000B Series

### 2. Select the Cursor Source.

### 3. Select a cursor type from one of the following:

- H Bars measure amplitude (typically in volts or amperes)
- V Bars measure horizontal parameters (typically time)
- Waveform and screen cursors measure vertical and horizontal parameters simultaneously. Waveform cursors are attached to the waveform, and screen cursors float, unattached to the waveform.

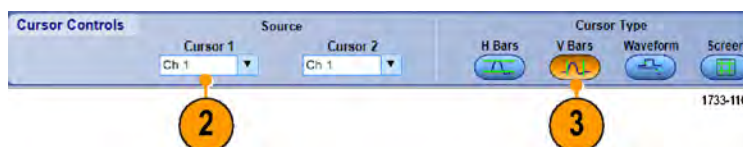

- To take measurements between two waveforms, select **Waveform**, and then select the waveform source for each cursor.

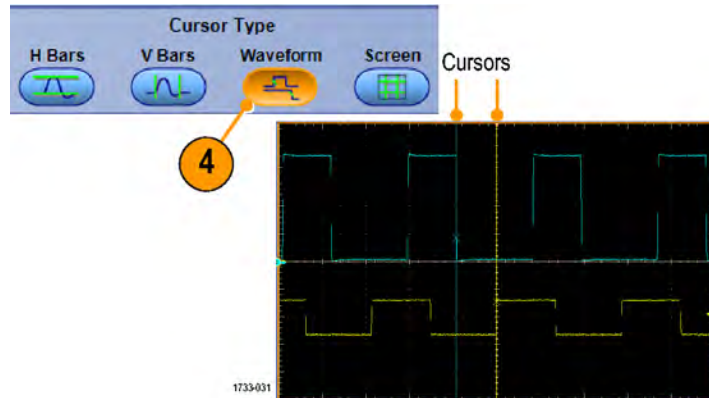

- Select **Cursors > Cursor Position...**, and then use the multipurpose knobs to adjust the cursor position.
- Read cursor measurement results in the display.

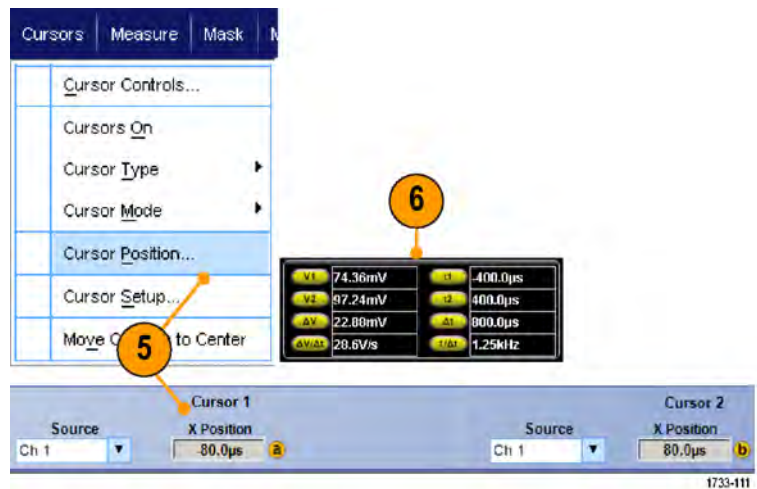

### Quick tips

- Use the Cursor Track Mode to set the cursors to move in tandem. Use the Cursor Independent mode to move the cursors separately.
- If you use the zoom graticule, you can place a cursor directly on a specific waveform point to take precision measurements.
- You can also move cursors by clicking and dragging them to a new position.
- You can also move cursors to the center of the display by pressing **Move Cursors to Center**.
- You can select solid or dashed cursors.
- Vertical cursors measure the time from the trigger point to the vertical cursor.

## Setting up a histogram

You can display either a vertical (voltage) or horizontal (time) histogram. Use histogram measurements to get statistical measurement data for a section of a waveform along one axis.

1. Click and drag the pointer across the segment of the waveform that you want the histogram to cover. For example, make the box for a horizontal histogram wider than it is tall.
2. Select **Histogram Vertical** or **Histogram Horizontal** from the shortcut menu.

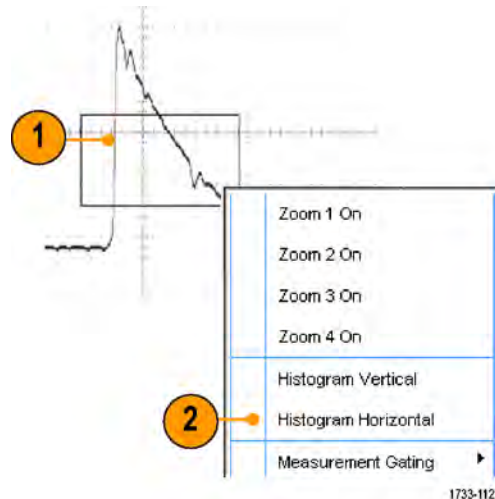

3. View the histogram at the top (for horizontal histograms) or the left edge (for vertical histograms) of the graticule.

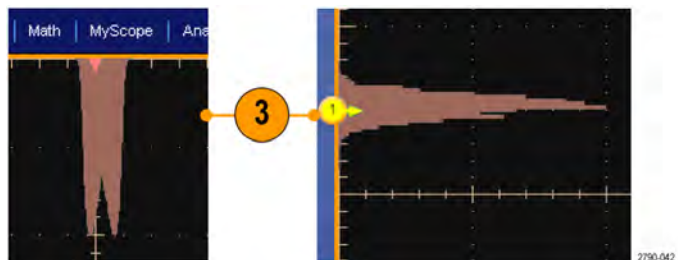

4. To make adjustments to the histogram scale or the size and location of the histogram box, select **Measure > Waveform Histograms**, and then use the Histogram Setup control window.
5. You can also take automated measurements on histogram data. (See page 116, *Taking automatic measurements*.)

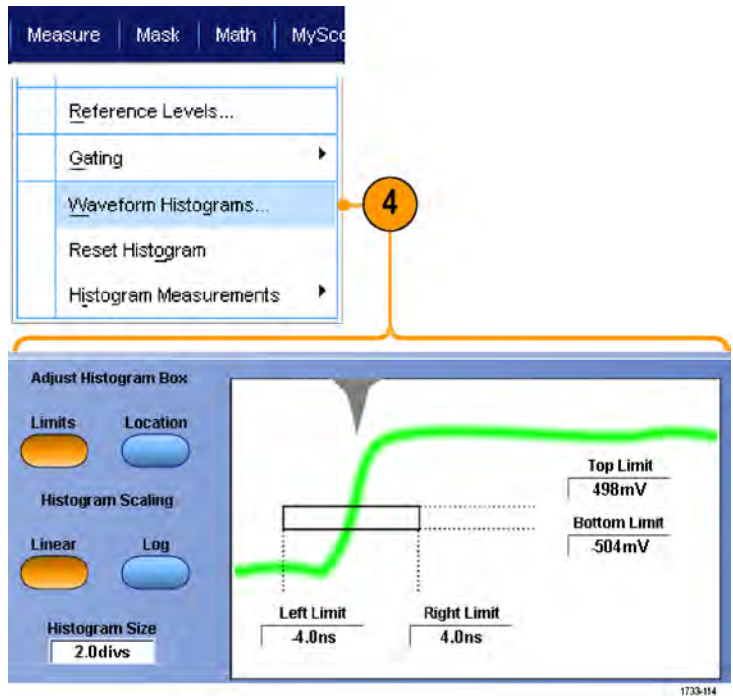

### Quick tips

- Use vertical histograms to measure signal noise and horizontal histograms to measure signal jitter.
- Use the click and drag procedure to activate the shortcut menu to turn the histogram display off.

## Using math waveforms

Create math waveforms to support the analysis of your channel and reference waveforms. By combining and transforming source waveforms and other data into math waveforms, you can derive the data view that your application requires.

Use the following procedure for predefined math equations.

1. Select **Math > Math Setup...**

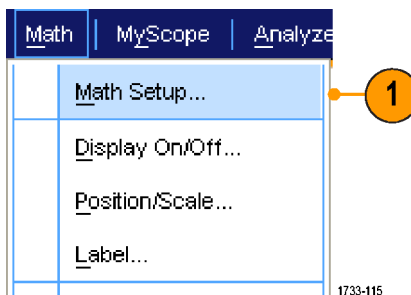

2. Choose one of the predefined math equations.

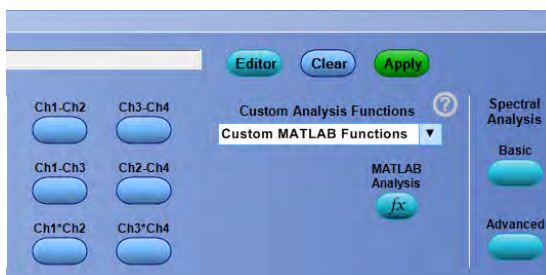

Use the following procedure to build an advanced math waveform expression.

1. Select **Math > Math Setup...**

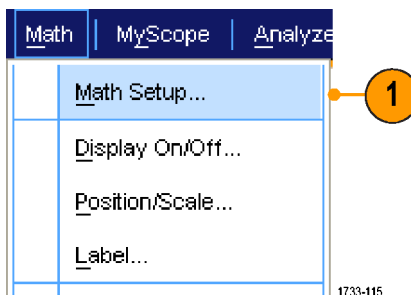

2. Click **Editor**.

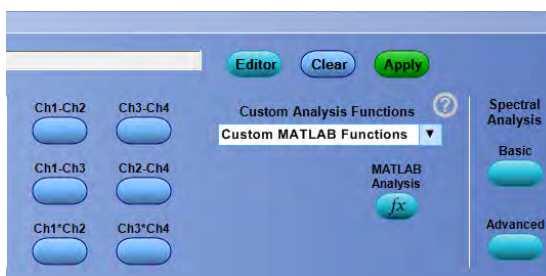

3. Build your advanced math waveform expression using sources, operators, constants, measurements, variables, and functions.
4. When you have defined the expression to your satisfaction, click **Apply**.

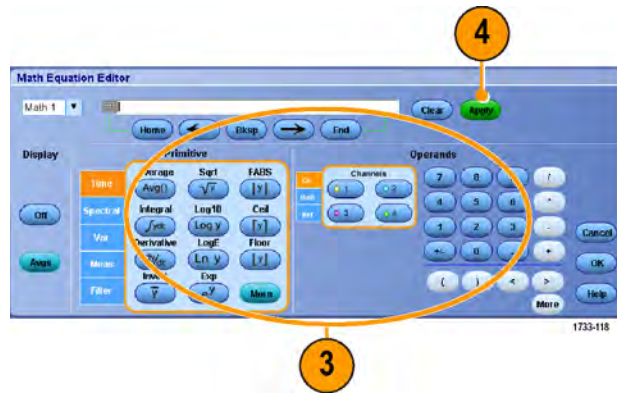

5. To add your own filter, click the **Filter** tab. Click **Load**.

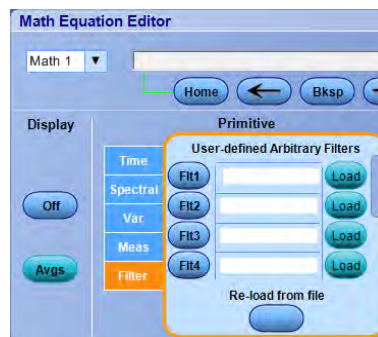

6. Double click the folder for the filters you want to use. Double click the filter you want to use.

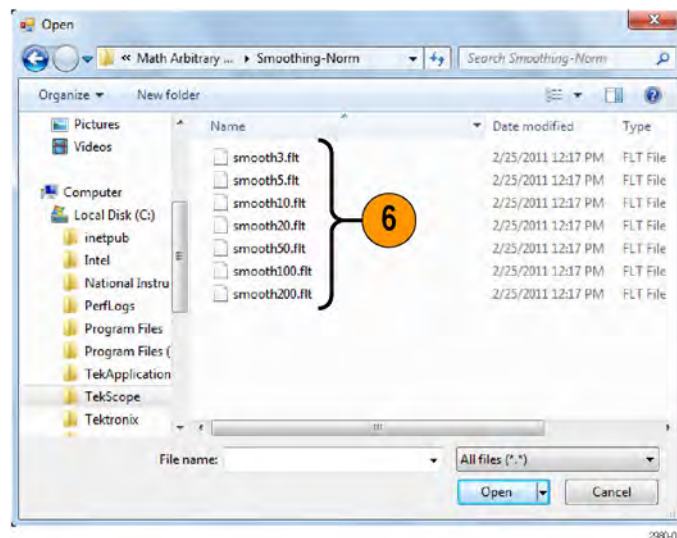



7. Build your math expression using the filter you selected.
8. When you have defined the expression to your satisfaction, click **Apply**.

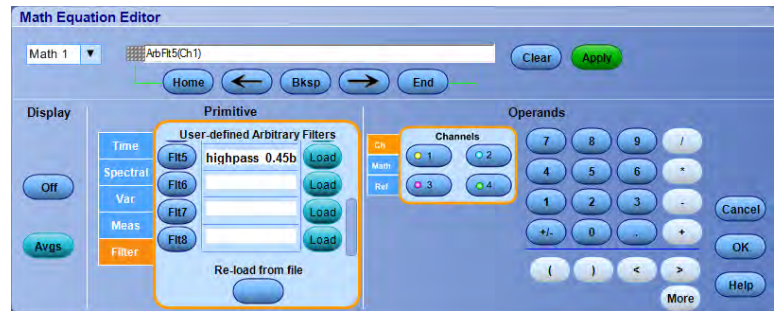

### Quick tips

- Double clicking on a math expression opens the Math Equation Editor.
- Math definitions are not implemented if the sources are not valid.
- Math waveforms are created from analog channel, reference, math source waveforms and from measurements.
- Digital channels are not valid in math waveforms. However iCapture waveforms are valid in math waveforms.
- Use Digital Properties to set the digital threshold of analog channels.
- Measurements are taken on math waveforms in the same way as on channel waveforms.
- Math waveforms derive their horizontal scale and position from the sources in their math expressions. Adjusting these controls for the source waveforms also adjusts the math waveform.
- If Autoscale is not checked, vertical scale and position are not calculated when a math waveform is turned on or the math equation is changed.
- Magnify math waveforms using MultiView Zoom; use the mouse for positioning the zoomed area.
- See the online help for more information on arbitrary math filters.

## Using Spectral Analysis

Use the following procedure for predefined spectral math expressions. See the online help for more information.

1. Select **Math > Math Setup...**

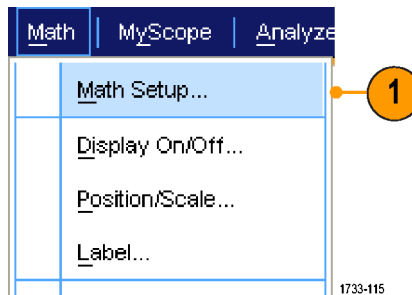

2. Choose one of the predefined spectral math expressions.
3. Click **Basic**.

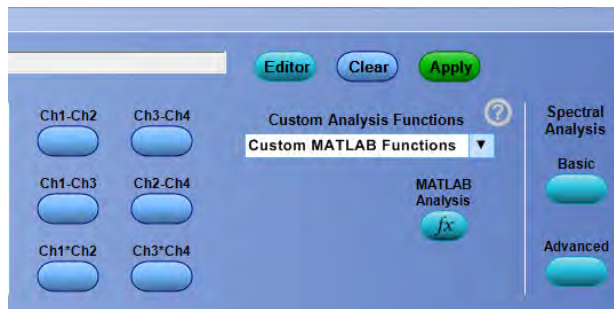

4. Click Resolution BW or Frequency Span and use the keypad or the multipurpose knobs to adjust the spectral display.

**NOTE.** Resolution BW and Frequency Span are only adjustable in Manual Horizontal Mode.

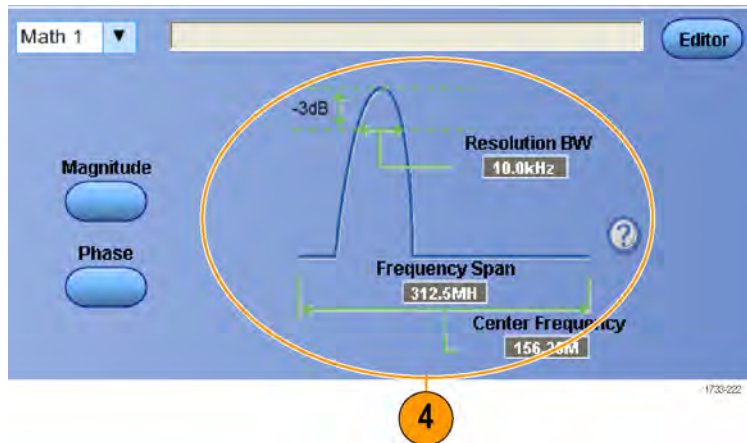

Use the following procedure to build an advanced spectral math expression.

1. Select **Math > Advanced Spectral...**

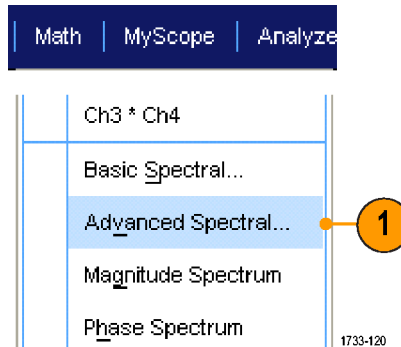

2. Select the math waveform that you want to define.
3. Click the type of spectral waveform that you want to create. To redefine a waveform, click Clear.
4. Select the source waveform.
5. Adjust the spectral waveform, using the controls in the Spectral Setup control window and use the multipurpose knobs.

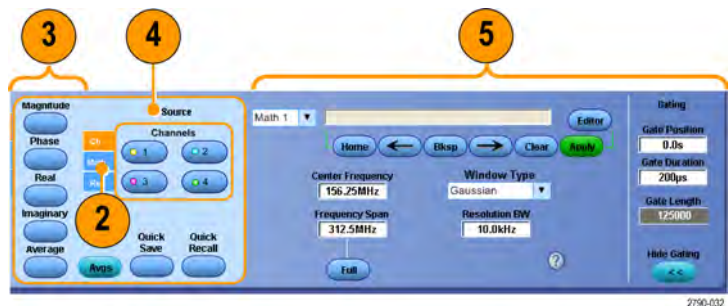

2790-032

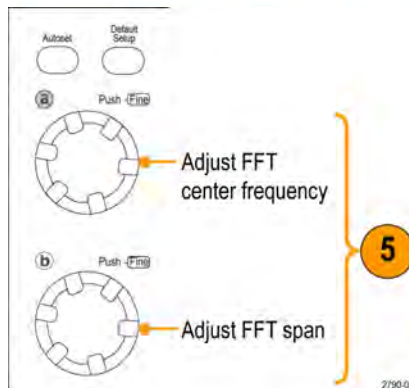

2790-033

MSO/DPO70000DX, MSO/DPO70000C, and DPO7000C Series

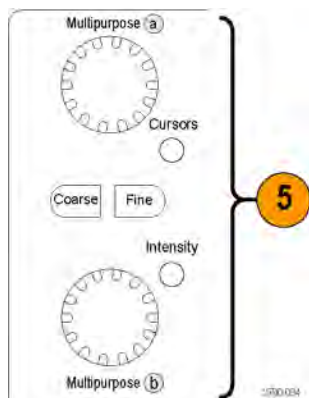

MSO5000B and DPO5000B Series

6. View time-domain and frequency-domain waveforms simultaneously.

Use **Gating** to select only a part of the time-domain waveform for spectral analysis. (See page 121, *Gating*.)

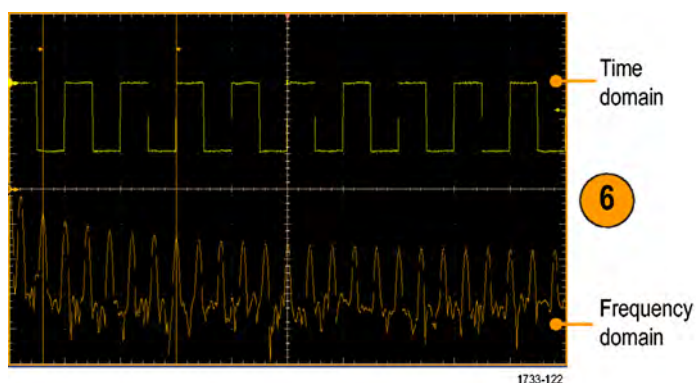

### Quick tips

- Sources for spectral math waveforms must be channel or other math waveforms.
- Use short record lengths for faster instrument response.
- Use long record lengths to lower the noise relative to the signal and increase the frequency resolution.
- Different window functions produce different filter response shapes in the spectrum and result in different resolution bandwidths. See the online help for more information.
- The resolution bandwidth (RBW) directly controls the gate width. Therefore, the time domain gate markers move as you adjust the control.
- You can display the linear magnitude of the real data or the imaginary data in the spectrum. This is useful if you process the spectrum off line and transform it back into a time domain trace.

## Using the Serial Error Detector

The Serial Error Detector requires option ERRDT. The oscilloscope Error Detector conducts Bit, Frame, Symbol, and Character tests much like a BERT. It has the advantage that it not only counts the errors and computes the error rates, but it also shows you where the error occurs in the signal and it allows you to connect probes to other channels to debug the source of the errors, such as crosstalk.

The Error Detector is often used in conjunction with TekExpress software applications to conduct receiver and margin testing.

The Error Detector has built-in preset setups that cover the most common use cases. These can be modified and saved as custom setup files for later recall. Sample arbitrary waveform generator (AWG) setup files are included for various SATA Gen3 and USB3 signals. These files make it easy to verify correct operation of the Error Detector, and may be used to test a device-under-test (DUT).

To use the Serial Error Detector, do the following steps:

1. Select **Analyze > Serial Error Detector** to display the Error Detector control window.

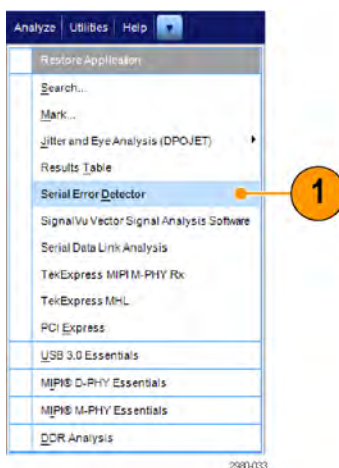

2. Select a setup from the **Preset Setting** drop-down list and press **Apply**.



If Custom Setup is not required, proceed to step 13.

3. When you select the **Custom\_Setup**, additional controls are shown on the display so you can browse for a setup file. The usual idea is to start with a setup that is close to what you want, use the UI to specify the settings you desire, and then save the result. When you enter a new name for the file in the file name text control, press **Enter** to have your editing changes accepted. Then press the **Save** button to save the setup into the file. To recall a setup file, browse to the file you want and press Open. The default location for Error Detector setup files is C:\Users\Public\Tektronix\TekScope>ErrorDetector.

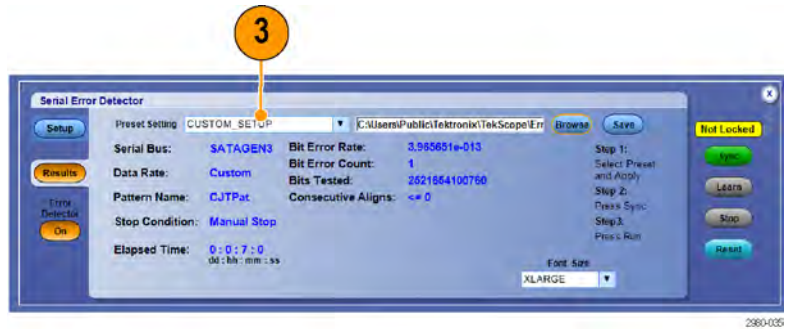

4. Select the **Setup** tab.

5. From the **Source Setup** tab, select the Serial Bus, Data Rate and signal Source from the drop-down lists.

6. Click the Error Detection option button for the type of error you want to detect.

The **Advanced** button will open the Advanced Settings window.

The advanced settings window provides controls for parameters that you may need to change for special testing. The default settings for these values are correct for most devices.

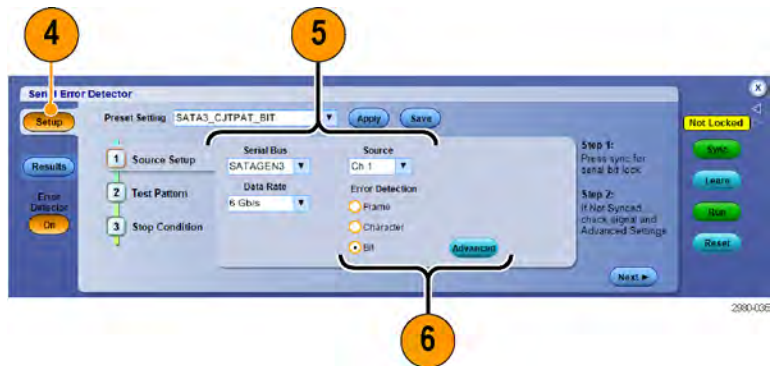

7. Click **On** or **Off** to turn Spread Spectrum Clocking (SSC Tracking) on or off.

SSC is on by default.

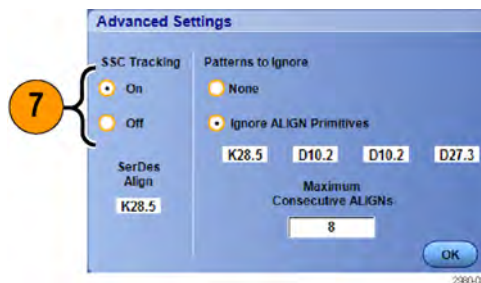

- To ignore align primitives, select the **Ignore Align Primitives** option button and specify the primitives using the keypad or keyboard.

Alignment Primitives are inserted into the signal by the DUT for purposes of pacing (keeping transmitter from overrunning the receiver).

- Enter the Maximum consecutive ALIGNs using the keypad or keyboard.

The maximum consecutive aligns is a design parameter of the particular device that indicates how many consecutive aligns are allowed.

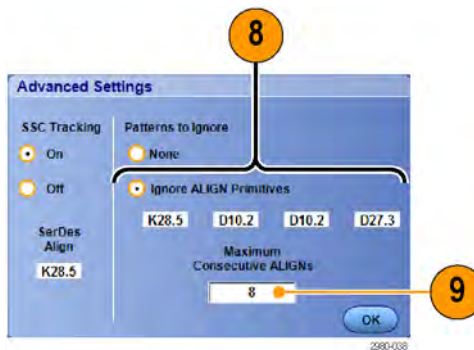

The Test Pattern Setup provides control of the signal test pattern length and the Sync Pattern description. These are often the most difficult settings, because they require knowledge of the signal. The Pattern Length is the number of bits in the repeating signal being sent to the DUT or oscilloscope by the signal generator or AWG. The Sync Pattern is a 10-, 20-, 30-, or 40-bit unique pattern in the signal that the error detector uses to align the signal to the acquired comparison pattern. The Advanced check box just allows you to set the Disparity of each of the Sync Pattern symbols individually. The X means don't care. The Preset Setups set these parameters to make the job easier for the common cases.

- From the Test Pattern tab, specify the Sync Pattern, Sync Pattern Polarity, and the Pattern Length.

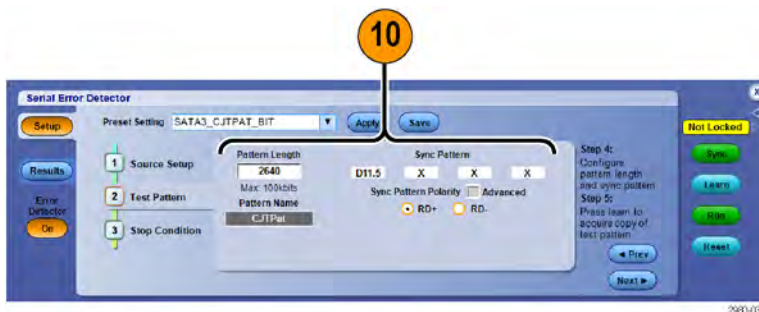

- From the **Stop Condition** tab, select the Stop When condition. You can stop manually, after a preset count or time that you specify, or on an error.

**NOTE.** Use large numbers for bit count tests. At 6 Gb/s, 60 billion bit tests take 10 seconds.

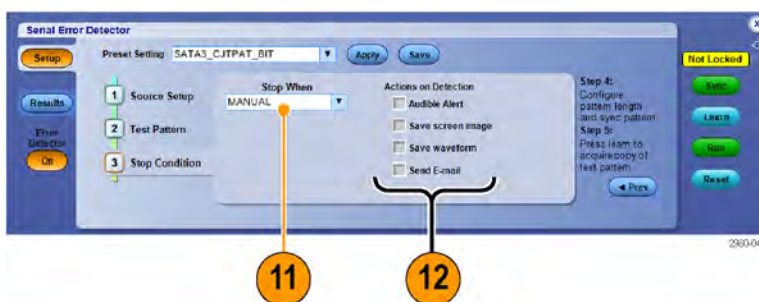

- Select and setup the actions to perform when the stop condition is met. Using these actions, you can preserve the information captured by the oscilloscope. You must set up the email address and the SMTP server for Send E-mail to work.

- Press the **Sync** button and wait for a status of Not Counting (about 6 seconds). Depending on the signal quality, you may need to press the Sync button more than once.

Sync gets the oscilloscope synchronized to the signal.

A status of **No Signal** status indicates that the oscilloscope cannot detect the signal. You may need to turn on the output of the signal generator or AWG. A status of **No Sync** may arise for Bit tests that require a known pattern length, sync pattern, or alignment character.



- Press the **Learn** button, if visible. Learn only applies to some Bit Error Tests. Frame, Symbol, and Character tests do not require the learn operation. Learn discovers the repeating pattern in the signal and stores it into system memory for comparison to the signal to determine errors in the signal. Once a signal is in memory, it remains there until a subsequent Learn operation, so you don't have to use the Learn button every time you start testing for errors.



- Press the **Run** button to start the error detector.

If desired, you may press Stop or Reset at anytime. After a Stop, you can press Run again.

Run starts the Error Detector testing for errors.



- Select the Results tab to see the results of running the error detector.

**NOTE.** The Serial Error Detector automatically resyncs and resets all counts to zero if you press **Reset** or disconnect and then reconnect the signal.





If you are using one of the supplied AWG signal patterns, you can press the **Force Event** button on the AWG to induce an error in the signal to verify the operation of the Error Detector. These AWG setup files are located in Win7 in the directory C:\User\Public\Tektronix\Tekscope\ErrorDetector\AWG

Alternatively, you can verify operation by disconnecting and reconnecting the signal. There will be massive errors when the signal is disconnected, but after the signal is reconnected the Error Detector will resynchronize to the signal, clear the error counts and rates, and resume testing.

- 17. Press the Error Detector Off button to end the error detector session. A popup will appear saying the trigger has changed to Edge.

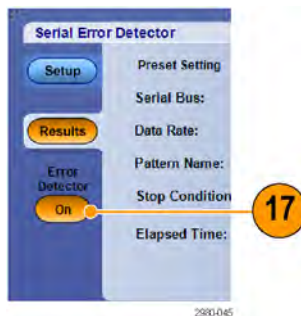

The typical startup sequence can be summarized as a) Select a Preset Setup; b) Press Sync; c) Press Learn (if visible); and d) Press Run. The Sync operations gets the oscilloscope synchronized to the signal, the Learn operation acquires the signal pattern into oscilloscope memory, and the Run operation starts the Error Detector testing for errors. Note that the Learn operation only applies to some Bit error tests. Remember, Frame, Symbol, and Character error tests do not require a Learn operation.

There are several cable arrangements you can use with the Serial Error Detector. The first cable setup specifically applies to SATA, PCIe, and generic 8b/10b bit testing, when a Learn operation is required to acquire the signal test pattern into Error Detector memory. However, you can use this same cable arrangement to verify Error Detector operation.

- 18. Connect the cabling as shown for the Learn operation in SATA, PCIe, and generic bit testing.

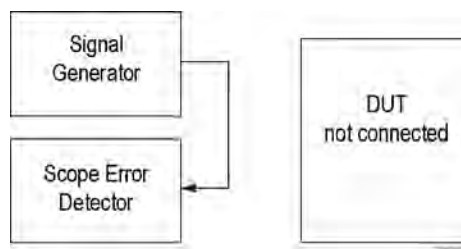

- 19. Having done the Learn operation, you can now insert the DUT in-between the Signal Generator and the Error Detector as shown.

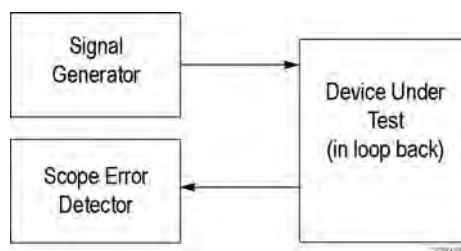

With the DUT inserted between the Signal Generator and the Serial Error Detector, all you need to do to get the Error Detector running is to press **Sync** and **Run** buttons, because the Learn operation was completed in the previous step. If you do another Learn operation, you risk learning errors created by the DUT.

20. To avoid having to rearrange the cables after the Learn operation, you may split the output of the signal generator, putting one branch into the Error Detector and one branch into the DUT. Here the Learn Operation is done on Ch1, but the actual error detection occurs on Ch2. You can adjust the amplitude of the signal generator to account for the loss due to splitting the signal. This works because the Error Detector learn operation stores the signal test pattern into non-channel-specific memory.

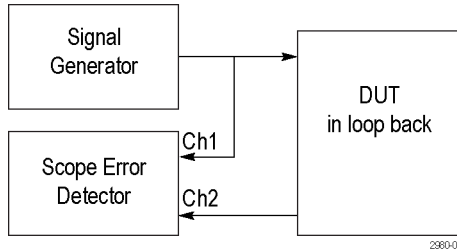

21. When the Error Detector is driven from the user interface, bus triggers are used whenever possible, so that bus decoding is automatically enabled. The Decoding indicates the location of the error in the signal by highlighting the decoded value in red, as shown in the screen shot below. You can use additional oscilloscope channels to simultaneously probe other signals to debug the cause of the error.



## Using mask testing

Serial Communications Mask Testing (Option MTM or MTH) allows you to compare your signal to a predefined template or mask. For the signal to pass the test, it must fall outside the segments defined by the mask. Generally, standards committees such as ANSI define the masks. To perform mask testing do the following:

1. Select **Mask > Source...**

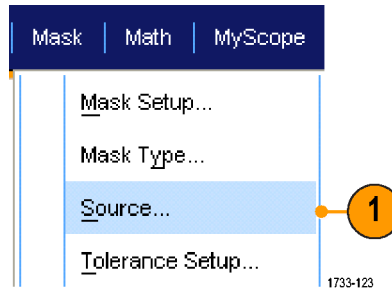

2. Select the signal source.

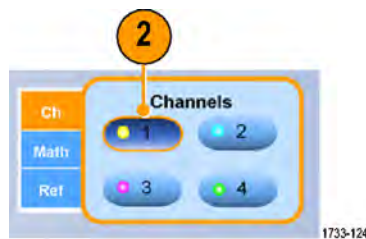

3. Click the **Masks** tab.

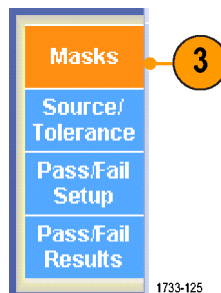

4. Select the Type and standard.

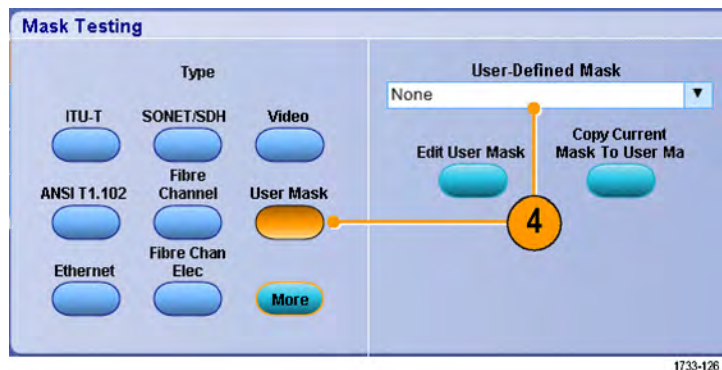

5. Click a **Config** button to access a Mask Configuration control window, where you can adjust how masks and violations are displayed and how Mask Autoset and Autofit are configured.
6. Click **Masks** to return to the Mask Setup control window.

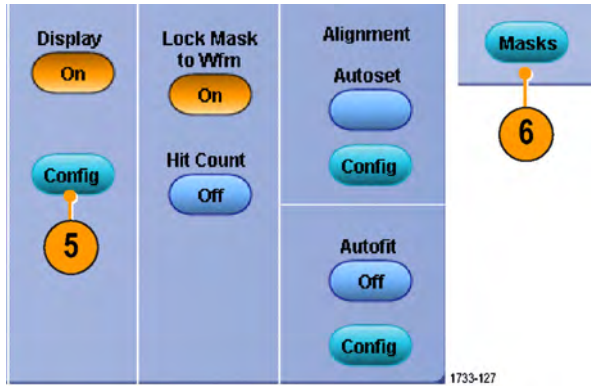

7. Click Lock Mask to Wfm **On** to track mask changes in the horizontal or vertical settings.
8. Toggle Hit Count **On** to highlight violations during a mask test.



9. Click **Autoset** to automatically align the waveform with the mask based on the characteristics of the input signal.
10. Toggle Autofit **On** to automatically reposition the waveform after each acquisition to minimize hits.

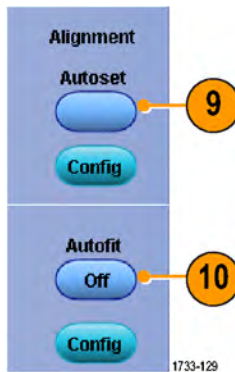

11. Click the **Tolerance** tab, and then set the tolerance.  
 Tolerance settings greater than 0% make the mask test harder to pass, settings less than 0% make the test easier to pass.  
 Use 0% if you want the mask as specified in the standard. Changing the percentage allows you to do margin testing.

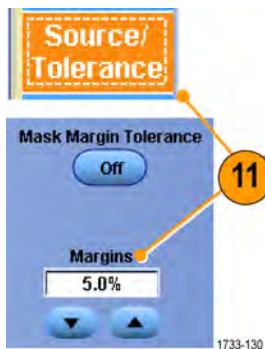

12. Select the **Pass/Fail Setup** tab, and then set up the pass/fail parameters. (When acquisition mode is Waveform Database, the # of Wfms label becomes Samples.)
13. Select your Pass/Fail Test Notifications.

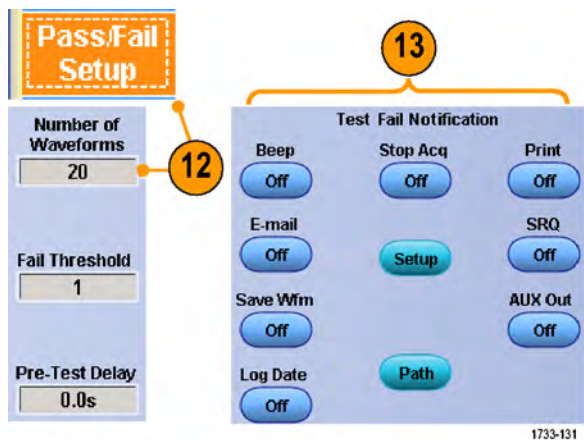

14. Select the polarity of the waveform you want to test.
15. Toggle Repeat **On** to run the mask test continuously.
16. Select the notice you want when the test is complete.

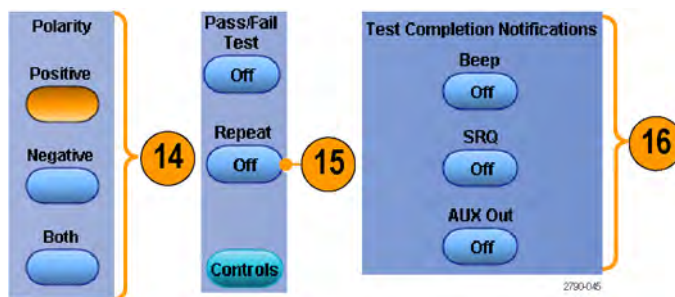

17. Click the **Pass/Fail Results** tab to view the test results.
18. Click Pass/Fail Test **On** to start the mask test.
19. Click **Reset** to reset the totals and clear any violations.

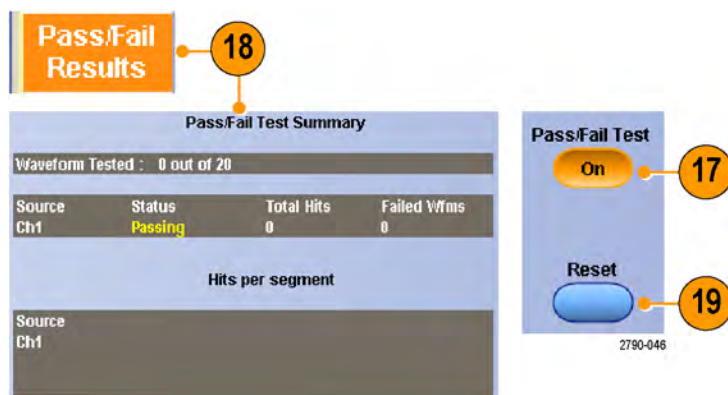

### Quick tips

- Mask testing is not available on digital channel waveforms.
- If the signal is not within the mask, enable Autoset to center the waveform in the mask.

## Using limit testing

Optional limit testing allows you to compare an active signal with a template waveform. Build your template waveform from a known good signal and use it to compare to an active signal to perform pass/fail testing.

1. Select **Mask > Limit Test Setup....**

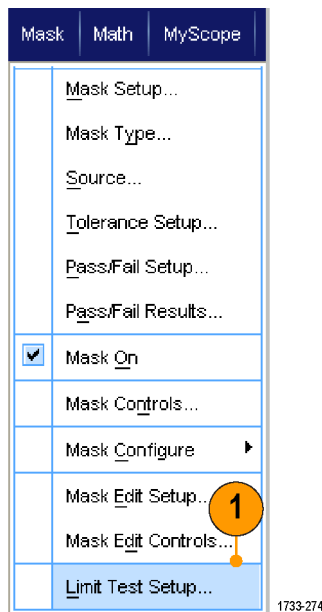

2. Create the template by selecting the Source, Destination, and Tolerances. Use the multipurpose knobs to adjust the Tolerances. Tolerances specify how much margin the signal is allowed before failing the limit test.

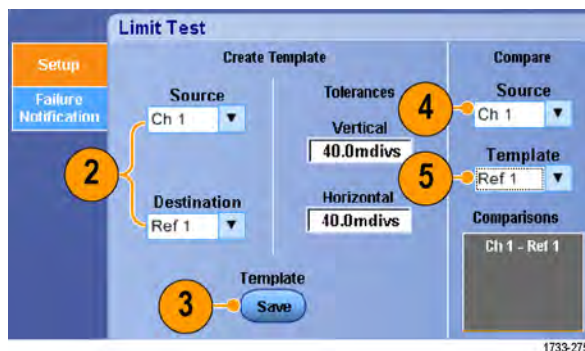

3. Click **Save**. You can create multiple templates and save them for later use.
4. Select the source waveform to compare to the template.
5. Select the template to compare to the Source waveform. (Usually, this is the template that you created in step 3.)

6. Click **Failure Notification** to set up the Failure Notification.
7. Select the failure notification(s), and then click **Setup** to return to the setup control window.

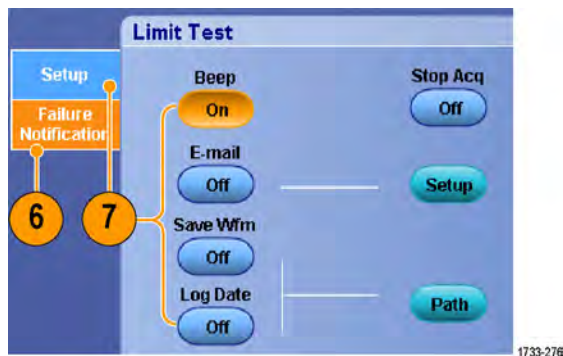

8. Click Lock Template to Waveform **On** to lock the vertical scale or position of the template to that of the source waveform.
9. Click Highlight Hits **On** to show points that fall outside the template in a different color.

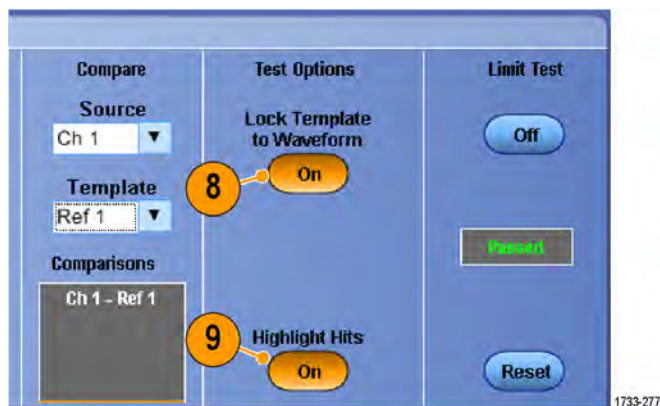

10. Toggle Limit Test to **On** to start the test.
11. Click **Reset** to clear all violations and reset the test.

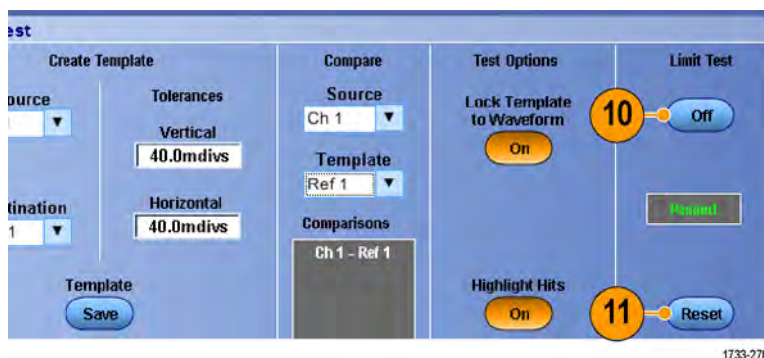

### Quick tips

- Use active or saved waveforms to create a limit test template.
- Using Average acquisition mode will create a smoother template waveform.
- Using Envelope acquisition mode will create a template that allows for occasional overshoots.

# MyScope

MyScope allows you to create custom control windows that include only the controls that you use regularly. Instead of switching between several control windows, put the controls you use into a custom control window.

This section contains procedures for creating and using MyScope control windows. Detailed information is available in the online help.

## Creating a new MyScope control window

1. Select **MyScope > New Control Window...**

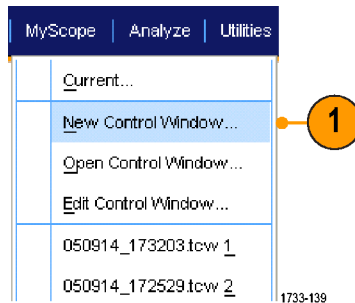

2. Click + to expand a category. Controls that you can add to your MyScope control window are contained within each category. The categories match the menu bar to help you find the controls you normally use.

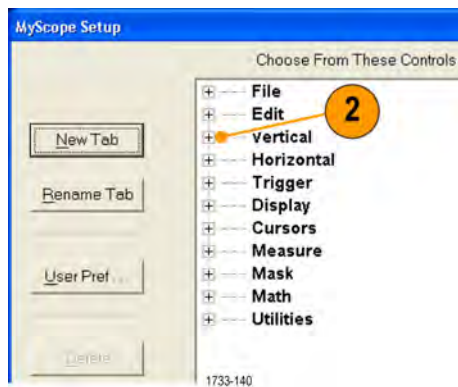



3. Click a control to preview it.

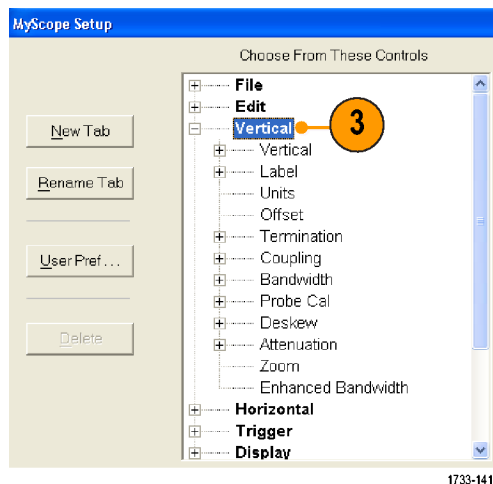

4. Double-click the control or click the + to expand the control list. (If there is no +, then the control cannot be customized further.)

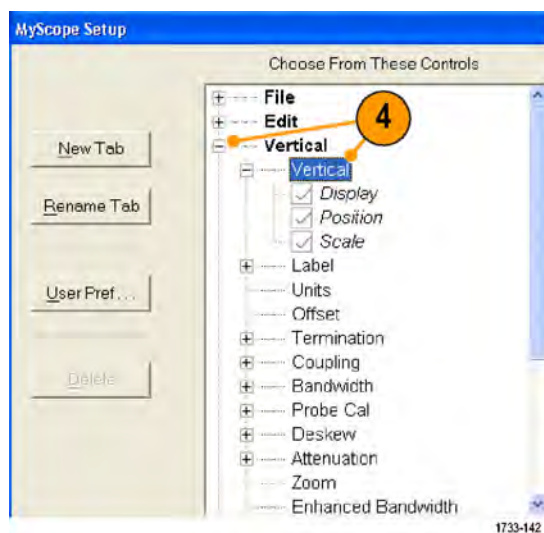

5. Clear the check boxes to remove any components that you do not want included in the control.

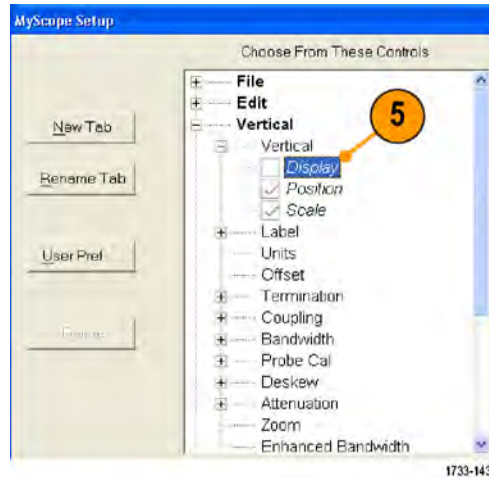

6. Click and drag the control to your MyScope control window. The control will snap to the nearest grid location when you release the mouse. Change the placement of the control in your MyScope control window by clicking and dragging.

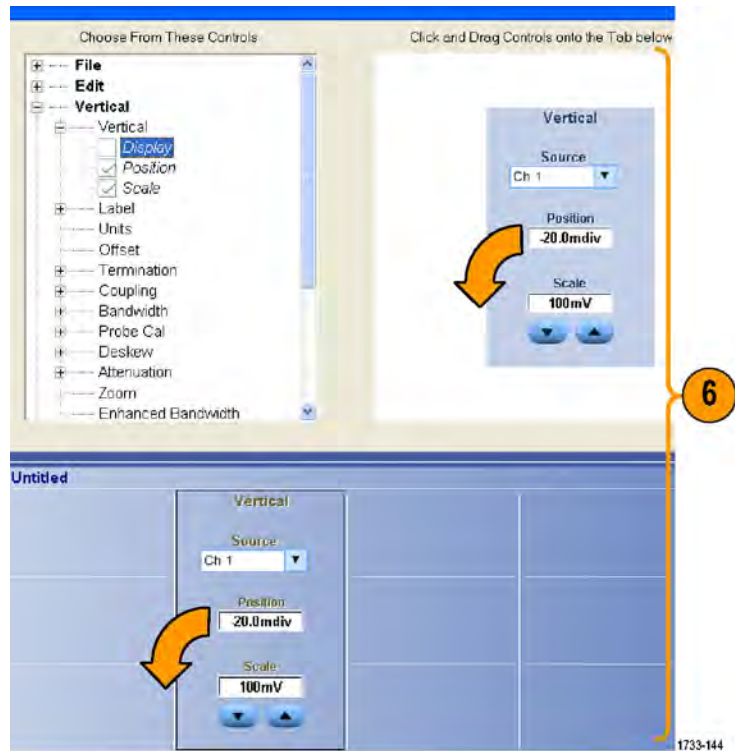

7. Click **New Tab** to add a tab to your MyScope control window. You can have up to six tabs.

8. To rename a tab do one of the following:

- Click **Rename Tab**.
- Double-click the tab, and then type the new name.

9. Click **User Pref...** to specify user preferences that are loaded with your MyScope control window.

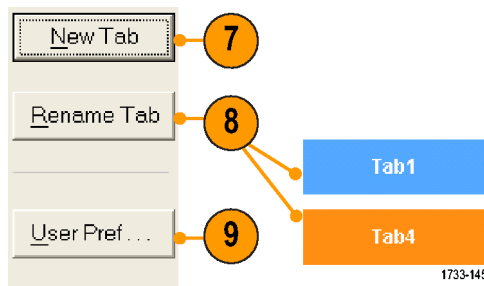

10. To delete controls do one of the following:

- Select a tab, and then click **Delete**. The tab and all of the controls are deleted.
- Select a control, and then click **Delete**. Just the selected control is deleted.

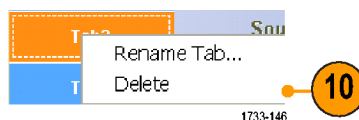

11. Click **Save**, and then enter a name for your MyScope control window, or use the default name.

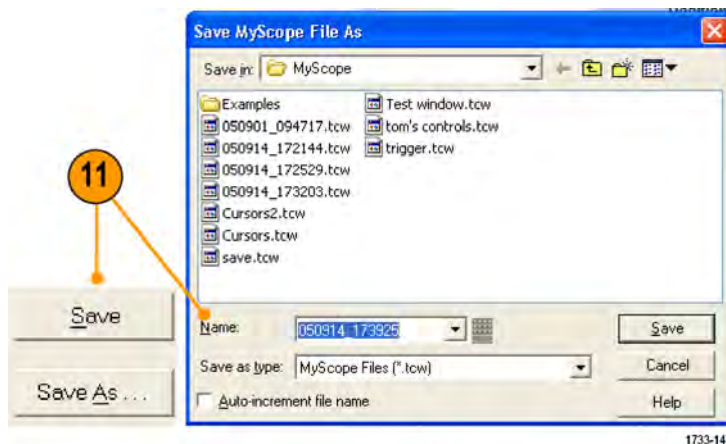

## Quick tips

- To reconfigure a control, click and drag it back to the preview window. Then select or clear the check boxes to include or remove components in the control.
- To change the tab order, click and drag a tab to a new location.
- To delete a control, click and drag it to the upper half of the screen (out of your MyScope control window).

## Using MyScope control windows

To open a previously defined MyScope control window, do the following:

1. Select **MyScope > Open Control Window...** or one of the five most recently used MyScope windows.

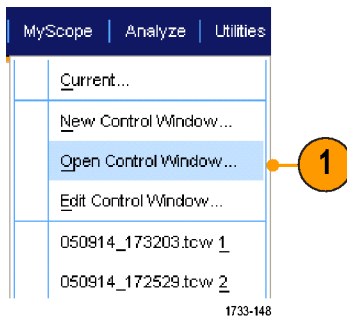

2. Select the MyScope control window you want to use, and then click **Open**.

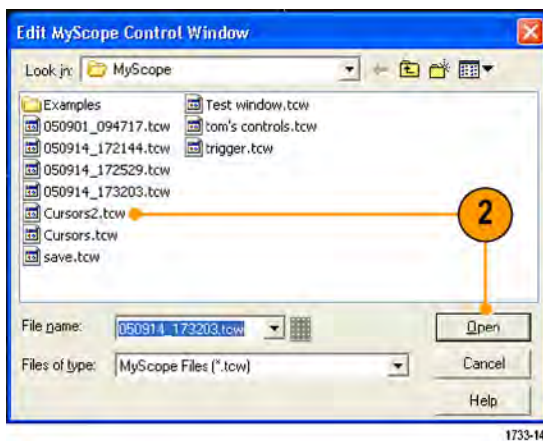

To display the active MyScope control window, do the following:

1. Select **MyScope > Current...** or click **MyScope** in the toolbar mode. (Your MyScope control window remains active even when it is not displayed.)

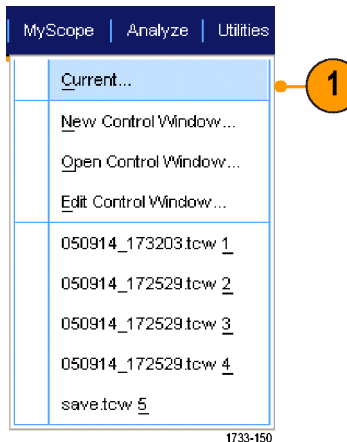

To edit a MyScope control window do the following:

1. Select **MyScope > Edit Control Window....**

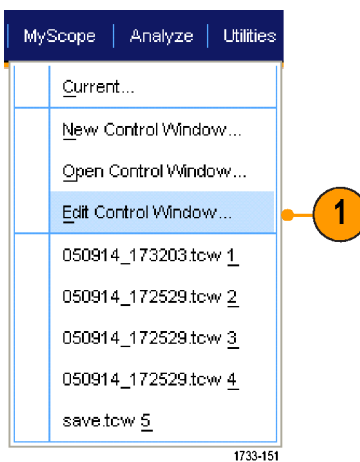

2. Select the control window you want to edit, and then click **Open**.

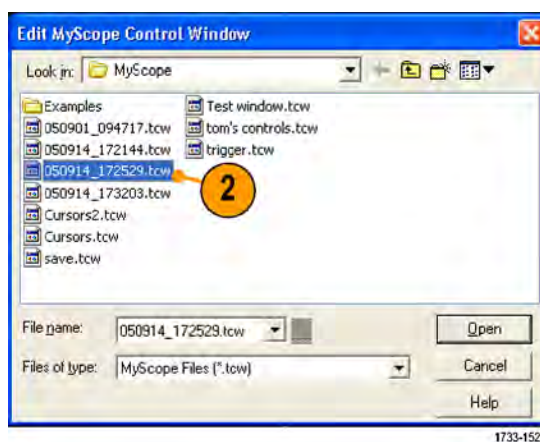

### Quick tips

- Some controls function differently in a MyScope control window than they do in the standard control window. For details, see the online help.
- You can copy MyScope control windows (.tcw files) to other MSO/DPO70000DX, MSO/DPO70000C, DPO7000C, and MSO/DPO5000B Series instruments.

## Saving and recalling information

This section contains procedures for saving and recalling screen captures and setups, saving measurements, using the clipboard, and printing on your instrument. Detailed information is available in the online help.

### Saving screen captures

1. Select **File > Save** or **Save As > Screen Capture...**

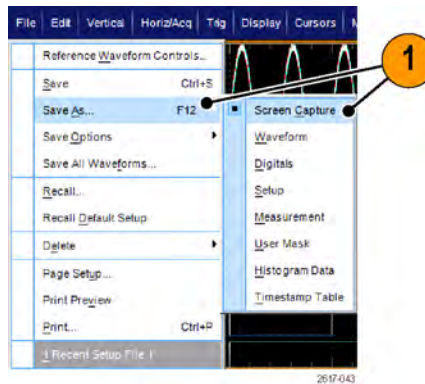

2. Click **Options...** to set up the Palette, View, Image, or Screen Capture Format options; otherwise, skip to step 3.

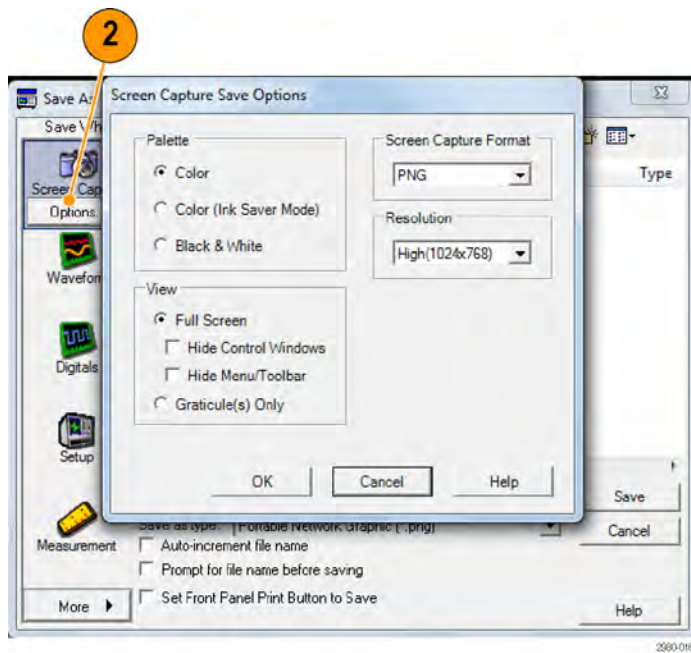

3. Select the location to save the screen capture.
4. Type in a name for the screen capture, or use the default name, and then select a file type.
5. Click **Save**.

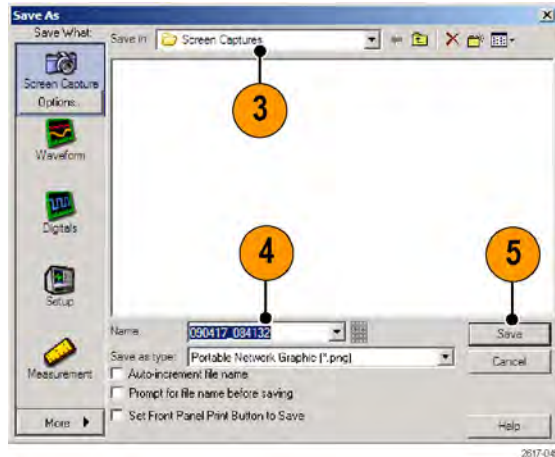

### Quick tip

- To quickly save multiple screen captures, select **Set Front Panel Print Button to Save**, and then click Save. You can now save a screen capture by pushing the front panel Print button.

## Saving waveforms

1. To save waveforms, select **File > Save** or **Save As > Waveform....**

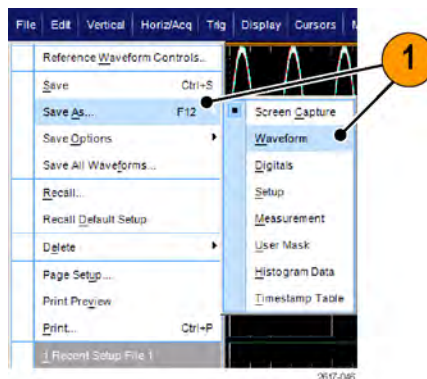

2. Click **Waveform**.
3. Click **Options...** to specify the Waveform Data Range, FastFrame Data Range, Waveform Detail, Data Destination, Source, or Data Ordering; otherwise, skip to step 4.

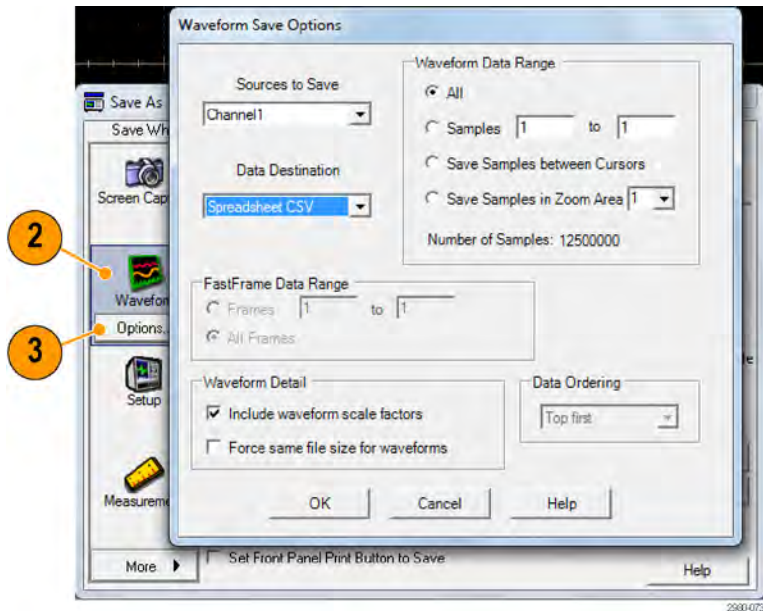

4. Select the Source.
5. You can either save the waveform as a reference waveform in the instrument memory or as a .wfm file in a Windows directory. To save the waveform as a reference, select Ref 1–4. To save as a .wfm file, select the location where you want to save the waveform.
6. If you are saving as a .wfm file, type in a file name, or use the default.
7. Click **Save**.

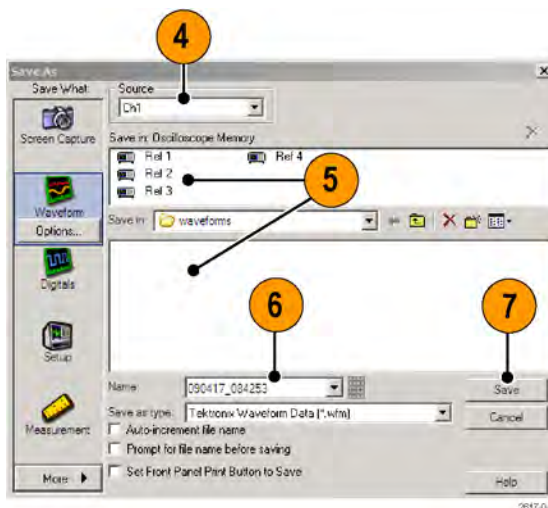

### Quick tips

- Select **Auto-increment file name** to save similar waveforms without having to retype the entire name.
- To quickly save multiple waveforms, select **Set Front Panel Print Button to Save**, and then click Save. You can now save a waveform by pushing the front-panel Print button.



## Recalling waveforms

1. Select **File > Recall...**

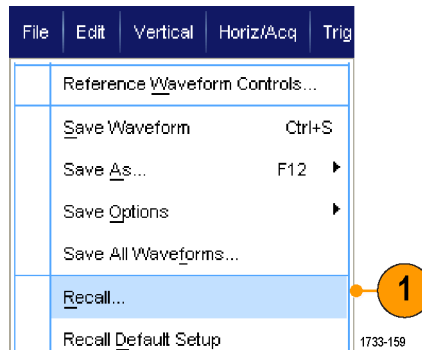

2. Click **Waveform**.
3. Select the Destination of the waveform you are recalling.
4. Select the waveform to recall.
5. Click **Recall**. Clicking Recall turns on the reference waveform and activates the Reference Waveform control window.

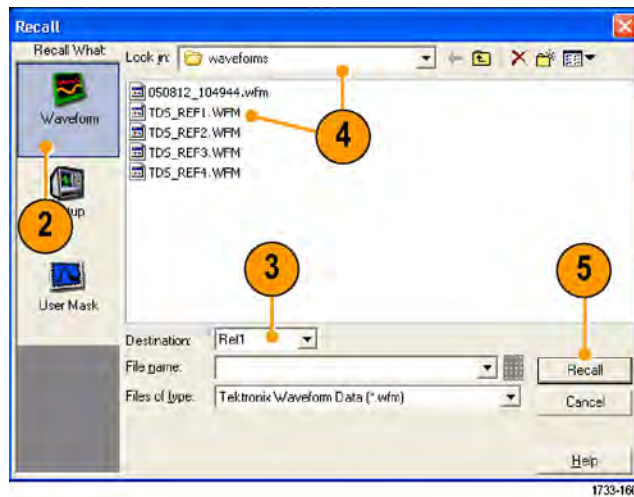

6. Use the controls to adjust the Reference waveform. You can also access the Reference Waveform control window by selecting **File > Reference Waveform Controls...**

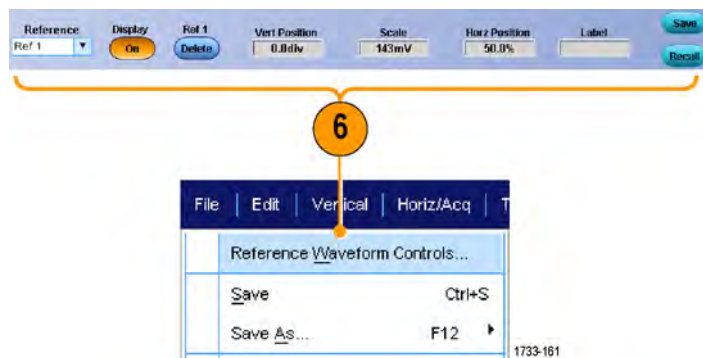

### Quick tip

- You can save several different file types but you can only recall setup (\*.set) files and waveform (\*.wfm) files.

## Saving digital waveforms

On MSO Series instruments, you can save digital waveforms in a .csv format file.

1. To save digital waveforms, select **File > Save or Save As > Digitals**.

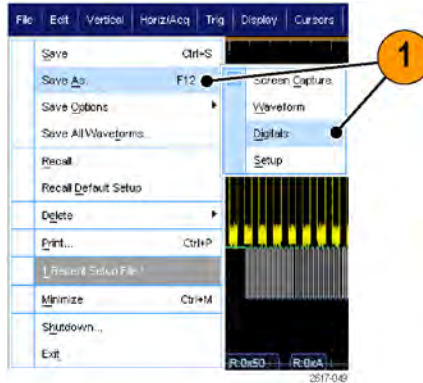

2. Click **Digitals**.
3. You can only save digital waveforms as a .csv file in a Windows directory. To save as a .csv file, select the location where you want to save the waveform.
4. Type in a file name, or use the default.
5. Click **Save**.

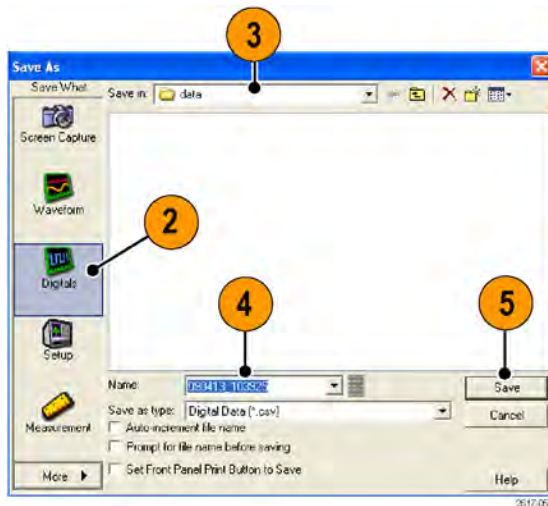

## Saving instrument setups

1. Select **File > Save or Save As > Setup...**

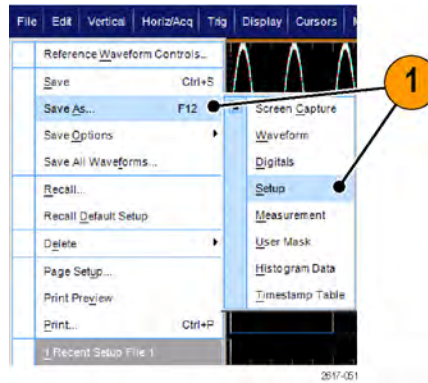

2. Click **Setup**.
3. Select the location where you want to save the setup. Either save the setup to the instrument memory in one of the ten setup storage locations or as a .set file in a Windows directory.
4. Type a file name or use the default name. Use the pop-up keyboard to type a file name for a setup saved to the instrument memory.
5. Click **Save**.

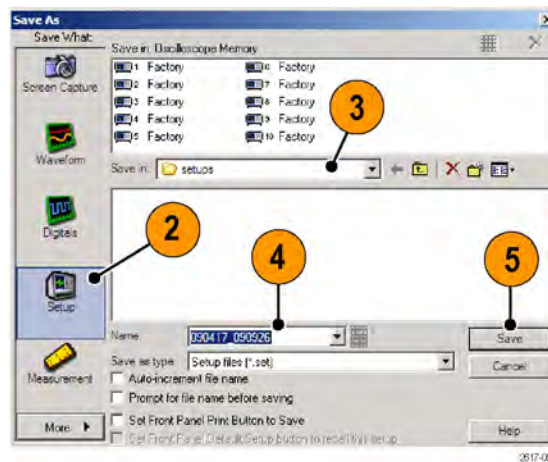

### Quick tips

- If the touch screen is enabled, use the pop-up keypad to label the setups for easy identification.
- Use Auto-increment file name to save similar files without having to retype the entire file name.
- To quickly save multiple setups, select **Set Front Panel Print Button to Save**, and then click Save. You can now save a setup by pushing the front panel Print button.

## Recalling instrument setups

1. Select **File > Recall...**

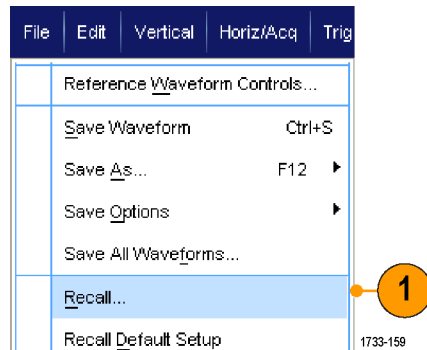

2. Click **Setup**.

3. Select the setup you want to recall. Recall a setup file from one of the ten locations in the instrument memory or from a Windows directory.

To retain your current deskew settings, click **Don't recall deskew values**.

4. Click **Recall**.

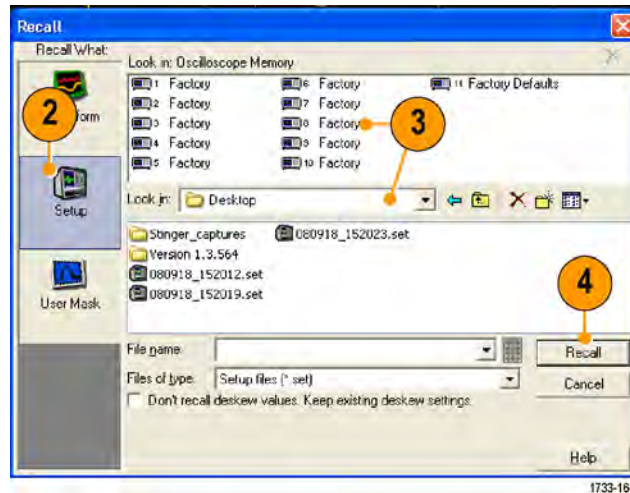

### Quick tip

- You can recall any setup stored on disk and then save it in an internal setup storage location for quicker access.

## Saving measurements

1. Select **File > Save or Save As > Measurement...**

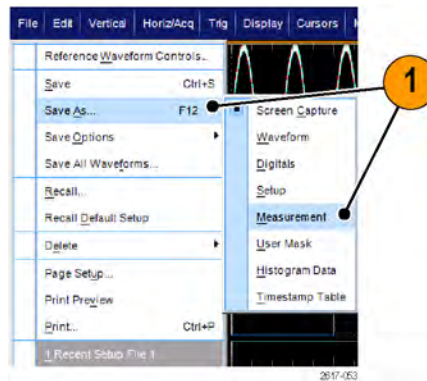

2. Click **Options...** to specify Displayed Measurements, Measurement Snapshot, or Measurement Format; otherwise, skip to step 3.

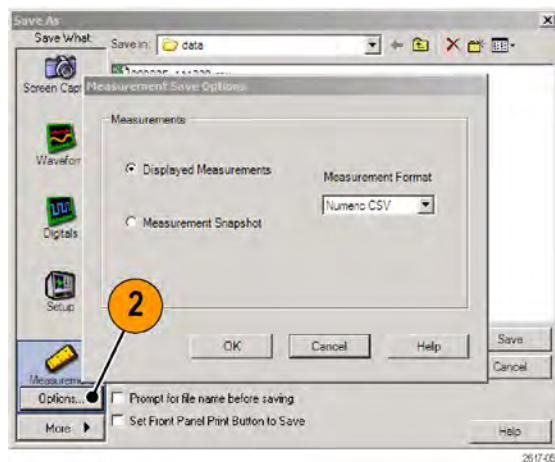

3. Select the location to save the measurement.
4. Type in a name for the measurement, and then select a file type.
5. Click **Save**.

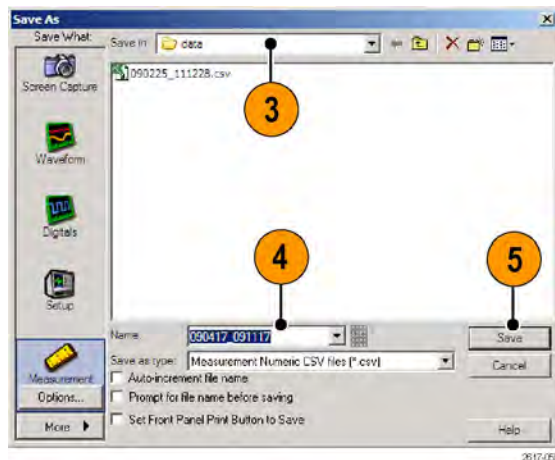

## Saving user masks

1. Select **File > Save** or **Save As > User Mask**.

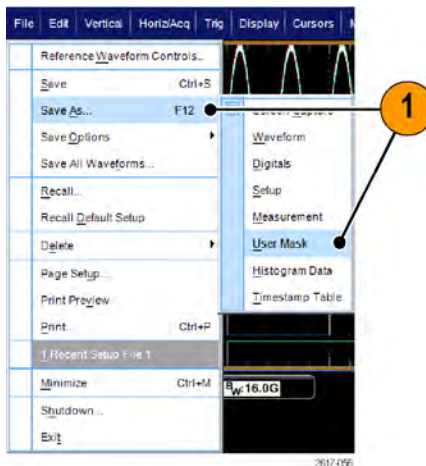

2. Click **User Mask**.
3. Select the location to save the mask.
4. Type in a name for the mask, and then select a file type.
5. Click **Save**.

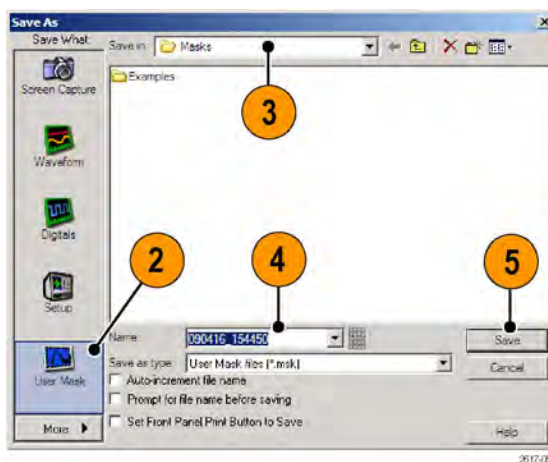

## Saving histogram data

1. Select **File > Save or Save As > Histogram Data**.

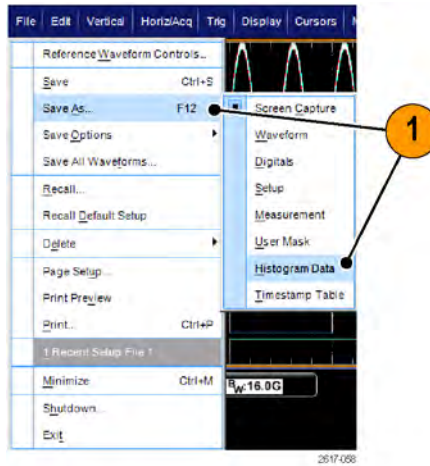

2. Select **Histogram**. Depending on previous selections, you may need to select **More > Histogram Data** to display the Histogram selection.
3. Select the location to save the histogram.
4. Type in a name for the histogram, and then select a file type.
5. Click **Save**.

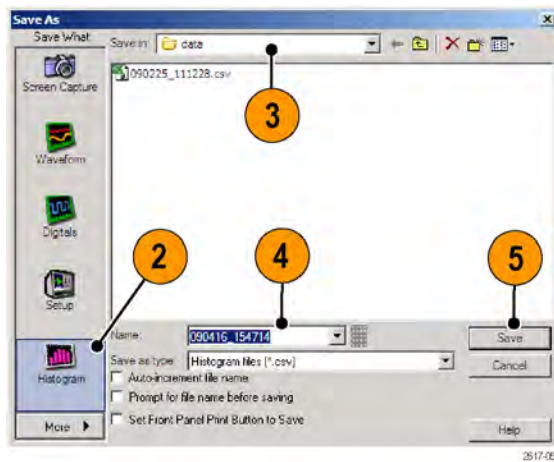

## Saving timestamps

1. Select **File > Save** or **Save As > Timestamp Table**.

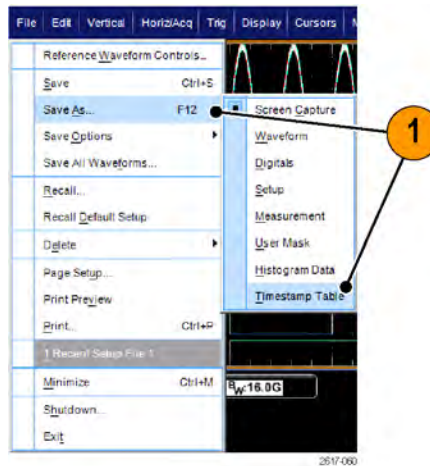

2. Click **Timestamp**. Depending on previous selections, you may need to select **More > Timestamp Table** to display the Timestamp selection.
3. Click **Options...** to specify the Source or FastFrame Data Range; otherwise, skip to step 4.

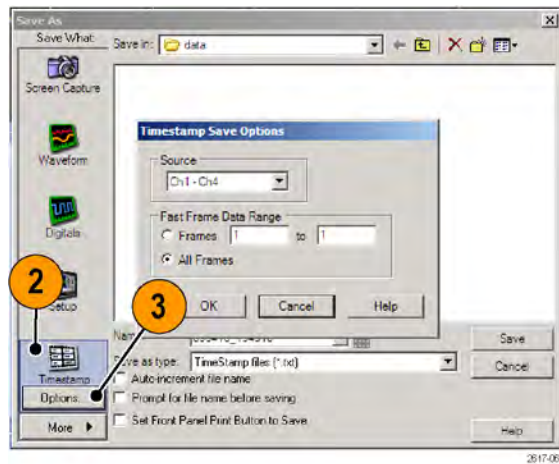

4. Select the location to save the timestamp.
5. Type in a name for the timestamp, and then select a file type.
6. Click **Save**.

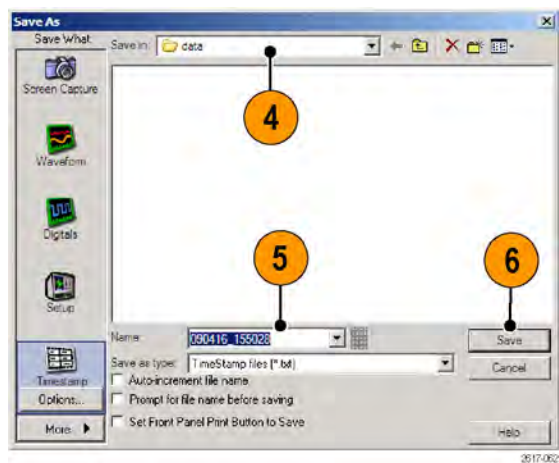



## Copying your results to the clipboard

Use the following procedure to set the output content and format for images, waveforms, or measurements to be copied to the Microsoft clipboard.

1. Select **Edit > Copy Setup...**

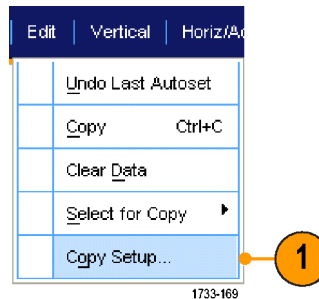

2. Click the **Images**, **Waveforms**, or **Measurements** tab, and then select the desired options.

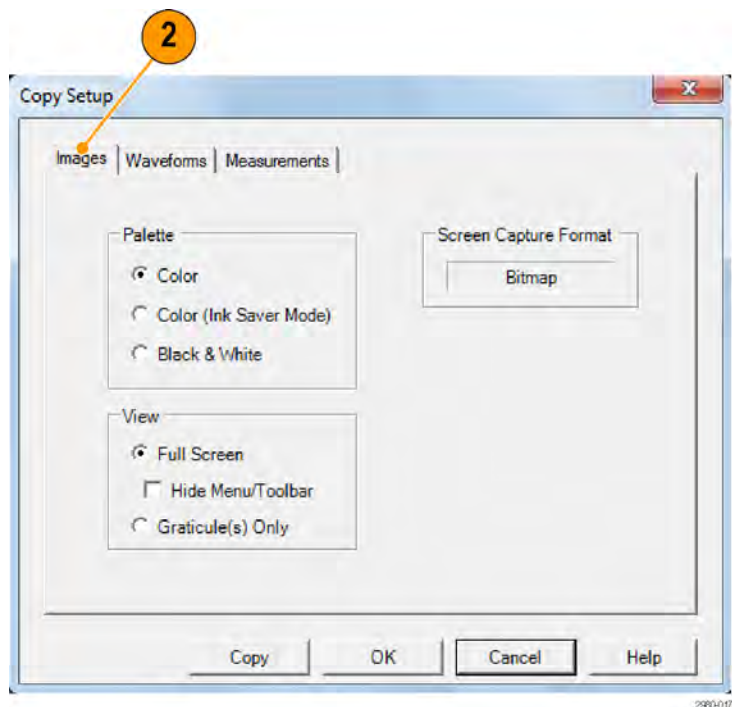

To copy images, waveforms, or measurements, use the following procedure:

1. Select the item that you want to copy.
2. Select **Edit > Copy** or press **Ctrl + C**.
3. Press **Ctrl + V** to paste the item into a Windows application.

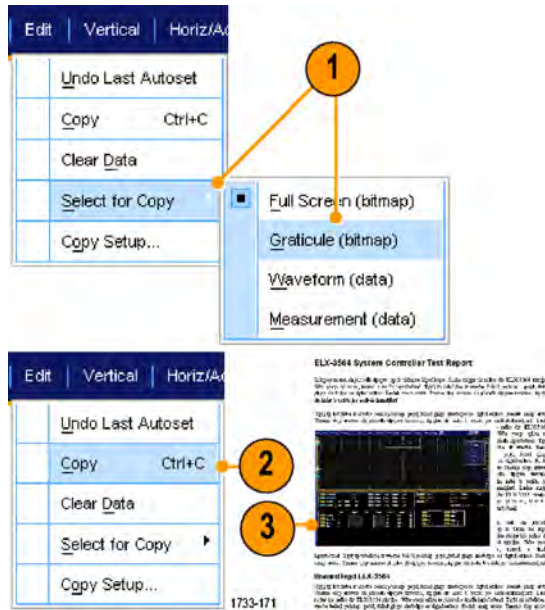

## Printing a hard copy

1. To print a hard copy, push the print button or select **File > Print**. If necessary, make changes to the page orientation in the Page Setup dialog box.

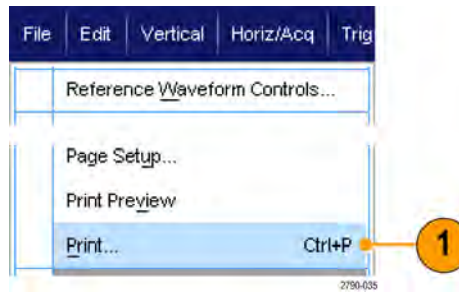

Your Print and Page Setup dialog boxes will depend on the printer you are using.

2. Click **Page Setup...**

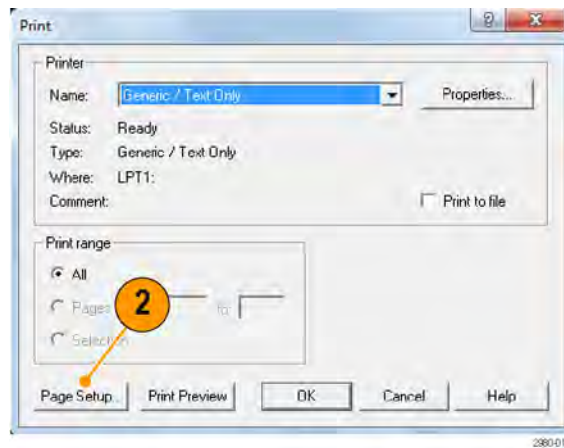

3. Select the printing parameters.

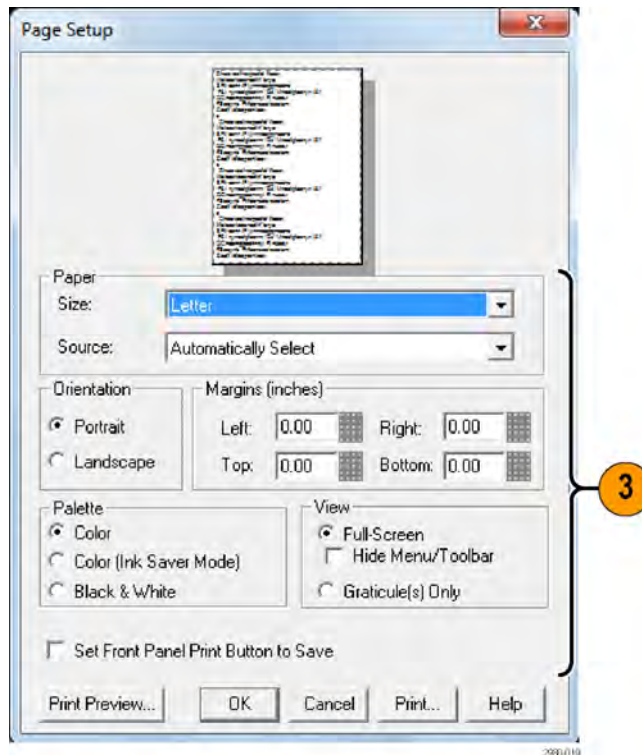

## Run application software

Each application is available for ten free trials on your instrument. These applications provide application-specific measurement solutions. Some examples are described below. Additional packages may be available. Some applications may not be available on your instrument. Contact your Tektronix representative or visit our Web site at [www.tektronix.com](http://www.tektronix.com) for more information.

- Use **DDRA** Memory Bus Analysis to automatically identify DDR1, LP-DDR1, LP-DDR2, LP-DDR3, DDR2, DDR3, DDR4, DDR3L, GDDR3 and GDDR5 read and writes.
- Use **DJA** DPOJET Jitter and Eye Diagram Analysis, Advanced to reliably measure complex clock, digital, and serial data signals. DPOJET Essentials included standard with all models.
- Use **D-PHY** for MIPI D-PHY Transmitter debug, characterization and compliance testing (requires option DJA).
- Use **DP12** Display Port Compliance Software to validate your IC, motherboard, and graphics card designs.
- Use **DVI** Compliance Test Solution Software for DVI physical layer compliance testing.
- Use **ERRDT** Frame and Bit Error Rate Detector to detect errors in high speed serial standards (requires option ST6G).
- Use **ET3** to perform 10/100/1000 Base-T Ethernet compliance testing.
- Use **HT3** HDMI Compliance Test Software for HDMI compliance testing for  $\geq 4$  GHz models.
- Use **HT3DS** HDMI Direct Synthesis for HDMI 1.4 (requires HT3) for HDMI analysis.
- Use **LT** Waveform Limit Testing to compare an acquired waveform to tolerance boundaries that you set.
- Use **MOST** Essentials for electrical compliance and debug testing for MOST50 and MOST150.
- Use **MTH** Communication Mask Testing Software for mask compliance testing on  $\geq 4$  GHz models.
- Use **MTM** Communication Mask Testing Software for mask compliance testing on  $< 4$  GHz models.
- Use **PCE3** PCI-Express compliance test for Gen3. Used with DPOJET.
- Use **PCE** compliance test for Gen1 and Gen2. Used with DPOJET.
- Use **PWR** Power Measurement Software to quickly measure and analyze power dissipation in power supply switching devices and magnetic components.
- Use **SDLA64** Serial Data Link Analysis Visualizer to emulate the serial data channel, de-embed a fixture, and add or remove transmitter equalization.
- Use **SR-810B** to enable serial triggering and analysis of 8B/10B signals.
- Use **SR-AERO** for MIL-STD-1553 Serial Triggering and Analysis.
- Use **SR-AUTO** for Serial Triggering, debugging, decode and Analysis of CAN, LIN, and FlexRay signals.
- Use **SR-COMP** to enable serial triggering and analysis of RS-232/422/485/UART signals.
- Use **SR-DPHY** for MIPI-DSI1 and MIPI-CSI2 serial analysis.
- Use **SR-EMBD** to enable serial triggering and analysis of I<sup>2</sup>C and SPI signals.
- Use **SR-ENET** for serial analysis of Ethernet signals.
- Use **SR-PCIE** Serial Data Compliance and Analysis (requires ST6G for serial triggering).
- Use **SR-USB** to enable serial triggering and analysis of USB2.0 and USB3.0 signals.

- Use **ST1G** or **ST6G** Serial Protocol Trigger Software to trigger and decode NRZ serial data (ST1G) and 8B/10B data on high-speed serial or data protocols (ST6G). Protocol triggering up to 6.25 GS/s (with ST6G).
- Use **SVP**, **SVM**, and **SVE** Spectral Analysis application to validate wideband designs and characterize wideband spectral events.
- Use **SVO** for flexible OFDM analysis, requires SVE.
- Use **SVT** for settling time measurements (frequency and phase), requires SVE.
- Use **USB** to characterize USB 2.0 signals including mask testing and parametric testing.
- Use **USB3** to verify, characterize, debug, and compliance test USB 3.0 systems (requires option DJA).
- Use **VET** to enable visual trigger and search.
- Use **XGBT** for 10 GBASE-T Ethernet physical medium attachment (PMA) physical-layer (PHY) electrical compliance testing.

Follow the instructions provided with the application software to install it. To run the software, select **Analyze** and then select the application.

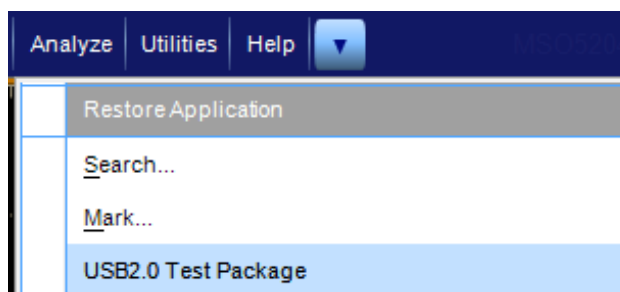

# Application examples

This section contains examples of using your instrument in common troubleshooting tasks and extending the use of your instrument.

## Capturing intermittent anomalies

One of the most difficult tasks that design engineers face is tracking down the cause of intermittent failures. If you know what type of anomaly you are looking for, it is easy to configure the oscilloscope advanced triggering capability to isolate it. However, when you do not know what you are looking for, it can be exceptionally tedious and time consuming to find infrequent anomalies, especially given the low waveform capture rate on traditional digital storage oscilloscopes.

Digital Phosphor Oscilloscopes enabled by DPX technology have an exceptionally fast acquisition mode called FastAcq, which allows you to find anomalies like these in a matter of seconds or minutes. A regular DSO would take hours or days to find the same event.

Use the following procedure to capture intermittent anomalies.

1. Connect the probe to the input signal source.

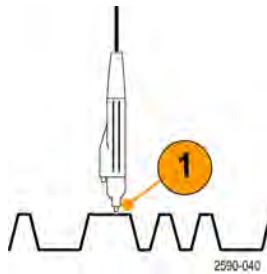

2. Push **Autoset**.

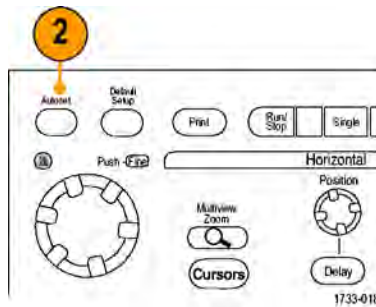

MSO/DPO70000DX, MSO/DPO70000C, and DPO7000C Series

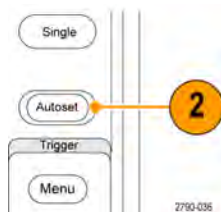

MSO5000B and DPO5000B Series

3. Select **Display > Display Persistence > Infinite Persistence**. In this example, you are looking at a clock signal. After observing the signal for 1–2 minutes, but before you look for the problem elsewhere, go to step 4.

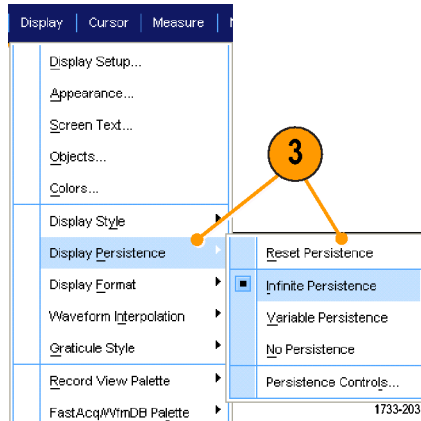

4. Push **FastAcq**.

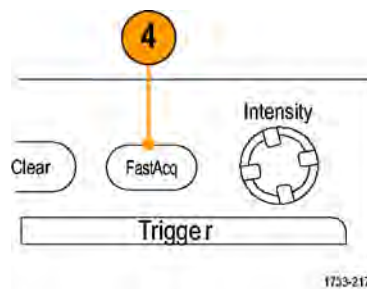

MSO/DPO70000DX, MSO/DPO70000C, and DPO7000C Series



MSO5000B and DPO5000B Series

5. Find glitches, transients, or other random anomalies that are present in the signal. In this example, FastAcq revealed an  $\approx 300$  ns positive glitch after only a few seconds.

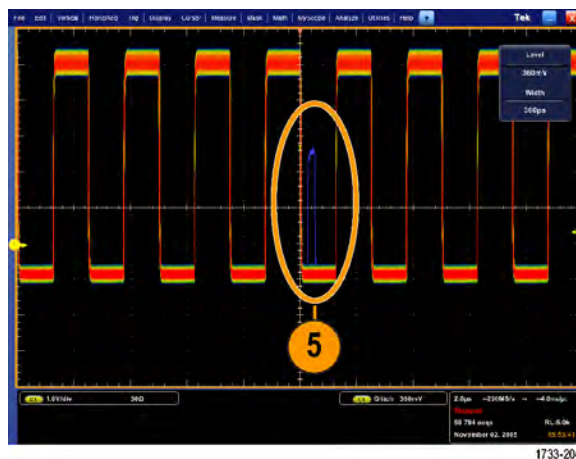

6. To trigger on the glitch that you identified in step 5, select **Glitch Setup...**
7. Select the appropriate polarity.
8. Click **Level**, and then set the level based on what you found in step 5.
9. Click **Width**, and then set the width based on what you found in step 5.  
Check HF Filtering if you want the trigger system to treat a high frequency burst as a single pulse.

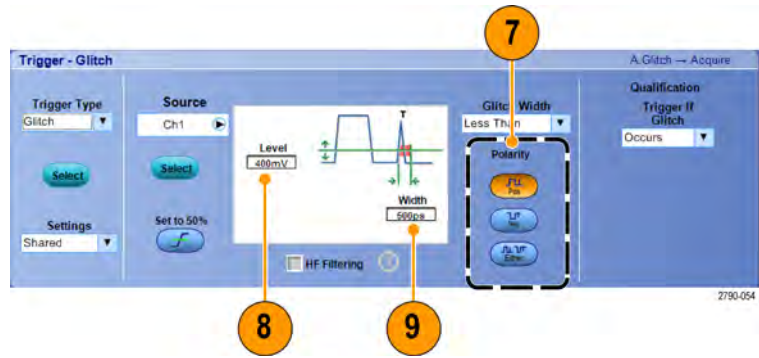

10. Click E-mail on Trigger **On**. (See page 88, *Setting up E-Mail on Event*.)

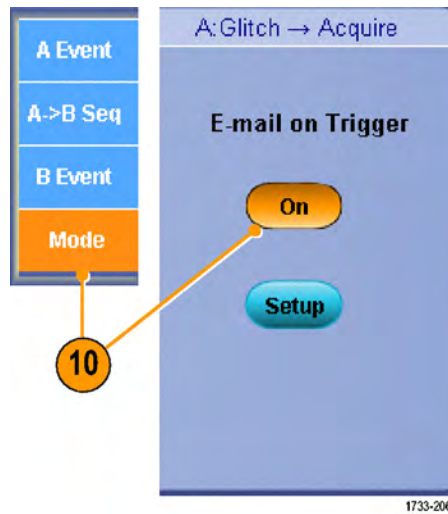

11. Push **Single** to trigger on a single glitch.

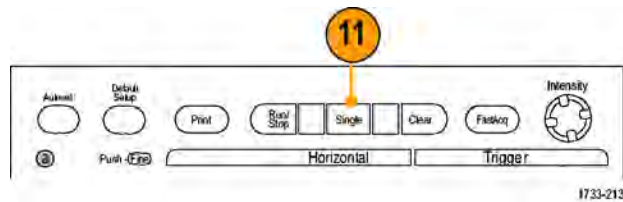

MSO/DPO7000DX, MSO/DPO7000C, and DPO7000C Series

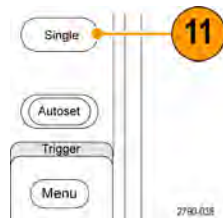

MSO5000B and DPO5000B Series



## Using the extended desktop and OpenChoice architecture for efficient documentation

Engineers often need to document their lab work for future reference. Instead of saving screen shots and waveform data to a CD or USB memory device, and then generating a report later, try using the OpenChoice architecture to document your work in real time.

To make your instrument the center of your design and documentation process, use the following procedure.

---

**NOTE.** On 64-bit systems, you will need 64-bit compatible device drivers and application software.

---

1. Load Microsoft Word or Excel on your instrument.
2. Connect a second monitor. (See page 12, *Adding a second monitor.*)

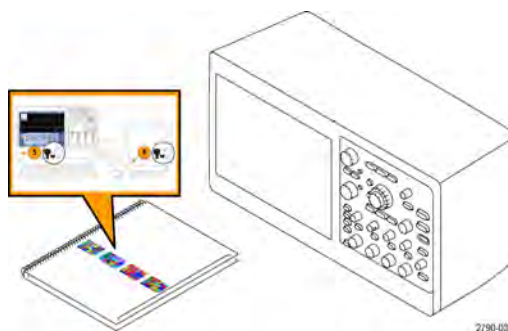

3. Open Microsoft Word, and then drag the Word window onto the extended desktop.



4. Click **TekScope** to restore the instrument application.



5. Select **Edit > Select for Copy > Full Screen (bitmap)**.

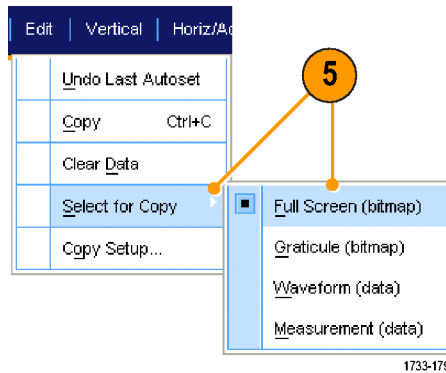

6. Press **Ctrl+C**.
7. Click in the Word document wherever you want to place the screen shot, and then press **Ctrl+V**.

### Quick tips

- The instrument comes with a variety of OpenChoice software tools designed for maximum efficiency and connectivity to the rest of your design environment.

## Triggering on buses

You can use your instrument to trigger on I<sup>2</sup>C, SPI, RS-232/422/485/UART, MIPI DSI-1, MIPI CSI-2, 8B/10B, USB, CAN, and parallel buses. The instrument can display both physical layer (as analog waveforms) and protocol level information (as digital and symbolic waveforms).

**NOTE.** Some trigger types are not available on some instruments.

For detailed bus triggering procedures, use the following procedures: (See page 80, *Triggering on a parallel bus.*) and (See page 83, *Triggering on a serial bus.*)

To set up the bus trigger:

1. Select **Vertical** > **Bus Setup**.

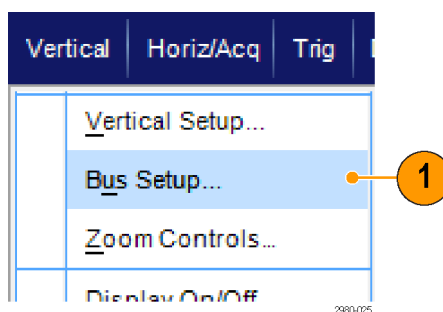

2. Select a bus type.
3. If you selected the **Serial** Bus Type, select the type of serial bus.
4. Specify the components.

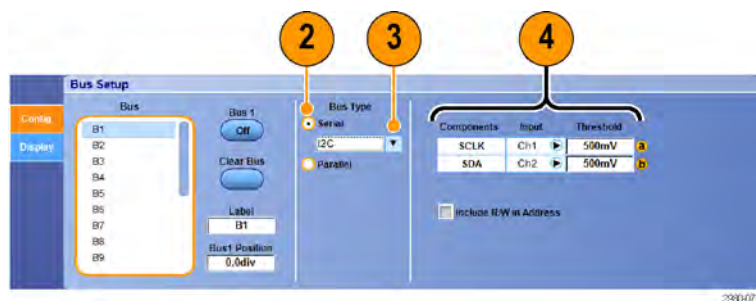

5. Select Trig > Bus Setup.

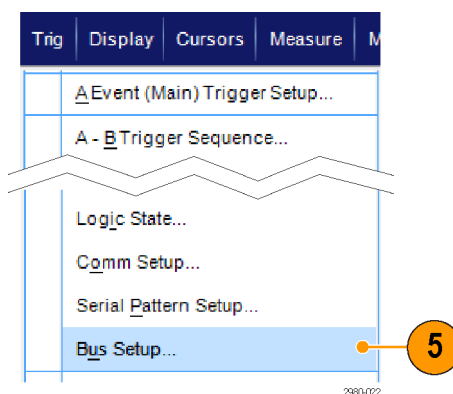

6. Select the bus you set up.
7. Select **Trigger On** to select the desired trigger on feature.

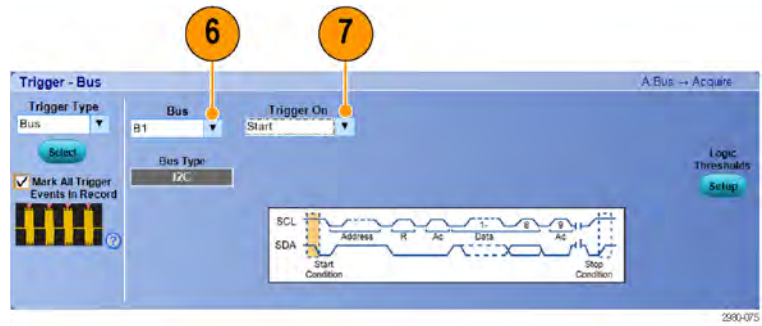

8. Depending on your **Trigger On** selection, you may need to make additional selections.

## Triggering on a video signal

The instrument supports triggering on NTSC, SECAM, PAL, and high definition signals.

To trigger on the video fields:

**NOTE.** The video trigger type is available only on DPO7000C, MSO5000B, and DPO5000B Series instruments.

1. Select **Trig > A Event (Main) Trigger Setup...**

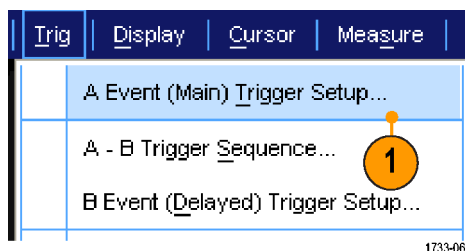

2. Set the A trigger type and source in the A Event tab.

Select **Format > 525i/NTSC**.

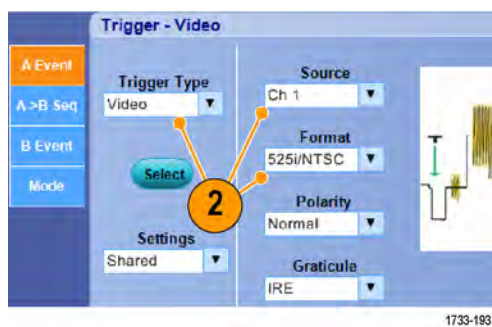

3. Select **Trigger On > Field**.  
Select **Odd, Even, or All** fields.

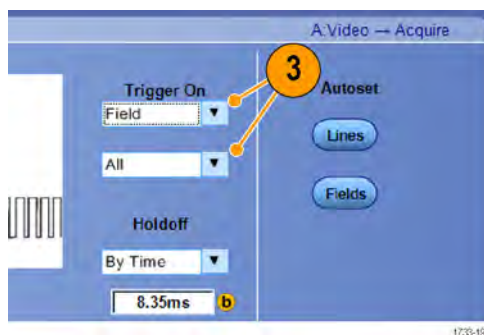

## Triggering on lines

To look at the video lines in the field:

1. Select **Trig > A Event (Main) Trigger Setup....**

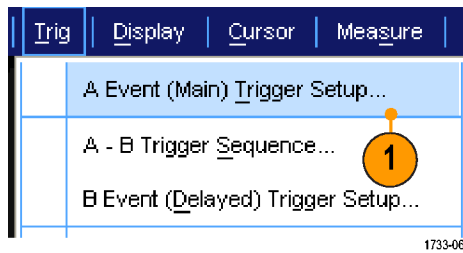

2. Set the A trigger type and source in the A Event tab.  
Select **Format > 525i/NTSC**.

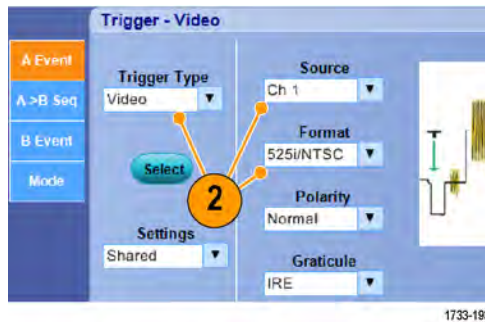

3. Select **Trigger On > All Lines**.

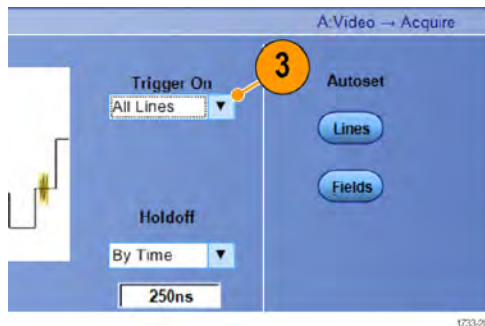

## Correlating data between a Tektronix oscilloscope and logic analyzer

Almost every design is a high-speed design with fast clock edges and data rates. For these designs, you need to see the analog characteristics of high-speed digital signals in relation to complex digital events in the circuit. iView is your window into the digital and analog world. The iView capability seamlessly integrates and automatically time-correlates data from Tektronix logic analyzers and oscilloscopes, so you can transfer analog waveforms from the oscilloscope to the logic analyzer display with the click of a mouse. View time-correlated analog and digital signals side-by-side and pinpoint the source of elusive glitches and other problems in moments.

The iView External Oscilloscope Cable allows you to connect your logic analyzer to a Tektronix oscilloscope, enabling communication between the two instruments. The Add External Oscilloscope wizard, which is available from the TLA application System menu, will guide you through the process of connecting the iView cable between your logic analyzer and oscilloscope.

A setup window is also available to help you in verifying, changing, and testing the oscilloscope settings. Before acquiring and displaying a waveform, you must establish a connection between your Tektronix Logic Analyzer and oscilloscope using the Add External Oscilloscope wizard.

1. Select **Add iView External Oscilloscope...** from the logic analyzer System menu.

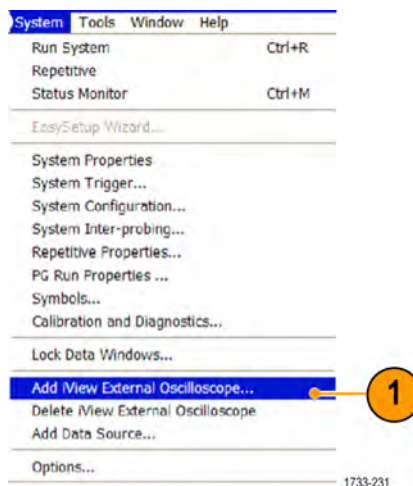

2. Select your model of oscilloscope.
3. Follow the on-screen instructions, and then click **Next**.
4. See your Tektronix Logic Analyzer documentation for more information on correlating data between the logic analyzer and the oscilloscope.

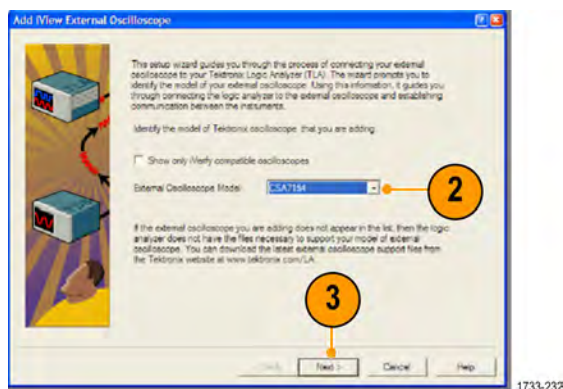

## Appendix A

### Cleaning

Use these procedures to clean your instrument. If additional cleaning is required, have your instrument serviced by qualified service personnel.

#### Exterior cleaning

Clean the exterior surfaces of the chassis with a dry lint-free cloth or a soft bristle brush. If any dirt remains, use a cloth or swab dipped in a 75% isopropyl alcohol solution. Use a swab to clean narrow spaces around controls and connectors. Do not use abrasive compounds on any part of the chassis.

Clean the On/Standby switch using a dampened cleaning towel. Do not spray or wet the switch directly.



**CAUTION.** *Improper cleaning agents, methods, or excessive force can damage the instrument. Do not use chemical cleaning agents that might damage the plastics used in this oscilloscope. Use only deionized water when cleaning the front-panel buttons. Use a 75% isopropyl alcohol solution as a cleaner and rinse with deionized water. Before using any other type of cleaner, consult your Tektronix Service Center or representative.*

*To prevent getting moisture inside the instrument during external cleaning, use only enough liquid to dampen the cloth or applicator.*

---



---

## Appendix B

### Obtaining the latest oscilloscope application and version releases

The latest version of an optional application that you ordered with your instrument may not be installed on your instrument. The following download location is a fast and easy way to get the latest software version.

To download the latest version of software, go to the home page of the Tektronix Web site ([www.tektronix.com](http://www.tektronix.com)), and locate the Downloads section on that page. Enter the application name in the ENTER MODEL NUMBER text box, and select Software in the Select Download Type pull-down menu.

---

**NOTE.** *The Release Notes file available on the Web page may contain more recent information than the readme.txt file contained within the downloadable executable file.*

---

To define the search criteria, use the title of the application in the ENTER MODEL NUMBER text box. For example, use the keyword DPOJET to search for and download the latest version of DPOJET.

If you purchased the application with your instrument, your Tektronix License Key will enable you to use the application.

If you are upgrading, follow the instructions on How to Install your new Tektronix License Key in the Readme.txt file to enable the application.

## Appendix C

### TPP0500 and TPP1000 500 MHz and 1 GHz 10X passive probes instructions

071-2809-xx

Copyright © Tektronix, Inc. All rights reserved.

#### Operating information

The TPP0500B & TPP1000 10X Passive Probes are compact passive probes with 10X attenuation that are designed for use with Tektronix MSO/DPO4000B & 5000B Series oscilloscopes.

The probes have no user- or Tektronix-serviceable parts.

#### Connecting the probe to the oscilloscope

Connect the probe as shown in the illustrations below.

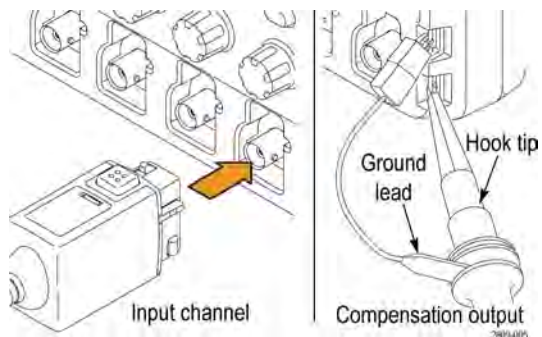

## Compensating the probe

**MSO/DPO5000B.** Perform the following steps to compensate the probe:

1. Connect the probe to an oscilloscope channel.
2. Connect the probe to the probe compensation output terminals on the oscilloscope front panel.
3. Select Vertical > Probe Cal.
4. Select the channel tab that the probe is attached to.
5. In the Probe Compensation section of the menu, click the Compensate Probe button.



**WARNING.** To avoid electric shock, only connect to the Probe Comp signal on the oscilloscope when making this adjustment.

---

If the probe compensation fails, verify that the signal and ground connections are secure at the Probe Comp connections on the oscilloscope. Also check that the ground connection is secure at the probe head, the rigid or pogo tip is secured tightly in the probe head, and the hook tip is securely connected to the tip.



## Standard accessories

The standard accessories included with the probe are shown below.

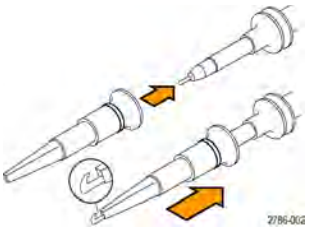
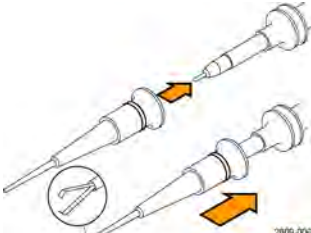
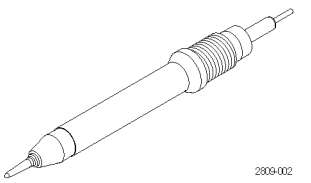
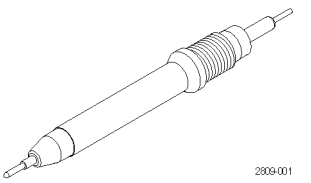
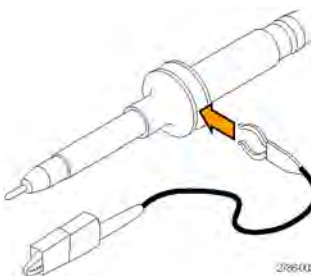

**WARNING.** To avoid electric shock when using the probe or accessories, keep fingers behind the finger guard of probe body and accessories.

---

Item	Description
	<p><b>Hook tip</b></p> <p>Press the hook tip onto the probe tip and then clamp the hook onto the circuit</p> <p>Reorder Tektronix part number 013-0362-XX</p>
	<p><b>Micro Hook tip</b></p> <p>Use this tip to access test points in tight spaces. Press the hook tip onto the probe tip and then clamp the hook onto the circuit</p> <p>Reorder Tektronix part number 013-0363-XX</p>
	<p><b>Rigid tip</b></p> <p>This tip is pre-installed on the probe.</p> <p>Reorder Tektronix part number 206-0610-XX</p>
	<p><b>Pogo tip</b></p> <p>This spring-loaded tip allows compliant testing of circuit boards.</p> <p>Reorder Tektronix part number 206-0611-XX</p>
	<p><b>Ground lead, with alligator clip</b></p> <p>Secure the lead to the probe head ground and then to your circuit ground.</p> <p>Reorder Tektronix part number 196-3521-XX</p>
	<p><b>Ground springs</b></p> <p>Attach the spring to the ground band on the probe tip to take measurements on test points that have ground connections nearby (&lt;0.75 in, std; XX in, short).</p> <p>Reorder Tektronix part numbers:            016-2028-XX (long, 2 ea.)            016-2034-XX (short, 2 ea.)</p>

## Optional accessories

The following accessories can be ordered for your probe.

Accessory	Tektronix part number
Ground Lead, Clip-on, 6 in	196-3198-xx
Ground Lead, Alligator, 12 in	196-3512-xx
MicroCKT Test Tip	206-0569-xx
Circuit Board Test Point/PCB Adapter	016-2016-xx
Compact Probe Tip Ckt Board Test Point	131-4210-xx
Wire, spool, 32 AWG	020-3045-xx

## Replacing the probe tip

Order Tektronix part number 206-0610-xx for rigid tip replacement, or order part number 206-0611-xx for pogo pin replacement.

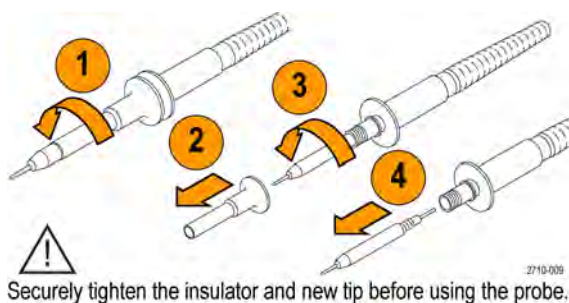

## Specifications

**Table 1: Electrical and mechanical specifications**

Characteristic	TPP0500/B	TPP1000
Bandwidth (-3 dB)	500 MHz	1 GHz
System rise time (typical)	<700 ps	<350 ps
System input capacitance	Rigid tip: 3.9 pF $\pm$ 0.3 pf Pogo pin tip: 5.1 pf $\pm$ 0.5 pf	
System attenuation accuracy	10:1 $\pm$ 2.2%	
Probe series resistance @DC	9.75 M $\Omega$ $\pm$ 0.5%	
System input resistance @DC	10 M $\Omega$ $\pm$ 2%	
Propagation delay	~5.67 ns	
Maximum input voltage	300 V <sub>RMS</sub> CAT II	
Cable length	1.3 m, $\pm$ 3 cm	

## Performance graphs

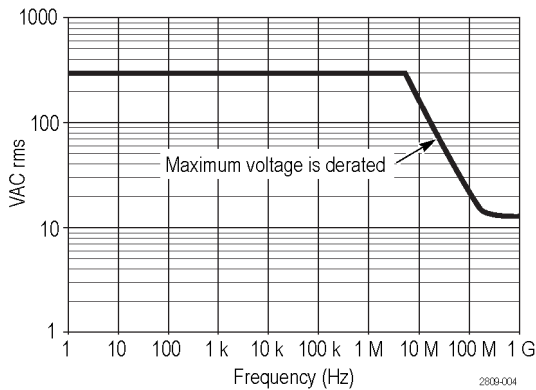
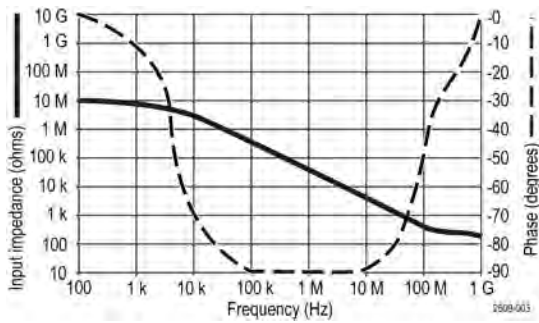

Refer to the reference lead derating curve above when making floating measurements.

**Table 2: Environmental specifications**

Characteristics	Description
Temperature	
Operating	-15 °C to +65 °C (+5 °F to +149 °F)
Nonoperating	-62 °C to +85 °C (-80 °F to +185 °F)
Humidity	
Operating	5% to 95% relative humidity @ up to 30 °C
Nonoperating	5% to 45% relative humidity @30 °C up to 50 °C
Altitude	
Operating	3.0 km (9,842 ft) maximum
Nonoperating	12.2 km (40,000 ft) maximum

**Table 3: Certifications and compliances**

Characteristics	Description	
EC Declaration of Conformity	Compliance was demonstrated to the following specification as listed in the Official Journal of the European Communities: Low Voltage Directive 2006/95/EC: EN61010-031/A1: 2008	
Measurement Category Descriptions	<i>Category</i> <i>Examples of Products in this Category</i>	
	CAT III	Distribution-level mains, fixed installation
	CAT II	Local-level mains, appliances, portable equipment
	CAT I	Circuits not directly connected to mains.
Pollution Degree 2	Do not operate in environments where conductive pollutants may be present (as defined in IEC 61010-1). Rated for indoor use only.	
Additional Safety Standards	UL61010-031, 2010. CAN/CSA-C22.2 No. 61010-31/A1:2008 IEC61010-031;IEC 61010-31/A1:2008	



**Equipment Recycling.** This product complies with the European Union's requirements according to Directive 2002/96/EC on waste electrical and electronic equipment (WEEE). For more information about recycling options, check the Support/Service section of the Tektronix Web site ([www.tektronix.com](http://www.tektronix.com)).

## Safety summary

Review the following safety precautions to avoid injury and prevent damage to this product or any products connected to it. To avoid potential hazards, use this product only as specified. Using the probe or accessories in a manner not specified could result in a shock or fire hazard.

### To avoid fire or personal injury

**Ground-Referenced oscilloscope use.** Do not float the reference lead of this probe when using with ground referenced oscilloscopes (for example, DPO, MSO, and TDS series oscilloscopes). The reference lead must be connected to earth potential (0 V).

**Connect and disconnect properly.** Connect the probe output to the measurement instrument before connecting the probe to the circuit under test. Disconnect the probe input and the probe reference lead from the circuit under test before disconnecting the probe from the measurement instrument.

**Avoid electric shock.** To avoid injury or loss of life, do not connect or disconnect probes or test leads while they are connected to a voltage source.

**Observe all terminal ratings.** To avoid fire or shock hazard, observe all ratings and markings on the product. Consult the product manual for further ratings information before making connections to the product.

**Avoid electric shock.** When using probe accessories, never exceed the lowest rating of the probe or its accessory, whichever is less, including the measurement category and voltage rating.

**Avoid electric overload.** To avoid injury or fire hazard, do not apply potential to any input, including the reference inputs, that varies from ground by more than the maximum rating for that input.

**Avoid exposed circuitry and do not operate without covers.** Do not touch exposed connections and components when power is present.

**Inspect the probe and accessories.** Before each use, inspect probe and accessories for damage (cuts, tears, defects in the probe body, accessories, cable jacket, etc.). Do not use if damaged.

**Do not operate in Wet/Damp conditions.**

**Do not operate in an explosive atmosphere.**

**Keep product surfaces clean and dry.**

**Safety terms and symbols terms in this manual.**

These terms may appear in this manual:



**WARNING.** Warning statements identify conditions or practices that could result in injury or loss of life.

---



**CAUTION.** Caution statements identify conditions or practices that could result in damage to this product or other property.

---

**Symbols on the product.** These symbols may appear on the product:



CAUTION  
Refer to Manual

## Contacting Tektronix

Web site: [www.tektronix.com](http://www.tektronix.com)  
Phone: 1-800-833-9200  
Address: Tektronix, Inc.  
Department or name (if known)  
14200 SW Karl Braun Drive  
P.O. Box 500  
Beaverton, OR 97077  
USA  
Email: [techsupport@tektronix.com](mailto:techsupport@tektronix.com)

## Warranty information

For warranty information, go to [www.tektronix.com/warranty](http://www.tektronix.com/warranty)



## Appendix D

### P6616 General-Purpose Logic Probe instructions

071-2831-00

Copyright © Tektronix, Inc. All rights reserved.

#### Product description

The P6616 general-purpose logic probe connects the Tektronix MSO/DPO5000B Series and MSO4000B Series of mixed-signal oscilloscopes to digital buses and signals on your target system. The probe contains 16 data channels split between two lead sets (GROUP 1 and GROUP 2).

The first lead in each set is identified by blue insulation, and the remaining seven leads are gray. All leads include a ground connection at the tip. You can connect the probe leads separately to the target system, or group the leads together using the probe tip holders.



## Connecting the probe to the oscilloscope

Connect the probe as shown in the illustration below.

1. Insert the probe label-side up into the connector on the oscilloscope.
2. To remove the probe, squeeze the buttons on the side and pull out the probe.

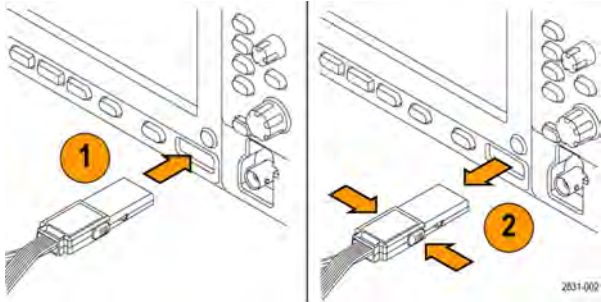

## Connecting the probe to your circuit

Attach the probe to the circuit using the connectors and adapters shown on the back of these instructions. Select the best method for your needs, and then proceed to Setting up the Probe.

### Setting up the probe

To set and view the digital channel parameters, do the following:

On MSO/DPO5000B Series instruments, select Vertical>Digital Setup or push the **D15-D0** button.

On MSO/DPO4000B Series instruments, push the **D15-D0** button.

The parameters listed below can be set on each digital channel:

- Threshold voltage and vertical position (the default threshold setting is 1.4 V)
- Signal height and position (set once for all 16 channels)
- Channel label

To set and view bus characteristics, do the following:

On MSO/DPO5000B Series instruments, use the controls in the Bus Setup menu.

On MSO/DPO4000B Series instruments, push the **B1** to **B4** buttons.

The setup screens allow you to set and view bus characteristics such as:

- Clock type
- Bus type (Serial or Parallel)
- Bus width
- Display format (Hex, Binary, or ASCII symbols)

Parallel bus setup information is resident on some oscilloscope models. However, for other buses such as SPI and I2C, you must have the appropriate option. See your oscilloscope manual or product data sheet for nomenclature and ordering details.

## Functional check

Logic activity immediately displays on all connected, active channels. If you do not see an active signal:

1. Push the **Trigger** button.
2. Select Edge for trigger type.
3. Select the channel that you are setting up as the source.
4. On MSO/DPO4000B Series instruments, push the **Autoset** button.

If you do not see an active signal, try another probe channel (or analog probe) to verify circuit activity at the test point.

## Typical application

1. Use the P6616 probe to view digital signals on a system bus.
2. Use an analog probe, such as the TPP0500/B or TPP1000 passive probe to view analog waveform information.

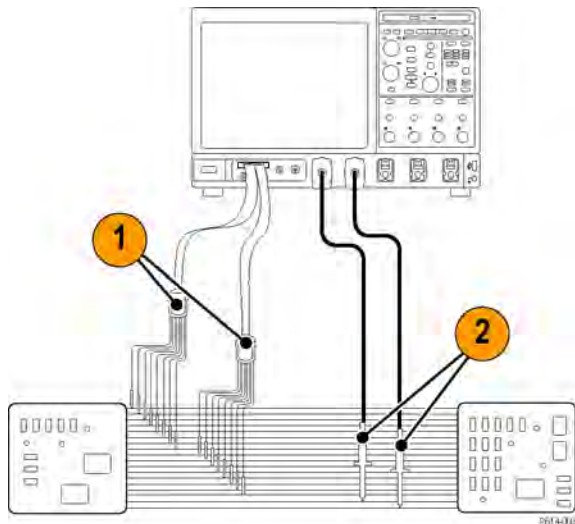

## Accessories

The following standard accessories ship with the probe and are shown in the illustration on the following page.

Item	Description	Quantity	Part number
—	Logic probe accessory kit	Item 1–6	020-2662-XX
1	Extension ground tip	1 set of 20	020-2711-XX
2	Probe tip	1 set of 10	131-5638-11
3	IC grabber	1 set of 20	020-2733-XX
4	Probe tip holder	2 ea	352-1115-XX
5	8" Ground lead	1 set of 2	020-2713-XX
6	3" Ground lead	1 set of 8	020-2712-XX
	Instructions <sup>1</sup>	1 ea	071-2831-XX

<sup>1</sup> Instructions are included with the probe, but not in the accessory kit. The instructions can be downloaded at [www.tektronix.com/manuals](http://www.tektronix.com/manuals).

These optional accessories can be ordered for your probe:

Description	Part number
P6960 Probe D-MAX Footprint to Square Pin Header Adapter	NEX-P6960PIN

## Specifications

**Table 4: Electrical and mechanical specifications**

Characteristic	Description
Input channels	16 digital
Input resistance	100 k $\Omega$ $\pm$ 1.0%
Input capacitance	3.0 pF
Input signal swing	
Minimum	400 mV p-p
Maximum	30 V p-p, $\leq$ 200 MHz (centered around the DC threshold voltage) at the probe tip 10 V p-p, $\geq$ 200 MHz (centered around the DC threshold voltage) at the probe tip
Maximum nondestructive input signal	$\pm$ 42 V
User defined threshold range	$\pm$ 40 V
Minimum detectable pulse width	1 ns
Digital channel-to-digital channel skew	200 ps
Probe length	1.0 m (3.28 ft)

**Table 5: Environmental specifications**

Characteristic	Description
Temperature	
Operating	0 $^{\circ}$ C to +50 $^{\circ}$ C (+32 $^{\circ}$ F to +122 $^{\circ}$ F)
Nonoperating	-55 $^{\circ}$ C to +75 $^{\circ}$ C (-67 $^{\circ}$ F to +167 $^{\circ}$ F)
Humidity	
Operating	5% to 95% relative humidity
Nonoperating	10% to 95% relative humidity
Altitude	
Operating	4.6 km (15,092 ft) maximum
Nonoperating	15 km (50,000 ft) maximum



**Equipment Recycling.** This product complies with the European Union's requirements according to Directive 2002/96/EC on waste electrical and electronic equipment (WEEE). For more information about recycling options, check the Support/Service section of the Tektronix Web site ([www.tektronix.com](http://www.tektronix.com)).

## Safety summary

To avoid potential hazards, use this probe only as specified.

**Connect and disconnect properly.** Connect the probe output to the measurement instrument before connecting the probe to the circuit under test. Disconnect the probe input and the probe ground from the circuit under test before disconnecting the probe from the measurement instrument.

**Observe all terminal ratings.** To avoid fire or shock hazard, observe all ratings and markings on the product. Consult the product manual for further ratings information before making connections to the product.

**Do not operate without covers.** Do not touch exposed connections and components when power is present.

**Avoid exposed circuitry.** Do not touch exposed connections and components when power is present.

**Do not operate with suspected failures.** If you suspect there is damage to this product, have it inspected by qualified service personnel.

**Do not operate in Wet/Damp conditions.** Do Not Operate in an Explosive Atmosphere.

**Keep product surfaces clean and dry.**

## Safety terms and symbols in this manual.

These terms may appear in this manual:



---

**WARNING.** *Warning statements identify conditions or practices that could result in injury or loss of life.*

---



---

**CAUTION.** *Caution statements identify conditions or practices that could result in damage to this product or other property.*

---

**Symbols on the product.** This symbol may appear on the product:



---

## Contacting Tektronix

Web site:	<a href="http://www.tektronix.com">www.tektronix.com</a>
Phone:	1-800-833-9200
Address:	Tektronix, Inc. Department or name (if known) 14200 SW Karl Braun Drive P.O. Box 500 Beaverton, OR 97077 USA
Email:	<a href="mailto:techsupport@tektronix.com">techsupport@tektronix.com</a>

## Warranty information

For warranty information, go to [www.tektronix.com/warranty](http://www.tektronix.com/warranty).

### Connecting the probe to the circuit

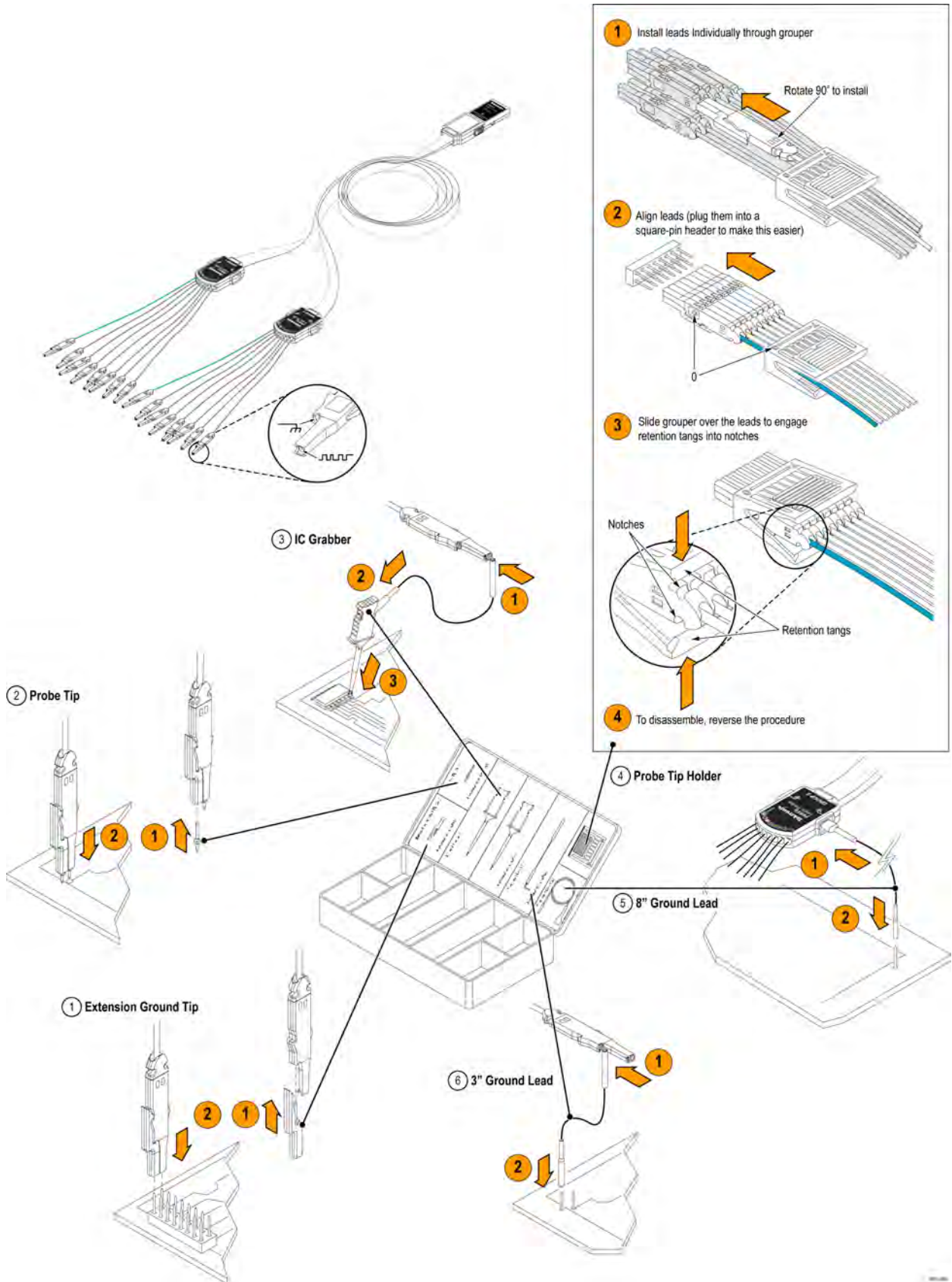



# Index

## A

- Accessories, 1
- Acquisition
  - input channels and digitizers, 37
  - sampling, 37
- Acquisition modes
  - changing, 42
  - defined, 40
- Action on event
  - setup, 86
- Add filtering
  - user definable, 130
- Amplitude measurements, 118
- Analyzing waveforms, 116
- Application examples, 168
- Application software, 166
- ARM status light, 74
- Automatic trigger mode, 68
- Autoscroll, 103, 104
- Autoset, 36
- Autoset Undo, 37
- Average acquisition mode, 40

## B

- B-Event scan, 78
- Bandwidth enhancement, 47
- Bandwidth limit, 48
- Bus, 173
  - configuring, 58
  - setting up a bus, 53
  - setting up a parallel bus, 56
  - setting up a serial bus, 55
- Buses, 173
- Button
  - D15 - D0, 60
  - Play-pause, 106
  - Set / Clear Mark, 108

## C

- Calibration, 31
- CAN, 173
- CAN trigger
  - defined, 73
- Choosing a Trigger Type, 70
- Cleaning, 178

- Color palettes, 98
- Communication
  - measurements, 120
  - trigger, defined, 73
- Control panel, 17
- Control panel map, 25
- Copying, 163
- Coupling
  - trigger, 69
- Cross Hair graticule style, 96
- Cursor measurements, 125

## D

- D15 - D0 button, 60
- Date and time, 97
- Default setup, 35
- Delayed trigger, 69, 74
- Diagnostics, 30
- Digital channels
  - analog characteristics, 61
  - setting up, 52
  - signal input, 51
- Digital waveforms
  - saving, 156
- Display
  - colors, 99
  - objects, 97
  - persistence, 92
  - style, 91
- Display map, 23
- Display Remote, 11
- Documentation, xvi
- Dots
  - displaying waveform record points as, 91
- DSP Bandwidth enhancement, 47
- Dual monitor, 12

## E

- E-mail on event
  - setup, 88
- E-mail on trigger, 87
- Edge trigger
  - defined, 72
- Effective number of bits
  - enhanced, 41
- Enhanced bandwidth, 47

- Enhanced effective number of bits, 41
- ENOB, 41
- Envelope acquisition mode, 40
- Error detector, 135
- ESD
  - preventing, 6
- Examples, 168
- Export *See* Saving
- Extended desktop, 12, 171
- Exterior cleaning, 178

## F

- Fast Acquisition, 46, 168
- FastAcq/WfmDB palette, 98
- FastFrame, 63
  - Frame finder, 66
- Force trigger, 68
- Frame graticule style, 96
- Front panel map, 17
- Full graticule style, 96

## G

- Gate width and resolution
  - bandwidth, 134
- Gating, 121
- Glitch trigger
  - defined, 72
- Glitches
  - capturing, 40, 46, 168
  - triggering on, 69
- Graticule styles, 96
- Grid graticule style, 96

## H

- H Bars cursor, 125
- Hard copy, 165
- Help, 28
- Hi Res acquisition mode, 40
- Histogram
  - saving, 161
- Histogram measurements, 119
- Histogram setup, 127
- Horizontal delay, 90
- Horizontal marker, 101

Horizontal mode  
 selection, 43  
 Horizontal position  
 and math waveforms, 131  
 defined, 34  
 Horizontal scale  
 and math waveforms, 131  
 How to  
 manage long record length  
 waveforms, 105  
 search through and add marks  
 to waveforms, 107  
 use MagniVu, 60  
 use Wave Inspector, 105

**I**

I2C, 173  
 Incoming inspection, 30  
 Infinite persistence, 92  
 Installation, 1  
 Instrument setup  
 recalling, 158  
 saving, 157  
 Intensified samples  
 displaying waveforms as, 91  
 Interface map, 23  
 Interpolation, 39, 94  
 iView, 177

**K**

Knob  
 pan, 106  
 zoom, 105

**L**

Label, 95  
 bus, 53  
 digital channel, 52  
 screen text, 95  
 Limit testing, 144  
 Linear interpolation, 94  
 Lock zoomed waveforms, 103, 104  
 Lock, standard laptop, 11  
 Logic analyzer  
 correlating data, 177  
 Long record length  
 management, 105

**M**

MagniVu, 60

Main trigger, 69, 75  
 Mark, 107, 108, 110  
 Mask  
 autofit, 142  
 autose, 142, 143  
 margin tolerance, 142  
 pass/fail testing, 143  
 saving, 160  
 Mask testing, 141  
 Math  
 arbitrary filters, 130  
 colors, 99  
 editor, 129  
 waveforms, 129  
 Measurements, 116  
 accuracy, 37  
 annotation, 123  
 cursor, 125  
 customizing, 121  
 defined, 118  
 reference levels, 124  
 saving, 159  
 snapshot, 122, 123  
 statistics, 122  
 Menus, 29  
 MIPI CSI-2, 173  
 MIPI DSI-1, 173  
 Monochrome gray color palette, 98  
 Monochrome green color palette, 98  
 More measurements, 119  
 Multiple zoom areas, 101  
 MultiView zoom, 99  
 MyScope  
 editing, 151  
 new control window, 146  
 using, 150

**N**

Network connection, 11  
 Normal color palette, 98  
 Normal trigger mode, 68

**O**

Objects  
 display, 97  
 Online help, 28  
 OpenChoice  
 example, 171  
 Operating specifications, 3  
 Operating system restore, 15  
 Overlay frames, 64

**P**

Pan, 105, 106  
 knob, 106  
 Parallel, 173  
 Pattern lock trigger, 72  
 Pattern trigger  
 defined, 72  
 Pause, 106  
 Peak Detect acquisition mode, 40  
 Persistence  
 display, 92  
 Pinpoint Triggers, 68  
 Play, 106  
 Play-pause button, 106  
 Play-pause mode, 106  
 Posttrigger, 68, 69  
 Power  
 removing, 10  
 Power off, 9  
 Power on, 7  
 Power supply, 7  
 Predefined math expressions, 129  
 Predefined spectral math  
 expressions, 132  
 Pretrigger, 68, 69  
 Preventing ESD, 6  
 Print, 165  
 Probe  
 calibration, 37  
 compensation, 37  
 deskew, 37  
 P6616, 187  
 TPP0500, 180  
 TPP1000, 180

**R**

Random noise, 40  
 Readout  
 trigger, 74  
 READY status light, 74  
 Rear panel map, 20  
 Recall  
 setup, 158  
 waveforms, 155  
 Record view palette, 98  
 Reference colors, 99  
 Reference levels, 124  
 Related documentation, xvi  
 Remote Display, 11  
 Removing power, 10  
 Right-click menu, 29  
 Roll mode, 50

Roll mode interactions, 50  
 Runt trigger  
   defined, 72

## S

Sample acquisition mode, 40  
 Sampling  
   equivalent-time, 38  
   interpolated real-time, 38  
   real-time, 37  
 Sampling process  
   defined, 37  
 Saving  
   histogram data, 161  
   masks, 160  
   measurements, 159  
   screen captures, 152  
   setup, 157  
   timestamps, 162  
   waveforms, 153  
 Saving digital waveforms, 156  
 Screen cursor, 125  
 Screen shots  
   saving, 152  
 Screen text, 95  
 Scroll zoomed waveforms, 103, 104  
 Search, 107, 108, 110  
 Security lock, 11  
 Segmented memory, 63  
 Sequential triggering, 75  
 Serial, 173  
 Serial error detector, 135  
 Serial mask testing, 141  
 Serial trigger  
   defined, 72  
 Set / Clear Mark button, 108  
 Setup/Hold trigger  
   defined, 72  
 Shortcut menu, 29  
 Side panel map, 20  
 Signal input, 33  
 Sin(x)/x interpolation, 94  
 Single sequence, 43  
 Snapshot, 122, 123  
 Software  
   latest release, 179  
   optional, 166  
   version, 179  
 Specifications  
   operating, 3  
   power supply, 7  
 Spectral analysis, 132

Spectral grading color palette, 98  
 Spectral math expression  
   advanced, 133  
 SPI, 173  
 Start an acquisition, 43  
 State trigger  
   defined, 72  
 Statistics, 122  
 Stop an acquisition, 43

## T

Temperature grading color  
 palette, 98  
 Termination voltage, 49  
 Time measurements, 118  
 Time Stamps, 64  
   defined, 63  
 Timeout trigger  
   defined, 72  
 Timestamp  
   saving, 162  
 Transition trigger  
   defined, 72  
 TRIG'D status light, 74  
 Trigger  
   B-Event scan, 78  
   concepts, 68  
   coupling, 69  
   E-mail on trigger, 87  
   forcing, 68  
   holdoff, 68  
   level, 69  
   modes, 68  
   parallel bus, 80, 173  
   posttrigger, 68, 69  
   pretrigger, 68, 69  
   readout, 74  
   selections, 72  
   serial bus, 83, 173  
   slope, 69  
   status, 74  
   types, 72  
   visual trigger, 84  
 Trigger event  
   defined, 68  
 Trigger level markers, 97  
 Trigger Position, 77

## U

Undo Last Autoset, 37  
 User defined color palette, 98

User marks, 107  
 User preferences, 37

## V

V Bars cursor, 125  
 Variable persistence, 92  
 Vectors  
   displaying waveforms as, 91  
 Vertical position, 34  
 Vertical position and autoset, 37  
 Video  
   Lines, 176  
 Video trigger  
   defined, 73  
 Video triggering, 175  
 Visual Trigger, 84

## W

Wave Inspector, 105  
 Waveform  
   analyzing, 116  
   cursors, 125  
   display style, 91  
   pan, 105, 106  
   pause, 106  
   play, 106  
   play-pause, 106  
   recalling, 155  
   saving, 153  
   search and mark, 107  
   user marks, 107  
   zoom, 105  
 Waveform database acquisition  
   mode, 40  
 Waveform record  
   defined, 39  
 Width trigger  
   defined, 72  
 Window trigger  
   defined, 72

## X

X-Y display format, 93  
 X-Y-Z display format, 93

## Y

Y-T display format, 93

## Z

- Zoom, 99, 105
  - graticule size, 106
  - knob, 105
- Zoom graticule size, 100



