

**DPO4000 Series
Digital Phosphor Oscilloscopes
User Manual**

www.tektronix.com
071-1785-00

Tektronix

Copyright © Tektronix. All rights reserved. Licensed software products are owned by Tektronix or its subsidiaries or suppliers, and are protected by national copyright laws and international treaty provisions.

Tektronix products are covered by U.S. and foreign patents, issued and pending. Information in this publication supersedes that in all previously published material. Specifications and price change privileges reserved.

TEKTRONIX and TEK are registered trademarks of Tektronix, Inc.

e*Scope, iView, OpenChoice, TekSecure, and TekVPI are registered trademarks of Tektronix, Inc.

Wave Inspector is a trademark of Tektronix, Inc.

Contacting Tektronix

Tektronix, Inc.
14200 SW Karl Braun Drive
P.O. Box 500
Beaverton, OR 97077
USA

For product information, sales, service, and technical support:

- In North America, call 1-800-833-9200.
- Worldwide, visit www.tektronix.com to find contacts in your area.

Warranty 4

Tektronix warrants that this product will be free from defects in materials and workmanship for a period of three (3) years from the date of shipment. If any such product proves defective during this warranty period, Tektronix, at its option, either will repair the defective product without charge for parts and labor, or will provide a replacement in exchange for the defective product. Parts, modules and replacement products used by Tektronix for warranty work may be new or reconditioned to like new performance. All replaced parts, modules and products become the property of Tektronix.

In order to obtain service under this warranty, Customer must notify Tektronix of the defect before the expiration of the warranty period and make suitable arrangements for the performance of service. Customer shall be responsible for packaging and shipping the defective product to the service center designated by Tektronix, with shipping charges prepaid. Tektronix shall pay for the return of the product to Customer if the shipment is to a location within the country in which the Tektronix service center is located. Customer shall be responsible for paying all shipping charges, duties, taxes, and any other charges for products returned to any other locations.

This warranty shall not apply to any defect, failure or damage caused by improper use or improper or inadequate maintenance and care. Tektronix shall not be obligated to furnish service under this warranty a) to repair damage resulting from attempts by personnel other than Tektronix representatives to install, repair or service the product; b) to repair damage resulting from improper use or connection to incompatible equipment; c) to repair any damage or malfunction caused by the use of non-Tektronix supplies; or d) to service a product that has been modified or integrated with other products when the effect of such modification or integration increases the time or difficulty of servicing the product.

THIS WARRANTY IS GIVEN BY TEKTRONIX WITH RESPECT TO THE PRODUCT IN LIEU OF ANY OTHER WARRANTIES, EXPRESS OR IMPLIED. TEKTRONIX AND ITS VENDORS DISCLAIM ANY IMPLIED WARRANTIES OF MERCHANTABILITY OR FITNESS FOR A PARTICULAR PURPOSE. TEKTRONIX' RESPONSIBILITY TO REPAIR OR REPLACE DEFECTIVE PRODUCTS IS THE SOLE AND EXCLUSIVE REMEDY PROVIDED TO THE CUSTOMER FOR BREACH OF THIS WARRANTY. TEKTRONIX AND ITS VENDORS WILL NOT BE LIABLE FOR ANY INDIRECT, SPECIAL, INCIDENTAL, OR CONSEQUENTIAL DAMAGES IRRESPECTIVE OF WHETHER TEKTRONIX OR THE VENDOR HAS ADVANCE NOTICE OF THE POSSIBILITY OF SUCH DAMAGES.

Table of Contents

General Safety Summary	v
Environmental Considerations	viii
Preface.....	x
Key Features.....	x
Where to Find More Information.....	xii
Conventions Used in This Manual.....	xiii
Installation	1
Before Installation.....	1
Operating Considerations	6
Connecting Probes	10
Powering On the Oscilloscope	11
Powering Off the Oscilloscope	14
Functional Check	15
Compensating the Probe	17
Installing an Application Module.....	19
Changing the User Interface Language	20
Changing the Date and Time	23
Signal Path Compensation	25
Upgrading Firmware	28
Connecting Your Oscilloscope to a Computer	34

Get Acquainted with the Instrument	45
Front-Panel Menus and Controls	45
Front-Panel Connectors	66
Side-Panel Connector	67
Rear-Panel Connectors	68
Acquire the Signal	70
Setting Up Signal Input	70
Using the Default Setup	73
Using Autoset	74
Acquisition Concepts	75
How the Acquisition Modes Work	78
Changing the Acquisition Mode and Record Length	80
Using Roll Mode	83
Defining a Serial Bus	84
Trigger Setup and Run	91
Triggering Concepts	91
Choosing a Trigger	98
Selecting Triggers	99
Triggering on Buses	102
Checking Trigger Status	107
Using A (Main) and B (Delayed) Triggers	107
Starting and Stopping an Acquisition	111

Display Waveform Data	112
Adding and Removing a Waveform	112
Setting the Display Style and Persistence	112
Setting Waveform and Graticule Intensity	115
Setting the Graticule Style	117
Setting the LCD Backlight	118
Scaling and Positioning a Waveform	120
Setting Input Parameters	122
Analyze Waveform Data	129
Taking Automatic Measurements	129
Selecting Automatic Measurements	131
Customizing an Automatic Measurement	137
Taking Manual Measurements with Cursors	144
Using Math Waveforms	150
Using FFT	153
Using Advanced Math	157
Using Reference Waveforms	160
Managing Long Record Length Waveforms	163
Save and Recall Information	174
Saving a Screen Image	174
Saving and Recalling Waveform Data	176
Saving and Recalling Setups	184

Saving with One Button Push	187
Printing a Hard Copy.....	189
Erasing DPO4000 Memory	196
Use Application Modules	200
Application Examples.....	201
Taking Simple Measurements	201
Analyzing Signal Detail	217
Triggering on a Video Signal	226
Capturing a Single-Shot Signal.....	230
Correlating Data With a TLA5000 Logic Analyzer	235
Tracking Down Bus Anomalies	238
Index	

General Safety Summary

Review the following safety precautions to avoid injury and prevent damage to this product or any products connected to it.

To avoid potential hazards, use this product only as specified.

Only qualified personnel should perform service procedures.

To Avoid Fire or Personal Injury

Use Proper Power Cord. Use only the power cord specified for this product and certified for the country of use.

Connect and Disconnect Properly. Do not connect or disconnect probes or test leads while they are connected to a voltage source.

Connect and Disconnect Properly. De-energize the circuit under test before connecting or disconnecting the current probe.

Ground the Product. This product is grounded through the grounding conductor of the power cord. To avoid electric shock, the grounding conductor must be connected to earth ground. Before making connections to the input or output terminals of the product, ensure that the product is properly grounded.

Observe All Terminal Ratings. To avoid fire or shock hazard, observe all ratings and markings on the product. Consult the product manual for further ratings information before making connections to the product.

The inputs are not rated for connection to mains or Category II, III, or IV circuits.

Connect the probe reference lead to earth ground only.

Do not apply a potential to any terminal, including the common terminal, that exceeds the maximum rating of that terminal.

Power Disconnect. The power switch disconnects the product from the power source. See instructions for the location. Do not block the power switch; it must remain accessible to the user at all times.

Do Not Operate Without Covers. Do not operate this product with covers or panels removed.

Do Not Operate With Suspected Failures. If you suspect that there is damage to this product, have it inspected by qualified service personnel.

Avoid Exposed Circuitry. Do not touch exposed connections and components when power is present.

Do Not Operate in Wet/Damp Conditions.

Do Not Operate in an Explosive Atmosphere.

Keep Product Surfaces Clean and Dry.

Provide Proper Ventilation. Refer to the manual's installation instructions for details on installing the product so it has proper ventilation.

Terms in this Manual

These terms may appear in this manual:



WARNING. *Warning statements identify conditions or practices that could result in injury or loss of life.*



CAUTION. *Caution statements identify conditions or practices that could result in damage to this product or other property.*

Symbols and Terms on the Product

These terms may appear on the product:

- DANGER indicates an injury hazard immediately accessible as you read the marking.
- WARNING indicates an injury hazard not immediately accessible as you read the marking.
- CAUTION indicates a hazard to property including the product.

The following symbols may appear on the product:

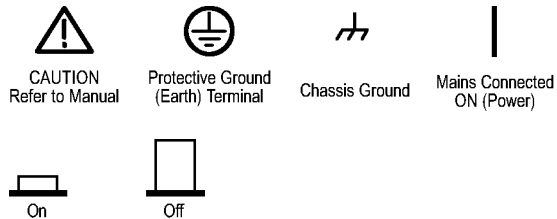

Environmental Considerations

This section provides information about the environmental impact of the product.

Product End-of-Life Handling

Observe the following guidelines when recycling an instrument or component:

Equipment Recycling. Production of this equipment required the extraction and use of natural resources. The equipment may contain substances that could be harmful to the environment or human health if improperly handled at the product's end of life. In order to avoid release of such substances into the environment and to reduce the use of natural resources, we encourage you to recycle this product in an appropriate system that will ensure that most of the materials are reused or recycled appropriately.

The symbol shown below indicates that this product complies with the European Union's requirements according to Directive 2002/96/EC on waste electrical and electronic equipment (WEEE). For information about recycling options, check the Support/Service section of the Tektronix Web site (www.tektronix.com).



Mercury Notification. This product uses an LCD backlight lamp that contains mercury. Disposal may be regulated due to environmental considerations. Please contact your local authorities or, within the United States, the Electronics Industries Alliance (www.eiae.org) for disposal or recycling information.

Restriction of Hazardous Substances

This product has been classified as Monitoring and Control equipment, and is outside the scope of the 2002/95/EC RoHS Directive. This product is known to contain lead, cadmium, mercury, and hexavalent chromium.

Preface

This manual describes the installation and operation of the following DPO4000 Series Instruments:

DPO4104

DPO4054

DPO4034

DPO4032

Key Features

DPO4000 Series instruments can help you verify, debug, and characterize electronic designs. Key features include:

- 1 GHz, 500 MHz, and 350 MHz bandwidths
- 2 and 4 channel models
- Sample rates up to 5 GS/s on all channels
- 10 Megapoint record length on all channels
- I²C, SPI, and CAN serial triggering and analysis
(Requires use of the DPO4EMBD (for I²C and SPI) or DPO4AUTO (for CAN) application modules)
- Wave Inspector controls for managing long record lengths, with zoom and pan, play and pause, search and mark
- 10.4 inch (264 mm) XGA color display
- Small footprint and lightweight, at 140 mm (5.5 inches) deep and 5 kg (11 pounds)
- USB and CompactFlash available for quick and easy storage
- Built-in Ethernet port
- USB 2.0 device port for direct PC control of the oscilloscope using USBTMC protocol

- OpenChoice documentation and analysis software
- Remote viewing with control (e*Scope and OpenChoice connectivity)
- TekVPI Versatile Probe Interface supports active, differential, and current probes for automatic scaling and units

Where to Find More Information

The following information is available for your oscilloscope:

To read about**Use these documents**

Installation and Operation

This *DPO4000 User Manual*

English: 071-1785-XX

French: 071-1799-XX

Italian: 071-1800-XX

German: 071-1801-XX

Spanish: 071-1802-XX

Japanese: 071-1803-XX

Portuguese: 071-1804-XX

Simplified Chinese: 071-1805-XX

Traditional Chinese: 071-1806-XX

Korean: 071-1807-XX

Russian: 071-1808-XX

Specifications and Performance
VerificationThe *DPO4000 Technical Reference* (071-1843-XX) (PDF only)

Programmer Commands

The *DPO4000 Programmer Manual* (071-1845-XX) (PDF only)

Analysis and Connectivity Tools

The optional *Getting Started with OpenChoice Solutions Manual* (020-2514-XX) (includes a CD)

To read about	Use these documents
Servicing and calibration	The optional <i>DPO4000 Service Manual (071-1844-XX)</i>
Installing and testing application modules	The <i>DPO4000 Series Application Module Installation Instructions</i> manual (071-1833-XX) (11 languages)

Conventions Used in This Manual

The following icons are used throughout this manual.

Sequence Step



Front panel power



Connect power

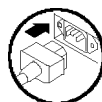

Network

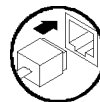

USB

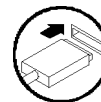

Installation

Before Installation

Unpack the oscilloscope and check that you received all items listed as standard accessories. The following pages list recommended accessories and probes, instrument options, and upgrades. Check the Tektronix Web site (www.tektronix.com) for the most current information.

Standard Accessories

Accessory	Tektronix part number	
<i>DPO4000 User Manual</i>	English (Option L0)	071-1785-XX
	French (Option L1)	071-1799-XX
	Italian (Option L2)	071-1800-XX
	German (Option L3)	071-1801-XX
	Spanish (Option L4)	071-1802-XX
	Japanese (Option L5)	071-1803-XX
	Portuguese (Option L6)	071-1804-XX
	Simple Chinese (Option L7)	071-1805-XX
	Traditional Chinese (Option L8)	071-1806-XX
	Korean (Option L9)	071-1807-XX
	Russian (Option L10)	071-1808-XX

Standard Accessories (cont.)

Accessory		Tektronix part number
<i>DPO4000 Documentation Browser CD</i>	Electronic versions of DPO4000 documents, including the Programmer Manual and the Technical Reference.	063-1810-XX
<i>OpenChoice Desktop CD</i>	Applications that let you capture and transfer data from your oscilloscope to an external PC. Use the standalone OpenChoice Desktop, MS Word, or MS Excel Toolbars.	020-2514-XX
Calibration certificate documenting traceability to national metrology institute(s), and ISO9001 quality system registration.		—
One 500 MHz, 10x passive probe per channel		P6139A
Front Cover	Hard plastic cover to help protect the instrument	200-4908-00
CompactFlash memory card	Extra storage	156-9413-00

Standard Accessories (cont.)

Accessory		Tektronix part number
Power Cord	North America (Option A0)	161-0104-00
	Universal Euro (Option A1)	161-0104-06
	United Kingdom (Option A2)	161-0104-07
	Australia (Option A3)	161-0104-05
	Switzerland (Option A5)	161-0167-00
	Japan (Option A6)	161-A005-00
	China (Option A10)	161-0306-00
	India (Option A11)	161-0400-00
	No power cord or AC adapter (Option A99)	—

Optional Accessories

Accessory		Tektronix Part Number
DPO4EMBD	The embedded serial triggering and analysis module enables triggering on packet level information on I ² C and SPI serial buses, as well as digital views of the signal, bus views, bus decoding, search tools, and packet decode tables with timestamp information	DPO4EMBD
DPO4AUTO	The embedding automotive serial triggering and analysis module enables triggering on packet level information on CAN serial buses, as well as digital views of the signal, bus views, bus decoding, search tools, and packet decode tables with timestamp information	DPO4AUTO
TPA-BNC	TekVPI to TekProbe 2 BNC Adapter	TPA-BNC
TEK-USB-488 Adapter	GPIB to USB Adapter	TEK-USB-488
Getting Started with OpenChoice Solutions Manual with CD	Describes ways to develop host-computer software applications that work with your oscilloscope	020-2513-XX
Rackmount kit	Adds rackmount brackets	RM4000
Soft transit case	Case for carrying instrument	AC4000
Hard transit case	Traveling case, which requires use of the soft transit case (AC4000)	HCTEK4321

Optional Accessories (cont.)

Accessory		Tektronix Part Number
CompactFlash memory card	Extra storage	156-9413-00
CompactFlash to USB memory card reader	Card reader	119-6827-00
DPO4000 Programmer Manual	Describes commands for remote control of the DPO4000 oscilloscope. Available electronically on the Documentation Browser CD or for download from www.tektronix.com .	071-1845-XX
DPO4000 Technical Reference Manual	Describes the DPO4000 oscilloscope specifications and performance verification procedure. Available electronically on the Documentation Browser CD or for download from www.tektronix.com .	071-1809-XX
DPO4000 Service manual	Service information	071-1844-XX
DPO4000 Module Installation Instructions	Manual	071-1833-XX

The DPO4000 oscilloscope works with multiple optional probes. (See page 10, *Connecting Probes*.) Check the Tektronix Web site (www.tektronix.com) for the most current information.

Operating Considerations

DPO4000 Series Oscilloscope

Input Voltage: 100 V to 240 V \pm 10%

Input Power Frequency:

47 Hz to 66 Hz (100 V to 240 V)

400 Hz (100 V to 132 V)

Power Consumption: 250 W maximum

Weight: 5 kg (11 lbs), stand-alone instrument

Height, including feet but not handle:

229 mm (9.0 in)

Width, from handle hub to handle hub: 439 mm

(17.3 in)

Depth, from feet to front of knobs: 137 mm

(5.4 in)

Depth, from feet to front of front cover: 145 mm

(5.7 in)

Clearance: 51 mm (2 in)

Temperature:

Operating: +0 °C to +50 °C

Nonoperating: -20 °C to +60 °C

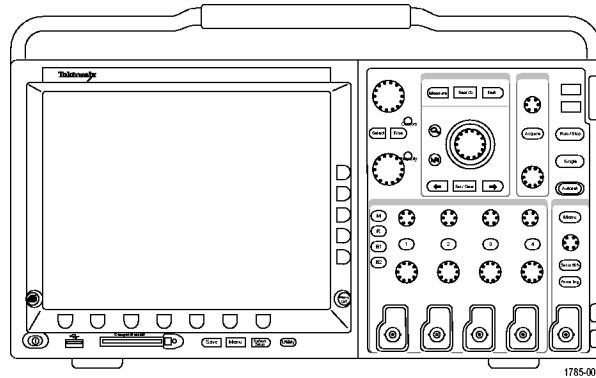

Humidity:

Operating: High: 40 °C to 50 °C, 10% to 60% RH

Operating: Low: 0 °C to 40 °C, 10 to 90% RH

Non-operating: High: 40 °C to 60 °C, 5 to 60% RH

Non-operating: Low: 0 °C to 40 °C, 5 to 90% RH

Altitude:

Operating: 3,000 m (about 10,000 ft)

Nonoperating Altitude: 12,192 m (40,000 ft)

Random Vibration:

Operating: 0.31 G_{RMS}, 5 – 500 Hz, 10 minutes per axis, 3 axes (30 minutes total)

Non-operating: 2.46 G_{RMS}, 5 – 500 Hz, 10 minutes per axis, 3 axes (30 minutes total)

Pollution Degree: 2, Indoor use only

Acquisition System: 1 M Ω

The maximum input voltage at the BNC, between center conductor and shield is 400 V_{peak} (DF \leq 39.2%), 250 V_{RMS} to 130 kHz derated to 2.6 V_{RMS} at 500 MHz.

The maximum transient withstand voltage is \pm 800 V_{peak}.

For steady-state sinusoidal waveforms, derate at 20 dB/decade above 200 kHz to 13 V_{pk} at 3 MHz and above.

Acquisition System: 50 Ω

The maximum input voltage at the BNC, between center conductor and shield is 5 V_{RMS}, with peaks \leq \pm 20 V (DF \leq 6.25%)

External Trigger: 1 M Ω

The maximum input voltage at the BNC, between center conductor and shield is 400 V_{peak} (DF \leq 39.2%), 250 V_{RMS} to 2 MHz derated to 5 V_{RMS} at 500 MHz.

The maximum transient withstand voltage is \pm 800 V_{peak}.

For steady-state sinusoidal waveforms, derate at 20 dB/decade above 200 kHz to 13 V_{peak} at 3 MHz and above.

P6139A Passive Probe

Input Voltage:

400 V_{RMS} or 400 V DC; CAT I (2,500 V_{peak} transient)

300 V_{RMS} or 300 V DC; CAT II (2,500 V_{peak} transient)

150 V_{RMS} or 150 V DC; CAT III (2,500 V_{peak} transient)

For steady-state, sinusoidal waveforms, derate at 20 dB/decade above 2.5 MHz to 50 V_{RMS} at 20 MHz and above.

Output Voltage (terminated into 1 M Ω):

40 V_{RMS} or 40 V DC; CAT I (2,500 V_{peak} impulse)

30 V_{RMS} or 30 V DC; CAT I (250 V_{peak} impulse)

15 V_{RMS} or 15 V DC; CAT I (250 V_{peak} impulse)

Temperature:

Operating: -15 °C to +65 °C (+5 °F to +149 °F)

Nonoperating: -62 °C to +85 °C (-80 °F to +185 °F)

Altitude: \leq 2,000 meters

Pollution Degree: 2, Indoor use only

Humidity:

Operating: High: 40 °C to 50 °C, 10% to 60% RH

Operating: Low: 0 °C to 40 °C, 10 to 90% RH



CAUTION. To ensure proper cooling, keep the sides and rear of the instrument clear of obstructions.

Cleaning

Inspect the oscilloscope and probes as often as operating conditions require. To clean the exterior surface, perform the following steps:

1. Remove loose dust on the outside of the oscilloscope and probes with a lint-free cloth. Use care to avoid scratching the clear glass display filter.
2. Use a soft cloth dampened with water to clean the oscilloscope. Use an aqueous solution of 75% isopropyl alcohol for more efficient cleaning.



CAUTION. To avoid damage to the surface of the oscilloscope or probes, do not use any abrasive or chemical cleaning agents.

Connecting Probes

The DPO4000 oscilloscope supports probes with the following:

1. Tektronix Versatile Probe Interface (TekVPI)

These probes support two-way communication with the oscilloscope through on-screen menus and remotely through programmable support. The remote control is useful in applications like ATE where you want the system to preset probe parameters.

2. TPA-BNC Adapter

The TPA-BNC Adapter allows you to use TekProbe Level II probe capabilities, such as providing probe power and passing information to the oscilloscope on scaling and whether the units are volts or amperes.

3. Plain BNC interfaces

These probes only pass the waveform signal to the oscilloscope. There is no other communication.

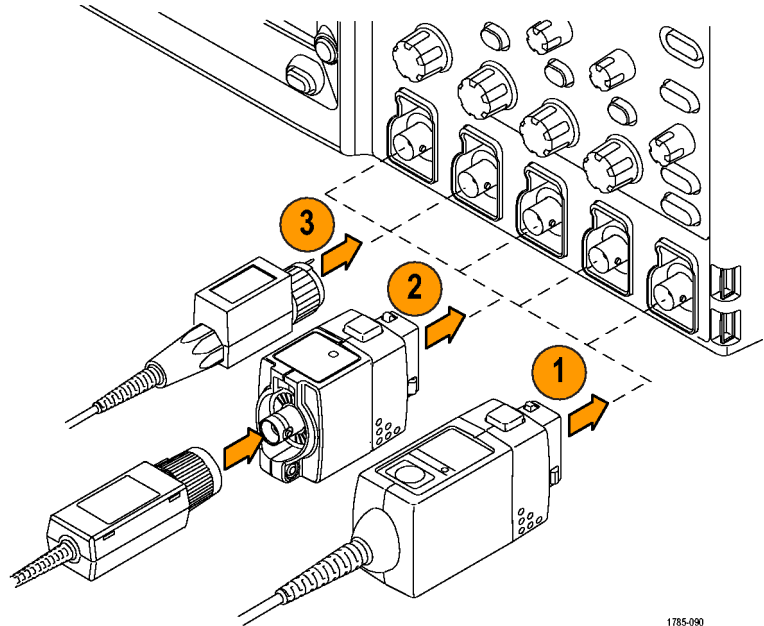

For more information on the many probes available for use with DPO4000 oscilloscopes, refer to www.tektronix.com.

Powering On the Oscilloscope

Ground the Oscilloscope and Yourself

Before pushing the power switch, connect the oscilloscope to an electrically neutral reference point, such as earth ground. Do this by plugging the three-pronged power cord into an outlet grounded to earth ground.

Grounding the oscilloscope is necessary for safety and to take accurate measurements. The oscilloscope needs to share the same ground as any circuits that you are testing.

If you are working with static sensitive components, ground yourself. Static electricity that builds up on your body can damage static-sensitive components. Wearing a grounding strap safely sends static charges on your body to earth ground.

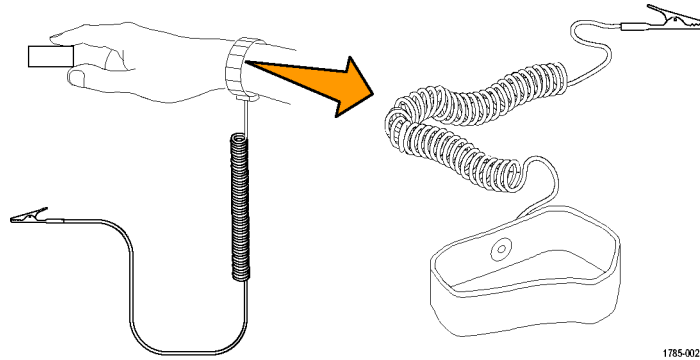

1785-002

To connect the power cord and power on the oscilloscope:

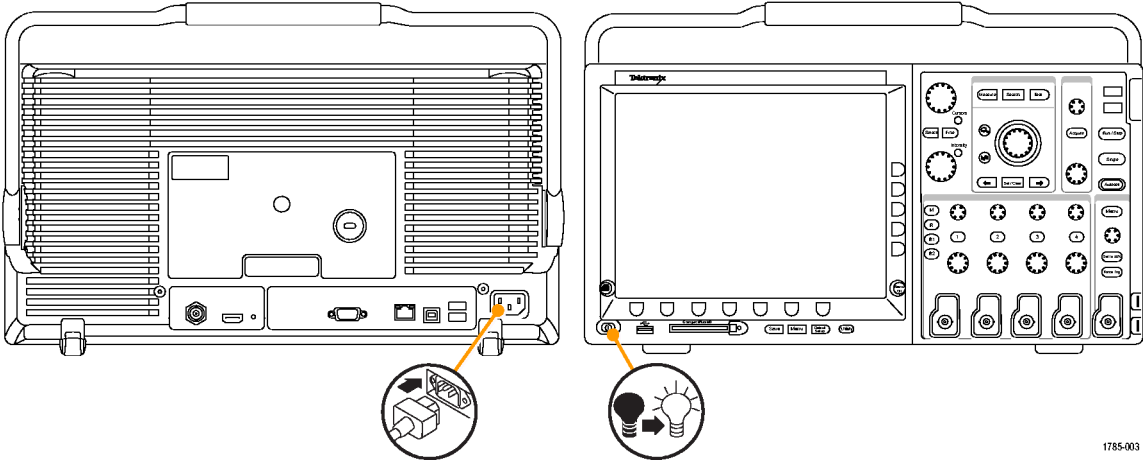

1785-003

Powering Off the Oscilloscope

To power off the oscilloscope and remove the power cord:

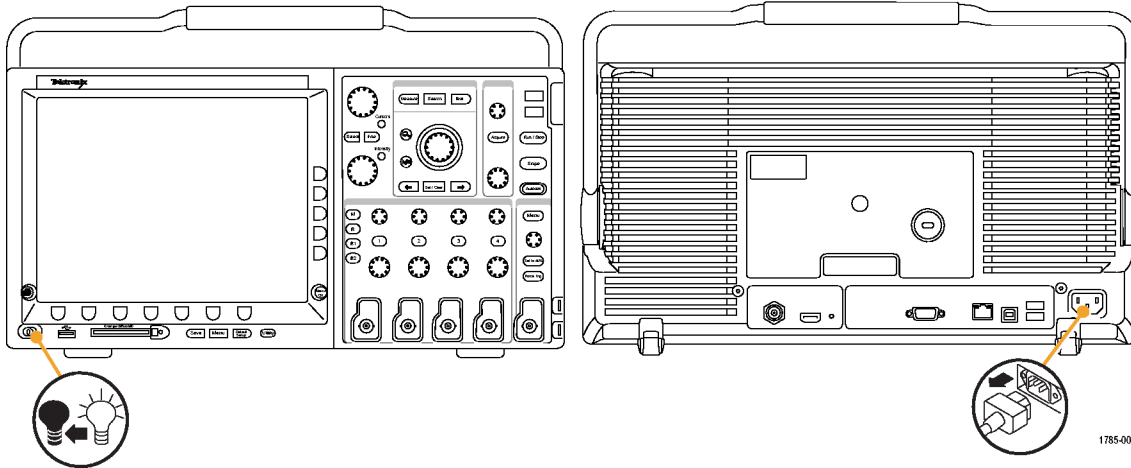

1785-004

Functional Check

Perform this quick functional check to verify that your oscilloscope is operating correctly.

1. Connect the oscilloscope power cable as described above.
2. Power on the oscilloscope.

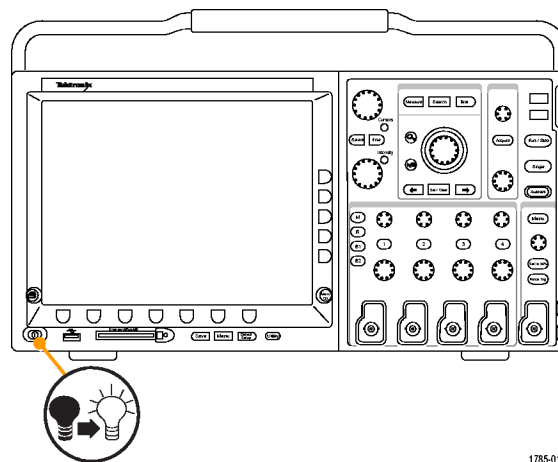

1785-012

3. Connect the oscilloscope P6139A probe tip and reference lead to the **PROBE COMP** connectors.

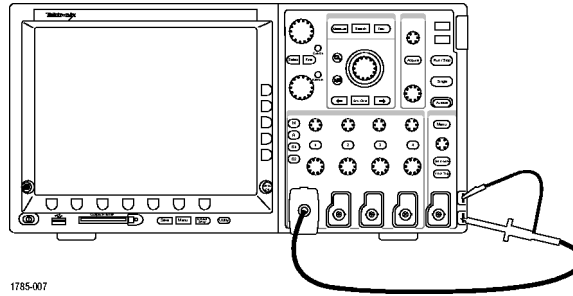

1785-007

4. Press **Default Setup**.

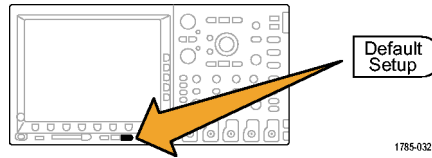

1785-032

5. Push the **Autoset** button. The screen should now display a square wave, approximately 2.5 V at 1 kHz.

If the signal appears but is misshapen, perform the procedures for compensating the probe. (See page 17, *Compensating the Probe*.)

If no signal appears, rerun the procedure. If it no signal still appears, have the instrument serviced by qualified service personnel.

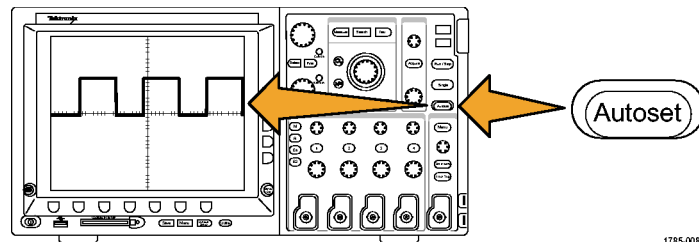

1785-008

Compensating the Probe

Whenever you attach a passive voltage probe for the first time to any input channel, compensate the probe to match it to the corresponding oscilloscope input channel.

To properly compensate your passive probe:

1. Follow the steps for the functional check. (See page 15, *Functional Check*.)

2. Check the shape of the displayed waveform to determine if your probe is properly compensated.
3. If necessary, adjust your probe. Repeat as needed.



Properly compensated



Under compensated



Over compensated

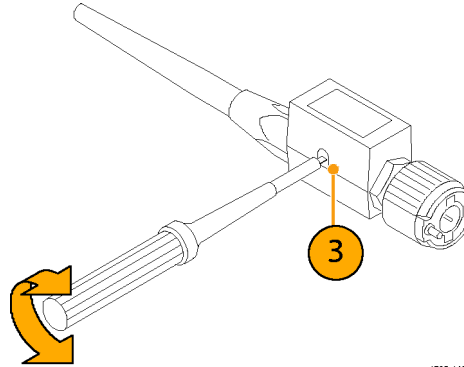

1785-140

Quick Tips

Use the shortest possible ground lead and signal path to minimize probe-induced ringing and distortion on the measured signal.

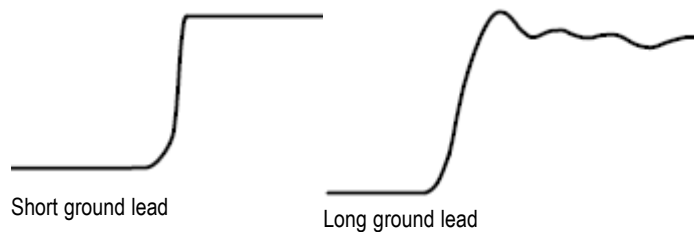

Installing an Application Module



CAUTION. To avoid damage to the oscilloscope or application module, observe ESD precautions. (See page 11, *Powering On the Oscilloscope.*)

Turn off the oscilloscope power while removing or adding an application module.

*(See page 14, *Powering Off the Oscilloscope.*)*

Optional application module packages extend the capability of your oscilloscope. Install up to four application modules at one time into the two slots with windows in the upper right corner of the front panel and the two additional slots hidden behind the two you can see.

Refer to the *DPO4000 Series Application Module Installation Instructions* that came with your application module for instructions on installing and testing an application module.

NOTE. *If you remove an application module, the features provided by the application module become unavailable. To restore the features, turn off the oscilloscope power, reinstall the module and turn on the oscilloscope power.*

Changing the User Interface Language

To change the language of the oscilloscope user interface and the front-panel button labels:

1. Push **Utility**.

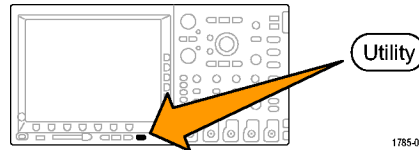

2. Push **System** repeatedly until you select **Config** from the pop-up menu.

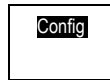

3. Push **Language** from the resulting lower-bezel menu.

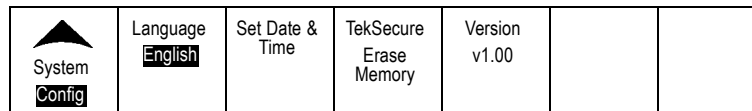

4. Push the side-bezel button corresponding to the desired language. Choose among: English, French, Italian, German, Spanish, Japanese, Brazilian Portuguese, Simplified Chinese, Traditional Chinese, Korean, and Russian.

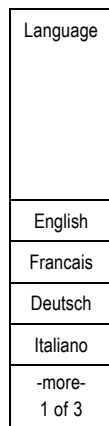

5. If you choose to use English, be sure that the plastic front-panel overlay is removed.
If you choose a language other than English, place the plastic overlay for the language that you desire over the front panel to display labels in that language.

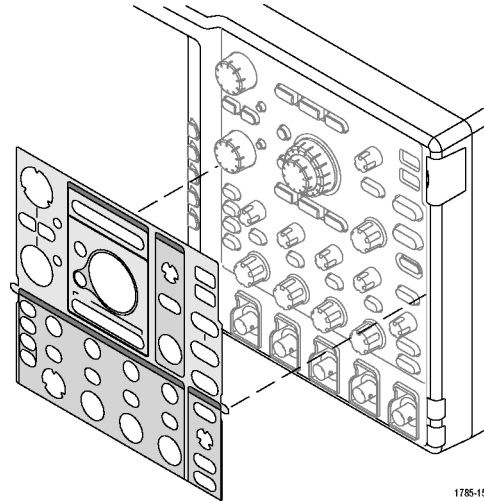

1785-156

Changing the Date and Time

To set the internal clock with the current date and time:

- 1. Push **Utility**.

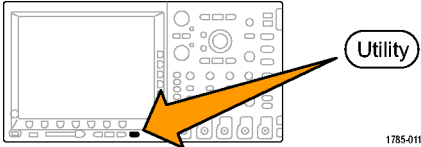

- 2. Push **System** repeatedly until you select **Config** from the pop-up menu.

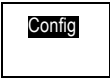

- 3. Push **Set Date & Time**.

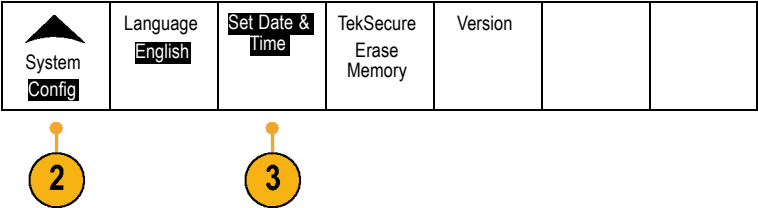

4. Push the side-panel buttons and rotate both multipurpose knobs (**a** and **b**) to set the time and date values.

Date Time Set
Display Date/Time ON OFF
Hour: 4 Min: 1
Month: July Day: 19
Year: 2005
OK Enter Date & Time

5. Push **OK Enter Date & Time**.



Signal Path Compensation

Signal Path Compensation (SPC) corrects for DC inaccuracies caused by temperature variations and/or long-term drift. Run the compensation whenever the ambient temperature has changed by more than 10 °C or once a week if you use vertical settings of 5 mV/division or less. Failure to do so may result in the instrument not meeting warranted performance levels at those volts/div settings.

To compensate the signal path:

1. Warm up the oscilloscope for at least 20 minutes. Remove all input signals (probes and cables) from channel inputs. Input signals with AC components adversely affect SPC.

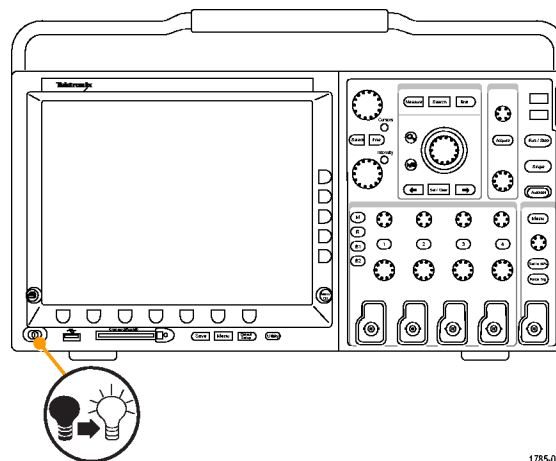

1785-012

2. Push **Utility**.

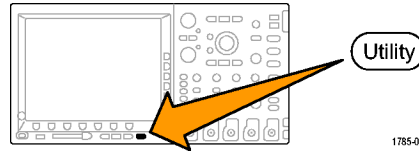

3. Push **System** repeatedly until you select **Calibration** from the resulting pop-up menu.



4. Push **Signal Path** from the lower-bezel menu.

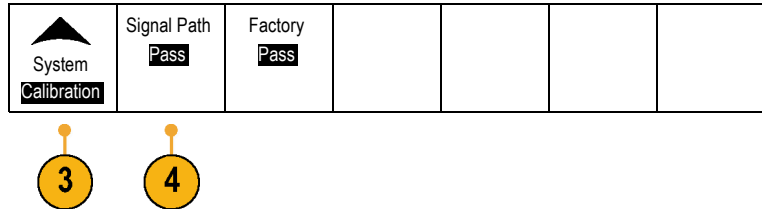

5. Push **OK Compensate Signal path** from the resulting side-bezel menu.



The calibration will take approximately 10 minutes to complete.

6. After calibration, verify that the status indicator on the lower-bezel menu displays **Pass**.

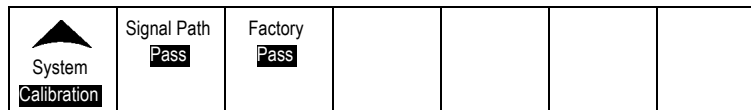

If it does not, then recalibrate the instrument or have the instrument serviced by qualified service personnel.



7. Service personnel use the factory calibration functions to calibrate the internal voltage references of the oscilloscope using external sources. Refer to your Tektronix field office or representative for assistance with factory calibration.

NOTE. *Signal Path Compensation does not include calibration to the probe tip. (See page 17, Compensating the Probe.)*

Upgrading Firmware

To upgrade the firmware of the oscilloscope:

1. Open up a Web browser and go to www.tektronix.com. Proceed to the software finder. Download the latest firmware for your DPO4000 series oscilloscope onto a USB storage device.

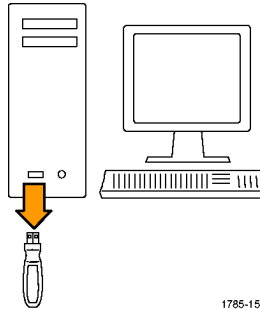

1785-157

2. Power off your DPO4000.

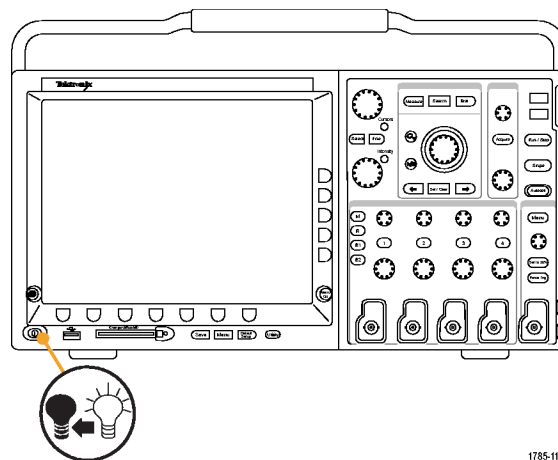

1785-111

3. Insert the USB storage device into the front-panel USB port on your DPO4000.

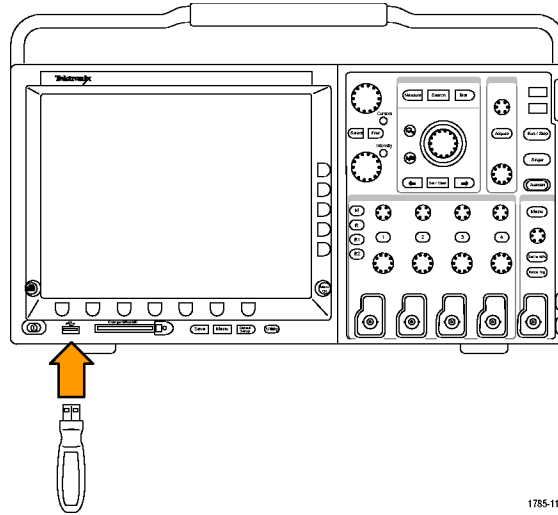

1785-113

4. Power on the DPO4000. The instrument automatically recognizes the replacement firmware and installs it.

If the instrument does not install the firmware, rerun the procedure. If the problem continues, contact qualified service personnel.



CAUTION. Do not power off the oscilloscope or remove the USB storage device until the oscilloscope finishes installing the firmware.

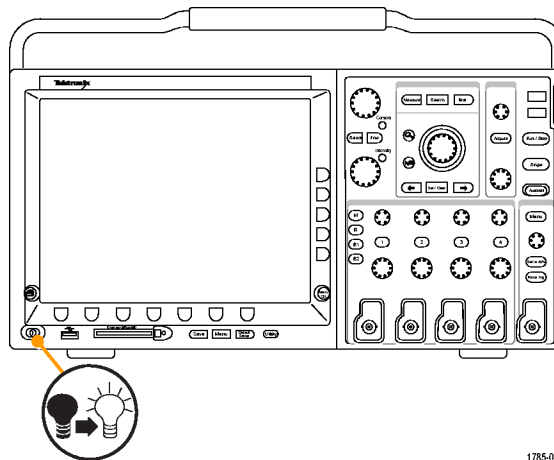

1785-012

5. Power off the DPO4000 and remove the USB storage device.

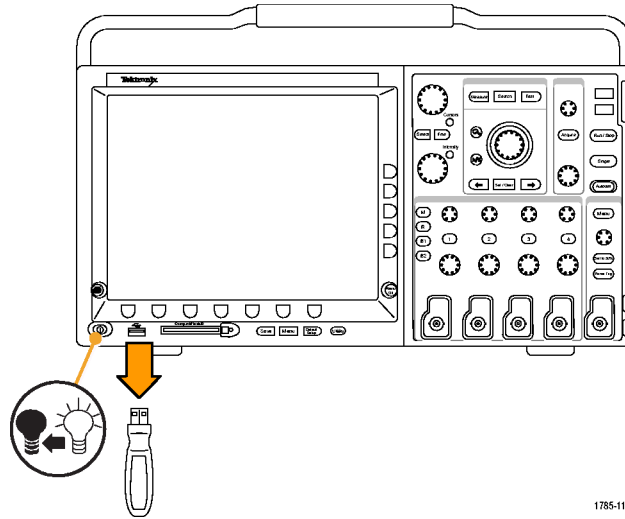

1785-114

6. Power on the DPO4000.

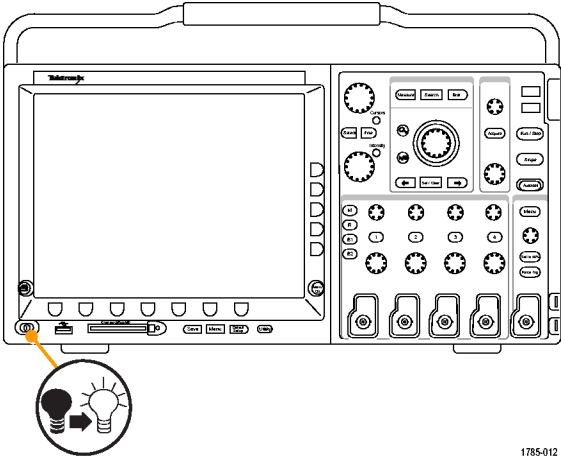

1785-012

7. Push **Utility**.

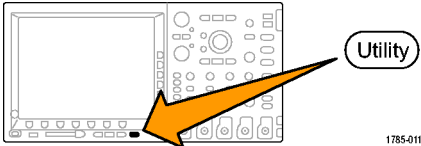

1785-011

8. Push **Version**. The oscilloscope displays the firmware version number.

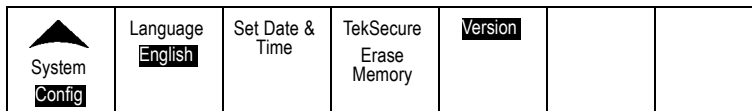

9. Confirm that the version number matches that of the new firmware.



Connecting Your Oscilloscope to a Computer

You may want to document your work for future reference. Instead of saving screen images and waveform data to a CompactFlash or USB storage device, and then generating a report later, you may want to send it directly to a remote PC for analysis. You may also want to control an oscilloscope at a remote location from your computer.

Two ways to connect your oscilloscope to a computer are the TekVISA-based OpenChoice and the e*Scope Web-enabled tool. Use OpenChoice to communicate with your oscilloscope from your computer through a software application. Use e*Scope to communicate with your oscilloscope through a Web browser.

Using OpenChoice

OpenChoice lets you use your MS-Windows computer to acquire data from your oscilloscope for use in an analysis package that runs on your PC, such as Microsoft Excel, National Instruments LabVIEW, or a program of your own creation. You can use a common communications protocol, such as USB, Ethernet, or GPIB to connect the computer to the oscilloscope.

To set up OpenChoice communications between your oscilloscope and a computer:

1. Load the TekVISA drivers on your computer.

Find these on the *OpenChoice Desktop CD* or at the Tektronix software finder Web page (www.tektronix.com). When done, the TekVISA icon appears in the Windows System Tray. Typically, this is the bottom right of the Windows desktop on your MS-Windows computer.

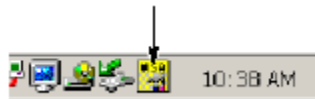

2. Connect the DPO4000 to your computer with the appropriate USB or Ethernet cable.

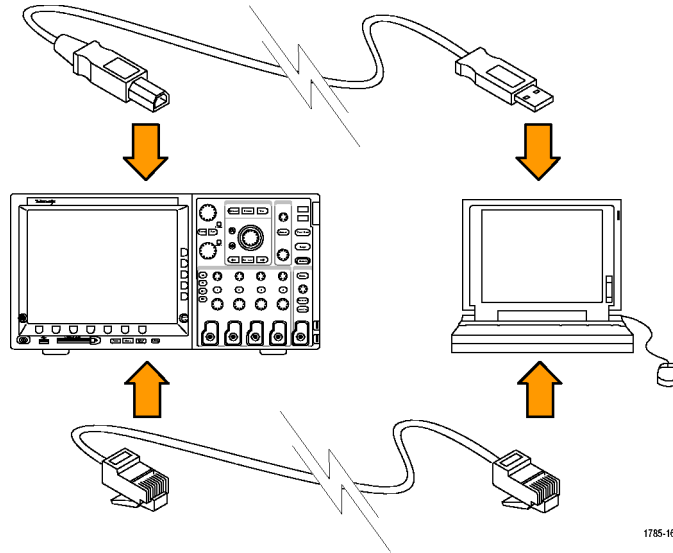

1785-167

To communicate between the DPO4000 and a GPIB system, connect the oscilloscope to the TEK-USB-488 GPIB-to-USB Adapter with a USB cable. Then connect the adapter to your GPIB system with a GPIB cable.

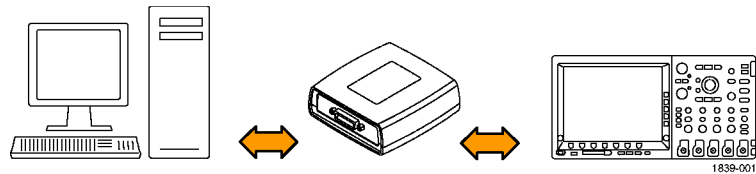

1839-001

3. Push **Utility**.

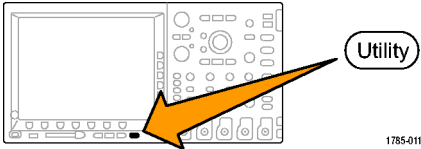

4. Push **System** repeatedly to select **I/O**.

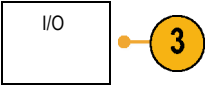

5. To use Ethernet, push **Ethernet Network Settings**.

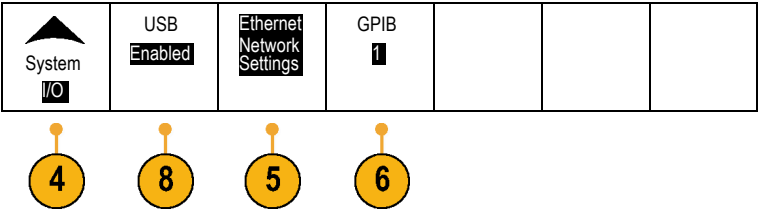

On the side-bezel menu, if you are on a DHCP Ethernet network and using a through cable, set DHCP to **On**. If you are using a cross-over cable, set it to **Off** and set a hard coded TCPIP address.

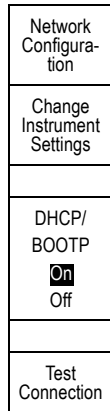

6. If you are using GPIB, push **GPIB**.
7. Enter the GPIB address on the side-bezel menu, using multipurpose knob **a**.

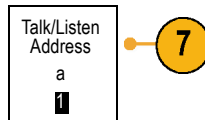

This will set the GPIB address on an attached TEK-USB-488 Adapter.

8. If you are using USB, the system sets itself up automatically for you, if USB is enabled.

Check **USB** on the bottom-bezel menu to be sure that USB is enabled. If it is not enabled, push **USB**. Then push **Enabled** on the side-bezel menu.

9. Run your application software on your computer.



10. In case of problems getting oscilloscope-to-PC communications to work, refer to the networking troubleshooter. To bring up the troubleshooter, click the TekVISA icon on the System Tray of your MS-Windows computer. Then go to the online help.



Quick Tips

- The DPO4000 comes with a variety of Windows-based software tools designed to ensure efficient connectivity between your oscilloscope and your computer. There are tool bars that speed connectivity with Microsoft Excel and Word. There is also a standalone acquisition program called the OpenChoice Desktop.
- The rear-panel USB 2.0 device port is the correct USB port for computer connectivity. Use the rear- and front-panel USB 2.0 host ports to connect your oscilloscope to storage devices and printers.

Using e*Scope

e*Scope lets you access any Internet-connected DPO4000 Series Oscilloscope from a browser on your workstation, PC, or laptop computer. No matter where you are, your DPO4000 is as close as the nearest browser.

To set up e*Scope communications between your oscilloscope and a Web browser running on a remote computer:

1. Connect the DPO4000 to your computer network with the appropriate Ethernet cable.

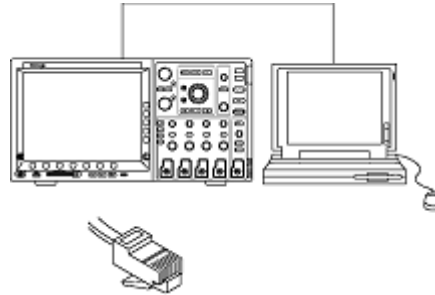

2. Push **Utility**.

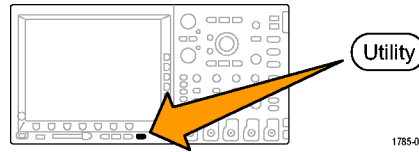

1785-011

3. Push **System** repeatedly to select **I/O**.

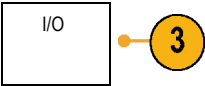

4. Push **Ethernet Network Settings**.

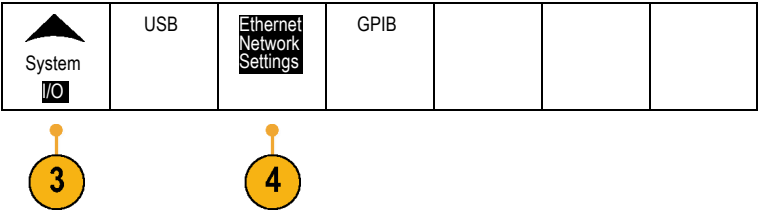

5. Push **Change Instrument Settings** to determine the Ethernet address and instrument name.

On the side-bezel menu, if you are on a DHCP Ethernet network and using dynamic addressing, set DHCP to **On**. If you are using static addressing, set it to **Off**.

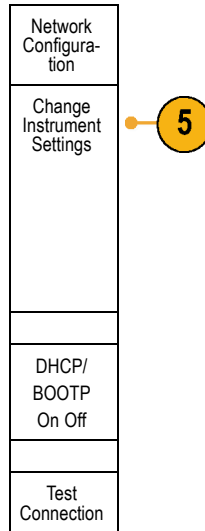

6. Start your browser on your remote computer. In the browser address line, enter the IP address or, if DHCP is set to **On** in the oscilloscope, simply enter the instrument name.

7. You should now see the e*Scope screen, with a copy of the oscilloscope display, on your Web browser.

If e*Scope does not work, rerun the procedure. If it still does not work, contact qualified service personnel.

Get Acquainted with the Instrument

Front-Panel Menus and Controls

The front panel has buttons and controls for the functions that you use most often. Use the menu buttons to access more specialized functions.

Using the Menu System

To use the menu system:

1. Push a front-panel menu button to display the menu that you want to use.

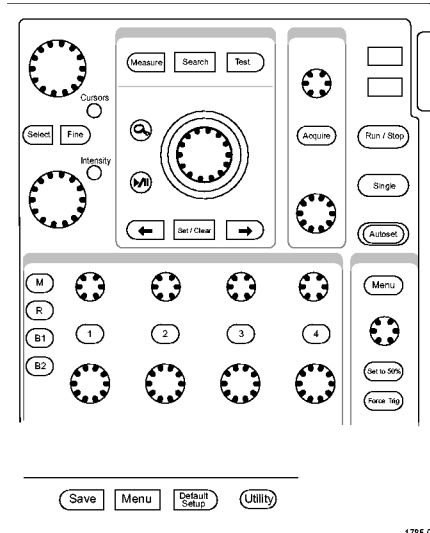

2. Push a lower-bezel button to select a menu item. If a pop-up menu appears, push the lower-bezel button repeatedly to select the desired choice.

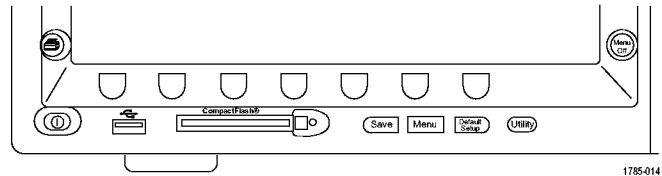

3. Push a side-bezel button to choose a side-bezel menu item.
If the menu item contains more than one choice, push the side-bezel button repeatedly to cycle through the choices.

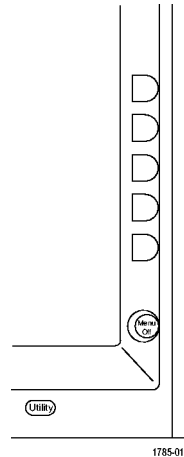

4. To remove a side-bezel menu, push the lower-bezel button again or push **Menu Off**.

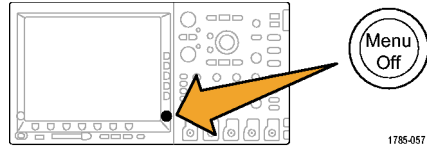

5. Certain menu choices require you to set a numerical value to complete the setup. Use the upper and lower multipurpose knobs **a** and **b** to adjust values.
6. Push **Fine** to turn off or on the ability to make smaller adjustments.

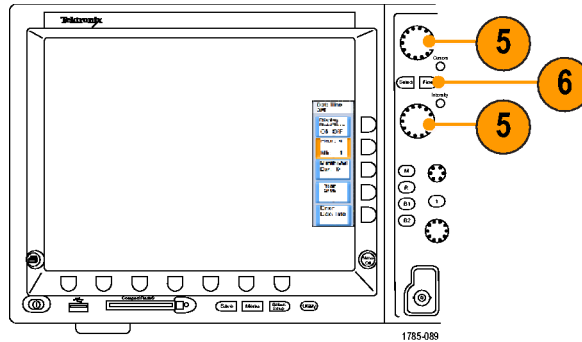

Using the Menu Buttons

Use the menu buttons to perform many functions in the oscilloscope.

1. **Measure.** Push to perform automated measurements on waveforms or to configure cursors.
2. **Search.** Push to search through an acquisition for user-defined events/criteria.
3. **Test.** Push to activate advanced or application-specific testing features.
4. **Acquire.** Push to set the acquisition mode and adjust the record length.
5. **Autoset.** Push to perform an automatic setup of oscilloscope settings.
6. **Trigger Menu.** Push to specify trigger settings.

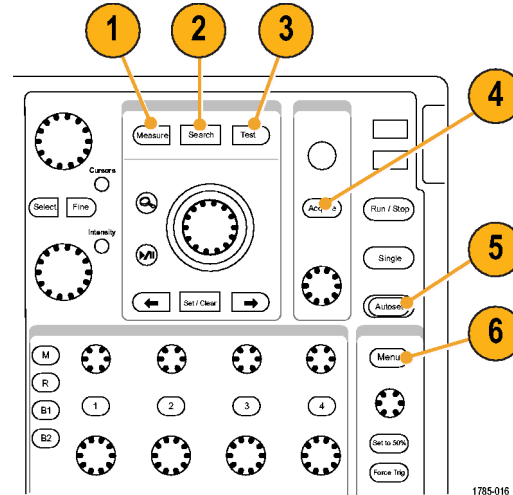

- 7. Utility.** Push to activate the system utility functions, such as selecting a language or setting the date/time.
- 8. Default Setup.** Push to restore the oscilloscope to the default settings.
- 9. Save / Recall Menu.** Push to save and recall setups, waveforms, and screen images to internal memory, a CompactFlash card, or a USB storage device.
- 10. Channel 1,2,3, or 4.** Push to set vertical parameters for input waveforms and to display or remove the corresponding waveform from the display.

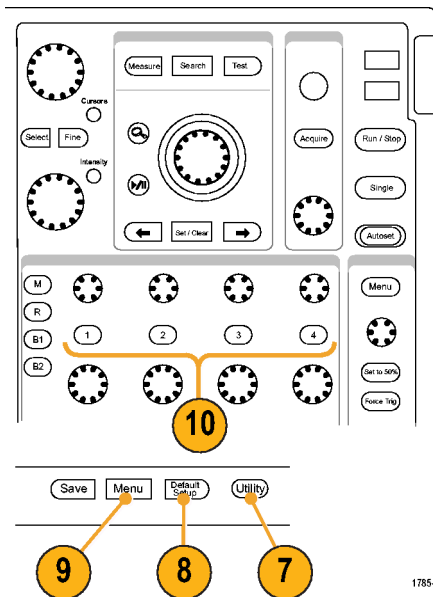

11. **B1** or **B2**. Push to define and display a bus, if you have the appropriate module application keys. The DPO4AUTO module supports CAN. The DPO4EMBD module supports I²C and SPI.

Also, push the **B1** or **B2** button to display or remove the corresponding bus from the display.

12. **R**. Push to manage reference waveforms, including the display or removal of each reference waveform from the display.

13. **M**. Push to manage the math waveform, including the display or removal of the math waveform from the display.

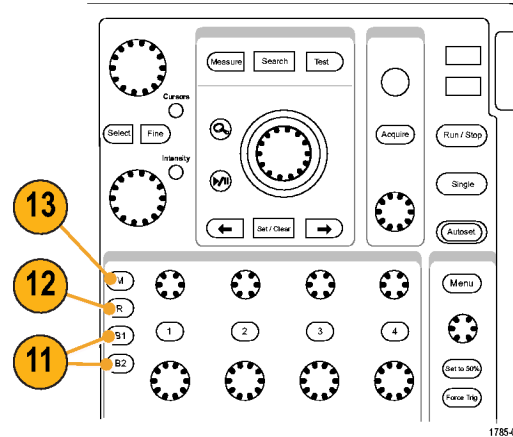

1785-018

Using Other Controls

These buttons and knobs control waveforms, cursors and other data input.

1. Turn the upper multipurpose knob **a**, when activated, to move a cursor or set a numerical parameter value for a menu item. Push the nearby **Fine** button to toggle between coarse and fine adjustment.

Screen icons tell you when **a** or **b** are active.

2. **Cursors**. Push once to activate the two vertical cursors. Push again to turn on the two vertical and two horizontal cursors. Push again to turn off all cursors.

When the cursors are on, you can turn the multipurpose knobs to control their position.

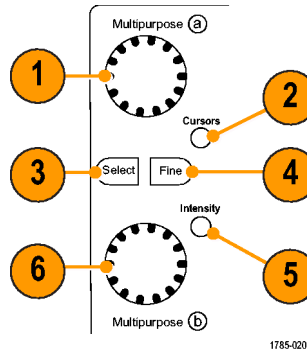

- 3. Select.** Push to activate special functions.
For example, when using the two vertical cursors (and no horizontal ones are visible), you can push this button to link or unlink the cursors. When the two vertical and two horizontal cursors are both visible, you can push this button to make either the vertical cursors or the horizontal ones active.
- 4. Fine.** Push to toggle between making coarse and fine adjustments with the vertical and horizontal position knobs, the trigger level knob, and many operations of multipurpose knobs **a** and **b**.
- 5. Waveform Intensity.** Push to enable multipurpose knob **a** to control waveform display intensity and knob **b** to control graticule intensity.

6. Turn the lower multipurpose knob **b**, when activated, to move a cursor or set a numerical parameter value for a menu item. Push **Fine** to make adjustments more slowly.
7. Zoom button. Push to activate zoom mode.
8. Pan (outer knob). Turn to scroll the zoom window through the acquired waveform.
9. Zoom (inner knob). Turn to control the zoom factor. Turning it clockwise zooms in further. Turning it counterclockwise zooms out.
10. Play-pause button. Push to start or stop the automatic panning of a waveform. Control the speed and direction with the pan knob.
11. ← **Prev**. Push to jump to the previous waveform mark.

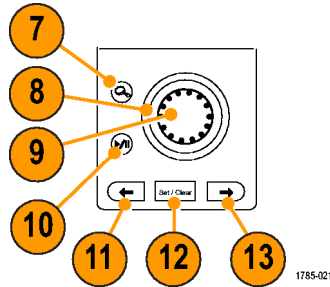

12. **Set/Clear Mark.** Push to establish or delete a waveform mark.
13. → **Next.** Push to jump to the next waveform mark.
14. **Horizontal Position.** Turn to adjust the trigger point location relative to the acquired waveforms. Push **Fine** to make smaller adjustments.
15. **Horizontal Scale.** Turn to adjust the horizontal scale (time/division).

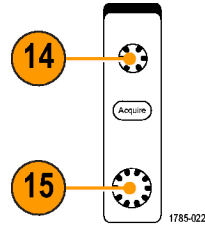

- 16. **Run/Stop.** Push to start or stop acquisitions.
- 17. **Single.** Push to make a single acquisition.
- 18. **Autoset.** Push to automatically set the vertical, horizontal, and trigger controls for a usable, stable display.
- 19. **Trigger Level.** Turn to adjust the trigger level.
- 20. **Set to 50%.** Push to set the trigger level to the midpoint of the waveform.
- 21. **Force Trig.** Push to force an immediate trigger event.

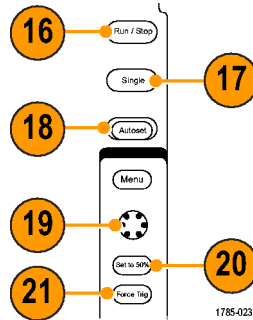

22. Vertical Position. Turn to adjust the vertical position of the corresponding waveform. Push **Fine** to make smaller adjustments.

23. 1, 2, 3, 4. Push to display or remove the corresponding waveform from the display and access the vertical menu.

24. Vertical Scale. Turn to adjust the vertical scale factor of the corresponding waveform (volts/division).

25. Print. Push to initiate a hard copy using the printer selected in the Utility menu.

26. Power switch. Push to power on or off the instrument.

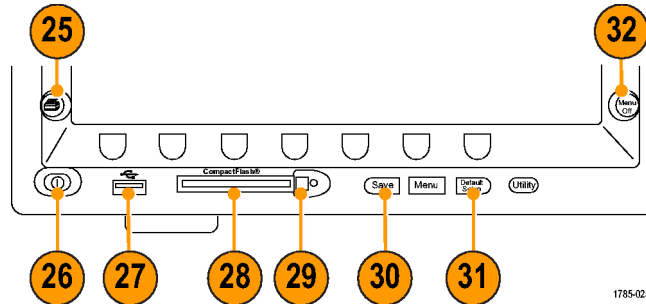
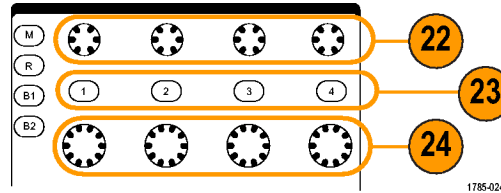

27. USB 2.0 host port. Insert a USB cable here to connect peripherals, such as printers and storage devices, to the oscilloscope. There are also two more USB 2.0 host ports on the rear panel.
28. CompactFlash Drive. Insert a CompactFlash card here.
29. CompactFlash Eject. Pops the CompactFlash card out of the CompactFlash drive.
30. **Save**. Push to perform an immediate save operation. The save operation uses the current save parameters, as defined in the Save / Recall menu.
31. **Default Setup**. Push to perform an immediate restore of the oscilloscope to the default settings.
32. **Menu Off**. Push to clear a displayed menu from the screen.

Identifying Items in the Display

The items shown to the right may appear in the display. Not all of these items are visible at any given time. Some readouts move outside the graticule area when menus are turned off.

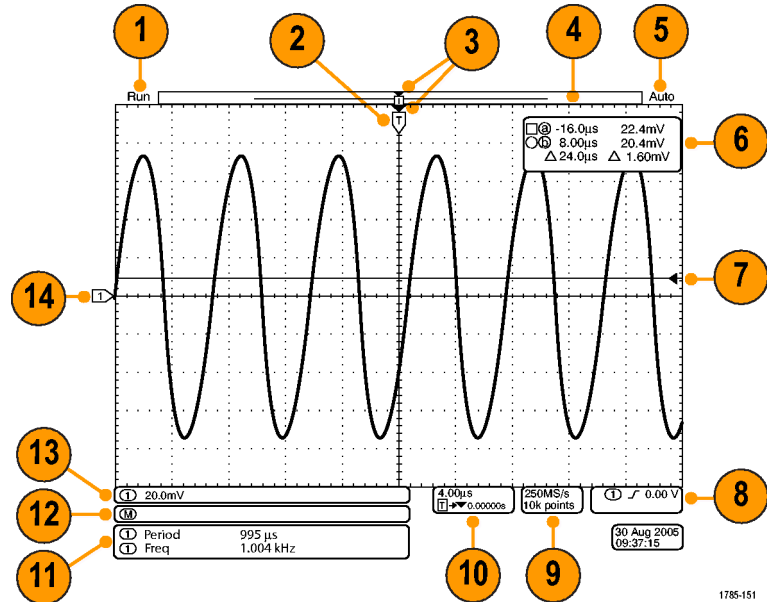

1785-151

1. The acquisition readout shows when an acquisition is running, stopped, or when acquisition preview is in effect. Icons are:

- Run: Acquisitions enabled
- Stop: Acquisitions not enabled
- Roll: In roll mode (40 ms/div or slower)
- PreVu: In this state, the oscilloscope is stopped or between triggers. You can change the horizontal or vertical position or scale to see approximately what the next acquisition will look like.

RUN

- The trigger position icon shows the trigger position in the acquisition.

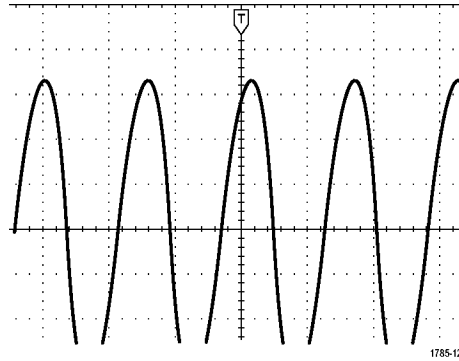

- The expansion point icon (an orange triangle) shows the point that the horizontal scale expands and compresses around.

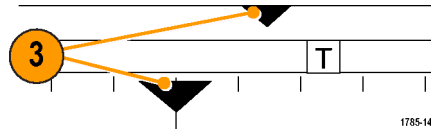

- The waveform record view shows the trigger location relative to the waveform record. The line color corresponds to the selected waveform color.



5. The trigger status readout shows trigger status. Status conditions are:

- Trig'd: Triggered
- Auto: Acquiring untriggered signal
- PrTrig: Acquiring pretrigger data
- Trig?: Waiting for trigger

Trig'd

6. The cursor readout shows time, amplitude, and delta (Δ) values for each cursor.

For FFT measurements, it shows frequency and magnitude.

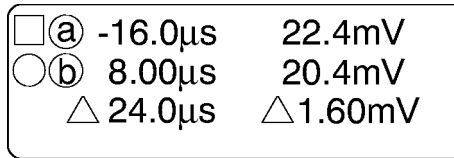

1785-134

7. The trigger level icon shows the trigger level on the waveform. The icon color corresponds to the trigger source channel color.

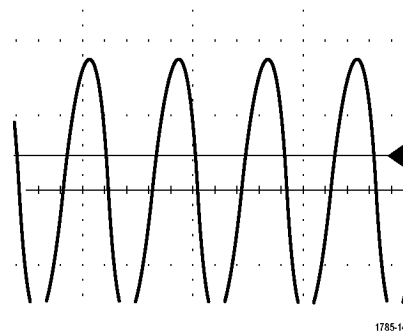

8. The edge trigger readout shows the trigger source, slope, and level. The trigger readouts for other trigger types show other parameters.

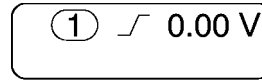

9. The top line of the record length/sampling rate readout shows the sampling rate (adjust with the **Horizontal Scale** knob). The bottom line shows the record length (adjust with the **Acquire** menu).

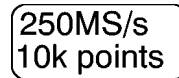

10. The horizontal position/scale readout shows on the top line the horizontal scale (adjust with the **Horizontal Scale** knob) and on the bottom line the time from the T symbol to the expansion point icon (adjust with the **Horizontal Position** knob).

Use horizontal position to insert added delay between when the trigger occurs and when you actually capture the data. Insert a negative time to capture more pretrigger information.

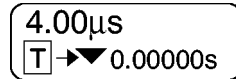

1785-136

11. The auxiliary waveform readouts show the vertical and horizontal scale factors of the math or reference waveforms.



1785-138

12. The channel readout shows the channel scale factor (per division), coupling, and invert status. Adjust with the **Vertical Scale** knob and the channel **1**, **2**, **3**, or **4** menus.

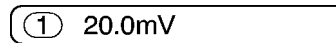

1785-139

13. Measurement readouts show the selected measurements. You can select up to four measurements to display at one time.

A  symbol appears instead of the expected numerical measurement if a vertical clipping condition exists. Part of the waveform is above or below the display. To obtain a proper numerical measurement, turn the vertical scale and position knobs to make all of the waveform appear in the display.

14. The waveform baseline indicator shows the zero-volt level of a waveform (ignoring the effect of offset). The icon colors correspond to the waveform colors.

①	Period	995 μ s
①	Freq	1.004 kHz

1785-144

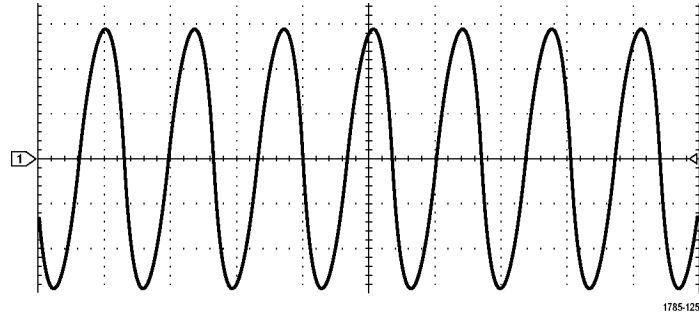

Front-Panel Connectors

1. Channel 1, 2, (3, 4). Channel inputs with TekVPI Versatile Probe Interface.
2. **Aux In.** Trigger level range is adjustable from +8 V to -8 V. The maximum input voltage is 400V peak, 250V RMS. Input resistance is $1\text{ M}\Omega \pm 1\%$ in parallel with $13\text{ pF} \pm 2\text{ pF}$.
3. **PROBE COMP.** Square wave signal source to compensate probes. Output voltage: 0 – 2.5V, amplitude $\pm 1\%$ behind $1\text{ k}\Omega \pm 2\%$. Frequency: 1 kHz.
4. Ground.
5. Application Module Slots.

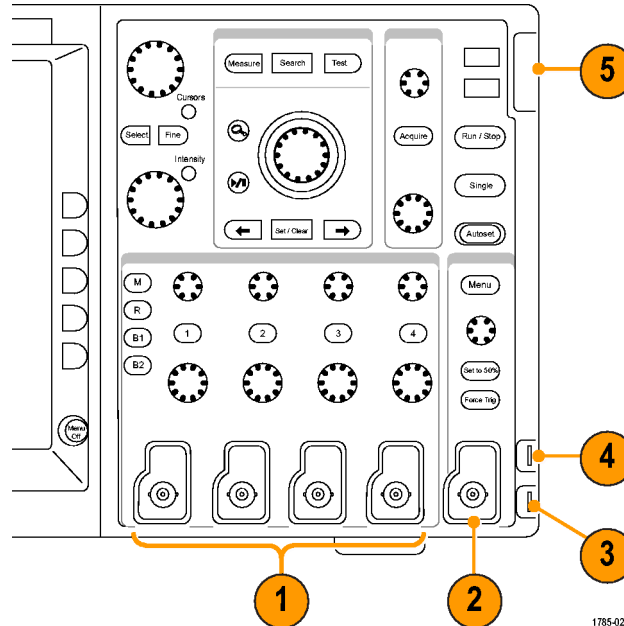

1785-026

Side-Panel Connector

1. Ground strap connector. This is a receptacle for a grounding strap.

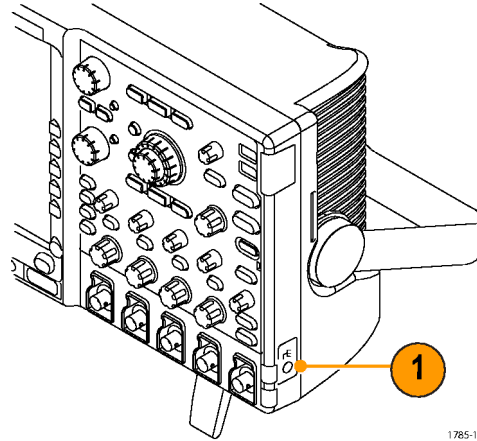

1785-158

Rear-Panel Connectors

- 1. Trigger Out.** Use the trigger signal output to synchronize other test equipment with your oscilloscope. A LOW to HIGH transition indicates the trigger occurred. The logic level for Vout (HI) is $\geq 2.5\text{V}$ open circuit; $\geq 1.0\text{ V}$ into a 50Ω load to ground. The logic level for Vout (LO) is $\leq 0.7\text{ V}$ into a load of $\leq 4\text{ mA}$; $\leq 0.25\text{ V}$ into a 50Ω load to ground.
- 2. XGA Out.** Use the XGA Video port (DB-15 female connector) to show the oscilloscope display on an external monitor or projector.
- 3. LAN.** Use the LAN (Ethernet) port (RJ-45 connector) to connect the oscilloscope to a 10/100 Base-T local area network.
- 4. Device.** Use the USB 2.0 High speed device port to control the oscilloscope through USBTMC or GPIB with a TEK-USB-488 Adapter. The USBTMC protocol allows USB devices to communicate using IEEE488 style messages. This lets you run your GPIB software applications on USB hardware.

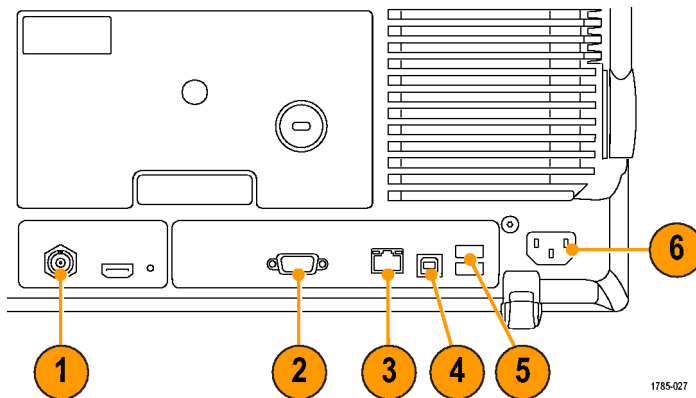

1785-027

5. **Host.** Use the USB 2.0 Full speed host ports (two) to take advantage of USB mass storage devices and printers.

6. **Power input.** Attach to an AC power line with integral safety ground. (See page 6, *Operating Considerations*.)

Acquire the Signal

This section describes concepts of and procedures for setting up the oscilloscope to acquire the signal as you want it to.

Setting Up Signal Input

Use front-panel buttons to set up your instrument to acquire the signal.

1. Connect the P6139A or VPI probe to the input signal source.

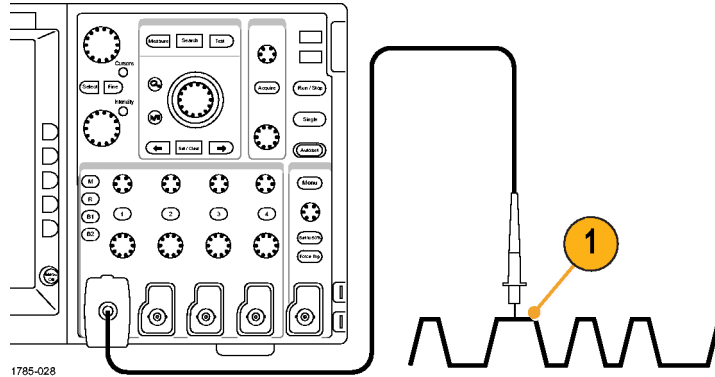

2. Select the input channel by pushing the front-panel buttons.

NOTE. If you are using a probe that does not supply probe encoding (not a P6139A nor a VPI probe), set the attenuation (probe factor) on the oscilloscope side-bezel menu.

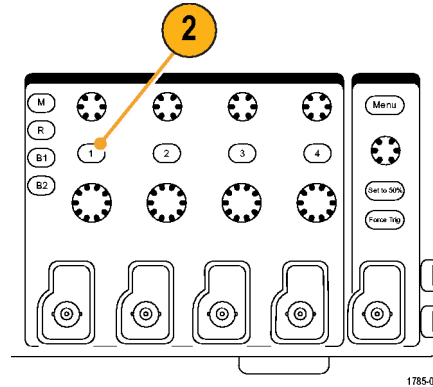

3. Push **Autoset**.

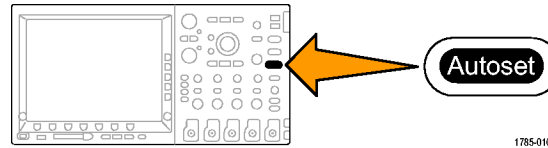

4. Push the desired channel button. Then adjust the vertical position and scale.

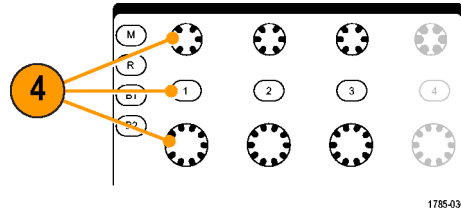

5. Adjust the horizontal position and scale.

The horizontal position determines the number of pretrigger and posttrigger samples.

The horizontal scale determines the size of the acquisition window relative to the waveform. You can scale the window to contain a waveform edge, a cycle, several cycles, or thousands of cycles.

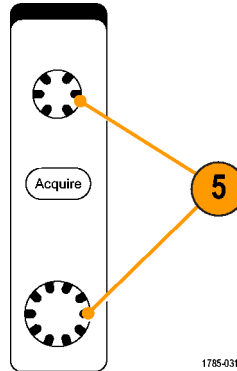

Quick Tip

- Use the zoom feature to see multiple acquisition cycles in the upper part and a single cycle in the lower part of the display. (See page 163, *Managing Long Record Length Waveforms*.)

Using the Default Setup

To return the oscilloscope to its default settings:

1. Push **Default Setup**.

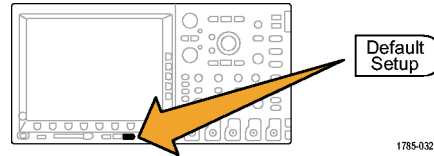

2. If you change your mind, push **Undo Default Setup** to undo the last default setup.



Quick Tip

- The DPO4000 Technical Reference describes the default setup settings in detail. This manual is available on the accompanying CD or at www.tektronix.com.

Using Autose

Autose adjusts the instrument (acquisition, horizontal, trigger, and vertical controls) such that it displays two or three waveform cycles with the trigger near the midlevel.

1. Connect the probe, and then select the input channel. (See page 70, *Setting Up Signal Input*.)

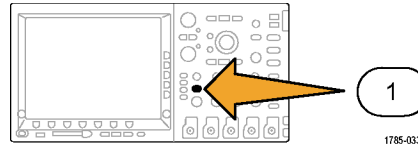

2. Push **Autose** to execute an Autose.

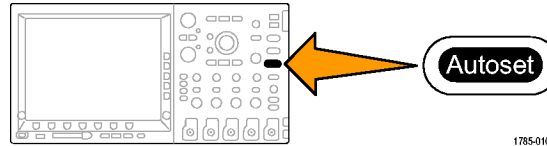

3. If desired, push **Autose Undo** to undo the last Autose.



Quick Tips

- To position the waveform appropriately, Autoset may change the vertical position. Autoset always sets vertical offset to 0 V.
- If you use Autoset when no channels are displayed, the instrument turns on channel one (1) and scales it.

Acquisition Concepts

Before a signal can be displayed, it must pass through the input channel where it is scaled and digitized. Each channel has a dedicated input amplifier and digitizer. Each channel produces a stream of digital data from which the instrument extracts waveform records.

Sampling Process

Acquisition is the process of sampling an analog signal, converting it into digital data, and assembling it into a waveform record, which is then stored in acquisition memory.

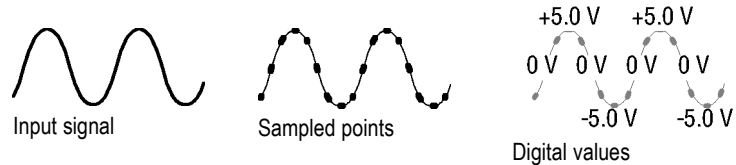

Real-time Sampling

DPO4000 series oscilloscopes use real-time sampling. In real-time sampling, the instrument digitizes all of the points it acquires using a single trigger event.

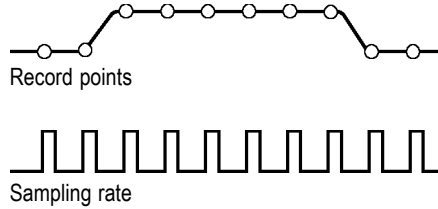

Waveform Record

The instrument builds the waveform record through use of the following parameters:

- **Sample interval:** The time between recorded sample points. Adjust this by turning the **Horizontal Scale** knob.
- **Record length:** The number of samples required to fill a waveform record. Set this by pushing the **Acquire** button and using the resulting lower-bezel menu.
- **Trigger point:** The zero time reference in a waveform record. It is shown on the screen by an orange T.

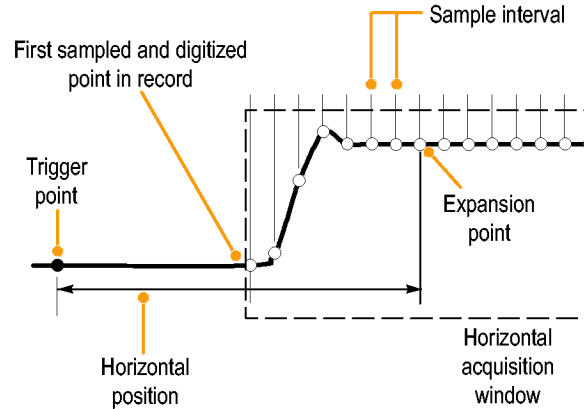

1785-109

- Horizontal position: The time from the trigger point to the expansion point. Adjust this by turning the **Horizontal Position** knob.
Use a positive time to acquire the record after the trigger point. Use a negative time to acquire it before the trigger point.
- Expansion point: The point that the horizontal scale expands and contracts around. It is shown by an orange triangle.

How the Acquisition Modes Work

Sample mode retains the first sampled point from each acquisition interval. Sample is the default mode.

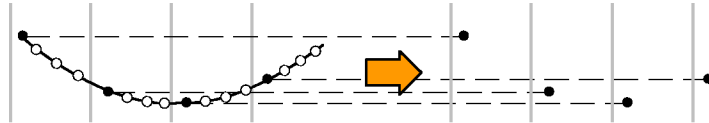

1785-128

Peak Detect mode uses the highest and lowest of all the samples contained in two consecutive acquisition intervals. This mode only works with real-time, noninterpolated sampling and is useful for catching high frequency glitches.

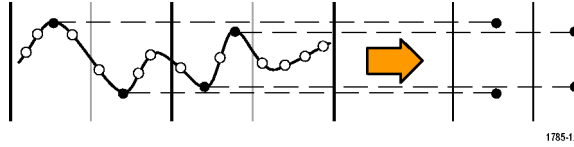

Hi Res mode calculates the average of all the samples for each acquisition interval. This mode also only works with real-time, noninterpolated sampling. Hi-Res provides a higher-resolution, lower-bandwidth waveform.

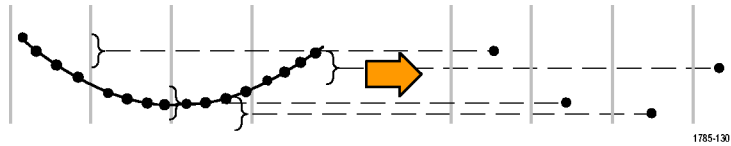

Envelope mode finds the highest and lowest record points over all acquisitions. Envelope uses Peak Detect for each individual acquisition.



Average mode calculates the average value for each record point over a user-specified number of acquisitions. Average uses Sample mode for each individual acquisition. Use average mode to reduce random noise.



Changing the Acquisition Mode and Record Length

Use this procedure to change the acquisition mode.

1. Push **Acquire**.

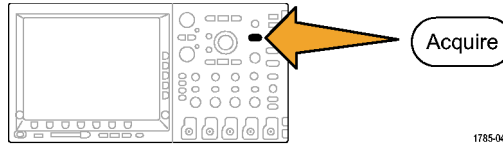

2. Push **Mode**.

Mode Average	Record Length 10k	Reset Horizontal Position	Waveform Display			
-----------------	----------------------	---------------------------	------------------	--	--	--

2 5

3. Then choose the acquisition mode from the side-bezel menu. You can choose from: Sample, Peak Detect, Hi Res, Envelope, or Average.

NOTE. Peak Detect and High Res require more than one sample point per sample interval. If there is only one sample point, these two modes will appear the same as sample mode.

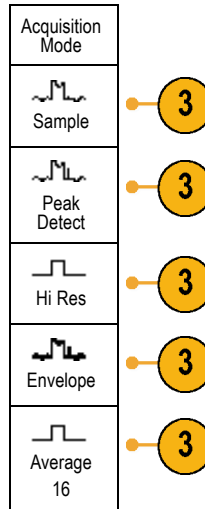

4. If you chose **Average**, turn multipurpose knob **a** to set the number of waveforms to average over.

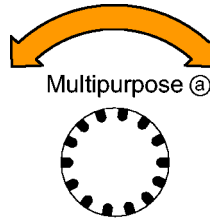

1785-038

5. Push **Record Length**.

6. Push the side-bezel menu, record length button.

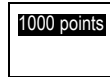

Choose between: 1000, 10 k, 100 k, 1 M, and 10 M points.

Using Roll Mode

Roll mode gives a display similar to a strip chart recorder for low-frequency signals. Roll mode lets you see acquired data points without waiting for the acquisition of a complete waveform record.

Roll mode is enabled when the trigger mode is auto and the horizontal scale is set to 40 ms/div or slower.

Quick Tips

- Switching to Envelope or Average acquisition mode, using math waveforms, or switching to normal trigger will disable Roll mode.
- Roll mode is disabled when you set the horizontal scale to 20 ms per division or faster.
- Push **Run/Stop** to halt Roll mode.

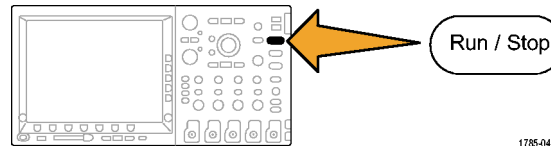

1785-040

Defining a Serial Bus

Your DPO4000 oscilloscope can trigger on I²C and SPI serial buses if the DPO4EMBD application module is installed. It can trigger on CAN serial buses if the DPO4AUTO application module is installed. It can display the physical layer of a bus (as analog waveforms), digital waveforms, and protocol level information (as symbolic waveforms). Plug in the DPO4EMBD application module to use the I²C and SPI features. Plug in the DPO4AUTO application module to use the CAN features.

Using buses in two steps

To quickly use serial bus triggering:

1. Push **B1** or **B2** and enter parameters of the bus to trigger on.

You can separately use **B1** and **B2** to view two different buses.

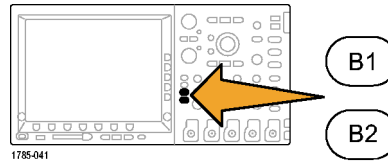

2. Push Trigger **Menu** and enter trigger parameters. (See page 98, *Choosing a Trigger*.)

You can display bus information without triggering on the bus signal.

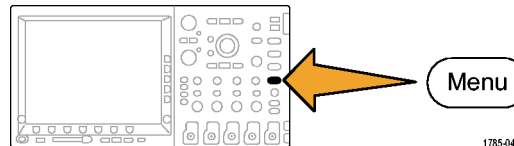

Setting up serial bus parameters

To set up bus parameters:

1. Push **B1** or **B2** to bring up the lower-bezel bus menu.

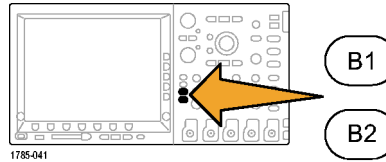

2. Push **Bus** as many times as needed to select the desired bus (I²C, SPI, or CAN) from the pop-up menu.

I ² C
SPI
CAN

3. Push **Define Inputs** and use the side-bezel buttons to assign oscilloscope channels to the serial bus signal(s).

For example, with an I²C bus, you might assign channel 1 to supply the SCLK signal and channel 2 to supply the SDA signal. You can assign any channel to a predefined bus signal.

For all serial bus sources, use channel 1 to channel 4. Do not use the Aux In input.



4. Push **Thresholds**.

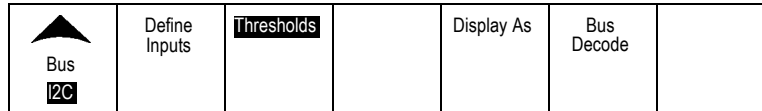

For each signal that makes up the serial bus, push the appropriate side-bezel menu button. Then turn the appropriate multipurpose knob to define the voltage level above which the oscilloscope treats the signal as high and below which as low.

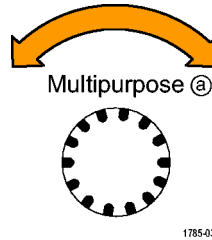

5. If you selected **CAN** above, push **Bit Rate** and the desired side-bezel menu choice.

Bus CAN	Define Inputs	Thresholds	Bit Rate 500 Kbps	Display As Bus	Bus Decode Hex	
-------------------	---------------	------------	-----------------------------	--------------------------	--------------------------	--



6. If you selected **SPI** above, push **Polarity** and the desired side-bezel menu choice.

Bus SPI	Define Inputs	Thresholds	Polarity	Display As Bus	Bus Decode Hex	
-------------------	---------------	------------	-----------------	--------------------------	--------------------------	--



Active High means when a signal is greater than the threshold value, it is considered a logical 1. Active Low means when the signal is lower than the threshold value, it is considered a logical 1.

7. Push **Display As** and use the side-bezel menu to define how to display the serial bus.

- Push **Bus** to display packet level information decoded for easy visual inspection, much like what you would see on a logic analyzer.
- Push **Waveforms** to display the digital (high or low) representations of the waveforms.
- Push **Bus and Waveforms** to display both views of the signal.
- Push **Event Table On** to display a list of packets in the bus.

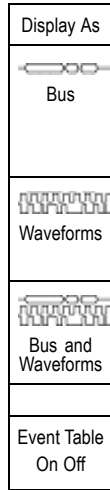

Sample bus information:



You can also trigger on packet level information on your serial bus. (See page 102, *Triggering on Buses*.)

NOTE. *To acquire signals from two buses simultaneously, use this procedure once to define the parameters of the **B1** bus and again to define the **B2** bus.*

Trigger Setup and Run

This section contains concepts and procedures for setting up the oscilloscope to trigger on your signal.

Triggering Concepts

Trigger Event

The trigger event establishes the time-reference point in the waveform record. All waveform record data is located in time with respect to that point. The instrument continuously acquires and retains enough sample points to fill the pretrigger portion of the waveform record. That is the part of the waveform that is displayed before, or to the left of, the triggering event on screen. When a trigger event occurs, the instrument starts acquiring samples to build the posttrigger portion of the waveform record, that is, the part displayed after or to the right of the trigger event. After a trigger is recognized, the instrument will not accept another trigger until the acquisition is complete and the holdoff time has expired.

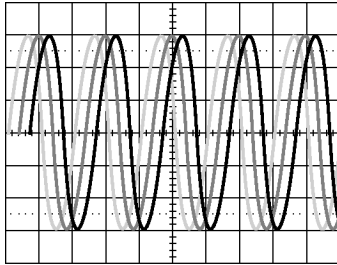

Untriggered display

1785-087a

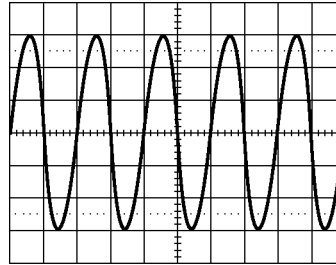

Triggered display

1785-087b

Trigger Modes

The trigger mode determines how the instrument behaves in the absence of a trigger event:

- Normal trigger mode enables the instrument to acquire a waveform only when it is triggered. If no trigger occurs, the last waveform record acquired remains on the display. If no last waveform exists, no waveform is displayed.
- Auto trigger mode enables the instrument to acquire a waveform even if a trigger does not occur. Auto mode uses a timer that starts when the acquisition is started, and the pretrigger information is obtained. If a trigger event is not detected before the timer times out, the instrument forces a trigger. The length of time it waits for a trigger event depends on the time base setting.

Auto mode, when forcing triggers in the absence of valid triggering events, does not synchronize the waveform on the display. The waveform will appear to roll across the screen. If valid triggers occur, the display will become stable.

You can also force the instrument to trigger by pushing the front-panel **Force Trig** button.

Trigger Holdoff

Adjust holdoff to obtain stable triggering when the instrument is triggering on undesired trigger events.

Trigger holdoff can help stabilize triggering, since the oscilloscope does not recognize new triggers during the holdoff time. When the instrument recognizes a trigger event, it disables the trigger system until acquisition is complete. In addition, the trigger system remains disabled during the holdoff period that follows each acquisition.

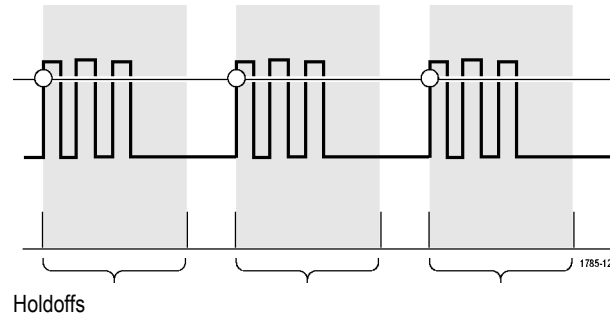

Trigger Coupling

Trigger coupling determines what part of the signal is passed to the trigger circuit. Edge triggering can use all available coupling types: DC, Low Frequency Rejection, High Frequency Rejection, and Noise Rejection. All other trigger types use DC coupling only.

Horizontal Position

Use horizontal position to acquire waveform detail in a region that is separated from the trigger location by a significant interval of time.

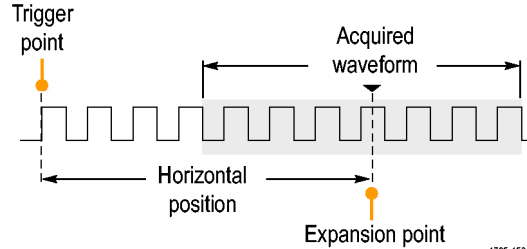

1. Adjust the position (delay) time by rotating the **Horizontal Position** knob.
2. Turn horizontal **SCALE** to acquire the detail that you need around the position (delay) expansion point.

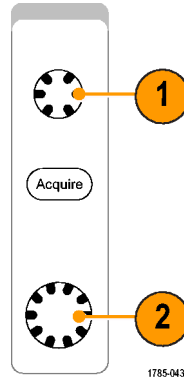

The part of the record that occurs before the trigger is the pretrigger portion. The part that occurs after the trigger is the posttrigger portion. Pretrigger data can help you troubleshoot. For example, to find the cause of an unwanted glitch in your test circuit, you can trigger on the glitch and make the pretrigger period large enough to capture data before the glitch. By analyzing what happens before the glitch, you may uncover information that helps you find the source of the glitch. Alternatively, to see what is happening in your system as a result of the trigger event, make the posttrigger period large enough to capture data after the trigger.

Slope and Level

The slope control determines whether the instrument finds the trigger point on the rising or the falling edge of a signal.

The level control determines where on that edge the trigger point occurs.

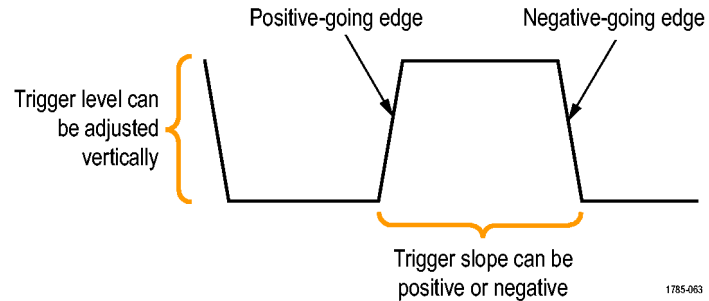

The DPO4000 provides a long horizontal bar or bars across the graticule to temporarily show the trigger level.

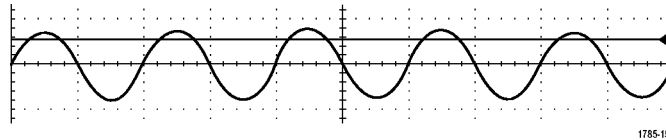

1. Turn the front-panel Trigger **Level** knob to adjust the trigger level without going to a menu.
2. Push the front-panel **Set to 50%** button to quickly set the trigger level to the midpoint of the waveform.

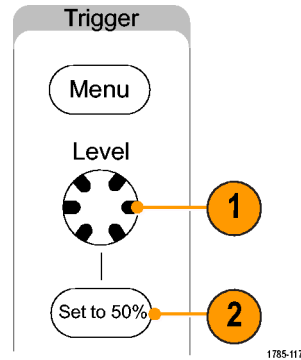

Delayed Trigger System

Trigger with the A (Main) trigger system alone or, if using an edge trigger, combine the A (Main) trigger with the B (Delayed) trigger to trigger on sequential events. When using sequential triggering, the A trigger event arms the trigger system, and the B trigger event triggers the instrument when the B trigger conditions are met. A and B triggers can (and typically do) have separate sources. The B trigger condition can be based on a time delay or a specified number of events. (See page 107, *Using A (Main) and B (Delayed) Triggers.*)

Choosing a Trigger

To select a trigger:

1. Push Trigger **Menu**.

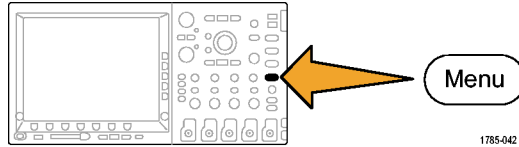

1785-042

2. Push **Type** repeatedly to select the trigger type to use.

NOTE. The bus trigger requires use of the DPO4EMBD or the DPO4AUTO application module.

Edge
Pulse Width
Runt
Logic
Setup & Hold
Rise/Fall Time
Video
Bus

3. Complete the trigger setup using the lower-bezel menu controls displayed for the trigger type. The controls to set up the trigger vary depending on the trigger type.

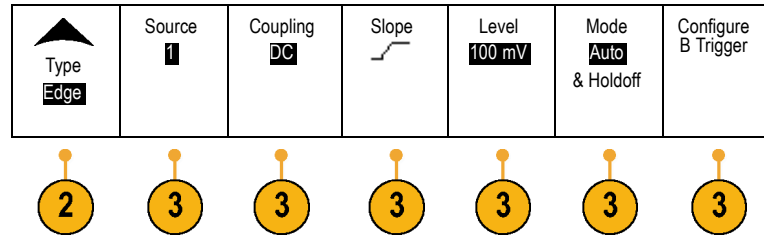

Selecting Triggers

Trigger Type

Edge

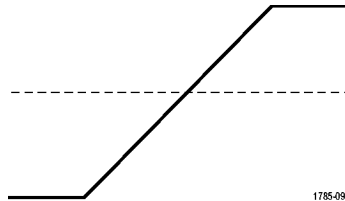

Trigger Conditions

Trigger on a rising or falling edge, as defined by the slope control. Coupling choices are DC, LF Reject, HF Reject, and Noise Reject. Edge triggers are the simplest and most commonly used trigger type, with both analog and digital signals. An edge trigger event occurs when the trigger source passes through a specified voltage level in the specified direction.

Trigger Type

Pulse/Width

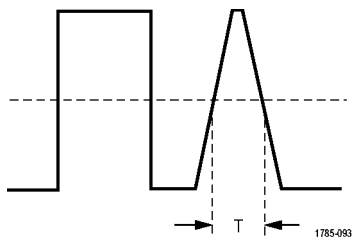

Trigger Conditions

Trigger on pulses that are less than, greater than, equal to, or not equal to a specified time. You can trigger on positive or negative pulses. Pulse/width triggers are primarily used on digital signals.

Runt

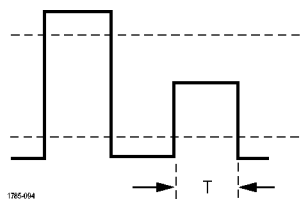

Trigger on a pulse amplitude that crosses one threshold but fails to cross a second threshold before recrossing the first. You can detect positive or negative (or either) runts, or only those wider than, less than, greater than, equal to, or not equal to a specified width. Runt triggers are primarily used on digital signals.

Logic

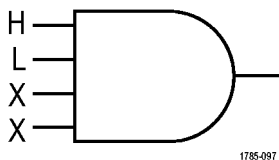

Logic triggers are primarily used with digital signals. You can set each input to high, low, or don't care. In addition, you can use one channel as a clock source set to either the rising or falling edge. Trigger when logic inputs cause the selected function to become True or False. You can also specify that the logic conditions be satisfied for a specific amount of time before triggering.

Trigger Type

Setup and Hold Violation

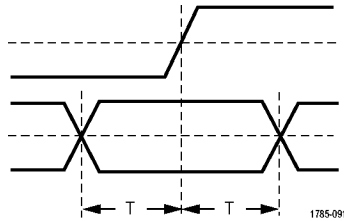

Trigger Conditions

Trigger when a logic data input changes state inside of the setup or hold time relative to a clock edge.

Setup is the amount of time that data should be stable and not change before a clock edge occurs. Hold is the time that data should be stable and not change after a clock edge occurs.

Rise/Fall Time

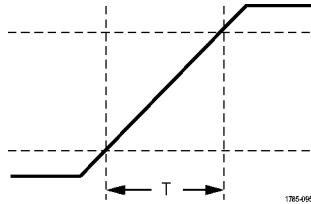

Trigger on rise and fall times. Trigger on pulse edges that traverse between two thresholds at faster or slower rates than the specified time. Specify pulse edges as positive or negative or either.

Video

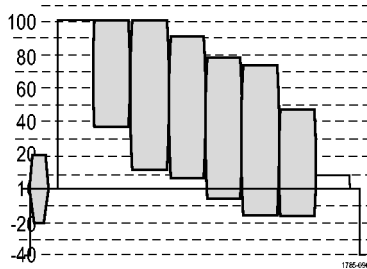

Trigger on specified fields or lines of a composite video signal. Only composite signal formats are supported.

Trigger on NTSC, PAL, or SECAM. Works with Macrovision signals.

Trigger Type

Bus

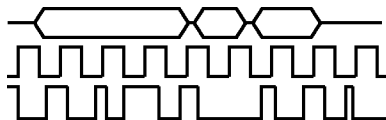

1785-008

Trigger Conditions

Optional: Trigger on common, serial-bus, packet-level information with the following application modules:

DPO4EMBD — I²C and SPI

DPO4AUTO — CAN

Triggering on Buses

You can use your DPO4000 oscilloscope to trigger on CAN, I²C, and SPI buses, if you have the DPO4AUTO or the DPO4EMBD application module installed. The DPO4000 can display both physical layer (as analog waveforms) and protocol level information (as digital and symbolic waveforms).

To set up the bus trigger:

1. If you have not already defined your bus using the front-panel **B1** or **B2** buttons, do so now. (See page 84, *Defining a Serial Bus.*)

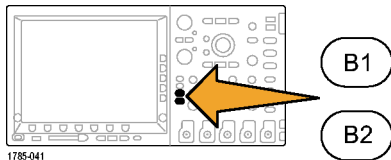

1785-041

2. Push Trigger **Menu**.

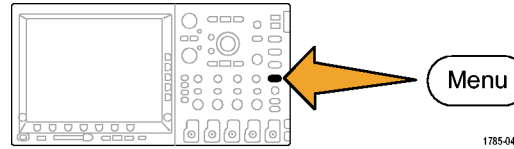

1785-042

Bus

3. Push and keep pushing the **Type** button of the lower-bezel menu until you select **Bus**.

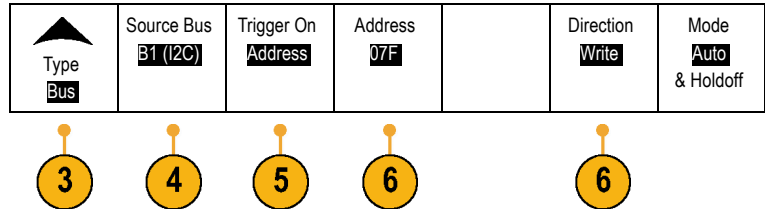

4. Push and keep pushing the **Source Bus** button of the lower-bezel menu until you select the bus that you want to trigger on.

B1 (I2C)
B2 (I2C)

5. Push and keep pushing the lower-bezel menu **Trigger On** button until you select the desired trigger on feature.

If you are using the I²C bus trigger, you can trigger on Start, Repeated Start, Stop, Missing Ack, Address, Data, or Address/Data.

If you are using the SPI bus trigger, you can trigger on SS Active, MOSI, MISO, or MOSI & MISO.

If you are using the CAN bus trigger, you can trigger on Start of Frame, Type of Frame, Identifier, Data, Id & Data, End of Frame, and Missing Ack.

6. If you are setting up an I²C trigger and have selected a **Trigger On** selection of **Address** or **Address/Data**, push the lower-bezel menu **Address** button to access the Address side-bezel menu. Press the side-bezel menu **Address** button. Enter the address parameters of interest with multipurpose knobs **a** and **b**.

Then push the lower-bezel menu **Direction** button to enter the direction of interest. Choices are: **Read**, **Write**, and **Read or Write**.

Bus Trigger Data Matching

Rolling window byte matching for I²C and SPI. You can use a rolling window to trigger on data with SPI and I²C buses. You define the number of bytes to match. Then the oscilloscope uses a rolling window to find any match within a packet, with the window rolling one byte at a time.

For example, if the number of bytes is one, the oscilloscope will match the first byte, second byte, third, and so on within the packet.

If the number of bytes is two, the oscilloscope will try to match any two consecutive bytes, such as one and two, two and three, three and four, and so on. If the oscilloscope finds a match, it will then trigger.

Specific byte matching (non-rolling window matching) for CAN, I²C, and SPI. You can trigger on a specific byte for SPI and I²C in two ways:

- For I²C and SPI, enter the number of bytes to match the number of bytes in the signal. Then use don't cares (X) to mask the bytes that you are not interested in.
- For I²C, push the bottom-bezel **Trigger On** to trigger on **Address/Data**. Push **Address**. On the side-bezel menu, push **Address** and rotate multipurpose knobs **a** and **b** as needed. Set the address to don't cares (X) if you want to mask the address. The data will be matched starting at the first byte without using a rolling window.
- For CAN, triggering occurs when the user-selected data input matches the data and qualifier in the signal starting at the first byte. Set the number of bytes to match the number of bytes of interest. Use the data qualifier to perform: =, !=, <, >, >=, and <= operations. Triggering on identifier and data always matches the identifier and data selected by the user, with the data starting at the first byte. No rolling window is used.

Checking Trigger Status

To quickly determine the settings of some key trigger parameters, check the Trigger readout at the bottom of the display. The readouts differ for edge and the advanced triggers.

1. Trigger source = channel 1.
2. Trigger slope = rising.
3. Trigger level = 0.00 V.

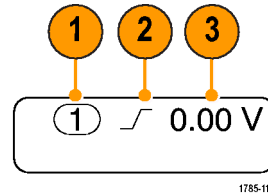

Edge trigger readout

Using A (Main) and B (Delayed) Triggers

Combine an edge A Event (Main) trigger with the B Event (Delayed) trigger to capture more complex signals. After the A Event occurs, the trigger system looks for the B Event before triggering and displaying the waveform.

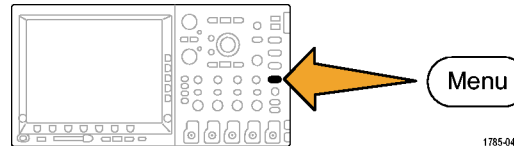

To use the B trigger:

1. Push Trigger **Menu**.



2. Press **Type** repeatedly to select a trigger type of **Edge**.

3. Push **Configure B Trigger**. This brings up the B trigger menu.
The B Trigger Setup item only appears if the A trigger is set to edge trigger.

 Type Edge	Source 1	Coupling DC	Slope 	Level 0.00 V	Mode Auto & Holdoff	Configure B Trigger
--	--------------------	-----------------------	--	------------------------	----------------------------------	----------------------------



4. Set the B trigger parameters as defined in the B trigger lower-bezel and side-bezel menu items.

B Trigger On	B Trigger After A Time	Source 1	Coupling DC	Slope 	Level 0.00V	Configure A Trigger
------------------------	----------------------------------	--------------------	-----------------------	--	----------------	---------------------

Trigger on B Event

The A trigger arms the instrument. Posttrigger acquisition starts on the nth B event.

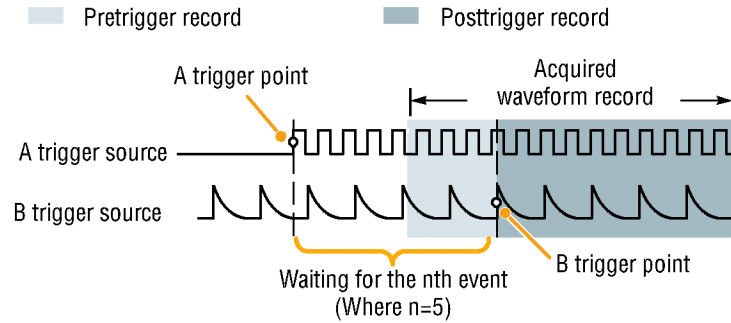

B Trigger After Delay Time

The A trigger arms the instrument. Posttrigger acquisition starts on the first B edge after the trigger delay time.

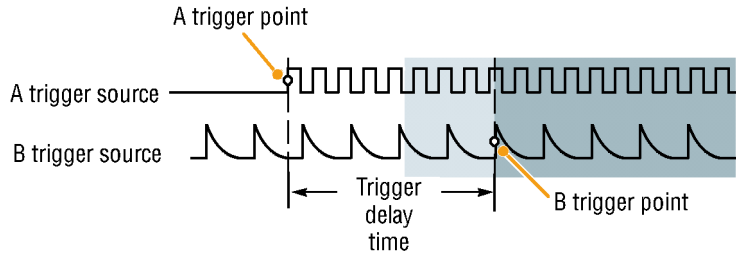

Quick Tips

- B-trigger delay time and horizontal position are independent functions. When you establish a trigger condition using either the A trigger alone or the A and B triggers together, you can also use horizontal position to delay the acquisition by an additional amount.
- When using the B trigger, the A and B trigger types can only be Edge.

Starting and Stopping an Acquisition

After you have defined the acquisition and trigger parameters, start the acquisition with **Run/Stop** or **Single**.

- Push **Run/Stop** to start the acquisition.
Push it again to stop the acquisition.
- Push **Single** to take a single acquisition.
Single sets the trigger mode to **Normal** for the single acquisition.

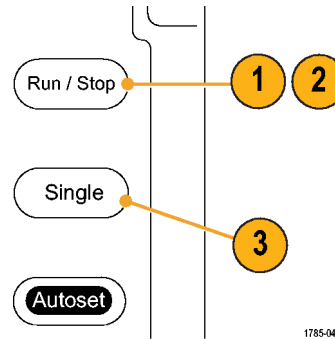

1785-044

Display Waveform Data

This section contains concepts and procedures for displaying the acquired waveform.

Adding and Removing a Waveform

1. To add or remove an active waveform from the display, push the relevant front-panel channel button.

You can use the channel as a trigger source whether or not it is displayed.

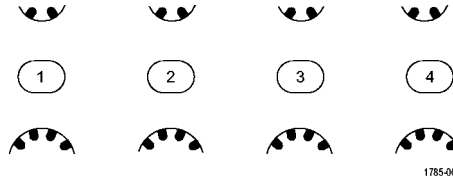

Setting the Display Style and Persistence

1. To set the display style, push **Acquire**.

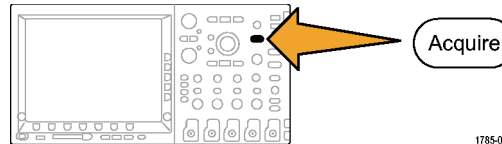

2. Push **Waveform Display**.

Mode Sample	Record Length 10k	Reset Horizontal Position	Waveform Display			
----------------	----------------------	---------------------------	------------------	--	--	--



3. Push **Dots Only On Off** from the side-bezel menu. Dots on will display the waveform record points as dots on the screen. Dots off connects the dots with vectors.
4. Push **Persist Time**, and turn multipurpose knob **a** to have waveform data remain on screen for a user-specified amount of time.
5. Push **Set to Auto** to have the oscilloscope automatically determine a persistence time for you.
6. Push **Clear Persistence** to reset the persistence information.

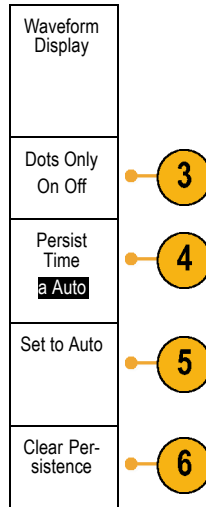

Quick Tips

- Variable persistence accumulates record points for a specified time interval. Each record point decays independently according to the time interval. Use variable persistence for displaying infrequently appearing signal anomalies, such as glitches.
- Infinite persistence continuously accumulates record points until you change one of the acquisition display settings. Use infinite persistence for displaying unique signal anomalies, such as glitches.

Setting Waveform and Graticule Intensity

1. Push the front-panel **Intensity** button.

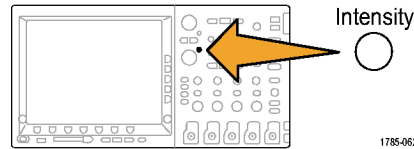

This will bring up the intensity readout on the display.

- a) Waveform Intensity: 33%
- b) Graticule Intensity: 33%

1785-160

2. Rotate multipurpose knob **a** to select the desired waveform intensity.

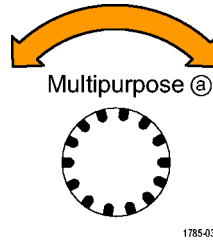

3. Rotate multipurpose knob **b** to select the desired intensity for the graticule and text.
4. Push **Intensity** again to clear the intensity readout from the display.

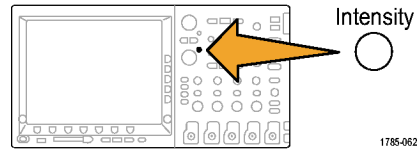

Setting the Graticule Style

1. To set the graticule style, push **Utility**.

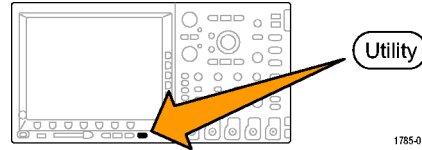

2. Push **System** repeatedly until you select **Display** from the pop-up menu.

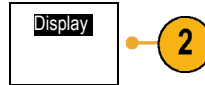

3. Push **Graticule** from the lower-bezel menu.

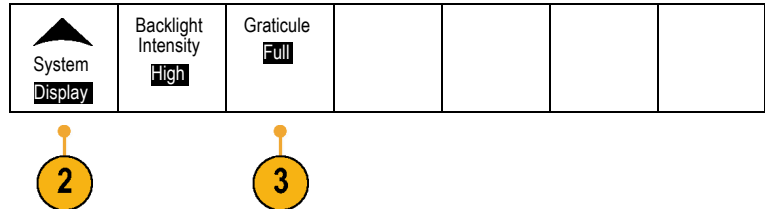

4. Select the desired style from the resulting side-bezel menu.

Use the **Full** graticule for quick estimates of waveform parameters.

Use the **Grid** graticule for full-screen measurements with cursors and automatic readouts when cross hairs are not needed.

Use the **Cross Hair** graticule for making quick estimates of waveforms while leaving more room for automatic readouts and other data.

Use the **Frame** graticule with automatic readouts and other screen text when display features are not needed.

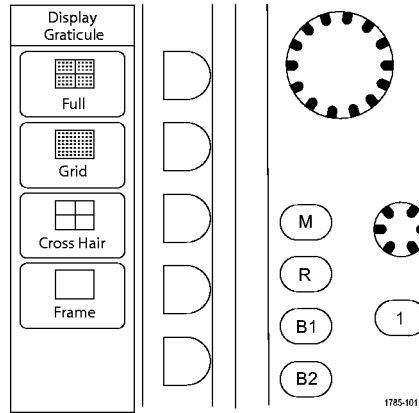

Setting the LCD Backlight

1. Push **Utility**.

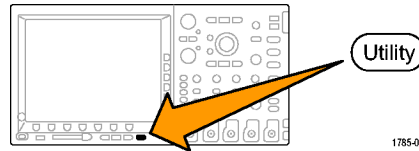

2. Push **System** repeatedly until you select **Display**.

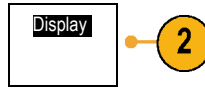

3. Push **Backlight Intensity**.

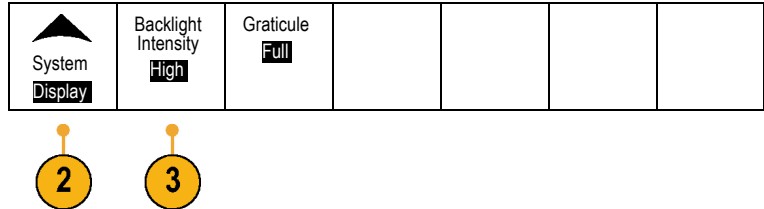

4. Select the intensity level from the resulting side-bezel menu. Choices are: **High, Medium, and Low**.

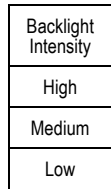

Scaling and Positioning a Waveform

Use the horizontal controls to adjust the time base, adjust the trigger point, and to examine waveform details more closely.

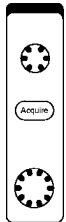

1785-065

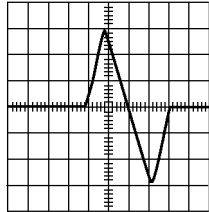

1785-120

Original waveform

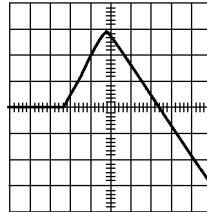

1785-123

Scaled horizontally

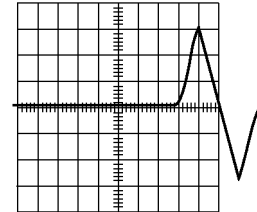

1785-124

Positioned horizontally

Use the vertical controls to select waveforms, adjust the waveform vertical position and scale, and set input parameters. Push a channel button (**1**, **2**, **3**, or **4**), the **MATH** button, or the **REF** button or the **B1** or **B2** button as many times as needed and the associated menu items to select, add, or remove a waveform.

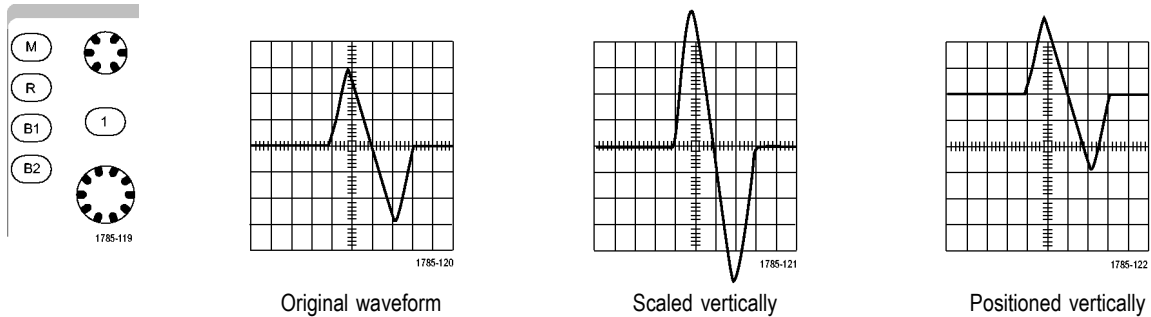

Quick Tips

- **Preview.** If you change the Position or Scale controls when the acquisition is stopped or when it is waiting for the next trigger, the oscilloscope rescales and repositions the relevant waveforms in response to the new control settings. It simulates what you will see when you next push the **RUN** button. The oscilloscope uses the new settings for the next acquisition.

You may see a clipped waveform if the original acquisition went off the screen.

The math waveform, cursors, and automatic measurements remain active and valid when using preview.

Setting Input Parameters

Use the vertical controls to select waveforms, adjust the waveform vertical position and scale, and set input parameters.

1. Push channel button **1**, **2**, **3**, or **4** to bring up the vertical menu for the designated waveform. The vertical menu only affects the selected waveform.

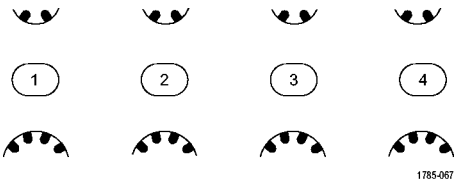

Pushing a channel button will also select or cancel that waveform selection.

2. Push **Coupling**.

Coupling DC	Invert Off	Bandwidth Full	Fine Scale 100mV/div	Offset 0.00V	Position 0.00 div	Probe Setup 1X
-----------------------	----------------------	--------------------------	--------------------------------	------------------------	-----------------------------	--------------------------



3. Push DC, AC, or GND (ground).

Use DC coupling to pass both AC and DC components.

Use AC coupling to block the DC component and show only the AC signal.

Use Ground (GND) to display the reference potential.

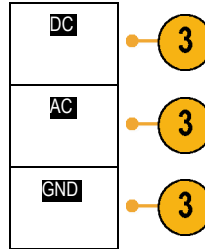
**4. Push Ω .**

Set the input impedance (termination) to 50 Ω or 1 M Ω if using DC or Gnd coupling. Input impedance is automatically set to 1 M Ω when using AC coupling.

For more information on input impedance, see **Quick Tips** below.

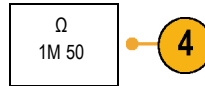

5. Push **Invert** to invert the signal.

Coupling DC	Invert Off	Bandwidth Full	Fine Scale 100mV/div	Offset 0.00V	Position 0.00 div	Probe Setup 1X
----------------	----------------------	-------------------	-------------------------	-----------------	----------------------	-------------------



Select **Invert Off** for normal operation and **Invert On** to invert the polarity of the signal in the preamplifier.

6. Push **Bandwidth**, and select the desired bandwidth from the resulting side-bezel menu.

Coupling DC	Invert Off	Bandwidth Full	Fine Scale 100mV/div	Offset 0.00V	Position 0.00 div	Probe Setup 1X
----------------	---------------	--------------------------	-------------------------	-----------------	----------------------	-------------------



The set choices are: Full, 250 MHz, and 20 MHz. Additional choices may appear, depending on the probe that you use.

Select **Full** to set the bandwidth to the full oscilloscope bandwidth.

Select **250 MHz** to set the bandwidth to 250 MHz.

Select **20 MHz** to set the bandwidth to 20 MHz.

7. Push **Fine Scale** to enable multipurpose knob **a** to make fine vertical scale adjustments.

Coupling DC	Invert Off	Bandwidth Full	Fine Scale 100mV/div	Offset 0.00V	Position 0.00 div	Probe Setup 1 X
----------------	---------------	-------------------	-------------------------	-----------------	----------------------	--------------------



8. Push **Offset** to enable multipurpose knob **a** to make vertical offset adjustments.

Coupling DC	Invert Off	Bandwidth Full	Fine Scale 100mV/div	Offset 0.00V	Position 0.00 div	Probe Setup 1 X
----------------	---------------	-------------------	-------------------------	-----------------	----------------------	--------------------



On the side-bezel menu, choose **Set to 0 V** to set the vertical offset to 0 V.

For more information on offset, see the **Quick Tips** below.

- Push **Position** to enable multipurpose knob **a** to make vertical position adjustments.

Coupling DC	Invert Off	Bandwidth Full	Fine Scale 100mV/div	Offset 0.00V	Position 0.00 div	Probe Setup 1 X
----------------	---------------	-------------------	-------------------------	-----------------	----------------------	--------------------

NOTE. You can also use the position knob on the front panel to do this.

On the side-bezel menu, choose **Set to 0 divs** to set the vertical position to the center of the screen.

For more information on vertical position, see the **Quick Tips** below.



10. Push Probe Setup to define probe parameters.

Coupling DC	Invert Off	Bandwidth Full	Fine Scale 100mV/div	Offset 0.00V	Position 0.00 div	Probe Setup 1 X
----------------	---------------	-------------------	-------------------------	-----------------	----------------------	--------------------

On the resulting side-bezel menu:

- Select **Voltage Probe** or **Current Probe** to set the probe gain or attenuation for probes that do not have the TekProbe II or TekVPI interface.
- Push **Deskew** to set the time skew correction to zero. Turn multipurpose knob **a** to adjust the time skew (deskew) correction for the probe attached to the selected channel. This shifts acquisition and display of the waveform left or right, relative to the trigger time. Use this to compensate for differences in cable lengths or probe types.
- Select **Attenuation** to choose the probe attenuation.



Quick Tips

- **Using Probes with the TekProbe II and TekVPI Interfaces.** When you attach a probe with the TekProbe II or the TekVPI interface, the oscilloscope sets the channel sensitivity, coupling, and termination resistance automatically to match the probe requirements. Tek Probe II probes require use of the TPA-BNC Adapter.
- **The Difference Between Vertical Position and Offset.** Vertical position is a display function. Adjust the vertical position to place the waveforms where you want to see them. The waveform baseline locations track adjustments made to their positions.

When you adjust vertical offset, you see a similar effect, but it is actually quite different. Vertical offset is applied before the oscilloscope preamplifier and can be used to increase the effective dynamic range of the inputs. For example, you can use vertical offset to look at small variations in a large DC voltage. Set the vertical offset to match the nominal DC voltage and the signal appears in the center of the screen.

- **50 Ω Protection.** If you select 50 Ω termination, the maximum vertical scale factor is limited to 1 V/div. If you apply excessive input voltage, the oscilloscope automatically switches to 1 M Ω termination to protect the internal 50 Ω termination. For more details, refer to the specifications in the *DPO4000 Technical Reference*.

Analyze Waveform Data

After having properly set up the acquisition, triggering, and display of your desired waveform, you can then analyze the results. Select from features such as cursors, automatic measurements, statistics, math, and FFT.

Taking Automatic Measurements

To take an automatic measurement:

1. Push **Measure**.

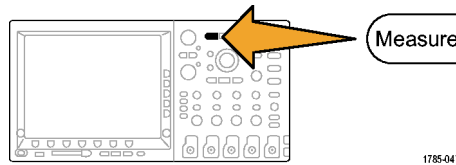

2. Push **Select Measurement**.

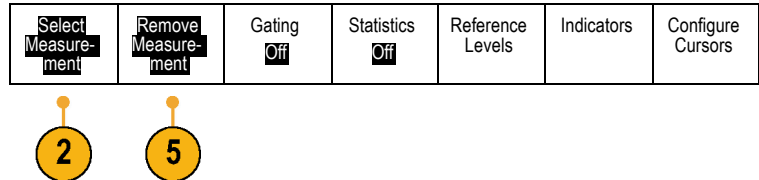

3. Turn multipurpose knob **a** to select the channel from which you want to measure. This step is only needed if you are acquiring data on more than one channel.

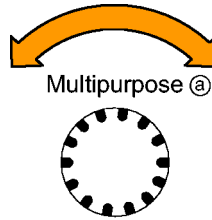

1785-039

4. Select the specific measurement or measurements from the side-bezel menu.
5. To remove a measurement, push **Remove Measurement** and the specific measurement from the resulting side-bezel menu.







Quick Tips

- To remove all measurements, select **Remove All**.
- A  symbol appears instead of the expected numerical measurement if a vertical clipping condition exists. Part of the waveform is above or below the display. To obtain a proper numerical measurement, turn the vertical scale and position knobs to make all of the waveform appear in the display.





Selecting Automatic Measurements

The following tables list each automatic measurement by category: amplitude or time. (See page 129, *Taking Automatic Measurements*.)

Time Measurements

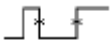
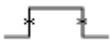
Measurement		Description
Period		The time required to complete the first cycle in a waveform or gated region. Period is the reciprocal of frequency and is measured in seconds.
Frequency		The first cycle in a waveform or gated region. Frequency is the reciprocal of the period; it is measured in hertz (Hz) where one Hz is one cycle per second.
Delay		The time between the mid reference (default 50%) amplitude point of two different waveforms. See also <i>Phase</i> .
Rise Time		The time required for the leading edge of the first pulse in the waveform or gated region to rise from the low reference value (default = 10%) to the high reference value (default = 90%) of the final value.
Fall Time		The time required for the falling edge of the first pulse in the waveform or gated region to fall from the high reference value (default = 90%) to the low reference value (default = 10%) of the final value.
Positive Duty Cycle		The ratio of the positive pulse width to the signal period expressed as a percentage. The duty cycle is measured on the first cycle in the waveform or gated region.

Time Measurements (cont.)

Measurement		Description
Negative Duty Cycle		The ratio of the negative pulse width to the signal period expressed as a percentage. The duty cycle is measured on the first cycle in the waveform or gated region.
Positive Pulse Width		The distance (time) between the mid reference (default 50%) amplitude points of a positive pulse. The measurement is made on the first pulse in the waveform or gated region.
Negative Pulse Width		The distance (time) between the mid reference (default 50%) amplitude points of a negative pulse. The measurement is made on the first pulse in the waveform or gated region.
Burst Width		The duration of a burst (a series of transient events) and is measured over the entire waveform or gated region.
Phase		The amount of time that one waveform leads or lags another waveform, expressed in degrees where 360° comprises one waveform cycle. See also <i>Delay</i> .

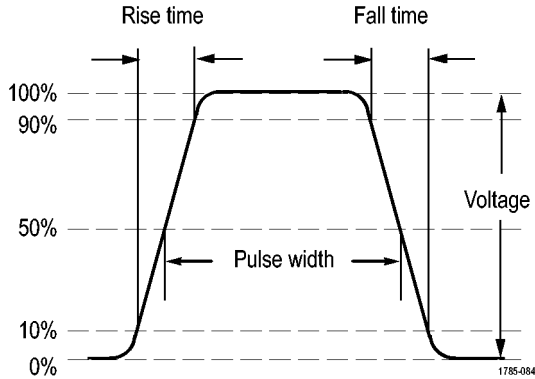

Amplitude Measurements

Measurement

Description

Positive
Overshoot

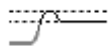







This is measured over the entire waveform or gated region and is expressed as:
Positive Overshoot = $(\text{Maximum} - \text{High}) / \text{Amplitude} \times 100\%$.

Negative
Overshoot



This is measured over the entire waveform or gated region and is expressed as:
Negative Overshoot = $(\text{Low} - \text{Minimum}) / \text{Amplitude} \times 100\%$.

Amplitude Measurements (cont.)

Measurement		Description
Pk-Pk		The absolute difference between the maximum and minimum amplitude in the entire waveform or gated region.
Amplitude		The high value less the low value measured over the entire waveform or gated region.
High		This value is used as 100% whenever high reference, mid reference, or low reference values are needed, such as in fall time or rise time measurements. Calculate using either the min/max or histogram method. The min/max method uses the maximum value found. The histogram method uses the most common value found above the midpoint. This value is measured over the entire waveform or gated region.
Low		This value is used as 0% whenever high reference, mid reference, or low reference values are needed, such as in fall time or rise time measurements. Calculate using either the min/max or histogram method. The min/max method uses the minimum value found. The histogram method uses the most common value found below the midpoint. This value is measured over the entire waveform or gated region.
Max		The most positive peak voltage. Max is measured over the entire waveform or gated region.
Min		The most negative peak voltage. Min is measured over the entire waveform or gated region.

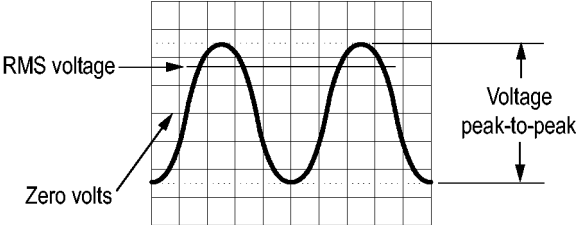

Amplitude Measurements (cont.)

Measurement	Description
Mean	The arithmetic mean over the entire waveform or gated region.
Cycle Mean	The arithmetic mean over the first cycle in the waveform or the first cycle in the gated region.
RMS	The true Root Mean Square voltage over the entire waveform or gated region.
Cycle RMS	The true Root Mean Square voltage over the first cycle in the waveform or the first cycle in the gated region.



1785-083

Miscellaneous Measurements

Measurement	Description
Area	 Area measurement is a voltage over time measurement. It returns the area over the entire waveform or gated region in volt-seconds. Area measured above ground is positive; area measured below ground is negative.
Cycle Area	 A voltage over time measurement. The measurement is the area over the first cycle in the waveform or the first cycle in the gated region expressed in volt-seconds. The area above the common reference point is positive while the area below the common reference point is negative.

Customizing an Automatic Measurement

You can customize automatic measurements by using gating, modifying measurement statistics, adjusting the measurement reference levels, or taking a snapshot.

Gating

Gating confines the measurement to a certain portion of a waveform. To use:

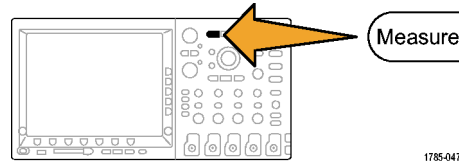

1. Push **Measure**.

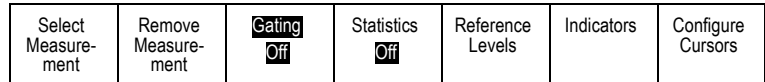

2. Push **Gating**.



3. Position the gates from the side-bezel menu options.

Gating
 Off (Full record)
 Screen
 Between cursors
Bring cursors on screen

Statistics

Statistics characterize the stability of measurements. To adjust statistics:

1. Push **Measure**.

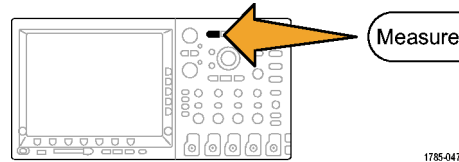

2. Push **Statistics**.



3. Push the side-bezel menu options. These include whether to turn statistics on or off and how many samples to use for mean and standard deviation calculations.

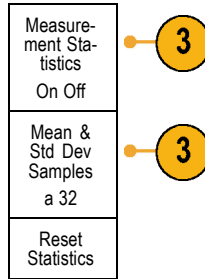

Snapshot

To see all the single-sourced measurements at one moment in time:

1. Push **Measure**.

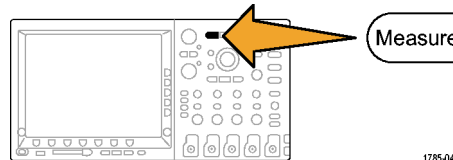

1785-047

2. Push **Select Measurement**.

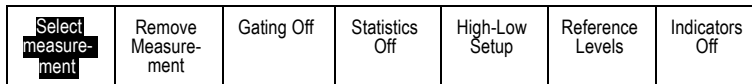

3. Push **Snapshot All Measurements**.



4. View results.

Snapshot on 1

Period:	588.0 ns	Freq:	1.701 MHz
+Width:	529.7 ns	-Width:	58.33 ns
BrstW:	39.91 μ s		
Rise:	2.014 μ s	Fall:	1.522 μ s
...

Reference Levels

Reference levels determine how time-related measurements are taken. For example, they are used in calculating rise and fall times.

1. Push **Measure**.

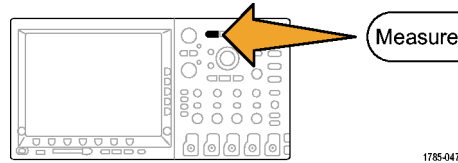

2. Push **Reference Levels**.



3. Set the levels from the side-bezel menu.

Use High and Low reference to calculate rise and fall times.

Use Mid reference primarily for measurements between edges such as pulse widths.

Reference Levels
Set Levels in % units
High Ref a 90.0 %
Mid Ref a 50.0 % b 50.0 %
Low Ref a 10.0 %
- more - 1 of 2

Taking Manual Measurements with Cursors

Cursors are on-screen markers that you position in the waveform display to take manual measurements on acquired data. They appear as horizontal and/or as vertical lines. To use cursors:

1. Push **Cursors**.

This changes the cursor state. The three states are:

- No cursors appear on the screen,
- Two vertical waveform cursors appear. They are attached to the selected waveform
- Four screen cursors appear. Two are vertical and two are horizontal. They are no longer specifically attached to a waveform

For example, the first time you push **Cursors** the state might be off.

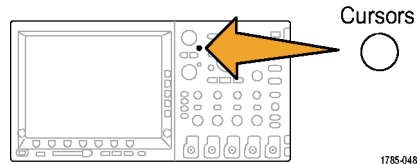

2. Push **Cursors** again.

In the example, two vertical cursors appear on the selected screen waveform. As you turn multipurpose knob **a**, you move one cursor to the right or left. As you turn knob **b**, you move the other cursor.

If you change the selected waveform by pushing the front-panel **1**, **2**, **3**, **4**, **M** or **R** button, both cursors jump to the new selected waveform.

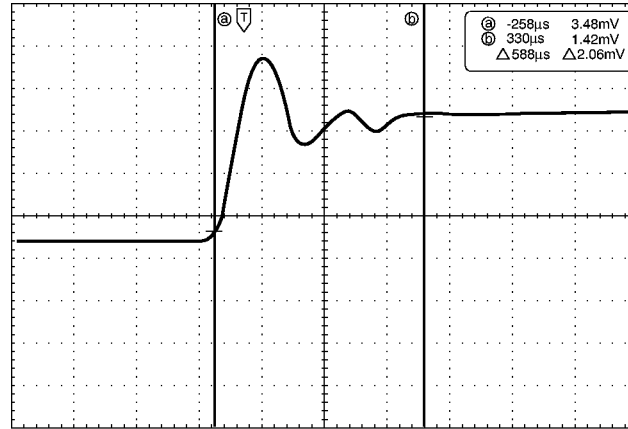

1785-146

3. Push **Select**.

This turns the cursor linking on and off. If linking is on, turning multipurpose knob **a** moves the two cursors together. Turning multipurpose knob **b** adjusts the time between the cursors.

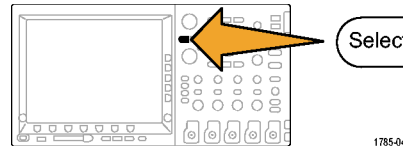

1785-049

- 4. Push **Fine** to toggle between a coarse or a fine adjustment for multipurpose knobs **a** and **b**.

Pushing **Fine** also changes the sensitivity of other knobs as well.

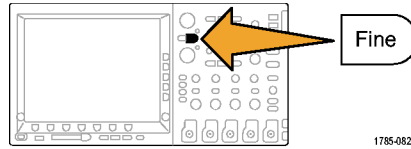

- 5. Push **Cursors** again.

This will put the cursors into screen mode. Two horizontal bars and two vertical bars span the graticule.

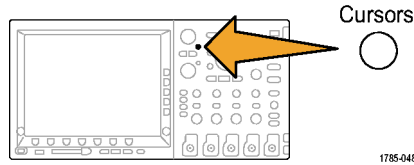

- 6. Turn multipurpose knobs **a** and **b** to move the pair of horizontal cursors.

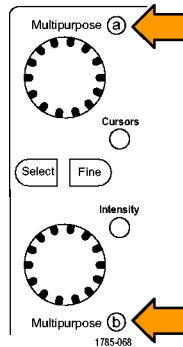

7. Push **Select**.

This makes the vertical cursors active and the horizontal ones inactive. Now, as you turn the multipurpose knobs, the vertical cursors will move.

Push **Select** again to make the horizontal cursors active again.

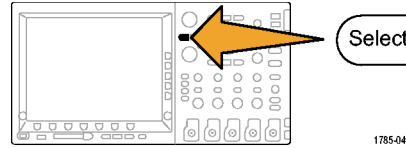

1785-048

8. View the cursor and the cursor readout.

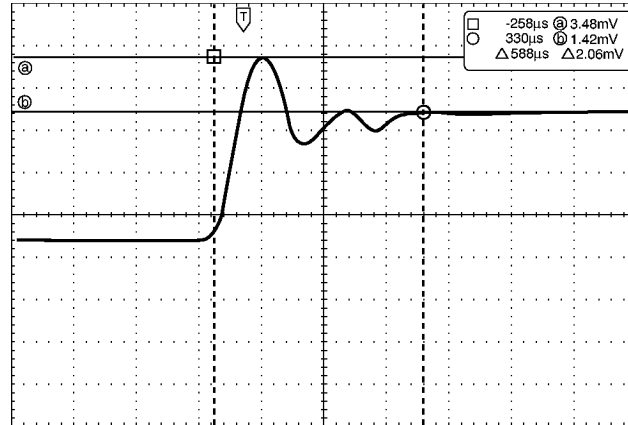

1785-147

9. Push **Cursors** again. This will turn off the cursor mode. The screen will no longer display the cursors and the cursor readout.

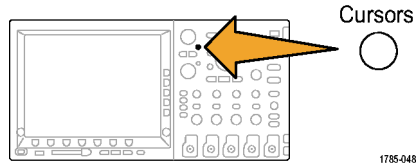

Using cursor readouts

Cursor readouts supply textual and numeric information relating to the current cursor positions.

Readouts appear in the upper right corner of the graticule. If Zoom is on, the readout appears in the upper right corner of the zoom window. The oscilloscope always shows the readouts when the cursors are turned on. When a bus is the currently selected waveform, the readout is the decoded bus data in whatever format you have selected (hexadecimal or binary).

Δ Readout:

The Δ readouts indicate the difference between the cursor positions.

a Readout:

Indicates the value is controlled by multipurpose knob **a**.

b Readout:

Indicates the value is controlled by multipurpose knob **b**.

The horizontal cursor lines on the display measure the vertical parameters, typically voltage.

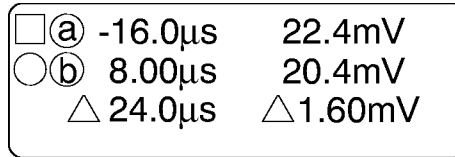

1785-134

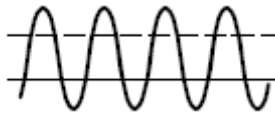

The vertical cursor lines on the display measure horizontal parameters, typically time.



Using Math Waveforms

Create math waveforms to support the analysis of your channel and reference waveforms. By combining and transforming source waveforms and other data into math waveforms, you can derive the data view that your application requires.

Use the following procedure for executing simple (+, -, *, ÷) math operations on two waveforms:

1. Push **Math**.

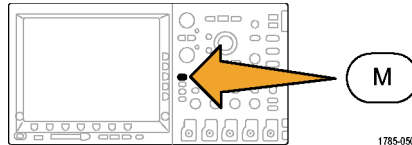

2. Push **Dual Wfm Math**.



3. On the side-bezel menu, set the sources to either channel **1, 2, 3, 4**, or reference waveforms **R1, 2, 3**, or **4**. Choose the **+**, **-**, **x**, or **÷** operators.
4. For example, you might calculate power by multiplying a voltage waveform and a current waveform.

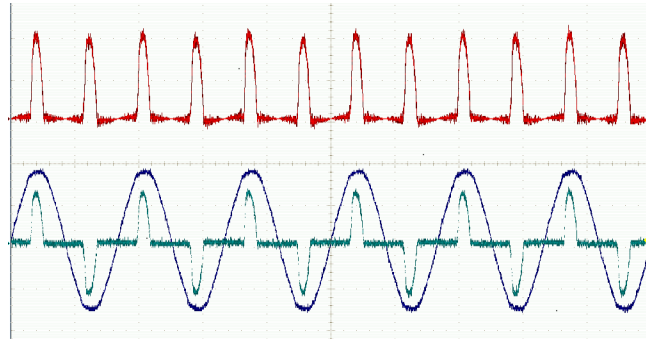

Quick Tips

- Math waveforms can be created from channel or reference waveforms or a combination of them.
- Measurements can be taken on math waveforms in the same way as on channel waveforms.
- Math waveforms derive their horizontal scale and position from the sources in their math expressions. Adjusting these controls for the source waveforms also adjusts the math waveform.
- You can zoom in on math waveforms using the inner knob of the Pan-Zoom control. Use the outer knob for positioning the zoomed area. (See page 163, *Managing Long Record Length Waveforms*.)

Using FFT

An FFT breaks down signals into component frequencies, which the oscilloscope uses to display a graph of the frequency domain of a signal, as opposed to the oscilloscope's standard time domain graph. You can match these frequencies with known system frequencies, such as system clocks, oscillators, or power supplies.

1. Push **Math**.

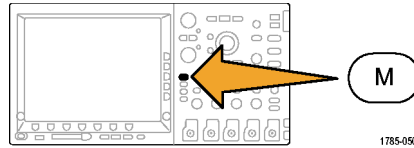

2. Push **FFT**.

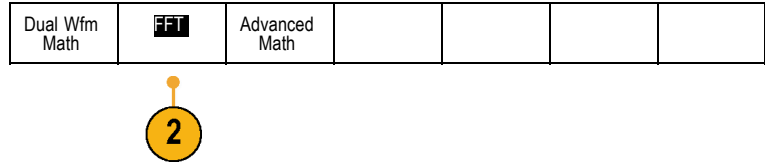

3. Push the side-bezel menu **FFT Source** button repeatedly to select the source to use. Choices are: channels 1, 2, 3, 4, reference waveforms 1, 2, 3, and 4.

4. Push the side-bezel **Vertical Scale** button repeatedly to select either Linear RMS or dBV RMS.

5. Push the side-bezel **Window** button repeatedly to select the desired window. Window choices are: Rectangular, Hamming, Hanning, and Blackman-Harris.

6. Push the side-bezel **Horizontal** button to activate multipurpose knobs **a** and **b** to pan and zoom the FFT display.

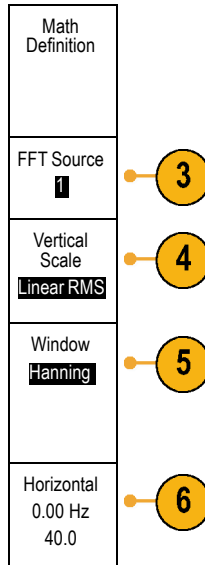

7. The FFT will appear on the display.

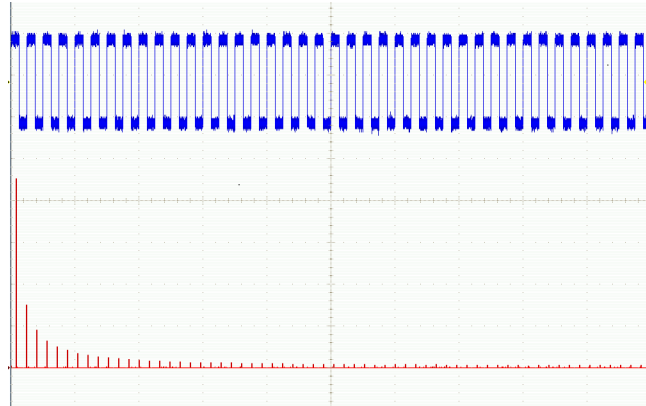

Quick Tips

- Use short record lengths for faster instrument response.
- Use long record lengths to lower the noise relative to the signal and increase the frequency resolution.

- If desired, use the zoom feature along with the horizontal **Position** and **Scale** controls to magnify and position the FFT waveform.
- Use the default dBV RMS scale to see a detailed view of multiple frequencies, even if they have very different amplitudes. Use the linear RMS scale to see an overall view of how all frequencies compare to each other.
- The FFT feature provides four windows. Each is a trade-off between frequency resolution and magnitude accuracy. What you want to measure and your source signal characteristics help determine which window to use. Use the following guidelines to select the best window.

Description

Rectangular

This is the best type of window for resolving frequencies that are very close to the same value but worst for accurately measuring the amplitude of those frequencies. It is the best type for measuring the frequency spectrum of nonrepetitive signals and measuring frequency components near DC.

Use Rectangular for measuring transients or bursts where the signal level before and after the event are nearly equal. Also, use this window for equal-amplitude sine waves with frequencies that are very close and for broadband random noise with a relatively slow varying spectrum.

Hamming

This is a very good window for resolving frequencies that are very close to the same value with somewhat improved amplitude accuracy over the rectangular window. It has a slightly better frequency resolution than the Hanning.

Use Hamming for measuring sine, periodic, and narrow band random noise. This window works on transients or bursts where the signal levels before and after the event are significantly different.

Window



Description**Window****Hanning**

This is a very good window for measuring amplitude accuracy but less so for resolving frequencies.

Use Hanning for measuring sine, periodic, and narrow band random noise. This window works on transients or bursts where the signal levels before and after the event are significantly different.

**Blackman-Harris:**

This is the best window for measuring the amplitude of frequencies but worst at resolving frequencies.

Use Blackman-Harris for measuring predominantly single frequency waveforms to look for higher order harmonics.



Using Advanced Math

The advanced math feature lets you create a custom math waveform expression that can incorporate active and reference waveforms, measurements, and/or numeric constants. To use this feature:

1. Push **Math**.

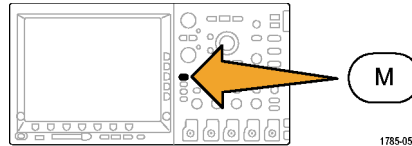

2. Push **Advanced Math**.



3. Use the side-bezel menu buttons to create custom expressions.
4. Push **Edit Expression** and use the multipurpose knobs and the resulting lower-bezel buttons to create an expression. When done, push the side-bezel menu **OK Accept** button.

For example, to use **Edit Expression** to take the integral of a square wave:

1. Push the lower-bezel **Clear** button
2. Turn multipurpose knob **a** to select **INTG(**
3. Push **Enter Selection**
4. Turn multipurpose knob **a** to select channel 1
5. Push **Enter Selection**
6. Turn multipurpose knob **a** to select)
7. Push **OK Accept**.

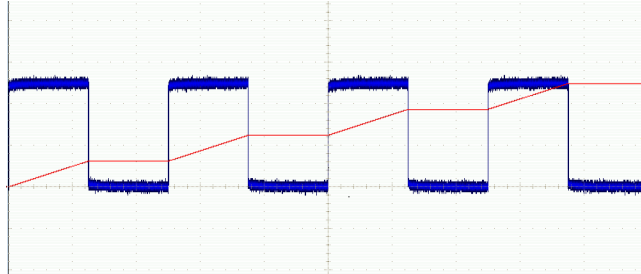

Using Reference Waveforms

Create a reference waveform to store a waveform. For example, you might do this to set up a standard against which to compare other waveforms. To use the reference waveforms:

1. Push **Ref R**. This brings up the lower-bezel reference menu.

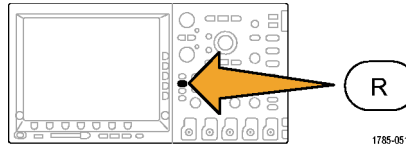

2. Use the resulting lower-bezel menu selections to display or select a reference waveform.

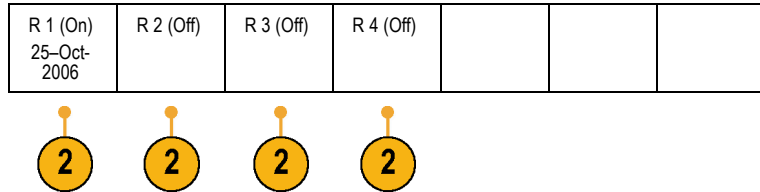

- Use the side-bezel menu and the multipurpose knobs to adjust the vertical and horizontal settings of the reference waveform.

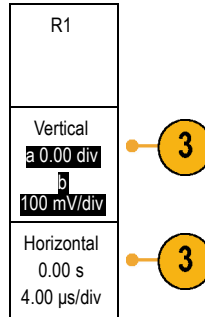

Quick Tips

- **Selecting and Displaying Reference Waveforms.** You can display all the reference waveforms at the same time. Push the appropriate screen button to select a particular reference waveform. The selected waveform appears brighter than other displayed reference waveforms.
- **Removing Reference Waveforms from the Display.** To remove a reference waveform from the display, push the front-panel **R** button to access the lower-bezel menu. Then push the associated button from the lower-bezel menu to turn it off.
- **Scaling and Positioning a Reference Waveform.** You can position and scale a reference waveform independently from all other displayed waveforms. Select the reference waveform and then adjust it with a multipurpose knob. You can do this whether acquisition is running or not.

If a reference waveform is selected, scaling and repositioning of the reference waveform operates the same way whether zoom is turned on or off.

- **Saving 10M Reference Waveforms.** 10M reference waveforms are volatile and not saved when the oscilloscope power is turned off. To keep these waveforms, save them to external storage.
- Recalling Reference Waveforms from External Storage.

Managing Long Record Length Waveforms

The DPO4000 Series Wave Inspector controls (zoom/pan, play/pause, marks, search) help you to efficiently work with long record length waveforms. To magnify a waveform horizontally, rotate the Zoom knob. To scroll through a zoomed waveform, rotate the Pan knob.

The Pan-Zoom Control consists of:

1. An outer pan knob
2. An inner zoom knob

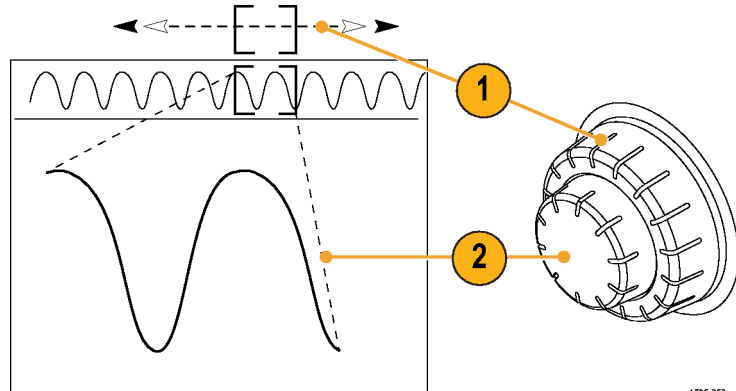

1785-053

Zooming a Waveform

To use zoom:

1. Rotate the inner knob on the Pan-Zoom control clockwise to zoom in on a selected portion of the waveform. Rotate the knob counterclockwise to zoom back out.

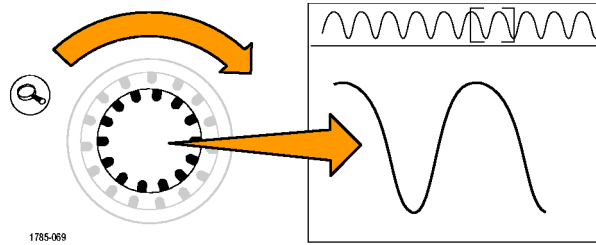

2. Alternatively, enable or disable the zoom mode by pushing the zoom button.

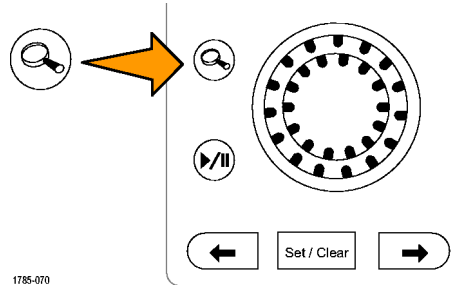

3. Examine the zoomed view of the waveform that appears on the larger, lower portion of the display. The upper portion of the display will show the position and size of the zoomed portion in the waveform, within the context of the overall record.

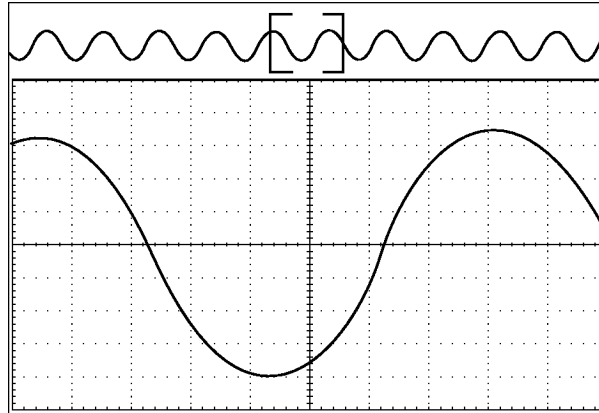

1785-154

Panning a Waveform

While the zoom feature is on, you can use the pan feature to quickly scroll through the waveform. To use pan:

1. Rotate the pan (outer) knob of the pan-zoom controls to pan the waveform. Turn the knob clockwise to pan forward. Turn it counterclockwise to pan backwards. The further you turn the knob, the faster the zoom window pans.

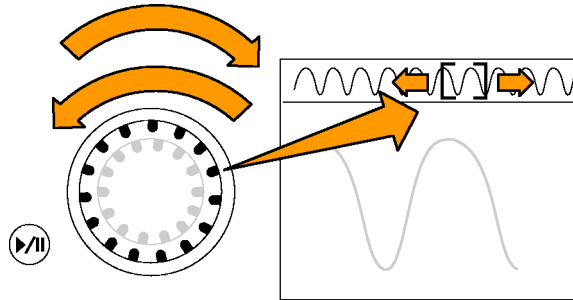

1785-073

Playing and Pausing a Waveform

Use the play-pause feature to automatically pan through a waveform record. To use it:

1. Enable the play-pause mode by pushing the play-pause button.
2. Adjust the play speed by turning the pan (outer) knob further. The further you turn it, the faster it goes.

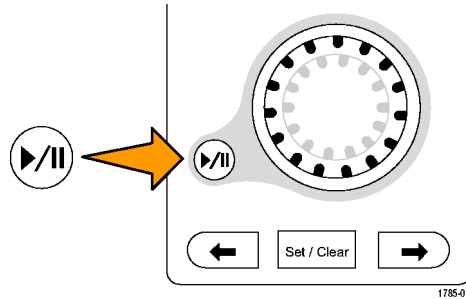

3. Change the play direction by reversing the direction that you are turning the pan knob.
4. During play, up to a point, the more you turn the ring, the faster the waveform accelerates. If you rotate the ring as far as it can go, the play speed does not change, but the zoom box quickly moves in that direction. Use this maximum rotation feature to replay a portion of the waveform that you just saw and want to see again.
5. Pause the play-pause feature by pushing the play-pause button again.

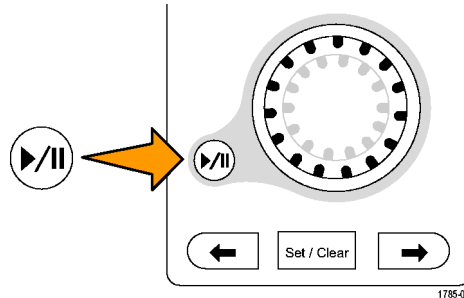

Searching and Marking Waveforms

You can mark locations of interest in the acquired waveform. These marks help you limit your analysis to particular regions of the waveform. You can mark areas of the waveform automatically, if they meet some special criteria, or you can manually mark each item of interest. You can use arrow keys to jump from mark to mark (area of interest to area of interest). You can automatically search and mark many of the same parameters that you can trigger on.

Search marks provide a way to mark a waveform region for reference. You can set marks automatically with search criteria. You can search for and mark regions with particular edges, pulse widths, runts, logic states, rise/fall times, setup and hold, and bus search types.

To manually set and clear (delete) marks:

1. Move (the zoom box) to the area on the waveform where you want to set (or clear) a search mark by turning the pan (outer) knob.

Push the next (→) or previous (←) arrow button to jump to an existing mark.

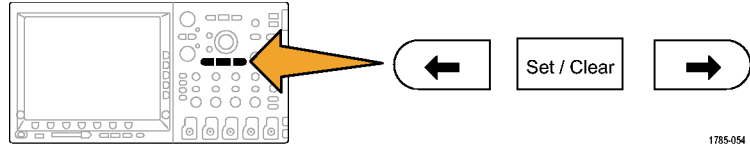

1785-054

2. Push **Set/Clear**.

If no search mark is at the screen center, the oscilloscope will add one.

3. Now investigate your waveform by moving from search mark to search mark. Use the next (→) or previous (←) arrow button to jump from one marked location to another, without adjusting any other controls.
4. Delete a mark. Push the next (→) or previous (←) arrow button to jump to the mark you want to clear. To remove the current, center-positioned mark, just push **Set/Clear**. It works on both manually and automatically created marks.

To automatically set and clear (delete) search marks:

1. Push **Search**.

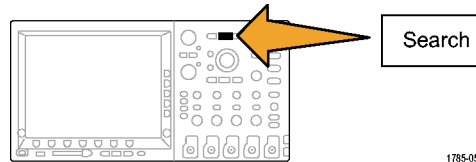

1785-055

2. Select the search type desired from the lower-bezel menu.

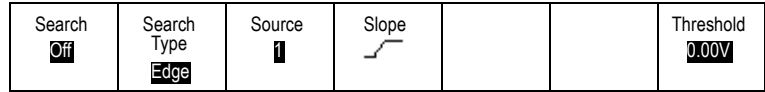

The search menu is similar to the trigger menu.

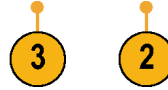

3. From the side-bezel menu, turn on the search.
4. On the screen, hollow triangles show the location of automatic marks and solid triangles show the custom (user-defined) locations. These appear on both normal and zoomed waveform views.

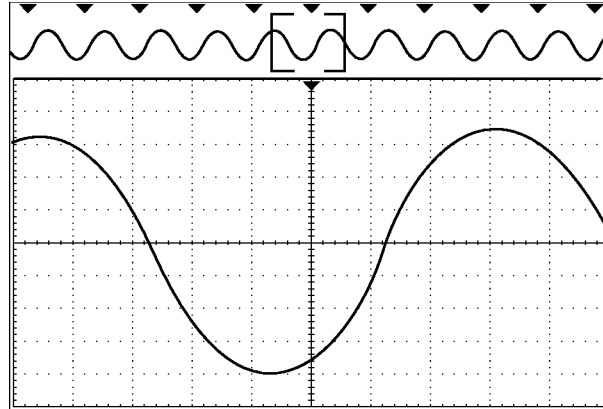

1785-155

5. Again, you can quickly investigate your waveform by moving from search mark to search mark with the next (→) and previous (←) arrow buttons. No other adjustments are needed.

Quick Tips.

- You can copy trigger settings to search for other locations in your acquired waveform that meet the trigger conditions.
- You can also copy search settings to your trigger.
- Custom (User) marks are saved with the waveform when the waveform is saved and when the setup is saved.
- Automatic search marks are not saved with the waveform when the waveform is saved. However, you can easily recapture them by re-using the search function.
- The search criteria are saved in the saved setup.
- With the optional DPO4EMBD and DPO4AUTO application modules installed, you can use the front-panel B1 and B2 buttons to define a combination of inputs to be either I²C, SPI, or CAN serial bus. Once set up, you can trigger on user-specified packet level content and have the DPO4000 automatically decode every packet in the acquisition into either binary or hex.

The Wave Inspector includes the following search capabilities:

Search	Description
Edge	Searches for edges (rising or falling) with a user-specified threshold level.
Pulse Width	Searches for positive or negative pulse widths that are >, <, =, or ≠ a user specified pulse width.

Search	Description
Runt	Searches for positive or negative pulses that cross one amplitude threshold but fail to cross a second threshold before crossing the first again. Search for all runt pulses or only those with a duration $>$, $<$, $=$, or \neq a user specified time.
Logic	Search for a logic pattern (AND, OR, NAND, or NOR) across multiple waveforms with each input set to either High, Low, or Don't Care. Search for when the event goes true, goes false, or stays valid for $>$, $<$, $=$, or \neq a user specified time. Additionally, you can define one of the inputs as a clock for synchronous (state) searches.
Setup & Hold	Search for violations of user specified Setup and Hold times.
Rise/Fall Time	Search for rising and/or falling edges that are $>$, $<$, $=$, or \neq a user specified time.
Bus	I ² C: Search for Start, Repeated Start, Stop, Missing Ack, Address, Data, or Address and Data. SPI: Search for SS Active, MOSI, MISO, or MOSI & MISO CAN: Search for Start of Frame, Type of Frame (Data, Remote, Error, Overload), Identifier (standard or extended), Data, Identifier and Data, End of Frame, or Missing Ack.

Save and Recall Information

The DPO4000 Series oscilloscope provides permanent storage for setups, waveforms, and screen images. Use the internal storage of the oscilloscope to save setups and reference waveform data. Use external storage, such as CompactFlash media and USB flash-memory storage devices to save setups, waveforms, and screen images. Use the external storage to carry data to remote computers for further analysis and for archiving.

Saving a Screen Image

A screen image consists of a graphical image of the oscilloscope screen. This is different from waveform data, which consists of numeric values for each point in the waveform. To save a screen image:

1. Push **Save / Recall Menu**.

Do not yet push the **Save** button.

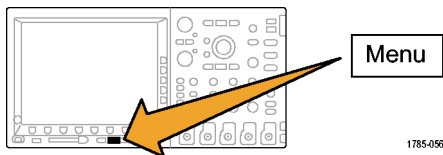

2. Push **Save Screen Image** from the lower-bezel menu.

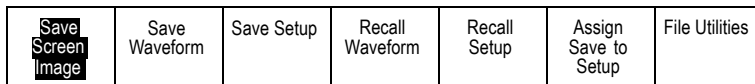

3. From the side-bezel menu, push **File Format** repeatedly to select among: .tif, .bmp, and .png formats.
4. Push **Orientation** to select between saving the image in a landscape (horizontal) and a portrait (vertical) orientation.
5. Push **Ink Saver** to turn the **Ink Saver** mode on or off. When on, this mode provides a white background.
6. Push **Edit File Name** to create a custom name for the screen image file. Skip this step to use a default name.
7. Push **OK Save Screen Image** to write the image to the selected media.

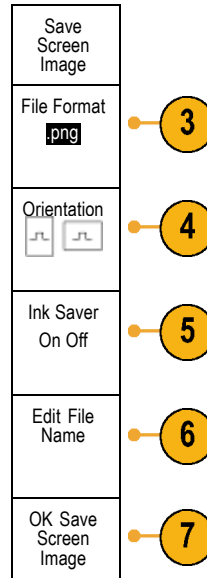

For information on printing screen images of waveforms, go to *Printing a Hardcopy*. (See page 189, *Printing a Hard Copy*.)

Saving and Recalling Waveform Data

Waveform data consists of the numeric values for each point in the waveform. It copies the data, as opposed to a graphical image of the screen. To save the current waveform data or to recall previously stored waveform data:

1. Push **Save / Recall Menu**.

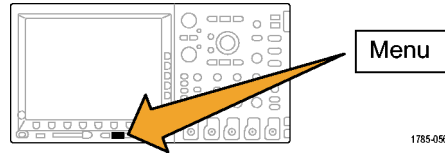

2. Push **Save Waveform** or **Recall Waveform** from the lower-bezel menu.

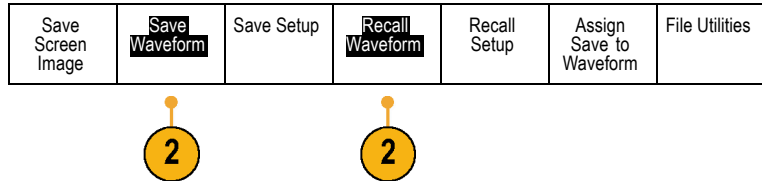

3. From the resulting side-bezel menu, select the location to save the waveform data to or to recall it from.

Save the information externally to a file on a CompactFlash card or USB memory stick. Alternatively, save the information internally to one of the four reference memories in the oscilloscope.

4. Push **To File** to save to a CompactFlash card or USB memory stick.



This brings up the file manager screen. Use it to define a custom file name. Skip this step to use the default name and location.

Editing File, Directory, Reference Waveform, or Instrument Setup Names. Give files descriptive names that you can recognize at a later date. To edit file names, directory names, reference waveform and instrument setup labels:

1. Push **Save / Recall Menu**.

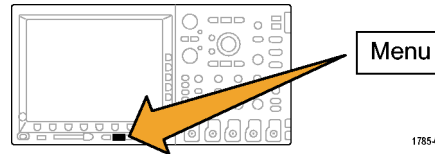

2. Push **Save Screen Image**, **Save Waveform**, or **Save Setup**.

Save Screen Image	Save Waveform	Save Setup	Recall Waveform	Recall Setup	Assign Save to Setup	File Utilities
-------------------	---------------	------------	-----------------	--------------	----------------------	----------------



3. Enter the file manager by pushing the side-bezel menu **To File** item.



4. Turn multipurpose knob **a** to scroll through the file structure.

D: is the CompactFlash drive.
 E: is the USB drive plugged into the USB port on the front of the oscilloscope.
 F: and G: are the USB drives plugged into the USB host ports on the rear of the oscilloscope.

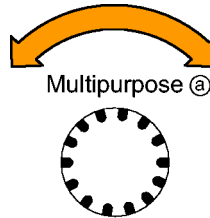

1785-038

5. Push **Select** to open or close file folders.

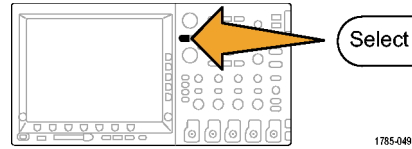

6. Push the **Menu Off** button to cancel the save operation, or push a side-bezel menu **OK Save** item to complete the operation.

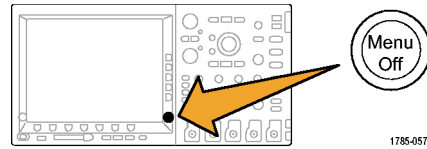

Naming Your File. The oscilloscope gives all files it creates the default name tekxxxxx where xxxx is an integer from 00000 to 99999.

For example, the first time you save a file, that file is named tek00000. The next file is named tek00001.

To define a file name of your own choosing:

1. Push **Save / Recall Menu**.

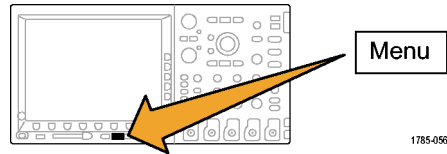

2. Push **Save Screen Image, Save Waveform, or Save Setup**.

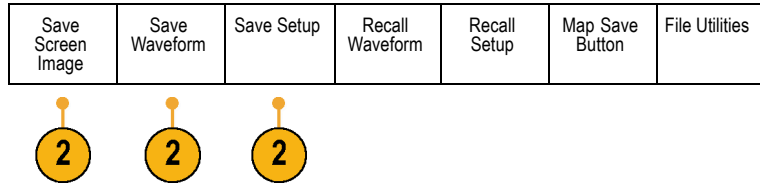

3. Enter the file manager by pushing the side-bezel menu **To File** item.



4. Push the front-panel **Select** or the lower-bezel menu **Enter Character** to select a character.

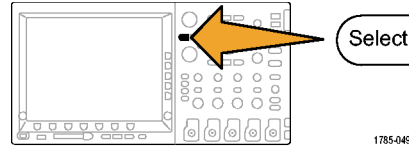

5. Push the **Menu Off** button to cancel the file naming operation or push a side-bezel menu **Save to Selected File** item to complete the operation.

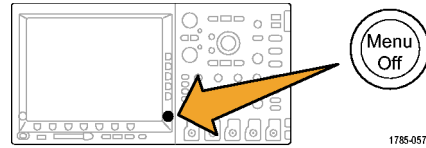

Saving a Waveform to File. When you push the **To File** side-bezel menu button, the oscilloscope changes the side- menu contents. The following table describes these side-bezel menu items for saving data to a mass storage file.

Side-bezel menu button	Description
Internal File Format (.ISF)	Sets the oscilloscope to save waveform data in internal waveform save file (.isf) format. This format is the fastest to write and creates the smallest-sized file. Use this format if you intend to recall a waveform to reference memory for viewing or measuring.
Spreadsheet File Format (.CSV)	Sets the oscilloscope to save waveform data as a comma-separated data file compatible with popular spreadsheet programs. This file cannot be recalled to reference memory.

Saving a Waveform to Reference Memory. To save a waveform to nonvolatile memory inside the oscilloscope, first select the waveform that you want to save. Push the **Save Waveform** screen button. Then select one of the reference waveform locations. Four-channel models have four reference locations. Two-channel models have two reference locations.

Saved waveforms contain only the most current acquisition. Gray-scale information, if any, is not saved.

Displaying a Reference Waveform. To display a waveform stored in nonvolatile memory:

1. Push **Ref R**.

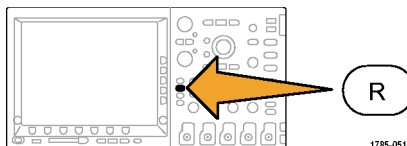

2. Push **R1**, **R2**, **R3**, or **R4**.

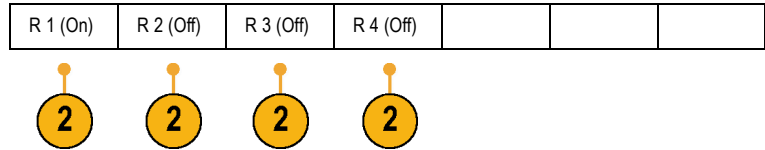

Removing a Reference Waveform from the Display. To remove a reference waveform from the display:

1. Push **Ref R**.

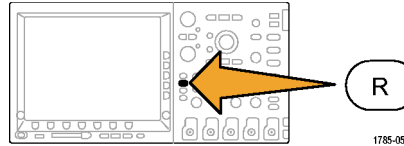

2. Push the **R1**, **R2**, **R3**, or **R4** screen button to select a reference waveform.

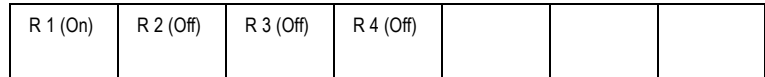

3. Push the front-panel **Ref** or the appropriate lower-bezel **R** button again to remove the reference waveform from the display.
The reference waveform is still in nonvolatile memory and can be displayed again.

Saving and Recalling Setups

Setup information includes acquisition information, such as vertical, horizontal, trigger, cursor, and measurement information. It does not include communications information, such as GPIB addresses. To save the setup information:

1. Push **Save / Recall Menu**.

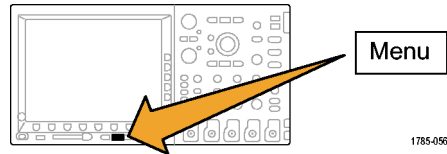

2. Push **Save Setup** or **Recall Setup** from the lower-bezel menu.

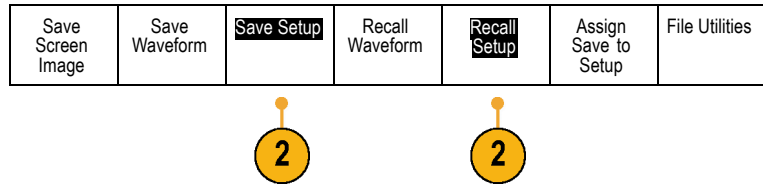

3. From the resulting side-bezel menu, select the location to save the setup to or to recall it from.

To save setup information to one of the ten internal setup memories in the oscilloscope, push the appropriate side-bezel button.

To save setup information to a CompactFlash or USB file, push the **To File** button.

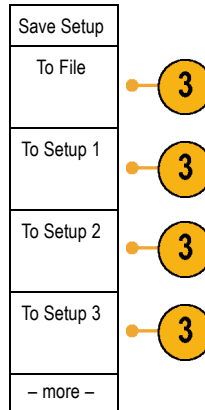

4. If you are saving information to a CompactFlash or USB memory device, turn multipurpose knob **a** to scroll through the file structure.
- D: is the CompactFlash drive.
 - E: is the USB drive plugged into the USB port on the front of the oscilloscope.
 - F: and G: are the USB drives plugged into the USB ports on the rear of the oscilloscope.

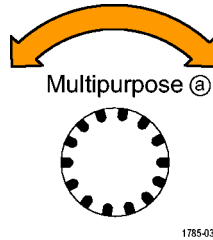

Push **Select** to open or close file folders.

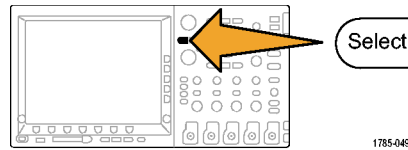

Push the **Menu Off** button to cancel the save operation, or push a side-bezel menu **Save to Selected File** item to complete the operation.

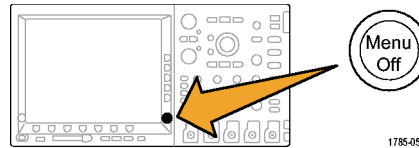

Save 1 to
Selected
File

Quick Tips

- **Recalling the Default Setup.** Push the front-panel **Default Setup** button to initialize the oscilloscope to a known setup. (See page 73, *Using the Default Setup*.)

Saving with One Button Push

After you have defined the save/recall parameters with the Save/Recall Menu button and menu, you can make saves to files with a single push of the **Save** button. For example, if you have defined the save operation to save waveform data to a USB drive, then each push of the **Save** button will save current waveform data to the defined USB drive.

1. To define the Save button behavior, push **Save/Recall Menu**.

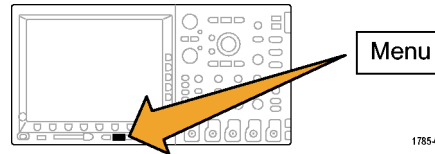

2. Push **Assign Save** button.

Save Screen Image	Save Waveform	Save Setup	Recall Waveform	Recall Setup	Assign Save to Setup	File Utilities
-------------------	---------------	------------	-----------------	--------------	----------------------	----------------



3. Push the action to assign to the **Save** button.

Assign Save to
Screen Image
Waveform
Setup

4. From now on, when you push **Save** the button will perform the action that you just specified rather than having to navigate menus each time.

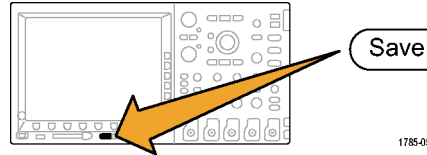

1785-058

Printing a Hard Copy

To print an image of what appears on the oscilloscope screen, do the following procedure.

Connect a Printer to Your Oscilloscope

Connect your printer to a USB port on the rear or front panel of the oscilloscope.

Alternatively, you can print to networked printers through the Ethernet port.

Set Up Print Parameters

To set up the oscilloscope to print hard copies:

1. Push **Utility**.

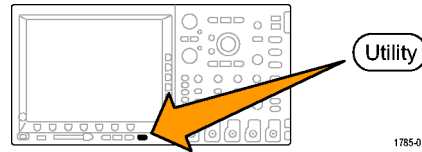

2. Push **System** as many times as needed to select **Print Setup** from the resulting pop-up menu.

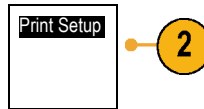

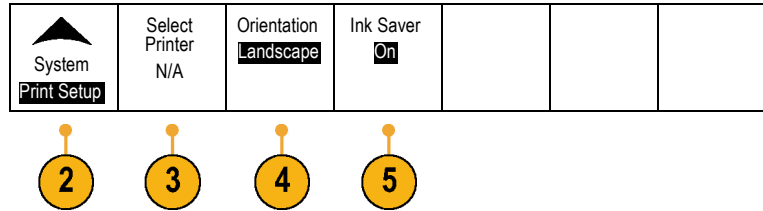

3. Push **Select Printer** if you are changing the default printer.
Turn multipurpose knob **a** to scroll through the list of available printers.
Push **Select** to choose the desired printer.
To add a USB printer to the list, plug the printer into the USB slot. The oscilloscope will automatically recognize it.
To add an Ethernet printer to the list, use the instructions in the section titled *Printing Over Ethernet*.

4. Select the image orientation (portrait or landscape).

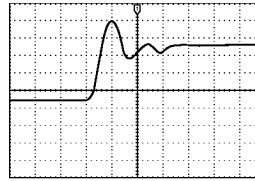

1785-116a

Landscape

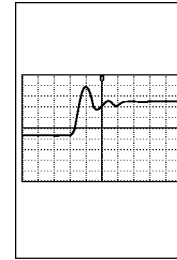

1785-116b

Portrait

5. Choose **Ink Saver On** or **Off**.

The **On** selection will print out a copy with a clear (white) background.

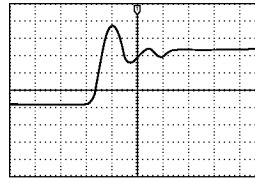

1785-145a

Ink Saver on

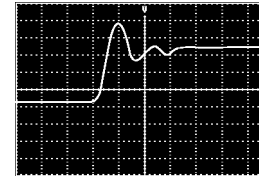

1785-145b

Ink Saver off

Printing Over Ethernet

To set up the oscilloscope to print over Ethernet:

1. Connect an Ethernet cable to the rear-panel Ethernet port.

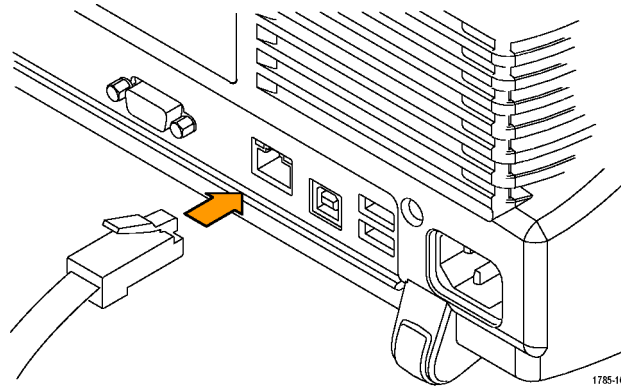

2. Push **Utility**.

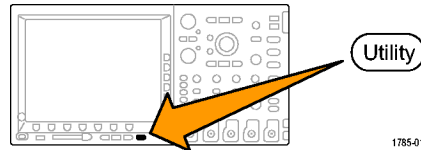

3. Push **System** repeatedly until you select **Print Setup**.



4. Push **Select Printer**.

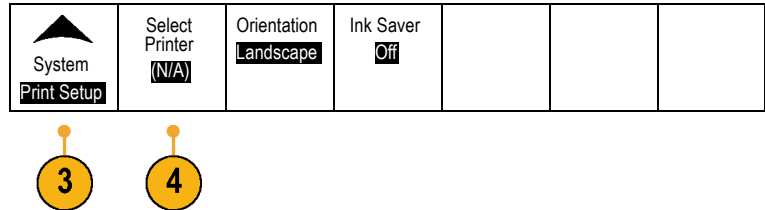

5. Push **Add Network Printer**.

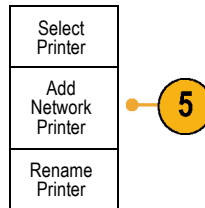

- Turn multipurpose knob **a** to scroll through the list of letters, numbers, and other characters to find the first character in the printer name that you want to enter.

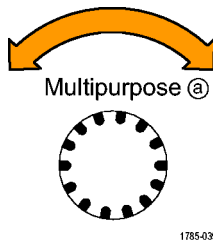

1785-038

ABCDEFGHIJKLMNOPQRSTUVWXYZ
 abcdefghijklmnopqrstuvwxyz
 0123456789_+!@#\$%^&*()[]{}<>/~"':;.,?

- Push **Select** or **Enter Character** to let the oscilloscope know that you have picked the proper character to use.

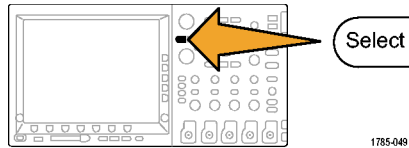

You can use the lower-bezel buttons to edit the name, as needed.

Enter Character		←	→	Back Space	Delete	Clear
-----------------	--	---	---	------------	--------	-------

- Continue scrolling and pushing **Select** until you have entered all the desired characters.

9. Push the down arrow key to move the character cursor down a row to the **Server Name** field.
10. Turn multipurpose knob **a** and push **Select** or **Enter Character** as often as needed to enter the name.
11. If desired, push the down arrow key to move the character cursor down a row to the **Server IP Address:** field.
12. Turn multipurpose knob **a** and push **Select** or **Enter Character** as often as needed to enter the name.

13. When done, push **OK Accept**.

Add Printer
↑
↓
OK Accept

NOTE. If you have multiple printers connected to the oscilloscope at the same time, the oscilloscope will print to the printer listed in the Utility > System > Print Setup > Select Printer menu item.

Print to a Printer

Once you have connected a printer to your oscilloscope and set up print parameters, you can print current screen images with a single push of a button:

1. Push the printer icon button in the lower left corner of the front panel.

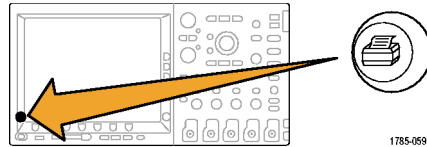

Erasing DPO4000 Memory

You can erase all setup and waveform information saved in the nonvolatile memory with the TekSecure function. If you have acquired confidential data on your oscilloscope, you may want to execute the TekSecure function before you return the oscilloscope to general use. The TekSecure function:

- Replaces all waveforms in all reference memories with null values

- Replaces the current front-panel setup and all stored setups with the default setup
- Displays a confirmation or warning message, depending on whether the verification is successful or unsuccessful

To use TekSecure:

1. Push **Utility**.

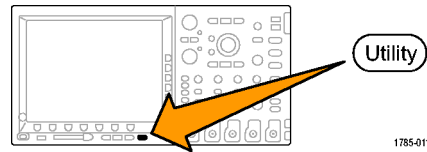

2. Push **System** repeatedly until you select **Config**.



3. Push **TekSecure**.

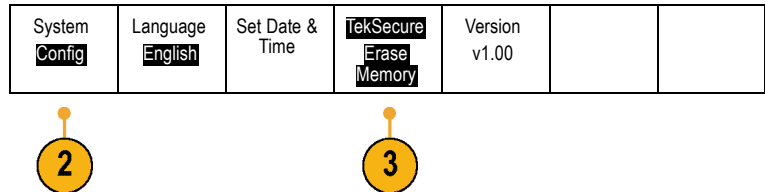

4. Push **OK Erase Setup and Ref Memory** from the side-bezel menu.

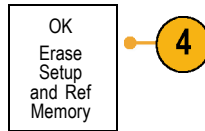

To abort the procedure, push **Menu Off**.

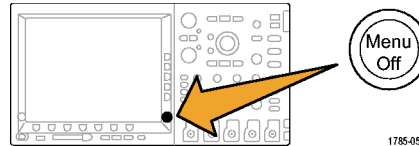

5. Power off the oscilloscope, and then power it back on to complete the process.

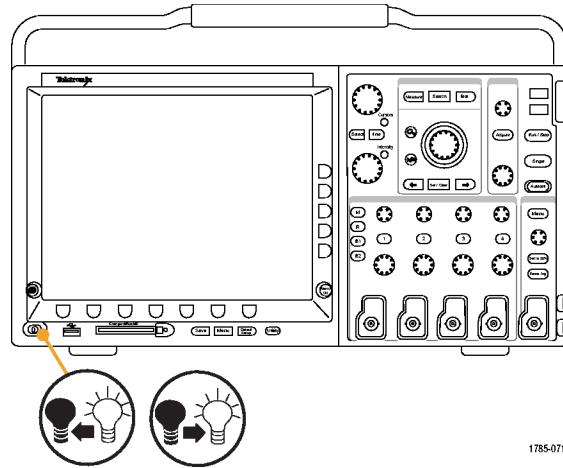

1785-071

Use Application Modules

Optional application module packages extend the capability of your oscilloscope. Install up to four application modules at one time. Application modules go into the two slots with windows in the upper right corner of the front panel. Two additional slots are directly behind the two that you can see.

Refer to the *DPO4000 Series Application Module Installation Instructions* that came with your application module for instructions on installing and testing an application module. Some modules are described below. Additional packages may be available. Contact your Tektronix representative or visit our Web site at www.tektronix.com for more information. Also, refer to *Contacting Tektronix* at the beginning of the manual.

- The **DPO4EMBD Serial Triggering and Analysis Module** adds triggering on packet level information in serial buses used in embedded designs (I²C and SPI), as well as analytical tools to help you efficiently analyze your serial bus. These include digital views of the signal, bus views, packet decoding, search tools, and event tables with timestamp information.
- The **DPO4AUTO Serial Triggering and Analysis Module** adds triggering on packet level information in serial buses used in automotive designs (CAN), as well as analytical tools to help you efficiently analyze your serial bus. These include digital views of the signal, bus views, packet decoding, search tools, and event tables with timestamp information.

Application Examples

This section contains ways to use your instrument in both common and advanced troubleshooting tasks.

Taking Simple Measurements

If you need to see a signal in a circuit, but you do not know the signal amplitude or frequency, connect the probe from channel 1 of the oscilloscope to the signal. Then display the signal and measure its frequency and peak-to-peak amplitude.

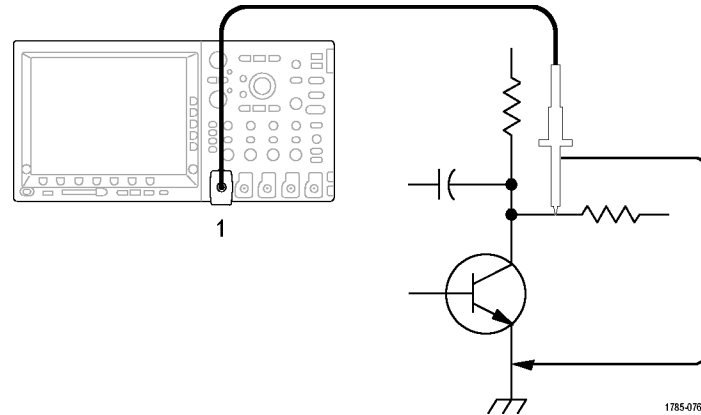

Using Autoset

To quickly display a signal:

1. Push **Autoset**.

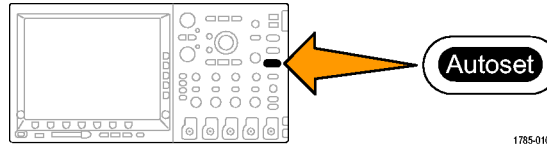

1785-010

The oscilloscope sets vertical, horizontal, and trigger controls automatically. You can manually adjust any of these controls if you need to optimize the display of the waveform.

When you are using more than one channel, the autoset function sets the vertical controls for each channel and uses the lowest-numbered active channel to set the horizontal and trigger controls.

Selecting Automatic Measurements

The oscilloscope can take automatic measurements of most displayed signals. To measure signal frequency and peak-to-peak amplitude:

1. Push **Measure**.

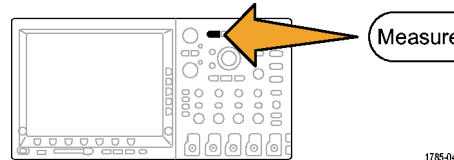

1785-047

2. Push **Select Measurement**.

Select Measure- ment a 1	Remove Measure- ment	Gating Off	Statistics Off	Reference Levels	Indicators	Configure Cursors
-----------------------------------	----------------------------	---------------	-------------------	---------------------	------------	----------------------



3. Turn multipurpose knob **a** to select the channel from which you want to measure. For example, select channel 1. This step is only needed if you are acquiring data on more than one channel.

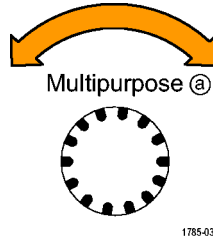

4. Select the **Frequency** measurement from the side-bezel menu.
5. Push **-more-** until you can select the **Pk-Pk** measurement.

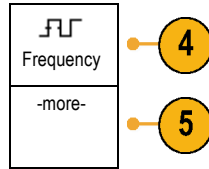

6. Push **Menu Off**.

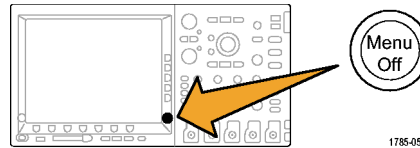

7. Observe that the measurements appear on the screen and update as the signal changes.

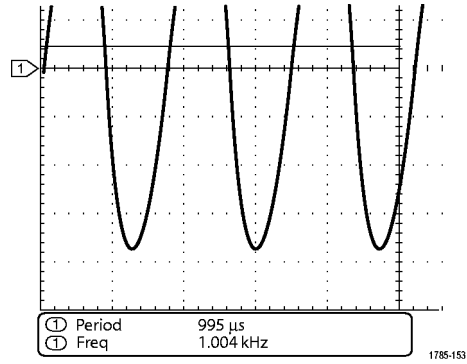

Measuring Two Signals

In this example, you are testing a piece of equipment and need to measure the gain of its audio amplifier. You have an audio generator that can inject a test signal at the amplifier input. Connect two oscilloscope channels to the amplifier input and output as shown. Measure both signal levels and use these measurements to calculate the gain.

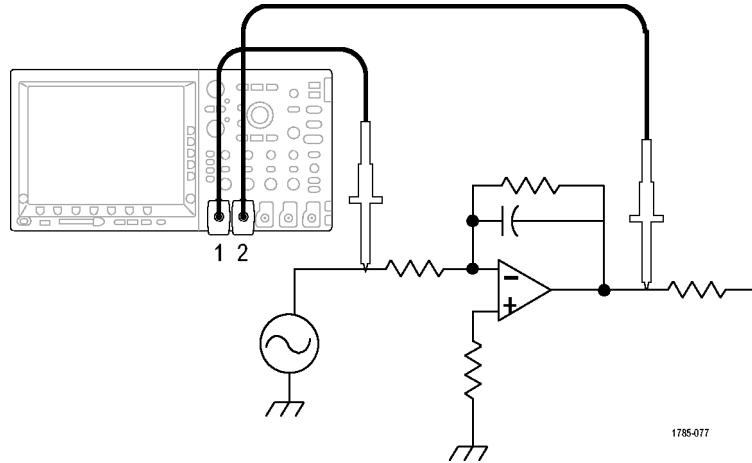

To display the signals connected to channels 1 and 2:

1. Push channel 1 and channel 2 to activate both channels.

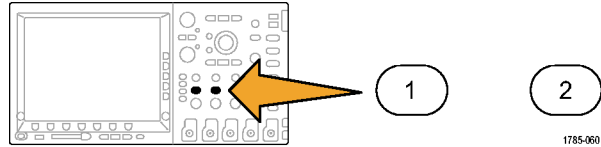

2. Push **Autoset**.

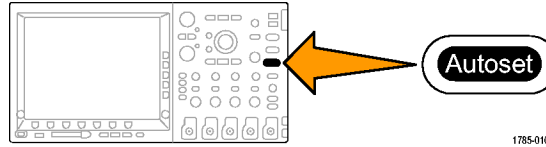

To select measurements for the two channels:

1. Push **Measure** to see the measurement menu.

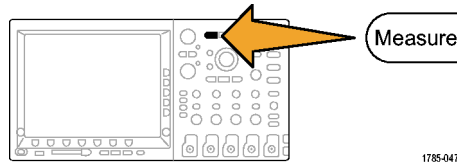

2. Push **Select Measurement**.

Select Measurement a 1	Remove Measurement	Gating Off	Statistics Off	Reference Levels	Indicators	Configure Cursors
---------------------------	--------------------	------------	----------------	------------------	------------	-------------------



3. Turn multipurpose knob **a** to select channel 1.

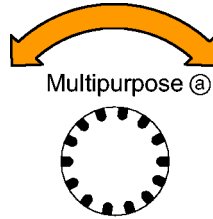

1785-039

4. Page through the measurement menus until you find **Amplitude**. Select **Amplitude**.



5. Turn multipurpose knob **a** to select channel 2.

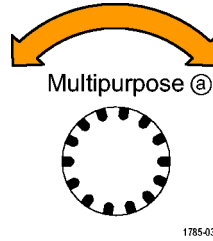

6. Select **Amplitude**.

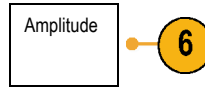

7. Calculate the amplifier gain using the following equations:

$$\text{Gain} = (\text{output amplitude} \div \text{input amplitude}) = (3.155 \text{ V} \div 130.0 \text{ mV}) = 24.27$$

$$\text{Gain (dB)} = 20 \times \log(24.27) = 27.7 \text{ dB}$$

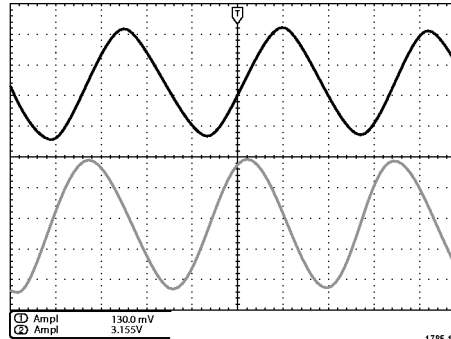

Customizing Your Measurements

In this example, you want to verify that the incoming signal to digital equipment meets its specifications. Specifically, the transition time from a low logic level (0.8 V) to a high logic level (2.0 V) must be 10 ns or less.

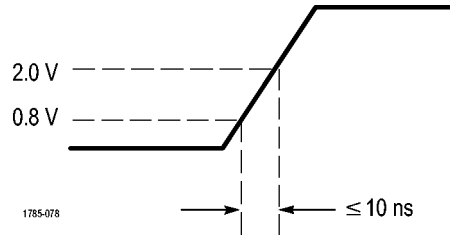

To select the rise time measurement.

1. Push **Measure**.

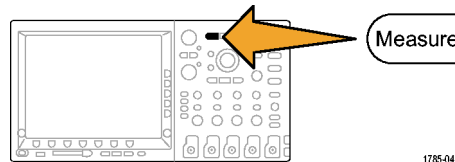

2. Push **Select Measurement**.

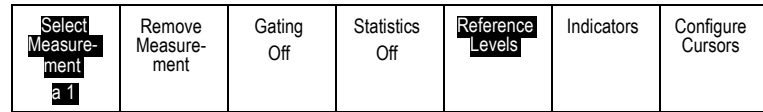

3. Turn multipurpose knob **a** to select channel 1. This step is only needed if you are acquiring data on more channels than just channel 1.

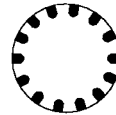

1785-039

4. Select the **Rise Time** measurement from the side-bezel menu.



5. Press **Reference Levels**.

6. Push **Set Levels in** to select **units**.

7. Push **High Ref** and turn multipurpose knob **a** to enter 2.00 V. If needed, push **Fine** to change the sensitivity of the multipurpose knob.

8. Push **Low Ref** and turn multipurpose knob **a** to enter 800 mV. If needed, push **Fine** to change the sensitivity of the multipurpose knob.

Reference Levels
Set Levels in % units
High Ref a 2.00 V
Mid Ref
Low Ref a 800 mV

Rise time is typically measured between the 10% and 90% amplitude levels of a signal. These are the default reference levels that the oscilloscope uses for rise time measurements. However, in this example, you need to measure the time that the signal takes to pass between the 0.8 V and 2.0 V levels.

You can customize the rise time measurement to measure the signal transition time between any two reference levels. You can set each of these reference levels to a specific percent of the signal amplitude or to a specific level in vertical units (such as volts or amperes).

Measuring Specific Events. Next you want to see the pulses in the incoming digital signal, but the pulse widths vary so it is hard to establish a stable trigger. To look at a snapshot of the digital signal, do this step:

1. Push **Single** to capture a single acquisition.

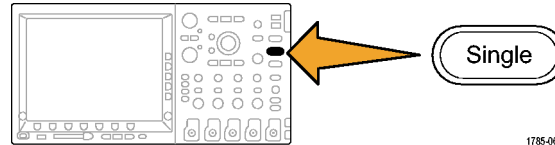

Now you want to measure the width of each displayed pulse. You can use measurement gating to select a specific pulse to measure. To measure the second pulse:

1. Push **Measure**.

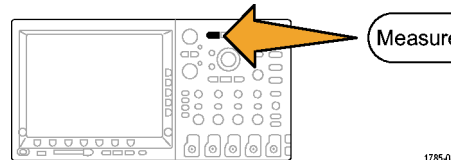

2. Push **Select Measurement**.

Select measurement a 1	Remove Measurement	Gating	Statistics	Reference Levels	Indicators	Configure Cursors
---------------------------	--------------------	--------	------------	------------------	------------	-------------------



3. Turn multipurpose knob **a** to select channel 1.



Multipurpose (a)



1785-039

4. Select **Positive Pulse Width** measurement.

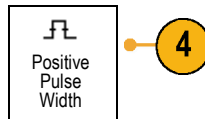

5. Push **Gating**.

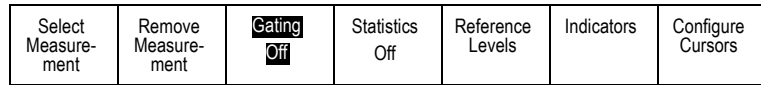

6. Select **Between Cursors** from the side-bezel menu to choose measurement gating using cursors.

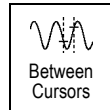

7. Place one cursor to the left and one cursor to the right of the second pulse.

8. View the resulting width measurement (160 ms) for the second pulse.

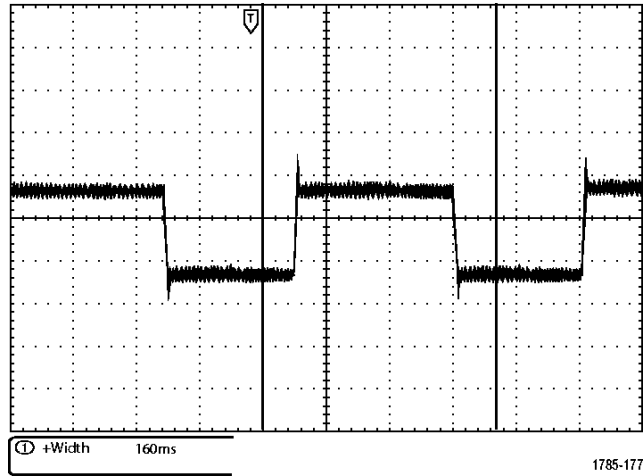

Analyzing Signal Detail

In this example, you have a noisy signal displayed on the oscilloscope, and you need to know more about it. You suspect that the signal contains much more detail than you can currently see in the display.

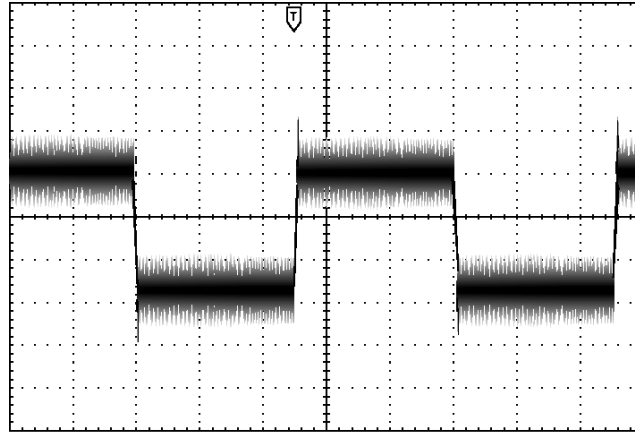

1785-175

Looking at a Noisy Signal

The signal appears noisy. You suspect that noise is causing problems in your circuit. To better analyze the noise:

1. Push **Acquire**.

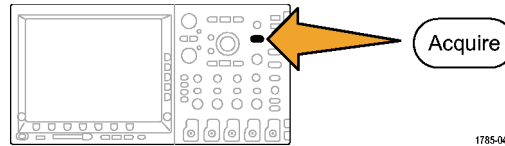

1785-046

2. Push **Mode** on the lower-bezel menu.

Mode	Record Length 10k	Reset Horizontal Position	Waveform Display			
------	----------------------	---------------------------------	---------------------	--	--	--



3. Push **Peak Detect** on the side-bezel menu.

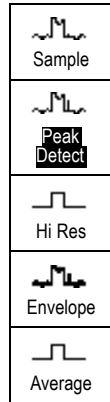

4. Push **Intensity** and turn multipurpose knob **a** to see the noise more easily.

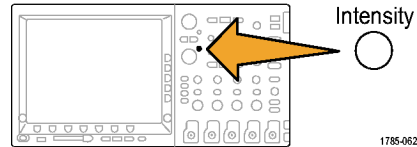

5. View the results on the display. Peak detect emphasizes noise spikes and glitches in your signal as narrow as 1 ns, even when the time base is set to a slow setting.

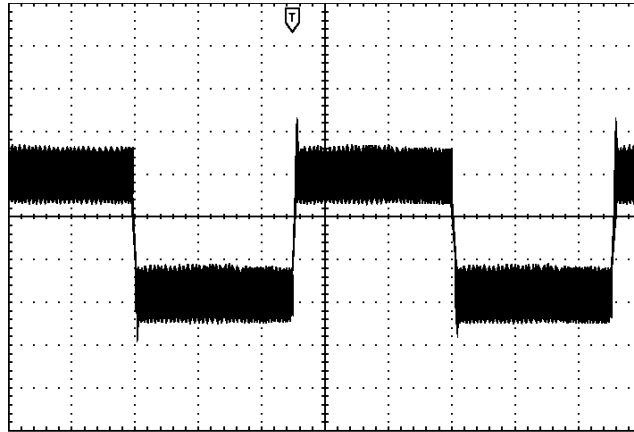

1785-174

Peak-detect and the other acquisition modes are explained earlier in this manual. (See page 75, *Acquisition Concepts*.)

Separating the Signal from Noise

Now you want to analyze the signal shape and ignore the noise. To reduce random noise in the oscilloscope display:

1. Push **Acquire**.

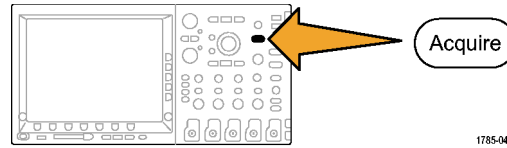

2. Push **Mode**.



3. Push **Average** on the side-bezel menu.



Averaging reduces random noise and makes it easier to see detail in a signal. In the example to the right, a ring shows on the rising and falling edges of the signal when the noise is removed.

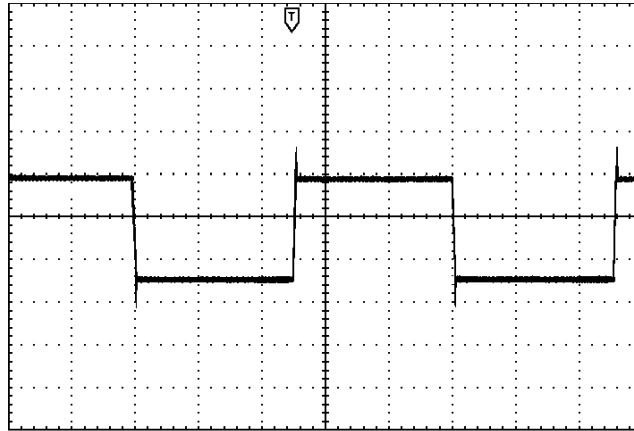

1785-176

Taking Cursor Measurements

You can use the cursors to take quick measurements on a waveform. To measure the ring frequency at the rising edge of the signal:

1. Push channel 1 to select the channel 1 signal.

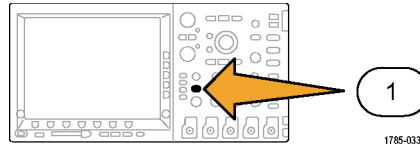

2. Push **Measure**.

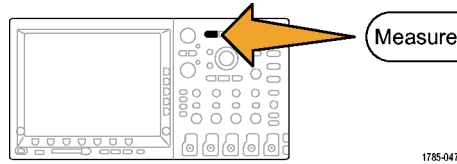

3. Push **Configure Cursors**.

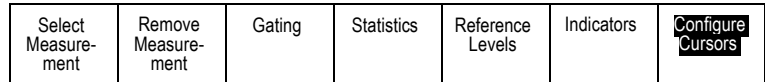

4. Push **Vertical Bar Units** repeatedly to select **Hz (1/s)**.



5. Push **Cursors** repeatedly until the two vertical bar cursors appear on the selected waveform.

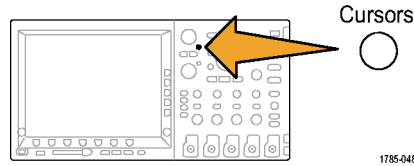

6. Place one cursor on the first peak of the ring using multipurpose knob **a**.

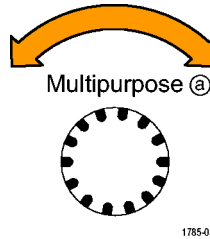

7. If the cursor readout says that the cursors are linked, push **Select** to unlink them.

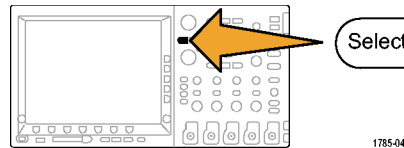

8. Place the other cursor on the next peak of the ring using multipurpose knob **b**.

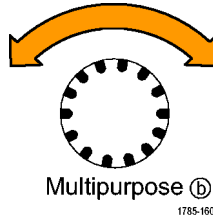

9. The cursor Δ readout shows the measured ring frequency is 227 kHz.

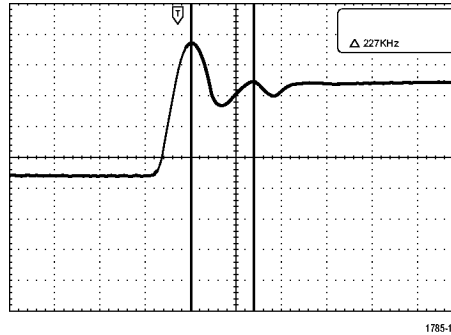

Triggering on a Video Signal

The DPO4000 Series of oscilloscopes supports triggering on NTSC, SECAM, and PAL signals.

In this example, you are testing the video circuit in a piece of medical equipment and need to display the video output signal. The video output is an NTSC standard signal. Use the video signal to obtain a stable display.

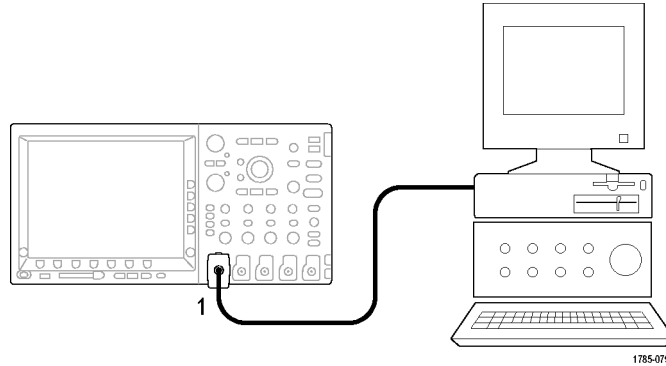

To trigger on the video fields:

1. Push **Trigger Menu**.

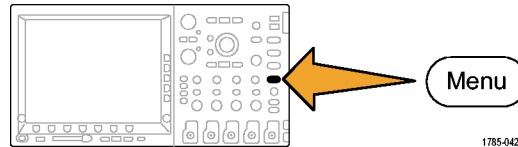

2. Push **Type** repeatedly to select **Video**.

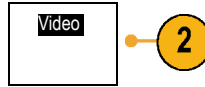

3. Push **Standard** repeatedly to select **525/NTSC**.

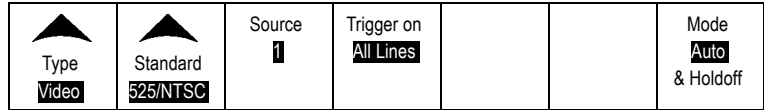

4. Push **Trigger On**.



5. Select **Odd Fields**.

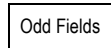

If the signal had been noninterlaced, you could choose to trigger on **All Fields**.

6. Turn the **Horizontal Scale** knob to see a complete field across the screen.

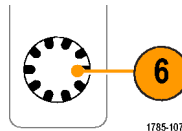

7. View results.

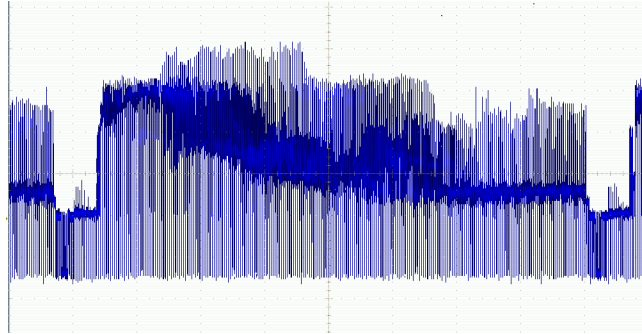

Triggering on Lines

Triggering on Lines. To look at the video lines in the field:

1. Push **Trigger Menu**.

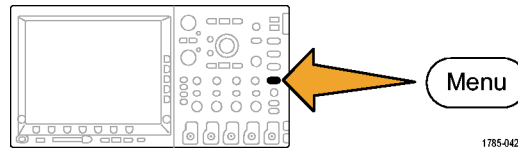

2. Push **Type** repeatedly to select **Video**.

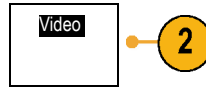

3. Push **Trigger On**.

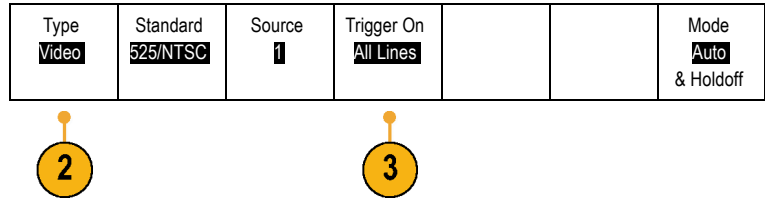

4. Select **All Lines**.



5. Adjust **Horizontal Scale** to see a complete video line across the screen.

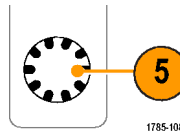

1785-108

6. Observe the results.

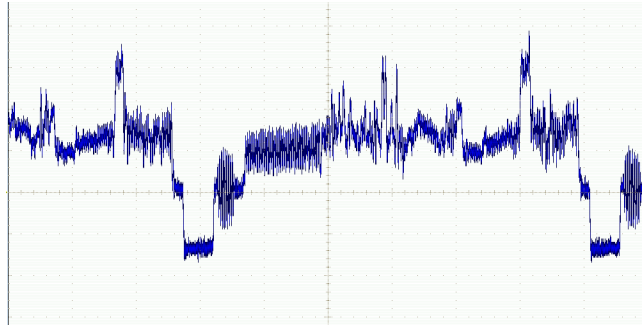

Capturing a Single-Shot Signal

In this example, the reliability of a reed relay in a piece of equipment has been poor, and you need to investigate the problem. You suspect that the relay contacts arc when the relay opens. The fastest you can open and close the relay is about once per minute, so you need to capture the voltage across the relay as a single-shot acquisition.

To set up for a single-shot acquisition:

1. Adjust the **Vertical Scale** and **Horizontal Scale** to appropriate ranges for the signal you expect to see.

2. Push **Acquire**.

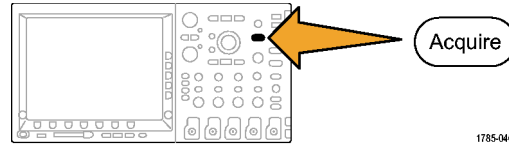

1785-046

3. Push **Mode**.
4. Select **Sample**.
5. Push **Trigger Menu**.

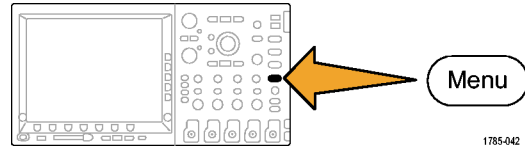

1785-042

6. Push **Slope** and .
7. Turn the **Trigger Level** knob to adjust the trigger level to a voltage midway between the open and closed voltages of the replay.

8. Push **Single** (single sequence).

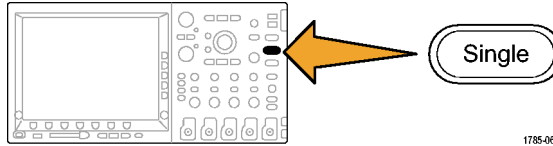

1785-061

When the relay opens, the oscilloscope triggers and captures the event.

The **Single** sequence button disables auto triggering so that only a valid triggered signal is acquired.

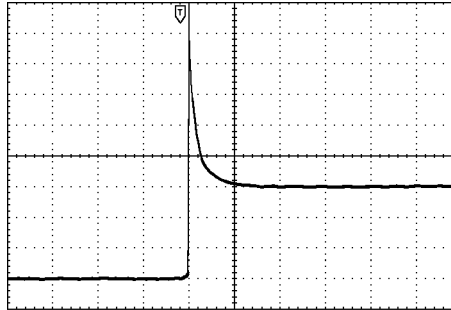

1785-171

Optimizing the Acquisition

The initial acquisition shows the relay contact beginning to open at the trigger point. This is followed by large spikes that indicate contact bounce and inductance in the circuit. The inductance can cause contact arcing and premature relay failure.

Before you take the next acquisition, you can adjust the vertical and horizontal controls to give you a preview of how the next acquisition might appear. As you adjust these controls, the current acquisition is repositioned, expanded, or compressed. This preview is useful to optimize the settings before the next single-shot event is captured.

When the next acquisition is captured with the new vertical and horizontal settings, you can see more detail about the relay contact opening. You can now see that the contact bounces several times as it opens.

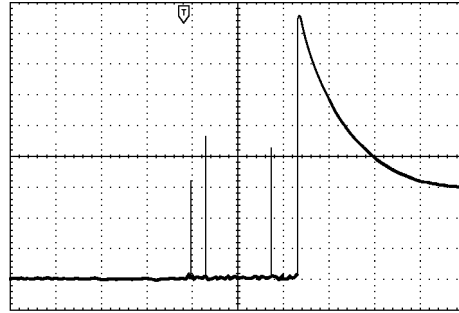

1785-173

Using the Horizontal Zoom Function

To take a close look at a particular point on the acquired waveform, use the horizontal zoom function. To look closely at the point where the relay contact first begins to open:

1. Turn the **Zoom** knob.

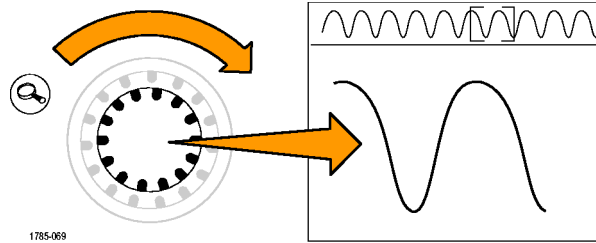

2. Turn the **Pan** knob to place the center of the zoom box close to where the relay contact begins to open.
3. Turn the **Zoom** knob to magnify the waveform in the zoom window.

The ragged waveform and the inductive load in the circuit suggest that the relay contact may be arcing as it opens.

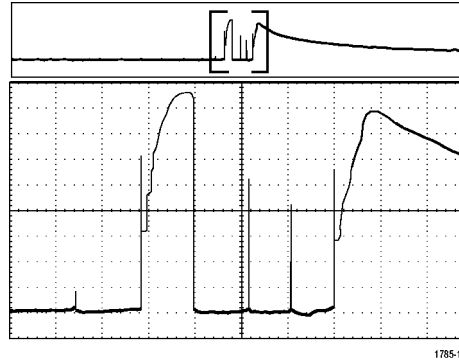

The zoom function works equally well when the acquisition is running or is stopped. Horizontal position and scale changes affect only the display, not the next acquisition.

Correlating Data With a TLA5000 Logic Analyzer

To troubleshoot designs with fast clock edges and data rates, it helps to view analog characteristics of digital signals in relation to complex digital events in the circuit. You can do that with iView, which lets you transfer analog waveforms from the oscilloscope to the logic analyzer display. You can then view time-correlated analog and digital signals side-by-side and use this to pinpoint sources of glitches and other problems.

The iView External Oscilloscope Cable allows you to connect your logic analyzer to a Tektronix oscilloscope. This enables communication between the two instruments. The Add External Oscilloscope wizard, which is available from the TLA application System menu, guides you through the process of connecting the iView cable between your logic analyzer and oscilloscope.

The TLA also provides a setup window to assist you in verifying, changing, and testing the oscilloscope settings. Before acquiring and displaying a waveform you must establish a connection between your Tektronix logic analyzer and oscilloscope using the Add External Oscilloscope wizard.

To do this:

1. Select **Add iView External Oscilloscope**
... from the logic analyzer System menu.

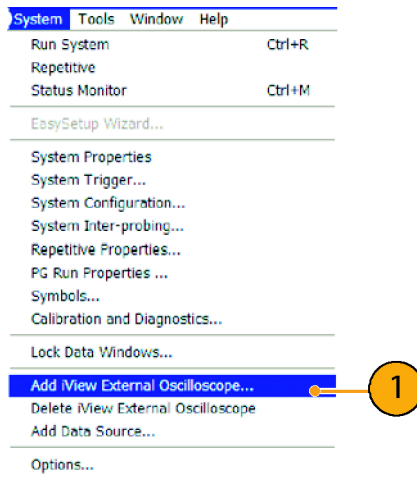

2. Select your model of oscilloscope.
3. Follow the on-screen instructions, and then click **Next**.
4. See your Tektronix Logic Analyzer documentation for more information on correlating data between a DPO4000 Series Oscilloscope and a Tektronix Logic Analyzer.

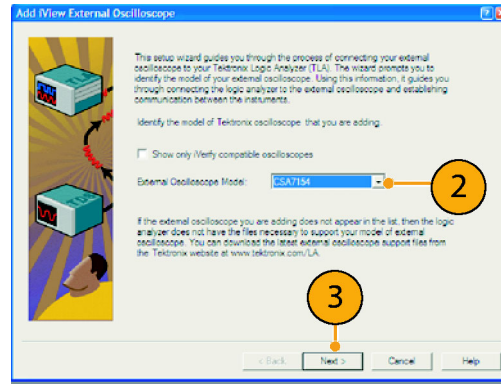

Tracking Down Bus Anomalies

In this example, you are testing your new I²C circuit. Something is not working. You tell the master IC to send a message to the slave IC. Then you expect to receive data back and an LED to light. The light never goes on. Where in the ten or so commands that were sent out did the problem occur? Once you locate the problem location, how do you determine what went wrong?

You can use your DPO4000 Series oscilloscope, with its serial triggering and long-record length management features, to track down the problem in both the physical layer and in the protocol layer of the bus.

Basic strategy

First, you will display and acquire the bus signal by setting up the bus parameters and trigger. Then, you will search through each packet with the search/mark functions.

NOTE. *Triggering on bus signals requires use of the DPO4EMBD or the DPO4AUTO Serial Triggering and Analysis Module.*

1. Connect the channel 1 probe to the clock line.
2. Connect the channel 2 probe to the data line.

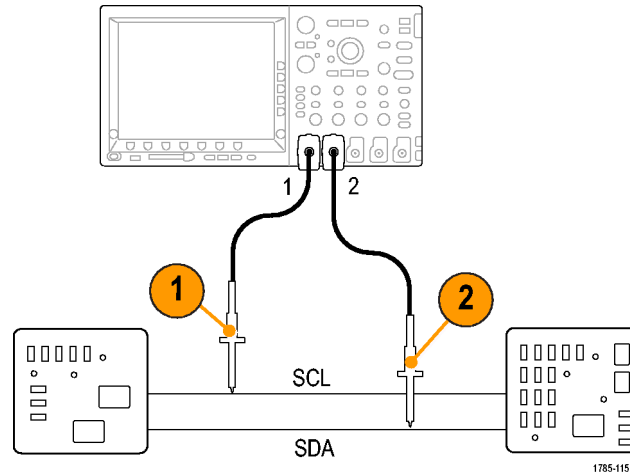

3. Push **Autoset**.

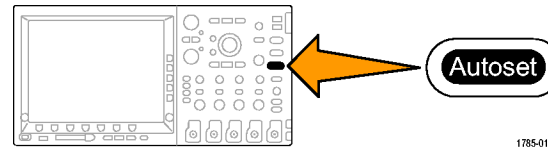

4. Push the **B1** button and enter the parameters of your I²C bus in the resulting screen menus.

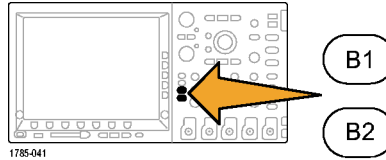

5. Push Trigger **Menu**.

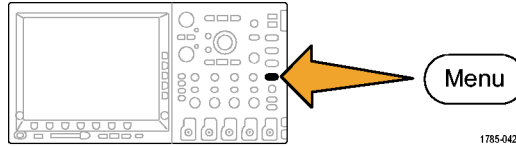

6. Push **Type** to select **Bus**. Enter trigger parameters in the resulting screen menus.

▲ Type Bus	▲ Source Bus B1 (I2C)	▲ Trigger On Address	Address 07F		Direction Read	Mode Auto & Holdoff
-------------------------	------------------------------------	-----------------------------------	-----------------------	--	--------------------------	----------------------------------



7. Analyze the physical layer. For example, you can use the cursors for manual measurements. (See page 144, *Taking Manual Measurements with Cursors.*) You can also use the automated measurements. (See page 129, *Taking Automatic Measurements.*)

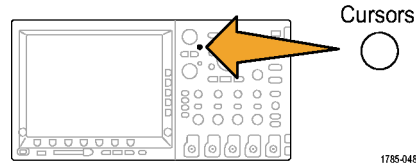

8. Push **Search**. Set **Search Marks** to **On**. Enter a search type, source, and other parameters as relevant on the lower-bezel menu and associated side-bezel menus. (See page 163, *Managing Long Record Length Waveforms.*)

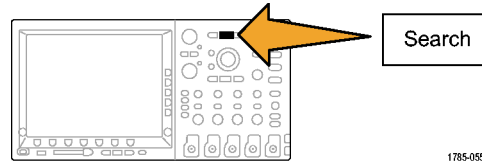

9. Jump ahead to the next search point by pushing the right arrow key. Push it again and again until you see all the events. Jump back with the left arrow key. Do you have all the packets that you expected to have? If not, at least you have narrowed your search down to the last packet sent.



10. Analyze the decoded packets in the protocol layer. Did you send the data bytes in the correct order? Did you use the correct address?

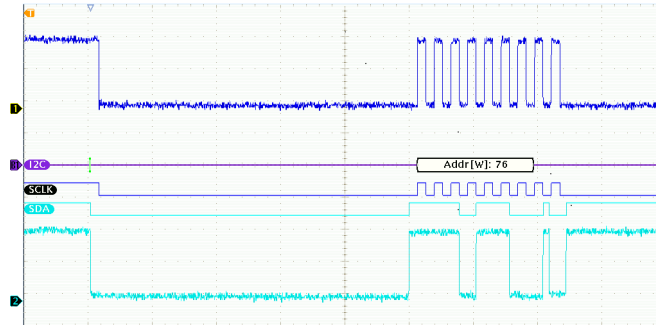

Index

Symbols and Numbers

50 Ω protection, 128

A

Accessories, 1

Acquire button, 49, 80, 112, 218, 221

Acquisition

input channels and digitizers, 75

modes defined, 78

readout, 60

sampling, 75

Adapter

TEK-USB-488, 4

TPA-BNC, 4, 10

Adding waveform, 112

Advanced math, 157

Altitude

DPO4000, 7

P6139A, 8

Analysis and Connectivity, xii

Application module

DPO4AUTO, 84

DPO4EMBD, 84

Application Module, xiii, 19

Applications modules, 200

Attenuation, 127

Auto trigger mode, 92

Autoset, 74, 202

Autoset button, 17, 49, 56, 71, 74,
202, 207

Autoset undo, 74

Auxiliary readout, 64

Average acquisition mode, 79

B

B Trigger, 109

B1 / B2 button, 51, 84, 85, 102

Backlight intensity, 119

Bandwidth, x

Before Installation, 1

Blackman-Harris FFT window, 157

BNC interface, 10

Bus

button, 84, 85, 102

menu, 51, 85

Bus trigger, defined, 102

Buses, 84, 102

Button

Acquire, 49, 80, 112, 218, 221

Autoset, 17, 49, 56, 71, 74, 202,
207

B1 / B2, 51, 84, 85, 102

bus, 84, 85, 102

Channel, 50

Cursors, 52, 144, 224

Default Setup, 50, 58, 73

Fine, 48, 52, 53, 54, 55, 57

Force Trig, 56, 93

hard copy, 57, 196

Intensity, 115

M, 51, 150, 153

Math, 51, 150, 153

Measure, 49, 129, 139, 140,
203, 207, 210, 213

Menu Off, 58, 204

Next, 55

play-pause, 167

Play-pause, 54

Previous, 54

printer icon, 57, 196

Ref, 51, 160, 182

- Run/Stop, 56, 83, 111
- Save / Recall, 50, 58, 174
- Search, 49, 170
- Select, 53, 224
- Set / Clear Mark, 55, 169
- Set to 50%, 56, 97
- Single, 56, 111, 213, 232
- Test, 49
- Trigger, 49
- Trigger level, 56
- Trigger menu, 226
- Trigger Menu, 98
- Utility, 20, 23, 26, 50, 117, 118, 189
- Vertical, 50
- Zoom, 54

C

- Calibration, 25, 27
- Calibration certificate, 2
- CAN, 51, 84, 102
- Channel button, 50
- Channel readout, 64
- Clearance, DPO4000, 6
- Communications, 35, 40
- CompactFlash, x, 2, 5, 50, 58, 174

- Compensate probe, 17
- Compensate signal path, 25
- Confidential data, 196
- Connectivity, 2, 35, 40
- Connector, side-panel, 67
- Connectors
 - front-panel, 66
 - rear-panel, 68
- Controls, 45
- Coupling, trigger, 94
- Cover, front, 2
- Cross Hair graticule style, 118
- Cursor readout, 62, 149
- Cursor, measurements, 144
- Cursors, 144
 - button, 52, 144, 224
 - linking, 145
- Cursors menu, 144

D

- Date and time, changing, 23
- Default setup, 187
- Default Setup, 73
 - button, 50, 58, 73
 - menu, 50
- Undo, 73

- Delayed trigger, 107
- Depth, DPO4000, 6
- Deskew, 127
- Display
 - persistence, 112
 - style, 112
- Displaying, reference waveforms, 182
- Documentation, xii
- DPO4AUTO, 84
- DPO4EMBD, 84
- Drivers, 35, 39
- Dual waveform math, 150

E

- e*Scope, 40
- Edge trigger, defined, 99
- Envelope acquisition mode, 79
- Erase setup and ref memory, 196
- Ethernet, x, 37, 40, 41
 - port, 68
 - printing, 192
- Event Table, 88, 89
- Excel, 34
- Expansion point icon, 61

F

- Factory calibration, 27
- FFT
 - Blackman-Harris, 157
 - controls, 153
 - Hamming, 156
 - Hanning, 157
 - Rectangular, 156
- File format, 175
 - Internal File Format (ISF), 182
 - Spreadsheet file format (.CSV), 182
- File system, 174, 177, 180
- Fine, 53
- Fine button, 48, 52, 54, 55, 57
- Firmware upgrade, 28
- Force Trig button, 56, 93
- Frame graticule style, 118
- Frequency, Input power
 - DPO4000, 6
- Front cover, 2
- Front panel, 45
- Front-panel connectors, 66
- Front-panel overlay, 22
- Full graticule style, 118
- Functional check, 15

G

- Gating, 137
- GPIO, 36, 38, 68
- GPIO address, 38
- Graticule
 - Cross Hair, 118
 - Frame, 118
 - Full, 118
 - Grid, 118
 - intensity, 115
 - styles, 117
- Grid graticule style, 118
- Ground, 11
- Ground lead, 19
- Ground strap, 67

H

- Hamming FFT window, 156
- Hanning FFT window, 157
- Hard copy, 57, 189
- Height, DPO4000, 6
- Hi Res acquisition mode, 79
- Holdoff, trigger, 93
- Horizontal delay, 94

- Horizontal position, 55, 94, 95, 120, 156, 234, 235
 - and math waveforms, 152
 - defined, 72

- Horizontal position/scale readout, 64
- Horizontal scale, 55, 120, 156, 227, 229, 230, 234
 - and math waveforms, 152
 - defined, 72

- How to
 - erase memory, 196
 - print a hard copy, 189
 - recall setups, 184
 - recall waveforms, 174
 - save screen images, 174
 - save setups, 184
 - save waveforms, 174

Humidity

- DPO4000, 7
- P6139A, 9

I

- I2C, 51, 84, 102

Icon

- Expansion point, 61
 - Trigger level, 63
 - Trigger position, 61
- Image orientation, 175, 191
- Impedance, 123
- Indicator, waveform baseline, 65
- Infinite persistence, 115
- Ink Saver, 175, 191
- Inner knob, 54, 152
- Installing, application modules, xiii
- Intensity button, 115
- Internal File Format, 182

K**Knob**

- inner, 54, 152
- Multipurpose, 24, 48, 53, 54, 80, 86, 177, 224, 225
- outer, 54
- pan, 54, 166, 169
- Trigger level, 97
- Vertical position, 57, 72
- Vertical scale, 57, 72
- zoom, 54, 152, 164

L

- LabView, 34
- Landscape, 175, 191
- Language
- change, 20
 - overlay, 22
- Level, trigger, 96
- Logic trigger, defined, 100
- Long record length, 238
- Long record length management, 163

M

- M button, 51, 150, 153
- Main trigger, 107
- Mark, 169
- Math
- Advanced, 157
 - button, 51, 150, 153
 - Dual waveform, 150
 - FFT, 153
 - menu, 51
 - waveforms, 150
- Measure button, 49, 129, 139, 140, 203, 207, 210, 213
- Measurement menu, 49

Measurements

- automatic, 129
- cursor, 144
- defined, 131
- reference levels, 142
- snapshot, 140
- statistics, 139

Memory, erasure of, 196**Menu**

- Bus, 51, 85
- Cursors, 144
- Default Setup, 50
- Math, 51
- Measurement, 49
- Reference, 51, 160, 161
- Save / Recall, 50, 58, 174
- Trigger, 49, 98, 108, 226
- Utility, 20, 23, 50, 57, 117, 189
- Vertical, 50, 122

Menu buttons, 49**Menu Off button, 58, 204****Menus, 45****Mode, roll, 83****Multipurpose knob, 48, 53, 54, 80, 86, 177, 224, 225**

N

Network printing, 192
Next button, 55
Normal trigger mode, 92

O

Offset and position, 128
OpenChoice, 2, 35
Operating specifications, 6
Orientation of the image, 175, 191
Outer knob, 54
Overlay, 22

P

Pan, 164, 166
 knob, 54, 166, 169
Pause, 166
Peak detect acquisition mode, 79
Performance verification, xii
Persistence
 display, 112
 infinite, 115
 variable, 115
Play, 166
Play-pause button, 54, 167

Play-pause mode, 167
Pollution Degree
 DPO4000, 7
 P6139A, 9
Portrait, 175, 191
Position
 Horizontal, 94, 95, 120, 156,
 234, 235
 Vertical, 121
Position and offset, 128
Posttrigger, 91, 96
Power
 cord, 3
 input, 69
 off, 14
 removing, 14
 supply, 11
 switch, 57
Power consumption, DPO4000, 6
Predefined math expressions, 150
Pretrigger, 91, 96
Previous button, 54
Print, 57, 189
Printing a hard copy, 189
Printing, Ethernet, 192
Probe Comp, 16
Probe compensation, 17

Probes

BNC, 10
 connecting, 10
 ground lead, 19
 TEK-USB-488 Adapter, 4
 TekVPI, 10
 TPA-BNC Adapter, 4, 10
Programmer Commands, xii
Pulse/Width trigger, defined, 100

R

Rackmount, 4
Readout
 Acquisition, 60
 Auxiliary, 64
 Channel, 64
 Cursor, 62, 149
 Horizontal position/scale, 64
 Record length/sampling rate, 63
 Trigger, 63, 107
 Trigger status, 62
Rear-panel connectors, 68
Recalling
 setups, 184
 waveforms, 174
Record length, x

- Record length/sampling rate
 - readout, 63
- Rectangular FFT window, 156
- Ref button, 51, 160
- Ref R, 182
- Reference button, 182
- Reference levels, 142
- Reference menu, 51, 160, 161
- Reference waveforms, 160
 - displaying, 182
 - removing, 161, 183
 - saving, 182
 - saving 10M waveforms, 162
- Related documents, xii
- Removing
 - reference waveforms, 183
- Removing reference waveforms, 161
- Removing waveform, 112
- Rise/Fall trigger, defined, 101
- Roll mode, 83
- Run/Stop button, 56, 83, 111
- Runt trigger, defined, 100

S

- Safety Summary, v
- Sample acquisition mode, 78

- Sample rates, x
- Sampling process, defined, 75
- Sampling, real-time, 76
- Save / Recall menu, 50, 58, 174
- Save / Recall Menu button, 50
- Save / Recall Save button, 58, 174
- Saving
 - reference waveforms, 182
 - screen images, 174
 - waveforms, 174
- Saving and recalling Information, 174
- Saving setups, 184
- Scale
 - Horizontal, 55, 120, 156, 227, 229, 230, 234
 - Vertical, 121, 230
- Search, 169
- Search / Mark, 238
- Search button, 49, 170
- Securing DPO4000 memory, 196
- Select button, 53, 224
- Sequential triggering, 107
- Serial, 84, 102, 238
- Service information, xiii
- Set / Clear Mark button, 55, 169
- Set to 50% button, 56, 97

- Setup
 - default, 58, 187
 - Default, 73
- Setup and Hold trigger, defined, 101
- Side panel connector, 67
- Signal path compensation, 25
- Single button, 56, 111, 213, 232
- Single sequence, 83, 111
- Slope, trigger, 96
- Snapshot, 140
- Software drivers, 35, 39
- Software, optional, 200
- SPC, 25
- Specifications, xii
 - operating, 6
 - power supply, 11
- SPI, 51, 84, 102
- Spreadsheet file format (.CSV), 182
- Start an acquisition, 111
- Statistics, 139
- Stop an acquisition, 111
- Switch, power, 57

T

- Table, Event, 88, 89
- TDSPCS1, 35

- TEK-USB-488 Adapter, 36, 38, 68
- TEK-USB-488 Adapter, 4
- TekSecure, 196
- TekVPI, 10
- Temperature
 - DPO4000, 6
 - P6139A, 8
- Termination, 123
- Test button, 49
- TPA-BNC Adapter, 4, 10
- Transit case, 4
- Transition trigger, defined, 101
- Trigger
 - concepts, 91
 - coupling, 94
 - delayed, 107
 - event, defined, 91
 - forcing, 92
 - holdoff, 93
 - level, 96
 - modes, 92, 98
 - posttrigger, 91, 96
 - pretrigger, 91, 96
 - readout, 107
 - sequential, 107
 - Serial, 84, 102, 238
 - slope, 96

- Trigger level
 - button, 56
 - icon, 63
 - knob, 97
- Trigger menu, 49, 98, 108, 226
- Trigger menu button, 226
- Trigger Menu button, 98
- Trigger modes
 - Auto, 92
 - Normal, 92
- Trigger position icon, 61
- Trigger readout, 63
- Trigger status
 - readout, 62
- Trigger types, defined, 99

U

- Undo
 - Autoset, 74
 - Default Setup, 73
- Upgrading firmware, 28
- USB, x, 5, 36, 39, 50, 58, 69, 174, 189
 - port, 68
- USBTMC, 68
- User marks, 169

- Utility button, 20, 23, 26, 50, 117, 118, 189
- Utility menu, 20, 23, 50, 57, 117

V

- Variable persistence, 115
- Versatile Probe Interface, 10
- Vertical
 - button, 50
 - menu, 50, 122
 - Position, 121
 - position and autoset, 75
 - position and offset, 128
 - Position knob, 57, 72
 - Scale, 121, 230
 - Scale knob, 57, 72
- Vibration, DPO4000, 7
- Video
 - lines, 228
 - port, 68
- Video trigger, defined, 101
- View
 - waveform record, 61
- Voltage, Input
 - DPO4000, 6
 - P6139A, 8

Voltage, Output, P6139A, 8

W

Waveform

- adding, 112
 - display style, 112
 - intensity, 115
 - pan, 164, 166
 - pause, 166
 - play, 166
 - play-pause, 167
 - record defined, 77
 - removing, 112
 - search and mark, 169
 - user marks, 169
 - zoom, 164
- Waveform baseline indicator, 65

Waveform record, 77

Waveform record view, 61

Weight

DPO4000, 6

Width

DPO4000, 6

Z

Zoom, 164

button, 54

graticule size, 166

Horizontal, 234

knob, 54, 164