

# Mixed Signal Oscilloscopes

## MSO2000B Series, DPO2000B Series Datasheet

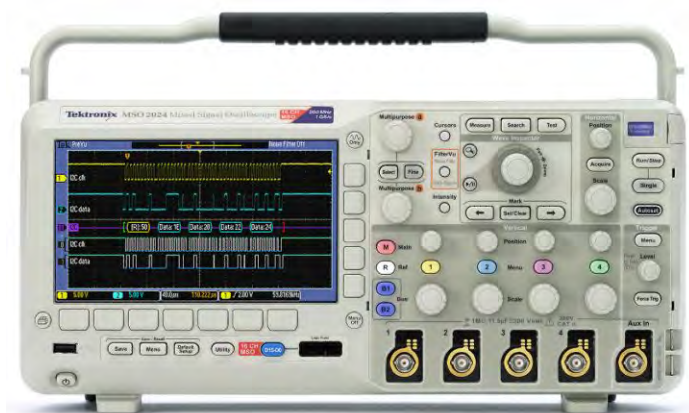

Offering up to 200 MHz bandwidth and 1 GS/s sample rate, the MSO/DPO2000B Mixed Signal Oscilloscope Series from Tektronix delivers advanced debug features at an entry-level price. Quickly find and diagnose problems in complex designs with up to 20 channels for analyzing analog and digital signals. With a deep record length of 1 Mpoints standard on all channels, the MSO/DPO2000B lets you capture long windows of signal activity while maintaining fine timing resolution.

### Key performance specifications

- 200, 100, 70 MHz bandwidth models
- 2 and 4 analog channel models
- 16 digital channels (MSO series)
- 1 GS/s sample rate on all channels
- 1 megapoint record length on all channels
- 5,000 wfms maximum waveform capture rate
- Suite of advanced triggers

### Key features

- Wave Inspector<sup>®</sup> controls provide easy navigation and automated search of waveform data
- FilterVu<sup>™</sup> variable low-pass filter allows for removal of unwanted signal noise while still capturing high-frequency events
- 29 automated measurements, and FFT analysis for simplified waveform analysis
- TekVPI<sup>®</sup> probe interface supports active, differential, and current probes for automatic scaling and units
- 7 in. (180 mm) wide-screen TFT-LCD color display
- Small footprint and lightweight - only 5.3 in. (134 mm) deep and 7 lb. 14 oz. (3.6 kg)
- Five-year warranty

### Connectivity

- USB 2.0 host port on the front panel for quick and easy data storage
- USB 2.0 device port on rear panel for easy connection to a PC or direct printing to a PictBridge<sup>®</sup>-compatible printer
- Optional 10/100 Ethernet port for network connection and video-out port to export the oscilloscope display to a monitor or projector

### Optional serial triggering and analysis

- Automated serial triggering, decode, and search options for I<sup>2</sup>C, SPI, CAN, LIN, and RS-232/422/485/UART

## Feature-rich tools for debugging mixed signal designs

Simplify and speed up debugging your complex design with feature-rich tools including Wave Inspector® controls for rapid waveform navigation and automated serial and parallel bus analysis.

## Comprehensive features speed every stage of debug

The MSO/DPO2000B Series offers a robust set of features to speed every stage of debugging your design - from quickly discovering an anomaly and capturing it, to searching your waveform record for the event and analyzing its characteristics and your device's behavior.

### Discover

To debug a design problem, first you must know it exists. Every design engineer spends time looking for problems in their design, a time-consuming and frustrating task without the right debug tools.

The MSO/DPO2000B Series offers complete visualization of signals, providing fast insight into the real operation of your device. A waveform capture rate of 5,000 waveforms per second enables you to see glitches and other infrequent transients quickly, revealing the true nature of device faults. A digital phosphor display with intensity grading shows the history of a signal's activity by intensifying areas of the signal that occur more frequently, providing a visual display of just how often anomalies occur.

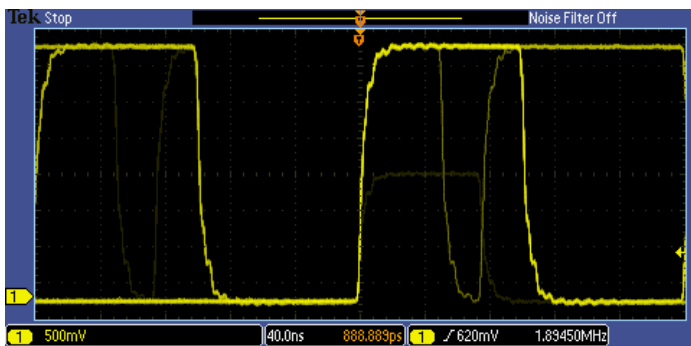

Discover - A waveform capture rate of 5,000 wfm/s maximizes the probability of capturing elusive glitches and other infrequent events.

### Capture

Discovering a device fault is only the first step. Next, you must capture the event of interest to identify root cause.

The MSO/DPO2000B Series provides a complete set of triggers - including runt, logic, pulse width/glitch, setup/hold violation, serial packet, and parallel data - to help quickly find your event. With up to a 1 Mpoint record length, you can capture many events of interest, even thousands of serial packets, in a single acquisition for further analysis while maintaining high resolution to zoom in on fine signal details.

From triggering on specific packet content to automatic decode in multiple data formats, the MSO/DPO2000B Series provides integrated support for a broad range of serial buses - I<sup>2</sup>C, SPI, CAN, LIN, and RS-232/422/485/UART. The ability to decode up to two serial and/or parallel buses simultaneously means you gain insight into system-level problems quickly.

To further help troubleshoot system-level interactions in complex embedded systems, the MSO2000B Series offers 16 digital channels in addition to its analog channels. Since the digital channels are fully integrated into the oscilloscope, you can trigger across all input channels, automatically time-correlating all analog, digital, and serial signals.

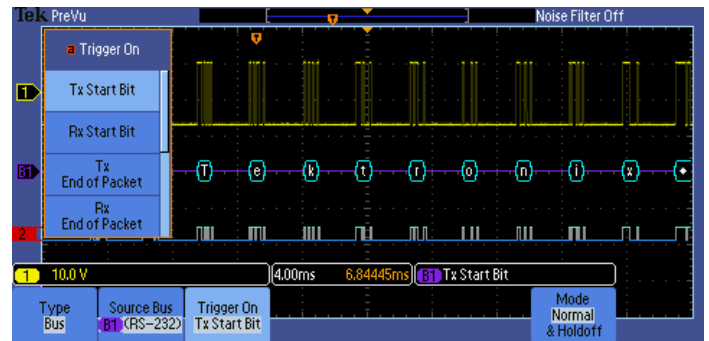

Capture - Triggering on a specific transmit data packet going across an RS-232 bus. A complete set of triggers, including triggers for specific serial packet content, ensures you quickly capture your event of interest.

### Search

Finding your event of interest in a long waveform record can be time consuming without the right search tools. With today's record lengths pushing to a million data points, locating your event can mean scrolling through thousands of screens of signal activity.

The MSO/DPO2000B Series offers the industry's most comprehensive search and waveform navigation with its innovative Wave Inspector® controls. These controls speed panning and zooming through your record. A unique force-feedback system lets you move from one end of your record to the other in just seconds. You can mark any location you may want to reference later for further investigation, and automatically search the record using criteria that you define. Wave Inspector will instantly search your entire record, including analog, digital, and serial bus data. Along the way, it will automatically mark every occurrence of your defined event so you can quickly move between events.

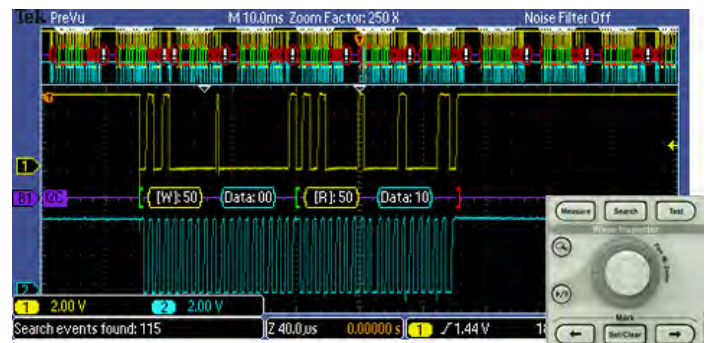

Search - I<sup>2</sup>C decode showing results from a Wave Inspector search for Address value 50. Wave Inspector controls provide unprecedented efficiency in viewing and navigating waveform data.

## Analyze

Verifying that your prototype's performance matches simulations and meets the project's design goals requires analyzing its behavior. Tasks can range from simple checks of rise times and pulse widths to sophisticated power loss analysis and investigation of noise sources.

The MSO/DPO2000B Series offers a comprehensive set of integrated analysis tools including waveform- and screen-based cursors, 29 automated measurements, and FFT analysis. Specialized application support for serial bus analysis is also available.

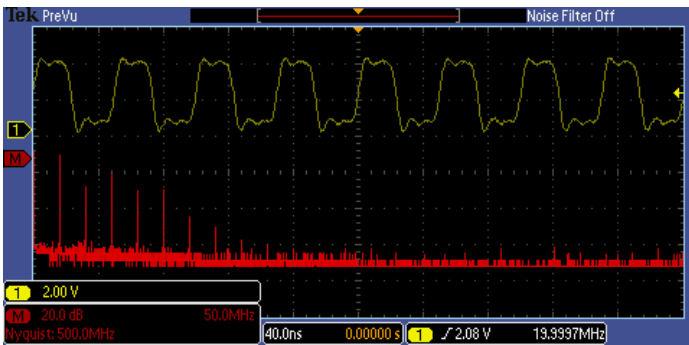

Analyze - FFT analysis of a pulsed signal. A comprehensive set of integrated analysis tools speeds verification of your design's performance.

## Wave Inspector® navigation and search

A 1 M point record length represents thousands of screens of information. The MSO/DPO2000B Series enables you to search through it all and find your event in seconds with Wave Inspector, the industry's best tool for navigation and search.

Wave Inspector offers the following innovative controls:

### Zoom/pan

A dedicated, two-tier front-panel control provides intuitive control of both zooming and panning. The inner control adjusts the zoom factor (or zoom scale); turning it clockwise activates zoom and goes to progressively higher zoom factors, while turning it counterclockwise results in lower zoom factors and eventually turning zoom off. No longer do you need to navigate through multiple menus to adjust your zoom view. The outer control pans the zoom box across the waveform to quickly get to the portion of waveform you are interested in. The outer control also utilizes force-feedback to determine how fast to pan on the waveform. The farther you turn the outer control, the faster the zoom box moves. Pan direction is changed by simply turning the control the other way.

## Play/pause

A dedicated **play/pause** front-panel button scrolls the waveform across the display automatically while you look for anomalies or an event of interest. Playback speed and direction are controlled using the intuitive pan control. Once again, turning the control further makes the waveform scroll faster and changing direction is as simple as turning the control the other way.

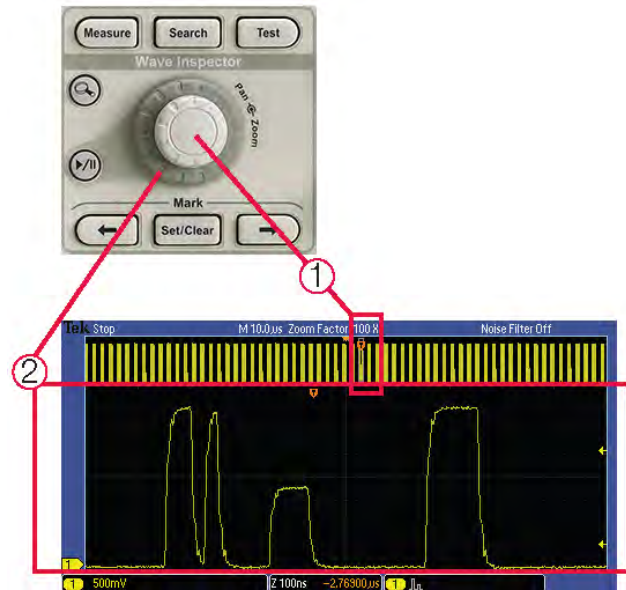

Wave Inspector controls provide unprecedented efficiency in viewing, navigating, and analyzing waveform data. Zip through your 1 Mpoint record by turning the outer pan control (1). Get from the beginning to end in seconds. See something of interest and want to see more details? Just turn the inner zoom control (2).

## User marks

Press the **Set Mark** front-panel button to place one or more marks on the waveform. Navigating between marks is as simple as pressing the **Previous** (←) and **Next** (→) buttons on the front panel.

## Search marks

The **Search** button allows you to automatically search through your long acquisition looking for user-defined events. All occurrences of the event are highlighted with search marks and are easily navigated to, using the front-panel **Previous** (←) and **Next** (→) buttons. Search types include edge, pulse width/glitch, runt, logic, setup and hold, rise/fall time parallel bus, and I<sup>2</sup>C, SPI, CAN, LIN, and RS-232/422/485/UART packet content.

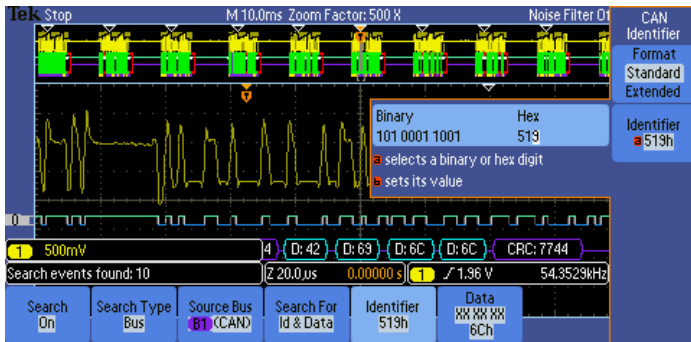

Search step 1: You define what you would like to find.

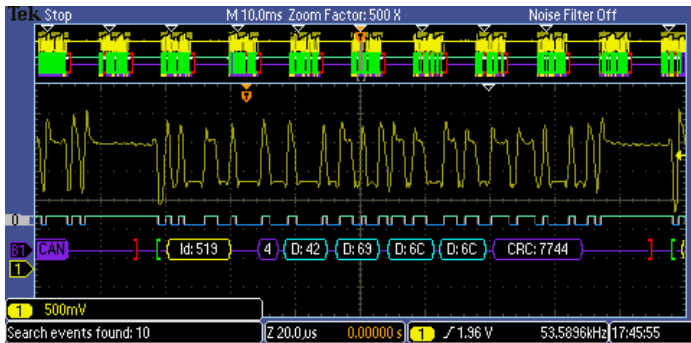

Search step 2: Wave Inspector automatically searches through the record and marks each event with a hollow white triangle. You can then use the **Previous** and **Next** buttons to jump from one event to the next.

## Digital phosphor technology

The MSO/DPO2000B Series' digital phosphor technology provides you with fast insight into the real operation of your device. Its waveform capture rate of 5,000 wfm/s gives you a high probability of quickly seeing the infrequent problems common in digital systems: runt pulses, glitches, timing issues, and more.

Waveforms are superimposed with one another and waveform points that occur more frequently are intensified. This quickly highlights the events that over time occur more often or, in the case of infrequent anomalies, occur less often.

With the MSO/DPO2000B Series, you can choose infinite persistence or variable persistence, determining how long the previous waveform acquisitions stay on-screen. This allows you to determine how often an anomaly is occurring.

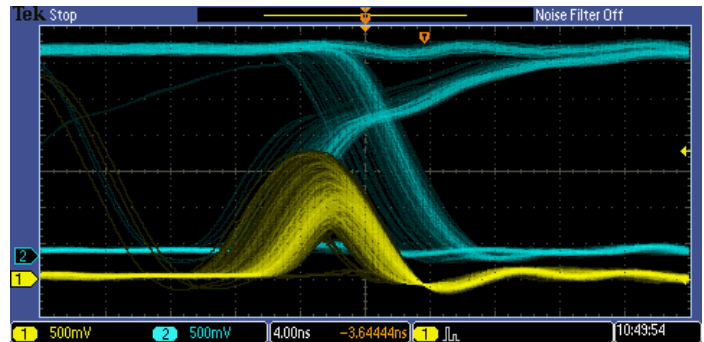

Digital phosphor technology enables a 5,000 wfm/s waveform capture rate and real-time intensity grading on the MSO/DPO2000B Series.

## Mixed signal design and analysis (MSO series)

The MSO2000B Series Mixed Signal Oscilloscopes provide 16 digital channels. These channels are tightly integrated into the oscilloscope's user interface, simplifying operation and making it possible to solve mixed-signal issues easily.

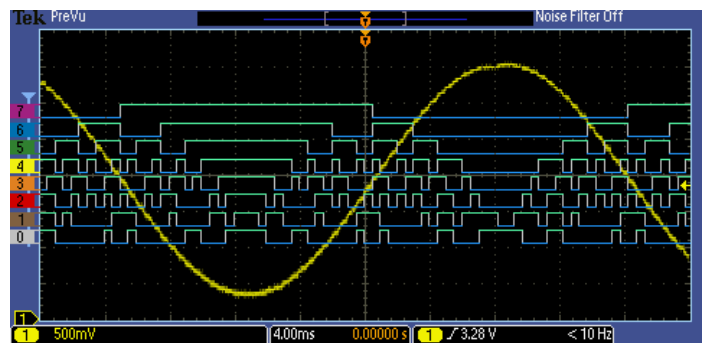

The MSO Series provides 16 integrated digital channels enabling you to view and analyze time-correlated analog and digital signals.

## Color-coded digital waveform display

The MSO2000B Series has redefined the way you view digital waveforms. One common problem shared by both logic analyzers and mixed-signal oscilloscopes is determining if data is a one or a zero when zoomed in far enough that the digital trace stays flat all the way across the display. The MSO2000B Series has color-coded digital traces, displaying ones in green and zeros in blue.



## P6316 MSO probe

This unique probe design offers two eight-channel pods, simplifying the process of connecting to the device-under-test. When connecting to square pins, the P6316 can connect directly to 8×2 square pin headers spaced on tenth-inch centers. When more attachment flexibility is required, you can use the included flying lead sets and grabbers to clip onto surface mount devices or test points. The P6316 offers outstanding electrical characteristics applying only 8 pF of capacitive loading with 101 kΩ input impedance.



The P6316 MSO probe offers two eight-channel pods to simplify connecting to your device.

## FilterVu™ variable low-pass filter

Tired of being limited to a 20 MHz bandwidth filter in your oscilloscope? Simply turn on FilterVu and adjust the variable low-pass noise filter. Unlike other variable low-pass filters, FilterVu filters out the unwanted noise from your signal while still capturing glitches and other signal details up to the full bandwidth of the oscilloscope. It does this by showing two waveforms: a waveform that can be filtered (foreground waveform) and a glitch capture waveform (background waveform).

The filtered waveform uses a variable low-pass filter to block out noise, yielding a cleaner waveform to more precisely locate signal edges and amplitude levels. The result is improved confidence in your cursor measurements and cleaner documentation of important signal attributes. When the noise filter is adjusted to the lowest available noise-cutoff frequency, no more than 1% of high-frequency content that could cause the oscilloscope to alias will pass through the filter.

The glitch capture waveform shows signal details up to the full bandwidth of the oscilloscope. The oscilloscope captures pulses as narrow as 5 ns, using peak-detect min/max sampling, protecting you from missing unexpected glitches or other high-frequency events.

FilterVu is ideal for repetitive, nonrepetitive, and single-shot events.

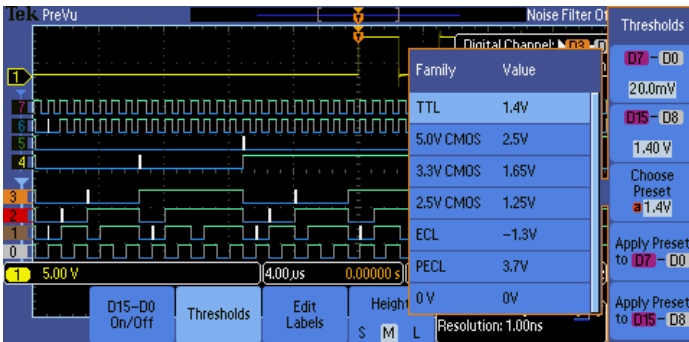

With the color-coded digital waveform display, groups are created by simply placing digital channels together on the screen, allowing the digital channels to be moved as a group. You can set threshold values for each pod of eight channels, enabling support for up to two different logic families.



White edges indicate additional information is available by acquiring at a higher sample rate.

The multiple transition detection hardware of the MSO2000B Series will show you a white edge on the display when the system detects multiple transitions. This acts as a visual reminder that increasing the sample rate on the next acquisition will reveal higher frequency information than your previous settings could acquire.

The MSO2000B Series simplifies channel setup by allowing you to group digital waveforms and enter waveform labels by using a USB keyboard. By simply placing digital waveforms next to each other, they form a group. Once a group is formed, you can position all the channels contained in that group collectively. This greatly reduces the normal setup time associated with positioning channels individually.

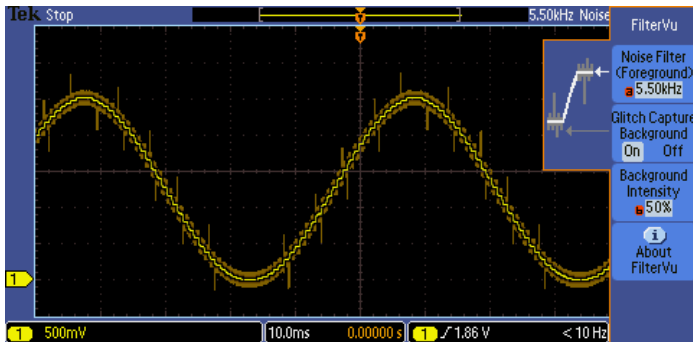

Output of DAC Signal - Notice how FilterVu™ clearly shows the noise-free steps of the DAC in the foreground trace (yellow) which has removed all frequencies above 5.5 kHz. FilterVu also captures and displays high-frequency glitches up to the full bandwidth of the oscilloscope in the background trace (orange).

### Serial triggering analysis (optional)

On a serial bus, a single signal often includes address, control, data, and clock information. This can make isolating events of interest difficult. The MSO/DPO2000B Series offers a robust set of tools for debugging serial buses with automatic trigger, decode, and search for I<sup>2</sup>C, SPI, CAN, LIN, and RS-232/422/485/UART.

### Serial triggering

Trigger on packet content such as start of packet, specific addresses, specific data content, unique identifiers, etc. on popular serial interfaces such as I<sup>2</sup>C, SPI, CAN, LIN, and RS-232/422/485/UART.

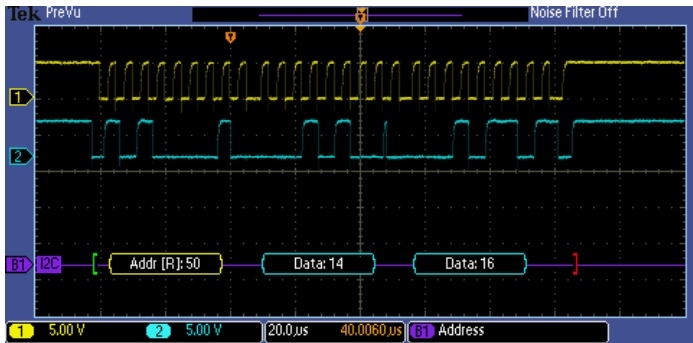

Triggering on a specific data packet going across an I<sup>2</sup>C bus. The yellow waveform is clock and the blue waveform is data. A bus waveform provides decoded packet content including Start, Address, Read/Write, Data, and Stop.

### Bus display

Provides a higher-level, combined view of the individual signals (clock, data, chip enable, etc.) that make up your bus, making it easy to identify where packets begin and end and identifying subpacket components such as address, data, identifier, CRC, etc.

### Bus decoding

Tired of having to visually inspect the waveform to count clocks, determine if each bit is a 1 or a 0, combine bits into bytes, and determine the hex value? Let the oscilloscope do it for you! Once you've set up a bus, the MSO/DPO2000B Series will decode each packet on the bus, and display the value in hex, binary, decimal (LIN only), or ASCII (RS-232/422/485/UART only) in the bus waveform.

### Event table

In addition to seeing decoded packet data on the bus waveform itself, you can view all captured packets in a tabular view much like you would see in a software listing. Packets are time stamped and listed consecutively with columns for each component (Address, Data, etc.).

Time	Identifier	DLC	Data	CRC	Missing Ack	Event Table
-44.93ms	1FFFFFFF	8	FFFF FFFF FFFF FFFF	1863		Event Table
-39.61ms	BEBEBE	4	787E 3A9C	37EE		On Off
-39.40ms	100	0		380A		Save Event Table
-39.23ms	101	2	0103	562D		
-39.16ms	10000001	5	1122 3344 55	6A85		
-38.94ms	12345678	8	1122 3344 5566 7788	4C2		
-38.67ms	1537EEB2	8	FFFF 0000 EEEE 1111	216E		
-38.39ms	519	4	4269 6C6C	7744		
-38.23ms	1537EEB2	8	AE4F FFF1 0272 DF6B	2180		
-37.96ms	527DE32	1	11	7F3D		
-37.80ms	140014	3	1122 33	5EDC		
-37.61ms	160016	5	1122 3344 55	3911		
-37.33ms	18181818	7	F1F2 F3F4 F5F6 F7	5F9B		

Event table showing decoded Identifier, DLC, DATA, and CRC for every CAN packet in a long acquisition.

### Search

Serial triggering is very useful for isolating the event of interest, but once you've captured it and need to analyze the surrounding data, what do you do? In the past, users had to manually scroll through the waveform counting and converting bits and looking for what caused the event. With the MSO/DPO2000B Series, you can have the oscilloscope automatically search through the acquired data for user-defined criteria including serial packet content. Each occurrence is highlighted by a search mark. Rapid navigation between marks is as simple as pressing the **Previous** (←) and **Next** (→) buttons on the front panel.

## Designed to make your work easier

The MSO/DPO2000B is designed to make your work easier. The bright, widescreen display shows a long time window. Dedicated front-panel controls simplify operation. A USB host port on the front panel allows you to easily transfer screenshots, instrument settings, and waveform data to a memory st



## Bright, widescreen display

The MSO/DPO2000B Series features a 7 inch (180 mm) widescreen, TFT-LCD display for seeing intricate signal details.

## Dedicated front-panel controls

Per-channel vertical controls provide simple and intuitive operation. No longer do you need to share one set of vertical controls across all four channels.

## Connectivity

A USB host port on the front panel enables easy transfer of screenshots, instrument settings, and waveform data to a USB thumb drive. The rear panel contains a USB device port for controlling the oscilloscope remotely from a PC or for connecting a USB keyboard. The USB device port can also be used to print directly to a PictBridge®-compatible printer. An optional 10/100 Ethernet port enables easy connection to networks and an optional Video Out port allows the oscilloscope display to be exported to an external monitor or projector.

## Compact form factor

A compact, portable form factor allows the MSO/DPO2000B Series to be easily moved between labs and, with a depth of just 5.3 inches (134 mm), it saves you valuable space on your test bench.



The MSO/DPO2000B Series' compact form factor frees up valuable space on your bench or desktop.

## TekVPI® probe interface

The TekVPI probe interface sets the standard for ease of use in probing. TekVPI probes feature status indicators and controls, as well as a probe menu button right on the comp box itself. This button brings up a probe menu on the oscilloscope display with all relevant settings and controls for the probe. TekVPI probes can be controlled remotely through USB, GPIB, or Ethernet, enabling more versatile solutions in ATE environments.



TekVPI probe interface simplifies connecting your probes to the oscilloscope.

## Extended analysis

Acquiring data and measurements from the MSO/DPO2000B Series is as simple as connecting a USB cable from the oscilloscope to your PC. Key software applications - OpenChoice® Desktop, and Microsoft Excel and Word toolbars - are included standard with each oscilloscope to enable fast and easy direct communication with your Windows PC.

For simple tasks, the included OpenChoice Desktop enables fast and easy communication between the oscilloscope and your PC through USB, GPIB, or LAN for transferring settings, waveforms, and screen images.

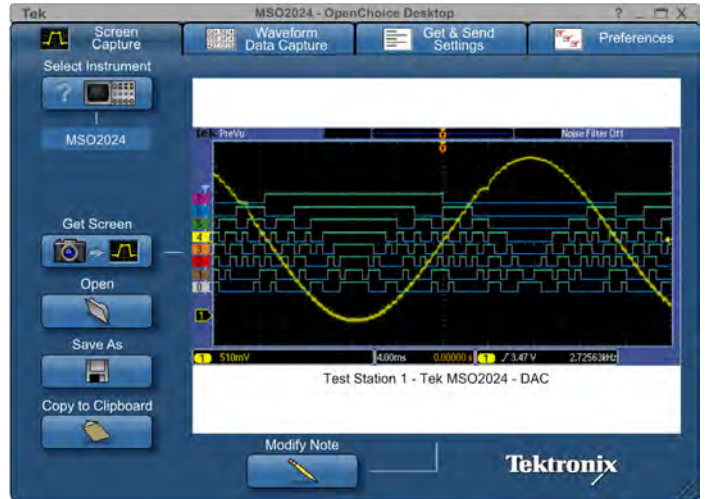

OpenChoice® Desktop software enables seamless connection between the oscilloscope and your PC.



# Specifications

All specifications apply to all models unless noted otherwise.

## Model overview

	MSO2002B and DPO2002B	MSO2004B and DPO2004B	MSO2012B and DPO2012B	MSO2014B and DPO2014B	MSO2022B and DPO2022B	MSO2024B and DPO2024B
Analog channels	2	4	2	4	2	4
Bandwidth <sup>1</sup>	70 MHz	70 MHz	100 MHz	100 MHz	200 MHz	200 MHz
Rise time	5 ns	5 ns	3.5 ns	3.5 ns	2.1 ns	2.1 ns
Sample rate	1 GS/s	1 GS/s	1 GS/s	1 GS/s	1 GS/s	1 GS/s
Record length	1 M points	1 M points	1 M points	1 M points	1 M points	1 M points
Digital channels	MSO models - add 16 digital channels to the corresponding DPO model					

## Vertical system analog channels

<b>Hardware bandwidth limits</b>	20 MHz
<b>Input coupling</b>	AC, DC, GND
<b>Input impedance</b>	1 M $\Omega$ $\pm$ 2%, 11.5 pF $\pm$ 2 pF
<b>Input sensitivity range</b>	2 mV/div to 5 V/div
<b>Vertical resolution</b>	8 bits
<b>Maximum input voltage, 1 M<math>\Omega</math></b>	300 V <sub>RMS</sub> with peaks $\leq$ $\pm$ 450 V
<b>DC gain accuracy (with offset set to 0 V)</b>	$\pm$ 3% for 10 mV/div to 5 V/div $\pm$ 4% for 2 mV/div to 5 mV/div

**Channel-to-channel isolation** (Any two channels at equal vertical scale)

MSO2002B, DPO2002B, MSO2004B, DPO2004B	MSO2012B, DPO2012B, MSO2014B, DPO2014B	MSO2022B, DPO2022B, MSO2024B, DPO2024B
$\geq$ 100:1 at $\leq$ 70 MHz	$\geq$ 100:1 at $\leq$ 100 MHz	100:1 at $\leq$ 200 MHz

**Offset range**

Volts/div setting	Offset range
	<b>1 M<math>\Omega</math> input</b>
2 mV/div to 200 mV/div	$\pm$ 1 V
>200 mV/div to 5 V/div	$\pm$ 25V

## Vertical system digital channels

<b>Input channels</b>	16 digital (D15 to D0)
<b>Thresholds</b>	Threshold per set of 8 channels
<b>Threshold selections</b>	TTL, CMOS, ECL, PECL, User-defined
<b>User-defined threshold range</b>	$\pm$ 20 V
<b>Threshold accuracy</b>	$\pm$ [100 mV + 3% of threshold setting]
<b>Maximum input voltage</b>	$\pm$ 40 V
<b>Input dynamic range</b>	80 V <sub>pk-pk</sub> (threshold setting dependent)

<sup>1</sup> Bandwidth is 20 MHz at 2 mV/div, all models.

## Datasheet

Minimum voltage swing	500 mV <sub>p-p</sub>
Input resistance	101 kΩ
Probe loading	8 pF
Vertical resolution	1 bit

### Horizontal system analog channels

Maximum duration of time captured at highest sample rate (all channels)	1 ms
Time base range	200 MHz models: 2ns to 100s 70, 100 MHz models: 4ns to 100s
Time-base delay time range	-10 divisions to 5000 s
Channel-to-channel deskew range	±100 ns
Time base accuracy	±25 ppm over any ≥1 ms interval

### Horizontal system digital channels

Maximum sample rate (main)	<b>When using any of channels D7 - D0</b>	<b>When using any of channels D8 - D15</b>
	1 GS/s (1 ns resolution)	500 MS/s (2 ns resolution)
Maximum record length (main, all channels)	1 M points	
Minimum detectible pulse width	5 ns	
Channel-to-channel skew	2 ns typical	

### Trigger system

Trigger modes	Auto, Normal, and Single
Trigger coupling	DC, HF reject (attenuates >85 kHz), LF reject (attenuates <65 kHz), noise reject (reduces sensitivity)
Trigger holdoff range	20 ns to 8 s

Trigger sensitivity, typical	<b>Trigger source</b>	<b>Sensitivity</b>
	Internal DC coupled	0.4 div from DC to 50 MHz 0.6 div > 50 MHz to 100 MHz 0.8 div > 100 MHz to 200 MHz
	External (aux input)	200 mV from DC to 100 MHz, 1X attenuation

#### Trigger level ranges

Any input channel	±4.92 divisions from center of screen
Aux Input (external trigger)	±6.25 V, 1X attenuation ±12.5 V, 10X attenuation

#### Trigger types

Edge	Positive or negative slope on any channel or front-panel auxiliary input. Coupling includes DC, AC, HF reject, LF reject, and noise reject.
Pulse Width	Trigger on width of positive or negative pulses that are >, <, =, ≠, or inside/outside a specified period of time.
Runt	Trigger on a pulse that crosses one threshold but fails to cross a second threshold before crossing the first again.

<b>Logic</b>	Trigger when any logical pattern of channels goes false or stays true for specified period of time. Any input can be used as a clock to look for the pattern on a clock edge. Pattern (AND, OR, NAND, NOR) specified for all input channels defined as High, Low, or Don't Care.
<b>Setup and Hold</b>	Trigger on violations of both setup time and hold time between clock and data present on any of the analog and digital input channels.
<b>Rise/Fall Time</b>	Trigger on pulse edge rates that are faster or slower than specified. Slope may be positive, negative, or either.
<b>Video</b>	Trigger on all lines, odd, even, or all fields on NTSC, PAL, and SECAM video signals.
<b>I<sup>2</sup>C (optional)</b>	Trigger on Start, Repeated Start, Stop, Missing ACK, Address (7 or 10 bit), Data, or Address and Data on I <sup>2</sup> C buses up to 3.4 Mb/s.
<b>SPI (optional)</b>	Trigger on SS, MOSI, MISO, or MOSI and MISO on SPI buses up to 10.0 Mb/s.
<b>RS-232/422/485/UART (optional)</b>	Trigger on Tx Start Bit, Rx Start Bit, Tx End of Packet, Rx End of Packet, Tx Data, Rx Data, Tx Parity Error, and Rx Parity Error up to 10 Mb/s.
<b>CAN (optional)</b>	Trigger on Start of Frame, Frame Type (data, remote, error, overload), Identifier (standard or extended), Data, Identifier and Data, End of Frame, Missing ACK, or Bit Stuffing Error on CAN signals up to 1 Mb/s. Data can be further specified to trigger on $\leq$ , $<$ , $=$ , $>$ , $\geq$ , or $\neq$ a specific data value. User-adjustable sample point is set to 50% by default.
<b>LIN (optional)</b>	Trigger on Sync, Identifier, Data, Identifier and Data, Wakeup Frame, Sleep Frame, Errors such as Sync, Parity, or Checksum Errors.
<b>Parallel (available on MSO models only)</b>	Trigger on a parallel bus data value.

## Acquisition system

### Acquisition Modes

<b>Sample</b>	Acquire sampled values.
<b>Peak Detect</b>	Captures glitches as narrow as 3.5 ns at all sweep speeds.
<b>Averaging</b>	From 2 to 512 waveforms included in average.
<b>Roll</b>	Scrolls waveforms right to left across the screen at sweep speeds slower than or equal to 40 ms/div.

## Waveform measurements

<b>Cursors</b>	Waveform and Screen.
<b>Automatic measurements</b>	29, of which up to four can be displayed on-screen at any one time. Measurements include: Period, Frequency, Delay, Rise Time, Fall Time, Positive Duty Cycle, Negative Duty Cycle, Positive Pulse Width, Negative Pulse Width, Burst Width, Phase, Positive Overshoot, Negative Overshoot, Peak to Peak, Amplitude, High, Low, Max, Min, Mean, Cycle Mean, RMS, Cycle RMS, Positive Pulse Count, Negative Pulse Count, Rising Edge Count, Falling Edge Count, Area and Cycle Area.
<b>Gating</b>	Isolate the specific occurrence within an acquisition to take measurements on, using either the screen, or waveform cursors.

## Waveform math

<b>Arithmetic</b>	Add, subtract, and multiply waveforms.
<b>FFT</b>	Spectral magnitude. Set FFT Vertical Scale to Linear RMS or dBV RMS, and FFT Window to Rectangular, Hamming, Hanning, or Blackman-Harris.

## Datasheet

### Software

<b>OpenChoice® Desktop</b>	Enables fast and easy communication between a Windows PC and your oscilloscope using USB or LAN. Transfer and save settings, waveforms, measurements, and screen images. Included Word and Excel toolbars automate the transfer of acquisition data and screen images from the oscilloscope into Word and Excel for quick reporting or further analysis.
<b>IVI driver</b>	Provides a standard instrument programming interface for common applications such as LabVIEW, LabWindows/CVI, Microsoft .NET, and MATLAB.
<b>eScope® Web-based remote control</b>	Enables control of the oscilloscope over a network connection through a standard web browser. Simply enter the IP address or network name of the oscilloscope and a web page will be served to the browser.

### Display system

<b>Display type</b>	7 inch (180 mm) wide format liquid crystal TFT color display.
<b>Display resolution</b>	480 horizontal × 234 vertical pixels (WQVGA).
<b>Waveform styles</b>	Vectors, Dots, Variable Persistence, Infinite Persistence.
<b>Graticules</b>	Full, Grid, Cross Hair, Frame.
<b>Format</b>	YT and XY.
<b>Maximum waveform capture rate</b>	Up to 5,000 wfms/s.

### Input/output ports

<b>USB 2.0 high-speed host port</b>	Supports USB mass storage devices, printers, and keyboards. One port available on rear panel and one on front panel.
<b>USB 2.0 high-speed device port</b>	Rear-panel connector allows for communication/control of oscilloscope through USBTMC or GPIB with a TEK-USB-488, and direct printing to all PictBridge®-compatible printers.
<b>LAN port (Ethernet)</b>	RJ-45 connector, supports 10/100BASE-T (requires DPO2CONN).
<b>Video out port</b>	DB-15 female connector, connect to show the oscilloscope display on an external monitor or projector (requires DPO2CONN).
<b>Auxiliary input</b>	Front-panel BNC connector. Input Impedance 1 MΩ ±2%. Max input 300 V <sub>RMS</sub> CAT II with peaks ≤ ±450 V.
<b>Probe compensator output voltage and frequency</b>	Front-panel pins
<b>Amplitude</b>	5 V
<b>Frequency</b>	1 kHz
<b>Kensington-style lock</b>	Rear-panel security slot connects to standard Kensington-style lock.

### Power source

<b>Power source voltage</b>	100 to 240 V ±10%
<b>Power source frequency</b>	45 to 65 Hz (90 to 264 V) 360 to 440 Hz (100 to 132 V)
<b>Power consumption</b>	80 W maximum
<b>Optional TekVPI® external power supply<sup>2</sup></b>	
<b>Output voltage</b>	12 V
<b>Output current</b>	5 A
<b>Power consumption</b>	50 W

<sup>2</sup> Required when total oscilloscope probe power usage exceeds 20 W.



**Physical characteristics****Dimensions**

	mm	in.
Height	180	7.1
Width	377	14.9
Depth	134	5.3

**Weight**

	kg	lb.
Net	3.6	7.9
Shipping	6.2	13.7

**Rackmount configuration**

4U

**Cooling clearance**

2 in. (50 mm) required on left side and rear of instrument

**EMC, environment, and safety****Temperature****Operating**

0 °C to +50 °C (+32 °F to 122 °F)

**Nonoperating**

-40 °C to +71 °C (-40 °F to 160 °F)

**Humidity****Operating**

High: 30 °C to 50 °C, 5% to 60% relative humidity

Low: 0 °C to 30 °C, 5% to 95% relative humidity

**Nonoperating**

High: 30 °C to 55 °C, 5% to 60% relative humidity

Low: 0 °C to 30 °C, 5% to 95% relative humidity

**Altitude****Operating**

3,000 meters (9,843 feet)

**Nonoperating**

12,000 meters (39,370 feet)

**Random vibration****Operating**0.31 G<sub>RMS</sub> from 5 to 500 Hz, 10 minutes each axis, 3 axes, 30 minutes total**Nonoperating**2.46 G<sub>RMS</sub> from 5 to 500 Hz, 10 minutes each axis, 3 axes, 30 minutes total**Regulatory****Electromagnetic compatibility**

EC Council Directive 2004/108/EC

**Safety**

UL61010-1:2004; CAN/CSA-C22.2 No. 61010.1: 2004; EN61010-1:2001; complies with the Low Voltage Directive 2004/108/EC for Product Safety.

## Ordering information

### MSO/DPO2000B family

DPO2002B	70 MHz, 1 GS/s, 1 M record length, 2-channel digital phosphor oscilloscope
DPO2004B	70 MHz, 1 GS/s, 1 M record length, 4-channel digital phosphor oscilloscope
DPO2012B	100 MHz, 1 GS/s, 1 M record length, 2-channel digital phosphor oscilloscope
DPO2014B	100 MHz, 1 GS/s, 1 M record length, 4-channel digital phosphor oscilloscope
DPO2022B	200 MHz, 1 GS/s, 1 M record length, 2-channel digital phosphor oscilloscope
DPO2024B	200 MHz, 1 GS/s, 1 M record length, 4-channel digital phosphor oscilloscope
MSO2002B	70 MHz, 1 GS/s, 1 M record length, 2+16 channel mixed-signal oscilloscope
MSO2004B	70 MHz, 1 GS/s, 1M record length, 4+16 channel mixed-signal oscilloscope
MSO2012B	100 MHz, 1 GS/s, 1M record length, 2+16 channel mixed-signal oscilloscope
MSO2014B	100 MHz, 1GS/s, 1M record length, 4+16 channel mixed-signal oscilloscope
MSO2022B	200 MHz, 1 GS/s, 1M record length, 2+16 channel mixed-signal oscilloscope
MSO2024B	200 MHz, 1 GS/s, 1 M record length, 4+16 channel mixed-signal oscilloscope

### Standard accessories

#### Probes

TPP0200	200 MHz, 10x passive probe (one per analog channel) for 100 and 200 MHz models
TPP0100	100 MHz, 10x passive probe (one per analog channel) for 70 MHz models
P6316 (MSO models only)	16-channel logic probe and accessory kit (one per instrument)

#### Accessories

200-5045-xx	Front protective cover
063-4472-xx	Documentation CD
016-2008-xx	Accessory pouch
071-3078 -xx	Installation and safety manual
—	Power cord
—	OpenChoice® Desktop software
—	Calibration certificate documenting traceability to National Metrology Institute(s) and ISO9001 quality system registration

## Warranty

Five-year warranty covering all parts and labor, excluding probes.

## Application modules

<b>DPO2AUTO</b>	Automotive Serial Triggering and Analysis Module. Enables triggering on packet-level information on CAN bus and LIN bus as well as analytical tools such as digital views of the signal, bus views, packet decoding, search tools, and packet decode tables with time stamp information.
<b>DPO2COMP</b>	Computer Serial Triggering and Analysis Module. Enables triggering on packet-level information on RS-232/422/485/UART buses as well as analytical tools such as digital views of the signal, bus views, packet decoding, search tools, and packet decode tables with time stamp information.
<b>DPO2EMBD</b>	Embedded Serial Triggering and Analysis Module. Enables triggering on packet-level information on I <sup>2</sup> C and SPI buses as well as analytical tools such as digital views of the signal, bus views, packet decoding, search tools, and packet decode tables with time stamp information. Only two-wire SPI support is available on two-channel models.

## Instrument options

### Power cord and plug options

Please specify power plug version when ordering.

<b>Opt. A0</b>	North America power plug (115 V, 60 Hz)
<b>Opt. A1</b>	Universal Euro power plug (220 V, 50 Hz)
<b>Opt. A2</b>	United Kingdom power plug (240 V, 50 Hz)
<b>Opt. A3</b>	Australia power plug (240 V, 50 Hz)
<b>Opt. A5</b>	Switzerland power plug (220 V, 50 Hz)
<b>Opt. A6</b>	Japan power plug (100 V, 110/120 V, 60 Hz)
<b>Opt. A10</b>	China power plug (50 Hz)
<b>Opt. A11</b>	India power plug (50 Hz)
<b>Opt. A12</b>	Brazil power plug (60 Hz)
<b>Opt. A99</b>	No power cord

### Language options <sup>3 4</sup>

<b>Opt. L0</b>	English manual
<b>Opt. L1</b>	French manual
<b>Opt. L2</b>	Italian manual
<b>Opt. L3</b>	German manual
<b>Opt. L4</b>	Spanish manual
<b>Opt. L5</b>	Japanese manual
<b>Opt. L6</b>	Portuguese manual
<b>Opt. L7</b>	Simplified Chinese manual
<b>Opt. L8</b>	Traditional Chinese manual

<sup>3</sup> User manuals (PDF) in 11 languages are available on the CD and for download from <http://www.tektronix.com/manuals>. There are no printed user manuals.

<sup>4</sup> The English option includes a front-panel label on the instrument. The other language options include a front-panel overlay.

## Datasheet

Opt. L9	Korean manual
Opt. L10	Russian manual
Opt. L99	No manual

Language options include translated front-panel overlay for the selected language(s).

## Service options

Opt. D1	Calibration Data Report
---------	-------------------------

## Recommended accessories

### Probes

Tektronix offers over 100 different probes to meet your application needs. For a comprehensive listing of available probes, please visit [www.tektronix.com/probes](http://www.tektronix.com/probes).

ADA400A	100X, 10X, 1X, 0.1X high-gain differential amplifier <sup>6 5</sup>
P5100A	2.5 kV, 500 MHz, 100X high-voltage passive probe
TAP1500	1.5 GHz TekVPI® active voltage probe <sup>6</sup>
TCP0020	50 MHz TekVPI® 20 Ampere AC/DC current probe <sup>6</sup>
TCP0030	120 MHz TekVPI® 30 Ampere AC/DC current probe <sup>6</sup>
TCP0150	20 MHz TekVPI® 150 Ampere AC/DC current probe <sup>6</sup>
TCP2020	50 MHz TekVPI® 20 Ampere AC/DC current probe
TCPA300/400	Current measurement systems amplifier <sup>7</sup>
TCP305	DC to 50 MHz 50 Ampere current probe for use with TCPA300
TCP404XL	DC to 2 MHz 500 Ampere current probe for use with TCPA400
TDP0500	500 MHz TekVPI® differential voltage probe with $\pm 42$ V differential input voltage <sup>6 8</sup>
THDP0200	$\pm 1.5$ kV 200 MHz high-voltage differential probe <sup>6</sup>
THDP0100	$\pm 6$ kV 100 MHz high-voltage differential probe <sup>6</sup>
TMDP0200	$\pm 750$ V 200 MHz high-voltage differential probe <sup>6</sup>

<sup>5</sup> Requires TPA-BNC adapter.

<sup>6</sup> Requires TekVPI external power adapter (119-7465-00); one per oscilloscope.

<sup>7</sup> Requires 50  $\Omega$  feed through termination between the oscilloscope input and the BNC cable.

<sup>8</sup> Probes terminate into 50  $\Omega$  but oscilloscope will automatically adjust to account for 1 M $\Omega$  input.



**Accessories**

<b>DPO2CONN</b>	Adds Ethernet (10/100Base-T) and video out port
<b>077-0737-xx</b>	Service manual (English only) PDF-only, downloadable from <a href="http://www.tektronix.com/manuals">www.tektronix.com/manuals</a>
<b>TPA-BNC</b>	TekVPI® to TekProbe® BNC adapter
<b>TEK-DPG</b>	TekVPI® Deskew pulse generator signal source
<b>067-1686-xx</b>	Power measurement deskew and calibration fixture
<b>196-3508-xx</b>	Digital Probe Leadset (8 channels)
<b>119-7465-xx</b>	TekVPI® external power supply (power cord not included)
<b>TEK-USB-488</b>	GPIB-to-USB adapter
<b>ACD2000</b>	Soft transit case
<b>200-5045-xx</b>	Front protective cover
<b>HCTEK4321</b>	Hard transit case (requires ACD2000)
<b>RMD2000</b>	Rackmount kit



Tektronix is registered to ISO 9001 and ISO 14001 by SRI Quality System Registrar.



Product(s) complies with IEEE Standard 488.1-1987, RS-232-C, and with Tektronix Standard Codes and Formats.

**ASEAN / Australasia** (65) 6356 3900  
**Belgium** 00800 2255 4835\*  
**Central East Europe and the Baltics** +41 52 675 3777  
**Finland** +41 52 675 3777  
**Hong Kong** 400 820 5835  
**Japan** 81 (3) 6714 3010  
**Middle East, Asia, and North Africa** +41 52 675 3777  
**People's Republic of China** 400 820 5835  
**Republic of Korea** 001 800 8255 2835  
**Spain** 00800 2255 4835\*  
**Taiwan** 886 (2) 2722 9622

**Austria** 00800 2255 4835\*  
**Brazil** +55 (11) 3759 7627  
**Central Europe & Greece** +41 52 675 3777  
**France** 00800 2255 4835\*  
**India** 000 800 650 1835  
**Luxembourg** +41 52 675 3777  
**The Netherlands** 00800 2255 4835\*  
**Poland** +41 52 675 3777  
**Russia & CIS** +7 (495) 6647564  
**Sweden** 00800 2255 4835\*  
**United Kingdom & Ireland** 00800 2255 4835\*

**Balkans, Israel, South Africa and other ISE Countries** +41 52 675 3777  
**Canada** 1 800 833 9200  
**Denmark** +45 80 88 1401  
**Germany** 00800 2255 4835\*  
**Italy** 00800 2255 4835\*  
**Mexico, Central/South America & Caribbean** 52 (55) 56 04 50 90  
**Norway** 800 16098  
**Portugal** 80 08 12370  
**South Africa** +41 52 675 3777  
**Switzerland** 00800 2255 4835\*  
**USA** 1 800 833 9200

\* European toll-free number. If not accessible, call: +41 52 675 3777

Updated 10 April 2013

**For Further Information.** Tektronix maintains a comprehensive, constantly expanding collection of application notes, technical briefs and other resources to help engineers working on the cutting edge of technology. Please visit [www.tektronix.com](http://www.tektronix.com).

Copyright © Tektronix, Inc. All rights reserved. Tektronix products are covered by U.S. and foreign patents, issued and pending. Information in this publication supersedes that in all previously published material. Specification and price change privileges reserved. TEKTRONIX and TEK are registered trademarks of Tektronix, Inc. All other trade names referenced are the service marks, trademarks, or registered trademarks of their respective companies.



17 Apr 2013

3GW-28413-1

[www.tektronix.com](http://www.tektronix.com)

**Tektronix**<sup>®</sup>

