

# User Manual



## **CSA7404B Communications Signal Analyzers, TDS7704B, TDS7404B, TDS7254B & TDS7154B Digital Phosphor Oscilloscopes**

**071-1226-03**

This document supports firmware version 4.0.3  
and above.

**[www.tektronix.com](http://www.tektronix.com)**

Copyright © Tektronix, Inc. All rights reserved. Licensed software products are owned by Tektronix or its suppliers and are protected by United States copyright laws and international treaty provisions.

Use, duplication, or disclosure by the Government is subject to restrictions as set forth in subparagraph (c)(1)(ii) of the Rights in Technical Data and Computer Software clause at DFARS 252.227-7013, or subparagraphs (c)(1) and (2) of the Commercial Computer Software - Restricted Rights clause at FAR 52.227-19, as applicable.

Tektronix products are covered by U.S. and foreign patents, issued and pending. Information in this publication supercedes that in all previously published material. Specifications and price change privileges reserved.

TEKTRONIX and TEK are registered trademarks of Tektronix, Inc.

TekConnect, MyScope, and VocalLink are registered trademarks of Tektronix, Inc.

TekVISA, FastFrame, and MultiView Zoom are trademarks of Tektronix, Inc.

## **Contacting Tektronix**

Tektronix, Inc.  
14200 SW Karl Braun Drive or P.O. Box 500  
Beaverton, OR 97077 USA

For product information, sales, service, and technical support:

- In North America, call 1-800-833-9200.
- Worldwide, visit [www.tektronix.com](http://www.tektronix.com) to find contacts in your area.

## WARRANTY

Tektronix warrants that the products that it manufactures and sells will be free from defects in materials and workmanship for a period of one (1) year from the date of shipment. If this product proves defective during its warranty period, Tektronix, at its option, will either repair the defective product without charge for parts and labor, or provide a replacement in exchange for the defective product.

This warranty applies only to products returned to the designated Tektronix depot or the Tektronix authorized representative from which the product was originally purchased. For products returned to other locations, Customer will be assessed an applicable service charge. The preceding limitation shall not apply within the European Economic Area, where products may be returned for warranty service to the nearest designated service depot regardless of the place of purchase.

In order to obtain service under this warranty, Customer must provide the applicable office of Tektronix or its authorized representative with notice of the defect before the expiration of the warranty period and make suitable arrangements for the performance of service. Customer shall be responsible for packaging and shipping the defective product to the service center designated by Tektronix or its representative, with shipping charges prepaid. Tektronix or its representative shall pay for the return of the product to Customer. Customer shall be responsible for paying any associated taxes or duties.

This warranty shall not apply to any defect, failure or damage caused by improper use or improper or inadequate maintenance and care. Tektronix shall not be obligated to furnish service under this warranty:

- a) to repair damage resulting from attempts by personnel other than Tektronix representatives to install, repair or service the product;
- b) to repair damage resulting from improper use or connection to incompatible equipment;
- c) to repair any damage or malfunction caused by the use of non-Tektronix supplies or consumables;
- d) to repair a product that has been modified or integrated with other products when the effect of such modification or integration increases the time or difficulty of servicing the product; or
- e) to repair damage or malfunction resulting from failure to perform user maintenance and cleaning at the frequency and as prescribed in the user manual (if applicable).

**THE ABOVE WARRANTIES ARE GIVEN BY TEKTRONIX WITH RESPECT TO THIS PRODUCT IN LIEU OF ANY OTHER WARRANTIES, EXPRESS OR IMPLIED. TEKTRONIX AND ITS VENDORS DISCLAIM ANY IMPLIED WARRANTIES OF MERCHANTABILITY OR FITNESS FOR A PARTICULAR PURPOSE. TEKTRONIX' RESPONSIBILITY TO REPAIR OR REPLACE DEFECTIVE PRODUCTS IS THE SOLE AND EXCLUSIVE REMEDY PROVIDED TO THE CUSTOMER FOR BREACH OF THIS WARRANTY. TEKTRONIX AND ITS VENDORS WILL NOT BE LIABLE FOR ANY INDIRECT, SPECIAL, INCIDENTAL, OR CONSEQUENTIAL DAMAGES IRRESPECTIVE OF WHETHER TEKTRONIX OR THE VENDOR HAS ADVANCE NOTICE OF THE POSSIBILITY OF SUCH DAMAGES.**



# Table of Contents

<b>General Safety Summary</b> .....	<b>xi</b>
<b>Preface</b> .....	<b>xiii</b>
About This Manual .....	xiii
Related Manuals and Online Documents .....	xiv

## Getting Started

<b>Product Description</b> .....	<b>1-1</b>
Models .....	1-1
Key Features .....	1-1
Product Software .....	1-3
Software Upgrade .....	1-3
<b>Installation</b> .....	<b>1-5</b>
Unpacking .....	1-5
Checking the Environment Requirements .....	1-6
Connecting Peripherals .....	1-7
Powering On the Instrument .....	1-9
Shutting Down the Instrument .....	1-10
Backing Up User Files .....	1-11
Removing the Removable Hard Drive .....	1-11
Reinstalling the Removable Hard Drive .....	1-12
Installing Software .....	1-13
Enabling or Disabling Your LAN and Connecting to a Network .....	1-16
Setting up a Dual Display .....	1-17
<b>Incoming Inspection</b> .....	<b>1-21</b>
Assemble Equipment .....	1-21
Self Tests .....	1-22
Functional Tests .....	1-23
Check Vertical Operation .....	1-23
Check Horizontal Operation .....	1-26
Check Trigger Operation .....	1-28
Check File System .....	1-30
Perform the Extended Diagnostics .....	1-32
<b>Accessories &amp; Options</b> .....	<b>1-33</b>
Options .....	1-33
Accessories .....	1-35

## Operating Basics

<b>Operational Maps</b> .....	<b>2-1</b>
<b>Documentation Map</b> .....	<b>2-2</b>
<b>System Overview Maps</b> .....	<b>2-3</b>
Functional Model Map .....	2-3
Process Overview Map .....	2-5
<b>User Interface Map - Complete Control and Display</b> .....	<b>2-6</b>

<b>Front-Panel Map - Quick Access to Most Often Used Features . . . .</b>	<b>2-7</b>
<b>Display Map - Single Graticule . . . . .</b>	<b>2-8</b>
<b>Front Panel I/O Map . . . . .</b>	<b>2-9</b>
<b>Rear Panel I/O Map . . . . .</b>	<b>2-10</b>

## Reference

<b>Overview . . . . .</b>	<b>3-1</b>
<b>Acquiring Waveforms . . . . .</b>	<b>3-7</b>
Signal Connection and Conditioning . . . . .	3-8
Connecting and Conditioning Your Signals . . . . .	3-9
To Set Up Signal Input . . . . .	3-12
To Autoset the Instrument . . . . .	3-15
To Reset the Instrument . . . . .	3-16
To Get More Help . . . . .	3-16
Input Conditioning Background . . . . .	3-17
Setting Acquisition Controls . . . . .	3-23
Using the Acquisition Controls . . . . .	3-24
To Set Acquisition Modes . . . . .	3-29
To Start and Stop Acquisition . . . . .	3-32
To Set Roll Mode . . . . .	3-33
Acquisition Control Background . . . . .	3-34
Acquisition Hardware . . . . .	3-34
Sampling Process . . . . .	3-35
Acquisition Modes . . . . .	3-35
Waveform Record . . . . .	3-36
Real-Time Sampling . . . . .	3-37
Equivalent-Time Sampling . . . . .	3-37
Interpolation . . . . .	3-39
Interleaving . . . . .	3-40
Using Fast Acquisition Mode . . . . .	3-40
Using Fast Acquisitions . . . . .	3-41
To Turn Fast Acquisitions On and Off . . . . .	3-44
To Set Display Format . . . . .	3-47
Using FastFrame . . . . .	3-48
Using FastFrame Acquisitions . . . . .	3-49
To Set FastFrame Mode . . . . .	3-50
Time Stamping Frames . . . . .	3-52
O/E Converter . . . . .	3-55
Connecting Optical Signals . . . . .	3-55
Attenuating Optical Signals . . . . .	3-55
Front Panel Connectors . . . . .	3-56
Optical Input Connector . . . . .	3-56
Output Connectors . . . . .	3-56
O/E Electrical Out-to-Ch1 Input Adapter . . . . .	3-57
O/E-to-SMA Adapter . . . . .	3-57
Cleaning Optical Connectors . . . . .	3-57
Optical Dark Compensation . . . . .	3-58
Compensation . . . . .	3-59
Wavelength, Filter, and Bandwidth Selection . . . . .	3-59

Optical Bandwidth .....	3-60
Bandwidth for Unfiltered Settings .....	3-61
Bandwidth for Reference Receiver settings .....	3-61
<b>Triggering .....</b>	<b>3-63</b>
Triggering Concepts .....	3-64
The Trigger Event .....	3-64
Trigger Sources .....	3-64
Trigger Types .....	3-65
Trigger Modes .....	3-65
Trigger Holdoff .....	3-66
Trigger Coupling .....	3-67
Horizontal Position .....	3-67
Slope and Level .....	3-67
Delayed Trigger System .....	3-68
Triggering from the Front Panel .....	3-68
Access Procedures .....	3-68
To Check Trigger Status .....	3-72
Additional Trigger Parameters .....	3-73
Advanced Triggering .....	3-77
To Trigger on a Glitch .....	3-83
To Trigger on a Runt Pulse .....	3-85
Trigger Based on	
Pulse Width .....	3-87
To Trigger Based	
on Transition Time .....	3-89
Triggering on a Window .....	3-92
Trigger Based on	
Pulse Timeout	
.....	3-94
Trigger on a Pattern .....	3-95
To Trigger on a State .....	3-98
To Trigger on Setup/	
Hold Time Violations .....	3-99
Logic Qualify a Trigger .....	3-102
Sequential Triggering .....	3-103
Using Sequential Triggering .....	3-104
To Trigger on a Sequence .....	3-109
Comm Triggering .....	3-117
Serial Pattern Triggering .....	3-117
<b>Displaying Waveforms .....</b>	<b>3-119</b>
Using the Waveform Display .....	3-119
Using the Display .....	3-121
To Display Waveforms in the Main Graticule .....	3-124
Setting MultiView Zoom Controls .....	3-125
Using with Waveforms .....	3-126
To Zoom Waveforms .....	3-126
Customizing the Display .....	3-131
Using Display Controls .....	3-132
Set Display Styles .....	3-135
Customize Graticule and Waveforms .....	3-137

<b>Measuring Waveforms</b> .....	<b>3-139</b>
Taking Automatic Measurements .....	3-140
Using Automatic Measurements .....	3-142
To Take Automatic Measurements .....	3-144
To Localize a Measurement .....	3-149
Taking Cursor Measurements .....	3-151
Using Cursors .....	3-152
To Set the Cursor Sources .....	3-155
Taking Histograms .....	3-157
Using Histograms .....	3-158
To Start and Reset Histogram Counting .....	3-158
Histogram Measurements .....	3-160
Optimizing Measurement Accuracy .....	3-160
To Compensate the Instrument .....	3-160
To Connect the Probe Calibration Fixture .....	3-162
To Calibrate Probes .....	3-162
To Deskew Channels .....	3-162
To Compensate Passive Probes .....	3-163
Serial Mask Testing .....	3-165
<b>Creating and Using Math Waveforms</b> .....	<b>3-167</b>
Defining Math Waveforms .....	3-168
Using Math .....	3-169
To Define a Math Waveform .....	3-175
Operations on Math Waveforms .....	3-177
Using Math Waveforms .....	3-178
To Use Math Waveforms .....	3-179
Defining Spectral Math Waveforms .....	3-182
Using Spectral Math Controls .....	3-183
Recognizing Aliasing .....	3-204
To Select a Predefined Spectral Math Waveform .....	3-206
To Define a Spectral Math Waveform .....	3-207
Spectral Math Example .....	3-215
<b>Data Input/Output</b> .....	<b>3-221</b>
Saving and Recalling a Setup .....	3-221
Using Auto-Increment File Name .....	3-222
To Save Your Setup .....	3-223
To Recall Your Setup .....	3-226
Saving and Recalling Waveforms .....	3-227
To Save Your Waveform .....	3-228
To Recall Your Waveform .....	3-231
To Clear References .....	3-233
Exporting and Copying Waveforms .....	3-235
To Export Your Waveform .....	3-236
To Use an Exported Waveform .....	3-244
To Copy Your Waveform .....	3-246



Printing Waveforms .....	3-250
To Print from Front Panel .....	3-250
To Print from Menu Bar .....	3-250
To Set Up the Page .....	3-251
To Preview the Page .....	3-252
To Print Using Print Screen .....	3-253
To Date/Time Stamp Hardcopies .....	3-254
Remote Communication .....	3-255
<b>MyScope .....</b>	<b>3-257</b>
Using MyScope Control Windows .....	3-260
<b>Accessing Online Help .....</b>	<b>3-263</b>
How to Use Online Help .....	3-263

## Appendices

<b>Appendix A: Specifications .....</b>	<b>A-1</b>
Product and Feature Description .....	A-2
Acquisition Features .....	A-2
Signal Processing Features .....	A-3
Display Features .....	A-3
Measurement Features .....	A-3
Trigger Features .....	A-4
Convenience Features .....	A-4
Specification Tables .....	A-5
<b>Appendix B: Automatic Measurements Supported .....</b>	<b>B-1</b>
Levels Used in Taking Amplitude, Timing, and Area Measurements .....	B-5
Levels Used in Taking Eye Measurements .....	B-6
P Values .....	B-7
T1 Values .....	B-8
T2 Values .....	B-8
DCD Values .....	B-8
Measurements Annotations .....	B-9
<b>Appendix C: Menu Bar Commands .....</b>	<b>C-1</b>
File Commands .....	C-1
Edit Commands .....	C-3
Vertical Commands .....	C-4
Horizontal and Acquisition Commands .....	C-5
Trigger Commands .....	C-7
Display Commands .....	C-9
Cursors Commands .....	C-11
Measure Commands .....	C-11
Masks Commands .....	C-13
Math Commands .....	C-13
Application Commands .....	C-14
Utilities Commands .....	C-15
Help Commands .....	C-16
Buttons .....	C-16

<b>Appendix D: Cleaning</b> .....	<b>D-1</b>
Exterior Cleaning .....	D-1
Flat Panel Display Cleaning .....	D-2

**Glossary**  
**Index**

# List of Figures

<b>Figure 1-1: Locations of peripheral connectors on rear panel . . . . .</b>	<b>1-8</b>
<b>Figure 1-2: Powering on the instrument . . . . .</b>	<b>1-10</b>
<b>Figure 1-3: Removing the hard drive . . . . .</b>	<b>1-12</b>
<b>Figure 1-4: Reinstalling the hard drive . . . . .</b>	<b>1-13</b>
<b>Figure 1-5: Enabling your LAN and connecting to a network . . . . .</b>	<b>1-16</b>
<b>Figure 1-6: Setting up a dual display . . . . .</b>	<b>1-18</b>
<b>Figure 1-7: Drag area for Windows task bar . . . . .</b>	<b>1-19</b>
<b>Figure 1-8: Moving Windows desktop icons to the external monitor . . . . .</b>	<b>1-19</b>
<b>Figure 1-9: Universal test hookup for functional tests - CH 1 shown . . . . .</b>	<b>1-24</b>
<b>Figure 1-10: Channel button location . . . . .</b>	<b>1-25</b>
<b>Figure 1-11: Setup for time base test . . . . .</b>	<b>1-27</b>
<b>Figure 1-12: Setup for trigger test . . . . .</b>	<b>1-29</b>
<b>Figure 1-13: Setup for the file system test . . . . .</b>	<b>1-30</b>
<b>Figure 3-1: Input and Acquisition Systems and Controls . . . . .</b>	<b>3-8</b>
<b>Figure 3-2: Setting vertical range and position of input channels . . . . .</b>	<b>3-19</b>
<b>Figure 3-3: Varying offset moves the vertical acquisition window on the waveform . . . . .</b>	<b>3-20</b>
<b>Figure 3-4: Horizontal Acquisition window definition . . . . .</b>	<b>3-21</b>
<b>Figure 3-5: Common trigger, record length, and acquisition rate for all channels . . . . .</b>	<b>3-23</b>
<b>Figure 3-6: Roll mode . . . . .</b>	<b>3-28</b>
<b>Figure 3-7: Aliasing . . . . .</b>	<b>3-29</b>
<b>Figure 3-8: Digitizer configuration . . . . .</b>	<b>3-35</b>
<b>Figure 3-9: Digital acquisition — sampling and digitizing . . . . .</b>	<b>3-35</b>
<b>Figure 3-10: The waveform record and its defining parameters . . . . .</b>	<b>3-36</b>
<b>Figure 3-11: Real-time sampling . . . . .</b>	<b>3-37</b>
<b>Figure 3-12: Equivalent-time sampling . . . . .</b>	<b>3-39</b>
<b>Figure 3-13: Normal DSO Acquisition and Display mode versus Fast Acquisition mode . . . . .</b>	<b>3-43</b>
<b>Figure 3-14: Normal DSO and Fast Acquisition displays . . . . .</b>	<b>3-44</b>
<b>Figure 3-15: Fast Acquisition XY display . . . . .</b>	<b>3-47</b>
<b>Figure 3-16: FastFrame . . . . .</b>	<b>3-49</b>
<b>Figure 3-17: FastFrame time stamp . . . . .</b>	<b>3-54</b>

Figure 3-18: Optical-to-Electrical converter and recovered clock and data connectors .....	3-56
Figure 3-19: Using the O/E Electrical Out-to-Ch1 Input adapter ..	3-57
Figure 3-20: Vertical setup menu with optical controls .....	3-59
Figure 3-21: Triggered versus untriggered displays .....	3-64
Figure 3-22: Triggered versus untriggered displays .....	3-66
Figure 3-23: Holdoff adjustment can prevent false triggers .....	3-67
Figure 3-24: Slope and level controls help define the trigger .....	3-68
Figure 3-25: Example advanced trigger readout .....	3-78
Figure 3-26: Violation zones for Setup/Hold triggering .....	3-82
Figure 3-27: Triggering on a Setup/Hold time violation .....	3-102
Figure 3-28: Triggering with Horizontal Delay off .....	3-105
Figure 3-29: Triggering with Horizontal Delay on .....	3-106
Figure 3-30: Reset trigger limitation .....	3-107
Figure 3-31: Trigger and Horizontal Delay summary .....	3-108
Figure 3-32: Display elements .....	3-120
Figure 3-33: Horizontal Position includes time to Horizontal Reference .....	3-123
Figure 3-34: Graticule, Cursor, and Automatic measurements ....	3-140
Figure 3-35: Annotated display .....	3-141
Figure 3-36: High/Low tracking methods .....	3-143
Figure 3-37: Reference-level calculation methods .....	3-144
Figure 3-38: Horizontal cursors measure amplitudes .....	3-152
Figure 3-39: Components determining Time cursor readout values .....	3-153
Figure 3-40: Horizontal histogram view and measurement data .....	3-157
Figure 3-41: Probe calibration and deskew fixtures .....	3-162
Figure 3-42: Pass/Fail mask testing .....	3-165
Figure 3-43: Spectral analysis of an impulse .....	3-167
Figure 3-44: Functional transformation of an acquired waveform .	3-168
Figure 3-45: Derivative math waveform .....	3-172
Figure 3-46: Peak-peak amplitude measurement of a derivative waveform .....	3-173
Figure 3-47: Duration and resolution control effects .....	3-184
Figure 3-48: Definition of gate parameters .....	3-185
Figure 3-49: Effects of frequency domain control adjustments ....	3-187
Figure 3-50: Effects of adjusting the reference level .....	3-189
Figure 3-51: Effects of adjusting the reference level offset control .....	3-189

<b>Figure 3-52: Example of the effects of setting the phase suppression threshold</b> .....	<b>3-191</b>
<b>Figure 3-53: Windowing the time domain record</b> .....	<b>3-193</b>
<b>Figure 3-54: Example of scallop loss for a Hanning window without zero fill</b> .....	<b>3-195</b>
<b>Figure 3-55: Time and frequency graphs for the Gaussian window</b> .....	<b>3-196</b>
<b>Figure 3-56: Time and frequency domain graphs for the Rectangular window</b> .....	<b>3-197</b>
<b>Figure 3-57: Time and frequency graphs of the Hamming window</b> .....	<b>3-198</b>
<b>Figure 3-58: Time and frequency graphs for the Hanning window</b> .....	<b>3-199</b>
<b>Figure 3-59: Time and frequency graphs for the Kaiser-Bessel window</b> .....	<b>3-200</b>
<b>Figure 3-60: Time and frequency graphs of the Blackman-Harris window</b> .....	<b>3-201</b>
<b>Figure 3-61: Time and frequency domain graphs for the Flatop2 window</b> .....	<b>3-202</b>
<b>Figure 3-62: Tek Exponential window in the time and the frequency domains</b> .....	<b>3-203</b>
<b>Figure 3-63: How aliased frequencies appear in a spectral waveform</b> .....	<b>3-205</b>
<b>Figure 3-64: Auto-increment file name feature</b> .....	<b>3-223</b>
<b>Figure 3-65: Print window</b> .....	<b>3-250</b>
<b>Figure 3-66: Hardcopy formats</b> .....	<b>3-251</b>
<b>Figure 3-67: Page setup window</b> .....	<b>3-252</b>
<b>Figure 3-68: Print preview window</b> .....	<b>3-253</b>
<b>Figure B-1: Levels used to determine measurements</b> .....	<b>B-5</b>
<b>Figure B-2: Eye-diagram and optical values</b> .....	<b>B-7</b>

## List of Tables

<b>Table 1-1: Additional accessory connection information</b> .....	<b>1-9</b>
<b>Table 1-2: Line fuses</b> .....	<b>1-9</b>
<b>Table 1-3: Vertical settings</b> .....	<b>1-25</b>
<b>Table 1-4: Options</b> .....	<b>1-33</b>
<b>Table 1-5: Standard accessories</b> .....	<b>1-35</b>
<b>Table 1-6: Optional accessories</b> .....	<b>1-36</b>
<b>Table 3-1: Additional resolution bits</b> .....	<b>3-25</b>
<b>Table 3-2: Sampling mode selection</b> .....	<b>3-38</b>
<b>Table 3-3: How interleaving affects sample rate</b> .....	<b>3-40</b>
<b>Table 3-4: XY and XYZ format assignments</b> .....	<b>3-48</b>
<b>Table 3-5: Pattern and state logic</b> .....	<b>3-80</b>
<b>Table 3-6: Defining and displaying waveforms</b> .....	<b>3-121</b>
<b>Table 3-7: Operations performed based on the waveform type</b> ...	<b>3-122</b>
<b>Table 3-8: Customizable display elements</b> .....	<b>3-132</b>
<b>Table 3-9: Cursor functions (types)</b> .....	<b>3-151</b>
<b>Table 3-10: Cursor units</b> .....	<b>3-154</b>
<b>Table 3-11: Math expressions and the math waveforms produced</b> .....	<b>3-170</b>
<b>Table 3-12: Spectral analyzer controls</b> .....	<b>3-183</b>
<b>Table 3-13: Window characteristics</b> .....	<b>3-194</b>
<b>Table A-1: Instrument models</b> .....	<b>A-2</b>
<b>Table A-2: Channel input and vertical specifications</b> .....	<b>A-5</b>
<b>Table A-3: Horizontal and acquisition system specifications</b> .....	<b>A-11</b>
<b>Table A-4: Trigger specifications</b> .....	<b>A-15</b>
<b>Table A-5: Serial Trigger specifications (optional on TDS7000B Series)</b> .....	<b>A-19</b>
<b>Table A-6: Display specifications</b> .....	<b>A-19</b>
<b>Table A-7: Input/output port specifications</b> .....	<b>A-20</b>
<b>Table A-8: O/E converter (CSA7000B Series only)</b> .....	<b>A-23</b>
<b>Table A-9: Data storage specifications</b> .....	<b>A-25</b>
<b>Table A-10: Power source specifications</b> .....	<b>A-25</b>
<b>Table A-11: Mechanical specifications</b> .....	<b>A-26</b>
<b>Table A-12: Environmental specifications</b> .....	<b>A-27</b>
<b>Table A-13: Certifications and compliances</b> .....	<b>A-28</b>
<b>Table B-1: Supported measurements and their definition</b> .....	<b>B-1</b>

---

<b>Table B-2: Comm measurements and their definition</b> .....	<b>B-4</b>
<b>Table B-3: Supported measurements and their definition</b> .....	<b>B-9</b>
<b>Table C-1: File menu commands</b> .....	<b>C-1</b>
<b>Table C-2: Edit menu commands</b> .....	<b>C-3</b>
<b>Table C-3: Vertical menu commands</b> .....	<b>C-4</b>
<b>Table C-4: Horiz/Acq menu commands</b> .....	<b>C-5</b>
<b>Table C-5: Trig menu commands</b> .....	<b>C-7</b>
<b>Table C-6: Display menu commands</b> .....	<b>C-9</b>
<b>Table C-7: Cursor menu commands</b> .....	<b>C-11</b>
<b>Table C-8: Measure menu commands</b> .....	<b>C-11</b>
<b>Table C-9: Masks menu commands</b> .....	<b>C-13</b>
<b>Table C-10: Math menu commands</b> .....	<b>C-14</b>
<b>Table C-11: Application menu commands</b> .....	<b>C-14</b>
<b>Table C-12: Utilities menu commands</b> .....	<b>C-15</b>
<b>Table C-13: Help menu commands</b> .....	<b>C-16</b>





# General Safety Summary

Review the following safety precautions to avoid injury and prevent damage to this product or any products connected to it. To avoid potential hazards, use this product only as specified.

*Only qualified personnel should perform service procedures.*

While using this product, you may need to access other parts of the system. Read the *General Safety Summary* in other system manuals for warnings and cautions related to operating the system.

## To Avoid Fire or Personal Injury

**Use Proper Power Cord.** Use only the power cord specified for this product and certified for the country of use.

**Connect and Disconnect Properly.** Do not connect or disconnect probes or test leads while they are connected to a voltage source.

**Ground the Product.** This product is grounded through the grounding conductor of the power cord. To avoid electric shock, the grounding conductor must be connected to earth ground. Before making connections to the input or output terminals of the product, ensure that the product is properly grounded.

**Observe All Terminal Ratings.** To avoid fire or shock hazard, observe all ratings and markings on the product. Consult the product manual for further ratings information before making connections to the product.

**Do Not Operate Without Covers.** Do not operate this product with covers or panels removed.

**Use Proper Fuse.** Use only the fuse type and rating specified for this product.

**Avoid Exposed Circuitry.** Do not touch exposed connections and components when power is present.

**Wear Eye Protection.** Wear eye protection if exposure to high-intensity rays or laser radiation exists.

**Do Not Operate With Suspected Failures.** If you suspect there is damage to this product, have it inspected by qualified service personnel.

**Do Not Operate in Wet/Damp Conditions.**

**Do Not Operate in an Explosive Atmosphere.**

**Keep Product Surfaces Clean and Dry.**

**Provide Proper Ventilation.** Refer to the manual's installation instructions for details on installing the product so it has proper ventilation.

## Symbols and Terms

**Terms in this Manual.** These terms may appear in this manual:



---

**WARNING.** *Warning statements identify conditions or practices that could result in injury or loss of life.*

---



---

**CAUTION.** *Caution statements identify conditions or practices that could result in damage to this product or other property.*

---

**Terms on the Product.** These terms may appear on the product:

DANGER indicates an injury hazard immediately accessible as you read the marking.

WARNING indicates an injury hazard not immediately accessible as you read the marking.

CAUTION indicates a hazard to property including the product.

**Symbols on the Product.** The following symbols may appear on the product:



CAUTION  
Refer to Manual



WARNING  
High Voltage



Protective Ground  
(Earth) Terminal



Mains Disconnected  
OFF (Power)



Mains Connected  
ON (Power)



Standby

# Preface

This user manual covers the following information:

- Describes the capabilities of the instrument, how to install it and how to reinstall its software
- Explains how to operate the instrument: how to control acquisition of, processing of, and input/output of information
- Lists specifications and accessories of the instrument

## About This Manual

This manual is composed of the following chapters:

- *Getting Started* shows you how to configure and install your instrument and provides an incoming inspection procedure.
- *Operating Basics* uses maps to describe the various interfaces for controlling the instrument, including the front panel and the software user interface. These maps provide overviews of the product and its functions from several viewpoints.
- *Reference* comprises an encyclopedia of topics (see *Overview* on page 3-1) that describe the instrument interface and features, and gives background and basic information on how to use them. (The online help onboard the instrument application describes the interface, features, and their usage; detailed descriptions of all programming commands are found in the Programmer Online Guide.)
- *Appendices* provides additional information including the specifications, measurements, and cleaning information.

## Related Manuals and Online Documents

This manual is part of a document set of standard-accessory manuals and online documentation; this manual mainly focuses on installation, background, and user information needed to use the product features. See the following list for other documents supporting instrument operation and service. (Manual part numbers are listed in *Accessories & Options* on page 1-33.)

Document name	Description
Online Help	An online help system, integrated with the User Interface application that ships with this product. The help is preinstalled in the instrument.
Reference	A quick reference to major features of the instrument and how they operate.
Programmer Online Guide	An alphabetical listing of the programming commands and other information related to controlling the instrument over the GPIB <sup>1</sup> . This document is available as both an online help program and as a PDF manual.
Service Manual	Describes how to service the instrument to the module level. This optional manual must be ordered separately.
<i>Option SM Serial Mask Testing</i> <i>Option ST Serial Pattern Trigger User Manual</i>	Describes how to use serial mask testing and serial pattern triggers.

**1** Located on the Product Software CD. See CD instructions for installation instructions.

For more information on how the product documentation relates to the instrument operating interfaces and features, see *Documentation Map* on page 2-2.

# Product Description

This chapter describes the CSA7000B Series Communications Signal Analyzers and the TDS7000B Series Digital Phosphor Oscilloscopes and their options. Following this description are three sections:

- *Installation* shows you how to configure and install the instrument, as well as how to reinstall the system software included with the product.
- *Incoming Inspection* provides a procedure for verifying basic operation and functionality.
- *Accessories & Options* lists the standard and optional accessories for this product.

## Models

This manual supports the following instruments:

- CSA7404B Communications Signal Analyzer
- TDS7704B Digital Phosphor Oscilloscope
- TDS7404B Digital Phosphor Oscilloscope
- TDS7254B Digital Phosphor Oscilloscope
- TDS7154B Digital Phosphor Oscilloscope

Differences between the instruments will be called out when necessary. Otherwise, the material applies to all instruments. The word “instrument” refers to all products.

## Key Features

CSA7000B Series and TDS7000B Series instruments are high performance solutions for verifying, debugging, and characterizing sophisticated electronic designs. The series features exceptional signal acquisition performance, operational simplicity, and open connectivity to the design environment. Classic analog-style controls, a large touch-sensitive display, and graphical menus provide intuitive control. Open access to the Windows operating system enables unprecedented customization and extensibility. Key features include:

- Up to 7 GHz bandwidth and 20 GS/s real time sampling rate, depending on the model

- Record lengths up to 64,000,000 samples, depending on model and option
- Fast acquisition at up to 400,000 acquisitions per second for analog instrument emulation and isolation of data-dependent failures during conformance/performance testing and for examination of very low-level signals in pseudo-random bit streams
- CSA7000B Series: Communication signal analysis, serial mask testing, serial pattern triggering, and triggering on communications signals. Use of these features is described in the *Option SM Serial Mask Testing and Option ST Serial Pattern Trigger User Manual*
- CSA7000B Series: Optical-to-Electrical converter, optical reference receiver, and clock recovery provides single-connection convenience, protects integrity of system calibration, and increases versatility
- Up to 2% DC vertical gain accuracy, depending on the model
- Four input channels (each with 8-bit resolution), CH 3 signal output, and auxiliary trigger input and output
- Sample, envelope, peak-detect, high-resolution, waveform database, and average acquisition modes
- Full programmability, with an extensive GPIB-command set and a message-based interface
- Trigger modes include edge, logic, pulse (may be logic qualified), serial (CSA7000B Series, optional on TDS7000B Series), communication (CSA7000B Series and optional on TDS7000B Series), and sequence at up to 4 GHz bandwidth, depending on the model. Window trigger mode triggers as the trigger source passes into or out of a defined window. Triggers can be logic qualified. Setup and hold trigger mode triggers when a logic input changes state inside of the setup and hold times relative to the clock. Trigger jitter is as low as 1 ps RMS. You can trigger on a glitch or runt of less than 250 ps
- Powerful built-in measurement capability, including histograms, automatic measurements, eye pattern measurements (CSA7000B Series and optional on TDS7000B Series), and measurement statistics
- A large 10.4 inch (264.2 mm) high resolution XGA color display that supports color grading of waveform data to show sample density
- MultiView Zoom to view and compare up to four zoom areas at a time. Lock and manually or automatically scroll up to four zoom areas
- An intuitive, graphical user interface (UI), with online help that is built in and available on screen
- Internal, removable disk storage

- Wide array of probing solutions

## Product Software

The instrument includes the following software:

- System Software. Includes a specially configured version of Windows XP preinstalled on the instrument. Windows XP is the operating system on which the user-interface application of this product runs, and provides an open desktop for you to install other compatible applications. Do not attempt to substitute any version of Windows that is not specifically provided by Tektronix for use with your instrument.
- Product Software. Comes preinstalled on the instrument. This software, running on Windows XP, is the instrument application. This software starts automatically when the instrument is powered on, and provides the user interface (UI) and all other instrument control functions. You can also minimize the instrument application.
- Support Software. Not preinstalled on the instrument. The compact discs, included with the instrument, contain additional software and files that may be useful to you:
  - Readme file. This file contains release notes and updates that could not be included in other product documentation.
  - GPIB Programmer Online Help software. This software, in an online help format, contains the information that you need to program the instrument through its GPIB interface. A printable PDF file of this information is also available on the compact disc.
  - Performance Verification Procedures. The compact disc contains instructions to perform a performance verification.

See the instructions for the compact discs for information about installing the support software.

Occasionally new versions of software for your instrument may become available at our web site. See *Contacting Tektronix* on the back of the title page.

## Software Upgrade

Tektronix may offer software upgrade kits for the instrument. Contact your Tektronix service representative for more information (see *Contacting Tektronix* on the back of the title page).





# Installation

This chapter covers installation of the instrument, addressing the following topics:

- *Unpacking* on page 1-5
- *Checking the Environment Requirements* on page 1-6
- *Connecting Peripherals* on page 1-7
- *Powering On the Instrument* on page 1-9
- *Shutting Down the Instrument* on page 1-10
- *Backing Up User Files* on page 1-11
- *Installing Software* on page 1-13
- *Enabling or Disabling Your LAN and Connecting to a Network* on page 1-16
- *Setting up a Dual Display* on page 1-17

## Unpacking

Verify that you have received all of the parts of your instrument. The graphical packing list shows the standard accessories that you should find in the shipping carton (probes depend on the option you ordered.) You should also verify that you have:

- The correct power cord for your geographical area.

- The compact discs that include copies of the software installed on the instrument and additional support software that may be useful to you: the Operating System Restore, Product Software, and Optional Applications Software. Store the product software in a safe location where you can easily retrieve it.

---

**NOTE.** *The certificate of authenticity (Microsoft Windows licence agreement) is attached to the rear of your instrument. This certificate proves your ownership of the Windows operating system in your instrument. Without this certificate, you might have to purchase a new Windows license if the hard disk in your instrument ever needs rebuilding or replacement.*

---

- All the standard and optional accessories that you ordered.

Fill out and send in the customer registration card.

## Checking the Environment Requirements

Read this section before attempting any installation procedures. This section describes site considerations, power requirements, and ground connections for your instrument.

### Site Considerations

The instrument is designed to operate on a bench or on a cart in the normal position (on the bottom feet). For proper cooling, at least three inches (7.62 cm) of clearance is required on both sides of the instrument, and the bottom requires the clearance provided by the instrument feet.

If you operate the instrument while it is resting on the rear feet, make sure that you properly route any cables coming out of the rear of the instrument to avoid damaging them.



---

**CAUTION.** *To prevent damage to the instrument, keep the bottom and sides of the instrument clear of obstructions for proper cooling.*

---

**Operating Requirements**

The Specifications in *Appendix A* list the operating requirements for the instrument. Power source, temperature, humidity, and altitude are listed.

**Connecting Peripherals**

The peripheral connections are the same as those you would make on a personal computer. The connection points are shown in Figure 1-1. See Table 1-1 on page 1-9 for additional connection information.



---

**CAUTION.** *To avoid product damage, either power off the instrument or place the instrument in Standby power mode before installing any accessories except a USB mouse or keyboard to the instrument connectors. (You can connect and disconnect USB devices with the power on.) See Shutting Down the Instrument on page 1-10.*

---

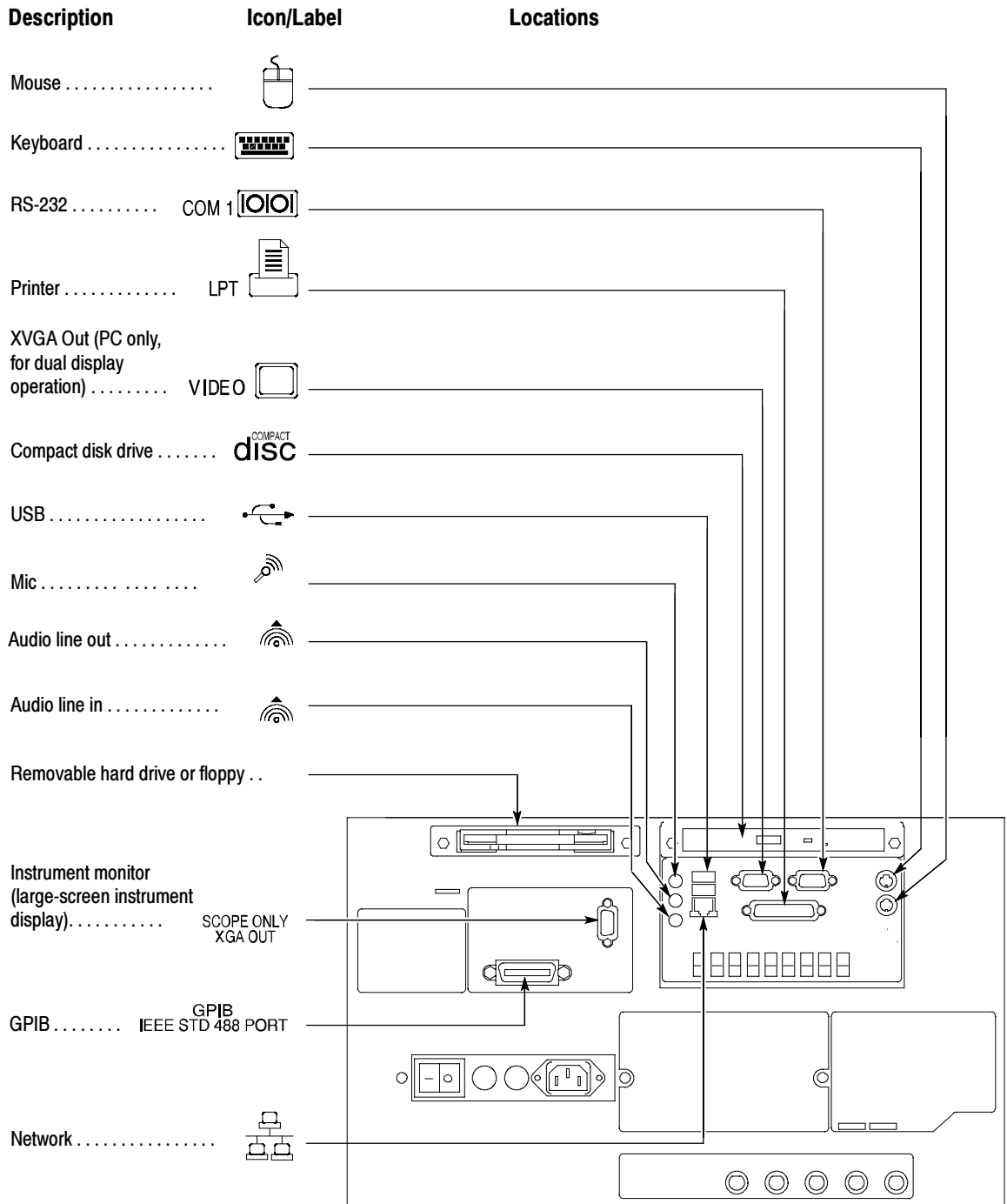


Figure 1- 1: Locations of peripheral connectors on rear panel

**Table 1-1: Additional accessory connection information**

Item	Description
Monitor	If you use a nonstandard monitor, you may need to change the Windows display settings to achieve the proper resolution for your monitor. To set up a dual display, see page 1-17.
Printer	Connect the printer to the EPP (enhanced parallel port) connector directly. If your printer has a DB-25 connector, use the adapter cable that came with your printer to connect to the EPP connector. For information on printer usage, see <i>Printing Waveforms</i> on page 3-250.
Rackmount	Refer to the Rackmount Installation Instructions for information on installing the rackmount kit.
Other	Refer to the Readme file on the Product Software CD for possible additional accessory installation information not covered in this manual.

## Powering On the Instrument

Follow these steps to power on the instrument for the first time.

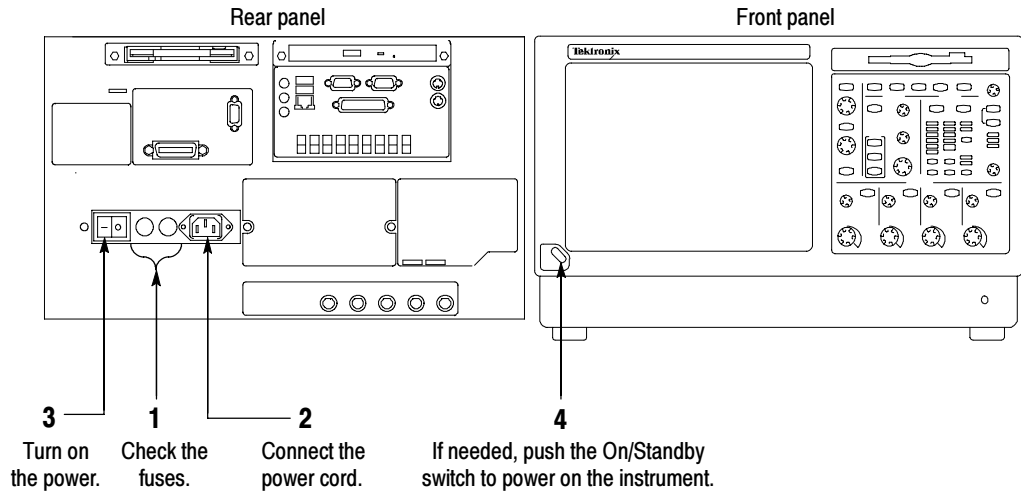
Either one of the following fuse sizes can be used, each size requires a different fuse cap. Both fuses must be the same type. See Table 1-2 and Figure 1-2.

**Table 1-2: Line fuses**

Line voltage	Description	Part number
100 V to 250 V operation	UL198G and CSA C22.2, No. 59, fast acting: 8 A, 250 V	Tektronix 159-0046-00 Bussman ABC-8 Littelfuse 314008
	IEC127, sheet 1, fast acting "F", high breaking capacity: 6.3 A, 250 V	Tektronix 159-0381-00 Bussman GDA-6.3 Littelfuse 21606.3



**CAUTION.** *Connect the keyboard, mouse, and other accessories before applying power to the product.*



**Figure 1-2: Powering on the instrument**

## Shutting Down the Instrument

When you push the front-panel On/Standby switch, the instrument starts a shutdown process (including a Windows shutdown) to preserve settings and then removes power from most circuitry in the instrument. Avoid using the rear-panel power switch or disconnecting the line cord to power off the instrument.

---

**NOTE.** *If you do not use the On/Standby switch to shut down the instrument before powering off the instrument, the instrument will be in the factory Default Setup when powered on the next time.*

---

To completely remove power to the instrument, perform the shutdown just described, set the power switch on the rear panel to off, and then remove the power cord from the instrument.

## Backing Up User Files

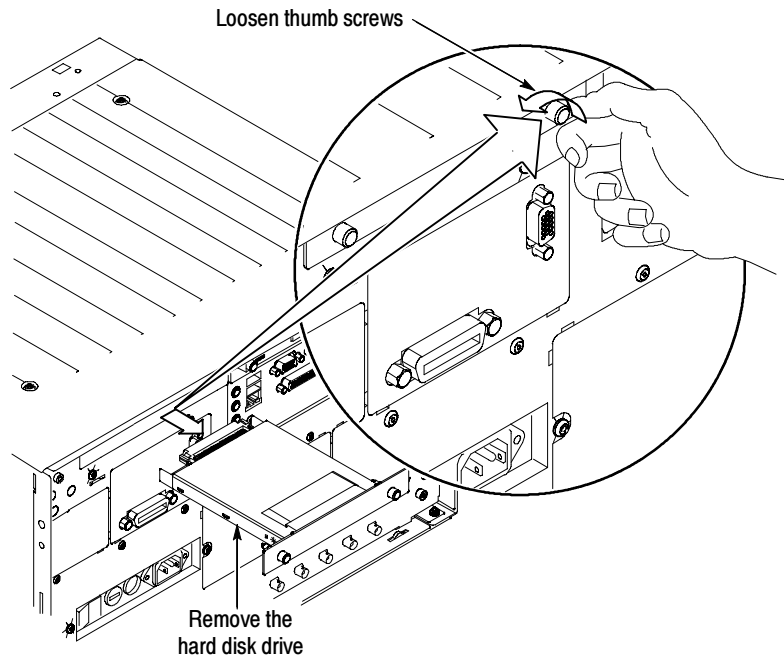
You should always back up your user files on a regular basis. Use the Back Up tool to back up files stored on the hard disk. The Back Up tool is located in the System Tools folder in the Accessories folder.

1. Minimize the instrument application by selecting **Minimize** in the File menu.
2. Touch the Windows **Start** button.
3. Select **Programs, Accessories, System Tools, Backup** in the Start menu.
4. Use the backup tool that displays to select your backup media and to select the files and folders that you want to back up. Use the Windows online help for information on using the Backup tool. You can back up to the floppy drive or to a third-party storage device over the printer port (rear panel).

## Removing the Removable Hard Drive

The removable hard drive is preinstalled at the factory. You can secure data separate from the instrument with the removable hard drive. To remove the hard drive follow these steps:

1. Verify that the instrument is powered off.
2. Set the instrument so its bottom is down on the work surface and its rear panel is facing you. See Figure 1-3 on page 1-12. Note, if you have option FHD installed on your instrument, the front panel should be facing you instead of the rear panel.
3. Loosen the thumb screws that secure the hard drive to the drive tray.
4. Grasp the hard disk drive assembly by the thumb screws and pull until the handle is exposed. Grasp the handle and pull the hard drive assembly straight out of the instrument.



**Figure 1-3: Removing the hard drive**

## Reinstalling the Removable Hard Drive

To reinstall the hard drive follow these steps. See Figure 1-4 on page 1-13:

1. Verify that the instrument is powered off.
2. Leaving the cover/handle extended, push the hard drive assembly into place until it stops, ensuring that it is straight. Push the hard drive assembly firmly to ensure that the connector is seated properly.
3. Slide the cover/handle in until it stops. It will be almost flush with the back panel.
4. Finger tighten the two thumb screws to ensure that the removable hard drive is properly seated.



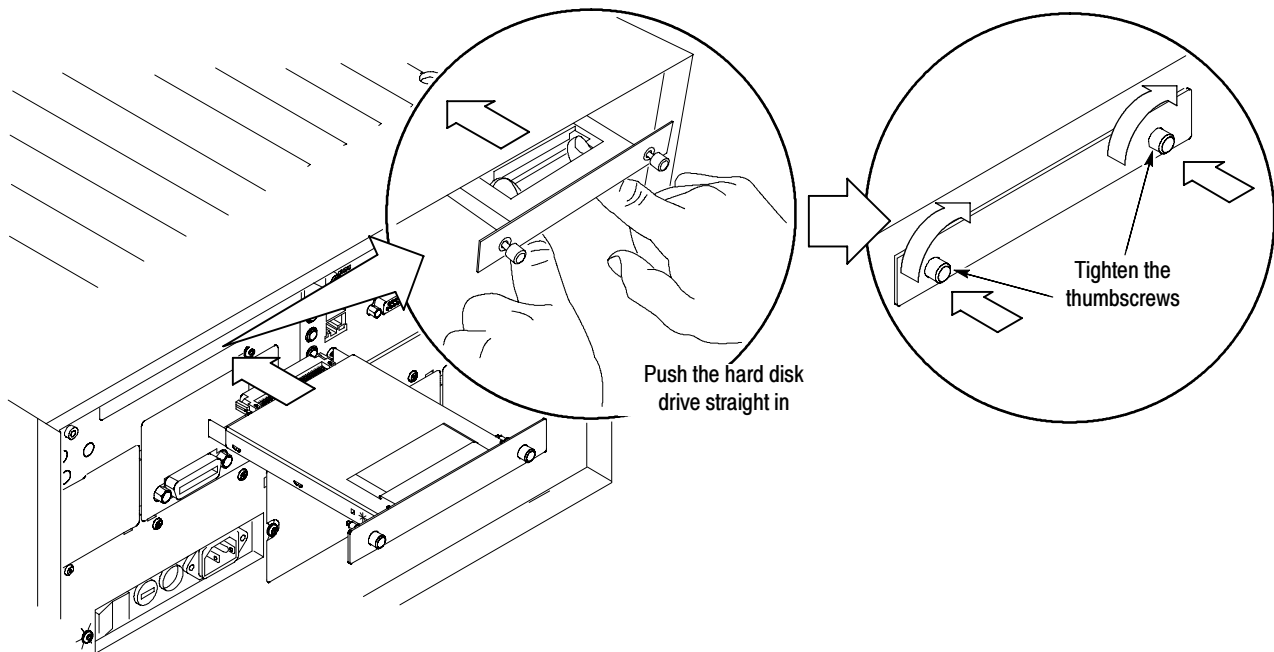


Figure 1-4: Reinstalling the hard drive

## Installing Software

The instrument system and application software is preinstalled at the factory. If you have to reinstall the software for any reason, refer to the instructions that accompany the CDs that are shipped with the instrument. If you need to restore the operating system, you also need the Windows license information from the Certificate of Authenticity that is shipped with the instrument.

### Software Release Notes

Read the software release notes README.TXT ASCII file on the product-software CD before performing installation procedures. This file contains additional installation and operation information that supercedes other product documentation.

To view the README.TXT file, open the Notepad Windows accessory. Then open the file on the Product Software CD.

## Accessory Software

The Product Software CD also contains accessory software and files that you can choose to install in the instrument or in another computer. Refer to the instructions that accompany the CD for installation information.

**GPIB Programmer Online Help Software.** You can install the GPIB Programmer online help on the instrument, but it may be more convenient to install it on the PC that is functioning as the GPIB system controller. From the system controller, you can copy and paste commands from the help directly into your test programs. The programmer information contains the following content:

- GPIB configuration information for the instrument
- Lists of the command groups and the commands they contain
- Detailed command descriptions including syntax and examples
- Status and error messages
- Programming examples

The CD also contains a printable version of the programmer information in the form of a PDF file.

**Manual Performance Verification Procedure.** This is a printable PDF file that describes how to verify the instrument performance using generic test equipment.

**User manual.** This is a PDF file of this user manual.

**Serial Mask User Manual.** This is a PDF file that describes how to use the serial mask features of the instrument.

**Optional Accessory Software.** The *Optional Applications Software* CD contains programs that you can install and run five times per application. You can then purchase an upgrade from Tektronix if you decide that you want to continue to use the application. Refer to the instructions that accompany the CD for installation information.

## Desktop Applications

You can install desktop application software on the instrument. The instrument has been tested with the following software products installed:

- Microsoft Office 2000 (including Word, Excel, Powerpoint, and Access)
- MathCad
- MATLAB

Other software products may be compatible but have not been tested by Tektronix. If the instrument malfunctions after you install software, you should uninstall the software, and then reinstall the instrument application to restore proper operation.

**Exiting the Instrument Application.** Before installing other desktop applications, you should exit the instrument application. Follow these steps to exit the instrument application:

---

**NOTE.** *If you are not using a USB keyboard and mouse, you must power on the instrument after attaching your keyboard and mouse.*

---

1. Connect a keyboard and mouse to the instrument.
2. While holding down the **CTRL** and **ALT** keys, press the **DELETE** key.
3. Select **Task Manager**.
4. In the Applications tab, select **TekScope.exe**, and then select **End Process** to stop the instrument application.

The instrument application will restart after you restart the entire system, following the installation of the desktop application software.

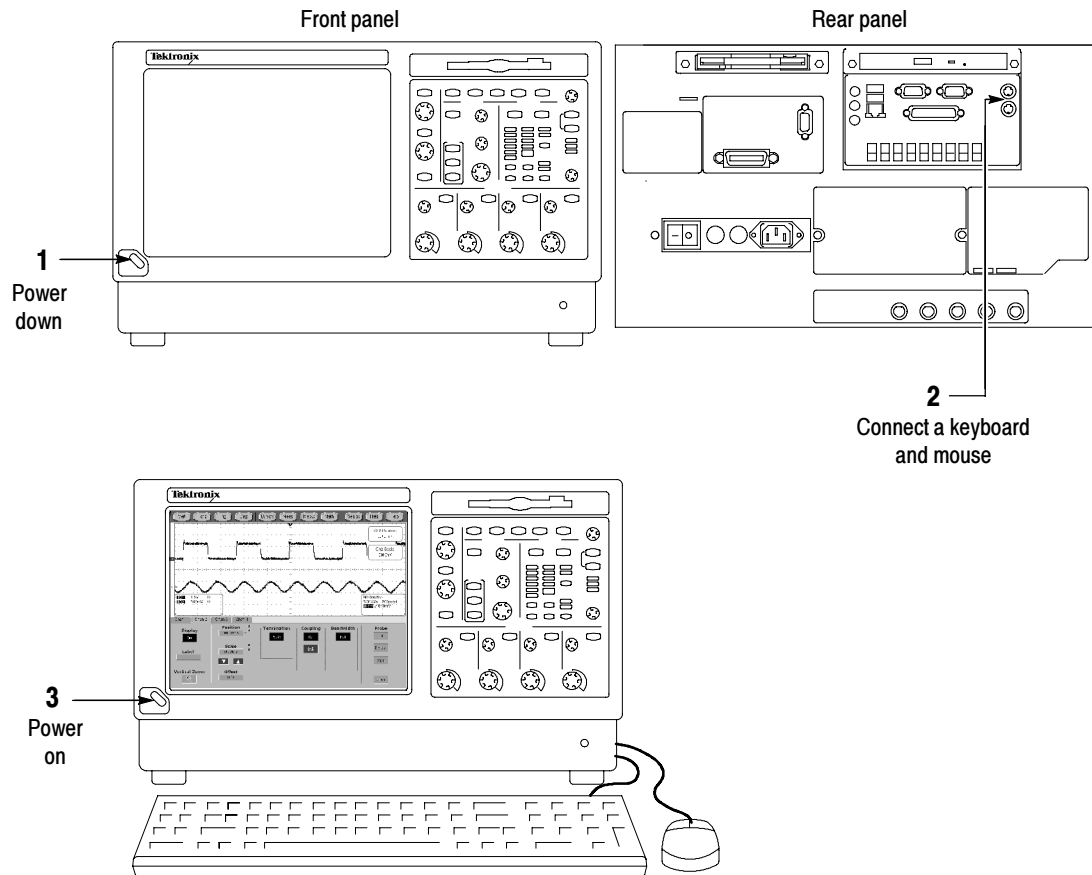
## Options

Some options contain software that must be installed and/or enabled. To do the installation, follow the specific instructions that come with the option.

Tektronix provides a key that you must enter (one time) to enable all the options that you have purchased for your instrument. To enter the key, select **Option Installation** in the **Utilities** menu, and then follow the on-screen instructions.

## Enabling or Disabling Your LAN and Connecting to a Network

You can connect the instrument to a network to enable printing, file sharing, internet access, and other communications functions. Before you make the connection, do the following steps to enable (the default) network access to the instrument:



**Figure 1-5: Enabling your LAN and connecting to a network**

4. As the instrument begins to boot, press the **F2** key on the keyboard repeatedly until the message “**Entering SETUP**” (“Loading SETUP” on some instruments) appears.
5. In the BIOS Setup Utility, use the right-arrow key on the keyboard to highlight the **Advanced** menu at the top of the screen.
6. Use the arrow down key to highlight **Peripheral Configuration** in the Advanced screen, and then press **Enter**.

7. Use the arrow down key to highlight **Onboard LAN** in the Peripheral Configuration screen, and then press **Enter**.
8. Use the arrow up or down key to highlight **Enabled**, and then press **Enter**.
9. Press the **F10** key to save and exit. Confirm the Save of Configuration changes when you are prompted on screen.
10. Use the Windows network setup utility to define the instrument as a network client and configure it for your network. You can find the network setup utility in the Windows **Start** menu if you select **Settings > Control Panel** and then double-click **Network**. Consult your network administrator for specific instructions to make these settings.

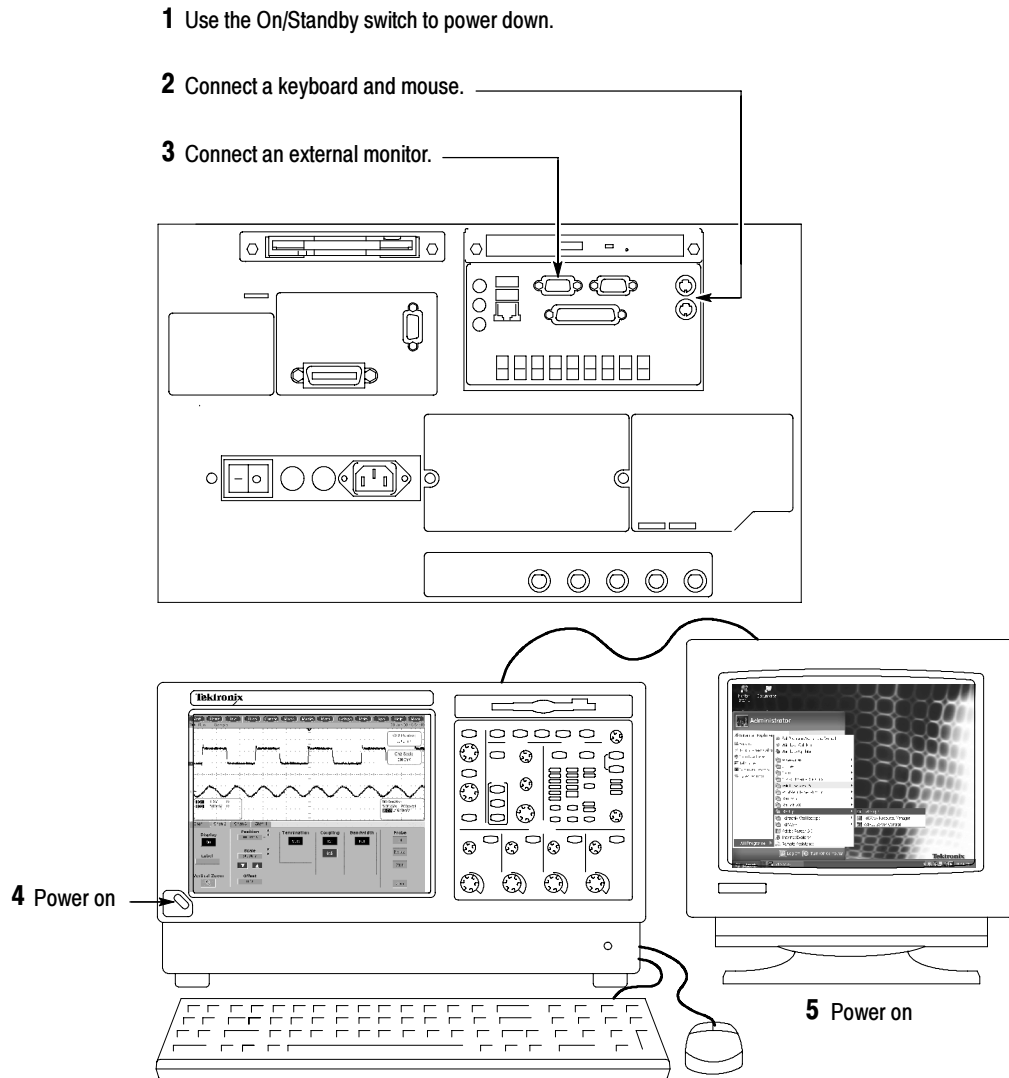
---

**NOTE.** *If you want to disable network access for the instrument, perform the above procedure except substitute **Disabled** for the command listed in step 8. The instrument will boot faster with network access disabled.*

---

## Setting up a Dual Display

Use the following steps to set up the instrument for dual display operation. You can operate the instrument while having full use of Windows and other applications on the external monitor.



**Figure 1-6: Setting up a dual display**

6. The instrument should detect that the new monitor was connected. Follow the instructions, if any, on the instrument display to install new drivers for the monitor.
7. Type a **Control-M** to minimize the instrument application.
8. In the Windows desktop, right-click the mouse, and then select **Properties** to display the Display Properties dialog box.
9. Select the **Settings** tab. Click on the grayed out external monitor (2) in the display box, and drag it to the left of monitor 1.
10. Select **Yes** when you are prompted to enable the new monitor.



**CAUTION.** Do not change the resolution or color settings for the internal LCD monitor. The internal resolution must be 1024 x 768 and the color setting must be True Color (24 bit).

11. Select **OK** to apply the settings. Select **Yes** to restart your instrument. After the instrument restarts, the new monitor will display additional desktop area.

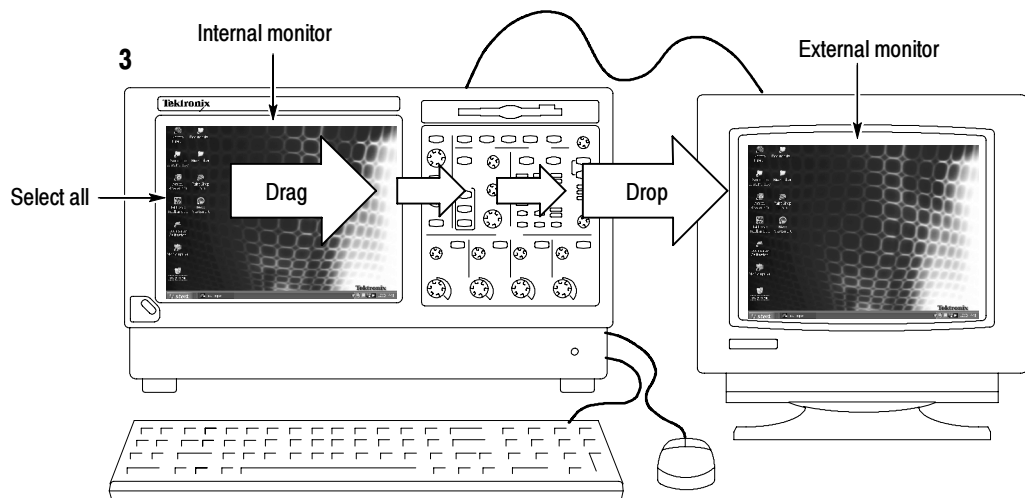
To make the best use of the new display area, do these additional steps to move the Windows controls to the external monitor:

1. Click (and hold) on the Windows task bar in the area shown in Figure 1-7, and then drag it upwards and toward the external monitor. The task bar will first go to the side of the internal monitor, then to the side of the external monitor, and finally to the bottom of the external monitor.



**Figure 1-7: Drag area for Windows task bar**

2. Release the mouse when the task bar is where you want it to be.



**Figure 1-8: Moving Windows desktop icons to the external monitor**

4. If you use the instrument help system, you can drag the help windows to the external monitor so that you can read them while you operate the instrument.
5. When you open any Windows application, drag the windows from the application to the external monitor.



# Incoming Inspection

This chapter contains instructions for performing the *Incoming Inspection Procedure*. This procedure verifies that the instrument is operating correctly after shipment, but does not check product specifications. This procedure contains the following parts:

- *Self Tests* on page 1-22 provides instructions for performing the internal self tests.
- *Functional Tests* on page 1-23 measures the time- and amplitude-reference signals at the PROBE COMPENSATION connector.
- *Perform the Extended Diagnostics* on page 1-32 provides instructions for performing internal self calibration and the extended diagnostics.

If the instrument fails any test within this section, it may need service. To contact Tektronix for service, see *Contacting Tektronix* on the back of the title page.

Make sure you have put the instrument into service as detailed in *Installation* starting on page 1-5. Then assemble the following test equipment and proceed with the procedures that follow.

## Assemble Equipment

Self tests do not require any test equipment. The functional tests require the following test equipment:

- One BNC cable, such as Tektronix part number 012-0076-xx
- One 1.44 Mbyte, 3.5 inch formatted disk to check the file system
- A P7240 probe (P7260 probe with TDS7704B)
- A probe calibration and deskew fixture, Tektronix part number 067-0405-xx (067-0848-xx for TDS7704B)
- One TCA-BNC TekConnect adapter, or one TCA-SMA TekConnect adapter and one SMA male-to-BNC female adapter, such as Tektronix part number 015-1018-xx

## Self Tests

This procedure uses internal routines to verify that the instrument functions and was adjusted properly. No test equipment or hookups are required.

<b>Equipment required</b>	None
<b>Prerequisites</b>	Power on the instrument and allow a 20 minute warm-up before doing this procedure.

1. *Verify that internal diagnostics pass:* Do the following substeps to verify passing of internal diagnostics.
  - a. *Display the System diagnostics menu:*
    - If the instrument is in toolbar mode, touch the **MENU** button to put the instrument into menu bar mode.
    - From the **Utilities** menu, select **Instrument Diagnostics . . . .** This displays the diagnostics control window.
  - b. *Run the System Diagnostics:*
    - First disconnect any input signals and probes from all four channels.
    - Touch the **Run** button in the diagnostics control window.
  - c. *Wait:* The internal diagnostics do an exhaustive verification of proper instrument function. This verification will take several minutes. When the verification is finished, the resulting status will appear in the diagnostics control window.

---

**NOTE.** *If diagnostic error message 512 is displayed, run signal-path compensation, and then rerun Instrument Diagnostics.*

---

- d. *Verify that no failures are found and reported on-screen.* All tests should pass.
- e. *Run the signal-path compensation routine:*
  - From the **Utilities** menu, select **Instrument Calibration . . . .** This displays the Instrument Calibration control window.
  - Touch the **Calibrate** button to start the routine.
- f. *Wait:* Signal-path compensation may take five to ten minutes to run.

- g. *Confirm signal-path compensation returns passed status:* Verify that the word **Pass** appears in the instrument calibration control window.
2. *Return to regular service:* Touch the **Close** button to exit the instrument calibration control window.

## Functional Tests

The purpose of these procedures is to confirm that the instrument functions properly. A list of required test equipment is shown on page 1-21.

---

**NOTE.** *These procedures verify that the instrument features operate. They do not verify that they operate within limits.*

*Therefore, when the instructions in the functional tests that follow call for you to verify that a signal appears on-screen “that is about five divisions in amplitude” or “has a period of about six horizontal divisions,” and so forth, do not interpret the quantities given as limits.*

---



---

**NOTE.** *Do not make changes to the front-panel settings that are not called out in the procedures. Each verification procedure will require you to set the instrument to certain default settings before verifying functions. If you make changes to these settings, other than those called out in the procedure, you may obtain invalid results. In this case, redo the procedure from step 1.*

*When you are instructed to press a front-panel button or screen button, the button may already be selected (its label will be highlighted). If this is the case, it is not necessary to push the button.*

---

### Check Vertical Operation

<b>Equipment required</b>	One BNC cable One P7240 probe (P7260 probe for TDS7704B) One 067-0405-xx (067-0484-xx for TDS7704B) probe calibration and deskew fixture
<b>Prerequisites</b>	None

1. *Initialize the instrument:* Push the front-panel **DEFAULT SETUP** button.
2. *Hook up the signal source:* Connect the equipment as shown in Figure 1-9 to the channel input you want to test (beginning with CH 1).

**NOTE.** If a probe is not available, connect the probe compensation output to the channel input using a BNC cable and adapters.

3. **Turn off all channels:** If any of the front-panel channel buttons are lighted, push those buttons to turn off the displayed channels. See Figure 1-10.
4. **Select the channel to test:** Push the channel button for the channel you are currently testing. The button lights and the channel display comes on.

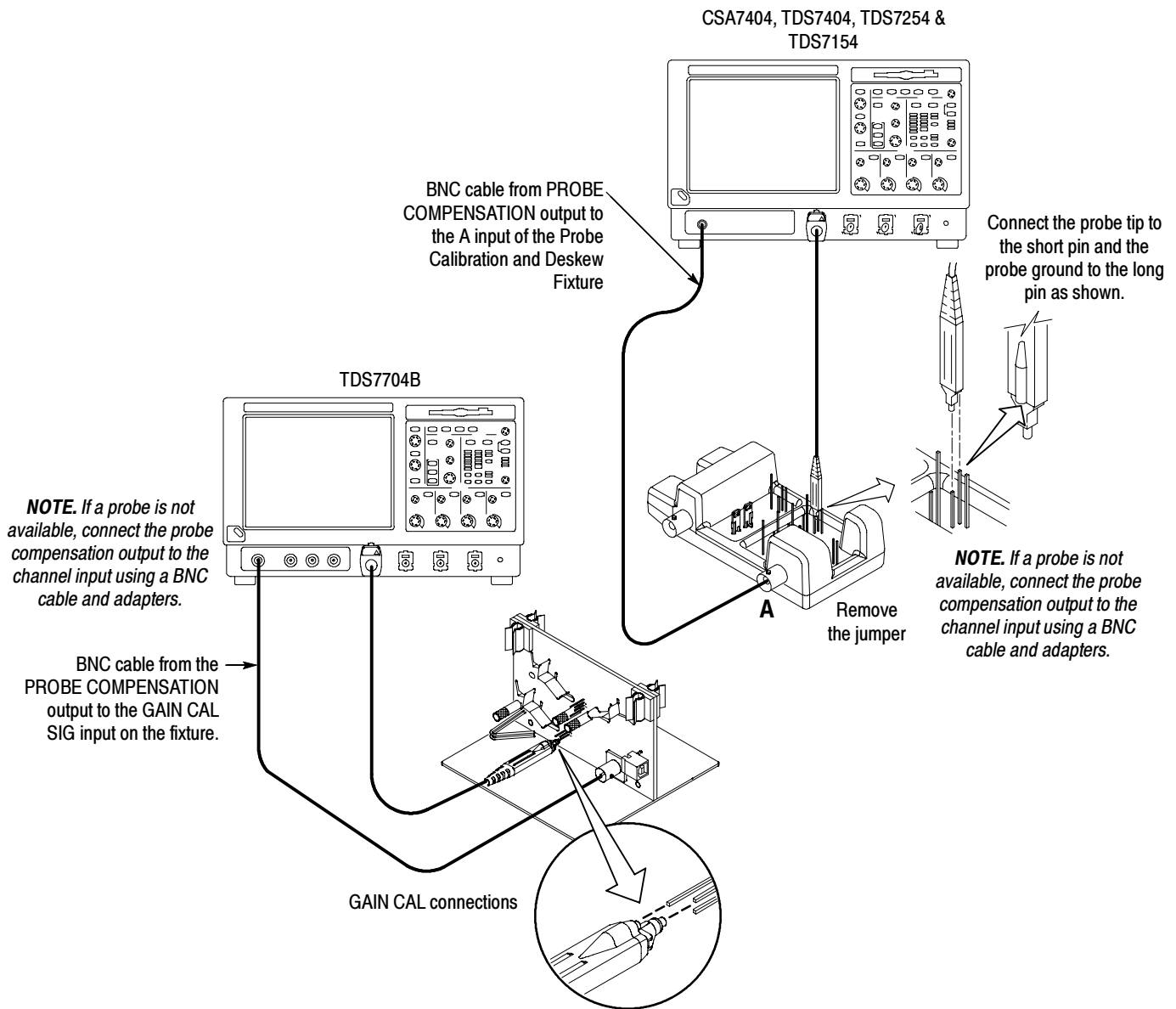
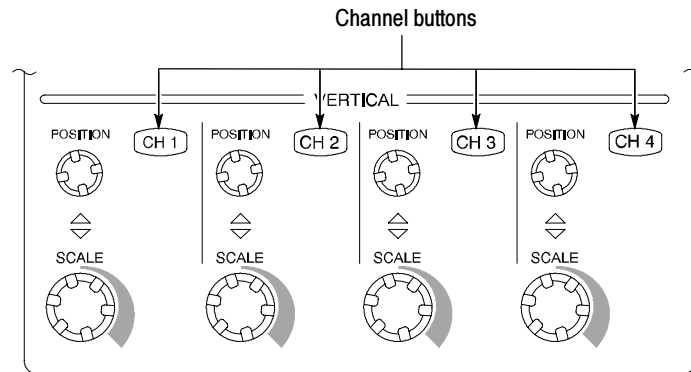


Figure 1-9: Universal test hookup for functional tests - CH 1 shown



**Figure 1-10: Channel button location**

**5. Set up the instrument:**

- Push the front-panel **AUTOSET** button. This sets the horizontal and vertical scale and vertical offset for a usable display and sets the trigger source to the channel that you are testing.
- Touch the **Vert** button and then touch **Offset**. Confirm that the Ch1 Offset is about **-0.18 to -0.54 V** (0.0 V if not using a probe).

**6. Verify that the channel is operational:** Confirm that the following statements are true.

- Verify that the vertical scale readout and the waveform amplitude for the channel under test are as shown in Table 1-3.

**Table 1-3: Vertical settings**

Setting	CSA7404, TDS7704B, TDS7404, TDS7254, & TDS7154	
	With P7240 or P7260	Without a probe
Scale	200 mV	200 mV
Waveform amplitude	5.2 divisions	2.5 divisions

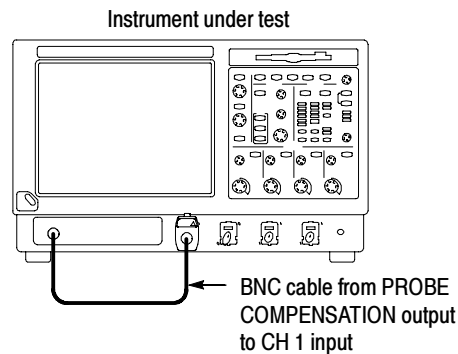
- The front-panel vertical **POSITION** knob (for the channel you are testing) moves the signal up and down the screen when rotated.
- Turning the vertical **SCALE** knob counterclockwise (for the channel you are testing) decreases the amplitude of the waveform on-screen, turning the knob clockwise increases the amplitude, and returning the knob to the original scale setting returns the amplitude to that shown in Table 1-3 for that scale setting.

7. *Verify that the channel acquires in all acquisition modes:* From the **Horiz/Acq** menu, select **Horizontal/Acquisition Setup . . .**. Touch the **Acquisition** tab in the control window that displays. Touch each of the acquisition modes and confirm that the following statements are true (see *Using the Acquisition Controls* on page 3-24 for more information):
  - Sample mode displays an actively acquiring waveform on-screen. (Note that there is a small amount of noise present on the square wave).
  - Peak Detect mode displays an actively acquiring waveform on-screen with the noise present in Sample mode “peak detected.”
  - Hi Res mode displays an actively acquiring waveform on-screen with the noise that was present in Sample mode reduced.
  - Average mode displays an actively acquiring waveform on-screen with the noise reduced.
  - Envelope mode displays an actively acquiring waveform on-screen with the noise displayed.
  - Waveform Database mode displays an actively acquiring waveform on-screen that is the accumulation of several acquisitions.
8. *Test all channels:* Repeat steps 2 through 7 until all four input channels are verified.
9. *Remove the test hookup:* Disconnect the equipment from the channel input and the probe compensation output.

**Check Horizontal Operation**

<b>Equipment required</b>	One BNC cable One TekConnect adapter
<b>Prerequisites</b>	None

1. *Initialize the instrument:* Push the front-panel **DEFAULT SETUP** button.
2. *Hook up the signal source:* Connect the equipment to the CH 1 input as shown in Figure 1-11.



**Figure 1-11: Setup for time base test**

3. *Set up the instrument:* Push the front-panel **AUTOSET** button.
4. Touch the **Vert** button and then touch **Offset**. Adjust the Ch1 Offset to **-0.25 V** using the multipurpose knob.
5. Set the Vertical **SCALE** to **100 mV** per division.
6. *Set the time base:* Set the horizontal **SCALE** to **200  $\mu\text{s}/\text{div}$** . The time-base readout is displayed at the bottom of the graticule.
7. *Verify that the time base operates:* Confirm the following statements.
  - One period of the square-wave probe-compensation signal is about five horizontal divisions on-screen for the 200  $\mu\text{s}/\text{div}$  horizontal scale setting.
  - Rotating the horizontal **SCALE** knob clockwise expands the waveform on-screen (more horizontal divisions per waveform period), counter-clockwise rotation contracts it, and returning the horizontal scale to 200  $\mu\text{s}/\text{div}$  returns the period to about five divisions.
  - The horizontal **POSITION** knob positions the signal left and right on-screen when rotated.
8. *Verify horizontal delay:*
  - a. *Center a rising edge on screen:*
    - Set the horizontal **POSITION** knob so that the rising edge where the waveform is triggered is lined up with the center horizontal graticule.
    - Change the horizontal **SCALE** to **20  $\mu\text{s}/\text{div}$** . The rising edge of the waveform should remain near the center graticule and the falling edge should be off screen.
  - b. *Turn on and set horizontal delay:*

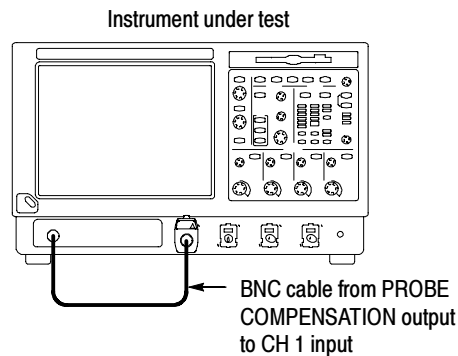
- From the **Horiz/Acq** menu, select **Horizontal/Acquisition Setup . . . .**
  - Touch the **Horizontal** tab in the displayed control window.
  - Touch the **Delay Mode** button to turn delay on.
  - Double-touch the **Horiz Delay** control in the control window to display the pop-up keypad. Touch the keypad buttons to set the horizontal delay to **1 ms**, and then touch the **ENTER** key.
- c. *Verify the waveform:* Verify that a rising edge of the waveform is within a few divisions of center screen.
- d. *Adjust the horizontal delay:* Rotate the upper multipurpose knob to change the horizontal delay setting. Verify that the rising edge shifts horizontally. Rotate the front-panel horizontal **POSITION** knob. Verify that this knob has the same effect (it also adjusts delay, but only when delay mode is on).
- e. *Verify the delay toggle function:*
- Rotate the front-panel horizontal **POSITION** knob to center the rising edge horizontally on the screen.
  - Change the horizontal **SCALE** to **40 ns/div**. The rising edge of the waveform should remain near the center graticule.
  - Readjust the delay setting to position the rising edge 2 divisions to the right of the center graticule line.
  - Push the front-panel **DELAY** button several times to toggle delay off and on and back off again. Verify that the display switches quickly between two different points in time (the rising edge shifts horizontally on the display).
9. *Remove the test hookup:* Disconnect the equipment from the channel input and the probe compensation output.

### Check Trigger Operation

<b>Equipment required</b>	One BNC cable One TCA-BNC TekConnect adapter
<b>Prerequisites</b>	None

1. *Initialize the instrument:* Push the front-panel **DEFAULT SETUP** button.
2. *Hook up the signal source:* Connect the equipment to the CH 1 input as shown in Figure 1-12.
3. *Set up the instrument:* Push the front-panel **AUTOSET** button.





**Figure 1-12: Setup for trigger test**

4. Touch the **Vert** button, and then touch **Offset**. Adjust the Ch1 Offset to **-0.25 V** using the multipurpose knob.
5. Set the Vertical **SCALE** to **100 mV** per division.
6. *Verify that the main trigger system operates:* Confirm that the following statements are true.
  - The trigger level readout for the A (main) trigger system changes with the trigger-**LEVEL** knob.
  - The trigger-**LEVEL** knob can trigger and untrigger the square-wave signal as you rotate it. (Leave the signal *untriggered*).
  - Pushing the front-panel trigger **LEVEL** knob sets the trigger level to the 50% amplitude point of the signal and triggers the signal that you just left untriggered. (Leave the signal triggered.)
7. *Verify that the delayed trigger system operates:*
  - a. *Set up the delayed trigger:*
    - From the **Trig** menu, select **A→B Sequence . . .**. This displays the A→B Sequence tab of the trigger setup control window.
    - Touch the **Trig After Time** button under A Then B.
    - Touch the **B Trig Level** control in the control window.
  - b. *Confirm that the following statements are true:*
    - The trigger-level readout for the B trigger system changes as you turn the lower multipurpose knob.
    - As you rotate the lower multipurpose knob, the square-wave probe-compensation signal can become triggered and untriggered. (Leave the signal triggered.)

c. *Verify the delayed trigger counter:*

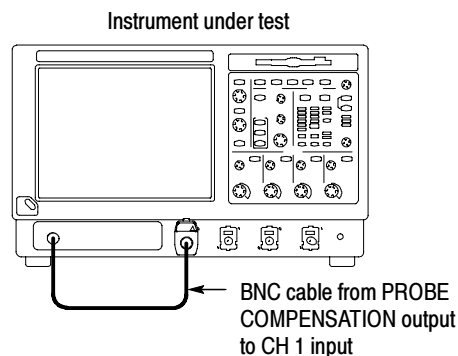
- Touch the **TRIGGER MODE** button to set the mode to NORM.
- Double-touch the **Trig Delay** control to pop up a numeric keypad for that control.
- Touch the keypad to enter a trigger delay time of **1 second**, and then touch **Enter**.
- Verify that the trigger **READY** indicator on the front panel flashes about once every second as the waveform is updated on-screen.

8. *Remove the test hookup:* Disconnect the equipment from the channel input and the Probe Compensation output.

**Check File System**

<b>Equipment required</b>	One BNC cable One 1.44 Mbyte, 3.5 inch DOS-compatible formatted disk. One TCA-BNC TekConnect adapter
<b>Prerequisites</b>	None

1. *Initialize the instrument:* Push the front-panel **DEFAULT SETUP** button.
2. *Hook up the signal source:* Connect the equipment to the CH 1 input as shown in Figure 1-13.



**Figure 1-13: Setup for the file system test**

3. *Insert the test disk:* Insert the floppy disk in the floppy disk drive.
4. *Set up the instrument:* Push the front-panel **AUTOSET** button.
5. Touch the **Vert** button, and then touch **Offset**. Adjust the Ch1 Offset to **-0.25 V** using the multipurpose knob.

6. Set the Vertical **SCALE** to **100 mV** per division.
7. *Set the time base:* Set the horizontal **SCALE** to **1 ms/div**. The time-base readout is displayed at the bottom of the graticule.
8. *Save the settings:*
  - a. Pull down the **File** menu to select **Instrument Setup . . .**. This displays the instrument setups control window.
  - b. Touch the **Save** button under Save settings to file in the control window. This displays a familiar Windows dialog box for choosing a destination directory naming the file.
  - c. In the Save Instrument Setup As dialog box, select the **3<sup>1</sup>/<sub>2</sub> Floppy (A:)** icon in the **Save in:** drop-down list to set the save destination to the floppy disk.
  - d. Note the default file name, and then touch the **Save** button to save the setup to the default file name.
9. *Change the settings again:* Set the horizontal **SCALE** to **200  $\mu$ s/div**.
10. *Verify the file system works:*
  - a. Touch the **Recall Setups** tab in the control window.
  - b. Touch the **Recall** button under Recall settings from file in the control window. This displays a familiar Windows dialog box for locating the settings file that you want to recall.
  - c. In the Recall Instrument Setup dialog box, select the **3<sup>1</sup>/<sub>2</sub> Floppy (A:)** icon in the **Look in:** drop-down list.
  - d. Locate and double-touch in the dialog box on the setup file that you previously stored.
  - e. Verify that the instrument retrieved the saved setup from the disk. Do this by noticing the horizontal **SCALE** is again 1 ms and the waveform shows ten cycles just as it did when you saved the setup.
11. *Remove the test hookup:*
  - a. Disconnect the equipment from the channel input and the probe compensation output.
  - b. Remove the floppy disk from the floppy disk drive.

## Perform the Extended Diagnostics

Extended diagnostics and self calibration perform a more detailed functionality check than the incoming inspection and Power-on diagnostics.

---

**NOTE.** Allow a 20-minute warm-up before running the self calibration.

---

Disconnect any attached probes from the instrument. Then select the Utilities menu. Run the self calibration followed by the extended diagnostics by first selecting the Instrument Calibration (see page 3-160 for additional information on signal path compensation) and then the Instrument Diagnostics tabs. Results of the tests display on their property pages.

### Checking the Underlying System (Optional)

To check the hardware and Windows software underlying the instrument UI (user interface), run the CheckIt Utilities from the Windows Start menu:

1. Minimize the instrument application before running the external diagnostics. From the File menu select **Minimize**.
2. Touch **Start**, then touch **Programs** in the Start Menu. Finally, touch **CheckIt Utilities**.
3. From the Go To menu, select and run the tests you want to perform.
4. Check test results. All tests except the Modem and CD-ROM tests should pass. The CD-ROM test requires data from the CheckIt Utilities CD.
5. Dismiss the CheckIt Utilities: Select **Exit** in the File menu.
6. Restart your instrument UI software: On the Quick Launch bar, touch **TekScope**.

# Accessories & Options

This section lists the standard and optional accessories available for the instrument, as well as the product options.

## Options

The following options can be ordered for the instrument:

**Table 1-4: Options**

Option	Description	TDS700B	CSA7404B	TDS7404B	TDS7254B	TDS7154B
1K	K4000 Instrument Cart	✓	✓	✓	✓	✓
1R	Rack Mount Kit (includes: hardware and instructions for converting to rackmount configuration)	✓	✓	✓	✓	✓
FHD	Front-panel removable hard disk drive. Floppy disk drive is on the rear panel	✓	✓	✓	✓	✓
Acquisition memory						
2M	Long record length: 2 Ms per channel, 8 Ms maximum	✓	✓	✓	✓	✓
3M	Long record length: 4 Ms per channel, 16 Ms maximum	✓	✓	✓	✓	✓
4M	Long record length: 8 M per channel, 32 Ms maximum	✓	✓	✓	✓	✓
5M	Long record length: 16 M per channel, 64 Ms maximum	✓	✓	✓	✓	✓
Power cords						
A0	North American 115 V, 60 Hz power cord (standard)	✓	✓	✓	✓	✓
A1	Universal European 230 V, 50 Hz power cord	✓	✓	✓	✓	✓
A2	United Kingdom 230 V, 50 Hz power cord	✓	✓	✓	✓	✓
A3	Australian 230 V, 50 Hz power cord	✓	✓	✓	✓	✓
A5	Switzerland 230 V, 50 Hz power cord	✓	✓	✓	✓	✓
A6	Japan power cord	✓	✓	✓	✓	✓
A10	China 230 V, 50 Hz power cord	✓	✓	✓	✓	✓
A99	No power cord	✓	✓	✓	✓	✓
Software applications						
DVI	TDSDVI DVI compliance test application	✓	✓	✓	✓	
DVD	TDSDVD Optical storage analysis application	✓	✓	✓	✓	✓
ET3	TDSET3 Ethernet compliance test application	✓	✓	✓	✓	✓
J2	TDSDDM2 Disk Drive Measurements application	✓	✓	✓	✓	✓

**Table 1-4: Options (Cont.)**

Option	Description	TDS7704B	CSA7404B	TDS7404B	TDS7254B	TDS7154B
J3E	TDSJIT3 Essentials application	✓	✓	✓	✓	✓
JT3	TDSJIT3 Advanced Jitter Analysis application with random and deterministic jitter analysis	✓	✓	✓	✓	✓
CP2	TDSCPM2 Compliance Testing for ITU-T G.703 and ANSI T1.102 communications standards (Requires Option SM)	✓	✓	✓	✓	✓
PW3	TDSPWR3 Power measurement and analysis application. Option 3M and a TCA-1MEG buffer amplifier recommended for use with this software	✓	✓	✓	✓	✓
RTE	Serial Data Compliance and Analysis application	✓	✓	✓	✓	✓
PCE	PCI Express Compliance Module for Option RTE (Requires Option RTE)	✓	✓	✓		
IBA	INFINIBand Compliance Module for Option RTE (Requires Option RTE)	✓	✓	✓		
USB	USB2 Compliance Testing Software for USB1.0/USB2.0 standards (requires TDSUSBF USB test fixture)	✓	✓	✓	✓	✓
SM	Serial Communications Mask Testing (Standard on CSA7000B Series)	✓		✓	✓	✓
ST	Serial Pattern Triggering (Standard on CSA7000B Series)	✓		✓	✓	✓
TC1	Add one TCA-1MEG TekConnect high-impedance buffer amplifier				✓	✓
Field upgrades						
CSA7BUP	Many are available. Contact Tektronix (see the back of the title page) for a complete list of available CSA7UP options.		✓			
TDS7BUP	Many are available. Contact Tektronix (see the back of the title page) for a complete list of available TDS7UP options.	✓		✓	✓	✓
Service offerings						
C1	Calibration services extended to cover one year	✓	✓	✓	✓	✓
C3	Calibration services extended to cover three years	✓	✓	✓	✓	✓
C5	Calibration services extended to cover five years	✓	✓	✓	✓	✓
D1	Calibration data report	✓	✓	✓	✓	✓
D3	Test Data for calibration services in Opt. C3	✓	✓	✓	✓	✓
D5	Test Data for calibration services in Opt. C5	✓	✓	✓	✓	✓
R1	Repair warranty extended to cover one year	✓	✓	✓	✓	✓
R3	Repair warranty extended to cover three years	✓	✓	✓	✓	✓
R5	Repair warranty extended to cover five years	✓	✓	✓	✓	✓

## Accessories

This section lists the standard and optional accessories available for this instrument.

**Standard** The following accessories are shipped with the instrument:

**Table 1-5: Standard accessories**

Accessory	Part number
Graphical Packing List	071-1231-xx
User Manual	071-1226-xx
Reference Kit	020-2519-xx
Product Software CD CSA7404B, TDS7404B, TDS7254B, & TDS7154B TDS7704B	063-3632-xx 063-3633-xx
Operating System Restore CD	020-2569-xx
Oscilloscope Analysis and Connectivity Made Easy	020-2449-xx
Optional Applications Software CD and Documentation Kit	020-2450-xx
Getting Started with OpenChoice™ Solutions Kit	020-2513-xx
Option SM and ST User Manual	071-1228-xx
Online Help (part of the application software)	—
Performance Verification (a pdf file on the Product Software CD)	—
Programmer Online Guide (files on the Product Software CD)	—
NIST, Z540-1, and ISO9000 Calibration Certificate	—
Four TekConnect-to-SMA adapters, TDS7704B, CSA7404B, & TDS7404B	TCA-SMA
Four TekConnect-to-BNC adapters, TDS7254B & TDS7154B	TCA-BNC
Two TekConnect high-impedance buffer amplifiers, includes 2 P6139A 500 MHz 10x passive probes, TDS7254B & TDS7154B	TCA-1MEG
Adapters, CSA7404B O/E Electrical Out-to-CH1 Input adapter (Tektronix part number 013-0327-xx) O/E-to-SMA adapter (Tektronix part number 013-0326-xx)	020-2423-xx
U.S. Power Cord	161-0104-00
Mouse, optical	119-6936-xx
Keyboard, USB	119-B146-xx
Front Cover	200-4653-xx
Accessory Pouch	016-1441-xx

**Table 1-5: Standard accessories (Cont.)**

Accessory	Part number
Probe Calibration and Deskew Fixture, with instructions CSA7404B, TDS7404B, TDS7254B, & TDS7154B TDS7704B, TDS7404B, & CSA7404B	067-0405-xx 067-0484-xx
Fiber cleaning kit, CSA7404B	020-2494-xx
FC/PC UCI adapter, installed, CSA7404B	119-4516-xx
Click'N Burn Software CD	063-3575-xx

**Optional**

The accessories in Table 1-6 are orderable for use with the instrument at the time this manual was originally published. Consult a current Tektronix catalog for additions, changes, and details.

**Table 1-6: Optional accessories**

Accessory	Part number
Service Manual	071-1227-xx
Transit Case	016-1522-xx
Scope Cart	K4000 (Option 1K)
P6158 20x 1 k $\Omega$ low capacitance voltage divider probe <sup>1</sup>	P6158
P6245 1.5 GHz high speed active probe <sup>1</sup>	P6245
P6248 1.5 GHz differential probe <sup>1</sup>	P6248
P7240 active 4 GHz probe	P7240
P7260 active 6 GHz probe, TDS7704B	P7260
P7330 differential 3.5 GHz probe	P7330
P7350 differential 5 GHz probe	P7350
P7380SMA >8 GHz Differential acquisition system with SMA Inputs	P7380SMA
P6139A 500 MHz passive 10x probe <sup>1</sup>	P6139A
P6243 1 GHz high speed active probe <sup>1</sup>	P6243
P6246 400 MHz differential probe <sup>1</sup>	P6246
P6247 1 GHz differential probe <sup>1</sup>	P6247
P6249 4 GHz differential probe <sup>1</sup>	P6249
P6330 differential 3 GHz probe <sup>1</sup>	P6330
TCP202 DC to 50 MHz current probe <sup>1</sup>	TCP202
P5205 high voltage differential probe <sup>1</sup>	P5205
P5210 high voltage differential probe <sup>1</sup>	P5210



**Table 1-6: Optional accessories (Cont.)**

<b>Accessory</b>	<b>Part number</b>
P6015A high voltage probe <sup>1</sup>	P6015A
ADA400A differential preamplifier <sup>1</sup>	ADA400A
CT1 1 GHz current probe <sup>1</sup>	CT1
CT6 2 GHz current probe <sup>1</sup>	CT6
AM503S DC/AC current measurement system <sup>1</sup>	AM503S
P7260 6 GHz 5X/25X active probe	P7260
P6150 9 GHz/3 GHz low capacitance divider probe <sup>1</sup>	P6150
P6701B optical/electrical converter (500 to 950 nm) <sup>1</sup>	P6701A/B
P6703B optical/electrical converter (1100 to 1650 nm) <sup>1</sup>	P6703A/B
AFTDS Telecomm differential electrical interface adapter (for line rates <8 Mb/s; requires TCA-BNC adapter) <sup>1</sup>	AFTDS
TDSUSBF USB test fixture; used with Option USB	TDSUBF
AMT75 1 GHz 75 $\Omega$ ohm adapter <sup>1</sup>	AMT75
TekConnect-to-SMA adapter	TCA-SMA
TekConnect-to-BNC adapter	TCA-BNC
TekConnect-to-N adapter	TCA-N
TekConnect high-impedance buffer amplifier, 500 MHz 1 M $\Omega$ BNC-to-TekConnect adapter (includes one P6139A probe)	TCA-1MEG
TekConnect adapter, 4 GHz, 75 $\Omega$ to 50 $\Omega$ adapter with 75 $\Omega$ BNC input	
WSTRO WaveStar Software	WSTRO
GPIB cable (1 m)	012-0991-01
GPIB cable (2 m)	012-0991-00
RS-232 cable	012-1298-xx
USB Keyboard	119-6633-xx
Centronics cable	012-1214-xx
Replacement hard disk	650-4271-xx

**Table 1-6: Optional accessories (Cont.)**

<b>Accessory</b>	<b>Part number</b>
Optical Connector Adapters, CSA7404B	
FC/PC	119-5115-00
SC/PC	119-5116-00
ST/PC	119-4513-00
DIN/PC 47256	119-4546-00
Diamond 2.5	119-4556-00
Diamond 3.5	119-4558-00
SMA 2.5	119-4517-00
SMA	119-4557-00
Dust cap, optical, CSA7404B	200-4104-00

<sup>1</sup> **Requires TCA-BNC TekConnect BNC adapter**

---

**NOTE.** *The P6339A probe is not supported by this instrument.*

---

# Operational Maps

This chapter acquaints you with how the instrument functions and operates. It consists of several maps that describe the system, its operation, and its documentation:

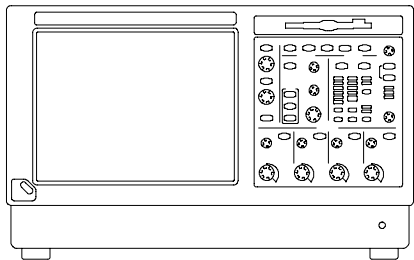
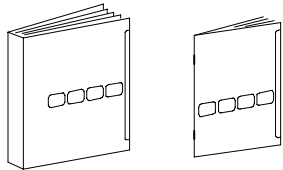
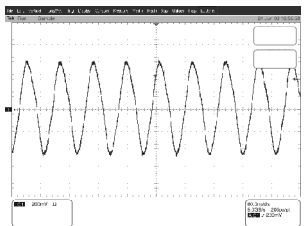

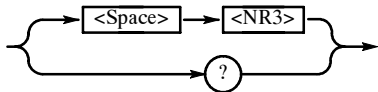

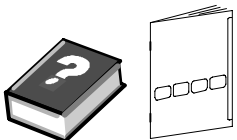
- *Documentation Map*, on page 2-2, lists the documentation that supports the instrument.
- *System Overview Maps* on page 2-3, describe the high-level operating blocks and operating cycle of the instrument.
- *User-Interface Map*, on page 2-6, describes the elements of the User Interface (UI) application, which provides complete control of the instrument.
- *Front-Panel Map*, on page 2-7, describes the elements of the instrument front panel and cross references information relevant to each element.
- *Display Map*, on page 2-8, describes elements and operation of single-graticule and multiple-graticule displays.
- *Front Panel I/O Map*, on page 2-9, describes inputs, outputs, and peripherals.
- *Rear Panel I/O Map*, on page 2-10, describes input/output ports and peripherals.

Tutorial (How to?) procedures are available online, as part of the online help.

For information on configuring and installing your instrument, refer to Chapter 1, *Getting Started*.

# Documentation Map

This instrument ships with documents individually tailored to address different aspects or parts of the product features and interface. The table below cross references each document to the instrument features and interfaces it supports.

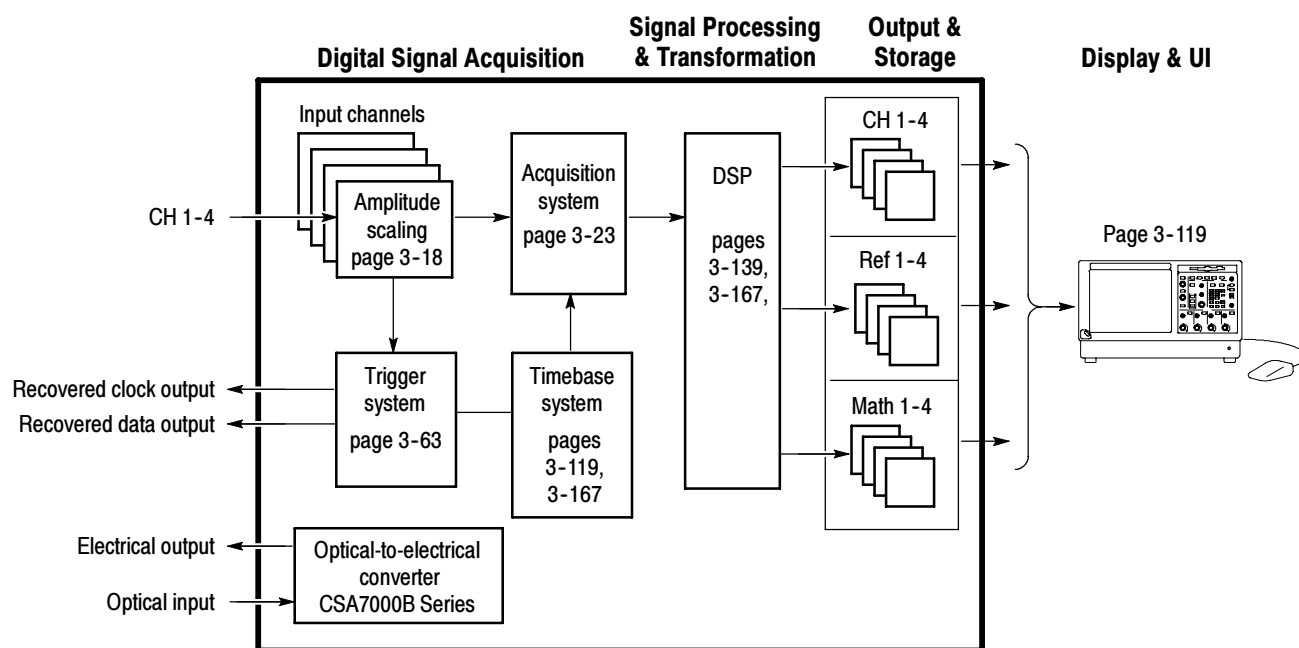
To read about...	Refer to these documents:	Description
<b>Installation, Specification, &amp; Operation (overviews)</b> 	<b>User Manual</b> <b>Reference Manual</b> 	<p>Read the <i>Reference</i> for a quick overview of instrument features and their usage.</p> <p>Read the <i>User Manual</i> for general information about your instrument—procedures on how to put it into service, specifications of its performance, maps of its user interface controls, overviews and background on its features.</p> <p>For more usage information, see <i>Online Help System</i> below.</p>
<b>In Depth Operation and UI Help</b> 	<b>Online Help System</b> 	<p>Access online help from the instrument for context-sensitive information on virtually all controls and elements on screen.</p> <p>Online help includes procedures for using instrument functions. See <i>Accessing Online Help</i> on page 3-263.</p>
<b>GPIB Commands</b> 	<b>Online Programmers Guide</b> 	<p>Quickly find the syntax of a command, and copy the command if desired. Read about communication, error handling, and other information on GPIB usage. This guide is on the product software CD.</p>
<b>Analysis and Connectivity Tools</b>	<b>Oscilloscope Analysis and Connectivity Made Easy</b> <b>TekVISA Programming Manual</b> <b>VXIplug&amp;play Driver Help</b> <b>TekVISA Excel Toolbar Help</b> 	<p>These documents consists of various connectivity and analysis tools that you can install and configure for your instrument. For more information, see the <i>Analysis and Connectivity Support</i> topic in the instrument online help.</p>

An optional service manual is available for this product if you self-service or performance test this instrument. See *Accessories & Options* on page 1-33.

# System Overview Maps

The instrument is a highly capable waveform acquisition, test, and measurement system. The following model provides background information on its operation, which, in turn, may provide you insight on how the instrument can be used.

## Functional Model Map



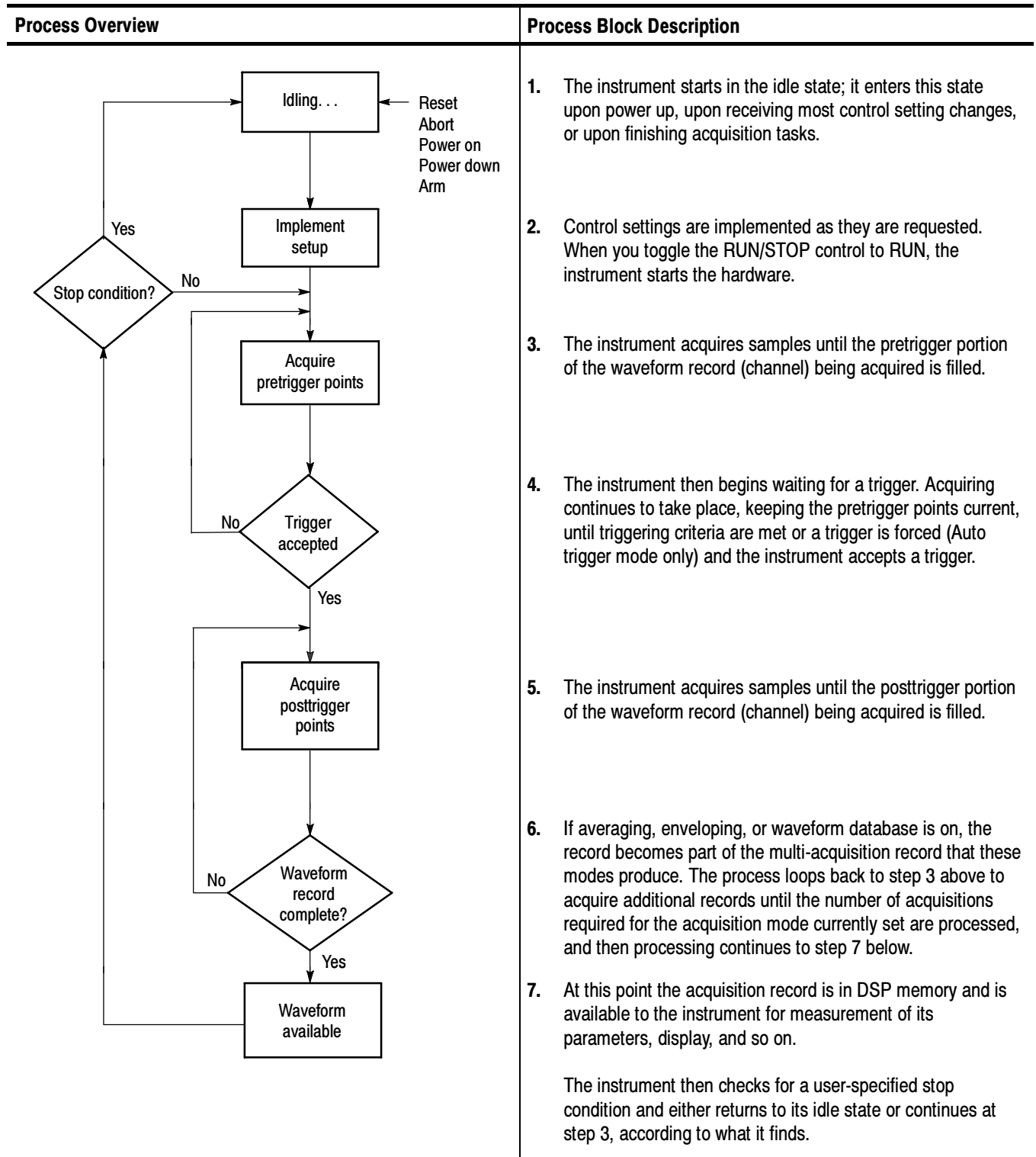
The model comprises four high-level subsystems or processes (embodying a variety of hardware and software functions) and the data that connects them:

- **Digital Signal Acquisition System.** Acquires a waveform record from each signal that you input to each channel using the following subsystems:
  - **Input Channels.** Conditions the input signal, primarily through the use of analog hardware, before the signal is converted to digital form.
  - **Trigger System.** Recognizes a specific event of interest on the input trigger signal and informs the Timebase of the occurrence of the event. Also provides recovered clock and data signals (optional on TDS7000B Series instruments).

- **Timebase System.** Tells the Acquisition system to start an acquisition cycle (that is, to convert from analog to digital). In more general terms, synchronizes the capturing of digital samples in the Acquisition system to the trigger events generated from the Trigger system.
- **Acquisition System.** Performs the actual A/D conversion and storing of digital samples.
- **Optical-to-Electrical Converter.** CSA7000B Series: Converts optical signals to electrical signals.
- **DSP Transformation System.** Performs a variety of transformations or operations, beginning with the most fundamental data element(s) in the system, the Channel Waveform(s). Waveform math operations, automatic measurements, spectral waveforms, and histogram generation are examples.
- **Input/Output Systems.** Provides output (and sometimes input) of instrument-data elements in a form suitable to the user and also provides user input control.

The process overview that follows describes each step in the top-level cycle of instrument operation.

## Process Overview Map



# User Interface Map - Complete Control and Display

**Menu Bar:** Access to data I/O, printing, online help system, and instrument functions here

**Status Bar:** Display of acquisition status, mode, and number of acquisitions; trigger status; warnings; date; and time

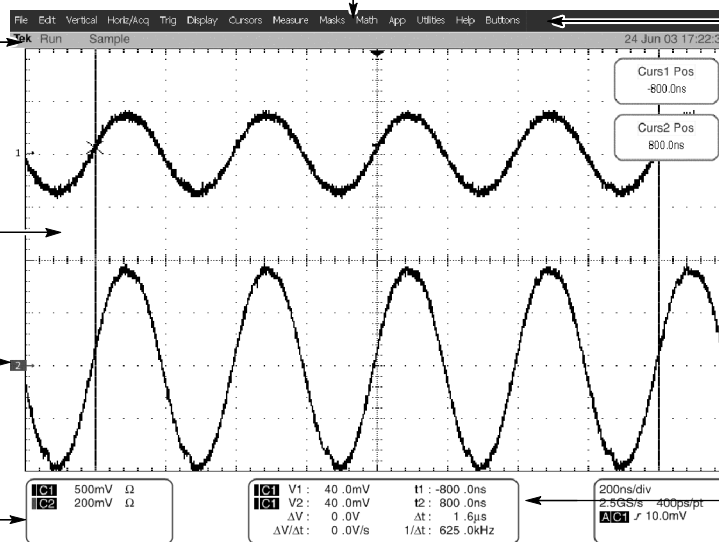
**Display:** Live, reference, & math waveforms display here, along with cursors

**Waveform Handle:** Touch and drag to change vertical position of waveform. Touch the handle and change the position and scale using the multipurpose knobs

**Controls Status:** Quick reference to vertical, horizontal, and trigger selections, scale, and parameters

If a setup menu is displayed, these readouts move to the graticule area

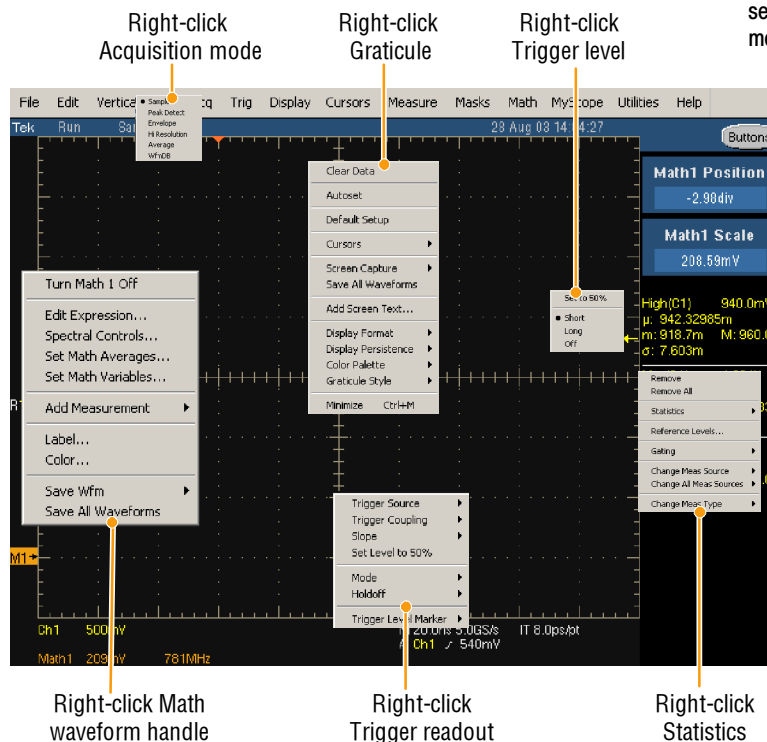
For a shortcut menu, right-click anywhere in the graticule or on an object. The shortcut menu is context sensitive and varies with the area or object where you right-clicked. Some examples are shown in the figure at right.



**Buttons/Menu:** Touch to toggle between toolbar and menu bar modes

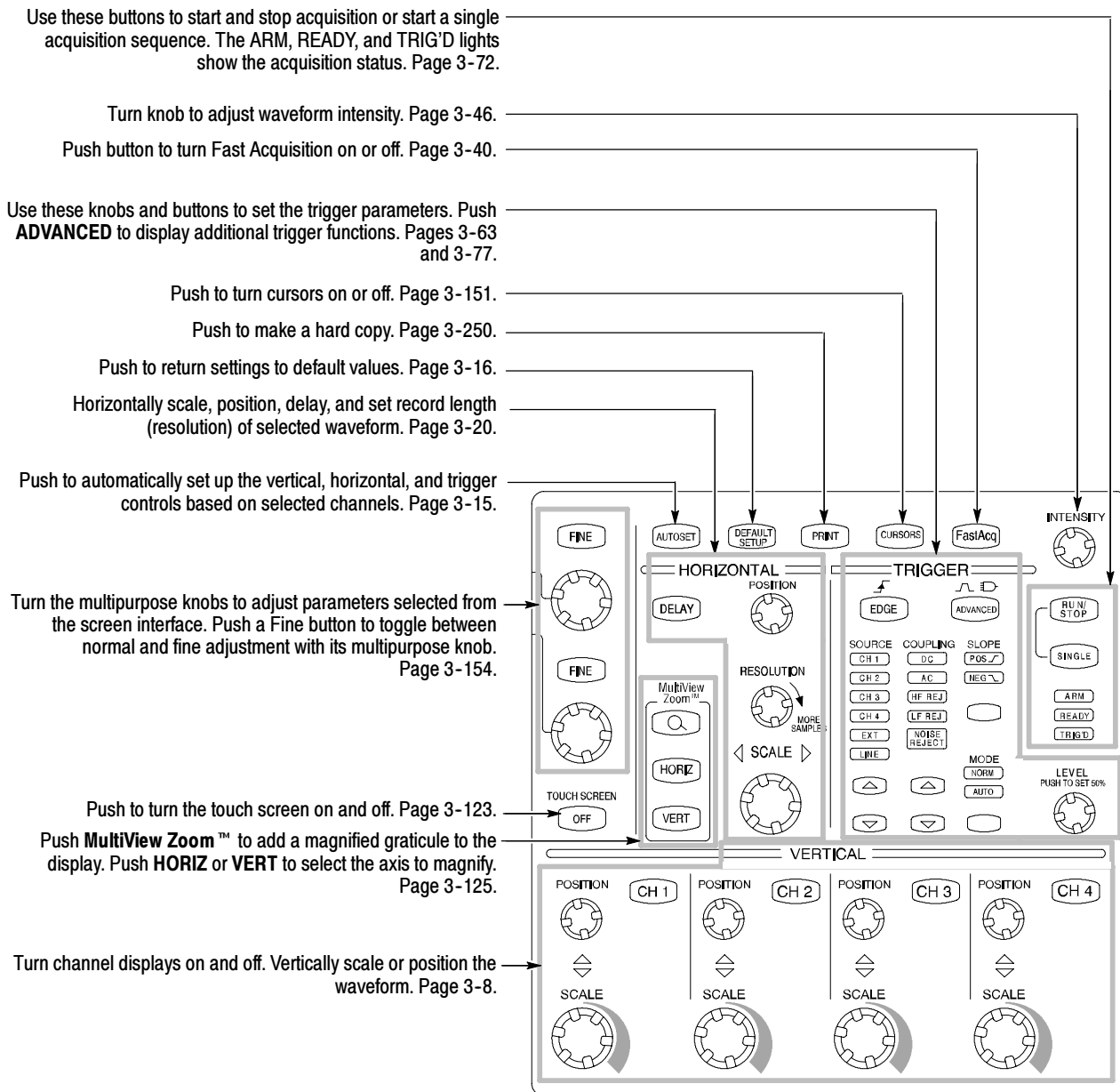
**Multipurpose Knob Readouts:** Adjust parameters controlled by multipurpose knobs

**Readouts:** Display cursor readouts and measurement readouts in this area, selectable from the menu bar or toolbar





# Front-Panel Map - Quick Access to Most Often Used Features



# Display Map - Single Graticule

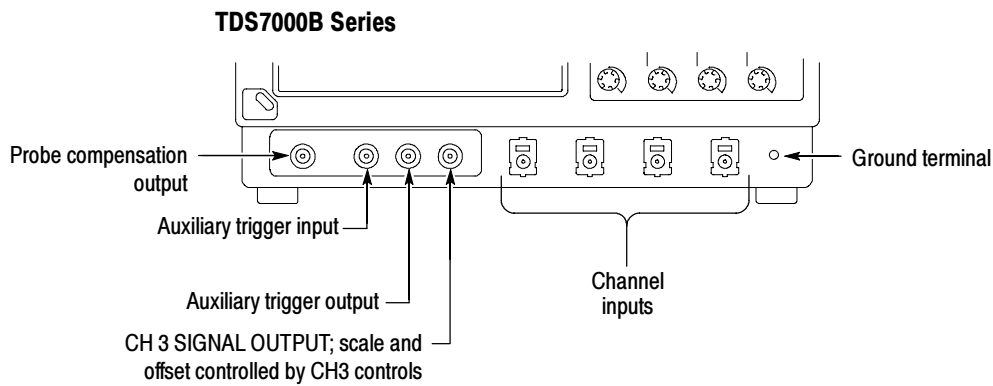
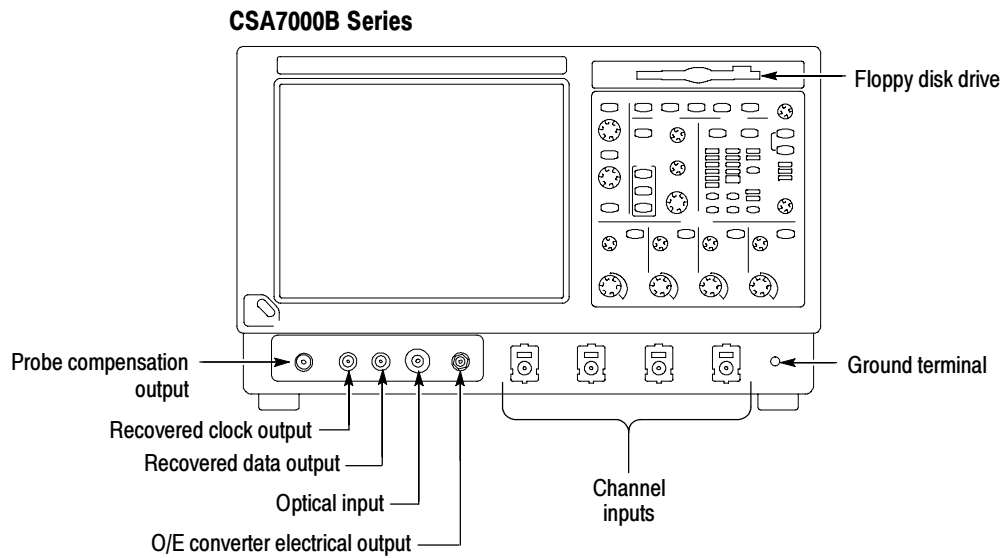
The image shows a screenshot of a Tektronix oscilloscope interface with a single graticule display. The interface includes a menu bar at the top with options: Vert, Horiz, Trig, Disp, Cursor, Meas, Masks, Math, Setups, Refs, App, Help, and Men. Below the menu bar, the status bar shows 'Tek Run Sample' and the date/time '25 Jun 03 13:21 48'. The main display area shows a periodic waveform on a grid. A rectangular box highlights a segment of the waveform. A context menu is open over this box, listing options: Zoom 1 On, Zoom 2 On, Zoom 3 On, Zoom 4 On, Histogram Vertical, Histogram Horizontal, Measurement Gating, Zoom Off, Histogram Off, Measurement Gating Off, and Cancel. Annotations with arrows point to various parts of the interface:

- Drag icon to change the trigger level:** Points to the 'Trig' menu item.
- Drag cursors to measure waveforms on screen:** Points to the vertical cursors on the waveform.
- Drag the position icons to reposition a waveform:** Points to the small square icons on the horizontal axis.
- Click icon to assign multipurpose knobs to waveform vertical position and scale:** Points to a small square icon on the vertical axis.
- Drag across the waveform area to zoom the boxed waveform segment. Also enable/disable histograms and measurement gating:** Points to the context menu.

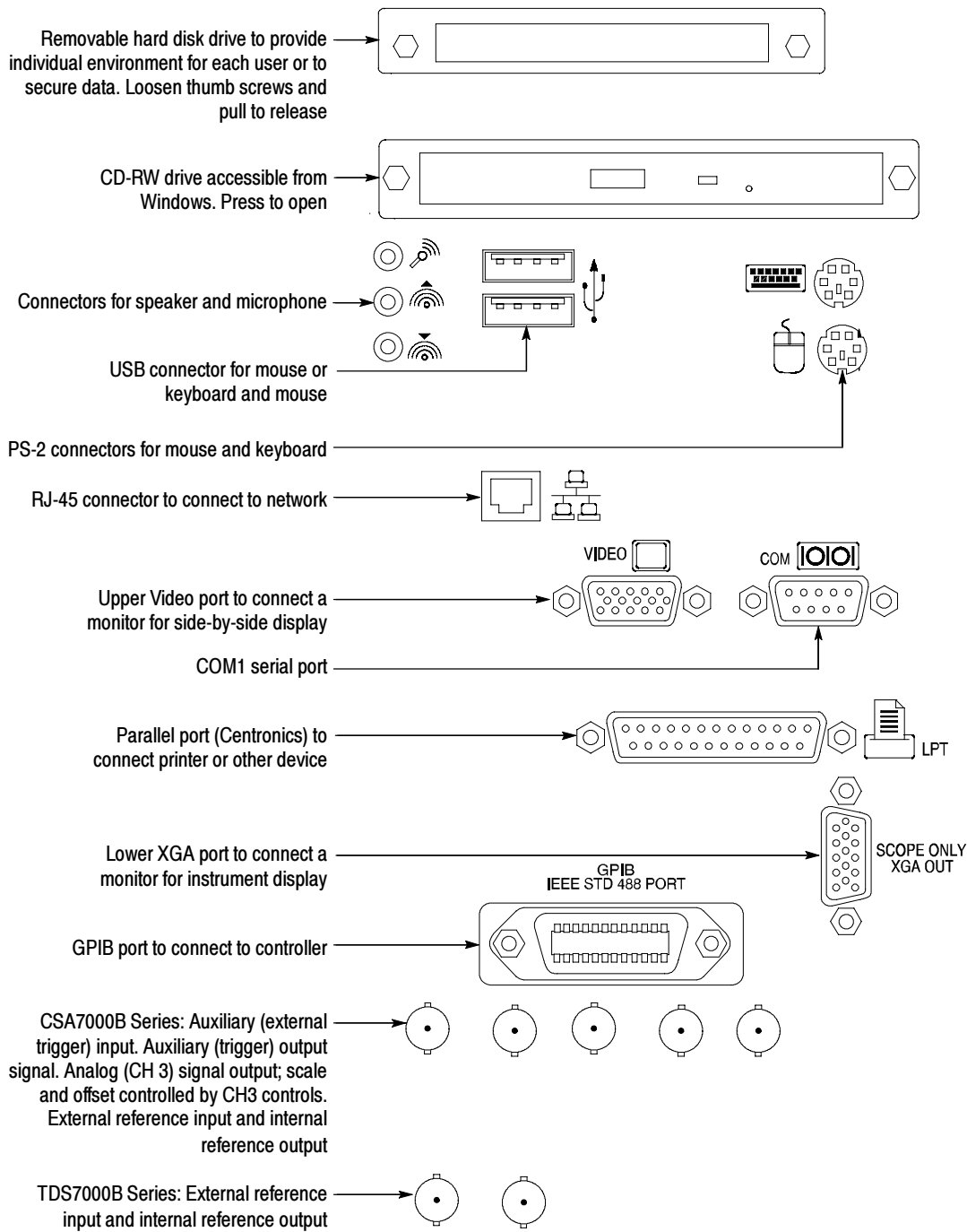
Additional information on the screen includes:

- Cursor Readouts:** Curs1 Pos: -113.6 $\mu$ s, Curs2 Pos: 99.2 $\mu$ s.
- Scale and Units:** 500mV  $\Omega$ .
- Measurement Data:** 40.0 $\mu$ s/div, 1.25MS/s, 800ns/pt, A/C 70.0mV.

# Front Panel I/O Map



# Rear Panel I/O Map



# Overview

This chapter describes in depth how the many features of the instrument operate. Please note the following points on using this chapter:

- Each section in this chapter provides background information needed to operate your instrument effectively as well as the higher-level procedures for accessing and using the features. These procedures emphasize using the front panel when possible.
- Lower-level, detailed usage procedures are in the online help system.

The table that follows on page 3-2 lists operating tasks and the sections in this chapter that document those tasks.

<b>Tasks or topics</b>	<b>Subtasks or subtopics</b>	<b>Section title</b>	<b>Contents</b>	<b>Page no.</b>
Signal Input	Acquiring waveforms	<i>Acquiring Waveforms</i>	Overview of section contents	3-7
		<i>Signal Connection and Conditioning</i>	Overview of signal connection and conditioning techniques and setups	3-8
		<i>To Set Up Signal Input</i>	Setting up signal input	3-12
		<i>To Autoselect the Instrument</i>	Automatic setup of the acquisition, triggering systems and input channels	3-15
		<i>To Reset the Instrument</i>	Resetting the instrument	3-16
		<i>To Get More Help</i>	Accessing the online help	3-16
		<i>Input Conditioning Background</i>	Background information on input signal conditioning	3-17
		<i>Setting Acquisition Controls</i>	Background and setup of acquisition controls and roll mode	3-23
		<i>To Set Acquisition Modes</i>	Set up of the acquisition system	3-29
		<i>To Start and Stop Acquisition</i>	Starting and stopping acquisitions	3-32
		<i>To Set Roll Mode</i>	Setting up roll mode	3-33
		<i>Acquisition Control Background</i>	Background information on acquisition controls	3-34
		<i>Using Fast Acquisition Mode</i>	Overview and setup of Fast Acquisition mode	3-40
		<i>To Turn Fast Acquisitions On and Off</i>	Turning fast acquisitions on and off	3-44
		<i>Using FastFrame</i>	Overview and setup of FastFrame	3-48
		<i>To Set FastFrame Mode</i>	Setting up FastFrame mode	3-50
		<i>Time Stamping Frames</i>	Setting up FastFrame time stamps	3-52
		<i>O/E Converter CSA7000B Series only</i>	Overview and reference to documentation on using optical signals and the O/E Converter	3-55
		<i>Front Panel Connectors CSA7000B Series only</i>	Overview of O/E Converter front-panel connectors	3-56
<i>Wavelength, Filter, and Bandwidth Selection CSA7000B Series only</i>	Overview of optical controls	3-59		
<i>Optical bandwidth CSA7000B Series only</i>	Overview of optical bandwidth	3-60		

<b>Tasks or topics</b>	<b>Subtasks or subtopics</b>	<b>Section title</b>	<b>Contents</b>	<b>Page no.</b>
Signal Input	Triggering waveforms	<i>Triggering</i>	Background on basic trigger operation	3-63
		<i>Triggering Concepts</i>	Background on triggering concepts	3-64
		<i>Triggering From the Front Panel</i>	Using the front-panel edge trigger controls	3-68
		<i>Access Procedures</i>	Setting up triggers with front-panel controls	3-68
		<i>To Check Trigger Status</i>	Checking trigger status	3-72
		<i>Additional Trigger Parameters</i>	Using additional trigger controls	3-73
		<i>Advanced Triggering</i>	Overview and setup for triggering on specific pulse and logic conditions	3-77
		<i>To Trigger on a Glitch</i>	Setting up glitch triggering	3-83
		<i>To Trigger on a Runt Pulse</i>	Setting up runt pulse triggering	3-85
		<i>Trigger Based on Pulse Width</i>	Setting up pulse width triggering	3-87
		<i>To Trigger Based on Transition Time</i>	Setting up transition time triggering	3-89
		<i>Trigger Based on Pulse Timeout</i>	Setting up pulse timeout triggering	3-94
		<i>Trigger on a Pattern</i>	Setting up pattern triggering	3-95
		<i>To Trigger on a State</i>	Setting up state triggering	3-98
		<i>To Trigger on Setup/Hold Time Violations</i>	Setting up setup/hold time violation triggering	3-99
		<i>Sequential Triggering</i>	Overview and setup for triggering after time delay and triggering on events	3-103
		<i>To Trigger on a Sequence</i>	Setting up triggering on a sequence	3-109
<i>Comm Triggering (optional on TDS7000B Series)</i>	Overview and reference to documentation on using communications triggering	3-117		
<i>Serial Pattern Triggering (optional on TDS7000B Series)</i>	Overview and reference to documentation on using serial pattern triggering	3-117		

<b>Tasks or topics</b>	<b>Subtasks or subtopics</b>	<b>Section title</b>	<b>Contents</b>	<b>Page no.</b>
Display Features	Using the Display	<i>Displaying Waveforms</i>	Using display features and customizing the display	3-119
		<i>Using the Waveform Display</i>	Overview of display features and setup of the display	3-119
		<i>To Display Waveforms in the Main Graticule</i>	Display adjustments you can make	3-124
		<i>Setting Zoom Controls</i>	Overview and use of Zoom	3-125
		<i>To Zoom Waveforms</i>	Setup to zoom a waveform	3-126
		<i>Customizing the Display</i>	Customizing display elements	3-131
		<i>Set Display Styles</i>	Overview of display adjustments you can make	3-135
		<i>Customize Graticule and Waveforms</i>	Overview of graticule and waveform adjustments you can make	3-137
Data Processing (Calculation)	Taking Measurements	<i>Measuring Waveforms</i>	Setup for measuring parameters	3-139
		<i>Taking Automatic Measurements</i>	Overview and setup for taking automatic measurements	3-140
		<i>To Take Automatic Measurements</i>	Set for automatic measurements	3-144
		<i>To Localize a Measurement</i>	Setup to measure a segment of a waveform	3-149
		<i>Taking Cursor Measurements</i>	Overview and setup for taking cursor measurements	3-151
		<i>To Set the Cursor Sources</i>	Selecting the cursor sources	3-155
		<i>Taking Histograms</i>	Overview and setup for taking Histograms	3-157
		<i>To Start and Reset Histogram Counting</i>	Setup for histogram counting	3-158
		<i>Optimizing Measurement Accuracy</i>	Increase accuracy by compensating the instrument and adjusting deskew	3-160
		<i>To Compensate the Instrument</i>	Setup to compensate the instrument	3-160



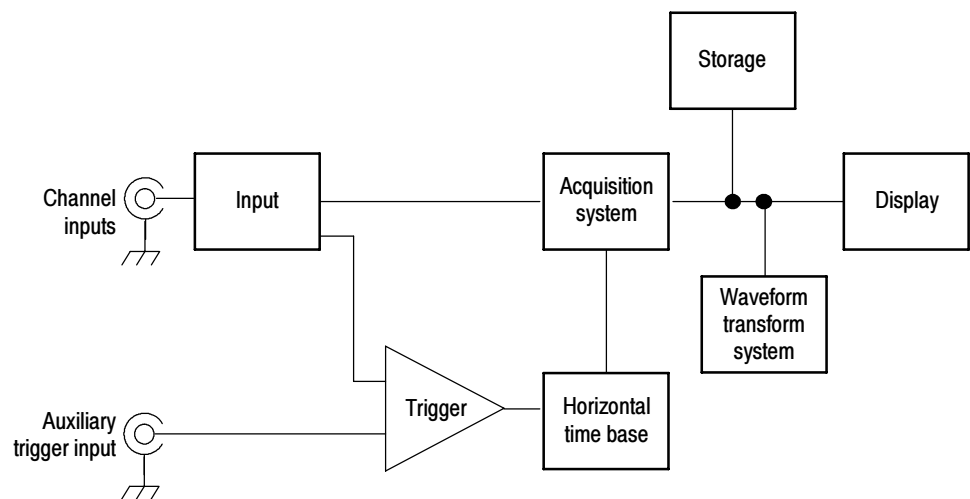
Tasks or topics	Subtasks or subtopics	Section title	Contents	Page no.	
Data Processing (Calculation) (Cont.)	Taking Measurements (Cont.)	<i>To Connect the Probe Calibration Fixture</i>	Connecting the probe calibration and deskew fixture to the instrument	3-162	
		<i>To Calibrate Probes</i>	Improving measurement accuracy by calibrating your probes	3-162	
		<i>To Compensate Passive Probes</i>	Compensating passive probes	3-163	
		<i>To Deskew Channels</i>	Adjusting delay between channels	3-162	
		<i>Serial Mask Testing</i>	Pointer to mask testing information	3-165	
	Math (+, -, /, *, Chs, Exx, $\equiv$ , $\geq$ , $\neq$ , $\leq$ , $>$ , $<$ , Intg, Diff, Fabs, Sin, Cos, Tan, Min, Max, Ceil, Floor, ASin, ACos, ATan, Sinh, Cosh, Tanh, Average, Invert, Sqrt, Log 10, Log e, Exp, Magnitude, Real, Phase, and Imag)	<i>Creating and Using Math Waveforms</i>	Functions for processing waveforms, extracting segments of waveforms, etc.	3-167	
		<i>Defining Math Waveforms</i>	Overview of performing math operation on waveforms	3-168	
		<i>To Define a Math Waveform</i>	Defining math waveforms	3-175	
		<i>Operations on Math Waveforms</i>	Overview of measuring and adjusting math waveforms	3-177	
		<i>To Use Math Waveforms</i>	Example setups for measuring and adjusting math waveforms	3-179	
	Spectral Math operations	<i>Defining Spectral Math Waveforms</i>	Functions for frequency domain analysis of your waveforms.	3-182	
		<i>To Select a Predefined Spectral Math Waveform</i>	Selecting a predefined spectral math waveform	3-206	
		<i>To Define A Spectral Math Waveform</i>	Setup to define a spectral math waveform	3-207	
		<i>Spectral Math Example</i>	An example of performing spectral analysis of a signal	3-215	
	Optimizing Measurement Accuracy	Instrument compensation and compensation or calibration of probes	<i>Optimizing Measurement Accuracy</i>	Procedures for compensating the instrument, compensating passive probes, and calibrating active, voltage probes	3-160

<b>Tasks or topics</b>	<b>Subtasks or subtopics</b>	<b>Section title</b>	<b>Contents</b>	<b>Page no.</b>
Data Input and Output	All uploading and downloading of waveforms, calculation results, and other data	<i>Data Input/Output</i>	Primary reference for uploading and downloading of any data to or from the instrument	3-221
		<i>Saving and Recalling a Setup</i>	Background and setup for saving and recalling setups	3-221
		<i>To Save Your Setup</i>	Saving an instrument setup	3-223
		<i>To Recall Your Setup</i>	Recalling an instrument setup	3-226
		<i>Saving and Recalling Waveforms</i>	Background and setup for saving and recalling waveforms	3-227
		<i>To Save Your Waveform</i>	Saving a waveform	3-228
		<i>To Recall Your Waveform</i>	Recalling a saved waveform	3-231
		<i>To Clear References</i>	Setup to clear references	3-233
		<i>Exporting and Copying Waveforms</i>	Background and setup for exporting waveforms and using exported waveforms	3-235
		<i>To Export Your Waveform</i>	Exporting a waveform to a file	3-236
		<i>To Use an Exported Waveform</i>	Using an exported waveform in Excel	3-244
		<i>To Copy Your Waveform</i>	Copying a waveform to the clipboard	3-246
		<i>Printing Waveforms</i>	Background and setup for printing waveforms	3-250
		<i>To Date/Time Stamp Hardcopies</i>	Background and setup to display the date and time	3-254
Remote Communication	GPIB	<i>Remote Communication</i>	Information on programming the instrument over the GPIB	3-255
MyScope Control Windows	Creating, editing, using MyScope control windows	<i>MyScope</i>	Information on creating, using, and editing MyScope control windows	3-257
Help	Using Online Help	<i>Accessing Online Help</i>	Information on accessing the information in the online help	3-263
Help	Using Online Help	<i>How to Use Online Help</i>	Using the online help	3-263

# Acquiring Waveforms

Before you can do anything (display, print, measure, analyze, or otherwise process) to a waveform, you must acquire the signal. This instrument comes equipped with the features that you need for capturing your waveforms before further processing them according to your requirements. The following topics cover capturing signals and digitizing them into waveform records:

- *Signal Connection and Conditioning:* How to connect waveforms to the instrument channels; how to scale and position the channels and timebase for acquiring waveforms.
- *Setting Acquisition Controls:* How to choose the appropriate acquisition mode for acquiring your waveforms; how to start and stop acquisition.
- *Acquisition Control Background:* Background information on the data sampling and acquisition process.
- *Using Fast Acquisition Mode:* Using Fast Acquisition mode to capture and display transient events, such as glitches or runt pulses, often missed during longer dead times that accompany normal DSO operation.
- *Using FastFrame:* Using FastFrame to capture many records in a larger record, and then view and measure each record individually.
- *O/E Converter (CSA7000B Series):* Using the Optical-to-Electrical Converter to test optical signals.



**NOTE.** This section describes how the vertical and horizontal controls define the acquisition of live waveforms. These controls also define how all waveforms are displayed, both live and derived waveforms (math waveforms, reference waveforms, and so on). The sections that follow cover display-related usage:

- Displaying Waveforms on page 3-119.
- Creating and Using Math Waveforms on page 3-167.

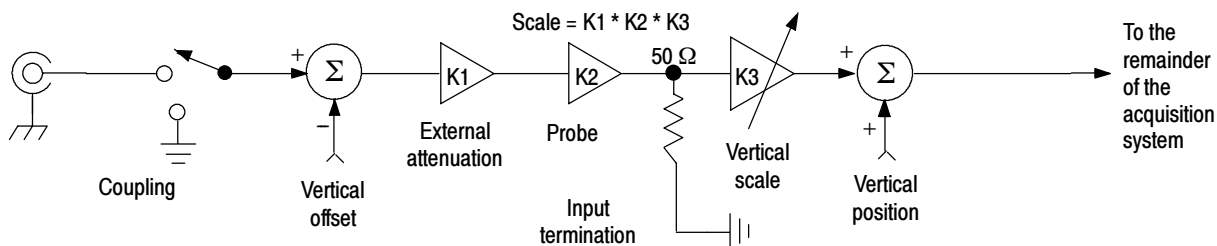
## Signal Connection and Conditioning

This section presents overviews of the instrument features related to setting up the input signal for digitizing and acquisition. It addresses the following topics:

- How to turn on channels and adjust vertical scale, position, and offset
- How to set horizontal scale, position, and access record-length and trigger-position controls
- How to get a basic trigger on your waveform

**NOTE. Terminology:** This manual uses the terms vertical acquisition window and horizontal acquisition window throughout this section and elsewhere. These terms refer to the vertical and horizontal range of the segment of the input signal that the acquisition system acquires. The terms do not refer to any windows or display windows on screen.

Figure 3-1 shows the model for each input channel.



**Figure 3-1: Input and Acquisition Systems and Controls**

Use input conditioning to ensure the instrument acquires the data that you want to display, measure, or otherwise process. To ensure the best possible data for displaying and further processing, do the following:

- Set the vertical scale to control the size of the vertical acquisition window for each channel to capture part or all of the vertical amplitude of the input signal. When vertical scaling is set to capture only a fraction of the input signal range (for increased detail), the vertical offset control may be used to determine which portion of the input signal is captured by the vertical acquisition window.
- Set horizontal scale to control the size of the horizontal acquisition window to capture as much as you want of the input signal(s). Set the horizontal position to delay the window relative to a trigger and to control where in the input signal (data stream) that the horizontal acquisition window acquires.

For more background on acquisition window concepts, see *Input Conditioning Background* on page 3-17.

The instrument can automatically obtain and display a stable waveform of usable size. Pushing the Autoset button automatically sets up the instrument controls based on the characteristics of the input signal. Autoset is much faster and easier than a manual control-by-control setup.

The instrument can also be reset to its factory default settings.

Usage of some input conditioning controls or features may be limited when other control settings are in effect. Voltage offset is incompatible with reference waveforms because offset is an acquisition control.

## Connecting and Conditioning Your Signals

Read the following topics related to waveform acquisition; they provide details that can make it easier to set up and acquire your waveforms.

**Probes and Signal Connection.** Select the probe or cable that brings the signal into the instrument. Choose the probe or cable that best fits your acquisition task, whether it is connecting an active probe to test a digital circuit, or connecting to a test fixture through SMA cables to characterize a device. The connection to the instrument depends on your application.

Tektronix provides a variety of probes and cables for this product. For a list of probes available for use, see *Accessories and Options* on page 1-33. You can also check your Tektronix catalog for connection accessories that may support your application. More information about your probes can be found in the user manual for your probes.

Four acquisition channels are available. Each channel can be displayed as a waveform or can contribute waveform data to other waveforms (math and reference waveforms for example).

**Coupling.** All instruments and probes specify a maximum signal level. (See *Specifications* in your user manuals for exact limits.)



---

**CAUTION.** Exceeding the maximum limit, even momentarily, may damage the input channel. Use external attenuators, if necessary, to prevent exceeding the limits.

---

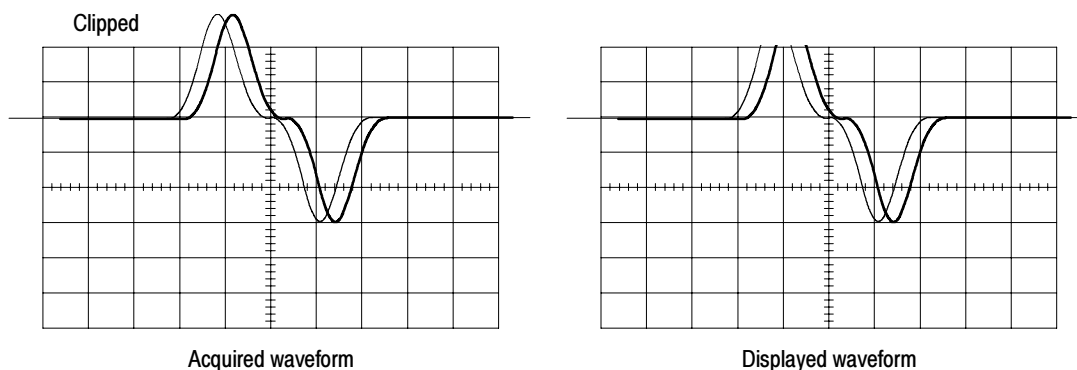
Coupling determines whether an input signal is directly connected to the input channel or not connected at all. These choices are referred to as DC coupling, and GND coupling.

The input resistance of each input channel is 50  $\Omega$ . To properly terminate signals in other impedance environments, use an adapter.

All probes expect a specific coupling and input termination. Both coupling and input termination resistance are displayed on screen.

**Scaling and Positioning.** These key controls determine the portion of the input signal presented to the acquisition system:

- Set vertical scaling, positioning, and DC offsets to display the features of interest on your waveform and avoid clipping. (See *Note* that follows.) *Vertical Acquisition Window Considerations* on page 3-18 describes the vertical acquisition window.



- Set horizontal scale, position, and resolution (record length) so that the acquired waveform record includes the waveform attributes of interest with good sampling density on the waveform. The settings that you make define the horizontal acquisition window (see *Horizontal Acquisition Window Considerations* on page 3-20).

---

**NOTE.** *Waveform data outside the vertical acquisition window is clipped; that is, the data is limited to the minimum or maximum boundaries of the vertical acquisition window. This limiting causes inaccuracies in amplitude-related measurements. Note that the acquisition window also includes 1 division above and below the displayed graticule area. See Vertical Acquisition Window Considerations on page 3-18.*

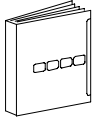
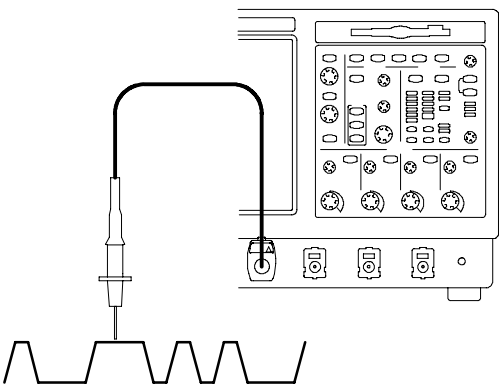
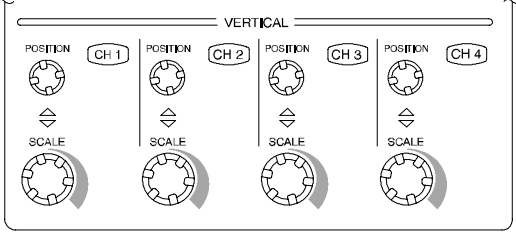
---

**Trigger and Display.** Set basic trigger controls to gate waveform acquisition, and use the display to interactively scale, position, and offset waveforms. See the sections *Triggering* on page 3-63 and *Displaying Waveforms* on page 3-119.

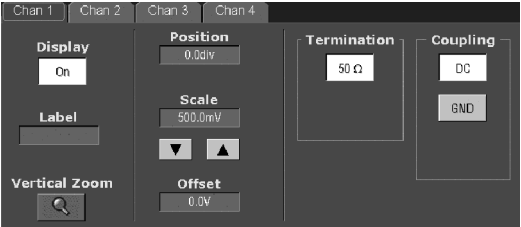
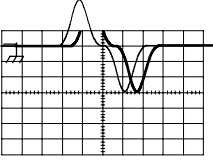
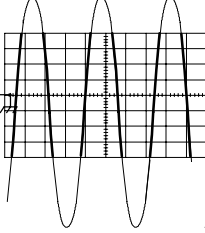
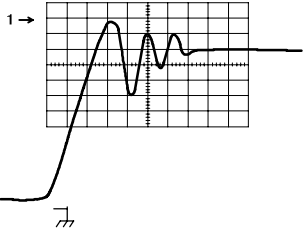
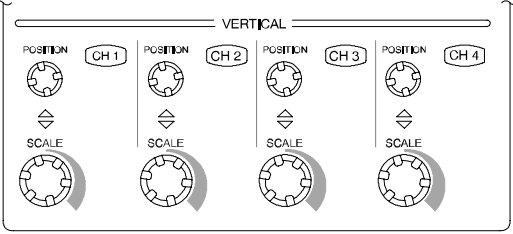
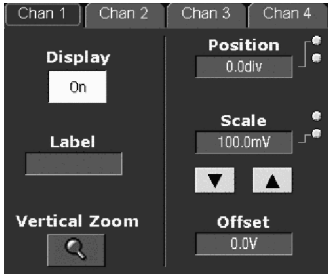
**Flexible Control Access.** This manual focuses on basic setup through the front panel, and then through use of the User Interface (UI) Application displayed on screen. The online help system also documents the UI.

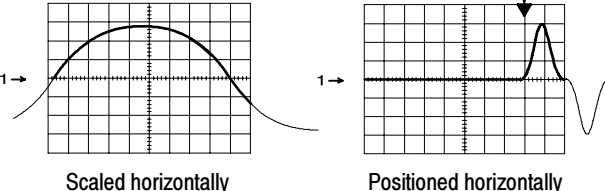
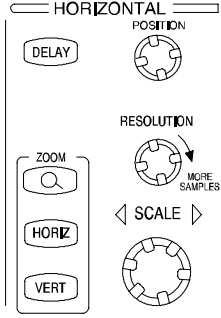

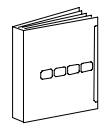
**To Set Up Signal Input**

Use the procedure that follows when setting up the instrument to scale and position input signals for acquisition. For more information, display online help while performing the procedure.

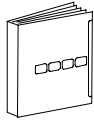
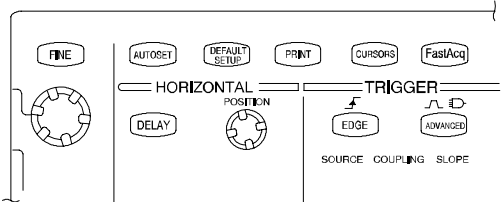

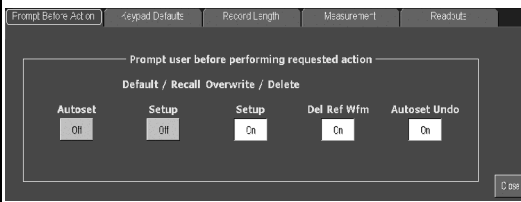
Overview	To set up signal input	Related control elements and resources
<p><b>Prerequisites</b></p>	<p>1. The acquisition system should be set to run continuously.</p>	 <p>See page 3-29 for acquisition setup and page 3-63 for trigger setup.</p>
<p><b>Connect input signal</b></p>	<p>2. Connect to the signal to be acquired using proper probing and connecting techniques.</p> <p><i>Note.</i> For more details on control over input setup, push the Vert button to display the Vertical control window, and then touch the HELP button.</p>	
<p><b>Select the input signal channel</b></p>	<p>3. Push a channel button (CH 1-CH 4) to select the signal channel.</p> <p>A channel button lights when its channel is on.</p>	



Overview	To set up signal input (Cont.)	Related control elements and resources
<p><b>Select input coupling</b></p>	<p>4. Touch Vert to display the Vertical control window. To change the input coupling, select the channel tab and then select from:</p> <ul style="list-style-type: none"> <li>■ DC to couple both the AC and DC components of an input signal</li> <li>■ GND to disconnect the input signal from the acquisition</li> </ul> <p>Touch Close to close the window.</p> <p><b>Note.</b> CSA7000B Series: If the O/E Electrical Out-to-CH1 adapter is installed, the Termination, Coupling, and Bandwidth selections are replaced with Wavelength and Dark Level selections.</p>	
<p><b>Set vertical acquisition window</b></p>	<p>5. Use the vertical knobs to scale and position the waveform on screen.</p> <div style="display: flex; justify-content: space-around;"> <div style="text-align: center;"> <p>Positioned vertically</p>  </div> <div style="text-align: center;"> <p>Scaled vertically</p>  </div> </div> <p>Dragging the waveform handle also positions the waveform.</p> <p>6. Touch Vert to display the Vertical control window. To change the offset, touch the Offset control and turn the multipurpose knob to adjust the offset.</p> 	  

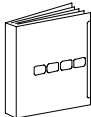
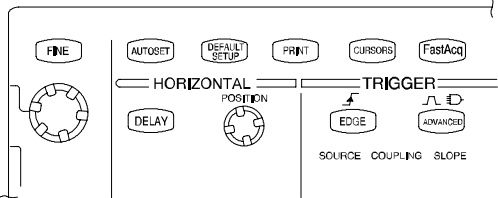
Overview	To set up signal input (Cont.)	Related control elements and resources
<p><b>Set horizontal acquisition window</b></p>	<p>7. Use horizontal knobs to scale and position the waveform on screen and to set record length.</p> <p>Dragging the reference icon also positions the waveform.</p>  <p>The Resolution knob sets the record length. (See discussion on page 3-21.)</p> <p>If required to stabilize the display, push LEVEL to set the trigger level to 50%.</p>	
<p><b>For help</b></p>	<p>8. For more information on the controls described in this procedure, push the Vert or Horiz button. Touch the HELP button in the toolbar.</p>	
<p><b>Continue with acquisition setup</b></p>	<p>9. To finish acquisition setup, you must set the acquisition mode and start the acquisition.</p>	 <p>See <i>To Set Acquisition Modes</i> on page 3-29.</p>

**To Autoset the Instrument** Autoset automatically sets up the instrument controls (*acquisition, display, horizontal, trigger, and vertical*) based on the characteristics of the input signal. Autoset is much faster and easier than a manual control-by-control setup. When the input signal is connected, do an autoset to automatically set up the instrument:

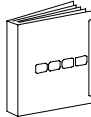
Overview	To autoset the instrument	Control elements and resources
<p><b>Prerequisites</b></p>	<p>1. Signals must be connected to channels. A triggering source must be provided.</p>	 <p>See page 3-63 in this manual for trigger setup information.</p>
<p><b>Execute</b></p>	<p>2. Push the Autoset button to execute an Autoset.</p> <p>If you use Autoset when one or more channels are displayed, the instrument selects the lowest numbered channel for horizontal scaling and triggering. All channels in use are individually vertically scaled.</p> <p>If you use Autoset when no channels are displayed, the instrument turns on channel one (CH 1) and scales it.</p>	
<p><b>Execute Autoset Undo</b></p>	<p>3. The Autoset Undo control window opens automatically after an Autoset operation. Touch Undo if you want to undo the last Autoset.</p> <p>Only the parameters that were set by the last Autoset are undone. Parameters that you changed that are not controlled by Autoset retain their settings.</p> <p>If you don't want this window to appear, set the Utilities/User Preferences/Autoset Undo button to Off. You can still do an Autoset Undo using the Horiz/Acq menu.</p>	
<p><b>Prompt</b></p> <p><b>Done</b></p>	<p>4. Select User Preferences in the Utilities menu to display the Prompt Before Action window. Touch Autoset to toggle between ON and OFF:</p> <ul style="list-style-type: none"> <li>■ OFF to set up for performing an autoset when the AUTOSSET button is pushed</li> <li>■ ON to set up for displaying a prompt before performing an autoset when the AUTOSSET button is pushed</li> </ul> <p>Touch Close to save your prompt selection.</p>	

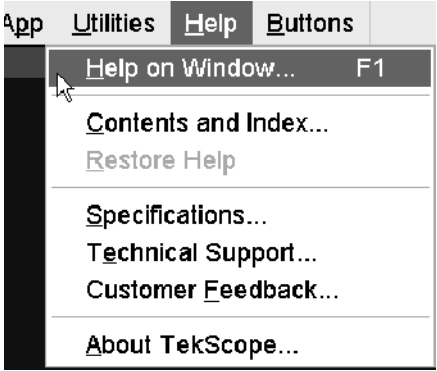
**NOTE.** Autoset may change the vertical position to position the waveform appropriately. It sets vertical offset to 0 V unless an offsetable probe is attached. If you are not using an offsetable probe and your signal contains offset (such as the probe compensation signal), you may need to adjust the Vertical Offset and SCALE to display the signal.

**To Reset the Instrument** You may want to revert to the factory default setup; if so, reset the instrument:

Overview	To reset the instrument	Control elements and resources
<b>Prerequisites</b>	1. The instrument is powered up and running.	 <p>See <i>Powering On the Instrument</i> on page 1-9.</p>
<b>Execute</b>	2. Push the DEFAULT SETUP button.	

**To Get More Help** You can get help on the vertical and acquisition controls by accessing online help:

Overview	To get more help	Control elements and resources
<b>Prerequisites</b>	1. Instrument powered up and running.	 <p>See <i>Powering On the Instrument</i> on page 1-9.</p>

Overview	To get more help (Cont.)	Control elements and resources
<p><b>Access vertical set up help</b></p>	<p>2. Touch the Help button in toolbar mode or select Help on Window from the Help menu in menu bar mode.</p> <p>3. You can also select topics related to the vertical controls from the online help Contents/Index/Find window: select Contents and Index in the Help menu, as shown at right.</p>	

## Input Conditioning Background

This section contains background information that can help you more effectively set up the acquisition window of each channel.

**Input.** This instrument samples in real-time or random equivalent-time; both sampling systems provide pretrigger information by using the trigger to stop an already running acquisition. Both sampling systems also sample the input after it is scaled, providing improved input protection and dynamic range.



**CAUTION.** To prevent damage to the acquisition system, do not overdrive the inputs and observe static-safe procedures.

**Autoset Considerations.** Autoset acquires samples from the input signal and attempts to take the following actions based on the input data:

- Evaluate the amplitude range of the input signals and set the size and vertical offset of the vertical acquisition window to acquire the signal with good resolution, but without clipping.
- Set the trigger to the approximate midlevel of the signal being autoset and switches to edge trigger mode.
- Evaluate the signal transitions and set the horizontal scale to produce a waveform display of 2 or 3 cycles of the input signal.

Sometimes Autoset cannot produce a correct display due to the nature of the input signal; if so, you may have to adjust the scale, trigger, and acquisition controls manually. Some conditions that can cause Autoset to fail are:

- No signal present
- Signals with extreme or variable duty cycles

- Signals with multiple or unstable signal periods
- Signals with too low amplitude
- No recognizable trigger signal
- Signals with a frequency > 50 Hz
- Signals with a frequency above the bandwidth of the instrument
- Signals with high offset and low peak-to-peak variations

**Vertical Acquisition Window Considerations.** You can set the vertical size, position, and offset of each channel independently of other channels. Vertical scale and offset specify the vertical acquisition window for each channel. Parts of the signal amplitude that fall within the vertical window are acquired; parts outside (if any) are not.

The offset control subtracts a constant DC level from the input signal before the vertical scale factor is applied, and the vertical position control adds a constant number of divisions of signal after the scale factor is applied to the resulting difference.

The vertical scale and position controls have the following effects on the vertical acquisition window and the displayed waveform:

- The vertical volts per division that you set determines the vertical size of the acquisition window, allowing you to scale it to contain all of a waveform amplitude or only part. Figure 3-2 on page 3-19 shows two vertical acquisition windows that contain the entire waveform, but only one window contains the entire waveform in the graticule on screen.

---

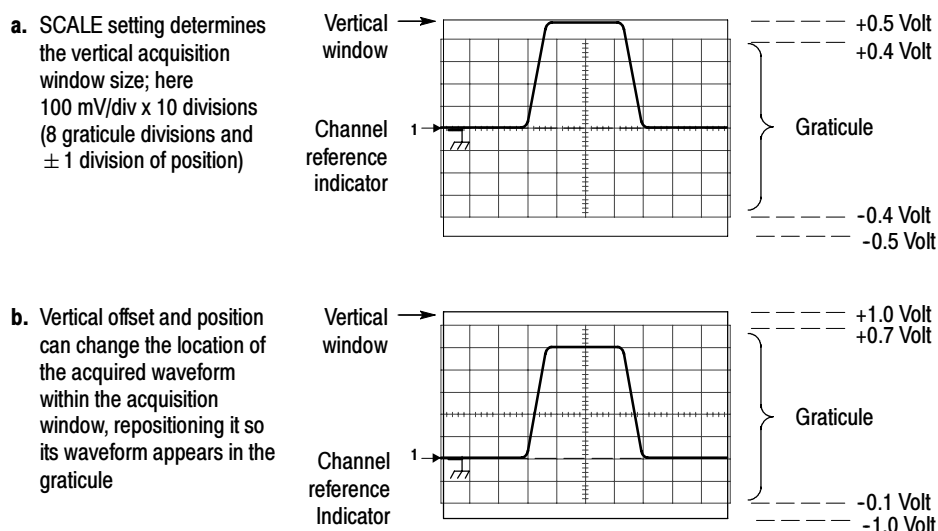
**NOTE.** *Amplitude-related automatic measurements (for example, peak-to-peak and RMS) will be accurate for vertical windows like those shown in Figure 3-2a and b because neither waveform is clipped (that is, both waveforms are acquired). But if signal amplitude were to extend outside the vertical acquisition window, the data acquired is clipped. Clipped data causes inaccurate results if used in amplitude-related automatic measurements. Clipping also causes inaccurate amplitude values in waveforms that are stored or exported for use in other programs.*

*If the scale of a math waveform is changed so that the math waveform is clipped, it will not affect amplitude measurements on that math waveform.*

---

- The vertical position adjusts the acquisition, and therefore the display, of the acquired waveform relative to the vertical acquisition window. Figure 3-2b shows how vertical position moves the acquired waveform vertically in the acquisition window to place the acquired waveform in the graticule display.

- As you vary the vertical position, the vertical acquisition window moves up and down ( $\pm 5$  divisions) on the waveform. With input signals that are smaller than the window, it appears the waveform moves in the window. Actually, the position moves the vertical acquisition window up and down on the input signal.

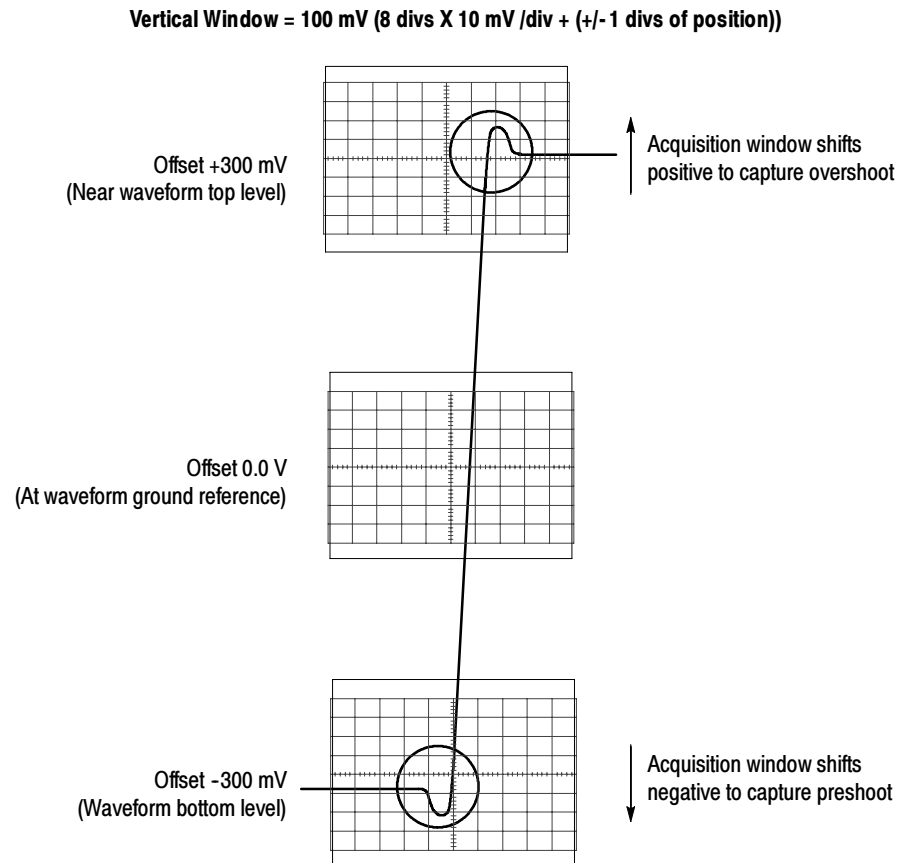


**Figure 3-2: Setting vertical range and position of input channels**

The vertical offset control affects the vertical acquisition window and the displayed waveform as follows:

- The vertical range (window) is always centered around the offset value. It is the voltage level at the middle of the vertical acquisition window. With no (zero) offset, as shown in Figure 3-2 a and b, that voltage level is zero (ground).
- As you vary vertical offset, the middle voltage level moves relative to zero. This moves the vertical acquisition window up and down on the waveform. With input signals that are smaller than the window, it appears the waveform moves in the window. Actually, a larger signal shows what really happens: the offset moves the middle of the vertical acquisition window up and down on the input signal. Figure 3-3 shows how offset moves the acquisition window to control the portion of the waveform amplitude the window captures.

- Applying a negative offset moves the vertical range down relative to the DC level of the input signal. Likewise, applying a positive offset moves the vertical range up. See Figure 3-3.



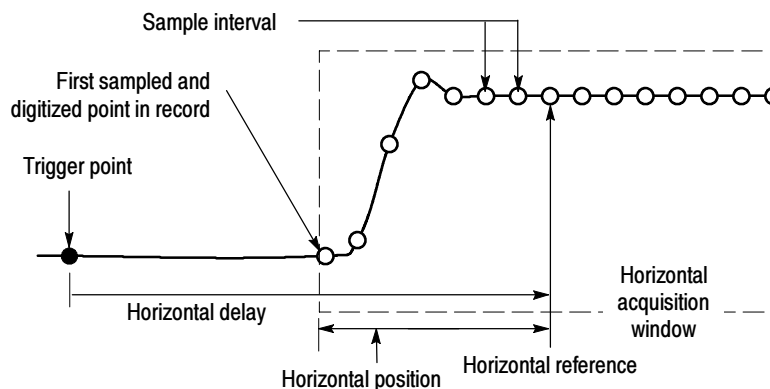
**Figure 3-3: Varying offset moves the vertical acquisition window on the waveform**

**Horizontal Acquisition Window Considerations.** The instrument lets you define the horizontal acquisition window, that is, set several parameters that determine the segment of an incoming signal that becomes the waveform record when acquired. (For background, read *Waveform Record* on page 3-36.) These common parameters specify a horizontal acquisition window that is applied to all channels in parallel. (See *Independent vs. Shared Window* on page 3-23.) These parameters are:

- The trigger condition that you set up determines the point on the waveform that triggers the instrument.
- Horizontal position also determines the number of pretrigger and posttrigger samples; samples before the reference point are pretrigger samples and those after the reference are posttrigger samples.



- The Horizontal Delay that you set determines the time from the trigger point to the Horizontal Reference.
- The horizontal scale and waveform record length (number of samples) that you set determines the horizontal size of the window relative to any waveform, allowing you to scale it to contain a waveform edge, a cycle, or several cycles.



**Figure 3-4: Horizontal Acquisition window definition**

#### **Horizontal Scale Versus Record Length Versus Sample Interval Versus Resolution.**

These parameters all relate to each other and specify the horizontal acquisition window. Because the horizontal acquisition window must fit in the 10 horizontal division display, for most cases, you just set the duration of the horizontal acquisition window (10 divs x the scale setting) as described in (1) below. By also setting a record length in samples, you indirectly set the resolution/sample interval/sample rate for the horizontal acquisition window (waveform record). The relationships between these horizontal elements for 10 division waveforms follow:

1. *Time Duration (seconds) = 10 divs (window size) x Horizontal scale (sec/div)*

$$2. \text{ Time Duration (seconds)} = \text{Sample Interval (seconds/sample)} \times \text{Record Length (samples)},$$

where:

*Time Duration* is the horizontal acquisition window time duration

and:

$$\text{Sample Interval (sec/sample)} = \text{Resolution (sec/sample)} = 1/\text{Sample Rate (samples/sec)}$$

In (2) above, note that it is Sample Interval that varies to accommodate the window time duration (and its scale setting) and the Record Length setting as these latter two elements can be set by you. These elements behave as follows:

- If Record Length or Time Duration vary, Sample Interval varies to accommodate, up to highest sample rate/lowest sample interval/highest resolution.
- If Sample Interval reaches its lower limit, Record Length must decrease if Time Duration decreases (you set faster scale settings), or Time Duration must increase (forcing slower scale settings) if Record Length increases (you set longer record lengths). The equation becomes:

$$\text{Maximum Record Length} = \text{Time Duration} \div \text{Min Sample Interval}$$

For example, at 200 ps/div and 10 divisions, the record length must be 500 points:

$$\text{Max Rec Length} = (10 \text{ divs} \times 200 \text{ ps/div}) \div 4 \text{ ps/sample}$$

$$\text{Max Rec Length} = 500 \text{ samples}$$

---

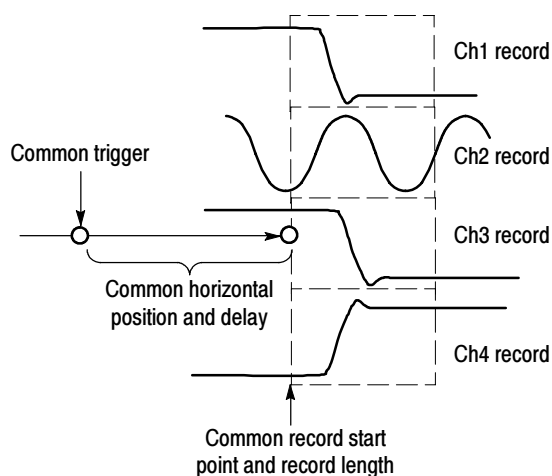
**NOTE.** As implied from the operation just described, resolution and the equivalent elements, sample interval and sample rate (see equation 2 above), cannot be set directly, but are derived. You can, however, check the resolution at anytime in the resolution readout. Also note, that the Resolution control actually adjusts the record length to increase sample density.

The above discussion also assumes that horizontal scale is held constant. You can, however, choose to hold the sample rate constant instead, by selecting Hold Sample Rate Constant in the Utilities, User Preferences menu.

---

**Independent vs. Shared Window.** The instrument applies the same horizontal acquisition window to all channels from which it acquires data. Unlike the vertical acquisition window that you size and offset independently for each channel, the same time/div, resolution (record length), and horizontal position (from the same trigger point) apply to all channels simultaneously. One trigger, from a single trigger source, will locate a common horizontal acquisition window for all active channels, which you can shift in parallel by setting the horizontal position control.

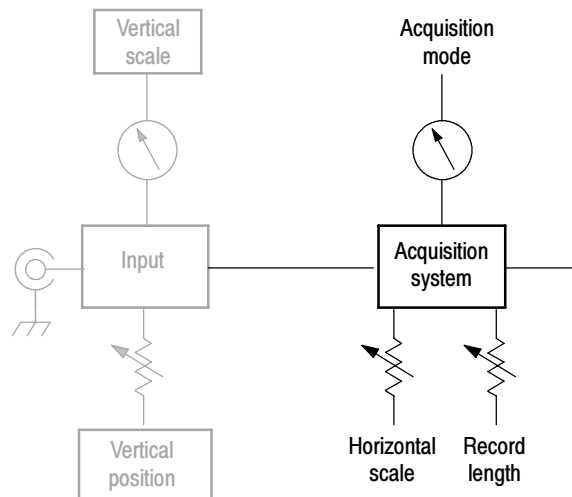
The horizontal acquisition window determines the waveform records extracted from all signals present at all active channels. You can think of the horizontal acquisition window as cutting across any input signals present in the input channels to extract the same slice of time into waveform records. See Figure 3-5.



**Figure 3-5: Common trigger, record length, and acquisition rate for all channels**

## Setting Acquisition Controls

This section presents overviews of the instrument acquisition features—those that start and stop acquisitions and those that control how the instrument processes the data as it is acquired (just sampled, or averaged or enveloped). Special features, keys to using, and operation controls are covered.



Roll mode gives a strip chart recorder-like display for low frequency signals. Roll mode lets you see acquired data points without waiting for the acquisition of a complete waveform record. For example, in normal acquisition mode, when the Horizontal Scale is 1 second per division, 10 seconds are required to fill the waveform record. Without roll mode you must wait 10 seconds to see that the position control is set wrong. With roll mode you can start seeing results almost immediately.

The following table indicates which acquisition features and modes are incompatible with other features or modes:

Control/Feature	Incompatible with	Explanation
Average	Single acquisition	Acquisitions continue until the specified number of waveforms have been acquired and averaged
Envelope	Single acquisition	Acquisitions continue until the specified number of waveforms have been acquired for the enveloped waveform
Roll	Measurements	Measurements are not available until you stop acquisitions

### Using the Acquisition Controls

Consider the mode that you want to use to acquire data:

- Sample.** The instrument does no postprocessing of acquired samples. The instrument saves the first sample (of perhaps many) during each acquisition interval (an acquisition interval is the time covered by the waveform record divided by the record length.) Sample mode is the default mode.

- **Peak Detect.** The instrument alternates between saving the lowest sample in one acquisition interval and the highest sample in the next acquisition interval. This mode only works with real-time, noninterpolated sampling.
- **Hi Res.** The instrument creates a record point by averaging all samples taken during an acquisition interval. Hi Res results in a higher-resolution, lower-bandwidth waveform. This mode only works with real-time, noninterpolated sampling.

A key advantage of Hi Res is its potential for increasing vertical resolution regardless of the input signal. Table 3-1 indicates that you can obtain up to 13 significant bits with Hi res mode. The instrument uses 16-bit memory. This is allocated as 15 bits + 1 sign bit. Round-off errors and internal noise limit the effective bits for Hi Res mode and signal averaging to about 13 bits. You can calculate the theoretical number of bits of enhancement using the following formula, where  $N_d$  is the number of points acquired during a sample interval:

$$\text{Bits of enhancement} = 0.5 \log_2 * N_d$$

**Table 3-1: Additional resolution bits**

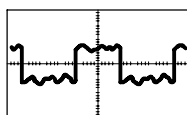
Sample Rate (S/s)	$N_d$ (extra samples)	Theoretical enhancement (bits)	Resulting effective bits
5.00E+00	2.50E+08	13.95	13.00
1.00E+01	1.25E+08	13.45	13.00
2.50E+01	5.00E+07	12.79	13.00
5.00E+01	2.50E+07	12.29	13.00
1.00E+02	1.25E+07	11.79	13.00
2.50E+02	5.00E+06	11.13	13.00
5.00E+02	2.50E+06	10.63	13.00
1.00E+03	1.25E+06	10.13	13.00
2.50E+03	5.00E+05	9.47	13.00
5.00E+03	2.50E+05	8.97	13.00
1.00E+04	1.25E+05	8.47	13.00
2.50E+04	5.00E+04	7.80	13.00
5.00E+04	2.50E+04	7.30	13.00
1.00E+05	1.25E+04	6.80	12.80
2.50E+05	5.00E+03	6.14	12.14
5.00E+05	2.50E+03	5.64	11.64
1.00E+06	1.25E+03	5.14	11.14
2.50E+06	5.00E+02	4.48	10.48

**Table 3- 1: Additional resolution bits (Cont.)**

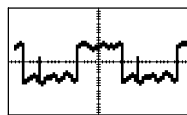
Sample Rate (S/s)	Nd (extra samples)	Theoretical enhancement (bits)	Resulting effective bits
5.00E+06	2.50E+02	3.98	9.98
1.00E+07	1.25E+02	3.48	9.48
2.50E+07	5.00E+01	2.82	8.82
5.00E+07	2.50E+01	2.32	8.32
1.00E+08	1.25E+01	1.82	7.82
2.50E+08	5.00E+00	1.16	7.16
5.00E+08	2.50E+00	0.66	6.66
1.25E+09	1.00E+00	0.00	6.00

- **Envelope.** Continuously, as subsequent waveforms are acquired, the instrument retains the running minimum (Min) and maximum (Max) values in adjacent sample intervals, creating an envelope of the number of waveforms that you specify. Once the specified number of waveforms is reached, the data is cleared and the process starts over. This is similar to the Peak Detect mode, but Envelope mode, unlike Peak Detect, gathers peaks over many trigger events.
- **Average.** The instrument processes the number of waveforms that you specify into the acquired waveform, creating a running average of the input signal. This mode reduces random noise.

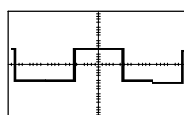
Acquiring and displaying a noisy square wave signal illustrates the difference between the modes. Note how Average reduces the noise while Envelope captures its extremes:



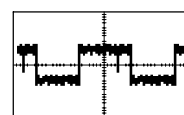
Sample



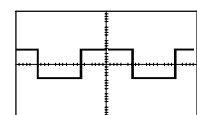
Peak Detect



Hi Res



Envelope



Average

- **Waveform Database.** Using waveform database technology, the instrument processes a much larger sample of data. The waveform database is a three-dimensional accumulation of source waveform data over several acquisitions. In addition to amplitude and timing information, the database includes a count of the number of times a specific waveform point (time and amplitude) has been acquired. The database is 200 lines by 500 columns with a 64 bit counter for each pixel location. You can use color-graded displays based on counts to highlight waveform activity. Parametric

measurements derived from the database use statistical techniques to produce more stable, accurate results.

If you select Infinite Persistence, the counts accumulate continuously.

Samples sets the minimum number of samples required to complete a single acquisition sequence and the minimum number of samples required to complete a mask test. If not using display persistence, samples sets the minimum number of samples that is required to release the waveform to the display. Similar to FastFrame, selecting RunStop, will cause the waveform to be displayed with what has been acquired so far.

The actual number of samples acquired is determined by the Samples setting, the selected Record Length, and if in equivalent time acquisitions, the actual number of samples acquired in an acquisition. For example, in real-time acquisition mode with the entire trace displayed, if the Record Length is set to 5000 points and Samples is set to 5001 points, then two acquisitions are required and 10000 points are acquired. If Samples is set to 5000 points, one acquisition is required and 5000 points are acquired. If Samples is set to 4999 points, one acquisition is required and 5000 points are acquired.

For Single Sequence and Mask Pass/Fail Testing, a sample is only counted if the sample would be displayed in the graticule area. In Single Sequence, all eligible samples in an acquisition are counted. In Mask Test, with infinite persistence on, all acquisitions acquired in a batch are counted. In nondisplay persistence, the minimum number of samples for the waveform may include multiple batches of acquisitions.

In ET mode, fewer samples are acquired per acquisition, but more acquisitions may be acquired in a batch. Samples divided by the Record Length roughly indicates the number of waveforms in a batch of acquisitions.

Batch processing minimizes the overhead of displaying and processing other features, such as measurements and histograms. The higher the number of samples, the greater the acquisition throughput and the potential for less frequent display updates.

Also, consider how you want to control acquisition; you have two main options, settable from the Run/Stop control window (select Run/Stop from the Horiz/Acq menu):

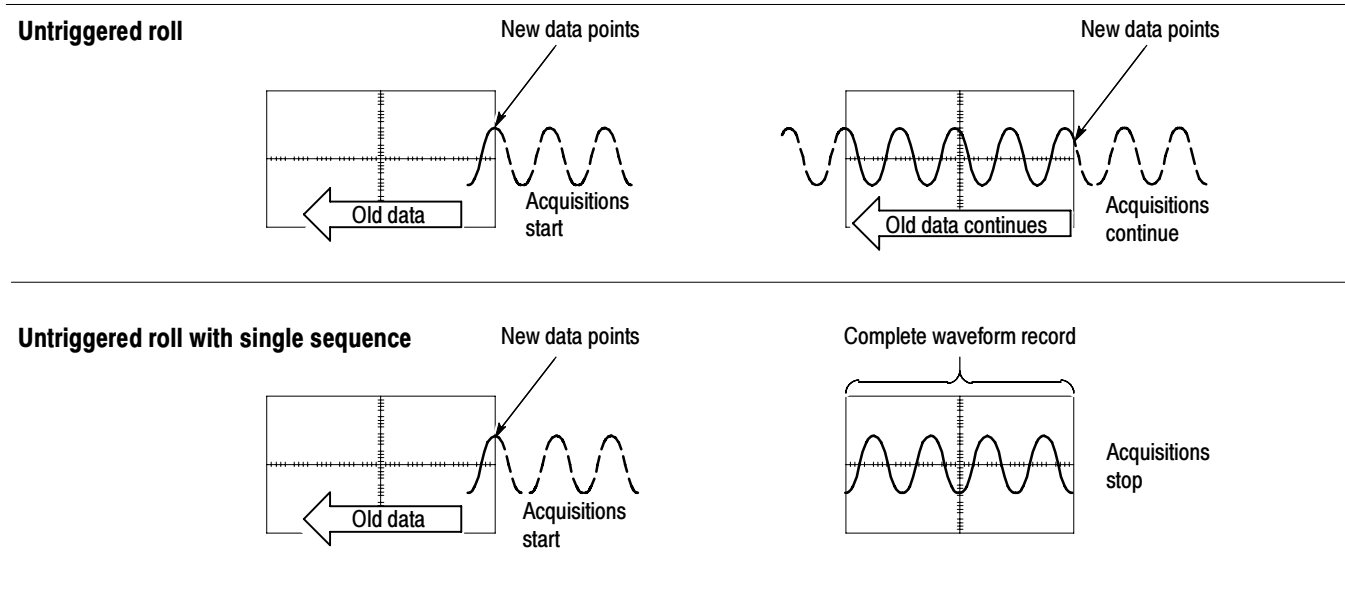
- **Run/Stop Button Only.** Sets the instrument to start and stop the acquisition only when you push the Run/Stop button, available on the front panel, or in the Run/Stop control window. If toggled to Run, acquisition will start if a valid trigger occurs. If toggled to Stop, acquisition stops immediately.

- Single Sequence.** In addition to the Run/Stop Button, which can always stop an acquisition, the SINGLE button (or Single Sequence control) will automatically stop acquisition when one complete acquisition sequence is completed. See step 4, *Set the stop mode*, on page 3-30, or access the online help from the Run/Stop control window for more information.

**Untriggered Roll.** Untriggered roll mode displays newly acquired data points at the right edge of the waveform record while moving older waveform data points to the left. To stop acquiring data push **RUN/STOP** (see Figure 3-6).

Use untriggered roll to continuously observe a slow process, knowing that you can always see the most recent view of that process. Math and measurements work after you push STOP.

**Untriggered Roll with Single Sequence.** Untriggered roll mode with single sequence displays newly acquired data points at the right edge of the waveform record while moving older waveform data points to the left. Acquisitions automatically stop after a complete waveform record is acquired (see Figure 3-6). Use untriggered roll with single sequence to observe data for later viewing.



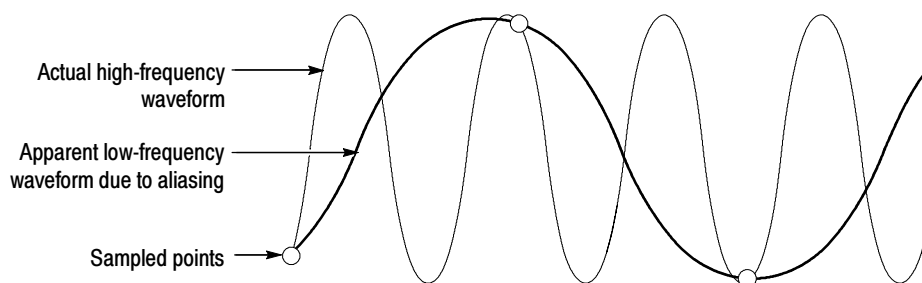
**Figure 3-6: Roll mode**

**Global Controls.** Like the horizontal controls, the acquisition controls apply to all active channels; for example, channel 1 cannot acquire in Sample mode while channel 2 acquires in Envelope mode. You cannot stop channel 4 from acquiring (if turned on) while other channels continue to acquire.



**Preventing Aliasing.** Under certain conditions, a waveform may be aliased on screen. Read the following description about aliasing and the suggestions for preventing it.

When a waveform aliases, it appears on screen with a frequency lower than the actual waveform being input or it appears unstable even though the TRIG'D light is lighted. Aliasing occurs because the instrument is not sampling the signal fast enough to construct an accurate waveform record. (See Figure 3-7.)



**Figure 3-7: Aliasing**

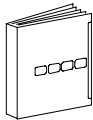

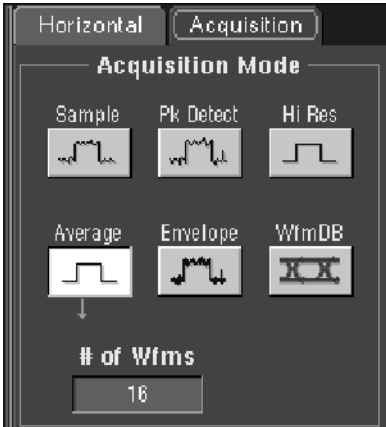
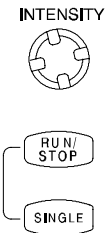
**Methods to Check and Eliminate Aliasing.** To quickly check for aliasing, slowly increase the horizontal scale (time per division setting). If the shape of the displayed waveform changes drastically or becomes stable at a faster time base setting, your waveform was probably aliased.


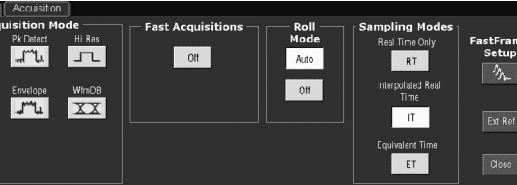
To avoid aliasing, be sure to sample the input signal at a rate more than twice as fast as the highest frequency component. For example, a signal with frequency components of 500 MHz would need to be sampled at a rate faster than 1 Gigasamples/second to represent it accurately and to avoid aliasing. The following tips may help you eliminate aliasing on a signal:

- Turn on Fast Acquisition mode to maximize the waveform capture rate.
- Turn on Waveform Database mode to capture more data.
- Try adjusting the horizontal scale for proper waveform display.
- Try pushing the AUTOSSET button.
- Try switching the acquisition to Envelope mode. Envelope searches for samples with the highest and lowest values over multiple acquisitions and can detect faster signal components over time.
- Turn on PeakDetect acquisition mode. If the waveform becomes an envelope, aliasing was occurring.

**To Set Acquisition Modes** Use the procedure that follows to set the data acquisition mode and specify

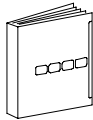









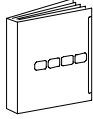
acquisition start/stop methods. For more information, display online help when performing the procedure.

Overview	To set acquisition modes	Control elements and resources
<p><b>Prerequisites</b></p>	<p>1. Instrument must be powered up, with horizontal and vertical controls set up. Triggering should also be set up.</p>	 <p>See page 3-63 for trigger setup.</p>
<p><b>To select an acquisition mode</b></p>	<p>2. Touch the Horiz button. Select the Acquisition tab from the Horiz/Acq setup window.</p>	
<p><b>Select the acquisition mode</b></p> <p><b>Set waveform count (average and envelope only)</b></p>	<p>3. Touch an Acquisition Mode button to set the acquisition mode; choose from the following modes:</p> <ul style="list-style-type: none"> <li>■ Sample</li> <li>■ Peak Detect</li> <li>■ Hi Res</li> <li>■ Envelope</li> <li>■ Average</li> <li>■ Waveform Database</li> </ul> <p>For Average and Envelope modes only, select the number of acquisitions to average or envelope. For Waveform Database mode, select the number of samples desired.</p>	
<p><b>Set the stop mode</b></p>	<p>4. Push the RUN/STOP button (or touch Run/Stop in the Run/Stop control window) to toggle between starting (Running) and stopping acquisitions.</p> <p>5. Push the SINGLE button (or touch Single Sequence in the Run/Stop control window) to acquire enough waveforms to satisfy the acquisition mode and then stop.</p>	

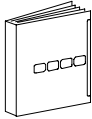
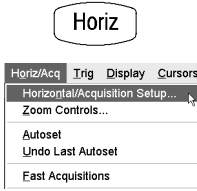

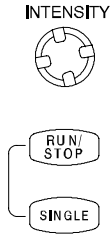
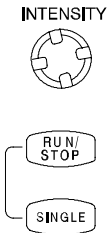
Overview	To set acquisition modes (Cont.)	Control elements and resources
<p><b>To select real-time or equivalent-time sampling</b></p>	<p>To select real-time sampling, interpolated real-time sampling, or equivalent-time sampling:</p> <ol style="list-style-type: none"> <li>6. Touch the Horiz button. Select the Acquisition tab from the Horiz/Acq control window,</li> </ol> <p>Or select Horizontal/Acquisition Setup from the Horiz/Acq menu to display the Acquisition Mode control window. Select the Acquisition tab.</p> <ol style="list-style-type: none"> <li>7. Select the sampling mode: <ul style="list-style-type: none"> <li>■ Equivalent Time uses both the real-time and equivalent-time sampling as appropriate (see Table 3-2 on page 3-38).</li> <li>■ Real Time Only limits the instrument to real-time sampling. Real Time Only prevents the very fast horizontal scale settings from being selected.</li> <li>■ Interpolated Real Time limits the instrument to real-time sampling. If the instrument cannot accurately get enough samples for a complete waveform, it will interpolate.</li> </ul> </li> </ol> <p><b>Note.</b> The instrument will use the interpolation method selected in the display menu to fill in the missing record points — either linear or <math>\sin(x)/x</math> interpolation. The default method is <math>\sin(x)/x</math>. See Interpolation on page 3-39 for a discussion of interpolation.</p>	<div style="text-align: center; margin-bottom: 20px;">  </div> 

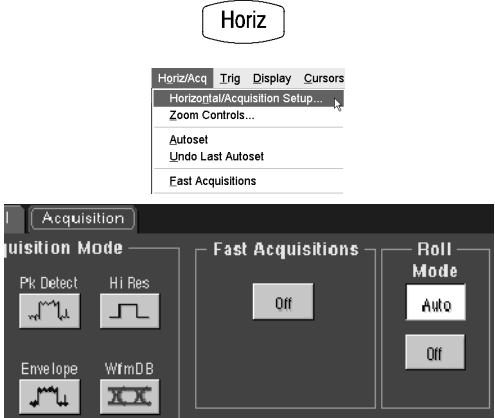
**To Start and Stop Acquisition**

Use the procedure that follows to start and stop acquisition.

Overview	To start and stop acquisition	Control elements and resources
<p><b>Prerequisites</b></p>	<p>1. The horizontal and vertical controls must be set up. Triggering should also be set up.</p>	 <p>See page 3-29 for acquisition setup and page 3-63 for trigger setup.</p>
<p><b>To start acquiring</b></p>	<p>2. Make sure all the channels to be acquired are turned on (use channel buttons; see <i>To Set Up Signal Input</i> on page 3-12 if needed). Then push the RUN button to begin acquiring.</p>	<p>INTENSITY</p>   
<p><b>To stop acquiring</b></p>	<p>3. Push the RUN/STOP button to stop acquisition. Acquisition will also stop if triggering ceases while in Normal trigger mode.</p>	<p>INTENSITY</p>   
<p><b>To take a single acquisition</b></p>	<p>4. Push the SINGLE button to start acquiring and acquire enough waveforms to satisfy the acquisition mode and then stop.</p>	<p>INTENSITY</p>   
<p><b>For more help</b></p>	<p>5. See references listed at right.</p>	 <p>See <i>To Set Acquisition Modes</i> on page 3-29 and <i>To Get More Help</i> on page 3-16.</p>

**To Set Roll Mode** Use the procedure that follows to set up roll mode acquisitions.

Overview	To set Roll Mode	Control elements and resources
<p><b>Prerequisites</b></p>	<p>1. The horizontal and vertical controls must be set up. Triggering should also be set up.</p>	 <p>See page 3-29 for acquisition setup and page 3-63 for trigger setup.</p>
<p><b>To enable roll mode</b></p>	<p>2. Touch the Horiz button. Select the Acquisition tab from the Horiz/Acq control window, or select Horizontal/Acquisition Setup from the Horiz/Acq menu to display the Acquisition Mode control window. Select the Acquisition tab.</p> <p>3. Select Roll Mode AUTO to enable roll mode.</p> <p>When the horizontal scale is 100 ms per division at a record length of 500 points and the acquisition mode is Sample or Pk Detect, roll mode turns on. As the record length becomes larger, the time per division required to enter roll mode becomes slower.</p> <p><b>Note.</b> Envelope, Average, FastAcq, and Waveform Database acquisition modes inhibit roll mode.</p>	 
<p><b>To single sequence roll mode</b></p>	<p>4. Push the SINGLE button to start acquiring and acquire enough waveforms to satisfy the acquisition mode and then stop.</p>	
<p><b>To turn off roll mode acquisitions</b></p>	<p>5. Do the following step to stop acquisitions in roll mode:</p> <ul style="list-style-type: none"> <li>■ If you are not in Single Sequence, push RUN/STOP to stop roll mode.</li> <li>■ If you are in Single Sequence, roll mode acquisitions stop automatically when a complete record is acquired.</li> </ul>	

Overview	To set Roll Mode (Cont.)	Control elements and resources
<p><b>To disable roll mode</b></p>	<p>6. Touch the Horiz button. Select Acquisition tab from the Horiz/Acq control window,</p> <p>Or select Horizontal/Acquisition Setup from the Horiz/Acq menu to display the Acquisition Mode control window. Select the Acquisition tab.</p> <p>7. Select Roll Mode OFF to disable roll mode.</p> <p>Or, whenever you set the Horizontal SCALE to 40 ms per division or faster, roll mode turns off. At record lengths greater than 500 points, the time per division required to turn off roll mode becomes slower.</p> <p><b>Note.</b> <i>Envelope, Average, Fast Acquisition, and Waveform Database acquisition modes inhibit roll mode.</i></p>	

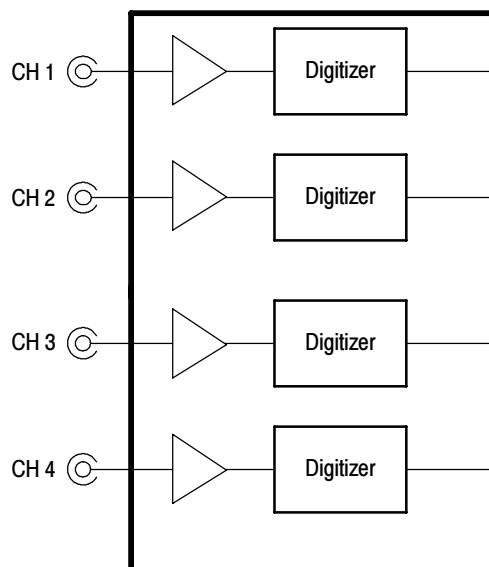
## Acquisition Control Background

This section contains background information on the data sampling and acquisition process that can help you more effectively set up the acquisition window of each channel. This section describes the following:

- The acquisition hardware
- The sampling process, sampling modes, and the waveform record
- Both the normal and Fast Acquisitions acquisition cycles

### Acquisition Hardware

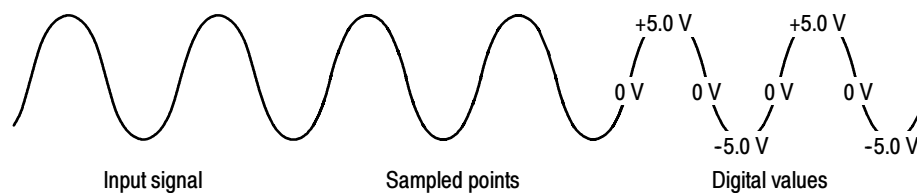
Before a signal can be acquired, it must pass through the input channel where it is scaled and digitized. Each channel has a dedicated input amplifier and digitizer as shown in Figure 3-8; each channel can produce a stream of digital data from which waveform records can be extracted. See *Signal Connection and Conditioning* on page 3-8 for further description of scaling, positioning, and DC offsetting of channels.



**Figure 3-8: Digitizer configuration**

### Sampling Process

Acquisition is the process of sampling the analog input signal of an input channel, converting it into digital data, and assembling it into a waveform record, which is then stored in acquisition memory. Sampling, then, is the process that provides a waveform record per trigger event (see Figure 3-10 on page 3-36). The signal parts within the vertical range of the amplifier are digitized. See Figure 3-9.



**Figure 3-9: Digital acquisition — sampling and digitizing**

### Acquisition Modes

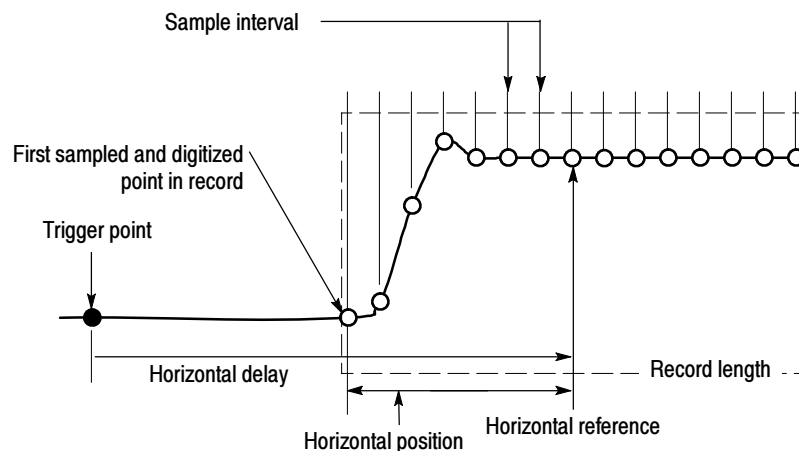
The instrument acquisition system can process the data as it is acquired, averaging or enveloping the waveform data to produce enhanced waveform records. Once the waveform record exists (enhanced or not), you can use the postprocessing capabilities of the instrument to further process that record: perform measurements, waveform math, and so on. Refer to *Using the Acquisition Controls* on page 3-24 for a description of the acquisition modes.

## Waveform Record

While sampling on the input signal provides the data that makes up the waveform record for any given channel, the instrument builds the waveform record through use of some common parameters (common means that they affect the waveforms in all channels).

Figure 3-10 shows how these common parameters define the waveform record; as shown in the figure, they define where in the data stream and how much data is taken. Locate the following parameters in the figure:

- **Sample Interval.** The time between sample points taken during acquisition.
- **Record Length.** The number of samples required to fill a waveform record.
- **Trigger Point.** The trigger point marks the time zero in a waveform record. All waveform samples are located in time with respect to the trigger point.
- **Horizontal Position.** If horizontal delay is off, the time lapse from the first sample taken (first point in the waveform record) to the trigger point (in percent of samples before the trigger). When horizontal delay is off, the trigger point and the horizontal reference are at the same point in the waveform record.



**Figure 3-10: The waveform record and its defining parameters**

As Figure 3-10 shows, the instrument acquires points in order from left to right.

When all the points in the waveform record have been sampled and digitized, the waveform record is in acquisition memory and becomes available for display (or use in math waveforms, storage, and so on).

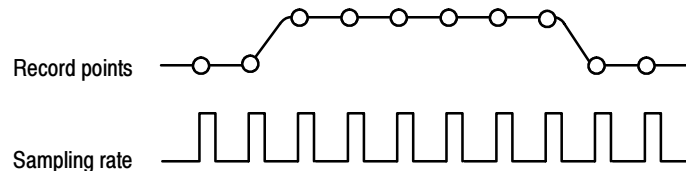
For a control-oriented discussion of the waveform record, see *Horizontal Acquisition Window Considerations* on page 3-20 and *Horizontal Scale vs. Record Length vs. Sample Interval vs. Resolution* on page 3-21.



### Real-Time Sampling

The two general methods of sampling are real-time and equivalent-time. This instrument uses both real- and equivalent-time sampling.

In real-time sampling, the instrument digitizes all the points it acquires after one trigger event (see Figure 3-11). Always use real-time sampling to capture single-shot or transient events.



**Figure 3-11: Real-time sampling**

### Equivalent-Time Sampling

The instrument uses equivalent time sampling to extend its sample rate beyond its real-time maximum sampling rate, but only under two conditions:

- You must have selected Equivalent Time in the Acquisition Setup control window.
- You must have set the instrument to a sampling rate that is too fast to allow it to get enough samples with which to create a waveform record using real-time sampling.

If both conditions are met, the instrument takes a few samples with each trigger event and eventually obtains enough samples to construct a waveform record. The instrument makes multiple acquisitions of a repetitive waveform to obtain the sample density required for a waveform record. (See Figure 3-12.) Equivalent-time sampling should only be used on repetitive signals.

The sampling speeds and the number of channels that you choose affect the mode the instrument uses to sample waveforms:

- The instrument always real-time samples at slower time base settings; faster time settings force the instrument to switch from real-time sampling to equivalent-time sampling or interpolation, depending on whether Equivalent Time or Interpolated Real Time is selected.
- The instrument extends the limit at which it must switch from real-time sampling by using the digitizers of channels that are turned off to sample the channel or channels that are turned on.

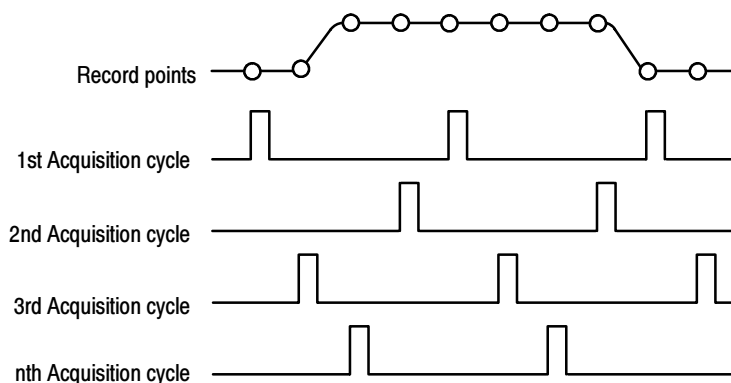
Check Table 3-2 below to determine the time base setting(s) at which the switch from real-time sampling (RT) to equivalent time sampling or interpolation (ETI) occurs for your instrument.

**Table 3-2: Sampling mode selection**

Channels on <sup>1</sup>	1	2	3 or 4
<b>Time base<sup>2</sup></b>			
$\geq 10$ ns $\geq 20$ ns	Real-time sampling	Real-time sampling	Real-time sampling
5 ns	Real-time sampling	Real-time sampling	Equivalent-Time or Interpolated Sampling
2.5 ns	Real-time sampling	Equivalent-Time or Interpolated Sampling	Equivalent-Time or Interpolated Sampling
$\leq 1.25$ ns	Equivalent-Time or Interpolated Sampling	Equivalent-Time or Interpolated Sampling	Equivalent-Time or Interpolated Sampling

<sup>1</sup> This table assumes a 500 point record length. Longer record lengths cause the switch to equivalent time to occur at slower time per division settings.

<sup>2</sup> “>” means “slower than”; “<” means “faster than.”



**Figure 3-12: Equivalent-time sampling**

The type of equivalent-time sampling the instrument uses is called random equivalent-time sampling. Although it takes the samples sequentially in time, it takes them randomly with respect to the trigger. Random sampling occurs because the instrument sample clock runs asynchronously with respect to the input signal and the signal trigger. The instrument takes samples independently of the trigger position and displays them based on the time difference between the sample and the trigger.

## Interpolation

Your instrument can interpolate between the samples it acquires. In equivalent-time sampling, it interpolates only when it does not have all the *real* samples it needs to fill its displayed waveform. When setting ZOOM to progressively larger amounts of expansion, the instrument then interpolates to create the intervening points in the displayed waveform. If the time per division is set fast enough to require equivalent time but equivalent time is disabled, the instrument interpolates points. There are two options for interpolation: linear or  $\sin(x)/x$ . (The instrument can also equivalent-time sample to acquire more samples; see *Equivalent-Time Sampling* on page 3-37.)

**Linear interpolation.** Linear interpolation computes record points between actual acquired samples by using a straight line fit. It assumes all the interpolated points fall in their appropriate point in time on that straight line. Linear interpolation is useful for many waveforms such as pulse trains.

**$\sin(x)/x$  interpolation.**  $\sin(x)/x$  interpolation computes record points using a curve fit between the actual values acquired. It assumes all the interpolated points fall along that curve.  $\sin(x)/x$  is particularly useful when acquiring more rounded waveforms such as sine waves. Actually, it is appropriate for general use, although it may introduce some overshoot or undershoot in signals with fast rise times, especially if you use zoom and the waveform edges are undersampled.

**NOTE.** When using either type of interpolation, you may want to set the display style so that the real samples are displayed intensified and interpolated samples are dimmed. The instructions under *Select the Display Style* on page 3-135 explain how to turn on intensified samples.

**Interleaving**

The instrument can interleave its channels to attain higher digitizing rates without equivalent-time sampling. The instrument applies the digitizing resources of unused channels (that is, channels that are turned off) to sample those that are in use (turned on). Table 3-3 lists how interleaving more than one digitizer to sample a channel extends the maximum digitizing rate.

Once you set horizontal scale to exceed the maximum digitizing rate for the number of channels in use (see Table 3-3), the instrument will not be able to get enough samples to create a waveform record. At that point, the instrument will switch from real to equivalent time sampling to obtain additional samples. (See *Equivalent-Time Sampling* on page 3-37.)

**Table 3-3: How interleaving affects sample rate**

Number of channels in use	Maximum digitizing rate when real-time sampling				
	CSA7404B	TDS7704B	TDS7404B	TDS7254B	TDS7154B
One	20 GS/sec	20 GS/sec	20 GS/sec	20 GS/sec	20 GS/sec
Two	10 GS/sec	10 GS/sec	10 GS/sec	10 GS/sec	10 GS/sec
Three or Four	5 GS/sec	5 GS/sec	5 GS/sec	5 GS/sec	5 GS/sec

**Using Fast Acquisition Mode**

This section describes how to use Fast Acquisition mode and how it differs from normal acquisition mode.

Fast acquisition mode reduces the dead time between waveform acquisitions that normally occur when digitizing storage instruments (DSOs) acquire waveforms. This dead-time reduction enables Fast Acquisition mode to capture and display transient events, such as glitches or runt pulses, often missed during longer dead times that accompany normal DSO operation. Fast Acquisition mode can also display waveform phenomena at an intensity that reflects their rate-of-occurrence.

Fast acquisition XY and XYZ modes also provide intensity information by accepting continuous, non-triggered data from the input channels.

Measurements and histograms are done directly on the two dimensional array of display pixels. In infinite persistence mode, the array accumulates more information and measurements are more accurate.

Some modes/features are incompatible with Fast Acquisitions mode and if you select them they will inhibit Fast Acquisitions:

- FastFrame and Zoom modes
- Envelope, Average, Waveform Database, Hi Res, and Single Acquisition Sequence acquisition modes
- Interpolation (equivalent time sampling is used instead)
- Vectors when in equivalent time mode (waveforms are displayed using Dots). To determine under what conditions the instrument normally interpolates or uses equivalent time, see *Equivalent-Time Sampling* on page 3-37.
- Math waveforms
- Measurements on channels when in Fast XY or XYZ
- Mask testing (optional on TDS7000B Series instruments)

If you select any of these modes before or while Fast Acquisitions is on, they will inhibit, temporarily turn off, Fast Acquisitions mode.

## Using Fast Acquisitions

Consider the mode that you want to use to acquire data:

**Automatic Selection.** Fast Acquisitions automatically selects record length and sample rate to optimize the displayed image by optimizing live time and minimizing dead time. Fast Acquisitions selects the sample rates and record lengths and compresses them to 500 pixels to produce the maximum display content.

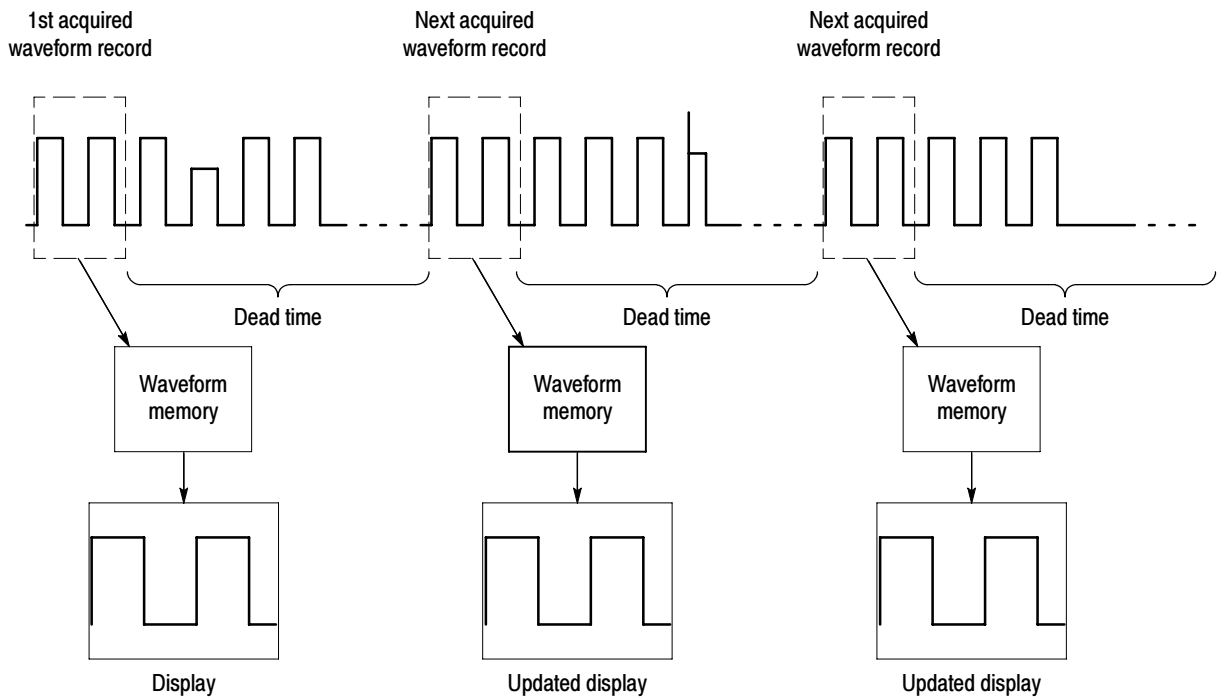
**Waveform Capture Rate.** Figures 3-13 and 3-14 illustrate how Fast Acquisitions mode differs from the normal acquisition mode used by digital storage instruments. Note that normal mode follows a capture waveform-digitize waveform-update waveform memory-display waveform cycle. Normal mode misses short term events occurring during the long dead times. Typical waveform capture rates are 50 waveforms per second.

Fast Acquisitions mode increases the waveform capture rate to up to 400,000 waveforms per second, updating the waveform array many times between displays. This very fast capture rate greatly increases the probability that runts, glitches, and other infrequent events will accumulate in waveform memory. The instrument then displays the waveform at the normal display rate. You can

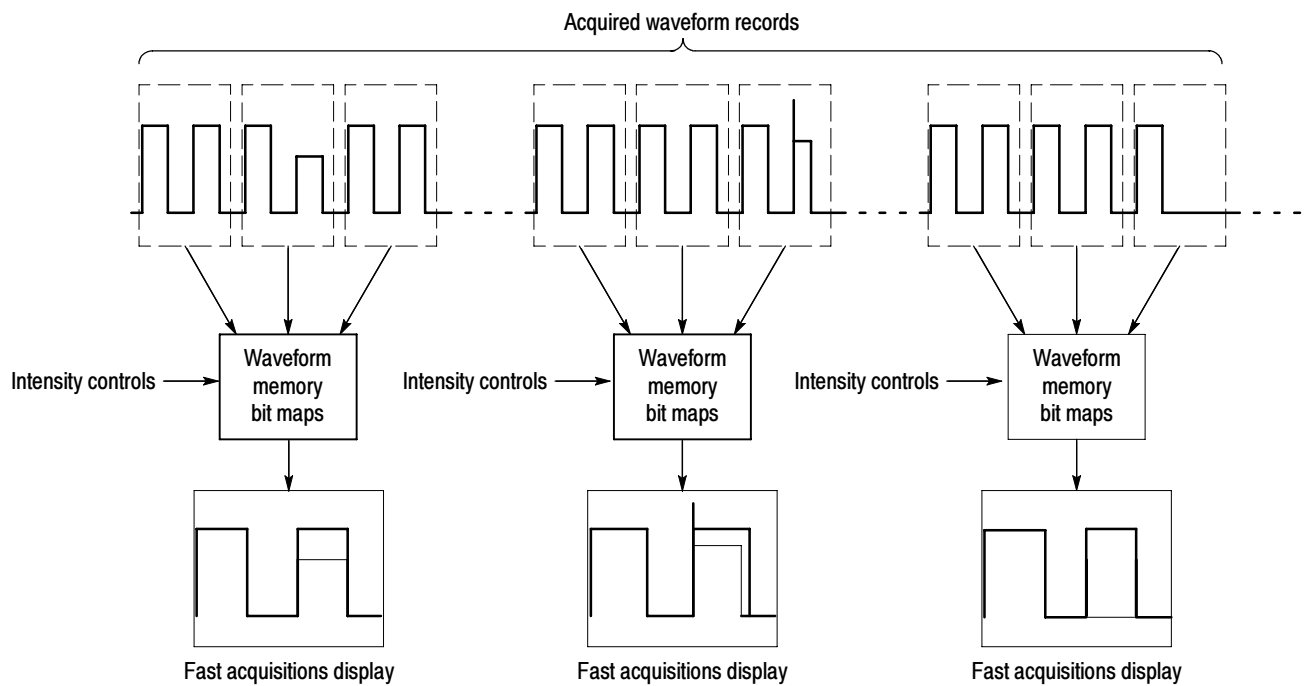
control the waveform intensity using adjustable or automatic brightness (see *To adjust the intensity* on page 3-46 for more information).

Fast Acquisitions mode adds intensity or gray scale information, like an analog instrument, to each point in the waveform array. The waveform array is a three dimensional array, two dimensions of display pixels and a third dimension of pixel values. Display pixel values are incremented each time they are written by a waveform acquisition.

**Normal DSO mode**



**Fast Acquisition mode**



**Figure 3-13: Normal DSO Acquisition and Display mode versus Fast Acquisition mode**

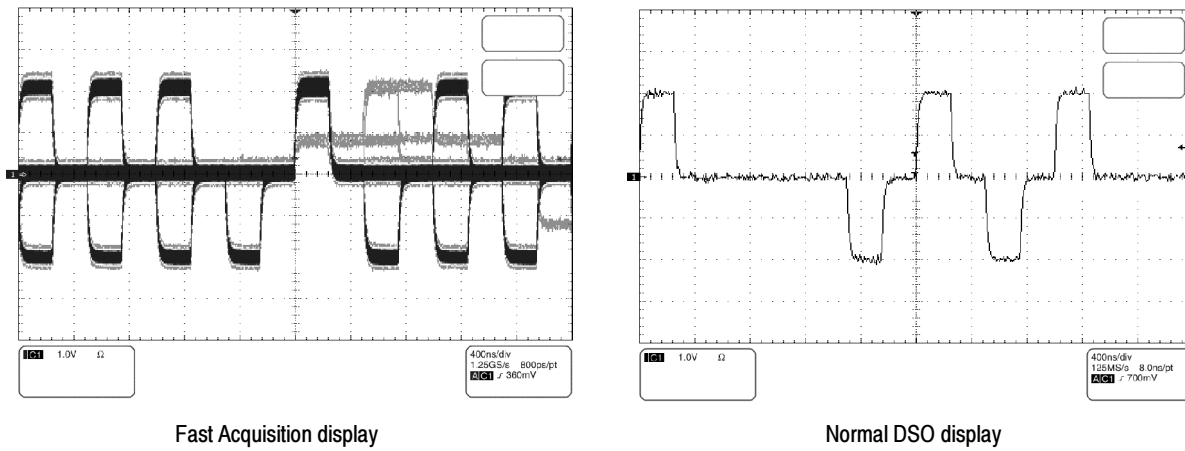
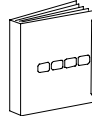


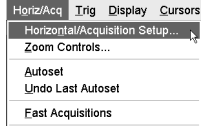

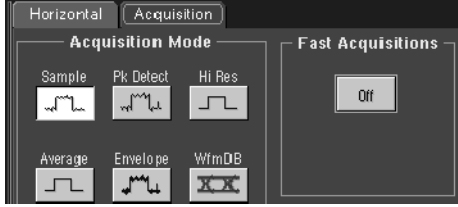

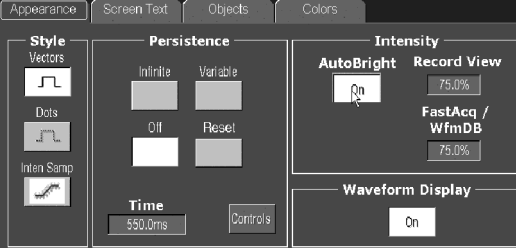


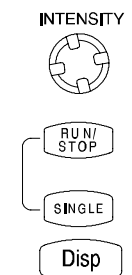
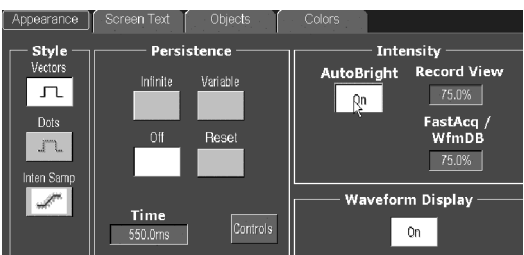

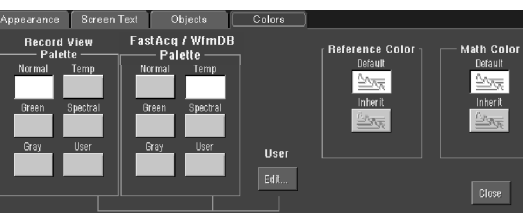
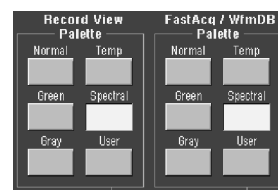
Figure 3- 14: Normal DSO and Fast Acquisition displays

**To Turn Fast Acquisitions On and Off** Use the procedure that follows to set up Fast Acquisitions mode.

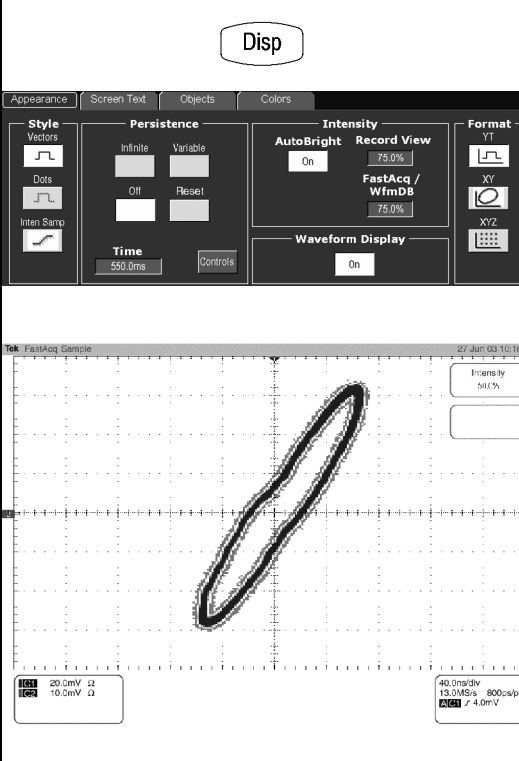
Overview	To turn Fast Acquisitions on and off	Control elements and resources
<p><b>Prerequisites</b></p>	<ol style="list-style-type: none"> <li>The horizontal and vertical controls must be set up. Triggering should also be set up.</li> </ol>	<div style="text-align: center;">  <p>See page page 3-29 for acquisition setup.</p> </div>




Overview	To turn Fast Acquisitions on and off (Cont.)	Control elements and resources
<p><b>To enable fast acquisitions mode</b></p>	<p>2. Enable fast acquisitions in one of three ways:</p> <ul style="list-style-type: none"> <li>■ Push the front-panel FastAcq button.</li> <li>■ Touch the Horiz button. Select the Acquisition tab from the Horiz/Acq control window</li> </ul> <p>or</p> <ul style="list-style-type: none"> <li>■ Select Horizontal/Acquisition Setup from the Horiz/Acq menu to display the Acquisition Mode control window. Select the Acquisition tab.</li> </ul> <p>3. Touch Fast Acquisitions to toggle Fast Acquisitions to On.</p> <p>Fast Acquisitions mode will stay on until you turn it off or until you select an incompatible mode that temporarily inhibits fast acquisitions.</p>	    
<p><b>To set the style</b></p>	<p>4. Touch the DISP button and select the Appearance tab.</p> <p>5. Select between Vectors, Dots, or Inten Samp display styles. (Dots is the default setting when in Equivalent Time (ET) acquisition mode. Vectors is the default when not in ET acquisition mode.)</p> <p>6. Select between Off, Variable, and Infinite Display Persistence. (Off is the factory default setting.)</p> <p>Variable persistence is explained on page 3-134. No Persistence erases the display each time a new waveform array is displayed.</p> <p>If your instrument supports mask testing, Mask Autofit can affect persistence. When enabled Autofit moves the waveform vertically and horizontally to reduce the number of hits within a given mask. If infinite or variable persistence is enabled, the movements will clear any persisted data. If Autofit makes frequent adjustments, there can be very little or even no persisted data displayed.</p> <p>7. If you select Variable, touch Persist Time and adjust the persistence time (decay rate).</p>	 

Overview	To turn Fast Acquisitions on and off (Cont.)	Control elements and resources
<p><b>To adjust the intensity</b></p>	<p>8. Rotate the INTENSITY knob to adjust the intensity of displayed waveforms, or touch Intensity and enter the intensity value with the keypad or the multipurpose knob.</p> <p>Or</p> <p>9. Touch the DISP button and select the Appearance tab.</p> <p>10. Touch Waveform AutoBright to toggle between On and Off.</p> <ul style="list-style-type: none"> <li>■ On automatically sets the intensity maximum to the value of the most frequent event.</li> <li>■ Off lets the displayed brightness depend on the trigger rate, creating a display like an analog instrument.</li> </ul> <p>11. To change the intensity setting for fast acquisition and waveform database waveforms, touch FastAcq/WfmDB and enter the intensity value with the keypad or the multipurpose knob.</p>	 
<p><b>To select the color palette</b></p>	<p>12. Touch the DISP button and select the Colors tab.</p> <p>Normal, Green, and Gray give the appearance of an intensity-graded display similar to an analog instrument.</p> <p>Spectral and Temp use hue to indicate the frequency of occurrence and to highlight events.</p> <p>User and User Palette let you create a custom color palette.</p> <p>13. Choose the Spectral color palette.</p> <p>In Fast Acquisition mode, Temp and Spectral show more detail than the other color palettes.</p> <p>For a definition of each color palette, see <i>Color Palette</i> on page 3-132.</p>	  

**To Set Display Format** The instrument displays waveforms in one of three formats: YT, XY, or XYZ. Use the procedure that follows to set the display format.

Overview	To set display format	Control elements and resources
<p><b>To select the format</b></p>	<ol style="list-style-type: none"> <li>To set the display axis format, touch the DISP button and select the Appearance tab.</li> <li>Select between YT, XY, and XYZ display formats: <ul style="list-style-type: none"> <li><b>YT.</b> This format is the conventional instrument display format. It shows a signal voltage (the vertical axis) as it varies over time (the horizontal axis).</li> <li><b>XY.</b> This format compares the voltage levels of two waveform records point by point (see Figure 3-15). That is, the instrument displays a graph of the data of one channel versus another. In fast acquisition mode XY, the data is a continuous stream which is not triggered, and there are no waveform records. In record view XY, the data is triggerable and the individual X and Y waveform records are available. This mode is particularly useful for studying phase relationships. When you set the VERTICAL POSITION and Vertical Offset to center the display in YT mode, the XY display is at center screen, and each division of display in YT mode produces a division of display in XY mode.</li> </ul> <p>When you choose the XY format, channels are assigned to the axis indicated in Table 3-4 and displayed as part of an XY pair. If only one source in an XY pair is displayed, the instrument automatically turns on the other source to complete the XY pair. Moreover, once XY is on, selecting either source in a pair turns the pair on; turning either waveform of a pair off removes both sources from the display.</p> <p>XY format is a dot-only display, although it can have persistence. The Vector style selection has no effect when you select XY format.</p> <p>If in fast acquisition XY or XYZ, histograms are allowed. In record view XY, histograms, measurements, math, cursors, zoom, and waveform database are not allowed. The HORIZONTAL controls still control the timebase, sample rate, and so forth, but the changes are not reflected in the horizontal axis as in YT display format.</p> </li> </ol>	 <p><b>Figure 3-15: Fast Acquisition XY display</b></p>

Overview	To set display format (Cont.)	Control elements and resources
<b>To select the format (Cont.)</b>	XYZ. This format compares the voltage levels of the CH 1 (X) and CH 2 (Y) waveform records point by point as in XY format. XYZ requires Fast Acquisitions mode. The displayed waveform intensity is modulated by the CH 3 (Z) waveform record. XYZ format is not triggered. A -5 division signal (including position and offset) on CH 3 produces a blank screen; a +5 division signal produces full intensity.	
<b>For help</b>	3. For more information on the controls described in this procedure, touch the Disp or Horiz button. Touch the HELP button in the toolbar.	

**Table 3-4: XY and XYZ format assignments**

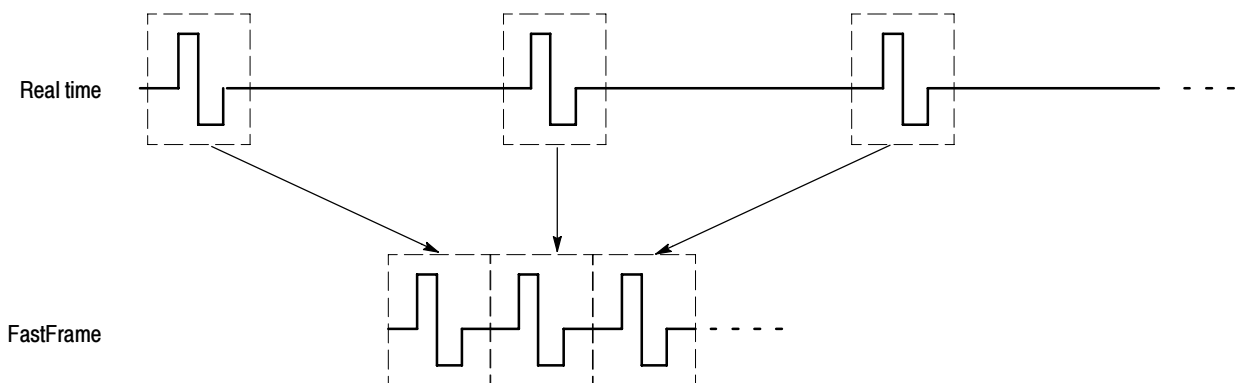
Instruments	Assignments	X-Axis source	Y-Axis source	Intensity source
CSA7000B Series and TDS7000B Series	XY	Ch 1 Ch 3 Ref1 Ref3	Ch 2 Ch 4 Ref2 Ref4	
In fast acquisition	XY	Ch 1	Ch 2	
	XYZ	Ch 1	Ch 2	Ch 3

## Using FastFrame

FastFrame is an acquisition mode that lets you capture many records in a larger record, and then view and measure each record individually.

FastFrame lets you quickly capture multiple acquisitions in the acquisition memory of a single channel. Figure 3-16 shows how FastFrame combines the desired captured frames into one larger waveform. For example, FastFrame would let you store 4000 frames (depending on the record length option installed) of 500 samples each into one waveform.

FastFrame mode lets you jump to and view the frame that you select. Time Stamps can display the absolute trigger time for a specific frame and the relative time between triggers of two specified frames. FastFrame lets you compare different waveforms. Math is available on each frame.



**Figure 3-16: FastFrame**

FastFrame is not compatible with these features or modes:

- Equivalent Time
- Histograms
- Fast Acquisitions
- Average
- Envelope
- Waveform Database

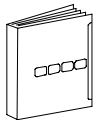
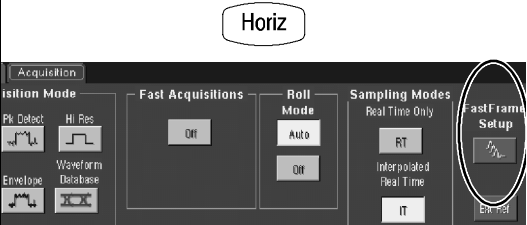
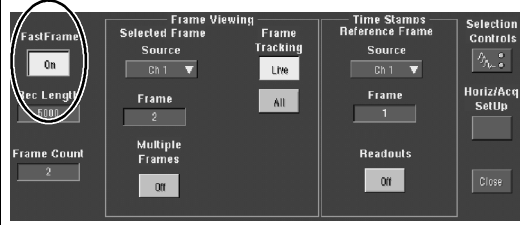
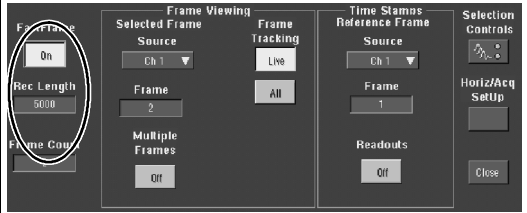
### Using FastFrame Acquisitions

Consider the following operating characteristics when using FastFrame:

- You can push **RUN/STOP** to terminate a FastFrame sequence. If any frames were acquired, they are displayed. If no frames were acquired, the previous FastFrame waveform is displayed.
- Because FastFrame introduces additional processing time into the operation cycle of acquire, process, and display, it is best to use Single Sequence Acquisition (see Acquire menu, Stop After menu). With Single Sequence selected, you will see the current acquisition sequence; otherwise, the display lags the current sequence by one sequence. You can also see the current sequence by pushing the RUN/STOP button to stop the acquisition.

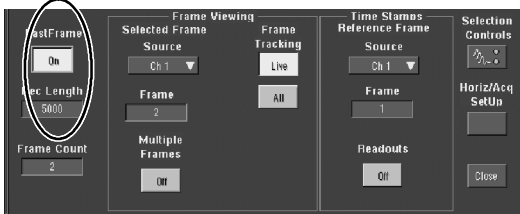
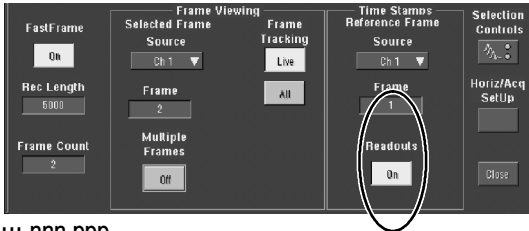
- FastFrame reduces the time required before the trigger is rearmed, while preserving the individual subrecords, a detail lost in Fast Acquisitions, which writes all acquired records to a single pixel map.

**To Set FastFrame Mode** Use the procedure that follows to set up FastFrame mode acquisitions.


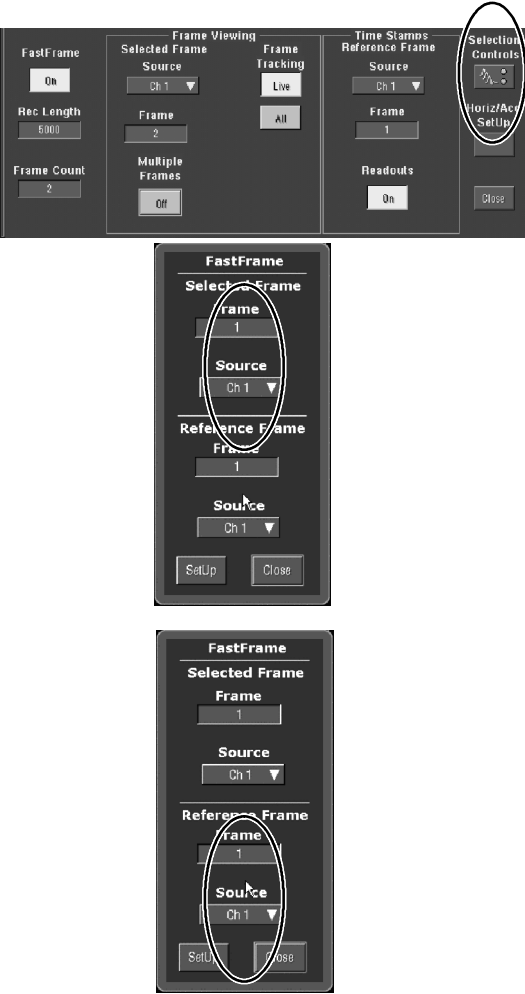
Overview	To set FastFrame mode	Control elements and resources
<p><b>Prerequisites</b></p>	<p>1. The horizontal and vertical controls must be set up. Triggering should also be set up.</p>	 <p>See page 3-29 for acquisition setup and page 3-63 for trigger setup.</p>
<p><b>To set FastFrame mode</b></p>	<p>2. Touch the Horiz button. Select the Acquisition tab from the Horiz/Acq control window. Touch FastFrame Setup to display the FastFrame Setup control window.</p> <p>3. Touch FastFrame to toggle FastFrame to On.</p>	 
<p><b>Set frame length</b></p>	<p>4. Touch Rec Length, and set the number of samples per frame.</p> <p>Record length is the number of samples in each acquisition.</p>	

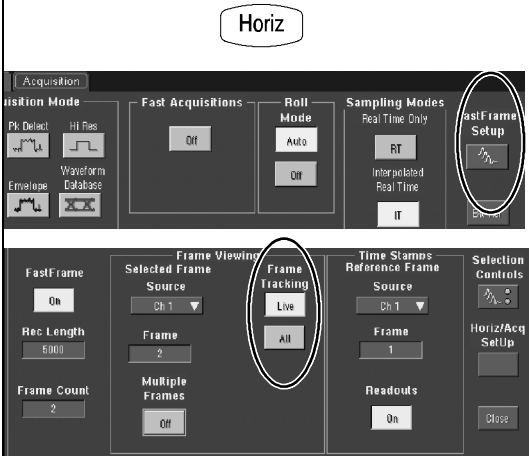
Overview	To set FastFrame mode (Cont.)	Control elements and resources
<p><b>Set frame count</b></p>	<p>5. Touch Frame Count, and enter the number of frames to acquire per waveform record.</p> <p>Frame count is the number of acquisitions to store in the acquisition memory of the channel. If the product of the record length and the frame count exceeds the available memory, the instrument will reduce the record length or frame count in size such that the product will fit the amount of memory available.</p>	
<p><b>Select the frame to view</b></p>	<p>6. In the Frame Viewing controls, touch Source and select the source of the frame you want to view.</p> <p>7. In the Frame Viewing control, touch Frame and use the multipurpose knob or keypad to enter the number of the specific frame you want to view. The frame that you select appears on the display.</p>	
<p><b>To view multiple frames</b></p>	<p>8. In the Frame Viewing controls, touch Multiple Frames to toggle it to On.</p> <p>9. In the Frame Viewing control, touch Start Frame and use the multipurpose knob or keypad to enter the number of the starting frame you want to view. Touch # of Frames and use the multipurpose knob or keypad to enter the number of frames you want to view. The number of frames that you select to view will appear overlaid on the display.</p> <p>10. The frames within the selected range are displayed superimposed over each other in the color of the Source channel. The Selected Frame is also superimposed on the display of frames, but in a dark blue color. The blue line is drawn in normal or monochrome color selections, no persistence, and when no Refs are displayed. You may find it difficult to distinguish the dark blue Selected Frame if the selected color palette is Spectral or Temp.</p>	

**Time Stamping Frames** Use Time Stamps to display the absolute trigger time for a specific frame and the relative time between triggers of two specified frames. To start FastFrame Time Stamps, do the following steps:

Overview	Time stamping frames	Control elements and resources
<p><b>Prerequisites</b></p>	<ol style="list-style-type: none"> <li>1. FastFrame mode should be set up as described in the previous example.</li> <li>2. Turn on FastFrame as described on page 3-50.</li> </ol>	
<p><b>Turn readouts on or off</b></p>	<ol style="list-style-type: none"> <li>3. In the Time Stamps controls, touch Readouts to toggle time stamp readouts on or off: <ul style="list-style-type: none"> <li>■ On displays time stamp readouts (see Figure 3-17 on page 3-54). Time stamps are always acquired.</li> <li>■ Off turns off the display of time stamp readouts</li> </ul> <p>The displayed time uses the following format:  Sel Ch# F xxx    DD MMM YYYY HH:MM:SS.mmm μμμ nnn ppp  Ref Ch# F xxx    DD MMM YYYY HH:MM:SS.mmm μμμ nnn ppp  Δ                    DD MMM YYYY HH:MM:SS.mmm μμμ nnn ppp</p> <p>Where:  Sel and Ref Ch# F xxx are the selected or reference frame number  DD MMM YYYY        is the date (day, month, and year)  HH:MM:SS.mmm,     is the clock time (hours, minutes, seconds, and milliseconds)  μμμ,nnn,ppp        is a fraction of a second (to picoseconds)</p> </li> </ol>	



Overview	Time stamping frames (Cont.)	Control elements and resources
<p><b>Select the reference frame</b></p>	<ol style="list-style-type: none"> <li>In the Time Stamps controls, touch Source and select the source of the reference frame.</li> <li>In the Time Stamps controls, touch Frame and use the multipurpose knob or keypad to enter the number of the reference frame. This value sets the starting frame when measuring the relative time between two frames.</li> </ol>	
<p><b>Select the FastFrame and time stamps selection controls</b></p>	<p>You may set the Selected Frame and Reference Frame as previously shown or you can set them from the Selection Controls window.</p> <ol style="list-style-type: none"> <li>Touch Selection Controls from the Time Stamps control window to display the FastFrame controls.</li> <li>In the FastFrame controls window, touch Selected Frame Source and select the source of the frame you want to view.</li> <li>Touch Selected Frame Frame and use the multipurpose knob or keypad to enter the number of the specific frame you want to view and take time stamps on. The frame you select appears on the display.</li> </ol> <p><b>Note.</b> The <math>\Delta</math> is the selected time stamp minus the reference time stamp.</p> <ol style="list-style-type: none"> <li>Touch the Reference Frame Source and select the source of the reference frame. Touch Frame and use the multipurpose knob or keypad to enter the number of the reference frame.</li> </ol>	

Overview	Time stamping frames (Cont.)	Control elements and resources
<p><b>To lock the reference position frames</b></p>	<p>10. Touch the Horiz button. Select the Acquisition tab from the Horiz/Acq control window. Touch FastFrame Setup to display the FastFrame Setup control window.</p> <p><i>Note. You can also get the FastFrame Setup control window by touching the Set Up button on the Selection Controls window.</i></p> <p>11. Touch either Frame Tracking Live or All to lock the reference and position frames together. When the frames are locked, they maintain the same relative distance from each other when either frame is adjusted:</p> <ul style="list-style-type: none"> <li>■ Live locks together the channel and math waveforms. All reference waveforms are locked together, but they are separate from the channel and math waveforms.</li> <li>■ All locks together all channel, math, and reference waveforms; adjusting one waveform adjusts all waveforms.</li> </ul>	

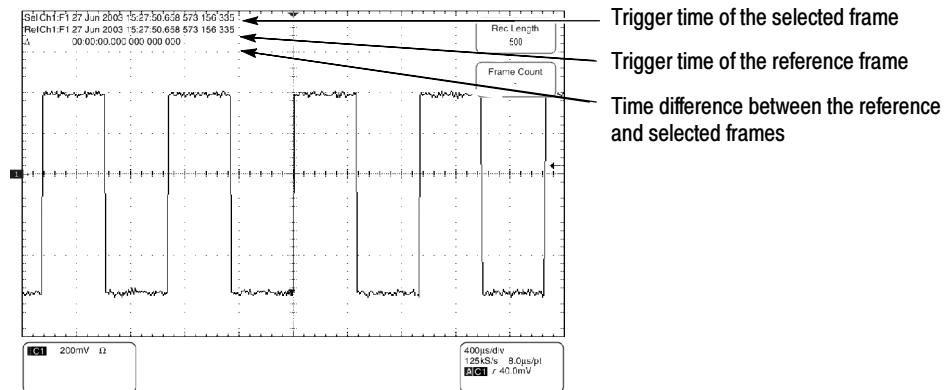


Figure 3-17: FastFrame time stamp

## O/E Converter

CSA7000B Series: The O/E converter converts the optical signal to an electrical signal for use in the instrument. Figure 3-18 on page 3-56 shows the input and output connectors.

This section describes the front panel, connecting to the circuit under test, how to select the optical wavelength, and explains optical bandwidth.



---

**CAUTION.** To avoid damaging your instrument, replace the protective cap on the input connector when the Optical Input is not in use.

To prevent loss of optical power or damage to the optical connectors, keep the connectors clean at all times. Also ensure that all connectors and jumpers attached to the inputs are clean prior to insertion. See *Cleaning Optical Connectors* on page 3-57.

---

### Connecting Optical Signals

Take care to preserve the integrity of optical connectors by keeping them free of contamination. For cleaning information, see *Cleaning Optical Connectors* on page 3-57.

The instrument can couple to multimode fibers with a core diameter of 62.5/50  $\mu\text{m}$  or singlemode fiber with a core diameter of 9  $\mu\text{m}$ . Alternate types can be coupled by use of UCI (universal connector interface) series adapters. (Refer to a current Tektronix catalog for details.)

Attach the fiber optic cable with a suitable connector or a UCI Interface adapter to the optical input receptacle as follows:

1. Firmly press the cable connector or adapter over the interface ferrule until it reaches the stop.
2. Rotate the cable connector or the adapter body until the antirotation pin engages.
3. Firmly tighten the cable connector or the adapter shell. Tighten with finger pressure only.
4. To remove, unscrew the cable connector or adapter shell.

### Attenuating Optical Signals

To keep the optical input power to an appropriate level, it may be necessary to attenuate the optical signal.



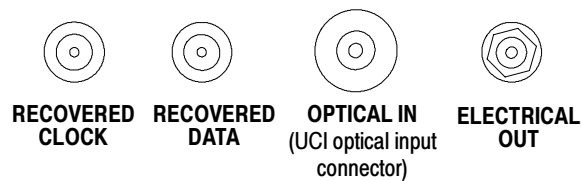

---

**CAUTION.** To avoid damaging the optical input, to maintain the levels within performance range, and to avoid clipping; attenuate optical signals to less than that listed in Absolute maximum nondestructive optical input on page A-23 and Maximum nonsaturating linear response to transient input on page A-23.

---

## Front Panel Connectors

CSA7000B Series: The O/E converter connectors are shown in Figure 3-18.



**Figure 3-18: Optical-to-Electrical converter and recovered clock and data connectors**

### Optical Input Connector

The optical input connector uses a universal connector interface (UCI) that allows use of many standard fiber-optic female connector styles. Some of the standard UCI interfaces supported are FC, ST, SC, and DIN. (Refer to a current Tektronix catalog for details.)

### Output Connectors

Clock and data-recovery circuitry provides recovered clock and data outputs. The signals are also available internally for use by the instrument. Circuitry also provides electrical output from the O/E (optical-to-electrical) converter.

**RECOVERED DATA.** This output provides a 50  $\Omega$ , AC-coupled,  $\sim$ ECL/2 level signal from the optical data signal. This signal is digitally buffered and retimed to be synchronous with the serial recovered clock.

**RECOVERED CLOCK.** This output is synchronous with the incoming data signal. A sample of the input data is routed to the serial clock recovery circuit. Recovered clock is available when using either optical or electrical signals.

---

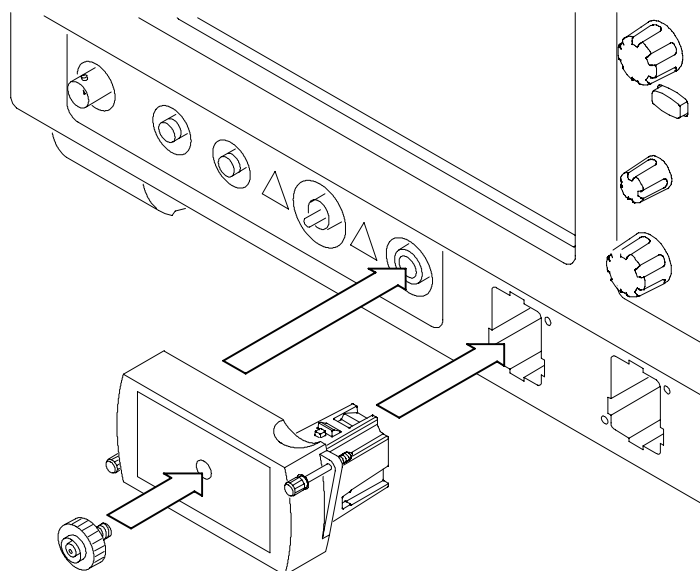
**NOTE.** If no signal (or an inappropriate signal) is applied to the front panel, the recovered clock and data will oscillate.

---

**ELECTRICAL OUT.** This output is the electrical output from the O/E converter. Use the supplied adapters to connect to the Ch1 input or other equipment.

### O/E Electrical Out-to-Ch1 Input Adapter

Use the O/E Electrical Out-to-Ch1 Input adapter to connect the Electrical Out of the optical-to-electrical converter to the CH1 input of the instrument. This connection allows you to use the instrument as a calibrated reference receiver. Adapters are interchangeable between CSA7000B Series instruments while still allowing calibrated reference receiver mode.



**Figure 3-19: Using the O/E Electrical Out-to-Ch1 Input adapter**

### O/E-to-SMA Adapter

Use the O/E-to-SMA adapter if you need to connect the Electrical Out of the optical-to-electrical converter to input channels other than CH1, or if you need to connect the output to other equipment. Store the O/E-to-SMA adapter on the front of the O/E Electrical Out-to-Ch1 Input adapter.

### Cleaning Optical Connectors

Small dust particles and oils can easily contaminate optical connectors and reduce or block the signal. Take care to preserve the integrity of the connectors by keeping them free of contamination.



---

**CAUTION.** *To prevent loss of optical power or damage to the optical connectors, keep the connectors clean at all times.*

*When cleaning the connectors with a swab, use gentle circular motions. Use only high quality cleaning supplies that are non-abrasive and leave no residue.*

*To reduce the need for cleaning, immediately replace protective caps on the optical connectors when not in use.*

---

Use the following items to clean optical connectors:

- Clean, dust-free compressed air
- Fiber-optic cleaning swabs
- Pure, electronics-grade isopropyl alcohol

---

**NOTE.** *If isopropyl alcohol is used, care must be taken to have a truly clean, pure, electronics-grade isopropyl alcohol source. Bottles of isopropyl alcohol can become contaminated after several uses; the alcohol can then leave a residue on optical connectors after drying.*

*Cleaning kits for optical connectors (such as the Tektronix Optical Connector Cleaner kit number 020-2357-00) are available from a number of suppliers.*

---

To clean optical connectors, follow these steps:

1. Remove the UCI adapter.
2. Hold the can of compressed air upright, and spray the can into the air to purge any propellant.
3. Spray the clean compressed air on the connectors to remove any loose particles or moisture.
4. Moisten a clean optical swab with isopropyl alcohol, and then lightly swab the surfaces of the connectors.
5. Spray the clean compressed air on the connectors again to remove any loose particles or isopropyl alcohol.
6. Blow clean compressed air through the UCI adapter before replacing it.

### **Optical Dark Compensation**

The Vertical Setup menu lets you access the optical wavelength and the Dark Level compensation procedure. This menu is shown in Figure 3-20 on page 3-59. Wavelength and Dark Level menus are not available unless the O/E Electrical Out-to-CH1 Input adapter is installed.

Select the Optical Wavelength appropriate for the signals with which you are working. Optical conversion gain is set appropriately for the wavelength you select.

Before performing dark level calibration, remove your optical signal from the input and cover the optical input. Select Dark Level Calibration to start the dark level compensation. Follow the displayed instructions to complete the compensation. For more information, consult the instrument online help.

### Compensation

Execute a signal path compensation of the instrument as soon as the instrument has reached operation equilibrium (that is, after a 20 minute warm-up). Initiate compensation from the Utilities menu Instrument Calibration command. For more information, see *Optimizing Measurement Accuracy* on page 3-160. Compensation of the instrument also performs an optical dark level compensation.

## Wavelength, Filter, and Bandwidth Selection

CSA7000B Series: To select the optical wavelength, use the Vertical Setup menu. This menu is shown in Figure 3-20 on page 3-59. Wavelength and Dark Level menus are not available unless the O/E Electrical Out-to-CH1 Input adapter is installed.



**Figure 3-20: Vertical setup menu with optical controls**

First select Ch1 in the Waveform section of the menu. Then touch the Wavelength button that matches your system.

You select the mask, bandwidth, and Bessel-Thompson filter appropriate for your optical standard using the Masks menus. If the Bessel-Thompson filter is on, the instrument is a reference receiver. For detailed information on using masks, see the *CSA7000B & TDS7000B Series Option SM Serial Mask Testing and Option ST Serial Triggering User Manual*.

## Optical Bandwidth

CSA7000B Series: Traditionally bandwidth is defined as the frequency at which the power out is one half the power out at a frequency near DC. In the voltage domain the power dissipated into a resistive load (such as a 50  $\Omega$  termination of an input) is the  $V_{RMS}^2/R$  where  $V_{RMS}$  is the RMS of the voltage swing seen at the resistive load, and R is the resistance value. A logarithmic scale using decibels is typically used to describe the frequency dependent response. A value expressed in terms of a decibel relative to a reference is defined as:

$$dB = 10 \log\left(\frac{value}{reference}\right)$$

For electrical bandwidths the reference of a system is commonly the response of the system to a sinusoidal frequency at or near DC. The point at which the system response is one half would therefore be:

$$dB = 10 \log\left(\frac{0.5}{response\ at\ DC}\right) = -3dB$$

In terms of frequency, voltage, and resistance the bandwidth is expressed as:

$$-3dB = 10 \log\left(\frac{V(f)^2}{R} \div \frac{V(DC)^2}{R}\right)$$

where  $V(f)$  is the RMS of the voltage swing response at the bandwidth frequency and  $V(DC)$  is the RMS voltage swing response at a frequency approaching DC. Further math yields  $V(f) = 0.707 \times V(DC)$ .

The expression is simplified by cancelling the R and moving the squared term inside the log expression to a multiple outside the log expression:

$$10 \log\left(\frac{V(f)^2}{R} \div \frac{V(DC)^2}{R}\right) = 2 \times 10 \log\left(\frac{V(f)}{V(DC)}\right) = 20 \log\left(\frac{V(f)}{V(DC)}\right)$$



In CSA7000B Series instruments, the vertical units displayed for an optical module are not in voltage, but watts; this is a unit of power. The optical-to-electrical converter inside the instrument outputs a voltage whose amplitude is linearly dependent on the incoming optical power; in this condition the voltage applied at the electrical input already represents optical power in its linear form (as opposed to having to square the voltage and divide by R). For the optical input then, the bandwidth where the displayed optical power is one half that approaching DC is:

$$dB = 10 \log \left( \frac{0.5}{\text{response at DC}} \right) = -3dB$$

The  $V(f)$  is the frequency at which the vertical swing is one half (0.5) the  $V(DC)$  not 0.707. The optical bandwidth therefore corresponds to the traditional electrical bandwidth of -6 dB. During testing of optical systems by impulse testing, the resulting impulse waveform is converted to frequency by Fourier transform and the bandwidth is defined as  $-3 \text{ dB} = 10 \log (\text{vertical swing at frequency} / \text{vertical swing at DC})$ . During reference receiver curve calculation, however, the definition is changed to match the industry standard definition which assumes electrical bandwidths are  $-3 \text{ dB} = 20 \times \log (\text{vertical swing at frequency} / \text{vertical swing at DC})$ .

#### **Bandwidth for Unfiltered Settings**

The curve calculation of frequency response for the unfiltered settings uses the definition for dB and bandwidth where  $-3 \text{ dB} = 10 \log (\text{vertical swing at frequency} / \text{vertical swing at DC})$ ; that is, the optical bandwidth.

#### **Bandwidth for Reference Receiver settings**

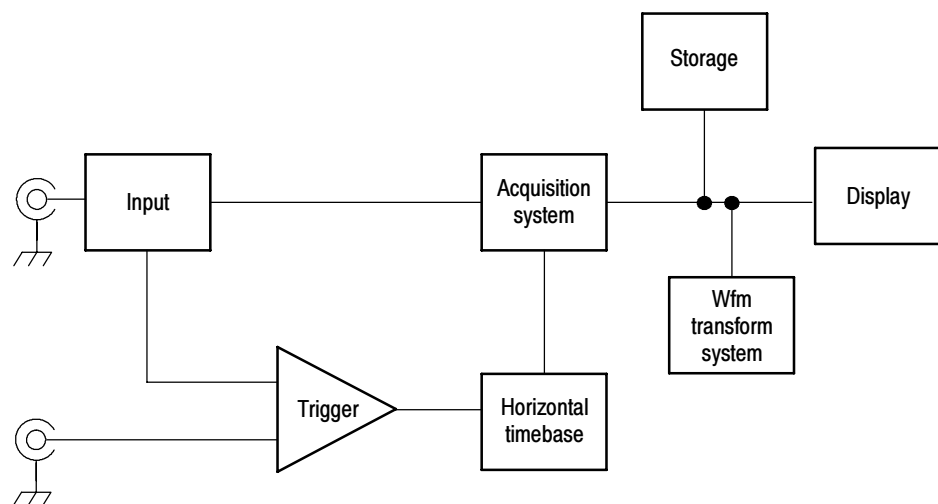
The curve calculation of frequency response for reference receiver settings uses the definition of dB and bandwidth that matches the industry standard which assumes electrical bandwidths where  $-3 \text{ dB} = 20 \log (\text{vertical swing at frequency} / \text{vertical swing at DC})$ .



# Triggering

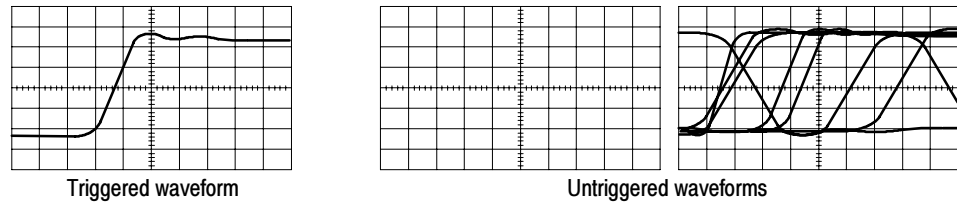
To properly acquire data, that is, to use the instrument to sample a signal and digitize it into a waveform record that you want to measure or otherwise process, you need to set up the trigger conditions. This section provides background on, and the procedures for using, the basic elements of triggering: source, holdoff, mode, and so on. This section covers the following topics:

- *Triggering Concepts* which describes some basic principles of triggering and the following trigger elements: *type, source, coupling, holdoff, mode,* and so on
- *Triggering from the Front Panel* which describes how to use the front-panel triggering controls each of which is common to most of the trigger types the instrument provides
- *Additional Trigger Parameters* which describes how to access common trigger functions in the Trigger control window
- *Advanced Triggering* which describes trigger types that you can use to isolate specific signal phenomena
- *Sequential Triggering* which describes how to combine the A (Main) and B (Delayed) trigger systems to capture unique events
- *Comm Triggering* (optional on TDS7000B Series) which describes triggering on communications signals
- *Serial Pattern Triggering* (optional on TDS7000B Series) which describes triggering on serial data patterns



## Triggering Concepts

Triggers determine when the instrument stops acquiring and displays a waveform. They help create meaningful waveforms from unstable jumbles or blank screens. (See Figure 3-21.) The instrument has simple edge triggers as well as a variety of advanced triggers you can use.



**Figure 3-21: Triggered versus untriggered displays**

### The Trigger Event

The trigger event establishes the time-zero point in the waveform record. All points in the record are located in time with respect to that point. The instrument continuously acquires and retains enough sample points to fill the pretrigger portion of the waveform record (that part of the waveform that is displayed before, or to the left of, the triggering event on screen). When a trigger event occurs, the instrument starts acquiring samples to build the posttrigger portion of the waveform record (displayed after, or to the right of, the trigger event). Once a trigger is recognized, the instrument will not accept another trigger until the acquisition is complete and the holdoff time has expired.

### Trigger Sources

The trigger source provides the signal that triggers acquisition. Use a trigger source that is synchronized with the signal you are acquiring and displaying. You can derive your trigger from the following sources:

- Input channels are the most commonly used trigger sources. You can select any one of the four input channels. The channel that you select as a trigger source will function whether it is displayed or not.
- AC Line Voltage is a convenient trigger source when you are looking at signals related to the power line frequency. Examples include devices such as lighting equipment and power supplies. Because the instrument generates the trigger from the power line, you do not have to use a channel input.
- Auxiliary Trigger (AUX IN) provides a fifth source that you can use as a trigger input when you need to use the four input channels for other signals. For example, you might want to trigger on a clock while displaying four other logic signals. To use the auxiliary trigger, connect the signal to the Auxiliary Trigger input connector. The Auxiliary Trigger input is not compatible with most probes, nor can you display the auxiliary trigger signal.

## Trigger Types

The instrument provides the following categories of trigger types:

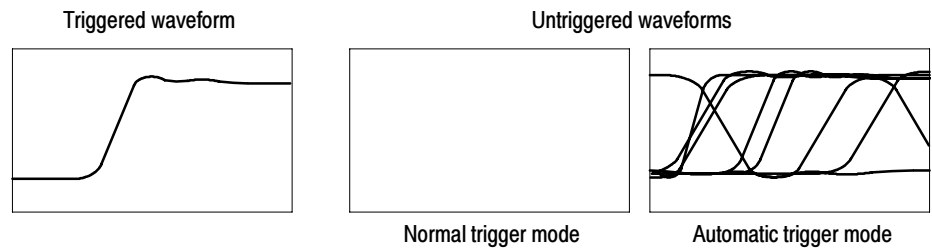
- Edge is the simplest and most commonly used trigger type. You can use it with analog or digital signals. An edge trigger event occurs when the trigger source (the signal the trigger circuit is monitoring) passes through a specified voltage level in the specified direction (the trigger slope).
- Advanced triggers are a collection of trigger types that are primarily used with digital signals to detect specific conditions. The glitch, runt, width, transition, and timeout types trigger on unique properties of pulses that you can specify. The pattern and state types trigger on logic combinations of several signals. The setup/hold type triggers on the relative timing between two signals.
- Comm (optional on TDS7000B Series) is a special trigger used on communication signals. You can use Comm triggers to test communications signals, and Mask testing automatically uses Comm triggers to set up signals for mask testing. You can trigger on the clock recovered from optical (CSA7000B Series only) or electrical communication signals.
- Serial (optional on TDS7000B Series) is a special trigger used on signals with serial data patterns. You can trigger on the clock recovered from optical (CSA7000B Series only) or electrical communication signals.

## Trigger Modes

The trigger mode determines how the instrument behaves in the absence of a trigger event:

- Normal trigger mode enables the instrument to acquire a waveform only when it is triggered. If no trigger occurs, the instrument will not acquire a waveform, rather the last waveform record acquired remains “frozen” on the display. If no last waveform exists, none is displayed. See the *Normal trigger mode* part of Figure 3-22. (You can push FORCE TRIGGER, in the Trigger control window, to force the instrument to make a single acquisition.)
- Auto trigger mode (automatic mode) enables the instrument to acquire a waveform even if a trigger does not occur. Auto mode uses a timer that starts after a trigger event occurs. If another trigger event is not detected before the timer times out, the instrument forces a trigger. The length of time it waits for a trigger event depends on the time base setting.

Be aware that auto mode, when forcing triggers in the absence of valid triggering events, does not synchronize the waveform on the display. See the *Automatic trigger mode* part of Figure 3-22. Successive acquisitions will not be triggered at the same point on the waveform; therefore, the waveform will appear to roll across the screen. Of course, if valid triggers occur the display will become stable on screen.



**Figure 3-22: Triggered versus untriggered displays**

### Trigger Holdoff

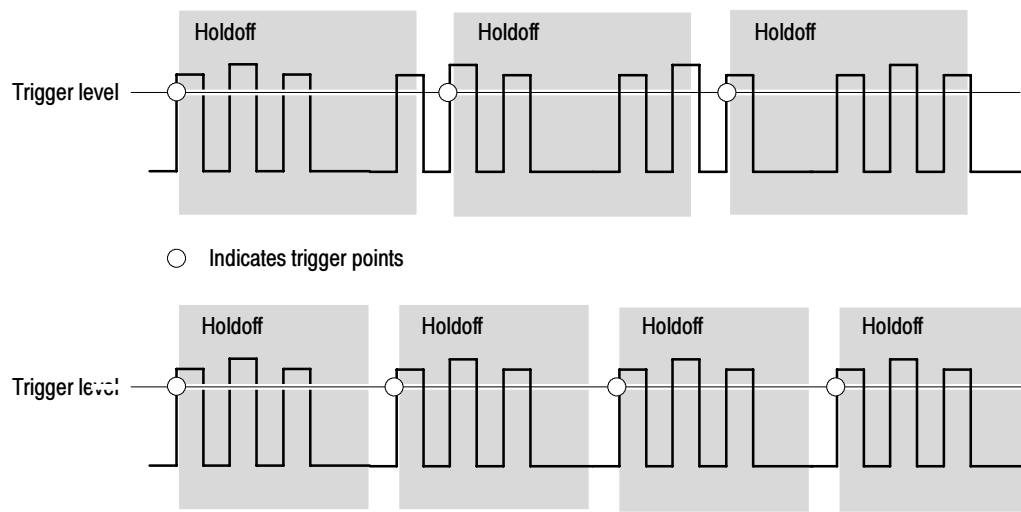
Trigger holdoff can help stabilize triggering. When the instrument recognizes a trigger event, it disables the trigger system until acquisition is complete. In addition, the trigger system remains disabled during the holdoff period that follows each acquisition. You adjust holdoff to obtain stable triggering when the instrument is triggering on undesired trigger events as shown in Figure 3-23.

A digital pulse train is a good example of a complex waveform. (See Figure 3-23.) Each pulse looks like any other, so many possible trigger points exist. Not all of these will result in the same display. The holdoff period allows the instrument to trigger on the correct edge, resulting in a stable display.

Holdoff is adjustable from 250 ns (minimum holdoff available) to 12 seconds (maximum holdoff available). To see how to set holdoff, see *To set holdoff* on page 3-74.

You can also set an auto holdoff. Auto holdoff varies with the horizontal scale and is equal to 5 divisions times the current time/division setting.

Random holdoff selects a new random holdoff time for each acquisition cycle. Rather than helping the instrument synchronize on a particular feature of a pulse train, random holdoff prevents synchronization, helping to reveal features of some pulse trains.



At the longer holdoff time for the top waveform, unstable triggering occurs. With a shorter holdoff set for the bottom waveform, triggers all occur on the first pulse in the burst to remedy the unstable trigger.

**Figure 3-23: Holdoff adjustment can prevent false triggers**

### Trigger Coupling

Trigger coupling determines what part of the signal is passed to the trigger circuit. Edge triggering can use all available coupling types: AC, DC, Low Frequency Rejection, High Frequency Rejection, and Noise Rejection. All the advanced trigger types use only DC coupling. See *To set the trigger coupling* on page 3-71 for a description of each coupling type.

### Horizontal Position

Horizontal position is adjustable and defines where on the waveform record the trigger occurs. It lets you choose how much the instrument acquires before and after the trigger event. The part of the record that occurs before the trigger is the pretrigger portion. The part that occurs after the trigger is the posttrigger portion.

When horizontal delay is off, the reference marker shows the trigger position in the waveform.

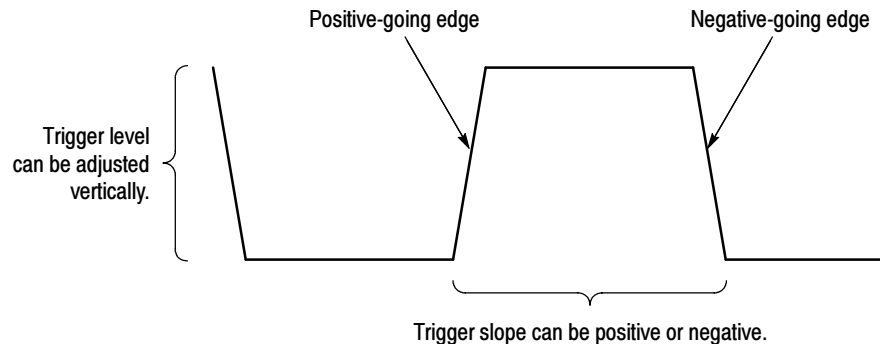
Displaying pretrigger information can be valuable when troubleshooting. For example, if you are trying to find the cause of an unwanted glitch in your test circuit, you can trigger on the glitch and make the pretrigger period large enough to capture data before the glitch. By analyzing what happened before the glitch, you may uncover clues about its source.

### Slope and Level

The slope control determines whether the instrument finds the trigger point on the rising or the falling edge of a signal. (See Figure 3-24.)

You set trigger slope by pushing the SLOPE button on the front panel to toggle between the positive-going and negative-going edge.

The level control determines where on that edge the trigger point occurs. (See Figure 3-24.) You can set the trigger level with the LEVEL knob on the front panel. Push the LEVEL knob to automatically set the trigger level to the 50% amplitude point of the signal.



**Figure 3-24: Slope and level controls help define the trigger**

### Delayed Trigger System

You can trigger with the A (Main) trigger system alone or you can combine the A (Main) trigger with the B (Delayed) trigger to trigger on sequential events. When using sequential triggering, the A trigger event arms the trigger system and then the B trigger event triggers the instrument when the B trigger conditions are met. A and B triggers can (and typically do) have separate sources. The B trigger condition can be based on a time delay or a specified number of counted events. See *Sequential Triggering* on page 3-103 to learn how to use the delayed trigger system.

## Triggering from the Front Panel

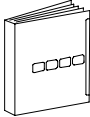
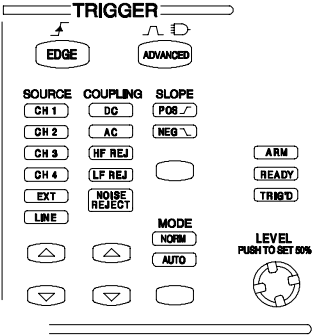
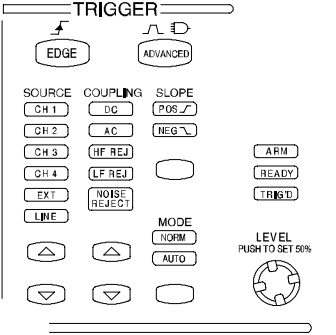
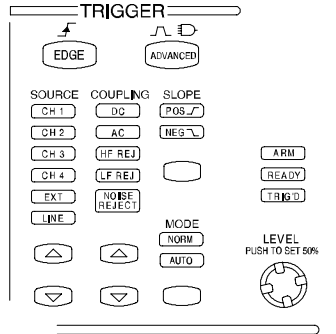
The front panel provides quick access to the most frequently used trigger controls. The trigger readout shows you the state of the trigger system.

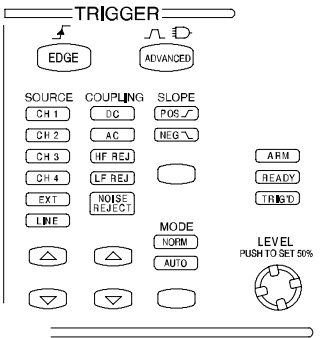
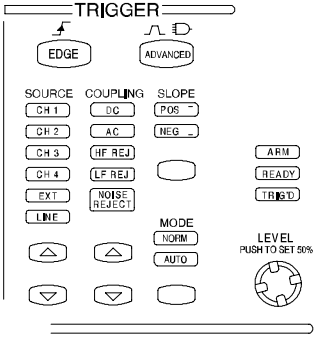
The slope, coupling, and source controls only work for edge triggering. To access the advanced trigger controls, display the Trigger Control window by pushing the ADVANCED button (See *Advanced Triggering* on page 3-77 for more information).

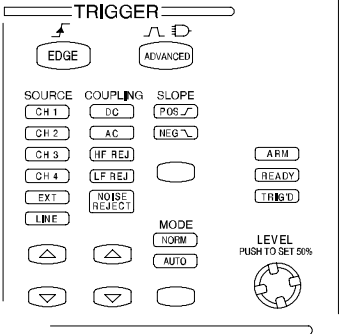
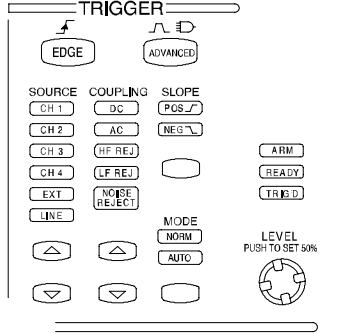
### Access Procedures

Use the procedure that follows when setting up the instrument to trigger using the front-panel controls.

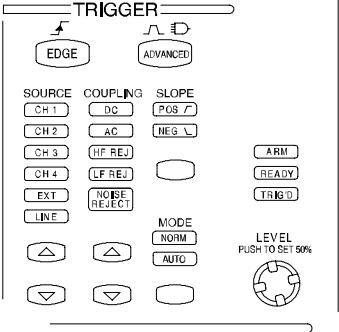
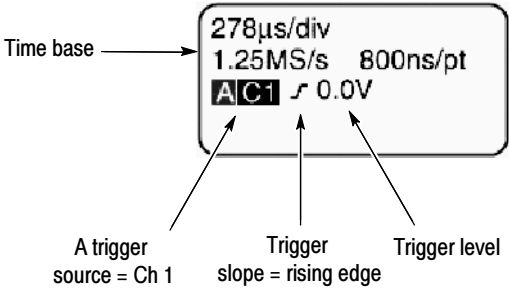


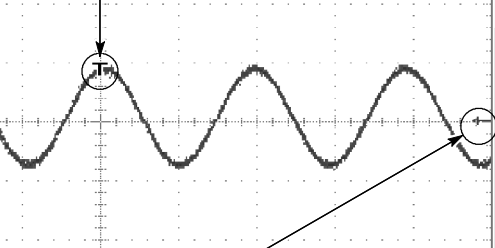
Overview	Triggering from the front panel	Control elements and resources
<p><b>Prerequisites</b></p>	<p>1. The instrument must be installed and operating. Acquisition system should be set to Run, and the vertical and horizontal controls should be set appropriately for the signal to be acquired.</p>	 <p>See page 3-23 for acquisition setup</p>
<p><b>To select the trigger type</b></p>	<p>2. Push the EDGE button to select edge type triggering. Push ADVANCED to bring up the Trigger control window where you can select and set up other trigger types.</p>	
<p><b>To select the trigger slope</b></p>	<p>3. Push the TRIGGER SLOPE button to toggle between POS and NEG:</p> <ul style="list-style-type: none"> <li>■ POS triggers on a rising edge (positive going) signal</li> <li>■ NEG triggers on a falling edge (negative going) signal</li> </ul> <p>You can also set the slope in the Trigger setup window.</p> <ul style="list-style-type: none"> <li>■ Either triggers on both the rising edge and falling edge of the signal (select Either in the setup window)</li> </ul>	
<p><b>To set level</b></p>	<p>4. To manually change the trigger level when edge triggering (or certain threshold levels when logic or pulse triggering), turn the trigger LEVEL knob.</p> <p>You can also set the level in the Trigger setup window.</p> <p>Using the Trigger Setup window you can make trigger level settings shared or independent of the Source selection:</p> <ul style="list-style-type: none"> <li>■ Shared makes level settings the same for all trigger sources</li> <li>■ Independent makes level settings apply only to the selected trigger source</li> </ul>	

Overview	Triggering from the front panel (Cont.)	Control elements and resources
<p><b>To set to 50%</b></p>	<p><b>5.</b> To quickly obtain an edge, glitch, timeout, serial, or width trigger, push the trigger LEVEL knob. The instrument sets the trigger level to the halfway point between the peaks of the trigger signal. This function has no effect for the other advanced trigger types.</p> <p>You can also set the level to 50% in the Trigger control window.</p> <p>When the phased locked loop is active (Comm and Serial Trigger only which are optional on the TDS7000B Series), pushing the trigger LEVEL knob recycles the clock-recovery trigger circuit. The instrument will attempt to acquire lock once. If the input data is disrupted, removed, or heavily distorted, the instrument may not acquire lock or may lose lock. If the recovered clock is not locked to the incoming data, the waveform display will not be stable. Once the input data is available, press the PUSH SET TO 50% knob to force the instrument to reacquire lock.</p> <p>When using Comm triggering, pushing the trigger PUSH SET TO 50% knob sets the levels for the selected code.</p>	 <p>The diagram shows the TRIGGER control panel with the following elements:</p> <ul style="list-style-type: none"> <li><b>TRIGGER</b> header with <b>EDGE</b> and <b>ADVANCED</b> sub-headers.</li> <li><b>SOURCE</b> section: CH 1, CH 2, CH 3, CH 4, EXT, LINE.</li> <li><b>COUPLING</b> section: DC, AC, HF REJ, LF REJ, NOISE REJECT.</li> <li><b>SLOPE</b> section: POS, NEG, and a blank button.</li> <li><b>MODE</b> section: NORM, AUTO, and a blank button.</li> <li><b>LEVEL</b> knob and <b>PUSH TO SET 50%</b> button.</li> <li><b>ARM</b>, <b>READY</b>, and <b>TRIGD</b> buttons.</li> <li>Up and down arrow buttons.</li> </ul>
<p><b>To select the trigger source</b></p>	<p><b>6.</b> Push the up and down arrow buttons to toggle through the possible trigger sources:</p> <ul style="list-style-type: none"> <li>■ CH 1 - CH 4 are the input channels. The channel you select as a trigger source will function whether it is displayed or not.</li> <li>■ LINE is the AC Line Voltage. Because the instrument generates the trigger, you do not have to input a signal to create the trigger.</li> <li>■ AUX is a fifth, nondisplayable trigger source. To use the auxiliary trigger, connect the external triggering signal to the Auxiliary Trigger input connector on the front panel.</li> </ul>	 <p>This diagram is identical to the one in the previous row, showing the TRIGGER control panel with its various buttons and knobs.</p>

Overview	Triggering from the front panel (Cont.)	Control elements and resources
<p><b>To set the trigger coupling</b></p>	<p>7. Push the up and down arrow buttons to toggle through the possible trigger couplings:</p> <ul style="list-style-type: none"> <li>■ DC passes all (both AC and DC components) of the input signal.</li> <li>■ AC passes only the AC components of an input signal.</li> <li>■ HF REJ attenuates signals above 30 kHz.</li> <li>■ LF REJ attenuates signals below 80 kHz.</li> <li>■ NOISE REJ provides lower sensitivity, reducing the chance of falsely triggering on noise.</li> </ul>	
<p><b>To select the trigger mode</b></p>	<p>8. Push the TRIGGER MODE button to toggle between NORMAL and AUTO trigger modes:</p> <ul style="list-style-type: none"> <li>■ NORMAL trigger mode requires a trigger to acquire a waveform.</li> <li>■ AUTO trigger mode acquires a waveform even if a trigger does not occur (after a time-out).</li> </ul> <p>Be aware that in AUTO mode, the acquired waveforms may not be triggered.</p>	

**To Check Trigger Status** To see the state and setup of the triggering circuit, use the trigger status lights, readout, and screen.

Overview	To check trigger status	Control elements and resources
<p><b>Trigger status from trigger status lights</b></p>	<p>1. To quickly determine trigger status, check the three status lights TRIG'D, READY, and ARM in the Trigger control area.</p> <ul style="list-style-type: none"> <li>■ TRIG'D on: the instrument has recognized a valid trigger and is filling the posttrigger portion of the waveform.</li> <li>■ READY on: the instrument can accept, and is waiting for, a valid trigger to occur.</li> <li>■ ARM on: the trigger circuitry is filling the pretrigger portion of the waveform record.</li> <li>■ TRIG'D and READY on: valid A trigger recognized, waiting for a delayed trigger. When a delayed trigger is recognized, the posttrigger portion of the delayed waveform will fill.</li> <li>■ ARM, TRIG'D, and READY off: the digitizer is stopped.</li> </ul>	 <p>The diagram shows the TRIGGER control panel with the following elements:</p> <ul style="list-style-type: none"> <li><b>TRIGGER</b> header with <b>EDGE</b> and <b>ADVANCED</b> options.</li> <li><b>SOURCE</b> section: CH 1 (DC), CH 2 (AC), CH 3 (HF REJ), CH 4 (LF REJ), EXT, LINE.</li> <li><b>COUPLING</b> section: DC, AC.</li> <li><b>SLOPE</b> section: POS ↑, NEG ↓.</li> <li><b>MODE</b> section: NORM, AUTO.</li> <li><b>NOISE REJECT</b> section: NOISE REJECT.</li> <li><b>LEVEL</b> section: LEVEL PUSH TO SET 50%.</li> <li><b>Status Lights</b>: ARM, READY, TRIG'D.</li> <li>Navigation buttons: up/down arrows and a circular button.</li> </ul>
<p><b>Trigger status from acquisition readout</b></p>	<p>2. To quickly determine the settings of some key trigger parameters, check the Trigger readout at the bottom of the display. The readouts differ for edge and the advanced triggers.</p>	 <p>The diagram shows the Trigger readout with the following information:</p> <ul style="list-style-type: none"> <li><b>Time base</b>: 278 μs/div</li> <li><b>Trigger source</b>: A C1 (A trigger source = Ch 1)</li> <li><b>Trigger slope</b>: 1.25MS/s (Trigger slope = rising edge)</li> <li><b>Trigger level</b>: 800ns/pt, 0.0V (Trigger level)</li> </ul>

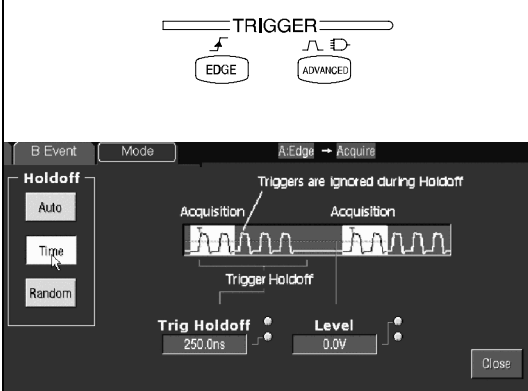
Overview	To check trigger status (Cont.)	Control elements and resources
<p><b>Trigger location and level from display</b></p>	<p><b>3.</b> To see the trigger point and level on the waveform display, check the graphic indicators Trigger Point and Trigger Level Indicator.</p> <p>Both the trigger point indicator and level bar are displayed from the Display menu. See <i>Customizing the Display</i> on page 3-131 for more information.</p> <p>The trigger point indicator shows horizontal position. It can be positioned horizontally off screen to the left when horizontal delay is on. The trigger level indicator shows only the trigger level. It remains on screen, regardless of the horizontal position, as long as the channel providing the trigger source is displayed. You can choose between two types of trigger level indicators: a horizontal bar or an arrow at the right side of the graticule.</p>	<p>Trigger point indicator shows the trigger position on the waveform record.</p>  <p>Trigger level indicator shows the trigger level on the waveform record. You can drag the indicator to set the trigger level.</p>

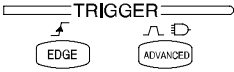
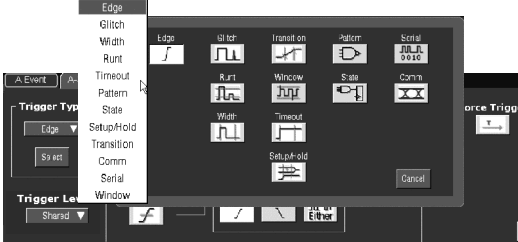

## Additional Trigger Parameters

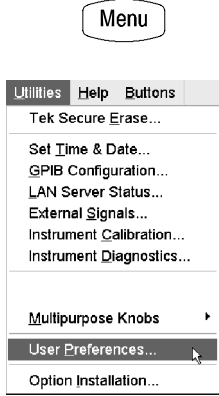
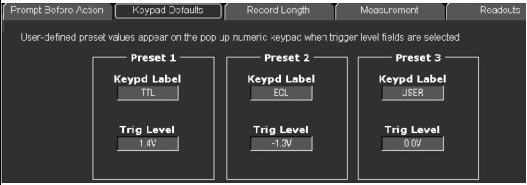
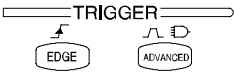
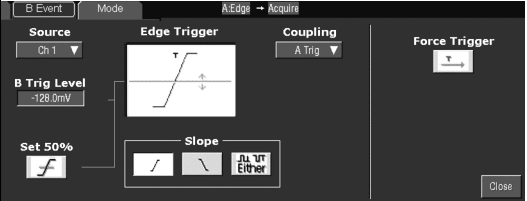
Some additional trigger parameters are accessible only through the Trigger control window:

- Holdoff
- Trigger level presets
- Force trigger
- Single sequence

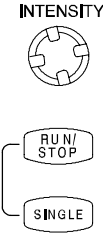
Use the procedures that follow to set up these additional trigger parameters. For more information, display online help while performing the procedure.

Overview	Additional trigger parameters	Control elements and resources
<p><b>To set holdoff</b></p>	<p>You can change the holdoff time to help stabilize triggering. See <i>Trigger Modes</i> and <i>Trigger Holdoff</i> beginning on page 3-65 for a description of trigger holdoff. To set holdoff, do the following steps:</p> <ol style="list-style-type: none"> <li>1. Push the ADVANCED button, and select the Mode tab.</li> <li>2. Select Auto, Time, or Random: <ul style="list-style-type: none"> <li>■ The Auto holdoff varies with the horizontal scale and is equal to 5 divisions times the current time/division setting. Auto maintains a good value for multipurpose triggering.</li> <li>■ Time lets you enter a holdoff that may allow more stable triggering than the Auto holdoff. This time is used at all horizontal scale settings.</li> <li>■ Random selects a new random holdoff time for each acquisition cycle.</li> </ul> </li> <li>3. To change the holdoff time when Time is selected, select Trig Holdoff, and enter a value in time using the multipurpose knob or the keypad.</li> </ol> <p>You can set holdoff from 250 ns (minimum holdoff available) to 12 s (maximum available).</p>	 <p>The diagram shows a 'TRIGGER' section with two buttons: 'EDGE' and 'ADVANCED'. Below it is a screenshot of the oscilloscope's trigger menu. The 'Holdoff' menu is open, showing 'Auto', 'Time', and 'Random' options. The 'Time' option is selected. The 'Trig Holdoff' is set to '250.0ns' and the 'Level' is set to '0.0V'. A waveform is shown with 'Acquisition' periods and a 'Trigger Holdoff' period where 'Triggers are ignored during Holdoff'. A 'Close' button is visible in the bottom right of the screenshot.</p>

Overview	Additional trigger parameters (Cont.)	Control elements and resources
<p><b>To select a preset trigger level</b></p>	<ol style="list-style-type: none"> <li>1. Push the ADVANCED button, select the A Event tab, and touch either of the Trigger Type buttons.</li> <li>2. Select a Trigger Type, such as Edge, that uses a level adjustment.</li> <li>3. Select Level and touch the keyboard icon to display the keyboard. Select either TTL, ECL, or USER: <ul style="list-style-type: none"> <li>■ TTL fixes the trigger level at +1.4 V.</li> <li>■ ECL fixes the trigger level at -1.3 V.</li> <li>■ USER fixes the trigger level at the USER preset voltage.</li> </ul> <p>When you set the volts/div smaller than 200 mV, the instrument reduces the TTL or ECL trigger levels below standard TTL and ECL levels. This reduction occurs because the trigger level range is fixed at <math>\pm 12</math> divisions from the center. At 100 mV (the next smaller setting after 200 mV) the trigger range is <math>\pm 1.2</math> V, which is smaller than the typical TTL (+1.4 V) or ECL (-1.3 V) level.</p> </li> </ol>	  

Overview	Additional trigger parameters (Cont.)	Control elements and resources
<p><b>To define new trigger level presets</b></p>	<ol style="list-style-type: none"> <li>If the Menu Bar is not displayed, touch the Menu button to display the Menu Bar.</li> <li>Touch Utilities, and select User Preferences to display the User Preferences control window.</li> <li>Select the Keypad Defaults tab. Select a Trigger Level, and adjust the Trigger Level preset using the multipurpose knob or keypad.</li> <li>Select a Keypad Label, and change the label of the preset using the keypad.</li> </ol>	 
<p><b>To force a trigger</b></p>	<ol style="list-style-type: none"> <li>Push the ADVANCED front-panel button to display the trigger control window.</li> <li>Select the A Event or B Event tab, and select the Edge trigger type.</li> <li>To force the instrument to immediately acquire one waveform record even without a trigger event, touch the Force Trigger button.</li> </ol> <p>Forcing a trigger is useful when in normal trigger mode and the input signal is not supplying a valid trigger. By touching Force Trigger, you can quickly confirm that there is a signal present for the instrument to acquire. Once that is established, you can determine how to trigger on it (push PUSH TO SET 50%, check trigger source setting, and so on).</p> <p>The instrument recognizes and acts on Force Trigger even when you touch it before the end of pretrigger holdoff. However, the button has no effect if the acquisition system is stopped.</p>	 



Overview	Additional trigger parameters (Cont.)	Control elements and resources
<b>To single trigger</b>	<ol style="list-style-type: none"> <li data-bbox="358 365 971 485">1. To trigger on the next valid trigger event and then stop, push the SINGLE front-panel button. Push the SINGLE button each time you want to initiate the single sequence of acquisitions.</li> <li data-bbox="358 512 971 569">2. To leave Single Trigger mode, push the front-panel RUN/STOP button.</li> </ol> <p data-bbox="407 596 971 961">The exact function of the SINGLE button depends on the acquisition mode. In Sample, Peak Detect, or Hi Res acquisition modes, acquisition stops after a single waveform is acquired. In Average or Envelope acquisition modes, acquisition stops after N waveforms are acquired, where N is the number of averages or envelopes specified. In equivalent time, it takes several triggers to partially fill a record. In Waveform Database mode, acquisition stops after N samples are acquired, where N is the number of samples specified. It may take a number of sequences of acquisitions to fill a waveform to the desired number of samples.</p> <p data-bbox="407 989 971 1045">Single sequence triggering is not available in Fast Acquisition mode.</p>	 <p data-bbox="1182 365 1252 386">INTENSITY</p> <p data-bbox="1192 394 1258 449"></p> <p data-bbox="1170 491 1258 533">RUN/STOP</p> <p data-bbox="1192 562 1258 596">SINGLE</p>

## Advanced Triggering

The instrument can trigger on glitch or runt pulses, or it can trigger based on the width, slew rate, or timeout period of a pulse. These capabilities make the instrument suitable for such tasks as unattended monitoring for, and capturing of, a power supply glitch or GO/NO GO slew rate testing of operational amplifiers. This subsection describes how to use advanced triggers: glitch, runt, width, transition (slew rate), window, and timeout triggering. Edge, runt, glitch, width, transition, timeout, setup/hold, and window triggers can be logic qualified.

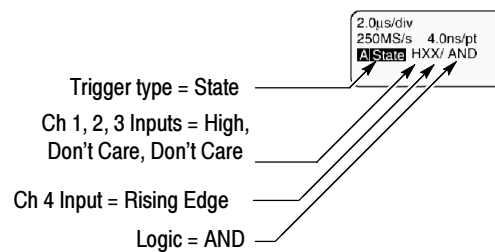
The instrument can also trigger on a logic or binary pattern and on the state of a logic pattern at the time it is clocked. The instrument can trigger on data that violates setup and hold times relative to a clock. This subsection also describes how to use the advanced triggers: pattern, state, and setup/hold.

These trigger types are available for both A and B triggering, allowing you extensive latitude in defining both trigger events in the sequence, to capture complex signals. See *Sequential Triggering* on page 3-103 for more information.

Runt, glitch, width, transition, timeout, and window pulses are not recognized until the instrument sees the trailing edge of the pulse. The instrument then triggers or, if the trigger is logic qualified, checks the logic status of the other

channels. If the logic qualifying signals are present, a trigger is generated. Due to this timing, there is a chance that the pulse and the logic qualifying signals were present at the same time, but not when the instrument checks for them.

You can check the advanced trigger status in the readout. The readout indicates the trigger type and then shows sources, levels, or any other parameters that are important for the particular trigger type. Figure 3-25 shows an example readout for the state trigger type.



**Figure 3-25: Example advanced trigger readout**

Read the following topics; they provide details that can help prevent false steps in setting up to trigger on your waveforms.

**Glitch Trigger.** A glitch trigger occurs when the trigger source detects a pulse narrower (or wider) than some specified time. It can trigger on glitches of either polarity. Or you can set the glitch trigger to reject glitches of either polarity.

**Runt Trigger.** A runt trigger occurs when the trigger source detects a short pulse that crosses one threshold but fails to cross a second threshold before recrossing the first. You can set the instrument to detect any positive or negative runt pulse, or only those wider than a specified minimum width.

**Width Trigger.** A width trigger occurs when the trigger source detects a pulse that is inside or, optionally, outside some specified time range (defined by the upper limit and lower limit). The instrument can trigger on positive or negative width pulses.

**Transition Trigger.** A transition (slew rate) trigger occurs when the trigger source detects a pulse edge that transitions (slews) between two amplitude levels at a rate faster or slower than you specify. The instrument can trigger on positive or negative transitions. You can also think of transition triggering as triggering based on the slope (change in voltage/change in time) of a pulse edge.

**Window Trigger.** A window trigger occurs when the trigger source passes into or out of a window defined by two thresholds. The trigger can be time or logic qualified.









**Timeout Trigger.** A timeout trigger occurs when the trigger source does *not* detect an expected pulse transition. If the pulse transition occurs prior to a specified timeout time (the expected case), then no trigger results.

**Pattern Trigger.** A pattern trigger occurs when the logic inputs to the logic function that you select cause the function to become TRUE (or at your option FALSE). When you use a pattern trigger, you define:

- The precondition for each logic input — logic high, low, or do not care (the logic inputs are channels 1, 2, 3, and 4)
- The Boolean logic function — select from AND, NAND, OR, and NOR
- The condition for triggering — whether the trigger occurs when the Boolean function becomes TRUE (logic high) or FALSE (logic low), and whether the TRUE condition is time qualified

The pattern (and state) logic choices are summarized in Table 3-5.

**Table 3-5: Pattern and state logic**

Pattern	State	Definition <sup>1, 2</sup>
 <b>AND</b>	 <b>Clocked AND</b>	If <i>all</i> the preconditions selected for the logic inputs <sup>3</sup> are TRUE, then the instrument triggers.
 <b>NAND</b>	 <b>Clocked NAND</b>	If <i>not all</i> of the preconditions selected for the logic inputs <sup>3</sup> are TRUE, then the instrument triggers.
 <b>OR</b>	 <b>Clocked OR</b>	If <i>any</i> of the preconditions selected for the logic inputs <sup>3</sup> are TRUE, then the instrument triggers.
 <b>NOR</b>	 <b>Clocked NOR</b>	If <i>none</i> of the preconditions selected for the logic inputs <sup>3</sup> are TRUE, then the instrument triggers.

- <sup>1</sup> For state triggers, the definition must be met at the time the clock input changes state.
- <sup>2</sup> The definitions given here are correct for the Goes TRUE setting in the Trigger When menu. If that menu is set to Goes False, swap the definition for AND with that for NAND and for OR with NOR for both pattern and state types.
- <sup>3</sup> The logic inputs are channels 1, 2, 3, and 4 when using Pattern triggers. For State triggers, channel 4 becomes the clock input, leaving the remaining channels as logic inputs.

**State Trigger.** A state trigger occurs when the logic inputs to the logic function cause the function to be TRUE (or at your option FALSE) at the time the clock input changes state. When you use a state trigger, you define:

- The precondition for each logic input, channels 1, 2, and 3
- The direction of the state change for the clock input, channel 4
- The Boolean logic function — select from clocked AND, NAND, OR, and NOR
- The condition for triggering — whether the trigger occurs when the Boolean function becomes TRUE (logic high) or FALSE (logic low)

The state (and pattern) logic choices are summarized in Table 3-5.

**Setup/Hold Trigger.** A setup/hold trigger occurs when a logic input changes state inside of the setup and hold times relative to the clock. When you use setup/hold triggering, you define:

- The channel containing the logic input (the data source) and the channel containing the clock (the clock source)

- The direction of the clock edge to use
- The clocking level and data level that the instrument uses to determine if a clock or data transition has occurred
- The setup and hold times that together define a time range relative to the clock

Data that changes state within the setup/hold violation zone triggers the instrument. Figure 3-26 shows how the setup and hold times that you choose position this zone relative to the clock.

Setup/hold triggering uses the setup/hold violation zone to detect when data is unstable too near the time it is clocked. Each time trigger holdoff ends, the instrument monitors the data and clock sources. When a clock edge occurs, the instrument checks the data stream it is processing (from the data source) for transitions occurring within the setup/hold violation zone. If any occur, the instrument triggers with the trigger point located at the clock edge.

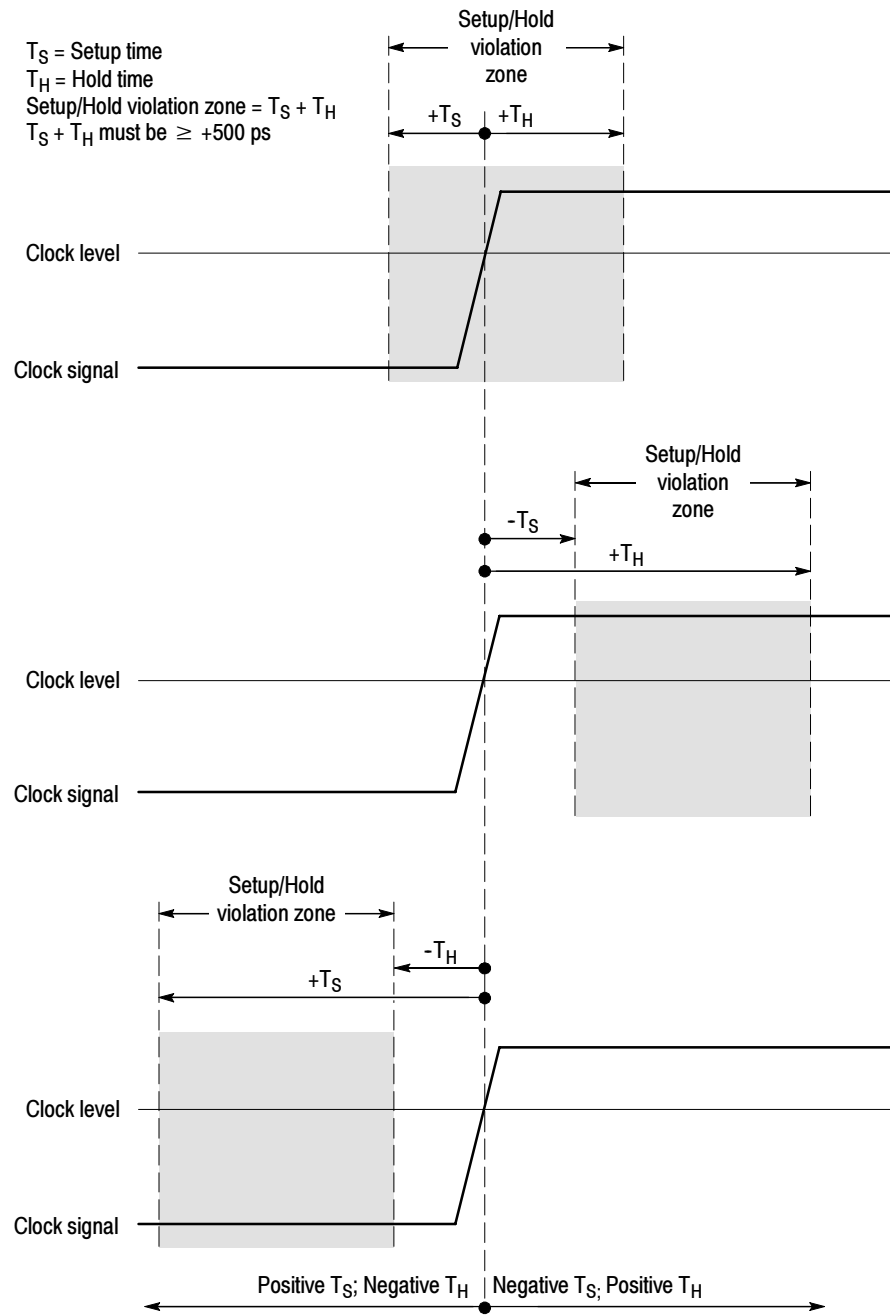
Positive settings for both setup and hold times (the most common application) locate the setup/hold violation zone so it spans the clocking edge. (See the top waveform in Figure 3-26.) The instrument detects and triggers on data that does not become stable long enough before the clock (setup time violation) or that does not stay stable long enough after the clock (hold time violation).

Negative settings for setup or hold times skew the setup/hold violation zone to locate it before or after the clocking edge. (See the bottom and center waveforms of Figure 3-26.) The instrument can then detect and trigger on violations of a time range that occurs before or one that occurs after the clock.

---

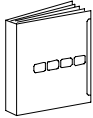
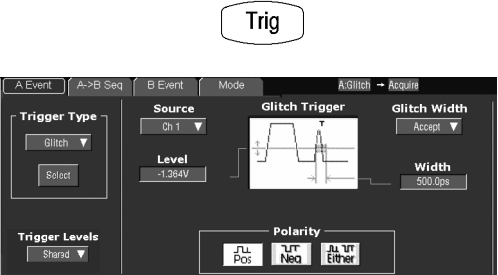
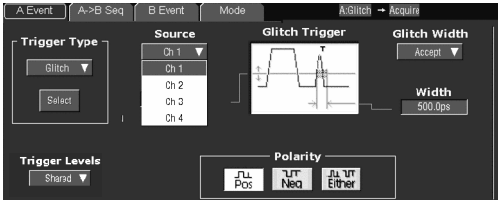
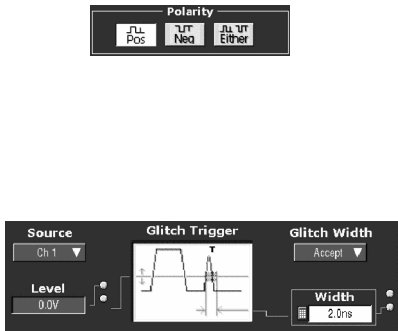
**NOTE.** Keep the hold-time setting to no more than 1.5 ns less than one-half the clock period ( $\text{hold time} \leq (\text{period}/2) - 1.5 \text{ ns}$ ) or the instrument cannot trigger (this assumes a 50% duty cycle clock).


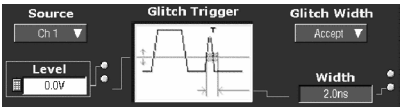
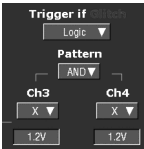
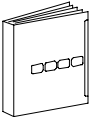
---



**Figure 3-26: Violation zones for Setup/Hold triggering**

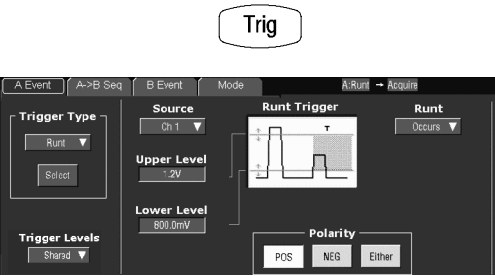
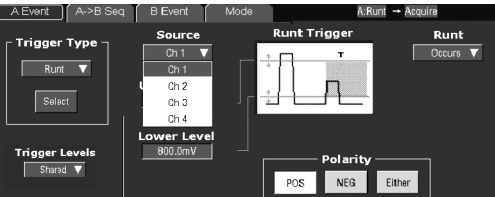
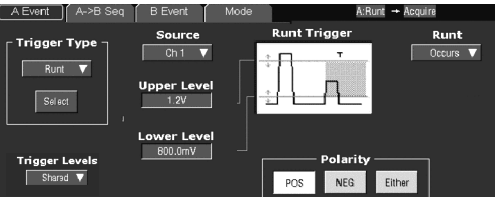
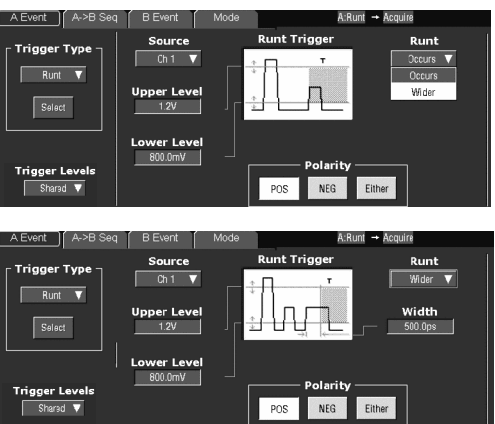
**To Trigger on a Glitch** When you select the type Glitch, the instrument will trigger on a pulse narrower (or wider) in width than some specified time. To set up for glitch triggering, do the following procedures.

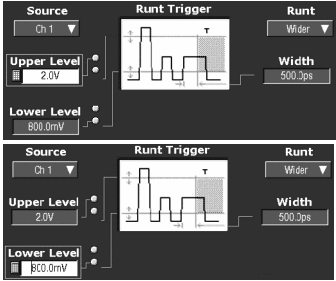
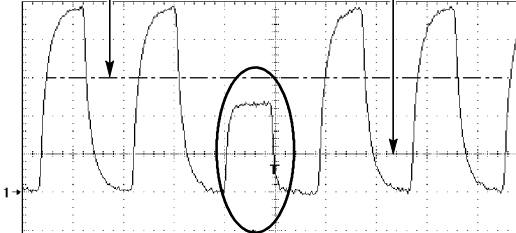
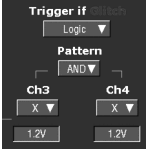
Overview	To trigger on a glitch	Control elements and resources
<p><b>Prerequisites</b></p>	<p>1. The instrument must be installed with a signal connected to an input channel. Acquisition system should be set to Run, and the vertical and horizontal controls should be set appropriately for the signal to be acquired.</p>	 <p>See page 3-23 for acquisition setup</p>
<p><b>Select glitch triggering</b></p>	<p>2. From the toolbar, touch Trig, select the A Event tab of the Trigger control window, and touch Select.</p> <p>3. Touch Glitch.</p>	 <p>The screenshot shows the 'Trig' control window with the 'A Event' tab selected. The 'Trigger Type' is set to 'Glitch'. The 'Source' is 'Ch 1', 'Level' is '-1.254V', and 'Glitch Width' is '500.0ps'. The 'Polarity' is set to 'Pos'.</p>
<p><b>Select the source</b></p>	<p>4. To specify which channel becomes the trigger source, touch Source, and select the source from the list.</p>	 <p>The screenshot shows the 'Trig' control window with the 'Source' dropdown menu open, listing 'Ch 1', 'Ch 2', 'Ch 3', and 'Ch 4'.</p>
<p><b>Select the polarity and width</b></p>	<p>5. To specify the glitch polarity, touch Pos (positive), Neg (negative) or Either from the Polarity window:</p> <ul style="list-style-type: none"> <li>■ Pos looks at positive-going pulses.</li> <li>■ Neg looks at negative-going pulses.</li> <li>■ Either looks at both positive and negative pulses.</li> </ul> <p>6. To specify the width of the glitch, touch Width, and set the glitch width using the multipurpose knob or keypad.</p>	 <p>The top screenshot shows the 'Polarity' window with three buttons: 'Pos', 'Neg', and 'Either'. The bottom screenshot shows the 'Width' control window with a 'Width' knob set to '2.0ns'.</p>

Overview	To trigger on a glitch (Cont.)	Control elements and resources
<p><b>Set to trigger if width</b></p>	<p>7. To specify whether to trigger on glitches narrower or greater than the width you specify, touch Glitch Width and select from the list:</p> <ul style="list-style-type: none"> <li>■ Trig if Width Less Than will trigger only on pulses narrower than the width you specified.</li> <li>■ Trig if Width Greater Than will trigger only on pulses wider than the specified width.</li> </ul>	
<p><b>Set the level</b></p>	<p>8. To set the Level that the glitch must cross to be recognized by the instrument, touch Glitch Trigger Level, and use the multipurpose knobs, keypad, or front-panel LEVEL knob to set the glitch trigger level.</p> <p><i>Note.</i> You can set the level to a value appropriate to either TTL or ECL logic families. To do so, touch Level, and select the keypad; touch either TTL or ECL.</p>	
<p><b>Logic qualify the trigger</b></p>	<p>9. To logic qualify the trigger, see <i>Logic Qualify a Trigger</i> on page 3-102.</p>	
<p><b>To set mode and holdoff</b></p>	<p>10. Mode and holdoff can be set for all standard trigger types. To learn more about trigger mode and holdoff, see <i>Trigger Modes</i> on page 3-65 and <i>Trigger Holdoff</i> on page 3-66.</p>	 <p>See <i>To set holdoff</i> on page 3-74 and <i>To select the trigger mode</i> on page 3-71 for mode and holdoff setup. To learn more about trigger mode and holdoff, see <i>Trigger Modes</i> on page 3-65 and <i>Trigger Holdoff</i> on page 3-66.</p>



**To Trigger on a Runt Pulse** When you select the type Runt, the instrument will trigger on a short pulse that crosses one threshold but fails to cross a second threshold before recrossing the first. To set up for runt triggering, do the following procedures.

Overview	To trigger on a runt pulse	Control elements and resources
<p><b>Select runt triggering</b></p>	<ol style="list-style-type: none"> <li>From the toolbar, touch Trig, select the A Event tab of the Trigger control window, and touch Select.</li> <li>Touch Runt.</li> </ol>	
<p><b>Select the source</b></p>	<ol style="list-style-type: none"> <li>To specify which channel becomes the pulse trigger source, touch Source, and select the source from the list.  The source selected becomes the trigger source for Glitch, Runt, Width, and Transition.</li> </ol>	
<p><b>Select the polarity</b></p>	<ol style="list-style-type: none"> <li>To specify the direction of the runt pulse, touch Polarity, and select Pos (positive), Neg (negative) or Either from the window. <ul style="list-style-type: none"> <li>Pos looks at positive-going pulses.</li> <li>Neg looks at negative-going pulses.</li> <li>Either looks at both positive and negative pulses.</li> </ul> </li> </ol>	
<p><b>Set to trigger when</b></p>	<p>To determine how wide a runt pulse the instrument will trigger on:</p> <ol style="list-style-type: none"> <li>Touch Runt and select from the list: <ul style="list-style-type: none"> <li>Occurs triggers on all runt pulses regardless of width.</li> <li>Wider triggers only on runt pulses that exceed the width you set. Enter the width using the multipurpose knob or keypad.</li> </ul> </li> <li>To specify the minimum width of the runt pulse, touch Width, and set the value using the multipurpose knob or keypad.</li> </ol>	

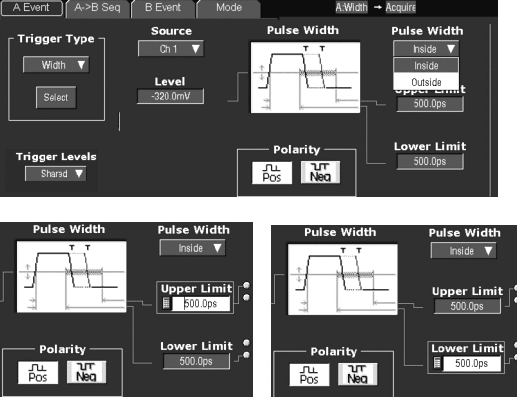
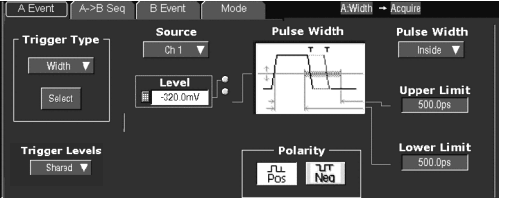
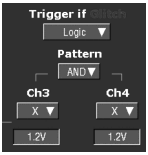
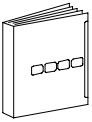
Overview	To trigger on a runt pulse (Cont.)	Control elements and resources
<p><b>Set the thresholds</b></p>	<p>7. To set the two threshold levels used in detecting a runt pulse, touch Upper Limit or Lower Limit, and use the multipurpose knob or keypad to set the values for the upper and lower thresholds.</p> <p><b>Note.</b> To use the trigger bar to set the threshold levels, touch the Disp button, select the Objects tab, and then touch Long to display the long trigger bar.</p> <p>Note the position of the trigger indicator. Triggering occurs at the point the pulse returns over the first (lower) threshold going negative without crossing the second threshold level (upper). The polarity selected in the Polarity window determines the order that the threshold must be crossed for a runt trigger to occur:</p> <ul style="list-style-type: none"> <li>Positive requires that the lower threshold must be first crossed going positive, then recrossed going negative without the upper threshold being crossed at all.</li> <li>Negative requires that the upper threshold must be first crossed going negative, then recrossed going positive without the lower threshold being crossed at all.</li> <li>Either requires only that either one of the thresholds must be first crossed going in either direction, then recrossed going in the opposite direction without the other threshold being crossed at all.</li> </ul> <p>For all three polarity settings, triggering occurs at the point the runt pulse recrosses its first threshold.</p>	 <p>Selected trigger bar at upper threshold.      Unselected trigger bar at lower threshold.</p>  <p>Runt pulse crosses first threshold only, recrosses first threshold level, and triggers acquisition</p>
<p><b>Logic qualify the trigger</b></p>	<p>8. To logic qualify the trigger, see <i>Logic Qualify a Trigger</i> on page 3-102.</p>	

Overview	To trigger on a runt pulse (Cont.)	Control elements and resources
<p><b>To set mode and holdoff</b></p>	<p>9. Mode and holdoff can be set for all standard trigger types.</p>	<div data-bbox="1192 365 1279 485" data-label="Image"> </div> <p>See <i>To set holdoff</i> on page 3-74 and <i>To select the trigger mode</i> on page 3-71 for mode and holdoff setup. To learn more about trigger mode and holdoff, see <i>Trigger Modes</i> on page 3-65 and <i>Trigger Holdoff</i> on page 3-66.</p>

**Trigger Based on Pulse Width**

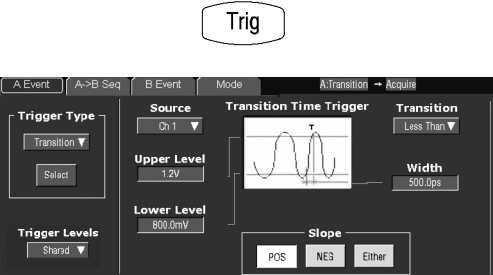
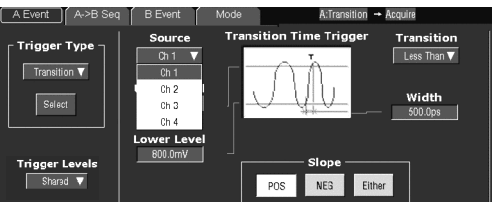

When you select the type Width, the instrument will trigger on a pulse narrower (or wider) than some specified range of time (defined by the upper limit and lower limit). To set up for width triggering, do the following procedures.

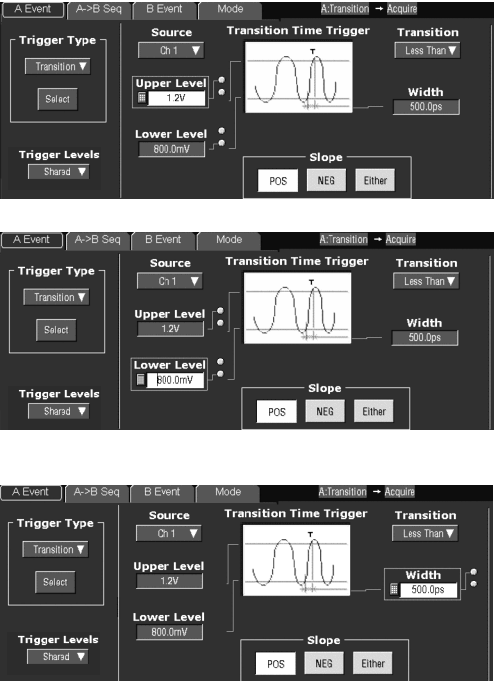
Overview	Trigger based on pulse width	Control elements and resources
<p><b>Select width triggering</b></p>	<ol style="list-style-type: none"> <li>From the toolbar, touch Trig, select the A Event tab of the Trigger control window, and touch Select.</li> <li>Touch Width.</li> </ol>	<div data-bbox="1175 961 1256 1003" data-label="Image"> </div>
<p><b>Select the source</b></p>	<ol style="list-style-type: none"> <li>To specify which channel becomes the trigger source, touch Source, and select the source from the list.</li> </ol>	
<p><b>Select the polarity</b></p>	<ol style="list-style-type: none"> <li>To specify the polarity of the pulse, touch Pos (positive) or Neg (negative) from the window: <ul style="list-style-type: none"> <li>Pos looks at positive-going pulses.</li> <li>Neg looks at negative-going pulses.</li> </ul> </li> </ol>	

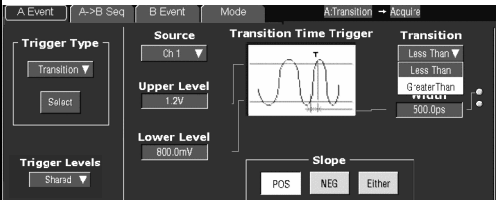
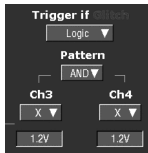
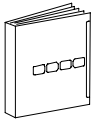
Overview	Trigger based on pulse width (Cont.)	Control elements and resources
<p><b>Set to trigger when</b></p>	<p>To set the range of widths (in units of time) the trigger source will search for and to specify whether to trigger on pulses that are outside this range or within this range, do the following steps:</p> <ol style="list-style-type: none"> <li>5. Touch Pulse Width, and select from the list: <ul style="list-style-type: none"> <li>■ Inside triggers on pulses that fall within the specified range.</li> <li>■ Outside triggers on pulses that are outside the range.</li> </ul> </li> <li>6. To set the range of pulse widths in units of time, touch Upper or Lower Limit, and enter the values with the multipurpose knob or keypad: <ul style="list-style-type: none"> <li>■ Upper Limit is the maximum valid pulse width the trigger source will look for.</li> <li>■ Lower Limit is the minimum valid pulse width. The instrument will always force the Lower Limit to be less than or equal to the Upper Limit.</li> </ul> </li> </ol>	
<p><b>Set the level</b></p>	<ol style="list-style-type: none"> <li>7. Touch Level, and use the multipurpose knob or keypad to set the trigger level.</li> </ol>	
<p><b>Logic qualify the trigger</b></p>	<ol style="list-style-type: none"> <li>8. To logic qualify the trigger, see <i>Logic Qualify a Trigger</i> on page 3-102.</li> </ol>	
<p><b>To set mode and holdoff</b></p>	<ol style="list-style-type: none"> <li>9. Mode and holdoff can be set for all standard trigger types.</li> </ol>	 <p>See <i>To set holdoff</i> on page 3-74 and <i>To select the trigger mode</i> on page 3-71 for mode and holdoff setup. To learn more about trigger mode and holdoff, see <i>Trigger Modes</i> on page 3-65 and <i>Trigger Holdoff</i> on page 3-66.</p>

**To Trigger Based on Transition Time**

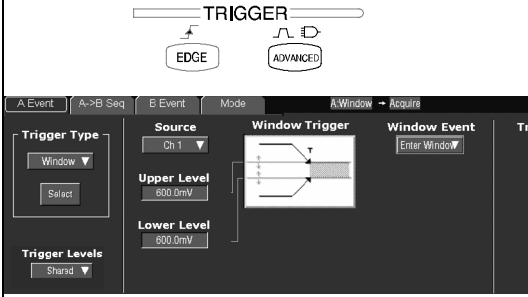
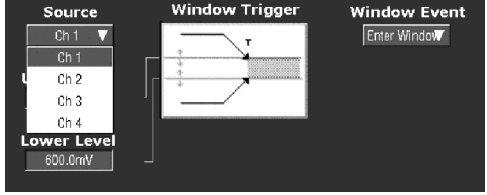
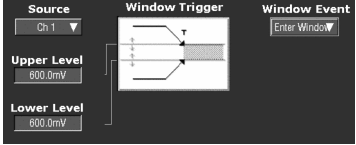
When you select the type Transition Time (slew rate), the instrument will trigger on a pulse edge that traverses between an upper and lower threshold faster or slower than a transition time you specify. To set up for transition time triggering, do the following procedures.

Overview	To trigger based on transition time	Control elements and resources
<p><b>Select transition triggering</b></p>	<ol style="list-style-type: none"> <li>From the toolbar, touch Trig, and select the A Event tab of the Trigger control window.</li> <li>Touch Transition.</li> </ol>	
<p><b>Select the source</b></p>	<ol style="list-style-type: none"> <li>To specify which channel becomes the trigger source, touch Source, and select the source from the list.</li> </ol>	
<p><b>Select slope</b></p>	<ol style="list-style-type: none"> <li>To specify the direction of the pulse edge, touch Slope and select Pos (positive), Neg (negative) or Either from the window: <ul style="list-style-type: none"> <li>Pos monitors the transition time (slew rate) of the positive-going edges of pulses. The edge must first cross the lower threshold and then cross the upper threshold.</li> <li>Neg monitors the transition time (slew rate) of the negative-going edges of pulses. The edge must first cross the upper threshold and then cross the lower threshold.</li> <li>Either monitors positive- and negative-going edges of pulses. The edge may first cross either threshold and then cross the other.</li> </ul> </li> </ol>	

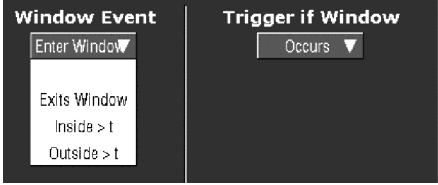

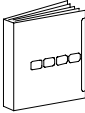
Overview	To trigger based on transition time (Cont.)	Control elements and resources
<p><b>Set the transition time</b></p>	<p>The threshold levels and the delta time setting determine the transition time (slew rate) setting. To set these parameters:</p> <ol style="list-style-type: none"> <li>5. Touch the Upper Level or Lower Level button and use the multipurpose knob or keypad to set the values for the upper and lower levels.                     <p><i>Note. You can set the level to a value appropriate to either TTL or ECL logic families. To do so touch Level and select the keypad; touch either TTL or ECL.</i></p> <p><i>To use the Trigger Bar to set the threshold levels, touch the Disp button, select the Objects tab, and then touch Long to display the long trigger bar.</i></p> </li> </ol> <p>The level settings determine the voltage component of slew rate (Volts/Second). To finish specifying the slew rate (transition time), set the time component by doing the following steps:</p> <ol style="list-style-type: none"> <li>6. Touch Width and use the multipurpose knob or keypad to set the delta time value.</li> </ol>	

Overview	To trigger based on transition time (Cont.)	Control elements and resources
<p><b>Set to trigger when</b></p>	<p>The instrument compares the pulse edge of the trigger source against the transition time (slew rate) set by the upper and lower threshold settings and the delta time set in the window. To select whether to trigger on edges with transitions times (slew rates) faster than or slower than that set by these controls, do the following step:</p> <p>7. Touch Transition Less Than or Transition Greater Than:</p> <ul style="list-style-type: none"> <li>■ Less Than triggers when the transition time is greater than the time you set.</li> <li>■ Greater Than triggers when the transition time is less than the time you set</li> </ul> <p>If you select Transition Greater Than and the instrument does not trigger, it may be because the pulse edge is too fast rather than too slow. To check the edge speed, switch to edge triggering. Then trigger on the pulse edge and determine the time the edge takes to travel between the levels set in the slew rate Thresholds menu. The instrument cannot transition trigger on pulse edges that traverse between threshold levels in 600 ps or less.</p> <p>Also, to reliably transition trigger, a pulse must have a width of 8.5 ns or more. A pulse of less width may trigger on the wrong slope or not trigger at all. Switch to edge triggering and check the pulse width if you can't transition trigger as expected.</p>	
<p><b>Logic qualify the trigger</b></p>	<p>8. To logic qualify the trigger, see <i>Logic Qualify a Trigger</i> on page 3-102.</p>	
<p><b>To set mode and holdoff</b></p>	<p>9. Mode and holdoff can be set for all standard trigger types.</p>	 <p>See <i>To set holdoff</i> on page 3-74 and <i>To select trigger mode</i> on page 3-71 for mode and holdoff setup. To learn more about trigger mode and holdoff, see <i>Trigger Modes</i> on page 3-65 and <i>Trigger Holdoff</i> on page 3-66.</p>

**Triggering on a Window** Use this procedure to trigger the instrument when the input signal enters or leaves a window set by an upper or lower threshold level.

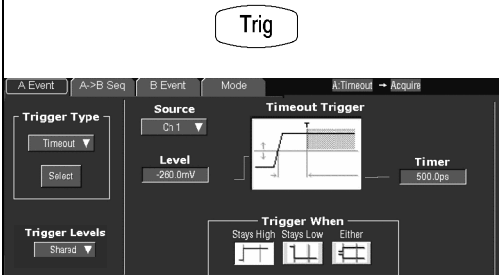
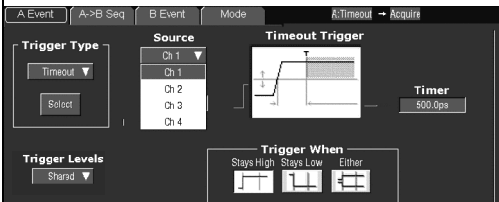
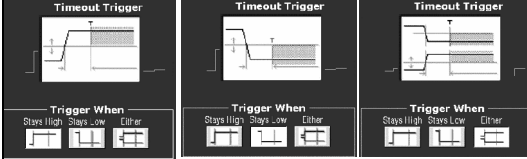
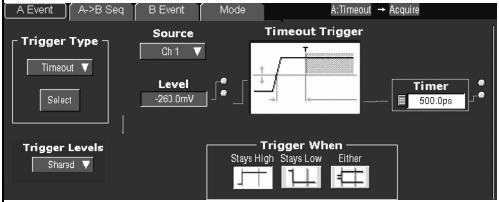
Overview	To trigger on a window threshold violation	Control elements and resources
<p><b>Select window triggering</b></p>	<ol style="list-style-type: none"> <li>1. Push the front-panel ADVANCED button.</li> <li>2. On the Trigger Setup control window, select the A Event tab, and touch Select.</li> <li>3. Touch Window.</li> </ol>	 <p>The diagram shows a TRIGGER button with two options: EDGE and ADVANCED. Below it is a screenshot of the Trigger Setup window. The 'Trigger Type' is set to 'Window'. The 'Source' is 'Ch 1'. The 'Upper Level' and 'Lower Level' are both set to 800.0mV. The 'Window Trigger' section shows a waveform with a shaded window. The 'Window Event' section has an 'Enter Window' button.</p>
<p><b>Select the source</b></p>	<ol style="list-style-type: none"> <li>4. To specify which channel becomes the trigger source, touch Source and select the source from the list.</li> </ol>	 <p>The screenshot shows the Trigger Setup window with the 'Source' dropdown menu open. The options are Ch 1, Ch 2, Ch 3, and Ch 4. The 'Lower Level' is set to 800.0mV. The 'Window Trigger' section shows a waveform with a shaded window. The 'Window Event' section has an 'Enter Window' button.</p>
<p><b>Set the thresholds</b></p>	<ol style="list-style-type: none"> <li>5. The upper and lower threshold levels define the voltage limits of the window. To set the threshold levels, touch Upper Level or Lower Level, and use the multipurpose knobs or pop-up keypad to set the values.</li> </ol>	 <p>The screenshot shows the Trigger Setup window with the 'Upper Level' and 'Lower Level' fields. Both are set to 800.0mV. The 'Window Trigger' section shows a waveform with a shaded window. The 'Window Event' section has an 'Enter Window' button.</p>

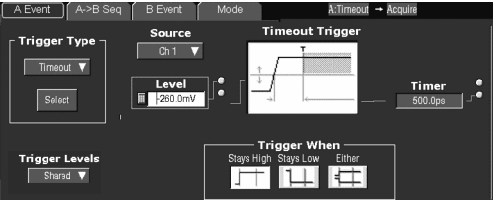
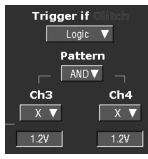
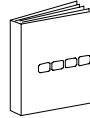


Overview	To trigger on a window threshold violation	Control elements and resources
<p><b>Qualify window trigger</b></p>	<p>6. To qualify the window trigger, select from these Trigger drop-down list combinations. Note that the Trigger controls change as you select different combinations of options.</p> <ul style="list-style-type: none"> <li>■ Enter Window and Occurs or Exits Window and Occurs: Trigger the instrument when the signal enters (or leaves) the window defined by the threshold levels.</li> <li>■ Inside limits and greater than or Outside limits and greater than: Trigger the instrument when the signal enters (or leaves) the window defined by the threshold levels for the time specified by Time.</li> <li>■ Window Event and Trigger if Window Logic: When the instrument detects a signal entering or leaving the window defined by the threshold levels, it checks the logic state of up to two other available channels and triggers only if their conditions are met. For more information on qualifying triggers, see <i>Logic Qualify a Trigger</i> on page 3-102.</li> </ul>	 
<p><b>Set mode and holdoff</b></p>	<p>7. Mode and holdoff can be set for all standard trigger types. Refer to <i>Select the trigger mode</i> on page 3-71 and <i>Set holdoff</i> on page 3-74. To learn more about trigger mode and holdoff, see <i>Trigger Modes</i> on page 3-65 and <i>Trigger Holdoff</i> on page 3-66.</p>	 <p>For mode and holdoff setup, see <i>Select the trigger mode</i> on page 3-71 and <i>Set holdoff</i> on page 3-74.</p>

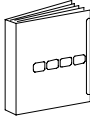
### Trigger Based on Pulse Timeout

When you select the type Timeout, the instrument will trigger if a pulse transition does not occur within a specified time limit. That is, the trigger will occur when, depending on the polarity that you select, the signal stays higher or stays lower than the trigger level for the timeout value. To set up for timeout triggering, do the following procedures.

Overview	Trigger based on pulse timeout	Control elements and resources
<p><b>Select timeout triggering</b></p>	<ol style="list-style-type: none"> <li>From the toolbar, touch Trig, select the A Event tab of the Trigger control window, and touch Select.</li> <li>Touch Timeout.</li> </ol>	
<p><b>Select the source</b></p>	<ol style="list-style-type: none"> <li>To specify which channel becomes the trigger source, touch Source, and select the source from the list.</li> </ol>	
<p><b>Set to trigger when</b></p>	<ol style="list-style-type: none"> <li>Touch Stays High, Stays Low, or Either from the Trigger When window: <ul style="list-style-type: none"> <li>Stays High causes a trigger if the signal stays higher than the trigger level for longer than the timeout value.</li> <li>Stays Low causes a trigger if the signal stays lower than the trigger level for longer than the timeout value.</li> <li>Either causes a trigger if the signal stays lower or stays higher than the trigger level for longer than the timeout value.</li> </ul> </li> </ol>	
<p><b>Set the timer</b></p>	<ol style="list-style-type: none"> <li>To set the timeout timer, touch Timer and use the multipurpose knob or keyboard to set the time.</li> </ol>	

Overview	Trigger based on pulse timeout (Cont.)	Control elements and resources
<p><b>Set the level</b></p>	<p><b>6.</b> To set the Level, touch Level and use the multipurpose knobs or keypad to set the timeout trigger level.</p> <p><i>Note.</i> You can set the level to a value appropriate to either TTL or ECL logic families. To do so, touch Level, and select the keypad; touch either TTL or ECL.</p>	
<p><b>Logic qualify the trigger</b></p>	<p><b>7.</b> To logic qualify the trigger, see <i>Logic Qualify a Trigger</i> on page 3-102.</p>	
<p><b>To set mode and holdoff</b></p>	<p><b>8.</b> Mode and holdoff can be set for all standard trigger types.</p>	 <p>See <i>To set holdoff</i> on page 3-74 and <i>To select the trigger mode</i> on page 3-71 for mode and holdoff setup. To learn more about trigger mode and holdoff, see <i>Trigger Modes</i> on page 3-65 and <i>Trigger Holdoff</i> on page 3-66.</p>

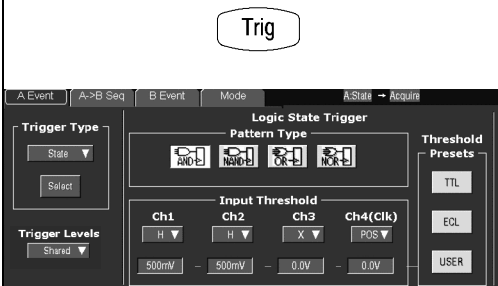
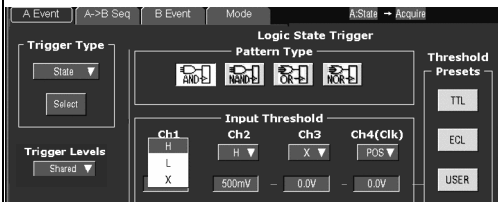
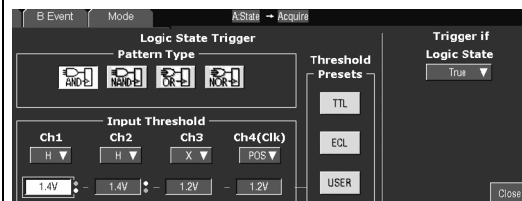
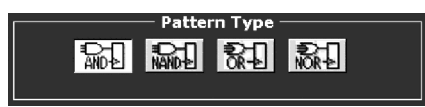
**Trigger on a Pattern** When you select the type Pattern, the instrument will trigger when the inputs to the logic function that you select cause the function to become TRUE (or at your option FALSE). To setup pattern trigger, do the following procedures.

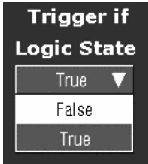
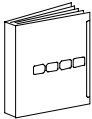
Overview	Trigger on a pattern	Control elements and resources
<p><b>Prerequisites</b></p>	<p><b>1.</b> The instrument must be installed and operating. The acquisition system should be set to Run, and the vertical and horizontal controls should be set appropriately for the signal to be acquired.</p>	 <p>See page 3-23 for acquisition setup</p>

Overview	Trigger on a pattern (Cont.)	Control elements and resources
<p><b>To Trigger on a pattern</b></p>	<ol style="list-style-type: none"> <li>From the toolbar, touch Trig, select the A Event tab of the Trigger control window, and touch Select.</li> <li>Touch Pattern.</li> </ol>	
<p><b>To define pattern inputs</b></p>	<ol style="list-style-type: none"> <li>To set the logic state for each of the input channels (Ch1, Ch2, . . .), touch each Input Threshold, and select either High (H), Low (L), or don't care (X) from the menu.</li> </ol>	
<p><b>To set thresholds</b></p>	<ol style="list-style-type: none"> <li>To set the logic threshold for each channel, select the channel threshold, and use the multipurpose knobs, keypad, or threshold presets to set each threshold.</li> </ol>	
<p><b>To define the logic</b></p>	<ol style="list-style-type: none"> <li>To choose the logic pattern type, you want applied to the input channels, touch an available type from the Pattern Type window. (See Table 3-5 on page 3-80 for definitions of the logic functions for both pattern and state triggers.)</li> </ol>	
<p><b>To set trigger when</b></p>	<ol style="list-style-type: none"> <li>To choose to trigger when the logic condition is met (goes TRUE) or when the logic condition is not met (goes FALSE), touch Trigger When Pattern, and select False, Less Than, More Than, or True from the list.                     <p>The list items More Than and Less Than are used to time qualify a pattern trigger. See the procedure <i>To define a time qualified pattern trigger</i> that follows for instructions.</p> </li> </ol>	

Overview	Trigger on a pattern (Cont.)	Control elements and resources
<p><b>To set mode and holdoff</b></p>	<p><b>8.</b> Mode and holdoff can be set for all standard trigger types.</p>	<div data-bbox="1192 365 1284 485" style="text-align: center;"> </div> <p>See <i>To set holdoff</i> on page 3-74 and <i>To select the trigger mode</i> on page 3-71 for mode and holdoff setup. To learn more about trigger mode and holdoff, see <i>Trigger Modes</i> on page 3-65 and <i>Trigger Holdoff</i> on page 3-66.</p>
<p><b>To define a time qualified pattern trigger</b></p>	<p>You can time qualify a pattern logic trigger. That is, you specify a time that the boolean logic function (AND, NAND, OR, or NOR) must be TRUE. To specify the time limit as well as the type of time qualification (More Than or Less Than the time limit specified) for a pattern trigger, do the following step:</p> <p><b>9.</b> Select Pattern More Than, and set the time using the multipurpose knob or keypad.</p> <p>When you select TRUE for Less Than and specify a time, the input conditions that you specify must drive the logic function high (TRUE) for less than the time you specify. Conversely, the TRUE for More Than item requires the boolean function to be TRUE for longer than the time that you specify.</p> <p>Note the position of the trigger indicator. Triggering occurs at the point that the instrument determines that the logic function that you specify is TRUE within the time that you specify. The instrument determines the trigger point in the following manner:</p> <ul style="list-style-type: none"> <li>■ It waits for the logic condition to become TRUE.</li> <li>■ It starts timing and waits for the logic function to become FALSE.</li> <li>■ It compares the times and, if the time TRUE is longer (for TRUE for more than) or shorter (for TRUE for less than), then it triggers a waveform display at the point the logic condition became FALSE. This time can be, and usually is, different from the time set.</li> </ul> <p>In the figure, the delay between the vertical bar cursors is the time the logic function is TRUE. Since this time is more (5.2 <math>\mu</math>s) than that set in the TRUE for More Than item (2 <math>\mu</math>s), the instrument issues the trigger at that point, not at the point at which it has been TRUE for 2 <math>\mu</math>s.</p>	<div data-bbox="1166 690 1305 835" style="text-align: center;"> </div> <p>Logic function (AND) becomes TRUE</p> <p>Logic function becomes FALSE and triggers acquisition</p> <div data-bbox="980 1024 1500 1409" style="text-align: center;"> </div> <p>Time logic function is TRUE</p> <p>Time Logic Function Must be TRUE = 2 <math>\mu</math>s</p>

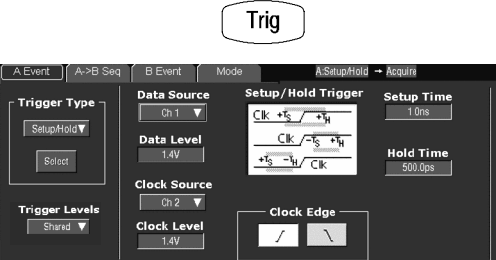
**To Trigger on a State** When you select the type State, the instrument uses channel 4 as a clock and triggers on a logic circuit made from the rest of the channels (page 3-80 describes how state triggers work). To use state triggering, do the following procedures.

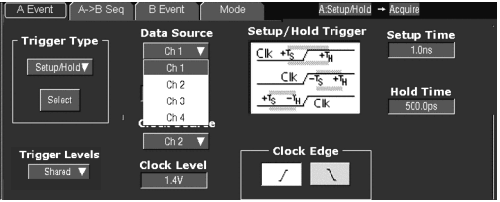
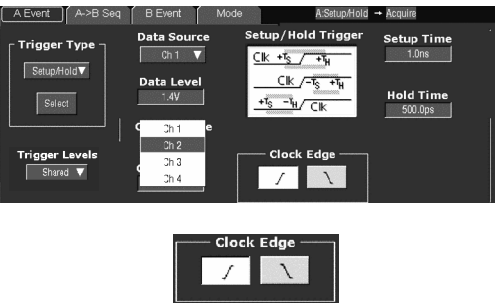
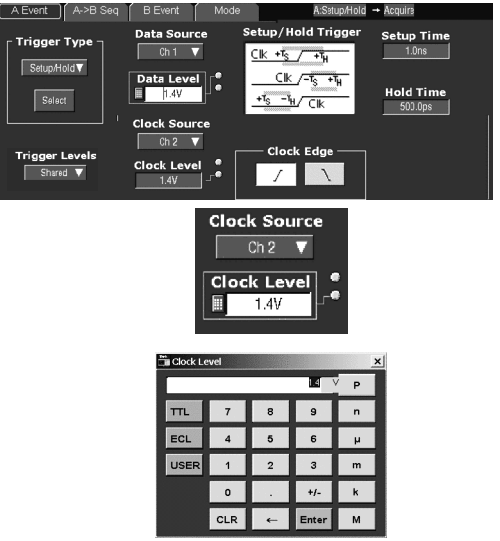
Overview	To trigger on a state	Control elements and resources
<p><b>Select state triggering</b></p>	<ol style="list-style-type: none"> <li>From the toolbar, touch Trig, select the A Event tab of the Trigger control window, and touch Select.</li> <li>Touch State.</li> </ol>	
<p><b>Define inputs</b></p>	<ol style="list-style-type: none"> <li>To set the logic state for each of the input channels (Ch1, Ch2, Ch3, and Ch4), touch each Input Threshold and select either High (H), Low (L), or don't care (X) from the menu. The choices for Ch4 are rising (POS) edge and falling (NEG) edge.</li> </ol>	
<p><b>Set thresholds</b></p>	<ol style="list-style-type: none"> <li>To set the logic threshold for each channel, select the channel threshold, and use the multipurpose knob or keypad to set each threshold.</li> </ol>	
<p><b>Define logic</b></p>	<ol style="list-style-type: none"> <li>To choose the logic pattern type you want applied to channels 1 through 3, touch an available type from the Pattern Type window. (See Table 3-5 on page 3-80 for definitions of the logic functions for both pattern and state triggers.)</li> </ol>	

Overview	To trigger on a state (Cont.)	Control elements and resources
<p><b>Set trigger when</b></p>	<p>6. To choose to trigger when the logic condition is met (goes TRUE) or when the logic condition is not met (goes FALSE), touch Trigger When Pattern and select False or True from the list.</p> <p>For the simplest operation, leave this control set to TRUE. Setting the control to FALSE complements the output of the chosen pattern function, for example, from AND to NAND or NOR to OR.</p>	
<p><b>To set mode and holdoff</b></p>	<p>7. Mode and holdoff can be set for all standard trigger types.</p>	 <p>See <i>To set holdoff</i> on page 3-74 and <i>To select the trigger mode</i> on page 3-71 for mode and holdoff setup. To learn more about trigger mode and holdoff, see the descriptions <i>Trigger Modes</i> on page 3-65 and <i>Trigger Holdoff</i> on page 3-66.</p>

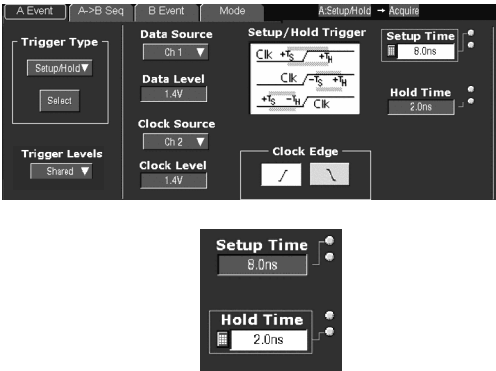
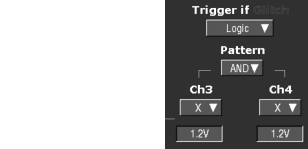
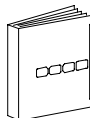
**To Trigger on Setup/ Hold Time Violations**

When you select the type Setup/Hold, the instrument uses one channel as a data channel (the factory default setting is Ch1), another channel as a clock channel (default is Ch2), and triggers if the data transitions within the setup or hold time of the clock. (*Setup/Hold Trigger* on page 3-80 describes how setup/hold triggers work.) To use setup and hold triggering, do the following procedures.

Overview	To trigger on setup/hold time violations	Control elements and resources
<p><b>Select setup/ hold triggering</b></p>	<ol style="list-style-type: none"> <li>From the toolbar, touch Trig, select the A Event tab of the Trigger control window, and touch Select.</li> <li>Touch Setup/Hold.</li> </ol>	

Overview	To trigger on setup/hold time violations (Cont.)	Control elements and resources
<p><b>Define the data source</b></p>	<p>3. To select the channel that is to contain the data signal, touch Data Source, and select the source from the list.</p> <p><b>Note.</b> Do not select the same channel for both the data and clock sources.</p>	
<p><b>Define the clock source and edge</b></p>	<p>4. To select the channel that is to contain the clock signal and the edge to use to clock, touch Clock Source, and select the source from the list.</p> <p>Do not select the same channel for both the data and clock sources.</p> <p>5. To select the edge to use to clock, select either Pos or Neg from the Clock Edge window.</p>	
<p><b>Set the data and clock levels</b></p>	<p>To set the transition levels that the clock and data must cross to be recognized by the instrument:</p> <p>6. Touch Data Level and use the multipurpose knobs or keypad to set the data level.</p> <p>7. Touch Clock Level and use the multipurpose knobs or keypad to set the clock level.</p> <p><b>Note.</b> You can set the levels to a value appropriate to either TTL or ECL logic families. To do so, touch either the Data Level or Clock Level, and select the keypad; touch either TTL or ECL.</p> <p>The instrument uses the clock level that you set to determine when a clock edge occurs. The instrument uses the point the clock crosses the clock level as the reference point from which it measures setup and hold time settings.</p>	



Overview	To trigger on setup/hold time violations (Cont.)	Control elements and resources
<p><b>Set the setup and hold times</b></p>	<p>To set the setup time and the hold time relative to the clock:</p> <ol style="list-style-type: none"> <li>8. Touch Setup Time and use the multipurpose knobs or keypad to set the setup time.</li> <li>9. Touch Hold Time, and use the multipurpose knobs or keypad to set the hold time. See Figure 3-27 on page 3-102.</li> </ol> <p>Positive setup time always leads the clock edge; positive hold time always follows the clocking edge. Setup time always leads the hold time by at least 2 ns (<math>T_S + T_H \geq 2 \text{ ns}</math>).</p> <p><b>Note.</b> Attempting to set either time to reduce the 2 ns limit adjusts the other time to maintain the limit.</p> <p>In most cases, you will enter positive values for both setup and hold time. Positive values set the instrument to trigger if the data source is still settling inside the setup time before the clock or if it switches inside the hold time after the clock. You can skew this “setup/hold violation zone” that the setup and hold times form by entering negative values. See Figure 3-26 on page 3-82.</p>	 <p>The screenshot shows the 'Setup/ Hold Trigger' control panel. It includes sections for 'Trigger Type' (Setup/Hold), 'Data Source' (Ch 1), 'Data Level' (1.4V), 'Clock Source' (Ch 2), and 'Clock Level' (1.4V). The 'Setup/ Hold Trigger' section has a diagram showing clock and data signals with setup and hold time windows. Below this, there are two separate control panels: 'Setup Time' set to 8.0ns and 'Hold Time' set to 2.0ns.</p>
<p><b>Logic qualify the trigger</b></p>	<ol style="list-style-type: none"> <li>10. To logic qualify the trigger, see <i>Logic Qualify a Trigger</i> on page 3-102.</li> </ol>	 <p>The screenshot shows the 'Trigger if' control panel. It has a 'Logic' dropdown menu and a 'Pattern' dropdown menu set to 'AND'. Below this, there are two channels, 'Ch3' and 'Ch4', each with a logic input 'X' and a level setting of '1.2V'.</p>
<p><b>To set mode and holdoff</b></p>	<ol style="list-style-type: none"> <li>11. Mode and holdoff can be set for all standard trigger types.</li> </ol>	 <p>See <i>To set holdoff</i> on page 3-74 and <i>To select the trigger mode</i> on page 3-71 for mode and holdoff setup. To learn more about trigger mode and holdoff, see <i>Trigger Modes</i> on page 3-65 and <i>Trigger Holdoff</i> on page 3-66.</p>

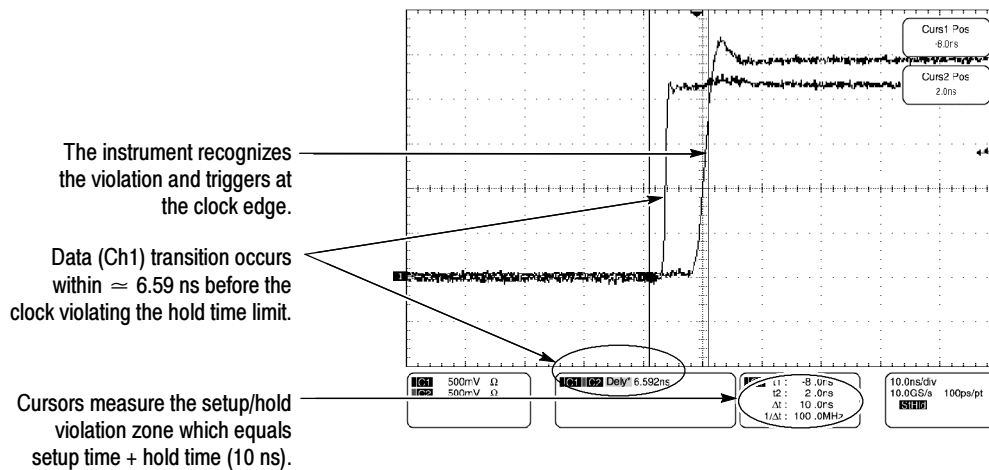
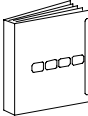
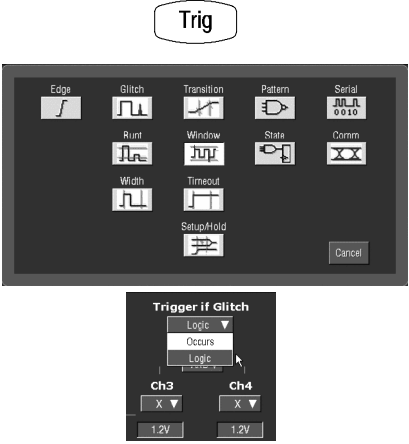
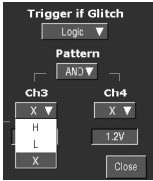
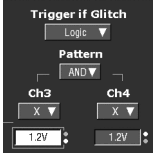
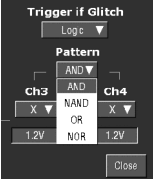
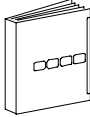


Figure 3-27: Triggering on a Setup/Hold time violation

**Logic Qualify a Trigger**

When you logic qualify a trigger type, the instrument will trigger when the inputs to the logic function that you select cause the function to become TRUE (or at your option FALSE). To logic qualify a trigger, do the following procedures.

Overview	Trigger on a pattern	Control elements and resources
<p><b>Prerequisites</b></p>	<ol style="list-style-type: none"> <li>The instrument must be installed and operating. The acquisition system should be set to Run, and the vertical and horizontal controls should be set appropriately for the signal to be acquired.</li> </ol>	 <p>See page 3-23 for acquisition setup</p>
<p><b>To Trigger on a pattern</b></p>	<ol style="list-style-type: none"> <li>From the toolbar, touch Trig, select the A Event tab of the Trigger control window, and touch Select.</li> <li>Touch Glitch, Width, Runt, Timeout, Setup and Hold, Transition, or the Window trigger type.</li> <li>From the Trigger if drop-down menu, select Logic.</li> </ol>	

Overview	Trigger on a pattern (Cont.)	Control elements and resources
<p><b>To define pattern inputs</b></p>	<p>5. To set the logic state for each of the input channels (Ch1, Ch2, . . .), touch each Input Threshold, and select either High (H), Low (L), or don't care (X) from the menu. The instrument checks the logic state of up to two other available channels and triggers only if their conditions are met. Each channel can have a value of high (H), low (L), or "don't care" (X). A value is considered high if the channel input voltage is greater than the specified threshold voltage; a value is considered low if the channel input voltage is less than the specified threshold voltage. Use the "don't care" selection for any channels that will not be used as part of the pattern.</p>	
<p><b>To set thresholds</b></p>	<p>6. To set the logic threshold for each channel, select the channel threshold, and use the multipurpose knob or keypad to set each threshold.</p>	
<p><b>To define the logic</b></p>	<p>7. To choose the logic pattern type, you want applied to the input channels, touch an available type from the Pattern type window. (See Table 3-5 on page 3-80 for definitions of the logic functions.)</p>	
<p><b>For further assistance</b></p>	<p>8. Touch the Help button while in the Trigger setup window to access a context-sensitive overview of the Logic controls and their set up.</p>	 <p>See page 3-263 for information on online assistance</p>

## Sequential Triggering

In applications that involve two or more signals, you may be able to use sequential triggering to capture more complex events. Sequential triggering uses the A (Main) trigger to arm the trigger system, and then uses the B (Delayed) trigger to trigger the instrument if a specific condition is met. You can choose one of two trigger conditions:

- **Trig After Time:** After the A trigger arms the trigger system, the instrument triggers on the next B-trigger event that occurs after the Trigger Delay Time.

You can set the trigger delay time with the keypad or the multipurpose knobs.

- **Trigger on  $n^{\text{th}}$  Event:** After the A trigger arms the trigger system, the instrument triggers on the  $n^{\text{th}}$  B event. You can set the number of B events with the keypad or the multipurpose knobs.

---

**NOTE.** *The traditional delayed trigger mode called “Runs After” is served by Horizontal Delay. You can use horizontal delay to delay acquisition from any trigger event, whether from the A (Main) trigger alone or from a sequential trigger that uses both the A (Main) and B (Delayed) triggers. See Triggering with Horizontal Delay On on page 3-106 for more information.*

---

### Using Sequential Triggering

Read the following topics; they provide details that can help prevent false steps in setting up to trigger on your waveforms.

**Trigger Sources.** In most cases, it makes sense to set separate trigger sources for the A (Main) and B (Delayed) triggers. Line is not available as a source for the B trigger.

**Trigger Types.** When using sequential triggering, both the A trigger and B trigger systems can be set independently to any one the following types: Edge, Glitch, Width, Timeout, Runt, Transition, Window, Setup/Hold, Pattern, or State. Except for Pattern and State, all of these types can be logic qualified. Comm and Serial trigger cannot be logic qualified, nor are they available with B triggers.

**Triggering with Horizontal Delay Off.** Figure 3-28 compares the sequential trigger choices A-Only, Trig After Time, and Trig on  $n^{\text{th}}$  Event when horizontal delay is off. Each illustration shows where pretrigger and posttrigger data is acquired relative to the trigger event.

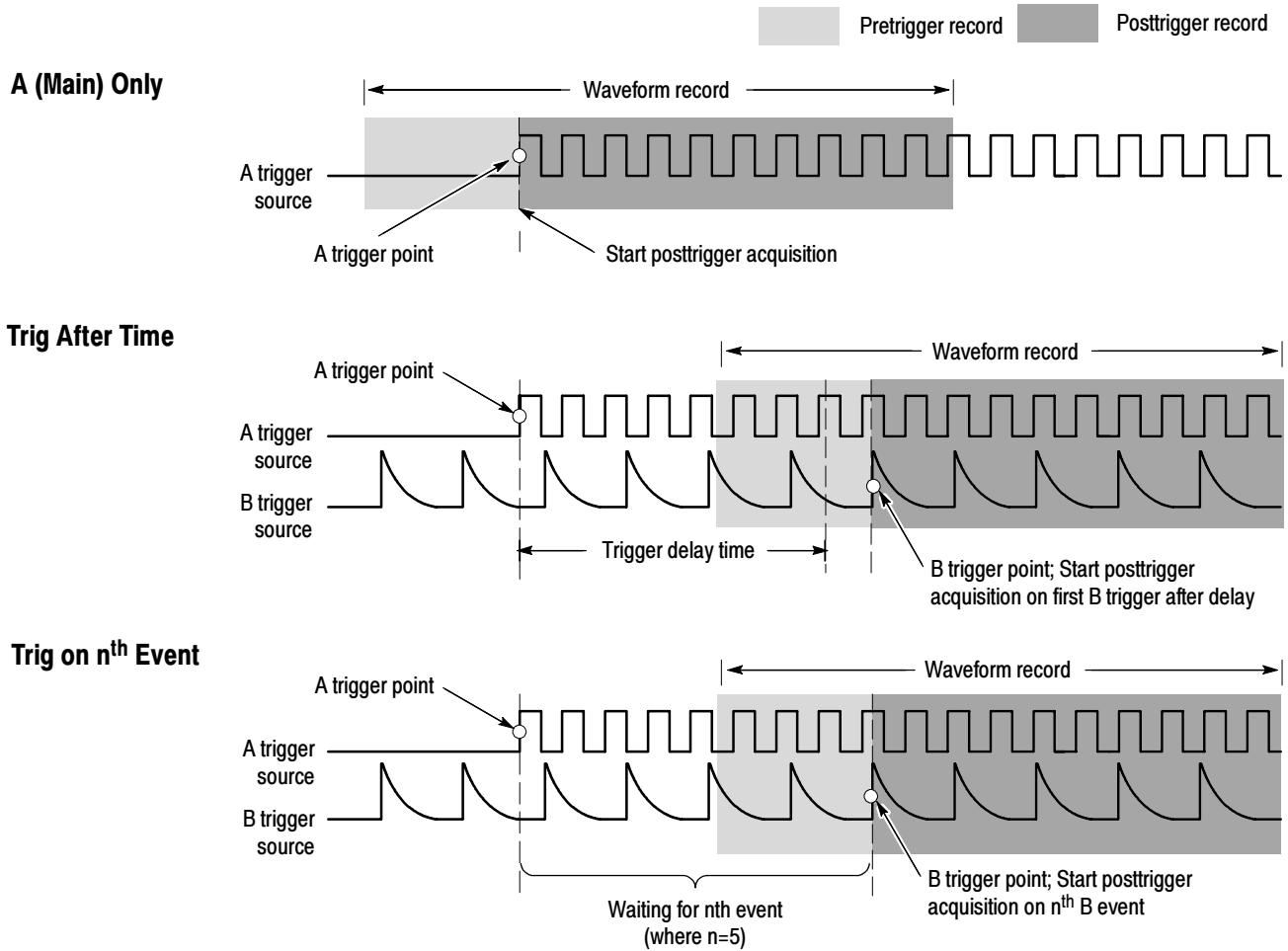


Figure 3-28: Triggering with Horizontal Delay off

**Triggering with Horizontal Delay On.** You can use horizontal delay when you want to acquire a waveform record that is separated from the trigger event by a significant interval of time. The horizontal delay function can be used with any trigger setup. You can turn horizontal delay on and off from the front panel, the Horizontal/Acquisition control window, and many of the Trigger control windows. Figure 3-29 compares the sequential trigger choices A-Only, Trig After Time, and Trig on  $n^{\text{th}}$  Event when horizontal delay is on. Each illustration shows where pretrigger and posttrigger data is acquired relative to the trigger event.

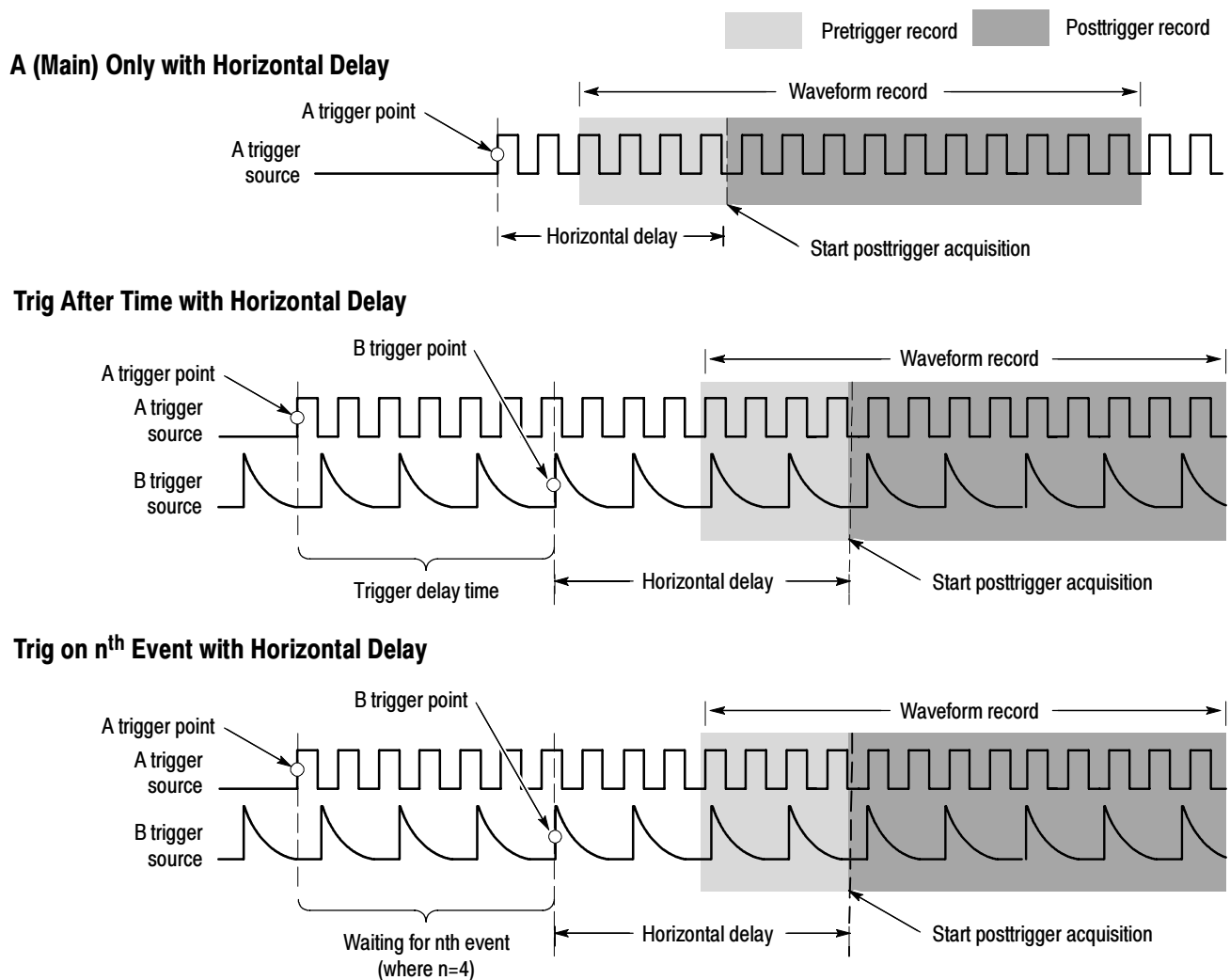
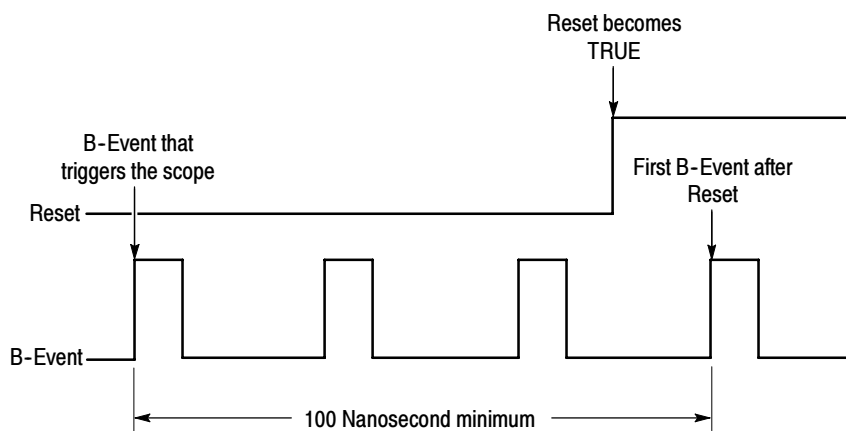


Figure 3-29: Triggering with Horizontal Delay on

**Triggering with Reset.** You can specify a condition that, if it occurs before the B trigger event, resets the trigger system. When the reset event occurs, the trigger system stops waiting for the B event, and returns to waiting for an A event. You can specify a Reset when the B trigger event does not occur:

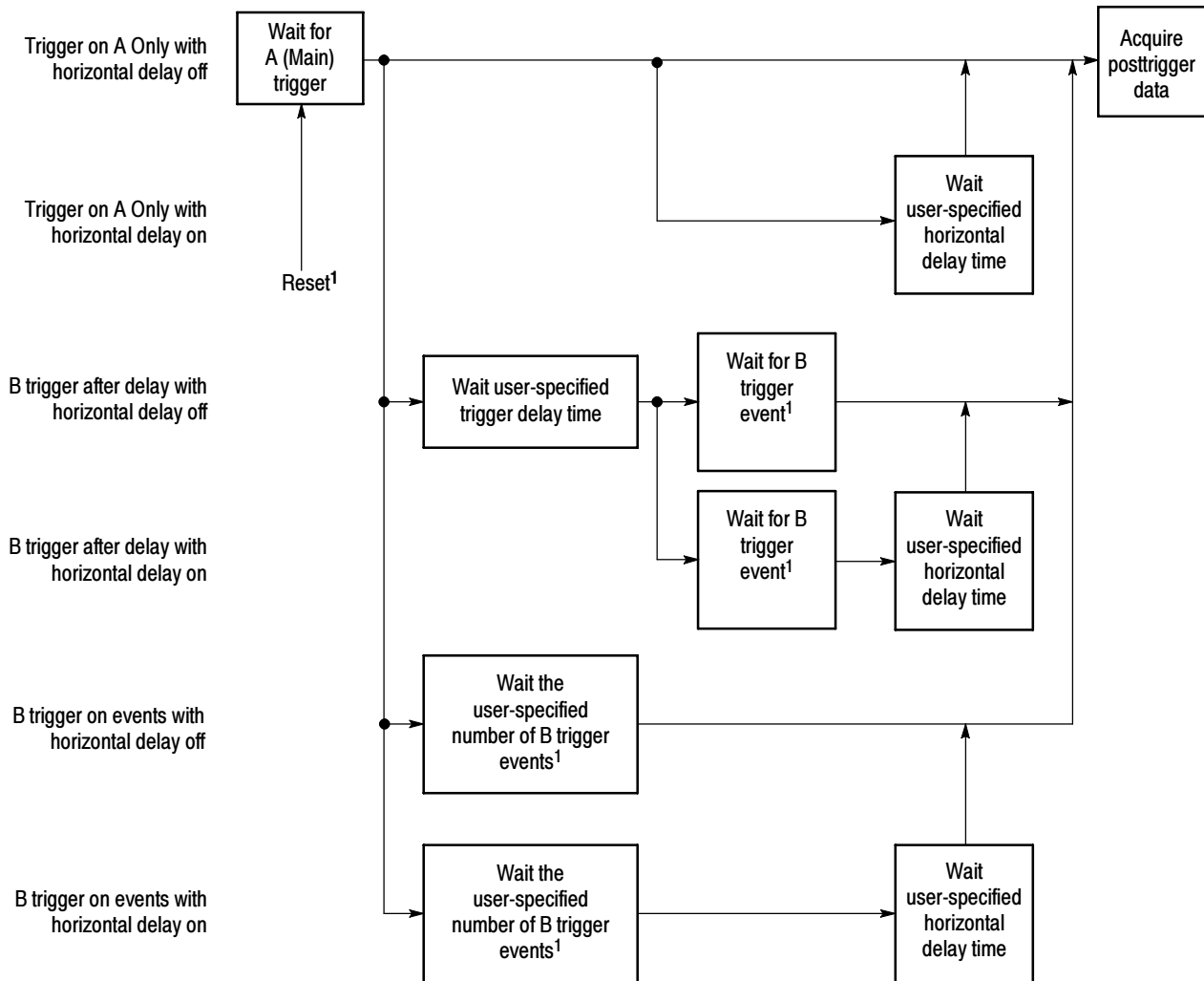
- before a **timeout** that you specify
- before an input signal that you specify enters a **state** that you specify
- before an input signal that you specify **transitions** in a direction that you specify

**NOTE.** A minimum of 100 ns must exist between the B Event that triggers the oscilloscope and any B-Event occurring after Reset becomes TRUE. Since any number of intervening B-Events may occur, the 100 ns limit is usually not a problem, except when the B-Event that triggers the oscilloscope immediately precedes the Reset Event.



**Figure 3-30: Reset trigger limitation**

The flow diagram in Figure 3-31 summarizes all combinations of triggering and horizontal delay.



<sup>1</sup>If Reset is set, waiting on B event(s) only occurs until Reset condition you specify is satisfied. At that point, the Trigger system resets, and the sequence restarts with waiting for the A Event.

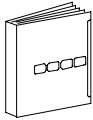
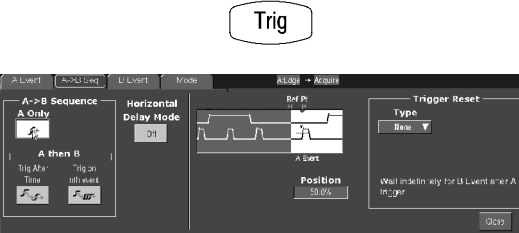
**Figure 3-31: Trigger and Horizontal Delay summary**

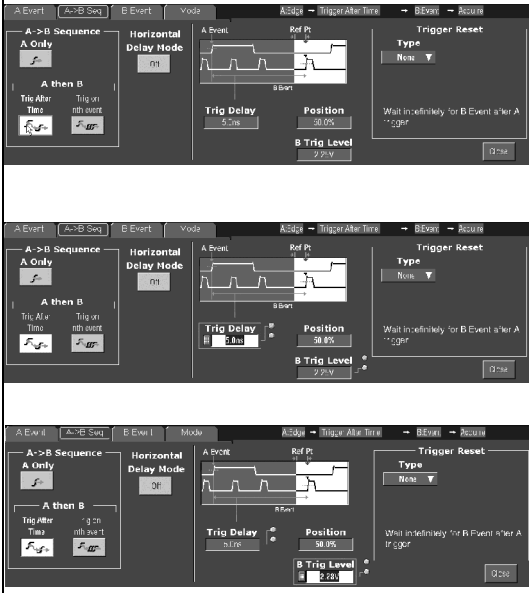
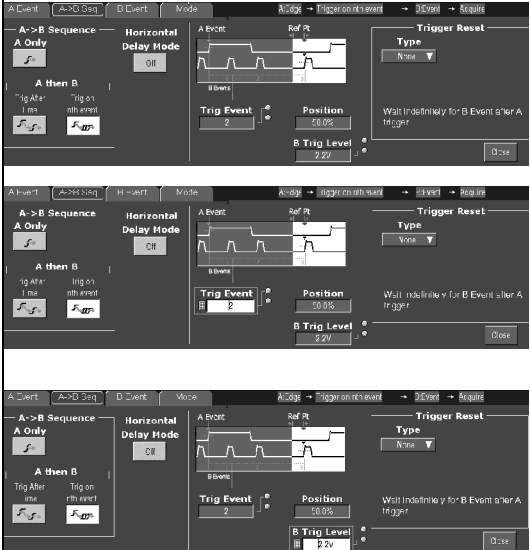


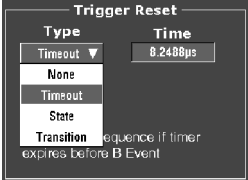
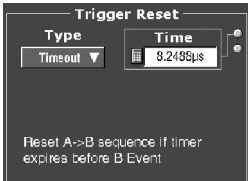
**Sequential Trigger Reset.** You can choose three methods to reset sequential triggers:

- **None** does not reset sequential triggers. Triggers function as previously explained
- **Timeout** resets sequential triggers if the time you set expires before the B trigger event occurs
- **Transition** resets sequential triggers if a signal transition you select occurs before the B trigger event occurs
- **State** resets sequential triggers if a signal state you select occurs before the B trigger event occurs

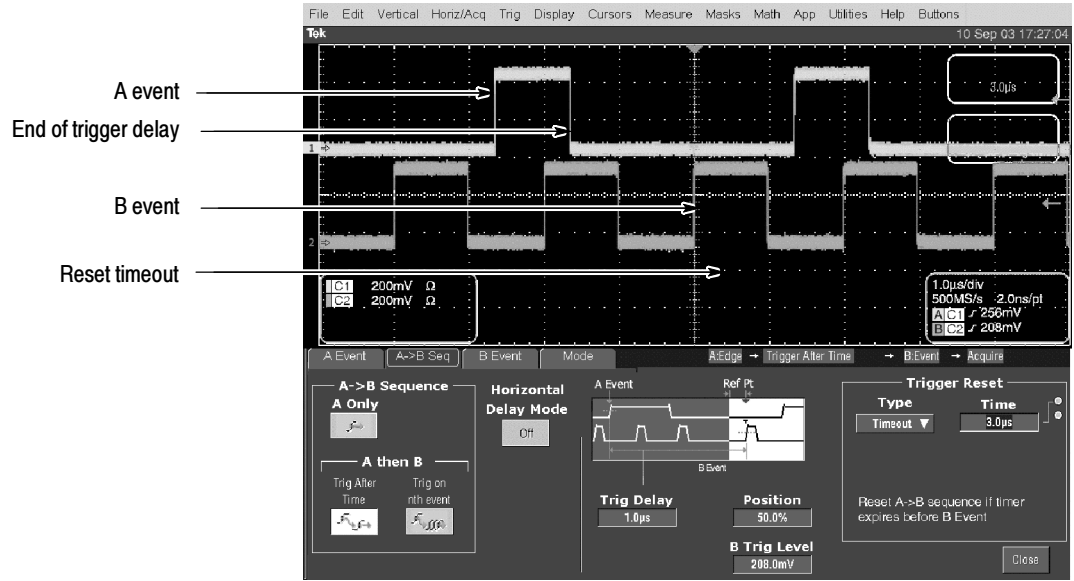
**To Trigger on a Sequence** Use the procedure that follows when setting up the instrument to trigger on a sequence. For more information, display online help while performing the procedure.

Overview	To trigger on a sequence	Control elements and resources
<p><b>Prerequisites</b></p>	<ol style="list-style-type: none"> <li>The instrument must be installed with a signal connected to an input channel. Acquisition system should be set to Run, and the vertical and horizontal controls should be set appropriately for the signal to be acquired.</li> </ol>	 <p>See page 3-23 for acquisition setup</p>
<p><b>To trigger on a (main) only</b></p>	<ol style="list-style-type: none"> <li>From the toolbar, touch Trig and select the A-&gt;B Seq tab of the Trigger control window.</li> <li>Touch A Only to turn off sequential triggering.</li> </ol>	

Overview	To trigger on a sequence (Cont.)	Control elements and resources
<p><b>To trigger on B after time</b></p>	<ol style="list-style-type: none"> <li>To set the time base to run after an A trigger, a trigger delay, and a B trigger, from the toolbar, touch Trig, and select the A-&gt;B Seq tab of the Trigger control window</li> <li>Touch Trig After Time.</li> <li>To set the trigger delay, touch Trig Delay, and use the multipurpose knob or keypad to set the time.</li> <li>To set the B trigger level, touch B Trig Level, and use the multipurpose knob or keypad to set the level.</li> <li>If using any other trigger type, see <i>To set up B triggering</i> on page 3-115.</li> </ol>	<p style="text-align: center;">Trig</p> 
<p><b>To trigger on B events</b></p>	<ol style="list-style-type: none"> <li>To set the time base to trigger after an A trigger and a specified number of B trigger events, from the toolbar, touch Trig, and select the A-&gt;B Seq tab of the Trigger control window.</li> <li>Touch A Then B Trig on nth Event.</li> <li>To set the number of B trigger events, touch Trig Event, and use the multipurpose knob, keypad, or up and down arrows to set the number of events.</li> <li>To set the B trigger level, touch B Trig Level, and use the multipurpose knob or keypad to set the level.</li> <li>If using any other trigger type, see <i>To set up B triggering</i> on page 3-115.</li> </ol>	<p style="text-align: center;">Trig</p> 

Overview	To trigger on a sequence (Cont.)	Control elements and resources
<p><b>To reset sequential triggers</b></p>	<p>1. To reset sequential triggers, select the Trigger Reset Type:</p> <ul style="list-style-type: none"> <li>■ <b>None</b> to sequential trigger without using Trigger Reset</li> <li>■ <b>Timeout</b> to reset sequential triggers if the time you set occurs before the B trigger</li> <li>■ <b>Transition</b> to reset sequential triggers if the transition event you specify occurs before the B trigger</li> <li>■ <b>State</b> to reset sequential triggers if the state event you specify occurs before the specified number of B trigger events. Triggers remain reset as long as the state is true</li> </ul>	
<p><b>To reset sequential triggers (Cont.)</b></p>	<p>2. If the Timeout Type of Trigger Reset is selected, touch Time and use the multipurpose knobs or keypad to set the reset time. The reset time is the time from the A trigger that you want to reset the sequential triggers if the B trigger has not occurred. If the reset occurs, the instrument does not trigger. If the reset occurs, the instrument starts over looking for the A trigger.</p> <p>In the example, the edge trigger A event occurs on the rising edge of the pulse on Ch1. The trigger delay expires 1 <math>\mu</math>s after the rising edge of the pulse on Ch1. Ch2 provides the B events. The reset event window starts with the A event and ends 3 <math>\mu</math>s later.</p> <p>If the trigger reset timeout were reduced to 2 <math>\mu</math>s, the instrument would not trigger because the timeout would occur before the next B event on Ch2.</p>	

Overview	To trigger on a sequence (Cont.)	Control elements and resources
----------	----------------------------------	--------------------------------



**To reset sequential triggers (Cont.)**

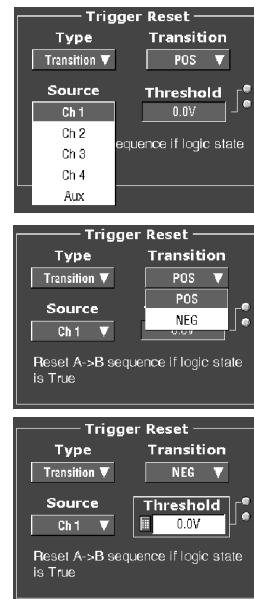
3. If the Transition Type of Trigger Reset is selected, touch Source and select the source of the transition from the list.

Touch Slope and select the slope of the transition from the list.

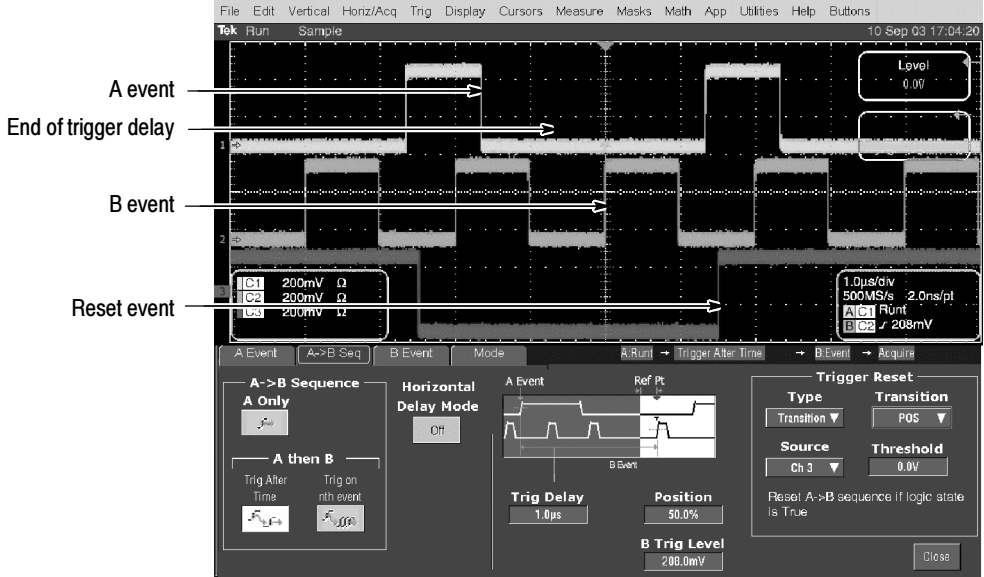
Touch Level and use the multipurpose knobs or keypad to set the level that the source must pass through to reset the triggers.

In the example, the runt trigger A event occurs on the falling edge of the pulse on Ch1. The trigger delay expires 1 µs after the falling edge of the pulse on Ch1. Ch2 provides the B events, and Ch3 provides the reset event. The reset event window is from the A event to the reset event at the rising edge of Ch3.

If the trigger delay is increased from 1 µs to 2 µs, the instrument will not trigger because the Ch3 reset event would occur before the next Ch2 event.



Overview	To trigger on a sequence (Cont.)	Control elements and resources
----------	----------------------------------	--------------------------------



**To reset sequential triggers (Cont.)**

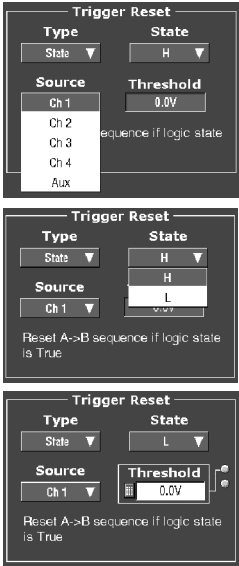
4. If the State Type of Trigger Reset is selected, touch Source and select the source of the state from the list.

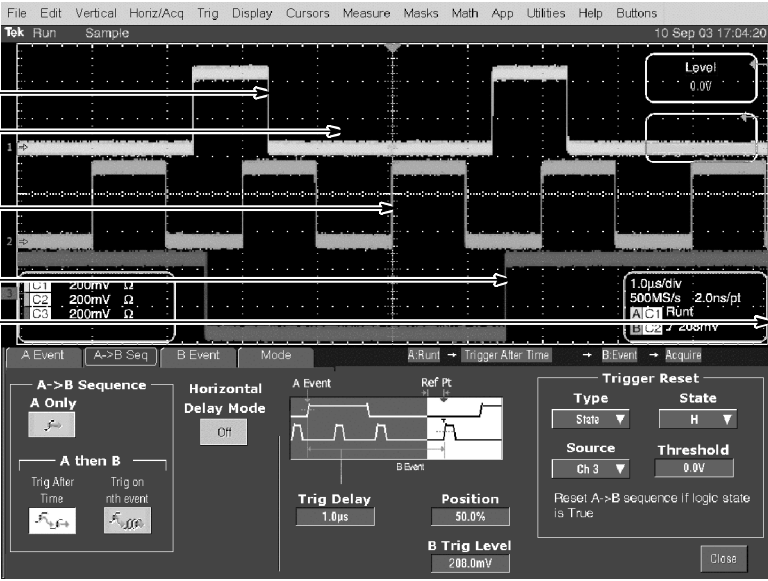
Touch State and select the True level of the event from the list.

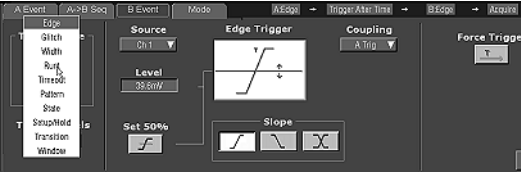
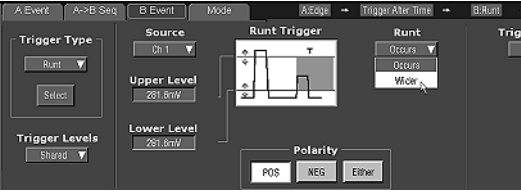
Touch Threshold and use the multipurpose knobs or keypad to set the threshold that the source must be in to reset the triggers.


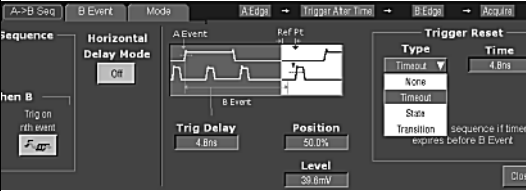
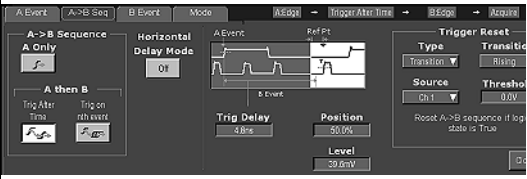

In the example, the runt trigger A event occurs on the falling edge of the pulse on Ch1. The trigger delay expires 1 µs after the falling edge of the pulse on Ch1. Ch2 provides the B events, and Ch3 provides the reset event. The reset event window is from the A event to the reset event at the rising edge of Ch3. Triggers remain reset as long as the reset event is true.

If the trigger delay is increased from 1 µs to 2 µs, the instrument will not trigger because the Ch3 reset event would occur before the next Ch2 event.



Overview	To trigger on a sequence (Cont.)	Control elements and resources
	<p>A event</p> <p>End of trigger delay</p> <p>B event</p> <p>Reset event start</p> <p>Reset event end</p>	 <p>The screenshot shows a Tektronix oscilloscope interface. The top panel displays three waveforms: a square wave labeled 'A event', a square wave labeled 'B event', and a signal labeled 'Reset'. The 'Reset' signal is shown to be active during the 'A event' and 'B event' sequences. The bottom panel shows the configuration menu for 'A-&gt;B Sequence'. The 'A Only' mode is selected. The 'Horizontal Delay Mode' is set to 'Off'. The 'Trig Delay' is set to 1.0µs, and the 'Position' is set to 50.0%. The 'B Trig Level' is set to 200.0mV. The 'Trigger Reset' section shows 'Type' and 'State' settings, with a note: 'Reset A-&gt;B sequence if logic state is True.' The 'Level' is set to 0.0V.</p>

Overview	To trigger on a sequence (Cont.)	Control elements and resources
<p><b>To set up B triggering</b></p>	<ol style="list-style-type: none"> <li>To set the B Event trigger, from the toolbar, touch Trig, and select the B Event tab of the Trigger control window.</li> <li>To specify the trigger type, select it from the Trigger Type list. The Trigger control window will display controls for the trigger type you select.</li> <li>To set the trigger controls for the type you selected, make appropriate settings in the controls that displayed from step 2. For assistance, click Help from the toolbar to display help on the controls.</li> </ol> <p>You can also read about setting up the various trigger types in the procedures that follow. Just remember to select the B Event tab, not the A, when setting up B trigger types:</p> <ul style="list-style-type: none"> <li>To Trigger on a Glitch on page 3-83</li> <li>To Trigger on a Runt Pulse on page 3-85</li> <li>Trigger Based on Pulse Width on page 3-87</li> <li>To Trigger Based on Transition Time on page 3-89</li> <li>Triggering on a Window on page 3-92</li> <li>Trigger Based on Pulse Timeout on page 3-94</li> <li>Trigger on a Pattern on page 3-95</li> <li>To Trigger on a State on page 3-98</li> <li>To Trigger on Setup/ Hold Time Violations on page 3-99</li> </ul>	<p style="text-align: center;">Trig</p>  

Overview	To trigger on a sequence (Cont.)	Control elements and resources
<p><b>To Reset if no B Trigger</b></p>	<ol style="list-style-type: none"> <li>To set the trigger system to reset the sequence if a B trigger does not occur within certain constrains, from the toolbar, touch Trig, and select the A-&gt;B Seq tab of the Trigger control window.</li> <li>Set the Trigger Reset Type in the pulldown menu. The controls that are appropriate to your selection appear. <i>Note. Selections for Reset vary with the B trigger type you select.</i></li> <li>Set the time, or specify the state or transition, that forces reset. To not reset, set to None.</li> </ol>	  
<p><b>For further assistance</b></p>	<ol style="list-style-type: none"> <li>Touch the Help button in the Trigger control window to access the online assistance specific to triggering commands.</li> </ol>	 <p>See page 3-263 for information on online assistance</p>



## Comm Triggering

The instrument can trigger on communication signals (optional on TDS7000B Series). For detailed information on using comm triggering to trigger on your communications signals, see the *CSA7000B & TDS7000B Series Options SM Serial Mask Testing and Option ST Serial Triggering User Manual*.

## Serial Pattern Triggering

In applications that involve signals with serial data patterns, you may be able to use serial pattern triggering (optional on TDS7000B Series) to capture more complex events. Serial trigger provides a direct means to analyze pattern dependent issues, even on a single-shot basis. Acquisition of low power signals can be enhanced by combining serial trigger and signal averaging to reduce random noise. You can specify patterns with up to 64 bits, including don't-care bits. The serial trigger system can be clocked from an external source or from internal clock recovery. Serial pattern trigger operates on NRZ-encoded signals at data rates up to 1.25 Gb/s.

For detailed information on using serial pattern triggering to trigger on your serial pattern data signals see the *CSA7000B & TDS7000B Series Options SM Serial Mask Testing and Option ST Serial Triggering User Manual*.

---

**NOTE.** *The instrument will attempt to acquire lock once. If the input data is disrupted, removed, or heavily distorted, the instrument may not acquire lock or may lose lock. If the recovered clock is not locked to the incoming data, the waveform display will not be stable. Once the input data is available, press the PUSH SET TO 50% knob to force the instrument to reacquire lock.*

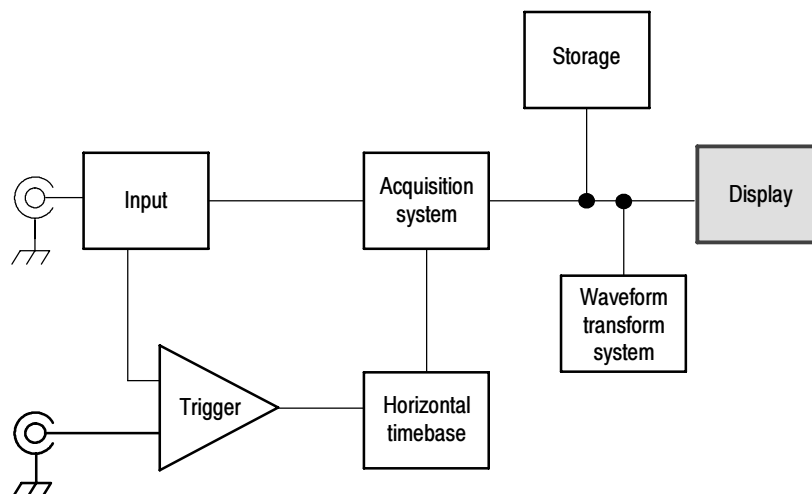
---



# Displaying Waveforms

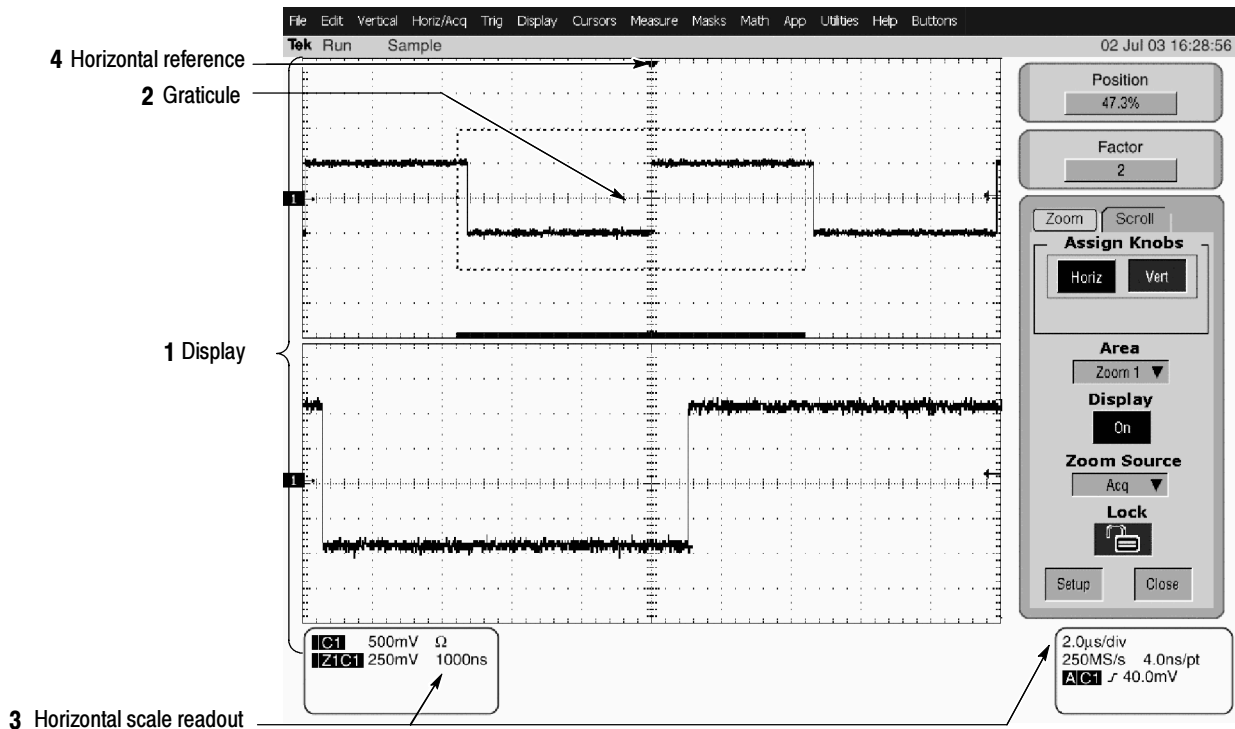
This instrument includes a flexible, customizable display that you can control to display the waveforms that you acquire. This section presents the following topics:

- *Using the Waveform Display*
- *Setting MultiView Zoom Controls*
- *Customizing the Display*



## Using the Waveform Display

The waveform shown below is displayed as part of the User Interface (UI) application. The UI application takes up the entire screen of the instrument, and the graticule takes up most of the UI application. Some terms that are useful in discussing the display follow.



**Figure 3- 32: Display elements**

(1) Display area. The area where the waveforms appear. The display comprises the timebase and graticules, the waveforms, histograms, and some readouts.

(2) Graticule. A grid marking the display area. When MultiView Zoom is on, the upper graticule displays unmagnified waveforms, and the lower graticule displays magnified waveforms.

(3) Horizontal-scale readout. Displays the scale or magnified and unmagnified waveforms.

(4) Horizontal reference. A control that you can position to set the point around which channel waveforms expand and contract horizontally on screen as you change the Horizontal Scale control or push the MultiView Zoom button. The reference is also the trigger point when the horizontal delay is 0%.

Touch Screen (not shown). A feature that lets you touch on-screen controls or touch and drag screen objects to operate the instrument.

Some features of the display follow:

- Flexible Display Control. Front-panel knobs and buttons support quick access to the most often used adjustments — those that display, position, and scale waveforms. Mouse, keyboard, and touch-screen interfaces support

complete setup of all the display parameters. Anything you can do with the mouse, you can do with the touch screen.

- **Fast Access to MultiView Zoom.** Waveform inspection has never been easier. Just touch and drag a box around the feature of interest and select zoom from the choices offered, and the feature of interest displays zoomed in the magnified graticule. Both vertical and horizontal zoom functions are available. Zoomed waveforms can be aligned, locked, and automatically scrolled.
- **Acquisition Preview.** When the next acquisition is delayed due to slow triggers or long acquisition duration, acquisition preview attempts to show what the next acquisition will look like. Acquisition preview does not recalculate math waveforms or represent changes in trigger levels, trigger modes, or different acquisition modes. Acquisition preview waveforms cannot be saved as data.

### Using the Display

Read the following topics; they provide the details that can help you set up the instrument display so that it best supports your data-analysis tasks.

**Waveform Display.** In general, the method of displaying a waveform is to define the waveform, if necessary (math and reference waveforms), and then turn it on. Table 3-6 summarizes this process as it applies to the different waveforms.

**Table 3-6: Defining and displaying waveforms**

Waveform	To define:	To turn on:
Channel: Ch1 - Ch4	Channels are predefined	Push the Vertical CH button to toggle the channel on or off.
Reference: Ref1 - Ref4	Define an active reference waveform by: <ul style="list-style-type: none"> <li>■ Saving a channel, reference, or math waveform to one of locations Ref1 - Ref4.</li> <li>■ Recalling a waveform previously saved to a file into one of locations Ref1 - Ref4.</li> </ul> Both of these operations can be performed from the File menu.	From the Refs setup control window, touch Display to toggle display of the selected reference on or off.
Math: Math1 - Math4	Define a math waveform by creating a math waveform using existing sources (channel, math, and reference waveforms, and measurements).  This operation can be performed by touching the Math button and then selecting Define/Edit Expression.	When defining a math waveform, you turn it on in the Math setup control window.

**Operations on Waveforms.** In general, the method of adjusting (vertically scaling, offsetting, positioning, and so on) is from the front panel: adjust a waveform using its Vertical Scale and Position knobs.

Table 3-7 summarizes operations you can perform for the three waveform types.

**Table 3-7: Operations performed based on the waveform type**

Control function	Waveform supports			Operating notes
	Ch	Ref <sup>1</sup>	Math	
Vertical Scale	Yes	Yes	Yes	Math and reference waveforms are scaled and positioned from their setup control windows.
Vertical Position	Yes	Yes	Yes	
Vertical Offset	Yes	No	No	
Horizontal Scale	Yes	Yes	Yes	Waveforms are adjusted according to the Zoom Lock setting.
Horizontal Position	Yes	Yes	Yes	
Horizontal Record Length	Yes	No	No	
Quick Horizontal and Vertical Scale Adjust (Zoom)	Yes	Yes	Yes	Dragging a box around a portion of the selected waveform adjusts horizontal scale to fill the zoom graticule with the boxed portion (see <i>Setting MultiView Zoom Controls</i> on page 3-125).

<sup>1</sup> **Pixel-map reference waveforms, those saved while in fast acquisitions mode or waveform database mode, cannot be repositioned or rescaled.**

**Graticules.** Select a graticule size from the Graticule Size drop-down list in the Zoom Setup window to change the size of the acquisition waveform and zoomed waveform windows. The 50-50 selection allocates half of the available display for the zoomed graticule and half of the available display for the acquisition window. The 80-20 selection allocates 80% of the available display for the zoomed graticule and 20% for the acquisition window. Touch 100 to use the entire display for the zoomed graticule.

Figure 3-32 on page 3-120 shows the elements of the graticules; the elements are the same for each graticule displayed.

**Operations on the Timebase.** In general, the method of adjusting (horizontally scaling, setting resolution/record length, positioning, and so on) is from the front panel: adjust the timebase using the Horizontal Scale, Resolution, and Position knobs. Only channel waveforms can be set directly.

Table 3-7 shows how horizontal operations relate to the waveform types; the key points follow:

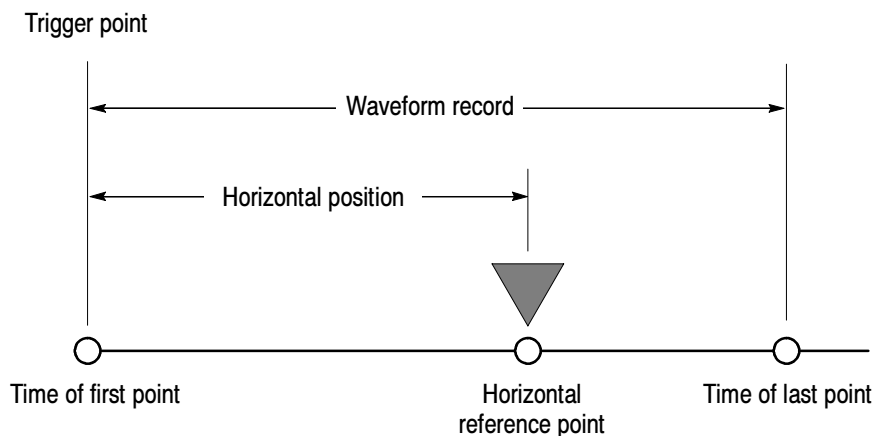
- The instrument displays a reference waveform with horizontal settings in effect at the time it was saved. You cannot adjust these settings. See *Saving and Recalling Waveforms* on page 3-227 for more information on reference waveforms.

- The instrument displays a math waveform with the horizontal settings derived from the math expression that creates it. You cannot change these directly. See *Creating and Using Math Waveforms* on page 3-167 for more information on math waveforms.
- All waveforms are displayed fit-to-screen; that is, within the horizontal divisions that the graticule provides. However, some waveforms may be wider or narrower than the full graticule due to acquisition rate/time scale combinations and acquisition preview.

**Display and Acquisition Controls.** For channel waveforms, the vertical and horizontal controls that you set also adjust the instrument acquisition parameters. See the following descriptions for more information:

- *Vertical Acquisition Window Considerations* on page 3-18
- *Horizontal Acquisition Window Considerations* on page 3-20

**Horizontal Position and the Horizontal Reference.** The time values that you set for horizontal position are from the trigger point to the horizontal reference point. This is not the time from the trigger point to the start of the waveform record unless you set the horizontal reference to 0%. See Figure 3-33.

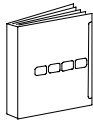
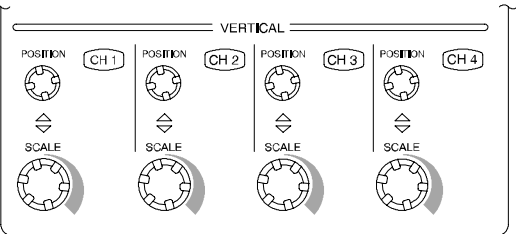
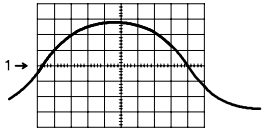
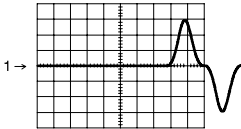
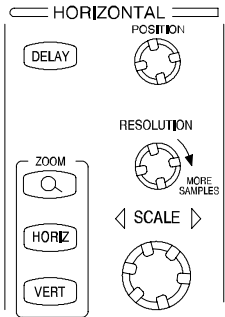



**Figure 3-33: Horizontal Position includes time to Horizontal Reference**

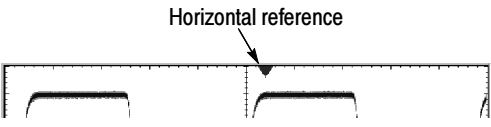
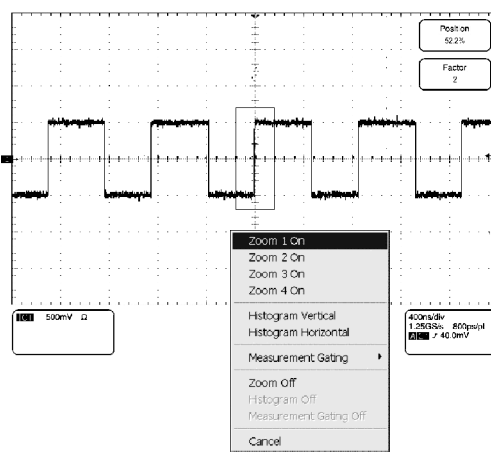
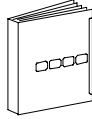
**Mouse and Touch Screen Operation.** In general, anything that you can do with the mouse, you can do by touching the screen, if the touch screen is on. You can select or change all menus and buttons that are displayed on screen by mouse clicks or touching the on-screen control while the touch screen is on.

**To Display Waveforms in the Main Graticule**

Use the procedure that follows to become familiar with the display adjustments you can make.

Overview	To display waveforms in the main graticule	Related control elements and resources
<p><b>Prerequisites</b></p>	<ol style="list-style-type: none"> <li>1. The instrument must be installed and operating.</li> <li>2. The acquisition system should be set to run continuously.</li> </ol>	 <p>See page 3-29 for acquisition setup and page 3-63 for trigger setup.</p>
<p><b>Set vertical display parameters</b></p>	<ol style="list-style-type: none"> <li>3. Push a channel button to select the waveform (it displays). A channel button lights when its channel is on.</li> </ol> <p><b>Note.</b> For information on math waveforms, see To Define a Math Waveform on page 3-175. For information on reference waveforms, see Saving and Recalling Waveforms on page 3-227.</p> <ol style="list-style-type: none"> <li>4. Use the Vertical knobs to achieve a good display of each waveform that you select.</li> </ol>	
<p><b>Set horizontal display parameters</b></p>	<ol style="list-style-type: none"> <li>5. To make sure the main graticule is selected, push the MultiView Zoom button to toggle it off. Use the horizontal knobs to scale and position the waveform on screen and to set sample resolution.</li> </ol> <div style="display: flex; justify-content: space-around; align-items: flex-start;"> <div style="text-align: center;"> <p>Scaled Horizontally</p>  </div> <div style="text-align: center;"> <p>Positioned Horizontally</p>  </div> </div> <p>The Resolution knob sets the record length. (See discussion of record length on page 3-21.)</p> <p>Push PUSH TO SET TO 50% if required to stabilize display.</p>	 <p style="text-align: center;">LEVEL PUSH TO SET 50%</p> 



Overview	To display waveforms in the main graticule (Cont.)	Related control elements and resources
<p><b>Adjust the horizontal reference</b></p>	<p>6. To adjust the point around which the waveforms expand and contract, touch the Horizontal Reference, and drag it left or right on screen.</p> <p>Move the Horizontal Reference along the horizontal axis until it aligns to the point on the waveform that you want to be stationary on screen.</p> <p><b>Note.</b> If Delay is off, Horizontal Reference is the same as Horizontal Position.</p> <p>7. Release the Horizontal Reference, and then adjust the Horizontal Scale.</p>	
<p><b>Quick-adjust the timebase (zoom)</b></p>	<p>8. To quickly rescale a portion of a channel waveform so that it expands to fill the 10 divisions on screen, touch and drag across the segment of the waveform that you want to see in greater detail. Then select Zoom 1 On, Zoom 2 On, Zoom 3 On, or Zoom 4 On from the list to magnify the highlighted waveform segment.</p> <p><b>Note.</b> The instrument displays the box-enclosed area on the waveform magnified in the graticule.</p> <p>Both vertical and horizontal zoom functions are available. Zoomed waveforms can be aligned, locked, and automatically scrolled. See <i>Setting MultiView Zoom Controls</i> on page 3-125 for more information.</p>	
<p><b>Explore the zoom controls</b></p>	<p>9. The next procedure describes setting up and controlling MultiView Zoom.</p>	 <p>See <i>Setting MultiView Zoom Controls</i> on page 3-125.</p>

## Setting MultiView Zoom Controls

The instrument can expand or compress (zoom in or out) on a waveform without changing the acquisition parameters (sample rate, record length, and so on). This section describes how to use MultiView Zoom and how it interacts with the selected waveform.

Use MultiView Zoom (push the MultiView Zoom button) when you want to expand a waveform to inspect small feature(s) on that waveform or compare the feature to the non-zoomed waveform(s). For example, to temporarily expand the front corner of a pulse to inspect its aberrations, use MultiView Zoom to expand it horizontally and vertically.

**Using with Waveforms**

To help you use MultiView Zoom effectively, consider how it operates on waveforms. When in zoom mode, the instrument vertically expands or contracts one waveform at a time unless zoom lock is on. Also, the instrument only vertically positions one waveform at a time when in MultiView Zoom.

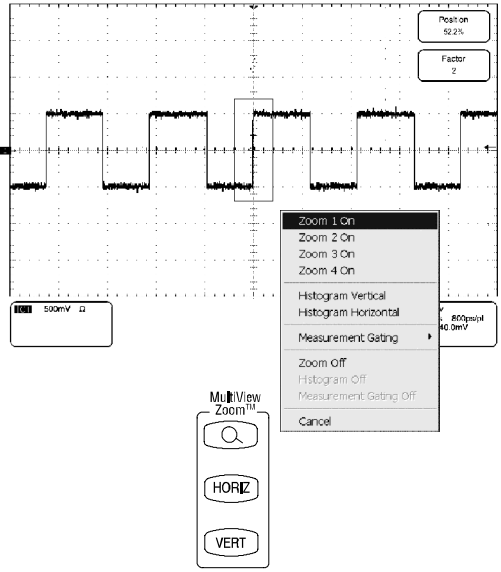
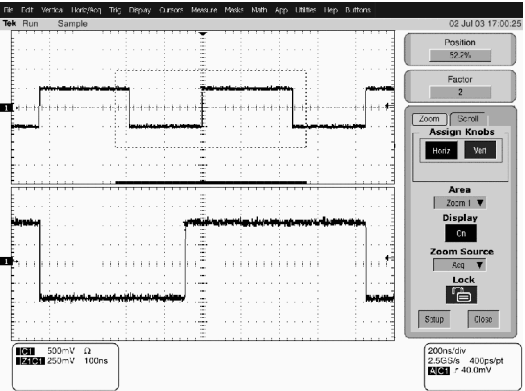
When zooming horizontally, MultiView Zoom expands all waveforms at the same time.




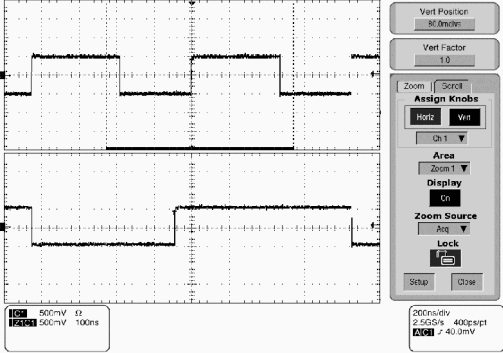
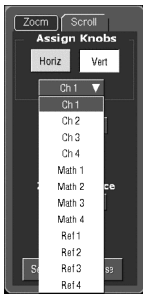
When zooming horizontally or vertically, MultiView Zoom expands or contracts the waveform by the zoom scale factor.

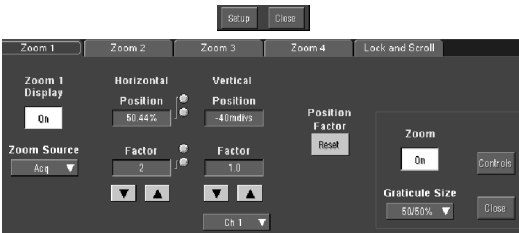
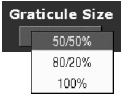
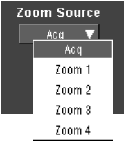
**To Zoom Waveforms**

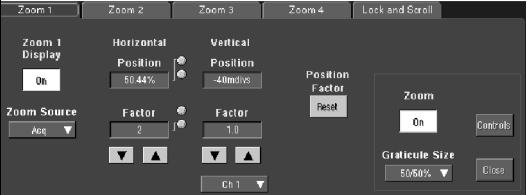
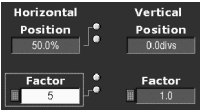
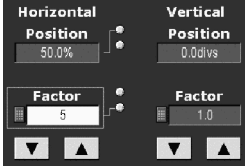


Use the procedure that follows to zoom a waveform. For more information, display online help when performing the procedure.






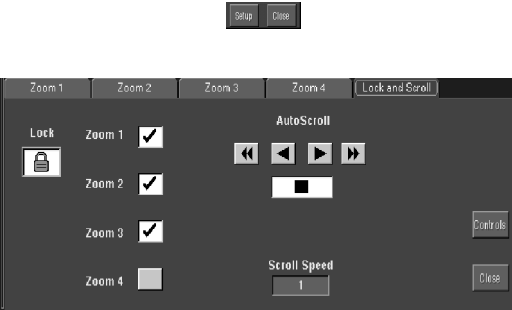

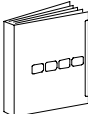
Overview	To zoom waveforms	Control elements and resources
<p><b>Prerequisites</b></p>	<p>1. The instrument must be installed and operating. Instrument must be powered up, with horizontal and vertical controls and triggering set up.</p>	<div data-bbox="1128 1087 1219 1205" data-label="Image"> </div> <p data-bbox="1057 1230 1338 1257">See page 3-63 for trigger setup.</p>

Overview	To zoom waveforms (Cont.)	Control elements and resources
<p><b>Select zoom</b></p>	<p>2. You can select zoom in two ways:</p> <ul style="list-style-type: none"> <li>To zoom a waveform, touch and drag across the segment of the waveform that you want to see in greater detail. Then select Zoom 1 On, Zoom 2 On, Zoom 3 On, or Zoom 4 On to magnify the highlighted waveform segment in one of the 4 zoom areas.</li> </ul> <p><b>Note.</b> The instrument displays the box-enclosed area on the waveform magnified in the graticule. If two graticules are shown, the magnified waveform is shown in the bottom graticule.</p> <ul style="list-style-type: none"> <li>Push the MultiView Zoom button to split the screen and add a zoom graticule.</li> </ul> <p>If the instrument creates two graticules, the magnified waveform(s) is displayed in the lower graticule, and the unmagnified waveform(s) in the upper graticule. Use the Zoom Setup menu to change the graticule size.</p>	 <p>The top screenshot shows a zoom menu with options: Zoom 1 On, Zoom 2 On, Zoom 3 On, Zoom 4 On, Histogram Vertical, Histogram Horizontal, Measurement Gating, Zoom Off, Histogram Off, Measurement Gating Off, and Cancel. Below the menu is a 'MultiView Zoom' button with a magnifying glass icon and 'HORIZ' and 'VERT' options.</p>  <p>The bottom screenshot shows a split-screen view with two graticules. The top graticule shows the original waveform, and the bottom graticule shows a magnified view of a portion of the waveform. The right side of the screen has a 'Zoom Setup' menu with options for Position (52.2%), Factor (2), Zoom (Zoom 1), Area (Zoom 1), Display (On), Zoom Source (50), Lock, Setup, and Close. The bottom left shows scale information: 500mV/div, 200ns/div, 2.00000, 400ps/div, 100ns, and 40.0mV.</p>

Overview	To zoom waveforms (Cont.)	Control elements and resources
<p><b>Zoom a waveform</b></p>	<p>3. To zoom a waveform, start by using one of two methods to select the axis that you want to adjust:</p> <ul style="list-style-type: none"> <li>■ Push the HORIZ button or the VERT button to select the axis that you want to adjust in the zoom graticule.</li> <li>■ Touch the HORIZ button or the VERT button in the control window to select which axis is controlled by the multipurpose knobs.</li> </ul> <p>4. Use the multipurpose knobs to adjust the zoom factor and position of the magnified waveform.</p> <p><b>Note.</b> As you change the zoom factor or move the unmagnified waveform relative to the box, the instrument alters the magnified display accordingly to include only the waveform portion within the box.</p> <p>As you change the zoom factor or move the magnified waveform, the instrument scales or moves the box relative to the unmagnified waveform, so that the box encloses only the magnified portion of the waveform.</p> <p>If multiple waveforms are displayed, the zoom position for all waveforms is not 0.0, or zoom lock is not on; the magnified display may not match what is shown enclosed in the zoom box.</p> <p>5. To select the waveform that you want to change, select the channel (Ch), Math, or reference (Ref) number for the waveform that you want to change, or touch its level-marker with the mouse or touch screen.</p>	   <p>Nonzoomed waveforms, with box</p>  <p>Zoomed (magnified) waveforms</p> 

Overview	To zoom waveforms (Cont.)	Control elements and resources
<p><b>Set up MultiView Zoom</b></p>	<p>6. To display the Zoom setup window, touch Setup in the controls window. Select the tab for the zoomed waveform area that you want to set up.</p> <p><b>Note.</b> To reduce the Zoom setup window to the controls window, touch Controls.</p> <p>7. Select from the Graticule Size list to change the size of the unmagnified (Acquisition) and Zoom windows:</p> <ul style="list-style-type: none"> <li>■ 50-50 allocates half of the available display for the zoomed graticule and half of the available display for the acquisition window.</li> <li>■ 80-20 allocates 80% of the available display for the zoomed graticule and 20% for the acquisition window.</li> <li>■ 100 uses the entire display for the zoomed graticule.</li> </ul> <p><b>Note.</b> The instrument displays the box-enclosed area on the waveform magnified in the graticule. If two graticules are shown, the magnified waveform is shown in the bottom graticule.</p> <p>8. To select the source of your zoomed waveform area, touch Zoom Source and select the source from the drop-down list. You can select the live acquisitions or one of the four zoom areas.</p>	  

Overview	To zoom waveforms (Cont.)	Control elements and resources
<p><b>Checking the zoom factor and position</b></p>	<p>9. To quickly determine the zoom factor and position of a zoomed waveform, check the readouts:</p> <ul style="list-style-type: none"> <li>■ The Zoom setup window displays the horizontal and vertical position and zoom factor of the selected zoom area.</li> <li>■ From the Zoom Setup window, touch the Vertical or Horizontal Position or Factor controls to assign the multipurpose knobs to the factor and position controls.</li> <li>■ Use the multipurpose knobs or keypad to change the zoom position and factor. The knob readout also displays the zoom position and factor. You can also use the up and down arrows to change the zoom factor.</li> </ul>	  
<p><b>Reset zoom</b></p>	<p>10. To reset all Horizontal zoom factors to their defaults, from the Zoom control window touch Setup.</p> <p>11. Touch Reset to reset the zoom factor and position.</p>	 

Overview	To zoom waveforms (Cont.)	Control elements and resources
<p><b>To Lock and Automatically Scroll Zoom Areas</b></p>	<p>12. To display the zoom Lock and Scroll setup window, touch Setup in the controls window. Select the Lock and Scroll tab.</p> <p>13. To select which zoom areas to lock, touch Zoom 1, Zoom 2, Zoom 3, or Zoom 4 to toggle the areas you want to lock on (check mark).</p> <p>14. To lock control of the zoom areas selected in the previous step, touch Lock to toggle it on.</p> <p>15. To control the automatic scrolling of the selected zoom areas, touch an AutoScroll control:</p> <ul style="list-style-type: none"> <li> Forward</li> <li> Fast forward</li> <li> Reverse</li> <li> Fast reverse</li> <li> Stop</li> </ul> <p>16. To change the scrolling speed, touch Scroll Speed and use the multipurpose knobs or keypad to change the scrolling speed.</p>	 
<p><b>For further assistance</b></p>	<p>17. Touch the Help button while in the Zoom setup window to access a context-sensitive overview of the MultiView Zoom controls and their setup.</p>	 <p>See <i>Accessing Online Help</i> on page 3-263 for an overview of the online help system.</p>

## Customizing the Display

Use the display customizing features this instrument provides to present the display elements — color, graticule style, waveform representation, and so on — according to your preferences.

From the Color Palette, you can select temperature, spectral, or gray scale color grading of a waveform so that its data color or intensity reflects the sample density of the data in that area of the waveform.

### Using Display Controls

Read the following topics; they provide the details that can help you set up the the display system so that it displays waveforms and other display elements as you prefer.

**Display Settings.** Table 3-8 lists display attributes that you can set and where they are accessed.

**Table 3-8: Customizable display elements**

Display attribute	Access		Options
	Menu name <sup>1</sup>	Entry	
Graticule Style	Display	Graticule Style	Choose from: Full, Grid, Cross-hair, and Frame styles.
	Disp	Objects	
Display Persistence	Display	Display Persistence	Choose from No Persistence (Off), Infinite Persistence, and Variable Persistence Modes. Reset the persistence display. Set the Variable Persistence time. Display the persistence control window.
	Disp	Appearance	
Display Style	Display	Display Style	Choose Dots to display each waveform as a series of dots. Choose Vectors to display vectors or lines between the dots. Choose Intensified Samples to display actual samples as bright dots.
	Disp	Appearance	
Screen Text	Display	Screen Text	Enter text that you can display and position on screen. Also see <i>Label The Waveform</i> on page 3-229
	Disp	Screen Text	
Color Palette (Record View and Waveform Data- base)	Display	Colors	Choose Normal to use system colors for best viewing. Choose Green to display variable persistence waveforms in shades of green. Choose Gray to display variable persistence waveforms in shades of gray. Choose Temp (temperature) to display variable persistence waveforms with the highest sample density points appearing in warmer colors (reds). Choose Spectral to display variable persistence waveforms with the highest sample density points appearing in blue shades. Choose User to use custom palette colors for the selected source. Choose User Palette Edit. . . to display the window in which you can set custom hue, lightness, and saturation for the selected source.
	Disp	Colors	
Reference Colors	Display	Colors	Choose Default to use the default system color (white) for reference waveforms. Choose Inherit to use the same color for the reference waveform as the original waveform.
	Disp	Colors	



**Table 3-8: Customizable display elements (Cont.)**

Display attribute	Access		Options
	Menu name <sup>1</sup>	Entry	
Math Colors	Display	Colors	Choose Default to use the default system color (red) for math waveforms.
	Disp	Colors	Choose Inherit to use the same color for the math waveform as the waveform the math function is based on.
Waveform Interpolation	Display	Appearance	Choose from Sin(x)/x or Linear interpolation.
	Disp	Appearance	
Waveform Intensity	Display	Appearance	Toggle AutoBright On to set the brightness maximum to the value of the most frequent event.
	Disp	Appearance	Toggle AutoBright Off to let the brightness depend on the trigger rate, creating a display like an analog instrument. Touch Record View or FastAcq/WfmDB, and use the keypad or multipurpose knobs to adjust the intensity of waveforms.
Display format	Display	Appearance	Choose YT, XY, or XYZ display formats. For additional information see <i>To Set Display Format</i> on page 3-47.
Display format	Display	Appearance	Choose YT, XY, or XYZ display formats. For additional information see <i>To Set Display Format</i> on page 3-47.
Waveform Display	Disp	Appearance	Toggle the waveform display on and off. Some processes are faster if waveforms are not displayed.
Trigger Level Marker	Disp	Objects	Choose a Short level marker at the right side of the graticule, a Long level marker the width of the graticule, or Off for no trigger level marker.
Trigger T	Display	Display Trigger T	Toggle on and off the display of a T at the trigger point.
	Disp	Objects	
Date and Time	Display	Display Date and Time	Toggle on and off the display of the system date and time.
	Disp	Objects	
Set Date and Time	Utilities	Set Date and Time	Set the date and time using the Set Time and Date setup window that is displayed.
Data Clear			Right click in the graticule area and click the Data Clear button to reset histograms, statistics, persistence, and mask count data.

<sup>1</sup> The Menu Names refer to the menus found in the menu bar or toolbar at the top of the instrument screen.

**Normal and Persistence Displays.** Use the display persistence to control how waveform data ages:

- Off style displays waveforms without persistence: each new waveform record replaces the previously acquired record for a channel. You can choose to display normal waveforms as vectors, which displays lines between the record points or dots (vectors off) which displays the record points only. You can also choose an interpolation mode. See *Interpolation* on page 3-134.
- Variable Persistence style accumulates the waveform-record points on screen and displays them only for a specific time interval. Previous waveform data continuously fades from the display as new waveform records acquire.
- Infinite Persistence style accumulates the data record points until you change some control (such as scale factor) causing the display to be erased. Waveform data builds up as new data records acquire.

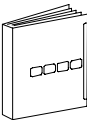
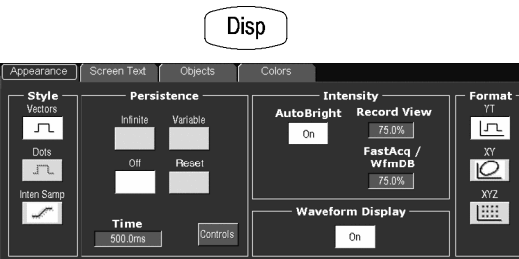
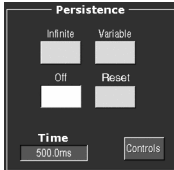

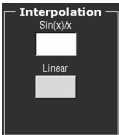
Persistence style is only available for live waveforms (waveforms with data that is being updated); reference waveforms are static and do not use persistence. Math waveforms use persistence if their sources are live waveforms.


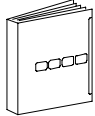
**Interpolation.** When, due to preview, zoom, or Real Time mode with limited samples, the available sample density falls to less than 1 sample per display column, the instrument calculates intermediate points by either the linear or sine algorithms, and uses them to produce points. There are two options for interpolation:

- Sin(x)/x interpolation computes record points using a curve-fit between the actual values acquired. The curve-fit assumes all the interpolated points fall along that curve. Sin(x)/x interpolation is particularly useful when acquiring more rounded waveforms such as sine waves. It is also appropriate for general use, although it may introduce some overshoot or undershoot in signals with fast rise times.
- Linear interpolation computes record points between actual acquired samples by using a straight-line-fit. The straight-line-fit assumes all the interpolated points fall in their appropriate point in time on that straight line. Linear interpolation is useful for many waveforms such as pulse trains.

Interpolation is used whenever the displayed sample density falls below 1 sample per column. If the acquired record length is 500 points, zoom of 2x requires interpolation. If instead, the record length of the acquisition is 100K, horizontal zoom of 200x produces 1 sample per column ( $100,000/500 = 200$ ); therefore, you will see interpolated samples starting at the next scale setting.

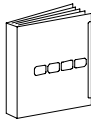
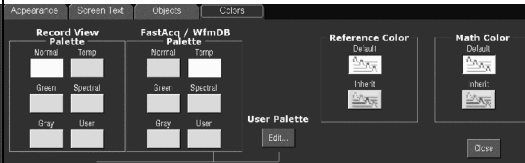
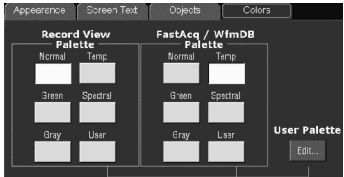
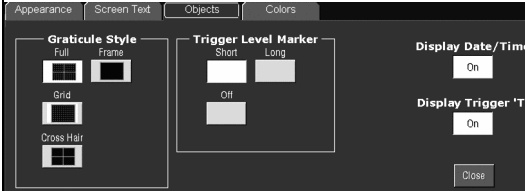
**Set Display Styles** Use the procedure that follows to become familiar with the display adjustments that you can make.

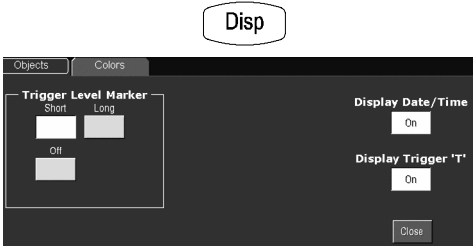

Overview	Set display styles	Related control elements and resources
<p><b>Prerequisites</b></p>	<p>1. The instrument must be powered up, with any waveform you want to display on screen.</p>	 <p>See page 3-29 for acquisition setup and page 3-63 for trigger setup.</p>
<p><b>Access the display setup dialog box</b></p>	<p>2. From the toolbar, touch Disp, and then select the Appearance tab. See right.</p>	
<p><b>Select the display style and persistence and waveform interpolation mode</b></p>	<p>3. From display Persistence, choose a persistence mode:</p> <ul style="list-style-type: none"> <li>■ Off displays Waveforms with new data replacing the data from previous waveform acquisitions (no persistence).</li> <li>■ Infinite persistence continuously accumulates record points until you change an acquisition setting.</li> <li>■ Variable persistence accumulates record points for a specified time. Each point decays in a set time interval.</li> </ul> <p>4. From display Style, select an available style:</p> <ul style="list-style-type: none"> <li>■ Vectors displays lines between waveform dots.</li> <li>■ Dots displays waveform record points as dots.</li> <li>■ Inten Samp displays actual samples as bright dots and blacks out interpolated samples.</li> </ul> <p><i>Note.</i> Adjustment of display intensity may be necessary to set display intensity to the desired level.</p> <p>5. Select an Interpolation mode by choosing Sin(x)/x or Linear. For more information see <i>Interpolation</i> on page 3-134.</p>	  

Overview	Set display styles (Cont.)	Related control elements and resources
<p><b>Select a persistence mode</b></p>	<p>6. From the the Display setup control window (see right), choose a persistence mode:</p> <ul style="list-style-type: none"> <li>■ Infinite Persistence to make data persist indefinitely. Waveform displays accumulate data as new waveform records acquire, resulting in a build up of data in the displayed waveforms.</li> <li>■ Variable Persistence to make data persist momentarily, but also decay. New waveform displays accumulate data as new waveform records acquire, but with continuous replacement of the oldest data.</li> </ul> <p>If you select Variable Persistence, set a time at which the oldest data fades away.</p> <ul style="list-style-type: none"> <li>■ Off to make data display for the current acquisition only.</li> <li>■ Reset to restart the accumulation of data.</li> </ul>	
<p><b>Continue with next procedure</b></p>	<p>7. For more ways to customize the display, see the next procedure.</p>	 <p>See <i>Customize Graticule and Waveforms</i> on page 3-137.</p>

### Customize Graticule and Waveforms

Use the procedure that follows to become familiar with the display adjustments that you can make.

Overview	Customizations you can make	Related control elements and resources
<p><b>Prerequisites</b></p>	<ol style="list-style-type: none"> <li>1. Display the waveforms to be measured on screen. The waveform may be a channel, reference, or math waveform.</li> </ol>	 <p>See page 3-29 for acquisition setup and page 3-63 for trigger setup.</p>
<p><b>Change waveform colors</b></p>	<ol style="list-style-type: none"> <li>2. From the Display setup control window, select the Colors tab.</li>   <li>3. Choose a color palette from the Color Palette list.  Normal, Green, and Gray give the appearance of an intensity-graded display similar to an analog instrument.  Spectral and Temp use hue to indicate the frequency of occurrence and to highlight events.  User and User Palette let you create a custom color palette.</li> </ol>	 
<p><b>Change graticule style</b></p>	<ol style="list-style-type: none"> <li>4. From the Display setup control window, select the Objects tab.</li>   <li>5. Touch the Full, Grid, Cross Hair, or Frame button to select that style of graticule.</li> </ol>	

Overview	Customizations you can make (Cont.)	Related control elements and resources
<p><b>To set the display readout options</b></p>	<ol style="list-style-type: none"> <li>6. Touch the DISP button and select the Objects tab.</li> <li>7. Touch Display Date/Time to toggle between On and Off. (On displays the date and time.)</li> <li>8. Touch Display Trigger T to toggle between On and Off. (On displays the trigger T at the trigger location.)</li> </ol>	
<p><b>For further assistance</b></p>	<ol style="list-style-type: none"> <li>9. Touch the Help button in the toolbar to access a context-sensitive overview of the display controls and their setup.</li> </ol>	 <p>See <i>Accessing Online Help</i> on page 3-263 for overview of the online help system.</p>

# Measuring Waveforms

The instrument comes equipped with cursors and automatic measurements to assist you in analyzing your waveforms. This section describes these tools and how you use them:

- *Taking Automatic Measurements*, on page 3-140, describes how you can setup the instrument to automatically measure and display a variety of waveform parameters. See Figure 3-34.
- *Taking Cursor Measurements*, on page 3-151, describes using cursors to make measurements on waveforms. See Figure 3-34.
- *Taking Histograms*, on page 3-157, describes how to take histograms to view the horizontal or vertical distribution of data on your waveforms.
- *Optimizing Measurement Accuracy*, on page 3-160, tells you how to run compensation routines and how to deskew channels to optimize the accuracy of your measurements.

---

**NOTE.** *You can also make graticule measurements, counting graticule divisions and multiplying them by the vertical or horizontal scales set for the waveform that you are measuring.*

---

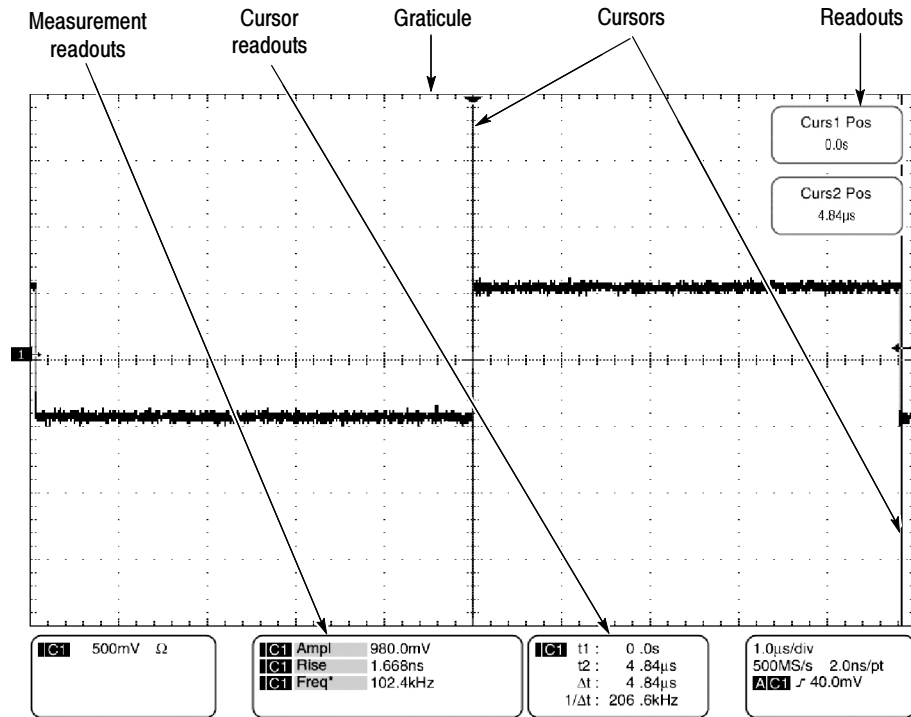


Figure 3-34: Graticule, Cursor, and Automatic measurements

## Taking Automatic Measurements

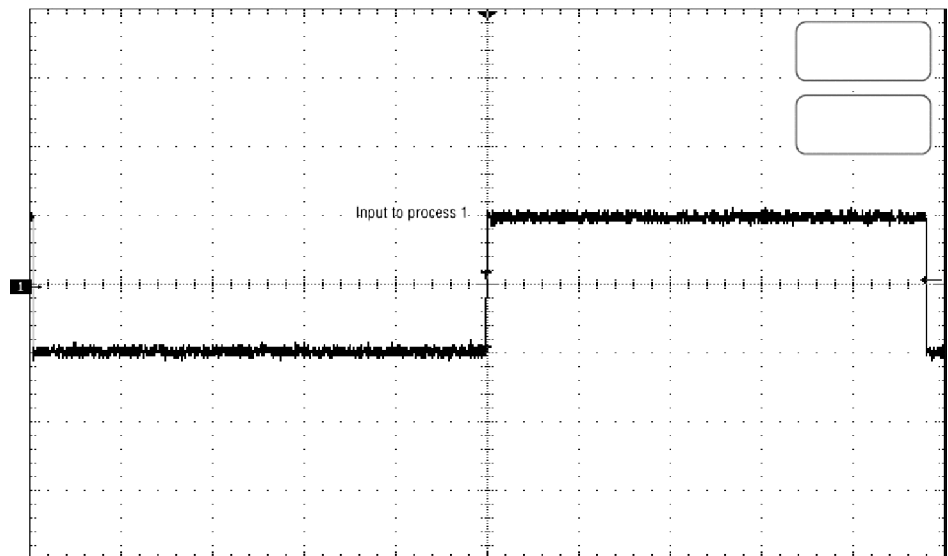
The instrument automatically takes and displays waveform measurements. This section describes how to set up the instrument to let it do the work of taking measurements for you.

Because automatic measurements use the waveform record points, and Fast Acquisitions mode and Waveform Database mode measurements use a multidimensional array of points, automatic measurements are usually more accurate than cursor and graticule measurements. And the instrument does the work, continuously taking, updating, and displaying these measurements.

Some features of automatic measurements follow.

**Annotate Waveforms On Screen.** You can create text to mark characterization levels that each measurement uses to compute results (see Figure 3-35). See *Customizing the Display* on page 3-131, *Label the Waveform* on page 3-229, and *Annotate Measurements* on page 3-146 for additional information.





**Figure 3-35: Annotated display**

**Customize Measurements.** To allow you control over how your waveform data is characterized by measurements, the instrument lets you set the methods used for each measurement. See *High/Low Method* on page 3-142 and *Reference Levels Method* on page 3-143.

**See Statistics on Measurement Results.** To see how automatic measurements vary statistically, you can display a readout of the Min, Max, Mean, and Standard Deviation of the measurement results. See *Display measurement statistics* on page 3-146 for more information.

**Select Measurement Parameters.** You can select from an extensive range of parameters to measure; for a list, see *Appendix B: Automatic Measurements Supported*.

**Measure Part of a Waveform.** You can feed the entire waveform to a measurement or limit the measurement to a segment of the waveform. By default, the instrument takes each automatic measurement over the entire waveform record, but you can use measurement gates and zoom to localize each measurement to a section of a waveform (see *To Localize a Measurement* on page 3-149).

**Select Measurement Sources.** Select from these measurement sources: channel, reference, and math waveforms.

**Take Measurements on a Frame.** In FastFrame, measurements are taken only on the displayed frame.

### Using Automatic Measurements

Read the following topics; they provide the details that can help you set up automatic measurements so that they best support your data-analysis tasks.

**Measurement Selection.** The instrument takes automatic measurements of the following categories: Amplitude, Timing, More, Histogram, and Comm (optional on TDS7000B Series). Check *Appendix B: Automatic Measurements Supported* for a listing of the measurements that you can choose.

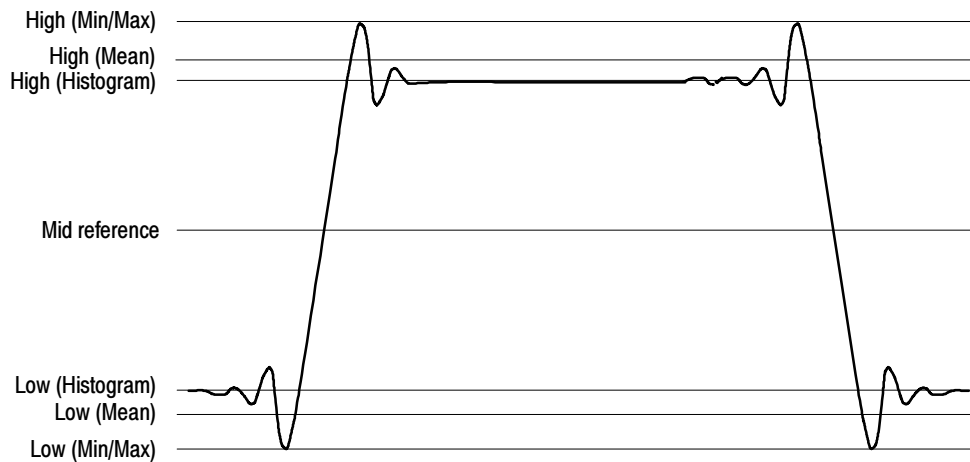
**Number of Measurements.** The instrument can take and update up to eight measurements at one time. You can apply measurements to any combination of sources (described below). You can take all eight measurements on Ch1, for example or you can take measurements on Ch1 - Ch4, Math1 - Math4, Ref1 - Ref4, or a histogram.

**Measurement Sources.** All channel, reference, and math waveforms can serve as sources for automatic measurements.

Some measurements, such as delay and phase, require two sources. For example, delay would be used to measure an input from one measurement source (for example, C1) with respect to an output in another source (C2).

**High/Low Method.** The levels that the automatic measurement system derives as the High (Top) or Low (Bottom) for a waveform influence the fidelity of amplitude and aberration measurements. You can select among the modes the instrument provides for determining these levels. You can set the modes differently for each measurement:

- **Histogram.** Sets the values statistically. It selects the most common value either above or below the midpoint (depending on whether it is defining the high or low reference level). Since this statistical approach ignores short term aberrations (overshoot, ringing, and so on.), Histogram is the best setting for examining pulses. See Figure 3-36.



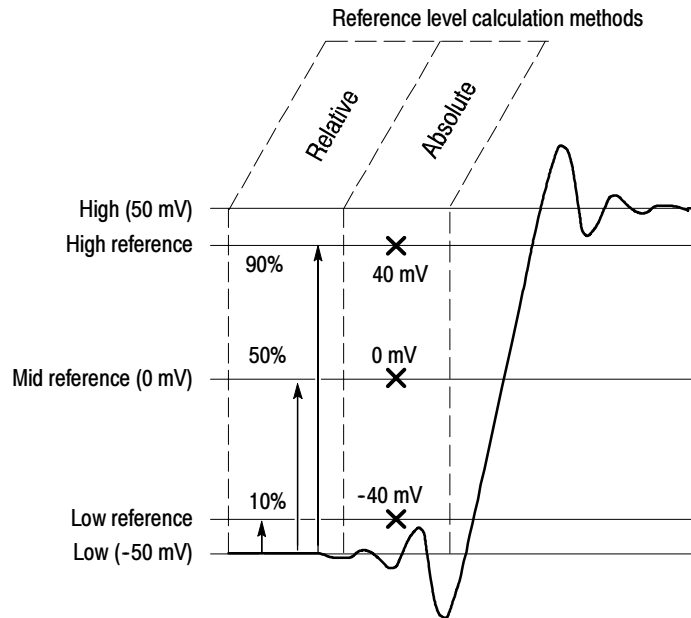
**Figure 3-36: High/Low tracking methods**

- **Min-max.** Uses the highest and lowest values of the waveform record. This setting is best for examining waveforms that have no large, flat portions at a common value, such as sine waves and triangle waves — almost any waveform except for pulses. See Figure 3-36.
- **Histogram mean.** Sets the values statistically. Using a histogram, it selects the mean or average value derived using all values either above or below the midpoint (depending on whether it is defining the high or low reference level). This setting is best for examining eye patterns and optical signals. See Figure 3-36.
- **Noise.** (Optional on TDS7000B Series) Tells the instrument if the noise measurement is at the top or the bottom of the eye diagram.
- **Signal Type.** (Optional on TDS7000B Series) Lets the instrument know if the signal to be measured is a pulse waveform or an eye diagram.

**Reference Levels Method.** A second set of levels affect the fidelity of time-related measurements, the Hi, Mid, and Lo references. For example, the measurement system takes risetime measurements from the waveform-edge that transitions from the Low to High reference levels.

You can set the calculation method for each measurement. The instrument provides the following calculation methods; refer to Figure 3-37 as you read about each method:

- **Relative Reference** Calculated as a percentage of the High/Low range.
- **Absolute Reference** Set by absolute values in user units.

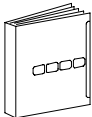



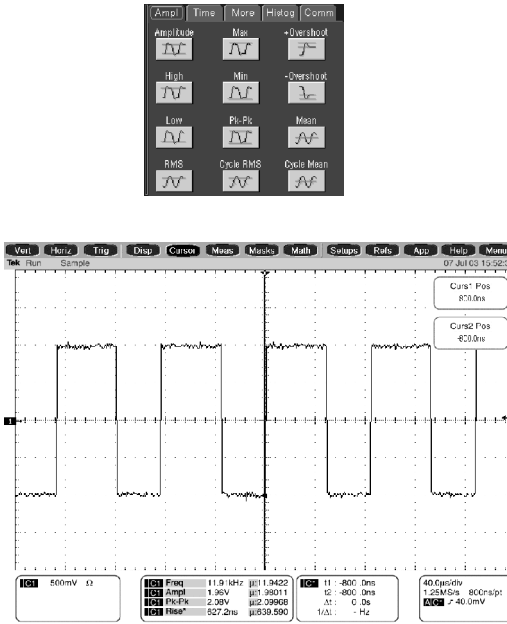

**Figure 3-37: Reference-level calculation methods**

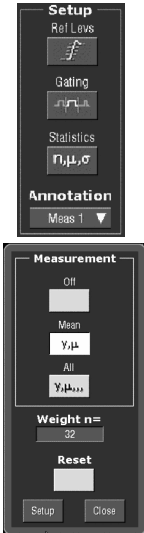

The High and Low levels from which the reference levels are calculated are the levels established using the selected Hi/Low method described on page 3-142.

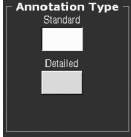
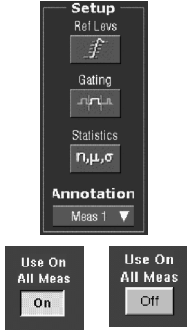
**To Take Automatic Measurements**



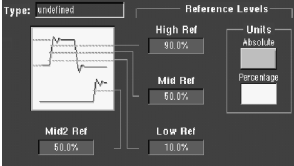
Use the procedure that follows to quickly take a measurement based on the default settings for High/Low and for reference-levels.

Overview	To take automatic measurements	Related control elements and resources
<p><b>Prerequisites</b></p>	<p>1. Obtain a stable display of the waveform to be measured.</p>	<div style="text-align: center;">  </div> <p>See page 3-29 for acquisition setup and page 3-63 for trigger setup.</p>

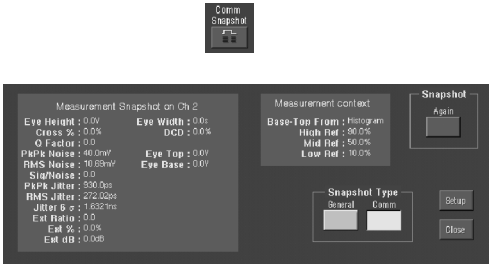

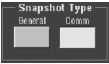

Overview	To take automatic measurements (Cont.)	Related control elements and resources																																																												
<p><b>Select the waveform</b></p>	<p>2. From the toolbar, touch Meas to display the Measurement setup control window.</p> <p>3. To select the source waveform that you want to measure, select the Ch, Math, or Ref Source tab, and then touch the Channel, Math, or Reference button for the waveform.</p> <p>The waveform may be a channel, reference, or math waveform.</p>	 <p>The image shows a 'Meas' button in a rounded rectangle. Below it is a 'Source' selection window with three tabs: 'Ch', 'Math', and 'Ref'. Under each tab are four buttons labeled '1', '2', '3', and '4'.</p>																																																												
<p><b>Take automatic measurements</b></p>	<p>4. From the Measurement setup control window, select the Ampl, Time, More, Histogram, or Comm (optional on TDS7000B Series) tab that contains the measurement that you want to take.</p> <p>5. Touch the button for the measurement that you want to take. For a list of the measurements this instrument can take, see <i>Appendix B: Automatic Measurements Supported</i>.</p> <p>The readout for the measurement is automatically displayed, and the measurement is added to the measurement list in the setup window.</p> <p>Measurements are displayed below the graticule area as shown here. If the area is occupied or there are too many measurements to fit in that area, measurements are displayed in the lower graticule area.</p> <p>In Roll mode measurements are not available until after you stop acquisitions.</p>	 <p>The image shows a measurement selection menu with tabs: 'Ampl', 'Time', 'More', 'Histo', and 'Comm'. Under 'Ampl' are buttons for 'High', 'Low', 'RMS', 'Pk-Pk', 'Cycle RMS', 'Mean', and 'Cycle Mean'. Under 'Time' are buttons for 'Max', 'Min', and 'Overshoot'. Under 'More' is a button for 'Overshoot'. Under 'Histo' is a button for 'Overshoot'. Under 'Comm' is a button for 'Overshoot'. Below the menu is a waveform display with two cursors. The top cursor is at 80.0ns and the bottom cursor is at 60.0ns. At the bottom of the display is a measurement list:</p> <table border="1"> <tr> <td>100</td> <td>500mV</td> <td>10</td> <td>100</td> <td>Freq</td> <td>11.91kHz</td> <td>μ1: 1.9422</td> <td>100</td> <td>11</td> <td>500</td> <td>0ms</td> <td>40.0ps/div</td> <td>1.00k/div</td> <td>800ns/div</td> <td>7.40.0mV</td> </tr> <tr> <td>101</td> <td>Ampl</td> <td>1.90V</td> <td>μ1: 28013</td> <td>101</td> <td>12</td> <td>400</td> <td>0ms</td> <td>102</td> <td>0</td> <td>0s</td> <td></td> <td></td> <td></td> <td></td> </tr> <tr> <td>102</td> <td>Pk-Pk</td> <td>2.30V</td> <td>μ1: 29968</td> <td>103</td> <td>13</td> <td>100</td> <td>0ms</td> <td>104</td> <td>0</td> <td>0s</td> <td></td> <td></td> <td></td> <td></td> </tr> <tr> <td>103</td> <td>Rise</td> <td>527.2ns</td> <td>μ1: 830.506</td> <td>105</td> <td>14</td> <td>1</td> <td>Hz</td> <td></td> <td></td> <td></td> <td></td> <td></td> <td></td> <td></td> </tr> </table>	100	500mV	10	100	Freq	11.91kHz	μ1: 1.9422	100	11	500	0ms	40.0ps/div	1.00k/div	800ns/div	7.40.0mV	101	Ampl	1.90V	μ1: 28013	101	12	400	0ms	102	0	0s					102	Pk-Pk	2.30V	μ1: 29968	103	13	100	0ms	104	0	0s					103	Rise	527.2ns	μ1: 830.506	105	14	1	Hz							
100	500mV	10	100	Freq	11.91kHz	μ1: 1.9422	100	11	500	0ms	40.0ps/div	1.00k/div	800ns/div	7.40.0mV																																																
101	Ampl	1.90V	μ1: 28013	101	12	400	0ms	102	0	0s																																																				
102	Pk-Pk	2.30V	μ1: 29968	103	13	100	0ms	104	0	0s																																																				
103	Rise	527.2ns	μ1: 830.506	105	14	1	Hz																																																							
<p><b>Remove measurements</b></p>	<p>6. To remove the measurement, touch Clear, and the last measurement selected is removed.</p> <p>7. To remove any measurement in the measurement list, touch the measurement prior to touching the Clear button. More than one measurement can be selected. Touch the first measurement that you want to remove, drag across all of the measurements that you want to select, and then touch the Clear button.</p> <p>8. You can also toggle the display of measurements on and off by touching the Display button.</p>	 <p>The image shows a 'Clear' button in a rounded rectangle. Below it is a 'Source' selection window with 'Ch', 'Math', and 'Ref' tabs. Under 'Ch' are buttons for '1', '2', '3', and '4'. Under 'Math' are buttons for 'High' and 'Low'. Under 'Ref' are buttons for 'Ch 1' and 'Ch 2'. Below the 'Source' window is a 'Display' button with 'On' and 'Off' options.</p>																																																												

Overview	To take automatic measurements (Cont.)	Related control elements and resources
<p><b>Display measurement statistics</b></p>	<p>9. From the Measurements setup control window, touch Setup Statistics.</p> <p>10. From the Statistics control window, select Off, Mean, or All.</p> <ul style="list-style-type: none"> <li>■ Off. Turns off measurement statistics</li> <li>■ Mean. Displays the mean of measurements</li> <li>■ All. Displays the Mean, Min, Max, and Standard Deviation of measurements</li> </ul> <p>11. To set the number of measurements included in the measurement statistics, touch Weight n=, and use the multipurpose knobs or keypad to set the weighting.</p>	
<p><b>Annotate measurements</b></p>	<p>Measurement annotation graphically shows the position on the waveform of the elements from which the measurement result is derived. Horizontal bars, vertical bars, horizontal arrows, and vertical arrows indicate the elements used by the measurement. See <i>Measurement Annotations</i> on page B-9 for a description of the annotations. To annotate measurements, perform the following steps:</p> <p>12. From the Measurements setup control window, touch Setup Annotation.</p> <p>13. From the drop down list, select the measurement to annotate. The readout of the annotated measurement contains an asterisk (*).</p>	

Overview	To take automatic measurements (Cont.)	Related control elements and resources
<p><b>Show more annotation detail</b></p>	<p>14. To select the amount of annotation detail shown with a measurement, from the menu bar touch Utilities, User Preferences, and then select the Measurement tab to display the Annotation Type setup window.</p> <p>15. From the window select either the Standard or Detailed annotation type. Selecting Detailed displays more annotations than selecting standard.</p>	
<p><b>Set measurement reference levels</b></p>	<p>16. From the Measurements control window, touch Setup Ref Levs to display the Reference Levels setup control window.</p> <p>17. To use these settings for all measurements, toggle the Use On All Meas button to On. To set different values for some measurements, toggle the Use On all Meas button to Off.</p>	

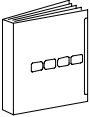
Overview	To take automatic measurements (Cont.)	Related control elements and resources
<p><b>Set measurement reference levels (Cont.)</b></p>	<p><b>18.</b> To select how the instrument determines the base and top of the waveform, touch Min-Max, Histogram, or Histogram mean.</p> <ul style="list-style-type: none"> <li>■ Min-max. Uses the highest and lowest values of the waveform record. This setting is best for examining waveforms that have no large, flat portions at a common value, such as sine waves and triangle waves — almost any waveform except for pulses. See Figure 3-36 on page 3-143.</li> <li>■ Histogram. Selects the most common values above or below the midpoint. Since this approach ignores short term aberrations (overshoot, ringing, and so on), Histogram is the best setting for examining pulses. See Figure 3-36 on page 3-143.</li> <li>■ Histogram mean. Calculates the mean value using all values either above or below the midpoint (depending on whether it is defining the high or low reference level). Histogram mean is best for examining eye patterns and optical signals.</li> </ul> <p><b>19.</b> To select the reference level units, touch Units Absolute or Percentage.</p> <ul style="list-style-type: none"> <li>■ Absolute. Sets the units to absolute values in user units.</li> <li>■ Percentage. Sets the units as a percentage of the High/Low range.</li> </ul> <p><b>20.</b> To set the reference levels, touch HighRef, Mid Ref, Low Ref, or Mid2 Ref, and use the multipurpose knobs or keypad to set the levels.</p>	 <p>The image shows a 'Method' menu with three options: 'Min-Max' (selected), 'Histogram', and 'Histogram mean'. Each option is accompanied by a small waveform icon.</p>  <p>The image shows a 'Units' menu with two options: 'Absolute' (selected) and 'Percentage'.</p>  <p>The image shows a 'Reference Levels' control panel. It includes a 'Type' dropdown set to 'Mid2 Ref', a waveform display, and three reference level knobs: 'High Ref' (90.0%), 'Mid Ref' (50.0%), and 'Low Ref' (10.0%). A 'Units' dropdown is also present, set to 'Absolute'.</p>


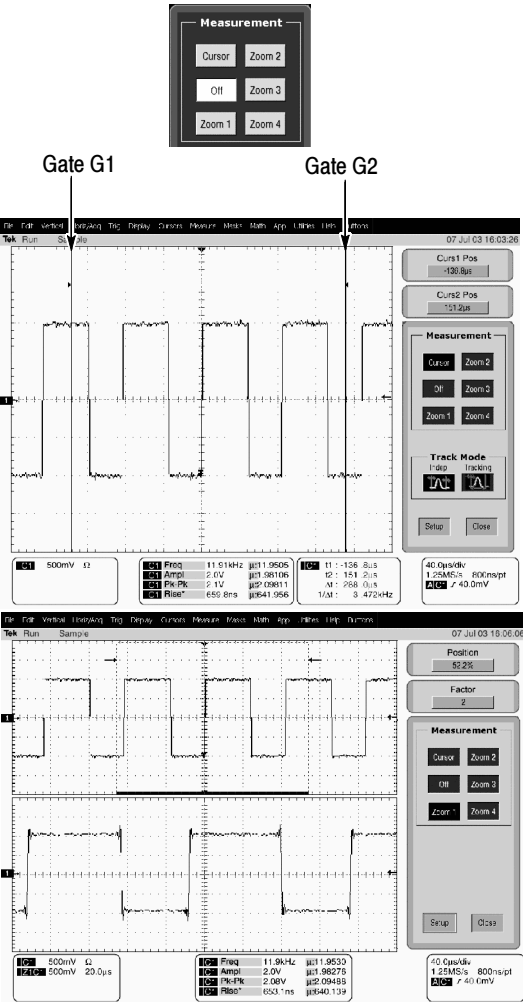


Overview	To take automatic measurements (Cont.)	Related control elements and resources
<p><b>Take a snapshot of measurements</b></p>	<p>21. From the Measurement setup control window, touch the Snapshot button (Comm Snapshot button if the Comm tab is selected) to display a window of all single waveform measurements or Comm measurements (optional on TDS7000B Series).</p> <p><i>Note: Snapshot measurements are taken on the selected waveform. The Snapshot window tells you the waveform that the measurements are being taken on and the reference levels used.</i></p> <p>22. Snapshot measurements are not continuously updated. To update snapshot measurements, touch the Snapshot Again button.</p> <p>To select the type of snapshot measurements, touch one of the Snapshot Type buttons:</p> <ul style="list-style-type: none"> <li>■ Comm. Selects snapshots of Comm measurements (optional on TDS7000B Series)</li> <li>■ General. Selects all single waveform measurements</li> </ul> <p>Phase, Delay, and Histogram measurements are not included in a snapshot.</p>	  
<p><b>For further assistance</b></p>	<p>23. Touch the Help button in the Measurements setup control window to access the online assistance.</p> <p>24. See <i>Appendix B: Automatic Measurements Supported</i>, on page B-1 for a list of the measurements and their definitions.</p>	 <p>See page 3-263 to learn about using online help.</p>

**To Localize a Measurement**

Use the procedure that follows to take a measurement over a segment of the waveform (otherwise, the entire waveform is included in the measurement).

Overview	To gate a measurement	Related control elements and resources
<p><b>Prerequisites</b></p>	<p>1. Set up as from last procedure.</p>	 <p>See <i>To Take Automatic Measurements</i> on page 3-144</p>

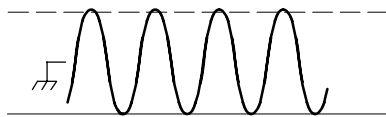
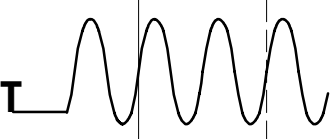
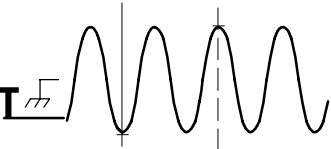
Overview	To gate a measurement (Cont.)	Related control elements and resources
<p><b>Access gating</b></p>	<p>2. From the toolbar, select Meas, and then select Gating from the Measurement setup control window.</p>	
<p><b>Enable and position the gates</b></p>	<p>3. To select how to control the gated area, touch Measurement Gating Cursor, Zoom 1, Zoom 2, Zoom 3, Zoom 4, or Off:</p> <ul style="list-style-type: none"> <li>■ <b>Cursor.</b> Sets the gated area to the area between the cursors. Use the multipurpose knobs to adjust the cursors on screen such that the area to measure is between the cursors.</li> <li>■ <b>Zoom 1 - 4.</b> Sets the gated area to the waveform area contained in the Zoom graticule.</li> <li>■ <b>Off.</b> Turns off measurement gating.</li> </ul> <p>Turning V Bar cursors off will not turn gating off. You must turn gating off in the Measurement Gating control window or the Zoom drop-down list.</p>	

## Taking Cursor Measurements

Because cursor measurements give immediate feedback of the amplitude or time values they measure, they are usually quick to take and are more accurate than graticule measurements. Since you position cursors wherever you want them on the waveform, they are easier to localize to a waveform segment or feature than automatic measurements.

You can measure time or amplitude or both. Vertical cursors measure time or distance on screen, horizontal cursors measure voltage or amplitude, and waveform and screen cursors measure both. Table 3-9 expands on these definitions.

**Table 3-9: Cursor functions (types)**

Cursor function	Parameter measured	Cursor readout
 <p>Horizontal cursors</p>	<p>Horizontal cursors measure amplitude (volts, watts). Each cursor measures with respect to:</p> <ul style="list-style-type: none"> <li>V1 = Level @ Cursor 1 with respect to its source ground level</li> <li>V2 = Level @ Cursor 2 with respect to its source ground level</li> <li><math>\Delta V</math> = Level @ Cursor 2 - Level at Cursor 1</li> </ul> <p>Level is cursor displacement from the source ground times the source volts/div. Note that the two cursors may have different sources and therefore can have different volts/div settings.</p>	<div style="border: 1px solid black; padding: 2px; margin-bottom: 2px;">Curs1 Pos 1.51V</div> <div style="border: 1px solid black; padding: 2px; margin-bottom: 2px;">Curs2 Pos -1.49V</div> <div style="border: 1px solid black; padding: 2px;"> C1 V1 : 1.51V V2 : -1.49V <math>\Delta V</math> : -3.0V</div>
 <p>Vertical cursors</p>	<p>Vertical cursors measure distance (time in seconds or bits). Each cursor measures with respect to:</p> <ul style="list-style-type: none"> <li>T1 = Time @ Cursor 1 with respect to the trigger point</li> <li>T2 = Time @ Cursor 2 with respect to the trigger point</li> <li><math>\Delta T</math> = Time @ Cursor 2 - Time @ Cursor 1</li> </ul> <p>Time is divisions of displacement of the cursor from its source trigger point times the source time/div.</p>	<div style="border: 1px solid black; padding: 2px; margin-bottom: 2px;">Curs1 Pos -136.8<math>\mu</math>s</div> <div style="border: 1px solid black; padding: 2px; margin-bottom: 2px;">Curs2 Pos 151.2<math>\mu</math>s</div> <div style="border: 1px solid black; padding: 2px;"> C1 t1 : -136.8<math>\mu</math>s t2 : 151.2<math>\mu</math>s <math>\Delta t</math> : 288.0<math>\mu</math>s 1/<math>\Delta t</math> : 3.472kHz</div>
 <p>Waveform (and Screen) cursors</p>	<p>Waveform cursors measure both voltage and time. Each cursor is, in effect, both a vertical and horizontal cursor. You can select the style of the cursors. These waveform cursors cannot be moved off the waveform.</p> <p>Note that Screen cursors are the same as waveform cursors except that the cursors can be moved off the waveform.</p>	<div style="border: 1px solid black; padding: 2px; margin-bottom: 2px;">Curs1 Pos -136.8<math>\mu</math>s</div> <div style="border: 1px solid black; padding: 2px; margin-bottom: 2px;">Curs2 Pos 151.2<math>\mu</math>s</div> <div style="border: 1px solid black; padding: 2px;"> C1 V1 : 1.01V t1 : -136.8<math>\mu</math>s  C1 V2 : -970.0mV t2 : 151.2<math>\mu</math>s <math>\Delta V</math> : -1.96V <math>\Delta t</math> : 288.0<math>\mu</math>s <math>\Delta V/\Delta t</math> : -6.875kV/s 1/<math>\Delta t</math> : 3.472kHz</div>

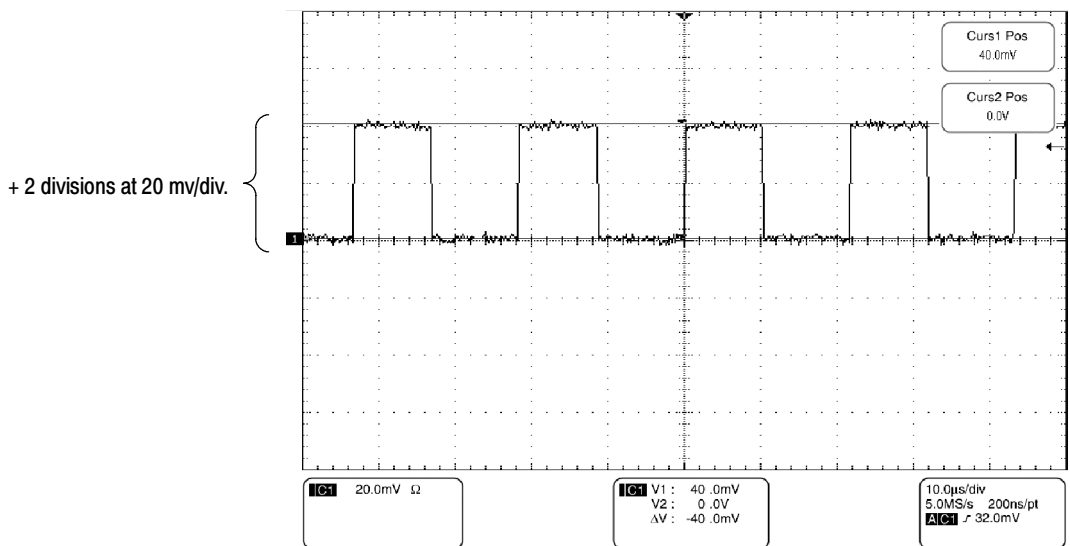
Cursors can measure channel, reference, and math waveforms. You must set the source of each cursor explicitly in the Cursor Setup control window.

Cursors are not available with histograms, XY, or XYZ modes.

**Using Cursors**

Cursor operation is easy, you move the cursors on screen and read the results in the cursor readouts. The following key points will help you use the cursors effectively:

**Cursor Types.** The cursor types are described in Table 3-9 on page 3-151. There are two cursors displayed for all types, Cursor 1 and Cursor 2. You can move cursors with the multipurpose knobs or the cursor position controls in the Cursor Setup control window.



**Figure 3- 38: Horizontal cursors measure amplitudes**

**Cursors are Display-Limited.** You cannot move a cursor off screen. Also, if you resize waveforms, the cursors do not track. That is, a cursor stays at its screen position, ignoring changes to horizontal and vertical scale and position, and vertical offset (waveform cursors will track a waveform vertically).

**Cursors Ignore the Selected Waveform.** Each cursor measures its source, defined in the Cursors Setup dialog box. Selecting a waveform for scaling on screen (by pushing the CH 3 front-panel button, for example) does not change the source that each cursor measures.

After you have selected the source from the Cursors Setup control window, you can operate the cursor from the front-panel knobs and buttons.

**Cursors Treat Sources Independently.** Each cursor can take a different, independent source, with each source having its own amplitude scale. Consider the example presented by Figure 3-38 on page 3-152:

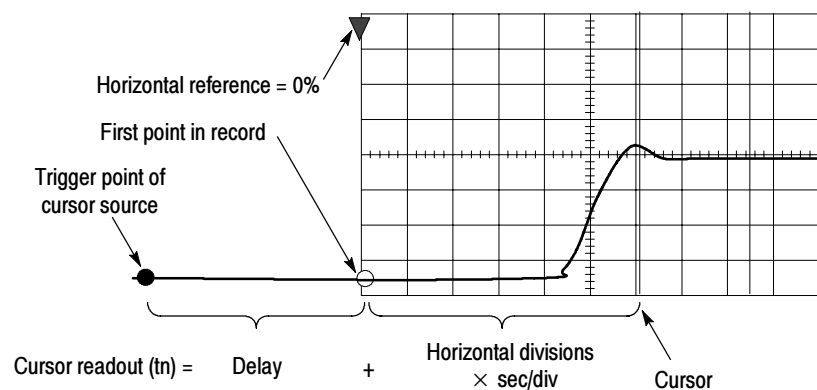
- Cursor 1 is set to measure channel 3 (Ch3), which is set to 100 mV per division, so cursor readout v1 measures Ch3 relative to its ground as 3 divisions  $\times$  100 mV/div, or about 300 mV.
- Cursor 2 is set to measure reference 4 (Ref4), which is set to 20 mV per division, so cursor readout v2 measures R4 relative to its ground as 3 divisions  $\times$  20 mV/div, or about 60 mV.
- Note that the value of each graticule division is not readily apparent relative to the delta readout, because the delta-amplitude readout ( $\Delta v$ ) must account for the different amplitude-scale settings of the sources. To do so, the  $\Delta v$  readout displays the results of  $v2 - v1$  (60 mV - 300 mV = -240 mV), automatically accounting for the different scales of the cursor sources.

---

**NOTE.** If a cursor readout does not seem correct, check the source of each cursor in the Cursor setup dialog box. Each cursor readout relates to the amplitude and time base settings of its source.

---

**Vertical Cursors Measure from the Trigger Point.** Remember that each vertical cursor measures the time from the trigger point to itself. This relationship is shown in Figure 3-39 on page 3-153.



**Figure 3-39: Components determining Time cursor readout values**

Note that a vertical cursor readout includes and varies directly with the Time-to-First-Point component, which varies directly with the horizontal position set for the timebase. To see the amount of time to the first point, set Horizontal DELAY to 0.0 and set Horizontal Ref to 0%. Now the Horizontal position readout shows the time following the first point, and adding this value to the cursor readout yields the cursor position on screen relative to first point. (You can find the horizontal readout both in the control window and in the readout at the bottom of the screen.) The following relationships hold:

*Time from First Point = Horiz. Position (when Horiz. Delay and Ref Position are zero)*

*T1 readout = Time to First Point + Additional Time to Cursor*

**Cursor Units Depend on Sources.** A cursor that measures amplitude or time will read out in the units of its source as indicated in Table 3-10. Note mixed sources require Delta-Cursor readouts to follow units of the cursor 1 source.

**Table 3-10: Cursor units**

Cursors	Standard units <sup>1</sup>	Readout names
Horizontal	volts, watts	V1, V2, ΔV
Vertical	seconds, bits	T1, T2, ΔT, F1, F2, ΔF
Waveform, Screen	volts, watts, seconds, bits	V1, V2, ΔV, T1, T2, ΔT

<sup>1</sup> **If the V1 and V2 units do not match, the ΔV readout defaults to the units used by the V1 readout.**

**Multipurpose knobs.** You can change cursor position using the position controls in the Cursor setup window, dragging the cursor into position using the touch screen or mouse, or by turning the front-panel multipurpose knobs.

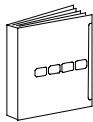


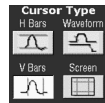

The multipurpose knobs also work with other controls. If a setup window item has an adjustable value, you can adjust it with the multipurpose knob or keypad after touching the setup control.








---

**NOTE.** *To make small changes with the multipurpose knobs, push the FINE button before turning the knob. When a FINE button is illuminated, its multipurpose knob makes smaller adjustments.*

---

**To Set the Cursor Sources** You must target the cursors to the source they are to measure. (See *Cursors Treat Sources Independently* on page 3-153). To do so, use the procedure that follows.

Overview	To set the cursor sources	Related control elements and resources
<p><b>Prerequisites</b></p>	<p>1. Display the waveform to be measured on screen. The waveform may be a channel, reference, or math waveform.</p>	 <p>See page 3-29 for acquisition setup and page 3-63 for trigger setup.</p>
<p><b>Display the cursor controls window</b></p>	<p>2. Push the CURSORS front-panel button, or from the toolbar, touch Cursors.</p>	
<p><b>Select the cursor sources</b></p>	<p>3. From the Cursor Source menu, select the channel, math, or reference tab, and then select the waveform to take cursor measurements on. If you are using Waveform or Screen cursors, you must select a source for both cursors by first touching a cursor button before selecting a source.</p> <p><b>Note.</b> If a waveform is not available, its source button is grayed out.</p>	
<p><b>Select a cursor type</b></p>	<p>4. From the Cursor Type menu, select the H Bars, V Bars, Waveform, or Screen cursor type. See Table 3-9 on page 3-151 for an explanation of the cursor types.</p>	
<p><b>Change cursor position</b></p>	<p>5. To change the position of a cursor, use the multipurpose knobs or the keypad to move a cursor.</p>	

Overview	To set the cursor sources (Cont.)	Related control elements and resources
<p><b>Set cursor tracking</b></p>	<p>6. To change the cursor tracking mode, from the Cursor controls window select Setup.</p> <p>7. Touch Track Mode Indep or Tracking:</p> <ul style="list-style-type: none"> <li>■ Indep. Makes each cursor positionable without regard to the position of the other cursor.</li> <li>■ Tracking. Makes both cursors move in unison and maintain a fixed horizontal or vertical distance between each other.</li> </ul> <p>8. To return to the Cursor controls window, touch the Controls button.</p> <p>9. To toggle the display of cursors on or off, touch the Cursor button.</p> <p><i>Note. All adjustments that you can make in the Cursor controls window can also be made in this window.</i></p>	   
<p><b>Set cursor style</b></p>	<p>10. To change the waveform and screen cursor marker style, from the Cursor controls window, select Setup.</p> <p>11. Touch Style, and select Lines, Line &amp; X, or X.</p>	 
<p><b>For further assistance</b></p>	<p>12. Touch the Help button in the Cursor setup control window or the Cursor controls window to access the online assistance.</p>	 <p>See page 3-263 to learn about using online help.</p>



## Taking Histograms

The instrument can display histograms constructed from the selected waveform data. You can display both vertical (voltage) and horizontal (time) histograms, but only one at a time. Use histogram measurements to get statistical measurement data for a section of a waveform along one axis.

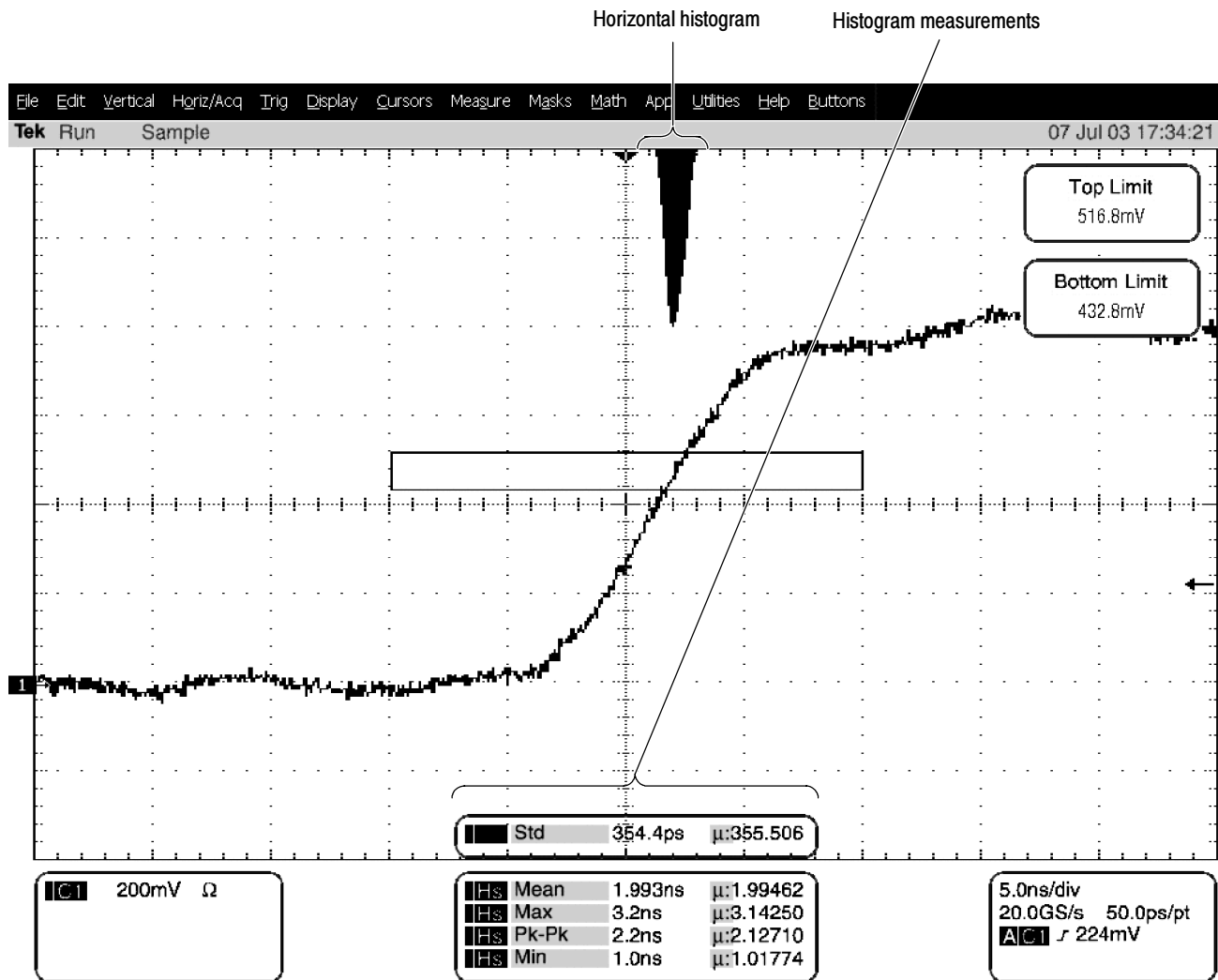


Figure 3-40: Horizontal histogram view and measurement data

A histogram source can be any waveform (channel or math), including a reference waveform.

In addition to using limit controls to set histogram box boundaries, you can also use standard Windows drag-and-drop to resize and reposition the histogram box.

Histograms are not available in FastFrame, Record View XY, or Zoom modes.

**Using Histograms**





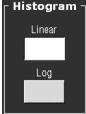
**Histogram Size.** The maximum vertical histogram size is 200. The maximum horizontal size is 500.

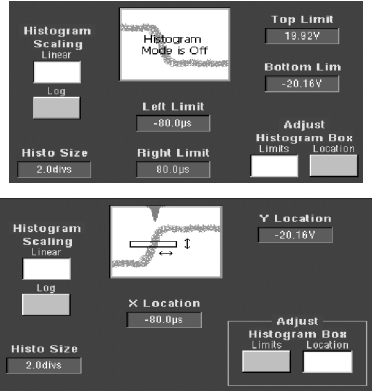
**Histogram Counting Stays On.** Turning on histograms starts histogram counting and data accumulation. A sample histogram display is shown in Figure 3-40. Histogram data is continuously accumulated until you explicitly turn off histograms. This allows you to continue collecting histogram data even when you turn off the histogram display.

**To Start and Reset Histogram Counting**

Use the procedure that follows to quickly take a measurement based on the default settings for histograms.

Overview	To start and reset histogram counting	Related control elements and resources
<p><b>Prerequisites</b></p>	<p>1. The instrument must have a waveform displayed.</p>	<div data-bbox="1192 1108 1279 1224" data-label="Image"> </div> <p data-bbox="987 1241 1479 1266">See page 3-119 for information on displaying waveforms.</p>
<p><b>Open histogram setup window</b></p>	<p>2. From the toolbar, touch the Meas button, and then touch the Histogram button to display the Histogram setup window.</p>	<div data-bbox="1192 1335 1279 1482" data-label="Image"> </div>

Overview	To start and reset histogram counting (Cont.)	Related control elements and resources
<p><b>Set, display, and reset histogram source and type</b></p>	<p>3. Select either the Source Ch, Math, or Ref tab, and then select the waveform source for the histogram.</p> <p>4. Touch either Histogram Mode Horiz or Vert to start histogram counting and display the histogram data:</p> <ul style="list-style-type: none"> <li>■ Horiz. Displays a horizontal histogram that shows how time varies in the histogram box</li> <li>■ Vert. Displays a vertical histogram that shows how your vertical units vary in the histogram box</li> <li>■ Off. Turns off histogram counting and display</li> </ul> <p><i>Note.</i> This control turns on histogram counting and data display. You can only display one type of histogram at a time.</p> <p>5. Touch Reset to reset the histogram count. Histograms track numbers of counts. Touching Reset resets those counts to zero and begins counting from zero.</p>	  
<p><b>Set histogram display options</b></p>	<p>6. Touch Display to toggle the display of the selected histogram on and off.</p> <p>7. Select Linear to display histogram data linearly. Bin counts smaller than the maximum counts are scaled linearly by dividing the bin count by the maximum bin count.</p> <p>8. Select Log to display histogram data logarithmically. Bin counts smaller than the maximum counts are scaled logarithmically. Logarithmic scaling provides better visual details for bins with low counts.</p>	 

Overview	To start and reset histogram counting (Cont.)	Related control elements and resources
<p><b>Set histogram limit controls</b></p>	<p>9. Touch Adjust Histogram Box Limits, and use the Top Limit, Bottom Limit, Left Limit, and Right Limit controls to set the size of the histogram box. The histogram box selects the section of the waveform used for histograms.</p> <p>10. Touch Adjust Histogram Box Location, and use the X Location and Y Location controls to set the location of the histogram box.</p>	

**Histogram Measurements**

Table B-1 on page B-1 includes a list of the available histogram measurements and a brief description of each.

## Optimizing Measurement Accuracy

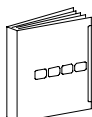
The procedures given here will increase the accuracy of the measurements that you take.


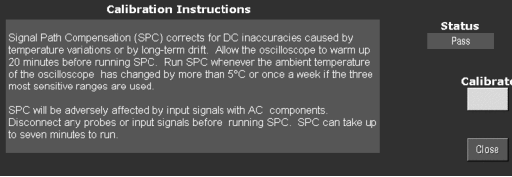
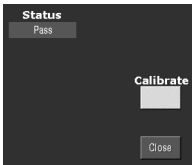

This instrument can compensate itself and the attached probes, optimizing the internal signal path used to acquire the waveforms you measure. Compensation optimizes the capability of the instrument to take accurate measurements based on the ambient temperature.

If you are using optical signals (CSA7000B Series only), see *Optical Dark Compensation* on page 3-58 to perform a dark level calibration.

**To Compensate the Instrument**

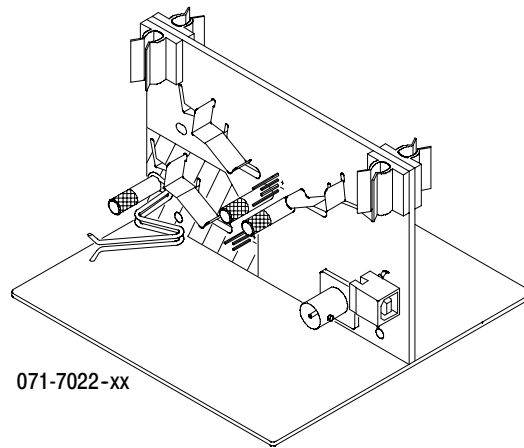
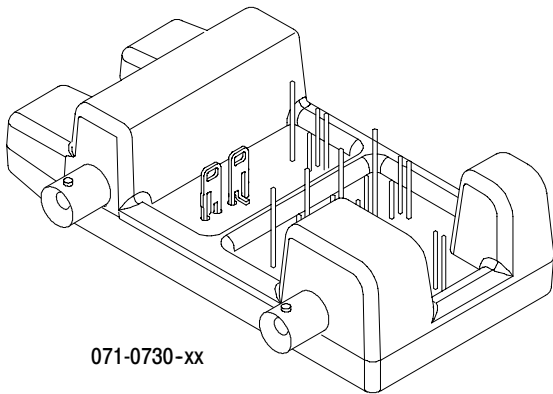
To compensate the instrument so that it can take accurate measurements based on the ambient temperature, use the procedure that follows.

Overview	To compensate the instrument	Related control elements and resources
<p><b>Prerequisites</b></p>	<p>1. Instrument should be powered on. Allow a 20 minute warm up. Remove all input signals.</p>	 <p>See page 3-29 for acquisition setup and <i>Power on the Instrument</i> on page 1-9.</p>

Overview	To compensate the instrument (Cont.)	Related control elements and resources
<p><b>Display the calibration instructions</b></p>	<p>2. From the menu bar, select Utilities, and then select Instrument Calibration.</p>	
<p><b>Check the calibration status</b></p>	<p>3. The calibration status should be Pass. If the status is Warm-up, wait until the status changes. If the status does not change to Pass, use the following steps to calibrate the instrument.</p> <p><i>Note: Signal Path Compensation is the only calibration that is accessible to users.</i></p>	
<p><b>Calibrate the instrument</b></p>	<p>4. Touch Calibrate to start the calibration. Calibration may take several minutes. Calibration is complete after Working is no longer displayed in the Calibrate button and Running is no longer displayed in the Status readout.</p>	
<p><b>Check the calibration status</b></p>	<p>5. The calibration status should be Pass. If not, recalibrate the instrument, or have the instrument serviced by qualified service personnel.</p>	
<p><b>For further assistance</b></p>	<p>6. Touch the Help button to access the online assistance.</p>	 <p>See page 3-263 to learn about using online help.</p>

**To Connect the Probe Calibration Fixture**

To compensate or calibrate probes you must connect the Probe Calibration and Deskew Fixture to the instrument; use the procedure in the manual that came with the deskew fixture you are using (see Figure 3-41).



**Figure 3-41: Probe calibration and deskew fixtures**

**To Calibrate Probes**

To compensate the instrument so that it can take accurate measurements based on the ambient temperature, use the procedure in the manual that came with the deskew fixture you are using (see Figure 3-41).

**To Deskew Channels**

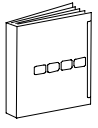
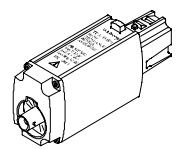
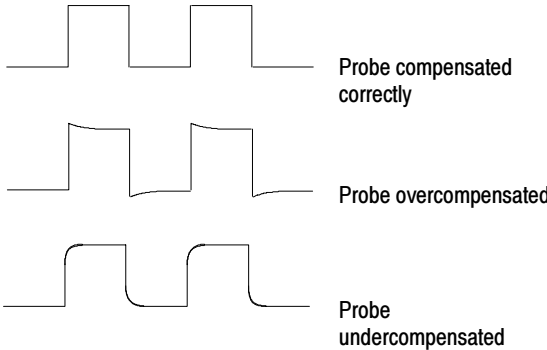
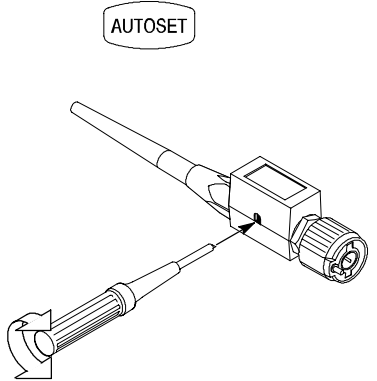
You can adjust a relative time delay for each channel. This lets you align the signals to compensate for signals that may come in from cables of differing lengths. The instrument applies deskew values after it completes each acquisition; therefore, the deskew values do not affect logic triggering. Also, deskew has no affect on fast acquisition XY and XYZ display formats.


To deskew channels, use the procedure in the manual that came with the deskew fixture you are using (see Figure 3-41).

Select Display Only On with deskew for the fastest measurement and math throughput. Select Display Only Off with deskew for the most accurate measurements and math. See the online help for more information.

**To Compensate Passive Probes**

To compensate passive probes to ensure maximum distortion-free input to the instrument and to avoid high frequency amplitude errors, use the procedure that follows.

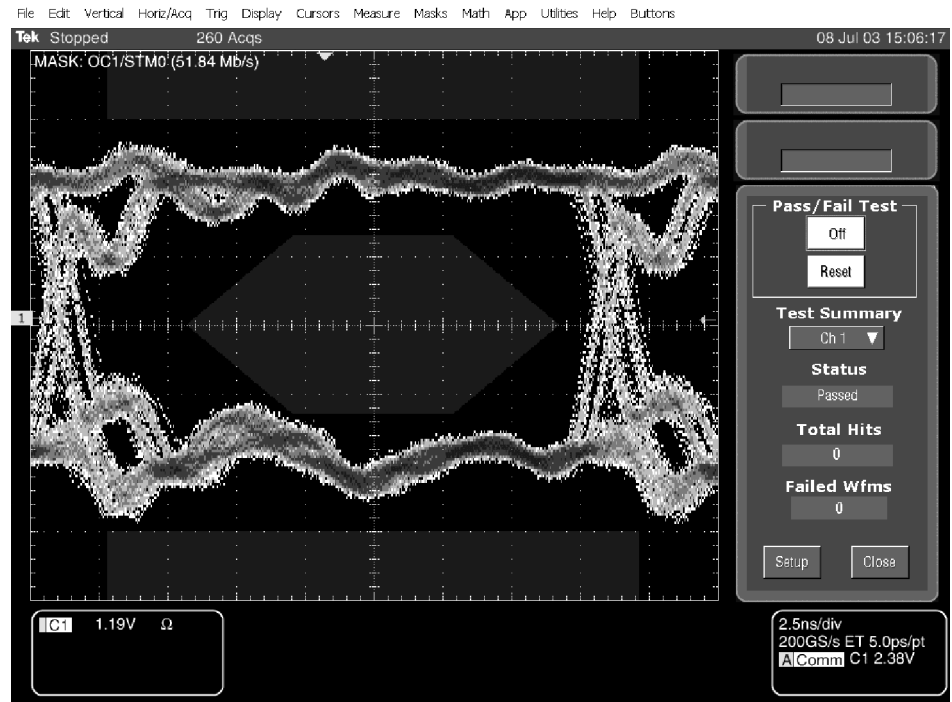
Overview	To compensate passive probes	Related control elements and resources
<p><b>Prerequisites</b></p>	<p>1. Instrument should be powered on. Allow a 20 minute warm up.</p>	 <p>See page 3-29 for acquisition setup and <i>Power on the Instrument</i> on page 1-9.</p>
<p><b>Use adapter</b></p>	<p>2. If your probe is a 1 M Ohm probe without a TCA interface, connect it to the instrument using a TCA-1MEG adapter.</p>	
<p><b>Low frequency compensation</b></p>	<p>3. Connect fixture to the instrument (see <i>To Connect Probe Calibration Fixture</i> on page 3-162).</p> <p>4. Connect one probe to the fixture.</p> <p>5. Push the <b>AUTOSET</b> button on the instrument.</p> <p>6. Adjust the probe compensation box for best square corner:</p>  <p>7. Remove the connections.</p>	

Overview	To compensate passive probes (Cont.)	Related control elements and resources
<b>For further assistance</b>	<b>8.</b> Touch the Help button to access the online assistance.	 See page 3-263 to learn about using online help.



## Serial Mask Testing

The instrument provides a portfolio of masks (optional on the TDS7000B Series) for verifying compliance to optical and electrical standards. You can verify circuit design performance and perform interface compliance testing. Mask testing results are reported live, providing real time feedback. Mask hits are highlighted on the display and accompanied by readouts indicating the number of waveforms tested, pass/fail results, and hit counts.



**Figure 3-42: Pass/Fail mask testing**

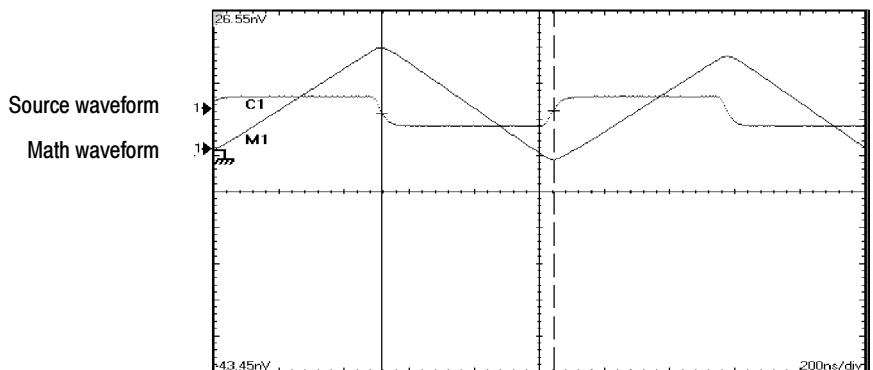
If the Bessel-Thompson filter is on, the instrument is an optical reference receiver.

For detailed information on using Serial Mask Testing to test your signals for compliance to optical and electrical standards see the *CSA7000B & TDS7000B Option SM Serial Mask Testing and Option ST Serial Triggering User Manual*.



# Creating and Using Math Waveforms

Once you have acquired waveforms or taken measurements on waveforms, the instrument can mathematically combine them to create a waveform that supports your data-analysis task. For example, you might have a waveform obscured by background noise. You can obtain a cleaner waveform by subtracting the background noise from your original waveform (note that the background noise you subtract must be identical to the noise in your signal). Or, you can integrate a single waveform into an integral math waveform as shown below.



With spectral analysis you can analyze waveforms in the frequency domain. The interface is similar to a dedicated spectrum analyzer, relieving you of the burden of knowing the details of the underlying algorithms (see Figure 3-43).

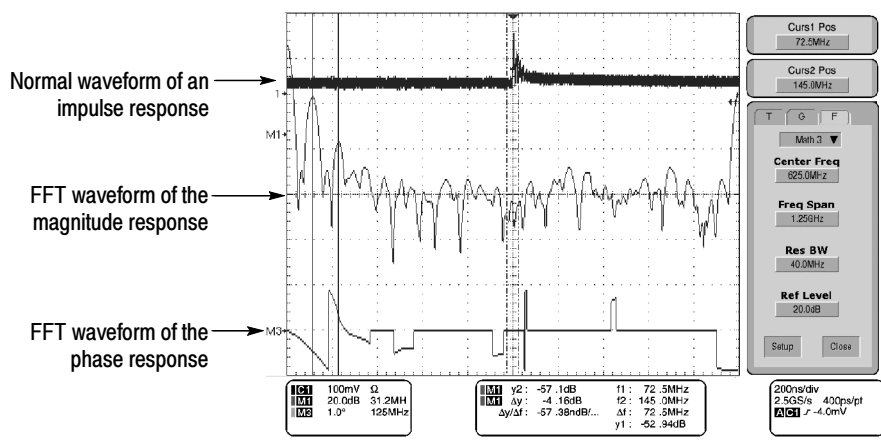
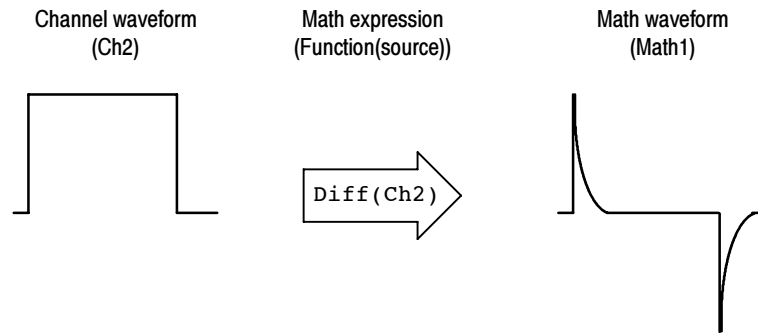


Figure 3-43: Spectral analysis of an impulse

## Defining Math Waveforms

This instrument supports mathematical combination and functional transformations of waveforms it acquires. Figure 3-44 shows this concept:



**Figure 3-44: Functional transformation of an acquired waveform**

You create math waveforms to support the analysis of your channel and reference waveforms. By combining and transforming source waveforms and other data into math waveforms, you can derive the data view that your application requires. You can create math waveforms that result from:

- Mathematical operations on one or several waveforms: add, subtract, multiply, and divide
- Logical operations: greater than, less than, less than or equal, greater than or equal, not equal or equal
- Variables that you set
- Regular scalars such as 3.14
- Function transforms of waveforms, such as integrating, differentiating, and so on
- Spectral analysis of waveforms, such as an impulse
- Measurement scalars can be used in expression; for example, you can use the measurement feature this instrument provides to measure the average of a waveform and subtract it from the original waveform to define a new math waveform

You can create up to four math waveforms; see *Using Math* on page 3-169 for more examples.

Math waveforms can be used in other math. Math waveforms autoscale when the math waveform is first defined and turned on. Advanced functions, such as

integrate, differentiate, average, square root, and log, can be taken on single waveforms or complicated expressions.

In FastFrame, math is applied to each frame.

Some operations that you cannot use with math waveforms follow:

- **Circular Math-on-Math, Measurements in Math, and Measurements on Math**—You cannot use circular definitions of math waveforms. For example, if you define  $\text{Math2} = \text{Ch1} - \text{Math1}$ , and then define a second math waveform as  $\text{Math3} = \text{Ch2} + \text{Math2}$ , you cannot define a third math waveform as  $\text{Math1} = \text{Math2} + \text{Ch3}$ . If you do, the Math1 definition is rejected with an error because a circular definition is not allowed.
- **Measurements**—Meas1 - Meas8 are allowed in a math definition, but not measurement functions, such as rise (Ch1).

CSA7000B Series & TDS7000B Series:

- **Fast Acquisition**—Math is not allowed in Fast Acquisition mode.
- **Roll Mode**—Math is updated when acquisition is stopped.

## Using Math

The following topics provide details that can help you create the math waveform that best supports your data-analysis tasks.

**How to Create.** You create math waveforms when you create a math expression. You do so by applying numerical constants, math operators and functions to operands, which can be channel waveforms, reference waveforms, math waveforms, or measurements (scalars). You can display and manipulate these derived math waveforms much like you can the channel and reference waveforms (see *Operations on Math Waveforms* on page 3-177).

Some examples of typical math waveforms follow:

**Table 3-11: Math expressions and the math waveforms produced**

To . . .	Enter this math expression. . .	and get this math waveform. . .
<p>Normalize a waveform</p>	<p>...</p> <p><math>(Ch1 - Meas1) / Meas2</math>,                      where                      Ch1 is the waveform shown at left                      Meas1 = Low of Ch1                      Meas2 = Amplitude of Ch1</p>	<p>...</p>
<p>Simulate ac coupling</p>	<p>...</p> <p><math>Intg(Ch1 - Meas1)</math>,                      where                      Ch1 is the waveform shown at left                      Meas1 = Mean or Cycle Mean of Ch1</p>	<p>ac component removed before integration</p>

**Sources.** Math Waveforms can incorporate the following sources:

- Channel waveforms
- Reference waveforms
- Measurements (automated measurements) that measure channel, reference, histogram, or math waveforms
- Math waveforms

**Source Dependencies.** Math waveforms that include sources as operands are affected by updates to those sources:

- Shifts in amplitude or DC level of input sources that cause the source to clip also clips the waveform data supplied to the math waveform.
- Changes to the vertical offset setting for a channel source that clips its data also clips the waveform data supplied to the math waveform.
- Changes to the acquisition mode globally affects all input channel sources, thereby modifying any math waveforms using them. For example, with the acquisition mode set to Envelope, a Ch1 + Ch2 math waveform will receive enveloped channel 1 and channel 2 data and, therefore, will also be an envelope waveform.

- Clearing the data in a waveform source causes a baseline (ground) to be delivered to any math waveform that includes that source until the source receives new data.

**Expression Syntax.** You build math waveforms using the Define/Edit Expression control window. To help you create valid math waveforms, this window blocks most illegal entries by disabling any window element that would create an invalid entry in the math waveform expression.

The syntax that follows describes valid math expressions, which can be quite complex (in excess of 100 characters long):

```

<MathWaveform> := <Expression>

<Expression> := <UnaryExpression> | <BinaryExpression>

<UnaryExpression> := <UnaryOperator> ( <Term> )
                  | <UnaryOperator> ( <Expression> )

<BinaryExpression> := <Term> <BinaryOperator> <Term> | <Scalar>
                   <BinaryOperator> <Term> | <Term> <BinaryOperator> <Scalar>

<Term> := <Waveform> | ( <Expression> )

<Scalar> := <Integer> | <Float> | <Meas-Result> | <Variable>

<Waveform> := <ChannelWaveform> | <ReferenceWaveform> | <MathWaveform>

<ChannelWaveform> := Ch1 | Ch2 | Ch3 | Ch4

<ReferenceWaveform> := Ref1 | Ref2 | Ref3 | Ref4

<MathWaveform> := Math1 | Math2 | Math3 | Math4

<UnaryOperator> := Average | Integral | Derivative | Invert | Sqrt | Exp
                | log 10 | log e | Fabs | Sin | Min | Max | Ceil | Cos | Tan
                | ASin | Sinh | ACos | Cosh | ATan | Tanh | Floor
                | Spectral Magnitude | Spectral Phase | Spectral Real | Spectral Imag

<BinaryOperator> := + | - | / | * | == | != | < | <= | > | >= | CHS | EXX

    The logical operators generate a vector that is all 0.0 or 1.0. Operators && and
    | | are not provided, but if x and y are expressions equal to 0 or 1, then x*y is
    the same as x&& y and (x+y)>0.99 is the same as x|y.

<Meas-Result> := meas1 | meas2 | meas3 | meas4 | meas5 | meas6 | meas7 | meas8

<Variable> := VAR1 | VAR2 | VAR3 | VAR4 | VAR5 | VAR6 | VAR7 | VAR8
    
```

**Waveform Differentiation.** The math capabilities of the instrument include waveform differentiation. This allows you to display a derivative math waveform that indicates the instantaneous rate of change of the waveform acquired.

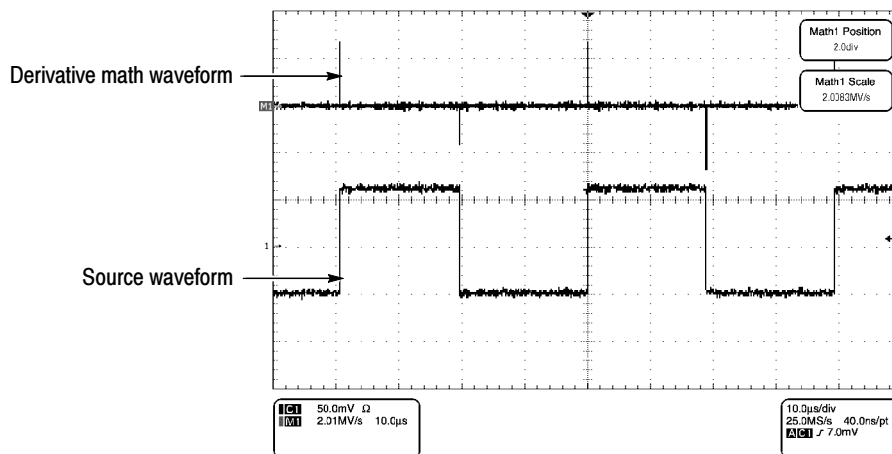
Derivative waveforms are used in the measurement of slew rate of amplifiers and in educational applications. You can create a derivative math waveform and then use it as a source for another derivative waveform. The result is the second derivative of the waveform that was first differentiated.

The math waveform, derived from the sampled waveform, is computed based on the following equation:

$$Y_n = (X_{(n+1)} - X_n) \frac{1}{T}$$

- Where: X is the source waveform
- Y is the derivative math waveform
- T is the time between samples

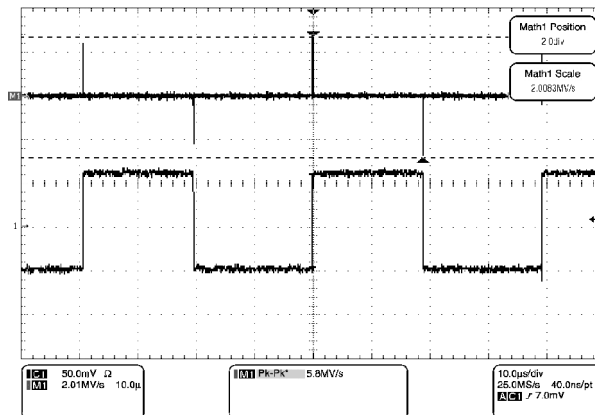
Since the resultant math waveform is a derivative waveform (See Figure 3-45), its vertical scale is in volts/second (its horizontal scale is in seconds). The source signal is differentiated over its entire record length; therefore, the math waveform record length equals that of the source waveform.



**Figure 3- 45: Derivative math waveform**



**Cursor Measurements.** You can also use cursors to measure derivative waveforms. Use the same procedure as is found under *Take cursor measurements* on page 3-181. When using that procedure, note that the amplitude measurements on a derivative waveform will be in volts per second rather than in volt-seconds as is indicated for the integral waveform measured in the procedure.



**Figure 3-46: Peak-peak amplitude measurement of a derivative waveform**

**Offset, Position, and Scale.** The settings that you make for offset, scale, and position affect the math waveform that you obtain. Note the following tips for obtaining a good display:

- You should scale and position the source waveform so that it is contained on screen. (Off screen waveforms may be clipped, resulting in errors in the derivative waveform).
- You can use vertical position and vertical offset to position your source waveform. The vertical position and vertical offset will not affect your derivative waveform unless you position the source waveform off screen so it is clipped.

**Waveform Integration.** The Math capabilities of the instrument include waveform integration. This allows you to display an integral math waveform that is an integrated version of the acquired waveform.

Integral waveforms find use in the following applications:

- Measuring power and energy, such as in switching power supplies
- Characterizing mechanical transducers, as when integrating the output of an accelerometer to obtain velocity

The integral math waveform, derived from the sampled waveform, is computed based on the following equation:

$$y(n) = scale \sum_{i=1}^n \frac{x(i) + x(i-1)}{2} T$$

Where:  $x(i)$  is the source waveform  
 $y(n)$  is a point in the integral math waveform  
scale is the output scale factor  
T is the time between samples

Since the resultant math waveform is an integral waveform, its vertical scale is in volt-seconds (its horizontal scale is in seconds). The source signal is integrated over its entire record length; therefore, the math waveform record length equals that of the source waveform.

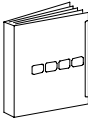
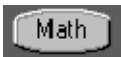
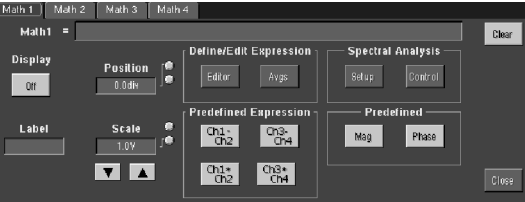
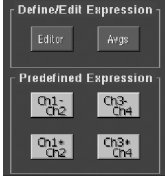
**Offset and Position.** When creating integrated math waveforms from live channel waveforms, consider the following topics:


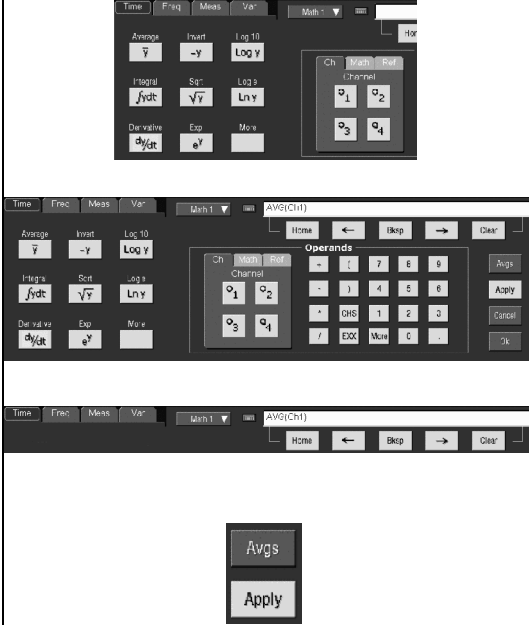
- You should scale and position the source waveform so that it is contained on screen. (Off screen waveforms may be clipped, which will result in errors in the integral waveform).
- You can use vertical position and vertical offset to position your source waveform. The vertical position and vertical offset will not affect your integral waveform unless you position the source waveform off screen so that it is clipped.

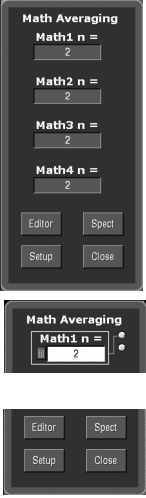


**DC Offset.** The source waveforms that you connect to the instrument often have a DC offset component. The instrument integrates this offset along with the time varying portions of your waveform. Even a few divisions of offset in the source waveform may be enough to ensure that the integral waveform saturates (clips), especially with long record lengths.

**To Define a Math Waveform**

Use the procedure that follows when defining a math waveform. Remember, to ensure that the sources you use exist. Acquisitions should be running or the channels should already be on, and reference waveform sources should contain saved waveforms, and so on. These sources do not have to be displayed to be used.

Overview	To define a math waveform	Related control elements and resources
<p><b>Prerequisites</b></p>	<p>1. All channel and reference Waveforms and automatic measurement scalars that you will use in your math waveform must be available (channels and references contain data, measurement scalars are defined, and so on).</p>	 <p>See page 3-29 for acquisition setup and page 3-63 for trigger setup.</p>
<p><b>Display the math control window</b></p>	<p>2. From the toolbar, touch the Math button to display the Define Math control window.</p>	
<p><b>Select a math waveform</b></p>	<p>3. Select the Math(x) tab for the math waveform that you want to define. Be sure to touch Display to toggle it on, so that the waveform displays.</p> <p>If the waveform that you select already exists, its math expression appears in the window. You can still use the waveform by touching the Clear button, which discards its previous math expression. Or repeat step 3 to select another waveform.</p>	
<p><b>To define an expression</b></p>	<p>4. Touch one of the Predefined Expression buttons to use a predefined math expression, or touch Editor to Define/Edit a new math expression.</p>	

Overview	To define a math waveform (Cont.)	Related control elements and resources
<p><b>To define/edit a math expression</b></p>	<p>5. Use the control window at right to define a math expression. See Table 3-11 on page 3-170 for expression examples; some guidelines for creating your expression follow:</p> <ul style="list-style-type: none"> <li>■ Sources — Ch1-Ch4, Ref1-Ref4, and Meas1-Meas8 — should be set up before you use them (channels acquired or acquisitions running, references and automated measurement scalars defined).</li> <li>■ Math definitions are not implemented if sources or other elements of the definition are not valid.</li> <li>■ Use the backspace button to remove the last entry; use the clear key to remove the entire expression and start over.</li> <li>■ Use parentheses to group terms in the expression to control execution order, for example; 5*(Ch1 + Ch2).</li> </ul>	
<p><b>Select a function</b></p>	<p>6. Select the Time, Freq, Meas, or Var tabs to display the available functions.</p> <p>7. Touch a function button to enter the function in the math expression. Select an operand for the function to operate on.</p> <p>8. Use the Home and arrow buttons to move within the math expression. Use the Bksp (backspace) button to delete portions of the expression.</p> <p>9. Touch Apply to apply your new math expression to the math waveform.</p>	

Overview	To define a math waveform (Cont.)	Related control elements and resources
<p><b>Apply averaging</b></p>	<p>10. Touch Avgs to display the Math Averaging control window. The controls in the window apply to the math waveform defined by the expression.</p> <p>11. Select one of the Math(x) n = controls and set the number of averages using the multipurpose knobs or keypad. This number of averages affect math waveforms if the Avg() function is used.</p> <p>12. Touch Close to close the window, touch Editor to open the Define/Edit Expression window, touch Setup to open the math control window, or touch Spect to open the Spectral control window.</p>	
<p><b>Finished</b></p>	<p>13. Once you have defined the math expression to your satisfaction, Touch the the apply button. Then touch the OK button to dismiss the dialog box. See <i>To Use Math Waveforms</i> on page 3-179 for more procedures.</p>	
<p><b>For further assistance</b></p>	<p>14. Touch the Help button in the toolbar to access context-sensitive help on math waveforms.</p>	 <p>See <i>Accessing Online Help</i> on page 3-263 for overview of the online help system.</p>

## Operations on Math Waveforms

This instrument supports many of the same operations for math waveforms that it provides for channel (live) and reference waveforms. For example, you can measure math waveforms with cursors. This section introduces these operations.

- Vertical display scaling and positioning
- Taking automatic measurements
- Taking cursor measurements
- Histograms on math waveforms

Many of the same instrument tools that prove to be powerful adjuncts for displaying, processing, and analyzing other waveforms also work on math waveforms. For example, in addition to the operations listed above, you can save math waveforms as references.

**Independent horizontal scaling.** Each math waveform that you create derives its horizontal scale and position from the sources that you include in its math expression. You can adjust these controls for the source waveforms, and your adjustments will reflect in the math waveform as the sources update. You can also magnify all waveforms, including math waveforms, using zoom.

### Using Math Waveforms

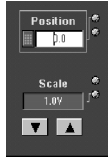
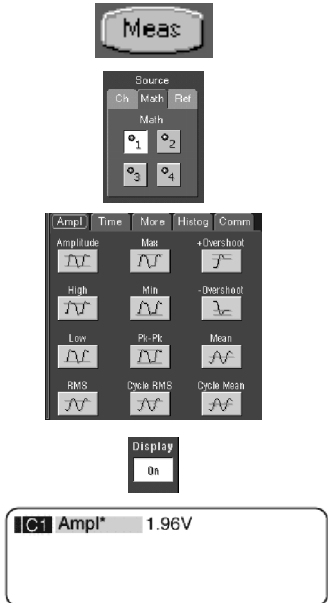
Basically, you use the same techniques to work with math waveforms that work with channel waveforms.

**Consider the Source.** Changes to source waveforms that you include as math-expression operands are reflected in the math waveform. However, if Ch1 is 4 divisions high at 100 mV per division, then at 50 mV per division Ch1 is 8 divisions high. Any math using Ch1 will not be affected by this change because the Ch1 voltage levels have not changed. See *Source Dependencies* on page 3-170.

**How to manage displaying.** Turn on and off the display of math waveforms from the Math control window. Use the same control-window controls (waveform selection buttons, vertical position, and vertical scale knobs). Mouse or touch screen operations for positioning waveforms on screen work also.

**To Use Math Waveforms** The procedure that follows demonstrates some common operations that you can perform on math waveforms:

Overview	To use math waveforms	Related control elements and resources
<p><b>Prerequisites</b></p>	<p>1. The Math waveform must be defined and displayed. See the reference listed at right.</p>	<div data-bbox="1182 485 1268 596" data-label="Image"> </div> <p data-bbox="1029 606 1446 632">See <i>To Define a Math Waveform</i> on page 3-175</p>
<p><b>Select and display</b></p>	<p>2. Touch the Math button to display the Math control window.</p> <p>3. Touch any Math(x) tab to make that math waveform the selected waveform.</p> <ul style="list-style-type: none"> <li>■ If the waveform that you select is not defined, use the <i>To Define a Math Waveform</i> procedure starting on page 3-175 to define the math waveform.</li> <li>■ If the waveform is not displayed, touch Display to toggle it on.</li> </ul>	<div data-bbox="1175 701 1297 753" data-label="Image"> </div> <div data-bbox="972 774 1500 974" data-label="Image"> </div>

Overview	To use math waveforms (Cont.)	Related control elements and resources
<p><b>Set scale and position</b></p>	<p>4. Touch Position or Scale and use the multipurpose knobs or keypad to size and position the waveform on screen as you want it.</p> <p><b>Note.</b> Position is in divisions, so changing the scale can make the math waveform disappear until position is also changed (the same effect happens with channel waveforms).</p> <p>You can touch and drag a waveform handle to change the waveform vertical position.</p> <p>You can adjust the waveform vertical position and scale by first touching the waveform handle and then using the multipurpose knobs to adjust the scale and position.</p> <p>You cannot adjust the offset of a math waveform.</p> <p>You cannot adjust horizontal scale, position, and sample density (resolution) of math waveforms; different length source waveforms result in a math waveform of the shortest source record length. If you adjust these settings for sources for a math waveform, the adjustment is reflected in the math waveform.</p>	
<p><b>Take automatic measurements</b></p>	<p>5. Touch the Meas button, select the Math tab, and touch a math button to choose a math waveform from Math1 - Math4. (See right.)</p> <p>6. Select a measurement (for more information, see <i>Taking Automatic Measurements</i> on page 3-140).</p> <p>Touch the Help button in the menu bar for more information.</p> <p>7. To display the measurement, touch Display to toggle it to on.</p> <p>8. Read the results in the measurements readout.</p>	



Overview	To use math waveforms (Cont.)	Related control elements and resources
<p><b>Take cursor measurements</b></p>	<p>You can also use cursors to measure math waveforms. Use the same procedures found under <i>Taking Cursor Measurements</i> on page 3-151.</p> <ol style="list-style-type: none"> <li>9. From the toolbar, touch the Cursor button to display the cursors and the cursor control window.</li> <li>10. Select the Math tab and touch the numbered button for the math waveform that you want to measure.</li> <li>11. Select the cursor type by touching either the H Bars, V Bars, Waveform, or Screen buttons (for more information, see <i>Taking Cursor Measurements</i> starting on page 3-151).</li> <li>12. Turn the multipurpose knobs to position each cursor on the math waveform to measure the feature that interests you.</li> <li>13. Read the results in the cursor readout. The cursor readout is displayed under the multipurpose readouts or in the upper right corner of the graticule area.</li> </ol> <p><b>Note.</b> Amplitude measurements on a derivative waveform are in volts per second and volt-seconds for an integral waveform measurement.</p>	
<p><b>For further assistance</b></p>	<ol style="list-style-type: none"> <li>14. Touch the Help button in the toolbar to access context-sensitive help on math waveforms, or see <i>Measuring Waveforms</i> on page 3-139.</li> </ol>	<p>See <i>Accessing Online Help</i> on page 3-263 for overview of the online help system.</p>

## Defining Spectral Math Waveforms

The math capabilities of the instrument include spectrum analysis of a waveform. This section describes a spectral analyzer that allows you to control the analysis intuitively with time domain and frequency domain controls. These controls merge the time domain controls with the frequency domain controls to provide a complete spectral analyzer.

Signals may be represented by their characteristics in both the time and the frequency domain. By combining and transforming source waveforms into spectral math waveforms, you can simultaneously view signal characteristics in both domains.

This spectral analyzer provides a complete set of controls and features that allow you to make time and frequency domain measurements without the need to learn extensive details about FFT algorithms.

- **Frequency Domain Controls:** You can operate the spectral analyzer using traditional spectrum analyzer controls. You can set the center frequency, span, and resolution bandwidth directly.
- **Time Domain Controls:** The spectral analyzer has time domain controls for the acquired waveform. These controls set the time duration and the resolution time between samples. You can easily set the required sample rate and record length.
- **Gating Controls:** These controls are the bridge that connect the time domain to the frequency domain. You can perform spectral analysis on a gated region of the input waveform. This gating also determines the resolution bandwidth of the analyzer.
- **Window Functions:** There are eight different window functions that shape the filter response of the spectral analyzer.
- **Magnitude Versus Frequency:** You can choose to display data in dB or linear mode. You may display the real or imaginary parts of the spectral magnitude only. Ref level offset and reference level controls give complete control over the vertical position and offset of the spectrum. The log zero dB ref level may be dialed in manually or set to dBm with a single button touch.
- **Phase Versus Frequency:** You can display phase data as a function of frequency in radians or degrees. You can zero the noise phase for magnitudes below a threshold level. Finally, you can select Phase unwrap and  $d\theta/d\omega$ , group delay.
- **Spectral Averaging:** You can turn on averaging in the frequency domain for phase and magnitude waveforms.

- Multiple analyzer control locks:** Up to four spectral analyzers may be used simultaneously. They may all be assigned to different gates on the same source waveform or to different channel sources. The controls of Math1 and Math2 may be locked and the controls of Math3 and Math4 may be locked; that is, turning a control on one analyzer changes the control on the other analyzer to the same value. Other combinations of locking, including all four analyzers, are available using GPIB commands.

The same exclusions for math waveforms apply to spectral math waveforms. In addition, sources for spectral math waveforms must be channel waveforms.

### Using Spectral Math Controls

Read the following topics; they provide details that can help you create the spectral waveform that best supports your data-analysis tasks.

The spectral analyzer contains five primary control categories. These are shown in Table 3-12.

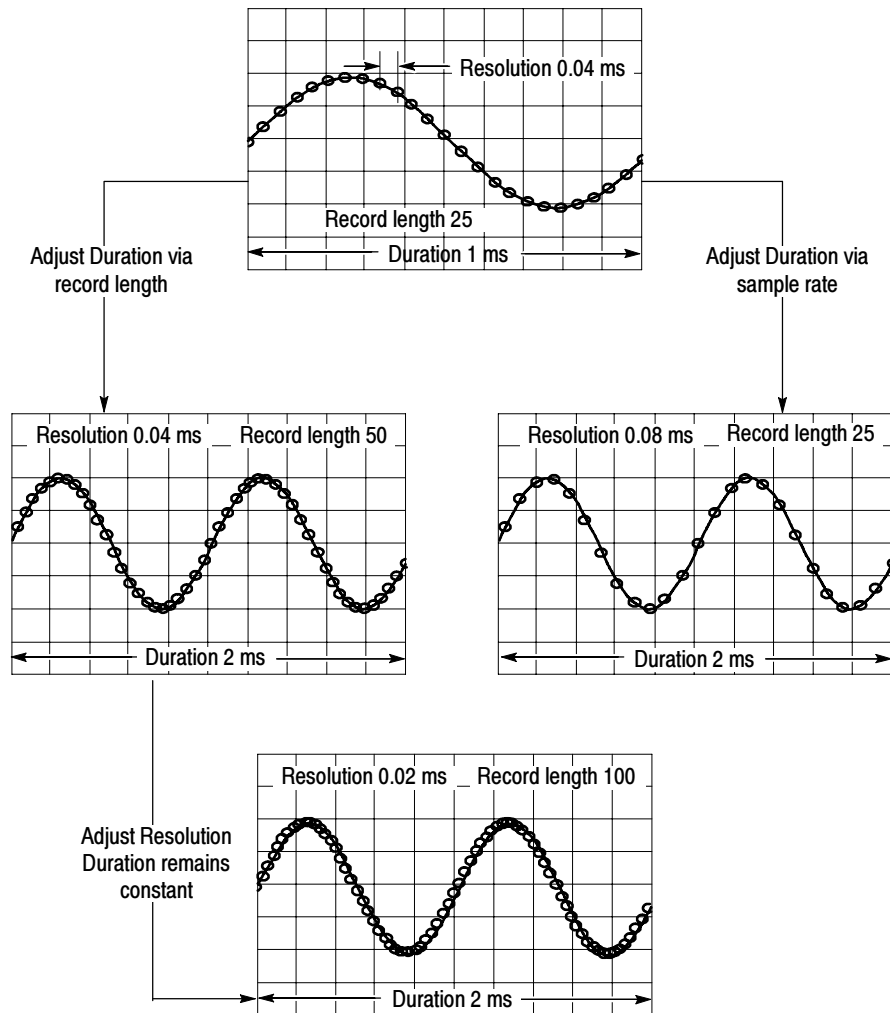
**Table 3-12: Spectral analyzer controls**

Time controls	Gate controls	Frequency controls	Magnitude controls	Phase controls
Source	Position	Center	dB, dBm linear, real imaginary	degrees, radians, group delay
Duration, record length	Duration	Span	Ref level	Zero threshold
Duration, sample rate	Window	Resolution bandwidth	Ref level offset	Phase Unwrap
Resolution				

**Using the time controls.** The operation of the time domain controls for the spectral analyzer is summarized by the following rules:

- Duration selects the time from the beginning to the end of the acquired waveform. You may set duration using the record length control or the sample rate control.
- Resolution determines the time between samples. Duration is kept constant as resolution is changed. Therefore, the Resolution control affects both the sample rate and the record length simultaneously.
- Most often, you will want to use a short record length because long record lengths can slow instrument response. However, long record lengths lower the noise relative to the signal and increase the frequency resolution for the spectral math waveform. More important, they might be needed to capture the waveform feature you want to include in the waveform.

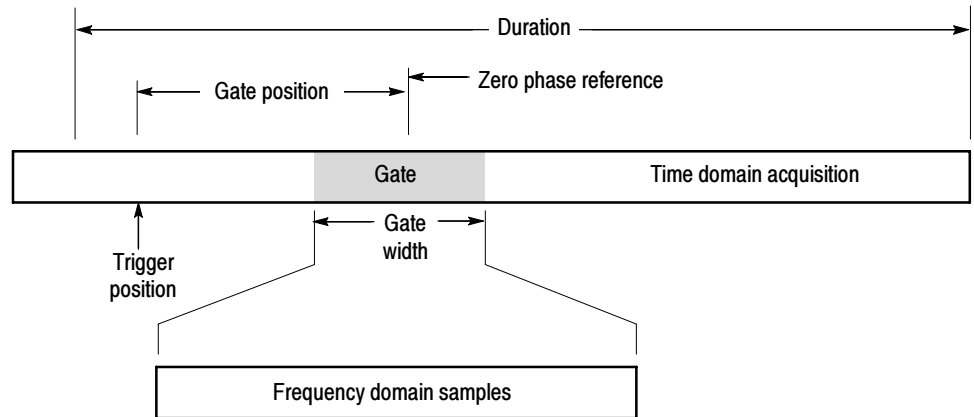
Examples of how duration and resolution affect the acquired waveform are shown in Figure 3-47.



**Figure 3-47: Duration and resolution control effects**

**Using the gate controls.** Gating determines what portion of the acquired waveform is transformed into the frequency domain. The gate has a position and a width control.

The gate position is the time in seconds from the trigger location to the center 50% position of the gate interval (see Figure 3-48). The position and width units are seconds.



**Figure 3-48: Definition of gate parameters**

The gate must reside within the duration interval of the source waveform. If the source waveform duration is adjusted and the gate position and width would result in the gate being outside of that duration then the gate position or width is set within the limits.

The width of the gate affects the resolution bandwidth of the spectral analyzer. See *Using Spectral Math Controls* on page 3-183 for more details.

The data contained in the gated region is transformed to the frequency domain.

The gate is identified on the display using dashed markers (similar to cursors). The default gate width setting is equal to the duration of the source waveform.

**Using the Frequency Domain controls.** The gated region of the source waveform is transformed by the spectral analyzer to a spectral waveform. This may be a phase or magnitude waveform. The horizontal units are always Hz. The vertical units depend on whether phase or magnitude is selected. The frequency domain controls for the spectral waveform are span, center, and resolution bandwidth. The spectrum normally appears on the display fit to a screen width of 10 divisions.

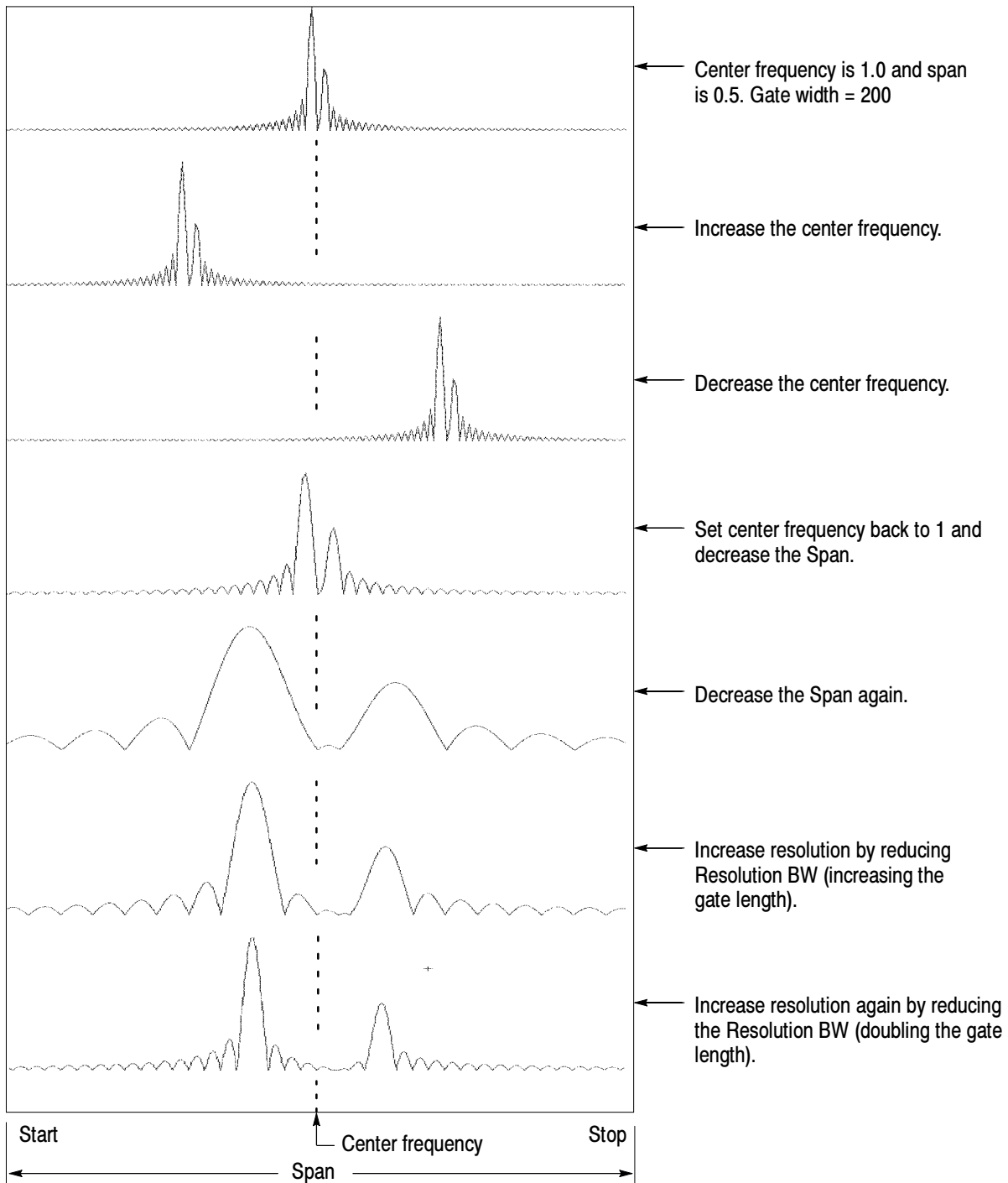
- **Span.** The span is the stop frequency at the end of the spectral waveform minus the start frequency at the beginning of the waveform. The span control maximum value is equal to the current sample rate divided by two. Therefore, if you are unable to increase the span to the desired value and if you want to keep the same source waveform duration, go to the timebase controls and increase the sample rate using the resolution control. Or, if you want to also decrease the source waveform duration, adjust the sample rate control. If you decrease the sample rate, the span setting may decrease, if necessary, to keep the span less than the sample rate divided by two.

- **Center.** This is the frequency at the center of the spectral waveform. Center is equal to the start frequency plus one half of the span. The adjustment range depends on the sample rate and the current span setting. Remember that the span must always be in the interval of zero to one half of the sample rate. Where one end of the span goes to DC or Nyquist, depending on which direction the center frequency is adjusted, the span decreases to allow the center frequency to go further in the direction it is being adjusted. If you are unable to increase the center to the desired value then increase the sample rate using either the sample rate or resolution controls. You may also change sample rate by using the HORIZONTAL SCALE knob on the instrument front panel.
- **Resolution Bandwidth, RBW.** This is the 3 dB down bandwidth of the spectral analyzer frequency response to a sine wave input. The resolution bandwidth is affected by two parameters.
  - Different window functions produce different filter response shapes in the spectrum and result in different resolution bandwidths.
  - The gate width, of the input data, affects the resolution bandwidth (RBW). Gate width has units of seconds. The resolution bandwidth directly controls the gate width, but the numerical value is entered in units of Hz. Therefore, the time domain gate markers move as you adjust the RBW control.

$$RBW = \frac{\text{Window Bin Width}}{\text{Gate Width}}$$

Where the Window Bin Width is the resolution bandwidth in units of bins. It depends on what window function is used. The gate width is in units of seconds.

Figure 3-49 demonstrate the effects of adjusting center frequency and span. Center frequency is a horizontal position control for the spectrum. Span is a horizontal scale control. Resolution bandwidth usually adjusts the bandwidth of the analyzer filters without affecting the span and center frequency.



**Figure 3-49: Effects of frequency domain control adjustments**

**Using the magnitude controls.** Vertical units can be either linear or logarithmic. You can select these choices by touching the Math menu button. Then touch the Spectral Analysis Setup button. Then select the Mag tab. Then select the desired scale type from Linear, dB, or dBm.

- **Linear.** When the spectrum is linear magnitude the vertical units are the same as the source waveform. Usually this is volts. However, it may also be watts or amperes. The vertical axis is the linear RMS. When the sin wave has  $2 V_{p-p}$  ( $V_{max}$  is +1 V and  $V_{min}$  is -1 V) and is done in FFT, the peak value of linear RMS is displayed as 0.707 V.
- **dB.** This sets the vertical scale of the magnitude spectrum to dB. Use the Reference Level Offset to set what vertical position in the magnitude spectrum will be zero dB. The following equation applies:

$$dB = 20 \log\left(\frac{|X|}{Ref}\right)$$

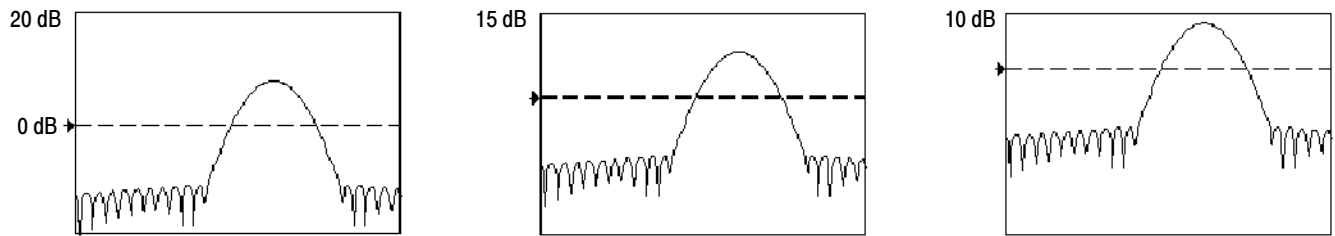
- If the input units are watts, the the following equation applies:

$$dB = 10 \log\left(\frac{|X|}{Ref}\right)$$

Where X is a complex data point in the spectrum and Ref is the Reference-Level Offset value.

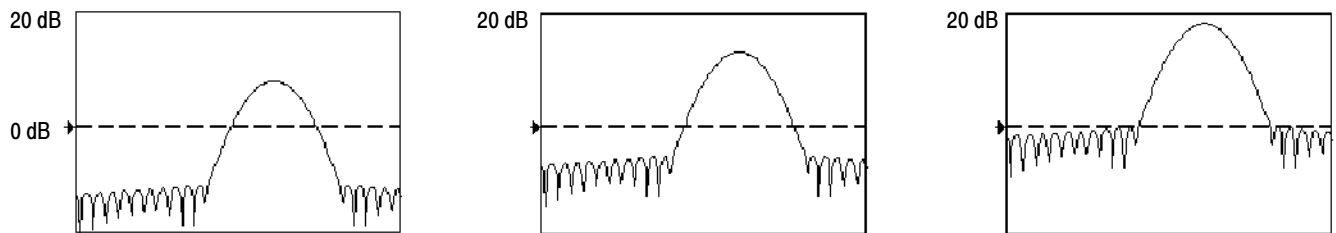
- **dBm.** This selects dB as described in the above equation, but it also sets the Reference-Level Offset to a value that is equivalent to 1 mW of power into 50  $\Omega$ . Therefore, if the input units are volts, then the value is set to 223.6 mV. If the input units are amperes, then the value is set to 40  $\mu$ A. If the input units are watts, then the value is set to 1 mW.
- **Reference Level.** This sets the vertical position of the displayed spectrum. Its value is the magnitude at the top of the display screen. When this control is adjusted, the spectral waveform along with its zero reference marker move vertically on the screen (see Figure 3-50). This control does not change the spectral data.





**Figure 3-50: Effects of adjusting the reference level**

- Reference Level Offset. This changes the value of Ref in the equation for dB shown above. Unlike the Reference Level control, this control actually changes the output data values in the spectrum. Zero dB is shown on the display screen by the marker associated with the spectral waveform. Adjusting the reference-level offset causes the spectral waveform to move vertically with respect to the waveform reference marker. This moves the waveform without changing the Reference-Level control setting. Sometimes it is beneficial to adjust this control so that the peak of a fundamental is at zero dB. Then you can measure other harmonics in terms of how many dB they are down from the fundamental. Touch the dBm button to preset this level to the equivalent of 1 mW into 50  $\Omega$ .



**Figure 3-51: Effects of adjusting the reference level offset control**

- Real and Imaginary Magnitudes. You may set the spectral analyzer to display the linear magnitude of the real data or the imaginary data in the spectrum. This is useful if you process the spectrum off line and transform it back into a time domain trace. You could save the real and the imaginary spectrum into a reference memory. You can export the waveforms directly into Mathcad, Matlab, and Excel documents and update in real time.

To turn on a real or imaginary spectrum, touch the Math button, the Define/Edit Expression Editor button, and then select the Freq tab. Touch either the Real or the Imag menu items to enter an expression. Then touch the Ch tab and one of the channel buttons. Touch apply.

**Using the Phase Controls.** You can set the vertical units to degrees, radians, or seconds of group delay. You select these choices by touching the Math button, the Spectral Analysis Setup button, and then selecting the Phase tab. Select the desired scale type from Degrees, Radians, or Group Delay.

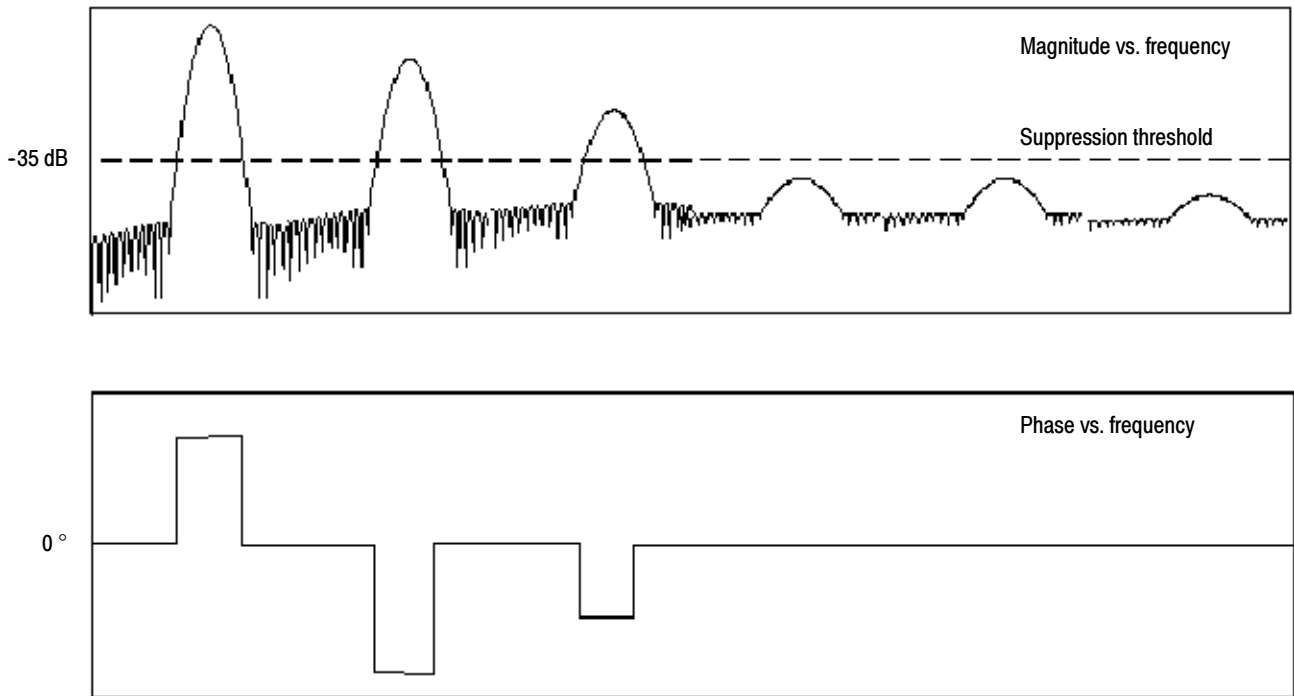
- **Phase Reference Position.** Phase is a relative measurement that must have a time domain reference point. The phase value is specified with respect to this phase reference position.

For the spectral analyzer, the phase reference position is the 50% position of the gate, that is, the middle of the gate interval of the data that is input to the spectral analyzer. This is true for all window functions except for the Tek Exponential window. This window has the reference point at the 20% position of the gate.

- **Phase Unwrap.** The spectral analyzer produces phase values from  $-\pi$  to  $\pi$  radians or  $-180$  to  $180$  degrees. However, when you perform impulse response testing and the phase is continuous, then phase values outside these ranges may occur. The spectral analyzer then wraps the data with discontinuities in the display from  $+180$  to  $-180$  degrees. Phase unwrap will display the correct result by unwrapping the phase.

Phase unwrap is only valid when the phase spectrum is a continuous function of frequency. Therefore, do not use it when analyzing the harmonic content of the typical repetitive signal.

- **Suppression Threshold.** Random noise in the spectrum may have phase values over the entire range. This could make the phase display unusable. However, you can set the suppression threshold control to a level in dB. The phase of any complex spectral points with a magnitude below this threshold is set to zero.
- **Phase Unwrap Algorithm.** The algorithm searches for the largest magnitude in the current span. Phase unwrap is then performed in both directions in frequency from that point. This results in a stable phase unwrap.
- **Phase Spectrum dejitter.** An instrument acquisition system jitters by one sample interval. Signals at the Nyquist frequency only have two samples per cycle. This would cause  $180^\circ$  of phase jitter if it were not corrected. The instrument phase spectrum is dejittered so that accurate measurements of phase are obtained from DC to the Nyquist frequency.



**Figure 3-52: Example of the effects of setting the phase suppression threshold**

- **Group Delay.** When the phase spectrum is a continuous function of frequency, group delay may be computed. This is true of impulse response testing where an impulse is fed into the system and the spectrum of the response of the system output is computed.

Group delay measures how well a system passes a signal in terms of phase distortion. Group delay is the negative derivative of the phase with respect to frequency.

This feature is not useful for analysis of harmonic content of signals where the phase response is not continuous.

- **Impulse Response Testing.** When performing impulse response testing of a system, place the impulse at the zero-phase reference position of the acquisition. This produces a correct phase display. Because the Tek Exponential window has its zero phase reference position at the 20% point, more of the impulse response is captured. All other window functions have their phase reference position at the 50% position in the gated region.

There are several ways to adjust the position of the zero phase reference point with respect to your input signal:

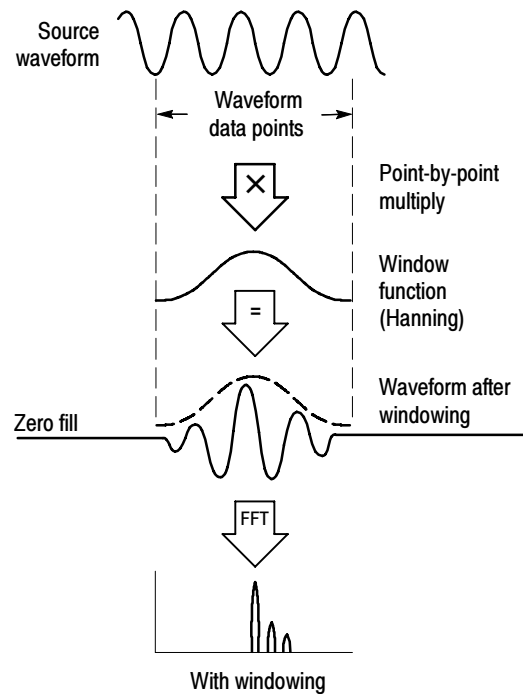
- Adjust the spectral analyzer gate position

- Perform fine adjustment using the front-panel trigger level control
- Adjust the front-panel HORIZONTAL POSITION control

**Using windows to filter.** There are eight different spectral analyzer windows:

- Rectangular
- Hamming
- Hanning
- Kaiser-Bessel
- Gaussian
- Blackman-Harris
- Flattop2
- TekExponential

In the time domain a window is a bell-shaped function equal in length to the gate duration. For most windows this function tapers to zero at both ends of the gate region. Before computation of the spectral transform, the window is multiplied, sample by sample, times the input data in the gate region. The window function affects the shape of the spectral analyzer response in the frequency domain. The window functions affect the ability to resolve frequency in the output spectrum and can affect the accuracy of the magnitude and phase measurements. Figure 3-53 shows how the time domain record is processed.



**Figure 3-53: Windowing the time domain record**

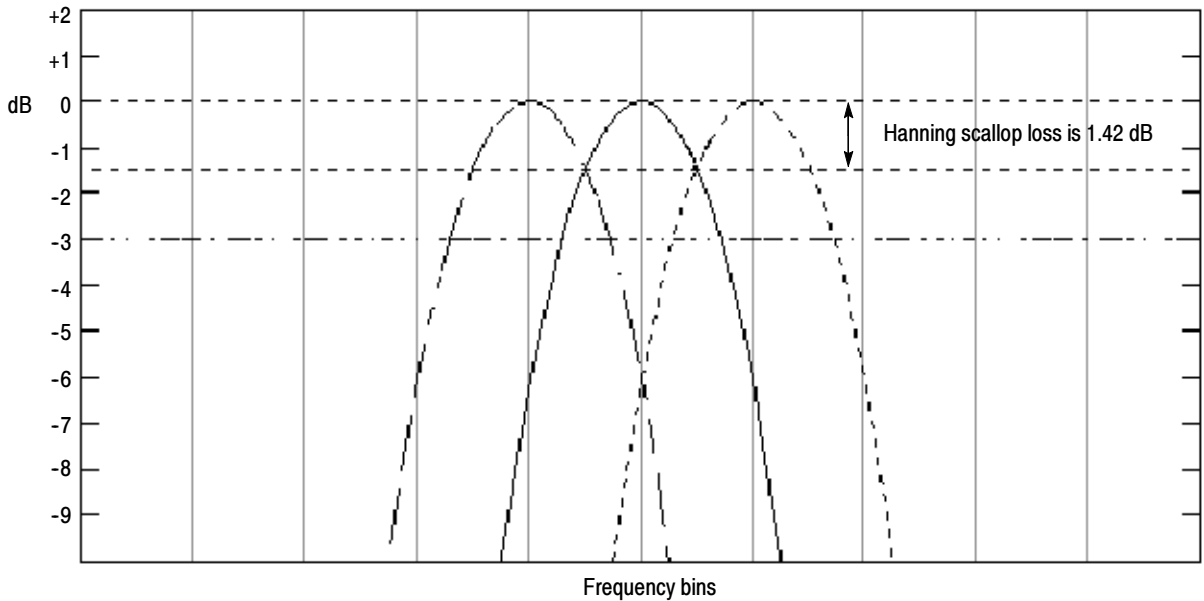
Accurate magnitude measurements require that the input source waveform be stationary within the gate region. This means that waveform parameters such as frequency and amplitude do not change significantly as a function of time within the gate region that is input to the spectral analyzer. Also, the gate width must be greater than or equal to the period of the start frequency of the span of the spectral analyzer, that is, there must be at least one cycle of the harmonic being measured within the gate region.

- Choice of a window. Your choice of window function will depend on the input source characteristics which you want to observe and the characteristics of the window function. The window characteristics are shown in Table 3-13.
- FFT length. The FFT length is controlled so that the gate width in samples is never more than 0.8 of the FFT length. Thus, zero fill is always in effect. This essentially eliminates scallop loss errors in magnitude that would occur without zero fill.

**Table 3-13: Window characteristics**

Window	3 dB BW in bins	Scallop loss	Nearest side lobe	Zero phase reference	Coefficients
Rectangular	0.89	3.96 dB	-13 dB	50%	1.0
Hamming	1.3	1.78 dB	-43 dB	50%	0.543478, 0.456522
Hanning	1.44	1.42 dB	-32 dB	50%	0.5, 0.5
Kaiser-Bessel	1.72	1.02 dB	-69 dB	50%	0.40243, 0.49804, 0.09831, 0.00122
Blackman - Harris	1.92	0.81 dB	-92 dB	50%	0.35875, 0.48829, 0.14128, 0.01168
Gaussian	2.0	0.76 dB	-79 dB	50%	a = 3.75 (not cosine series)
Flatop2	3.8	0.0065 dB	-90 dB	50%	0.213348, -0.206985, 0.139512, -0.043084, 0.003745
Tek Exponential	1.42	0.60 dB	-67 dB	20%	na

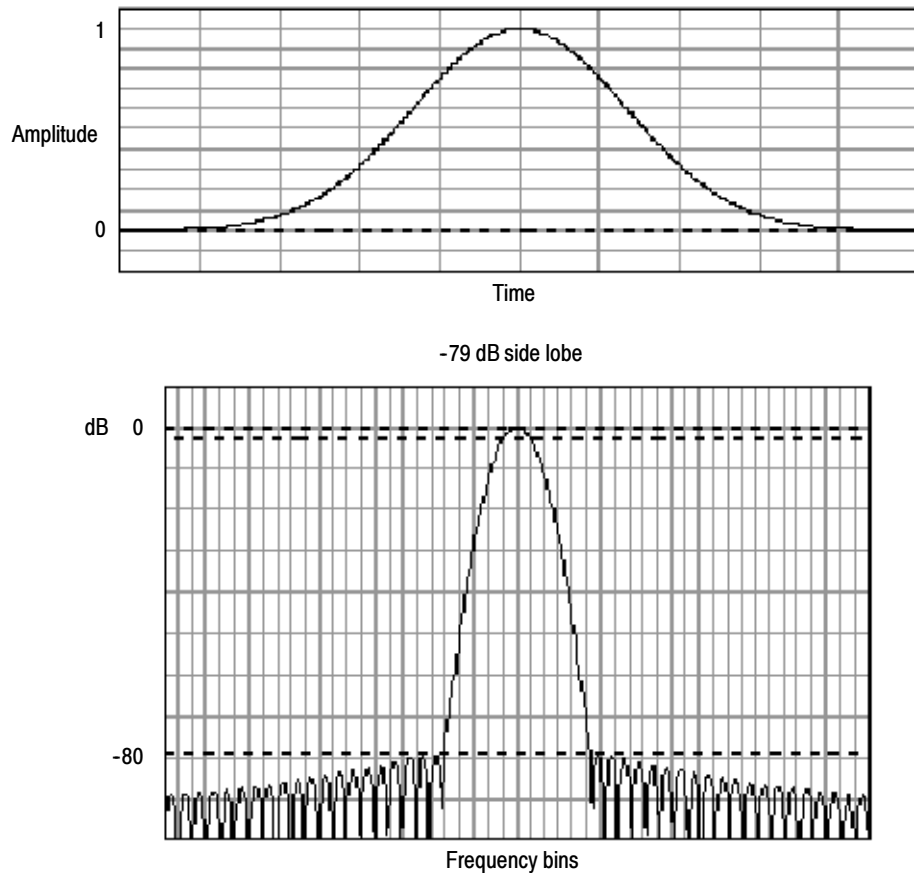
- **3 dB BW in Bins.** This is the bandwidth of the filter response of the spectral analyzer to a sine wave input for a given window function. It is given in units of bins. A bin is the interval between spectral samples when the interpolation ratio due to FFT zero fill is one. The bandwidth is measured between the points on the lobe that are 3 dB down from the peak of the lobe. The bandwidth in Hz may be computed by dividing the BW in bins by the gate duration in seconds. This is also referred to as resolution bandwidth (RBW).
- **Coherent gain.** The gain factor normally associated with different window functions is correctly scaled into the magnitude spectrum output. Therefore, the magnitudes in the output spectrum do not change as different windows are selected.
- **Scallop Loss.** This is the magnitude error of an FFT when the frequency of the observed signal is exactly half way between two frequency samples of the spectrum when the interpolation ratio due to zero fill of the FFT is one. The spectral analyzer FFT length is controlled so that zero fill is always in effect. This essentially eliminates scallop loss because zero fill in the time domain causes interpolation in the frequency domain. This results in accurate magnitude measurements for all window functions.



**Figure 3-54: Example of scallop loss for a Hanning window without zero fill**

- **Nearest Side Lobe.** This is the difference in magnitude between the spectral lobe peak in the spectrum and the next side lobe that occurs due to energy leakage. Different windows have different leakage characteristics. The more narrow the resolution bandwidth of the window, the more leakage in the spectrum.
- **Zero Phase Reference.** This is the position in the time domain gate that is the reference point for phase in the output spectrum. That is, if a sine wave input has its peak at the zero phase reference position, then it reads out as zero phase in the spectrum. If the phase is to be correct when doing impulse response testing, the impulse in the time domain must be located at this position in the gate interval.
- **Coefficients.** These are used to generate the windows which are constructed from a cosines series. For the Gaussian window the value of “a” is given instead of a set of coefficients. You can find descriptions of cosine series windows in *Handbook of Digital Signal Processing Engineering Applications* by Elliot. ISBN 0-12-237075-9.

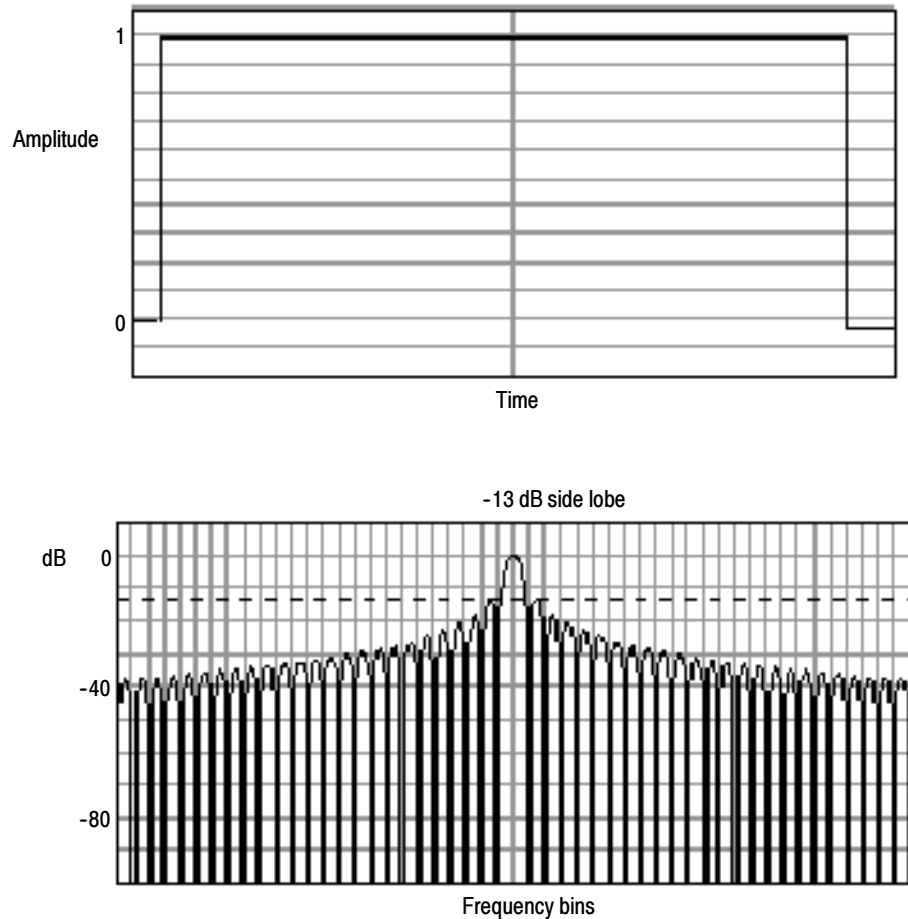
- **Gaussian Window.** This is the default window function (see Figure 3-55). It is unique in that the time-domain shape of an exponential Gaussian function transforms into a Gaussian exponential shape in the frequency domain. This window provides optimal localization in both the time and the frequency domain. This is the filter shape most commonly used in spectrum analyzers.



**Figure 3-55: Time and frequency graphs for the Gaussian window**

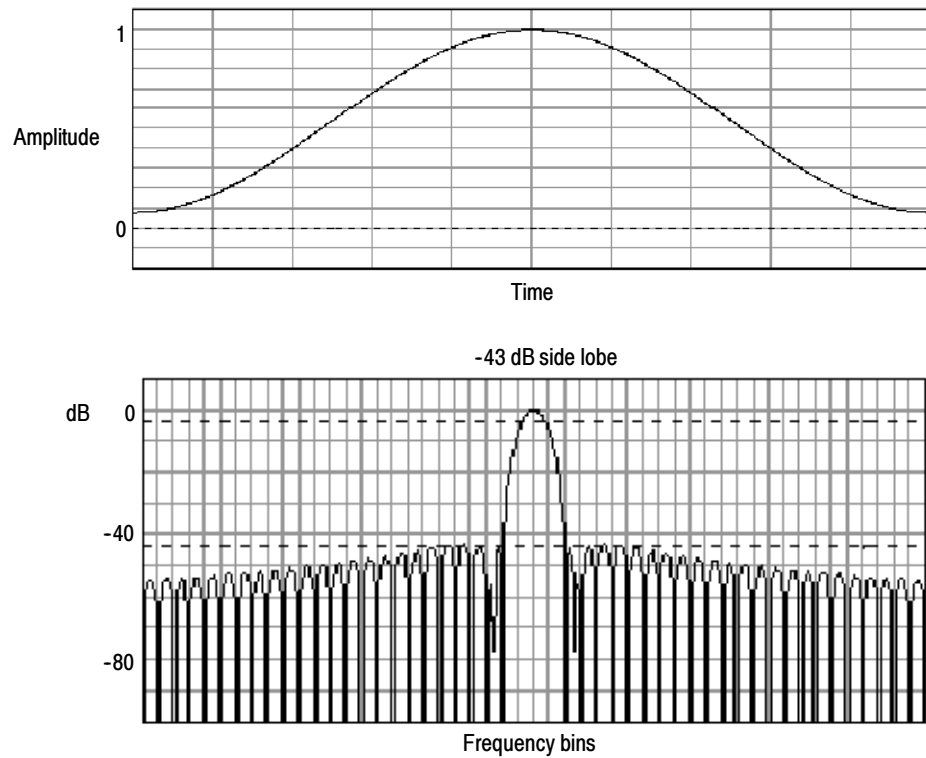


- **Rectangular Window.** This window is equal to unity (see Figure 3-56). This means the data samples in the gate are not modified before input to the spectral analyzer. This window has the narrowest resolution bandwidth of any of the windows, but it also has the most spectral leakage and the highest side lobes.



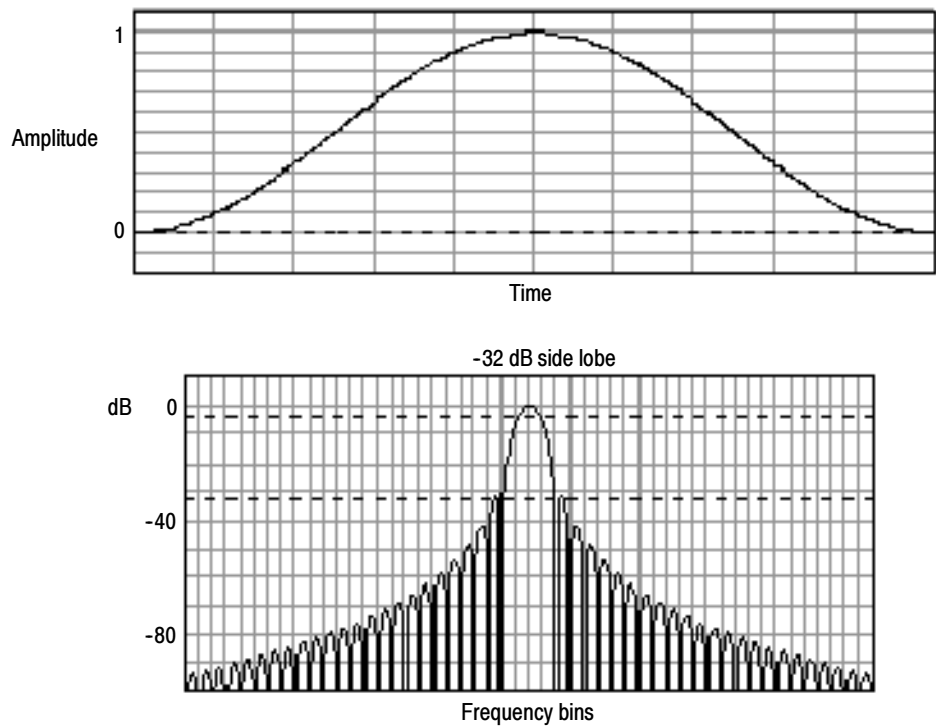
**Figure 3-56: Time and frequency domain graphs for the Rectangular window**

- **Hamming Window.** This window is unique in that the time domain shape does not taper all the way to zero at the ends (see Figure 3-57). This makes it a good choice if you wanted to process the real and imaginary parts of the spectrum off line and inverse transform it back to the time domain. Because the data does not taper to zero you could then remove the effect of the window function from the result.

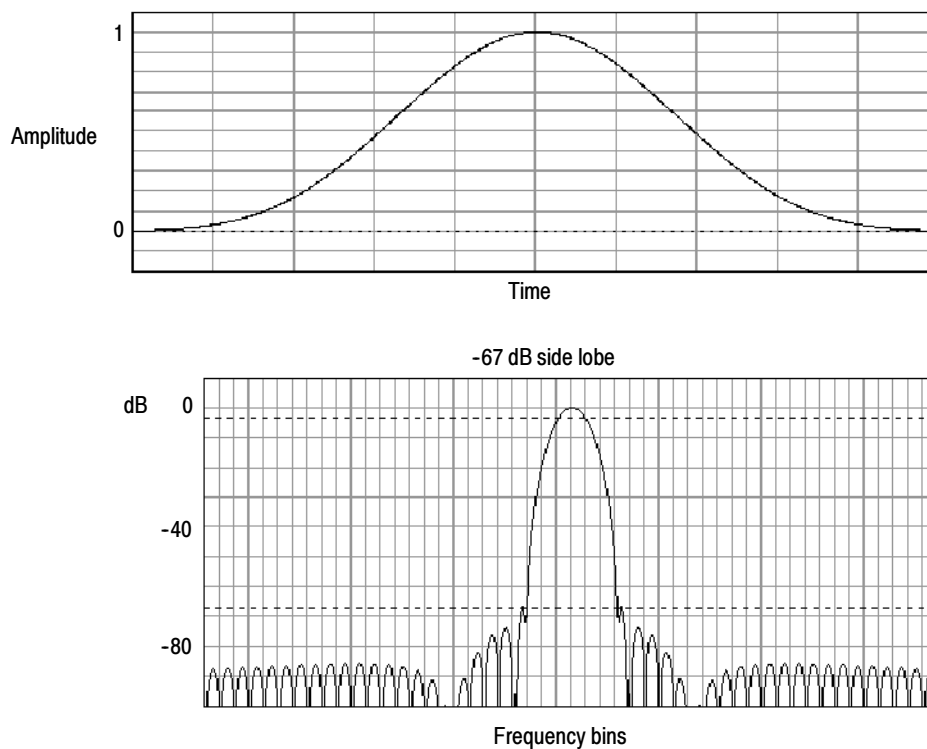


**Figure 3- 57: Time and frequency graphs of the Hamming window**

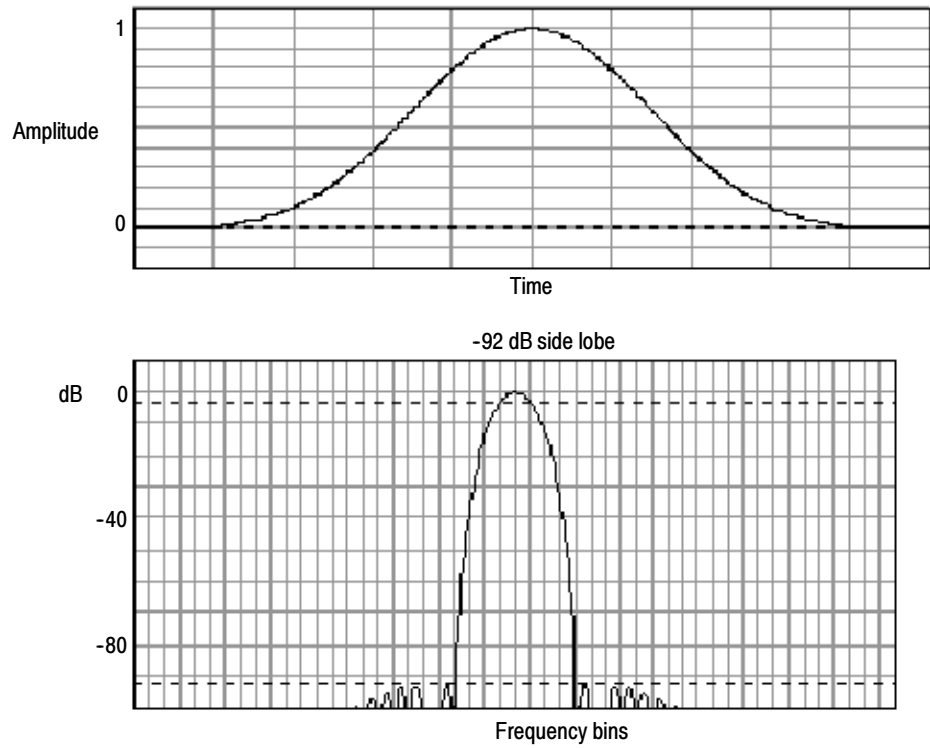
- Hanning, Kaiser-Bessel, and Blackman-Harris Windows. These windows have various resolution bandwidths and scallop losses (see figures 3-58, 3-59, and 3-60). Choose the one that best allows you to view the signal characteristics that you are interested in. The Blackman-Harris has a low amount of energy leakage compared to the other windows. The Hanning has the narrowest resolution bandwidth, but higher side lobes.



**Figure 3-58: Time and frequency graphs for the Hanning window**



**Figure 3-59: Time and frequency graphs for the Kaiser-Bessel window**



**Figure 3-60: Time and frequency graphs of the Blackman-Harris window**

- **Flattop2 Window.** This window has the lowest scallop loss of any of the windows (see Figure 3-61). It also has a wider resolution bandwidth but lower side lobe attenuation. Also, it is unique because the time domain shape has negative values.

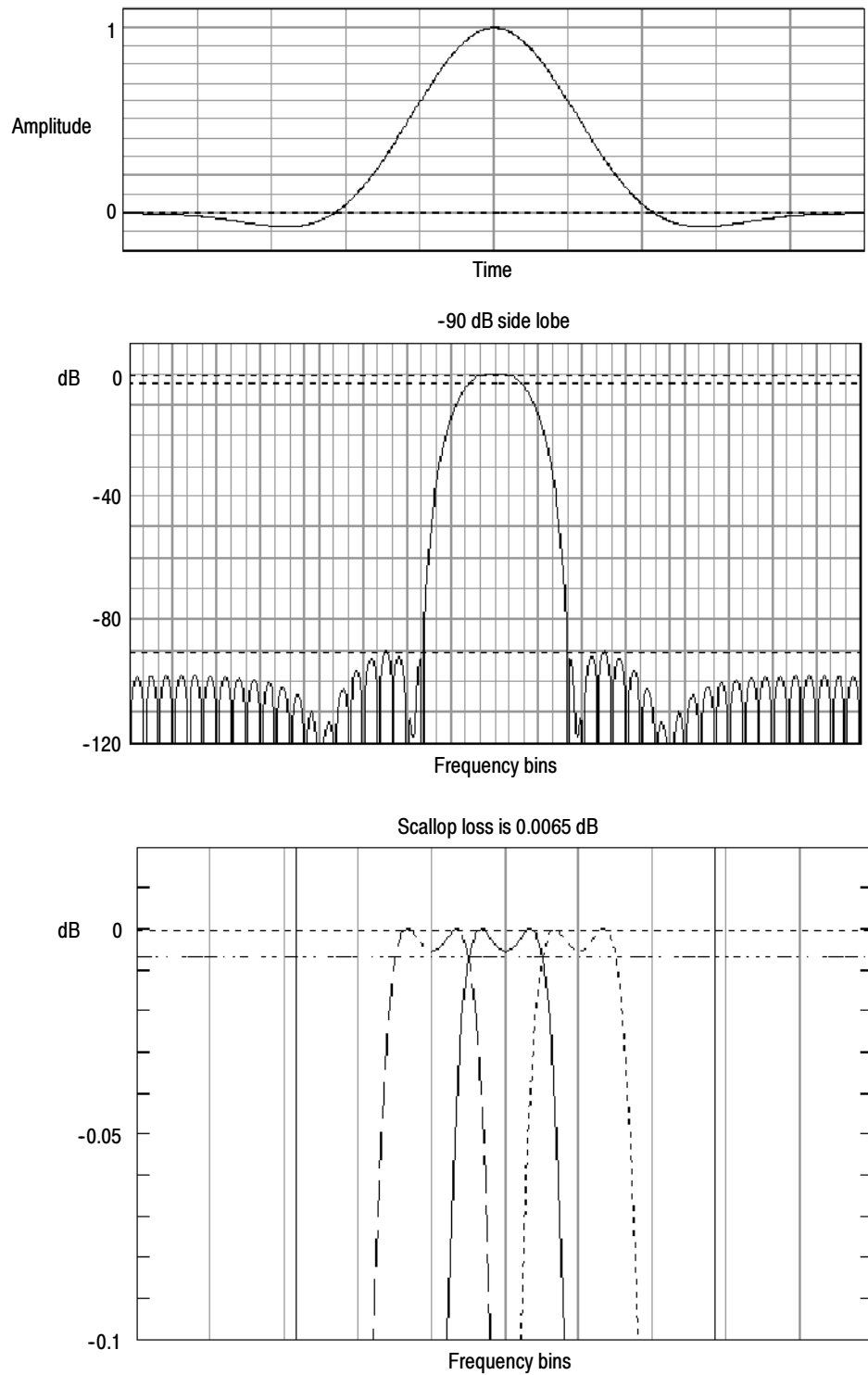
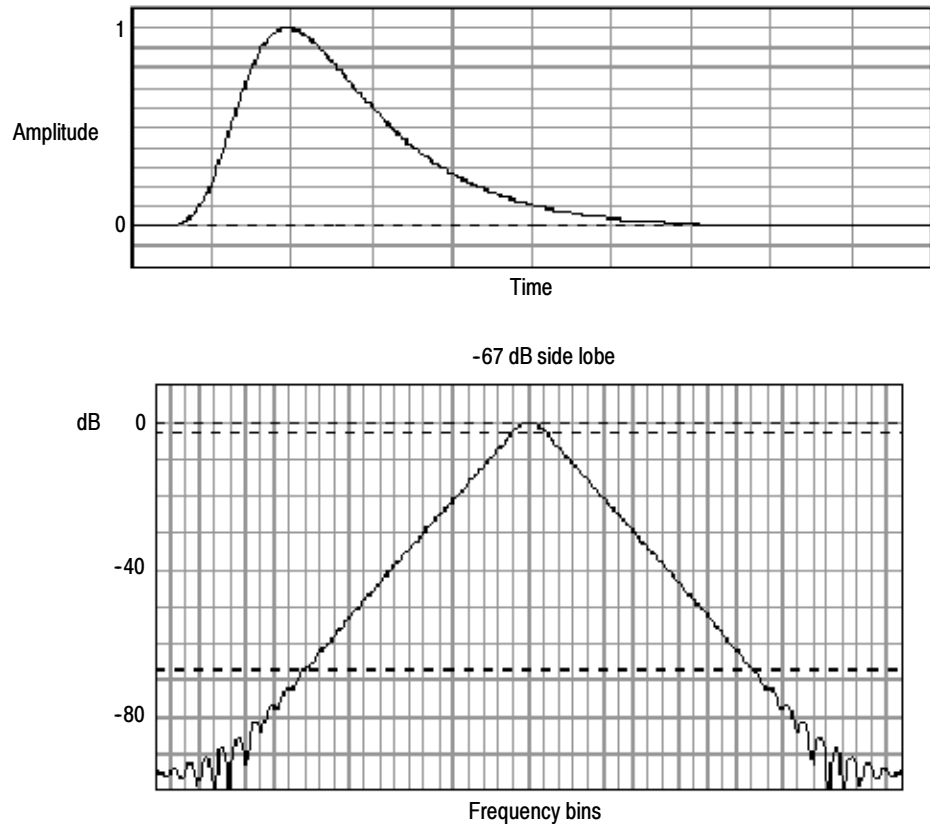


Figure 3-61: Time and frequency domain graphs for the Flattop2 window

- **Tek Exponential Window.** The Tek Exponential window (see Figure 3-62) was invented at Tektronix. In the time domain, it is not a symmetrical bell shape as is the case with the other windows (see Figure 3-62). Instead, it is exponential with a peak at the 20% position of the time domain gate. The frequency domain shape is triangular. Use this window for impulse response testing where the 20% position is the zero phase reference point. More of the acquired data record length is used to capture the impulse response. Exact details of how to compute its values were published in the article, “Impulse-response testing lets a single test do the work of thousands” by John Pickerd in *EDN* magazine, April 27, 1995, page 95.



**Figure 3-62: Tek Exponential window in the time and the frequency domains**

**Effects of trigger jitter.** The instrument acquisition system has a sample clock that is asynchronous with respect to the input signal. This means that from one acquisition to the next, samples may be in a different position on the waveform with respect to the trigger. Samples may vary in position by up to one sample interval.

There are only two samples per cycle of a signal that have a frequency equal to one half of the sample rate. This is the highest nonaliased signal that can be output from the spectral analyzer. Thus, at this frequency, one sample of acquisition jitter will show up in the spectrum as 180 degree phase variations. The phase spectrum is dejittered by using the fractional trigger value of the instrument to correct all phases in the spectrum. Therefore phase is accurately measured from DC to the Nyquist frequency.

- Effects of Average and High Res acquisition modes. The result of averaging the time domain acquisition using either average mode or Hi Res acquisition mode affects the frequency response of the instrument. This is due to the one sample of jitter in the acquisition system. Both High Res and average acquisition modes have the same affect on the frequency response. These modes cause the response to roll off from a magnitude value of one at DC to a magnitude value of 0.63 at Nyquist which is the frequency equal to one half of the sample rate. This is true regardless of the real time sample rate setting.
- Frequency Domain Averaging. You may turn on average for a math waveform by editing the math expression. Sometimes it is more desirable to average in the spectrum than in the time domain. For example, consider a signal that has time domain components that are asynchronous to the trigger. If you turn on averaging in the time domain, these components may go to zero or produce strange non-deterministic effects on the resultant waveform. Thus, these signal components may end up not appearing in the spectrum. However, if averaging is done in the frequency domain instead, then these components will be present. An example is:

Math1 = AVG(SpectralMag(Ch1)).

## Recognizing Aliasing

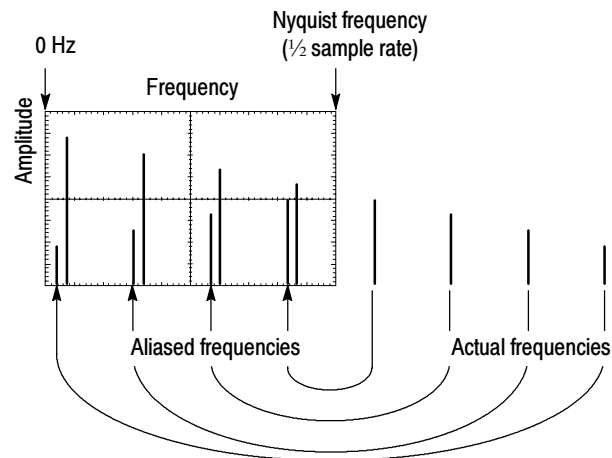
Aliasing occurs when the input frequency of a signal is greater than one half of the sampling frequency (the sample rate).

Set the sample rate high enough so that the signals in the spectrum appear at the correct frequencies as opposed to a lower aliased frequency value. Also, complex signal shapes that have many harmonics in them, such as a triangle or square wave, can appear to be OK in the time domain when, in fact, many of the harmonics in that signal are aliased.

One way to check for aliasing is to increase the sample rate and observe whether any of the harmonics unwrap to different frequency locations.



Higher order harmonics usually have decreasing magnitudes compared to lower order harmonics. Thus, if you see a series of increasing harmonic magnitude values as frequency increases, then you can suspect that they may be aliased. In the spectral math waveform, the actual higher frequency components are undersampled, and therefore, they appear as lower frequency aliases that “fold back” around the Nyquist point. (See Figure 3-63.) You can test by increasing the sample rate and observing if aliases unwrap to different frequency positions.



**Figure 3-63: How aliased frequencies appear in a spectral waveform**

Another way to observe aliasing, if you have a variable frequency signal source, is to adjust the frequency slowly while watching the spectral display. If some of the harmonics are aliased, you will see the harmonics decreasing in frequency when they should be increasing or vice versa. Using averaging in either the time or frequency domain will make these frequency shifts more sluggish.

**To Take Cursor Measurements of a Spectral Math Waveform.** Once you have displayed a spectral math waveform, use cursors to measure the frequency amplitude or phase angle. See *Taking Cursor Measurements* on page 3-151.

**To Take Automated Measurements of a Spectral Math Waveform.** You can use automated measurements to measure spectral math waveforms. Use the procedure *To Take Automated Measurements* on page 3-144.

**Swept Sine Wave Analysis.** Many applications of the spectral analyzer require swept sine wave input. The following equation determines the maximum sweep speed of the sine wave generator for a given span and resolution bandwidth.

$$T = \frac{(freq\ span * K)}{RBW^2}$$

T = minimum time to sweep the sine over the requested span

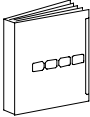


freq span = frequency span of interest

RBW = resolution bandwidth

K = 2 dB BW in bins for the window function in use as shown in Table 3-13 on page 3-194. K = 2 for a Gaussian window.

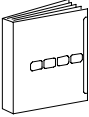


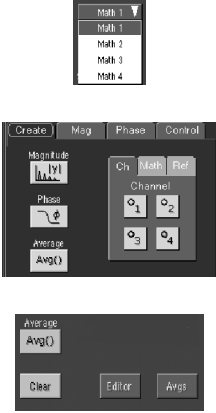
**To Select a Predefined Spectral Math Waveform**

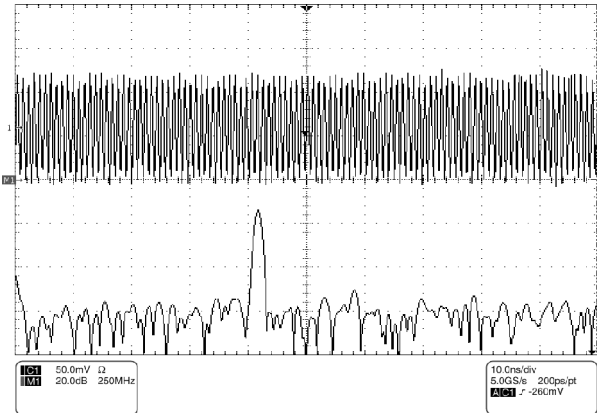
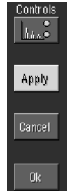
Use the procedure that follows to select a predefined spectral math waveform. Remember, a channel source must be acquiring or have acquired data. This source does not have to be displayed to be used.




Overview	To select a predefined spectral math waveform	Related control elements and resources
<b>Prerequisites</b>	<ol style="list-style-type: none"> <li>1. All channel and reference Waveforms and automatic measurement scalars that you will use in your math waveform must be available (channels and references contain data, measurement scalars are defined, and so on).</li> </ol>	 <p>See page 3-29 for acquisition setup and page 3-63 for trigger setup.</p>
<b>Display the math control window</b>	<ol style="list-style-type: none"> <li>2. From the toolbar, touch the Math button to display the Define Math control window.</li> </ol>	
<b>Select a predefined spectral analysis math waveform</b>	<ol style="list-style-type: none"> <li>3. Touch Mag or Phase to select a predefined magnitude or phase spectral analysis waveform. Selecting a predefined spectral waveform turns on display of the waveform.</li> </ol>	

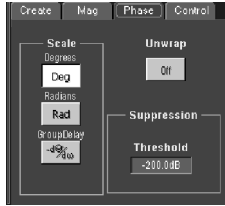



**To Define a Spectral Math Waveform**

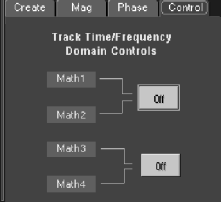

Use the procedure that follows when defining a spectral math waveform. Remember to ensure that the sources you use exist. Channel sources must be acquiring or have acquired data. These sources do not have to be displayed to be used.

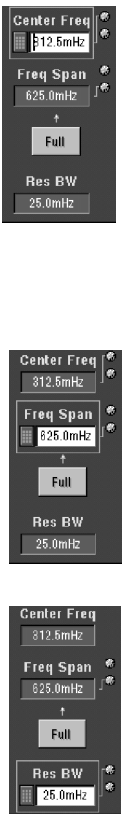
Overview	To define a spectral math waveform	Related control elements and resources
<p><b>Prerequisites</b></p>	<p>1. All channel and reference Waveforms and automatic measurement scalars that you will use in your math waveform must be available (channels and references contain data, measurement scalars are defined, and so on).</p>	 <p>See page 3-29 for acquisition setup and page 3-63 for trigger setup.</p>
<p><b>Display the math control window</b></p>	<p>2. From the toolbar, touch the Math button to display the Define Math control window.</p>	
<p><b>Select spectral analysis setup</b></p>	<p>3. Touch Spectral Analysis Setup, and then select the Create tab to display the Spectral Analysis Setup control window.</p>	
<p><b>Select a spectral waveform</b></p>	<p>4. Touch Math(x) and select the math waveform that you want to create from the list.</p> <p>5. Touch Magnitude to create a magnitude spectral waveform, or touch Phase to create a phase spectral waveform.</p> <p>6. Touch the channel number that contains input data for the spectral analyzer.</p> <p>7. If you want an averaged spectral waveform, touch Average, touch Avgs, and then set the number of averages in the control window.</p> <p><b>Note.</b> If you want to redefine your waveform, touch the Clear button and repeat the above steps.</p>	

Overview	To define a spectral math waveform (Cont.)	Related control elements and resources
<p><b>Display the spectral waveform</b></p>	<p>8. To display your spectral waveform, touch either the Apply or the OK button.</p> 	


Overview	To define a spectral math waveform (Cont.)	Related control elements and resources
<p><b>Set the magnitude scale</b></p>	<p>9. Select the Mag tab.</p> <p>10. To select the vertical scale factor, touch dB, dBm, or Linear. The units will be dB, W, A, V, or whatever units are attached to the spectral analyzer input waveform.</p> <ul style="list-style-type: none"> <li>■ dB — Magnitude is displayed using log scale, expressed in dB relative to the reference level offset.</li> <li>■ Linear — Magnitude is displayed using units equal to the source units.</li> <li>■ dBm — Reference level offset is set to predefined values for dBm; see next step.</li> </ul> <p><i>Note.</i> You can adjust the scale and position by first touching the waveform handle and then using the multipurpose knobs to adjust the scale and position.</p> <p>11. To set the reference level, touch Level, and use the multipurpose knobs or keypad to set the reference level.</p> <p><i>Note.</i> Reference level is the value at the top of the display screen. It only applies to magnitude waveforms. Adjusting the reference level positions the waveform with respect to the top of the display, but does not change the position of the waveform with respect to its ground reference.</p> <p>12. To set the reference level offset, touch Level Offset, and use the multipurpose knobs or keypad to set the offset.</p> <p><i>Note.</i> Offset determines where zero dB is in the output waveform. Changing offset moves the waveform with respect to its ground reference. When the input is equal to the offset, it will display as zero dB in the output.</p>	    

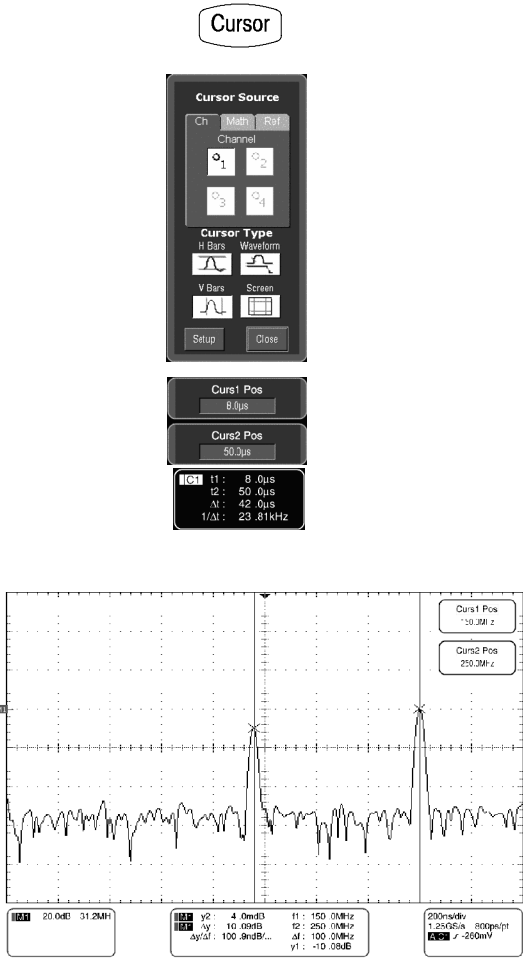

Overview	To define a spectral math waveform (Cont.)	Related control elements and resources
<p><b>Set the phase scale</b></p>	<p><b>13.</b> Select the Phase tab.</p> <p><b>14.</b> To select the vertical scale factor, touch Degree, Radian, or GroupDelay:</p> <ul style="list-style-type: none"> <li>■ Degree sets the phase units to degrees. Phase is displayed using degrees as the scale, where degrees wrap from <math>-180^\circ</math> to <math>+180^\circ</math>.</li> <li>■ Radian sets the phase units to radians. Phase is displayed using radians as the scale, where radians wrap from <math>-\pi</math> to <math>+\pi</math>.</li> <li>■ GroupDelay unwraps the phase spectrum and displays its negative derivative.</li> </ul> <p>The topic <i>Using the Phase Controls</i>, on page 3-190, provides in depth information on the setup for phase displays.</p> <p><b>15.</b> To specify whether to unwrap phase in a spectral analysis phase waveform, touch Unwrap to toggle it on or off.</p> <p><b>16.</b> To set the level in dB that a magnitude in the spectrum must exceed to have its phase computed (to reduce the effect of noise in your phase waveform), touch Suppression Threshold, and use the multipurpose knobs or keypad to set the threshold level. If the magnitude is less than the threshold, then its phase is set to zero (for an example, see Figure 3-52 on page 3-191).</p> <p>The <i>Suppression Threshold</i> bullet on page 3-190, provides additional information on phase suppression.</p>	   

Overview	To define a spectral math waveform (Cont.)	Related control elements and resources
<p><b>Set time and frequency domain control tracking</b></p>	<p>17. Touch the Control tab.</p> <p>18. To allow changing time and frequency domain controls for one math waveform to change the same controls for another math waveform, touch the Track Time/Freq Domain Controls buttons to toggle them on or off.</p>	
<p><b>Select the window type</b></p>	<p>19. To select the window type, touch Window Type and select from the list. See <i>Using Windows to Filter</i> on page 3-192 for a description of the available FFT windows.</p> <ul style="list-style-type: none"> <li>■ Rectangular. Best type of window for resolving frequencies that are very close to the same value. Best type for measuring the frequency spectrum of nonrepetitive signals and measuring frequency components near DC.</li> <li>■ Hamming, Hanning, Blackman-Harris, Kaiser-Bessel, and FlatTop2. These window are based on cosine series. Each has a different RBW and spectral leakage characteristics. Use the window which best highlights the features you want to observe in the spectrum.</li> <li>■ Gaussian. Best localization in both time and frequency.</li> <li>■ Tek Exponential. Best for impulse testing. It sets the zero-phase reference to the 20% position in the time record allowing the test to use more of the instrument record length.</li> </ul> <p>The bullet <i>Choice of a window</i>, on page 3-193, provides in depth information on choosing the right window for your application.</p>	

Overview	To define a spectral math waveform (Cont.)	Related control elements and resources
<p><b>Set the frequency domain controls</b></p>	<p>The spectral analyzer center frequency and the frequency span must be within the bandwidth setting determined by the sample rate.</p> <p>See Figure 3-49 on page 3-187 to see how a signal consisting of two sine waves looks on screen as the spectral analyzer controls are adjusted. A rectangular window was used.</p> <p><b>20.</b> To set the frequency range over which the spectral analysis is performed, touch Freq Span, and use the multipurpose knobs or keypad to set the frequency range.</p> <p>Higher sample rates allow you to set greater frequency spans. To set the frequency span to the maximum allowed by the current sample rate, touch the Full button.</p> <p><b>21.</b> To set the center frequency of the spectral analysis, touch Center Freq and use the multipurpose knobs or keypad to set the center frequency.</p> <p>Resolution bandwidth determines how small of a frequency difference may be resolved in the frequency domain output data. It basically defines the bandwidth of the filters used to do the frequency domain analysis.</p> <p><b>22.</b> To set the resolution bandwidth, touch Res BW, and use the multipurpose knobs or keypad to set the resolution bandwidth.</p>	 <p>The figure consists of three vertically stacked screenshots of the spectral analyzer control panel. Each screenshot shows four main control elements: Center Freq, Freq Span, a Full button, and Res BW. In the top screenshot, Center Freq is 312.5mHz, Freq Span is 625.0mHz, and Res BW is 25.0mHz. In the middle screenshot, Center Freq is 312.5mHz, Freq Span is 625.0mHz, and Res BW is 25.0mHz. In the bottom screenshot, Center Freq is 312.5mHz, Freq Span is 625.0mHz, and Res BW is 25.0mHz.</p>

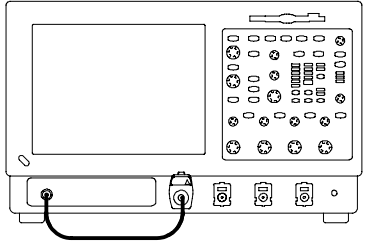
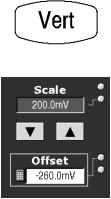


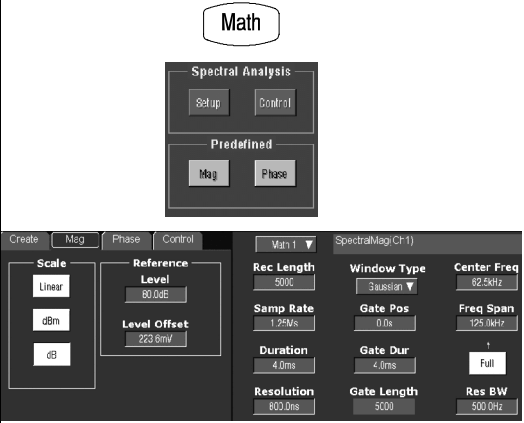
Overview	To define a spectral math waveform (Cont.)	Related control elements and resources
<p><b>Set the time domain controls</b></p>	<p>Time domain controls of the spectral analyzer determine the sample rate and record length of the acquisition. Front panel controls also affect the sample rate and record length, but not in the same way. These controls allow you to change the duration on the acquisition without changing the sample rate. This allows you to control the acquisition in a way that is analogous to the frequency domain span and center frequency controls in a spectral analyzer.</p> <p><b>23.</b> From the Spectral Analysis Setup menu, touch Resolution, and adjust the time interval between data samples of the input waveform.</p> <p><i>Note.</i> Resolution is the inverse of Sample rate. Adjust resolution to adjust sample rate. Resolution will also cause a change in record length such that the duration is kept constant at the value selected by the Duration control.</p> <p><b>24.</b> To adjust the number of seconds over the duration of the acquired waveform (record length), touch Duration, and use the multipurpose knobs or keypad to adjust the duration.</p> <p><i>Note.</i> Changing duration also changes the record length.</p> <p><b>25.</b> To set the gate position, touch Gate Pos, and use the multipurpose knobs or keypad to adjust the gate position.</p> <p>Gate position is the position of the phase reference point in the gate with respect to the trigger in seconds. The gate position and gate duration must be within the acquisition.</p> <p><b>26.</b> To set the gate duration, touch Gate Dur, and use the multipurpose knobs or keypad to adjust the gate duration.</p> <p>Gate duration and resolution bandwidth both control gate duration; gate duration is displayed in seconds and resolution bandwidth in hertz.</p>	 <p>The figure consists of four screenshots of the Spectral Analysis Setup menu, arranged vertically. Each screenshot shows a different control element being adjusted:</p> <ul style="list-style-type: none"> <li><b>Top screenshot:</b> Shows the 'Resolution' control set to 8.0ms. Other visible controls include 'Rec Length' (500), 'Sample Rate' (125.0S/s), and 'Duration' (2.0us).</li> <li><b>Second screenshot:</b> Shows the 'Duration' control set to 2.0us. Other visible controls include 'Rec Length' (5000), 'Sample Rate' (125.0S/s), and 'Resolution' (8.0ms).</li> <li><b>Third screenshot:</b> Shows the 'Gate Pos' control set to 200.0ms. Other visible controls include 'Window Type' (Gaussian), 'Gate Dur' (200.0ms), and 'Gate Length' (101).</li> <li><b>Bottom screenshot:</b> Shows the 'Gate Dur' control set to 200.0ms. Other visible controls include 'Window Type' (Gaussian), 'Gate Pos' (200.0ms), and 'Gate Length' (101).</li> </ul>


Overview	To define a spectral math waveform (Cont.)	Related control elements and resources
<p><b>Take cursor measurements</b></p>	<p>27. From the toolbar, touch the Cursor button to display the cursors and the cursor control window.</p> <p>28. Select the Math tab and touch the numbered button for the spectral waveform that you want to measure.</p> <p>29. Select the cursor type by touching either the H Bars, V Bars, Waveform, or Screen buttons (for more information, see <i>Taking Cursor Measurements</i> starting on page 3-151).</p> <p>30. Turn the multipurpose knobs to position each cursor on the waveform to measure the feature that interests you.</p> <p>31. Read the results in the cursor readout. The cursor readout is displayed below the graticule as shown here or at the bottom of the graticule area.</p> <p>The figure shows the cursor measurement of a frequency magnitude on an FFT. The readout reads about 0 dB (4.0 mdB) because it is aligned with the reference level offset. The other readout reads -10.08 dB indicating the magnitude of the frequency it is measuring is -10.08 dB relative to reference level offset. Display of the source waveform is turned off.</p> <p>The cursor units will be in dB or volts for magnitude waveforms and in degrees or radians for those measuring phase.</p> <p>32. Select V Bars, and use the multipurpose knobs to align the two vertical cursors to points of interest along the horizontal axis of the waveform.</p> <p>33. Read the frequency difference between the cursors from the <math>\Delta</math>: readout. Read the frequency of each cursor relative to the zero frequency point from the cursors readout.</p>	
<p><b>For further assistance</b></p>	<p>34. Touch the Help button in the toolbar to access context-sensitive help on math waveforms.</p>	 <p>See <i>Accessing Online Help</i> on page 3-263 for an overview of the online help system.</p>


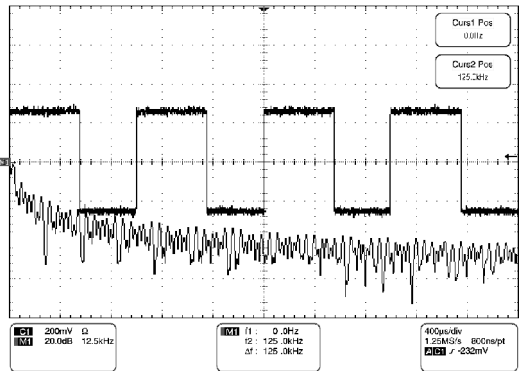
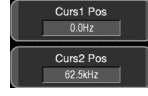
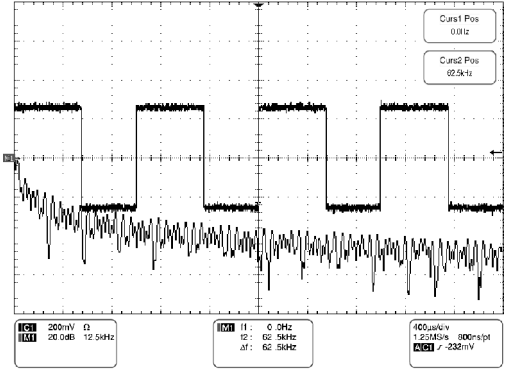
**Spectral Math Example**

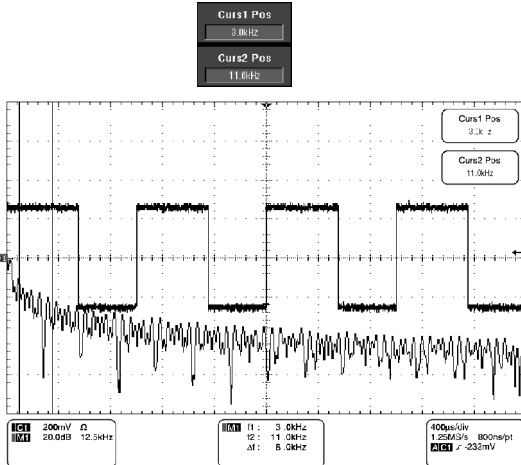

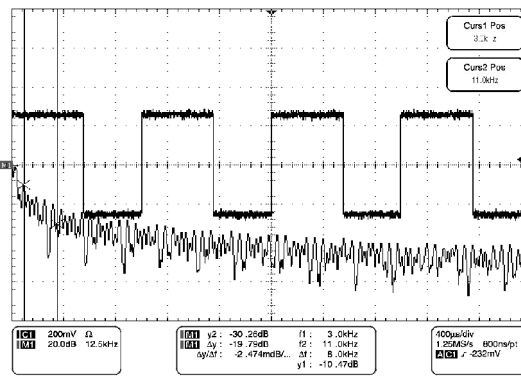
The following procedure is an example of setting up the instrument to perform spectral analysis of a signal. This example uses the probe compensation signal available on the front panel of the instrument.

Overview	Spectral math example	Control elements and resources
<p><b>Install the test hookup</b></p>	<ol style="list-style-type: none"> <li>1. Connect the probe compensation signal to CH 1 through a suitable cable and adapter.</li> <li>2. Press DEFAULT SETUP.</li> <li>3. Press AUTOSET.</li> </ol>	
<p><b>Display the waveform</b></p>	<ol style="list-style-type: none"> <li>4. From the toolbar, touch Vert, and select the Chan 1 tab.</li> <li>5. Touch Offset, and using the multipurpose knobs or keypad, set the offset to <b>-260 mV</b> and the Ch1 Scale to <b>200 mV</b>.</li> </ol>	

Overview	Spectral math example (cont.)	Control elements and resources
<p><b>Display the spectral math waveform</b></p>	<p>6. From the toolbar, touch Math, and select the Math 1 tab.</p> <p>7. Touch the Predefined Mag button.</p> <p>The instrument sets up a predefined magnitude spectral analysis waveform.</p> <p>8. To see the settings, touch the Spectral Analysis Setup button.</p> <ul style="list-style-type: none"> <li>■ Scale sets the vertical scale factor and lets you set the vertical scale.</li> <li>■ Reference sets the value at the top of the display, and offset sets the waveform position with respect to its ground reference.</li> <li>■ Rec Length sets the number of samples in the waveform acquisition.</li> <li>■ Sample rate sets the sample rate.</li> <li>■ Duration sets the time over the acquired waveform (also changes record length).</li> <li>■ Resolution controls sample rate and record length to keep the duration constant while changing the time between samples of the acquired waveform.</li> </ul>	

Overview	Spectral math example (cont.)	Control elements and resources
<p><b>Display the spectral math waveform (Cont.)</b></p>	<ul style="list-style-type: none"> <li>■ Window Type affects the shape of the spectral analyzer response in the frequency domain; that is, the ability to resolve frequency in the output spectrum.</li> <li>■ Gate Position sets the position of the gate on the acquired waveform. The data in the gate region is input to the spectral analyzer. The gate position is the time from the trigger to the zero phase reference position in the gate.</li> <li>■ Gate Duration sets the width of the gate in seconds, and it is inversely proportional to the resolution bandwidth. For narrow band frequency resolution, use a wide gate.</li> <li>■ Gate Length displays the number of samples over the specified gate duration.</li> <li>■ Resolution BW sets the bandwidth, in hertz, of the filters used in the spectral analysis. Resolution BW is inversely proportional to the gate duration.</li> </ul> <p>9. Touch Center Freq, and use the multipurpose knobs or keypad to set the frequency span to 125 kHz and the center frequency to 62.5 kHz (if necessary, reduce the sample rate).</p>	

Overview	Spectral math example (cont.)	Control elements and resources
<p><b>Set up the cursors</b></p>	<p><b>10.</b> From the toolbar, touch <b>Cursors</b>.</p> <p><b>11.</b> To assign the cursors to the spectral analysis math waveform, touch the Cursor Source Math tab, and touch the Math 1 button.</p> <p><b>12.</b> Use the multipurpose knobs or keypad to set the Curs1 Pos to 0.0 Hz and the Curs2 Pos to 125 kHz.</p> <p>The cursor readout now indicates the frequency span set in step 9.</p> <p><b>13.</b> Use the multipurpose knobs or keypad to set the Curs2 Pos to 62.5 kHz.</p> <p>The cursor readout now indicates the center frequency set in step 9.</p>	   

Overview	Spectral math example (cont.)	Control elements and resources
<p><b>Measure the test results</b></p>	<p>14. Use the multipurpose knobs or keypad to set the Curs1 Pos to 3.0 kHz and the Curs2 Pos to 11.0 kHz.</p> <p>In this example, the cursors are now on the third and eleventh harmonic of the probe compensation signal. Read the frequencies from the cursor readouts.</p> <p>15. Touch the Cursor Type Waveform button. Touch the Cursor 2 button and then the Math 1 button.</p> <p>Now in addition to the frequency at the cursor locations, the cursor readout displays the amplitude at the cursor locations. The readout also displays the difference in frequency and amplitude between the cursor locations.</p>	  
<p><b>For more information</b></p>	<p>16. For additional information on setting up and using spectral math, see <i>Defining Spectral Math Waveforms</i> starting on page 3-182.</p>	





# Data Input/Output

This section describes the input and output capabilities of your instrument. Specifically, it covers:

- *Saving and Recalling a Setup* on page 3-221
- *Saving and Recalling Waveforms* on page 3-227
- *Exporting and Copying Waveforms* on page 3-235, including exporting and copying of images, waveforms, measurements, and histograms
- *Printing Waveforms* on page 3-250
- *Remote Communication* on page 3-255

## Saving and Recalling a Setup

This instrument can save a number of different instrument setups for later recall, limited only by the space you have to store the setups.

By saving and recalling different setups, you can switch from setup to setup without having to first manually record your settings and then manually set them. This capability is helpful when you want to:

- Save and recall a setup that optimizes the instrument for displaying and analyzing a certain signal.
- Save a series of setups to help automate a procedure through recall of a sequence of saved setups as part of performing the procedure.
- Export a setup for sharing with a second instrument.

The Save-Setup and the Recall-Setup control windows provide for including and viewing comments with your saved setups. You can store information, readable upon recall, that describes each setup you save and its intended application.

If you do not have a keyboard connected, you can still enter comments and name setup files. The Save and Recall Setup windows include the Virtual Keyboard. When you touch or click a setup name, the instrument displays a keyboard on screen that you can use with your mouse or the touch screen to enter the setup-path name, setup-file name, and comment.

The instrument excludes the following items when saving setups:

- Waveforms in Ch1 to Ch4 and references (Ref1-Ref4). Control settings (scale, position, and so on) are saved but not the waveform data. Upon recall of the setup, the settings are applied, but the data is not restored.

- Waveforms in Math Waveforms (Math1-Math4). Control settings and the math expression are retained but not the waveform data. Upon setup recall, however, the recalled math waveform expressions will be applied, but math waveform data is not restored.
- User Options that are stored in the Windows Registry. These include all options accessed by first selecting Utilities (menu bar), and then User Preferences (Utilities menu).

You cannot recall into a channel or a math waveform. The instrument recalls each waveform into one of the reference waveform locations (Ref1-Ref4).

If you want to save a waveform in a useful format for other applications, such as a spreadsheet, use the export function (see *Exporting and Copying Waveforms* on page 3-235).

A few things to remember when saving and recalling setups:

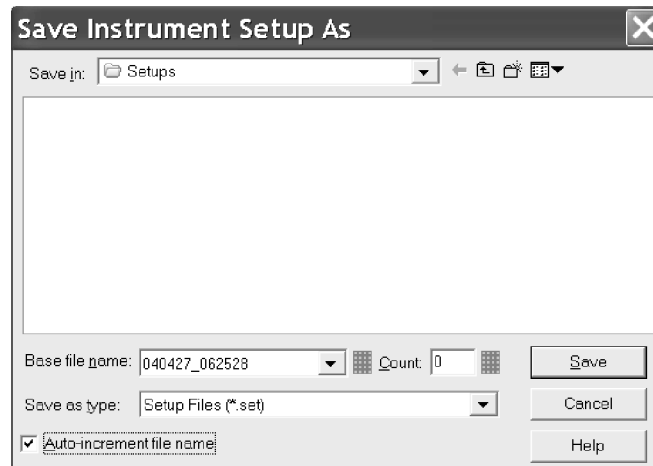
**All Settings are Retained.** The instrument includes almost all instrument settings, with a few exceptions (such as user options) in the saved setup.

**Retaining Current Settings.** Recalling a setup replaces the current setup with the recalled setup. If you do not want to lose your current setup, save it to its own setup file for later recall before you recall a setup.

**Avoiding Setup/Waveform Mismatches.** Saved setups may contain settings inappropriate for waveforms currently in your instrument. For example, if you save a setup that displays a math waveform that is the inverse of reference 1, when you recall the setup, if the reference is empty, the math and reference waveforms are not displayed.

### Using Auto-Increment File Name

Auto-increment file name in the Save As and Export dialog boxes enables saving numerous files without entering a file name each time. To auto-increment file names, select Auto-increment file name on the dialog box as shown in Figure 3-64.



**Figure 3-64: Auto-increment file name feature**

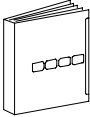
Enter a Base file name and touch Save. For the initial save, the default count is 000. Your first file is saved as *[Basefilename][count].ext*, where *ext* is the file extension. On subsequent saves, the instrument searches for the highest numbered file name and increases the number by one, as in *Basefilename001.ext*.

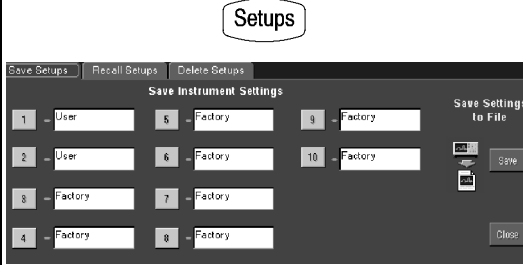
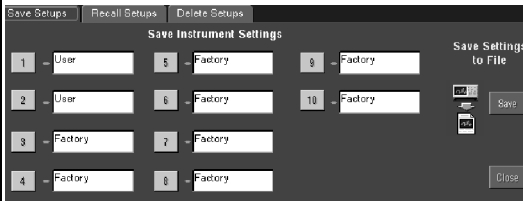

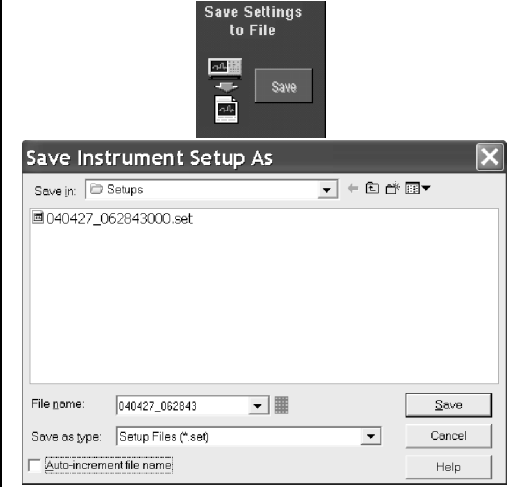
For example, if you save a series of rise time data files, you can use Risetime as the base file name. Your first file is saved as *Risetime000.ext*. The next file will be *Risetime001.ext*, and so on.


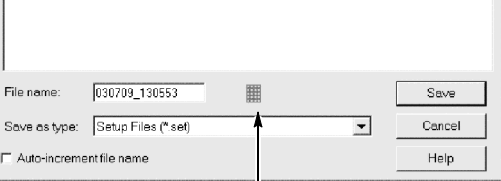
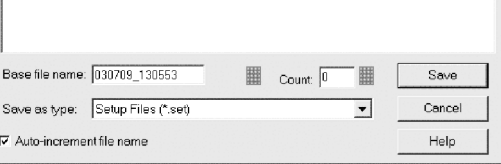


If Count reaches 999, it is suggested that you change the base file name to *Basefilename1* (for example, *Risetime1*) on the next save. Your next file will then be saved as *Risetime1000.ext*.

### To Save Your Setup

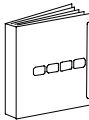
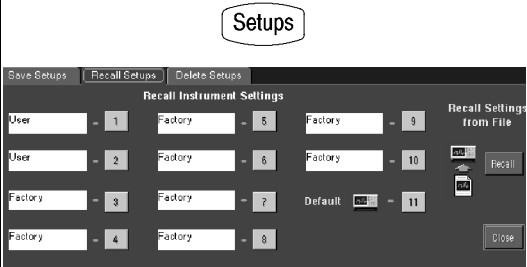
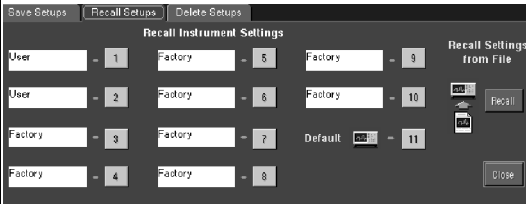
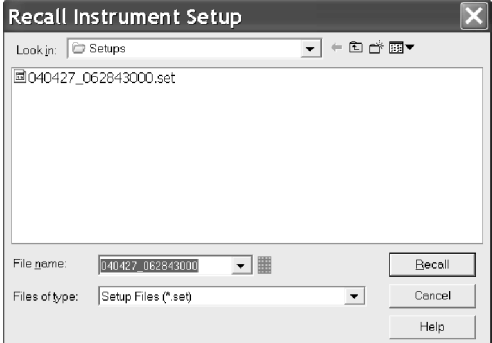

Use the procedure that follows to save a setup to one of ten internal locations, the instrument hard disk, a floppy disk, or third-party storage device.

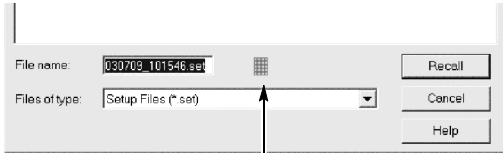


Overview	To save your setup	Control elements and resources
<p><b>Prerequisites</b></p>	<ol style="list-style-type: none"> <li>1. The instrument must be powered up.</li> <li>2. Setup the instrument controls as you want them saved as part of a recallable setup.</li> </ol> <p>For help in making your setup, check the references at right and other sections in this chapter specific to the setup you wish to make.</p>	 <ul style="list-style-type: none"> <li>■ See <i>Powering On the Instrument</i> on page 1-9.</li> <li>■ See page 3-29 for acquisition setup.</li> <li>■ See page 3-63 for trigger setup.</li> </ul>

Overview	To save your setup (Cont.)	Control elements and resources
<p><b>Display the setups control window</b></p>	<p>3. From the toolbar, touch Setups and select the Save Setups tab of the Setups control window.</p>	
<p><b>Save the setup</b></p>	<p>4. Touch the number of the setup in which you want to save your setup. Data in the existing setup will be overwritten.</p>	
<p><b>Name your setup</b></p>	<p>5. Name your setup file by either:</p> <ul style="list-style-type: none"> <li>■ Accepting the name that appears in the name field.</li> <li>■ Double-clicking in the name field and using the keyboard window to enter a new name, replacing the default file name.</li> </ul> <p><b>Note.</b> You can use the mouse or touch screen with the virtual keyboard to type entries in the name field.</p> <ul style="list-style-type: none"> <li>■ Clicking the existing name and using an attached keyboard to enter a new name.</li> </ul>	
<p><b>To save to a file</b></p>	<p>6. To display the Save Instrument Setup As dialog, from the Setup control window, touch Save.</p> <p>The Save Instrument Setup dialog allows for the entry of a file name, file type, and location.</p>	

Overview	To save your setup (Cont.)	Control elements and resources
<p><b>Name a destination</b></p>	<p>7. Use the Save in: drop-down list and buttons to navigate to the directory in which to save your setup.</p>	
<p><b>Name your setup</b></p>	<p>8. Name your setup file by doing one of the following steps:</p> <ul style="list-style-type: none"> <li>■ Accepting the default file name that appears in the File name: field.</li> <li>■ Clicking in the File name field and typing a new name, replacing the default file name.</li> <li>■ Clicking an existing name in the file list (if any are listed). Data in the existing file will be overwritten.</li> </ul> <p><b>Note.</b> If your instrument lacks a keyboard, touch or click the keyboard icon to display a virtual keyboard. You can use the mouse or touch screen with the virtual keyboard to type entries in the name fields and comments fields.</p> <p>Select the Auto-increment file name check box to save a series of files without typing in a new name each time. For more information, see <i>Using Auto-Increment File name</i> on page 3-222.</p> <p>9. If not selected, select *.set in the Save as type field as the type of file to save. (Setup files are always type *.set.)</p> <p><b>Note.</b> Only change the type if you want to temporarily see any other types of files in the current directory. Otherwise, leave it set at *.set.</p>	 <p style="text-align: center;">Access to virtual keyboard</p> 
<p><b>Save your setup</b></p>	<p>10. Touch the Save button to save the setup file. To cancel without saving, touch the Cancel button.</p>	
<p><b>For further assistance</b></p>	<p>11. For more help on saving setups, touch the Help button in the toolbar to access contextual help on screen.</p>	 <p>See page 3-263 to learn about using online help.</p>

**To Recall Your Setup** Use the procedure that follows to recall a setup to the instrument. Remember that recalling a setup replaces the existing setup, which is lost.

Overview	To recall your setup	Control elements and resources
<p><b>Prerequisites</b></p>	<p>1. The instrument must be powered up. You must have access to a setup saved by the instrument.</p> <p><b>Note.</b> This procedure does not make the setup active.</p>	 <p>See <i>Powering On the Instrument</i> on page 1-9.</p>
<p><b>Display the setups control window</b></p>	<p>2. From the toolbar, touch Setups and select the Recall Setups tab of the Setups control window.</p>	
<p><b>Recall the setup</b></p>	<p>3. Touch the number of the setup that you want to recall. The current instrument setup is overwritten.</p>	
<p><b>Recall setup from a file</b></p>	<p>4. To display the Recall Instrument Setup dialog, from the Recall Setup control window, touch Recall.</p> <p>The Recall Instrument Setup dialog allows navigation to directories, lists setup files in the directory, and provides for selection of a setup file.</p>	
<p><b>Find the source directory</b></p>	<p>5. Use the Look in: drop-down list and buttons to navigate to the directory, which contains a setup that you want to recall.</p>	

Overview	To recall your setup (Cont.)	Control elements and resources
<p><b>Select your setup</b></p>	<p>6. If not selected, select *.set in the Save as type of file to include in the file listing. (Setup files are always type *.set.)</p> <p><i>Note. Only change the type if you want to temporarily see other types of files in the current directory. Otherwise, leave it set at *.set.</i></p> <p>7. Choose your setup file by either:</p> <ul style="list-style-type: none"> <li>■ Clicking an existing name in the file list.</li> <li>■ Clicking in the File name field and typing a new name, replacing the default file name.</li> </ul> <p><i>Note. If your instrument lacks a keyboard, touch or click on the icons as indicated right to display a virtual keyboard. You can use the mouse or touch screen with the virtual keyboard to type entries in the name fields and comments fields.</i></p>	 <p>Access to virtual keyboard</p>
<p><b>Recall your setup</b></p>	<p>8. Touch the Recall button to recall the setup file. To cancel without recalling a setup, touch the Cancel button.</p>	
<p><b>For further assistance</b></p>	<p>9. For more help on recalling setups, touch the Help button in the toolbar to display contextual help on screen.</p>	 <p>See page 3-263 to learn about using online help.</p>

## Saving and Recalling Waveforms

This instrument can save any number of waveforms, limited only by the space you have to store them.

By saving a waveform, you can recall it at a later time for comparison, evaluation, and documentation. This capability is helpful when you want to:

- Recall a waveform for further evaluation or comparison with other waveforms.

- Extend the waveform carrying capacity of the instrument. The instrument supports four reference, four channel, and four math waveforms. If you want more than four references, you can save the additional reference to disk for recall later.

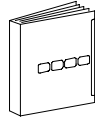
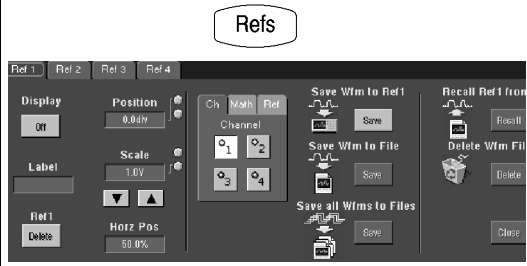
The Reference Waveform control window contains a Label field for including comments with your saved waveforms. Using comments you can store information, readable upon recall, describing each waveform that you save.

Virtual Keyboarding. If you do not have a keyboard connected, you can still enter comments and name waveform files. The Reference control window includes a Keyboard button. When you touch or click it, the instrument displays a virtual keyboard on screen that you can use with your mouse or the touch screen to enter the waveform-path name, file name, and comment.



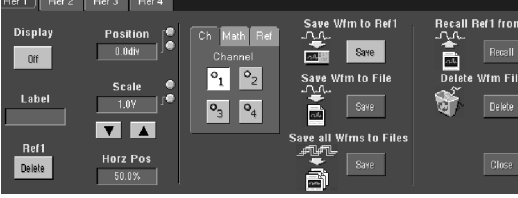
You cannot recall a waveform *into* a channel or a math waveform. The instrument recalls each waveform into one of the reference waveform locations (Ref1-Ref4).


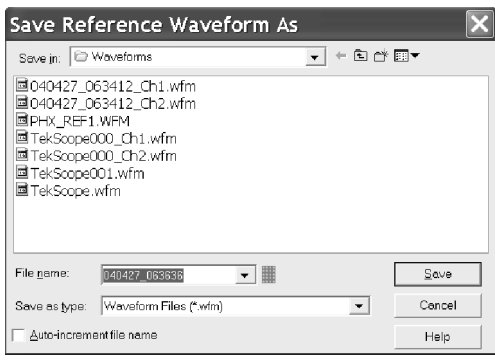

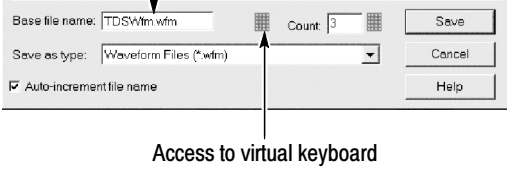
**To Save Your Waveform**

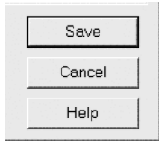

Use the procedure that follows to save a waveform or waveforms to a reference location, the instrument hard disk, CD-RW disk, a floppy disk, or third party storage device.

Overview	To save a waveform	Control elements and resources
<p><b>Prerequisites</b></p>	<ol style="list-style-type: none"> <li>1. The instrument must be powered up.</li> <li>2. Make sure the waveform to be saved exists; that is, your source must be a channel, an active math waveform, or an active reference. Display the waveform with the setup in which you want to save it.  For help in setup and acquiring waveforms, check the references at right.</li> </ol>	 <ul style="list-style-type: none"> <li>■ See <i>Powering On the Instrument</i> on page 1-9.</li> <li>■ See page 3-29 for acquisition setup.</li> <li>■ See page 3-63 for trigger setup.</li> </ul>
<p><b>Display the reference control window</b></p>	<ol style="list-style-type: none"> <li>3. From the toolbar, touch Refs and select the Ref 1 to Ref 4 tab of the reference in which you want to save the waveform.</li> </ol>	
<p><b>Select the waveform to save</b></p>	<ol style="list-style-type: none"> <li>4. Select the Ch, Math, or Ref tab of the waveform that you want to save, and then touch the number of the channel, math, or reference waveform that you want to save.</li> </ol>	



Overview	To save a waveform (Cont.)	Control elements and resources
<p><b>Label the waveform</b></p>	<p>5. If you want to label the waveform, touch Label, and use your keyboard or the pop-up keyboard to create a label for your waveform.</p> <p>You can label any channel, math, or reference waveform and position the label relative to the display edge and the vertical position of the waveform using the Label control window:</p> <ul style="list-style-type: none"> <li>■ Using the menu bar, select Vertical and then Label</li> <li>■ From the Label control window, select the waveform that you want to label using the Source buttons</li> <li>■ From the Label control window, touch Label, and use your keyboard or the pop-up keyboard to create a label for your waveform</li> <li>■ Position the label relative to the waveform using the multipurpose knobs, your keyboard, or the pop-up keyboard</li> </ul>	 <p>The screenshot shows the 'Label' control window with a menu bar containing 'Vertical', 'Horiz/Acq', and 'Trig'. The 'Vertical' menu is open, showing options: 'Vertical Setup...', 'Zoom Controls...', 'Display On/Off...', 'Position/Scale...', and 'Label...'. Below the menu is a 'Source' window with buttons for 'Ch', 'Math', and 'Ref', and four channel selection buttons labeled 'Q1', 'Q2', 'Q3', and 'Q4'. A 'Label' button is at the bottom of the source window.</p>  <p>Two control windows are shown below: 'X Pos' with a value of 1.00v and a 'Close' button, and 'Y Pos' with a value of 2.20v and a 'Close' button.</p>
<p><b>Save the waveform to a reference</b></p>	<p>6. Touch the Save Wmf to Ref(x) Save button to save your waveform. Data in the existing reference will be overwritten.</p>	 <p>The screenshot shows the 'Label' control window with the 'Save Wmf to Ref1' button highlighted. The button has a 'Save' sub-button. Other buttons in the window include 'Recall Ref1 from...', 'Delete Wfm File', 'Delete', 'Close', 'Save Wfm to File', 'Save', 'Save all Wfms to Files', and 'Save'.</p>

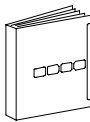

Overview	To save a waveform (Cont.)	Control elements and resources
<p><b>Save the waveform to a file</b></p>	<p>7. To save the waveform to a file, touch the Save Wfm to File Save button, or to save all active waveforms to files, touch the Save all Wfms to Files Save button.</p> <p>The Save Reference Waveform As window lists all available waveforms, allows for browsing to a destination directory (saving to file), and allows you to name the waveform file.</p>	 
<p><b>Select a destination</b></p>	<p>8. Use the Save in: drop-down list and buttons to navigate to the directory in which to save your waveform.</p>	
<p><b>Select directory and name file</b></p>	<p>9. To specify the file name in which to save your waveform you can:</p> <ul style="list-style-type: none"> <li>■ Use the default name and directory appearing in the File Path field.</li> <li>■ Rename the file by typing a new name into the File name field.</li> <li>■ Select the Auto-increment file name check box to save a series of files without typing in a new name each time. For more information, see <i>Using Auto-Increment File Name</i> on page 3-222.</li> </ul>	<p>Edit path and file name</p>  <p>Access to virtual keyboard</p>


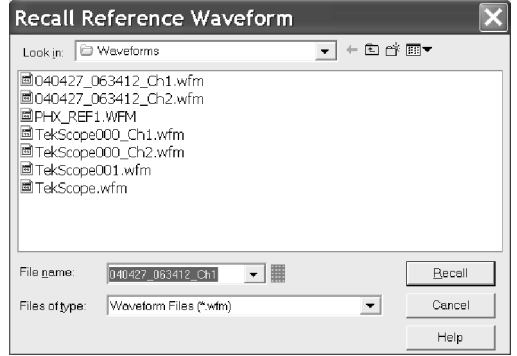

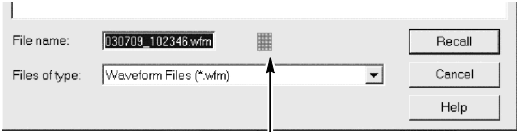
Overview	To save a waveform (Cont.)	Control elements and resources
<b>Save your waveform</b>	10. Touch the Save button to save the waveform file or reference. To cancel without saving, touch the Cancel button.	
<b>For further assistance</b>	11. For more help on saving waveforms, touch the Help button in the toolbar to access the contextual online help.	 See page 3-263 to learn about using online help.


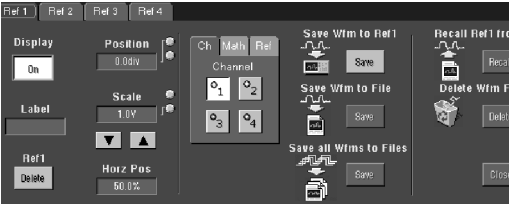

## To Recall Your Waveform

Use the procedure that follows to recall a waveform to a reference. You can only recall waveforms into references.

**NOTE.** Reference waveforms do not recall because they are already reside in the instrument. You can copy a reference waveform to another reference: first display the reference to be copied, and then use the Save Waveform procedure to save it to another reference (Ref1-Ref4).

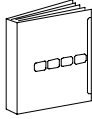
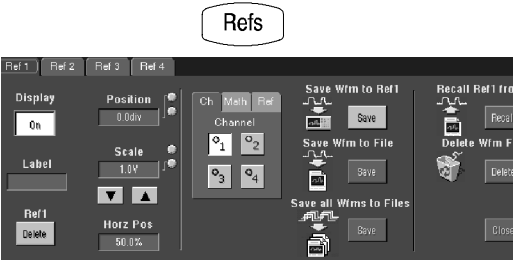
Overview	To recall your waveform	Control elements and resources
<b>Prerequisites</b>	1. The instrument must be powered up. You must have access to a waveform saved by the instrument.	 <ul style="list-style-type: none"> <li>See <i>Powering On the Instrument</i> on page 1-9.</li> </ul>
<b>Display the reference control window</b>	2. From the toolbar, touch Refs, and then select the Ref 1 to Ref 4 tab of the reference in which you want to recall the waveform.	
<b>Recall the waveform</b>	3. If recalling an internal reference, touch Display to toggle the display of the reference waveform on.	

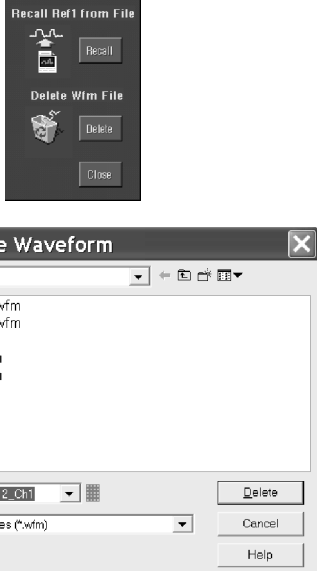
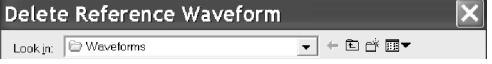
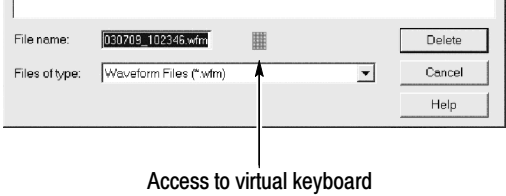
Overview	To recall your waveform (Cont.)	Control elements and resources
<p><b>Recall a reference waveform from a file</b></p>	<p>4. To display the Recall Reference Waveform window, from the Recall Ref(x) from File window, touch Recall.</p> <p>The Recall Reference Waveform window allows navigation to directories, lists waveform files in the directory, and provides for selection of a waveform file.</p>	 
<p><b>Find the source directory</b></p>	<p>5. Use the Look in: drop-down list and buttons to navigate to the directory, which contains a waveform that you want to recall.</p>	
<p><b>Select your waveform</b></p>	<p>6. If not selected, select *.wfm in the Files of type field to force the file listing to only include these types. Use *.wfm for waveforms.</p> <p><b>Note.</b> Only change the type if you want to temporarily see any other types of files in the current directory. Otherwise, leave it set to *.wfm.</p> <p>7. Choose your waveform file by either:</p> <ul style="list-style-type: none"> <li>■ Clicking an existing name in the file list.</li> <li>■ Clicking in the File name field and typing a new name, replacing the default file name.</li> </ul> <p><b>Note.</b> If your instrument lacks a keyboard, touch or click the keyboard icon to display a virtual keyboard. You can use the mouse or touch screen with the virtual keyboard to type entries in the name fields.</p>	 <p style="text-align: center;">Access to virtual keyboard</p>



Overview	To recall your waveform (Cont.)	Control elements and resources
<b>Recall your waveform</b>	<b>8.</b> Touch the Recall button to recall the waveform file. To cancel without recalling a waveform, touch the Cancel button.	
<b>Display your reference waveform</b>	<b>9.</b> Touch Display to toggle the display of the reference waveform on.	
<b>For further assistance</b>	<b>10.</b> For more help on recalling waveforms, touch the Help button to access contextual online help.	 See page 3-263 to learn about using online help.

**To Clear References**

You can clear individual references of data or delete waveform files. If you are sure you do not want the data a reference waveform contains, use the procedures that follow to clear it. To clear all references and setups, use Tek Secure.

Overview	To clear references	Control elements and resources
<b>Prerequisites</b>	<b>1.</b> The instrument must be powered up. You must have access to a waveform saved by the instrument.	 ■ See <i>Powering On the Instrument</i> on page 1-9.
<b>Display the reference control window</b>	<b>2.</b> From the toolbar, touch Refs, and select the tab (Ref 1 to Ref 4) of the reference that you want to delete.	
<b>Delete the reference</b>	<b>3.</b> Touch Delete to delete the reference waveform.	

Overview	To clear references (Cont.)	Control elements and resources
<p><b>Delete a reference waveform file</b></p>	<p>4. To display the Delete Reference Waveform window, from the Delete Wfm File window, touch Delete.</p> <p>The Delete Reference Waveform window allows navigation to directories, lists waveform files in the directory, and provides for selection of a waveform file.</p>	 <p>The 'Recall Ref1 from File' window has a 'Recall' button. The 'Delete Wfm File' window has a 'Delete' button. The 'Delete Reference Waveform' window shows a file list with '040427_063412_Ch1.wfm' selected. The 'File name' field contains '040427_063412_Ch1' and the 'Files of type' is set to 'Waveform Files (*.wfm)'.</p>
<p><b>Find the file directory</b></p>	<p>5. Use the Look in: drop-down list and buttons to navigate to the directory of the file to delete.</p>	 <p>The 'Look in:' field is set to 'Waveforms'.</p>
<p><b>Find your file</b></p>	<p>6. Select the file type in the Files of type drop-down list to force the file listing to only include these types. Use *.wfm for waveforms.</p> <p><i>Note. Only change the type if you want to temporarily see any other types of files in the current directory. Otherwise, leave it set to *.wfm for waveforms.</i></p> <p>7. Choose your waveform file by clicking an existing name in the file list.</p> <p><i>Note. If your instrument lacks a keyboard, touch or click the keyboard icon to display a virtual keyboard. You can use the mouse or touch screen with the virtual keyboard to type entries in the name fields.</i></p>	 <p>The 'File name' field contains '030709_102346.wfm'. The 'Files of type' is set to 'Waveform Files (*.wfm)'. An arrow points to the keyboard icon with the text 'Access to virtual keyboard'.</p>

Overview	To clear references (Cont.)	Control elements and resources
<b>Delete the file</b>	<b>8.</b> Touch the Delete button to Delete the file. To cancel without deleting a file, touch the Cancel button.	
<b>For further assistance</b>	<b>9.</b> For more help on deleting files, touch the Help button to access contextual online help.	 <p data-bbox="993 716 1403 741">See page 3-263 to learn about using online help.</p>

## Exporting and Copying Waveforms

This instrument also supports export of waveform data to a file. The instrument can export waveforms, images, and measurements in several formats. You can also copy waveform data to the clipboard for use with other applications.

By exporting a waveform, you can use it with other analysis tools, such as spreadsheets or math-analysis applications.

Waveforms export as a series of comma-separated values (CSV), which are amplitudes without units. There is no timing information, but data is placed in the file in sequence from the first sample in the waveform record to the last.

Because the waveforms are exported as CSV, without timing and scaling information, the instrument does not import these waveforms directly. If you intend to recall a waveform later, save it (see the procedure *To Save Your Waveform* on page 3-228) instead of exporting it.

You may also choose to copy a waveform and paste it directly into an application such as Microsoft Word or Excel. If so, select your waveform, and then select Copy in the Edit menu.

**File Formats.** To make exported files more useful, you may select a file format usable by your analysis tools:

- Numeric creates files (.txt) in a numeric format usable by text and word processors.
- Text creates files (.txt) in a text format usable by text and word processors.
- Bitmap creates files (.bmp) in a bitmap file format usable by many graphic programs.

- JPEG creates files (.jpg) in a compressed image format usable by many graphic programs.
- PNG creates files (.png) in a compressed image format that is nonlossy.
- Spreadsheet creates files (.CSV) in a format usable by spreadsheets (Excel, Lotus 1-2-3, and Quattro Pro).
- MatLab creates files (.DAT) in a format usable by MatLab.
- MathCad creates files (.DAT) in a format usable by MathCad.

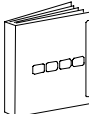
Note that the MathCad file is an ASCII file, the first four values of which contain header information:

- The first header value holds the record length.
- The second header value holds time, in seconds, between samples.
- The third header value holds the trigger position (expressed as an index in the data position).
- The fourth header value refers to the fractional trigger position.

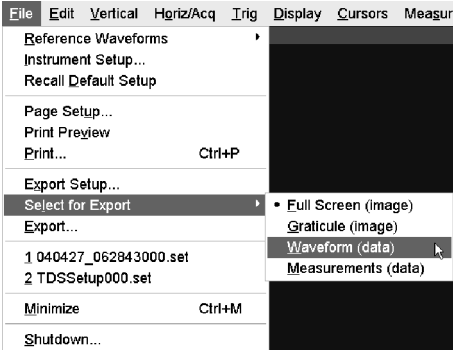

Also note that the delimiters are carriage returns.

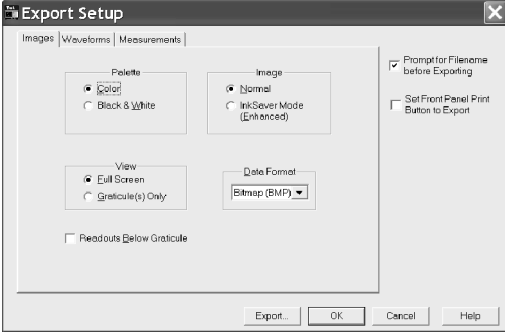
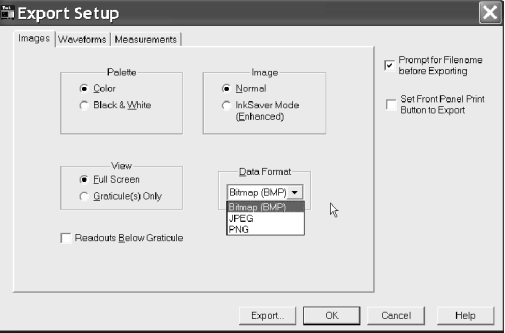
**To Export Your Waveform**

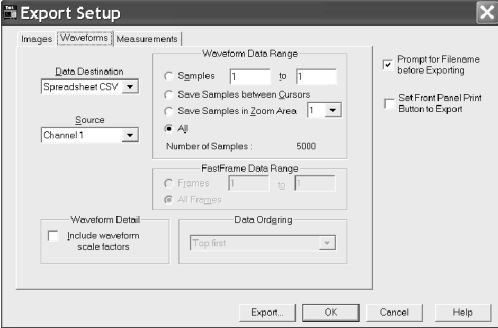
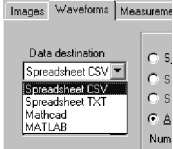
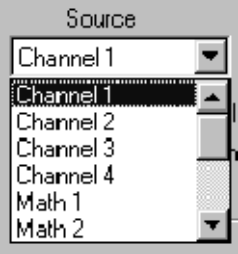
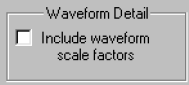
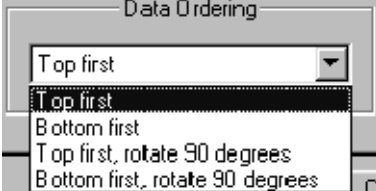
Use the procedure that follows to export a waveform or waveforms to the instrument hard disk, a floppy disk, or third party storage device.

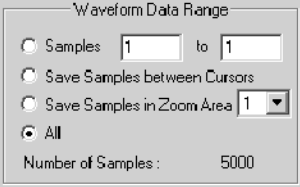
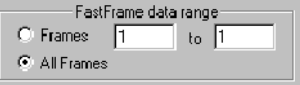
Overview	To save a waveform	Control elements and resources
<p><b>Prerequisites</b></p>	<ol style="list-style-type: none"> <li>1. The instrument must be powered up.</li> <li>2. Make sure the waveform, image, or measurement to be exported exists; that is, your source must be a channel, an active math waveform, an active reference, and so forth.</li> </ol>	<div style="text-align: center;">  </div> <ul style="list-style-type: none"> <li>■ See <i>Powering On the Instrument</i> on page 1-9.</li> <li>■ See page 3-29 for acquisition setup.</li> <li>■ See page 3-63 for trigger setup.</li> </ul>

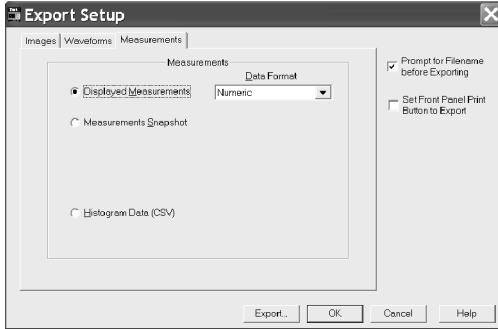
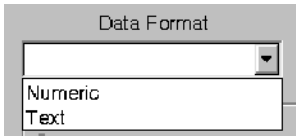
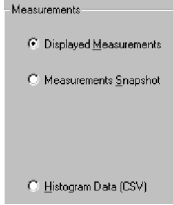





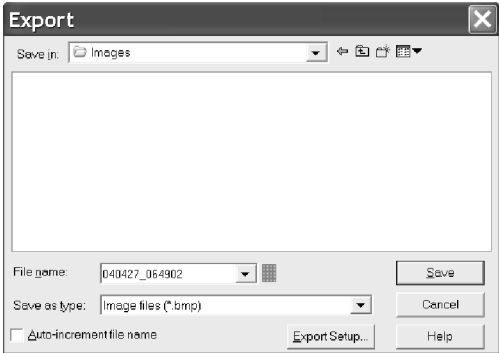
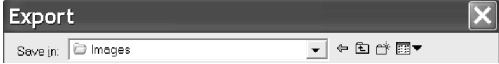
Overview	To save a waveform (Cont.)	Control elements and resources
<p><b>Select for export</b></p>	<p><b>3.</b> From the menu bar, select File, and then select Select for Export.</p> <p>The menu lists all available waveform, image, and measurement types available for export:</p> <ul style="list-style-type: none"> <li>■ Full Screen to export a bitmap of all screen contents</li> <li>■ Graticule to export a bitmap of only the graticule area</li> <li>■ Waveform to export waveform data</li> <li>■ Measurements to export measurement data</li> </ul>	 <p>The screenshot shows the File menu with the following items: Reference Waveforms, Instrument Setup..., Recall Default Setup, Page Setup..., Print Preview, Print... (Ctrl+P), Export Setup..., Select for Export (expanded), Export..., 1 040427_062843000.set, 2 TDSSetup000.set, Minimize (Ctrl+M), and Shutdown... The expanded 'Select for Export' sub-menu includes: Full Screen (Image), Graticule (Image), Waveform (data), and Measurements (data).</p>
<p><b>Select setup for export</b></p>	<p><b>4.</b> From the menu bar, select File, and then select Export Setup to display the Export Setup control window.</p>	 <p>The screenshot shows the File menu with the following items: Reference Waveforms, Instrument Setup..., Recall Default Setup, Page Setup..., Print Preview, Print... (Ctrl+P), Export Setup... (selected), Select for Export, Export..., 1 040427_062843000.set, 2 TDSSetup000.set, Minimize (Ctrl+M), and Shutdown... The 'Export Setup...' item is highlighted with a mouse cursor.</p>

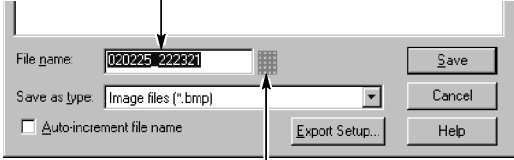
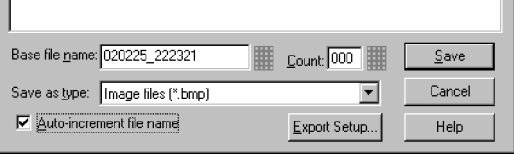


Overview	To save a waveform (Cont.)	Control elements and resources
<p><b>Setup to export images</b></p>	<ol style="list-style-type: none"> <li>5. Select the Images tab to display the Images control window.</li> <li>6. In the Palette window, select Color or Black &amp; White for the color palette of your exported images.</li> <li>7. In the View window, select whether you want to export the Full Screen or Graticules Only.</li> <li>8. In the Image window, select whether you want to export using Normal or InkSaver with Enhanced Waveform Color Mode.                             <ul style="list-style-type: none"> <li>■ Normal exports the image exactly as it appears on-screen</li> <li>■ InkSaver with Enhanced Waveform Color exports the image with colors designed to print with the white background</li> </ul> </li> <li>9. Touch Data Format, and select the data format from the drop-down list.</li> </ol>	 

Overview	To save a waveform (Cont.)	Control elements and resources
<p><b>Setup to export waveforms</b></p>	<p><b>10.</b> Select the Waveforms tab to display the Waveforms control window.</p> <p><b>11.</b> Touch Data Destination, and select the destination (format) of your exported waveform file (see <i>File Formats</i> on page 3-235 for information on the available formats).</p> <p><b>12.</b> Touch Source Waveform, and select the source of the waveform (a channel, math, or reference waveform) to export from the list.</p> <p><b>13.</b> If you want waveform scale factors and time values included in your MathCad/Mathlab files, touch Include waveform scale factors; if not checked, only voltage (vertical) values are exported.</p> <p><b>14.</b> Touch Data Ordering, and select the data order (top first, bottom first, or rotate) from the list.</p>	    

Overview	To save a waveform (Cont.)	Control elements and resources
	<p><b>15.</b> In the Waveform data range window, select the data to include in the exported files:</p> <ul style="list-style-type: none"> <li>■ Samples to enter the data range of the data to include in the exported files</li> <li>■ Save Samples between Cursors to include data between the cursors in the exported files</li> <li>■ Save Samples in Zoom Area to include data in zoom area 1, 2, 3, or 4 in the exported files</li> <li>■ All to include all data in the exported files</li> </ul> <p><b>16.</b> If using FastFrame, select the frame range to include in the exported files:</p> <ul style="list-style-type: none"> <li>■ All Frames to include all frames in the exported files</li> <li>■ Frames to enter a range of frames to include in the exported files</li> </ul>	 <p>The 'Waveform Data Range' dialog box contains the following controls:</p> <ul style="list-style-type: none"> <li>Radio button: <input type="radio"/> Samples (with input fields for '1' and '1' and 'to' text)</li> <li>Radio button: <input type="radio"/> Save Samples between Cursors</li> <li>Radio button: <input type="radio"/> Save Samples in Zoom Area (with a dropdown menu showing '1')</li> <li>Radio button: <input checked="" type="radio"/> All</li> <li>Text: Number of Samples : 5000</li> </ul>  <p>The 'FastFrame data range' dialog box contains the following controls:</p> <ul style="list-style-type: none"> <li>Radio button: <input type="radio"/> Frames (with input fields for '1' and '1' and 'to' text)</li> <li>Radio button: <input checked="" type="radio"/> All Frames</li> </ul>

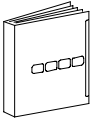
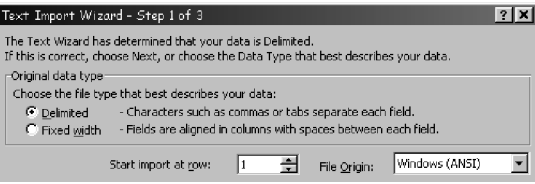
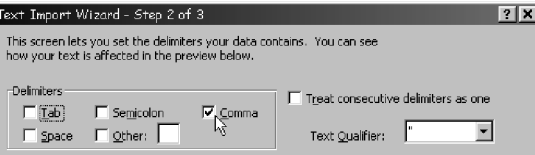
Overview	To save a waveform (Cont.)	Control elements and resources
<p><b>Setup to export measurements</b></p>	<p><b>17.</b> Select the Measurements tab to display the Measurements control window.</p> <p><b>18.</b> Touch Data Format, and select the data format (text or numeric) from the list.</p> <p><b>19.</b> Select the Measurements that you want to export:</p> <ul style="list-style-type: none"> <li>■ Displayed Measurements exports measurements that are displayed on screen</li> <li>■ Measurements Snapshot exports a snapshot of all measurements</li> <li>■ Histogram Data exports current histogram data</li> </ul> <p><b>20.</b> Touch OK to accept your changes, Cancel to close the window without making changes, or Help to access more information.</p>	   

Overview	To save a waveform (Cont.)	Control elements and resources
<p><b>Export your file</b></p>	<p><b>21.</b> To export the file, from the menu bar, select Export.</p> <p>You can also attach the front-panel PRINT button to Export. Then, pressing the PRINT button will export your file. Do the following to attach the PRINT button to Export:</p> <ul style="list-style-type: none"> <li>■ From the menu bar, select File, and then select Export Setup to display the Export Setup control window</li> <li>■ Touch Set Print button to Export</li> </ul> <p><b>22.</b> The Export window lists all available waveforms, allows for browsing to the destination directory, naming the file, and selecting the file format.</p>	 <p>The screenshot shows the 'File' menu with 'Export...' highlighted. Other menu items include Reference Waveforms, Instrument Setup..., Recall Default Setup, Page Setup..., Print Preview, Print... (Ctrl+P), Export Setup..., Select for Export, Minimize (Ctrl+M), and Shutdown...</p>  <p>The screenshot shows the 'Export Setup' dialog box with two checked options: 'Prompt for filename before exporting' and 'Set Print button to Export'.</p>  <p>The screenshot shows the 'Export' dialog box. The 'Save in:' field is set to 'Images'. The 'File name:' field contains '040427_064902'. The 'Save as type:' is set to 'Image files (*.bmp)'. Buttons for 'Save', 'Cancel', 'Export Setup...', and 'Help' are visible.</p>
<p><b>Select a destination</b></p>	<p><b>23.</b> Use the Save in: drop-down list and buttons to navigate to the directory in which you want to save the file.</p>	 <p>The screenshot shows the 'Export' dialog box with the 'Save in:' field set to 'Images'.</p>

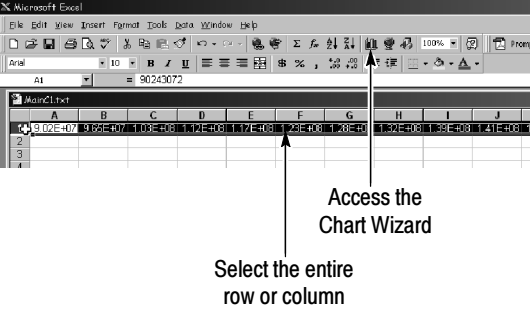
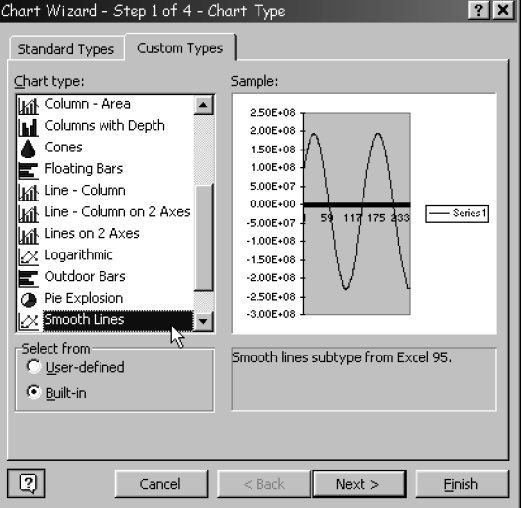
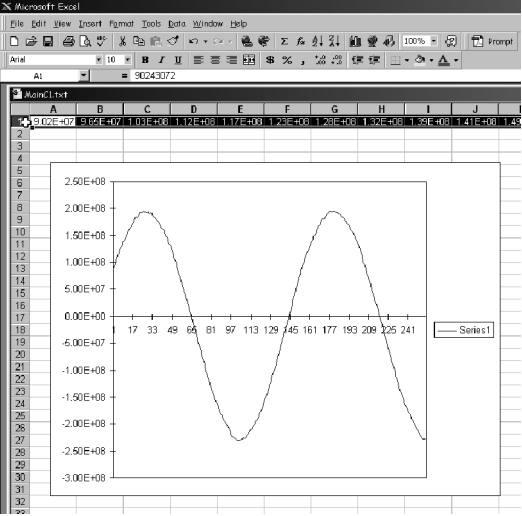
Overview	To save a waveform (Cont.)	Control elements and resources
<p><b>Name the file</b></p>	<p><b>24.</b> Select the file type in the Save as type drop-down list to force the file listing to only include these types. Use *.dat for waveforms.</p> <p><b>Note.</b> Only change the type if you want to temporarily see any other types of files in the current directory. Otherwise, leave it as set by the Export Setup control window.</p> <p><b>25.</b> Specify the filename in which to save your waveform. You can:</p> <ul style="list-style-type: none"> <li>■ Use the default name and directory appearing in the File name field.</li> <li>■ Rename the file by typing a new name into the File name field.</li> <li>■ Select the Auto-increment file name check box to save a series of files without typing in a new name each time. For more information, see <i>Using Auto-Increment File Name</i> on page 3-222.</li> </ul> <p><b>Note.</b> If your instrument lacks a keyboard, touch or click the keyboard icon buttons to display a virtual keyboard. You can use the mouse or touch screen with the virtual keyboard to type entries in the name fields.</p>	<p style="text-align: center;">Edit path and file name</p>  <p style="text-align: center;">Access to virtual keyboard</p> 
<p><b>Save the file</b></p>	<p><b>26.</b> Touch the Save button to save the file. To cancel without saving a file, touch the Cancel button.</p>	
<p><b>For further assistance</b></p>	<p><b>27.</b> For more help on exporting files, touch the Help button to access contextual online help.</p>	 <p style="text-align: center;">See page 3-263 to learn about using online help.</p>


**To Use an Exported Waveform**

How you use the exported waveform depends on your application. The following example is a simple application; the procedure is general and may require adapting for your spreadsheet or other data-analysis tool.

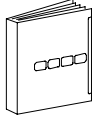
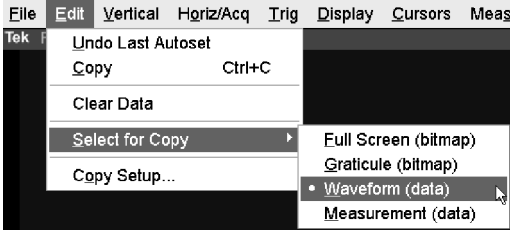
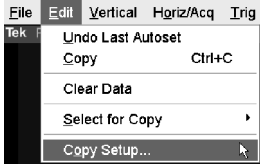
Overview	To use exported waveforms	Control elements and resources												
<p><b>Prerequisites</b></p>	<ol style="list-style-type: none"> <li>MS Excel 97, 2000, or 2002 running on a PC or on the instrument.</li> <li>Access to a waveform exported by the instrument.</li> </ol>	 <ul style="list-style-type: none"> <li>See <i>To Save Your Waveform</i> on page 3-228.</li> </ul>												
<p><b>Import the waveform data</b></p>	<ol style="list-style-type: none"> <li>In Excel, select Open from the File menu. Use the window that pops up to navigate to the directory containing the file.                     <p><b>Note.</b> If using MS Excel 2000 or 2002, skip the next step.</p> </li> <li>In the dialog that displays, make the selections as shown at the right as you navigate through the Text Import Wizard. You must select <b>delimiter</b> as your data type, <b>comma</b> as the delimiter type, and <b>General</b> as your Column data format.                     <p><b>Note.</b> This step assumes MS Excel 97; your tool may have similar import features for comma-separated data. Check its documentation.</p> <p><b>Note.</b> To plot 2 channels, export the first channel with scale factors and time values. Export the second channel as voltages only.</p> </li> </ol>	 <p>Text Import Wizard - Step 1 of 3 The Text Wizard has determined that your data is Delimited. If this is correct, choose Next, or choose the Data Type that best describes your data.</p> <p>Original data type Choose the file type that best describes your data:  <input checked="" type="radio"/> Delimited - Characters such as commas or tabs separate each field.  <input type="radio"/> Fixed width - Fields are aligned in columns with spaces between each field.</p> <p>Start import at row: 1 File Origin: Windows (ANSI)</p>  <p>Text Import Wizard - Step 2 of 3 This screen lets you set the delimiters your data contains. You can see how your text is affected in the preview below.</p> <p>Delimiters:  <input type="checkbox"/> Tab <input type="checkbox"/> Semicolon <input checked="" type="checkbox"/> Comma <input type="checkbox"/> Treat consecutive delimiters as one  <input type="checkbox"/> Space <input type="checkbox"/> Other: <input type="text"/> Text Qualifier: <input type="text"/></p> <p>General converts numeric values to numbers, date values to dates, and all remaining values to text.  <input checked="" type="radio"/> Text  <input type="radio"/> Date: MDY  <input type="radio"/> Do not import column (Skip)</p> <p>Data preview</p> <table border="1"> <thead> <tr> <th>General</th> <th>General</th> <th>General</th> <th>General</th> <th>General</th> <th>General</th> </tr> </thead> <tbody> <tr> <td>199884800</td> <td>233439232</td> <td>264830976</td> <td>292880384</td> <td>321323008</td> <td>3432775</td> </tr> </tbody> </table> <p>Buttons: Cancel &lt; Back Next &gt; Finish</p>	General	General	General	General	General	General	199884800	233439232	264830976	292880384	321323008	3432775
General	General	General	General	General	General									
199884800	233439232	264830976	292880384	321323008	3432775									

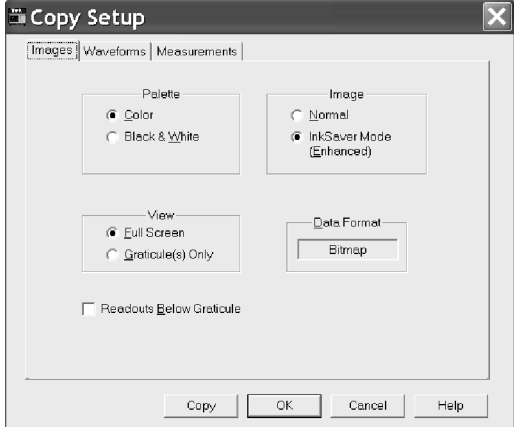
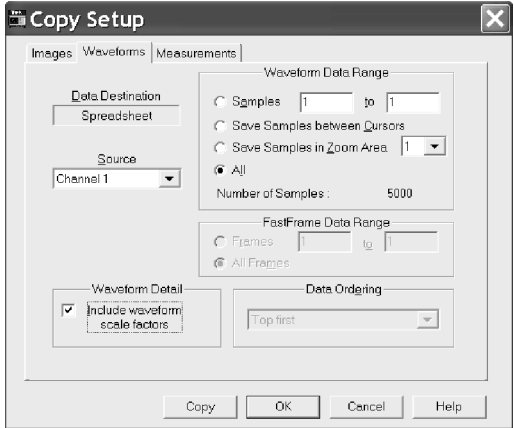


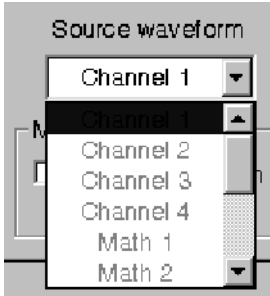
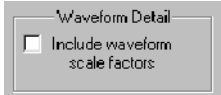
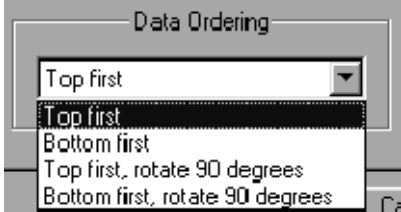
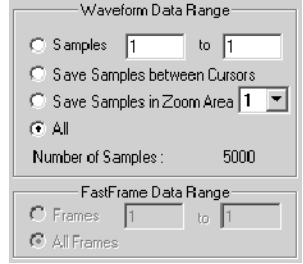
Overview	To use exported waveforms (Cont.)	Control elements and resources
<p><b>Begin your chart</b></p>	<ol style="list-style-type: none"> <li>5. Touch the row or column number to select the entire row or column containing your imported waveform values (see right).</li> <li>6. Select the Chart button from the toolbar or from the Insert menu.</li> </ol>	
<p><b>Specify a line-graph chart</b></p>	<ol style="list-style-type: none"> <li>7. From the Chart Wizard, make sure <b>Built In</b> is selected. Then select either of the following: <ul style="list-style-type: none"> <li>■ Lines in the Standards Types tab</li> <li>■ Smooth lines in the Custom Types tab</li> </ul> </li> </ol>	
<p><b>Finish the chart</b></p>	<ol style="list-style-type: none"> <li>8. Click Next to step through the next two steps accepting the defaults setting at each step. Click the Finish button in step 4. You should have a waveform display similar to that shown at the right. <p><i><b>Note.</b> This procedure assumes MS Excel 97. You can likely specify titles, customize the treatment and labeling of the x and y axes, and so forth in your data-analysis application—either as you create the chart or afterward. Use the help for your data-analysis application to determine if it has these capabilities and for instructions in using them.</i></p> </li> </ol>	

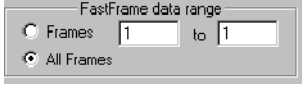

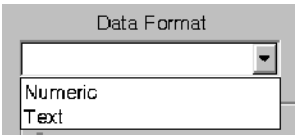


Overview	To use exported waveforms (Cont.)	Control elements and resources
<p><b>For further assistance</b></p>	<p>9. For more help on exporting waveforms, touch the Help button in the window to access contextual online help.</p>	<div style="text-align: center;">  </div> <p style="text-align: center;">See page 3-263 to learn about accessing online help.</p>

**To Copy Your Waveform** Use the procedure that follows to copy a waveform to the clipboard.

Overview	To save a waveform	Control elements and resources
<p><b>Prerequisites</b></p>	<p>1. Make sure the waveform, image, or measurement to be copied exists; that is, your source must be a channel, an active math waveform, an active reference, and so forth.</p>	<div style="text-align: center;">  </div> <ul style="list-style-type: none"> <li>■ See <i>Powering On the Instrument</i> on page 1-9.</li> <li>■ See page 3-29 for acquisition setup.</li> <li>■ See page 3-63 for trigger setup.</li> </ul>
<p><b>Select for copy</b></p>	<p>2. From the menu bar, select Edit, and then select Select for Copy.</p> <p>The menu lists all available waveform, image, and measurement types available for export:</p> <ul style="list-style-type: none"> <li>■ Full Screen to export a bitmap of all screen contents</li> <li>■ Graticule to export a bitmap of only the graticule area</li> <li>■ Waveform to export waveform data</li> <li>■ Measurements to export measurement data</li> </ul>	
<p><b>Select setup for copy</b></p>	<p>3. From the menu bar, select Edit, and then select Copy Setup to display the Copy Setup control window.</p>	

Overview	To save a waveform (Cont.)	Control elements and resources
<p><b>Setup to copy images</b></p>	<ol style="list-style-type: none"> <li>4. Select the Images tab to display the Images control window.</li> <li>5. In the Palette window, select Color or Black &amp; White for the color palette of your copied images.</li> <li>6. In the View window, select whether you want to copy the Full Screen or Graticules Only.</li> <li>7. In the Image window, select whether you want to copy using Normal or InkSaver Mode.</li> </ol>	
<p><b>Setup to copy waveforms</b></p>	<ol style="list-style-type: none"> <li>8. Select the Waveforms tab to display the Waveforms control window.</li> </ol>	

Overview	To save a waveform (Cont.)	Control elements and resources
<p><b>Setup to copy waveforms (Cont.)</b></p>	<p>9. Touch Source Waveform, and select the source of the waveform (a channel, math, or reference waveform) to copy from the list.</p> <p>10. If you want waveform scale factors included in your Mathcad files, touch Include waveform scale factors.</p> <p>11. Touch Data Ordering, and select the data order (top first; bottom first; top first, rotate 90 degrees; or bottom first, rotate 90 degrees) from the list.</p> <p>12. In the Waveform data range window, select the data to include in the exported files:</p> <ul style="list-style-type: none"> <li>■ Samples to enter the data range of the data to include in the exported files</li> <li>■ Save Samples between Cursors to include data between the cursors in the exported files</li> <li>■ Save Samples in Zoom Area to include data in zoom area 1, 2, 3, or 4 in the exported files</li> <li>■ All to include all data in the exported files</li> </ul>	   

Overview	To save a waveform (Cont.)	Control elements and resources
	<p><b>13.</b> If using FastFrame, select the frame range to include in the copied files:</p> <ul style="list-style-type: none"> <li>■ All Frames to include all frames in the copied files</li> <li>■ Frames to enter a range of frames to include in the copied files</li> </ul>	 <p>The dialog box titled "FastFrame data range" has two radio buttons. The first is labeled "Frames" and is followed by two input fields containing the number "1" and the word "to" between them. The second radio button is labeled "All Frames".</p>
<p><b>Setup to copy measurements</b></p>	<p><b>14.</b> Select the Measurements tab to display the Measurements control window.</p> <p><b>15.</b> Select Displayed Measurements to copy measurements that are displayed on screen, select Measurements Snapshot to copy a snapshot of all measurements, or select Histogram Data to copy histogram data in comma separated values format.</p> <p><b>16.</b> Touch Data Format and select the data format (text or numeric) from the list.</p>	 <p>The "Copy Setup" dialog box has three tabs: "Images", "Waveforms", and "Measurements". The "Measurements" tab is active. It contains three radio buttons: "Displayed Measurements" (selected), "Measurements Snapshot", and "Histogram Data (CSV)". To the right of the "Displayed Measurements" radio button is a "Data Format" dropdown menu showing "Text". At the bottom are "Copy", "OK", "Cancel", and "Help" buttons.</p>  <p>The "Data Format" dialog box shows a dropdown menu with "Numeric" and "Text" options.</p>
<p><b>Copy your file</b></p>	<p><b>17.</b> Touch OK to accept your changes and copy the file to the clipboard, Cancel to close the window without making changes, or Help to access more information.</p>	 <p>A row of three buttons: "OK", "Cancel", and "Help".</p>
<p><b>For further assistance</b></p>	<p><b>18.</b> For more help on copying files, touch the Help button to access contextual online help.</p>	 <p>See page 3-263 to learn about using online help.</p>

## Printing Waveforms

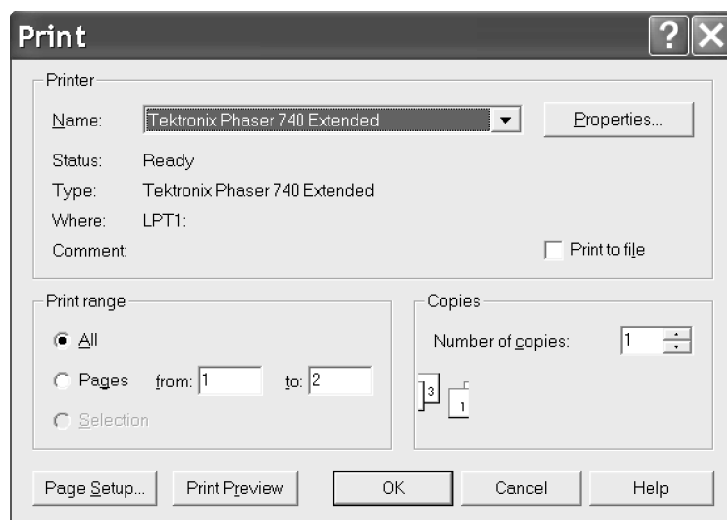
You can print the display screen, including any waveforms displayed. Before you can print, you must install and set up your printer. Consult the instructions that come with your printer. Also for printer setup instructions, you can display Windows help and access its section on printers.

### To Print from Front Panel

To print a waveform from the front panel, push the front-panel PRINT button. The display screen will print on the default printer. For additional print options, see the topics that follow.

### To Print from Menu Bar

To print a waveform, from the application menu bar, select the File menu, and then select Print. The instrument displays the standard Microsoft Windows XP Print window shown in Figure 3-65. Access the Windows help system for more information.

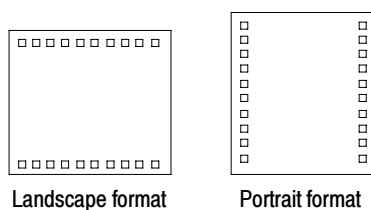


**Figure 3-65: Print window**

**To Set Up the Page**

To set the format of the printed page, from the menu bar select the File menu, and then select Page Setup. The instrument displays the Page Setup window shown in Figure 3-67.

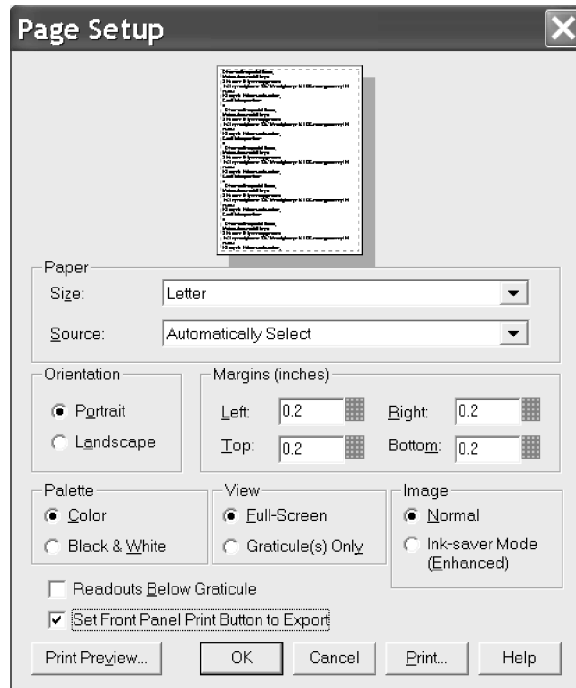
- **Paper:** select the paper size and source from the drop-down lists.
- **Orientation:** select either Portrait or Landscape (see Figure 3-66).
- **Margins:** set the margins you want for your page.



**Figure 3-66: Hardcopy formats**

- **Palette:** select either Color or Black & White.
- **View:** select either Full-Screen or Graticule(s) Only:
  - Full-Screen displays both the graticule and menu areas of the screen
  - Graticule(s) displays only the graticule area of the display
- **Image:** select either Normal or InkSaver with Enhanced Waveform Color Mode.
  - Normal exports the image exactly as it appears on-screen
  - InkSaver with Enhanced Waveform Color exports the image with colors designed to print with the white background

Touch Help for more information.



**Figure 3-67: Page setup window**

### To Preview the Page

To preview your printout, from the menu bar select the File menu, and then select Print Preview. The instrument displays the standard MS Windows XP Print Preview window shown in Figure 3-68. Access the Windows help system for more information.



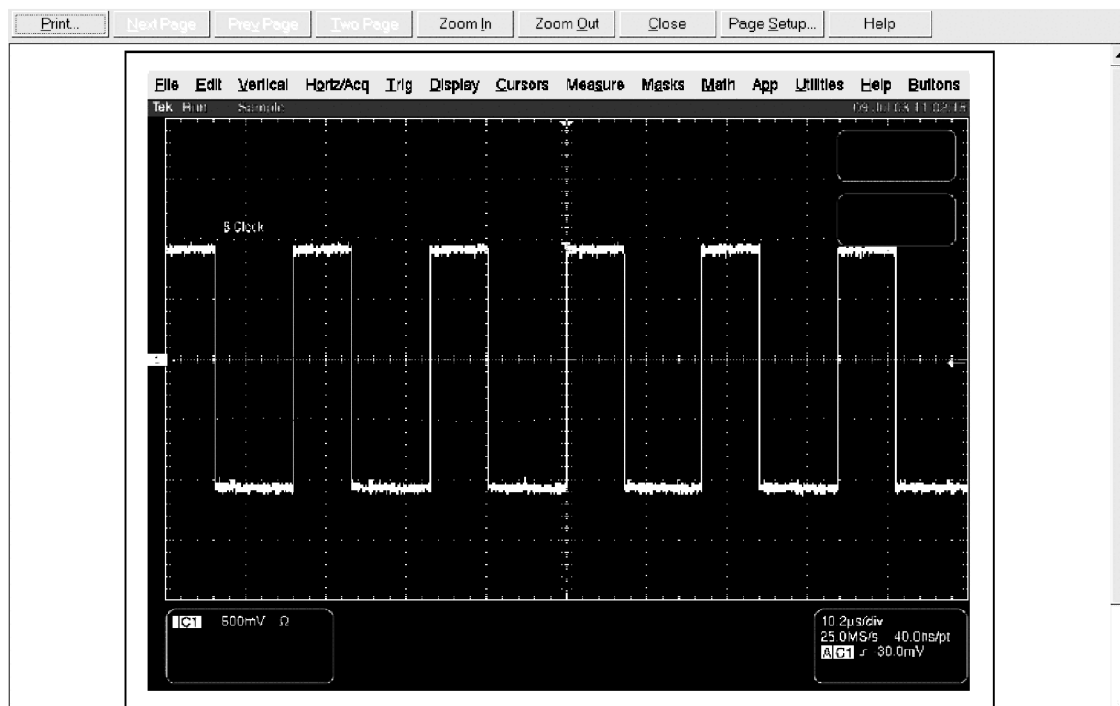


Figure 3-68: Print preview window

### To Print Using Print Screen

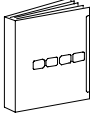

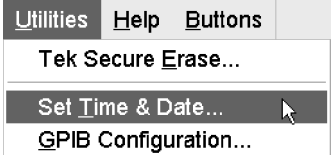
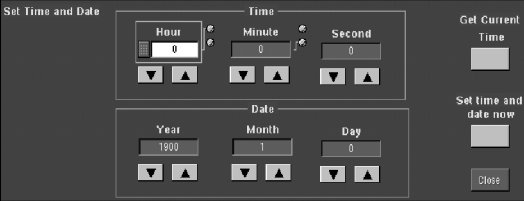


Pressing the Windows Print Screen key copies the currently displayed bitmap to the clipboard. This bitmap does not include the instrument waveforms or graticule. The waveforms and graticule are displayed by the graphics adapter outside of normal Windows mechanisms.

The graphics adapter uses a technique similar to that used by TV weathermen. They stand in front of a blank (blue) screen that is electronically replaced by a weather map. The instrument uses a blank (dark gray) image that is electronically replaced by the graticule and the waveforms that are currently being displayed. If you load the bitmap into a program such as Paint, the graticule and waveforms are not part of the bitmap, and, although they are visible on Paint's window, they will not be saved or printed.

To capture the instrument screen with its graticule and waveform, either use Copy in the Edit menu after selecting Image in the Copy Setup menu, or if you want to build a bitmap file, select Export in the File menu after selecting Full Screen (bitmap) in the Select for Export menu. For additional information see *Exporting and Copying Waveforms* on page 3-235.

**To Date/Time Stamp  
Hardcopies**

You can display the current date and time on screen so that they appear on hardcopies that you print. To date and time stamp your hardcopy, do the following steps:

Overview	To date/time stamp hardcopies	Control elements and resources
<p><b>Prerequisites</b></p>	<p>1. The instrument must be powered on.</p>	 <p>See <i>Powering On the Instrument</i> on page 1-9.</p>
<p><b>To display the date and time</b></p>	<p>2. From the toolbar, touch Disp and select the Objects tab. 3. Touch Display Date/Time to toggle it on.</p>	
<p><b>To set the date and time</b></p>	<p>4. From the menu bar, touch Utilities and select Set Time &amp; Date to display the Set Time and Date control window.  5. Touch Hour, Minute, or Second and use the multipurpose knobs, keypad, or arrow buttons to enter the time. 6. Touch Year, Month, or Day and use the multipurpose knobs, keypad, or arrow buttons to enter the date.  7. Touch Set time and date now to set the time and date.</p>	  
<p><b>To get the current time</b></p>	<p>8. Touch Get Current Time to get the current time from the Windows operating system.</p>	

## Remote Communication

Remote communication is performed through the GPIB interface. Consult the online Programmer Guide for help with establishing remote communication and control of the instrument.

To access the Programmer Guide, locate the Product Software CD that was shipped with the instrument. Install the CD in the personal computer that you want to use, typically your instrument controller. Follow the directions in the CD booklet.

You can install the guide in the instrument, but that may not be convenient because it will cover the instrument screen.

For information on connecting the instrument to a network to enable printing, file sharing, internet access, and other communications functions, see *Connecting to a Network* on page 1-16.

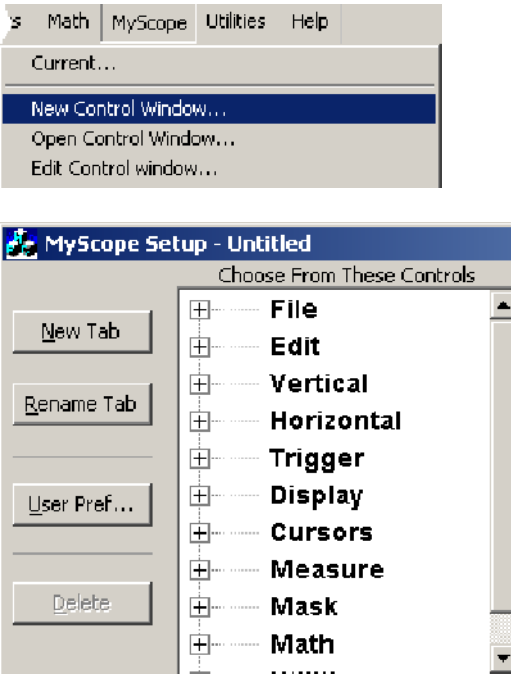


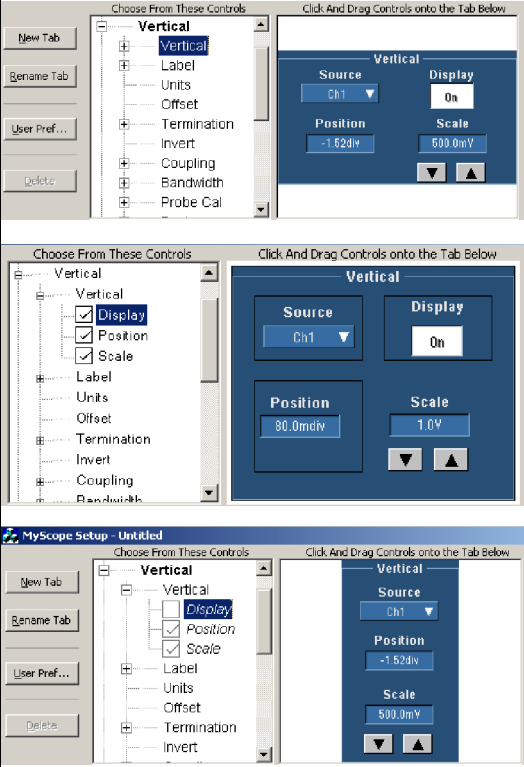
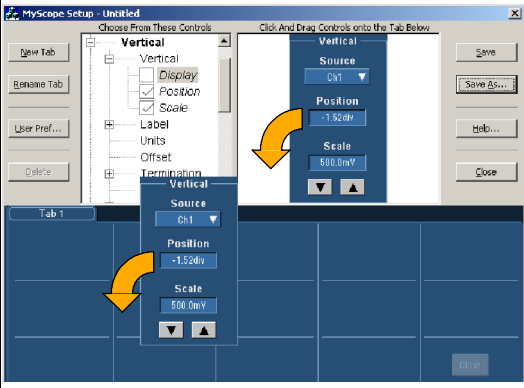
# MyScope

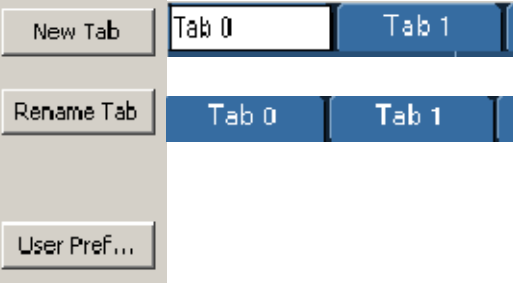
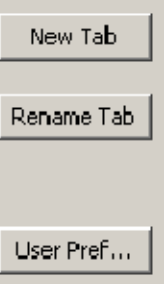

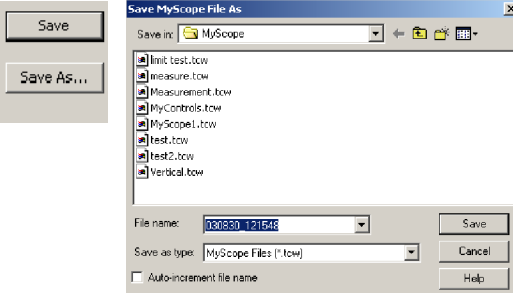
MyScope allows you to create custom control windows that include only the controls that you use regularly. Instead of switching between several control windows, you can put the controls that you use into a custom control window.

## Creating MyScope Control Windows

This section contains procedures for creating MyScope control windows. Detailed information is available in the online help.

Overview	To create a new MyScope control window	Control elements and resources
<p><b>Select from menu</b></p>	<ol style="list-style-type: none"> <li>1. Select <b>MyScope &gt; New Control Window...</b></li> <li>2. Click + to expand a category.</li> </ol> <p>Controls that can be added to your MyScope control window are contained within each category. The categories match the menu bar to aid you in finding the controls you normally use.</p>	 <p>The screenshot shows the 'MyScope' menu bar with 'New Control Window...' selected. Below it, the 'MyScope Setup - Untitled' dialog box is open, displaying a list of control categories: File, Edit, Vertical, Horizontal, Trigger, Display, Cursors, Measure, Mask, and Math. Each category has a '+' icon to its left, indicating it can be expanded.</p>

Overview	To create a new MyScope control window (Cont.)	Control elements and resources
<p><b>Make control selections</b></p>	<ol style="list-style-type: none"> <li>Click a control to preview it.</li> <li>Double-click the control or click the + to expand the control list. (If there is no +, then the control cannot be customized further.)</li> <li>Clear the check boxes to remove any components that you do not want included in the control.</li> </ol>	 <p>The first screenshot shows the 'Choose From These Controls' dialog with 'Vertical' selected in the tree. The second screenshot shows 'Display', 'Position', and 'Scale' checked in the tree, and their respective controls (Source, Display, Position, Scale) visible in the preview window. The third screenshot shows 'Display', 'Position', and 'Scale' unchecked, and their controls hidden in the preview window.</p>
<p><b>Create a control window</b></p>	<ol style="list-style-type: none"> <li>Click and drag the control to your MyScope control window.</li> </ol> <p>The control will snap to the nearest grid location when you release the mouse. You can change the placement of the control in your MyScope control window by clicking and dragging.</p> <p>To reconfigure a control, click and drag it back to the preview window. Then select or clear the check boxes to include or remove components in the control.</p>	 <p>The screenshot shows the 'MyScope Setup' dialog box. A control is being dragged from the preview window (top right) to a control window (bottom left). Orange arrows indicate the drag path. The control window has a grid background.</p>

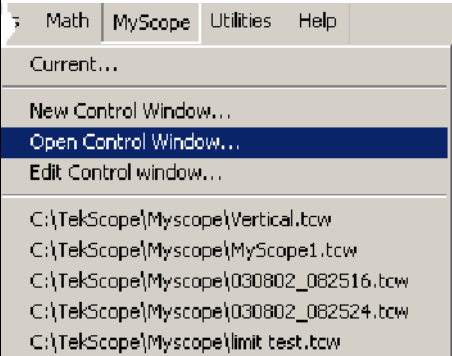
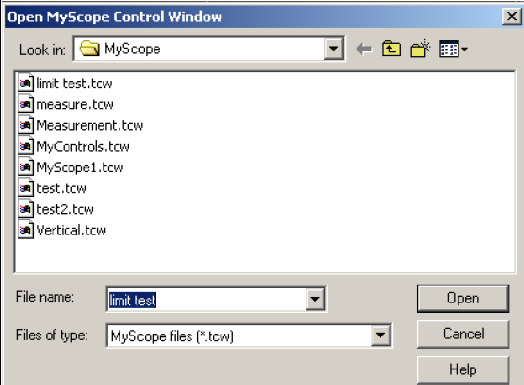
Overview	To create a new MyScope control window (Cont.)	Control elements and resources
<p><b>Add tabs</b></p>	<p>7. Click <b>New Tab</b> to add a tab to your MyScope control window. You can have up to eight tabs.</p> <p>8. To rename a tab do one of the following:</p> <ul style="list-style-type: none"> <li>■ Click <b>Rename Tab</b></li> <li>■ Double-click the tab</li> </ul> <p>Then type the new name.</p> <p>9. To change the tab order, click and drag a tab to a new location.</p>	 <p>The screenshot shows a vertical menu on the left with three buttons: 'New Tab', 'Rename Tab', and 'User Pref...'. To the right is a horizontal tab bar with two tabs, 'Tab 0' and 'Tab 1'. The 'New Tab' button is positioned above the 'Tab 0' tab, and the 'Rename Tab' button is positioned above the 'Tab 1' tab.</p>
<p><b>Set user preferences</b></p>	<p>10. Click <b>User Pref...</b> to specify user preferences that are loaded with your MyScope control window.</p>	 <p>The screenshot shows a vertical menu with three buttons: 'New Tab', 'Rename Tab', and 'User Pref...'. The 'User Pref...' button is highlighted.</p>
<p><b>Delete controls</b></p>	<p>11. To delete controls do one of the following:</p> <ul style="list-style-type: none"> <li>■ Select a tab, and then click <b>Delete</b>. The tab and all of the controls are deleted.</li> <li>■ Select a control, and then click <b>Delete</b>. Just the selected control is deleted.</li> <li>■ Click and drag the control to the upper half of the screen (off your MyScope control window).</li> </ul>	 <p>The screenshot shows a single button labeled 'Delete'.</p>
<p><b>Save MyScope control window</b></p>	<p>12. Click <b>Save</b>, and then enter a name for your MyScope control window, or use the default name.</p>	 <p>The screenshot shows a vertical menu with two buttons: 'Save' and 'Save As...'. To the right is a 'Save MyScope File As' dialog box. The dialog box has a 'Save in:' field set to 'MyScope', a list of files including 'Init.test.tow', 'measure.tow', 'Measurement.tow', 'MyControl.tow', 'MyScope1.tow', 'test.tow', 'test2.tow', and 'Vertical.tow'. The 'File name:' field contains '130830_121548'. The 'Save as type:' is set to 'MyScope Files (*.tow)'. There are 'Save', 'Cancel', and 'Help' buttons at the bottom.</p>

## Using MyScope Control Windows

The following section describes how to use MyScope control windows after you have created them.

### To Open a MyScope Control Window

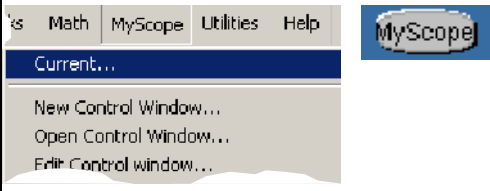
Use the following procedure to open an existing MyScope control window.

Overview	To open a MyScope control window	Control elements and resources
<p><b>Select from menu</b></p>	<p>1. Select <b>MyScope &gt; Open Control Window...</b> or one of the five most recently used MyScope windows.</p>	 <p>A screenshot of the MyScope application menu. The menu items are: Math, MyScope, Utilities, and Help. Below these are: Current..., New Control Window..., Open Control Window... (highlighted in blue), Edit Control window..., and a list of recently used files: C:\TekScope\MyScope\Vertical.tcw, C:\TekScope\MyScope\MyScope1.tcw, C:\TekScope\MyScope\030802_082516.tcw, C:\TekScope\MyScope\030802_082524.tcw, and C:\TekScope\MyScope\limit test.tcw.</p>
<p><b>Select a control window</b></p>	<p>2. Select the MyScope control window that you want to use, and then click <b>Open</b>.</p>	 <p>A screenshot of the 'Open MyScope Control Window' dialog box. The 'Look in:' field shows 'MyScope'. The file list contains: limit test.tcw, measure.tcw, Measurement.tcw, MyControls.tcw, MyScope1.tcw, test.tcw, test2.tcw, and Vertical.tcw. The 'File name:' field contains 'limit test'. The 'Files of type:' field is set to 'MyScope files (*.tcw)'. Buttons for 'Open', 'Cancel', and 'Help' are visible at the bottom right.</p>



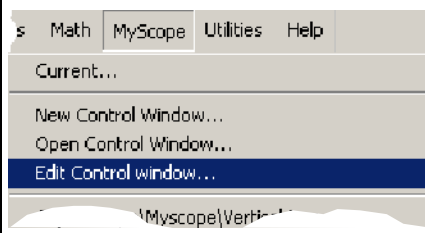
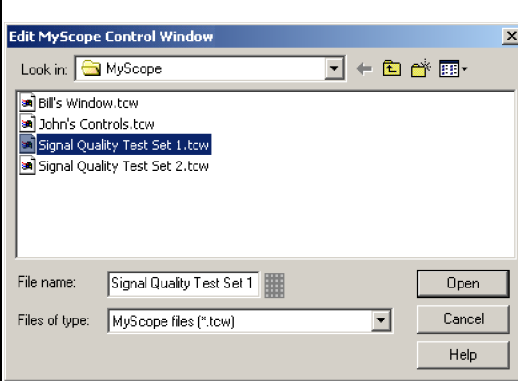
### To Display the Active Myscope Control Window

Use the following procedure to display the active MyScope control window.

Overview	To display the active MyScope control window	Control elements and resources
Select from menu	1. Select <b>MyScope &gt; Current...</b> or click <b>MyScope</b> in the toolbar mode. (Your MyScope control window remains active even when it is not displayed.)	

### To Edit a MyScope Control Window

Use the following procedure to edit a MyScope control window.

Overview	To edit a MyScope control window	Control elements and resources
Select from menu	1. Select <b>MyScope &gt; Edit Control Window...</b>	
Select a control window	2. Select the control window that you want to edit, and then click <b>Open</b> .	

### Quick Tips

- Some controls function differently in a MyScope control window than they do in the standard control window. For details, see the online help.
- You can copy MyScope control windows (.tcw files) to other CSA/TDS7000B Series instruments.



# Accessing Online Help

This manual represents only part of the user assistance available to you — the online help system, integrated as part of the instrument user interface, provides quick-to-access support for operating this instrument. This section describes the help system and how to access it.

This instrument provides the following help resources online:

- Help Topics
- Programmers Guide

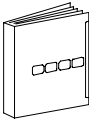
Much of the information you need to operate this instrument and use it effectively is found online, where you can quickly access it and display it on your instrument screen. You need to access the online documentation for most operating information.


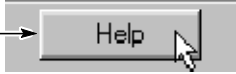

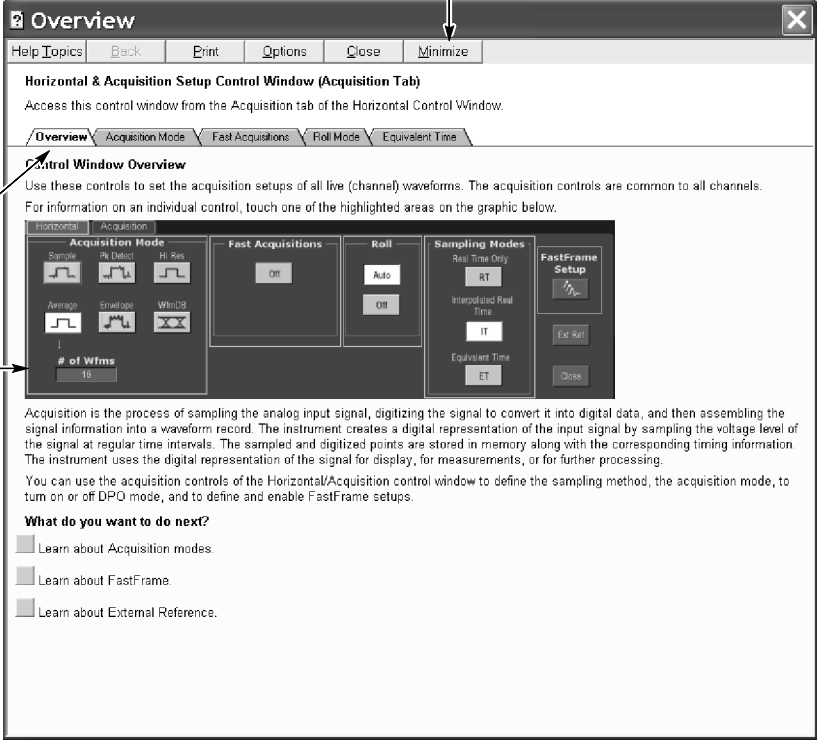
A few keys to remember when using online help follow:

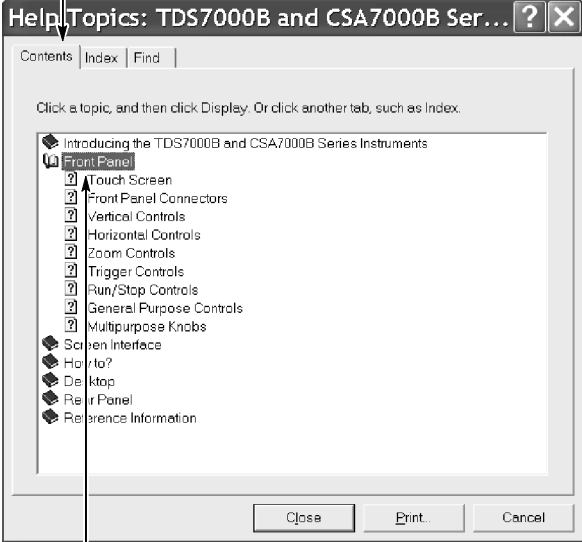
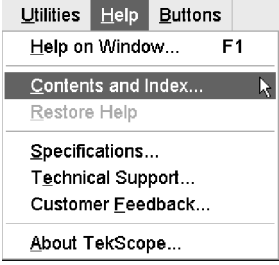
- Use online help when you want to minimize interruption to your work flow. Help Topics are there when you need more details about a feature.
- Use the manuals for instructions on putting the instrument into service, for procedures on reinstalling its product software, for listings of specifications, and for overviews of features and their operation.
- Use the online Programmers Guide, either displayed on the instrument screen, or on your windows-equipped PC, for support on operating the instrument from the GPIB.


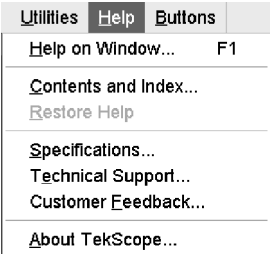
## How to Use Online Help

Use the procedure steps that follow to access contextual help and to learn how to search the help system for more information.

Overview	To use online help	Control elements and resources
<b>Prerequisites</b>	1. The instrument must be powered up and running.	 See <i>Installation</i> , page 1-5.

Overview	To use online help (Cont.)	Control elements and resources
<p><b>For in-depth, contextual overviews</b></p>	<ol style="list-style-type: none"> <li>When using the toolbar and you have a control window displayed, touch the Help button to open the help system with an overview of the control window that is currently displayed.</li> <li>Some windows have a help button as shown at the right. Touch the button to open the help system with an overview of the dialog box that is currently displayed. See right.</li> </ol> <p>Touch the Minimize button in a help window to move the help out of the way so you can operate the instrument. Touch the Restore Help button to see the last help topic again.</p> <p>Touch a tab in a help window to navigate between the Overview and specific topics.</p> <p>Touch an outlined control shown in the help window to receive more specific information about the control.</p>	<div style="text-align: center;">  </div> <div style="text-align: center;">  </div> <div style="text-align: right; margin-top: 20px;">  </div> <div style="text-align: center; margin-top: 20px;">  </div>

Overview	To use online help (Cont.)	Control elements and resources
<p><b>To dig deeper</b></p>	<p>4. You can search for help using the usual methods available for help on a PC: From the menu bar, select Help, and then select Contents and Index.</p> <p>5. From the online help finder (see below), choose from the three tabs.</p>  <p>6. Touch to explore the topic titles and to highlight one for display. Touch the Display button to open the topic in a help window.</p>	

Overview	To use online help (Cont.)	Control elements and resources
<p><b>To enable full-text search</b></p>	<p>7. If you cannot find the information in the Contents or Index tabs of the online finder, you may want to enable full text search: From the application menu bar, select Help, and then select Contents and Index.</p> <p>8. From the online help finder (see below), choose the Find tab.</p>  <p>9. Choose the method for word list generation and select next or finish. Once the word list generation finishes, touching the Find tab will access a pane for searching with full text search.</p>	

# Appendix A: Specifications

This chapter contains the specifications for the CSA7000B Series Communications Signal Analyzers and the TDS7000B Series Digital Phosphor Oscilloscopes. All specifications are guaranteed unless labeled “typical.” Typical specifications are provided for your convenience but are not guaranteed. Specifications that are marked with the ✓ symbol are checked in chapter four, *Performance Verification*, of the service manual.

All specifications apply to all models unless noted otherwise. To meet specifications, the following conditions must be met:

- The instrument must have been calibrated in an ambient temperature between 20 °C and 30 °C (68 °F and 86 °F).
- The instrument must be operating within the environmental limits listed in Table A-12 on page A-27.
- The instrument must be powered from a source that meets the specifications listed in Table A-10 on page A-25.
- The instrument must have been operating continuously for at least 20 minutes within the specified operating temperature range.
- You must perform the Signal Path Compensation procedure after the 20-minute warm-up period, and if the ambient temperature changes more than 5 °C (41 °F), repeat the procedure. See *Optimizing Measurement Accuracy* on page 3-160 for instructions to perform this procedure.

## Product and Feature Description

Your instrument is shown in Table A-1.

**Table A-1: Instrument models**

Model	Number of channels	Bandwidth	Maximum sample rate (real time)
TDS7704B	4	7 GHz	20 GS/s
CSA7404B	4	4 GHz	20 GS/s
TDS7404B	4	4 GHz	20 GS/s
TDS7254B	4	2.5 GHz	20 GS/s
TDS7154B	4	1.5 GHz	20 GS/s

### Acquisition Features

**Separate Digitizers.** Ensure accurate timing measurements with separate digitizers for each channel. Acquisition on multiple channels is always concurrent. The digitizers can also be combined to yield a higher sample rate on a single channel.

**Fast Acquisition.** Acquire up to 400,000 waveforms per second to see rapidly changing signals or intermittent signal irregularities.

**Long Record Lengths.** Choose record lengths from 500 points up to 500,000 points per channel (up 2,000,000 points on a single channel). Extend the maximum record length up to a maximum of 64,000,000 points with memory options.

**Peak Detect Acquisition Mode.** See pulses as narrow as 400 ps even at the slower time base settings. Peak detect helps you see noise and glitches in your signal.

**Acquisition Control.** Acquire continuously or set up to capture single shot acquisitions. Enable or disable optional acquisition features such as equivalent time or roll mode. Use Fast Frame acquisition to capture and time stamp many events in a rapid sequence.

**Horizontal Delay.** Use delay when you want to acquire a signal at a significant time interval after the trigger point. Toggle delay on and off to quickly compare the signal at two different points in time.



---

	<p><b>Optical-to-Electrical Converter.</b> CSA7000B Series only. Test optical signals using the integrated optical-to-electrical converter and a fully calibrated signal path. Recovered clock and data signals are available. Optical reference receivers are available for selected optical communications standards.</p>
<b>Signal Processing Features</b>	<p><b>Average, Envelope, and Hi Res Acquisition.</b> Use Average acquisition mode to remove uncorrelated noise from your signal. Use Envelope to capture and display the maximum variation of the signal. Use Hi Res to increase vertical resolution for lower bandwidth signals.</p> <p><b>Waveform Math.</b> Set up simple math waveforms using the basic arithmetic functions or create more advanced math waveforms using the math expression editor. Waveform expressions can even contain measurement results and other math waveforms.</p> <p><b>Spectral Analysis.</b> Display spectral magnitude and phase waveforms based on your time-domain acquisitions. Control the instrument using the traditional spectrum analyzer controls such as span and center frequency.</p>
<b>Display Features</b>	<p><b>Color LCD Display.</b> Identify and differentiate waveforms easily with color coding. Waveforms, readouts, and inputs are color matched to increase productivity and reduce operating errors. Enhance visualization of waveforms with color grading.</p> <p><b>Digital Phosphor.</b> The instrument can clearly display intensity modulation in your signals. The instrument automatically overlays subsequent acquisitions and then decays them to simulate the writing and decay of the phosphor in an analog instrument CRT. The feature results in an intensity-graded or color-graded waveform display that shows the information in the intensity modulation.</p> <p><b>Fit to Screen.</b> The Digital Phosphor technology performs the compression required to represent all record points on the screen, even at the maximum record length settings.</p> <p><b>MultiView Zoom.</b> To take advantage of the full resolution of the instrument you can zoom in on a waveform to see the fine details. Both vertical and horizontal zoom functions are available. Zoomed waveforms can be aligned, locked, and automatically scrolled.</p>
<b>Measurement Features</b>	<p><b>Cursors.</b> Use cursors to take simple voltage, time, and frequency measurements.</p>

**Automatic Measurements.** Choose from a large palette of amplitude, time, and histogram measurements. You can customize the measurements by changing reference levels or by adding measurement gating.

**Mask Testing.** Optional on TDS7000B Series. Provides mask testing for verifying compliance to optical (CSA7000B Series only) and electrical standards. Optical mask testing uses integrated reference receivers.

## Trigger Features

**Simple and Advanced Trigger Types.** Choose simple edge trigger or choose from eight advanced trigger types to help you capture a specific signal fault or event.

**Dual Triggers.** Use the A (main) trigger system alone or add the B trigger to capture more complex events. You can use the A and B triggers together to set up a delay-by-time or delay-by-events trigger condition.

**Comm Triggers.** Optional on TDS7000B Series. Use comm triggers to trigger on communication signals.

**Serial Triggers.** Optional on TDS7000B Series. Use serial triggers to trigger on serial pattern data.

**Recovered Clock and Data Triggers.** Use recovered clock and data internally to trigger your waveforms. They are also available externally (CSA7000B Series only).

## Convenience Features

**Autoset.** Use Autoset to quickly set up the vertical, horizontal, and trigger controls for a usable display. If a standard mask is active (optional on TDS7000B Series), Autoset adjusts the selected waveform to match the mask, if possible.

**Touch Screen Interface.** You can operate all instrument functions (except the power switch and the touch screen enable/disable switch) from the touch screen interface. If convenient, you can also install a mouse and keyboard to use the interface.

**Toolbar or Menu Bar.** You can choose a toolbar operating mode that is optimized for use with the touch screen, or a PC-style menu bar operating mode that is optimized for use with a mouse.

**Open Desktop.** The instrument is built on a Microsoft Windows software platform; the instrument application program starts automatically when you apply power to the instrument. You can minimize the instrument application and take full advantage of the built-in PC to run other applications. Moving waveform images and data into other applications is as simple as a copy/paste operation.

**Dedicated Front Panel Controls.** The front panel contains knobs and buttons to provide immediate access to the most common instrument controls. Separate vertical controls are provided for each channel. The same functions are also available through the screen interface.

**Data Storage and I/O.** The instrument has a removeable hard disk drive, a CD-RW, and a floppy disk drive that can be used for storage and retrieval of data. The instrument has GPIB, USB, Centronics, and Ethernet ports for input and output to other devices.

**Online Help.** The instrument has a complete online help system that covers all features. The help system is context sensitive; help for the displayed control window is automatically shown if you touch the help button. Graphical aids in the help windows assist you in getting to the information you need. You can also access the help topics through a table of contents or index.

## Specification Tables

**Table A-2: Channel input and vertical specifications**

Characteristic	Description								
Input channels	Four								
Input coupling	Channel input is disconnected from input termination when using GND coupling.								
	DC 50 $\Omega$ and GND								
✓ Input impedance, DC coupled									
	50 $\Omega$ $\pm$ 2.5% at 25 °C (77 °F), $\pm$ 0.2% over 0 to 50 °C (122 °F)								
VSWR, typical									
CSA7404B, TDS7404B, TDS7254B, & TDS7154B	1.5 for $f_{in}$ <1 GHz 1.7 for $f_{in}$ <2.5 GHz 2.0 for $f_{in}$ <4 GHz								
TDS7704B	<table border="0"> <tr> <td>&lt; 100 mV/div</td> <td><math>\geq</math> 100 mV/div</td> </tr> <tr> <td>1.5 for <math>f_{in}</math> &lt;2 GHz</td> <td>1.1 for <math>f_{in}</math> &lt;2 GHz</td> </tr> <tr> <td>2 for <math>f_{in}</math> &lt;3 GHz</td> <td>1.2 for <math>f_{in}</math> &lt;3 GHz</td> </tr> <tr> <td>2.5 for <math>f_{in}</math> &lt;6 GHz</td> <td>1.3 for <math>f_{in}</math> &lt;6 GHz</td> </tr> </table>	< 100 mV/div	$\geq$ 100 mV/div	1.5 for $f_{in}$ <2 GHz	1.1 for $f_{in}$ <2 GHz	2 for $f_{in}$ <3 GHz	1.2 for $f_{in}$ <3 GHz	2.5 for $f_{in}$ <6 GHz	1.3 for $f_{in}$ <6 GHz
< 100 mV/div	$\geq$ 100 mV/div								
1.5 for $f_{in}$ <2 GHz	1.1 for $f_{in}$ <2 GHz								
2 for $f_{in}$ <3 GHz	1.2 for $f_{in}$ <3 GHz								
2.5 for $f_{in}$ <6 GHz	1.3 for $f_{in}$ <6 GHz								

**Table A-2: Channel input and vertical specifications (Cont.)**

Characteristic	Description	
✓ Maximum input voltage, CSA7404B, TDS7404B, TDS7254B, & TDS7154B  TDS7704B	<1 V <sub>RMS</sub> for <100 mV/division settings and <5 V <sub>RMS</sub> for ≥ 100 mV settings  <6.5 V <sub>RMS</sub> for ≥ 100 mV settings for temperatures ≤ 45 °C <6.0 V <sub>RMS</sub> for ≥ 100 mV settings for temperatures > 45 °C	
Number of digitized bits	8 bits	
Sensitivity range	Fine adjustment available with ≥1% resolution	
	2 mV/div to 1 V/division, in a 1-2-5 sequence	
✓ DC gain accuracy  TDS7704B	<i>Net offset is the nominal voltage that must be applied to the channel to bring the trace to center screen. Net offset = offset - ( position × volts/division) and is expressed in volts</i>	
	2 mV/div to 3.98 mV/div	± (3% +(6% ×   net offset/1V   ))
	4 mV/div to 99.5 mV/div	± (2.5% +(2% ×   net offset/1V   ))
	100 mV/div to 1 V/div	± (2.5% +(2% ×   net offset/10V   ))

Table A-2: Channel input and vertical specifications (Cont.)

Characteristic	Description	
CSA7404B, TDS7404B, TDS7254B, & TDS7154B	2 mV/div to 3.98 mV/div	$\pm (2.5\% + (6\% \times   \text{net offset}/1\text{V}   ))$
	4 mV/div to 99.5 mV/div	$\pm (2\% + (2\% \times   \text{net offset}/1\text{V}   ))$
	100 mV/div to 1 V/div	$\pm (2\% + (2\% \times   \text{net offset}/10\text{V}   ))$
✓ DC voltage measurement accuracy CSA7404B, TDS7404B, TDS7254B, & TDS7154B	<i>Measurement type</i>	<i>DC accuracy (in volts)</i>
Average acquisition mode ( $\geq 16$ averages)	2 mV/div to 3.98 mV/div	$\pm [(2.5\% + (6\% \times   \text{net offset}/1\text{V}   )) \times   \text{reading} - \text{net offset}   + \text{offset accuracy} + 0.08 \text{ division} \times \text{V/division}]$
	4 mV/div to 99.5 mV/div	$\pm [(2\% + (2\% \times   \text{net offset}/1\text{V}   )) \times   \text{reading} - \text{net offset}   + \text{offset accuracy} + 0.08 \text{ division} \times \text{V/division}]$
	$\geq 100$ mV/div	$\pm [(2\% + (2\% \times   \text{net offset}/10\text{V}   )) \times   \text{reading} - \text{net offset}   + \text{offset accuracy} + 0.08 \text{ division} \times \text{V/division}]$
Delta voltage measurement between any two averages of $\geq 16$ waveforms acquired under the same setup and ambient conditions	2 mV/div to 3.98 mV/div	$\pm [(2.5\% + (6\% \times   \text{net offset}/1\text{V}   )) \times   \text{reading}   + 0.16 \text{ division} \times \text{V/division setting}]$
	4 mV/div to 99.5 mV/div	$\pm [(2\% + (2\% \times   \text{net offset}/1\text{V}   )) \times   \text{reading}   + 0.16 \text{ division} \times \text{V/division setting}]$
	100 mV/div to 1 V/div	$\pm [(2\% + (2\% \times   \text{net offset}/10\text{V}   )) \times   \text{reading}   + 0.16 \text{ division} \times \text{V/division setting}]$
	<i>Net offset is the nominal voltage that must be applied to the channel to bring the trace to center screen. Net offset = offset - ( position <math>\times</math> volts/division) and is expressed in volts</i>	
✓ DC voltage measurement accuracy, TDS7704B	<i>Measurement type</i>	<i>DC accuracy (in volts)</i>
Average acquisition mode ( $\geq 16$ averages)	2 mV/div to 3.98 mV/div	$\pm [(3\% + (6\% \times   \text{net offset}/1\text{V}   )) \times   \text{reading} - \text{net offset}   + \text{offset accuracy} + 0.08 \text{ division} \times \text{V/division}]$
	4 mV/div to 99.5 mV/div	$\pm [(2.5\% + (2\% \times   \text{net offset}/1\text{V}   )) \times   \text{reading} - \text{net offset}   + \text{offset accuracy} + 0.08 \text{ division} \times \text{V/division}]$
	100 mV/div to 1 V/div	$\pm [(2.5\% + (2\% \times   \text{net offset}/10\text{V}   )) \times   \text{reading} - \text{net offset}   + \text{offset accuracy} + 0.08 \text{ division} \times \text{V/division}]$

Table A-2: Channel input and vertical specifications (Cont.)

Characteristic	Description	
Delta voltage measurement between any two averages of $\geq 16$ waveforms acquired under the same setup and ambient conditions	2 mV/div to 3.98 mV/div	$\pm[(3\% + (6\% \times  \text{net offset}/1\text{V} )) \times  \text{reading}  + 0.16 \text{ division} \times \text{V/division setting}]$
	4 mV/div to 99.5 mV/div	$\pm[(2.5\% + (2\% \times  \text{net offset}/1\text{V} )) \times  \text{reading}  + 0.16 \text{ division} \times \text{V/division setting}]$
	100 mV/div to 1 V/div	$\pm[(2.5\% + (2\% \times  \text{net offset}/10\text{V} )) \times  \text{reading}  + 0.16 \text{ division} \times \text{V/division setting}]$
	<i>Net offset is the nominal voltage that must be applied to the channel to bring the trace to center screen. Net offset = offset - (position <math>\times</math> volts/division) and is expressed in volts</i>	
Nonlinearity, typical	< 1 digitization level (DL), differential; $\leq 2$ DL integral, independently based	
✓ Analog bandwidth	DC 50 $\Omega$ coupling, Full bandwidth, TCA-SMA or TCA-N adapter, operating ambient 15 °C (0 °C for TDS7154B, and TDS7254B) to 50 °C (59 °F to 122 °F), derated by 30 MHz/°C below 15 °C (59 °F)	
	<i>SCALE range</i>	<i>Bandwidth</i>
	2 mV/div to 3.9 mV/div	DC to $\geq 1$ GHz
	4 mV/div to 9.9 mV/div	DC to $\geq 1.25$ GHz
	$\geq 10$ mV/div	TDS7704B DC to 7 GHz, DC to 7.25 GHz, typical  CSA7404B, & TDS7404B: DC to 4 GHz  TDS7254B: DC to $\geq 2.5$ GHz  TDS7154B: DC to 1.5 GHz
Analog bandwidth with P7240 active probe or TCA-BNC adapter, typical CSA7404B & TDS7404B	DC 50 $\Omega$ coupling, Full bandwidth, operating ambient 15 °C to 30 °C (59 °F to 86 °F), derated by 20 MHz/°C above 30 °C (86 °F)	
	<i>SCALE range</i>	<i>Bandwidth</i>
	2 mV/div to 3.9 mV/div	DC to 1 GHz
	4 mV/div to 9.9 mV/div	DC to 1.25 GHz
	$\geq 10$ mV/div	DC to 4 GHz

**Table A-2: Channel input and vertical specifications (Cont.)**

Characteristic	Description	
Analog bandwidth with P7330 active probe, typical CSA7404B and TDS7404B	DC 50 $\Omega$ coupling, Full bandwidth, operating ambient 15 °C to 30 °C, derated by 20 MHz/°C above 30 °C	
	<i>SCALE range</i>	<i>Bandwidth</i>
	2 mV/div to 3.9 mV/div	DC to 1 GHz
	4 mV/div to 9.9 mV/div	DC to 1.25 GHz
	$\geq 10$ mV/div	DC to 3.5 GHz
Analog bandwidth with P7260 active probe or TCA-BNC adapter, typical TDS7704B	Operating ambient 15 °C to 30 °C (59 °F to 86 °F) at V/div $\geq 10$ mV/div, derated by 20 MHz/°C above 30 °C (86 °F)	
	<i>SCALE range</i>	<i>Bandwidth</i>
	2 mV/div to 3.9 mV/div	DC to 1 GHz
	4 mV/div to 9.9 mV/div	DC to 1.25 GHz
	$\geq 10$ mV/div	DC to 6 GHz
Calculated rise time, typical <sup>1</sup>		
TDS7704B	62 ps	
CSA7404B & TDS7404B	100 ps	
TDS7254B	130 ps	
TDS7154B	200 ps	
Step response settling errors, typical	Full bandwidth	
	<i>SCALE range and step amplitude</i>	<i>Settling error at time after step</i>
	2 mV/div to 99.5 mV/div, with $\leq 1.5$ V step	20 ns: $\leq 2\%$ 1 ms: $\leq 0.1\%$
	100 mV/div to 1 V/div, with $\leq 3$ V step	20 ns: $\leq 2\%$ 1 ms: $\leq 0.2\%$

**Table A-2: Channel input and vertical specifications (Cont.)**

Characteristic	Description	
Pulse response, peak detect, or envelope mode	Sample rate setting	Minimum pulse width
	2.5 GS/s or less	400 ps
Position range	± 5 divisions	
Offset range	<i>SCALE range</i>	<i>Offset range</i>
	2 mV/div to 50 mV/div	±0.50 V
	50.5 mV/div to 99.5 mV/div	±0.25 V
	100 mV/div to 500 mV/div	±5 V
	505 mV/div to 1 V/div	±2.5 V
✓ Offset accuracy	<i>Net offset is the nominal voltage that must be applied to the channel to bring the trace to center screen. Net offset = offset - (position × volts/division). Offset accuracy is the accuracy of this voltage level.</i>	
CSA7404B, TDS7404B, TDS7254B, & TDS7154B	<i>SCALE range</i>	<i>Offset accuracy</i>
	2 mV/div to 9.95 mV/div	±(0.2% ×   net offset   + 1.5 mV + 0.1 div × V/div setting)
	10 mV/div to 99.5 mV/div	±(0.35% ×   net offset   + 1.5 mV + 0.1 div × V/div setting)
TDS7704B	100 mV/div to 1 V/div	±(0.35% ×   net offset   + 15 mV + 0.1 div × V/div setting)
	<i>SCALE range</i>	<i>Offset accuracy</i>
	2 mV/div to 9.95 mV/div	±(0.35% ×   net offset   + 1.5 mV + 0.1 div × V/div setting)
	10 mV/div to 99.5 mV/div	±(0.5% ×   net offset   + 1.5 mV + 0.1 div × V/div setting)
	100 mV/div to 1 V/div	±(0.5% ×   net offset   + 15 mV + 0.1 div × V/div setting)



**Table A-2: Channel input and vertical specifications (Cont.)**

Characteristic	Description	
Effective bits, typical  CSA7404B, TDS7704B, TDS7404B, TDS7254B, & TDS7154B	Nine division sine wave input at the indicated frequency, sampled at 50 mV/division and 20 GS/s	
	<i>Input frequency</i>	<i>Effective bits</i>
	1 MHz	6.0 bits
	1 GHz	5.7 bits
	1.5 GHz	5.5 bits
	2 GHz, CSA7404B, TDS7404B, TDS7704B & TDS7254B only	5.3 bits
	2.5 GHz, CSA7404B, TDS7704B, TDS7404B & TDS7254B only	5.2 bits
	3 GHz, CSA7404B, TDS7704B & TDS7404B only	5.1 bits
	4 GHz, CSA7404B, TDS7704B & TDS7404B only	4.9 bits
	5 GHz, TDS7704B only	4.5 bits
	6 GHz, TDS7704B only	3.5 bits
	7 GHz, TDS7704B only	3.0 bits
✓ Delay between channels	≤ 30 ps between any two channels with the same scale and coupling settings	
✓ Channel-to-channel crosstalk	≥15:1 at rated bandwidth (CSA7404B, TDS7704B, TDS7404B & TDS7254B only), and ≥ 80:1 at ≤ 1.5 GHz or the rated bandwidth, whichever is less. Assumes two channels with the same scale settings	

<sup>1</sup> **Rise time calculation: A simple formula relating these times to bandwidth for all instruments is not available. The instruments have been characterized with the typical rise times listed.**

**Table A-3: Horizontal and acquisition system specifications**

Characteristic	Description	
Real-time sample rate range	<i>Number of channels acquired</i>	<i>Sample rate range</i>
	1	5 S/s to 20GS/s
	2	5 S/s to 10GS/s
	3 or 4	5 S/s to 5GS/s

**Table A-3: Horizontal and acquisition system specifications (Cont.)**

Characteristic	Description
Equivalent-time sample rate or interpolated waveform rate range	Equivalent-time acquisition can be enabled or disabled. When disabled, waveforms are interpolated at the fastest time base settings. 10GS/s to 1TS/s
Acquisition modes	Sample, Peak detect, Hi Res, Average, Envelope, and Waveform database
Minimum record length	500 points
Maximum record length, sample mode	Depends on the number of active channels and the record length options installed. Maximum record length is less in serial trigger mode
Standard	500,000 points (3 or 4 channels) 1,000,000 points (1 or 2 channels only) 2,000,000 points (1 channel only)
Option 2M installed	2,000,000 points (3 or 4 channels) 4,000,000 points (1 or 2 channels only) 8,000,000 points (1 channel only)
Option 3M installed	4,000,000 points (3 or 4 channels) 8,000,000 points (1 or 2 channels only) 16,000,000 points (1 channel only)
Option 4M installed	8,000,000 points (3 or 4 channels) 16,000,000 points (1 or 2 channels only) 32,000,000 points (1 channel only)
Option 5M installed	16,000,000 points (3 or 4 channels) 32,000,000 points (1 or 2 channels only) 64,000,000 points (1 channel only)

**Table A-3: Horizontal and acquisition system specifications (Cont.)**

Characteristic	Description	
Maximum record length, HiRes mode, sample rate $\leq 1.25$ GS/s	2,000,000 points (1, 2, 3, or 4 channels)	
Seconds/division range	50 ps/div to 10 s/div	
Maximum FastFrame update rate, nominal	265,000 frames per second	
Frame length and maximum number of frames	Maximum number of frames for Sample or Peak Detect acquisition mode, depending on memory option installed	
	<i>Frame length</i>	<i>Maximum number of frames</i>
	50 points	Standard: 648-5872 Option 2M: 2660-24088 Option 3M: 5321-48192 Option 4M: 5321-48192 Option 5M: 10644-96408
	500 points	Standard: 580-3560 Option 2M: 2381-14632 Option 3M: 4765-29272 Option 4M: 4765-29272 Option 5M: 9531-58552
	5000 points	Standard: 163-720 Option 2M: 669-2968 Option 3M: 1339-5936 Option 4M: 1339-5936 Option 5M: 2679-11880
	50,000 points	Standard: 19-80 Option 2M: 81-328 Option 3M: 163-656 Option 4M: 163-656 Option 5M: 327-1320
	500,000 points	Standard: 2-8 Option 2M: 8-32 Option 3M: 16-64 Option 4M: 16-64 Option 5M: 32-128

**Table A-3: Horizontal and acquisition system specifications (Cont.)**

Characteristic	Description						
Update rate, maximum	Fast Acquisition on: 400,000 waveforms per second Fast Acquisition off: 60 waveforms per second						
✓ Internal time-base reference frequency	10 MHz $\pm$ 2.5 ppm over any $\geq$ 100 ms interval. Aging < 1 ppm per year						
✓ Long term sample rate and delay time accuracy	$\pm$ 2.5 ppm over any $\geq$ 100 ms interval. Aging < 1 ppm per year						
Aperture uncertainty, typical	Short term: $\leq$ 2 ps rms, records having duration $\leq$ 100 ms. $\leq$ 800 fs rms, records having duration $\leq$ 10 $\mu$ s  Long term: $\leq$ 15 parts per trillion rms, records having duration $\leq$ 1 minute						
Time base delay time range	5 ns to 250 s						
✓ Delta time measurement accuracy	For a single channel, with signal amplitude > 5 divisions, reference level set at 50%, interpolation set to sin(x)/x, with risetime $>1.4 \times T_s$ and $<4 \times T_s$ or 150 ps (whichever is greater) and acquired $\geq$ 10 mV/Div, where $T_s$ is the sample period. RMS specification is typical.						
	<table border="1"> <thead> <tr> <th>Conditions</th> <th>Accuracy</th> </tr> </thead> <tbody> <tr> <td>Single shot signal, Sample acquisition mode, Full bandwidth</td> <td><math>\pm</math> (0.06/sample rate +2.5 ppm <math>\times</math>   reading   ) RMS  <math>\pm</math> (0.3/sample rate +2.5 ppm <math>\times</math>   reading   ) peak</td> </tr> <tr> <td>Average acquisition mode, &gt;100 averages, Full bandwidth</td> <td><math>\pm</math> (4 ps +2.5 ppm <math>\times</math>   reading   ) peak</td> </tr> </tbody> </table>	Conditions	Accuracy	Single shot signal, Sample acquisition mode, Full bandwidth	$\pm$ (0.06/sample rate +2.5 ppm $\times$   reading   ) RMS  $\pm$ (0.3/sample rate +2.5 ppm $\times$   reading   ) peak	Average acquisition mode, >100 averages, Full bandwidth	$\pm$ (4 ps +2.5 ppm $\times$   reading   ) peak
Conditions	Accuracy						
Single shot signal, Sample acquisition mode, Full bandwidth	$\pm$ (0.06/sample rate +2.5 ppm $\times$   reading   ) RMS  $\pm$ (0.3/sample rate +2.5 ppm $\times$   reading   ) peak						
Average acquisition mode, >100 averages, Full bandwidth	$\pm$ (4 ps +2.5 ppm $\times$   reading   ) peak						

Table A- 4: Trigger specifications

Characteristic	Description	
Trigger jitter, typical		
TDS7704B	1.2 ps rms for low frequency, fast rise time signal	
CSA7404B & TDS7404B	1.5 ps rms for low frequency, fast rise time signal	
TDS7254B, & TDS7154B	2 ps rms for low frequency, fast rise time signal	
✓ Edge Trigger Sensitivity	All sources, for vertical scale settings $\geq 10$ mV/div and $\leq 1$ V/div	
	<i>Trigger Source</i>	<i>Sensitivity</i>
	Main trigger, DC coupled	$\leq 0.5$ div from DC to 50 MHz CSA7404B, TDS7704B, TDS7404B $\leq 1.5$ div at 3 GHz TDS7254B: $\leq 1$ div at 2.5 GHz TDS7154B $\leq 1$ div at 1.5 GHz
	Delayed trigger, DC coupled	$\leq 0.5$ div from DC to 50 MHz CSA7404B, TDS7704B, TDS7404B $\leq 1.5$ div at 3 GHz TDS7254B: $\leq 1$ div at 2.5 GHz TDS7154B $\leq 1$ div at 1.5 GHz
	Auxiliary input, DC coupled	$\leq 150$ mV from DC to 50 MHz, increasing to 500 mV at 2.5 GHz (typical between 2 and 2.5 GHz)
Edge Trigger Sensitivity, either slope, DC coupled, typical	All sources, for vertical scale settings $\geq 10$ mV/div and $\leq 1$ V/div	
	<i>Trigger coupling</i>	<i>Sensitivity</i>
	DC	$\leq 0.5$ div from DC to 50 MHz $\leq 1$ div at 1.25 GHz
	NOISE REJ	$3 \times$ the DC-coupled limits
	AC	Same as DC-coupled limits for frequencies $> 100$ Hz, attenuates signals $< 100$ Hz
	HF REJ	Same as DC-coupled limits for frequencies $< 20$ kHz, attenuates signals $> 20$ kHz
	LF REJ	Same as DC-coupled limits for frequencies $> 200$ kHz, attenuates signals $< 200$ kHz

**Table A-4: Trigger specifications (Cont.)**

Characteristic	Description	
Edge trigger sensitivity, 4 GHz, typical CSA7404B, TDS7704B, TDS7404B	CH1 — CH4	
	<i>Trigger coupling</i>	<i>Sensitivity</i>
	Main trigger, DC coupled	2.7 divisions at 4 GHz
Edge trigger sensitivity, not DC coupled, typical	All sources, for vertical scale settings $\geq 10$ mV/div and $\leq 1$ V/div	
	<i>Trigger coupling</i>	<i>Sensitivity</i>
	NOISE REJ	$3 \times$ the DC-coupled limits
	AC	Same as DC-coupled limits for frequencies $> 100$ Hz, attenuates signals $< 100$ Hz
	HF REJ	Same as DC-coupled limits for frequencies $< 20$ kHz, attenuates signals $> 20$ kHz
	LF REJ	Same as DC-coupled limits for frequencies $> 200$ kHz, attenuates signals $< 200$ kHz
Auxiliary trigger input characteristics, typical	$50 \Omega \pm 10\%$ , $\pm 5$ V (DC + peak AC)	
Lowest frequency for Set Level to 50%, typical	50 Hz	
Advanced trigger sensitivity, typical	For vertical scale settings 10 mV/div and 1 V/div	
	Advanced triggers: 1.0 div, from DC to 1 GHz at the TekConnect connector	
Advanced trigger timing	For vertical scale settings 10 mV/div and 1 V/div	
	<i>Minimum recognizable event width or time</i>	<i>Minimum rearm time to recognize next event</i>
Glitch type	Minimum glitch width = 225 ps (170 ps on the TDS7704B)	250 ps
Runt type	Minimum runt width = 225 ps	250 ps
Time-qualified runt type	Minimum runt width = 340 ps	450 ps
Width type	Minimum difference between upper and lower limits = 225 ps	250 ps
Window type	225 ps	300 ps

Table A-4: Trigger specifications (Cont.)

Characteristic	Description		
Transition type	Minimum transition time = 0 ps	225 ps	
Timeout type	Minimum timeout time = 340 ps	450 ps	
Logic or state type, typical	Minimum event width = 100 ps	500 ps	
Setup/Hold type, typical	<i>Minimum clock pulse width from active edge to inactive edge</i>	<i>Minimum clock pulse width from inactive edge to active edge</i>	
	500 ps + hold time setting for times $\geq 0$ 1.5 ns + hold time setting for times $< 0$	500 ps	
Advanced trigger timer ranges	<i>Limits</i>		
Glitch type	340 ps to 1 s		
Runt type, time qualified	340 ps to 1 s		
Width type	340 ps to 10 s		
Timeout type	340 ps to 1 s		
Transition type	340 ps to 1 s		
Pattern type	340 ps to 1 s		
Window type	340 ps to 1 s		
Setup/Hold type	<i>Setup and Hold timers</i>	<i>Limits</i>	
	Setup time (time from data transition to clock edge)	-100 ns to +100 ns	
	Hold time (time from clock edge to data transition)	-1 ns to +102 ns	
	Setup time + Hold time (algebraic sum of the two settings)	500 ps	
Logic-qualified pulse-type trigger minimum timing requirements	Minimum event duration	Setup time	Hold time
Glitch	100 ps	40 ps	60 ps
Runt	Runt width + 150 ps	160 ps	-16 ps
Time-qualified runt	Runt width + 330 ps	160 ps	175 ps
Width	190 ps	40 ps	175 ps
Transition	330 ps	225 ps	175 ps
Window	190 ps	-20 ps	0 ps

Table A-4: Trigger specifications (Cont.)

Characteristic	Description	
✓ Time-qualified trigger timer accuracy	For Glitch, Timeout, or Width types	
	<i>Time range</i>	<i>Accuracy</i>
	340 ps to 1.5 $\mu$ s (360 ps to 1.8 ns typical)	$\pm 5\%$ of setting
	1.5 $\mu$ s to 1 s	$\pm 91$ ns
Trigger level or threshold range	<i>Trigger Source</i>	<i>Sensitivity</i>
	Any channel	$\pm 12$ divisions from center of screen
	Auxiliary input	$\pm 5$ V
	Line	$\pm 0$ V, not settable
Trigger level or threshold accuracy, typical	Edge trigger, DC coupling, for signals having rise and fall times $\leq 1$ ns	
	<i>Trigger Source</i>	<i>Accuracy</i>
	Any channel	$\pm [(2\% \times   \text{setting} - \text{net offset}  ) + (0.35 \text{ div} \times \text{volts/div setting}) + \text{offset accuracy}] (\geq 10 \text{ mV/div only})$
	Auxiliary	Not specified
	<i>where, net offset = offset - (position <math>\times</math> volts/division)</i>	
B Event (Delayed) trigger	<i>Trigger After Time</i>	<i>Trigger on <math>n^{\text{th}}</math> Event</i>
	Range	Delay time = 5 ns to 250 s
	Minimum pulse width, typical	—
	Minimum time between events, typical	—
Trigger position error, typical	Edge trigger, DC coupling, for signals having a slew rate at the trigger point of $\geq 0.5$ division/ns	
	<i>Acquisition mode</i>	<i>Error</i>
	Sample, Average	$\pm (1 \text{ waveform interval} + 200 \text{ ps})$
	Peak Detect, Envelope	$\pm (2 \text{ waveform interval} + 200 \text{ ps})$
Trigger holdoff range	250 ns to 12 s plus random holdoff, if enabled. Minimum resolution is 8 ns for settings $\leq 1.2 \mu$ s. A dither of 800 ps is added to the holdoff setting	



**Table A-5: Serial Trigger specifications (optional on TDS7000B Series)**

Characteristic	Description	
Serial trigger number of bits	64	
Serial trigger encoding types	NRZ	
Serial trigger baud rate limits	Up to 1.25 GBd	
Serial trigger, serial word recognizer position accuracy	Edge trigger, DC coupling, for signals having a slew rate at the trigger point of $\geq 0.5$ division/ns	
	<i>Acquisition mode</i>	<i>Error</i>
	Sample, Average	$\pm$ (1 waveform interval + 200 ps)
	Peak Detect, Envelope	$\pm$ (2 waveform interval + 200 ps)
Clock recovery frequency range	1.5 MBd to 3.125 GBd. Above 1250 MHz the clock is only available internally as a trigger source. Below 1250 MHz the clock is also available at the Recovered Clock output along with regenerated data (CSA7000B Series only).	
Clock recovery jitter, typical	< 0.25% bit period + 2 ps rms for PRBS data patterns. < 0.25% bit period + 1.2 ps rms for repeating 01 data patterns.	
Clock recovery tracking/acquisition range, typical	$\pm 2\%$ of requested baud	
Minimum signal amplitude needed for clock recovery, typical	1 division p-p up to 1.25 GBd 1.5 divisions p-p above 1.25 GBd	

**Table A-6: Display specifications**

Characteristic	Description
Display type	210.4 mm (8.3 in) (W) $\times$ 157.8 mm (6.2 in) (H), 263 mm (10.4 in) diagonal, liquid crystal active-matrix color display
Display resolution	1024 horizontal $\times$ 768 vertical pixels
Pixel pitch	0.2055 mm horizontal, 0.2055 mm vertical
Response time, typical	15 ms, white to black
Display refresh rate	59.94 frames per second
Viewing angle, typical	Horizontal: 60 degrees left, 60 degrees right Vertical: 60 degrees up, 45 degrees down
Displayed intensity levels	Each R-G-B input is 6 bits, giving 64 intensity levels of each color component

**Table A-7: Input/output port specifications**

<b>Characteristic</b>	<b>Description</b>
Rear-panel I/O ports	Ports located on the rear panel
Video output port	Upper video port, DB-15 female connector, connect a second monitor to use dual-monitor display mode. Video is DDC2B compliant.
Scope XGA video port	Lower video port, DB-15 female connector, 31.6 kHz sync, EIA RS-343A compliant, connect to show the instrument display, including live waveforms, on an external monitor
Parallel port (IEEE 1284)	DB-25 connector, supports the following modes: standard (output only) bidirectional (PS-2 compatible) bidirectional enhanced parallel port (IEEE 1284 standard, mode 1 or mode 2, v 1.7) bidirectional high-speed extended capabilities port (ECP)
Serial port	DB-9 COM1 port, uses NS16C550-compatible UARTS, transfer speeds up to 115.2 kb/s
Keyboard port	PS-2 compatible, instrument must be powered down to make connection
Mouse port	PS-2 compatible, instrument must be powered down to make connection
LAN port	RJ-45 connector, supports 10 base-T and 100 base-T
Audio ports	Miniature phone jacks for stereo microphone input and stereo line output
USB ports, two	Allows connection or disconnection of USB keyboard and/or mouse while instrument power is on
GPIB port	IEEE 488.2 standard interface

Table A-7: Input/output port specifications (Cont.)

Characteristic	Description					
✓ Probe Compensator Output	<p>Front-panel BNC connector, requires Probe Cal Deskew Fixture for probe attachment</p> <p>Note: During probe calibration only, a relay switches a DC calibration voltage to this output in place of the 1 kHz square wave. This voltage varies from -10 V to +10 V with a source impedance less than 1 <math>\Omega</math> and short circuit current as high as 300 mA.</p> <table border="1"> <thead> <tr> <th>Output voltage</th> <th>Frequency</th> </tr> </thead> <tbody> <tr> <td>500 mV (from base to top) <math>\pm</math> 20% into a 50 <math>\Omega</math> load (Vol = -500 mV, Voh = 0 V typical)</td> <td rowspan="2">1 kHz <math>\pm</math> 5%</td> </tr> <tr> <td>1 V (from base to top) <math>\pm</math> 20% into a 1 M<math>\Omega</math> load (Vol = -1.0 V, Voh = 0 V typical)</td> </tr> </tbody> </table>	Output voltage	Frequency	500 mV (from base to top) $\pm$ 20% into a 50 $\Omega$ load (Vol = -500 mV, Voh = 0 V typical)	1 kHz $\pm$ 5%	1 V (from base to top) $\pm$ 20% into a 1 M $\Omega$ load (Vol = -1.0 V, Voh = 0 V typical)
Output voltage	Frequency					
500 mV (from base to top) $\pm$ 20% into a 50 $\Omega$ load (Vol = -500 mV, Voh = 0 V typical)	1 kHz $\pm$ 5%					
1 V (from base to top) $\pm$ 20% into a 1 M $\Omega$ load (Vol = -1.0 V, Voh = 0 V typical)						
✓ Analog Signal Output amplitude	<p>BNC connector, provides a buffered version of the signal that is attached to the channel 3 input when channel 3 is the trigger source</p> <p>20 mV/div <math>\pm</math> 20% into a 1 M<math>\Omega</math> load  10 mV/div <math>\pm</math> 20% into a 50 <math>\Omega</math> load</p> <p>Offset: between -100 mV and -170 mV into 50 <math>\Omega</math></p>					
Analog Signal Output bandwidth, typical	1.8 GHz into a 50 $\Omega$ load					
✓ Auxiliary Output levels	<p>BNC connector, provides a TTL-compatible pulse (polarity selectable) for each A or B trigger (selectable)</p> <table border="1"> <thead> <tr> <th><math>V_{out\ high}</math></th> <th><math>V_{out\ low\ (true)}</math></th> </tr> </thead> <tbody> <tr> <td><math>\geq</math>2.5 V into open circuit, <math>\geq</math>1.0 V into 50 <math>\Omega</math> load</td> <td><math>\leq</math>0.7 V with <math>\leq</math>4 ma sink, <math>\leq</math>0.25 V into 50 <math>\Omega</math> load</td> </tr> </tbody> </table>	$V_{out\ high}$	$V_{out\ low\ (true)}$	$\geq$ 2.5 V into open circuit, $\geq$ 1.0 V into 50 $\Omega$ load	$\leq$ 0.7 V with $\leq$ 4 ma sink, $\leq$ 0.25 V into 50 $\Omega$ load	
$V_{out\ high}$	$V_{out\ low\ (true)}$					
$\geq$ 2.5 V into open circuit, $\geq$ 1.0 V into 50 $\Omega$ load	$\leq$ 0.7 V with $\leq$ 4 ma sink, $\leq$ 0.25 V into 50 $\Omega$ load					

**Table A-7: Input/output port specifications (Cont.)**

Characteristic	Description	
Auxiliary Output pulse width, typical	Pulse width varies, 1 $\mu$ s minimum	
External reference	Run SPC whenever the external reference is more than 2000 ppm different than the internal reference or the reference at which SPC was last run.	
Frequency range	9.8 MHz to 10.2 MHz	
✓ Input sensitivity	$\geq 200$ mV <sub>p-p</sub> for frequencies between 9.8 MHz to 10.2 MHz	
Input voltage, maximum	7 V <sub>p-p</sub>	
Input impedance	1.5 k $\Omega$ , C <sub>in</sub> = 40 pF, measured at >100 kHz	
✓ Internal reference output		
Frequency	10 MHz $\pm$ 2.5 ppm over any $\geq 100$ ms interval. Aging < 1 ppm per year	
Output voltage	<i>V<sub>out high</sub></i>	<i>V<sub>out low (true)</sub></i>
	$\geq 2.5$ V into open circuit, $\geq 1.0$ V into 50 $\Omega$ load	$\leq 0.7$ V with $\leq 4$ ma sink, $\leq 0.25$ V into 50 $\Omega$ load
Serial data output baud rate range (CSA7000B Series only)	F <sub>baud</sub> < 1250 MBd. Output swing of 1010 repeating pattern at this baud will be at least 200 mV into 50 $\Omega$ .	
Serial clock output frequency range (CSA7000B Series only)	Peak-to-peak output swing at 625 MHz is at least 200 mV p-p into 50 $\Omega$ . Higher frequencies are further attenuated by approximately 6 dB per octave above 625 MHz.  Use AC or DC coupled 50 $\Omega$ termination; AC coupling the clock provides about 10% more amplitude.	
Serial data and clock output voltages, typical (CSA7000B Series only)	V <sub>oh</sub> = -1.0 V V <sub>ol</sub> = -1.7 V Assumes a load impedance greater than 1 k $\Omega$ . (50 $\Omega$ source termination.)  If a 50 $\Omega$ or 75 $\Omega$ load is used, either use a DC blocking capacitor in series with the signal or reference the termination to about -1.3 V. The signal amplitude will be correspondingly reduced.	
Serial data output latency, typical (CSA7000B Series only)	11 ns $\pm$ 4 ns plus 35.5 clock cycles	

**Table A-8: O/E converter (CSA7000B Series only)**

Characteristic <sup>1</sup>	Description
Optical input connector	Rifocs universal connector
O/E wavelength range	700 nm to 1650 nm
✓O/E gain	$\geq 0.27$ V/mW (0.35 V/mW typical) at 780 nm $\pm 20$ nm $\geq 0.33$ V/mW (0.40 V/mW typical) at 850 nm $\pm 20$ nm $\geq 0.64$ V/mW (0.75 V/mW typical) at 1310 nm $\pm 20$ nm $\geq 0.64$ V/mW (0.75 V/mW typical) at 1550 nm $\pm 20$ nm  Applies to graded index multimode fiber with core diameter 62.5 $\mu$ m or smaller at the input and O/E Electrical-to-CH1 Input adapter
Optical Channel DC measurement accuracy, typical	$\pm ((2\% + (2\% \times \text{net offset}/1 \text{ mW})) \times  \text{reading} + (\text{Position} \times \text{W}/\text{div}) - \text{Offset}  + 0.35\% \times  \text{Net Offset}  + 3 \mu\text{W} + 0.18 \text{ div} \times \text{W}/\text{div})$ only between 10 $\mu$ W/div and 50 $\mu$ W/div inclusive. Average of $\geq 16$ waveforms  The delta between any two averages of $\geq 16$ waveforms acquired under the same setup and ambient conditions: $\pm ((2\% + (2\% \times \text{net offset}/1 \text{ mW})) \times  \text{reading}  + 0.16 \text{ div} \times \text{W}/\text{div})$  Excludes normal variations due to fiber connection to the front of the instrument
✓Optical Channel Bandwidth (includes O/E, O/E-to-TekConnect adaptor, and instrument)	5 °C to 25 °C: 2.4 GHz
DC conversion gain linearity	< 4 mV/div: $\pm (4.5\% + (6\% \times \text{net offset}))$ 4 mV/div to 99.5 mV/div: $\pm (4\% + (2\% \times \text{net offset}))$ 100 mV/div to 1.0 V/div: $\pm (4\% + (2\% \times \text{net offset}/10))$
Absolute maximum nondestructive optical input	5 mW average; 10 mW peak at the wavelength with the highest relative responsivity
Maximum nonsaturating linear response to transient input, typical	The transient optical signal response is linear ( $\pm 6\%$ ) for < 170 $\mu$ W average input (340 $\mu$ W p) at 850 nm < 120 $\mu$ W average input (240 $\mu$ W p) at 1310 and 1550 nm
Output zero (Dark level)	$\pm (1.6 \mu\text{W} + 0.1 \text{ division} \times \text{W}/\text{div})$ from 10 $\mu$ W to 50 $\mu$ W per division vertical scale setting
✓Maximum noise output, rms	CSA7404B: 1310 nm and 1550 nm $\leq 1.1 \mu\text{W} + (6.5\% \text{ of } \text{W}/\text{div} \text{ setting})$ 850 nm $\leq 2.1 \mu\text{W} + (6.5\% \text{ of } \text{W}/\text{div} \text{ setting})$ 780 nm $\leq 2.6 \mu\text{W} + (6.5\% \text{ of } \text{W}/\text{div} \text{ setting})$ O/E converter alone $\leq 0.85 \mu\text{W}$

**Table A-8: O/E converter (CSA7000B Series only) (Cont.)**

Characteristic <sup>1</sup>	Description
Optical return loss, typical	<p>With 50 <math>\mu\text{m}</math> or 62.5 <math>\mu\text{m}</math> core multimode fiber (CPC6):            &gt;14 dB for 780 nm <math>\pm</math> 20 nm            &gt;14 dB for 850 nm <math>\pm</math> 20 nm</p> <p>With 9 <math>\mu\text{m}</math> core singlemode fiber (SMF-28):            &gt;28 dB for 1310 nm <math>\pm</math> 20 nm            &gt;28 dB for 1550 nm <math>\pm</math> 20 nm</p> <p>The return loss includes optical reflection contributions from the device under test's SC-SPC connector interface with the user's PC style connector as well as all other optical reflections from that interface up to and including the device under test's final photo diode termination.</p>
Peak-to-peak aberrations in response to falling edge, typical	11% peak-to-peak total aberration (system including O/E-to-CH1 input adapter, and instrument)
Maximum falling edge 10% to 2% settling time (ORR disabled), typical	The step response to a fast optical square OFF edge reaches toc within 2% of the final 0% level within 2 ns after the 10% transition point.
Smallest average power for mask test (sensitivity), typical	<p>1310 nm and 1550 nm:            40 <math>\mu\text{W}</math> peak-to-peak. 20 <math>\mu\text{W}</math> (-17 dBm) average power assuming 50% average duty cycle</p> <p>780 nm and 850 nm:            80 <math>\mu\text{W}</math> peak-to-peak. 40 <math>\mu\text{W}</math> (-14 dBm) average power assuming 50% average duty cycle</p> <p>Assumes the scale factor is set to minimum <math>\mu\text{W}/\text{div}</math> settings and signal is at least 2 divisions peak-to-peak</p>
Optical scale factor range	<p>10 <math>\mu\text{W}</math> per division to 500 <math>\mu\text{W}</math> per division</p> <p>Optical reference receiver typically available from the following scale factors:            1310 nm and 1550 nm:                13.5 <math>\mu\text{W}</math> per division to 66 <math>\mu\text{W}</math> per division            850 nm:                25 <math>\mu\text{W}</math> per division to 125 <math>\mu\text{W}</math> per division            780 nm:                28 <math>\mu\text{W}</math> per division to 142 <math>\mu\text{W}</math> per division</p>

<sup>1</sup> All specifications are with the O/E electrical out-to-CH1 input adapter installed.

**Table A- 9: Data storage specifications**

Characteristic	Description
Nonvolatile memory retention time, typical	≥ 5 years
Floppy disk	3.5 in floppy disk drive, 1.44 MB capacity
Hard disk	Removeable hard disk drive, ≥ 20 GB capacity
CD-RW	CD-RW drive
Windows memory	1 GB

**Table A- 10: Power source specifications**

Characteristic	Description
Power consumption	≤ 600 Watts (900 VA)
Source voltage and frequency	100 to 240 V ± 10%, 50 Hz to 60 Hz 115 V ± 10%, 400 Hz CAT II
Fuse rating	Either one of the following sizes can be used, each size requires a different fuse cap. Both fuses must be the same type. Line and Neutral are fused.
0.25 in × 1.25 in size	UL198G and CSA C22.2, No. 59, fast acting: 8 A, 250 V (Tektronix part number 159-0046-00, Bussman ABC-8, Littelfuse 314008)
5 mm × 20 mm size	IEC127, sheet 1, fast acting “F”, high breaking capacity: 6.3 A, 250 V (Tektronix part number 159-0381-00, Bussman GDA 6.3, Littelfuse 21606.3)

**Table A- 11: Mechanical specifications**

Characteristic	Description	
Weight		
Benchtop configuration	17.7 kg (39 lbs) instrument only 19.1 kg (42 lbs) with fully accessorized pouch 38.8 kg (85.5 lbs) when packaged for domestic shipment	
Rackmount kit	18.6 kg (41 lbs) rackmounted instrument 5.6 kg (12.5 lbs) kit packaged for domestic shipment	
Dimensions		
Benchtop configuration	With front cover	Without front cover
	278 mm (10.95 in) height 330 mm (13 in) with feet extended 455 mm (17.9 in) width 435 mm (17.13 in) depth	277 mm (10.9 in) height 330 mm (13 in) with feet extended 455 mm (17.9 in) width 426 mm (16.75 in) depth
Rackmount configuration (Option 1R)	With rack handles	Without rack handles
	267 mm (10.5 in) height 502 mm (19.75 in) width 486 mm (19.13 in) depth	267 mm (10.5 in) height 482 mm (19 in) width 435 mm (17.13 in) depth
Cooling	Fan-forced air circulation with no air filter	
Required clearances	Top	0 mm (0 in)
	Bottom	19 mm (0.75 in) minimum or 0 mm (0 in) when standing on feet, flip stands down
	Left side	76 mm (3 in)
	Right side	76 mm (3 in)
	Front	0 mm (0 in)
	Rear	0 mm (0 in) on rear feet
Construction material	Chassis parts are constructed of aluminum alloy, front panel is constructed of plastic laminate, circuit boards are constructed of glass laminate, and the outer shell is molded and textured from a polycarbonate/ABS blend	



**Table A- 12: Environmental specifications**

<b>Characteristic</b>	<b>Description</b>
Temperature, operating	+5 °C to +50 °C (41 °F to +122 °F), excluding floppy disk and compact disk drives +10 °C to +45 °C (50 °F to +113 °F), including floppy disk and compact disk drives
Nonoperating	-22 °C to +60 °C (71 °F to +140 °F)
Humidity, operating	20% to 90% relative humidity with a maximum wet bulb temperature of +29 °C (+84 °F) at or below +50 °C (+122 °F), noncondensing Upper limit derates to 25% relative humidity at +50 °C (+122 °F)
Nonoperating	With no diskette in floppy disk drive 20% to 90% relative humidity with a maximum wet bulb temperature of +29 °C (+84 °F) at or below +60 °C (+140 °F), noncondensing Upper limit derates to 20% relative humidity at +60 °C (+140 °F)
Altitude, operating	3,048 m (10,000 ft.)
Nonoperating	12,190 m (40,000 ft.)
Random vibration, operating	0.24 g <sub>RMS</sub> from 5 Hz to 500 Hz, 10 minutes on each axis, 3 axis, 30 minutes total, with floppy disk and compact disk installed
Nonoperating	2.28 g <sub>RMS</sub> from 5 Hz to 500 Hz, 10 minutes on each axis, 30 minutes total, 3 axis

**Table A-13: Certifications and compliances**

Category	Standards or description
EC Declaration of Conformity - EMC	<p>Meets intent of Directive 89/336/EEC for Electromagnetic Compatibility. Compliance was demonstrated to the following specifications as listed in the Official Journal of the European Union:</p> <p>EN 61326 Emissions <sup>1, 3, 4</sup> Class A Radiated and Conducted Emissions</p> <p>EN 61326 Immunity <sup>1, 4</sup></p> <p>IEC 1000-4-2 Electrostatic Discharge Immunity ±4 kV contact discharge, ±4 kV air discharge</p> <p>IEC 1000-4-3 RF field immunity 3 V/m, 80 MHz to 1 GHz, 80% amplitude modulated with a 1 kHz sinewave<sup>2</sup></p> <p>IEC 1000-4-4 Electrical Fast Transient/Burst Immunity 1 kV on AC mains, 500 V on I/O cables</p> <p>IEC 1000-4-5 AC Surge Immunity 1 kV differential mode, 2 kV common mode</p> <p>IEC 1000-4-6 RF Conducted Immunity 3 V, 150 kHz to 80 MHz, 80% amplitude modulated with a 1 kHz sinewave<sup>2</sup></p> <p>IEC 1000-4-11 AC Mains Voltage Dips and Interruption Immunity 100% reduction for one cycle</p> <p>EN 61000-3-2 Power Harmonic Current Emissions</p> <p>EN 61000-3-3 Voltage Changes, Fluctuations, and Flicker</p> <p><sup>1</sup> If interconnect cables are used, they must be low-EMI shielded cables such as the following Tektronix part numbers or their equivalents: 012-0991-00, 012-0991-01, 012-0991-02 or 012-0991-03 GPIB Cable; 012-1213-00 (or CA part number 0294-9) RS-232 Cable; 012-1214-00 Centronics Cable; or LCOM part number CTL3VGAMM-5 VGA Cable.</p> <p><sup>2</sup> Under these conditions, the specifications are amended as follows: 10 mV/division to 1 V/division: ≤0.4 division waveform displacement or ≤0.8 division increase in peak-to-peak noise 5 mV/division and 2 mV/division, typical: ≤8 mV increase in peak-to-peak noise</p> <p><sup>3</sup> Radiated emissions may exceed the levels specified in EN 61326 when this instrument is connected to a test object.</p> <p><sup>4</sup> Tested in accordance with EN 61326 Annex D.</p>
Australia/New Zealand Declaration of Conformity — EMC	Complies with EMC provision of Radiocommunications Act per the following standard(s): AS/NZS 2064.1/2 Industrial, Scientific, and Medical Equipment: 1992, Class A

**Table A- 13: Certifications and compliances (Cont.)**











Category	Standards or description
EC Declaration of Conformity - Low Voltage	<p>Compliance was demonstrated to the following specification as listed in the Official Journal of the European Union:</p> <p>Low Voltage Directive 73/23/EEC, amended by 93/68/EEC</p> <p>EN 61010-1/A2:1995      Safety requirements for electrical equipment for measurement control and laboratory use.</p>
U.S. Nationally Recognized Testing Laboratory Listing	<p>UL3111-1, First Edition      Standard for electrical measuring and test equipment.</p>
Canadian Certification	<p>CAN/CSA C22.2, No. 1010.1-92      Safety requirements for electrical equipment for measurement, control, and laboratory use.</p>
Additional Compliance	<p>IEC61010-1      Safety requirements for electrical equipment for measurement, control, and laboratory use.</p>
Installation (Overvoltage) Category Definition	<p>Terminals on this product may have different installation (overvoltage) category designations. The installation categories are:</p> <p>CAT III      Distribution-level mains (usually permanently connected). Equipment at this level is typically in a fixed industrial location.</p> <p>CAT II      Local-level mains (wall sockets). Equipment at this level includes appliances, portable tools, and similar products. Equipment is usually cord-connected.</p> <p>CAT I      Secondary (signal level) or battery operated circuits of electronic equipment.</p>
Pollution Degree Definition	<p>A measure of the contaminates that could occur in the environment around and within a product. Typically the internal environment inside a product is considered to be the same as the external. Products should be used only in the environment for which they are rated.</p> <p>Pollution Degree 2      Normally only dry, nonconductive pollution occurs. Occasionally a temporary conductivity that is caused by condensation must be expected. This location is a typical office/home environment. Temporary condensation occurs only when the product is out of service.</p>
<b>Safety Certification Compliance</b>	
Equipment Type	Test and measuring
Safety Class	Class 1 (as defined in IEC 61010-1, Annex H) - grounded product
Pollution Degree	Pollution Degree 2 (as defined in IEC 61010-1). Note: Rated for indoor use only.



# Appendix B: Automatic Measurements Supported

This appendix provides a list of all supported measurements and their definitions. An illustration showing the levels used to take measurements is also included.

**Table B- 1: Supported measurements and their definition**

Name	Definition
 <b>Amplitude</b>	Voltage measurement. The high value less the low value measured over the entire waveform or gated region.  <i>Amplitude = High-Low</i>
 <b>Area</b>	Area measurement (Voltage over time measurement). The area over the entire waveform or gated region in volt-seconds. Area measured above ground is positive; area below ground is negative.
 <b>Cycle Area</b>	Voltage over time measurement. The area over the first cycle in the waveform, or the first cycle in the gated region, in volt-seconds. Area measured above ground is positive; area below ground is negative.
 <b>Burst Width</b>	Timing measurement. The duration of a burst. Measured over the entire waveform or gated region.
 <b>Cycle Mean</b>	Voltage measurement. The arithmetic mean over the first cycle in the waveform or the first cycle in the gated region.
 <b>Cycle RMS</b>	Voltage measurement. The true Root Mean Square voltage over the first cycle in the waveform or the first cycle in the gated region.
 <b>Delay</b>	Timing measurement. The time between the MidRef crossings of two different traces or the gated region of the traces.
 <b>Fall Time</b>	Timing measurement. Time taken for the falling edge of the first pulse in the waveform or gated region to fall from a High Ref value (default = 90%) to a Low Ref value (default = 10%) of its final value.
 <b>Frequency</b>	Timing measurement for the first cycle in the waveform or gated region. The reciprocal of the period. Measured in Hertz (Hz) where 1 Hz = 1 cycle per second.
 <b>High</b>	The value used as 100% whenever High Ref, Mid Ref, and Low Ref values are needed (as in fall time and rise time measurements). Calculated using either the min/max or the histogram method. The <i>min/max</i> method uses the maximum value found. The <i>histogram</i> method uses the most common value found above the mid point. Measured over the entire waveform or gated region.

**Table B-1: Supported measurements and their definition (Cont.)**




























Name	Definition
 <b>Low</b>	The value used as 0% whenever High Ref, Mid Ref, and Low Ref values are needed (as in fall time and rise time measurements). May be calculated using either the min/max or the histogram method. With the min/max method it is the minimum value found. With the histogram method, it refers to the most common value found below the midpoint. Measured over the entire waveform or gated region.
 <b>Maximum</b>	Voltage measurement. The maximum amplitude. Typically the most positive peak voltage. Measured over the entire waveform or gated region.
 <b>Mean</b>	Voltage measurement. The arithmetic mean over the entire waveform or gated region.
 <b>Minimum</b>	Voltage measurement. The minimum amplitude. Typically the most negative peak voltage. Measured over the entire waveform or gated region.
 <b>Negative Duty Cycle</b>	Timing measurement of the first cycle in the waveform or gated region. The ratio of the negative pulse width to the signal period expressed as a percentage. $NegativeDutyCycle = \frac{NegativeWidth}{Period} \times 100\%$
 <b>Negative Overshoot</b>	Voltage measurement. Measured over the entire waveform or gated region. $NegativeOvershoot = \frac{Low-Min}{Amplitude} \times 100\%$
 <b>Negative Width</b>	Timing measurement of the first pulse in the waveform or gated region. The distance (time) between MidRef (default 50%) amplitude points of a negative pulse.
 <b>Peak to Peak</b>	Voltage measurement. The absolute difference between the maximum and minimum amplitude in the entire waveform or gated region.
 <b>Phase</b>	Timing measurement. The amount one waveform leads or lags another in time. Expressed in degrees, where 360° comprise one waveform cycle.
 <b>Period</b>	Timing measurement. Time it takes for the first complete signal cycle to happen in the waveform or gated region. The reciprocal of frequency. Measured in seconds.
 <b>Positive Duty Cycle</b>	Timing measurement of the first cycle in the waveform or gated region. The ratio of the positive pulse width to the signal period expressed as a percentage. $PositiveDutyCycle = \frac{PositiveWidth}{Period} \times 100\%$

Table B- 1: Supported measurements and their definition (Cont.)

Name	Definition
 <b>Positive Overshoot</b>	Voltage measurement over the entire waveform or gated region. $PositiveOvershoot = \frac{Max-High}{Amplitude} \times 100\%$
 <b>Positive Width</b>	Timing measurement of the first pulse in the waveform or gated region. The distance (time) between MidRef (default 50%) amplitude points of a positive pulse.
 <b>Rise time</b>	Timing measurement. Time taken for the leading edge of the first pulse in the waveform or gated region to rise from a Low Ref value (default = 10%) to a High Ref value (default = 90%) of its final value.
 <b>RMS</b>	Voltage measurement. The true Root Mean Square voltage over the entire waveform or gated region.
 <b>Mean</b>	The average of all acquired points within (or on) the histogram box.
 <b>Median</b>	Half of all acquired points within (or on) the histogram box are less than and half are greater than this value.
 <b>StdDev</b>	The standard deviation (Root Mean Square (RMS) deviation) of all acquired points within (or on) the histogram box.
 <b>Hits in Box</b>	Displays the number of points in the histogram box or on the box boundary.
 <b>Waveform Count</b>	Displays the number of waveforms that have contributed to the histogram.
 <b>Peak Hits</b>	Displays the number of points in the largest bin of the histogram.
 <b>Pk-Pk</b>	Displays the peak-to-peak value of the histogram. Vertical histograms display the “voltage” of the highest nonzero bin minus the “voltage” of the lowest nonzero bin. Horizontal histograms display the “time” of the rightmost nonzero bin minus the “time” of the leftmost nonzero bin (Max - Min).
 <b>Max</b>	Displays the maximum voltage or time.
 <b>Min</b>	Displays the minimum voltage or time.
 <b>Mean ± 1 StdDev</b>	The percentage of points in the histogram that are within 1 standard deviation of the histogram mean.
 <b>Mean ± 2 StdDev</b>	The percentage of points in the histogram that are within 2 standard deviations of the histogram mean.
 <b>Mean ± 3 StdDev</b>	The percentage of points in the histogram that are within 3 standard deviations of the histogram mean.

**Table B-2: Comm measurements and their definition**














Name	Definition
 <b>Ext Ratio</b>	The ratio of eye top to base. $Ext\ Ratio = PTop_{mean}/PBase_{mean}$
 <b>Extinction Ratio %</b>	The ratio of eye base to top in %. $Ext\ Ratio\ \% = 100*(PBase_{mean}/PTop_{mean})$
 <b>Extinction Ratio dB</b>	The ratio of eye top to base in dB. $Ext\ Ratio\ dB = 10*Log(PTop_{mean}/PBase_{mean})$
 <b>Eye Height</b>	The eye height in watts or volts. $Eye\ Height = (PTop_{mean} - 3*PTop_{sigma}) - (PBase_{mean} + 3*PBase_{sigma})$
 <b>Eye Width</b>	The eye width in seconds. $Eye\ Width = (TCross2_{mean} - 3*TCross2_{sigma}) - (TCross1_{mean} + 3*TCross1_{sigma})$
 <b>Crossing %</b>	The eye crossing point as a percentage of eye height. $Crossing\ \% = 100*[(PCross1_{mean} - PBase_{mean})/(PTop_{mean} - PBase_{mean})]$
<b>Eye Top</b>	The top of the eye.
<b>Eye Base</b>	The base of the eye.
 <b>Jitter Pk-Pk</b>	The peak-to-peak value for the edge jitter in the current horizontal units. $Jitter\ PP = TCross1_{PP}$
 <b>Jitter RMS</b>	The RMS value of the edge jitter in the current horizontal units. $Jitter\ RMS = TCross1_{sigma}$
<b>Jitter 6σ</b>	$6\ x\ (Jitter\ RMS)$
 <b>Noise Pk-Pk</b>	The peak-to-peak value of the noise of the top or base of the signal as specified by the user. $Noise\ Pk-Pk = PTop_{pk-pk}\ or\ PBase_{pk-pk}$
 <b>Noise RMS</b>	The RMS value of the noise of the top or base of the signal as specified by the user. $Noise\ RMS = PTop_{sigma}\ or\ PBase_{sigma}$



Table B-2: Comm measurements and their definition (Cont.)

Name	Definition
 <b>S/N Ratio</b>	Ratio of the signal amplitude to the noise of the top or base of the signal as specified by the user. $S/N \text{ Ratio} = (P_{Top} - P_{Base}) / (P_{Top\sigma} \text{ or } P_{Base\sigma})$
 <b>Duty Cycle Distortion</b>	The peak-to-peak time variation of the first eye crossing measured at the MidRef as a percent of the eye period. $DCD (\%) = 100\% \times TDCD_{p-p} / (TCross2_{mean} - TCross1_{mean})$
 <b>Quality Factor</b>	Ratio of eye size to noise. $Quality \text{ Factor} = (P_{Top_{mean}} - P_{Base_{mean}}) / (P_{Top\sigma} + P_{Base\sigma})$

## Levels Used in Taking Amplitude, Timing, and Area Measurements

Refer to Figure B-1 and the descriptions that follow to interpret the definitions of waveforms in categories Amplitude, Timing, and Area. Low reference, mid reference, and high reference are the default reference levels and are adjustable.

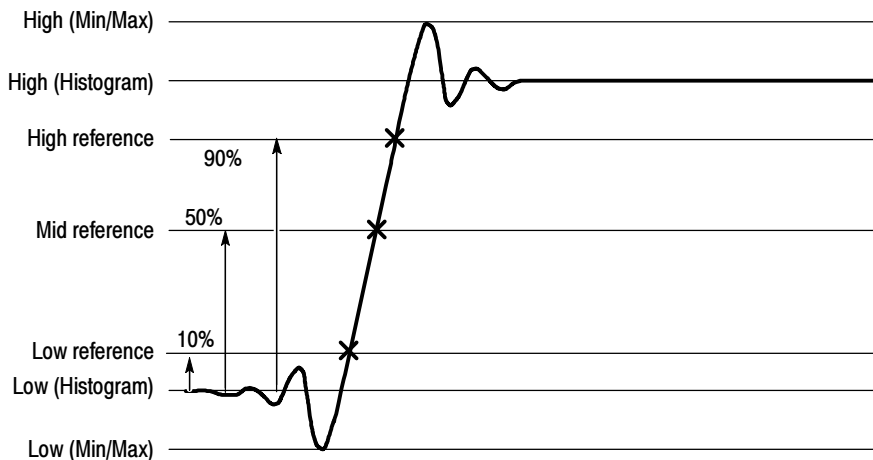


Figure B-1: Levels used to determine measurements

**High.** The value used as the 100% level in amplitude measurements, such as Peak and +Overshoot. High is also used to help derive the HighRef, MidRef, MidRef2, and LowRef values.

**Low.** The value used as the 0% level in amplitude measurements, such as Peak and -Overshoot. Low is also used to help derive the HighRef, MidRef, MidRef2, and LowRef values.

**HighRef.** The waveform high reference level, used in such measurements as fall time and rise time. Typically set to 90%. You can choose how this level is set; see *Reference Levels Method* on page 3-143.

**MidRef.** The waveform middle reference level used in such measurements as Period and Duty Cycle. Typically set to 50%. You can choose how this level is set; see *Reference Levels Method* on page 3-143.

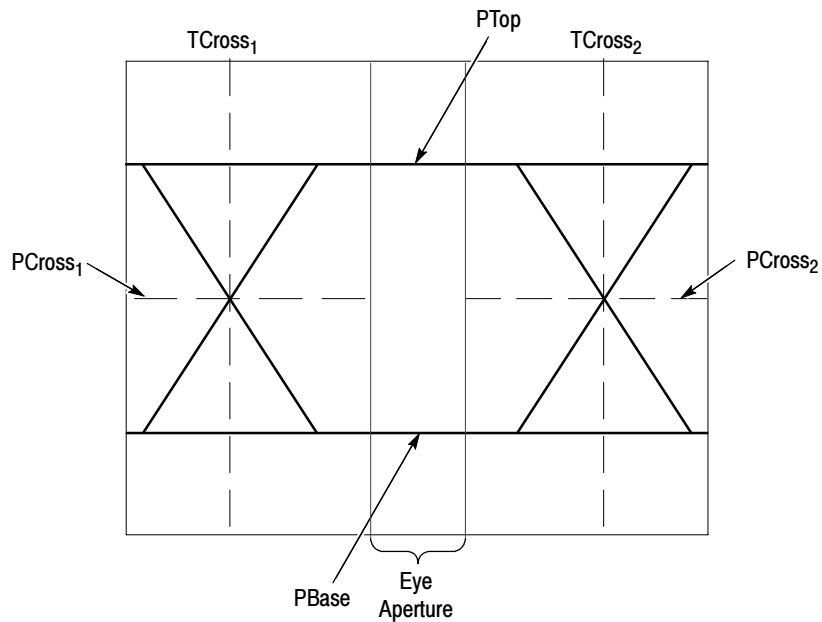
**LowRef.** The waveform low reference level. Used in fall and rise time calculations. Typically set to 10%. You can choose how this level is set; see *Reference Levels Method* on page 3-143.

**Mid2Ref.** The middle reference level for a second waveform (or the second middle reference of the same waveform). Used in two-waveform time measurements, such as the Delay and Phase measurements. You can choose how this level is set; see *Reference Levels Method* on page 3-143.

## Levels Used in Taking Eye Measurements

All eye-diagram measurements are based on the power level, the voltage level, or the time locations of edges within each acquisition.

Figure B-2 shows an eye-diagram and the areas from which values are taken that are used to calculate measurements.



**Figure B-2: Eye-diagram and optical values**

**P Values** The P values include the mean and standard deviation of the vertical location of  $P_{Top}$  and  $P_{Base}$ . These areas are used with a specified sample size to statistically measure the following values:

- $P_{Top_{mean}}$ , the mean value of  $P_{Top}$
- $P_{Top_{sigma}}$ , the standard deviation of  $P_{Top}$
- $P_{Top_{pk-pk}}$ , The vertical peak-to-peak deviation of  $P_{Top}$
- $P_{Base_{mean}}$ , the mean value of  $P_{Base}$  within the Eye Aperture<sup>1</sup>
- $P_{Base_{sigma}}$ , the standard deviation of  $P_{Base}$  within the Eye Aperture<sup>1</sup>
- $P_{Base_{pk-pk}}$ , the vertical peak-to-peak deviation of  $P_{Base}$

<sup>1</sup>The Eye Aperture defaults to the center 20% of the interval from  $TCross_1$  to  $TCross_2$ .

- T1 Values**     The T1 values are vertical and horizontal values associated with the leftmost crossing point. These areas are used to establish the following directions:
- $TCross1_{mean}$ , the horizontal mean of the left crossing point at  $TCross_1$
  - $TCross1_{sigma}$ , the horizontal standard deviation of the left crossing point at  $TCross_1$
  - $TCross1_{p-p}$ , the horizontal peak-to-peak deviation of the left crossing point at  $TCross_1$
  - $PCross1_{mean}$ , the vertical mean of the left crossing point at  $PCross_1$

- T2 Values**     The T2 values are vertical and horizontal values associated with the rightmost crossing point. These areas are used to establish the following directions:
- $TCross2_{mean}$ , the horizontal mean of the right crossing point at  $TCross_2$
  - $TCross2_{sigma}$ , the horizontal standard deviation of the right crossing point at  $TCross_2$
  - $TCross2_{p-p}$ , the horizontal peak-to-peak deviation of the right crossing point at  $TCross_2$

- DCD Values**     The duty cycle distortion (DCD) values are horizontal values associated with the rightmost crossing point at 50% of the eye height. These areas are used to establish the  $DCD_{p-p}$ , the horizontal peak-to-peak deviation of the left crossing point at half the height of the eye.

## Measurements Annotations

Table B-3 describes the annotations for each measurement.

**Table B- 3: Supported measurements and their definition**

Measurements	Annotation descriptions	
<b>Amplitude measurement annotations</b>	Amplitude	2 horizontal bars indicating the amplitude value.
	High	1 horizontal bar indicating the high value.
	Low	1 horizontal bar indicating the low value.
	RMS	1 horizontal bar indicating the RMS value.
	Max	1 horizontal bar indicating the Max value. 1 vertical arrow indicating the time of the Max.
	Min	1 horizontal bar indicating the Min value. 1 vertical arrow indicating the time of the Min.
	Pk-Pk	2 horizontal bars indicating the Max and Min. 2 vertical arrows indicating the time of the Max and Min.
	Cycle RMS	3 horizontal bars indicating the High, the Low, and the RMS value. 2 horizontal arrows facing each other at the mid ref indicating the cycle time.
	+Overshoot	3 horizontal bars indicating the Max, High, and the Low. 1 vertical arrow indicating the time of the Max.
	-Overshoot	3 horizontal bars indicating the High, Low, and the Min. 1 vertical arrow indicating the time of the Min.
	Mean	1 horizontal bar indicating the Mean value.
	Cycle Mean	3 horizontal bars indicating the High, Low, and the Cycle Mean. 2 horizontal arrows facing each other at the mid ref indicating the cycle time.

**Table B-3: Supported measurements and their definition (Cont.)**

Measurements	Annotation descriptions
<b>Time measurement annotations</b>	These annotations are not visible when the reference level units are absolute instead of a percentage.
	Rise Time      2 horizontal arrows facing each other at the high and low ref indicating the start and end time. In detailed mode there are 2 horizontal bars indicating the high and low.
	Fall Time      2 horizontal arrows facing each other at the high and low ref indicating the start and end time. In detailed mode there are 2 horizontal bars indicating the high and low.
	+Duty Cyc      3 horizontal arrows on the mid ref indicating the start, mid, and end time. End arrows point toward each other and the mid arrow points toward the positive part of the cycle. In detailed mode there are 2 horizontal bars indicating the high and low.
	-Duty Cyc      3 horizontal arrows on the mid ref indicating the start, mid, and end time. End arrows point toward each other and the mid arrow points toward the negative part of the cycle. In detailed mode there are 2 horizontal bars indicating the high and low.
	Pos Width      2 horizontal arrows facing each other at the mid ref indicating the start and end time. In detailed mode there are 2 horizontal bars indicating the high and low.
	Neg Width      2 horizontal arrows facing each other at the mid ref indicating the start and end time. In detailed mode there are 2 horizontal bars indicating the high and low.
	Period      2 horizontal arrows facing each other at the mid ref indicating the start and end time. In detailed mode there are 2 horizontal bars indicating the high and low.
	Freq      2 horizontal arrows facing each other at the mid ref indicating the start and end time. In detailed mode there are 2 horizontal bars indicating the high and low.
	Delay      2 horizontal arrows pointing toward each other at their own mid refs indicating the start and end time. In detailed mode there are 4 horizontal bars indicating the highs and lows.
<b>More measurement annotations</b>	Area      None
	Cyc Area      2 horizontal arrows facing each other at the mid ref indicating the start and end time. In detailed mode there are 2 horizontal bars indicating the high and low.
	Phase      3 horizontal arrows indicating the crossing positions and 4 horizontal bars indicating the highs and lows.
	Burst Wid      2 horizontal arrows at the mid ref indicating the start and end time. In detailed mode there are 2 horizontal bars indicating the high and low.

**Table B- 3: Supported measurements and their definition (Cont.)**

Measurements	Annotation descriptions	
<b>Histogram measurement annotations</b>	Wfm Ct	None
	Hts in Box	None
	Peak Hits	1 vertical or horizontal bar indicating the peak hits.
	Median	1 vertical or horizontal bar indicating the median bin.
	Max	1 vertical or horizontal bar indicating the max bin.
	Min	1 vertical or horizontal bar indicating the min bin.
	Pk-Pk	2 vertical or horizontal bars indicating the min and max bins.
	Mean	1 vertical or horizontal bar indicating the mean bin.
	Std Dev	3 vertical or horizontal bars indicating the mean and mean $\pm 1$ standard deviation.
	U+/-1	3 vertical or horizontal bars indicating the mean and mean $\pm 1$ standard deviation.
	U+/-2	3 vertical or horizontal bars indicating the mean and mean $\pm 2$ standard deviation.
	U+/-3	3 vertical or horizontal bars indicating the mean and mean $\pm 3$ standard deviation.

**Table B-3: Supported measurements and their definition (Cont.)**

Measurements	Annotation descriptions
<b>Comm measurement annotations (Cont.)</b>	Ext Ratio 4 horizontal arrows and 2 horizontal bars indicating the eye top, and eye base.
	Ext Ratio % 4 horizontal arrows and 2 horizontal bars indicating the eye top, and eye base.
	Ext Ratio (dB) 4 horizontal arrows and 2 horizontal bars indicating the eye top, and eye base.
	Eye Height 4 horizontal arrows and 2 horizontal bars indicating the eye window top, right, bottom, and left. In detailed mode there are 2 horizontal bars indicating the eye top and base.
	Eye Width 2 horizontal arrows indicating the eye width at the crossing level. In detailed mode there are 2 vertical bars indicating the crossing times.
	Crossing % In Detailed mode 4 horizontal arrows and 2 horizontal bars indicating the eye window left, right, top, and base. 1 horizontal arrow indicating the crossing position. In standard mode 1 horizontal arrow indicating the crossing position.
	Eye Top 2 horizontal arrows and 1 horizontal bar indicating the eye window left, the eye window right, and the eye top.
	Eye Base 2 horizontal arrows and 1 horizontal bar indicating the eye window left, the eye window right, and the eye base.
	Jitter P-P 1 box indicating the histogram boundaries. In detailed mode, 4 horizontal arrows and 2 horizontal bars indicating the eye window left, right, top, and base.
	Jitter RMS 1 box indicating the histogram boundaries. In detailed mode, 4 horizontal arrows and 2 horizontal bars indicating the eye window left, right, top, and base.
Jitter 6 1 box indicating the histogram boundaries. In detailed mode, 4 horizontal arrows and 2 horizontal bars indicating the eye window left, right, top, and base.	



**Table B- 3: Supported measurements and their definition (Cont.)**

Measurements	Annotation descriptions	
<b>Comm measurement annotations</b>	Noise P-P	1 box indicating the histogram boundaries. In detailed mode, 4 horizontal arrows and 2 horizontal bars indicating the eye window left, right, top, and base.
	Noise RMS	1 box indicating the histogram boundaries. In detailed mode, 4 horizontal arrows and 2 horizontal bars indicating the eye window left, right, top, and base.
	S/N Ratio	1 box indicating the histogram boundaries. In detailed mode, 4 horizontal arrows and 2 horizontal bars indicating the eye window left, right, top, and base.
	Cyc Distortion	2 horizontal arrows indicating the time of the rise, time of the fall, and the reference level. In detailed mode, 4 horizontal arrows and 2 horizontal bars indicating the eye window left, right, top, and base. In detailed mode, 2 horizontal arrows indicating the position of the crossings.
	Q-Factor	4 horizontal arrows and 2 horizontal bars indicating the eye window left, right, top, and base. In detailed mode, 2 horizontal bars indicating the eye top and base.



# Appendix C: Menu Bar Commands

Both the instrument menu bar and a toolbar allow you to control instrument operation. Where possible, this manual describes operation using first, the front panel and then, the toolbar. This appendix describes functions available from the menu bar. For more information about these commands, see the online help.

## File Commands

Table C-1 lists the commands available from the File menu on the menu bar.

**Table C- 1: File menu commands**

Menu	Submenu	Function
Reference Waveforms	Reference Setup	Displays the Reference Setup window that you use to set up and control reference waveforms
	Display On/Off	Displays the Waveform Display control window that you can use to turn the display of waveforms on and off
	Position/Scale	Displays the control window that you use to position the waveform and set the vertical scale
	Label	Displays a control window that you use to label your waveforms
	Save Wfm	Displays the Reference Setup window that you use to save and control reference waveforms
	Save All Wfm	Displays the window that you use to save all reference waveforms
	Recall Wfm	Displays the Reference Setup window that you use to recall and control reference waveforms
	Delete All Refs	Deletes all reference waveforms
Instrument Setup		Displays the Instrument Setup window that you use to save instrument setups to nonvolatile memory or to a file, recall saved setups, or delete saved setups
Recall Default Setup		Recalls the factory default instrument setup

**Table C-1: File menu commands (Cont.)**

<b>Menu</b>	<b>Submenu</b>	<b>Function</b>
Page Setup		Displays the Page Setup dialog box that you use to define the page before sending data to a printer
Print Preview		Shows you a preview of the page before you print the page
Print		Displays the Print dialog box that you use to send data to your printer
Export Setup		Displays the Export Setup window that you use to set up and export images, waveforms, and measurements:  Images: Select the Palette (Color, GrayScale, or Black & White), View (Full Screen or Graticules Only), Image (Normal or InkSaver Mode), or Data Format used when exporting images  Waveforms: Select the Data Destination, channel Source, data range, Waveform Detail, and Data Ordering used when exporting waveforms  Measurements: Select the Data Format and type of Measurements used when exporting measurements
Select for Export	Full Screen (bitmap) Graticule (bitmap) Waveform (data) Measurements (data)	Select from the list what you want to export to a file or use with other applications
Export		Exports the full screen, graticule, waveform, or measurement to a file or other application
1 Recent Setup File 1		Recalls (loads) a recent setup file (menu name is replace by the names of setup files)
Minimize		Minimizes the instrument application, displaying the Windows desktop
Shutdown		Shut downs the instrument

## Edit Commands

Table C-2 lists the commands available from the Edit menu on the menu bar.

**Table C-2: Edit menu commands**

Menu	Submenu	Function
Undo Last Autoset		Undoes the last autoset
Copy		Copies the full screen, graticule, waveform, or measurement to the clipboard for use with other applications
Select for Copy	Full Screen (bitmap) Graticule (bitmap) Waveform (data) Measurement (data)	Select from the list what you want to copy to the clipboard
Copy Setup		Displays the Copy Setup window that you use to set up and copy images, waveforms, and measurements:  Images: Select the Palette (Color, GrayScale, or Black & White), View (Full Screen or Graticules Only), Image (Normal or InkSaver Mode), or Data Format used when copying images  Waveforms: Select the Data Destination, channel Source, data range, Waveform Detail, and Data Ordering used when copying waveforms  Measurements: Select the Data Format and type of Measurements used when copying measurements

## Vertical Commands

Table C-3 lists the commands available from the Vertical menu.

**Table C-3: Vertical menu commands**

Menu	Submenu	Function
Vertical Setup		Displays the Vertical Setup window that you use to set the position, scale, offset, termination, coupling, and bandwidth of a channel. You can also calibrate, deskew, and set the external attenuation of attached probes.
Zoom Controls		Displays the Zoom control window that you use to set the position and scale of zoomed waveforms
Display On/Off		Displays the Waveform Display control window that you can use to turn the display of waveforms on and off
Position/Scale		Displays the control window that you use to position the waveform and set the vertical scale
Label		Displays a control window that you use to label your waveforms. Vertical labels move if the waveform position changes (also see display screen text on page C-9).
Offset		Displays the Vertical Offset control window you use to set the vertical offset and scale of a waveform
Termination		Displays the Termination control window you use to select input termination for a channel
Coupling		Displays the Coupling control window you use to select input coupling for a channel
Bandwidth		Displays the Bandwidth control window you use to set the bandwidth of a channel
Probe Cal		Displays the Probe Cal control window you use to check a probe status and compensate the entire signal path from the probe tip to digitized signal
Deskew		Displays the Deskew control window you use to compensate for propagation delays of input channels
Attenuation		Displays the Attenuation control window you use to inform the instrument of the external attenuation or gain between the signal and the input channels

**Table C- 3: Vertical menu commands (Cont.)**

Menu	Submenu	Function
Zoom Setup		Displays the Zoom Setup window you use to set up the horizontal and vertical zoom controls
Zoom Graticule Size	50/50%	Sets the zoom graticule split mode to 50/50%
	80%/20%	Sets the zoom graticule split mode to 80/20%
	100%	Sets the zoom graticule split mode to 100%
	Size	Displays the Zoom control window you use to select the zoom graticule size

## Horizontal and Acquisition Commands

Table C-4 lists the commands available from the Horiz/Acq menu.

**Table C- 4: Horiz/Acq menu commands**

Menu	Submenu	Function
Horizontal/Acquisition Setup		Displays the Horizontal and Acquisition Setup window you use to set up the Horizontal and Vertical subsystems:  <i>Horizontal:</i> You can set the record length, scale, resolution, sample rate, duration delay, reference point, and zoom  <i>Acquisition:</i> You can set the acquisition mode, enable fast acquisitions, roll mode, equivalent time, interpolated real time, equivalent time, and FastFrame on instruments with these features
Zoom Controls		Displays the Zoom control window you use to set the position and scale of zoomed waveforms
Autoset		Automatically sets up the front-panel controls based on the characteristics of the input signal and default selections
Undo Last Autoset		Undoes the last autoset
Fast Acquisitions		Toggles Fast Acquisitions mode on and off on instruments with this feature

**Table C-4: Horiz/Acq menu commands (Cont.)**

Menu	Submenu	Function
Run/Stop		Displays the Run/Stop control window that you can use to start and stop acquisitions, control a single sequence of acquisitions, and display the acquisition status
Delay Mode On		Toggles horizontal delay mode on and off
Roll Mode Auto		Toggles roll mode on and off on instruments with this feature. When on, the instrument automatically enters roll mode at slower horizontal scale settings
Sampling Modes	Real Time Only	Sets the sampling mode to real time
	Interpolated Real Time	Sets the sampling mode to real time. The instrument automatically uses interpolated real time sampling when the sample rate is too fast to acquire enough samples using real-time sampling
	Equivalent Time	The instrument automatically uses equivalent time sampling when the sample rate is too fast to acquire enough samples using real-time sampling
Position/Scale		Displays the Horizontal control window that you use to turn on and off delay mode, position the waveform, and set the horizontal scale
Resolution		Displays the Resolution control window that you use to set the record length and view the duration, sample rate, and resolution
Acquisition Mode	Sample, Pk Detect, Hi-Res, Average, Envelope, Wfm DB, Mode	Allows you to select the acquisition mode, or displays the Acquisition Mode control window that you use to select the acquisition mode
FastFrame Setup		Displays the FastFrame Setup window that you use to set up FastFrame acquisitions on instruments with this feature
FastFrame Controls		Displays the FastFrame control window that you use to select the frame to view and the reference frame used by time stamps on instruments with this feature
Zoom Setup		Displays the Zoom Setup window that you use to set up the horizontal and vertical zoom controls



**Table C- 4: Horiz/Acq menu commands (Cont.)**

<b>Menu</b>	<b>Submenu</b>	<b>Function</b>
Zoom Graticule Size	50/50%	Sets the zoom graticule split mode to 50/50%
	80%/20%	Sets the zoom graticule split mode to 80/20%
	100%	Sets the zoom graticule split mode to 100%
	Size	Displays the Zoom Display Area control window that you use to set the zoom graticule size

## Trigger Commands

Table C-5 lists the commands available from the Trig menu on the menu bar.

**Table C- 5: Trig menu commands**

<b>Menu</b>	<b>Submenu</b>	<b>Function</b>
A Event (Main) Trigger Setup		Displays the Trigger Setup window you use to set up the A Event triggers
Quick Select	Edge, Glitch, Width, Runt, Window, Timeout, Transition, Setup/Hold, Logic Pattern, Logic State, Comm, Serial Pattern	Sets up the selected trigger type

**Table C-5: Trig menu commands (Cont.)**

Menu	Submenu	Function
Edge Setup		Displays the Trigger Setup window and sets up the selected trigger type
Glitch Setup		
Width Setup		
Runt Setup		
Window Setup		
Timeout Setup		
Transition Setup		
Setup/Hold Setup		
Logic Pattern Setup		
Logic State Setup		
Comm Setup (optional on TDS7000B Series)		
Serial Pattern Setup (optional on TDS7000B Series )		
A-B Trigger Sequence		
B Event (Delayed) Trigger Setup		
Holdoff		Displays the trigger Holdoff control window you use to set trigger holdoff
Mode		Displays the Trigger Mode control window you can use to select the trigger mode, force a trigger, and set the trigger level to 50%
Run/Stop		Displays the Run/Stop control window you can use to start and stop acquisitions, control a single sequence of acquisitions, and display the acquisition status

## Display Commands

Table C-6 lists the commands available from the Display menu.

**Table C-6: Display menu commands**

Menu	Submenu	Function
Display Setup		Displays the Display Setup window (select the display appearance, display screen text, display screen objects, and select colors)
Appearance		Displays the Appearance tab of the Display Setup window (select the display style, persistence, intensity, format, and interpolation)
Screen Text		Displays the Screen Text tab of the Display Setup window. You can enter text that you can display and position on screen. Changing the waveform position does not move screen text (also see vertical label on page C-4).
Objects		Displays the Objects tab of the Display Setup window (select the graticule style, trigger level marker, and date and time display)
Colors		Displays the Colors tab of the Display Setup window (select the color of screen objects)
Display Style	Dots, Vectors, Intensified Samples	Choose Dots to display each waveform as a series of dots Choose Vectors to display vectors or lines between the dots Choose Intensified Samples to display actual samples as bright dots; interpolated dots are blacked out
Display Persistence	Reset All No Persistence, Infinite Persistence, Variable Persistence Persistence Controls	Resets the display persistence Choose from No Persistence, Infinite Persistence, and Variable Persistence Modes Displays the Persistence Controls window that you use to control display persistence
Display Format	YT, XY, XYZ	Choose YT, XY, or XYZ display formats. For additional information see <i>To Set Display Format</i> on page 3-47.
Waveform Interpolation	Sin(x)/x, Linear	Choose from Sin(x)/x or Linear interpolation
Graticule Style	Full, Grid, Cross-Hair, Frame	Choose from: Full, Grid, Cross-hair, and Frame styles

**Table C-6: Display menu commands (Cont.)**

<b>Menu</b>	<b>Submenu</b>	<b>Function</b>
Record View Palette	Normal, Monochrome Gray, Monochrome Green, Temperature Grading, Spectral Grading User	Choose Normal to use system colors for best viewing  Choose Green to display waveforms in shades of green  Choose Gray to display waveforms in shades of gray  Choose Temp (temperature) to display waveforms with the highest sample density points appearing in warmer colors (reds)  Choose Spectral to display waveforms with the highest sample density points appearing in blue shades  Choose User to display a control window to design your own colors
FastAcq/WfmDB Palette	Normal, Monochrome Green, Monochrome Gray, Temperature Grading, Spectral Grading, User	Choose Normal to use system colors for best viewing  Choose Green to display fast acquisition and waveform database waveforms in shades of green  Choose Gray to display fast acquisition and waveform database waveforms in shades of gray  Choose Temp (temperature) to display fast acquisition and waveform database waveforms with the highest sample density points appearing in warmer colors (reds)  Choose Spectral to display fast acquisition and waveform database waveforms with the highest sample density points appearing in blue shades  Choose User to display a control window to design your own colors
User Palette		Displays a window that you use to set hue, lightness, and saturation for the selected object. The Reset button allows you to reset the palette to factory defaults. The Setup button displays the Color Setup window.
Display Trigger T		Toggle on and off the display of a T at the trigger point
Waveform Display On		Toggle on and off the waveform display
Display Date and Time		Toggle on and off the display of the system date and time
Display Remote		Toggle on and off remote display support. VNC or pcAnywhere must be installed on the instrument and on the remote PC. When Display Remote is enabled, display updates, control window accessing and menu items are slow.

## Cursors Commands

Table C-7 lists the commands available from the Cursors menu.

**Table C-7: Cursor menu commands**

Menu	Submenu	Function
Cursor Controls		Displays the Cursor Controls window that you use to set up and control cursors
Cursors On		Toggles cursors on and off
Cursor Type	H-bars, V-bars, Waveform, Screen	Enables the selected cursor type
Cursor Mode	Independent, Track	Sets the selected cursor tracking mode
Cursor Position		Displays the Cursor Position control window that you use to position the cursors
Cursor Setup		Displays the Cursor Setup control window that you use to set up and control cursors

## Measure Commands

Table C-8 lists the commands available from the Measure menu.

**Table C-8: Measure menu commands**

Menu	Submenu	Function
Measurement Setup		Displays the Math Setup control window you use to display measurements, setup measurement reference levels, gating, statistics, and histograms
Snapshot		Displays a snapshot of all single waveform measurements of the selected waveform
Amplitude	High Level, Low Level, Amplitude, Maximum, Minimum, Peak to Peak, Pos Overshoot, Neg Overshoot, Mean, RMS, Cycle Mean, Cycle RMS	Displays the selected measurement of the selected waveform

**Table C-8: Measure menu commands (Cont.)**

Menu	Submenu	Function
Time	Rise Time, Fall Time, Positive Width, Negative Width, Period, Frequency, Delay, Pos Duty Cycle, Neg Duty Cycle	Displays the selected measurement of the selected waveform
Comm	Ext Ratio, Ext Ratio %, Ext Ratio (dB), Eye Height, Eye Width, Eye Top, Eye Base, Crossing %, Jitter Pk-Pk, Jitter Rms, Jitter 6 Sigma, Noise Pk-Pk, Noise RMS, S/N Ratio, Cycle Distortion, Quality factor	Displays the selected measurement of the selected waveform
More	Area, Cycle Area, Phase, Burst Width	Displays the selected measurement of the selected waveform
Histogram Measurements	Waveform Count, Hits in Box, Peak Hits, Median, Maximum, Minimum, Peak to Peak, Mean, Standard Deviation, Mean $\pm$ 1 StdDev, Mean $\pm$ 2 StdDev, Mean $\pm$ 3 StdDev	Displays the selected measurement of the histogram
Statistics	Reset Statistics  Off, Mean, All  Statistics Controls	Resets measurement statistics  Displays the selected measurement statistics of current measurements  Displays the Statistics Controls window
Reference Levels		Displays the Reference Levels setup window you use to set the reference levels used by your measurements
Gating	Cursor, Zoom 1, Zoom 2, Zoom 3, Zoom 4, Off, Gating	Allows you to select the gating method, turn off gating, or displays the Measurement Gating control window you use to define the portion of the waveform you want your measurements taken between
Waveform Histograms	Reset Histograms  Horiz, Vert, Off,  Setup. . .	Resets histogram counting  Enables a horizontal histogram Enables a vertical histogram Turns off histograms  Displays the Waveform Histogram setup window you use to set histograms on your waveforms

**Table C- 8: Measure menu commands (Cont.)**

Menu	Submenu	Function
Annotation	Standard, Detailed, Off, Meas1, Meas 2, Meas 3, Meas 4, Meas 5, Meas 6, Meas 7, Meas 8	Allows you to select the type of measurement annotations, turn measurement annotations off, or to select the measurement that you want to annotate.

## Masks Commands

Table C-9 lists the commands available from the Masks menu (optional on TDS7000B Series) on the menu bar.

**Table C- 9: Masks menu commands**

Menu	Submenu	Function
Mask Setup		Displays the Mask Setup window that you use to create mask waveforms
Mask Type		Displays the Type tab of the Mask Setup window that you use to select the type of mask
Source		Displays the Source tab of the Mask Setup window that you use to select the source of mask
Tolerance Setup		Displays the Tolerance Setup tab of the Mask Setup window that you use to set up the mask margin tolerance
Pass/Fail Setup		Displays the Pass/Fail Setup tab of the Mask Setup window that you use to set up pass/fail testing
Pass/Fail Results		Displays the Pass/Fail Results tab of the Mask Setup window that you use to view test results
Mask On		Toggles the mask on or off
Mask Controls		Displays the Mask control window that you use to control mask pass/fail testing and display test results
Mask Configure	Display, AutoSet, Autofit . . .	Displays the Mask Configuration setup window that you use to configure the display, autoset, and autofit features of mask testing
Mask Edit Setup		Displays the Mask Edit Setup window that you use to create user masks
Mask Edit Controls		Displays the Mask Edit control window that you use to edit user masks

## Math Commands

Table C-10 lists the commands available from the Math menu on the menu bar.

**Table C-10: Math menu commands**

Menu	Submenu	Function
Math Setup		Displays the Math Setup control window that you use to create math waveforms
Display On/Off		Toggles the display of math waveforms on and off
Position/Scale		Displays the vertical Position and Scale control window that you can use to change the vertical position and scale of waveforms
Label		Displays a control window that you use to label your waveforms
Ch1-Ch2		Creates a predefined math waveform
Ch3-Ch4		Creates a predefined math waveform
Ch1*Ch2		Creates a predefined math waveform
Ch3*Ch4		Creates a predefined math waveform
Spectral Setup		Displays the Spectral Math Setup control window that you use to create spectral math waveforms
Magnitude Spectrum		Creates a predefined magnitude spectral math waveform
Phase Spectrum		Creates a predefined phase spectral math waveform
Spectral Controls		Displays the Spectral Math controls window that you can use to control your spectral math waveform
Set Math Averages		Displays the Math Averaging controls window that you use to set up averaging in math waveforms
Equation Editor		Displays the Math Equation Editor setup window that you use to create math waveforms

## Application Commands

Table C-11 lists the commands available from the applications menu.

**Table C-11: Application menu commands**

Menu	Submenu	Function
Restore Application		Restores the minimized window of the currently running application
Installed application 1		Starts an installed application
Installed application 2		



## Utilities Commands

Table C-12 lists the commands available from the Utilities menu.

**Table C- 12: Utilities menu commands**

Menu	Submenu	Function
Tek Secure Erase		Erases all setup and reference memory
Set Time & Date		Displays a menu that you use to set the instrument date and time
GPIB Configuration		Displays a control window that you use to set the GPIB talk/listen mode and the bus address
LAN Server Status		Displays the server status window that allows you to turn the server on and off
External Signals		Choose the source and polarity of the AUX OUT signal  Choose the internal or an external clock reference. Whenever you change the reference, you must perform a signal path compensation, see page 3-160.
Instrument Calibration		Displays a window that you use to perform signal path compensation and, if in service mode, instrument calibration
Instrument Diagnostics		Displays a window that you use to run instrument diagnostics and view the diagnostic status and error log. If errors are displayed, refer the instrument to qualified service personnel <sup>1</sup> .
Multipurpose Knobs	Deassign Multipurpose Knobs	Deassigns the multipurpose knobs from their current function
	Momentary Readouts Always Show Readouts Never Show Readouts	Set the multipurpose knob readouts to display momentarily, always, or never
	Readout Setup. . .	Displays and allows you to set the time the momentary readouts are displayed
User Preferences		Displays a window that you use to enable prompts before the instrument performs requested actions (autoset, autoset undo, default/recall setup, overwrite/delete setup, or delete reference waveform), set keypad trigger level defaults, select whether horizontal scale or sample rate is held constant when you change record length, and select the type of measurement annotations
Option Installation		Displays a window that you use to enable optional features and external applications

<sup>1</sup> **If error code 512 is displayed, from the Utilities/Instrument Calibration menu run Signal Path Compensation, and then from the Utilities/Instrument Diagnostics menu run the diagnostics.**

## Help Commands

Table C-13 lists the commands available from the Help menu on the menu bar.

**Table C-13: Help menu commands**

<b>Menu</b>	<b>Submenu</b>	<b>Function</b>
Help on Window		Displays online help on the current window
Contents and Index		Displays the contents and index dialog of the online help
Restore Help		If the help window is minimized, help is redisplayed
Specifications		Displays the instrument specifications
Technical Support		Displays how to obtain technical support
Customer Feedback		Displays how to supply customer feedback
About TekScope		Displays the instrument version number, serial number, instrument id, copyright, installed option list, and option installation key

## Buttons

Touch Buttons to switch to toolbar mode.

## Appendix D: Cleaning

Use these procedures to clean your instrument. If additional cleaning is required, have your instrument serviced by qualified service personnel.



---

**CAUTION.** *To prevent getting moisture inside the instrument during external cleaning, use only enough liquid to dampen the cloth or applicator.*

---

### Exterior Cleaning

Clean the exterior surfaces of the chassis with a dry lint-free cloth or a soft-bristle brush. If any dirt remains, use a cloth or swab dipped in a 75% isopropyl alcohol solution. Use a swab to clean narrow spaces around controls and connectors. Do not use abrasive compounds on any part of the chassis.

Clean the On/Standby switch using a dampened cleaning towel. Do not spray or wet the switch directly.



---

**CAUTION.** *Do not use chemical cleaning agents which might damage the plastics used in this instrument. Use only deionized water when cleaning the front-panel buttons. Use a 75% isopropyl alcohol solution as a cleaner and rinse with deionized water. Before using any other type of cleaner, consult your Tektronix Service Center or representative.*

---

## Flat Panel Display Cleaning

The display is soft plastic and must be treated with care during cleaning.



---

**CAUTION.** *Improper cleaning agents or methods can damage the flat panel display.*

*Do not use abrasive cleaners or commercial glass cleaners to clean the display.*

*Do not spray liquids directly on the display surface.*

*Do not scrub the display with excessive force.*

---

Clean the flat panel display surface by gently rubbing the display with a clean-room wipe (such as Wypall Medium Duty Wipes, #05701, available from Kimberly-Clark Corporation).

If the display is very dirty, moisten the wipe with distilled water or a 75% isopropyl alcohol solution and gently rub the display surface. Avoid using excess force or you may damage the plastic display surface.

# Glossary

**AC coupling**

A type of signal transmission that blocks the DC component of a signal but uses the dynamic (AC) component.

**Accuracy**

The closeness of the indicated value to the true value.

**Acquisition**

The process of sampling signals from input channels, digitizing the samples into data points, and assembling the data points into a waveform record. The waveform record is stored in memory. The trigger marks time zero in that process.

**Acquisition interval**

The time duration of the waveform record divided by the record length. Except in equivalent time, the instrument acquires one data point for every acquisition interval.

**Aliasing**

A false representation of a signal due to insufficient sampling of high frequencies or fast transitions. A condition that occurs when an instrument digitizes at an effective sampling rate that is too slow to reproduce the input signal. The waveform displayed on the instrument may have a lower frequency than the actual input signal.

**Amplitude**

The High waveform value less the Low waveform value.

**AND**

A logic (Boolean) function in which the output is true when and only when all the inputs are true. On the instrument, a trigger logic pattern and state function.

**Analog-to-Digital Converter**

A device that converts an analog signal to a digital signal.

**Area**

Measurement of the waveform area taken over the entire waveform or the gated region. Expressed in mixed amplitude and time units, such as volt-seconds. Area above ground is positive; area below ground is negative.

**Attenuation**

The degree the amplitude of a signal is reduced when it passes through an attenuating device such as a probe or attenuator. That is, the ratio of the input measure to the output measure. For example, a 10X probe will attenuate, or reduce, the input voltage of a signal by a factor of 10.

**Automatic trigger mode**

A trigger mode that causes the instrument to automatically acquire if triggerable events are not detected within a specified time period.

**Autoset**

A function of the instrument that automatically produces a stable waveform of usable size. Autoset sets up front-panel controls based on the characteristics of the active waveform. A successful autoset will set the volts/div, time/div, and trigger level to produce a coherent and stable waveform display.

**Average acquisition mode**

In this mode, the instrument acquires and displays a waveform that is the averaged result of several acquisitions. Averaging reduces the apparent noise. The instrument acquires data as in the sample mode and then averages it according to a specified number of averages.

**Averaging**

Displaying a trace that is the combined result of several acquisitions, thereby reducing apparent noise.

**Bandwidth**

The highest frequency signal the instrument can acquire with no more than 3 dB ( $\times .707$ ) attenuation of the original (reference) signal.

**Burst width**

A timing measurement of the duration of a burst.

**Control knob**

*See Knob.*

**Channel**

One type of input used for signal acquisition. The instrument has four channels.

**Channel/probe deskew**

A relative time delay for each channel. This lets you align signals to compensate for the fact that signals may come in from cables of differing length.

**Channel Reference Indicator**

The indicator on the left side of the display that points to the position around which the waveform contracts or expands when vertical scale is changed. This position is ground when offset is set to 0 V; otherwise, it is ground plus offset.

**Control window**

A group of related controls for a major instrument function that the instrument displays at the right of the screen.

**Coupling**

The association of two or more circuits or systems in such a way that power or information can be transferred from one to the other. You can couple the input signal to the trigger and vertical systems several different ways.

**Cursors**

Paired markers that you can use to make measurements between two waveform locations. The instrument displays the values (expressed in volts or time) of the position of the active cursor and the distance between the two cursors.

**Cycle area**

A measurement of waveform area taken over one cycle. Expressed in volt-seconds. Area above ground is positive; area below ground is negative.

**Cycle mean**

An amplitude (voltage) measurement of the arithmetic mean over one cycle.

**Cycle RMS**

The true Root Mean Square voltage over one cycle.

**dB**

Decibel: a method of expressing power or voltage ratios. The decibel scale is logarithmic. It is often used to express the efficiency of power distribution systems when the ratio consists of the energy put into the system divided by the energy delivered (or in some cases, lost) by the system. One milliwatt of optical power is usually the optical reference for 0 dBm. The formula for decibels is:

$$dB = 20 \log\left(\frac{V_i}{V_l}\right) \quad \text{for optical,} \quad dB = 10 \log\left(\frac{P_o}{P_i}\right)$$

where  $V_i$  is the voltage of the incident pulse,  $V_l$  is the voltage reflected back by the load,  $P_o$  is the power out,  $P_i$  is the power in, and log is the decimal-based logarithmic function. See *Optical Bandwidth* on page 3-60.

**dBm**

A logarithmic measure of power referenced to 1 milliwatt (1 mW optical power = 0.0 dBm):

$$dBm = 10 \log\left(\frac{\text{optical power}}{1 \text{ mW}}\right)$$

**DC coupling**

A mode that passes both AC and DC signal components to the circuit. Available for both the trigger system and the vertical system.

**Delay measurement**

A measurement of the time between the middle reference crossings of two different waveforms.

**Delay time**

The time between the trigger event and the acquisition of post trigger data.

**Digitizing**

The process of converting a continuous analog signal such as a waveform to a set of discrete numbers representing the amplitude of the signal at specific points in time. Digitizing is composed of two steps: sampling and quantizing.



**Display system**

The part of the instrument that shows waveforms, measurements, control windows, status, and other parameters.

**Dragging**

The act of changing your touch panel selection by moving your finger without removing it from the screen. The selection that is activated is the last one that you were touching before removing your finger.

**Dual Graticule**

A display with two graticules. Each one is half the height of the single graticule.

**Fast Acquisition mode**

A mode that increases the waveform capture rate up to 400,000 waveforms per second. This very fast capture rate greatly increases the probability that runts, glitches, and other short term changes will accumulate in waveform memory. The instrument then displays the waveform at the normal display rate using variable or infinite persistence. This display mode emulates the display of an analog instrument.

**Edge Trigger**

Triggering occurs when the instrument detects the source passing through a specified voltage level in a specified direction (the trigger slope).

**Envelope acquisition mode**

A mode in which the instrument acquires and displays a waveform that shows the variation extremes of several acquisitions.

**Equivalent-time sampling (ET)**

A sampling mode in which the instrument acquires signals over many repetitions of the event. These instruments use a type of equivalent-time sampling called *random equivalent-time sampling*, which uses an internal clock that runs asynchronously with respect to the input signal and the signal trigger. The instrument takes samples continuously, independent of the trigger position, and displays them based on the time difference between the sample and the trigger. Although the samples are taken sequentially in time, they are random with respect to the trigger.

**Fall Time**

A measurement of the time it takes for the trailing edge of a pulse to fall from a HighRef value (typically 90%) to a LowRef value (typically 10%) of its amplitude.

**Fiber Optics**

A method of transmitting information in which light is modulated and transmitted over high-purity, filaments of glass. The bandwidth of fiber optic cable is much greater than that of copper wire.

**Frequency**

A timing measurement that is the reciprocal of the period. Measured in Hertz (Hz) where 1 Hz = 1 cycle per second.

**Gated Measurements**

A feature that lets you limit automated measurements to a specified portion of the waveform. You define the area of interest using the vertical cursors.

**Glitch positive trigger**

Triggering occurs if the instrument detects positive spike widths less than the specified glitch time.

**Glitch negative trigger**

Triggering occurs if the instrument detects negative spike widths less than the specified glitch time.

**Glitch either trigger**

Triggering occurs if the instrument detects either positive or negative spike widths less than the specified glitch time.

**GPIB (General Purpose Interface Bus)**

An interconnection bus and protocol that allows you to connect multiple instruments in a network under the control of a controller. Also known as IEEE 488 bus. It transfers data with eight parallel data lines, five control lines, and three handshake lines.

**Graticule**

A grid on the display screen that creates the horizontal and vertical axes. You can use it to visually measure waveform parameters.

**Ground (GND) coupling**

Coupling option that disconnects the input signal from the vertical system.

**Hardcopy**

An electronic copy of the display in a format useable by a printer or plotter.

**Hi Res acquisition mode**

An acquisition mode in which the instrument averages all samples taken during an acquisition interval to create a record point. That average results in a higher-resolution, lower-bandwidth waveform. This mode only works with real-time, non-interpolated sampling.

**High**

The value used as 100% in automated measurements (whenever high ref, mid ref, and low ref values are needed as in fall time and rise time measurements). May be calculated using either the min/max or the histogram method. With the min/max method (most useful for general waveforms), it is the maximum value found. With the histogram method (most useful for pulses), it refers to the most common value found above the mid point.

**Holdoff, trigger**

The time after a trigger signal that elapses before the trigger circuit will accept another trigger signal. Trigger holdoff helps ensure a stable display.

**Horizontal acquisition window**

The range of the segment of the input signal that the acquisition system acquires.

**Horizontal bar cursors**

The two horizontal bars that you position to measure the voltage parameters of a waveform. The instrument displays the value of the active (moveable) cursor with respect to ground and the voltage value between the bars.

**Horizontal Reference Point**

The point about which the trace is expanded or contracted when horizontal size adjustments are made. The horizontal reference point remains anchored as the rest of the trace grows or shrinks around it.

**Initialize**

Setting the instrument to a completely known, default condition.

**Interpolation**

The way the instrument calculates values for record points when the instrument cannot acquire all the points for a complete record with a single trigger event. That condition occurs when the instrument is limited to real time sampling and the time base is set to a value that exceeds the effective sample rate of the instrument. The instrument has two interpolation options: *linear* or *sin(x)/x interpolation*.

Linear interpolation calculates record points in a straight-line fit between the actual values acquired. Sin(x)/x computes record points in a curve fit between the actual values acquired. It assumes all the interpolated points fall in their appropriate point in time on that curve.

**Intensity**

Display brightness.

**Interleaving**

A method by which instruments attain higher digitizing speeds. The instrument applies the digitizing resources of unused channels (that is, channels that are turned off) to sample those that are in use (turned on). Table 3-3 on page 3-40 lists acquisition rates vs. number of channels that are on.

**Knob**

A rotary control.

**Knob Resolution**

The amount of change caused by each click of a knob.

**Live Waveforms**

Waveforms that can update as the acquisition system updates them. Channel waveforms are live waveforms; reference waveforms are not. Math waveforms are live if they contain live waveforms in their expressions: Ch1 + Ref1 defines a live math waveform; Ref1 + Ref2 does not.

**Logic state trigger**

The instrument checks for defined combinatorial logic conditions on channels 1, 2, and 3 on a transition of channel 4 that meets the set slope and threshold conditions. If the conditions of channels 1, 2, and 3 are met then the instrument triggers.

**Logic pattern trigger**

The instrument triggers depending on the combinatorial logic condition of channels 1, 2, 3, and 4. Allowable conditions are AND, OR, NAND, and NOR.

**Low**

The value used as 0% in automated measurements (whenever high ref, mid ref, and low ref values are needed as in fall time and rise time measurements). May be calculated using either the min/max or the histogram method. With the min/max method (most useful for general waveforms) it is the minimum value found. With the histogram method (most useful for pulses) it refers to the most common value found below the mid point.

**Maximum**

Amplitude (voltage) measurement of the maximum amplitude. Typically the most positive peak voltage.

**Mean**

Amplitude (voltage) measurement of the arithmetic mean over the entire waveform.

**Measurement**

An automated numeric readout that the instrument provides directly from the displayed trace in real time, without operator intervention.

**Measurement Parameter**

One of several controls that the instrument operator can exercise over the automated measurement process.

**Measurement Statistics**

The accumulation of a history of individual measurement readouts, showing the mean and standard deviation of a selected number of samples.

**Measurement Tracking**

The process of automatically adjusting the measurement parameters to reflect changes in the trace.

**Mesial**

The middle point of a range of points. The middle measurement point between proximal and distal points for timing measurements, and the intermediate height between baseline and topline for amplitude measurements.

**Minimum**

Amplitude (voltage) measurement of the minimum amplitude. Typically the most negative peak voltage.

**Mode**

A stable condition of oscillation in a laser. A laser can operate in one mode (single mode) or in many modes (multimode).

**Multimode Cable**

A thick cored optical fiber (compared to single mode cable) that can propagate light of multiple modes.

**Multipurpose knobs**

Front-panel knobs you can use to change the value of the assigned parameter.

**NAND**

A logic (Boolean) function in which the output of the AND function is complemented (true becomes false, and false becomes true). On the instrument, that is a trigger logic pattern and state function.

**Negative duty cycle**

A timing measurement representing the ratio of the negative pulse width to the signal period, expressed as a percentage.

**Negative overshoot measurement**

Amplitude (voltage) measurement.

$$\text{NegativeOvershoot} = \frac{\text{Low} - \text{Min}}{\text{Amplitude}} \times 100\%$$

**Negative width**

A timing measurement of the distance (time) between two amplitude points — falling-edge *MidRef* (default 50%) and rising-edge *MidRef* (default 50%) — on a negative pulse.

**Normal trigger mode**

A mode on which the instrument does not acquire a waveform record unless a valid trigger event occurs. It waits for a valid trigger event before acquiring waveform data.

**NOR**

A logic (Boolean) function in which the output of the OR function is complemented (true becomes false, and false becomes true). On the instrument, a trigger logic pattern and state function.

**Optical-to-Electrical converter**

A device that converts an optical signal to an electrical signal.

**OR**

A logic (Boolean) function in which the output is true if any of the inputs are true. Otherwise the output is false. On the instrument, a trigger logic pattern and state function.

**Peak Detect acquisition mode**

A mode in which the instrument saves the minimum and maximum samples over two adjacent acquisition intervals. For many glitch-free signals, this mode is indistinguishable from the sample mode. (Peak detect mode works with real-time, non-interpolation sampling only.)

**Peak-to-Peak**

Amplitude (voltage) measurement of the absolute difference between the maximum and minimum amplitude.

**Period**

A timing measurement of the time covered by one complete signal cycle. It is the reciprocal of frequency and is measured in seconds.

**Persistence**

The amount of time a data point remains displayed. There are three persistence modes available in the instrument Variable, Infinite, and Off.

**Phase**

A timing measurement between two waveforms of the amount one leads or lags the other in time. Phase is expressed in degrees, where 360° comprise one complete cycle of one of the waveforms. Waveforms measured should be of the same frequency or one waveform should be a harmonic of the other.

**Pixel**

A visible point on the display. The instrument display is 640 pixels wide by 480 pixels high.

**Positive duty cycle**

A timing measurement of the ratio of the positive pulse width to the signal period, expressed as a percentage.

**Positive overshoot**

Amplitude (voltage) measurement.

$$PositiveOvershoot = \frac{Max - High}{Amplitude} \times 100\%$$

**Positive width**

A timing measurement of the distance (time) between two amplitude points — rising-edge *MidRef* (default 50%) and falling-edge *MidRef* (default 50%) — on a positive pulse.

**Posttrigger**

The specified portion of the waveform record that contains data acquired after the trigger event.

**Pretrigger**

The specified portion of the waveform record that contains data acquired before the trigger event.

**Principal Power Switch**

The master power switch located on the rear panel of the instrument.



**Probe**

An input device.

**Probe compensation**

Adjustment that improves low-frequency response of a probe.

**Proximal**

The point closest to a reference point. As used in the instrument, the beginning measurement point for timing measurements.

**Pulse trigger**

A trigger mode in which triggering occurs if the instrument finds a pulse, of the specified polarity, with a width between, or optionally outside the user-specified lower and upper time limits.

**Quantizing**

The process of converting an analog input that has been sampled, such as a voltage, to a digital value.

**Real-time sampling**

A sampling mode where the instrument samples fast enough to completely fill a waveform record from a single trigger event. Use real-time sampling to capture single-shot or transient events.

**Record length**

The specified number of samples in a waveform.

**Recovered Clock**

A clock signal derived from and synchronous with a received data sequence.

**Reference memory**

Memory in an instrument used to store waveforms or settings. You can use that waveform data later for processing. The instrument saves the data even when the instrument is turned off or unplugged.

**Reference Waveforms**

Waveforms that are static, not live (see live waveforms). Reference waveforms are channel or math waveforms that you save to references. Once saved, they do not update.

**Rise time**

The time it takes for a leading edge of a pulse to rise from a *LowRef* value (typically 10%) to a *HighRef* value (typically 90%) of its amplitude.

**RMS**

Amplitude (voltage) measurement of the true Root Mean Square voltage.

**Runt trigger**

A mode in which the instrument triggers on a runt. A runt is a pulse that crosses one threshold but fails to cross a second threshold before recrossing the first. The crossings detected can be positive, negative, or either.

**Sample acquisition mode**

The instrument creates a record point by saving the first sample during each acquisition interval. That is the default mode of the acquisition.

**Sample interval**

The time interval between successive samples in a time base. For real-time digitizers, the sample interval is the reciprocal of the sample rate. For equivalent-time digitizers, the time interval between successive samples represents equivalent time, not real time.

**Sampling**

The process of capturing an analog input, such as a voltage, at a discrete point in time and holding it constant so that it can be quantized. Two general methods of sampling are: *real-time sampling* and *equivalent-time sampling*.

**Screen text**

Lines displayed on screen that you use to indicate measurement reference levels and points that an automatic measurement is using to derive the measurement value.

**Setting**

The state of the front panel and system at a given time.

**Setup control window**

A group of related controls for a major instrument function that the instrument displays across the bottom of the screen.

**Setup/Hold trigger**

A mode in which the instrument triggers when a data source changes state within the setup or hold time relative to a clock source. Positive setup times precede the clock edge; positive hold times follow the clock edge. The clock edge may be the rising or falling edge.

**Selected waveform**

The waveform on which all measurements are performed, and which is affected by vertical position and scale adjustments. The light over one of the channel selector buttons indicates the current selected waveform.

**Single-Mode Cable**

An optical cable with a very small core diameter (usually in the range of 2-10 microns). Such cables are normally used only with laser sources due to their very small acceptance cone. Since the cone diameter approaches the wavelength of the source, only a single mode is propagated.

**Slew Rate trigger**

A mode in which the instrument triggers based on how fast a pulse edge traverses (slews) between an upper and lower threshold. The edge of the pulse may be positive, negative, or either. The instrument can trigger on slew rates faster or slower than a user-specified rate.

**Slope**

The direction at a point on a waveform. You can calculate the direction by computing the sign of the ratio of change in the vertical quantity (Y) to the change in the horizontal quantity. The two values are rising and falling.

**Statistical Measurement**

An automated measurement that is derived from color graded waveform data and is based on histograms computed at the crossing levels. A statistical measurement can be selected only in color graded display mode.

**Tek Secure**

This feature erases all waveform and setup memory locations (setup memories are replaced with the factory setup). Then it checks each location to verify erasure. This feature finds use where this *instrument* is used to gather security sensitive data, such as is done for research or development projects.

**Time base**

The set of parameters that let you define the time and horizontal axis attributes of a waveform record. The time base determines when and how long to acquire record points.

**Timeout trigger**

A trigger mode in which triggering occurs if the instrument does NOT find a pulse, of the specified polarity and level, within the specified time period.

**Trace**

The visible representation of an input signal or combination of signals. Identical to waveform.

**Trace Expression**

The definition of what the trace displays. It can include one or more channels combined arithmetically and modified by functions.

**Trigger**

An event that marks time zero in the waveform record. It results in acquisition and display of the waveform.

**Trigger level**

The vertical level the trigger signal must cross to generate a trigger (on edge trigger mode).

**Vertical acquisition window**

The vertical range of the segment of the input signal that the acquisition system acquires.

**Vertical bar cursors**

The two vertical bars you position to measure the time parameter of a waveform record. The instrument displays the value of the active (moveable) cursor with respect to the trigger and the time value between the bars.

**Waveform**

The shape or form (visible representation) of a signal.

**Waveform database mode**

An acquisition mode that processes and displays a larger sample of data. The waveform database is a three-dimensional accumulation of source waveform data over several acquisitions. In addition to amplitude and timing information, the database includes a count of the number of times a specific waveform point has been acquired.

**Waveform interval**

The time interval between record points as displayed.

**XY format**

A display format that compares the voltage level of two waveform records point by point. It is useful for studying phase relationships between two waveforms.

**XYZ format**

A display format that compares the voltage level of two waveform records point by point as in XY format. The displayed waveform intensity is modulated by the CH 3 (Z) waveform record.

**YT format**

The conventional instrument display format. It shows the voltage of a waveform record (on the vertical axis) as it varies over time (on the horizontal axis).



# Index

## Symbols

- \*\*Empty\*\*, C-14
- <, A Trigger control window, 3-84
- >, A Trigger control window, 3-84

## Numbers

- 1 recent setup file 1, C-2
- 100%, Zoom, C-5
- 50/50%, Zoom, C-5
- 80/20%, Zoom, C-5

## A

- A event (main) trigger setup, C-7
- A Only, trigger, how to set up, 3-109
- A Only, A Trigger control window, 3-109
- A Then B, A->B Seq Trigger control window, 3-110, 3-116
- A Trigger
  - holdoff, 3-74
  - level presets, 3-75, 3-76
  - trigger when, 3-97
- A Trigger control window, 3-83, 3-85, 3-89, 3-94, 3-96, 3-98, 3-99, 3-102, 3-109, 3-115
  - <, 3-84
  - >, 3-84
  - A Only, 3-109
  - AND, 3-96, 3-98, 3-103
  - Ch1, Ch2 ..., 3-83, 3-85, 3-87, 3-89, 3-94, 3-96, 3-98, 3-100, 3-103
  - clock source, 3-100
  - data source, 3-100
  - define inputs, 3-96, 3-98, 3-100, 3-101, 3-103
  - define pattern type, 3-96, 3-98, 3-103
  - delay time, 3-110
  - either, 3-83, 3-85, 3-87, 3-89
  - falling edge, 3-98, 3-100
  - FALSE, 3-96, 3-99
  - glitch, 3-83, 3-84, 3-102
  - level, 3-84, 3-88, 3-95
  - logic, 3-96, 3-98, 3-99
  - lower level, 3-92
  - NAND, 3-96, 3-98, 3-103
  - negative, 3-83, 3-85, 3-87, 3-89
  - NOR, 3-96, 3-98, 3-103
  - OR, 3-96, 3-98, 3-103
  - pattern, 3-96
  - polarity and width, 3-83, 3-85, 3-87
  - positive, 3-83, 3-85, 3-87, 3-89
  - pulse, 3-83, 3-85, 3-87, 3-89, 3-94
  - rising edge, 3-98, 3-100
  - runt, 3-85, 3-102
  - set thresholds, 3-96, 3-98, 3-103
  - set to ECL, 3-90
  - set to TTL, 3-90
  - setup/hold, 3-99, 3-102
  - slew rate, 3-89
  - source, 3-83, 3-85, 3-87, 3-89, 3-92, 3-94
  - state, 3-98
  - thresholds, 3-86, 3-90
  - timeout, 3-94, 3-102
  - timer, 3-94
  - transition, 3-89, 3-102
  - trig delay, 3-110
  - trigger if, 3-93
  - trigger when, 3-96, 3-99
  - TRUE, 3-96, 3-99
  - upper level, 3-92
  - width, 3-87, 3-102
  - window, 3-92, 3-102
- A Trigger level
  - ECL, 3-75, 3-76
  - TTL, 3-75, 3-76
  - user, 3-75, 3-76
- A->B Seq Trigger control window, 3-110, 3-116
  - A Then B, 3-110, 3-116
  - B Trig Level, 3-110
  - B trigger level, 3-110
  - Trig Event, 3-110
  - trigger events, 3-110
- A->b trigger sequence, C-8
- About TekScope, C-16
- Absolute reference, 3-143
- AC coupling, Glossary-1
- AC line voltage, trigger input, 3-64, 3-70
- Access vertical set up help, 3-17
- Accessories, 1-33
  - optional, 1-36
  - standard, 1-35
- Accessory software, 1-14
- Accuracy, Glossary-1
- Acquiring and displaying waveforms, 3-7
- Acquisition, Glossary-1
  - input channels and digitizers, 3-34
  - interval, Glossary-1

- modes, 3-35
  - Envelope, 3-49
- record, 3-36
- sampling (see sampling), 3-35
- Acquisition controls
  - acquisition control background, 3-34
  - acquisition hardware, 3-34
  - acquisition modes, 3-35
  - aliasing illustrated, 3-29
  - average, 3-26, 3-30
  - condition, 3-28
  - envelope, 3-26, 3-30
  - equivalent-time sampling, 3-37
  - equivalent-time sampling, illustrated, 3-39
  - global controls, 3-28
  - Hi Res, 3-25, 3-30
  - intensity, 3-46
  - interleaving, 3-40
  - interpolation, 3-39
  - linear interpolation, 3-39
  - methods to check and eliminate aliasing, 3-29
  - peak detect, 3-25, 3-30
  - preventing aliasing, 3-29
  - real time, 3-31
  - real-time sampling, 3-37
  - record length, 3-36
  - repetitive signal, 3-31
  - roll, 3-28
  - RUN/STOP, 3-30
  - Run/Stop button only, 3-27
  - sample, 3-24, 3-30
  - sample interval, 3-36
  - sampling and acquisition mode, 3-37
  - sampling mode selection, 3-38
  - sampling process, 3-35
  - select the acquisition mode, 3-30
  - set the stop mode, 3-30
  - set waveform count (average and envelope only), 3-30
  - sin(x)/x interpolation, 3-39
  - SINGLE, 3-28, 3-30
  - single sequence, 3-28
  - single sequence off, 3-30
  - to disable roll mode, 3-34
  - to enable roll mode, 3-33
  - to select an acquisition mode, 3-30
  - to select real-time or equivalent-time sampling, 3-31
  - to set acquisition modes, 3-29
  - to set roll mode, 3-33
  - to single sequence roll mode, 3-33
  - to start acquiring, 3-32
  - to start and stop acquisition, 3-32
  - to stop acquiring, 3-32
  - to take a single acquisition, 3-32
  - to turn off roll mode acquisitions, 3-33
  - trigger point, 3-36
  - untriggered roll, 3-28
  - untriggered roll with single sequence, 3-28
  - using, 3-24
  - using fast acquisition mode, 3-40
  - using FastFrame, 3-48
  - waveform database, 3-26, 3-30
  - waveform record, 3-36
- Acquisition mode, C-6
  - spectral math, 3-204
- Acquisition modes, incompatible with fast acquisitions, 3-41
- Acquisition overview, 3-34
- Acquisition preview, 3-121
- Acquisition setup, C-5
- Advanced, 3-77
- Aliasing, 3-29, 3-204, Glossary-1
  - eliminating, 3-29
  - illustrated, 3-29
  - recognizing, 3-204
- All, C-12
- Amplitude, B-1, C-11, Glossary-1
- Analog-to-digital converter, Glossary-1
- Analyzer control locks, 3-183
- AND, Glossary-1
- AND, A Trigger control window, 3-96, 3-98, 3-103
- Annotate, 3-146
  - waveforms on screen, 3-140
- Annotated display, 3-141
- Appearance, C-9
- Applications, 1-14
  - derivative math waveforms, 3-172
  - integral math waveforms, 3-174
  - optional, 1-14
- Area, B-1, C-12, Glossary-2
- Attenuating optical signals, 3-55
- Attenuation, Glossary-2
- Attenuation, input, C-4
- Auto-increment file name, 3-222, 3-225, 3-230, 3-243
- AutoBright, 3-133
- Automated measurements, 3-140
  - of FFT math waveforms, 3-205
- Automatic measurements, 3-140
  - high and low levels defined, B-6
  - levels used in taking, B-5, B-6
  - reference levels defined, B-6
  - reference levels defined (eye pattern/optical), B-7
- Automatic trigger mode, 3-65, 3-71, Glossary-2
- Autoset, 3-17, C-5, Glossary-2
  - how to execute, 3-15



- undoing, 3-15
  - undo, C-5
  - Autoset Undo, 3-15
  - Autoset undo, C-3
  - AUX Out configuration, C-15
  - Auxiliary trigger, 3-64, 3-70
  - Average, 3-26, 3-30, 3-49
    - incompatible with fast acquisitions, 3-41
  - Average acquisition mode, Glossary-2
  - Averaging, Glossary-2
    - spectral math, 3-204
- B**
- B event (delayed) trigger setup, C-8
  - B Trig Level, A->B Seq Trigger control window, 3-110
  - B trigger level, A->B Seq Trigger control window, 3-110
  - Backing up user files, 1-11
  - Bandwidth, C-4, Glossary-2
    - optical, 3-60
    - selection, 3-59
  - Bitmap, file format, 3-235
  - Blackman-Harris, 3-192, 3-194, 3-199, 3-211
  - Burst width, B-1, C-12
  - Button
    - DELAY, 3-68
    - FORCE TRIG, 3-76
    - SET LEVEL TO 50%, 3-70
    - SINGLE TRIG, 3-77
    - ZOOM, 3-125, 3-127
- C**
- Calibrate probes, 3-162
  - Calibrate the oscilloscope, 3-161
  - Calibration instructions, 3-161
  - Calibration status, 3-161
  - CD-ROMs, optional applications, 1-14
  - Center, 3-186
  - Ch1 - Ch2, C-14
  - Ch1 \* Ch2, C-14
  - Ch1, Ch2 ..., A Trigger control window, 3-83, 3-85, 3-87, 3-89, 3-94, 3-96, 3-98, 3-100, 3-103
  - Ch3 - Ch4, C-14
  - Ch3 \* Ch4, C-14
  - CH3 signal output, 2-9, 2-10
  - Channel, 3-141, 3-142, Glossary-3, Glossary-8, Glossary-13
    - configuration, 3-35
    - readout, 3-130
    - reference indicator, Glossary-3
    - trigger input, 3-64, 3-70
  - Channel-probe deskew, 3-162, Glossary-3
  - Channels
    - deskew, 3-162
    - digitizer configuration, 3-34
    - shared horizontal window, 3-23
    - shared parameters, illustrated, 3-23
  - Circuit loading, Glossary-3
  - Cleaning
    - exterior, D-1
    - flat panel display, D-2
    - optical connectors, 3-57
  - Clear all references and setups, 3-233
  - Clear Data, 3-133
  - Clipping
    - derivative math waveforms, 3-173
    - how to avoid, 3-173, 3-174
    - integral math waveforms, 3-174
  - CLOCK, 3-56
  - Clock, recovery outputs, 3-56
  - Clock source, A Trigger control window, 3-100
  - Color
    - math, 3-133
    - palette, 3-132, C-10
    - reference, 3-132
  - Color palette, 3-46, 3-132, 3-137, C-10
    - changing, 3-137
    - definition, 3-132, C-10
  - Colors, C-9
  - Comm, C-12
    - setup, C-8
    - trigger, C-7
    - triggering, 3-117
  - Communication, remote, 3-255
  - Compensation, 3-58, 3-59
  - Configuration
    - software installation, 1-13-1-15
    - system, 1-5
  - Connect input signal, 3-12
  - Connecting and conditioning your signals, 3-9
  - Connecting optical signals, 3-55
  - Connecting peripherals, 1-7
  - Connection, to a network, 1-16
  - connection, to a LAN, 1-16
  - Connectivity tools, 2-2
  - Contents and index, C-16
  - Control knob, Glossary-3
  - Control window, Glossary-3
    - A Trigger, 3-83, 3-85, 3-89, 3-94, 3-96, 3-98, 3-99, 3-102, 3-109
    - A->B Seq Trigger, 3-110, 3-116
    - B trigger, 3-115

- Controlling data input and output, 3-221
- Copy, C-3
  - a waveform, 3-246
  - setup, C-3
  - waveforms, 3-246
- Copy MyScope control window, 3-261
- Copying waveforms, 3-235
- Coupling, 3-10, C-4
  - ground, Glossary-7
  - trigger, 3-67
- Create custom control window, 3-257
- Create MyScope control window, 3-257
- Creating and using math waveforms, 3-167
- Cross-hair, graticule, 3-137, C-9
- Crossing %, B-4, C-12
- Cursor, 3-150
  - controls, C-11
  - measurements, 3-140, 3-151, 3-214
  - mode, C-11
  - position, 3-155, C-11
  - sources, 3-155
  - style, 3-156
  - tracking, 3-156
  - type, 3-155, C-11
  - types, 3-152
  - units, 3-154
- Cursor controls window, 3-155
- Cursor measurements, 3-214
- Cursor readout, V-bars, 3-214
- Cursors, 3-151, Glossary-3
  - using, 3-152
  - with derivative waveforms, 3-173, 3-181
  - with FFT waveforms, 3-205, 3-214
- Cursors menu
  - cursor controls, C-11
  - cursor mode, C-11
  - cursor position, C-11
  - cursor setup, C-11
  - cursor type, C-11
  - h-bars, C-11
  - independent, C-11
  - screen, C-11
  - track, C-11
  - v-bars, C-11
  - waveform, C-11
- Custom control window, 3-257
- Customer feedback, C-16
- Customize measurements, 3-141
- Customizing the display, 3-131
- Cycle area, B-1, C-12, Glossary-3
- Cycle distortion, B-5, C-12
- Cycle mean, B-1, C-11, Glossary-3
- Cycle RMS, B-1, C-11, Glossary-3

## D

- DATA, 3-56
- Data, controlling input and output, 3-221
- Data Clear, 3-133
- Data input/output, 3-221
  - all settings are retained, 3-222
  - avoiding setup/waveform mismatches, 3-222
  - begin your chart, 3-245
  - bitmap, file format, 3-235
  - copy your file, 3-249
  - copying waveforms, 3-235
  - delete a reference waveform file, 3-234
  - delete the file, 3-235
  - delete the reference, 3-233
  - display the reference control window, 3-228, 3-231, 3-233
  - display the setups control window, 3-224, 3-226
  - display your reference waveform, 3-233
  - export your file, 3-242
  - exporting and copying waveforms, 3-235
  - file formats, 3-235
  - find the file directory, 3-234
  - find the source directory, 3-226, 3-232
  - find your file, 3-234
  - finish the chart, 3-245
  - hardcopy formats, 3-251
  - image, 3-251
  - import the waveform data, 3-244
  - JPEG, file format, 3-236
  - label the waveform, 3-229
  - margins, 3-251
  - MathCad, file format, 3-236
  - MathLab, file format, 3-236
  - name a destination, 3-225
  - name the file, 3-243
  - name your setup, 3-224, 3-225
  - numeric, file format, 3-235
  - orientation, 3-251
  - page setup window, 3-252
  - palette, 3-251
  - paper, 3-251
  - PNG, file format, 3-236
  - print preview window, 3-253
  - print window, illustration, 3-250
  - printing waveforms, 3-250
  - recall a reference waveform from a file, 3-232
  - recall setup from a file, 3-226
  - recall the setup, 3-226
  - recall the waveform, 3-231
  - recall your setup, 3-227
  - recall your waveform, 3-233
  - remote communication, 3-255

- retaining current settings, 3-222
  - save all waveforms to files, 3-230
  - save the file, 3-243
  - save the setup, 3-224
  - save the waveform to a file, 3-230
  - save the waveform to a reference, 3-229
  - save your setup, 3-225
  - save your waveform, 3-231
  - saving and recalling a setup, 3-221
  - saving and recalling waveforms, 3-227
  - select a destination, 3-230, 3-242
  - select directory and name file, 3-230
  - select for copy, 3-246
  - select for export, 3-237
  - select setup for copy, 3-246
  - select setup for export, 3-237
  - select the waveform to save, 3-228
  - select your setup, 3-227
  - select your waveform, 3-232
  - setup to copy images, 3-247
  - setup to copy measurements, 3-249
  - setup to copy waveforms, 3-247, 3-248
  - setup to export histograms, 3-241
  - setup to export images, 3-238
  - setup to export measurements, 3-241
  - setup to export waveforms, 3-239
  - specify a line-graph chart, 3-245
  - spreadsheet, file format, 3-236
  - text, file format, 3-235
  - to clear references, 3-233
  - to copy your waveform, 3-246
  - to date/time stamp hardcopies, 3-254
  - to display the date and time, 3-254
  - to export your waveform, 3-236
  - to get the current time, 3-254
  - to preview the page, 3-252
  - to print from front panel, 3-250
  - to print from menu bar, 3-250
  - to recall your setup, 3-226
  - to recall your waveform, 3-231
  - to save to a file, 3-224
  - to save your setup, 3-223
  - to save your waveform, 3-228
  - to set the date and time, 3-254
  - to set up the page, 3-251
  - to use an exported waveform, 3-244
  - using auto-increment filename, 3-222
  - view, 3-251
- Data Source, A Trigger control window, 3-100
- Date and time
- display, 3-133, C-10
  - displaying, 3-254
  - on hardcopies, 3-254
  - setting, 3-133, 3-254
- dB, 3-209, Glossary-4
- dBm, Glossary-4
- DC coupling, Glossary-4
- DC offset, with math waveforms, 3-174
- Decibel, Glossary-4
- Default setup, how to execute, 3-16
- Define inputs, A Trigger control window, 3-96, 3-98, 3-100, 3-101, 3-103
- Define pattern type, A Trigger control window, 3-96, 3-98, 3-103
- Defining and displaying waveforms, 3-121
- Degree, 3-210
- DELAY, button, 3-68
- Delay, C-12
- measurement, Glossary-4
  - mode on, C-6
  - time, Glossary-4
- Delay time, A Trigger control window, 3-110
- Delayed runs after time, 3-68
- Delayed trigger, 3-68
- how to set up, 3-110
- Delayed triggerable on events, 3-68
- Delete all refs, C-1
- Derivative math waveform, 3-172
- applications, 3-172
  - derivation of, 3-172
  - procedure for measuring, 3-173, 3-181
  - record length of, 3-172
- Description
- key features, 1-1
  - product, 1-1
- Deskew, 3-162, C-4, Glossary-3
- channels, 3-162
  - vertical controls window, 3-162
- Diagnostics, C-15
- Differentiation
- of a derivative, 3-172
  - waveform, 3-171
- Digitizing, Glossary-4
- process, defined, 3-35
- Display
- customizing, 3-131, 3-132
  - date and time, C-10
  - elements, 3-120
  - format, 3-133, C-9
  - persistence, 3-132, C-9
  - settings, 3-132
  - setup, 3-135, C-9
  - style, 3-132, C-9
  - styles, 3-135
  - system, Glossary-5
- Display control, 3-120

- Display control window
  - dots, 3-134
  - infinite persistence, 3-134
  - variable persistence, 3-134
  - vectors, 3-134
- Display controls, intensity, 3-46
- Display menu
  - appearance, C-9
  - color palette, C-10
  - colors, C-9
  - cross-hair, C-9
  - display date and time, C-10
  - display format, C-9
  - display persistence, C-9
  - display setup, C-9
  - display style, C-9
  - Display trigger T, C-10
  - dots, C-9
  - frame, C-9
  - full, C-9
  - graticule style, C-9
  - grid, C-9
  - infinite persistence, C-9
  - intensified samples, C-9
  - intensity, 3-46
  - linear, C-9
  - monochrome gray, C-10
  - monochrome green, C-10
  - n, C-10
  - no persistence, C-9
  - objects, C-9
  - persistence controls, C-9
  - remote display, C-10
  - reset all, C-9
  - screen text, C-9
  - $\sin(x)/x$ , C-9
  - spectral grading, C-10
  - temperature grading, C-10
  - user palette, C-10
  - variable persistence, C-9
  - vectors, C-9
  - waveform display on, C-10
  - waveform intensity, 3-46
  - waveform interpolation, C-9
  - xy, 3-47, C-9
  - xyz, 3-48, C-9
  - yt, 3-47, C-9
- Display on/off, C-1, C-4, C-13, C-14
- Display only, 3-162
- Display trigger T, C-10
- Displaying waveforms, 3-119
  - access the display Setup dialog box, 3-135
  - acquisition preview, 3-121
  - adjust the horizontal reference, 3-125
  - change graticule style, 3-137
  - change waveforms colors, 3-137
  - checking the zoom scale and position, 3-130
  - color palette, 3-132
  - customizable display elements, 3-132
  - customize graticule & waveforms, 3-137
  - customizing the display, 3-131
  - date and time, 3-133
  - defining and displaying waveforms, 3-121
  - display and acquisition controls, 3-123
  - display control, 3-120
  - display elements, 3-120
  - display format, 3-133
  - display persistence, 3-132
  - display settings, 3-132
  - display style, 3-132
  - dots, 3-132, 3-135
  - explore the zoom controls, 3-125
  - graticule, 3-120, 3-137
  - graticule area, 3-120
  - graticule style, 3-132
  - graticules, 3-122
  - horizontal position, 3-122, 3-123
  - horizontal position and the horizontal reference, 3-123
  - horizontal record length, 3-122
  - horizontal reference, 3-120, 3-123
  - horizontal scale, 3-122
  - horizontal zoom, 3-130
  - horizontal-scale readout, 3-120
  - infinite persistence, 3-134, 3-135, 3-136
  - intensified samples, 3-132, 3-135
  - intensity, 3-133
  - interpolation, 3-133, 3-134
  - linear, 3-135
  - linear interpolation, 3-134
  - math colors, 3-133
  - mouse, 3-123
  - mouse and touch screen operation, 3-123
  - normal and persistence displays, 3-134
  - operations on the timebase, 3-122
  - operations on waveforms, 3-122
  - operations performed based on the waveform type, 3-122
  - persistence, 3-136
  - persistence displays, 3-134
  - quick adjust the timebase (zoom), 3-125
  - record length, 3-122
  - reference colors, 3-132
  - reset zoom, 3-130, 3-131
  - scale, 3-122
  - screen text, 3-132

- select a persistence mode, 3-136
- select the display persistence, 3-135
- select the display style, 3-135
- select zoom, 3-127
- set date and time, 3-133
- set display styles, 3-135
- set horizontal display parameters, 3-124
- set up MultiView zoom, 3-129
- set up zoom, 3-129
- set vertical display parameters, 3-124
- setting MultiView zoom controls, 3-125
- setting zoom controls, 3-125
- $\sin(x)/x$  interpolation, 3-134
- $\text{sine}(x)/x$ , 3-135
- to display waveforms in the main graticule, 3-124
- to zoom waveforms, 3-126
- touch screen, 3-120, 3-123
- trigger level marker, 3-133
- trigger T, 3-133
- using display controls, 3-132
- using the display, 3-121
- using the waveform display, 3-119
- using zoom with waveforms, 3-126
- variable persistence, 3-134, 3-135, 3-136
- vectors, 3-132, 3-135
- vertical offset, 3-122
- vertical position, 3-122
- vertical scale, 3-122
- vertical zoom, 3-130
- waveform display, 3-121, 3-133
- waveform intensity, 3-133
- waveform interpolation, 3-133
- waveforms, 3-137
- xy, 3-133
- xyz, 3-133
- yt, 3-133
- zoom, 3-121, 3-122, 3-125
- zoom a waveform, 3-128
- zoom position, 3-130
- zoom reset, 3-130, 3-131
- zoom scale, 3-130
- Dots, 3-132, 3-134, 3-135, C-9
  - display control window, 3-134
- DPO, Glossary-5
- Dragging, Glossary-5
- Dual display setup, 1-17
- Dual graticule, Glossary-5
- Duration, 3-183
- Duty cycle, Glossary-10, Glossary-12
  - distortion, B-5

## E

- ECL, 3-84, 3-90, 3-95, 3-100
  - A Trigger level, 3-75, 3-76
- Edge
  - setup, C-8
  - trigger, 3-65, C-7, Glossary-5
- Edit menu
  - copy, C-3
  - copy setup, C-3
  - full screen, C-3
  - graticule, C-3
  - measurement, C-3
  - select for copy, C-3
  - waveform, C-3
- Edit MyScope control window, 3-261
- Either, A Trigger control window, 3-83, 3-85, 3-87, 3-89
- Electrical out, 3-57
- Envelope, 3-26, 3-30, 3-49
  - acquisition mode, 3-49
  - incompatible with fast acquisitions, 3-41
- Envelope acquisition mode, Glossary-5
- Environment requirements, 1-6
- Equation editor, C-14
- Equivalent time, C-6
- Equivalent-time sampling, 3-37, 3-49
  - random, Glossary-5
- Erase all references and setups, 3-233
- Error log, C-15
- Ethernet, 3-255
- Excel, 3-244
- Exiting the application, 1-15
- Export, C-2
  - save format, 3-235
  - setup, C-2
  - waveforms, 3-236
- Exporting files using PRINT button, 3-242
- Exporting waveforms, 3-235
- Ext ratio, C-12
- Ext ratio (dB), C-12
- Ext ratio %, C-12
- External reference, 2-10, C-15
- External signals, C-15
- Extinction ratio, B-4
- Extinction ratio %, B-4
- Extinction ratio dB, B-4
- Eye
  - base, B-4
  - diagram, B-6

- height, B-4
  - top, B-4
  - width, B-4
  - Eye base, C-12
  - Eye height, C-12
  - Eye top, C-12
  - Eye width, C-12
- F**
- Fall time, B-1, C-12, Glossary-6
  - Falling edge, A Trigger control window, 3-98, 3-100
  - FALSE, A Trigger control window, 3-96, 3-99
  - Fast acquisition, 3-40, 3-49
    - automatic selection, 3-41
    - normal DSO and fast acquisition displays, 3-44
    - to adjust the intensity, 3-46
    - to enable fast acquisitions mode, 3-45
    - to select the color palette, 3-46
    - to select the format, 3-47
    - to set display format, 3-47
    - to set the display readout options, 3-138
    - to set the style, 3-45
    - to turn fast acquisitions on and off, 3-44
    - using fast acquisition mode, 3-40
    - using fast acquisitions, 3-41
    - vs. normal DSO mode (illustrated), 3-43
    - waveform capture rate, 3-41
  - Fast acquisitions, C-5
  - Fast acquisitions mode, modes incompatible with, 3-41
  - Fast Fourier transforms, description, 3-182
  - FastFrame, 3-48, 3-142, 3-169
    - controls, C-6
    - FastFrame time stamp, illustrated, 3-54
    - incompatible with fast acquisitions, 3-41
    - interactions, 3-49
    - RUN/STOP, 3-49
    - select the FastFrame and time stamps selection
      - controls, 3-53
    - select the frame to view, 3-51
    - select the reference frame, 3-53
    - set frame count, 3-51
    - set frame length, 3-50
    - setup, C-6
    - time stamping frames, 3-52
    - to lock the reference position frames, 3-54
    - to set FastFrame mode, 3-50
    - turn readouts on or off, time stamps, 3-52
    - using FastFrame acquisitions, 3-49
    - view multiple frames, 3-51
  - FastFrame mode, using, 3-50
  - FastFrame setup, horizontal menu, 3-50, 3-54
  - FFT math waveform
    - automated measurements of, 3-205
    - phase suppression, 3-210
    - procedure for displaying, 3-207
    - procedure for measuring, 3-205, 3-214
  - Fiber optics, Glossary-6
  - File formats, 3-235
  - File menu
    - 1 recent setup file !, C-2
    - delete all refs, C-1
    - display on/off, C-1
    - export, C-2
    - export setup, C-2
    - full screen, C-2
    - graticule, C-2
    - instrument setup, C-1
    - label, C-1
    - measurements, C-2
    - minimize, C-2
    - page setup, C-2
    - position/scale, C-1
    - print, C-2
    - print preview, C-2
    - recall default setup, C-1
    - recall waveform, C-1
    - reference setup, C-1
    - reference waveforms, C-1
    - run application, C-14
    - save waveform, C-1
    - select for export, C-2
    - shutdown, C-2
    - waveform, C-2
  - Filter selection, 3-59
  - Flat panel display, cleaning, D-2
  - Flattop2 window, 3-192, 3-194, 3-201
  - Flexible control access, 3-11
  - FORCE TRIG button, 3-76
  - Frame
    - graticule, 3-137, C-9
    - horizontal menu, 3-51, 3-53
  - Frame count, horizontal menu, 3-51
  - Frame length, horizontal menu, 3-50
  - Frame, horizontal menu, 3-53
  - Frequency, B-1, C-12, Glossary-6
  - Frequency domain controls, 3-182
  - Front panel, triggering, 3-68
  - Front panel connectors, 3-56
  - Front-panel controls, INTENSITY, 3-46
  - Full, graticule, 3-137, C-9
  - Full screen, C-2, C-3

Fuses, 1-9

## G

Gate controls, 3-184

Gated measurements, Glossary-6

Gating, 3-150, C-12

controls, 3-182

Gaussian window, 3-192, 3-194, 3-196

Glitch

A Trigger control window, 3-83, 3-84

either trigger, Glossary-6

negative trigger, Glossary-6

setup, C-8

Glitch trigger, 3-78, C-7, Glossary-6

how to set up, 3-83, 3-102

GPIB, 3-255, Glossary-6

configuration, C-15

remote communication, 3-255

Graticule, 3-120, C-2, C-3, Glossary-6

100% zoom, C-7

50/50% zoom, C-7

80/20% zoom, C-7

area, 3-120

measurements, 3-140

size button, 3-122

split, 3-129

style, 3-132, 3-137, C-9

zoom, C-7

Graticules, 3-122

Grid graticule, 3-137, C-9

Ground coupling, Glossary-7

GroupDelay, 3-210

## H

Hamming window, 3-192, 3-194, 3-198, 3-211

Hanning window, 3-192, 3-194, 3-199, 3-211

hard drive, removing and installing, 1-11

Hardcopy, Glossary-7

Hardcopy formats, 3-251

H-bars, C-11

Help, 3-263

for in-depth contextual overviews, 3-264

how to get, 3-16

how to use online help, 3-263

on window, C-16

to dig deeper, 3-265

to enable full-text search, 3-266

Help menu, C-16

about TekScope, C-16

contents and index, C-16

customer feedback, C-16

help on window, C-16

restore help, C-16

specifications, C-16

technical support, C-16

Hi Res, 3-25

acquisition mode, Glossary-7

incompatible with fast acquisitions, 3-41

High, B-1, Glossary-7

High level, C-11

High/low method, 3-142

Histogram, 3-148

limit controls, 3-160

mean, 3-148

measurements, C-12

setup window, 3-158

Histogram counting

resetting, 3-158

starting, 3-158

Histograms, 3-49, 3-157, 3-165

Hits in box, B-3, C-12

Holdoff, C-8

A Trigger, 3-74

trigger, 3-66

Holdoff, trigger, Glossary-7

Horiz, C-12

Horiz/acq, run/stop, C-6

Horiz/acq menu

acquisition mode, C-6

autoset, C-5

delay mode on, C-6

equivalent time, C-6

fast acquisitions, C-5

FastFrame controls, C-6

FastFrame setup, C-6

horizontal/acquisition setup, C-5

interpolated real time, C-6

position/scale, C-6

real time only, C-6

resolution, C-6

roll mode auto, C-6

sampling modes, C-6

zoom controls, C-5

zoom setup, C-6

Horizontal

acquisition window, Glossary-7

acquisition window considerations, 3-20

acquisition window, illustrated, 3-21

bar cursors, Glossary-7

cursors, 3-151

delay, 3-108

position, 3-67, 3-122, 3-123

record length, 3-122

- reference, 3-120, 3-123
- scale, 3-21, 3-122
- zoom, 3-130
- Horizontal menu
  - FastFrame setup, 3-50, 3-54
  - frame count, 3-51
  - frame length%, 3-50
  - frame%, 3-51, 3-53
  - multiple frames, 3-51
- Horizontal offset, overview, 3-20
- Horizontal reference point, Glossary-7
- Horizontal scale and offset, setting up, overview, 3-20
- Horizontal scale vs. record length vs. sample interval
  - vs. resolution, 3-21
- Horizontal/acquisition setup, C-5
- Horizontal-scale readout, 3-120

## I

- Image, printing, 3-251
- Impulse response testing, 3-191
- Incoming inspection , test equipment, 1-21
- Incoming inspection procedure, 1-21-1-32
- Independent, C-11
  - trigger level, 3-69
- Independent vs. shared Window, 3-23
- Index, reference, 3-2
- Infinite persistence, 3-135, 3-136, C-9
  - display control window, 3-134
- Initialize, Glossary-8
- Input, 3-221
  - connector, 3-56
- Input conditioning background, 3-17
- Input coupling, 3-13
  - AC, 3-13
  - DC, 3-13
  - GND, 3-13
- install, hard drive, 1-12
- Installation, 1-5-1-20
  - incoming inspection procedure, 1-21
  - option, C-15
  - software installation, 1-13-1-15
- Instrument
  - diagnostics, C-15
  - id, C-16
  - setup, C-1
- Integral math waveform, 3-174
  - applications, 3-174
  - derivation of, 3-174
  - record length of, 3-174
- Integration, waveform, 3-173
- Inten samp, 3-135

- Intensified samples, 3-135, C-9
- Intensity, 3-46, Glossary-8
  - display menu, 3-46
  - Waveform, 3-133
- Interleaving, 3-40, Glossary-8
- Internal reference, 2-10, C-15
- Interpolated real time, C-6
- Interpolation, 3-39, 3-40, 3-133, 3-134, C-9,
  - Glossary-8
  - incompatible with DPO, 3-41
- Introduction, to this manual, xv

## J

- Jitter
  - 6 sigma, B-4, C-12
  - pk-pk, C-12
  - pk-pk measurement, B-4
  - RMS, B-4
  - rms, C-12
- JPEG, file format, 3-236

## K

- Kaiser-Bessel window, 3-192, 3-194, 3-199
- Knob, Glossary-8
  - multipurpose, 3-154, Glossary-10
  - resolution, Glossary-8
  - trigger MAIN LEVEL, 3-68

## L

- Label, C-1, C-4, C-14
- Label the waveform, 3-229
- LAN, enabling, 1-16
- LAN connection, 1-16
- Level, 3-69
  - A Trigger control window, 3-84, 3-88, 3-95
  - trigger, 3-67
- Level presets, 3-75
  - A Trigger, 3-76
- Line, trigger input, 3-64, 3-70
- Linear, 3-135, C-9
- Linear interpolation, 3-39, 3-134, Glossary-8
- Logic pattern setup, C-8
- Logic pattern, trigger, C-7
- Logic qualified trigger, 3-102
- Logic state setup, C-8
- Logic state, trigger, C-7
- Logic trigger, 3-80
  - definitions, 3-80



pattern, Glossary-9  
 state, 3-79, 3-80, Glossary-9  
 Logic triggering, 3-77  
 Logic, A Trigger control window, 3-98, 3-99  
   logic, 3-96  
   pulse, 3-83  
 Logic, main trigger menu, pulse, 3-89, 3-94  
 Low, B-2, Glossary-9  
 Low frequency compensation, 3-163  
 Low level, C-11  
 Low method, 3-142

## M

Magnitude spectrum, C-14  
 Magnitude versus frequency, 3-182  
 Main trigger menu  
   polarity, 3-85, 3-87  
   pulse, 3-89, 3-94  
   Set to 50%, 3-70  
   slope, 3-89  
   state, 3-98, 3-99  
   true for less than, 3-97  
   true for more than, 3-97  
   width, 3-83, 3-85  
 Manuals  
   part numbers, 1-35  
   related, xvi  
 Margins, printing, 3-251  
 Mask testing, 3-165  
 Math, overview, 3-167  
 Math color, 3-133  
 Math menu  
   Ch1 - Ch2, C-14  
   Ch1 \* Ch2, C-14  
   Ch3 - Ch4, C-14  
   Ch3 \* Ch4, C-14  
   display on/off, C-13, C-14  
   equation editor, C-14  
   label, C-14  
   magnitude spectrum, C-14  
   math setup, C-13, C-14  
   phase spectrum, C-14  
   position/scale, C-13, C-14  
   set math averages, C-14  
   spectral controls, C-14  
   spectral setup, C-14  
 Math setup, C-13, C-14  
 Math waveforms, 3-141, 3-142  
   apply averaging, 3-177  
   consider the source, 3-178  
   creating and using math waveforms, 3-167  
   cursor measurements, 3-173  
   defining math waveforms, 3-168  
   defining spectral math waveforms, 3-182  
     *See also* Spectral Math  
   derivative. *See* Derivative math waveform  
   derivative math waveform, illustration, 3-172  
   differentiation, 3-171  
   disallowed in DPO, 3-41  
   display the math control window, 3-175  
   expression syntax, 3-171  
   FastFrame, 3-169  
   functional transformation of an acquired waveform,  
     illustration, 3-168  
   how to create, 3-169  
   how to manage displaying, 3-178  
   incompatible with fast acquisitions, 3-41  
   integral. *See* Integral math waveform  
   offset, position, and scale, 3-173  
   operations on math waveforms, 3-177  
   peak-peak amplitude measurement of a derivative  
     waveform, illustration, 3-173  
   select a function, 3-176  
   select a math waveform, 3-175  
   select and display, 3-179  
   set scale and position, 3-180  
   source dependencies, 3-170  
   sources, 3-170  
   spectral analysis of an impulse, illustration, 3-167  
   spectral math waveforms, 3-182  
   take automatic measurements, 3-180  
   take cursor measurements, 3-181  
   to define a math waveform, 3-175  
   to define an expression, 3-175  
   to define/edit a math expression, 3-176  
   to use, 3-179  
   to use math waveforms, 3-179  
   using math, 3-169  
   using math waveforms, 3-178  
   waveform differentiation, 3-171  
   waveform integration, 3-173  
 MathCad, file format, 3-236  
 MathLab, file format, 3-236  
 Max, 3-146  
 Maximum, B-2, C-11, C-12, Glossary-9  
 Mean, 3-146, B-2, B-3, C-11, C-12, Glossary-9  
 Mean +- 1 stddev, B-3  
 Mean +- 2 stddev, B-3  
 Mean +- 3 stddev, B-3  
 Measure menu  
   all, C-12  
   amplitude, C-11  
   area, C-12

burst width, C-12  
 Comm, C-12  
 crossing %, C-12  
 cycle area, C-12  
 cycle distortion, C-12  
 cycle mean, C-11  
 cycle RMS, C-11  
 delay, C-12  
 ext ratio, C-12  
 ext ratio (dB), C-12  
 ext ratio %, C-12  
 eye height, C-12  
 eye top, C-12  
 eye width, C-12  
 fall time, C-12  
 frequency, C-12  
 gating, C-12  
 high level, C-11  
 histogram measurements, C-12  
 hits in box, C-12  
 Horiz, C-12  
 jitter 6 sigma, C-12  
 jitter pk-pk, C-12  
 jitter rms, C-12  
 low level, C-11  
 maximum, C-11, C-12  
 mean, C-11, C-12  
 mean +-1 stddev, C-12  
 mean +-2 stddev, C-12  
 mean +-3 stddev, C-12  
 measurement setup, C-11  
 median, C-12  
 minimum, C-11, C-12  
 more, C-12  
 neg duty cycle, C-12  
 neg overshoot, C-11  
 negative width, C-12  
 noise pk-pk, C-12  
 noise RMS, C-12  
 off, C-12  
 peak hits, C-12  
 peak-to-peak, C-11, C-12  
 period, C-12  
 phase, C-12  
 pos duty cycle, C-12  
 pos overshoot, C-11  
 positive width, C-12  
 reference levels, C-12  
 reset histograms, C-12  
 reset statistics, C-12  
 rise time, C-12  
 RMS, C-11  
 s/n ratio, C-12

snapshot, C-11  
 standard deviation, C-12  
 statistics, C-12  
 statistics controls, C-12  
 time, C-12  
 value count, C-12  
 value mean, C-12  
 Vert, C-12  
 waveform histograms, C-12  
 Measurement, C-3, Glossary-9  
 amplitude, B-1, Glossary-1  
 annotation, 3-146  
 area, B-1, Glossary-2  
 burst width, B-1, Glossary-2  
 crossing %, B-4  
 cycle area, B-1, Glossary-3  
 cycle mean, B-1, Glossary-3  
 cycle RMS, B-1, Glossary-3  
 delay, Glossary-4  
 duty cycle, Glossary-10, Glossary-12  
 duty cycle distortion, B-5  
 extinction ratio, B-4  
 extinction ratio %, B-4  
 extinction ratio dB, B-4  
 eye base, B-4  
 eye height, B-4  
 eye top, B-4  
 eye width, B-4  
 fall time, B-1  
 frequency, B-1, Glossary-6  
 gated, Glossary-6  
 high, B-1, Glossary-7  
 hits in box, B-3  
 jitter 6 sigma, B-4  
 jitter pk-pk, B-4  
 jitter RMS, B-4  
 low, B-2, Glossary-9  
 maximum, B-2, Glossary-9  
 mean, B-2, B-3, Glossary-9  
 mean +- 1 stddev, B-3  
 mean +- 2 stddev, B-3  
 mean +- 3 stddev, B-3  
 median, B-3  
 minimum, B-2, Glossary-10  
 negative duty cycle, B-2  
 negative overshoot, B-2  
 negative width, B-2  
 noise pk-pk, B-4  
 noise RMS, B-4  
 overshoot, Glossary-12  
 parameter, Glossary-9  
 peak hits, B-3  
 peak-to-peak, B-2, Glossary-11

- period, B-2, Glossary-11
- phase, B-2, Glossary-12
- pk-pk, B-3
- positive duty cycle, B-2
- positive overshoot, B-3
- positive width, B-3
- propagation delay, B-1
- quality factor, B-5
- rise time, B-3, Glossary-14
- RMS, B-3, Glossary-14
- S/N ratio, B-5
- setup, C-11
- statistics, 3-146, Glossary-9
- stddev, B-3
- tracking, Glossary-10
- undershoot, Glossary-10
- waveform count, B-3
- width, Glossary-11, Glossary-12
- Measurement accuracy, ensuring maximum, 3-160-3-166
- Measurements, C-2
  - automated, 3-140
  - Classes of, 3-139
  - cursor, 3-151
  - eye diagram, B-6
  - high and low levels defined, B-6
  - levels used in taking, B-5, B-6
  - reference levels defined, B-6
  - reference levels defined (eye pattern/optical), B-7
- Measuring waveforms, 3-139
  - absolute reference, 3-143
  - access gating, 3-150
  - annotate measurement, 3-146
  - annotate waveforms on screen, 3-140
  - annotated display, 3-141
  - automatic measurements, 3-140
  - calibrate the oscilloscope, 3-161
  - change cursor position, 3-155
  - channel, 3-141, 3-142
  - check the calibration status, 3-161
  - components determining time cursor readout values, 3-153
  - connect the probe calibration fixture, 3-162
  - cursor, 3-150
  - cursor measurements, 3-140
  - cursor types, 3-151, 3-152
  - cursor units depend on sources, 3-154
  - cursors are display limited, 3-152
  - cursors ignore the selected waveform, 3-152
  - cursors treat sources independently, 3-153
  - customize measurements, 3-141
  - display measurement statistics, 3-146
  - display the calibration instructions, 3-161
  - display the cursor controls window, 3-155
  - enable & position the gates, 3-150
  - FastFrame, 3-142
  - gates, 3-141
  - gating, 3-150
  - graticule, cursor and automatic measurements, 3-140
  - high/low method, 3-142
  - histogram, 3-142, 3-148
  - histogram counting, 3-158
  - histogram counting stays on, 3-158
  - histogram mean, 3-143, 3-148
  - histogram measurements, 3-160
  - histogram size, 3-158
  - horizontal cursors, 3-151
  - horizontal histogram view and measurement data, illustrated, 3-157
  - indep, cursor, 3-156
  - low frequency compensation, 3-163
  - math waveforms, 3-141, 3-142
  - max, 3-146
  - mean, 3-146
  - measure part of a waveform, 3-141
  - measurement gating, 3-150
  - measurement selection, 3-142
  - measurement sources, 3-142
  - min, 3-146
  - min-max, 3-143, 3-148
  - multipurpose knobs, 3-154
  - noise, 3-143
  - number of measurements, 3-142
  - open histogram setup window, 3-158
  - optimizing measurement accuracy, 3-160
  - paired cursors, 3-151
  - reference levels method, 3-143
  - reference-level calculation methods, 3-144
  - references, 3-141, 3-142
  - relative reference, 3-143
  - remove measurements, 3-145
  - see statistics on measurement results, 3-141
  - select a cursor type, 3-155
  - select measurement parameters, 3-141
  - select measurement sources, 3-141
  - select the cursor sources, 3-155
  - select the waveform, 3-145
  - set cursor style, 3-156
  - set cursor tracking, 3-156
  - set display and reset histogram source and type, 3-159
  - set histogram display options, 3-159
  - set histogram limit controls, 3-160
  - set measurement reference levels, 3-147, 3-148
  - signal type, 3-143

- sources, 3-141, 3-142
- split cursors, 3-151
- standard deviation, 3-146
- statistics, 3-141
- take a snapshot of measurements, 3-149
- take measurements on a frame, 3-142
- taking automatic measurements, 3-140
- taking cursor measurements, 3-151
- taking histograms, 3-157, 3-165
- to calibrate probes, 3-162
- to compensate passive probes, 3-163
- to compensate the oscilloscope, 3-160
- to deskew channels, 3-162
- to set the cursor sources, 3-155
- to start and reset histogram counting, 3-158
- to take automatic measurements, 3-144
- tracking, cursor, 3-156
- using automatic measurements, 3-142
- using cursors, 3-152
- using histograms, 3-158
- vertical cursors, 3-151
- vertical cursors measure from the trigger point, 3-153
- zoom, 3-150

Median, B-3, C-12

Mesial, Glossary-10

Min, 3-146

- take automatic measurements, 3-145

Minimize, C-2

Minimum, B-2, C-11, C-12, Glossary-10

Min-max, 3-148

Mode, Glossary-10

- acquisition, 3-35, C-6
- trigger, C-8

Monochrome gray, C-10

Monochrome green, C-10

More, C-12

Mouse, 3-123

Multimode cable, Glossary-10

Multipurpose knob, Glossary-10

Multipurpose knobs, 3-154, C-15

MultiView zoom, 3-125–3-138

- See also* Zoom
- feature, 3-125

MyScope, using, 3-260

MyScope control window, 3-257

## N

NAND, Glossary-10

NAND, A Trigger control window, 3-96, 3-98, 3-103

Neg duty cycle, C-12

Neg overshoot, C-11

Negative duty cycle, B-2

Negative overshoot, B-2

Negative width, B-2, C-12

Negative, A Trigger control window, 3-83, 3-85, 3-87, 3-89

Net offset, A-6, A-7

Network connection, 1-16

No persistence, C-9

Noise

- pk-pk, C-12
- pk-pk measurement, B-4
- reducing in phase FFTs, 3-210
- reducing in phase waveforms, 3-190
- RMS, B-4, C-12

NOR, Glossary-11

NOR, A Trigger control window, 3-96, 3-98, 3-103

Normal trigger mode, 3-65, 3-71, Glossary-11

Normal, display, C-10

Numeric, file format, 3-235

Nyquist frequency, 3-204

## O

O/E electrical out to Ch1 input adapter, 3-57

O/E converter, 3-55

O/E to SMA adapter, 3-57

Objects, display, C-9

Off, C-12

Offset, C-4

- DC. *See* DC Offset
- vertical, 3-18, 3-173, 3-174

Online help, 3-263

Operating requirements, 1-7

Optical

- dark compensation, 3-58
- input connector, 3-56
- O/E electrical out to Ch1 input adapter, 3-57
- O/E to SMA adapter, 3-57
- wavelength gain compensation, 3-58

Optical-to-electrical converter, Glossary-11

Option installation, 1-15, C-15

Option key, 1-15

Option software, 1-15

Optional accessories, 1-36

Options key, C-16

Options list, C-16

OR, Glossary-11

OR, A Trigger control window, 3-96, 3-98, 3-103

Orientation, printing, 3-251

Output, 3-221

Outputs, 3-56

Overshoot, Glossary-12

## P

Page preview, 3-252

Page setup, C-2

Palette, printing, 3-251

Paper, printing, 3-251

Pattern trigger, 3-79, 3-95

    how to setup, 3-96

pcAnywhere, C-10

Peak detect, 3-25, 3-30

Peak detect acquisition mode, Glossary-11

Peak hits, B-3, C-12

Peak-to-peak, B-2, C-11, C-12, Glossary-11

Performance verification, 1-14

    of functions, 1-23

    self tests, 1-22

Period, B-2, C-12, Glossary-11

Peripheral, connecting, 1-7

Persistence, 3-134

Persistence controls, C-9

Phase, B-2, C-12, Glossary-12

Phase spectrum, C-14

Phase suppression, 3-190

Phase verses frequency, 3-182

Pixel, Glossary-12

Pk-pk, B-3

Plug&play software, 1-13-1-20

PNG, file format, 3-236

Polarity and width, A Trigger control window, 3-83,  
3-85, 3-87

Polarity, main trigger menu, 3-85, 3-87

Pos duty cycle, C-12

Pos overshoot, C-11

Position, vertical, 3-173, 3-174, C-4

Position/scale, C-1, C-4, C-6, C-13, C-14

Positive duty cycle, B-2

Positive overshoot, B-3

Positive width, B-3, C-12

Positive, A Trigger control window, 3-83, 3-85, 3-87,  
3-89

Posttrigger, 3-64, Glossary-12

Powering off, 1-10

Powering on, 1-9

Preferences, C-15

Pretrigger, 3-64, Glossary-12

Principal power switch, Glossary-12

Print, C-2

Print preview, 3-253, C-2

Printing, 3-250

    waveforms, 3-250

Probe

    accessories, 1-36

    cal, C-4

    calibrate, 3-162

    calibration fixture, 3-162

    compensation, Glossary-13

    definition, Glossary-13

    low frequency compensation, 3-163

Probe-channel deskew, 3-162, Glossary-3

Probes and signal connection, 3-9

Product

    accessories, 1-33

    description, 1-1

    software, 1-3

Programmer help, 1-14

Propagation delay, B-1

Proximal, Glossary-13

Pulse trigger, Glossary-13

Pulse triggering, 3-77

    A Trigger control window, 3-85

Pulse, A Trigger control window, 3-83, 3-87, 3-89,  
3-94

## Q

Q factor, B-5

Quality factor, B-5, C-12

Quantizing, Glossary-13

Quitting the application, 1-15

## R

Window trigger, C-7

Radian, 3-210

Range, vertical input, 3-18

Readout

    channel, 3-130

    cursor, V-bars, 3-214

    trigger, 3-72

Real time only, C-6

Real time, acquisition controls, 3-31

Real-time sampling, 3-37, Glossary-13

Recall default setup, C-1

Recall waveform, C-1

Recalling a setup, 3-221

Recalling a waveform, 3-227

Recent setup file, C-2

Record, acquisition, shared by all channels, 3-23

Record length, 3-21, 3-122, 3-183, Glossary-13  
    defined, 3-36

    derivative math waveforms, 3-172

- integral math waveforms, 3-174
- Recovered
  - clock, 3-55, 3-56, 3-65, 3-117, Glossary-13
  - data, 3-55, 3-56
- Rectangular window, 3-192, 3-194, 3-197, 3-211
- Reference
  - clock, 2-10, C-15
  - color, 3-132
  - levels, 3-147, 3-148
  - levels method, 3-143
  - memory, Glossary-13
  - setup, C-1
  - waveforms, C-1, Glossary-13
- Reference selection, C-15
- Reference-level calculation methods, 3-144
- References, 3-141, 3-142
  - clear, 3-233
  - clearing, 3-233
  - delete, 3-233
- Related manuals, xvi
- Relative reference, 3-143
- Release notes, for plug & play software, 1-13
- Remote communication, 3-255
- Remote control, C-10
- Remote display, C-10
- removable hard drive, 1-12
- Remove measurements, 3-145
- remove the hard drive, 1-11
- Repetitive signal, 3-31
- Reset all, C-9
- Reset histogram counting, 3-158
- Reset histograms, C-12
- Reset statistics, C-12
- Reset zoom factors, zoom menu, 3-130
- Resolution, 3-21, 3-183, C-6
- Resolution bandwidth, 3-186, 3-212
- Restore application, C-14
- Restore help, C-16
- Right-click map, 2-6
- Rise time, B-3, C-12, Glossary-14
- Rising edge, A Trigger control window, 3-98, 3-100
- RMS, B-3, C-11, Glossary-14
- Roll mode
  - auto, C-6
  - illustrated, 3-28
  - incompatible with fast acquisitions, 3-41
  - untriggered, 3-28
  - untriggered, with single sequence, 3-28
  - using, 3-33
- Run application, C-14
- RUN/STOP, 3-30, 3-49
- Run/stop, C-6, C-8
- Run/Stop button only, 3-27

- Runt setup, C-8
- Runt trigger, 3-78, C-7, Glossary-14
  - A Trigger control window, 3-85
  - how to set up, 3-85-3-118
  - how to setup, 3-102

## S

- S/N ratio, B-5, C-12
- Sample, 3-24, 3-30
- Sample acquisition mode, Glossary-14
- Sample interval, 3-21, Glossary-14
  - defined, 3-36
- Sample rate, maximum, 3-40
- Samples, number of, 3-27
- Sampling, 3-37, Glossary-14
  - modes, C-6
  - process, defined, 3-35
  - process, illustrated, 3-35-3-40
- Sampling and acquisition mode, 3-37
- Save format, export, 3-235
- Save waveform, C-1
- Saving a setup, 3-221
- Saving a waveform, 3-227
- Scale, 3-122
  - horizontal, C-6
  - vertical, 3-173, C-1, C-4
- Scaling and positioning, 3-10
- Screen, C-11
- Screen text, 3-132, C-9, Glossary-14
- Second monitor setup, 1-17
- Select for copy, C-3
- Select for export, C-2
- Select input coupling, 3-13
- Select slope, 3-89
- Select the input signal channel, 3-12
- Select waveform interpolation, 3-135
- Selected waveform, Glossary-15
- Selecting zoom, 3-127
- Sequential triggering, 3-103
- Serial number, C-16
- Serial pattern setup, C-8
- Serial pattern triggering, 3-117
- Serial pattern, trigger, C-7
- Set FFT vert scale, 3-209
- Set horizontal acquisition window, 3-14
- SET LEVEL TO 50% button, 3-70
- Set math averages, C-14
- Set thresholds, A Trigger control window, 3-96, 3-98, 3-103
- Set time & date, C-15
- Set to 50%, main trigger menu, 3-70

- Set to ECL, A Trigger control window, 3-90
- Set to TTL, A Trigger control window, 3-90
- Set vertical acquisition window, 3-13
- Set/hold trigger, 3-81
- Setting, Glossary-14
- Setting acquisition controls, 3-23
- Setting vertical range and position, 3-19
- Setup
  - control window, Glossary-14
  - dual display, 1-17
  - file, C-2
  - recalling, 3-221
  - saving, 3-221
  - second monitor, 1-17
- Setup and hold trigger, how to setup, 3-102
- Setup/hold setup, C-8
- Setup/hold trigger, 3-80, C-7
  - how to set up, 3-99
  - maximum hold time, 3-81
  - negative setup or hold times, 3-81
  - positive setup or hold times, 3-81
  - trigger point location, 3-81
- Shared, trigger level, 3-69
- Shutdown, C-2
- Shutting down, 1-10
- Signal connection and conditioning, 3-8
- SIGNAL OUTPUT, 2-9, 2-10
- Signal path compensation, 3-160–3-166
- Sin(x)/x, 3-135, C-9
- Sin(x)/x interpolation, 3-39, 3-134, Glossary-8
- SINGLE, 3-28, 3-30
- Single sequence, 3-28
- Single sequence off, 3-30
- SINGLE TRIG button, 3-77
- Single-shot sampling, 3-37
- Single-mode cable, Glossary-15
- Site considerations, 1-6
- Size, zoom, C-5, C-7
- Slew rate trigger, 3-79, Glossary-15
  - 600 ps limitation, 3-91
  - 7.5 ns limitation, 3-91
  - how to set up, 3-89–3-118
- Slope, 3-69, Glossary-15
- Slope, main trigger menu, 3-89
- Slope, trigger, 3-67
- Snapshot, C-11
- Snapshot of measurements, 3-149
- Software, upgrade, 1-3
- Software installation, 1-13–1-15
- Source, A Trigger control window, 3-83, 3-85, 3-87, 3-89, 3-94
- Sources, 3-141, 3-142
- Span, 3-185
- Specifications, A-1
  - help menu, C-16
- Spectral analysis, displaying phase, 3-210
- Spectral analyzer controls, 3-212
- Spectral averaging, 3-182
- Spectral controls, C-14
- Spectral grading, C-10
- Spectral Math, reference level, 3-188
- Spectral math
  - 3 dB BW in bins, 3-194
  - acquisition mode, 3-204
  - affects of frequency domain control adjustments, illustrated, 3-187
  - affects of trigger jitter, 3-203
  - aliasing, 3-204
  - averaging, 3-204
  - bandwidth, 3-212
  - Blackman-Harris, 3-192, 3-194, 3-199, 3-211
  - center, 3-186
  - center frequency, 3-212, 3-214
  - coefficients, 3-194, 3-195
  - coherent gain, 3-194
  - dB, 3-188, 3-209
  - dBm, 3-188, 3-209
  - defining spectral math waveforms, 3-182
  - definition of gate parameters, illustrated, 3-185
  - degree, 3-210
  - display the math control window, 3-206, 3-207
  - display the spectral waveform, 3-208
  - duration, 3-183, 3-213
  - duration and resolution control effects, illustrated, 3-184
  - example, 3-215
  - example of scallop loss for a Hanning Window without zero fill, illustration, 3-195
  - example of the effects of setting the phase suppression threshold, illustrated, 3-191
  - FFT length, 3-193
  - Flattop2 window, 3-192, 3-194, 3-201, 3-211
  - frequency domain controls, 3-182
  - frequency domain span, 3-213
  - frequency range, 3-212
  - frequency span, 3-212
  - gate controls, 3-184
  - gate duration, 3-213
  - gate position, 3-213
  - gating controls, 3-182
  - Gaussian window, 3-192, 3-194, 3-196, 3-211
  - group delay, 3-191, 3-210
  - Hamming window, 3-192, 3-194, 3-198, 3-211
  - Hanning window, 3-192, 3-194, 3-199, 3-211

- how aliased frequencies appear in a spectral waveform, illustrated, 3-205
- impulse response testing, 3-191
- Kaiser-Bessel window, 3-192, 3-194, 3-199, 3-211
- linear, 3-188, 3-209
- magnitude versus frequency, 3-182
- multiple analyzer control locks, 3-183
- nearest side lobe, 3-194, 3-195
- phase reference point, 3-213
- phase reference position, 3-190
- phase unwrap, 3-190
  - algorithm, 3-190
  - dejitter, 3-190
- phase versus frequency, 3-182
- radian, 3-210
- real and imaginary magnitudes, 3-189
- recognizing aliasing, 3-204
- record length, 3-183, 3-213
- Rectangular window, 3-192, 3-194, 3-197, 3-211
- reducing noise, 3-210
- reference level offset, 3-189
- resolution, 3-183, 3-213
- resolution bandwidth, 3-186, 3-212, 3-213
- sample rate, 3-212, 3-213
- scale factor, 3-209, 3-210
- scallop Loss, 3-194
- scallop loss, 3-194
- select a predefined spectral analysis math waveform, 3-206
- select a spectral waveform, 3-207
- select spectral analysis setup, 3-207
- select the window type, 3-211
- set the frequency domain controls, 3-212
- set the magnitude scale, 3-209
- set the phase scale, 3-210
- set the time domain controls, 3-213
- set time and frequency domain control tracking, 3-211
- setup, C-14
- span, 3-185
- spectral analyzer controls, 3-183
- spectral averaging, 3-182
- suppression threshold, 3-190
- swept sine wave analysis, 3-206
- take cursor measurements, 3-214
- Tek Exponential window, 3-192, 3-194, 3-203, 3-211
- Tek Exponential window in the time and the frequency domains, illustration, 3-203
- time and frequency domain graphs for the Flattop2 window, illustration, 3-202
- time and frequency domain graphs for the Rectangular window, illustration, 3-197
- time and frequency graphs for the Gaussian Window, illustration, 3-196
- time and frequency graphs for the Hanning window, illustration, 3-199
- time and frequency graphs for the Kaiser-Bessel window, illustration, 3-200
- time and frequency graphs of the Blackman-Harris window, illustration, 3-201
- time and frequency graphs of the Hamming window, 3-198
- time domain controls, 3-182
- to define a spectral math waveform, 3-207
- to select a predefined spectral math Waveform, 3-206
- to take automated measurements of a spectral math waveform, 3-205
- to take cursor measurements of a spectral math waveform, 3-205
- unwrap phase, 3-210
- using spectral math controls, 3-183
- using the frequency domain controls, 3-185
- using the gate controls, 3-184
- using the magnitude controls, 3-188
- using the phase controls, 3-190
- using the time controls, 3-183
- using windows to filter, 3-192
- window characteristics, 3-192, 3-194
- window functions, 3-182
- windowing the time domain record, illustrated, 3-193
- zero phase reference, 3-194, 3-195
- Spectral math waveform
  - aliasing, 3-204
  - phase suppression, 3-190
  - undersampling, 3-204
  - zero phase reference, 3-195
- Spectral math waveforms. *See* Spectral Math
- Split cursors, 3-151
- Spreadsheet, file format, 3-236
- Standard, accessories, 1-35
- Standard deviation, 3-146, C-12
- Start histogram counting, 3-158
- State, main trigger menu, 3-98, 3-99
- State trigger, 3-80, 3-98
  - how to set up, 3-98
- Statistical measurement, Glossary-15
- Statistics, 3-146, C-12
  - controls, C-12
  - on measurement results, 3-141



Status, calibration, 3-161  
Stddev, B-3

## T

Trig events, A->B Seq Trigger control window, 3-110  
Technical support, C-16  
Tek Exponential window, 3-192, 3-194, 3-203  
Tek Secure, 3-233, C-15, Glossary-15  
TekVISA, 2-2  
Temperature compensation, 3-160–3-166  
Temperature grading, C-10  
Termination, C-4  
Test equipment, for incoming inspection, 1-21  
Text  
    file format, 3-235  
    On screen, 3-132  
    on screen, C-9  
Thresholds, A Trigger control window, 3-86, 3-90  
Time, C-12  
    get current, 3-254  
Time base, Glossary-16  
Time cursor readout values, 3-153  
Time domain controls, 3-182  
Timebase, 3-122  
Timeout trigger, 3-79, 3-94, C-7, Glossary-16  
    A Trigger control window, 3-94  
    how to set up, 3-94, 3-102  
Timer, A Trigger control window, 3-94  
To autoselect the instrument, 3-15  
To get more help, 3-16  
To reset the instrument, 3-16  
Touch screen, 3-120, 3-123  
Trace, Glossary-16  
Trace expression, Glossary-16  
Track, C-11  
Transition  
    setup, C-8  
    trigger, 3-79, C-7  
Transition trigger, how to setup, 3-102  
Trig delay, A Trigger control window, 3-110  
Trigger, 3-64, Glossary-16  
    A Only, 3-109  
    AC line voltage, 3-64, 3-70  
    auxiliary, 3-64, 3-70  
    coupling, 3-67  
    delay, 3-68  
    edge, 3-65, Glossary-5  
    glitch, 3-78, 3-83, 3-102, Glossary-6  
    holdoff, 3-66  
    independent level, 3-69  
    level, 3-67, 3-69, Glossary-16  
    level marker, 3-133  
    line, 3-64, 3-70  
    logic, 3-77, 3-80  
    marker, 3-133  
    mode, 3-65  
    overview, 3-63  
    pattern, 3-79, 3-96  
    position, 3-67  
    pulse, 3-77  
    readout, 3-72  
    runt, 3-78, 3-85, 3-102, Glossary-14  
    setup, C-7  
    setup and hold, 3-102  
    setup/hold, 3-80, 3-81, 3-99  
    shared level, 3-69  
    slew rate, 3-79, Glossary-15  
    slope, 3-67, 3-69  
    source, 3-64  
    state, 3-80, 3-98  
    status lights, 3-72  
    T, 3-133, C-10  
    timeout, 3-79, 3-94, 3-102, Glossary-16  
    transition, 3-79, 3-102  
    types, 3-69  
    width, 3-78, 3-87, 3-102  
    window, 3-79, 3-92, 3-102  
Trigger after A, 3-110, 3-116  
Trigger after events, 3-110  
Trigger after time, 3-110, 3-116  
    how to set up, 3-110  
Trigger and display, 3-11  
Trigger events, A->B Seq Trigger control window, 3-110  
Trigger MAIN LEVEL knob, 3-68, 3-69  
Trigger menu  
    a event (main) trigger setup, C-7  
    a->b trigger sequence, C-8  
    b event (delayed) trigger setup, C-8  
    comm, C-7  
    comm setup, C-8  
    edge, C-7  
    edge setup, C-8  
    glitch, C-7  
    glitch setup, C-8  
    holdoff, C-8  
    logic pattern, C-7  
    logic pattern setup, C-8  
    logic state, C-7  
    logic state setup, C-8  
    mode, C-8  
    quick select, C-7  
    run/stop, C-8

- runt, C-7
- runt setup, C-8
- serial pattern, C-7
- serial pattern setup, C-8
- setup/hold, C-7
- setup/hold setup, C-8
- timeout, C-7
- timeout setup, C-8
- transition, C-7
- transition setup, C-8
- width, C-7
- width setup, C-8
- window, C-7
- window setup, C-8
- Trigger point, defined, 3-36
- Trigger when
  - A Trigger, 3-97
  - A Trigger control window, 3-96, 3-99
  - transition is <, A Trigger control window, 3-91
  - transition time >, A Trigger control window, 3-91
- Trigger, delayed, how to set up, 3-110
- Trigger, glitch, how to set up, 3-83
- Trigger, runt, how to set up, 3-85-3-118
- Trigger, slew rate, how to set up, 3-89-3-118
- Trigger, timeout, how to set up, 3-94
- Trigger, width, how to set up, 3-87-3-118
- Triggering
  - advanced, 3-65
  - advanced triggering, 3-77
  - comm triggering, 3-65, 3-117
  - define inputs, 3-98
  - define logic, 3-98
  - define the clock source and edge, 3-100
  - define the data source, 3-100
  - delayed trigger system, 3-68
  - edge, 3-65
  - glitch trigger, 3-78
  - horizontal position, 3-67
  - logic qualify, 3-102
  - logic trigger definitions, 3-80
  - overview of, 3-63
  - pattern trigger, 3-79
  - posttrigger, 3-64
  - pretrigger, 3-64
  - runt trigger, 3-78
  - select glitch triggering, 3-83
  - select runt triggering, 3-85
  - select setup/hold Triggering, 3-99
  - select the polarity, 3-85, 3-87
  - select the polarity and width, 3-83
  - select the source, 3-83, 3-85, 3-87, 3-89, 3-94
  - select timeout triggering, 3-94
  - select transition triggering, 3-89
  - select width triggering, 3-87
  - sequential trigger reset, 3-109
  - sequential triggering, 3-103
  - serial pattern triggering, 3-65, 3-117
  - set the data and clock levels, 3-100
  - set the level, 3-84, 3-88, 3-95
  - set the setup and hold times, 3-101
  - set the thresholds, 3-86
  - set the timer, 3-94
  - set the transition time, 3-90
  - set thresholds, 3-98
  - set to trigger if width, 3-84
  - set to trigger when, 3-85, 3-88, 3-91, 3-94
  - set trigger when, 3-99
  - Setting mode and holdoff, 3-93
  - setup/hold trigger, 3-80
  - slope and level, 3-67
  - state trigger, 3-80
  - the trigger event, 3-64
  - timeout trigger, 3-79
  - to check trigger status, 3-72
  - to define a time qualified pattern trigger, 3-97
  - to define new trigger level presets, 3-76
  - to define pattern inputs, 3-96, 3-103
  - to define the logic, 3-96, 3-103
  - to force a trigger, 3-76
  - to logic qualify a trigger, 3-102
  - to reset sequential triggers, 3-111, 3-112, 3-113
  - to select a preset trigger level, 3-75
  - to select the trigger mode, 3-71
  - to select the trigger slope, 3-69
  - to select the trigger source, 3-70
  - to select the trigger type, 3-69
  - to set holdoff, 3-74
  - to set level, 3-69
  - to set mode and holdoff, 3-84, 3-87, 3-88, 3-91, 3-95, 3-97, 3-99, 3-101
  - to set the trigger coupling, 3-71
  - to set thresholds, 3-96, 3-103
  - to set to 50%, 3-70
  - to set trigger when, 3-96
  - to set up B Triggering, 3-115
  - to single trigger, 3-77
  - to trigger based on transition time, 3-89
  - to trigger on A (Main) only, 3-109
  - to trigger on a glitch, 3-83
  - to trigger on a pattern, 3-96
  - to trigger on a runt pulse, 3-85
  - to trigger on a state, 3-98
  - to trigger on B After Time, 3-110
  - to trigger on B Events, 3-110
  - to trigger on setup/hold time violations, 3-99
  - transition trigger, 3-79

- trigger and horizontal delay summary, 3-108
- trigger based on pulse timeout, 3-94
- trigger based on pulse width, 3-87
- trigger coupling, 3-67
- trigger holdoff, 3-66
- trigger location and level from display, 3-73
- trigger modes, 3-65
- trigger on a pattern, 3-95
- Trigger on a window, 3-92
- trigger sources, 3-64, 3-104
- trigger status from acquisition readout, 3-72
- trigger status from trigger status lights, 3-72
- trigger types, 3-65, 3-104
- triggering concepts, 3-64
- triggering from the front panel, 3-68
- triggering with horizontal delay off, 3-104
- triggering with horizontal delay on, 3-106, 3-107
- using sequential triggering, 3-104
- width, 3-78
- window trigger, 3-79
- Triggering from the front panel, 3-68
- True for less than, main trigger menu, 3-97
- True for more than, main trigger menu, 3-97
- TRUE, A Trigger control window, 3-96, 3-99
- TTL, 3-84, 3-90, 3-95, 3-100
  - A Trigger level, 3-76
  - trigger level, 3-75

## U

- Undershoot, Glossary-10
- Undo autose, C-3, C-5
- Unpacking, 1-5
- Update, software, 1-3
- Upgrade, software, 1-3
- User files, backing up, 1-11
- User palette, C-10
- User preferences, C-15
- USER, A Trigger level, 3-75, 3-76
- Using the acquisition controls, 3-24
- Using the waveform display, 3-119
- Utilities menu
  - AUX Out configuration, C-15
  - external signals, C-15
  - GPIB configuration, C-15
  - instrument calibration, C-15
  - instrument diagnostics, C-15
  - multipurpose knobs, C-15
  - option installation, C-15
  - reference selection, C-15
  - set time and date, C-15
  - Tek Secure, C-15

- user preferences, C-15

## V

- Value count, C-12
- Value mean, C-12
- Variable persistence, 3-135, 3-136, C-9
  - display control window, 3-134
- Varying vertical offset, 3-20
- V-bars, C-11
- Vectors, 3-132, 3-134, C-9
  - display control window, 3-134
- Vectors display, incompatible with DPO, 3-41
- Verification, incoming inspection procedure, 1-21
- Version number, C-16
- Vert, C-12
- Vertical
  - acquisition window, Glossary-16
  - acquisition window considerations, 3-18
  - bar cursors, Glossary-16
  - control window, deskew, 3-162
  - cursors, 3-151, 3-153
  - deskew, 3-162, Glossary-3
- Vertical menu
  - attenuation, C-4
  - bandwidth, C-4
  - coupling, C-4
  - deskew, C-4
  - display on/off, C-4
  - label, C-4
  - offset, C-4
  - position/scale, C-4
  - probe cal, C-4
  - termination, C-4
  - vertical setup, C-4
  - zoom controls, C-4
  - zoom setup, C-5
- Vertical offset, 3-122
  - discussion on setting, 3-18
- Vertical position, 3-122
- Vertical range, discussion on setting, 3-18
- Vertical scale, 3-122
- Vertical scale and offset
  - illustrated, 3-19
  - uses for, 3-9
- Vertical setup, C-4
  - purpose, 3-9
- Vertical window, overview, 3-17, 3-18
- View, printing, 3-251
- Virtual keyboard, control window, 3-221, 3-228
- VNC, C-10
- Voltage

overrange and underrange points, 3-18  
overview, 3-18

## W

Waveform, C-2, C-3, C-11, Glossary-16  
acquiring and displaying of, 3-7  
clipping. *See* Clipping  
copying, 3-235  
count, B-3  
database, 3-26, 3-30, 3-49, Glossary-17  
differentiation, 3-171  
Display, 3-133  
display, 3-121  
display on, C-10  
displaying, 3-119  
exporting, 3-235  
FFTs, 3-182  
histograms, C-12  
integration, 3-173  
intensity, 3-133  
interpolation, 3-133, C-9  
interval, Glossary-17  
printing, 3-250  
recalling, 3-227  
save formats, 3-235  
saving, 3-227  
Waveform clipping. *See* Clipping  
Waveform intensity, display menu, 3-46  
Waveform record, 3-36  
definition applied to all channels, 3-23  
illustrated, 3-36, 3-153  
spectral source, long versus short, 3-183  
Waveforms  
and zoom, 3-126  
clear, 3-233  
delete, 3-233  
Measuring, 3-139  
Wavelength, selection, 3-59  
Width, Glossary-11, Glossary-12  
setup, C-8  
trigger, C-7  
Width trigger, 3-78, 3-87  
A Trigger control window, 3-87  
how to set up, 3-87-3-118  
how to setup, 3-102  
main trigger menu, 3-83, 3-85  
Window, 3-192  
Blackman-Harris, 3-211  
characteristics, 3-192, 3-194  
Flattop2, 3-211  
functions, 3-182

Gaussian, 3-211  
Hamming, 3-211  
Hanning, 3-211  
Kaiser-Bessel, 3-211  
rectangular, 3-211  
rectangular vs. bell-shaped, 3-197  
selecting, 3-193  
setup, C-8  
Tek Exponential, 3-211  
trigger, 3-79  
Window trigger  
defining limits, 3-93  
how to set up, 3-102  
logic inputs, 3-93  
setting up, 3-92  
Source, 3-92  
threshold levels, 3-92  
trigger if, 3-93  
Windows, descriptions of, 3-211

## X

XY, C-9  
format, 3-47, Glossary-17  
XYZ, C-9  
format, 3-47, Glossary-17

## Y

YT, C-9  
format, 3-47, Glossary-17

## Z

Zero phase reference point, 3-195  
establishing for impulse testing, 3-195  
Zoom, 3-121, 3-122, 3-125-3-138, 3-150  
100%, C-5, C-7  
50/50%, C-5, C-7  
80/20%, C-5, C-7  
a waveform, 3-128  
and waveforms, 3-126  
button, 3-127  
controls, C-4, C-5  
feature, 3-125  
graticule, C-5, C-7  
graticule size, C-7  
incompatible with fast acquisitions, 3-41  
lock, 3-131  
reset zoom factors, 3-130  
scroll, 3-131

setup, 3-122, C-5, C-6

Size, C-5

