

MS9710C
Optical Spectrum Analyzer
Operation Manual

11th Edition

**For safety and warning information, please read this manual before attempting to use the equipment.
Keep this manual with the equipment.**

ANRITSU CORPORATION

Safety Symbols

To prevent the risk of personal injury or loss related to equipment malfunction, Anritsu Corporation uses the following safety symbols to indicate safety-related information. Ensure that you clearly understand the meanings of the symbols BEFORE using the equipment. Some or all of the following symbols may be used on all Anritsu equipment. In addition, there may be other labels attached to products that are not shown in the diagrams in this manual.

Symbols used in manual

DANGER  This indicates a very dangerous procedure that could result in serious injury or death if not performed properly.

WARNING  This indicates a hazardous procedure that could result in serious injury or death if not performed properly.

CAUTION  This indicates a hazardous procedure or danger that could result in light-to-severe injury, or loss related to equipment malfunction, if proper precautions are not taken.

Safety Symbols Used on Equipment and in Manual

The following safety symbols are used inside or on the equipment near operation locations to provide information about safety items and operation precautions. Ensure that you clearly understand the meanings of the symbols and take the necessary precautions BEFORE using the equipment.



This indicates a prohibited operation. The prohibited operation is indicated symbolically in or near the barred circle.



This indicates an obligatory safety precaution. The obligatory operation is indicated symbolically in or near the circle.



This indicates a warning or caution. The contents are indicated symbolically in or near the triangle.



This indicates a note. The contents are described in the box.



These indicate that the marked part should be recycled.

MS9710C
Optical Spectrum Analyzer
Operation Manual

24 February 1999 (First Edition)
26 December 2008 (11th Edition)

Copyright © 1999-2008, ANRITSU CORPORATION.

All rights reserved. No part of this manual may be reproduced without the prior written permission of the publisher.

The contents of this manual may be changed without prior notice.

Printed in Japan

For Safety

WARNING



1. ALWAYS refer to the operation manual when working near locations at which the alert mark shown on the left is attached. If the advice in the operation manual is not followed there is a risk of personal injury or reduced equipment performance. The alert mark shown on the left may also be used with other marks and descriptions to indicate other dangers.

2. IEC 61010 Standard

The IEC 61010 standard specifies four categories to ensure that an instrument is used only at locations where it is safe to make measurements. This instrument is designed for measurement category I (CAT I). DO NOT use this instrument at locations specified as category II, III, or IV as defined below.

Measurement category I (CAT I):

Secondary circuits of a device that is not directly connected to a power outlet.

Measurement category II (CAT II):

Primary circuits of a device that is directly connected to a power outlet, e.g., portable tools or home appliance.

Measurement category III (CAT III):

Primary circuits of a device (fixed equipment) to which power is supplied directly from the distribution panel, and circuits running from the distribution panel to power outlet.

Measurement category IV (CAT IV):

Building service-line entrance circuits, and circuits running from the service-line entrance to the meter or primary circuit breaker (distribution panel).

For Safety

WARNING

3. Laser radiation warning
 - NEVER look directly into the cable connector on the equipment nor into the end of a cable connected to the equipment. There is a risk of injury if laser radiation enters the eye.
 - The Laser Safety label is attached to the equipment for safety use as indicated in "Laser Safety" later in this section.

Electric Shock

4. To ensure that the instrument is earthed, always use the supplied 3-pin power cord, and insert the plug into an outlet with an earth terminal. If power is supplied without earthing the equipment, there is a risk of receiving a severe or fatal electric shock or causing damage to the internal components.

Repair

WARNING 

5. This equipment cannot be repaired by the operator. DO NOT attempt to remove the equipment covers or unit covers or to disassemble internal components. Only qualified service personnel with a knowledge of electrical fire and shock hazards should service this equipment. There are high-voltage parts in this equipment presenting a risk of severe injury or fatal electric shock to untrained personnel. In addition, there is a risk of damage to precision components.

Calibration



6. The performance-guarantee seal verifies the integrity of the equipment. To ensure the continued integrity of the equipment, only Anritsu service personnel, or service personnel of an Anritsu sales representative, should break this seal to repair or calibrate the equipment. If the performance-guarantee seal is broken by you or a third party, the performance of the equipment cannot be guaranteed. Be careful not to break the seal by opening the equipment or unit covers.

Falling Over

7. This equipment should always be positioned in the correct manner. If the cabinet is turned on its side, etc., it will be unstable and may be damaged if it falls over as a result of receiving a slight mechanical shock.
Always set up the equipment in a position where the power switch can be reached without difficulty.

For Safety

WARNING

LCD

8. This instrument uses a Liquid Crystal Display (LCD). DO NOT subject the instrument to excessive force or drop it. If the LCD is subjected to strong mechanical shock, it may break and liquid may leak.

This liquid is very caustic and poisonous.

DO NOT touch it, ingest it, or get in your eyes. If it is ingested accidentally, spit it out immediately, rinse your mouth with water and seek medical help. If it enters your eyes accidentally, do not rub your eyes, rinse them with clean running water and seek medical help. If the liquid gets on your skin or clothes, wash it off carefully and thoroughly.

For Safety

CAUTION

Fuse Replacement

CAUTION 

1. Always remove the mains power cable from the power outlet before replacing blown fuses. There is a risk of electric shock if fuses are replaced with the power cable connected. Always use new fuses of the type and rating specified on the rear panel of the instrument. There is a risk of fire if a fuse of a different rating is used.

T3.15A indicates a time-lag fuse.

Cleaning

2. Keep the power supply and cooling fan free of dust.
 - Clean the power inlet regularly. If dust accumulates around the power pins, there is a risk of fire.
 - Keep the cooling fan clean so that the ventilation holes are not obstructed. If the ventilation is obstructed, the cabinet may overheat and catch fire.
-

For Safety

Laser Safety

The laser in this equipment is classified as Class 1 according to the IEC 60825-1:2001 specifications, or as Class I according to the 21 CFR 1040.10:1995 specifications. These classes of lasers are safe under reasonably foreseeable operating conditions.

Table 1

Model number	Standard Name	
	IEC 60825-1	21 CFR 1040.10
MS9710C-03	Class 1	Class I
MS9710C-04	Class 1	Class I
MS9710C-05	Class 1	Class I
MS9710C-13	Class 1	Class I
MS9710C-14	Class 1	Class I

Class 1 indicate the danger degree of the laser radiation specified below according to IEC 60825-1:2001.

Class 1: Lasers that are safe under reasonably foreseeable conditions of operation, including the use of optical instruments for intrabeam viewing.

Class I indicate the degree of danger of the laser radiation outlined below as defined by 21 CFR 1040.10:1995.

Class I: Class I labels of laser radiation are not considered to be hazardous.

CAUTION

Caution-Use of controls or adjustments or performance of procedures other than those specified herein may result in hazardous radiation exposure.

The use of optical instruments with this product will increase eye hazard.

For Safety

Laser Radiation Markings

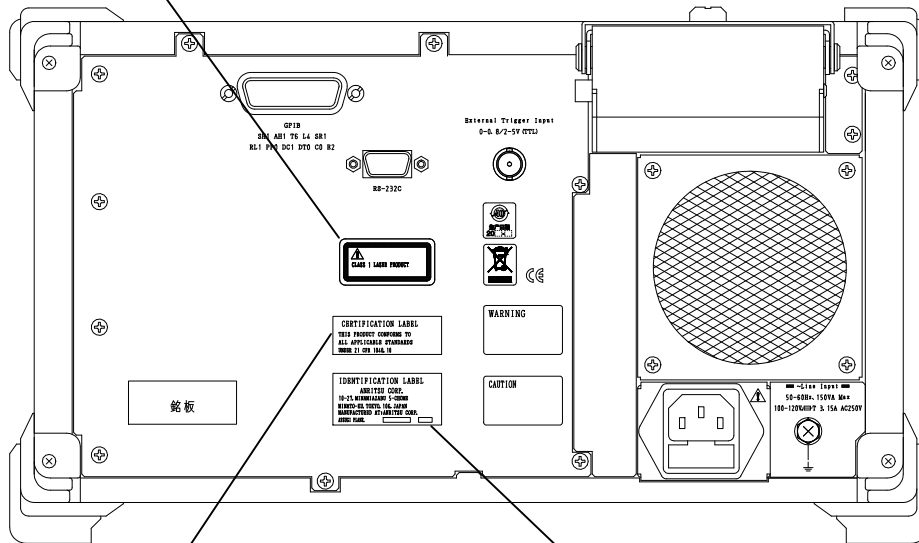

CERTIFICATION LABEL
THIS PRODUCT CONFORMS TO
ALL APPLICABLE STANDARDS
UNDER 21 CFR 1040.10

IDENTIFICATION LABEL
ANRITSU CORP.
5-1-1, ONNA, ATSUGI-SHI
KANAGAWA 243-8555, JAPAN
MANUFACTURED AT: TOHOKU ANRITSU CO., LTD
KORIYAMA PLANT, NOVEMBER 2006

For Safety

CAUTION

Replacing Memory Back-up Battery

This equipment uses a Poly-carbomonofluoride lithium battery to backup the memory. This battery must be replaced by service personnel when it has reached the end of its useful life; contact the Anritsu sales section or your nearest representative.

Note: The battery used in this equipment has a maximum useful life of 7 years. It should be replaced before this period has elapsed.

External Storage Media

This equipment uses floppy disks as external storage media for storing data and programs.

If this media is mishandled or becomes faulty, important data may be lost. To prevent this chance occurrence, all important data and programs should be backed-up.

Anritsu will not be held responsible for lost data.

Pay careful attention to the following points.

- Never remove the memory card from the pulse tester while it is being accessed.
- The memory card may be damaged by static electric charges.
- The external storage media shipped with the instrument has been thoroughly tested. Users should note that since all other devices have not been tested in this manner, Anritsu is unable to guarantee their performance or suitability.

Floppy Disk

Do not place in a dusty area.

Clean the magnetic head periodically to ensure normal operation.

Refer to the section on cleaning the head later in this manual.

Use in a residential environment

This instrument is designed for an industrial environment.

In a residential environment this instrument may cause radio interference in which case the user may be required to take adequate measures.

Equipment Certificate

Anritsu Corporation certifies that this equipment was tested before shipment using calibrated measuring instruments with direct traceability to public testing organizations recognized by national research laboratories, including the National Institute of Advanced Industrial Science and Technology, and the National Institute of Information and Communications Technology, and was found to meet the published specifications.

Anritsu Warranty

Anritsu Corporation will repair this equipment free-of-charge if a malfunction occurs within one year after shipment due to a manufacturing fault, under the condition that this warranty is void when:

- The fault is outside the scope of the warranty conditions described in the operation manual.
- The fault is due to mishandling, misuse, or unauthorized modification or repair of the equipment by the customer.
- The fault is due to severe usage clearly exceeding normal usage.
- The fault is due to improper or insufficient maintenance by the customer.
- The fault is due to natural disaster including fire, flooding, earthquake, etc.
- The fault is due to use of non-specified peripheral equipment, peripheral parts, consumables, etc.
- The fault is due to use of a non-specified power supply or in a non-specified installation location.

In addition, this warranty is valid only for the original equipment purchaser. It is not transferable if the equipment is resold.

Anritsu Corporation will not accept liability for equipment faults due to unforeseen and unusual circumstances, nor for faults due to mishandling by the customer.

Anritsu Corporation Contact

In the event that this equipment malfunctions, contact an Anritsu Service and Sales office. Contact information can be found on the last page of the printed version of this manual, and is available in a separate file on the CD version.

Notes On Export Management

This product and its manuals may require an Export License/Approval by the Government of the product's country of origin for re-export from your country.

Before re-exporting the product or manuals, please contact us to confirm whether they are export-controlled items or not.

When you dispose of export-controlled items, the products/manuals need to be broken/shredded so as not to be unlawfully used for military purpose.

Reuse parts

Anritsu group promotes recycling activities in order to reuse available resources and save energy. This product may use recycled parts (mechanical components) that conform to Anritsu's quality standards.

Lifetime of Parts

The life span of certain parts used in this instrument is determined by the operating time or the power-on time. Due consideration should be given to the life spans of these parts when performing continuous operation over an extended period. These parts must be replaced at the customer's expense even if within the guaranteed period described in Warranty at the beginning of this manual. For details on life span, refer to the corresponding section in this manual.

Crossed-out Wheeled Bin Symbol

Equipment marked with the Crossed-out Wheeled Bin Symbol complies with council directive 2002/96/EC (the “WEEE Directive”) in European Union.



For Products placed on the EU market after August 13, 2005, please contact your local Anritsu representative at the end of the product's useful life to arrange disposal in accordance with your initial contract and the local law.

CE Conformity Marking

Anritsu affixes the CE Conformity marking on the following product(s) in accordance with the Council Directive 93/68/EEC to indicate that they conform to the EMC and LVD directive of the European Union (EU).

CE marking



1. Product Model

Model: MS9710C Optical Spectrum Analyzer

2. Applied Directive

EMC: Directive 2004/108/EC

LVD: Directive 2006/95/EC

3. Applied Standards

- EMC: Emission: EN 61326-1: 2006 (Class A)
Immunity: EN 61326-1: 2006 (Table 2)

	Performance Criteria*
IEC 61000-4-2 (ESD)	B
IEC 61000-4-3 (EMF)	A
IEC 61000-4-4 (Burst)	B
IEC 61000-4-5 (Surge)	B
IEC 61000-4-6 (CRF)	A
IEC 61000-4-8 (RPFMF)	A
IEC 61000-4-11 (V dip/short)	B, C

*: Performance Criteria

- A: During testing normal performance within the specification limits.
- B: During testing temporary degradation, or loss of function or performance which is self-recovering.
- C: During testing, temporary degradation, or loss of function or performance which requires operator intervention or system reset occurs.

Harmonic current emissions:

EN 61000-3-2: 2006 (Class A equipment)

- LVD: EN 61010-1: 2001 (Pollution Degree 2)

4. Authorized representative

Name: Loic Metais
European Quality Manager
ANRITSU S.A. France

Address, city: 16/18 Avenue du Québec SILIC 720 Zone de
Courtaboeuf
91951 Les Ulis Cedex

Country: France

C-Tick Conformity Marking

Anritsu affixes the C-Tick marking on the following product(s) in accordance with the regulation to indicate that they conform to the EMC framework of Australia/New Zealand.

C-Tick marking



1. Product Model

Model: MS9710C Optical Spectrum Analyzer

2. Applied Standards

EMC:Emission: EN 61326-1: 2006 (Class A equipment)

Power Line Fuse Protection

For safety, Anritsu products have either one or two fuses in the AC power lines as requested by the customer when ordering.

Single fuse: A fuse is inserted in one of the AC power lines.

Double fuse: A fuse is inserted in each of the AC power lines.

Example 1: An example of the single fuse is shown below:

Fuse Holder

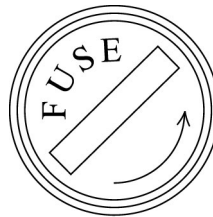

Example 2: An example of the double fuse is shown below:

Fuse Holders

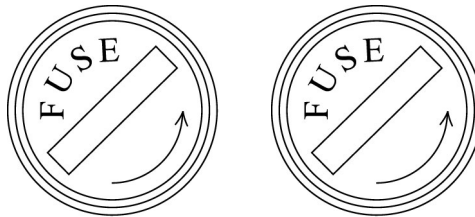

About This Manual

This manual explains the operation, calibration and maintenance of the MS9710C Optical Spectrum Analyzer. The basic functions and operations of this analyzer are outlined in Section 4 “Operation.” For an in-depth explanation of each menu screen refer to Section 5 “Explanation of Screens.”

The  symbol indicates the section where more detailed or related information may be found.

If this analyzer is operated by remote control from a computer, the measurement results can be processed by the computer. For details on the computer interface, refer to the MS9710C Remote Control Operation Manual (W1580AE).

Contents

For Safety	iii
About This Manual	I
Section 1 Introduction.....	1-1
1.1 MS9710C Optical Spectrum Analyzer	1-2
1.2 Main Functions	1-3
1.3 Features	1-4
1.4 Standard Configuration	1-5
1.5 Options	1-6
1.6 Related Parts	1-7
1.7 Main Specifications	1-8
1.8 User Interface	1-12
Section 2 Front and Back Panel Description	2-1
2.1 Unpacking	2-2
2.2 Instrument Overview	2-3
2.3 Front Panel	2-5
2.4 Back Panel	2-7
2.5 Screen Displays	2-9
2.6 Shortcut Keys	2-10
2.7 Sweep Keys	2-11
2.8 Marker keys	2-11
2.9 Data Entry Keys and Knob	2-12
Section 3 Preparations Before Use	3-1
3.1 Installation Conditions	3-2
3.2 Power Connection	3-3
3.3 Vibration Precautions	3-5
3.4 Memory	3-5
3.5 Floppy Disk (FD)	3-6
3.6 Optical Attenuator	3-7
3.7 Printer	3-8
3.8 Optional Light Sources	3-11
3.9 Changing Optical Connector	3-12
3.10 Changing Fuses	3-14

Section 4	Operation	4-1
4.1	Connecting Optical Fiber	4-2
4.2	Switching Power On	4-3
4.3	Basic Function and Example of the Operation	4-4
4.4	Analyzing Measured Waveforms	4-12
4.5	Saving and Recalling Measured Waveforms	4-15
4.6	Printing Waveforms	4-18
4.7	Measuring Modulated Light Using External Trigger Signal	4-19
4.8	Use of the Optional Light Sources	4-20
4.9	Transmission Characteristics	4-21
4.10	Tracking Measurement	4-22
Section 5	Explanation of Screens	5-1
5.1	Setting Wavelength	5-8
5.2	Setting Level	5-12
5.3	Setting Resolution and Averaging	5-16
5.4	Peak/Dip Search	5-22
5.5	Analyzing Waveforms	5-25
5.6	Trace Memory	5-38
5.7	Saving and Recalling Measured Data	5-41
5.8	Setting Graph Type	5-50
5.9	Application Measurement Functions	5-55
5.10	Special Measurement Modes	5-90
5.11	Setting Titles	5-95
5.12	Calibration Function	5-97
5.13	Saving and Recalling Measurement Conditions	5-101
5.14	Other Functions	5-105
5.15	Marker Select Screen	5-114
5.16	Zone Marker Screen	5-118
Section 6	Calibration and Testing Performance	6-1
6.1	Calibrating Level	6-2
6.2	Calibrating Wavelength	6-4
6.3	Testing Performance	6-6

1

2

3

4

5

6

7

Appendix

Index

Contents

Section 7	Maintenance and Troubleshooting	7-1
7.1	Periodic Maintenance	7-2
7.2	Storage Precautions	7-4
7.3	Transporting	7-4
7.4	Troubleshooting	7-5
Appendix	Appn-1
Appendix A	Specifications	A-1
Appendix B	Initial Settings	B-1
Appendix C	Error Codes	C-1
Appendix D	Relationship Between the Resolution, VBW, and Sensitivity	D-1
Appendix E	Checking Actual Display Resolution	E-1
Appendix F	Optical Fiber Cord	E-1
Appendix G	Example of Performance Test Result Record Sheet	G-1
Appendix H	Automatic Measurement Processing	H-1
Appendix I	Switching Marker Frequency Display	I-1
Appendix J	Limited Life Span Parts	J-1
Index	Index-1

Section 1 Introduction

This section is an outline of the MS9710C Optical Spectrum Analyzer and related equipments.

1.1	MS9710C Optical Spectrum Analyzer	1-2
1.2	Main Functions	1-3
1.3	Features	1-4
1.4	Standard Configuration	1-5
1.5	Options	1-6
1.6	Related Parts	1-7
1.7	Main Specifications	1-8
1.8	User Interface	1-12

1.1 MS9710C Optical Spectrum Analyzer

The MS9710C Optical Spectrum Analyzer is a diffraction grating spectrum analyzer. This rugged, compact unit is ideal for field as well as laboratory applications, including:

- characterization of LED's, Fabry-Perot LDs, and DFB LDs
- EDFA Noise Figure and Gain
- Polarization MODE Dispersion measurements
- Transmission characteristics of passive elements such as isolators and filters

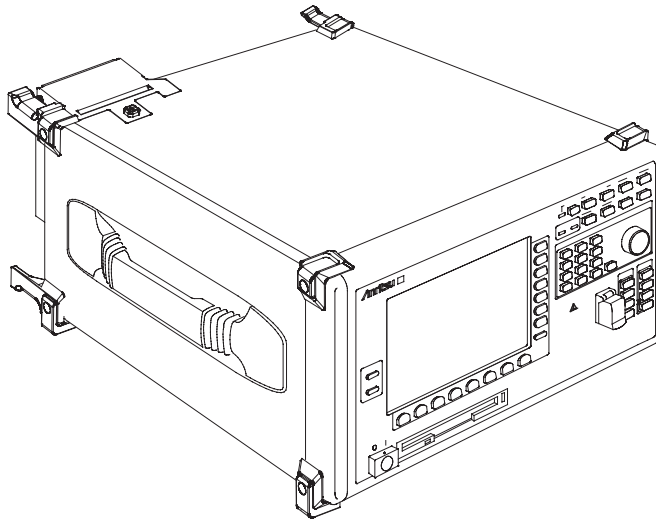

1.2 Main Functions

Optical levels in the wavelength range from 600 to 1750 nm can be measured with a maximum resolution of 0.07 nm. However, in the 1550 nm band, measurement can be performed at a resolution equivalent to 0.05 nm. The level measurement range is -90 to +10 dBm and this can be increased to +23 dBm by using the internal attenuator. This performance varies with the measurement range so refer to section 1.7 in Appendix A for more details. Settings such as the resolution, averaging, smoothing and number of measurement points, etc., can be set according to the measurement purpose.

In addition, peaks and troughs can be detected, the spectrum can be analyzed and the spectrum width and SMSR, etc., can be found. Furthermore, multiple peaks found in spectrum in WDM can be analyzed by setting zone markers.

When calibrating the analyzer using the optional wavelength reference, the wavelength accuracy is ± 20 pm (at 1530 to 1570 nm) which is especially useful in performing accurate high-reliability measurement when evaluating WDM systems, etc.

The spectra of modulated and pulse light sources can be measured using the external signal sync function.

The measured data and waveform can be saved to floppy disk (hereinafter referred as FD) in the MS9710C data format, MS-DOS text format, or MS-Windows bitmapped format. The text and bitmapped files can be easily incorporated into popular word-processor and spreadsheet applications.

1.3 Features

The features of the MS9710C are listed below.

- (1) Fast and accurate measurement of polarization dependency and level linearity in 1.55 μm band
- (2) Wide dynamic range (70 dB), high sensitivity (-90 dBm) and measurement up to $+23$ dBm using optical attenuator (optional)
- (3) Much smaller and lighter than earlier spectrum analyzers
- (4) Spectrum peak detection and analysis with full lineup of built-in calculation functions for evaluating many different device
- (5) Data saved to FD both in MS9710C format and MS-DOS text and MS-Windows bitmapped formats
- (6) External control via both GP-IB and RS-232C interfaces
- (7) Optional internal light source for calibrating wavelength
- (8) Tracking measurement with MG9637/MG9638 Tunable Laser Source

1.4 Standard Configuration

Standard Accessories of the MS9710C Optical Spectrum Analyzer

- AC Power Cord
- T3.15 Fuses Power Supply
- Operation Manual (this manual)
- Front Cover
- Printer Paper
- Remote Control Operation Manual
- Labview Measuring Instruments Driver for RS-232C
- Labview Measuring Instruments Driver for GPIB

1.5 Options

Two or more than two of those MS9710C-02, -05, -13, -14 optional equipments cannot be installed simultaneously.

(1) MS9710C-02 White Light Source

A low-cost white light source can be installed in the main unit for measurements not requiring wide dynamic range.

(2) MS9710C-05 Wavelength Reference Light Source

A wavelength reference light source can be installed in the main unit.

(3) MS9710C-13 Wavelength Reference and SLD Light Source with Temp. Control

A wavelength reference and a SLD light source for measuring transmission characteristics which are controlled the temperature can be installed in the main unit.

(4) MS9710C-14 SLD Light Source with Temp. Control

A SLD light source for measuring transmission characteristics which is controlled the temperature can be installed in the main unit.

(5) MS9710C-15 L-Band Enhancement

L-band (1570 to 1620 nm) have enhanced for additional this option.

(6) Available Optical Connectors

One of the following connectors is specified by customer at the time of order.

- E2000 (DIAMOND) Connector MS9710C-27
- FC Connector MS9710C-37
- ST Connector MS9710C-38
- DIN (47256) Connector MS9710C-39
- SC Connector MS9710C-40
- HMS-10A (DIAMOND) Connector MS9710C-43

1.6 Related Parts

RS-232C Cable (9 P to 9 P)	J0654A
RS-232C Cable (9 P to 25 P)	J0655A
GPIB Cable	J0007
Replaceable Optical Connector	
• FC Connector	J0617B
• ST Connector	J0618D
• DIN (47256) Connector	J0618E
• HMS-10A (DIAMOND) Connector	J0618F
• SC Connector	J0619B
Optical Fiber Cord (2 m, SM10/125)	J0575
Printer Paper Roll	TP080-20L
Ferrule Cleaner	Z0282
Ferrule Cleaner Tape	Z0283
Adapter Cleaner	Z0284

1.7 Main Specifications

To obtain stable operation, allow at least 5 minutes to elapse after power-on. The following specifications are guaranteed 2 hours after power-on. If the instrument is out-of-specification, perform automatic optical-axis alignment (Auto Align) and then keep the instrument at a constant temperature. W1 Cal (Ref) indicates calibration with the reference wavelength light source. Reference wavelength light source means option 03 or option 05 for this instrument. However, the following specifications are not guaranteed at power monitoring and tracking measurement.

MS9710C Optical Spectrum Analyzer

Wavelength axis	Specification	Condition
Wavelength Range	600 to 1750 nm	
Wavelength Sweep Width	0.2 to 1200 nm, 0 nm	
Wavelength Accuracy	After W1 Cal (Ext)	
	±300 pm	600 to 1530, 1570 to 1750 nm
	±200 pm	1530 to 1570 nm
	After W1 Cal (Ref)	
	0.05 to 0.2 nm Resolution	
	±50 pm	1520 to 1530, 1570 to 1620 nm
	±20 pm	1530 to 1570 nm
	0.5, 1.0 nm Resolution	
	±100 pm	1520 to 1620 nm
Wavelength Stability	±5 pm	1 minute, 11 pt smoothing, half width wavelength
Wavelength Linearity	±20 pm	1530 to 1570 nm
Setting Resolution	0.05, 0.07, 0.1, 0.2, 0.5, 1 nm	
Resolution Accuracy	1530 to 1570 nm Center Wavelength	
	±7%	Setting Res.: 0.1 nm
	±3%	Setting Res.: 0.2 nm
	±2.2%	Setting Res.: 0.5 nm
	1530 to 1530, 1570 to 1620 nm Center Wavelength	
	±10%	Setting Res.: 0.1 nm
	±5%	Setting Res.: 0.2 nm
	±4%	Setting Res.: 0.5 nm
	Other Center Wavelengths	
	±30%	Setting Res.: 0.1 nm
	±15%	Setting Res.: 0.2 nm
	±7%	Setting Res.: 0.5 nm

Level axis	Specification	Condition	
Level Range		Resolution: 0.07 nm min., VBW: 10 Hz, Sweep Averaging: 10 times)	
		Optical attenuator Off	
		0° to 30°C	
		-65 to +10 dBm	600 to 1000 nm
		-85 to +10 dBm	1000 to 1250 nm
		-90 to +10 dBm	1250 to 1600 nm
		-75 to +10 dBm	1600 to 1700 nm
		-55 to +10 dBm	1700 to 1750 nm
		30° to 50°C	
		-60 to +10 dBm	600 to 1000 nm
		-80 to +10 dBm	1000 to 1250 nm
		-85 to +10 dBm	1250 to 1600 nm
		-70 to +10 dBm	1600 to 1700 nm
		-50 to +10 dBm	1700 to 1750 nm
		Optical attenuator On	
	0° to 30°C		
	-70 to +23 dBm	1100 to 1600 nm	
	30° to 50°C		
	-65 to +23 dBm	1100 to 1600 nm	
Level Accuracy	±0.4 dB	Setting Res.: 0.1 nm min., -23 dBm input, Wavelength: 1300 and 1550 nm	
Level Stability	±0.02 dB	1 minute, Setting Res.: 0.1 nm min., -23 dBm input, no polarization variation	
Level Linearity		Optical attenuator Off	
	±0.05 dB	-50 to 0 dBm, 1550 nm	
Level Flatness		Optical attenuator On	
	±0.05 dB	-30 to +20 dBm, 1550 nm	
Level Flatness	±0.1 dB	1530 to 1570 nm	
	±0.3 dB	1520 to 1530, 1570 to 1620 nm	
		Setting Res.: 0.5 nm min., Optical attenuator Off, using ML9050A reference power meter	
Polarization Dependency	±0.05 dB	1550 nm, 1600 nm	
	±0.1 dB	1300 nm	
		Setting Res.: 0.5 nm min., Supported connectors: FC, SC, ST, DIN, HMS-10/A)	

Section 1 Introduction

Level axis	Specification	Condition
Dynamic Range		Setting Res: 0.05 nm, Wavelength: 1550 nm, Optical attenuator: Off, 20° to 30°C)
	High dynamic range mode	
	70 dB	at wavelength 1 nm from peak
	60 dB	at wavelength 0.4 nm from peak
	42 dB	at wavelength 0.2 nm from peak
	Normal dynamic range mode	
	62 dB	at wavelength 1 nm from peak
	58 dB	at wavelength 0.4 nm from peak
	42 dB	at wavelength 0.2 nm from peak
Backscatter Attenuation	35 dB	1550 or 1300 nm
Others	Specification	Condition
Sweep Speed	0.5 s/500 nm (typ.)	VBW = 10 kHz, Normal dynamic range mode, Center wavelength: 1200 nm, time from sweep start to sweep end, no optical input, 501 sampling points)
Using Temperature Range	0 to 50°C	FDD: +5 to 50°C
Dimensions	177 (H) × 320 (W) × 350 (W) mm	
Mass	≥16.5 kg	
Power Supply	Operating voltage: AC85 to 132/170 to 250 V Frequency: 47.5 to 63 Hz Capacity: 150 VA (max.)	
Temperature and Humidity	Operating: 0° to 50°C (FDD: 5° to 50°C) Storage: -20° to +60°C Relative humidity: 0% to 90%, no condensation (FDD: 20% to 80%)	

White Light Source (Option 02)

Item	Specification	Condition
Optical Output	≥-59 dBm/nm	Multimode fiber
Wavelength Range	900 to 1600 nm	
Operation Temperature	18° to 28°C	

SLD Light Source (Option 13 and 14)

Item	Specification	Condition
Optical Output	>-40 dBm (MS9710C Resolution: 1 nm, 1550 nm \pm 10 nm)	
Optical Output Level Stability	\pm 0.04 dB (for 20 min, 1550 nm of wavelength, with no Polarization drift, no temperature drift)	
Operating Temperature	0 to +40°C	

L-Band Enhancement (Option 15)

Item	Specification	Condition
Wavelength Accuracy	\pm 0.02 nm (after Wcal (Ref)) (Res: 0.07 to 0.2 nm 1520 to 1620 nm)	
Resolution Accuracy	1520 to 1620 nm Center Wavelength < \pm 7% (Setting Res: 0.1 nm) < \pm 3% (Setting Res: 0.2 nm) < \pm 2.2% (Setting Res: 0.5 nm)	
Level Linearity	< \pm 0.05 dB (-50 to +0 dBm, 1550 nm, 1600 nm wavelength, ATT Off) \pm 0.05 dB (-30 to +20 dBm, 1550 nm, 1600 nm wavelength) -30 to +20 dBm, 1550 nm, 1600 nm wavelength, ATT On)	
Level Flatness	< \pm 0.1 dB (1520 to 1620 nm) using ML9050A Power Meter	

Functions

Measurement Functions	Auto Measure, Pulse Light Measurement (External Trigger), Power Monitor
Display Functions	Zoom, Overlap, Normalize, Max Hold, Wavelength in vacuum, Effective resolution, Trace A/B
Resolution Functions	Waveform analysis (Threshold, n dB Loss, Envelope, RMS, SMSR, Integrated spectrum power), Peak/Dip search, Light source (DFB-LD, FP-LD, LED) evaluation, Optical amp evaluation, WDM evaluation
Calibration Functions	Auto alignment, Wavelength calibration, Offset calibration
Memory Functions	Measurement conditions saved to internal memory, Waveform data saved to floppy disk
I/O Functions	GPIB, RS-232C, External trigger input (0 to 0.8 V/2 to 5V, high impedance)
Data Output Functions	Print to internal printer, Screen shot bit map and waveform data text output to floppy disk

1.8 User Interface

The measurement settings of the MS9710C are screens from the displays called “cards” which can be flipped back and forth like a stuck of cards. The cards are selected by pressing the (F1) to (F7) card selection keys along the bottom of the screen. Each card has associated options which are selected using the function keys (f1) to (f7) arranged on the right side of the screen.

The seven cards starting from the Wavelength card are called Foreground cards and the seven cards starting from the Graph card are called Background cards. Those card displays can be switched by pressing the (F8) key to select change button ↔.

(1) Foreground cards

- Wavelength card: (F1) Sets wavelength
- Level Scale card: (F2) Sets level
- Res/VBW/Avg card: (F3) Sets Resolution, received light bandwidth, and averaging
- Peak/Dip/Search card: (F4) Detects peaks and troughs
- Analysis card: (F5) Analyzes waveform
- Trace card: (F6) Switches memory and trace
- Save/Recall card: (F7) Saves and recalls data)

(2) Background cards

- Graph card: (F1) Switches graph display
- Application card: (F2) Switches application measurement functions
- Measure mode card: (F3) Sets special measurement mode)
- Title card: (F4) Sets screen titles
- Cal card: (F5) Sets calibration function
- Condition card: (F6) Saves and recalls measurement conditions
- Others card: (F7) Sets other functions

Foreground card

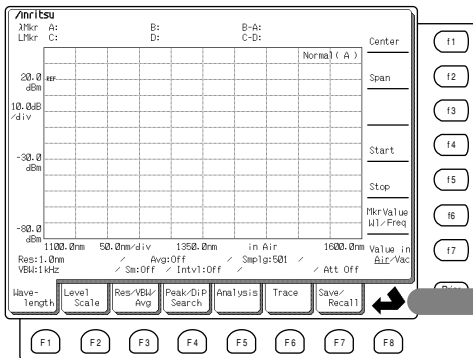

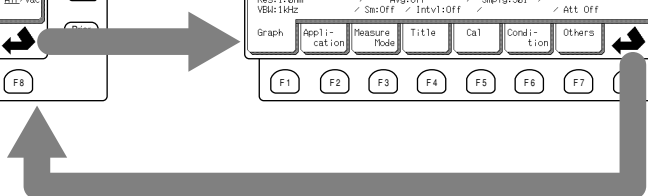
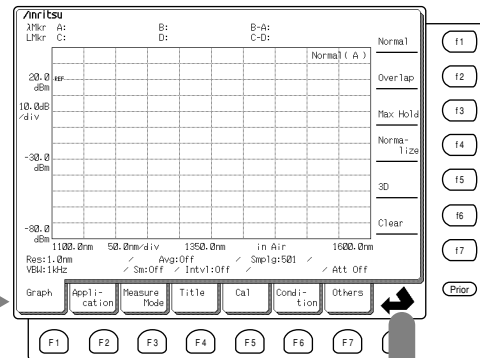

Background card



For the names of each part of each screen, refer to Section 2.5 “Screen Displays,” for more details on each screen, refer to Section 5 “Explanation of Screens.”

To improve the functionality, the MS9710C also has a number of keys corresponding to major functions called shortcut keys. These can select functions without using the cards.

 **Section 2.6**

Marker-related functions can be accessed by pressing the Marker Select key  or the Zone Marker key .

 **Section 5.15 and 5.16**

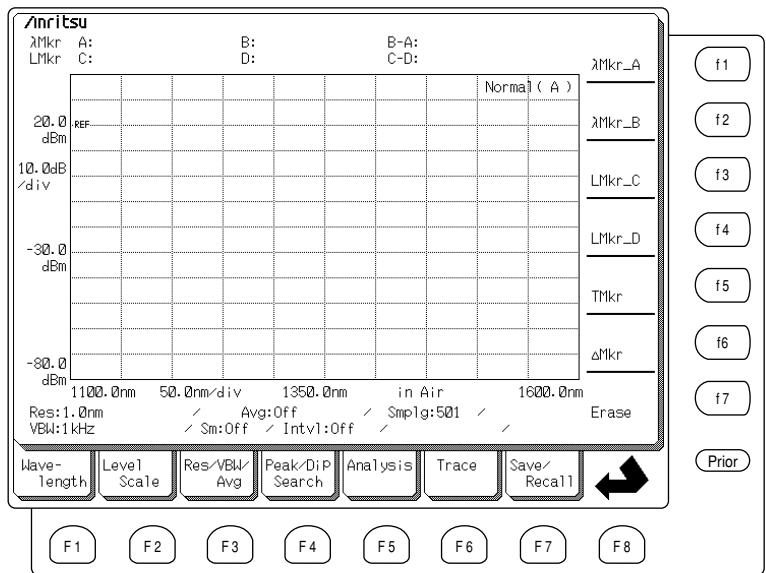

Marker Select screen

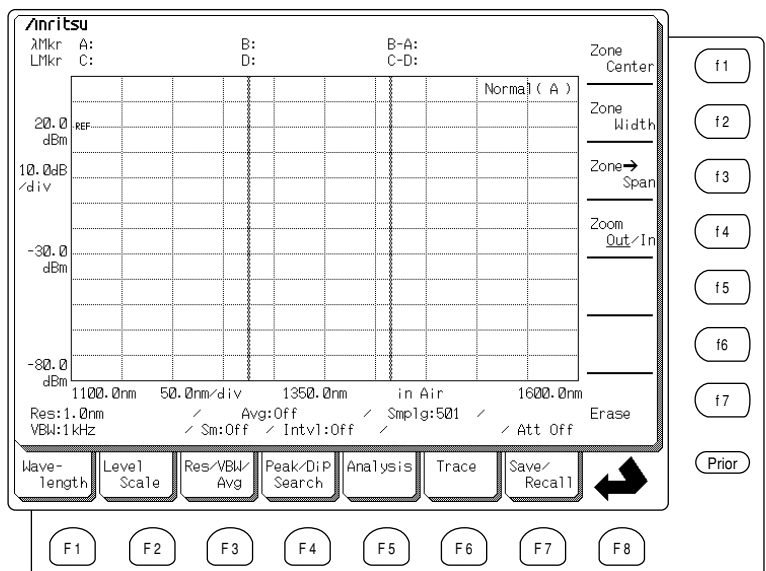

Zone Marker screen

Section 2 Front and Back Panel Description

This section describes each part of the front and back panels of the MS9710C Optical Spectrum Analyzer. Section 4 “Operation” gives examples of the main measurement functions. Section 5 “Explanation of Screens” gives a detailed explanation of how to use each card screen.

2.1	Unpacking	2-2
2.2	Instrument Overview	2-3
2.3	Front Panel	2-5
2.4	Back Panel	2-7
2.5	Screen Displays	2-9
2.6	Shortcut Keys	2-10
2.7	Sweep Keys	2-11
2.8	Marker Keys	2-11
2.9	Data Entry Keys and Knob	2-12
2.9.1	Data Entry Keys	2-12
2.9.2	Knob	2-13

2.1 Unpacking

Remove the main unit and accessories from the packing case and check that all the parts described on the enclosed packing list are present. If anything is missing or damaged, please contact Anritsu Corporation or your sales representative immediately.

Equipment Composition







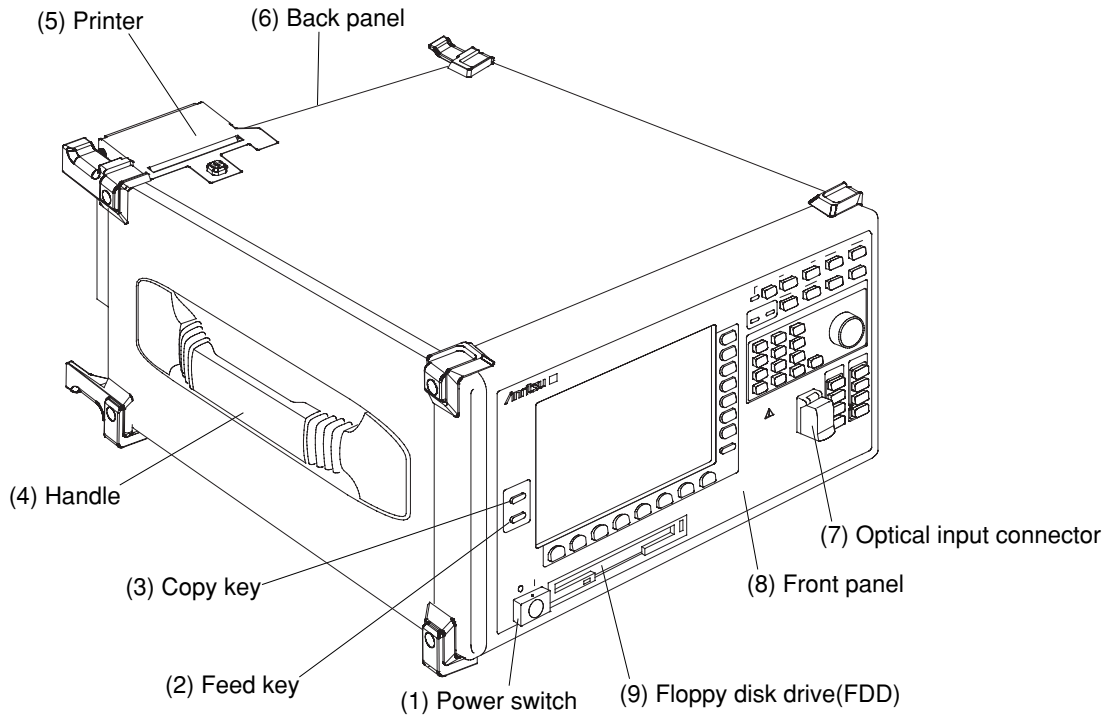

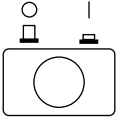

Name	Qty.	Model/Order No.
Main Unit		
Optical Spectrum Analyzer	1	MS9710C
Standard Accessories		
AC Power Cord	1	
T3.15 A Fuses	2	T3.15 A AC250 V
for AC100 V/AC200 V		for AC100 V/AC200 V
Operation Manual	1	W1579AE
Front Cover	1	B0329G
Printer Paper Roll	2	TP080-20L
Remote Control Operation Manual	1	W1580AE
Labview Measuring Instruments Driver		
for RS-232C	1	MX971003S
for GPIB	1	MX971003G

2.2 Instrument Overview

This section describes the names and functions of each parts of the MS9710C.



Section 2 Front and Back Panel Description

- (1)  Power switch
- (2) **Feed key**  Feeds printer paper while pressed
- (3) **Copy key**  Prints hard copy of screen to internal or external printer when pressed
 **Section 5.14**
- (4) **Handles** Handles are on each side of this analyzer for carriage
Always carry this analyzer using both handles and keep this analyzer horizontal as much as possible. If this analyzer is carried vertically with one handle, there is a danger that precision internal components may be damaged.
- (5) **Printer** This is a thermal printer. When the internal printer is selected and the Copy key  described in (3) above is pressed, the current screen display is printed.
 **Section 3.7 and 5.14**
- (6) **Back Panel**  **Section 2.4**
- (7) **Optical Input Connector** This connector inputs optical signal for measurement. The maximum permissible level is +10 dBm with the attenuator On, and +23 dBm with the attenuator Off.
 **Section 3.6 and 3.9**
- (8) **Front Panel**  **Section 2.3**
- (9) **Floppy Disk Drive (hereinafter referred as FDD)** The waveform displayed on the screen can be saved to a FD.
 **Section 3.5**

2.3 Front Panel

This section describes the names and functions of each parts on the front panel of the MS9710C.

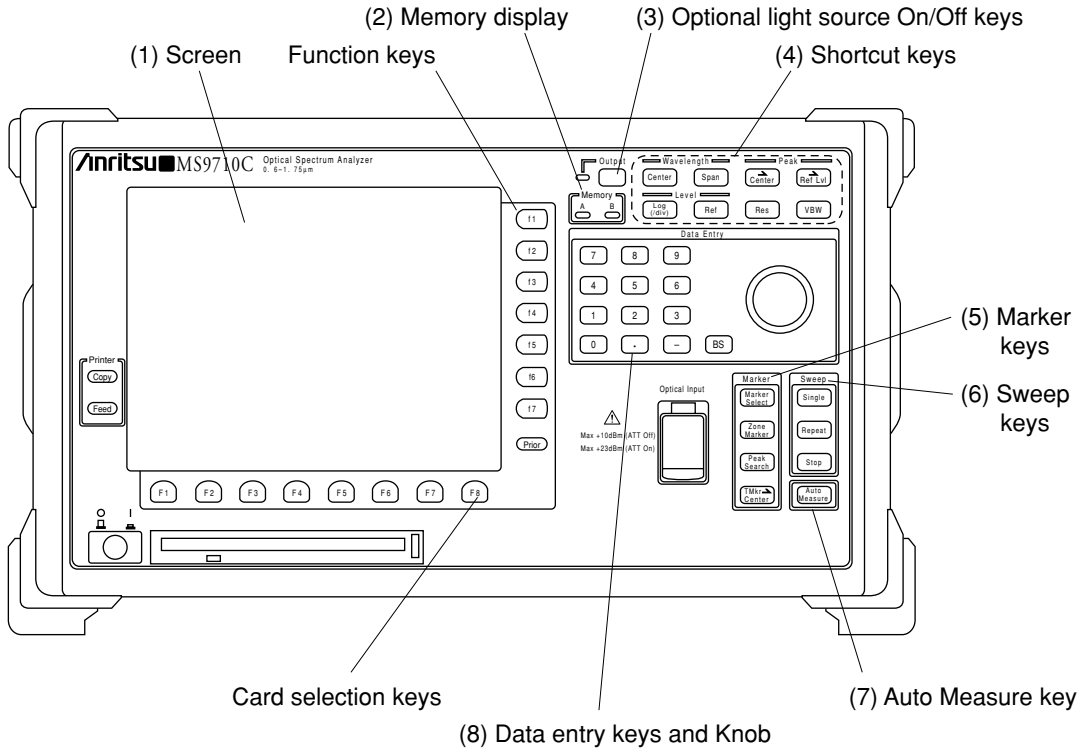

Section 2 Front and Back Panel Description

(1) Screen

In addition to displaying the measured spectrum, the screen displays the cards for selecting this analyzer's functions. Eight cards of which names are aligned along the bottom of the screen can be displayed using the card selection keys (F1) to (F8). The function options within each card can be selected by pressing seven corresponding function key, or one of the (f1) to (f7) function keys aligned along the right side of the screen. The Prior key (Prior) cancels the selected function and returns to the previous condition. The Prior key is also used to clear the Settings display field.

 **Section 2.5 and 5**

(2) Memory display

There are two memories (A and B) for saving measurement results. The lamp of the selected memory is lit.

 **Section 3.4**

(3) Option light source On/Off key

This key switches optional light source On/Off. When the light source is On, the lamp on the left is lit.

 **Section 3.8**

(4) Shortcut keys

Shortcut keys are dedicated to special functions, enable setting function, etc., without selecting the cards and the function from the card.

 **Section 2.6**

(5) Marker keys

Marker-related keys

 **Section 2.8**

(6) Sweep keys

These keys execute single or repeated measurement sweep on the screen. The Stop key terminates a measurement.

 **Section 2.7**

(7) Auto Measure key Automatically measures input light in wavelength range of 900 to 1650 nm. The measurement range is matched to the spectrum peak wavelength just by pressing this key. However, automatic measurement is not possible when the display type is any of 3D, Normalized, Overlapped, or Max. hold, as well as at Tracking measurement. There is a possibility of an error at optical inputs of less than 900 nm. For details, refer to Appendix H: Automatic Measurement Processing.

(8) Data entry keys and Knob

For inputting numeric values

 **Section 2.9**

2.4 Back Panel

This section describes the names and functions of each parts on the back panel of the MS9710C.

The diagram below shows the back panel with all the options installed.

When a light source is installed, a number of labels providing information about handling are attached to the back panel. Refer to pages iv and v in this manual for the laser safety and other related information provided by these labels.

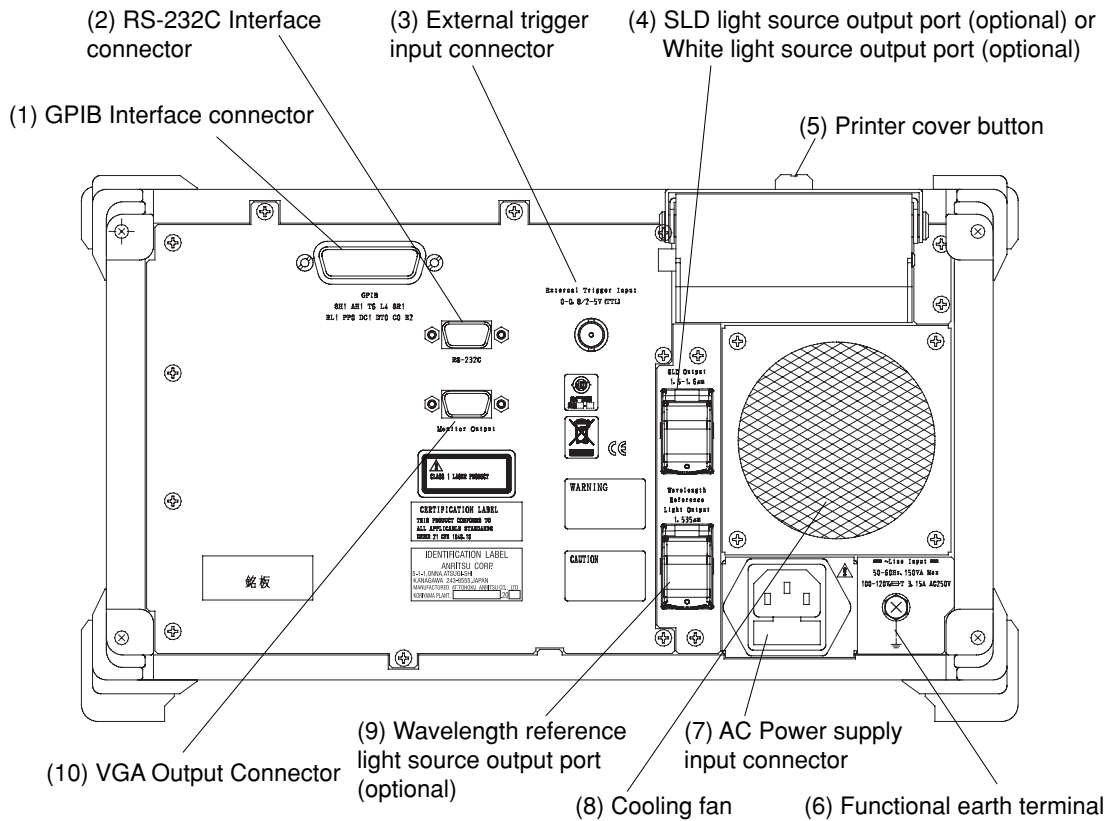

Section 2 Front and Back Panel Description

(1) GPIB interface connector

This connector connects the external computer or printer.

(2) RS-232C interface connector

This connector connects the external computer, also used as dedicated interface for the MG9637/MG9638 in the tracking measurement.

(3) External trigger input connector

This connector inputs trigger signal for synchronizing modulation signals, etc. When a TTL level signal is added, the data is held at a signal rise.

 **Section 4.8 and 4.9**

(4) SLD light source output port (optional) or White light source output port (optional)

When the optional wavelength reference and SLD light source is installed, the back panel has the optional SLD light source output for measuring transmission characteristics. When the separate optional white light source is installed, the back panel has the wide-dynamic-range white light source output port.

 **Section 3.8**

(5) Printer cover button

When this button is turned either left or right, the printer cover lock is released and the cover can be removed.

 **Section 3.7**

(6) Functional earth terminal

This is the terminal that is electrically connected to the chassis of the equipment.

 **Section 3.2**

(7) AC Power supply input connector

AC input connector

(8) Fan

Cooling fan

(9) Wavelength reference light source output port (optional)

When the optional wavelength reference and SLD light source is installed, the back panel has the wavelength reference light source output for calibrating wavelength.

 **Section 3.8**

(10) VGA Output Connector







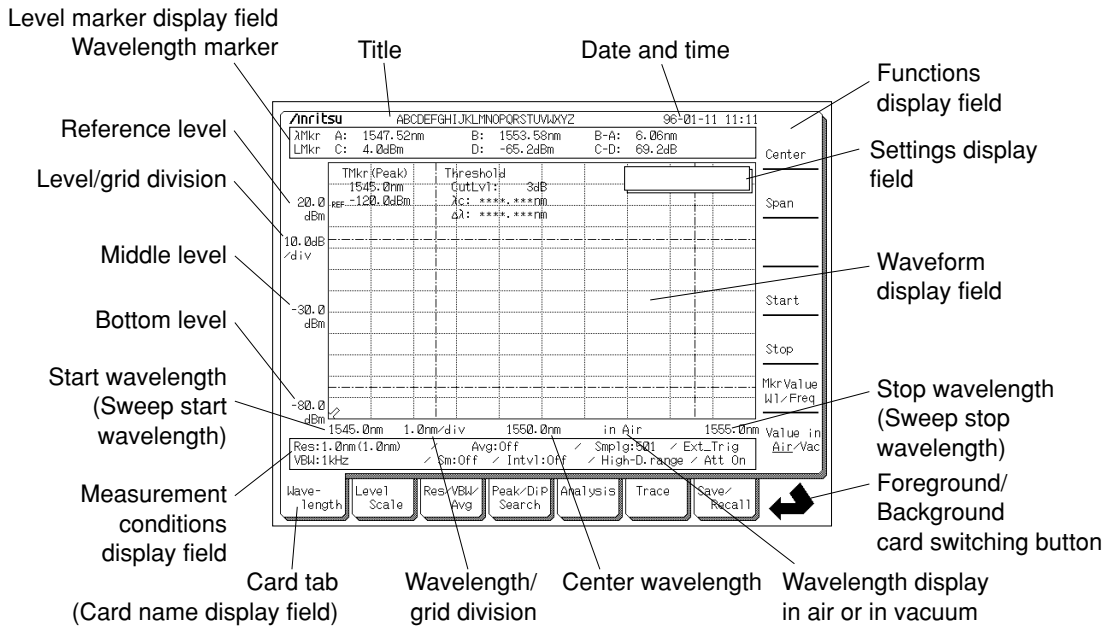









The measurement screen can be displayed on a connected VGA monitor.

2.5 Screen Displays

The screen displays the following information. The Settings display field at the top right of the screen displays the current settings and is displayed when a numeric value is input. When the Settings display field is not displayed, the graph and trace status are displayed. The displayed graph kind is one of the following five formats: Normal, Overlap, Max Hold Normal and 3D. The trace status is one of the following five formats: trace A, B, A&B, A-B and B-A.









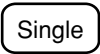
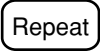
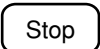

2.6 Shortcut Keys

	Sets Center wavelength	 Section 5.1
	Sets Wavelength sweep width	 Section 5.1
	Sets spectrum Peak point to Center wavelength	 Section 5.1
	Sets level of spectrum Peak point to reference level	 Section 5.2
	Sets logarithmic unit	 Section 5.2
	Sets reference level	 Section 5.2
	Sets Resolution	 Section 5.3
	Sets received light bandwidth (the received light bandwidth is also called video bandwidth, hereinafter referred as VBW)	 Section 5.3

2.7 Sweep Keys

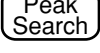
 Single	Executes one sweep measurement from Start wavelength to Stop wavelength
 Repeat	Executes repeated sweep measurement from Start wavelength to Stop wavelength
 Stop	Stops measurement

2.8 Marker Keys

 Marker Select	Displays Marker Selection screen	 Section 5.15
 Zone Marker	Displays Zone Marker screen	 Section 5.16
 Peak Search	Places Trace marker at peak value in measured spectrum	 Section 5.4
 TMkr  Center	Sets wavelength specified as Center wavelength by trace marker. This function cannot be used in the Trace A&B, Trace A-B, Trace B-A nor when the trace marker is turned Off.	

2.9 Data Entry Keys and Knob

Data entry keys

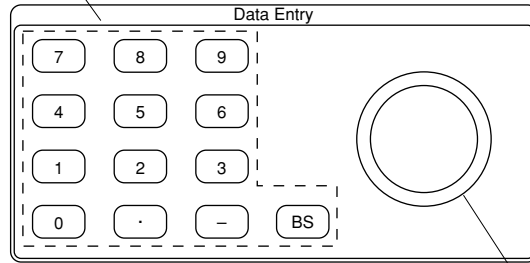

Knob

2.9.1 Data Entry Keys

The Data entry keys include the numerics 0 to 9 keys, the period (.) key, the minus (-) symbol key, and the backspace key (BS). They are used for inputting the wavelength and level as numeric values. The Data entry keys are very useful for inputting a numeric value that is a long way from the current setting.

Inputting numeric values with Data entry keys

An example of inputting the Center wavelength using the Ten keys is explained.

- (1) When the Center key  (shortcut key) is pressed, the current Center wavelength is displayed and the new Center wavelength can be input.
- (2) Input starts when the Data entry keys are pressed, the units are displayed on the right side of the screen adjacent to the functions keys as shown below. When numeric input using the Data entry keys is completed, press the function key to select the units.

To correct a value input with Data entry keys, press the Backspace key to erase the value by moving the cursor to the left side of the number. Alternately, pressing the Clear key clears the entire input and returns the original value.

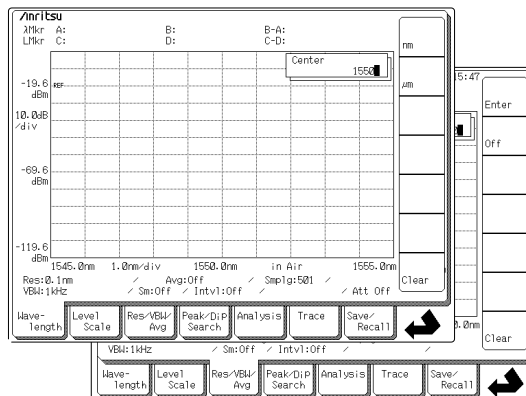

- (3) The input value is confirmed when the units are selected and the new Center wavelength is displayed on the screen.
- (4) The set value can be changed until either another shortcut key is pressed or until a different function card is selected. To input another value from the Data entry keys again, start over from step (2).

2.9.2 Knob

The Knob is turned to input numeric values such as the wavelength and level. The Knob is useful when inputting a numeric value that is close to the current setting.

When the Knob is turned clockwise, the input value is increased; when it is turned counterclockwise, it is decreased.

During input with the Data entry keys, if the Knob is turned before the Enter function key is pressed for conformation, the value input with the Data entry keys is cleared.

Section 3 Preparations Before Use

This section describes the preparations that must be made before using MS9710C Optical Spectrum Analyzer. These steps are important to ensure to keep this analyzer functions properly and safely.

3.1	Installation Conditions	3-2
3.2	Power Connection	3-3
3.2.1	Power Requirements	3-3
3.2.2	Connecting the Power Cord	3-3
3.3	Vibration Precautions	3-5
3.4	Memory	3-5
3.5	Floppy Disk (FD)	3-6
3.6	Optical Attenuator	3-7
3.7	Printer	3-8
3.7.1	Paper Manual Loading	3-8
3.8	Optional Light Sources	3-11
3.9	Changing Optical Connector	3-12
3.9.1	Replaceable Optical Connectors	3-12
3.9.2	Connectors not Replaceable at User Site	3-13
3.10	Changing Fuses	3-14

3.1 Installation Conditions

Orientation

Use this analyzer in a horizontal position.

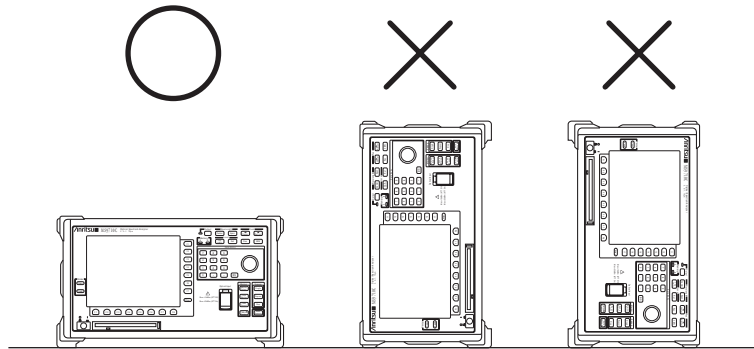

Operating Environment

This analyzer should be used in a temperature range from 0 to 50 °C. In addition, to prevent malfunctions, it should not be used:

- Where there are high levels of vibration
- In very humid or dusty locations
- On an incline
- In direct sunlight
- Where there are active gases
- Where there are extreme temperature changes

Furthermore, if this analyzer is moved to a warm location after being used in cold location for an extended period, condensation may form inside and possibly cause a malfunction due to short-circuiting. In these circumstances, allow the analyzer to dry out thoroughly before supplying power to it.

Fan Clearance

A cooling fan is mounted on the back panel of this analyzer. Leave a clearance of at least 10 cm around the analyzer from walls and peripheral equipment to allow the free passage of air.

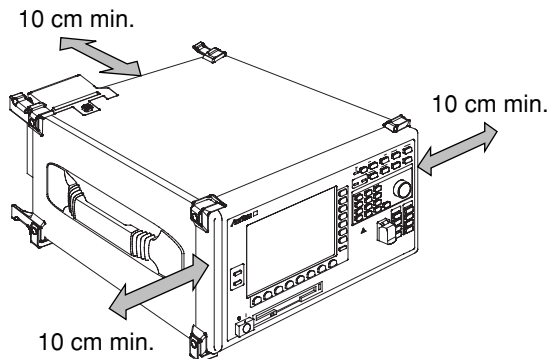

3.2 Power Connection

This section describes the procedures for supplying power.

3.2.1 Power Requirements

For normal operation of the instrument, observe the power voltage range described below.

Power source	Voltage range	Frequency
100 Vac system	100 to 120 V	47.5 to 63 Hz
200 Vac system	200 to 225 V	47.5 to 63 Hz

Changeover between 100 and 200 V systems is made automatically.

CAUTION

Supplying power exceeding the above range may result in electrical shock, fire, failure, or malfunction.

3.2.2 Connecting the Power Cord

Check that the power switch on the front panel is turned off (switched to the (O) side).

Insert the power plug into an outlet, and connect the other end to the power inlet on the rear panel. To ensure that the instrument is earthed, always use the supplied 3-pin power cord, and insert the plug into an outlet with an earth terminal.

WARNING

If the power cord is connected without the instrument earthed, there is a risk of receiving a fatal electric shock. In addition, the peripheral devices connected to the instrument may be damaged.

When connecting to the power supply, DO NOT connect to an outlet without an earth terminal. Also, avoid using electrical equipment such as an extension cord or a transformer.

CAUTION 

If an emergency arises causing the instrument to fail or malfunction, disconnect the instrument from the power supply by either turning off the power switch on the front panel (switch to the (O) side), or by pulling out the power cord or the power inlet.

When installing the instrument, place the instrument so that an operator may easily operate the power switch.

If the instrument is mounted in a rack, a power switch for the rack or a circuit breaker may be used for power disconnection.

3.3 Vibration Precautions

The heart of this analyzer is a diffraction grating with a precision on the order of several microns. When using, maintaining and transporting this analyzer, it is important to take precautions against excessive vibration and mechanical shock. Always carry this analyzer using both handles and keep the analyzer horizontal as much as possible. If this analyzer is carried vertically with one handle, there is a danger that precision internal components may be damaged.

3.4 Memory

This analyzer has two memories (A and B) for saving measured data. When data is saved in memory, either memory can be selected independently using the Trace card. The screen displaying memory A is called Trace A, and the screen displaying memory B is called Trace B.

The data in memory A and memory B can be displayed simultaneously using Trace A&B; Trace A-B or Trace B-A, provided the measurement conditions (example: Span, center) for both memory A and B are exactly the same.

Trace A&B, Trace A-B, and Trace B-A cannot be used if memory A and B do not have common measurement conditions.

3.5 Floppy Disk (FD)

The MS9710C uses 3.5-inch FD to save data. When attempting to save data to a new FD, the FD must be formatted first. This analyzer formats FDs in the MS-DOS format.

Both double-density (2DD) and high-density (2HD) FDs can be used. High-density FDs (2HD) can be formatted at either 1.44 MB or 1.2 MB of capacity.

FD Type	Capacity
2DD	720 KB
2HD	1.44 MB
2HD	1.2 MB

When saving data to an FD, or when formatting an FD, first ensure that the FD is not write-protected.

Inserting Floppy Disk

Insert the FD into the FDD with the label facing upwards as shown in the following diagram.

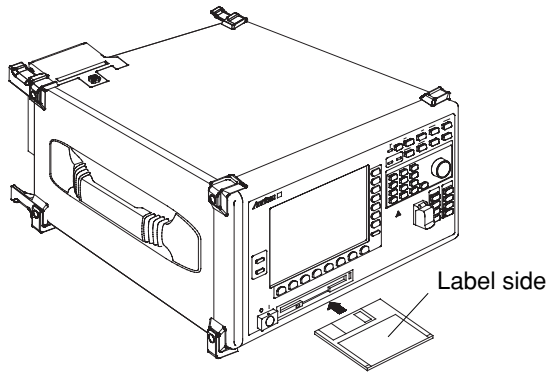

The FDD can be used at ambient temperatures of 5 to 50 °C.

3.6 Optical Attenuator

The optical attenuator can be switched between Insert (On) and Not insert (Off) by opening the Level Scale card and pressing the **F2** card selection key. When the attenuator is Off, the maximum input power is +10 dBm; when it is On, the maximum input power is +23 dBm. The level of the input light displayed on the screen is the value at the input connector irrespective of whether the optical attenuator is On or Off.

 **Section 5.2**

3.7 Printer

3.7.1 Paper Manual Loading

Check that the printer paper roll is installed in the printer at the top left of the back panel. If the paper has run out, load more paper as described below.

- (1) On the upper side of the MS9710B, rotate the printer cover button clockwise or counterclockwise to unlock the printer cover.

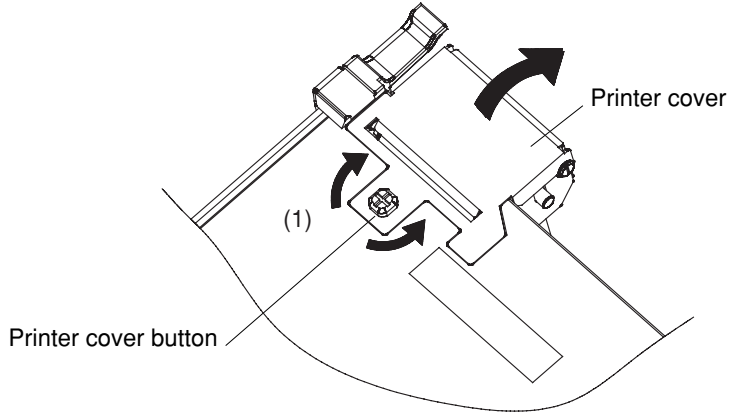

- (2) Push the release lever in the direction of the arrow in the figure below.
- (3) Check that the printer roller is released from the printer, and then lift the printer roller.

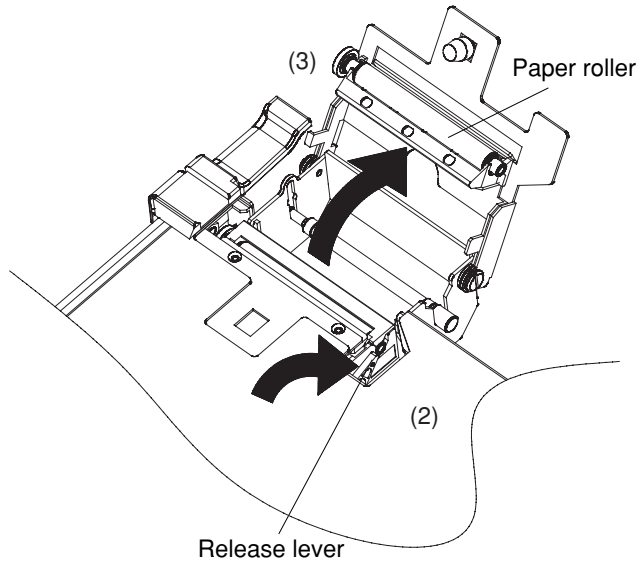

- (4) Lift the paper roll lever.
- (5) Set the paper roll as shown below. Note the paper feed direction. Next, return the paper roll lever to its original position so that the paper roll is set straight against the printer head.

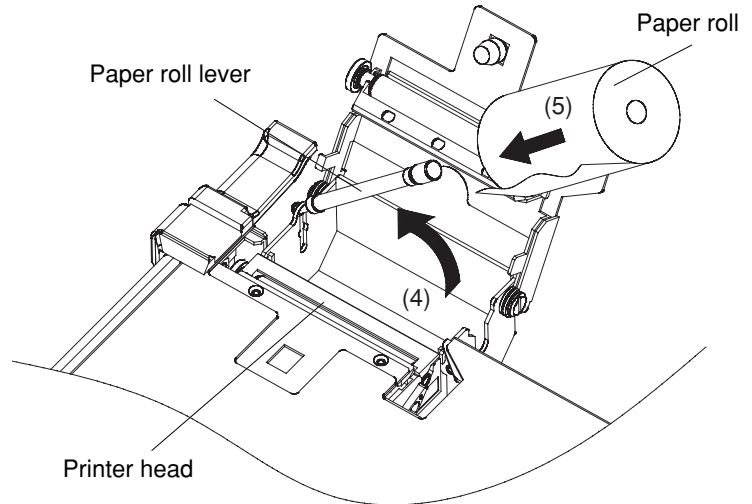

- (6) Pull the end of the paper roll and feed it between the printer roller and the printer head.
- (7) Press the printer roller until it clicks.

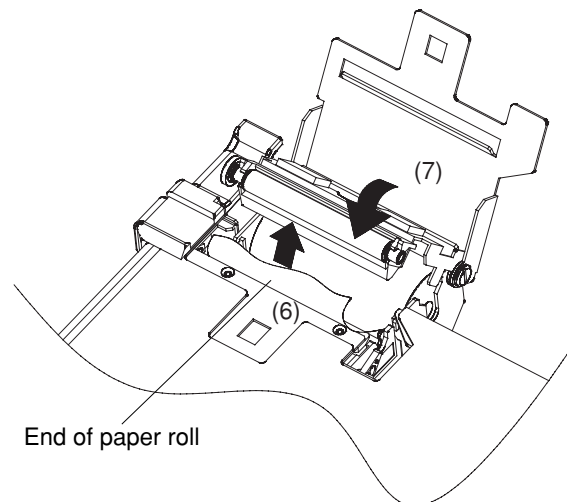

Section 3 Preparations Before Use

- (8) Feed the end of the paper roll through the slit of the printer cover.
- (9) Return the printer cover back to its original position, and then lock it by rotating the printer cover button clockwise or counterclockwise.

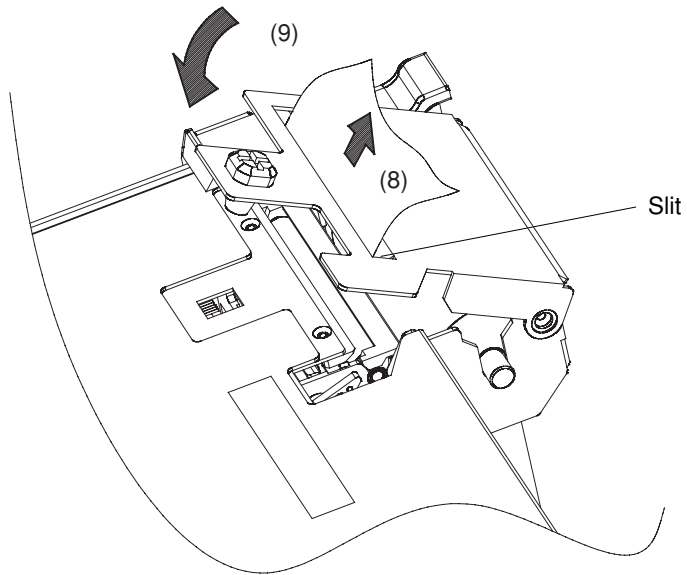

CAUTION

Only use the specified printer paper. The following problems may occur if other non-specified printer paper is used.

- The print quality may be poor due to poor sensitivity.
 - Coarse paper may damage the print head.
 - The head may be damaged or worn during printing.
 - The print may disappear due to poor paper stability.
-

3.8 Optional Light Sources

Wavelength Reference Light Source and SLD Light Source

The level reference light (SLD light source) for measuring transmission characteristics is output from Port 1, and the reference light for wavelength calibration is output from Port 2.

White Light Source

The white light source has the following characteristics for applications not requiring high dynamic range.

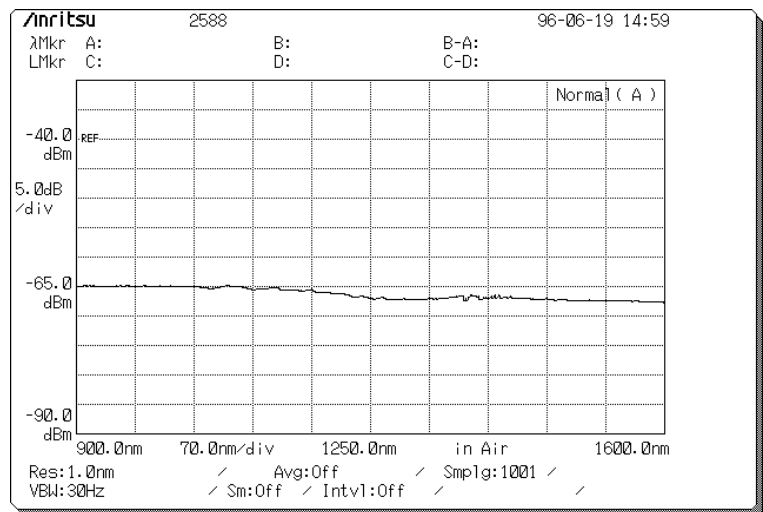

The lamp used in the light source has a life of 2500 hours. Replacement of the lamp is not free of charge even when the equipment warranty is still effective.

3.9 Changing Optical Connector

3.9.1 Replaceable Optical Connectors

Unless otherwise specified, the FC connector (MS9710C-37) is supplied as the standard connector with the main unit. The following connectors are also available and can be changed by the operator.

Name	Model
ST Connector	MS9710C-38
DIN (47256) Connector	MS9710C-39
SC Connector	MS9710C-40
HMS-10/A (DIAMOND) Connector	MS9710C-43

Remove the optical connector supplied with the main unit and fit the new connector (sold separately). The inner face of the optical connector can also be cleaned.

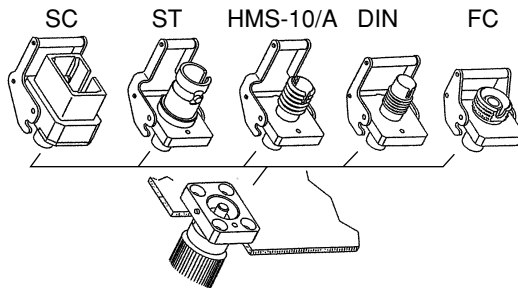

Use the following procedure to remove the optical connector. For the cleaning method, refer to Section 7.1 “Periodic Maintenance.”

- (1) Open the connector cover.
- (2) Lift up the connector lever and gently pull the connector straight out after confirming that the locking latch is disengaged.

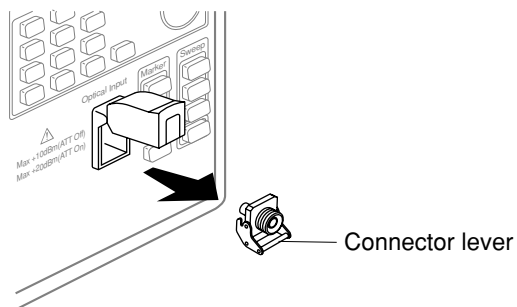

- (3) Fit the new connector in the reverse procedure of removal. Take great care not to scratch or otherwise damage the connector or end face of the ferrule.

3.9.2 Connectors not Replaceable at User Site

Please contact your service representative for replacing the following connectors.

Name	Model
E2000 (DIAMOND) Connector	MS9710C-27

3.10 Changing Fuses

If a fuse blows, first find the reason why and perform the repair. Then change the fuse following the steps in the caution below.

CAUTION

1. **BEFORE** changing a fuse, **ALWAYS** disconnect the power cord from the power outlet. If the fuse is changed with the power cord connected to the power outlet, there is a risk of receiving a serious or fatal electric shock.
2. In addition, **ALWAYS** replace the blown fuse with a new fuse of the same type and power rating. The fuse rating and type are indicated on the back panel of the main unit and in the operation manual. The marking T3.5 A on the fuse indicates a timelag fuse rated at 3.5 A. Use a 3.5-A fuse for 100-V systems and a 1.6 A fuse for 200-V systems.

Fuse Replacement Procedure

- (1) The AC fuse holders are on the back panel under the AC power input connector. Remove the fuse holder caps.
- (2) Find the brown fuse and replace it.
- (3) Mount the fuse holder caps.

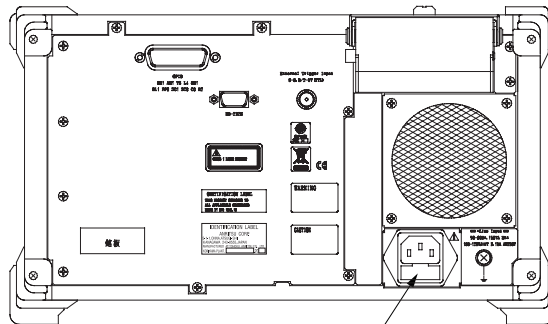

Section 4 Operation

This section describes the basic functions and how to operate the MS9710C Optical Spectrum Analyzer. It explains some measurement procedures as well as the composition of the operation panels and screens. Refer to Section 5 “Explanation of Screen” for more details on each screen.

4.1	Connecting Optical Fiber	4-2
4.2	Switching Power On	4-3
4.3	Basic Function and Example of the Operation ..	4-4
4.4	Analyzing Measured Waveforms	4-12
4.5	Saving and Recalling Measured Waveforms ..	4-15
4.6	Printing Waveforms	4-18
4.7	Measuring Modulated Light Using External Trigger Signal	4-19
4.8	Use of the Optional Light Sources	4-20
4.9	Transmission Characteristics	4-21
4.10	Tracking Measurement	4-22
4.10.1	Connecting MG9637/MG9638 Tunable Light Source	4-22
4.10.2	Setting MG9637/MG9638	4-22
4.10.3	Execute Tracking Wavelength Calibration (Adjust to TLS)	4-23
4.10.4	Tracking Measurement	4-24
4.10.5	Quitting Tracking Measurement	4-24

4.1 Connecting Optical Fiber

Open the cover of the optical input connector and connect the optical fiber to the connector.

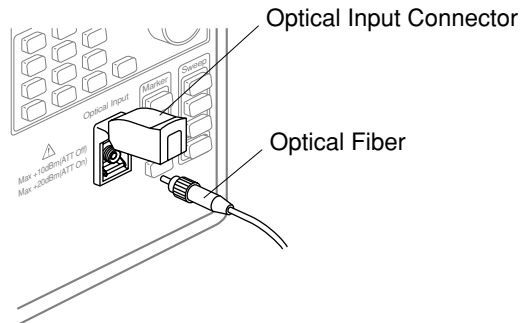

CAUTION

1. Before connecting the optical fiber, always clean the end face of the fiber. In addition, periodically clean the end face of the socket in the optical input connector. If either the end face of the input connector or optical fiber is dirty when light at high power levels in input, there is a possibility that the part may be damaged by scorching. Refer to Section 7.1 “Periodic Maintenance” for the cleaning method.
2. Before connecting the input light, check that the light does not exceed the maximum specified level. When the optical attenuator is inserted, the maximum level is +23 dBm. When it is not inserted, the maximum level is +10 dBm. If the optical input exceeds the maximum level, there is a risk of damaging the optical section in the analyzer.

4.2 Switching Power On

- (1) When using the 3-wire power cord, supplied as an accessory with the conversion adapter, ALWAYS either connect the green wire from the conversion adapter to ground, or ground the Frame Ground terminal on the back panel, BEFORE supplying power to the MS9710C.
- (2) Check that the power switch on the front panel is Off and plug the power cord into the power inlet on the back panel.
- (3) Press the power switch to set the analyzer to On.

The startup screen is displayed for about 1 minute and the analyzer can be used after the startup changes to the following screen. (The wavelength and level displays will probably not be the same as on the following screen.)

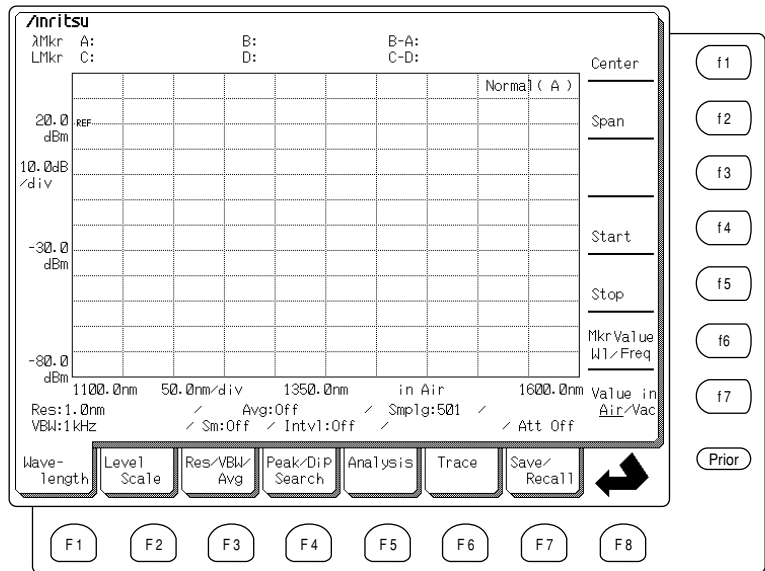

4.3 Basic Function and Example of the Operation

As an example of a basic operation, measurement of an LD light source is described. An FP-LD with a peak level of about -20 to -10 dBm in the $1.55 \mu\text{m}$ wavelength band is used.

(1) Return the measurement conditions to the factory settings.

This analyzer has a function for saving the measurement conditions. Therefore, when the power is switched On, measurement can be performed at the same conditions before the power was turned Off. The following section explains how to return the measurement conditions to the factory settings.

Appendix B

- (a) If the Foreground cards are displayed at the bottom edge of the screen, display the Background cards, selecting change button  by pressing **(F8)** key.
- (b) Press the **(F6)** key to select the Condition card.
- (c) Press the Recall function key **(f2)** to display the Condition Recall screen.
- (d) Input 0 using the Data entry keys to set the Memory select number at the center top of the screen to Init.
- (e) Press the Execute function key **(f1)** to return the measurement conditions to the factory settings.

(2) Connect the optical fiber to the optical input connector.

(3) Connect the other end of the optical fiber to the light source output.

(4) Set the Center wavelength to 1550 nm.

Section 5.1

- (a) Either press the **(F1)** key to select the Wavelength card and press the Center function key **(f1)**, or press the Center key **(Center)** of shortcut key. Actual value of Center wavelength is displayed in the Settings display field, and its unit options are displayed in the Functions display field at right-hand side of the screen using function keys.
- (b) Input 1550 using the Data entry keys.
- (c) Select its unit [nm] by pressing function key **(f1)**, which completes the setting of the Center wavelength to 1550 nm. The Center wavelength can also be set using the Knob instead of the Data entry keys.

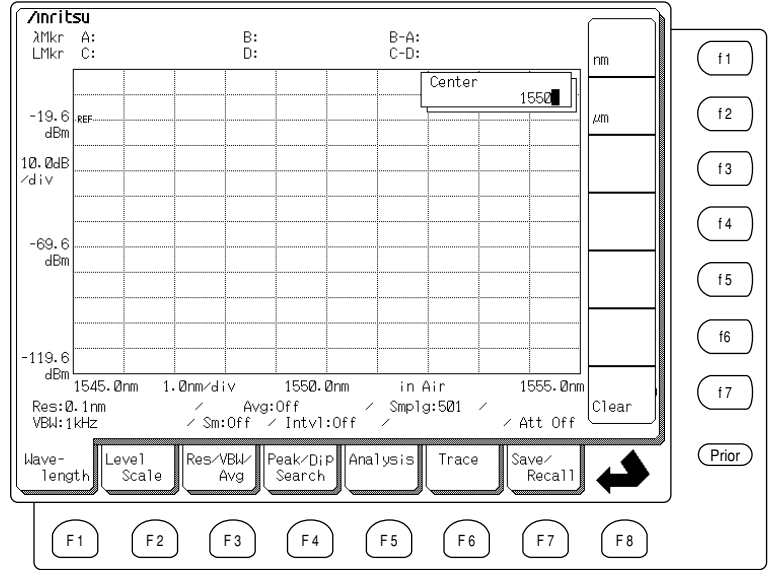

(5) Set the Span (sweep width) to 50 nm.

Section 5.1

- (a) Either press the **(F1)** key to select the Wavelength card and press the Span function key **(f2)**, or press the Span key **(Span)** of shortcut keys. Actual value of Span is displayed in the Settings display field. The value of Span can be selected from the Functions display field at right-hand side of the screen using function keys.
- (b) Select 50 nm by pressing function key **(f6)**, or input 50 using the Data entry keys and select its unit [nm] by pressing function key **(f1)** to complete the setting. The value of Span can also be set using the Knob.

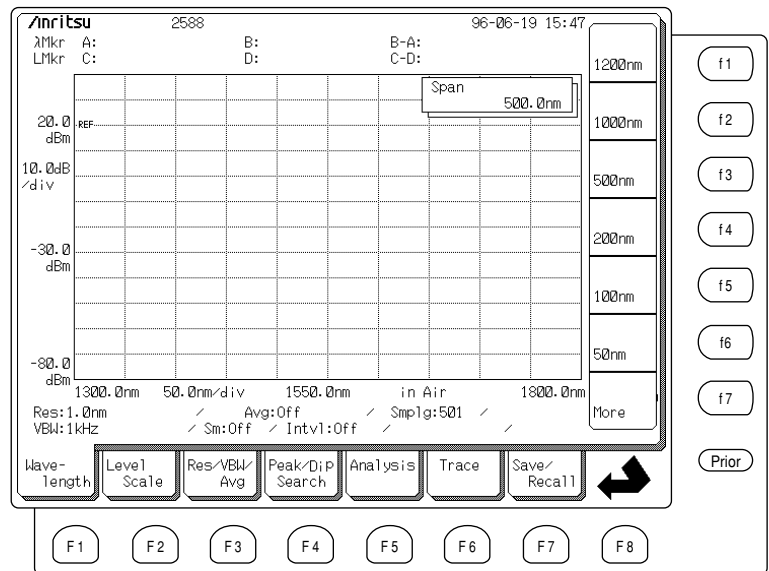

(6) Set the Resolution to 0.1 nm.



- (a) Either press the **(F3)** key to select the Res/VBW/Avg card and press the Res function key **(f1)**, or press the Res key **(Res)** of shortcut keys. The current Resolution is displayed in the Settings display field. The value of Resolution can be selected from the Functions display field at right-hand side of the screen using function keys.
- (b) Select 0.1 nm by pressing function key **(f4)** to set the Resolution to 0.1 nm.

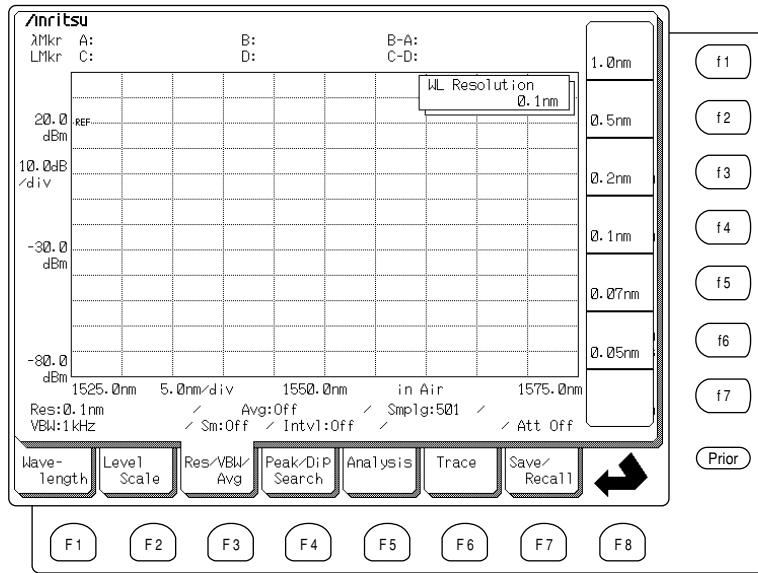

(7) Set the Video Bandwidth (VBW) to 1 kHz.

 Section 5.3

- (a) Either press the **(F3)** key to select the Res/VBW/Avg card and press the VBW function key **(f2)**, or press the VBW key **(vbw)** of shortcut keys. The current VBW is displayed in the Settings display field. The VBW can be selected from the Functions display field at right-hand side of the screen using function keys.
- (b) Select 1 kHz by pressing function key **(f4)** to set the VBW to 1 kHz.

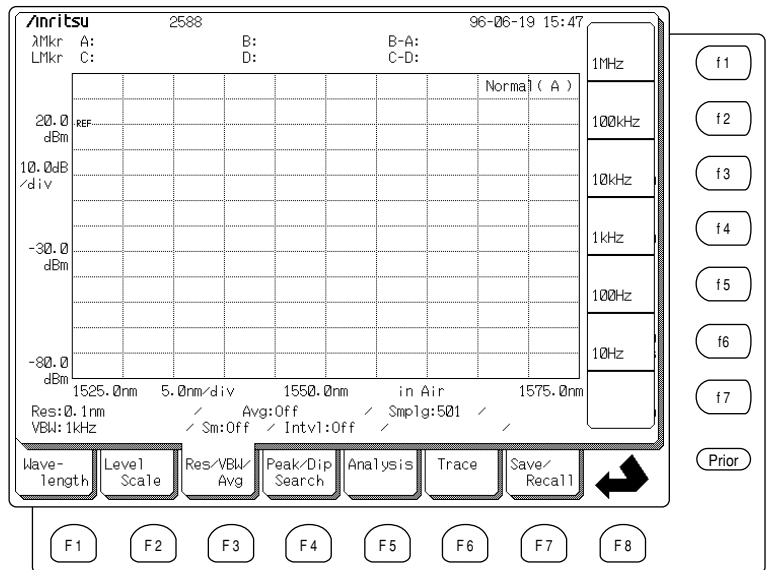

(8) Execute the measurement.



Press the Single key  of Sweep keys to execute one measurement sweep and display the measured waveform on the screen.

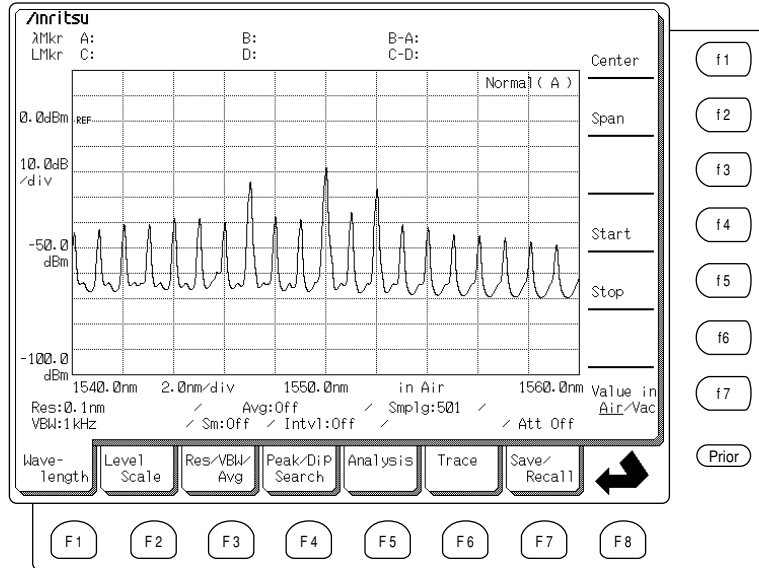

(9) Set the peak level wavelength as the Center wavelength.



Press the Peak→Center  of shortcut key to set the wavelength at the peak level to be displayed at the center of the screen.

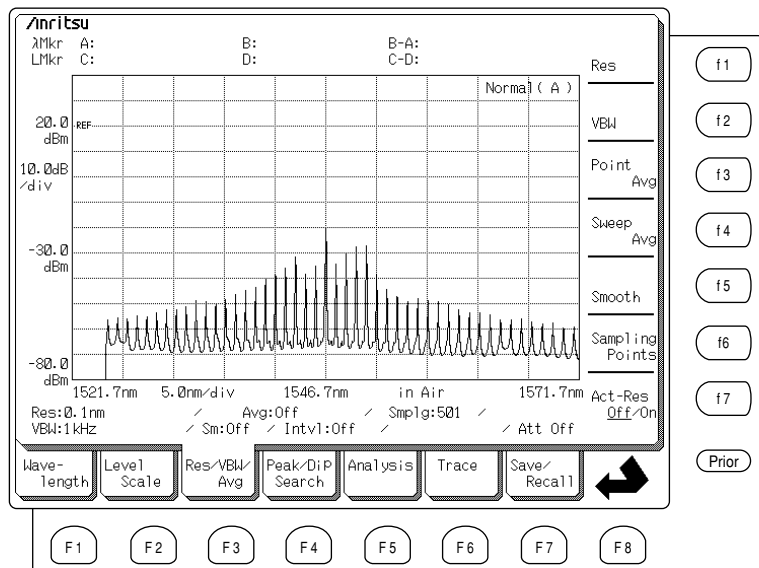

(10) Set the peak level as the reference level.

 Section 2.6

Press the Peak→Ref Level  of shortcut keys to set the peak level to the reference level.

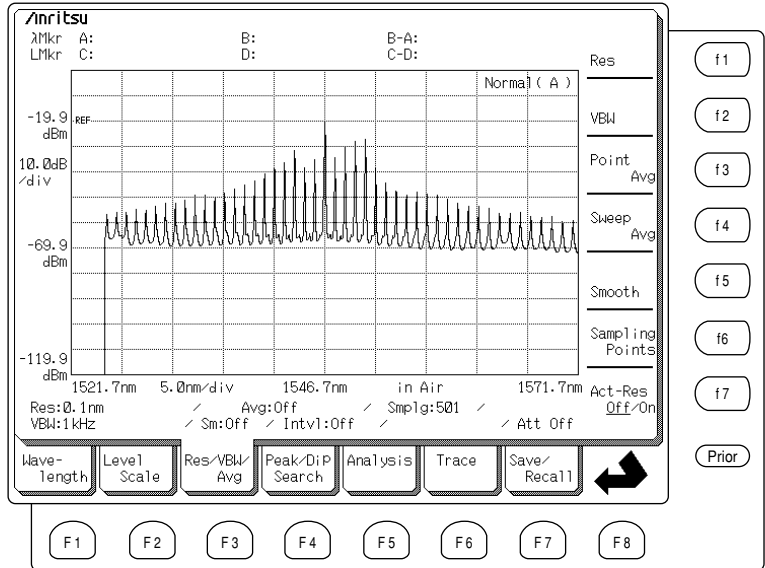

(11) Set the Span (sweep width) to 20 nm.



- (a) Either press the **(F1)** key to select the Wavelength card and press the Span function key **(f2)**, or press the Span key **Span** of shortcut keys. Actual value of Span is displayed in the Settings display field. The value of Span can be selected using function keys.
- (b) Press the More function key **(f7)** to display page 2 of the Functions display field for more options. Select 20 nm by pressing the **(f1)** function key, or input 20 using the Data entry keys. It is necessary to press the **(f1)** function key to select the unit [nm]. The Span can also be set using the Knob.

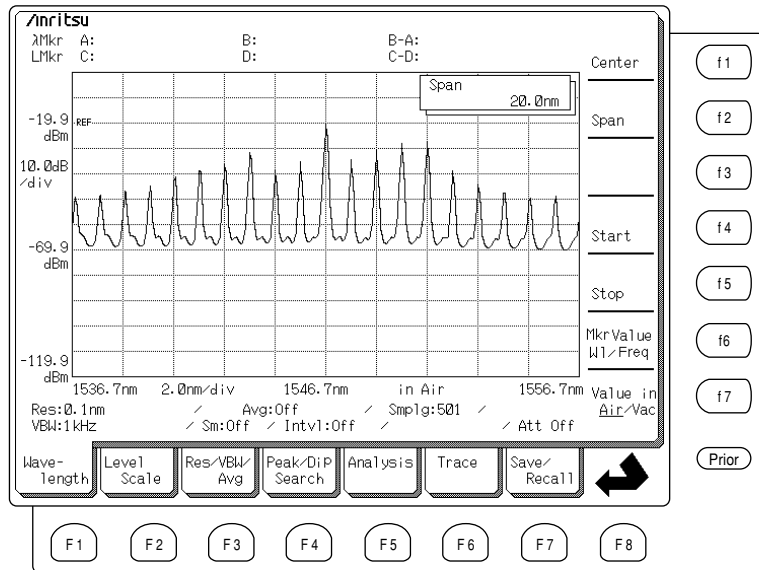

(12) Execute another measurement.



New data is not obtained by only changing the settings. Press the Single key **Single** or Repeat key **Repeat** of the Sweep keys to execute the measurement sweep.

(13) Use the Repeat Sweep function.



Press the Repeat key **Repeat** of the Sweep keys to take measurements continuously using the Repeat Sweep function, and change measurement conditions during a Repeat Sweep to optimize the displayed trace. Alternately, the Auto Measurement function can be used to quickly obtain the waveform. However, user adjustments are required after Auto Measurement to improve the displayed trace occasionally.

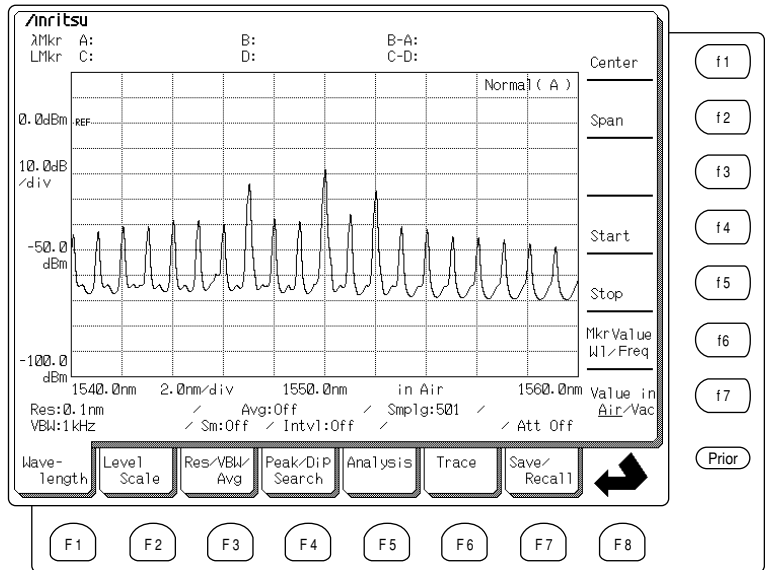

Set the best measurement conditions while using the Repeat Sweep function. Press the Single key **Single** of Sweep keys after confirming the measurement conditions, that completes measurement after one sweep. To terminate a measurement during the sweep, press the Stop key **Stop** of the Sweep keys.

4.4 Analyzing Measured Waveforms

This section explains how to analyze the waveform obtained in the previous section.

(1) Execute RMS analysis.

The basic operation of RMS analysis, which is one of the Analysis function of the MS9710C, is as follows.

 **Section 5.5**

Press the **(F5)** key to select the Analysis card then press the RMS function key **(f5)**. Analysis markers are displayed around the spectrum and the analysis results are displayed at the top center of the screen.

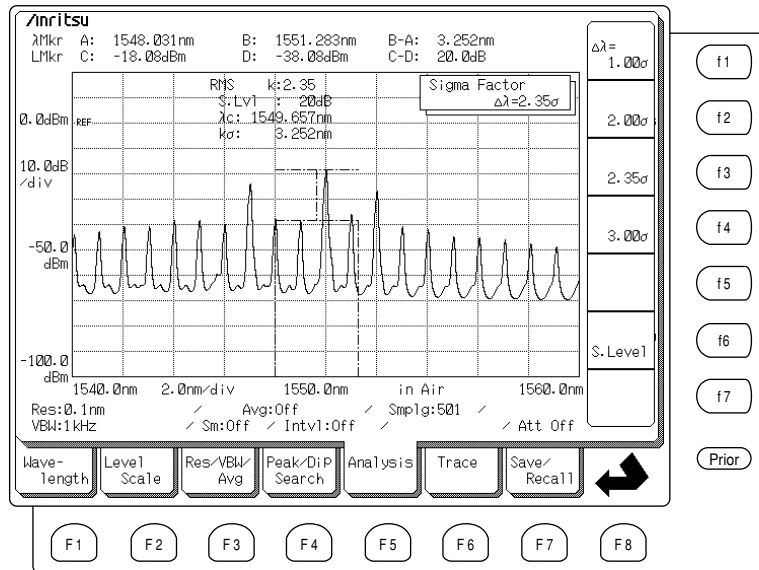

In this state, by selecting $\Delta\lambda$ function key from the function key ability display area on the right of the screen, you can set one of analysis expressions from "1.00 σ / 2.00 σ / 2.35 σ / 3.00 σ ". In this example, 2.35 σ is set as the expression. Also, by selecting the S. Level function key **(f6)** and using the ten keys and encoder, you can set the slice level. In this example, the slice level is set to 20 dB.

As the analysis result, the center wavelength and 2.35 σ selected as the expression are displayed.

(2) Execute Peak Search.

 Section 5.4

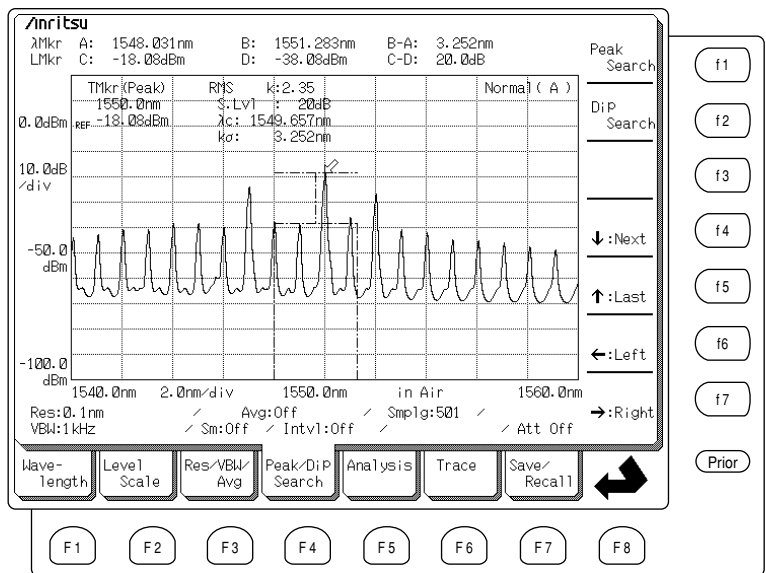

Find the Peak point of the waveform using Peak Search. Either press the **(F4)** key to select the Peak/Dip Search card and press the Peak Search function key **(f1)**, or press the Peak Search key **(Peak Search)** of shortcut keys. The Peak point on the waveform is found and a trace marker is displayed at that point.

Press the **(F4)** card selection key to select the Peak/Dip Search card and then press the \downarrow , or Next function key **(f4)**. To move the trace marker to the peak with the next highest level.



(3) Use the Zone Marker.

 **Section 2.8 and 5.16**

Press the Zone Marker key  of shortcut keys to display the zone marker is displayed on the screen. Press Zone Width function key  to set the zone marker to a width of about 1 grid division on the screen, and use Zone Center function pressing the Zone Center function key  to move the zone area on the screen to the best position. Both analysis and Peak Search is executed within the zone bounded by the zone marker.

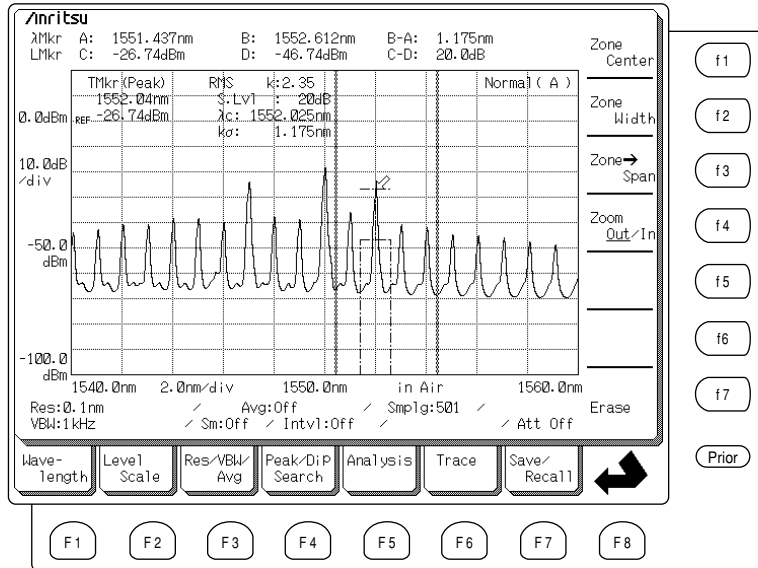

This Zone Marker function is useful for analyzing a specific spectrum individually while monitoring several spectra simultaneously as in WDM applications, etc.

4.5 Saving and Recalling Measured Waveforms

This section explains how to save and recall measured waveforms.

(1) Format the Floppy Disk.

This analyzer can save measured data to FD. In addition, previously saved data can be read and analyzed.

 **Section 5.7**

Before saving the waveform to FD, the FD must be formatted. To format the FD, press **(F7)** card selection key to display the Save/Recall cards, and press the File Format function key **(f6)** to format the FD. The default format of this analyzer is 1.44 MB but it can be set to 1.2 MB format using the File option settings of Save/Recall card.

 **Section 5.7**

To change the file format settings, press **(F7)** card selection key to display Save/Recall card and press the File Option function key **(f4)**.

The FD can be formatted by this analyzer or by a personal computer. Note that formatting a previously-used FD, completely erases the previous contents of the FD.

(2) Save Measured Data.

To save measured data, press **(F7)** key to select the Save/Recall card, and press the Save function key **(f1)** to input the file name or number.

 **Section 5.7**

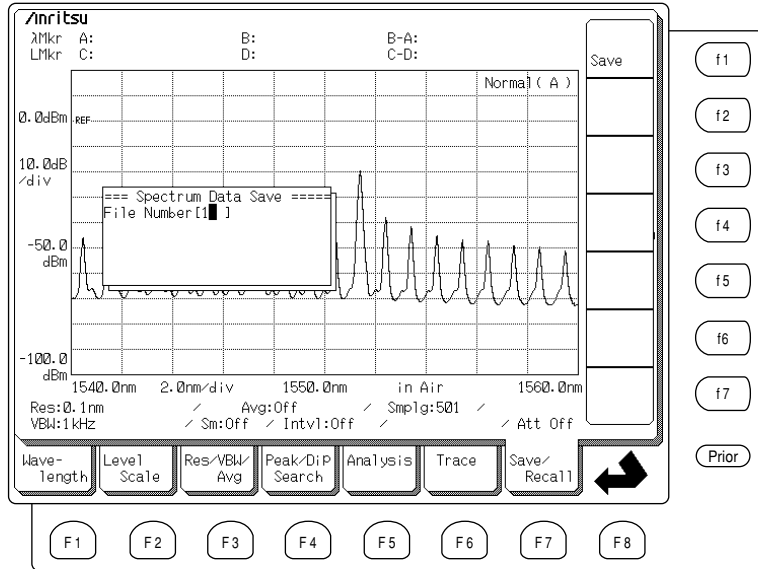

This example explains how to save the data to file number 1. When 1 is input as the file number, a file called “data001.dat” is created on the FD. The name of the file created at this time may be different such as “data001.bmp” or “data001.txt” depending on the File Option settings of Save/Recall card.

(3) Recall Saved Data.

For an example of recalling data, recall the data saved in the example of (2) “Save Measured Data.” To recall saved data, press the (F7) to select the Save/Recall card, and press the Recall function key (f2). A list of saved files is displayed; move the cursor to the recalling file name, then for this example select the file named “data001.dat” and execute recall.

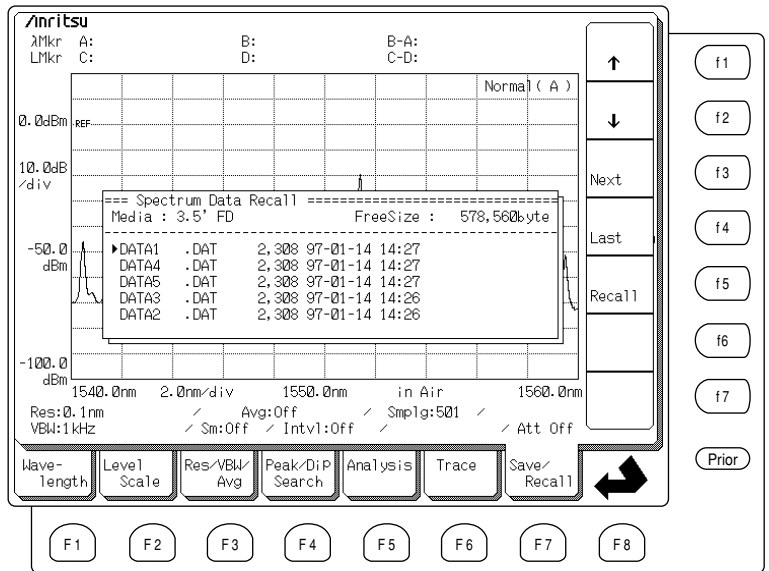

This operation recalls the data saved in item (2) “Save Measured Data”.

4.6 Printing Waveforms

When the Copy key **(Copy)** is pressed, the screen displayed at that instant is hard copied by either the internal printer or an external printer. A sample of printout is shown below.

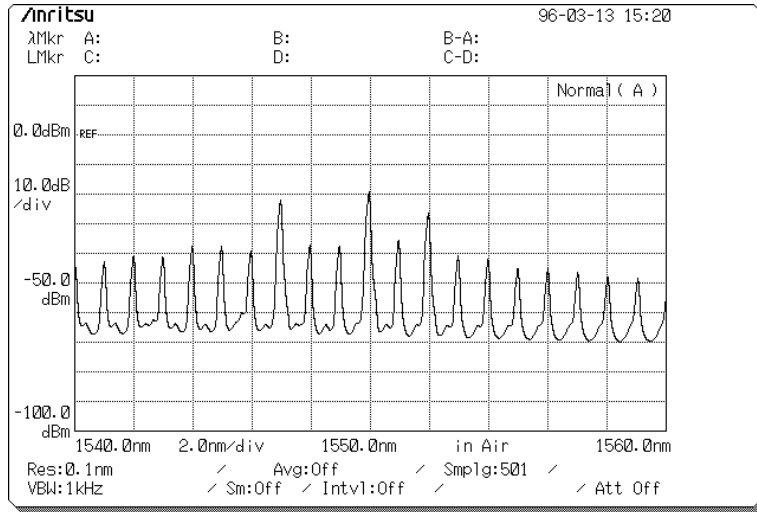

To set the print output destination, press the **(F7)** key to display Other card and press the Printer Prmtr function key **(f1)** to display the setting screen.

4.7 Measuring Modulated Light Using External Trigger Signal

Modulated light can be measured by inputting an external trigger signal synchronized with the modulation.

The setting example of measuring DFB-LL is as shown below.

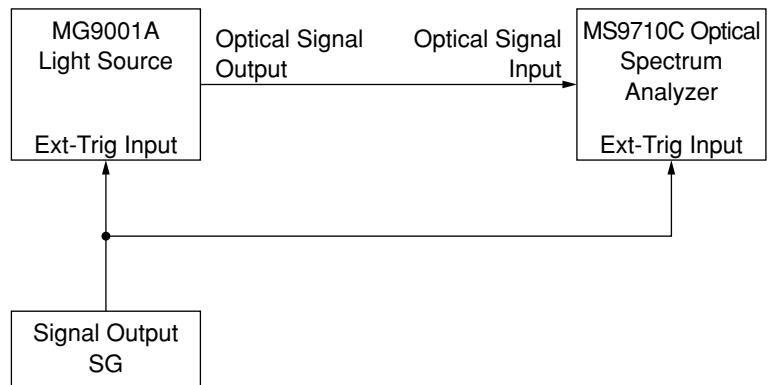

- (1) Use a signal generator (hereinafter referred as SG) that can output a TTL level modulation signal and connect the SG output to the external trigger input connectors of the light source (MG9001A) and the MS9710C. Connect the output of the light source to the optical input connector on the front panel of the MS9710C.
- (2) Press the **(F3)** card selection key to display Measure Mode card and press for Ext. Trigger function key **(f3)**.
- (3) Use Data entry keys or Knob to set the Delay Time so that the level of the measured spectrum becomes the maximum value.

The relationship between the peak of trigger signal and the sampling point depending on the Delay Time settings is as shown below.

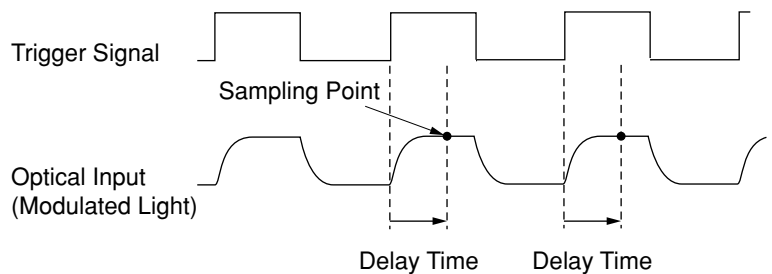

4.8 Use of the Optional Light Sources

There are four optional light sources, white light source, and wavelength reference and SLD light sources.

White Light Source (Option 02)

This light source is light from a small halogen lamp coupled to the optical fiber and output. The light has wide range of wavelength but this option uses lights from 0.9 μm to 1.75 μm of wavelength. This light source can be used for measuring transmission characteristics. Refer to Section 4.9 “Transmission Characteristic” for more details.

Wavelength Reference Light Source and SLD Light Sources (Option 03)

For this light source two optical outputs are available from a single light source: Wavelength reference light source and SLD light source.

SLD Light Source (Option 04)

Light from the front of the SLD element is directly connected to optical fiber and is led to the SLD output connector. Light from the SLD element can be coupled to an SM optical fiber with high efficiency and it is suitable as light source for loss wavelength measurement.

Also, because a very ripple less light source is used in this equipment, the level characteristics is flat over wide wavelength range. The SLD has characteristics of wide spectrum range and high level output at 1.55 μm band, so it can be used for measurement of wide dynamic range transmission characteristics. (The SLD has no random polarization characteristics. When transmission characteristics is measured for polarization dependence devices with the SLD light source, measured values may vary in conditions.) Refer to Section “4.9 Transmission Characteristics” for more details on the use of this light source.

Wavelength Reference Light Source (Option 05)

Light from the front of the SLD element is led into a cell in which acetylene gas is charged, and is output from the wavelength reference output connector on the back panel. The absorption wavelength of the acetylene gas is approximately 1.535 μm . This wavelength is often used as standard wavelength because it is stable to environmental changes. To calibrate this equipment using this wavelength, connect the wavelength reference light output connector and the optical input connector on the front panel with an SM fiber cord. Refer to Section 5.12 “Calibration Function” for more details on the calibration procedure.

4.9 Transmission Characteristics

The transmission characteristics can be measured by using the light source with wide range spectrum and the subtraction function with memory A and memory B. In the beginning, a measuring system without device under test (DUT) is measured and the data is stored, and then, a device under test is measured using the measuring system and the first data is subtracted from the measurement data. Input the light from the light source directly to this equipment and measure the spectrum and store the data to Memory A as shown in Fig. 4-1. Then change to Memory B and connect the light from the light source to the device under test as shown in Fig. 4-2. Measure the spectrum and store the measured data into the memory. When Trace B-A is displayed, the transmission characteristics excluding the measurement system characteristics can be viewed. Adjust the level scale to fit measured results.

If there is any difference in fiber connection loss between when the DUT is excluded and included, the measurement may not be accurate. Take sufficient care to avoid difference of optical path other than in device under test.

When using the built-in light source, connect a fiber cord to the light output connector on the back panel (SLD output or wavelength reference output), and turn on the optical light source On/Off switch on the front panel. An external light source can be used for measurement.

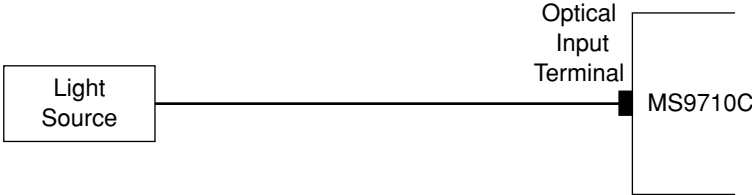

Fig. 4-1 Measuring Measurement System

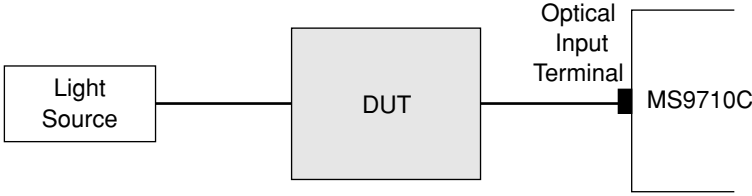

Fig. 4-2 Measuring Device Under Test

4.10 Tracking Measurement

The MG9637/MG9638 tunable light source can be used for tracking measurement in combination with the MS9710C. The tracking measurement and output wavelength of the tunable light source is controlled by the MS9710C; the side sending the set wavelength (MG9637/MG9638) and the receiving side (MS9710C) can perform synchronized measurement.

As a result of the MG9637/MG9638 wavelength accuracy and the MS9710C dynamic range, it is possible to evaluate the characteristics of optical receiver elements such as wide-dynamic range filters.

4.10.1 Connecting MG9637/MG9638 Tunable Light Source

Connect the MS9710C with the MG9637/MG9638 using an RS-232C cable (J0654A) between the RS-232C I/F of each instrument. When making the connection, ensure that the connectors are connected securely. Poor connection will cause misoperation.

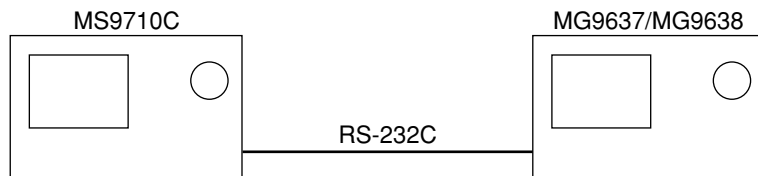

4.10.2 Setting MG9637/MG9638

Set the MG9637/MG9638 to the tracking measurement status. Set Interface GPIB/RS-232C at the MG9637/MG9638 Advance menu to RS-232C and execute Setting to OSA. Refer to the MG9637/MG9638 Instruction Manual for more details on the MG9637/MG9638 settings and operation method.

4.10.3 Execute Tracking Wavelength Calibration (Adjust to TLS)

Calibrate the tracking wavelength of the MS9710C and the MG9637/MG9638. Connect the MS9710C and the MG9637/MG9638 directly with an optical fiber cord. After setting the Center wavelength of the MS9710C to the Center wavelength to be measured, press the **(F3)** key to select the Measure Mode card and Press TLS Tracking function key **(f5)**.

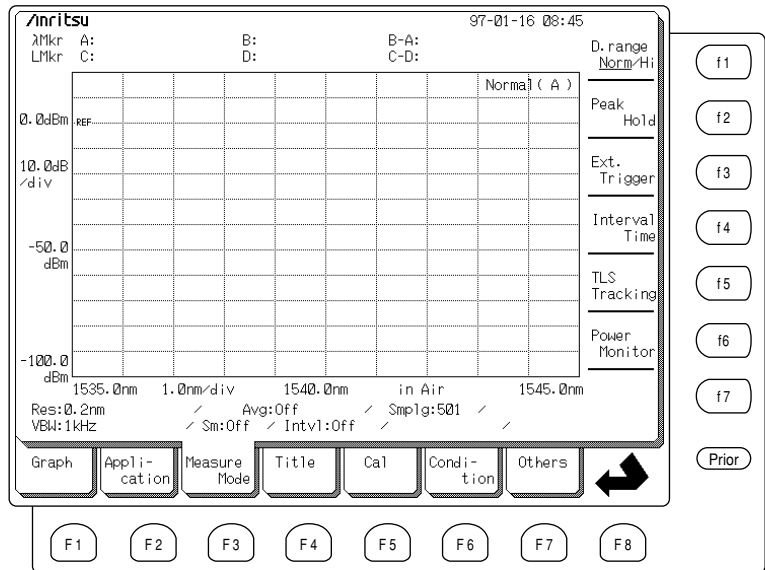

Press the Adjust to TLS function key **(f2)** then select Execute by pressing the function key **(f1)**, which sets the measurement conditions automatically and start calibration. Calibration of the tracking wavelength will take about a few minutes.

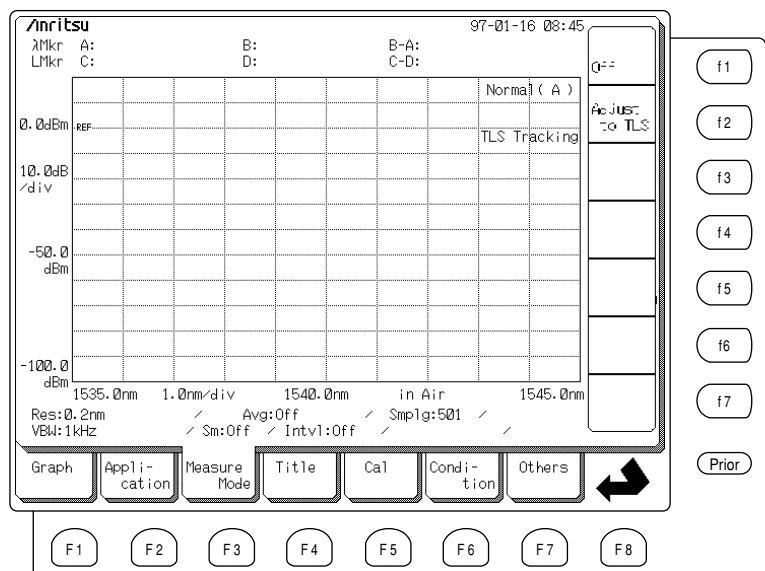

If the message "TLS Interface Error" is displayed at this time, check the cable connections again and the MG9637/MG9638 settings.

4.10.4 Tracking Measurement

Now, necessary setup has been completed for the tracking measurement. Refer to Section 4.9. “Transmission Characteristics” for more details on measurement of transmission.

An example of filter measurement by tracking measurement is as shown below.

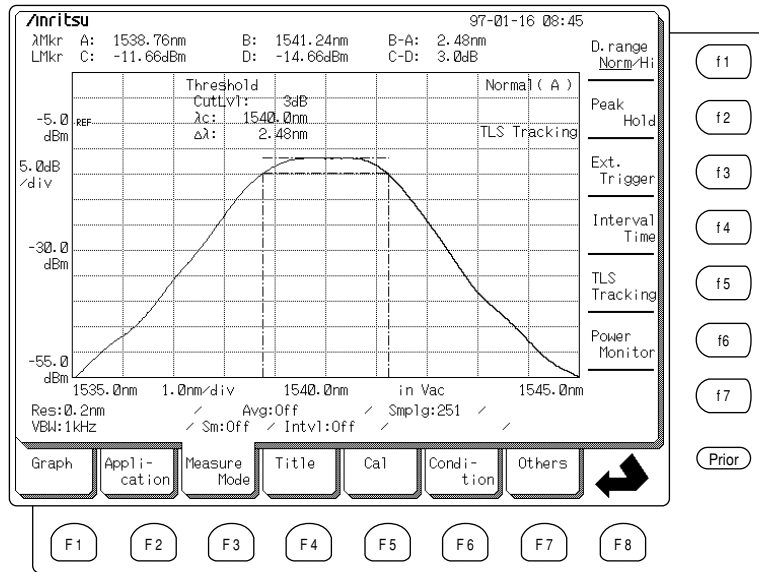

Note that during tracking measurement, the Auto measurement and the W1 Off-set function key (f1) of the Cal card selected by pressing (F5) key is not possible to be used.

4.10.5 Quitting Tracking Measurement

To quit tracking measurement and return to the normal spectrum measurement, press the (F3) key to display Measure Mode card, then press TLS Tracking function key (f5) and finally press Off function key (f1).

However, once tracking measurement has been terminated, the tracking wavelength calibration becomes invalid and re-calibration will be required when tracking measurement is executed again.



Furthermore, when the measurement wavelength (Center wavelength, vacuum/air display) is changed, tracking wavelength will need calibrating again.

In addition, at tracking measurement, the Resolution must be set to 0.2 minimum.

Section 5 Explanation of Screens

This section explains how to select functions of MS9710C Optical Spectrum Analyzer from its screens. The most-commonly-used functions have dedicated keys (shortcut keys) on the front panel.

This analyzer has a number of function screens each called a “card”, that are switched using the card selection keys. Each time a card selection key, which is corresponding to the card tab at the bottom of the screen, is pressed, the function card is displayed along with functions of the card corresponding to the function keys. The seven cards starting from the Wavelength card are called “Foreground cards” and the seven cards starting from the Graph card are called “Background cards.” The displayed card are switched foreground to background or in other way by pressing the (F8) key to select change button .

Marker related functions can be selected from the Marker Select screen and the Zone Marker screen which are displayed by pressing the Marker Select key  and Zone Marker key  of Marker keys, respectively.

This section explains the operation of each function in the sequence of Foreground cards, Background cards, Marker Select screen and Zone Marker screen. The section contents are listed in detail on pages 5-2 to 5-7.

<Foreground cards>

5.1	Setting Wavelength	5-8
5.2	Setting Level	5-12
5.3	Setting Resolution and Averaging	5-16
5.4	Peak/Dip Search	5-22
5.5	Analyzing Waveforms	5-25
5.6	Trace Memory	5-38
5.7	Saving and Recalling Measured Data	5-41

<Background cards>

5.8	Setting Graph Type	5-50
5.9	Application Measurement Functions	5-55
5.10	Special Measurement Modes	5-90
5.11	Setting Titles	5-95
5.12	Calibration Function	5-97
5.13	Saving and Recalling Measurement Conditions	5-101
5.14	Other Functions	5-105

<Marker Select Screen>

5.15	Marker Select Screen	5-114
------	----------------------------	-------

<Zone Marker Screen>

5.16	Zone Marker Screen	5-118
------	--------------------------	-------

<Foreground cards>

The tabs of Foreground cards appear at the bottom of the MS9710C screen. The Background cards are displayed by pressing the (F8) key to select the change button .

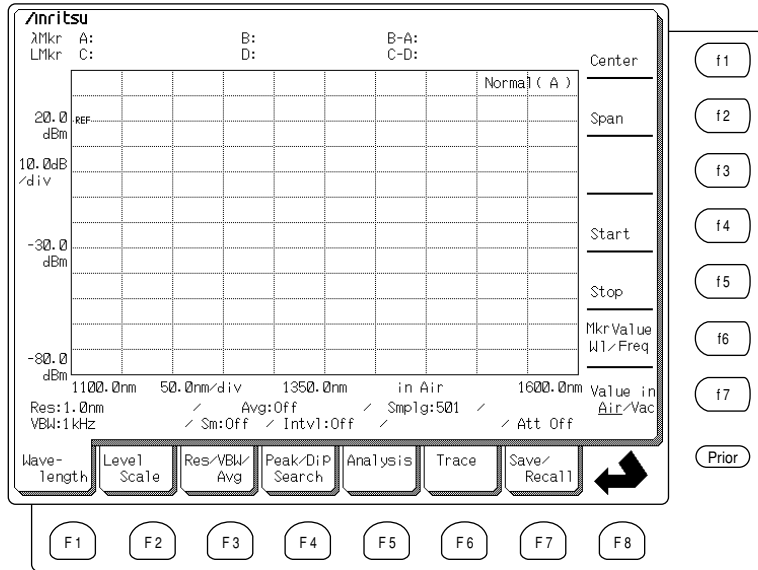

5.1	Setting Wavelength (Wavelength Card (F1))	5-8
5.1.1	Setting Center Wavelength (Center (f1))	5-8
5.1.2	Setting Sweep Width (Span (f2))	5-9
5.1.3	Setting Start Wavelength (Start (f4))	5-10
5.1.4	Setting Stop Wavelength (Stop (f5))	5-10
5.1.5	Switching Marker Frequency Display (Mkr Value W1/Freq (f6))	5-11
5.1.6	Switching Wavelength Display (Value in Air/Vac (f7))	5-11
5.2	Setting Level (Level Scale Card (F2))	5-12
5.2.1	Setting Log Scale (Log (/div) (f1))	5-12
5.2.2	Setting Reference Level (Ref Level (f2))	5-13
5.2.3	Setting Linear Scale (Linear Level (f4))	5-14
5.2.4	Optical Attenuator On/Off (Opt. Att Off/On (f6)) ..	5-15
5.3	Setting Resolution and Averaging (Res/VBW/Avg Card (F3))	5-16
5.3.1	Setting Resolution (Res (f1))	5-17
5.3.2	Setting Video Band Width (VBW (f2))	5-18
5.3.3	Setting Point Average (Point Average (f3))	5-18
5.3.4	Setting Sweep Average (Sweep Average (f4)) ...	5-19
5.3.5	Setting Smoothing (Smooth (f5))	5-20
5.3.6	Setting Sampling Points (Sampling Points (f6)) ..	5-21
5.3.7	Switching Actual Resolution (Act-Res Off/On (f7))	5-21

5.4	Peak/Dip Search (Peak/Dip Search Card F4)	5-22
5.4.1	Searching for Peak Points (Peak Search f1)	5-22
5.4.2	Searching for Dip Points (Dip Search f2)	5-22
5.4.3	Searching for Next Largest/Smallest Peak/Dip Point (↓: Next f4)	5-23
5.4.4	Searching for Last Largest/Smallest Peak/Dip Point (↑: Last f5)	5-23
5.4.5	Searching for Next Left Peak/Dip Point (←: Left f6)	5-23
5.4.6	Searching for Next Right Peak/Dip Point (→: Right f7)	5-24
5.4.7	Releasing Peak/Dip Search	5-24
5.5	Analyzing Waveforms (Analysis Card F5)	5-25
5.5.1	Threshold Analysis (Threshold f1)	5-26
5.5.2	ndB-Loss Analysis (ndB-Loss f2)	5-28
5.5.3	Side Mode Suppression Ratio Analysis (SMSR f3) ..	5-30
5.5.4	Envelope Analysis (Envelope f4)	5-32
5.5.5	RMS Analysis (RMS f5)	5-34
5.5.6	Spectrum Power Analysis (Spectrum Power f6) ..	5-36
5.5.7	Deleting Analysis Results (Off f7)	5-37
5.6	Trace Memory (Trace Card F6)	5-38
5.6.1	Selecting Memory A (Memory A f1)	5-39
5.6.2	Selecting Memory B (Memory B f2)	5-39
5.6.3	Selecting Trace A (Trace A f3)	5-39
5.6.4	Selecting Trace B (Trace B f4)	5-39
5.6.5	Displaying Two Traces Simultaneously (Trace A&B f5)	5-39
5.6.6	Comparing Trace A–B (Trace A–B f6)	5-39
5.6.7	Comparing Trace B–A (Trace B–A f7)	5-40
5.7	Saving and Recalling Measured Data (Save/Recall Card F7)	5-41
5.7.1	Saving Measured Data (Save f1)	5-42
5.7.2	Recalling Saved Data (Recall f2)	5-45
5.7.3	Setting Options (File Option f4)	5-46
5.7.4	Deleting Files (File Delete f5)	5-48
5.7.5	Formatting Floppy Disk (File Format f6)	5-49
	Go to Background cards ( Change button F8)	5-4

<Background cards>

The tabs of Background cards appear at the bottom of the MS9710C screen. The Foreground cards are displayed by pressing the (F8) key to select the change button .

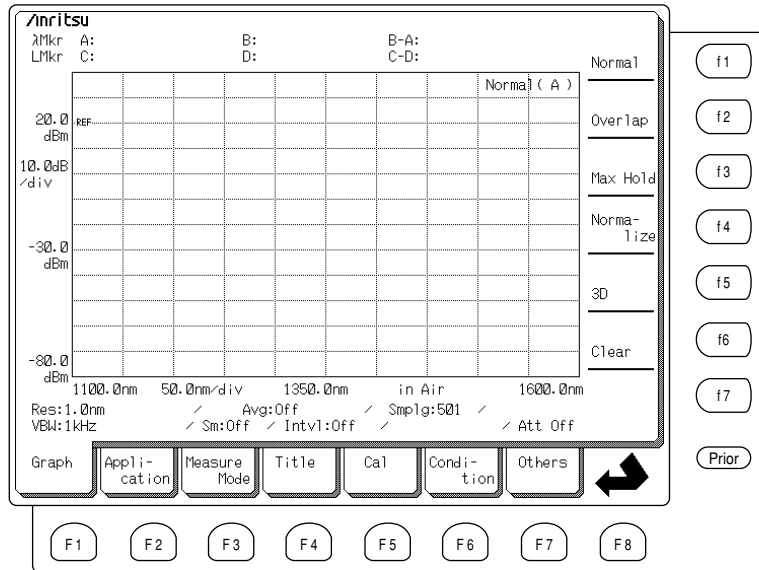



5.8	Setting Graph Type (Graph Card (F1))	5-50
5.8.1	Normal Display (Normal (f1))	5-50
5.8.2	Overlap Display (Overlap (f2))	5-50
5.8.3	Max Hold Display (Max Hold (f3))	5-51
5.8.4	Normalize Display (Normalize (f4))	5-51
5.8.5	3D Display (3D (f5))	5-52
5.8.6	Clearing Graphs (Clear (f6))	5-54
5.9	Application Measurement Functions (Application Card (F2)) ..	5-55
5.9.1	Evaluating DFB-LDs (DFB-LD Test (f1))	5-56
5.9.2	Evaluating FP-LDs (FP-LD Test (f2))	5-58
5.9.3	Evaluating LEDs (LED Test (f3))	5-60
5.9.4	Evaluating PMD (PMD Test (f4))	5-63
5.9.5	Evaluating Optical Amplifiers (Opt. Amp Test (f5))	5-67
5.9.6	WDM Evaluation (WDM (f6))	5-81
5.10	Special Measurement Modes (Measure Mode Card (F3)) ..	5-90
5.10.1	Wide Dynamic Range Measurement (D. range Norm/Hi (f1))	5-91
5.10.2	Modulated Light Measurement (Ext. Trig (f3))	5-91
5.10.3	Interval Measurement (Interval (f4))	5-92

5.10.4	Tracking Measurement (TLS Tracking (f5))	5-93
5.10.5	Power Monitor Measurement (Power Monitor (f6))	5-94
5.11	Setting Titles (Title Card (F4))	5-95
5.12	Calibration Function (Cal Card (F5))	5-97
5.12.1	Setting Wavelength Offset (WI Offset (f1))	5-98
5.12.2	Setting Level Offset (Level Offset (f2))	5-98
5.12.3	Calibrating Wavelength using External Wavelength Reference (WI Cal (Ext) (f3))	5-99
5.12.4	Calibrating Wavelength using Optional Internal Wavelength Reference (WI Cal (Int) (f4))	5-99
5.12.5	Initializing Wavelength Calibration Data (WI Cal (Init) (f5))	5-100
5.12.6	Automatic Optical Axis Alignment (Auto Align (f6))	5-100
5.12.7	Calibrating Effective Resolution (Res Cal (f7))....	5-100
5.13	Saving and Recalling Measurement Conditions (Condition Card (F6))	5-101
5.13.1	Saving Measurement Conditions (Condition Save (f1))	5-102
5.13.2	Recalling and Initializing Measurement Conditions (Recall (f2))	5-103
5.13.3	Listing Current Measurement Conditions (View (f4))	5-104
5.14	Other Functions (Others Card (F7))	5-105
5.14.1	Setting Printer (Printer Prmtr (f1))	5-106
5.14.2	Setting GPIB Address (GPIB Address (f2))	5-107
5.14.3	Setting Date and Time (Date/Time (f3))	5-108
5.14.4	Setting Screen Display Color (Display Color (f4))	5-110
5.14.5	Setting Backlight Off Time (Backlight (f5))	5-111
5.14.6	Setting Buzzer On/Off (Buzzer On/Off (f6))	5-111
5.14.7	Setting RS-232C (RS-232C Prmtr (f7))	5-112
	Go to Foreground cards ( Change button (F8))	5-2

<Marker Select Screen>

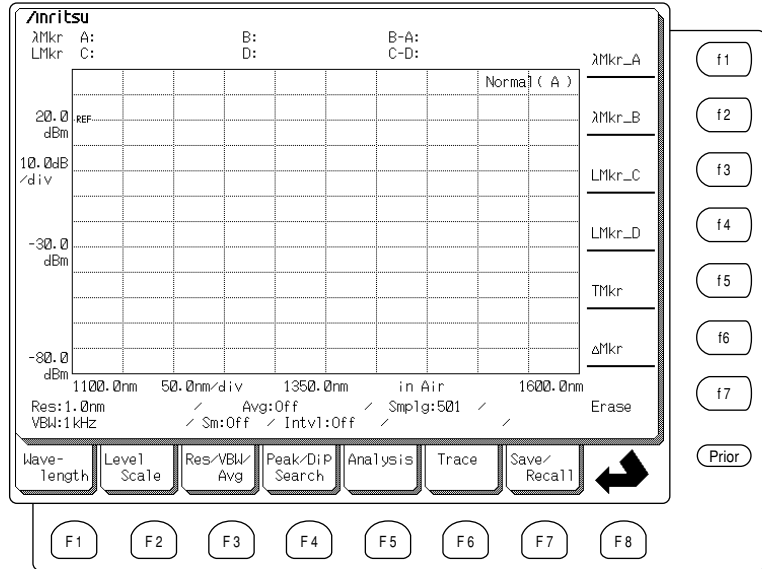
The screen shown below is displayed when the Marker Select key  of the Marker keys is pressed. To select a Foreground card, press any of the (F1) to (F7) card selection keys. To go back to the Graph card (the (F1) key) press (F8) key.



5.15 Marker Select Screen (Marker Select Key ) 5-114

5.15.1 Setting Wavelength Markers
(λ Mkr_A (f1) , λ Mkr_B (f2)) 5-115

5.15.2 Setting Level Markers
(LMkr_C (f3) , LMkr_D (f4)) 5-116





5.15.3 Setting Trace Marker (TMkr (f5)) 5-116

5.15.4 Setting Delta Marker (Δ Mkr (f6)) 5-117





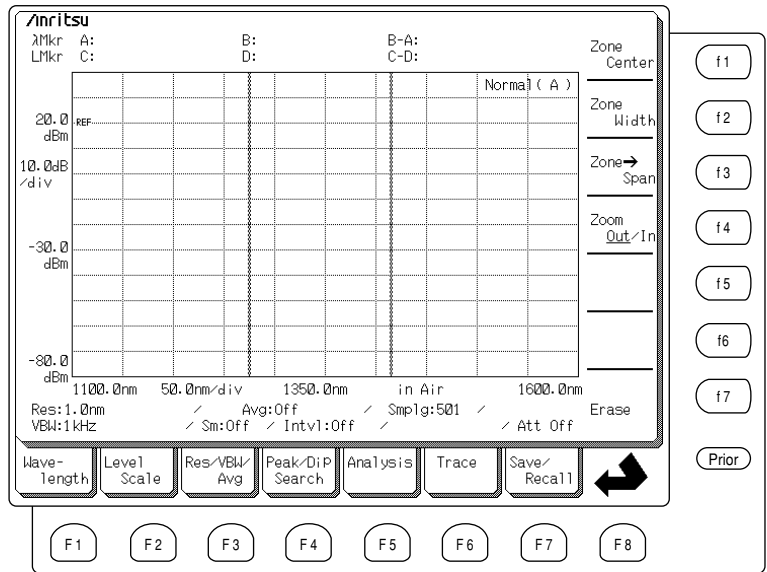

5.15.5 Deleting Markers (Mkr Erase (f7)) 5-117

5.15.6 Setting Trace Marker→Center Wavelength
(TMkr→Center Key ) 5-117

<Zone Marker Screen>

The screen shown below is displayed when the Zone Marker key  of the Marker keys is pressed. To select a Foreground card, press any of the  to  card selection keys. To go back to the Graph card (the  key) press  key.



- 5.16 Zone Marker Screen (Zone Marker Key ) 5-118
 - 5.16.1 Setting Zone Center (Zone Center ) 5-118
 - 5.16.2 Setting Zone Width (Zone Width ) 5-119
 - 5.16.3 Setting Zone→Span (Zone→Span ) 5-119
 - 5.16.4 Zooming-In/Zooming-Out
(Zoom In/Zoom Out ) 5-119
 - 5.16.5 Deleting Zone Marker (Zone Mkr Erase ) 5-119

5.1 Setting Wavelength (Wavelength Card (F1))

The Wavelength card displayed by pressing the (F1) key is used to set the measurement conditions related to wavelength. (horizontal axis of the screen)

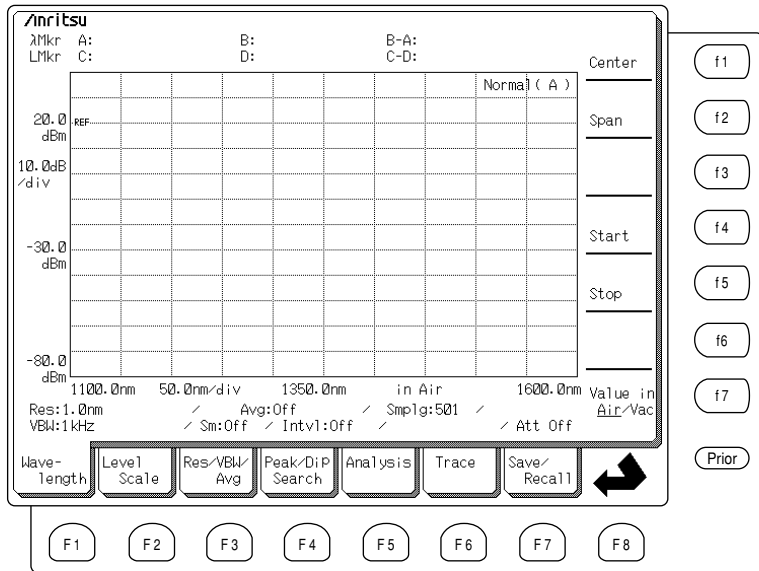

5.1.1 Setting Center Wavelength (Center Function Key (f1))

This key sets the wavelength to be displayed to the center of the screen. This wavelength is called the Center wavelength. When the Center wavelength is changed, the Start and Stop wavelengths are automatically updated to match the current Span setting. However, this function cannot be used in the Trace A&B, Trace A-B, and Trace B-A.

(1) Setting Center Wavelength

Either press the (F1) key to select the Wavelength card and press the Center function key (f1), or press the Center key (Center) of the shortcut keys. The currently-set value of Center wavelength is displayed in the Settings display field. Input a new value of Center wavelength using the Data entry keys or Knob.

(2) Setting Peak Level to Center Wavelength

When the Peak→Center key (Center) of the shortcut keys is pressed, the wavelength currently-set as the Peak point in the measured spectrum is displayed at the Center wavelength. This function cannot be used in the Trace A&B, Trace A-B, and Trace B-A.

(3) Settable Range

The Center wavelength can be set in the range of 600 nm (0.6 μm) to 1750 nm (1.75 μm).

5.1.2 Setting Sweep Width (Span Function Key (f2))

This key sets the wavelength range to be displayed on the horizontal axis of the screen. This wavelength range is called the sweep width or Span. When the Span is changed, the Center wavelength is centered and the Start and Stop wavelengths are automatically adjusted. This function cannot be used in the Trace A&B, Trace A–B, and Trace B–A.

(1) Setting Span

Either press the (F1) key to select the Wavelength card and press the Span function key (f2), or press the Span key (Span) of shortcut key. The value of currently-set Span is displayed in the Settings display field. Input a new Span using the Data entry keys, Knob, or the function keys. The following values are displayed in the Functions display field at the right side of the screen and can be input using the function keys. Page 2 values are accessible by pressing the More function key (f7) to display additional options.

	(f1)	(f2)	(f3)	(f4)	(f5)	(f6)
Page 1	1200 nm	1000 nm	500 nm	200 nm	100 nm	50 nm
Page 2	20 nm	10 nm	5 nm	2 nm	1 nm	0 nm

(2) Settable Range

The Span can be set in the range of 0 nm or 0.2 nm (0.0002 μm) to 1200 nm (1.2 μm). The Span has the following relationship with the Resolution (Res) and number of Sampling Points.

$$\text{Span (Span Width)} \leq \text{Res (Resolution)} \times \text{Number of Sampling Points}$$

If this relationship is not satisfied, there is a possibility that measurement will not be performed correctly, and the message “Res_uncal” will be displayed at the bottom right of the screen. In this case, either make the Span narrower, or increase the Resolution or Number of Sampling Points so that the above relationship is satisfied.

5.1.3 Setting Start Wavelength (Start Function Key **f4**)

This key sets the wavelength displayed at the left side of the screen. This wavelength is called the Start wavelength. When the Start wavelength is changed, the Stop wavelength remains unchanged but the Span is adjusted automatically. This function cannot be used in the Trace A&B, Trace A-B, and Trace B-A.

(1) Setting Start Wavelength

Press the **F1** key to select the Wavelength card, then press the Start function key **f4** to display the currently-set Start wavelength in the Settings display field. Input the new Start wavelength using the Data entry keys or Knob.

(2) Settable Range

The Start wavelength can be set in the range of 600 nm (0.6 μm) to the Stop wavelength. However, Start wavelengths at which the Span becomes 0.1 nm or smaller cannot be set.

5.1.4 Setting Stop Wavelength (Stop Function Key **f5**)

This key sets the wavelength displayed at the right side of the screen. This wavelength is called the Stop wavelength. When the Stop wavelength is changed, the Start wavelength remains unchanged but the Span is adjusted automatically. This function cannot be used in the Trace A&B, Trace A-B, and Trace B-A.

(1) Setting Stop Wavelength

Press the **F1** key to select the Wavelength card, then press the Stop function key **f5** to display the currently-set Stop wavelength in the Settings display field. Input the new Stop wavelength using the Data entry keys or Knob.

(2) Settable Range

The Stop wavelength can be set in the range of 1800 nm (1.8 μm) from the Start wavelength but the measurable range is up to 1750 nm (1.75 μm). However, Stop wavelengths at which the Span becomes 0.1 nm or smaller cannot be set.

5.1.5 Switching Marker Frequency Display (Mkr Value Wl/Freq Function Key **(f6)**)

This key switches the wavelength value of the Trace marker and the analysis part to the frequency value.

The display items that can be switched between wavelength and frequency display are the Trace marker wavelength, wavelength marker A and B wavelengths, and wavelength values calculated using the Analysis card analysis function.

(1) Switching Wavelength and Frequency Display of Marker and Analysis Part

The marker and analysis displays are switched alternately between the wavelength and frequency value each time the Mkr Value Wl/Freq key at the Wavelength card is pressed.

The frequency f is found from the wavelength λ in a vacuum using the following equation:

$$f = \frac{c}{\lambda}$$

Where, $c = 2.99792458 \times 10^8$ (m/s).

(2) Switching Frequency Display in Air/Vacuum

When the frequency value (Freq) is selected at the marker display, the Air/Vac display is switched forcibly to the Vac display.

When the Air/Vac setting is set to Air, the Trace A&B, Trace A-B, and Trace B-A displays cannot be switched to the frequency display.



Appendix I Switching Marker Frequency Display

5.1.6 Switching Wavelength Display (Value in Air/Vac Function Key **(f7)**)

This key switches the wavelength display between the value in air and the value in a vacuum. This function cannot be used in the Trace A&B, Trace A-B, and Trace B-A.

The display is toggled between the two values each time pressing the Air/Vac function key **(f7)** in the Wavelength card displayed by pressing the **(F1)** key. The current display type is indicated at the bottom right of the screen by an underline under Air or Vac.

5.2 Setting Level (Level Scale Card (F2))

The Level Scale card displayed by pressing the (F2) key used to set measurement conditions related to the power level. (vertical axis of the screen)

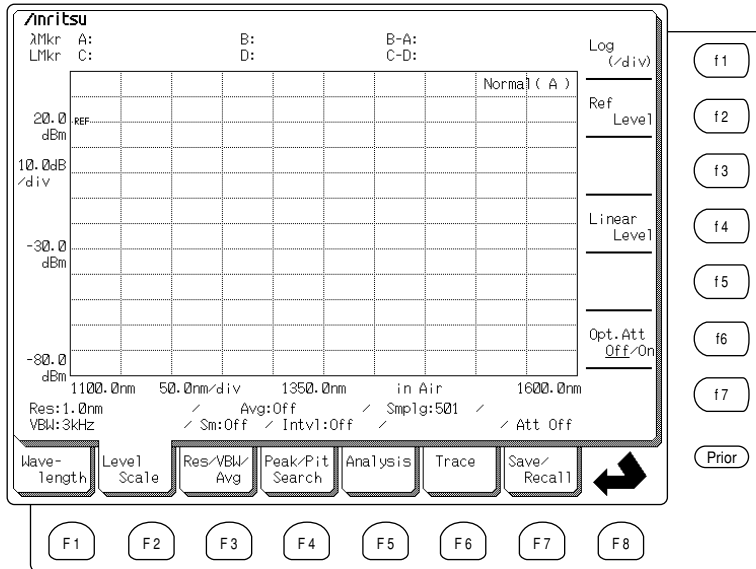

5.2.1 Setting Log Scale (Log (/div) Function Key (f1))

This key sets the vertical axis to a user specified log scale (dB/div).

(1) Setting Log Scale

Either press the (F2) key to select the Level Scale card and press the Log (/div) function key (f1), or press the Log (/div) key (Log (/div)) of shortcut key. The currently-set value, or div, is displayed in the Settings display field. The new value [dB] can be input using the Data entry keys, the Knob, or the function Keys.

The following values are displayed in the Functions display field at the right side of the screen and can be input using the function keys.

(f1)	(f2)	(f3)	(f4)	(f5)	(f6)	(f7)
10 dB	5 dB	2 dB	1 dB	0.5 dB	0.2 dB	0.1 dB

(2) Settable Range

The Log (/div) can be set in the range of 0.1 dB to 10 dB.

5.2.2 Setting Reference Level (Ref Level Function Key (f2))

This key sets the reference display level (REF value displayed on vertical axis) when the vertical axis is set to Log Scale. However, when Linear Scale is selected, the origin of the vertical axis becomes 0 and it is not possible to change the zero-level position.

(1) Setting Reference Level

Either press the (F2) key to select the Level Scale card and press the Ref Level function key (f2), or press the Ref Lvl key (Ref) of the Shortcut keys. The current setting is displayed in the Settings display field. Input the Reference Level using the Data entry keys or Knob.

(2) Setting Peak Point to Reference Level

When the Peak→Ref Lvl key (RefLvl) of shortcut key is pressed, the Peak point in the currently-measured spectrum is searched and the value is set for the Reference Level.

(3) Settable Range

Ref Level can be set in the range of -90 dBm to 30 dBm. However, for relative displays such as the Normalize display, the possible setting range is -100 dB to 100 dB.

5.2.3 Setting Linear Scale (Linear Level Function Key f4)

This key sets the vertical axis to a linear unit, and sets the value [W] of top end of the scale.

(1) Setting Linear Scale

Press the F2 key to select the Level Scale card, then press the Linear Level function key f4 to display the current setting at the top right of the scale. To change the top end of the scale, use the Data entry keys, the Knob, or the function keys.

The following values are displayed in the Functions display field at the right side of the screen and can be input using the function keys. Page 2 values are accessible by pressing the More function key f7 . As the value is selected, its unit selections are displayed. Select the scale by the function keys to complete the setting and change the top end of the scale.

	f1	f2	f3	f4	f5	f6
Page 1	500	200	100	50	20	10
Page 2	5	2	1			

The following units are selectable: W, mW, nW, and pW.

(2) Setting Peak Level to Top of Scale

When the Peak→Ref Lvl key Ref Lvl of the shortcut keys is pressed, the Peak point in the currently-measured spectrum is set as the top end of the scale.

(3) Settable Range

The top of the unit can be set in the range of 1 pW to 1 W.

5.2.4 Optical Attenuator On/Off (Opt. Att Off/On Function Key (f6))

This key sets whether or not to insert the optical attenuator, permitting measurement of high-level optical inputs. The optical attenuator is inserted each time the function key (f6) is pressed. At On, the optical attenuator is inserted into the optical path. The displayed level of the input light is the value at the optical input connector and is independent of whether or not the optical attenuator is On or Off.

(1) Switching Optical Attenuator

Press the (F2) key to select the Level Scale card, then press the Opt. Att Off/On function key (f6). The optical attenuator is toggled On (inserted) and Off (not inserted) each time the key is pressed. The current setting is displayed at the bottom of the screen and either On or Off is displayed underlined in the function key text.

CAUTION

The maximum input power is +10 dBm when the attenuator is not inserted, and +23 dBm when the attenuator is inserted. If light exceeding these specified levels is input to the analyzer even momentarily, there is a danger of causing serious damage to the internal optics and analyzer.

Conversely, if the optical attenuator is inserted when measuring very weak light, the measurement may not be performed correctly. Do not use the attenuator for input light levels below +5 dBm.

5.3 Setting Resolution and Averaging (Res/VBW/Avg Card (F3))

The Res/VBW/Avg card displayed by pressing the (F3) key is used to set measurement conditions related to Resolution, Averaging, Smoothing, and Number of Sample Points.

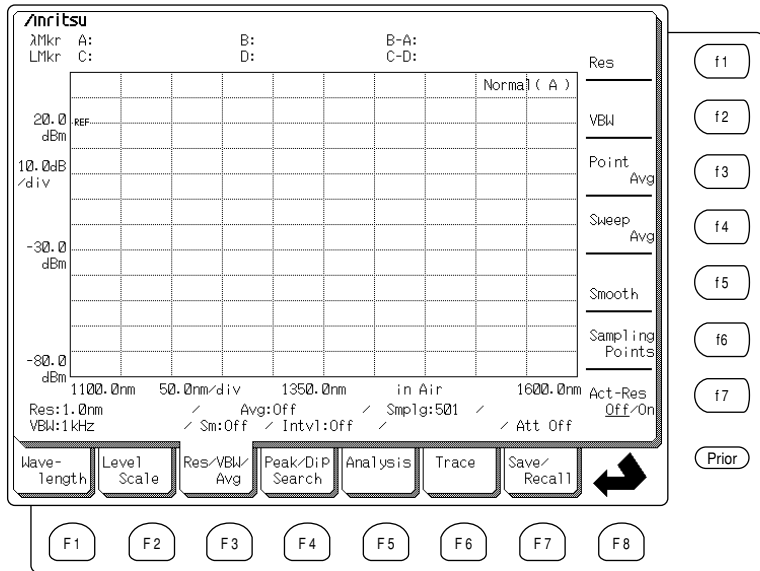

5.3.1 Setting Resolution (Res Function Key (f1))

This key sets the wavelength resolution. When measuring the optical input of narrow spectra such as LDs, etc., it is necessary to set a small resolution value. Moreover, when a large resolution is set for input of wide spectra such as LEDs, etc., measurement can be performed with a good S/N ratio. This function cannot be used in the Trace A&B, Trace A-B, and Trace B-A displays.

(1) Setting Resolution

Either press the Res function key (f1) at the Res/VBW/Avg card, or press the Res key to display the current resolution in the settings field.

The following six resolutions can be set using the function keys displayed at the right side of the screen.

(f1)	(f2)	(f3)	(f4)	(f5)	(f6)
1 nm	0.5 nm	0.2 nm	0.1 nm	0.07 nm	0.05 nm

(2) Settable Range

The resolution can only be set to the six values listed above.

* Although a resolution of 0.05 nm can be set across the full wavelength range, at short wavelengths, the actual resolution is closer to 0.07 nm. An actual resolution of close to 0.05 nm is achieved at wavelengths of 1500 nm or more at room temperature.

NOTE:

This function sets the display resolution. To find the actual resolution (effective resolution), set the Act-Res Off/On function key (f7) at the Res/VBW/Avg card to On.

5.3.2 Setting Video Band Width (VBW Function Key (f2))

This key sets the Video Bandwidth. When a wide-band VBW is set, measurement can be performed at high speed. Conversely, when a narrow VBW is set, sweep speeds are slower but sensitivity is improved due to additional noise suppression.

 Appendix D

(1) Setting VBW

Either press the (F3) key to select the Res/VBW/Avg card and press the VBW function key (f2), or press the VBW key (VBW) of shortcut key. The current VBW is displayed in the Settings display field. The following values are displayed in the Functions display field and can be input using the function keys.

(f1)	(f2)	(f3)	(f4)	(f5)	(f6)
1 MHz	100 kHz	10 kHz	1 kHz	100 Hz	10 Hz

(2) Settable Range

The VBW can only be set to the six values listed above.

5.3.3 Setting Point Average (Point Average Function Key (f3))

This key is used to activate the Point Average function. A point in the trace is measured a user-specified number of times. These measurements are averaged together and the result for that point is displayed. This process repeats for the next point in the trace. This is commonly known as a “Point-to Point” averaging technique. This function cannot be used simultaneously with the Sweep Average function described in the next section.

(1) Setting Point Average On

Press the (F3) key to select the Res/VBW/Avg card, then press the Point Average function key (f3). Press the On function key displayed in the Functions display field.

(2) Setting the Number of Point Average Processings

Press the (F3) key to select the Res/VBW/Avg card, then press the Point Avg function key (f3). The current number of point average processings is displayed in the Settings display field. Input the number of point average processings using the Data entry keys or Knob.

(3) Setting Point Average Off

Press the (F3) key to select the Res/VBW/Avg card, then press the for Point Avg function key (f3). Select the Off function displayed in the Functions display field.

(4) Settable Range

The number of point average processings can be set in the range of 2 to 1000.

5.3.4 Setting Sweep Average (Sweep Average Function Key **f4**)

This key is used to activate the Sweep Avg function. A user-specified number of traces are average together and the results are displayed. This is commonly known as a “Sweep-to Sweep” averaging technique. This function cannot be used simultaneously with the Point Average function described in the previous section. This function cannot be used in the Overlap and 3D display.

(1) Setting Sweep Average On

Press the **F3** key to select the Res/VBW/Avg card, then press the Sweep Average function key **f4**. Select the On function displayed in the Functions display field.

(2) Setting the Number of Sweep Average Processings

Press the **F3** key to select the Res/VBW/Avg card, then press the Sweep Average function key **f4**. The current number of sweep average processings is displayed in the Settings display field. Input the number of sweep average processings using the Data entry keys or Knob.

(3) Setting Point Average Off

Press the **F3** key to select the Res/VBW/Avg card, then press the Sweep Average function key **f4**. Select the Off function displayed in the Functions display field.

(4) Settable Range

The number of sweep average processings can be set in the range of 2 to 1000 times.

5.3.5 Setting Smoothing (Smooth Function Key (f5))

This key smooths the level of a data point based on the levels on both sides of the point. It is possible to set correction based on only the preceding and succeeding points, or based on a number of data points (point number). If the point number is set too large, the true waveform may be distorted.

(1) Setting Smoothing On

Press the (F3) key to select the Res/VBW/Avg card, then press the Smooth function key (f5). The current point number is displayed in the Settings display field. The following values are displayed in the Functions display field at the right side of the screen and can be input using the function keys.

(f1)	(f2)	(f3)	(f4)	(f5)	(f6)
Off	3 pt	5 pt	7 pt	9 pt	11 pt

(2) Setting Smoothing Off

Press the (F3) key to select the Res/VBW/Avg card, then press the Smooth function key (f5). Select the Off function key displayed in the Functions display field to turn the Smooth function Off.

(3) Settable Range

The Smoothing Point number can only be set to the six states listed above.

5.3.6 Setting Sampling Points (Sampling Points Function Key **f6**)

This key sets the number of measured data points (Sampling point number) within the Span. When the Sampling point number is small, measurement can be performed at high speed, but to measure with good Resolution over a wide range, the Sampling point number must be large. The Sampling point number is related to the Resolution and Span, and if the correct measurement results cannot be obtained at the set value, the message “Res_uncal” is displayed at the bottom right of the screen. This number cannot be set for the Trace A&B, Trace A–B, and Trace B–A displays. Refer to Section 5.1 “Setting Wavelength” for more details on Span.

(1) Setting Sampling Point Number

Press the **F3** key to select the Res/VBW/Avg card, then press the Sampling points function key **f6**. The current Sampling point number is displayed in the Settings display field. The following values are displayed in the Functions display field and can be input using the function keys.

f1	f2	f3	f4	f5	f6	f7
51 pt	101 pt	251 pt	501 pt	1001 pt	2001 pt	5001 pt

(2) Settable Range

The Sampling point number can only be set to the seven values listed above.

5.3.7 Switching Actual Resolution (Act-Res Off/On Function Key **f7**)

This key toggles the Actual Resolution display On/Off. With Actual Resolution On, the display specifies the exact wavelength Resolution used in the last measurement.

(1) Switching Actual Resolution

Press the **F3** key to select the Res/VBW/Avg card, then press the Act-Res On/Off function key **f7**, to toggled On/Off the actual Resolution setting. The actual Resolution is displayed in parentheses on the Res line of the Measurement Conditions displayed field, and the current Resolution is displayed in the Settings display field. The underlined On or Off function key also indicates the current setting.

5.4 Peak/Dip Search (Peak/Dip Search Card (F4))

The Peak/Dip Search card displayed by pressing the (F4) key is used to search for Peak (maximum) points and Dip (minimum) point in the measured spectrum.

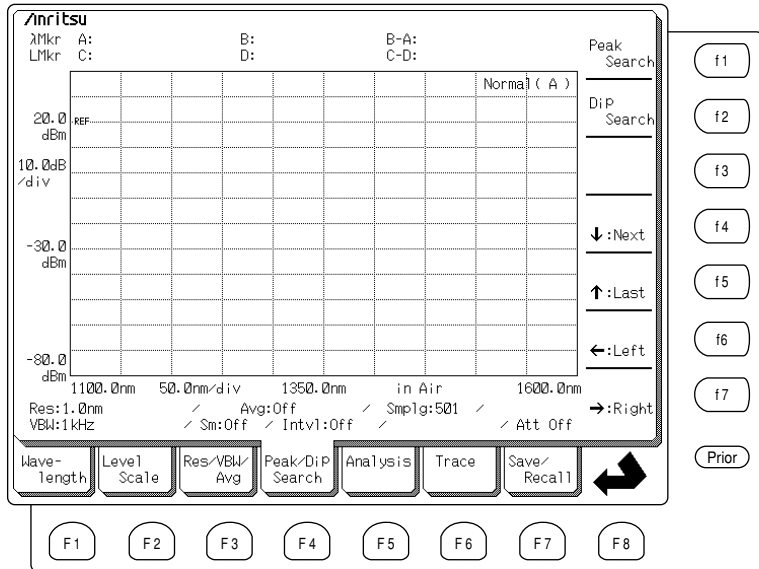

5.4.1 Searching for Peak Points (Peak Search Function Key (f1))

Press the (F4) key to select the Peak/Dip Search card, then press the Peak Search function key (f1) to move the trace marker to the Peak point in the measured spectrum. When the zone marker is On, the Peak point within the zone is found. This function cannot be used in the 3D and Overlap displays. This function is executed for selected memory in the Trace A & B.

5.4.2 Searching for Dip Points (Dip Search Function Key (f2))

Press the (F4) key to select the Peak/Dip Search card, then press the Dip Search function key (f2) to move the trace marker to the minimum point in the measured spectrum. When the zone marker is On, the minimum point within the zone is found. This function cannot be used in the 3D and Overlap displays. This function is executed for selected memory in the Trace A & B.

5.4.3 Searching for Next Largest/Smallest Peak/Dip Point

(↓: Next function key (f4))

Press the (F4) key to select the Peak/Dip Search card, then press the ↓, or Next function key, (f4) to move the Trace marker to the next highest Peak point or next smallest Dip point. This operation is the exact opposite of the operation when the ↑, or Last function key, (f5) is pressed.

The target data of this search is the data within the zone when the zone marker is On and the data displayed on the screen when the zone marker is Off. This function cannot be used with the 3D and Overlap displays. This function is executed for selected memory in the Trace A & B.

5.4.4 Searching for Last Largest/Smallest Peak/Dip Point

(↑: Last function key (f5))

Press the (F4) key to select the Peak/Dip Search card, then press the ↑, or Last function key, (f5) to move the Trace marker to a larger Peak point or a smaller DIP point. This operation is the exact opposite of the operation when the ↓, or Next function key, (f4) is pressed.

The target data of this search is the data within the zone when the zone marker is On and the data displayed on the screen when the zone marker is Off. This function cannot be used with the 3D and Overlap displays. This function is executed for selected memory in the Trace A & B.

5.4.5 Searching for Next Left Peak/Dip Point

(←: Left Function Key (f6))

Press the (F4) key to select the Peak/Dip Search card and press the ←, or Left function key, (f6) to move the Trace Marker to the Peak or Dip point to the left of the current Peak or Dip. This operation is the exact opposite of the operation when the →, or Right function key, (f7) is pressed.

When executing Peak Search within the measured spectrum, the Trace marker moves to a Peak point on the left. When executing Dip Search, the Trace marker moves to a Dip point on the left. The target data of this search is the data within the zone when the zone marker is On and the data displayed on the screen when the zone marker is Off. This function cannot be used with the 3D and Overlap displays. This function is executed for selected memory in the Trace A & B.

5.4.6 Searching for Next Right Peak/Dip Point

(→: Right Function Key (f7))

Press the (F4) key to select the Peak/Dip Search card, then press the →, or Right function key, (f7) to move the Trace Marker to the Peak or Dip point to the right of the current Peak or Dip. This operation is the exact opposite of the operation when the ←, or Left Function Key, (f6) is pressed.

When executing Peak Search within the measured spectrum, the Trace marker moves to a Peak point on the right. When executing Dip Search, the Trace marker moves to a Dip point on the right. The target data of this search is the data within the zone when the zone marker is On and the data displayed on the screen when the zone marker is Off. This function cannot be used in the 3D and Overlap displays. This function is executed for selected memory in the Trace A or B.

5.4.7 Releasing Peak/Dip Search

Press the Marker Select key  of Marker keys to display the Marker Select screen. When the Off function key (f7) is pressed in this screen and the Tmkr is cleared, the Trace Marker Peak/Dip display is erased as well.

5.5 Analyzing Waveforms (Analysis Card **F5**)

The Analysis card displayed by pressing **F5** key is used for analyzing measured spectra.

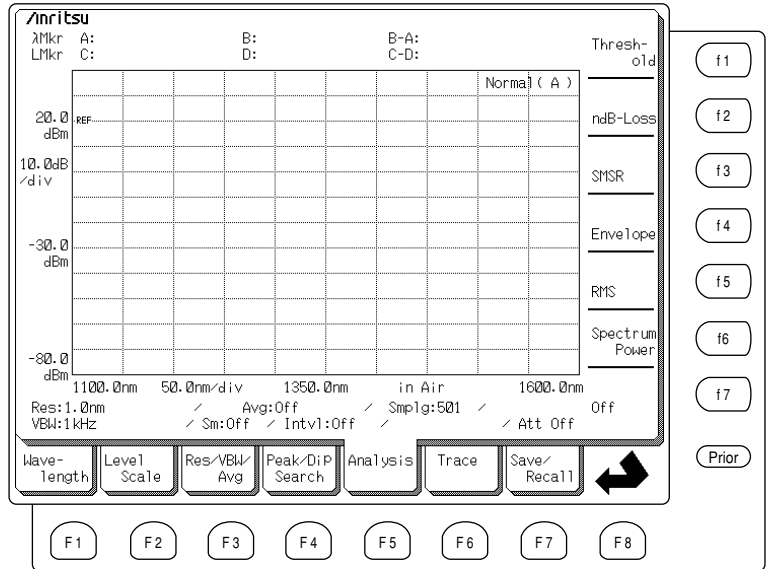

5.5.1 Threshold Analysis (Threshold Function Key (f1))

Press the (F5) key to select the Analysis card, then press the Threshold function key (f1) to perform Threshold analysis on measured spectrum. This analysis is useful for finding the spectrum half width, etc. The target data of this analysis is the data within the zone when the zone marker is On and the data displayed on the screen when the zone marker is Off. This function cannot be used with Trace A&B.

Furthermore, the analysis result can be switched between wavelength display and frequency display by switching the marker frequency display.

The analysis markers are displayed as shown in the following screen. The measurement results are expressed as λ_c (Center wavelength) and $\Delta\lambda$ (spectrum width at level down by the s from the peak level). The Cut Level set from the function keys is displayed at the right side of the screen.

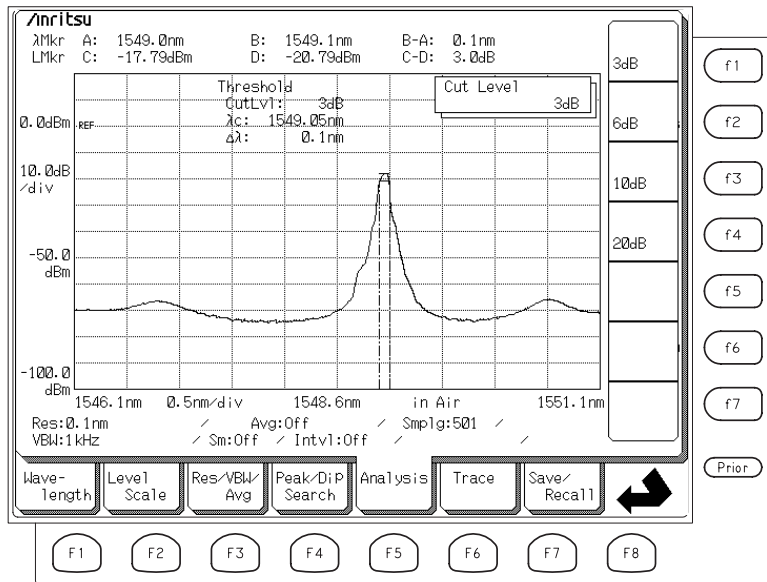

Analysis Marker	Marker Meaning
Wavelength_A (left side)	Indicates wavelength of Cut Level point at left side of Peak point
Wavelength_B (right side)	Indicates wavelength of Cut Level point at right side of Peak point
Level_C (top)	Indicates level of Peak point
Level_D (bottom)	Indicates level at point cut from level of Peak point

The Cut Level can be set with the Data entry keys, the Knob, or function keys. The following values are displayed in the Functions display field at the right side of the screen and can be input using the function keys.

f1	f2	f3	f4
3 dB	6 dB	10 dB	20 dB

(1) Calculation and Processing of Threshold Analysis

The spectrum peak is found and used as the Cut Level reference. The Cut Level is placed ndB down from the peak. A search identifies the upper and lower wavelength values which intercept the Cut Level (λ_1 and λ_2). The “center” wavelength is calculated from the average of λ_1 and λ_2 .

$$\lambda_c = \frac{(\lambda_1 + \lambda_2)}{2}$$

$$\Delta\lambda = \lambda_2 - \lambda_1$$

(2) Settable Range

The Threshold Cut Level (Cut Lvl) can be set in the range of 0.1 dB to 50.0 dB.

5.5.2 ndB-Loss Analysis (ndB-Loss Function Key (f2))

Press the (F5) key to select the Analysis card, then press the ndB-Loss function key (f2) to perform ndB-Loss analysis on the measured spectrum. The ndB-Loss analysis is for analysis of multimode spectra. If the target spectrum is single mode, the same analysis as Threshold analysis is performed. The target data of this analysis is the data within the zone when the zone marker is On and the data displayed on the screen when the zone marker is Off. This function cannot be used with Trace A&B.

Furthermore, the analysis result can be switched between wavelength display and frequency display by switching the marker frequency display.

The following screen shows the analysis markers; the analysis results are displayed as λ_c (Center wavelength), $\Delta\lambda$ (spectrum width at a Cut Level from the peak), and N (Mode number). The Cut Level can be input using the function keys displayed at the right side of the screen.

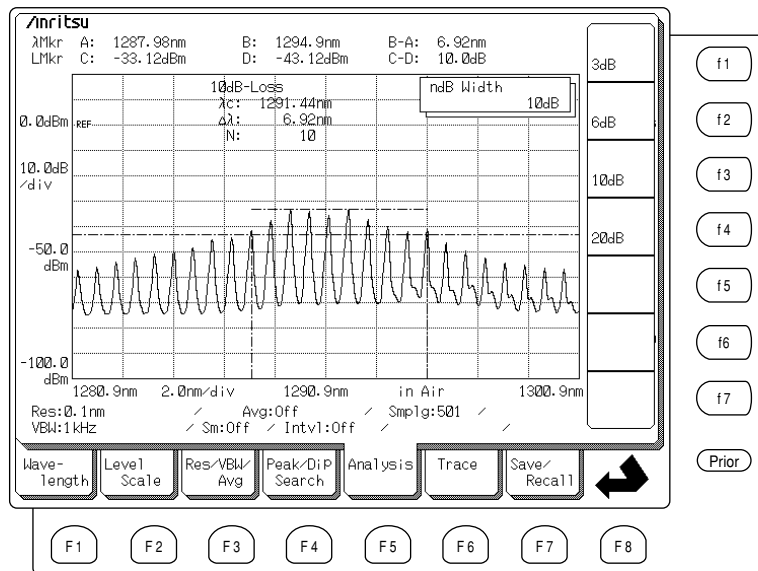

Analysis Marker	Marker Meaning
Wavelength_A (left side)	Indicates wavelength of Cut Level point at left side of Peak point
Wavelength_B (right side)	Indicates wavelength of Cut Level point at right side of Peak point
Level_C (top)	Indicates level of Peak point
Level_D (bottom)	Indicates level at point cut from level of Peak point

The Cut Level can be set with the Data entry keys, the Knob, or function keys. The following values are displayed in the Functions display field at the right side of the screen and can be input using the function keys.

f1	f2	f3	f4
3 dB	6 dB	10 dB	20 dB

(1) Calculation and Processing of ndB-Loss Analysis

The spectrum peak is found and used as the Cut Level reference. The Cut Level is placed ndB down from the peak. A search identifies all the spectra whose magnitude are above the Cut Level. The wavelengths of the spectra furthest from the peak (and above the Cut Level) are determined (λ_1, λ_2). The number of discrete spectra peaks that are above the Cut Level is indicated with the value N (mode number). The “center” wavelength is calculated from the average of λ_1 , and λ_2 .

$$\lambda_c = \frac{(\lambda_1 + \lambda_2)}{2}$$

$$\Delta\lambda = \lambda_2 - \lambda_1$$

(2) Settable Range

The ndB-Loss Cut Level (ndB Width) can be set in the range of 0.1 dB to 50.0 dB.

5.5.3 Side Mode Suppression Ratio Analysis (SMSR Function Key (f3))

Press the (F5) key to select the Analysis card, then press the SMSR function key (f3) to perform a side mode suppression ratio analysis of the measured spectrum. SMSR specifies the level ratio between the Peak and Side mode. Either the next largest peak after the Peak point, or the peak immediately to the left or right of the Peak point can be selected as the Side mode. The target data of this analysis is the data within the zone when the zone marker is On and the data displayed on the screen when the zone marker is Off. This function cannot be used with Trace A&B.

Furthermore, the analysis result can be switched between wavelength display and frequency display by switching the marker frequency display.

The following screen shows the analysis markers.

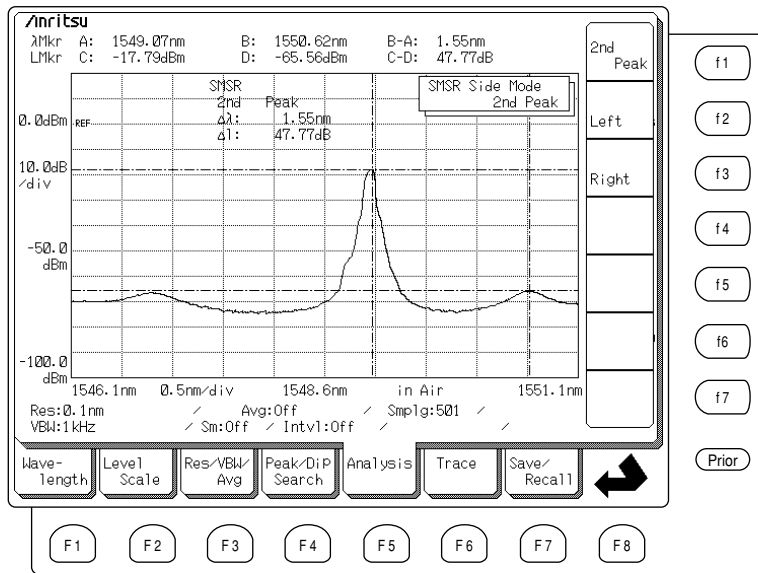

Analysis Marker	Marker Meaning
Wavelength_A (left side)	Indicates wavelength of Peak point or Side mode
Wavelength_B (right side)	Indicates wavelength of Peak point or Side mode
Level_C (top)	Indicates level of Peak point
Level_D (bottom)	Indicates level of Side mode

Three Side modes can be selected with the function keys as follows:

Function Key	Side Mode
(f1) : 2nd	Next largest level from Peak point Side mode
(f2) : Left	Peak immediately to left of Peak point Side mode
(f3) : Right	Peak immediately to right of Peak point Side mode

(1) Calculation and Processing of SMSR Analysis

SMSR is found from the following equation: where, L_{\max} is the level of the Peak point, and L_{side} is the level of the side mode.

$$\text{SMSR} = L_{\max} - L_{\text{side}} \text{ [dB]}$$

In addition, the wavelength difference, $\Delta\lambda$, is found from the following equation: where, λ_1 is the wavelength of the Peak point, and λ_2 is the wavelength of the Side mode.

$$\Delta\lambda = |\lambda_1 - \lambda_2|$$

5.5.4 Envelope Analysis (Envelope Function Key (f4))

Press the (F5) key to select the Analysis card, then press the Envelope function key (f4) to perform an Envelope analysis of the measured spectrum. This analysis finds the envelope from the Peak points of several spectra and displays the measurement results. The target data of this analysis is the data within the zone when the zone marker is On and the data displayed on the screen when the zone marker is Off. This function cannot be used with Trace A&B.

The analysis markers are displayed as shown in the following screen. The measurement results are expressed in λ_c (Center wavelength), and $\Delta\lambda$ (spectrum width at a Cut Level from the peak).

Furthermore, the analysis result can be switched between wavelength display and frequency display by switching the marker frequency display.

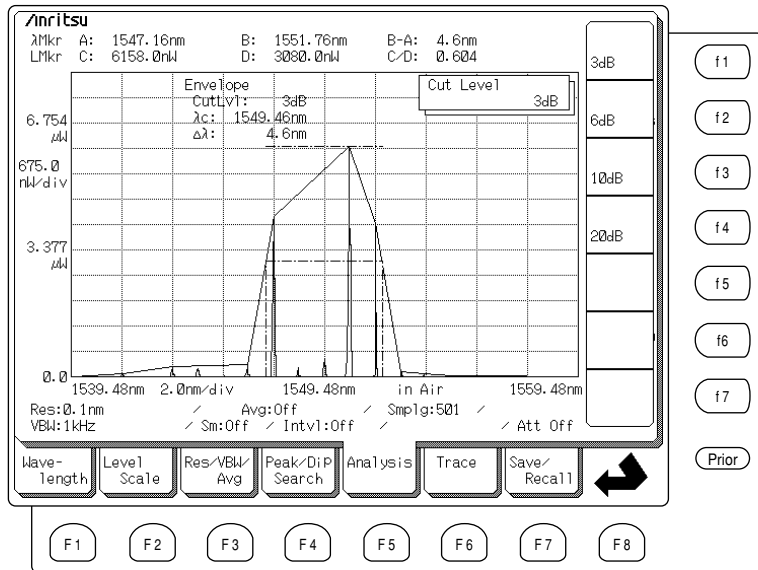

Analysis Marker	Marker Meaning
Wavelength_A (left side)	Indicates wavelength of Cut Level point at left side of Peak point
Wavelength_B (right side)	Indicates wavelength of Cut Level point at right side of Peak point
Level_C (top)	Indicates level of Peak point
Level_D (bottom)	Indicates level at point cut from level of Peak point

The Cut Level can be set with the Data entry keys, the Knob, or the function keys. The following values are displayed in the Functions display field at the right side of the screen and can be input using the function keys.

f1	f2	f3	f4
3 dB	6 dB	10 dB	20 dB

(1) Calculation and Processing of Envelope Analysis

The spectrum peak is found and used as the Cut Level reference. The Cut Level is placed ndB down from the peak. An envelope connecting all the largest peaks is generated. The intersection of the Cut Level with the envelope determines λ_1 and λ_2 . The “center” wavelength is calculated from the average of λ_1 and λ_2 .

$$\lambda_c = \frac{(\lambda_1 + \lambda_2)}{2}$$

$$\Delta\lambda = \lambda_2 - \lambda_1$$

(2) Settable Range

The Cut Level (Cut Lvl) can be set in the range of 0.1 dB to 20.0 dB.

5.5.5 RMS Analysis (RMS Function Key f5)

Press the F5 key to select the Analysis card, then press the RMS function key f5 to perform a Root mean square analysis (hereinafter referred as RMS analysis) of the measured spectrum. RMS analysis is for analyzing multimode spectra. The target data of this analysis is the data within the zone when the zone marker is On and the data displayed on the screen when the zone marker is Off. This function cannot be used with Trace A&B.

Furthermore, the analysis result can be switched between wavelength display and frequency display by switching the marker frequency display.

The following screen shows the analysis markers. The measurement results are expressed in λ_c (Center wavelength) and $K\sigma$ (Spectrum width, assuming a gaussian behavior).

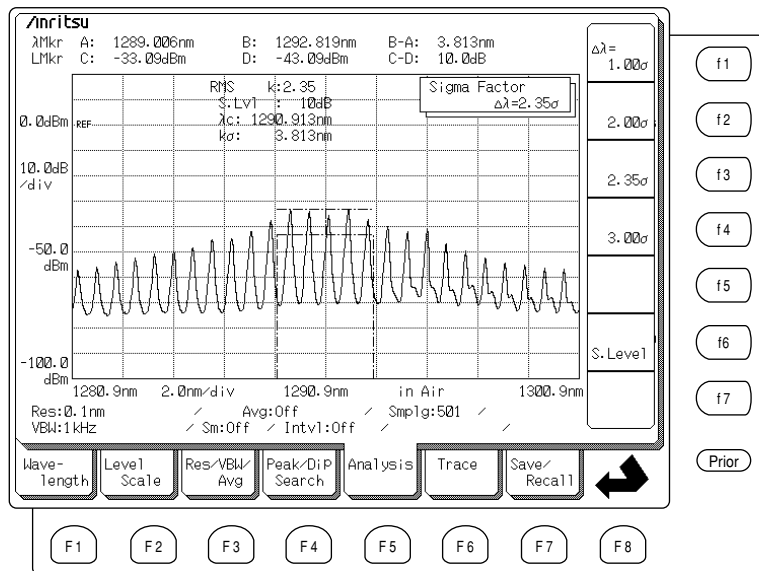

Analysis Marker	Marker Meaning			
	σ	2σ	2.35σ	3σ
Wavelength_A (left side)	$\lambda_c - 0.5\sigma$	$\lambda_c - \sigma$	$\lambda_c - 1.1774\sigma$	$\lambda_c - 1.5\sigma$
Wavelength_B (right side)	$\lambda_c + 0.5\sigma$	$\lambda_c + \sigma$	$\lambda_c + 1.1774\sigma$	$\lambda_c + 1.5\sigma$
Level_C (top)	Indicates level of Peak point			
Level_D (bottom)	Indicates half level			

The slice level can be set with the Data entry keys, the Knob, or the function Keys. The following values are displayed in the Functions display field at the right side of the screen and can be set for $\Delta\lambda$ using the function keys.

f1	f2	f3	f4
1σ	2σ	2.35σ	3σ

(1) Calculation and Processing of RMS Analysis

When setting the wavelength and level of the peaks of spectrum exceeding the level which lowers from the maximum peak by the preset level to “An” and “λ_n” (n = 1, 2, 3 ... i), you can calculate center wavelength “λ_c” and spectrum width σ as below:

$$\lambda_c = \frac{\sum(A_n \times \lambda_n)}{\sum A_n} = \frac{A_1 \lambda_1 + A_2 \lambda_2 + \dots + A_i \lambda_i}{A_1 + A_2 + \dots + A_i}$$

$$\sigma = \sqrt{\frac{\sum A_n \times \lambda_n^2}{\sum A_n} - \lambda_c^2}$$

(2) Settable Range

The Δλ can be set to 1 σ, 2 σ, 2.35 σ and 3 σ. The slice level can be set in the range of 1 dB to 30 dB.

5.5.6 Spectrum Power Analysis (Spectrum Power Function Key (F6))

Press the (F5) key to select the Analysis card, then press the Spectrum Power function key (F6) to perform a Spectrum Power analysis. Spectrum analysis finds the power distribution of the measured spectrum and calculates the total power. The target data of this analysis is the data within the zone when the zone marker is On and the data displayed on the screen when the zone marker is Off. It cannot be used with Trace A&B, Trace A-B, and Trace B-A. Furthermore, the analysis result can be switched between wavelength display and frequency display by switching the marker frequency display.

The following screen shows the analysis markers. The analysis results are displayed as λ_c (power Center wavelength) and Pow (total power).

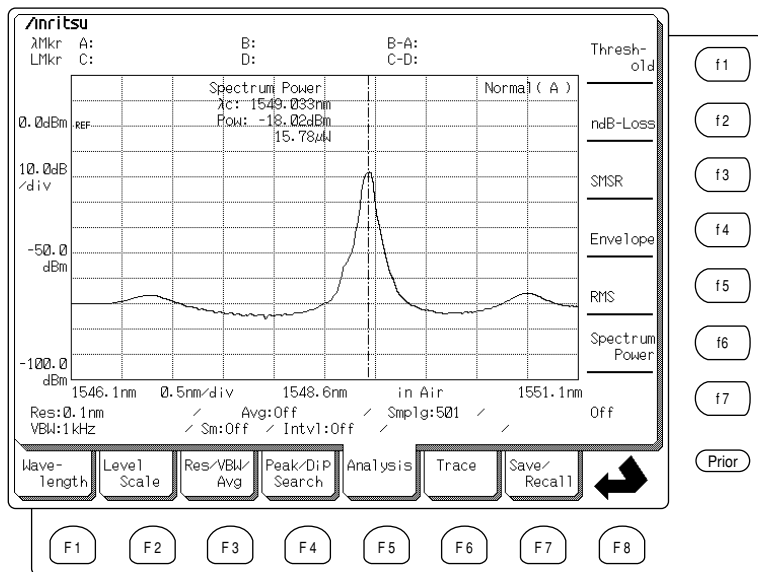

Analysis Marker	Marker Meaning
Center wavelength marker	Indicates Center wavelength calculated from average of spectral power

(1) Calculation and Processing

The Center wavelength, λ_c is found from the following equation where λ_k is the wavelength and L_k is the level of the measured data point.

$$\lambda_c = \frac{\sum \lambda_k \times L_k}{\sum L_k}$$

The total power Pow is found from the following equation.

$$P_s = \frac{\alpha \Delta \lambda}{R_{res}} \sum L_k$$

Where, α is the correction factor depending on the slit, Res is the actual Resolution and $\Delta\lambda$ is the sampling wavelength interval.

5.5.7 Deleting Analysis Results (Off Function Key f7)

Press the F5 key to select the Analysis card, then press the Off function key f7 to delete the results when the screen is displaying the analysis results for a measured spectrum. Markers used in the analysis revert to wavelength or level markers.

5.6 Trace Memory (Trace Card (F6))

The trace card (F6) is used to switch the memory in which the measured data is stored or change the display (trace) method. The unit has two memories: Memory A and Memory B. You can use each of them individually or combine the two. The data is stored in the memory whose indicator (A or B) is lit.

When Memory A is selected, if Trace B is selected for data display and measurement is performed, note that Memory B, which is displayed, does not change but Memory A is overwritten.

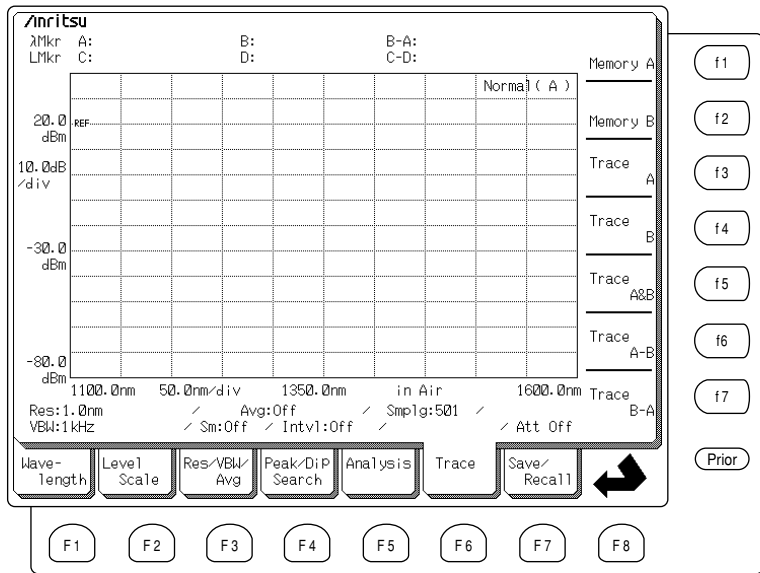

5.6.1 Selecting Memory A (Memory A Function Key **f1**)

To store the spectrum measurement data in Memory A, select Memory A function key **f1** from Trace card **F6**. The screen which displays the data stored in Memory A is called Trace A. When selecting Memory A function key **f1** while Trace B is displayed, the display screen is switched to Trace A.

5.6.2 Selecting Memory B (Memory B Function Key **f2**)

To store the spectrum measurement data in Memory B, select Memory B function key **f2** from Trace card **F6**. The screen which displays the data stored in Memory B is called Trace B. When selecting Memory B function key **f2** while Trace A is displayed, the display screen is switched to Trace B.

5.6.3 Selecting Trace A (Trace A Function Key **f3**)

Press the **F6** key to select the Trace card, then press the Trace A function key **f3** to display the data in Memory A. When the Memory B function key **f2** is pressed while Trace A is displayed, the trace switches to Trace B.

5.6.4 Selecting Trace B (Trace B Function Key **f4**)

Press the **F6** key to select the Trace card, then press the Trace A function key **f4** to display the data in Memory B. When the Memory A function key **f1** is pressed while Trace B is displayed, the trace switches to Trace A.

5.6.5 Displaying Two Traces Simultaneously (Trace A&B Function Key **f5**)

Press the **F6** key to select the Trace card, then press the Trace A&B function key **f5** to display the data in Memories A and B simultaneously. If the measurement conditions related to the wavelength data in Memories A and B are different, an error will be displayed.

5.6.6 Comparing Trace A–B (Trace A–B Function Key **f6**)

Press the **F6** key to select the Trace card, then press the Trace A–B function key **f6** to subtract the Trace-B data from the Trace-A data and display the result when a Log Scale is displayed. The subtraction is performed with a dB display and the displayed waveform displays the ratio of the waveforms saved in Memories A and B.

When a linear scale is displayed, the Memory-B data is subtracted from the Memory-A data and result is displayed.

5.6.7 Comparing Trace B–A (Trace B–A Function Key f7)

Press the F6 key to select the Trace card, then press the Trace B–A function key f7 to subtract the Trace-A data from the Trace-B data and display the result when a Log Scale is displayed. The subtraction is performed with a dB display and the displayed waveform displays the ratio of the waveforms saved in memories B and A.

When a linear scale is displayed, the Memory-A data is subtracted from the Memory-B data and result is displayed.

5.7 Saving and Recalling Measured Data (Save/Recall Card (F7))

The Save/Recall card displayed by pressing (F7) key is used to save/recall measured data to/from a FD. In addition to using its own file format, this analyzer can create MS-Windows® bitmapped and MS-DOS® text formats files so that the data can be accessed by a personal computer, etc.

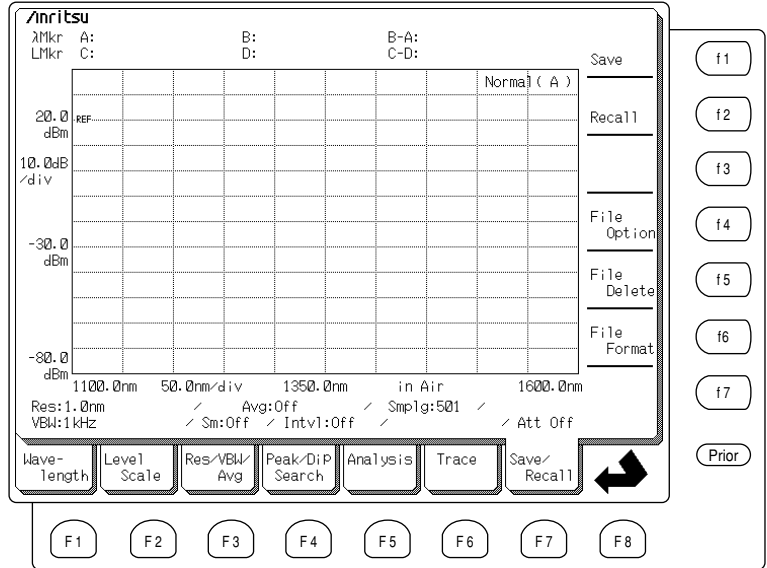

5.7.1 Saving Measured Data (Save Function Key **f1**)

Press the **F7** key to select the Save/Recall card, then press the Save function key **f1** to save the measured data to FD. The data is saved to the standard analyzer proprietary format (.dat). To save the data in additional formats (.bmp and/or .txt) the user must select these formats in the File Option screen displayed by pressing the **f4** before saving the data.

The file identifier (File ID) can be either 8 alphanumeric characters or a 3 digit number. The user specifies the File ID type in the File Option screen displayed by pressing the **f4** before saving the data.

If a file with the same name is already on the FD, a screen message requesting overwrite confirmation is displayed even if the format of the existing file is different from the format of the file to be saved. To overwrite the file, select Yes; to cancel the saving and leave the existing file untouched, select number. Since the overwritten file is erased, making a backup of the data is recommended.

NOTES:

1. Do not eject a FD while the drive is accessing the disk.
2. Maximum of 50 data files can be stored in a single FD. However, the number of stored data may vary depending on the file option selection and format type.
3. Data cannot be saved during measurement. Save data when measurement is stopped.

5.7 Saving and Recalling Measured Data (Save/Recall Card **F7**)

(1) Saving as File Name

Press the **F7** key to select the Save/Recall card, then press the Save function key **f1** to display the following screen. Enter a file name of up to 8 alphanumeric characters using the Data entry key and function keys and press the Save function key **f5** to complete the saving. (This assumes that the File ID type in the File Options screen has been set to "Name".)

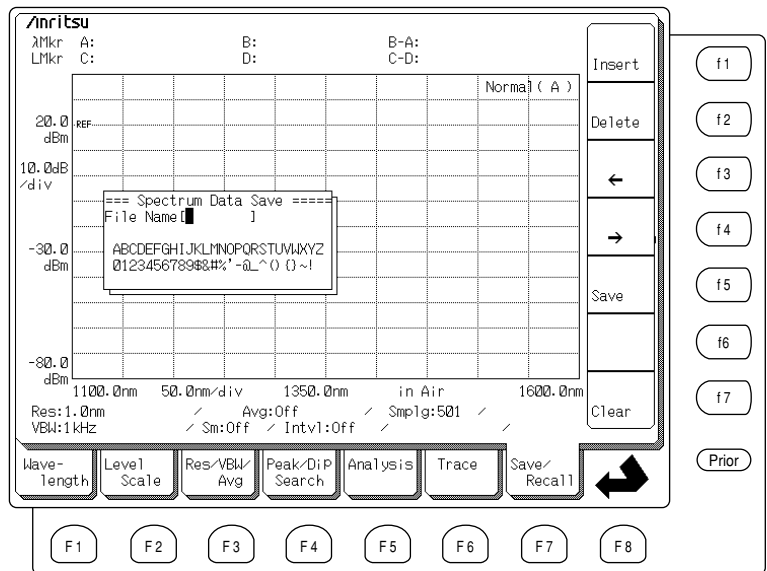

The following function keys are displayed in the Functions display field at right-hand side of the screen.

Key Name	Description
f1 : Ins	Inserts selected character at cursor position
f2 : Del	Deletes character at cursor position
f3 : ←	Moves cursor to left
f4 : →	Moves cursor to right
f5 : Save	Saves data with currently-set name
f7 : Clear	Clears (deletes) file name

(2) Saving as File Number

Press the **(F7)** key to select the Save/Recall card, then press the Save function key **(f1)** to display the following screen. Enter a file number using the Data entry key and press the Save function key **(f5)** to complete the saving. This assumes that the File ID type in the File Options screen has been set to “Number”. The saved file has the identifier DATA ### where ### is a user-selected 3 digit number. The File Number is input using the Data entry keys. To assist the user, the analyzer prompts with the next available (“unused”) number. If the user selects a number that is already present on the FD, a screen message requesting overwrite confirmation is displayed. Press the Overwrite function key to overwrite the old file; press the Cancel function key to leave the old file untouched.

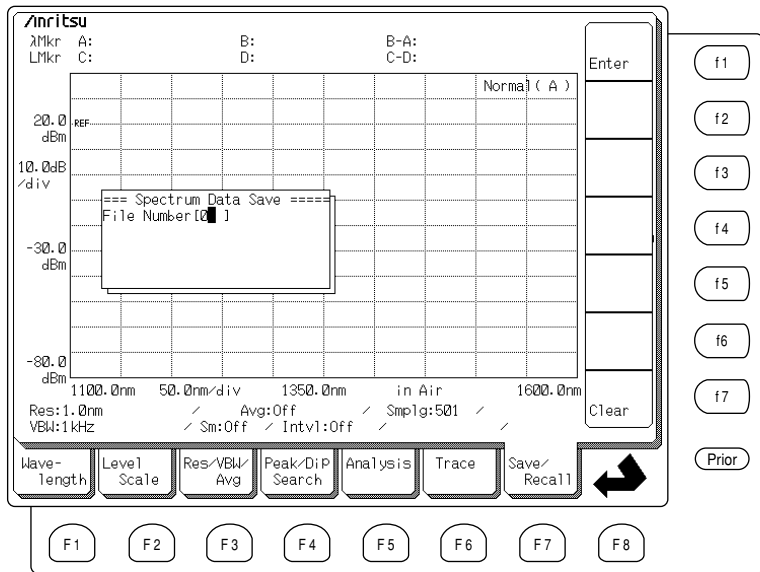

5.7.2 Recalling Saved Data (Recall Function Key (f2))

Press the (F7) key to select the Save/Recall card, then press the Recall function key (f2) to recall a file saved in the analyzer format from the FD. However, the files saved in bitmap format of MS-Windows™ and text format of MS-DOS™ cannot be recalled.

When the following screen is displayed, move the cursor to the file to be recalled using the ↑ and ↓ keys and press the Recall function key (f5) to recall the file and display it on the screen.

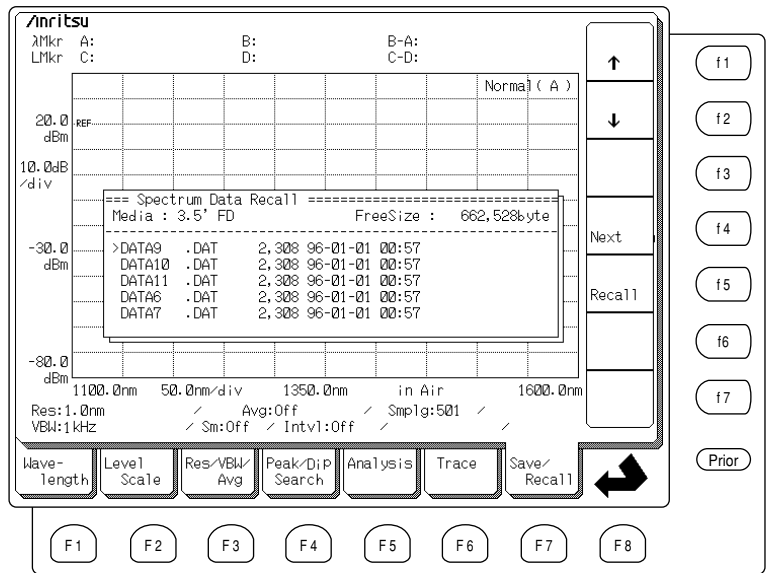

The following function keys are displayed in the Functions display field at right-hand side of the screen.

Key Name	Description
(f1) : ↑	Selects preceding file
(f2) : ↓	Selects next file
(f3) : Last	Displays files on previous page
(f4) : Next	Displays files on next page
(f5) : Recall	Recalls selected file

5.7.3 Setting Options (File Option Function Key (f4))

The following options related to saving data can be set.

Saved File Format

The file can be saved in the analyzer format, bitmapped format or text format.

File Name Input

The file can be saved as a file name or a file number.

Media Format

The FD can be formatted at 1.44 MB or 1.2 MB

Press the (F7) key to select the Save/Recall card and press the Option function key (f4) to display the following screen. Use the function keys to select the item indicated by the reverse displayed cursor.

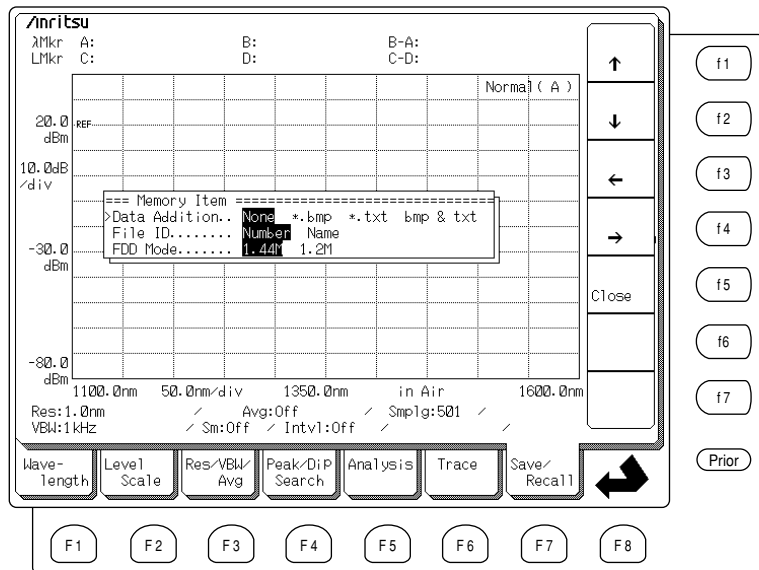

The following function keys are displayed in the Functions display field at right-hand side of the screen.

Key Name	Description
(f1) : ↑	Moves cursor up (select set item)
(f2) : ↓	Moves cursor down (select set item)
(f3) : ←	Moves cursor to the left (change setting contents)
(f4) : →	Moves cursor to the right (change setting contents)
(f5) : Close	Confirms setting contents and closes window

(1) Selecting Data Addition (Additional Save File)

When saving a file, in addition to the standard format, the file format can be selected from the following four items. The additional file name(s) has the same name as the standard format file but the extension is different. The meanings of the extensions are as follow:

(a) None

Save only as standard format file. The extension is .dat.

(b) *.bmp

In addition to standard format file, save as Windows™ bitmapped file.

(c) *.txt

In addition to standard format file, save as MS-DOS™ text file.

(d) bmp & txt

In addition to standard format file, save as both bitmapped and text files.

(2) Selecting File ID (Save Name Method)

This selects whether to save the file as a number or a name.

(a) Name

Input the file name as up to 8 alphanumeric characters.

(b) Number

Input the file as 3 digits; the saved file is saved as DATA ###, where ### is the input 3-digit number.

(3) Selecting FDD Mode

This selects whether to format the 2HD FD as a 1.44 MB FD or a 1.2 MB FD in the NEC/EPSON format. This setting becomes enabled after the power to the analyzer has been turned On/Off. This setting is not enabled if a 2DD FD is inserted in the analyzer.

(a) 1.44 MB

Sets 1.44 MB format density for using FD in PC/AT compatibles. The factory default setting is 1.44 MB.

(b) 1.2 MB

Sets 1.2 MB NEC/Epson format density.

5.7.4 Deleting Files (File Delete Function Key (f5))

Press the (F7) key to select the Save/Recall card, then press the File Delete function key (f5) to delete a standard format file saved on the FD. Files deleted with this function cannot be recovered. Making a backup of the file is recommended.

Only standard format files (.dat) can be deleted with this function. Files used by an external computer such as bitmapped and text files cannot be deleted by the analyzer. Use a computer to delete those files.

Press the File Delete function key (f5) to display the following screen. Move the cursor to the file to be deleted using the ↑ and ↓ function keys and select Delete. Yes and No to be selected by the function keys are displayed. Press Yes to delete the file, and No to leave the file untouched.

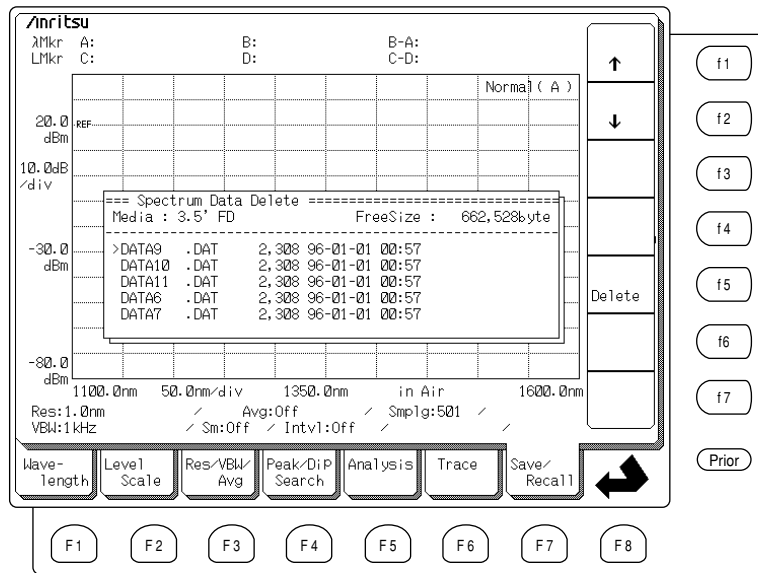

The following function keys are displayed in the Functions display field at right-hand side of the screen.

Key Name	Description
(f1) : ↑	Selects preceding file
(f2) : ↓	Selects next file
(f5) : Delete	Deletes selected file

5.7.5 Formatting Floppy Disk (File Format Function Key **f6**)

Press the **F7** key to select the Save/Recall card, then press the File Format function key **f6** to format the FD.

When attempting to save data to a new FD, the FD must be formatted first. Note that formatting a FD erases all current data on the disk.

To read data saved by the analyzer on a computer, etc., the FD must have been formatted in the same format as that used by the computer. In this case, press the **F7** key to select the Save/Recall card, then press the File Option function key **f6** and set the FDD MODE to 1.44 MB or 1.2 MB.

When the File Format function key is pressed, Yes and No to be selected by the function keys are displayed. Press Yes to format the FD and No to cancel the formatting. When Yes is pressed, FD formatting is displayed at the top right of the Graph display field and the FDD access lamp is lit. Wait a few minutes until formatting is completed. When the Formatting Completed message is displayed, the FD can be ejected.

If an attempt is made to format a 2DD FD in a 2HD format, the 2DD FD is formatted automatically in the correct (720 MB) format.

5.8 Setting Graph Type (Graph Card **F1**)

The Graph card displayed by pressing **F1** key is used to select the graph display format. The user can choose from five display formats: Normal, Overlap, Max Hold, Normalize, and 3D.

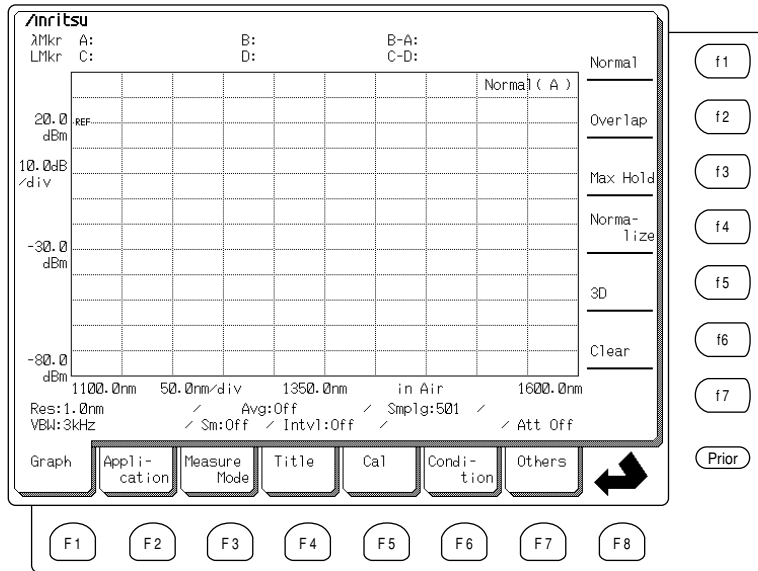

5.8.1 Normal Display (Normal Function Key **f1**)

Press the **F1** key to select the Graph card, then press the Normal function key **f1** to display the graph in the Normal format.

5.8.2 Overlap Display (Overlap Function Key **f2**)

Press the **F1** key to select the Graph card, then press the Overlap function key **f2** to display the graph in the Overlap format. In this format, the displayed spectrum from the previous sweeps are not deleted and the current sweep is superimposed (overlapped) on the display. This is very useful for monitoring any variations in the spectrum over time. To delete the graph, press the Clear function key **f6**, or to return to the Normal display format pressing the Normal function key **f1**.

5.8.3 Max Hold Display (Max Hold Function Key **f3**)

Press the **F1** key to select the Graph card, then press the Max Hold function key **f3** to display the peak level at each measurement point for multiple sweeps.

This is useful for monitoring the peak values of a changing spectrum. To delete the graph, press the Clear function key **f6**, or to return to the Normal display format pressing the Normal function key **f1**.

5.8.4 Normalize Display (Normalize Function Key **f4**)

Press the **F1** key to select the Graph card, then press the Normalize function key **f4** to normalize the spectrum at the Peak point. The vertical scale is in [dB] for Log scale, and [%] for Linear scale. If the Normalize function is used in the Trace A–B or Trace B–A displays, the trace from the selected memory is also normalized and displayed.

5.8.5 3D Display (3D Function Key (f5))

Press the (F1) key to select the Graph card, then press the 3D function key (f5) to display repeatedly measured spectra as a 3D graph. The display format can be selected from Type 1, Type 2, or Type 3.

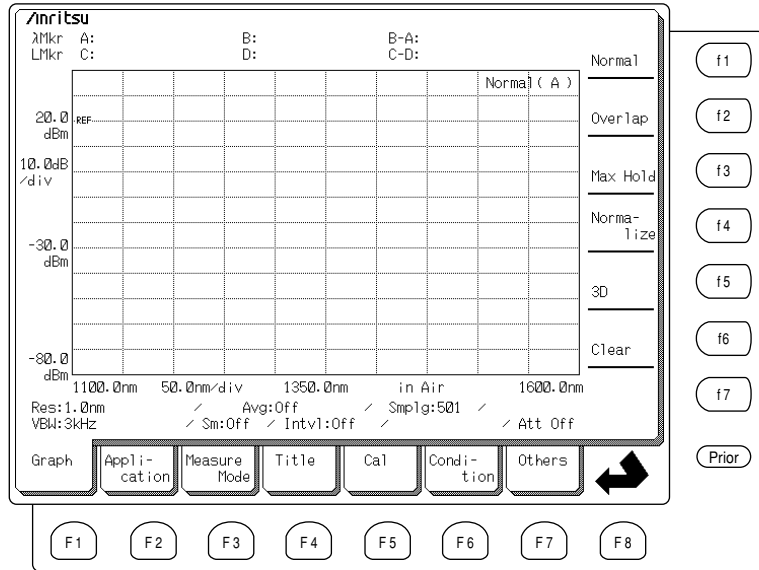

(1) Type 1 graph display format

In the Type 1 graph display format, wavelength is displayed on the x-axis, level on the y-axis, and time (number of times) on the z-axis. The z-axis display angle can be selected from 30°, 45°, 60° and 90° using the (f4) to (f7) function keys, respectively.

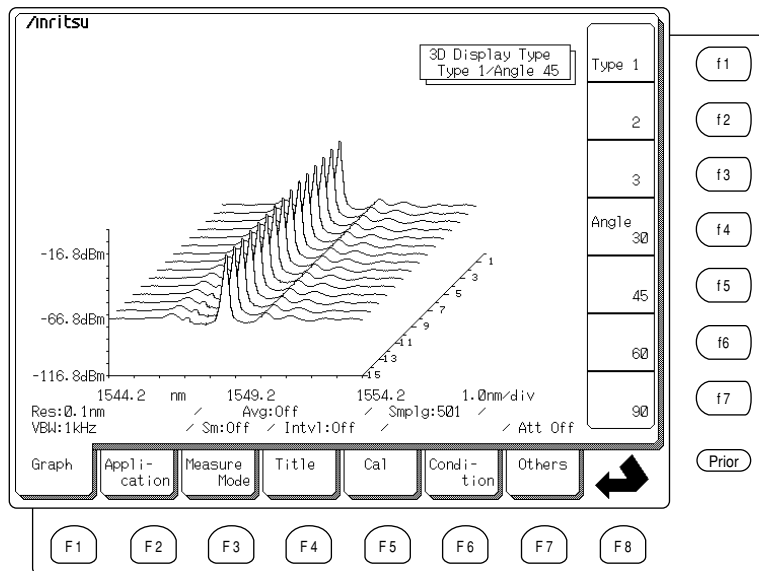

(2) Type 2 graph display Format

In the Type 2 graph display format, wavelength is displayed on the x-axis, level on the y-axis, and time (number of times) on the z-axis. The z-axis display angle can be selected from 30°, 45°, 60° and 90° using the (f4) to (f7) function keys, respectively.

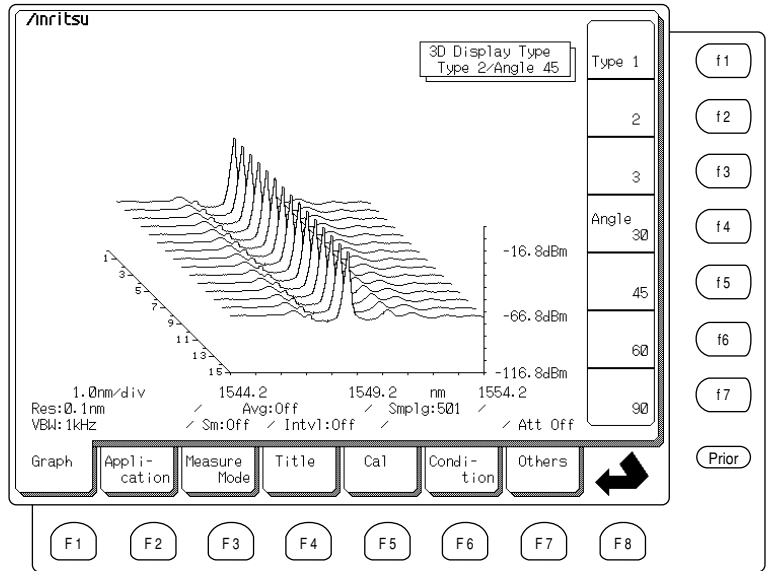

(3) Type 3 Graph display format

In the Type 3 graph display format, time (number of times) is displayed on the x-axis, level on the y-axis, and wavelength on the z-axis. The z-axis display angle is only in 45°.

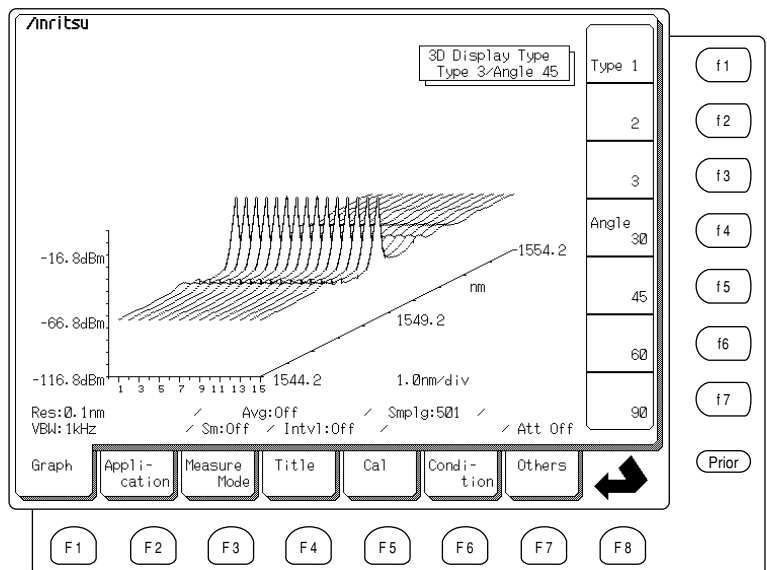

5.8.6 Clearing Graphs (Clear Function Key f6)

Press the F1 key to select the Graph card, then press the Clear function key f6 to clear the displayed graphs. When the graphs are cleared, both Memories A and B are cleared as well.

5.9 Application Measurement Functions (Application Card **F2**)

The Application card displayed by pressing the **F2** key has a variety of convenient functions for use in device and WDM system evaluations.

- DFB-LD Test evaluates DFB-LDs
- FP-LD Test evaluates FP-LDs (Fabry-Perot LDs)
- LED Test evaluates LEDs
- PMD Test evaluates Polarized Mode Dispersion
- Opt. Amp Test evaluates optical amplifiers
- WDM For WDM Analysis

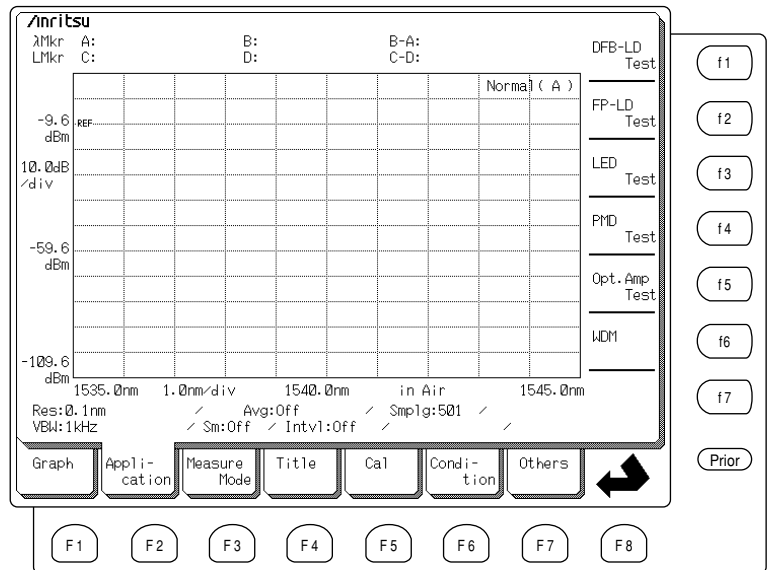

5.9.1 Evaluating DFB-LDs (DFB-LD Test Function Key **f1**)

This function determines the SMSR, spectrum width (ndB width), stop band, mode offset, and center offset, etc., from the DFB-LD spectrum. This function cannot be used with Trace A&B, Trace A-B, or Trace B-A.

Press the **F2** key to select the Application card, then press the DFB-LD function key **f1** to display the analysis results as shown on the following screen.

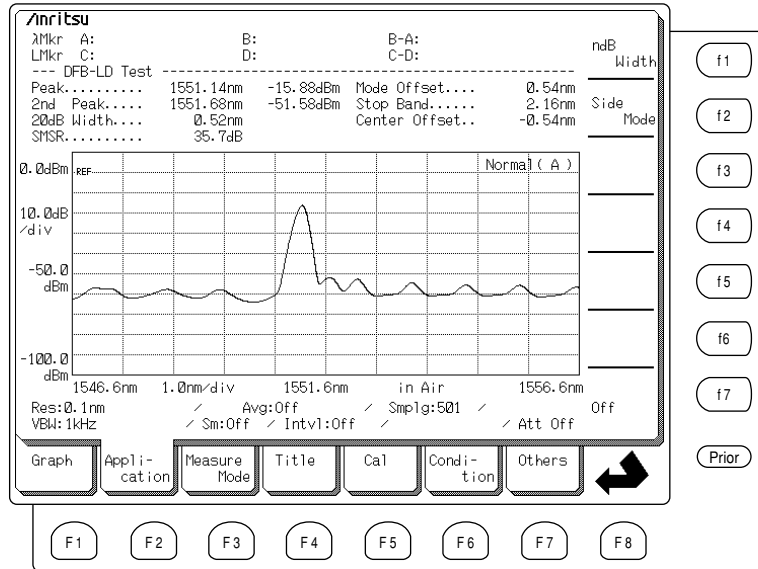

The following function keys are displayed in the Functions display field at right-hand side of the screen.

Key Name	Description
f1 : ndB Width	Sets value of n for finding spectrum width at a point ndB lower than Peak
f2 : Side Mode	Side Mode detection
f7 : Off	Quits DFB-LD evaluation function

Press the ndB Width function key **f1** and input the value n with the Data entry keys or Knob to find the ndB width.

Press the Side Mode function key **f2** key and activate the automatic Side Mode detection function to obtain the graph in Side mode.

Key Name	Description
f1 : 2nd	Next largest level from Peak point Side mode
f2 : Left	Peak immediately to left of Peak point Side mode
f3 : Right	Peak immediately to right of Peak point Side mode

5.9 Application Measurement Functions (Application Card (F2))

The names and descriptions of the data collected by this function is explained below.

Data Name	Description
Peak	Displays wavelength and level of Peak point
2nd Peak	
Left Peak	Displays wavelength and level for each side mode
Right Peak	
ndB Width	Width of spectrum at level ndB lower than Peak point
SMSR	Side Mode Suppression Ratio
Mode Offset	Wavelength difference between Peak point and side mode
Stop Band	Wavelength difference between Peak point and side modes of both sides
Center Offset	Difference between Peak point wavelength and Center wavelength calculated from both side modes

(1) Settable Range

The value n can be set in the range of 1 dB to 50 dB.

(2) Calculation and Processing

The Mode Offset, Stop Band, and Center Offset are found from the following equations: where, λ_{right} and λ_{left} are the wavelengths of the side modes on both sides of the Peak point, and λ_{side} is the side mode wavelength.

$$\text{Mode Offset} = \lambda_{side} - \lambda_{max}$$

$$\text{Stop Band} = \lambda_{right} - \lambda_{left}$$

$$\text{Center Offset} = \lambda_{max} - \frac{(\lambda_{right} + \lambda_{left})}{2}$$

λ_{side} can be selected from 2nd Left or Right.

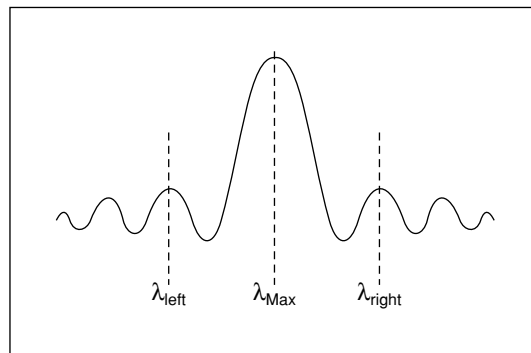

5.9.2 Evaluating FP-LDs (FP-LD Test Function Key (f2))

FP-LD Test Function is used to find the peak, RMS analysis results, oscillation vertical mode Number, vertical mode interval, total power, etc., from the FP-LD spectrum. This function cannot be used in the Trace A&B, Trace A-B, and Trace B-A.

Press the (F2) key to select the Application card, then press the FP-LD Test function key (f2) to execute the analysis and display the results as shown on the following screen.

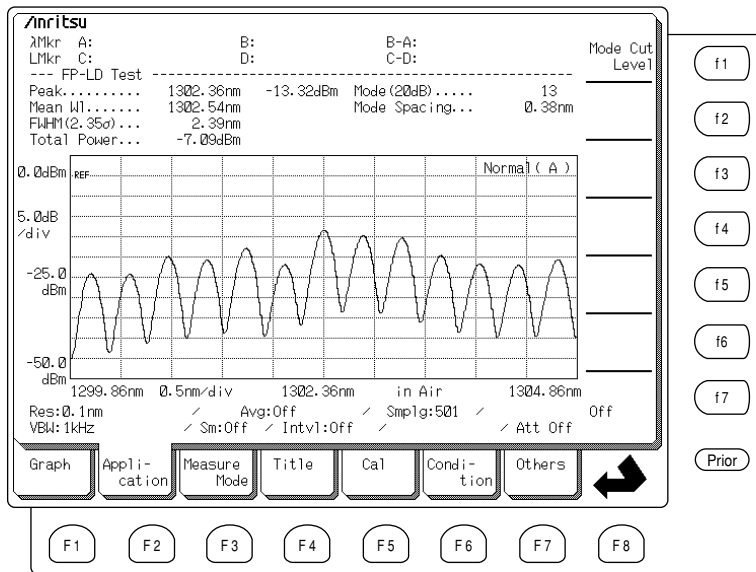

The following function keys are displayed in the Functions display field at right-hand side of the screen.

Key Name	Description
(f1) : Mode Cut Level	Referenced with respect to Peak level. Side modes greater than Mode Cut level are included in λ_c , $\Delta\lambda$, and mode calculations.
(f7) : Off	Quits FP-LD evaluation function

Press the Mode Cut level function key (f1) and input using the Data entry keys or Knob to find the Mode Cut level.

5.9 Application Measurement Functions (Application Card (F2))

The names and descriptions of the data collected by this function is explained below.

Data Name	Description
Peak	Displays wavelength and level of Peak point
Mean W1	Center wavelength calculated by RMS analysis
FWHM (2.35 σ)	Half width calculated by RMS analysis
Total Power	Total power
Mode (ndB)	Vertical mode Number. Number of side modes greater than Mode Cut Level
Mode Spacing	Side mode interval

(1) Settable Range

The settable range is from 1 dB to 50 dB.

(2) Calculation and Processing

The spectrum peak is found and used as the Mode Cut Level reference. The Mode Cut Level is placed ndB down from the peak. A search identifies all the side modes whose magnitude is above the slice level. These side modes (λ_i) and their levels (L_i) are used to calculate the theoretical Center wavelength λ_c , and the Full Width Half Max (hereinafter referred as FWHM) value. Total power is the ΣL_i .

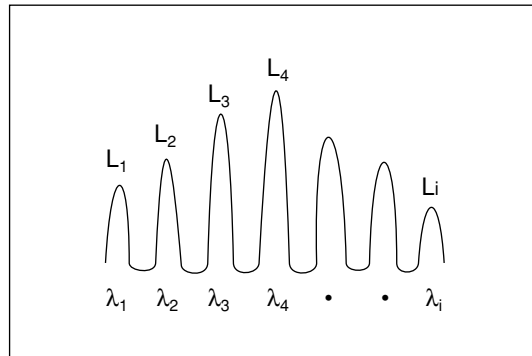

- Mean W1 (Center wavelength by RMS analysis)

$$\lambda_c = \frac{\sum(L_i \cdot \lambda_i)}{\sum L_i}$$

- FWHM (Half width by RMS analysis)

$$\Delta\lambda = 2.35\sigma = 2.35 \sqrt{\frac{\sum L_i \cdot \lambda_i^2}{\sum L_i} - \lambda_c^2} \text{ [FWHM]}$$

- Total Power (Peak Level Distribution)

$$P_{ow} = \sum L_i$$

5.9.3 Evaluating LEDs (LED Test Function Key (f3))

This function finds the peak, Center wavelength, spectrum width (ndB width), total power and power per nm, etc. This function cannot be used in the Trace A&B, Trace A–B, and Trace B–A.

Press the (F2) key to select the Application card, then press the LED test function key (f3) to execute the analysis and the display the results as shown on the following screen.

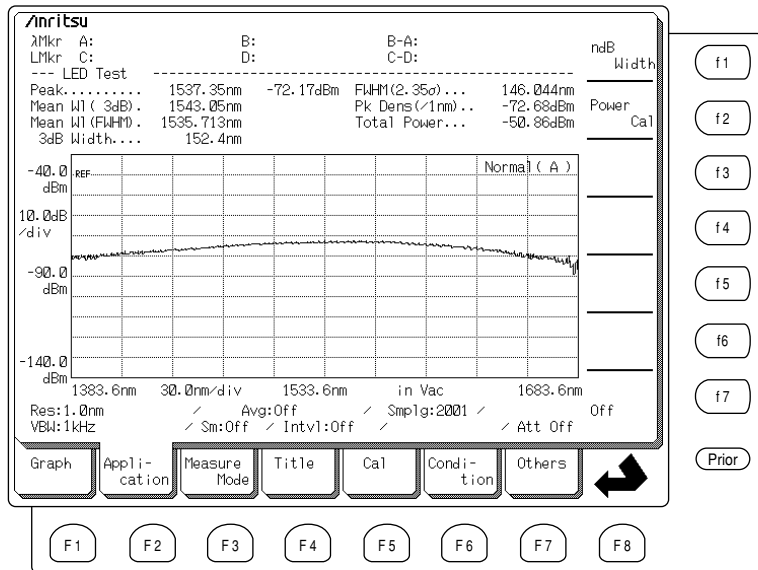

The following function keys are displayed in the Functions display field at right-hand side of the screen.

Key Name	Description
(f1) : ndB Width	Sets value n for finding spectrum width of level ndB lower than Peak
(f2) : Power Cal	Sets Total Power calibration factor
(f7) : Off	Quits LED test function

Press the ndB Width function key (f1) and set the value n using the Data entry keys or Knob to find the spectrum width.

Press the Power Cal function key (f2) and set the calibration factor using the Data entry keys or Knob to execute Total Power calibration.

5.9 Application Measurement Functions (Application Card F_2)

The names and descriptions of the data collected by this function are explained below.

Data Name	Description
Peak	Displays wavelength and level of Peak point
Mean W1 (ndB)	Center wavelength calculated by Threshold analysis
Mean W1 (FWHM)	Center wavelength calculated by Averaging processing
ndB Width	Spectrum width calculated by Threshold analysis
FWHM (2.35σ)	Half width calculated by standard deviation
Pk Dens (/1nm)	Peak power per 1 nm
Total Power	Total power

(1) Settable Range

The value of n can be set in the range of 1 dB to 50 dB. Power Cal can be set in the range of -10 dB to 10 dB.

(2) Calculation and Processing

Mean W1 (ndB) and ndB width use the same calculation method used in Threshold Analysis.



Mean W1 (FWHM), FWHM, Total Power, and Pk Dens (/1nm) are calculated from all the measured points in the displayed spectrum.

- **Mean W1 (ndB):**

$$\lambda_c [\text{ndB}] = \frac{\lambda_a + \lambda_b}{2}$$

λ_a, λ_b ($\lambda_a < \lambda_b$) are the Threshold analysis cut points.

- **Mean W1 (FWHM)**

$$\lambda_c [\text{FWHM}] = \frac{\sum L_n \cdot \lambda_n}{\sum L_n}$$

- **ndB Width**

$$\Delta\lambda [\text{ndB}] = \lambda_b - \lambda_a$$

- **FWHM**

$$\Delta\lambda [\text{FWHM}] = 2.35\sigma = 2.35 \sqrt{\frac{\sum L_n \cdot \lambda_n^2}{\sum L_n} - \lambda_c^2} [\text{FWHM}]$$

- **Total Power (Integrated value of measured points)**

$$P_{ow} = \text{PowerCal} \cdot \frac{\text{Sampling Resolution}}{\text{Actual Resolution}} \cdot \sum L_n$$

- **Pk Dens (/1 nm)**

$$P_k \text{Dens}(1 \text{ nm}) = \text{PowerCal} \cdot \frac{\text{Sampling Resolution}}{\text{Actual Resolution}} \cdot \sum_{\lambda_{p-0.5}[\text{nm}]}^{\lambda_{p+0.5}[\text{nm}]} L_n$$

5.9.4 Evaluating PMD (PMD Test Function Key (f4))

This function evaluates PMD (Polarization Mode Dispersion). This function cannot be used in the Trace A&B.

Press the (F2) key to select the Application card, then press the PDM Test function key (f4) to perform PMD evaluation. PMD evaluation is executed for the currently-displayed waveform, and it displays the results as shown on the following screen.

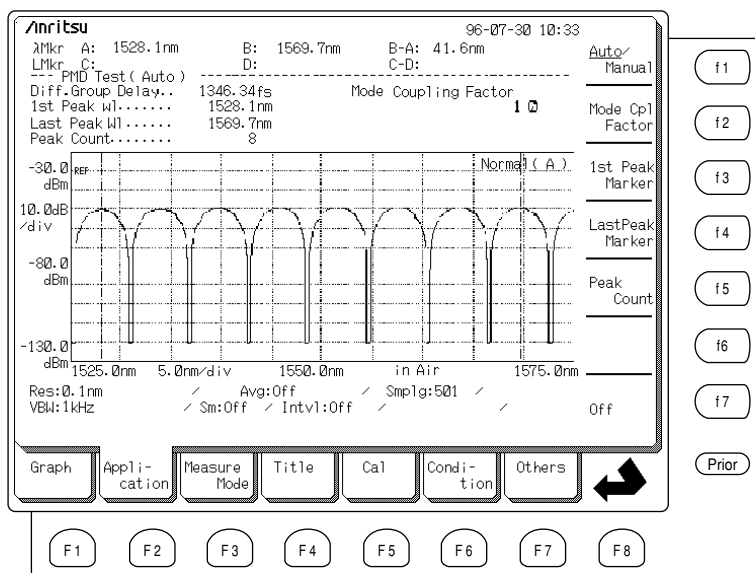

The following function keys are displayed in the Functions display field at right-hand side of the screen.

Key Name	Description
(f1) : Auto/Manual	Toggles operation between automatic calculation and manual calculation. With automatic calculation, the 1st Peak and last Peak as well as the number of peaks are found automatically and the Differential Group Delay time is displayed. With manual calculation, the Differential Group Delay time is computed when the 1st Peak, last Peak and number of peaks are set manually.
(f2) : Mode Cpl Factor	Sets mode coupling factor
(f3) : 1st Peak Marker	Sets Marker to 1st Peak at Manual
(f4) : Last Peak Marker	Sets Marker to Last Peak at Manual
(f5) : Peak Count	Sets inclusive number of peaks from 1st Peak to Last Peak
(f7) : Off	Quits PMD Test

Section 5 Explanation of Screens

The names and descriptions of the data collected by this function are explained below.

Data Name	Description
Diff. Group Delay	Differential Group Delay Time
1st Peak	Wavelength of first peak in analysis range
Last Peak	Wavelength of last peak in analysis range
Peak Count	Number of inclusive peaks in analysis range. Displays value detected automatically in Auto, or value set manually in Manual

The PMD analysis can be performed on a saved trace (Trace in Memory A or B). The results are updated after each new sweep.

(1) Settable Range

Mode Cpl Factor can be set in the range of 0.01 to 1. In the manual mode, the 1st Peak Marker and Last Peak Marker can be set in the range of the Start wavelength to the Stop wavelength. (1st Peak Marker < Last Peak Marker)

(2) Calculation and Processing

Diff. Group Delay $\Delta\tau$

$$\Delta\tau = \frac{k(n-1) \times \lambda_1 \times \lambda_2}{c(\lambda_2 - \lambda_1)}$$

The descriptions of the symbols used in the formula above are as follow.

- k: Mode Cpl Factor
- c: Velocity of Light (2.9979×10^8 m/s)
- n: Peak Count
- λ_1 : 1st Peak wavelength
- λ_2 : Last Peak wavelength

(3) Measurement Example

The following diagram shows a setup for performing a simple PMD Test.

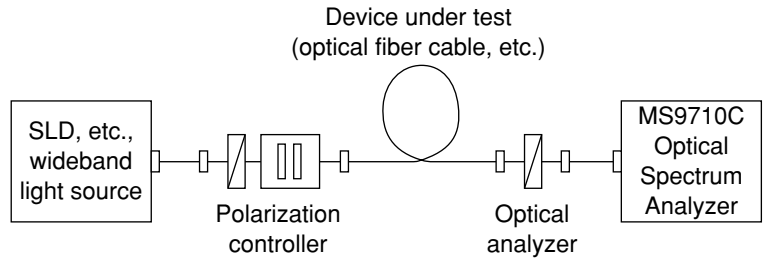

Convert the light from a wideband light source to a polarized wave using a polarization controller; pass this polarized light through the device under test, and input it to the MS9710C through an analyzer. The MS9710C measures the optical power polarization wavelength changes and calculates the PMD.

(4) Automatic Calculation Measurement Procedure

(a) Set PMD Test to Auto.

Press the **F2** key to select the Application card and press the PMD function key **f4**. Select Auto by pressing the Auto/Manual function key **f1**.

(b) Measure the spectrum.

Adjust the measurement conditions (Span, ref level, scale, etc.) to obtain the best spectrum.

(c) Adjust the polarization controllers.

Press the Repeat key of the Sweep keys to perform Repeat Sweep. Adjust the polarizers to maximize the difference between the Peak and Dip Points in the spectrum.

(d) Obtain the analysis results.

Complete the PMD test by executing a Single Sweep. The calculation is performed each time the Repeat Sweep is completed. The results are displayed on the screen.

(5) Manual Calculation Measurement Procedure

(a) Set PMD Test to Manual.

Press the **(F2)** key to select the Application card and press the PMD function key **(f4)**. Select Manual by pressing the Auto/Manual function key **(f1)**.

(b) Measure the spectrum.

Adjust the measurement conditions (Span, ref level, scale, etc.) to obtain the best spectrum.

(c) Adjust the polarization controllers.

Press the Repeat key **(Repeat)** of the Sweep keys to perform Repeat Sweep. Adjust the polarizers to maximize the difference between the Peak and Dip Points in the spectrum.

(d) Set the 1st Peak.

Press the 1st Peak Marker function key **(f3)** and set the 1st Peak Marker to the position of the peak on the left side of the spectrum using the Data entry keys or Knob.

(e) Set the Last Peak.

Press the Last Peak Marker function key **(f4)** and set the Last Peak Marker to the position of the peak on the right side of the spectrum using the Data entry keys or Knob.

(f) Set the Peak Count.

Press the Peak Count function key **(f5)** and set the number of peaks using the Data entry keys or Knob. This number includes the 1st Peak and the Last Peak, as shown in the diagram below.

(g) Obtain the analysis results.

Complete the PMD test by executing a Single or Repeat Sweep. The calculation is performed each time the Repeat Sweep is completed. The results are displayed on the screen.

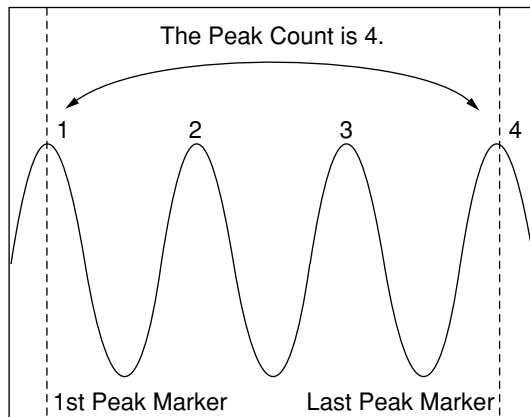

5.9.5 Evaluating Optical Amplifiers (Opt. Amp Test Function Key (f5))

This function evaluates optical amplifiers. This function cannot be used in the Trace A-B, Trace B-A.

Press the (F2) key to select the Application card, then press the Opt. Amp Test function key (f5) to display the following screen and perform an evaluation of an optical amplifier.

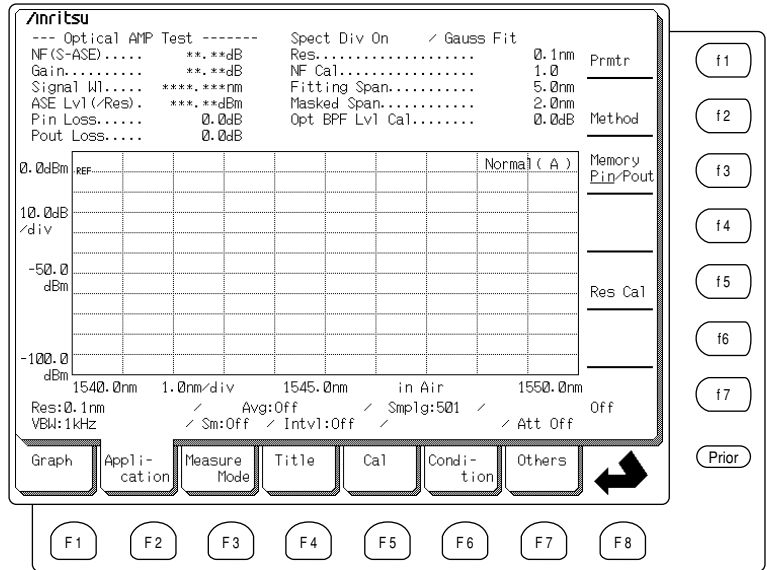

Section 5 Explanation of Screens

The following function keys are displayed in the Functions display field at right-hand side of the screen.

Key Name	Description
(f1) : Prmtr	Opens window for setting various test parameters.
(f2) : Method	<p>Sets evaluation method. The following five methods can be used.:</p> <ul style="list-style-type: none"> • Spect Div Off NF measurement without using spectrum division • Spect Div On NF measurement using spectrum division • Plzn Null Method NF measurement using polarization null method • Pulse Method NF measurement using pulse method • WDM Method NF measurement using WDM method
(f3) : Memory Pin/Pout	Sets whether to measure optical signal before optical amplifier (Pin) or after (Pout)
(f4) : $P_{out} \rightarrow P_{ase}$	For Plzn Null Method, copies spectrum written to memory P_{out} to internal memory P_{ase} (the Amplified Stimulated Emission output). Not displayed for other measurement methods.
(f5) : Res Cal	Calibrates Resolution. Set the Resolution to one used in actual measurement and then measure spectrum of single mode light source such as DFB-LD, and finally execute Res Cal. When the Resolution setting is changed, the calibration is not effective at the new Resolution.
(f6) : Ext. Trig Delay	For Pulse Method or WDM Method, sets external trigger delay time. Not displayed for other measurement methods.
(f7) : Off	Quits Opt. Amp Test

5.9 Application Measurement Functions (Application Card (F2))

Press the (F2) key to select the Application card and press the Opt. Amp Test function key (f5) to display the Prmtr function. When the Prmtr function key (f1) is pressed, the following screen is displayed.

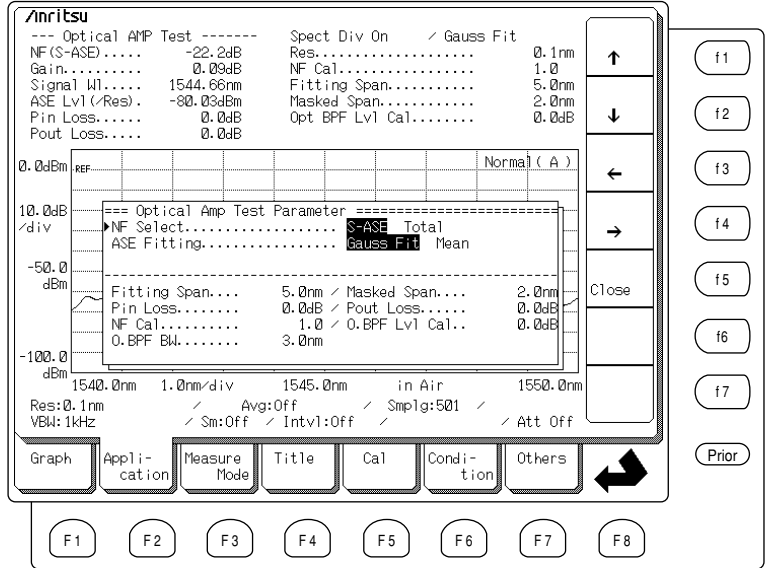

The following function keys are displayed in the Functions display field at right-hand side of the screen. Use the function keys to select the item indicated by the reverse displayed cursor, and set the value using the Data entry keys or Knob.

Key Name	Description
(f1) : ↑	Moves cursor up (select set item)
(f2) : ↓	Moves cursor down (select set item)
(f3) : ←	Moves cursor to the left (change setting contents)
(f4) : →	Moves cursor to the right (change setting contents)
(f5) : Close	Confirms setting contents and closes window

The descriptions of each parameters are as follow.

Parameter	Description
NF Select	Selects the types of noise included in the Noise Figure calculation. In the S-ASE setting, only the beat noise between the optical signal (Signal) and the Amplified Spontaneous Emission (ASE) is included in the NF calculation. In the total setting, the beat noise between Signal and ASE, the beat noise between ASEs, the Signal shot noise and the ASE shot noise are all the included in the NF calculation.
ASE Fitting	Sets fitting method (approximation) for determining ASE level from the output of the optical amplifier. With Gauss Fit, curve fitting is performed using a Gaussian function. With Mean, the ASE is calculated from a simple two point liner fit. The ASE Fitting parameter is not displayed for pulse and WDM methods.
Fitting Span	Sets portion of spectrum used in ASE interpolation calculation. Refer to Item (2) (c) of Calculation and Processing, Section 5.9.5.
Masked Span	Selects the subset of the Fitting Span which is excluded from ASE interpolation calculation. Refer to Item (2) (c) of Calculation and Processing, Section 5.9.5.
Pin Loss	Power offset factor which accounts for the difference between the level input to the analyzer and the level actually input to the optical amplifier.
Pout Loss	Power offset factor which accounts for the difference between the level input to the analyzer and the level actually output from the amplifier.
NF Cal	Sets calibration factor used in NF calculation. Refer to Item (2) (a) of Calculation and Processing, Section 5.9.5.
O. BPF Lvl Cal	Sets difference between level passed by optical passband filter inserted between optical amplifier and analyzer and unfiltered level. When a filter is not inserted, or when evaluating the characteristics of the optical amplifier including the filter, set to 0 dB.

5.9 Application Measurement Functions (Application Card (F2))

Parameter	Description
O. BPF BW	Sets optical passband filter bandwidth. The bandwidth is centered around the wavelength of the Signal. O. BPF BW can only be used when calculating the Total NF; it is not displayed for S-ASE. Set 999 nm when the filter is not inserted.
Pol Loss	Only displayed when Polarization Null Method is selected. Power offset factor which accounts for the setup losses due to the polarizer.

Set Pin, displayed by pressing the Memory Pin/Pout function key (f3), and measure the optical input; select Pout and measure the optical output. (The measurement order is not effect its result.)

When using Resolution calibration, input the required values for each items and press the Res Cal function key (f5) and select Execute to start the calibration. The analysis and calculation are performed and the results are displayed.

To quit the Opt. Amp Test, press the Off function key (f7).

The names and descriptions of the data collected by this function are explained below.

Data Name	Description
NF	NF of optical amplifier
Gain	Level gain of optical amplifier
Signal W1	Peak wavelength of optical amplifier
ASE Lvl (/Res)	ASE output level of optical amplifier
Pin Lvl	Level of input optical signal
Pout Lvl	Level of output optical signal

(1) Settable Range

The Ext. Trig Delay can be set in the range of 0 to 5 s. The setting ranges of other parameters are as follow.

Parameter	Setting Range
Fitting Span	0.10 to 100.00 [nm]
Masked Span	0.10 to 100.00 [nm] (Masked Span < Fitting Span)
Pin Loss	-10.00 to 10.00 [dB]
Pout Loss	-10.00 to 10.00 [dB]
NF Cal	0.100 to 10.00
O. BPF LvL Cal	0.00 to 30.00 [dB]
O. BPF BW	0.01 to 999.99 [nm]
Pol Loss	-10.00 to 10.00 [dB]

(2) Calculation and Processing

(a) The Gain [dB] is found from the following formula.

$$\text{Gain} = 10 \text{ Log } (G)$$

where,

$$G = \frac{P_{\text{out}}(\lambda_s) - P_{\text{ase}}}{P_{\text{in}}(\lambda_s)}$$

The descriptions of the symbols used in the formulas above are as follow.

- G: Linear gain
- λ_s : Amplifier signal wavelength [nm]
- $P_{\text{in}}(\lambda_s)$: Level of input signal [W]
- $P_{\text{out}}(\lambda_s)$: Level of output signal [W]
- P_{ase} : ASE level [W]

NF (S-ASE) [dB] is found from the following equation.

$$\text{NF} = 10 \text{ Log } \left(k \frac{P_{\text{ase}}}{h \cdot v \cdot G \cdot \Delta v_s} \right)$$

where, k is correction value (Setting value of NF Cal, usually 1)

$$v_s = \frac{c}{\lambda_{sv} \cdot 10^{-9} - \frac{\text{Res}_{\text{real}} \cdot 10^{-9}}{2}} - \frac{c}{\lambda_{sv} \cdot 10^{-9} + \frac{\text{Res}_{\text{real}} \cdot 10^{-9}}{2}}$$

$$v = \frac{c}{\lambda_{sv} \cdot 10^{-9}}$$

5.9 Application Measurement Functions (Application Card (F2))

The descriptions of the symbols used in the formulas above are as follows.

λ_{sv} :	Wavelength of output optical signal in vacuum [nm]
ν :	Signal frequency [Hz]
Res_{real} :	Actual Resolution (calibrated by Res Cal) [nm]
$\Delta\nu_s$:	Frequency band of analyzer at Pase measurement [Hz]
h :	Planck's constant 6.626×10^{-34} [J.S]
c :	Velocity of light 2.9979×10^8 [m/s]

(b) NF (Total) [dB] is found from the following equation.

$$\text{NF} = 10 \text{ Log } k \left(\frac{P_{\text{ase}}}{h \cdot \nu \cdot G \cdot \Delta\nu_s} + \frac{P_{\text{aset}}^2}{2 \cdot h \cdot \nu \cdot G^2 \cdot P_n(\lambda_s) \cdot \Delta\nu_s} + \frac{1}{G} + \frac{P_{\text{aset}}}{G \cdot P_n(\lambda_s)} \right)$$

The meaning of each term is as follows:

- Term 1: Beat noise between optical signal and ASE output
- Term 2: Beat noise between ASEs
- Term 3: Optical signal shot noise
- Term 4: ASE shot noise

where,

$$P_{\text{ase}} = \frac{P_{\text{ase}} \Delta\nu_a}{\Delta\nu_s}$$

(c) ASE (P_{ase}) [dBm] is approximated by Mean Fitting.

Set wavelength of the data point, which is one of two points innermost in the approximated data of amplified optical spectra (data obtained by removing the range set in Masked Span from the range set in Fitting Span) and closer to a shorter wavelength within reference to the signal optical wavelength, to " λ_1 " and its level (linear value) to " L_1 ". Set wavelength of the data point, which is the other one of the above two points, closer to a longer wavelength with reference to the signal optical wavelength, to " λ_2 " and its level (linear value) to " L_2 ".

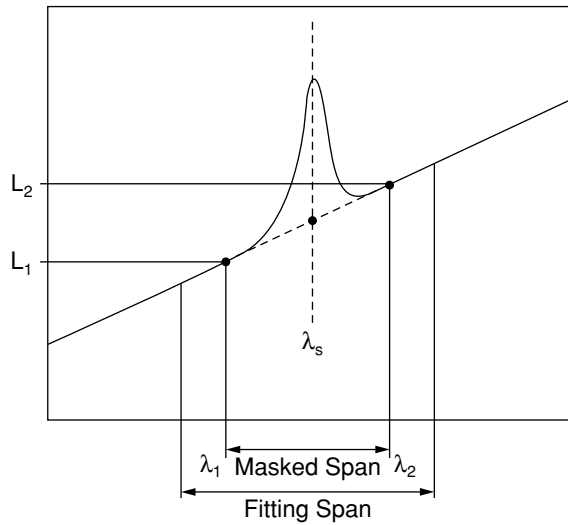

$$P_{ase} = 10 \text{ Log } (P_{ase}) + \text{LCal}_{\text{BPF}}$$

where,

$$P_{ase} = \frac{1}{2} (L_2 - L_1) + L_1$$

The descriptions of the symbols used in the formula above are as follow.

- LCal_{BPF} : Calibration factor of optical bandpass filter
- P_{ase} : ASE output (linear) found from measured spectrum

5.9 Application Measurement Functions (Application Card F2)

- (d) ASE (P_{ase}) [dBm] approximated by Gauss Fitting Points (λ_1, L_1) and (λ_2, L_2) are used to calculate $P_{ase}(\lambda_s)$ using a least square fit. The points (λ_1, L_1) and (λ_2, L_2) correspond to the end points of the Masked Span region

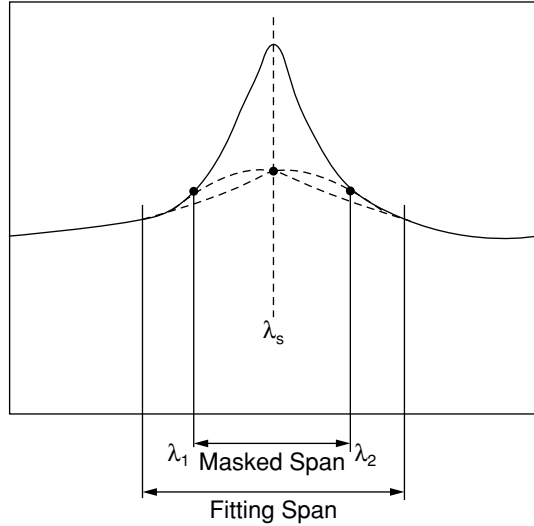

$$P_{ase} = L(\lambda_s) = a\lambda^2 + b\lambda + c$$

The descriptions of the symbols used in the formula above are as follows.

- $L(\lambda)$: Gauss Fitting Curve function
a, b, c: Constants

(3) Measurement Procedure and Example

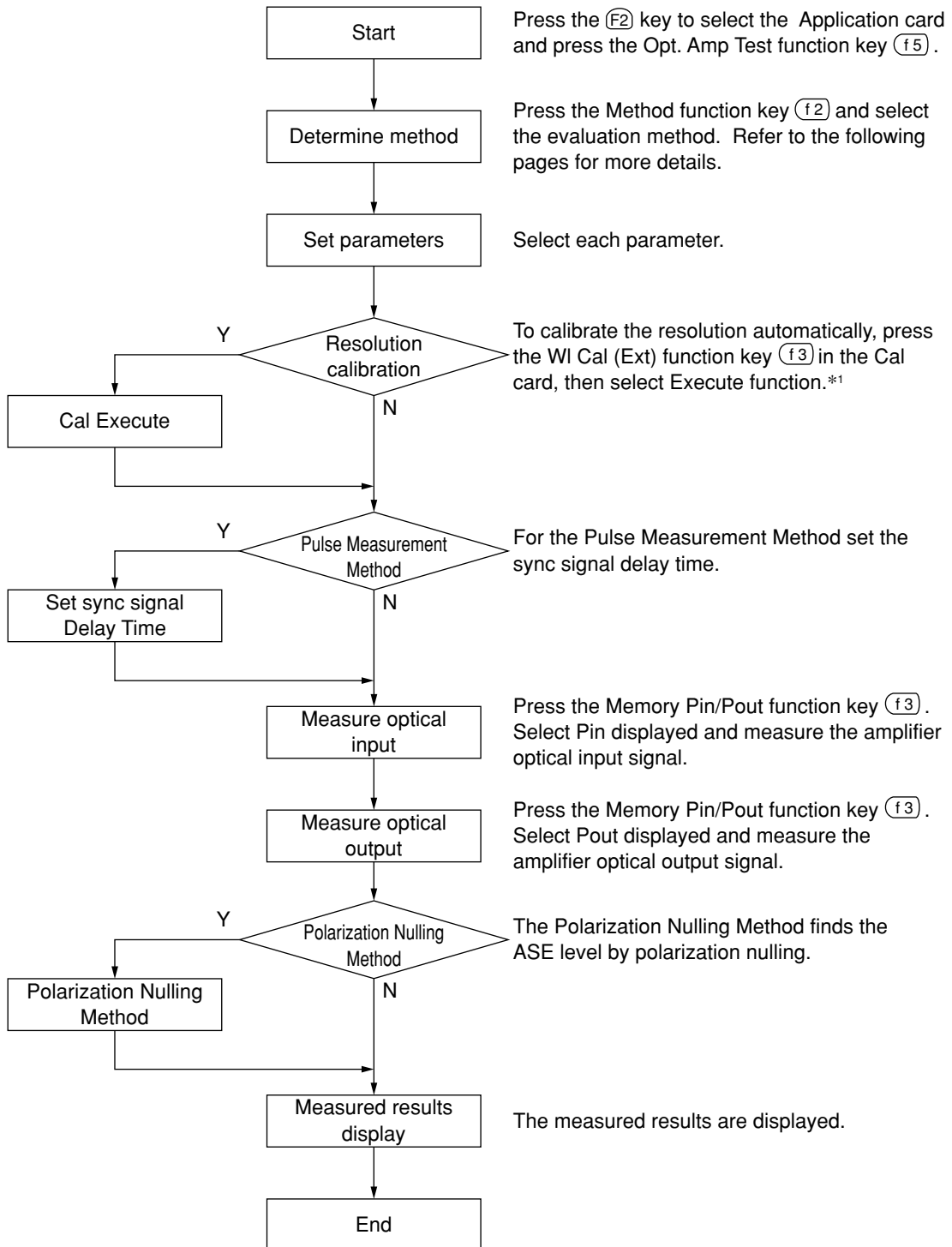

NOTE *1 :

When calibrating Resolution, always use a single-mode light source such as a DFB-LD, and match the Center wavelength to the Peak wavelength of the DFB-LD spectrum.

When the Resolution setting is changed during measurement, the Resolution data becomes void; Execute the calibration procedure for the new Resolution setting.

(4) Details of Evaluation Method

(a) Spectrum Div Off

This is the simplest (and potentially least accurate) method of measuring the optical amplifier NF and Gain. If high accuracy NF measurements are required, use the Polarization Null, Pulse, or WDM methods. The gain is found from measurements of the input and output of the optical amplifier. The ASE output is calculated by fitting from the measured optical output and NF is found.

(b) Spectrum Div On

This method is a slight variation to the Spectrum Div On Method. A correction is made to the measured amplifier output spectrum to account for the loss of the output bandpass filter used in the test setup. If no filter is used (O, BPF Lv1 Ca1 = 0) then Spectrum Div On Method will give same results as Spectrum Div Off Method. The corrected spectrum is calculated from the optical inputs and outputs and the ASE is computed by fitting to this corrected spectrum to find the gain and NF.

In the Spectrum Division Method, the corrected spectrum (factor) $P_{corr}(\lambda)$ is found from the following equation.

$$P_{corr}(\lambda) = P_{out}(\lambda) \cdot P_{outloss} - \frac{G_1 \cdot P_{in}(\lambda) \cdot P_{inloss}}{LCal_{bpf}}$$

$$G_1 = \frac{P_{out}(\lambda_s) \cdot P_{outloss}}{P_{in}(\lambda_s) \cdot P_{inloss}}$$

The descriptions of the symbols used in the formula above are as follow.

At $P_{corr}(\lambda) \leq 0$, $P_{corr}(\lambda) = 0$

$P_{out}(\lambda)$: Level (linear) at optical output wavelength λ

$P_{in}(\lambda)$: Level (linear) at optical input wavelength λ

G_1 : Liner Amplifier Gain

P_{inloss} : Linear value of Pin Loss

$P_{outloss}$: Linear value of Pout Loss

$LCal_{bpf}$: Linear value of O. BPF Lv1 Cal

(c) Plzn Null Lvl Method

In this method, the optical amplifier is evaluated by eliminating polarization. Both input light and output light of the optical amplifier are measured. Then, the signal light is cut off from output light through the polarization nullifying stage and the ASE is measured, as described in the following procedure. With this measured ASE and curve fitting, the level of the ASE at the signal light waveform is obtained, and Gain and NF are calculated. The example of the measurement system is as follows.

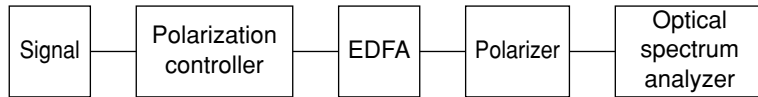

- (i) Press the Memory Pin/Pout function key **(f3)** and measure the optical signal.
- (ii) Adjust the polarization direction of the optical signal using the polarization controller and optical sensor so that the signal level becomes minimum and press the Pout→Pase function key **(f4)** to measure the Pase level.
- (iii) Once again, adjust the polarization direction so that the signal level becomes maximum. The signal level at this time is Pout. The ASE output level is derived from the polarized amplifier output spectrum by using curve fitting and a 3 dB correction factor.

$$P_{ase} = 2 \cdot P_{sp-ase} \cdot Pol_{loss}$$

$$P_{in}(\lambda) = P_{sp-in}(\lambda) \cdot P_{inloss}$$

$$P_{out}(\lambda) = P_{sp-out}(\lambda) \cdot P_{outloss}$$

The meanings of the abbreviated words used in the formula above are as follow.

P_{sp-ase} : ASE calculated by fitting

Pol_{loss} : Linear value of Pol Loss

$P_{sp-in}(\lambda)$: Input optical level (linear) measured by analyzer

$P_{sp-out}(\lambda)$: Output optical level (linear) measured by analyzer

(d) Pulse Method

In this method the ASE is accurately measured from the pulsed optical output of the DUT. This ASE value is used to calculate the NF. The following diagram shows an example of the measurement set up. An optical pulse (strongly modulated) light is input to the optical amplifier. To synchronize the sampling timing with this modulated optical pulse, the modulation signal of the light source is input to the Ext. Trig terminal of the MS9710C.

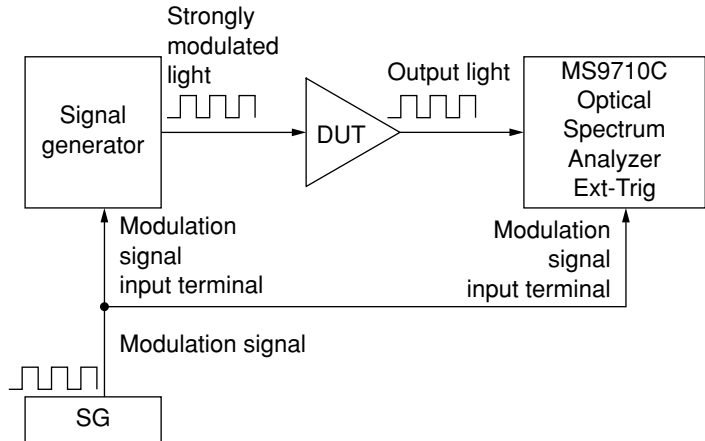

A measurement is taken τ msec after the Ext. Trig signal rising edge. This τ is called the Ext. Trig Delay and is set by pressing (f6). The settable Ext. Trig Delay range is 0 to 5 s. The modulated input signal is measured first and then the modulated amplified light is measured.

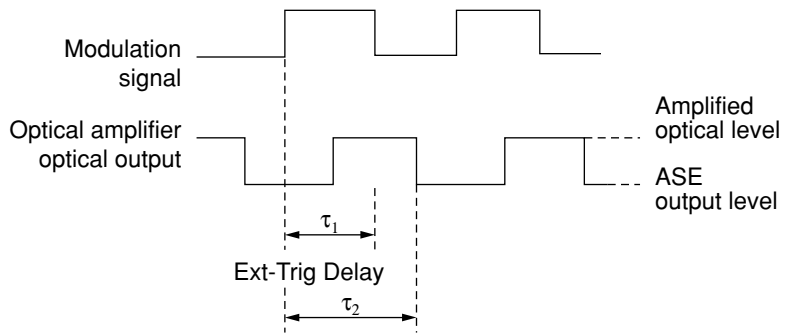

To measure the amplified optical level the Ext. Trig Delay should be set to τ_1 . The ASE output level is measured when the Ext. Trig Delay is set to τ_2 .

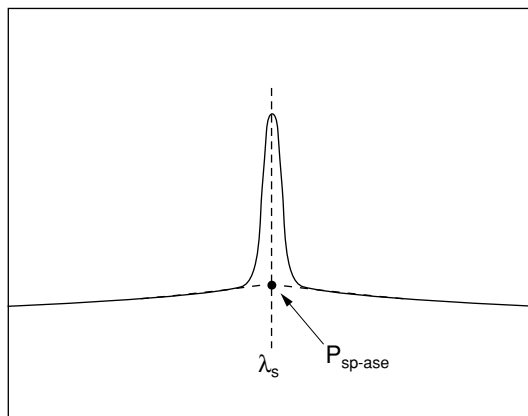

(e) WDM Method

This method is a variation on the Pulse Method which is useful for WDM systems. One channel in the WDM system is pulsed. The Amplified optical level and the ASE output level for this channel are measured using the same technique described previously for the Pulse Method.

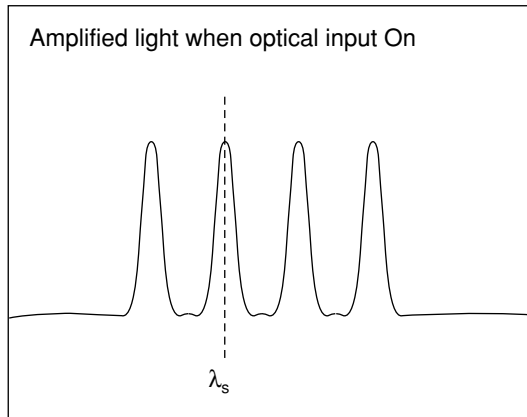

Measurement is performed with automatic evaluation whether or not wavelength of the optical signal is modulated by switching the optical input On and Off.

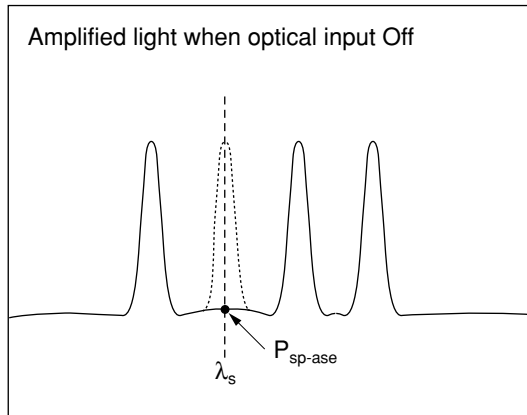

The Resolution is correction (Res Cal) as follows:

Measure the signal input to the optical amplifier and find the ratio of the peak level to the spectrum power.

5.9.6 WDM Evaluation (WDM **f6**)

This function is used to find the SNR of signal peaks as well as the wavelength and level differences between peaks, which are important parameters in WDM analysis. A maximum of 300 peaks from the short wavelength side can be detected. Evaluation is performed using Trace A and Trace B.

To perform WDM evaluation, press the WDM function key **f6** at the Application card.

At SNR evaluation using the WDM signal analysis function, in addition to being able to use either the right or left sides of the peak as the noise type, it is also possible to use the average of the left and right sides. Moreover, the signal wavelength detection method can be selected from either the maximum wavelength peak using normal peak detection, or a half width center wavelength peak using Threshold analysis.

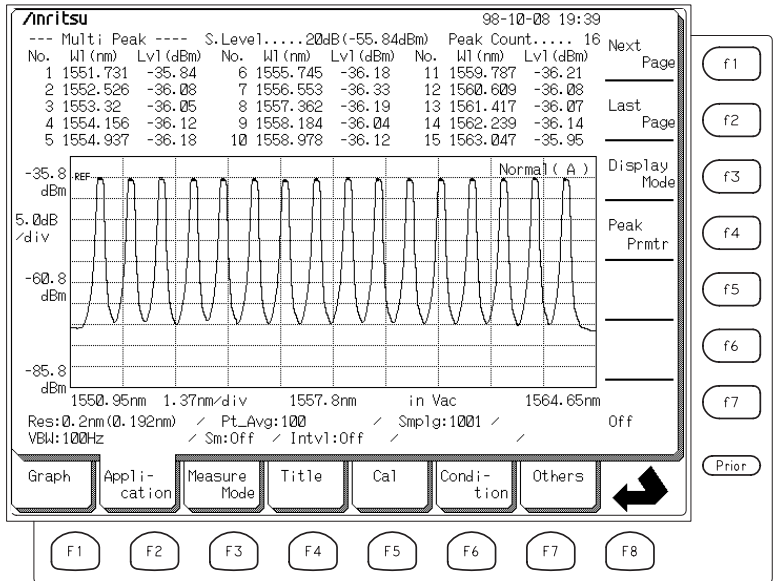

Section 5 Explanation of Screens

There are four display modes for WDM signal analysis: Multi Peak, SNR, Relative, and Table, and the displayed items are different in each mode.

To change the display mode, press the Display Mode function key (F3) and select the mode to be displayed.

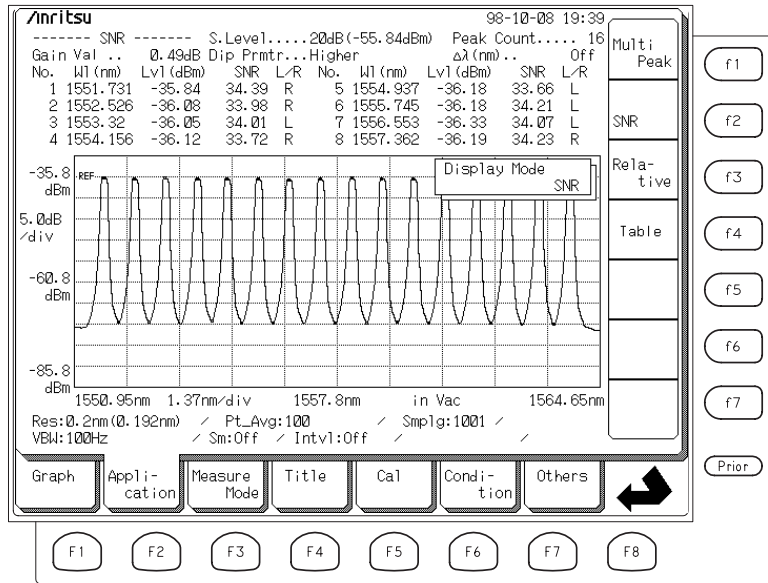

<Multi Peak>

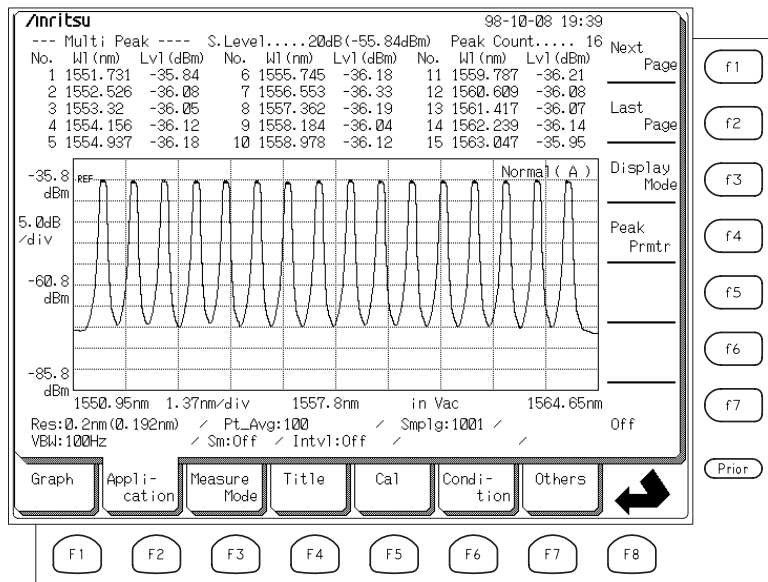

In the Multi Peak Mode, the wavelength and level of up to 15 peaks can be displayed simultaneously. Next page displays the following page.

5.9 Application Measurement Functions (Application Card **F2**)

<SNR>

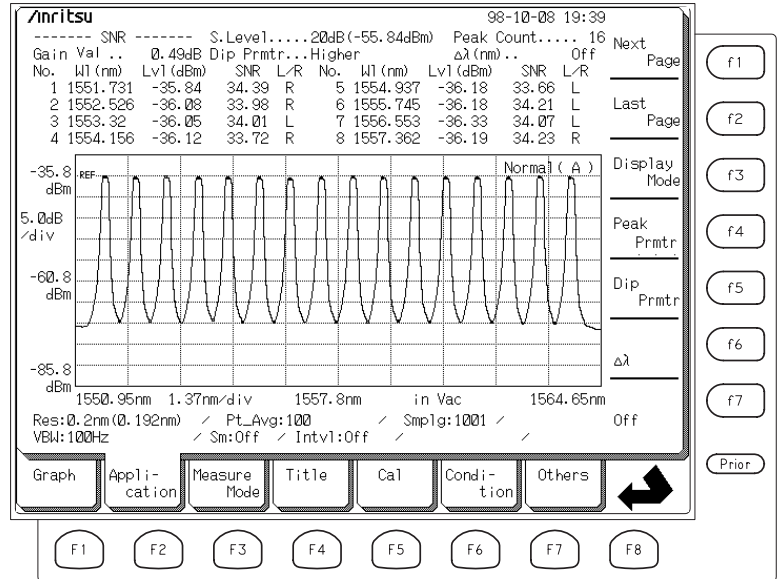

In the SNR mode, the wavelength, level, and SNR of up to 8 peaks can be displayed simultaneously.

<Relative>

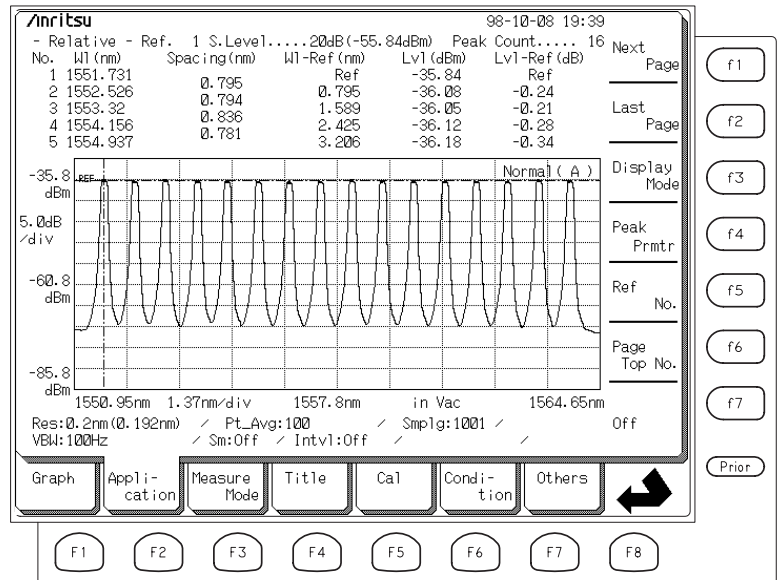

In the Relative mode, the wavelength, level, and wavelength spacing, or the wavelength and level relative to a reference peak, can be displayed for up to 5 peaks simultaneously.

<Table>

Anritsu					98-10-08 19:39	
----- Table -----			S.Level.....20dB(-55.84dBm)		Peak Count..... 16	
No.	Signal (nm)	Signal (THz)	Level (dBm)	SNR (dB)	Spacing WL (nm)	Spacing WL (GHz)

Res: 0.2nm (0.192nm)
VBW: 100Hz

Pt_Avg: 100
Sm: Off / Intvl: Off

Smp1g: 1001 /
Off

Graph

Appli-
cation

Measure
Mode

Title

Cal

Condi-
tion

Others

f1

f2

f3

f4

f5

f6

f7

f8

In the Table mode, the wavelength, level, SNR, and spacing of up to 16 peaks can be displayed simultaneously. In addition, the peak wavelength and spacing can be displayed as frequency.

The frequency *f* is found from the wavelength λ in a vacuum using the following equation:

$$f = \frac{c}{\lambda}$$

Where, *c* = 2.99792458 × 10⁸ (m/s).

5.9 Application Measurement Functions (Application Card F_2)

The following table lists the names of the data found by this function and the meaning.

Item (Key Name)	Operation and Setting
Next Page	Scrolls detected-peak data display range to next page
Last Page	Scrolls detected-peak data display range to previous page
Display Mode	Selects Display Mode from Multi Peak, SNR, Relative, and Table
Peak Prmtr	Sets peak detection Slice Level and detection method. The peak detection method can be selected from either detection of the maximum peak or the half width center wavelength using Threshold analysis. In the maximum peak detection method, the maximum point is detected as the peak and analysis is performed using that wavelength and level. In the Threshold method, the intermediate value between two wavelengths below the level set at Cut Level from the peak and the peak are used as the analysis values.
Dip Prmtr	Sets noise detection method in SNR display mode. The detection direction is the left side of the peak at Left, the right side of the peak at Right and whichever side has the larger level at Higher. At $(L+R)/2$, the average value of Left and Right is used as the noise value. In addition, it is possible to set whether or not to perform normalization using the effective resolution of the noise level. This key is only enabled in the SNR and Table display modes.
$\Delta\lambda$	Sets whether or not to detect at point X nm in direction set at Dip Prmtr from SNR display noise peak. When this parameter is set to Off, the dip in the direction set at Dip Prmtr is detected automatically. This key is only enabled in the SNR and Table display modes.
Ref. No	Sets reference peak number for Relative display. This function calculates the wavelength and level relative to the peak set as the reference peak. The reference peak is indicated by a marker on the spectrum. This key is only enabled in the Relative display mode.
Page Top No.	Sets peak number displayed at head of page in Relative display mode. This key is only enabled in the Relative display mode.
Off	Quits WDM function

<Peak Prmtr Setting Window>

```
=== Peak Prmtr =====  
S.Level ..... 30 dB  
-----  
Peak Type ..... Max Threshold  
Threshold Cut Level ..... 3.0 dB
```

Set the target for peaks to be analyzed up to X dB below the maximum peak at S.Level in the Peak Prmtr window. Select whether to use the wavelength of the point with the maximum measured level (MAX), or the center wavelength using Threshold analysis (Threshold) as the peak wavelength detection method at Peak Type. In both cases, the peak level is the level of the point measured as the peak.

<Dip Prmtr Setting Window>

```
=== Dip Prmtr =====  
Dip Type ..... Higher Left Right (L+R)/2  
Resolution Normalize .....Off On
```

Set the noise detection method to use the SNR evaluation at Dip Type in the Dip Prmtr window. The SNR is calculated at the noise level at the peak of the left side for Left, the peak of the right side for Right, the higher of the left or right sides for Higher, and the average of the left and right side for (L+R)/2. In addition, when Normalize is On, the value detected as the noise is divided by the set effective resolution to normalize the noise level per unit resolution (1 nm) and the SNR is calculated.

5.9 Application Measurement Functions (Application Card F_2)

The following table lists the names of the data found by this function and the meaning.

Data Name	Meaning
No.	Peak No. Appends sequential number from short wavelength side to detected peak.
Wl (nm) or Signal (nm)	Peak wavelength. Displays peak wavelength.
Signal (GHz)	Peak wavelength. Calculates and displays frequency of peak wavelength. Only displayed when Display Mode is Table.
Lvl (dBm)	Peak level. Displays peak level.
Peak count	Peak count. Displays total number of detected peaks.
Gain Var	Gain Variation. Displays level difference between maximum and minimum peaks. Only displayed when Display Mode is SNR or Table.
SNR or SNR (\bullet nm)	Displays Signal to Noise Ratio. Displays SNR (\bullet nm) or noise level normalized by effective resolution when Resolution Normalize of Dip Prmter is On. Only displayed when Display Mode is SNR or Table.
L/R	Displays SNR noise detection direction. Only displayed when Display Mode is SNR or Table. L represents left side, R represents R side and A represents average of left and right sides.
Spacing (nm)	Spacing. Displays wavelength difference between peaks. Only displayed when Display Mode is Relative or Table.
Spacing (Hz)	Calculates and displays wavelength difference between peaks as frequency. Only displayed when Display Mode is Table.
W1-Ref (nm)	Relative wavelength. Displays wavelength difference from reference peak. Displays wavelength difference between peaks. Only displayed when Display Mode is Relative.
Lvl-Ref (dB)	Relative level. Displays level difference from reference peak. Displays wavelength difference between peaks. Only displayed when Display Mode is Relative.

(1) Setting Ranges

S. Level can be set in the range from 1 to 50. $\Delta\lambda$ can be set in the range 0.01 to 20 nm and the Peak Prmtr Threshold Cut Level can be set in the range 0.1 to 50.0 dB.

Ref Peak No. cannot be set outside the number of detected peaks.

(2) Calculation and Processing

At WDM analysis, up to 128 peaks below the maximum peak that are larger than the threshold level set by S.Level of Peak Prmtr are detected from the short wavelength side and analyzed.

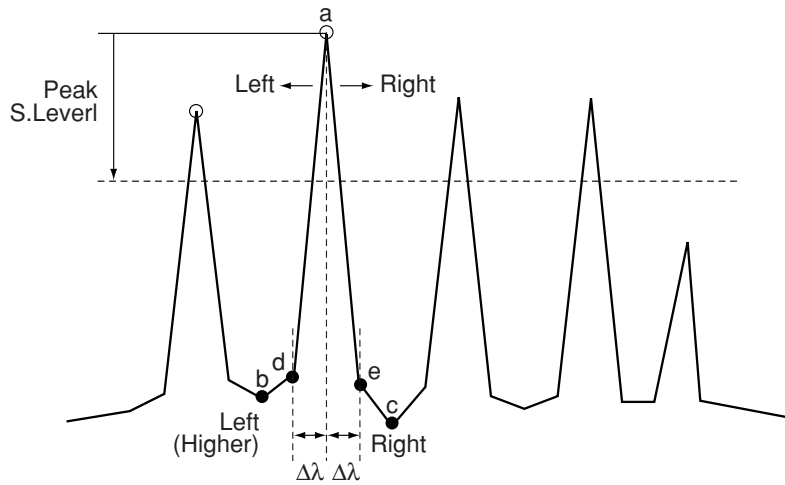

The peak level L_p [dBm] detects the value of peak point a. The peak wavelength λ_p is the wavelength of peak a when Peak Type of Peak Prmtr is set to MAX and the half-width center wavelength of the peak when Peak Type is set to Threshold.

When Display Mode is set to SNR or Table, the SNR value is calculated as follows:

$$SNR = 10 \log \left(\frac{L_{SLin}}{L_{NLin}} \right) \quad [dB]$$

Where,

L_{SLin} : Max. point a linear value [W]

L_{NLin} : Noise level linear value [W]

5.9 Application Measurement Functions (Application Card (F2))

When $\Delta\lambda$ is Off, if Dip Type of Dip Prmtr is set to Left, the noise level L_{NLin} is the level of dip point b at the short wavelength side of the peak; if Dip Type of Dip Prmtr is set to Right, it is the level of dip point c at the long wavelength side of the peak. When Higher is set, the level of dip point b of the higher of the left or right side (left side in above figure) is used. When Average is set, the average of the sum of the left and right sides is used:

$$L_{NLin} = \frac{L_{NLinLeft} + L_{NLinRight}}{2}$$

When $\Delta\lambda$ is On, if Dip Type of Dip Prmtr is set to Left, the noise level L_{NLin} is the level of point d separated just by $\Delta\lambda$ at the short wavelength side from the peak; if Dip Type of Dip Prmtr is set to Right, it is the level of point e separated just by $\Delta\lambda$ at the long wavelength side from the peak. Similarly, when Higher is set, the level of the higher point on the left or right side separated by $\Delta\lambda$ from the peak (left side in above figure) is used. When Average is set, the average of the sum of the two points on left and right sides separated by $\Delta\lambda$ from the peak is used:

$$L_{NLin} = \frac{L_{NLinLeft} + L_{NLinRight}}{2}$$

In addition, when Resolution Normalize of Dip Prmtr is On, the noise level is calibrated by the resolution and the SNR is calculated relative to the level L'_{NLin} per 1 nm (resolution unit) as follows:

$$SNR = 10 \log \left(\frac{L_{SLin}}{L'_{NLin}} \right) \quad [\text{dB}\cdot\text{nm}]$$

Where,

L'_{NLin} : Noise level linear value calibrated by effective resolution [W]

At other than Average, the noise level is calibrated by the effective resolution at that wavelength.

$$L'_{NLin} = \frac{L_{NLin}}{Res_{Act}(\lambda_N)} \quad [\text{W}/\text{nm}]$$

Where,

$Res_{Act}(\lambda_N)$: Effective resolution [nm] at noise wavelength λ_N

At Average, the noise level at the left and right sides is normalized by the effective resolution at each respective wavelength.

$$L'_{NLin} = \left(\frac{L_{NLinLeft} + L_{NLinRight}}{2} \right) \Bigg/ Res(\lambda_{NSignal})$$

5.10 Special Measurement Modes (Measure Mode Card **F3**)

The Measure Mode card selected by pressing **F3** key is used to set the measurement environment.

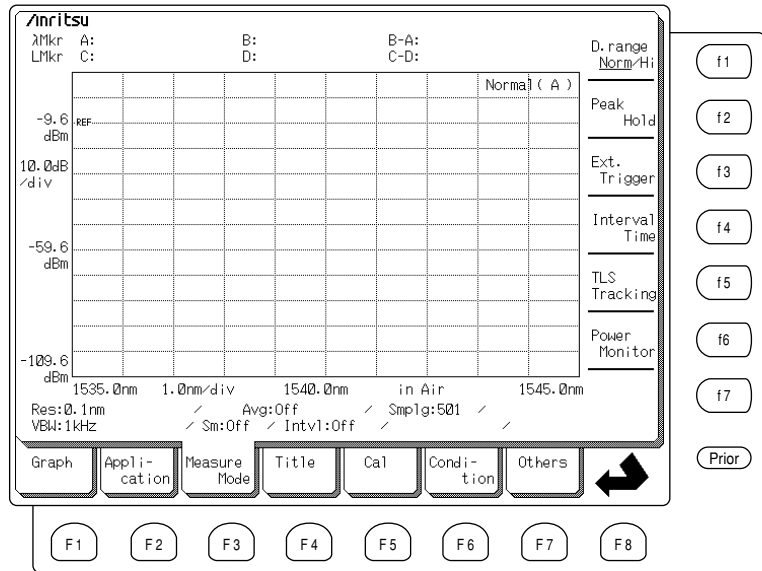

5.10.1 Wide Dynamic Range Measurement (D. range Norm/Hi Function Key **f1**)

This function switches the dynamic range between Normal (hereinafter referred as Norm) and Hi. Usually, measurement is performed in the Norm range, but when a high dynamic range measurement is required, switch to Hi. The measurement time is longer when the dynamic range is set to Hi than when it is set to Norm.

Press the **F3** key to select the Measure Mode card and press the D. range Norm/Hi function key **f1** to toggled the dynamic range between Norm and Hi

5.10.2 Modulated Light Measurement (Ext. Trig Function Key **f3**)

By using the Ext. Trigger function, it is possible for the analyzer to monitor modulated light. The signal used to modulate the light is input to the Ext. Trigger terminal on the back panel of the MS9710C.

The analyzer's measurements are then synchronized to Ext. Trigger rising edges. Fine tuning of this sampling point can be achieved by adjusting the delay time parameter.

Press the **F3** key to select the Measure Mode card and press the Ext. Trigger function key **f3** to turn Ext. Trigger measurement On. The delay time can be input using the Data entry keys or Knob.

When the Off function key is pressed, Ext. Trigger is set to Off and the measurement returns to normal.

(1) Settable Range

The delay time can be set in the range of 0 to 5 s.

Adjust the delay time so that the measured spectrum becomes maximum. When the pulse width of the modulated optical input is narrow, the VBW must be set to a wide band range.

5.10.3 Interval Measurement (Interval Function Key f4)

When performing a measurement using Repeat Sweep, it is possible to set the Interval Time from the start of one sweep to the start of the next sweep. The default Interval Time is 0 s.

Press the F3 key to select the Measure Mode card, then press the Interval function key f4 to display the currently-set Interval Time on the screen. The Interval Time can be set using the Data Enter Keys or Knob.

(1) Settable Range

The Interval Time can be set in the range of 0 to 99 s.

When the analyzer sweep period is longer than the set Interval Time, the message “Intvl:**” is displayed.

5.10.4 Tracking Measurement (TLS Tracking Function **f5**)

Tracking measurement can be performed with the MG9637/MG9638A. The output wavelength of the tunable light source is controlled from the MS9710C and tracking measurement is performed. In the tracking measurement mode, the wavelength offset cannot be set using Wl Offset and neither can Auto Measurement nor Power Monitor measurement be used.

Press the **F3** key to select the Measure Mode card and press the TLS Tracking function key **f5** to perform tracking measurement.

(1) Executing Tracking Measurement

First, use an RS-232C cross-connect cable to connect the MG9637/MG9638A and the MS9710C. After setting the tunable light source communication conditions and the OSA measurement conditions, execute Adjust to TLS and calibrate the tracking wavelength. After selecting the tracking measurement mode and changing the Center wavelength, execute calibration using the Adjust to TLS function key **f2** described in the previous measurement. Refer to Section 4.10 “Tracking Measurement for additional information.

 **Section 4.10**

(2) Returning to Normal Measurement

Press the **F3** key to select the Measure Mode card, then press the TLS Tracking function key **f5** to return to normal measurement and press Off function key.

NOTE:

Tracking measurement cannot be used at a resolution of 0.1 nm or less.

5.10.5 Power Monitor Measurement (Power Monitor Function Key (f6))

This function sets this analyzer to the Power Monitor mode.

(1) Measuring Total Power of Optical Input

Press the (F3) key to select the Measure Mode card, then press the Power Monitor function key (f6) to display the measured power at the top right of the Graph field as shown below and display the function keys on the right side of the screen.

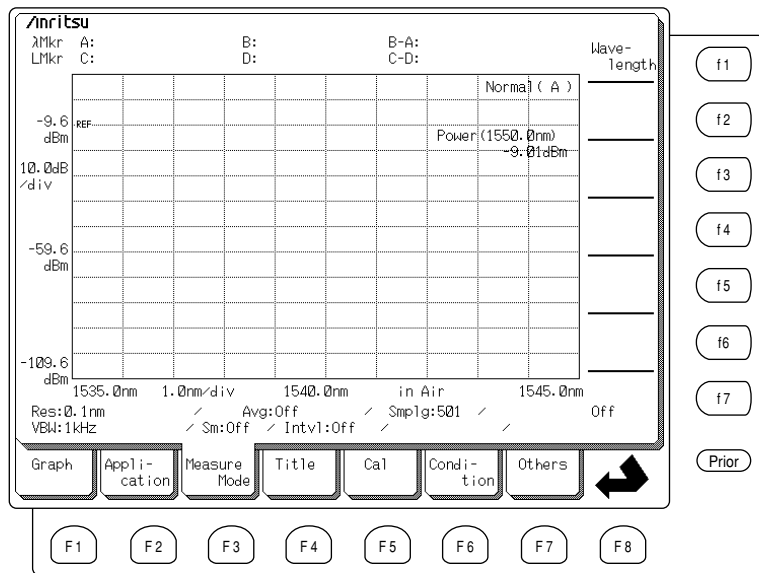

(2) Setting Wavelength Band

This function can improve the accuracy of the Power Monitor measurement. Press the (F3) key to select the Measure Mode card, then press the Power Monitor function key (f6) to display the Wavelength function, then press the Wavelength function key (f1) to specify the Wavelength Band in which power is to be measured. The user can select from four popular bands by pressing the Wavelength Band key.

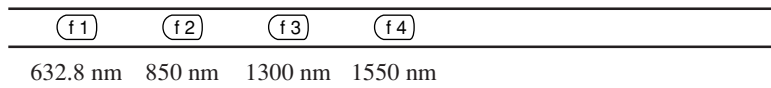

(3) Returning to Normal Measurement

Press the (F3) key to select the Measure Mode card, then press the Power Monitor function key (f6) and press the Off function key.

5.11 Setting Titles (Title Card (F4))

This function inputs titles of up to 30 characters at the top of the screen.

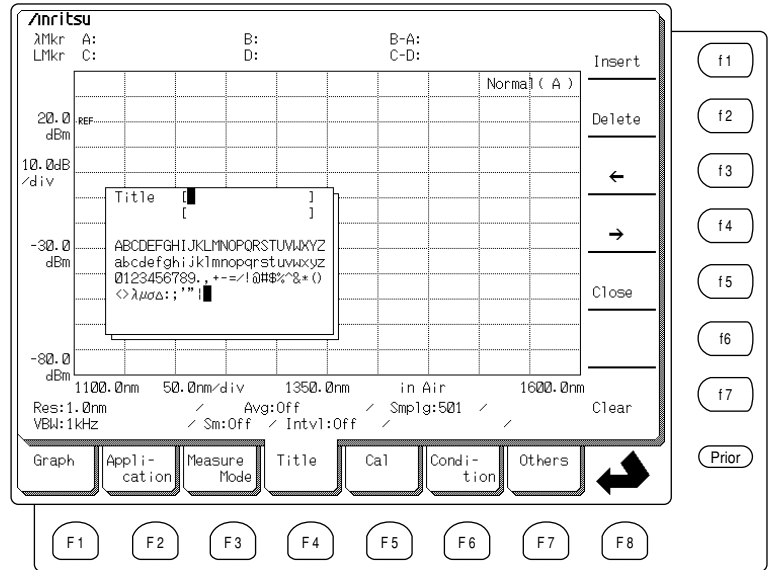

When the Title card is selected by pressing the (F4) key, the character selection window shown above is displayed. Use the Knob to move the cursor to the position of the desired character, or use the function keys to move the cursor and insert a blank space. The following function keys are displayed in the Functions display field at right-hand side of the screen.

Key Name	Description
(f1) : Insert	Inserts 1 space at cursor position
(f2) : Delete	Deletes 1 character at cursor position
(f3) : ←	Moves cursor 1 character left
(f4) : →	Moves cursor 1 character right
(f5) : Close	Confirms input title
(f7) : Clear	Deletes title

For example, set the title "YOU" as follows:

- (1) Select the Title card by pressing **(F4)** key. The character selection window is displayed in the middle of the screen.
- (2) Use the Knob to move the cursor in the character selection window to the Y.
- (3) Move the cursor to the right of Y using the → key pressing the **(f4)** function key.
- (4) Use the Knob to move the cursor in the character selection window to the O.
- (5) Move the cursor to the right of O using the → key pressing the **(f4)** function key.
- (6) Use the Knob to move the cursor in the character selection window to the U.
- (7) Confirm the title by pressing the Close function key **(f5)**.

To delete an input character, press Delete function key **(f2)**. To delete the entire title, press Clear function key **(f7)**.

5.12 Calibration Function (Cal Card (F5))

The Cal card displayed by pressing (F5) key is used to calibrate the MS9710C. Calibration makes it possible to obtain higher-accuracy measurement results.

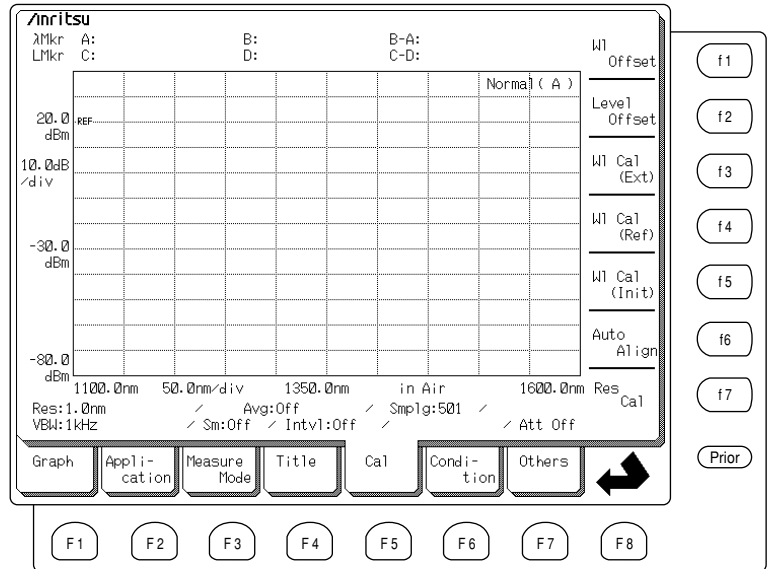

CAUTION

If this function is used when no external reference optical signal is input, or when an improper optical signal is input, subsequent measurement results will not be correct. If this occurs, perform the correct calibration or press the W1 Cal Init function key (f5) in the Cal card displayed by pressing (F5) to initialize the calibration wavelength data.

5.12.1 Setting Wavelength Offset (Wl Offset Function Key f1)

When the wavelength offset component is input, the spectrum is displaced horizontally left/right. When a positive value is input to the wavelength offset data, the displayed spectrum of the subsequent measurements is shifted to longer wavelengths.

Press the F5 key to select the Cal card and press the Wl Offset function key f1 to display the “Wavelength Offset $\pm\#. \#\#$ nm” in the Settings display field at the top right of the screen to indicate that the wavelength offset can be input. Input the offset value using the Data entry keys or Knob.

When the wavelength offset is a numeric value other than 0 nm, the characters WLOFST are displayed at the bottom left of the display.

(1) Settable Range

The wavelength offset can be set in the range of -1.00 nm to $+1.00$ nm.

5.12.2 Setting Level Offset (Level Offset Function Key f2)

When the level offset component is input, the spectrum is displaced vertically up/down. When a positive value is input to the level offset data, the displayed spectrum is shifted upwards.

Press the F5 key to select the Cal card and press the Level Offset function key f2 to input the Wavelength level offset. The value of level can be input using the Data entry keys or Knob.

When the wavelength offset is a numeric value other than 0 nm, the characters LVLOFST are displayed at the bottom left of the display.

(1) Settable Range

The level offset can be set in the range of -30.00 dB to $+30.00$ dB.

5.12.3 Calibrating Wavelength using External Wavelength Reference (WI Cal (Ext) Function Key (f3))

This function uses an external wavelength reference to calibrate wavelength.

Press the (F5) key to select the Cal card and press the WI Cal (Ext) function key (f3) to display Execute and Cancel in the Functions display field on the right side of the screen. When executing calibration, check that the output of the external wavelength reference is connected to the optical input connector and press the Execute function key. To stop calibration during execution, press the Cancel key.

For calibration, use a light source with a stabilized output level. In addition, before executing calibration, performing Auto Align (automatic optical axis adjustment) for better level accuracy is recommended. Best results are achieved when the source is a DFB-LD.

5.12.4 Calibrating Wavelength using Optional Internal Wavelength Reference (WI Cal (Int) Function Key (f4))

This function is for calibrating wavelength using the optional internal wavelength reference.

Press the (F5) key to select the Cal card and press the WI Cal (Int) function key (f4) to display Execute and Cancel in the Functions display field on the right side of the screen. Before executing calibration, check that the output of the optional Wavelength reference light source on the back panel is connected to the optical input connector and that the optical output is on. Press the Execute function key to start the calibration. To stop calibration while it is executing, press the Cancel key.

5.12.5 Initializing Wavelength Calibration Data (WI Cal (Init) Function Key (f5))

This function initializes the wavelength calibration data to the factory default values. If the wavelength calibration fails for some reason, use this function to return the calibration data to the factory default.

Press the (F5) key to select the Cal card and press the WI Cal (Init) function key (f5) to display Execute in the Functions display field on the right side of the screen. Press Execute to initialize the wavelength calibration data.

CAUTION

This function overwrites all existing calibration data with factory default values.

5.12.6 Automatic Optical Axis Alignment (Auto Align Function Key (f6))

The Auto Align function is used to improve the level accuracy in a particular band of interest. A reference signal with a wavelength in the band of interest is input into the MS9710C. The analyzer uses this reference to optimize the position of the internal optical axis. The Auto Align calibration should be performed whenever extremely high accuracy is required.

Press the (F6) key to select the Cal card and press the Auto Align function key (f6) to display Execute, Cancel and Init in the Functions display field on the right side of the screen. To align the optical axis, select Execute. To stop auto alignment, press Cancel. In addition, the factory default setting can be returned by pressing Init.

A DFB-LD reference source is recommended for the auto align calibration.

5.12.7 Calibrating Effective Resolution (Res Cal Function key (f7))

It is possible to calibrate the effective resolution when required, such as at evaluation of the NF of fiber amplifiers, etc. To calibrate the effective resolution, press the Res Cal function key at the Cal card. Calibration is started by Execute. In addition, the current calibration value can be initialized by Init. The resolution calibration value becomes invalid when the wavelength or resolution is changed and is initialized.

When calibrating the effective resolution, always set the wavelength and resolution to be used at measurement and use a DFB-LD with a wavelength close to the center wavelength as the calibration light source.

5.13 Saving and Recalling Measurement Conditions (Condition Card (F6))

Up to five different measurement conditions can be saved to internal memory. The measurement conditions can also be returned to the factory default settings.

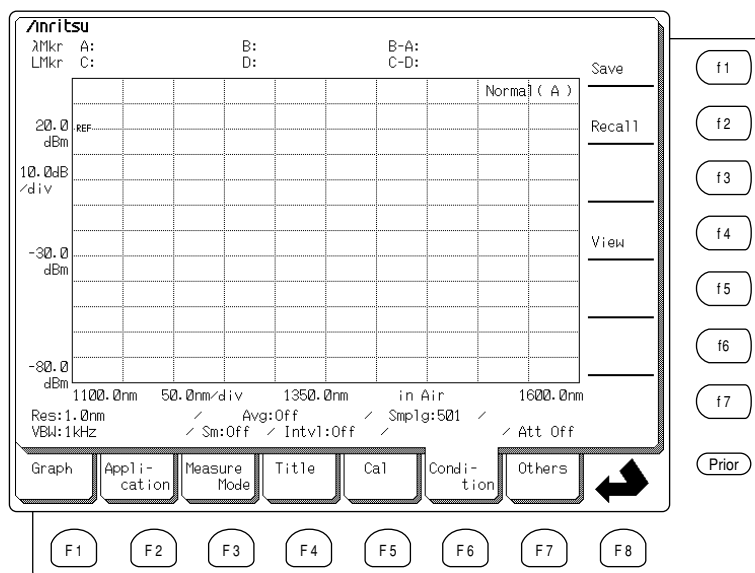

The measurement conditions are as follow:

- Wavelength
- Center
- Span
- Start
- Stop
- Value in Air/Vacuum
- Level Scale
- Scale Select
- Log (/div)
- Reference Level
- Linear Level
- Opt. ATT On/Off
- Resolution
- Actual Resolution
- VBW
- Average On/Off
- Smooth On/Off
- Sampling Points

- Optical Att On/Off
- Interval Time
- Dynamic Range
- Graph
- Mod. Mode
- Analysis/Application

5.13.1 Saving Measurement Conditions (Condition Save Function Key **f1**)

The current measurement conditions can be saved to memory number 1 to 5.

Press the **F6** key to select the Condition card, then press the Condition Save function key **f1** to display the Condition Save screen as shown below.

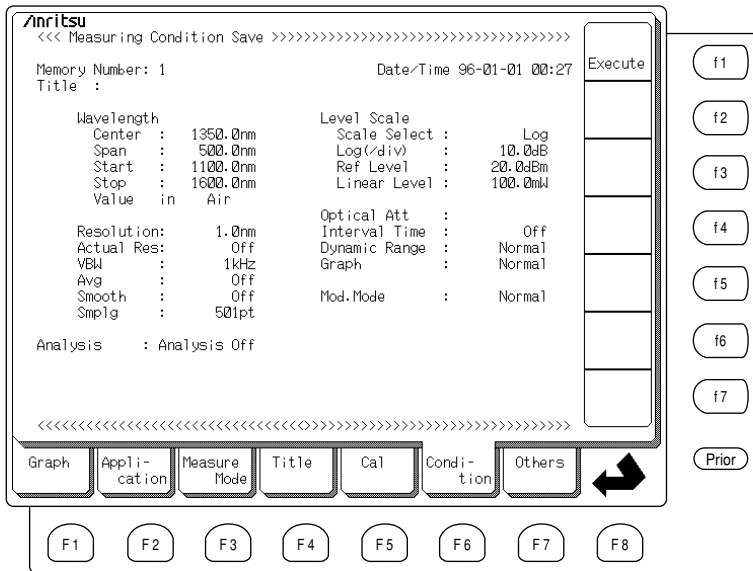

Input the number in the range 1 to 5 at Memory Number at the top left of the screen using the Data entry keys. The current settings are saved when the Execute function key **f1** is pressed.

CAUTION

This function overwrites the previous contents of the selected memory.

5.13.2 Recalling and Initializing Measurement Conditions (Recall Function Key (f2))

This function recalls saved measurement conditions.

Press the (F6) key to select the Condition card, then press the Recall function key (f2) to display the Recall screen as shown below.

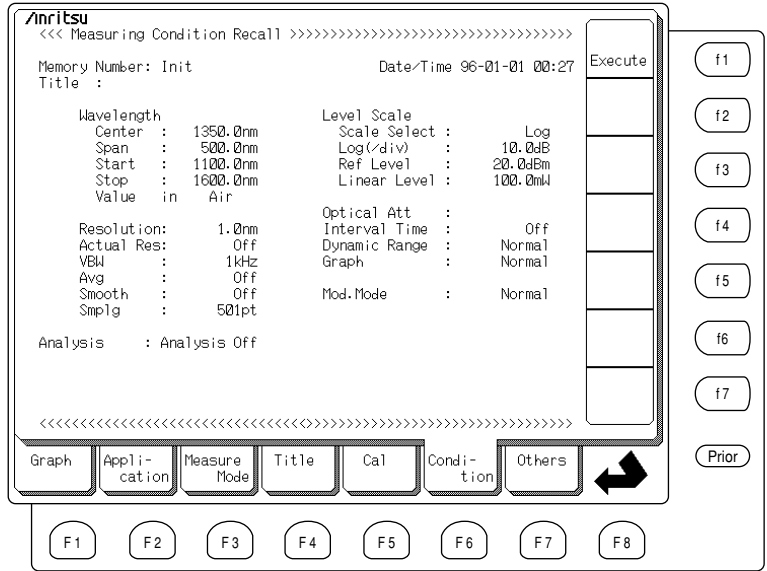

Select the desired Memory Number at the top left of the screen, then press the Execute function key (f1) to recall the measurement conditions. When Memory Number 0 is selected, the factory default memory conditions are recalled.

CAUTION

This function overwrites the currently-set conditions

5.13.3 Listing Current Measurement Conditions (View Function Key **f4**)

This function displays the currently-set measurement conditions.

Press the **F6** key to select the Condition card, then press the View function key **f4** to display condition View screen as shown below. Refer to Appendix B “Factory Default Settings” for additional information.

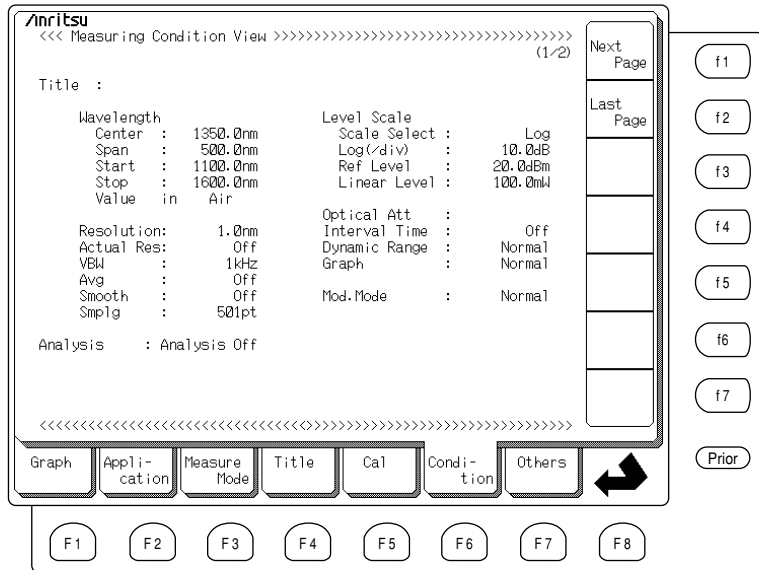

On this screen, press the Next Page function key **f1** to display the system setting conditions as shown below. To return to the measurement conditions screen, press the Last Page function key **f2**.

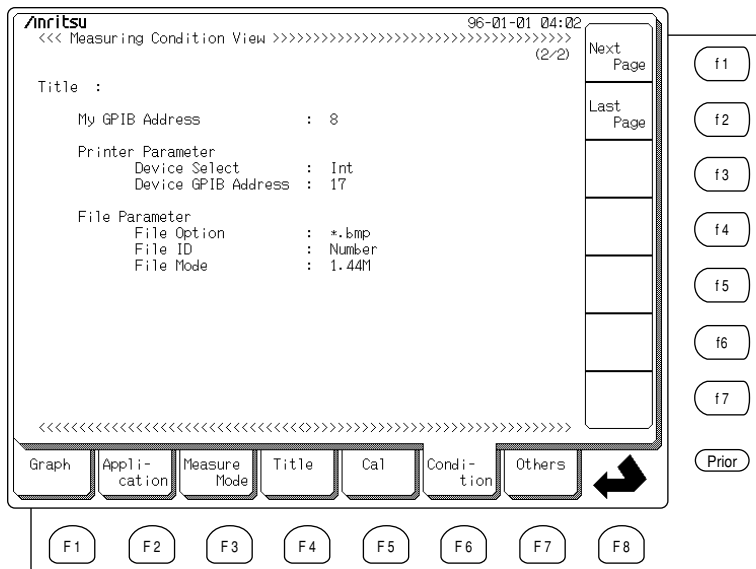

5.14 Other Functions (Others Card **F7**)

The following items can be set in this card:

- Printer Parameters
- Display Colors
- GPIB Address
- Backlight On/Off
- System Date-Time
- Buzzer On/Off

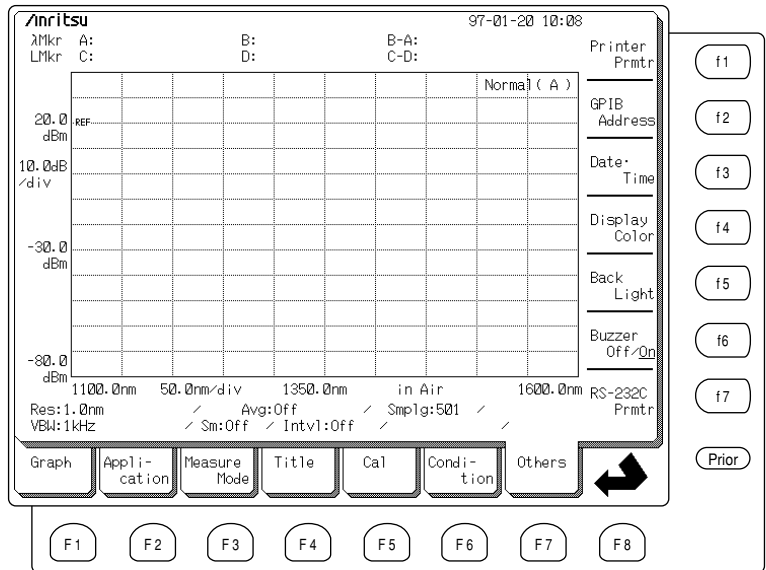

5.14.1 Setting Printer (Printer Prmtr Function Key (f1))

This function switches between the internal and external printer, and selects the type of external printer.

Press the (F7) key to select the Others card, then press the Printer Prmtr function key (f1) to display the following screen.

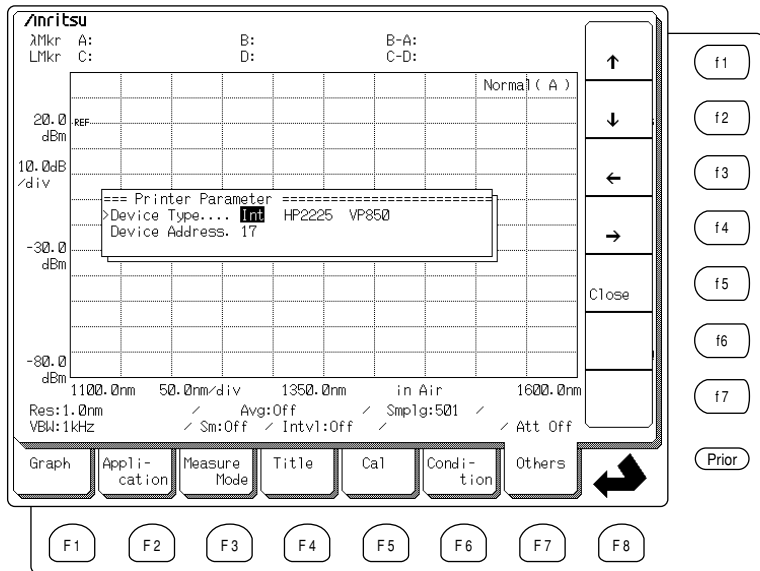

The following function keys are displayed in the Functions display field at right-hand side of the screen.

Key Name	Description
(f1) : ↑	Moves cursor up (select set item)
(f2) : ↓	Moves cursor down (select set item)
(f3) : ←	Moves cursor to the left (change setting contents)
(f4) : →	Moves cursor to the right (change setting contents)
(f5) : Close	Confirms setting contents and closes window

The descriptions of each settings art as follows.

Setting Item	Description
Device Type	Int Internal printer HP2225 Externally-connected printer (GPIB) VP850 Externally-connected printer (GPIB)
Device Address	Printer address

5.14.2 Setting GPIB Address (GPIB Address Function Key **f2**)

This function sets the GPIB address of the MS9710C.

Press the **F7** key to select the Others card and press the GPIB Address function key **f2** to input the address using the Data entry keys or Knob. When the Data entry keys are used, press the Enter function key **f1** to complete the setting.

(1) Settable Range

The address can be set in the range of 0 to 30.

5.14.3 Setting Date and Time (Date/Time Function Key (f3))

This function sets the date and time of the internal timer.

Press the (F7) key to select the Others, then and press the Date/Time function key (f3) to display the following screen.

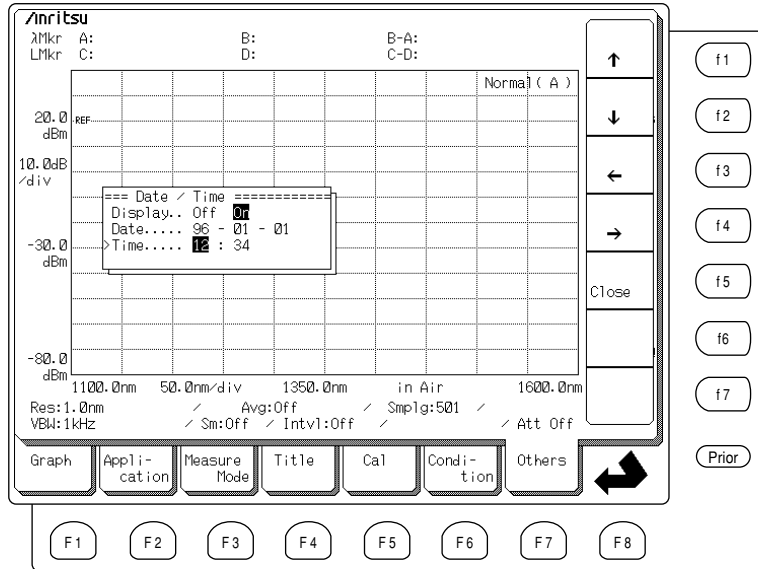

The following function keys are displayed in the Functions display field at right-hand side of the screen. Use the function keys to select the item indicated by the reverse displayed cursor.

Key Name	Description
(f1) : ↑	Moves cursor up (select set item)
(f2) : ↓	Moves cursor down (select set item)
(f3) : ←	Moves cursor to the left (change setting contents)
(f4) : →	Moves cursor to the right (change setting contents)
(f5) : Close	Confirms setting contents and closes window

The descriptions of each settings are as follows.

Setting Item	Descriptions
Display	Sets whether or not to display the date and time on the screen On Date/Time Displayed Off Date/Time Not Displayed
Date	Sets date
Time	Sets time

5.14.4 Setting Screen Display Color (Display Color Function Key (f4))

This function sets the display color.

Press the (F7) key to select the Others card, then press the Display Color function key (f4) to display the following screen. The following function keys are displayed in the Functions display field at right-hand side of the screen.

Use the Knob to set the numeric values describing the RGB color distribution. When the Std. Color function key (f6) is pressed, the display color is returned to the standard display color.

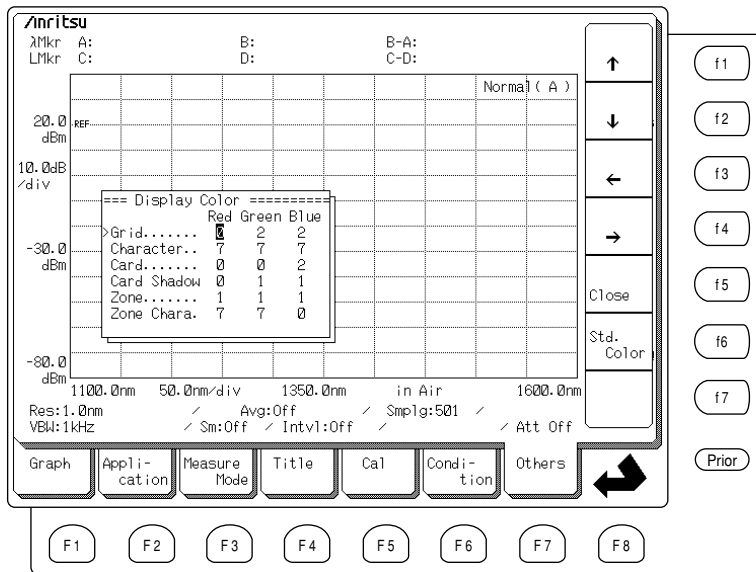

The following function keys are displayed in the Functions display field at right-hand side of the screen. Use the function keys to select the item indicated by the reverse displayed cursor.

Key Name	Description
(f1) : ↑	Moves cursor up (select set item)
(f2) : ↓	Moves cursor down (select set item)
(f3) : ←	Moves cursor to the left (change setting contents)
(f4) : →	Moves cursor to the right (change setting contents)
(f5) : Close	Confirms setting contents and closes window
(f6) : Std. Color	The display color is returned to the standard display color

(1) Settable Range

The range can be set from 0 to 7.

5.14.5 Setting Backlight Off Time (Backlight Function Key (f5))

This function sets the Keypad idling time before the LCD screen is turned Off. When the backlighting is Off, it is switched on as soon as any key is pressed.

Press the (F7) key to select the Others card, then press the Backlight function key (f5), then input the time increment until the backlighting is switched off. The time can be set using the Data entry keys or Knob. If 0 min is set, the backlighting is never switched Off.

(1) Settable Range

The time can be set in the range of 0 to 7. A setting of 0 min means that the backlighting is not switched Off.

5.14.6 Setting Buzzer On/Off (Buzzer On/Off Function Key (f6))

This function sets whether or not the buzzer sounds when an error occurs. Press the (F7) key to select the Others card, then press the Buzzer On/Off function key (f6). The setting is toggled On/Off each time the key is pressed.

- On Buzzer sounds
- Off Buzzer does not sound

5.14.7 Setting RS-232C (RS-232C Prmtr Function Key **(f7)**)

This function switches the remote-control interface to either RS-232C or GPIB and sets the RS-232C communication conditions.

Press the **(F7)** key to select the Other card, then press the RS-232C Prmtr function key **(f7)** to display the following screen.

When the interface is selected using the function keys, the RS-232C communication conditions can be set.

Use the \uparrow and \downarrow keys to move the cursor to the items to be set.

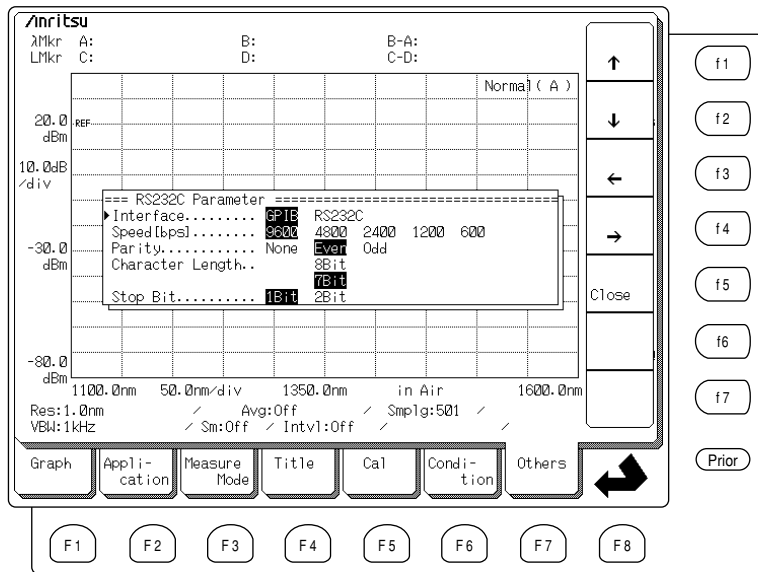

The following function keys are displayed in the Functions display field at right-hand side of the screen. Use the function keys to select the item indicated by the reverse displayed cursor.

Key Name	Description
(f1) : \uparrow	Moves cursor up (select set item)
(f2) : \downarrow	Moves cursor down (select set item)
(f3) : \leftarrow	Moves cursor to the left (change setting contents)
(f4) : \rightarrow	Moves cursor to the right (change setting contents)
(f5) : Close	Confirms setting contents and closes window

The descriptions of each settings are as follows.



Setting Item	Description
Interface	Selects remote control interface from GPIB and RS-232C. RS-232C cannot be used for remote control interface in tracking measurement with TLS.
Speed	Selects communication speed from 9600, 4800, 2400, 1200, and 600 bps
Parity	Selects parity bit None Does not add parity bit Even Adds even parity bit Odd Adds odd parity bit
Character length	Selects character length 7 7 bits 8 8 bits
Stop bit	Selects number of stop bits 1 Adds 1-bit stop bit 2 Adds 2-bit stop bit

5.15 Marker Select Screen (Marker Select Key)

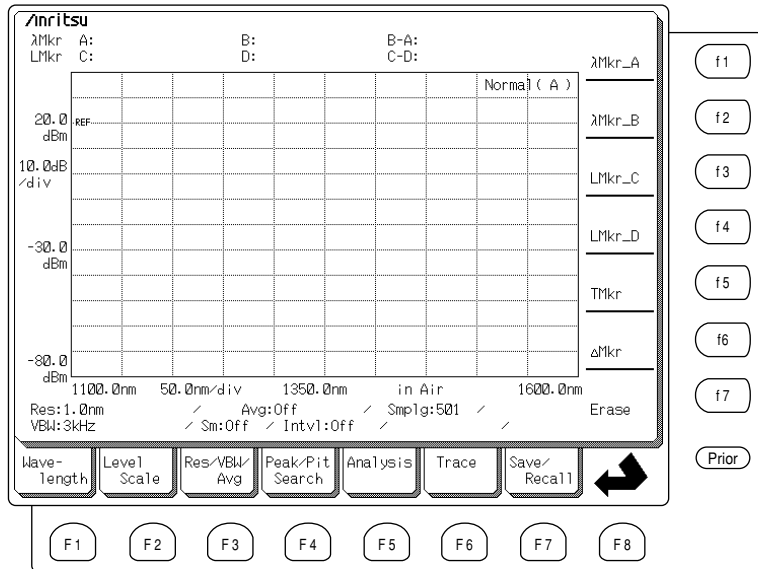

To make waveform analysis easier, the MS9710C has wavelength markers A and B, level markers C and D, trace marker TMkr, and delta marker Δ Mkr. When the Marker Select key  is pressed, the Marker card is displayed and the items in the Functions display field change as shown below.



5.15.1 Setting Wavelength Markers

(λ Mkr_A Function Key , λ Mkr_B Function Key )

Wavelength markers A and B (λ Mkr_A, λ Mkr_B) are displayed as vertical lines in the Wavelength display field. The wavelengths at the markers A and B as well as the difference between the two markers (B-A) are displayed in the Marker display field at the top of the screen. These markers cannot be used with the 3D display.

Press the Marker Select key  of the Marker keys to display the Marker card. Select λ Mkr_A with the function key , or λ Mkr_B with the function key . Both the markers can be displayed but only the selected marker can be moved using the Data entry keys or Knob. To determine a wavelength, move a marker to that position using the Knob and read the wavelength displayed in the Marker display field. To move a marker to a known wavelength, input the wavelength using the Data entry keys and select the units using the function keys at the right side of the screen.

Wavelength marker A is always displayed at the short wavelength side and Wavelength marker B is always displayed at the long wavelength side.

When a marker is moved, if it seems likely to move over the other marker, both wavelength markers move simultaneously. In addition, when the Wavelength card marker frequency display switch is set to frequency (Freq.), the frequency equivalent to the wavelength is displayed.

To delete the wavelength markers, press the Erase function key .

5.15.2 Setting Level Markers

(LMkr_C Function Key **f3**, LMkr_D Function Key **f4**)

Level markers C and D (LMkr_C, LMkr_D) are displayed as horizontal lines in the Wavelength display field. The difference between the two markers (C–D) (relative scale) or (C/D) (linear scale) is displayed in the Marker display field at the top of the screen. These markers cannot be used with the 3D display.

Press the Marker Select key **Marker Select** of the Marker keys to display the Marker card. Select LMkr_C with the function key **f3**, or LMkr_D with the function key **f4**. Both the markers can be displayed but only the selected marker can be moved using the Data entry keys or Knob. To determine a level, move a marker to that position using the Knob and read the level displayed in the Level display field. To move a marker to a known level, input the level using the Data entry keys and select the units using the function keys at the right side of the screen.

When markers C and D are both active, marker C indicates the higher level, and D the lower level. When moving markers, at the point where one marker will pass the other marker, both markers move simultaneously.

To delete the level markers, press the Erase function key **f7**.

5.15.3 Setting Trace Marker (TMkr Function Key **f5**)



The Trace Marker (TMkr) is a marker for tracing the measured spectrum. The wavelength and level at the point specified by the Trace Marker are displayed on the screen. With Trace A&B, the waveform of the selected memory can be traced. This marker cannot be used with the 3D display.

Press the Marker Select key and then press the TMkr function key in the displayed Marker card. The trace marker moves when the knob is turned and the wavelength and level are displayed in the Marker field. When the wavelength is input using the ten Data Entry keys and the units are selected with the function key, the Trace Marker moves to the specified wavelength. The level at this point can be read from the Marker field. In addition, when the Wavelength card marker frequency display switch is set to frequency (Freq.), the frequency equivalent to the wavelength is displayed.

To delete the trace marker, press the Erase function key **f7**.

5.15.4 Setting Delta Marker (Δ Mkr Function Key)



The Delta Marker (Δ Mkr) is a marker for tracing the spectrum in the same way as the Trace Marker, but it displays wavelength difference and level difference from the Trace Marker in the Marker display field. Δ Mkr can be used with Trace A&B. This marker cannot be used with the 3D display.

Press the Marker Select key  and then press the Δ Mkr function key  at the marker card. The Δ marker moves when the knob is turned. To move the Δ marker to a specific point, input the wavelength using the ten Data Entry keys and select the units with the function key. In addition, when the Wavelength card marker frequency display switch is set to frequency (Freq.), the frequency equivalent to the wavelength is displayed.

To delete the trace marker, press the Erase function key .

5.15.5 Deleting Markers (Mkr Erase Function Key)

This function deletes all markers except the Zone Marker.

Press the Marker Select key  of the Marker keys to display the Marker card and then press the Erase function key .

5.15.6 Setting Trace Marker \rightarrow Center Wavelength (TMkr \rightarrow Center Key)

When the TMkr \rightarrow Center Key  of the Marker keys is pressed, the Trace Marker wavelength is set to the Center wavelength and the screen is redrawn. This function cannot be used in the Trace A&B, Trace A-B, and Trace B-A.

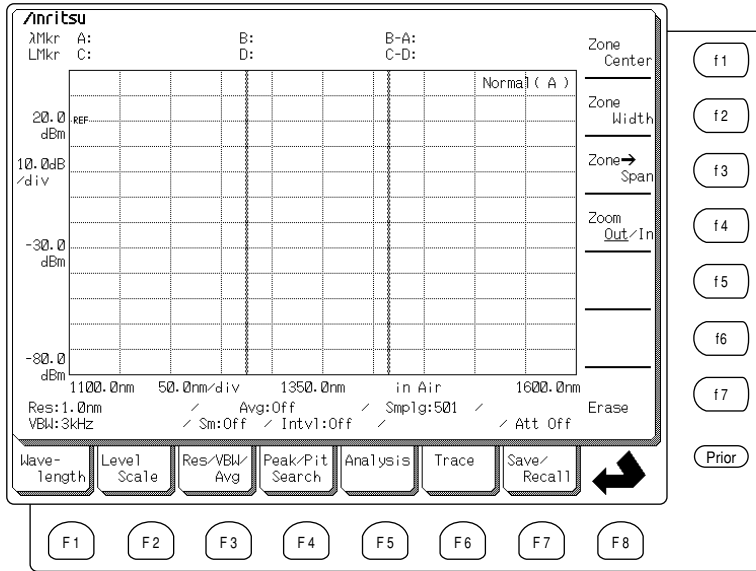

5.16 Zone Marker Screen (Zone Marker Key)

Press the Zone Marker key  of the Marker keys to display the Zone Marker card as shown below and activate the zone marker. The zone marker specifies a subset of the wavelength range for measurement and analysis. The zone marker offers a simple alternative to zooming by manually changing Span.



5.16.1 Setting Zone Center (Zone Center Function Key)



This function sets the Center wavelength of the zone marker. When the Zone Center is changed, the interval between the two zone marker lines is maintained while the two lines move along the wavelength axis. This function cannot be used with the 3D display.

Press the Zone Marker key  of the Marker keys to display the Zone Marker card and press the Zone Center function key . When the Knob is turned, the interval between the two zone marker lines is maintained while the two lines move along the wavelength axis. If a value is input using the Data entry keys, the zone markers move to the specified position.

The zone marker can be moved anywhere within the screen display. Consequently, the range of values that can be set at Zone center changes with the Zone width setting. For example, if the Zone width has already been set to the full width of the screen, the Zone center cannot be changed.



5.16.2 Setting Zone Width (Zone Width Function Key)

This function sets the interval between the two lines of the zone marker. It cannot be used at 3D displays.

Press the Zone Marker key  of the Marker keys to display the Zone Marker card and press the Zone Width function key . Set the width between the two lines of the zone marker using the Data entry keys or Knob. The range can be set within the Graph display field.

5.16.3 Setting Zone→Span (Zone→Span Function key)



This function sets the zone delimited by the zone marker as the Span. This function cannot be used with the 3D, Trace A&B, Trace A–B and Trace B–A displays.

Press the Zone Marker key  of Marker keys to display the Zone Marker card and press the Zone→Span function key .

5.16.4 Zooming-In/Zooming-Out



(Zoom In/Zoom Out Function Key)

This function expands the display of the zone delimited by the zone marker to fill the entire screen (Zoom Out), and returns it to the normal display (Zoom In).

Press the Zone Marker key  of the Marker keys to display the Zone Marker card and press the Zoom In/Zoom Out function key . The function cannot be used with the 3D display.

5.16.5 Deleting Zone Marker (Zone Mkr Erase Function Key)

This function deletes the zone marker.

Press the Zone Marker key  of the Marker keys to display the Zone Marker card and press the Erase function key .

Section 6 Calibration and Testing Performance

This section describes how to calibrate level and wavelength using the MS9710C Optical Spectrum Analyzer.

6.1	Calibrating Level	6-2
6.2	Calibrating Wavelength	6-4
6.2.1	Calibration using Internal Wavelength Reference	6-4
6.2.2	Calibration using External Wavelength Reference	6-5
6.3	Testing Performance	6-6
6.3.1	Checking Wavelength	6-7
6.3.2	Checking Level	6-8

6.1 Calibrating Level

(1) Inputting Reference Level Light

Connect the output of a single-mode oscillation light source (calibrated with an optical power meter to a level of -30 dBm minimum) to the input of the MS9710C. A suitable light source would be a $1.3\ \mu\text{m}$ or $1.55\ \mu\text{m}$ DFB-LD. Calibration cannot be performed accurately with a multimode light source such as an FP-LD. The following diagrams show a typical setup for calibration.

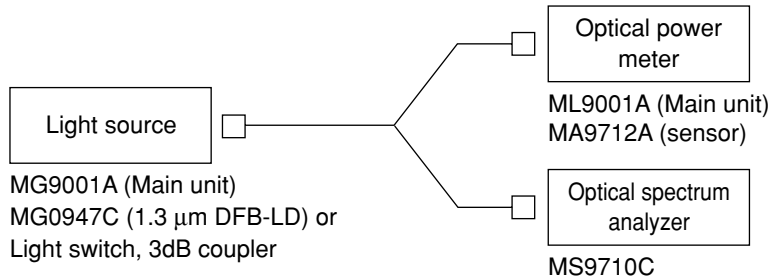

(2) Adjusting Optical Axis





Press the **(F5)** key to select the Cal card and press the Auto Align function key **(f6)**, then select Execute. It takes about 1 minute for automatic alignment of the optical axis. During calibration, "Calibration Execute" is displayed; all other keys except Cancel are disabled.

If "Align Error" is displayed when executing Auto Align, re-execute Auto Align several times.

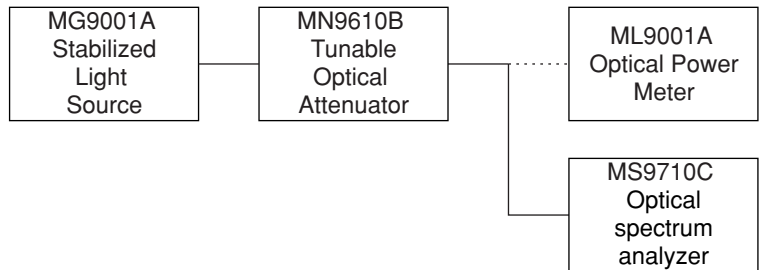
(3) Adjusting Level Offset

(a) Connect the tester and measuring instruments as shown below.



- (b) Set the wavelength output mode of the MG9001A Stabilized Light Source to the CW mode, and set the MN9610B Tunable Optical Attenuator so that the level measured by the ML9001A Optical Power Meter is -23 dBm.
- (c) Connect the output of the MN9610B to the MS9710C.
- (d) Press the Repeat key  to repeatedly measure the reference level, and press the Peak Search key  of Marker keys to display the peak level.
- (e) Press the  key to select the Cal card, then press the Level Offset key  and adjust the Peak Level value to -23 dBm using the Knob. This adjustment value (offset) is saved even when the power of MS9710C is switched off.

6.2 Calibrating Wavelength

6.2.1 Calibration using Internal Wavelength Reference

(1) Inputting Reference Wavelength Light

To adjust the optical axis, connect the output of a single-mode oscillation light source with a level of -30 dBm minimum to the optical input connector of the MS9710C. A suitable light source would be a $1.3\ \mu\text{m}$ or $1.55\ \mu\text{m}$ DFB-LD. Calibration cannot be performed accurately with a multimode light source such as an FP-LD.

(2) Adjusting Optical Axis

Press the Cal card (F5) key and press the Auto Align function key (f6), then select Execute. It takes about 1 minute for automatic alignment of the optical axis. During calibration, the message “Execute Calibration” is displayed; all other keys except Cancel are disabled.

If “Align Error” is displayed when executing Auto Align, re-execute Auto Align several times.

(3) Inputting Reference Wavelength Light

Set the optional reference wavelength light source to On and use SM fiber to connect the output on the back panel of the MS9710C to the optical input connector on the front panel.

(4) Executing Wavelength Calibration

Press the Cal card (F5) key and press the Wl Cal (Int) function key (f4), then select Execute. During calibration, the message “Execute Calibration” is displayed; all other keys except Cancel are disabled. This calibrated condition is saved even when the MS9710C is switched Off.

6.2.2 Calibration using External Wavelength Reference

(1) Inputting Reference Wavelength Light

Connect the output of a single-mode light source calibrated with an optical wavelength meter to the input of the MS9710C. A suitable light source would be a 1.3 μm or 1.55 μm DFB-LD with output power of -30 dB minimum. Calibration cannot be performed accurately with a multimode light source such as an FP-LD.

(2) Adjusting Optical Axis

Press the Cal card (F5) key and press the Auto Align function key (f6), then select Execute. It takes about 1 minute for automatic alignment of the optical axis. During calibration, the message “Execute Calibration” is displayed; all other keys except Cancel are disabled.

(3) Executing Wavelength Calibration

Press the (F5) key to select the Cal card, then press the Wl Cal (Ext) function key (f3) and select Execute. During calibration, the message “Execute Calibration” is displayed; all other keys except Cancel are disabled.

NOTE:

The value measured by the Anritsu MF9630A Optical Wavelength Meter is the absolute value of the wavelength in a vacuum. When using the MF9630A for wavelength calibration, set the MS9710C wavelength display to the wavelength in a vacuum.

 **Section 5.1**

(4) Adjusting Wavelength Offset

Press the Repeat key to repeatedly measure the reference wavelength and read the Peak wavelength using the Peak Search key (Peak Search) of the Sweep keys. Press the Cal card (F5) key, then press the Wl Offset function key (f1) and use the Knob to adjust the Peak wavelength value to the wavelength of the external wavelength reference. This adjustment value (offset) is saved even when the MS9710C is switched off.

6.3 Testing Performance

The following items are tested to confirm the performance of the tester.

- (1) Wavelength accuracy
- (2) Level accuracy

Clean all connectors before testing performance. In addition, allow the tester to warm up sufficiently and always make sure to execute the calibration described in Section 6.1 “Calibrating Level.”

The specifications for the test items and the measuring instruments required for measurement are shown below. However, the following specifications are the values obtained using the built-in reference light source.

Wavelength accuracy	± 20 pm (0.1, 0.2 Resolution) ± 100 pm (0.5, 1 nm Resolution)
Level accuracy	± 0.4 dB (0.1 nm min. Resolution, -23 dBm input)

(1) Wavelength accuracy

- (a) Tunable light source MG9637A**
- Wavelength range 1500 to 1580 nm
 - Setting Resolution 1 pm
 - Wavelength accuracy ± 0.1 nm
 - Wavelength stability ± 100 MHz
 - Wavelength reproducibility ± 35 pm

- (b) Optical Wavelength Meter MF9630A**
- Wavelength range 600 to 1600 nm
 - Wavelength accuracy ± 0.5 ppm

(2) Level accuracy

- (a) Stabilized light source MG9001A + MG0948C**
- Wavelength 1550 ± 20 nm
 - Level stability 0.05 dB
(constant temperature, 1 hour)

- (b) Optical power meter ML9001A + MA9714B**
- Level range -47 to $+23$ dBm
 - Level linearity ± 0.15 (-37 to $+23$ dBm)
 - Level accuracy ± 5 % (measured light -23 dBm)

- (c) Tunable light source MN9610B**
- Wavelength range 1100 to 1650 nm
 - Maximum attenuation 60 dB
 - Switching reproducibility ± 0.01 dB

Refer to Appendix G “Example of Performance Test Results Record Sheet” for an example of test results record. Either copy the page or create a similar table to record the test results in your convenience.

6.3.1 Checking Wavelength

(1) Setup

Connect the tester and measuring instruments as shown below.

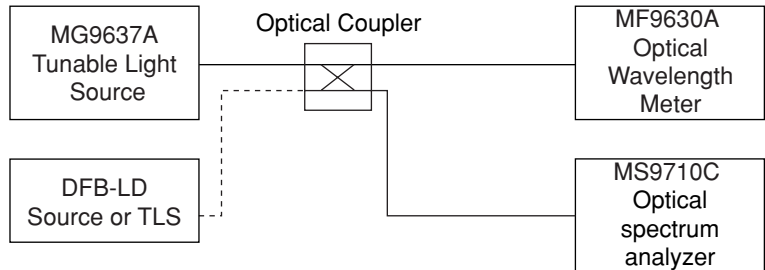

(2) Test Procedure

- (a) Set the wavelength output mode of the MG9637A tunable light source to the CW mode and set the MG9637A so that the wavelength measured by the MF9630A Optical Wavelength Meter is 1550 nm.
- (b) Connect the output of the MG9637A to the MS9710C and measure the spectrum. At this time, it is important that the wavelength value display is for a vacuum.
- (c) Check that the difference between the spectrum Peak wavelength measured by the WDM Network Tester and the value measured by the Optical Power Meter is within the specifications.
- (d) Repeat steps (a) through (c) for the following wavelengths.
1530 nm, 1540 nm, 1550 nm, 1560 nm, 1570 nm
- (e) Prepare the DFB-LD or another light source, such as the TLS, which can use a long waveband (1580 to 1620 nm). Use the light source of which wavelength is sufficiently stable.
- (f) Repeat steps (b) through (d) for the following wavelengths.
1580 nm, 1590 nm, 1600 nm, 1610 nm, 1620 nm

6.3.2 Checking Level

(1) Setup

Connect the tester and measuring instruments as shown below.

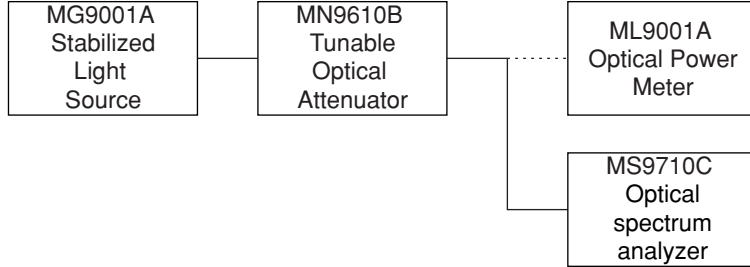

(2) Test Procedure

- (a) Set the wavelength output mode of the MG9001A Stabilized Light Source to the CW mode and set the MN9610B Tunable Optical Attenuator so that the level measured by the ML9001A Optical Power Meter is -23 dBm.
- (b) Connect the output of the MN9610B to the MS9710C and measure the spectrum.
- (c) Press the **(F5)** key to select the Analysis card and press the Spectrum Power function key **(f6)** to analyze and calculate the total power of the measured spectrum.
- (d) Check that the difference between the calculated total power and the value measured by the Optical Power Meter is within the specifications.

Section 7 Maintenance and Troubleshooting

This section describes the periodic maintenance procedures, storage precautions, transporting and troubleshooting of the MS9710C Optical Spectrum Analyzer.

7.1	Periodic Maintenance	7-2
7.1.1	Cleaning Exterior	7-2
7.1.2	Cleaning Screen	7-2
7.1.3	Cleaning Ferrule	7-3
7.1.4	Cleaning the Cable Ferrule	7-3
7.2	Storage Precautions	7-4
7.3	Transporting	7-4
7.4	Troubleshooting	7-5

7.1 Periodic Maintenance

7.1.1 Cleaning Exterior

If the exterior of this analyzer becomes soiled, or before long-term storage, clean off using a soft cloth lightly moistened with soapy water. Do not use thinners or benzene solvents which will damage the case.

7.1.2 Cleaning Screen

If the LCD becomes soiled, wipe it gently with a clean cloth. If it is very dirty, clean it by wiping gently with a soft cloth lightly moistened with soapy water.

CAUTION

The MS9710C uses micron-precision components; do not disassemble or lubricate it.

7.1.3 Cleaning Ferrule

Remove the optical input connector as described below and clean inner part of the ferrule before measurement.

- (1) Open the connector cover.
- (2) Lift the connector lever until it unlatches and carefully remove the connector.

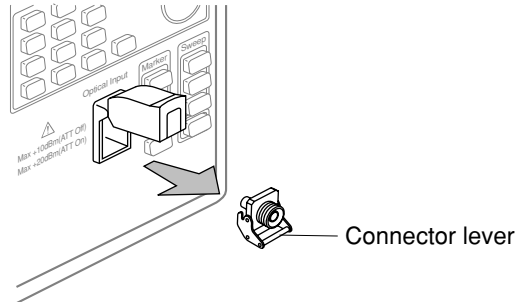

- (3) Carefully wipe any dirt from the end face of the ferrule.

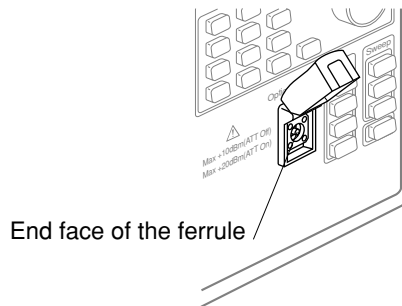

- (4) Carefully refit the optical input connector taking care not to scratch or otherwise damage the end face of the ferrule.

7.1.4 Cleaning the Cable Ferrule

To clean the end of ferrule at the end of cable, use Ferrule Cleaner (Z0282) which is one of the related parts.

CAUTION

If alcohol is used to clean the end of ferrule using cotton bud, dirt can be left when the alcohol vapors. To clean the optical fiber cable, use Ferrule Cleaner (Z0282) to which solvent such as alcohol is not required to apply.

CAUTION

Make sure to clean the surface of inside ferrule and optical fiber carefully before measurement.

7.2 Storage Precautions

Do not store this analyzer where:

- The temperature exceeds 60 °C or is less than –20 °C
- It will be exposed to direct sunlight
- It is very dusty
- High humidity will cause condensation
- There are active gases.

7.3 Transporting









Note the following precautions when repacking the MS9710C for transport.

- Repack this analyzer in the original packing that the analyzer was delivered in.
- Instruct the shipper to keep this analyzer horizontal as much as possible during shipping.









If the original packing cannot be used for some reason, repack as described below.









- (1) Fit the protective covers (sold separately) to the front panel.
- (2) Wrap this analyzer in a plastic sheet.
- (3) Put this analyzer in a cardboard, wooden or aluminum box 10 to 15 cm larger than the analyzer on all sides.
- (4) Pack 10 to 15 cm of shock-absorbent material around the analyzer on all sides.
- (5) Securely bind the box using packing cord, adhesive tape, bands or other means.

7.4 Troubleshooting







Problem	Probable case	Solution
No power	Power switch not on	Switch on.
	AC power cord not properly connected to AC inlet or AC socket	Connect AC power cord.
	Fuse blown	Find reason why fuse blew and change fuse.  Section 3.10
Initialization screen not completed within 2 minutes after power-on		Turn OFF the power supply. Then, turn it ON again. If the same condition persists, turn OFF the power and call service engineer.
Cannot connect optical fiber cord	Optical fiber cord and optical input connector mismatched	Change to correct optical input connector.  Section 3.9
	Fiber and connector misaligned	Check alignment and reconnect.
Waveform not displayed when either Single or Repeat key pressed	Trace B selected while measuring with Memory A, or vice versa	Set correct memory to display trace.  Section 5.6
	Modulation measurement mode set and external sync signal input incorrect	Set modulation measurement to Off or input correct sync signal.  Section 5.10
Measurement (sweep) is slow.	VBW is set too narrow.	To sweep at high speed, set VBW wide.  Section 5.3
	Point Average is set.	To sweep at high speed, set Point Average Off.  Section 5.3
	Sampling point number is set too large.	To sweep at high speed, set small Sampling point number.  Section 5.3
	Wide Dynamic Range mode is set.	To sweep at high speed, set dynamic range to Normal mode.  Section 5.10

Section 7 Maintenance and Troubleshooting

Problem	Probable case	Solution
Measured spectrum is incorrect.	Resolution is set incorrectly. Set wide Resolution for narrow-spectrum light sources such as LDs.	Set appropriate Resolution.  Section 5.3
	Smoothing point number is set too large.	Set Smooth to Off, or set appropriate Point No.  Section 5.3
	Trace B is selected while measuring with Memory A, or vice versa. Trace A–B or Trace B–A being used.	Set correct memory for displaying Trace.  Section 5.6
Measured spectrum wavelength is incorrect.	Calibration incorrect	Calibrate using Cal card. Check wavelength offset and calibrate.  Section 5.12 and Section 6
	Wavelength is displayed (In Vacuum/In Air) incorrectly.	Select correct measurement condition.  Section 5.1
Measured spectrum level is incorrect (low).	Fiber cord end face or optical input connector is dirty.	Clean fiber end face and connector.  Section 7.1
	Fiber cord is not connected correctly to optical input connector.	Check connection of fiber cord to optical input connector
	Fiber cord is bent excessively, etc.	Check for heavy object pinching fiber cord or other stresses on cord.
	Calibration is incorrect.	Calibrate using Cal card. Check level offset and perform optical axis Auto Align.  Section 5.12 and Section 6
Measurement is impossible due to the noise when measuring low-level light.	VBW is set too wide.	Set narrow VBW and measured.  Section 5.3
	Measuring with Optical Attenuator (optional) is set to On.	When measuring low-power light, set Optical Attenuator to Off.  Section 5.2

Problem	Probable case	Solution
Measurement is impossible due to the noise when measuring low-level light. (Continue)	Resolution is set incorrectly. Set narrow Resolution for measuring wide-spectrum light sources such as LEDs.	Set appropriate Resolution.  Section 5.3
Method does not change when Peak/Dip Search is set to Off.		Erase markers at Marker Select screen.  Section 5.15
Peak point is not found in Peak Search.	Zone marker is On. With Zone Marker On, Peak Search only searches zone.	Erase Zone Marker at Zone Marker screen.  Section 5.16
Waveform Analysis is not executed for whole waveform.	Zone marker is On. With Zone Marker On, analysis only performed for zone	Erase Zone Marker at Zone Marker screen.  Section 5.16
Unable to save/delete measured data to/from FD. Unable to format FD.	FD is write protected.	Set FD write protection to Off.
Unable to save/recall measured data to/from FD.	FD is unformatted or formatted with incorrect format.	Format FD with correct format using PC or analyzer.  Section 3.5
	Analyzer is set to 1.2 MB for 1.44 MB formatted FD, or vice versa.	Set analyzer File Option to match FD.  Section 3.5
Text format for MS-DOS™ and bitmapped format for MS-Windows™ files are not obtainable from FD.	Output file is not set at File Option.	Set required output file format at File Option.  Section 5.7
Printing is not executed when Copy key pressed.	GPIB cable is not connected correctly.	Connect GPIB cable correctly.  Section 5.14
	Printer type or GPIB address setting is incorrect.	Set correct printer type or GPIB address.
Date/Time is incorrect.		Set correct Date/Time.  Section 5.14

Section 7 Maintenance and Troubleshooting

Problem	Probable case	Solution
Screen color is unusual.	Screen color setting is changed.	Set correct screen color.  Section 5.14
GPIB/RS-232C is not operating.	GPIB/RS-232C cable is not connected correctly.	Connect GPIB/RS-232C cable correctly.
	RS-232C cable type is incorrect.	Use RS-232C crossover cable.  Remote Control Operation Manual
GPIB/RS-232C does not work.	GPIB/RS-232C selection is incorrect.	Select correctly.  Section 5.14 and Remote Control operation Manual
	Address setting is incorrect.	Set correctly.  Section 5.14 and Remote Control operation Manual
'Align Error' is displayed when executing Auto Align.		Execute Auto Align several times. If 'Align Error' is still displayed, check the wavelength stability of the light source.  6.3 Testing Performance Re-execute Auto Align several times. If the problem still remains unsolved, turn off the power and contact Anritsu Customer Service.
Tracking measurement is not possible.	Cable connection is incorrect or wrong cable type.	Connect correctly using specified cable.
	Incorrect communication settings at TLS. Tried to measure at out of specification wavelength.	Set communication settings of TLS correctly. Measure in range of TLS specifications.
	Calibration is incorrect. Wavelength was changed after calibration.	Execute calibration at measurement wavelength.
Measurement results is incorrect (in TLS Tracking).	Tried to measure at out of specification wavelength.	Measure in range of TLS specifications.
	There is a drop point at some dB in measured wavelength when wide Span is measured in high frequency.	This is due to accuracy limitation of this equipment and TLS in wavelength. Degrade Resolution and try again.
Error is in Adjust to TLS.	Fiber cord is not connected correctly.	Connect this equipment and TLS directly using fiber cord to execute calibration.
	Calibration is not executed correctly.	Execute calibration correctly using Cal function.  Section 5.12 and Section 6

Appendix A	Specifications	A-1
Appendix B	Initial Settings	B-1
Appendix C	Error Codes	C-1
Appendix D	Relationship Between the Resolution, VBW, and Sensitivity	D-1
Appendix E	Checking Actual Display Resolution ..	E-1
Appendix F	Optical Fiber Cord	E-1
Appendix G	Example of Performance Test Result Record Sheet	G-1
Appendix H	Automatic Measurement Processing ...	H-1
Appendix I	Switching Marker Frequency Display	I-1

Appendix A Specifications

This section describes the specification of the MS9710C Optical Spectrum Analyzer.

A.1	Wavelength	A-2
A.2	Level	A-3
A.3	Others	A-4
A.4	White Light Source (Option 02)	A-4
A.5	SLD Light Source (Option 13 and 14)	A-5
A.6	L-Band Enhancement (Option 15)	A-5
A.7	Functions	A-5

To obtain stable operation, allow at least 5 minutes to elapse after power-on. The following specifications are guaranteed 2 hours after power-on. If the instrument is out-of-specification, perform automatic optical-axis alignment (Auto Align) and then keep the instrument at a constant temperature. W1 Cal (Ref) indicates calibration with the reference wavelength light source. Reference wavelength light source means option 03 or option 05 for this instrument. However, the following specifications are not guaranteed at power monitoring and tracking measurement.

A.1 Wavelength

Wavelength axis	Specification	Condition
Wavelength Range	600 to 1750 nm	
Wavelength Sweep Width	0.2 to 1200 nm, 0 nm	
Wavelength Accuracy	After W1 Cal (Ext)	
	±300 pm	600 to 1530, 1570 to 1750 nm
	±200 pm	1530 to 1570 nm
	After W1 Cal (Ref)	
	0.05 to 0.2 nm Resolution	
	±50 pm	1520 to 1530, 1570 to 1620 nm
	±20 pm	1530 to 1570 nm
	0.5, 1.0 nm Resolution	
	±100 pm	1520 to 1620 nm
Wavelength Stability	±5 pm	1 minute, 11 pt smoothing, half width wavelength
Wavelength Linearity	±20 pm	1530 to 1570 nm
Setting Resolution	0.05, 0.07, 0.1, 0.2, 0.5, 1 nm	
Resolution Accuracy	1530 to 1570 nm Center Wavelength	
	±7%	Setting Res.: 0.1 nm
	±3%	Setting Res.: 0.2 nm
	±2.2%	Setting Res.: 0.5 nm
	1530 to 1530, 1570 to 1620 nm Center Wavelength	
	±10%	Setting Res.: 0.1 nm
	±5%	Setting Res.: 0.2 nm
	±4%	Setting Res.: 0.5 nm
	Other Center Wavelengths	
	±30%	Setting Res.: 0.1 nm
	±15%	Setting Res.: 0.2 nm
	±7%	Setting Res.: 0.5 nm

A.2 Level

Level axis	Specification	Condition	
Level Range		Resolution: 0.07 nm min., VBW: 10 Hz, Sweep Averaging: 10 times)	
		Optical attenuator Off	
		0° to 30°C	
		-65 to +10 dBm	600 to 1000 nm
		-85 to +10 dBm	1000 to 1250 nm
		-90 to +10 dBm	1250 to 1600 nm
		-75 to +10 dBm	1600 to 1700 nm
		-55 to +10 dBm	1700 to 1750 nm
		30° to 50°C	
		-60 to +10 dBm	600 to 1000 nm
		-80 to +10 dBm	1000 to 1250 nm
		-85 to +10 dBm	1250 to 1600 nm
		-70 to +10 dBm	1600 to 1700 nm
		-50 to +10 dBm	1700 to 1750 nm
		Optical attenuator On	
		0° to 30°C	
	-70 to +23 dBm	1100 to 1600 nm	
	30° to 50°C		
	-65 to +23 dBm	1100 to 1600 nm	
Level Accuracy	±0.4 dB	Setting Res.: 0.1 nm min., -23 dBm input, Wavelength: 1300 and 1550 nm	
Level Stability	±0.02 dB	1 minute, Setting Res.: 0.1 nm min., -23 dBm input, no polarization variation	
Level Linearity	Optical attenuator Off		
	±0.05 dB	-50 to 0 dBm, 1550 nm	
Level Flatness	Optical attenuator On		
	±0.05 dB	-30 to +20 dBm, 1550 nm	
Level Flatness	±0.1 dB	1530 to 1570 nm	
	±0.3 dB	1520 to 1530, 1570 to 1620 nm	
Polarization Dependency		Setting Res.: 0.5 nm min., Optical attenuator Off, using ML9050A reference power meter	
	±0.05 dB	1550 nm, 1600 nm	
	±0.1 dB	1300 nm	
		Setting Res.: 0.5 nm min., Supported connectors: FC, SC, ST, DIN, HMS-10/A)	

Appendix A Specifications

Level axis	Specification	Condition
Dynamic Range		Setting Res: 0.05 nm, Wavelength: 1550 nm, Optical attenuator: Off, 20° to 30°C)
	High dynamic range mode	
	70 dB	at wavelength 1 nm from peak
	60 dB	at wavelength 0.4 nm from peak
	42 dB	at wavelength 0.2 nm from peak
	Normal dynamic range mode	
	62 dB	at wavelength 1 nm from peak
	58 dB	at wavelength 0.4 nm from peak
	42 dB	at wavelength 0.2 nm from peak
Backscatter Attenuation	35 dB	1550 or 1300 nm

A.3 Others

Others	Specification	Condition
Sweep Speed	0.5 s/500 nm (typ.)	VBW = 10 kHz, Normal dynamic range mode, Center wavelength: 1200 nm, time from sweep start to sweep end, no optical input, 501 sampling points)
Using Temperature Range	0 to 50°C	FDD: +5 to 50°C
Dimensions	177 (H) × 320 (W) × 350 (W) mm	
Mass	≥16.5 kg	
Power Supply	Operating voltage: AC85 to 132/170 to 250 V	
	Frequency: 47.5 to 63 Hz	
	Capacity: 150 VA (max.)	
Temperature and Humidity	Operating: 0° to 50°C (FDD: 5° to 50°C)	
	Storage: -20° to +60°C	
	Relative humidity: 0% to 90%, no condensation (FDD: 20% to 80%)	

A.4 White Light Source (Option 02)

Item	Specification	Condition
Optical Output	≥-59 dBm/nm	Multimode fiber
Wavelength Range	900 to 1600 nm	
Operation Temperature	18° to 28°C	

A.5 SLD Light Source (Option 13 and 14)

Item	Specification	Condition
Optical Output	>-40 dBm (MS9710C Resolution: 1 nm, 1550 nm \pm 10 nm)	
Optical Output Level Stability	\pm 0.04 dB (for 20 min, 1550 nm of wavelength, with no Polarization drift, no temperature drift)	
Operating Temperature	0 to +40°C	

A.6 L-Band Enhancement (Option 15)

Item	Specification	Condition
Wavelength Accuracy	\pm 0.02 nm (after Wcal (Ref)) (Res: 0.07 to 0.2 nm 1520 to 1620 nm)	
Resolution Accuracy	1520 to 1620 nm Center Wavelength < \pm 7% (Setting Res: 0.1 nm) < \pm 3% (Setting Res: 0.2 nm) < \pm 2.2% (Setting Res: 0.5 nm)	
Level Linearity	< \pm 0.05 dB (-50 to +0 dBm, 1550 nm, 1600 nm wavelength, ATT Off) \pm 0.05 dB (-30 to +20 dBm, 1550 nm, 1600 nm wavelength) -30 to +20 dBm, 1550 nm, 1600 nm wavelength, ATT On)	
Level Flatness	< \pm 0.1 dB (1520 to 1620 nm) using ML9050A Power Meter	

A.7 Functions

Functions	
Measurement Functions	Auto Measure, Pulse Light Measurement (External Trigger), Power Monitor
Display Functions	Zoom, Overlap, Normalize, Max Hold, Wavelength in vacuum, Effective resolution, Trace A/B
Resolution Functions	Waveform analysis (Threshold, n dB Loss, Envelope, RMS, SMSR, Integrated spectrum power), Peak/Dip search, Light source (DFB-LD, FP-LD, LED) evaluation, Optical amp evaluation, WDM evaluation
Calibration Functions	Auto alignment, Wavelength calibration, Offset calibration
Memory Functions	Measurement conditions saved to internal memory, Waveform data saved to floppy disk
I/O Functions	GPIB, RS-232C, External trigger input (0 to 0.8 V/2 to 5V, high impedance)
Data Output Functions	Print to internal printer, Screen shot bit map and waveform data text output to floppy disk

Appendix B Initial Settings

This section lists the factory default settings of the MS9710C Optical Spectrum Analyzer.

The factory defaults can be returned at any time by pressing the (F6) key in Condition card, pressing the Recall function key (f2), and selecting Memory Number 0.

B.1	Wavelength Card	B-2
B.2	Level Scale Card	B-2
B.3	Res/VBW/Avg Card	B-2
B.4	Peak/Dip Search Card	B-2
B.5	Analysis Card	B-3
B.6	Save/Recall Card	B-3
B.7	Graph Card	B-3
B.8	Application Card	B-4
B.9	Measure Mode Card	B-4
B.10	Title Card	B-5
B.11	Cal Card	B-5
B.12	Others Card	B-5

B.1 Wavelength Card

Setting Item	Factory Default Setting
Center	1350 nm
Span	500 nm
Start	1100 nm
Stop	1600 nm
Mkr Value Wl/Freq	W1
Value in Air/Vac	Air

B.2 Level Scale Card

Setting Item	Factory Default Setting
Scale Select	Log
Log (/div)	10 dB/div
Reference Level	20 dBm
Linear Level	100 mW
Optical Att	Off

B.3 Res/VBW/Avg Card

Setting Item	Factory Default Setting
Resolution	1.0 nm
VBW	1 kHz
Point Average	Off
Sweep Average	Off
Smooth	Off
Sampling Points	501 pt
Actual Res	Off

B.4 Peak/Dip Search Card

Setting Item	Factory Default Setting
Status	Off

B.5 Analysis Card

Setting Item	Factory Default Setting	
Status	Off	
Threshold	Cut Lvl:	3 dB
ndB Loss	ndB:	3 dB
SMSR	Side mode:	2nd Peak
Envelope	Cut Lvl:	3 dB
RMS	k:	2.35
	S-Level:	20 dB

B.6 Save/Recall Card

Setting Item	Factory Default Setting	
File Option	File Option:	None
	File ID:	Number
	FDD Mode:	1.44 MB

B.7 Graph Card

Setting Item	Factory Default Setting	
Status	Normal	
3D	Type:	1
	Angle:	45°

B.8 Application Card

Setting Item	Factory Default Setting
Status	Off
DFB-ID	ndB Width: 20 dB Side Mode: 2nd Peak
FP-LD	Mode Cut Lvl: 3 dB
LED	ndB Width: 3 dB Power Cal Factor: 1
PMD	Auto/Manual: Auto Mode Cal Factor: 1
O. Amp	NF Select: S-ASE Spect Div: On ASE Fitting: Gauss Fit Fitting Span: 5 nm Masked Span: 2 nm Pin Loss: 0 dB Pout Loss: 0 dB NF Cal: 1 O. BPF Lvl Cal: 0 dB O. BPF BW: 3 nm Method: Spect Div On
WDM	Display Mode: Multi Peak Ref Peak No.: 1 Page Top No.: 1 S. Level: 30 dB Peak Type: Max Peak Threshold Cut Level: 3 dB Dip Prmtr: Higher Resolution Normalize: Off $\Delta\lambda$: 0.04 nm

B.9 Measure Mode Card

Setting Item	Factory Default Setting
Dynamic range	Normal
Peak Hold	Off Gate Time: 1 ms
Ext. Trigger	Off Delay Time: 0 μ s
Interval Time	0 s (off)
Power Monitor	Off Wavelength: 1550 nm

B.10 Title Card

(Blank)

B.11 Cal Card

Setting Item	Factory Default Setting
WI Offset	0 nm
Level Offset	0 dB

B.12 Others Card

Setting Item	Factory Default Setting
Plot Prmtr	Device Type: Int Device Address: 17
Back Light	On Time: 10 min.
My GPIB Address	8
RS-232C Parameter	
Interface	GPIB
Speed [bps]	9600
Parity	Even
Character Length	8 Bit
Stop Bit	1 Bit
Buzzer	On

Appendix C Error Codes

This section describes the Error Cards.

C.1	System Error Codes (000 to 009)	C-2
C.2	Measurement-related Errors (100 to 199)	C-2
C.3	Key Operation Errors (200 to 299)	C-3
C.4	Device-related Errors (300 to 499).....	C-5

C.1 System Error Codes (000 to 009)

No.	Error Message	Status	Output Condition
000	No error		
001	Optical Error (RAM)		RAM error
002	Optical Error (Slit-1)		Slit-1 error
003	Optical Error (Slit-2)		Slit-2 error
004	Optical Error (WI Align)		Wavelength alignment error
005	Optical Error (Opt Att)		Optical attenuator error
006	Not used		
007	Optical Error (Light Source)		Light source error
008	Optical Error (Grating)		Grating error
009	Optical Error (Offset)		Offset error
010	Optical Error (Over Power)		Excess optical input error

C.2 Measurement-related Errors (100 to 199)

No.	Error Message	Status	Output Condition
100	Auto Measure Incomplete	ESE-DDE	Auto measurement not completed normally
101	Can t Find Peak	ESE-DDE	No peak found
102	Can t Find Dip	ESE-DDE	No dip found
103	Not used		
104	TMkr Not Display	ESE-DDE	Trace marker not displayed
105 to 109	Not used		
110	WI Cal Error (Optical Level)	ESE-DDE	Optical level insufficient for wavelength calibration
111	WI Cal Error	ESE-DDE	Wavelength calibration error
112	Align Error (Optical Level)	ESE-DDE	Optical level insufficient for optical axis auto alignment
113	Align Error	ESE-DDE	Optical axis alignment error *1
114	Res Cal Error	ESE-DDE	Resolution calibration error
115	TLS Calibration Error	ESE-DDE	Calibration error with TLS

*1: Refer to Section 7.4 "Trouble Shooting."

C.3 Key Operation Errors (200 to 299)

No.	Error Message	Status	Output Condition
200	Not used		
201	Input Value Error	ESE-EXE	Input value exceeds permitted range
202 to 204	Not used		
205	Invalid In Smooth	EXE-DDE	Cannot be executed during Smooth processing
206	Invalid In Peak Hold	EXE-DDE	Cannot be executed during Peak Hold measurement
207	Invalid In Ext. Trig	EXE-DDE	Cannot be executed during external triggering measurement
208 to 209	Not used		
210	Valid Only In Spectrum Mode	ESE-DDE	Cannot be executed except in spectrum measurement
211	Invalid In Auto Measure	ESE-DDE	Cannot be executed in Auto Measure mode
212	Invalid In Condition	ESE-DDE	Cannot be executed in Condition
213	Invalid In Memory Select	ESE-DDE	Cannot be executed while memory list displayed
214	Invalid In Title Input	ESE-DDE	Cannot be executed during Title Input
215	Invalid In Others Input	ESE-DDE	Cannot be executed during Others card Input
216	Invalid In Measurement	ESE-DDE	Cannot be executed during Measurement
217	Invalid In This Resolution	ESE-DDE	Cannot be executed Resolution
218	Valid Only In Power Monitor	ESE-DDE	Cannot be executed except Power Monitor mode
219	Valid Only In Analysis	ESE-DDE	Cannot be executed except in Waveform Analysis
220	Valid Only In Normal Disp	ESE-DDE	Cannot be executed except in Normal display
221	Valid Only In 3D Display	ESE-DDE	Cannot be executed except in 3D display
222	Not used		
223	Invalid In Normalize Disp	ESE-DDE	Cannot be executed during Normalize display
224	Invalid In 3D Disp	ESE-DDE	Cannot be executed during 3D display
225	Invalid In 3D Disp Type 3	ESE-DDE	Cannot be executed during 3D Type 3 display
226	Invalid In Peak/Dip Searching	ESE-DDE	Cannot be executed during Peak/Dip Search
227	Invalid In Overlap Disp	ESE-DDE	Cannot be executed during Overlap display
228	Invalid In Max Hold Disp	ESE-DDE	Cannot be executed during Max Hold display
229	Invalid In Power Monitor	ESE-DDE	Cannot be executed during Power Monitor measurement
230	Valid Only In Log Scale	ESE-DDE	Level Scale not LOG
231	Valid Only In Linear Scale	ESE-DDE	Level Scale not Linear
232	Level Unit Error	ESE-EXE	Level scale incorrect
233	Invalid In Application Mode	ESE-DDE	Cannot be executed during Application measurement
234	Invalid In Opt. Amp	ESE-DDE	Cannot be executed during Opt. Amp measurement
235	Invalid In Zone Marker	ESE-DDE	Cannot be executed during Zone Marker display
236	Invalid In Zero Span	ESE-DDE	Cannot be executed when Zero Span is 0 nm
237	Invalid In Auto PMD	ESE-DDE	Cannot be executed in Auto mode (PMD)

Appendix C Error Codes

No.	Error Message	Status	Output Condition
238	Invalid In Analysis	ESE-DDE	Cannot be executed while Analysis mode selected
239	Invalid In Swp-Avg	ESE-DDE	Cannot be executed while Sweep Analysis selected
240	Set A Trace or B Trace	ESE-DDE	Not Trace A or Trace B
241	Invalid In A-B, B-A Trace	ESE-DDE	Cannot be executed when trace is A-B or B-A
242	Invalid In A-B Trace	ESE-DDE	Cannot be executed when trace is A-B or B-A
243	Invalid In B-A Trace	ESE-DDE	Cannot be executed when trace is B-A
244	Invalid In A&B Trace	ESE-DDE	Cannot be executed when trace is A&B
245	Invalid In Multi Peak	ESE-DDE	Cannot be executed while Multi Peak executing
246	Invalid In Opt. Amp-Test	ESE-DDE	Cannot be executed Opt. Amp-Test
247	Invalid In Smplg-5001 pnt	ESE-DDE	Cannot be executed when sample point is 5001
248	Invalid In Plzn Null, Pulse, WDM	ESE-DDE	Cannot be executed in Plzn Null, Pulse, and WDM test modes
249	Invalid In This State	ESE-DDE	Cannot be set under these measurement conditions
250	Set Same WI For A, B	ESE-DDE	Wavelengths different for Memories A and B
251	Set Same Resolution For A, B	ESE-DDE	Resolutions different for Memories A and B
252	Set Same Points For A, B	ESE-DDE	No. of measurement points different for Memories A and B
253	Set Same Air/Vac For A, B	ESE-DDE	Air/Vac settings different for memories A and B
254	Option Error	ESE-DDE	Option Error
260	Invalid In TLS Tracking	ESE-DDE	Cannot be executed in TLS Tracking
261	Invalid In Frequency Marker	ESE-DDE	Cannot be executed when Marker is Frequency display

C.4 Device-related Errors (300 to 499)

No.	Error Message	Status	Output Condition
	YErrors relating to FD		
300	FD Does Not Exist	ESE-DDE	FD not inserted in FDD
301	FD Format Error	ESE-DDE	FD format incorrect
302	Can't Find File	ESE-DDE	Specified file not found
303	FD Memory Full	ESE-DDE	FD full
304	FD Write Protected	ESE-DDE	FD write protected
305	File Incomplete	ESE-DDE	FD file not written completely
306	Date File Full	ESE-DDE	Exceeded file number limit of FD
	YErrors relating to Printer		
320	No paper	ESE-DDE	Out-of-paper detection
321	Printer Cover Release	ESE-DDE	Printer cover unlocked
322	Printer Error	ESE-DDE	Printer not connected or incorrect printer type
324	Printer Error	ESE-DDE	Printer head temperature anomaly
325	Printer Error	ESE-DDE	Built-in printer hardware error
	YErrors relating to GPIB/RS-232C		
400	Not used		
401	Command Error	ESE-CME	Undefined header received
402	Command Error	ESE-CME	Integer part of numeric data incorrect
403	Command Error	ESE-CME	Real part of numeric data incorrect, or real format input data invalid
404	Command Error	ESE-CME	Index part of numeric data incorrect, or index format input data invalid
405	Command Error	ESE-CME	Suffix part (units) incorrect
406	Command Error	ESE-CME	Command syntax error
407	Command Error	ESE-CME	PCB command received but no controller function
408 to 419	Not used		
420	TLS Interface Error		Abnormality in connecting with TLS
421	TLS Not Respond		No response from TLS

Appendix D Relationship Between the Resolution, VBW, and Sensitivity

The relationship between the VBW, sweep speed and minimum received light sensitivity is shown in the following table.

VBW	10 Hz	100 Hz	1 kHz	10 kHz	100 kHz	1 MHz
Sweep Speed (typ)	30 s	5 s	0.5 s	0.5 s	0.5 s	0.5 s
Minimum Received Light Sensitivity*1	-90 dBm	-80 dBm	-70 dBm	-60 dBm	-50 dBm	-40 dBm

NOTE:

The above value is an approximated one.

NOTE *1:

RMS Noise level (1.25 to 1.6 μm)

Appendix E Checking Actual Display Resolution

This section explains improvement of display Resolution accuracy.

Upgrading from the MS9710A to the MS9710B or MS9710C improves the accuracy of the actual display resolution in the 1530 to 1570 nm band. In addition, the definition of Resolution has been changed from the half width value to the ratio between the peak level and integrated power.

E.1	Previous definition of Resolution	E-2
E.2	New method	E-2

E.1 Previous definition of Resolution

In the MS9710A, as shown in the diagram below, the half width of the spectrum of a single-mode oscillation light source was used as the Resolution width.

In this method, the accuracy of the Resolution measurement is not good due to limitations on the accuracy of the wavelength axis, especially at narrow setting Resolutions.

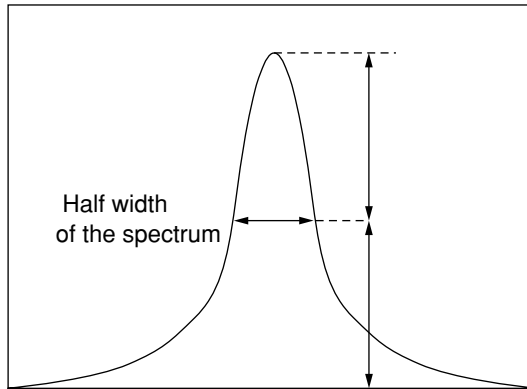

E.2 New method

In the MS9710B, MS9710C, the actual Resolution is found from the following equation:

where $\int P(\lambda) d\lambda$ is the integrated spectrum of a single-mode oscillation light source, and P_{peak} is peak level.

$$\text{Actual resolution} = \frac{\int P(\lambda) d\lambda}{P_{\text{peak}}}$$

In this method, the Resolution measurement accuracy approaches the level measurement accuracy, providing a better accuracy than the previous method.

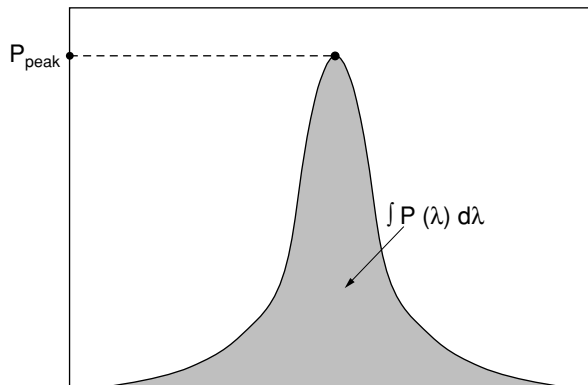

Appendix F Optical Fiber Cord

The MS9710C uses a 10/125 μm optical fiber cord at the optical input. At measurement, if the core eccentricity of the optical fiber cord connector is large, there is a possibility that the specified level accuracy may not be met. Anritsu uses a specified master cord with an external diameter accuracy of better than 0.5 μm , a core eccentricity of less than 0.2 μm and a connection loss of less than 0.2 dB. (Contact your sales agent for details about the master cord.)

In addition, if fibers with a different core diameter are connected, the amount of stray light may be large due to the effect of optical propagation by the cladding layer. Even when fibers of the same core diameter are connected, when the wavelength is less than 1.27 μm , there may be fluctuations in the measured level resulting from the effect of harmonic modes.

Appendix G Example of Performance Test Result Record Sheet

Record No. : _____
 Test Location: _____
 Test Date: _____
 Tester: _____
 Tested Model: MS9710C Optical Spectrum Analyzer
 Serial No.: _____
 Power Supply Frequency: _____ Hz
 Ambient Temperature: _____ °C
 Relative Humidity: _____ %
 Remarks _____

MS9710C Optical Spectrum Analyzer No.: _____ Date _____

Wavelength Accuracy (0.1, 0.2 nm resolution)

Wavelength Meter	Measured Value	Wavelength Difference	Specification Bottom Limit	Specification Top Limit	Pass/Fail
1530.00 nm	nm	nm	1529.98 nm	1530.02 nm	Pass/Fail
1540.00 nm	nm	nm	1539.98 nm	1540.02 nm	Pass/Fail
1550.00 nm	nm	nm	1549.98 nm	1550.02 nm	Pass/Fail
1560.00 nm	nm	nm	1559.98 nm	1560.02 nm	Pass/Fail
1570.00 nm	nm	nm	1569.98 nm	1570.02 nm	Pass/Fail
1580.00 nm	nm	nm	1579.98 nm	1580.02 nm	Pass/Fail
1590.00 nm	nm	nm	1589.98 nm	1590.02 nm	Pass/Fail
1600.00 nm	nm	nm	1599.98 nm	1600.02 nm	Pass/Fail
1610.00 nm	nm	nm	1609.98 nm	1610.02 nm	Pass/Fail
1620.00 nm	nm	nm	1619.98 nm	1620.02 nm	Pass/Fail

Level Accuracy

Power Meter	Measurement Value	Level Difference	Specification Bottom Limit	Specification Top Limit	Pass/Fail
-23 dBm	dBm	dB	-23.4 dBm	-22.6 dBm	Pass/Fail

Appendix H Automatic Measurement Processing

The automatic measurement processing function of this equipment has been optimized for measurement of input light in the range of 1300 to 1550 nm. However, measurement is possible in the range of 900 to 1650 nm. The automatic measurement function procedure is outlined below.

- (1) Perform measurement in the range of 1250 to 1750 nm and search for the peak level.
- (2) When a peak is found in this range, measurements is performed repeatedly, centered around this peak focussing on the best measurement conditions.
- (3) If a peak cannot be found in the above wavelength range, or if the detected peak does not reach a sufficient level, the entire wavelength range is measured and the peak is detected.
- (4) If a peak cannot be found in the full wavelength range, the automatic measurement function fails and quits. When a peak is found, the best measurement conditions are focused on.

NOTE:

At input of an optical signal below 900 nm, there is a possibility that an incorrect signal will be detected. For example, when automatic measurement is used for an optical signal from a He-Ne light source (633 nm), the secondary harmonic (1266 nm) of the input optical signal may be detected as a normal signal with a sufficient level at the first sweep, and there is a possibility that automatic measurement will be continued detecting the secondary harmonic.

Appendix I Switching Marker Frequency Display

The marker frequency display switching function of this instrument switches the display of the trace marker, Δ marker and analysis part between a wavelength value and frequency value. The items that can be switched between the wavelength and frequency displays are: the trace marker and Δ marker wavelength, the wavelength marker A and wavelength marker B wavelengths, and wavelengths calculated using the Analysis card.

These trace marker, Δ marker, and wavelength markers A and B can be set with the wavelength value, respectively, when the wavelength display is selected. And if the frequency display is selected, those can be set with the frequency value.

The same operation is also possible by remote control.

To display the marker value as a frequency value, the Air/Vac setting of the wavelength display value must be set to Vac (value in vacuum). If the marker display value is switched to frequency value display at the Air setting, the wavelength display is switched forcibly to Vac. Moreover, if the trace at this time is set to Trace A&B, Trace A-B, or Trace B-A, an error message requesting switching to Trace A or Trace B is displayed, and the display is not switched to the frequency value.

Appendix J Limited Life Span Parts

The MS9710C uses consumable parts for which the life span is determined according to the usage frequency (times). A fee will be charged for replacement of such parts due to end of life even if it is within the warranty period of the MT9080 Series.

Take the life span of the consumable parts into consideration when using the MT9080 Series continuously for a long period of time.

Display backlight

Cold-cathode tubes are used as the backlight of the MT9080 Series display (LCD.) Luminance deteriorates as lighting time advances.

The lifetime of the backlight is between 50,000 hours. When replacing the backlight, the entire display device should be replaced because they are joined.

When replacing the display device, contact an Anritsu Service and Sales office.

- 3D Display 5-52
 - 3D Function Key 5-52
 - ↓: Next function key 5-23
 - Δ Mkr Function Key 5-117
 - ←: Left Function Key 5-23
 - ↑: Last function key 5-23
 - : Right Function Key 5-24
- A**
- Act-Res Off/On Function Key 5-21
 - Analysis Card 5-25
 - Analyzing Measured Waveforms 4-12
 - Analyzing Waveforms 5-25
 - Application Card 5-55
 - Application Measurement Functions 5-55
 - Auto Align Function Key 5-100
 - Automatic Optical Axis Alignment 5-100
- B**
- Background cards 5-4
 - Backlight Function Key 5-111
 - Buzzer On/Off Function Key 5-111
- C**
- Cal Card 5-97
 - Calibrating Level 6-2
 - Calibrating Wavelength 6-3
 - Calibrating Wavelength using External Wavelength R 5-99
 - Calibrating Wavelength using Optional Internal Wav 5-99
 - Calibration 6-1
 - Calibration Function 5-97
 - Center Function Key 5-8
 - Changing Fuses 3-14
 - Clear Function Key 5-54
 - Clearing Graphs 5-54
 - Comparing Trace A–B 5-39
 - Comparing Trace B–A 5-40
 - Condition Card 5-101
 - Condition Save Function Key 5-102
 - Connecting Optical Fiber 4-2
- D**
- D. range Norm/Hi Function Key 5-90
 - Date/Time Function Key 5-108
 - Deleting Analysis Results 5-37
 - Deleting Files 5-48
 - Deleting Markers 5-117
 - Deleting Zone Marker 5-119
 - DFB-LD Test Function Key 5-56
 - Dip Search Function Key 5-22
 - Display Color Function Key 5-110
 - Displaying Two Traces Simultaneously 5-39
- E**
- Envelope Analysis 5-32
 - Envelope Function Key 5-32
 - Evaluating DFB-LDs 5-56
 - Evaluating FP-LDs 5-58
 - Evaluating LEDs 5-60
 - Evaluating Optical Amplifiers 5-67
 - Evaluating PMD 5-63
 - Ext. Trig Function Key 5-92
- F**
- File Delete Function Key 5-48
 - File Format Function Key 5-49
 - File Option Function Key 5-46
 - Floppy Disk 3-6
 - Foreground cards 5-2
 - Formatting Floppy Disk 5-49
 - FP-LD Test Function Key 5-58
- G**
- GPIB Address Function Key 5-107
 - Graph Card 5-50

I

- Initializing Wavelength Calibration Data 5-100
- Interval Function Key 5-92
- Interval Measurement 5-92

L

- l Mkr_A Function Key 5-115
- l Mkr_B Function Key 5-115
- LASER SAFETY *vii*
- LED Test Function Key 5-60
- Level Offset Function Key 5-98
- Level Scale Card 5-12
- Linear Level Function Key 5-14
- Listing Current Measurement Conditions 5-104
- LMkr_C Function Key 5-116
- LMkr_D Function Key 5-116
- Log (/div) Function Key 5-12

M

- Marker Select Key 5-114
- Marker Select Screen 5-114
- Max Hold Display 5-51
- Max Hold Function Key 5-51
- Measure Mode Card 5-90
- Measuring Modulated Light 4-19
- Memory 3-5
- Memory A Function Key 5-39
- Memory B Function Key 5-39
- Mkr Erase Function Key 5-117
- Modulated Light Measurement 5-92

N

- ndB-Loss Analysis 5-28
- ndB-Loss Function Key 5-28
- Normal Display 5-50
- Normal Function Key 5-50
- Normalize Display 5-51
- Normalize Function Key 5-51

O

- Off Function Key 5-37
- Opt. Amp Test Function Key 5-67
- Opt. Att Off/On Function Key 5-15
- Optical Attenuator 3-7
- Optical Attenuator On/Off 5-15
- Optical Connector 3-12
- Optional Light Sources 3-11, 4-21
- Options 1-6
- Other Functions 5-105
- Others Card 5-105
- Overlap Display 5-50
- Overlap Function Key 5-50

P

- Paper Manual Loading 3-8
- Peak Search Function Key 5-22
- Peak/Dip Search 5-22
- Peak/Dip Search Card 5-22
- Periodic Maintenance 7-2
- PMD Test Function Key 5-63
- Power Monitor Function Key 5-94
- Power Monitor Measurement 5-94
- Power Supply 3-3
- Printer 3-8
- Printer Prmtr Function Key 5-106

R

- Recall Function Key 5-45, 5-103
- Recalling and Initializing Measurement
Conditions 5-103
- Recalling Saved Data 5-45
- Ref Level Function Key 5-13
- Releasing Peak/Dip Search 5-24
- Res/VBW/Avg Card 5-16
- RMS Analysis 5-34
- RMS Function Key 5-34
- RS-232C Prmtr Function Key 5-112

S

- Sampling Points Function Key 5-21
- Save Function Key 5-42
- Save/Recall Card 5-41
- Saving and Recalling Measured Data 5-41
- Saving and Recalling Measured Waveforms 4-15
- Saving and Recalling Measurement Conditions 5-101
- Saving Measured Data 5-42
- Saving Measurement Conditions 5-102
- Searching for Dip Points 5-22
- Searching for Last Largest/Smallest Peak/Dip Point 5-23
- Searching for Next Largest/Smallest Peak/Dip Point 5-23
- Searching for Next Left Peak/Dip Point 5-23
- Searching for Next Right Peak/Dip Point 5-24
- Searching for Peak Points 5-22
- Selecting Memory A 5-39
- Selecting Memory B 5-39
- Selecting Trace A 5-39
- Selecting Trace B 5-39
- Setting Backlight Off Time 5-111
- Setting Buzzer On/Off 5-111
- Setting Center Wavelength 5-8
- Setting Date and Time 5-108
- Setting Delta Marker 5-117
- Setting GPIB Address 5-107
- Setting Graph Type 5-50
- Setting Level 5-12
- Setting Level Markers 5-116
- Setting Level Offset 5-98
- Setting Linear Scale 5-14
- Setting Log Scale 5-12
- Setting Options 5-46
- Setting Printer 5-106
- Setting Reference Level 5-13
- Setting Resolution and Averaging 5-16
- Setting RS-232C 5-112
- Setting Sampling Points 5-21
- Setting Screen Display Color 5-110
- Setting Smoothing 5-20
- Setting Start Wavelength 5-10
- Setting Stop Wavelength 5-10
- Setting Sweep Average 5-19
- Setting Sweep Width 5-9
- Setting Titles 5-95
- Setting Trace Marker 5-116
- Setting Trace MarkerÆCenter Wavelength 5-117
- Setting Video Band Width 5-18
- Setting Wavelength 5-8
- Setting Wavelength Markers 5-115
- Setting Wavelength Offset 5-98
- Setting Zone Center 5-118
- Setting Zone Width 5-119
- Setting ZoneÆSpan 5-119
- Side Mode Suppression Ratio Analysis 5-30
- SLD Light Source 3-11, 4-21
- Smooth Function Key 5-20
- SMSR Function Key 5-30
- Span Function Key 5-9
- Special Measurement Modes 5-90
- Spectrum Power Analysis 5-36
- Spectrum Power Function Key 5-36
- Start Function Key 5-10
- Stop Function Key 5-10
- Storage 7-4
- Sweep Average Function Key 5-19
- Switching Actual Resolution 5-21
- Switching Wavelength Display 5-11

T

Testing Performance 6-1, 6-5
Threshold Analysis 5-26
Threshold Function Key 5-26
Title Card 5-95
TLS Tracking Function 5-93
TMkr Function Key 5-116
TMkrÆCenter Key 5-117
Trace A Function Key 5-39
Trace A&B Function Key 5-39
Trace A–B Function Key 5-39
Trace B Function Key 5-39
Trace B–A Function Key 5-40
Trace Card 5-38
Trace Memory 5-38
Tracking Measurement 5-93
Transmission Characteristics 4-22
Transporting 7-4

V

Value in Air/Vac Function Key 5-11
VBW Function Key 5-18
View Function Key 5-104

W

Wavelength Card 5-8
Wavelength Reference Light Source 3-11, 4-21
WDM 5-81
WDM Evaluation 5-81
White Light Source 4-21
Wide Dynamic Range Measurement 5-90
W1 Cal (Ext) Function Key 5-99
W1 Cal (Init) Function Key 5-100
W1 Cal (Int) Function Key 5-99
W1 Offset Function Key 5-98

Z

Zone Center Function Key 5-118
Zone Marker Key 5-118
Zone Marker Screen 5-118
Zone Mkr Erase Function Key 5-119
Zone Width Function Key 5-119
ZoneÆSpan Function key 5-119
Zoom In/Zoom Out Function Key 5-119
Zooming-In/Zooming-Out 5-119