

Agilent 86120C Multi-Wavelength Meter User's Guide

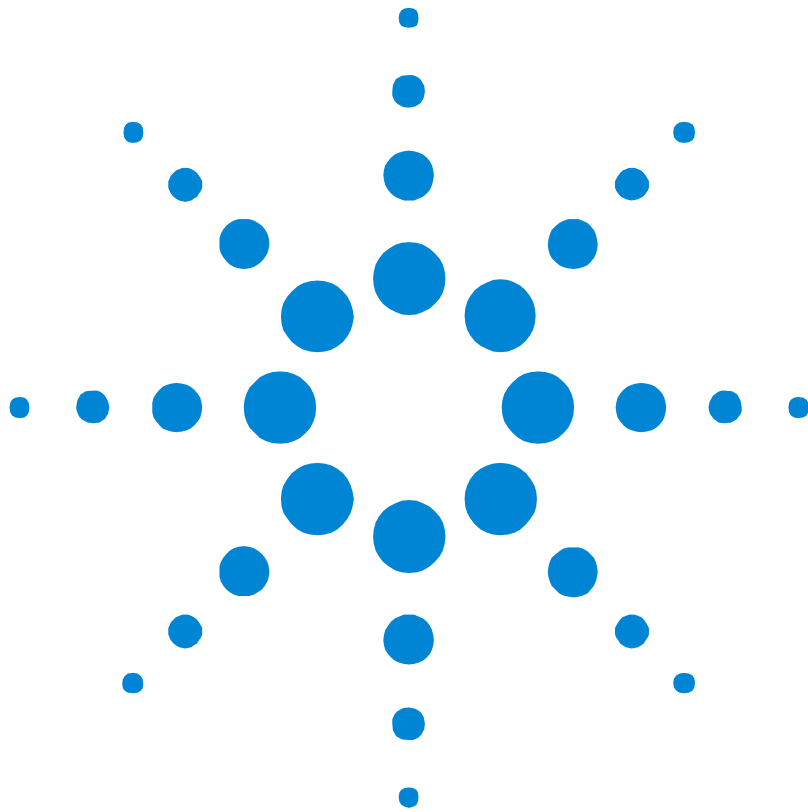

Notices

This document contains proprietary information that is protected by copyright. All rights are reserved.

No part of this document may be reproduced in (including electronic storage and retrieval or translation into a foreign language) without prior agreement and written consent from Agilent Technologies Deutschland GmbH as governed by United States and international copyright laws.

© Copyright 2001 - 2004 by:
Agilent Technologies
Deutschland GmbH
Herrenberger Str. 130
71034 Böblingen
Germany

Subject Matter

The material in this document is subject to change without notice.

Agilent Technologies *makes no warranty of any kind with regard to this printed material, including, but not limited to, the implied warranties of merchantability and fitness for a particular purpose.*

Agilent Technologies shall not be liable for errors contained herein or for incidental or consequential damages in connection with the furnishing, performance, or use of this material.

Warranty

This Agilent Technologies instrument product is warranted against defects in material and workmanship for a period of one year from date of shipment. During the warranty period, Agilent will, at its option, either repair or replace products that prove to be defective.

For warranty service or repair, this product must be returned to a service facility designated by Agilent. Buyer shall prepay shipping charges to Agilent and Agilent shall pay shipping charges to return the product to Buyer. However, Buyer shall pay all shipping charges, duties, and taxes for

products returned to Agilent from another country. Agilent warrants that its software and firmware designated by Agilent for use with an instrument will execute its programming instructions when properly installed on that instrument. Agilent does not warrant that the operation of the instrument, software, or firmware will be uninterrupted or error free.

Limitation of Warranty

The foregoing warranty shall not apply to defects resulting from improper or inadequate maintenance by Buyer, Buyer-supplied software or interfacing, unauthorized modification or misuse, operation outside of the environmental specifications for the product, or improper site preparation or maintenance.

No other warranty is expressed or implied. Agilent Technologies specifically disclaims the implied warranties of Merchantability and Fitness for a Particular Purpose.

Exclusive Remedies

The remedies provided herein are Buyer's sole and exclusive remedies. Agilent Technologies shall not be liable for any direct, indirect, special, incidental, or consequential damages whether based on contract, tort, or any other legal theory.

Assistance

Product maintenance agreements and other customer assistance agreements are available for Agilent Technologies products. For any assistance contact your nearest Agilent Technologies Sales and Service Office.

Certification

Agilent Technologies Inc. certifies that this product met its published specifications at the time of shipment from the factory. Agilent Technologies further certifies that its calibration measurements are traceable to the United States National Institute of Standards and Technology, NIST (formerly the United States National Bureau of Standards, NBS) to the

extent allowed by the Institutes' calibration facility, and to the calibration facilities of other International Standards Organization members.

ISO 9001 Certification

Produced to ISO 9001 international quality system standard as part of our objective of continually increasing customer satisfaction through improved process control.

Safety Notices

CAUTION

Caution denotes a hazard. It calls attention to a procedure which, if not correctly performed or adhered to, could result in damage to or destruction of the product. Do not proceed beyond a caution sign until the indicated conditions are fully understood and met.

WARNING

Warning denotes a hazard. It calls attention to a procedure which, if not correctly performed or adhered to, could result in injury or loss of life. Do not proceed beyond a warning sign until the indicated conditions are fully understood and met.



The instruction manual symbol. The product is marked with this warning symbol when it is necessary for the user to refer to the instructions in the manual.



The laser radiation symbol. This warning symbol is marked on products which have a laser output.



The AC symbol is used to indicate the required nature of the line module input power.



The ON symbols are used to mark the positions of the instrument power line switch.



The OFF symbols are used to mark the positions of the instrument power line switch.



The CE mark is a registered trademark of the European Community.



The CSA mark is a registered trademark of the Canadian Standards Association.



The C-Tick mark is a registered trademark of the Australian Spectrum Management Agency.

ISM1-A

This text denotes the instrument is an Industrial Scientific and Medical Group 1 Class A product.

Typographical Conventions.

The following conventions are used in this book:

Key type for keys or text located on the keyboard or instrument.

Softkey type for key names that are displayed on the instrument's screen.

Display type for words or characters displayed on the computer's screen or instrument's display.

User type for words or characters that you type or enter.

Emphasis type for words or characters that emphasize some point or that are used as place holders for text that you type.

Second Edition

86120-90C03 August 2004

First Edition:

86120-90035: February 2000

The Agilent 86120C—At a Glance

The Agilent 86120C Multi-Wavelength Meter measures the wavelength and optical power of laser light in the 1270–1650 wavelength range. Because the Agilent 86120C simultaneously measures multiple laser lines, you can characterize wavelength-division-multiplexed (WDM) systems and the multiple lines of Fabry-Perot lasers.

NOTE

The front-panel OPTICAL INPUT connector uses a single-mode input fiber.

CAUTION

For Option 022 instruments, the front-panel OPTICAL INPUT connector is an angled physical contact interface.

Characterize laser lines easily

With the Agilent 86120C you can quickly and easily measure any of the following parameters:

- Measure up to 200 laser lines simultaneously
- Wavelengths and powers
- Average wavelength
- Total optical power
- Laser line separation
- Laser drift (*wavelength and power*)
- Signal-to-noise ratios
- Fabry-Perot lasers

The Agilent 86120C—At a Glance

In addition to these measurements, a “power bar” is displayed that shows power changes like a traditional analog meter. You can see the power bar shown in the following figure of the Agilent 86120C’s display.

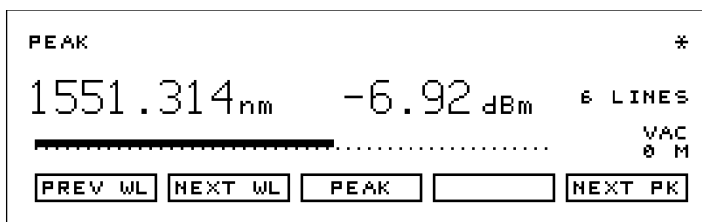

peakwl

CAUTION

The input circuitry of the Agilent 86120C can be damaged when *total* input power levels exceed +18 dBm. To prevent input damage, this specified level must not be exceeded.

Print measurement results

You can get hardcopy results of your measurements by connecting a printer to the rear-panel PARALLEL PRINTER PORT connector.

Program the instrument for automatic measurements

The Agilent 86120C offers an extensive set of GPIB programming commands. These commands allow you to perform automated measurements on manufacturing production lines and remote sites. [Chapter 3, “Programming”](#) and [Chapter 4, “Programming Commands”](#) provide all the information you’ll need to know in order to program the Agilent 86120C.

Display wavelengths as if measured in vacuum or standard air

Although all measurements are made in air, displayed results are corrected for air dispersion to accurately show wavelength values in vacuum or in “standard air.” To ensure accurate wavelength measurements, make sure that you enter the elevation from which you will be making measurements as described in [Chapter 1, “Getting Started”](#).

Measurement accuracy—it's up to you!

Fiber-optic connectors are easily damaged when connected to dirty or damaged cables and accessories. The Agilent 86120C's front-panel INPUT connector is no exception. When you use improper cleaning and handling techniques, you risk expensive instrument repairs, damaged cables, and compromised measurements.

Before you connect any fiber-optic cable to the Agilent 86120C, [refer to "Cleaning Connections for Accurate Measurements" on page 2-40.](#)

General Safety Considerations

General Safety Considerations

This product has been designed and tested in accordance with IEC 61010-1, and has been supplied in a safe condition. The instruction documentation contains information and warnings which must be followed by the user to ensure safe operation and to maintain the product in a safe condition.

Laser Classification: This product is classified according to IEC 60825-1.

There is no output laser aperture

The Agilent 86120C does not have an output laser aperture. However, light less than 1 nW escapes out of the front-panel OPTICAL INPUT connector. Operator maintenance or precautions are not necessary to maintain safety. No controls, adjustments, or performance of procedures result in hazardous radiation exposure.

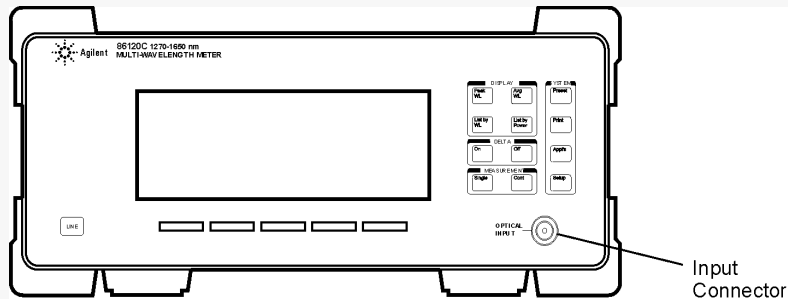

inptconn

WARNING If this instrument is not used as specified, the protection provided by the equipment could be impaired. This instrument must be used in a normal condition (in which all means for protection are intact) only.

WARNING No operator serviceable parts inside. Refer servicing to qualified personnel. To prevent electrical shock, do not remove covers.

WARNING To prevent electrical shock, disconnect the Agilent 86120C from mains before cleaning. Use a dry cloth or one slightly dampened with water to clean the external case parts. Do not attempt to clean internally.

WARNING This is a Safety Class 1 product (provided with protective earth). The mains plug shall only be inserted in a socket outlet provided with a protective earth contact. Any interruption of the protective conductor inside or outside of the product is likely to make the product dangerous. Intentional interruption is prohibited.

WARNING For continued protection against fire hazard, replace line fuse only with same type and ratings, (type F 6.3A/250V IEC 60127 type 5x20mm). The use of other fuses or materials is prohibited. Verify that the value of the line-voltage fuse is correct.

General Safety Considerations

CAUTION This product complies with Overvoltage Category II and Pollution Degree 2.

CAUTION VENTILATION REQUIREMENTS: When installing the product in a cabinet, the convection into and out of the product must not be restricted. The ambient temperature (outside the cabinet) must be less than the maximum operating temperature of the product by 4°C for every 100 watts dissipated in the cabinet. If the total power dissipated in the cabinet is greater than 800 watts, then forced convection must be used.

CAUTION Always use the three-prong ac power cord supplied with this instrument. Failure to ensure adequate earth grounding by not using this cord may cause instrument damage.

CAUTION *Do not* connect ac power until you have verified the line voltage is correct as described in [“Line Power Requirements” on page 1-5](#). Damage to the equipment could result.

CAUTION This instrument has autoranging line voltage input. Be sure the supply voltage is within the specified range.

Contents

The Agilent 86120C—At a Glance iii
General Safety Considerations vi

1 Getting Started

Step 1. Inspect the Shipment 4
Step 2. Connect the Line-Power Cable 5
Step 3. Connect a Printer 6
Step 4. Turn on the Agilent 86120C 7
Step 5. Enter Your Elevation 8
Step 6. Select Medium for Wavelength Values 9
Step 7. Turn Off Wavelength Limiting 10
Returning the Instrument for Service 11

2 Making Measurements

Measuring Wavelength and Power 3
Changing the Units and Measurement Rate 12
Defining Laser-Line Peaks 15
Measuring Laser Separation 18
Measuring Laser Drift 22
Measuring Signal-to-Noise Ratios 25
Measuring Signal-to-Noise Ratios with Averaging 29
Measuring Fabry-Perot (FP) Lasers 31
Measuring Modulated Lasers 34
Measuring Total Power Greater than 10 dBm 36
Calibrating Measurements 37
Printing Measurement Results 39
Cleaning Connections for Accurate Measurements 40

3 Programming

Addressing and Initializing the Instrument 3
Making Measurements 5
Monitoring the Instrument 16
Reviewing SCPI Syntax Rules 23
Example Programs 28
Lists of Commands 43

Contents

4 Programming Commands

Common Commands	3
Measurement Instructions	15
CALCulate1 Subsystem	25
CALCulate2 Subsystem	31
CALCulate3 Subsystem	44
CONFigure Measurement Instruction	74
DISPlay Subsystem	75
FETCh Measurement Instruction	79
HCOPy Subsystem	80
MEASure Measurement Instruction	81
READ Measurement Instruction	82
SENSe Subsystem	83
STATus Subsystem	90
SYSTem Subsystem	97
TRIGger Subsystem	103
UNIT Subsystem	107

5 Performance Tests

Test 1. Absolute Wavelength Accuracy	3
Test 2. Sensitivity	4
Test 3. Polarization Dependence	5
Test 4. Optical Input Return Loss	6
Test 5. Amplitude Accuracy and Linearity	9

6 Specifications and Regulatory Information

Definition of Terms	3
Specifications—NORMAL Update Mode	5
Specifications—FAST Update Mode	8
Operating Specifications	11
Laser Safety Information	12
Compliance with Canadian EMC Requirements	13
Declaration of Conformity	14
Product Overview	15

7 Reference

Instrument Preset Conditions	2
------------------------------	---

Contents

Menu Maps	4
Error Messages	11
Front-Panel Fiber-Optic Adapters	17
Power Cords	18
Agilent Technologies Service Offices	18

1

- Step 1. Inspect the Shipment 1-4
- Step 2. Connect the Line-Power Cable 1-5
- Step 3. Connect a Printer 1-6
- Step 4. Turn on the Agilent 86120C 1-7
- Step 5. Enter Your Elevation 1-8
- Step 6. Select Medium for Wavelength Values 1-9
- Step 7. Turn Off Wavelength Limiting 1-10
- Returning the Instrument for Service 1-11

Getting Started



Getting Started

The instructions in this chapter show you how to install your Agilent 86120C. You should be able to finish these procedures in about ten to twenty minutes. After you've completed this chapter, continue with [Chapter 2, "Making Measurements"](#).

Refer to [Chapter 6, "Specifications and Regulatory Information"](#) for information on operating conditions such as temperature.

If you should ever need to clean the cabinet, use a damp cloth only.

CAUTION

This product has autoranging line voltage input. Be sure the supply voltage is within the specified range.

CAUTION

The front panel LINE switch disconnects the mains circuits from the mains supply after the EMC filters and before other parts of the instrument.

CAUTION

Install the instrument so that the LINE switch is readily identifiable and is easily reached by the operator. The LINE switch or the detachable power cord is the instrument disconnecting device. It disconnects the mains circuits from the mains supply before other parts of the instrument. Alternately, an externally installed switch or circuit breaker (which is readily identifiable and is easily reached by the operator) may be used as a disconnecting device.

CAUTION

Install the instrument according to the enclosure protection provided. This instrument does not protect against the ingress of water. This instrument protects against finger access to hazardous parts within the enclosure.

Measurement accuracy—it's up to you!

Fiber-optic connectors are easily damaged when connected to dirty or damaged cables and accessories. The Agilent 86120C's front-panel INPUT connector is no exception. When you use improper cleaning and handling techniques, you risk expensive instrument repairs, damaged cables, and compromised measurements.

Before you connect any fiber-optic cable to the Agilent 86120C, [refer to "Cleaning Connections for Accurate Measurements" on page 2-40.](#)

Step 1. Inspect the Shipment

- 1 Verify that all system components ordered have arrived by comparing the shipping forms to the original purchase order. Inspect all shipping containers.

If your shipment is damaged or incomplete, save the packing materials and notify both the shipping carrier and the nearest Agilent Technologies sales and service office. Agilent Technologies will arrange for repair or replacement of damaged or incomplete shipments without waiting for a settlement from the transportation company. Notify the Agilent Technologies customer engineer of any problems.

- 2 Make sure that the serial number and options listed on the instrument's rear-panel label match the serial number and options listed on the shipping document. The following figure is an example of the rear-panel serial number label:



Step 2. Connect the Line-Power Cable

WARNING

This is a Safety Class I Product (provided with protective earth). The mains plug shall only be inserted in a socket outlet provided with a protective earth contact. Any interruption of the protective conductor inside or outside of the instrument is likely to make the instrument dangerous. Intentional interruption is prohibited.

CAUTION

Always use the three-prong AC power cord supplied with this instrument. Failure to ensure adequate earth grounding by not using this cord may cause instrument damage.

CAUTION

Do not connect ac power until you have verified the line voltage is correct as described in the following paragraphs. Damage to the equipment could result.

CAUTION

This instrument has autoranging line voltage input. Be sure the supply voltage is within the specified range.

- 1 Verify that the line power meets the requirements shown in the following table.

Line Power Requirements

Power:	max. 70 W
Voltage:	max: 110 / 115 / 230 / 240 V~
Frequency	50 / 60 Hz

- 2 Connect the line-power cord to the instrument's rear-panel connector.

Step 3. Connect a Printer

- 3 Connect the other end of the line-power cord to the power receptacle.

Various power cables are available to connect the Agilent 86120C to ac power outlets unique to specific geographic areas. The cable appropriate for the area to which the Agilent 86120C is originally shipped is included with the unit. The cable shipped with the instrument also has a right-angle connector so that the Agilent 86120C can be used while sitting on its rear feet. You can order additional ac power cables for use in different geographic areas. Refer to “Power Cords” on page 7-18.

Step 3. Connect a Printer

The Agilent 86120C can print hardcopies of measurement results on a printer. The output is ASCII text. If you don't have a printer, continue with “Step 4. Turn on the Agilent 86120C” on page 1-7.

- 1 Using a standard parallel printer cable, connect the printer to the Agilent 86120C's rear-panel PARALLEL PRINTER PORT connector.

Step 4. Turn on the Agilent 86120C

- 1 Press the front-panel LINE key. After approximately 20 seconds, the display should look similar to the figure below.

The front-panel LINE switch disconnects the mains circuits from the mains supply after the EMC filters and before other parts of the instrument.

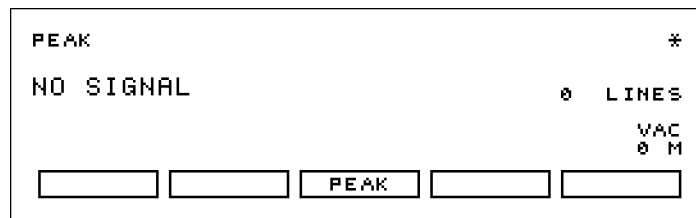

- 2 If the Agilent 86120C fails to turn on properly, consider the following possibilities:
 - Is the line fuse good?
 - Does the line socket have power?
 - Is it plugged into the proper ac power source?

If the instrument still fails, return it to Agilent Technologies for repair. Refer to [“Returning the Instrument for Service”](#) on page 1-11.

Instrument firmware version

When the instrument is first turned on, the display briefly shows the instrument's firmware version number. In the unlikely event that you have a problem with the Agilent 86120C, you may need to indicate this number when communicating with Agilent Technologies.

Step 5. Enter Your Elevation

In order for your Agilent 86120C to accurately measure wavelengths and meet its published specifications, you must enter the elevation where you will be performing your measurements.

- 1 Press the Setup key.
- 2 Press the *MORE* softkey.
- 3 Press the *CAL* softkey.
- 4 Press *ELEV*.
- 5 Use the \uparrow and \downarrow softkeys to enter the elevation in meters. Entries jump in 500 meter steps from 0 m to 5000 m.

The elevation value selected with the softkeys must be within 250 meters of the actual elevation.

- 6 Press *RETURN* to complete the entry.

Converting feet to meters

If you know your elevation in feet, you can convert this value to meters by using the following equation:

$$m = \frac{ft}{3,281}$$

Step 6. Select Medium for Wavelength Values

Because wavelength varies with the material that the light passes through, the Agilent 86120C offers wavelength measurements in two mediums: vacuum and standard air.

- 1 Press the Setup key.
- 2 Press the *MORE* softkey.
- 3 Press the *CAL* softkey.
- 4 Make the following selection:
 - Press *VACUUM* for wavelength readings in a vacuum.
 - Press *STD AIR* for wavelength readings in standard air.
- 5 Press *RETURN* to complete the entry.

Definition of standard air

Standard air is defined to have the following characteristics:

Barometric pressure: *1013 mbar*

Temperature: *15°C*

Relative humidity: *0%*

Step 7. Turn Off Wavelength Limiting

The instrument's Preset key sets the entire Agilent 86120C wavelength range of 1270–1650 nm. If a user-defined wavelength range limit was set using *WL LIM*, the following procedure will ensure that responses across the full wavelength are measured by returning the instrument to its preset state.

- 1 Press the Setup key.
- 2 Press the *WL LIM* softkey.
- 3 Press *LIM OFF* to remove the limits on wavelength range.

Returning the Instrument for Service

The instructions in this section show you how to properly return the instrument for repair or calibration. Always call the Agilent Technologies Instrument Support Center first to initiate service *before* returning your instrument to a service office. This ensures that the repair (or calibration) can be properly tracked and that your instrument will be returned to you as quickly as possible. Call this number regardless of where you are located. Refer to “Agilent Technologies Service Offices” on page 7-18 for a list of service offices.

Agilent Technologies Instrument Support Center +1 (877) 447 7278

If the instrument is still under warranty or is covered by an Agilent Technologies maintenance contract, it will be repaired under the terms of the warranty or contract (the warranty is at the front of this manual). If the instrument is no longer under warranty or is not covered by an Agilent Technologies maintenance plan, Agilent Technologies will notify you of the cost of the repair after examining the unit.

When an instrument is returned to a Agilent Technologies service office for servicing, it must be adequately packaged and have a complete description of the failure symptoms attached. When describing the failure, please be as specific as possible about the nature of the problem. Include copies of additional failure information (such as the instrument failure settings, data related to instrument failure, and error messages) along with the instrument being returned.

Preparing the instrument for shipping

- 1 Write a complete description of the failure and attach it to the instrument. Include any specific performance details related to the problem. The following information should be returned with the instrument.
 - Type of service required.
 - Date instrument was returned for repair.
 - Description of the problem:
 - Whether problem is constant or intermittent.
 - Whether instrument is temperature-sensitive.
 - Whether instrument is vibration-sensitive.
 - Instrument settings required to reproduce the problem.
 - Performance data.
 - Company name and return address.
 - Name and phone number of technical contact person.
 - Model number of returned instrument.
 - Full serial number of returned instrument.
 - List of any accessories returned with instrument.
- 2 Cover all front or rear-panel connectors that were originally covered when you first received the instrument.

CAUTION

Cover electrical connectors to protect sensitive components from electrostatic damage. Cover optical connectors to protect them from damage due to physical contact or dust.

CAUTION

Instrument damage can result from using packaging materials other than the original materials. Never use styrene pellets as packaging material. They do not adequately cushion the instrument or prevent it from shifting in the carton. They may also cause instrument damage by generating static electricity.

- 3 Pack the instrument in the original shipping containers. Original materials are available through any Agilent Technologies office. Or, use the following guidelines:
 - Wrap the instrument in antistatic plastic to reduce the possibility of damage caused by electrostatic discharge.
 - For instruments weighing less than 54 kg (120 lb), use a double-walled, corrugated cardboard carton of 159 kg (350 lb) test strength.
 - The carton must be large enough to allow approximately 7 cm (3 inches) on all sides of the instrument for packing material, and strong enough to accommodate the weight of the instrument.
 - Surround the equipment with approximately 7 cm (3 inches) of packing material, to protect the instrument and prevent it from moving in the carton. If packing foam is not available, the best alternative is S.D-240 Air Cap™ from Sealed Air Corporation (Commerce, California 90001). Air Cap looks like a plastic sheet filled with air bubbles. Use the pink (antistatic) Air Cap™ to reduce static electricity. Wrapping the instrument several times in this material will protect the instrument and prevent it from moving in the carton.
- 4 Seal the carton with strong nylon adhesive tape.
- 5 Mark the carton “FRAGILE, HANDLE WITH CARE”.
- 6 Retain copies of all shipping papers.

Getting Started

Returning the Instrument for Service

Measuring Wavelength and Power	2-3
Peak WL mode	2-4
List by WL or Power modes	2-6
Total power and average wavelength	2-7
Limiting the wavelength measurement range	2-8
Measuring broadband devices and chirped lasers	2-9
Graphical display of optical power spectrum	2-10
Instrument states	2-11
Power bar	2-11
Changing the Units and Measurement Rate	2-12
Displayed units	2-12
Measurement rate	2-13
Continuous or single measurements	2-14
Defining Laser-Line Peaks	2-15
Measuring Laser Separation	2-18
Channel separation	2-19
Measuring flatness	2-21
Measuring Laser Drift	2-22
Measuring Signal-to-Noise Ratios	2-25
Measuring Signal-to-Noise Ratios with Averaging	2-29
Measuring Fabry-Perot (FP) Lasers	2-31
Measuring Modulated Lasers	2-34
Measuring Total Power Greater than 10 dBm	2-36
Calibrating Measurements	2-37
Printing Measurement Results	2-39
Cleaning Connections for Accurate Measurements	2-40

Making Measurements

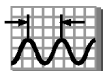

Making Measurements

In this chapter, you'll learn how to make a variety of fast, accurate measurements. As you perform these measurements, keep in mind the following points:

- 1270–1650 maximum input wavelength range
- +10 dBm maximum total displayed input power
- Laser linewidths assumed to be less than 5 GHz
- If you change the elevation where you will be using your Agilent 86120C, refer to [“Calibrating Measurements” on page 2-37](#).
- Press the green Preset key to return the Agilent 86120C to its default state.

CAUTION

Do not exceed +18 dBm source power. The Agilent 86120C's input circuitry can be damaged when total input power exceeds 18 dBm. You can measure power levels that are greater by adding attenuation and entering a power offset as described in [“To measure total power exceeding 10 dBm” on page 2-36](#).

Measuring Wavelength and Power

This section gives you step-by-step instructions for measuring peak wavelength, average wavelength, peak power, and total input power. There are three display modes:

- Peak wavelength
- List-by-wavelength *or* power
- Average wavelength and total power

If the measured amplitudes are low, clean the front-panel OPTICAL INPUT connector.

This section includes:

Peak WL mode 2-4

List by WL or Power modes 2-6

Total power and average wavelength 2-7

Limiting the wavelength measurement range 2-8

Measuring broadband devices and chirped lasers 2-9

Graphical display of optical power spectrum 2-10

Instrument states 2-11

Power bar 2-11

Peak WL mode

When Peak WL is pressed, the display shows the largest amplitude line in the spectrum. The word **PEAK** is shown on the screen. If multiple laser lines are present at the input, the number of lines located will be shown along the right side of the screen. In peak wavelength mode, the Agilent 86120C can measure up to 200 laser lines simultaneously.

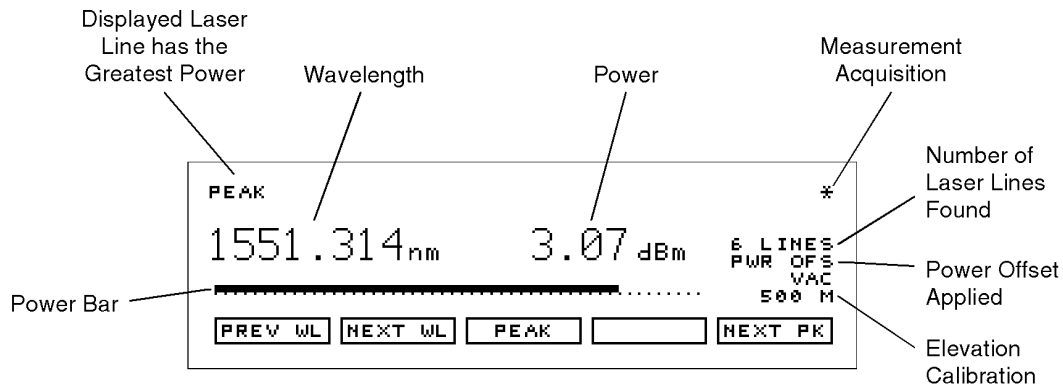

peakwl2

Figure 2-1. Display after "Peak WL" key pressed

In addition to the digital readouts, there is a power bar. It provides a convenient analog "meter movement" for tuning laser power.

Although the Peak WL mode shows one signal at a time, softkeys are provided that allow you to scroll through and display all the measured laser lines. You can scroll through the list according to the wavelengths or powers measured.

To display peak wavelength and power

- 1 Connect the fiber-optic cable to the front-panel OPTICAL INPUT connector.
- 2 To display the peak wavelength and power, do one of the following:
 - Press the green Preset key.
 - Press *Peak WL*.

3 To move the cursor to view other signals, press:

- *PREV WL* to select next (previous) shorter wavelength.
- *NEXT WL* to select next longer wavelength.
- *PEAK* to signal with greatest power.
- *PREV PK* to select next lower power signal.
- *NEXT PK* to select next higher power signal.

List by WL or Power modes

In the list-by-wavelength or list-by-power modes, the measurements of five laser lines can be displayed at any one time. Use the \updownarrow and $\leftarrow\rightarrow$ softkeys to move the cursor \leftrightarrow through the list of signals; the list can contain up to 200 entries. Press the SELECT key, and the display changes to peak wavelength mode with the signal at the cursor displayed.

Annotation in the upper right corner of the display indicates whether the signals are ordered according to wavelength (BY WL) or power (BY PWR). The cursor shows the currently selected laser line. As you scroll through the responses, the current position of the selection cursor is shown along the screen's right side.

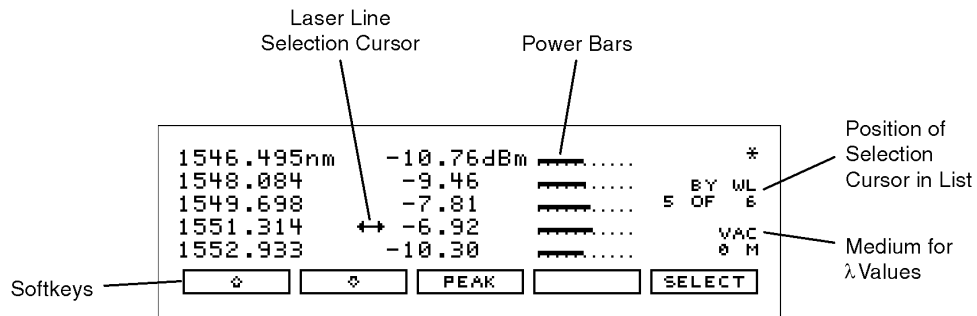

Figure 2-2. Display after "List by WL" key pressed

Also notice that power bars graphically show the relative power levels between laser lines.

To display multiple laser lines

- 1 Connect the fiber-optic cable to the front-panel OPTICAL INPUT connector.
- 2 Press the green Preset key.
- 3 Press List by WL to display the laser lines from the shortest wavelength to the longest wavelength.
- 4 Press List by Power to display the laser lines in order of decreasing amplitudes.

Total power and average wavelength

In the third available display mode, the Agilent 86120C displays the average wavelength as shown in the following figure. The displayed power level is the total input power to the instrument. It is the sum of the powers of each laser line; it is *not* a measure of the average power level of the laser lines.

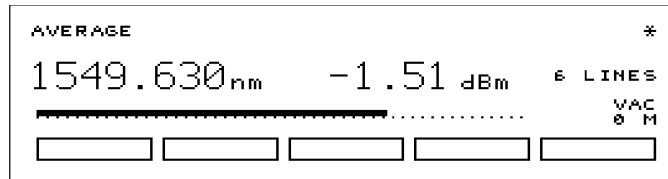

The following equation shows how individual wavelengths of laser lines are summed together to obtain the average wavelength value:

$$\lambda_{avg} = \frac{\sum_{i=1}^n P_i \lambda_i}{\sum_{i=1}^n P_i}$$

where,

n is the number of laser lines included in the average.

P_i is the peak power of an individual laser line. Power units are in Watts (linear).

Making Measurements

Measuring Wavelength and Power

The following equation shows how individual powers of laser lines are summed together to obtain the total power value:

$$P_{total} = \sum_{i=1}^n P_i$$

where,

n is the number of laser lines included in the measurement.

P_i is the peak power of an individual laser line. Power units are in Watts (linear).

To display average wavelength and total power

- Press the Avg WL key.

Limiting the wavelength measurement range

The wavelength range of measurement can be limited with the wavelength limit function. Both start and stop wavelengths can be chosen. The units of wavelength start and stop are the same as the currently selected wavelength units. If wavelength units are later changed, the start and stop wavelength units will change accordingly. Note that a *start* wavelength limit in nm will become a *stop* wavelength limit if THz or cm^{-1} is chosen. See [“To change the units of measure” on page 2-12](#).

The graphical display uses the start and stop wavelength values to plot the power spectrum, whether the wavelength limit function is on or off.

Preset turns wavelength limiting on. Only responses that are within the boundaries of the chosen start and stop wavelength limits are measured. This includes Peak WL, List by WL, and List by Power modes.

To limit the wavelength range

- 1 Press the Setup key.
- 2 Press the *WL LIM* softkey.
- 3 Press the *STARTWL* softkey to adjust the start wavelength value.
- 4 Press the *STOP WL* softkey to adjust the stop wavelength value.

Measuring broadband devices and chirped lasers

When first turned on (or the green Preset key is pressed), the Agilent 86120C is configured to measure narrowband devices such as DFB lasers and modes of FP lasers. If you plan to measure broadband devices such as LEDs, optical filters, and chirped lasers, use the Setup menu first to reconfigure the instrument. When broadband devices are selected, the display shows the BROAD annotation on the screen.

The measurement algorithm for broadband devices determines the wavelength based upon the center-of-mass of the power spectrum. The peak excursion function is used to determine the value of the integration limits. Care must be taken to ensure that the integration limits are above any noise. This is especially true when measuring devices with sloping noise floors, like an EDFA amplifier. For more information on peak excursion, refer to [“Defining Laser-Line Peaks” on page 2-15](#).

Instrument specifications apply when the Agilent 86120C is configured to measure narrowband devices. Specifications do not apply when the instrument is configured to measure wideband devices.

To measure broadband devices

- 1 Press the Setup key.
- 2 Press *MORE* twice, and then the *DEVICE* softkey.
- 3 Press the *BROAD* softkey.

To return to measuring narrowband devices, press *NARROW*.

Graphical display of optical power spectrum

A graphical display of optical power versus wavelength is shown from the start wavelength value to the stop wavelength value. The start wavelength value is shown in the upper-left corner of the graphical display, and the stop wavelength value is shown in the upper-right corner of the graphical display. The power scale is a fixed dB scale, with +10 dBm at the display top and -53 dBm at the display bottom. The power scale is not affected by the Power Offset value. In most cases, the noise floor will be visible if the total input power is greater than about -5 dBm.

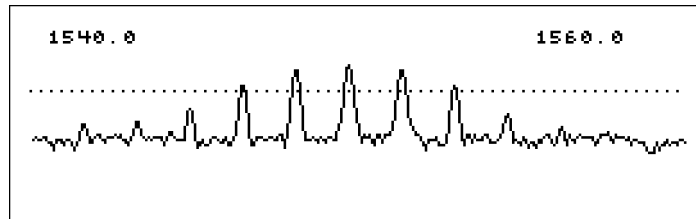

The Agilent 86120C graphical display.

The Peak Threshold value is displayed as a dotted line. All peaks above this dotted line are displayed in the List by Wavelength and List by Power modes. All peaks below this line are not displayed. Adjust the Peak Threshold value with the Setup key, and the *THRSHLD* softkey.

The wavelength limit start and stop wavelength values are used for the graphical display even if the wavelength limit function is off.

The graphical display cannot be printed.

To see the graphical display

- 1 Press the List by WL or List by Power key.
- 2 Press the *GRAPH* softkey.
- 3 To exit the graphical display, press any softkey.

Instrument states

Four different instrument states can be saved and recalled at a later time. The actual instrument conditions that are saved are identical to those saved from the previous state after power is turned on. These conditions are shown in [Table 5-22 on page 7-2](#). If drift measurements or an application (such as signal-to-noise) is on when an instrument state is saved, it is off when that state is recalled.

To save an instrument state

- 1 Press the Setup key.
- 2 Press the *SAV/RCL* softkey.
- 3 Press the *SAVE* softkey.
- 4 Press one of the four *SAVE* softkeys to save the instrument state.

To recall an instrument state

- 1 Press the Setup key.
 - 2 Press the *SAV/RCL* softkey.
 - 3 Press the *RECALL* softkey.
 - 4 Press one of the four *RCL* softkeys to recall an instrument state.
-

Power bar

To control the power bar

- 1 Press the Setup key.
- 2 Press *MORE* twice, and then *PWR BAR*.
- 3 Press *BAR ON* to display the power bar, and press *BAR OFF* to hide the power bar display.

Changing the Units and Measurement Rate

This section includes step-by-step instructions for changing the units and measurement rate.

This section includes:

[Displayed units](#) 2-12

[Measurement rate](#) 2-13

[Continuous or single measurements](#) 2-14

Displayed units

As described below, it's easy to change the wavelength and amplitude units. You can choose between the following units:

Table 2-1. Available Units

Wavelength (Frequency)	Power
nm	dBm
cm ⁻¹	mW
THz	μW

To change the units of measure

- 1 Press Setup.
- 2 Press the *MORE* softkey.
- 3 Press the *UNITS* softkey.

- 4 Press *WL* and select one of the following units. Then, press *RETURN* to complete your selection:
 - *NM* for nanometers
 - *THZ* for Tera Hertz
 - *CM⁻¹* for wave number
- 5 Press *POWER* and select one of the following units:
 - *DBM* for decibels relative to a milliwatt
 - *MW* for milliwatts
 - *UW* for microwatts

Measurement rate

Under normal operation, the Agilent 86120C makes a measurement and displays the results about once every second. It is in this normal update mode that maximum accuracy and wavelength resolution are achieved. However, should a faster update be desired, for example when real-time feedback is required to tune a laser to its designated channel, the Agilent 86120C can be set to update approximately two times per second. This reduces both wavelength resolution and accuracy but can be beneficial in some applications.

The instrument resolution in *NORMAL* update mode is 7 GHz (0.06 nm at 1550 nm). This resolution is useful when measuring closely spaced laser lines carrying data at up to 5 Gb/s rates.

The instrument resolution in *FAST* update mode is 14 GHz (0.12 nm at 1550 nm). This resolution is useful when measuring laser lines carrying data at up to 10 Gb/s rates.

NOTE

When measuring laser lines carrying data at 10 Gb/s in *NORMAL* update mode, the instrument resolution is less than the modulation bandwidth of the laser lines. In this case, the displayed power of the laser lines will be less than the actual power by approximately 1 dB. This power offset can be calculated by comparing the displayed power to that measured by a power meter. Then, the power offset can be entered, by pressing Setup, *MORE*, *CAL*, *PWR OFS*, to display the correct power.

To change the measurement speed

- 1 Press the Setup key.
- 2 Press the *MORE* softkey.
- 3 Press the *UPDATE* softkey.
- 4 Select either *NORMAL* or *FAST*.

Continuous or single measurements

The Agilent 86120C continuously measures the input spectrum at the front-panel OPTICAL INPUT connector. Whenever measurements are being acquired, an asterisk (*) is displayed in the display's upper-right corner. When you switch between normal and fast update modes, the rate that the asterisk blinks changes.

You can specify that the instrument perform a measurement only when the front-panel Single key is pressed. This is the single-acquisition measurement mode, and it is useful for capturing and preserving data. After capturing the data, you can display it using many of the procedures included in this chapter. You can return to continuous measurement mode at any time by pressing the Cont key.

To select single measurement acquisition

- Press the Single key.

Defining Laser-Line Peaks

The Agilent 86120C uses two rules to identify valid laser-line peaks. Understanding these rules is essential to getting the most from your measurements. For example, these rules allow you to “hide” AM modulation sidebands or locate laser lines with small amplitudes.

In order to identify a laser line, the laser-line must meet *both* of the following rules:

- Power must be greater than the power established by the *peak threshold limit*
- Power must rise and then fall by at least the *peak excursion* value

In addition, the input wavelength range can be limited as described in this section.

Peak threshold limit

The peak threshold limit is set by subtracting the peak threshold value from the power of the largest laser line. So, if the largest laser line is 2 dBm and the peak threshold value is 10 dB, the peak threshold limit is -8 dBm ($-8 \text{ dBm} = 2 \text{ dBm} - 10 \text{ dB}$). You can set the peak threshold value between 0 to 40 dB.

The peak threshold’s default value is 10 dB. This ensures that any modulated signals being measured are not confused with their AM sidebands. For unmodulated lasers, or Fabry-Perot lasers, it may be desirable to increase this threshold to look for responses that are more than 10 dB from the peak.

Peak threshold can be used to suppress spurious signals. For example, a laser that is amplitude modulated in the audio frequency range can cause spurious wavelengths to be displayed below and above the correct wavelength. The power of these spurious wavelengths is below that of the correct wavelength. These spurious signals can be eliminated by decreasing Peak threshold from its Preset value.

Making Measurements
Defining Laser-Line Peaks

Peak excursion The peak excursion defines the rise and fall in amplitude that must take place in order for a laser line to be recognized. The rise and fall can be out of the noise, or in the case of two closely spaced signals, out of the filter skirts of the adjacent signal. The peak excursion's default value is 15 dB. Any laser line that rises by 15 dB and then falls by 15 dB passes the rule. You can set the peak excursion value from 1 to 30 dB.

Examples of valid and invalid signals In the following figure, three laser lines are identified: responses 1, 3 and 4. Response 2 is not identified because it is below the peak threshold. The portion of each signal that is within the peak excursion limits is shown in bold lines.

Because of the peak excursion rule, responses 4 and 5 are identified as one laser line—the minimum point between 4 and 5 does not drop to the peak excursion limit. This response has the highest power shown, which is peak 4.

Whenever the peak threshold limit or peak excursion value is changed, the new limits are applied to the current displayed measurements even if the instrument is in the Single measurement mode.

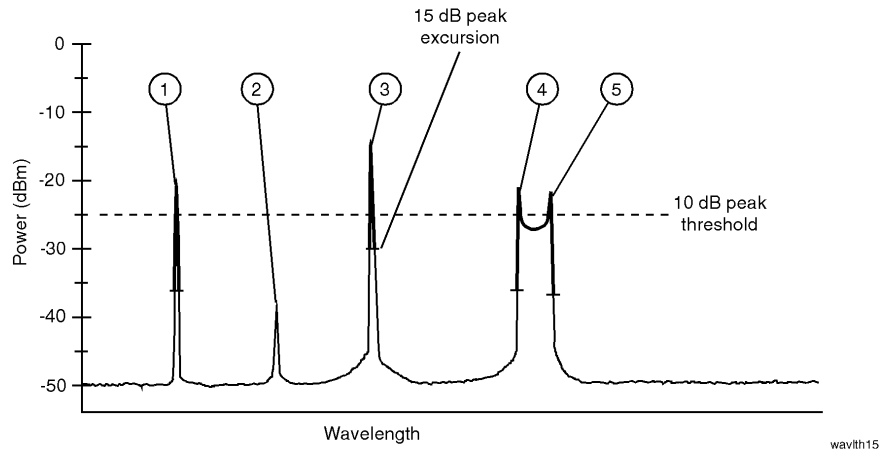

To define laser-line peaks

- 1 Press the Setup key.
- 2 Press the *THRSHLD* softkey.

- 3 Press *PX EXC*, and enter the peak excursion value. Use the **+** softkey to select the digit that requires editing. Use the **↶** and **↷** softkeys to change the value.

The peak excursion value can range from 1 to 30 dB. The default value is 15 dB.

- 4 Press *RETURN*.

- 5 Press *PK THLD* and then enter the peak threshold value.

The peak threshold value can range from 0 to 40 dB. Setting this value to 0 dB ensures that only the peak wavelength is identified. The default value is 10 dB.

Pressing the green PRESET key changes the peak excursion and peak threshold values to their default settings. It also turns wavelength range limiting on. Turning the Agilent 86120C's power off and then on does not change these settings.

If too many lines are identified

If the following message is displayed, too many laser lines have been identified:

E15 MAX NUMBER OF SIGNALS FOUND

The maximum number of laser lines that the instrument can measure is 200. If this message appears, decrease the peak threshold value, increase the peak excursion value, or decrease the wavelength range of operation with the *WL LIM**START WL* and *STOP WL* functions.

Measuring Laser Separation

It is often important to measure the wavelength and power separation between multiple laser lines. This is especially true in wavelength-division-multiplexed (WDM) systems where channel spacing must be adhered to. The Agilent 86120C can display the wavelength and amplitude of any laser line relative to another. In fact, the following types of relative measurements can be made compared to the reference:

- Relative wavelength, absolute power
- Relative power, absolute wavelength
- Relative wavelength and power

This section includes:

[Channel separation](#) 2-19

[Measuring flatness](#) 2-21

Channel separation

Suppose that you want to measure separation on a system having the spectrum shown in the following figure.

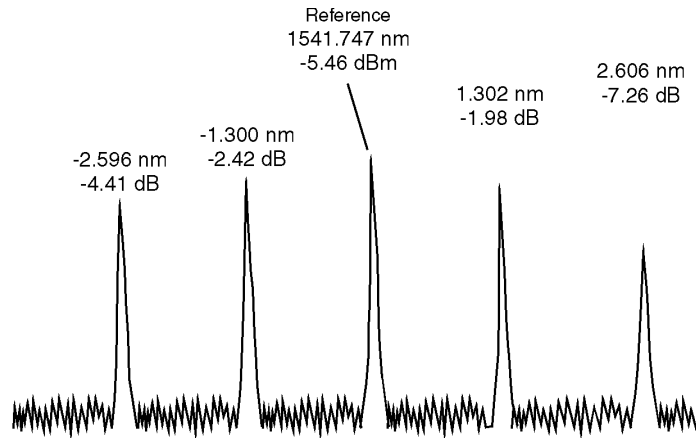

peaks

The Agilent 86120C displays separation on this spectrum as shown in the following figure. Notice that the 1541.747 nm laser line is selected as the reference. It is shown in absolute units. The wavelengths and powers of the remaining responses are shown relative to this reference. For example, the first response is 2.596 nm below the reference.

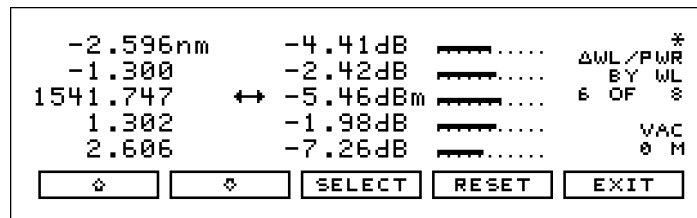

To determine channel spacing, simply read the relative wavelength measurement of the laser lines immediately preceding and following the reference. Use the ◊, ◊, and *SELECT* softkeys to change the reference laser line and read the channel spacing between each channel.

Making Measurements
Measuring Laser Separation

To measure channel separation

- 1 Press the front-panel Preset key.
- 2 Press List by WL.
- 3 Press the Delta On key.
Use the Off key to turn off the measurement.
- 4 Select the type of separation to observe:
 - ΔWL displays channel separation.
 - $\Delta WL / \Delta PWR$ displays both channel separation and differences in power.
- 5 Use the \leftarrow and \rightarrow softkeys to select the reference laser line.
- 6 Press *SELECT*.
Press *SELECT* at any time to select a new reference. Press *RESET* at any time to turn off the delta calculation.

Measuring flatness

You can use relative power measurements to measure flatness (pre-emphasis) in a WDM system. Simply select one carrier as the reference and measure the remaining carriers relative to the reference level. The power differences represent the system flatness.

Press *RESET* to turn off the delta calculations so that all responses are shown in absolute wavelength and powers.

To measure flatness

1 Press the front-panel Preset key.

2 Press List by Power.

This lists the input signals by power with the largest response listed first.

3 Press the Delta On key.

4 Select Δ PWR.

5 Use the \uparrow and \downarrow softkeys to select the first laser line.

6 Press *SELECT*.

7 Since the largest power signal is the reference, the relative power measurements for the other responses shows system flatness.

Measuring Laser Drift

In this section, you'll learn how the Agilent 86120C can be used to monitor drift (changes to a laser's wavelength and amplitude over time). Drift is measured simultaneously for every laser line that is identified at the input. The Agilent 86120C keeps track of each laser line's initial, current, minimum, and maximum values and displays their differences relative to itself. This allows the Agilent 86120C to be used for laser transmitter evaluation, burn-in, or development. In addition, you can monitor system performance over time, temperature, or other condition.

The following display shows power and wavelength drift measured on five laser lines. The DRIFT annotation, item 1, tells you that drift measurements are being performed. The current relative drift values for wavelength and power are shown in items 2 and 3, respectively. Item 4 indicates the absolute reference values for the laser line indicated by the cursor \leftrightarrow . The reference values are measured before the measurement starts.

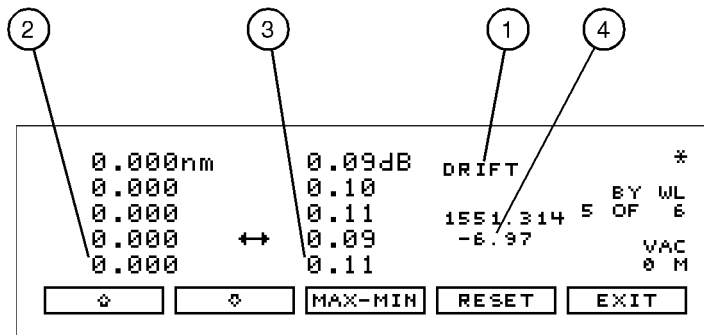

drift

You can restart the drift measurement at any time by pressing the *RESET* softkey. All minimum and maximum values are reset to the reference values, and the Agilent 86120C begins to monitor drift from the current laser line values. Move the cursor up and down the listing to see the reference wavelength and power of each laser line.

If measurement updating stops or the values become blanked

If, in the middle of a measurement, the number of laser lines present changes, the measurement stops until the original number of lines returns. You'll notice that a *CLEAR* softkey appears and one of the following message is displayed:

E46 NUM LINES < NUM REFS

E47 NUM LINES > NUM REFS

To view the data measured before the conditions changed, press *CLEAR* and then *MAX-MIN*. Notice that the measurement acquisition is changed from continuous to single.

To restart testing, press *CLEAR*, the *CONT* key, and then *RESET* to use the new number of lines as the reference. Pressing *CONT* restarts continuous measurement acquisition. Or, you can restore the original number of lines on the input so that the drift measurement can continue.

To measure drift

- 1 Press the front-panel Preset key.
- 2 Press Peak WL, List by WL, or List by Power to select the display style for observing drift.
- 3 Press Appl's and then *DRIFT*.

Pressing *DRIFT* sets the current laser-line values as the reference from which to compare all drift.

- 4 Press *MAX-MIN* for the desired type of drift measurement as described in the following paragraphs:

MAX-MIN

Display shows the current values of laser lines relative to the wavelength and power values measured when the test was begun or the *RESET* softkey was pressed.

MAX-MIN

Display shows absolute maximum values since the drift measurement was started. This measurement gives the *longest* wavelength and *greatest* power measured. The laser line of interest may have since drifted to a lesser value. Note that the

Making Measurements

Measuring Laser Drift



maximum wavelength and maximum power may not have occurred simultaneously.

MAX-MIN

Display shows absolute minimum values since the drift measurement was started. This measurement gives the *shortest* wavelength and *smallest* power measured. The laser line of interest may have since drifted to a greater value. Note that the minimum wavelength and minimum power may not have occurred simultaneously.

MAX-MIN

Display shows the *total* drift from the reference since the drift measurement was started. Values represent the minimum wavelength and power drift values subtracted from the maximum drift values.

- 5 In the List by WL and List by Power displays, use the  and  softkeys to view the reference values (wavelength and power values of each laser line before the test was started).

During the measurement, you can change the display mode to Peak WL, List by WL, List by Power, or Avg WL. When List by WL or List by Power is selected, the signal list is sorted by reference values and not by the current, maximum, or minimum values.

To restart the drift measurements, press *RESET*. This resets the reference values.

Measuring Signal-to-Noise Ratios

Signal-to-noise measurements provide a direct indication of system performance. Signal-to-noise measurements are especially important in WDM systems because there is a direct relation between signal-to-noise and bit error rate. The Agilent 86120C displays signal-to-noise measurements in the third column. For example, the selected signal in the following figure has a signal-to-noise ratio of 30.0 dB.

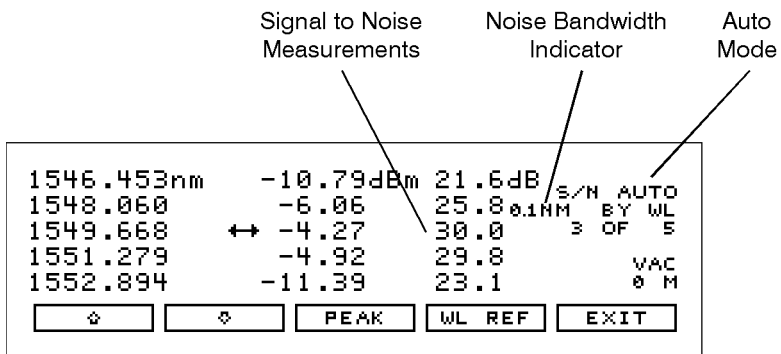

Signal-to-noise display.

During a signal-to-noise measurement, the absolute power of the carrier, in dBm, is compared to the absolute power of the noise at the carrier wavelength. See the following figure. The noise power at the carrier must be determined by interpolation because the carrier, in most cases, can not or should not be turned off.

You can select one of two methods used to determine the wavelength where the noise is measured: automatic interpolation or a user-entered wavelength. In the figure above, notice that “S/N AUTO” is displayed to indicate that automatic interpolation is selected.

Making Measurements
Measuring Signal-to-Noise Ratios

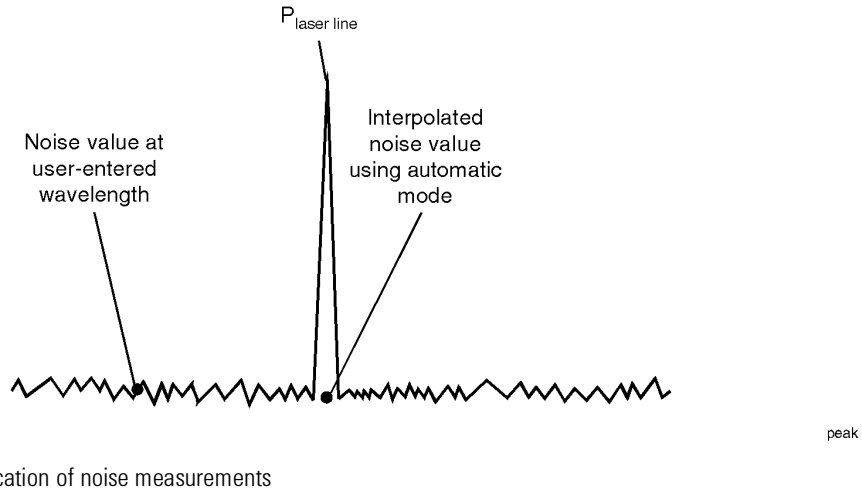

Automatic interpolation

When the signal-to-noise “auto” function is selected, the Agilent 86120C first determines the proximity of any adjacent signal. If the next closest signal is ≤ 200 GHz (approximately 1.6 nm at 1550 nm) away from the signal of interest, then the noise power is measured half way between the two channels and an equal distance to the other side of the signal of interest. See points P_{n1} and P_{n2} in the following figure.

If the closest signal is more than 200 GHz from the signal of interest, or if there is no other signals present, then the noise power is measured at 100 GHz on either side of the signal of interest. The two measured noise power levels are then averaged to estimate the noise power level at the signal wavelength. The noise power measurements use linear interpolation to estimate the noise power level at the signal of interest’s wavelength.

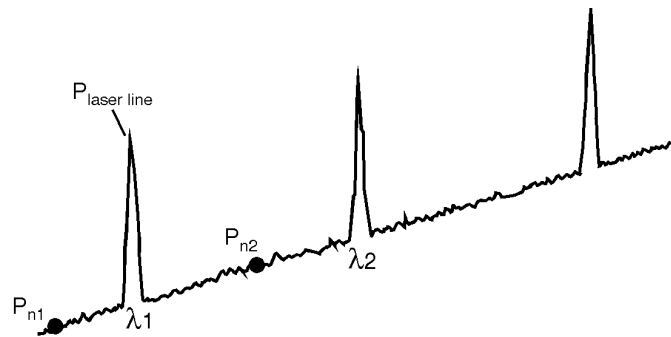

sun

Automatic interpolation

User-entered wavelength

When the signal-to-noise “user” function is selected, the Agilent 86120C uses only one wavelength to measure the noise power for all signals. This wavelength is set by the user and all signals are compared to the noise level at this wavelength to determine their corresponding signal-to-noise ratios.

Noise bandwidth

When measuring noise power, the Agilent 86120C must account for the noise bandwidth used during the measurement. Because noise bandwidth varies with measurement bandwidth (a wide bandwidth allows more noise to the Agilent 86120C’s detector than a narrow bandwidth), the Agilent 86120C normalizes all noise power measurements to a bandwidth of 0.1 nm. The annotation 0.1 nm is displayed to show that the noise bandwidth is being normalized to a 0.1 nm bandwidth.

Repetitive data formats

The Agilent 86120C signal-to-noise application works best when the laser being tested is not modulated, or modulated with non-repetitive data formats. With repetitive data formats, such as PRBS data and SONET formats, there is significant low-frequency amplitude modulation of the laser. This modulation raises the noise floor of the Agilent 86120C significantly. The signal-to-noise measured can be limited to about 15 dB while measuring lasers modulated by repetitive data formats. For improved performance when the laser is modulated with repetitive data formats, use the Signal-to-Noise with Averaging application.

Making Measurements

Measuring Signal-to-Noise Ratios

To measure signal-to-noise

- 1 Press the front-panel Preset key.
- 2 Press List by WL or List by Power.
- 3 Press Appl's and then *S/N*.
- 4 To select the wavelength reference for measuring the noise, do the following steps:
 - a Press *WL REF*, and
 - press *AUTO* to let the instrument interpolate the wavelength,
or
 - press *USER* to select the last wavelength manually entered.
 - b If you chose *USER*, you can specify the wavelength by pressing *USER WL*. Use the **+** softkey to select the digit that requires editing. Use the **↶** and **↷** softkeys to change the value.
 - c Press *RETURN*.
- 5 While the signal-to-noise measurements are displayed, you can press *PEAK* anytime to select the signal with the highest power.

Measuring Signal-to-Noise Ratios with Averaging

When the lasers being measured are modulated, especially with repetitive data formats such as SONET or PRBS, the noise floor is raised. Averaging reduces the noise floor and allows an improvement of greater than 10 dB in a signal-to-noise measurement. In general, averaging will decrease the noise floor caused by modulation until the true optical noise level is reached. The displayed signal-to-noise will improve with each average until the true optical noise level is reached, and then the displayed signal-to-noise will remain approximately constant. If, however, the true signal-to-noise is below the instrument sensitivity of approximately 40 dB (in a 0.1 nm noise bandwidth), it will not be measured.

Averaging can also improve the accuracy of measuring signal-to-noise of unmodulated lasers.

1546.454nm	-10.81dBm	31.7dB	S/N A100
1548.060	-6.06	36.7	0.1NM BY WL
1549.669	↔ -4.28	37.8	3 OF 5
1551.281	-4.94	37.0	VAC
1552.894	-11.22	33.4	0 M
<input type="checkbox"/>	<input type="checkbox"/>	PEAK	NUM AVG
<input type="checkbox"/>	<input type="checkbox"/>	EXIT	

Signal-to-noise with averaging display.

Averaging is performed on the noise, not on the wavelength or power of the laser signals.

The signal-to-noise with averaging measurement uses the automatic interpolation method to determine the wavelengths where the noise is measured. See "Measuring Signal-to-Noise Ratios" for a description of automatic interpolation. There is no user-entered wavelength selection in signal-to-noise with averaging.

During a signal-to-noise with averaging measurement, the display indicates

S/N A xx, where A indicates averaging and xx is the number of

Making Measurements

Measuring Signal-to-Noise Ratios with Averaging

averages taken so far. The maximum number of averages is 900, the minimum number of averages is 10, and the default (Preset) value is 100 averages. A measurement with 100 averages takes about 2 minutes to complete. When the measurement is complete, the instrument switches to single measurement mode. Then, pressing the Cont key will start a completely new measurement. During a measurement and before the number of averages has been reached, pressing the Single key will stop the measurement. Then, pressing the Cont key will continue with the current measurement.

While making a signal-to-noise with averaging measurement, the number of averages can be changed. As long as the new number of averages is greater than the number of averages taken so far, the measurement continues. If the new number of averages selected is less than the number of averages taken so far, the measurement stops and the instrument switches to single measurement mode. Then, pressing the Cont key will start a completely new measurement.

Noise bandwidth affects measurement

When measuring noise power, the Agilent 86120C must account for the noise bandwidth used during the measurement. Because noise bandwidth varies with measurement bandwidth (a wide bandwidth allows more noise to the Agilent 86120C's detector than a narrow bandwidth), the Agilent 86120C normalizes all noise power measurements to a bandwidth of 0.1 nm. The annotation 0.10 nm is displayed to show that the noise bandwidth is being normalized to a 0.1 nm bandwidth.

To measure signal-to-noise with averaging

- 1 Press the front panel Preset key.
- 2 Press *List by WL* or *List by Power*.
- 3 Press *Appl's* and then *S/NAVG*.
- 4 To change the number of averages, press *NUMAVG*. The default (Preset) value is 100.
- 5 To stop the measurement at the current number of averages shown, press the Single key. Then press the Cont key to continue the present measurement.
- 6 When the measurement is complete, the instrument will switch to the single measurement mode and stop.
- 7 To make a new measurement, press the Cont key.
- 8 To exit, press the *EXIT* softkey, then press the Cont key for continuous measurement.

Measuring Fabry-Perot (FP) Lasers

The Agilent 86120C can perform several measurements on Fabry-Perot lasers including FWHM and mode spacing. The display shows the measurement results in the selected wavelength and amplitude units. In addition, the mode spacing measurement always shows results in frequency as well as the selected wavelength units. Refer to “Displayed units” on page 2-12 to learn how to change the units. The number of laser lines included in the measurement results is also listed as shown in the following figure.

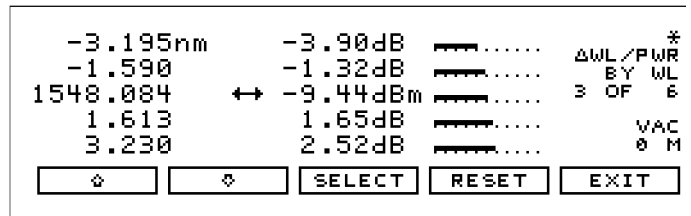

To characterize a Fabry-Perot laser

- 1 Press Appl's.
- 2 Press *FP TEST* to measure the Fabry-Perot laser's characteristics.

If you want to stop the updating of measurement data with each sweep, press Single. Because Fabry-Perot lasers are sensitive to reflections it is good measurement practice to place an optical isolator or attenuator between the laser and the Agilent 86120C.

Making Measurements

Measuring Fabry-Perot (FP) Lasers

<u>Measurement</u>	<u>Description</u>
FWHM	<p>FWHM (full width at half maximum) describes the spectral width of the half-power points of the laser, assuming a continuous, Gaussian power distribution. The half-power points are those where the power spectral density is one-half that of the peak amplitude of the computed Gaussian curve.</p> $\text{FWHM} = 2.355 \sigma$ <p>where, σ is sigma as defined below.</p>
MEAN	<p>The wavelength representing the center of mass of selected peaks. The power and wavelength of each spectral component are used to calculate the mean wavelength.</p> $\text{MeanWavelength} = \sum_{i=1}^N P_i \left(\frac{\lambda_i}{P_o} \right)$ <p>where, P_o is total power as defined in this section.</p>
MODE	<p>The mean wavelength spacing between the individual spectral components of the laser.</p>
PEAK	<p>The power level of the peak spectral component of the laser. The wavelength of the peak spectral component.</p>
SIGMA	<p>An rms calculation of the spectral width of the laser based on a Gaussian distribution. The power and wavelength of each spectral component is used to calculate mean wavelength.</p>

$$\sigma = \sqrt{\sum_{i=1}^N P_i \frac{(\lambda_i - \bar{\lambda})^2}{P_o}}$$

where:

$\bar{\lambda}$ is the mean wavelength as defined above.

P_i is the power of a single peak.

P_o is total power as defined in this section.

PWR The summation of the power in each of the selected peaks, or modes, that satisfy the peak-excursion and peak-threshold criteria.

$$Total\ Power = \sum_{i=1}^N P_i$$

The peak excursion and peak threshold settings define the laser modes included in the measurement. Because the default peak excursion value is 10 dB, measurement results normally include all laser modes within 10 dB of the peak response. Use the *PK THLD* softkey to change the number of laser modes used in the measurements. Refer to “Defining Laser-Line Peaks” on page 2-15 for information on the peak threshold and peak excursion settings.

The peak excursion value (in dB) can also be used to determine which side modes are included in the measurements. To be accepted, each trace peak must rise, and then fall, by at least the peak excursion value about a given spectral component. Setting the peak-excursion value too high results in failure to include the smaller responses near the noise floor. Setting the value too low may cause unwanted responses, including noise spikes, to be identified. Use *PK EXC* to change the peak excursion value.

Measuring Modulated Lasers

A laser that is amplitude modulated at low frequencies (for example, modulated in the audio frequency range) can cause spurious wavelengths to be displayed below and above the correct wavelength. The power of these spurious wavelengths is below that of the correct wavelength. These spurious signals can be eliminated by decreasing the peak threshold. Refer to “Defining Laser-Line Peaks” on page 2-15. Even when the laser is amplitude modulated, the correct wavelength and power is displayed.

The spurious wavelengths caused by low frequency amplitude modulation will be located above and below the correct wavelength by the following wavelength spacing:

$$spacing = 6 \times 10^{-10} F \lambda^2$$

where F is the modulation frequency in Hz, and λ is the correct wavelength in nm. For example, an amplitude modulation of 10 kHz on a 1550 nm laser will produce spurious wavelengths spaced by 15 nm from the correct wavelength, and the spurious wavelengths will be at 1535 and 1565 nm.

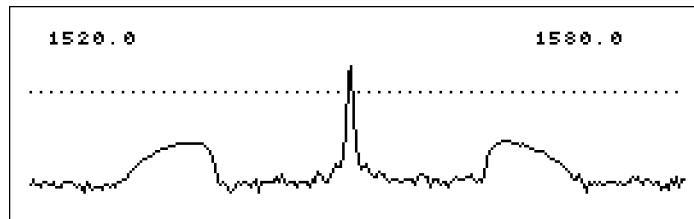

Low frequency (10 kHz) AM modulation graph showing rounded sideband spurs.

The graphical display is useful for locating these spurious wavelengths. Their amplitude will be below that of the correct wavelength and they will be broad, rounded peaks compared to the sharp peak of the correct wavelength. Use the Peak Threshold function to place the dotted line above the spurious peaks so they will not be displayed in the List by WL or List by Power table.

A laser modulated at high frequency (in the RF or microwave range) can also cause spurious wavelengths to be displayed, especially when the modulation is of a repetitive nature such as that of PRBS or SONET digital formats. In general, no spurious wavelengths will be displayed using preset instrument conditions. The preset condition includes peak excursion, peak threshold, and wavelength range limiting. However, increasing peak threshold can cause spurious wavelengths to be displayed.

Even when the laser being tested is modulated with repetitive formats, the carrier's correct wavelength and power is displayed; the wavelength and power of the spurious sidebands are incorrect.

The graphical display is useful to see the effects of high frequency modulation. Without modulation, the noise floor is typically 45 dB below the laser power. In general, high frequency modulation will raise the noise floor to about 25 dB below the laser power. The noise floor is typically flat, or white. The actual level of the noise floor depends on the type of data format and the data rate.



PRBS modulation graph showing raised noise floor.

Measuring Total Power Greater than 10 dBm

The maximum total power that can be measured by the Agilent 86120C is 10 dBm. However, with the addition of an external attenuator, more power can be applied. This may be necessary at the transmit end of a wavelength-division-multiplexed system where large signal levels are present. By entering an amplitude offset equal to the amount of attenuation at the instrument's input, accurate amplitude measurements are shown on the display. Additional amplification can also be accounted for.

CAUTION

The maximum total input power that can be applied to the Agilent 86120C before damage occurs is 18 dBm. The maximum total input power that can be measured is 10 dBm.

To measure total power exceeding 10 dBm

- 1 Connect an optical attenuator between the front-panel OPTICAL INPUT connector and the fiber-optic cable.

The attenuator must reduce the total input power to the Agilent 86120C so that it is below +10 dBm.

- 2 Press Setup, *MORE*, *CAL*, and then *PWR OFS*.

Notice that the *PWR OFS* annotation appears on the screen to indicate an offset is applied.

- 3 Use the **+** softkey to select the digit that requires editing.
- 4 Use the **↶** and **↷** softkeys to change the value.

Power offset values are added to the display power readings. For example, if you placed a 10 dB attenuator on the front-panel connector, enter a power offset value of +10 dB. Negative values can also be entered if you connect an amplifier instead of an attenuator.

Calibrating Measurements

The wavelength of light changes depending on the material that the light is passing through. To display meaningful wavelength measurements, the Agilent 86120C performs two steps:

- 1 Measures the wavelength in air.
- 2 Converts the wavelength to show values in either a vacuum or “standard air”.

For example, a laser line with a wavelength of 1550.000 nm in a vacuum would have a wavelength in standard air of 1549.577 nm.

Because all measurements made inside the Agilent 86120C are performed in air, the density of air, due to elevation, affects the wavelength results. You must calibrate the Agilent 86120C by entering the elevation. Elevations from 0 to 5000 meters can be entered. The elevation correction is immediately applied to the current measurement even if the instrument is in the single measurement acquisition mode.

Annotation on the display shows the current calibration elevation in meters and whether the wavelength measurements are shown for a vacuum (VAC) or standard air (STD AIR).

If you select frequency instead of wavelength measurements, switching between vacuum and standard air will not affect the measurement results. This is because the frequency of an optical signal does not change in different mediums—only the wavelength changes.

Definition of standard air

Standard air is defined to have the following characteristics:

Barometric pressure: 1013 mbar
Temperature: 15°C
Relative humidity: 0%

Making Measurements
Calibrating Measurements

To enter the elevation

- 1 Press the Setup key.
- 2 Press the *MORE* softkey.
- 3 Press the *CAL* softkey.
- 4 Press *ELEV*.
- 5 Use the \uparrow and \downarrow softkeys to enter the elevation in meters. Entries jump in 500 meter steps from 0 m to 5000 m.

In order for the Agilent 86120C to meet its published specifications, the elevation value selected with the softkeys must be within 250 meters of the actual elevation.

- 6 Press *RETURN* to complete the entry.

Converting feet to meters

If you know your elevation in feet, you can convert this value to meters by using the following equation:

$$m = \frac{ft}{3,281}$$

To select the medium for light

- 1 Press the Setup key.
- 2 Press the *MORE* softkey.
- 3 Press the *CAL* softkey, and make the following selection:
 - Press *VACUUM* for wavelengths in a vacuum.
 - Press *STD AIR* for wavelengths in standard air.
- 4 Press *RETURN* to complete the entry.

Printing Measurement Results

Measurement results can be sent directly to a printer. Simply connect a compatible printer to the rear-panel PARALLEL PRINTER PORT connector. The output is ASCII text. An example of a compatible printer is Hewlett-Packard's LaserJet¹ series printer. Be sure to use a parallel printer cable to connect the printer.

The printer output is not a copy of the display. Rather, it is a listing of all signals present at the input (up to 200). The measurement values printed depend on the settings of the instrument when the Print key is pressed. The following is an example of a typical printout:

```
Agilent 86120C SER US39400020
Firmware Ver. 1.000
List By Wavelength
8 Lines
Power Offset 0.0 dB
Vacuum
Elevation 0 Meters
Update Normal
Peak Excursion 15 dB
Peak Threshold 10 dB
Device Narrow
```

```
Input
Wavelength      Power
1280.384nm     -16.97dBm
1281.473       -13.14
1282.569       -13.92
1283.651       -13.34
1284.752       -11.69
1285.840       -8.11
1286.944       -10.38
1288.034       -14.65
```

To create a hardcopy

- 1 Connect the printer to the Agilent 86120C's rear-panel PARALLEL PRINTER PORT connector.
- 2 Press Print. You can use the *ABORT* and *CONT* softkey to stop and restart a print job that is in progress.

1. Hewlett-Packard and LaserJet are registered trademarks of Hewlett-Packard Company.

Cleaning Connections for Accurate Measurements

Today, advances in measurement capabilities make connectors and connection techniques more important than ever. Damage to the connectors on calibration and verification devices, test ports, cables, and other devices can degrade measurement accuracy and damage instruments. Replacing a damaged connector can cost thousands of dollars, not to mention lost time! This expense can be avoided by observing the simple precautions presented in this book. This book also contains a brief list of tips for caring for electrical connectors.

Choosing the Right Connector

A critical but often overlooked factor in making a good lightwave measurement is the selection of the fiber-optic connector. The differences in connector types are mainly in the mechanical assembly that holds the ferrule in position against another identical ferrule. Connectors also vary in the polish, curve, and concentricity of the core within the cladding. Mating one style of cable to another requires an adapter. Agilent Technologies offers adapters for most instruments to allow testing with many different cables. [Figure 2-3 on page 2-41](#) shows the basic components of a typical connectors.

The system tolerance for reflection and insertion loss must be known when selecting a connector from the wide variety of currently available connectors. Some items to consider when selecting a connector are:

- How much insertion loss can be allowed?
- Will the connector need to make multiple connections? Some connectors are better than others, and some are very poor for making repeated connections.
- What is the reflection tolerance? Can the system take reflection degradation?

Cleaning Connections for Accurate Measurements

- Is an instrument-grade connector with a precision core alignment required?
- Is repeatability tolerance for reflection and loss important? Do your specifications take repeatability uncertainty into account?
- Will a connector degrade the return loss too much, or will a fusion splice be required? For example, many DFB lasers cannot operate with reflections from connectors. Often as much as 90 dB isolation is needed.

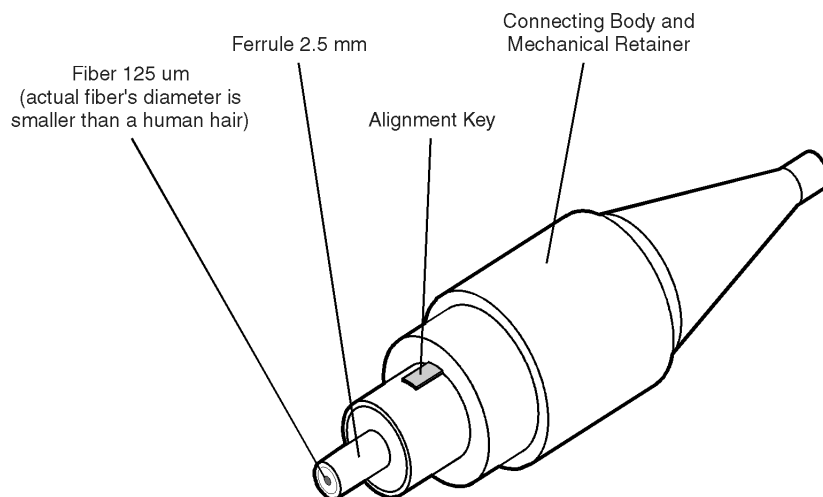

Figure 2-3. Basic components of a connector.

Over the last few years, the FC/PC style connector has emerged as the most popular connector for fiber-optic applications. While not the highest performing connector, it represents a good compromise between performance, reliability, and cost. If properly maintained and cleaned, this connector can withstand many repeated connections.

However, many instrument specifications require tighter tolerances than most connectors, including the FC/PC style, can deliver. These instruments cannot tolerate connectors with the large non-concentricities of the fiber common with ceramic style ferrules. When tighter alignment is required, Agilent Technologies instruments typically use a connector such as the Diamond HMS-10, which has concentric tolerances within a few tenths of a micron. Agilent Technologies then uses a special universal adapter, which allows other cable types to mate with this precision connector. See [Figure 2-4](#).

Making Measurements

Cleaning Connections for Accurate Measurements



Figure 2-4. Universal adapters to Diamond HMS-10.

The HMS-10 encases the fiber within a soft nickel silver (Cu/Ni/Zn) center which is surrounded by a tough tungsten carbide casing, as shown in [Figure 2-5](#).

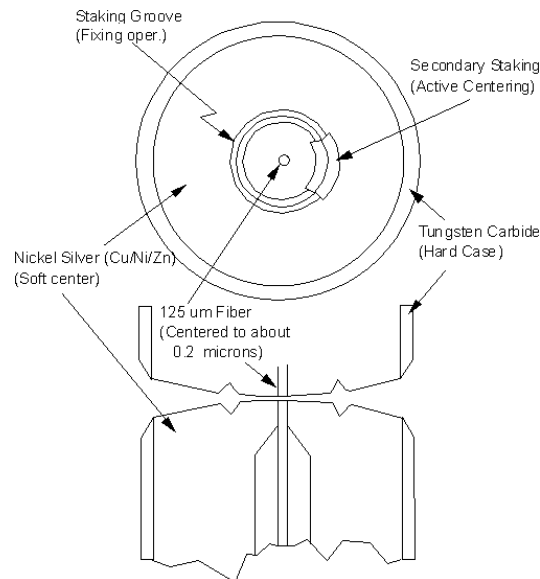

Figure 2-5. Cross-section of the Diamond HMS-10 connector.

The nickel silver allows an active centering process that permits the glass fiber to be moved to the desired position. This process first stakes the soft nickel silver to fix the fiber in a near-center location, then uses a post-active staking to shift the fiber into the desired position within 0.2 μm . This process, plus the keyed axis, allows very precise core-to-core alignments. This connector is found on most Agilent Technologies lightwave instruments.

The soft core, while allowing precise centering, is also the chief liability of the connector. The soft material is easily damaged. Care must be taken to minimize excessive scratching and wear. While minor wear is not a problem if the glass face is not affected, scratches or grit can cause the glass fiber to move out of alignment. Also, if unkeyed connectors are used, the nickel silver can be pushed onto the glass surface. Scratches, fiber movement, or glass contamination will cause loss of signal and increased reflections, resulting in poor return loss.

Inspecting Connectors

Because fiber-optic connectors are susceptible to damage that is not immediately obvious to the naked eye, poor measurements result without the user being aware. Microscopic examination and return loss measurements are the best way to ensure good measurements. Good cleaning practices can help ensure that optimum connector performance is maintained. With glass-to-glass interfaces, any degradation of a ferrule or the end of the fiber, any stray particles, or finger oil can have a significant effect on connector performance. Where many repeat connections are required, use of a connector saver or patch cable is recommended.

Figure 2-6 shows the end of a clean fiber-optic cable. The dark circle in the center of the micrograph is the fiber's 125 μm core and cladding which carries the light. The surrounding area is the soft nickel-silver ferrule. **Figure 2-7** shows a dirty fiber end from neglect or perhaps improper cleaning. Material is smeared and ground into the end of the fiber causing light scattering and poor reflection. Not only is the precision polish lost, but this action can grind off the glass face and destroy the connector.

Figure 2-8 shows physical damage to the glass fiber end caused by either repeated connections made without removing loose particles or using improper cleaning tools. When severe, the damage of one connector end can be transferred to another good connector endface that comes in contact with the damaged one. Periodic checks of fiber ends, and replacing connecting cables after many connections is a wise practice.

The cure for these problems is disciplined connector care as described in the following list and in [“Cleaning Connectors” on page 2-47](#).

Making Measurements

Cleaning Connections for Accurate Measurements

Use the following guidelines to achieve the best possible performance when making measurements on a fiber-optic system:

- Never use metal or sharp objects to clean a connector and never scrape the connector.
- Avoid matching gel and oils.

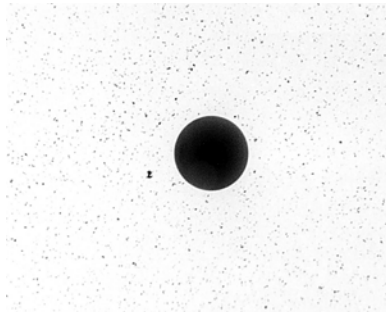

Figure 2-6. Clean, problem-free fiber end and ferrule.

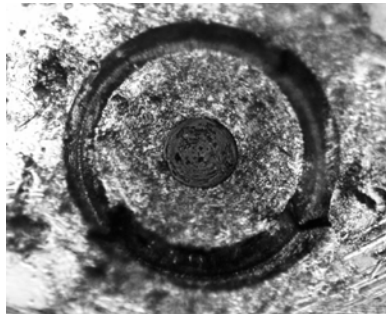

Figure 2-7. Dirty fiber end and ferrule from poor cleaning.

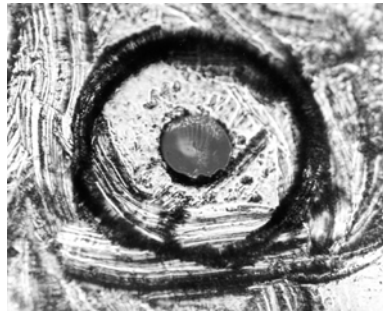

Figure 2-8. Damage from improper cleaning.

While these often work well on first insertion, they are great dirt magnets. The oil or gel grabs and holds grit that is then ground into the end of the fiber. Also, some early gels were designed for use with the FC, non-contacting connectors, using small glass spheres. When used with contacting connectors, these glass balls can scratch and pit the fiber. If an index matching gel or oil must be used, apply it to a freshly cleaned connector, make the measurement, and then immediately clean it off. Never use a gel for longer-term connections and never use it to improve a damaged connector. The gel can mask the extent of damage and continued use of a damaged fiber can transfer damage to the instrument.

- When inserting a fiber-optic cable into a connector, gently insert it in as straight a line as possible. Tipping and inserting at an angle can scrape material off the inside of the connector or even break the inside sleeve of connectors made with ceramic material.
- When inserting a fiber-optic connector into a connector, make sure that the fiber end does not touch the outside of the mating connector or adapter.
- Avoid over tightening connections.

Unlike common electrical connections, tighter is *not* better. The purpose of the connector is to bring two fiber ends together. Once they touch, tightening only causes a greater force to be applied to the delicate fibers. With connectors that have a convex fiber end, the end can be pushed off-axis resulting in misalignment and excessive return loss. Many measurements are actually improved by backing off the connec-

Cleaning Connections for Accurate Measurements

tor pressure. Also, if a piece of grit does happen to get by the cleaning procedure, the tighter connection is more likely to damage the glass. Tighten the connectors just until the two fibers touch.

- Keep connectors covered when not in use.
- Use fusion splices on the more permanent critical nodes. Choose the best connector possible. Replace connecting cables regularly. Frequently measure the return loss of the connector to check for degradation, and clean every connector, every time.

All connectors should be treated like the high-quality lens of a good camera. The weak link in instrument and system reliability is often the inappropriate use and care of the connector. Because current connectors are so easy to use, there tends to be reduced vigilance in connector care and cleaning. It takes only one missed cleaning for a piece of grit to permanently damage the glass and ruin the connector.

Measuring insertion loss and return loss

Consistent measurements with your lightwave equipment are a good indication that you have good connections. Since return loss and insertion loss are key factors in determining optical connector performance they can be used to determine connector degradation. A smooth, polished fiber end should produce a good return-loss measurement. The quality of the polish establishes the difference between the “PC” (physical contact) and the “Super PC” connectors. Most connectors today are physical contact which make glass-to-glass connections, therefore it is critical that the area around the glass core be clean and free of scratches. Although the major area of a connector, excluding the glass, may show scratches and wear, if the glass has maintained its polished smoothness, the connector can still provide a good low level return loss connection.

If you test your cables and accessories for insertion loss and return loss upon receipt, and retain the measured data for comparison, you will be able to tell in the future if any degradation has occurred. Typical values are less than 0.5 dB of loss, and sometimes as little as 0.1 dB of loss with high performance connectors. Return loss is a measure of reflection: the less reflection the better (the larger the return loss, the smaller the reflection). The best physically contacting connectors have return losses better than 50 dB, although 30 to 40 dB is more common.

Visual inspection of fiber ends

Visual inspection of fiber ends can be helpful. Contamination or imperfections on the cable end face can be detected as well as cracks or chips in the fiber itself. Use a microscope (100X to 200X magnification) to inspect the entire end face for contamination, raised metal, or dents in the metal as well as any other imperfections. Inspect the fiber for cracks and chips. Visible imperfections not touching the fiber core may not affect performance (unless the imperfections keep the fibers from contacting).

WARNING

Always remove both ends of fiber-optic cables from any instrument, system, or device before visually inspecting the fiber ends. Disable all optical sources before disconnecting fiber-optic cables. Failure to do so may result in permanent injury to your eyes.

Cleaning Connectors

The procedures in this section provide the proper steps for cleaning fiber-optic cables and Agilent Technologies universal adapters. The initial cleaning, using the alcohol as a solvent, gently removes any grit and oil. If a caked-on layer of material is still present, (this can happen if the beryllium-copper sides of the ferrule retainer get scraped and deposited on the end of the fiber during insertion of the cable), a second cleaning should be performed. It is not uncommon for a cable or connector to require more than one cleaning.

Cleaning Connections for Accurate Measurements

CAUTION

Agilent Technologies strongly recommends that index matching compounds *not* be applied to their instruments and accessories. Some compounds, such as gels, may be difficult to remove and can contain damaging particulates. If you think the use of such compounds is necessary, refer to the compound manufacturer for information on application and cleaning procedures.

Table 2-2. Cleaning Accessories

Item	Agilent Part Number
Any commercially available denatured alcohol	—
Cotton swabs	5080-5400

Table 2-3. Dust Caps Provided with Lightwave Instruments

Item	Agilent Part Number
FC/PC dust cap	08154-44102
DIN dust cap	08154-44103
HMS10/dust cap	08154-44101

To clean a non-lensed connector

CAUTION

Do not use any type of foam swab to clean optical fiber ends. Foam swabs can leave filmy deposits on fiber ends that can degrade performance.

- 1 Apply pure isopropyl alcohol to a clean lint-free cotton swab or lens paper.

Cotton swabs can be used as long as no cotton fibers remain on the fiber end after cleaning.

- 2 Clean the ferrules and other parts of the connector while avoiding the end of the fiber.
- 3 Apply isopropyl alcohol to a new clean lint-free cotton swab or lens

paper.

- 4 Clean the fiber end with the swab or lens paper.

Do *not* scrub during this initial cleaning because grit can be caught in the swab and become a gouging element.

- 5 Immediately dry the fiber end with a clean, dry, lint-free cotton swab or lens paper.
- 6 Blow across the connector end face from a distance of 6 to 8 inches using filtered, dry, compressed air. Aim the compressed air at a shallow angle to the fiber end face.

Nitrogen gas or compressed dust remover can also be used.

CAUTION

Do not shake, tip, or invert compressed air canisters, because this releases particles in the can into the air. Refer to instructions provided on the compressed air canister.

- 7 As soon as the connector is dry, connect or cover it for later use.

If the performance, after the initial cleaning, seems poor try cleaning the connector again. Often a second cleaning will restore proper performance. The second cleaning should be more arduous with a scrubbing action.

To clean an adapter

The fiber-optic input and output connectors on many Agilent Technologies instruments employ a universal adapter such as those shown in the following picture. These adapters allow you to connect the instrument to different types of fiber-optic cables.



Figure 2-9. Universal adapters.

- 1 Apply isopropyl alcohol to a clean foam swab.

Cotton swabs can be used as long as no cotton fibers remain after cleaning. The foam swabs listed in this section's introduction are small enough to fit into adapters.

Making Measurements

Cleaning Connections for Accurate Measurements

Although foam swabs can leave filmy deposits, these deposits are very thin, and the risk of other contamination buildup on the inside of adapters greatly outweighs the risk of contamination by foam swabs.

- 2 Clean the adapter with the foam swab.
- 3 Dry the inside of the adapter with a clean, dry, foam swab.
- 4 Blow through the adapter using filtered, dry, compressed air.

Nitrogen gas or compressed dust remover can also be used. Do not shake, tip, or invert compressed air canisters, because this releases particles in the can into the air. Refer to instructions provided on the compressed air canister.

3

Addressing and Initializing the Instrument	3-3
To change the GPIB address	3-4
Making Measurements	3-5
Commands are grouped in subsystems	3-7
Measurement instructions give quick results	3-9
The format of returned data	3-15
Monitoring the Instrument	3-16
Status registers	3-17
Queues	3-22
Reviewing SCPI Syntax Rules	3-23
Example Programs	3-28
Example 1. Measure a DFB laser	3-30
Example 2. Measure WDM channels	3-32
Example 3. Measure WDM channel drift	3-34
Example 4. Measure WDM channel separation	3-37
Example 5. Measure signal-to-noise ratio of each WDM channel	3-39
Example 6. Increase a source's wavelength accuracy	3-41
Lists of Commands	3-43

Programming



Programming

This chapter explains how to program the Agilent 86120C. The programming syntax conforms to the IEEE 488.2 Standard Digital Interface for Programmable Instrumentation and to the Standard Commands for Programmable Instruments (SCPI).

Where to begin...

The programming examples for individual commands in this manual are written in HP¹ BASIC 6.0 for an HP 9000 Series 200/300 Controller.

For more detailed information regarding the GPIB, the IEEE 488.2 standard, or the SCPI standard, refer to the following books:

Hewlett-Packard Company. *Tutorial Description of Hewlett-Packard Interface Bus*, 1987.

Hewlett-Packard Company. *SCPI—Standard Commands for Programmable Instruments*, 1995.

International Institute of Electrical and Electronics Engineers. *IEEE Standard 488.1-1987, IEEE Standard Digital Interface for Programmable Instrumentation*. New York, NY, 1987.

International Institute of Electrical and Electronics Engineers. *IEEE Standard 488.2-1987, IEEE Standard Codes, Formats, Protocols and Common commands For Use with ANSI/IEEE Std 488.1-1987*. New York, NY, 1987.

Types of commands

The Agilent 86120C responds to three types of commands:

- Common commands
- Measurement instructions
- Subsystem commands

All of these commands are documented in [Chapter 4, “Programming Commands”](#).

1. HP is a registered trademark of Hewlett-Packard Company.

Addressing and Initializing the Instrument

The Agilent 86120C's GPIB address is configured at the factory to a value of 20. You must set the output and input functions of your programming language to send the commands to this address. You can change the GPIB address from the front panel as described in [“To change the GPIB address” on page 3-4](#).

Remote mode and front-panel lockout

Whenever the instrument is controlled by a computer, the `Remote` message is displayed on the instrument's screen and the softkey menu is blanked except for the `LOCAL` softkey. This softkey can be pressed by the user to restore front panel control of the instrument.

You can specify a local lockout mode that prevents the `LOCAL` softkey from being displayed. If the instrument is in local lockout mode, all the softkeys may be blanked. For example, if the instrument is first placed in local lockout mode and then placed in remote mode, no softkeys are displayed.

Consult the documentation for your programming environment to determine which commands are used to put an instrument in the remote and local lockout modes. These are not Agilent 86120C commands; they control GPIB control lines and do not send any characters to the Agilent 86120C.

Initialize the instrument at start of every program

It is good practice to initialize the instrument at the start of every program. This ensures that the bus and all appropriate interfaces are in a known state. HP BASIC provides a `CLEAR` command which clears the interface buffer and also resets the instrument's parser. (The parser is the program that reads the instructions that you send.) Whenever the instrument is under remote programming control, it should be in the single measurement acquisition mode. This is automatically accomplished when the `*RST` common command is used. The `*RST` command initializes the instrument to a preset state:

```
CLEAR 720  
OUTPUT 720;”*RST”
```

Programming



Addressing and Initializing the Instrument

Notice in the example above, that the commands are sent to an instrument address of 720. This indicates address 20 on an interface with select code 7. Pressing the green Preset key does not change the GPIB address.

Set single acquisition mode

An advantage of using the *RST command is that it sets the Agilent 86120C into the single measurement acquisition mode. Because the READ and MEASure data queries expect this mode, their proper operation is ensured.

To change the GPIB address

- 1 Press the Setup key.
- 2 Press *MORE* twice, then *GPIB*.
- 3 Use the  and  softkeys to change the GPIB address.
- 4 Press *RETURN*.

Making Measurements

Making measurements remotely involves changing the Agilent 86120C's settings, performing a measurement, and then returning the data to the computer. The simplified block diagram of the Agilent 86120C shown here lists some of the available programming commands. Each command is placed next to the instrument section it configures or queries data from.

Notice that there are two buffers from which data can be queried: an uncorrected data buffer and a corrected data buffer. With each scan of the input wavelength range, the analog-to-digital converter loads 65,536 data values into the uncorrected data buffer. This is considered to be one "measurement". A fast-update measurement mode is available for quicker measurement acquisition. But, because only 32,768 data values are collected in fast-update measurement mode, the ability to resolve closely spaced signals is reduced.

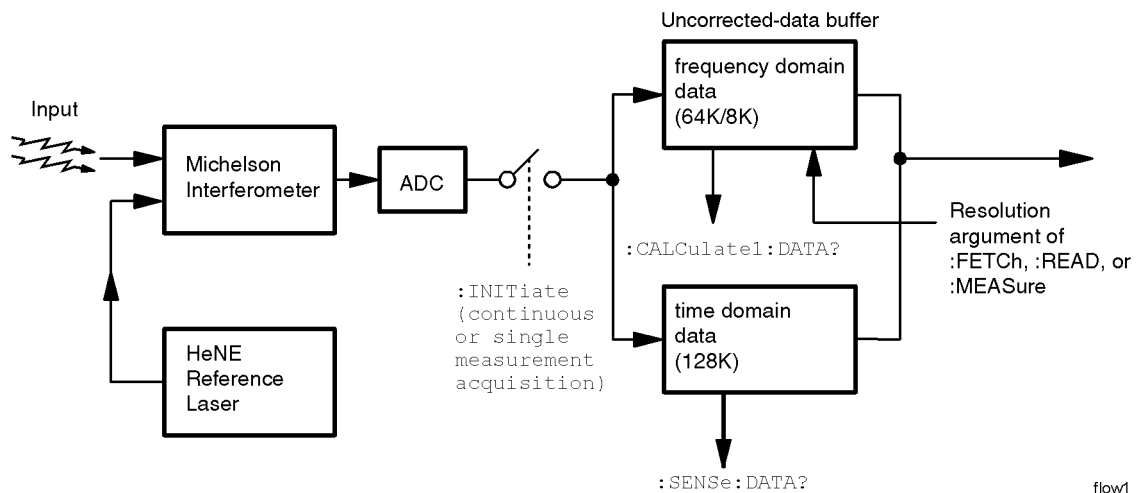

Programming
Making Measurements

After collecting the uncorrected data, the Agilent 86120C searches the data for the first 200 peak responses. (For WLIMit:OFF, searching starts at 1650 nm and progresses towards 1270 nm. For WLIMit:ON, searching starts at WLIMit:START and progresses toward WLIMit:STOP.) These peak values are then placed into the corrected data buffer. Each peak value consists of an amplitude and wavelength measurement. Amplitude and wavelength correction factors are applied to this data.

For a listing of the programming commands (including a cross reference to front-panel keys), refer to the following tables:

- [Table 3-10, “Programming Commands,” on page 3-43](#)
- [Table 3-11, “Keys Versus Commands,” on page 3-48](#)

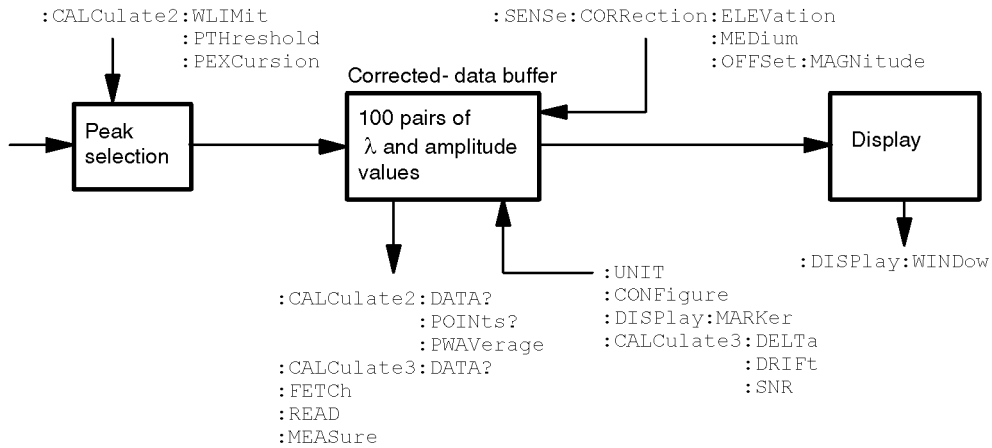

flow2

Commands are grouped in subsystems

The Agilent 86120C commands are grouped in the following subsystems. You'll find a description of each command in [Chapter 4, "Programming Commands"](#).

<u>Subsystem</u>	<u>Purpose of Commands</u>
Measurement Instructions	Perform frequency, wavelength, and wavenumber measurements.
CALCulate1	Queries <i>uncorrected</i> frequency-spectrum data.
CALCulate2	Queries <i>corrected</i> peak data and sets wavelength limits.
CALCulate3	Performs delta, drift, signal-to-noise, and Fabry-Perot measurements.
DISPlay	Applies markers and displays power bars.
HCOPY	Prints measurement results.
SENSe	Sets elevation-correction values, selects readings for air or vacuum, and enters amplitude offsets. Queries time-domain values of the input data.
STATus	Queries instrument status registers.
SYSTem	Presets Agilent 86120C and queries error messages.
TRIGger	Stops current measurement. Acquires new measurement data. Also used to select single or continuous acquisition of measurement data.
UNIT	Sets the amplitude units to watts or dBm.

[Table 2-4 on page 3-8](#) shows the kinds of measurements that the Agilent 86120C can perform and the associated programming commands used to return that data. In some cases, there is more than one method that can be used to obtain the desired data. Refer to [Chapter 4, "Programming Commands"](#) for the correct syntax for these commands.

Programming
Making Measurements

Table 2-4. Commands for Capturing Data

Desired Measurement	Command to Configure Measurement (partial listing)	Command to Query Data
Wavelength (nm)	CONFigure, FETCh, READ, and MEASure	MEASure:ARRay:POWer:WAVelengt h?
Frequency (THz)	CONFigure, FETCh, READ, and MEASure	MEASure:ARRay:POWer:FREQuency ?
Wavenumber (m ⁻¹)	CONFigure, FETCh, READ, and MEASure	MEASure:ARRay:POWer:WNUMber?
Power (W, dBm)	CONFigure, FETCh, READ, and MEASure	MEASure:ARRay:POWer?
Average Wavelength, Wavenumber, or Frequency	CALCulate2:PWAVerage:STATe	CALCulate2:DATA?
Total Power (W, dBm)	CALCulate2:PWAVerage:STATe	CALCulate2:DATA?
Fabry-Perot Laser	CALCulate3:FPERot	Refer to “FPERot[::STATE]” on page 4-62
Laser-Line Separation	CALCulate3:DELTA:REFerence	CALCulate3:DATA?
Laser-Line Drift	CALCulate3:DRIFT:STATe	CALCulate3:DATA?
Signal-to-Noise Ratio	CALCulate3:SNR:STATe	CALCulate3:DATA?
Signal-to-Noise Ratio Average	CALCulate3:ASNR:STATe	CALCulate3:DATA?
Time-Domain Data	CALCulate1:TRANSform:FREQuency:POINt s	SENSe:DATA?
Corrected Frequency Domain Data	CALCulate1:TRANSform:FREQuency:POINt s	CALCulate2:DATA?
Uncorrected Frequency Domain Data	CALCulate1:TRANSform:FREQuency:POINt s	CALCulate1:DATA?

Measurement instructions give quick results

The easiest way to measure wavelength, frequency, or power is to use the MEASure command. The MEASure command is one of four measurement instructions: MEASure, READ, FETCh, and CONFIgure. The syntax for measurement instructions is documented in [“Measurement Instructions” on page 4-15](#).

Each measurement instruction has an argument that controls the measurement update rate. This is equivalent to using the *NORMAL* and *FAST* softkeys.

:MEASure command

MEASure configures the Agilent 86120C, captures new data, and queries the data all in one step. For example, to measure the longest wavelength, send the following command:

```
:MEASure:SCALar:POWer:WAVelength? MAX
```

Table 2-5. The Different Forms of MEASure

Desired Measurement Data	Use this MEASure Query	Display Format
Power (W, dBm)	:MEASure:ARRay:POWer?	List by Power
	:MEASure:SCALar:POWer?	single wavelength mode
Frequency (Hz)	:MEASure:ARRay:POWer:FREQuency?	List by WL (<i>frequency</i>)
	:MEASure:SCALar:POWer:FREQuency?	single wavelength mode
Wavelength (m)	MEASure:ARRay:POWer:WAVelength?	List by WL
	MEASure:SCALar:POWer:WAVelength?	single wavelength mode
Wavenumber (m ⁻¹)	:MEASure:ARRay:POWer:WNUMber?	List by WL
	:MEASure:SCALar:POWer:WNUMber?	single wavelength mode

Specifying SCALar places the display in the single wavelength format and returns a single value to the computer. Specifying ARRArray places the display in the List by Power or List by WL modes; an array of data is returned to the computer.

Programming

Making Measurements

A common programming error is to send the :MEASure command when the instrument is in the continuous measurement acquisition mode. Because :MEASure contains an :INIT:IMM command, which expects the single measurement acquisition mode, an error is generated, and the INIT command is ignored.

:READ command

The READ command works like the MEASure command except that it does not configure the instrument's settings. You can use the CONFigure command to configure the instrument for a particular measurement without returning any data.

The MEASure and READ commands are identical to combining the following commands:

<u>Command</u>	<u>Equivalent Commands</u>
:MEASure	:ABORt;:CONFigure;:READ
:READ	:ABORt;:INITiate:IMMEDIATE;:FETCh

A common programming error is to send the :READ command when the instrument is in the continuous measurement acquisition mode. Because :READ contains an :INIT:IMM command, which expects the single measurement acquisition mode, an error is generated, and the INIT command is ignored.

:FETCh command

The FETCh command returns data from previously performed measurements; it does not initiate the collection of new data. Because FETCh does not configure the instrument or acquire new input data, you can use FETCh repeatedly on the same set of acquired data. For example, use two FETCh commands to return wavelength and then power values for the same measurement. This is shown in the following program fragment:

```
OUTPUT 720;":INIT:CONT OFF;"
OUTPUT 720;":CONF:ARR:POW MAX"
OUTPUT 720;":INIT:IMM"
OUTPUT 720;":FETC:ARR:POW?"
ENTER 720:powers$
OUTPUT 720;":FETC:ARR:POW:WAV?"
ENTER 720:wavelengths$
```

In the example above, the data in the power and wavelength arrays are returned in the same order so that powers can be matched to wavelengths.

Also, because new data is not collected, FETCh is especially useful when characterizing transient data.

FETCh does not reconfigure the display. For example, if the display is in the Peak WL mode, sending :FETCh:ARRay does not configure the display to the List by WL even though an array of data is returned to the computer.

A common programming error occurs when the :FETCh command is used after an *RST command. This generates error number -230, *"Data corrupt or stale"*. In this instance, you must send :INIT:IMM after the *RST command and before the :FETCh command to capture a new array of measurement data.

:CONFigure command

The CONFigure command changes measurement settings without taking a measurement. The instrument is placed in the List by WL, List by Ampl, or Peak WL display application.

CONFigure can be queried. The query returns the last configuration setup by the CONFigure command. The instrument returns a string which is the last instrument function sent by a CONFigure command or MEASure query. The returned string is in the short command form. Use caution when using this query, because if any instrument settings were changed since the last CONFigure command or MEASure query these changes may not be included in the returned string.

For example, if the last CONFigure command was:

```
:CONFigure:SCALar:POWer:WAVelength 1300NM, MAX
```

a CONFigure? query would return a string that is similar to the following line:

```
"POW:WAV 1.300000e-6,0.01"
```

The *1300NM* and *resolution* values track the actual instrument settings and input signals. Notice that the quotation marks are part of the returned string.

Return single or multiple measurement values

You can specify whether FETCh, READ, or MEASure returns a single value (SCALar) or multiple values (ARRay). The following example specifies SCALar data which returns a single value.

```
:MEASure:SCALar:POWer:WAVelength? MAX
```

Programming
Making Measurements

ARRay and the SCPI standard

According to the SCPI command reference, the ARRArray command causes an instrument to take multiple measurements. (A <size> parameter indicates the number of measurements to take.) However, the Agilent 86120C's ARRArray command refers to the measurements performed for one measurement sweep; this results in an array of measured signals. Because the <size> parameter does not apply, any <size> parameter sent will be ignored by the instrument. No syntax error will be generated if a <size> parameter is sent.

Always force the Agilent 86120C to wait for non-sequential commands

The Agilent 86120C normally processes its remote programming commands sequentially. The instrument waits until the actions specified by a particular command are completely finished before reading and executing the next command. However, there are a few non-sequential commands where this is not true. Non-sequential commands do *not* finish executing before the next command is interpreted.

The following is a list of the Agilent 86120C's non-sequential commands:

```
:CALCulate1:TRANSform:FREQuency:POINts  
:CALCulate2:PEXCursion  
:CALCulate2:PTHReshold  
:CALCulate2:WLIMit:STARt:FREQuency  
:CALCulate2:WLIMit:STARt:WAVelength  
:CALCulate2:WLIMit:STARt:WNUMber  
:CALCulate2:WLIMit:STOP:FREQuency  
:CALCulate2:WLIMit:STOP:WAVelength  
:CALCulate2:WLIMit:STOP:WNUMber  
:CALCulate3:SNR:AUTO  
:SENSe:CORRection:ELEVation  
:INITiate:CONTinuous  
:INITiate[:IMMediate]
```

The following additional commands are also non-sequential commands if CALCulate3:SNR:AUTO is set to OFF:

```
:CALCulate3:REFerence:FREQuency  
:CALCulate3:REFerence:WAVelength  
:CALCulate3:REFerence:WNUMber
```

The benefit of non-sequential commands is that, in some situations, they can reduce the overall execution times of programs. For example, you can set the peak excursion, peak threshold, and elevation and use a *WAI command at the end to save time. However, non-sequential commands can also be a source of annoying errors. Always use the *OPC query or *WAI command with the non-sequential commands to ensure that your programs execute properly.

For example, suppose that you wanted to set the elevation correction value and then send an :INIT:IMM command. The following programming fragment results in an error “-213 Init ignored”. This occurs because the :ELEVation command causes the recalculation of the data which is like sending the :INIT:IMM command. When the actual :INIT:IMM is sent, the error occurs because the command is already in progress.

```
OUTPUT 720;":INIT:IMM"  
OUTPUT 720;":SENSe:CORRection:ELEVation 1000"  
OUTPUT 720;":INIT:IMM"
```

Use an *OPC? query to ensure that the :ELEVation command has completed as shown in the following lines:

```
OUTPUT 720;":INIT:IMM"  
OUTPUT 720;":SENSe:CORRection:ELEVation 1000"  
OUTPUT 720;":*OPC?"  
ENTER 720;Response$  
OUTPUT 720;":INIT:IMM"
```

Or, the *WAI command could be used:

```
OUTPUT 720;":INIT:IMM"  
OUTPUT 720;":SENSe:CORRection:ELEVation 1000"  
OUTPUT 720;":*WAI?"  
OUTPUT 720;":INIT:IMM"
```

Measure delta, drift, and signal-to-noise

To select a measurement, use one of the following STATE commands:

CALC3:DELT:POW:STAT (*delta power*)
CALC3:DELT:WAV:STAT (*delta wavelength*)
CALC3:DELT:WPOW:STAT (*delta power and wavelength*)
CALC3:DRIF:STAT (*drift*)
CALC3:SNR:STAT (*signal-to-noise ratios*)
CALC3:ASNR:STAT (*signal-to-noise ratio averaging*)

If you select a drift measurement, you can select one of the following additional states:

CALC3:DRIF:DIFF:STAT (*difference*)
CALC3:DRIF:MAX:STAT (*maximum drift*)
CALC3:DRIF:MIN:STAT (*minimum drift*)
CALC3:DRIF:REF:STAT (*drift reference values*)

The :CALCulate3:DRIFt:PRESet command turns off the minimum, maximum, difference, and reference states but leaves the drift state on.

Attempting to turn more than one state on at a time results in an “-221 Settings Conflict” error.

The *RST and SYSTEM:PRESet commands turn all calculations off.

CALCulate3:PRESet turns off any CALCulate3 calculations.

The format of returned data

Measurements are returned as strings

All measurement values are returned from the Agilent 86120C as ASCII strings. When an array is returned, the individual values are separated by the comma character.

Determine the number of data points

When a FETCh, READ, or MEASure command is used (with ARRAy specified), the first returned value indicates the total number of measurement values returned in the query.

If you use the:CALCulate1:DATA?, :CALCulate2:DATA?, or :CALCulate3:DATA? queries to query data, send the :POINts? query first to determine the number of values returned in the string. The string does not contain a first value which specifies the string length. This is shown in the following example:

```
OUTPUT 720;":CALCulate1:POINts?"  
ENTER 720;Length  
OUTPUT 720;":CALCulate1:DATA?"  
ENTER 720;Result$
```

Data can be corrected for elevation and vacuum

Normally, the Agilent 86120C provides measurement values calculated for conditions in air at sea level. Use the :SENSe:CORRection:ELEVation command to compensate for air dispersion. Altitudes up to 5000 meters can be entered. Use the :SENSe:CORRection:MEDIum command to switch to readings in a vacuum.

Amplitude units

The default amplitude units are dBm. If you need measurements in watts, use the :UNIT:POWEr command. When the Agilent 86120C is turned on, the amplitude units are automatically set to the units used before the instrument was last turned off.

Monitoring the Instrument

Almost every program that you write will need to monitor the Agilent 86120C for its operating status. This includes querying execution or command errors and determining whether or not measurements have been completed. Several status registers and queues are provided to accomplish these tasks.

In this section, you'll learn how to enable and read these registers. In addition to the information in this section, you should review the commands documented in [“Common Commands” on page 4-3](#) and [“STATUS Subsystem” on page 4-90](#).

Status registers

The Agilent 86120C provides four registers which you can query to monitor the instrument's condition. These registers allow you to determine the following items:

- Status of an operation
- Availability of the measured data
- Reliability of the measured data

All four registers are shown in the figure on the following page and have the following uses:

<u>Register</u>	<u>Definition</u>
Status Byte	Monitors the status of the other three registers.
Standard Event Status	This is the standard IEEE 488.2 register. Contains bits which indicate the status of the other two registers.
OPERation Status	Contains bits that report on the instrument's normal operation.
QUESTionable Status	Contains bits that report on the condition of the signal.

Status Byte register

The Status Byte Register contains summary bits that monitor activity in the other status registers and queues. The Status Byte Register's bits are set and cleared by the presence and absence of a summary bit from other registers or queues. Notice in the following figure that the bits in the Standard Event Status, OPERATION status, and QUESTionable status registers are "or'd" to control a bit in the Status Byte Register. If a bit in the Status Byte Register goes high, you can query the value of the source register to determine the cause.

Programming
Monitoring the Instrument

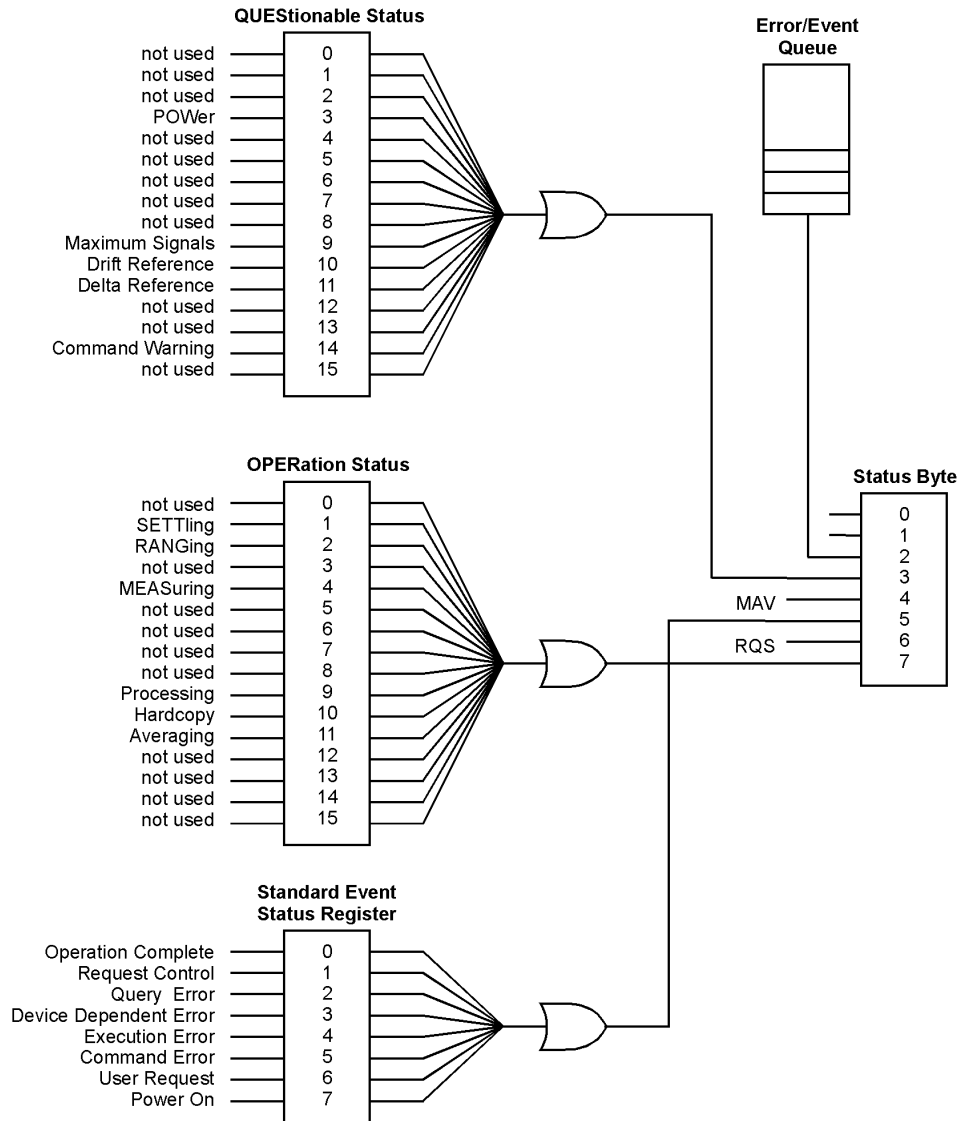

stat

The Status Byte Register can be read using either the *STB? common command or the GPIB serial poll command. Both commands return the decimal-weighted sum of all set bits in the register. The difference between the two methods is that the serial poll command reads bit 6 as the Request Service (RQS) bit and clears the bit which clears the SRQ interrupt. The *STB? command reads bit 6 as the Master Summary Status (MSS) and does not clear the bit or have any effect on the SRQ interrupt. The value returned is the total bit weights of all of the bits that are set at the present time.

OPERation Status and QUEStionable Status registers

You can query the value of the OPERation Status and QUEStionable Status registers using commands in the STATus subsystem.

The STATus subsystem also has transition filter software which give you the ability to select the logic transitions which set bits in the OPERation Status and QUEStionable Status registers. For example, you can define the POWER bit of the QUEStionable Status register to report an event when the condition transitions from false to true. This is a positive transition. You can also specify a negative transition where the bit is set when the condition transitions from true to false.

Table 3-6. Bits in Operation Status Register

Bit	Definition
0	<i>not used</i>
1	<i>SETTling</i> - indicating that the instrument is waiting for the motor to reach the proper position before beginning data acquisition.
2	<i>RANGing</i> - indicating the instrument is currently gain ranging.
3	<i>not used</i>
4	<i>MEASuring</i> - indicating that the instrument is making a measurement.
5 through 8	<i>not used</i>
9	<i>Processing</i> - indicating that the instrument is currently processing the data acquired.
10	<i>Hardcopy</i> - indicating that the instrument is currently printing the data to the parallel port.
11	<i>Averaging</i> - indicating that the instrument is in the process of averaging the noise for the signal-to-noise ratio calculation.
12 through 16	<i>not used</i>

Programming
Monitoring the Instrument

Table 3-7. Bits in Questionable Status Register

Bit	Definition
0, 1, and 2	<i>not used</i>
3	<i>POWer</i> - indicating that the instrument is measuring too high of a power.
3 through 8	not used
9	<i>Maximum signals</i> - indicating that the instrument has found the maximum number of signals.
10	<i>Drift Reference</i> - indicating that the number of reference signals is different from the current number of input signals.
11	<i>Delta Reference</i> - indicating that there is no delta reference signal.
12 through 13	not used
14	<i>Command Warning</i> - indicating that the instrument has received some extra unexpected parameters for one of the measurement functions.
15	<i>not used</i>

Standard Event Status register

The Standard Event Status Register monitors the following instrument status events:

- OPC - Operation Complete
- RQC - Request Control
- QYE - Query Error
- DDE - Device Dependent Error
- EXE - Execution Error
- CME - Command Error
- URQ - User Request
- PON - Power On

When one of these events occur, the event sets the corresponding bit in the register. If the bits are enabled in the Standard Event Status Enable Register, the bits set in this register generate a summary bit to set bit 5 (ESB) in the Status Byte Register.

The contents of the Standard Event Status Register can be read and the register cleared by sending the *ESR? query. The value returned is the total bit weights of all of the bits that are set at the present time.

Enabling register bits with masks

Several masks are available which you can use to enable or disable individual bits in each register. For example, you can disable the Hard-copy bit in the OPERation Status Register so that even though it goes high, it can never set the summary bit in the status byte high.

Use the *SRE common command to set or query the mask for the Status Byte Register.

The masks for the OPERation Status and QUEStionable Status registers are set and queried using the STATus subsystem's ENABle commands.

Use the *ESE common command to set or query the mask for the Standard Event Status Register.

The *CLS common command clears all event registers and all queues except the output queue. If *CLS is sent immediately following a program message terminator, the output queue is also cleared. In addition, the request for the *OPC bit is also cleared.

For example, suppose your application requires an interrupt whenever any type of error occurs. The error related bits in the Standard Event Status Register are bits 2 through 5. The sum of the decimal weights of these bits is 60. Therefore, you can enable any of these bits to generate the summary bit by sending the *ESE 60 command.

Whenever an error occurs, it sets one of these bits in the Standard Event Status Register. Because the bits are all enabled, a summary bit is generated to set bit 5 in the Status Byte Register.

If bit 5 (ESB) in the Status Byte Register is enabled (via the *SRE command), an SRQ service request interrupt is sent to the external computer.

Standard Event Status Register bits that are not enabled still respond to their corresponding conditions (that is, they are set if the corresponding event occurs). However, because they are not enabled, they do not generate a summary bit to the Status Byte Register.

Queues

There are two queues in the instrument: the output queue and the error queue. The values in the output queue and the error queue can be queried.

Output queue

The output queue stores the instrument responses that are generated by certain commands and queries that you send to the instrument. The output queue generates the Message Available summary bit when the output queue contains one or more bytes. This summary bit sets the MAV bit (bit 4) in the Status Byte Register. The method used to read the Output Queue depends upon the programming language and environment. For example, with HP BASIC, the output queue may be read using the ENTER statement.

Error queue

As errors are detected, they are placed in an error queue. Instrument specific errors are indicated by positive values. General errors have negative values. You can clear the error queue by reading its contents, sending the *CLS command, or by cycling the instrument's power.

The error queue is first in, first out. If the error queue overflows, the last error in the queue is replaced with error -350, "Queue overflow." Any time the queue overflows, the least recent errors remain in the queue, and the most recent error is discarded. The length of the instrument's error queue is 30 (29 positions for the error messages, and 1 position for the "Queue overflow" message).

The error queue is read with the SYSTEM:ERROR? query. Executing this query reads and removes the oldest error from the head of the queue, which opens a position at the tail of the queue for a new error. When all the errors have been read from the queue, subsequent error queries return 0, "No error."

For more information on reading the error queue, refer to ["ERRor" on page 4-98](#). For a list of errors messages, refer to ["Error Messages" on page 7-11](#).

Reviewing SCPI Syntax Rules

SCPI command are grouped in subsystems

In accordance with IEEE 488.2, the instrument's commands are grouped into "subsystems." Commands in each subsystem perform similar tasks. The following subsystems are provided:

- Measurement Instructions
- Calculate1 Subsystem
- Calculate2 Subsystem
- Calculate3 Subsystem
- Display Subsystem
- Hcopy Subsystem
- Sense Subsystem
- Status Subsystem
- System Subsystem
- Trigger Subsystem
- Unit Subsystem

Sending a command

It's easy to send a command to the instrument. Simply create a command string from the commands listed in this book, and place the string in your program language's output statement. For commands other than common commands, include a colon before the subsystem name. For example, the following string places the cursor on the peak laser line and returns the power level of this peak:

```
OUTPUT 720;":MEAS:SCAL:POW? MAX"
```

Use either short or long forms

Commands and queries may be sent in either long form (complete spelling) or short form (abbreviated spelling). The description of each command in this manual shows both versions; the extra characters for the long form are shown in lowercase. The following is a long form of a command:

```
OUTPUT 720;":MEASure:SCALar:POWer? MAXimum"
```

And this is the short form of the same command:

Programming
Reviewing SCPI Syntax Rules

OUTPUT 720;":MEAS:SCAL:POW? MAX"

Programs written in long form are easily read and are almost self-documenting. Using short form commands conserves the amount of controller memory needed for program storage and reduces the amount of I/O activity.

The rules for creating short forms from the long form is as follows:

The mnemonic is the first four characters of the keyword unless the fourth character is a vowel, in which case the mnemonic is the first three characters of the keyword.

This rule is *not* used if the length of the keyword is exactly four characters.

Table 3-8. Examples of Short Forms

Long Form	Equivalent Short Form
ROUTE	ROUT
LAYER	LAY
SYSTEM	SYST
ERROR	ERR

You can use upper or lowercase letters

Program headers can be sent using any combination of uppercase or lowercase ASCII characters. Instrument responses, however, are always returned in uppercase.

Combine commands in the same subsystem

You can combine commands from the same subsystem provided that they are both on the same level in the subsystem's hierarchy. Simply separate the commands with a semi-colon (;). For example, the following two lines,

```
OUTPUT 720;":CALC2:PEXC 12"  
OUTPUT 720;":CALC2:PTHR 20"
```

can be combined into one line:

```
OUTPUT 720;":CALC2:PEXC 12;PTHR 20"
```

The semicolon separates the two functions.

Combine commands from different subsystems

You can send commands and program queries from different subsystems on the same line. Simply precede the new subsystem by a semicolon followed by a colon. In the following example, the colon and semicolon pair before DISP allows you to send a command from another subsystem.

```
OUTPUT 720;":CALC2:PEXC 12;:DISP:WIND:GRAP:STAT OFF"
```

Sending common commands

If a subsystem has been selected and a common command is received by the instrument, the instrument remains in the selected subsystem. For example, if the program message

```
"DISPLAY:MARK:MAX:LEFT;*CLS;DISP:MARK:MAX:RIGHT"
```

is received by the instrument, the Display subsystem remains selected.

If some other type of command is received within a program message, you must reenter the original subsystem after the command.

Adding parameters to a command

Many commands have parameters that specify an option. Use a space character to separate the parameter from the command as shown in the following line:

```
OUTPUT 720;":INIT:CONT ON"
```

Separate multiple parameters with a comma (,). Spaces can be added around the commas to improve readability.

```
OUTPUT 720;":MEAS:SCAL:POW:FREQ? 1300, MAX"
```

White space

White space is defined to be one or more characters from the ASCII set of 0 through 32 decimal, excluding 10 (NL). White space is usually optional, and can be used to increase the readability of a program.

Numbers

All numbers are expected to be strings of ASCII characters. Thus, when sending the number 9, you would send a byte representing the ASCII code for the character "9" (which is 57). A three-digit number like 102 would take up three bytes (ASCII codes 49, 48, and 50). This

Programming
Reviewing SCPI Syntax Rules

is taken care of automatically when you include the entire instruction in a string. Several representations of a number are possible. For example, the following numbers are all equal:

28
0.28E2
280E-1
28000m
0.028K
28E-3K

If a measurement cannot be made, no response is given and an error is placed into the error queue. For example,

```
*RST  
FETCh:POW?
```

will timeout the controller and place a *Data stale or corrupt* error in the error queue.

Table 3-9. Suffix Multipliers

Multiplier	Mnemonic
1E18	EX
1E15	PE
1E12	T
1E9	G
1E6	MA
1E3	K
1E-3	M
1E-6	U
1E-9	N
1E-12	P
1E-15	F
1E-18	A

Program message terminator

The string of instructions sent to the instrument are executed after the instruction terminator is received. The terminator may be either a new-line (NL) character, the End-Of-Identify (EOI) line asserted, or a combination of the two. All three ways are equivalent. Asserting the EOI sets the EOI control line low on the last byte of the data message. The NL character is an ASCII linefeed (decimal 10). The NL terminator has the same function as an EOS (End Of String) and EOT (End Of Text) terminator.

Querying data

Data is requested from the instrument using a query. Queries can be used to find out how the instrument is currently configured. They are also used to get results of measurements made by the instrument, with the query actually activating the measurement. String responses are returned as upper-case letters.

Queries usually take the form of a command followed by a question mark (?). After receiving a query, the instrument places the answer in its output queue. The answer remains in the output queue until it is read or another command is issued. For example, the query

```
OUTPUT 720;":CALCULATE2:POINTS?"
```

places the number of points in the data set in the output queue. In HP BASIC, the controller input statement:

```
ENTER 720;Range
```

passes the value across the bus to the controller and places it in the variable Range. A newline character is appended to the response.

Sending another command or query before reading the result of a query causes the output queue to be cleared and the current response to be lost. This also generates an error in the error queue.

The output of the instrument may be numeric or character data depending on what is queried. Refer to the specific commands for the formats and types of data returned from queries.

You can send multiple queries to the instrument within a single program message, but you must also read them back within a single program message. This can be accomplished by either reading them back into a string variable or into multiple numeric variables. When you read the result of multiple queries into string variables, each response is separated by a semicolon.

Example Programs

The following example programs are provided in this section:

- Example 1. Measure a DFB laser 3-30
- Example 2. Measure WDM channels 3-32
- Example 3. Measure WDM channel drift 3-34
- Example 4. Measure WDM channel separation 3-37
- Example 5. Measure signal-to-noise ratio of each WDM channel 3-39
- Example 6. Increase a source's wavelength accuracy 3-41

These programs are provided to give you examples of using Agilent 86120C remote programming commands in typical applications. They are not meant to teach general programming techniques or provide ready-to-use solutions. They should allow you to see how measurements are performed and how to return data to the computer.

All of the examples are written in the HP BASIC programming language.

Many subroutines are repeated in the examples

The first five example programs contain several common subroutines. These routines, along with one function, are described in the rest of this introduction. The descriptions are listed in the general order that the subroutines are called in the programs.

Error_msg subroutine

This function is found in examples 2, 3, 4, and 5. It displays an error message on the computer's screen explaining the reason that the program's execution stopped.

Set_ese subroutine

The subroutine sets the enable mask for the event status register to a value of 52. This allows bits 2, 4, and 5 to be set whenever a query error (QYE), execution error (EXE), or command error (CME) respectively occurs. All this is accomplished using the *ESE common command.

The `Err_mngmt` subroutine is used to actually read the value of the event status register. Examples 1 through 5 call this subroutine.

FNIdentity function

When this function is called, it resets the instrument and queries the instrument's identification string which is displayed on the computer's screen by the calling function. To accomplish this task, the `FNIdentity` function uses the `*RST`, `*OPC?`, and `*IDN?` common commands. This function is called from Examples 1 through 5.

Err_mngmt subroutine

This subroutine checks to make sure that no errors have set bits in the event status register and that there are no errors in the queue. Exiting this subroutine is only possible if no errors have occurred. Notice that the logic test in the subroutine tests for the same event status register bits enabled by the `Set_ese` subroutine: `BIT(Cme,5)`, `BIT(Cme,4)`, `BIT(Cme,2)`.

This subroutine is called in Examples 1 through 5. However, it is modified in Examples 3, 4, and 5 to allow it to indicate the last programming command that was sent to the instrument before an error occurred. This is accomplished by adding an optional argument string.

Cmd_opc subroutine

The `Cmd_opc` subroutine, found in Examples 3, 4, and 5, pauses the program until a non-sequential command has finished executing on the Agilent 86120C. It uses the `*OPC?` query.

For more information on non-sequential commands, refer to [“Always force the Agilent 86120C to wait for non-sequential commands” on page 3-12.](#)

Tempo subroutine

This subroutine, which is only found in Example 3, pauses the program for a few seconds while the Agilent 86120C measures the drift on a laser. The argument in the example sets the pause for 10 seconds.

Example 1. Measure a DFB laser

This program measures the power and wavelength of a DFB laser. It first sets the Agilent 86120C in the single-acquisition measurement mode. Then, it triggers the Agilent 86120C with the MEASure command to capture measurement data of the input spectrum. Because the data is stored in the instrument's memory, it can be queried as needed.

Refer to the introduction to this section for a description of each sub-routine that is contained in this program.

```
COM /Instrument/ @Mwm
ASSIGN @Mwm TO 720

Set_ese
PRINT USING "37A,33A"; "Multi-Wavelength Meter Identity is : ";FNIdentity$
OUTPUT @Mwm;":INIT:CONT OFF"
ON TIMEOUT 7,5 CALL Err_mngmt
OUTPUT @Mwm;":MEAS:SCAL:POW:WAV?"
ENTER @Mwm;Current_wl
OUTPUT @Mwm;":FETC:SCAL:POW?"
ENTER @Mwm;Current_pwr
OFF TIMEOUT
PRINT USING "20A,4D.3D,3A,19A,M2D.2D,4A"; "The wavelength is : ";Current_wl /1.0E-9; " nm"; " with a
power of : ";Current_pwr; " dBm"
END

Err_mngmt:SUB Err_mngmt
  COM /Instrument/ @Mwm
  DIM Err_msg$[255]
  INTEGER Cme
  CLEAR 7
  REPEAT !
    OUTPUT @Mwm;"*ESR?"
    ENTER @Mwm;Cme
    OUTPUT @Mwm;":SYST:ERR?"
    ENTER @Mwm;Err_msg$
    PRINT Err_msg$
  UNTIL NOT BIT(Cme,2) AND NOT BIT(Cme,4) AND NOT BIT(Cme,5) AND
  POS(Err_msg$,"+0")
Subend:SUBEND

Set_ese:SUB Set_ese
  COM /Instrument/ @Mwm
  OUTPUT @Mwm;"*ESE ";IVAL("00110100",2)
SUBEND
```

```
Identity:DEF FNIdentity$;  
  COM /Instrument/ @MwmV  
  DIM Identity${50}  
  Identity$=""  
  OUTPUT @Mwm;"*RST"  
  OUTPUT @Mwm;"*OPC?"  
  ENTER @Mwm;Opc_done  
  OUTPUT @Mwm;"*IDN?"  
  ENTER @Mwm;Identity$  
  RETURN Identity$  
FNEND
```

Example 2. Measure WDM channels

This program measures the multiple laser lines of a WDM system. It measures both the power and wavelengths of each line. First, the program sets the Agilent 86120C in the single-acquisition measurement mode. Then, it triggers the Agilent 86120C with the MEASure command to capture measurement data of the input spectrum. Because the data is stored in the instrument's memory, it can be queried as needed.

Refer to the introduction to this section for a description of each sub-routine that is contained in this program.

```
COM /Instrument/ @Mwm
ASSIGN @Mwm TO 720
ON ERROR GOTO Error_msg,
Set_ese
PRINT USING "37A,33A";"Multi-Wavelength Meter Identity is : ";FNIdentity$

OUTPUT @Mwm;":INIT:CONT OFF"
ON TIMEOUT 7,5 CALL Err_mngmt
OUTPUT @Mwm;":MEAS:ARR:POW:WAV?"
ENTER @Mwm USING "#,K";Nb_wl
ALLOCATE Current_wl(1:Nb_wl)
ENTER @Mwm USING "#,K";Current_wl(*)
OUTPUT @Mwm;":FETC:ARR:POW?"
ENTER @Mwm USING "#,K";Nb_wl
ALLOCATE Current_pwr(1:Nb_wl)
ENTER @Mwm USING "#,K";Current_pwr(*)
FOR I=1 TO Nb_wl
    PRINT USING "22A,2D,6A,4D.2DE,4A,S2D.2D,3A";"The wavelength number
    ";Current_wl(I);" at ";Current_pwr(I);"dBm"
NEXT I
OFF TIMEOUT
STOP

Error_msg:
    PRINT "the prgm is aborted due to : ";ERRM$
END

Err_mngmt:SUB Err_mngmt
    COM /Instrument/ @Mwm
    DIM Err_msg$(255)
    INTEGER Cme
    CLEAR 7
    REPEAT
        OUTPUT @Mwm; "*ESR?"
        ENTER @Mwm;Cme
        OUTPUT @Mwm; ":SYST:ERR?"
        ENTER @Mwm;Err_msg$
```

```
        PRINT Err_msg$
        UNTIL NOT BIT(Cme,2) AND NOT BIT(Cme,4) AND NOT BIT(Cme,5) AND
        Err$,"+0")
Subend:SUBEND

Set_ese:SUB Set_ese
        COM /Instrument/ @Mwm
        OUTPUT @Mwm; "*ESE";IVAL("00110100",2)
SUBEND

Identity:DEF FNIdentity$;
        COM /Instrument/ @Mwm
        DIM Identity${50}
        Identity$=""
        OUTPUT @Mwm; "*RST"
        OUTPUT @Mwm; "*OPC?"
        ENTER @Mwm;Opc_done
        OUTPUT @Mwm; "*IDN?"
        ENTER @Mwm;Identity$
        RETURN Identity$
FNEND
```

Example 3. Measure WDM channel drift

This program measures the drift of channels in a WDM system. It measures drift in both power and wavelength of each line. First, the program sets the Agilent 86120C in the continuous-acquisition measurement mode. Then, it measures drift using commands from the CALCulate3 subsystem.

Notice the use of the Tempo subroutine to pause the program for 10 seconds while the Agilent 86120C measures the drift on the system.

The use of the Err_mngmt subroutine is optional. Refer to the introduction to this section for a description of each subroutine that is contained in this program.

```
COM /Instrument/ @Mwm
ASSIGN @Mwm TO 720
DIM Key$[1]
ON ERROR GOTO Error_msg
Set_ese
PRINT USING "37A,33A";"Multi-Wavelength Meter Identity is: ";FNIdentity$
ON TIMEOUT 7,5 CALL Err_mngmt
Cmd_opc("RST")
Cmd_opc("INIT:IMM")
Cmd_opc("OPC")
Cmd_opc("CONF:ARR:POW:WAV")

! Turn on the drift calculation

Cmd_opc("CALC3:DRIF:STAT ON")
Err_mngmt("CALC3:DRIF:STAT ON")

! Turn off all drift states

Cmd_opc("CALC3:DRIF:PRES")
Err_mngmt("CALC3:DRIF:PRES")

! Turn on drift reference state

Cmd_opc("CALC3:DRIF:REF:STAT ON")
Err_mngmt("CALC3:DRIF:REF:STAT ON")

! Query the number of data points

OUTPUT @Mwm;"CALC3:POIN?"
ENTER @Mwm USING "#,K";Nb_pt
ALLOCATE Current_ref_wl(1:Nb_pt)
ALLOCATE Current_ref_pwr(1:Nb_pt)
```



```

! Query reference wavelengths and powers

OUTPUT @Mwm;":CALC3:DATA? WAV"
ENTER @Mwm USING "#,K";Current_ref_wl(*)
OUTPUT @Mwm;":CALC3:DATA? POW"
ENTER @Mwm USING "#,K";Current_ref_pwr(*)

! Turn off drift reference state

Cmd_opc("CALC3:DRIF:REF:STAT OFF")
Err_mngmt("CALC3:DRIF:REF:STAT OFF")

! Turn on drift max min calculation

Cmd_opc("CALC3:DRIF:DIFF:STAT ON")
Err_mngmt("CALC3:DRIF:DIFF:STAT ON")

Tempo(10)

ALLOCATE Current_diff_wl(1:Nb_pt)
ALLOCATE Current_diff_pwr(1:Nb_pt)

! Query drift wavelengths and powers

OUTPUT @Mwm;":CALC3:DATA? WAV"
ENTER @Mwm USING "#,K";Current_diff_wl(*)
OUTPUT @Mwm;":CALC3:DATA? POW"
ENTER @Mwm USING "#,K";Current_diff_pwr(*)
OFF TIMEOUT
FOR I=1 TO Nb_pt
  PRINT USING "18A,2D,6A,M4D.2DE,3A,21A,MDD.3DE,3A";"Wavelength number "
  ;I;" is : ";Current_ref_wl(I);" m";" with a drift from : ";Current_diff_wl(I);" m"
  PRINT USING "28A,SDD.2DE,4A,20A,MDD.3DE,3A,/" ;"it has a power level of
  : ";Current_ref_pwr(I);" dBm";" with a drift from : ";Current_diff_pwr(I);" dB";
NEXT I
STOP

Error_msg: !
  PRINT "The program is aborted due to : ";ERRM$
END

Err_mngmt:SUB Err_mngmt(OPTIONAL Cmd_msg$)
  COM /Instrument/ @Mwmt
  DIM Err_msg$(255)
  INTEGER Cme
  CLEAR @Mwm
  REPEAT
    OUTPUT @Mwm;"*ESR?"
    ENTER @Mwm;Cme
    OUTPUT @Mwm;":SYST:ERR?"
    ENTER @Mwm;Err_msg$
    IF NPAR>0 AND NOT POS(Err_msg$,"+0") THEN PRINT "This command
    ";Cmd_msg$;" makes the following error : "
    IF NOT POS(Err_msg$,"+0") THEN PRINT Err_msg$
  UNTIL NOT BIT(Cme,2) AND NOT BIT(Cme,4) AND NOT BIT(Cme,5) AND
  POS(Err_msg$,"+0")

```

Programming

Example Programs

```
Subend:SUBEND
```

```
Set_ese:SUB Set_ese  
  COM /Instrument/ @Mwm  
  OUTPUT @Mwm;"*ESE ";IVAL("00110100",2)  
SUBEND
```

```
Identity:DEF FNIdentity$;  
  COM /Instrument/ @Mwm  
  DIM Identity$(50)  
  Identity$=""  
  OUTPUT @Mwm;"*RST"  
  OUTPUT @Mwm;"*OPC?"  
  ENTER @Mwm;Opc_done  
  OUTPUT @Mwm;"*IDN?"  
  ENTER @Mwm;Identity$  
  RETURN Identity$  
FNEND
```

```
Cmd_opc:SUB Cmd_opc(Set_cmd$)  
  COM /Instrument/ @Mwm  
  OUTPUT @Mwm;Set_cmd$  
  OUTPUT @Mwm;"*OPC?"  
  ENTER @Mwm;Opc_done$  
SUBEND
```

```
Tempo:SUB Tempo(Temp)  
  FOR I=Temp TO 0 STEP -1  
    DISP "Waiting for ";VAL$(I);" sec . . . "  
    WAIT 1  
  NEXT I  
  DISP ""  
SUBEND
```

Example 4. Measure WDM channel separation

This program measures the line separations on a WDM system. It measures separation (delta) between power and wavelength of each line using commands from the CALCulate3 subsystem.

Refer to the introduction to this section for a description of each subroutine that is contained in this program.

```

COM /Instrument/ @Mwm
ASSIGN @Mwm TO 720
DIM Key$[1]
ON ERROR GOTO Error_msg
Set_ese
PRINT USING "37A,33A";"Multi-Wavelength Meter Identity is : ";FNIdentity$
ON TIMEOUT 7,5 CALL Err_mngmt
Cmd_opc("**RST")

! Change to list-by-wavelength display
Cmd_opc(":CONF:ARR:POW:WAV")

! Trigger and wait for one measurement
Cmd_opc(":INIT")
Cmd_opc("**WAI")

! Turn on delta mode
Cmd_opc(":CALC3:DELT:WPOW:STAT ON")

! Set first wavelength as reference
Cmd_opc(":CALC3:DELT:REF:WAV MIN")

! Query number of data points
OUTPUT @Mwm;":CALC3:POIN?"
ENTER @Mwm USING "#,K";Nb_pt
ALLOCATE Delta_wl(1:Nb_pt)
ALLOCATE Delta_pwr(1:Nb_pt)

! Query wavelengths and powers
OUTPUT @Mwm;":CALC3:DATA? WAV"
ENTER @Mwm;Delta_wl(*)
OUTPUT @Mwm;":CALC3:DATA? POW"
ENTER @Mwm;Delta_pwr(*)
OFF TIMEOUT
FOR I=1 TO Nb_pt-1
    PRINT USING "6A,2D,17A,M4D.3D,31A,S2D.2D,4A";"Line :";I;" wavelength is :
```

Programming

Example Programs

```
";(Delta_wl(I)+(NOT I=1)*Delta_wl(1))/1.0E-9;" nm. Absolute line level is :
";Delta_pwr(I)+(NOT I=1)*Delta_pwr(1);" dBm"
PRINT USING "17A,2D,6A,M4D.3D,23A,2D,6A,S2D.2D,3A";"Delta Wl to line ",I+1,"
is : ";(Delta_wl(I+1)-(NOT I=1)*Delta_wl(I))/1.E-9;" nm, Delta Pwr to line ",I+1," is :
";(I=1)*(Delta_pwr(I+1)+(NOT I=1)*(Delta_pwr(I+1)-Delta_pwr(I)));" dB"
NEXT I
PRINT USING "6A,2D,17A,M4D.3D,31A,S2D.2D,4A";"Line : ";I;" wavelength is :
";(Delta_wl(1)+Delta_wl(Nb_pt))/1.0E-9;" nm. Absolute line level is : ";Delta_pwr(1)+Delta_pwr(Nb_pt);"
dBm"
STOP
Error_msg: !
PRINT "The program is aborted due to : ";ERRM$
END

Err_mngmt:SUB Err_mngmt(OPTIONAL Cmd_msg$)
COM /Instrument/ @Mwmt
DIM Err_msg$[255]
INTEGER Cme
CLEAR @Mwm
REPEAT
OUTPUT @Mwm;"*ESR?"
ENTER @Mwm;Cme
OUTPUT @Mwm;":SYST:ERR?"
ENTER @Mwm;Err_msg$
IF NPAR>0 AND NOT POS(Err_msg$,"+0") THEN PRINT "This command
";Cmd_msg$;" makes the following error : "
IF NOT POS(Err_msg$,"+0") THEN PRINT Err_msg$
UNTIL NOT BIT(Cme,2) AND NOT BIT(Cme,4) AND NOT BIT(Cme,5) AND
POS(Err_msg$,"+0")
Subend:SUBEND

Set_ese:SUB Set_ese
COM /Instrument/ @Mwm
OUTPUT @Mwm;"*ESE ";IVAL("00110100",2)
SUBEND

Identity:DEF FNIdentity$;
COM /Instrument/ @Mwm
DIM Identity$[33]
Identity$=""
OUTPUT @Mwm;"*RST"
OUTPUT @Mwm;"*OPC?"
ENTER @Mwm;Opc_done
OUTPUT @Mwm;"*IDN?"
ENTER @Mwm;Identity$
RETURN Identity$
FNEND

Cmd_opc:SUB Cmd_opc(Set_cmd$)
COM /Instrument/ @Mwm
OUTPUT @Mwm;Set_cmd$
OUTPUT @Mwm;"*OPC?"
ENTER @Mwm;Opc_done$
SUBEND
```

Example 5. Measure signal-to-noise ratio of each WDM channel

This program measures signal-to-noise ratios on a WDM system. It measures the ratio for each line using commands from the CALCulate3 subsystem.

Refer to the introduction to this section for a description of each subroutine that is contained in this program.

```

COM /Instrument/ @Mwm
ASSIGN @Mwm TO 720
DIM Key$[1]
ON ERROR GOTO Error_msg,
Set_ese
PRINT USING "37A,33A";"Multi-Wavelength Meter Identity is : ";FNIdentity$
ON TIMEOUT 7,5 CALL Err_mngmt
Cmd_opc("RST")
OUTPUT @Mwm;":MEAS:ARR:POW:WAV?"
ENTER @Mwm USING "#,K";Nb_pt
ALLOCATE Current_wl(1:Nb_pt)
ENTER @Mwm USING "#,K";Current_wl(*)
OUTPUT @Mwm;":FETC:ARR:POW?"
ENTER @Mwm USING "#,K";Nb_pt
ALLOCATE Current_pwr(1:Nb_pt)
ENTER @Mwm USING "#,K";Current_pwr(*)

! Turn signal-to-noise ratio on

Cmd_opc("CALC3:SNR:STAT ON")
Err_mngmt("CALC3:SNR:STAT ON")

! Set first wavelength as noise reference

Cmd_opc("CALC3:SNR:REF:WAV MIN")
Err_mngmt("CALC3:SNR:REF:WAV MIN")

! Query number of data points

OUTPUT @Mwm;":CALC3:POIN?"
ENTER @Mwm USING "#,K";Nb_pt
ALLOCATE Snr_pwr(1:Nb_pt)

! Query signal-to-noise values

OUTPUT @Mwm;":CALC3:DATA? POW"
ENTER @Mwm;Snr_pwr(*)
OFF TIMEOUT

```

Programming

Example Programs

```
FOR I=1 TO Nb_pt
  PRINT USING "7A,2D,17A,M4D.3D,25A,S2D.2D,22A,2D.2D,3A";"Line : ";I;"
  wavelength is : ";Current_wl(I)/1.0E-9;" nm, absolute level is : ";Current_pwr(I);" dBm,
  with a SNR of : ";Snr_pwr(I);" dB"
NEXT I
STOP
```

```
Error_msg: !
  PRINT "The program is aborted due to : ";ERRM$
END
```

```
Err_mngmt:SUB Err_mngmt(OPTIONAL Cmd_msg$)
  COM /Instrument/ @Mwmt
  DIM Err_msg$(255)
  INTEGER Cme
  CLEAR @Mwm
  REPEAT !
    OUTPUT @Mwm;"*ESR?"
    ENTER @Mwm;Cme
    OUTPUT @Mwm;"*SYST:ERR?"
    ENTER @Mwm;Err_msg$
    IF NPAR>0 AND NOT POS(Err_msg$,"+0") THEN PRINT "This command
    ";Cmd_msg$;" makes the following error : "
    IF NOT POS(Err_msg$,"+0") THEN PRINT Err_msg$
    UNTIL NOT BIT(Cme,2) AND NOT BIT(Cme,4) AND NOT BIT(Cme,5) AND
    POS(Err_msg$,"+0")
  Subend:SUBEND
```

```
Set_ese:SUB Set_ese
  COM /Instrument/ @Mwm
  OUTPUT @Mwm;"*ESE ";IVAL("00110100",2)
SUBEND
```

```
Identity:DEF FNIdentity$;
  COM /Instrument/ @Mwm
  DIM Identity$(50)
  Identity$=""
  OUTPUT @Mwm;"*RST"
  OUTPUT @Mwm;"*OPC?"
  ENTER @Mwm;Opc_done
  OUTPUT @Mwm;"*IDN?"
  ENTER @Mwm;Identity$
  RETURN Identity$
FNEND
```

```
Cmd_opc:SUB Cmd_opc(Set_cmd$)
  COM /Instrument/ @Mwmd
  OUTPUT @Mwm;Set_cmd$
  OUTPUT @Mwm;"*OPC?"
  ENTER @Mwm;Opc_done$
SUBEND
```

Example 6. Increase a source's wavelength accuracy

This example program uses the Agilent 86120C to increase the absolute wavelength accuracy of Agilent 8167A, 8168B, and 8168C Tunable Laser Sources. Essentially, the Agilent 86120C's accuracy is transferred to the tunable laser source. The absolute accuracy of the tunable laser source is increased from $<\pm 0.1$ nm to $<\pm 0.003$ nm which is the Agilent 86120C's absolute accuracy (at 1550 nm).

In order to run this program, the tunable laser source's firmware must support the automatic alignment command, WAVEACT.

The program uses the following measurement algorithm:

- Identify and initialize the Agilent 86120C and tunable laser source
- Ask user for desired wavelength
- Set wavelength of tunable laser source
- Turn tunable laser source's output on
- Enter loop
 - Measure wavelength
 - Compare wavelength to desired wavelength
 - Realign tunable laser source's wavelength
 - Check if wavelength changed from last pass
- Repeat until (delta wavelength < 0.0015 nm *or* wavelength is stable)

Programming

Example Programs

```
COM Current_wl,Diff_wl,Target_wl,Previous_diff,Diff_diff
Current_wl=0
Diff_wl=0
Target_wl=0
Previous_diff=0
Diff_diff=0

ASSIGN @Tls TO 724
ASSIGN @Mwm TO 720

! Initialize instrument

DIM Identity${50}
Identity$=""
OUTPUT @Tls;"CLS"
OUTPUT @Tls;"IDN?"
ENTER @Tls;identity$
PRINT "TLS IS A ";identity$
OUTPUT @Mwm;"RST"
OUTPUT @Mwm;"CLS"
OUTPUT @Mwm;"IDN?"
ENTER @Mwm;identity$
PRINT "MWM IS A ";identity$

! Ask user for desired wavelength

INPUT "What wavelength (nm)do you wish to have",Target_wl
Target_wl=Target_wl*1.0E-9
PRINT "the target wavelength is :";Target_wl

! Set wavelength of tunable laser source

OUTPUT @Tls;".WAVE ";VAL$(Target_wl)
OUTPUT @Tls;".OUTP ON"

! Enter realignment loop

REPEAT
  OUTPUT @Mwm;".MEAS:SCAL:POW:WAV?"
  ENTER @Mwm;Current_wl
  PRINT "The current wavelength is : ";VAL$(Current_wl)
  Diff_wl=PROUND(ABS(Target_wl-Current_wl),-16)
  PRINT "Diff between target & Current is (+ or -) : ";VAL$(Diff_wl)
  OUTPUT @Tls;".WAVEACT ";VAL$(Current_wl)
  Diff_diff=PROUND(ABS(Diff_wl-Previous_diff),-16)
  PRINT "differential difference between two turn : ";VAL$(Diff_diff)
  Previous_diff=Diff_wl
UNTIL (Diff_wl<1.5*1.0E-12) OR (Diff_diff=0)
END
```

Lists of Commands

Table 3-10. Programming Commands (1 of 5)

Command	Description	Code
Codes: S indicates a standard SCPI command. I indicates an instrument specific command.		
Common Commands		
*CLS	Clears all event registers and the error queue.	
*ESE	Sets the bits in the standard-event status enable register.	
*ESR?	Queries value standard-event status register.	
*IDN?	Queries instrument model number and firmware version.	
*OPC	Sets operation complete bit of the standard-event status register.	
*RCL	Recalls a saved instrument state.	
*RST	Resets instrument.	
*SAV	Saves an instrument state.	
*SRE	Sets bits in service-request enable register.	
*STB	Queries value of status byte.	
*TRG	Triggers acquisition of measurement data.	
*TST?	Performs an instrument self test.	
*WAI	Causes instrument to finish processing current command before continuing.	
Measurement Instructions		
:CONFigure	Configures instrument for wavelength, wavenumber, frequency, power, and measurements.	I
:FETCh	Queries wavelength, wavenumber, frequency, power, and measurements that have already been captured.	I
:MEASure	Configures, measures, and queries wavelength, wavenumber, frequency, power, and measurements.	I
:READ	Measures and queries wavelength, wavenumber, frequency, power, and measurements.	I

Programming
Lists of Commands

Table 3-10. Programming Commands (2 of 5)

Command	Description	Code
Codes: S indicates a standard SCPI command. I indicates an instrument specific command.		
CALCulate1 (CALC1) Subsystem		
:CALCulate1:DATA?	Queries the uncorrected frequency-spectrum data of the input signal.	S
:CALCulate1:TRANSform:FREQuency:POINts?	Sets and queries the number of points in the data set.	S
CALCulate2 (CALC2) Subsystem		
:CALCulate2:DATA?	Queries the corrected frequency-spectrum data of the input signal.	S
:CALCulate2:PEXCursion	Sets the peak excursion limit.	I
:CALCulate2:POINts?	Queries the number of points in the data set.	I
:CALCulate2:PTHReshold	Sets the peak threshold limit.	I
:CALCulate2:PWAverage[:STATe]?	Places the instrument in the average-wavelength mode. Data queries return the power-weighted average frequency, wavelength, or wavenumber or total power.	I
:CALCulate2:WLIMit[:STATe]	Turns wavelength limiting on and off.	I
:CALCulate2:WLIMit:STARt:FREQuency	Sets the starting frequency for the wavelength limit range.	I
:CALCulate2:WLIMit:STARt[:WAVelength]	Sets the starting wavelength for the wavelength limit range.	I
:CALCulate2:WLIMit:STARt:WNUMber	Sets the starting wavenumber for the wavelength limit range.	I
:CALCulate2:WLIMit:STOP:FREQuency	Sets the stopping frequency for the wavelength limit range.	I
:CALCulate2:WLIMit:STOP[:WAVelength]	Sets the stopping wavelength for the wavelength limit range.	I
:CALCulate2:WLIMit:STOP:WNUMber	Sets the stopping wavenumber for the wavelength limit range.	I
CALCulate3 (CALC3) Subsystem		
:CALCulate3:ASNR:CLEar	Resets and restarts the signal-to-noise ratio averaging.	I
:CALCulate3:ASNR:COUNT	Sets the number of measurements to average the signal-to-noise ratio.	I
:CALCulate3:ASNR[:STATe]	Turns signal-to-noise ratio averaging mode on and off.	I
:CALCulate3:DATA?	Queries the data resulting from delta, drift, and signal-to-noise measurements.	S
:CALCulate3:DELTA:POWer[:STATe]	Turns the delta power measurement mode on and off.	I
:CALCulate3:DELTA:REFerence:FREQuency	Selects the signal to be used as the reference for the DELTA calculations.	I
:CALCulate3:DELTA:REFerence:POWer?	Queries the power level of the reference signal.	I

Table 3-10. Programming Commands (3 of 5)

Command	Description	Code
Codes: S indicates a standard SCPI command. I indicates an instrument specific command.		
:CALCulate3:DELTA:REFERENCE[:WAVelength]	Selects the signal to be used as the reference for the DELTA calculations.	I
:CALCulate3:DELTA:REFERENCE:WNUMBER	Selects the signal to be used as the reference for the DELTA calculations.	I
:CALCulate3:DELTA:WAVelength[:STATe]	Turns the delta wavelength measurement mode on and off.	I
:CALCulate3:DELTA:WPOWER[:STATe]	Turns the delta wavelength and power measurement mode on and off.	I
:CALCulate3:DRIFT:DIFFerence[:STATe]	Sets the drift calculation to subtract the minimum values measured from the maximum values measured.	I
:CALCulate3:DRIFT:MAXimum[:STATe]	Sets the drift calculation to return the maximum power (frequency) values measured.	I
:CALCulate3:DRIFT:MINimum[:STATe]	Sets the drift calculation to return the minimum power (frequency) values measured.	I
:CALCulate3:DRIFT:PRESet	Turns off all the drift states for DIFFerence, MAXimum, MINimum, and REFerence.	I
:CALCulate3:DRIFT:REFERENCE:RESet	Places the current list of signals into the reference list.	I
:CALCulate3:DRIFT:REFERENCE[:STATe]	Turns the drift state on and off so that CALC3:DATA? will return the reference signal list.	I
:CALCulate3:DRIFT[:STATe]	Turns the drift measurement calculation on and off.	I
:CALCulate3:FPERot[:STATe]	Turns the Fabry-Perot measurement mode on and off.	I
:CALCulate3:FPERot:MEAN:[WAVelength]?	Queries the mean wavelength of the selected modes.	I
:CALCulate3:FPERot:MEAN:FREQuency?	Queries the mean frequency of the selected modes.	I
:CALCulate3:FPERot:MEAN:WNUMBER?	Queries the mean wavenumber of the selected modes.	I
:CALCulate3:FPERot:PEAK:[WAVelength]?	Queries the peak wavelength of the selected modes.	I
:CALCulate3:FPERot:PEAK:FREQuency?	Queries the peak frequency of the selected modes.	I
:CALCulate3:FPERot:PEAK:WNUMBER?	Queries the peak wavenumber of the selected modes.	I
:CALCulate3:FPERot:PEAK:POWER?	Queries the peak power of the selected modes.	I
:CALCulate3:FPERot:FWMH:[WAVelength]?	Queries full width half-max wavelength of selected modes.	I
:CALCulate3:FPERot:FWMH:FREQuency?	Queries full width half-max frequency of selected modes.	I
:CALCulate3:FPERot:FWMH:WNUMBER?	Queries full width half-max wavenumber of selected modes.	I
:CALCulate3:FPERot:MODE:SPACing:[WAVelength]?	Queries the mode spacing wavelength of the selected modes.	I
:CALCulate3:FPERot:MODE:SPACing:FREQuency?	Queries the mode spacing frequency of the selected modes.	I
:CALCulate3:FPERot:MODE:SPACing:WNUMbe r?	Queries the mode spacing wavenumber of the selected modes.	I

Programming
Lists of Commands

Table 3-10. Programming Commands (4 of 5)

Command	Description	Code
Codes: S indicates a standard SCPI command. I indicates an instrument specific command.		
:CALCulate3:FPERot:POWer:[WAVelength]?	Queries the power wavelength of the selected modes.	I
:CALCulate3:FPERot:POWer:FREQUency?	Queries the power frequency of the selected modes.	I
:CALCulate3:FPERot:POWer:WNUMber?	Queries the power wavenumber of the selected modes.	I
:CALCulate3:FPERot:SIGMa:[WAVelength]?	Queries the sigma wavelength of the selected modes.	I
:CALCulate3:FPERot:SIGMa:FREQUency?	Queries the sigma frequency of the selected modes.	I
:CALCulate3:FPERot:SIGMa:WNUMber?	Queries the sigma wavenumber of the selected modes.	I
:CALCulate3:POINts?	Queries the number of points in the data set.	I
:CALCulate3:PRESet	Turns off any CALCulate3 calculation that is on.	I
:CALCulate3:SNR:AUTO	Selects the internal or externally entered frequency value for the noise measurement reference in the SNR calculation.	I
:CALCulate3:SNR:REFeRence:FREQUency	Sets the frequency used for the noise measurement reference in the SNR calculation.	I
:CALCulate3:SNR:REFeRence:[WAVelength]	Sets the wavelength used for the noise measurement reference in the SNR calculation.	I
:CALCulate3:SNR:REFeRence:WNUMber	Sets the wave number used for the noise measurement reference in the SNR calculation.	I
:CALCulate3:SNR[:STATe]	Turns the SNR calculation on and off.	I
DISPlay Subsystem		
:DISPlay:MARKer:MAXimum	Sets the marker to the signal with the largest power.	I
:DISPlay:MARKer:MAXimum:LEFT	Moves marker to signal with the next lower wavelength or frequency.	I
:DISPlay:MARKer:MAXimum:NEXT	Moves the marker to the signal with the closest power level just below the power level of the signal at the current marker position.	I
:DISPlay:MARKer:MAXimum:PREVious	Moves the marker to the signal with the closest power level just above the power level of the signal at the current marker position.	I
:DISPlay:MARKer:MAXimum:RIGHT	Moves marker to the next higher wavelength or frequency.	I
:DISPlay[:WINDow]:GRAPhics:STATe	Turns the instrument display of the power bars on and off.	S
HCOPY Subsystem		
:HCOPY:IMMEDIATE	Starts a printout.	S
SENSe Subsystem		
:SENSe:CORRection:DEVice	Configures wavelength measurements for narrowband or wideband devices.	I

Table 3-10. Programming Commands (5 of 5)

Command	Description	Code
Codes: S indicates a standard SCPI command. I indicates an instrument specific command.		
:SENSe:CORRection:ELEVation	Sets the elevation value used by the instrument to compensate for air dispersion.	I
:SENSe:CORRection:OFFSet:MAGNitude	Sets the power offset value used by the instrument.	S
:SENSe:CORRection:MEDium	Sets the instrument to return the wavelength reading in a vacuum when the parameter is on. Parameters are VAC and AIR.	I
:SENSe:DATA?	Queries the time domain samples of the input signal.	I
STATus Subsystem		
:STATus:{OPERation QUEStionable}:CONDition?	Returns the value for the condition register for the node.	S
:STATus:{OPERation QUEStionable}:EVENT?	Returns the value of the event register for the node.	S
:STATus:{OPERation QUEStionable}:ENABle	Sets the enable register.	S
:STATus:{OPERation QUEStionable}:PTRansit ion	Sets the positive transition filter register.	S
:STATus:{OPERation QUEStionable}:NTRansit ion	Sets the negative transition filter register.	S
:STATus:PRESet	Presets the enable registers for all status nodes.	S
SYSTem Subsystem		
:SYSTem:ERRor?	Queries an error from the error queue.	S
:SYSTem:HELP:HEADers?	Queries an ASCII listing of all Agilent 86120C remote commands.	I
:SYSTem:PRESet	Performs the equivalent of a front-panel PRESET key press.	S
:SYSTem:VERSion	Queries the version of SCPI with which this instrument is compliant.	S
TRIGger Subsystem		
:ABORt	Stops the current measurement sequence.	S
:INITiate:IMMEDIATE	Places the instrument into the initiated state and initiates a new measurement sequence.	S
:INITiate:CONTinuous	Sets the instrument for single or continuous measurement.	S
UNIT Subsystem		
:UNIT[:POWer]	Sets the power units to watts (linear) or dBm (logarithmic).	S

Programming
Lists of Commands

Table 3-11. Keys Versus Commands (1 of 2)

Key	Equivalent Command
Δ PWR	:CALCulate3:DELTA:POWer[:STATe]
Δ WL	:CALCulate3:DELTA:WAVelength[:STATe]
Δ WL/PWR	:CALCulate3:DELTA:WPOWer[:STATe]
Appl's	See DRIFT, S/N, and FP TEST
AUTO	:CALCulate3:SNR:AUTO ON
Avg WL	:CALCulate2:PWAVerage[:STATe]
BAR OFF	:DISPlay[:WINDow]:GRAPhics:STATe
BAR ON	:DISPlay[:WINDow]:GRAPhics:STATe
BROAD	:SENSe:CORRection:DEVIce BROAD
CAL	See ELEV, PWR OFS, STD AIR, and VACUUM
CM-1	:MEASure:ARRay:POWer:WNUMber
Cont	:INITiate:CONTInuous ON
DBM	:UNIT:POWer
DEVICE	:SENSe:CORRection:DEVIce
DRIFT	:CALCulate3:DRIFt[:STATe]
ELEV	:SENSe:CORRection:ELEVation
EXIT	State dependent
FAST	See UPDATE
FP TEST	:CALCulate3:FPERot[:STATe]
GPIB	none
List by Power	:CONFigure:ARRay:POWer
List by WL	:MEASure:ARRay:POWer:WAVelength
MAX-MIN	:CALCulate3:DRIFt:MINimum[:STATe] and :CALCulate3:DRIFt:MAXimum[:STATe]
MW	:UNIT:POWer
NARROW	:SENSe:CORRection:DEVIce NARRow
NEXT PK	:DISPlay:MARKer:MAXimum:NEXT
NEXT WL	:DISPlay:MARKer:MAXimum:RIGHT
NM	:MEASure:ARRay:POWer:WAVelength
NORMAL	See UPDATE
OFF	:CALCulate3:DELTA:POWer[:STATe]
ON	:CALCulate3:DELTA:POWer[:STATe]
PEAK	:DISPlay:MARKer:MAXimum

Table 3-11. Keys Versus Commands (2 of 2)

Key	Equivalent Command
Peak WL	See NEXT PK, NEXT WL, PEAK, PREV PK, and PREV WL
PK EXC	:CALCulate2:PEXCursion
PK THLD	:CALCulate2:PTHReshold
POWER	:UNIT:POWer
Preset	:SYSTem:PRESet
PREV PK	:DISPlay:MARKer:MAXimum:PREVious
PREV WL	:DISPlay:MARKer:MAXimum:LEFT
Print	:HCOPY:IMMEDIATE
PWR BAR	See BAR ON and BAR OFF
PWR OFF	:SENSe:CORRection:OFFSet:MAGNitude
RESET	:CALCulate3:DRIFT:REFeRence:RESet
S/N	:CALCulate3:SNR:STATe
S/N AVG	:CALCulate3:ASNR:STATe
SELECT	:CONFigure:POWer
Setup	See CAL, UNITS, and UPDATE
Single	:INITiate:CONTInuous OFF
START WL	:CALCulate2:WLIMit:STARt
STOP WL	:CALCulate2:WLIMit:STOP
STD AIR	:SENSe:CORRection:MEDIum AIR
THRSHLD	See PK EXC and PK THLD
THZ	:MEASure:ARRAy:POWer:FREQuency
UNITS	:UNIT:POWer
UPDATE	Measurement Instructions and :CALCulate1:TRANSform:FREQuency:POINts
USER	:CALCulate3:SNR:AUTO OFF
USER WL	:CALCulate3:SNR:REFeRence[:WAVelength]
UW	UNIT:POWer
VACUUM	:SENSe:CORRection:MEDIum VACuum
WL	See CM, NM, and THZ
WL REF	See AUTO, USER, and USER WL

Programming
Lists of Commands

4

Common Commands	4-3
Measurement Instructions	4-15
CALCulate1 Subsystem	4-25
CALCulate2 Subsystem	4-31
CALCulate3 Subsystem	4-44
CONFigure Measurement Instruction	4-74
DISPlay Subsystem	4-75
FETCh Measurement Instruction	4-79
HCOPy Subsystem	4-80
MEASure Measurement Instruction	4-81
READ Measurement Instruction	4-82
SENSe Subsystem	4-83
STATus Subsystem	4-90
SYSTem Subsystem	4-97
TRIGger Subsystem	4-103
UNIT Subsystem	4-107

Programming Commands



Programming Commands

This chapter is the reference for all Agilent 86120C programming commands. Commands are organized by subsystem.

Table 4-12. Notation Conventions and Definitions

Convention	Description
< >	Angle brackets indicate values entered by the programmer.
	“Or” indicates a choice of one element from a list.
[]	Square brackets indicate that the enclosed items are optional.
{ }	When several items are enclosed by braces, one, and only one of these elements must be selected.
<integer>	An ASCII string representing an integer. This is defined by the IEEE 488.2 <NR1> format.
<real>	An ASCII string representing a real number. This is defined by the IEEE 488.2 <NR2> or <NRf> formats.

Common Commands

Common commands are defined by the IEEE 488.2 standard. They control generic device functions which could be common among many different types of instruments. Common commands can be received and processed by the instrument whether they are sent over the GPIB as separate program messages or within other program messages.

*CLS

The *CLS (clear status) command clears all the event status registers summarized in the status byte register.

Syntax

*CLS

Description

With the exception of the output queue, all queues that are summarized in the status byte register are emptied. The error queue is also emptied. Neither the event status enable register, nor the service request enable register are affected by this command.

After the *CLS command, the instrument is left in the idle state. The command does not alter the instrument setting. *OPC and *OPC? actions are cancelled.

This command cannot be issued as a query.

*ESE

The *ESE (event status enable) command sets the bits in the event status enable register and enables the corresponding bits in the event status register.

Syntax

*ESE <integer>
*ESE?

Programming Commands

Common Commands

<integer> is a mask from 0 to 255.

Description

The event status enable register contains a mask value for the bits to be enabled in the event status register. A bit set to one (1) in the event status enable register enables the corresponding bit in the event status register to set the event summary bit in the status byte register. A zero (0) disables the bit. Refer to the following table for information about the event status enable register bits, bit weights, and what each bit masks. The event status enable register is cleared at power-on. The *RST and *CLS commands do not change the register. The *ESE? query returns the value of the event status enable register.

Table 4-13. Event Status Enable Register

Bit ^a	Bit Weight	Enables
7	128	PON – Power On
6	64	Not Used
5	32	CME – Command Error
4	16	EXE – Execution Error
3	8	DDE – Device Dependent Error
2	4	QYE – Query Error
1	2	Not Used
0	1	OPC – Operation Complete

a. A high enables the event status register bit.

Query Response

<integer> is a mask from 0 to 255.

Example

```
OUTPUT 720; **ESE 32
```

In this example, the *ESE 32 command enables CME (event summary bit) bit 5 of the event status enable register. Therefore, when an incorrect programming command is received, the CME (command error bit) in the status byte register is set.

***ESR?**

The *ESR (event status register) query returns the value of the event status register.

Syntax

*ESR?

Description

When you read the standard event status register, the value returned is the total of the bit weights of all of the bits that are set to one at the time you read the byte. The following table shows each bit in the event status register and its bit weight. The register is cleared when it is read.

Table 4-14. Standard Event Status Register

Bit	Bit Weight	Condition
7	128	PON – Power On
6	64	Not Used
5	32	CME – Command Error
4	16	EXE – Execution Error
3	8	DDE – Device Dependent Error
2	4	QYE – Query Error
1	2	Not Used
0	1	OPC – Operation Complete

Query Response

<integer> ranges from 0 to 255.

Example

```
OUTPUT 720;"*ESR?"
ENTER 720;Event
PRINT Event
```

***IDN?**

The *IDN? (identification number) query returns a string value which identifies the instrument type and firmware version.

Syntax

*IDN?

Description

An *IDN? query must be the last query in a program message. Any queries after the *IDN? query in a program message are ignored. The maximum length of the identification string is 50 bytes.

Query Response

The following identification string is returned. The third entry is the instrument's serial number. The last entry in the string is the firmware version number; this value may vary between instruments.

Agilent 86120C, USaaaabbbb, 1.000

Example

```
DIM Id${50}
OUTPUT 720; "*IDN?"
ENTER 720; Id$
PRINT Id$
```

*OPC

The *OPC (operation complete) command sets the operation complete bit in the event status register when all pending device operations have finished.

Syntax

*OPC
*OPC?

Description

The *OPC? query places an ASCII “1” in the output queue when all pending device operations have finished.

This command is useful when the computer is sending commands to other instruments. The computer can poll the event status register to check when the Agilent 86120C has completed the operation. Use the *OPC? query to ensure all operations have completed before continuing the program. By following a command with an *OPC? query and an ENTER statement, the program will pause until the response (ASCII “1”) is returned by the instrument.

Be sure the computer’s timeout limit is at least two seconds, since some of the Agilent 86120C commands take approximately one second to complete.

Query Response

1

Example

```
OUTPUT 720;”*OPC?”  
ENTER 720;Op$
```

*RCL

This command recalls a saved instrument state.

Syntax

*RCL <integer>
<integer> range is 1 to 4.

Description

For a description of an instrument state, see *SAV command.

***RST**

The *RST (reset) command returns the Agilent 86120C to a known condition.

Syntax

*RST

Description

For a listing of reset conditions, refer to the following table. This command cannot be issued as a query. Since this command places the instrument in single measurement acquisition mode, any current data is marked as invalid and a measurement query such as :FETCh? results in error number -230, "Data corrupt or stale". You must initiate a new sweep with :INIT:IMM before you can use the :FETCh command.

Table 4-15. Conditions Set by *RST Reset (1 of 2)

Item	Setting
Display mode	single wavelength
Start wavelength	1270 nm
Stop wavelength	1650 nm
Graphical display	off
Measurement acquisition	single
Wavelength calibration	vacuum
Elevation correction value	0 meters
Wavelength units	nm
Amplitude units	dBm
Power offset	0 dB
Peak threshold	10 dB
Peak excursion	15 dB
Measurement speed	normal

Table 4-15. Conditions Set by *RST Reset (2 of 2)

Item	Setting
Number of uncorrected data points	15,047
Delta Measurements:	
Δ power	off
Δ wavelength	off
Δ wavelength and power	off
reference signal position	1270 nm
Drift measurements	off
Signal-to-Noise Measurements:	
measurement	off
wavelength reference	auto
reference (user) wavelength	1550 nm in vacuum
number of averages (count)	100
GPIB address	not affected
Power-bar display	on

*SAV

This command saves an instrument state.

Syntax

*SAV <integer>

<integer> range is 1 to 4.

Description

The following constitutes an instrument state: single/continuous measurement mode, power bar on/off, vacuum/STD air mode, normal/fast update, list by WL, list by Pwr, peak, or avg display mode, frequency units, power units, elevation, peak excursion, peak threshold, power

Programming Commands

Common Commands

offset, signal-to-noise auto mode on/off, wavelength limit on/off, wavelength limit start, wavelength limit stop, and signal-to-noise average count.

*SRE

The *SRE (service request enable) command sets the bits in the service request enable register.

Syntax

*SRE <integer>
*SRE?

<integer> is defined as an integer mask from 0 to 255.

Description

The service request enable register contains a mask value for the bits to be enabled in the status byte register. A bit set to one in the service request enable register enables the corresponding bit in the status byte register to generate a service request. A zero disables the bit. The following table lists the bits in the service request enable register and what they mask.

The service request enable register is cleared when the instrument is turned on. The *RST and *CLS commands do not change the register. The *SRE? query returns the value of the service request enable register.

Table 4-16. Service Request Enable Register

Bit ^a	Bit Weight	Enables
7	128	Not Used
6	64	Not Used
5	32	Event Status Bit (ESB)
4	16	Message Available (MAV)
3	8	Not Used
2	4	Error queue status
1	2	Not Used
0	1	Not Used

a. High enables the status byte register bit.

Query Response *<integer>* from 0 to 63 or from 128 to 191.

Example

OUTPUT 720; "SRE 32"

In this example, the command enables ESB (event summary) bit 5 in the status byte register to generate a service request.

***STB?**

The *STB (status byte) query returns the current value of the instrument's status byte.

Syntax

*STB?

Description

The master summary status (MSS) bit 6 indicates whether or not the device has at least one reason for requesting service. When you read the status byte register, the value returned is the total of the bit weights of all of the bits set to one at the time you read the byte. The following table shows each bit in the status byte register and its bit weight. The *STB? query does not affect the contents of the status byte register.

Table 4-17. Status Byte Register

Bit	Bit Weight	Condition
7	128	Not Used
6	64	Master Summary Status (MSS)
5	32	Event Status Bit (ESB)
4	16	Message Available (MAV)
3	8	Not Used
2	4	Error queue status
1	2	Not Used
0	1	Not Used

Query Response

<integer> from 0 to 255.

Example

```
OUTPUT 720;"*STB?"
ENTER 720;Value
PRINT Value
```

*TRG

The *TRG (trigger) command is identical to the group execute trigger (GET) message or RUN command.

Syntax

*TRG

Description

This command acquires data according to the current settings. This command cannot be issued as a query. If a measurement is already in progress, a trigger is ignored, and an error is generated.

Example

The following example starts the data acquisition according to the current settings.

```
OUTPUT 720;"*TRG"
```

*TST?

The *TST (test) query starts a self-test on the instrument.

Syntax

*TST?

Description

The result of the test is placed in the output queue. A zero indicates the test passed and a non-zero value indicates the test failed. The instrument will initiate a measurement and check for any hardware errors after the measurement is complete.

Query Response

<integer>

Example

```
OUTPUT 720;"*TST?"  
ENTER 720;Result  
PRINT Result
```

***WAI**

The *WAI command prevents the instrument from executing any further commands until the current command has finished executing.

Syntax

*WAI

Description

All pending operations are completed during the wait period. This command cannot be issued as a query.

Measurement Instructions

Use the measurement instructions documented in this section to perform measurements and return the desired results to the computer. Four basic measurement instructions are used: CONFigure, FETCh, READ, and MEASure. Because the command trees for each of these four basic measurement instructions are identical, only the MEASure tree is documented.

To perform a measurement, append to the measurement instruction a POWER or LENGth function. The POWER functions select power, frequency, wavelength, or wave number measurements.

When the :SCALar command is used, data for a single measurement value is returned. When the :ARRay command is used, multiple data values are returned.

The MEASure measurement instruction always acquires new measurement data. In order to obtain both wavelength and power values from the same measurement data, use two FETCh commands. This is shown in the following program fragment:

```
OUTPUT 720;":INIT:CONT OFF;"
OUTPUT 720;":CONF:ARR:POW MAX"
OUTPUT 720;":INIT:IMM"
OUTPUT 720;":FETC:ARR:POW?"
ENTER 720:powers$
OUTPUT 720;":FETC:ARR:POW:WAV?"
ENTER 720:wavelengths$
```

In the example above, the data in the power and wavelength arrays are returned in the same order so that powers can be matched to wavelengths. You can also send a MEASure command followed by a FETCh command.

Programming Commands
Measurement Instructions

The commands in this subsystem have the following command hierarchy:

```
{:MEASure | :READ[?] | :FETCh[?] | :CONFigure[?]}  
  {:ARRay | [:SCALar] }  
    :POWer[?]  
      :FREQuency[?]  
      :WAVelength[?]  
      :WNUMber[?]
```

MEASure{:ARRay | [:SCALAr]] :POWer?

Returns amplitude values.

Syntax :POWer? [<expected_value>[,<resolution>]]

Used With	<expected_value>	<resolution>
SCALAr	optional	ignored
ARRAy	ignored	ignored

Description When used with a :SCALAr command, a single value is returned. The display is placed in the single-wavelength mode, and the marker is placed on the signal having a power level that is closest to the <expected_value> parameter.

When used with an :ARRAy command, an array of amplitudes is returned. The display is placed in the list-by-power mode.

Returned values are in the current power units. Wavelength units are not affected.

CONFigure command

When this function is used with the CONFigure command, the query question mark character "?" *must not* be included in the string. However, the FETCh, READ, and MEASure command are queries and require the question mark. Refer to the examples for this command.

<expected_value> Constants

MAXimum	Displays the highest power signal
MINimum	Displays the lowest power signal
DEFault	Displays the signal at the current marker position

Programming Commands
Measurement Instructions

Examples

```
:CONF:ARR:POW  
:FETC:ARR:POW?  
:READ:ARR:POW?  
:MEAS:ARR:POW?  
  
:CONF:SCAL:POW -10 dBm  
:FETC:SCAL:POW? MAX  
:READ:SCAL:POW? MIN  
:MEAS:SCAL:POW? DEF
```

Query Response

The following line is an example of a returned string when
:MEAS:SCAL:POW? MAX is sent:

```
-5.88346500E+000
```

If six laser lines are located and :MEAS:ARR:POW? is sent, the following string could be returned. Notice that the first returned number indicates the number of laser-line values returned in the query. The measurement units are in dBm.

```
6,-1.37444400E+001,-1.10996100E+001,-9.62396600E+000,  
-7.94024500E+000,-7.01303200E+000,-1.04536200E+001
```

MEASure{:ARRay | [:SCALAr]] :POWer:FREQUen- cy?

Returns frequency values.

Syntax

:POWer:FREQUenCy? [<expected_value>[,<resolution>]]

Used With	<expected_value>	<resolution>
SCALAr	optional	optional
ARRAy	ignored ^a	optional

a. Although ignored, this argument must be present if the resolution argument is specified.

Description

When used with a :SCALAr command, a single value is returned. The display is placed in the single-wavelength mode, and the marker is placed on the signal having a frequency that is closest to the <expected_value> parameter. Default units for <expected_value> parameter are in Hz. When used with an :ARRAy command, an array of frequencies is returned. The display is placed in the list-by-wavelength mode.

The <resolution> parameter sets the resolution of the measurement. It is a unitless number whose value will be limited to either 0.01 or 0.001 (whichever is closer). MAXimum resolution is equivalent to the FAST measurement update mode. MINimum resolution is equivalent to the NORMAL measurement update mode.

Returned values are in Hz (display is in THz). Power units are not affected.

CONFigure command

When this function is used with the CONFigure command, the query question mark character "?" *must not* be included in the string. However, the FETCh, READ, and MEASure command are queries and require the question mark. Refer to the examples for this command.

<expected_value> Constants

MAXimum	The highest frequency signal
MINimum	The lowest frequency signal

Programming Commands
Measurement Instructions

	DEFAult	The current marker position
<resolution> Constants	MAXimum	0.01 resolution (fast update)
	MINimum	0.001 resolution (normal)
	DEFAult	Current resolution

Examples

```
:CONF:ARR:POW:FREQ DEF, MIN  
:FETC:ARR:POW:FREQ? DEF, MAX  
:READ:ARR:POW:FREQ?  
:MEAS:ARR:POW:FREQ?
```

```
:CONF:SCAL:POW:FREQ 230.8THZ, MAX  
:FETC:SCAL:POW:FREQ? 230.8THZ, MIN  
:READ:SCAL:POW:FREQ? 230.8THZ  
:MEAS:SCAL:POW:FREQ? 230.8THZ
```

Query Response

The following line is an example of a returned string when
:MEAS:SCAL:POW:FREQ? MAX is sent:

```
+1.94055176E+014
```

If six laser lines are located and :MEAS:ARR:POW:FREQ? is sent, the following string is an example of the returned data. Notice that the first returned number indicates the number of laser-line values returned in the query.

```
6,+1.94055100E+014,+1.93854100E+014,+1.93653000E+014,+1.93452000E+014,+1.93250900E+014,+1.93050000E+014
```

MEASure{:ARRay | [:SCALar]} :POWer:WAVElength?

Returns wavelength values.

Syntax

:POWer:WAVelength? [<expected_value>[,<resolution>]]

Used With	<expected_value>	<resolution>
SCALar	optional	optional
ARRay	ignored ^a	optional

a. Although ignored, this argument must be present if the resolution argument is specified.

Description

When used with a :SCALar command, a single value is returned. The display is placed in the single-wavelength mode, and the marker is placed on the signal having a wavelength that is closest to the <expected_value> parameter. Default units for <expected_value> parameter are in meters.

When used with an :ARRay command, an array of wavelengths is returned. The display is placed in the list-by-wavelength mode.

The <resolution> parameter sets the resolution of the measurement. It is a unitless number whose value will be limited to either 0.01 or 0.001 (whichever is closer).

Returned values are in meters. Displayed units are nanometers. Power units are not affected.

CONFigure command

When this function is used with the CONFigure command, the query question mark character "?" *must not* be included in the string. However, the FETCh, READ, and MEASure command are queries and require the question mark. Refer to the examples for this command.

<expected_value> Constants	MAXimum	The highest wavelength signal
	MINimum	The lowest wavelength signal
	DEFault	The current marker position

Programming Commands
Measurement Instructions

<resolution> Constants	MAXimum	0.01 resolution (fast update)
	MINimum	0.001 resolution (normal)
	DEFault	Current resolution

Examples

```
:CONF:ARR:POW:WAV DEF, MAX
:FETC:ARR:POW:WAV? DEF, MIN
:READ:ARR:POW:WAV?
:MEAS:ARR:POW:WAV?

:CONF:SCAL:POW:WAV 1300NM, MAX
:FETC:SCAL:POW:WAV? 1300NM, MIN
:READ:SCAL:POW:WAV? 1300NM
:MEAS:SCAL:POW:WAV? 1300NM
```

Query Response The following line is an example of a returned string when :MEAS:SCAL:POW:WAV? MAX is sent:

```
+1.5529258E-006
```

If six laser lines are located and :MEAS:ARR:POW:WAV? is sent, the following string could be returned. Notice that the first returned number indicates the number of laser-line values returned in the query.

```
6,+1.54488100E-006,+1.54648400E-006,+1.54809000E-006,+1.54969900E-006,+1.55131100E-006,+1.55292600E-006
```

MEASure{:ARRay | [:SCALAr]] :POWer:WNUMber?

Returns a wave number value.

Syntax

:POWer:WNUMber? [<expected_value>[,<resolution>]]

Used With	<expected_value>	<resolution>
SCALAr	optional	optional
ARRay	ignored ^a	optional

a. Although ignored, this argument must be present if the resolution argument is specified.

Description

When used with a :SCALAr command, a single value is returned. The display is placed in the single-wavelength mode, and the marker is placed on the signal having a wave number that is closest to the <expected_value> parameter. Default units for <expected_value> parameter are in m⁻¹.

When used with an :ARRay command, an array of wave number is returned. The display is placed in the list-by-wavelength mode.

The <resolution> parameter sets the resolution of the measurement. It is a unitless number whose value will be limited to either 0.01 or 0.001 (whichever is closer).

Returned values are in inverse meters. Displayed units are inverse centimeters. Power units are not affected.

CONFigure command

When this function is used with the CONFigure command, the query question mark character "?" *must not* be included in the string. However, the FETCh, READ, and MEASure command are queries and require the question mark. Refer to the examples for this command.

<expected_value> Constants

MAXimum	The laser line having the largest wave number
MINimum	The laser line having the smallest wave number
DEFault	The current marker position

Programming Commands
Measurement Instructions

<resolution> Constants	MAXimum	0.01 resolution (fast update)
	MINimum	0.001 resolution (normal)
	DEFault	Current resolution

Examples

```
:CONF:ARR:POW:WNUM DEF, MAX  
:FETC:ARR:POW:WNUM? DEF, MIN  
:READ:ARR:POW:WNUM?  
:MEAS:ARR:POW:WNUM?  
:CONF:SCAL:POW:WNUM 6451, MAX  
:FETC:SCAL:POW:WNUM? 6451, MIN  
:READ:SCAL:POW:WNUM? 6451  
:MEAS:SCAL:POW:WNUM? 6451
```

Query Response If the :MEAS:SCAL:POW:WNUM? 6451 command is sent, and a 1550 nm laser line is present, the following response would be returned to the computer:

```
+6.45286262E+005
```

Notice that the returned units are m^{-1} . If six laser lines are measured and :MEAS:ARR:POW:WNUM? is sent, the following response is returned. Notice that the first returned number indicates the number of laser-line values returned in the query.

```
6,+6.47298400E+005,+6.46627900E+005,+6.45957000E+005,+6.45286300E+005,+6.44615600E+005,+6.43945300E+005
```

CALCulate1 Subsystem

Use the CALCulate1 commands to query *uncorrected* frequency-spectrum data. In *NORMAL* measurement update mode, 15,047 values are returned. If the Agilent 86120C is set for *FAST* measurement update mode (low resolution), 7,525 values are returned.

The commands in this subsystem have the following command hierarchy:

```
:CALCulate1
  :DATA?
  :TRANSform
    :FREQuency
    :POINts
```

DATA?

Queries *uncorrected* frequency-spectrum data of the input laser line.

Syntax :CALCulate1:DATA?

Attribute Summary Preset State: not affected
SCPI Compliance: standard
Query Only

Description The returned values are proportional to squared Watts (linear) units. No amplitude or frequency correction is applied to the values. To obtain the logarithmic (dB) result, normalize the returned values by the largest value, then take five times the logarithm of the normalized values.

Be prepared to process a large amount of data when this query is sent. The amount of data returned depends on the measurement update state of the instrument which can be set using the :CALCulate1:TRANSform:FREQuency:POINTs command or the resolution argument of an instrument function. [Refer to “Measurement Instructions” on page 4-15.](#)

When *NORMAL* measurement update is specified, over 250 kilobytes of data (15,047 values) can be returned to the computer. When *FAST* measurement update is specified, over 125 kilobytes of data (7,525 values) can be returned.

The following string is a typical example of the first few returned values:

```
+4.02646500E+001,+6.78125100E+001,+6.17986600E+001,+4.26768200E+001,+4.80245300E+001,  
+3.10491300E+001,+1.13409400E+001,+5.07832500E+001,+2.77746200E+001,+3.89150500E+001,  
+3.50217600E+001,+7.34649800E-001,+5.64983800E+000,
```

Notice that only measurement values are returned to the computer. There is no first value that indicates the number of values contained in the string as there is, for example, with the FETCh, READ, and MEASure commands. Use the :CALCulate1:TRANSform:FREQuency:POINTs command to query the number of points the :CALC1:DATA? returns.

When *NORMAL* measurement mode is selected, the uncorrected frequency domain data consists of 64K values. Only the frequency domain data corresponding to 1270–1650 wavelength (in vacuum) is returned (15,047 values). In *FAST* measurement mode, the data consists of 32K values of which 7,525 values are returned.

In *NORMAL* measurement mode, the frequency spacing between values is uniform and is equal to 3.613378 GHz. Note that the spacing between values is not uniform in wavelength units. The values returned are in ascending optical frequency.

The first value of the uncorrected frequency data corresponds to an optical frequency of 181.6915 THz (1650.008 nm). The last value of the uncorrected frequency data corresponds to an optical frequency of 236.0584 THz (1269.993 nm). For example, a laser line peak located at the 3,000th returned value has an optical frequency of:

$$\begin{aligned} \text{frequency} &= 181,6915 \text{ THz} + 2,999(3,613378 \text{ GHz}) \\ &= 192,5280 \text{ THz} \end{aligned}$$

or, 1557.137 nm (in vacuum).

When *FAST* measurement mode is selected, the frequency spacing between elements is uniform and is equal to 7.226756 GHz. Note the spacing between values is not uniform in wavelength units. The values returned are in ascending optical frequency. Only the frequency domain data corresponding to 1270–1650 wavelength (in vacuum) is returned (7,525 values). The first value of the uncorrected frequency data corresponds to an optical frequency of 181.6879 THz (1650.041 nm). The last value of the uncorrected frequency data corresponds to an optical frequency of 236.0620 THz (1269.974 nm). For example, a laser line peak located at the 1500th returned value has an optical frequency of:

$$\begin{aligned} \text{frequency} &= 181,6879 \text{ THz} + 1,499(7,226756 \text{ GHz}) \\ &= 192,5208 \text{ THz} \end{aligned}$$

or, 1557.195 nm (in vacuum).

If your program is aborted or interrupted after sending this query, the Agilent 86120C continues to process the data but does not place it in the output buffer. Because of the amount of data processed, the instrument *will not respond* to any new commands in its input buffer for up to 20 seconds.

Programming Commands

CALCulate1 Subsystem

This query will generate a “Settings conflict” error if the instrument is in the signal-to-noise average application.

TRANSform:FREQuency:POINts

Sets the size of the fast Fourier transform (FFT) performed by the instrument.

Syntax

:CALCulate1:TRANSform:FREQuency:POINts{?| {<integer> | MINimum | MAXimum}}

<integer> Sets FFT size. Must be either 15,047 or 7,525. Other values result in an error.

<u>Constant</u>	<u>Description</u>
MINimum	7,525
MAXimum	15,047

Attribute Summary

Non-sequential command
Preset State: array size set to 15,047
*RST State: 15,047
SCPI Compliance: instrument specific

Description

A *NORMAL* updated display corresponds to an FFT size of 15,047. A *FAST* updated display corresponds to an FFT size of 7,525. These values are a subset of the uncorrected-data buffer shown in the figure that is located in [“Making Measurements” on page 3-5](#). Changing the number of points causes the instrument to reprocess the current set of data.

The query form of the command returns the number of points in the data set. This is the number of measurement points that will be returned by the CALC1:DATA? query.

Non-sequential command

Always use an *OPC? query or a *WAI command to ensure that this command has the time to complete before sending any more commands to the instrument. Refer to [“Always force the Agilent 86120C to wait for non-sequential commands” on page 3-12](#) for more information.

Programming Commands
CALCulate1 Subsystem

Query Response For normal update:
+15,047
For fast update:
+7,525

CALCulate2 Subsystem

Use the CALCulate2 commands to query *corrected* values frequency-spectrum data.

The commands in this subsystem have the following command hierarchy:

```
:CALCulate2
:DATA?
:PEXCursion
:POINTs?
:PTHReshold
:PWAVerage
[:STATe]
:WLIMit
[:STATe]
:START
:FREQuency
[:WAVelength]
:WNUMber
:STOP
:FREQuency
[:WAVelength]
:WNUMber
```

DATA?

Queries the corrected peak data of the input laser line.

Syntax

:CALCulate2:DATA? {FREQuency | POWer | WAVelength | WNUMber}

<u>Constant</u>	<u>Description</u>
FREQuency	Queries the array of laser-line frequencies after the peak search is completed. If :CALC2:PWAV:STAT is on, the power-weighted average frequency is returned.
POWer	Queries the array of laser-line powers after the peak search is completed. If :CALC2:PWAV:STAT is on, the total input power is returned.
WAVelength	Queries the array of laser-line wavelengths after the peak search is completed. If :CALC2:PWAV:STAT is on, the power-weighted average wavelength is returned.
WNUMber	Queries the array of laser-line wave numbers after the peak search is completed. If :CALC2:PWAV:STAT is on, the power-weighted average wave number is returned.

Attribute Summary

Preset State: not affected
SCPI Compliance: standard
Query Only

Description

Use the CALC2:POIN? query to determine the number of points the CALC2:DATA? query will return. The following string is a typical example of the first few returned values when WAVelength is specified:

```
+1.54488600E-006,+1.54649100E-006,+1.54808300E-006,+1.54969600E-006,+1.55131200E-006,+1.55293000E-006
```

This next string resulted by specifying the WNUMber argument:

```
+6.47296600E+005,+6.46625000E+005,+6.45959900E+005,+6.45287500E+005,+6.44615500E+005,+6.43943900E+005
```

Notice that only measurement values are returned to the computer. There is no first value that indicates the number of values contained in the string as there is, for example, with the FETCh, READ, and MEASure commands.

When there is no input signal, the POWer query returns -200 dBm; the WAVelength query returns 100 nm (1.0E-7).

PEXCursion

Sets the peak excursion limit used by the Agilent 86120C to determine valid laser line peaks.

Syntax

:CALCulate2:PEXCursion{?| {<integer> | MINimum | MAXimum | DEFault}}

<integer> represents logarithmic units in dB. Valid range is 1 to 30 dB.

<u>Constant</u>	<u>Description</u>
MINimum	1 dB
MAXimum	30 dB
DEFault	15 dB

Attribute Summary

Non-sequential command
Preset State: 15 dB
*RST State: 15 dB
SCPI Compliance: instrument specific

Description

A laser line is identified as a valid peak if its amplitude is greater than the peak excursion plus the amplitudes of the closest local minima on either side of the peak. This command works in conjunction with the peak threshold setting. Refer to “PTHreshold” on page 4-34. Changing the peak excursion limit causes the instrument to reprocess the current set of data. Refer also to “Defining Laser-Line Peaks” on page 2-15.

The query response is the current value. For example, if the current value is set to 15 dB, the following value is returned:

15

Non-sequential command

Always use an *OPC? query or a *WAI command to ensure that this command has the time to complete before sending any more commands to the instrument. Refer to [“Always force the Agilent 86120C to wait for non-sequential commands” on page 3-12](#) for more information.

POINTs?

Queries the number of points in the data set.

Syntax :CALCulate2:POINTs?

Attribute Summary
 Preset State: unaffected
 *RST State: unaffected
 SCPI Compliance: instrument specific
 Query Only

Description This is the number of points that will be returned by the CALC2:DATA? query.

Query Response For example, if six laser lines are located:
 +6

PTHReshold

Sets the peak threshold limit used by the instrument to determine valid laser line peaks.

Syntax :CALCulate2:PTHReshold{?| {<integer> | MINimum | MAXimum | DEFault}}

<integer> represents logarithmic units in dB. Valid range is 0 to 40.

<u>Constant</u>	<u>Value</u>
MINimum	0 dB
MAXimum	40 dB

DEfault 10 dB

Attribute Summary Non-sequential command
Preset State: 10 dB
*RST State: 10 dB
SCPI Compliance: instrument specific

Description A laser line is identified as a valid peak if its amplitude is above the maximum amplitude minus the peak threshold value. The subtraction is done in dB units. This setting works in conjunction with the peak excursion setting to determine which responses are located. Refer to “PEXCursion” on page 4-33. Changing the peak threshold limit causes the instrument to reprocess the current set of data. Refer also to “Defining Laser-Line Peaks” on page 2-15.

The query response is the current value. For example, if the current value is set to 15 dB, the following value is returned:

15

Non-sequential command

Always use an *OPC? query or a *WAI command to ensure that this command has the time to complete before sending any more commands to the instrument. Refer to “Always force the Agilent 86120C to wait for non-sequential commands” on page 3-12 for more information.

PWAVerage[:STATe]

Places the instrument in the power-weighted average mode.

Syntax :CALCulate2:PWAVerage[:STATe]{? | {ON | OFF | 1 | 0}}

Attribute Summary Preset State: off
*RST State: off

Description When the state is on, the CALC2:DATA? POW query returns the total power and the CALC2:DATA? WAV, FREQ, or WNUM query returns the power-weighted average wavelength, frequency, or wave number values.

Programming Commands

CALCulate2 Subsystem

Turning power-weighted average mode on while making delta, Fabry-Perot, or signal-to-noise measurements results in a “-221 Settings conflict” error.

WLIMit[:STATe]

Turns wavelength limiting on and off.

Syntax :CALCulate2:WLIMit[:STATe]{?| {ON | OFF | 1 | 0}}

Attribute Summary
Non-sequential command
Preset State: on
*RST State: on
SCPI Compliance: instrument specific

Description When this function is on, the Agilent 86120C has an input range from the WLIMit START to the WLIMit STOP. When this function is off, the instrument displays peaks over the full wavelength range. The graphics display always shows the range between WLIMit:START and WLIMit:STOP, regardless of the state of this command.

Whenever the Agilent 86120C receives this command, it reprocesses the data and performs a new peak search.

Non-sequential command

Always use an *OPC? query or a *WAI command to ensure that this command has the time to complete before sending any more commands to the instrument. Refer to [“Always force the Agilent 86120C to wait for non-sequential commands”](#) on page 3-12 for more information.

WLIMit:STARt:FREQUency

Sets the start frequency for the wavelength limit range.

Syntax

:CALCulate2:WLIMit:STARt:FREQUency {?|{<real> | MINimum | MAXimum}}

<real> is a frequency value that is within the following limits:

<u>Constant</u>	<u>Description</u>
MINimum	181.6924 THz (1650 nm)
MAXimum	wavelength limit stop value

Attribute Summary

Non-sequential command
Preset State: 181.6924 THz
*RST State: 181.6924 THz
SCPI Compliance: instrument specific

Description

This command sets the starting range for the wavelength limit in hertz. The start frequency value must be less than or equal to the stop frequency value or the start frequency will be clipped to the stop frequency and a “Data out of range” error will be generated. The default units for the <real> parameter are hertz.

Non-sequential command

Always use an *OPC? query or a *WAI command to ensure that this command has the time to complete before sending any more commands to the instrument. Refer to “Always force the Agilent 86120C to wait for non-sequential commands” on page 3-12 for more information.

WLIMit:STARt[:WAVelength]

Syntax

CALCulate2:WLIMit:STARt[:WAVelength] {?|<real> | MINimum | MAXimum}}

<real> is a wavenumber value that is within the following limits:

<u>Constant</u>	<u>Description</u>
MINimum	1270 nm
MAXimum	wavelength limit stop value

Attribute Summary

Non-sequential command
Preset State: 1270 nm
*RST State: 1270 nm
SCPI Compliance: instrument specific

Description

This command sets the starting range for the wavelength limit. The start wavelength value must be less than or equal to the stop wavelength value or the start wavelength will be clipped to the stop wavelength and a “Data out of range” error will be generated. Setting the start wavelength is equivalent to setting the stop frequency/wavenumber because of the inverse relationship of frequency to wavelength. The default units for the <real> parameter are meters.

Non-sequential command

Always use an *OPC? query or a *WAI command to ensure that this command has the time to complete before sending any more commands to the instrument. Refer to “Always force the Agilent 86120C to wait for non-sequential commands” on page 3-12 for more information.

WLIMit:STARt:WNUMber

Sets the starting wavenumber for the wavelength limit range.

Syntax

:CALCulate2:WLIMit:STARt:WNUMber {?|<real> | MINimum | MAXimum}

<real> is a wavenumber value that is within the following limits:

<u>Constant</u>	<u>Description</u>
MINimum	6060 cm ⁻¹ (1650 nm)
MAXimum	wavelength limit stop value

Attribute Summary

Non-sequential command
Preset State: 6.060606E5 m⁻¹
*RST State: 6.060606E5 m⁻¹
SCPI Compliance: instrument specific

Description

This command sets the starting range for the wavelength limit. The default units for the <real> parameter value are m⁻¹. The start wavenumber value must be less than or equal to the stop wavenumber value or the start wavenumber will be clipped to the stop wavenumber and a “Data out of range” error will be generated.

Non-sequential command

Always use an *OPC? query or a *WAI command to ensure that this command has the time to complete before sending any more commands to the instrument. Refer to “Always force the Agilent 86120C to wait for non-sequential commands” on page 3-12 for more information.

WLIMit:STOP:FREQuency

Sets the stopping frequency for the wavelength limit range.

Syntax

:CALCulate2:WLIMit:STOP:FREQuency {?|{<real> | MINimum | MAXimum }}

<real> is a frequency value that is within the following limits:

<u>Constant</u>	<u>Description</u>
MINimum	start wavelength limit
MAXimum	236.0571 THz (1270 nm)

Attribute Summary

Non-sequential command
Preset State: 236.0571 THz
*RST State: 236.0571 THz
SCPI Compliance: instrument specific

Description

This command sets the stopping range for the wavelength limit. The default units for the <real> parameter are Hz. The stop frequency value must be greater than or equal to the start frequency value or the stop frequency will be clipped to the start frequency and a “Data out of range” error will be generated.

Non-sequential command

Always use an *OPC? query or a *WAI command to ensure that this command has the time to complete before sending any more commands to the instrument. Refer to “Always force the Agilent 86120C to wait for non-sequential commands” on page 3-12 for more information.

WLIMit:STOP[:WAVelength]

Sets the stopping wavelength for the wavelength limit range.

Syntax

:CALCulate2:WLIMit:STOP[:WAVelength] {?|{<real> | MINimum | MAXimum}}

<real> is a wavelength value that is within the following limits:

<u>Constant</u>	<u>Description</u>
MINimum	start wavelength limit
MAXimum	1650.0 nm

Attribute Summary

Non-sequential command
Preset State: 1650 nm
*RST State: 1650 nm
SCPI Compliance: instrument specific

Description

This command sets the stopping range for the wavelength limit. The default units for the <real> parameter are meters. The stop wavelength value must be greater than or equal to the start wavelength value or the stop wavelength will be clipped to the start wavelength and a “Data out of range” error will be generated. Setting the start wavelength is equivalent to setting the start frequency/wavenumber because of the inverse relationship of frequency to wavelength.

Non-sequential command

Always use an *OPC? query or a *WAI command to ensure that this command has the time to complete before sending any more commands to the instrument. Refer to [“Always force the Agilent 86120C to wait for non-sequential commands” on page 3-12](#) for more information.

WLIMit:STOP:WNUMber

Sets the stopping wavenumber for the wavelength limit range.

Syntax

:CALCulate2:WLIMit:STOP:WNUMber {?|{<real> | MINimum | MAXimum }}

<real> is a wavenumber value that is within the following limits:

<u>Constant</u>	<u>Description</u>
MINimum	start wavelength limit
MAXimum	7874 cm ⁻¹ (1270 nm)

Attribute Summary

Non-sequential command
Preset State: 7.87401E5 m⁻¹
*RST State: 7.87401E5 m⁻¹
SCPI Compliance: instrument specific

Description

This command sets the stopping range for the wavelength limit. The default units for the <real> parameter are inverse meters. The stop wavenumber value must be less than or equal to the start wavenumber value or the stop wavenumber will be clipped to the start wavenumber and a “Data out of range” error will be generated.

Non-sequential command

Always use an *OPC? query or a *WAI command to ensure that this command has the time to complete before sending any more commands to the instrument. Refer to “Always force the Agilent 86120C to wait for non-sequential commands” on page 3-12 for more information.

CALCulate3 Subsystem

Use the CALCulate3 commands to perform delta, drift, signal-to-noise, and Fabry-Perot measurements. The commands in this subsystem have the following command hierarchy:

```
:CALCulate3
  :ASNR
    :CLEar
    :COUNt
    [:STATe]
  :DATA?
  :DELTA
    :POWer
      [:STATe]
    :PRESet
    :REFerence
      :FREQuency
      :POWer?
      [:WAVelength]
      :WNUMber
    :WAVelength
      [:STATe]
    :WPOWer
      [:STATe]
  :DRIFT
    :DIFFerence
      [:STATe]
    :MAXimum
      [:STATe]
    :MINimum
      [:STATe]
    :PRESet
    :REFerence
      :RESet
      [:STATe]
    [:STATe]
```

:FPERot
[:STATE]
:FWHM
[:WAVelength]?
:FREQuency?
:WNUMber?
:MEAN
[:WAVelength]?
:FREQuency?
:WNUMber?
:MODE
[:WAVelength]?
:FREQuency?
:WNUMber?
:PEAK
[:WAVelength]?
:FREQuency?
:WNUMber?
:POWer?
:POWer
[:WAVelength]?
:FREQuency?
:WNUMber?
:SIGMa
[:WAVelength]?
:FREQuency?
:WNUMber?
:POINts?
:PRESet
:SNR
:AUTO
:REference
:FREQuency
[:WAVelength]
:WNUMber
[:STATe]

ASNR:CLEar

Clears the number of measurements used in the average signal-to-noise calculation.

Syntax :CALCulate3:ASNR:CLEar

Attribute Summary
Preset State: not affected
*RST State: not affected
SCPI Compliance: instrument specific

Description This command clears the number of measurements used in the average signal-to-noise calculation. The current measurement is used as the new reference for the average signal-to-noise calculation.

ASNR:COUNT

Sets the number of measurements to be used for the average signal-to-noise calculation.

Syntax

:CALCulate3:ASNR:COUNT {?|{<integer> | MINimum | MAXimum}}

<integer> is a value that is within the following limits:

<u>Constant</u>	<u>Description</u>
MINimum	10
MAXimum	900

Attribute Summary

Preset State: 100
*RST State: 100
SCPI Compliance: instrument specific

Description

This command sets the number of measurements to be used for the average signal-to-noise calculation. If this count is changed while the average signal calculation is on, and the new count is less than the number of measurements already taken, the instrument will go into single measurement mode.

ASNR[:STATe]

Turns the average signal-to-noise ratio on or off.

Syntax :CALCulate3:ASNR[:STATe] {?|}{ON | OFF | 1 | 0 }

Attribute Summary
Preset State: off
*RST State: off
SCPI Compliance: instrument specific

Description This command turns the average signal-to-noise calculation on or off. Only one of the CALCulate3 calculations (ASNR, DELTA, DRIFT, or SNR) can be turned on at a time. Turning on the ASNR calculation while another calculation is on will generate a “Settings conflict” error. When the calculation is first turned on, the lines measured in the current measurement will be used as the reference values for the signal-to-noise ratio. Subsequent measurements will average the noise values. The signal values are not updated until the number of measurements used to average the noise is greater than or equal to the COUNT value.

Note

Only one STATE command can be turned on at any one time. Attempting to turn more than one state on at a time results in a “-221 Settings Conflict” error. Refer to [“Measure delta, drift, and signal-to-noise” on page 3-14](#) for additional information on selecting measurements.

DATA?

Queries the data resulting from delta, drift, and signal-to-noise measurements.

Syntax

:CALCulate3:DATA? {POWER | FREQUENCY | WAVELENGTH | WNUMBER}

<u>Argument</u>	<u>Description</u>
POWER	Queries the array of laser-line powers after the calculation is completed.
FREQUENCY	Queries the array of laser-line frequencies after the calculation is completed.
WAVELENGTH	Queries the array of laser-line wavelengths after the calculation is completed.
WNUMBER	Queries the array of laser-line wave numbers after the calculation is completed.

Attribute Summary

Preset State: not affected
SCPI Compliance: standard
Query Only

Description

The data returned by the query depends upon which calculation state is on. If no calculation state is on, an error is generated. The returned data is comma delimited. The following string is a typical example of six values returned when POWER is specified from a delta power measurement:

```
-7.42833100E+000,-1.00087200E+000,-2.52121400E+000,  
-3.41918900E+000,-3.80437200E+000,-6.36282900E+000
```

Notice that only measurement values are returned to the computer. There is no first value that indicates the number of values contained in the string as there is, for example, with the FETCH, READ, and MEASURE commands. Use the CALC3:POIN? query to determine the number of points the CALC3:DATA? query returns.

In the SNR or ASNR calculation, only the POWER argument is valid. The other arguments will generate a “Settings conflict” error. Use the CALC2:DATA? query to retrieve the signal wavelengths and powers.

DELTA:POWer[:STATe]

Turns the delta-power measurement mode on and off.

Syntax :CALCulate3:DELTA:POWer[:STATe]{?| {ON | OFF | 1 | 0}}

Attribute Summary Preset State: off
*RST State: off
SCPI Compliance: instrument specific

Description When this state is on, the power of the reference laser line is subtracted from the power values of all laser lines except the reference. The power data returned by the CALC3:DATA? query is the array of laser line power levels normalized to the power level of the reference laser line. The power of the reference laser line is returned as an absolute power (unnormalized). The frequency data returned is the array of absolute frequency values.

Note

Only one STATE command can be turned on at any one time. Attempting to turn more than one state on at a time results in a “-221 Settings Conflict” error. Refer to “Measure delta, drift, and signal-to-noise” on page 3-14 for additional information on selecting measurements.

DELTA:PRESet

Turns off all delta measurement states.

Syntax :CALCulate3:DELTA:PRESet

Attribute Summary Preset State: not affected
*RST State: not affected
SCPI Compliance: instrument specific
Command Only

DELTA:REFerence:FREQuency

Selects the reference laser line for DELTA calculations.

Syntax

:CALCulate3:DELTA:REFerence:FREQuency{? | {<real> | MINimum | MAXimum}}

<real> is a frequency value that is within the following limits:

<u>Constant</u>	<u>Description</u>
MINimum	181.6924 THz
MAXimum	236.0571 THz

Attribute Summary

Preset State: 236.0571 THz (1270 nm)
*RST State: 236.0571 THz (1270 nm)
SCPI Compliance: instrument specific

Description

The reference will be the laser line at the frequency closest to the frequency entered. Subsequent measurements will use the frequency closest to the reference frequency used for the previous measurement.

The query returns the reference laser line's frequency. The default units for the <real> parameter are Hz.

DELTA:REFerence:POWer?

Queries the reference laser line's power level.

Syntax

:CALCulate3:DELTA:REFerence:POWer?

Attribute Summary

Preset State: not affected
*RST State: not affected
SCPI Compliance: instrument specific
Query Only

DELTA:REFerence[:WAVelength]

Selects the reference laser line for DELTA calculations.

Syntax

:CALCulate3:DELTA:REFerence[:WAVelength]{?| {<real> | MINimum | MAXimum}}

<real> is a wavelength value that is within the following limits:

<u>Constant</u>	<u>Description</u>
MINimum	1270 nm
MAXimum	1650 nm

Attribute Summary

Preset State: 1270 nm (236.0571 THz)
*RST State: 1270 nm (236.0571 THz) laser line
SCPI Compliance: instrument specific

Description

The reference will be the laser line at the wavelength closest to the wavelength entered. Subsequent measurements will use the wavelength closest to the reference wavelength used for the previous measurement.

The query returns the current wavelength of the reference laser line. The default units for the <real> parameter are meters.

DELTA:REFERENCE:WNUMBER

Selects the reference laser line for delta calculations.

Syntax

:CALCulate3:DELTA:REFERENCE:WNUMBER{?| {<real> | MINimum | MAXimum}}

<real> is a wave number value that is within the following limits:

<u>Constant</u>	<u>Description</u>
MINimum	6,060 cm ⁻¹ (1650 nm)
MAXimum	7,824 cm ⁻¹ (1270 nm)

Attribute Summary

Preset State: 7,824 cm⁻¹ (1270 nm)
*RST State: 7,824 cm⁻¹ (1270 nm)
SCPI Compliance: instrument specific

Description

The reference will be the laser line at the wave number closest to the wave number entered. Subsequent measurements will use the wave number closest to the reference wave number used for the previous measurement.

The query returns the current wave number of the reference laser line. The default units for the <real> parameter are m⁻¹.

DELTA:WAVelength[:STATe]

Turns the delta wavelength measurement mode on and off.

Syntax :CALCulate3:DELTA:WAVelength[:STATe]{?| {ON | OFF | 1 | 0}}

Attribute Summary Preset State: off
*RST State: off
SCPI Compliance: instrument specific

Description When on, the wavelength of the reference laser line is subtracted from the wavelength values of all laser lines except the reference. For the CALC3:DATA? query, the power data returned is the array of absolute powers measured for each laser line. The frequency data is the array of frequency values normalized to the frequency of the reference laser line. The frequency of the reference laser line is returned as an absolute frequency (unnormalized).

Note

Only one STATE command can be turned on at any one time. Attempting to turn more than one state on at a time results in a “-221 Settings Conflict” error. Refer to [“Measure delta, drift, and signal-to-noise” on page 3-14](#) for additional information on selecting measurements.

DELTA:WPOWer[:STATe]

Turns the delta wavelength and power measurement mode on and off.

Syntax :CALCulate3:DELTA:WPOWer[:STATe]{?| {ON | OFF | 1 | 0}}

Attribute Summary Preset State: off
*RST State: off
SCPI Compliance: instrument specific

Description When on, the wavelength of the reference laser line is subtracted from the wavelength values of all laser lines except the reference. The power value of the reference is subtracted from the power values of all laser lines except the reference.

For the CALC3:DATA? query, the power data returned is the array of powers normalized to the power of the reference laser line. The power of the reference laser line is returned as an absolute power (unnormalized).

The frequency data is the array of frequency values normalized to the frequency of the reference laser line. The frequency of the reference laser line is returned as an absolute frequency (unnormalized).

Note

Only one STATE command can be turned on at any one time. Attempting to turn more than one state on at a time results in a “-221 Settings Conflict” error. Refer to [“Measure delta, drift, and signal-to-noise” on page 3-14](#) for additional information on selecting measurements.

DRIFt:DIFFerence[:STATe]

Sets the drift calculation to subtract the minimum values measured from the maximum values measured.

Syntax :CALCulate3:DRIFt:DIFFerence[:STATe]{?| {ON | OFF | 1 | 0}}

Attribute Summary
Preset State: off
*RST State: off
SCPI Compliance: instrument specific

Description Use the CALC3:DRIF:PRES command to turn off all the drift states before turning on this state. The CALC3:DATA? query returns the maximum power and frequency minus the minimum power and frequency.

Note

Only one STATe command can be turned on at any one time. Attempting to turn more than one state on at a time results in a “-221 Settings Conflict” error. Refer to [“Measure delta, drift, and signal-to-noise” on page 3-14](#) for additional information on selecting measurements.

DRIFt:MAXimum[:STATe]

Sets the drift calculation to return the maximum power and frequency values measured.

Syntax :CALCulate3:DRIFt:MAXimum[:STATe]{?| {ON | OFF | 1 | 0}}

Attribute Summary
Preset State: off
*RST State: off
SCPI Compliance: instrument specific

Description Use the CALC3:DRIF:PRES command to turn off all the drift states before turning on this state. The CALC3:DATA? query returns the maximum power and frequency.

Note

Only one STATe command can be turned on at any one time. Attempting to turn more than one state on at a time results in a “-221 Settings Conflict” error. Refer to [“Measure delta, drift, and signal-to-noise” on page 3-14](#) for additional information on selecting measurements.

DRIFt:MINimum[:STATe]

Sets the drift calculation to return the minimum power and frequency values measured.

Syntax :CALCulate3:DRIFt:MINimum[:STATe]{?| {ON | OFF | 1 | 0}}

Attribute Summary
Preset State: off
*RST State: off
SCPI Compliance: instrument specific

Description Use the CALC3:DRIF:PRES command to turn off all the drift states before turning on this state. The CALC3:DATA? query returns the minimum power or frequency.

Note

Only one STATe command can be turned on at any one time. Attempting to turn more than one state on at a time results in a “-221 Settings Conflict” error. Refer to [“Measure delta, drift, and signal-to-noise” on page 3-14](#) for additional information on selecting measurements.

DRIFt:PRESet

Turns off all the drift states for DIFFerence, MAXimum, MINimum, and REFerence.

Syntax :CALCulate3:DRIFt:PRESet

Attribute Summary Preset State: unaffected by
*RST State: unaffected by
SCPI Compliance: instrument specific
Command Only

Description This command allows the CALC3:DATA? query to return the difference between the current measurement and the reference.

DRIFt:REFerence:RESet

Places the current list of laser lines into the reference list.

Syntax :CALCulate3:DRIFt:REFerence:RESet

Attribute Summary Preset State: unaffected by
*RST State: unaffected by
SCPI Compliance: instrument specific
Command Only

DRIFt:REFerence[:STATe]

Turns on and off the drift reference state.

Syntax :CALCulate3:DRIFt:REFerence[:STATe]{?| {ON | OFF | 1 | 0}}

Attribute Summary
Preset State: off
*RST State: off
SCPI Compliance: instrument specific

Description When this command is set to on, the CALC3:DATA? command returns the reference laser lines. Use the CALC3:DRIF:PRES command to turn off all the drift states before turning on the drift reference state.

Note

Only one STATe command can be turned on at any one time. Attempting to turn more than one state on at a time results in a “-221 Settings Conflict” error. Refer to [“Measure delta, drift, and signal-to-noise” on page 3-14](#) for additional information on selecting measurements.

DRIFt[:STATe]

Turns on and off the drift measurement calculation.

Syntax :CALCulate3:DRIFt[:STATe]{?| {ON | OFF | 1 | 0}}

Attribute Summary
Preset State: off
*RST State: off
SCPI Compliance: instrument specific

Description When the drift mode is first turned on, the current list of laser lines is placed into the reference. All subsequent measurements take the new data, subtract the reference data, and display the differences in wavelengths and powers.

The CALC3:DATA? query returns the power and frequency of the current measurement minus the power and frequency of the reference.

Note

Only one STATE command can be turned on at any one time. Attempting to turn more than one state on at a time results in a “-221 Settings Conflict” error. Refer to [“Measure delta, drift, and signal-to-noise” on page 3-14](#) for additional information on selecting measurements.

FPERot[:STATE]

Turns on and off the Fabry-Perot measurement mode.

Syntax :CALCulate3:FPERot[:STATE] {? | {ON | OFF | 1 | 0}}

Attribute Summary Preset State: off
*RST State: off
SCPI Compliance: instrument specific

Description When the state is ON, the Agilent 86120C measures characteristics of the Fabry-Perot laser modes. The modes are defined by the peak excursion and peak threshold commands.

FPERot:FWMH?

Queries the full width half-maximum data of the selected modes.

Syntax :CALCulate3:FPERot:FWMH{[:WAVelength] | :FREQuency | :WNUMber}?

<u>Argument</u>	<u>Description</u>
WAVelength	Returns the full width half-maximum wavelength of the selected modes.
FREQuency	Returns the full width half-maximum frequency of the selected modes.
WNUMber	Returns the full width half-maximum wavenumber of the selected modes.

Example Query Response

WAVelength	+5.47128800E-009
FREQuency	+6.93436400E+011
WNUMber	+2.31306200E+001

Attribute Summary
 Preset State: not affected
 *RST State: not affected
 SCPI Compliance: instrument specific
 Query only

FPERot:MEAN?

Queries the mean data of the selected modes.

Syntax :CALCulate3:FPERot:MEAN{[:WAVelength] | :FREQuency | :WNUMber}?

<u>Argument</u>	<u>Description</u>
WAVelength	Returns the mean wavelength of the selected modes.
FREQuency	Returns the mean frequency of the selected modes.
WNUMber	Returns the mean wavenumber of the selected modes.

Example Query Response

WAVelength	+1.53878000E-006
FREQuency	+1.94824800E+014
WNUMber	+6.49865400E+003

Attribute Summary
 Preset State: not affected
 *RST State: not affected
 Query only
 SCPI Compliance: instrument specific

FPERot:MODE:SPACing?

Queries the mode spacing data of the selected modes.

Syntax

:CALCulate3:FPERot:MODE:SPACing{[:WAVelength] | :FREQuency | :WNUMber}?

<u>Argument</u>	<u>Description</u>
WAVelength	Returns the mode spacing wavelength of the selected modes.
FREQuency	Returns the mode spacing frequency of the selected modes.
WNUMber	Returns the mode spacing wavenumber of the selected modes.

Example Query Response

WAVelength	+3.18277200E-010
FREQuency	+4.02787400E+011
WNUMber	+1.34356200E+001

Attribute Summary

Preset State: not affected
*RST State: not affected
SCPI Compliance: instrument specific
Query only

FPERot:PEAK?

Queries the peak data of the selected modes.

Syntax

:CALCulate3:FPERot:PEAK{[:WAVelength] | :FREQuency | :WNUMber | :POWer{[:DBM] | :WATTs}}?

<u>Argument</u>	<u>Description</u>
WAVelength	Returns the peak wavelength of the selected modes.
FREQuency	Returns the peak frequency of the selected modes.
WNUMber	Returns the peak wavenumber of the selected modes.
POWer	Returns the peak amplitude of the selected modes in dBm or watts.

Example Query Response

WAVelength	+1.54073400E-006
FREQuency	+1.94577600E+014
WNUMber	+6.49041000E+003
POWer	-9.09446600E+000 (dBm)
	+1.23183800E-004 (watts)

Attribute Summary

Preset State: not affected
 *RST State: not affected
 SCPI Compliance: instrument specific
 Query only

FPERot:POWer?

Queries the total power data of the selected modes.

Syntax

:CALCulate3:FPERot:POWer{[:DBM]|:WATts}?

<u>Argument</u>	<u>Description</u>
DBM	Returns the total power in dBm.
WATts	Returns the total power in watts.

Example Query Response

dBm (DBM)	-4.46895600E+000
watts (WATts)	+3.57358800E-004

Attribute Summary

Preset State: not affected
*RST State: not affected
SCPI Compliance: instrument specific
Query only

FPERot:SIGMa?

Queries the sigma data of the selected modes.

Syntax

:CALCulate3:FPERot:SIGMa{[:WAVelength] | :FREQuency | :WNUMber}?

<u>Argument</u>	<u>Description</u>
WAVelength	Returns the sigma wavelength of the selected modes.
FREQuency	Returns the sigma frequency of the selected modes.
WNUMber	Returns the sigma wavenumber of the selected modes.

Example Query Response

WAVelength	+2.32784700E-009
FREQuency	+2.94452900E+011
WNUMber	+9.82124900E+000

Attribute Summary

Preset State: not affected
*RST State: not affected
SCPI Compliance: instrument specific
Query only

POINTs?

Queries the number of points in the data set.

Syntax :CALCulate3:POINTs?

Attribute Summary Preset State: unaffected by
RST State: unaffected by
SCPI Compliance: instrument specific
Query Only

Description The value returned is the number of points returned by the CALC3:DATA? query.

PRESet

Turns off any CALCulate3 calculation that is on.

Syntax :CALCulate3:PRESet

Attribute Summary Preset State: unaffected by
RST State: unaffected by
SCPI Compliance: instrument specific
Command Only

Description This command turns off any CALCulate3 calculation (delta, drift, Fabry-Perot, or signal-to-noise) that is on.

SNR:AUTO

Selects the reference frequency value for measuring noise in the signal-to-noise calculation.

Syntax :CALCulate3:SNR:AUTO{?| {ON | OFF | 1 | 0}}

<u>Constant</u>	<u>Description</u>
ON	Selects internally generated reference frequency.
OFF	Selects user-entered reference frequency.

Attribute Summary
Preset State: on
*RST State: on
SCPI Compliance: instrument specific

Description The command argument allows you to select either an internally generated or a user-entered frequency reference for measuring the noise. To enter a value to use as the reference, use the SNR:REfERENCE:FRE-Quency, SNR:REfERENCE:WAVelength, and SNR:REfERENCE:WNUMBER commands.

SNR:REFerence:FREQuency

Enters a frequency that can be used for the noise measurement reference in signal-to-noise calculations.

Syntax

:CALCulate3:SNR:REFerence:FREQuency{?| {<real> | MINimum | MAXimum}}

<real> is a frequency value that is within the following limits:

<u>Constant</u>	<u>Description</u>
MINimum	181.6924 THz
MAXimum	236.0571 THz

**Attribute
Summary**

Preset State: unaffected by
*RST State: 193.4145 THz (1550.0 nm in a vacuum)
SCPI Compliance: instrument specific

Description

After entering this value, use the SNR:AUTO command to configure the instrument to use this value in subsequent signal-to-noise calculations. The default units for the <real> parameter are Hz.

SNR:REFerence[:WAVelength]

Sets the wavelength used for the noise measurement reference in the signal-to-noise calculation.

Syntax

:CALCulate3:SNR:REFerence[:WAVelength]{?| {<real> | MINimum | MAXimum}}

<real> is a wavelength value that is within the following limits:

<u>Constant</u>	<u>Description</u>
MINimum	1270 nm
MAXimum	1650 nm

Attribute Summary

Preset State: unaffected by
*RST State: 1550.0 nm in a vacuum
SCPI Compliance: instrument specific

Description

After entering this value, use the SNR:AUTO command to configure the instrument to use this value in subsequent signal-to-noise calculations. The number entered is converted internally to the corresponding frequency.

The default units for the <real> parameter are meters.

SNR:REFerence:WNUMber

Sets the wave number used for the noise measurement reference in the signal-to-noise calculation.

Syntax

:CALCulate3:SNR:REFerence:WNUMber{?| {<real> | MINimum | MAXimum}}

<real> is a wave number value that is within the following limits:

<u>Constant</u>	<u>Description</u>
MINimum	6060 cm ⁻¹ (1650 nm)
MAXimum	7874 cm ⁻¹ (1270 nm)

Attribute Summary

Preset State: unaffected by
 *RST State: 6451.614 cm⁻¹ (1550 nm)
 SCPI Compliance: instrument specific

Description

After entering this value, use the SNR:AUTO command to configure the instrument to use this value in subsequent signal-to-noise calculations. The wave number entered is converted internally to the corresponding frequency.

The default units for the <real> parameter are m⁻¹.

SNR[:STATe]

Turns the signal-to-noise calculation on and off.

Syntax :CALCulate3:SNR[:STATe]{?| {ON | OFF | 1 | 0}}

Attribute Summary
Preset State: off
*RST State: off
SCPI Compliance: instrument specific

Note

Only one STATE command can be turned on at any one time. Attempting to turn more than one state on at a time results in a “-221 Settings Conflict” error. Refer to [“Measure delta, drift, and signal-to-noise” on page 3-14](#) for additional information on selecting measurements.

CONFigure Measurement Instruction

For information on the CONFigure measurement instruction, [refer to “Measurement Instructions” on page 4-15.](#)

DISPlay Subsystem

The commands in this subsystem have the following command hierarchy:

```
:DISPlay
  :MARKer:
    :MAXimum
    :LEFT
    :NEXT
    :PREVIOUS
    :RIGHT
  [:WINDow]
    :GRAPhics
    :STATe
```

MARKer:MAXimum

Sets the marker to the laser line that has the maximum power.

Syntax :DISPlay:MARKer:MAXimum

Attribute Summary Preset State: marker set to maximum-power laser line
*RST State: marker set to maximum-power laser line
SCPI Compliance: instrument specific
Command Only

MARKer:MAXimum:LEFT

Moves the marker left to the next laser line.

Syntax :DISPlay:MARKer:MAXimum:LEFT

Attribute Summary Preset State: marker set to maximum-power laser line
*RST State: marker set to maximum-power laser line
SCPI Compliance: instrument specific
Command Only

Description Moves the marker from the current marker position to the next laser line having the following characteristic:

- shorter wavelength
- lower frequency
- lower wave number

If the display is in the List by Ampl mode, it will be changed to List by WL before the marker is moved.

MARKer:MAXimum:NEXT

Moves the marker to the laser line with the next lower power level.

Syntax :DISPlay:MARKer:MAXimum:NEXT

Attribute Summary Preset State: marker set to maximum-power laser line
*RST State: marker set to maximum-power laser line
SCPI Compliance: instrument specific
Command Only

Description If the display is in the List by WL mode, it will be changed to List by Ampl before the marker is moved.

MARKer:MAXimum:PREVious

Moves the marker to the laser line that has the next higher power level.

Syntax :DISPlay:MARKer:MAXimum:PREVious

Attribute Summary Preset State: marker set to maximum-power laser line
*RST State: marker set to maximum-power laser line
SCPI Compliance: instrument specific
Command Only

Description If the display is in the List by WL mode, it will be changed to List by Ampl before the marker is moved.

MARKer:MAXimum:RIGHt

Moves the marker right to the next laser line.

Syntax :DISPlay:MARKer:MAXimum:RIGHt

Attribute Summary Preset State: marker set to maximum-power laser line
*RST State: marker set to maximum-power laser line
SCPI Compliance: instrument specific
Command Only

Description Moves the marker from the current marker position to the next laser line having the following characteristic:

- longer wavelength
- higher frequency
- higher wave number

If the display is in the List by Ampl mode, it will be changed to List by WL before the marker is moved.

[WINDow]:GRAPhics:STATe

Turns on and off the display of the power bars.

Syntax :DISPlay[:WINDow]:GRAPhics:STATe{?| {ON | OFF | 1 | 0}}

Attribute Summary Preset State: on
*RST State: on
SCPI Compliance: standard

Description Specifying on displays the power bars in all modes except the drift and signal-to-noise modes. Specifying off prevents the display of power bars for all instrument modes.

FETCh Measurement Instruction

For information on the FETCh measurement instruction, [refer to “Measurement Instructions” on page 4-15.](#)

HCOPy Subsystem

Use the command in this subsystem to print the displayed measurement results to a printer. This subsystem has the following command hierarchy:

```
:HCOPy  
  [:IMMediate]
```

[:IMMediate]

Prints measurement results on a printer.

Syntax

:HCOPy:IMMediate

**Attribute
Summary**

Preset State: none
*RST State: none
SCPI Compliance: standard
Command Only

Description

Connect the printer to the Agilent 86120C's rear-panel PARALLEL PRINTER PORT connector. The output to the printer is ASCII text.

MEASure Measurement Instruction

For information on the MEASure measurement instruction, [refer to “Measurement Instructions” on page 4-15.](#)

READ Measurement Instruction

For information on the READ measurement instruction, refer to “[Measurement Instructions](#)” on page 4-15.

SENSe Subsystem

Use the **SENSe** commands to correct measurement results for elevation above sea level and to select between measurements in air or vacuum. You can also enter an amplitude offset. The commands in this subsystem have the following command hierarchy:

```
[ :SENSe ]  
  :CORRection  
    :DEVice  
    :ELEVations  
    :MEDium  
    :OFFSet  
      [:MAGNitude]  
  :DATA?
```

CORRection:DEVIce

Selects the wavelength measurement algorithm.

Syntax :SENSe:CORRection:[DEVIce]{?| {NARRow | BROad}}

<u>Constant</u>	<u>Description</u>
NARRow	Selects wavelength measurements for narrowband devices such as DFB lasers and modes of FP lasers.
BROad	Selects wavelength measurements for broadband devices such as optical filters and LEDs.

Attribute Summary Non-sequential command
 Preset State: NARRow
 *RST sets this value to NARRow
 SCPI Compliance: instrument specific

Description The narrow bandwidth algorithm, used for measuring lasers, determines the wavelength based upon the peak.

The broad bandwidth algorithm, used for LEDs, filters, and chirped lasers, determines the wavelength based upon the center-of-mass of the power spectrum. The peak excursion function is used to determine the value of the integration limits. Care must be taken to ensure that the integration limits are above any noise. This is especially true when measuring devices with sloping noise floors, like an EDFA amplifier. For more information on peak excursion, [refer to “PEXCursion” on page 4-33](#).

Instrument specifications apply when the device is set to NARRow. Specifications do not apply in BROad mode.

Query Response The query form returns the previously selected device.
 NARRow

CORRection:ELEVation

Sets the elevation value used by the instrument to compensate for air dispersion.

Syntax :SENSe:CORRection:ELEVation{?| {<integer> | MINimum | MAXimum}}
<integer> is the altitude in meters.

<u>Constant</u>	<u>Description</u>
MINimum	0 m
MAXimum	5000 m

Attribute Summary Non-sequential command
Preset State: unaffected by
*RST sets this value to the minimum.
SCPI Compliance: instrument specific

Description Changing the elevation value causes the current data to be reprocessed.

Query Response The query form returns the current elevation setting as shown in the following example:

+1500

Non-sequential command

Always use an *OPC? query or a *WAI command to ensure that this command has the time to complete before sending any more commands to the instrument. Refer to [“Always force the Agilent 86120C to wait for non-sequential commands” on page 3-12](#) for more information.

CORRection:MEDium

Sets the Agilent 86120C to return wavelength readings in a vacuum or standard air.

Syntax :SENSe:CORRection:MEDium{? | {AIR | VACuum}}

<u>Argument</u>	<u>Description</u>
AIR	Selects wavelength values in standard air.
VACuum	Selects wavelength values in a vacuum.

Attribute Summary
Preset State: VAC
*RST State: VAC
SCPI Compliance: instrument specific

Description Standard air is defined to have the following characteristics:
Barometric pressure: 760 torr
Temperature: 15°C
Relative humidity: 0%

CORRection:OFFSet[:MAGNitude]

Enters an offset for amplitude values.

Syntax

:SENSe:CORRection:OFFSet:MAGNitude{?| {<real> | MINimum | MAXimum}}

<real> is the logarithmic units in dB.

<u>Constant</u>	<u>Description</u>
MINimum	-40.0 dB
MAXimum	40.0 dB

Attribute Summary

Preset State: 0.0
*RST State: 0.0
SCPI Compliance: standard

Query Response

The query form returns the current offset setting as shown in the following example:

+5.00000000E+000

DATA?

Queries the time domain samples of the input laser line.

Syntax :SENSe:DATA?

Attribute Summary Preset State: none
SCPI Compliance: instrument specific
Query Only

Description Be prepared to process a large amount of data when this query is sent. The amount of data returned depends on the measurement update state of the instrument which is set using the resolution argument of an instrument function. Refer to “Measurement Instructions” on page 4-15.

When *NORMAL* measurement update is specified, over 2,200 kilobytes of data (2^{17} values) can be returned to the computer. When *FAST* measurement update is specified, over 1,100 kilobytes of data (2^{16} values) can be returned.

The floating point values are scaled from 1.000 to 1.999756 ($1 + 4095/4096$). Amplitude values are not calibrated.

The input laser line(s) generate an interference pattern on the photodetector as a function of the Michelson interferometer optical path delay. The time domain data is sampled at uniform optical path delay increments of the reference laser wavelength, or 0.632991 microns. When *NORMAL* measurement update is selected, the first data value is sampled at -41.48 mm optical path delay, and the last value is sampled at +41.48 mm optical path delay. When *FAST* measurement update is selected, the first data value is sampled at +20.74 mm optical path delay, and the last value is sampled at -20.74 mm optical path delay. The data value that corresponds to zero optical path delay is approximately, but not exactly, located in the center of the time domain data.

If your program is aborted or interrupted after sending this query, the Agilent 86120C continues to process the data but does not place it in the output buffer. Because of the amount of data processed, the instrument *will not respond* to any new commands in its input buffer for 30 or 40 seconds.

Query Response The following string shows an example of the first few measurements returned by this query.

```
+1.51367200E+000,+1.51855500E+000,+1.49902300E+000,+1.47949200E+000,+1.50488300E+000,  
+1.53320300E+000,+1.50097700E+000,+1.47265600E+000,+1.50293000E+000,+1.50781300E+000,  
+1.51171900E+000,+1.48242200E+000,+1.50097700E+000,+1.51855500E+000,+1.50683600E+000,  
+1.48632800E+000,+1.50488300E+000
```

Notice that only values are returned to the computer. There is no first value that indicates the number of values contained in the string as there is, for example, with the FETCh, READ, and MEASure commands.

STATus Subsystem

Use the commands in this subsystem to control the Agilent 86120C's status-reporting structures. These structures provide registers that you can use to determine if certain events have occurred.

The commands in this subsystem have the following command hierarchy:

```
:STATus
  :OPERation
    :CONDition?
    :ENABle
    [:EVENT]?
    :PTRansition
    :NTRansition
  :PRESet
  :QUEStionable
    :CONDition?
    :ENABle
    [:EVENT]?
    :PTRansition
    :NTRansition
```

{OPERation | QUEStionable}:CONDition?

Queries the value of the questionable or operation condition register.

Syntax :STATus:{OPERation | QUEStionable}:CONDition?

Query Response 0 to 32767

Attribute Summary
Preset State: none
*RST State: none
SCPI Compliance: standard
Query Only

Description Use this command to read the value of the OPERation Status or QUEStionable Status registers. Refer to [“Monitoring the Instrument” on page 3-16](#).

Example OUTPUT 720;":STATUS:OPERATION:CONDITION?"

{OPERation | QUEStionable}:ENABLE

Sets the enable mask for the questionable or operation event register.

Syntax :STATus:{OPERation | QUEStionable}:ENABLE{?| <value>}
<integer> an integer from 0 to 65535.

Attribute Summary Preset State: none
*RST State: none
SCPI Compliance: standard

Description The enable mask selects which conditions in the event register cause the summary bit in the status byte to be set. If a bit in the enable mask is set true and the corresponding event occurs, the summary bit (bit 3 for the questionable status or bit 7 for the operation status) in the status byte will be set.

Example OUTPUT 720;":STATUS:QUESTIONABLE:ENABLE 1024"

Query Response When queried, the largest value that can be returned is 65535. This is because the most-significant register bit cannot be set true.

{OPERation | QUEStionable}{:EVENT}

Queries the contents of the questionable or operation event registers.

Syntax :STATus:{OPERation | QUEStionable}:EVENT?

Query Response 0 to 32767

Attribute Summary
Preset State: none
*RST State: none
SCPI Compliance: standard
Query Only

Description The response will be a number from 0 to 32767 indicating which bits are set. Reading the register clears the register.

Example OUTPUT 720;":STATUS:OPERATION:EVENT?"

{OPERation | QUEStionable}:NTRansition

Selects bits in the event register which can be set by negative transitions of the corresponding bits in the condition register.

Syntax :STATus:OPERation:NTRansition{?| <integer>}
<integer> an integer from 0 to 65535.

Attribute Summary Preset State: none
*RST State: none
SCPI Compliance: standard

Description Changes in the state of a condition register bit causes the associated OPERATION Status or QUEStionable Status register bit to be set. This command allows you to select a negative bit transition to trigger an event to be recognized. A negative transition is defined to occur whenever the selected bit changes states from a 1 to a 0. You can enter any value from 0 to 65535.

When queried, the largest value that can be returned is 32767. This is because the most-significant register bit cannot be set true.

Example OUTPUT 720;":STATUS:OPER:NTRansition 16"

{OPERation | QUEStionable}:PTRansition

Selects bits in the event register which can be set by positive transitions of the corresponding bits in the condition register.

Syntax :STATus:OPERation:PTRansition{? | *<integer>*}
<integer> an integer from 0 to 65535.

Attribute Summary Preset State: none
*RST State: none
SCPI Compliance: standard

Description Changes in the state of a condition register bit causes the associated OPERATION Status or QUEStionable Status event register bit to be set. This command allows you to select a positive bit transition to trigger an event to be recognized. A positive transition is defined to occur whenever the selected bit changes states from a 0 to a 1. You can enter any value from 0 to 65535.
When queried, the largest value that can be returned is 32767. This is because the most-significant register bit cannot be set true.

Example OUTPUT 720;":STATUS:OPER:PTRansition 16"

PRESet

Presets the enable registers and the PTRansition and NTRansition filters.

Syntax :STATus:PRESet

Attribute Summary
Preset State: none
*RST State: none
SCPI Compliance: standard
Command Only

Description The PRESet command is defined by SCPI to affect the enable register. If you want to clear all event registers and queues, use the *CLS command.

Table 4-18. Preset Values

Status Node	Preset Value
Operation enable register	0
Questionable enable register	0
PTRansition filters	32767
NTRansition filters	0

Example OUTPUT 720;":STATUS:PRESET"

SYSTem Subsystem

The commands in this subsystem have the following command hierarchy:

- :SYSTem
 - :ERRor?
 - :HELP
 - :HEADers?
 - :PRESet
 - :VERSion?

ERRor

Queries an error from the error queue.

Syntax :SYSTem:ERRor?

Attribute Summary
Preset State: none
*RST State: none
SCPI Compliance: standard
Query Only

Description The Agilent 86120C has a 30 entry error queue. The queue is a first-in, first-out buffer. Repeatedly sending the query :SYSTEM:ERROR? returns the error numbers and descriptions in the order in which they occur until the queue is empty. Any further queries returns +0, "No errors" until another error occurs.

For a complete list of error messages, refer to "Error Messages" on page 7-11.

Query Response <value>, <string>

<value> is an integer. <string> is the text of the error message. The following is an example of a response:

-113,"Undefined header"

Example
DIM Error\$(250)
OUTPUT 720;":SYSTEM:ERROR?"
ENTER 720;Error\$
PRINT Error\$

HELP:HEADers?

Queries a listing of all the remote programming commands available for the Agilent 86120C.

Syntax :SYSTem:HELP:HEADers?

Attribute Summary
Preset State: none
*RST State: none
SCPI Compliance: instrument specific
Query Only

Description The returned ASCII string of commands is in the IEEE 488.2 arbitrary-block data format. The first line indicates the total number of bytes returned to the computer. That is, the # character is followed by one digit which indicates how many of the following digits convey the byte count. The next digits give the actual byte count. For example, in the listing below, 4387 bytes are indicated in the file.

Each command in the listing is separated by a linefeed character.

The following is an example of the first few lines and last few lines returned in the string. The term *nquery* indicates that a command cannot be sent as a query. The term *qonly* indicates that a command can only be sent as a query.

```
#44387
:ABORt/nquery/
:CALCulate:DATA?/qonly/
:CALCulate:TRANSform:FREQuency:POINts
:CALCulate1:DATA?/qonly/
:CALCulate1:TRANSform:FREQuency:POINts
:CALCulate2:DATA?/qonly/
.
.
.
*IDN?/qonly/
*OPC
*RCL/nquery/
*RST/nquery/
*SAV/nquery/
*SRE
*STB?/qonly/
*TRG/nquery/
*TST?/qonly/
*WAI/nquery/
```

PRESet

Performs the equivalent of pressing the front-panel PRESET key.

Syntax :SYSTem:PRESet

Attribute Summary
Preset State: none
*RST State: none
SCPI Compliance: standard
Command Only

Description The instrument state is set according to the settings shown in the following table.

Table 4-19. Instrument Conditions (1 of 2)

Item	Settings after Preset Key Pressed	Settings after Power Turned On
Display mode	single wavelength	last state ^a
Wavelength range limiting	on	last state
Start wavelength	1270 nm	last state
Stop wavelength	1650 nm	last state
Graphical display	off	off
Measurement acquisition	continuous	last state
Wavelength calibration	vacuum	last state
Elevation correction value	not affected	last state
Wavelength units	nm	last state
Amplitude units	dBm	last state
Power offset	0 dB	last state
Peak threshold	10 dB	last state
Peak excursion	15 dB	last state

Table 4-19. Instrument Conditions (2 of 2)

Item	Settings after Preset Key Pressed	Settings after Power Turned On
Measurement speed	normal	last state
Measurement bandwidth	narrowband	narrowband
Drift measurements	off	off
Fabry-Perot laser measurements	off	off
Delta measurements:		
Δ power	off	off
Δ wavelength	off	off
Δ wavelength and power	off	off
reference signal position	1270 nm	1270 nm
Signal-to-noise measurements		
measurement	off	off
wavelength reference	auto	last state
user wavelength	not affected	last state
number of averages	100	last state
GPIB address	not affected	last state
Power-bar display	on	last state

a. The term "last state" refers to the last setting that this parameter was in before the instrument power was turned off.

VERsion

Queries the version of SCPI that the Agilent 86120C complies with.

Syntax :SYSTem:VERsion

Attribute Summary
Preset State: none
*RST State: none
SCPI Compliance: standard
Query Only

Description The SCPI version used in the Agilent 86120C is 1995.0.

Table 4-20. SCPI Version Numbers

SCPI Version	Instrument Serial Prefix
1995.0	US3545 and above

TRIGger Subsystem

The SCPI definition defines the TRIGger subsystem to include ABORt, ARM, INITiate, and TRIGger commands. The Agilent 86120C has no ARM or TRIGger commands.

The commands in this subsystem have the following command hierarchy:

ABORt

INITiate

 :CONTinuous

 [:IMMediate]

ABORt

Halts the current measurement sequence and places the instrument in the idle state.

Syntax :ABORt

Attribute Summary
Preset State: not affected
SCPI Compliance: standard
Command Only

Description If the instrument is configured for continuous measurements, a new measurement sequence will begin. Otherwise, the instrument stays in the idle state until a new measurement is initiated.

INITiate:CONTinuous

Selects single or continuous measurement acquisition.

Syntax :INITiate:CONTinuous{?| {ON | OFF | 1 | 0}}

Attribute Summary
Non-sequential command
Preset State: on
*RST State: off
SCPI Compliance: standard

Description When on is specified, the instrument continuously measures the input spectrum.

Non-sequential command

Always use an *OPC? query or a *WAI command to ensure that this command has the time to complete before sending any more commands to the instrument. [Refer to "Always force the Agilent 86120C to wait for non-sequential commands" on page 3-12](#) for more information.

INITiate[:IMMediate]

Initiates a new measurement sequence.

Syntax :INITiate:IMMediate

Attribute Summary
Non-sequential command
Preset State: none
SCPI Compliance: standard
Command Only

Non-sequential command

Always use an *OPC? query or a *WAI command to ensure that this command has the time to complete before sending any more commands to the instrument. Refer to [“Always force the Agilent 86120C to wait for non-sequential commands” on page 3-12](#) for more information.

UNIT Subsystem

The only command provided in this subsystem is the POWER command as shown in the following command hierarchy:

```
:UNIT  
  [:POWer]
```

[:POWer]

Sets the power units to watts (linear) or dBm (logarithmic).

Syntax	:UNIT[:POWer]{? {W DBM}}
Attribute Summary	Preset State: dBm *RST State: dBm SCPI Compliance: standard

Programming Commands

UNIT Subsystem

5

- Test 1. Absolute Wavelength Accuracy 5-3
- Test 2. Sensitivity 5-4
- Test 3. Polarization Dependence 5-5
- Test 4. Optical Input Return Loss 5-6
- Test 5. Amplitude Accuracy and Linearity 5-9

Performance Tests

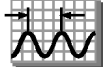

Performance Tests

The procedures in this chapter test the Agilent 86120C's performance using the specifications listed in [Chapter 6, "Specifications and Regulatory Information"](#) as the performance standard. All of the tests are done manually without the aid of a computer. None of these tests require access to the interior of the instrument.

[Test 1. Absolute Wavelength Accuracy 5-3](#)

[Test 2. Sensitivity 5-4](#)

[Test 3. Polarization Dependence 5-5](#)

[Test 4. Optical Input Return Loss 5-6](#)

[Test 5. Amplitude Accuracy and Linearity 5-9](#)

Allow the Agilent 86120C to warm up for 15 minutes before doing any of the performance tests.

Calibration Cycle

This instrument requires periodic verification of performance. The instrument should have a complete verification of specifications once every two years.

Test 1. Absolute Wavelength Accuracy

Description	Wavelength accuracy is verified using traceable light sources such as the following devices: <ul style="list-style-type: none">• Stable lasers• Gas lamps• HeNe gas lasers
CAUTION	Do not exceed +18 dBm source power. The Agilent 86120C's input circuitry can be damaged when total input power exceeds 18 dBm.
Procedure	Use three or four light standards that cover the Agilent 86120C's wavelength range. Connect the traceable sources to the Agilent 86120C and verify that the Agilent 86120C is reading the sources to within the absolute wavelength accuracy specification.

Test 2. Sensitivity

Description

Sensitivity is verified using the following devices:

- Optical power meter
- Optical attenuator
- 1310 nm and 1550 nm lasers (>0 dBm output power)

CAUTION

Do not exceed +18 dBm source power. The Agilent 86120C's input circuitry can be damaged when total input power exceeds 18 dBm.

Procedure

Perform the following procedure first using the 1310 nm laser and then repeat the steps using the 1550 nm laser.

- 1 Connect the laser's output to the optical attenuator's input.
- 2 Connect the optical attenuator's output to the optical power meter.
- 3 Adjust the attenuator for a reading of 0 dBm on the power meter. Record the attenuator's setting.
Attenuation at 0 dBm: _____
- 4 Adjust the attenuator for a reading of -35 dBm on the power meter. Record the attenuator's setting.
Attenuation at -35 dBm: _____
- 5 Disconnect the fiber-optic cable at the power meter's input and connect the cable to the Agilent 86120C being tested.
- 6 Reset the optical attenuator to the setting recorded in [Step 3](#).
- 7 Read the power and wavelength measured on the Agilent 86120C, and compare them to the specifications listed in [Chapter 6, "Specifications and Regulatory Information"](#).
- 8 Reset the optical attenuator to the setting recorded in [Step 4](#).
- 9 Read the power and wavelength measured on the Agilent 86120C, and compare them to the specifications listed in [Chapter 6, "Specifications and Regulatory Information"](#).

Test 3. Polarization Dependence

Description	Polarization Dependence is verified using the following devices: <ul style="list-style-type: none">• 1310 nm and 1550 nm DFB lasers• Optical attenuator• Agilent 11896A polarization controller
CAUTION	Do not exceed +18 dBm source power. The Agilent 86120C's input circuitry can be damaged when total input power exceeds 18 dBm.
Procedure	<p>Perform the following procedure first using the 1310 nm laser and then repeat the steps using the 1550 nm laser.</p> <ol style="list-style-type: none">1 Turn on the lasers and allow them to warm up.2 Set the polarization controller to a scan rate of 5.3 On the Agilent 86120C, press the Preset key.4 Connect the laser's optical output to the polarization controller's optical input.5 Connect the polarization controller's optical output to the Agilent 86120C being tested.6 Set the polarization controller to autoscans.7 On the Agilent 86120C, press Peak WL, Appl's, and then <i>DRIFT</i>. Press <i>MAX-MIN</i> so that both <i>MAX</i> and <i>MIN</i> in the softkey label are highlighted. The display shows the total drift since the drift measurement was started.8 Wait five minutes, read the peak amplitude drift from the Agilent 86120C, and compare with the specification listed in Chapter 6, "Specifications and Regulatory Information".

Test 4. Optical Input Return Loss

Description

Input return loss is verified using the following devices:

- Agilent 8153A lightwave multimeter
- Agilent 81553SM 1550 nm Fabry-Perot laser, SM 9/125 μm source module
- Agilent 81534A return loss module

Procedure

Standard instruments (flat contacting connectors)

- 1 Turn the source module's output off.
- 2 Connect a single-mode patchcord between the source module's optical output and the return loss module's INPUT SOURCE connector.
- 3 Set the return loss module's wavelength to 1550 nm, and select an average time of 1 second.
- 4 Locate an HMS-10/HRL to FC/PC patchcord. Connect the HMS-10/HRL end of the patchcord to the return loss module's OUTPUT connector. Terminate the other end of the cable.
- 5 Zero the return loss module.
- 6 Turn on the source module.
- 7 Remove the termination from the cable, and leave the cable's free end uncovered.
- 8 The return loss module measures the reflection reference (14.6 dB return loss of the patchcord's FC/PC connector in air).
- 9 Make a low-reflection termination in the HMS-10/HRL to FC/PC patchcord. Do this by wrapping the cable 6 times around a 5 mm diameter mandrel.
- 10 The return loss module measures the termination parameter.
- 11 Connect the HMS-10/HRL to FC/PC patchcord to the Agilent 86120C's front panel OPTICAL INPUT connector.
- 12 The lightwave multimeter measures the return loss. Compare this measurement with the specification listed in [Chapter 6, "Specifications"](#)

[and Regulatory Information](#)".

Procedure***Option 022 instruments (angled contacting connectors)***

- 1** Turn the source module's output off.
- 2** Connect a single-mode patchcord between the source module's optical output and the return loss module's INPUT SOURCE connector.
- 3** Set the return loss module's wavelength to 1550 nm, and select an average time of 1 second.
- 4** Locate an HMS-10/HRL to FC/APC (angled FC) patchcord. Connect the HMS-10/HRL end of the patchcord to the return loss module's OUTPUT connector. Terminate the FC/APC end of the cable.
- 5** Zero the return loss module.
- 6** Turn on the source module.
- 7** Remove the termination from the cable, and connect the FC/APC end of an FC/APC to FC/PC cable to the free end of this cable. Leave the cable's free end uncovered.
- 8** The return loss module measures the reflection reference (14.6 dB return loss of the patchcord's FC/PC connector in air).
- 9** Disconnect the FC/APC to FC/PC cable.
- 10** Make a low-reflection termination in the HMS-10/HRL to FC/APC patchcord. Do this by wrapping the cable 6 times around a 5 mm diameter mandrel.
- 11** The return loss module measures the termination parameter.
- 12** Connect the HMS-10/HRL to FC/APC patchcord to the Agilent 86120C's front panel OPTICAL INPUT connector.
- 13** The lightwave multimeter measures the return loss. Compare this measurement with the specification listed in [Chapter 6, "Specifications and Regulatory Information"](#).

Performance Tests

Test 4. Optical Input Return Loss

FC/APC patchcord loss

The effect of having loss in the FC/APC patchcord 1 to 2 connector pair is to under measure the return loss by twice the FC/APC patchcord 1 to 2 loss. For example, if this connector pair loss is 0.5 dB, then the actual return loss caused by the 14.6 dB Fresnel reflection is 15.6 dB, but we enter 14.6 dB as an R value. Then, if the device under test return loss is exactly 40 dB below that of the 14.6 dB Fresnel reflection, the optical return loss module will display 53.6 dB because the 0.5 dB connector pair loss (seen twice) is removed. In reality, the return loss is 54.6 dB (exactly 40 dB below 14.6 dB), better than that displayed.

Test 5. Amplitude Accuracy and Linearity

Equipment

Amplitude linearity is performed using the following devices:

- 1550 nm DFB lasers
- Optical attenuator
- Agilent 11896A polarization controller
- Optical power meter

Procedure

Polarization sensitivity

To ensure measurement accuracy, minimize the movement of any fiber-optic cables during this procedure. Moving cables causes polarization changes which affect amplitude measurements.

- 1 Turn on the laser and allow it to warm up.
- 2 Connect the laser's output to the optical attenuator's input.
- 3 Connect the optical attenuator's output to the polarization controller's optical input.
- 4 Connect the polarization controller's optical output to the optical power meter.
- 5 Configure the optical power meter for 1550 nm.
- 6 Adjust the optical attenuator so that the power meter measures a power level of 0 dBm.
- 7 Enter the attenuator setting and the measured power level in the first row of [Table 5-21 on page 5-11](#). Be sure to enter these values into the "Attenuator Settings" and "Power Meter Readings" columns.
- 8 Enter the measured power on the following line:
Pwr: _____
- 9 Change the attenuator in 1 dB steps as shown in [Table 5-21](#), and enter the attenuator settings and power measurements.

After completing this step, the first two columns of the table should be

Performance Tests

Test 5. Amplitude Accuracy and Linearity

completely filled in.

- 10 Disconnect the fiber-optic cable from the optical power meter and connect it to the Agilent 86120C's OPTICAL INPUT connector.
- 11 Set the optical attenuator for the value that you recorded in [Step 8](#).
- 12 Place the polarization controller in the auto scan mode.
- 13 Press the Agilent 86120C's front-panel Preset key.
- 14 Press List by Power, Appl's, and then *DRIFT*.
- 15 After two minutes, stop the polarization controller's auto scan function.
- 16 Press the *MAX-MIN* softkey so that *MAX* is highlighted. Enter the maximum drift reading on the following line:

maximum drift: _____

- 17 Press the *MAX-MIN* softkey so that *MIN* is highlighted. Enter the minimum drift reading on the following line:

minimum drift: _____

- 18 Use the values recorded in [Step 8](#), [Step 16](#), and [Step 17](#) to calculate the power-correction offset value as shown in the following equation:

$$\text{offset} = \frac{\text{minimum drift} + \text{maximum drift}}{2} - P_{wr}$$

Enter the calculate value on the following line:

power-correction offset: _____

- 19 Change the attenuator to the settings shown in [Table 5-21](#). For each setting, record the power measured on the Agilent 86120C.

After completing this step, the table's column titled "Agilent 86120C Power Reading" should be completely filled in.

- 20 Calculate the "Linearity" value for each row in the table using the following equation:

$$\text{Linearity} = \text{Power Meter Reading} - 86120C \text{ Power Reading} - \text{offset}$$

- 21 Compare the linearity values with the specification listed in [Chapter 6](#), "[Specifications and Regulatory Information](#)". The data may show multiple amplitude plateaus separated by small amplitude steps. This is *not* a problem as long as the amplitude steps are within the linearity specification.

Performance Tests
Test 5. Amplitude Accuracy and Linearity

Table 5-21. Linearity Data Values

Desired Power (dBm)	Attenuator Setting	Power Meter Reading	Agilent 86120C Power Reading	Linearity
0				
-1				
-2				
-3				
-4				
-5				
-6				
-7				
-8				
-9				
-10				
-11				
-12				
-13				
-14				
-15				
-16				
-17				
-18				
-19				
-20				

6

Definition of Terms	6-3
Specifications—NORMAL Update Mode	6-5
Specifications—FAST Update Mode	6-8
Operating Specifications	6-11
Laser Safety Information	6-12
Compliance with Canadian EMC Requirements	6-13
Declaration of Conformity	6-14
Product Overview	6-15

Specifications and Regulatory Information



Specifications and Regulatory Information

This chapter lists specification and characteristics of the instrument. The distinction between these terms is described as follows:

- Specifications describe warranted performance over the temperature range 0°C to +55°C and relative humidity <95% (unless otherwise noted). All specifications apply after the instrument's temperature has been stabilized after 15 minutes of continuous operation.
- *Characteristics* provide useful information by giving functional, but nonwarranted, performance parameters. *Characteristics are printed in italics.*

Calibration Cycle

This instrument requires periodic verification of performance. The instrument should have a complete verification of specifications once every two years.

Definition of Terms

Wavelength

Range refers to the allowable wavelength range of the optical input signal. *Absolute accuracy* indicates the maximum wavelength error over the allowed environmental conditions. The wavelength accuracy is based on fundamental physical constants, which are absolute standards not requiring traceability to artifacts kept at national standards laboratories. Two He-Ne gas lasers are used. First, there is an internal 632.991 nm-vacuum (473.6127 THz) reference laser¹. To verify absolute wavelength accuracy, an external laser is measured during manufacturing at 1523.488 nm, or 196.7804 THz².

Differential Accuracy indicates the maximum wavelength error in measuring the wavelength difference between two signals that are simultaneously present.

Minimum Resolvable Separation indicates the minimum wavelength separation of two laser lines required to measure each wavelength simultaneously. Two laser lines closer in wavelength than the minimum resolvable separation are not resolved and one average wavelength is displayed.

Display Resolution indicates the minimum incremental change in displayed wavelength.

Amplitude

Calibration Accuracy indicates the maximum power calibration error at the specified wavelengths over the allowed environmental conditions. The amplitude calibration accuracy is traceable to a National Institute of Standards and Technology (NIST) calibrated optical power meter. NIST is the national standards laboratory of the United States.

Flatness refers to the maximum amplitude error in a measurement between two lines that are separated in wavelength by no more than the specified amount.

Linearity indicates the maximum power error in measuring the change in power

1. Obarski, G. E. 1990. "Wavelength Measurement System for Optical Fiber Communications" *NIST Technical Note 1336* (February): 18. Take the average of the two frequencies straddling gain center.
2. D. A. Jennings, F. R. Peterson, and K. M. Evenson. 1979. "Frequency measurement of the 260-THz (1.15 micron) He-Ne laser" *Optics Letters Vol. 4, No. 5* (May): 129-130.

Specifications and Regulatory Information

Definition of Terms

of one laser line.

Polarization Dependence indicates the maximum displayed power variation as the polarization of the input signal is varied.

Display Resolution indicates the minimum incremental change in displayed power.

Sensitivity	<i>Sensitivity</i> is defined as the minimum power level of a single laser-line input to measure wavelength and power accurately. A laser line with less than the minimum power may be measured but with reduced wavelength and power accuracy. For multiple laser-lines input, sensitivity may be limited by total input power.
Selectivity	<i>Selectivity</i> indicates the ability to measure the wavelength and power of a weak laser line in the proximity of a specified stronger laser line and separated by the specified amount.
Input Power	<i>Maximum displayed level</i> indicates the maximum total input power (total of all laser lines present) to accurately measure wavelength and power. <i>Maximum safe input power</i> indicates the maximum total input power (total of all laser lines present) to avoid permanent optical damage to the instrument.
Maximum Number of Lines Input	<i>Maximum number of lines input</i> is the maximum number of displayed lines. If more than 200 lines are input, only the 200 longest wavelength lines are displayed.
Input Return Loss	<i>Input Return Loss</i> indicates the optical power reflected back to the user's fiber cable relative to the input power. It is limited by the return loss of the front-panel connector, and assumes the user's connector is good.
Measurement Cycle Time	<i>Measurement cycle time</i> refers to the cycle time when measuring wavelength and power of laser lines. Specific advanced applications may require longer cycle times.

Specifications—NORMAL Update Mode

Each laser line is assumed to have a linewidth (including modulation sidebands) of less than 5 GHz.

All specifications apply when the instrument is in the following modes:

- NORMAL update mode unless noted. Refer to “Measurement rate” on page 2-13.
- Configured to measure narrowband devices. Specifications do *not* apply when the instrument is configured to measure broadband devices. Refer to “Measuring broadband devices and chirped lasers” on page 2-9.

Wavelength

Range	1270–1650
Absolute accuracy (lines separated by ≥ 15 GHz)	± 2 ppm (± 0.003 nm at 1550 nm and 1310 nm)
<i>Differential accuracy (characteristic)</i>	± 1 ppm
<i>Minimum resolvable separation^a (characteristic)</i>	10 GHz (0.08 nm at 1550 nm, 0.06 nm at 1300 nm)
Display resolution	0.001 nm

a. Signals of equal amplitude. For lines that are separated by less than 30 GHz, wavelength accuracy is reduced.

Specifications and Regulatory Information
Specifications—NORMAL Update Mode

Amplitude

Calibration accuracy at calibration wavelengths	± 0.5 dB (at 1310 and 1550 nm ± 30 nm)
Flatness, ± 30 nm from any wavelength	
1270-1600 nm (characteristic)	± 0.2 dB
1270-1650 nm (characteristic)	± 0.5 dB
Linearity, 1270 nm to 1600 nm, lines above -30 dBm	± 0.3 dB
Polarization dependence	
1270-1600 nm	± 0.5 dB
1600-1650 nm (characteristic)	± 1.0 dB
Display resolution	0.01 dB

Sensitivity

1270-1600 nm, single line input	-40 dBm
1600-1650 nm, single line input	-30 dBm
1270-1650 nm, multiple lines input (characteristic)	30 dB below total input power, but not less than single line input sensitivity.

Selectivity

Two lines input separated by ≥ 50 GHz (characteristic)	25 dB
Two lines input separated by ≥ 15 GHz (characteristic)	10 dB
Input Power	
Maximum displayed level (sum of all lines)	+10 dBm
Maximum safe input level (sum of all lines)	+18 dBm
Maximum Number of Laser Lines Input	200

Input Return Loss

With straight contactconnectors	35 dB
With angled contact connectors (Option 022)	50 dB

Measurement Cycle Time

<i>Normal update mode (characteristic)</i>	<i>1.0 s (1 measurement-per-second)</i>
--	---

Measurement Applications

<i>Signal-to-Noise Ratio (characteristic) ^a</i>	
<i>channel spacing ≥ 100 GHz</i>	<i>>35 dB</i>
<i>channel spacing ≥ 50 GHz</i>	<i>>27 dB</i>
<i>Signal-to-Noise Ratio with Averaging, modulated lasers (characteristic) ^a</i>	
<i>channel spacing ≥ 100 GHz</i>	<i>>35 dB with 100 averages</i>
<i>channel spacing ≥ 50 GHz</i>	<i>>27 dB with 100 averages</i>

a. 0.1 nm noise bandwidth, lines above -25 dBm.

Specifications—FAST Update Mode

Each laser line is assumed to have a linewidth (including modulation sidebands) of less than 10 GHz.

All specifications apply when the instrument is in the following modes:

- FAST update mode unless noted. Refer to “Measurement rate” on page 2-13.
- Configured to measure narrowband devices. Specifications do *not* apply when the instrument is configured to measure broadband devices. Refer to “Measuring broadband devices and chirped lasers” on page 2-9.

Wavelength

Range	1270–1650
Absolute accuracy (lines separated by ≥ 30 GHz)	± 3 ppm (± 0.005 nm at 1550 nm, ± 0.004 nm at 1310 nm)
<i>Differential accuracy (characteristic)</i>	± 2 ppm
<i>Minimum resolvable separation^a (characteristic)</i>	20 GHz (0.16 nm at 1550 nm, 0.11 nm at 1300 nm)
Display resolution	0.001 nm

a. Signals of equal amplitude. For lines that are separated by less than 30 GHz, wavelength accuracy is reduced.

Amplitude

Calibration accuracy at calibration wavelengths	± 0.5 dB (at 1310 and 1550 nm ± 30 nm)
Flatness, ± 30 nm from any wavelength	
1270-1600 nm (characteristic)	± 0.2 dB
1270-1650 nm (characteristic)	± 0.5 dB
Linearity, 1270 nm to 1600 nm, lines above -30 dBm	± 0.3 dB
Polarization dependence	
1270-1600 nm	± 0.5 dB
1600-1650 nm (characteristic)	± 1.0 dB
Display resolution	0.01 dB

Sensitivity

1270-1600 nm, single line input	-40 dBm
1600-1650 nm, single line input	-30 dBm
1270-1650 nm, multiple lines input (characteristic)	30 dB below total input power, but not less than single line input sensitivity.

Selectivity

Two lines input separated by ≥ 100 GHz (characteristic)	25 dB
Two lines input separated by ≥ 30 GHz (characteristic)	10 dB
Input Power	
Maximum displayed level (sum of all lines)	+10 dBm
Maximum safe input level (sum of all lines)	+18 dBm
Maximum Number of Laser Lines Input	200

Specifications and Regulatory Information
Specifications—FAST Update Mode

Input Return Loss

With flat contacting connectors	35 dB
With angled contacting connectors (Option 022)	50 dB

Measurement Cycle Time

<i>Fast update mode (characteristic)</i>	<i>0.5 s (2 measurements-per-second)</i>
--	--

Measurement Applications

<i>Signal-to-Noise Ratio (characteristic) ^a</i>	
<i>channel spacing ≥ 200 GHz</i>	<i>>35 dB</i>
<i>channel spacing ≥ 100 GHz</i>	<i>>27 dB</i>
<i>Signal-to-Noise Ratio with Averaging, modulated lasers (characteristic) ^a</i>	
<i>channel spacing ≥ 200 GHz</i>	<i>>35 dB with 100 averages</i>
<i>channel spacing ≥ 100 GHz</i>	<i>>27 dB with 100 averages</i>

a. 0.1 nm noise bandwidth, lines above -25 dBm.

Operating Specifications

Operating Specifications

Use	indoor
Power:	70 W max
Voltage	100 / 115 / 230 / 240 V ~
Frequency	50 / 60 Hz
Altitude	Up to 2000 m (~ 6600 ft)
Operating temperature	0°C to +55°C
Maximum relative humidity	80% for temperatures up to 31°C decreasing linearly to 50% relative humidity at 40°C
Weight	8.5 kg (19 lb)
Dimensions (H × W × D)	140 × 340 × 465 mm (5.5 × 13.4 × 18.3 in)

Laser Safety Information

The light sources specified by this user guide are classified according to IEC 60825-1 (2001).

The light sources comply with 21 CFR 1040.10 except for deviations pursuant to Laser Notice No. 50, dated 2001-July-26.

Laser Safety

Laser type	LED
Wavelength	1200-1650nm
Max. CW output power *	1 nW
Beam waist diameter	10 μ m
Numeric aperture	0.1
Laser class according to IEC 60825-1 (2001)	1
Max. permissible CW output power**	10 mW
* Max. CW output power means the highest possible optical CW power that the laser source can produce at its output.	
** Max. permissible CW output power is the highest optical power that is permitted within the appropriate IEC laser class.	

WARNING

Please pay attention to the following laser safety warnings:

- Under no circumstances look into the end of an optical cable attached to the optical output when the device is operational. The laser radiation can seriously damage your eyesight.
- Do not enable the laser when there is no fiber attached to the optical output connector.
- Pressing the "active" button enables the laser. The laser is on when the green LED is lit.
- The use of optical instruments with this product will increase eye hazard.
- Refer servicing only to qualified and authorized personnel.

Compliance with Canadian EMC Requirements

This ISM device complies with Canadian ICES-001.
Cet appareil ISM est conforme à la norme NMB-001 du Canada.

Notice for Germany: Noise Declaration

Acoustic Noise Emission	Geräuschemission
LpA < 70 dB	LpA < 70 dB
Operator position	am Arbeitsplatz
Normal position	normaler Betrieb
per ISO 7779	nach DIN 45635-1

Specifications and Regulatory Information
Declaration of Conformity

Declaration of Conformity

 Agilent Technologies	DECLARATION OF CONFORMITY According to ISO/IEC Guide 22 and CEN/CENELEC EN 45014	
---	--	---

Manufacturer's Name: Agilent Technologies International sarl
Manufacturer's Address: Rue de la Gare 29
CH - 1110 Morges
Switzerland

Declares under sole responsibility that the product as originally delivered

Product Name: Multi Wavelength Meter
Product Numbers: 86120B, 86120C
Product Options: *This declaration covers all options of the above products.*

complies with the essential requirements of the following applicable European Directives, and carries the CE marking accordingly:

- The Low Voltage Directive 73/23/EEC, amended by 93/68/EEC
- The EMC Directive 89/336/EEC, amended by 93/68/EEC

and conforms with the following product standards:

	Standard	Limit
EMC	IEC 61326:1997+A1/1998+A2/2000 / EN 61326:1997+A1/1998+A2/2001 CISPR 11:1997+A1:1999 / EN 55011:1998+A1:1999 IEC 61000-4-2:2001 / EN 61000-4-2:1995+A1:1998+A2:2001 IEC 61000-4-3:2002 / EN 61000-4-3:2002 IEC 61000-4-4:2001 / EN 61000-4-4:1995+A1:2001+A2:2001 IEC 61000-4-5:2001 / EN 61000-4-5:1995+A1:2001 IEC 61000-4-6:1995+A1:2000 / EN 61000-4-6:1996+A1:2001 IEC 61000-4-8:2001 / EN 61000-4-8:1993+A1:2001 IEC 61000-4-11:1994+A1:2000 / EN 61000-4-11:1994+A1:2001 Canada: ICES-001:1998 Australia/New Zealand: AS/NZS 2064.1	Group 1 Class A 4 kV CD, 8 kV AD 3 V/m, 80-1000 MHz 0.5 kV signal lines, 1 kV power lines 0.5 kV line-line, 1 kV line-ground 3 V, 0.15-80 MHz 30 A/m 1 cycle/100%
Safety	IEC 61010-1:2001 / EN 61010-1:2001 Canada: CSA C22.2 No. 1010.1:1992 USA: UL 3111-1:1994	

Supplementary Information:

The products were tested in a typical configuration with Agilent Technologies test systems.

This DoC applies to above-listed products placed on the EU market after:

2004-August-01
Date

Hans-Martin Fischer
Name

Product Regulations Representative PMD, DVS
Agilent Technologies
Title

For further information, please contact your local Agilent Technologies sales office, agent or distributor.

Product Overview

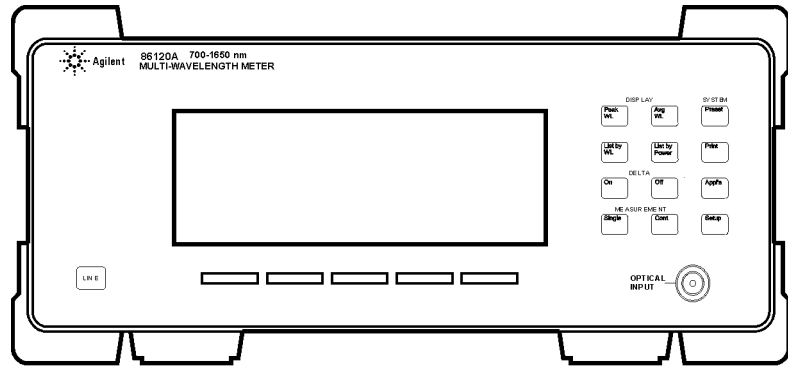

frnt view

Front view of instrument

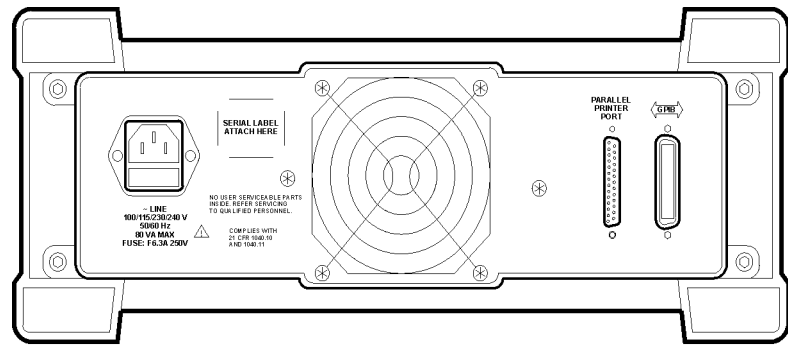

rearview

Rear view of instrument

Specifications and Regulatory Information

Product Overview

7

Instrument Preset Conditions 7-2
Menu Maps 7-4
Error Messages 7-11
Front-Panel Fiber-Optic Adapters 7-17
Power Cords 7-18
Agilent Technologies Service Offices 7-18

Reference



Reference

Instrument Preset Conditions

Table 5-22. Instrument Preset Conditions (1 of 2)

Item	Settings after Preset Key Pressed	Settings after Power Turned On
Display mode	single wavelength	last state ^a
Wavelength range limiting	on	last state
Start wavelength	1270 nm	last state
Stop wavelength	1650 nm	last state
Graphical display	off	off
Measurement acquisition	continuous	last state
Wavelength calibration	vacuum	last state
Elevation correction value	not affected	last state
Wavelength units	nm	last state
Amplitude units	dBm	last state
Power offset	0 dB	last state
Peak threshold	10 dB	last state
Peak excursion	15 dB	last state
Measurement speed	normal	last state

Table 5-22. Instrument Preset Conditions (2 of 2)

Item	Settings after Preset Key Pressed	Settings after Power Turned On
Device bandwidth	narrowband	last state
Drift measurements	off	off
Fabry-Perot laser measurements	off	off
Delta measurements:		
Δ power	off	off
Δ wavelength	off	off
Δ wavelength and power	off	off
reference signal position	1270 nm	1270 nm
Signal-to-noise measurements		
measurement	off	off
wavelength reference	auto	last state
user wavelength	not affected	last state
number of averages	100	last state
GPIB address	not affected	last state
Power-bar display	on	last state

a. The term "last state" refers to the last setting that this parameter was in before the instrument power was turned off.

Menu Maps

This section provides menu maps for the Agilent 86120C softkeys. The maps show which softkeys are displayed after pressing a front-panel key; they show the relationship between softkeys. The softkeys in these maps are aligned vertically instead of horizontally as on the actual display. This was done to conserve space and to make the maps easier to interpret.

Appl's Menu

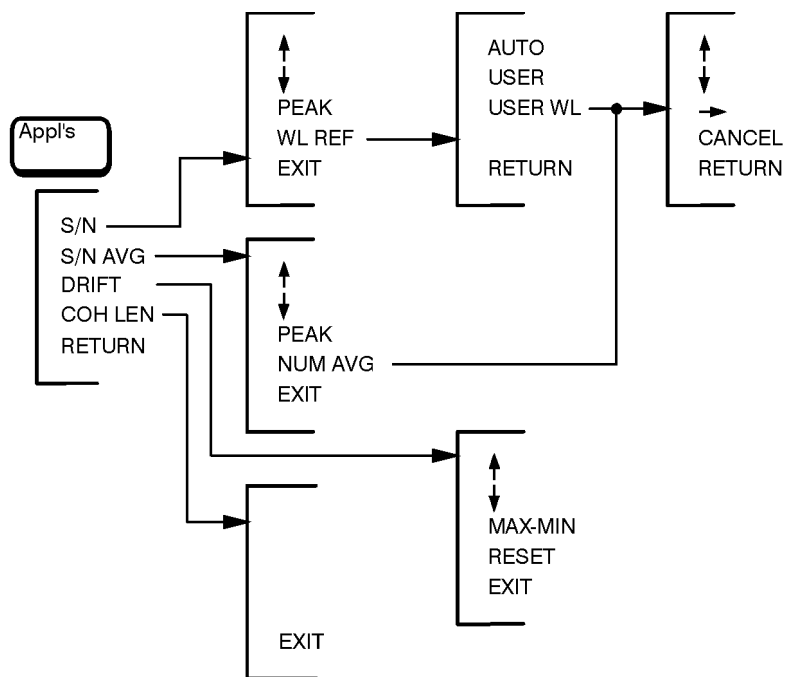

mappls

Display Avg WL Menu

There is no menu associated with this key.

Measurement Cont Menu

There is no menu associated with this key.

Display List by Power Menu

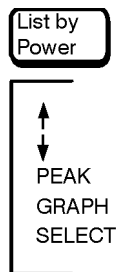

m1istpwr

Display List by WL Menu

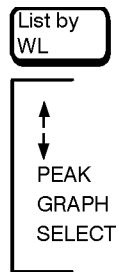

mlistwl

Delta On Menu

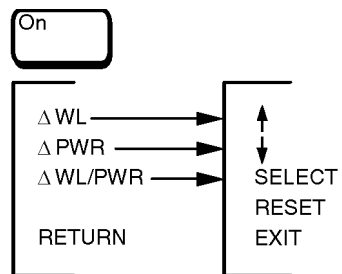

mon

Delta Off Menu

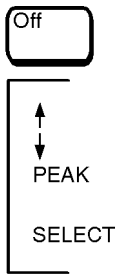

moff

Display Peak WL and System Preset Menus

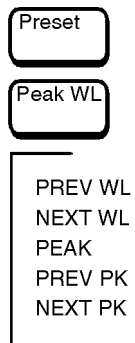

mppreset

Measurement Single Menu

There is no menu associated with this key.

System Print Menu

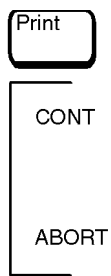

mprint

System Setup Menu

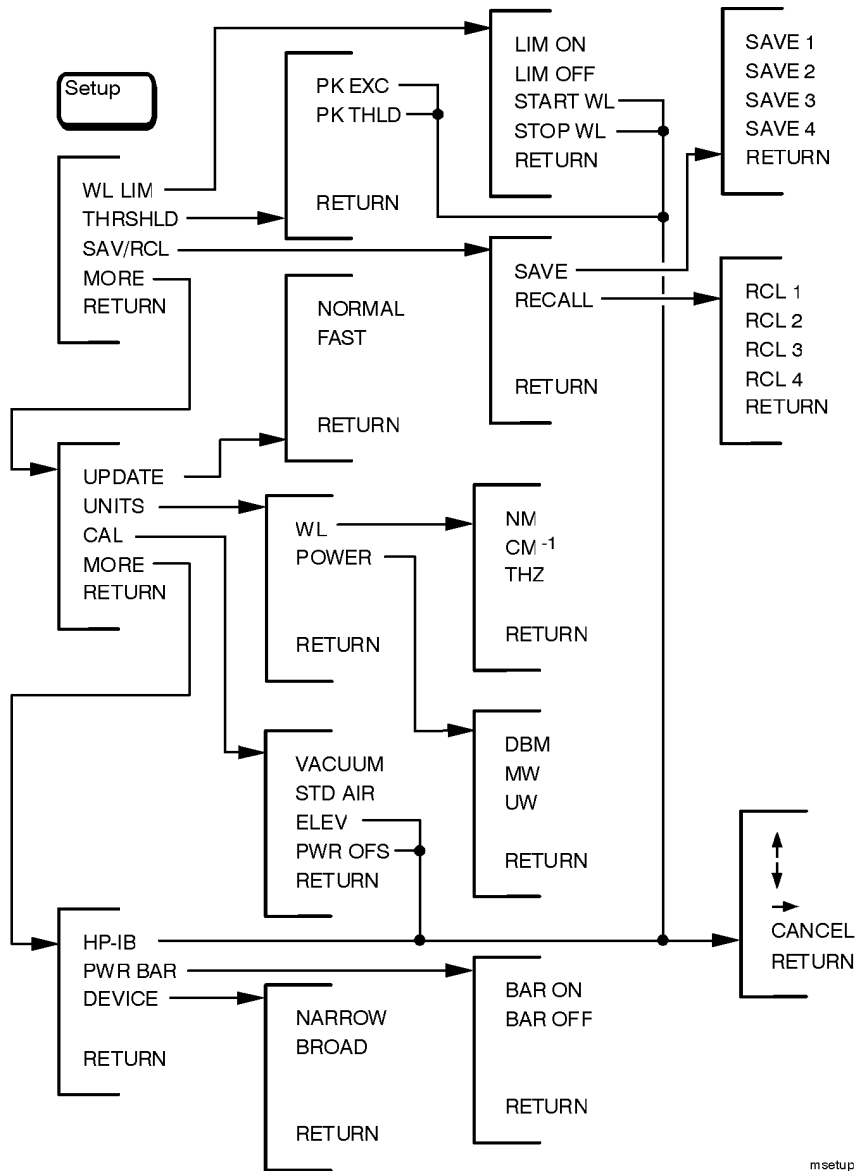

msetup

Error Messages

In this section, you'll find all the error messages that the Agilent 86120C can display on its screen. [Table 5-23 on page 7-11](#) lists all instrument-specific errors. [Table 5-24 on page 7-14](#) lists general SCPI errors.

Table 5-23. Instrument Specific Error Messages (1 of 3)

Error Number	Error Message
1	BAD CHECKSUM FROM MOTOR
2	MOTOR COMMUNICATION PROBLEM
3	MOTOR NOT MOVING
4	MOTOR INDEX PULSE NOT FOUND
5	MOTOR CHIP SET INIT FAILED
6	MOTOR COMMUTATION FAILURE
7	MOTOR NOT SETTLED
8	MOTOR DID NOT STOP
9	MOTOR MOTION ERROR
10	MOTOR POSITION LIMIT FAILED
11	MOTOR POSITION WRAP FAILED
12	POWER LEVEL TOO HIGH
13	DATA DOWNLOAD PROBLEM
14	DATA ACQUISITION PROBLEM
15	MAX NUMBER OF SIGNALS FOUND
16	MOTOR INTERRUPT RECEIVED

Reference

Error Messages

Table 5-23. Instrument Specific Error Messages (2 of 3)

Error Number	Error Message
17	ROM BYTE UNERASED
18	ROM WRITE OPERATION FAILED
19	ROM DEFECTIVE
20	ROM DATA INVALID
21	ROM VERSION INCOMPATIBLE
22	ROM POLLING LIMITED OUT
23	INPUT OUT OF RANGE
24	BAD CAL ROM DATA
25	BAD CAL ROM DATA
26	BAD CAL ROM DATA
27	BAD CAL ROM DATA
28	BAD CAL ROM DATA
29	BAD CAL ROM DATA
30	NVSRAM WRITE OPERATION FAILED
31	SOFTWARE INITIALIZATION FAIL
32	HARDWARE INITIALIZATION FAIL
33	INITIALIZATION TIMEOUT
34	BATTERY FAILED
36	TOO MANY ERRORS
37	FUNCTION NOT YET IMPLEMENTED
38	PRINTER OFF LINE
39	PRINTER OUT OF PAPER
40	PRINTER ERROR DETECTED
41	PRINTER TIMED OUT

Table 5-23. Instrument Specific Error Messages (3 of 3)

Error Number	Error Message
42	PRINTOUT WAS ABORTED
43	NOT ALLOWED IN FABRY PEROT
44	NOT ALLOWED IN S/N
45	UNKNOWN KEYPRESS
46	NUM LINES < NUM REFS
47	NUM LINES > NUM REFS
48	NO REFERENCE SIGNAL
49	GAIN RANGING ERROR
50	INCOMPATIBLE HARDWARE
51	UNKNOWN ERROR

Reference

Error Messages

Table 5-24. General SCPI Error Messages (1 of 3)

Error Number	Description
+0	"No errors"
-100	"Command error (unknown command)"
-101	"Invalid character"
-102	"Syntax error"
-103	"Invalid separator"
-104	"Data type error"
-105	"GET not allowed"
-108	"Parameter not allowed"
-109	"Missing parameter"
-112	"Program mnemonic too long"
-113	"Undefined header"
-120	"Numeric data error"
-121	"Invalid character in number"
-123	"Exponent too large"
-124	"Too many digits"
-128	"Numeric data not allowed"
-131	"Invalid suffix"
-134	"Suffix too long"
-138	"Suffix not allowed"
-141	"Invalid character data"
-148	"Character data not allowed"
-150	"String data error"
-151	"Invalid string data"

Table 5-24. General SCPI Error Messages (2 of 3)

Error Number	Description
-158	"String data not allowed"
-161	"Invalid block data"
-168	"Block data not allowed"
-170	"Expression error"
-171	"Invalid expression"
-178	"Expression data not allowed"
-200	"Execution error"
-211	"Trigger ignored" Caused by sending the *TRG command when the instrument is already taking a measurement or when the instrument is in continuous measurement mode.
-213	"Init ignored" Caused by sending an INIT:IMM, READ, or MEASure command while a measurement is already in progress or while the instrument is in continuous measurement mode.
-221	"Settings conflict" Caused by trying to set the instrument to a state that is not allowed. For example, turning on drift maximum and drift minimum state simultaneously or turning on SNR state while drift or delta state is on.
-222	"Data out of range"
-223	"Too much data"
-224	"Illegal parameter value"
-230	"Data corrupt or stale" Caused by trying to query measurement data immediately after a *RST command. For example, sending *RST; FETCh or sending *RST; :CALC2:DATA? pow.
-232	"Data questionable" Caused by sending a resolution value in one of the measurement functions that is outside the instrument's range.
-273	"Illegal macro label"







Reference

Error Messages

Table 5-24. General SCPI Error Messages (3 of 3)

Error Number	Description
-310	"System error"
-321	"Out of memory"
-350	"Too many errors"
-400	"Query error"
-410	"Query INTERRUPTED"
-420	"Query UNTERMINATED"
-430	"Query DEADLOCKED"
-440	"Query UNTERMINATED after indef resp" Query was unterminated after an indefinite response.

Front-Panel Fiber-Optic Adapters







Front Panel Fiber-Optic Adapter	Description	Agilent Part Number
	Diamond HMS-10	81000AI
	FC/PC ^a	81000FI
	D4	81000GI
	SC	81000KI
	DIN	81000SI
	ST	81000VI
	Biconic	81000WI

a. The FC/PC is the default front-panel optical connector.

Dust Covers	Agilent Part Number
FC connector	1005-0594
Diamond HMS-10 connector	1005-0593
DIN connector	1005-0595
ST connector	1005-0596
SC connector	1005-0597

Reference
Power Cords

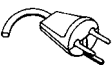
Power Cords

Plug Type	Cable Part No.	Country
250V 	8120-1351	United Kingdom, Cyprus, Nigeria, Zimbabwe, Singapore
250V 	8120-1369	Australia, New Zealand, China
250V 	8120-1689	East and West Europe, Saudi Arabia, So. Africa, India (unpolarized in many nations)
125V 	8120-1378	United States, Canada, Mexico, Philippines, Taiwan
250V 	8120-2104	Switzerland
220V 	8120-3997	Denmark
250V 	8120-4211	Republic of South Africa, India
100V 	8120-4753	Japan
	8120-5182	Israel
	8120-6868	Argentina
	8120-6979	Chile
	8120-8376	China
	8120-8871	Brazil, Thailand

* Part number shown for plug is the industry identifier for the plug only. Number shown for cable is the Agilent Technologies part number for the complete cable including the plug.

Agilent Technologies Service Offices

Agilent Technologies Service Offices

Before returning an instrument for service, call the Agilent Technologies Instrument Support Center at +1 (877) 447 7278, visit the Test and Measurement Web Sites by Country page at <http://www.agilent.com/comms/techsupport>, select your country and enter the "Technical Support" link, or call one of the numbers listed below.

Agilent Technologies Service Numbers

Austria	0820 87 44 11
Belgium	+32 (0) 2 404 9340
Brazil	+11 7297-8600
China	800 810 0508
Denmark	+45 70 131515
Finland	+358 (0) 10 855 2100
France	0825 010 700
Germany	01805 24 6337
India	1600 112 626
Italy	+39 02 9260 8484
Ireland	+353 1890 924 204
Japan	0120 421 345
Korea	080 769 0800
Mexico	(5) 258-4826
Netherlands	+31 (0) 20 547 2111
Norway	+47 67101 080
Russia	+7 (095) 797 3930
Spain	+34 91 631 3300
Sweden	0200 88 22 55
Switzerland	0800 80 5353
United Kingdom	+44 (0) 7004 666666
United States	+1 (877) 447 7278

Index

ASNR, 48

Numerics

1 nm annotation, 27, 30

A

ABORT programming command, 104

ABORT softkey, 39

ac power cables, 6

adapters, fiber optic, 17

adding parameters, 25

address. *See* GPIB address

Agilent Technologies offices, 18

air, measurements in, 37

AM modulation, 15, 34

amplitude

offset, 36

specifications, 6, 9

annotation

* (asterisk), 4, 14

1 nm, 27, 30

AVERAGE, 7

BROAD, 9

BY PWR, 6

BY WL, 6

DRIFT, 22

M, 4

PEAK, 4

PWR OFS, 36

Remote, 3

S/N AUTO, 25

S/N USER, 25

STD AIR, 37

VAC, 37

Appl's

key, 23, 28, 31

menu map, 5

ARRay programming command, 15

ASNR

CLear programming command, 46

COUNt programming command, 47

* (asterisk), 4, 14

attenuation. *See* external attenuation

audio modulation, effects of, 15, 34

AUTO

programming command, 69

softkey, 28

AVERAGE annotation, 7

average wavelength, iii, 7

Avg WL key, 7, 8

B

BAR OFF softkey, 11

BAR ON softkey, 11

bit error rate, 25

block diagram, 5

BROAD annotation, 9

BROAD softkey, 9

broadband devices, measuring, 9

programming command, 84

broadband mode, 9, 5, 8

BY PWR annotation, 6

BY WL annotation, 6

C

cabinet, cleaning, vii, 2

CAL softkey, 8

CALCulate1 subsystem, 25

CALCulate2 subsystem, 31

CALCulate3 subsystem, 14, 34, 37, 39, 44

calibration

accuracy, 3

cycle, 2

elevation, 8

measurements, 37

medium for light, 9

care

of cabinet, vii, 2

of fiber optics, v

case sensitivity, 24

channel spacing, 19

characteristics, 5

chirped lasers, 9

classification

product, vii

classification, laser, vi, 12

cleaning

adapters, 49

cabinet, vii, 2

fiber-optic connections, 40, 48

non-lensed connectors, 48

CLEAR softkey, 23

Index

- *CLS, 21, 3
- CM -1 softkey, 13
- Cmd_opc subroutine, 29
- colon, 25
- commands
 - combining, 24
 - common, 23
 - measurement instructions, 23
 - non sequential, 12, 29, 34, 35, 37, 38, 39, 40, 41, 42, 43, 85, 105, 106
 - standard SCPI, 23
 - termination, 27
- common commands
 - *CLS (clear status), 3
 - *ESE (event status enable), 28, 3
 - *ESR (event status register), 5
 - *IDN (identification number), 29, 6
 - *OPC (operation complete), 29, 7
 - *RST (reset), 29, 8
 - *SRE (service request enable), 10
 - *STB (status byte), 12
 - *TRG (trigger), 13
 - *TST (test), 13
 - *WAI (wait), 14
- definition, 23
- sending, 25
- computer control, 5
- CONFigure measurement instruction, 15
- connector
 - care, 40
- connector care, 40
- Cont key, 14, 23
- CONT softkey, 39
- CONTinuous programming command, 105
- cotton swabs, 48
- covers, dust, 17
- cursor, 6

D

- damaged shipment, 4
- data corrupt or stale, 26, 8, 15
- data questionable, 15
- DATA? programming command, 26, 32, 49, 88
- DBM softkey, 13
- default GPIB address, 3
- Delta Off softkey. *See* Off
- Delta On softkey. *See* On

- DEVICES softkey, 9
- DFB lasers, 9
- dispersion. *See* calibration, measurements
- display
 - annotation. *See* annotation
 - cursor, 6
 - modes, 3
 - resolution, 4, 6, 9
 - scrolling through, 6
 - setting update rate, 14
 - softkeys blanked, 3
 - update rate, 13
- DISPlay subsystem, 75
- down-arrow softkey, 6
- DRANge programming command, 34
- DRIFT
 - annotation, 22
 - softkey, 23
- drift, laser. *See* laser drift
- dust caps, 48
- dust covers, 17

E

- E15 MAX NUMBER OF SIGNALS FOUND message, 17
- E46 NUM LINES < NUM REFS message, 23
- E47 NUM LINES > NUM REFS message, 23
- EDFA amplifier, 9
- ELEV softkey, 8, 38
- elevation
 - changing feet to meters, 8, 38
 - effects of, 37
 - entering, 8, 38
- ELEVation programming command, 84, 85
- ENABLE programming command, 92
- EOI signal, 27
- Err_mngmt subroutine, 29
- error
 - messages, 11
 - queue, 22
- ERRor programming command, 98
- Error_msg subroutine, 28
- *ESE, 28, 3
- *ESR, 5
- EVENT programming command, 91, 93
- event status enable register, 28, 4
- example programs, 28

- increase source accuracy, 41
- measure DFB laser, 30
- measure SNR, 39
- measure WDM channel drift, 34
- measure WDM channel separation, 37
- measure WDM channels, 32
- external attenuation, 36

F

- Fabry-Perot lasers, iii, 9
 - measuring, 15, 31
- fast fourier transform, 29
- FAST softkey, 14, 9, 88
- FETCh measurement instruction, 15
- fiber optics
 - adapters, 17
 - care of, v
 - cleaning connections, 40
 - connectors, covering, 12
- firmware version
 - displayed, 7
 - over GPIB, 6
- flatness, 3, 6, 9
- FNIdentity function, 29
- FP TEST softkey, 31
- FPERot programming command, 62–67
- FREQUency programming command, 19, 51, 70
- front panel
 - adapters, 17
 - labels, 15
 - lockout, 3
- fuse
 - values, vii

G

- GPIB
 - address, 3
 - address, changing from front panel, 4
 - address, default, 3
 - softkey, 4

H

- hardcopy. *See* printer
- HCOPY subsystem, 80
- HELP:HEADers? programming command, 99

- HP BASIC, 2, 28

I

- *IDN?, 29, 6
- IEC Publication 1010, vi
- IEEE 488.2 standard, 2
- IMMediate programming command, 80, 106
- init ignored, 15
- initializing the instrument, 3
- input
 - connector, iii, 40
 - power, definition of, 4
- INPUT connector, v
- inspecting
 - instrument, 4
- installing, 2
- instrument
 - addressing over GPIB, 3
 - default state, 2
 - front view, 15
 - preset conditions, 100, 2
 - rear view, 15
 - returning for service, 11
 - state when turned on, 100, 2
- integration limits, 9

L

- laser
 - aperture, vi
 - classification, vi, 12
 - drift, iii, 22, 23
 - line separation, iii, 18
 - linewidth, 2
 - modulated, 34
 - tuning power, 4
- Laser safety, 12
- LEFT programming command, 76
- LIM OFF softkey, 10
- LIM ON softkey, 10
- LINE key, 7
- linearity, 4, 6, 9
- line-power
 - cable, 5
 - cables, 18
 - initial state, 100, 2
 - requirements, 5

Index

- specifications, 11
- linewidth, 2
- List by Power
 - menu map, 6
 - mode, 9
 - softkey, 6, 23
- List by WL
 - key, 6
 - menu map, 7
 - mode, 9
 - softkey, 6, 23
- LOCAL softkey, 3
- long form commands, 23
- lowercase letters, 24

M

- M annotation, 4
- MAGNitude programming command, 87
- MAX NUMBER OF SIGNALS FOUND, 17
- maximum power input, iv
- MAXimum programming command, 76
- MAX-MIN softkey, 23
- MEASure measurement instruction, 30, 32, 15
- measurement
 - accuracy, 3
 - air, in, 37
 - AM modulation, 15, 34
 - audio modulation, effects of, 15, 34
 - average wavelength, 7
 - calibration, 37
 - channel separation, 20
 - channel spacing, 19
 - continuous acquisition, 14
 - cycle time, 4, 7, 10
 - definition of peaks, 15
 - elevation, effects of, 37
 - Fabry-Perot lasers, 31
 - flatness, 21
 - via GPIB, 5
 - instructions, 23, 15
 - laser drift, 22
 - laser line separation, 18
 - modulated lasers, effects of, 34
 - monitoring performance over time, 22
 - multiple laser lines, 6, 12
 - of broadband devices, 9
 - PRBS format present, 27, 35

- relative power, 18
- relative wavelength, 18
- repetitive data formats, 27
- signal-to-noise, 25, 28
- single acquisition, 14
- SONET format present, 27, 35
- speed, 13, 9, 29, 88
- total power, 8
- units, 12
- update rate, 9, 29, 88
- in vacuum, 37

- measuring
 - chirped lasers, 9
 - EDFA amplifiers, 9
- menu maps, 4
- messages, error, 11
- microwatts, 13
- milliwatts, 13
- modulated lasers, 34
- monitoring the instrument, 16
- MW softkey, 13

N

- nanometers, 13
- NARROW softkey, 9
- narrowband mode, 9
- new-line character, 27
- NEXT PK softkey, 5
- NEXT programming command, 77
- NEXT WL softkey, 5
- NM softkey, 13
- noise declaration, 13
- noise power
 - automatic interpolation, 26
 - bandwidth, 27, 30
 - user entered wavelength, 27
- non-sequential command, 12, 29, 34, 35, 37, 38, 39, 40, 41, 42, 43, 85, 105, 106
- NORMAL softkey, 14, 9, 88
- notation definitions, 2
- NTRansition programming command, 94
- NUM LINES < NUM REFS, 23
- NUM LINES > NUM REFS, 23
- numbers, 25

O**Off**

- key, 20
- menu map, 8

On

- key, 20
- menu map, 7

*OPC, 29, 3, 7

OPTICAL INPUT connector, iii, vi, 14
output queue, 22, 27

P

packaging for shipment, 13

PARALLEL PRINTER PORT connector, 6, 39

parameters, adding, 25

PEAK

- annotation, 4
- softkey, 5, 28

peak

- definition of, 15
- excursion, 9, 16
- power, iii, 4
- threshold limit, 15, 17, 35
- wavelength, iii, 4

Peak WL

- key, 4
- menu map, 8
- softkey, 4, 23

performance tests, 2

PEXCursion programming command, 33

PK EXC softkey, 17

PK THLD softkey, 17

POINts? programming command, 29, 34, 68

polarization dependence, 4, 6, 9

power

- bar, iv, 4, 11
- maximum before damage, 2
- maximum input, iv
- maximum measurable, 2
- measuring total, 7, 32, 35
- peak, 4
- separation, 18
- state when turned on, 100, 2
- tuning laser, 4

POWer programming command, 17, 51, 107

POWER softkey, 13

PRBS, 27, 35

Preset

- conditions set by, 100, 2
- key, 2, 9, 4
- menu map, 8

PRESet programming command, 50, 59, 96, 100

PREV PK softkey, 5

PREV WL softkey, 5

PREVious programming command, 77

Print

- key, 39
- menu map, 9

printer

- cable, 6
- connecting, 6
- output, 39

programming, 2

- command notation convention, 2
- examples. *See* example programs
- list of commands by key, 48
- list of commands by subsystem, 43
- measurement instructions, 15

programming command, 48

PTRansition programming command, 95

PWR BAR softkey, 11

PWR OFS

- annotation, 36
- softkey, 36

△ PWR softkey, 21

Q

queries, 27

multiple, 27

queues, 22

R

radiation exposure, vi

range, wavelength, 37

READ measurement instruction, 15

rear panel

- labels, 15

regulatory duration, 2

Remote annotation, 3

repetitive data formats, 27

RESet programming command, 59

RESET softkey, 21, 23, 24

Index

- return loss, 4, 7, 10
- returning
 - data, 27
 - for service, 11
- RF modulation, 35
- RIGHT programming command, 78
- *RST, 3, 29, 8

- S**
- S/N AUTO annotation, 25
- S/N softkey, 28
- S/N USER annotation, 25
- safety, vi, vii
 - laser classification, vii
 - symbols, iii
- sales and service offices, 18
- SCALar programming command, 15
- SCPI (standard commands for programmable instruments)
 - standard, 2
 - syntax rules, 23
- SELECT softkey, 6, 19
- selectivity, 4, 6, 9
- semicolon, 23
- sending common commands, 25
- SENSe subsystem, 83
- sensitivity, 4, 6, 9
- serial number
 - instrument, 4
- service, 11
 - request enable register, 21, 10
 - returning for, 11
 - sales and service offices, 18
- Set_ese subroutine, 28
- settings conflict error, 14, 36, 48, 50, 54, 55, 57, 58, 60, 61, 73, 15
- Setup
 - key, 10, 11, 4
 - menu map, 10
- shipping
 - procedure, 12
- short form commands, 23
- signal-to-noise
 - measurements, 25
 - noise calculation, 25, 69
 - ratios, iii
 - specification, 7, 10

- Single key, 14, 16, 31
- softkey
 - menus, 4
- SONET, 27, 35
- specifications, 2, 5
 - and wideband mode, 9
 - definition of terms, 2
 - operating, 11
- spurious signals
 - suppressing, 15
- *SRE, 10
- standard
 - air, 9, 37
 - event status register, 5
 - SCPI commands, 23
- STATe programming command, 35, 50, 54, 55, 56, 57, 58, 60, 61, 73, 78
- status
 - byte register, 12
 - reporting, 16
- STATus subsystem, 90
- *STB, 12
- STD AIR
 - annotation, 37
 - softkey, 9, 38
- subsystems, 23
- swabs, 48
- syntax rules, 23–27
- SYSTEM subsystem, 97

- T**
- Tempo subroutine, 29
- terahertz, 13
- THRESHLD softkey, 16
- THZ softkey, 13
- total power, iii, 8
 - maximum measurable, 36
 - measuring, 7
- transient data, 11
- *TRG, 13
- trigger ignore, 15
- TRIGger subsystem, 103
- *TST, 13

- U**
- UNIT subsystem, 107

units of measure, 12
UNITS softkey, 12
up-arrow softkey, 6
UPDATE softkey, 14
uppercase letters, 24
USER softkey, 28
USER WL softkey, 28
UW softkey, 13

V

VAC annotation, 37
VACuum programming command, 86
VACUUM softkey, 9, 38
vacuum, measurements in, 37
VERSion programming command, 102

W

*WAI, 14
wave number, 13
wavelength
 definition of, 3
 input range, 2
 peak, 4
 range, 37
 separation, 18
 specifications, 5, 8
WAVelength programming command, 21, 52, 71
WDM
 flatness, 21
 system, 18
white space characters, 25
WL LIM softkey, 10
WL REF softkey, 28
 Δ WL softkey, 20
WL softkey, 13
 Δ WL/PWR softkey, 20
WLImit programming command, 37, 38, 40, 41, 42,
 43
WNUMber programming command, 23, 53, 72

© Agilent Technologies GmbH 2004

Printed in Germany August 2004
Second edition, August 2004



86120-90C03