

infiniium DCA

Agilent 86100B

Wide-Bandwidth Oscilloscope

Technical Specifications

Three instruments in one

*A digital communications analyzer,
a full featured wide-bandwidth oscilloscope,
and a time-domain reflectometer.*

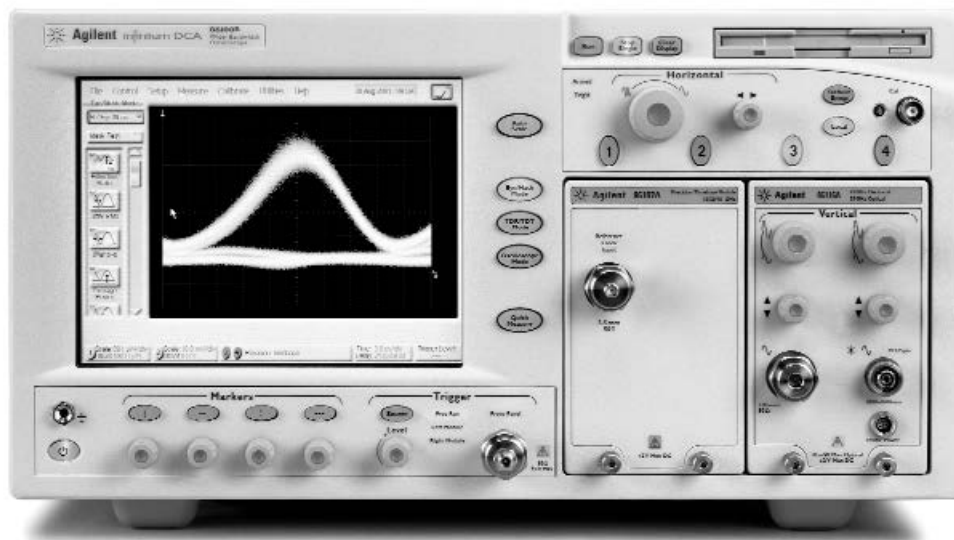

- Modular platform for testing waveforms up to 40 Gb/s
- Compatible with Agilent 86100A-series, 83480A-series and 54750-series modules
- 200 fs inherent jitter
- Windows® 98 User Interface



Agilent Technologies

Table of Contents

Overview

Features	3
40 Gb/s	7

Specifications

Mainframe & Triggering	
(includes Precision Time Base Module)	8
Computer System & Storage	10
Modules	
Overview	11
Module Selection Table	12
Specifications	
Multimode/Single-Mode	13
Single-Mode	15
Dual Optical	16
Dual Electrical	17
TDR	18
Clock Recovery	18
Ordering Information	19

Overview of Infiniium DCA

Features

Three Instruments in One

For basic oscilloscope operation there is easy front panel access with that familiar analog-look and feel. A Windows®-based system lets you easily navigate through the user-interface. The 86100B Infiniium DCA can be viewed as three high-performance instruments in one. It's a general-purpose wide-bandwidth sampling oscilloscope. It's a digital communications analyzer. It's a time domain reflectometer. Just select the instrument mode and start making measurements.

Configurable to Meet Your Needs

The 86100B supports a wide range of plug-ins for testing both optical and electrical signals. Select plug-ins to get the specific bandwidth, filtering, and sensitivity you need.

Digital Communications Analysis

Accurate eye-diagram analysis is essential for characterizing the quality of transmitters used from 100 Mb/s to 40 Gb/s. The 86100B was designed specifically for the complex task of analyzing digital communications waveforms. Compliance mask and parametric testing no longer require a complicated sequence of setups and configurations. If you can press a button, you can perform a complete compliance test. The important measurements you need are right at your fingertips, including:

- industry standard mask testing with built-in margin analysis,
- extinction ratio measurements with accuracy and repeatability, and
- eye measurements: crossing %, eye height and width, '1' and '0' levels, jitter, rise or fall times and more.

The key to accurate measurements of lightwave communications waveforms is the optical receiver. The 86100B has a broad range of precision receivers integrated within the instrument.

- Built-in photodiodes, with flat frequency responses, yield the highest waveform fidelity. This provides high accuracy for extinction ratio measurements.
- Standards-based transmitter compliance measurements require filtered responses. The 86100B has a broad range of filter combinations. Filters can be automatically and repeatably switched in or out of the measurement channel remotely over GPIB or with a front panel button. The frequency response of the entire measurement path is calibrated, and will maintain its performance over long-term usage.
- The integrated optical receiver provides a calibrated optical channel. With the accurate optical receiver built into the module, optical signals are accurately measured and displayed in optical power units.

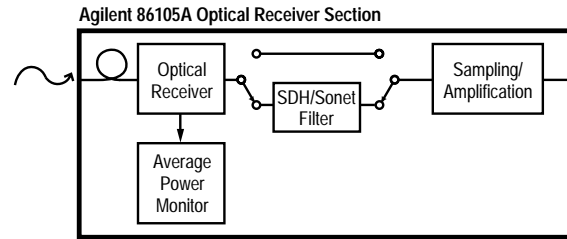

The integrated optical channel can be used as a fully calibrated SONET/SDH/Gigabit Ethernet or Fibre Channel reference receiver or as a wide-bandwidth receiver.

Switches or couplers are not required for an average power measurement. Signal routing is simplified and signal strength is maintained.

Eye Diagram Mask Testing

The 86100B provides efficient, high-throughput waveform compliance testing with a suite of standards based eye-diagram masks. The test process has been streamlined into a minimum number of keystrokes for testing at industry standard data rates.

Standard Masks

	Rate (Mb/s)
1X Gigabit Ethernet	1250
2X Gigabit Ethernet	2500
10 Gigabit Ethernet	9953.28
10 Gigabit Ethernet	10312.5
FC 1063	1062.5
FC 2125	2125
10X Fibre Channel	10518.75
STM0/OC1	51.84
STM1/OC3	155.52
STM4/OC12	622.08
STM16/OC48	2488.3
Infiniband	2500
XAUI	3125
STM64/OC192	9953.28
STM64/OC192 FEC	10664.2
STM64/OC192 FEC	10709
STM64/OC192 Super FEC	12500
STM256/OC768	39813
STS1 EYE	51.84
STS3 EYE	155.52

Other eye-diagram masks are easily created through scaling those listed at left. In addition, mask editing allows for new masks either by editing existing masks, or creating new masks from scratch. A new mask can also be created or modified on an external PC using a text editor such as Notepad, then can be transferred to the instrument's hard drive using LAN or the A: drive.

Perform these mask conformance tests with convenient user-defin-

able measurement conditions, such as mask margins for guardband testing, number of waveforms tested, and stop/limit actions.

Measurement Speed

Measurement speed has been increased with both fast hardware and a user-friendly instrument. In the lab, don't waste time trying to figure out how to make a measurement. With the simple-to-use 86100B, you don't have to relearn how to make a measurement each time you use it.

In manufacturing, it is a battle to continually reduce the cost per test. Solution: Fast PC-based processors, resulting in high measurement throughput and reduced test time.

Measure

Standard Measurements/Features

The following measurements are available from the tool bar, as well as the pull down menus. Measurements available are dependent on the DCA operating mode.

Oscilloscope Mode

Time

Rise Time, Fall Time, Jitter RMS, Jitter p-p, Period, Frequency, + Pulse Width, - Pulse Width, Duty Cycle, Delta Time, [T_{max}, T_{min}, T_{edge}—remote commands only]

Amplitude

Overshoot, Average Power, V amptd, V p-p, V rms, V top, V base, V max, V min, V avg

Eye/Mask Mode

NRZ Eye Measurements

Extinction Ratio, Jitter RMS, Jitter p-p, Average Power, Crossing Percentage, Rise Time, Fall Time, One Level, Zero Level, Eye Height, Eye Width, Signal to Noise (Q-Factor), Duty Cycle Distortion, Bit Rate, Eye Amplitude

RZ Eye Measurements

Extinction Ratio, Jitter RMS, Jitter p-p, Average Power, Rise Time, Fall Time, One Level, Zero Level, Eye Height, Eye Amplitude, Opening Factor, Eye Width, Pulse Width, Signal to Noise (Q-Factor), Duty Cycle, Bit Rate, Contrast Ratio

Mask Test

Open Mask, Start Mask Test, Exit Mask Test, Filter, Mask Test Margins, Mask Test Scaling, Create NRZ Mask

TDR/TDT Mode (requires TDR module)

Quick TDR, TDR/TDT Setup, Normalize, Response, Rise Time, Fall Time, Δ Time

Standard Functions

Standard functions are available through pull down menus and soft keys, and some functions are also accessible through the front panel knobs.

Markers

Two vertical and two horizontal (user selectable)

TDR Markers

Horizontal – seconds or meter
Vertical – volts, ohms or Percent Reflection
Propagation – Dielectric Constant or Velocity

Limit Tests

Acquisition Limits

Limit Test Run Until Conditions – Off, # of Waveforms, # of Samples

Report Action on Completion – Save waveform to memory or disk, Save screen image to disk

Measurement Limit Test

Specify Number of Failures to Stop Limit Test

When to Fail Selected Measurement – Inside Limits, Outside Limits, Always Fail, Never Fail

Report Action on Failure - Save waveform to memory or disk, Save screen image to disk, Save summary to disk

Mask Limit Test

Specify Number of Failed Mask Test Samples

Report Action on Failure – Save waveform to memory or disk, Save screen image to disk, Save summary to disk

Configure Measurements

Thresholds

10%, 50%, 90% or 20%, 50%, 80% or Custom

Eye Boundaries

1 and 2

Format Units for

Duty Cycle Distortion – Time or Percentage
Extinction Ratio – Ratio, Decibel or Percentage
Eye Height – Amplitude or Decibel (dB)
Eye Width – Time or Ratio
Average Power – Watts or Decibels (dB)
TDR – Ohm (Ω) or Volts
Meters or Seconds

Top Base Definition

Standard or Custom

Δ Time Definition

First Edge Number, Edge Direction, Threshold
Second Edge Number, Edge Direction, Threshold

Quick Measure Configuration

4 User Selectable Measurements for Each Mode

Default Settings

(Eye/Mask Mode)

Extinction Ratio, Jitter RMS, Average Power, Crossing Percentage

Default Settings

(Oscilloscope Mode)

Rise Time, Fall Time, Period, V amptd

Histograms

Configure

- Histogram Scale (1 to 8 divisions)
- Histogram Axis (vertical or horizontal)
- Histogram Window (Adjustable Window via Marker Knobs)

Math Measurements

4 User Definable Functions

Operator – Magnify, Invert, Subtract, Versus, Min, Max

Source – Channel, Function, Memory, Constant, Response (TDR)

Calibrate

All Calibrations

- Module (Amplitude)
- Horizontal (Time Base)
- Extinction Ratio
- Probe
- Optical Channel

Front Panel Calibration Output Level

User Selectable –2V to 2V

Horizontal Skew Adjustment

Per Channel, User Selectable

Utilities

Set Time and Date

Remote Interface

Set GPIB Interface

Touch Screen

Configuration/Calibration

Calibration

Upgrade Software

Upgrade Mainframe

Upgrade Module

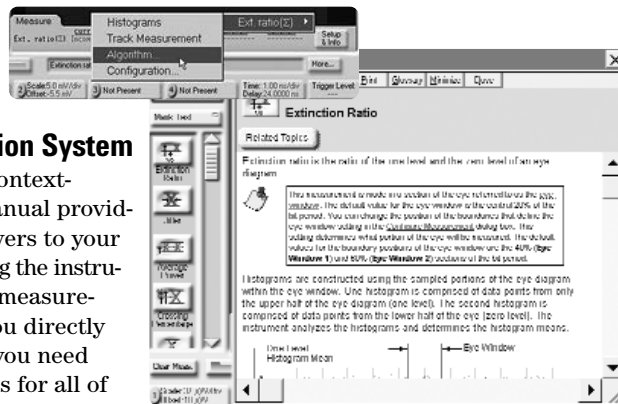

Built-in Information System

The 86100B has a context-sensitive on-line manual providing immediate answers to your questions about using the instrument. Links on the measurement screen take you directly to the information you need including algorithms for all of the measurements. The on-line manual includes technical specifications of the mainframe and plug-in modules. It also provides useful information such as the mainframe serial number, module serial numbers, firmware revision and date, and hard disk free space. There is no need for a large paper manual consuming your shelf space.

File Sharing and Storage

Use the internal 10 GB hard drive or 3.5 inch, 1.44 MB floppy disk drive to store instrument setups, waveforms, or screen images. Images can be stored in formats easily imported into various programs for documen-

tation and further analysis. LAN interface is also available for network file management and printing. The mainframe also has an integrated CD-ROM drive for firmware upgrades.

Powerful Display Modes

Use gray scale and color graded trace displays to gain insight into device behavior. Waveform densities are mapped to color or easy-to-interpret gray shades. These are infinite persistence modes where shading differentiates the number of times data in any individual screen pixel has been acquired.

Internal Triggering Through Clock Recovery

Very high-speed oscilloscopes are not capable of triggering directly on the signal under test. Typically an external timing reference is used to synchronize the oscilloscope to the test signal. In cases where a trigger signal is not available, clock recovery modules are available to derive a timing reference directly from the waveform to be measured. The Agilent 8349XA series of clock recovery modules cover the three most popular transmission media

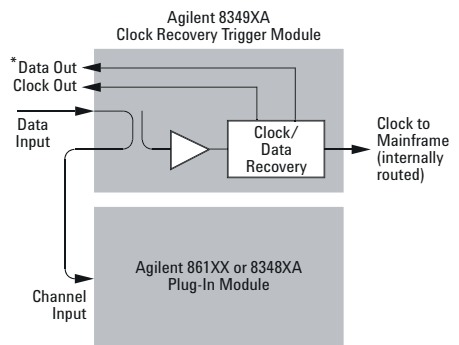

*Depends on clock recovery module

used today—electrical lines, multimode, and single-mode fiber. A built-in coupler reduces external hardware requirements. All five modules have excellent jitter performance to ensure accurate measurements. Each clock recovery module is designed to synchronize to a variety of common transmission rates.

Clock Recovery Loop Bandwidth

The Agilent clock recovery modules have two loop bandwidth settings. Loop bandwidth is very important in determining the accuracy of your waveform when measuring jitter, as well as testing for compliance.

- Narrow loop bandwidth provides a clean system clock for accurate jitter measurements
- Wide loop bandwidth in some applications is specified in the standards for compliance testing. It allows the recovered clock to track the data and is useful for extracting a signal that may have propagated through a complex network and have large amounts of jitter. While this obviously negates any ability to quantify the jitter, it does allow other parameters of an eye to be measured.

Note: When using recovered clocks for triggering, jitter measurement accuracy is suspect unless the scheme has a very narrow loop bandwidth.

Improved Autoscaling

Autoscaling has been significantly improved to provide quick horizontal and vertical scaling of both pulse and eye-diagram (RZ and NRZ) waveforms.

Time Domain Reflectometer (TDR)

TDR measurements are focused on high-speed applications where it is necessary to optimize electrical system components, such as microstrip lines, PC board traces, SMA edge launchers and coaxial cables where imperfections cause signal distortion and reflections. Signal integrity is a critical requirement in high-speed digital signal transmission.

Gated Triggering

Trigger gating port allows easy external control of data acquisition for circulating loop or burst-data experiments. Use TTL-compatible signals to control when the instrument does and does not acquire data.

Easier Calibrations

Calibrating your instrument has been simplified by placing all the performance level indicators and calibration procedures in a single high-level location. This provides greater confidence in the measurements made and saves time in maintaining equipment.

Stimulus Response Testing Using the Agilent N4906A Serial BERT

Error performance analysis represents an essential part of digital transmission test. The Agilent 86100B and N4906A SmartBERT have similar user interfaces and together create a powerful test solution.

Transitioning from the Agilent 83480A and 86100A to the 86100B

The 86100B has been designed to be a virtual drop-in replacement for the Agilent 86100A and Agilent 83480A digital communications analyzers and Agilent 54750A wide-bandwidth oscilloscope. All modules used in the Agilent 83480A and 54750A can also be used in the 86100B. The remote programming command set for the 86100B has been designed for direct compatibility with software written to control the 86100A, 83480A and 54750A.

Accurate views of your 40 Gb/s waveforms

When developing 40 Gb/s devices, even a small amount of inherent scope jitter can become significant since 40 Gb/s waveforms only have a bit period of 25 ps. Scope jitter of 1ps RMS can result in 6 to 9 ps of peak-to-peak jitter, causing eye closure even if your signal is jitter-free. The Agilent 86100A and B have been improved specifically for 40 Gb/s waveform analysis.

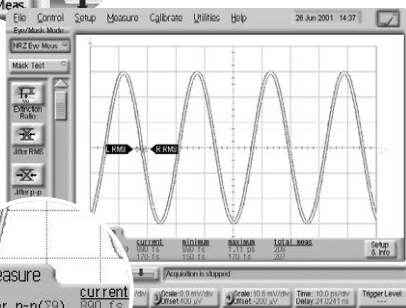
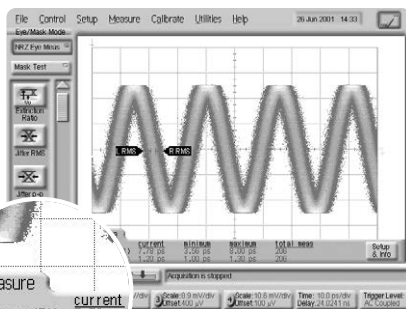

The same 40 GHz sinewave captured using current DCA (top) and now with 86107A precision timebase module (bottom).

The new 86107A precision timebase reference module represents one of the most significant improvements in wide-bandwidth sampling oscilloscopes in over a decade.¹ Jitter performance has been reduced by almost an order of magnitude to 200 fs RMS. Oscilloscope jitter is virtually eliminated! The reduced jitter of the 86107A precision timebase module allows you to measure the true jitter of your signal. The 86107A requires a 10, 20 or 40 GHz electrical reference clock that is synchronous with the signal under test. Timebase resolution has also been improved from 10 ps/division to 2 fs/division, a 5 times improvement.

Meeting your growing need for more bandwidth

Today's communication signals have significant frequency content well beyond an oscilloscope's 3-dB bandwidth. A high-bandwidth scope does not alone guarantee an accurate representation of your waveform. Careful design of the scope's frequency response (both amplitude and phase) minimizes distortion such as overshoot and ringing.

The Agilent 86116A, 86116B and 86109B are plug-in modules that include an integrated optical receiver designed to provide the optimum in bandwidth, sensitivity, and waveform fidelity. The 86116B extends the bandwidth of the 86100B Infinium DCA to 80 GHz electrical, 65 GHz optical in the 1550nm wavelength band. The 86116A covers the 1300nm and 1550nm wavelength bands with 63 GHz of electrical bandwidth and 53 GHz of optical bandwidth. The 86109B is an economical solution with 50 GHz electrical and 40 GHz optical bandwidth. You can build the premier solution for 40 Gb/s waveform analysis around the 86100 mainframe that you already own.

Performing return-to-zero (RZ) waveform measurements

An extensive set of automatic RZ measurements are built-in for the complete characterization of return-to-zero (RZ) signals at the push of a button.

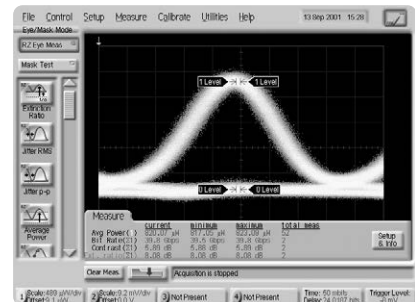

¹ Unique methods and algorithm used in the precision timebase module will be discussed upon receipt of U.S. patent protection.

Specifications

Specifications describe warranted performance over the temperature range of +10°C to +40°C (unless otherwise noted). The specifications are applicable for the temperature after the instrument is turned on for one (1) hour, and while self-calibration is valid. Many performance parameters are enhanced through frequent, simple user calibrations. **Characteristics provide useful, non-warranted information about the functions and performance of the instrument. Characteristics are printed in italic typeface.**

Factory Calibration Cycle -For optimum performance, the instrument should have a complete verification of specifications once every twelve (12) months.

General Specifications

This instrument meets Agilent Technologies' environmental specifications (section 750) for class B-1 products with exception as described for temperature and condensation. Contact your local field engineer for complete details.

<p>Temperature Operating Non-operating</p> <p>Humidity Operating Non-operating</p> <p>Altitude Operating Non-operating</p> <p>Vibration Operating Non-operating</p> <p>Power Requirements Voltage Power (including modules)</p> <p>Weight Mainframe without modules Each Module</p> <p>Mainframe Dimensions (excluding handle) Without front connectors and rear feet With front connectors and rear feet</p>	<p>10°C to +40°C (50°F to +104°F) -40°C to +70°C (-40°F to +158°F)</p> <p>Up to 90% humidity (non-condensing) at +40°C (+104°F) Up to 95% relative humidity at +65°C (+149°F)</p> <p>Up to 4,600 meters (15,000 ft) Up to 15,300 meters (50,000 ft)</p> <p>Random vibration 5–500 Hz, 10 minutes per axis, 2.41 g (rms) Random vibration 5–500 Hz, 10 minutes per axis, 0.3 g (rms); Resonant search, 5–500 Hz swept sine, 1 octave/min sweep rate, 0.75 g, 5 minute resonant dwell at 4 resonances/axis</p> <p>90–132 or 198–264 Vac, 48–66 Hz 604 VA; 391 W</p> <p>15.5 kg (34 lb) 1.2 kg (2.6 lb)</p> <p>215.1 mm H x 425.5 mm W x 566 mm D (8.47 in x 16.75 in x 22.2 in) 215.1 mm H x 425.5 mm W x 629 mm D (8.47 in x 16.75 in x 24.8 in)</p>
--	---

Mainframe Specifications

<p>HORIZONTAL SYSTEM (Time Base) Scale Factor (Full scale is ten divisions.) Minimum Maximum</p> <p>Delay¹ Minimum Maximum</p> <p>Time Interval Accuracy</p> <p>Time Interval Resolution Display Units</p>	<p>2 ps/div (with 86107A: 500 fs/div) 1 s/div</p> <p>≥24 ns (Standard), 28 ns (Option 001) 1000 screen diameters or 10 s, whichever is smaller</p> <p>≤8 ps + 0.1% of reading (dual marker measurement performed at a temperature within ±5°C of horizontal calibration temperature) 8 ps + 0.1% + 0.5 ps/°C to (5 < absolute temperature value <15°C) ≤ (screen diameter)/(record length) or 62.5 fs, whichever is larger</p> <p>Bits or time (TDR mode—meters)</p>
<p>VERTICAL SYSTEM (Channels) Number of Channels Vertical Resolution Full Resolution Channel Scales</p> <p>Adjustments Typical Acquisition Rate Record Length</p>	<p>4 (simultaneous acquisition) 12 bit A/D converter (up to 15 bits with averaging) Adjusts in a 1-2-5-10 sequence for coarse adjustment or fine adjustment resolution from the front panel knob Scale, offset, activate filter, sampler bandwidth, attenuation factor, transducer conversion factors 40 kHz per Channel Manual setting between 450 and 4050 samples (increments of 1, 1350 default sample setting) or using up arrow/down arrow keys, increments of 450 samples: 450, 900, 1350 (default) etc. up to 4050 samples</p>

¹ Time offset relative to the front panel trigger output on the instrument mainframe.

Mainframe Specifications *(continued)*

	Standard (Direct Trigger)	Option 001 (Divided Trigger)
Trigger Modes		
Internal Trigger ¹	Freerun	
External Direct Trigger ²		
Limited Bandwidth ³	DC to 100 MHz	
Full Bandwidth	DC to 2.75 GHz	
External Divided Trigger		2 to 12 GHz <i>(1 to 15 GHz)</i>
Jitter		
Characteristic	$< 1.0 \text{ ps RMS} + 5 \cdot 10^{-5}$ of delay setting ⁴	<i>1.2 ps RMS for time delays less than 100 ns</i>
Maximum	$1.5 \text{ ps RMS} + 5 \cdot 10^{-5}$ of delay setting ⁴	<i>1.7 ps RMS for time delays less than 100 ns</i>
Trigger Sensitivity	200 m Vpp (sinusoidal input or 200 ps minimum pulse width)	200 m Vpp sinusoidal input from 2 to 12 GHz
Trigger Configuration		
Trigger Level Adjustment	-1 V to +1 V	AC coupled
Edge Select	Positive or negative	
Hysteresis ⁵	Normal or high sensitivity	
Trigger Gating		
Gating Input Levels (TTL compatible)	<i>Disable: 0 to 0.6 V</i> <i>Enable: 3.5 to 5 V</i> <i>Pulse width >500 ns, period >1 μs</i>	
Gating Delay	<i>Disable: 627 ns + trigger period + Max time displayed</i> <i>Enable: 100 ns</i>	
Trigger Impedance		
Nominal Impedance	50 Ω	
Reflection	10% for 100 ps rise time	
Connector Type	3.5 mm (male)	
Maximum Trigger Signal	$\pm 2 \text{ V} + 2 \text{ Vac peak (+16 dBm)}$	

¹ The freerun trigger mode internally generates an asynchronous trigger that allows viewing the sampled signal amplitude without an external trigger signal but provides no timing information. Freerun is useful in troubleshooting external trigger problems.

² The sampled input signal timing is recreated by using an externally supplied trigger signal that is synchronous with the sampled signal input.

³ The DC to 100 MHz mode is used to minimize the effect of high frequency signals or noise on a low frequency trigger signal.

⁴ Measured at 2.5 GHz with the triggering level adjusted for optimum trigger.

⁵ High Sensitivity Hysteresis Mode improves the high frequency trigger sensitivity but is not recommended when using noisy, low frequency signals that may result in false triggers without normal hysteresis enabled.

Precision Time Base 86107A

	86107A option 010	86107A option 020	86107A option 040
Trigger Bandwidth	2.4 – 4.0 GHz 9.0 – 12.6 GHz	9.0 – 12.6 GHz 18.0 – 25.0 GHz	9.0 – 12.6 GHz 18.0 – 25.0 GHz 39.0 – 43.0 GHz
Typical Jitter (RMS)	2.4 – 4.0 GHz trigger: <280 fs 9 – 12.6 GHz trigger: <200 fs	<200 fs	9 – 12.6 GHz, 18 – 25 GHz trigger bands: <250 fs 38 – 45 GHz trigger: <200 fs
Time Base Linearity Error	< 100 fs		
Input Signal Type	Synchronous clock, no constraint on waveform shape.		
Input Signal Level	0.5 – 1.0 Vpp ¹ 0.2 – 1.5 Vpp (Typical functional performance)		
DC Offset Range	$\pm 200 \text{ mV}$		
Required Trigger Signal-to-Noise Ratio	$\geq 200 : 1$		
Trigger Gating	Disable: 0 to 0.6 V		
Gating Input Levels (TTL compatible)	Enable: 3.5 to 5 V Pulse width >500 ns, period >1 μ s		
Trigger Impedance	50 Ω		
Connector Type	3.5 mm (male)		3.5 mm (male) 2.4 mm (male)

¹ To achieve characteristic performance:

Requires 86100A or B with 86100A software revision 3.0 or above.

For the 86107A with option 020, the Agilent 11742A (DC Block) is recommended if the DC offset magnitude is greater than 200 mV.

Computer System and Storage

CPU	866 MHz Microprocessor
Disk Drives	10 GByte internal hard drive and 3.5" MS-DOS® compatible 1.44 MB floppy disk drive. Store and recall setups, waveforms, and screen images to both the hard drive and the floppy drive. Storage capacity is limited only by disk space. CD-ROM drive.
File Types/Management (Internal¹)	Setup files .SET Waveform files .WFM Color grade gray scale files .CGS Mask files .MSK TDR/TDT normalization files .TDR Upgrade header files .HDR
Waveforms	Internal, verbose,Y values (Verbose and Y values are .TXT)
Images	bmp, eps , gif, pcx, ps, jpeg, tif
Operating System	Microsoft Windows 98
Waveform Store	1 color grade-grayscale memory 4 nonvolatile waveform memories Waveform memory setup (for each channel) (vertical scale, offset, horizontal scale, position)
Printer	Configure Printer Options Waveform only Include instrument setup info Monochrome Invert waveform background color Add printer
DISPLAY	
Display Area	170.9 mm x 128.2 mm (8.4 inch diagonal color active matrix LCD module incorporating amorphous silicon TFTs)
Active Display Area	171 mm x 128 mm (21,888 square mm) 6.73 in x 5.04 in (33.92 square inches)
Waveform Viewing Area	103 mm x 159 mm (4.06 in x 6.25 in)
Entire Display Resolution	640 pixels horizontally x 480 pixels vertically
Graticule Display Resolution	451 pixels horizontally x 256 pixels vertically
Waveform Colors	Select from 100 hues, 0–100% saturation and 0–100% luminosity
Persistence Modes	Gray scale, color grade, variable, infinite
Waveform Overlap	When two waveforms overlap, a third color distinguishes the overlap area
Connect-the-dots	On/Off selectable
Persistence	Minimum, Variable (100 ms to 40 s), Infinite
Graticule	On/Off
Grid Intensity	0 to 100%
Backlight Saver	2 to 8 hrs, enable option
Dialog Boxes	Opaque or transparent
FRONT AND REAR PANEL INPUTS AND OUTPUTS	
Cal	BNC (female) and test clip, banana plug
Trigger	APC 3.5 mm, 50Ω, ±2 V maximum
GPIB	Fully programmable, complies with IEEE 488.2
RS-232	Serial Printer, 9 pin D-sub (male)
Centronics	Parallel Printer port, 25 pin D-sub (female)
+15 V Bias	100 ma, 15 V, SMB
Mouse	PS/2
Gated Trigger Input	TTL compatible
Keyboard	IBM 5 pin (female) (for optional keyboard)
LAN	A keyboard must be used to setup LAN connection
Video Output	VGA, full color, 15 pin D-sub (female)

1. These files are internal files and can only be used in the 86100A/B mainframes.

MS-DOS is a U.S. registered trademark of Microsoft Corporation.

Module Overview

Optical/Electrical Modules

750–860 nm

The 86101A, 86102A and 86102U modules support waveform compliance testing of short wavelength signals with up to 15 GHz of optical bandwidth. Each module also has an electrical channel with 20 GHz of bandwidth.

1000–1600 nm

<20 GHz Optical and Electrical Channels:

The 86103A, 86103B, 86105A and 86105B modules are optimized for testing long wavelength signals with up to 20 GHz of optical bandwidth. Each module also has an electrical channel with 20 GHz of bandwidth.

20 – 40 GHz Optical and Electrical Channels:

The 86106B and 86109A are optimized for testing 10 Gb/s signals. The 86106B has 28 GHz of optical bandwidth with multiple 10Gb/s compliance filters. The 86109A has 30 GHz of optical bandwidth. Each of these module also has an electrical channel with 40 GHz of bandwidth.

40 GHz and Greater Optical and Electrical Channels:

The 86109B and 86116A are optimized for testing 40 Gb/s signals. The 86109B has an optical channel with 40 GHz of bandwidth and an electrical channel with 50 GHz of bandwidth. The 86116A has more than 50 GHz of optical bandwidth and 60 GHz of electrical bandwidth. The 86116B is the widest bandwidth optical module with more than 65 GHz optical (1550nm band only) and 80 GHz electrical bandwidth.

Dual Optical Channel Modules

86111A and 86111U are short wavelength optical modules that have up to 15 GHz of bandwidth optimized for testing signals from 155 Mb/s to 3125 Mb/s.

86113A is a long wavelength module with 2.85 GHz of optical bandwidth optimized for testing of signals up to 2.488 Gb/s.

86115B is a long wavelength module that has 28 GHz of optical bandwidth. This module is designed for testing 10 Gb/s signals.

Dual Electrical Modules

86112A has two low-noise electrical channels with 20 GHz of bandwidth.

86117A has two electrical channels with up to 50 GHz of bandwidth ideal for testing signals up to 10 Gb/s.

86117B has two electrical channels with up to 65 GHz of bandwidth ideal for testing signals up to 40 Gb/s.

86118A has two electrical channels, each housed in a compact remote sampling head, attached to the module with separate light weight cables. With over 70 GHz of bandwidth, this module is intended for 40 Gb/s and above measurements.

Clock Recovery Modules

This range of clock recovery modules is designed to provide a trigger signal for the Infiniium DCA when no clock is present. In each case, the input signal can be fed to the module input; the module taps off a portion of the signal, and supplies the remainder to an output connector on the front panel, so that the signal can be patched across to the input of an adjacent sampling module. Each also has recovered clock outputs on the front panel to supply other test equipment if desired.

The 83491A is an electrical module. It works for rates up to 2.5 Gb/s.

The 83492A works for optical signals and has multimode inputs, one working over the 750 – 860 nm range, the other 1000 – 1600 nm.

The 83493A and 83494A work with single-mode input, 1000 – 1600 nm. The 83493A works for various rates up to 2.5 Gb/s. The 83494A works for various rates up to 10 Gb/s.

The 83495A works for optical and electrical signals and has either multimode (750 – 860 nm) or single mode (1000 – 1600 nm) inputs. It operates over a continuous range of rates from 9.95 Gb/s – 11.3 Gb/s.

Time Domain Reflectometry (TDR)

The Infiniium DCA may also be used as a powerful, high accuracy TDR, using the 54754A differential TDR module.

Module Specifications: Single-Mode & Multimode Optical/Electrical

Multimode and Single-Mode	86101A	86102A	86102U
OPTICAL CHANNEL SPECIFICATIONS			
Optical Channel Unfiltered Bandwidth	2.85 GHz (3 GHz typical)	10 GHz	15 GHz
Wavelength Range	750–860 nm		
Calibrated Wavelengths	850 nm		
Optical Sensitivity¹	–17 dBm	–13.5 dBm	–7.5 dBm
Transition Time (10% to 90% calculated from TR = 0.48/BW optical)			
Unfiltered	160 ps	48 ps	32 ps
RMS Noise			
Characteristic	1.5 μ W	3.4 μ W	14 μ W
Maximum	2.5 μ W	5.5 μ W	20 μ W
Scale Factor (per division)			
Minimum	5 μ W		20 μ W
Maximum	100 μ W		500 μ W
CW Accuracy (single marker, referenced to average power monitor, <50 μ W/division)	$\pm 6 \mu$ W $\pm 0.4\%$ of full scale $\pm 3\%$ of (reading-channel offset)		$\pm 25 \mu$ W $\pm 2\%$ of (reading-channel offset), 15 GHz
CW Offset Range (referenced two divisions from screen bottom)	+0.2 mW to –0.6 mW		+1 mW to –3 mW
Average Power Monitor (specified operating range)	–30 dBm to –2.2 dBm	–30 dBm to –2.2 dBm	–27 dBm to +3 dBm
Factory Calibrated Accuracy	$\pm 5\% \pm 100$ nW \pm connector uncertainty, 20°C to 30°C		
User Calibrated Accuracy	$\pm 2\% \pm 100$ nW \pm power meter uncertainty, <5°C change		
Maximum Input Power			
Maximum non-destruct average	0.4 mW (–4 dBm)	0.8 mW (–1 dBm)	2 mW (+3 dBm)
Maximum non-destruct peak	10 mW (+10 dBm)		
Fiber Input	62.5/125 μ m, user selectable connector		
Input Return Loss (HMS-10 connector fully filled fiber)	20 dB		

ELECTRICAL CHANNEL SPECIFICATIONS

Electrical Channel Bandwidth	12.4 and 20 GHz
Transition Time (10% to 90%, calculated from TR = 0.35/BW)	28.2 ps (12.4 GHz) 17.5 ps (20 GHz)
RMS Noise	0.25 mV (12.4 GHz)
Characteristic	0.5 mV (20 GHz)
Maximum	0.5 mV (12.4 GHz) 1 mV (20 GHz)
Scale Factor	
Minimum	1 mV/division
Maximum	100 mV/division
DC Accuracy (single marker)	$\pm 0.4\%$ of full scale ± 2 mV $\pm 1.5\%$ of (reading-channel offset), 12.4 GHz $\pm 0.4\%$ of full scale ± 2 mV $\pm 3\%$ of (reading-channel offset), 20 GHz
DC Offset Range (referenced to center of screen)	± 500 mV
Input Dynamic Range (relative to channel offset)	± 400 mV
Maximum Input Signal	± 2 V (+16 dBm)
Nominal Impedance	50 ohm
Reflections (for 30ps rise time)	5%
Electrical Input	3.5 mm (male)

¹ Smallest average optical power required for mask test. Values represent typical sensitivity of NRZ eye diagrams. Assumes mask test with complicate filter switched in.

Module Specifications: Single-Mode & Multimode Optical/Electrical *(continued)*

Multimode and Single-Mode Optical/Electrical Modules	86103A	86103B	86105B
OPTICAL CHANNEL SPECIFICATIONS			
Optical Channel Unfiltered Bandwidth	2.85 GHz	10 GHz	15 GHz
Wavelength Range	1000–1600 nm		
Calibrated Wavelengths	1310 nm/1550 nm		
Optical Sensitivity¹	–20 dBm	–15 dBm	–12 dBm
Transition Time (10% to 90% calculated from TR = 0.48/BW optical)	160 ps	48 ps	32 ps
RMS Noise			
Characteristic	0.75 μ W Opt 201 1.0 μ W Opt 202	2 μ W	5 μ , (10 GHz) 12 μ W, (15 GHz)
Maximum	1.5 μ W Opt 201 2.5 μ W Opt 202	3.7 μ W	8 μ W, (10 GHz) 15 μ W (15 GHz)
Scale Factor (per division)			
Minimum	5 μ W		20 μ W
Maximum	100 μ W		500 μ W
CW Accuracy (single marker, referenced to average power monitor)	$\pm 6 \mu$ W $\pm 0.4\%$ of full scale $\pm 3\%$ of (reading-channel offset)		$\pm 25 \mu$ W $\pm 2\%$ of (reading-channel offset), 10 GHz $\pm 25 \mu$ W $\pm 4\%$ of (reading-channel offset), 15 GHz
CW Offset Range (referenced two divisions from screen bottom)	+0.2 mW to –0.6 mW		+1 mW to –3 mW
Average Power Monitor (specified operating range)	–30 dBm to 0 dBm		–30 dBm to +3 dBm
Factory Calibrated Accuracy			
Single mode	$\pm 5\% \pm 100$ nW \pm connector uncertainty (20°C to 30°C)		
Multi mode	$\pm 10\% \pm 100$ nW \pm connector uncertainty (20°C to 30°C)		N/A
User Calibrated Accuracy	$\pm 2\% \pm 100$ nW \pm power meter uncertainty, <5°C change		
Maximum Input Power			
Maximum non-destruct average	0.4 mW (–4 dBm)	0.8 mW (–1 dBm)	2 mW (+3 dBm)
Maximum non-destruct peak	10 mW (+10 dBm)		
Fiber Input	62.5/125 μ m, user selectable connector		9/125 μ m user selectable connector
Input Return Loss (HMS-10 connector fully filled fiber)	20 dB		33 dB
ELECTRICAL CHANNEL SPECIFICATIONS			
Electrical Channel Bandwidth	12.4 and 20 GHz		
Transition Time (10% to 90%, calculated from TR = 0.35/BW)	28.2 ps (12.4 GHz) 17.5 ps (20 GHz)		
RMS Noise			
Characteristic	0.25 mV (12.4 GHz) 0.5 mV (20 GHz)		
Maximum	0.5 mv (12.4 GHz) 1 mV (20 GHz)		
Scale Factor			
Minimum	1 mV/division		
Maximum	100 mV/division		
DC Accuracy (single marker)	$\pm 0.4\%$ of full scale ± 2 mV $\pm 1.5\%$ of (reading-channel offset), 12.4 GHz $\pm 0.4\%$ of full scale ± 2 mV $\pm 3\%$ of (reading-channel offset), 20 GHz		
DC Offset Range (referenced to center of screen)	± 500 mV		
Input Dynamic Range (relative to channel offset)	± 400 mV		
Maximum Input Signal	± 2 V (+16 dBm)		
Nominal Impedance	50 ohm		
Reflections (for 30ps rise time)	5%		
Electrical Input	3.5 mm (male)		

¹ Smallest average optical power required for mask test. Values represent typical sensitivity of NRZ eye diagrams. Assumes mask test with compliance filter switched in.

Module Specifications: Single-Mode Optical/Electrical

High Bandwidth, Single-Mode Optical/Electrical Modules	86106B	86109A	86109B	86116A ¹	86116B ¹
OPTICAL CHANNEL SPECIFICATIONS					
Optical Channel Unfiltered Bandwidth	28 GHz	30 GHz	40 GHz ²	53 GHz	65 GHz (best pulse fidelity)
Wavelength Range	1000–1600 nm				55 GHz (best sensitivity)
Calibrated Wavelengths	1310/1550 nm				1480-1620 nm
Optical Sensitivity⁴	–7 dBm	N/A			
Transition Time (10% to 90%, calculated from TR = 0.48/BW optical)	18 ps	16 ps	12 ps (FWHM) ³	9.0 ps (FWHM) ³	7.4 ps (FWHM)
RMS Noise					
<i>Characteristic</i>	13 μ W (Filtered) 23 μ W (Unfiltered)	12 μ W	25 μ W (30 GHz) 65 μ W (40 GHz)	60 μ W (50 GHz) 190 μ W (53 GHz)	140 μ W (65 GHz) 50 μ W (55 GHz)
Maximum	15 μ W (Filtered) 30 μ W (Unfiltered)	30 μ W	30 μ W (30 GHz) 75 μ W (40 GHz)	90 μ W (50 GHz) 260 μ W (53 GHz)	250 μ W (65 GHz) 85 μ W (55 GHz)
Scale Factor					
Minimum	20 μ W/division			200 μ W/division	
Maximum	500 μ W/division		1.0 mW/division	2.5 mW/division	5 mW/division
CW Accuracy (single marker, referenced to average power monitor)	\pm 50 μ W \pm 4% of (reading-channel offset)		\pm 150 μ W \pm 4% of (reading-channel offset)		
CW Offset Range (referenced two divisions from screen bottom)	+1 mW to –3 mW		+6 mW to –2 mW	+5 mW to –15mW	+8 to –12 mW
Average Power Monitor (specified operating range)	–27 dBm to +3 dBm		–23 dBm to + 9 dBm		
Factory Calibrated Accuracy	\pm 5% \pm 100 nW \pm connector uncertainty, 20°C to 30°C				
User Calibrated Accuracy	\pm 2% \pm 100 nW \pm power meter uncertainty, <5°C change				
Maximum Input Power					
Maximum non-destruct average	2 mW (+3 dBm)		10 mW (+10 dBm)		
Maximum non-destruct peak	10 mW (+10 dBm)		50 mW (+17 dBm)		
Fiber Input	9/125 μ m, user selectable connector				
Input Return Loss (HMS-10 connector fully filled fiber)	30 dB				20 dB
¹ 86116A requires the 86100A/B software revision A.3.0 or above.					
² Specified with 8 point moving average in frequency response.					
³ FWHM (Full Width Half Max) as measured from optical pulse with 700 fs FWHM, 5 MHz repetition rate and 10 mW peak power.					
⁴ Smallest average optical power required for mask test. Values represent typical sensitivity of NRZ eye diagrams. Assumes mask test with compliance filter switched in.					
ELECTRICAL CHANNEL SPECIFICATIONS					
Electrical Channel Bandwidth	18 and 40 GHz		26 and 50 GHz	43 and 63 GHz	80, 55 and 30 GHz
Transition Time (10% to 90%, calculated from TR = 0.35/BW)	19.5 ps (18 GHz) 9 ps (40 GHz)		<13.2 ps (26 GHz) 7 ps (50 GHz)	8.1 ps (43 GHz) 5.6 ps (63 GHz)	6.4 ps (55 GHz) 4.4 ps (80 GHz)
RMS Noise					
<i>Characteristic</i>	0.25 mV (18 GHz) 0.5 mV (40 GHz)		0.25 mV (26 GHz) 0.60 mV (50 GHz)	0.6 mV (43 GHz) 1.7 mV (63 GHz)	0.6 mV (55 GHz) 1.1 mV (80 GHz)
Maximum	0.5m V (18 GHz) 1.0 mV (40 GHz)		0.50 mV (26 GHz) 1.0 mV (50 GHz)	0.9 mV (43 GHz) 2.5 mV (63 GHz)	1.1 mV (55 GHz) 2.2 mV (80 GHz)
Scale Factor					
Minimum	1 mV/division			2 mV/division	
Maximum	100 mV/division			100 mV/division	
DC Accuracy (single marker)	\pm 0.4% of full scale \pm 2 mV \pm 1.5% of (reading-channel offset), 18 GHz \pm 0.4% of full scale \pm 2 mV \pm 3% of (reading-channel offset), 40 GHz		\pm 0.4% of full scale \pm 2 mV \pm 1.5% of (reading-channel offset), 26 GHz \pm 0.4% of full scale \pm 2 mV \pm 2% of (reading-channel offset), 50 GHz	\pm 0.8% of full scale \pm 2 mV \pm 1.5% of (reading-channel offset), 43 GHz \pm 2.5% of full scale \pm 2 mV \pm 2% of (reading-channel offset), 63 GHz	\pm 0.4% of full scale \pm 3 mV \pm 2% of (reading-channel offset), \pm 2% of offset (all bandwidths)
DC Offset Range (referenced to center of screen)	\pm 500 mV				
Input Dynamic Range (relative to channel offset)	\pm 400 mV				
Maximum Input Signal	\pm 2 V (+16 dBm)				
Nominal Impedance	50 ohm				
Reflections (for 20 ps rise time)	5%				10% (DC–70 GHz) 20% (70–100 GHz)
Electrical Input	2.4 mm (male)			1.85 mm (male)	

Module Specifications: Dual Optical

Dual Mode Optical Modules ¹	86111A	86111U	86113A	86115B
OPTICAL CHANNEL SPECIFICATIONS				
Optical Channel Unfiltered Bandwidth	2.85 GHz	15 GHz	2.85 GHz	28 GHz
Wavelength Range	750-860 nm		1000–1600 nm	
Calibrated Wavelengths	850 nm		1310/1550 nm	
Optical Sensitivity¹	-17 dBm	-7.5 dBm	-20 dBm	-7 dBm
Transition Time (10% to 90%,calculated from TR = 0.48/BW optical)				
Unfiltered	160 ps	32ps	160 ps	18 ps
RMS Noise				
Characteristic	1.5 μ W	14 μ W	1.0 μ W	13 μ W (Filtered) 23 μ W (Unfiltered)
Maximum	2.5 μ W	20 μ W	2.5 μ W	15 μ W (Filtered) 30 μ W (Unfiltered)
Scale Factor				
Minimum	5 μ W	20 μ W	5 μ W	20 μ W
Maximum	100 μ W	500 μ W	100 μ W	500 μ W
CW Accuracy (single marker, referenced to average power monitor)	$\pm 6 \mu\text{W} \pm 0.4\%$ of full scale $\pm 3\%$ of (reading-channel offset)	$25 \mu\text{W} \pm 2\%$ of (reading-channel offset), 15 GHz	$\pm 6 \mu\text{W} \pm 0.4\%$ of full scale $\pm 3\%$ of (reading-channel offset)	$\pm 50 \mu\text{W} \pm 4\%$ of (reading-channel offset)
CW Offset Range (referenced two divisions from screen bottom)	+0.2 mW to -0.6 mW	+1 mW to -3 mW	+0.2 mW to -0.6 mW	+1 mW to -3 mW
Average Power Monitor (specified operating range)	-30 dBm to -2.2 dBm	-27 dBm to +3 dBm	-30 dBm to 0 dBm	-27 dBm to +3 dBm
Factory Calibrated Accuracy				
Single mode	$\pm 5\% \pm 100 \text{ nW} \pm \text{connector uncertainty, (20}^\circ\text{C to 30}^\circ\text{C)}$			
Multi mode	$\pm 10\% \pm 100 \text{ nW} \pm \text{connector uncertainty, (20}^\circ\text{C to 30}^\circ\text{C)}$			N/A
User Calibrated Accuracy				
	$\pm 2\% \pm 100 \text{ nW} \pm \text{power meter uncertainty, <5}^\circ\text{C change}$			
Maximum Input Power				
Maximum non-destruct average	0.4 mW (-4 dBm)	2 mW (+3 dBm)	0.4 mW (-4 dBm)	2 mW (+3 dBm)
Maximum non-destruct peak	10 mW (+10 dBm)			
Fiber Input				
	62.5/125 μm , user selectable connector			9/125 μm , user selectable connector
Input Return Loss (HMS-10 connector fully filled fiber)				
	20dB			30 dB

¹ Requires the 86100A/B software revision 3.0 or above.

Module Specifications: Dual Electrical

Dual Electrical Channel Modules	86112A	54754A
Electrical Channel Bandwidth	12.4 and 20 GHz	12.4 and 18 GHz
Transition Time (10% to 90%, calculated from TR = 0.35/BW)	28.2 ps (12.4 GHz); 17.5 ps (20 GHz)	28.2 ps (12.4 GHz); 19.4 ps (18 GHz)
RMS Noise		
Characteristic	0.25 mV (12.4 GHz); 0.5 mV (20 GHz)	0.25 mV (12.4 GHz); 0.5 mV (18 GHz)
Maximum	0.5 mV (12.4 GHz); 1 mV (20 GHz)	0.5 mV (12.4 GHz); 1 mV (18 GHz)
Scale Factor		
Minimum	1 mV/division	
Maximum	100 mV/division	
DC Accuracy (single marker)	±0.4% of full scale ±2mV ±1.5% of (reading-channel offset), 12.4 GHz ±0.4% of full scale ±2 mV ±3% of (reading-channel offset), 20 GHz	±0.4% of full scale or marker reading (whichever is greater) ±2 mV ±1.2% of (reading-channel offset)
CW Offset Range (referenced from center of screen)	±500 mV	
Input Dynamic Range (relative to channel offset)	±400 mV	
Maximum Input Signal	±2 V (+16 dBm)	
Nominal Impedance	50 ohm	
Reflections (for 30 ps rise time)	5%	
Electrical Input	3.5 mm (male)	

Dual Electrical Channel Modules	86117A	86117B	86118A
Electrical Channel Bandwidth	30 and 50 GHz	30, 50 and 65 GHz	50 and 70 GHz
Transition Time (10% to 90%, calculated from TR = 0.35/BW)	11.7 ps (30 GHz) 7 ps (50 GHz)	11.7 ps (30 GHz) 7 ps (50 GHz) 5.4 ps (65 GHz)	
RMS Noise			
Characteristic	0.4 mV (30 GHz) 0.6 mV (50 GHz)	0.4 mV (30 GHz) 0.5 mV (50 GHz) 1.3 mV (65 GHz)	0.7 mV (50 GHz) 1.3 mV (70 GHz)
Maximum	0.7 mV (30 GHz); 1.0 mV (50 GHz)	0.7 mV (30 GHz) 0.9 mV (50 GHz) 2.2 mV (65 GHz)	1.8 mV (50 GHz) 2.5 mV (70 GHz)
Scale Factor			
Minimum	1 mV/division		
Maximum	100 mV/division		
DC Accuracy (single marker)	±0.4% of full scale ±2 mV ±1.2% of (reading-channel offset) (30 GHz) ±0.4% of full scale ±2 mV ±2% of (reading-channel offset) (50 GHz)	±0.4% of full scale ±2 mV ±1.2% of (reading-channel offset) (30 GHz) ±0.4% of full scale ±2 mV ±2% of (reading-channel offset) (50 GHz) ±0.4% of full scale ±2 mV ±2% of (reading-channel offset) (65 GHz)	±0.4% of full scale ±1.5 mV ±1% of (reading-channel offset) (50 GHz) ±0.4% of full scale ±1.5 mV ±3% of (reading-channel offset) (70 GHz)
CW Offset Range (referenced from center of screen)	±500 mV		
Input Dynamic Range (relative to channel offset)	±400 mV		
Maximum Input Signal	±2 V (+16 dBm)		
Nominal Impedance	50 ohm		
Reflections (for 30 ps rise time)	5%		
Electrical Input	2.4 mm (male)	1.85 mm (male)	1.85 mm (male)

TDR System

TDR System	Oscilloscope/TDR Performance	Normalized Characteristics
Rise Time	40 ps nominal	Adjustable from larger of 10 ps or 0.08 x time/div Maximum: 5 x time/div
TDR Step Flatness	$\leq \pm 1\%$ after 1 ns from edge $\leq \pm 5\%$, -3% 1 ns from edge	$\leq 0.1\%$
Low Level High Level	0.00 V ± 2 mV ± 200 mV ± 2 mV	0.00 V ± 2 mV ± 200 mV ± 2 mV

Clock Recovery

Clock Recovery Single Mode, Multimode and Electrical Modules	83491A	83492A	83493A	83494A
Channel Type	Electrical	Multimode Optical	Single Mode Optical	Single Mode Optical
Clock Recovery Phase Locked Loop Bandwidth				
Internal Path Triggering	50 to 70 kHz			90 kHz
External Output	4 MHz $\pm 10\%$			
Data Rates (Mb/s)	155, 622, 1063, 1250, 2125, 2488, 2500	155, 622, 1063, 1250, 2125, 2488, 2500	155, 622, 1250, 2488, 2500	155, 622, 2488, 9953
Tracking/Acquisition Range	$\pm 0.1\%$			155, 622, 2488, $\pm 0.1\%$; 9953 $\pm 0.03\%$
Internal Splitter Ratio	50/50	50/50	10/90	10/90
Output Jitter	< 0.0125 UI RMS			155, 622, 2488 0.02 UI RMS 9953 0.03 UI RMS
Input Power for Clock Recovery	-10 dBm to +3 dBm	750 to 860 nm, -10 to +3 dBm 1000 to 1600 nm, -13 to +3 dBm	-20 dBm to +3 dBm	-12 dBm to +3 dBm (155, 622, 2488 Mb/s) -8 dBm to +3 dBm (9953 Mb/s)
Input/Output Connectors	APC 3.5 mm, 50 ohm	FC/PC, 62.5/125 μ m multimode, user selectable connector	FC/PC, 9 /125 μ m	
Auxiliary Recovered Clock and Regenerated Data Outputs	Type N with SMA adapters			
Input Return Loss	DC-1250 MHz, 20 dB 1250-2500 MHz, 15 dB	20 dB	28 dB	28 dB
Input Insertion Loss	DC-1250 MHz, 7 dB 1250-2500 MHz, 15 dB	5 dB Maximum	1.5 dB Maximum	

PRELIMINARY

Clock Recovery Single Mode, Multimode and Electrical Modules	83495A-100	83495A-101
Channel Type	Single Mode Optical & Electrical	Multimode Optical & Electrical
Clock Recovery Phase Locked Loop Bandwidth		
Internal Path Triggering	≤ 100 KHz or ≤ 4 MHz (3.5 MHz typical ¹) user selectable ²	
External Output	≤ 100 KHz or ≤ 4 MHz (3.5 MHz typical ¹) user selectable ²	
Data Rates (Gb/s)	9.953 to 11.32	
Tracking/Acquisition Range	Continuous within data rate range	
Internal Splitter Ratio	20/80	30/70
Clock Output Jitter	0.01 UI (0.007 UI typical) RMS ³	
Input Level for Clock Recovery ⁴	-11 dBm to +1 dBm optical 0.10 to 2.0 Vp-p electrical	-8 dBm to +1 dBm optical ⁵ 0.10 to 2.0 Vp-p electrical
Input/Output Connectors	FC/PC, 9/125 μ m & Type N	
Auxiliary Recovered Clock and Regenerated Data Outputs	Type N with SMA adapters (no data output)	
Input Return Loss	32 dB maximum optical DC-2.5 GHz, 20 dB electrical 2.5 GHz-11.32 GHz, 15 dB electrical	28 dB maximum optical DC-2.5 GHz, 20 dB electrical 2.5 GHz-11.32 GHz, 15 dB electrical
Input Insertion Loss	2.5 dB maximum optical	3.0 dB maximum optical

¹ Achieved with input power ≥ -8 dBm for option 100; ≥ -5 dBm for option 101.

² Loop BW transfer function is guaranteed to be less than a low pass response with the specified corner frequency rolling off -20 dB/dec.

³ Measured with a PRBS 2²³-1 pattern. For total scope jitter, RSS clock output jitter with mainframe jitter.

⁴ For optical input power, source extinction ratio ≥ 8.2 dB when measured per TIA/EIA OFSTP-4A. For extinction ratio equal to 8.2 dB, OMA is defined as $(P_1 - P_0)$ and is equal to average input power (dBm) + 1.68 dB.

⁵ Input is a fully filled multimode signal.

Ordering Information

86100B	Infiniium DCA mainframe, wide bandwidth digital oscilloscope
86100B-001	12 GHz trigger bandwidth
86100B-AX4	Rack mount flange kit
86100B-AXE	Rack mount flange kit with handles
86100B-UK6	Commercial cal certificate with test data

Optical/Electrical Modules

86101A	2.85 GHz optical channel; multimode, amplified (750-860 nm) 20 GHz electrical channel
86101A-201	155, 622 Mb/s
86101A-202	1.063, 1.25 Gb/s
86102A	10 GHz optical channel; multimode, amplified (750-860 nm) 20 GHz electrical channel
86102A-201	2.125, 3.187 Gb/s
86102A-202	2.488, 3.125 Gb/s
86102A-203	2.72, 3.32 Gb/s
86102U	15 GHz optical channel; multimode, unamplified (750-860 nm) 20 GHz electrical channel
86102U-201	1.25, 2.488 Gb/s
86102U-202	2.488, 3.125 Gb/s
86102U-203	3.125, 10.3125 Gb/s
86103A	2.85 GHz optical channel; multimode, amplified (1000-1600 nm) 20 GHz electrical channel
86103A-201	155, 622 Mb/s
86103A-202	1.063, 1.25 Gb/s
86103B	10 GHz optical channel; multimode, amplified (1000-1600 nm) 20 GHz electrical channel
86103B-201	622 Mb/s, 2.488 Gb/s
86103B-202	1.063, 1.25 Gb/s
86103B-203	2.125, 2.488 Gb/s
86105B	15 GHz optical channel; single-mode, unamplified (1000-1600 nm) 20 GHz electrical channel
86105B-101	9.953, 10.3125, 10.51875, 10.664, 10.709 Gb/s
86105B-102	155, 622 Mb/s 2.488, 2.666, 9.953, 10.3125, 10.51875, 10.664, 10.709 Gb/s
86105B-103	1.063, 1.250, 2.125, 2.488, 2.666, 9.953, 10.3125, 10.51875, 10.664, 10.709 Gb/s
86106B	28 GHz optical channel; single-mode, unamplified (1000-1600 nm) 40 GHz electrical channel
86106B-410	9.953, 10.3125, 10.664, 10.709 Gb/s
86109A	30 GHz optical channel; single-mode, unamplified (1000-1600 nm) 40 GHz electrical channel

86109B	40 GHz optical channel; single-mode, unamplified (1000-1600 nm) 50 GHz electrical channel
86116A	53 GHz optical channel; single-mode, unamplified (1000-1600 nm) 63 GHz electrical channel
86116B	65 GHz optical channel; single-mode, unamplified (1480-1620 nm) 80 GHz electrical channel

Dual Optical Channel Modules

86111A	Dual 2.85 GHz optical channels; multimode, amplified (750-860 nm)
86111A-201	155, 622 Mb/s
86111A-202	1.063, 1.25 Gb/s
86111U	Dual 15 GHz optical channels; multimode, unamplified (750-860 nm)
86111U-201	1.25, 2.488 Gb/s
86111U-202	2.488, 3.125 Gb/s
86111U-203	3.125, 10.3125 Gb/s
86113A	Dual 2.85 GHz optical channels; multimode, amplified (1000-1600 nm)
86113A-201	155, 622 Mb/s
86113A-202	1.063, 1.25 Gb/s
86113A-301	155 Mb/s, 622 Mb/s, 2.488 Gb/s
86115B	Dual 28 GHz optical channels; single-mode, unamplified (1000-1600 nm)
86115B-101	9.953 Gb/s
86115B-410	9.953 Gb/s, 10.3125, 10.664, 10.709 Gb/s

Dual Electrical Channel Modules

86112A	Dual 20 GHz electrical channels
86117A	Dual 50 GHz electrical channels
86117B	Dual 65 GHz electrical channels
86118A	Dual 70 GHz electrical remote sampling channels

TDR/TDT Modules

Included with each of these TDR modules is a TDR demo board, programmers guide, 2 50Ω terminations, APC-3.5 (m), and one short, APC-3.5 (m).	
54754A	Differential TDR module with dual 18 GHz TDR/electrical channels

Trigger Module

86107A	Precision timebase reference module
86107A-010	2.5 and 10 GHz clock input capability
86107A-020	10 and 20 GHz clock input capability
86107A-040	10, 20 and 40 GHz clock input capability

Clock Recovery Modules

The following modules provide a recovered clock from the data signal for triggering at standard telecommunications and enterprise data rates:

83491A	Electrical signals. Data rates 155, 622, 1063, 1250, 2125, 2488, 2500 Mb/s
83492A	Multimode optical. Data rates 155, 622, 1063, 1250, 2125, 2488, 2500 Mb/s
83493A	Single-mode signals. Data rates 155, 622, 1250, 2488, 2500 Mb/s
83494A	Single-mode signals. Data rates 155, 622, 2488 Mb/s and 9.953 Gb/s
83494A-103	Single-mode signals. Data rates 155, 622, 2488 Mb/s and 10.3125 Gb/s
83494A-106	Single-mode signals. Data rates 155, 622, 2488, 2666 Mb/s and 10.664 Gb/s
83494A-107	Single-mode signals. Data rates 155, 622, 2488, 2666 Mb/s and 10.709 Gb/s
83495A	10 Gb/s Clock recovery module
83495A-100	Single-mode signals (1000–1600 nm) and electrical
83495A-101	Multimode signals (750–860 nm) and electrical
83495A-200	Continuous data rates from 9.953 Gb/s to 11.32 Gb/s

Warranty Options (for all products)

R1280A	Customer return repair service
R1282A	Customer return calibration service

Connector Options

(for All Optical Modules)

81000 AI	Diamond HMS-10 connector
81000 FI	FC/PC connector adapter
81000 SI	DIN connector adapter
81000 VI	ST connector adapter
81000 KI	SC Connector Adapter

Accessories

10086A	ECL terminator
11667B	Power splitter, DC to 26.5 GHz, APC 3.5 mm
11667C	Power splitter, DC to 50 GHz, 2.4mm
11742A	45 MHz to 26.5 GHz DC blocking capacitor
11742A-K01	50 GHz DC blocking capacitor
11898A	1.5 meter remote extender module
54008B	24 ns delay line
54121-68701	RF accessories kit
83430A	2.5 Gb/s lightwave transmitter
83440B/C/D	Optical-to-electrical converters (6/20/32 GHz)
83446A	2.5 Gb/s lightwave receiver
8490D-020	2.4 mm 20dB attenuator
86101-60005	Filler panel
C3751-60201	Mouse (included with 86100B)
E2610-68700	Keyboard (included with 86100B)
N1020A	6 GHz TDR probe kit
N1025A	1 GHz active differential probe

Probes

1130 Series InfiniiMax probing systems

1134A	7 GHz InfiniiMax probe amp – order one or both E266xA connectivity kits per amp
1132A	5 GHz InfiniiMax probe amp – order one or both E266xA connectivity kits per amp
1131A	3.5 GHz InfiniiMax probe amp – order one or both E266xA connectivity kits per amp

Connectivity kits model

E2669A	InfiniiMax connectivity kit for differential measurements
E2668A	InfiniiMax connectivity kit for single-ended measurements

Additional Components

E2675A	InfiniiMax differential browser probe head and accessories. Includes 20 replaceable tips and ergonomic handle. Order E2658A for replacement accessories.
E2676A	InfiniiMax single-ended browser probe head and accessories. Includes 2 ground collar assemblies, 10 replaceable tips, a ground lead socket and ergonomic browser handle. Order E2663A for replacement accessories.
E2677A	InfiniiMax differential solder-in probe head and accessories. Includes 20 full bandwidth and 10 medium bandwidth damping resistors. Order E2670A for replacement accessories.
E2678A	InfiniiMax single-ended/differential socketed probe head and accessories. Includes 48 full bandwidth damping resistors, 6 damped wire accessories, 4 square pin sockets and socket heatshrink. Order E2671A for replacement accessories.
E2679A	InfiniiMax single-ended solder-in probe head and accessories. Includes 16 full bandwidth and 8 medium bandwidth damping resistors and 24 zero ohm ground resistors. Order E2672A for replacement accessories.

Adapters

N1022A	Adapts 113x/115x active probes to 86100 Infinii DCA
---------------	---

Other Compatible Probes

54006A	6 GHz passive probe
54701A	2.5 GHz active probe

Adapters for Electrical Channels

11900B	2.4mm (f-f) adapter
11901B	2.4mm (f) to 3.5mm (f) adapter
11901C	2.4mm (m) to 3.5mm (f) adapter
54124-24101	2.4mm termination
5061-5311	3.5mm (f-f) adapter
1250-1158	SMA (f-f) adapter
1810-0118	3.5mm termination

Firmware and software

Firmware and software upgrades are available through the Web or your local sales office. www.agilent.com/comms/dcaupgrade

Agilent Technologies' Test and Measurement Support, Services, and Assistance

Agilent Technologies aims to maximize the value you receive, while minimizing your risk and problems. We strive to ensure that you get the test and measurement capabilities you paid for and obtain the support you need. Our extensive support resources and services can help you choose the right Agilent products for your applications and apply them successfully. Every instrument and system we sell has a global warranty. Support is available for at least five years beyond the production life of the product. Two concepts underlie Agilent's overall support policy: "Our Promise" and "Your Advantage."

Our Promise

Our Promise means your Agilent test and measurement equipment will meet its advertised performance and functionality. When you are choosing new equipment, we will help you with product information, including realistic performance specifications and practical recommendations from experienced test engineers. When you use Agilent equipment, we can verify that it works properly, help with product operation, and provide basic measurement assistance for the use of specified capabilities, at no extra cost upon request. Many self-help tools are available.

Your Advantage

Your Advantage means that Agilent offers a wide range of additional expert test and measurement services, which you can purchase according to your unique technical and business needs. Solve problems efficiently and gain a competitive edge by contracting with us for calibration, extra-cost upgrades, out-of-warranty repairs, and on-site education and training, as well as design, system integration, project management, and other professional engineering services. Experienced Agilent engineers and technicians worldwide can help you maximize your productivity, optimize the return on investment of your Agilent instruments and systems, and obtain dependable measurement accuracy for the life of those products.

By internet, phone, or fax, get assistance with all your test & measurement needs.

Online assistance:

www.agilent.com/comms/lightwave

Phone or Fax

United States:

(tel) 1 800 452 4844

Canada:

(tel) 1 877 894 4414

(fax) (905) 282 6495

China:

(tel) 800-810-0189

(fax) 1-0800-650-0121

Europe:

(tel) (31 20) 547 2323

(fax) (31 20) 547 2390

Japan:

(tel) (81) 426 56 7832

(fax) (81) 426 56 7840

Korea:

(tel) (82-2) 2004-5004

(fax) (82-2) 2004-5115

Latin America:

(tel) (305) 269 7500

(fax) (305) 269 7599

Taiwan:

(tel) 080-004-7866

(fax) (886-2) 2545-6723

Other Asia Pacific Countries:

(tel) (65) 375-8100

(fax) (65) 836-0252

Email: tm_asia@agilent.com

Product specifications and descriptions in this document subject to change without notice.

© 2000, 2001, 2002, 2003 Agilent Technologies

Printed in USA August 27, 2003

5988-5311EN



Agilent Technologies