

Agilent 81940A, 44A, 49A, 80A & 89A
Compact Tunable Laser Source modules

User's Guide

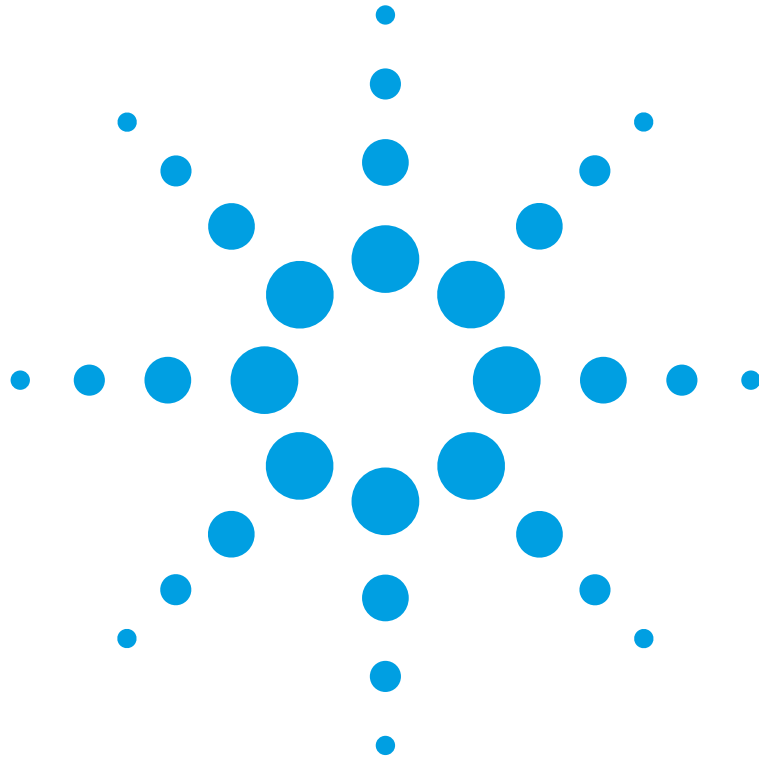

Notices

© Agilent Technologies, Inc. 2002 - 2005

No part of this manual may be reproduced in any form or by any means (including electronic storage and retrieval or translation into a foreign language) without prior agreement and written consent from Agilent Technologies, Inc. as governed by United States and international copyright laws.

Agilent Technologies, Deutschland GmbH
Herrenberger Straße 130
71034 Böblingen, Germany.

Manual Part Number

81980-90A11

Edition

Fourth edition, April 2005

Third edition, January 2005

Second edition, July 2004

First edition, October 2003

Printed in Germany

Subject Matter

The material in this document is subject to change without notice.

Agilent Technologies *makes no warranty of any kind with regard to this printed material, including, but not limited to, the implied warranties of merchantability and fitness for a particular purpose.*

Agilent Technologies shall not be liable for errors contained herein or for incidental or consequential damages in connection with the furnishing, performance, or use of this material.

Warranty

The material contained in this document is provided “as is,” and is subject to being changed, without notice, in future editions. Further, to the maximum extent permitted by applicable law, Agilent disclaims all warranties, either express or implied, with regard to this manual and any information contained herein, including but not limited to the implied warranties of merchantability and fitness for a particular purpose. Agilent shall not be liable for errors or for incidental or consequential damages in connection with the furnishing, use, or performance of this document or of any information contained herein. Should Agilent and the user have a separate written agreement with warranty terms covering the material in this document that conflict with these terms, the warranty terms in the separate agreement shall control.

Technology Licenses

The hardware and/or software described in this document are furnished under a license and may be used or copied only in accordance with the terms of such license.

Restricted Rights Legend

If software is for use in the performance of a U.S. Government prime contract or subcontract, Software is delivered and licensed as “Commercial computer software” as defined in DFAR 252.227-7014 (June 1995), or as a “commercial item” as defined in FAR 2.101(a) or as “Restricted computer software” as defined in FAR 52.227-19 (June 1987) or any equivalent agency regulation or contract clause. Use, duplication or disclosure of Software is subject to Agilent Technologies’ standard commercial license terms, and non-DOD Departments and Agencies of the U.S. Government will receive no greater than Restricted Rights as defined in FAR 52.227-19(c)(1-2) (June 1987). U.S. Government users will receive no greater

than Limited Rights as defined in FAR 52.227-14 (June 1987) or DFAR 252.227-7015 (b)(2) (November 1995), as applicable in any technical data.

Safety Notices

CAUTION

A **CAUTION** notice denotes a hazard. It calls attention to an operating procedure, practice, or the like that, if not correctly performed or adhered to, could result in damage to the product or loss of important data. Do not proceed beyond a **CAUTION** notice until the indicated conditions are fully understood and met.

WARNING

A **WARNING** notice denotes a hazard. It calls attention to an operating procedure, practice, or the like that, if not correctly performed or adhered to, could result in personal injury or death. Do not proceed beyond a **WARNING** notice until the indicated conditions are fully understood and met.

Agilent Technologies Sales and Service Offices

For more information about Agilent Technologies test and measurement products, applications, services, and for a current sales office listing, visit our web site:

<http://www.agilent.com/comms/lightwave>

You can also contact one of the following centers and ask for a test and measurement sales representative.

United States:	1 800 829 4444 1 800 829 4433 (FAX)
Canada:	1 877 894 4414 1 905 282 6495 (FAX)
Europe:	+31 20 547 2111 +31 20 547 2190 (FAX)
Japan:	120 421 345 120 421 678 (FAX)
Mexico	(52 55) 5081 9469 (52 55) 5081 9467 (FAX)
Australia:	800 629 485 800 142 134 (FAX)
Asia-Pacific:	+852 800 930 871 +852 2 506 9233(FAX)
Latin America	+55 11 4197 3600 +55 11 4197 3800 (FAX)

In This Guide...

Chapter 1, "Getting Started.

This chapter contains an introductory description of the modules and aims to make the modules familiar to you.

Chapter 2, "Accessories.

This chapter contains details of the various modules and options available.

Chapter 3, "Specifications.

This chapter contains the full performance specifications for the modules.

Chapter 4, "Performance Tests.

This chapter contains full detailed instructions that enable you to run a performance test on a High Power Optical Attenuator. Also included are Test Report sheets to record the measurements taken during the performance test.

Chapter 5, "Cleaning Information.

This appendix contains information as to how best clean your instrument, along with some general safety instructions that you should follow when cleaning your instrument.

Table of Contents

Getting Started	11
Safety Considerations	12
Safety Symbols	12
Initial Inspection	13
Line Power Requirements	13
Operating Environment	13
Input/Output Signals	14
Storage and Shipment	14
Initial Safety Information for Tunable Laser Modules	15
Laser Safety Labels	16
Introduction	17
Typical Use Models	20
Optical Output	22
Polarization Maintaining Fiber	22
Angled and Straight Contact Connectors	23
Signal Input and Output	24
Accessories	25
Modules and Options	26
Modules	27
Options	27
Connector Interfaces	28
User's Guides	29
Specifications	31
Definition of Terms	32
General Definitions	46
Compact Tunable Laser Module Specifications	47
Conditions	53
Supplementary Performance Characteristics	54
General	56

Performance Tests	57
<hr/>	
Required Test Equipment	58
Test Record	59
Performance Test Instructions	60
General test Setup	60
Wavelength Tests	61
Wavelength Meter Settings for all Wavelength Tests	61
Wavelength Accuracy	62
Absolute and Relative Wavelength Accuracy	62
Mode-Hop Free Tuning	66
Wavelength Repeatability	67
Power Tests	69
Maximum Output Power	69
Power Linearity	74
Power Flatness versus Wavelength	77
Power Stability	80
Signal-to-Source Spontaneous Emission Ratio	83
Optional Performance Tests	86
Signal-to-Total-Source Spontaneous Emission Ratio	86
Test Records	90
Test Record	91
Test Record	101
Test Record	111
Test Record	118
Test Record	128
Cleaning Information	139
<hr/>	
Cleaning Instructions	140
Safety Precautions	140
Why is it important to clean optical devices ?	141
What do I need for proper cleaning?	142
Preserving Connectors	146
Cleaning Instrument Housings	146
Which Cleaning Procedure should I use?	147
How to clean connectors	148
How to clean connector interfaces	150



How to clean bare fiber adapters	151
How to clean instruments with a fixed connector interface	152
Additional Cleaning Information	153
Other Cleaning Hints	154
Index	155





List of Figures



1

Getting Started

This chapter provides a general description of Agilent 81980A, 81940A, 81944A, 81989A, 81949A Compact TLS modules.

Safety Considerations	12
Safety Symbols	12
Initial Inspection	13
Line Power Requirements	13
Operating Environment	13
Input/Output Signals	14
Storage and Shipment	14
Initial Safety Information for Tunable Laser Modules ...	15
Laser Safety Labels	16
Introduction	17
What is a Tunable Laser Source?	17
Installation	17
Front Panels	17
Front Panel Controls and Indicators	19
Typical Use Models	20
Optical Output	22
Polarization Maintaining Fiber	22
Angled and Straight Contact Connectors	23
Signal Input and Output	24

Safety Considerations

The following general safety precautions must be observed during all phases of operation, service, and repair of this instrument. Failure to comply with these precautions or with specific warnings elsewhere in this manual violates safety standards of design, manufacture, and intended use of the instrument. Agilent Technologies Inc. assumes no liability for the customer's failure to comply with these requirements.

Before operation, review the instrument and manual, including the red safety page, for safety markings and instructions. You must follow these to ensure safe operation and to maintain the instrument in safe condition.

WARNING

The WARNING sign denotes a hazard. It calls attention to a procedure, practice or the like, which, if not correctly performed or adhered to, could result in injury or loss of life. Do not proceed beyond a WARNING sign until the indicated conditions are fully understood and met.



Safety Symbols

The apparatus will be marked with this symbol when it is necessary for the user to refer to the instruction manual in order to protect the apparatus against damage.



Hazardous laser radiation.

Initial Inspection

Inspect the shipping container for damage. If there is damage to the container or cushioning, keep them until you have checked the contents of the shipment for completeness and verified the instrument both mechanically and electrically.

The Performance Tests give procedures for checking the operation of the instrument. If the contents are incomplete, mechanical damage or defect is apparent, or if an instrument does not pass the operator's checks, notify the nearest Agilent Technologies Sales/Service Office.

WARNING

To avoid hazardous electrical shock, do not perform electrical tests when there are signs of shipping damage to any portion of the outer enclosure (covers, panels, etc.).

WARNING

You *MUST* return instruments with malfunctioning laser modules to an Agilent Technologies Sales/Service Center for repair and calibration.

Line Power Requirements

The Agilent 81980A, 81940A, 81944A, 81989A and 81949A Compact Tunable Laser Source modules operate when installed in Agilent 8163A/B Lightwave Multimeters, Agilent 8164A/B Lightwave Measurement Systems, and Agilent 8166A/B Lightwave Multichannel Systems.

Operating Environment

The safety information in your mainframe's User's Guide summarizes the operating ranges for the Agilent 81980A, 81940A, 81944A, 81989A and 81949A Compact Tunable Laser Source modules. In order for these modules to meet specifications, the operating environment must be within the limits specified for your mainframe.

Input/Output Signals

CAUTION

There is one BNC input connector on the front panel of an Agilent 81980A, 81940A, 81944A, 81989A or 81949A Compact Tunable Laser Source module.

An absolute maximum of ± 6 V can be applied as an external voltage to any BNC connector.

Storage and Shipment

An Agilent 81980A, 81940A, 81944A, 81989A or 81949A Compact Tunable Laser Source module can be stored or shipped at temperatures between -40°C and +70°C.

Protect the module from temperature extremes that may cause condensation within it.

Initial Safety Information for Tunable Laser Modules

The laser sources specified by this user guide are classified according to IEC 60825-1 (2001).

The laser sources comply with 21 CFR 1040.10 except for deviations pursuant to Laser Notice No. 50 dated 2001-July-26:

	Agilent 81980A	Agilent 81940A	Agilent 81944A	Agilent 81989A	Agilent 81949A
<i>Laser Type</i>	ECL-Laser InGaAsP	ECL-Laser InGaAsP	ECL-Laser InGaAsP	ECL-Laser InGaAsP	ECL-Laser InGaAsP
<i>Wavelength range</i>	1465 nm-1575 nm	1520 nm-1630 nm	1525 nm-1620 nm	1465 nm-1575 nm	1520 nm-1630 nm
<i>Max. CW output power*</i>	30 mW	30 mW	30 mW	30 mW	30 mW
<i>Beam waist diameter</i>	9 μ m	9 μ m	9 μ m	9 μ m	9 μ m
<i>Numerical aperture</i>	0.1	0.1	0.1	0.1	0.1
<i>Laser Class according to IEC 60825-1 (2001)- Intl.</i>	1M	1M	1M	1M	1M
<i>Max. permissible CW output power**</i>	163 mW	163 mW	163 mW	163 mW	163 mW
<p>* <i>Max. CW output power</i> is defined as the highest possible optical power that the laser source can produce at its output connector.</p> <p>** <i>Max. permissible CW output power</i> is the highest optical power that is permitted within the appropriate laser class.</p>					

Laser Safety Labels

Laser class 1M label

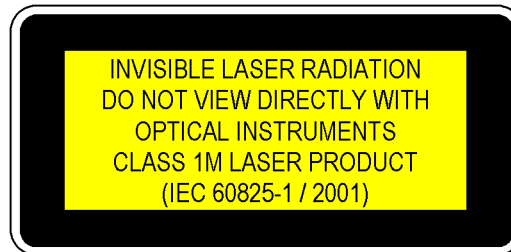

Figure 1 Class 1M Safety Label - 81980A, 81940A, 81944A, 81980A, 81949A

A sheet of laser safety labels is included with the laser module as required. In order to meet the requirements of IEC 60825-1 we recommend that you stick the laser safety labels, in your language, onto a suitable location on the outside of the instrument where they are clearly visible to anyone using the instrument.

WARNING

Please pay attention to the following laser safety warning:

Under no circumstances look into the end of an optical cable attached to the optical output when the device is operational. The laser radiation can seriously damage your eyesight.

Do not enable the laser when there is no fiber attached to the optical output connector.

The laser is enabled by pressing the 'active' button close to the optical output connector on the front panel of the module. The laser is on when the green LED on the front panel of the instrument is lit.

The use of optical instruments with this product will increase eye hazard.

The laser module has a built-in safety circuitry which will disable the optical output in the case of a fault condition

Refer servicing only to qualified and authorized personnel.

Introduction

What is a Tunable Laser Source?

A Tunable Laser Source (TLS) is a laser source for which the wavelength can be varied through a specified range. The Agilent Technologies range of TLS modules also allow you to set the output power, and to choose between continuous wave or modulated power.

The Agilent Technologies range of compact TLS modules are flexible stimulus modules suitable for applications such as the testing of optical amplifiers, DWDM components, and complete DWDM systems.

Installation

The Agilent 81980A, 81940A, 81944A, 81989A, 81949A Compact TLS modules are front-loadable modules.

For a description of how to install your module, refer to “How to Fit and Remove Modules” in the Installation and Maintenance chapter of your mainframe’s User’s Guide.

Front Panels

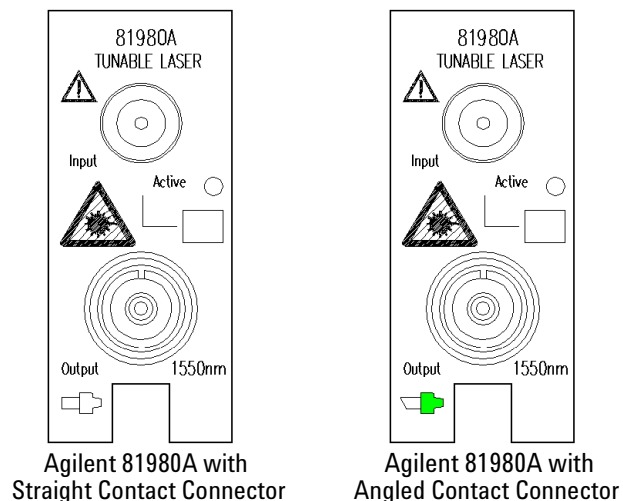
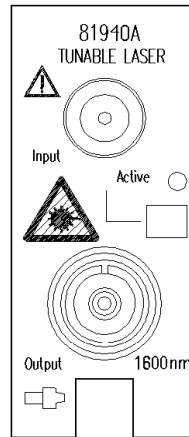
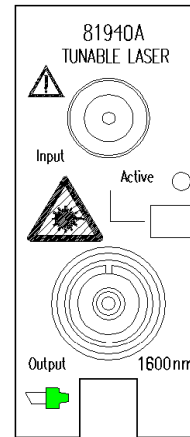

Figure 2 Agilent 81980A Compact Tunable Laser Modules



Agilent 81940A with Straight Contact Connector



Agilent 81940A with Angled Contact Connector

Figure 3 Agilent 81940A Compact Tunable Laser Modules

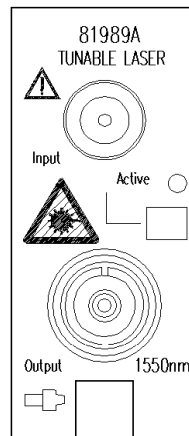

Agilent 81989A with Straight Contact Connector

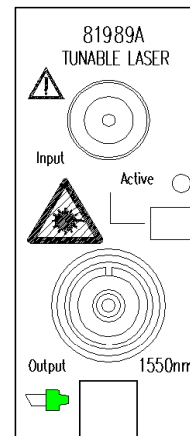

Agilent 81989A with Angled Contact Connector

Figure 4 Agilent 81989A Compact Tunable Laser Modules

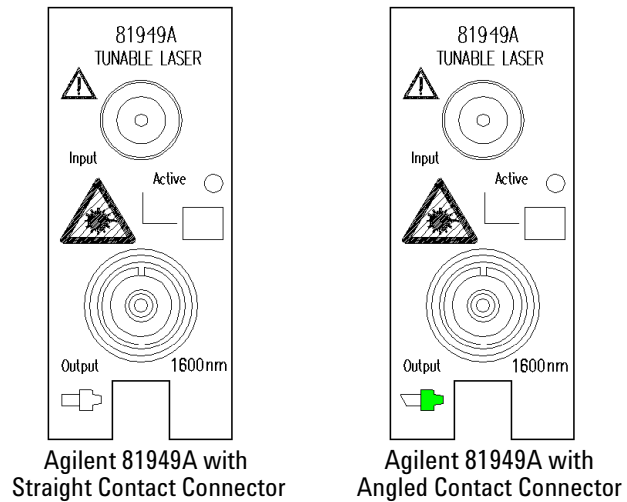

Figure 5 Agilent 81949A Compact Tunable Laser Modules

Front Panel Controls and Indicators

Switch the laser source on or off using the switch on its front panel, using the *[State]* parameter in the instrument's Graphical User Interface, or remotely using GP-IB commands. When the Active LED is lit the source is emitting radiation. When the Active LED is not lit the source is not emitting radiation.

Typical Use Models

High power compact Tunable Laser modules for S-, C- and L-band

The Agilent 81980A, 81940A, 81944A, 81989A, 81949A Compact TLS modules provide high output power up to +13 dBm.

Each module covers a total wavelength range of 110 nm, either:

- In the S and C-bands
with the high power in C-band (81980A and 81989A), or
- In the C and L-bands
with the high power in the L-band (81940A, 81944A and 81949A).

Their compact single-slot format makes them a flexible and cost-effective stimulus for single channel and multichannel DWDM applications

Device Characterization at high power levels

The high optical output power of the Agilent 81980A, 81940A, 81944A, 81989A, 81949A Compact TLS module improves the testing of all types of optical amplifiers and other active components as well as broadband passive optical components. It helps overcome losses in test setups or in the device under test itself. Thus, engineers can test optical amplifiers such as EDFAs, Raman amplifiers, SOAs and EDWAs to their limits. This tunable laser provides the high power levels required to help speed the development of innovative devices by enabling the test and measurement of nonlinear effects.

SBS suppression feature enables high launch power

A new SBS Suppression feature avoids the reflection of light induced by Stimulated Brillouin Scattering (SBS). It enables the launch of the high optical output power into long fibers without intensity modulation to avoid impairment in time-domain measurements.

Coherence Control avoids interference-induced power fluctuations

A high-frequency modulation function is used to increase the effective linewidth to avoid power fluctuations due to coherent interference effects. The modulation pattern is optimized for stable power measurements, even in the presence of reflections.

Built-in wavelength meter for active wavelength control

The 81980A, 81940A and 81944A feature a built-in wavelength meter with a closed feedback loop for enhanced wavelength accuracy. In continuous sweep mode, it allows dynamic wavelength logging to make measurements during the sweep.

Dynamic power control for excellent reproducibility

The integrated dynamic power control loop ensures a high reproducibility in power level. This allows highly repeatable measurements to reduce errors when comparing the results of several wavelength sweeps. As these modules feature mode-hop free tunability over their entire tuning range with continuous output power, they achieve highly accurate measurements over wavelength.

Continuous Sweep Mode with wavelength logging

All 819xxA modules can be operated in the stepped mode, usually used where measurements are done at particular wavelength.

The 81980A, 81940A and 81944A can also be operated in the continuous sweep mode with dynamic wavelength logging to make measurements during the wavelength sweep.

Internal Modulation

The internal modulation feature enables an efficient and simple Time-Domain Extinction (TDE) method for Erbium based optical amplifier test when used together with the external gating feature of Agilent's OSA.

It also supports the transient testing of optical amplifiers by simulating channel add and drop events.

Specifications:

For further details on specifications, see the [“Definition of Terms”](#) in [Chapter 3](#), “Specifications.”

Optical Output

Polarization Maintaining Fiber

A Polarization maintaining fiber (PMF) output is standard for Agilent 81980A, 81940A, 81944A, 81989A, 81949A Compact TLS modules.

PMF is aligned to maintain the state of polarization. A well defined state of polarization helps ensure constant measurement conditions.

The fiber is of Panda type, with TE mode in the slow axis in line with the connector key.

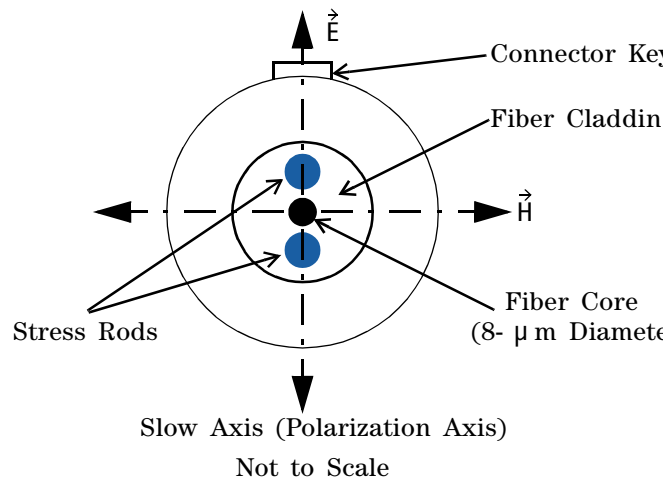

Figure 6 PMF Output Connector

See [Chapter 2](#), "Modules and Options for further details on connector interfaces and accessories.

Angled and Straight Contact Connectors

Angled contact connectors are available as an option for Agilent 81980A, 81940A, 81944A, 81989A, 81949A Compact TLS modules.

Angled contact connectors help you to control return loss, since reflected light tends to reflect into the cladding, reducing the amount of light that reflects back to the source.

CAUTION

If the contact connector on your instrument is angled, you can only use cables with angled connectors with the instrument



Figure 7 Angled and Straight Contact Connector Symbols

[Figure 7](#) shows the symbols that tell you whether the contact connector of your Tunable Laser module is angled or straight. The angled contact connector symbol is colored green.

You should connect straight contact fiber end connectors with neutral sleeves to straight contact connectors and connect angled contact fiber end connectors with green sleeves to angled contact connectors.

NOTE

Angled non-contact fiber end connectors with orange sleeves cannot be directly connected to the instrument.

See “Connector Interfaces” on page 28 for further details on connector interfaces and accessories.

Signal Input and Output

CAUTION

There is one BNC input connector on the front panel of Agilent 81980A, 81940A, 81944A, 81989A, 81949A Compact TLS modules.

An absolute maximum of ± 6 V can be applied as an external voltage to any BNC connector.



2

Accessories

The Agilent 81980A, 81940A, 81944A, 81989A, 81949A Compact TLS module are available in various configurations for the best possible match to the most common applications.

This chapter provides information on the available options and accessories.

Modules and Options	26
Modules	27
Options	27
Option 071	27
Option 072	27
Connector Interfaces	28
Option 071:	28
Option 072:	28
User's Guides	29

Modules and Options

Figure 8 shows all the options that are available for Agilent 81980A, 81940A, 81944A, 81989A, 81949A Compact TLS module, and the instruments that support these modules.

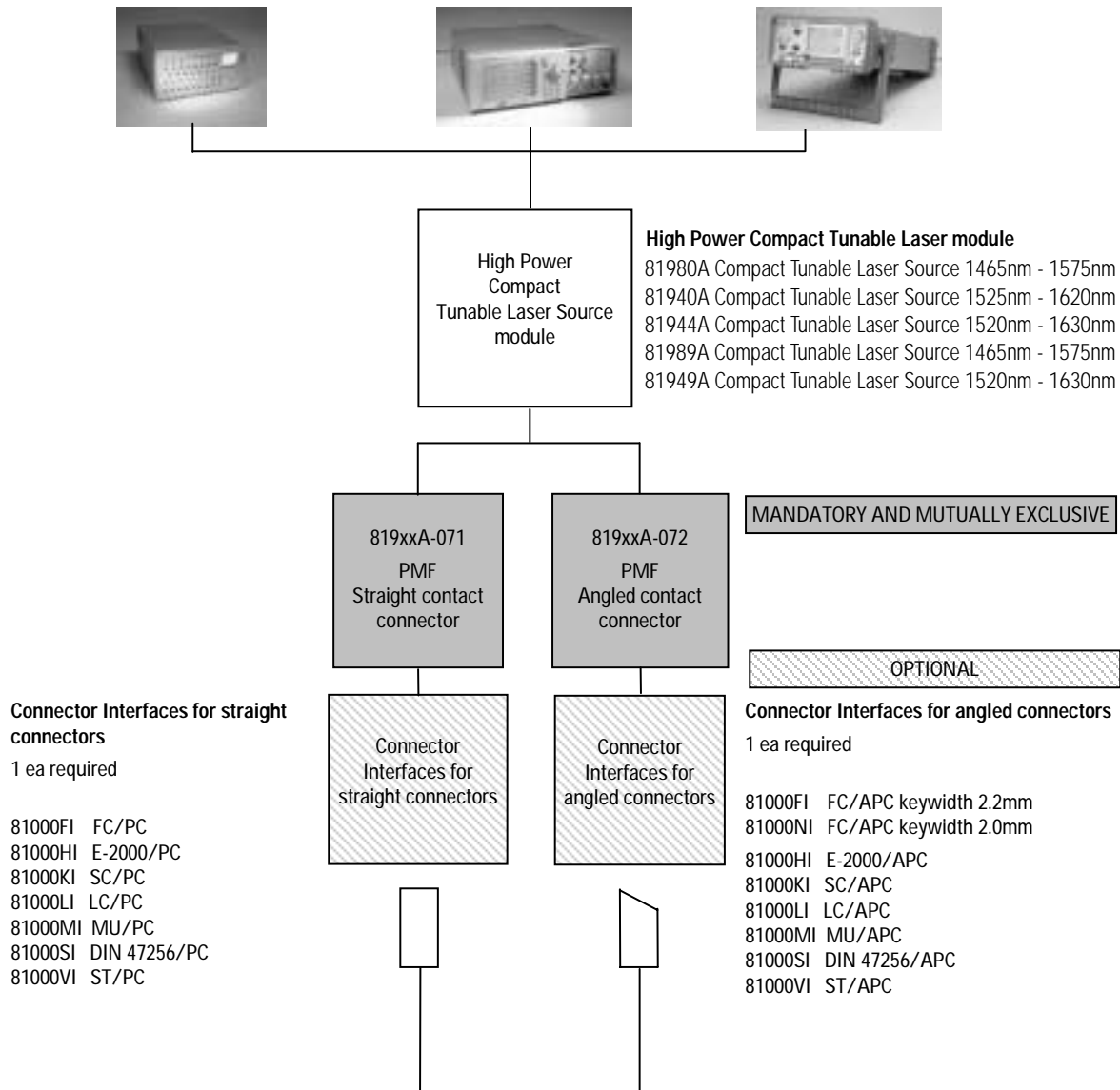

Note: 819xxA - 072 is highly recommended over 819xxA - 071 to reduce front-panel reflections, which will greatly reduce interference noise and spectral ripple in the test setup.

Figure 8 Mainframes, Tunable Laser Modules, and Options

Modules

Agilent 81980A, 81940A, 81944A, 81989A, 81949A Compact TLS module can be hosted by:

- Agilent 8163A and Agilent 8163B Lightwave Multimeters,
- Agilent 8164A and Agilent 8164B Lightwave Measurement Systems,
- Agilent 8166A and Agilent 8166B Lightwave Multichannel Systems.

Table 1 Compact Tunable Laser Modules

Model Number	Description
Agilent 81980A	High Power Compact Tunable Laser, 1465 nm - 1575 nm
Agilent 81940A	High Power Compact Tunable Laser, 1520 nm - 1630 nm
Agilent 81944A	High Power Compact Tunable Laser, 1525 nm - 1620nm, for use as part of the N3909A PMD and DGD Analyzer
Agilent 81989A	High Power Compact Tunable Laser, 1465 nm - 1575 nm
Agilent 81949A	High Power Compact Tunable Laser, 1520 nm - 1630 nm

Options

The following options are available for these Compact TLS module:

Option 071

Polarization-maintaining fiber, Panda-type, for straight contact connectors.

Option 072

Polarization-maintaining fiber, Panda-type, for angled contact connectors.

NOTE

Option 072 recommended 819xxA - 072 is highly recommended over 819xxA - 071, which will greatly reduce interference noise and spectral ripple in the test setup.

Connector Interfaces

The following connector interfaces are available for these Compact TLS module:

Option 071:

Straight Contact Connectors

If you want to use straight connectors (such as FC/PC/SPC, E-2000, SC/PC/SPC, DIN 47256 or ST) to connect to the instrument, you must do the following:

- 1 Attach your connector interface to the interface adapter.
- 2 See [Table 2](#) for a list of the available connector interfaces.

Table 2 Straight Contact Connector Interfaces

Description	Model number
FC/PC/SPC	Agilent 81000 FI
E-2000	Agilent 81000 HI
SC/PC/SPC	Agilent 81000 KI
DIN 47256 / 4108.6	Agilent 81000 SI
ST	Agilent 81000 VI

- 3 Connect your cable.

Option 072:

Angled Contact Connectors

If you want to use angled connectors (such as E-2000 APC, SC/APC, FC/APC or DIN 4108.6/4108.6) to connect to the instrument, you must do the following:

- 1 Attach your connector interface to the interface adapter.
- 2 See [Table 3](#) for a list of the available connector interfaces.

Table 3 Angled Contact Connector Interfaces

Description	Model number
E-2000 APC	Agilent 81000 HI
SC/APC	Agilent 81000 KI
FC/APC	Agilent 81000 NI
DIN 47256 / 4108.6	Agilent 81000 SI

- 3 Connect your cable.

User's Guides

The following User's Guides are applicable to these Compact TLS module:

Table 4 User's Guides

Description	Part number
Agilent 81980A, 81940A, 81944A, 81989A and 81949A Compact Tunable Laser Source modules User's Guide.	81980-90A11
Agilent 8163A/B Lightwave Multimeter, Agilent 8164A/B Lightwave Measurement System, & Agilent 8166A/B Lightwave Multichannel System User's Guide.	08164-90B15
Agilent 8163A/B Lightwave Multimeter, Agilent 8164A/B Lightwave Measurement System, & Agilent 8166A/B Lightwave Multichannel System Programming Guide.	08164-90B64

3

Specifications

Agilent 81980A, 81940A, 81944A, 81989A, 81949A Compact TLS module are produced to the ISO 9001 international quality system standard as part of Agilent’s commitment to continually increasing customer satisfaction through improved quality control.

Definition of Terms	32
General Definitions	46
Compact Tunable Laser Module Specifications	47
Conditions	53
Supplementary Performance Characteristics	54
General	56

Specifications:

Specifications apply, unless otherwise noted, for the stated environmental conditions, after warm-up, in CW mode (unmodulated output, coherence control off, SBS suppression off) and at uninterrupted line voltage.

“Constant temperature” is a stable operating temperature within ± 1 K.

Definition of Terms

This section defines terms that are used both in this chapter and in Chapter 4, "Performance Tests.

Measurement principles are indicated. Alternative measurement principles of equal value are also acceptable.

Absolute wavelength accuracy	33
Effective linewidth	33
External digital modulation - delay time	33
External analog modulation - modulation depth	34
Internal digital modulation - duty cycle	34
Internal digital modulation - rise and fall time	34
Linewidth	35
Maximum output power	36
Maximum sweep speed	36
Mode-hop free tunability	37
Mode-hop free sweeping range	37
Modulation extinction ratio	37
Operating temperature and humidity	37
Output isolation	37
Polarization extinction ratio	38
Power flatness versus wavelength	39
Power linearity	39
Power repeatability	40
Power stability	40
Relative intensity noise (RIN)	41
Relative wavelength accuracy	41
Return loss	42
SBS suppression - effective linewidth	42
SBS suppression - residual amplitude modulation (depth)	42
Side-mode suppression ratio	42
Signal to source spontaneous emission ratio	43
Signal to total source spontaneous emission ratio	44
Tuning time	44
Wavelength range	44
Wavelength repeatability	45
Wavelength resolution	45
Wavelength stability	45

Absolute wavelength accuracy

The maximum difference between the displayed wavelength and the actual wavelength of the tunable laser source. Wavelength is defined as wavelength in vacuum.

Effective linewidth

The time-averaged 3 dB width of the optical spectrum with coherence control on, expressed in Hertz.

Conditions:

As specified.

Measurement:

Using a heterodyning technique: The output of the laser under test is mixed with another laser of the same type on a wide bandwidth photodetector. The electrical noise spectrum of the photodetector current is measured with an Agilent Lightwave signal analyzer, and the linewidth calculated from the heterodyne spectrum (Lightwave signal analyzer settings: resolution bandwidth 1 MHz, video bandwidth 10 kHz, sweep time 20 ms, single scan).

External digital modulation - delay time

Specifies the time between the falling edge of the external trigger (when reaching logical zero) and the falling edge of the optical pulse (at 10% of its original value).

Conditions:

Modulation input signal and duty cycle as specified, modulation frequency as specified.

Measurement:

Using a photoreceiver (of sufficient bandwidth) and an oscilloscope.

External analog modulation - modulation depth

Specifies half the peak-to-peak optical power change divided by the average optical power for a sinusoidal input voltage at the analog modulation input. The average power is defined as half the sum of maximum and minimum power.

Conditions:

Modulation input signal as specified, modulation frequency as specified.

NOTE

Modulation depth is a value between 0 and 100%

Measurement:

Using a photoreceiver (of sufficient bandwidth) and an oscilloscope.

Internal digital modulation - duty cycle

When the laser is internally (digitally) modulated at a frequency f , the duty cycle is specified as $\tau_{on} \times f$, where τ_{on} is the time the laser is on during one modulation cycle (expressed in percent).

Conditions:

Modulation frequency as specified.

Measurement:

Using a photoreceiver (of sufficient bandwidth) and an oscilloscope.

Internal digital modulation - rise and fall time

Fall time specifies the time for the optical pulse to fall from 90% to 10% of its original power value.

Rise time specifies the time for the optical pulse to rise from 10% to 90% of its final power value.

Conditions:

Modulation frequency as specified.

Measurement:

Using a photoreceiver (of sufficient bandwidth) and an oscilloscope.

Linewidth

The 3 dB width of the optical spectrum, expressed in Hertz.

Conditions:

Coherence control off.

Measurement:

Using a self-heterodyning technique: The output of the laser under test is sent through a Mach-Zehnder interferometer in which the length difference of the two arms is longer than the coherence length of the laser. The electrical noise spectrum of the photodetector current is measured with Agilent lightwave signal analyzer, and the linewidth is calculated from the heterodyne spectrum.

Alternatively, Using a heterodyning technique: The output of the laser under test is mixed with another laser of the same type on a wide bandwidth photodetector. The electrical noise spectrum of the photodetector current is measured with Agilent Lightwave signal analyzer, and the linewidth is calculated from the heterodyne spectrum. (Lightwave signal analyzer settings: resolution bandwidth 1 MHz, video bandwidth 10 kHz, sweep time 20 ms, single scan).

Maximum output power

The maximum achievable output power of the tunable laser source and the maximum output power for which the tunable laser source specifications apply.

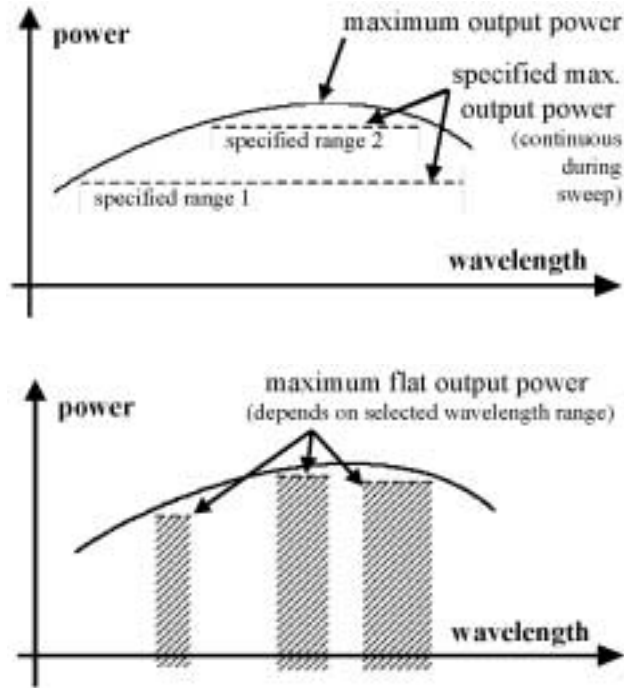

Figure 9 Maximum Output Power vs. Wavelength, Maximum Flat Output Power vs. Wavelength

Conditions:

As specified.

Measurement:

Using a power meter at the end of a single-mode fiber patchcord.

Maximum sweep speed

The maximum selectable sweep speed in ["Continuous sweep mode"](#).

NOTE

To ensure constant speed within the chosen wavelength range the actual wavelength range is automatically expanded by the tunable laser source to account for acceleration and deceleration effects

Mode-hop free tunability

Specifies the wavelength range for which no abrupt wavelength change occurs in “[Stepped mode](#)”. Abrupt change is defined as change of more than the specified “[Absolute wavelength accuracy](#)”.

Mode-hop free sweeping range

Specifies the wavelength range for which no abrupt wavelength change occurs in “[Continuous sweep mode](#)”. Abrupt change is defined as change of more than the specified “[Absolute wavelength accuracy](#)”.

Conditions:

Output power as specified. Ambient temperature as specified.

Modulation extinction ratio

The ratio of total power in the on-state to total power in the off-state, expressed in dB.

Conditions:

Internal or external modulation.

Operating temperature and humidity

The ambient temperature range and humidity range of the tunable laser source for which the specifications apply.

NOTE

If the optical mainframe hosting the tunable laser source module is rack-mounted the temperature and humidity within the rack apply.

Output isolation

The insertion loss of the built-in isolator in the backward direction.

Measurement:

This characteristic cannot be measured from outside the module. It is based on known isolator characteristics.

Polarization extinction ratio

NOTE

The 81944A compact tunable laser source has a built-in polarization controller which alters the polarization of the output.

The information here about the polarization extinction ratio does not apply to the 81944A.

Specifies the ratio of the optical power in the slow axis of a connected polarization-maintaining fiber to optical power in the fast axis, expressed in dB

Conditions:

Applicable to tunable laser sources utilizing polarization maintaining fiber that has its TE mode in the slow axis and aligned with the connector key.

Measurement:

Using a polarization analyzer at the end of a polarization-maintaining patchcord, by sweeping the wavelength to create circular traces on the Poincaré sphere. Calculate the polarization extinction ratio from the diameters of these circles.

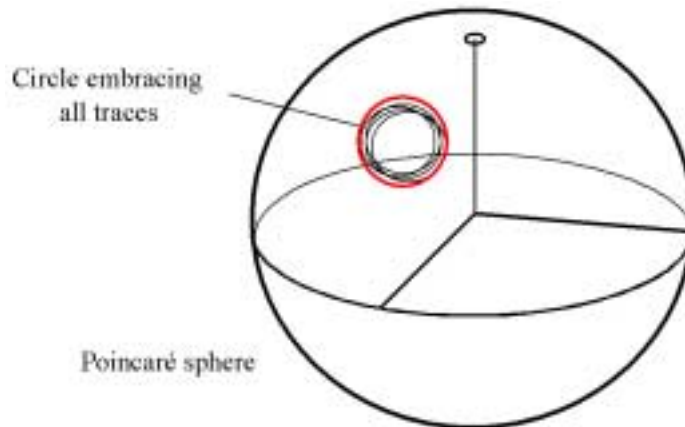

Figure 10 Circular traces on the Poincaré sphere used to calculate polarization extinction ratio.

Power flatness versus wavelength

Specifies \pm half the span (in dB) between the maximum and the minimum actual power levels of the tunable laser source when changing the wavelength.

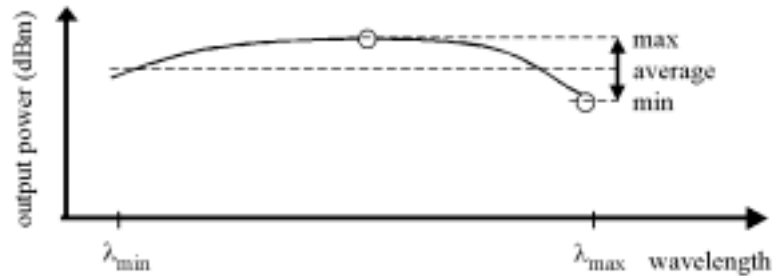

Figure 11 Power flatness vs. wavelength.

Conditions:

Uninterrupted tunable laser source output power, constant power setting, constant temperature.

Power linearity

When measuring ratios (in dB) between the displayed power level and the actual power level for different output power levels of the tunable laser source, the power linearity is \pm half the difference between the maximum and the minimum value of all ratios.

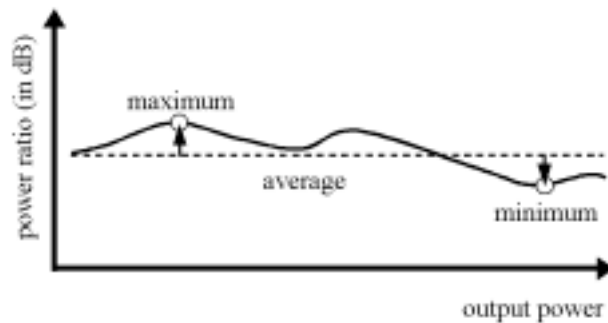

Figure 12 Power linearity.

Conditions:

Uninterrupted tunable laser source output power, constant wavelength setting, constant temperature.

Power repeatability

The uncertainty in reproducing the power level after changing and re-setting the power level. The power repeatability is \pm half the span between the highest and lowest actual power (in dBm).

Conditions:

Uninterrupted tunable laser source output power, constant wavelength setting, constant temperature.

NOTE

The long-term power repeatability can be obtained by taking the power repeatability and power stability into account.

Power stability

Specifies the change of the power level of the tunable laser source over time, expressed as \pm half the span (in dB) between the highest and lowest actual power.

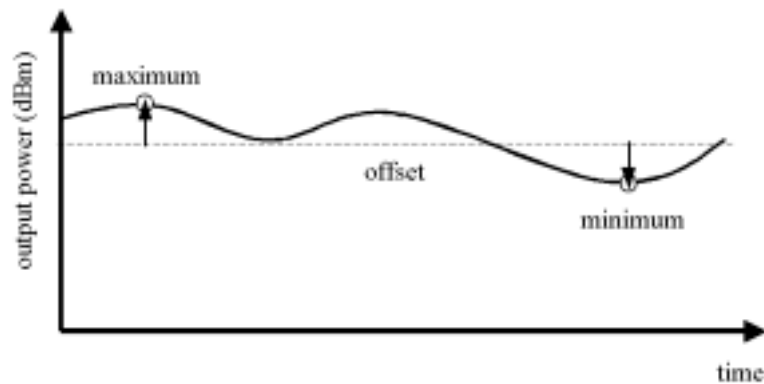

Figure 13 Power stability.

Conditions:

Time span as specified. Uninterrupted tunable laser source output power, constant wavelength and power level settings, constant temperature.

Relative intensity noise (RIN)

Specifies the ratio between the mean-square of the optical power fluctuation amplitude $\Delta P_{f,B}$ within a specified frequency range f and for bandwidth B , and the square of the average optical power P_{avg} .

$$RIN = \frac{\langle \Delta P_{f,B}^2 \rangle}{P_{\text{avg}}^2 \cdot B} \left[\frac{1}{\text{Hz}} \right]$$

RIN, if expressed as “dB/Hz”, is calculated by:

$$RIN_{\text{dB/Hz}} = 10 \cdot \log \left(\frac{\Delta P_{f,B}^2 \cdot 1\text{Hz}}{P_{\text{avg}}^2 \cdot B} \right)$$

Conditions:

As specified.

Measurement:

Using an Agilent Lightwave signal analyzer and bandwidth set to 3 MHz.

Relative wavelength accuracy

When randomly changing the wavelength of the tunable laser source and measuring the differences between the displayed and the actual wavelength, the relative wavelength accuracy is \pm half the span between the maximum and the minimum value of all differences.

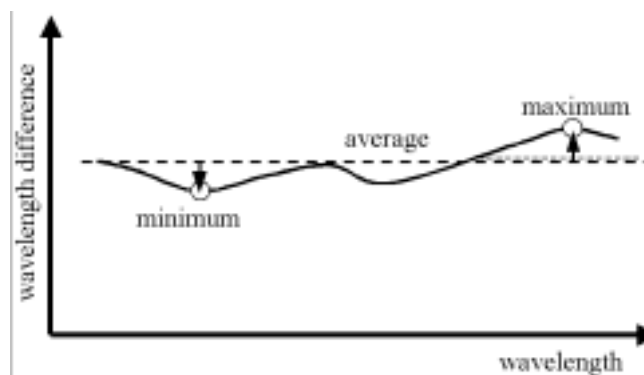

Figure 14 Relative wavelength accuracy.

Conditions: Uninterrupted tunable laser source output power, constant power setting, constant temperature.

Return loss

Specifies the ratio of the optical power incident to the tunable laser source output port at the wavelength set on the tunable laser source, to the power reflected from the tunable laser source output port.

Conditions:

Tunable laser source output off.

SBS suppression - effective linewidth

Specifies the peak-to-peak change of the periodically modulated wavelength resulting from the SBS suppression feature, expressed in Hertz.

SBS suppression - residual amplitude modulation (depth)

Specifies the peak-to-peak difference of the periodically modulated optical power resulting from the SBS suppression feature, divided by the sum of minimum power P_{\min} and maximum power P_{\max} .

$$\text{modulation depth} = \frac{P_{\max} - P_{\min}}{P_{\max} + P_{\min}}$$

NOTE

Modulation depth is a value between 0 and 100%

Side-mode suppression ratio

The ratio of optical power in the main mode to the optical power of the highest sidemode, expressed in dB:

$$SSR_{\text{dB}} = 10 \cdot \log \left(\frac{P_{\text{signal}}}{P_{\text{highest sidemode}}} \right)$$

Conditions:

As specified.

Measurement:

Using the Agilent Lightwave signal analyzer, by analyzing the heterodyning between the main signal and the highest sidemode.

Signal to source spontaneous emission ratio

Specifies the ratio between signal power and maximum spontaneous emission (SSE) power. The SSE power is determined in a specified bandwidth within a ± 3 nm window around the signal wavelength, where ± 1 nm around the signal wavelength are excluded, expressed in dB per nm.

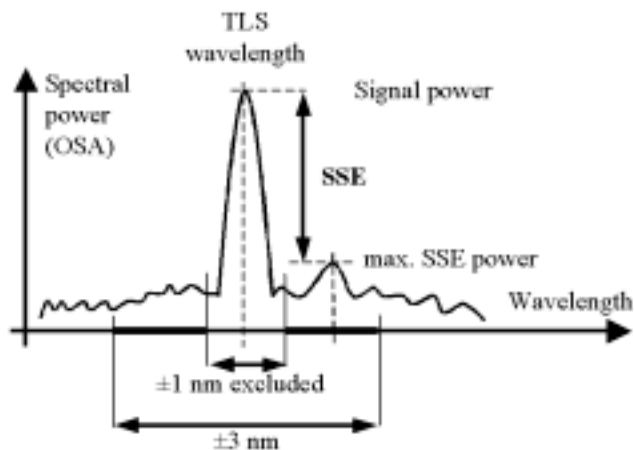

Figure 15 Signal to source spontaneous emission ratio.

Conditions:

As specified.

Measurement:

Using an optical spectrum analyzer at 0.5 nm resolution bandwidth (to address the possibility of higher SSE within a narrower bandwidth), then extrapolated to 1 nm bandwidth.

Signal to total source spontaneous emission ratio

The ratio of signal power to total spontaneous emission power within the specified wavelength range, expressed in dB.

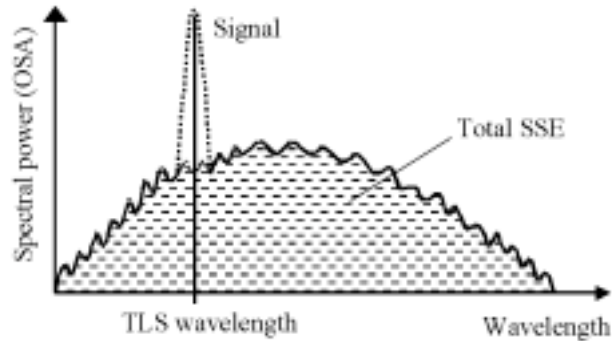

Figure 16 Signal to total source spontaneous emission ratio.

Conditions:

As specified.

Measurement:

Using an optical spectrum analyzer, by integrating the source spontaneous emission and excluding the remnant signal.

Tuning time

Specifies the time needed to tune to another wavelength in “[Stepped mode](#)” .

Conditions:

Tuning distance as specified. The time is measured from sending the command to the TLS until the tuning operation has finished.

Wavelength range

The range of wavelengths for which the specifications apply (if not otherwise specified).

Wavelength repeatability

The random uncertainty in reproducing a wavelength of the tunable laser source after changing and re-setting the wavelength. The wavelength repeatability is \pm half the span between the maximum and the minimum of all actual values of this wavelength.

Conditions:

Uninterrupted tunable laser source output power, constant power setting, constant temperature.

NOTE

The **long-term wavelength repeatability** can be obtained by taking the wavelength repeatability and wavelength stability into account.

Wavelength resolution

The smallest selectable wavelength increment or decrement.

Wavelength stability

Specifies the change of the actual wavelength of the tunable laser source over time, expressed as \pm half the span between the maximum and minimum of all wavelengths.

Conditions:

Time span as specified, uninterrupted tunable laser source output power, constant wavelength and power level settings, constant temperature.

General Definitions

Dynamic conditions

The dynamic specifications describe the behavior of the instrument in “Continuous sweep mode” .

Static conditions

The static specifications describe the behavior of the instrument in “Stepped mode” .

Logged wavelength

This is the wavelength measured and recorded by the internal wavelength meter during a sweep at the corresponding trigger signal. This recorded wavelength can be read with the logging function.

NOTE

The logged wavelength positions during a sweep depend on environmental conditions and may slightly differ between repeated sweeps.

Stepped mode

In stepped mode the tunable laser source is operated statically, so that a user's measurement is made at a fixed wavelength of the tunable laser source. When tuning to a new wavelength the static specifications are valid after completion of the tuning operation.

Continuous sweep mode

In continuous sweep mode the tunable laser source is operated dynamically, so that a user's measurement is made while the wavelength of the tunable laser source changes in a defined way (given by start wavelength, end wavelength and sweep speed). During a continuous sweep the dynamic specifications and the “Logged wavelength” applies.

Compact Tunable Laser Module Specifications

Agilent 81980A Compact Tunable Laser Source, 1465 nm to 1575 nm. . .	48
Agilent 81940A Compact Tunable Laser Source, 1520 nm to 1630 nm. . .	49
Agilent 81944A Compact Tunable Laser Source, 1525 nm to 1620 nm. . .	50
Agilent 81989A Compact Tunable Laser Source, 1465 nm to 1575 nm. . .	51
Agilent 81949A Compact Tunable Laser Source, 1520 nm to 1630 nm. . .	52
Conditions	53
Supplementary Performance Characteristics	54
General.	56

Specifications:

Describe guaranteed product performance that is valid under stated conditions. The confidence level is 95%, as recommended by the ISO standard.

Typical Values:

Describe product performance that is usually met but not guaranteed.

Supplementary performance characteristics:

Describe the module's non-warranted typical performance.

Because of the modular nature of the instrument, these performance specifications apply to these modules rather than the mainframe unit.

Agilent 81980A Compact Tunable Laser Source, 1465 nm to 1575 nm	
	Agilent 81980A 1.0
Wavelength range	1465 nm to 1575 nm
Wavelength resolution	1 pm, 125 MHz at 1550 nm
Mode-hop free tunability	full wavelength range
Maximum sweep speed	50 nm/s
Absolute wavelength accuracy	± 20 pm, typ. ± 5 pm ^[1]
Relative wavelength accuracy	± 10 pm, typ. ± 5 pm
Wavelength repeatability	± 2.5 pm, typ. ± 1 pm
Wavelength stability (typ., over 24 h) ^[4]	± 2.5 pm
Linewidth (typ.), coherence control off Effective linewidth (typ.), coherence control on ^[2]	100 kHz > 50 MHz (1525 nm - 1575 nm)
Maximum output power (continuous power during tuning)	$\geq +14.5$ dBm peak (typ.) $\geq +13$ dBm (1525 nm - 1575 nm) $\geq +10$ dBm (1465 nm - 1575 nm)
Power linearity	± 0.1 dB
Power stability ^[4]	± 0.01 dB over 1 hour typ. ± 0.0075 dB over 1 hour typ. ± 0.03 dB over 24 hours.
Power flatness versus wavelength	± 0.2 dB, typ. ± 0.1 dB (1525 nm - 1575 nm) ± 0.3 dB, typ. ± 0.15 dB (full range)
Power repeatability (typ.)	± 0.01 dB
Side-mode suppression ratio (typ.) ^[2]	≥ 50 dB
Signal to source spontaneous emission ratio ^[2]	≥ 45 dB/nm ^[3] ≥ 48 dB/nm (1525 nm - 1575 nm) ^[3] typ. 58 dB/0.1 nm (1525 nm - 1575 nm) ^[5]
Signal to total source spontaneous emission ratio (typ.) ^[2]	≥ 25 dB ≥ 30 dB (1525 nm - 1575 nm)
Relative intensity noise (RIN) (typ.) ^[2]	- 145 dB/Hz (0.1 GHz - 6 GHz)
Dimensions (H x W x D)	75 mm x 32 mm x 335 mm (2.8" x 1.3" x 13.2")
Weight	0.95 kg

^[1] At day of calibration.

^[2] At maximum output power as specified per wavelength range.

^[3] Value for 1 nm resolution bandwidth.

^[4] At constant temperature ± 0.5 K

^[5] Value for 0.1 nm resolution bandwidth.

Agilent 81940A Compact Tunable Laser Source, 1520 nm to 1630 nm	
	Agilent 81940A 1.0
Wavelength range	1520 nm to 1630 nm
Wavelength resolution	1 pm, 125 MHz at 1550 nm
Mode-hop free tunability	full wavelength range
Maximum sweep speed	50 nm/s
Absolute wavelength accuracy	± 20 pm, typ. ± 5 pm ^[1]
Relative wavelength accuracy	± 10 pm, typ. ± 5 pm
Wavelength repeatability	± 2.5 pm, typ. ± 1 pm
Wavelength stability (typ., over 24 h) ^[4]	± 2.5 pm
Linewidth (typ.), coherence control off Effective linewidth (typ.), coherence control on ^[2]	100 kHz > 50 MHz (1570 nm - 1620 nm)
Maximum output power (continuous power during tuning)	$\geq +14.5$ dBm peak (typ.) $\geq +13$ dBm (1570 nm - 1620 nm) $\geq +10$ dBm (1520 nm - 1630 nm)
Power linearity	± 0.1 dB
Power stability ^[4]	± 0.01 dB over 1 hour typ. ± 0.0075 dB over 1 hour typ. ± 0.03 dB over 24 hours.
Power flatness versus wavelength	± 0.2 dB, typ. ± 0.1 dB (1570 nm - 1620 nm) ± 0.3 dB, typ. ± 0.15 dB (full range)
Power repeatability (typ.)	± 0.01 dB
Side-mode suppression ratio (typ.) ^[2]	≥ 50 dB
Signal to source spontaneous emission ratio ^[2]	≥ 45 dB/nm ^[3] ≥ 48 dB/nm (1570 nm - 1620 nm) ^[3] typ. 58 dB/0.1 nm (1570 nm - 1620 nm) ^[5]
Signal to total source spontaneous emission ratio (typ.) ^[2]	≥ 25 dB ≥ 30 dB (1570 nm - 1620 nm)
Relative intensity noise (RIN) (typ.) ^[2]	- 145 dB/Hz (0.1 GHz - 6 GHz)
Dimensions (H x W x D)	75 mm x 32 mm x 335 mm (2.8" x 1.3" x 13.2")
Weight	0.95 kg

^[1] At day of calibration.

^[2] At maximum output power as specified per wavelength range.

^[3] Value for 1 nm resolution bandwidth.

^[4] At constant temperature ± 0.5 K

^[5] Value for 0.1 nm resolution bandwidth.

Agilent 81944A Compact Tunable Laser Source, 1525 nm to 1620 nm	
This laser source is used in combination with Agilent's PMD test set N3909A	
	Agilent 81944A 1.1
Wavelength range	1525 nm to 1620 nm
Wavelength resolution	1 pm, 125 MHz at 1550 nm
Mode-hop free tunability	full wavelength range
Running Time (typ.)	50 nm/s
Absolute wavelength accuracy	± 20 pm, typ. ± 5 pm ^[1]
Relative wavelength accuracy	± 10 pm, typ. ± 5 pm
Wavelength repeatability	± 2.5 pm, typ. ± 1 pm
Wavelength stability (typ., over 24h) ^[4]	± 2.5 pm
Linewidth (typ.), coherence control off Effective linewidth (typ.), coherence control on ^[2]	100 kHz > 50 MHz (1570 nm - 1620 nm)
Maximum output power (mean value) (continuous power during tuning)	$\geq +10.5$ dBm typ. (1525 nm to 1620 nm) $\geq +9.5$ dBm (1525 nm to 1620 nm)
Side-mode suppression ratio (typ.) ^[2]	≥ 50 dB
Signal to source spontaneous emission ratio ^[2]	≥ 45 dB/nm ^[3]
Signal to total source spontaneous emission ratio (typ.) ^[2]	≥ 25 dB
Relative intensity noise (RIN) (typ.) ^[2]	- 145 dB/Hz (0.1 GHz - 6 GHz)
Dimensions (H x W x D)	75 mm x 64 mm x 335 mm (2.8" x 2.6" x 13.2")
Weight	1.8 kg

^[1] At day of calibration.

^[2] At maximum output power as specified.

^[3] Value for 1 nm resolution bandwidth

^[4] At constant temperature ± 0.5 K

^[5] Value for 0.1 nm resolution bandwidth.

Agilent 81989A Compact Tunable Laser Source, 1465 nm to 1575 nm	
	Agilent 81989A 1.0
Wavelength range	1465 nm to 1575 nm
Wavelength resolution	5 pm, 625 MHz at 1550 nm
Mode-hop free tunability	full wavelength range
Tuning time (typ.)	3 s for 100 nm
Absolute wavelength accuracy	±100 pm
Relative wavelength accuracy	±50 pm
Wavelength repeatability	±5 pm
Wavelength stability (typ., over 24 h) ^[3]	±5 pm
Linewidth (typ.), coherence control off Effective linewidth (typ.), coherence control on ^[1]	100 kHz > 50 MHz (1525 nm - 1575 nm)
Maximum output power (continuous power during tuning)	≥ +14.5 dBm peak (typ.) ≥ +13 dBm (1525 nm - 1575 nm) ≥ +10 dBm (1465 nm - 1575 nm)
Power linearity	±0.1 dB
Power stability ^[3]	±0.01 dB over 1 hour typ. ±0.0075 dB over 1 hour typ. ±0.03 dB over 24 hours.
Power flatness versus wavelength	±0.2 dB, typ. ±0.1 dB (1525 nm - 1575 nm) ±0.3 dB, typ. ±0.15 dB (full range)
Power repeatability (typ.)	±0.01 dB
Side-mode suppression ratio (typ.) ^[1]	≥ 50 dB
Signal to source spontaneous emission ratio ^[2]	≥ 45 dB/nm ^[2] ≥ 48 dB/nm (1525 nm - 1575 nm) ^[2] typ. 58 dB/0.1 nm (1525 nm - 1575 nm) ^[4]
Signal to total source spontaneous emission ratio (typ.) ^[1]	≥ 25 dB ≥ 30 dB (1525 nm - 1575 nm)
Relative intensity noise (RIN) (typ.) ^[1]	- 145 dB/Hz (0.1 GHz - 6 GHz)
Dimensions (H x W x D)	75 mm x 32 mm x 335 mm (2.8" x 1.3" x 13.2")
Weight	0.95 kg

^[1] At maximum output power as specified per wavelength range.

^[2] Value for 1 nm resolution bandwidth.

^[3] At constant temperature ± 0.5 K

^[4] Value for 0.1 nm resolution bandwidth.

Agilent 81949A Compact Tunable Laser Source, 1520 nm to 1630 nm	
	Agilent 81949A 1.0
Wavelength range	1520 nm to 1630 nm
Wavelength resolution	5 pm, 625 MHz at 1550 nm
Mode-hop free tunability	full wavelength range
Tuning time (typ.)	3 s for 100 nm
Absolute wavelength accuracy	±100 pm
Relative wavelength accuracy	±50 pm
Wavelength repeatability	±5 pm
Wavelength stability (typ., over 24 h) ^[3]	±5 pm
Linewidth (typ.), coherence control off Effective linewidth (typ.), coherence control on ^[1]	100 kHz > 50 MHz (1570 nm - 1620 nm)
Maximum output power (continuous power during sweeping)	≥ +14.5 dBm peak (typ.) ≥ +13 dBm (1570 nm - 1620 nm) ≥ +10 dBm (1520 nm - 1630 nm)
Power linearity	±0.1 dB
Power stability ^[3]	±0.01 dB over 1 hour typ. ±0.0075 dB over 1 hour typ. ±0.03 dB over 24 hours.
Power flatness versus wavelength	±0.2 dB, typ. ±0.1 dB (1570 nm - 1620 nm) ±0.3 dB, typ. ±0.15 dB (full range)
Power repeatability (typ.)	±0.01 dB
Side-mode suppression ratio (typ.) ^[1]	≥ 50 dB
Signal to source spontaneous emission ratio ^[1]	≥ 45 dB/nm ^[2] ≥ 48 dB/nm (1570 nm - 1620 nm) ^[2] typ. 58 dB/0.1 nm (1570 nm - 1620 nm) ^[4]
Signal to total source spontaneous emission ratio (typ.) ^[1]	≥ 25 dB ≥ 30 dB (1570 nm - 1620 nm)
Relative intensity noise (RIN) (typ.) ^[1]	- 145 dB/Hz (0.1 GHz - 6 GHz)
Dimensions (H x W x D)	75 mm x 32 mm x 335 mm (2.8" x 1.3" x 13.2")
Weight	0.95 kg

^[1] At maximum output power as specified per wavelength range.

^[2] Value for 1 nm resolution bandwidth.

^[3] At constant temperature ± 0.5 K

^[4] Value for 0.1 nm resolution bandwidth.

Conditions

Storage Temperature:

-40 °C to +70 °C

Operating Temperature:

+10 °C to +35 °C

Humidity:

< 80% R.H. at 10 °C to 35 °C

Warm-up time:

1 h

immediate operation after boot-up

Output Power:

Specifications are valid at output power $\geq +5$ dBm.

Specifications are valid in non-condensing conditions, in CW operation.

Supplementary Performance Characteristics

Modulation:

Internal digital modulation ^[1]

50% duty cycle
200 Hz to 1 MHz (extinction > 30 dB)
rise and fall time < 100 ns.

Modulation output (mainframe):

TTL reference signal

External digital modulation ^[1]

> 45% duty cycle, fall time
<300 ns, 200 Hz to 1 MHz

Modulation input (mainframe):

TTL signal

External analog modulation

≥ 15% modulation depth,
5 kHz to 1 MHz

Modulation input (mainframe):

5 V_{p-p}

Coherence Control:

For measurements on components with 2 m long patchcords and connectors with 14 dB return loss, the effective linewidth results in a typical power stability of < ±0.025 dB over 1 minute by drastically reducing interference effects in the test setup.

SBS Suppression:

Effective linewidth: 500 MHz
Residual amplitude modulation: <±0.5%

^[1] Displayed wavelength represents average wavelength while digital modulation is active.

**Continuous Sweep Mode
(Agilent 81980A, 81940A and 81944A)**

Mode-hop free sweeping:

Full wavelength range at flat output power $\geq +10$ dBm

Ambient temperature within $+20$ °C and $+30$ °C

General

Output Isolation (typ.):

50 dB. ^[2]

Return Loss (typ.):

60 dB (option 072)

40 dB (option 071)

Wavelength stability (typ., over 1 minute):

(typ., over 1 min): ± 0.5 pm

Polarization Maintaining Fiber

(Options 071, 072)

Fiber type:

Panda. ^[2]

Orientation:

TE mode in slow axis, in line with connector key. ^[2]

Polarization extinction ratio:

16 dB typ. ^[2]

Recommended re-calibration period:

2 years.

Connector Option: (Must)

Tunable Laser must be ordered with one connector option.

Option 071:

PMF ^[3], straight contact output connector.

Option 072:

PMF ^[3], angled contact output connector.

Connector Interface:

One Agilent 81000xl-series connector interface is required.

^[2] Does not apply to 81944A.

^[3] 81944A: Standard SMF fiber used.

4

Performance Tests

The procedures in this chapter test the optical performance of Agilent 81980A, 81940A, 81944A, 81989A, 81949A Compact TLS module. The complete specifications to which each module is tested are given in “Specifications” on page 31.

All tests can be performed without access to the interior of the module. The performance tests refer specifically to tests using the listed test equipment and to the associated figures and descriptions of the test setups.

Required Test Equipment	58
Test Record	59
Performance Test Instructions.....	60
General test Setup	60
Wavelength Tests	61
Wavelength Meter Settings for all Wavelength Tests	61
Wavelength Accuracy	62
Absolute and Relative Wavelength Accuracy	62
Mode-Hop Free Tuning.....	66
Wavelength Repeatability	67
Power Tests.....	69
Maximum Output Power	69
Power Linearity	74
Power Flatness versus Wavelength.....	77
Power Stability	80
Signal-to-Source Spontaneous Emission Ratio	83
Optional Performance Tests	86
Signal-to-Total-Source Spontaneous Emission Ratio	86
Test Records	90

Required Test Equipment

The equipment required for the performance test is listed in [Table 5](#). Any equipment that satisfies the critical specifications of the equipment given in [Table 5](#) may be substituted for the recommended models.

Table 5 Equipment Required

Instrument/Accessory	Description	#071	#072
Agilent 86142B ^[1]	Optical Spectrum analyzer	1	1
Agilent 8164A/B	Lightwave Measurement System	1	1
Agilent 86120C ^[2]	Multi-Wavelength meter	1	1
Agilent 81618A or 81619A	Optical Head Interface Module	1	1
Agilent 81626B #C01	Standard Optical Head	1	1
Agilent 81000SA	DIN 47256/4108 Connector Adapter	1	1
Agilent 81000AI	HMS-10 Connector Interface	1	
Agilent 81000SI	DIN 47256/4108 Connector Interface	1	1
Agilent 81000FI	FC/PC Connector Interface	1	1
Agilent 81101AC	Diamond HMS-10 — Diamond HMS-10 Patchcord	1	
Agilent 81101PC	Diamond HMS-10 — Agilent FC/PC Patchcord	1	
Agilent 81113PC	Diamond HMS-10 — Agilent FC/Super PC Patchcord	1	1
Agilent 81113SC	Diamond HMS-10 — Agilent DIN 47256/4108 Patchcord		1

^[1] You can use the HP 71452B or HP 71450A #100 instead of the Agilent 86142B.

^[2] You can use the Agilent 86120B or 86122A or Burleigh WA-1500 Wavemeter instead of the Agilent 86120C.

Test Record

Results of the performance test may be tabulated on the Test Record provided at the end of the test procedures. It is recommended that you fill out the Test Record and refer to it while executing the test. Since the test limits and setup information are printed on the Test Record for easy reference, the record can also be used as an abbreviated test procedure (if you are already familiar with the test procedure). The Test Record can also be used as a permanent record and may be reproduced without written permission from Agilent Technologies.

Test Failure

Always ensure that you use the correct cables and adapters, and that all connectors are undamaged and extremely clean.

If an Agilent 81980A, 81940A, 81944A, 81989A, 81949A Compact TLS module fails any performance test, return it to the nearest Agilent Technologies Sales/Service Office for repair.

Instrument Specification

Specifications are the performance characteristics of the instrument that are certified. These specifications, listed in “Compact Tunable Laser Module Specifications” on page 47 are the performance standards or limits against which an Agilent 81980A, 81940A, 81944A, 81989A, 81949A Compact TLS module can be tested.

The specifications also list some “[Supplementary Performance Characteristics](#)” of the Agilent 81980A, 81940A, 81944A, 81989A, 81949A Compact TLS module on page 54. Supplementary Performance Characteristics should be regarded as additional information.

Any changes to the specification due to manufacturing changes, design, or traceability to the National Institute of Standards and Technology (NIST), will be covered in a manual change supplement, or revised manual. Such specifications supersede any that were previously published.

Performance Test Instructions

NOTE**Environment**

- Make sure that all fiber connections are clean.
 - Turn the instruments on, enable the laser and allow the instruments to warm up.
 - Ensure that the Device Under Test (DUT) and all the test equipment is held within the environmental specifications given in “Compact Tunable Laser Module Specifications” on page 47.
-

General test Setup

Insert your Compact Tunable Laser Source from the front of Slot 1 of the Agilent 8164A/B Lightwave Measurement System.

Wavelength Tests

NOTE

Zeroing Zero the Compact Tunable Laser Source before performing wavelength tests.

- Move to Channel 1, press [Menu], select < λ Zeroing>

Zeroing takes approximately 2 minutes.

Connect the Compact Tunable Laser Source module to the Wavelength Meter as shown in [Figure 17](#).

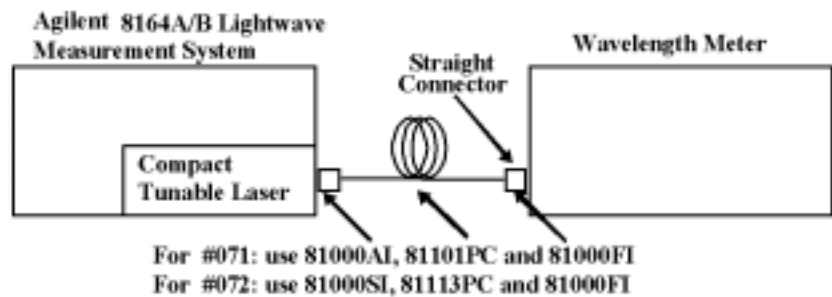

Figure 17 Test Setup for Wavelength Tests

Wavelength Meter Settings for all Wavelength Tests

Set the Wavelength meter:

- Set **Display** to **Wavelength**,
- Set **Medium** to **Vacuum**,
- Set **Resolution** to **Auto**,
- Set **Averaging** to **On**,
- Set **Input Attenuation** to **Auto**.

Wavelength Accuracy

The procedures in this section show how to calculate the Relative Wavelength Accuracy, Absolute Wavelength Accuracy, Mode-hop Free Tuning, and Wavelength Repeatability results.

Absolute and Relative Wavelength Accuracy

For definitions, see “Absolute wavelength accuracy” on page 33 and “Relative wavelength accuracy” on page 41.

Measurement Principle

The TLS is set to certain wavelengths and the actual wavelength is measured using a well-calibrated wavelength meter. Ideally, the displayed and measured wavelengths should coincide. The difference between the displayed and measured (actual) wavelength is the Absolute Wavelength Accuracy.

Relative Wavelength Accuracy describes the instrument's ability to generate precise wavelength steps. For example, if the wavelength setting is changed by 1 nm, the actual wavelength should change by 1 nm. To test for deviations from this ideal, the tunable laser source is set to various wavelengths, and the actual wavelength is measured using a wavelength meter.

The measurement of the relative wavelength accuracy includes the measurement of absolute wavelength accuracy. The absolute wavelength accuracy measurement program generates all the results needed for the calculation of the relative wavelength accuracy.

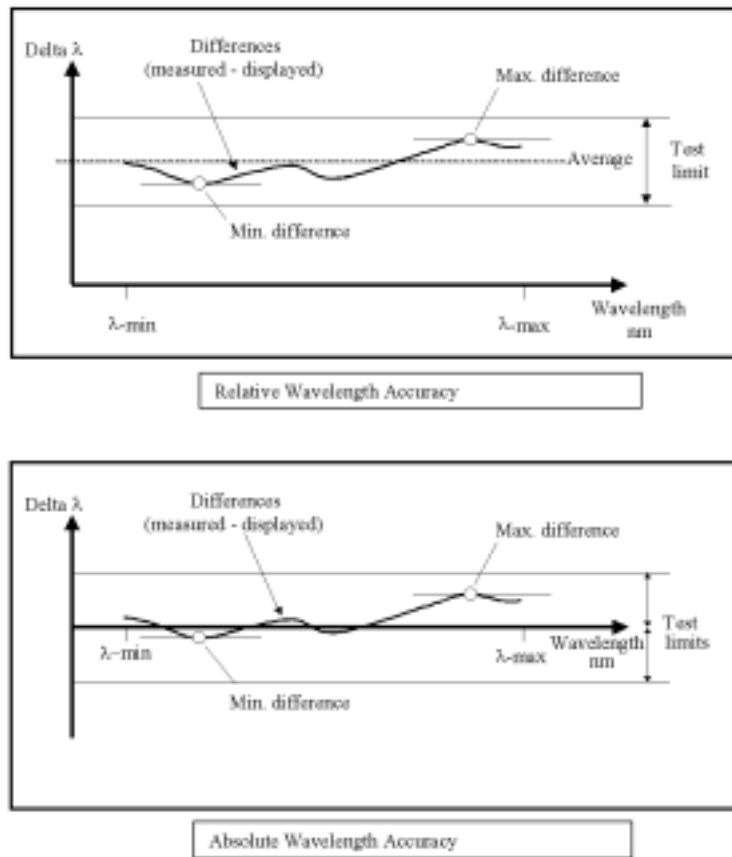

Figure 18 Absolute and Relative Wavelength Accuracy.

At the start of the test, the TLS is set:

- To its lowest specified wavelength,
- To the highest power the TLS can deliver over the full wavelength range,

NOTE

Attenuate the Power Output from the TLS Reduce the output power delivered by the TLS to a level compatible with the capabilities of the wavelength meter.

Use the TLS module's built-in attenuator, or an external attenuator.

- Such that any modulation is off.

At the end of the test, the TLS is set to its maximum specified wavelength.

Test Procedure

- 1 Move to the Compact TLS channel of the Agilent 8164A/B Lightwave Measurement System and press [Menu].
- 2 Set the menu parameters to:

Tunable Laser Channel Menu Parameters	Values
<Wavelength Mode>	< λ >
<Source State>	<Off>
<Power Unit>	<dBm>
<Power Mode>	<Automatic>
Modulation: <mod src>	<Off>

- 3 Connect the fiber to the optical output.
- 4 Set the initial wavelength and power of your compact TLS to:

Compact TLS module	Wavelength [λ]	Power [P]
Agilent 81980A	1465.000 nm	+ 10.00 dBm
Agilent 81989A	1465.000 nm	+ 10.00 dBm
Agilent 81940A	1520.000 nm	+ 10.00 dBm
Agilent 81944A	1525.000 nm	+ 7.00 dBm
Agilent 81949A	1520.000 nm	+ 10.00 dBm

- 5 Switch on the TLS output.
- 6 Wait until the wavelength meter has settled then note the wavelength displayed by the wavelength meter in the test record.
- 7 Set the TLS module to the next wavelength given in the Test record.
- 8 Repeat step 6 and step 7 to the maximum wavelength value for the TLS module:

Compact TLS module	Maximum Wavelength Value
Agilent 81980A	1575.000 nm
Agilent 81989A	1575.000 nm
Agilent 81940A	1630.000 nm
Agilent 81944A	1620.000 nm
Agilent 81949A	1630.000 nm

- 9 Repeat step 4 to step 8 another four times.

- 10 Select the maximum and minimum deviations from each repetition of the measurements, and note these values in the Test Record.
- 11 Determine the *Relative Wavelength Accuracy* and *Summary of all Repetitions*.
 - a Take the *Largest Maximum Deviation* and note it in the Test Record,
 - b Take the *Smallest Minimum Deviation* and note it in the Test Record.

NOTE**Determining the Maximum and the Minimum Deviations**

- The *Largest Maximum Deviation* is the most positive value (or the least negative, if all values are negative).
 - The *Smallest Minimum Deviation* is the most negative value (or the least positive, if all values are positive).
-

- 12 Determine, and note in the Test Record, the *Relative Wavelength Accuracy*, which is the *Smallest Minimum Deviation* subtracted from the *Largest Maximum Deviation*.
- 13 Determine, and note in the Test Record, the *Absolute Wavelength Accuracy*, which is the largest deviation (of either the *Smallest Minimum Deviation* or the *Largest Maximum Deviation*).

Mode-Hop Free Tuning

For definition, see “Mode-hop free tunability” on page 37.

This test does NOT apply to the 81944A.

Measurement Principle

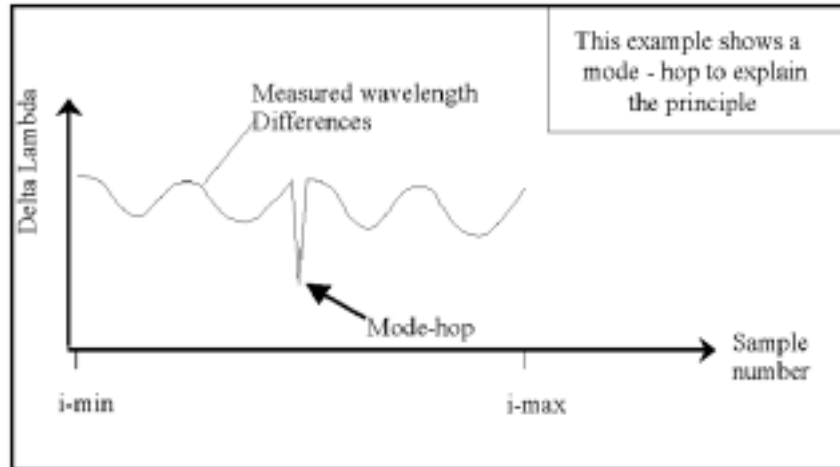

Figure 19 Mode-hop free Tuning Range.

A mode - hop is an abrupt change of the laser wavelength occurring while tuning, when the laser changes to another longitudinal mode.

The mode-hop free tuning range is defined for the stepped mode. It is automatically ensured by the wavelength regulation performed by the built-in wavelength meter, because the relative wavelength accuracy is better than a mode-hop. Consequently, the mode-hop free tuning range can not be tested manually in a way of measuring wavelength accuracy. The wavelength is always forced to the value referenced to and controlled by the built-in wavelength meter. As a result, a mode-hop is generally not possible. The previous tests of absolute and relative wavelength accuracy have proved the functionality and performance of the built-in wavelength meter.

Wavelength Repeatability

For definition, see “Wavelength repeatability” on page 45.

Measurement Principle

The TLS is set to any wavelength (an initial reference wavelength) within the specified wavelength range and the actual wavelength measured. Then the TLS is set to another wavelength (generally chosen at random), re-set to the initial wavelength and the actual wavelength measured again. This sequence is repeated several times. The maximum deviation of the measured wavelength after being reset to the reference is calculated and compared to the test limits.

Then the TLS is set to a second (initial reference) wavelength, and the sequence repeated.

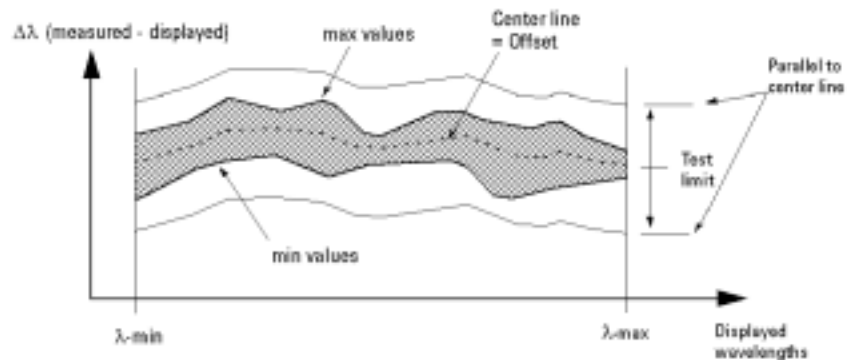

Figure 20 Wavelength Repeatability.

At the start of the test, the TLS is set:

- To its lowest specified wavelength,
- To the highest power the TLS can deliver over the full wavelength range,

NOTE

Attenuate the Power Output from the TLS Reduce the output power delivered by the TLS to a level compatible with the capabilities of the wavelength meter.

Use the TLS module’s built-in attenuator, or an external attenuator.

- Such that any modulation is off,

At the end of the test, the TLS is set to its maximum specified wavelength.

Test Procedure

- 1 Move to the compact TLS channel of the Agilent 8164A/B Lightwave Measurement System and press [Menu].
- 2 Set the menu parameters to:

Tunable Laser Channel Menu Parameters	Values
<Wavelength Mode>	< λ >
<Source State>	<Off>
<Power Unit>	<dBm>
<Power Mode>	<Automatic>
Modulation: <mod src>	<Off>

- 3 Connect the fiber to the optical output.
- 4 Set the initial wavelength and power of your compact TLS to:

Compact TLS module	Wavelength [λ]	Power [P]
Agilent 81980A	1465.000 nm	+ 10.00 dBm
Agilent 81989A	1465.000 nm	+ 10.00 dBm
Agilent 81940A	1520.000 nm	+ 10.00 dBm
Agilent 81944A	1525.000 nm	+ 7.00 dBm
Agilent 81949A	1520.000 nm	+ 10.00 dBm

- 5 Switch on the compact TLS output.
- 6 Wait until the wavelength meter has settled then note the wavelength displayed by the wavelength meter in the Test Record as the Initial Setting, the reference wavelength "REF".
- 7 Set the compact TLS module to any wavelength in its range. In the Test Record, this is given in the "from wavelength" column.
- 8 Set the wavelength of your compact TLS module back to the reference wavelength and wait until the wavelength meter has settled.
- 9 Measure the wavelength using the Wavelength Meter and note the result in the Test Record.
- 10 Repeat step 7 to step 9 for all the wavelength settings given in the "from wavelength" column of the Test Record.
- 11 From all wavelength measurements, pick the largest measured value and the smallest measured value.
- 12 Calculate the wavelength repeatability by subtracting the smallest measured value from the largest measured value.

Power Tests

The procedures in this section show how to measure the Maximum Output Power, Power Linearity, Power Flatness versus Wavelength, and Power Stability.

Maximum Output Power

For definition, see “Maximum output power” on page 36.

Make sure the instruments have warmed up before starting the measurement.

Measurement Principle

The TLS' output power is set to excessive power (indicated on the display by “ExP”) to get the highest achievable power. For each wavelength within the specified wavelength range, the actual output power is measured and compared against (wavelength-dependent) test limits.

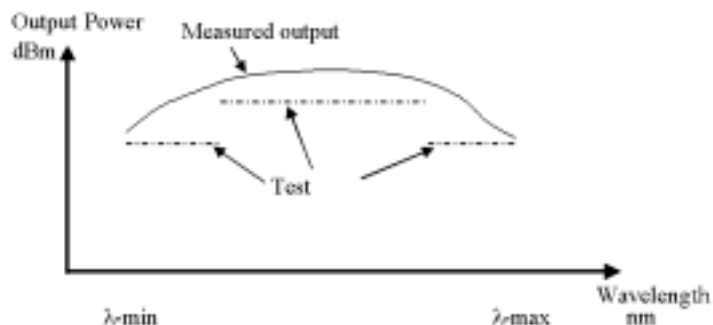

Figure 21 Maximum Output Power.

NOTE

- Absolute power *accuracy* is not specified.
- The result of the measurement is greatly influenced by the quality and matching of the interconnections used.

At the start of the test, the TLS is set:

- To its lowest specified wavelength,
- To an output power larger than the specified output power,
- Such that any modulation is off.

At the end of the test, the TLS is set to its maximum specified wavelength.

Test Procedure for 81940A, 81949A, 81980A, 81989A

1 Set up the equipment as shown in Figure 22:

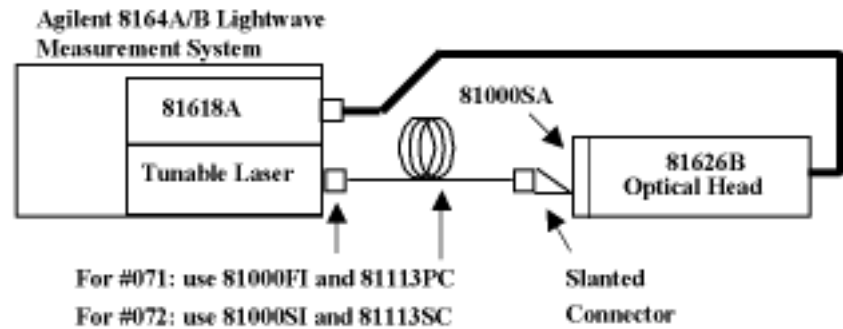

Figure 22 Test Setup for Maximum Output Power Tests

2 Move to the power meter channel:

- Select **Automatic** ranging (this is the default setting),
- Set the **Averaging Time** to 500 ms,
- Select **<dBm>** as the power units,
- While the laser is **Off**, Zero the power meter. Select **<Menu>** then **<Zero>**.

3 Move to the compact TLS channel. Set the menu parameters to:

Tunable Laser Channel Menu Parameters	Values
<Wavelength Mode>	< λ >
<Source State>	<Off>
<Power Unit>	<dBm>
<Power Mode>	<Automatic>
Modulation: <mod src>	<Off>

4 Connect the fiber to the optical output.

5 Set the initial wavelength and power of the compact TLS to:

Compact TLS module	Wavelength [λ]	Power [P]
Agilent 81980A	1465.000 nm	+ 15.00 dBm
Agilent 81989A	1465.000 nm	+ 15.00 dBm
Agilent 81940A	1520.000 nm	+ 15.00 dBm
Agilent 81949A	1520.000 nm	+ 15.00 dBm

NOTE

Exp •Excessive power indicator.

The laser output is limited to its maximum possible value at this wavelength.

The display will probably show Exp (Excessive Power).

- 6 Switch on the TLS output.
- 7 Set the wavelength of the 81626B to the same as the compact TLS module, as given in step 5.
- 8 Measure the output power using the 81626B and note the result for this wavelength in the Test Record.
- 9 Increase λ , the output wavelength, of the compact TLS module to the next value given in the Test Record.
- 10 Increase the wavelength of the 81626B to the same value.
- 11 Note the measured power for the wavelength in the Test Record.
- 12 Repeat step 9 to step 11 for the full wavelength range.

Test Procedure for 81944A

The 81944A has an integrated building block which modulates the output power versus wavelength and temperature. Even very small changes would vary the output power randomly. This function is required for use in the 3909A PDM system. The following test covers both the maximum (mean) output power, as well as the amount of the output power modulation.

- 1 Set up the equipment as shown in [Figure 23](#):

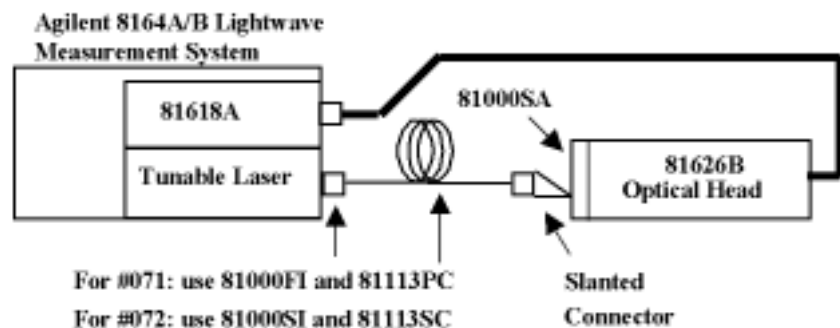

Figure 23 Test Setup for Maximum Output Power Tests

- 2 Move to the power meter channel:
 - Select **Automatic** ranging (this is the default setting),
 - Select **<dBm>** as the power units,
 - While the laser is **Off**, Zero the power meter. Select **<Menu>** then **<Zero>**.
- 3 Move to the compact TLS channel. Set the menu parameters to:

Tunable Laser Channel Menu Parameters	Values
<Wavelength Mode>	< λ >
<Source State>	<Off>
<Power Unit>	<dBm>
<Power Mode>	<Automatic>
Modulation: <mod src>	<Off>

- 4 Connect the fiber to the optical output.
- 5 Set the initial wavelength and power of the compact TLS to:

Compact TLS module	Wavelength [λ]	Power [P]
Agilent 81944A	1525.000 nm	+ 15.00 dBm

NOTE

Exp •Excessive power indicator.

The laser output is limited to its maximum possible value at this wavelength.

The display will probably show Exp (Excessive Power).

- 6 Switch on the TLS output.
- 7 Set the wavelength of the 81626B to the same as the compact TLS module, as given in step 5.
- 8 Select the Stability application. Press [*AppI*] then select **<Stability>**.
- 9 Within the Stability application, set the power meter:
 - Select module 2.1 (if 81619A is in slot 2, the 81626B connected to "Head 1").
 - Select [*Parameter*].
 - a Set Total Time to 1 minute, 00:01:00.
 - b Set AvgTime to 100 μ s.

- c Set Max to 4000 (this value will be changed automatically when running the application).
 - d Set λ , the wavelength to the same as the compact TLS module, as given in the test record.
- 10 Start the measurement, press [*Measure*].
 - 11 When the measurement has finished, select [*Analyze*], then select [*More*].
 - 12 Read and note in the test record the values for minimum power measured <min>, maximum power measured <max> and power variation < ΔP >.
 - 13 From the min and max value, calculate and note in the test record the mean value by:
mean power = (maximum power + minimum power) / 2
 - 14 Increase λ , the output wavelength, of the compact TLS module to the next value given in the Test Record.
 - 15 Repeat step 7 to step 14 for the full wavelength range.

Power Linearity

For definition, see “Power linearity” on page 39.

This test does NOT apply to the 81944A.

Measurement Principle

Power linearity describes the TLS' ability to generate precise power steps. For example, if the power setting is changed by 3 dB, the actual power should change by 3 dB. The deviations from this ideal are tested by setting defined power steps and measuring them using the power meter.

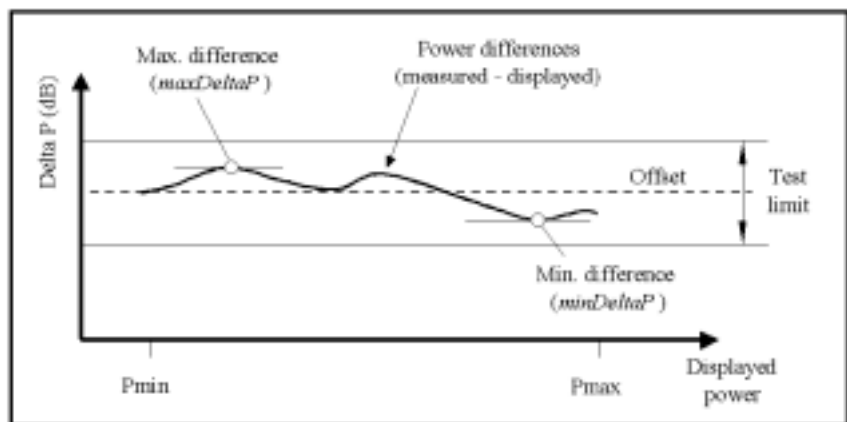

Figure 24 Power Linearity

At the start of the test, the TLS is set:

- To any fixed wavelength, preferably to a wavelength where the highest specified output power can be achieved,
- To the maximum output power specified for this wavelength,
- Such that any modulation is off.

The output power is measured and compared to the displayed power value. For simplicity, the start value is defined to a reference, and all sequencing differences between the measured and displayed power values are compared to this reference.

Output power is decremented in 1 dB steps.

At the end of the test, the compact TLS is set to its minimum output power.

Test Procedure

- 1 Set up the equipment as shown in [Figure 25](#):

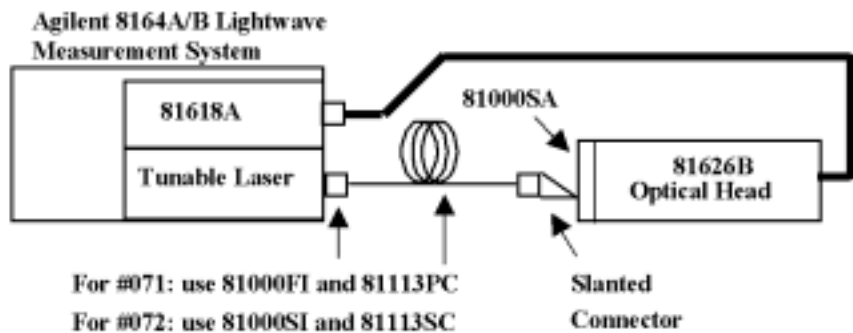

Figure 25 Test Setup for Power Linearity Tests

- 2 Move to the compact TLS channel. Set the [Menu] parameters to:

Tunable Laser Channel [Menu] Parameters	Values
<Wavelength Mode>	< λ >
<Source State>	<Off>
<Power Unit>	<dBm>
<Power Mode>	<Manual Att>
Modulation: <mod src>	<Off>

- 3 Set the initial wavelength and power of the compact TLS to:

Compact TLS module	Wavelength [λ]	Power [P]
Agilent 81980A	1550.000 nm	+ 13.00 dBm
Agilent 81989A	1550.000 nm	+ 13.00 dBm
Agilent 81940A	1590.000 nm	+ 13.00 dBm
Agilent 81949A	1590.000 nm	+ 13.00 dBm

- 4 Connect the fiber to the optical output.
- 5 Make sure the optical output is switched **off**.
- 6 At the 81626B:
 - Zero the 81626B. Select <Menu> then <Zero>.
 - Set the **power range** manually to **+20 dBm**,
 - Set the **Averaging Time** to **500 ms**,
 - Select <dB> as the power units,

- Set λ , the wavelength, to the same as the compact TLS module, as given in step 3.
- 7 Switch on the TLS output.
 - 8 Note the power value displayed by the 81626B in the Test Record.
 - 9 At the 81626B, select <Menu> then <Disp → Ref>
 - 10 Change the power setting of the compact TLS module to the next value given in the Test Record.
 - 11 Note the (relative) power displayed by the 81626B as the “Measured Relative Power from start”.
 - 12 Calculate the “Power Linearity at current setting” as the sum of “Measured Relative Power from start” and “Power Reduction from start”.
 - 13 Repeat step 10 to step 12 for all power levels listed in the Test record.
 - 14 Determine the maximum value and the minimum value of the calculated Power Linearity at the various settings and record them in the test record them as “Maximum Power Linearity at current setting”, and “Minimum Power Linearity at current setting”, respectively.
 - 15 Subtract the minimum power linearity value from the maximum power linearity value and record the result as the **Total Power Linearity**.

Table 6 Example: Agilent 81980A Power Linearity.

	Power Setting from start	Measured Relative Power from start	Power reduction from start	Power Linearity at current setting
Start = REF	+ 13.0 dBm	0.00 dBm	+ 0.00 dBm	= 0.00 dBm
	+ 12.0 dBm	- 1.02 dBm	+ 1.00 dBm	= - 0.02 dBm
	+ 11.0 dBm	- 1.98 dBm	+ 2.00 dBm	= + 0.02 dBm
	+ 10.0 dBm	- 2.97 dBm	+ 3.00 dBm	= + 0.03 dBm
	+ 9.0 dBm	- 4.03 dBm	+ 4.00 dBm	= - 0.03 dBm
	+ 8.0 dBm	- 4.96 dBm	+ 5.00 dBm	= + 0.04 dBm
	+ 7.0 dBm	- 5.97 dBm	+ 6.00 dBm	= + 0.03 dBm
	+ 6.0 dBm	- 6.98 dBm	+ 7.00 dBm	= + 0.02 dBm

Maximum Power Linearity at current setting: + 0.04 dBm

Minimum Power Linearity at current setting: - 0.03 dBm

Total Linearity

= Max. Power Linearity - Min. Power Linearity **0.07 dBpp**

Power Flatness versus Wavelength

For definition, see “Power flatness versus wavelength” on page 39.

This test does NOT apply to the 81944A.

Measurement Principle

At a fixed power level, the wavelength is tuned over a given wavelength span. At each wavelength, the power is measured. Ideally, all power levels would be identical. Any deviation is expressed as power flatness

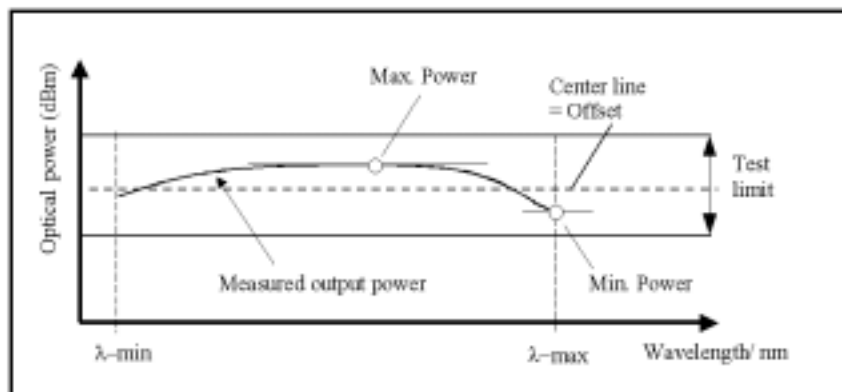

Figure 26 Power Flatness

At the start of the test, the TLS is set:

- To its lowest specified wavelength,
- To the highest power the TLS can deliver over the full wavelength range,
- Such that any modulation is off.

The wavelength is increased in 5 nm increments and the difference between the measured and the displayed power is recorded.

At the end of the test, the TLS is set to its maximum specified wavelength.

Test Procedure

- 1 Set up the equipment as shown in Figure 27:

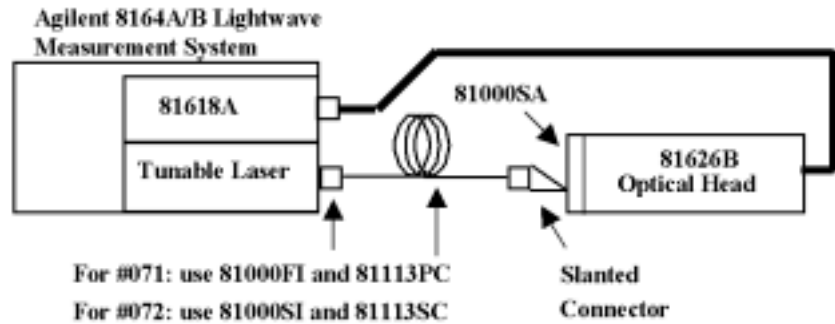

Figure 27 Test Setup for Power Linearity Tests

- 2 Connect the fiber to the optical output.
- 3 Move to the compact TLS channel. Set the [Menu] parameters to:

Tunable Laser Channel [Menu] Parameters	Values
<Wavelength Mode>	< λ >
<Source State>	<Off>
<Power Unit>	<dBm>
<Power Mode>	<Automatic>
Modulation: <mod src>	<Off>

- 4 Set the initial wavelength and power of the compact TLS to:

Compact TLS module	Wavelength [λ]	Power [P]
Agilent 81980A	1465.000 nm	+ 10.00 dBm
Agilent 81989A	1465.000 nm	+ 10.00 dBm
Agilent 81940A	1520.000 nm	+ 10.00 dBm
Agilent 81949A	1520.000 nm	+ 10.00 dBm

- 5 Make sure the optical output is switched **off**.

- 6 At the 81626B:
 - Zero the 81626B. Select *<Menu>* then *<Zero>*,
 - Set the **power range** manually to **+10 dBm**,
 - Set the **Averaging Time** to **500 ms**,
 - Select *<dB>* as the power units,
 - Set λ , the wavelength, to the same as the compact TLS module, as given in step 3.
- 7 Switch on the TLS output.
- 8 At the 81626B, select *<Menu>* then *<Disp → Ref>*
- 9 Increase λ , the output wavelength, of the compact TLS module and of the power meter to the next value listed in the Test Record.
- 10 Measure the change in output power (in dB) and note this value in the Test Record.
- 11 Repeat step 9 to step 10 for all wavelength settings listed in the Test Record.
- 12 Determine the maximum deviation and the minimum deviation from REF and record them in the Test Record.
- 13 Subtract the minimum deviation from the maximum deviation and record the result as the **Flatness**.

Power Stability

For definition, see “Power stability” on page 40.

This test does NOT apply to the 81944A.

Measurement Principle

The compact TLS output is measured over a given time span at constant temperature.

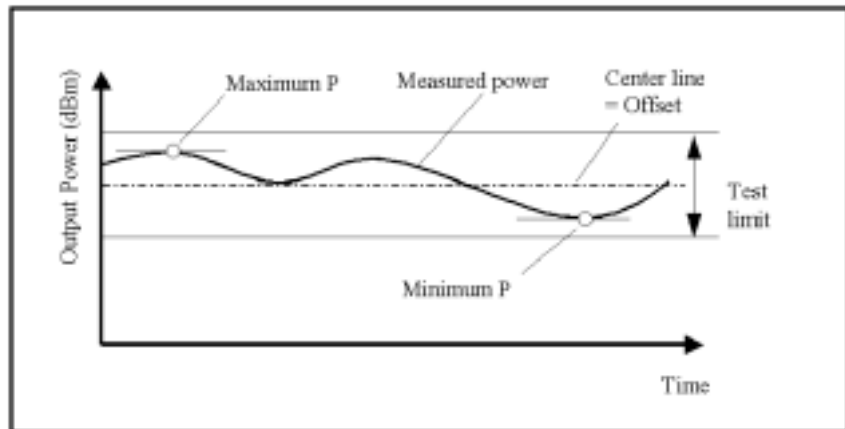

Figure 28 Stability of Output Power vs Time

NOTE

When testing Power Stability: A test duration of approximately 15 minutes (rather than 1 hour) is sufficient to demonstrate whether or not the power control loop is working correctly.

At the start of the test, the compact TLS is set:

- To any wavelength within its specified wavelength range,
- To any power specified for the compact TLS at this wavelength.

The lower limit is the minimum output power specified; the upper limit by the maximum output power specified.

- Such that any modulation is off.

At the start of the test, a reference power value is taken.

At any time during the measurement, the actual output power is compared to the reference and recorded.

The end of the test is defined by the specified stability time.

Test Procedure

- 1 Set up the equipment as shown in Figure 29:

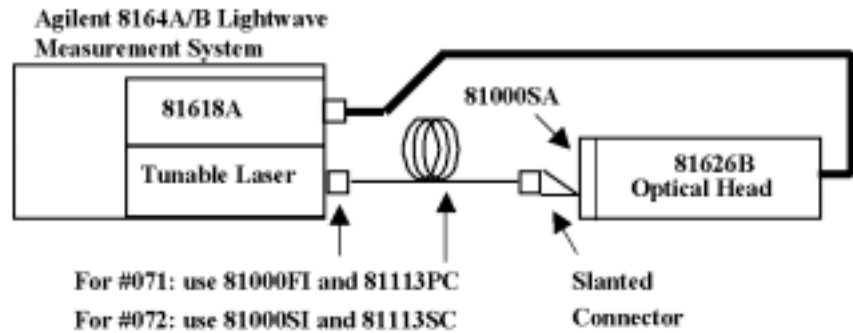

Figure 29 Test Setup for Power Stability Tests

- 2 Connect the fiber to the optical output.
- 3 Move to the compact TLS channel. Set the [Menu] parameters to:

Tunable Laser Channel [Menu] Parameters	Values
<Wavelength Mode>	< λ >
<Source State>	<Off>
<Power Unit>	<dBm>
<Power Mode>	<Automatic>
Modulation: <mod src>	<Off>

- 4 Set the initial wavelength and power of the compact TLS to:

Compact TLS module	Wavelength [λ]	Power [P]
Agilent 81980A	1540.000 nm	+ 6.000 dBm
Agilent 81989A	1540.000 nm	+ 6.000 dBm
Agilent 81940A	1580.000 nm	+ 6.000 dBm
Agilent 81949A	1580.000 nm	+ 6.000 dBm

- 5 Make sure the optical output is switched **off**.
- 6 Zero the power meter. Press [Menu] then select <Zero>.
- 7 Switch on the TLS output, then wait for 1 minute.
- 8 Select the logging application. Press [AppI] then select <Logging>.

- 9 Within the logging application, set the power meter:
 - Select module **2.1** (if 81619A is in slot 2, the 81626B connected to “Head 1”)
 - Set λ , the wavelength, to the same as the compact TLS module, as given in step 4,
 - Set **Range** to **10 dBm**,
 - Set **Ref mode** to **Value**,
 - Set **Samples** to **4000**,
 - Set the **Averaging Time** to **200 ms**,
 - Set **Range mode** to **common**,
 - Set **Power unit** to **dB**,
 - Set **Ref** to the value given at step 4.
- 10 Select [*Measure*] to start the logging application. A progress indicator is displayed.
- 11 When the measurement has finished, select [*Analysis*]
- 12 From the Statistics window, note the following results in the Test Record:
 - The “max” value as the *Maximum Deviation*,
 - The “min” value as the *Minimum Deviation*,
 - The “ ΔP ” value as the *Power Stability*.

Signal-to-Source Spontaneous Emission Ratio

For definition, see “Signal to source spontaneous emission ratio” on page 43.

Measurement Principle

The compact TLS is set to a number of wavelengths. For each wavelength, the Signal-to-Source Spontaneous Emission Ratio (SSE) spectrum is measured for a ± 3 nm window around the set wavelength using an Optical Spectrum Analyzer (OSA). The SSE spectrum within ± 1 nm of the set wavelength is excluded because of the limited dynamic range of the OSA. The OSA bandwidth resolution is set to 0.5 nm to catch the peaks of the SSE ripple caused by the chip modes of the laser chip. An extrapolation to 1 nm is done by adding 3 dB to the SSE measurement result.

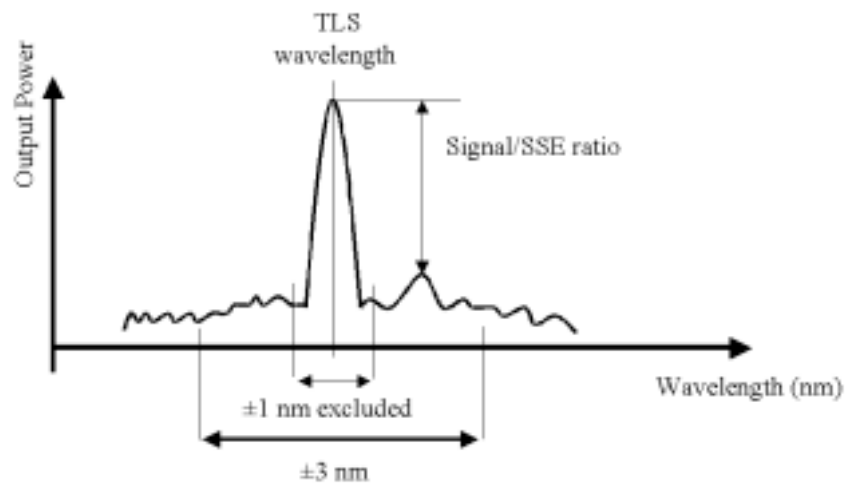

Figure 30 Signal-to-source spontaneous emission ratio

At the start of the test the compact TLS is set:

- To its lowest specified wavelength,
- To the output power specified for the compact TLS at this wavelength,
- Such that any modulation is off.

With a bandwidth resolution of 0.5 nm, SSE is measured directly using the OSA, then the measurement result is extrapolated for a bandwidth resolution of 1 nm (a factor of 2 relates to 3 dB). This value is recorded as the test result.

The wavelength is increased, preferably in 10 nm increments. For each wavelength, the associated SSE value is measured, extrapolated to 1 nm bandwidth resolution and recorded.

At the end of the test, the compact TLS is set to its maximum specified wavelength.

Test Procedure

- 1 Set up the equipment as shown in [Figure 31](#):

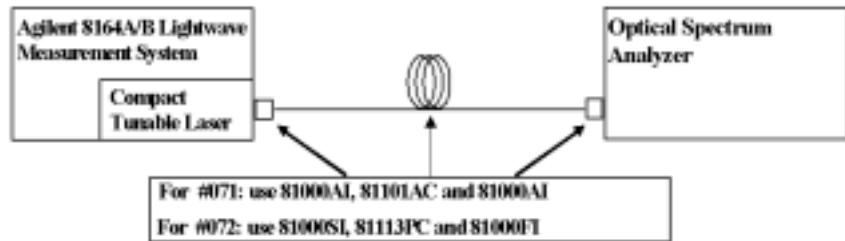

Figure 31 Test Setup for Source Spontaneous Emission Test.

- 2 Connect the fiber to the optical output of the compact TLS and to the optical input of the OSA.
- 3 Move to the compact TLS channel of the 8164A/B mainframe. Set the [Menu] parameters to:

Tunable Laser Channel [Menu] Parameters	Values
<Wavelength Mode>	< λ >
<Source State>	<Off>
<Power Unit>	<dBm>
<Power Mode>	<Automatic>
Modulation: <mod src>	<Off>

- 4 Make sure the optical output is switched **off**.
- 5 Set the wavelength of the compact TLS to:

Compact TLS module	Wavelength [λ]
Agilent 81980A	1465.000 nm
Agilent 81989A	1465.000 nm
Agilent 81940A	1520.000 nm
Agilent 81944A	1525.000 nm
Agilent 81949A	1520.000 nm

- 6 Set the power of the compact TLS to its maximum specified output power (as given in the Test Record).
- 7 Switch on the compact TLS output.
- 8 Initialize the OSA. Press [*Preset*] then select <Auto Meas.>.
- 9 Set the OSA:
 - Set **Span** to **4 nm**,
Press [*Span*] then enter the value.
 - Set **Resolution Bandwidth (RBW)** to **0.5 nm**,
Press [*Ampl*], press [*BW Sup*], then enter the value.
 - Set **Sensitivity** to **-60 dBm**,
Press [*Ampl*], press [*Sens*], then enter the value.
 - Set **Wavelength** to the value given at step 5.

NOTE

Extrapolation to an RBW of 1 nm: Although an RBW of 0.5 nm is used for the measurement, this is extrapolated to an RBW of 1.0 nm by subtracting 3 dB from the absolute value since this factor of 2 in the RBW gives 2 x power = 3 dB.

For example:

RBW=0.5 nm results in $|SSE_{0.5 \text{ nm}}| = 55.5 \text{ dB}$ measured.

RBW=1.0 nm extrapolates to $|SSE_{1 \text{ nm}}| = |SSE_{0.5 \text{ nm}}| - 3 \text{ dB}$
 $= 55.5 \text{ dB} - 3 \text{ dB} = 52.5 \text{ dB}$.

- 10 At the OSA, set the **marker** to the highest peak then select delta.
[*Marker*] → [*Highest Peak*] → [*Delta*]
- 11 Use the [*Modify*] knob to move the **second marker** to the highest peak of the displayed side modes, and note the difference, *delta*, between the two markers in the Test Record.
- 12 Increase the wavelength of the compact TLS by 10 nm, as listed in the Test Record.
- 13 Repeat step 10 to step 12 for all wavelength settings listed in the Test Record.

Optional Performance Tests

These tests refer to some typical characteristics of the compact TLS that are not guaranteed, and which are not part of the standard re-calibration. However, the tests can be performed in qualified Agilent Service Centers on special request.

Signal-to-Total-Source Spontaneous Emission Ratio

For definition, see “Signal to total source spontaneous emission ratio” on page 44.

NOTE

Qualified Agilent Service Center recommended: Although the following description should allow users to verify their products' performance, due to the high complexity of this test Agilent recommends that it be performed in a qualified Agilent Service Center.

Measurement Principle

The compact TLS is set to a number of wavelengths. For each wavelength, the Signal-to-Source Spontaneous Emission Ratio (SSE) spectrum is measured in the specified wavelength range using an OSA resolution bandwidth of 1 nm. One sample per nm is taken and summed to the total SSE. The SSE spectrum near the signal (within a ± 3 nm window) is substituted by the average SSE based on the last sample on the left, at -3 nm, and the first sample on the right, at +3 nm.

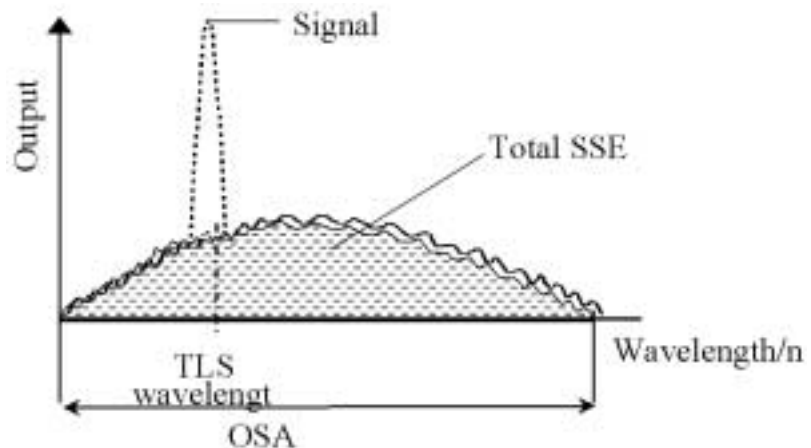

Figure 32 Total SSE Measurement.

Test Procedure

- 1 Set up the equipment as shown in [Figure 33](#):

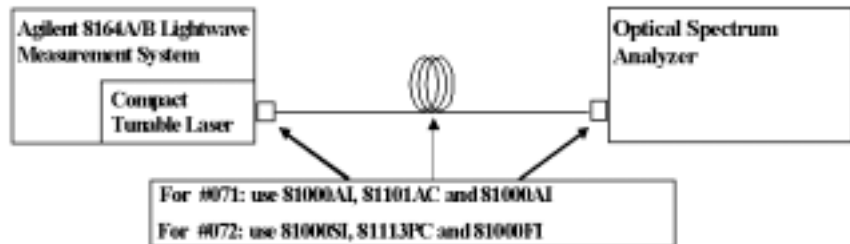

Figure 33 Test Setup for Source Spontaneous Emission Test.

- 2 Move to the compact TLS channel of the 8164A/B mainframe. Set the [Menu] parameters to:

Tunable Laser Channel [Menu] Parameters	Values
<Wavelength Mode>	< λ >
<Source State>	<Off>
<Power Unit>	<dBm>
<Power Mode>	<Automatic>
Modulation: <mod src>	<Off>

- 3 Set the wavelength and power of the compact TLS to:

Compact TLS module	Wavelength [λ]	Power [P]
Agilent 81980A	1550.000 nm	+ 13.00 dBm
Agilent 81989A	1550.000 nm	+ 13.00 dBm
Agilent 81940A	1590.000 nm	+ 13.00 dBm
Agilent 81944A	1590.000 nm	+ 10.00 dBm
Agilent 81949A	1590.000 nm	+ 13.00 dBm

- 4 Set the OSA:

- Set **Span** to **30 nm**,
Press [*Span*] then enter the value.
- Set **Resolution Bandwidth (RBW)** to **1 nm**,
Press [*Ampl*], press [*BW Sup*], then enter the value.
- Set **Sensitivity** to **- 60 dBm**,
Press [*Ampl*], press [*Sens*], then enter the value.

- 5 Record the Spectrum (run a single sweep):
- Press [Peak Search] in the *Marker* field.
 - Set [*Marker*] to [*Center Wavelength*] and note its displayed wavelength as:

OSA_λ_center = _____ nm

- 6 Find the maximum power level at OSA_λ_center, peak_power, and enter the result in the test record in [pW]:

Peak_power = _____ 10^{-12} W = _____ pW

- 7 Measure partial noise of the spectrum.

- With a sampling step of 1 nm on the OSA, check all 24 power levels within the recorded spectrum, starting at OSA_λ_center -15 nm and finishing at OSA_λ_center +15 nm without recording values between OSA_λ_center ±3 nm.
- Record the “partial noise power level” values in the table in pW, where 1 pW = 10^{-12} W.

For Example:

Wavelength, Relative to OSA_λ_center	Partial Noise Power Levels
-15 nm	pW
-14 nm	pW
-13 nm	pW
...	pW
...	pW
-4 nm	no value
-3 nm	no value
-2 nm	no value
-1 nm	no value
±0 nm (=OSA_λ_center)	no value
+1 nm	no value
+2 nm	no value
+3 nm	no value
+4 nm	no value
...	pW
...	pW
+13 nm	pW
+14 nm	pW
15 nm	pW
	pW
Sum of all partial noise power levels	pW

- 8 Determine total noise power by adding up all 24 partial noise power levels:

OSA_noise = Sum of all partial noise power levels

OSA_noise = _____ pW

- 9 Note the OSA_noise value in the Test Record.

- 10 Determine the SSE of the compact TLS output signal by using the maximum value at its border:

a Note the power measured at OSA_λ_center - 3 nm,

b Note the power measured at OSA_λ_center + 3 nm,

c Determine the larger of these two power values and record it as SSE_power_λTLS_max,

Record all the power values in pW, where 1 pW = 10⁻¹² W.

d SSE_power_λTLS_max = _____ 10⁻¹² W = _____ pW.

- 11 Determine the Total SSE power, power_total_SSE,
Add the values of OSA_noise and SSE_power_λTLS_max:

power_total_SSE = OSA_noise + SSE_power_λTLS_max

= _____ 10⁻¹² W = _____ pW.

- 12 Calculate the Total SSE (in dB) using:

$$Total\ SSE = 10 \times \log \frac{peak_power}{power_total_SSE}$$

NOTE

Use consistent power units!: Record all power values using the same units, such as Watts W, or picoWatts pW.

This ensures that the equation in step 12 delivers the Total SSE in decibels dB.

- 13 Note the result in the Test Record:

Total SSE = _____ dB

Test Records

This section contains Test Records for Agilent 81980A, 81940A, 81944A, 81989A, 81949A Compact TLS module.

Results of the performance test may be tabulated on the Test Records. It is recommended that you fill out the Test Record and refer to it while executing the test. Since the test limits and setup information are printed on the Test Record for easy reference, the record can also be used as an abbreviated test procedure (if you are already familiar with the test procedure). The Test Record can also be used as a permanent record and may be reproduced without written permission from Agilent Technologies.

Agilent 81980A Performance Test	91
Agilent 81940A Performance Test	101
Agilent 81944A Performance Test	111
Agilent 81989A Performance Test	118
Agilent 81949A Performance Test	128

Test Record

Agilent 81980A Performance Test

Test Facility:

Page 1 of 10

Report No.:

Date:

Customer:

Tested By:

Model: Agilent 81980A Compact Tunable Laser Source module

Serial No. _____

Ambient temperature

_____ °C

Options. _____

Relative humidity

_____ %

Firmware Rev.

Line frequency

_____ Hz

Special Notes:

Agilent Compact Tunable Laser Source module Performance Test

Page 2 of 10

Model: Agilent 81980A

Report No. _____

Date: _____

Test Equipment Used

Description	Model No.	Trace No.	Cal. due date
1. Standard Optical Head	_____	_____	/ /
2. Optical Spectrum Analyzer	_____	_____	/ /
3. Wavelength Meter	_____	_____	/ /
4. _____	_____	_____	/ /
5. _____	_____	_____	/ /
6. _____	_____	_____	/ /
7. _____	_____	_____	/ /
8. _____	_____	_____	/ /
9. _____	_____	_____	/ /
10. _____	_____	_____	/ /
11. _____	_____	_____	/ /
12. _____	_____	_____	/ /

Agilent Compact Tunable Laser Source module Performance Test

Page 3 of 10

Model: Agilent 81980A

Report No. _____

Date: _____

Relative Wavelength Accuracy

Wavelength Setting	Repetition 1		Repetition 2		Repetition 3	
	Wavelength Measured	Wavelength Deviation ^[1]	Wavelength Measured	Wavelength Deviation ^[1]	Wavelength Measured	Wavelength Deviation ^[1]
1465.000 nm	nm	nm	nm	nm	nm	nm
1480.000 nm	nm	nm	nm	nm	nm	nm
1495.000 nm	nm	nm	nm	nm	nm	nm
1510.000 nm	nm	nm	nm	nm	nm	nm
1525.000 nm	nm	nm	nm	nm	nm	nm
1540.000 nm	nm	nm	nm	nm	nm	nm
1555.000 nm	nm	nm	nm	nm	nm	nm
1565.000 nm	nm	nm	nm	nm	nm	nm
1575.000 nm	nm	nm	nm	nm	nm	nm
Within full tuning range 1465 nm - 1575 nm						
Maximum Deviation		nm	nm		nm	
Minimum Deviation		nm	nm		nm	

Wavelength Setting	Repetition 4		Repetition 5	
	Wavelength Measured	Wavelength Deviation ^[1]	Wavelength Measured	Wavelength Deviation ^[1]
1465.000 nm	nm	nm	nm	nm
1480.000 nm	nm	nm	nm	nm
1495.000 nm	nm	nm	nm	nm
1510.000 nm	nm	nm	nm	nm
1525.000 nm	nm	nm	nm	nm
1540.000 nm	nm	nm	nm	nm
1555.000 nm	nm	nm	nm	nm
1565.000 nm	nm	nm	nm	nm
1575.000 nm	nm	nm	nm	nm
Within full tuning range 1465 nm - 1575 nm				
Maximum Deviation		nm	nm	
Minimum Deviation		nm	nm	

^[1] Wavelength Deviation = Wavelength Measured - Wavelength Setting

Agilent Compact Tunable Laser Source module Performance Test

Page 4 of 10

Model: Agilent 81980A

Report No. _____

Date: _____

Relative Wavelength Accuracy

Largest Maximum Deviation _____ nm

Summary of all Repetitions

Smallest Minimum Deviation _____ nm

Relative Wavelength Accuracy Result

(= Largest Maximum Deviation - Smallest Minimum Deviation)

Relative Wavelength Accuracy _____ nm

Upper Test Limit 0.02 nmMeasurement Uncertainty: ±0.2 pm

Absolute Wavelength Accuracy Result

Largest Value of Deviation (= largest of either
Largest Maximum Deviation or Smallest Minimum Deviation).

Absolute Wavelength Accuracy _____ nm

Test Limit ±0.02 nmMeasurement Uncertainty: ±0.6 pm

Agilent Compact Tunable Laser Source module Performance Test
 Model: Agilent 81980A Report No. _____

Page 5 of 10
 Date: _____

Wavelength Repeatability

Repeatability of 1465.000 nm (= REF)	Measurement Result
Initial Setting	REF= _____ nm
from 1490.000 nm to REF	_____ nm
from 1520.000 nm to REF	_____ nm
from 1550.000 nm to REF	_____ nm
from 1575.000 nm to REF	_____ nm
largest measured wavelength	_____ nm
smallest measured wavelength	_____ nm
Wavelength Repeatability (= largest measured wavelength - smallest measured wavelength)	_____ nm
Upper Test Limit	0.005 nm
Performance Characteristic	0.002 nm typical

Repeatability of 1520.000 nm (= REF)	Measurement Result
Initial Setting	REF= _____ nm
from 1465.000 nm to REF	_____ nm
from 1490.000 nm to REF	_____ nm
from 1550.000 nm to REF	_____ nm
from 1575.000 nm to REF	_____ nm
largest measured wavelength	_____ nm
smallest measured wavelength	_____ nm
Wavelength Repeatability (= largest measured wavelength - smallest measured wavelength)	_____ nm
Upper Test Limit	0.005 nm
Performance Characteristic	0.002 nm typical

Repeatability of 1575.000 nm (= REF)	Measurement Result
Initial Setting	REF= _____ nm
from 1465.000 nm to REF	_____ nm
from 1490.000 nm to REF	_____ nm
from 1520.000 nm to REF	_____ nm
from 1550.000 nm to REF	_____ nm
largest measured wavelength	_____ nm
smallest measured wavelength	_____ nm
Wavelength Repeatability (= largest measured wavelength - smallest measured wavelength)	_____ nm
Upper Test Limit	0.005 nm
Performance Characteristic	0.002 nm typical

Measurement Uncertainty: ±0.1 pm

Agilent Compact Tunable Laser Source module Performance Test
 Model: Agilent 81980A Report No. _____

Page 6 of 10
 Date: _____

Maximum Power Test

Wavelength Setting	Power Measured	Minimum Lower Test Limit
1465.000 nm	_____ dBm	+ 10.00 dBm
1475.000 nm	_____ dBm	+ 10.00 dBm
1485.000 nm	_____ dBm	+ 10.00 dBm
1495.000 nm	_____ dBm	+ 10.00 dBm
1505.000 nm	_____ dBm	+ 10.00 dBm
1515.000 nm	_____ dBm	+ 10.00 dBm
1525.000 nm	_____ dBm	+ 13.00 dBm
1535.000 nm	_____ dBm	+ 13.00 dBm
1545.000 nm	_____ dBm	+ 13.00 dBm
1555.000 nm	_____ dBm	+ 13.00 dBm
1565.000 nm	_____ dBm	+ 13.00 dBm
1475.000 nm	_____ dBm	+ 13.00 dBm

Measurement Uncertainty: $\pm 4.5\%$

Agilent Compact Tunable Laser Source module Performance Test
 Model: Agilent 81980A Report No. _____

Page 7 of 10
 Date: _____

Power Linearity

	Power Setting from Start	Measured Relative Power from Start	Power reduction from start	Power Linearity at current setting
Start = REF	+13dBm	0.00 dB	+ 0.00 dB	= 0.00 dB
	+12dBm	_____ dB	+ 1.00 dB	= _____ dB
	+11 dBm	_____ dB	+ 2.00 dB	= _____ dB
	+10dBm	_____ dB	+ 3.00 dB	= _____ dB
	+ 9dBm	_____ dB	+ 4.00 dB	= _____ dB
	+ 8dBm	_____ dB	+ 5.00 dB	= _____ dB
	+ 7dBm	_____ dB	+ 6.00 dB	= _____ dB
	+ 6dBm	_____ dB	+ 7.00 dB	= _____ dB

Maximum Power Linearity at current setting _____ dB

Maximum Power Linearity at current setting _____ dB

Total Power Linearity at current setting _____ dBpp
 (= Maximum Power Linearity - Minimum Power Linearity)

Upper Test Limit 0.2 dBpp

Measurement Uncertainty ±0.04 dB

Agilent Compact Tunable Laser Source module Performance Test
 Model: Agilent 81980A Report No. _____

Page 8 of 10
 Date: _____

Power Flatness

Wavelength	Power Setting: + 6.00 dBm	
	Power Deviation	
Start = REF 1465.000 nm	0.00	dB
1470.000 nm		dB
1475.000 nm		dB
1480.000 nm		dB
1485.000 nm		dB
1490.000 nm		dB
1495.000 nm		dB
1500.000 nm		dB
1505.000 nm		dB
1510.000 nm		dB
1515.000 nm		dB
1520.000 nm		dB
1525.000 nm		dB
1530.000 nm		dB
1535.000 nm		dB
1540.000 nm		dB
1545.000 nm		dB
1550.000 nm		dB
1555.000 nm		dB
1560.000 nm		dB
1565.000 nm		dB
1570.000 nm		dB
1575.000 nm		dB
Full Wavelength Range (1465 nm - 1575 nm)		
Maximum deviation:		dB
Minimum deviation:		dB
Flatness = Maximum - Minimum deviation:		dB
Upper Test Limit:	0.60	dBpp
Performance Characteristic:	0.3	dBpp
Wavelength Range (1525 nm - 1575 nm)		
Maximum deviation:		dB
Minimum deviation:		dB
Flatness = Maximum - Minimum deviation:		dB
Upper Test Limit:	0.40	dBpp
Performance Characteristic:	0.2	dBpp

Measurement Uncertainty: $\pm 2.6\%$

Agilent Compact Tunable Laser Source module Performance Test
 Model: Agilent 81980A Report No. _____

Page 9 of 10
 Date: _____

Power Stability

	Power Setting: + 6.00dBm
Maximum Deviation	_____ dB
Minimum Deviation	_____ dB
Power Stability ΔP	_____ dB
Upper Test Limit	0.02 dBp
Measurement Uncertainty	±0.005 dB

Signal-to-Source Spontaneous Emission

Wavelength	Output Power	Results	Lower Test Limit
1465.000 nm	+ 10.00 dBm	_____ dB	45 dB
1470.000 nm	+ 10.00 dBm	_____ dB	45 dB
1475.000 nm	+ 10.00 dBm	_____ dB	45 dB
1480.000 nm	+ 10.00 dBm	_____ dB	45 dB
1485.000 nm	+ 10.00 dBm	_____ dB	45 dB
1490.000 nm	+ 10.00 dBm	_____ dB	45 dB
1495.000 nm	+ 10.00 dBm	_____ dB	45 dB
1500.000 nm	+ 10.00 dBm	_____ dB	45 dB
1505.000 nm	+ 10.00 dBm	_____ dB	45 dB
1510.000 nm	+ 10.00 dBm	_____ dB	45 dB
1515.000 nm	+ 10.00 dBm	_____ dB	45 dB
1520.000 nm	+ 10.00 dBm	_____ dB	45 dB
1525.000 nm	+ 13.00 dBm	_____ dB	48 dB
1530.000 nm	+ 13.00 dBm	_____ dB	48 dB
1535.000 nm	+ 13.00 dBm	_____ dB	48 dB
1540.000 nm	+ 13.00 dBm	_____ dB	48 dB
1545.000 nm	+ 13.00 dBm	_____ dB	48 dB
1550.000 nm	+ 13.00 dBm	_____ dB	48 dB
1555.000 nm	+ 13.00 dBm	_____ dB	48 dB
1560.000 nm	+ 13.00 dBm	_____ dB	48 dB
1565.000 nm	+ 13.00 dBm	_____ dB	48 dB
1570.000 nm	+ 13.00 dBm	_____ dB	48 dB
1575.000 nm	+ 13.00 dBm	_____ dB	48 dB

Measurement Uncertainty: ±0.20 dB

Agilent Compact Tunable Laser Source module Performance Test

Page 10 of 10

Model: Agilent 81980A Report No. _____

Date: _____

Optional Test: Signal-to-Total-Source Spontaneous Emission

OSA noise	_____ pW	
SSE_power_λTLS_max	_____ pW	
Power_total_SSE = OSA_noise + SSE_power_λTLS_max		_____ pW
Measurement Result = Total SSE (use formula below)		_____ pW

Lower Test Limit 22 dB

Performance Characteristic 25 dB typical

$$Total\ SSE = 10 \times \log \frac{peak_power}{power_total_SSE}$$

Measurement Uncertainty: ±2.0 dB

Test Record

Agilent 81940A Performance Test

Test Facility:

Page 1 of 10

Report No.:

Date:

Customer:

Tested By:

Model: Agilent 81940A Compact Tunable Laser Source module

Serial No. _____

Ambient temperature

_____ °C

Options. _____

Relative humidity

_____ %

Firmware Rev.

Line frequency

_____ Hz

Special Notes:

Agilent Compact Tunable Laser Source module Performance Test

Page 2 of 10

Model: Agilent 81940A

Report No. _____

Date: _____

Test Equipment Used

Description	Model No.	Trace No.	Cal. due date
1. Standard Optical Head	_____	_____	/ /
2. Optical Spectrum Analyzer	_____	_____	/ /
3. Wavelength Meter	_____	_____	/ /
4. _____	_____	_____	/ /
5. _____	_____	_____	/ /
6. _____	_____	_____	/ /
7. _____	_____	_____	/ /
8. _____	_____	_____	/ /
9. _____	_____	_____	/ /
10. _____	_____	_____	/ /
11. _____	_____	_____	/ /
12. _____	_____	_____	/ /

Agilent Compact Tunable Laser Source module Performance Test
 Model: Agilent 81940A Report No. _____

Page 3 of 10
 Date: _____

Relative Wavelength Accuracy

Wavelength Setting	Repetition 1		Repetition 2		Repetition 3	
	Wavelength Measured	Wavelength Deviation ^[1]	Wavelength Measured	Wavelength Deviation ^[1]	Wavelength Measured	Wavelength Deviation ^[1]
1520.000 nm	nm	nm	nm	nm	nm	nm
1535.000 nm	nm	nm	nm	nm	nm	nm
1550.000 nm	nm	nm	nm	nm	nm	nm
1565.000 nm	nm	nm	nm	nm	nm	nm
1580.000 nm	nm	nm	nm	nm	nm	nm
1595.000 nm	nm	nm	nm	nm	nm	nm
1610.000 nm	nm	nm	nm	nm	nm	nm
1620.000 nm	nm	nm	nm	nm	nm	nm
1630.000 nm	nm	nm	nm	nm	nm	nm
Within full tuning range 1520 nm - 1630 nm						
Maximum Deviation		nm	nm		nm	
Minimum Deviation		nm	nm		nm	

Wavelength Setting	Repetition 4		Repetition 5	
	Wavelength Measured	Wavelength Deviation ^[1]	Wavelength Measured	Wavelength Deviation ^[1]
1520.000 nm	nm	nm	nm	nm
1535.000 nm	nm	nm	nm	nm
1550.000 nm	nm	nm	nm	nm
1565.000 nm	nm	nm	nm	nm
1580.000 nm	nm	nm	nm	nm
1595.000 nm	nm	nm	nm	nm
1610.000 nm	nm	nm	nm	nm
1620.000 nm	nm	nm	nm	nm
1630.000 nm	nm	nm	nm	nm
Within full tuning range 1520 nm - 1630 nm				
Maximum Deviation		nm	nm	
Minimum Deviation		nm	nm	

^[1] Wavelength Deviation = Wavelength Measured - Wavelength Setting

Agilent Compact Tunable Laser Source module Performance Test

Page 4 of 10

Model: Agilent 81940A

Report No. _____

Date: _____

Relative Wavelength Accuracy

Largest Maximum Deviation _____ nm

Summary of all Repetitions

Smallest Minimum Deviation _____ nm

Relative Wavelength Accuracy Result

(= Largest Maximum Deviation - Smallest Minimum Deviation)

Relative Wavelength Accuracy _____ nm

Upper Test Limit 0.02 nmMeasurement Uncertainty: ±0.2 pm

Absolute Wavelength Accuracy Result

Largest Value of Deviation (= largest of either
Largest Maximum Deviation or Smallest Minimum Deviation).

Absolute Wavelength Accuracy _____ nm

Test Limit ±0.02 nmMeasurement Uncertainty: ±0.6 pm

Agilent Compact Tunable Laser Source module Performance Test
 Model: Agilent 81940A Report No. _____

Page 5 of 10
 Date: _____

Wavelength Repeatability

Repeatability of 1520.000 nm (= REF)	Measurement Result
Initial Setting	REF= _____ nm
from 1545.000 nm to REF	_____ nm
from 1575.000 nm to REF	_____ nm
from 1605.000 nm to REF	_____ nm
from 1630.000 nm to REF	_____ nm
largest measured wavelength	_____ nm
smallest measured wavelength	_____ nm
Wavelength Repeatability (= largest measured wavelength - smallest measured wavelength)	_____ nm
Upper Test Limit	0.005 nm
Performance Characteristic	0.002 nm typical

Repeatability of 1575.000 nm (= REF)	Measurement Result
Initial Setting	REF= _____ nm
from 1520.000 nm to REF	_____ nm
from 1545.000 nm to REF	_____ nm
from 1605.000 nm to REF	_____ nm
from 1630.000 nm to REF	_____ nm
largest measured wavelength	_____ nm
smallest measured wavelength	_____ nm
Wavelength Repeatability (= largest measured wavelength - smallest measured wavelength)	_____ nm
Upper Test Limit	0.005 nm
Performance Characteristic	0.002 nm typical

Repeatability of 1630.000 nm (= REF)	Measurement Result
Initial Setting	REF= _____ nm
from 1520.000 nm to REF	_____ nm
from 1545.000 nm to REF	_____ nm
from 1575.000 nm to REF	_____ nm
from 1605.000 nm to REF	_____ nm
largest measured wavelength	_____ nm
smallest measured wavelength	_____ nm
Wavelength Repeatability (= largest measured wavelength - smallest measured wavelength)	_____ nm
Upper Test Limit	0.005 nm
Performance Characteristic	0.002 nm typical

Measurement Uncertainty: ±0.1 pm

Agilent Compact Tunable Laser Source module Performance Test
 Model: Agilent 81940A Report No. _____

Page 6 of 10
 Date: _____

Maximum Power Test

Wavelength Setting	Power Measured	Minimum Lower Test Limit
1520.000 nm	_____ dBm	+ 10.00 dBm
1530.000 nm	_____ dBm	+ 10.00 dBm
1540.000 nm	_____ dBm	+ 10.00 dBm
1550.000 nm	_____ dBm	+ 10.00 dBm
1560.000 nm	_____ dBm	+ 10.00 dBm
1570.000 nm	_____ dBm	+ 13.00 dBm
1580.000 nm	_____ dBm	+ 13.00 dBm
1590.000 nm	_____ dBm	+ 13.00 dBm
1600.000 nm	_____ dBm	+ 13.00 dBm
1610.000 nm	_____ dBm	+ 13.00 dBm
1620.000 nm	_____ dBm	+ 13.00 dBm
1630.000 nm	_____ dBm	+ 10.00 dBm

Measurement Uncertainty: $\pm 4.5\%$

Agilent Compact Tunable Laser Source module Performance Test
 Model: Agilent 81940A Report No. _____

Page 7 of 10
 Date: _____

Power Linearity

	Power Setting from Start	Measured Relative Power from Start	Power reduction from start	Power Linearity at current setting
Start = REF	+13dBm	0.00 dB	+ 0.00 dB	= 0.00 dB
	+12dBm	_____ dB	+ 1.00 dB	= _____ dB
	+11 dBm	_____ dB	+ 2.00 dB	= _____ dB
	+10dBm	_____ dB	+ 3.00 dB	= _____ dB
	+ 9dBm	_____ dB	+ 4.00 dB	= _____ dB
	+ 8dBm	_____ dB	+ 5.00 dB	= _____ dB
	+ 7dBm	_____ dB	+ 6.00 dB	= _____ dB
	+ 6dBm	_____ dB	+ 7.00 dB	= _____ dB

Maximum Power Linearity at current setting _____ dB

Maximum Power Linearity at current setting _____ dB

Total Power Linearity at current setting _____ dBpp
 (= Maximum Power Linearity - Minimum Power Linearity)

Upper Test Limit 0.2 dBpp

Measurement Uncertainty ±0.04 dB

Agilent Compact Tunable Laser Source module Performance Test
 Model: Agilent 81940A

Report No. _____

Page 8 of 10

Date: _____

Power Flatness

Wavelength	Power Setting: + 6.00 dBm	
	Power Deviation	
Start = REF 1520.000 nm	0.00	dB
1525.000 nm		dB
1530.000 nm		dB
1535.000 nm		dB
1540.000 nm		dB
1545.000 nm		dB
1550.000 nm		dB
1555.000 nm		dB
1560.000 nm		dB
1565.000 nm		dB
1570.000 nm		dB
1575.000 nm		dB
1580.000 nm		dB
1585.000 nm		dB
1590.000 nm		dB
1595.000 nm		dB
1600.000 nm		dB
1605.000 nm		dB
1610.000 nm		dB
1615.000 nm		dB
1620.000 nm		dB
1625.000 nm		dB
1630.000 nm		dB
Full Wavelength Range (1520 nm - 1630 nm)		
Maximum deviation:		dB
Minimum deviation:		dB
Flatness = Maximum - Minimum deviation:		dB
Upper Test Limit:	0.60	dBpp
Performance Characteristic:	0.3	dBpp
Wavelength Range (1570 nm - 1620 nm)		
Maximum deviation:		dB
Minimum deviation:		dB
Flatness = Maximum - Minimum deviation:		dB
Upper Test Limit:	0.40	dBpp
Performance Characteristic:	0.2	dBpp

Measurement Uncertainty: $\pm 2.6\%$

Agilent Compact Tunable Laser Source module Performance Test
 Model: Agilent 81940A Report No. _____

Page 9 of 10
 Date: _____

Power Stability

	Power Setting: + 6.00dBm
Maximum Deviation	_____ dB
Minimum Deviation	_____ dB
Power Stability ΔP	_____ dB
Upper Test Limit	0.02 dBp
Measurement Uncertainty	±0.005 dB

Signal-to-Source Spontaneous Emission

Wavelength	Output Power	Results	Lower Test Limit
1520.000 nm	+ 10.00 dBm	_____ dB	45 dB
1525.000 nm	+ 10.00 dBm	_____ dB	45 dB
1530.000 nm	+ 10.00 dBm	_____ dB	45 dB
1535.000 nm	+ 10.00 dBm	_____ dB	45 dB
1540.000 nm	+ 10.00 dBm	_____ dB	45 dB
1545.000 nm	+ 10.00 dBm	_____ dB	45 dB
1550.000 nm	+ 10.00 dBm	_____ dB	45 dB
1555.000 nm	+ 10.00 dBm	_____ dB	45 dB
1560.000 nm	+ 10.00 dBm	_____ dB	45 dB
1565.000 nm	+ 10.00 dBm	_____ dB	45 dB
1570.000 nm	+ 13.00 dBm	_____ dB	48 dB
1575.000 nm	+ 13.00 dBm	_____ dB	48 dB
1580.000 nm	+ 13.00 dBm	_____ dB	48 dB
1585.000 nm	+ 13.00 dBm	_____ dB	48 dB
1590.000 nm	+ 13.00 dBm	_____ dB	48 dB
1595.000 nm	+ 13.00 dBm	_____ dB	48 dB
1600.000 nm	+ 13.00 dBm	_____ dB	48 dB
1605.000 nm	+ 13.00 dBm	_____ dB	48 dB
1610.000 nm	+ 13.00 dBm	_____ dB	48 dB
1615.000 nm	+ 13.00 dBm	_____ dB	48 dB
1620.000 nm	+ 13.00 dBm	_____ dB	48 dB
1625.000 nm	+ 10.00 dBm	_____ dB	45 dB
1630.000 nm	+ 10.00 dBm	_____ dB	45 dB

Measurement Uncertainty: ±0.20 dB

Agilent Compact Tunable Laser Source module Performance Test
 Model: Agilent 81940A Report No. _____

Page 10 of 10
 Date: _____

Optional Test: Signal-to-Total-Source Spontaneous Emission

OSA noise	_____ pW	
SSE_power_λTLS_max	_____ pW	
Power_total_SSE = OSA_noise + SSE_power_λTLS_max		_____ pW
Measurement Result = Total SSE (use formula below)		_____ pW

Lower Test Limit 22 dB

Performance Characteristic 25 dB typical

$$Total\ SSE = 10 \times \log \frac{peak_power}{power_total_SSE}$$

Measurement Uncertainty: ±2.0 dB

Test Record

Agilent 81944A Performance Test

Test Facility:

Page 1 of 7

Report No.:

Date:

Customer:

Tested By:

Model: Agilent 81944A Compact Tunable Laser Source module

Serial No. _____

Ambient temperature

_____ °C

Options. _____

Relative humidity

_____ %

Firmware Rev. _____

Line frequency

_____ Hz

Special Notes:

Agilent Compact Tunable Laser Source module Performance Test

Model: Agilent 81944A

Report No. _____

Page 2 of 7

Date: _____

Test Equipment Used

Description	Model No.	Trace No.	Cal. due date
1. Standard Optical Head	_____	_____	/ /
2. Optical Spectrum Analyzer	_____	_____	/ /
3. Wavelength Meter	_____	_____	/ /
4. _____	_____	_____	/ /
5. _____	_____	_____	/ /
6. _____	_____	_____	/ /
7. _____	_____	_____	/ /
8. _____	_____	_____	/ /
9. _____	_____	_____	/ /
10. _____	_____	_____	/ /
11. _____	_____	_____	/ /
12. _____	_____	_____	/ /

Agilent Compact Tunable Laser Source module Performance Test

Page 3 of 7

Model: Agilent 81944A

Report No. _____

Date: _____

Relative Wavelength Accuracy

Wavelength Setting	Repetition 1		Repetition 2		Repetition 3	
	Wavelength Measured	Wavelength Deviation ^[1]	Wavelength Measured	Wavelength Deviation ^[1]	Wavelength Measured	Wavelength Deviation ^[1]
1525.000 nm	nm	nm	nm	nm	nm	nm
1550.000 nm	nm	nm	nm	nm	nm	nm
1565.000 nm	nm	nm	nm	nm	nm	nm
1580.000 nm	nm	nm	nm	nm	nm	nm
1595.000 nm	nm	nm	nm	nm	nm	nm
1610.000 nm	nm	nm	nm	nm	nm	nm
1620.000 nm	nm	nm	nm	nm	nm	nm
Within full tuning range 1525 nm - 1620 nm						
Maximum Deviation		nm	nm		nm	
Minimum Deviation		nm	nm		nm	

Wavelength Setting	Repetition 4		Repetition 5	
	Wavelength Measured	Wavelength Deviation ^[1]	Wavelength Measured	Wavelength Deviation ^[1]
1525.000 nm	nm	nm	nm	nm
1550.000 nm	nm	nm	nm	nm
1565.000 nm	nm	nm	nm	nm
1580.000 nm	nm	nm	nm	nm
1595.000 nm	nm	nm	nm	nm
1610.000 nm	nm	nm	nm	nm
1620.000 nm	nm	nm	nm	nm
Within full tuning range 1525 nm - 1620 nm				
Maximum Deviation		nm	nm	
Minimum Deviation		nm	nm	

^[1] Wavelength Deviation = Wavelength Measured - Wavelength Setting

Agilent Compact Tunable Laser Source module Performance Test

Page 4 of 7

Model: Agilent 81944A

Report No. _____

Date: _____

Relative Wavelength Accuracy

Largest Maximum Deviation _____ nm

Summary of all Repetitions

Smallest Minimum Deviation _____ nm

Relative Wavelength Accuracy Result

(= Largest Maximum Deviation - Smallest Minimum Deviation)

Relative Wavelength Accuracy _____ nm

Upper Test Limit 0.02 nmMeasurement Uncertainty: ±0.2 pm

Absolute Wavelength Accuracy Result

Largest Value of Deviation (= largest of either
Largest Maximum Deviation or Smallest Minimum Deviation).

Absolute Wavelength Accuracy _____ nm

Test Limit ±0.02 nmMeasurement Uncertainty: ±0.6 pm

Agilent Compact Tunable Laser Source module Performance Test
 Model: Agilent 81944A Report No. _____

Page 5 of 7
 Date: _____

Wavelength Repeatability

Repeatability of 1525.000 nm (= REF)	Measurement Result
Initial Setting	REF= _____ nm
from 1545.000 nm to REF	_____ nm
from 1575.000 nm to REF	_____ nm
from 1605.000 nm to REF	_____ nm
from 1620.000 nm to REF	_____ nm
largest measured wavelength	_____ nm
smallest measured wavelength	_____ nm
Wavelength Repeatability (= largest measured wavelength - smallest measured wavelength)	_____ nm
Upper Test Limit	0.005 nm
Performance Characteristic	0.002 nm typical

Repeatability of 1575.000 nm (= REF)	Measurement Result
Initial Setting	REF= _____ nm
from 1525.000 nm to REF	_____ nm
from 1545.000 nm to REF	_____ nm
from 1605.000 nm to REF	_____ nm
from 1620.000 nm to REF	_____ nm
largest measured wavelength	_____ nm
smallest measured wavelength	_____ nm
Wavelength Repeatability (= largest measured wavelength - smallest measured wavelength)	_____ nm
Upper Test Limit	0.005 nm
Performance Characteristic	0.002 nm typical

Repeatability of 1620.000 nm (= REF)	Measurement Result
Initial Setting	REF= _____ nm
from 1525.000 nm to REF	_____ nm
from 1545.000 nm to REF	_____ nm
from 1575.000 nm to REF	_____ nm
from 1605.000 nm to REF	_____ nm
largest measured wavelength	_____ nm
smallest measured wavelength	_____ nm
Wavelength Repeatability (= largest measured wavelength - smallest measured wavelength)	_____ nm
Upper Test Limit	0.005 nm
Performance Characteristic	0.002 nm typical

Measurement Uncertainty: ±0.1 pm

Agilent Compact Tunable Laser Source module Performance Test
 Model: Agilent 81944A Report No. _____

Page 6 of 7
 Date: _____

Mean Maximum Power and Power Variation Test

Wavelength Setting	Measured Maximum Power	Measured Minimum Power	Mean Maximum Output Power ^[1]	Minimum Lower Test Limit Mean Maximum Output Power	Measured Power Variation ΔP	Minimum Lower Test Limit Power Variation
1525.000 nm	_____ dBm	_____ dBm	_____ dBm	+ 7.00 dBm	_____ dBpp	1.5 dBpp
1550.000 nm	_____ dBm	_____ dBm	_____ dBm	+ 7.00 dBm	_____ dBpp	1.5 dBpp
1575.000 nm	_____ dBm	_____ dBm	_____ dBm	+ 10.00 dBm	_____ dBpp	1.5 dBpp
1600.000 nm	_____ dBm	_____ dBm	_____ dBm	+ 10.00 dBm	_____ dBpp	1.5 dBpp
1620.000 nm	_____ dBm	_____ dBm	_____ dBm	+ 10.00 dBm	_____ dBpp	1.5 dBpp

Measurement Uncertainty: $\pm 4.5\%$

^[1] Mean Maximum Output Power = (Measured Maximum Power + Measured Minimum Power) / 2

Agilent Compact Tunable Laser Source module Performance Test

Page 7 of 7

Model: Agilent 81944A

Report No. _____

Date: _____

Optional Test: Signal-to-Total-Source Spontaneous Emission

OSA noise	_____ pW	
SSE_power_λTLS_max	_____ pW	
Power_total_SSE = OSA_noise + SSE_power_λTLS_max		_____ pW
Measurement Result = Total SSE (use formula below)		_____ pW

Lower Test Limit

20 dB

Performance Characteristic

25 dB typical

$$Total\ SSE = 10 \times \log \frac{peak\ power}{power_total_SSE}$$

Measurement Uncertainty: ±2.0 dB

Test Record

Agilent 81989A Performance Test

Test Facility:

Page 1 of 10

_____	Report No.:	_____
_____	Date:	_____
_____	Customer:	_____
_____	Tested By:	_____

Model: Agilent 81989A Compact Tunable Laser Source module

Serial No.	_____	Ambient temperature	_____	°C
Options.	_____	Relative humidity	_____	%
Firmware Rev.		Line frequency	_____	Hz

Special Notes:

Agilent Compact Tunable Laser Source module Performance Test

Model: Agilent 81989A

Report No. _____

Page 2 of 10

Date: _____

Test Equipment Used

Description	Model No.	Trace No.	Cal. due date
1. Standard Optical Head	_____	_____	/ /
2. Optical Spectrum Analyzer	_____	_____	/ /
3. Wavelength Meter	_____	_____	/ /
4. _____	_____	_____	/ /
5. _____	_____	_____	/ /
6. _____	_____	_____	/ /
7. _____	_____	_____	/ /
8. _____	_____	_____	/ /
9. _____	_____	_____	/ /
10. _____	_____	_____	/ /
11. _____	_____	_____	/ /
12. _____	_____	_____	/ /

Agilent Compact Tunable Laser Source module Performance Test
 Model: Agilent 81989A Report No. _____

Page 3 of 10
 Date: _____

Relative Wavelength Accuracy

Wavelength Setting	Repetition 1		Repetition 2		Repetition 3	
	Wavelength Measured	Wavelength Deviation ^[1]	Wavelength Measured	Wavelength Deviation ^[1]	Wavelength Measured	Wavelength Deviation ^[1]
1465.000 nm	nm	nm	nm	nm	nm	nm
1480.000 nm	nm	nm	nm	nm	nm	nm
1495.000 nm	nm	nm	nm	nm	nm	nm
1510.000 nm	nm	nm	nm	nm	nm	nm
1525.000 nm	nm	nm	nm	nm	nm	nm
1540.000 nm	nm	nm	nm	nm	nm	nm
1555.000 nm	nm	nm	nm	nm	nm	nm
1565.000 nm	nm	nm	nm	nm	nm	nm
1575.000 nm	nm	nm	nm	nm	nm	nm
Within full tuning range 1465 nm - 1575 nm						
Maximum Deviation		nm	nm		nm	
Minimum Deviation		nm	nm		nm	

Wavelength Setting	Repetition 4		Repetition 5	
	Wavelength Measured	Wavelength Deviation ^[1]	Wavelength Measured	Wavelength Deviation ^[1]
1465.000 nm	nm	nm	nm	nm
1480.000 nm	nm	nm	nm	nm
1495.000 nm	nm	nm	nm	nm
1510.000 nm	nm	nm	nm	nm
1525.000 nm	nm	nm	nm	nm
1540.000 nm	nm	nm	nm	nm
1555.000 nm	nm	nm	nm	nm
1565.000 nm	nm	nm	nm	nm
1575.000 nm	nm	nm	nm	nm
Within full tuning range 1465 nm - 1575 nm				
Maximum Deviation		nm	nm	
Minimum Deviation		nm	nm	

^[1] Wavelength Deviation = Wavelength Measured - Wavelength Setting

Agilent Compact Tunable Laser Source module Performance Test

Page 4 of 10

Model: Agilent 81989A

Report No. _____

Date: _____

Relative Wavelength Accuracy

Largest Maximum Deviation _____ nm

Summary of all Repetitions

Smallest Minimum Deviation _____ nm

Relative Wavelength Accuracy Result

(= Largest Maximum Deviation - Smallest Minimum Deviation)

Relative Wavelength Accuracy _____ nm

Upper Test Limit 0.1 nmMeasurement Uncertainty: ±0.2 pm

Absolute Wavelength Accuracy Result

Largest Value of Deviation (= largest of either
Largest Maximum Deviation or Smallest Minimum Deviation).

Absolute Wavelength Accuracy _____ nm

Test Limit ±0.1 nmMeasurement Uncertainty: ±0.6 pm

Agilent Compact Tunable Laser Source module Performance Test
 Model: Agilent 81989A Report No. _____

Page 5 of 10
 Date: _____

Wavelength Repeatability

Repeatability of 1465.000nm (= REF)	Measurement Result
Initial Setting	REF= _____ nm
from 1490.000nm to REF	_____ nm
from 1520.000nm to REF	_____ nm
from 1550.000nm to REF	_____ nm
from 1575.000nm to REF	_____ nm
largest measured wavelength	_____ nm
smallest measured wavelength	_____ nm
Wavelength Repeatability (= largest measured wavelength - smallest measured wavelength)	_____ nm
Upper Test Limit	0.01 nm

Repeatability of 1520.000nm (= REF)	Measurement Result
Initial Setting	REF= _____ nm
from 1465.000nm to REF	_____ nm
from 1490.000nm to REF	_____ nm
from 1550.000nm to REF	_____ nm
from 1575.000nm to REF	_____ nm
largest measured wavelength	_____ nm
smallest measured wavelength	_____ nm
Wavelength Repeatability (= largest measured wavelength - smallest measured wavelength)	_____ nm
Upper Test Limit	0.01 nm

Repeatability of 1575.000nm (= REF)	Measurement Result
Initial Setting	REF= _____ nm
from 1465.000nm to REF	_____ nm
from 1490.000nm to REF	_____ nm
from 1520.000nm to REF	_____ nm
from 1550.000nm to REF	_____ nm
largest measured wavelength	_____ nm
smallest measured wavelength	_____ nm
Wavelength Repeatability (= largest measured wavelength - smallest measured wavelength)	_____ nm
Upper Test Limit	0.01 nm

Measurement Uncertainty: ± 0.1 pm

Agilent Compact Tunable Laser Source module Performance Test

Model: Agilent 81989A Report No. _____

Page 6 of 10

Date: _____

Maximum Power Test

Wavelength Setting	Power Measured	Minimum Lower Test Limit
1465.000 nm	_____ dBm	+ 10.00 dBm
1475.000 nm	_____ dBm	+ 10.00 dBm
1485.000 nm	_____ dBm	+ 10.00 dBm
1495.000 nm	_____ dBm	+ 10.00 dBm
1505.000 nm	_____ dBm	+ 10.00 dBm
1515.000 nm	_____ dBm	+ 10.00 dBm
1525.000 nm	_____ dBm	+ 13.00 dBm
1535.000 nm	_____ dBm	+ 13.00 dBm
1545.000 nm	_____ dBm	+ 13.00 dBm
1555.000 nm	_____ dBm	+ 13.00 dBm
1565.000 nm	_____ dBm	+ 13.00 dBm
1475.000 nm	_____ dBm	+ 13.00 dBm

Measurement Uncertainty: $\pm 4.5\%$

Agilent Compact Tunable Laser Source module Performance Test
 Model: Agilent 81989A Report No. _____

Page 7 of 10
 Date: _____

Power Linearity

	Power Setting from Start	Measured Relative Power from Start	Power reduction from start	Power Linearity at current setting
Start = REF	+13dBm	0.00 dB	+ 0.00 dB	= 0.00 dB
	+12dBm	_____ dB	+ 1.00 dB	= _____ dB
	+11 dBm	_____ dB	+ 2.00 dB	= _____ dB
	+10 dBm	_____ dB	+ 3.00 dB	= _____ dB
	+ 9 dBm	_____ dB	+ 4.00 dB	= _____ dB
	+ 8 dBm	_____ dB	+ 5.00 dB	= _____ dB
	+ 7 dBm	_____ dB	+ 6.00 dB	= _____ dB
	+ 6 dBm	_____ dB	+ 7.00 dB	= _____ dB

Maximum Power Linearity at current setting _____ dB

Maximum Power Linearity at current setting _____ dB

Total Power Linearity at current setting _____ dBpp
 (= Maximum Power Linearity - Minimum Power Linearity)

Upper Test Limit 0.2 dBpp

Measurement Uncertainty ± 0.04 dB

Agilent Compact Tunable Laser Source module Performance Test
 Model: Agilent 81989A Report No. _____

Page 8 of 10
 Date: _____

Power Flatness

Wavelength	Power Setting: + 6.00dBm	
	Power Deviation	
Start = REF 1465.000nm	0.00	dB
1470.000nm		dB
1475.000nm		dB
1480.000nm		dB
1485.000nm		dB
1490.000nm		dB
1495.000nm		dB
1500.000nm		dB
1505.000nm		dB
1510.000nm		dB
1515.000nm		dB
1520.000nm		dB
1525.000nm		dB
1530.000nm		dB
1535.000nm		dB
1540.000nm		dB
1545.000nm		dB
1550.000nm		dB
1555.000nm		dB
1560.000nm		dB
1565.000nm		dB
1570.000nm		dB
1575.000nm		dB
Full Wavelength Range (1465nm - 1575nm)		
Maximum deviation:		dB
Minimum deviation:		dB
Flatness = Maximum - Minimum deviation:		dB
Upper Test Limit:	0.60	dBpp
Performance Characteristic:	0.3	dBpp
Wavelength Range (1525nm - 1575nm)		
Maximum deviation:		dB
Minimum deviation:		dB
Flatness = Maximum - Minimum deviation:		dB
Upper Test Limit:	0.40	dBpp
Performance Characteristic:	0.2	dBpp

Measurement Uncertainty: ±2.6%

Agilent Compact Tunable Laser Source module Performance Test
 Model: Agilent 81989A Report No. _____

Page 9 of 10
 Date: _____

Power Stability

	Power Setting: + 6.00dBm
Maximum Deviation	_____ dB
Minimum Deviation	_____ dB
Power Stability ΔP	_____ dB
Upper Test Limit	0.02 dBp
Measurement Uncertainty	± 0.005 dB

Signal-to-Source Spontaneous Emission

Wavelength	Output Power	Results	Lower Test Limit
1465.000 nm	+ 10.00 dBm	_____ dB	45 dB
1470.000 nm	+ 10.00 dBm	_____ dB	45 dB
1475.000 nm	+ 10.00 dBm	_____ dB	45 dB
1480.000 nm	+ 10.00 dBm	_____ dB	45 dB
1485.000 nm	+ 10.00 dBm	_____ dB	45 dB
1490.000 nm	+ 10.00 dBm	_____ dB	45 dB
1495.000 nm	+ 10.00 dBm	_____ dB	45 dB
1500.000 nm	+ 10.00 dBm	_____ dB	45 dB
1505.000 nm	+ 10.00 dBm	_____ dB	45 dB
1510.000 nm	+ 10.00 dBm	_____ dB	45 dB
1515.000 nm	+ 10.00 dBm	_____ dB	45 dB
1520.000 nm	+ 10.00 dBm	_____ dB	45 dB
1525.000 nm	+ 13.00 dBm	_____ dB	48 dB
1530.000 nm	+ 13.00 dBm	_____ dB	48 dB
1535.000 nm	+ 13.00 dBm	_____ dB	48 dB
1540.000 nm	+ 13.00 dBm	_____ dB	48 dB
1545.000 nm	+ 13.00 dBm	_____ dB	48 dB
1550.000 nm	+ 13.00 dBm	_____ dB	48 dB
1555.000 nm	+ 13.00 dBm	_____ dB	48 dB
1560.000 nm	+ 13.00 dBm	_____ dB	48 dB
1565.000 nm	+ 13.00 dBm	_____ dB	48 dB
1570.000 nm	+ 13.00 dBm	_____ dB	48 dB
1575.000 nm	+ 13.00 dBm	_____ dB	48 dB

Measurement Uncertainty: ± 0.20 dB

Agilent Compact Tunable Laser Source module Performance Test

Page 10 of 10

Model: Agilent 81989A

Report No. _____

Date: _____

Optional Test: Signal-to-Total-Source Spontaneous Emission

OSA noise	_____ pW	
SSE_power_λTLS_max	_____ pW	
Power_total_SSE = OSA_noise + SSE_power_λTLS_max		_____ pW
Measurement Result = Total SSE (use formula below)		_____ pW

Lower Test Limit

22 dB

Performance Characteristic

25 dB typical

$$Total\ SSE = 10 \times \log \frac{peak_power}{power_total_SSE}$$

Measurement Uncertainty: ±2.0 dB

Test Record

Agilent 81949A Performance Test

Test Facility:

Page 1 of 10

_____	Report No.:	_____
_____	Date:	_____
_____	Customer:	_____
_____	Tested By:	_____

Model: Agilent 81949A Compact Tunable Laser Source module

Serial No.	_____	Ambient temperature	_____	°C
Options.	_____	Relative humidity	_____	%
Firmware Rev.		Line frequency	_____	Hz

Special Notes:

Agilent Compact Tunable Laser Source module Performance Test

Model: Agilent 81949A

Report No. _____

Page 2 of 10

Date: _____

Test Equipment Used

Description	Model No.	Trace No.	Cal. due date
1. Standard Optical Head	_____	_____	/ /
2. Optical Spectrum Analyzer	_____	_____	/ /
3. Wavelength Meter	_____	_____	/ /
4. _____	_____	_____	/ /
5. _____	_____	_____	/ /
6. _____	_____	_____	/ /
7. _____	_____	_____	/ /
8. _____	_____	_____	/ /
9. _____	_____	_____	/ /
10. _____	_____	_____	/ /
11. _____	_____	_____	/ /
12. _____	_____	_____	/ /

Agilent Compact Tunable Laser Source module Performance Test
 Model: Agilent 81949A Report No. _____

Page 3 of 10
 Date: _____

Relative Wavelength Accuracy

Wavelength Setting	Repetition 1		Repetition 2		Repetition 3	
	Wavelength Measured	Wavelength Deviation ^[1]	Wavelength Measured	Wavelength Deviation ^[1]	Wavelength Measured	Wavelength Deviation ^[1]
1520.000 nm	nm	nm	nm	nm	nm	nm
1535.000 nm	nm	nm	nm	nm	nm	nm
1550.000 nm	nm	nm	nm	nm	nm	nm
1565.000 nm	nm	nm	nm	nm	nm	nm
1580.000 nm	nm	nm	nm	nm	nm	nm
1595.000 nm	nm	nm	nm	nm	nm	nm
1610.000 nm	nm	nm	nm	nm	nm	nm
1620.000 nm	nm	nm	nm	nm	nm	nm
1630.000 nm	nm	nm	nm	nm	nm	nm
Within full tuning range 1520 nm - 1630 nm						
Maximum Deviation		nm	nm		nm	
Minimum Deviation		nm	nm		nm	

Wavelength Setting	Repetition 4		Repetition 5	
	Wavelength Measured	Wavelength Deviation ^[1]	Wavelength Measured	Wavelength Deviation ^[1]
1520.000 nm	nm	nm	nm	nm
1535.000 nm	nm	nm	nm	nm
1550.000 nm	nm	nm	nm	nm
1565.000 nm	nm	nm	nm	nm
1580.000 nm	nm	nm	nm	nm
1595.000 nm	nm	nm	nm	nm
1610.000 nm	nm	nm	nm	nm
1620.000 nm	nm	nm	nm	nm
1630.000 nm	nm	nm	nm	nm
Within full tuning range 1520 nm - 1630 nm				
Maximum Deviation		nm	nm	
Minimum Deviation		nm	nm	

^[1] Wavelength Deviation = Wavelength Measured - Wavelength Setting

Agilent Compact Tunable Laser Source module Performance Test

Page 4 of 10

Model: Agilent 81949A

Report No. _____

Date: _____

Relative Wavelength Accuracy

Largest Maximum Deviation _____ nm

Summary of all Repetitions

Smallest Minimum Deviation _____ nm

Relative Wavelength Accuracy Result

(= Largest Maximum Deviation - Smallest Minimum Deviation)

Relative Wavelength Accuracy _____ nm

Upper Test Limit 0.1 nmMeasurement Uncertainty: ±0.2 pm

Absolute Wavelength Accuracy Result

Largest Value of Deviation (= largest of either
Largest Maximum Deviation or Smallest Minimum Deviation).

Absolute Wavelength Accuracy _____ nm

Test Limit ±0.1 nmMeasurement Uncertainty: ±0.6 pm

Agilent Compact Tunable Laser Source module Performance Test
 Model: Agilent 81949A Report No. _____

Page 5 of 10
 Date: _____

Wavelength Repeatability

Repeatability of 1520.000nm (= REF)	Measurement Result
Initial Setting	REF= _____ nm
from 1545.000nm to REF	_____ nm
from 1575.000nm to REF	_____ nm
from 1605.000nm to REF	_____ nm
from 1630.000nm to REF	_____ nm
largest measured wavelength	_____ nm
smallest measured wavelength	_____ nm
Wavelength Repeatability (= largest measured wavelength - smallest measured wavelength)	_____ nm
Upper Test Limit	0.01 nm

Repeatability of 1575.000nm (= REF)	Measurement Result
Initial Setting	REF= _____ nm
from 1520.000nm to REF	_____ nm
from 1545.000nm to REF	_____ nm
from 1605.000nm to REF	_____ nm
from 1630.000nm to REF	_____ nm
largest measured wavelength	_____ nm
smallest measured wavelength	_____ nm
Wavelength Repeatability (= largest measured wavelength - smallest measured wavelength)	_____ nm
Upper Test Limit	0.01 nm

Repeatability of 1630.000nm (= REF)	Measurement Result
Initial Setting	REF= _____ nm
from 1520.000nm to REF	_____ nm
from 1545.000nm to REF	_____ nm
from 1575.000nm to REF	_____ nm
from 1605.000nm to REF	_____ nm
largest measured wavelength	_____ nm
smallest measured wavelength	_____ nm
Wavelength Repeatability (= largest measured wavelength - smallest measured wavelength)	_____ nm
Upper Test Limit	0.01 nm

Measurement Uncertainty: ± 0.1 pm

Agilent Compact Tunable Laser Source module Performance Test
 Model: Agilent 81949A Report No. _____

Page 6 of 10
 Date: _____

Maximum Power Test

Wavelength Setting	Power Measured	Minimum Lower Test Limit
1520.000 nm	_____ dBm	+ 10.00 dBm
1530.000 nm	_____ dBm	+ 10.00 dBm
1540.000 nm	_____ dBm	+ 10.00 dBm
1550.000 nm	_____ dBm	+ 10.00 dBm
1560.000 nm	_____ dBm	+ 10.00 dBm
1570.000 nm	_____ dBm	+ 13.00 dBm
1580.000 nm	_____ dBm	+ 13.00 dBm
1590.000 nm	_____ dBm	+ 13.00 dBm
1600.000 nm	_____ dBm	+ 13.00 dBm
1610.000 nm	_____ dBm	+ 13.00 dBm
1620.000 nm	_____ dBm	+ 13.00 dBm
1630.000 nm	_____ dBm	+ 10.00 dBm

Measurement Uncertainty: $\pm 4.5\%$

Agilent Compact Tunable Laser Source module Performance Test
 Model: Agilent 81949A Report No. _____

Page 7 of 10
 Date: _____

Power Linearity

	Power Setting from Start	Measured Relative Power from Start	Power reduction from start	Power Linearity at current setting
Start = REF	+13dBm	0.00 dB	+ 0.00 dB	= 0.00 dB
	+12dBm	_____ dB	+ 1.00 dB	= _____ dB
	+11 dBm	_____ dB	+ 2.00 dB	= _____ dB
	+10 dBm	_____ dB	+ 3.00 dB	= _____ dB
	+ 9 dBm	_____ dB	+ 4.00 dB	= _____ dB
	+ 8 dBm	_____ dB	+ 5.00 dB	= _____ dB
	+ 7 dBm	_____ dB	+ 6.00 dB	= _____ dB
	+ 6 dBm	_____ dB	+ 7.00 dB	= _____ dB

Maximum Power Linearity at current setting _____ dB

Maximum Power Linearity at current setting _____ dB

Total Power Linearity at current setting _____ dBpp
 (= Maximum Power Linearity - Minimum Power Linearity)

Upper Test Limit 0.2 dBpp

Measurement Uncertainty ± 0.04 dB

Agilent Compact Tunable Laser Source module Performance Test
 Model: Agilent 81949A Report No. _____

Page 8 of 10
 Date: _____

Power Flatness

Wavelength		Power Setting: + 6.00dBm	
		Power Deviation	
Start = REF	1520.000nm	0.00	dB
	1525.000nm		dB
	1530.000nm		dB
	1535.000nm		dB
	1540.000nm		dB
	1545.000nm		dB
	1550.000nm		dB
	1555.000nm		dB
	1560.000nm		dB
	1565.000nm		dB
	1570.000nm		dB
	1575.000nm		dB
	1580.000nm		dB
	1585.000nm		dB
	1590.000nm		dB
	1595.000nm		dB
	1600.000nm		dB
	1605.000nm		dB
	1610.000nm		dB
	1615.000nm		dB
	1620.000nm		dB
	1625.000nm		dB
	1630.000nm		dB
Full Wavelength Range (1520nm - 1630nm)			
	Maximum deviation:		dB
	Minimum deviation:		dB
	Flatness = Maximum - Minimum deviation:		dB
	Upper Test Limit:	0.60	dBpp
	Performance Characteristic:	0.3	dBpp
Wavelength Range (1570nm - 1620nm)			
	Maximum deviation:		dB
	Minimum deviation:		dB
	Flatness = Maximum - Minimum deviation:		dB
	Upper Test Limit:	0.40	dBpp
	Performance Characteristic:	0.2	dBpp

Measurement Uncertainty: ±2.6%

Agilent Compact Tunable Laser Source module Performance Test
 Model: Agilent 81949A Report No. _____

Page 9 of 10
 Date: _____

Power Stability

	Power Setting: + 6.00dBm
Maximum Deviation	_____ dB
Minimum Deviation	_____ dB
Power Stability ΔP	_____ dB
Upper Test Limit	0.02 dBp
Measurement Uncertainty	± 0.005 dB

Signal-to-Source Spontaneous Emission

Wavelength	Output Power	Results	Lower Test Limit
1520.000 nm	+ 10.00 dBm	_____ dB	45 dB
1525.000 nm	+ 10.00 dBm	_____ dB	45 dB
1530.000 nm	+ 10.00 dBm	_____ dB	45 dB
1535.000 nm	+ 10.00 dBm	_____ dB	45 dB
1540.000 nm	+ 10.00 dBm	_____ dB	45 dB
1545.000 nm	+ 10.00 dBm	_____ dB	45 dB
1550.000 nm	+ 10.00 dBm	_____ dB	45 dB
1555.000 nm	+ 10.00 dBm	_____ dB	45 dB
1560.000 nm	+ 10.00 dBm	_____ dB	45 dB
1565.000 nm	+ 10.00 dBm	_____ dB	45 dB
1570.000 nm	+ 13.00 dBm	_____ dB	48 dB
1575.000 nm	+ 13.00 dBm	_____ dB	48 dB
1580.000 nm	+ 13.00 dBm	_____ dB	48 dB
1585.000 nm	+ 13.00 dBm	_____ dB	48 dB
1590.000 nm	+ 13.00 dBm	_____ dB	48 dB
1595.000 nm	+ 13.00 dBm	_____ dB	48 dB
1600.000 nm	+ 13.00 dBm	_____ dB	48 dB
1605.000 nm	+ 13.00 dBm	_____ dB	48 dB
1610.000 nm	+ 13.00 dBm	_____ dB	48 dB
1615.000 nm	+ 13.00 dBm	_____ dB	48 dB
1620.000 nm	+ 13.00 dBm	_____ dB	48 dB
1625.000 nm	+ 10.00 dBm	_____ dB	45 dB
1630.000 nm	+ 10.00 dBm	_____ dB	45 dB

Measurement Uncertainty: ± 0.20 dB

Agilent Compact Tunable Laser Source module Performance Test

Page 10 of 10

Model: Agilent 81949A Report No. _____

Date: _____

Optional Test: Signal-to-Total-Source Spontaneous Emission

OSA noise	_____ pW	
SSE_power_λTLS_max	_____ pW	
Power_total_SSE = OSA_noise + SSE_power_λTLS_max		_____ pW
Measurement Result = Total SSE (use formula below)		_____ pW

Lower Test Limit 22 dB

Performance Characteristic 25dB typical

$$Total\ SSE = 10 \times \log \frac{peak_power}{power_total_SSE}$$

Measurement Uncertainty: ±2.0 dB

5

Cleaning Information

The Cleaning Instructions provided in this chapter apply to a number of different types of Optical Equipment.

Cleaning Instructions for this Module If you must clean the Agilent Compact TLS module, please refer the module to the skilled personnel of Agilent’s service team.

Cleaning Instructions.....	140
Safety Precautions	140
Why is it important to clean optical devices ?	141
What do I need for proper cleaning?	142
Preserving Connectors.....	146
Cleaning Instrument Housings.....	146
Which Cleaning Procedure should I use?.....	147
How to clean connectors.....	148
How to clean connector interfaces	150
How to clean bare fiber adapters.....	151
How to clean instruments with a fixed connector interface .	152
Additional Cleaning Information.....	153
Other Cleaning Hints	154

Cleaning Instructions

The following Cleaning Instructions contain some general safety precautions, which must be observed during all phases of cleaning. Consult your specific optical device manuals or guides for full information on safety matters.

Please try, whenever possible, to use physically contacting connectors, and dry connections. Clean the connectors, interfaces, and bushings carefully after use.

If you are unsure of the correct cleaning procedure for your optical device, we recommend that you first try cleaning a dummy or test device.

Agilent Technologies assume no liability for the customer's failure to comply with these requirements.

Safety Precautions

Please follow the following safety rules:

- Do not remove instrument covers when operating.
- Ensure that the instrument is switched off throughout the cleaning procedures.
- Use of controls or adjustments or performance of procedures other than those specified may result in hazardous radiation exposure.
- Make sure that you disable all sources when you are cleaning any optical interfaces.
- Under no circumstances look into the end of an optical device attached to optical outputs when the device is operational. The laser radiation is not visible to the human eye, but it can seriously damage your eyesight.
- To prevent electrical shock, disconnect the instrument from the mains before cleaning. Use a dry cloth, or one slightly dampened with water, to clean the external case parts. Do not attempt to clean internally.
- Do not install parts or perform any unauthorized modification to optical devices.
- Refer servicing only to qualified and authorized personnel.

Why is it important to clean optical devices ?

In transmission links optical fiber cores are about 9 μm (0.00035") in diameter. Dust and other particles, however, can range from tenths to hundredths of microns in diameter. Their comparative size means that they can cover a part of the end of a fiber core, and as a result will reduce the performance of your system.

Furthermore, the power density may burn dust into the fiber and cause additional damage (for example, 0 dBm optical power in a single mode fiber causes a power density of approximately 16 million W/m^2). If this happens, measurements become inaccurate and non-repeatable.

Cleaning is, therefore, an essential yet difficult task. Unfortunately, when comparing most published cleaning recommendations, you will discover that they contain several inconsistencies. In this section, we want to suggest ways to help you clean your various optical devices, and thus significantly improve the accuracy and repeatability of your lightwave measurements.

What do I need for proper cleaning?

Some Standard Cleaning Equipment is necessary for cleaning your instrument. For certain cleaning procedures, you may also require certain Additional Cleaning Equipment.

Standard Cleaning Equipment

Before you can start your cleaning procedure you need the following standard equipment:

- Dust and shutter caps
- Isopropyl alcohol
- Cotton swabs
- Soft tissues
- Pipe cleaner
- Compressed air

Dust and shutter caps All of Agilent Technologies' lightwave instruments are delivered with either laser shutter caps or dust caps on the lightwave adapter. Any cables come with covers to protect the cable ends from damage or contamination.

We suggest these protected coverings should be kept on the equipment at all times, except when your optical device is in use. Be careful when replacing dust caps after use. Do not press the bottom of the cap onto the fiber too hard, as any dust in the cap can scratch or pollute your fiber surface.

If you need further dust caps, please contact your nearest Agilent Technologies sales office.

Isopropyl alcohol This solvent is usually available from any local pharmaceutical supplier or chemist's shop.

If you use isopropyl alcohol to clean your optical device, do not immediately dry the surface with compressed air (except when you are cleaning very sensitive optical devices). This is because the dust and the dirt is solved and will leave behind filmy deposits after the alcohol is evaporated. You should therefore first remove the alcohol and the dust with a soft tissue, and then use compressed air to blow away any remaining filaments.

If possible avoid using denatured alcohol containing additives. Instead, apply alcohol used for medical purposes.

Never try to drink this alcohol, as it may seriously damage your health.

Do not use any other solvents, as some may damage plastic materials and claddings. Acetone, for example, will dissolve the epoxy used with fiber optic connectors. To avoid damage, only use isopropyl alcohol.

Cotton swabs We recommend that you use swabs such as Q-tips or other cotton swabs normally available from local distributors of medical and hygiene products (for example, a supermarket or a chemist's shop). You may be able to obtain various sizes of swab. If this is the case, select the smallest size for your smallest devices.

Ensure that you use natural cotton swabs. Foam swabs will often leave behind filmy deposits after cleaning.

Use care when cleaning, and avoid pressing too hard onto your optical device with the swab. Too much pressure may scratch the surface, and could cause your device to become misaligned. It is advisable to rub gently over the surface using only a small circular movement.

Swabs should be used straight out of the packet, and never used twice. This is because dust and dirt in the atmosphere, or from a first cleaning, may collect on your swab and scratch the surface of your optical device.

Soft tissues These are available from most stores and distributors of medical and hygiene products such as supermarkets or chemists' shops.

We recommend that you do not use normal cotton tissues, but multi-layered soft tissues made from non-recycled cellulose. Cellulose tissues are very absorbent and softer. Consequently, they will not scratch the surface of your device over time.

Use care when cleaning, and avoid pressing on your optical device with the tissue. Pressing too hard may lead to scratches on the surface or misalignment of your device. Just rub gently over the surface using a small circular movement.

Use only clean, fresh soft tissues and never apply them twice. Any dust and dirt from the air which collects on your tissue, or which has gathered after initial cleaning, may scratch and pollute your optical device.

Pipe cleaner Pipe cleaners can be purchased from tobacconists, and come in various shapes and sizes. The most suitable one to select for cleaning purposes has soft bristles, which will not produce scratches.

There are many different kinds of pipe cleaner available from tobacco shops.

The best way to use a pipe cleaner is to push it in and out of the device opening (for example, when cleaning an interface). While you are cleaning, you should slowly rotate the pipe cleaner.

Only use pipe cleaners on connector interfaces or on feed through adapters. Do not use them on optical head adapters, as the center of a pipe cleaner is hard metal and can damage the bottom of the adapter.

Your pipe cleaner should be new when you use it. If it has collected any dust or dirt, this can scratch or contaminate your device.

The tip and center of the pipe cleaner are made of metal. Avoid accidentally pressing these metal parts against the inside of the device, as this can cause scratches.

Compressed air Compressed air can be purchased from any laboratory supplier.

It is essential that your compressed air is free of dust, water and oil. Only use clean, dry air. If not, this can lead to filmy deposits or scratches on the surface of your connector. This will reduce the performance of your transmission system.

When spraying compressed air, hold the can upright. If the can is held at a slant, propellant could escape and dirty your optical device. First spray into the air, as the initial stream of compressed air could contain some condensation or propellant. Such condensation leaves behind a filmy deposit.

Please be friendly to your environment and use a CFC-free aerosol.

Additional Cleaning Equipment

Some Cleaning Procedures need the following equipment, which is not required to clean each instrument:

- Microscope with a magnification range about 50X up to 300X
- Ultrasonic bath
- Warm water and liquid soap
- Premoistened cleaning wipes
- Polymer film
- Infrared Sensor Card

Microscope with a magnification range about 50X up to 300X A microscope can be found in most photography stores, or can be obtained through or specialist mail order companies. Special fiber-scopes are available from suppliers of splicing equipment.

Ideally, the light source on your microscope should be very flexible. This will allow you to examine your device closely and from different angles.

A microscope helps you to estimate the type and degree of dirt on your device. You can use a microscope to choose an appropriate cleaning

method, and then to examine the results. You can also use your microscope to judge whether your optical device (such as a connector) is severely scratched and is, therefore, causing inaccurate measurements.

Ultrasonic bath Ultrasonic baths are also available from photography or laboratory suppliers or specialist mail order companies.

An ultrasonic bath will gently remove fat and other stubborn dirt from your optical devices. This helps increase the life span of the optical devices.

Only use isopropyl alcohol in your ultrasonic bath, as other solvents may damage.

Warm water and liquid soap Only use water if you are sure that there is no other way of cleaning your optical device without corrosion or damage. Do not use hot water, as this may cause mechanical stress, which can damage your optical device.

Ensure that your liquid soap has no abrasive properties or perfume in it. You should also avoid normal washing-up liquid, as it can cover your device in an iridescent film after it has been air-dried.

Some lenses and mirrors also have a special coating, which may be sensitive to mechanical stress, or to fat and liquids. For this reason we recommend you do not touch them.

If you are not sure how sensitive your device is to cleaning, please contact the manufacturer or your sales distributor.

Premoistened cleaning wipes Use pre-moistened cleaning wipes as described in each individual cleaning procedure. Cleaning wipes may be used in every instance where a moistened soft tissue or cotton swab is applied.

Polymer film Polymer film is available from laboratory suppliers or specialist mail order companies.

Using polymer film is a gentle method of cleaning extremely sensitive devices, such as reference reflectors and mirrors.

Infrared Sensor Card Infrared sensor cards are available from laboratory suppliers or specialist mail order companies.

With this card you are able to control the shape of laser light emitted. The invisible laser beam is projected onto the sensor card, then becomes visible to the normal eye as a round spot.

Take care never to look into the end of a fiber or any other optical component, when they are in use. This is because the laser can seriously damage your eyes.

Preserving Connectors

Listed below are some hints on how best to keep your connectors in the best possible condition.

Making Connections Before you make any connection you must ensure that all cables and connectors are clean. If they are dirty, use the appropriate cleaning procedure.

When inserting the ferrule of a patchcord into a connector or an adapter, make sure that the fiber end does not touch the outside of the mating connector or adapter. Otherwise you will rub the fiber end against an unsuitable surface, producing scratches and dirt deposits on the surface of your fiber.

Dust Caps and Shutter Caps Be careful when replacing dust caps after use. Do not press the bottom of the cap onto the fiber as any dust in the cap can scratch or dirty your fiber surface.

When you have finished cleaning, put the dust cap back on, or close the shutter cap if the equipment is not going to be used immediately.

Keep the caps on the equipment always when it is not in use.

All of Agilent Technologies' lightwave instruments and accessories are shipped with either laser shutter caps or dust caps. If you need additional or replacement dust caps, contact your nearest Agilent Technologies Sales/Service Office.

Immersion Oil and Other Index Matching Compounds Where it is possible, do not use immersion oil or other index matching compounds with your device. They are liable to impair and dirty the surface of the device. In addition, the characteristics of your device can be changed and your measurement results affected.

Cleaning Instrument Housings

Use a dry and very soft cotton tissue to clean the instrument housing and the keypad. Do not open the instruments as there is a danger of electric shock, or electrostatic discharge. Opening the instrument can cause damage to sensitive components, and in addition your warranty will be voided.

Which Cleaning Procedure should I use?

Light dirt

If you just want to clean away light dirt, observe the following procedure for all devices:

- Use compressed air to blow away large particles.
- Clean the device with a dry cotton swab.
- Use compressed air to blow away any remaining filament left by the swab.

Heavy dirt

If the above procedure is not enough to clean your instrument, follow one of the procedures below. Please consult “Cleaning Instructions for this Module” on page 139 for the procedure relevant for this instrument.

If you are unsure of how sensitive your device is to cleaning, please contact the manufacturer or your sales distributor.

How to clean connectors

Cleaning connectors is difficult as the core diameter of a single-mode fiber is only about 9 μm . This generally means you cannot see streaks or scratches on the surface. To be certain of the condition of the surface of your connector and to check it after cleaning, you need a microscope.

In the case of scratches, or of dust that has been burnt onto the surface of the connector, you may have no option but to polish the connector. This depends on the degree of dirtiness, or the depth of the scratches. This is a difficult procedure and should only be performed by skilled personal, and as a last resort as it wears out your connector.

WARNING

Never look into the end of an optical cable that is connected to an active source.

To assess the projection of the emitted light beam you can use an infrared sensor card. Hold the card approximately 5 cm from the output of the connector. The invisible emitted light is project onto the card and becomes visible as a small circular spot.

Preferred Procedure

Use the following procedure on most occasions.

- 1 Clean the connector by rubbing a new, dry cotton-swab over the surface using a small circular movement.
- 2 Blow away any remaining lint with compressed air.

Procedure for Stubborn Dirt

Use this procedure particularly when there is greasy dirt on the connector:

- 1 Moisten a new cotton-swab with isopropyl alcohol.
- 2 Clean the connector by rubbing the cotton-swab over the surface using a small circular movement.
- 3 Take a new, dry soft-tissue and remove the alcohol, dissolved sediment and dust, by rubbing gently over the surface using a small circular movement.
- 4 Blow away any remaining lint with compressed air.

An Alternative Procedure

A better, more gentle, but more expensive cleaning procedure is to use an ultrasonic bath with isopropyl alcohol.

- 1 Hold the tip of the connector in the bath for at least three minutes.
- 2 Take a new, dry soft-tissue and remove the alcohol, dissolved sediment and dust, by rubbing gently over the surface using a small circular movement.
- 3 Blow away any remaining lint with compressed air.

How to clean connector interfaces

CAUTION

Be careful when using pipe-cleaners, as the core and the bristles of the pipe-cleaner are hard and can damage the interface.

Do not use pipe-cleaners on optical head adapters, as the hard core of normal pipe cleaners can damage the bottom of an adapter.

Preferred Procedure

Use the following procedure on most occasions.

- 1 Clean the interface by pushing and pulling a new, dry pipe-cleaner into the opening. Rotate the pipe-cleaner slowly as you do this.
- 2 Then clean the interface by rubbing a new, dry cotton-swab over the surface using a small circular movement.
- 3 Blow away any remaining lint with compressed air.

Procedure for Stubborn Dirt

Use this procedure particularly when there is greasy dirt on the interface:

- 1 Moisten a new pipe-cleaner with isopropyl alcohol.
- 2 Clean the interface by pushing and pulling the pipe-cleaner into the opening. Rotate the pipe-cleaner slowly as you do this.
- 3 Moisten a new cotton-swab with isopropyl alcohol.
- 4 Clean the interface by rubbing the cotton-swab over the surface using a small circular movement.
- 5 Using a new, dry pipe-cleaner, and a new, dry cotton-swab remove the alcohol, any dissolved sediment and dust.
- 6 Blow away any remaining lint with compressed air.

How to clean bare fiber adapters

Bare fiber adapters are difficult to clean. Protect from dust unless they are in use.

CAUTION

Never use any kind of solvent when cleaning a bare fiber adapter as solvents can damage the foam inside some adapters.

They can deposit dissolved dirt in the groove, which can then dirty the surface of an inserted fiber.

Preferred Procedure

Use the following procedure on most occasions.

- 1 Blow away any dust or dirt with compressed air.

Procedure for Stubborn Dirt

Use this procedure particularly when there is greasy dirt on the adapter:

- 1 Clean the adapter by pushing and pulling a new, dry pipe-cleaner into the opening. Rotate the pipe-cleaner slowly as you do this.

CAUTION

Be careful when using pipe-cleaners, as the core and the bristles of the pipe-cleaner are hard and can damage the adapter.

- 2 Clean the adapter by rubbing a new, dry cotton-swab over the surface using a small circular movement.
- 3 Blow away any remaining lint with compressed air.

How to clean instruments with a fixed connector interface

You should only clean instruments with a fixed connector interface when it is absolutely necessary. This is because it is difficult to remove any used alcohol or filaments from the input of the optical block.

It is important, therefore, to keep dust caps on the equipment at all times, except when your optical device is in use.

If you do discover filaments or particles, the only way to clean a fixed connector interface and the input of the optical block is to use compressed air.

If there are fluids or fat in the connector, please refer the instrument to the skilled personnel of Agilent's service team.

CAUTION

Only use clean, dry compressed air. Make sure that the air is free of dust, water, and oil. If the air that you use is not clean and dry, this can lead to filmy deposits or scratches on the surface of your connector interface. This will degrade the performance of your transmission system.

Never try to open the instrument and clean the optical block by yourself, because it is easy to scratch optical components, and cause them to be misaligned.

Additional Cleaning Information

The following cleaning procedure may be used with other optical equipment:

How to clean bare fiber ends

Bare fiber ends are often used for splices or, together with other optical components, to create a parallel beam. The end of a fiber can often be scratched. You make a new cleave. To do this:

- 1 Strip off the cladding.
- 2 Take a new soft-tissue and moisten it with isopropyl alcohol.
- 3 Carefully clean the bare fiber with this tissue.
- 4 Make your cleave and immediately insert the fiber into your bare fiber adapter in order to protect the surface from dirt.

Other Cleaning Hints

Selecting the correct cleaning method is an important element in maintaining your equipment and saving you time and money. This Appendix highlights the main cleaning methods, but cannot address every individual circumstance.

This section contain some additional hints which we hope will help you further. For further information, please contact your local Agilent Technologies representative.

Making the connection Before you make any connection you must ensure that all lightwave cables and connectors are clean. If not, then use appropriate the cleaning methods.

When you insert the ferrule of a patchcord into a connector or an adapter, ensure that the fiber end does not touch the outside of the mating connector or adapter. Otherwise, the fiber end will rub up against something which could scratch it and leave deposits.

Lens cleaning papers Note that some special lens cleaning papers are not suitable for cleaning optical devices like connectors, interfaces, lenses, mirrors and so on. To be absolutely certain that a cleaning paper is applicable, please ask the salesperson or the manufacturer.

Immersion oil and other index matching compounds Do not use immersion oil or other index matching compounds with optical sensors equipped with recessed lenses. They are liable to dirty the detector and impair its performance. They may also alter the property of depiction of your optical device, thus rendering your measurements inaccurate.

Cleaning the housing and the mainframe When cleaning either the mainframe or the housing of your instrument, only use a dry and very soft cotton tissue on the surfaces and the numeric pad.

Never open the instruments as they can be damaged. Opening the instruments puts you in danger of receiving an electrical shock from your device, and renders your warranty void.

Index

C

Cleaning connectors 148

Connectors

- angled contact 23, 28
- straight contact 23, 28

D

Definition

- absolute wavelength accuracy 33
- continuous sweep mode 46
- dynamic conditions 46
- effective linewidth 33
- external analog modulation - modulation depth 34
- external digital modulation - delay time 33
- internal digital modulation - duty cycle 34
- internal digital modulation - rise and fall time 34
- linewidth 35
- logged wavelength 46
- maximum output power 36
- maximum sweep speed 36
- mode-hop free sweeping range 37
- mode-hop free tunability 37
- modulation extinction ratio 37
- operating temperature and humidity 37
- output isolation 37
- polarization extinction ratio 38
- power flatness vs. wavelength 39
- power linearity 39
- power repeatability 40
- power stability 40
- relative wavelength accuracy 41
- return loss 42
- RIN 41
- SBS Supp - effective linewidth 42
- SBS Supp. - residual amplitude modulation 42
- side-mode suppression ratio 42
- signal to source SSE 43
- signal to total source SSE 44
- static conditions 46
- stepped mode 46
- tuning time 44
- wavelength range 44
- Wavelength repeatability 45
- wavelength resolution 45
- wavelength stability 45

F

Front Panel

- Controls and Indicators 19

I

Inspection 13

M

Modulation

- coherence control 54
- SBS Suppression 54

Modules

- connector interfaces 28
- interface options 27
- optional features 26
- User's Guides 29

O

Optical Output 22

P

Perf Validation

- absolute & relative wavelength accuracy 62
- instructions 60
- maximum output power 69
- mode-hop free tuning 66
- power flatness vs. wavelength 77
- power linearity 74
- power stability 80
- signal to source SSE 83
- signal to total source SSE (optional) 86
- test equipment 58
- test failure 59
- Test Record 59
- wavelength repeatability 67

Polarization Maintaining Fiber 22

S

Safety

- Line Power 13
- Operating Environment 13
- Symbols 12

Signal Input 24

Signal Output 24

Specifications

- 81940A 49
- 81949A 52
- 81980A 48
- 81989A 51

Storage 14

Supplementary Performance Characteristics 54

T

Test Records

- 81940A 101
- 81944A 111
- 81949A 128
- 81980A 91
- 81989A 118

U

Use Models 20

User's Guides 29

© Agilent Technologies 2002 - 2005

Printed in Germany April 2005
Fourth edition, April 2005



81980-90A11