

Agilent 8163A/B Lightwave Multimeter,
Agilent 8164A/B Lightwave Measurement System, &
Agilent 8166A/B Lightwave Multichannel System

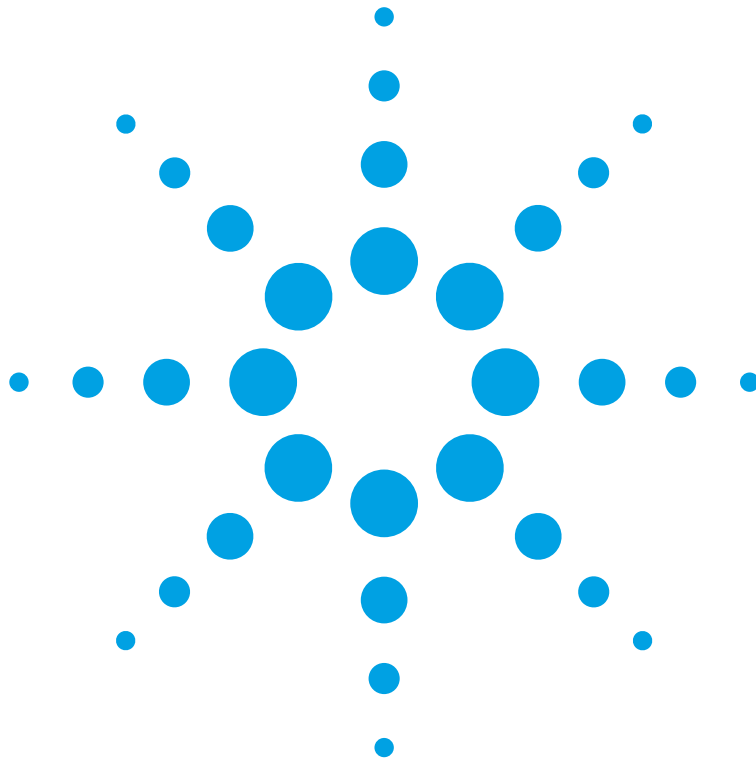

Notices

© Agilent Technologies, Inc. 2002-2004
This document contains proprietary information that is protected by copyright. All rights are reserved.

No part of this document may reproduced in (including electronic storage and retrieval or translation into a foreign language) without prior agreement and written consent from Agilent Technologies GmbH as governed by United States and international copyright laws.

Agilent Technologies Deutschland GmbH
Herrenberger Str. 130
71034 Böblingen
Germany

Manual Part Number

08164-90B15

Edition

Sixth edition, December 2004

Fifth edition, July 2003

Fourth edition, February 2002

Third edition, October 2001

Second edition, September 2001

First edition, August 2001

Warranty

This Agilent Technologies instrument product is warranted against defects in material and workmanship for a period of one year from date of shipment. During the warranty period, Agilent will, at its option, either repair or replace products that prove to be defective.

For warranty service or repair, this product must be returned to a service facility designated by Agilent. Buyer shall prepay shipping charges to Agilent and Agilent shall pay shipping charges to return the product to Buyer. However, Buyer shall pay all shipping charges, duties, and taxes for products returned to Agilent from another country. Agilent warrants that its software and

firmware designated by Agilent for use with an instrument will execute its programming instructions when properly installed on that instrument. Agilent does not warrant that the operation of the instrument, software, or firmware will be uninterrupted or error free.

Limitation of Warranty

The foregoing warranty shall not apply to defects resulting from improper or inadequate maintenance by Buyer, Buyer-supplied software or interfacing, unauthorized modification or misuse, operation outside of the environmental specifications for the product, or improper site preparation or maintenance.

No other warranty is expressed or implied. Agilent Technologies specifically disclaims the implied warranties of Merchantability and Fitness for a Particular Purpose.

Exclusive Remedies

The remedies provided herein are Buyer's sole and exclusive remedies. Agilent Technologies shall not be liable for any direct, indirect, special, incidental, or consequential damages whether based on contract, tort, or any other legal theory.

Assistance

Product maintenance agreements and other customer assistance agreements are available for Agilent Technologies products. For any assistance contact your nearest Agilent Technologies Sales and Service Office.

Certification

Agilent Technologies Inc. certifies that this product met its published specifications at the time of shipment from the factory.

Agilent Technologies further certifies that its calibration measurements are traceable to the United States National Institute of Standards and Technology, NIST (formerly the United States National Bureau of Standards, NBS) to the extent allowed by the Institutes' calibration facility, and to the calibration facilities of other International Standards Organization members.

ISO 9001 Certification

Produced to ISO 9001 international quality system standard as part of our objective of continually increasing customer satisfaction through improved process control.

Safety Notices

CAUTION

A CAUTION notice denotes a hazard. It calls attention to an operating procedure, practice, or the like that, if not correctly performed or adhered to, could result in damage to the product or loss of important data. Do not proceed beyond a CAUTION notice until the indicated conditions are fully understood and met.

WARNING

A WARNING notice denotes a hazard. It calls attention to an operating procedure, practice, or the like that, if not correctly performed or adhered to, could result in personal injury or death. Do not proceed beyond a WARNING notice until the indicated conditions are fully understood and met.

Agilent Technologies Sales and Service Offices

For more information about Agilent Technologies test and measurement products, applications, services, and for a current sales office listing, visit our web site:

<http://www.agilent.com/comms/lightwave>

You can also contact one of the following centers and ask for a test and measurement sales representative.

United States:	1 800 829 4444 1 800 829 4433 (FAX)
Canada:	1 877 894 4414 1888 900 8921 (FAX)
Europe:	(31 20) 547 2111 (31 20) 547 2190 (FAX)
Japan:	0120 421 345 0120 421 678 (FAX)
Mexico	(52 55) 5081 9469 (52 55) 5081 9467 (FAX)
Australia:	1 800 629 485 1 800 142 134 (FAX)
Asia-Pacific:	800 930 871 800 908 476 (FAX)
Brazil	(55 11) 4197 3600 (55 11) 4197 3800 (FAX)

Table of Contents

Getting Started	23
<hr/>	
Safety Considerations	25
General	26
Operating Environment	26
Line Power Requirements	27
Input/Output Signals	27
Line Power Connectors	28
Instrument Markings	29
Laser Safety Information	30
Laser Safety Labels	34
Agilent 8163A/B Lightwave Multimeter	36
Agilent 8164A/B Lightwave Measurement System	37
Agilent 8166A/B Lightwave Multichannel System	38
A Description of the User Interface	39
Password	40
User Interface Features	41
How to Navigate/Modify the Display	43
How to Change the Value of a Parameter	53
How to Select a Parameter	53
How to Accept the New Value of a Parameter	54
How to Make a Big Change to a Continuous Parameter	54
How to Make a Small Change to a Continuous Parameter	55
How to Change a Discrete Parameter	57
How to Set All Parameters to Their Default Values	58
If You Make a Mistake	58
If the Parameter Changes to Different Value	58
A Sample Session	59
How to Measure the Power of a Modulated Signal	60
Additional Information	63
<hr/>	
Using the System Utilities	64
How to Set the Backlight	65



How to Set the Date & Time	66
How to Lock/Unlock the High-Power Laser Sources	68
How to Set the Trigger Configuration	69
How to Configure Startup Applications	70
How to Configure your Foot Pedal	71
How to Set the GPIB Address	72
How to Set the Speed of the Serial Interface	73
How to Update a Module	74
How to Select the Printer Type	75
How to Change the Password	76
If You Forget Your Password	76
How to Get Information About Modules	77
How to Get Information About the Mainframe	79
How to Connect an External Monitor	80
How to Connect a Printer	81

Power Measurement 83

How to Measure Power	84
The Power Value	84
How to Set the Power Unit	85
How to Set the Calibration Offset	87
How to Set the Reference Level	88
How to Set the Wavelength	91
How to Remove Electrical Offsets	91
How to Choose the Range Mode	94
How to Set the Range	95
How to Set the Averaging Time	100
How to Choose the MinMax Mode	101
How to Turn Off MinMax Mode	103
How to Hold the Screen	103
How to Use Triggers	104
Dual Power Meters - Master and Slave Channels	107

Laser Sources 109

How to Use Laser Source Modules	110
The Laser Wavelength Value	110



How to Enable/Disable Laser Output	111
How to Set Attenuation	112
How to Modulate the Optical Output	113
How to Use the Internal Modulation	114
How to Use Triggers	117

Tunable Lasers 119

What is a Tunable Laser ?	121
How to Set the Power	121
How to Set the Output Power of a CW Signal	122
What is Excessive Power ?	126
How to Set the Laser to the Dark Position	127
The Analog Output	128
How to Set the Wavelength	130
Wavelength Range	130
How to Set the Wavelength Directly	131
How to Set a Relative Wavelength	132
How to Perform a Wavelength Sweep	134
What is a Wavelength Sweep ?	134
How to Set the Wavelength Sweep	135
How to Perform a Sweep	137
How to Modulate a Signal	142
How to Use the Internal Modulation	142
How to Use External Modulation	144
How to Configure the Modulation Output	149
How to Use Triggers	150
How to Use Input Triggering	150
How to Use Output Triggering	152
How to Use Auxiliary Functions	153
Automatic Realignment	153
How to Perform a Lambda Zero	155
Auto Cal Off	156

Compact Tunable Lasers 159

Compact Tunable Laser modules	160
-------------------------------	-----

How to Use a compact Tunable Laser	161
The User Interface	161
SBS Suppression	161
Return Loss Measurement	163
<hr/>	
Getting Started With Return Loss	165
What is Return Loss?	165
What is Insertion Loss?	165
Equipment required	166
How to Choose a Light Source	167
Return Loss Modules	168
Calibration Measurements	170
Return Loss Measurement	171
Setup	172
Calibrating the Return Loss Module	176
Calibration using the Agilent 81000BR Reference Reflector	177
Calibration using the Agilent 81610CC Reference Cable	180
How to Measure Return Loss	184
Viewing the Calibration Values	186
A Background to Return Loss Measurement	189
Measuring the Reflected Power from a Component with Known Reflection Factor	189
Measuring the Power Transmitted Through the Reflection Reference	190
Measuring the Power when there are No Reflections	190
Measuring the Power Transmitted Through the Measurement Patchcord	191
Measuring the Reflections from the DUT	191
Measuring the Power Transmitted Through the DUT	192
Calculating the Return Loss of the DUT	192
Calculating the Front Panel Delta	195
Calculating the Insertion Loss of the DUT	196
Setting Attenuation and/or Power Levels	197
<hr/>	
Agilent 8157xA Variable Optical Attenuator modules	198
How to Use a Variable Optical Attenuator module	199



The User Interface	199
How to Control the Shutter	202
How to Set Attenuation	203
How to Set a Power Level	207
How to Compensate for Wavelength Dependencies in your test setup	212
How to Use the Power Control Feature	216
Attenuator Menu Options	217
Attenuator Status Indicators	218

Switching Optical Routes 219

Agilent 8159xB Optical Switch modules	220
How to Use an Optical Switch module	221
The User Interface	221
Dependent and Independent Routing	223
How to set Route A	224
How to set Route B	224
How to Toggle the Switch path	225
Typical Applications	226
Selecting a Laser Source	226
Selecting Measurement and Calibration Paths	227
Inserting or Bypassing an Optical Component	227
Selecting one of several DUTs in a parallel test setup	228
Selecting one of several instruments	228

Applications 229

Working with Application Graphs	231
How to Set Markers	233
How to Zoom In	233
How to Zoom Out	234
To Switch the Grid On/Off	234
How to Use Legends	235
How to Select the Samples Display	237
How to Read Curve Values	239
The Logging Application	242
How to Set Up a Logging Function	243



Running a Logging Application	248
Analysing a Logging Application	250
On-Screen Messages	253
The Stability Application	254
How to Set Up a Stability Function	256
Running a Stability Application	260
Analysing a Stability Application	262
On-Screen Messages	265
The PACT Application	266
What is the PACT ?	266
How to Set Up PACT	267
How to Measure the Reference	270
How to Perform a Loss Measurement	272
Analysing a PACT Measurement	276
On-Screen Messages	277
The Pmax Curve	278
What is the Pmax Curve ?	278
How to View the Pmax Curve	278
The Return Loss Application	279
Starting the Application	279
Measuring Return Loss	279
Measuring Return Loss and Insertion Loss	280
On-Screen Messages	280
Configuration	281
User Interface	281
Recording Measurement Results	283
Printing Application Measurement Results	283
Saving Application Measurement Results to Diskette	285

Installation and Maintenance 287

Safety Considerations	289
Initial Inspection	290
AC Line Power Supply Requirements	291
Line Power Requirements	291
Line Power Cable	292
Changing the Battery	295



Changing the Fuse	295
Operating and Storage Environment	296
Temperature	296
Humidity	297
Altitude	297
Pollution Protection	297
Storage and Shipment	297
Instrument Cooling	298
Storage Position	300
Carrying the Instrument	301
Using Modules	302
How to Fit and Remove Modules	302
Adding a Connector Interface	307
Protecting Empty Module Slots	308
Input and Output Connectors	310
The Remote Interlock (RIL) connector	311
GPIB Interface	312
Cables and Adapters	312
Connector	313
GPIB Logic Levels	314
Serial Interface	315
Parallel Port, PCMCIA Slot, Keyboard connector and 24V DC Output	316
Claims and Repackaging	317
Return Shipments to Agilent Technologies	317
Accessories	319
<hr/>	
Instrument and Options - Agilent 8163A/B	320
Modules	321
Instrument and Options - Agilent 8164A/B	324
Modules	325
Agilent 81645A Filler Module	328
Options	328
Instrument and Options - Agilent 8166A/B	329
Modules	330
GPIB Cables and Adapters	333

Specifications and Regulations Compliance 335

Agilent 8163A Specifications	337
Agilent 8163B Specifications	338
Agilent 8164A Specifications	339
Agilent 8164B Specifications	340
Agilent 8166A Specifications	341
Agilent 8166B Specifications	342
Declarations of Conformity	343
Agilent 8163A Lightwave Multimeter	344
Agilent 8163B Lightwave Multimeter	345
Agilent 8164A Lightwave Measurement System	346
Agilent 8164B Lightwave Measurement System	347
Agilent 8166A Lightwave Multichannel System	348
Agilent 8166B Lightwave Multichannel System	349
Regulations Information	350
Safety Canada	350
EMC Canada	350
EMC Australia/New Zealand	350

Performance Tests 351

Equipment Required	352
Test Record	353
Test Failure	353
Instruments Specifications	353
Performance Test Instructions	354
Display/Key Functional Test	355
Module Interaction Test	358
GPIB Interface Test (Optional)	360
Test Record	361

Error Messages 379

SYST:ERR?	380
Screen Status Messages	382

Mainframes	383
8163A	383
8163B	384
8164A	384
8164B	385
8166A	385
8166B	386
Errors appearing on pop-up menus	387
Error on Module	387
Error	390
Tunable Laser Sources	391
Initialization Tests	391
Selftests	396
Return Loss Meters	400
Powermeters & Interface Modules with Optical Head	404
Fixed Laser Sources (Fabry Perot)	409
DFB Laser Sources	412
Attenuator Modules	414
Optical Switch modules	417
Cleaning Instructions	421
<hr/>	
Safety Precautions	423
Why is it important to clean optical devices ?	424
What do I need for proper cleaning?	425
Standard Cleaning Equipment	425
Additional Cleaning Equipment	428
Preserving Connectors	431
Cleaning Instrument Housings	432
Which Cleaning Procedure should I use ?	433
How to clean connectors	434
How to clean connector adapters	436
How to clean connector interfaces	437
How to clean bare fiber adapters	438
How to clean lenses	439



How to clean instruments with a fixed connector interface	440
How to clean instruments with an optical glass plate	441
How to clean instruments with a physical contact interface	442
How to clean instruments with a recessed lens interface	443
How to clean optical devices which are sensitive to mechanical stress and pressure	444
How to clean metal filters or attenuator gratings	445
Additional Cleaning Information	446
How to clean bare fiber ends	446
How to clean large area lenses and mirrors	446
Other Cleaning Hints	448
Firmware Upgrades	451
<hr/>	
Firmware Upgrade Process	452
How to Get a Firmware Upgrade	453
How to Upgrade Firmware	455
Index	463
<hr/>	

List of Figures

Figure 1	Class 1 Safety Label - Agilent 81650A/51A/52A/54A/11A/12A/13A/14A	34
Figure 2	Class 1M Safety Label - Agilent 81655A/6A/7A, 81662A/3A, 81600B family, (81480B/82B/ 81640B/42B/80B/82B/72B), 81980A/40A/89A/49A, (81649A/89A/89B).	35
Figure 3	The Agilent 8163B Lightwave Multimeter Mainframe	36
Figure 4	The Agilent 8164B Lightwave Measurement System Mainframe	37
Figure 5	The Agilent 8166A/B Lightwave Multichannel System Mainframe	38
Figure 6	The Agilent 8164A/B Lightwave Measurement System User Interface	39
Figure 7	The Agilent 8163A/B Lightwave Multimeter User Interface	40
Figure 8	The Agilent 8163B's Overview Screen	43
Figure 9	The Agilent 8164A/B's Overview Screen	44
Figure 10	The Agilent 8166A Overview Screen	44
Figure 11	The Cursor Key	45
Figure 12	The Modify Knob	45
Figure 13	The Agilent 8163B's Details Screen for a Power Sensor Channel	46
Figure 14	The Agilent 8164A/B's Details Sreen for a Tunable Laser Channel	47
Figure 15	The Agilent 8166A Details Screen for a Power Sensor Channel	47
Figure 16	The Agilent 8163B/6B Menu for a Power Sensor Channel	48
Figure 17	The Agilent 8164A/B Menu for Power Sensor Channel	48
Figure 18	The Agilent 8163B System Configuration Menu	49
Figure 19	The Agilent 8164A/B System Configuration Menu	49
Figure 20	The Agilent 8164A/B Help Screen	50
Figure 21	The Agilent 8164A/B Help Index	50
Figure 22	The Applications Menu	51
Figure 23	The First Digit Before the Decimal Point is Highlighted First	55
Figure 24	Averaging Time Menu	57
Figure 25	Connecting the Instrument for the Sample Session	60
Figure 26	The Agilent 8163B/6B Configuration Menu	64
Figure 27	The Agilent 8164A/B System Configuration Menu	64
Figure 28	Entering a Backlight Value	65
Figure 29	Editing the Date and the Time	67
Figure 30	Unlocking the Instrument	68
Figure 31	Changing the Triggering Mode	69
Figure 32	Enabling/Disabling the Foot Panel	71
Figure 33	Entering a GPIB Address	72
Figure 34	Selecting a Baudrate for the Serial Interface	73
Figure 35	Module Update mode	74
Figure 36	Selecting a Printer Type	75
Figure 37	Slots with Installed Modules	77
Figure 38	Viewing Information About a Module	78
Figure 39	Viewing Information About the Mainframe	79
Figure 40	Rear Panel of the Agilent 8164B Lightwave Measurement System	80
Figure 41	The Number of Digits Menu	84
Figure 42	Selecting the Power Unit	86
Figure 43	Referencing Another Channel	90
Figure 44	Module Channels that are Setting	92

Figure 45	Zeroing Sreen	92
Figure 46	Zeroing Fails, if the Power Meter Receives Input Light.	93
Figure 47	Auto-Range Mode	95
Figure 48	Manual Range Mode - Within Range	96
Figure 49	Out of Range - Power Greater Than Upper Power Limit	97
Figure 50	Out of Range - Power Less Than Resolution	97
Figure 51	Range Value Menu	98
Figure 52	Measurement with Tavg ~1 second	100
Figure 53	The Window and Refresh Modes	102
Figure 54	MinMax Mode Screen	102
Figure 55	Power Module Channel is Held - Overview Screen	103
Figure 56	Input Trigger Mode	104
Figure 57	Output Trigger Mode	105
Figure 58	Menu of Parameters for a Fixed Wavelength Laser Source	110
Figure 59	Dual-Wavelength Laser Source Outputs Both Wavelength	111
Figure 60	The Power Sensor Details Screen	112
Figure 61	The Modulated Signal	114
Figure 62	Output Trigger Mode	117
Figure 63	Setting Hogh Power parameters	123
Figure 64	Setting Low SSE parameter	123
Figure 65	Setting Attenuation	125
Figure 66	Excessive Power	126
Figure 67	Output Power and the Analog Output in <Manual ATT.> Mode	128
Figure 68	Specified and Permitted Wavelength Range	130
Figure 69	Setting a Relative Wavelength	132
Figure 70	The Parameters for a Stepped Wavelength Sweep	135
Figure 71	Repeat Modes	136
Figure 72	Executing a Stepped Sweep	138
Figure 73	Pausing a Stepped Sweep	138
Figure 74	Performing a Manual Sweep	141
Figure 75	The Modulated Signal	142
Figure 76	External Digital Modulation	144
Figure 77	External Analog Modulation and Output Powr	145
Figure 78	Wavelength Locking	146
Figure 79	Input Trigger Mode	151
Figure 80	Output Trigger Mode	152
Figure 81	Realign Screen	153
Figure 82	I Zeroing Screen	155
Figure 83	Updated Tunable Laser channel Details including SBS Suppression	162
Figure 84	Measuring Return Loss and Insertion Loss	166
Figure 85	The Contents of the Agilent 81610A Return Loss module	168
Figure 86	The Contents of the Agilent 81611A and Agilent 81612A Return Loss modules	168
Figure 87	The Contents of the Agilent 81613A Return Loss modules	169
Figure 88	Return Loss Measurement Setup - External Source used	172
Figure 89	Return Loss Measurement Setup - Internal Source used	172
Figure 90	Agilent 8161x Details Screen	173
Figure 91	Reflectance Calibration using RL Reference	175
Figure 92	Termination Calibration	175
Figure 93	Reflectance Calibration - External Source	177
Figure 94	Reflection Calibration - Internal Source	177

Figure 95	Measuring the Reflection Reference	178
Figure 96	Termination Calibration - External source	179
Figure 97	Termination Calibration - Internal Source	179
Figure 98	Measuring the Return Loss of the Reference Cable - External Source	180
Figure 99	Measuring the Return Loss of the Reference Cable - Internal Source	180
Figure 100	Power Transmitted through the Reference Cable - External Source	181
Figure 101	Power Transmitted through the Reference Cable - Internal Source	181
Figure 102	Power Transmitted through the Measurement Patchcord - External Source	182
Figure 103	Power Transmitted through the Measurement Patchcord - Internal Source	182
Figure 104	Measuring the Termination Parameter - External Source	183
Figure 105	Measuring the Termination Parameter - Internal Source	183
Figure 106	Measuring the Return Loss of the DUT (in this example: a Connector Pair)	184
Figure 107	Measuring the Power Transmitted through the DUT (a Connector Pair)	184
Figure 108	The Calibration Parameters Screens - Return Loss Diode	186
Figure 109	The Calibration Parameters Screens - Monitor Diode	187
Figure 110	The Calibration Parameters Screens - User Data	188
Figure 111	Measuring the Power from a Component with a Known Reflection Factor	189
Figure 112	Measuring the Power transmitted through the Reflection Reference	190
Figure 113	Measuring the Power with the Connector Terminated	190
Figure 114	Measuring the Power transmitted through the Measurement Patchcord	191
Figure 115	Measuring the Reflections from the Device Under Test	191
Figure 116	Measuring the Power transmitted through the Device Under Test	192
Figure 117	Generalization of a Return Loss Measurement	195
Figure 118	81576A/77A Attenuator module power control loop	198
Figure 119	81570A/71A/73A Attenuator module, 8164A/B GUI Overview	199
Figure 120	81570A/71A/73A Attenuator module, 8164A/B GUI Details	200
Figure 121	Attenuation factor set to 4.000 dB	203
Figure 122	81570A/71A/73A - Attenuation factor applied with no offset	205
Figure 123	81570A/71A/73A Attenuation Offset	205
Figure 124	81576A/77A Setting P _{SET} after calibration using [PM->Off]	211
Figure 125	The λ Offset Table	213
Figure 126	Extrapolation and Interpolation of Offset Values	215
Figure 127	81570A/71A/73A Attenuator Menu Options	217
Figure 128	81576A/77A Attenuator Menu Options	217
Figure 129	Agilent 81594B Optical Switch module (1x4, angled contact connectors)	220
Figure 130	Optical Switch module, User Interface Overview display	221
Figure 131	Optical Switch module, 8164A/B User Interface Details	222
Figure 132	Laser Source selection	226
Figure 133	Measurement Path selection	227
Figure 134	Circuit selection with crossover switch	227

Figure 135	DUT selection in a parallel test setup	228
Figure 136	Test instruments selection	228
Figure 137	The Application Graph	231
Figure 138	The Graph Legend Screen	236
Figure 139	Samples Display - <Line>	237
Figure 140	Samples Display - <Samples>	238
Figure 141	Samples Display - <Samples & Line>	238
Figure 142	The Lock to Curve Menu	239
Figure 143	Lock to Samples On	240
Figure 144	Lock the Samples Off	241
Figure 145	Example Logging Application	242
Figure 146	The Applications Menu	243
Figure 147	The Agilent 8164A/B Logging Setup Screen	244
Figure 148	The Agilent 8163B Logging Modules Setup Screen	244
Figure 149	The Agilent 8163B Logging Parameter Setup Screen	245
Figure 150	The Logging Measurement Screen - Measurement Running	248
Figure 151	The Logging Measurement Screen - Measurement Completed	249
Figure 152	The Agilent 8164A/B Logging Analysis Screen	250
Figure 153	The Agilent 8163B Logging Analysis Screen - First Screen	251
Figure 154	The Agilent 8163B Logging Analysis Screen - Second Screen	252
Figure 155	Example Stability Application	254
Figure 156	The Agilent 8164A/B Stability Setup Screen	256
Figure 157	The Agilent 8163B Stability Module Setup Screen	257
Figure 158	The Agilent 8163B Stability Parameter Setup Screen	258
Figure 159	The Stability Measurement Screen - Measurement Running	260
Figure 160	The Stability Measurement Screen - Measurement Completed	261
Figure 161	The Agilent 8164A/B Stability Analysis Screen	262
Figure 162	The Agilent 8163B Stability Analysis Screen - First Screen	263
Figure 163	The Agilent 8163A/B Stability Analysis Screen - Second Screen	264
Figure 164	The PACT Setup Screen	267
Figure 165	PACT Reference Screen	270
Figure 166	Connection Prompt Screen	271
Figure 167	PACT Reference Measurement Finished Box	272
Figure 168	PACT Measurement Screen	273
Figure 169	Low Dynamic Range	274
Figure 170	High Dynamic Range	275
Figure 171	The PACT Measurement Screen - Measurement Completed	275
Figure 172	The PACT Analysis Screen	276
Figure 173	The Pmax Curve Screen	278
Figure 174	Main Screen of the Return Loss Application	281
Figure 175	The Printing in Progress Screen	283
Figure 176	Printed Results	284
Figure 177	The File Name Editor	285
Figure 178	Agilent 8163A/B Lightwave Multimeter System Power Key	292
Figure 179	Agilent 8164A/B Lightwave Measurement System Power Key	292
Figure 180	Agilent 8166A/B Lightwave Multichannel System Power Key	293
Figure 181	AC Power Requirement Markings - Agilent 8163A/B	294
Figure 182	AC Power Requirement Markings - Agilent 8164A/B	294
Figure 183	AC Power Requirement Markings - Agilent 8166A/B	294
Figure 184	Correct Operating Position of the 8163A/B	298
Figure 185	Correct Operating Position of the Agilent 8164A/B	299
Figure 186	Correct Operating Position of the Agilent 8166A/B	299

Figure 187	Storing the Agilent 8164A/B on its Back Legs.	300
Figure 188	Carry the Agilent 8164A/B Lightwave Measurement System using this Strap	301
Figure 189	How to Remove a Front-Loadable Module	302
Figure 190	How to Insert a Front-Loadable Module	303
Figure 191	Back Panel of Agilent 8164B Lightwave Measurement System ...	304
Figure 192	Side View of a Back-Loadable Module	304
Figure 193	Removing a Back-Loadable Module from the Agilent 8164A/B ...	305
Figure 194	Fitting a Back-Loadable Module	306
Figure 195	Adding a Connector Interface	307
Figure 196	Fitting a Blind Panel	308
Figure 197	Rear Panel of the Agilent 8163B Lightwave Multimeter System ..	310
Figure 198	Rear Panel of the Agilent 8164B Lightwave Measurement System	310
Figure 199	Rear Panel of the Agilent 8166B Lightwave Multichannel System	311
Figure 200	GPIB Connector	313
Figure 201	Mainframe Setup	354
Figure 202	Firmware Upgrade Flowchart	454



List of Tables

Table 1	Standard Laser Source Modules - Laser Safety Information	30
Table 2	High Power Laser Source Modules - Laser Safety Information	30
Table 3	DFB Laser Source Modules - Laser Safety Information	31
Table 4	Backloadable Tunable Laser Modules - Laser Safety Information	32
Table 5	Backloadable Tunable Laser Modules (discontinued) - Laser Safety Information	32
Table 6	Compact Tunable Laser Modules - Laser Safety Information	33
Table 7	Compact Tunable Laser Modules (discontinued)- Laser Safety Information	33
Table 8	Return Loss Modules - Laser Safety Information	34
Table 9	Upper Power Limits and Resolution for Various Power Ranges	99
Table 10	Parameters that can only be set using the master channel	107
Table 11	The Agilent compact TLS family	160
Table 12	High Return-Loss Patchcords	171
Table 13	The Agilent 8157xA Variable Optical Attenuator family	198
Table 14	Attenuator Status Indicators	218
Table 15	The Agilent 8159xB Optical Switch family	220
Table 16	Logging Application On-Screen Messages	253
Table 17	Stability Application On-Screen Messages	265
Table 18	PACT Application On-Screen Messages	277
Table 19	Return Loss Application On-Screen Messages	280
Table 20	Specified Temperature Ranges	296
Table 21	Equipment Required for Performance Tests	352
Table 22	Reference Wavelength and Power Settings	359
Table 23	Cleaning Instructions for Modules	421



1

Getting Started

This chapter introduces the features of the Agilent 8163A/B Lightwave Multimeter, the Agilent 8164A/B Lightwave Measurement System, and the Agilent 8166A/B Lightwave Multichannel System. Here you will find a quick description of the instrument, how to use the user interface and how to perform a simple sample session

The central element of the instrument is the Agilent 8163A/B Lightwave Multimeter, the Agilent 8164A/B Lightwave Measurement System, and the Agilent 8166A/B Lightwave Multichannel System mainframes. You customize the instrument using plug-in modules and changeable fiber-connector interfaces. You can use this instrument as a tunable laser source and also to take associated measurements.

Safety Considerations	25
General	26
Operating Environment	26
Line Power Requirements	27
Input/Output Signals	27
Line Power Connectors	28
Instrument Markings	29
Laser Safety Information	30
Laser Safety Labels	34
Agilent 8163A/B Lightwave Multimeter	36
Agilent 8164A/B Lightwave Measurement System	37
Agilent 8166A/B Lightwave Multichannel System	38
A Description of the User Interface	39
Password	40
User Interface Features	41
How to Navigate/Modify the Display	43

How to Change the Value of a Parameter	53
How to Select a Parameter	53
How to Accept the New Value of a Parameter	54
How to Make a Big Change to a Continuous Parameter	54
How to Make a Small Change to a Continuous Parameter	55
How to Change a Discrete Parameter	57
How to Set All Parameters to Their Default Values	58
If You Make a Mistake	58
If the Parameter Changes to Different Value	58
A Sample Session	59
How to Measure the Power of a Modulated Signal	60

Safety Considerations

The following general safety precautions must be observed during all phases of operation, service, and repair of this instrument. Failure to comply with these precautions or with specific warnings elsewhere in this manual violates safety standards of design, manufacture, and intended use of the instrument. Agilent Technologies Inc. assumes no liability for the customer's failure to comply with these requirements.

This product has been designed and tested in accordance with IEC Publication 61010-1, Safety Requirements for Electrical Equipment for Measurement, Control and Laboratory Use, and has been supplied in a safe condition. The instruction documentation contains information and warnings that must be followed by the user to ensure safe operation and to maintain the product in a safe condition.

Safety Symbols

CAUTION

The *caution* sign denotes a hazard. It calls attention to a procedure which, if not correctly performed or adhered to, could result in damage to or destruction of the product. Do not proceed beyond a caution sign until the indicated conditions are fully understood and met.

WARNING

The *warning* sign denotes a hazard. It calls attention to a procedure which, if not correctly performed or adhered to, could result in injury or loss of life. Do not proceed beyond a warning sign until the indicated conditions are fully understood and met.

General

This is a Safety Class 1 instrument (provided with a protective earth terminal) and has been manufactured and tested according to international safety standards.

Before operation, you should review the instrument and manual for safety markings and instructions. You must follow these to ensure safe operation and to maintain the instrument in safe condition.

Some Agilent 8164B circuits and some Agilent 8166B circuits are powered whenever the instrument is connected to the AC power source. To disconnect from the line power, disconnect the power cord either at the rear power inlet or at the AC line power source (receptacle). One of these must always be accessible. If the instrument is in a cabinet, it must be disconnected from the line power by the system's line power switch.

WARNING

To avoid hazardous electrical shock, do not perform electrical tests when there are signs of shipping damage to any portion of the outer enclosure (covers, panels, and so on).

Operating Environment

WARNING

The Agilent 8163A/B Lightwave Multimeter, Agilent 8164A/B Lightwave Measurement System, and Agilent 8166A/B Lightwave Multichannel System are not designed for outdoor use. To prevent potential fire or shock hazard, do not expose the instrument to rain or other excessive moisture.

Line Power Requirements

CAUTION

The Agilent 8163A/B Lightwave Multimeter System complies with overvoltage category II and can operate from the single-phase AC power source that supplies between 100 V and 240 V at a frequency in the range 50 to 60 Hz. The maximum power consumption is 120 VA with all options installed.

CAUTION

The Agilent 8164A/B Lightwave Measurement System complies with overvoltage category II and can operate from any single-phase AC power source that supplies between 100 V and 240 V at a frequency in the range from 50 to 60 Hz. The maximum power consumption is 270 VA with all options installed.

CAUTION

The Agilent 8166A/B Lightwave Multichannel System complies with overvoltage category II and can operate from any single-phase AC power source that supplies between 100 V and 240 V at a frequency in the range from 50 to 60 Hz. The maximum power consumption is 450 VA with all options installed.

Input/Output Signals

CAUTION

There are two input BNC connectors: the Remote Interlock Connector and the Trigger Input, see “Input and Output Connectors” on page 310. These are TTL inputs. A maximum of 5 V can be applied as an external voltage to either of these input connectors.

There is one output BNC connector: the Trigger Output, see “Input and Output Connectors” on page 310. This is a TTL output. Do not apply an external voltage to this connector.

Line Power Connectors

In accordance with international safety standards, the instrument has a three-wire power cable. When connected to an appropriate AC power receptacle, this cable earths the instrument cabinet. The type of power cable shipped with each instrument depends on the country of destination. Please refer to “Accessories” on page 319 for the part numbers of available power cables.

WARNING

To avoid the possibility of injury or death, you must observe the following precautions before switching on the instrument.

- **Insert the power cable plug only into a socket outlet provided with a protective earth contact. Do not negate this protective action by the using an extension cord without a protective conductor.**
- **Do not interrupt the protective earth connection intentionally.**
- **Do not remove protective covers. Operating personnel must not remove instrument covers. Component replacement and internal adjustments must be made only by qualified service personnel.**
- **Instruments that appear damaged or defective should be made inoperative and secured against unintended operation until they can be repaired by qualified service personnel.**
- **Defective, damaged, or malfunctioning laser sources must be returned to an Agilent Technologies Service Center.**

Do not operate the instrument in the presence of flammable gases or fumes. Operation of any electrical instrument in such an environment constitutes a definite safety hazard.

Instrument Markings



The instruction manual symbol. The product is marked with this warning symbol when it is necessary for the user to refer to the instructions in the manual.



The laser radiation symbol. This warning symbol is marked on products which have a laser output.



The AC symbol is used to indicate the required nature of the line module input power.



The ON symbols are used to mark the positions of the instrument power line switch.



The OFF symbols are used to mark the positions of the instrument power line switch.



The CE mark is a registered trademark of the European Community.



The CSA mark is a registered trademark of the Canadian Standards Association.



The C-Tick mark is a registered trademark of the Australian Spectrum Management Agency.

ISM1-A

This text denotes the instrument is an Industrial Scientific and Medical Group 1 Class A product.



Frame or chassis terminal.



Protective conductor Terminal



Caution, risk of electric shock.



Magnetic fields may interfere with a pacemaker



Caution, hot surface

Laser Safety Information

The laser sources specified by this user guide are classified according to IEC 60825-1 (2001).

The laser sources comply with 21 CFR 1040.10 except for deviations pursuant to Laser Notice No. 50 dated 2001-July-26.

Initial Safety Information for Laser Source Modules

Table 1 Standard Laser Source Modules - Laser Safety Information

	Agilent 81650A	Agilent 81651A	Agilent 81652A ²	Agilent 81654A
Laser type	FP-Laser InGaAsP	FP-Laser InGaAsP	FP-Laser InGaAsP	FP-Laser InGaAsP
Wavelength ($\pm 15\text{nm}$)	1310 nm	1550 nm	1550/1625 nm	1310/1550 nm
Max. CW output power¹	<1.8 mW	<1.8 mW	<1.8 mW	<1.8 mW
Beam waist diameter	9 μm	9 μm	9 μm	9 μm
Numerical aperture	0.1	0.1	0.1	0.1
Laser Class according to IEC 60825-1 (2001)- International	1	1	1	1
Max. permissible CW output power	15.6 mW	10 mW	10 mW	15.6 mW/10 mW
¹ Max. CW output power is defined as the highest possible optical power that the laser source can produce at its output connector.				
² Discontinued				

Table 2 High Power Laser Source Modules - Laser Safety Information

	Agilent 81655A	Agilent 81656A	Agilent 81657A
Laser Type	FP-Laser InGaAsP	FP-Laser InGaAsP	FP-Laser InGaAsP
Wavelength ($\pm 15\text{nm}$)	1310 nm	1550 nm	1310/1550 nm
Max. CW output power¹	<28 mW	<28 mW	<28 mW
Beam waist diameter	9 μm	9 μm	9 μm
Numerical aperture	0.1	0.1	0.1
Laser Class according to IEC 60825-1 (2001)- International	1M	1M	1M
Max. permissible CW output power	52 mW	163 mW	52 mW/163 mW
¹ Max. CW output power is defined as the highest possible optical power that the laser source can produce at its output connector. .			

Table 3 DFB Laser Source Modules - Laser Safety Information

	Agilent 81662A	Agilent 81663A
Laser Type	CW DFB Laser with built-in isolator	CW DFB Laser with built-in isolator
Wavelength range	1500 - 1650 nm see display	1500 - 1650 nm see display
Max. CW output power¹	<15 mW	<28 mW
Beam waist diameter	9 μm	9 μm
Numerical aperture	0.1	0.1
Laser Class according to IEC 60825-1 (2001)- International	1M	1M
Max. permissible CW output power	163 mW	163 mW
¹ Max. CW output power is defined as the highest possible optical power that the laser source can produce at its output connector.		

Initial Safety Information for Tunable Laser Modules

Table 4 Backloadable Tunable Laser Modules - Laser Safety Information

	81660B #200	81600B #160	81600B #150	81600B #140	81600B #130	81600B #142	81600B #132
Laser Type	EC-Laser InGaAsP	EC-Laser InGaAsP	EC-Laser InGaAsP	EC-Laser InGaAsP	EC-Laser InGaAsP	EC-Laser InGaAsP	EC-Laser InGaAsP
Wavelength range	1440 - 1640 nm	1495 - 1640 nm	1450 - 1590 nm	1370 - 1495 nm	1260 - 1375 nm	1370 - 1495 nm	1260 - 1375 nm
Max. CW output power¹	<15 mW	<15 mW	<15 mW	<15 mW	<15 mW	<15 mW	<15 mW
Beam waist diameter	9 μm	9 μm	9 μm	9 μm	9 μm	9 μm	9 μm
Numerical aperture	0.1	0.1	0.1	0.1	0.1	0.1	0.1
Laser Class according to IEC 60825-1 (2001)- Intl.	1M	1M	1M	1M	1M	1M	1M
Max. permissible CW output power	163 mW	163 mW	163 mW	52 mW/ 163 mW	52 mW/ 163 mW	52 mW/ 163 mW	52 mW/ 163 mW

¹ Max. CW output power is defined as the highest possible optical power that the laser source can produce at its output connector.

Table 5 Backloadable Tunable Laser Modules (discontinued) - Laser Safety Information

	Agilent 81480B	Agilent 81482B	Agilent 81680B	Agilent 81682B	Agilent 81640B	Agilent 81642B	Agilent 81672B
Laser Type	FP-Laser InGaAsP	FP-Laser InGaAsP	FP-Laser InGaAsP	FP-Laser InGaAsP	FP-Laser InGaAsP	FP-Laser InGaAsP	FP-Laser InGaAsP
Wavelength range	1370-1495 nm	1370-1495 nm	1460-1580 nm	1460-1580 nm	1495-1640 nm	1495-1640 nm	1260-1375 nm
Max. CW output power¹	<15 mW	<15 mW	<15 mW	<15 mW	<15 mW	<15 mW	<15 mW
Beam waist diameter	9 μm	9 μm	9 μm	9 μm	9 μm	9 μm	9 μm
Numerical aperture	0.1	0.1	0.1	0.1	0.1	0.1	0.1
Laser Class according to IEC 60825-1 (2001)- Intl.	1M	1M	1M	1M	1M	1M	1M
Max. permissible CW output power	52 mW/ 163 mW	52 mW/ 163 mW	163 mW	163 mW	163 mW	163 mW	52 mW

¹ Max. CW output power is defined as the highest possible optical power that the laser source can produce at its output connector.

Table 6 Compact Tunable Laser Modules - Laser Safety Information

	Agilent 81980A	Agilent 81940A	Agilent 81944A	Agilent 81989A	Agilent 81949A
Laser Type	ECL-Laser InGaAsP	ECL-Laser InGaAsP	ECL-Laser InGaAsP	ECL-Laser InGaAsP	ECL-Laser InGaAsP
Wavelength range	1465 nm-1575 nm	1520 nm-1630 nm	1520 nm-1630 nm	1465 nm-1575 nm	1520 nm-1630 nm
Max. CW output power ¹	20 mW	20 mW	20 mW	20 mW	20 mW
Beam waist diameter	9 μm	9 μm	9 μm	9 μm	9 μm
Numerical aperture	0.1	0.1	0.1	0.1	0.1
Laser Class according to IEC 60825-1 (2001)- International	1M	1M	1M	1M	1M
Max. permissible CW output power	163 mW	163 mW	163 mW	163 mW	163 mW

¹ Max. CW output power is defined as the highest possible optical power that the laser source can produce at its output connector.

Table 7 Compact Tunable Laser Modules (discontinued)- Laser Safety Information

	Agilent 81689A	Agilent 81689B	Agilent 81649A
Laser Type	FP-Laser InGaAsP	FP-Laser InGaAsP	FP-Laser InGaAsP
Wavelength range	1400-1620 nm	1400-1620 nm	1400-1620 nm
Max. CW output power ¹	<15 mW	<15 mW	<15 mW
Beam waist diameter	9 μm	9 μm	9 μm
Numerical aperture	0.1	0.1	0.1
Laser Class according to IEC 60825-1 (2001)- International	1M	1M	1M
Max. permissible CW output power	163 mW	163 mW	163 mW

¹ Max. CW output power is defined as the highest possible optical power that the laser source can produce at its output connector.

Initial Safety Information for Return Loss Modules

Table 8 Return Loss Modules - Laser Safety Information

	Agilent 81611A ²	Agilent 81612A ²	Agilent 81613A	Agilent 81614A ²
<i>Laser type</i>	FP-Laser InGaAsP	FP-Laser InGaAsP	FP-Laser InGaAsP	FP-Laser InGaAsP
<i>Wavelength (± 15nm)</i>	1310 nm	1550 nm	1550/1625 nm	1310/1550 nm
<i>Max. CW output power</i> ¹	<1.8mW	<1.8mW	<1.8mW	<1.8mW
<i>Beam waist diameter</i>	9 µm	9 µm	9 µm	9 µm
Numerical aperture	0.1	0.1	0.1	0.1
<i>Laser Class according to IEC 60825-1 (2001) International</i>	1	1	1	1
<i>Max. permissible CW output power</i>	15.6 mW	10 mW	10 mW	15.6 mW/10 mW
¹ Max. CW output power is defined as the highest possible optical power that the laser source can produce at its output connector				
² Discontinued				

Laser Safety Labels

Laser class 1 label



Figure 1 Class 1 Safety Label - Agilent 81650A/51A/52A/54A/11A/12A/13A/14A

Laser class 1M label

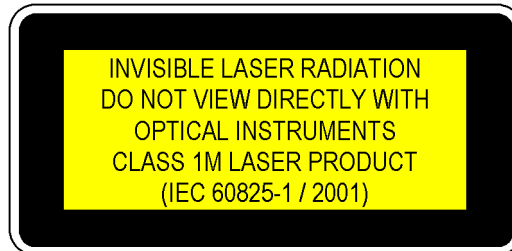

Figure 2 Class 1M Safety Label - Agilent 81655A/6A/7A, 81662A/3A, 81600B family, (81480B/82B/ 81640B/42B/80B/82B/72B), 81980A/40A/89A/49A, (81649A/89A/89B).

A sheet of laser safety labels is included with the laser module as required. In order to meet the requirements of IEC 60825-1 we recommend that you stick the laser safety labels, in your language, onto a suitable location on the outside of the instrument where they are clearly visible to anyone using the instrument

WARNING

Please pay attention to the following laser safety warnings:

- Under no circumstances look into the end of an optical cable attached to the optical output when the device is operational. The laser radiation can seriously damage your eyesight.
- Do not enable the laser when there is no fiber attached to the optical output connector.
- The laser is enabled by pressing the gray button close to the optical output connector on the front panel of the module. The laser is on when the green LED on the front panel of the instrument is lit.
- The use of other optical instruments with this product will increase the hazard to your eyes.
- The laser module has built-in safety circuitry which will disable the optical output in the case of a fault condition.
- Refer servicing *only* to qualified and authorized personnel.

Agilent 8163A/B Lightwave Multimeter

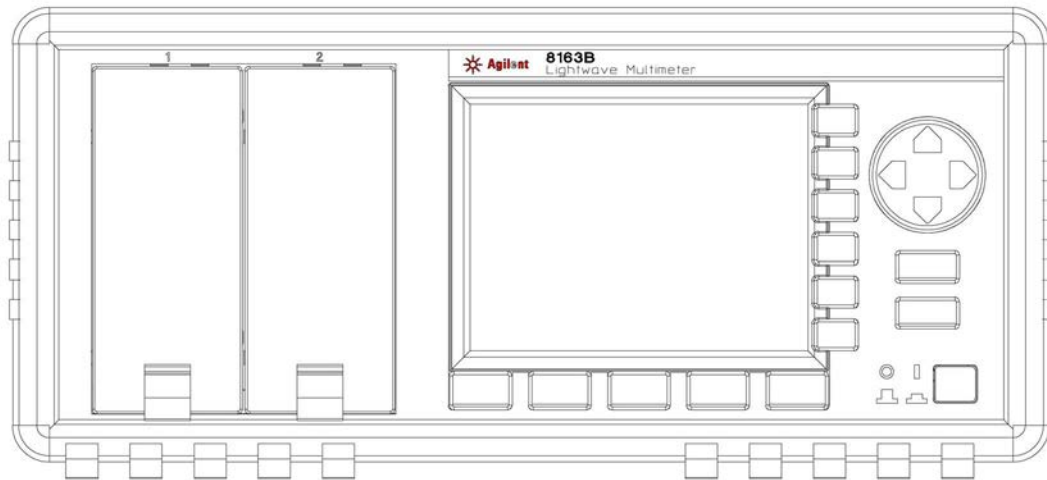

Figure 3 The Agilent 8163B Lightwave Multimeter Mainframe

The Agilent 8163A/B Lightwave Multimeter is a high-performance optical multimeter for the characterization and evaluation of optical components.

It's modular format makes it flexible enough to meet changing needs when measuring optical power, power loss, or return loss for single or multi-mode components.

The Agilent 8163A/B Lightwave Multimeter mainframe has two slim module slots. The system can host up to two front-loadable modules, of any combination of the following types:

- compact Tunable Laser modules, such as the the Agilent 81689A,
- fixed wavelength Laser Sources, such as the Agilent 81650A,
- DFB Source modules, such as the Agilent 81662A
- Power Sensors, both dual and single, such as the Agilent 81635A,
- Fast Power Sensor Modules, such as the Agilent 81637B,
- Interface Modules for Optical Heads, such as the Agilent 81618A,
- Return Loss Modules, such as the Agilent 81610A
- Attenuator Modules, such as the Agilent 81570A
- Optical Switch Modules. such as the Agilent 81591B

The front-loadable module slots also support all modules designed for the 8153A Lightwave Multimeter.

Agilent 8164A/B Lightwave Measurement System

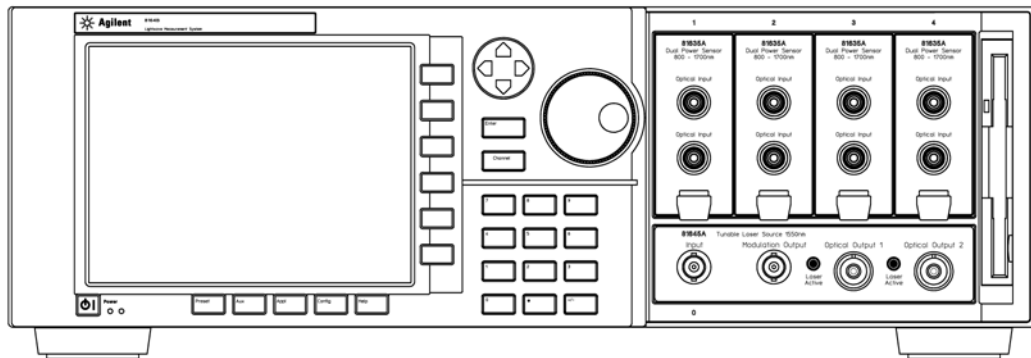

Figure 4 The Agilent 8164B Lightwave Measurement System Mainframe

The Agilent 8164A/B Lightwave Measurement System mainframe has one large and four slim module slots.

The system can host:

- 1** one back-loadable Tunable Laser module, such as the Agilent 81672B
- 2** and up to four front-loadable modules, of any combination of the following types:
 - compact Tunable Laser modules, such as the the Agilent 81689A,
 - fixed wavelength Laser Sources, such as the Agilent 81650A,
 - DFB Source modules, such as the Agilent 81662A
 - Power Sensors, both dual and single, such as the Agilent 81635A,
 - Fast Power Sensor Modules, such as the Agilent 81637B,
 - Interface Modules for Optical Heads, such as the Agilent 81618A,
 - Return Loss Modules, such as the Agilent 81610A
 - Attenuator Modules, such as the Agilent 81570A
 - Optical Switch Modules. such as the Agilent 81591B

The front-loadable module slots also support all modules designed for the 8153A Lightwave Multimeter.

Agilent 8166A/B Lightwave Multichannel System

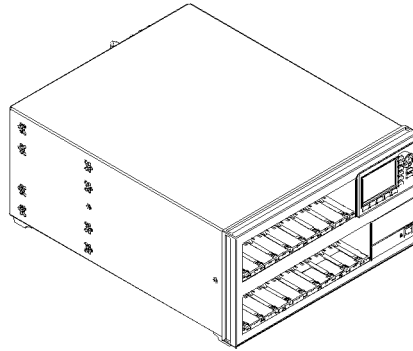

Figure 5 The Agilent 8166A/B Lightwave Multichannel System Mainframe

The Agilent 8166A/B Lightwave Multichannel System has 17 slim module slots.

The system can host up to seventeen front-loadable modules, of any combination of the following types:

- compact Tunable Laser modules, such as the the Agilent 81689A,
- fixed wavelength Laser Sources, such as the Agilent 81650A,
- DFB Source modules, such as the Agilent 81662A
- Power Sensors, both dual and single, such as the Agilent 81635A,
- Fast Power Sensor Modules, such as the Agilent 81637B,
- Interface Modules for Optical Heads, such as the Agilent 81618A,
- Return Loss Modules, such as the Agilent 81610A
- Attenuator Modules, such as the Agilent 81570A
- Optical Switch Modules. such as the Agilent 81591B

The front-loadable module slots do **not** support any modules designed for the 8153A Lightwave Multimeter, that is, modules with part numbers less than 81600.

A Description of the User Interface

Figure 6 and Figure 7 show the user interface of the Agilent 8164A/B, the Agilent 8163A/B and Agilent 8166A/B, respectively, and the names used in this manual to describe the groups of keys.

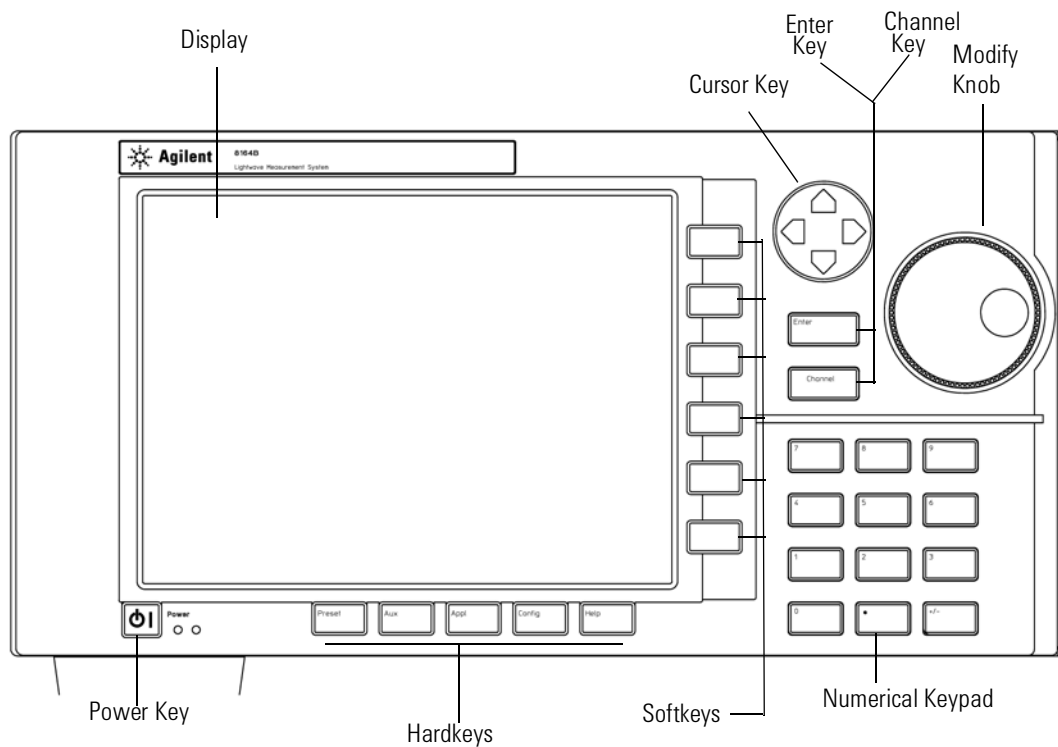

Figure 6 The Agilent 8164A/B Lightwave Measurement System User Interface

The Agilent 8163A/B and the Agilent 8166A/B do not provide the following two features of the Agilent 8164A/B's user interface:

- the Modify Knob, and
- the Numerical Keypad.

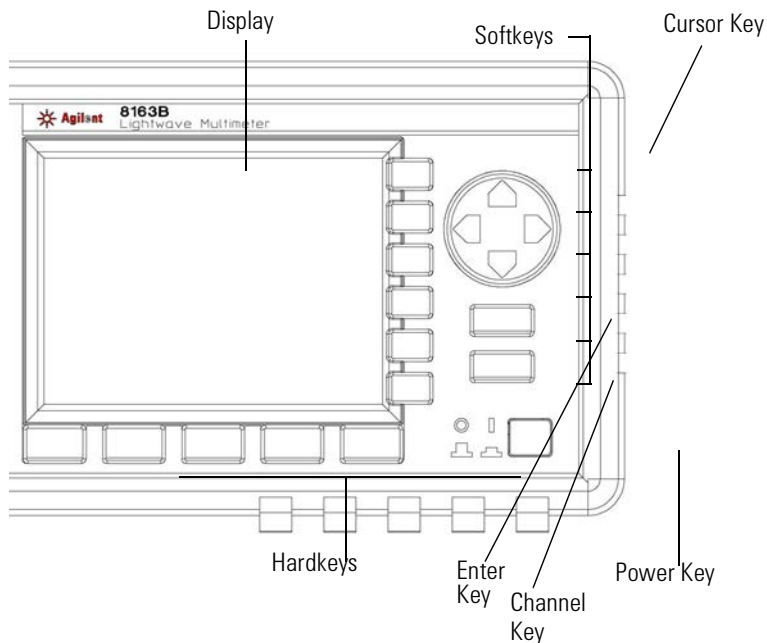

Figure 7 The Agilent 8163A/B Lightwave Multimeter User Interface

Password

When you use this instrument with high-power Laser Source modules or Tunable Laser modules, you must enter the password to unlock the instrument.

NOTE

The default password is *1234*.

If You Forget Your Password

If you forget your password, contact your nearest Agilent Technologies Sales/Service Office. Find contact details by accessing <http://www.agilent.com/> on the internet.

User Interface Features

Introducing Softkeys

A softkey is a key whose function changes depending on the keys that you have pressed before. The function of the softkey is shown on the display to the left of the softkey.

Introducing Hardkeys

A hardkey is a key that always has the same function.

Special Module States

Besides parameter or measurement values, you may also see some texts instead.

<empty>The slot is empty.

<unknown>The installed module is not supported by the firmware revision.

Slot and Channel Numbers

Each module is identified by a slot number and a channel number.

You can use slot and channel numbers:

- to identify each channel in the overview screen with a number at the side of the screen,
- to identify each channel in the Details screen with a tab at the top of the screen,
- to identify the channel when referencing the power measured by another channel, see *“How to Reference Another Power Measurement Channel”* on page 89,
- to identify the channel when using an application, see *“Applications”* on page 229, and
- to identify a channel when using a GPIB command, see the *Agilent 8163A/B Lightwave Multimeter, Agilent 8164A/B Lightwave Measurement System, & Agilent 8166A/B Lightwave Multichannel System Programming Guide* for more information on GPIB commands.

The slot number represents the module's position in the mainframe. Front-loadable modules are numbered:

- from one to two from left to right for the Agilent 8163A/B,
- from one to four from left to right for the Agilent 8164A/B, and
- from one to seventeen from left to right for the Agilent 8166A/B.

These numbers are displayed on the front panel beside each module slot. The Agilent 8164A/B slot for back-loadable modules is numbered zero.

NOTE

Modules with two channels, for example, the Agilent 81635A Dual Power Sensor, use the channel number to distinguish between these channels.

The channel number of single channel modules is always one.

How to Navigate/Modify the Display

Overview Screen

Figure 8 shows the overview screen for the Agilent 8163B Lightwave Multimeter, this screen is shown immediately after start-up. It shows the most important parameters of all installed modules.

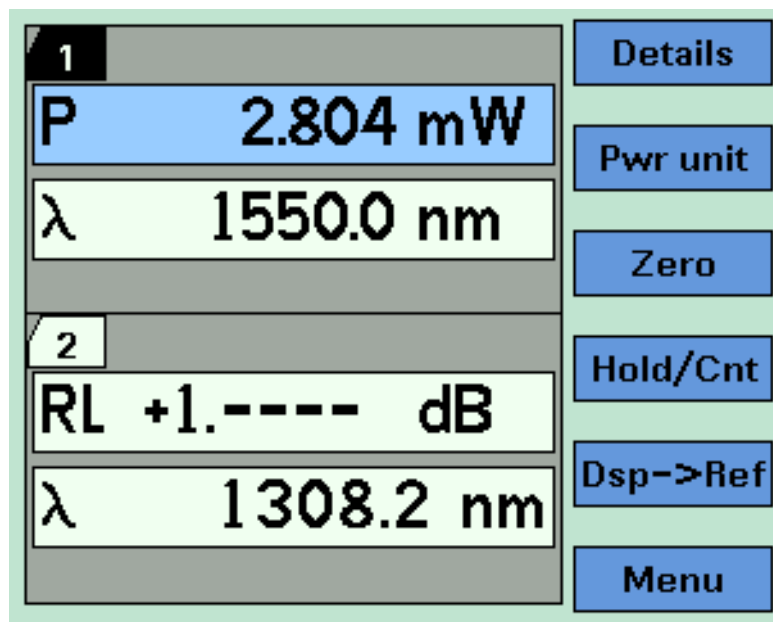

Figure 8 The Agilent 8163B's Overview Screen

NOTE

The display of the Agilent 8163A and the Agilent 8166A is black and white only.

Figure 8 shows the overview screen for the Agilent 8164A/B Lightwave Measurement System, this screen is shown immediately after start-up. It shows the most important parameters of all installed modules



Figure 9 The Agilent 8164A/B's Overview Screen

Figure 10 shows the overview screen for the Agilent 8166A Lightwave Multichannel System, this screen is shown immediately after start-up. It shows the module slots that are occupied.

1.1	1.2	9	Details
2.1	2.2	10	
3.1	3.2	11	
4.1	4.2	12	Pwr unit
5.1	5.2	13	
6.1	6.2	---	Hold/Cnt
7.1	7.2	---	
8.1	8.2	---	Dsp->Ref
		17	Menu

Figure 10 The Agilent 8166A Overview Screen

How to Use the Cursor Key

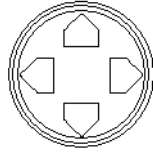

Figure 11 The Cursor Key

You can move the highlighted marker between parameters using the [Cursor] hardkey.

When editing a parameter, see *“How to Change the Value of a Parameter” on page 53*, the up and down cursor keys can be used to increment and decrement the value of a digit and the left and right cursor keys can be used to move the highlighted digit left and right.

How to Use the Numerical Keypad

NOTE

The Numerical Keypad is only available if you use the Agilent 8164A/B.

You can use the Numerical Keypad to change the value of a parameter. See *“How to Change the Value of a Parameter” on page 53*.

How to Use the Modify Knob

NOTE

The Modify Knob is only available if you use the Agilent 8164A/B.

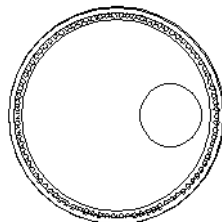

Figure 12 The Modify Knob

You can use the Modify Knob to navigate around the display. When you turn the Modify Knob through one click, one action is performed.

Turning the Modify Knob clockwise moves the highlighted marker right and then down. Turning the Modify Knob anti-clockwise moves the highlighted marker left and then up.

You can use the Modify Knob to change the value of a parameter. See “How to Change the Value of a Parameter” on page 53.

How to Change Channel

You can navigate between module channels by pressing the *Channel* hardkey. You can use this key when either the overview screen or the details screen is displayed.

How to Access the Details Screen

You can access the parameters of a module that are not shown on the overview screen by pressing *Channel* to select the channel and pressing the [Details] softkey. You should see the Details screen as shown in Figure 13 , Figure 14 , or Figure 15 .

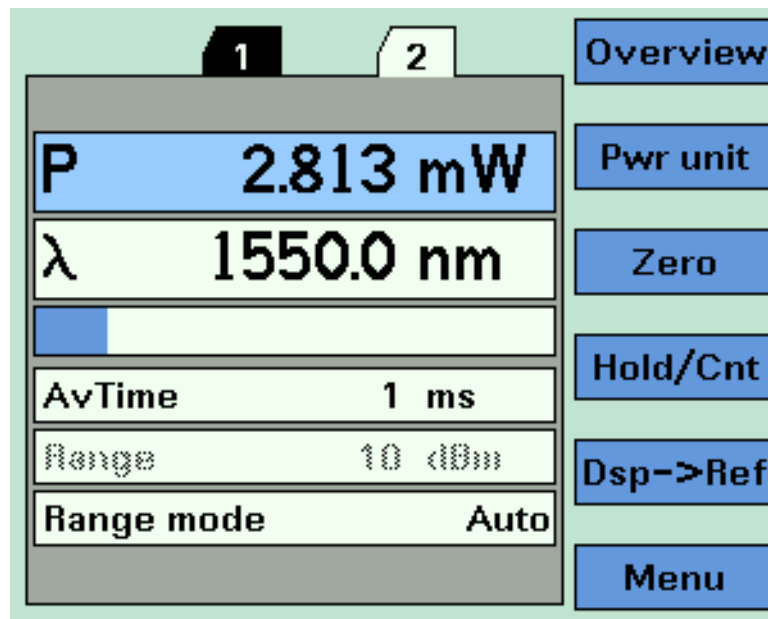

Figure 13 The Agilent 8163B's Details Screen for a Power Sensor Channel

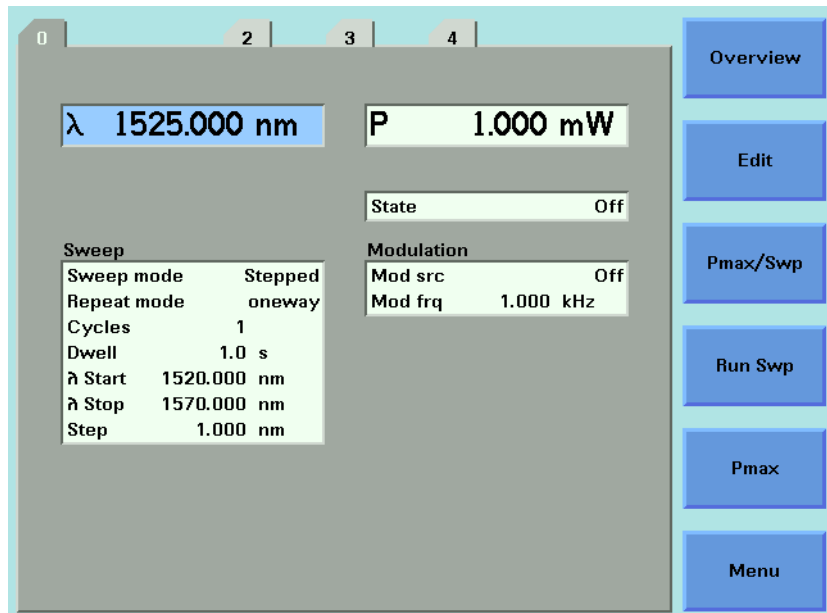

Figure 14 The Agilent 8164A/B's Details Screen for a Tunable Laser Channel

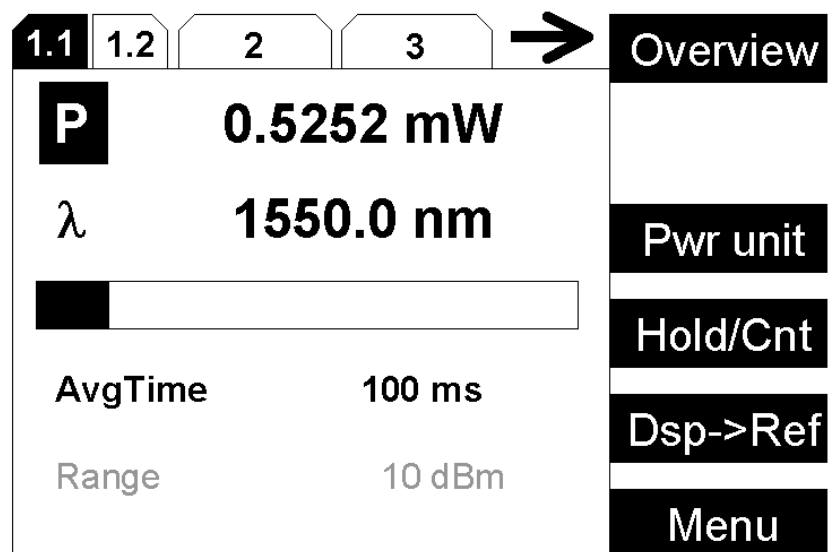

Figure 15 The Agilent 8166A Details Screen for a Power Sensor Channel

If more than 3 modules are inserted in the Agilent 8166A/B Lightwave Multichannel System, the user interface cannot display each channel number in the details screen. The arrow indicates that undisplayed channels can be accessed by pressing the *Channel* hardkey.

To return to the overview screen press the [Overview] softkey.

How to Access the Menu

Press the [Menu] softkey to access all the parameters and functions that apply to a module. Figure 16 and Figure 18 show the type of menu you should see for a Power Sensor channel.

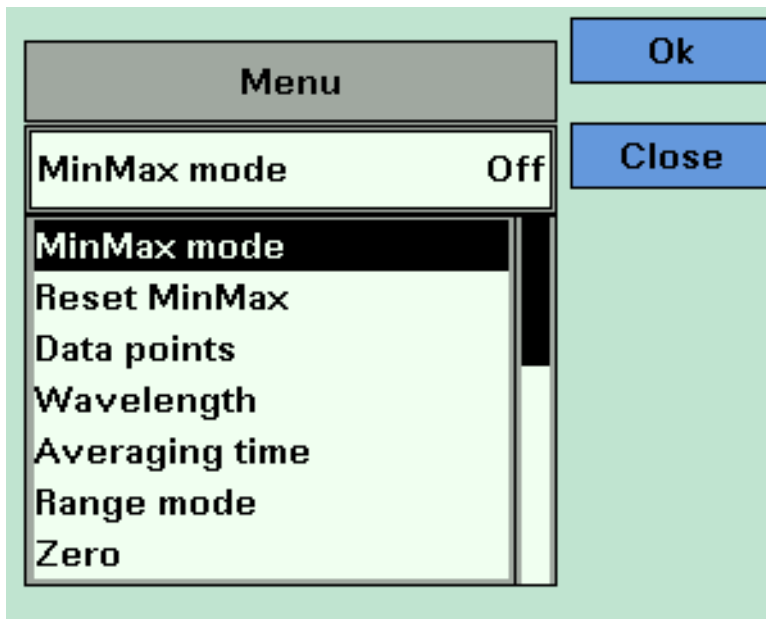

Figure 16 The Agilent 8163B/6B Menu for a Power Sensor Channel

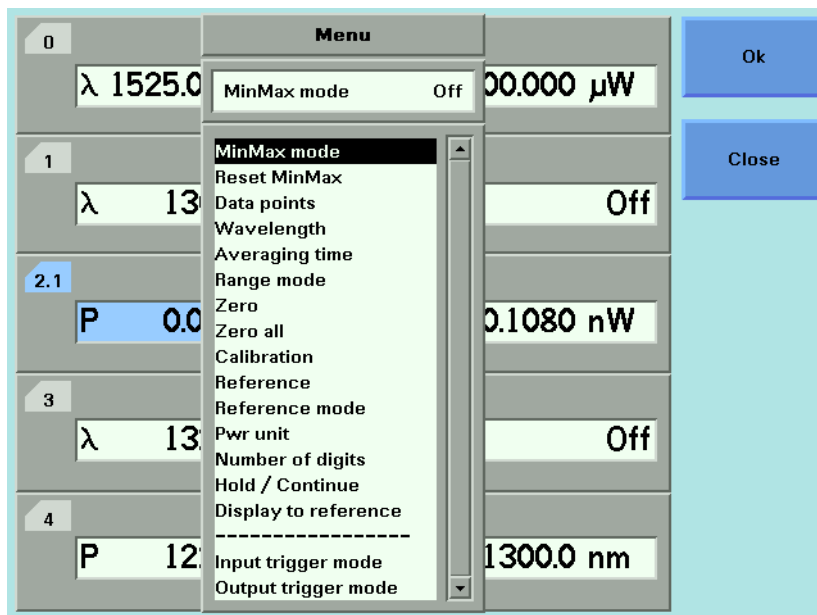

Figure 17 The Agilent 8164A/B Menu for Power Sensor Channel

How to Change the System Configuration

Press the *Config* hardkey to access all the system configuration parameters that can be changed. Figure 18 and Figure 19 show the menu you should see. See “Additional Information” on page 63 for more details.

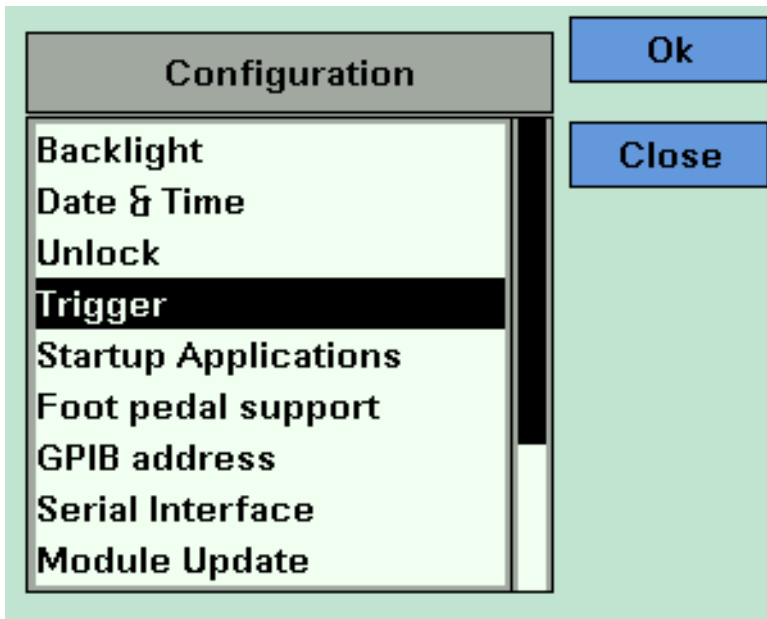

Figure 18 The Agilent 8163B System Configuration Menu

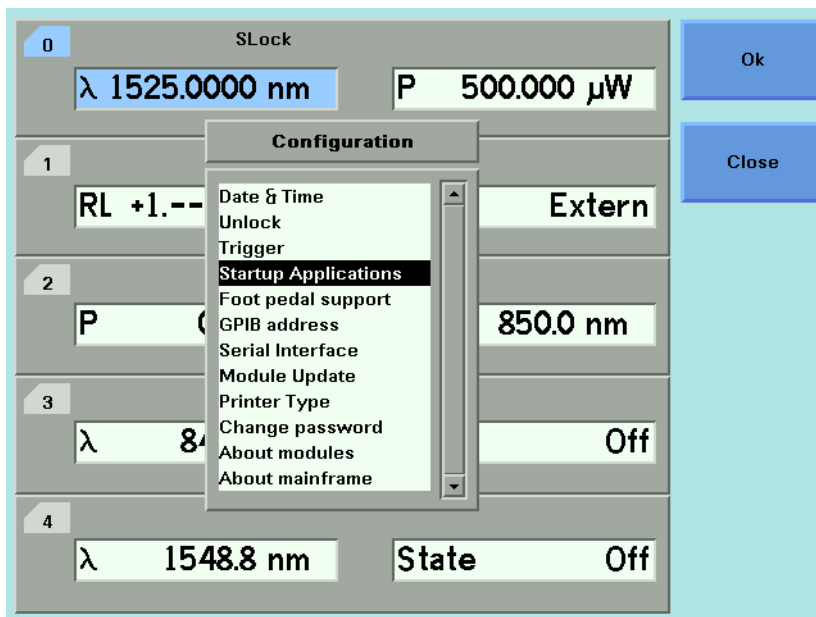

Figure 19 The Agilent 8164A/B System Configuration Menu

How to Get Help

Press the *Help* hardkey any time you need more information. The instrument displays online documentation for the currently selected parameter.

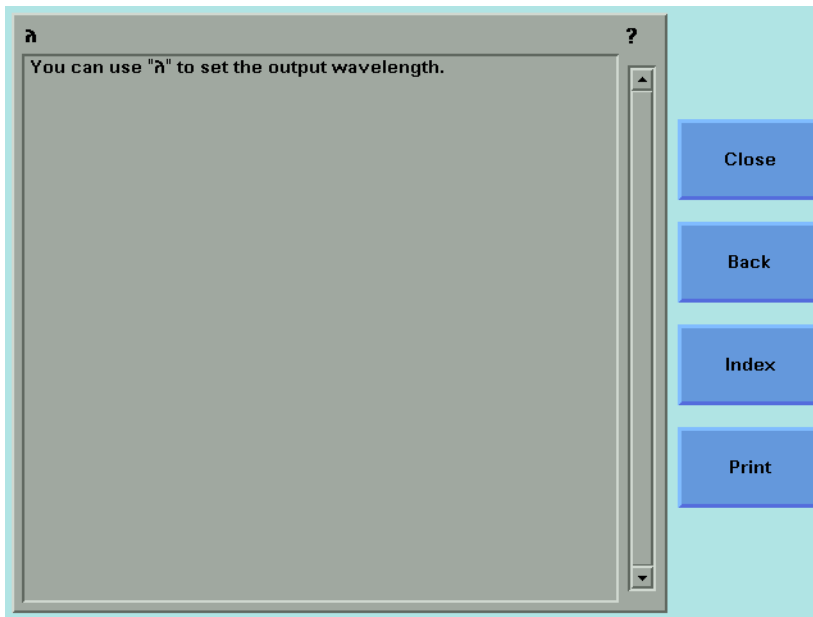

Figure 20 The Agilent 8164A/B Help Screen

Press the [Index] softkey to access the Index of help topics.

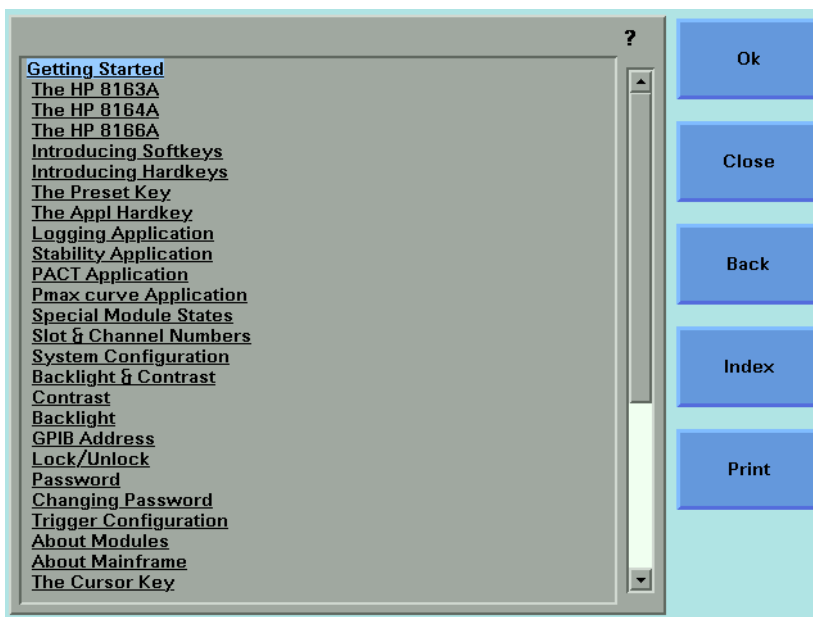

Figure 21 The Agilent 8164A/B Help Index

Press the [Back] softkey to return to the last Help topic you accessed.

You can scroll through the text using the up and down cursor keys. The scroll bar displays the current position in the text.

Cross-references within the text allow you to access relevant topics. Cross-references are underlined. If a cross-reference is highlighted, it is selected. Use the left or right cursor keys to move to another cross-reference. If you press the "Enter" hardkey or the [OK] softkey, you will jump to the chosen cross-reference.

Press the [Print] softkey to print the current help page. See *"How to Connect a Printer" on page 81* for more information on printing.

Press the [Close] softkey to leave the online documentation and resume your task.

How to Access Applications

You can access these applications for the Agilent 8163A/B Lightwave Multimeter or Agilent 8164A/B Lightwave Measurement System by pressing the *AppI* hardkey, the Applications Menu appears, as shown in Figure 22 . See *"Applications" on page 229* for further details.

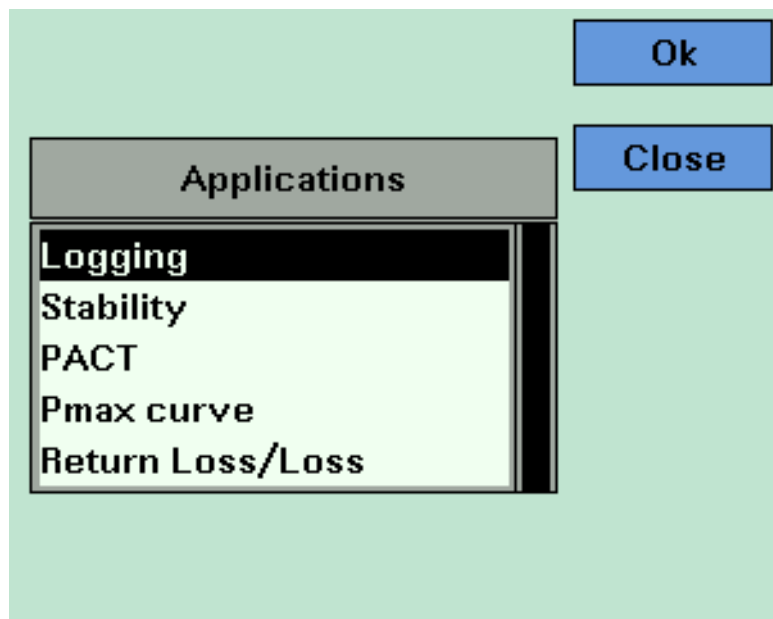

Figure 22 The Applications Menu

NOTE

These applications are not available for the Agilent 8166A/B Lightwave Multichannel System.

The Return Loss Application is only available for the Agilent 8163B Lightwave Multimeter.

NOTE

After you exit from the application, any modules selected by these applications will automatically be preset, all parameters will be set to their default values for the selected modules.

How to Change the Value of a Parameter

What follows is a description of the various ways of changing the value of parameters. Examples in which particular parameter values are changed are given with the parameter descriptions.

Parameters can be either:

- continuous, you may choose any value within a given range, or
- discrete, you may choose a value from a menu.

How to Select a Parameter

You can select the parameter from the following screens:

- from the Details screen, after pressing the [Details] softkey,
- from the Menu screen, after pressing the [Menu] softkey, or,
- for the Agilent 8163A/B and Agilent 8164A/B, from the Overview screen.

To start editing a parameter, you move to it and:

- press the *Enter* hardkey,
- press the [Edit] softkey,
- press the Modify Knob (if you are using the Agilent 8164A/B), or,
- for numerical parameters only, type a digit on the numerical keypad (if you are using the Agilent 8164A/B).

How to Accept the New Value of a Parameter

When you have changed the value of a parameter, to accept this change:

- press the *Enter* hardkey,
- press the [OK] softkey,
- or, press the Modify Knob (if you are using the Agilent 8164A/B).

These keys all perform the same purpose. All references to pressing *Enter* throughout this User's Guide, refer to one of these three actions.

How to Make a Big Change to a Continuous Parameter

If you are changing the value of a parameter completely, type in the value on the numerical keypad (if you are using the Agilent 8164A/B), and press *Enter*.

To change the output power from 100 μW to 755 μW :

- 1 Press the [Menu] softkey.
- 2 Move to Power, using the cursor key, and press *Enter*.
- 3 Type 755.000 on the numerical keypad and press *Enter*.

How to Make a Small Change to a Continuous Parameter

For small changes to a parameter use the up and down cursor keys, the numerical keypad (if you are using the Agilent 8164A/B), or the modify knob (if you are using the Agilent 8164A/B).

Move to the parameter and then:

- 1 Press [Edit]. The first digit before the decimal point will be highlighted first, as shown in Figure 23 .

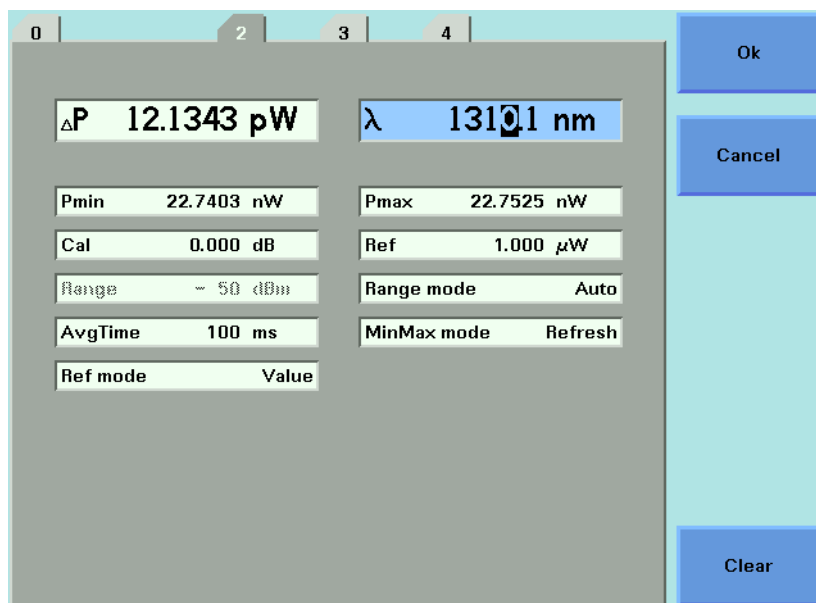

Figure 23 The First Digit Before the Decimal Point is Highlighted First

- 2 If you want to select another digit to edit, use the left or right cursor key.
- 3 Enter the new value for the digit by using the numerical keypad, the up and down cursors or turning the modify knob.
- 4 Repeat steps 2 and 3 to continue editing the value.
- 5 When you have finished editing the value, press *Enter*. The edited value becomes the new value of the parameter.

To change the wavelength from 1540.000 nm to 1525.000 nm:

- 1 Move to the wavelength parameter for a Tunable Laser module and press [Edit]. The most significant digit is highlighted.
- 2 Press the left cursor once to highlight the digit four.
- 3 Press the down cursor twice to change the value of the digit to two.
- 4 Press the right cursor once to move the cursor one digit right.

- 5 Press the up cursor five times to change the value of the digit to five. Press *Enter* to end the editing.

How to Change a Discrete Parameter

For discrete parameters, you may choose a particular values within a given range.

For a Power Sensor module:

- 1 Move to the Power Sensor channel and press the [Details] softkey.
- 2 Move to the [AvgTime] parameter and press *Enter*.
- 3 Move to 1 s, by using the cursor key, and press *Enter*.

or

- 1 Move to the Power Sensor channel and press the [Menu] softkey.
- 2 Move to the <Averaging Time> parameter and press *Enter*. You see the screen in Figure 24 .
- 3 Move to <1 s>, by using the cursor key, and press *Enter*.

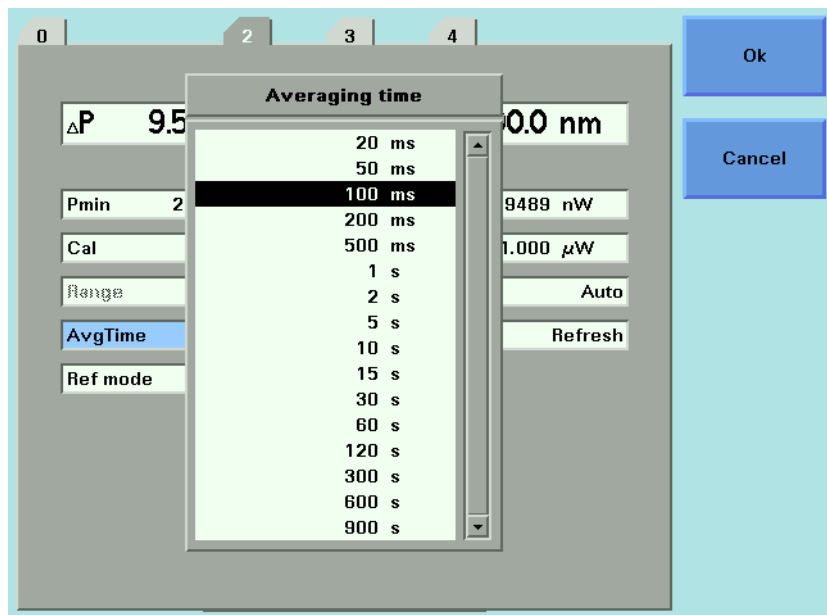

Figure 24 Averaging Time Menu

How to Set All Parameters to Their Default Values

Press *Preset* to set all parameters to their default values.

If You Make a Mistake

If you make a mistake while you are editing a parameter, you can cancel the editing, and retain the previous value for the parameter by pressing the [Cancel] softkey.

If the Parameter Changes to Different Value

If you press *Enter* or the [OK] softkey and the parameter changes to a different value, then you tried to enter a value outside the calibrated range. The new value is the nearest valid value to the value you entered.

A Sample Session

This sample session shows you how to measure the power of a modulated signal at a single wavelength.

The sample session is written for the Agilent 8163A/B Lightwave Multimeter or Agilent 8164A/B Lightwave Measurement System, the Agilent 81689A Tunable Laser module, and the Agilent 81632A Power Sensor. To perform the sample session as described here, you also need a patchcord (if you are using the 81000AI Connector interface, then a Diamond HMS-10/Agilent/HRL to Diamond HMS-10/Agilent patchcord, Agilent 81109AC).

How to Measure the Power of a Modulated Signal

We want to measure the power of a 1540 nm signal, modulated by a 100 kHz square wave, at 500 μ W.

- 1 Make sure that all your connectors, and connector interfaces are clean.
- 2 Make sure that the Optical Output of the Laser Source is not active.
- 3 Connect the output of the Laser Source to the input of the Power Sensor module, as shown in Figure 25 . You must connect the correct fiber end connector for your Tunable Laser module:
 - a For straight contact connectors, use a straight contact fiber end connector with a black sleeve.
 - b For angled contact connectors with a green sign beside the Tunable Laser module's optical output connector, use an angled contact fiber end connector with a green sleeve.

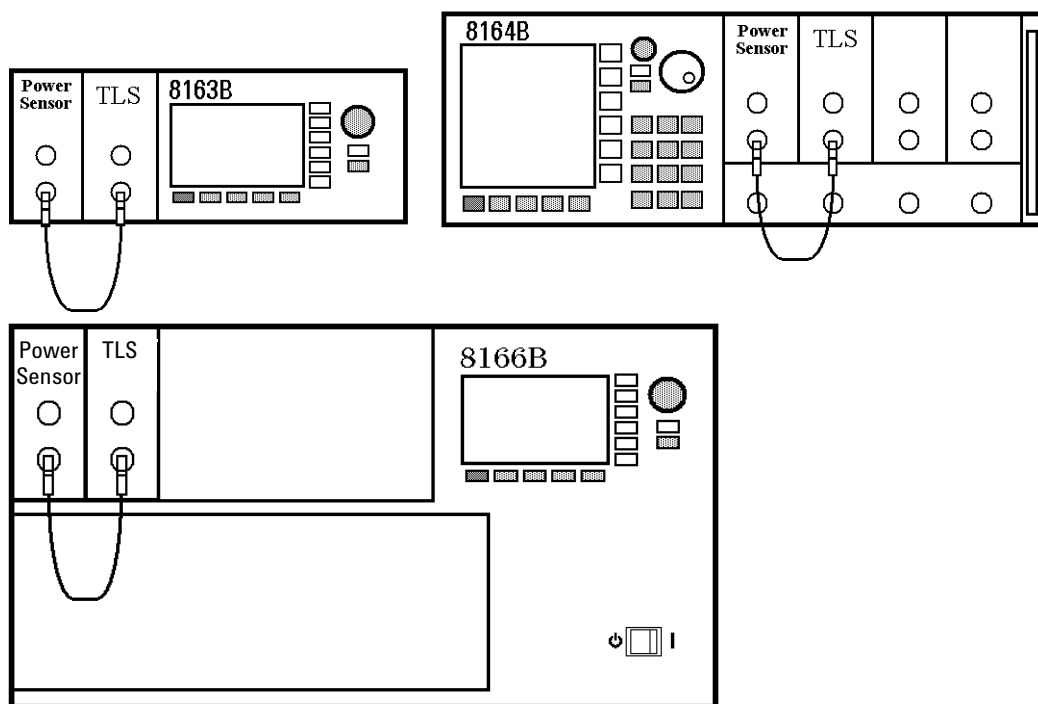

Figure 25 Connecting the Instrument for the Sample Session

- 4 Make sure the instrument is powered up.
- 5 How to set the wavelength for the Power Sensor module:
 - a Move to the wavelength parameter, [λ], for the Power Sensor module and press *Enter*.

- b** Enter 1540.000 and press *Enter*.
- 6** How to set the averaging time for the Power Sensor module:
 - a** Move to the measurement averaging time, [*Tavg*], and press *Enter*.
 - b** Move to <1 s>, using the cursor key, and press *Enter*.
- 7** For the Power Sensor module, make sure that Watts are the selected Power Unit and that the instrument is in automatic ranging mode. To change these settings:
 - a** Move to the power parameter, [*P*], and press the [Power Unit] softkey.
 - b** Move to <W>, using the cursor key, and press *Enter*.
 - c** Move to the [*Range Mode*] parameter and press *Enter*.
 - d** Move to <Auto>, using the cursor key, and press *Enter*.
- 8** How to set the wavelength for the Tunable Laser module:
 - a** Move to the wavelength parameter, [λ], for the Tunable Laser module and press *Enter*.
 - b** Enter 1540.000 and press *Enter*.
- 9** How to set the modulated power for the Tunable Laser module:
 - a** If power is not displayed in Watts, move to the [*P*] parameter and press the [Power Unit] softkey.
 - b** Move to <W>, using the cursor key, and press *Enter*.
 - c** Move to the [*P*] parameter and press *Enter*.
 - d** Enter 500.000.
 - e** Change units to μW , if necessary, using the [Unit+] or [Unit–] softkey.
 - f** Press *Enter*.
- 10** How to set the modulation frequency for the Tunable Laser module:
 - a** Select the [*Frequency*] parameter and press *Enter*.
 - b** Enter 100.000 and press *Enter*.
- 11** For the Tunable Laser module, press the button beside the Optical Output. The green LED should switch on to indicate that the laser is now active.

You should notice that the power reading is approximately half the value set on the Tunable Laser module. This is because the output is modulated by a square wave with a 50% duty cycle.

2

Additional Information

This chapter describes the system functions of the Agilent 8163A/B Lightwave Multimeter, the Agilent 8164A/B Lightwave Measurement System, and the Agilent 8166A/B Lightwave Multichannel System. Here you will find out how to set the configuration settings and how to connect an external monitor.

Using the System Utilities	64
How to Set the Backlight	65
How to Set the Date & Time	66
How to Lock/Unlock the High-Power Laser Sources	68
How to Set the Trigger Configuration	69
How to Configure Startup Applications	70
How to Configure your Foot Pedal	71
How to Set the GPIB Address	72
How to Set the Speed of the Serial Interface	73
How to Update a Module	74
How to Select the Printer Type	75
How to Change the Password	76
If You Forget Your Password	76
How to Get Information About Modules	77
How to Get Information About the Mainframe	79
How to Connect an External Monitor	80
How to Connect a Printer	81

Using the System Utilities

Press the *Config* hardkey to access configuration information for your mainframe. You see the screens in Figure 26 and Figure 27 .

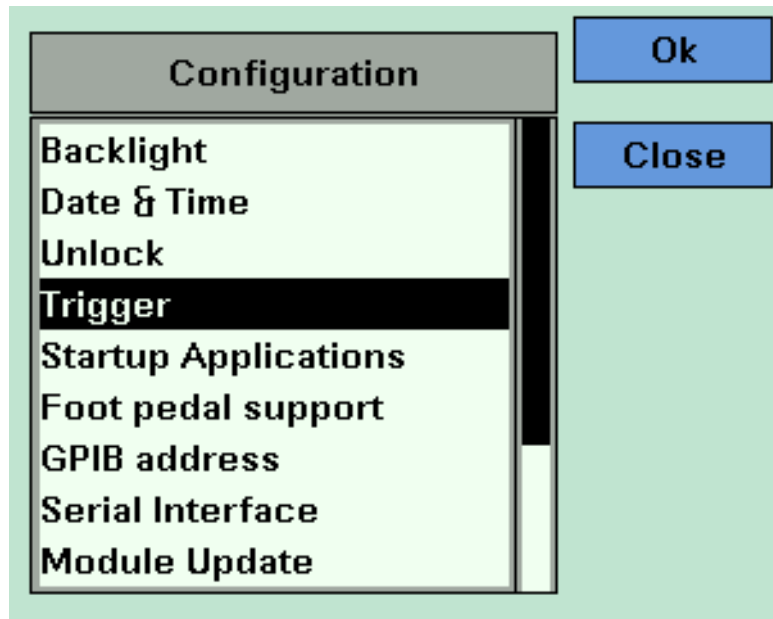

Figure 26 The Agilent 8163B/6B Configuration Menu

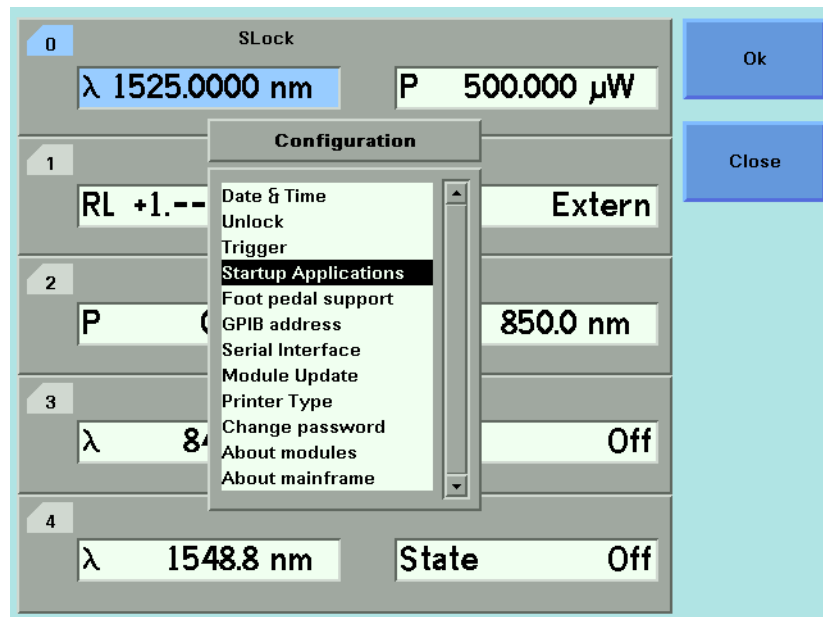

Figure 27 The Agilent 8164A/B System Configuration Menu

You can move to any of the menu items by using the cursor key or the Modify knob. Select an item by pressing *Enter* or the [OK] softkey.

How to Set the Backlight

The Backlight and menu option allows you to change the appearance of the screen.

NOTE

The Backlight menu option is supported by the Agilent 8163A/B and Agilent 8166A/B but not by the Agilent 8164A/B.

To Set the Backlight

To change the backlight level of the Agilent 8163A/B/.6A/B's screen:

- 1 Press the *Config* hardkey.
- 2 Move to the *<Backlight>* menu option and press *Enter*. You see a box displaying the current setting.

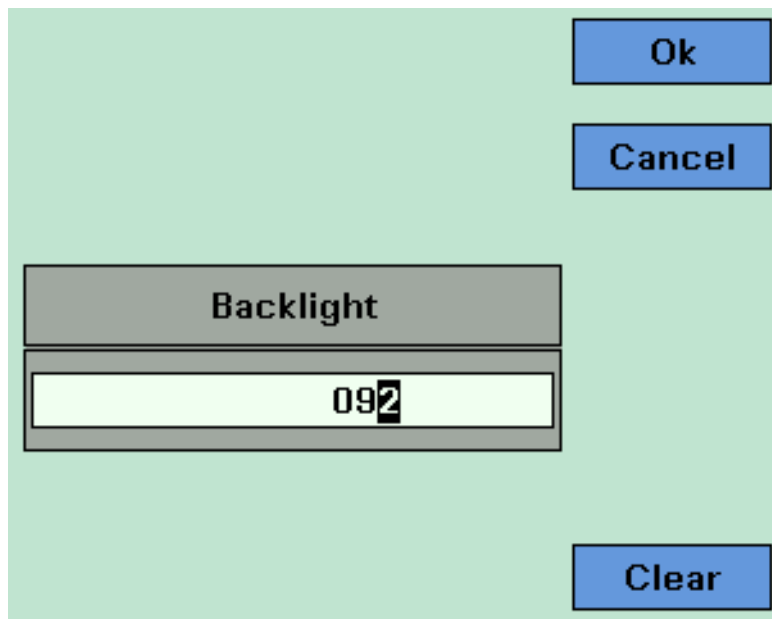

Figure 28 Entering a Backlight Value

- 3 Enter an integer value between zero and one hundred in this box and press *Enter*.

NOTE

The Contrast can also be set for the Agilent 8163A and the 8166A models, but *only* these models, as follows:

- 1 Press the *Config* hardkey.
- 2 Move to the *<Contrast>* menu option and press *Enter*. You see a box displaying the current setting
- 3 Enter an integer value between zero and one hundred in this box and press *Enter*.

How to Set the Date & Time

The instrument uses the date and time when:

- you print out data from an application,
- you save data to diskette from an application, and
- you send the `:SYSTem:DATE?` or `:SYSTem:TIME?` GPIB commands, see your instrument's Programming Guide for more details.

To set the date and time:

- 1 Press the *Config* hardkey.
- 2 Move to the *<Date & Time>* menu option and press *Enter*. You see a box, similar to Figure 29 , displaying the current date and time settings.

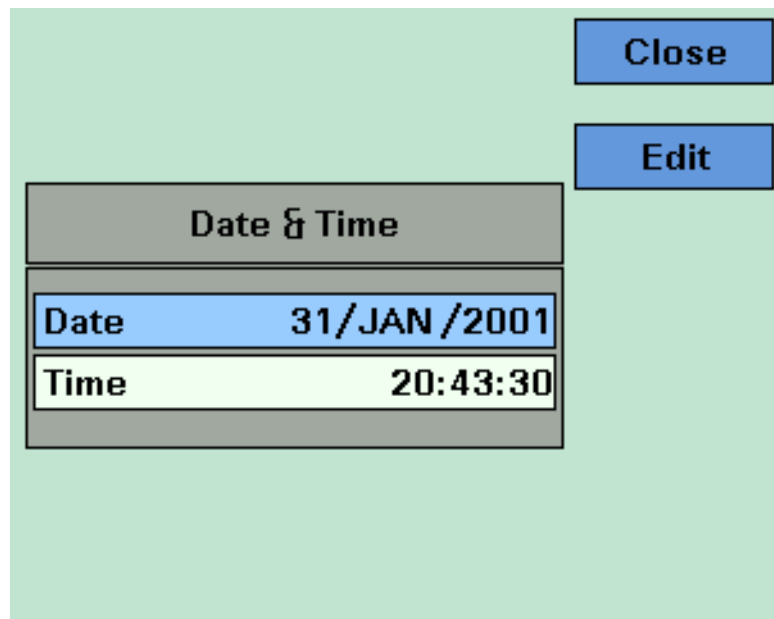

Figure 29 Editing the Date and the Time

- 3** Use the cursor key to move to the Date field. Press the [Edit] softkey. The day of the month is highlighted.
- 4** Use the left and right cursor keys to move to the day, month or year. Edit the day, month or year using the cursor key. Press *Enter*.
- 5** Perform steps 3 to 4 again if the date is not fully correct.
- 6** Use the cursor key to move to the Time field. Press the [Edit] softkey. The hour of the day is highlighted. The 24-hour clock is used.
- 7** Use the left and right cursor keys to move to the hour, minute, or second. Edit the hour, minute, or second using the cursor key. Press [OK].
- 8** Perform steps 6 to 7 again if the date is not fully correct.
- 9** When the time and date are both correct, press [Close] to return to the configuration menu.

How to Lock/Unlock the High-Power Laser Sources

To unlock high-power laser sources (including Tunable Laser modules):

- 1 Press the *Config* hardkey.
- 2 Move to the *<Unlock>* menu option and press *Enter*. You see a box requesting you to enter the password.

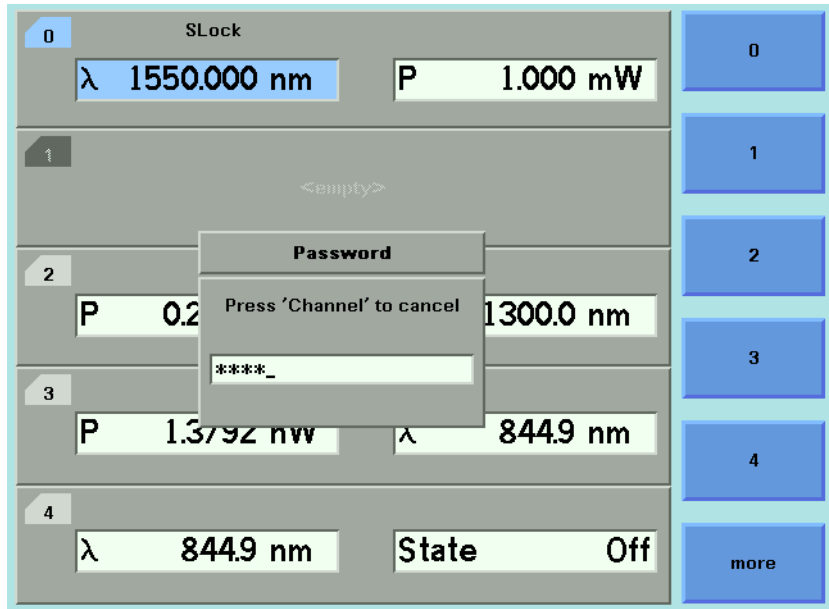

Figure 30 Unlocking the Instrument

- 3 Enter the password, using the softkeys or the numerical keypad. Press *Enter* and the instrument unlocks.

NOTE

The default password is *1234*.

To lock the instrument, perform the steps above, but in step 2 move to the *<Lock>* menu option in place of the *<Unlock>* menu option.

How to Set the Trigger Configuration

The trigger level at the external trigger connectors is by default active high, this means when a trigger rises above the high TTL level (rising edge), a trigger is accepted.

You can select three modes of triggering from the trigger configuration menu:

- *<None>*, which you should choose if you do not want to use triggering.
- *<Default>*, which you should choose if you want to enable the trigger connectors.
- *<Pass Through>*, which you should choose if you want an input trigger to automatically generate an output trigger. This allows you to trigger another instrument almost simultaneously.
- *<Feedback>*, which you should choose if you want an output trigger to automatically generate an input trigger. For example, using this mode, you could trigger each step of a wavelength sweep with just one externally generated input trigger.

To change the triggering mode:

- 1 Press the *Config* hardkey.
- 2 Move to the *<Trigger>* menu option and press *Enter*. You see a box displaying the available triggering modes.

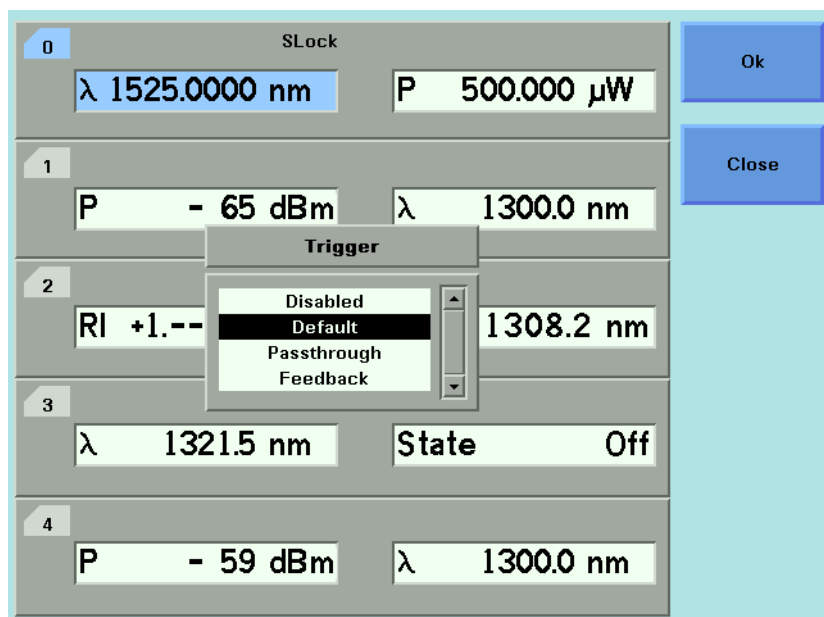

Figure 31 Changing the Triggering Mode

- 3 Move to your chosen triggering mode and press *Enter*.

How to Configure Startup Applications

NOTE

Only valid for the 8163B and 8164B

Several Applications on the 8163B and 8164B can be configured to start up when the system is switched on.

To configure startup applications:

- 1 Press the *Config* hardkey.
- 2 Move to the <Startup Applications> menu option and press *Enter*.
- 3 Select the application you want to start up when the system is switched on.

How to Configure your Foot Pedal

You can use an Agilent 81610FP Foot Pedal (*Part Number 81610-68709*) to generate triggers. This accessory is similar to a mouse, you press the Foot Pedal and a trigger is generated. You can attach the Foot Pedal to the Input Trigger BNC Connector, see *“Input and Output Connectors” on page 310*.

To configure your Foot Pedal:

- 1 Press the *Config* hardkey.
- 2 Move to the *<Foot pedal support>* menu option and press *Enter*. You see a box displaying *<On>* and *<Off>*.

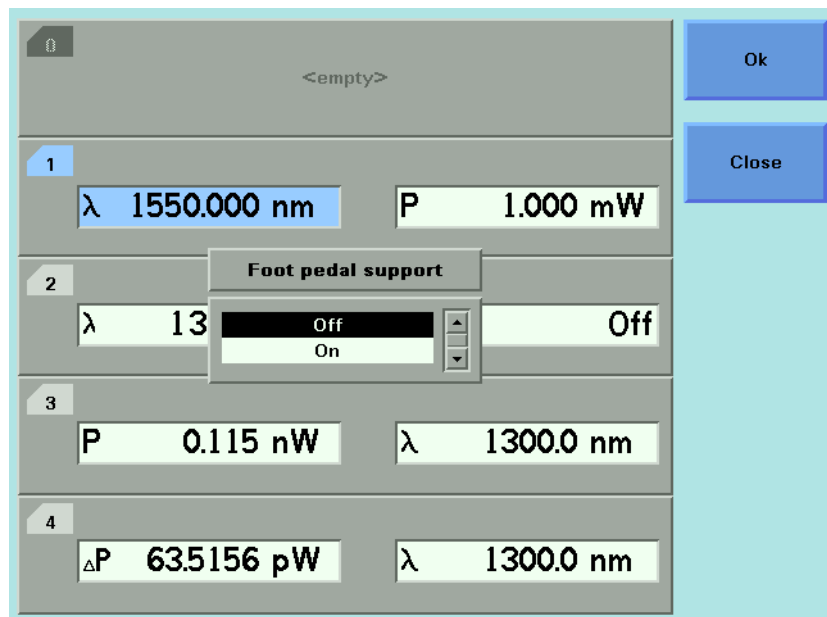

Figure 32 Enabling/Disabling the Foot Panel

- 3 Move to *<On>* to enable the Agilent 81610FP Foot Pedal or move to *<Off>* to disable the Agilent 81610FP Foot Pedal.
- 4 Press *Enter*.

NOTE

Valid for 8163A, 8164A, and 8166A only.

This functionality requires FPGA version 1.5 or higher. The FPGA version number and date is displayed after you boot up the instrument.

NOTE

The Trigger configuration must not be set to “disabled”

How to Set the GPIB Address

NOTE

The default GPIB address is 20.

To set the GPIB address:

- 1 Press the *Config* hardkey.
- 2 Move to the <GPIB Address> menu option and press *Enter*. You see a box displaying the current GPIB address.

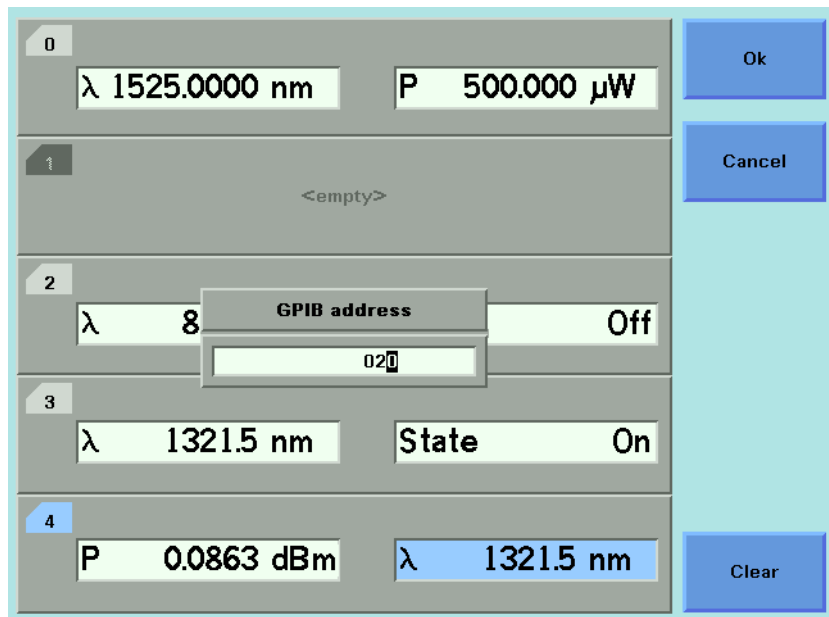

Figure 33 Entering a GPIB Address

- 3 Enter an integer value between 0 and 30 into this box and press *Enter*. The address is set to this value.

NOTE

Avoid using 21 as the GPIB address because this number is often the controller's default GPIB address.

How to Set the Speed of the Serial Interface

NOTE

The default Baudrate of the serial interface is 38400 bps.

To set the Baudrate of the instrument's serial interface:

- 1 Press the *Config* hardkey.
- 2 Move to the *<Serial Interface>* menu option and press *Enter*. You see a box displaying all the available line speeds in bps.

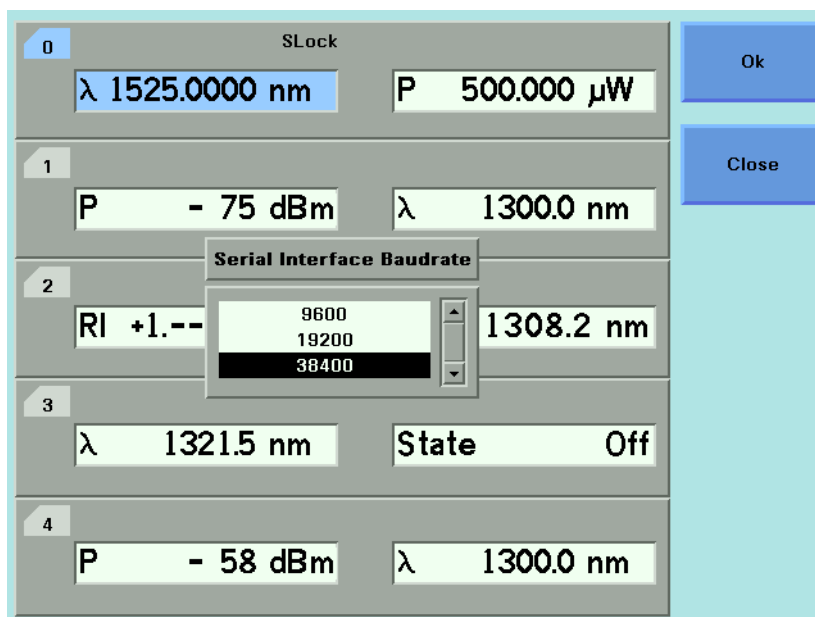

Figure 34 Selecting a Baudrate for the Serial Interface

- 3 Move to the Baudrate required and press *Enter*.

NOTE

The Baudrate set for the serial interface of the instrument should match that set for the PC serial interface connected to it.

The PC serial interface should be configured to match the instrument's fixed parameters. Refer to "Serial Interface" on page 315

How to Update a Module

For information about instrument and module firmware upgrade procedures refer to “Firmware Upgrades” on page 451

To set the mainframe in *Module Update* mode:

NOTE

Module Update mode is necessary only when updating a module via the serial interface.

- 1 Press the *Config* hardkey.
- 2 Move to the *<Module Update>* menu option and press *Enter*. You see a box that displays *Module Update* mode as *on*.
- 3 Press [OK] to start the *Module Firmware Download* process.

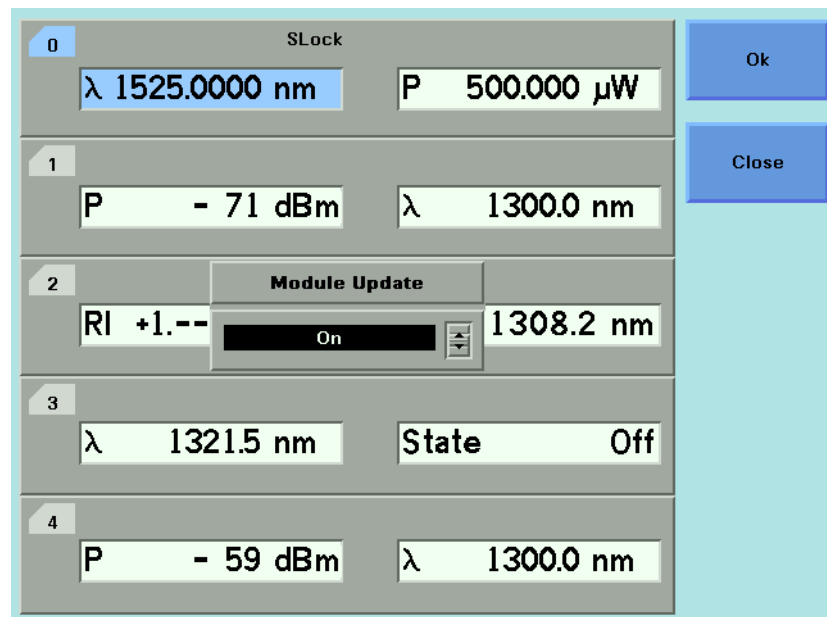

Figure 35 Module Update mode

NOTE

Reboot the mainframe to restore normal operation.

How to Select the Printer Type

You can use a printer connected to the parallel port on the rear panel of your mainframe, see *"Input and Output Connectors"* on page 310 for a diagram of your mainframe's rear panel.

You can print out any of the following information:

- a help screen, see *"How to Get Help"* on page 50,
- data from an application, see *"Printing Application Measurement Results"* on page 283.

To select a printer type:

- 1 Press the *Config* hardkey.
- 2 Move to the *<Printer Type>* menu option and press *Enter*. You see a box, as shown in Figure 36, displaying the following printer types:
 - *<HP PCL>*, you can use any printer that uses the Hewlett-Packard Printer Control Language Level 3 or higher, and
 - *<EPSON 8 pin>*, you can use any printer that is compliant with Epson 8 pin printers.

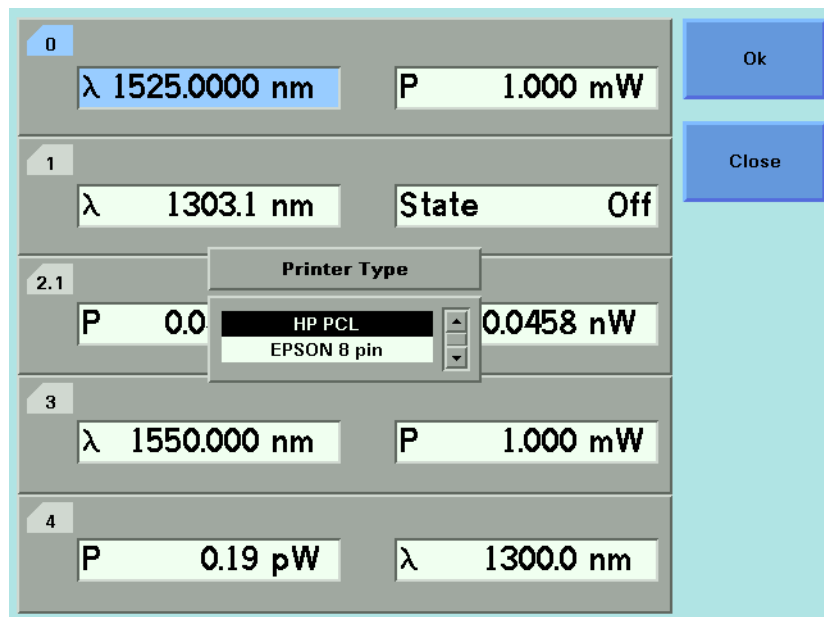

Figure 36 Selecting a Printer Type

- 3 Move to your printer type and press *Enter*. You return to the configuration menu.

How to Change the Password

The password is used for unlocking the instrument. To change the password:

- 1 Press the *Config* hardkey.
- 2 Move to the *<Change Password>* menu option and press *Enter*. You see a box requesting you to enter the password.
- 3 Enter the current password, using the softkeys or the numerical keypad and press *Enter*. You see a box requesting you to enter the new password.
- 4 Enter your new password. It should be 4 digits long. Press *Enter*.

If You Forget Your Password

If you forget your password, contact your nearest Agilent Technologies Sales/Service Office. Find contact details by accessing <http://www.agilent.com/> on the internet.

How to Get Information About Modules

To get information about modules:

- 1 Press the *Config* hardkey.
- 2 Move to the *<About Modules>* menu option and press *Enter*. You see a box displaying the slots which have installed modules, see Figure 37 .

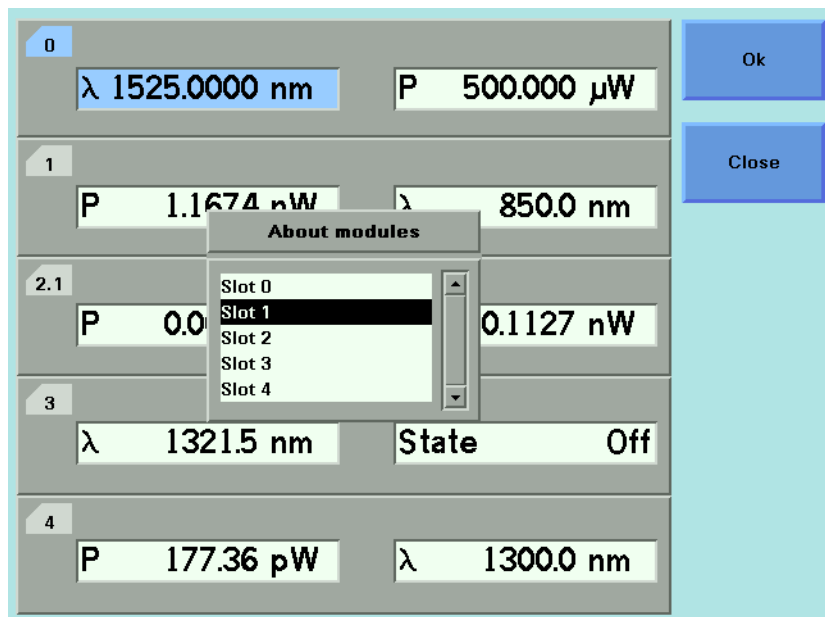

Figure 37 Slots with Installed Modules

- 3 Move to the module using the cursor key for which you require information. Press *Enter*.
- 4 The part number, serial number, and firmware revision of the chosen module are displayed, as shown in Figure 38 .

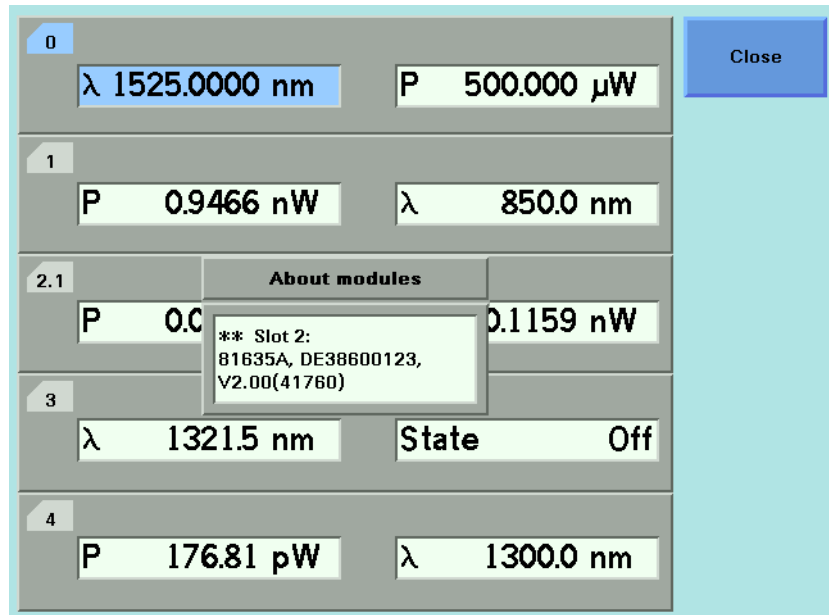

Figure 38 Viewing Information About a Module

- 5 Press [Close] to return to the menu in Figure 37 .
- 6 Perform steps 3 to 5 to view information about other module slots or press [Close] to return to the configuration menu.

NOTE

- The Agilent 81640A/42A/80A/82A/89A Tunable Laser modules will always return HEWLETT-PACKARD as the manufacturer.
- All other Agilent 8163A/B Series modules return Agilent Technologies as the manufacturer.
- The 8153A Series modules will always return HEWLETT-PACKARD as the manufacturer.

See “How to Get Information About the Mainframe” on page 79 for information on mainframe identity strings.

How to Get Information About the Mainframe

To get information about the mainframe:

- 1 Press the *Config* hardkey.
- 2 Move to the *<About Mainframe>* menu option and press *Enter*. You see a box displaying information about your mainframe, see Figure 39 . The manufacturer, part number, serial number, and firmware revision of the mainframe are listed.

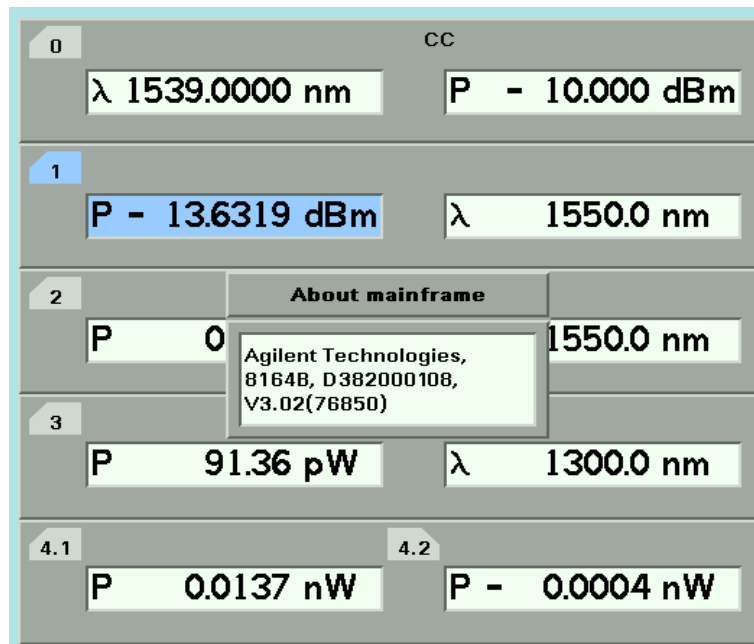

Figure 39 Viewing Information About the Mainframe

- 3 Press [Close] to return to the configuration menu.

The Agilent 8163A, Agilent 8164A, and Agilent 8166A will always return Agilent as the manufacturer. This will not be affected by the transition of these instruments to Agilent Technologies. This will allow programs that use this string to continue functioning.

NOTE

The Agilent 8163B, Agilent 8164B, and Agilent 8166B will always return Agilent Technologies as the manufacturer.

See “How to Get Information About Modules” on page 77 for information on module identity strings.

How to Connect an External Monitor

You can connect a standard VGA monitor to the Agilent 8164A/B Lightwave Measurement System and the Agilent 8166B Lightwave Multichannel System. This is a useful feature for making presentations or for training courses.

NOTE

You cannot connect a monitor to the Agilent 8163A/B Lightwave Multimeter or Agilent 8166A Lightwave Multichannel system.

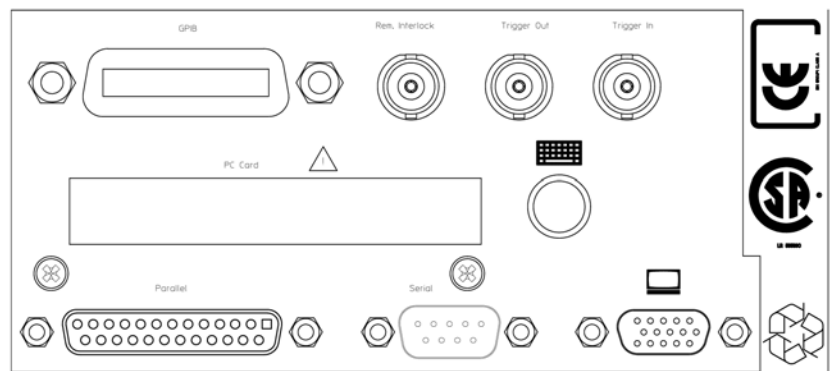

Figure 40 Rear Panel of the Agilent 8164B Lightwave Measurement System

- Place your monitor on a flat sturdy surface.
- Before you make any connections make sure the Lightwave Measurement System and monitor are turned off.
- Connect the power cable to the video input on the back of your monitor. Tighten the thumbscrews on the plug.
- Connect the video cable (it has a 15-pin plug) to the video outlet on the back of the Lightwave Measurement System. Tighten the thumbscrews on the plug.
- Connect the power cord to the display.
- Plug the power cord into the power outlet.

NOTE

Refer to the user's guide that came with your monitor, if necessary, to locate your monitor's output and input ports.

How to Connect a Printer

You can use a printer connected to the parallel port on the rear panel of your mainframe, see *"Input and Output Connectors"* on page 310 for a diagram of your mainframe's rear panel.

You can use either of the following printer types:

- *<HP PCL>*, a printer that uses the Hewlett-Packard Printer Control Language, or
- *<EPSON 8 pin>*, a printer that is compliant with Epson 8 pin printers.

To set up the printer, perform the following steps:

- 1** Set up your printer as described in your printer's User's Guide.
- 2** Connect a parallel cable between your printer's parallel connector to the parallel port on the rear panel of your mainframe, see *"Input and Output Connectors"* on page 310 for a diagram of your mainframe's rear panel.
- 3** To select a printer type, see *"How to Select the Printer Type"* on page 75.

You can then print out any of the following information:

- a help screen, see *"How to Get Help"* on page 50,
- data from an application, see *"Printing Application Measurement Results"* on page 283.

3

Power Measurement

This chapter describes how to use the Agilent 8163A/B Lightwave Multimeter, the Agilent 8164A/B Lightwave Measurement System, and the Agilent 8166A/B Lightwave Multichannel System to measure optical power using a Power Meter, that is:

- a Power Sensor module or
- an Optical Head in conjunction with an Optical Head Interface module.

How to Measure Power	84
The Power Value	84
How to Set the Power Unit	85
How to Set the Calibration Offset	87
How to Set the Reference Level	88
How to Set the Wavelength	91
How to Remove Electrical Offsets	91
How to Choose the Range Mode	94
How to Set the Range	95
How to Set the Averaging Time	100
How to Choose the MinMax Mode	101
How to Turn Off MinMax Mode	103
How to Hold the Screen	103
How to Use Triggers	104
Dual Power Meters - Master and Slave Channels	107

How to Measure Power

The Power Value

The $\langle P \rangle$ parameter displays the power measurement value. In MinMax mode, this parameter changes to $\langle \Delta P \rangle$, the difference between minimum and maximum power, see “How to Choose the MinMax Mode” on page 101.

How to Set the Number of Digits

You can set the maximum number of digits that are used in power measurement. This is the maximum number of digits after the decimal point.

To change the number of digits to two:

- 1 Move to the Power Meter channel and press the [Menu] softkey.
- 2 Move to $\langle \text{Number of Digits} \rangle$ option and press *Enter*. You will see the screen in Figure 41 .

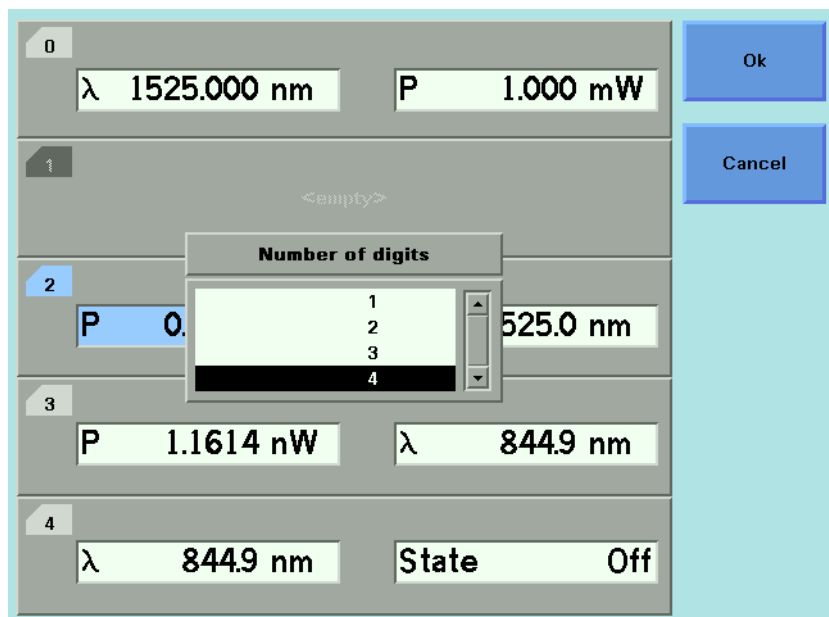

Figure 41 The Number of Digits Menu

- 3 Move to 2 and press *Enter*.
- 4 Press the [Close] softkey to exit the menu.

How to Set the Power Unit

Pressing the Power Unit softkey allows you to select either W, dB, or dBm as the units in which power is displayed. The Power Unit softkey is visible when you move to the [P] or [Ref] parameters. Alternatively the Power Unit can be changed by using the Power Meter menu.

What are the Power Units ?

Watts (W) are the SI unit for power measurement.

You can also measure power in dB or dBm. Values displayed in these units are derived from measurement in Watts.

By selecting dBm, the following calculation is made:

$$P_{dBm} = 10 \log \frac{P_{input}(W)}{1 \times 10^{-3}(W)}$$

Where,

P_{dBm} is the power value displayed in dBm, and

P_{input} is the input signal level in Watts.

Power, in units of dBm, is measured relative to 1 mW, it is an absolute power measurement.

By selecting dB, the following calculation is made:

$$P_{dB} = 10 \log \frac{P_{input}(W)}{P_{ref}(W)}$$

Where,

P_{dB} is the power value displayed in dB,

P_{input} is the input signal level in Watts, and

P_{ref} is the chosen reference power value in Watts.

Power, in units of dB, is measured relative to a particular reference power value. For information on selecting this reference value, see *“How to Input a Reference Level” on page 88.*

To set the power unit to dBm:

- 1 Move to the [P] parameter and press the [Power Unit] softkey. You will see the menu in *Figure 42* .

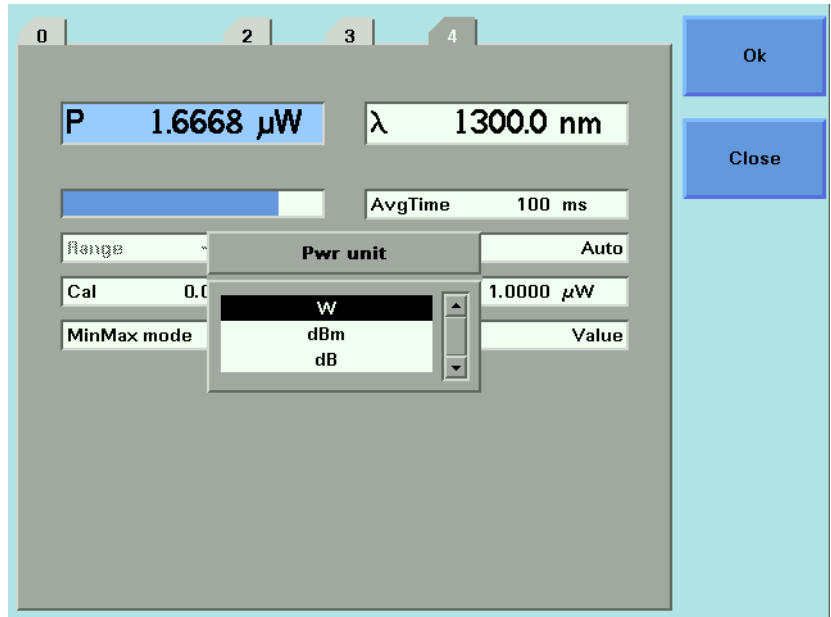

Figure 42 Selecting the Power Unit

- 2 Move to <dBm>, by using the cursor key, and press *Enter*.

How to Set the Calibration Offset

This is a calibration offset that you can enter to compensate for external optical circuitry, for example, the Agilent 81022FF Integrating Sphere or a 3 dB coupler. The calibration offset, $[Cal]$, is automatically subtracted from the input signal.

$$P_{\text{measured}}(\text{dBm}) = P_{\text{input}}(\text{dBm}) - \text{CAL}(\text{dB})$$

Where,

P_{measured} is the adjusted value of the signal read in dBm,

P_{input} is the input signal level in dBm, and

CAL is the calibration offset in decibels (dB).

To set the calibration offset to 40.000 dB:

- 1 Move to the Power Meter channel and press the [Details] softkey.
- 2 Move to the $[Cal]$ parameter and press *Enter*.
- 3 Enter 40.000 and press *Enter*.

How to Set the Reference Level

How to Input a Reference Level

dB results are shown relative to a reference level. The *[Ref]* parameter sets the reference level. Setting, or changing, the reference only affects results that are displayed in dB.

The reference level is displayed in units of dBm or Watts. Depending on which is selected the following equations are used to calculate the power level in dB:

$$P_{display}(dB) = P_{measured}(dBm) - REF(dBm)$$

or

$$P_{display}(dB) = 10 \log \frac{P_{measured}(W)}{REF(W)}$$

Where,

$P_{display}$ is the displayed relative power,

$P_{measured}$ is the absolute power level (see “How to Set the Calibration Offset” on page 87), and

REF is the reference level.

You can choose the units for the reference using the Power Unit softkey. If you choose dB, the power value changes to dB and the displayed reference level changes to dBm.

To set the reference level to 10 mW:

- 1 Move to the Power Meter channel and press the *[Details]* softkey.
- 2 Move to the *[Ref]* parameter and press the *[Power Unit]* softkey.
- 3 Move to *<W>* and press *Enter* twice.
- 4 Change the units to mW using the *[Unit+]* and *[Unit-]* softkeys.
- 5 Enter 10.000 and press *Enter*.

How to Set the Reference Value to the Current Power Value

In addition to entering a new reference value, you can change the reference value to the currently displayed power value by pressing the *[Dsp->Ref]* softkey.

Pressing the *[Dsp->Ref]* softkey takes the input power level and stores it as the reference. Setting the reference only affects results displayed in dB.

When you press the [Dsp->Ref] softkey, the absolute power level, the power value in dBm or Watts, is stored as the reference, that is:

$$REF = P_{measured}$$

Where,

REF is the reference, and

$P_{measured}$ is the absolute power level (see “How to Set the Calibration Offset” on page 87).

The [Dsp->Ref] softkey is displayed if you move to a power measurement channel.

How to Reference Another Power Measurement Channel

You can use the reference mode, [Ref Mode], to reference another Power Meter’s current power level. If you choose this mode, the reference of the channel continuously updates to the current power value measured by the other channel.

The following equations describe how the power in dB is calculated if you reference another channel:

$$P_{display}(dB) = P_{measuredA}(dBm) - P_{measuredB}(dBm) - REF(dB)$$

or

$$P_{display}(dB) = 10 \log \frac{P_{measuredA}(W)}{P_{measuredB}(W)} - REF(dB)$$

Where:

$P_{display}$ is the displayed relative power,

$P_{measuredA}$ is the absolute power level (see “How to Set the Calibration Offset” on page 87) measured by the current Power Meter, and

$P_{measuredB}$ is the absolute power level (see “How to Set the Calibration Offset” on page 87) measured by the Power Meter you choose to reference, and

REF is the reference level in decibels (dB).

NOTE

You can only set the reference level, REF , in decibels (dB) when you reference Power Meter’s current power level. This reference level is stored in separate memory than the absolute reference level.

To reference another channel:

- 1 Move to the Power Meter channel and press the [Details] softkey.
- 2 Move to the [Ref Mode] parameter and press *Enter*.
- 3 Move to the channel number you want to reference, using the cursor key, and press *Enter*. For example, in Figure 43, you could choose 3.1 (for channel 3.1). Refer to “Slot and Channel Numbers” on page 41 for information on channel numbers.

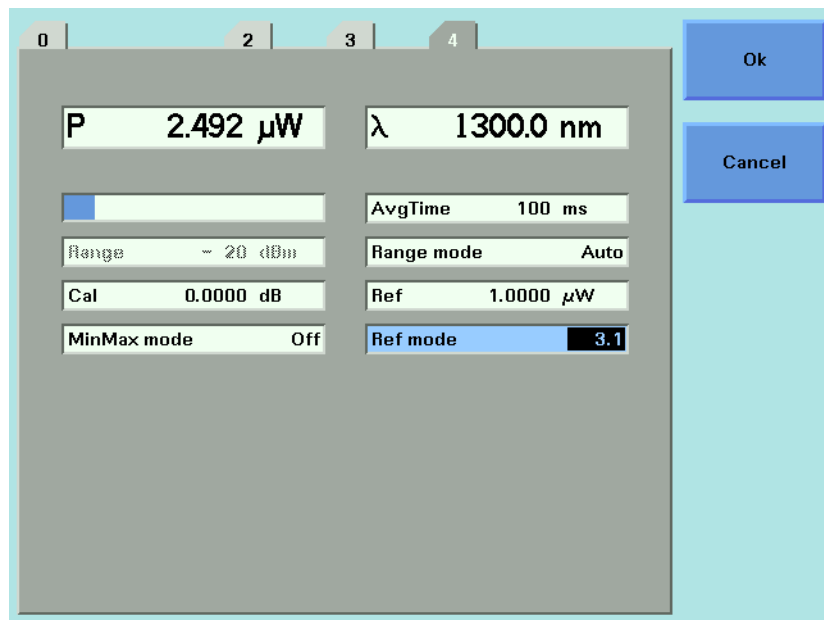

Figure 43 Referencing Another Channel

To return to setting a constant reference level:

- 1 Move to the Power Meter channel and press the [Details] softkey.
- 2 Move to the [Ref Mode] parameter and press *Enter*.
- 3 Move to the <Value> menu option and press *Enter*.

How to Set the Wavelength

This is the wavelength value. The responsivity of the Power Meter varies with wavelength. For accurate power measurement, you need to input the wavelength of the optical input. To set the wavelength to 1545.000 nm:

- 1 Move to the Power Meter channel and press the [Details] softkey.
- 2 Move to the [λ] parameter and press *Enter*.
- 3 Enter 1545.000 and press *Enter*.

How to Remove Electrical Offsets

Optical Power Meters measure optical power by converting optical power to electrical power, and then measuring electrical power. An electrical offset is electrical power that is always present, even if there no optical power is input. If electrical offsets are not removed, they affect the accuracy of power measurement.

Performing a zero sets the zero power level to the average electrical offset level for the current environmental conditions.

NOTE

The environmental conditions and the temperature of the instrument affect electrical offset. For the best results you must:

- Allow the instrument time to acclimatize (around 24 hours).
- Allow the instrument time to warm up (around 20 minutes).
- Make sure that the optical input is not receiving any light. If you are using multi-mode fiber-optic cable, you must disconnect the cable and cover the input to the Power Meter to perform a zero.

It is good practice to perform a zero before making any important measurements.

To remove electrical offsets:

- 1 Make sure the optical input is not receiving any light. If the instrument has just been switched on, wait until **SETTLING** is not displayed for the module channel.

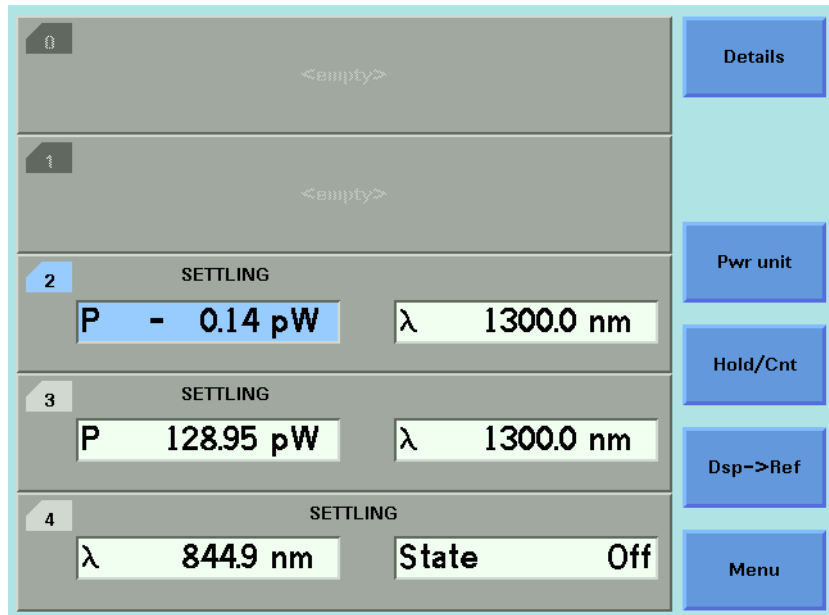

Figure 44 Module Channels that are Setting

- 2 Move to the Power Meter channel and press the [Menu] softkey.
- 3 Move to the *<Zero>* option to zero the current power measurement channel or the *<Zero All>* option to zero all power measurement channels. You will see the screen shown in Figure 45 , this appears for around 30 seconds while zeroing is performed.

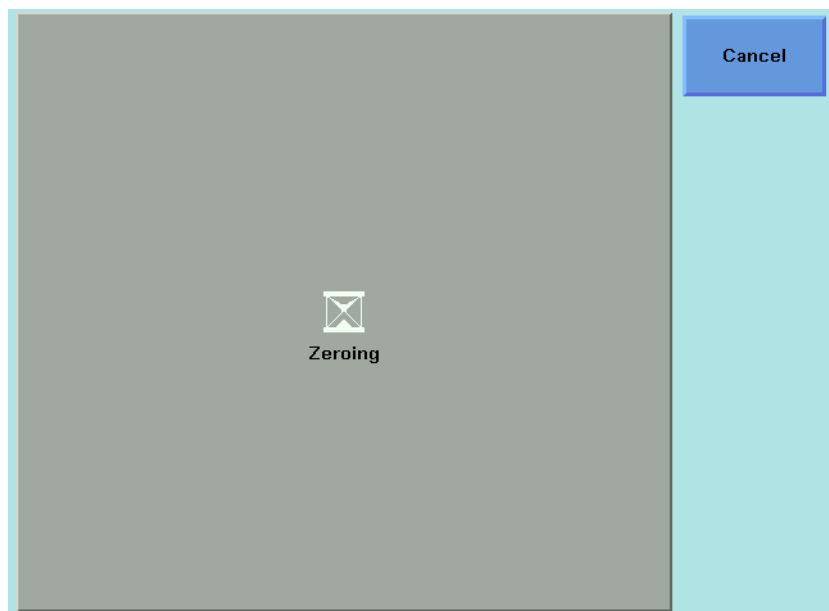

Figure 45 Zeroing Screen

NOTE

If you see the screen shown in Figure 46, the zeroing operation has failed because the Power Meter received light. The most common reason for zeroing to fail is if:

- a source is connected to the Power Meter's input connector,
- the fiber connected to the Power Meter's input connector is collecting light, or
- the Power Meter receives ambient light because the input connector is uncovered.

Press *Enter* and start again at step 1.

- 4 When the zeroing operation finishes, press the [Close] softkey to close the menu.

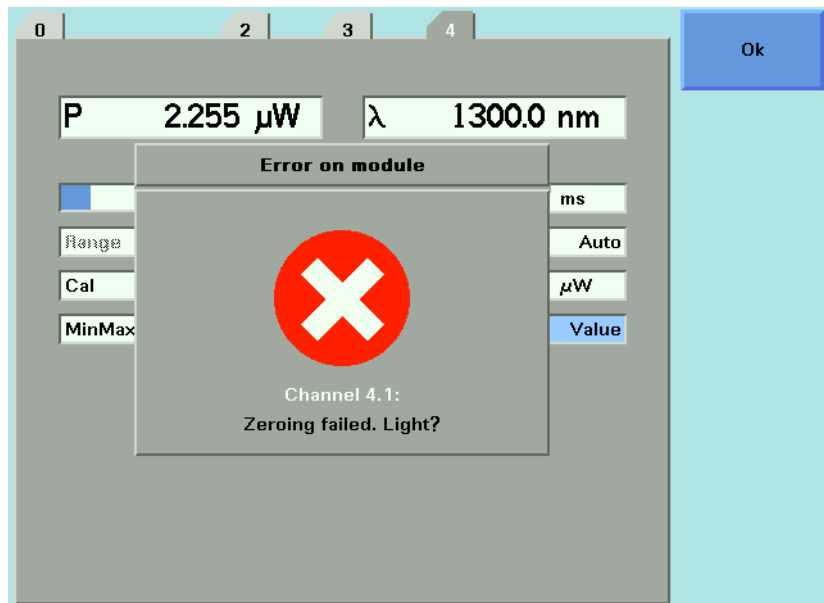

Figure 46 Zeroing Fails, if the Power Meter Receives Input Light.

How to Choose the Range Mode

NOTE

For a Dual Power Sensor, you cannot set the range mode of the slave channel, channel 2, directly. By default, the range mode of the slave channel, channel 2, is the same as that for the master channel, channel 1. See Table 10 on page 107 for more details.

You can choose either of two ranging modes from the Range mode menu:

- *<Auto>*, the auto-ranging mode, ensures that the result has a displayed value between 9% and 100% of full scale. The default state is for automatic ranging to be enabled.
- *<Manual>*, which allows you to set a user-defined range.

How to Set the Range

If you choose *<Auto>* from the Range mode menu, this parameter can not be set. The Range parameter, *[Range]*, is displayed in light grey text, see Figure 47, in automatic ranging mode and displays the automatically-determined range.

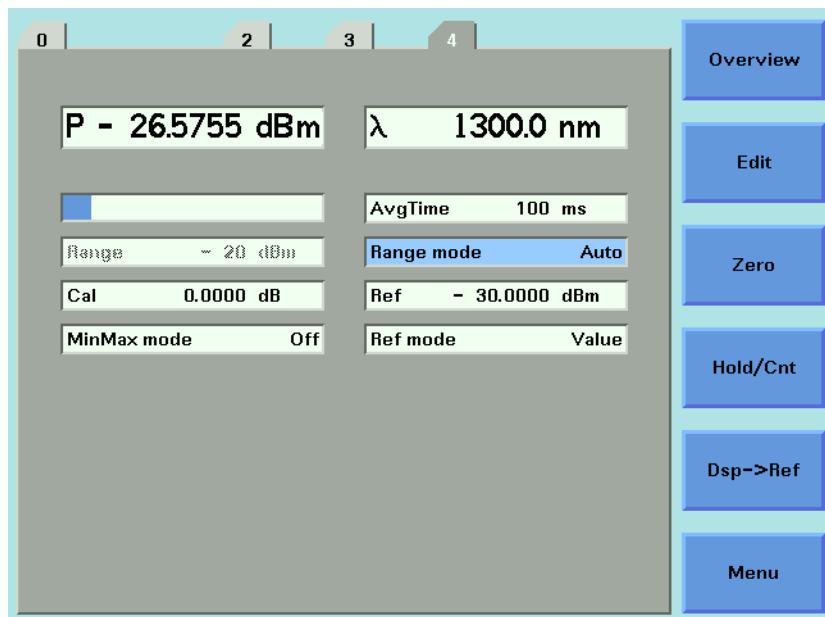

Figure 47 Auto-Range Mode

If you choose *<Manual>* from the Range mode menu, you must choose a range setting from the Range menu.

To choose a range setting, follow the following steps:

- 1 Setup the instrument.
- 2 Move to the Power Meter channel and press the [Details] softkey.
- 3 Move to the [P] parameter and press the [Power Unit] softkey. You will see the menu in Figure 42.
- 4 Move to *<dBm>*, by using the cursor key, and press *Enter*.
- 5 Move to the [Range Mode] parameter and press *Enter*.
- 6 Move to *<Auto>*, by using the cursor key, and press *Enter*.
- 7 Perform a set of measurements.
- 8 Note the highest [Range] that the instrument automatically set during this set of measurements.
- 9 Move to the Power Meter channel and press the [Details] softkey.

- 10 Move to the [*Range Mode*] parameter and press *Enter*.
- 11 Move to <*Manual*>, by using the cursor key, and press *Enter*.
- 12 Move to the [*Range*] parameter and press *Enter*.
- 13 Enter the range value determined in Step 8, by using the cursor key, and press *Enter*.

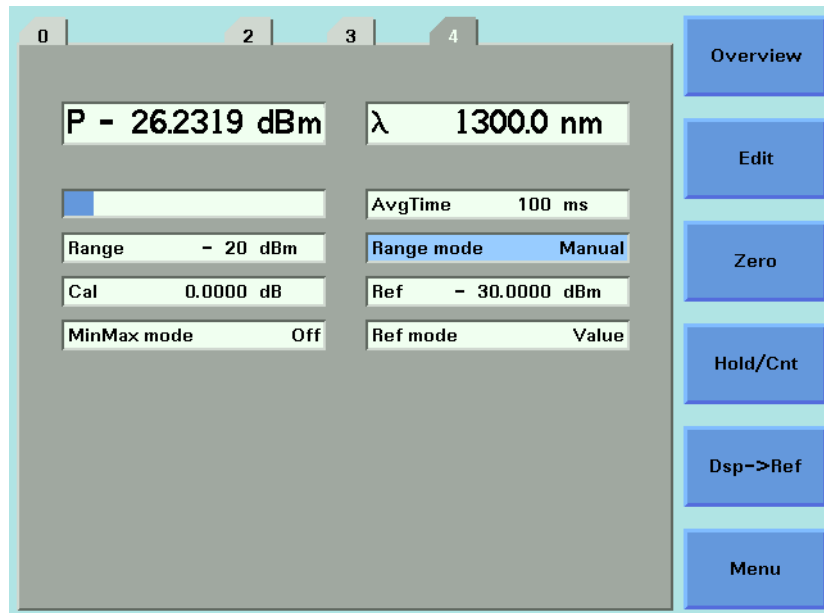

Figure 48 Manual Range Mode - Within Range

If the measured power is more than 3dBm greater than the range setting, it is impossible for power to be displayed. The power value, +1.--- dBm, as shown in Figure 49, is shown. This means that the measured power is greater than the Upper Power Limit. You must decrease the [*Range*] value.

See Table 9 on page 99 for more details.

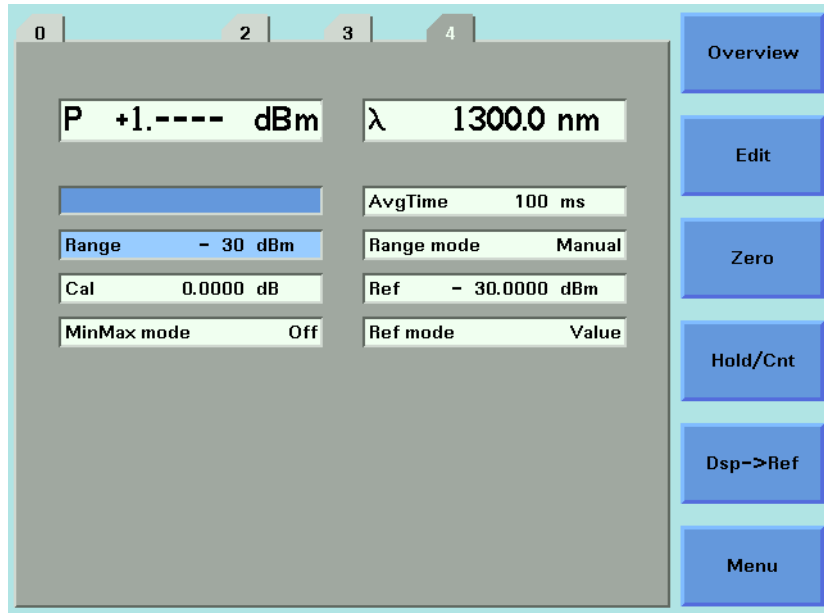

Figure 49 Out of Range - Power Greater Than Upper Power Limit

If the measured power is more than 40 dBm less than the range setting, it is impossible for power to be displayed. The power value, -1.--- dBm, as shown in Figure 50, is shown. This means that the measured power is greater than the resolution at this [Range] value. You must increase the [Range] value.

See Table 9 on page 99 for more details.

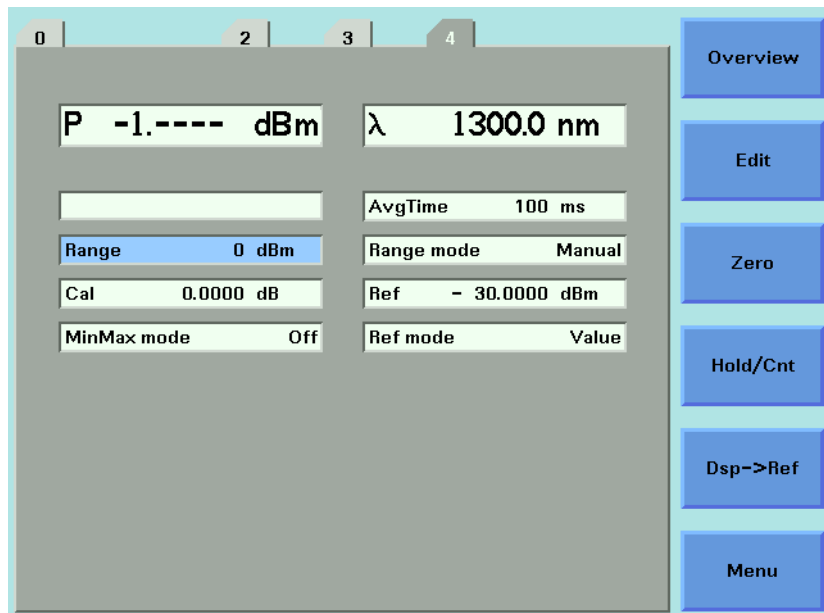

Figure 50 Out of Range - Power Less Than Resolution

Figure 51 shows an example of the range values you can choose for the Agilent 81634B. In this case the values range from 10 dBm (upper power limit of 13 dBm) to -70 dBm (upper power limit of -67 dBm) in 10 dBm increments.

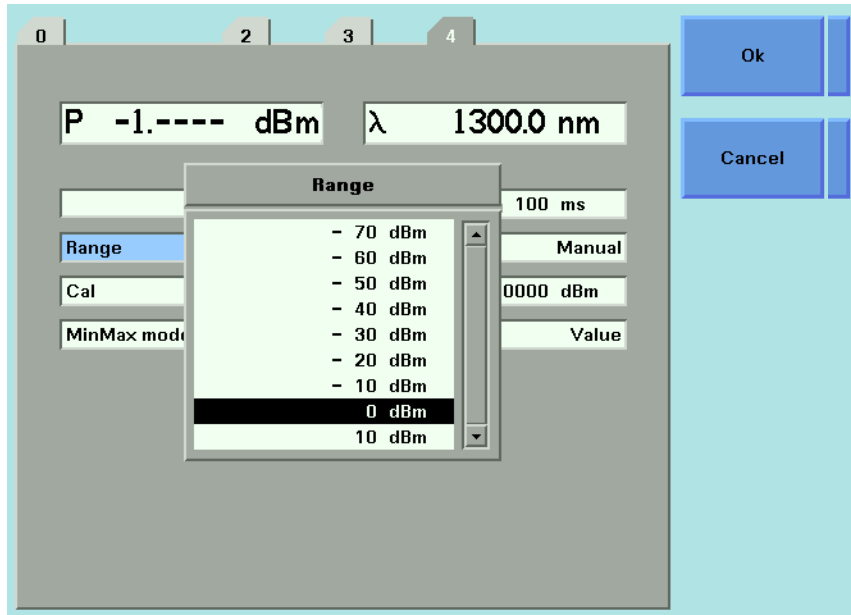

Figure 51 Range Value Menu

Upper Power Limit and Resolution

Table 9 shows the upper power limit and measurement resolution at various power ranges. As can be seen the resolution decreases as the chosen [Range] decreases. The resolution is always 40 dBm less than the chosen [Range] value. The Upper Power Limit is always 3 dBm greater than the chosen [Range] value.

Table 9 Upper Power Limits and Resolution for Various Power Ranges

[RANGE]	Upper Power Limit		Resolution	
40 dBm	19.999 W	43.000 dBm	0.001 W	-0.000 dBm
30 dBm	1.9999 W	33.000 dBm	0.1 mW	-10.000 dBm
20 dBm	199.99 mW	23.000 dBm	0.01 mW	-20.000 dBm
10 dBm	19.999 mW	13.000 dBm	0.001 mW	-30.000 dBm
0 dBm	1.9999 mW	3.000 dBm	0.1 μ W	-40.000 dBm
-10 dBm	199.99 μ W	-7.000 dBm	0.01 μ W	-50.000 dBm
-20 dBm	19.999 μ W	-17.000 dBm	0.001 μ W	-60.000 dBm
-30 dBm	1.9999 μ W	-27.000 dBm	0.1 nW	-70.000 dBm
-40 dBm	199.99 nW	-37.000 dBm	0.01 nW	-80.000 dBm
-50 dBm	19.999 nW	-47.000 dBm	0.001 nW	-90.000 dBm
-60 dBm	1.9999 nW	-57.000 dBm	0.1 pW	-100.000 dBm
-70 dBm	199.99 pW	-67.000 dBm	0.01 pW	-110.000 dBm

How to Set the Averaging Time

NOTE

For a Dual Power Sensor, you cannot set the averaging time of the slave channel, channel 2, directly. By default, the averaging time of the slave channel, channel 2, is the same value as that for the master channel, channel 1. See Table 10 on page 107 for more details.

This is the length of time over which a signal is averaged. Longer averaging times increase the accuracy and improve the noise rejection. Longer averaging times also decrease sensitivity.

For averaging times of 1 second or less, a new measurement is shown at the end of each averaging time. This is drawn in Figure 52. A new measurement is shown on the display at each x.

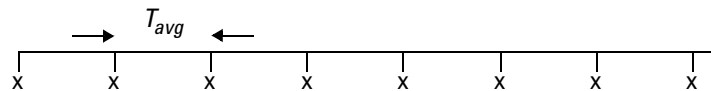

Figure 52 Measurement with $T_{avg} \sim 1$ second

With modules designed for the 8153A Lightwave Multimeter, for averaging times of more than 1 second, the displayed power is given by the formula:

$$P_{new} = P_{old} \left(1 - \frac{T_{sample}}{T_{avg}} \right) + Sample \left(\frac{T_{sample}}{T_{avg}} \right)$$

Where,

- P_{new} is the new displayed result,
- P_{old} is the previously displayed result,
- $Sample$ is the value read by the hardware,
- T_{avg} is the averaging time, as set by the user, and
- T_{sample} is the time the hardware takes to make a reading.

If the measurement condition change (for example, a range change in automatic ranging), P_{old} is reset and the averaging starts again. This is why the display update seems faster in automatic ranging.

To set the averaging time to 1 second:

- 1 Move to the Power Meter channel and press the [Details] softkey.
- 2 Move to the [AvgTime] parameter and press *Enter*.
- 3 Move to <1 s>, by using the cursor key, and press *Enter*.

How to Choose the MinMax Mode

NOTE

For a Dual Power Sensor, you cannot set the averaging time of the slave channel, channel 2, directly. By default, the averaging time of the slave channel, channel 2, is the same value as that for the master channel, channel 1. See Table 10 on page 107 for more details.

MinMax mode measures the incoming power and displays the minimum value measured, [P_{min}], and the maximum value measured, [P_{max}]. The difference between these values, ΔP , is displayed in place of P, the power value. This mode is intended principally for polarization dependent measurements, but can be used for other types of measurement.

You can choose three modes of operation from the MinMax mode menu:

- *<Continuous>* mode, which compares each new measured value with the maximum and minimum values so far, and replaces them as necessary. This mode is useful for measuring the Polarization Dependent Loss (PDL) of a component. Run the application while sweeping the polarization of the source applied to the component.
- *<Window>* mode, which compares each new measured value with the maximum and minimum values of each of the previous N samples. When a new measurement is taken it is added to a buffer containing the previous N samples and the oldest measurement is deleted.
- *<Refresh>* mode, which adds each new measurement to a buffer. The minimum and maximum values, in this buffer, are displayed. After N samples are added to the buffer, the buffer resets and a new buffer is created. You can use Window and Refresh modes, for example, when you are searching for or setting the position of minimum PDL.

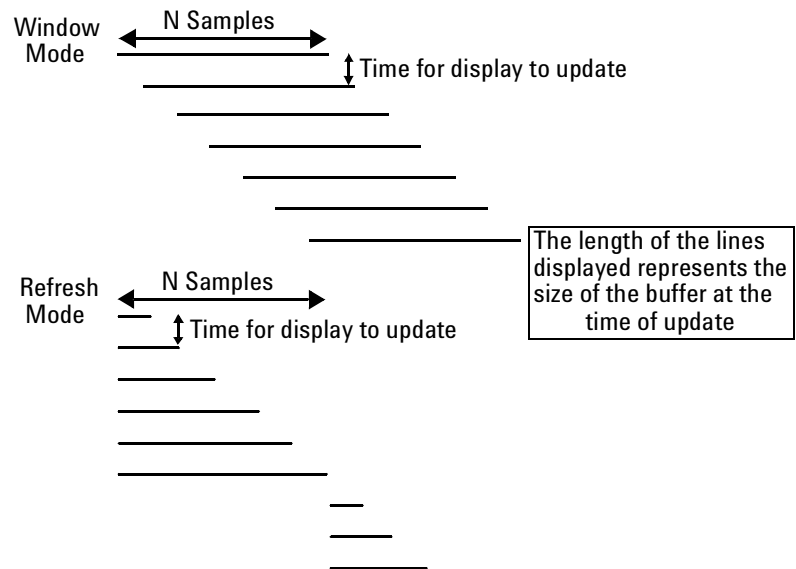

Figure 53 The Window and Refresh Modes

To choose the *<Refresh>* MinMax mode:

- 1 Move to the Power Meter channel and press the [Details] softkey.
- 2 Move to the [MinMax Mode] parameter and press *Enter*.
- 3 Move to *<Refresh>*, by using the cursor key, and press *Enter*. The screen in Figure 54 appears.

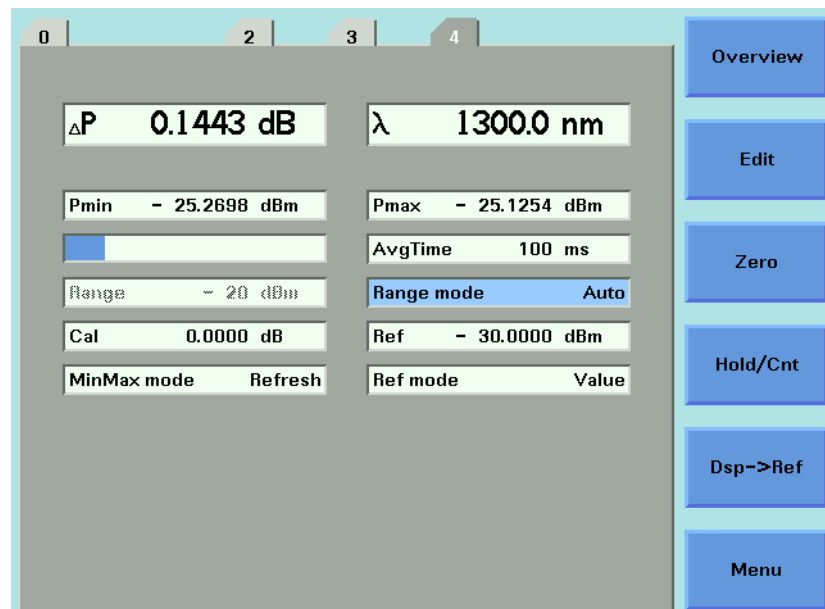

Figure 54 MinMax Mode Screen

- 4 Press *Menu*, move to *<Data Points>* and press *Enter*.
- 5 Enter 100 and press *Enter*.

How to Turn Off MinMax Mode

To turn off MinMax mode, and return to continuous power measurement:

- 1 Move to the Power Meter channel and press the [Details] softkey.
- 2 Move to the [MinMax Mode] parameter and press *Enter*.
- 3 Move to <Off>, by using the cursor key, and press *Enter*.

How to Hold the Screen

Pressing the [Hold/Cnt] softkey allows you to hold the screen so that no new measurements are displayed. Hold is displayed as shown in Figure 55 .

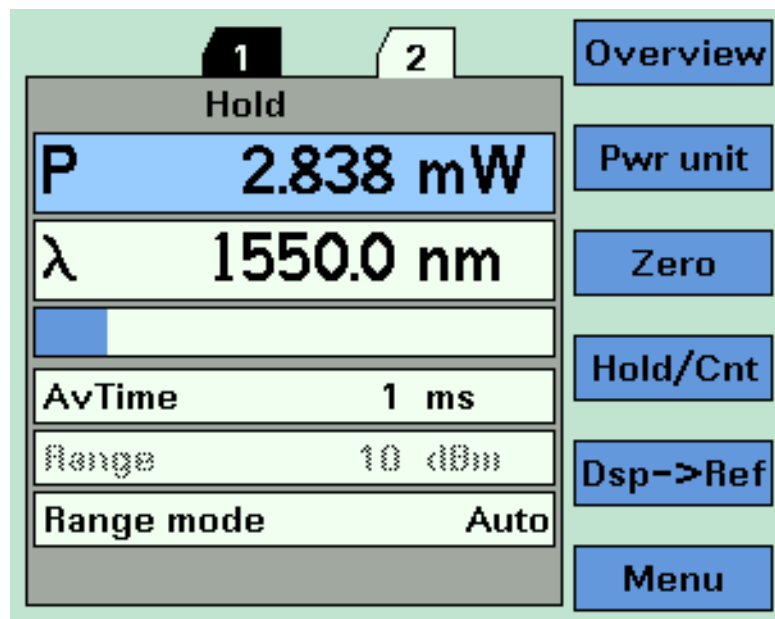

Figure 55 Power Module Channel is Held - Overview Screen

By pressing the [Hold/Cnt] softkey a second time the screen will display new measurements continuously.

How to Use Triggers

Agilent 8163A/B Series Power Meter modules allow you trigger the instrument to perform tasks and to output trigger signals to external measurement instruments.

NOTE

For a Dual Power Sensor, you cannot set the averaging time of the slave channel, channel 2, directly. By default, the averaging time of the slave channel, channel 2, is the same value as that for the master channel, channel 1. See Table 10 on page 107 for more details.

How to Trigger Power Measurements

You can configure Agilent 8163A/B Series Power Meter modules to perform certain tasks when you apply a trigger to the Input Trigger Connector.

You must prearm a measurement function before an action can be triggered:

- 1 See "How to Set the Trigger Configuration" on page 69 for how to configure the trigger connectors.
- 2 Move to the Power Meter channel and press the [Menu] softkey.
- 3 Move to <Input Trigger Mode>, by using the cursor key, and press *Enter*. You will see the screen in Figure 56 .

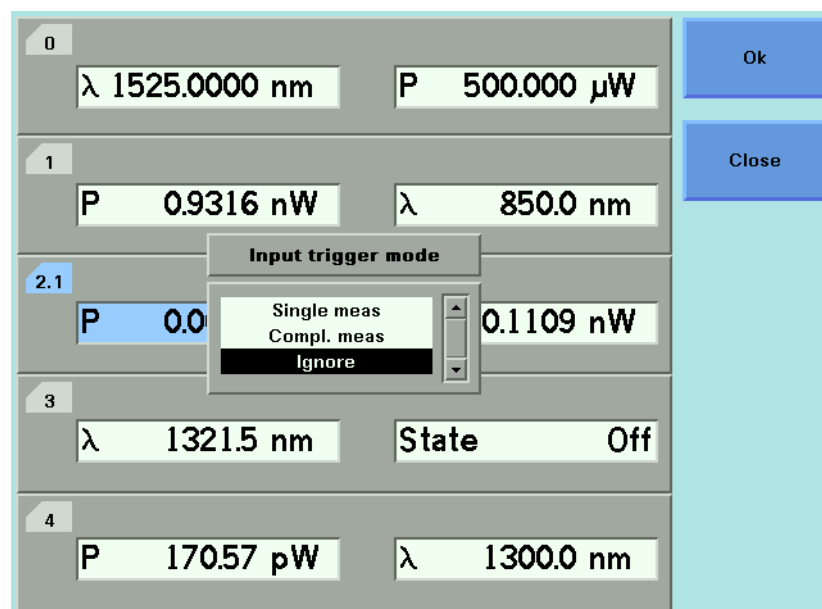

Figure 56 Input Trigger Mode

4 Move to one of the following, by using the cursor key:

- *<Single meas>*, an input trigger will trigger one sample of a measurement function to be performed and to store the result in a data array.
- *<Compl. meas>*, an input trigger will trigger a complete measurement function to be performed.
- *<Ignore>*, input triggers are ignored.

5 Press *Enter*.

You can generate input triggers in any of the following ways:

- trigger the Input Trigger Connector on the rear panel of your instrument,
- set *<Trigger Configuration>* to *<Loopback>* so that an output trigger automatically generates an input trigger, or
- use the *:TRIGger* GPIB command, see your mainframe's Programming Guide.

How to Use Output Triggering

You can configure Agilent 8163A/B Series Power Meter modules to output a trigger when the instrument performs certain tasks.

To set your module's Output Trigger Configuration:

- 1 See "How to Set the Trigger Configuration" on page 69 for how to configure the trigger connectors.
- 2 Move to the Power Meter channel and press the [Menu] softkey.
- 3 Move to *<Output Trigger Mode>*, by using the cursor key, and press *Enter*. You will see the screen in Figure 57 .

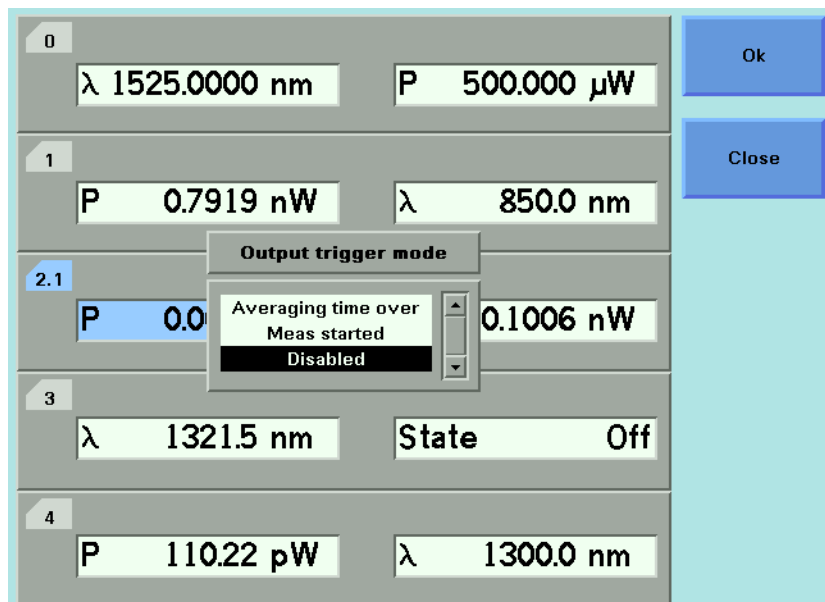

Figure 57 Output Trigger Mode

4 Move to one of the following, by using the cursor key:

- *<Averaging Time Over>*, a trigger is output when the averaging time period of a measurement finishes.
- *<Meas Started>*, a trigger is output when the averaging time period of a measurement begins.
- *<Disabled>*, the output trigger mode is disabled.

5 Press *Enter*.

Dual Power Meters - Master and Slave Channels

For the Agilent 81635A Dual Power Sensor and the Agilent 81619A Dual Optical Head Interface module, channel 1 is the master channel and channel 2 is the slave channel. The master and slave channels share the same software and hardware triggering system. For some commands, setting parameters for the master channel sets the parameters for the slave channel. In these cases, you may only set parameters for the slave channel by setting master channel parameters.

The parameters listed in Table 10 can only be set or viewed using the master channel.

Table 10 Parameters that can only be set using the master channel

Parameter
<Zero>
<MinMax mode>
<Reset MinMax>
<Data points>
<Averaging time>
<Range mode>
<Input trigger mode>
<Output trigger mode>



4

Laser Sources

This chapter describes how to use the Agilent 8163A/B Lightwave Multimeter, the Agilent 8164A/B Lightwave Measurement System, and the Agilent 8166A/B Lightwave Multichannel System to control fixed-wavelength laser source modules.

How to Use Laser Source Modules	110
The Laser Wavelength Value	110
How to Enable/Disable Laser Output	111
How to Set Attenuation	112
How to Modulate the Optical Output	113
How to Use the Internal Modulation	114
How to Use Triggers	117

How to Use Laser Source Modules

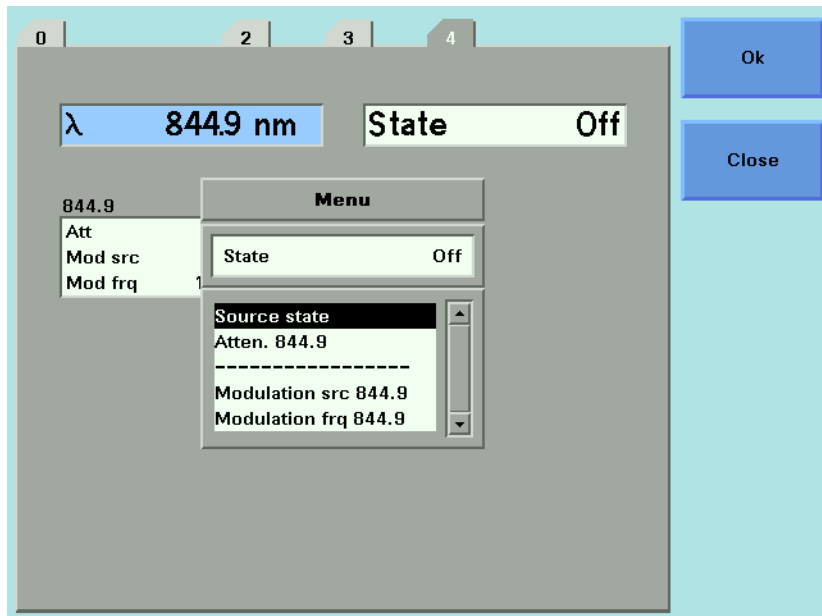

Figure 58 Menu of Parameters for a Fixed Wavelength Laser Source

The Laser Wavelength Value

The laser wavelength value [λ] for a fixed-wavelength laser source module is the calibrated optical wavelength value for the laser source. This is a fixed value, you can display the value but you cannot edit it.

Dual-Wavelength Laser Source Modules

Dual-wavelength laser source modules have optical outputs at two wavelengths. You can choose to output an optical signal at either a single wavelength or at both wavelengths simultaneously.

To choose both output wavelengths for a dual-wavelength laser source module:

- 1 Move to [λ] parameter and press *Enter*.

- 2 Select <1309.6+1551.6>, using the cursor key, and press *Enter*. You will see the screen in Figure 59 .

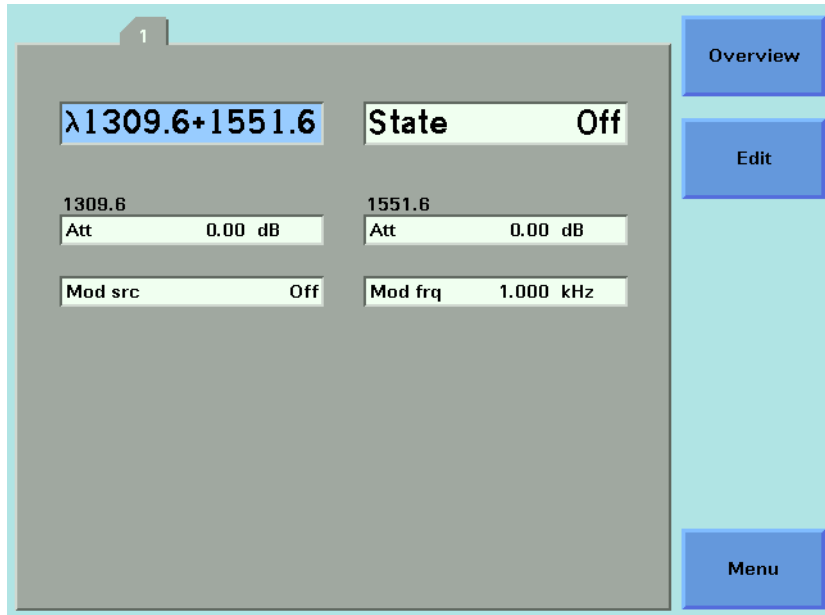

Figure 59 Dual-Wavelength Laser Source Outputs Both Wavelength

NOTE

For further information on modulating the optical output of a dual-wavelength laser source module, see “*How to Modulate Dual-Wavelength Laser Source Modules*” on page 115.

How to Enable/Disable Laser Output

To enable laser output using the user interface:

- 1 Move to [*State*] parameter and press *Enter*.
- 2 Move to [*On*], by using the cursor key, and press *Enter*. The green LED on the module front panel switches on.

To disable laser output using the user interface:

- 1 Move to [*State*] parameter and press *Enter*.
- 2 Move to [*Off*], by using the cursor key, and press *Enter*. The green LED on the module front panel switches off.

How to Set Attenuation

The amount of power that is output from a source can be controlled. You can use the attenuation parameter to reduce the optical power of the laser output.

$$P_{\text{output}} = P_{\text{source}} - \text{ATT (dB)}$$

Where,

P_{output} is the power level at the output of the module,

P_{source} is the power level at the output of the source, and

ATT is the attenuation parameter.

To set the attenuation value to 2 dB:

- 1 Move to the laser source channel and press the [Details] softkey. You see the screen in Figure 60 .

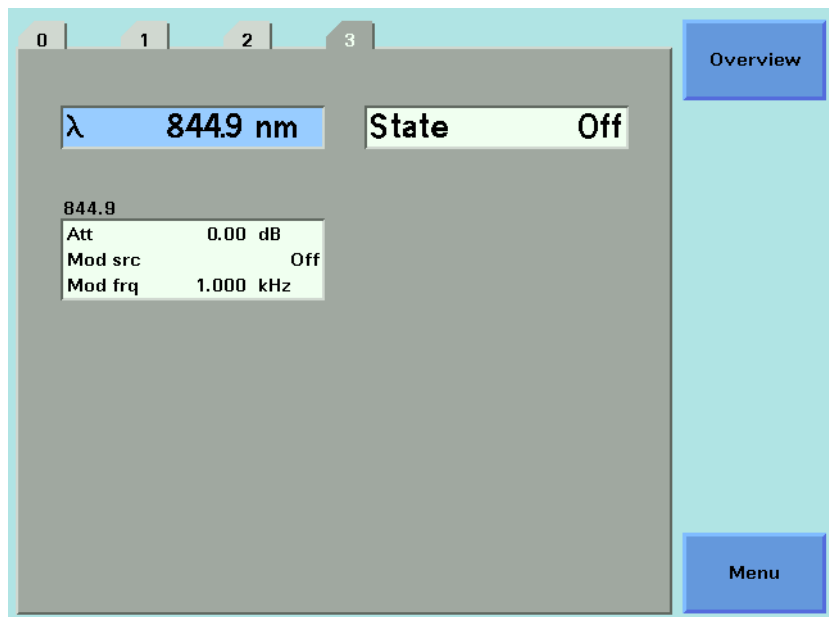

Figure 60 The Power Sensor Details Screen

- 2 Move to the [Attenuation] parameter and press *Enter*.
- 3 Enter 2.00 and press *Enter*.

How to Modulate the Optical Output

How to Change Modulation Source

The Modulation Source parameter, [*Mod Src*], allows you to modulate the output signal. This parameter can be set to Off, Internal, Coherence Control, or Backplane.

For details of the Off setting “How to Disable Modulation” on page 113.

For details of the Internal setting “How to Use the Internal Modulation” on page 114

For details of the Coherence Control setting “How to Increase Linewidth” on page 114

For details of the Backplane setting “External Digital Modulation using Input Trigger Connector” on page 147.

How to Disable Modulation

If *<Off>* is displayed as the Modulation Source parameter, [*Mod Src*], the laser source outputs an unmodulated continuous-wave signal.

To disable modulation:

- 1 Move to the Laser Source channel and press [Details] softkey.
- 2 Move to the modulation source parameter, [*Mod Src*], and press *Enter*.
- 3 Move to *<Off>*, by using the cursor key, and press *Enter*.

How to Use the Internal Modulation

The internal modulation is a square wave with a 50% duty cycle. You can set both the amplitude and the frequency of this signal. The amplitude is set by the power parameter. This is the maximum output power of the output signal; at the minimum output power, no power is output.

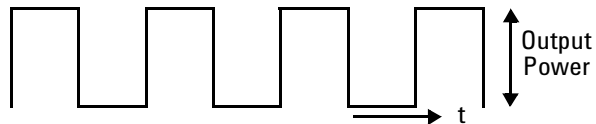

Figure 61 The Modulated Signal

How to Set the Frequency of a Modulated Signal

To set the frequency of the modulation to 6.500 kHz:

- 1 Move to the frequency parameter, [*Mod Frq*], press *Enter*.
- 2 Enter 6.500 press *Enter*.

How to Set the Modulation Mode

- 3 Move to the modulation source parameter, [*Mod Src*], and press *Enter*.
- 4 Move to *<Internal>*, by using the cursor key, and press *Enter*. The text *Int* appears in the Laser Source channel.

How to Increase Linewidth

You can use coherence control to increase the linewidth of the optical signal output from your Agilent 8163A/B Series Laser Source module.

Enabling the coherence control increases the linewidth of the optical output signal to between 50 and 500 MHz (typically). Coherence control greatly reduces interference effects and therefore improves the power stability in sensitive test setups.

To enable coherence control:

- 1 Move to the Laser Source channel and press [Details].
- 2 Move to [*Mod Src*] and press *Enter*.
- 3 Move to *<Coherence Ctrl.>*, Coherence Control, to increase linewidth.

For typical values, refer to User's Guide for your laser source module, among the Supplementary Performance Characteristics provided with the module's Specifications.

- 4 Press *Enter*. The text *CC* appears in the Laser Source channel.

How to Modulate Dual-Wavelength Laser Source Modules

NOTE

You cannot modulate both wavelengths of the 81554SM Dual-Wavelength Laser Source module independently. If you select both wavelength outputs using the $[\lambda]$ parameter, you can choose to modulate both outputs at the same frequency or to output both outputs as CW signals.

NOTE

If you choose to output both wavelengths of the 81554SM Dual-Wavelength Laser Source and to modulate the optical output signal, the two signals may be 180° out of phase with each other.

For Agilent 8165x Series Dual-Wavelength Laser Source modules, you can choose independent modulation sources and independent modulation frequencies for both wavelengths.

NOTE

If you choose independent modulation sources for a Dual-Wavelength Laser Source module, the text Mod will be displayed in the Laser Source channel.

If you choose the same modulation sources for both wavelengths of a Dual-Wavelength Laser Source module, the relevant text will be displayed in the Laser Source channel, for example, Int if both wavelengths use internal modulation.

To modulate the lower wavelength source at 100 kHz using internal modulation and the upper wavelength source using coherence control for a Dual-Wavelength Laser Source module:

- 1 Move to the laser source channel and press the [Details] softkey.
- 2 Move to $[\lambda]$ parameter and press *Enter*.
- 3 Select the lower wavelength source, for example, <1309.6>, using the cursor key, and press *Enter*.
- 4 Move to the [Mod Frq] parameter for the lower wavelength source and press *Enter*.
- 5 Enter 100.000 and press *Enter*.
- 6 Move to the [Mod Src] parameter for the lower wavelength source and press *Enter*.
- 7 Move to <Internal>, by using the cursor key, and press *Enter*. The text Mod appears in the Laser Source channel.
- 8 Move to the [Mod Src] parameter for the upper wavelength source and press *Enter*.

- 9** Move to *<Coherence Ctrl.>*, by using the cursor key, and press *Enter*. The text *Mod* is still displayed in the Laser Source channel.
- 10** Enable the laser output, by pressing the *Active* hardkey on the module's front panel.

How to Use Triggers

Some Laser Source modules allow you to output trigger signals to external measurement instruments.

How to Use Output Triggering

You can configure the output trigger connector to output a TTL signal at the frequency of the internal modulation of a Agilent 8163A/B Series Laser Source module.

To set your module's Output Trigger Configuration:

- 1 See "How to Set the Trigger Configuration" on page 69 for how to configure the trigger connectors.
- 2 Move to the Laser Source channel and press [Menu].
- 3 Move to <Output Trigger Mode>, by using the cursor key, and press *Enter*. You will see the screen in Figure 62 .

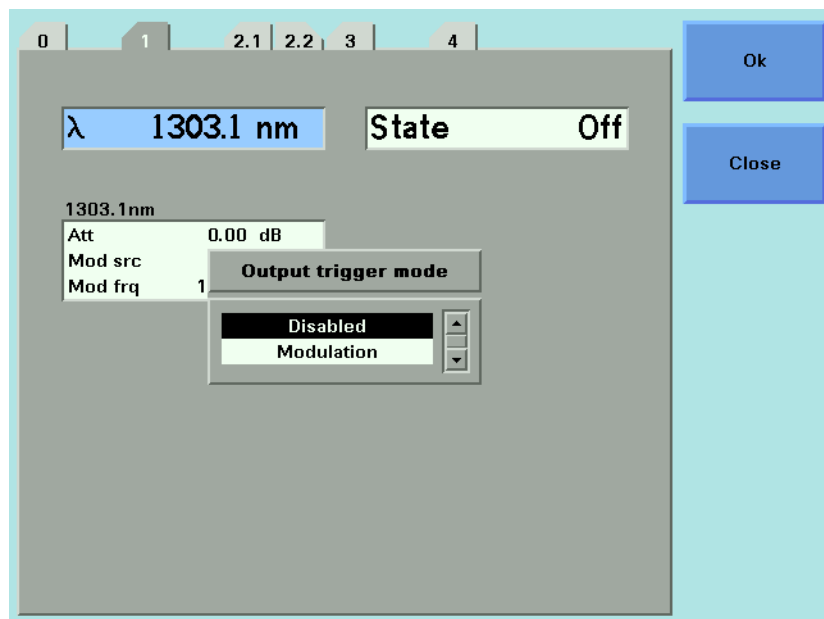

Figure 62 Output Trigger Mode

- 4 Move to one of the following, by using the cursor key:
 - <Disabled>, the output trigger mode is disabled.
 - <Modulation>, the output trigger connector outputs a TTL signal at the frequency of the internal modulation. This signal is output whether the laser is switched on or off.
- 5 Press *Enter*.

5

Tunable Lasers

This chapter explains how to control Tunable Laser modules from the user interface of the Agilent 8163A/B Lightwave Multimeter, the Agilent 8164A/B Lightwave Measurement System, and the Agilent 8166A/B Lightwave Multichannel System.

What is a Tunable Laser ?	121
How to Set the Power	121
How to Set the Output Power of a CW Signal	122
What is Excessive Power ?	126
How to Set the Laser to the Dark Position	127
The Analog Output	128
How to Set the Wavelength	130
Wavelength Range	130
How to Set the Wavelength Directly	131
How to Set a Relative Wavelength	132
How to Perform a Wavelength Sweep	134
What is a Wavelength Sweep ?	134
How to Set the Wavelength Sweep	135
How to Perform a Sweep	137
How to Modulate a Signal	142
How to Use the Internal Modulation	142
How to Use External Modulation	144
How to Configure the Modulation Output	149
How to Use Triggers	150
How to Use Input Triggering	150
How to Use Output Triggering	152
How to Use Auxiliary Functions	153
Automatic Realignment	153

How to Perform a Lambda Zero	155
Auto Cal Off	156

What is a Tunable Laser ?

A tunable laser is a laser source for which the wavelength can be varied through a specified range. The Agilent Technologies Tunable Laser modules also allow you to set the output power, and to choose between continuous wave or modulated power.

How to Set the Power

The laser output can be either:

- a continuous wave (CW) signal, fixed amplitude signal, see *"How to Set the Output Power of a CW Signal"* on page 122,
- a modulated signal, see *"How to Modulate a Signal"* on page 142, or
- a signal with increased linewidth (coherence control), see *"How to Increase Linewidth"* on page 148.

If [*Mod Src*] is *<Off>*, a continuous wave signal is the chosen optical output. A continuous wave signal is the default.

If any other [*Mod Src*] source is chosen, the chosen source modulates the signal. For possible modulation sources, see *"How to Modulate a Signal"* on page 142.

Attenuator

If your tunable laser has an built-in optical attenuator, you can choose one of the two following power modes:

- *<Automatic>* Attenuation Mode, you specify the output power and the instrument automatically sets the optical output power by using the optimum combination of laser diode current and optical attenuation, or
- *<Manual Att.>* Mode, you specify the output power and the attenuation.

The two modes are separate, the values set in one mode do not affect values set in the other.

How to Set the Output Power of a CW Signal

How to Set Output Power

To set the output power to 555.000 μ W:

Attenuator

If your tunable laser has an built-in optical attenuator, move to [Power Mode], press Enter, move to <Automatic>, and press Enter.

- 1 Move to the power parameter, [P], and press [Pwr unit].
- 2 Move to <W> and press *Enter*.
- 3 Press *Enter* to start editing the output power value.
- 4 Enter 555.000, press [Unit+] or [Unit-], as required, to select μ W as the power units, and press *Enter*.

How to Set the Optical Output

To set the Optical Output of a Tunable Laser module with two optical outputs:

- 1 Press [Details].
- 2 Move to [Optical Output] and press *Enter*.
- 3 Use the Modify Knob to move to one of the following:
 - <High Power (2)>, a high power optical output, for example, for use in testing Erbium Doped Fiber Amplifiers (EDFAs), you see a screen similar to Figure 63 ,
 - <Low SSE (1)>, a lower power optical output with low Source Spontaneous Emission (SSE), for example, for use in passive component test, you see a screen similar to Figure 64 ,
 - <Both (master:2)>, where both optical outputs can be enabled but only the output of the high power optical output can be regulated, and
 - <Both (master:1)>, where both optical outputs can be enabled but only the output of the low SSE optical output can be regulated.

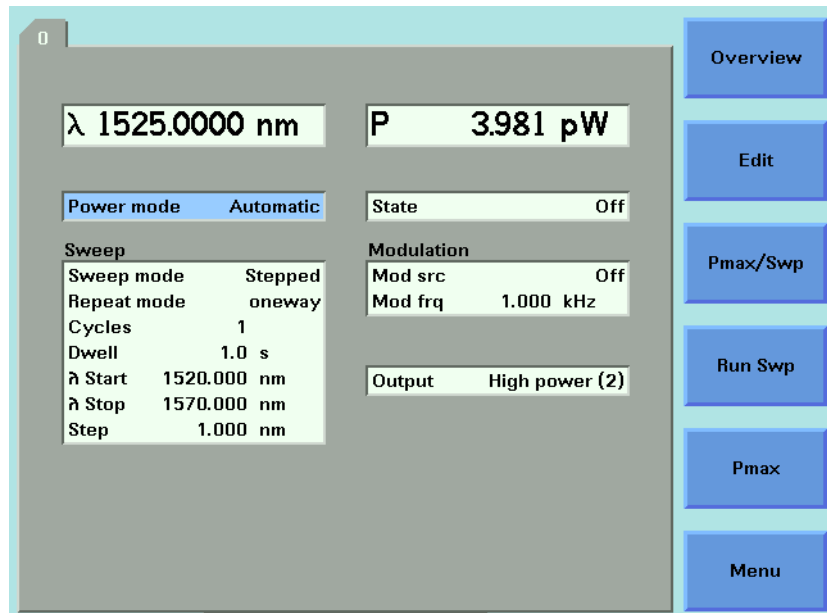

Figure 63 Setting High Power parameters

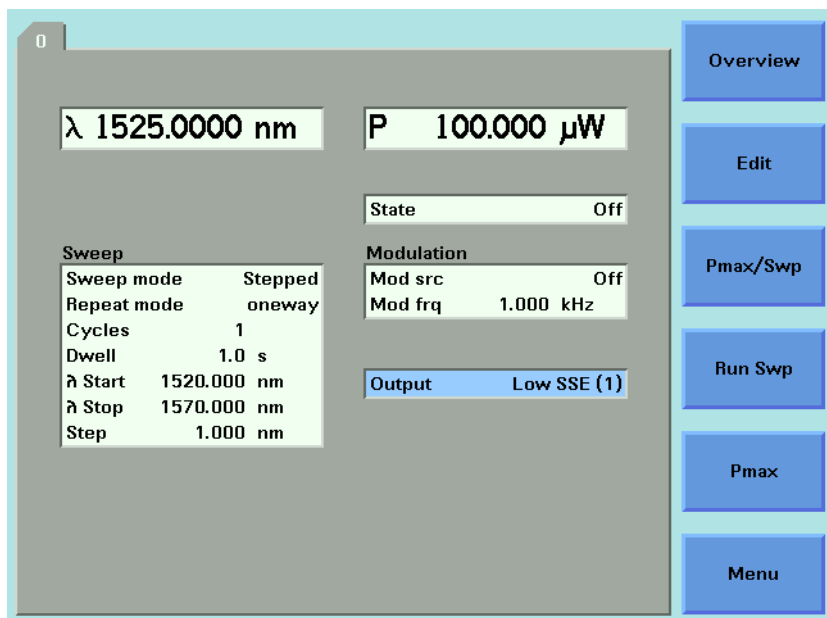

Figure 64 Setting Low SSE parameter

NOTE

If you select *<Both (master:2)>* or *<Both (master:1)>* as the regulated path, both channels output optical power. You can only view or set the parameters for the primary optical output, for example, the high power output for *<Both (master:2)>*.

The LED beside the primary optical output is lit constantly, while the LED beside the secondary optical output flashes. For example, if you select *<Both (master:2)>* as the regulated path, the LED beside Output 2, the High Power Output, is lit constantly and the LED beside Output 1, the Low SSE optical output, flashes.

How to Set the Optical Output

- 1 Move to [Output] and press *Enter*.
- 2 Move to your chosen optical output and press *Enter*.

How to Enable the Optical Output

- 3 Move to [State] and press *Enter*.
- 4 Move to *<On>*, by using the cursor key, and press *Enter* to enable the output. The LED beside the optical output is lit constantly.

NOTE

If you enable the laser output for a module with two optical outputs by pressing the *Active* hardkey on the module's front panel, you automatically choose the optical output for that module. For example, if you press the *Active* hardkey beside Output 1, the Low SSE optical output, you choose *<Low SSE>* as the optical output, the LED beside the Output 1 lights constantly, and you see the screen in Figure 64 .

Furthermore, if you then proceed to press the *ACTIVE* hardkey beside Output 2, the High Power Output, you choose *<Both (master:1)>* as the optical output, the LED beside the Output 2 flashes.

If you press the *Active* hardkey beside a flashing LED, you disable the unregulated optical output. If you press the *Active* hardkey beside a constantly lit LED, you disable both optical outputs.

How to Set Power and Attenuation

Attenuator

If your tunable laser has an built-in optical attenuator, you can set the laser output power and then set the attenuation.

- 1 Move to the Tunable Laser channel and press [Details].
- 2 Choose the Output 2, the high power output, for a Tunable Laser module with two optical outputs, as described in "How to Set the Optical Output" on page 122. For modules with one optical output this is not necessary.
- 3 Move to the power parameter, [P], and press [Pwr unit].

- 4 Move to <dBm> and press Enter.
- 5 Type 5.000, using the numerical keypad and press Enter.
- 6 If [Power Mode] is not set to <Manual Att.> (see Figure 63), that is, it is set <Automatic>, perform the following steps:
 - a Move to [Power Mode] and press Enter.
 - b Move to <Manual Att.> and press Enter. The attenuation parameter, [Atten.], appears, see Figure 65 .
- 7 Move to [Atten.], type 3.000, using the numerical keypad, and press Enter.

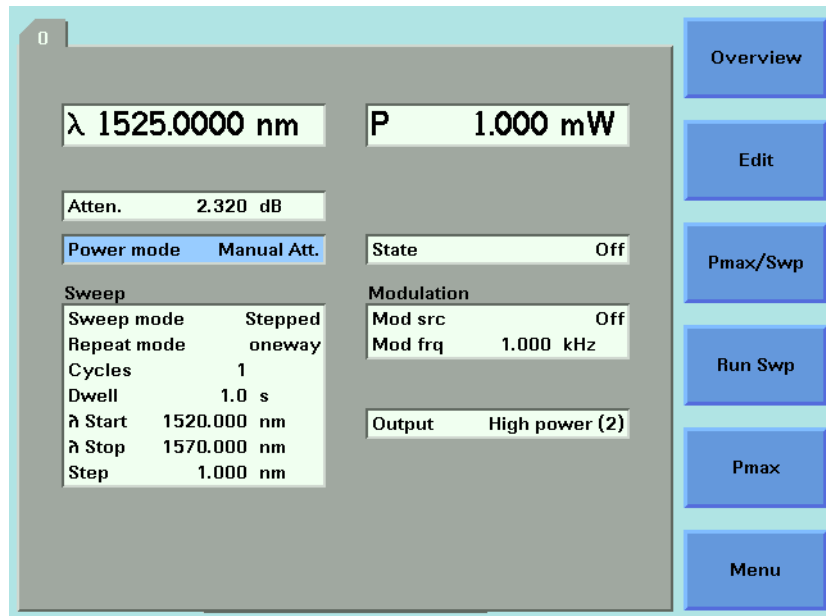

Figure 65 Setting Attenuation

What is Excessive Power ?

If the text ExP is displayed in a Tunable Laser channel, see Figure 66 , you have set an output power level that is larger than the laser diode can produce at the selected wavelength.

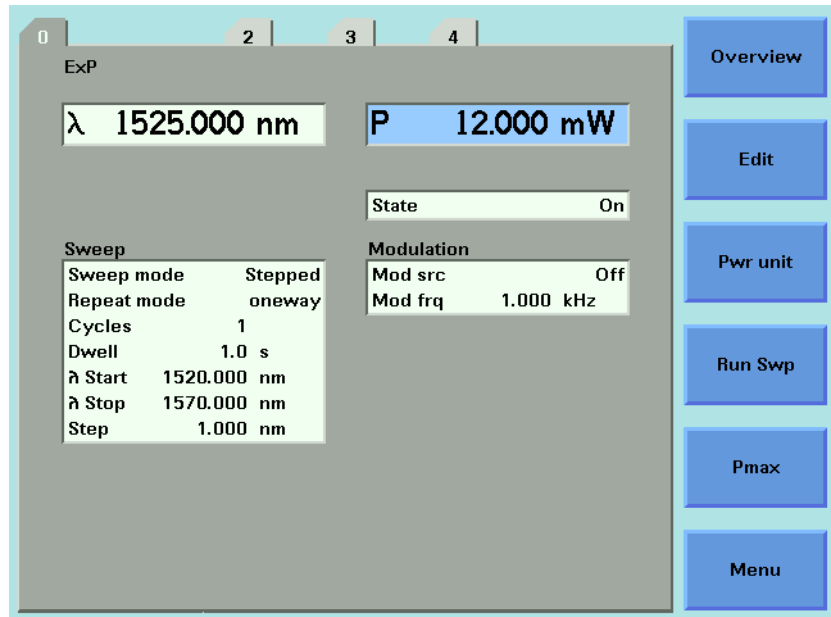

Figure 66 Excessive Power

To avoid this you can:

- reduce the optical output power,
- press [Pmax] to select the highest permissible power for the selected wavelength value, or
- press [Pmax/Swp] to select the highest permissible power for the selected wavelength sweep.

How to Set the Laser to the Dark Position

Attenuator

If your tunable laser has an built-in optical attenuator, you can use <Dark position> to block all laser light from the output. You can use this as an alternative to disabling the laser. To enable/disable the dark position:

- 1** Move to the Tunable Laser channel and press the [Menu] softkey.
- 2** Move to the <Dark position> and press Enter. The Dark Position box appears.
- 3** Move to one of the following menu items:
 - <On>, to enable the dark position, or
 - <Off>, to disable the dark position
- 4** Press Enter to return to the Menu screen.
- 5** Press [Close] to exit from the Menu screen.

The Analog Output

If there is an output BNC connector on the front panel of your Tunable Laser module, you can output a DC voltage level that is proportional to the laser output power. The relationship between this voltage level and the output power is not calibrated.

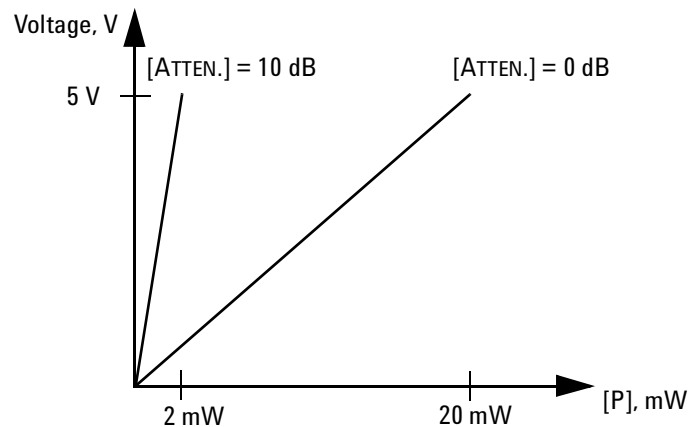

Figure 67 Output Power and the Analog Output in <Manual ATT.> Mode

Attenuator

If your Tunable Laser module has an attenuator installed, the Analog Output signal depends on the power mode you have chosen. The voltage level is proportional to the optical power produced by the laser diode (not the optical output power).

In <Manual Att.> Mode, the relationship between the power value, [P], and the voltage level is only proportional to the output power if the attenuation remains constant. The attenuator adds a constant offset to the voltage level.

In <Automatic> Attenuation Mode, the laser output power, and therefore the Analog Output signal, is not linearly proportional to the output power. This is because the actual output optical power is derived by the optimum combination of the laser output power and the attenuation.

To set the power to -10 dBm:

- 1 Move to power parameter, [P], and press [Pwr unit]. You should see the power unit menu.
- 2 Move to <dBm> and press *Enter*.
- 3 Press *Enter* to edit the power value.
- 4 Enter -10.000 and press *Enter*.

How to Set the BNC Output Line Mode as an Analog Output

- 5 Press [Menu], move to <*BNC Output*> and press [OK].
- 6 Move to <*V~P*>, to choose an analog output signal, press *Enter*, and press [Close].

Attenuator

If you want to use the analog output signal and your Tunable Laser module has an attenuator installed, it is advisable to use <Manual Att.> Mode and choose a constant attenuation value.

How to Set the Wavelength

There are three ways to set the wavelength of the Tunable Laser.

- You can set the wavelength (λ) directly,
- You can set the wavelength from a base wavelength and an offset in the frequency domain, or
- You can set a wavelength range for the instrument to “sweep”.

Wavelength Range

Every Tunable Laser module has a specified wavelength range. This range is available for all Tunable Laser modules. See Appendix C of the Agilent 81640B/42B/72B/80B/82B & 81480B/82B Tunable Laser User’s Guide to find your module’s specified range.

Every Tunable Laser module has a permitted wavelength range. This range is greater than the specified range. The permitted wavelength range varies for each Tunable Laser module. You can set the wavelength to any value within the permitted wavelength range.

Figure 68 shows an example of specified and permitted wavelength range.

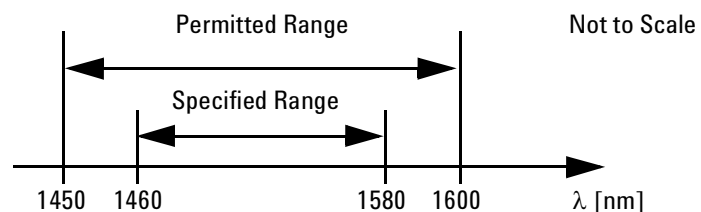

Figure 68 Specified and Permitted Wavelength Range

How to Set the Wavelength Directly

You can set a constant wavelength.

To set the wavelength to 1545.500 nm:

- 1** Move to the Tunable Laser channel.
- 2** Move to the wavelength parameter, [λ], and press *Enter*.
- 3** Enter 1545.500 and press *Enter*.

How to Set a Relative Wavelength

You use a relative wavelength for heterodyning, for example, when you are measuring the linewidth of DFB (distributed feedback) lasers.

The output wavelength, λ , is set from the base wavelength, λ_0 , and the frequency offset, df . The formula for calculating the output wavelength is:

$$\lambda = \frac{c\lambda_0}{\lambda_0 df + c}$$

where c is the speed of light in a vacuum ($2.998 \times 10^8 \text{ ms}^{-1}$).

To set a frequency offset of 1.000 THz from a base wavelength of 1545 nm:

- 1 Move to the Tunable Laser channel and press [Details].
- 2 Press [Menu]. The menu appears.
- 3 Move to <Wavelength Mode> in the menu and press *Enter*. A menu appears.
- 4 Move to <Offset>, by using the cursor key, press *Enter*, and press *Close*. You see the screen in Figure 69 .

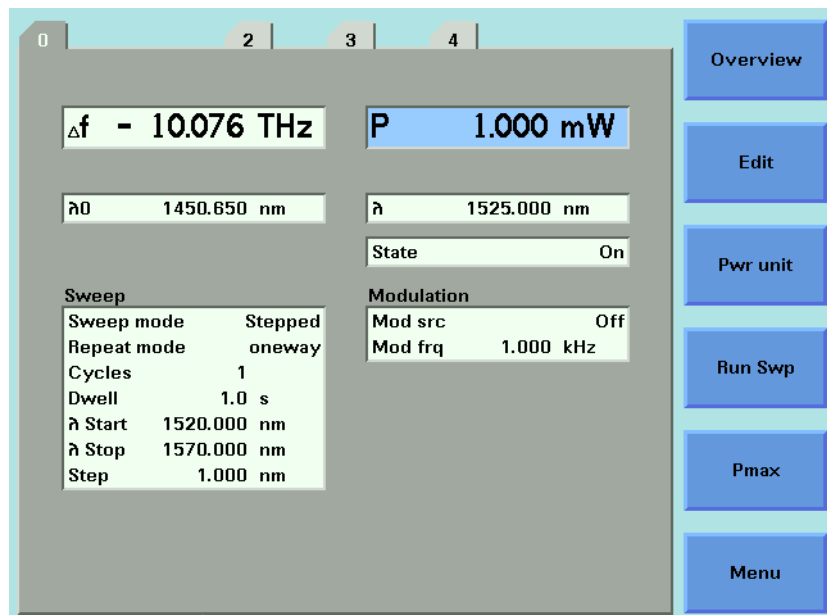

Figure 69 Setting a Relative Wavelength

How to Change the Output Wavelength

- 1 Move to $[\lambda]$ and press *Enter*. $[\lambda]$ is the output wavelength, λ , in the equation above.
- 2 Enter 1570 and press *Enter*.

NOTE

Note how the frequency offset, $[\Delta f]$, changes as you change the value of $[\lambda]$.

How to Set the Base Wavelength

NOTE

You cannot set $\langle \lambda_0 \rangle$, the base wavelength directly.

- 3 Press $[\lambda \rightarrow \lambda_0]$ to set $\langle \lambda_0 \rangle$ to 1570 nm. $\langle \lambda_0 \rangle$ represents the base wavelength, λ_0 , in the equation above.

NOTE

Note how the frequency offset, $[\Delta f]$, changes to zero when you press $[\lambda \rightarrow \lambda_0]$.

How to Change the Frequency Offset

- 4 Move to $[\Delta f]$ and press *Enter*. $[\Delta f]$ represents the frequency offset, df , in the equation above.
- 5 Enter 1.000 and press *Enter*. The frequency offset, $[\Delta f]$, changes to 1.000 THz.

NOTE

Note how the output wavelength, $[\lambda]$, changes as you change the value of $[\Delta f]$.

How to Perform a Wavelength Sweep

What is a Wavelength Sweep ?

A wavelength sweep is performed when the instrument changes the optical wavelength of the optical output across a user-defined wavelength range. You can use a wavelength sweep to measure the wavelength-dependent loss of an optical component.

How to Set the Wavelength Sweep

The Sweep Parameters

These are the parameters for the wavelength sweep:

- [λ *Start*], the wavelength at which the sweep begins,
- [λ *Stop*], the wavelength at which the sweep ends,
- [*Step*], the size of the change in the wavelength for each step of a stepped sweep,
- [*Cycles*], the number of times the sweep is repeated,
- [*Dwell*], the amount of time spent at the wavelength during each step, for a stepped sweep
- [*Vsweep*], the speed of a continuous sweep,
- [*Sweep mode*], see “How to Perform a Sweep” on page 137,
- [*Repeat mode*], see “How to Set the Repeat Mode” on page 135.

NOTE

For a <Continuous> sweep, [*Step*] sets the wavelength interval between output triggers, if you have set <Output Trigger Mode> to <Step Finished>, see “How to Use Output Triggering” on page 152.

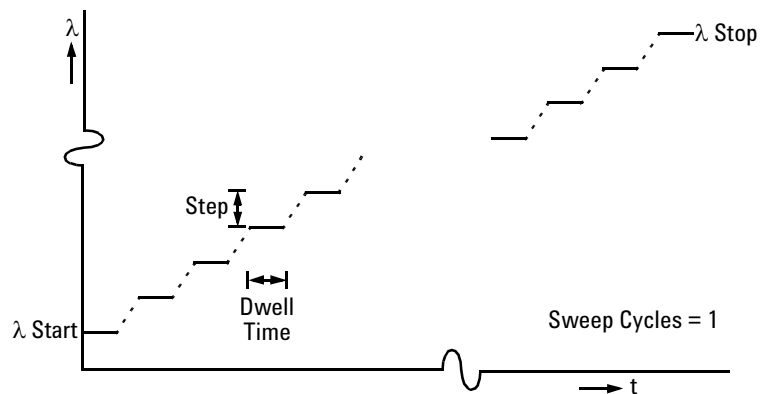

Figure 70 The Parameters for a Stepped Wavelength Sweep

How to Set the Repeat Mode

The [*Repeat Mode*] determines how the instrument performs a multi-cycle sweep.

- Select <Twoway>, if you want to start every odd sweep cycle at [λ *Start*] and to start each even sweep cycle at [λ *Stop*].

- Select *<Oneway>*, if you want to start every sweep cycle at [λ Start] and to end every sweep cycle at [λ Stop].

Figure 71 illustrates how these modes work for a three-cycle wavelength sweep.

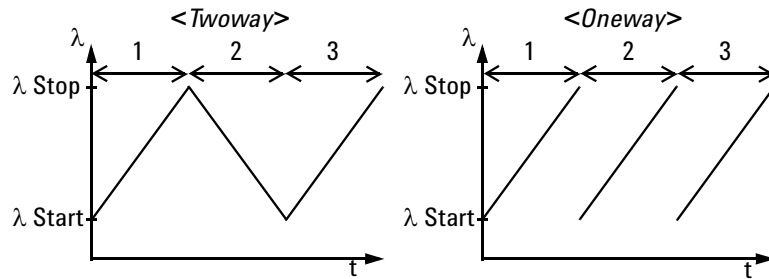

Figure 71 Repeat Modes

How to Set the Maximum Power for the Sweep Range

Pressing [Pmax/Swp] sets the power to the maximum for the selected sweep range. Alternatively, you can set a power level in the way described in *“How to Set the Output Power of a CW Signal”* on page 122. Pressing [Pmax/Swp] ensures the power will be constant for the whole sweep.

How to Perform a Sweep

There are three sweep modes:

- *<Stepped>*, which dwells at wavelengths that are separated by a certain step size,
- *<Continuous>*, which sweeps continually at the speed you set, and
- *<Manual>*, which you can run each step manually.

NOTE

You cannot turn the laser off by pressing the *Active* hardkey on the Tunable Laser front panel, while a wavelength sweep is running.

You can press [Stop] and, then, press the *Active* hardkey on the Tunable Laser front panel, to turn off the laser.

How to Execute a Stepped Sweep

To execute a stepped wavelength sweep over the range 1510 nm to 1570 nm, three times, sweeping two ways, in 1 nm steps, stopping for half a second at each wavelength step:

- 1 Move to the Tunable Laser channel and press [Details].
- 2 Move to [Sweep Mode] and press *Enter*.
- 3 Move to the *<Stepped>* sweep mode and press *Enter*.
- 4 Move to [λ Start] and press *Enter*.
- 5 Enter 1510.000 and press *Enter*.
- 6 Move to [λ Stop] and press *Enter*.
- 7 Enter 1570.000, press *Enter*.
- 8 Move to [Cycles] and press *Enter*.
- 9 Enter 3 and press *Enter*.
- 10 Move to [Repeat Mode] and press *Enter*.
- 11 Move to *<Twoway>*, by using the cursor key, and press *Enter*.
- 12 Move to [Step] and press *Enter*.
- 13 Enter 1.000 and press *Enter*.
- 14 Move to [Dwell] and press *Enter*.
- 15 Enter 0.5000 and press *Enter*.
- 16 Press the [Active] hardkey on the front panel of your Tunable Laser module to enable the optical output.
- 17 Press [Run Swp] to start the sweep. The screen in Figure 72 appears.

18 The wavelength is swept automatically but you can:

- a press [Stop] to end the sweep, or
- b press [Pause] to pause the sweep. The screen in Figure 73 appears. You can:
 - Press [Continue] to continue sweeping automatically.
 - Press [Prev] or [Next] to sweep manually.
 - Press [Stop] to end the sweep.

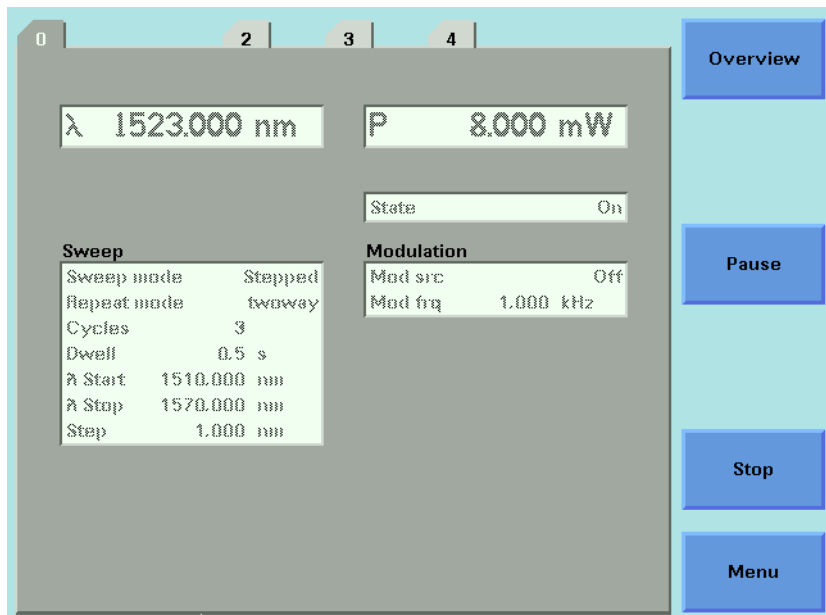

Figure 72 Executing a Stepped Sweep

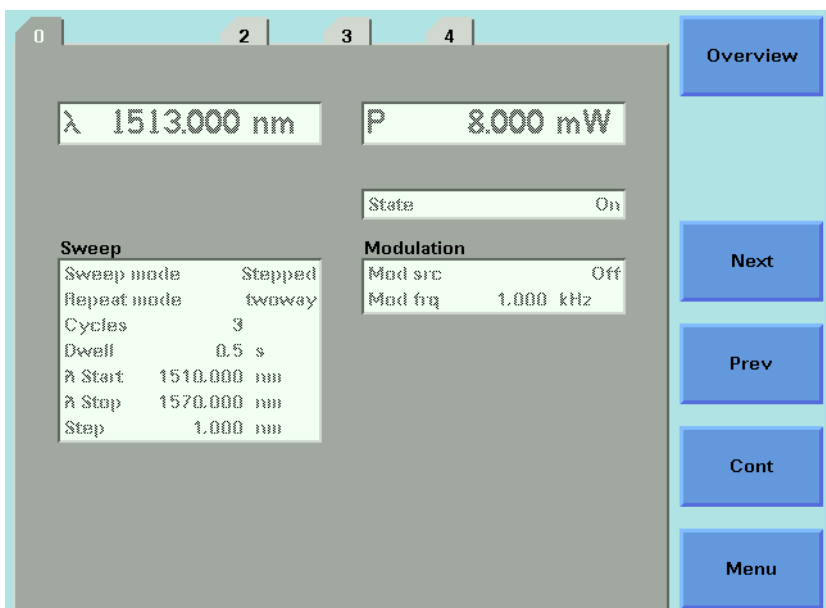

Figure 73 Pausing a Stepped Sweep

How to Execute a Continuous Sweep

NOTE

Continuous sweep mode is not available for the Agilent 81689A Tunable Laser module.
You cannot choose a repeat mode for a continuous sweep. All multi-cycle sweeps are one-directional, see Figure 71 .

To execute a continuous wavelength sweep over the range 1520 nm to 1560 nm, three times, at a speed of 5 nm/s:

- 1 Move to the Tunable Laser channel and press [Details].
- 2 Move to [*Sweep Mode*] and press *Enter*.
- 3 Move to the <*Continuous*> sweep mode and press ENTER.
- 4 Move to [λ *Start*] and press *Enter*.
- 5 Enter 1520.000 and press *Enter*.
- 6 Move to [λ *Stop*] and press *Enter*.
- 7 Enter 1560.000, press *Enter*.
- 8 Move to [*Sweep Cycles*] and press *Enter*.
- 9 Enter 0003 and press *Enter*.
- 10 Move to [*Vsweep*] and press *Enter*.
- 11 Move to 5 nm/s, by using the cursor key, and press *Enter*.
- 12 Move to [*Step*] and press *Enter*.
- 13 Enter 1.000 and press *Enter*.

NOTE

For a <*Continuous*> sweep, [*Step*] sets the wavelength interval between output triggers, if you have set <*Output Trigger Mode*> to <*Step Finished*>, see "How to Use Output Triggering" on page 152.

- 14 Press the [Active] hardkey on the front panel of your Tunable Laser module to enable the optical output.
- 15 Press [Run Swp] to start the sweep.

NOTE

The following table explains all possible configuration problems:

368,LambdaStop <=LambdaStart	start wavelength must be smaller than stop wavelength
369,sweepTime < min	the total time of the sweep is too small
370,sweepTime > max	the total time of the sweep is too large
371,triggerFreq > max	the trigger frequency (calculated from sweep speed divided by sweep step) is too large
372,step < min	step size too small
373,triggerNum > max	the number of triggers exceeds the allowed limit
374,LambdaLogging = On AND Modulation = On AND ModulationSource! = CoherenceControl	The only allowed modulation source with the lambda logging function is coherence control.
375,LambdaLogging = On AND TriggerOut! = StepFinished	lambda logging only works "Step Finished" output trigger configuration
376,Lambda logging in stepped mode	lambda logging can only be done in continuous sweep mode
377,step not multiple of <x>	the step size must be a multiple of the smallest possible step size

16A continuous sweep can end in two ways:

- a** when the sweep is completed, or
- b** when you press [Stop].

How to Perform a Manual Sweep

You can perform a manual sweep if you choose the *<Manual>* sweep mode or if you press [Pause] during an automatic sweep. In a manual sweep you choose when you want to perform each step of a stepped sweep. You can choose to move forward or backward a wavelength or to end the sweep.

To perform a manual wavelength sweep over the range 1510 nm to 1570 nm, three times, sweeping two ways, in 1 nm steps:

- 1** Move to the Tunable Laser channel and press [Details].
- 2** Move to [Sweep Mode] and press *Enter*.
- 3** Move to the *<Manual>*, by using the cursor key, and press *Enter*.
- 4** Perform step 4 to step 13 on page 137 to set the sweep parameters.
- 5** Press the [Active] hardkey on the front panel of your Tunable Laser module to enable the optical output.

6 Press [Run Swp] to start the sweep. The screen in Figure 74 then appears.

7 You can:

- press [Next] to move on to the next wavelength step,
- press [Prev] to move on to the previous wavelength step, or
- press [Stop] to end the sweep.

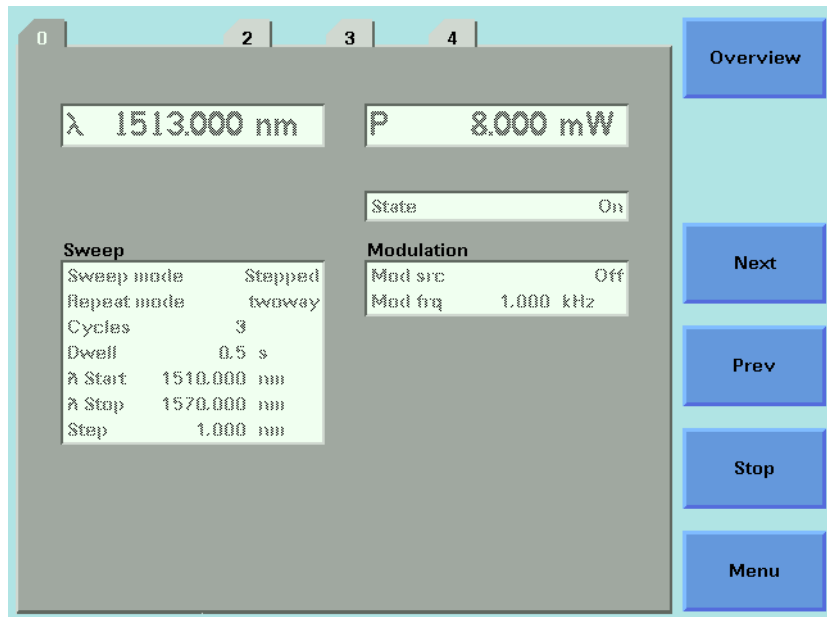

Figure 74 Performing a Manual Sweep

8 Perform step 6 until you choose to press [Stop].

How to Modulate a Signal

NOTE

The signal modulation feature is not available when Auto Cal Off is selected.

There are two ways of modulating the amplitude of the optical output.

- Using the internal modulation, and
- using external modulation.

How to Use the Internal Modulation

The internal modulation is a square wave with a 50% duty cycle. You can set both the amplitude and the frequency of this signal. The amplitude is set by the power parameter. This is the maximum output power of the output signal; at the minimum output power, no power is output.

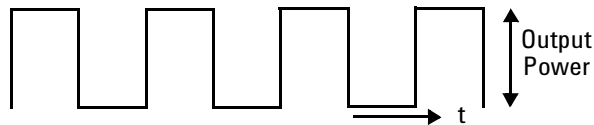

Figure 75 The Modulated Signal

How to Set the Output Power of a Modulated Signal

To set the output power to 555.000 μW :

- 1 Move to the Tunable Laser channel and press [Details] softkey.
- 2 Move to the power parameter, [P], and press [Pwr unit].
- 3 Move to <W>, by using the cursor key, and press *Enter*.
- 4 Press *Enter* to start editing the output power value.
- 5 Enter 555.000, press [Unit+] or [Unit-], as required, to select < μW > as the power units, and press *Enter*.

How to Set the Frequency of a Modulated Signal

To set the frequency of the modulation to 6.500 kHz:

- 6 Move to the frequency parameter, [Mod Frq], press *Enter*.

7 Enter 6.500 press *Enter*.

How to Set the Modulation Mode

8 Move to the modulation source parameter, [*Mod Src*], and press *Enter*.

9 Move to *<Internal>*, by using the cursor key, and press *Enter*. The text *Int* appears in the Tunable Laser channel.

How to Use External Modulation

The following external modulation modes are available:

- *<External Digital>* - External Digital Modulation
- *<External Analog>* - External Analog Modulation
- *<Wavel. Locking>* - Wavelength Locking
- *<Backplane>* - External Digital Modulation using Input Trigger connector or Trigger Feedback from another module in the same mainframe.
- *<Coherence Ctrl.>* - Coherence Control

External Digital Modulation

External digital modulation uses a TTL-level signal. Apply this signal to the input BNC connector on the front panel of your Tunable Laser module.

CAUTION

There are two BNC connectors on the front panel of the Agilent 81480B, Agilent 81482B, Agilent 81672B, Agilent 81680B, Agilent 81682B, Agilent 81640B and Agilent 81642B - a BNC input connector and a BNC output connector.

There is one BNC connector on the front panel of the Agilent 81689A - a BNC input connector.

An absolute maximum of ± 6 V can be applied as an external voltage to any BNC connector.

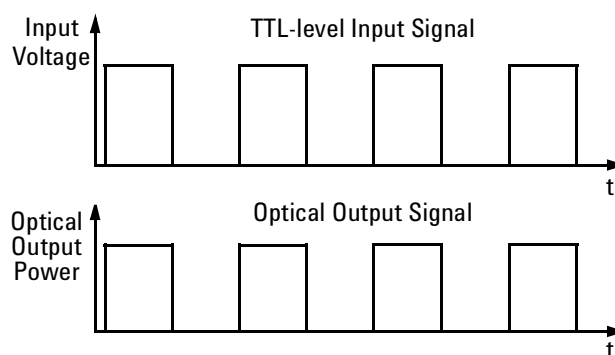

Figure 76 External Digital Modulation

Figure 76 shows how a TTL-level input signal modulates the optical output. Digital modulation sets the frequency of the output signal.

To set the amplitude of the output signal, set the power parameter. This is the maximum output power of the output signal; at the minimum output power, no power is output.

To enable external digital modulation:

- 1 Move to the Tunable Laser channel and press [Details].
- 2 Move to [Mod Src] and press *Enter*.
- 3 Move to <External Digital> by using the cursor key, and press *Enter*. The text ExtD appears in the Tunable Laser channel.

External Analog Modulation

External analog modulation uses a signal of up to $5 V_{pp}$. A $5 V_{pp}$ signal causes 15% modulation of the power of the optical signal. Apply this signal to the input BNC connector on the front panel of your Tunable Laser module.

CAUTION

There are two BNC connectors on the front panel of the Agilent 81480B, Agilent 81482B, Agilent 81672B, Agilent 81680B, Agilent 81682B, Agilent 81640B and Agilent 81642B - a BNC input connector and a BNC output connector.

There is one BNC connector on the front panel of the Agilent 81689A - a BNC input connector.

An absolute maximum of $\pm 6 V$ can be applied as an external voltage to any BNC connector.

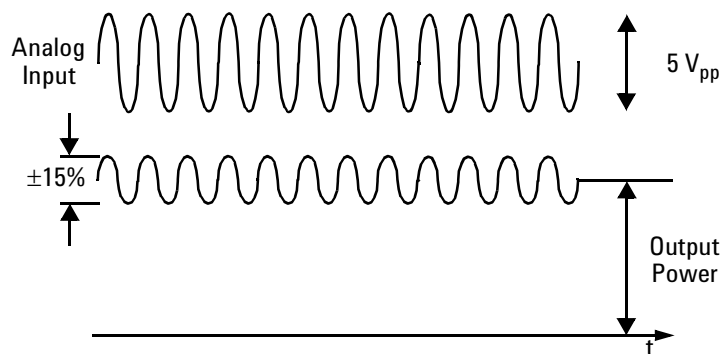

Figure 77 External Analog Modulation and Output Power

To enable external analog modulation:

- 1 Move to the Tunable Laser channel and press [Details].
- 2 Move to [Mod Src] and press *Enter*.
- 3 Move to <External Analog>, by using the cursor key, and press *Enter*. The text ExtA appears in the Tunable Laser channel.

Wavelength Locking

You can choose wavelength locking as the modulation source, so the change in output wavelength is roughly proportional to the voltage you apply to the input BNC connector on the front panel of your Tunable Laser module as shown in Figure 78. This enables you to fine tune the output wavelength within a limited wavelength range.

Wavelength locking may exhibit some hysteresis effects. The wavelength change may differ slightly when you increase voltage from when you decrease voltage.

If you modulate the input signal, the amplitude of the wavelength change of the modulated optical output reduces with increasing modulation frequency. See Appendix C of the Tunable Laser Modules User's Guide for more details.

CAUTION

There are two BNC connectors on the front panel of the Agilent 81480B, Agilent 81482B, Agilent 81672B, Agilent 81680B, Agilent 81682B, Agilent 81640B and Agilent 81642B - a BNC input connector and a BNC output connector.

An absolute maximum of ± 6 V can be applied as an external voltage to any BNC connector.

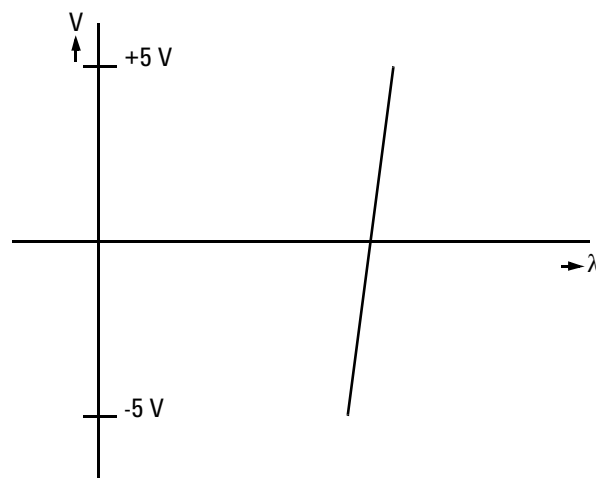

Figure 78 Wavelength Locking

To enable wavelength locking:

- 1 Move to the Tunable Laser channel and press [Details].
- 2 Move to `<Mod Src>` and press *Enter*.
- 3 Move to `<Wavel. Locking>`, by using the cursor key, and press *Enter*. The text λ Lock appears in the Tunable Laser channel.

External Digital Modulation using Input Trigger Connector

External digital modulation uses a TTL-level signal. Apply this signal to the Input Trigger connector on the rear panel of your mainframe. For information on external digital modulation, see “*External Digital Modulation*” on page 144.

CAUTION

A maximum of 5 V can be applied as an external voltage to the Input Trigger connector, see page 310.

Take care not to use the Trigger Output connector or the Remote Interlock connector for modulation. Do not apply an external voltage to these connectors.

NOTE

If external digital modulation using the Input Trigger Connector, <Backplane>, is chosen as the modulation source, [Mod Src], the Agilent 81689A Tunable Laser module behaves differently from all other modules. If the duty cycle varies:

NOTE

If external digital modulation, <backplane>, is chosen for the DFB or Fabry-Perot Laser modules, the applied triggering should have a 50% duty cycle and a frequency of 200 Hz - 100 kHz.

- the average power of the output signal of the Agilent 81689A Tunable Laser module varies in proportion with the change in duty cycle, while,
- the power of the output signal of all other modules adjusts so that the average power of the output signal is always 50% of the set power.

To enable external digital modulation using the Input Trigger Connector:

- 1 Move to the Tunable Laser channel and press [Details].
- 2 Move to [Mod Src] and press *Enter*.
- 3 Move to <Backplane>, by using the cursor key, and press *Enter*. The text Back appears in the Tunable Laser channel.

External Digital Modulation Using Trigger Feedback

The trigger for External Digital Modulation can be provided by another module in the same mainframe by using the Trigger Feedback configuration as described on page 71. This can be used to synchronize the modulation of several sources. To use synchronized modulation:

1 Choose a “master” source module. Set as follows:

Menu -> Modulation Source -> internal

Menu -> Modulation Frequency -> desired value

Menu -> Output trigger mode -> Modulation

2 Set all “slave” modules:

Menu -> Modulation Source -> Backplane (new for DFB modules)

Menu -> Output trigger mode -> disabled (important)

3 To pass the master trigger to the slaves, set up the mainframe through the “Config” button under the screen:

Config -> Trigger -> Feedback

Note that the master laser must always be turned on, if one or more slaves are on.

How to Increase Linewidth

You can use coherence control to increase the linewidth of the optical signal output from your Tunable Laser module.

Enabling the coherence control increases the linewidth of the optical output signal to between 50 and 500 MHz (typically). Coherence control greatly reduces interference effects and therefore improves the power stability in sensitive test setups.

To enable coherence control:

1 Move to the Tunable Laser channel and press [Details].

2 Move to [*Mod Src*] and press ENTER.

3 Move to <*Coherence Ctrl.*>, Coherence Control, to increase linewidth to approximately 500 MHz.

4 Press *Enter*. The text CC appears in the Tunable Laser channel.

How to Set the Output Power of a Modulated Signal

All external modulation modes require you to set the output power. To set the output power, see “*How to Set the Output Power of a Modulated Signal*” on page 142.

How to Configure the Modulation Output

If your Tunable Laser module has a BNC output connector on its front panel, to synchronize your external measuring equipment to the modulation of the module:

- 1 Move to the Tunable Laser channel and press *Menu*.

How to Set the BNC Output Line Mode as a Modulation Output

- 2 Move to *<BNC Output>* and press [OK].
- 3 Move to *<Modulation>*, by using the cursor key. A TTL-level signal is output, if the optical output is digitally modulated, that is, if you choose *<Internal>*, *<External Digital>*, or *<Backplane>* as the chosen modulation source. The output signal has the same frequency as the optical output.
- 4 Press [OK].

How to Set the Modulation Output Mode

- 5 Move to *<Modout>* and press [OK].
- 6 Move to either of the following two menu items, by using the cursor key:
 - *<FRQ&RDY>*, where the modulation signal is combined with the laser-ready signal, so that the output is kept low when there is no optical signal being output, for example, when the laser is turned off or when you set the attenuator to the dark position, or
 - *<FRQ>*, where the modulation signal is output all the time regardless of laser state.
- 7 Press [OK].
- 8 Press [Close] to return to the overview or detail screen.

How to Use Triggers

Some Tunable Laser modules allow you to trigger the instrument to perform tasks and to output trigger signals to external measurement instruments.

How to Use Input Triggering

You can configure your Tunable Laser module to perform certain tasks when you apply a trigger to the Input Trigger Connector.

CAUTION

A maximum of 5 V can be applied as an external voltage to the Input Trigger connector, see page 310.

Take care not to use the Trigger Output connector or the Remote Interlock connector for modulation. Do not apply an external voltage to these connectors.

To set your module's Input Trigger Configuration:

- 1 See "How to Set the Trigger Configuration" on page 69 for how to configure the trigger connectors.
- 2 Move to the Tunable Laser channel and press [Menu].
- 3 Move to <Input Trigger Mode>, by using the cursor key, and press ENTER. You will see the screen in Figure 79 .

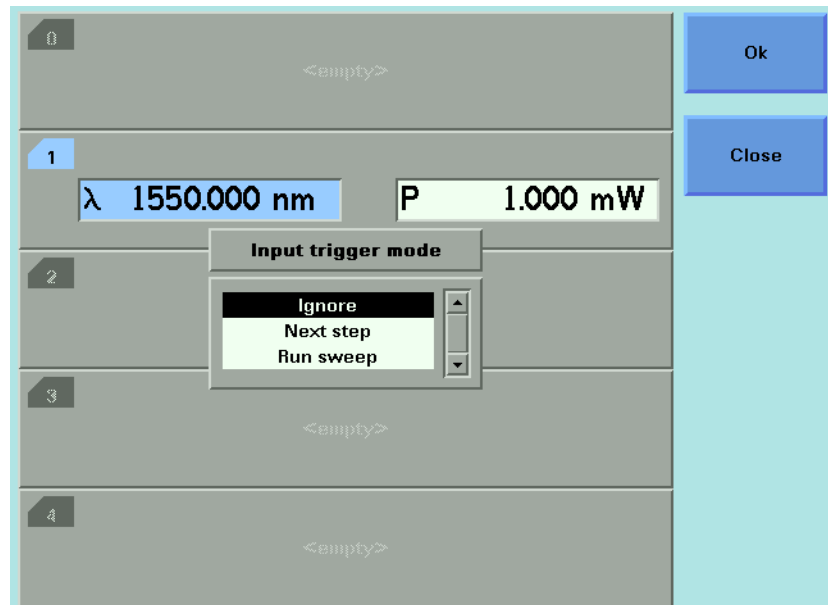

Figure 79 Input Trigger Mode

4 Move to one of the following, by using the cursor key:

- *<Ignore>*, input triggers are ignored.
- *<Next Step>*, an input trigger will cause the next step of a stepped sweep to be performed.
- *<Run Sweep>*, an input trigger will start a single sweep cycle.

5 Press *Enter*.

You can generate input triggers in any of the following ways:

- applying a trigger to the Input Trigger Connector on the rear panel of your instrument,
- setting *<Trigger Configuration>* to *<Loopback>* so that an output trigger automatically generates an input trigger, or
- using the *:TRIGger* GPIB command, see your mainframe's Programming Guide.

How to Use Output Triggering

You can configure your Tunable Laser module to output a trigger when the instrument performs certain tasks.

To set your module's Output Trigger Configuration:

- 1 See "How to Set the Trigger Configuration" on page 69 for how to configure the trigger connectors.
- 2 Move to the Tunable Laser channel and press [Menu].
- 3 Move to <Output Trigger Mode>, by using the cursor key, and press *Enter*. You will see the screen in Figure 80 .

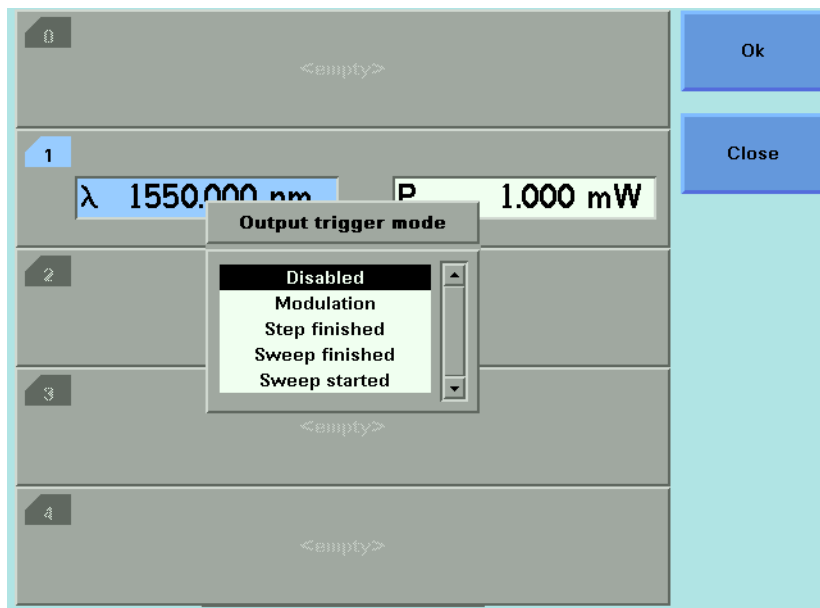

Figure 80 Output Trigger Mode

- 4 Move to one of the following, by using the cursor key:
 - <Disabled>, the output trigger mode is disabled.
 - <Modulation>, the output trigger connector outputs a TTL signal at the frequency of the internal modulation. This signal is output whether the laser is switched on or off.
 - <Step Finished>, a trigger is output after every step of a sweep finishes.
 - <Sweep Finished>, a trigger is output after a sweep cycle finishes.
 - <Sweep Started>, a trigger is output after a sweep cycle starts.
- 5 Press *Enter*.

NOTE

If you choose <Step Finished> and a <Continuous> sweep, the wavelength interval between hardware triggers is set by the [Step] parameter, although, the sweep is not stepped.

How to Use Auxiliary Functions

Automatic Realignment

Automatic Realignment realigns the laser cavity after Laser Protection. You should use Automatic Realignment if you have already tried to reactivate the laser and to reduce power, and this has been unsuccessful.

NOTE

To get the specified performance, ensure that the warm-up time has passed before starting realignment.

To realign the laser cavity:

- 1 Move to the Tunable Laser channel and press *Menu*.
- 2 Move to *<Realign>* and press *[OK]*. You will see the screen in Figure 81 .
- 3 Wait approximately 30 minutes. This time depends on how much the wavelength of the instrument has drifted since the last Automatic Realignment was performed.

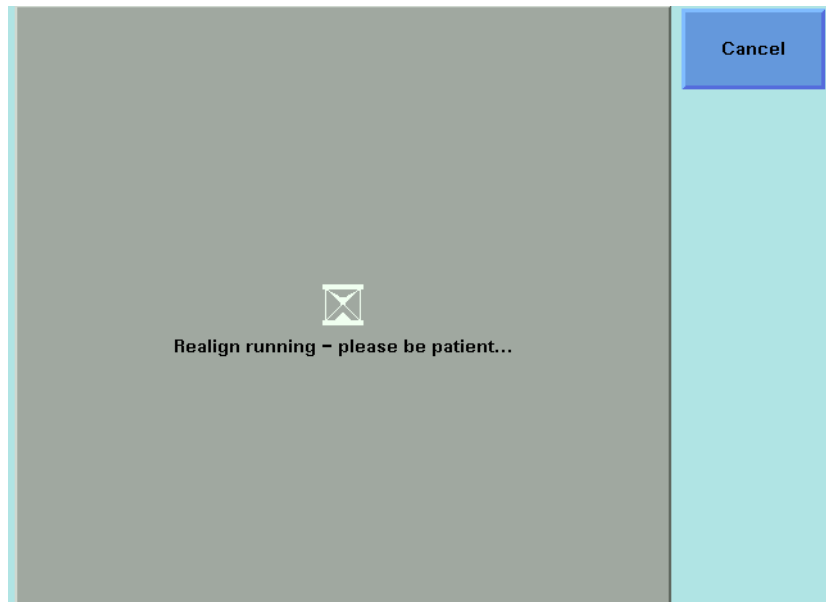

Figure 81 Realignment Screen

NOTE

If the TLS recommends Realign (after boot or during a manual lambda zero), then “UNCAL” is shown on the user interface in both Autocal modes. No Accuracy class is shown in the Autocal Off mode.

The bit 6 “ARA recommended” is set in the “questionable condition register” (See the *Agilent 8163A/B Lightwave Multimeter*, *Agilent 8164A/B Lightwave Measurement System*, *Agilent 8166A/B Lightwave Multichannel System Programming Guide*)

Please execute Realign in this case.

How to Perform a Lambda Zero

Performing a Lambda Zero recalibrates the optical wavelength. This wavelength may drift due to a change in temperature and other environmental conditions.

A Lambda Zero is automatically performed when the instrument boots or when an Automatic Realignment is performed.

The instrument automatically performs a wavelength zero from time to time. To avoid interruption of your measurements, you should perform a wavelength zero at a time of your choice.

To perform a wavelength zero:

- 1 Move to the Tunable Laser channel and press *Menu*.
- 2 Move to $\langle \lambda \text{ Zeroing} \rangle$ and press [OK]. You will see the screen in Figure 82 .

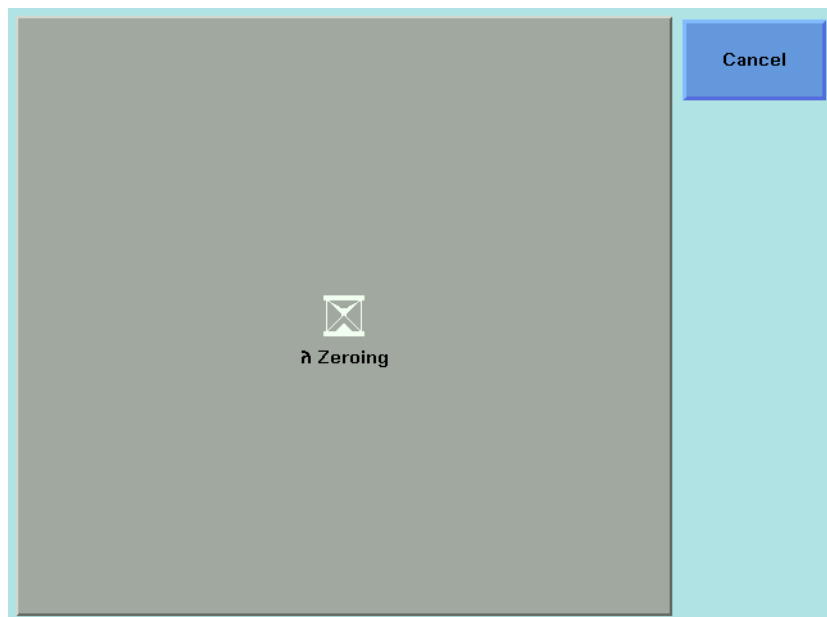

Figure 82 λ Zeroing Screen

- 3 Wait several minutes. This time depends on how much the wavelength of the instrument has drifted since the last Lambda Zero was performed.

NOTE

The instrument automatically performs a Lambda Zero if there is a ± 4.4 K temperature change since the last Lambda Zero was performed.

Auto Cal Off

The disabling of the Auto Calibration feature enables the TLS to operate for a long period without interrupting the operation for “Auto Lambda Zeroing (setting)”. When Auto Calibration is disabled, it is possible to operate the TLS at a temperature that differs more than 4.4 K from the last Lambda Zeroing temperature. In this case, the accuracy and wavelength performance of the TLS can become less optimal due to temperature variation. The relevant accuracy class is indicated on the user interface when Auto Calibration is off.

NOTE

The Auto Calibration mode is NOT stored in the Instrument Settings. After reboot or preset the Auto Calibration is always on. Agilent VEE will send a preset before scanning for devices as default. This default preset can be disabled.

NOTE

When Auto Cal Off is selected the digital signal modulation feature is not available.

NOTE

See the table below for the wavelength accuracies of ACC1, ACC2, and ACC3.

Class	Wavelength accuracy (typ.)		
	Max Temperature Deviation	Absolute	Relative
ACC1	$\pm 4.4\text{K}$	refer to specification	
ACC2	$\pm 10\text{K}$	$\pm 8 \text{ pm}$	$\pm 3 \text{ pm}$
ACC3	$\pm 25\text{K}$	$\pm 10 \text{ pm}$	$\pm 5 \text{ pm}$

NOTE

To get the specified performance ensure the warm-up time has passed and execute then a Lambda Zero before switching Auto Cal off.

NOTE

If Lambda Zero is recommended (Accuracy Class is not ACC1) the 10th bit of the “questionable condition register” is set (See the *Agilent 8163A/B Lightwave Multimeter*, *Agilent 8164A/B Lightwave Measurement System*, *Agilent 8166A/B Lightwave Multichannel System Programming Guide*). This is done in both Auto Cal On and Off.

NOTE

When Auto Cal is on, during sweeps, there is no interruption to the measurement due to settling. Also no settling will occur during operation at a fixed wavelength when at least one output is switched on. By periodically checking the “questionable condition register” bit 10 you can detect when Lambda Zero is recommended.

6

Compact Tunable Lasers

This chapter explains how to use the Agilent 8163A/B Lightwave Multimeter, Agilent 8164A/B Lightwave Measurement System, or Agilent 8166A/B Lightwave Multichannel System together with the modular Agilent compact Tunable Laser family.

Here you will find:

- A brief description of the compact Tunable Laser family,
- A description of how to use these modules, including the SBS Suppression feature.

Compact Tunable Laser modules	160
How to Use a compact Tunable Laser	161
The User Interface	161
SBS Suppression	161

Compact Tunable Laser modules

The Agilent compact Tunable Laser Source (TLS) family includes:

Table 11 The Agilent compact TLS family

Module	Description
81980A	S and C band compact TLS with SBS suppression for swept applications
81940A	C and L band compact TLS with SBS suppression for swept applications
81944A	C and L band compact TLS with SBS suppression for swept applications used with PMD test system N3909A
81989A	S and C band compact TLS with SBS suppression
81949A	C and L band compact TLS with SBS suppression

The Agilent 81980A, 81940A, 81989A, 81949A Compact TLS modules provide high output power up to +13 dBm.

- The 81980A and 81989A cover the S and C bands, with high power in the C band.
- The 81940A and 81949A cover the C and L bands, with high power in the L band.

Each module covers a total wavelength range of 110 nm.

How to Use a compact Tunable Laser

The User Interface

Compact TLS modules utilize the User Interface described in the “Tunable Lasers” on page 119. A description of how to use their modulation features given following “How to Modulate a Signal” on page 142.

SBS Suppression

SBS Suppression is a frequency modulation that allows you to launch high optical output power into longer fibers without the impairment to time-domain measurements that can be associated with intensity (amplitude) modulation.

To use the SBS Suppression control (SBS-C) feature:

Refer to Figure 83 on page 162.

- 1 Move to the Tunable Laser channel and press the [Details] softkey.
- 2 Set appropriate values in the Freq. Modulation box:
 - The Frq Mod scr > SBS-Ctrl field is fixed, since SBS-Ctrl is the only frequency modulation source currently available.
 - Set a value for the SBS suppression control frequency, SBSC frq, appropriate to your application.

- Set a value for the SBS suppression control level, SBSC lvl, appropriate to your application.

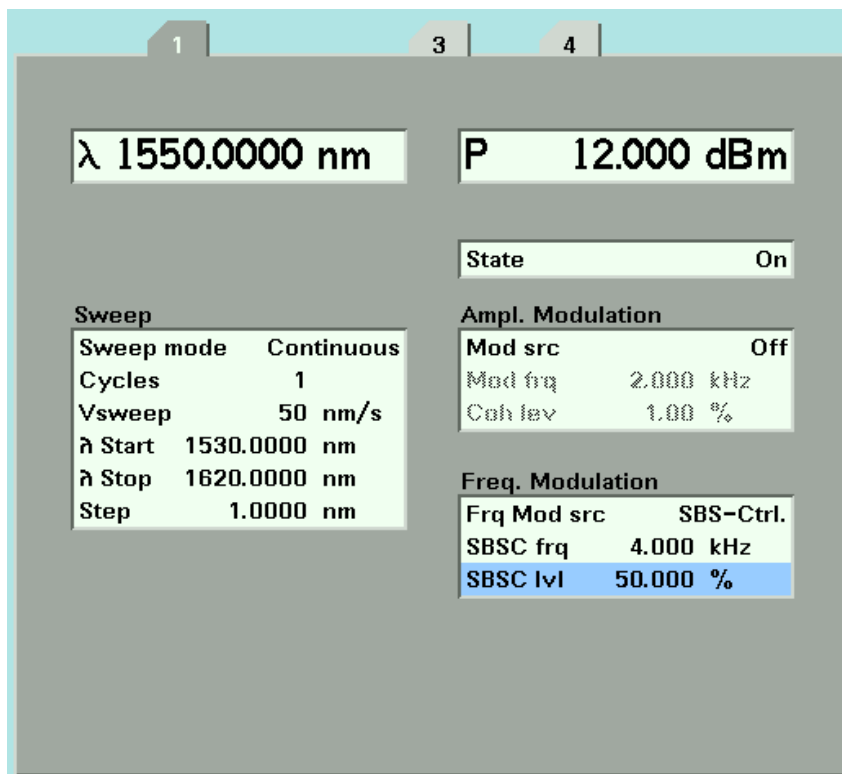

Figure 83 Updated Tunable Laser channel Details including SBS Suppression

7

Return Loss Measurement

This chapter explains how to use the Agilent 8163A/B Lightwave Multimeter, Agilent 8164A/B Lightwave Measurement System, or Agilent 8166A/B Lightwave Multichannel System to measure Return Loss.

Here you will find:

- a quick explanation of the terms Return Loss and Insertion Loss,
- a description of how to measure Return Loss and Insertion Loss using Agilent 8161x series Return Loss modules,
- a brief discussion of the theoretical background to Return Loss measurements using Agilent 8161x series Return Loss modules.

NOTE

For information about 81534A Return Loss Modules, refer to the “Operating and Programming Manual for the 81534A Return Loss Module.” 81534-90012.

Getting Started With Return Loss	165
What is Return Loss?	165
What is Insertion Loss?	165
Equipment required	166
How to Choose a Light Source	167
Return Loss Modules	168
Calibration Measurements	170
Return Loss Measurement	171
Setup	172
Calibrating the Return Loss Module	176
Calibration using the Agilent 81000BR Reference Reflector ..	177
Calibration using the Agilent 81610CC Reference Cable	180
How to Measure Return Loss	184
Viewing the Calibration Values	186
A Background to Return Loss Measurement	189
Measuring the Reflected Power from a Component with Known Reflection Factor	189
Measuring the Power Transmitted Through the Reflection Reference	190
Measuring the Power when there are No Reflections	190
Measuring the Power Transmitted Through the Measurement Patchcord	191
Measuring the Reflections from the DUT	191
Measuring the Power Transmitted Through the DUT	192
Calculating the Return Loss of the DUT	192
Calculating the Front Panel Delta	195
Calculating the Insertion Loss of the DUT	196

Getting Started With Return Loss

What is Return Loss?

When light passes through an optical component most of it travels in the intended direction, but some light is reflected or scattered. In many applications these reflections are unwanted, because they can affect the emission characteristics of any laser in the system. In such applications, it is important to measure the reflections for the components of the system.

The reflection factor for a component is a measure of how much light the component reflects. It is a ratio of the power reflected by the device to the power incident on the device. More normally we talk about the return loss of a component. The return loss has units of dB. Return loss is given by:

$$\text{Return Loss}(dB) = -10\log(\text{Reflection Factor})(dB)$$

or

$$\text{Return Loss}(dB) = -10\log\left(\frac{\text{Reflected Power}}{\text{Incident Power}}\right)(dB)$$

What is Insertion Loss?

Light that is absorbed, scattered, or reflected by a component also affects how much light a component transmits.

The transmission factor for a component is a measure of how much light the component transmits. It is a ratio of the power transmitted by the device to the power incident on the device. More normally we talk about the Insertion Loss of a component. The insertion loss has units of dB. Insertion Loss is given by:

$$\text{Insertion Loss}(dB) = -10\log(\text{Transmission Factor})(dB)$$

or

$$\text{Insertion Loss}(dB) = -10\log\left(\frac{\text{Transmitted Power}}{\text{Incident Power}}\right)(dB)$$

Equipment required

Return Loss and Insertion Loss can be measured in several ways. The method used by the Agilent 8161x series Return Loss modules requires the following equipment:

- An Agilent 81610A Return Loss module (where an internal source is not present), or an Agilent 81611A, 81612A or 81613A Return Loss module (where an internal source is present).
- If the Return Loss module does not include an internal source, or you choose to use an external source, a Laser Source module.

NOTE

If you are using an 81534A Return Loss Module, it is important that the Laser Source has a stable output. Agilent 8161x Return Loss modules include a monitor diode to compensate for power variation in the Laser Source.

- A Power Meter.

A typical setup, using an Agilent 81610A Return Loss module, where the DUT is a connector pair, is described in Figure 84 .

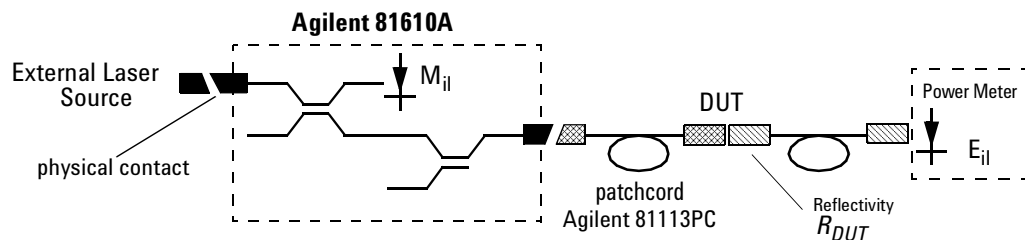

Figure 84 Measuring Return Loss and Insertion Loss

To measure insertion loss you measure the power transmitted through the DUT, see *“How to Measure Return Loss”* on page 184

How to Choose a Light Source

Highly accurate return loss measurement requires that you use a light source with a subset of the following properties:

- low coherence length
- high power
- [and, for the 81534A, power stability.]

If a return loss module with at least one internal source (such as the Agilent 81611A, 81612A or 81613A) is not available, we recommend that you use any of the following as part of your return loss measurement setup:

- *Agilent 83438A Erbium ASE Source.*
This source offers a high-power low-coherence output that is very stable over time.
- *Laser Source modules.*
See “Accessories” on page 319 for a list of modules that can be installed in your mainframe. Refer to the note below that explains the use of highly coherent light sources.
- *Tunable Lasers*, when you want to measure Return Loss over a wavelength range.
See “Accessories” on page 319 for a list of modules that can be installed in your mainframe. Refer to the note below that explains the use of highly coherent light sources.
- *LED sources.*
The intensity of the output of LED sources is very stable over time, although the low power output of LEDs restricts the dynamic range of return loss measurement.

NOTE

If you use high-coherence light sources, you can improve performance by:

- modulating the output signal at 2 kHz or higher, or
- using coherence control to reduce the coherence length of the signal.

Return Loss Modules

The applicability of the available Return Loss modules is outlined below:

Agilent 81610A Return Loss module

The Agilent 81610A Return Loss Module includes a power sensor, monitor diode and two couplers in one module. It is for use in the Agilent 8163A/B Lightwave Multimeter, the Agilent 8164A/B Lightwave Measurement System, and the Agilent 8166A/B Lightwave Multichannel System for making return loss measurements.

The Agilent 81610A Return Loss module does not include an internal source, and must be used in conjunction with a suitable external source.

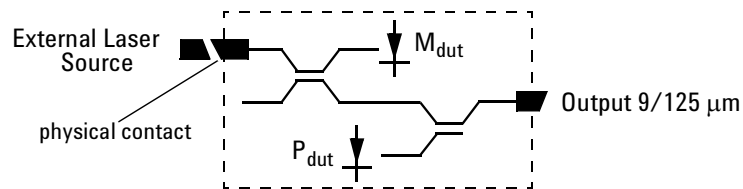

Figure 85 The Contents of the Agilent 81610A Return Loss module

Agilent 81611A and Agilent 81612A Return Loss modules

Agilent 81611A and Agilent 81612A Return Loss modules include a power sensor, monitor diode, two couplers, and an internal laser source in one module. It is for use in the Agilent 8163A/B Lightwave Multimeter, the Agilent 8166A/B Lightwave Measurement System, and the Agilent 8164A/B Lightwave Multichannel System for making return loss measurements.

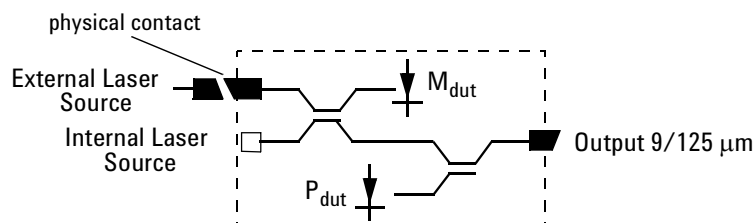

Figure 86 The Contents of the Agilent 81611A and Agilent 81612A Return Loss modules

Agilent 81613A Return Loss modules

Agilent 81613A Return Loss modules include a power sensor, monitor diode, three couplers, and two internal laser source in one module. They are for use in the Agilent 8163B Lightwave Multimeter, the Agilent 8164A/B Lightwave Measurement System, and the Agilent 8166A/B Lightwave Multichannel System for making return loss measurements.

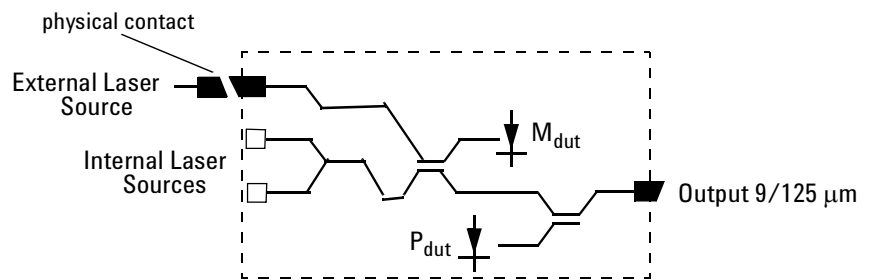

Figure 87 The Contents of the Agilent 81613A Return Loss modules

All Agilent 8161x series Return Loss modules include an input for an external laser source.

Calibration Measurements

Before measuring the reflection factor of a device under test (DUT), it is important to take calibration measurements as described in “Calibrating the Return Loss Module” on page 176. These calibrations eliminate wavelength dependencies, coupler directivity, insertion losses, backscattering and other non-ideal characteristics of the system.

Return Loss Measurement

Connectors

The Return Loss measurement setup described uses Diamond HMS-10/Agilent/HRL and Diamond HMS-10/Agilent connectors throughout.

Patchcord on RL module Output

It is recommended that you attach a patchcord with a high return loss connector to the Return Loss module output.

CAUTION

Agilent Technologies supplies patchcords with a Diamond HMS-10/Agilent/HRL high return loss connector on one end. These patchcords are necessary so that the connector at the output is not damaged. The full range of patchcords available are described in Table 12 .

Table 12 High Return-Loss Patchcords

Model No.	High Return-Loss Patchcords Description
Agilent 81113EC	DIN47256/4108 (angled) - Radiall EC
Agilent 81113PC	DIN47256/4108 (angled) - FC/PC
Agilent 81113SC	DIN47256/4108 (angled) - DIN47256/4108 (angled)
Agilent 81113BC	DIN47256/4108 (angled) - Bare Fiber

Setup

External and Internal Sources

The Return Loss measurement setup described uses:

- An Agilent 81654A Source module, inserted as a second module in the the same mainframe as the Return Loss module, or
- An internal source (Agilent 81611A/2A/3A/4A Return Loss modules only).

Making sure all the connectors are clean, set up the instrument as shown in Figure 88 if you are using an External Source,

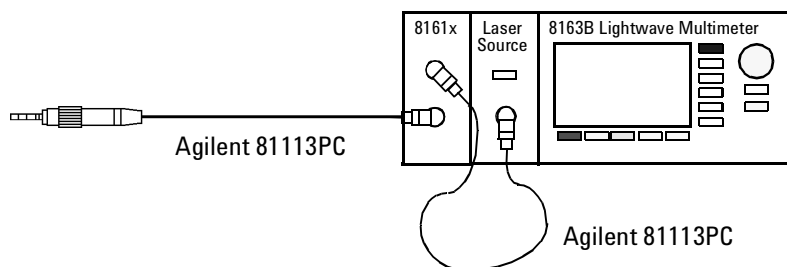

Figure 88 Return Loss Measurement Setup - External Source used

or Figure 89 if you are using an internal source (Agilent 81611A/2A/3A/4A Return Loss modules only).

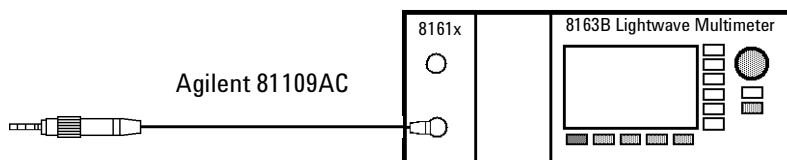

Figure 89 Return Loss Measurement Setup - Internal Source used

- If an external source is used, connect it to the Return Loss module Input.

NOTE

If you are using a Fabre-Perot source, you must fix its output cable to ensure minimum cable movement.

- Attach the high return loss connector of the patchcord to the Return Loss module Output. The high return loss connector is the connector with the orange sleeve.

Remove electrical offsets

- 3 Make sure that the source is not active and that you have covered the end of the patchcord to prevent light being coupled into the end. Move to the Return Loss module channel and press [Zero] to remove electrical offsets in the instrument.

Set Averaging Time

- 4 Move to the [AvgTime] parameter (the measurement averaging time). Make sure that the selected averaging time is suitable for your measurements.

Use an averaging time of at least 200 ms, but increase this to at least 1 s for return losses greater than 50 dB. Longer averaging times give more accurate results, but reduce the speed at which the instrument can complete a measurement.

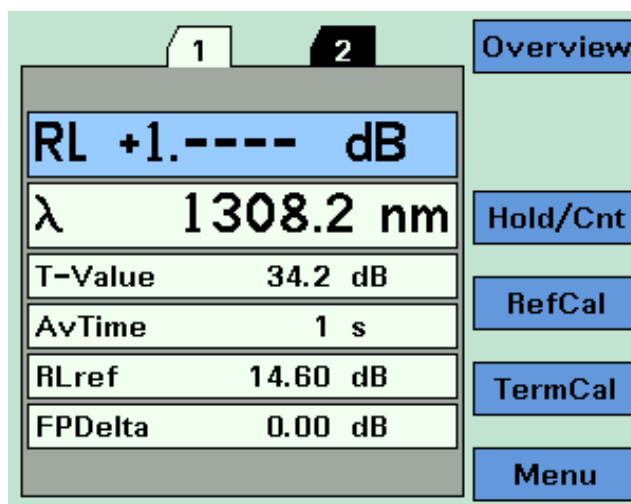

Figure 90 Agilent 8161x Details Screen

Set Wavelength

- 5 Move to [λ] and either:
 - set this parameter to *Extern*.
 - choose an internal source by selecting its wavelength (Agilent 81611A/2A/3A/4A Return Loss modules only).
- 6 Enable the source.

T-Value

The T-value can be described as the effective return loss of a system, with all internal parasitic reflections taken into account, in one parameter. The system's internal parasitic reflections include backscattering in the measurement patchcord, reflections due to imperfect directivity of the internal couplers, reflections at internal terminations, reflections at connector ends and diodes. Intuitively, one could call the T-value the "noise" of the system (set up). The T-value is used to evaluate how well the calibration was done, and thereby provide information on how high return losses (low reflectances) can be measured. The correlation between the T-value and the displayed return loss is that the power that corresponds to the T-value (system "noise") is subtracted from the power that corresponds to the measured return loss at the return loss diode, yielding the actual return loss. When the actual return loss is high, then this subtraction becomes inaccurate when the T-value is not sufficiently high. Therefore, it is imperative for measurements of high return losses that the T-value is as high and as stable as possible. A "rule of thumb" is that one can only measure 5-10 dB higher return losses (lower reflections) than the T-value, meaning if a T-value of 65 dB is achieved after calibration it is possible to measure accurate return losses up to 70 or 75 dB. The equation for the T-value is as follows:

$$T - value = 10 \log \left[\left(\frac{P_{ref}}{P_{para}} \right) \left(\frac{M_{para}}{M_{ref}} \right) \right] + RL_{ref} \approx 10 \log \left[\frac{P_{ref}}{P_{para}} \right] + RL_{ref}$$

Where:

P_{ref} is the reflected power from the measurement path at the return loss diode when making a reference calibration.

P_{para} is the backward-flowing power from the measurement path at the return loss diode when making a terminated/parasitic calibration.

M_{ref} is the power at the source monitor diode when making a reference calibration.

M_{para} is power at the source monitor diode when making a terminated/parasitic calibration.

RL_{ref} is the return loss reference value set by the user for the reference calibration.

These parameters are made available using the "Show Calibration " menu item, or using the GPIB query:

SENSe [n]:[CHANnel [m]]:RETurnloss:CALibration:VALUES?

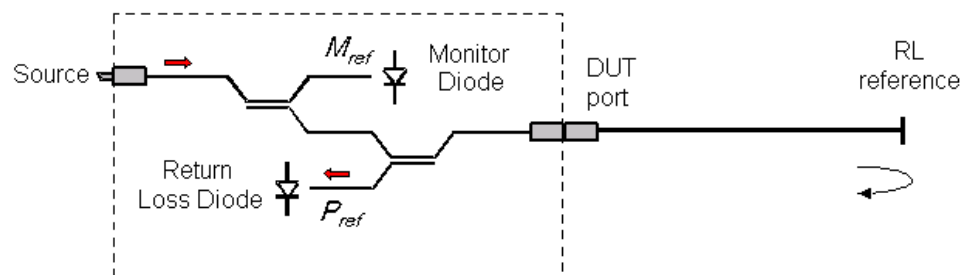

Figure 91 Reflectance Calibration using RL Reference

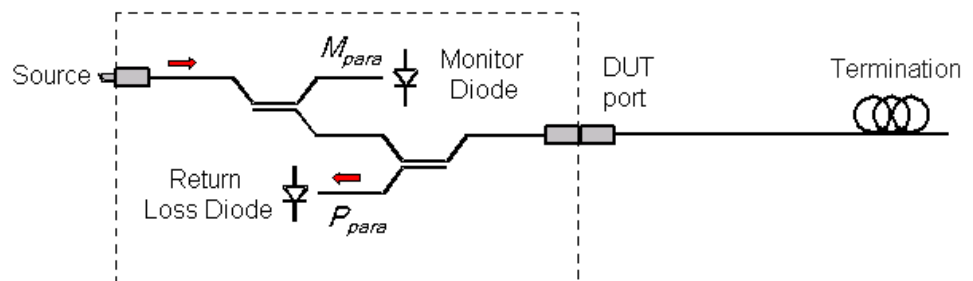

Figure 92 Termination Calibration

Calibrating the Return Loss Module

Whenever a Return Loss module is in the mainframe, a return loss value is displayed. The calibration values used are either the most recently measured, where these are available, or factory default values.

If you are unsure of any of the calibration values that you are using, or if you have changed the measurement setup, take the appropriate calibration measurements again.

- First, calibrate the return loss module against a component of known reflectance.
 - The Agilent 81000BR Reference Reflector allows you to make a Reflectance Calibration and a Termination Calibration.
 - These procedures are described in “Calibration using the Agilent 81000BR Reference Reflector” on page 177.
 - The Agilent 81610CC Reference Cable also allows you to make a Reflectance Calibration. Use the measurement patchcord to make a Termination Calibration.
 - To measure insertion loss and the front panel delta of the system (see “Calculating the Front Panel Delta” on page 195), you must also measure the insertion loss of the Reference Cable and measurement patchcord.
 - These procedures are described in “Calibration using the Agilent 81610CC Reference Cable” on page 180.

Calibration using the Agilent 81000BR Reference Reflector

You can use the Agilent 81000BR Reference Reflector to make a Reflectance Calibration, and a Termination Calibration.

Reflectance Calibration

Use this procedure to calibrate the Return Loss module against a component of known return loss.

- 1 Making sure all the connectors are clean, set up the instrument as shown in Figure 93 if you are using an External Source.

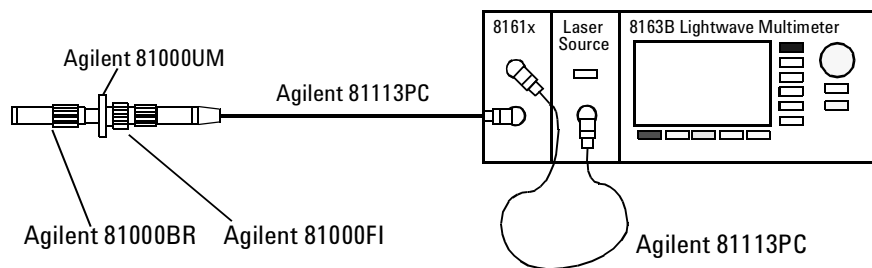

Figure 93 Reflectance Calibration - External Source

or Figure 94 if you are using an internal source (Agilent 81611A/2A/3A/4A Return Loss modules only).

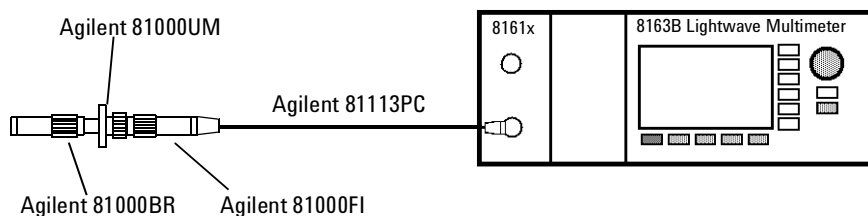

Figure 94 Reflection Calibration - Internal Source

Tip: For best results and higher repeatability, fix the cable.

- 2 Attach a component with a known return loss to the end of the patchcord.

Tip: The Agilent 81000BR Back Reflector is such a component, offering a return loss of 0.18 ± 0.1 dB.

- 3 Move to the Return Loss channel, then press [Details]
- 4 Move to [FPDelta], press [Edit], set the value to 0.000, then press [OK].

- 5 Move to [RLref] and make sure that the displayed value is correct. Set [RLref] to the value of the return loss of the reference reflection you are using. For example, if you are using the Agilent 81000BR reference reflector, set [RLref] to 0.18 dB.

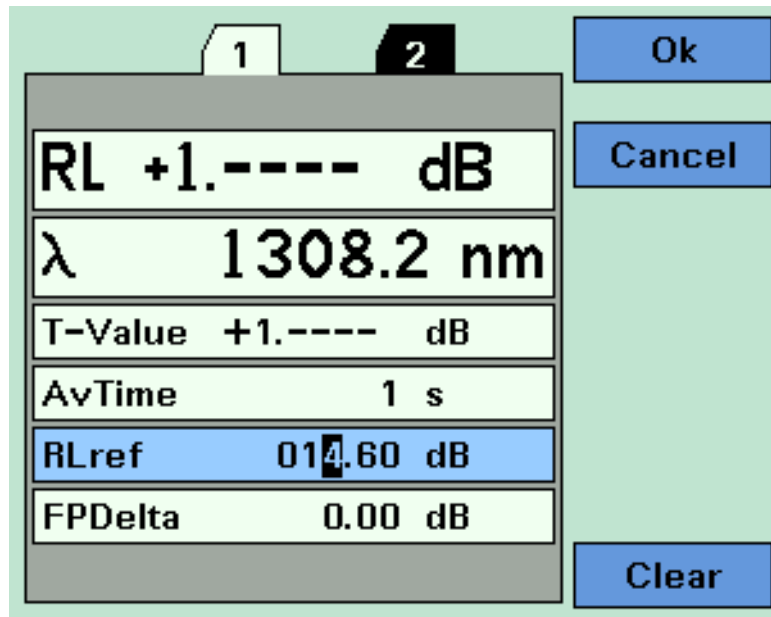

Figure 95 Measuring the Reflection Reference

- 6 Switch on the Laser.
- 7 Press [Menu]. Move to <Reflectance calibration> and press *Enter*. The instrument measures the power reflected by the back reflector. The [RL] value changes to the same value as entered for [RLref].

Tip: An alternative step [Step 7](#) is to select the Return Loss module's [Detail] screen, then press [RefCal]

Termination Calibration

Use this procedure to calibrate the Return Loss module against a terminated cable, that is when there are no reflections returning from its end.

- 1 Making sure all the connectors are clean, set up the instrument as shown in Figure 96 if you are using an External Source,

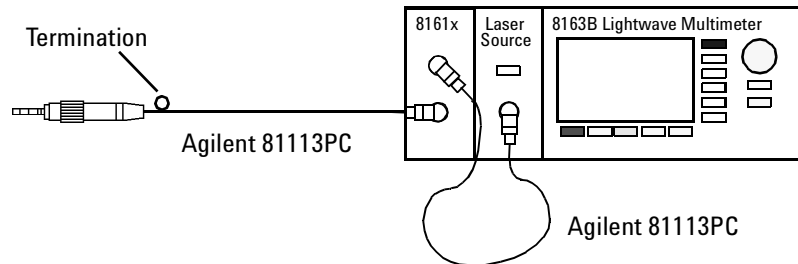

Figure 96 Termination Calibration - External source

- or Figure 97 if you are using an internal source (Agilent 81611A/2A/3A/4A Return Loss modules only).

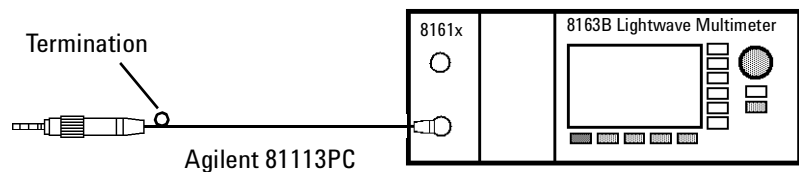

Figure 97 Termination Calibration - Internal Source

NOTE

If you are using a Fabry-Perot source, you must fix its output cable to ensure minimum cable movement.

- 2 Terminate the cable so that there are no reflections coming from the end.

Tip: You can do this by wrapping the fiber five times around the shaft of a screwdriver (or some similar object with a diameter of between 5mm and 7mm).

- 3 Press [Menu] to access the menu.

- 4 Move to <Terminated calibration> and press *Enter*. The instrument measures the power reflected by the cable, and sets the [Para] values used by the Return Loss monitor's power sensor and monitor diode.

Tip: An alternative steps 3 and 4 is to select the Return Loss module's [Details] screen, then press [TermCal].

Calibration using the Agilent 81610CC Reference Cable

Use the Agilent 816100CC Reference Cable to make a Reflectance Calibration, and the measurement patchcord to make a Termination Calibration.

To measure insertion loss and the front panel delta of the system (see *"Calculating the Front Panel Delta"* on page 195), you must also measure the insertion loss of the Reference Cable and measurement patchcord.

Reflectance Calibration

Use this procedure to calibrate the Return Loss module against a component of known return loss.

- 1 Making sure all the connectors are clean, set up the instrument as shown in Figure 98 if you are using an External Source,

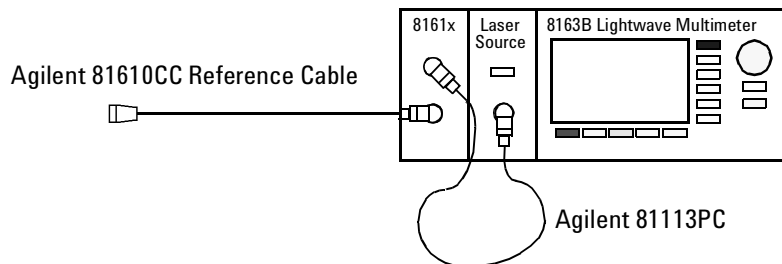

Figure 98 Measuring the Return Loss of the Reference Cable - External Source

or Figure 99 if you are using an internal source (Agilent 81611A/2A/3A/4A Return Loss modules only).

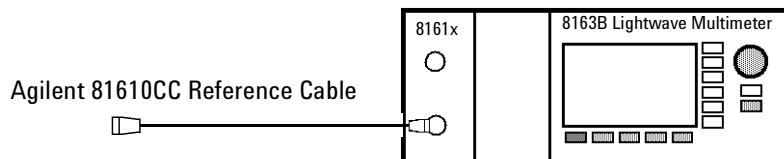

Figure 99 Measuring the Return Loss of the Reference Cable - Internal Source

Attach the high return loss connector of the reference cable to the output.

Tip: For best results and improved repeatability, fix the cable.

- 2 Move to [FPDelta], press [Edit], set the value to 0.000, then press [OK].

- 3 Move to $[RLref]$, press [Edit]. Make sure that the displayed value of $[RLref]$ is correct. If it is not, move to $[RLref]$, press [Edit], set the value the return loss value of the reference cable you are using, then press [OK].
- 4 Switch on the Laser.
- 5 Press [Menu]. Move to $\langle Reflectance\ calibration \rangle$ and press *Enter*. The instrument measures the power reflected by the reference cable. The $[RL]$ value changes to the same value as entered for $[RLref]$.

Front Panel Delta Calibration

For higher accuracy we recommend that you also calibrate for *Front Panel Delta*. This is the difference between the insertion loss of the reference cable, and the insertion loss of the patchcord used for return loss measurement.

Measuring the Power Transmitted Through the Reference Cable

First, measure the power transmitted through the reference cable.

- 1 Making sure all the connectors are clean, set up the instrument as shown in Figure 100 if you are using an External Source.

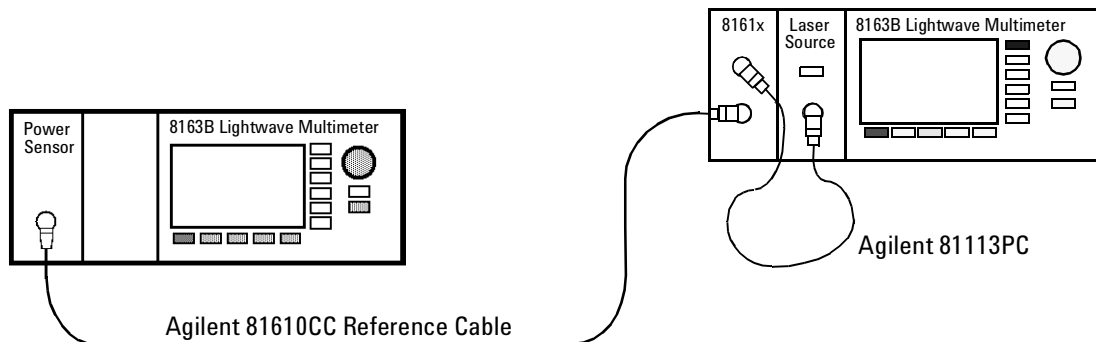

Figure 100 Power Transmitted through the Reference Cable - External Source

or Figure 101 if you are using an internal source (Agilent 81611A/2A/3A/4A Return Loss modules only).

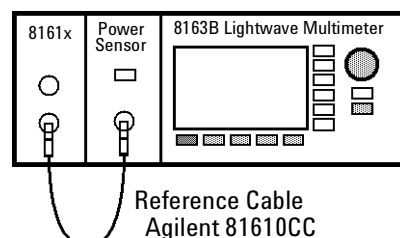

Figure 101 Power Transmitted through the Reference Cable - Internal Source

2 Move to the Power Sensor channel:

- Press [Menu].
- Move to $\langle Pwr\ unit \rangle$, move to $\langle dB \rangle$ and press *Enter*.
- Move to $\langle Display\ to\ Reference \rangle$ and press *Enter*. This sets the power transmitted through the reference cable, E_{Meas} , as the reference value $\langle Ref \rangle$.

3 Press [Close] to exit from the menu.***Measuring the Power Transmitted through the Measurement Patchcord***

Next, measure the power transmitted through the measurement patchcord.

1 Making sure all the connectors are clean, set up the instrument as shown in Figure 102 if you are using an External Source,

Figure 102 Power Transmitted through the Measurement Patchcord - External Source

or Figure 103 if you are using an internal source (Agilent 81611A/2A/3A/4A Return Loss modules only).

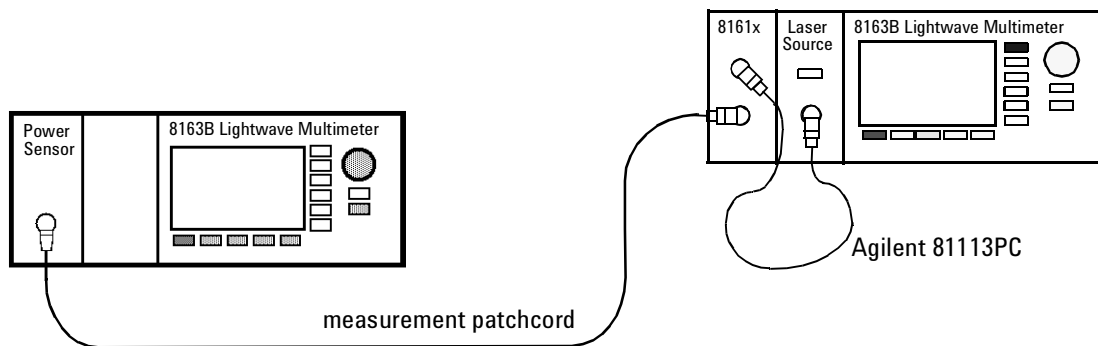
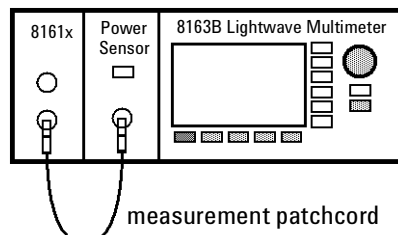

Figure 103 Power Transmitted through the Measurement Patchcord - Internal Source

2 .Move to the Power Sensor channel:

- Press [Menu].
- If necessary, move to $\langle Pwr\ unit \rangle$, move to $\langle dB \rangle$ and press *Enter*.
- The Power Sensor channel displays a power value in dB that is equal to the

front panel delta of the measurement system.

- Press [Close] to exit from the menu.

3 Move to the Return Loss module channel:

- Press [Menu], move to <FPDelta>, press [OK]
- Enter the power value in dB, [P], displayed by the power sensor, as the front panel delta, then press [OK].
- Press [Close] to exit from the menu.

Termination Calibration using the Measurement Patchcord

Use this procedure to calibrate the Return Loss module against a terminated patchcord, that is when there are no reflections returning from its end.

- 1** Making sure all the connectors are clean, set up the instrument as shown in Figure 104 if you are using an External Source,

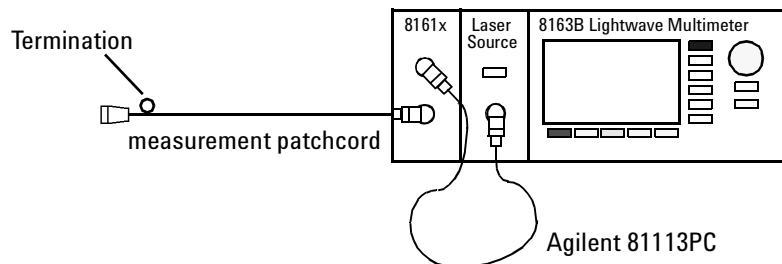

Figure 104 Measuring the Termination Parameter - External Source

or Figure 105 if you are using an internal source (Agilent 81611A/2A/3A/4A Return Loss modules only).

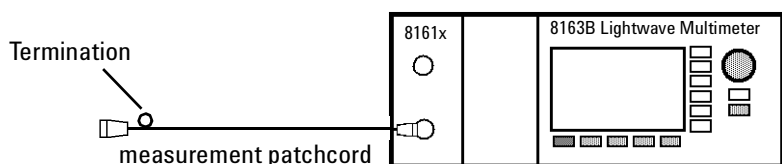

Figure 105 Measuring the Termination Parameter - Internal Source

- 2** Terminate the measurement patchcord so that there are no reflections coming from the end.

Tip: You can do this by wrapping the fiber five times around the shaft of a screwdriver (or some similar object with a diameter of between 5mm and 7mm).

- 3 Move to [*Terminated calibration*] and press *Enter*. The instrument measures the power reflected by the component, and sets the [*Para*] values used by the Return Loss monitor's power sensor and monitor diode.

How to Measure Return Loss

It is not necessary to make new calibration measurements for each DUT. You can make the calibration measurements for your system, and then measure the return loss of many devices.

The value shown in the result field for the Return Loss channel is the measured return loss.

- 1 Attach the DUT to the measurement patchcord. In the example shown in Figure 106, the DUT is a connector pair.

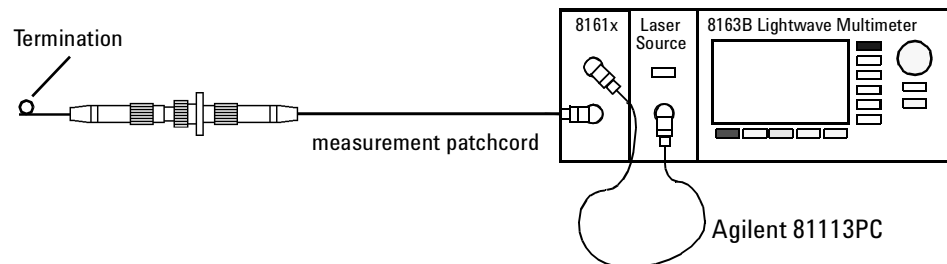

Figure 106 Measuring the Return Loss of the DUT (in this example: a Connector Pair)

Tip: Terminate your system close to the DUT to make sure that you are only measuring reflections from the DUT.

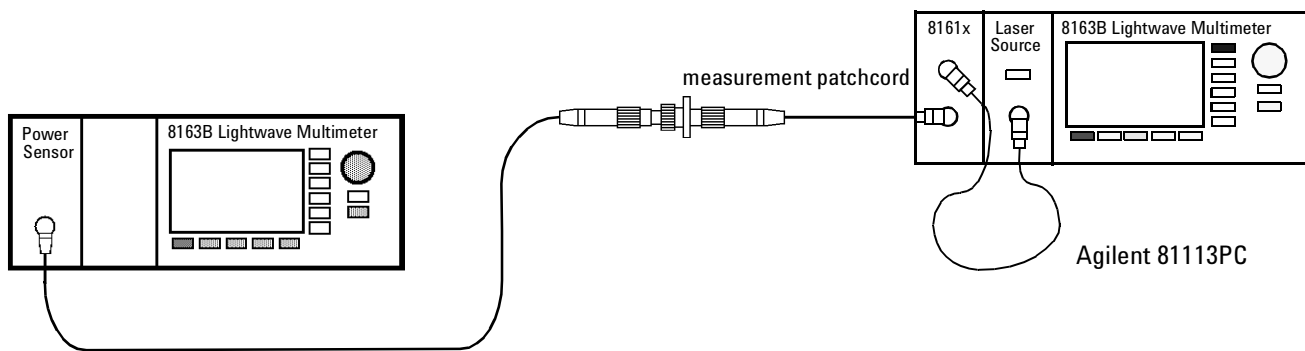

Figure 107 Measuring the Power Transmitted through the DUT (a Connector Pair)

Measuring the Insertion Loss

To measure insertion loss, you measure the power transmitted through the DUT, as shown in Figure 107 .

As you have already, in Step 2 on page 182, set the [*Ref*] parameter to the power transmitted through the Reference Cable. The displayed power in dB is equal to the insertion loss.

NOTE

Set the *Front Panel Delta* as described on “Front Panel Delta Calibration” on page 181.

Viewing the Calibration Values

The Return Loss module calibration values used are either the most recently measured, where these are available, or factory default values.

If you are unsure of the calibration values you are using, or if you have changed your measurement setup, make the appropriate calibration measurements again.

1 Press [Menu]. Move to the <Show calibration> menu item. The *Calibration parameters* screen for the *Return Loss Diode* appears, as displayed in Figure 108 . This screen shows current value for the following quantities:

- [Para], the parasitic power value measured by the Return loss Module's internal power sensor in dBm. This value is determined by the termination calibration, or you can use the default setting held in the factory calibration.
- [Ref], the power measured by the Return loss Module's internal power sensor during the reflectance calibration in dBm
- [Meas], the power currently measured by the Return loss Module's internal power sensor in dBm

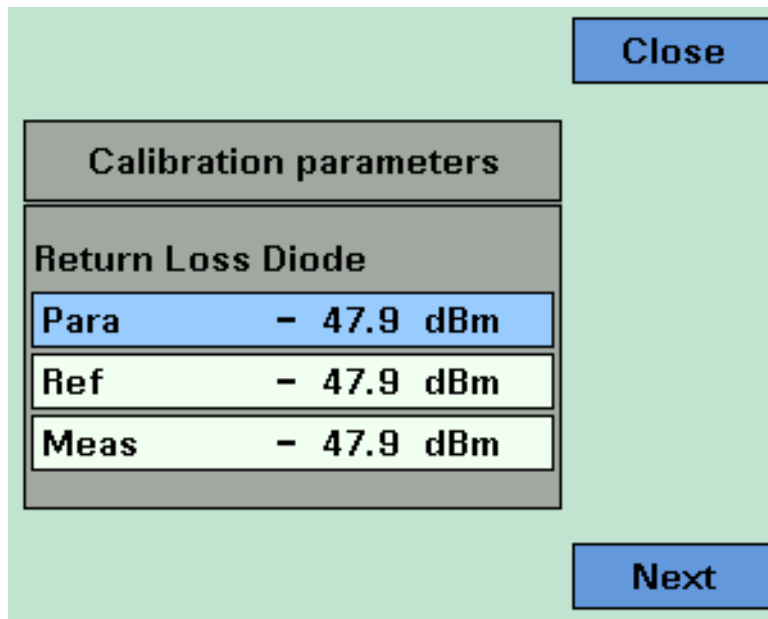

Figure 108 The Calibration Parameters Screens - Return Loss Diode

2 Press [Next]. The *Calibration parameters* screen for the *Monitor Diode* appears, as displayed in Figure 109 . This screen shows current value for the following quantities:

- [Para], the parasitic power value measured by the Return Loss module's monitor diode in dBm. This value is determined by the termination

calibration, or you can use the default setting held in the factory calibration.

- *[Ref]*, the power measured by the Return Loss module's monitor diode during the reflectance calibration in dBm
- *[Meas]*, the power currently measured by the Return loss Module's internal monitor diode in dBm

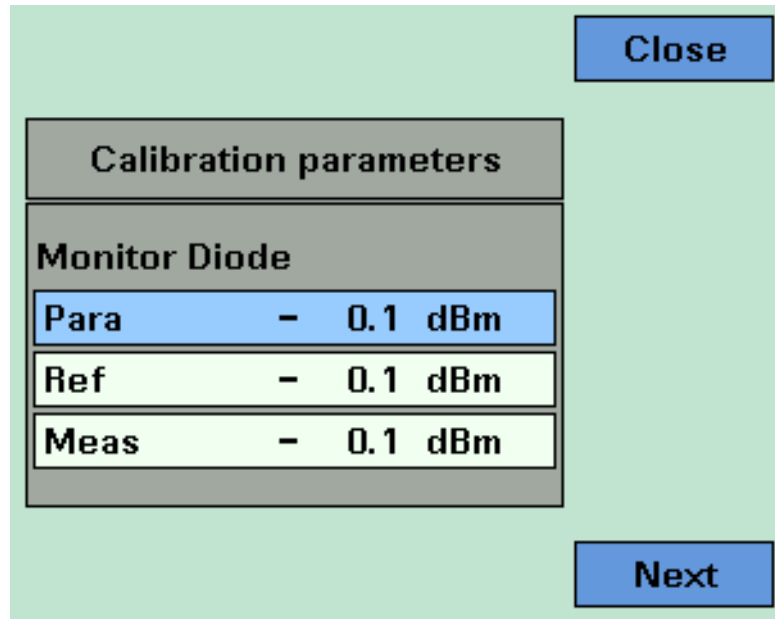

Figure 109 The Calibration Parameters Screens - Monitor Diode

3 Press [Next]. The *Calibration parameters* screen for *User Data* appears, as displayed in Figure 110 . This screen shows current value for the following quantities:

- *[FPDelta]*, the loss correction, in dB, due to differences between the reference cable and the measurement cable, such as differences in the front panel connector.
- *[RLref]* the value of the return loss of the reference relector used. If you are using a reference cable, this value will be around 14.6 dB

Calibration parameters	
User Data	
FPDelta	0.000 dB
RLref	14.600 dB
T-Value	0.0 dB

Figure 110 The Calibration Parameters Screens - User Data

A Background to Return Loss Measurement

Measuring the Reflected Power from a Component with Known Reflection Factor

First, attach a component with a known reflection factor in place of the DUT, and measure the power reflected. This component is called the reflection reference.

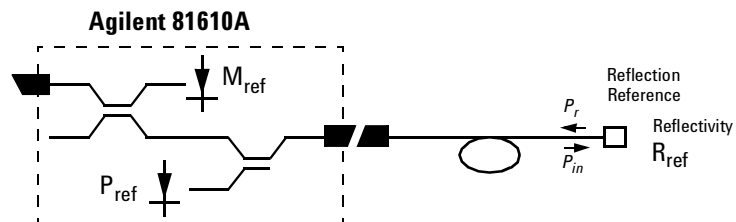

Figure 111 Measuring the Power from a Component with a Known Reflection Factor

This measured power from the reflection reference is called P_{Ref} .

The following two components are recommended for use as a reflection reference:

- the Agilent 81610CC Reference Cable, or
- the Agilent 81000BR Back Reflector.

NOTE

You can only measure the Front Panel Delta if you use a Reflection Reference Cable.

The reflection factor for the component is called R_R . Normally the return loss for the component (RL_R) is specified, but these values are related:

$$RL_R = -10 \log R_R = -10 \log \frac{P_r}{P_{in}}$$

Measuring the Power Transmitted Through the Reflection Reference

NOTE

You can only measure the Front Panel Delta if you use the a Reflection Reference Cable.

Connect your a Reflection Reference Cable to a Power Meter and measure the transmitted power, E_{ref} . You can use E_{ref} to calculate the front panel delta, see “Calculating the Front Panel Delta” on page 195.

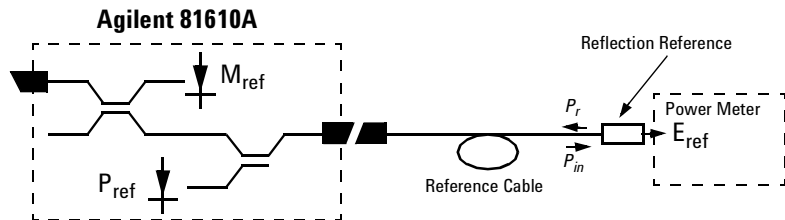

Figure 112 Measuring the Power transmitted through the Reflection Reference

Measuring the Power when there are No Reflections

Next, terminate the measurement patchcord so that there are no reflections from the end. All the power measured by the sensor now, is due to the non-ideal nature of the measurement system. This is our termination parameter.

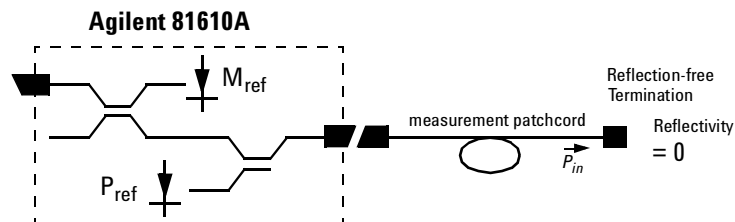

Figure 113 Measuring the Power with the Connector Terminated

This measured power for the termination parameter is called P_T .

Measuring the Power Transmitted Through the Measurement Patchcord

Connect the measurement patch cord (the cable you will use to connect to the Device Under Test, DUT) directly to a Power Meter and measure the transmitted power, E_{Meas} . You can use E_{Meas} to calculate the front panel delta, see “Calculating the Front Panel Delta” on page 195 and to calculate the insertion loss, see “Calculating the Insertion Loss of the DUT” on page 196.

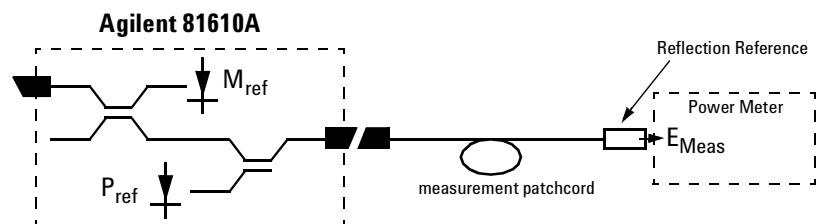

Figure 114 Measuring the Power transmitted through the Measurement Patchcord

Measuring the Reflections from the DUT

Now detach the measurement patchcord from the Power Meter and attach it to the DUT. The DUT should be terminated.

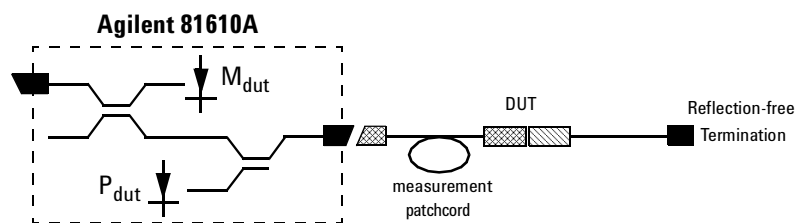

Figure 115 Measuring the Reflections from the Device Under Test

The instrument measures the power reflected from the DUT. This power is called P_{DUT} .

Measuring the Power Transmitted Through the DUT

Remove the termination from the DUT and connect the DUT to a Power Meter so that the power that is transmitted through the DUT can be measured. This power is called E_{ij}

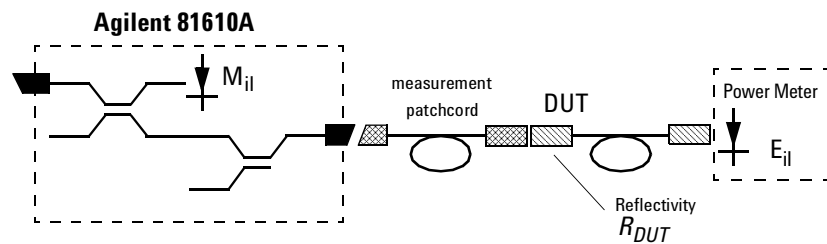
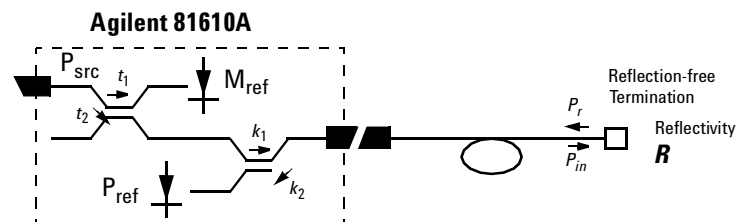

Figure 116 Measuring the Power transmitted through the Device Under Test

You can use E_{ij} to calculate the insertion loss, see “Calculating the Insertion Loss of the DUT” on page 196.

Calculating the Return Loss of the DUT

The system may be represented by the general diagram shown below:



The reflected power, measured by the instrument, (P), from the component with the known reflection factor, is given by the sum of:

- the part of the power, reflected by the component, which is transmitted through the coupler, and
- the reflections due to the measurement system.

That is:

$$P = t_2 k_1 k_2 P_{sxc} R + t_2 s M$$

where:

$$M = t_1 P_{sxc}$$

$$c_1 = \frac{t_2}{t_1} k_1 k_2$$

$$c_2 = \frac{t_2}{t_1} s$$

$$\Rightarrow P = c_1 M R + c_2 M \quad (1)$$

The constants t_1 , t_2 , k_1 and k_2 are multipliers giving the proportion of power transmitted through the coupler from the Input port to the Output port and from the Output port to the sensor port respectively. In other words, when optical power is input at the Output port, k_2 times that power is output at the sensor port. It is not necessary to know the value for these constants, they can be eliminated later.

The constant s is a multiplier giving the scattering factor. The scattering factor accounts for the directivity of the second coupler, backscatter in the fiber, and reflections of connectors. The calibration procedure helps you to eliminate the affect of these on return loss measurements.

For “Return Loss Measurement” on page 171, the reflection factor of the component is known. Here we refer to the reflection factor as R_{Ref} . This gives the following equation:

$$P_{Ref} = c_1 M_{Ref} R_{Ref} + c_2 M_{Ref} \quad (2)$$

For “Measuring the Power when there are No Reflections” on page 190, the value of the reflection factor is zero. This gives the following equation:

$$P_{para} = c_2 M_{para} \quad (3)$$

For “Measuring the Reflections from the DUT” on page 191, the value of the reflection factor of the DUT is called R_{DUT} . This gives the following equation:

$$P_{DUT} = c_1 M_{DUT} R_{DUT} + c_2 M_{DUT} \quad (4)$$

If we substitute equation 3 into equations 2 and 4, this gives us the following two equations:

$$P_{Ref} = c_1 M_{Ref} R_{Ref} + \frac{M_{ref}}{M_{para}} P_{para} \quad (5)$$

$$P_{DUT} = c_1 M_{DUT} R_{DUT} + \frac{M_{DUT}}{M_{para}} P_{para} \quad (6)$$

If we subtract P_{para} from equations 5 and 6, this gives us the following equations:

$$P_{Ref} - \frac{M_{Ref}}{M_{para}} P_{para} = c_1 M_{Ref} R_{Ref} \quad (7)$$

$$P_{DUT} - \frac{M_{DUT}}{M_{para}} P_{para} = c_1 M_{DUT} R_{DUT} \quad (8)$$

If we divide equation 8 by equation 7, this gives us the following equations:

$$R_{DUT} = \frac{M_{Ref}}{M_{DUT}} \frac{P_{DUT} - \frac{M_{DUT}}{M_{para}} P_{para}}{P_{Ref} - \frac{M_{Ref}}{M_{para}} P_{para}} R_{Ref} \quad (9)$$

Thus we can use the equation below to calculate return loss:

$$\begin{aligned} RL_{DUT} &= -10 \log R_{DUT} \\ &= -10 \log \frac{M_{Ref}}{M_{DUT}} \frac{P_{DUT} - \frac{M_{DUT}}{M_{para}} P_{para}}{P_{Ref} - \frac{M_{Ref}}{M_{para}} P_{para}} - 10 \log R_{Ref} \end{aligned} \quad (10)$$

The return loss of the reference reflection is given by:

$$RL_{Ref} = -10 \log R_{Ref} \quad (11)$$

Calculating the Front Panel Delta

The Front Panel Delta is the change in loss variation that is caused by replacing the reference cable, as used in *“Reflectance Calibration”* on page 180, with the measurement patchcord, as used in *“How to Measure Return Loss”* on page 184. This is caused by differences in reflections from the front panel connector and also differences in the backscatter level of the fibers.

To measure the front panel delta you must measure the power transmitted through the reference cable, *“Measuring the Power Transmitted Through the Reflection Reference”* on page 190, and the power transmitted through the measurement cable, see *“Measuring the Power Transmitted Through the Measurement Patchcord”* on page 191. The system may be represented by Figure 117 :

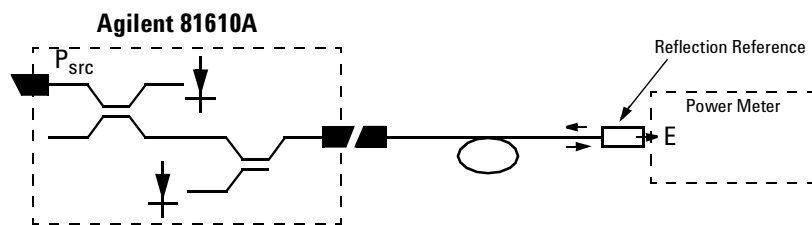

Figure 117 Generalization of a Return Loss Measurement

The transmitted power, (E), is directly proportional P_{src} .

That is:

$$E = aP_{src} \quad (12)$$

The constant a is a multiplier giving the proportion of power that the light source emits that is measured by the power meter.

The constants a_{Ref} and a_{Meas} apply to the setups described in *“Measuring the Power Transmitted Through the Reflection Reference”* on page 190 and in *“Measuring the Power Transmitted Through the Measurement Patchcord”* on page 191 respectively.

This gives the following two equations:

$$E_{Ref} = a_{Ref}P_{src} \quad (13)$$

$$E_{Meas} = a_{Meas}P_{src} \quad (14)$$

If we divide equation 11 by equation 12, this gives the following equation:

$$\frac{E_{Ref}}{E_{Meas}} = \frac{a_{Ref}}{a_{Meas}} \quad (15)$$

The loss variation, ΔL , due to exchanging the reference cable for the measurement cable is given by:

$$\Delta L = -10 \log \frac{a_{Ref}}{a_{Meas}} = -10 \log \frac{E_{Ref}}{E_{Meas}} \quad (16)$$

When you enter a value for the Front Panel Delta, $\langle FPDelta \rangle$, the instrument automatically performs the following calculation:

$$RL = RL_{DUT} + 2\Delta L \quad (17)$$

Calculating the Insertion Loss of the DUT

Insertion Loss is explained in “*What is Insertion Loss?*” on page 165.

To measure the insertion loss you must measure the power transmitted through the measurement cable, see “*Measuring the Power Transmitted Through the Measurement Patchcord*” on page 191 and the power transmitted through the DUT, see “*Measuring the Power Transmitted Through the DUT*” on page 192.

The equation below gives the insertion loss of the DUT, IL_{DUT} :

$$IL_{DUT} = -10 \log \frac{E_{ii}}{E_{Meas}} \quad (18)$$

8

Setting Attenuation and/or Power Levels

This chapter explains how to use the Agilent 8163A/B Lightwave Multimeter, Agilent 8164A/B Lightwave Measurement System, or Agilent 8166A/B Lightwave Multichannel System together with the 8157xA family of Variable Optical Attenuator modules to attenuate and control optical power in single-mode optical fibers.

Here you will find:

- A brief description of the modular Agilent 8157xA Variable Optical Attenuator family,
- A description of how to use these modules, including applying an attenuation factor, setting an output power, applying offset factors, constructing a table, and (for the 81576A and 81577A) using the power control feature.

Agilent 8157xA Variable Optical Attenuator modules . .	198
How to Use a Variable Optical Attenuator module	199
The User Interface	199
How to Control the Shutter	202
How to Set Attenuation	203
How to Set a Power Level	207
How to Compensate for Wavelength Dependencies in your test setup	212
How to Use the Power Control Feature	216
Attenuator Menu Options	217
Attenuator Status Indicators	218

Agilent 8157xA Variable Optical Attenuator modules

The Agilent 8157xA Variable Optical Attenuator family includes three attenuator modules and two attenuator modules with power control.

Table 13 The Agilent 8157xA Variable Optical Attenuator family

Module	Description
81570A	high power, single slot, straight connectors
81571A	high power, single slot, angled connectors
81573A	high power, single slot, SMF pigtail
81576A	high power, dual slot, power control, straight connectors
81577A	high power, dual slot, power control, angled connectors
81578A	high power, single slot, multimode

The 81570A, 81571A, 81573A and 81578A single-slot modules offer a small footprint, high resolution and low insertion loss. They also offer high power handling and a filter technology that is wavelength flat.

The 81576A and 81577A dual-slot modules incorporate a powermeter so that you can set the output power level of the attenuator directly. In addition, these modules feature power control functionality, high power handling and a filter technology that is wavelength flat.

Figure 118 shows how a signal from a photo-diode after a monitor coupler is used as an active feedback loop.

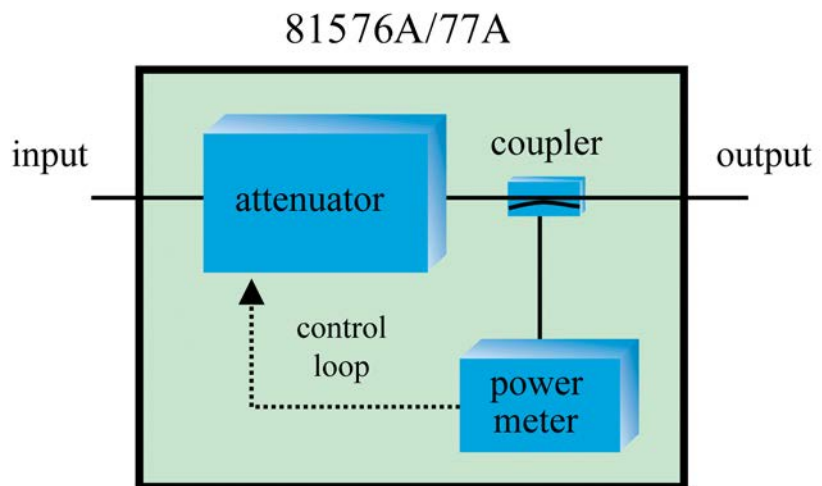

Figure 118 81576A/77A Attenuator module power control loop

How to Use a Variable Optical Attenuator module

The User Interface

The Overview Display

Figure 119 is an Overview screen taken from an 8164A/B mainframe.



Figure 119 81570A/71A/73A Attenuator module, 8164A/B GUI Overview

Here:

- Slot 1 hosts a tunable laser,
- Slot 2 hosts an 81570A/71A/73A Attenuator module,
- Slot 4 hosts a reference powermeter.

Hosting a Reference Powermeter

A reference powermeter is used to calibrate for losses in the optical test setup. The Agilent 81576xA Variable Optical Attenuator modules' user interface includes features that allow quick and easy calibration if the reference powermeter is hosted by the same mainframe as the Attenuator module.

- If the Attenuator module is not hosted by the same mainframe, the calibration can be done manually by entering the offset value and reference power level.

- If the Attenuator module and the reference powermeter are not hosted by the same mainframe, but the mainframes are connected via a GP-IB bus to a PC or host computer, GP-IB commands can be used to perform the calibration steps. The procedures used are outlined in our Application Note 5988-3159EN : “Variable Optical Attenuator in BER Test Applications”.

The Attenuator Details Display

To display the full user interface for the Attenuator module, as shown in Figure 120 , use the Cursor key to highlight the Attenuator slot, then press the [Details] softkey:

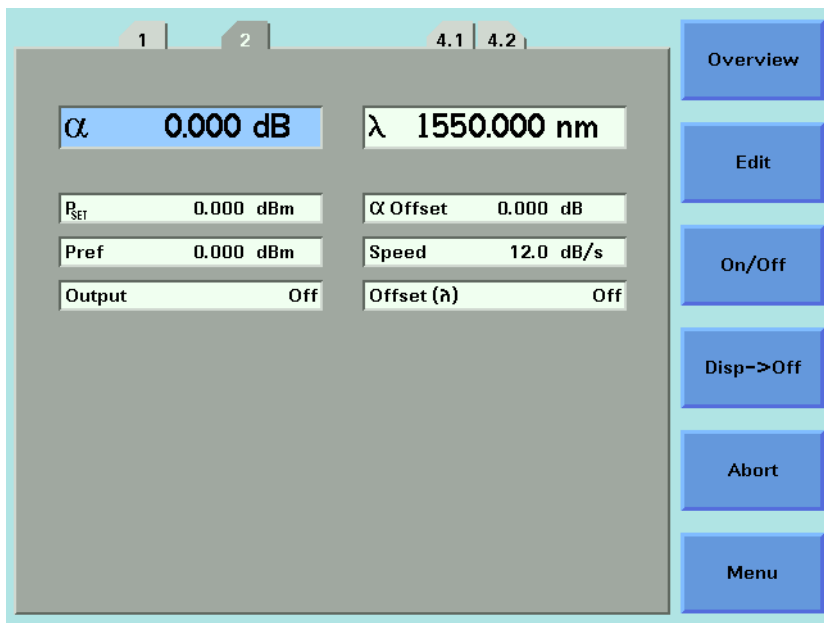

Figure 120 81570A/71A/73A Attenuator module, 8164A/B GUI Details

Screen Elements

All the figures in this chapter are taken from an 8164A/B mainframe. The user interface for an 8163A, 8163B, 8166A or 8166B mainframe may display fewer elements. Use the equivalent menu selection instead.

Number of Digits displayed

To select the number of significant decimal places displayed:

- 1 Press the [Menu] softkey.
- 2 Use the Cursor key to highlight *<Number of Digits>*, then press *Enter*.
- 3 Select *<1>*, *<2>*, *<3>* or *<4>*.
- 4 Press [OK], then press [Close].

Power Units

To select the units used to display power values:

- 1 Use the Cursor key to highlight a power parameter (P_{set} or P_{ref}), then press the [Pwr Unit] softkey.
- 2 Select *<W>* or *<dBm>*.
- 3 Press [OK].

The menu item *<Power Unit>* is functionally equivalent to the [Pwr Unit] softkey.

How to Control the Shutter

The optical path of the Attenuator module is controlled by a shutter, which you can use both for protection purposes or to simulate channel drops.

When the shutter is open, the green LED on the attenuator module's front panel is lit.

The Enable button

Press the *Enable* button, located on the front panel of the Attenuator module, to toggle the shutter state.

The On/Off Softkey

Press the [On/Off] softkey to toggle the shutter state.

The menu item *<Output State>*, and the parameter [Output], is functionally equivalent to the [On/Off] softkey.

Output at Startup

To select the shutter state at startup:

- 1 Press the [Menu] softkey.
- 2 Use the Cursor key to highlight *<Output at Startup>*, then press *Enter*.
- 3 Select *<Off>* or *<On>*.
- 4 Press [OK], then press [Close].

Remote Interlock

The Attenuator module's shutter state is protected by mainframe's Remote Interlock (RIL) feature. The shutter cannot be opened if the 50Ω resistor is removed from the RIL connector on the back panel of the mainframe. See "The Remote Interlock (RIL) connector" on page 311.

How to Set Attenuation

Before applying an attenuation factor, set the Attenuator module to the appropriate wavelength.

8157xA modules

The instrument utilizes a filter technology with a very low wavelength dependence. Nevertheless, for the best possible accuracy:

- If the source is of a particular wavelength, set the Attenuator module to that wavelength.
- If the source is a multi-wavelength DWDM signal, set the Attenuator module to the weighted wavelength of the spectrum.

Figure 121 shows an attenuation factor α of 4.000 dB applied to a 1550nm source.

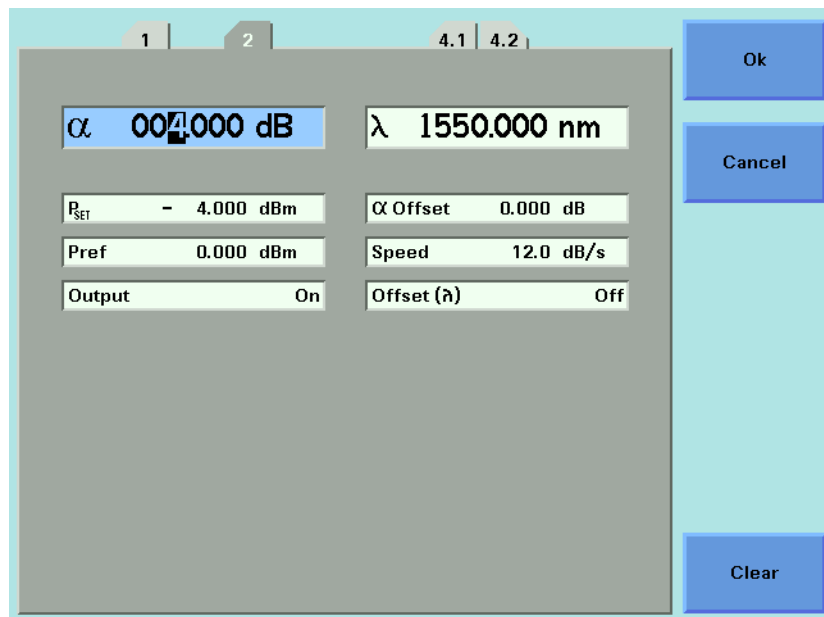

Figure 121 Attenuation factor set to 4.000 dB

To apply an attenuation factor:

- 1 Use the Cursor key to highlight the λ parameter, then press [Edit]
- 2 Use the Cursor key to enter the appropriate wavelength, in nm.
- 3 Press [OK].

- 4 Use the Cursor key to highlight the α parameter, then press [Edit].
- 5 Use the Cursor key to enter the required attenuation factor, in dB.
- 6 Press [OK].

Filter Transition Speed

By default, the Attenuator's filter transitions to a new α setting as quickly as possible. If your test setup requires a slower filter transition speed, press [Menu], then select the *<Speed>* option. Select a speed between 0.1 and 12 dB/s, then press [OK].

While the Attenuator module is transitioning to a new setting, its status is shown as 'B' (or 'Busy').

NOTE

Using very slow speeds may block this attenuator channel for several minutes.

How to Apply an Attenuation Offset

Attenuating an input signal to a DUT introduces additional connectors and other components into your optical test setup. An attenuation offset is typically applied to calibrate for the intrinsic insertion loss of these components. First you measure this insertion loss using a reference powermeter, then you compensate by entering the result into the Attenuator module's α_{Offset} parameter.

81570A/71A/73A/78A modules

- 1 Set the reference powermeter's λ parameter to the appropriate wavelength, its *<Power Unit>* to dB, and to an appropriate measurement *<Averaging Time>*.
- 2 Use a patchcord to connect the source output to the reference powermeter.
- 3 Press the powermeter's [Disp -> Ref] softkey. Power is now measured relative to this reference value, so the powermeter displays 0.000 dB.
- 4 Set the Attenuator module's λ parameter to the appropriate wavelength. Set the Attenuator module's α parameter, the attenuation factor, to 0.000 dB.
- 5 Connect the source output to the Attenuator module input.
- 6 Use another patchcord to connect the Attenuator module output to the reference powermeter input.
- 7 Note the insertion loss measurement displayed by the powermeter.
- 8 Select the details screen for the Attenuator.
- 9 Use the cursor key to select the α_{Offset} parameter, then press [Edit].

- 10** Use the cursor key to enter the insertion loss measured at [Step 7](#), then press [OK].
- 11** Disconnect the patchcord from the reference powermeter and connect it to the DUT input.

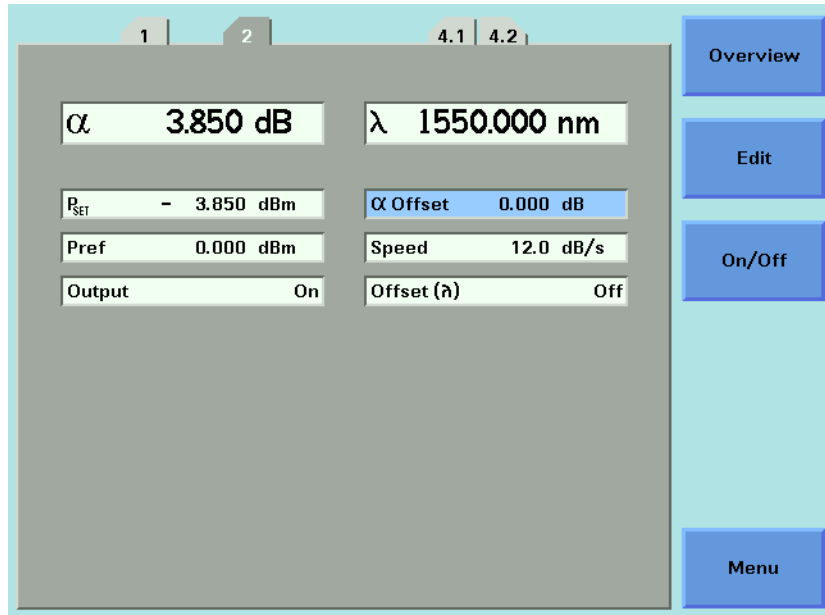

Figure 122 81570A/71A/73A - Attenuation factor applied with no offset

Figure 122 shows an attenuation factor α of 3.850 dB applied with no α_{Offset} .

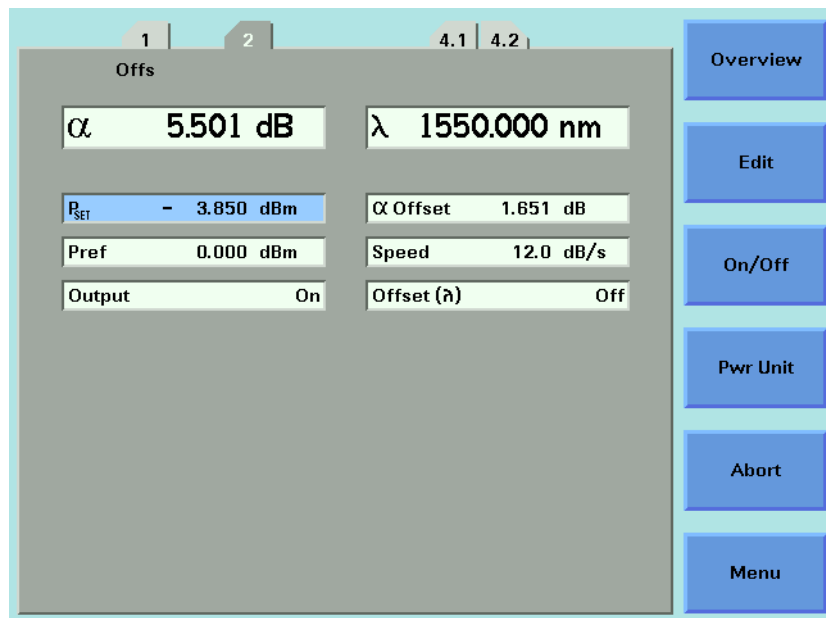

Figure 123 81570A/71A/73A Attenuation Offset

Figure 123 shows an α_{Offset} of 1.651 dB 'added in' to the attenuation factor α to calibrate for intrinsic insertion losses in the test setup.

815676A/77A modules

The [PM -> Off] softkey offered by the α_{Offset} parameter is functionally equivalent to the [PM -> Off] softkey offered by the P_{Offset} parameter. You can use the [PM -> Off] softkey to offset the difference between the power measured by the internal powermeter and your reference powermeter, as described "Calibrating Test Setups that use an 81576A/77A Attenuator module" on page 209.

- When the α_{Offset} parameter is selected, [PM -> Off] writes to α_{Offset}
- When the P_{Offset} parameter is selected, [PM -> Off] writes to P_{Offset}

These functions are mathematically identical.

Neither function is a measurement of total intrinsic insertion loss as described in "81570A/71A/73A/78A modules" on page 204, since the insertion loss of the Attenuator module itself is not included.

The Dsp -> Off softkey

For all Attenuator modules, the [Dsp -> Off] softkey offered by the α parameter copies the negative of the current value of α into α_{Offset} . The α field now displays zero, and 'Offs' is displayed to show that the offset has been applied.

You can now set the α parameter relative to α_{Offset} .

How to Set a Power Level

Single-wavelength signals

Set the λ parameters to the wavelength of the source.

You can edit P_{SET} to set the power output of the Attenuator directly.

Multi-wavelength DWDM signals

If you wish to set the output power of a multi-wavelength DWDM signal, use an 8157xA Attenuator module (rather than a now discontinued 8156xA Attenuator module) since these modules include a filter with minimum wavelength dependency.

The 81576A and 81577A modules incorporate a powermeter whose responsivity varies over wavelength. The module-specific response data is accessible via a computer interface, so an effective wavelength $\lambda_{\text{effective}}$ for your input signal's optical spectrum can be determined most readily, but not exclusively, by using the hp816x VXI PnP Spectral Calibration function (hp816x_spectralCalibration).

Refer to:

- Measuring the Dependence of Optical Amplifiers on Input Power Using an Attenuator. Application Note. Agilent Technologies publication number 5988-5260EN.
- Agilent 8163A/B Lightwave Multimeter, Agilent 8164A/B Lightwave Measurement System, and Agilent 8166A/B Lightwave Multichannel System, Programming Guide, part number 08164-90B63 (or a later edition).

NOTE

For accurate power measurements, the simple weighted wavelength of a multi-wavelength DWDM signal is insufficient.

Calibrating Test Setups that use an 81570A/71A/73A/78A Attenuator module

Requirement for Calibration

P_{SET} is a relative measurement that is meaningful only after your test setup has been calibrated against a reference powermeter.

Preconditions

- To make the calibration as quick and simple as possible, host your reference powermeter in the same mainframe as the Attenuator module, as described in “Hosting a Reference Powermeter” on page 199.
- Before taking a power measurement, make sure the source is warmed up so that its power output is stable.
- It is good practice to zero the reference powermeter before calibrating your test setup. Refer to “How to Remove Electrical Offsets” on page 91.

Calibration Procedure

To calibrate a test setup that utilizes an 81570A/71A/73A/78A Attenuator module, first measure the power applied by your test set up to the DUT input, then store this value as the Attenuator’s P_{ref} parameter.

After calibration, you edit the Attenuator’s P_{SET} parameter to set the power applied to the DUT.

- 1 Disconnect the DUT input in your test setup and connect it to your reference powermeter.
 - Set the λ parameter for the reference powermeter to the source wavelength or, for a multi-wavelength DWDM signal, the effective wavelength $\lambda_{effective}$
 - Set an appropriate measurement *<Averaging Time>*.
- 2 Display the details screen for the Attenuator module.

Make sure the λ parameter set for the Attenuator module matches the source wavelength or, for a multi-wavelength DWDM signal, $\lambda_{effective}$.
- 3 If the reference powermeter is hosted by the same mainframe as the Attenuator module:
 - Select the P_{ref} field,
 - Press the [PM-> ref] softkey,
 - Select the channel used to host your reference powermeter,
 - Press [OK].

The power value measured by your reference powermeter is copied to the Attenuator and stored as P_{ref} .
- 4 If the reference powermeter is hosted by another mainframe:
 - Manually enter the value of P_{ref} such that P_{SET} equals the power value measured by your reference powermeter.
- 5 Disconnect the input to the reference powermeter, then connect it to the DUT input.

- 6 Edit the P_{SET} parameter to set the power applied to the DUT.

The attenuation, α , displayed is updated to reflect the new P_{SET} value.

NOTE

Your calibration is valid until there is some change to the power applied to the input of the Attenuator module. For example, if you change the optical path to the Attenuator module, you must recalibrate.

For a multi-wavelength DWDM signal, your determined effective wavelength $\lambda_{\text{effective}}$ is valid until there is some change to the signal's optical power vs wavelength spectrum.

Calibrating Test Setups that use an 81576A/77A Attenuator module

Requirement for Calibration

81576A/77A Attenuator modules with Power Control incorporate a powermeter that allows you to control the output power level of the module. After calibration for the losses in the patchcords and connectors between this output and the DUT input, you can set absolute power levels at the DUT input.

Furthermore, when the Attenuator's Power Control feature is enabled, the Attenuator module automatically corrects for power changes at its input to maintain your desired output power.

Preconditions

- To make the calibration as quick and simple as possible, host your reference powermeter in the same mainframe as the Attenuator module, as described in "Hosting a Reference Powermeter" on page 199.
- Before taking a power measurement, make sure the source is warmed up so that its power output is stable.
- It is good practice to zero the powermeters in your test setup. Refer to "Hosting a Reference Powermeter" on page 199.
- To zero the powermeter incorporated in the Attenuator module, press [Menu], then select <Zero>.
- To zero all the powermeters hosted by the same mainframe as the Attenuator module (including the Attenuator module and, for example, the powermeter incorporated in a return loss module), press [Menu], then select <Zero All>.

- To set the measurement Averaging Time used by the powermeter incorporated in the Attenuator module, press [Menu] , select <Averaging Time>, press [OK], select your preferred Averaging Time, press [OK], then press [Close].

As with any powermeter, a longer Averaging Time increases accuracy and noise rejection, but increases response time.

Calibration Procedure

The power level measured by the integrated powermeter at the output of the module is displayed as P_{actual} . To calibrate your test setup, you apply a P_{Offset} to calibrate for the patchcord and connector losses that occur between the Attenuator module output and the DUT input.

After calibration, you edit the Attenuator's P_{SET} parameter to control the absolute power applied to the DUT.

- 1 Disconnect the DUT input in your test setup and connect it to your reference powermeter.
 - Set the λ parameter for the reference powermeter to the source wavelength or, for a multi-wavelength DWDM signal, the effective wavelength $\lambda_{\text{effective}}$. Refer to "Multi-wavelength DWDM signals" on page 207.
 - Set an appropriate measurement <Averaging Time>.
- 2 Display the details screen for the Attenuator module.
 - Make sure the λ parameter set for the Attenuator module matches the source wavelength or, for a multi-wavelength DWDM signal, $\lambda_{\text{effective}}$.
 - Make sure that the Averaging Time set for the integrated powermeter matches that set for the reference powermeter.
- 3 If the reference powermeter is hosted by the same mainframe as the Attenuator module:
 - Select the P_{Offset} field,
 - Press the [PM-> Off] softkey,
 - Select the channel used to host your reference powermeter,
 - Press [OK].

The difference between the power level measured by your reference powermeter and the power value measured by your Attenuator P_{actual} is stored by the Attenuator module as P_{Offset} , then applied to P_{SET} and P_{actual} .

- 4 If the reference powermeter is hosted by another mainframe:
 - Manually enter the value of P_{Off}
 - $P_{\text{Off}} = P_{\text{actual}} - P_{\text{ref}}$
 - where P_{ref} is the power level measured by your reference powermeter.
- 5 Disconnect the input to the reference powermeter, then connect it to the DUT input.

- 6 Edit the P_{SET} parameter to control the absolute power applied to the DUT. The attenuation, α , displayed is updated to reflect the new P_{SET} value.

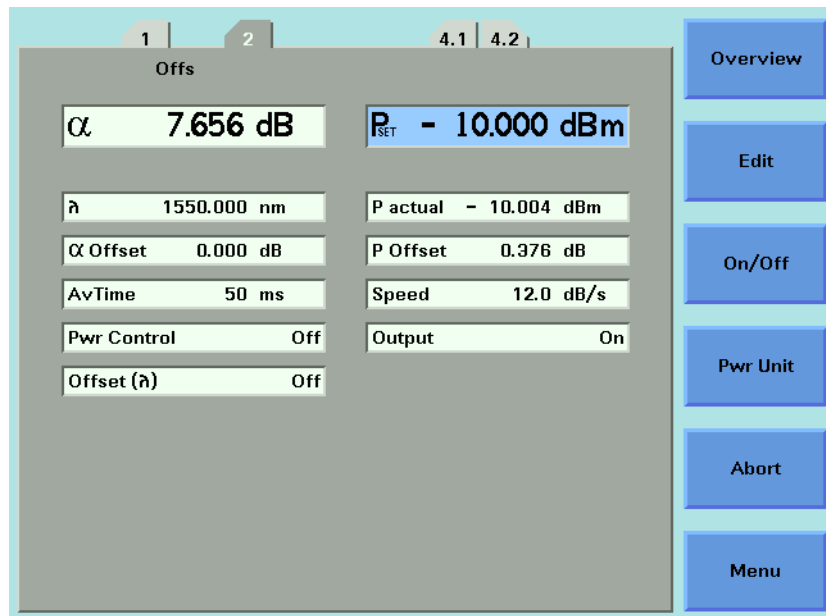

Figure 124 81576A/77A Setting P_{SET} after calibration using [PM->Off]

Figure 124 shows an absolute power P_{SET} of -10 dBm applied to a DUT. Here:

- A power offset P_{Offset} of 0.376 dB is applied to calibrate for losses between the Attenuator and the DUT.
- An attenuation factor α of 7.656 dB is applied by the Attenuator's filter.

NOTE

Your calibration is valid until there is some change to the optical path between the Attenuator module and your DUT. Changes to the power applied to the input of the Attenuator module are detectable by the integrated powermeter.

For a multi-wavelength DWDM signal, your determined effective wavelength $\lambda_{effective}$ is valid until there is some change to the signal's optical power vs wavelength spectrum.

If either too much, or too little, input power is applied for the Attenuator to maintain your desired P_{SET} , the Attenuator status display includes 'Exp'.

Refer to "How to Use the Power Control Feature" on page 216 for information about compensating for changes in input power.

How to Compensate for Wavelength Dependencies in your test setup

To allow you to compensate for wavelength dependencies in your test setup, your attenuator module can store an array of up to 1000 wavelength : Offset pairs in a λ Offset Table.

How to Apply a λ Offset Table

Select the [*Offset (λ)*] parameter to enable or disable the Wavelength Offset Table <On> or <Off>.

The Menu item <*Offset (λ)*> is functionally equivalent to the [*Offset (λ)*] parameter.

Editing the λ Offset Table

If you have previously characterized the output path:

- 1 Press the [Menu] softkey.
- 2 Set <*Offset (λ)*> to <off>.

You cannot edit the λ Offset Table if the Offset (I) function is on.

- 3 Press the [Table] softkey (or select the Menu item <*Offset Table*>)
 - For an 8164A/B mainframe, the first three λ Offset Table entries are displayed.
 - For an 8163A/B mainframe, or an 8166A/B mainframe, the first λ Offset Table entry is displayed.

If there are no entries, the message "Offset Table is Empty" is displayed.

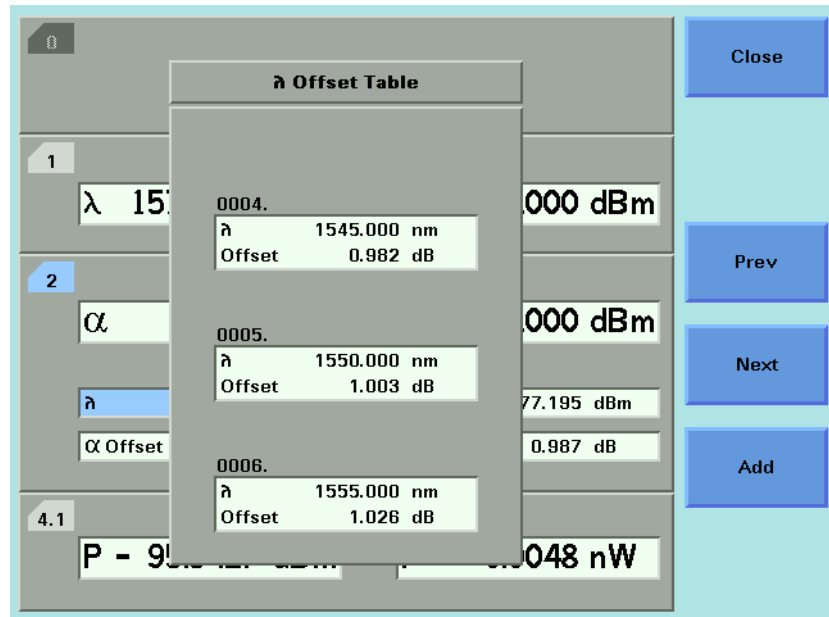

Figure 125 The λ Offset Table

Figure 125 shows the fourth, fifth and sixth entries in a λ Offset Table displayed on an 8164A/B mainframe.

- To display the previous three entries, press the [Prev] softkey.
- To display the next three entries, press the [Next] softkey.

4 Press the [Add] softkey.

- Enter the wavelength λ .
- Select, then enter the corresponding Offset

5 Press [OK] to store the result in the λ Offset Table.

- The λ Offset Table is automatically ordered by wavelength, there is no need to enter wavelength:offset pairs in any particular order.
- To edit the offset applied to an existing entry, use the cursor key to select its λ field, press [Add], enter the new offset, then press [OK].
- To remove an existing entry, use the cursor key to select its λ field, then press [Del]. The indices of the remaining table entries are automatically updated; [Del] does not leave a blank entry.

How to Construct a λ Offset Table

The procedures used to store the results of wavelength calibration process using GP-IB commands are outlined in our Application Note 5988-3159EN : “Variable Optical Attenuator in BER Test Applications”.

For simplicity, the following manual procedure assumes your reference powermeter is hosted by the same mainframe as the Attenuator module, as described in “Hosting a Reference Powermeter” on page 199.

For each wavelength of interest:

- 1 Set the source to the wavelength of interest.
- 2 Set the attenuator’s λ parameter to this wavelength.
- 3 Set the reference powermeter to this wavelength.
- 4 Press the [Menu] softkey.
- 5 Set <Offset (λ) > to <off >.

You cannot edit the I Offset Table if the Offset (I) function is on.

- 6 Press the [Table] softkey (or select the Menu item <Offset Table>)
- 7 Press the [Add] softkey.
 - Enter the wavelength λ .
 - Select <Offset>
 - Press the [PM -> off] softkey.
 - Select the channel used to host the reference powermeter.
 - Press [OK] to confirm.

The difference between the power measured by the Attenuator module’s integrated powermeter and that measured by the reference powermeter is stored in the I Offset Table as a wavelength:Offset pair.

- 8 Press [OK] to store the result in the λ Offset Table.
- 9 Press [Close].

NOTE

If your Attenuator module is not hosted by the same mainframe as your reference powermeter you can, at step 7, enter the appropriate Offset manually.

During a test that utilizes the λ Offset Table

When the Offset (λ) feature is on the exact offset applied depends on how the operating wavelength λ you set for the Attenuator module relates to the λ Offset Table entries, as shown in Figure 126 .

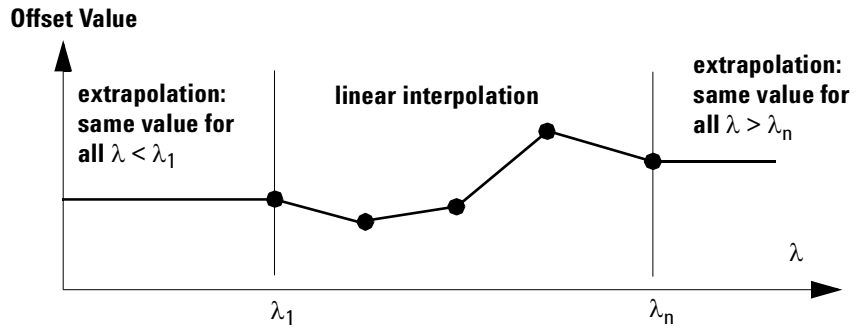

Figure 126 Extrapolation and Interpolation of Offset Values

- If the operating wavelength matches a wavelength stored in the λ Offset Table, the exact offset value is used. The Attenuator status display includes 'Exa'.
- If the operating wavelength is between two wavelengths stored in the λ Offset Table, the offset applied is calculated by linear interpolation. The Attenuator status display includes 'Int'.
- If the operating wavelength is greater than, or less than, the range of wavelengths stored in the λ Offset Table, the offset value for the closest wavelength is extrapolated. The Attenuator status display includes 'Ext'.

How to Use the Power Control Feature

81576A/77A Attenuator modules incorporate Power Control functionality that automatically corrects for power changes at its input to maintain your desired output power.

This feature is designed to compensate, for example, for output power drift by the source.

When Power Control is On:

- If P_{actual} deviates by more than 0.1 dB from your desired P_{SET} value, the Attenuator module automatically restores P_{SET} at the maximum possible filter transition speed of 12 dB/s.
- Input power is measured using your set Averaging Time.
- To avoid ‘hunting’, and consequent wear on the filter motor mechanism in response to an unstable source, for differences between P_{SET} and P_{actual} greater than 0.01 dB, but less than 0.1 dB, P_{SET} is updated approximately every 30 s.
- The Attenuator module does not respond to a power difference of 0.01 dB or less. Such a change is regarded as noise.
- If the attenuation is driven beyond 0 dB, Exp (“Excessive Power”) is displayed. There is now insufficient input power for the Attenuator to maintain your desired P_{SET} .

Power Control On/Off

To enable or disable Power Control, select the [*Pwr Ctrl*] parameter.

When Power Control is On the Attenuator’s status display includes ‘PC’.

The Menu item <*Pwr Control*> is functionally equivalent to the [*Pwr Control*] parameter.

Attenuator Menu Options

81570A/71A/73A Menu Options

Press the [Menu] softkey to display the window shown in Figure 127 .



Figure 127 81570A/71A/73A Attenuator Menu Options

81576A/77A Menu Options

Press the [Menu] softkey to display the window shown in Figure 128 :

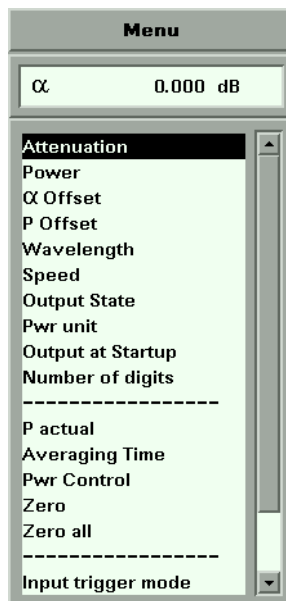

Figure 128 81576A/77A Attenuator Menu Options

- Use the Cursor key to scroll to two additional options: *<Offset (λ)>*, and *<Offset Table>*.
- The *<P actual>*, *<Averaging Time>*, *<Zero>*, *<Zero all >*, and *<Input trigger mode>* options are associated with the Attenuator's integrated powermeter.
- For more information about the *<Input trigger mode>* option, refer to "How to Use Triggers" on page 104.

Attenuator Status Indicators

Table 14 Attenuator Status Indicators

Status Indicator	Description
B (or Busy)	The Attenuator's filter is transitioning to a new setting.
Offs	Any combination of an α offset, P offset, or Offset(λ) has been applied.
Exa	An exact λ offset has been applied.
Int	An interpolated λ offset has been applied.
Ext	An extrapolated λ offset has been applied.
PC	The Power Control feature is on (81576A/77A)
Exp (81566A/67A/76A/ 77A only)	There is either too much, or too little, input power for the Attenuator module to set or maintain your desired P_{SET} .
RiL	The Remote Interlock Connector of your mainframe is open. No measurement is possible until the connection at the Remote Interlock Connector closes.

9

Switching Optical Routes

This chapter explains how to use the Agilent 8163A/B Lightwave Multimeter, Agilent 8164A/B Lightwave Measurement System, or Agilent 8166A/B Lightwave Multichannel System together with the 8159xB family of Optical Switch modules to change optical routes during a test without having to disconnect and reconnect fibers.

Here you will find:

- A brief description of the modular Agilent 8159xB Optical Switch family,
- Some examples of typical test configurations that utilize these Optical Switch modules.

Agilent 8159xB Optical Switch modules	220
How to Use an Optical Switch module	221
The User Interface	221
Dependent and Independent Routing	223
How to set Route A	224
How to set Route B	224
How to Toggle the Switch path	225
Typical Applications	226
Selecting a Laser Source	226
Selecting Measurement and Calibration Paths	227
Inserting or Bypassing an Optical Component	227
Selecting one of several DUTs in a parallel test setup	228
Selecting one of several instruments	228

Agilent 8159xB Optical Switch modules

The Agilent 8159xB Optical Switch family includes 1x2 Switch modules, 2x2 Switch modules, and 1x4 Switch modules. The switches are available in single-mode version (option 009) with angled 9/125 μm FC/APC connector interface or multimode version (option 062) with straight 50/125 μm FC/PC connector interface.

The discontinued 81591A, 81591S, 81592A, 81592S, 81594A, 81594S, and 81595A, 81595S are fully supported by the Agilent 816xA/B mainframes.

Table 15 The Agilent 8159xB Optical Switch family

Module	Description
81591B	Optical Switch, 1x2
81594B	Optical Switch, 2x2 non-blocking (crossover)
81595B	Optical Switch, 1x4

Options

Option 009:

Single-mode 9/125 μm , fixed FC/APC connector interfaces.

Option 062:

Multimode 50 (62.5)/125 μm , fixed FC/PC connector interfaces.



Figure 129 Agilent 81594B Optical Switch module (1x4, angled contact connectors)

How to Use an Optical Switch module

The User Interface

The Overview Display

Figure 130 is an Overview screen taken from an 8164A/B mainframe.

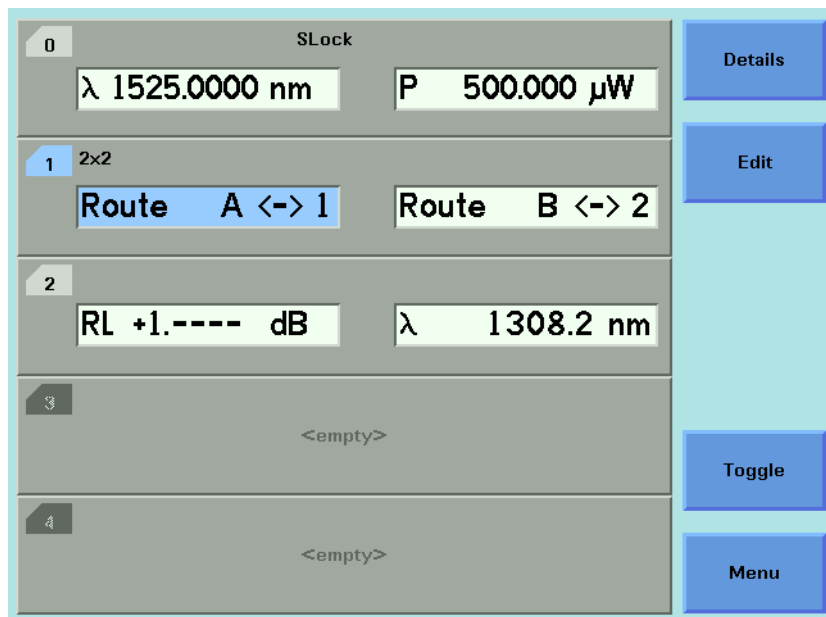

Figure 130 Optical Switch module, User Interface Overview display

Here:

- Slot 0 hosts a backloadable tunable laser,
- Slot 1 hosts an Agilent 81594B 2x2 non-blocking (crossover) switch,
- Slot 2 hosts a return loss module.

The Optical Switch Details Display

To display the full user interface for the Optical Switch module, as shown in Figure 131, use the Cursor key to highlight the Optical Switch slot, then press the [Details] softkey:

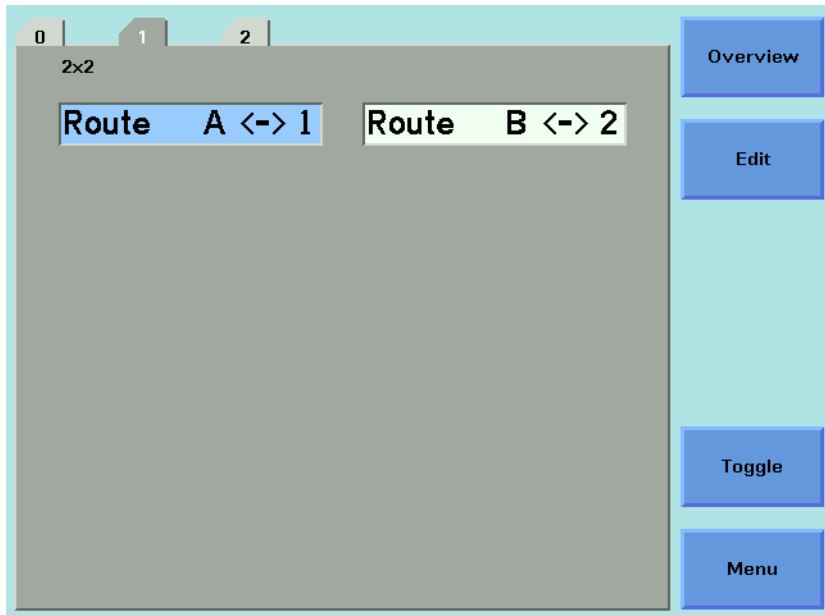

Figure 131 Optical Switch module, 8164A/B User Interface Details

Screen Elements

All the figures in this chapter are taken from an 8164A/B mainframe. The user interface for an 8163A, 8163B, 8166A or 8163B mainframe may differ in detail but the available functionality is identical.

Configuration

The Optical Switch configuration is indicated at the top left of the user interface.

In Figure 131, 2x2 indicates that this is an Agilent 81594B 2x2 non-blocking (crossover) switch.

Route

The [*Route A <->*] field describes the route between port A and another numbered port within the Optical Switch module.

If present, the [*Route B <->*] field describes the route between port B and another numbered port within the Optical Switch module.

In Figure 131 :

- The [*Route A <->*] field shows that, within the Optical Switch module, port A is connected to port 1.
- The [*Route B <->*] field shows that, within the Optical Switch module, port B is connected to port 2.

NOTE

For all switch modules the signal paths are bi-directional.

Dependent and Independent Routing

Dependent Routing

If Route A <-> is dependent on Route B <->, editing the number of the port assigned to Route A <-> automatically updates the number of the port assigned to Route B <->.

For example, an Agilent 81594B 2x2 non-blocking (crossover) switch has two routes described by [*Route A <-> 1*] [*Route B <-> 2*] and [*Route A <-> 2*] [*Route B <-> 1*].

Independent Routing

(Only possible for discontinued 81592A/S switch modules)

If Route A <-> is independent of Route B <->, there are two separate switched channels. There are two numbered ports that you can assign to Route A, and two separate numbered ports that you can assign to Route B.

For example, an Agilent 81592B dual 1x2 switch allows you to switch Route A <-> to [*Route A <-> 1*] or [*Route A <-> 2*], and Route B <-> to [*Route B <-> 1*] or [*Route B <-> 2*].

How to set Route A

To switch the route between port A and another numbered port:

- 1 Use the Cursor key to highlight [*Route A <->*], then press *Enter*.
- 2 Use the Cursor key to enter the number of the port required.

If the Switch module incorporates independent routing, you cannot select a numbered port assigned to port B.

- 3 Press [OK].

If the switch module has dependent routing, [*Route B <->*] is updated automatically.

The [Edit] softkey is functionally equivalent to the *Enter* hardkey.

The [Menu] softkey allows you to assign a route for port A and port B in turn.

How to set Route B

To switch the route between port B and another numbered port:

- 1 Use the Cursor key to highlight [*Route B <->*], then press *Enter*.
- 2 Use the Cursor key to enter the number of the port required.

If the Switch module incorporates independent routing, you cannot select a numbered port assigned to port A.

- 3 Press [OK].

If the switch module has dependent routing, [*Route A <->*] is updated automatically.

The [Edit] softkey is functionally equivalent to the *Enter* hardkey.

The [Menu] softkey allows you to assign a route for port A and port B in turn.

How to Toggle the Switch path

You can use [Toggle] softkey, or the *Toggle* button located on the Optical Switch module front panel, to select each of the available routes for a channel in turn.

NOTE

The route selected between port A and another numbered port is indicated in the user interface and by two lit green LEDs on the front panel of the Optical Switch module.

The route selected between port B, if present, and another numbered port is indicated in the user interface, and by two lit amber LEDs on the front panel of the Optical Switch module.

Typical Applications

This section provides some examples of typical test configurations that demonstrate how an Agilent 8159xB Optical Switch module can be used to achieve test automation, and improve test repeatability.

Selecting a Laser Source

In Figure 132 , an Agilent 81591B 1x2 Optical Switch is used to select one of two different sources (different wavelengths) as the input to the DUT.

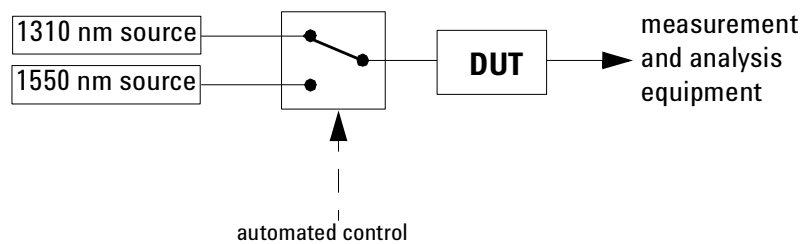

Figure 132 Laser Source selection

Selecting Measurement and Calibration Paths

In Figure 133 , an Agilent 81591B 1x2 Optical Switch is used to select between the measurement path and the calibration path.

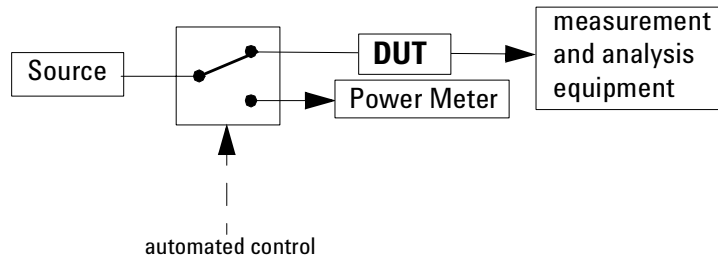

Figure 133 Measurement Path selection

Inserting or Bypassing an Optical Component

In Figure 134 , an Agilent 81594B 2x2 non-blocking (crossover) Optical Switch is used to insert or bypass a fiber spool.

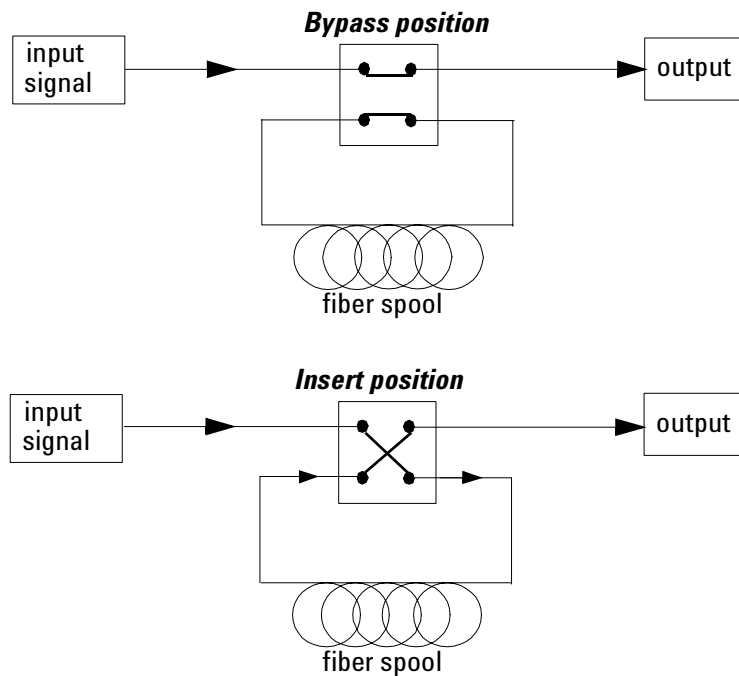

Figure 134 Circuit selection with crossover switch

Selecting one of several DUTs in a parallel test setup

In Figure 135 , two Agilent 81595B 1x4 Optical Switches are used to select one of up to four DUTs in a parallel test setup.

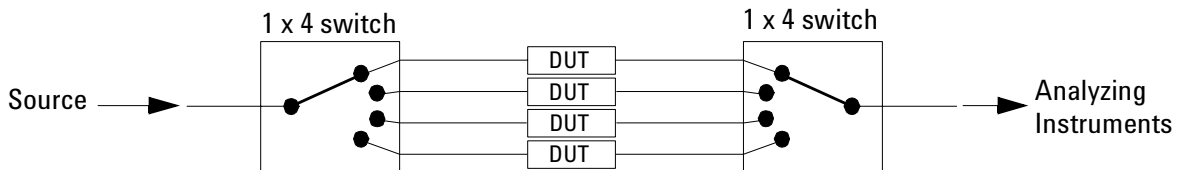

Figure 135 DUT selection in a parallel test setup

Selecting one of several instruments

In Figure 136 , an Agilent 81595B 1x4 Optical Switch is used to select one of up to four analysing instrument.

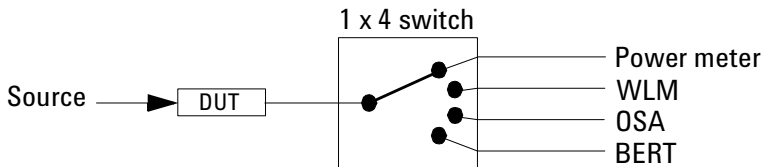

Figure 136 Test instruments selection

In each case, the advantages to be gained from using switch modules include speedier changes to the test setup, and improved measurement repeatability.

10

Applications

This chapter explains how to set up and perform the following applications using the Agilent 8163A/B Lightwave Multimeter or Agilent 8164A/B Lightwave Measurement System:

- The Logging application logs and displays power measurements. The Logging application performs measurements consecutively without the possibility of any pause between measurements.
- The Stability application logs and displays power measurements. The Stability application differs from the Logging application because:
 - you may use auto-ranging mode, and
 - the period time, the time it takes from the start of one measurement period until another measurement period starts, may be greater than or equal to the averaging time.
- The PACT application coordinates a wavelength sweep using a Tunable Laser module and power measurement using Power Meters.
- The Pmax Curve application displays the maximum power across the wavelength range of your Tunable Laser module.
- The Return Loss application can be used to measure return loss and insertion loss and to calibrate the instrument for this measurement.

NOTE

These applications are not available for the Agilent 8166A/B Lightwave Multichannel System. The Return Loss Application is only available for the Agilent 8163A/B Lightwave Multimeter.

You can access these applications by pressing the *AppI* hardkey.

NOTE

After you exit from the application, any modules that were available for use by these applications will automatically be preset, all parameters will be set to their default values.

Working with Application Graphs	231
How to Set Markers	233
How to Zoom In	233
How to Zoom Out	234
To Switch the Grid On/Off	234
How to Use Legends	235
How to Select the Samples Display	237
How to Read Curve Values	239
The Logging Application	242
How to Set Up a Logging Function	243
Running a Logging Application	248
Analysing a Logging Application	250
On-Screen Messages	253
The Stability Application	254
How to Set Up a Stability Function	256
Running a Stability Application	260
Analysing a Stability Application	262
On-Screen Messages	265
The PACT Application	266
What is the PACT ?	266
How to Set Up PACT	267
How to Measure the Reference	270
How to Perform a Loss Measurement	272
Analysing a PACT Measurement	276
On-Screen Messages	277
The Pmax Curve	278
What is the Pmax Curve ?	278
How to View the Pmax Curve	278
The Return Loss Application	279
Starting the Application	279
Measuring Return Loss	279
Measuring Return Loss and Insertion Loss	280
On-Screen Messages	280
Configuration	281
User Interface	281
Recording Measurement Results	283
Printing Application Measurement Results	283
Saving Application Measurement Results to Diskette	285

Working with Application Graphs

If you press the [Graph] softkey, a graph similar to Figure 137 appears. This section explains how to use the graph.

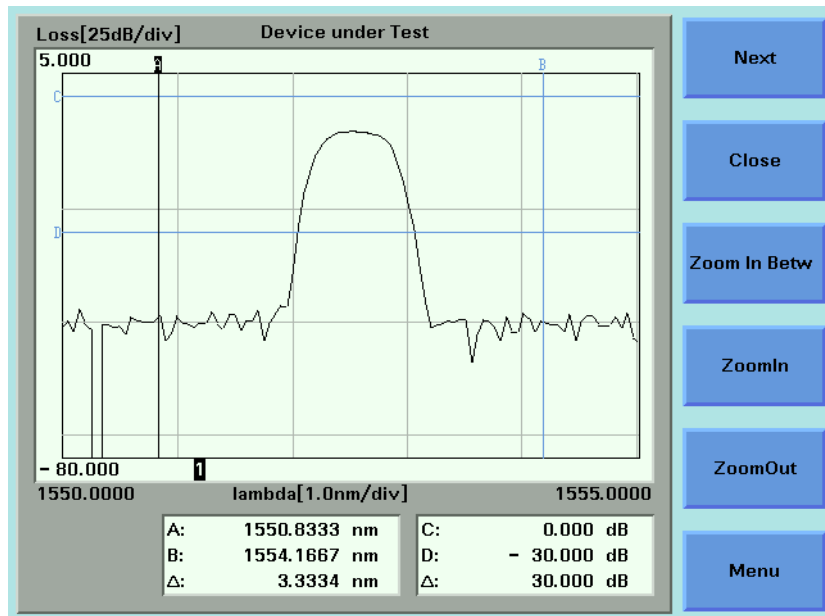

Figure 137 The Application Graph

There are four markers A, B, C, and D. You can use these markers to choose the area of the graph that you wish to zoom into.

For the Logging and Stability applications, the time values of A and B are displayed at the bottom of the screen in units of seconds. The symbol Δ that is listed directly beneath these values, displays the difference between A and B in seconds.

For the PACT application, the wavelength values of A and B are displayed at the bottom of the screen in units of nanometers (nm). The symbol Δ that is listed directly beneath these values, displays the difference between A and B in nanometers (nm).

The power values of C and D are displayed at the bottom of the screen in the chosen power units. The symbol Δ that is listed directly beneath these values, displays the difference between C and D in the chosen power units.

NOTE

As a default, the C and D markers are out of range when you first open a graph. See *“How to Set Markers” on page 233*, for more information on setting moving markers.

How to Set Markers

To position a marker:

- 1 Move to the marker by pressing [Next], the *Enter* hardkey, or the Modify Knob repeatedly until the marker is selected.
- 2 You can change the position of a marker in one of the following ways:
 - Press [Menu], move to *<Set Active Marker>*, and press *Enter*. The current setting for the selected marker appears. Edit this value to your required value and press *Enter*.
 - For A or B, use the left and right cursor keys to position the marker.
 - For C or D, use the up and down cursor keys to position the marker.
 - Use the Modify Knob to position the marker, this is quicker than using the cursor keys.

NOTE

The Modify Knob is only available for the Agilent 8164A/B Lightwave Measurement System.

How to Zoom In

To zoom in one level around the active marker:

- 1 Press the [Next] softkey until you move to your chosen marker.
- 2 Position the marker using the cursor key.
- 3 Press the [ZoomIn] softkey to zoom in one level around the active marker. In this way, you can zoom in around the active marker and the zoom function is separate for the x and y axes.

You can also zoom in between markers:

- 1 Set each marker as described above in *“How to Set Markers” on page 233*.
- 2 Press the [Zoom In Betw] softkey to zoom in between the markers.

How to Zoom Out

To zoom out one level around the active marker:

- 1 Press the [Next] softkey until you move to your chosen marker.
- 2 Position the marker using the cursor key.
- 3 Press the [ZoomOut] softkey to zoom out one level from the active marker. In this way, you can zoom out from the active marker and the zoom function is separate for the x and y axes.

To zoom out to the fullest extent:

- 1 Press the [Menu] softkey. The menu appears.
- 2 Move to <Zoom to Overview>.

To Switch the Grid On/Off

As a default, the graph is displayed with gridlines.

To switch this grid off:

- 1 Press the [Menu] softkey. The menu appears.
- 2 Move to <Grid Off>.

If the grid has been switched off, to switch the grid on:

- 1 Press the [Menu] softkey. The menu appears.
- 2 Move to <Grid On>.

How to Use Legends

Legends are used to identify Power Meter channels on the graph in the following ways:

- Legend numbers that are displayed on the graph.
- Legend texts can be accessed by pressing the [Menu] softkey and moving to *<Legend>*.

How to Identify Curves

Legend numbers can be related to the curves they represent in the following ways:

- For the Agilent 8163A/B Lightwave Multimeter the legend number is displayed at the same height as the first sample of the power measurement channel on the right-hand side of the screen.
- For the Agilent 8164A/B Lightwave Measurement System, the legend numbers are directly beneath the graph. Each number is the same colour as the curve it represents.

How to Change the Legend Label

To change the legend label:

NOTE

You cannot edit a legend label while a measurement is running.

- 1 Press the [Menu] softkey and move to *<Legend>*. A list of the Power Meter channels appears that is similar to Figure 138, where all the Power Meters are listed numerically with regard to legend number. All legend texts, if you have not previously edited the legend text, are of the "PM x.y", where x represents the slot number and y represents the channel number.

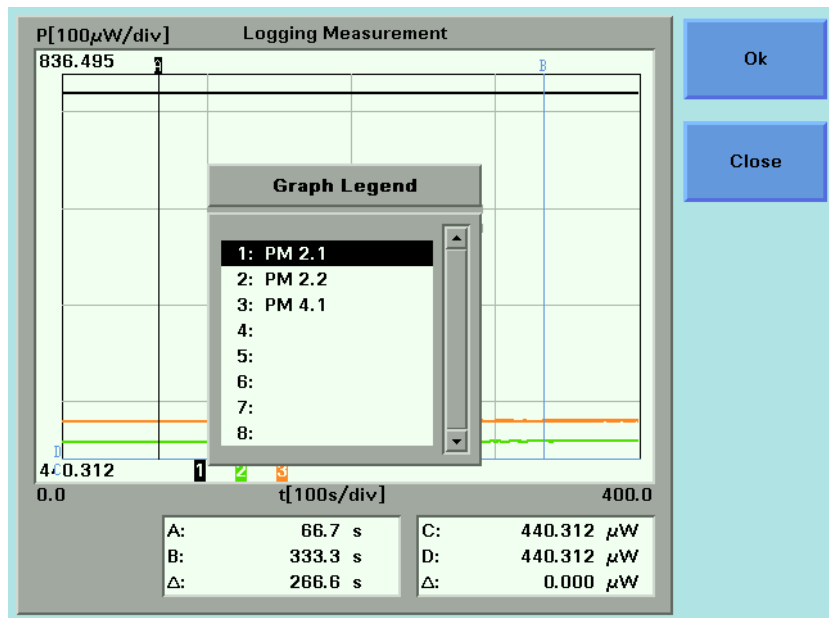

Figure 138 The Graph Legend Screen

- 2 Move to the legend number you wish to edit using the cursor keys and press *Enter*. The on-screen keyboard appears.
- 3 Use the on-screen keyboard to edit the legend label and press *Enter*.

The on-screen keyboard uses the following softkeys:

- Move to the required character using the cursor keys and press the [Select] softkey to select to add the selected character to the end of the legend label.
- Press the [Delete] softkey to delete the last character of the legend label.
- Press the [CapsLock] softkey to toggle between upper and lower case characters.
- Press the [Cancel] to reject the edited legend label and return to the menu.
- Press the [OK] to accept the edited legend label and return to the menu.

How to Select the Samples Display

The samples display determines how the curves of the graph are represented. To choose the samples display:

- 1 Press the [Menu] softkey and move to *<Samples Display>*. A box displaying the following options appears:
 - *<Line>* - the curve will be displayed using a line that connects between each sample of the curve.

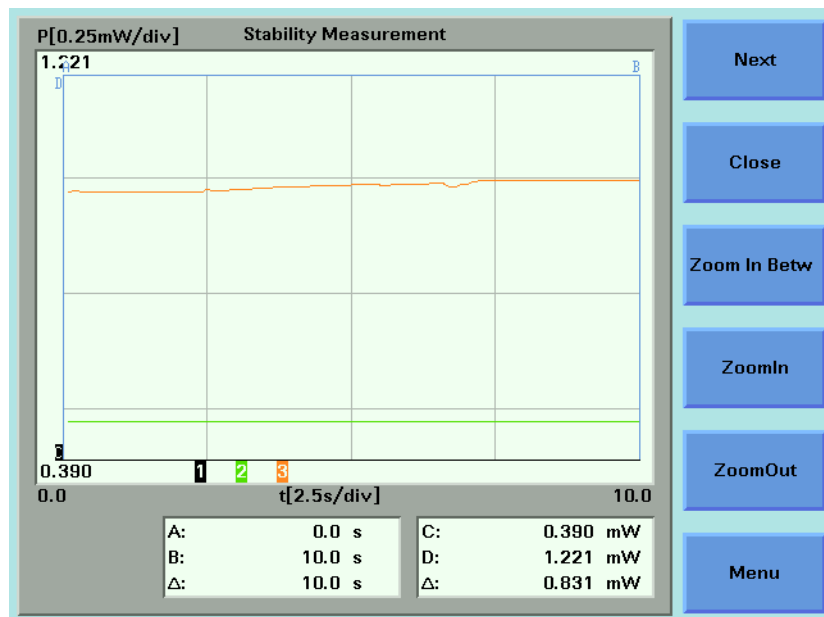

Figure 139 Samples Display - *<Line>*

- *<Samples>* - the curve will be displayed using dots to represent each sample of the curve. Depending on the zoom level you choose, if these dots are very close to each other, the curve will resemble a line.

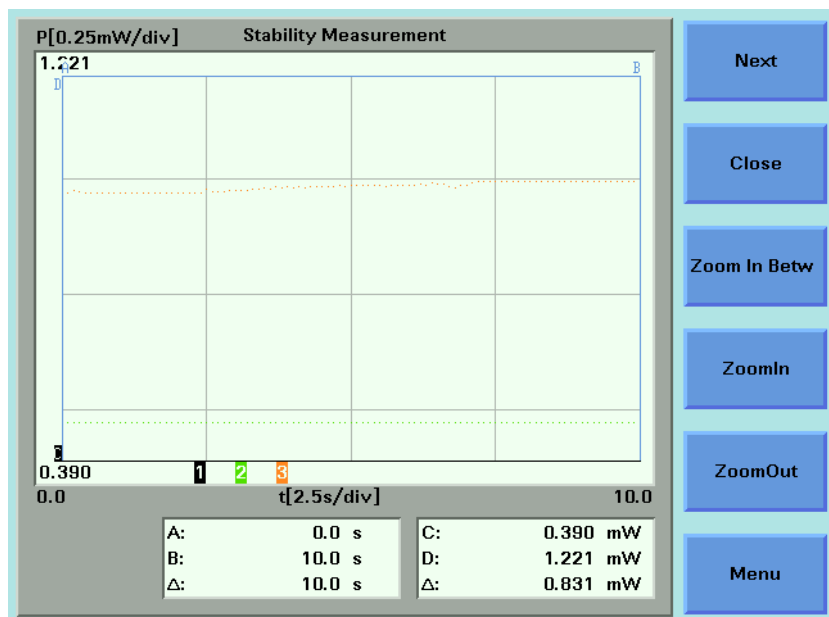

Figure 140 Samples Display - <Samples>

- <Samples & Line> - the curve will be displayed using both symbols for each sample of the curve and a line connecting each sample.

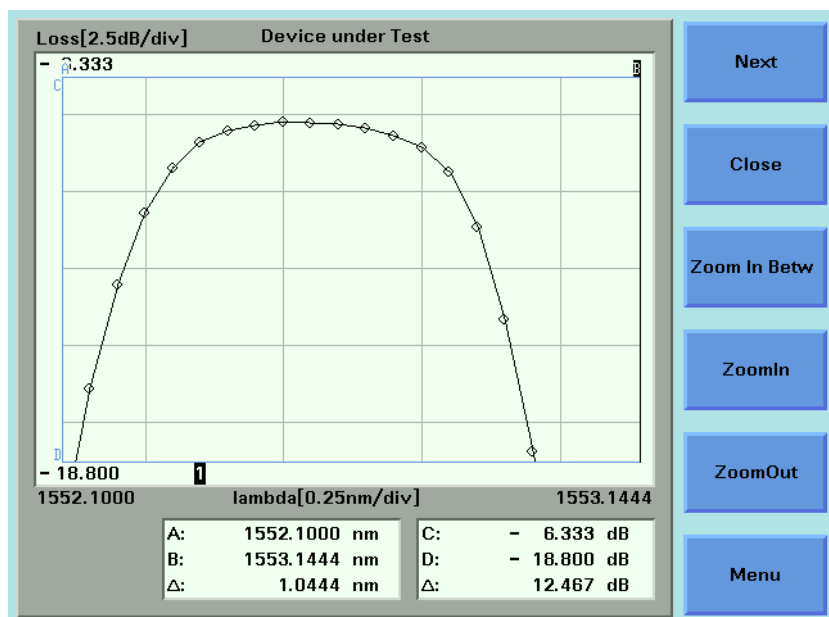

Figure 141 Samples Display - <Samples & Line>

- 2 Move to your selected option and press *Enter*.
- 3 Press the [Close] softkey to return to the graph.

How to Read Curve Values

You can lock markers A or B to a curve in order to move between individual samples. In this way, you can read the time/wavelength and power values that relate to each sample and the difference between these values for markers A and B.

How to Lock Markers to the Curve

You can lock markers A and B to curves by performing the following instructions:

- 1 Press the [Menu] softkey and move to <Lock to Curve>. A menu displaying the options displayed in "The Lock to Curve Menu" on page 239 appears.

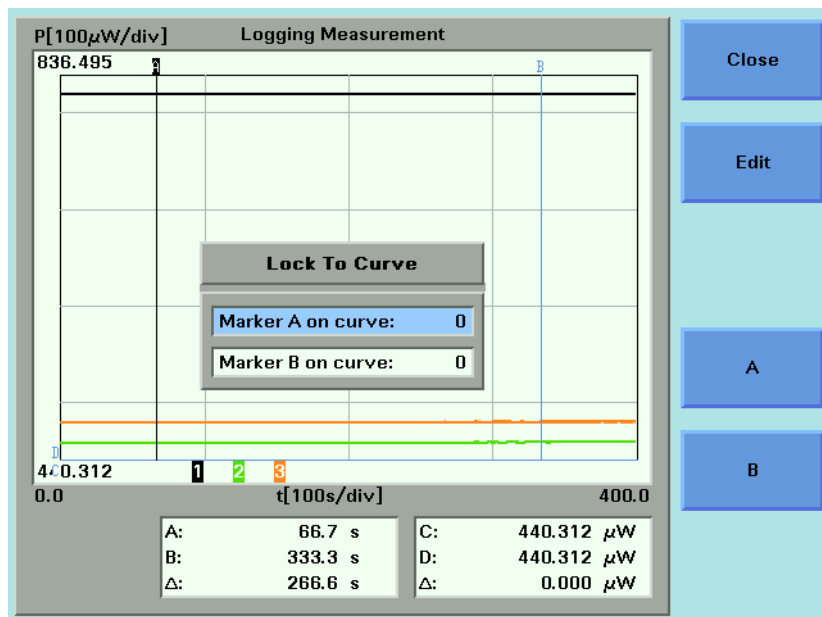

Figure 142 The Lock to Curve Menu

- 2 Press the [A] softkey to lock marker A to a curve. The number opposite Marker A on curve: is highlighted.
- 3 Use the cursor key to move to the legend number of the curve to which you want to lock marker A.
- 4 Press *Enter*. Marker B will be locked to the same curve as marker A, if it was assigned to curve 0 immediately before, that is, it was unassigned immediately before.

- 5 If you want to assign marker B to another curve, press the [B] softkey, use the cursor key to move to the legend number of the curve to which you want to lock marker B, and press *Enter*.
- 6 Press Close to return to the graph.

How to Unlock Markers from the Curve

You can unlock markers A and B from the curve by performing the following instructions:

- 1 Press the [Menu] softkey.
- 2 Move to <Unlock From Curve> and press *Enter* to return to the graph.

How to Lock/Unlock Markers to Samples

You can choose to lock the markers to samples, that is, the results that are returned are actual measurement results.

Figure 143 shows a graph where markers A and B are locked to samples. If you press the cursor key, the marker will move to another sample.

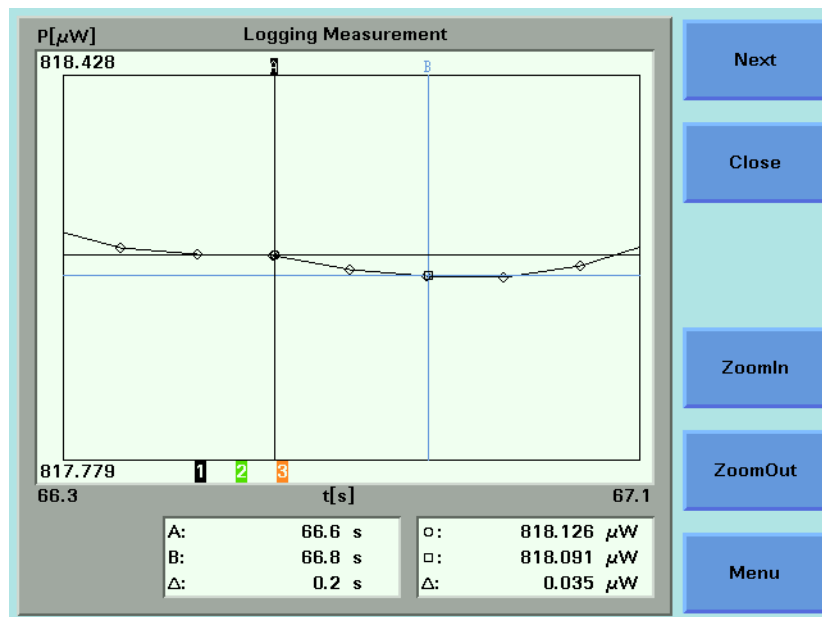

Figure 143 Lock to Samples On

Figure 144 shows a graph where markers A and B are not locked to samples. If you press the cursor key, the marker will move along the curve.

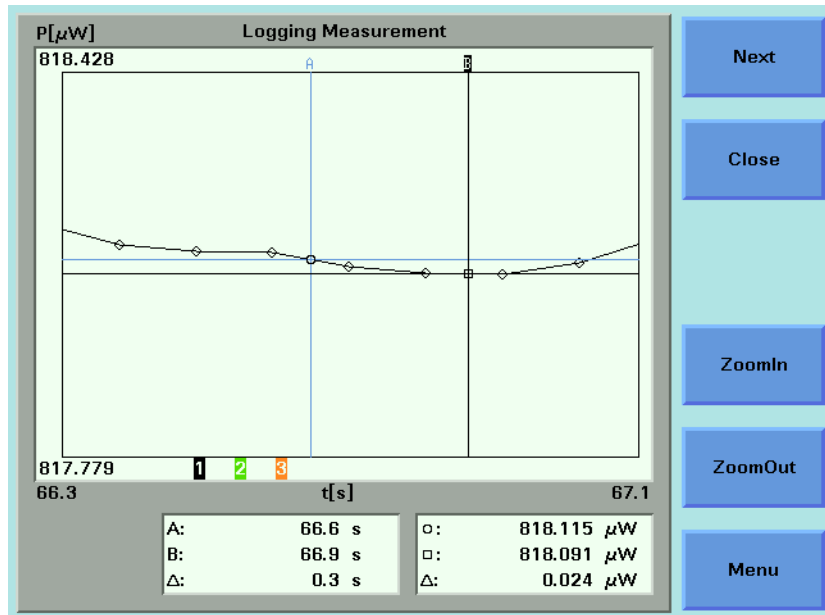

Figure 144 Lock the Samples Off

NOTE

You can only lock/unlock markers to samples if you have already locked markers to the curve, see *“How to Lock Markers to the Curve” on page 239.*

To lock/unlock markers to samples:

- 1 Press the [Menu] softkey.
- 2 Move to one of the following menu items:
 - <Lock to Samples On>, to lock markers to samples or
 - <Lock to Samples Off>, to lock markers to the curve.

NOTE

Only one of these menu items will be available for selection.

- 3 Press *Enter* to return to the graph.

The Logging Application

The Logging data acquisition application logs a series of power measurements for a number of Power Meter channels, plots the results as a graph, and generates a statistical analysis of the results.

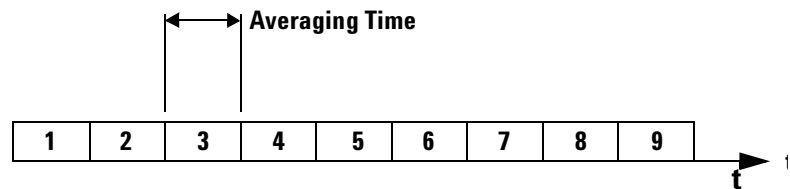

Figure 145 Example Logging Application

The most important parameters for the logging application are:

- *[Samples]*, this is the number of samples that will be performed during the logging application, and
- *[AvgTime]*, the averaging time is the length of time over which a signal is averaged. Longer averaging times increase the accuracy and improve the noise rejection. Longer averaging times also decrease sensitivity.

The total time for a logging application is the number of samples multiplied by the averaging time.

The Logging application differs from the *"The Stability Application"* on page 254 because all power measurements are performed consecutively without the possibility of any pause between measurements, as shown in Figure 145 .

All results can be:

- displayed on the screen,
- printed out to hardcopy, or
- saved to disk drive of your Agilent 8164A/B Lightwave Measurement System.

How to Set Up a Logging Function

To set up a logging function:

- 1 Press the *App/* hardkey. The Applications menu, as shown in Figure 146 , appears.

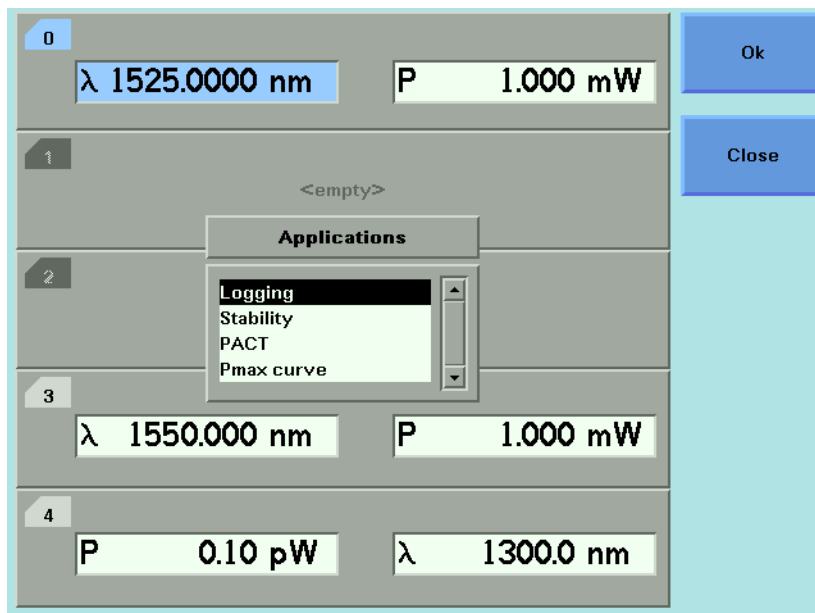

Figure 146 The Applications Menu

- 2 Move to *<Logging>* and press *Enter*. The Agilent 8164A/B Logging Setup Screen, as shown in Figure 147 , or the Agilent 8163A/B Logging Modules Setup Screen, as shown in Figure 148 , appears depending on the mainframe instrument you are using.

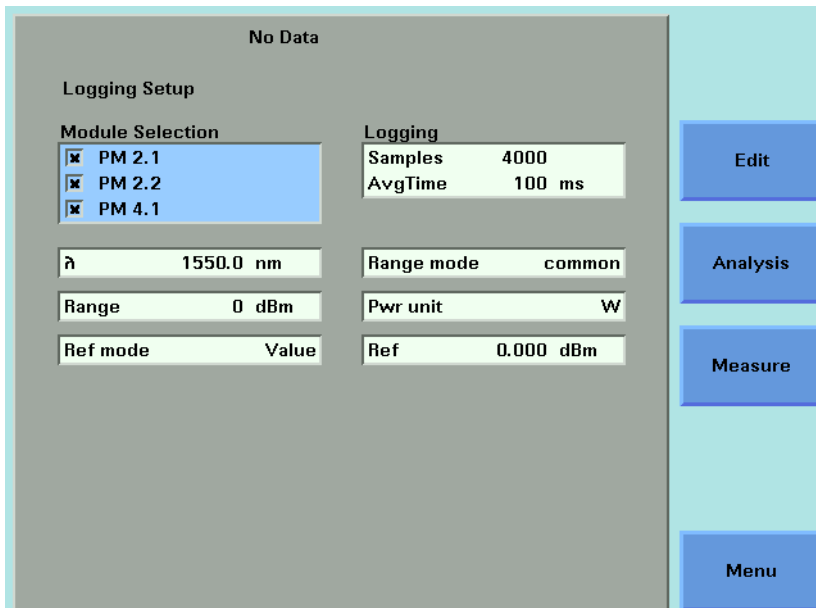

Figure 147 The Agilent 8164A/B Logging Setup Screen

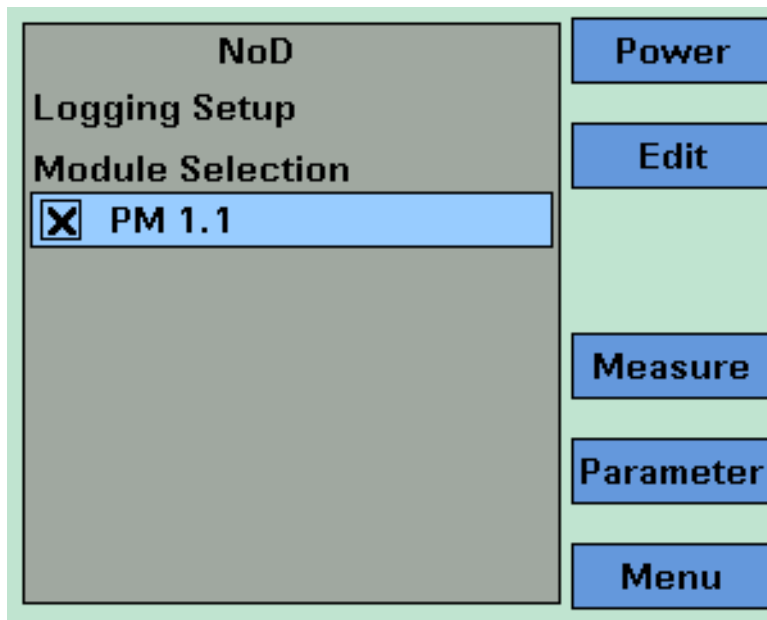

Figure 148 The Agilent 8163B Logging Modules Setup Screen

Selecting/Deselecting Power Meters

- 3 Move to the Module Selection box. As a default, all Power Meters are selected, this means that all Power Meters will log power measurements. Press [Edit].

- 4 To deselect a Power Meter channel, move to the Power Meter as denoted by slot and channel numbers, see “*Slot and Channel Numbers*” on page 41, press [Unset].
- 5 To select a Power Meter channel, press [Edit], move to the Power Meter as denoted by slot and channel numbers, see “*Slot and Channel Numbers*” on page 41, press [Set].
- 6 Perform steps until you have selected the required Power Meters for your application and press *Enter*.

NOTE

If no Power Meter channel is selected, you cannot ‘exit’ by pressing *Enter*.

Setting Power Meter Parameters

NOTE

If you are using the Agilent 8164A/B Lightwave Multimeter, you may set all Power meter parameters from the Logging Setup Screen, see Figure 147 .

NOTE

If you are using the Agilent 8163A/B Lightwave Multimeter, press [Parameter] to access the Logging Parameter Setup Screen, as shown in Figure 149 . To return to the Logging Modules Setup Screen, press [Modules].

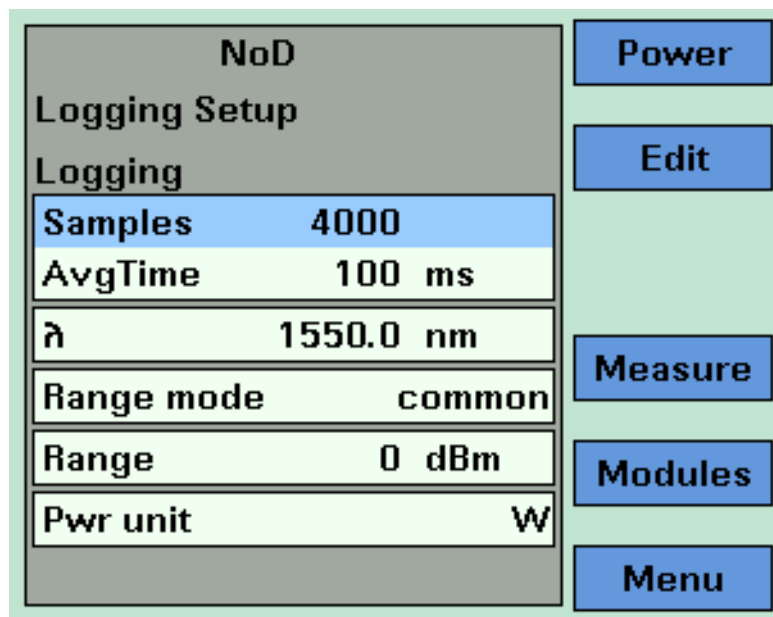

Figure 149 The Agilent 8163B Logging Parameter Setup Screen

- 7 Press [Menu] to access the Logging application menu screen.
- 8 Move to *<Pwr unit>*, press *Enter*, move to *<dBm>*, *<W>*, or *<dB>*, and press *Enter*. See “*What are the Power Units ?*” on page 85 for an explanation of power units.
- 9 Move to *< λ >*, press *Enter*, enter the wavelength value of your optical source, and press *Enter*.

NOTE

Make sure that you install Power Meters that have similar wavelength ranges. The wavelength range of the application is the overlapping wavelength range of all installed Power Meters

- 10 Move to *<Range Mode>*, press *Enter*, move to one of the following range modes:

- *<common>*, you set the same *<Range>* for each Power Meter,
- *<individual>*, you must choose an individual *<Range>* for each Power Meter, and
- press *Enter*.

NOTE

Auto-ranging mode is not available from the *<Range Mode>* menu. If you wish to use the auto-ranging mode, see “*The Stability Application*” on page 254.

- 11 Move to *<Range>* and press *Enter*.

- 12 If you have chosen *<common>* as the *<Range Mode>*, move to a range setting and press *Enter*.

If you have chosen *<individual>* as the *<Range Mode>*, a screen displaying all the selected Power Meter channels and their corresponding range settings is displayed. For each selected Power Meter channel, press *Enter*, move to a range setting, and press *Enter*.

NOTE

If you have chosen *<individual>* as the *<Range Mode>* and want to access the screen displaying all the selected Power Meter channels and their corresponding range settings from the Logging Setup screen, move to *[Range]*, press the [Edit] softkey.

13 Move to *<Ref Mode>*, press *Enter*, move to one of the following referencing modes:

- *<Value>*, you set a reference value using *<Ref>*, see step 14,
- *<First Sample>*, the first sample for each channel of the logging function is selected as the reference value for all subsequent measurements for that channel,
- *<Channel 1>*, the value that Channel 1 measures is updated as the reference value for each set of power measurements (thus, each data value for channel 1 will be 0 dB), and
- press *Enter*.

NOTE

These settings only have an effect when you choose *<dB>* as the *<Pwr unit>*. See step 8 or step 3.

14 If you have chosen *<Value>* as the *<Ref Mode>*, move to *<Ref>*, press the [Edit] softkey, enter a value for the reference, and press *Enter*.

Setting Logging Parameter

15 Move to *[Samples]*, press *Enter*, enter an integer value between 1 and 4000, and press *Enter*.

16 Move to *<AvgTime>*, press *Enter*, move to an averaging time period, and press *Enter*.

Running a Logging Application

- 1 You can run the logging application by pressing [Measure]. The Logging Measurement screen, as shown in Figure 150, appears. A progress bar shows the proportion of the logging application that has been completed.

NOTE

If the averaging time [*AvgTime*] is less than 100 ms for an Agilent 8163xA/B series powermeter, the progress bar and the graph are not updated until the measurement completes.

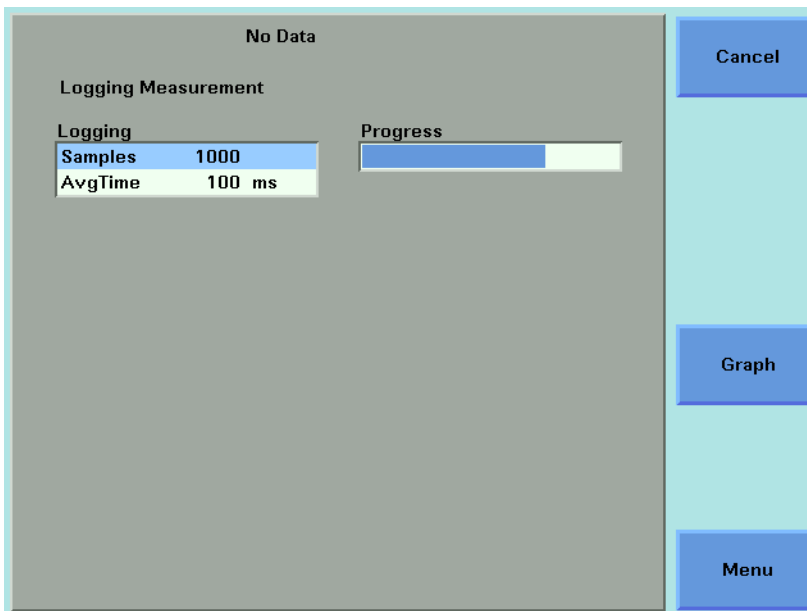

Figure 150 The Logging Measurement Screen - Measurement Running

- 2 There are two softkeys available from the Logging Measurement screen.
 - Press [Graph] to view a graph of the Measurement results as the results are measured. Press [Close] to return to the Logging Measurement screen. See *“Working with Application Graphs” on page 231* for information on zooming in and out.
 - Press [Cancel] to return to the Logging Setup screen without completing the logging application.
- 3 When the logging application completes, you hear a beep, an hourglass appears momentarily. If you are viewing the Logging Measurement Screen the available softkeys change as shown in Figure 151.

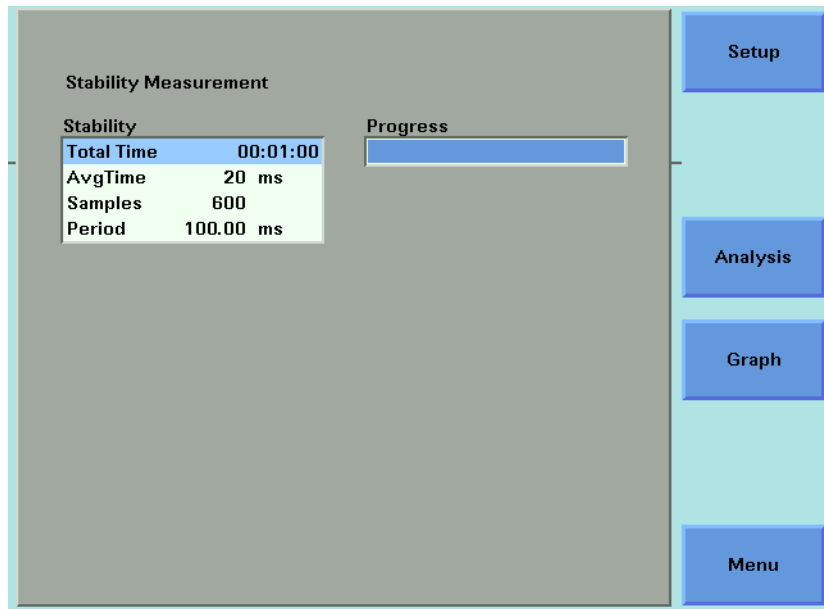

Figure 151 The Logging Measurement Screen - Measurement Completed

Analysing a Logging Application

You can access the Logging Analysis screen after the logging application completes, by completing the following instructions:

- 1 You cannot access the Logging Analysis screen from the graph. If you are viewing the graph, press [Close].
- 2 Press [Analysis]. The Logging Analysis screen appears as shown in Figure 152 for the Agilent 8164A/B and Figure 149 for the Agilent 8163B. \

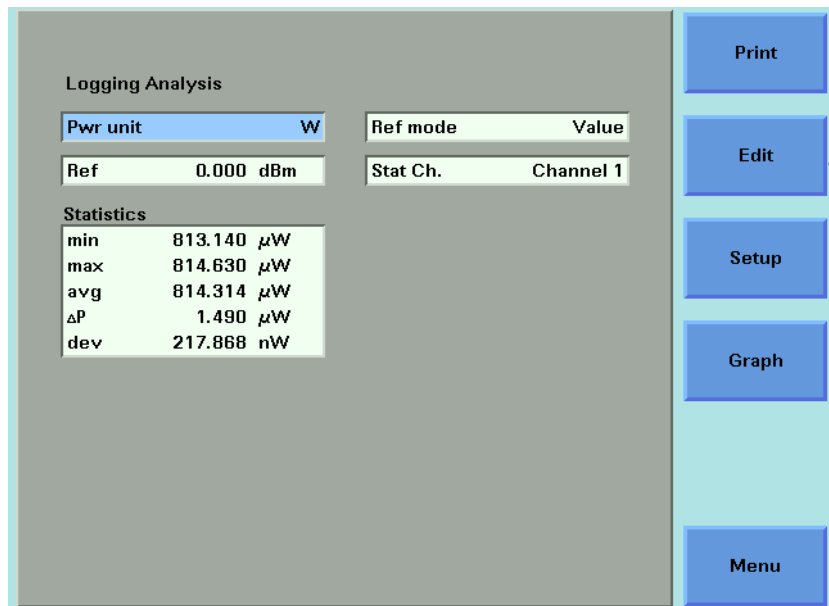

Figure 152 The Agilent 8164A/B Logging Analysis Screen

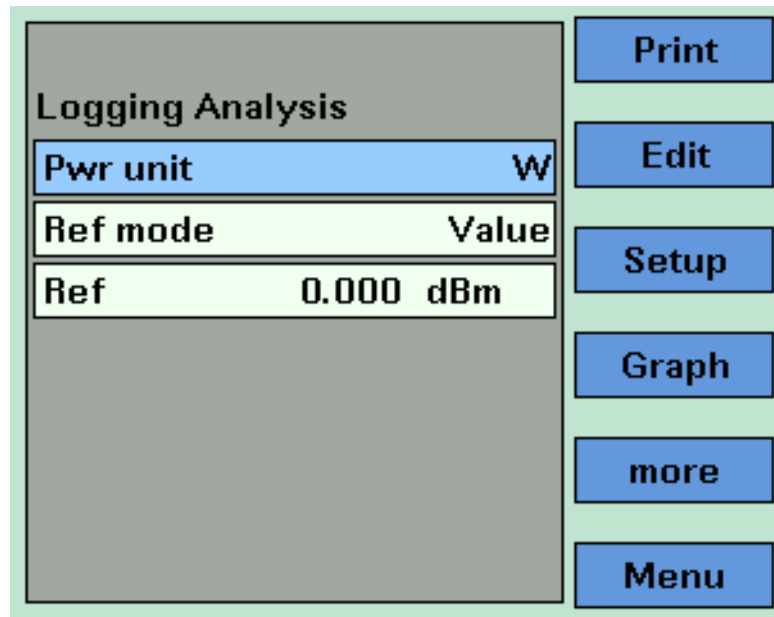

Figure 153 The Agilent 8163B Logging Analysis Screen - First Screen

Setting Analysis Parameters

- 3 To edit the power units used for the analysis, move to [W], press *Enter*, move to <dBm>, <W>, or <dB>, and press *Enter*. See “What are the Power Units?” on page 85 for an explanation of power units.
- 4 To edit the reference mode used for the analysis, move to <Ref Mode>, press *Enter*, move to one of the following referencing modes:
 - <Value>, you set a reference value using <Ref>, see step 5,
 - <First Sample>, the first sample of the logging function is selected as the reference value,
 - <Channel 1>, the value that Channel 1 measures is updated as the reference value for each set of power measurements (thus, each data value for channel 1 will be 0 dB), and
 - press *Enter*.

NOTE

These settings have an effect when you choose <dB> as the <Pwr unit>. See step 8 or step 3.

- 5 If you have chosen <Value> as the <Ref Mode>, move to <Ref>, press *Enter*, enter a value for the reference, and press *Enter*.

Viewing the Statistics for a Power Meter Channel

1 If you are using the Agilent 8164A/B, move to [*Stat Ch.*], press *Enter*, move to a Power Meter channel, and press *Enter*.

If you are using the Agilent 8163A/B, press [*More*], the screen in Figure 154 appears, move to [*Stat Ch.*], press *Enter*, move to a Power Meter channel, and press *Enter*.

Logging Analysis	
Stat Ch.	Channel 1
Statistics	
min	1.755 μW
max	1.761 μW
avg	1.758 μW
ΔP	6.032 nW
dev	1.318 nW

Figure 154 The Agilent 8163B Logging Analysis Screen - Second Screen

2 The following statistics are displayed for the chosen Power Meter channel:

- [*min*], the minimum power measurement measured,
- [*max*], the maximum power measurement measured,
- [*avg*], the average of all power measurements measured,
- [ΔP], the difference between [*max*] and [*min*],
- [*dev*], the standard deviation of all power measurements measured.

On-Screen Messages

The messages listed in the table below may appear at the top of the screen during the Logging application.

Table 16 Logging Application On-Screen Messages

Agilent 8163A/B Message	Agilent 8164A/B Message	Description
OvR	Overrange	One of the Power Meter channels has reported an overrange. The over-ranged value is clipped, statistical data is invalid.
NoH	No Head	There is an Optical Head Interface module inserted in the mainframe that does not have an Optical Head connected to it. No measurement is possible using this channel until you either: <ul style="list-style-type: none"> • reconnect an Optical Head or • deselect this Optical Head channel as a power measurement channel.
NoD	No Data	No data has been measured or measurement is not yet finished. You cannot access the Analysis Screen yet. Printout and file operations are not yet possible.

The Stability Application

The Stability data acquisition application logs a series of power measurements for a number of Power Meter channels, plots the results as a graph, and generates a statistical analysis of the results.

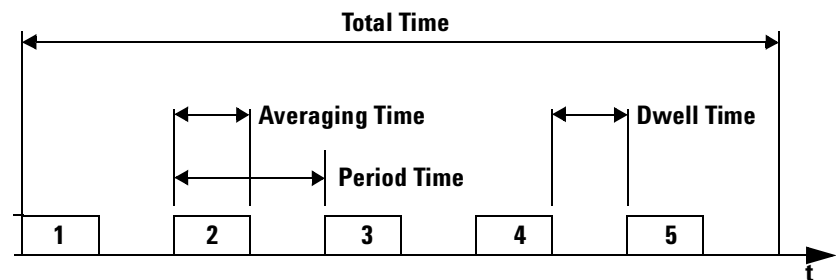

Figure 155 Example Stability Application

The Stability application differs from the *"The Logging Application"* on page 242 because you set the averaging time, the total time, and the maximum number of measurements and all power measurements and the instrument calculates a period time, a new measurement is started after the completion of every period time. Period time may be greater than or equal to the averaging time you set and is always greater than or equal to 100 ms.

This leaves the following two possibilities:

- The averaging time is less than the period time, there is a dwell time between the commencement of each power measurement, as shown in Figure 155 . This can happen because:
 - the maximum number of power measurements multiplied by the averaging time is less than the total time or
 - the averaging time is less than 100 ms.
- The averaging time is equal to the period time, all power measurement are performed without any dwell time.

NOTE

The total time concludes after the last dwell time period, not after the last averaging time period.

The Stability application enables you to make periodic power measurements over a relatively long time period (23 hours, 59 minutes and, 59 seconds).

The Stability application differs from “*The Logging Application*” on *page 242* because you may use auto-ranging mode, see step 9 on page 258 for more information.

All results can be:

- displayed on the screen,
- printed out to hardcopy, or
- saved to disk drive of your Agilent 8164A/B Lightwave Measurement System.

How to Set Up a Stability Function

To set up a stability function:

1 Press the *Appl* hardkey. The Applications menu, as shown in Figure 146 , appears.

Move to *<Stability>* and press *Enter*. The Stability Setup Screen, as shown in Figure 156 , appears.

Stability Setup	
Module Selection	
<input checked="" type="checkbox"/>	PM 2.1
<input checked="" type="checkbox"/>	PM 2.2
<input checked="" type="checkbox"/>	PM 4.1
λ	1550.0 nm
Range	0 dBm
Ref mode	Value
Stability	
Total Time	00:00:10
AvgTime	100 ms
Max	4000
Range mode	common
Pwr unit	W
Ref	0.000 dBm

Figure 156 The Agilent 8164A/B Stability Setup Screen

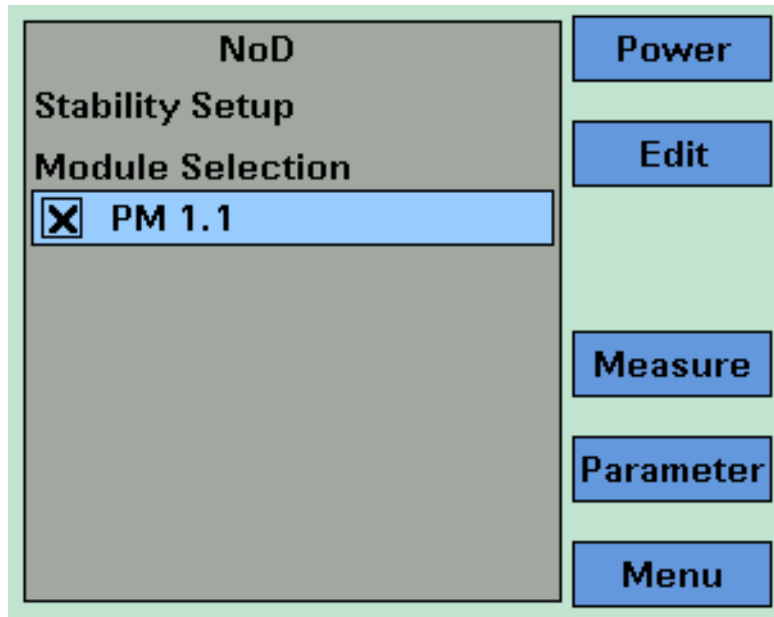

Figure 157 The Agilent 8163B Stability Module Setup Screen

Selecting/Deselecting Power Meters

- 2 Move to the Module Selection box. As a default, all Power Meters are selected, this means that all Power Meters will log power measurements. Press [Edit].
- 3 To deselect a Power Meter channel, move to the Power Meter as denoted by slot and channel numbers, see “*Slot and Channel Numbers*” on page 41, press [Unset].
- 4 To select a Power Meter channel, press [Edit], move to the Power Meter as denoted by slot and channel numbers, see “*Slot and Channel Numbers*” on page 41, press [Set].
- 5 Perform steps until you have selected the required Power Meters for your application and press *Enter*.

NOTE

If no Power Meter channel is selected, you cannot exit by pressing *Enter*.

Setting Power Meter Parameters

NOTE

If you are using the Agilent 8163B Lightwave Multimeter, press [Modules] to access the Stability Setup Screen, as shown in Figure 158 . Not all parameters are available from the Stability Setup Screen.

NoD		Power
Stability Setup		Edit
Stability		
Total Time	00:00:10	
AvgTime	100 ms	
Max	4000	
λ	1550.0 nm	Measure
Range mode	auto	Modules
Range	auto	
Pwr unit	W	Menu

Figure 158 The Agilent 8163B Stability Parameter Setup Screen

- 6 Press [Menu] to access the Stability application menu screen.
- 7 Move to <Pwr unit>, press *Enter*, move to <dBm>, <W>, or <dB>, and press *Enter*. See “What are the Power Units ?” on page 85 for an explanation of power units.
- 8 Move to < λ >, press *Enter*, enter the wavelength value of your optical source, and press *Enter*.

NOTE

Make sure that you install Power Meters that have similar wavelength ranges. The wavelength range of the application is the overlapping wavelength range of all installed Power Meters

- 9 Move to <Range Mode>, press *Enter*, move to one of the following range modes:
 - <common>, you set the same <Range> for each Power Meter,
 - <individual>, you must choose an individual <Range> for each Power Meter,
 - <Auto>, the auto-ranging mode, ensures that the result has a displayed value between 9% and 100% of full scale, and
 - press *Enter*.

NOTE

If you choose <Auto> and the power range changes, the time base of the stability application will be disrupted.

10 Move to *<Range>* and press *Enter*.

11 If you have chosen *<common>* as the *<Range Mode>*, move to a range setting and press *Enter*.

If you have chosen *<individual>* as the *<Range Mode>*, a screen displaying all the selected Power Meter channels and their corresponding range settings is displayed. For each selected Power Meter channel, press *Enter*, move to a range setting, and press *Enter*.

12 Move to *<Ref Mode>*, press *Enter*, move to one of the following referencing modes:

- *<Value>*, you set a reference value using *<Ref>*, see step 13,
- *<First Sample>*, the first sample of the stability function is selected as the reference value,
- *<Channel 1>*, the value that Channel 1 measures is updated as the reference value for each set of power measurements (thus, each data value for channel 1 will be 0 dB), and
- press *Enter*.

NOTE

These settings have an effect when you choose *<dB>* as the *<Pwr unit>*. See step 7 or step 22.

13 If you have chosen *<Value>* as the *<Ref Mode>*, move to *<Ref>*, press *Enter*, enter a value for the reference, and press *Enter*.

Setting Stability Parameter

14 Move to *[Total Time]*, press *Enter*. *[Total Time]* is a value of the form *xx:yy:zz*, where *xx* is a value in hours (maximum 23 hours), *yy* is a value in minutes (maximum 59 minutes), and *zz* is a value in seconds (maximum 59 seconds).

Enter a two-digit time value in hours, press the right cursor key, enter a two-digit time value in minutes, press the right cursor key, enter a two-digit time value in seconds, and press *Enter*.

15 Move to *[AvgTime]*, press *Enter*, move to an averaging time period, and press *Enter*.

16 Move to *[Max]*, press *Enter*, enter an integer value between 1 and 4000, and press *Enter*.

Running a Stability Application

17You can run the stability application by pressing [Measure]. The Stability Measurement screen, as shown in Figure 159, appears. A progress bar shows the proportion of the stability application that has been completed.

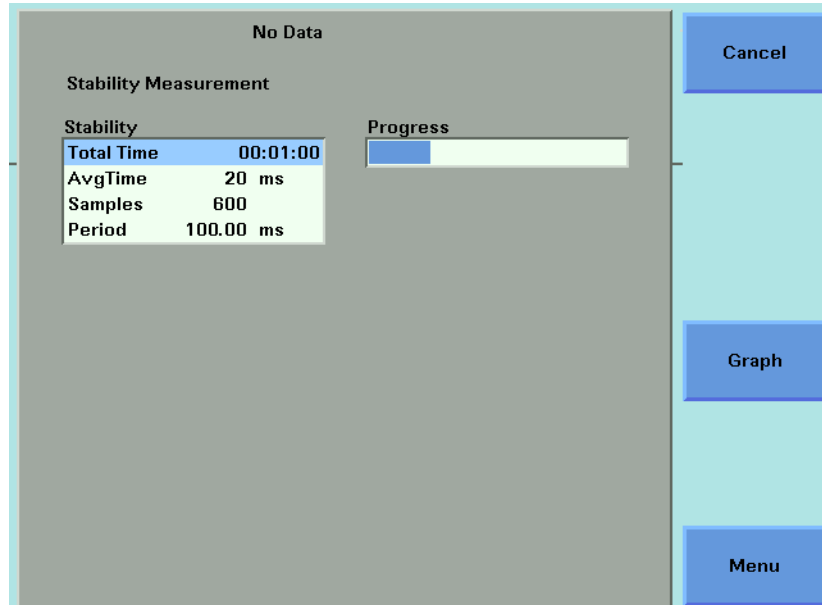

Figure 159 The Stability Measurement Screen - Measurement Running

18There are two softkeys available from the Stability Measurement screen.

- Press [Graph] to view a graph of the Measurement results as the results are measured. Press [Close] to return to the Stability Measurement screen. See *“Working with Application Graphs”* on page 231 for information on zooming in and out.
- Press [Cancel] to return to the Stability Setup screen without completing the stability application.

19When the stability application completes, you hear a beep, an hourglass appears momentarily. If you are viewing the Stability Measurement Screen, the available softkeys change as shown in Figure 159.

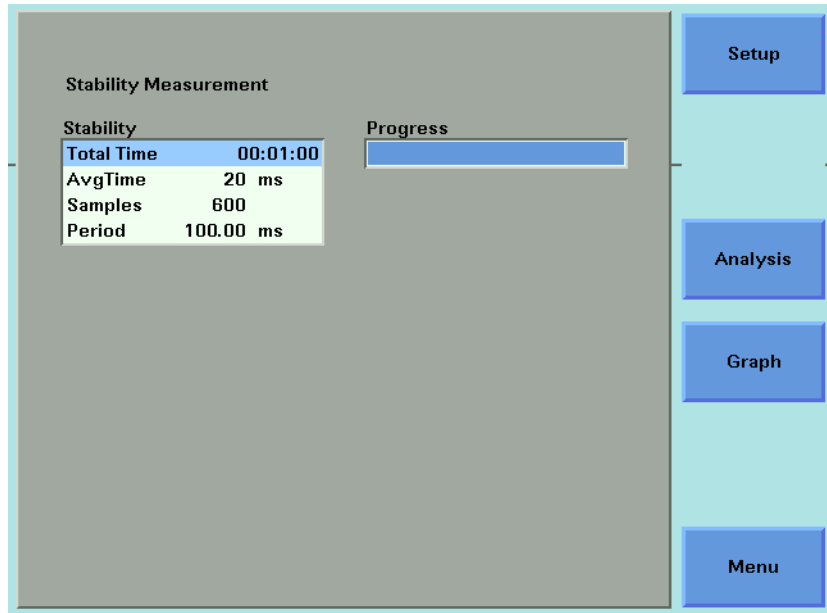

Figure 160 The Stability Measurement Screen - Measurement Completed

Analysing a Stability Application

You can access the Stability Analysis screen after the stability application completes, by completing the following instructions:

20 You cannot access the Stability Analysis screen from the graph. If you are viewing the graph, press [Close].

21 Press [Analysis]. The Stability Analysis screen appears as shown in Figure 161 for the Agilent 8164A/B and Figure 161 for the Agilent 8163B.

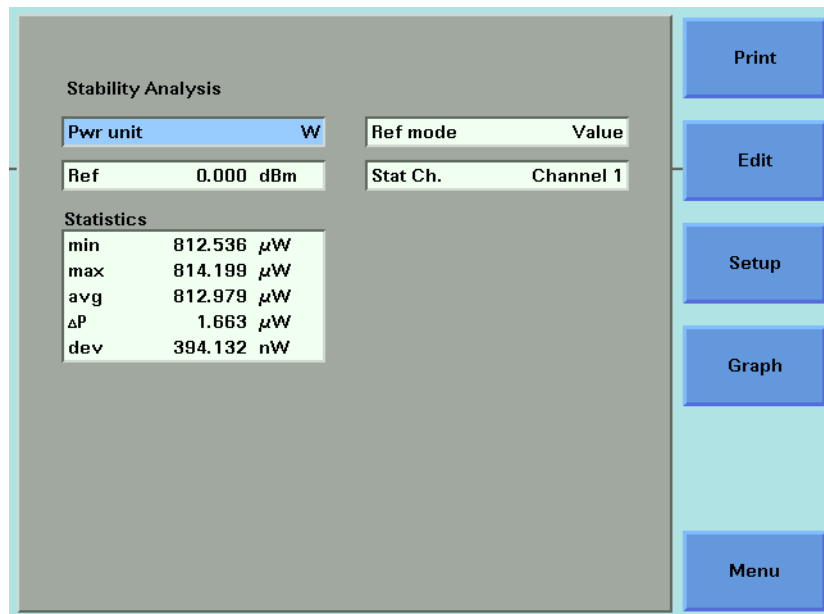

Figure 161 The Agilent 8164A/B Stability Analysis Screen

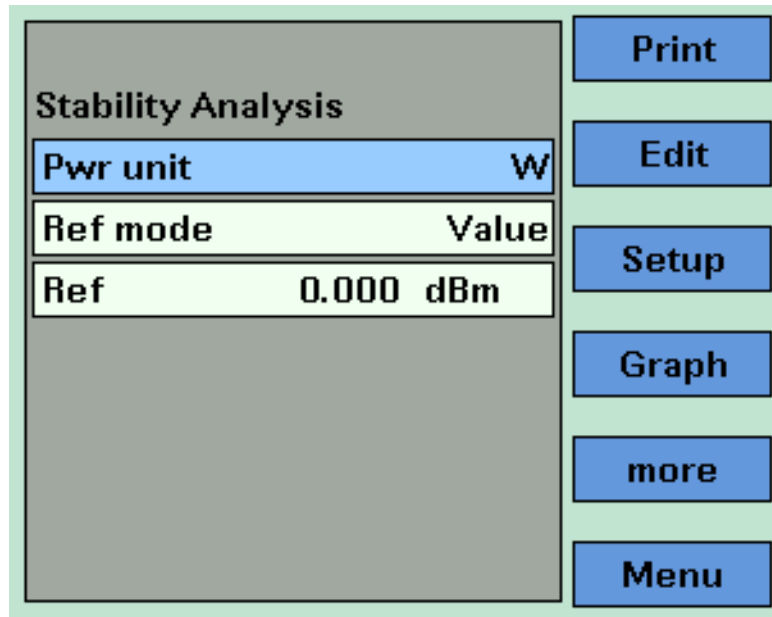

Figure 162 The Agilent 8163B Stability Analysis Screen - First Screen

Setting Analysis Parameters

22 To edit the power units used for the analysis, move to [*W*], press *Enter*, move to *<dBm>*, *<W>*, or *<dB>*, and press *Enter*. See “What are the Power Units ?” on page 85 for an explanation of power units.

23 To edit the reference mode used for the analysis, move to *<Ref Mode>*, press *Enter*, move to one of the following referencing modes:

- *<Value>*, you set a reference value using *<Ref>*, see step 24,
- *<First Sample>*, the first sample of the stability function is selected as the reference value,
- *<Channel 1>*, the value that Channel 1 measures is updated as the reference value for each set of power measurements (thus, each data value for channel 1 will be 0 dB), and
- press *Enter*.

NOTE

These settings have an effect when you choose *<dB>* as the *<Pwr unit>*. See step 7 or step 22.

24 If you have chosen *<Value>* as the *<Ref Mode>*, move to *<Ref>*, press *Enter*, enter a value for the reference, and press *Enter*.

Viewing the Statistics for a Power Meter Channel

25 If you are using the Agilent 8164A/B, move to [*Stat Ch.*], press *Enter*, move to a Power Meter channel, and press *Enter*.

If you are using the Agilent 8163A/B, press [*More*], a screen similar to that shown in Figure 163 appears, move to [*Stat Ch.*], press *Enter*, move to a Power Meter channel, and press *Enter*.

Stability Analysis	
Stat Ch.	Channel 1
Statistics	
min	1.803 μW
max	1.803 μW
avg	1.803 μW
ΔP	424.166 pW
dev	85.164 pW

Figure 163 The Agilent 8163A/B Stability Analysis Screen - Second Screen

The following statistics are displayed for the chosen Power Meter channel:

- [*min*], the minimum power measurement measured,
- [*max*], the maximum power measurement measured,
- [*avg*], the average of all power measurements measured,
- [ΔP], the difference between [*max*] and [*min*],
- [*dev*], the standard deviation of all power measurements measured.

On-Screen Messages

The messages listed in the table below may appear at the top of the screen during the Stability application.

Table 17 Stability Application On-Screen Messages

Agilent 8163A/B Message	Agilent 8164A/B Message	Description
OvR	Overrange	One of the Power Meter channels has reported an overrange. The over-ranged value is clipped, statistical data is invalid.
NoH	No Head	There is an Optical Head Interface module inserted in the mainframe that does not have an Optical Head connected to it. No measurement is possible using this channel until you either: <ul style="list-style-type: none"> • reconnect an Optical Head or • deselect this Optical Head channel as a power measurement channel.
NoD	No Data	No data has been measured or measurement is not yet finished. You cannot access the Analysis Screen yet. Printout and file operations are not yet possible.

The PACT Application

What is the PACT ?

PACT (Passive Component Test Software) makes it possible to use your Agilent 8163A/B Lightwave Multimeter or Agilent 8164A/B Lightwave Measurement System to control a system for testing pigtailed or connectorized passive devices (filters, couplers, and isolators) over wavelength. You must first install a Tunable Laser module and Power Meters in your Agilent 8163A/B Lightwave Multimeter or Agilent 8164A/B Lightwave Measurement System.

Depending on the configuration of the system you use, you can measure insertion loss (single channel power measurement) over wavelength.

All results can be:

- displayed on the screen,
- printed out to hardcopy, or
- saved to disk drive of your Agilent 8164A/B Lightwave Measurement System.

How to Set Up PACT

To set up PACT:

- 1 Insert a Tunable Laser module and at least one Power Meter module into your Agilent 8163A/B Lightwave Multimeter or Agilent 8164A/B Lightwave Measurement System.
- 2 Turn your instrument on.
- 3 Press the *App/* hardkey. The Applications menu, as shown in Figure 146 , appears.
- 4 Move to <PACT> and press *Enter*. The PACT Setup Screen, as shown in Figure 164 , appears.

No Ref No Data

PACT Setup

Module Selection		Sweep	
Laser Selection	TLS 0.1	λ Start	1550.000 nm
<input checked="" type="checkbox"/> PM 3.1		λ Stop	1560.000 nm
<input checked="" type="checkbox"/> PM 3.2		Step	0.0100 nm
<input checked="" type="checkbox"/> PM 4.1			

P max 1.500 dBm

Method Continuous

Output Low SSE (1)

Dynamic Medium

Reference

Edit

Analysis

Measure

Menu

Figure 164 The PACT Setup Screen

Selecting a Tunable Laser Module

- 5 Move to the Module Selection box. As a default, the Tunable Laser module with the lowest slot number is selected. Move to [*Laser Selection*]. Press [Edit].
- 6 To select a Tunable Laser module, press [Edit], use the cursor key to move to your preferred Tunable Laser module as denoted by slot and channel numbers, see “*Slot and Channel Numbers*” on page 41, and press *Enter*.
- 7 Perform steps until you have selected the required Tunable Laser modules for your application and press *Enter*.

NOTE

If no Tunable Laser module is selected, you cannot exit by pressing *Enter*.

Selecting/Deselecting Power Meters

8 Move to the Module Selection box. As a default, all Power Meters are selected, this means that all Power Meters will log power measurements. Press [Edit].

9 To deselect a Power Meter channel, move to the Power Meter as denoted by slot and channel numbers, see “*Slot and Channel Numbers*” on page 41, press [Unset].

10 To select a Power Meter channel, press [Edit], move to the Power Meter as denoted by slot and channel numbers, see “*Slot and Channel Numbers*” on page 41, press [Set].

11 Perform steps until you have selected the required Power Meters for your application and press *Enter*.

NOTE

If no Power Meter channel is selected, you cannot exit by pressing *Enter*.

Setting Sweep Parameters

12 Move to [λ Start], press *Enter*, enter the start wavelength of the sweep, and press *Enter*.

13 Move to [λ Stop], press *Enter*, enter the stop wavelength of the sweep, and press *Enter*.

14 Move to [Step], press *Enter*, enter the step size for the sweep, and press *Enter*.

NOTE

The step size defines:

- the size of the change in the wavelength for each step of a stepped sweep and
 - the wavelength interval between power measurements, the first power measurement is taken at [λ Start] and the last must be taken at [λ Stop].
-

15 Move to [P max], press *Enter*, enter the maximum power in dBm for the sweep, and press *Enter*. The instrument chooses a constant power level for the measurement using the following constraints:

- the power will be less than or equal to the [P max] value you set and
- the power will be less than or equal to the maximum power possible for the chosen Tunable Laser module across the chosen wavelength range.

16 Move to [*Method*], press *Enter*, and move to one of the following sweep modes:

- <*Stepped*>, which dwells at wavelengths that are separated by a certain step size, or
- <*Continuous*>, which sweeps continually at the speed you set.
- Press *Enter*.

NOTE

Continuous sweep mode is not available for the Agilent 81689A Tunable Laser module.

[*Dynamic*]

The [*Dynamic*] parameter, which is only relevant for <*Continuous*> sweep mode, allows you to achieve a higher dynamic range than is possible using one wavelength sweep. Depending on the menu item you choose, the Tunable Laser will be swept once, twice, or three times and the chosen Power Meters will be set to different power ranges for each wavelength sweep. The sweeps are combined using a "stitching" process to generate the final results.

This feature is useful when you wish to measure the transmission characteristics of a component that transmits or absorbs specific wavelengths selectively, for example, a Fiber Bragg Grating.

17 Move to [*Dynamic*], press *Enter*, and move to one of the following:

- <*Low*>, the wavelength is swept once, achieving a lower dynamic range but sweeping more quickly,
- <*Medium*>, the wavelength is swept twice, achieving a medium dynamic range and medium speed, and
- <*High*>, the wavelength is swept three times, achieving a higher dynamic range but sweeping less quickly.
- Press *Enter*.

18 If your Tunable Laser module has two optical outputs perform the step below.

Move to [*Optical Output*] and press *Enter*. Use the Modify Knob to move to one of the following:

- <*High Power (2)*>, a high power optical output, for example, for use in testing Erbium Doped Fiber Amplifiers (EDFAs), you see a screen similar to Figure 63 ,
- <*Low SSE (1)*>, a lower power optical output with low Source Spontaneous Emission (SSE), for example, for use in passive component test, you see a screen similar to Figure 64 ,
- <*Both (master:2)*>, where both optical outputs can be enabled but only the

output of the high power optical output can be regulated, and

- *<Both (master:1)>*, where both optical outputs can be enabled but only the output of the low SSE optical output can be regulated.
- Press *Enter*.

How to Measure the Reference

19 Press [Reference].

NOTE

If [*Step*] does not divide exactly into the difference between [*λ Stop*] and [*λ Start*], the parameters are automatically corrected to meet the constraints of PACT.

The PACT Reference Screen, as shown in Figure 165, appears. The number of samples that each Power Meter will record and the output laser power are displayed. If *<Continuous>* was selected as the sweep [*Method*], the sweep speed, [*V Sweep*], is displayed.

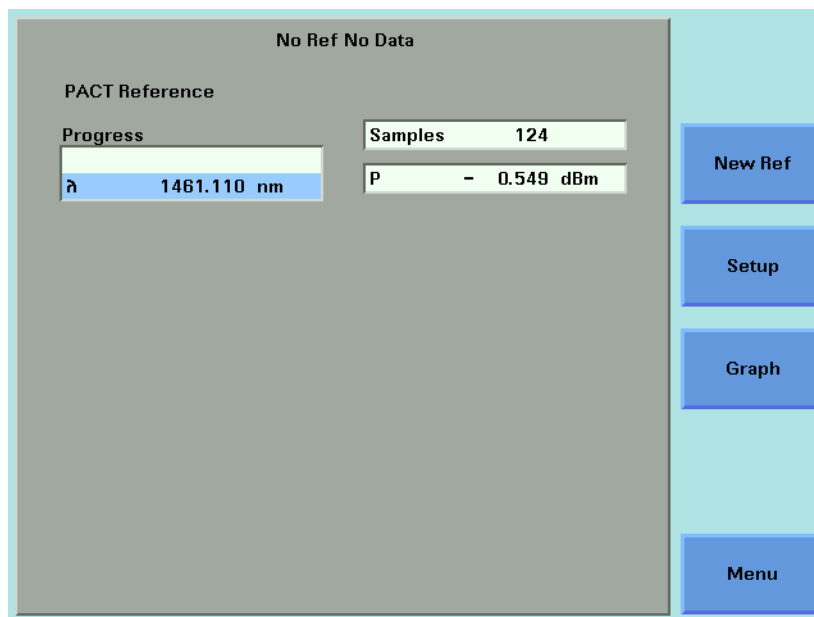

Figure 165 PACT Reference Screen

NOTE

The application chooses the power, $[P]$, see step 15 for more information.

20 Press [New Ref]. A box similar to the box in Figure 166 appears prompting you to connect a fiber to the first Power Meter channel.

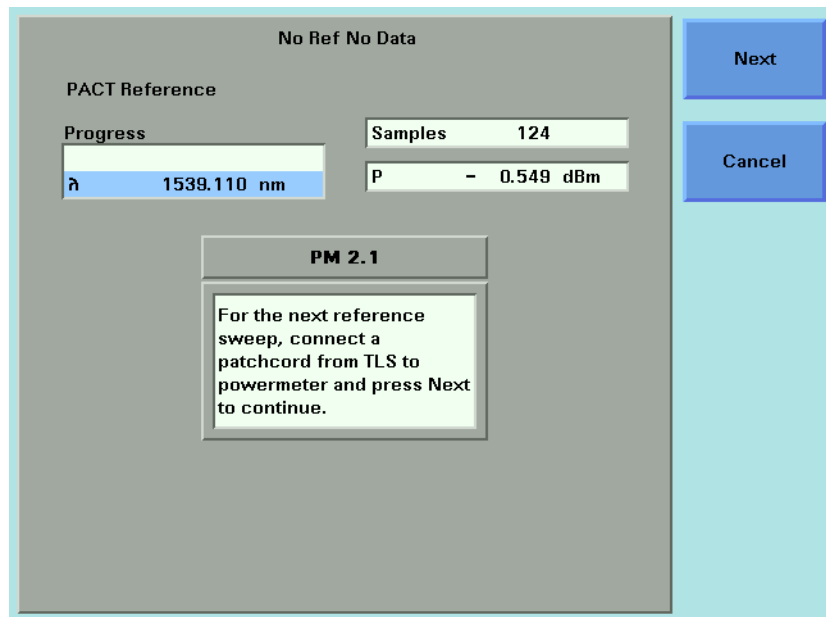

Figure 166 Connection Prompt Screen

21 Connect the Tunable Laser module to the Power Meter channel through all the system components, but excluding the Device Under Test. Press [Next] to start the reference measurement.

The PACT Reference Measurement screen, as shown in Figure 167, appears. A progress bar shows the proportion of the stability application that has been completed. The wavelength, λ , shows you the current wavelength of the Tunable Laser module.

22 There are two softkeys available from the PACT Reference Measurement screen.

- Press [Graph] to view a graph of the Measurement results as the results are measured. Press [Close] to return to the PACT Reference Measurement screen. See *“Working with Application Graphs”* on page 231 for information on zooming in and out.
- Press [Cancel] to return to the PACT Reference screen without completing the reference measurement, all reference values that were measured will be deleted.

23 When the PACT Reference Measurement completes, you hear a beep, an hourglass appears momentarily.

If there is another Power Meter channel to reference, you will be prompted to perform this reference measurement from the user interface by a prompt box similar to the box in Figure 166 . Restart this procedure at step 21.

If you are viewing the PACT Reference Measurement Finished box, reference sweeps have been performed for all selected Power Meters.

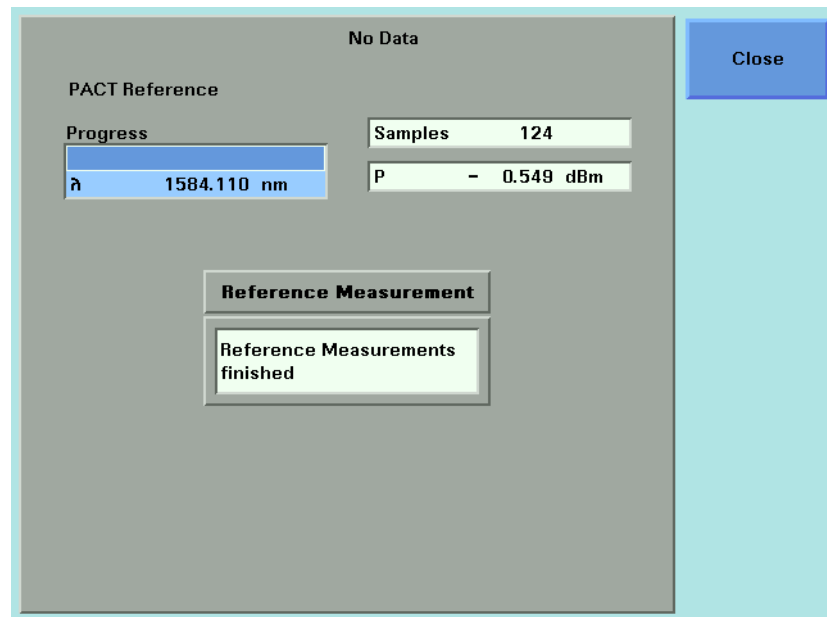

Figure 167 PACT Reference Measurement Finished Box

How to Perform a Loss Measurement

24 To return to the Setup screen, pressing [Menu], move to <Setup>, and press *Enter*.

NOTE

If you change any measurement parameters, the reference measurement becomes invalid.

25 Connect the Tunable Laser module to the Power Meter channel through all the system components, including the Device Under Test. Press [Measure].

NOTE

If [Step] does not divide exactly into the difference between [λ Stop] and [λ Start], the parameters are automatically corrected to meet the constraints of PACT.

If the step size is very large in comparison to the sweep range, a box requesting you to correct the [λ Stop], [λ Start], and [Step] may appear.

The PACT Measurement Screen, as shown in Figure 168, appears. The number of samples that each Power Meter will record and the output laser power are displayed. If <Continuous> was selected as the sweep [Method], the sweep speed, [V Sweep], is displayed.

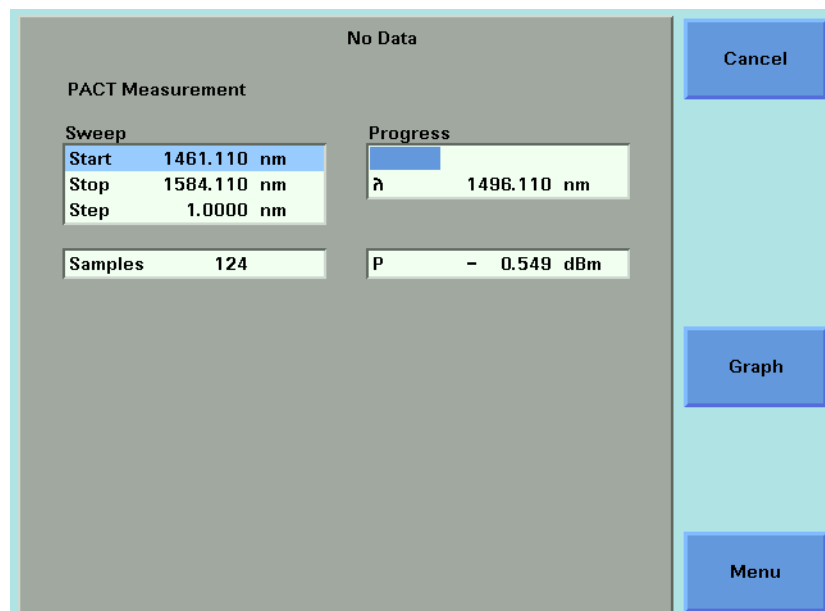

Figure 168 PACT Measurement Screen

NOTE

The application chooses the power level, [P], see *step 15* for more information.

The application chooses the power level, [P], see *step 15* for more information.

26 There are two softkeys available from the PACT Measurement screen.

- Press [Graph] to view a graph of the Measurement results as the results are measured. Press [Close] to return to the PACT Reference Measurement screen. See “Working with Application Graphs” on page 231 for information

on zooming in and out.

- Press [Cancel] to return to the PACT Reference screen without completing the stability application.

NOTE

If you choose *<High>* or *<Medium>* as the [Dynamic] parameter and *<Continuous>* sweep mode, the graph will update at the end of each sweep. Figure 169 shows a graph with low dynamic range that is the result of a single sweep. Figure 170 shows a graph with high dynamic range that is the result of a three sweeps that were combined using a "stitching" process.

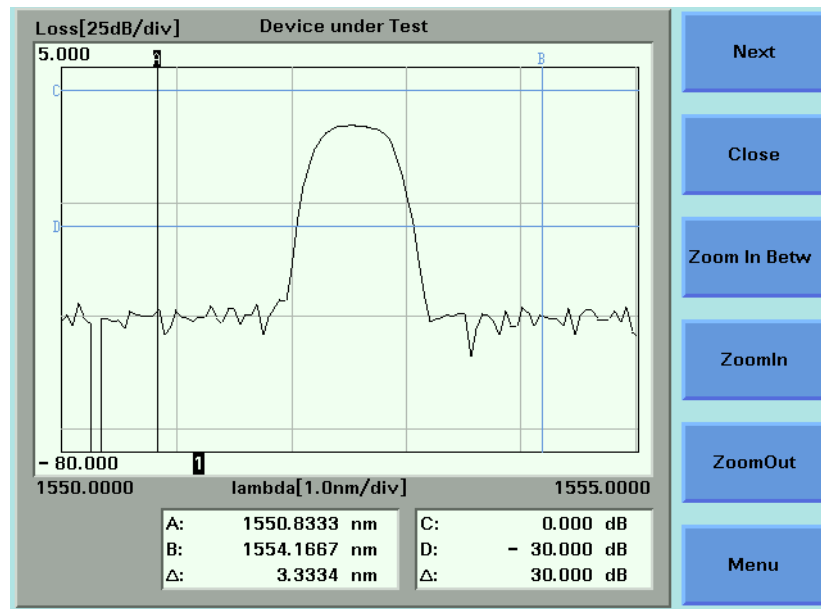

Figure 169 Low Dynamic Range

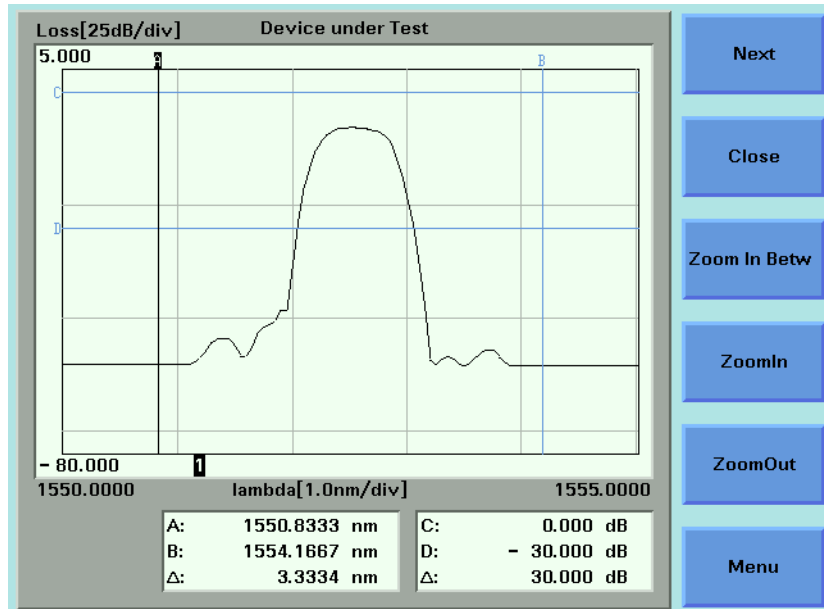

Figure 170 High Dynamic Range

27When the PACT Measurement application completes, you hear a beep, an hourglass appears momentarily. If you are viewing the PACT Measurement Screen, the available softkeys change as shown in Figure 171 .

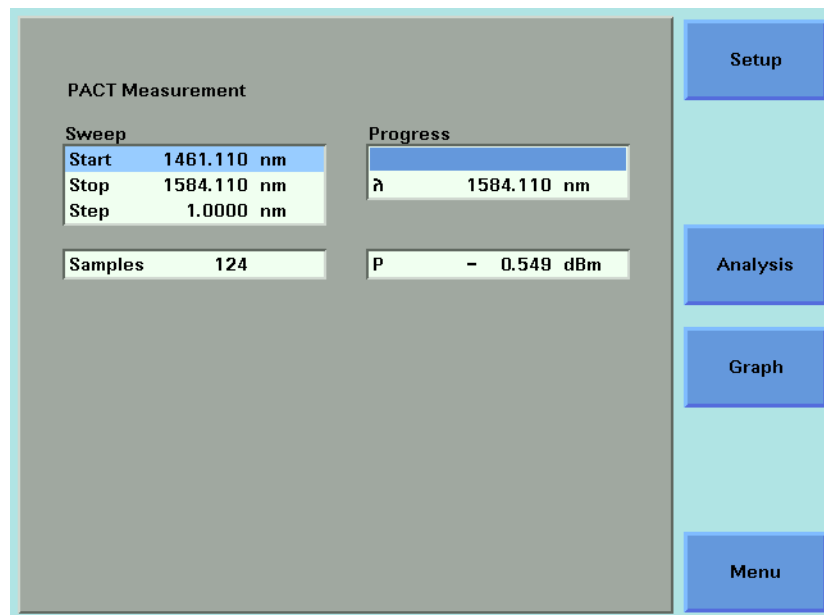

Figure 171 The PACT Measurement Screen - Measurement Completed

Analysing a PACT Measurement

You can access the PACT Analysis screen after the PACT Measurement completes, by completing the following instructions:

28 You cannot access the PACT Analysis screen from the graph. If you are viewing the graph, press [Close].

29 Press [Setup]. The Logging Analysis screen appears as shown in Figure 152 .

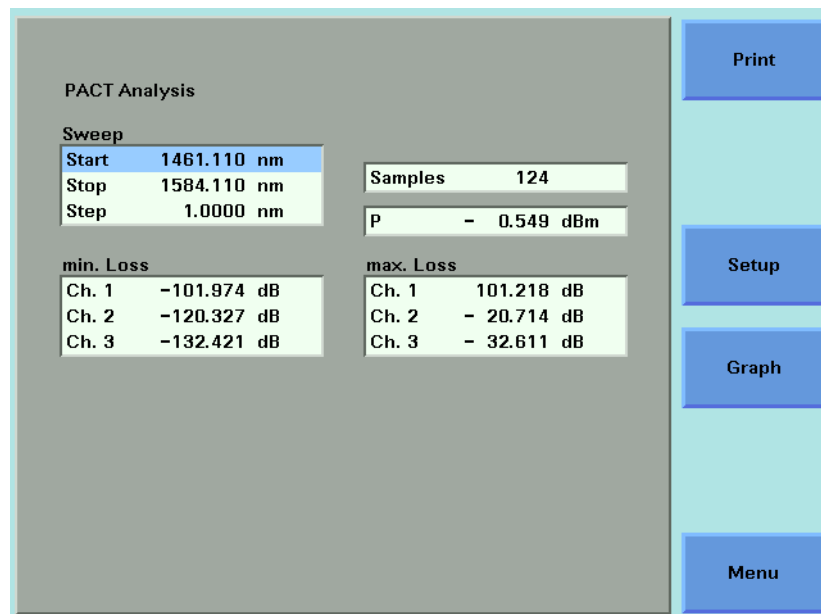

Figure 172 The PACT Analysis Screen

The sweep parameters are shown.

The following results of the PACT Measurement are shown for each selected Power Meter channel:

- min. Loss, the minimum loss value for the particular Power Meter channel for the sweep, and
- max. Loss, the maximum loss value for the particular Power Meter channel for the sweep.

On-Screen Messages

The messages listed in the table below may appear at the top of the screen during the PACT application.

Table 18 PACT Application On-Screen Messages

Agilent 8163A/B Message	Agilent 8164A/B Message	Description
SLck	SLock	The Tunable Laser module is locked. No measurement is possible until you unlock the module, see <i>"How to Lock/Unlock the High-Power Laser Sources"</i> on page 68 for details.
RiLck	RILock	The Remote Interlock Connector of your mainframe is open. No measurement is possible until the connection at the Remote Interlock Connector closes, see <i>"The Remote Interlock (RIL) connector"</i> on page 311 for details.
NoH	No Head	There is an Optical Head Interface module inserted in the mainframe that does not have an Optical Head connected to it. No measurement is possible using this channel until you either: <ul style="list-style-type: none"> • reconnect an Optical Head or • deselect this Optical Head channel as a power measurement channel.
NoD	No Data	No data has been measured or measurement is not yet finished. You cannot access the Analysis Screen yet. Printout and file operations are not yet possible.
Set	Settling	A Tunable Laser module is settling. The instrument is busy and no measurement can be performed yet.
NoR	No Ref	No reference sweep has been performed. Loss will be calculated using nominal laser power as a reference.

The Pmax Curve

What is the Pmax Curve ?

The Pmax Curve shows the maximum laser output power for your Tunable Laser module across the wavelength range of your Tunable Laser module.

How to View the Pmax Curve

To view the Pmax Curve:

- 1 Press the *Appl* hardkey. The Applications menu, as shown in Figure 146 , appears.
- 2 Move to *<Pmax curve>* and press *Enter*. The Pmax Curve Screen, as shown in Figure 173 , appears.

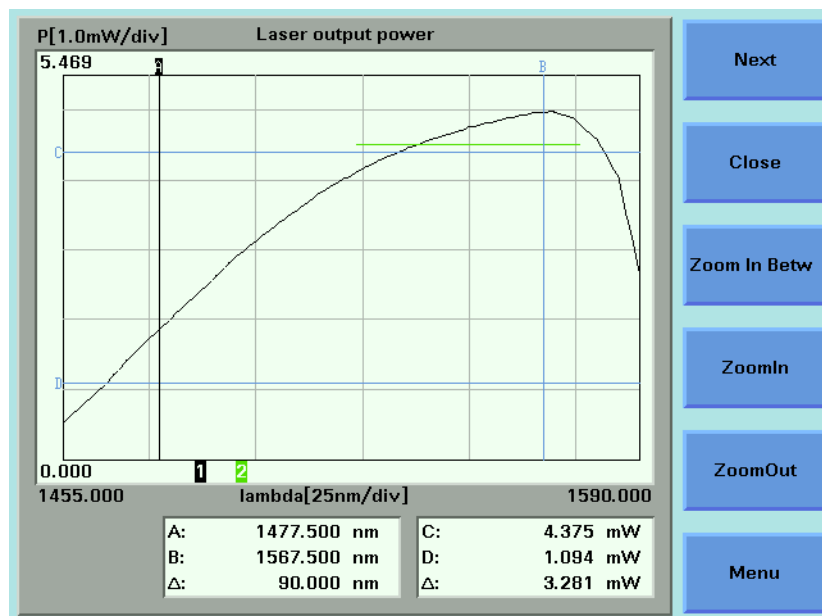

Figure 173 The Pmax Curve Screen

- 3 See “Working with Application Graphs” on page 231 for information on zooming in and out.
- 4 Press [Close] to exit from the Pmax Curve application.

The Return Loss Application

NOTE

The Return Loss Application supports the Agilent 81610A-81613A Return Loss Modules. The Application is not available for the Agilent 8164A/B Lightwave Measurement System or the Agilent 8166A/B Lightwave Multichannel System.

The Return Loss application allows measurement of Return Loss and/or Insertion Loss. Both values are displayed on the Agilent 8163A/B Lightwave Multimeter at the same time, depending on the calibration and configuration status. In addition, the Return Loss Application provides a simple step-by-step guided procedure for calibration of the instrument.

Starting the Application

As the other applications, the Return Loss Application can be configured to start up automatically. Alternatively, it can be started by pressing the **"Appl"** hardkey on the front of the Agilent 8163A/B Lightwave Multimeter.

Measuring Return Loss

To measure return loss, insert a Return Loss Module into the Agilent 8163A/B Lightwave Multimeter and connect it to the Device under Test (DUT). The Return Loss value is displayed on the Multimeter. You can freeze the measurement value during measurement either by pressing the **"Hold/Cnt"** softkey or by using a foot pedal if this option has been enabled via the **"Config"** hardkey. (See "How to Configure your Foot Pedal" on page 71 for further details). For general information on measuring Return Loss, please refer to "Return Loss Measurement" on page 163.

Measuring Return Loss and Insertion Loss

To measure return loss and insertion loss insert a Return Loss module and a Power Sensor module into the Agilent 8163A/B Lightwave Multimeter. Connect the Return Loss Module to the Power Sensor Module via the Device Under Test (DUT). Both values are shown simultaneously on the display depending on the calibration and configuration status. You can freeze the measurement values during measurement either by pressing the **“Hold/Cnt”** softkey or by using a foot pedal if this option has been enabled via the **“Config”** hardkey. (See “How to Configure your Foot Pedal” on page 71 for further details). For general information on measuring return loss and insertion loss, please refer to “Return Loss Measurement” on page 163.

NOTE

The Return Loss Application always uses the first available power meter channel on dual power meters.

On-Screen Messages

Table 19 Return Loss Application On-Screen Messages

Agilent 8163A/B Message	Description
Hold	Either the Hold/Cnt Softkey or the foot pedal have been pressed to freeze the measurement value
UnCal	Application has not performed a calibration cycle with selected wavelength. If dual wavelength is selected, at least one wavelength is uncalibrated.
NoH	There is an Optical Head Interface module inserted in the mainframe that does not have an Optical Head connected to it. No measurement is possible using this channel until you reconnect an optical head

Configuration

The Return Loss Application can be configured according to your measurement requirements. The following parameters can be configured:

- the tool used for reflection calibration (reference reflector or reference cable)
- the return loss reference value **RLref** of the reflector device
- the averaging time
- the wavelength of the return loss module.

User Interface

When the Return Loss Application is started the following screen appears on the Agilent 8163A/B Lightwave Multimeter:

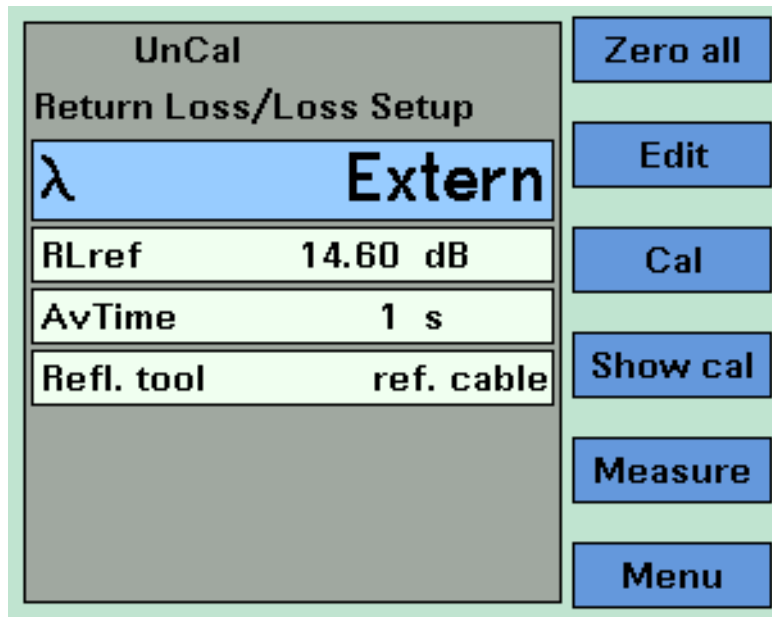

Figure 174 Main Screen of the Return Loss Application

The softkeys on the screen have the following functions:

Zero all

The Zero all softkey zeros all power measurement channels within the mainframe (Return Loss and optional Power Meter) at the same time.

Edit

The currently selected item on the main screen can be modified using this key.

Cal

This key starts the guided calibration procedure. Please follow the instructions on the screen to perform a Reflectance Calibration, a Termination Calibration and a Loss Calibration. You will be guided step by step through each stage of the calibration process.

Show Cal

To display the calibration parameters of the last calibration, press this key.

Measure

Press this key to start a new Return Loss and/or Insertion Loss measurement.

Menu

Press this key to access all parameters and functions that apply to the Return Loss Application.

Recording Measurement Results

Printing Application Measurement Results

You can print application measurement results by completing the following instructions.

- 1 Perform any of the following applications as described above:
 - “The Logging Application” on page 242,
 - “The Stability Application” on page 254, or
 - “The PACT Application” on page 266.
- 2 Move to the Analysis Screen.
- 3 Connect your printer to the instrument as described in “How to Connect a Printer” on page 81.
- 4 Select the printer type as described in “How to Select the Printer Type” on page 75.
- 5 Press [Menu], move to <Print>, and press *Enter*. The screen, shown in Figure 175, appears.

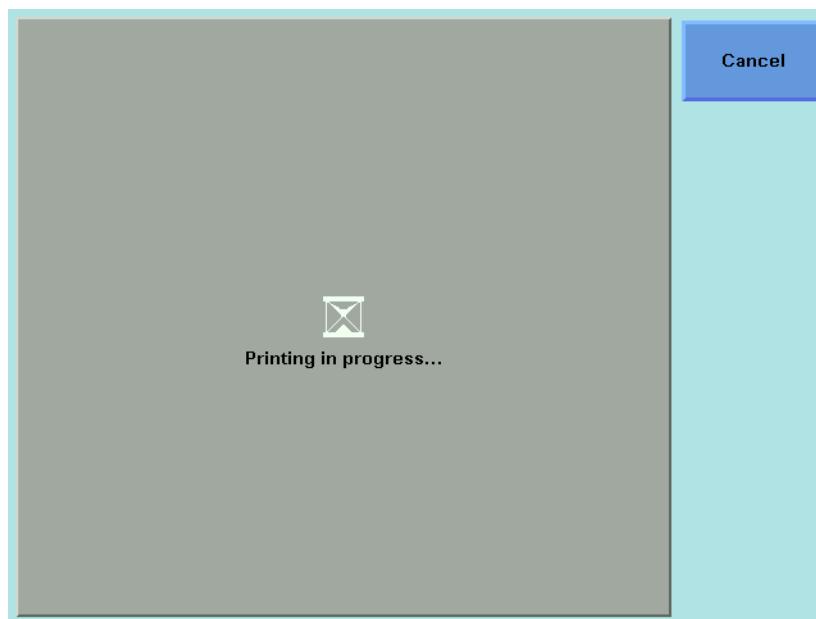

Figure 175 The Printing in Progress Screen

NOTE

If you want to cancel the print job, press the [Cancel] softkey.

6 The printed results should resemble the page shown in Figure 176 .

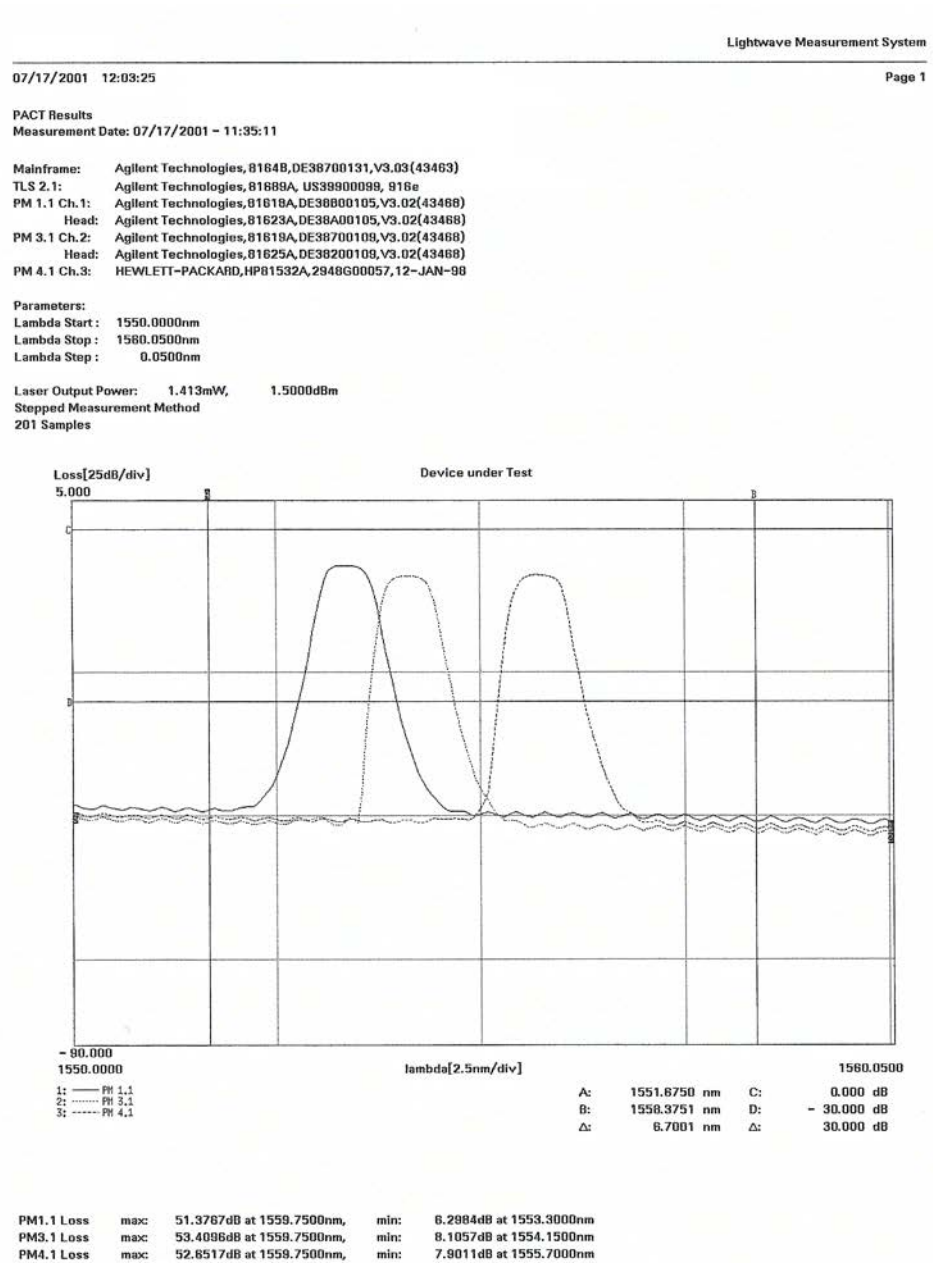

Figure 176 Printed Results

Saving Application Measurement Results to Diskette

If you are using the Agilent 8164A/B Lightwave Measurement System, you can save application measurement results to diskette by completing the following instructions:

- 1 Perform any of the following applications as described above:
 - *"The Logging Application" on page 242,*
 - *"The Stability Application" on page 254, or*
 - *"The PACT Application" on page 266.*
- 2 Move to the Analysis Screen.
- 3 Insert a floppy disk in the diskette drive of your Agilent 8164A/B Lightwave Measurement System.
- 4 Press [Menu].
- 5 Move to one of the following options:
 - *<Save Ascii File>*, the data will be saved in Ascii-text format, that can be opened by all text editors.
 - *<Save CSV File>*, the data will be saved in CSV format, that can be opened by Microsoft Excel.
- 6 Press *Enter*. The File Name Editor, as shown in Figure 177 , appears.

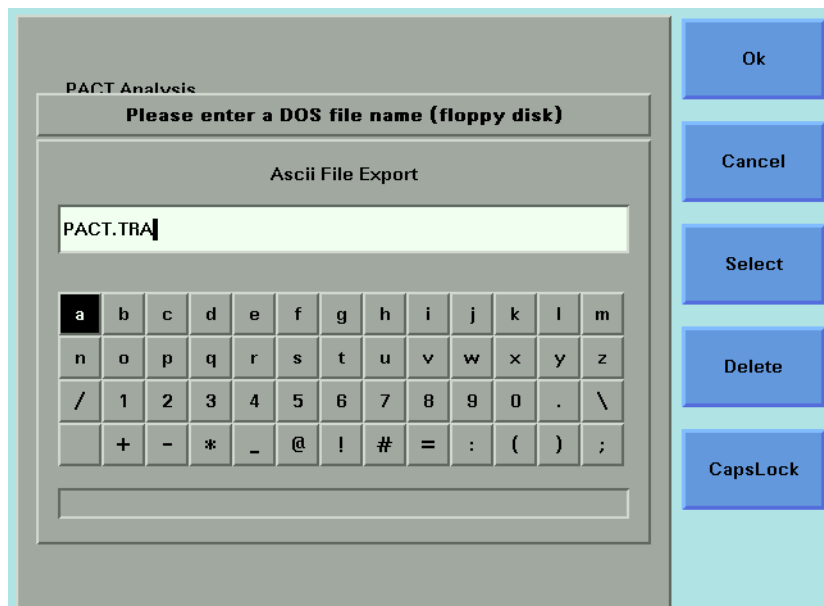

Figure 177 The File Name Editor

- 7** If you wish to change the suggested file name, use the on-screen keyboard to modify the name.
- 8** Press [OK] to save the data to diskette using the displayed file name.

11

Installation and Maintenance

This chapter provides installation instructions for the Agilent 8163A/B Lightwave Multimeter System, Agilent 8164A/B Lightwave Measurement System, and the Agilent 8166A/B Lightwave Multichannel System. It also includes information about initial inspection and damage claims, preparation for use, packaging, storage, and shipment.

Safety Considerations	289
Initial Inspection	290
AC Line Power Supply Requirements	291
Line Power Requirements	291
Line Power Cable	292
Changing the Battery	295
Changing the Fuse	295
Operating and Storage Environment	296
Temperature	296
Humidity	297
Altitude	297
Pollution Protection	297
Storage and Shipment	297
Instrument Cooling	298
Storage Position	300
Carrying the Instrument	301
Using Modules	302
How to Fit and Remove Modules	302
Adding a Connector Interface	307
Protecting Empty Module Slots	308
Input and Output Connectors	310
The Remote Interlock (RIL) connector	311

GPIB Interface	312
Cables and Adapters.....	312
Connector.....	313
GPIB Logic Levels	314
Serial Interface.....	315
Return Shipments to Agilent Technologies.....	317
Parallel Port, PCMCIA Slot, Keyboard connector and 24V DC Output	316
Claims and Repackaging.....	317

Safety Considerations



The Agilent 8163A/B Lightwave Multimeter System, Agilent 8164A/B Lightwave Measurement System, and the Agilent 8166A/B Lightwave Multichannel System are Safety Class 1 instruments (that is, instruments with a metal chassis directly connected to earth via the power supply cable). The shown symbol is used to show a protective earth terminal in the instrument.

Before operation, review the instrument and manual for safety markings and instructions. You must follow these to ensure safe operation and to maintain the instrument in safe condition.

Some Agilent 8164A/B Lightwave Measurement System and Agilent 8166A/B Lightwave Multichannel System circuits are powered whenever the instrument is connected to the AC power source. To disconnect from the line power, disconnect the power cord either at the rear power inlet, or at the AC line power source (receptacle). One of these must always be accessible. If the instrument is in a cabinet, it must be disconnected from the line power by the system's line power switch.

Initial Inspection

Inspect the shipping container for damage. If there is damage to the container or cushioning, keep them until you have checked the contents of the shipment for completeness and verified the instrument both mechanically and electrically.

The Function Tests give a procedure for checking the operation of the instrument. If the contents are incomplete, mechanical damage or defect is apparent, or if an instrument does not pass the operator's checks, notify the nearest Agilent Technologies Sales/Service Office.

WARNING

To avoid hazardous electrical shock, do not perform electrical tests when there are signs of shipping damage to any portion of the outer enclosure (covers, panels, and so on).

AC Line Power Supply Requirements

Line Power Requirements

The Agilent 8163A/B Lightwave Multimeter System complies with overvoltage category II and can operate from the single-phase AC power source that supplies between 100 V and 240 V at a frequency in the range 50 to 60 Hz. The maximum power consumption is 120 VA with all options installed.

The Agilent 8164A/B Lightwave Measurement System complies with overvoltage category II and can operate from any single-phase AC power source that supplies between 100 V and 240 V at a frequency in the range from 50 to 60 Hz. The maximum power consumption is 270 VA with all options installed.

The Agilent 8166A/B Lightwave Multichannel System complies with overvoltage category II and can operate from any single-phase AC power source that supplies between 100 V and 240 V at a frequency in the range from 50 to 60 Hz. The maximum power consumption is 450 VA with all options installed.

Line Power Cable

In accordance with international safety standards, the instrument has a three-wire power cable. When connected to an appropriate AC power receptacle, this cable earths the instrument cabinet. For the part number of the power cable for your country and instrument see “Accessories” on page 319.



Figure 178 Agilent 8163A/B Lightwave Multimeter System Power Key

CAUTION

If you need to turn off the power, unplug the instrument at the mains or remove the power cable connector from the appliance coupler at the rear of the instrument. For this reason, the power cable connection should be easily accessible - allowing you to turn off the power quickly. If the instrument is in a cabinet, it must be disconnected from the line power by the system's line power switch.

CAUTION

Please note that the power key on the front panel of the Agilent 8164A/B Lightwave Measurement System does not stop the flow of power to the instrument. The power key allows you to switch between stand-by mode and power-on mode.

When the green power-on LED is lit, you can use the instrument. When the orange stand-by mode LED is lit, the Lightwave Measurement System is in stand-by mode. Do not remove the instrument covers - the power supply is still operating in stand-by mode.

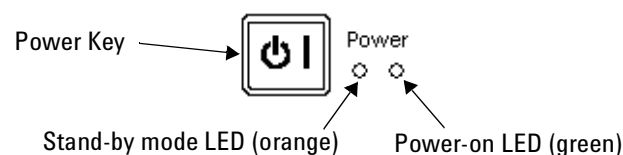

Figure 179 Agilent 8164A/B Lightwave Measurement System Power Key

CAUTION

If you need to turn off the power, unplug the instrument at the mains or remove the power cable connector from the appliance coupler at the rear of the instrument. For this reason, the power cable connection should be easily accessible - allowing you to turn off the power quickly. If the instrument is in a cabinet, it must be disconnected from the line power by the system's line power switch.

CAUTION

Please note that the power key on the front panel of the Agilent 8164A/B Lightwave Measurement System does not stop the flow of power to the instrument. The power key allows you to switch between stand-by mode and power-on mode.

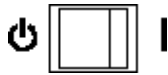

Figure 180 Agilent 8166A/B Lightwave Multichannel System Power Key

CAUTION

If you need to turn off the power, unplug the instrument at the mains or remove the power cable connector from the appliance coupler at the rear of the instrument. For this reason, the power cable connection should be easily accessible - allowing you to turn off the power quickly. If the instrument is in a cabinet, it must be disconnected from the line power by the system's line power switch.

The type of power cable shipped with each instrument depends on the country of destination.

NOTE

You only need to use the line power cable to connect to the AC adapter.

WARNING

To avoid the possibility of injury or death, you must observe the following precautions before switching on the instrument.

- **Insert the power cable plug only into a socket outlet provided with a protective earth contact. Do not negate this protective action by the using an extension cord without a protective conductor.**
- **Do not interrupt the protective earth connection intentionally.**

The AC power requirements are summarized on the rear panel of the instrument.

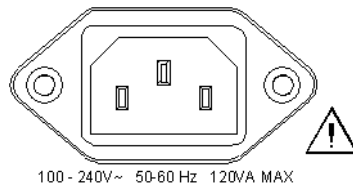

Figure 181 AC Power Requirement Markings - Agilent 8163A/B

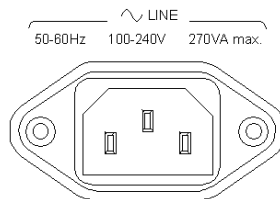

Figure 182 AC Power Requirement Markings - Agilent 8164A/B

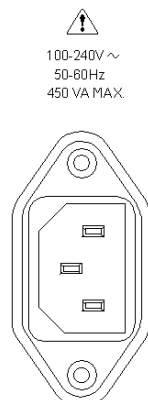

Figure 183 AC Power Requirement Markings - Agilent 8166A/B

Changing the Battery

CAUTION

The Agilent 8163A Lightwave Multimeter System, Agilent 8164A Lightwave Measurement System, and the Agilent 8166A Lightwave Multichannel System contain a disc shaped Lithium Thionyl Chloride battery.

The Agilent 8163B Lightwave Multimeter System, Agilent 8164B Lightwave Measurement System, and the Agilent 8166B Lightwave Multichannel System contain a cylindrical (" AA size) Lithium Manganese Dioxide battery.

The battery is not user replaceable. The battery is protected against loading by a special circuit and must be installed with the correct polarity. Changing the battery should be carried out only by Agilent Technologies service personnel. If you need to get the battery replaced refer to your nearest Agilent Technologies Sales/Service Office.

Changing the Fuse

CAUTION

There is no user replaceable fuse for the Agilent 8163A/B Lightwave Multimeter System, Agilent 8164A/B Lightwave Measurement System, and the Agilent 8166A/B Lightwave Multichannel System. Changing the fuse should be carried out only by Agilent Technologies service personnel. If you need to get the fuse replaced refer to your nearest Agilent Technologies Sales/Service Office.

The Agilent 8163A/B contains a F5.0A/250V fast-acting fuse.

The Agilent 8164A/B and Agilent 8166A/B contain a F10.0A/250V fast-acting fuse.

Operating and Storage Environment

The following summarizes the operating environment ranges. In order for the Agilent 8163A/B Lightwave Multimeter System, Agilent 8164A/B Lightwave Measurement System, and the Agilent 8166A/B Lightwave Multichannel System to meet specifications, the operating environment must be within these limits.

WARNING

The Agilent 8163A/B Lightwave Multimeter System, Agilent 8164A/B Lightwave Measurement System, and the Agilent 8166A/B Lightwave Multichannel System are not designed for outdoor use. To prevent potential fire or shock hazard, do not expose the instrument to rain or other excessive moisture.

Temperature

The instrument should be protected from temperature extremes and changes in temperature that may cause condensation within it.

The storage and operating temperature for the Lightwave Measurement System are given in the table below.

Table 20 Specified Temperature Ranges

Mainframe	Operating Range	Storage Range
Agilent 8163A/B	0° C to +45° C	-40°C to +70°C
Agilent 8164A/B	+10° C to +35° C	-40°C to +70°C
Agilent 8166A/B	0° C to +45° C	-40°C to +70°C

Humidity

The operating humidity for the Agilent 8164A/B Lightwave Measurement System is < 80% from 10°C to +35°C.

The operating humidity for the Agilent 8163A/B Lightwave Multimeter System and the Agilent 8166A/B Lightwave Multichannel System is up to 95% from 0°C to 45°C.

Altitude

The maximum operating altitude of the Agilent 8163A/B Lightwave Multimeter System, the Agilent 8164A/B Lightwave Measurement System, and the Agilent 8166A/B Lightwave Multichannel System is 2000 m.

Pollution Protection

The Agilent 8163A/B Lightwave Multimeter System, Agilent 8164A/B Lightwave Measurement System, and the Agilent 8166A/B Lightwave Multichannel System are designed for pollution degree 2.

Storage and Shipment

The instrument can be stored or shipped at temperatures between -40°C and +70°C. The instrument should be protected from temperature extremes that may cause condensation within it.

Instrument Cooling

The Agilent 8163A/B Lightwave Multimeter System and the Agilent 8164A/B Lightwave Measurement System have a cooling fan mounted internally.

The Agilent 8166A/B Lightwave Multichannel System has cooling fans mounted internally.

Mount or position your instrument upright and horizontally, as shown in Figure 184 , Figure 185 , or Figure 186 so that air can circulate through it freely.

Operating Position

When operating the Agilent 8163A/B, Agilent 8164A/B, or Agilent 8166A/B choose a location that provides at least 75 mm (3 inches) of clearance at the rear, and at least 25 mm (1 inch) of clearance at each side. Failure to provide adequate air clearance may result in excessive internal temperature, reducing instrument reliability. The instrument should not be operated when mounted on its rear or side panels.

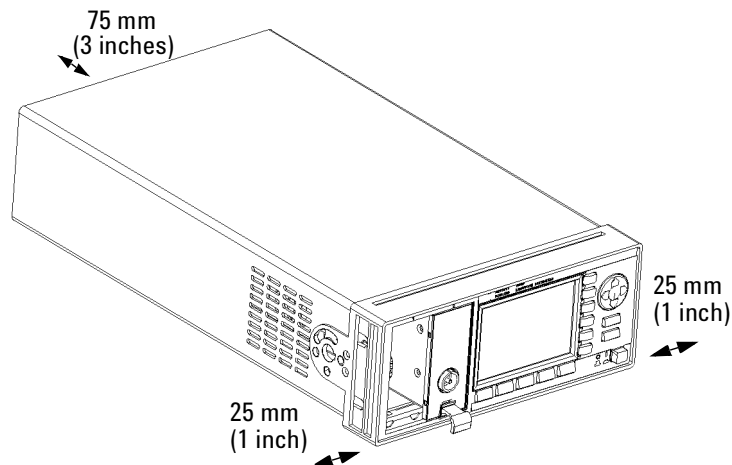

Figure 184 Correct Operating Position of the 8163A/B

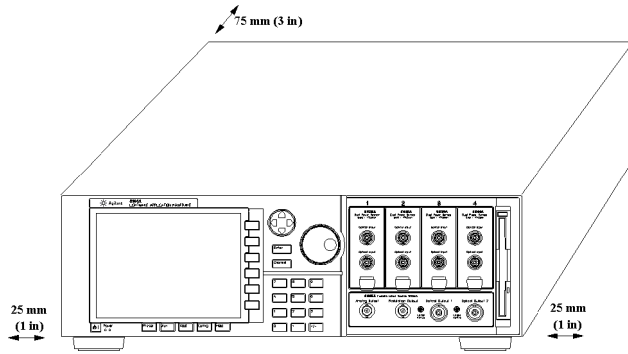

Figure 185 Correct Operating Position of the Agilent 8164A/B

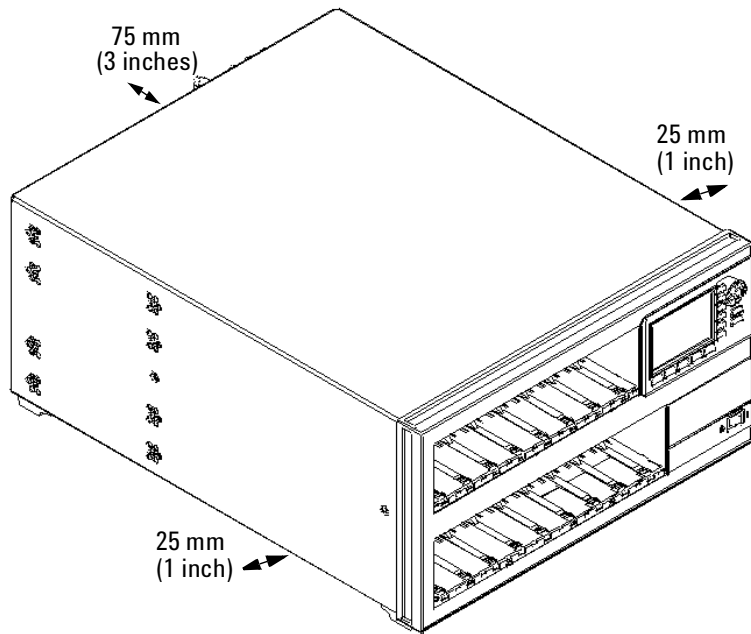

Figure 186 Correct Operating Position of the Agilent 8166A/B

Storage Position

The Agilent 8164A/B Lightwave Measurement System can be stored in its operating position, as shown in Figure 184 , or on its back legs as shown in Figure 187 . The back legs protect the connectors on the back panel from damage.

CAUTION

Before positioning the Agilent 8164A/B Lightwave Measurement System on its back legs:

- make sure that the instrument is in stand-by mode, see page 76 and
- disconnect all connections to the back panel.

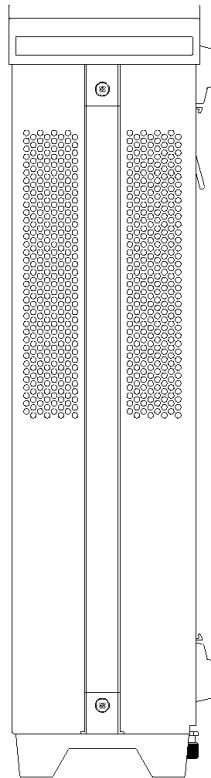

Figure 187 Storing the Agilent 8164A/B on its Back Legs.

Carrying the Instrument

When carrying the Agilent 8164A/B Lightwave Measurement System, grip the strap at the side of the instrument as shown in Figure 188 .

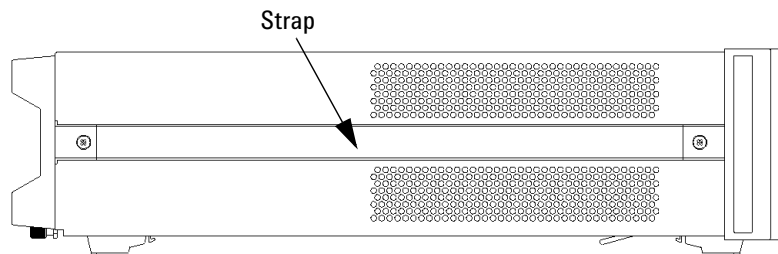

Figure 188 Carry the Agilent 8164A/B Lightwave Measurement System using this Strap

WARNING

If you need to lift the Agilent 8166A/B Lightwave Multichannel System ensure the following:

- **that you do not attempt to lift the instrument alone, at least two people are needed to carry the instrument,**
- **that your back is straight and you bend your legs rather than your spine,**
- **that the load is as close to your body as possible,**
- **when carrying, you never arch your spine backwards, and that you can cope with the weight of your load.**

Using Modules

How to Fit and Remove Modules

You can use two types of module:

- Front-loadable modules - these modules fit in the four module slots at the front of the Agilent 8164A/B Lightwave Measurement System or the two module slots at the front of the Agilent 8163A/B Lightwave Multimeter System or the 17 module slots at the front of the Agilent 8166A/B Lightwave Multichannel System.
- Back-loadable modules - these tunable laser source modules fit in the large module slot at the rear of the Agilent 8164A/B Lightwave Measurement System.

How to Remove a Front-Loadable Module

CAUTION

Do not use the electrical or optical connectors to pull the module out of the instrument, as this can cause damage to the connectors.

Make sure that the line power is switched off before you remove a module.

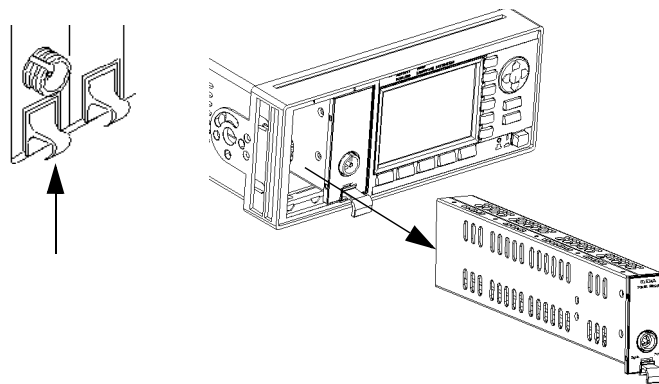

Figure 189 How to Remove a Front-Loadable Module

- 1 Lift the catch at the bottom front of the module.
- 2 With the catch lifted, pull the module out of the instrument. If the module does not slide out freely, check that you have lifted the catch high enough.

How to Fit a Front-Loadable Module

CAUTION

Do not use the electrical or optical connectors to push the module into the instrument, as this can cause damage to the connectors.

Make sure that the line power is switched off before you fit a module.

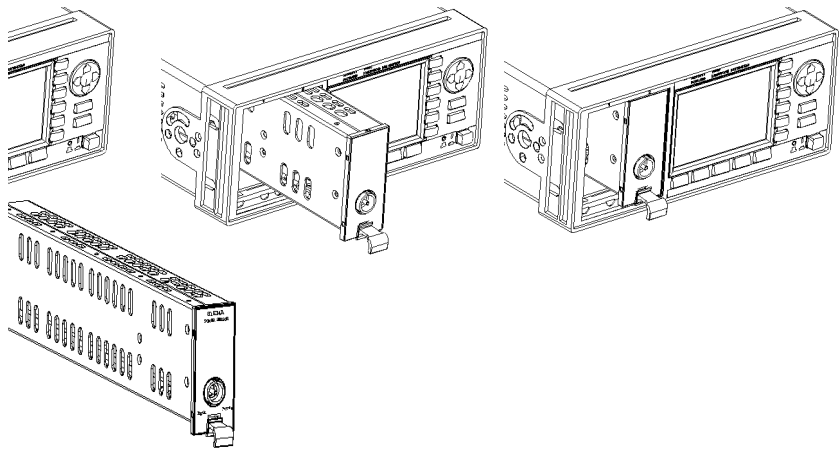

Figure 190 How to Insert a Front-Loadable Module

- 1** Position the module at an unoccupied slot, with the catch at the bottom front of the module.
- 2** Insert the module into the slot and onto the tracks. If the module does not slide in freely, check that you have correctly positioned and correctly oriented it and that there is no obstruction to its movement.
- 3** Apply pressure to the front panel, and push the module as far as it goes. You hear a small click when the module reaches its installed position. This is the catch making contact.

How to Remove a Back-Loadable Module

CAUTION

Disconnect all electrical and optical connectors before you remove this module from the instrument, as this can cause damage to the connectors.

Make sure that the instrument is in stand-by mode, see page 292, before you remove a module.

- 1 Untighten the retaining screws, see Figure 191 , that secure the module in the instrument.

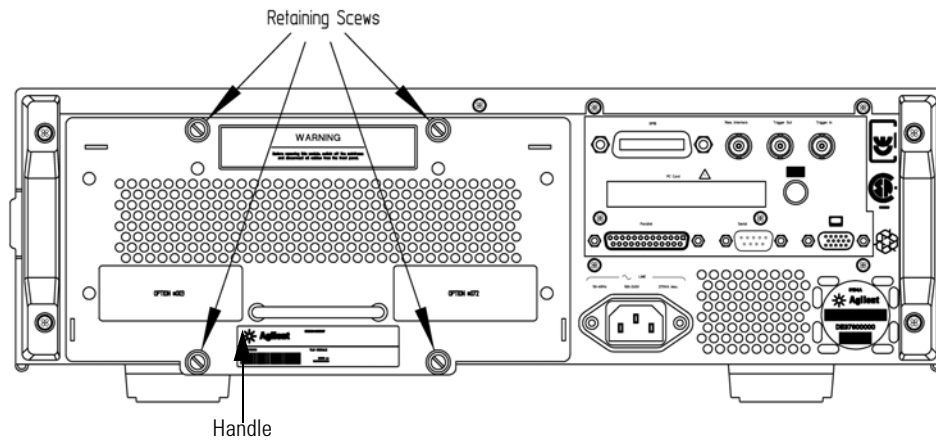

Figure 191 Back Panel of Agilent 8164B Lightwave Measurement System

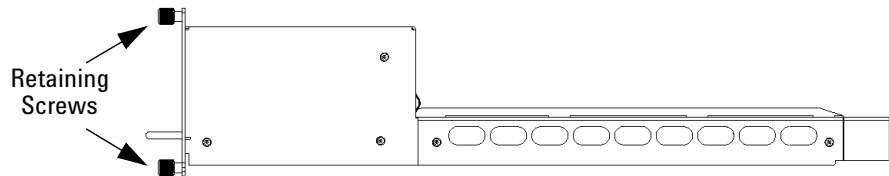

Figure 192 Side View of a Back-Loadable Module

- 2 Pull the module out of the mainframe, using the handle, being careful to keep the module completely flat.

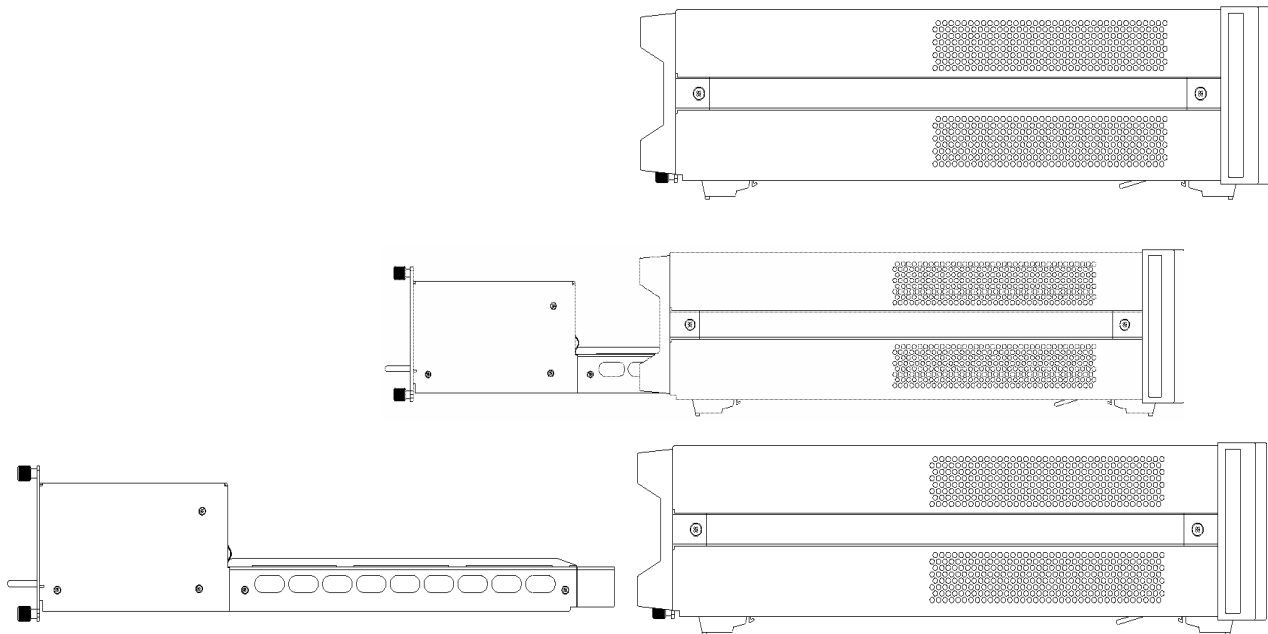

Figure 193 Removing a Back-Loadable Module from the Agilent 8164A/B

CAUTION

If you pull the module out at an angle or vertically, you may damage the instrument and the module. You should pull the module out along the direction shown by the arrow in Figure 193 .

How to Fit a Back-Loadable Module

CAUTION

Disconnect all electrical and optical connectors before you fit this module into the instrument, as this can cause damage to the connectors.

Make sure that the instrument is in stand-by mode, see page 292, before you remove a module.

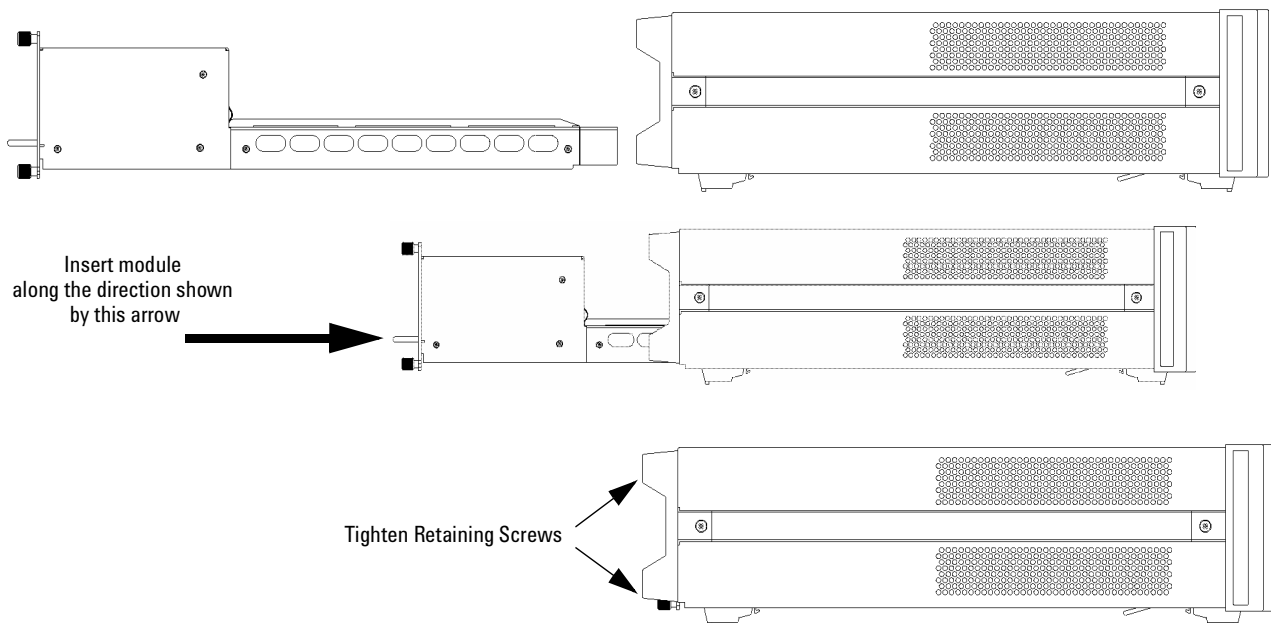

Figure 194 Fitting a Back-Loadable Module

- 1 Position the module at the rear of the instrument as shown in Figure 194 .
- 2 Insert the module into the mainframe, using the handle, being careful to keep the module completely flat. If the module does not slide freely, check that you have correctly oriented it and that there is no obstruction to its movement.

CAUTION

If you insert the module at an angle or vertically, you may damage the instrument and the module. You should insert the module along the direction shown by the arrow in Figure 194 .

- 3 Apply pressure to the handle, and push the module as far as it goes. You hear a small click when the module reaches its installed position. This is the catch making contact.
- 4 Tighten retaining screws, to hold module in place.

Adding a Connector Interface

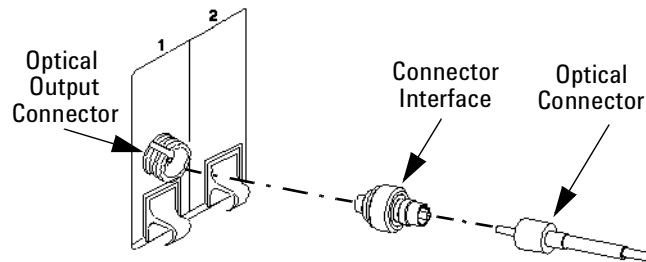

Figure 195 Adding a Connector Interface

NOTE

Before you attach a connector and fiber, you should clean them both. See *"Cleaning Instructions"* on page 421.

To use a connector interface to connect a module to an optical-fiber patchcord connector:

- 1 Select a connector interface to suit the optical connector that your optical fiber is terminated with.
- 2 Connect the connector interface to the optical output connector of the module, see Figure 195 .
- 3 You can now attach the optical connector to the connector interface.

Protecting Empty Module Slots

Fitting a Blind Panel or Filler Module helps to:

- prevent dust pollution and
- optimize cooling by guiding the air flow.

Fitting Blind Panels for Front-Loadable Module Slots

To fit the a blind panel (part number - 08163-40199), perform the following procedure.

- 1 Position the blind panel as shown in Figure 196 . Position the end closest to the handle against the bottom edge of the slot.

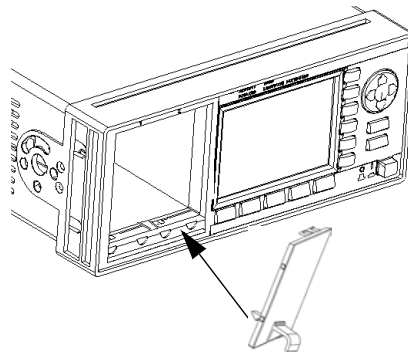

Figure 196 Fitting a Blind Panel

- 2 Push the top of the blind panel so that it clicks into position.

NOTE

To remove a blind panel, pull the handle.

Fitting a Filler Module for Back-Loadable Module Slots

The Agilent 81645A Filler Module must be used if you have not installed a back-loadable Tunable Laser module into the Agilent 8164A/B Lightwave Measurement System.

The Agilent 81645A Filler Module can be fitted in the same way as any back-loadable module, see *“How to Fit and Remove Modules” on page 302.*

The Agilent 81645A Filler Module can be removed in the same way as any back-loadable module, see *“How to Remove a Back-Loadable Module” on page 303*.

Input and Output Connectors

There are three BNC connectors on the rear panel of your instrument. These are the Remote Interlock, the Trigger Out and the Trigger In connectors.

CAUTION

There are two input BNC connectors: the Remote Interlock Connector and the Trigger Input, see Figure 197 or Figure 197. These are TTL inputs. A maximum of 5 V can be applied as an external voltage to either of these input connectors.

There is one output BNC connector: the Trigger Output, see Figure 197 or Figure 197. This is a TTL output. Do not apply an external voltage to this connector.

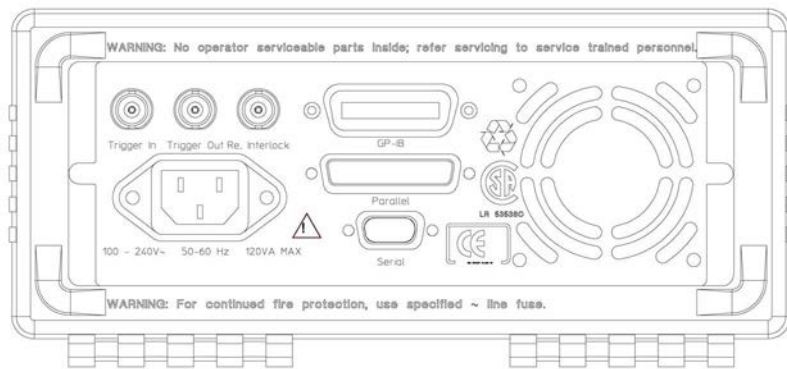

Figure 197 Rear Panel of the Agilent 8163B Lightwave Multimeter System

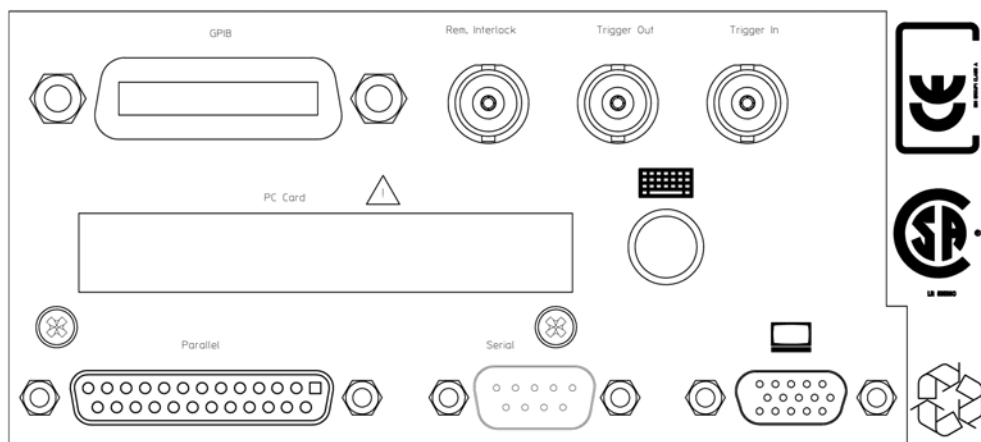

Figure 198 Rear Panel of the Agilent 8164B Lightwave Measurement System

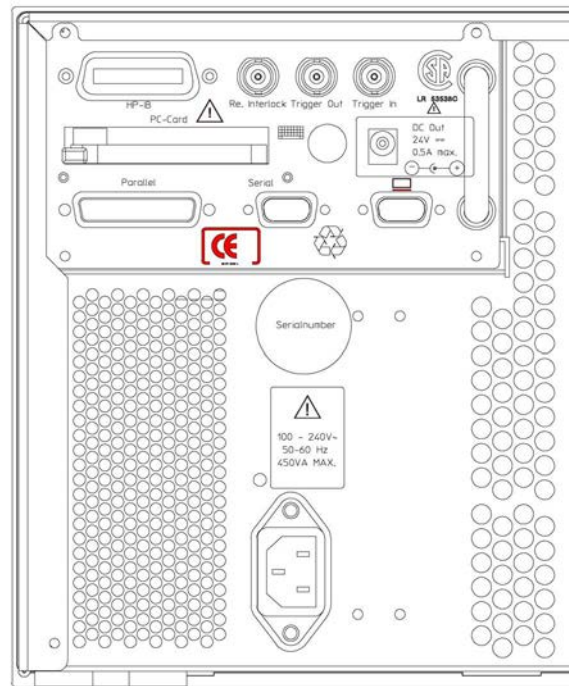

Figure 199 Rear Panel of the Agilent 8166B Lightwave Multichannel System

The Remote Interlock (RIL) connector

CAUTION

There is a Remote Interlock (RIL) connector at the back of the Agilent 8163A/B Lightwave Multimeter System, Agilent 8164A/B Lightwave Measurement System, and Agilent 8166A/B Lightwave Multichannel System for the purpose of the optional connection of a foot pedal. Setting the trigger configuration is explained in *“Additional Information” on page 63*. If the short circuit at this BNC connector is opened, the laser is switched off immediately and cannot be switched on until it is closed again.

GPIB Interface

You can connect your GPIB interface into a star network, a linear network, or a combination star and linear network. The limitations imposed on this network are as follows:

- The total cable length cannot exceed 20 meters
- The maximum cable length per device is 2 meters
- No more than 15 devices may be interconnected on one bus.

Cables and Adapters

See *"GPIB Cables and Adapters"* on page 333 for details on cables and adapters.

Connector

The following figure shows the connector and pin assignments.

Connector Part Number: 1251-0293

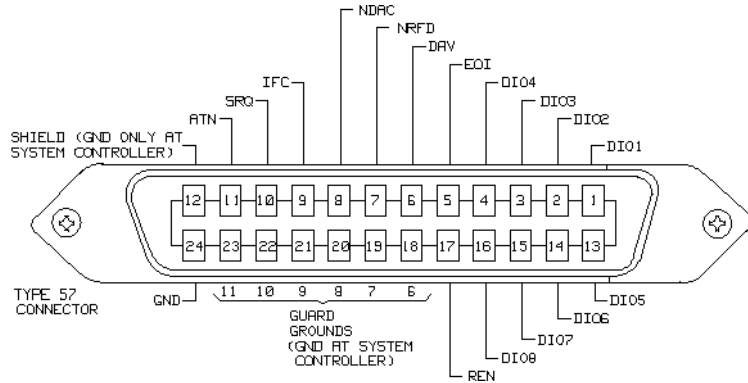

Figure 200 GPIB Connector

CAUTION

Agilent Technologies products delivered now are equipped with connectors having ISO metric-threaded lock screws and stud mounts (ISO M3.5×0.6) that are black in color. Earlier connectors may have lock screws and stud mounts with English-threaded lock screws and stud mounts (6-32 UNC) that have a shiny nickel finish.

CAUTION

It is recommended that you do not stack more than three connectors, one on top of the other.

Hand-tighten the connector lock screws. Do not use a screwdriver.

GPIB Logic Levels

The instrument's GPIB lines use standard TTL logic, as follows:

- True = Low = digital ground or 0 Vdc to 0.4 Vdc
- False = High = open or 2.5 Vdc to 5 Vdc

All GPIB lines have LOW assertion states. High states are held at 3.0 Vdc by pull-ups within the instrument. When a line functions as an input, it requires approximately 3.2 mA to pull it low through a closure to digital ground. When a line functions as an output, it will sink up to 48 mA in the low state and approximately 0.6 mA in the high state.

NOTE

The GPIB line screens are not isolated from ground.

Serial Interface

The mainframe's serial interface has configurable and fixed parameters.

- The Baudrate set for the serial interface of the instrument should match that set for the PC serial interface connected to it.
- The PC serial interface should be configured to match the instrument's fixed parameters.

Configurable Parameters

Baudrate. Refer to "How to Set the Speed of the Serial Interface" on page 73.

Fixed Parameters

These are:

Serial Interface Configuration - Fixed Parameters	
Data Bits	8
Parity	None
Stop Bits	1
Flow Control	Hardware (RTS/CTS)

NOTE

For serial communication use the null modem cable provided with your instrument (Agilent P/No. 5180-2477).

Parallel Port, PCMCIA Slot, Keyboard connector and 24V DC Output

- These interfaces are present on all models. In addition the 8164A Lightwave Measurement System has a PS/2 mouse connector.
- The parallel port is a standard centronics printer interface.
- The keyboard connector is a standard PS/2 connector.

NOTE

The PCMCIA Slot, the keyboard slot and the 24V DC output are reserved for future use.

Claims and Repackaging

If physical damage is evident or if the instrument does not meet specification when received, notify the carrier and the nearest Agilent Technologies Sales/Service Office. The Agilent Technologies Sales/Service Office will arrange for repair or replacement of the unit without waiting for settlement of the claim against the carrier.

Return Shipments to Agilent Technologies

If the instrument is to be shipped to a Agilent Technologies Sales/Service Office, attach a tag showing owner, return address, model number and full serial number and the type of service required.

The original shipping carton and packing material may be reusable, but the Agilent Technologies Sales/Service Office will provide information and recommendation on materials to be used if the original packing is no longer available or reusable. General instructions for repackaging are as follows:

- Wrap instrument in heavy paper or plastic.
- Use strong shipping container. A double wall carton made of 350-pound test material is adequate.
- Use enough shock absorbing material (3 to 4 inch layer) around all sides of the instrument to provide a firm cushion and prevent movement inside container. Protect control panel with cardboard.
- Seal shipping container securely.
- Mark shipping container FRAGILE to encourage careful handling.
- In any correspondence, refer to instrument by model number and serial number.

12

Accessories

The Agilent 8163A/B Lightwave Multimeter, the Agilent 8164A/B Lightwave Measurement System, and the Agilent 8166A/B Lightwave Multichannel System are available in various configurations for the best possible match to the most common applications.

This appendix provides information on the available options and accessories.

Instrument and Options - Agilent 8163A/B	320
Modules	321
Instrument and Options - Agilent 8164A/B	324
Modules	325
Agilent 81645A Filler Module	328
Options	328
Instrument and Options - Agilent 8166A/B	329
Modules	330
GPIB Cables and Adapters	333

Instrument and Options - Agilent 8163A/B

Product	Opt	Description	Part Number
Agilent 8163A/B		Lightwave Multimeter Mainframe	
		Additional User's Guide	08164-90B15
		Additional Programmer's Guide	08164-90B64
	1CM	Rack Mount Kit	
	900	Power Cord - United Kingdom	8120-1351
	901	Power Cord - Australia & New Zealand	8120-1369
	902	Power Cord - Continental Europe	8120-1689
	903	Power Cord - United States (120 V)	8120-1378
	905	Power Cord - Systems Cabinet Use - IEC 320	8120-1860
	906	Power Cord - Switzerland	8120-2104
	912	Power Cord - Denmark	8120-3997
	917	Power Cord - Republic of South Africa and India	8120-4211
	918	Power Cord - Japan	8120-4753
	919	Power Cord - Israel	8120-5182
	922	Power Cord - China	8120-8376
927	Power Cord - Thailand	8120-8871	

Modules

Power Sensor Modules	
Model No.	Description
Agilent 81630B	High Power module, +28 to -70 dBm, analog out
Agilent 81634B	Power Sensor, +10 to -110 dBm, analog out
Agilent 81635A	Dual Sensor InGaAs, +10 to -80 dBm
Agilent 81636B	Fast Power Sensor InGaAs, +10 to -80 dBm, analog out

Optical Heads	
Model No.	Description
Agilent 81623B	Ge Head, +10 to -80 dBm, Analog Output
Agilent 81624B	InGaAs Head, +10 to -90 dBm, Analog Output
Agilent 81626B	High Power Head, +27 to -80 dBm, Analog Output
Agilent 81628B	High Power Head, integrating sphere +37 to -60 dBm, Analog Output

Each Optical Head listed above, must be used with one of the following Optical Head Interface modules:

Optical Head Interfaces	
Model No.	Description
Agilent 81618A	Single Channel Interface
Agilent 81619A	Dual Channel Interface

Accessories for Optical Heads	
Model No.	Description
Agilent 81624CE	Head extension cable (4 m)
Agilent 81624DD	D-shape head adapter (magnetic)
Agilent 81624RM	Head mount kit (2 heads)
Agilent 81625RM	Head mount kit (4 heads)

Fabry-Perot Laser Diode Modules	
Model No.	Description
Agilent 81650A	LD Module 1310 nm, 0 dBm
Agilent 81651A	LD Module 1550 nm, 0 dBm
Agilent 81654A	LD Module 1310/1550 nm, 0 dBm
Agilent 81655A	LD Module 1310 nm, 13 dBm
Agilent 81656A	LD Module 1550 nm, 13 dBm
Agilent 81657A	LD Module 1310/1550 nm, 13 dBm

DFB Laser Diode Modules	
Model No.	Description
Agilent 81662A	DFB LD Module - 10 mW
Agilent 81663A	DFB LD Module - 20 mW

High Power Compact Tunable Laser Source Module	
Model No.	Description
Agilent 81980A	S and C band compact TLS with SBS suppression for swept multi-channel test applications
Agilent 81940A	C and L band compact TLS with SBS suppression for swept multi-channel test applications
Agilent 81944A	C and L band compact TLS with SBS suppression for swept multi-channel test applications used for PMD test system N3909A
Agilent 81989A	S and C band compact TLS with SBS suppression for multi-channel test applications
Agilent 81949A	C and L band compact TLS with SBS suppression for multi-channel test applications

Return Loss Modules	
Model No.	Description
Agilent 81610A	RL Module - no internal source
Agilent 81613A	RL Module - 1310/1550 nm internal source

Attenuator Modules	
Model No.	Description
Agilent 81570A	high power, single slot, straight connectors
Agilent 81571A	high power, single slot, angled connectors
Agilent 81573A	high power, single slot, SMF pigtail connectors
Agilent 81576A	high power, dual slot, power control, straight connectors
Agilent 81577A	high power, dual slot, power control, angled connectors
Agilent 81578A	high power, single slot, multimode, straight connectors

Instrument and Options - Agilent 8164A/B

Product	Opt	Description	Part Number
Agilent 8164A/B		Lightwave Measurement System Mainframe	
		Additional User's Guide	08164-90B15
		Additional Programmer's Guide	08164-90B64
	1CN	Front Handle Kit	
	1CM	Rack Mount Kit	
	900	Power Cord - United Kingdom	8120-1351
	901	Power Cord - Australia & New Zealand	8120-1369
	902	Power Cord - Continental Europe	8120-1689
	903	Power Cord - United States (120 V)	8120-1378
	905	Power Cord - Systems Cabinet Use - IEC 320	8120-1860
	906	Power Cord - Switzerland	8120-2104
	912	Power Cord - Denmark	8120-3997
	917	Power Cord - Republic of South Africa and India	8120-4211
	918	Power Cord - Japan	8120-4753
	919	Power Cord - Israel	8120-5182
	922	Power Cord - China	8120-8376
927	Power Cord - Thailand	8120-8871	

Modules

Power Sensor Modules	
Model No.	Description
Agilent 81630B	High Power module, +28 to -70 dBm, analog out
Agilent 81634B	Power Sensor, +10 to -110 dBm
Agilent 81635A	Dual Sensor InGaAs, +10 to -80 dBm
Agilent 81636B	Fast Power Sensor InGaAs, +10 to -80 dBm, analog out

Optical Heads	
Model No.	Description
Agilent 81623B	Ge Head, +10 to -80 dBm, Analog Output
Agilent 81624B	InGaAs Head, +10 to -90 dBm, Analog Output
Agilent 81626B	High Power Head, +27 to -80 dBm, Analog Output
Agilent 81628B	High Power Head, integrating sphere +37 to -60 dBm, Analog Output

Each Optical Head listed above, must be used with one of the following Optical Head Interface modules:

Optical Head Interfaces	
Model No.	Description
Agilent 81618A	Single Channel Interface
Agilent 81619A	Dual Channel Interface

Accessories for Optical Heads	
Model No.	Description
Agilent 81624CE	Head extension cable (4 m)
Agilent 81624DD	D-shape head adapter (magnetic)
Agilent 81624RM	Head mount kit (2 heads)
Agilent 81625RM	Head mount kit (4 heads)

Fabry-Perot Laser Diode Modules	
Model No.	Description
Agilent 81650A	LD Module 1310 nm, 0 dBm
Agilent 81651A	LD Module 1550 nm, 0 dBm
Agilent 81654A	LD Module 1310/1550 nm, 0 dBm
Agilent 81655A	LD Module 1310 nm, 13 dBm
Agilent 81656A	LD Module 1550 nm, 13 dBm
Agilent 81657A	LD Module 1310/1550 nm, 13 dBm

DFB Laser Diode Modules	
Model No.	Description
Agilent 81662A	DFB LD Module - 10 mW
Agilent 81663A	DFB LD Module - 20 mW

High Power Compact Tunable Laser Source Module	
Model No.	Description
Agilent 81980A	S and C band compact TLS with SBS suppression for swept multi-channel test applications
Agilent 81940A	C and L band compact TLS with SBS suppression for swept multi-channel test applications
Agilent 81944A	C and L band compact TLS with SBS suppression for swept multi-channel test applications used for PMD test system N3909A
Agilent 81989A	S and C band compact TLS with SBS suppression for multi-channel test applications
Agilent 81949A	C and L band compact TLS with SBS suppression for multi-channel test applications

Backloadable Tunable Laser Source Modules	
Model No.	Description
Agilent 81600B #200	Low SSE TLS for the Test of Critical Components 1400 - 1640 nm
Agilent 81600B #160	Low SSE TLS for the Test of Critical Components 1495 - 1640 nm
Agilent 81600B #150	Low SSE TLS for the Test of Critical Components 1450 - 1590 nm
Agilent 81600B #140	Low SSE TLS for the Test of Critical Components 1370 - 1495 nm
Agilent 81600B #142	High Power TLS for the Test of Critical Components 1370 - 1495 nm
Agilent 81600B #132	High Power TLS for the Test of Critical Components 1260 - 1375 nm
Agilent 81600B #130	Low SSE TLS for the Test of Critical Components 1260 - 1375 nm

Return Loss Modules	
Model No.	Description
Agilent 81610A	RL Module - no internal source
Agilent 81613A	RL Module - 1310/1550 nm internal source

Attenuator Modules	
Model No.	Description
Agilent 81570A	high power, single slot, straight connectors
Agilent 81571A	high power, single slot, angled connectors
Agilent 81573A	high power, single slot, SMF pigtail connectors
Agilent 81575A	high power, single slot, PMF pigtail connectors
Agilent 81576A	high power, dual slot, power control, straight connectors
Agilent 81577A	high power, dual slot, power control, angled connectors
Agilent 81578A	high power, single slot, multimode, straight connectors

Agilent 81645A Filler Module

The Agilent 81645A Filler Module is required to operate the Agilent 8164A/B mainframe if it is used without a back-loadable Tunable Laser module. See “Fitting a Filler Module for Back-Loadable Module Slots” on page 308 for more details.

Options

Option 003 - Agilent 81600B #142

Built-in optical attenuator with 60 dB attenuation range.

NOTE

The Agilent 81600B #200, #160 #150 and #140 have a built-in optical attenuator as standard for Output 2, the High Power output.

A built-in optical attenuator is not available for the Agilent 81600B #132.

Option 071 - All Tunable Laser Source Modules

Polarization-maintaining fiber, Panda-type, for straight contact connectors.

Option 072 - All Tunable Laser Source Modules

Polarization-maintaining fiber, Panda-type, for angled contact connectors.

Instrument and Options - Agilent 8166A/B

Product	Opt	Description	Part Number
Agilent 8166A/B		Lightwave Multimeter Mainframe	
		Additional User's Guide	08164-90B15
		Additional Programmer's Guide	08164-90B64
	1CM	Rack Mount Kit	
	900	Power Cord - United Kingdom	8120-1351
	901	Power Cord - Australia & New Zealand	8120-1369
	902	Power Cord - Continental Europe	8120-1689
	903	Power Cord - United States (120 V)	8120-1378
	905	Power Cord - Systems Cabinet Use - IEC 320	8120-1860
	906	Power Cord - Switzerland	8120-2104
	912	Power Cord - Denmark	8120-3997
	917	Power Cord - Republic of South Africa and India	8120-4211
	918	Power Cord - Japan	8120-4753
	919	Power Cord - Israel	8120-5182
	922	Power Cord - China	8120-8376
927	Power Cord - Thailand	8120-8871	

Modules

Power Sensor Modules	
Model No.	Description
Agilent 81630B	High Power module, +28 to -70 dBm, analog out
Agilent 81634B	Power Sensor, +10 to -110 dBm
Agilent 81635A	Dual Sensor InGaAs, +10 to -80 dBm
Agilent 81636B	Fast Power Sensor InGaAs, +10 to -80 dBm, analog out

Optical Heads	
Model No.	Description
Agilent 81623B	Ge Head, +10 to -80 dBm, Analog Output
Agilent 81624B	InGaAs Head, +10 to -90 dBm, Analog Output
Agilent 81626B	High Power Head, +27 to -80 dBm, Analog Output
Agilent 81628B	High Power Head, integrating sphere +37 to -60 dBm, Analog Output

Each Optical Head listed above, must be used with one of the following Optical Head Interface modules:

Optical Head Interfaces	
Model No.	Description
Agilent 81618A	Single Channel Interface
Agilent 81619A	Dual Channel Interface

Accessories for Optical Heads	
Model No.	Description
Agilent 81624CE	Head extension cable (4 m)
Agilent 81624DD	D-shape head adapter (magnetic)
Agilent 81624RM	Head mount kit (2 heads)
Agilent 81625RM	Head mount kit (4 heads)

Fabry-Perot Laser Diode Modules	
Model No.	Description
Agilent 81650A	LD Module 1310 nm, 0 dBm
Agilent 81651A	LD Module 1550 nm, 0 dBm
Agilent 81654A	LD Module 1310/1550 nm, 0 dBm
Agilent 81655A	LD Module 1310 nm, 13 dBm
Agilent 81656A	LD Module 1550 nm, 13 dBm
Agilent 81657A	LD Module 1310/1550 nm, 13 dBm

DFB Laser Diode Modules	
Model No.	Description
Agilent 81662A	DFB LD Module - 10 mW
Agilent 81663A	DFB LD Module - 20 mW

High Power Compact Tunable Laser Source Module	
Model No.	Description
Agilent 81980A	S and C band compact TLS with SBS suppression for swept multi-channel test applications
Agilent 81940A	C and L band compact TLS with SBS suppression for swept multi-channel test applications
Agilent 81944A	C and L band compact TLS with SBS suppression for swept multi-channel test applications used for PMD test system N3909A
Agilent 81989A	S and C band compact TLS with SBS suppression for multi-channel test applications
Agilent 81949A	C and L band compact TLS with SBS suppression for multi-channel test applications

Return Loss Modules	
Model No.	Description
Agilent 81610A	RL Module - no internal source
Agilent 81613A	RL Module - 1310/1550 nm internal source

Attenuator Modules	
Model No.	Description
Agilent 81570A	high power, single slot, straight connectors
Agilent 81571A	high power, single slot, angled connectors
Agilent 81573A	high power, single slot, SMF pigtail connectors
Agilent 81575A	high power, single slot, PMF pigtail connectors
Agilent 81576A	high power, dual slot, power control, straight connectors
Agilent 81577A	high power, dual slot, power control, angled connectors
Agilent 81578A	high power, single slot, multimode, straight connectors

GPIB Cables and Adapters

The GPIB connector is compatible with the connectors on the following cables and adapters:

- GPIB Cable, 10833A, 1 m (3.3 feet)
- GPIB Cable, 10833B, 2 m (6.6 feet).
- GPIB Cable, 10833C, 4 m (13.2 feet)
- GPIB Cable, 10833D, 0.5 m (1.6 feet)
- GPIB Adapter, 10834A, 2.3 cm extender. Use this adapter if there is no space to connect your GPIB cable directly to a GPIB interface.



13

Specifications and Regulations Compliance

The Agilent 8163A/B Lightwave Multimeter, the Agilent 8164A/B Lightwave Measurement System, and the Agilent 8166A/B Lightwave Multichannel System are produced to the ISO 9001 international quality system standard as part of Agilent Technologies' commitment to continually increasing customer satisfaction through improved quality control.

Specifications describe the instrument's warranted performance. Supplementary performance characteristics describe the instrument's non-warranted typical performance.

Because of the modular nature of the instrument, the performance specifications apply to the modules rather than the mainframe unit. The specifications for a module are supplied with that module.

Agilent 8163A Specifications	337
Agilent 8163B Specifications	338
Agilent 8164A Specifications	339
Agilent 8164B Specifications	340
Agilent 8166A Specifications	341
Agilent 8166B Specifications	342
Declarations of Conformity	343
Agilent 8163A Lightwave Multimeter	344
Agilent 8163B Lightwave Multimeter	345
Agilent 8164A Lightwave Measurement System	346
Agilent 8164B Lightwave Measurement System	347
Agilent 8166A Lightwave Multichannel System	348
Agilent 8166B Lightwave Multichannel System	349
Regulations Information	350
Safety Canada	350
EMC Canada	350
EMC Australia/New Zealand	350

Agilent 8163A Specifications

The Agilent 8163A Lightwave Multimeter displays two channels.

Display	Graphical display 190 × 300 points visible, monochrome.
Display Resolution (Power Meters)	0.0001 dB/dBm, 0.01 pW to 10 pW (depending on power range), up to 6.5 digits (user definable).
Compatibility	The Agilent 8163A mainframe supports all 8153A Series and Agilent 8163A Series modules. ^[1]
Data Acquisitions	
<i>Memory</i>	4000 measurement results / channel
<i>Selectable data averaging time</i>	depends on sensor module
<i>Selectable total data averaging time</i>	20 ms to 23:59:59 h
Trigger	True synchronous on all channels
Environmental	
<i>Storage temperature</i>	-40° C to +70° C
<i>Operating temperature</i>	0° C to +45° C
<i>Humidity</i>	<95% R.H. from 0° C to +45° C
Power	AC 100 - 240 V ± 10%, 48 - 66 Hz, 100 VA max.
Dimensions	88 mm × 213 mm × 380 mm (3.5" × 8.4" × 15")
Weight	net 4.200 kg (9.3 lbs); shipping 6.5 kg (14.5 lbs)
GPIB interface	All modes and parameters accessible via GPIB interface
<i>Function code</i>	SCPI standard ^[2]
Interfaces	Parallel port (Centronics) Serial port (RS232)
Number of Modules	2 Modules

^[1] Agilent 8163A Series modules are NOT compatible with the 8153A Lightwave Multimeter.

^[2] For code compatibility to the 8153A Lightwave Multimeter please refer to the mainframe's Programming Guide, part number 08164-91016.

Agilent 8163B Specifications

The Agilent 8163B Lightwave Multimeter displays two channels.

Display	Graphical color display 300 × 240 points visible
Display Resolution (Power Meters)	0.0001 dB/dBm, 0.01 pW to 10 pW (depending on power meter), up to 6.5 digits (user definable).
Compatibility	The Agilent 8163B mainframe supports all HP 8153A Series and Agilent 8163A/B Series modules. ^[1]
Environmental	
<i>Storage temperature</i>	-40° C to +70° C
<i>Operating temperature</i>	0° C to +45° C
<i>Humidity</i>	<95% R.H. from 0° C to +45° C
Power	AC 100 - 240 V ± 10%, 50 - 60 Hz, 120 VA max.
Dimensions	88 mm × 213 mm × 380 mm (3.5" × 8.4" × 15")
Weight	net 4.200 kg (9.3 lbs); shipping 6.5 kg (14.5 lbs)
GPIB interface	All modes and parameters accessible via GPIB interface
<i>Function code</i>	SH1, AH1, T6, L4, SR0, RL1, PP0, DC1, DT0, C0. SCPI standard ^[2]
GPIB Interface Performance	max. 300 kB/s (burst data rate during read of 12001 points from a power meter).
Trigger	True synchronous on all channels
Trigger Bandwidth	max. 100 kHz for triggering, and max. 1 MHz (50% duty cycle) for external digital modulation.
RS232C Interface: max. baud rate	115200 bps
Parallel Printer Interface	Centronics
Number of Modules	2 Modules

^[1] Agilent 8163B Series modules are NOT compatible with the 8153A Lightwave Multimeter.

^[2] For code compatibility to the 8153A Lightwave Multimeter please refer to the mainframe's Programming Guide, part number 08164-90B61.

Agilent 8164A Specifications

The Agilent 8164A Lightwave Measurement System displays five channels.

Display	600 × 400 pixels visible, active colour LCD. VGA connector for external monitor.
Compatibility	The Agilent 8164A mainframe supports all 8153A Series and Agilent 8163A Series modules. ^[1]
Environmental	
<i>Storage temperature</i>	-40° C to 70° C
<i>Operating temperature</i>	10° C to 35° C
<i>Humidity</i>	< 80% R.H. from 10° C to 35°C
Power	100 - 240 V _{rms} ± 10%, 50 - 60 Hz, 280 VA max.
Dimensions	145 mm × 426 mm × 545 mm (5.8" × 16.9" × 21.6")
Weight	net, 20 kg (45 lb.), 23 kg (51 lb.), including modules.
GPIB interface	
<i>Function code</i>	SH1, AH1, T6, L4, SR1, RL1, PP0, DC2, DT0, C0. SCPI standard; ^[2]
RS232C Interface: max. baud rate	115200 bps
Parallel Printer Interface	Centronics
Number of Modules	4 front-loadable Modules, 1 back-loadable Module
PC-Card slot	PCMCIA 2.0/JEIDA 4.0
Data Storage	Internal Hard Disk Drive: 3250 MByte Memory cards according to PCMCIA type I, II, and III.
External Keyboard	PS/2 connector

^[1] Agilent 8163A Series modules are NOT compatible with the 8153A Lightwave Multimeter.

^[2] For code compatibility to the 8153A Lightwave Multimeter please refer to the mainframe's Programming Guide, part number 08164-91016.

Agilent 8164B Specifications

The Agilent 8164B Lightwave Measurement System displays five channels.

Display	Graphic color display 640 × 480 pixels visible. VGA connector for external monitor.
Compatibility	The Agilent 8164B mainframes support all HP 8153A Series and Agilent 8163A/B Series modules. ^[1]
Environmental	
<i>Storage temperature</i>	-40° C to 70° C
<i>Operating temperature</i>	10° C to 35° C
<i>Humidity</i>	< 80% R.H. from 10° C to 35° C
Power	AC 100 - 240 V ± 10%, 50 - 60 Hz, 280 VA max.
Dimensions	145 mm × 426 mm A 545 mm (5.8" × 16.9" × 21.6")
Weight	net, 20 kg (45 lb.), 23 kg (51 lb.), including modules.
GPIB interface	All modes and parameters accessible via GPIB interface.
<i>Function code</i>	SH1, AH1, T6, L4, SR0, RL1, PP0, DC1, DT0, C0. SCPI standard. ^[2]
GPIB Interface Performance	max. 300 kB/s (burst data rate during read of 12001 points from a power meter).
Trigger	True synchronous on all channels
Trigger Bandwidth	max. 100 kHz for triggering, and max. 1 MHz (50% duty cycle) for external digital modulation.
RS232C Interface: max. baud rate	115200 bps
Parallel Printer Interface	Centronics
Number of Modules	4 front-loadable Modules, 1 back-loadable Module
External Keyboard	PS/2 connector (reserved for future use)

^[1] Agilent 8163B Series modules are NOT compatible with the 8153A Lightwave Multimeter.

^[2] For code compatibility to the 8153A Lightwave Multimeter please refer to the mainframe's Programming Guide, part number 08164-90B61.

Agilent 8166A Specifications

The Agilent 8166A Lightwave Multichannel System displays 17 channels.

Display	Graphical display 190 × 300 points visible, monochrome.
Display Resolution (Power Meters)	0.0001 dB/dBm, 0.01 pW to 10 pW (depending on power range), up to 6.5 digits (user definable).
Compatibility	The Agilent 8166A supports all Agilent 8163A Series modules. ^[1]
Trigger	True synchronous on all channels
Environmental	
<i>Storage temperature</i>	-40° C to +70° C
<i>Operating temperature</i>	0° C to +45° C
<i>Humidity</i>	<95% R.H. from 0° C to +45° C
Power	AC 100 - 240 V ± 10%, 50 - 60 Hz, 450 VA max.
GPIB interface	All modes and parameters accessible via GPIB interface
<i>Function code</i>	SCPI standard ^[2]
Interfaces	Parallel port (Centronics) Serial port (RS232)
Number of Modules	17 Modules
Dimensions	240 mm × 430 mm × 580mm (9.5" × 17" × 23")
Weight	net 23 kg (50.7 lbs); shipping 45 kg (94.8 lbs)

^[1] Modules designed for the 8153A Lightwave Multimeter are NOT compatible with the Agilent 8166A Lightwave Multichannel System.

^[2] For code compatibility to the 8153A Lightwave Multimeter please refer to the mainframe's Programming Guide, part number 08164-91016.

Agilent 8166B Specifications

The Agilent 8166B Lightwave Multichannel System displays 17 channels.

Display	Graphical color display 300 × 240 points visible.
Display Resolution (Power Meters)	0.0001 dB/dBm, 0.01 pW to 10 pW (depending on power range), up to 6.5 digits (user definable).
Compatibility	The Agilent 8166A/B supports all Agilent 8163A/B Series modules. ^[1]
Environmental	
<i>Storage temperature</i>	-40° C to +70° C
<i>Operating temperature</i>	0° C to +45° C
<i>Humidity</i>	<95% R.H. from 0° C to +45° C
Power	AC 100 - 240 V ± 10%, 50 - 60 Hz, 450 VA max.
Dimensions	240 mm × 430 mm × 580mm (9.5" × 17" × 23")
Weight	net 23 kg (50.7 lbs); shipping 45 kg (94.8 lbs)
GPIB interface	All modes and parameters accessible via GPIB interface
<i>Function code</i>	SH1, AH1, T6, L4, SR0, RL1, PP0, DC1, DT0, C0. SCPI standard; ^[2]
GPIB Interface Performance	max. 300 kB/s (burst data rate during read of 12001 points from a power meter).
Trigger	True synchronous on all channels
Trigger Bandwidth	max. 100 kHz for triggering, and max. 1 MHz (50% duty cycle) for external digital modulation.
RS232C Interface: max. baud rate	115200 bps
Parallel Printer Interface	Centronics
Number of Modules	17 Modules

^[1] Modules designed for the 8153A Lightwave Multimeter are NOT compatible with the Agilent 8166A/B Lightwave Multichannel System.

^[2] For code compatibility to the 8153A Lightwave Multimeter please refer to the mainframe's Programming Guide, part number 08164-90B61.

Declarations of Conformity

Agilent 8163A Lightwave Multimeter

DECLARATION OF CONFORMITY

According to ISO/IEC Guide 22 and CEN/CENELEC EN 45014



Manufacturer's Name: Agilent Technologies Deutschland GmbH
Manufacturer's Address: Photonic Measurement Division (PMD)
 Herrenberger Str. 130
 D-71034 Boeblingen

Declares, that the product

Product Name: Lightwave Multimeter Mainframe
Model Number: 8163A
Product Modules:

81611A ⁽¹⁾	Return Loss Module 1300nm
81612A ⁽¹⁾	Return Loss Module 1550nm
81613A ⁽¹⁾	Return Loss Module 1310/1550nm
81614A ⁽¹⁾	Return Loss Module 1550/1625nm
81650A ⁽¹⁾	Laser Module 1310nm
81651A ⁽¹⁾	Laser Module 1550nm
81652A ⁽¹⁾	Laser Module 1550/1625nm
81653A ⁽¹⁾	Laser Module 1650nm
81654A ⁽¹⁾	Laser Module 1310/1550nm
81655A ⁽¹⁾	Laser Module 1310nm
81656A ⁽¹⁾	Laser Module 1550nm
81657A ⁽¹⁾	Laser Module 1310/1550nm
81662A ⁽¹⁾	DFB Laser Module 1500nm-1650nm
81663A ⁽¹⁾	DFB Laser Module 1500nm-1650nm
81649A ⁽¹⁾	Compact Tunable Laser Module 1570nm-1620nm
81689A ⁽¹⁾	Compact Tunable Laser Module 1525nm-1575nm
81689B ⁽¹⁾	Compact Tunable Laser Module 1525nm-1575nm
81940A ⁽²⁾	Compact Tunable Laser Module 1520nm-1630nm
81949A ⁽²⁾	Compact Tunable Laser Module 1520nm-1630nm
81980A ⁽²⁾	Compact Tunable Laser Module 1465nm-1575nm
81989A ⁽²⁾	Compact Tunable Laser Module 1465nm-1575nm

Conforms with the following European Directives:

The product herewith complies with the requirements of the Low Voltage Directive 73/23/EEC and the EMC Directive 89/336/EEC (including 93/68/EEC) and carries the CE Marking accordingly.

Conforms with the following product standards:

	Standard	Limit
EMC	IEC 61326-1:1997+A1:1998 / EN 61326-1:1997+A1:1998 CISPR 11:1997 / EN 55011:1998 IEC 61000-3-2:2000 / EN 61000-3-2:1995+A1:1997+A2:1998 IEC 61000-3-3:1994 / EN 61000-3-3:1995 IEC 61000-4-2:1995+A1:1998 / EN 61000-4-2:1995 IEC 61000-4-3:1995 / EN 61000-4-3:1995 IEC 61000-4-4:1995 / EN 61000-4-4:1995 IEC 61000-4-5:1995 / EN 61000-4-5:1995 IEC 61000-4-6:1996 / EN 61000-4-6:1996 IEC 61000-4-11:1994 / EN 61000-4-11:1994 Canada: ICES-001:1998 Australia/New Zealand: AS/NZS 2064.1	Group 1 Class B 4kV CD, 8kV AD 3 V/m, 80-1000 MHz 0.5kV signal lines, 1kV power lines 0.5 kV line-line, 1 kV line-ground 3V, 0.15-80 MHz 1 cycle/100%
Safety	IEC 61010-1:1990+A1:1992+A2:1995 / EN 61010-1:1993+A2:1995 IEC 60825-1:2001 / EN 60825-1:1994+A11:1996+A2:2001 Canada: CSA C22.2 No. 1010.1:1992 USA:UL 3111-1:1994; FDA 21CFR1040.10+Laser Notice No. 50	

Supplemental Information:

The product was tested in a typical configuration with Agilent Technologies test systems.

- (1) FDA Accession Number 9521220-54
 (2) FDA Accession Number 9122175-10

2003-May-14
 Date

 Hans-Martin Fischer
 Name
 Product Regulations Representative
 Title

For further information, please contact your local Agilent Technologies sales office, agent or distributor.
 Authorized EU-representative: Agilent Technologies Deutschland GmbH, Herrenberger Strasse 130, D-71034 Boeblingen, Germany

Revision: G

Issue Date: 2003-May-14

Agilent 8163B Lightwave Multimeter

 Agilent Technologies	DECLARATION OF CONFORMITY According to ISO/IEC Guide 22 and CEN/CENELEC EN 45014	
---	--	---

Manufacturer's Name: Agilent Technologies International sarl
Manufacturer's Address: Rue de la Gare 29
 CH-1110 Morges
 Switzerland

Declares under sole responsibility that the product as originally delivered

Product Name:	Lightwave Multimeter Mainframe	
Model Number:	8163B	
Product Modules:	81611A ⁽¹⁾	Return Loss Module 1300nm
	81612A ⁽¹⁾	Return Loss Module 1550nm
	81613A ⁽¹⁾	Return Loss Module 1550/1625nm
	81614A ⁽¹⁾	Return Loss Module 1310/1550nm
	81650A ⁽¹⁾	Laser Source 1310nm
	81651A ⁽¹⁾	Laser Source 1550nm
	81652A ⁽¹⁾	Laser Source 1550/1625nm
	81654A ⁽¹⁾	Laser Source 1310/1550nm
	81655A ⁽¹⁾	Laser Source 1310nm
	81656A ⁽¹⁾	Laser Source 1550nm
	81657A ⁽¹⁾	Laser Source 1310/1550nm
	81662A ⁽¹⁾	DFB Laser Source 1500nm-1650nm
	81663A ⁽¹⁾	DFB Laser Source 1500nm-1650nm
	81940A ⁽²⁾	Compact Tunable Laser Source 1520nm-1630nm
	81949A ⁽²⁾	Compact Tunable Laser Source 1520nm-1630nm
	81980A ⁽²⁾	Compact Tunable Laser Source 1465nm-1575nm
	81989A ⁽²⁾	Compact Tunable Laser Source 1465nm-1575nm

complies with the essential requirements of the following applicable European Directives, and carries the CE marking accordingly:

- The Low Voltage Directive 73/23/EEC, amended by 93/68/EEC
- The EMC Directive 89/336/EEC, amended by 93/68/EEC

and conforms with the following product standards:

	Standard	Limit	
EMC	IEC 61326:1997+A1:1998+A2:2000 / EN 61326:1997+A1:1998+A2:2001	Group 1 Class A 4kV CD, 8kV AD 3 V/m, 80-1000 MHz 0.5kV signal lines, 1kV power lines 0.5 kV line-line, 1 kV line-ground 3V, 0.15-80 MHz 30 A/m 1 cycle/100%	
	CISPR 11:1997+A1:1999 / EN 55011:1998+A1:1999		
	IEC 61000-4-2:2001 / EN 61000-4-2:1995+A1:1998+A2:2001		
	IEC 61000-4-3:2002 / EN 61000-4-3:2002		
	IEC 61000-4-4:2001 / EN 61000-4-4:1995+A1:2001+A2:2001		
	IEC 61000-4-5:2001 / EN 61000-4-5:1995+A1:2001		
	IEC 61000-4-6:1995+A1:2000 / EN 61000-4-6:1996+A1:2001		
	IEC 61000-4-8:2001 / EN 61000-4-8:1993+A1:2001		
	IEC 61000-4-11:1994+A1:2000 / EN 61000-4-11:1994+A1:2001		
	Canada: ICES-001:1998		
	Australia/New Zealand: AS/NZS 2064.1		
	Safety		IEC 61010-1:2001 / EN 61010-1:2001
			IEC 60825-1:2001 / EN 60825-1:1994+A11:1996+A2:2001
Canada: CAN/CSA-C22.2 No. 61010-1:2004 USA: UL 61010-1:2004			

Supplementary Information:

- (1) FDA Accession Number 9521220
 (2) FDA Accession Number 9122175

The product was tested in a typical configuration with Agilent Technologies test systems.
 This DoC applies to above-listed products placed on the EU market after:

2004-October-01
 Date

 Hans-Martin Fischer
 Name
 Product Regulations Representative PMD, DVS
 Agilent Technologies
 Title

For further information, please contact your local Agilent Technologies sales office, agent or distributor.

Agilent 8164A Lightwave Measurement System

DECLARATION OF CONFORMITY
According to ISO/IEC Guide 22 and CEN/CENELEC EN 45014



Manufacturer's Name: Agilent Technologies Deutschland GmbH
Manufacturer's Address: Photonic Measurement Division (PMD)
 Herrenberger Str. 130
 D-71034 Boeblingen

Declares, that the product

Product Name: Lightwave Measurement System
Model Number: 8164A
Product Modules:

- 81611A Return Loss Module 1300nm
- 81612A Return Loss Module 1550nm
- 81613A Return Loss Module 1310/1550nm
- 81614A Return Loss Module 1550/1625nm
- 81650A Laser Module 1310nm
- 81651A Laser Module 1550nm
- 81652A Laser Module 1550/1625nm
- 81653A Laser Module 1650nm
- 81654A Laser Module 1310/1550nm
- 81655A Laser Module 1310nm
- 81656A Laser Module 1550nm
- 81657A Laser Module 1310/1550nm
- 81662A DFB Laser Module 1500nm-1650nm
- 81663A DFB Laser Module 1500nm-1650nm
- 81480A/B Tunable Laser Source Module 1370nm-1480nm
- 81482B Tunable Laser Source Module 1370nm-1495nm
- 81640A/B Tunable Laser Source Module 1510nm-1640nm
- 81642A/B Tunable Laser Source Module 1510nm-1640nm
- 81672B Tunable Laser Source Module 1260nm-1375nm
- 81680A/B Tunable Laser Source Module 1460nm-1580nm
- 81682A/B Tunable Laser Source Module 1460nm-1580nm
- 81649A Compact Tunable Laser Module 1570nm-1620nm
- 81689A/B Compact Tunable Laser Module 1525nm-1575nm
- 81940A Compact Tunable Laser Module 1520nm-1630nm
- 81949A Compact Tunable Laser Module 1520nm-1630nm
- 81980A Compact Tunable Laser Module 1465nm-1575nm
- 81989A Compact Tunable Laser Module 1465nm-1575nm

Conforms with the following European Directives:

The product herewith complies with the requirements of the Low Voltage Directive 73/23/EEC and the EMC Directive 89/336/EEC (including 93/68/EEC) and carries the CE Marking accordingly.

Conforms with the following product standards:

Standard	Limit
EMC	
IEC 61326-1:1997+A1:1998 / EN 61326-1:1997+A1:1998	Group 1 Class A
CISPR 11:1997 / EN 55011:1998	4kV CD, 8kV AD
IEC 61000-4-2:1995+A1:1998 / EN 61000-4-2:1995	3 V/m, 80-1000 MHz
IEC 61000-4-3:1995 / EN 61000-4-3:1995	0.5kV signal lines, 1kV power lines
IEC 61000-4-4:1995 / EN 61000-4-4:1995	0.5 kV line-line, 1 kV line-ground
IEC 61000-4-5:1995 / EN 61000-4-5:1995	3V, 0.15-80 MHz
IEC 61000-4-6:1996 / EN 61000-4-6:1996	1 cycle/100%
IEC 61000-4-11:1994 / EN 61000-4-11:1994	
Canada: ICES-001:1998	
Australia/New Zealand: AS/NZS 2064.1	
Safety	
IEC 61010-1:1990+A1:1992+A2:1995 / EN 61010-1:1993+A2:1995	
IEC 60825-1:2001 / EN 60825-1:1994+A11:1996+A2:2001	
Canada: CSA C22.2 No. 1010.1:1992	
USA:UL 3111-1:1994; FDA 21CFR1040.10+Laser Notice No. 50	

Supplemental Information:

The product was tested in a typical configuration with Agilent Technologies test systems.
 FDA Accession Numbers 9521220-54 and 9122175-10

2003-May-14
 Date

Name
 Product Regulations Representative
 Title

For further information, please contact your local Agilent Technologies sales office, agent or distributor.
 Authorized EU-representative: Agilent Technologies Deutschland GmbH, Herrenberger Strasse 130, D-71034 Boeblingen, Germany

Revision: G Issue Date: 2003-May-14

Agilent 8164B Lightwave Measurement System

 Agilent Technologies	DECLARATION OF CONFORMITY <small>According to ISO/IEC Guide 22 and CEN/CENELEC EN 45014</small>	
---	---	---

Manufacturer's Name: Agilent Technologies International sarl
Manufacturer's Address: Rue de la Gare 29
 CH-1110 Morges
 Switzerland

Declares under sole responsibility that the product as originally delivered

Product Name:	Lightwave Measurement System	
Model Number:	8164B	
Product Modules:	81611A ⁽¹⁾	Return Loss Module 1310nm
	81612A ⁽¹⁾	Return Loss Module 1550nm
	81613A ⁽¹⁾	Return Loss Module 1550/1625nm
	81614A ⁽¹⁾	Return Loss Module 1310/1550nm
	81650A ⁽¹⁾	Laser Source 1310nm
	81651A ⁽¹⁾	Laser Source 1550nm
	81652A ⁽¹⁾	Laser Source 1550/1625nm
	81654A ⁽¹⁾	Laser Source 1310/1550nm
	81655A ⁽¹⁾	Laser Source 1310nm
	81656A ⁽¹⁾	Laser Source 1550nm
	81657A ⁽¹⁾	Laser Source 1310/1550nm
	81662A ⁽¹⁾	DFB Laser Source 1500nm-1650nm
	81663A ⁽¹⁾	DFB Laser Source 1500nm-1650nm
	81600B ⁽¹⁾	Opt. 132 Tunable Laser Source 1260nm-1375nm
	81600B ⁽¹⁾	Opt. 140 Tunable Laser Source 1370nm-1495nm
	81600B ⁽¹⁾	Opt. 142 Tunable Laser Source 1370nm-1495nm
	81600B ⁽¹⁾	Opt. 150 Tunable Laser Source 1450nm-1590nm
	81600B ⁽¹⁾	Opt. 160 Tunable Laser Source 1495nm-1640nm
	81600B ⁽¹⁾	Opt. 200 Tunable Laser Source 1440nm-1640nm
	81940A ⁽²⁾	Compact Tunable Laser Source 1520nm-1630nm
	81949A ⁽²⁾	Compact Tunable Laser Source 1520nm-1630nm
	81980A ⁽²⁾	Compact Tunable Laser Source 1465nm-1575nm
	81989A ⁽²⁾	Compact Tunable Laser Source 1465nm-1575nm

complies with the essential requirements of the following applicable European Directives, and carries the CE marking accordingly:

- The Low Voltage Directive 73/23/EEC, amended by 93/68/EEC
- The EMC Directive 89/336/EEC, amended by 93/68/EEC

and conforms with the following product standards:

	Standard	Limit
EMC	IEC 61326:1997+A1:1998+A2:2000 / EN 61326:1997+A1:1998+A2:2001 CISPR 11:1997+A1:1999 / EN 55011:1998+A1:1999 IEC 61000-4-2:2001 / EN 61000-4-2:1995+A1:1998+A2:2001 IEC 61000-4-3:2002 / EN 61000-4-3:2002 IEC 61000-4-4:2001 / EN 61000-4-4:1995+A1:2001+A2:2001 IEC 61000-4-5:2001 / EN 61000-4-5:1995+A1:2001 IEC 61000-4-6:1995+A1:2000 / EN 61000-4-6:1996+A1:2001 IEC 61000-4-8:2001 / EN 61000-4-8:1993+A1:2001 IEC 61000-4-11:1994+A1:2000 / EN 61000-4-11:1994+A1:2001 Canada: ICES-001:1998 Australia/New Zealand: AS/NZS 2064.1	Group 1 Class A 4kV CD, 8kV AD 3 V/m, 80-1000 MHz 0.5kV signal lines, 1kV power lines 0.5 kV line-line, 1 kV line-ground 3V, 0.15-80 MHz 30 A/m 1 cycle/100%
Safety	IEC 61010-1:2001 / EN 61010-1:2001 IEC 60825-1:2001 / EN 60825-1:1994+A11:1996+A2:2001 Canada: CAN/CSA-C22.2 No. 61010-1:2004 USA: UL 61010-1:2004	

Supplementary Information:

- (1) FDA Accession Number 9521220
- (2) FDA Accession Number 9122175

The product was tested in a typical configuration with Agilent Technologies test systems. This DoC applies to above-listed products placed on the EU market after:

2004-October-01
 Date

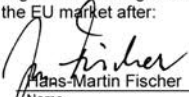

 Name
 Product Regulations Representative PMD, DVS
 Agilent Technologies

 Title

For further information, please contact your local Agilent Technologies sales office, agent or distributor.

Agilent 8166A Lightwave Multichannel System

DECLARATION OF CONFORMITY

According to ISO/IEC Guide 22 and CEN/CENELEC EN 45014



Manufacturer's Name: Agilent Technologies Deutschland GmbH
Manufacturer's Address: Photonic Measurement Division (PMD)
 Herrenberger Str. 130
 D-71034 Boeblingen

Declares, that the product

Product Name: Lightwave Multi-Channel System
Model Number: 8166A
Product Modules:

- 81611A ⁽¹⁾ Return Loss Module 1300nm
- 81612A ⁽¹⁾ Return Loss Module 1550nm
- 81613A ⁽¹⁾ Return Loss Module 1310/1550nm
- 81614A ⁽¹⁾ Return Loss Module 1550/1625nm
- 81650A ⁽¹⁾ Laser Module 1310nm
- 81651A ⁽¹⁾ Laser Module 1550nm
- 81652A ⁽¹⁾ Laser Module 1550/1625nm
- 81653A ⁽¹⁾ Laser Module 1650nm
- 81654A ⁽¹⁾ Laser Module 1310/1550nm
- 81655A ⁽¹⁾ Laser Module 1310nm
- 81656A ⁽¹⁾ Laser Module 1550nm
- 81657A ⁽¹⁾ Laser Module 1310/1550nm
- 81662A ⁽¹⁾ DFB Laser Module 1500nm-1650nm
- 81663A ⁽¹⁾ DFB Laser Module 1500nm-1650nm
- 81649A ⁽¹⁾ Compact Tunable Laser Module 1570nm-1620nm
- 81689A ⁽¹⁾ Compact Tunable Laser Module 1525nm-1575nm
- 81689B ⁽¹⁾ Compact Tunable Laser Module 1525nm-1575nm

Conforms with the following European Directives:

The product herewith complies with the requirements of the Low Voltage Directive 73/23/EEC and the EMC Directive 89/336/EEC (including 93/68/EEC) and carries the CE Marking accordingly.

Conforms with the following product standards:

	Standard	Limit
EMC	IEC 61326-1:1997+A1:1998 / EN 61326-1:1997+A1:1998	Group 1 Class B
	CISPR 11:1997 / EN 55011:1998	
	IEC 61000-3-2:2000 / EN 61000-3-2:1995+A1:1997+A2:1998	
	IEC 61000-3-3:1994 / EN 61000-3-3:1995	
	IEC 61000-4-2:1995+A1:1998 / EN 61000-4-2:1995	
	IEC 61000-4-3:1995 / EN 61000-4-3:1995	
	IEC 61000-4-4:1995 / EN 61000-4-4:1995	
	IEC 61000-4-5:1995 / EN 61000-4-5:1995	
	IEC 61000-4-6:1996 / EN 61000-4-6:1996	
	IEC 61000-4-11:1994 / EN 61000-4-11:1994	
	Canada: ICES-001:1998	
	Australia/New Zealand: AS/NZS 2064.1	
Safety	IEC 61010-1:1990+A1:1992+A2:1995 / EN 61010-1:1993+A2:1995	
	IEC 60825-1:2001 / EN 60825-1:1994+A11:1996+A2:2001	
	Canada: CSA C22.2 No. 1010.1:1992	
	USA:UL 3111-1:1994; FDA 21CFR1040.10+Laser Notice No. 50	

Supplemental Information:

The product was tested in a typical configuration with Agilent Technologies test systems.

(1) FDA Accession Number 9521220-54

2003-May-14

Date

 Hans-Martin Fischer

Name

Product Regulations Representative

Title

For further information, please contact your local Agilent Technologies sales office, agent or distributor.
 Authorized EU-representative: Agilent Technologies Deutschland GmbH, Herrenberger Strasse 130, D-71034 Boeblingen, Germany

Revision: F

Issue Date: 2003-May-14

Agilent 8166B Lightwave Multichannel System



Manufacturer's Name: Agilent Technologies International sarl
Manufacturer's Address: Rue de la Gare 29
 CH-1110 Morges
 Switzerland

Declares under sole responsibility that the product as originally delivered

Product Name:	Lightwave Multichannel System	
Product Number:	8166B	
Product Modules:	81611A ⁽¹⁾	Return Loss Module 1300nm
	81612A ⁽¹⁾	Return Loss Module 1550nm
	81613A ⁽¹⁾	Return Loss Module 1550/1625nm
	81614A ⁽¹⁾	Return Loss Module 1310/1550nm
	81650A ⁽¹⁾	Laser Source 1310nm
	81651A ⁽¹⁾	Laser Source 1550nm
	81652A ⁽¹⁾	Laser Source 1550/1625nm
	81654A ⁽¹⁾	Laser Source 1310/1550nm
	81655A ⁽¹⁾	Laser Source 1310nm
	81656A ⁽¹⁾	Laser Source 1550nm
	81657A ⁽¹⁾	Laser Source 1310/1550nm
	81662A ⁽¹⁾	DFB Laser Source 1500nm-1650nm
	81663A ⁽¹⁾	DFB Laser Source 1500nm-1650nm
	81940A ⁽²⁾	Compact Tunable Laser Source 1520nm-1630nm
	81949A ⁽²⁾	Compact Tunable Laser Source 1520nm-1630nm
	81980A ⁽²⁾	Compact Tunable Laser Source 1465nm-1575nm
	81989A ⁽²⁾	Compact Tunable Laser Source 1465nm-1575nm

complies with the essential requirements of the following applicable European Directives, and carries the CE marking accordingly:

- The Low Voltage Directive 73/23/EEC, amended by 93/68/EEC
- The EMC Directive 89/336/EEC, amended by 93/68/EEC

and conforms with the following product standards:

	Standard	Limit
EMC	IEC 61326:1997+A1:1998+A2:2000 / EN 61326:1997+A1:1998+A2:2001 CISPR 11:1997+A1:1999 / EN 55011:1998+A1:1999 IEC 61000-4-2:2001 / EN 61000-4-2:1995+A1:1998+A2:2001 IEC 61000-4-3:2002 / EN 61000-4-3:2002 IEC 61000-4-4:2001 / EN 61000-4-4:1995+A1:2001+A2:2001 IEC 61000-4-5:2001 / EN 61000-4-5:1995+A1:2001 IEC 61000-4-6:1995+A1:2000 / EN 61000-4-6:1996+A1:2001 IEC 61000-4-8:2001 / EN 61000-4-8:1993+A1:2001 IEC 61000-4-11:1994+A1:2000 / EN 61000-4-11:1994+A1:2001 Canada: ICES-001:1998 Australia/New Zealand: AS/NZS 2064.1	Group 1 Class A 4kV CD, 8kV AD 3 V/m, 80-1000 MHz 0.5kV signal lines, 1kV power lines 0.5 kV line-line, 1 kV line-ground 3V, 0.15-80 MHz 30 A/m 1 cycle/100%
Safety	IEC 61010-1:2001 / EN 61010-1:2001 IEC 60825-1:2001 / EN 60825-1:1994+A11:1996+A2:2001 Canada: CAN/CSA-C22.2 No. 61010-1:2004 USA: UL 61010-1:2004	

Supplementary Information:

- (1) FDA Accession Number 9521220
 (2) FDA Accession Number 9122175

The product was tested in a typical configuration with Agilent Technologies test systems.
 This DoC applies to above-listed products placed on the EU market after:

2004-October-01
 Date

 Hans-Martin Fischer
 Name

Product Regulations Representative PMD, DVS
 Agilent Technologies
 Title

For further information, please contact your local Agilent Technologies sales office, agent or distributor.

Regulations Information

Safety Canada



EMC Canada

These ISM devices comply with Canadian ICES-001.
Ces appareils ISM sont conformes à la norme NMB-001 du Canada.

EMC Australia/New Zealand



14

Performance Tests

The Mainframes 8163A/B, 8164A/B, and 8166A/B do not contain calibration data, therefore they are not subject to re-calibration. Consequently, these *Performance Tests* test the **functionality** of the instrument.

The Agilent 8163A/B Lightwave Multimeter, the Agilent 8164A/B Lightwave Measurement System, and the Agilent 8166A/B Lightwave Multichannel System comprises a power supply, a CPU, a hard-disk drive, and a display. The Agilent 8164A/B Lightwave Measurement System also has a floppy-disk drive.

The complete characteristics to which the Agilent 8163A/B Lightwave Multimeter, the Agilent 8164A/B Lightwave Measurement System, or the Agilent 8166A/B Lightwave Multichannel System is tested are given in "*Specifications and Regulations Compliance*" on page 335. All tests can be performed without access to the interior of the instrument. The performance tests refer specifically to tests using the Diamond HMS-10/Agilent connector.

Equipment Required	352
Test Record	353
Test Failure	353
Instruments Specifications	353
Performance Test Instructions	354
Display/Key Functional Test	355
Module Interaction Test	358
GPIB Interface Test (Optional)	360
Test Record	361

Equipment Required

Equipment required for the Performance Test is listed in the table below. Any equipment that satisfies the critical specifications given in the table may be substituted for recommended models.

Table 21 Equipment Required for Performance Tests

Description	Model		
Mainframe, Device under Test	Agilent 8163A/B Lightwave Multimeter	Agilent 8164A/B Lightwave Measurement System	Agilent 8166A/B Lightwave Multichannel System
Laser Source	Agilent 81650A (any other Agilent 8165x series Laser Source)	Agilent 81650A (any other Agilent 8165x series Laser Source)	Agilent 81650A (any other Agilent 8165x series Laser Source)
Power Sensor	Agilent 81632B (any other Agilent 8163x series Power Sensor) (Agilent 81618A or Agilent 81619A Interface Module plus Agilent 81626B Optical Head or any other Optical Head from the Agilent 8162x series)	Agilent 81632B (any other Agilent 8163x series Power Sensor) (Agilent 81618A or Agilent 81619A Interface Module plus Agilent 81626B Optical Head or any other Optical Head from the Agilent 8162x series)	Agilent 81632B (any other Agilent 8163x series Power Sensor) (Agilent 81618A or Agilent 81619A Interface Module plus Agilent 81626B Optical Head or any other Optical Head from the Agilent 8162x series)
NOTE	When using a high power laser source of type Agilent 81655A, Agilent 81656A, or Agilent 81657A, you must use an Interface Module and a high power Optical Head of type Agilent 81626B.		
Tunable Laser Module	N/A	Agilent 81640A/B (Agilent 81680A/B) (Agilent 81682A/B)	N/A
Connector Adapter	2 x Agilent 81000AI (depending on patchcord)	2 x Agilent 81000AI (depending on patchcord)	2 x Agilent 81000AI (depending on patchcord)
Singlemode Fiber	Agilent 81101AC (other Agilent patchcord depending on DUT's conenctor option)	Agilent 81101AC (other Agilent patchcord depending on DUT's conenctor option)	Agilent 81101AC (other Agilent patchcord depending on DUT's conenctor option)

Part numbers in brackets indicate alternative models.

Test Record

Results of the Performance Test may be tabulated in the Test Record provided after the test procedures. It is recommended that you fill out the Test Record and refer to it while doing the test. Since the test limits and set-up information are printed on the Test Record for easy reference, the record can also be used as an abbreviated test procedure (if you are familiar with test procedures). The Test Record can also be used as a permanent record and may be reproduced without written permission from Agilent Technologies.

Test Failure

If the Agilent 8163A/B Lightwave Multimeter, the Agilent 8164A/B Lightwave Measurement System, or the Agilent 8166A/B Lightwave Multichannel System fail any Performance Test, return the instrument to the nearest Agilent Technologies Sales/Service Office for repair.

Instruments Specifications

Specifications are the characteristics of the instrument that are certified. These specifications, listed in Appendix C are the limits against which the Agilent 8163A/B Lightwave Multimeter, the Agilent 8164A/B Lightwave Measurement System, or the Agilent 8166A/B Lightwave Multichannel System can be tested. Appendix C also lists some supplemental characteristics of the Agilent 8163A/B Lightwave Multimeter, the Agilent 8164A/B Lightwave Measurement System, and the Agilent 8166A/B Lightwave Multichannel System and should be considered as additional information.

Any changes in the specifications due to manufacturing changes, design, or traceability to the National Institute of Standards and Technology will be covered in a manual change supplement or revised manual. The specifications listed here supersede any previously published.

NOTE

Make sure that all optical connections of the test setups given in the procedure are dry and clean. **DO NOT USE INDEX MATCHING OIL.** For cleaning, use the cleaning instructions given in Appendix E.

Performance Test Instructions

Parameters to be tested:

- Backplane Connectors by Module Performance Test
- Power Supply by Module Interaction Test
- Display by Keystroke Test

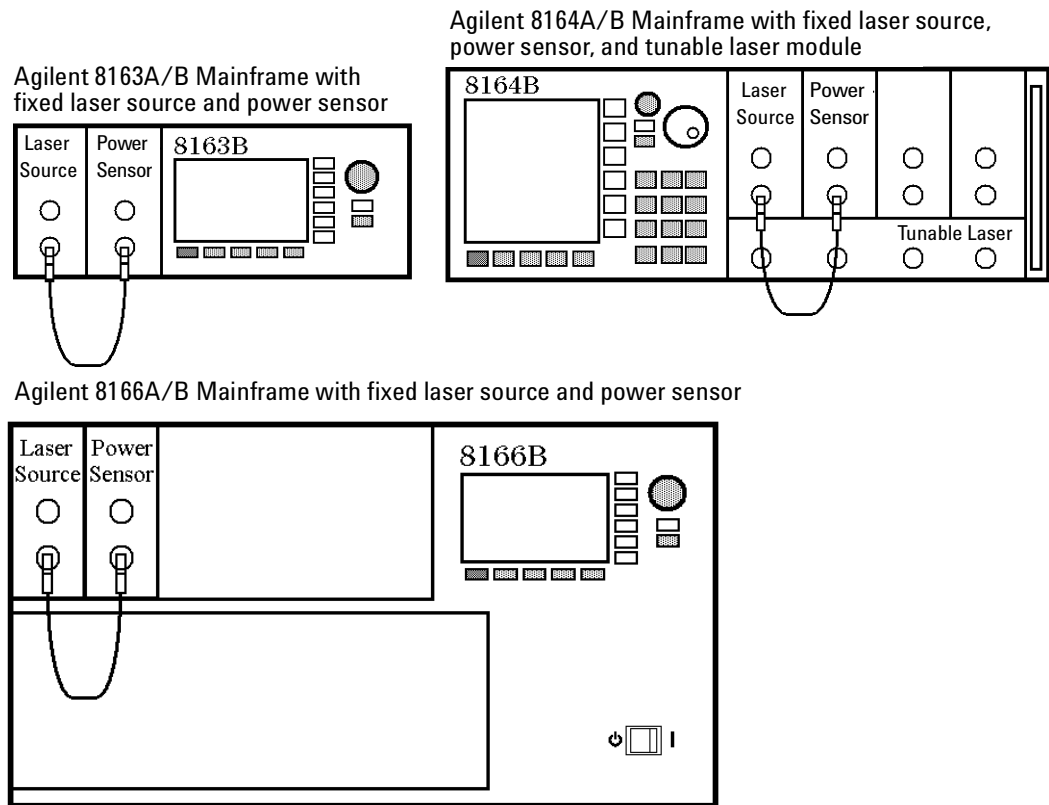

Figure 201 Mainframe Setup

Display/Key Functional Test

- 1 Setup the test equipment as shown in Figure 201 :
Insert the fixed laser source module in slot 1 and the power sensor in slot 2. If you use the Agilent 8164A/B Lightwave Measurement System, insert the back-loadable Tunable Laser module, if available, in slot 0.
- 2 Switch on the mainframe and wait until it has booted.

Testing Hardkeys

- 1 Press *Config*. You should see the Configuration menu.
- 2 Press *Aux*. You should hear a “beep” and the Configuration menu should disappear.
- 3 Press *Appl*. You should hear a “beep”.
- 4 Press *Help*. You should hear a “beep”.
- 5 Press *Preset*, the green hardkey. An egg-timer icon should be displayed while all parameters are set to their default values. The Overview Screen showing all channels should appear.
- 6 Press *Channel* several times.
The highlighted field on the display should toggle between the channels you have inserted a module into.

Testing the Softkeys and the Cursor Key

- 1 Press the right arrow of the cursor key several times.
Check the fields on the display being highlighted one after another.
- 2 Press the left arrow on the cursor key several times.
Check the fields on the display being highlighted one after another.
- 3 Press the up arrow on the cursor key several times.
Check the fields on the display being highlighted one after another.
- 4 Press the down arrow on the cursor key several times.
Check the fields on the display being highlighted one after another.
- 5 Using the cursor key, move to the power parameter, [P], of the Power Sensor module.

Testing the Softkeys and the ENTER Key

- 1 Press [Menu]. The menu should appear.
- 2 Press [Close]. The menu should disappear.
- 3 Press [Details]. The details screen should appear. You should see the [Cal], [Ref], and [Range] parameters in addition to [P] and [λ]. If you use the

Agilent 8164A/B Lightwave Measurement System, you will also see the [Range Mode], [AvgTime], and [MinMax Mode] parameters.

- 4** Press [Pwr Unit]. The power unit menu should appear. Move to <dBm> using the cursor key and press *Enter*.
- 5** Press [Close]. The power unit menu should disappear.
- 6** Press [Hold/Cnt]. HOLD should appear in the channel.
- 7** Press [Hold/Cnt]. HOLD should disappear.
- 8** Press [Dsp->Ref] several times. [Ref] should update to the same value as [P] with each click.
- 9** Press *Preset*, the green hardkey. An egg-timer icon should be displayed while all parameters are set to their default values. The Overview Screen showing all channels should appear.

Testing the the Modify Knob

NOTE

The Modify Knob is only available if you use the Agilent 8164A/B.

- 10** Turn the Modify Knob clockwise.
Check the fields on the display being highlighted one after another.
- 11** Turn the Modify Knob counter clockwise.
Check the fields on the display being highlighted one after another.
- 12** Using the Modify Knob, move to the [λ] parameter of the power sensor (that is, channel 2, right field).
- 13** Press the Modify Knob. The first digit left of the period should be highlighted.
- 14** Press [Cancel].
- 15** Press *Preset*, the green hardkey, to return to the Overview Screen.

Testing the Number Keys

NOTE

The Modify Knob is only available if you use the Agilent 8164A/B.

- 16** Using the cursor keys, move to the [P] parameter of the sensor channel, that is channel 2. Press [Details].
- 17** Using the cursor keys, move to [Cal], and press *Enter*. Use the cursor key to move the highlighted digit to the far left position.
- 18** Using the number keys press the following sequence: 1, 2, 3, 4, 5, and 6. 123.456 dB should be displayed as the [Cal] value.
- 19** Press *Enter* twice to get access to the [Cal] field again
- 20** Using the number keys press the following sequence: 1, 0, ., 7, 8, and 9. 10.789 dB should be displayed as the [Cal] value.
- 21** Press [+/-] several times. The [Cal] field should toggle between 10.789 dB and -10.789 dB.
- 22** Press *Preset*, the green hardkey, to return to the Overview Screen.

Module Interaction Test

NOTE

The following functional test assumes the use of modules which are within specification.

- 1** Setup the test equipment as shown in Figure 201 :
Insert the fixed laser source module in slot 1 and the power sensor in slot 2 . If you use the Agilent 8164A/B Lightwave Measurement System, insert the back-loadable Tunable Laser module, if available, in slot 0.
- 2** Switch on the mainframe and wait until it has booted.
- 3** Press *Preset*, the green hardkey, to set all parameters to their default values.
- 4** Ensure that $[\lambda]$, the wavelength of the power sensor module equals $[\lambda]$, the wavelength of the laser source in slot 1.
- 5** Ensure, the attenuation of the laser source is set to 0.00 dB.
- 6** Move to the power sensor channel, move to [P], press [Power Unit], and select <dBm> from the menu that appears.
- 7** Press the key beside the laser output on the module front panel to switch on the laser source.
- 8** Note the power reading of the power sensor in the test record. The Module Interaction Test ends here if you use the Agilent 8163A/B.

NOTE

If you use the Agilent 8164A/B, perform steps 9 to 12.
If you use the Agilent 8166A/B, perform steps 9 to 15.

- 9** Switch your mainframe off, by pressing the Power Key.
- 10** Move the laser source module from slot 1 to slot 3, and the power sensor module from slot 2 to slot 4.
- 11** Connect the output of the laser source in slot 3 to the input of the power sensor in slot 4.
- 12** Repeat step items 2 to 8.
- 13** Move the laser source to a slot with an odd number and the power sensor to the following slot with an even number. For the last test, leave the source in slot 15 and move the power sensor to slot 17.
- 14** Connect the output of the laser source to the input of the power sensor.
- 15** Repeat step items 2 to 8.

Test of the Tunable Laser Module Channel (Slot 0)

If you need to test a back-loadable Tunable Laser module slot, perform the remaining list items. This test only applies to the Agilent 8164A/B Lightwave Measurement System.

16 Connect the power output of the Tunable Laser module to the input of the power sensor.

17 Switch on the Agilent 8164A/B and wait until it has booted.

18 Press *Preset*, the green hardkey, to set all parameters to their default values.

19 Move to [λ], the wavelength of your Tunable Laser module, type 1550.00.

20 Move to [λ], the wavelength of your power sensor, type 1550.00.

21 Set the [P], the output power, and [Att], the attenuation, to the value given in Table 22.

Table 22 Reference Wavelength and Power Settings

Tunable Laser Module	Attenuation [ATT]	Power [P]
Agilent 81680A/B, Output 2, High Power	0 dB	-10.00 dBm
Agilent 81682A/B	Not applicable	0.00 dBm
Agilent 81682A/B #003	0 dB	-10.00 dBm
Agilent 81640A/B, Output 2, High Power	0 dB	-10.00 dBm

22 Note the power reading of the power sensor in the test record.

GPIB Interface Test (Optional)

You will need a controller/computer with GPIB capabilities for this test.

- 1** Connect the Agilent 8163A/B Lightwave Multimeter, the Agilent 8164A/B Lightwave Measurement System or the Agilent 8166A/B Lightwave Multichannel system to the controller via the GPIB.
- 2** Switch on the instrument and wait until it has booted and the user interface will be visible
- 3** Send the *IDN? query to the instrument from the controller.
- 4** Check that the lowest softkey is called [Local]. This indicates that the instrument received the query.
- 5** The reply from the instrument should be a string of the form, Agilent Technologies,<Model Number>,<Serial Number>,<Firmware Revision Number>
- 6** Press [Local] to return the instrument to local control.

Test Record

Agilent 8163A Lightwave Multimeter Performance Test

Page 1 of 2

Model	Agilent 8163A Lightwave Multimeter	Date	_____
Serial No.	_____	Ambient Temperature	_____ °C
Options	_____	Relative Humidity	_____ %
Firmware Rev.	_____	Line Frequency	_____ Hz
Test Facility	_____	Customer	_____
Performed by	_____	Report No	_____

Special Notes

Agilent 8163A Lightwave Multimeter Performance Test

Agilent 8163A Serial No. _____ Trace No. _____ Date _____

Test Equipment Used

	Description	Model No.	Trace No	Cal. Due Date
1	CW Laser Source	_____	_____	_____
2	Optical Power Sensor	_____	_____	_____
3	Opt. Head Interface Module	_____	_____	_____
4	Optical Head	_____	_____	_____
5	_____	_____	_____	_____
6	_____	_____	_____	_____
7	_____	_____	_____	_____
8	_____	_____	_____	_____
9	_____	_____	_____	_____
10	_____	_____	_____	_____
11	_____	_____	_____	_____
12	_____	_____	_____	_____
13	_____	_____	_____	_____
14	_____	_____	_____	_____
15	_____	_____	_____	_____

Display / Key Function Test

Check the appropriate function

Passed Failed

Test of the Hardkeys

Test of the Softkeys

Test of the Cursor Key

Module Interaction Test

Check the appropriate function

Test of	Min Spec	Result	Max Spec	Passed	Failed
Slot 1 and Slot 2	- 6 dBm	_____	+ 6 dBm	_____	_____

GPIB Interface Test

Check the appropriate function

Passed Failed

GPIB Interface Test

Agilent 8163B Lightwave Multimeter Performance Test

Model	Agilent 8163B Lightwave Multimeter	Date	_____
Serial No.	_____	Ambient Temperature	_____ °C
Options	_____	Relative Humidity	_____ %
Firmware Rev.	_____	Line Frequency	_____ Hz

Test Facility	_____	Customer	_____
Performed by	_____	Report No	_____

Special Notes

Agilent 8163B Lightwave Multimeter Performance Test

Page 2 of 2

Agilent 8163B Serial No. _____ Trace No. _____ Date _____

Test Equipment Used

Description	Model No.	Trace No	Cal. Due Date
1 CW Laser Source	_____	_____	_____
2 Optical Power Sensor	_____	_____	_____
3 Opt. Head Interface Module	_____	_____	_____
4 Optical Head	_____	_____	_____
5 _____	_____	_____	_____
6 _____	_____	_____	_____
7 _____	_____	_____	_____
8 _____	_____	_____	_____
9 _____	_____	_____	_____
10 _____	_____	_____	_____
11 _____	_____	_____	_____
12 _____	_____	_____	_____
13 _____	_____	_____	_____
14 _____	_____	_____	_____
15 _____	_____	_____	_____

Display / Key Function Test

Check the appropriate function

Passed Failed

Test of the Hardkeys

Test of the Softkeys

Test of the Cursor Key

Module Interaction Test

Check the appropriate function

Test of	Min Spec	Result	Max Spec	Passed	Failed
Slot 1 and Slot 2	- 6 dBm	_____	+ 6 dBm	_____	_____

GPIB Interface Test

Check the appropriate function

Passed Failed

GPIB Interface Test

Agilent 8164A Lightwave Measurement System Performance Test

Model	Agilent 8164A Lightwave Measurement System	Date	_____
Serial No.	_____	Ambient Temperature	_____ °C
Options	_____	Relative Humidity	_____ %
Firmware Rev.	_____	Line Frequency	_____ Hz
Test Facility	_____	Customer	_____
Performed by	_____	Report No	_____

Special Notes

Agilent 8164A Lightwave Measurement System Performance Test

Page 2 of 3

Agilent 8164A Serial No. _____ Trace No. _____ Date _____

Test Equipment Used

	Description	Model No.	Trace No	Cal. Due Date
1	CW Laser Source	_____	_____	_____
2	Optical Power Sensor	_____	_____	_____
3	Opt. Head Interface Module	_____	_____	_____
4	Optical Head	_____	_____	_____
5	Tunable Laser Module	_____	_____	_____
6	_____	_____	_____	_____
7	_____	_____	_____	_____
8	_____	_____	_____	_____
9	_____	_____	_____	_____
10	_____	_____	_____	_____
11	_____	_____	_____	_____
12	_____	_____	_____	_____
13	_____	_____	_____	_____
14	_____	_____	_____	_____
15	_____	_____	_____	_____
16	_____	_____	_____	_____

Agilent 8164A Lightwave Measurement System Performance Test

Agilent 8164A Serial No. _____ Trace No. _____ Date _____

Display / Key Function Test

Check the appropriate function

Passed	Failed
_____	_____
_____	_____
_____	_____
_____	_____
_____	_____

Test of the Hardkeys

Test of the Softkeys

Test of the Cursor Key

Test of the Modify Knob

Test of the Number Keys

Module Interaction Test

Check the appropriate function

Test of	Min Spec	Result	Max Spec	Passed	Failed
Slot 1 and Slot 2	- 6 dBm	_____	+ 6 dBm	_____	_____
Slot 3 and Slot 4	- 6 dBm	_____	+ 6 dBm	_____	_____
Slot 0 (Optional)					
Using Agilent 81680A/B	- 16 dBm	_____	- 4 dBm	_____	_____
Using Agilent 81682A/B, std	- 6 dBm	_____	+ 6 dBm	_____	_____
Using Agilent 81682A/B, #003	- 16 dBm	_____	- 4 dBm	_____	_____
Using Agilent 81640A/B	- 16 dBm	_____	- 4 dBm	_____	_____

GPIB Interface Test

Check the appropriate function

Passed	Failed
_____	_____

GPIB Interface Test

Agilent 8164B Lightwave Measurement System Performance Test

Model	Agilent 8164B Lightwave Measurement System	Date	_____
Serial No.	_____	Ambient Temperature	_____ °C
Options	_____	Relative Humidity	_____ %
Firmware Rev.	_____	Line Frequency	_____ Hz
Test Facility	_____	Customer	_____
Performed by	_____	Report No	_____

Special Notes

Agilent 8164B Lightwave Measurement System Performance Test

Page 2 of 3

Agilent 8164B Serial No. _____ Trace No. _____ Date _____

Test Equipment Used

	Description	Model No.	Trace No	Cal. Due Date
1	CW Laser Source	_____	_____	_____
2	Optical Power Sensor	_____	_____	_____
3	Opt. Head Interface Module	_____	_____	_____
4	Optical Head	_____	_____	_____
5	Tunable Laser Module	_____	_____	_____
6	_____	_____	_____	_____
7	_____	_____	_____	_____
8	_____	_____	_____	_____
9	_____	_____	_____	_____
10	_____	_____	_____	_____
11	_____	_____	_____	_____
12	_____	_____	_____	_____
13	_____	_____	_____	_____
14	_____	_____	_____	_____
15	_____	_____	_____	_____
16	_____	_____	_____	_____

Agilent 8164B Lightwave Measurement System Performance Test

Agilent 8164B Serial No. _____ Trace No. _____ Date _____

Display / Key Function Test

Check the appropriate function

Passed	Failed
_____	_____
_____	_____
_____	_____
_____	_____
_____	_____

Test of the Hardkeys

Test of the Softkeys

Test of the Cursor Key

Test of the Modify Knob

Test of the Number Keys

Module Interaction Test

Check the appropriate function

Test of	Min Spec	Result	Max Spec	Passed	Failed
Slot 1 and Slot 2	- 6 dBm	_____	+ 6 dBm	_____	_____
Slot 3 and Slot 4	- 6 dBm	_____	+ 6 dBm	_____	_____
Slot 0 (Optional)					
Using Agilent 81680A/B	- 16 dBm	_____	- 4 dBm	_____	_____
Using Agilent 81682A/B, std	- 6 dBm	_____	+ 6 dBm	_____	_____
Using Agilent 81682A/B, #003	- 16 dBm	_____	- 4 dBm	_____	_____
Using Agilent 81640A/B	- 16 dBm	_____	- 4 dBm	_____	_____

GPIB Interface Test

Check the appropriate function

Passed	Failed
_____	_____

GPIB Interface Test

Agilent 8166A Lightwave Multichannel System Performance Test

Model	Agilent 8166A Lightwave Multichannel System	Date	_____
Serial No.	_____	Ambient Temperature	_____ °C
Options	_____	Relative Humidity	_____ %
Firmware Rev.	_____	Line Frequency	_____ Hz
Test Facility	_____	Customer	_____
Performed by	_____	Report No	_____

Special Notes

Agilent 8166A Lightwave Multichannel System Performance Test

Page 2 of 3

Agilent 8166A Serial No. _____ Trace No. _____ Date _____

Test Equipment Used

	Description	Model No.	Trace No	Cal. Due Date
1	CW Laser Source	_____	_____	_____
2	Optical Power Sensor	_____	_____	_____
3	Opt. Head Interface Module	_____	_____	_____
4	Optical Head	_____	_____	_____
5	_____	_____	_____	_____
6	_____	_____	_____	_____
7	_____	_____	_____	_____
8	_____	_____	_____	_____
9	_____	_____	_____	_____
10	_____	_____	_____	_____
11	_____	_____	_____	_____
12	_____	_____	_____	_____
13	_____	_____	_____	_____
14	_____	_____	_____	_____
15	_____	_____	_____	_____
16	_____	_____	_____	_____

Agilent 8166A Lightwave Multichannel System Performance Test

Agilent 8166A Serial No. _____ Trace No. _____ Date _____

Display / Key Function Test

Check the appropriate function

Passed	Failed
_____	_____
_____	_____
_____	_____

Test of the Hardkeys

Test of the Softkeys

Test of the Cursor Key

Module Interaction Test

Check the appropriate function

Test of	Min Spec	Result	Max Spec	Passed	Failed
Slot 1 and Slot 2	- 6 dBm	_____	+ 20 dBm	_____	_____
Slot 3 and Slot 4	- 6 dBm	_____	+ 20 dBm	_____	_____
Slot 5 and Slot 6	- 6 dBm	_____	+ 20 dBm	_____	_____
Slot 7 and Slot 8	- 6 dBm	_____	+ 20 dBm	_____	_____
Slot 9 and Slot 10	- 6 dBm	_____	+ 20 dBm	_____	_____
Slot 11 and Slot 12	- 6 dBm	_____	+ 20 dBm	_____	_____
Slot 13 and Slot 14	- 6 dBm	_____	+ 20 dBm	_____	_____
Slot 15 and Slot 16	- 6 dBm	_____	+ 20 dBm	_____	_____
Slot 15 and Slot 17	- 6 dBm	_____	+ 20 dBm	_____	_____

GPIB Interface Test

Check the appropriate function

Passed	Failed
_____	_____

GPIB Interface Test

Agilent 8166B Lightwave Multichannel System Performance Test

Model	Agilent 8166B Lightwave Multichannel System	Date	_____
Serial No.	_____	Ambient Temperature	_____ °C
Options	_____	Relative Humidity	_____ %
Firmware Rev.	_____	Line Frequency	_____ Hz
Test Facility	_____	Customer	_____
Performed by	_____	Report No	_____

Special Notes

Agilent 8166B Lightwave Multichannel System Performance Test

Page 2 of 3

Agilent 8166B Serial No. _____ Trace No. _____ Date _____

Test Equipment Used

	Description	Model No.	Trace No	Cal. Due Date
1	CW Laser Source	_____	_____	_____
2	Optical Power Sensor	_____	_____	_____
3	Opt. Head Interface Module	_____	_____	_____
4	Optical Head	_____	_____	_____
5	_____	_____	_____	_____
6	_____	_____	_____	_____
7	_____	_____	_____	_____
8	_____	_____	_____	_____
9	_____	_____	_____	_____
10	_____	_____	_____	_____
11	_____	_____	_____	_____
12	_____	_____	_____	_____
13	_____	_____	_____	_____
14	_____	_____	_____	_____
15	_____	_____	_____	_____
16	_____	_____	_____	_____

Agilent 8166B Lightwave Multichannel System Performance Test

Agilent 8166B Serial No. _____ Trace No. _____ Date _____

Display / Key Function Test

Check the appropriate function

Passed	Failed
_____	_____
_____	_____
_____	_____

Test of the Hardkeys

Test of the Softkeys

Test of the Cursor Key

Module Interaction Test

Check the appropriate function

Test of	Min Spec	Result	Max Spec	Passed	Failed
Slot 1 and Slot 2	- 6 dBm	_____	+ 20 dBm	_____	_____
Slot 3 and Slot 4	- 6 dBm	_____	+ 20 dBm	_____	_____
Slot 5 and Slot 6	- 6 dBm	_____	+ 20 dBm	_____	_____
Slot 7 and Slot 8	- 6 dBm	_____	+ 20 dBm	_____	_____
Slot 9 and Slot 10	- 6 dBm	_____	+ 20 dBm	_____	_____
Slot 11 and Slot 12	- 6 dBm	_____	+ 20 dBm	_____	_____
Slot 13 and Slot 14	- 6 dBm	_____	+ 20 dBm	_____	_____
Slot 15 and Slot 16	- 6 dBm	_____	+ 20 dBm	_____	_____
Slot 15 and Slot 17	- 6 dBm	_____	+ 20 dBm	_____	_____

GPIB Interface Test

Check the appropriate function

Passed	Failed
_____	_____

GPIB Interface Test

15

Error Messages

SYST:ERR?	380
Screen Status Messages	382
Mainframes	383
8163A	383
8163B	384
8164A	384
8164B	385
8166A	385
8166B	386
Errors appearing on pop-up menus	387
Error on Module	387
Error	390
Tunable Laser Sources	391
Initialization Tests	391
Selftests	396
Return Loss Meters	400
Powermeters & Interface Modules with Optical Head ..	404
Fixed Laser Sources (Fabry Perot)	409
DFB Laser Sources	412
Attenuator Modules	414
Optical Switch modules	417

SYST:ERR?

The **sys:err?** command returns the next error from the error queue (refer to the *Programming Guide* for details).

Each error has an error code and a short description of the error, separated by comma. Please note that the error codes are returned as signed integer numbers in a range from -32768 to +32767 (INT16). Negative error numbers are defined by the SCPI standard, positive error numbers are device dependent.

Please find below a complete list of all implemented error codes:

- 185, "Subop out of range"
- 200, "Execution error (StatExecError)"
- +200, "Please be patient - GPIB currently locked out"
- 205, "Powermeter not running (StatMeterNotRunning)"
- 211, "Trigger ignored"
- 212, "Arm ignored"
- 213, "Init ignored"
- 220, "Parameter error (StatParmError)"
- 220, "Parameter error (StatParmOutOfRange)"
- 220, "Parameter error (StatParmIllegalVal)"
- 221, "Settings conflict (StatParmInconsistent)"
- 222, "Data out of range (StatParmTooLarge)"
- 222, "Data out of range (StatParmTooSmall)"
- 231, "Data questionable (StatValNyetAcc)"
- 231, "Data questionable (StatRangeTooLow)"
- 261, "Math error in expression (StatUnitCalculationError)"
- 284, "Function currently running (StatModuleBusy)"
- 286, "No function currently running"
- 290, "Application currently running - no GPIB support"
- 300, "Internal error"
- 300, "Internal error (StatValsLost)"
- 300, "Internal error (StatInternalError)"
- 301, "Module doesn't support this command (StatCmdUnknown)"
- 302, "Internal timeout error (StatTimedOut)"
- 303, "Module slot empty or slot / channel invalid"
- 304, "Command was aborted (StatAborted)"
- 305, "Internal messaging error (StatCmdError)"
- 305, "Internal messaging error (StatCmdNotAllowed)"

- 305, "Internal messaging error (StatWrongLength)"
- 305, "Internal messaging error (StatWrongReceiver)"
- 305, "Internal messaging error (StatBufAllocError)"
- 305, "Internal messaging error (StatDPRamFull)"
- 305, "Internal messaging error (StatSemError)"
- 306, "Channel doesn't support this command (StatCmdUnknown ForSlave)"
- 307, "Channel without head connection (StatHeadless)"
- 322, "Flash programming error (StatFlashEraseFailed)"
- 322, "Flash programming error (StatFlashWriteFailed)"
- 322, "Flash programming error (StatFlashDataCntError)"
- 322, "Flash programming error (StatFlashDPAIgoFailed)"
- 330, "Self-test failed"
- 340, "Printing error (StatPrintError)"
- 341, "Printing error - paper out (StatPaperOut)"
- 342, "Printing error - offline (StatOffline)"

Screen Status Messages

Message		Meaning	Description
8163A/B	8164A/B		
SL	SLock	Security Lock	The module is locked for security reasons. No measurement is possible until you unlock the module
RiL	RiLock	Remote InterLock	The remote interlock connector of your mainframe is open. No measurement is possible until the connection at the remote interlock connector closes
NoH	No Head	No Head	There is an optical head interface module inserted in the mainframe that does not have an Optical Head connected to it. No measurement is possible using this channel until you: <ul style="list-style-type: none"> - reconnect an optical head or - deselect this optical channel as a power measurement channel
NoD	No Data	No Data	No data has been measured or measurement is not finished. You cannot access the analysis screen yet. Printout and file operations are not yet possible.
Set	Settling	Settling	A tunable laser source module is settling. The instrument is busy and no measurement can be performed yet.
NoR	No Ref	No Reference	No reference sweep has been performed. Loss will be calculated using nominal laser power as a reference.
B	Busy	Busy	Module is busy performing last operation.

Mainframes

After initializing the instrument, the following bootup screen appears, listing all selftests of the instrument.

A FlashDisk selftest failure may occur after a firmware download to the instrument and is of no harm. No reboot is necessary for operation of the mainframe. However, after a reboot of the instrument, the FlashDisk test will pass again.

8163A

<Fw Rev>

ProductNo(SerialNo)Selftest:

** HW Revision <HWRevNo>

** SYSBIOS <SysBiosRevNo> <Date>

** EXTBIOS <ExtBiosRevNo> <Date>

** FPGA <FPGARevNo> <Date>

** BRAM <BRAMSize>-<passed/failed>

** FlashDisk <FlashSize>-<passed/failed>

NOTE

If one of the selftests fails, please try to reboot the instrument. If the selftest continues to fail, please return the mainframe to your local service center for repair.

8163B

<Fw Rev>

ProductNo(SerialNo)Selftest:

** PCB Revision <PCBRevNo>

** BIOS <BiosRevNo> <Date>

** EXTBIOS <ExtBiosRevNo> <Date>

** FPGA <FPGARevNo> <Date>

** CPLD <CPLDRevNo>

** BRAM <BRAMSize>-<passed/failed>

** HDD <passed/failed>

NOTE

If one of the selftests fails, please try to reboot the instrument. If the selftest continues to fail, please return the mainframe to your local service center for repair.

8164A

<Fw Rev>

ProductNo(SerialNo)Selftest:

** HW Revision <HWRevNo>

** SYSBIOS <SysBiosRevNo> <Date>

** EXTBIOS <ExtBiosRevNo>

** VGABIOS <VGABiosRev>

** FPGA <FPGARevNo> <Date>

** BRAM <BRAMSize>-<passed/failed>

** FDD -<passed/failed>

** HDD -<passed/failed>

Remedial Action:

If one of the selftests fails, please try to reboot the instrument. If the selftest continues to fail, please return the mainframe to your local service center for repair.

8164B

<Fw Rev>

ProductNo(SerialNo)Selftest:

** PCB Revision <PCBRevNo>

** BIOS <BiosRevNo> <Date>

** EXTBIOS <ExtBiosRevNo> <Date>

** FPGA <FPGARevNo> <Date>

** CPLD <CPLDRevNo>

** BRAM <BRAMSize>-<passed/failed>

** FDD <passed/failed>

** HDD <passed/failed>

** FDD -<passed/failed>

** HDD -<passed/failed>

Remedial Action:

If one of the selftests fails, please try to reboot the instrument. If the selftest continues to fail, please return the mainframe to your local service center for repair.

8166A

<Fw Rev>

ProductNo(SerialNo)Selftest:

** HW Revision <HWRevNo>

** SYSBIOS <SysBiosRevNo> <Date>

** EXTBIOS <ExtBiosRevNo> <Date>

** FPGA <FPGARevNo> <Date>

** FPGA2 <FPGA2RevNo> <Date>

** BRAM <BRAMSize>-<passed/failed>

** FlashDisk <FlashSize>-<passed/failed>

Remedial Action:

If one of the selftests fails, please try to reboot the instrument. If the selftest is continues to fail, please return the mainframe to your local service center for repair.

8166B

<Fw Rev>

ProductNo(SerialNo)Selftest:

** PCB Revision <PCBRevNo>

** BIOS <BiosRevNo> <Date>

** EXTBIOS <ExtBiosRevNo> <Date>

** FPGA <FPGARevNo> <Date>

** CPLD <CPLDRevNo>

** BRAM <BRAMSize>-<passed/failed>

** HDD <passed/failed>

Remedial Action:

If one of the selftests fails, please try to reboot the instrument. If the selftest is continues to fail, please return the mainframe to your local service center for repair.

Errors appearing on pop-up menus

Error on Module

```
Error on Module
Channel <slot><channel>
<error message>
```

error message	Calibration data corrupted
description	The calibration data loaded on the module is invalid. Either the caldata version number is not compatible with the firmware or the caldata is corrupt (checksum incorrect)
affected modules	all modules
action	Please return the unit to your local service center for repair

error message	Laser safety error
description	The laser control circuit has switched of the laser. Either the laser current or the laser power was too high.
affected modules	TLS
action	Try to run the automatic realign from the menu or to operate the laser at a lower power level. If the failure persists, please return the unit to your local service center for repair.

error message	Temperature out of range
description	The temperature to operate the tunable laser source module was measured outside given limits.
affected modules	TLS
action	Verify the fan is working and the ventilation system is not blocked. If the failure persists, please return the unit to your local service center for repair.

error message	Zeroing failed. Light?
description	Zeroing has still detected some light. Either the input is not darkened properly or there is some error on the powermeter module/head.
affected modules	Powermeter
action	Darken the optical input(s) properly. If the failure persists, please return the unit to your local service center for repair.

error message	Selftest failed
description	The selftest of the module in slot <slot> has failed. If the slot is occupied by an optical head interface module, the head selftest has failed.
affected modules	all
action	Please return the unit to your local service center for repair.

error message	BRAM corrupted
description	The battery buffered RAM is corrupted.
affected modules	Mainframe
action	Please return the unit to your local service center for repair.

error message	Please run realign (from menu)
description	The alignment of laser cavity is not ideal.
affected modules	TLS
action	Please follow this instruction and run the realignment, which can be selected from the menu of the tunable laser source module. If the failure persists, please return the unit to your local service center for repair.

error message	Out of specification
description	The unit has been found outside the specification. This may happen due to various reasons.
affected modules	TLS
action	Please run LambdaZero from the menu first. If the failure persists, reboot the mainframe and run realign from the menu. If this does not help, please return the unit to your local service center for repair.

error message	Duty cycle out of range
description	The power control loop cannot control the correct output power anymore, because the duty cycle of the external modulation is too small.
affected modules	TLS
action	Increase the duty cycle (that is, increase the on-state duration of the modulated signal)

error message	Beampath safety error
description	A problem on the module has lead to an unsafe operation state. For this reason, the shutter has been closed.
affected modules	All attenuators
action	If this problem occurs several times, please send the module to the local Agilent service center for repair.

error message	Module communication error
description	There was an error in communication between module and mainframe. For safety reasons, the module was disabled and the shutter closed.
affected modules	All attenuators
action	If this problem occurs several times, please send the module to the local Agilent service center for repair.

error message	Offset table is empty
description	The user has tried to activate the Offset(Lambda) function, but the table of wavelength dependent offsets is empty.
affected modules	All attenuators
action	Please construct a table with at least one entry, before activating this mode.

error message	Lambda offset active
description	The user has tried to program the table of wavelength dependent offsets, but the Offset(Lambda) mode is activated.
affected modules	All attenuators
action	Please deactivate the Offset(Lambda) mode first.

Error

```
Error
Channel <slot><channel>
Sweep Parameter Inconsistent
```

One or more of the following reasons may cause this error message:

firmware revision	all
modus	stepped sweep
parameter(s)	lambda logging on
action	switch lambda logging off

firmware revision	$\leq 2.5x$
modus	continuous sweep
parameter(s)	stop wavelength \leq start wavelength
	sweep time too small ($< 0.001s$)
	sweep time too large ($t > 400s$)
	trigger frequency too high ($f > 10kHz$)
	lambda logging: - coherence control active - cycles $\neq 1$ - trigger \neq step finished
action	check settings and correct where appropriate

firmware revision	> 2.6
modus	continuous sweep
parameter(s)	stop wavelength \leq start wavelength
	sweep time too small ($< 0.001s$)
	sweep time too large ($t > 400s$)
	trigger frequency too high ($f > 10kHz$)
	lambda logging: - coherence control active - trigger \neq step finished
action	check settings and correct where appropriate

Tunable Laser Sources

Initialization Tests

These tests are executed every time the instrument is powered on, before the selftests start.

error message	Initialization Error (AttInitialize(), error value)	
description	Error during attenuator initialization. No ready message from attenuator DSP after ...	
error value	1	reset
	2	init motor
	4	find index
	8	move to min position
action	Please return the unit to your local service center for repair	

error message	Initialization Error (AttMovePos(zeroPos), error value)	
description	No ready message from attenuator DSP after moving to zero position taken from caldata	
error value	8	(not significant)
action	Please return the unit to your local service center for repair	

error message	Initialization Error (CalData CRC wrong: <i>crc1</i> , stored: <i>crc2</i>)	
description	The checksum stored in the caldata does not match the calculated checksum	
error value	<i>crc1</i>	calculated checksum
	<i>crc2</i>	checksum read from caldata
action	Please return the unit to your local service center for repair	

error message	Initialization Error (Calibration Data Invalid, error value)	
description	The calibration data was tagged as invalid before it was loaded on to the module	
error value	0	not significant
action	Please return the unit to your local service center for repair	

error message	Initialization Error (CalOptZeroMeas, error value)	
description	Error in optical zero measurement	
error value	1	not significant
action	Please return the unit to your local service center for repair	

error message	Initialization Error (DspMainCalcKFactor failed, error value)	
description	DSP K factor calibration failed	
error value	-1	no TCFS (according to caldata)
	1	error when calibrating TCFS
	2	DSP sweep failed
	4	laser safety
action	Please return the unit to your local service center for repair	

error message	Initialization Error (DspMainWriteCaldata(), error value)	
description	Error while writing cal data to DSP	
error value	5	tried to access invalid array position
	6	wrong dimension
	7	unknown type found in variable array
	8	wrong parameter when trying to access one of the DSPs cal arrays
action	Please return the unit to your local service center for repair	

error message	Initialization Error (Firmware CRC wrong: crc1, stored: crc2!)	
description	The checksum stored in the firmware does not match the calculated checksum	
error value	crc1	calculated checksum
	crc2	checksum read from caldata
action	Reload the firmware of the module. If the failure persists, please return the unit to your local service center for repair	

error message	Initialization Error (HwAccessInit, error value)	
description	Error setting DAC	
error value	1	(not significant)
action	Please return the unit to your local service center for repair	

error message	Initialization Error (InitDacs, error value)	
description	Error setting DAC	
error value	1	(not significant)
action	Please return the unit to your local service center for repair	

error message	Initialization Error (InstSettingInit, error value)	
description	Error creating semaphore	
error value	2	(not significant)
action	Please return the unit to your local service center for repair	

error message	Initialization Error (LaserEEPROMInit, error value)	
description	Error reading laser EEPROM	
error value	1	(not significant)
action	Please return the unit to your local service center for repair	

error message	Initialization Error (MainEEPROMInit, error value)	
description	Error reading main EEPROM	
error value	1	(not significant)
action	Please return the unit to your local service center for repair	

error message	Initialization Error (MotorSelfCali failed, error value)	
description	Motor self calibration failed	
error value	-1	(not significant)
action	Please return the unit to your local service center for repair	

error message	Initialization Error (MotorZero, error value)	
description	DSP motor zero not finished in time	
error value	1	(not significant)
action	Please return the unit to your local service center for repair	

error message	Initialization Error (OptZero, error value)	
description	Optical zero disabled in caldata	
error value	-1	(not significant)
action	Please return the unit to your local service center for repair	

error message	Initialization Error (OptZero Opc, error value)	
description	Timeout while waiting for laser diode (16) and thermopositioner (64) to settle while preparing optical zero measurement	
error value	16	waiting for laser diode
	64	waiting for thermopositioner
action	Reboot the instrument. If the failure persists, please return the unit to your local service center for repair	

error message	Initialization Error (TASK_TIMEOUT, id1)	
description	An init task has not finished in time	
error value	id1	task name
action	Please return the unit to your local service center for repair	

error message	Initialization Error (TASK_VERIFY, id1, id2)	
description	A task could not be started	
error value	id1	task name
	id2	maximum available memory
action	Reboot the instrument. If the failure persists, please return the unit to your local service center for repair	

If one of the selftests fails, please try to reboot the instrument. If the selftest continues to fail, please return the mainframe to your local service center for repair.

error message	Initialization Error (Tcfs Amplifier Calibration failed, error value)	
description	The calibration of the tuning control feedback system amplifier has failed	
error value	0	(not significant)
action	Please return the unit to your local service center for repair	

error message	Initialization Error (TcfsAdpEEPROMInit, error value)	
description	Error reading tuning control feedback system adapter board EEPROM	
error value	1	(not significant)
action	Please return the unit to your local service center for repair	

error message	Initialization Error (TcfsEEPROMInit, error value)	
description	Error reading tuning control feedback system EEPROM	
error value	1	(not significant)
action	Please return the unit to your local service center for repair	

error message	Initialization Error (Tcfs temperature not settled, error value)	
description	Temperature has not settled at the tuning control feedback system	
error value	0	(not significant)
action	Please return the unit to your local service center for repair	

error message	Initialization Error (TmpCalDataInit, error value)	
description	Error accessing caldata	
error value	1	(not significant)
action	Please return the unit to your local service center for repair	

error message	Initialization Error (UpPiezoEnable, error value)	
description	Over current	
error value	1	(not significant)
action	Please return the unit to your local service center for repair	

error message	Initialization Error - module temperature out of range (please wait a little bit and try again)!	
description	Module temperature is too high	
error value		(no error value)
action	Doublecheck whether the fan is working and not blocked. Wait some time and reboot the instrument. If the failure persists, please return the unit to your local service center for repair.	

error message	Initialization Error - module temperature too high (please wait a little bit and try again)!	
description	Module temperature is too high	
error value		(no error value)
action	Doublecheck whether the fan is working and not blocked. Wait some time and reboot the instrument. If the failure persists, please return the unit to your local service center for repair.	

Selftests

These tests are started after initialization of the instrument. This test measures defined parameters, and tests them to limits.

error message	Main Peltier Temp. Selftest Failed (error value)	
description	Verifies whether the peltier temperature of the laser diode is within a given range	
error value	13010	Peltier temperature is not in target range
action	Please return the unit to your local service center for repair	

error message	Main Thermo Temp. Selftest Failed (error value)	
description	Verifies whether the temperature of the thermopositioner is within a given range	
error value	13020	Thermopositioner is not in target temperature range
action	Please return the unit to your local service center for repair	

error message	Main Peltier Curr. Selftest Failed (error value)	
description	Checks if peltier current for the laser diode peltier is below maximum	
error value	13050	Laser peltier current is above maximum value
action	Please return the unit to your local service center for repair	

error message	TCFS Temp. Selftest Failed (error value)	
description	Verifies if the peltier temperature is within target with a given uncertainty	
error value	15010	TCFS peltier temperature is not in target range
action	Please return the unit to your local service center for repair	

error message	TCFS Resistor Selftest Failed (error value)	
description	This test measures the R_d of the photodiodes at channel A, B and M	
error value	15021	Photodiode R_d in channel A is below limit
	15022	Photodiode R_d in channel B is below limit
	15023	Photodiode R_d in channel C is below limit
action	Please return the unit to your local service center for repair	

error message	TCFS Attenuator Selftest Failed (error value)	
description	Verifies whether an attenuator position is repeatable.	
error value	15030	Attenuator could not be positioned
action	Please return the unit to your local service center for repair	

error message	Main DC Selftest Failed (error value)	
description	Tests all fixed DC voltages available at the mainboard mux	
error value	23011	+15V Measurement DC voltage not in limits
	23012	-15V Measurement DC voltage not in limits
	23013	+5V Reference DC voltage not in limits
	23014	-5V Reference DC voltage not in limits
	23015	negative supply voltage of laser current source not in limits
	23016	positive pezo supply voltage not in limits
action	Please return the unit to your local service center for repair	

error message	Main Temperature Selftest Failed (error value)	
description	Checks whether the temperature sensors are within given limits	
error value	23021	internal temperature sensor above limit
	23022	T_FIRE_DIODE is possibly not connected
	23023	T_OPTIZ_DIODE is possibly not connected
	23024	T_BASEPLATE is possibly not connected
action	Please return the unit to your local service center for repair	

error message	Main Power Loop Selftest Failed (error value)	
description	Verifies the electronic of the power loop regulator	
error value	23051	power loop CW path failed
	23052	power loop modulation path failed
	23053	power loop regulator circuit failed
action	Please return the unit to your local service center for repair	

error message	Main Shutter. Selftest Failed (error value)	
description	Verifies the shutter drive electronic	
error value	23061	shutter 1 drive electronic failed
	23062	shutter 2 drive electronic failed
action	Please return the unit to your local service center for repair	

error message	Main Laser Safety Selftest Failed (error value)	
description	Verifies if the test laser current is within limits and whether the safety current sets an alarm if a current limit is reached	
error value	23071	test laser current not in limits
	23072	current laser safety did not trigger at overcurrent
action	Please return the unit to your local service center for repair	

error message	Main Piezo Amp. Selftest Failed (error value)	
description	Verifies if the piezo amplifier reaches the upper and lower limit. An error may indicate a defect amplifier transistor	
error value	23091	piezo amplifier could not set to maximum voltage
	23092	piezo amplifier could not set to minimum voltage
action	Please return the unit to your local service center for repair	

error message	Main Cavity Motor Selftest Failed (error value)	
description	Verifies the functionality of the cavity motor	
error value	23081	indicates an open motor connector
	23082	indicates that a motor coil is defect
	23083	indicates a short in a motor coil
action	Please return the unit to your local service center for repair	

error message	TCFS DC Selftest Failed (error value)	
description	Tests all fixed DC voltages available at the TCFS board mux	
error value	25011	+10V measurement voltage on TCFS board not in limits
	25012	-10V measurement voltage on TCFS board not in limits
	25013	+5V reference voltage on TCFS board not in limits
	25014	-5V reference voltage on TCFS board not in limits
	25015	+2.5V reference voltage on TCFS board not in limits
	25016	+5V attenuator encoder voltage on TCFS board not in limits
	25017	+2.5V attenuator encoder voltage on TCFS board not in limits
action	Please return the unit to your local service center for repair	

error message	TCFS Temperature Selftest Failed (error value)	
description	Verifies whether the TCFS temperature sensors are working correctly	
error value	25021	TCFS board temperature sensor U620 above limit
	25022	TCFS case temperature sensor possibly not connected
action	Please return the unit to your local service center for repair	

error message	TCFS Amp. Offset Selftest Failed (error value)	
description	Checks whether an applied offset for channel A, B and M is measured within limits	
error value	25031	TCFS Chan A offset not in limits
	25032	TCFS Chan B offset not in limits
	25034	TCFS Chan M offset not in limits
action	Please return the unit to your local service center for repair	

error message	TCFS Amplifier Selftest Failed (error value)	
description	This test calibrates the TCFS A, B and M channel and verifies if all resulting values are in limits	
error value	25041	TCFS Hybrid amplifier offset could not be removed
	25042	One of the channels A, B or M failed during calibration
action	Please return the unit to your local service center for repair	

error message	TCFS Adj. Circuit Selftest Failed (error value)	
description	Checks whether a signal between +15V and +21V can be selected at the 20V reference with the DAC	
error value	25050	TCFS 20V adjust is not possible
action	Please return the unit to your local service center for repair	

error message	TCFS Shutter Selftest Failed (error value)	
description	This test verifies the shutter driver by applying a designated test pattern	
error value	25060	TCFS shutter driver electronic fails
action	Please return the unit to your local service center for repair	

Return Loss Meters

error message	E10010: Invalid Caldata	
description	The Caldata loaded on the module is invalid. Either the caldata version number is not compatible with the firmware or the caldata is corrupt (checksum incorrect)	
test value		(no parameter)
action	Please return the unit to your local service center for repair	
error message	E10012: Dual ported RAM write/read test failed	
description	Writing bit patterns and reading them back to/from the dual ported ram failed	
test value		(no test value)
action	Please return the unit to your local service center for repair	
error message	E10013: FPGA not correctly initialized	
description	Loading the FPGA with data failed. This indicates a defective FPGA or an FPGA access problem	
test value		(no test value)
action	Please return the unit to your local service center for repair	
error message	E10014: Firmware corrupt, checksum error (a,b)	
description	Firmware in flash has an invalid checksum. Either the image which was programmed was corrupt or the flash memory has a failure	
test value	a	is the stored checksum
	b	is the calculated checksum
action	Reload the module firmware. If the failure persists, please return the unit to your local service center for repair	
error message	E1x031: 0.25 ref out of limits (a, b, c)	
description	The 0.25V reference voltage measured through the 16bit ADC is out of the acceptable limits	
test value	a	shows the ADC reading (0.25V = 3276)
	b	shows the lower limit
	c	shows the upper limit
	x	refers to the internal PM channel tested
action	Please return the unit to your local service center for repair	

error message	E10040: 10bit ADC test failed (a, b, c)	
description	The 10bit ADC has returned a value other than 512	
test value	a	shows the ADC reading
	b	shows the lower limit
	c	shows the upper limit
action	Please return the unit to your local service center for repair	

error message	E10051: Laser <a> temp out of limits (b)	
description	The laser temperature is outside the allowed range	
test value	a	laser number
	b	measured laser temperature
action	Verify whether the module is operated within the specified ambient temperature. If the failure persists, please return the unit to your local service center for repair	

error message	E10052: Photodiode <a> temp out of limits (b)	
description	The photodiode temperature is outside the allowed range	
test value	a	photodiode number
	b	measured photodiode temperature
action	Verify whether the module is operated within the specified ambient temperature. If the failure persists, please return the unit to your local service center for repair	

error message	E1x060: 0.25V offset failed (a, b)	
description	Verifies that the offset voltage for the 16-bit ADC (250 mV) is correctly added to the input signal	
test value	a	shows the ADC reading
	b	shows the maximum difference to the exact ADC reading of 3277
	x	refers to the internal PM channel tested
action	Please return the unit to your local service center for repair	

error message	E1x061: PGA DAC adj failed (a, b, c)	
description	Tries to adjust the offset voltage of the PGA	
test value	a	shows the ADC Offset reading
	b	shows the limit for an upper offset
	c	shows the limit for a lower offset
	x	refers to the internal PM channel tested
action	Please return the unit to your local service center for repair	

error message	E1x062: PGA gain adj failed (a, b, c)	
description	Verifies the gain settings of the PGA (x 1/10/100). A voltage of 25 mV is applied to the input of the PGA and then amplified	
test value	a	if 1, the required division has failed if 0, the calculated factors are correct
	b	shows the measured values for an amplification by 10
	c	shows the measured values for an amplification by 100
	x	refers to the internal PM channel tested
action	Please return the unit to your local service center for repair	

error message	E1x063: Lambda Dac adj failed (a, b, c, d)	
description	Verifies the gain of the responsiveness correction stage	
test value	a	if 1, the quotient d could not be calculated, otherwise 0
	b	shows the difference between DAC settings 1024 and 2048
	c	shows the difference between DAC settings 2048 and 4096
	d	shows the quotient of b divided by c
	x	refers to the internal PM channel tested
action	Please return the unit to your local service center for repair	

error message	E10070: Laser <a> control failed (b, c)	
description	Checks the laser current source	
test value	a	laser number
	b	low power setting
	c	high power setting
action	Please return the unit to your local service center for repair	

error message	E10080: Laser <a> control for safety test failed	
description	To test the current safety comparator the laser current needs to be set to two different values	
test value	a	laser number
action	Please return the unit to your local service center for repair	

error message	E10081: Safety comparator <a> test failed (b, c)	
description	Checks whether laser current safety comparator includes at the right conditions a safety interrupt at the CPU	
test value	a	laser number
	b	shows whether the interrupt flag was raised when the current was lower than the limit
	c	shows whether the interrupt flag was raised when the current was higher than the limit
action	Please return the unit to your local service center for repair	

Powermeters & Interface Modules with Optical Head

error message	E10010: Invalid Caldata	
description	The Caldata loaded on the module is invalid. Either the caldata version number is not compatible with the firmware or the caldata is corrupt (checksum incorrect)	
test value		(no test value)
action	Please return the unit to your local service center for repair	

error message	E10012: Dual ported RAM write/read test failed	
description	Writing bit patterns and reading them back to/from the dual ported ram failed	
test value		(no test value)
action	Please return the unit to your local service center for repair	

error message	E10013: FPGA not correctly initialized	
description	Loading the FPGA with data failed. This indicates a defective FPGA or an FPGA access problem	
test value		(no test value)
action	Please return the unit to your local service center for repair	

error message	E1x020: Communication with head failed	
description	An external head is available but it was not possible to access the registers of the head's FPGA	
test value	x	refers to the module channel tested
action	Please return the unit to your local service center for repair	

error message	E1x021: Invalid head caldata	
description	The head calibration data was detected as invalid	
test value	x	refers to the module channel tested
action	Please return the unit to your local service center for repair	

error message	E1x031: 0.25V ref out of limits (a, b, c)	
description	The 0.25V reference voltage measured through the 16bit ADC is out of the acceptable limits	
test value	a	shows the ADC reading (0.25 = 3276)
	b	shows the lower limit
	c	shows the upper limit
	x	refers to the module channel tested
action	Please return the unit to your local service center for repair	

error message	E10040: 10bit ADC test failed (a, b, c)	
description	The 10bit ADC has returned a value other than 512	
test value	a	shows the ADC reading
	b	shows the lower limit
	c	shows the upper limit
action	Please return the unit to your local service center for repair	

error message	E1x050: TEC NTC temp ou of limits (a, b, c, d)	
description	The sensor temperature is out of the acceptable limits	
test value	a	shows the sensor NTC temperature
	b	shows the sensor NTC temperature ADC reading
	c	shows the lower limit
	d	shows the upper limit
	x	refers to the module channel tested
action	Verify whether the module is operated within the specified ambient temperature. If the failure persists, please return the unit to your local service center for repair.	

error message	E1x051: TEC current out of limits (a, b, c)	
description	Verifies whether the TEC current is within a given range	
test value	a	shows the ADC reading of the TEC current
	b	shows the lower limit
	c	shows the upper limit
	x	refers to the module channel tested
action	Please return the unit to your local service center for repair	

error message	E1x052: TEC comparator test failed (a, b, c, d)	
description	Checks the TEC regulation voltage comparator	
test value	a	shows the 10bit ADC reading for the high output voltage
	b	shows the 10bit ADC reading for the low output voltage
	c	shows the lower limit
	d	shows the upper limit
	x	refers to the module channel tested
action	Please return the unit to your local service center for repair	

error message	E1x053: TEC default temp invalid (a)	
description	Verifies whether the default temperature is within a given range	
test value	a	shows the default temperature
	x	refers to the module channel tested
action	Please return the unit to your local service center for repair	

error message	E1x054: TEC control failed (a, b, c)	
description	When the TEC is enabled the temperature must move towards the default temperature, coming from a previous temperature before the TEC was enabled. The moving direction must be correct and the overshoot must be less than a certain limit	
test value	a	shows the temperature before the TEC was enabled
	b	shows the actual temperature while TEC is enabled
	c	shows the target temperature, where b should move to
	x	refers to the module channel tested
action	Please return the unit to your local service center for repair	

error message	E1x060: 0.25V offset failed (a, b)	
description	Verifies that the offset voltage for the 16-bit ADC (250 mv) is correctly added to the input signal	
test value	a	shows the ADC reading
	b	shows the maximum difference to the exact ADC reading of 3277
	x	refers to the module channel tested
action	Please return the unit to your local service center for repair	

error message	E1x061: PGA DAC adj failed (a, b, c)	
description	Tries to adjust the offset voltage of the PGA	
test value	a	shows the ADC offset reading
	b	shows the limit for an upper offset
	c	shows the limit for a lower offset
	x	refers to the module channel tested
action	Please return the unit to your local service center for repair	

error message	E1x062: PGA gain adj failed (a, b, c)	
description	Verifies the gain settings of the PGA (x 1/10/100). A voltage of 25 mV is applied to the input of the PGA and then amplified	
test value	a	if 1, the required division has failed if 0, the calculated factors are correct
	b	shows the measured values for an amplification by 10
	c	shows the measured values for an amplification by 100
	d	shows the quotient of b divided by c
	x	refers to the module channel tested
action	Please return the unit to your local service center for repair	

error message	E1x063: Lambda DAC adj failed (a, b, c, d)	
description	Verifies the gain of the responsiveness correction stage	
test value	a	if 1, the quotient d could not be calculated, otherwise 0
	b	shows the difference between DAC settings 1024 and 2048
	c	shows the difference between DAC settings 2048 and 4096
	d	shows the quotient of b divided by c
	x	refers to the module channel tested
action	Please return the unit to your local service center for repair	

error message	E1x080; TEC settling failed (a, b)	
description	Verifies the comparator output of the regulation circuit after the TEC is enabled and expects an ADC reading of about 512	
test value	a	shows the ADC reading of the comparator output
	b	shows the time when the temperature regulation has reached the default temperature. Waits maximum 30 seconds
	x	refers to the module channel tested
action	Please return the unit to your local service center for repair	

error message	E1x081: TEC current to temperature mismatch	
description	If the TEC temperature difference does not correspond to the measured Peltier current this test will fail	
test value	x	refers to the module channel tested
action	Verify whether the module is operated within the specified ambient temperature. If the failure persists, please return the unit to your local service center for repair.	

Fixed Laser Sources (Fabry Perot)

error message	E10010: Invalid Caldata	
description	The Caldata loaded on the module is invalid. Either the caldata version number is not compatible with the firmware or the caldata is corrupt (checksum incorrect)	
test value		(no test value)
action	Please return the unit to your local service center for repair	

error message	E10012: Dual ported RAM write/read test failed	
description	Writing bit patterns and reading them back to/from the dual ported ram failed	
test value		(no test value)
action	Please return the unit to your local service center for repair	

error message	E10013: FPGA not correctly initialized	
description	Loading the FPGA with data failed. This indicates a defective FPGA or an FPGA access problem	
test value		(no test value)
action	Please return the unit to your local service center for repair	

error message	E10040: 10bit ADC test failed (a, b, c)	
description	The 10bit ADC has returned a value other than 512	
test value	a	shows the ADC reading
	b	shows the lower limit
	c	shows the upper limit
action	Please return the unit to your local service center for repair	

error message	E10050: Board temp out of limits (a)	
description	The board temperature is outside the allowed range	
test value	a	measured board temperature
action	Please return the unit to your local service center for repair	

error message	E10051: Laser <a> temp out of limits (b)	
description	The laser temperature is outside the allowed range	
test value	a	laser number
	b	measured laser temperature
action	Verify whether the module is operated within the specified ambient temperature. If the failure persists, please return the unit to your local service center for repair	

error message	E10060: Laser <a> control failed (b, c, d, e)	
description	Checks the laser current source	
test value	a	laser number
	b	measured current at low power and normal current source setting
	c	measured current at low power and high current source setting
	d	measured current at high power and normal current source setting
	e	measured current at high power and high current source setting
action	Please return the unit to your local service center for repair	

error message	E10070: Peltier <a> temp diff amp failed	
description	Checks whether the comparator output changes from low to high values while the temperature DAC is set to two different temperatures	
test value	a	laser number
action	Please return the unit to your local service center for repair	

error message	E10071: Peltier <a> current control test failed (b, c, d, e)	
description	The Peltier temperature is set close to the ambient temperature. Using the current offset circuit, two different currents are set and measured. If the differences between vary more than a specific percentage this test fails	
test value	a	laser number
	b	delta current setting
	c	delta current measured
	d	actual difference between b and c
	e	allowed difference between b and c
action	Please return the unit to your local service center for repair	

error message	E10080: Laser <a> control for safety test failed	
description	To test the current safety comparator the laser current needs to be set to two different values	
test value	a	laser number
action	Please return the unit to your local service center for repair	

error message	E10081: Safety comparator <a> test failed (b, c)	
description	Checks whether laser current safety comparator includes at the right conditions a safety interrupt at the CPU	
test value	a	laser number
	b	shows whether the interrupt flag was raised when the current was lower than the limit
	c	shows whether the interrupt flag was raised when the current was higher than the limit
action	Please return the unit to your local service center for repair	

error message	E10090: Peltier <a> regulation failed (b, c, d)	
description	During boot time, when the Peltier control was disabled it is enabled for two seconds and the temperature moving direction is checked. If the movement delta is not approaching the target default temperature or if the temperature has not reached the default within the given ranges this test fails	
test value	a	laser number
	b	default temperature
	c	temperature with disabled peltier
	d	temperature with enabled peltier
action	Please return the unit to your local service center for repair	

error message	E10091: Peltier <a> regulation failed (b, c)	
description	Verifies whether the temperature is around the default value with the given limits	
test value	a	laser number
	b	default temperature
	c	actual temperature
action	Please return the unit to your local service center for repair	

DFB Laser Sources

error message	E10010: Invalid Caldata	
description	The Caldata loaded on the module is invalid. Either the caldata version number is not compatible with the firmware or the caldata is corrupt (checksum incorrect)	
test value		(no test value)
action	Please return the unit to your local service center for repair	

error message	E10012: Dual ported RAM write/read test failed	
description	Writing bit patterns and reading them back to/from the dual ported ram failed	
test value		(no test value)
action	Please return the unit to your local service center for repair	

error message	E10013: FPGA not correctly initialized	
description	Loading the FPGA with data failed. This indicates a defective FPGA or an FPGA access problem	
test value		(no test value)
action	Please return the unit to your local service center for repair	

error message	E10040: 10bit ADC test failed (a, b, c)	
description	The 10bit ADC has returned a value other than 512	
test value	a	shows the ADC reading
	b	shows the lower limit
	c	shows the upper limit
action	Please return the unit to your local service center for repair	

error message	E10050: Board temp out of limits (a)	
description	The board temperature is outside the allowed range	
test value	a	measured board temperature
action	Please return the unit to your local service center for repair	

error message	E10060: Laser <a> control failed (b, c, d, e)	
description	Checks the laser current source	
test value	a	laser number
	b	measured current at low per and normal current source setting
	c	measured current at low power and high current source setting
	d	measured current at high power and normal current source setting
	e	measured current at high power and high current source setting
action	Please return the unit to your local service center for repair	

error message	E10080: Laser <a> control for safety test failed	
description	To test the current safety comparator the laser current needs to be set to two different values	
test value	a	laser number
action	Please return the unit to your local service center for repair	

error message	E10081: Safety comparator <a> test failed (b, c)	
description	Checks whether laser current safety comparator includes at the right conditions a safety interrupt at the CPU	
test value	a	laser number
	b	shows whether the interrupt flag was raised when the current was lower than the limit
	c	shows whether the interrupt flag was raised when the current was higher than the limit
action	Please return the unit to your local service center for repair	

Attenuator Modules

The following Error Codes are applicable to attenuator modules.

Codes E10010, E10012, and E10014 are valid for all attenuators. The remaining codes are only valid for attenuators with power control.

error message	E10010: Invalid Caldata	
description	The Caldata loaded on the module is invalid. Either the caldata version number is not compatible with the firmware or the caldata is corrupt (checksum incorrect)	
test value		(no test value)
action	Please return the unit to your local service center for repair	

error message	E10012: Dual ported RAM write/read test failed	
description	Writing bit patterns and reading them back to/from the dual ported ram failed	
test value		(no test value)
action	Please return the unit to your local service center for repair	

error message	E10013: FPGA not correctly initialized	
description	Loading the FPGA with data failed. This indicates a defective FPGA or an FPGA access problem	
test value		(no test value)
action	Please return the unit to your local service center for repair	

error message	E10014: Firmware corrupt, checksum error (a,b)	
description	Firmware in flash has an invalid checksum. Either the image which was programmed was corrupt or the flash memory has a failure	
test value	a	is the stored checksum
	b	is the calculated checksum
action	Reload the module firmware. If the failure persists, please return the unit to your local service center for repair	

error message	E10031: 0.25 ref out of limits (a, b, c)	
description	The 0.25V reference voltage measured through the 16bit ADC is out of the acceptable limits	
test value	a	shows the ADC reading (0.25V = 3276)
	b	shows the lower limit
	c	shows the upper limit
action	Please return the unit to your local service center for repair	

error message	E1060: 0.25V offset failed (a, b)	
description	Verifies that the offset voltage for the 16-bit ADC (250 mV) is correctly added to the input signal	
test value	a	shows the ADC reading
	b	shows the maximum difference to the exact ADC reading of 3277
action	Please return the unit to your local service center for repair	

error message	E10061: PGA DAC adj failed (a, b, c)	
description	Tries to adjust the offset voltage of the PGA	
test value	a	shows the ADC Offset reading
	b	shows the limit for an upper offset
	c	shows the limit for a lower offset
action	Please return the unit to your local service center for repair	

error message	E10062: PGA gain adj failed (a, b, c)	
description	Verifies the gain settings of the PGA (x 1/10/100). A voltage of 25 mV is applied to the input of the PGA and then amplified	
test value	a	if 1, the required division has failed if 0, the calculated factors are correct
	b	shows the measured values for an amplification by 10
	c	shows the measured values for an amplification by 100
action	Please return the unit to your local service center for repair	

error message	E10063: Lambda Dac adj failed (a, b, c, d)	
description	Verifies the gain of the responsiveness correction stage	
test value	a	if 1, the quotient d could not be calculated, otherwise 0
	b	shows the difference between DAC settings 1024 and 2048
	c	shows the difference between DAC settings 2048 and 4096
	d	shows the quotient of b divided by c
action	Please return the unit to your local service center for repair	

The following error codes are attenuator module specific:

- Error Creating message queue!
- Error Init MCB!
- Error spawning tLowlvIMsgHandler!
- Error spawning tKeyPressed!
- Error spawning tTempCtrl!
- Error spawning tPowCtrl!
- Error checking firmware CRC!

Optical Switch modules

error message	InitError() failed!
description	Initialization of internal error buffer failed.
test value	
action	Please return the unit to your local service center for repair

error message	Invalid Caldata!
description	The calibration data loaded on the module is invalid. Either the version number is not compatible with the firmware or the calibration data is corrupt (checksum incorrect).
test value	
action	Please return the unit to your local service center for repair

error message	InitModule() failed!
description	Module initialization failed.
note	Normally something more descriptive appears (i.e. one of the other messages mentioned here.)
test value	
action	Please return the unit to your local service center for repair

error message	SanityChecks():channel X, configArray != -1 SanityChecks():channel X, configs == 0 SanityChecks() failed
description	Calibration data seems not to be correct
test value	X Channel number
action	Please return the unit to your local service center for repair

error message	InitModuleStruct() failed
description	Initialization of module structures failed
test value	
action	Please return the unit to your local service center for repair

error message	Unsupported module type
description	Module type described in calibration data not supported by the firmware or incorrect calibration data
test value	
action	Please return the unit to your local service center for repair

error message	<p>InitSwitchAccess():AllocTpuChannels() for switch failed</p> <p>InitSwitchAccess():Unsupported switchLocation</p> <p>SwitchAccessSwitch():Unsupported switchLocation</p> <p>SwitchInitSequence():Unsupported switchLocation</p> <p>InitSwitchAccess(): failed</p>
description	Initialization of the functionality used to access the switch hardware failed. Probably a calibration data problem.
test value	
action	Please return the unit to your local service center for repair
error message	<p>InitSwitchAccess():AllocTpuChannels() for LEDs failed</p> <p>InitSwitchAccess():Unsupported ledLocation</p> <p>SwitchAccessLED():Unsupported ledLocation</p>
description	Initialization of the functionality used to access the LEDs failed. Probably a calibration data problem.
test value	
action	Please return the unit to your local service center for repair
error message	<p>InitKey (&SendInternalKeyMsg) failed</p> <p>InitKey(): called more than once</p> <p>InitKey(): couldn't create enableMsgQ.</p> <p>InitKey(): couldn't spawn KeyEnableTask.</p> <p>InitKey(): couldn't create isrWatchdog.</p> <p>InitKey(): init() failed</p> <p>InitKey(): KeyEnable() failed</p> <p>KeyInitPortF(): wrong interrupt number</p> <p>KeyInitPortF(): intConnect() failed</p> <p>KeyInitTPU(): AllocTpuTlc() failed</p> <p>KeyInitTPU(): intConnect() failed</p>
description	Initialization of front panel key failed. Probably a calibration data or firmware problem.
test value	
action	Please return the unit to your local service center for repair

error message	<p>KeyDisable(): ERROR</p> <p>KeyDisable(): disabledCnt >= disabledMax</p> <p>KeyDisableTask(): received wrong channel number.</p> <p>KeyDisableTask(): disabledCnt <0.</p> <p>KeyDisableTask(): couldn't send myself a msg.</p> <p>KeyEnablePortF(): wrong interrupt number</p> <p>KeyDisablePortF(): wrong interrupt number</p>
description	Problem when enabling or disabling a front panel key. Probably a calibration data or firmware problem.
test value	
action	Please return the unit to your local service center for repair

error message	<p>KeySelftest() called without calling KeyInit() before</p> <p>KeySelftest(): KeyDisable() failed</p> <p>KeySelftest(): selftestPre() failed</p> <p>KeySelftest(): key pressed during selftest or hardware problem</p> <p>KeySelftest(): selftestPost() failed</p> <p>KeySelftest(): KeyEnable() failed</p> <p>KeySelftestExecPortF(): wrong interrupt number</p> <p>KeySelftestPreTPU(): FreeTpultc() failed</p> <p>KeySelftestExecTPU(): GetTpuDioState() failed</p> <p>KeySelftestPostTPU(): AllocTpultc() failed</p> <p>Selftest (stAll, 0) failed</p>
description	<p>Selftest problem. Possible causes:</p> <ul style="list-style-type: none"> - hardware failure - key pressed during selftest - calibration data or firmware incorrect
test value	
action	Please return the unit to your local service center for repair

error message	InitKey(): unsupported keyLocation KeyAck(): unsupported keyLocation KeyEnable(): unsupported keyLocation KeyDisable(): unsupported keyLocation KeySelftestPre(): unsupported keyLocation KeySelftestExec(): unsupported keyLocation KeySelftestPost(): unsupported keyLocation
description	Calibration data incorrect
test value	
action	Please return the unit to your local service center for repair
error message	Preset (0) failed Preset(): channel X, config Y failed
description	Preset failed, probably due to incorrect calibration data
test value	X module channel Y switch configuration number
action	Please return the unit to your local service center for repair
error message	Error checking firmware CRC!
description	The firmware CRC is wrong
test value	
action	Please return the unit to your local service center for repair
error message	Unknown internal error during init
description	Error with unknown cause occurred
test value	
action	Please return the unit to your local service center for repair
error message	InitDefaultCaldata(): couldn't alloc defaultCalData InitDefaultCaldata(): only 2 channels supported in default caldata InitDefaultCaldata(): unknown type
description	This only occurs when running special debug software
test value	
action	Please return the unit to your local service center for repair

16

Cleaning Instructions

The following Cleaning Instructions contain some general safety precautions, which must be observed during all phases of cleaning. Consult your specific optical device manuals or guides for full information on safety matters.

Please try, whenever possible, to use physically contacting connectors, and dry connections. Clean the connectors, interfaces, and bushings carefully after use.

If you are unsure of the correct cleaning procedure for your optical device, we recommend that you first try cleaning a dummy or test device.

Agilent Technologies assume no liability for the customer's failure to comply with these requirements.

Cleaning Instructions for this Instrument

The Cleaning Instructions apply to a number of different types of Optical Equipment. Table 23 lists the sections that are relevant to the various modules that can be installed in this instrument.

Table 23 Cleaning Instructions for Modules

Modules	Instruction
Optical Heads	"How to clean instruments with an optical glass plate" on page 441
Laser Source Modules	"How to clean instruments with a physical contact interface" on page 442
Tunable Laser Modules	"How to clean instruments with a physical contact interface" on page 442
Return Loss Modules	"How to clean instruments with a physical contact interface" on page 442
LED Source Modules	"How to clean instruments with a physical contact interface" on page 442
Power Sensor Modules	"How to clean instruments with a recessed lens interface" on page 443

Safety Precautions.....	423
Why is it important to clean optical devices ?.....	424
What do I need for proper cleaning?.....	425
Standard Cleaning Equipment.....	425
Additional Cleaning Equipment.....	428
Preserving Connectors	431
Cleaning Instrument Housings	432
Which Cleaning Procedure should I use ?.....	433
How to clean connectors	434
How to clean connector adapters.....	436
How to clean connector interfaces.....	437
How to clean bare fiber adapters.....	438
How to clean lenses	439
How to clean instruments with a fixed connector interface 440	
How to clean instruments with an optical glass plate .	441
How to clean instruments with a physical contact interface 442	
How to clean instruments with a recessed lens interface . 443	
How to clean optical devices which are sensitive to mechanical stress and pressure	444
How to clean metal filters or attenuator gratings.....	445
Additional Cleaning Information	446
How to clean bare fiber ends	446
How to clean large area lenses and mirrors.....	446
Other Cleaning Hints	448

Safety Precautions

Please follow the following safety rules:

- Do not remove instrument covers when operating.
- Ensure that the instrument is switched off throughout the cleaning procedures.
- Use of controls or adjustments or performance of procedures other than those specified may result in hazardous radiation exposure.
- Make sure that you disable all sources when you are cleaning any optical interfaces.
- Under no circumstances look into the end of an optical device attached to optical outputs when the device is operational. The laser radiation is not visible to the human eye, but it can seriously damage your eyesight.
- To prevent electrical shock, disconnect the instrument from the mains before cleaning. Use a dry cloth, or one slightly dampened with water, to clean the external case parts. Do not attempt to clean internally.
- Do not install parts or perform any unauthorized modification to optical devices.
- Refer servicing only to qualified and authorized personnel.

Why is it important to clean optical devices ?

In transmission links optical fiber cores are about $9\ \mu\text{m}$ (0.00035") in diameter. Dust and other particles, however, can range from tenths to hundredths of microns in diameter. Their comparative size means that they can cover a part of the end of a fiber core, and as a result will reduce the performance of your system.

Furthermore, the power density may burn dust into the fiber and cause additional damage (for example, 0 dBm optical power in a single mode fiber causes a power density of approximately 16 million W/m^2). If this happens, measurements become inaccurate and non-repeatable.

Cleaning is, therefore, an essential yet difficult task. Unfortunately, when comparing most published cleaning recommendations, you will discover that they contain several inconsistencies. In this section, we want to suggest ways to help you clean your various optical devices, and thus significantly improve the accuracy and repeatability of your lightwave measurements.

What do I need for proper cleaning?

Some Standard Cleaning Equipment is necessary for cleaning your instrument. For certain cleaning procedures, you may also require certain Additional Cleaning Equipment.

Standard Cleaning Equipment

Before you can start your cleaning procedure you need the following standard equipment:

- Dust and shutter caps
- Isopropyl alcohol
- Cotton swabs
- Soft tissues
- Pipe cleaner
- Compressed air

Dust and shutter caps

All of Agilent Technologies' lightwave instruments are delivered with either laser shutter caps or dust caps on the lightwave adapter. Any cables come with covers to protect the cable ends from damage or contamination.

We suggest these protected coverings should be kept on the equipment at all times, except when your optical device is in use. Be careful when replacing dust caps after use. Do not press the bottom of the cap onto the fiber too hard, as any dust in the cap can scratch or pollute your fiber surface.

If you need further dust caps, please contact your nearest Agilent Technologies sales office.

Isopropyl alcohol

This solvent is usually available from any local pharmaceutical supplier or chemist's shop.

If you use isopropyl alcohol to clean your optical device, do not immediately dry the surface with compressed air (except when you are cleaning very sensitive optical devices). This is because the dust and the dirt is solved and will leave behind filmy deposits after the alcohol is evaporated. You should therefore first remove the alcohol and the dust with a soft tissue, and then use compressed air to blow away any remaining filaments.

If possible avoid using denatured alcohol containing additives. Instead, apply alcohol used for medical purposes.

Never try to drink this alcohol, as it may seriously damage to your health.

Do not use any other solvents, as some may damage plastic materials and claddings. Acetone, for example, will dissolve the epoxy used with fiber optic connectors. To avoid damage, only use isopropyl alcohol.

Cotton swabs

We recommend that you use swabs such as Q-tips or other cotton swabs normally available from local distributors of medical and hygiene products (for example, a supermarket or a chemist's shop). You may be able to obtain various sizes of swab. If this is the case, select the smallest size for your smallest devices.

Ensure that you use natural cotton swabs. Foam swabs will often leave behind filmy deposits after cleaning.

Use care when cleaning, and avoid pressing too hard onto your optical device with the swab. Too much pressure may scratch the surface, and could cause your device to become misaligned. It is advisable to rub gently over the surface using only a small circular movement.

Swabs should be used straight out of the packet, and never used twice. This is because dust and dirt in the atmosphere, or from a first cleaning, may collect on your swab and scratch the surface of your optical device.

Soft tissues

These are available from most stores and distributors of medical and hygiene products such as supermarkets or chemists' shops.

We recommend that you do not use normal cotton tissues, but multi-layered soft tissues made from non-recycled cellulose. Cellulose tissues are very absorbent and softer. Consequently, they will not scratch the surface of your device over time.

Use care when cleaning, and avoid pressing on your optical device with the tissue. Pressing too hard may lead to scratches on the surface or misalignment of your device. Just rub gently over the surface using a small circular movement.

Use only clean, fresh soft tissues and never apply them twice. Any dust and dirt from the air which collects on your tissue, or which has gathered after initial cleaning, may scratch and pollute your optical device.

Pipe cleaner

Pipe cleaners can be purchased from tobacconists, and come in various shapes and sizes. The most suitable one to select for cleaning purposes has soft bristles, which will not produce scratches.

There are many different kinds of pipe cleaner available from tobacco shops.

The best way to use a pipe cleaner is to push it in and out of the device opening (for example, when cleaning an interface). While you are cleaning, you should slowly rotate the pipe cleaner.

Only use pipe cleaners on connector interfaces or on feed through adapters. Do not use them on optical head adapters, as the center of a pipe cleaner is hard metal and can damage the bottom of the adapter.

Your pipe cleaner should be new when you use it. If it has collected any dust or dirt, this can scratch or contaminate your device.

The tip and center of the pipe cleaner are made of metal. Avoid accidentally pressing these metal parts against the inside of the device, as this can cause scratches.

Compressed air

Compressed air can be purchased from any laboratory supplier.

It is essential that your compressed air is free of dust, water and oil. Only use clean, dry air. If not, this can lead to filmy deposits or scratches on the surface of your connector. This will reduce the performance of your transmission system.

When spraying compressed air, hold the can upright. If the can is held at a slant, propellant could escape and dirty your optical device. First spray into the air, as the initial stream of compressed air could contain some condensation or propellant. Such condensation leaves behind a filmy deposit.

Please be friendly to your environment and use a CFC-free aerosol.

Additional Cleaning Equipment

Some Cleaning Procedures need the following equipment, which is not required to clean each instrument:

- Microscope with a magnification range about 50X up to 300X
- Ultrasonic bath
- Warm water and liquid soap
- Premoistened cleaning wipes
- Polymer film
- Infrared Sensor Card

Microscope with a magnification range about 50X up to 300X

A microscope can be found in most photography stores, or can be obtained through or specialist mail order companies. Special fiber-scopes are available from suppliers of splicing equipment.

Ideally, the light source on your microscope should be very flexible. This will allow you to examine your device closely and from different angles.

A microscope helps you to estimate the type and degree of dirt on your device. You can use a microscope to choose an appropriate cleaning method, and then to examine the results. You can also use your microscope to judge whether your optical device (such as a connector) is severely scratched and is, therefore, causing inaccurate measurements.

Ultrasonic bath

Ultrasonic baths are also available from photography or laboratory suppliers or specialist mail order companies.

An ultrasonic bath will gently remove fat and other stubborn dirt from your optical devices. This helps increase the life span of the optical devices.

Only use isopropyl alcohol in your ultrasonic bath, as other solvents may damage.

Warm water and liquid soap

Only use water if you are sure that there is no other way of cleaning your optical device without corrosion or damage. Do not use hot water, as this may cause mechanical stress, which can damage your optical device.

Ensure that your liquid soap has no abrasive properties or perfume in it. You should also avoid normal washing-up liquid, as it can cover your device in an iridescent film after it has been air-dried.

Some lenses and mirrors also have a special coating, which may be sensitive to mechanical stress, or to fat and liquids. For this reason we recommend you do not touch them.

If you are not sure how sensitive your device is to cleaning, please contact the manufacturer or your sales distributor.

Premoistened cleaning wipes

Use pre-moistened cleaning wipes as described in each individual cleaning procedure. Cleaning wipes may be used in every instance where a moistened soft tissue or cotton swab is applied.

Polymer film

Polymer film is available from laboratory suppliers or specialist mail order companies.

Using polymer film is a gentle method of cleaning extremely sensitive devices, such as reference reflectors and mirrors.

Infrared Sensor Card

Infrared sensor cards are available from laboratory suppliers or specialist mail order companies.

With this card you are able to control the shape of laser light emitted. The invisible laser beam is projected onto the sensor card, then becomes visible to the normal eye as a round spot.

Take care never to look into the end of a fiber or any other optical component, when they are in use. This is because the laser can seriously damage your eyes.

Preserving Connectors

Listed below are some hints on how best to keep your connectors in the best possible condition.

Making Connections

Before you make any connection you must ensure that all cables and connectors are clean. If they are dirty, use the appropriate cleaning procedure.

When inserting the ferrule of a patchcord into a connector or an adapter, make sure that the fiber end does not touch the outside of the mating connector or adapter. Otherwise you will rub the fiber end against an unsuitable surface, producing scratches and dirt deposits on the surface of your fiber.

Dust Caps and Shutter Caps

Be careful when replacing dust caps after use. Do not press the bottom of the cap onto the fiber as any dust in the cap can scratch or dirty your fiber surface.

When you have finished cleaning, put the dust cap back on, or close the shutter cap if the equipment is not going to be used immediately.

Keep the caps on the equipment always when it is not in use.

All of Agilent Technologies' lightwave instruments and accessories are shipped with either laser shutter caps or dust caps. If you need additional or replacement dust caps, contact your nearest Agilent Technologies Sales/Service Office.

Immersion Oil and Other Index Matching Compounds

Where it is possible, do not use immersion oil or other index matching compounds with your device. They are liable to impair and dirty the surface of the device. In addition, the characteristics of your device can be changed and your measurement results affected.

Cleaning Instrument Housings

Use a dry and very soft cotton tissue to clean the instrument housing and the keypad. Do not open the instruments as there is a danger of electric shock, or electrostatic discharge. Opening the instrument can cause damage to sensitive components, and in addition your warranty will be voided.

Which Cleaning Procedure should I use ?

Light dirt

If you just want to clean away light dirt, observe the following procedure for all devices:

- Use compressed air to blow away large particles.
- Clean the device with a dry cotton swab.
- Use compressed air to blow away any remaining filament left by the swab.

Heavy dirt

If the above procedure is not enough to clean your instrument, follow one of the procedures below. Please consult "*Cleaning Instructions for this Instrument*" on page 421 for the procedure relevant for this instrument.

If you are unsure of how sensitive your device is to cleaning, please contact the manufacturer or your sales distributor

How to clean connectors

Cleaning connectors is difficult as the core diameter of a single-mode fiber is only about 9 μm . This generally means you cannot see streaks or scratches on the surface. To be certain of the condition of the surface of your connector and to check it after cleaning, you need a microscope.

In the case of scratches, or of dust that has been burnt onto the surface of the connector, you may have no option but to polish the connector. This depends on the degree of dirtiness, or the depth of the scratches. This is a difficult procedure and should only be performed by skilled personal, and as a last resort as it wears out your connector.

WARNING

Never look into the end of an optical cable that is connected to an active source.

To assess the projection of the emitted light beam you can use an infrared sensor card. Hold the card approximately 5 cm from the output of the connector. The invisible emitted light is project onto the card and becomes visible as a small circular spot.

Preferred Procedure

Use the following procedure on most occasions.

- 1 Clean the connector by rubbing a new, dry cotton-swab over the surface using a small circular movement.
- 2 Blow away any remaining lint with compressed air.

Procedure for Stubborn Dirt

Use this procedure particularly when there is greasy dirt on the connector:

- 1 Moisten a new cotton-swab with isopropyl alcohol.
- 2 Clean the connector by rubbing the cotton-swab over the surface using a small circular movement.
- 3 Take a new, dry soft-tissue and remove the alcohol, dissolved sediment and dust, by rubbing gently over the surface using a small circular movement.
- 4 Blow away any remaining lint with compressed air.

An Alternative Procedure

A better, more gentle, but more expensive cleaning procedure is to use an ultrasonic bath with isopropyl alcohol.

- 1** Hold the tip of the connector in the bath for at least three minutes.
- 2** Take a new, dry soft-tissue and remove the alcohol, dissolved sediment and dust, by rubbing gently over the surface using a small circular movement.
- 3** Blow away any remaining lint with compressed air.

How to clean connector adapters

CAUTION

Some adapters have an anti-reflection coating on the back to reduce back reflection. This coating is extremely sensitive to solvents and mechanical abrasion. Extra care is needed when cleaning these adapters.

Preferred Procedure

Use the following procedure on most occasions.

- 1 Clean the adapter by rubbing a new, dry cotton-swab over the surface using a small circular movement.
- 2 Blow away any remaining lint with compressed air.

Procedure for Stubborn Dirt

Use this procedure particularly when there is greasy dirt on the adapter:

- 1 Moisten a new cotton-swab with isopropyl alcohol.
- 2 Clean the adapter by rubbing the cotton-swab over the surface using a small circular movement.
- 3 Take a new, dry soft-tissue and remove the alcohol, dissolved sediment and dust, by rubbing gently over the surface using a small circular movement.
- 4 Blow away any remaining lint with compressed air.

How to clean connector interfaces

CAUTION

Be careful when using pipe-cleaners, as the core and the bristles of the pipe-cleaner are hard and can damage the interface.

Do not use pipe-cleaners on optical head adapters, as the hard core of normal pipe cleaners can damage the bottom of an adapter.

Preferred Procedure

Use the following procedure on most occasions.

- 1 Clean the interface by pushing and pulling a new, dry pipe-cleaner into the opening. Rotate the pipe-cleaner slowly as you do this.
- 2 Then clean the interface by rubbing a new, dry cotton-swab over the surface using a small circular movement.
- 3 Blow away any remaining lint with compressed air.

Procedure for Stubborn Dirt

Use this procedure particularly when there is greasy dirt on the interface:

- 1 Moisten a new pipe-cleaner with isopropyl alcohol.
- 2 Clean the interface by pushing and pulling the pipe-cleaner into the opening. Rotate the pipe-cleaner slowly as you do this.
- 3 Moisten a new cotton-swab with isopropyl alcohol.
- 4 Clean the interface by rubbing the cotton-swab over the surface using a small circular movement.
- 5 Using a new, dry pipe-cleaner, and a new, dry cotton-swab remove the alcohol, any dissolved sediment and dust.
- 6 Blow away any remaining lint with compressed air.

How to clean bare fiber adapters

Bare fiber adapters are difficult to clean. Protect from dust unless they are in use.

CAUTION

Never use any kind of solvent when cleaning a bare fiber adapter as solvents can damage the foam inside some adapters.

They can deposit dissolved dirt in the groove, which can then dirty the surface of an inserted fiber.

Preferred Procedure

Use the following procedure on most occasions.

- 1 Blow away any dust or dirt with compressed air.

Procedure for Stubborn Dirt

Use this procedure particularly when there is greasy dirt on the adapter:

- 1 Clean the adapter by pushing and pulling a new, dry pipe-cleaner into the opening. Rotate the pipe-cleaner slowly as you do this.

CAUTION

Be careful when using pipe-cleaners, as the core and the bristles of the pipe-cleaner are hard and can damage the adapter.

- 2 Clean the adapter by rubbing a new, dry cotton-swab over the surface using a small circular movement.
- 3 Blow away any remaining lint with compressed air.

How to clean lenses

Some lenses have special coatings that are sensitive to solvents, grease, liquid and mechanical abrasion. Take extra care when cleaning lenses with these coatings.

Lens assemblies consisting of several lenses are not normally sealed. Therefore, use as little alcohol as possible, as it can get between the lenses and in doing so can change the properties of projection.

Preferred Procedure

Use the following procedure on most occasions.

- 1 Clean the lens by rubbing a new, dry cotton-swab over the surface using a small circular movement.
- 2 Blow away any remaining lint with compressed air.

Procedure for Stubborn Dirt

Use this procedure particularly when there is greasy dirt on the lens:

- 1 Moisten a new cotton-swab with isopropyl alcohol.
- 2 Clean the lens by rubbing the cotton-swab over the surface using a small circular movement.
- 3 Using a new, dry cotton-swab remove the alcohol, any dissolved sediment and dust.
- 4 Blow away any remaining lint with compressed air.

How to clean instruments with a fixed connector interface

NOTE

Both the surface and the jacket of the attached connector should be completely dry and clean.

You should only clean instruments with a fixed connector interface when it is absolutely necessary. This is because it is difficult to remove any used alcohol or filaments from the input of the optical block.

It is important, therefore, to keep dust caps on the equipment at all times, except when your optical device is in use.

If you do discover filaments or particles, the only way to clean a fixed connector interface and the input of the optical block is to use compressed air.

If there are fluids or fat in the connector, please refer the instrument to the skilled personnel of Agilent's service team.

CAUTION

Only use clean, dry compressed air. Make sure that the air is free of dust, water, and oil. If the air that you use is not clean and dry, this can lead to filmy deposits or scratches on the surface of your connector interface. This will degrade the performance of your transmission system.

Never try to open the instrument and clean the optical block by yourself, because it is easy to scratch optical components, and cause them to be misaligned.

How to clean instruments with an optical glass plate

Some instruments, for example, the optical heads from Agilent Technologies have an optical glass plate to protect the sensor. Clean this glass plate in the same way as optical lenses (see *"How to clean lenses"* on page 439).

How to clean instruments with a physical contact interface

Remove any connector interfaces from the optical output of the instrument before you start the cleaning procedure.

Cleaning interfaces is difficult as the core diameter of a single-mode fiber is only about 9 μm . This generally means you cannot see streaks or scratches on the surface. To be certain of the degree of pollution on the surface of your interface and to check whether it has been removed after cleaning, you need a microscope.

WARNING

Never look into an optical output, because this can seriously damage your eyesight.

To assess the projection of the emitted light beam you can use an infrared sensor card. Hold the card approximately 5 cm from the interface. The invisible emitted light is project onto the card and becomes visible as a small circular spot.

Preferred Procedure

Use the following procedure on most occasions.

- 1 Clean the interface by rubbing a new, dry cotton-swab over the surface using a small circular movement.
- 2 Blow away any remaining lint with compressed air.

Procedure for Stubborn Dirt

Use this procedure particularly when there is greasy dirt on the interface:

- 1 Moisten a new cotton-swab with isopropyl alcohol.
- 2 Clean the interface by rubbing the cotton-swab over the surface using a small circular movement.
- 3 Take a new, dry soft-tissue and remove the alcohol, dissolved sediment and dust, by rubbing gently over the surface using a small circular movement.
- 4 Blow away any remaining lint with compressed air.

How to clean instruments with a recessed lens interface

WARNING

For instruments with a deeply recessed lens interface (for example the Agilent 81633A and 81634A Power Sensors) do NOT follow this procedure. Alcohol and compressed air could damage your lens even further.

Keep your dust and shutter caps on, when your instrument is not in use. This should prevent it from getting too dirty. If you must clean such instruments, please refer the instrument to the skilled personnel of Agilent's service team.

Preferred Procedure

Use the following procedure on most occasions.

- 1 Blow away any dust or dirt with compressed air. If this is not sufficient, then
- 2 Clean the interface by rubbing a new, dry cotton-swab over the surface using a small circular movement.
- 3 Blow away any remaining lint with compressed air.

Procedure for Stubborn Dirt

Use this procedure particularly when there is greasy dirt on the interface, and using the procedure for light dirt is not sufficient. Using isopropyl alcohol should be your last choice for recessed lens interfaces because of the difficulty of cleaning out any dirt that is washed to the edge of the interface:

- 1 Moisten a new cotton-swab with isopropyl alcohol.
- 2 Clean the interface by rubbing the cotton-swab over the surface using a small circular movement.
- 3 Take a new, dry soft-tissue and remove the alcohol, dissolved sediment and dust, by rubbing gently over the surface using a small circular movement.
- 4 Blow away any remaining lint with compressed air.

How to clean optical devices which are sensitive to mechanical stress and pressure

Some optical devices, such as the Agilent 81000BR Reference Reflector, which has a gold plated surface, are very sensitive to mechanical stress or pressure. Do not use cotton-swabs, soft-tissues or other mechanical cleaning tools, as these can scratch or destroy the surface.

Preferred Procedure

Use the following procedure on most occasions.

- 1 Blow away any dust or dirt with compressed air.

Procedure for Stubborn Dirt

To clean devices that are extremely sensitive to mechanical stress or pressure you can also use an optical clean polymer film. This procedure is time-consuming, but you avoid scratching or destroying the surface.

- 1 Put the film on the surface and wait at least 30 minutes to make sure that the film has had enough time to dry.
- 2 Remove the film and any dirt with special adhesive tapes.

Alternative Procedure

For these types of optical devices you can often use an ultrasonic bath with isopropyl alcohol. Only use the ultrasonic bath if you are sure that it won't cause any damage anything to the device.

- 1 Put the device into the bath for at least three minutes.
- 2 Blow away any remaining liquid with compressed air.

If there are any streaks or drying stains on the surface, repeat the cleaning procedure.

How to clean metal filters or attenuator gratings

This kind of device is extremely fragile. A misalignment of the grating leads to inaccurate measurements. Never touch the surface of the metal filter or attenuator grating. Be very careful when using or cleaning these devices. Do not use cotton-swabs or soft-tissues, as there is the danger that you cannot remove the lint and that the device will be destroyed by becoming mechanically distorted.

Preferred Procedure

Use the following procedure on most occasions.

- 1 Use compressed air at a distance and with low pressure to remove any dust or lint.

Procedure for Stubborn Dirt

Do not use an ultrasonic bath as this can damage your device.

Use this procedure particularly when there is greasy dirt on the device:

- 1 Put the optical device into a bath of isopropyl alcohol, and wait at least 10 minutes.
- 2 Remove the fluid using compressed air at some distance and with low pressure. If there are any streaks or drying stains on the surface, repeat the whole cleaning procedure.

Additional Cleaning Information

The following cleaning procedures may be used with other optical equipment:

- How to clean bare fiber ends
- How to clean large area lenses and mirrors

How to clean bare fiber ends

Bare fiber ends are often used for splices or, together with other optical components, to create a parallel beam. The end of a fiber can often be scratched. You make a new cleave. To do this:

- 1 Strip off the cladding.
- 2 Take a new soft-tissue and moisten it with isopropyl alcohol.
- 3 Carefully clean the bare fiber with this tissue.
- 4 Make your cleave and immediately insert the fiber into your bare fiber adapter in order to protect the surface from dirt.

How to clean large area lenses and mirrors

Some mirrors, as those from a monochromator, are very soft and sensitive. Therefore, never touch them and do not use cleaning tools such as compressed air or polymer film.

Some lenses have special coatings that are sensitive to solvents, grease, liquid and mechanical abrasion. Take extra care when cleaning lenses with these coatings.

Lens assemblies consisting of several lenses are not normally sealed. Therefore, use as little liquid as possible, as it can get between the lenses and in doing so can change the properties of projection.

Preferred Procedure

Use the following procedure on most occasions.

- 1 Blow away any dust or dirt with compressed air.

Procedure for Stubborn Dirt

Use this procedure particularly when there is greasy dirt on the lens:

CAUTION

Only use water if you are sure that your device does not corrode. Do not use hot water as this can lead to mechanical stress, which can damage your device.

Make sure that your liquid soap has no abrasive properties or perfume in it, because they can scratch and damage your device. Do not use normal washing-up liquid as sometimes an iridescent film remains.

- 1 Moisten the lens or the mirror with water.
- 2 Put a little liquid soap on the surface and gently spread the liquid over the whole area.
- 3 Wash off the emulsion with water, being careful to remove it all, as any remaining streaks can impair measurement accuracy.
- 4 Take a new, dry soft-tissue and remove the water, by rubbing gently over the surface using a small circular movement.
- 5 Blow away remaining lint with compressed air.

Alternative Procedure A

To clean lenses that are extremely sensitive to mechanical stress or pressure you can also use an optical clean polymer film. This procedure is time-consuming, but you avoid scratching or destroying the surface.

- 1 Put the film on the surface and wait at least 30 minutes to make sure that the film has had enough time to dry.
- 2 Remove the film and any dirt with special adhesive tapes.

Alternative Procedure B

If your lens is sensitive to water then:

- 1 Moisten the lens or the mirror with isopropyl alcohol.
- 2 Take a new, dry soft-tissue and remove the alcohol, dissolved sediment and dust, by rubbing gently over the surface using a small circular movement.
- 3 Blow away remaining lint with compressed air.

Other Cleaning Hints

Selecting the correct cleaning method is an important element in maintaining your equipment and saving you time and money. This Appendix highlights the main cleaning methods, but cannot address every individual circumstance.

This section contains some additional hints which we hope will help you further. For further information, please contact your local Agilent Technologies representative.

Making the connection

Before you make any connection you must ensure that all lightwave cables and connectors are clean. If not, then use appropriate the cleaning methods.

When you insert the ferrule of a patchcord into a connector or an adapter, ensure that the fiber end does not touch the outside of the mating connector or adapter. Otherwise, the fiber end will rub up against something which could scratch it and leave deposits.

Lens cleaning papers

Note that some special lens cleaning papers are not suitable for cleaning optical devices like connectors, interfaces, lenses, mirrors and so on. To be absolutely certain that a cleaning paper is applicable, please ask the salesperson or the manufacturer.

Immersion oil and other index matching compounds

Do not use immersion oil or other index matching compounds with optical sensors equipped with recessed lenses. They are liable to dirty the detector and impair its performance. They may also alter the property of depiction of your optical device, thus rendering your measurements inaccurate.

Cleaning the housing and the mainframe

When cleaning either the mainframe or the housing of your instrument, only use a dry and very soft cotton tissue on the surfaces and the numeric pad.

Never open the instruments as they can be damaged. Opening the instruments puts you in danger of receiving an electrical shock from your device, and renders your warranty void.



17

Firmware Upgrades

This chapter provides information about the firmware upgrade process for the Agilent 8163A/B Lightwave Multimeter, the Agilent 8164A/B Lightwave Measurement System, and the Agilent 8166A/B Lightwave Multichannel System.

Firmware Upgrade Process	452
How to Get a Firmware Upgrade	453
How to Upgrade Firmware.....	455

Firmware Upgrade Process

You may need to upgrade firmware because:

- You may need to use new modules that cannot work without the newest firmware. Your instrument will generate an error message if you try to insert a module that is not supported by your instrument's current firmware.
- New revisions of the 816x VXIplug&play Instrument Driver require the newest firmware revision. The 816x VXIplug&play Instrument Driver is supplied on the same Support Disk as firmware upgrades.
- To enhance the usability and functionality of your instrument. New features may be available with new firmware revisions.

CAUTION

READ THIS SECTION BEFORE UPGRADING FIRMWARE

For Agilent all modules with a particular firmware revision to operate correctly, your Agilent 8163A/B, 8164A/B, or 8166A/B mainframe must have the corresponding, or a later, firmware revision installed.

For example, for correct operation of 8165xA Laser Source modules where firmware revision 4.02 is installed, your 8163A/B, 8164A/B, or 8166A/B mainframe must have firmware revision 4.0x or higher installed.

Firmware files are provided on the Support CD-ROM supplied with the instrument, and the latest firmware revisions can also be downloaded via www.Agilent.com/comms/comp-test

The firmware for A and B versions of our mainframes is not binary compatible. Make sure you select the appropriate firmware for your instrument.

In addition, please note that:

- Updating mainframe firmware does not require you to update the firmware in every hosted module. New revisions of mainframe firmware are backwards compatible with older module firmware. You may find it advantageous to update module firmware. To help you determine which module firmware to update, a readme file is provided with the firmware file detailing its revision history.

How to Get a Firmware Upgrade

Receive a Support Disk with New Modules

The latest edition of the Support Disk is shipped with all modules and mainframes. The Support Disk is a compact disk that contains the latest revisions of the following software and utilities:

- Firmware Upgrades for mainframes and modules,
- the 816x *VXIplug&play* Instrument Driver, and
- User's Guides for mainframes and modules, including the Programming Guide.

Download Firmware Upgrade from the Internet

You can also download, free of charge, a new Firmware Upgrade for your instrument.

- 1 Access <http://www.agilent.com/comms/comp-test>
- 2 Select your instrument type from:
 - 8163A/B Lightwave Multimeter,
 - 8164A/B Lightwave Measurement System, or
 - 8166A/B Lightwave Multichannel System.
- 3 Under *Instrument Software* click on *Firmware Update* for your instrument.
- 4 Follow the instructions given on the download page.

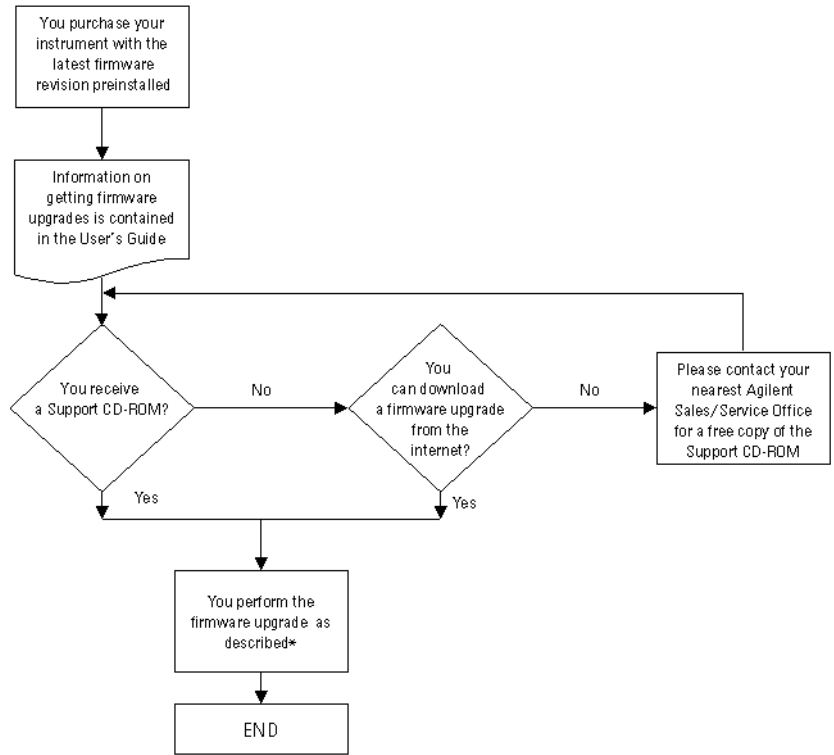

* If you need help installing firmware, please contact your nearest Agilent Technologies Sales/Service Office.

Figure 202 Firmware Upgrade Flowchart

How to Upgrade Firmware

You can receive a firmware upgrade on the following media:

- as a download from the internet, or
- on CD-ROM.

How to Upgrade Firmware from the Internet

You can download the firmware upgrade from the Internet. See the webpage mentioned in *"Download Firmware Upgrade from the Internet"* on page 453 for further information on installing the firmware.

How to Upgrade Firmware from CD-ROM

If the instrument's firmware is supplied to you on CD-ROM, insert the CD-ROM in the CD-ROM drive of your personal computer and follow the procedure for your instrument as described below.

Agilent 8163A Firmware Upgrade Procedure

To upgrade firmware for the 8163A, you require a PC, running MS Windows 95 or NT 4.0, or higher, plus a serial null-modem cable, that was supplied with your 8163A mainframe.

Perform the following instructions ("xxx" in a filename should be replaced by the current release number, i.e. 402 for release 4.02):

- 1 Copy the directory Firmware\8163A from the Support Disk to a directory on your PC. This directory contains the files "HPFlashWinR5.exe" and "63_flxxx.bin".
- 2 Click on HPFlashWinR5.exe to start the HPFLASH software.
- 3 Press the "File Selection" button, the file selection box appears.
- 4 Move to the file "63_flxxx.bin" and click on OK.
- 5 Click on 'Port Settings'.
- 6 Select the com port where the serial cable is connected. Choose the maximum baud rate. Click on OK.
- 7 Turn on the 8163A and wait for the first beep.

Now you must be quick:

- Press and hold the *Preset* hardkey.
- Still holding *Preset*, press and hold the *Aux* hardkey.
- Still holding *Preset* and *Aux*, press and hold the *App/* hardkey.

Tip: Use three fingers and place them near the keys in advance!

If you were successful, you hear a double beep and the display shows that the instrument is in download mode. Otherwise, turn off the power and try again.

8 Click on 'Program' and wait until the download completes. The instrument will reboot with the new firmware.

Agilent 8163B Firmware Upgrade Procedure

You require a PC running MS Windows 95, NT 4.0, or higher, and a null-modem serial cable, such as is supplied with your 8163B mainframe.

To upgrade the 8163B firmware:

1 Copy the Firmware\8163B folder from the Support CD-ROM to a folder on your PC. This folder contains the update tool ATTools_v1_23.exe and a firmware image file named 63B_Vxxx.Z

“xxx” in a filename refers to the firmware version. For example, 63B_V402.Z is firmware version 4.02 for the 8163B instrument.

2 Connect your instrument to your PC with the serial cable.

3 Turn on the 8163B and wait until the Agilent screen appears. Quickly:

- Press, but do not hold, the **Aux** hardkey
- Press the **Appl** hardkey.

If you were successful, the instrument displays:

“Instrument Maintenance Mode”.

Otherwise, turn off the power and try again.

4 At your PC, click on ATTools_v1_23.exe to start the update tool.

Click **OK** to confirm that you have completed steps 1 to 3.

When the serial connection has been established, which may be after a pause of around 30 seconds, the ATTools user interface is displayed.

5 Select the firmware image (file type .Z) in the file selection box, then click the **Update Firmware** button.

Click **OK** to confirm your choice of firmware upgrade.

6 The firmware upgrade is tracked by a progress bar in the ATTools user interface.

When the update is complete, a confirmation message is displayed.

Click **OK**.

7 Click **Exit** to terminate ATTools.

Your 8163B reboots automatically.

Agilent 8164A Firmware Upgrade Procedure

To upgrade firmware for the Agilent 8164A, you require two empty floppy disks.

Perform the following instructions ("xxx" in a filename should be replaced by the current release number, i.e. 402 for release 4.02) :

- 1 Copy the directory Firmware\8164A from the Support Disk to a directory on your PC. This directory contains the files "copydisk.exe", "64_xxx_1.img", and "64_xxx_2.img".
- 2 Format the two two floppy disks (3.5", 1.44 MByte) with your PC, and label them as DISK_1 and DISK_2.
- 3 Insert the DISK_1 into your PC and open a DOS command window if you are running Windows.
- 4 Copy the first firmware image file to DISK_1 using the command "copydisk.exe 64_xxx_1.img a:".

NOTE

In step 4 and step 6, we presume your diskette drive is "a:". If not, adjust the copydisk.exe command accordingly.

- 5 Insert the DISK_2 into your PC and open a DOS command window if you are running Windows.
- 6 Copy the second firmware image file to DISK_2 using the command "copydisk.exe 64_xxx_2.img a:".
- 7 Insert DISK_1 into the mainframe.
- 8 Turn on the 8164A and wait for the first beep.

Now you must be quick:

- Press and hold the *Preset* hardkey.
- Still holding *Preset*, press and hold the *Aux* hardkey.
- Still holding *Preset* and *Aux*, press and hold the *Appl* hardkey.

Tip: Use three fingers and place them near the keys in advance!

If you were successful, you hear a double beep and the display shows that the instrument is in download mode. Otherwise, turn off the power and try again.

- 9 Follow the instructions that appear on the screen.
- 10 Insert Disk_2 when requested to insert the disk containing the file "firmware.2".
- 11 After the programming finishes, cycle the power. The instrument will reboot with the new firmware. Don't forget to remove DISK_2.

Agilent 8164B Firmware Upgrade Procedure

NOTE

The upgrade process with floppy disks used for the 8164A is not supported for 8164B instruments.

You require a PC, running MS Windows 95, NT 4.0, or higher, and a null-modem serial cable, such as is supplied with your 8164B mainframe.

To upgrade the 8164B firmware:

1 Copy the Firmware\8164B folder from the Support CD-ROM to a folder on your PC. This folder contains the update tool ATTools_v1_23.exe and a firmware image file named 64B_Vxxx.Z

“xxx” in a filename refers to the firmware version. For example, 64B_V402.Z is firmware version 4.02 for the 8164B instrument.

2 Connect your instrument to your PC with the serial cable.

3 Turn on the 8164B and wait until the Agilent screen appears.

Quickly:

- Press, but do not hold the **Aux** hardkey
- Press the **Appl** hardkey.

If you were successful, the instrument displays:

“Instrument Maintenance Mode”.

Otherwise, turn off the power and try again.

4 At your PC, click on ATTools_v1_23.exe to start the update tool.

Click **OK** to confirm that you have completed steps 1 to 3.

When the serial connection has been established, which may be after a pause of around 30 seconds, the ATTools user interface is displayed.

5 Select the firmware image (file type .Z) in the file selection box, then click the **Update Firmware** button.

Click **OK** to confirm your choice of firmware upgrade.

6 The firmware upgrade is tracked by a progress bar in the the ATTools user interface.

When the update is complete, a confirmation message is displayed.

Click **OK**

7 Click **Exit** to terminate ATTools.

Your 8164B reboots automatically.

Agilent 8166A Firmware Upgrade Procedure

To upgrade firmware for the Agilent 8166A, you require a PC, running MS Windows 95 or NT 4.0, or higher, plus a serial null-modem cable, that was supplied with your Agilent 8166A mainframe.

Perform the following instructions ("xxx" in a filename should be replaced by the current release number, i.e. 402 for release 4.02):

- 1 Copy the directory Firmware\8166A from the Support Disk to a directory on your PC. This directory contains the files "HPFlashWinR5.exe" and "66_flxx.bin".
- 2 Click on HPFlashWinR5.exe to start the HPFLASH software.
- 3 Press the "File Selection" button, the file selection box appears.
- 4 Move to the file "66_flxx.bin" and click on OK.
- 5 Click on 'Port Settings'.
- 6 Select the com port where the serial cable is connected. Choose the maximum baud rate. Click on OK.
- 7 Turn on the 8166A and wait for the first beep.

Now you must be quick:

- Press and hold the *Preset* hardkey.
- Still holding *Preset*, press and hold the *Aux* hardkey.
- Still holding *Preset* and *Aux*, press and hold the *Appl* hardkey.

Tip: Use three fingers and place them near the keys in advance!

If you were successful, you hear a double beep and the display shows that the instrument is in download mode. Otherwise, turn off the power and try again.

- 8 Click on 'Program' and wait until the download completes. The instrument will reboot with the new firmware.

Agilent 8166B Firmware Upgrade Procedure

You require a PC, running MS Windows 95, NT 4.0, or higher, and a null-modem serial cable, such as is supplied with your 8166B mainframe.

To upgrade the 8166B firmware:

1 Copy the Firmware\8166B folder from the Support CD-ROM to a folder on your PC. This folder contains the update tool ATTools_v1_23.exe and a firmware image file named 66B_Vxxx.Z
“xxx” in a filename refers to the firmware version. For example: 66B_V402.Z is firmware version 4.02 for the 8166B instrument.

2 Connect your instrument to your PC with the serial cable.

3 Turn on the 8166B and wait until the Agilent screen appears.
Quickly:

- Press, but do not hold the **Aux** hardkey
- Press the **Appl** hardkey.

If you were successful, the instrument displays:

“Instrument Maintenance Mode”.

Otherwise, turn off the power and try again.

4 At your PC, click on ATTools_v1_23.exe to start the update tool.

Click **OK** to confirm that you have completed steps 1 to 3.

When the serial connection has been established, which may be after a pause of around 30 seconds, the ATTools user interface is displayed.

5 Select the firmware image (file type .Z) in the file selection box, then click the **Update Firmware** button.

Click **OK** to confirm your choice of firmware upgrade.

6 The firmware upgrade is tracked by a progress bar in the the ATTools user interface.

When the update is complete, a confirmation message is displayed.

Click **OK**

7 Click **Exit** to terminate ATTools.

Your 8166B reboots automatically.

Agilent Module Firmware Upgrade Procedure

Agilent module firmware is upgraded via GPIB or a serial null-modem cable.

You require a PC running MS Windows 95 or NT 4.0 or higher. To update via GPIB the PC must be fitted with a suitable interface card. Alternatively, a serial null-modem cable is required, such as is supplied with your Agilent 8163A/B mainframe.

You also require the module update program, which is supplied both on the Support CD-ROM and as a web download. Copy Module_Update.exe to a directory on your PC's hard drive, then execute Module_Update.exe to install the module update program.

NOTE

The readme.htm file associated with the module_update program contains

- Notification of prerequisites,
- Notification of known issues,

as well as detailed instructions for use.

Be sure to study this file before attempting to use the module update software.

NOTE

The floppy update procedure for the Agilent 81480A and 81640A/42A/80A/82A Tunable Laser Modules is no longer supported. Please update your modules via GPIB or a null-modem serial cable as described above.

Index

A

AC Power 291
ACC1 156
Accessories 319
Agilent 8163A/B 36
Agilent 8164A/B 37
Agilent 8166A/B 38
Appl hardkey 51
Application 229
 Appl Hardkey 51
 Graphs 231
 Legends 235
 Lock to Curve 239
 Logging 242
 Markers 233
 PACT 266
 Samples Display 237
 Stability 254
 Zoom 233
Attenuation
 laser sources 112
 tunable lasers 124
Attenuation & Power Levels 159, 197
Attenuators
 Attenuation Offset 204
 DWDM signals 207
 Menu options 217
 modules 198
 Power Control 216
 Reference Powermeter 199
 Setting Attenuation 203
 Setting Power Level 207
 Shutter 202
 Status Indicators 218
 User Interface 199
 Wavelength Dependencies 212
Auto Cal Off 156
Automatic Realignment 153
Auxiliary Functions 153
 automatic realignment 153
 wavelength zero 155

B

Backlight 65
Base Wavelength 133

C

Calibration Offset 87
caution, definition of 25

CE mark 29
Channel Numbers 41
Coherence Control
 tunable lasers 114, 148
Coherence control setting 113
Compact Tunable Lasers
 modules 160
 SBS Suppression 161
 User Interface 161
Configuration 64
 backlight 65
 contrast 65
 Foot Pedal 71
 GPIB address 72
 mainframe information 79
 Module Update 74
 modules information 77
 Serial Interface 73
 triggering 69
Connecting a Monitor 80
Conventions 3
Cross-over switch applications 227
CSA mark 29

D

dB 85
dBm 85
Declaration of Conformity
 Agilent 8163A 344
 Agilent 8163B 345
 Agilent 8164A 346
 Agilent 8164B 347
 Agilent 8166A 348
 Agilent 8166B 349
Default Password 40, 68
DFB
 external digital modulation 147
 linewidth measurement 132
 modulation source 148
 modules 322
DFB modules 31
Dual-Wavelength Laser Sources 110

E

Edit Parameters 53
 accept new values 53
 cancel softkey 58
Continuous 54
Discrete 57
outside range 58

selecting 53
set to default 58

Environment
 altitude 297
 humidity 297
 operating 296
 pollution 297
 Storage 296
 temperature 296

F

Firmware Revision
 mainframe 79
Foot Pedal 71
Frequency Offset 133

G

GPIB
 Address 72
 Cables and Adapters 333

H

Help hardkey 50

I

Initial inspection 290
Insertion Loss 165
Inspection 290
ISM1-A 29

J

Jumping between channels 46

K

Keypad 39

L

Lambda Zero 155
Laser Sources
 attenuation 112
 dual-wavelength sources 110
 enable/disable output 111
 how to use 110
 modulation 113
Line power cable 292
Lock high-power laser sources 68
Logging 242

M

- MinMax Mode 101
- Modulation
 - laser sources 113
 - tunable lasers 142
- Module
 - Update 74
- Modules
 - empty slots 308

O

- Optical Output
 - tunable lasers 122
- Optical Switches
 - Applications 226
 - Modules 220
 - Options 220
 - Toggle 225
 - User Interface 221
- Optional features
 - Agilent 8163A/B 320
 - Agilent 8164A/B 324
 - Agilent 8166A/B 329

P

- PACT 266
- Password 40, 68
 - change 76
 - default 40, 68
 - forgotten 40, 76
- Performance Test
 - Agilent 8163A 361
 - Agilent 8163B 363
 - Agilent 8164A 365, 369
 - Agilent 8166A 372
 - Agilent 8166B 375
- Performance Tests 351
 - required equipment 352
- Power
 - laser sources 112
 - power meters 84
 - tunable lasers 121
- Power Measurement 83
 - averaging time 100
 - calibration offset 87
 - hold screen 103
 - number of digits 84
 - power units 85
 - power value 84
 - reference 88
 - reference another channel 89
 - setting wavelength 91
- Power supply requirements
 - AC 291
- Power Units 85

R

- Range
 - auto 95
 - manual 95
 - range mode 94
 - setting 95
- Realignment, automatic 153
- Reference 88
- Return Loss 163
 - Getting Started 165
 - Light Source 167
 - modules 168

S

- Safety 289
 - information for laser source 30
- safety symbols 25
- Sample Session 59
- Serial Interface 73
- Settling 155
- Slot Numbers 41
- Specifications
 - Agilent 8163A 337
 - Agilent 8163B 338
 - Agilent 8164A 339
 - Agilent 8164B 340
 - Agilent 8166A 341
 - Agilent 8166B 342
- Stability 254
- symbols, safety 25

T

- Temperature for operation and storage 296
- Triggering
 - configuration 69
 - tunable lasers 150
- Triggers
 - Laser Sources 117
 - Power Meters 104
- Tunable Lasers
 - analog output 128
 - automatic realignment 153
 - attenuation 124
 - backplane modulation 147
 - BNC output 149
 - coherence control 114, 148
 - excessive power 126
 - external analog modulation 145
 - external digital modulation 144
 - external modulation 144
 - frequency offset 132
 - how to use 121
 - increase linewidth 114, 148
 - input triggering 150
 - internal modulation 114, 142
 - lambda zero 155

- low frequency coherence control 114, 148
- modout 149
- modulation 142
- modulation output 149
- optical output 122
- power 121
- relative wavelength 132
- triggering 150
- wavelength 130
- wavelength locking 146
- wavelength mode 132
- wavelength zero 155

U

- Unlock the Instrument 40, 75
- User Interface 39
 - channel hardkey 46
 - config softkey 49
 - cursor key 45
 - details screen 46
 - features 41
 - hardkeys 41
 - menu softkey 48
 - modify knob 45
 - numerical keypad 45
 - overview screen 43
 - softkeys 41

V

- Voltage
 - modulation input 144
- Vsweep parameter 135

W

- warning, definition of 25
- Watts 85
- Wavelength
 - laser sources 110
 - power meters 91
 - tunable lasers 130
- Wavelength Sweep 134
 - continuous 139
 - manual sweep 140
 - performing a sweep 137
 - repeat mode 135
 - stepped 137
 - sweep parameters 135
- Wavelength Zero 155

Z

- Zeroing Electrical Offsets 91
- Zoom 233

© Agilent Technologies, Deutschland
GmbH 2002-2004

Printed in Germany December 2004
Sixth edition, December 2004



08164-90B15



Agilent Technologies