

---

# User's Guide

---

## HP 71450B/1B/2B Optical Spectrum Analyzers

HP Part No. 70950-90049  
Edition 1  
Printed in USA June 1995

1400 Fountaingrove Parkway,  
Santa Rosa, CA  
95403-1799, USA

**Notice.** The information contained in this document is subject to change without notice. Hewlett-Packard makes no warranty of any kind with regard to this material, including but not limited to, the implied warranties of merchantability and fitness for a particular purpose. Hewlett-Packard shall not be liable for errors contained herein or for incidental or consequential damages in connection with the furnishing, performance, or use of this material.

**Restricted Rights Legend.** Use, duplication, or disclosure by the U.S. Government is subject to restrictions as set forth in subparagraph (c) (1) (ii) of the Rights in Technical Data and Computer Software clause at DFARS 252.227-7013 for DOD agencies, and subparagraphs (c) (1) and (c) (2) of the Commercial Computer Software Restricted Rights clause at FAR 52.227-19 for other agencies.

© Copyright Hewlett-Packard Company 1995  
All Rights Reserved. Reproduction, adaptation, or translation without prior written permission is prohibited, except as allowed under the copyright laws.

---

**WARNING**

Light energy can radiate from the front-panel MONOCHROMATOR OUTPUT connector on HP 71451B instruments (HP 70951B modules). The light emitted from this connector is the filtered and slightly attenuated light input to the front-panel MONOCHROMATOR INPUT connector. The MONOCHROMATOR OUTPUT connector radiates light energy in the following instrument modes: preselector, stimulus response, and photodetector test.

---

**CAUTION**

Condensation degrades the optical spectrum analyzer's performance. Always protect the optical spectrum analyzer from conditions that may cause condensation. Avoid moving the optical spectrum analyzer from a cold environment to a warm environment.

---

**CAUTION**

Total input power to the front-panel MONOCHROMATOR INPUT connector must not exceed +30 dBm. Power in excess of +30 dBm may damage the instrument. The maximum safe photodetector input level on HP 71451B instruments is +20 dBm. The largest measurable power level before signal compression is +10 dBm.

---

**CAUTION**

Electrostatic discharge (ESD) can damage circuits associated with rear-panel connectors. Therefore, before connecting any cable to a rear-panel connector, momentarily short the center and outer conductors of the cable together. Avoid touching the rear-panel connectors without first touching the frame of the instrument. Be sure that the optical spectrum analyzer is properly earth-grounded to prevent buildup of static charge.

---

# Optical Spectrum Analysis with the HP 71450B/1B/2B

Be sure to read this introduction for your optical spectrum analyzer. It introduces you to many of the optical spectrum analyzer's features. The optical spectrum analyzer displays the optical power of the input light spectra as a function of wavelength.

## Missing graticules

In this book, many figures of the optical spectrum analyzer's screen do not show the graticule. This is done to make it easier to see important details.

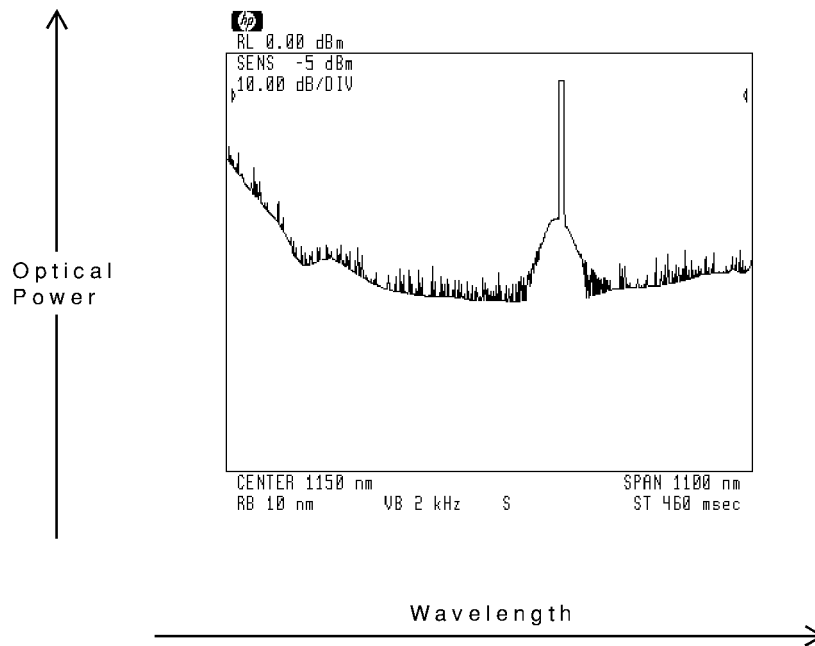

### **Accurate measurements require clean connections**

When connecting fiber-optic cables, do the following steps:

1. Clean the connectors as described in Chapter 1. Dry connections are recommended.
2. Align the connectors so that the fiber end does not touch the outside of the mating connector.

Do not rub the fiber end against any other surfaces.

3. After the ferrule is properly seated inside the connector, use one hand to keep it straight and finger-tighten it with the other hand.

Refer to the manufacturer's data sheet for torque recommendations. Overtightening or undertightening connectors can result in misalignment and nonrepeatable connections.

### **Automatic alignment ensures amplitude accuracy**

To ensure the maximum amplitude accuracy, use the optical spectrum analyzer's **AUTO ALIGN** feature. This is an automatic alignment procedure that should be performed whenever the optical spectrum analyzer has been:

- Moved.
- Subjected to large environmental temperature changes.
- Warmed up at the start of each day.

Refer to Chapter 1 for information on aligning and calibrating the optical spectrum analyzer.

**Softkeys select instrument features**

You control the optical spectrum analyzer using softkey menus. Softkeys are the seven buttons located on each side of the screen. Left-side softkeys select main menus. Right-side softkeys present instrument features. Right-side softkeys are often displayed in several *pages*.

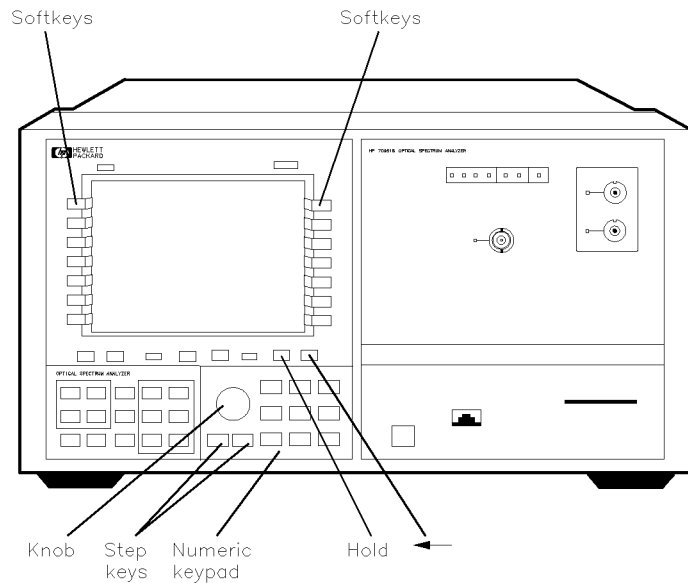

pkb2

**Changing measurement parameters is easy**

Use the front-panel knob, step keys, or numeric keypad to enter new measurements settings. For example, press the **CENTER** key to change the displayed center wavelength. After changing the setting, pressing the **HOLD** key disables the keypad, knob, and step keys until another function is selected. Pressing the **HOLD** key twice blanks the right-side softkeys.

Use the **←** (backspace) key to speed your navigation through softkey menus. When pressed, the previous softkey menu is displayed. Also, use this key to backspace over numbers entered using the data-entry keypad.

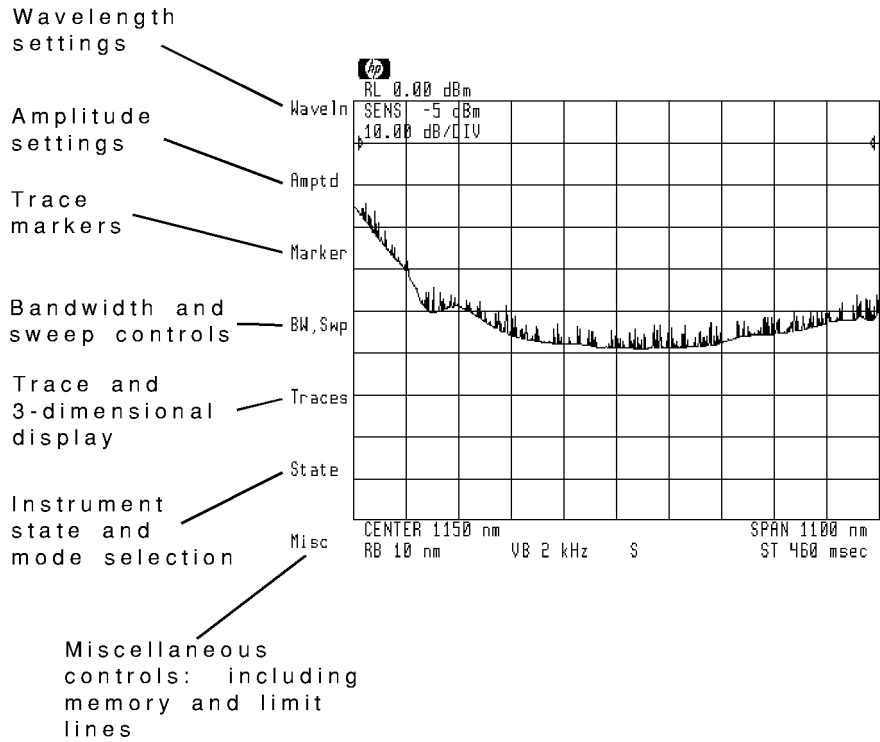

**Optical spectrum analyzer Menu Selections.**

**Keys in this manual**

**boxed** letters indicate normal front-panel keys. Most of these functions also can be performed using softkeys.

**shadow** letters indicate softkeys.

**Automatically locate and display signals**

Press the front-panel **AUTO MEAS** key automatically to locate and display the largest input signal. The optical spectrum analyzer zooms to the signal by changing the displayed center wavelength, span, and reference level values.

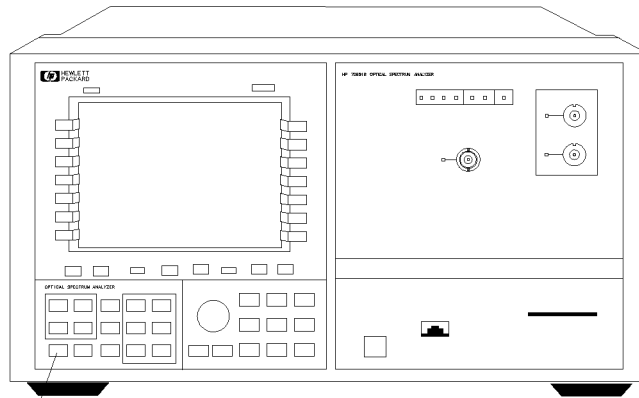

AUTO MEASURE

pk b 1



**Characterize signals with the press of a button**

Three advanced-measurement programs automatically characterize LEDs, DFB lasers, and Fabry-Perot lasers. Press the front-panel **(USER)** key to find and invoke these programs. You can design your own programs (also known as downloadable programs) using the information supplied in the *Programmer's Guide*.

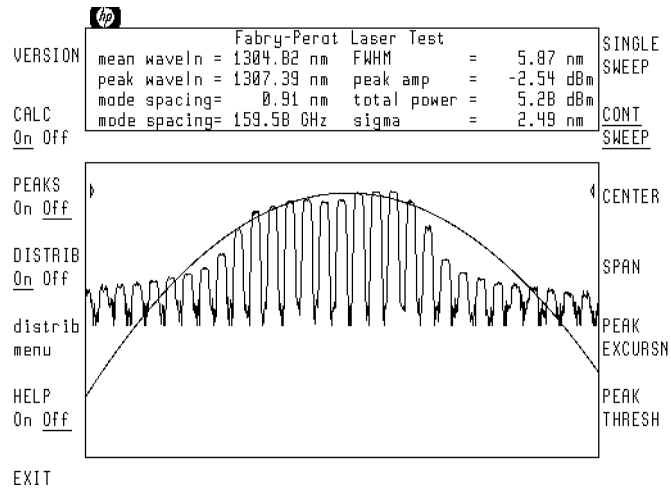

**Characterization of Fabry-Perot Laser**

**Instrument modes  
increase capability**

Depending on the model number, up to six separate operating modes are available:

- Optical spectrum analyzer. Refer to Chapter 1
- Stimulus-response measurement. Refer to Chapter 5.
- Fast pulse measurement. Refer to Chapter 5.
- Power meter. Refer to Chapter 5. *(HP 71451B only)*
- Preselector. Refer to Chapter 5. *(HP 71451B only)*
- Photodiode responsivity measurement. Refer to Chapter 5. *(HP 71451B only)*

**Use markers to measure  
values**

Trace markers allow you swiftly to measure the wavelength and amplitude of any position on the trace. You can even compare positions on separate traces. Markers and peak searches are discussed in Chapter 9.

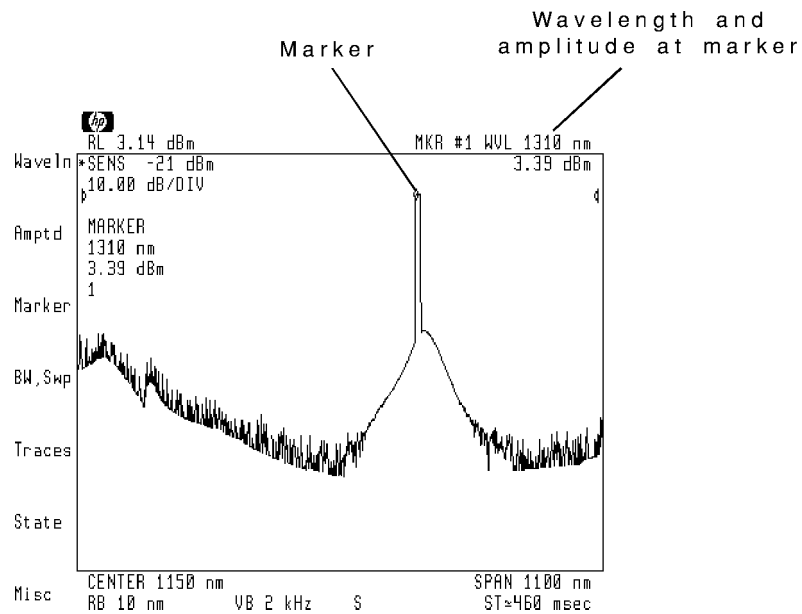

**View three-dimensional display**

The optical spectrum analyzer offers considerable trace control. This includes a three-dimensional view that provides a graphic history of a response. Refer to Chapter 8 for information on viewing three-dimensional displays.

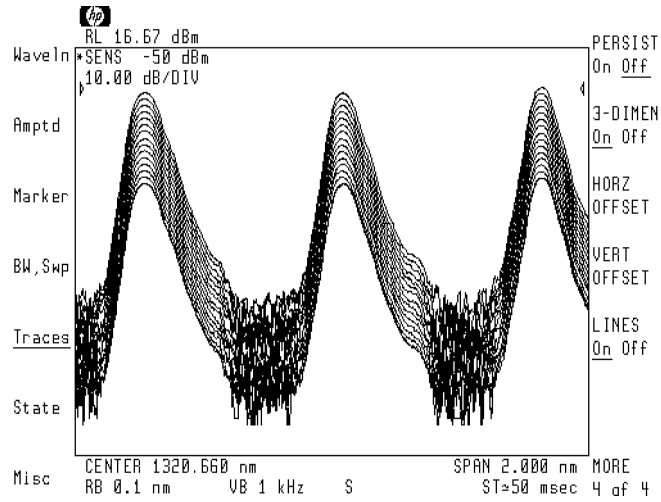

**Limit lines enhance production-line testing**

With the optical spectrum analyzer's limit-line feature, you can display a set of custom lines that describe the acceptable limits of a displayed response. Repeatable comparisons can then be made with **PASS** and **FAIL** conditions automatically displayed on the screen.

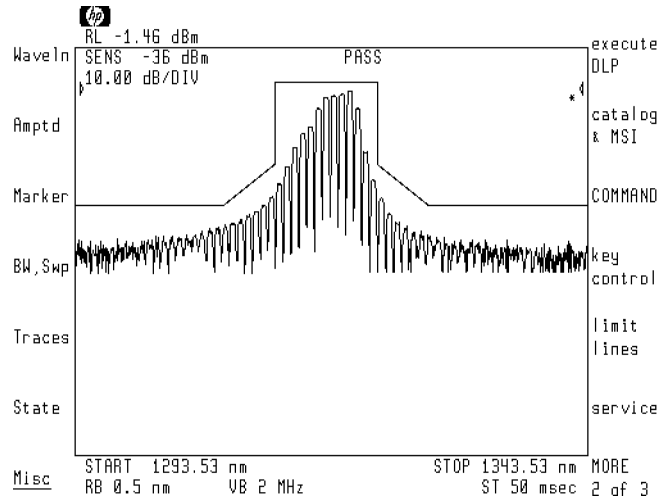

**Saving instrument setups saves you time**

If you repeatedly configure the optical spectrum analyzer to the same settings, be sure to save the settings as a measurement state. Measurement states can be recalled at any time to configure the optical spectrum analyzer automatically. Saving and recalling measurement states is described in Chapter 2.

**Use the custom keypad for swift measurements**

The optical spectrum analyzer comes with a custom keypad that snaps into the front panel of HP 70004A displays. The keypad gives you quick access to common instrument functions. (Each of these functions can also be accessed using the normal softkey menus.)

If you have the custom keypad, practice using it. You'll find that the time required for many of the procedures in this book will be significantly reduced.

If you need to remove the custom keypad, simply push the small button located on the keypad's right side.

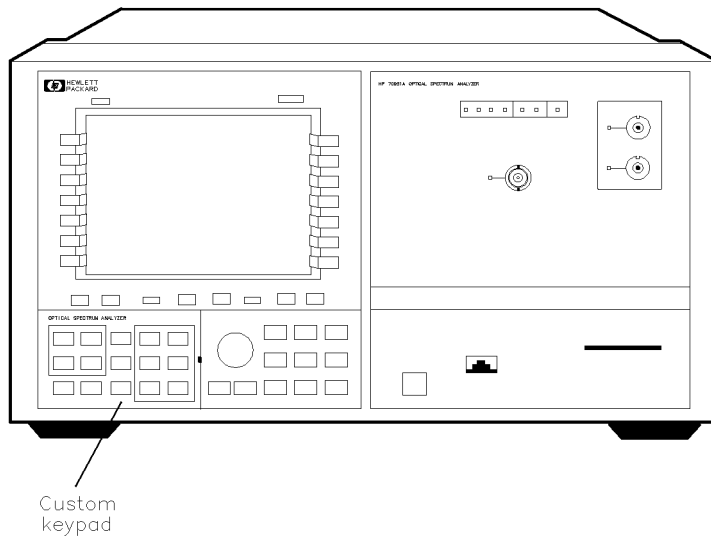

pkb3

**Screen annotation provides valuable information**

Annotation displayed on the screen shows you the current measurement window. This includes displayed wavelength, sensitivity, and sweep time. The display's active function area shows the value of any function that has been activated for change. In the following figure, the active function annotation indicates that the displayed wavelength span has been selected for change. You may change its value using the knob, keypad, or step keys. You may also press a softkey to select another active function.

The **S** displayed at the bottom of the screen shows that the optical spectrum analyzer is using sample detection. If the **S** is missing, peak detection is used.

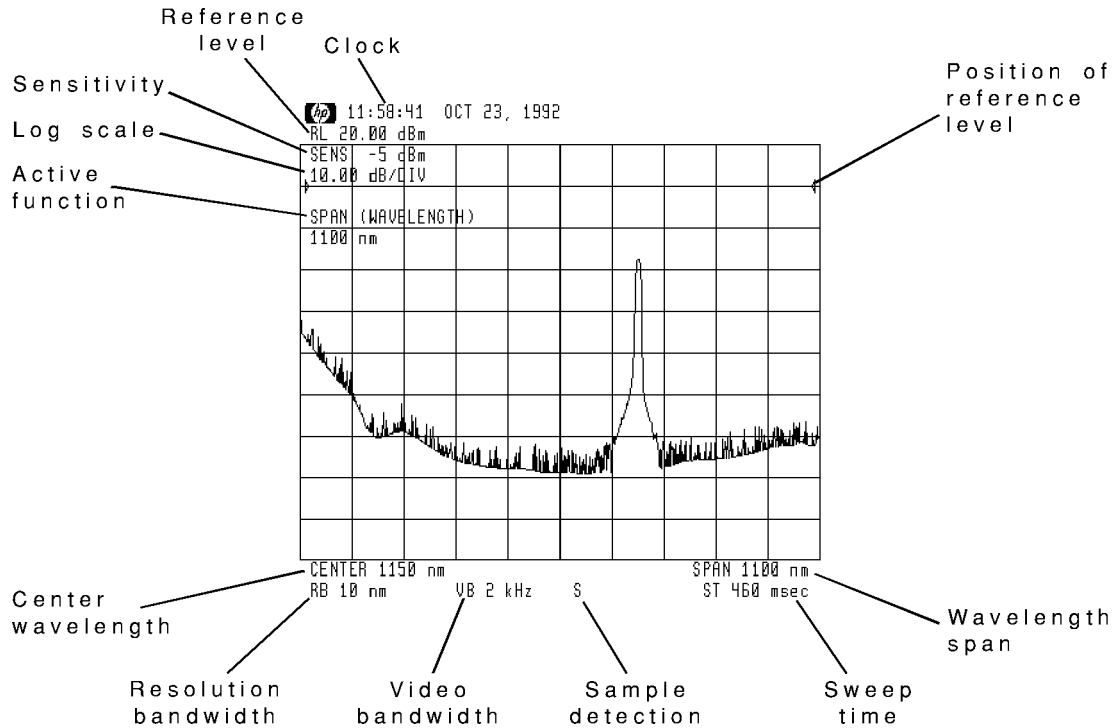

---

# Warranty

This Hewlett-Packard instrument product is warranted against defects in material and workmanship for a period of one year from date of shipment. During the warranty period, Hewlett-Packard Company will, at its option, either repair or replace products which prove to be defective.

For warranty service or repair, this product must be returned to a service facility designated by Hewlett-Packard. Buyer shall prepay shipping charges to Hewlett-Packard and Hewlett-Packard shall pay shipping charges to return the product to Buyer. However, Buyer shall pay all shipping charges, duties, and taxes for products returned to Hewlett-Packard from another country.

Hewlett-Packard warrants that its software and firmware designated by Hewlett-Packard for use with an instrument will execute its programming instructions when properly installed on that instrument. Hewlett-Packard does not warrant that the operation of the instrument, or software, or firmware will be uninterrupted or error-free.

## LIMITATION OF WARRANTY

The foregoing warranty shall not apply to defects resulting from improper or inadequate maintenance by Buyer, Buyer-supplied software or interfacing, unauthorized modification or misuse, operation outside of the environmental specifications for the product, or improper site preparation or maintenance.

NO OTHER WARRANTY IS EXPRESSED OR IMPLIED. HEWLETT-PACKARD SPECIFICALLY DISCLAIMS THE IMPLIED WARRANTIES OF MERCHANTABILITY AND FITNESS FOR A PARTICULAR PURPOSE.

## EXCLUSIVE REMEDIES

THE REMEDIES PROVIDED HEREIN ARE BUYER'S SOLE AND EXCLUSIVE REMEDIES. HEWLETT-PACKARD SHALL NOT BE LIABLE FOR ANY DIRECT, INDIRECT, SPECIAL, INCIDENTAL, OR CONSEQUENTIAL DAMAGES, WHETHER BASED ON CONTRACT, TORT, OR ANY OTHER LEGAL THEORY.

---

## Certification

Hewlett-Packard Company certifies that this product met its published specifications at the time of shipment from the factory. Hewlett-Packard further certifies that its calibration measurements are traceable to the United States National Institute of Standards and Technology, to the extent allowed by the Institute's calibration facility, and to the calibration facilities of other International Standards Organization members.



---

## Assistance

*Product maintenance agreements and other customer assistance agreements are available for Hewlett-Packard products.*

*For any assistance, contact your nearest Hewlett-Packard Sales and Service Office.*

---

## Safety Symbols

The following safety symbols are used throughout the manual set. Familiarize yourself with each of the symbols and its meaning before operating this instrument.

---

### **CAUTION**

---

The *caution* sign denotes a hazard. It calls attention to a procedure which, if not correctly performed or adhered to, could result in damage to or destruction of the instrument. Do not proceed beyond a *caution* sign until the indicated conditions are fully understood and met.

---

### **WARNING**

---

The *warning* sign denotes a hazard. It calls attention to a procedure which, if not correctly performed or adhered to, could result in injury or loss of life. Do not proceed beyond a *warning* sign until the indicated conditions are fully understood and met.

---

# Contents

<b>1. Displaying Signals (Part 1)</b>	
Setting Wavelength and Reference Level . . . . .	1-4
To view a signal using markers . . . . .	1-10
To return to full span . . . . .	1-10
To allow extended wavelength range . . . . .	1-10
To change the reference level . . . . .	1-11
To change the reference position . . . . .	1-11
To view the amplitude meter . . . . .	1-11
To change the center wavelength step size . . . . .	1-12
To offset annotation readouts . . . . .	1-12
Setting Sensitivity . . . . .	1-14
To increase the sensitivity level . . . . .	1-15
To disable autoranging . . . . .	1-15
Automatically Tuning to Signals . . . . .	1-16
To view a signal using automeasure . . . . .	1-17
To automeasure at a specified span . . . . .	1-17
To automeasure to a specified log scale . . . . .	1-18
To automeasure to a specified wavelength . . . . .	1-18
To automeasure optimizing sensitivity . . . . .	1-19
Changing the Amplitude Scale and Units . . . . .	1-20
To change the amplitude scale . . . . .	1-21
To change the amplitude units . . . . .	1-21
Understanding Multiple-Order Responses . . . . .	1-22
To test for sub-multiples . . . . .	1-26
Aligning the Optical Spectrum Analyzer . . . . .	1-28
To align at largest input signal . . . . .	1-29
To align at the marker . . . . .	1-29
To align with Option 002 internal light source . . . . .	1-30
To align with an external light source . . . . .	1-30
To remove alignment offsets . . . . .	1-31
Calibrating the Optical Spectrum Analyzer . . . . .	1-32
To calibrate wavelength . . . . .	1-35
To calibrate power and wavelength . . . . .	1-37
To turn off user-calibration . . . . .	1-40
To erase user-calibration . . . . .	1-41
Cleaning Connections for Accurate Measurements . . . . .	1-42

To clean a non-lensed connector . . . . .	1-44
To clean an adapter . . . . .	1-45
To test insertion loss . . . . .	1-45
To test return loss . . . . .	1-46
<b>2. Displaying Signals (Part 2)</b>	
Resolving Wavelengths . . . . .	2-4
To resolve closely spaced signals . . . . .	2-6
To change the RB/span ratio . . . . .	2-6
Reducing Displayed Noise . . . . .	2-8
To reduce the displayed noise . . . . .	2-11
Increasing Dynamic Range . . . . .	2-12
To increase dynamic range . . . . .	2-13
To disable chop mode . . . . .	2-14
Controlling Sweeps . . . . .	2-16
To set continuous or single sweeps . . . . .	2-19
To set the sweep time . . . . .	2-20
To stop the sweep . . . . .	2-20
To reduce sweep retrace time . . . . .	2-21
Triggering Sweeps . . . . .	2-22
To use freerun triggering . . . . .	2-25
To use video triggering . . . . .	2-25
To use line triggering . . . . .	2-26
To use external triggering . . . . .	2-26
To delay the sweep . . . . .	2-26
Saving Instrument Setups . . . . .	2-27
To save or recall a measurement state . . . . .	2-27
To protect measurement state files . . . . .	2-28
To select the power-on state . . . . .	2-28
<b>3. Displaying Pulsed Light</b>	
Synchronizing the Light Source . . . . .	3-4
To turn on ADC sync (standard instrument) . . . . .	3-9
To turn on ADC sync and pulsed current (Option 001) . . . . .	3-10
Synchronizing the Optical Spectrum Analyzer . . . . .	3-13
To synchronize the optical spectrum analyzer . . . . .	3-14
To select the trigger type . . . . .	3-15
Using the Gated Sweep Feature . . . . .	3-16
To use the gated sweep feature . . . . .	3-17

<b>4. Measuring Signals</b>	
Characterizing DFB Lasers . . . . .	4-4
To characterize a DFB laser . . . . .	4-9
To show the SMSR modes . . . . .	4-10
To show the stop-band . . . . .	4-11
Characterizing Fabry-Perot (FP) Lasers . . . . .	4-12
To characterize a Fabry-Perot laser . . . . .	4-17
To show the power-distribution trace . . . . .	4-17
To show the modes used in measurements . . . . .	4-18
To select the modes used in measurements . . . . .	4-19
Characterizing LEDs . . . . .	4-20
To characterize an LED . . . . .	4-25
To show the power-distribution trace . . . . .	4-25
To change the integration window . . . . .	4-26
Reinstalling Advanced-Measurement Programs . . . . .	4-28
To install from the memory card . . . . .	4-29
To install from a 3.5-inch diskette drive . . . . .	4-30
To install from a computer . . . . .	4-31
<b>5. Changing Instrument Modes</b>	
Performing Stimulus-Response Measurements . . . . .	5-4
To characterize a single-output device . . . . .	5-9
To characterize a dual-output device . . . . .	5-14
To display a trace of input power . . . . .	5-16
To make measurements on a linear scale . . . . .	5-16
To use alternative trace definitions . . . . .	5-18
Making Fast Pulse Measurements . . . . .	5-20
To measure fast pulses . . . . .	5-20
Measuring Broadband Power . . . . .	5-21
To measure broadband power . . . . .	5-24
Preselecting a Light Source . . . . .	5-26
To preselect a light source . . . . .	5-29
To use a single mode output cable . . . . .	5-31
Measuring Photodetector Responsivity . . . . .	5-33
To measure photodetector responsivity . . . . .	5-37
To display a trace of input power . . . . .	5-41

<b>6. Using Option 002, Built-in White Light Source</b>	
Operating the Light Source . . . . .	6-4
To turn on the light source . . . . .	6-4
Using the Light Source with the HP 71451B . . . . .	6-5
Stimulus-Response Measurements with the HP 71450B/2B	6-6
To characterize a single-output device . . . . .	6-10
To characterize a dual-output device . . . . .	6-15
To display a trace of input power . . . . .	6-17
To make measurements on a linear scale . . . . .	6-17
To use alternative trace definitions . . . . .	6-19
Replacing the Lamp . . . . .	6-21
To replace the lamp . . . . .	6-22
<b>7. Measuring Swept Polarization Dependent Loss</b>	
Characterizing Optical-to-Optical Devices . . . . .	7-4
Preferred test setup (EXT photodetector) . . . . .	7-5
Simplified test setup (INT photodetector) . . . . .	7-7
To measure PDL . . . . .	7-9
Characterizing Optical-to-Electrical Devices . . . . .	7-15
To measure PDL . . . . .	7-17
<b>8. Controlling Traces</b>	
Displaying Traces . . . . .	8-4
To display a trace . . . . .	8-7
To blank a trace . . . . .	8-7
To observe a drifting signal . . . . .	8-8
To exchange trace data . . . . .	8-10
To invoke default trace settings . . . . .	8-11
Viewing Three-Dimensional Displays . . . . .	8-12
To view the three-dimensional display . . . . .	8-15
Reducing Noise with Video Averaging . . . . .	8-16
To reduce displayed noise . . . . .	8-17
Displaying a Moveable Display Line . . . . .	8-18
To use the display line . . . . .	8-19
Setting the Trace Threshold . . . . .	8-20
To set the trace threshold . . . . .	8-21
Simulating an Analog Display . . . . .	8-22
To simulate an analog display . . . . .	8-22
Comparing Traces with Trace Math . . . . .	8-23
To compare responses . . . . .	8-26
Changing Trace Length and Interpolation . . . . .	8-30

To change the trace lengths . . . . .	8-32
To disable trace A interpolation . . . . .	8-33
Saving and Recalling Traces . . . . .	8-34
To save trace A . . . . .	8-34
To recall trace A . . . . .	8-35

## 9. Using Markers

Selecting and Moving Markers . . . . .	9-4
To display marker 1 . . . . .	9-7
To display markers 2 through 5 . . . . .	9-7
To move a marker to the next trace . . . . .	9-8
To turn markers off . . . . .	9-8
Performing Marker Searches . . . . .	9-9
To perform a peak search . . . . .	9-13
To move a marked signal to center screen . . . . .	9-14
To move a marked signal to the reference level . . . . .	9-14
To change the peak and pit definition . . . . .	9-15
Using Delta Markers . . . . .	9-16
To turn on a delta marker . . . . .	9-19
To change wavelength span . . . . .	9-19
To modify center-frequency step size . . . . .	9-20
To measure bandwidth . . . . .	9-20
To zoom to zero-span at marker . . . . .	9-21
Tracking a Drifting Signal . . . . .	9-22
To track a drifting signal . . . . .	9-22
To define the tracking limit . . . . .	9-23
Changing Marker Readouts . . . . .	9-24
To select the marker readout type . . . . .	9-25
Stopping and Pausing the Sweep . . . . .	9-26
To stop the sweep at the marker . . . . .	9-27
To pause the sweep at the marker . . . . .	9-27
Measuring Noise Level at Marker . . . . .	9-28
To measure the noise level . . . . .	9-28

## 10. Creating Limit Lines and Entering Amplitude Corrections

Creating Limit Lines . . . . .	10-4
To enter the limit-lines menu . . . . .	10-10
To create a limit line . . . . .	10-10
To make limit lines relative or fixed . . . . .	10-12
To turn on limit testing . . . . .	10-12
To turn on the fail-limit beeper . . . . .	10-12

To blank all traces . . . . .	10-13
To erase the limit-line table . . . . .	10-13
Saving and Recalling Limit Lines . . . . .	10-14
To save a limit line . . . . .	10-16
To list limit-line files in memory . . . . .	10-16
To recall a limit line . . . . .	10-17
Using Amplitude Corrections . . . . .	10-18
To create amplitude corrections . . . . .	10-21
To edit amplitude corrections . . . . .	10-22
To increase the limit-line table size . . . . .	10-23
To turn amplitude corrections on and off . . . . .	10-24
To erase amplitude corrections . . . . .	10-25
Tutorial: Using Limit Lines . . . . .	10-26
Step 1. View the response . . . . .	10-27
Step 2. Display the limit-line table . . . . .	10-28
Step 3. Enter the first segment point . . . . .	10-29
Step 4. Complete the table . . . . .	10-30
Step 5. Save the limit lines . . . . .	10-31
Step 6. Turn on limit-line testing . . . . .	10-32
Step 7. Begin testing . . . . .	10-33
Step 8. Make limit lines fixed . . . . .	10-35

## 11. Creating a User Menu

Designing User Menus . . . . .	11-4
To copy a menu softkey to the user menu . . . . .	11-9
To add a softkey that starts a DLP . . . . .	11-9
To remove a softkey from the user menu . . . . .	11-10
To preset the User menu . . . . .	11-11
To delete a User menu file . . . . .	11-11
To enter a small DLP . . . . .	11-11
To edit a small DLP . . . . .	11-13
Storing and Recalling User Menus . . . . .	11-14
To store and recall a User menu . . . . .	11-15

## 12. Controlling Annotation, Printing, and Plotting

Controlling Graticules, Annotation, and Titles . . . . .	12-4
To place graticules relative to 0 dBm . . . . .	12-6
To blank the screen graticule . . . . .	12-6
To blank the screen annotation . . . . .	12-7
To blank the clock display . . . . .	12-8
To write a title on the screen . . . . .	12-9



To remove a title from the screen . . . . .	12-12
Controlling the System Clock . . . . .	12-13
To blank the clock display . . . . .	12-14
To set the clock . . . . .	12-14
To select United States or European clock format . . . . .	12-15
Displaying Information About the Instrument . . . . .	12-16
To view the ROM version . . . . .	12-17
To display the internal state of the instrument . . . . .	12-18
Printing and Plotting . . . . .	12-19
To print or plot the display . . . . .	12-20
To enter the printer type and address . . . . .	12-21
To enter the plotter type and address . . . . .	12-22
To prevent softkey labels from printing or plotting . . . . .	12-23

### 13. Managing Memory

Selecting and Formatting Memory . . . . .	13-4
To insert a memory card . . . . .	13-7
To select the default memory . . . . .	13-8
To format memory . . . . .	13-9
To change a card's battery . . . . .	13-10
Working with Files . . . . .	13-12
To catalog all files . . . . .	13-16
To save a file . . . . .	13-17
To recall a file . . . . .	13-18
To copy internal memory . . . . .	13-19
To erase a file . . . . .	13-19
To erase all files . . . . .	13-20
To modify file names . . . . .	13-21
Increasing User Memory . . . . .	13-23
To increase user memory . . . . .	13-23
Securing the optical spectrum analyzer . . . . .	13-24
To prevent annotation from displaying . . . . .	13-25
To restrict operation to <b>(USER)</b> menu . . . . .	13-25
To restore operation of <b>(MENU)</b> menu . . . . .	13-28
To erase internal memory partially . . . . .	13-29
To erase internal memory fully . . . . .	13-29
To recover from a full memory erase . . . . .	13-30
Connecting an External HP-IB Disk Drive . . . . .	13-34
To connect the disk drive . . . . .	13-35

<b>14. If You Have A Problem</b>	
To perform the self-test routine . . . . .	14-4
If operation is erratic . . . . .	14-5
If displayed color, lines, and text are distorted . . . . .	14-7
If advanced-measurement programs are missing . . . . .	14-8
If UNCAL is displayed . . . . .	14-9
If USERCAL is displayed . . . . .	14-10
If ERR 2023 is displayed . . . . .	14-11
If ERR 2037 is displayed . . . . .	14-12
If ERR 2053 is displayed . . . . .	14-13
If ERR 2057 is displayed . . . . .	14-15
If ERR 2064 is displayed . . . . .	14-17

**Glossary**

**Index**

---

## Displaying Signals (Part 1)

---

## Displaying Signals (Part 1)

In this chapter, you'll learn how to display optical signals using the following controls:

- Wavelength
- Reference level
- Sensitivity
- Amplitude scale and units

This chapter explains how and when to align and calibrate the optical spectrum analyzer. Alignments and calibrations ensure accurate measurements.

Accurate measurements require clean connections. At the end of this chapter a section describes making proper fiber-optic connections.

<b>Contents</b>	Setting Wavelength and Reference Level .....	1-4
	To view a signal using markers .....	1-10
	To return to full span .....	1-10
	To allow extended wavelength range .....	1-10
	To change the reference level .....	1-11
	To change the reference position .....	1-11
	To view the amplitude meter .....	1-11
	To change the center wavelength step size .....	1-12
	To offset annotation readouts .....	1-12
	Setting Sensitivity .....	1-14
	To increase the sensitivity level .....	1-15
	To disable autoranging .....	1-15
	Automatically Tuning to Signals .....	1-16
	To view a signal using automeasure .....	1-17
	To automeasure to a specified span .....	1-17
	To automeasure to a specified log scale .....	1-18
	To automeasure to a specified wavelength .....	1-18
	To automeasure optimizing sensitivity .....	1-19
	Changing the Amplitude Scale and Units .....	1-20
	To change the amplitude scale .....	1-21
	To change the amplitude units .....	1-21
	Understanding Multiple-Order Responses .....	1-22
	To test for sub-multiples .....	1-26
	Aligning the Optical Spectrum Analyzer .....	1-28
	To align at largest input signal .....	1-29
	To align at the marker .....	1-29
	To align with Option 002 internal light source .....	1-30
	To align with an external light source .....	1-30
	To remove alignment offsets .....	1-31
	Calibrating the Optical Spectrum Analyzer .....	1-32
	To calibrate wavelength .....	1-35
	To calibrate power and wavelength .....	1-37
	To turn off user-calibration .....	1-40
	To erase user-calibration .....	1-41
	Cleaning Connections for Accurate Measurements .....	1-42
	To clean a non-lensed connector .....	1-44
	To clean an adapter .....	1-45
	To test insertion loss .....	1-45
	To test return loss .....	1-46

## Setting Wavelength and Reference Level

Displaying signals is as easy as setting the wavelength range, reference level, and sensitivity. Sweep speed is automatically set by the optical spectrum analyzer. In fact, the optical spectrum analyzer always uses the fastest sweep possible while still maintaining a calibrated display.

When the optical spectrum analyzer is first turned on, the wavelength range is set to the full 1100 nm span (600 nm to 1700 nm). There is an extended range that lets you view signals from 350 nm to 2000 nm. However, the display for signals within the extended range is not calibrated.

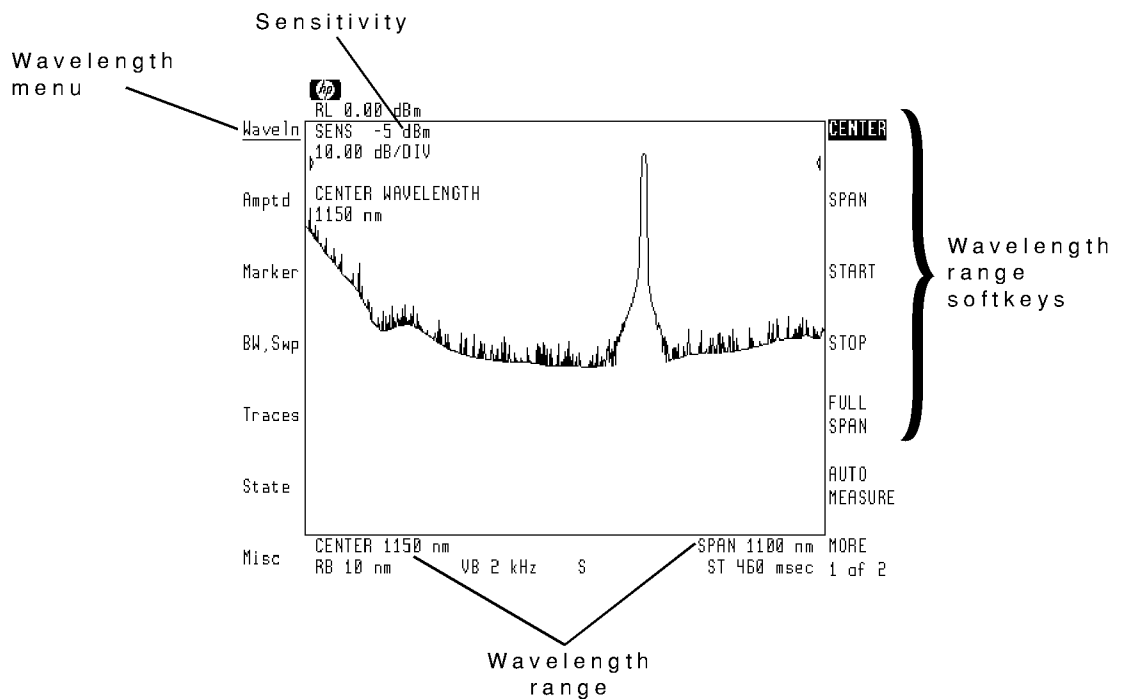

### Setting Wavelength and Reference Level

The position of the reference level is located on the display by two triangles. Its position can be changed. The default position is at the ninth major horizontal graticule line.

Use one of the following three methods to display a signal:

- Manually set the wavelength, reference level, and sensitivity.
- Use the automeasure routine. (Press **AUTO MEAS**.)
- Use markers.

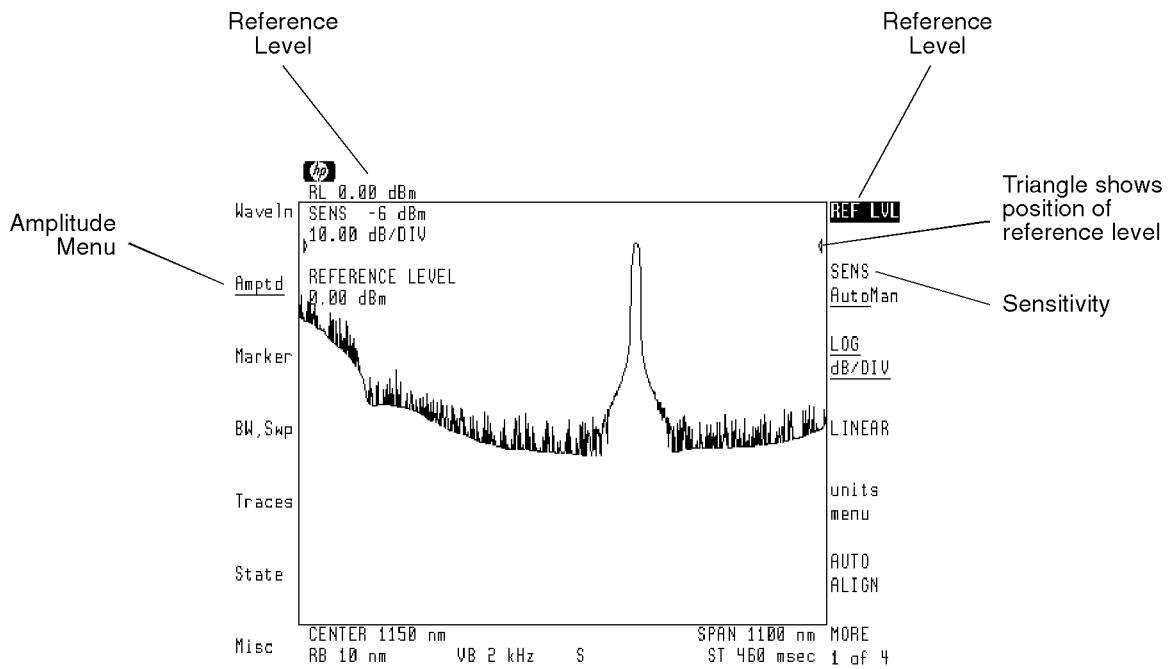

basic2

**Setting Wavelength and Reference Level**

**Waveln and Amptd  
menus control  
measurement range**

Use the Wavelength menu to control the wavelength range. Use the Amplitude menu to control the reference level and sensitivity. By selecting the softkeys on these two menus, you can enter the values you need.

After pressing a softkey, it becomes the active function and its value is displayed in the active function area. Once a function is activated, change its value using the knob, step keys, or numeric keypad. To discover how easy it is to adjust the optical spectrum analyzer's settings, connect an input signal, press the left-side **Waveln** softkey, then the right-side **CENTER** softkey. Now rotate the front-panel knob and watch the center wavelength change.

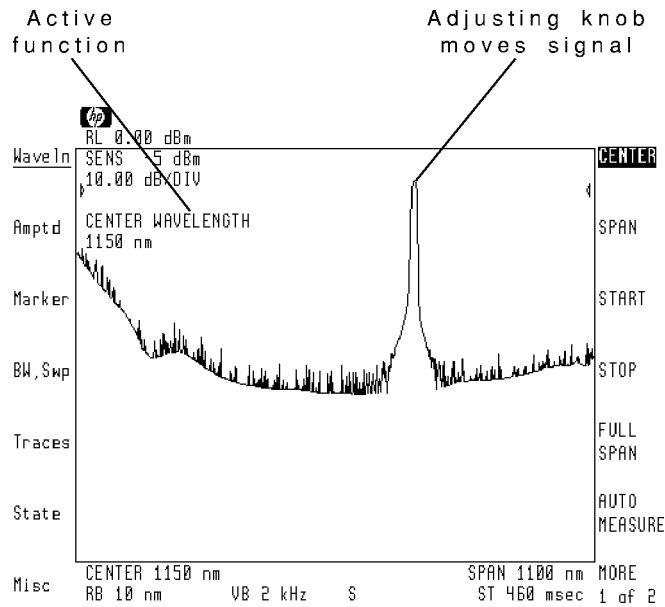



**Setting Wavelength and Reference Level**

**Center-wavelength step sizes can be changed** When center wavelength is the active function, pressing the **▲** and **▼** keys steps the center wavelength. The default step size is one tenth of the span. You can set the size of the steps to a set value. The value you enter does not depend upon the displayed span.

**Offsets can be added to annotation** The Wavelength and Amplitude menus allow you to add offsets to all displayed wavelength and amplitude values. One use of amplitude offsets is to compensate for signal attenuation caused by some devices. Although this method is fast, it is more accurate to use amplitude correction factors. Refer to Chapter 10 for a complete discussion of using amplitude correction factors.

**Custom keypad reminder**

In addition to using the softkey menus, don't forget the corresponding front-panel keys. For example, to set the wavelength range, reference level, and sensitivity use **CENTER**, **SPAN**, **START**, **STOP**, **REF LEVEL**, and **SENS**.

**Markers can tune the optical spectrum analyzer to signal peaks** Using the front-panel marker keys, you can tune to any signal peak. Step 1 of the following figures works for large signals. For small signals, you can press **NORMAL ON/OFF** to turn a marker on and then use the front-panel knob to place the marker on the signal peak. For a more complete discussion of marker use, refer to Chapter 9.

Displaying Signals (Part 1)

**Setting Wavelength and Reference Level**

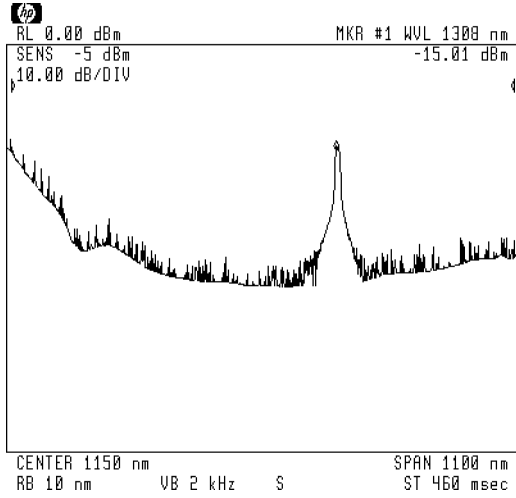

1. Press **PEAK SEARCH**.

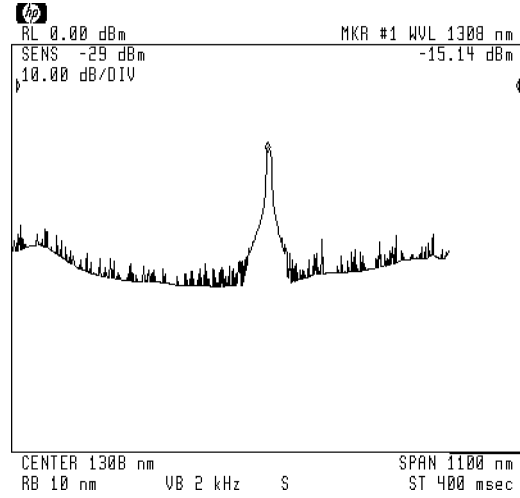

2. Press **TO CENTER**.

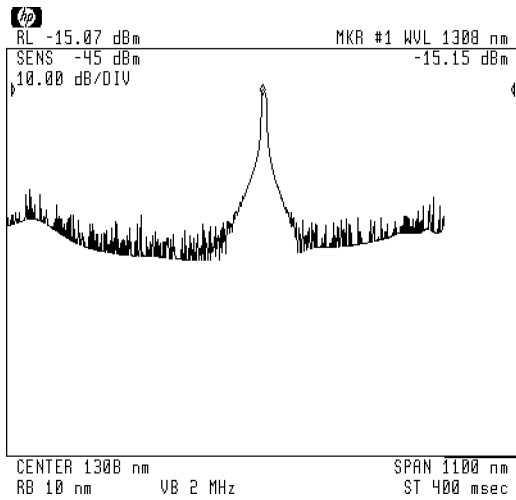

3. Press **TO REF LEVEL**.

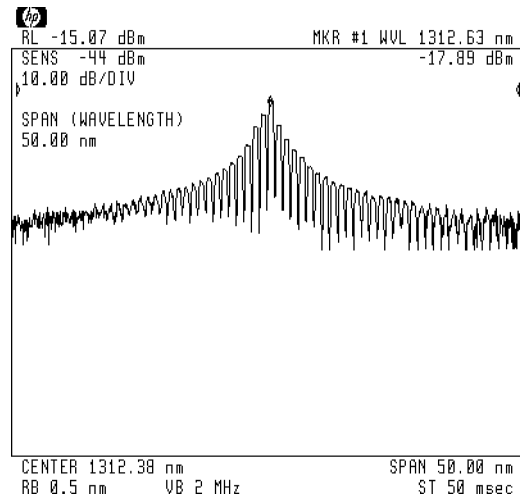

4. Press **SPAN** **▼** **▼** **▼** **▼**.

### Setting Wavelength and Reference Level

**Amplitude meter measures amplitude of current trace point**

An amplitude meter can be displayed showing the power level of each trace point as it is acquired. This is particularly useful when monitoring power as a function of time to observe both long and short term drift. The following figure shows the amplitude meter displayed on the screen.

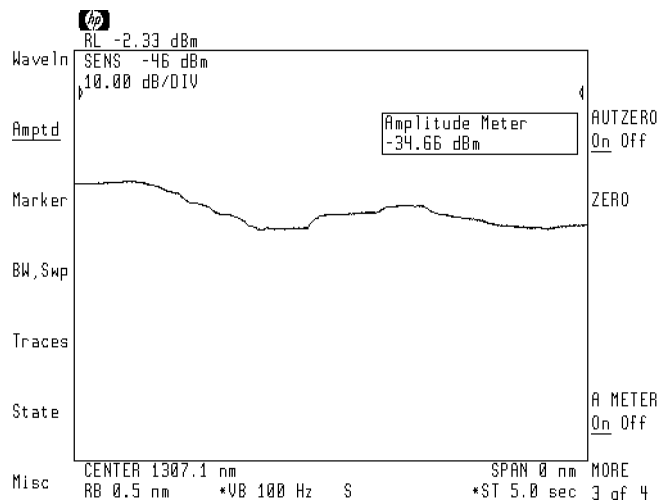

**Amplitude meter showing power level versus time.**

## To view a signal using markers

1. Press **PEAK SEARCH** to activate a marker, and place it on the highest trace point.
  2. If the signal you want to tune to is not the highest peak, rotate the knob to place the marker at the desired peak.
  3. Press **TO CENTER** to move the signal to the center wavelength.
  4. Press **TO REF LEVEL** to move the signal to the reference level.
  5. Press **SPAN**, and use the knob, step keys, or numeric keypad to reduce the span.
  6. Press **SENS** and adjust the sensitivity as needed.
- 

## To return to full span

1. Press the left-side **Waveln** softkey.
  2. Press **FULL SPAN**.
- 

## To allow extended wavelength range

1. Press the left-side **Waveln** softkey.
2. Press **MORE 1 of 2**.
3. Press the **WL LIM On Off** softkey so that **Off** is underlined.

The displayed wavelength range can now be set from 350 nm to 2000 nm. However, the extended range is not calibrated.

---

---

## To change the reference level

1. Press the left-side **Amptd** softkey.
2. Press **REF LVL** and enter a new reference level using the knob, step keys, or numeric keypad.

---

## To change the reference position

1. Press the left-side **Amptd** softkey.
2. Press **MORE 1 of 4** and then **REF LVL POSN**.
3. Enter a new reference level position using the knob, step keys, or numeric keypad.

The position can be from 0.0 to 10.0. The default position is 9.0.

---

## To view the amplitude meter

1. Press the left-side **Amptd** softkey.
2. Press the **MORE 1 of 4** and **MORE 2 of 4** softkeys.
3. Press **AMETER On Off** so that **On** is underlined.

---

## To change the center wavelength step size

1. Press the **WaveIn** softkey.
2. Press the **MORE 1 of 2** softkey.
3. Press **WL STEP AutoMan** and use the knob, step keys, or numeric keypad to enter a new center wavelength step size.

---

## To offset annotation readouts

- Offset all displayed amplitude readouts by pressing the following softkeys:
  1. Press the left-side **Amptd** softkey.
  2. Press **MORE 1 of 4** and then **AMP REF OFFSET**.
  3. Enter the desired value of the offset.
- Offset all displayed wavelength readouts by pressing the following softkeys:
  1. Press the left-side **WaveIn** softkey.
  2. Press **MORE 1 of 2** and then **WAVELEN OFFSET**.
  3. Enter the desired value of the offset.

Displaying Signals (Part 1)  
**Setting Wavelength and Reference Level**

---

## Setting Sensitivity

The sensitivity setting indicates the smallest signal amplitude that will be displayed across the current wavelength range. Due to instrument tolerances, the sensitivity's annotation is a nominal value. You can set the sensitivity just as easily as you would set the reference level. However, increasing sensitivity slows the sweep speed.

Normally, the optical spectrum analyzer automatically selects the greatest sensitivity possible that does not require amplification changes during the sweep. If you manually increase the sensitivity level, the sweep pauses to allow this change in gain. This is known as autoranging. If desired, autoranging can be disabled using the **AUTORNG On Off** softkey. This softkey also indicates the state of autoranging for a given sensitivity and video bandwidth setting. If autoranging is on, an asterisk appears next to the SENS screen annotation.

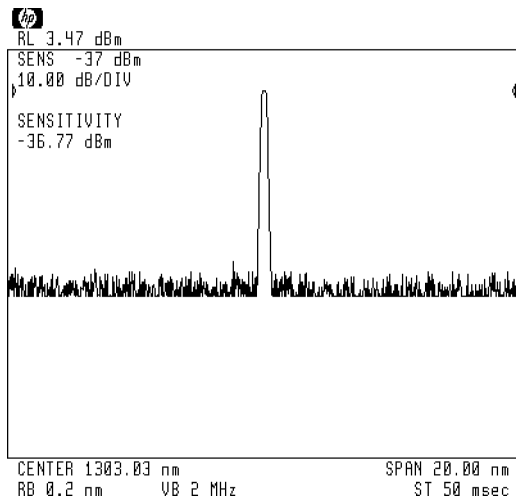

**Low sensitivity hides sidemodes.**

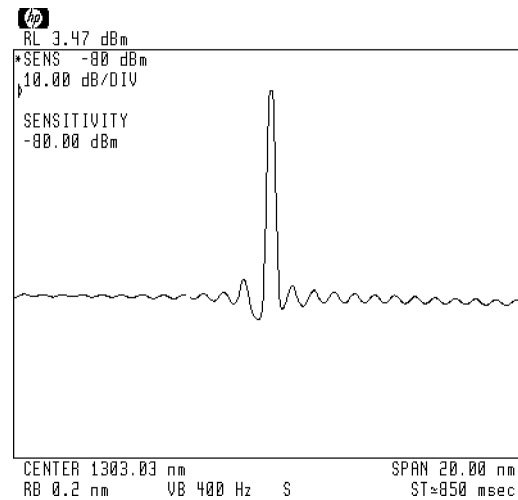

**Higher sensitivity reveals sidemodes.**



The sensitivity indicated for the full span (600 nm to 1700 nm) is around  $-5$  dBm. This shows the worst-case condition at 600 nm, which is due to loss in the internal monochromator. If the stop wavelength is set to less than 900 nm, the sensitivity dramatically improves. This is due to the diffraction grating order used. For complete information on diffraction grating orders, refer to “Understanding Multiple-Order Responses” in this chapter.

---

## To increase the sensitivity level

- Press **SENS**, and enter a new sensitivity level using the knob, step keys, or numeric keypad.  
or,
- Press **REF LEVEL**, and change the reference level to place the signal peak at the top of the screen.  
or,
- Press **BW,Swp**, **VID BW AutoMan**, and reduce the video bandwidth.

---

## To disable autoranging

1. Press the left-side **Amptd** softkey.
2. Press **MORE 1 of 4**.
3. Press the **AUTORNG On Off** softkey so that **Off** is underlined.

---

## Automatically Tuning to Signals

The optical spectrum analyzer's **(AUTO MEAS)** key automatically locates and views the largest input signal. Automeasure locates the largest signal in the full 600 nm to 1700 nm wavelength range, then reduces the span to display the signal properly. The reference level is set automatically to the signal's peak and the sensitivity is adjusted as needed.

Using the State menu, you can modify the automeasure routine to perform one of the following:

- Tune to the wavelength indicated by the active marker instead of locating the largest input signal.
- End at a predetermined wavelength span or amplitude scale.
- Optimize the sensitivity.

The automatic measurement routine uses a lower sensitivity setting in order to reduce the displayed noise. One example of using this feature is to allow the viewing of sidemodes on a DFB laser.

Pressing **(INSTR PRESET)** resets the automeasure routine to its default settings.

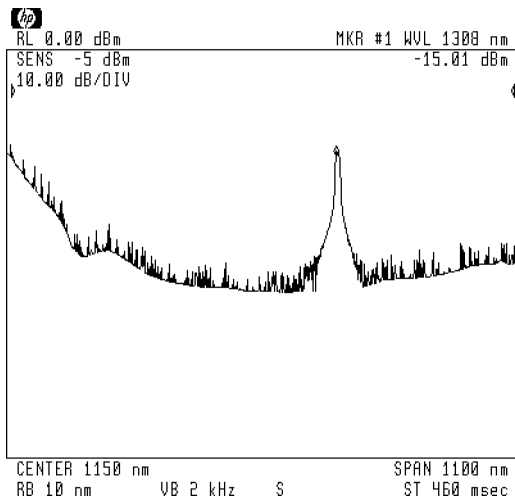

**Signal displayed before automeasure.**

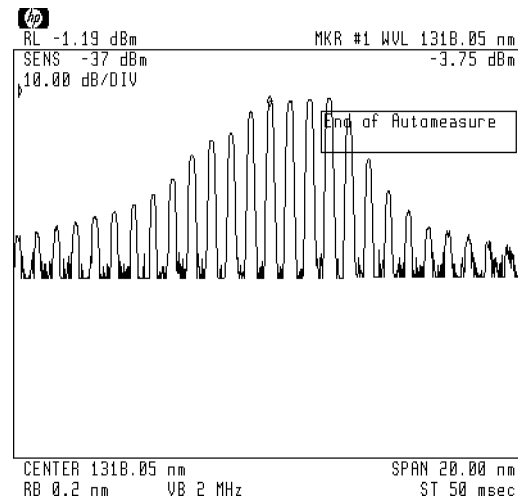

**Signal displayed after automeasure.**

---

## To view a signal using automeasure

1. If the signal you want to tune to is not the largest input signal, perform the following:
  - a. Press **(NORMAL ON/OFF)**, and use the front-panel knob to place the displayed marker on the peak of the signal of interest.
  - b. Press **State**, **autmeas state**, and then **AT MKR On Off** so that **On** is underlined.
2. Press **(AUTO MEAS)**. If no signal is present, an error occurs.

---

## To automeasure at a specified span

1. Press the left-side **State** softkey.
2. Press **autmeas state**.
3. Pressing **SPAN AutoMan** sets the final wavelength span selected at the end of the automeasure routine. Use the numeric keypad to enter the new span value.

Notice that the softkey label now has **Man** underlined to indicate the the span is manually selected.

---

## To automeasure to a specified log scale

1. Press the left-side **State** softkey.
2. Press **autmeas state**.
3. Pressing **DB/DIV AutoMan** sets the final amplitude scale used at the end of the automeasure routine. Use the numeric keypad to enter the new value.

The default value is 10 dB-per-division. Notice that the softkey label now has **Man** underlined to indicate that the span is manually selected.

---

## To automeasure to a specified wavelength

1. Press the left-side **State** softkey.
2. Press **autmeas state**.
3. Pressing **AT MKR On Off** so that **On** is underlined causes automeasure to tune to the wavelength indicated by the marker.

If no marker is displayed when **(AUTO MEAS)** is pressed, the optical spectrum analyzer locates the largest input signal. If no signal is present, an error occurs.

---

## To automeasure optimizing sensitivity

1. Press the left-side **State** softkey.
2. Press **autmeas state**.
3. Pressing **OPTSENS On Off** so that **On** is underlined.

---

## Changing the Amplitude Scale and Units

Use the amplitude menu to change the amplitude scale and annotation. Logarithmic and linear amplitude scales are available. Logarithmic scales range from 0.01 to 20.00 decibels-per-division. The 10 dB-per-division scale is the default setting. Regardless of the scale selected, the amplitude annotation can be set to units of dBm or watts. The watt is the default unit for linear scale; dBm is the default unit for log scale.

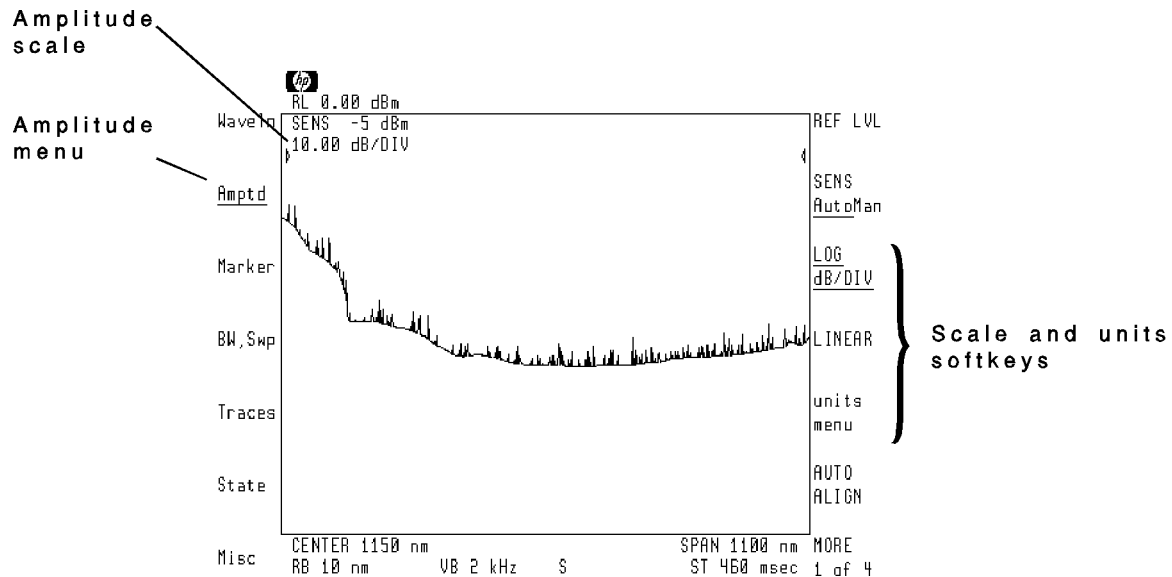

---

## To change the amplitude scale

1. Press the left-side **Amptd** softkey.
2. Perform one of the following:
  - Press **LOG dB/DIV** to select a logarithmic scale and enter the scale using the knob, step keys, or numeric keypad.
  - Press **LINEAR** to select a linear scale.

---

## To change the amplitude units

1. Press the left-side **Amptd** softkey.
2. Press **units menu**.
  - Pressing **A UNITS AutoMan** allows the optical spectrum analyzer to select the annotation automatically. The **Auto** selection is the optical spectrum analyzer's default setting.
  - Pressing **dBm** selects annotation in decibels relative to 1 mW.
  - Pressing **WATT** selects annotation in watts.

---

## Understanding Multiple-Order Responses

HP 71450B/1B/2B optical spectrum analyzers use a diffraction grating to separate the input wavelengths spatially. Because diffraction gratings operate in multiple modes, the display may show multiple images of the input signal. These multiple images depend on the input wavelength. Understanding the relationship between input wavelength and displayed images enables you to interpret the display correctly.

**Image wavelength depends on input wavelength**

The following table shows the relationship between input wavelength and displayed images. A 700 nm laser displays at both 700 nm and 1400 nm. Also, a 1500 nm laser displays at 1500 nm and 750 nm.

Light sources outside the 600 nm to 1700 nm input range can also result in displayed multiple images. For example a laser at 300 nm causes images at 600 nm, 900 nm, 1200 nm, and 1500 nm.

**Input Wavelength Versus Multiple Images**

<b>Input Wavelength</b>	<b>Wavelengths of Displayed Responses</b>
$\lambda \leq 850 \text{ nm}$	$\lambda, 2\lambda$
$\lambda \geq 1200 \text{ nm}$	$\lambda, \frac{\lambda}{2}$



**Understanding Multiple-Order Responses**

The following figures show the displayed response of a 632.8 nm helium-neon laser. In the figure on the left, both the laser response and its image are visible. In the figure on the right, the span is reduced around the 1265.6 nm image. Without an understanding of multiple-order responses, this multiple image could be mistaken for a true response.

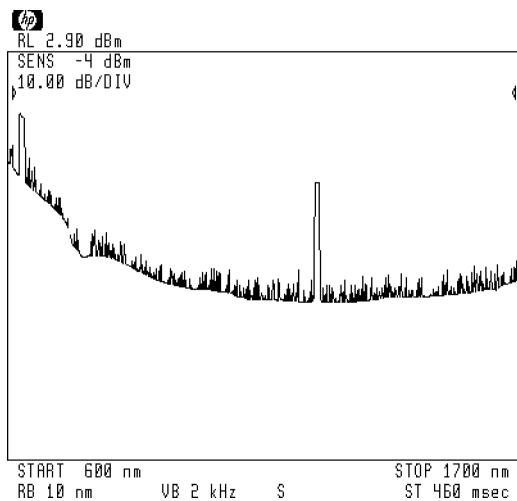

**Full span view: laser and 1265 nm image.**

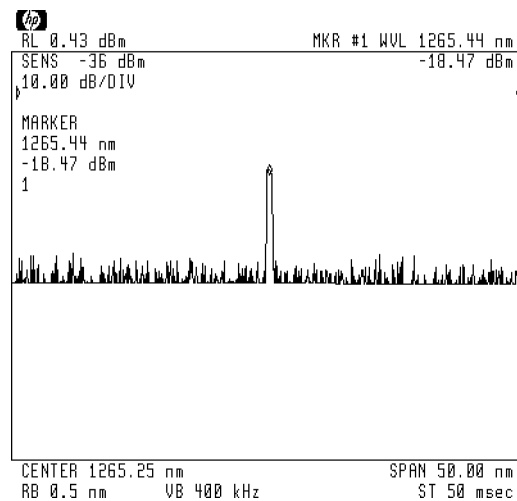

**Image response at 1265 nm**

### Understanding Multiple-Order Responses

In the following figures, a 1319 nm Fabry-Perot laser results in a sub-multiple image at 659.5 nm. However, unlike the multiple image shown in the previous figures, the Fabry-Perot laser's sub-multiple image cannot be seen in full span. (See the figure on the left.) If the stop wavelength is set below 900 nm as shown in the figure on the right, the sub multiple appears. This is due to the grating order used for this sweep. The following paragraphs discuss grating orders.

In full-span sweeps:

- Multiple images are displayed
- Sub-multiple images are *not* displayed

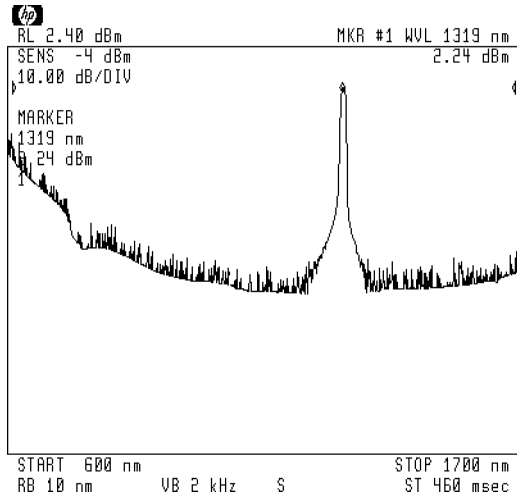

Full span view: sub-multiple not shown.

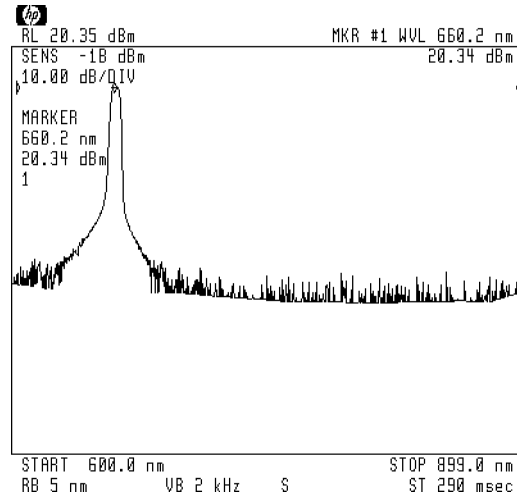

Sub-multiple response at 660 nm

**Understanding Multiple-Order Responses**

**The mode used depends on instrument settings**

The optical spectrum analyzer's internal monochromator operates in either the 1<sup>st</sup> or 2<sup>nd</sup> order diffraction-grating mode. The mode selected is based on the following instrument conditions:

- Full  $\lambda$  span . . . . . 1<sup>st</sup> order
- Stop  $\lambda < 900$  nm (RES BW = 10 nm) . . . . . 1<sup>st</sup> order
- Stop  $\lambda < 900$  nm (RES BW  $\neq$  10 nm) . . . . . 2<sup>nd</sup> order

The position of the diffraction grating for the 2<sup>nd</sup> order (600 nm – 899 nm) is the same as the 1<sup>st</sup> order (1200 nm – 1798 nm). Both the sub-multiple responses of input signals in the 1200 – 1798 nm range and 2<sup>nd</sup> order responses (the desired response) in the 600 – 899 nm range are displayed.

The optical spectrum analyzer never switches the order during a sweep. Notice that in full span (1<sup>st</sup> order), the monochromator loss near 600 nm is greater than if 2<sup>nd</sup> order is used.

**Change the order to test sub-multiple images**

If the optical spectrum analyzer's stop wavelength is less than 900 nm (and the resolution bandwidth is not 10 nm), 2<sup>nd</sup> order is used, and you can test for sub-multiples. Press **ORDER AutoMan** so that **Man** is underlined. (This always sets the 1<sup>st</sup> order mode.) If the displayed image disappears, it is a sub-multiple and not a true response.

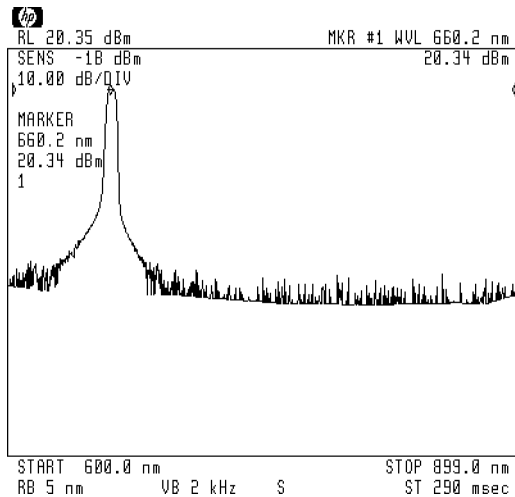

**2<sup>nd</sup> order: sub-multiple shown.**

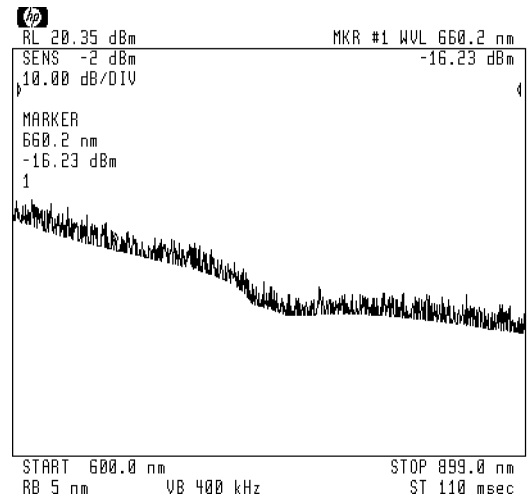

**1<sup>st</sup> order: sub-multiple not shown.**

## To test for sub-multiples

1. Ensure that the stop wavelength is set to 900 nm or less.
2. Ensure that the resolution bandwidth is not 10 nm.
3. Press the left-side **State** softkey.
4. Press **MORE 1 of 4** and then **MORE 2 of 4**.
5. Press **ORDER AutoMan** so that **Man** is underlined.

The optical spectrum analyzer changes from using the 2<sup>nd</sup> order diffraction grating mode to the 1<sup>st</sup> order.

6. If the image disappears, it is a sub-multiple image.



---

## Aligning the Optical Spectrum Analyzer

### **Alignment is easy to perform**

The automatic alignment adjusts the mechanical position of the optical spectrum analyzer's internal optical components. This ensures the amplitude accuracy of your measurements. An **AUTO ALIGN** takes approximately 20 seconds to complete and should be performed whenever the optical spectrum analyzer has been:

- Moved.
- Subjected to large environmental temperature changes.
- Warmed up at the start of each day.

The alignment requires a light source be displayed within the 600 to 1700 nm input range. Alignment is accomplished with the press of a single key. If needed, the compensation determined by the alignment can be removed as described in this section. (An instrument preset will not remove the alignment.)

Normally, the alignment occurs on the largest input signal located within the 600 to 1700 nm input range. However, if a marker is displayed, the alignment occurs at the wavelength indicated by the marker.

### **Extended alignments at multiple wavelengths**

An extended alignment is available using either the Option 002 built-in white-light source or an external white-light source. If the Option 002 white-light source is used, 17 equally spaced alignments are performed between 900 nm and 1700 nm. If an external white-light source is used, several equally-spaced alignments are performed with the alignments separated by no more than 50 nm.

---

## To align at largest input signal

1. Display a light-source response on the optical spectrum analyzer.
2. Perform one of the following steps:
  - Press **AUTO ALIGN**.
  - Press the left-side **Amptd** softkey and then **AUTO ALIGN**.
  - Press the left-side **Misc** softkey followed by **MORE 1 of 3**, **service**, **extnded align**, and then **MANUAL ALIGN**.

---

## To align at the marker

1. Display a light-source response on the optical spectrum analyzer.
2. If no markers are displayed (or if delta markers are displayed), press **NORMAL ON/OFF**.
3. Use the front-panel knob to place the marker on the signal that you want the alignment to use.
4. Press **AUTO ALIGN**.

## To align with Option 002 internal light source

This procedure requires that your optical spectrum analyzer is equipped with the Option 002 built-in white light source. Once started, the alignment takes about 2 to 3 minutes to complete.

1. Use a fiber-optic cable to connect the optical spectrum analyzer's **LIGHT SOURCE OUTPUT** and **MONOCHROMATOR INPUT** connectors.

On HP 71450B/2B optical spectrum analyzers, the **MONOCHROMATOR INPUT** connector will be labeled **OPTICAL INPUT**.

2. Press the left-side **Misc** softkey.
3. Press **MORE 1 of 3**, **service**, and then **extnded align**.
4. Press **W LIGHT ALIGN**.

---

## To align with an external light source

This procedure requires that you connect an external white-light source to the optical spectrum analyzer. Once started, the alignment takes about 2 to 3 minutes to complete. The light source must have the following characteristics:

Start wavelength .....  $\geq$  600 nm  
Stop wavelength .....  $\leq$  1700 nm  
Span .....  $>$ 10 nm

1. Use a fiber-optic cable to connect the external white-light source to the optical spectrum analyzer's **MONOCHROMATOR INPUT** connector.

On HP 71450B/2B optical spectrum analyzers, the **MONOCHROMATOR INPUT** connector will be labeled **OPTICAL INPUT**.

2. Press the left-side **Misc** softkey.
3. Press **MORE 1 of 3**, **service**, and then **extnded align**.



4. Press **AUTOPTS ALIGN**.

---

### To remove alignment offsets

1. Press the left-side **Misc** softkey.
2. Press **MORE 1 of 3**, **service**, and then **extnded align**.
3. Press **ALIGN PRESET**.

---

# Calibrating the Optical Spectrum Analyzer

Calibrating the optical spectrum analyzer ensures maximum wavelength and amplitude accuracy for your measurements.

**Verify factory calibration once every two years**

Your optical spectrum analyzer has been calibrated at the factory across its full wavelength range. You should verify this calibration once every two years using the automated procedures located in the optical spectrum analyzer's *Installation and Verification* manual. These factory calibration factors are stored in non-erasable memory and are always applied to the measured data.

**Perform user calibration to improve accuracy**

The calibration described in this section can improve wavelength and amplitude accuracy as specified in the *Reference* manual's "Specifications and Characteristics" chapter. User calibrations require a stable (amplitude and wavelength) single-frequency laser within the 600 to 1700 nm range. Wavelength and power calibrations are performed separately. You can access the Calibration menu from both the **Waveln** and **Amptd** menus.

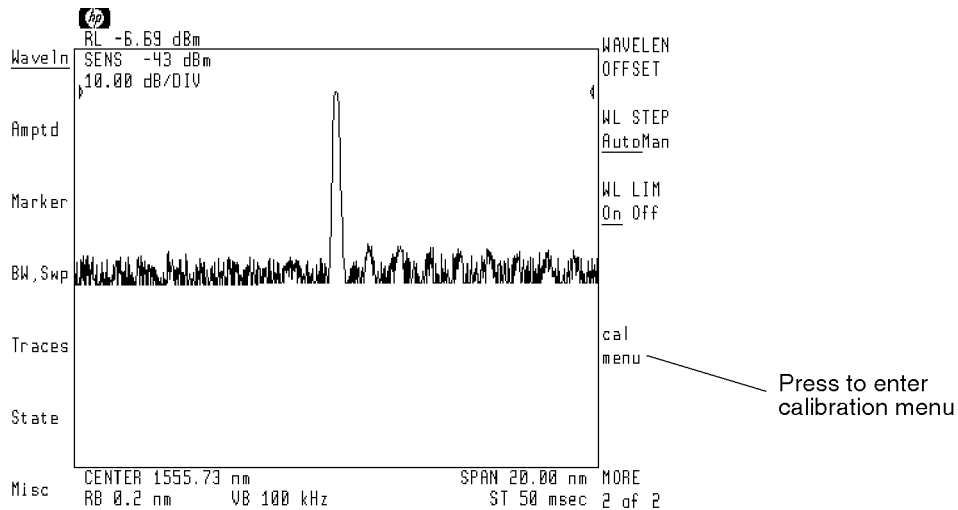

**Calibrating the Optical Spectrum Analyzer**

**Locating the calibration signal**

During a calibration, the optical spectrum analyzer defaults expect a signal within the following limits:

Power . . . . .  $-5 \text{ dBm} \pm 5 \text{ dB}$   
 Wavelength . . . . .  $1300 \pm 2 \text{ nm}$

If your signal is not within these limits, use **POWER FOR CAL** to enter the power and **WAVELEN FOR CAL** to enter the wavelength. If you calibrate only power, the approximate wavelength of the source must also be entered. If you calibrate only wavelength, the approximate power of the source must also be entered. Of course, if you are calibrating both wavelength and power, you will enter exact values. You can use markers to obtain the approximate wavelength and power values.

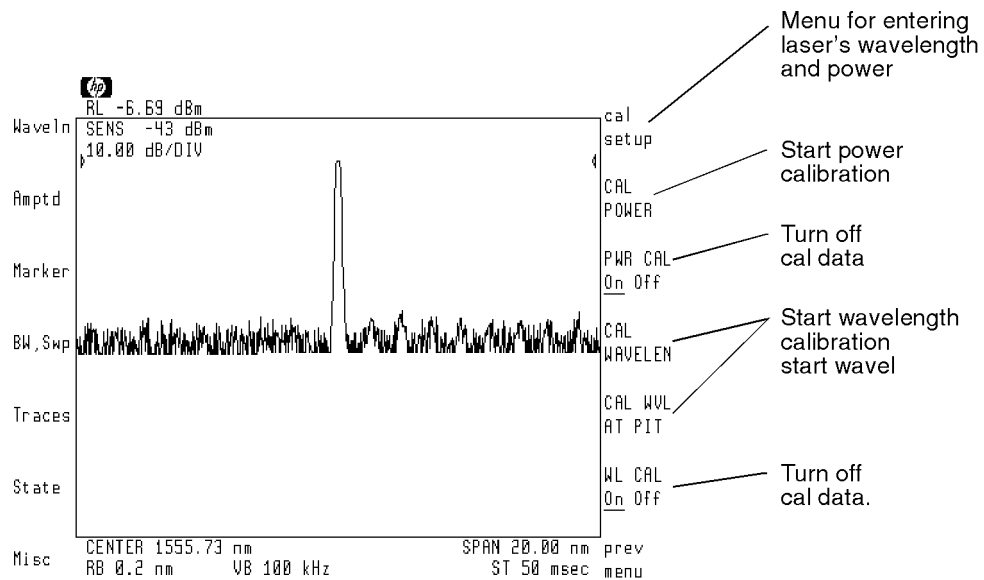

**The Calibration menu**

basic21

### **Calibrating the Optical Spectrum Analyzer**

The optical spectrum analyzer's maximum calibration adjustment is about 2 nm in wavelength. If a larger adjustment is attempted, error 2023, Illegal Cal signal is displayed. To ensure the success of a wavelength calibration, the entered power-calibration value must be close to the calibration signal's power level. This is true even though you may not perform a power calibration.

At any time, you can prevent the use of either wavelength or power calibration data. You can also reenter or erase the calibration from memory.

Because the optical spectrum analyzer is slightly polarization sensitive, power calibrations should be performed by persons knowledgeable on the effects of polarization on optical power measurements. During a power calibration, the light source's output power is first measured with a power meter. Then, the fiber-optic cable is disconnected from the power meter and connected to the optical spectrum analyzer. Because moving fiber-optic cables changes polarization, the output power may vary.

---

## To calibrate wavelength

1. Measure the wavelength of a precision single-mode laser between 600 to 1700 nm using a wavelength meter. Enter the wavelength in the space provided below.

wavelength: \_\_\_\_\_nm

### Factory calibration is at STP

The optical spectrum analyzer is calibrated at the factory to read wavelength in air at standard temperature and pressure. Measure the wavelength of the source in *air* to be consistent with factory calibration. Enter the wavelength in *vacuum* if you wish to have the optical spectrum analyzer read wavelength corrected to a vacuum environment.

2. Connect the laser to the optical spectrum analyzer's front-panel input connector.
3. Press **AUTO MEAS** to perform an automatic measurement of the signal.
4. Press **AUTO ALIGN** to align the optical spectrum analyzer.
5. Press the left-side **WaveIn** softkey.
6. Press **MORE 1 of 2**, **cal menu**, and then **cal setup**.
7. Press **WAVELEN FOR CAL**.
8. Use the numeric keypad to enter the wavelength value recorded in step 1.
9. Press **POWER FOR CAL**.
10. A marker should be positioned on the peak of the laser's response. Read the marker amplitude value shown at the top of the display, and use the numeric keypad to enter this value.

**Calibrating the Optical Spectrum Analyzer**

11. Press **prev menu** and then **CAL WAVELEN** to start the calibration routine.

The calibration routine takes several seconds to complete.

---

## To calibrate power and wavelength

This procedure calibrates both power and wavelength. You can also use it to calibrate only the power. In this case, simply enter the wavelength of the source as measured with the optical spectrum analyzer in step 1 of this procedure.

The optical spectrum analyzer stores separate user power-calibration offsets for the power-meter instrument mode and other instrument modes. User power-calibrations that are performed in the optical spectrum analyzer mode do not affect amplitude readings in power-meter instrument mode. To apply user-calibration corrections in power-meter instrument mode, calibrate the power (**CAL POWER**) in the power-meter instrument mode. If you calibrate the power in power-meter instrument mode, some of the following steps may not apply.

### **Ensuring amplitude accuracy**

During this procedure, avoid moving the fiber-optic cables whenever possible. Moving fiber-optic cables changes the polarization of the light which affects power measurements.

1. Measure the wavelength of a precision single-mode laser between 600 and 1700 nm:
  - Use a wavelength meter if you're calibrating both power and wavelength.
  - Use the optical spectrum analyzer if you're calibrating the power and *not* wavelength.

wavelength: \_\_\_\_\_nm

### Calibrating the Optical Spectrum Analyzer

#### Factory calibration is at STP

The optical spectrum analyzer is calibrated at the factory to read wavelength in air at standard temperature and pressure. Measure the wavelength of the source in *air* to be consistent with factory calibration. Enter the wavelength in *vacuum* if you wish to have the optical spectrum analyzer read wavelength corrected to a vacuum environment.

2. Connect the laser to a polarization controller. Connect the output of the polarization controller to a power meter.
3. Adjust the polarization controller to achieve the maximum power reading on the power meter. Record the power level on the following line:

maximum power: \_\_\_\_\_dBm

4. Adjust the polarization controller to achieve a minimum power reading on the power meter. Record the power level on the following line:

minimum power: \_\_\_\_\_dBm

If there is a significant change between the maximum and minimum values recorded above, check that the polarization state controller is appropriate for the source wavelength.

5. Calculate the average of the two power readings recorded in steps 3 and 4 using the following equation. Record the result below:

$$\text{average power} = \frac{\text{minimum power} + \text{maximum power}}{2}$$

average power: \_\_\_\_\_dBm

6. Disconnect the fiber-optic cable from the power meter, and connect the cable to the optical spectrum analyzer's input connector.
7. Press **AUTO MEAS** to display the laser's response.
8. Press **AUTO ALIGN** to align the optical spectrum analyzer.
9. Press **RES BW**, and enter a 0.5 nm bandwidth.
10. Press **PEAK SEARCH** and then **TO CENTER**.
11. Press **SPAN**, and enter a wavelength span of 1 nm.



**Calibrating the Optical Spectrum Analyzer**

12. Press **PEAK SEARCH** and then **TO CENTER**.
13. Press **SPAN**, and enter a wavelength span of 0 nm.
14. Press the left-side **Amptd** softkey.
15. Press **LOG dB/DIV**, **1**, and **dB** to select a 1 dB logarithmic amplitude scale.
16. Press the left-side **BW, Swp** softkey.
17. Press **SWPTIME AutoMan**, **1**, **0**, and then **s**.
18. Adjust the polarization controller to “peak” the trace displayed on the optical spectrum analyzer.

This sets the polarization for a maximum power reading.

19. Press **PEAK SEARCH**, and record the power level indicated by the marker:  
 maximum power: \_\_\_\_\_ dBm

20. Press **Δ**.

21. Adjust the polarization controller to “dip” the trace displayed on the optical spectrum analyzer to a minimum power value.

22. Record the marker-delta power level on the following line:

Δ power: \_\_\_\_\_ dBm

23. Use the values recorded in steps 19 and 22 to calculate the average displayed power as shown in the following equation. Record the result below:

$$average\ power = maximum\ power - \frac{\Delta\ power}{2}$$

average power: \_\_\_\_\_

24. Press the left-side **Amptd** softkey.
25. Press **MORE 1 of 4**, **MORE 2 of 4**, and then **AMETER On Off** so that **On** is underlined.
26. Adjust the polarization controller to achieve a displayed Amplitude Meter power level equal to the power level recorded in step 23.

**Ensuring amplitude accuracy**

It is very important not to move the fiber-optic cables during the remaining steps of this procedure.

27. Press the left-side **Waveln** softkey. Then, press **MORE 1 of 2**, **cal menu**, **cal setup**, and then **POWER FOR CAL**.
28. Use the numeric keypad to enter the power level recorded in step 5.
29. Press **WAVELEN FOR CAL**. Enter the wavelength recorded in step 1.
30. Select one or both of the following steps to complete the calibration:
  - If you're calibrating the wavelength, press **prev menu** and then **CAL WAVELEN**.
  - If you're calibrating the power, press **prev menu** and then **CAL POWER**.

---

## To turn off user-calibration

1. Press the left-side **Amptd** softkey.
2. Press **MORE 1 of 2** and then **cal menu**.
3. Press **PWR CAL On Off** so that **Off** is underlined to prevent the use of the power calibration.
4. Press **WL CAL On Off** so that **Off** is underlined to prevent the use of the wavelength calibration.

The **USERCAL** annotation is removed from the screen indicating that the user-calibrations are disabled. The factory-installed calibrations are still used.

## To erase user-calibration

1. Press the left-side **Amptd** softkey.
2. Press **MORE 1 of 2**, **cal menu**, and then **cal setup**.
3. Press **USERCAL PRESET**.

---

## Cleaning Connections for Accurate Measurements

Accurate and repeatable measurements require clean connections. Use the following guidelines to achieve the best possible performance when making measurements on a fiber-optic system:

- Keep connectors covered when not in use.
- Use dry connections whenever possible.
- Use the cleaning methods described in this section.
- Use care in handling all fiber-optic connectors.
- When inserting a fiber-optic connector into a front-panel adapter, make sure that the fiber end does not touch the outside of the mating connector or adapter.

Because of the small size of cores used in optical fibers, care must be used to ensure good connections. Poor connections result from core misalignment, air gaps, damaged fiber ends, contamination, and improper use and removal of index-matching compounds.

Use dry connections. Dry connectors are easier to clean and to keep clean. Dry connections can be used with physically contacting connectors (for example, Diamond HMS-10/HP, FC/PC, DIN, and ST). If a dry connection has 40 dB return loss or better, making a wet connection will probably not improve (and can degrade) performance.

---

**CAUTION**

---

Hewlett-Packard strongly recommends that index matching compounds NOT be applied to their instruments and accessories. Some compounds, such as gels, may be difficult to remove and can contain damaging particulates. If you think the use of such compounds is necessary, refer to the compound manufacturer for information on application and cleaning procedures.

### Cleaning Accessories

Item	HP Part Number
Isopropyl alcohol	8500-5344
Cotton swabs	8520-0023
Small foam swabs	9300-1223
Compressed dust remover (non-residue)	8500-5262

**Cleaning Connections for Accurate Measurements****Dust Caps Provided with Lightwave Instruments**

Item	HP Part Number
Laser shutter cap	08145-64521
FC/PC dust cap	08154-44102
Biconic dust cap	08154-44105
DIN dust cap	5040-9364
HMS10/HP dust cap	5040-9361
ST dust cap	5040-9366

**Inspecting Fiber-Optic Cables**

Consistent measurements with your lightwave equipment are a good indication that you have good connections. However, you may wish to know the insertion loss and/or return loss of your lightwave cables or accessories. If you test your cables and accessories for insertion loss and return loss upon receipt, and retain the measured data for comparison, you will be able to tell in the future if any degradation has occurred.

Connector (or insertion) loss is one important performance characteristic of a lightwave connector. Typical values are less than 1 dB of loss, and sometimes as little as 0.1 dB of loss with high performance connectors. Return loss is another important factor. It is a measure of reflection: the less reflection the better (the larger the return loss, the smaller the reflection). The best physically contacting connectors have return losses better than 50 dB, although 30 to 40 dB is more common.

**You can visually inspect your cables**

Although it is not necessary, visual inspection of fiber ends can be helpful. Contamination or imperfections on the cable end face can be detected as well as cracks or chips in the fiber itself. Use a microscope (100X to 200X magnification) to inspect the entire end face for contamination, raised metal, or dents in the metal as well as any other imperfections. Inspect the fiber for cracks and chips. Visible imperfections not touching the fiber core may not affect performance (unless the imperfections keep the fibers from contacting).

---

## To clean a non-lensed connector

---

**CAUTION**

---

Do not use any type of foam swab to clean optical fiber ends. Foam swabs can leave filmy deposits on fiber ends that can degrade performance.

1. Apply isopropyl alcohol to a clean lint-free cotton swab or lens paper.  
Cotton swabs can be used as long as no cotton fibers remain on the fiber end after cleaning.
2. Before cleaning the fiber end, clean the ferrules and other parts of the connector.
3. Apply isopropyl alcohol to a new clean lint-free cotton swab or lens paper.
4. Clean the fiber end with the swab or lens paper. Move the swab or lens paper back and forth across the fiber end several times.

Some amount of wiping or mild scrubbing of the fiber end can help remove particles when application of alcohol alone will not remove them. This technique can remove or displace particles smaller than one micron.

5. Immediately dry the fiber end with a clean, dry, lint-free cotton swab or lens paper.
6. Blow across the connector end face from a distance of 6 to 8 inches using filtered, dry, compressed air. Aim the compressed gas at a shallow angle to the fiber end face.

Nitrogen gas or compressed dust remover can also be used.

---

**CAUTION**

---

Do not shake, tip, or invert compressed air canisters, because this releases particles in the can into the air. Refer to instructions provided on the compressed air canister.

7. As soon as the connector is dry, connect or cover it for later use.

---

## To clean an adapter

1. Apply isopropyl alcohol to a clean foam swab.

Cotton swabs can be used as long as no cotton fibers remain after cleaning. The foam swabs listed in this section's introduction are small enough to fit into adapters.

Although foam swabs can leave filmy deposits, these deposits are very thin, and the risk of other contamination buildup on the inside of adapters greatly outweighs the risk of contamination by foam swabs.

2. Clean the adapter with the foam swab.
3. Dry the inside of the adapter with a clean, dry, foam swab.
4. Blow through the adapter using filtered, dry, compressed air.

Nitrogen gas or compressed dust remover can also be used.

---

### **CAUTION**

Do not shake, tip, or invert compressed air canisters, because this releases particles in the can into the air. Refer to instructions provided on the compressed air canister.

---

---

## To test insertion loss

Use an appropriate lightwave source and a compatible lightwave receiver to test insertion loss. Examples of test equipment configurations include the following equipment:

- HP 71450A or HP 71451A optical spectrum analyzers with Option 002 built-in white light source.
- HP 8702 or HP 8703 lightwave component analyzer system
- HP 83420 lightwave test set with an HP 8510 network analyzer
- HP 8153 lightwave multimeter with a source and power sensor module

## To test return loss

Use an appropriate lightwave source, lightwave receiver, and lightwave coupler to test return loss. Examples of test equipment configurations include the following equipment:

- HP 8703 lightwave component analyzer
- HP 8702 analyzer with the appropriate source, receiver, and lightwave coupler
- HP 8504 precision reflectometer
- HP 8153 lightwave multimeter with a source and power sensor module in conjunction with a lightwave coupler
- HP 81554SM dual source and HP 81534A return loss module



**————** Displaying Signals (Part 2)

## Displaying Signals (Part 2)

In this chapter, you'll learn how to control instrument settings manually. Normally, sweep time and bandwidths are automatically controlled to ensure a calibrated display. However, manual control allows closer inspection of input signals.

If an **UNCAL** message is displayed after manually changing a setting, the display has become uncalibrated. Trace data may not meet specifications. For example, amplitude readouts may not be accurate. Change the setting so that **Auto** is underlined. Each individual setting can be returned to automatic coupling by pressing its softkey so that **Auto** is underlined. All settings can be returned to their coupled mode by pressing **(INSTR PRESET)**.

In addition, this chapter shows how to pulse light sources and save instrument setups.

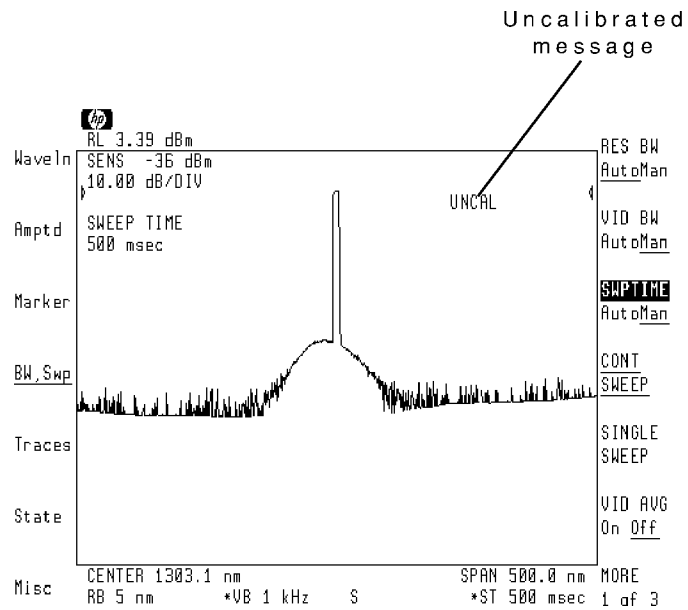

**Contents**

Resolving Wavelengths .....	2-4
To resolve closely spaced signals .....	2-6
To change the RB/span ratio .....	2-6
Reducing Displayed Noise .....	2-8
To reduce the displayed noise .....	2-11
Increasing Dynamic Range .....	2-12
To increase dynamic range .....	2-13
To disable chop mode .....	2-14
Controlling Sweeps .....	2-16
To set continuous or single sweeps .....	2-19
To set the sweep time .....	2-20
To stop the sweep .....	2-20
To reduce sweep retrace time .....	2-21
Triggering Sweeps .....	2-22
To use freerun triggering .....	2-25
To use video triggering .....	2-25
To use line triggering .....	2-26
To use external triggering .....	2-26
To delay the sweep .....	2-26
Saving Instrument Setups .....	2-27
To save or recall a measurement state .....	2-27
To protect measurement state files .....	2-28
To select the power-on state .....	2-28

---

# Resolving Wavelengths

## Resolution bandwidth determines wavelength resolution

The ability to display two closely spaced signals, in wavelength, as two distinct responses is determined by resolution bandwidth. The resolution bandwidth can be set to one of the following values: 0.08, 0.1, 0.2, 0.5, 1, 2, 5, or 10 nanometers. (The 0.08 nm filter does not guarantee warranted accuracies and can only be entered using the numeric keypad.)

Normally, the resolution bandwidth is coupled to the span in a preset 0.01:1 ratio. This means that the optical spectrum analyzer attempts to set a bandwidth value that is 1% of the span setting. (Because bandwidths are available in discrete steps, the actual bandwidth will be between 1% and 40% of the span.) You can alter this behavior by one of two methods:

- Manually setting the resolution bandwidth.
- Changing the resolution bandwidth to span ratio.

Manually entering a resolution bandwidth disengages the coupling between resolution bandwidths and span. This condition is indicated by an asterisk (\*RB) next to the screen annotation.

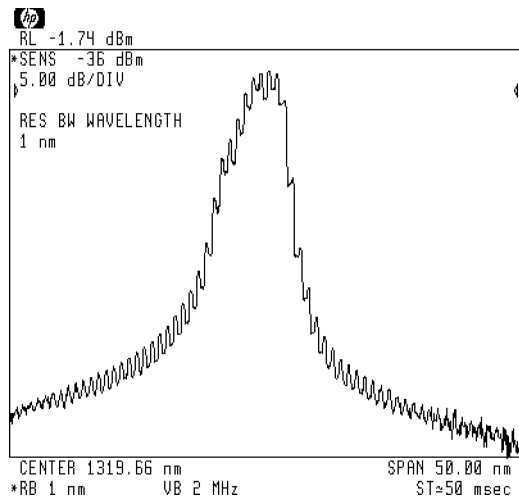

**Wide Resolution Bandwidth**

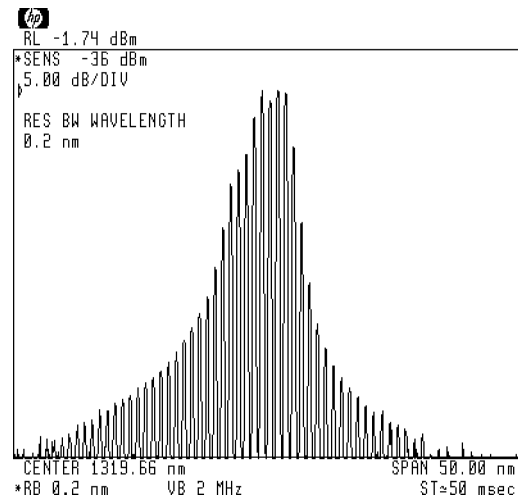

**Narrower Resolution Bandwidth**

The resolution bandwidth filter determines the shape of the displayed response. If the bandwidth is large, the top of the signal is flat and the signal wavelength is not easily identified. The following figure shows three modes of a Fabry-Perot laser. Each mode is displayed using a different resolution bandwidth. As the bandwidth is decreased, the signal's wavelength becomes evident.

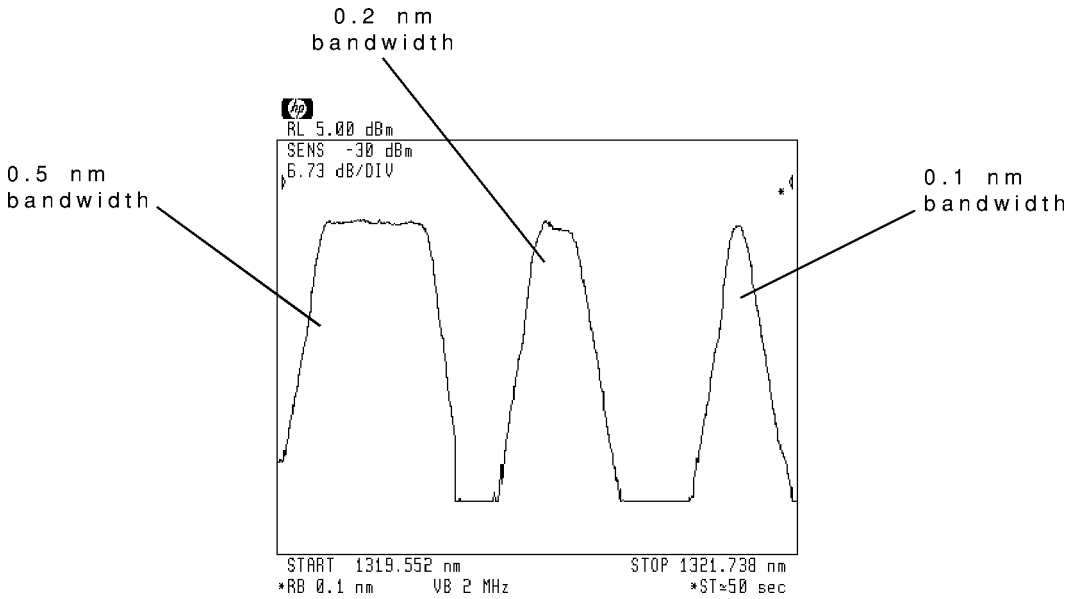

---

## To resolve closely spaced signals

1. Press the left-side **BW,Swp** softkey.
2. Press **RES BW AutoMan**.
3. Press **▼** to reduce the resolution bandwidth. Or, use the knob or numeric keypad to enter a reduced resolution bandwidth.

Valid bandwidths are 0.08, 0.1, 0.2, 0.5, 1, 2, 5, and 10 nanometers.

The 0.08 bandwidth can only be entered using the numeric keypad.

To return to autocoupled resolution bandwidths, press the **RES BW AutoMan** softkey so that **Auto** is underlined.

---

## To change the RB/span ratio

1. Press the left-side **BW,Swp** softkey.
2. Press **MORE 1 of 3**, **MORE 2 of 3**, and then **RB/SPAN RATIO**.
3. Enter a RB/span ratio using the knob, step keys, or numeric keypad.

The default ratio is: 0.01.



---

## Reducing Displayed Noise

### Sensitivity reduces displayed noise

Higher sensitivity settings reduce the displayed noise floor. Although this method often reveals signal that might otherwise be hidden, it also results in longer sweep times. For more information on changing the sensitivity, refer to Chapter 1.

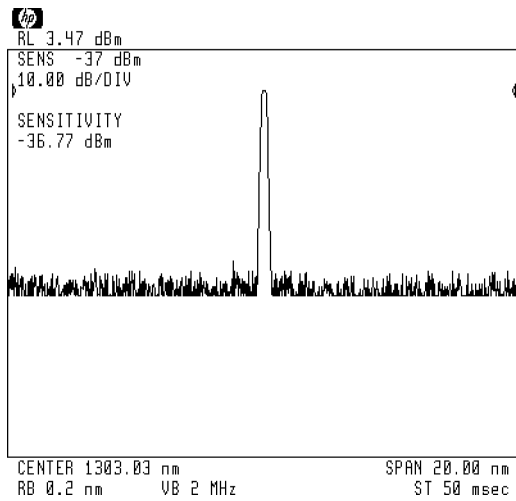

Low sensitivity hides sidemodes.

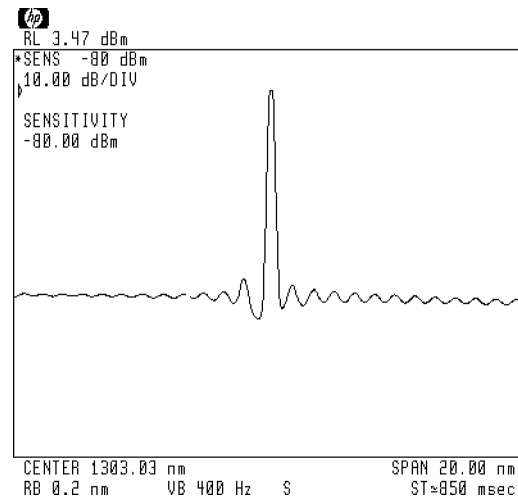

Higher sensitivity reveals sidemodes.



**Video bandwidth  
reduces displayed noise**

The video bandwidth determines the level of the displayed noise. Decreasing the video bandwidth reduces the displayed noise. Normally, the video bandwidth is coupled to the sensitivity. Manually entering a video bandwidth breaks this coupling. Manual video bandwidths are indicated by an asterisk (\*VB) next to the screen annotation.

The video bandwidth can be manually set from 100 mHz to 3 kHz up to a maximum value of 400 kHz. In the autocoupled mode, the video bandwidth has an extremely wide range. This allows the optical spectrum analyzer to avoid unnecessary filtering that would reduce the sweep speed more than required. The narrowest video bandwidths are obtained using one of the following methods:

- Entering a video bandwidth manually with **VID BW AutoMan**.
- Entering a lower sensitivity value.
- Reducing the reference level.
- Turning autoranging off (using the **AUTORNG On Off** softkey).

The following figures show how video filtering can be used to reveal side modes hidden by the noise.

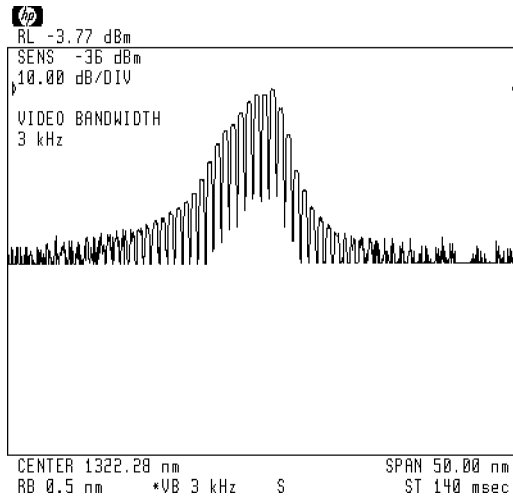

**3 kHz video filtering.**

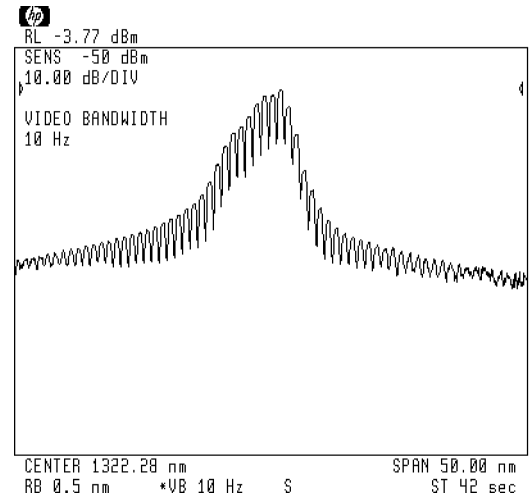

**10 Hz filtering.**

**Reducing Displayed Noise**

**Video averaging reduces displayed noise**

Video averaging allows you to view signals that are within 6 dB of the displayed noise floor. This eliminates the need to increase sensitivity at the expense of longer sweep times. Video averaging reduces displayed noise by averaging the response of multiple trace sweeps. The resulting display shows the value of the averaged traces.

Video averaging operates on trace A; it does not affect traces B or C. The optical spectrum analyzer keeps a running average using trace data from the number of sweeps you specify. The default average uses 100 sweeps. However, you can change the average from 1 to 10,000 traces. Use the front-panel keys to change the number of trace sweeps averaged.

Once started, you can restart averaging any time by turning video averaging off and then on again. Also, any change in the instrument's state that affects averaging automatically restarts the video averaging.

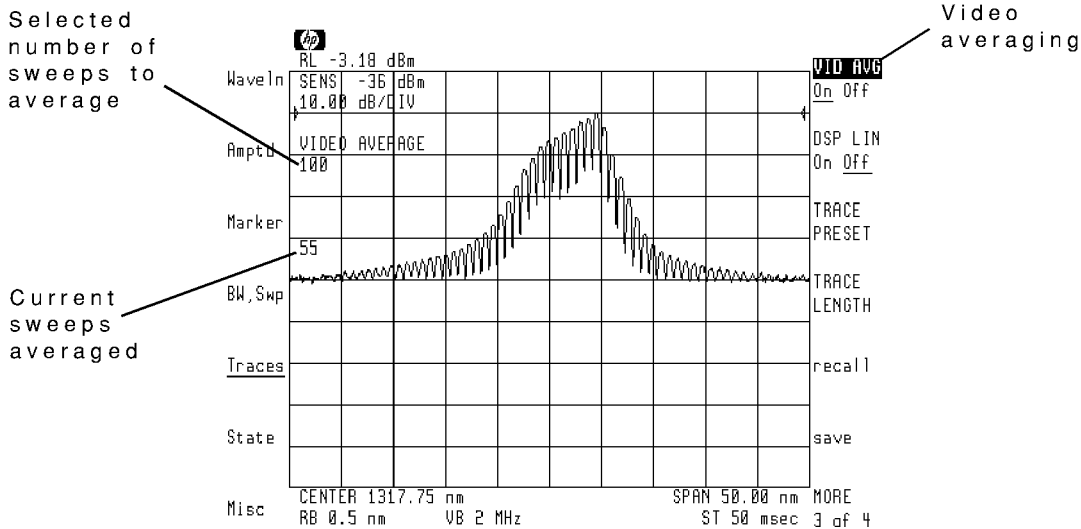

Page 3 of Traces Menu

---

## To reduce the displayed noise

- Via sensitivity:

1. Press the left-side **Amptd** softkey.
2. Press **SENS AutoMan** and use the knob, numeric keypad, or **▼** key to reduce the sensitivity.

To return to autocoupled sensitivity, press the **VID BW AutoMan** softkey so that **Auto** is underlined.

- Via video bandwidth:

1. Press the left-side **BW,Swp** softkey.
2. Press **VID BW AutoMan** and use the knob, numeric keypad, or **▼** key to reduce the video bandwidth.

To return to autocoupled video bandwidths, press the **VID BW AutoMan** softkey so that **Auto** is underlined.

- Via video averaging:

1. Press the left-side **Traces** softkey to enter the Traces menu. Trace A must be in the clear-write mode.
2. Press **MORE 1 of 4** and then **MORE 2 of 4**.
3. Press the **VID AVG On Off** softkey so that **On** is underlined.
4. Enter the number of sweeps to average the displayed trace. Or, use the default of 100 trace averages.
5. Press **VID AVG On Off** to **Off** and then **On** to restart averaging at any time.

---

## Increasing Dynamic Range

Dynamic range determines the ability to view small signals in the presence of a large signal. Large input signals can reduce dynamic range by producing stray light inside the optical spectrum analyzer's internal monochromator. This stray light raises the displayed noise floor, which reduces the dynamic range. To compensate for the effect of stray light, the optical spectrum analyzer uses a special "chop" mode. In chop mode, the optical spectrum analyzer's photodetector is "zeroed" before each measurement. (This effectively measures and subtracts the stray light and noise from each measured trace point.)

Chop mode also compensates for electronic drift during long sweeps. Although chop mode is not required for the optical spectrum analyzer to meet its dynamic range specifications, it can be used to enhance the dynamic range. Video averaging further enhances the effectiveness of chop mode.

Chop mode is automatically turned on whenever the sweep time is 40 seconds or longer. For many measurements, stray light and electronic drift will not be a problem. If needed, you can disable chop mode.

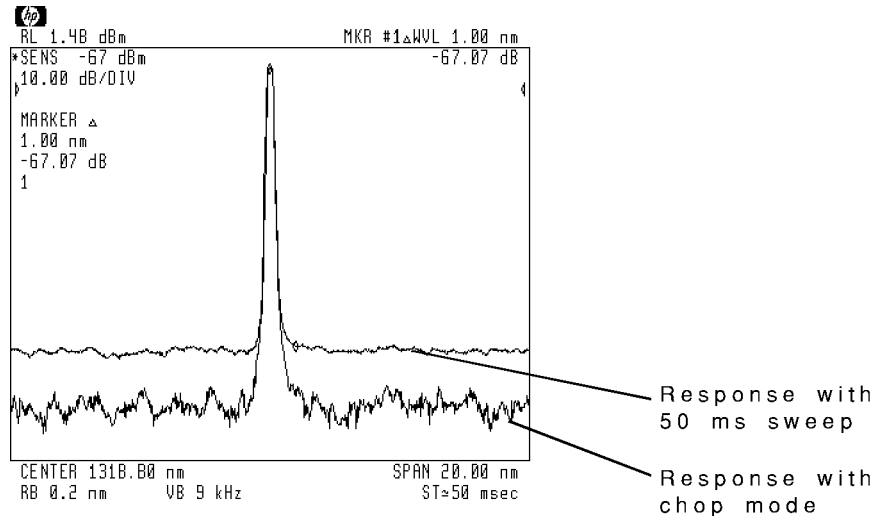

**Chop mode is related to trace length**

The sweep time at which chop mode turns on depends on the length of the displayed trace. For the default trace length of 800 points, chop mode turns on for sweep times of 40 seconds or longer. If the trace length is changed (as described in Chapter 8), the sweep time at which chop mode turns on changes as indicated by the following equation:

$$\text{sweep time} \simeq (50 \text{ ms}) (\text{trace length})$$

---

## To increase dynamic range

1. Press the left-side **BW, Swp** softkey.
2. Press **SWPTIME AutoMan**, and use the numeric keypad to enter 40 seconds.

Any sweep time of 40 seconds or more turns on chop mode operation. This is true unless the **CHOP On Off** softkey is set to off as described in “To disable chop mode”.

3. Press **VID AVG On Off** so that **On** is underlined.

Since chop mode enhances the dynamic range by subtracting very small values of stray light and noise, averaging several sweeps generally leads to more meaningful display.

## To disable chop mode

1. Press the left-side **Amptd** softkey.
2. Press **MORE 1 of 4**.
3. Press **CHOP On Off** so that **Off** is underlined.



---

## Controlling Sweeps

The optical spectrum analyzer provides a wide range of sweep times. The sweep times range from 50 ms to a maximum value that depends on the number of trace points used to draw the trace. This relationship is shown in the following equation:

$$50 \text{ ms} \leq \text{sweep time} \leq (1\text{s})(\text{trace points})$$

The default number of trace points is 800, so the maximum sweep time is normally 800 seconds. If you change the number of trace points, the maximum sweep time becomes longer. Refer to “Changing Trace Length and Interpolation” in Chapter 8 for information on changing the trace length.

Sweeps can be continuous or single. The optical spectrum analyzer automatically selects sweep times based on coupling to the following instrument settings:

- Wavelength span.
- Resolution bandwidth.
- Video bandwidth.
- Sensitivity.
- Power level at top screen



Displaying Signals (Part 2)  
**Controlling Sweeps**

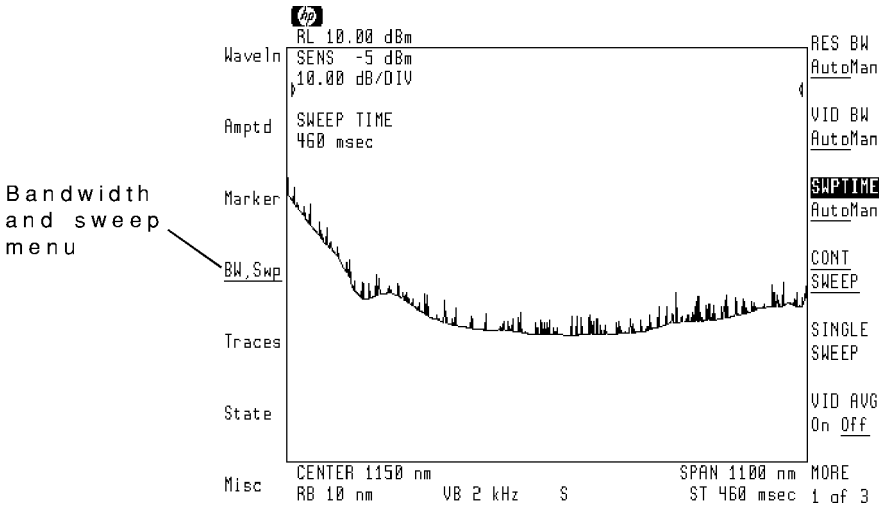

### Controlling Sweeps

#### Manual sweep times disable coupling

Manually setting the sweep time turns coupling off. If the sweep time is set too fast, an UNCAL message appears indicating the display is no longer calibrated and that trace data may not meet specifications. Increase the sweep time until UNCAL disappears. If the sweep time is set too slow, measurement times may be excessively long. Sweep times of 40 seconds or longer use a special “chop” mode. Chop mode provides the following advantages:

- Increases dynamic range.
- Stabilizes measurements against drift.
- Reduces effects of stray light.

Refer to “Increasing Dynamic Range” in this chapter to learn about chop mode. Manual sweep times are indicated by an asterisk (\*ST) next to the sweep time screen annotation.

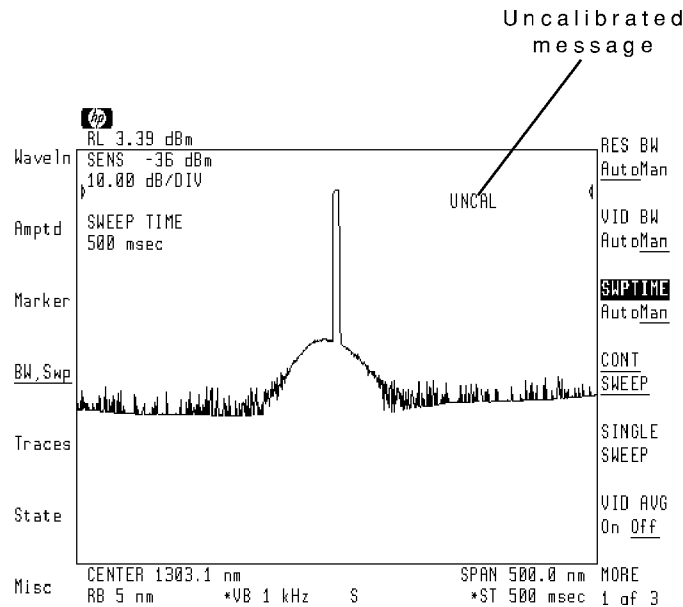

**Sweep retrace time can be reduced** The optical spectrum analyzer compensates for temperature-related current drift between each sweep. Although this “zeroing” increases amplitude accuracy, it increases the time between sweeps. If amplitude accuracy is not critical for your measurement, you can turn off “zeroing” between sweeps using the **AUTZERO On Off** softkey.

The optical spectrum analyzer performs a more complete “zeroing” when the instrument is first turned on. You can run this more complete routine anytime by pressing the **ZERO** softkey.

**The sweep can be disabled** You can prevent the optical spectrum analyzer from sweeping. Although the internal monochromator is rugged enough to withstand continuous sweeps, at times you may want to stop the sweep.

---

## To set continuous or single sweeps

1. Press the **BW,Swp** softkey.
2. Press one of the following softkeys:
  - **CONT SWEEP** to use continuous sweeping.
  - **SINGLE SWEEP** to sweep the measurement range once.

To repeat another single sweep, press **SINGLE SWEEP** again.

## Controlling Sweeps

---

### To set the sweep time

1. Press the **BW,Swp** softkey.
2. Use the knob, step keys, or numeric keypad to enter the desired sweep time.

To reestablish sweep time coupling, press **SWPTIME AutoMan** so that **Auto** is underlined.

Manually setting the sweep time disrupts the coupling used to maintain a calibrated display. Whenever a sweep time is selected that degrades accuracy, the uncalibrated warning **UNCAL** appears on the display.

---

### To stop the sweep

1. Press the left-side **BW,Swp** softkey.
2. Press **MORE 1 of 3** and then **MORE 2 of 3**.
3. Press **SWEEP On Off** so that **Off** is underlined.

---

## To reduce sweep retrace time

Reducing the sweep retrace time also decreases amplitude accuracy.

1. Press the left-side **Amptd** softkey.
2. Press **MORE 1 of 4** and then **MORE 2 of 4**.
3. Press **AUTZERO On Off** so that **Off** is underlined.

---

## Triggering Sweeps

You can select the type of trigger event used to start and synchronize each sweep. Choices are the following:

- Freerun.
- Video level (zero span only).
- Power line frequency.
- External trigger source.

When first turned on, the optical spectrum analyzer uses freerun triggering. Freerun triggering ensures continuous, evenly timed sweeps for a stable display of the current tuning range.

### **Video triggering uses the input signal**

Video triggering applies only to zero span sweeps. If the span is not 0 nm, freerun triggering occurs even if video is selected. Video triggering occurs on the detected and filtered input signal. A sweep occurs when the detected signal satisfies the following conditions: level, hysteresis, and direction. Hysteresis and direction allow you to specify triggering on a signal's rising or falling edge.

- Level: video signal amplitude that triggers the sweep. Preset value is  $-100$  dBm.
- Hysteresis: minimum increase or decrease in signal amplitude before crossing the trigger level. Preset value is 3 dB.
- Direction: whether the hysteresis is increasing (rising edge) or decreasing (falling edge). Preset direction is rising edge.

For example, if video hysteresis is  $+5$  dB, and the trigger level is  $-90$  dBm, the analyzer sweeps when the detected signal level changes from less than  $-95$  dBm to greater than  $-90$  dBm. Positive hysteresis values indicate triggering on the signal's rising edge. Negative values indicate triggering on the falling edge.

Use the **VID LIN On Off** softkey to display lines that show the current trigger level and hysteresis offset.

**Maximum and minimum values**  
Valid trigger levels range between  $\pm 300$  dBm. Valid hysteresis levels range between  $\pm 300$  dB.

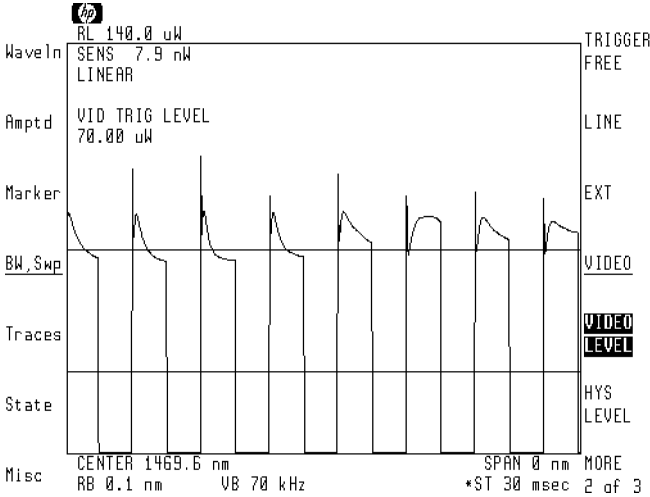

**Video trigger and hysteresis lines.**

### Triggering Sweeps

**External triggering uses an external signal**

External triggering synchronizes the sweep with a signal connected to the HP 70950A or HP 70951A module's rear-panel **EXT TRIG IN** connector. External triggering requires a TTL-compatible signal with a minimum of 0V and a maximum of +5V.

At times, there may be a delay between the event that you want to measure and the external trigger signal. If this delay is much larger than the sweep time, only a portion of the desired data may be seen. To remedy this situation, use the **TRIGGER DELAY** softkey to delay the start of the sweep up to 52 ms after the trigger condition is met. Delay can be entered with 1  $\mu$ s of resolution. The screen shows a " $\tau$ " symbol whenever delay is added to the trigger.

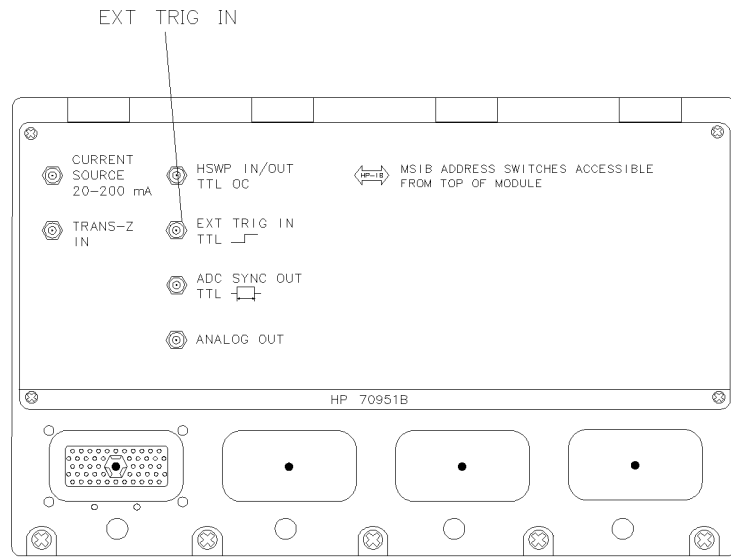

pkb10

**Rear panel of optical spectrum analyzer module.**



---

## To use freerun triggering

1. Press the left-side **BW, Swp** softkey.
2. Press **MORE 1 of 3** and then **TRIGGER FREE** softkey.

---

## To use video triggering

1. Press **SPAN**, and set the wavelength span to 0 nm.
2. Press the left-side **BW, Swp** softkey.
3. Press **MORE 1 of 3** and then **VIDEO LEVEL**, and enter the level required to trigger the sweep.
4. Press **HYS LEVEL**, and enter the hysteresis required to trigger the sweep.

Positive values indicate triggering on the signal's rising edge. Negative values indicate triggering on the falling edge. For example, if video hysteresis is +5 dB, and the trigger level is -90 dBm, the analyzer sweeps when the detected signal level changes from less than -95 dBm to greater than -90 dBm.

5. Press **VIDEO** to start video triggering.
6. If you want to view lines that show the video trigger and hysteresis levels, press **MORE 2 of 3** and then **VID LIN On Off**.

## Triggering Sweeps

---

### To use line triggering

1. Press the left-side **BW, Swp** softkey.
2. Press **MORE 1 of 3** and then **LINE**.

---

### To use external triggering

1. Connect the external trigger signal to the HP 70950A or HP 70951A module's rear-panel **EXT TRIG IN** connector.  

The trigger signal must be TTL-compatible (minimum and maximum values must be 0V and +5V).
2. Press the left-side **BW, Swp** softkey.
3. Press **MORE 1 of 3** and then **EXT**.

---

### To delay the sweep

1. Press the left-side **BW, Swp** softkey.
2. Press **MORE 1 of 3** and then **MORE 2 of 3**.
3. Press **TRIGGER DELAY**, and enter the amount of delay.

Up to 52 ms of delay can be entered with a 1 Hz resolution.

---

## Saving Instrument Setups

Measurement states greatly reduce the time required to set up measurements. Simply configure the optical spectrum analyzer for any measurement you repeatedly perform, then save the settings as a measurement state. Whenever this state is recalled, the previous instrument settings are automatically restored. Measurement states can be protected from accidental erasure using the **P STATE On Off** softkey.

The optical spectrum analyzer automatically configures to an instrument preset state whenever it is turned on. Using the **poweron menu** softkey, you can create a custom power-on state.

---

### To save or recall a measurement state

1. Press the left-side **State** softkey.
2. To store a measurement state, press **save**, and use the front-panel numeric keypad to enter a number for the file name.
3. To recall a measurement state you have stored, press **recall**, and use the front-panel numeric keypad to enter the file name's number.

If you cannot remember the file's number, enter the **Misc** menu's **catalog & MSI** menu to recall the file. Refer to Chapter 13 for information on using the catalog menu.

## Displaying Signals (Part 2)

---

### To protect measurement state files

1. Press the left-side **State** softkey.
2. Press **MORE 1 of 4**.
3. Press the **P STATE On Off** softkey so that **On** is underlined.

This procedure protects all measurement state files from accidental front-panel erasure. However, the files can still be erased by some programming applications.

---

### To select the power-on state

1. Press the left-side **State** softkey.
2. Press **MORE 1 of 4**, **MORE 2 of 4**, and then **poweron menu**.
3. Press one of the following selections:
  - **POWERON IP** selects the instrument preset condition.
  - **POWERON LAST** restores the last instrument settings before power was removed.
  - **POWERON RECALL** recalls state-register file 0.

**————** Displaying Pulsed Light

---

## Displaying Pulsed Light

The optical spectrum analyzer offers pulsed capability which allows you to make accurate measurements of time varying sources. For example, you could pulse a laser diode in chip form and accurately measure the spectrum without overheating the device. Another example is the testing of erbium-doped fiber amplifiers (EDFAs) where you might want to measure the signal and noise at different points in time relative to a modulated input signal.

Depending on your light source, you can view pulsed light by using one of the following techniques:

- Synchronizing the light source to the optical spectrum analyzer.
- Synchronizing the optical spectrum analyzer to the pulsed light.
- Displaying non-synchronized pulsed light.

In addition, the optical spectrum analyzer has an instrument mode that is optimized for accurately measuring fast pulses. For more information, refer to “Making Fast Pulse Measurements” in Chapter 5.

**Contents**

Synchronizing the Light Source .....3-4  
    To turn on ADC sync (standard instrument) ..... 3-9  
    To turn on ADC sync and pulsed current (Option 001) .....3-10  
Synchronizing the Optical Spectrum Analyzer ..... 3-13  
    To synchronize the optical spectrum analyzer .....3-14  
    To select the trigger type ..... 3-15  
Using the Gated Sweep Feature .....3-16  
    To use the gated sweep feature ..... 3-17

---

## Synchronizing the Light Source

Two signals are available at the rear-panel for synchronizing the light source to the optical spectrum analyzer:

- **ADC SYNC OUT** signal.
- **CURRENT SOURCE** signal (Option 001 only).

The **ADC SYNC OUT** signal uses TTL-compatible levels. Connect this signal to a light source having a TTL-compatible pulse-input connector. The output has one pulse for each trace point. The displayed data is synchronized to the trailing edge of the pulse. This ensures that the light source and optical spectrum analyzer's data acquisition system have adequate time to stabilize. You can adjust this time by setting the pulse width.

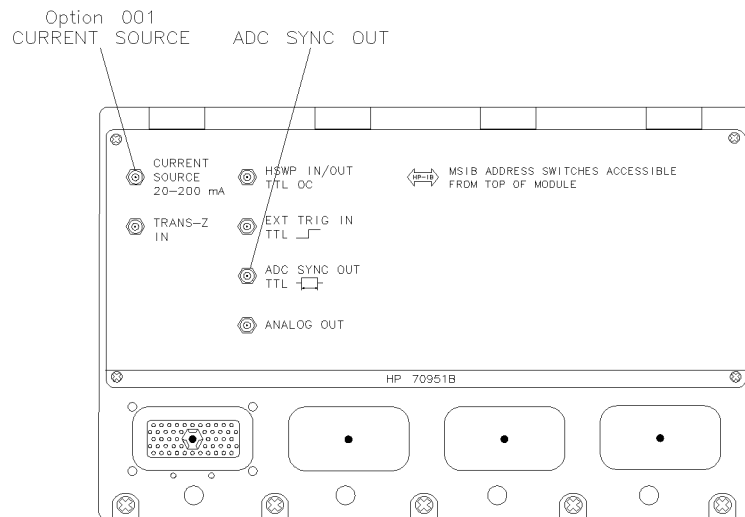

pkb9

**Rear panel of optical spectrum analyzer module.**



**Optional current source powers light source**

The CURRENT SOURCE signal allows you to supply current directly to the light source. The current source is available as Option 001. The current source supplies up to  $\pm 200$  milliamperes of either continuous or pulsed current. Current limiting is available to protect sensitive devices. The default limit is set to  $\pm 50$  mA.

**Observe current source load requirements**

If the current source does not correctly pulse the light source, you may be exceeding the current source's load handling capability. Refer to "Specifications and Characteristics" in the *Reference* manual for information on load limits.

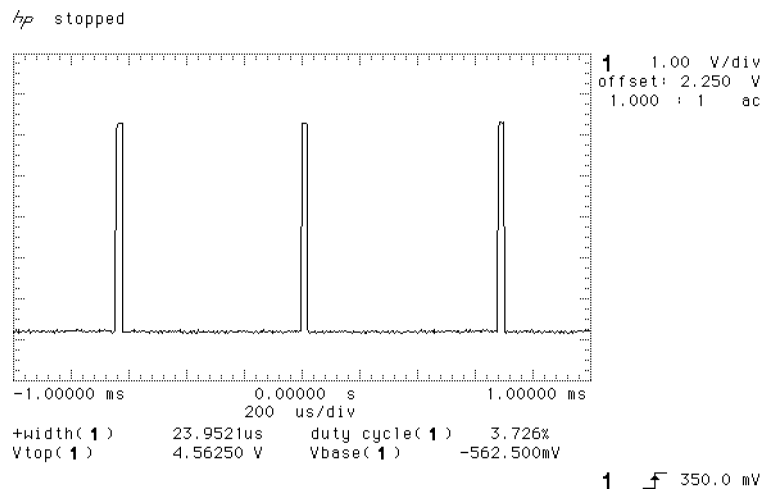

**TTL-compatible ADC SYNC OUT signal viewed on oscilloscope.**

Displaying Pulsed Light  
**Synchronizing the Light Source**

**Cables used for pulse measurements**

To reduce electrical noise, be sure to ground the cable that connects the rear panel with the light source. The rear panel's SMB connector is already grounded. Ground the connector at the light-source end of the cable.

The Hewlett-Packard part number for an SMB (f) to BNC (m) cable is 85680-60093.

**You control pulse parameters**

You control the pulse width and duty cycle of both the **ADC SYNC OUT** signal and the **CURRENT SOURCE** signal. If you have the Option 001 current source installed, setting the current source's pulse parameters also sets the **ADC SYNC OUT** parameters.

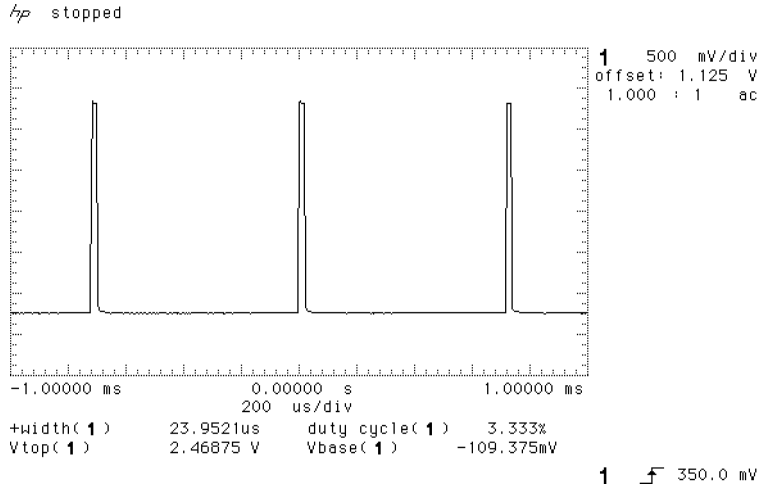

**CURRENT SOURCE signal viewed on oscilloscope.**

For the **ADC SYNC OUT** and **CURRENT SOURCE** output signals to be active, the optical spectrum analyzer's wavelength span must be greater than 0 nm. (When the span is set to 0 nm and the duty cycle is less than 100%, these outputs are disabled.)

Pulse width determines the time that the light source is turned on. Duty cycle determines the ratio of "on" and "off" time and is entered as a percentage:

$$duty\ cycle = \left( \frac{pulse\ width}{pulse\ period} \right) (100)$$

The pulse period may increase slightly during measurements to allow the optical spectrum analyzer to perform various internal tasks. Consider the following when selecting pulse width and duty cycle values:

- Duty cycle affects the average power dissipated by the light source.
- Pulse width sets the light source "on" time.
- Measurements are performed near the trailing edge of the pulse.

**Pulse width/duty cycle combinations are limited**

Pulse widths can range from 1  $\mu$ s to 6.5 ms. However, not all combinations of pulse widths and duty cycles are available. The optical spectrum analyzer limits and adjusts these parameters as needed to maintain the following conditions:

- Pulse must be off for at least 200  $\mu$ s.
- Sweep time cannot be longer in seconds than the number of trace measurement points.

For pulsed measurements, sweep times cannot be longer than 1 second per trace point. This is 800 seconds for the default value 800 trace points. The following equation shows how sweep time is approximately related to trace length, pulse width, and duty cycle:

$$sweep\ time \simeq (trace\ length) \left[ \frac{(pulse\ width)(100)}{duty\ cycle} \right]$$

Refer to Chapter 8 if you want to change the number of trace points.

### Synchronizing the Light Source

#### **UNCAL indicates narrow pulses**

Although the pulse widths can be set as narrow as  $1 \mu\text{s}$ , if the width is too narrow for the optical spectrum analyzer's circuitry, the displayed response may not faithfully represent the input light. To indicate this condition, the UNCAL message is displayed.

#### **Video bandwidth limits pulse widths**

The video bandwidth setting limits the minimum pulse width that can be used while still maintaining an amplitude calibrated display. With ADC sync operation, the data acquisition is limited to one sample per trace point and the video bandwidth is the analog bandwidth of the transimpedance amplifier. This changes as a function of the reference level. The minimum pulse widths available are shown in the following table.

<b>Video Bandwidth</b>	<b>Minimum Recommended Pulse Width</b>
700 kHz	$1 \mu\text{s}$
600 kHz	$1 \mu\text{s}$
60 kHz	$10 \mu\text{s}$
20 kHz	$30 \mu\text{s}$
200 Hz	3 ms

---

## To turn on ADC sync (standard instrument)

1. Press the left-side **State** softkey.
2. Press **sync out**.
3. Press **PULSE WIDTH**, and use the knob, step keys, or numeric keypad to enter the desired pulse width.
4. Press **DUTY CYCLE %**, and reduce the duty cycle to turn on pulse mode.

A duty cycle of 100% turns off pulse mode. Reducing the duty cycle turns on ADC sync output.

5. Connect the TTL-compatible pulse signal at the rear panel **ADC SYNC OUT** connector to the light source's pulse input connector.

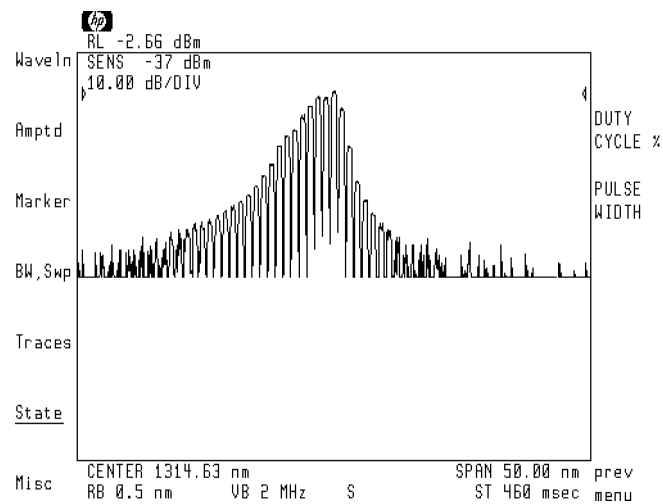

---

## To turn on ADC sync and pulsed current (Option 001)

1. Press the left-side **State** softkey.
2. Press **current source**.
3. Press **PULSE WIDTH**, and use the knob, step keys, or numeric keypad to enter the desired duty cycle in percent.

A duty cycle of 100% turns off pulse mode. Reducing the duty cycle turns on the ADC sync output. The current source timing is now linked to the ADC sync output.
4. Press **DUTY CYCLE %**, and use the knob, step keys, or numeric keypad to enter the desired pulse width.
5. If you are using a light source that is pulsed with a TTL signal, connect the light source to the optical spectrum analyzer's **TTL ADC SYNC OUT** connector.
6. If you are using a light source that requires current supplied by the optical spectrum analyzer, continue with the following steps:
  - a. Press **IGEN LIMIT**, and enter a positive limit value for the current.

Current limiting protects light sources against damage from large currents. The default value is  $\pm 50$  mA. This allows the current to be set between  $-50$  ma and  $+50$  ma. Maximum current is  $\pm 200$  mA.

Displaying Pulsed Light  
**Synchronizing the Light Source**

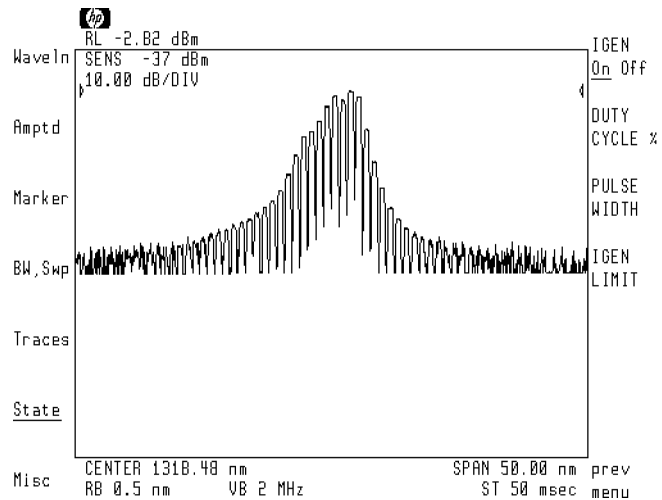

- b. Press **IGEN On Off**, and enter the value of current to supply the light source.

Positive and negative values of current can be entered. Positive current indicates current flowing out of the optical spectrum analyzer. Negative current indicates the optical spectrum analyzer is sinking current. Maximum current is  $\pm 200$  mA.

- c. Press **IGEN On Off** so that **On** is underlined.

This step turns the current source on. To turn the current source off, press the softkey so that **Off** is underlined.

- d. Connect the light source to the optical spectrum analyzer's rear-panel **CURRENT SOURCE** connector. This connector supplies current to the light source.

Displaying Pulsed Light  
**Synchronizing the Light Source**



---

## Synchronizing the Optical Spectrum Analyzer

Measurements of time variant light sources can be made with the optical spectrum analyzer. The light source must provide a TTL-compatible trigger signal. Connect this trigger signal to the optical spectrum analyzer's rear-panel **EXT TRIG IN** connector. An edge on the trigger signal causes the internal analog-to-digital converter (ADC) to measure the signal synchronously with the trigger signal.

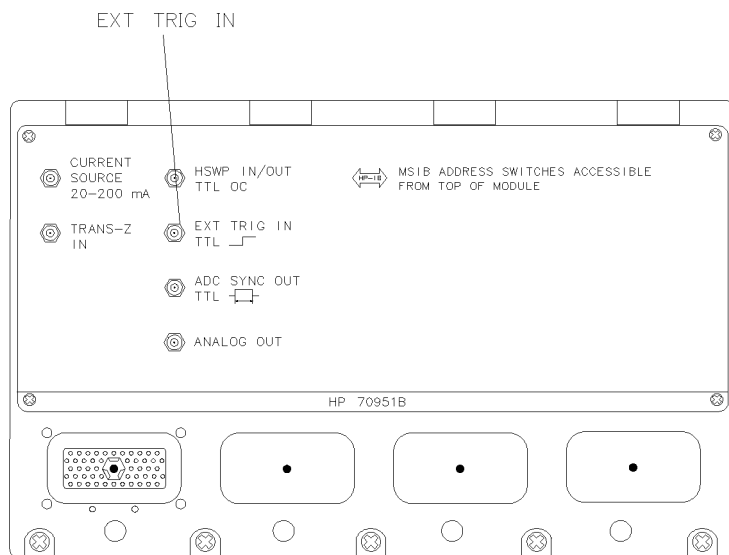

pkb10

### Several trigger types are available

You can select the position on the trigger signal that triggers the ADC to perform a measurement. Selections include the positive (rising) edge, the negative (falling) edge, or AC (alternately on rising and falling edges). If you select AC, the amplitudes measured on opposite edges are subtracted and the absolute value of the result becomes the trace amplitude value. It is also possible to delay the ADC triggering from the rising or falling edge by entering an ADC trigger delay value.

## Synchronizing the Optical Spectrum Analyzer

### External trigger frequency interacts with sweep time

When using external triggering (**EXT TRIG IN**) in non-zero spans, the frequency of the external trigger signal can affect measurement accuracy. The optical spectrum analyzer's sweep time must be greater than

$$\text{sweep time} > \frac{1.5(\text{trace length})}{\text{frequency}}.$$

In some cases, a factor as high as 2.0 may be required instead of 1.5. If the ADC trigger rate is too low for the current combination of trace length and sweep time, the error message **2070 Sweep too fast** is displayed. This warning is reported once for every sweep where there was an invalid trace point.

### Avoid oversweeping the video bandwidth

When using external triggering (**EXT TRIG IN**), displayed video bandwidths are not accurate and must be set not to over sweep the actual video bandwidth. Use the following equation to estimate the actual video bandwidth:

$$\text{video bandwidth} \approx \frac{(\text{factor})(\text{displayed bw})(\text{external trigger frequency})}{27,000}$$

where:

*factor* is a function of the external trigger frequency. *factor* is always less than 1.0 and may be as low as 0.5.

To obtain the proper sweep time, estimate the actual video bandwidth (as described above), and then set the optical spectrum analyzer's video bandwidth to that setting. Then, observe the coupled sweep time, and set the sweep time to the value for the original setting.

---

## To synchronize the optical spectrum analyzer

1. Confirm that the light source provides a TTL-compatible trigger signal.
2. Connect this trigger signal to the optical spectrum analyzer's rear-panel **EXT TRIG IN** connector.
3. Press the left-side **BW Swp** softkey.

4. Press the **MORE 1 of 3**, **MORE 2 of 3**, and then **adc trigger** softkeys.
5. Select the trigger type: **ADCTRIG POSEDGE**, **ADCTRIG NEGEDGE**, or **ADCTRIG AC**.

---

## To select the trigger type

1. Press the left-side **BW Swp** softkey.
2. Press the **MORE 1 of 3**, **MORE 2 of 3**, and then **adc trigger** softkeys.
3. Press one of the following softkeys:
  - **ADCTRIG FREE** selects internal triggering. External triggering is ignored. The ADC is triggered during sweeps by the optical spectrum analyzer's internal clock.
  - **ADCTRIG POSEDGE** triggers measurements on the rising edge of the external trigger signal.
  - **ADCTRIG NEGEDGE** triggers measurements on the falling edge of the external trigger signal.
  - **ADCTRIG AC** alternately triggers measurements on the rising and falling edges of the external trigger signal. The amplitudes measured on opposite edges are subtracted and the absolute value of the result becomes the trace amplitude value.
  - **ADCTRIG DELAY** allows you to set the delay of the measurements from the selected edge of the trigger signal.

---

## Using the Gated Sweep Feature

In the previous two sections, you learned how to synchronize the optical spectrum analyzer and a pulsed-light source. This section describes how to display pulsed light that is not synchronized with the optical spectrum analyzer's sweep.

**Gated sweeps indicate validity of displayed data**

If a measurement for a trace point occurs when the light source is off, the data measured will be invalid. Using gated sweeps makes it easy to determine which trace points contain valid data. When the **GATESWP On Off** function is on, invalid trace points are displayed at the bottom of the screen. (The trace data value is loaded with a minimum value.) Connect a TTL-compatible gating signal from the light source to the rear-panel **EXT TRIG IN** connector. When the signal is high, measurement data for a trace point is displayed. When the TTL signal is low, the trace point is loaded with a minimum value that results in the trace point being displayed at the bottom of the screen.

**Pulse width and timing are important**

Gating the sweep does not prevent or change the timing of measurements during a sweep. The number of measurements taken for a sweep is equal to the number of trace points (trace length). The default trace length is 800 points. (You can change the trace length in the Traces menu.) Use the following equation to determine the approximate time between measurements:

$$\text{time between measurements} \approx \frac{\text{sweep time}}{\text{trace length}}$$

You should allow for at least one pulse for every trace measurement. Because the timing between measurements varies slightly, having two or more pulses reduces the chance that a measurement will occur when the gating signal is TTL low. Each light pulse must be on for at least  $2 \mu\text{s}$  to ensure enough time to complete the measurement.

If your particular measurement setup results in trace points being displayed at the bottom of the screen, do the following to obtain a complete trace of data. Select maximum holding for the trace, and let the optical spectrum analyzer sweep several times.

---

## To use the gated sweep feature

1. Connect a TTL gating signal from the light source to the optical spectrum analyzer's rear-panel **EXT TRIG IN** connector.  

This signal must be TTL "high" when the light pulse is on and TTL "low" when the light pulse is off.
2. It may be useful to control the light source so that it is on only when the optical spectrum analyzer is sweeping. Use the optical spectrum analyzer's rear-panel **HSWP IN/OUT** signal for this purpose.
3. Set the optical spectrum analyzer's sweep time so that one or more light pulses occur during each trace-point measurement.
4. Set the light source's pulses so that each pulse is on for at least 2  $\mu$ s.
5. Press the left-side **BW, Swp** softkey.
6. Press **MORE 1 of 3**, **MORE 1 of 3** and then **GATESWP On Off**.

Displaying Pulsed Light  
**Using the Gated Sweep Feature**



**Measuring Signals**

---

## Measuring Signals

Your optical spectrum analyzer comes with three advanced-measurement programs. These programs provide one-button solutions for characterizing distributed-feedback (DFB) lasers, Fabry-Perot (FP) lasers, and light-emitting diodes (LEDs). To start one of the programs, press **USER**, then select the appropriate softkey: **DFB**, **FP**, or **LED**. If these programs are accidentally erased from memory, you will need to reinstall them. Backup copies are provided on both memory card and diskette and are shipped with the optical spectrum analyzer. If needed, the version number of an advanced-measurement program can be obtained by pressing **VERSION** softkey provided in each program.

### **Amplitude accuracy**

In order to ensure the best absolute amplitude accuracy of the advanced-measurement programs, the following must be observed:

- Use a  $9\mu\text{m}$  input fiber-optic cable.
- Set the resolution bandwidth  $\geq 0.2$  nm.

### **Battery Power**

Automatic measurement programs are stored in battery powered memory. If the internal battery loses power, the programs are erased from memory. With normal use, the internal battery lasts for several years. To replace the internal battery, return the optical spectrum analyzer to a Hewlett Packard service center.



**Contents**

Characterizing DFB Lasers .....	4-4
To characterize a DFB laser .....	4-9
To show the SMSR modes .....	4-10
To show the stop-band .....	4-11
Characterizing Fabry-Perot (FP) Lasers .....	4-12
To characterize a Fabry-Perot laser .....	4-17
To show the power distribution trace .....	4-17
To show the modes used in measurements .....	4-18
To select the modes used in measurements .....	4-19
Characterizing LEDs .....	4-20
To characterize an LED .....	4-25
To show the power-distribution trace .....	4-25
To change the integration window .....	4-26
Reinstalling the Advanced-Measurement Programs .....	4-28
To install from the memory card .....	4-29
To install from the 3.5-inch diskette drive .....	4-30
To install from a computer .....	4-31

# Characterizing DFB Lasers

The DFB Advanced-Measurement Program performs a series of automatic measurements on distributed-feedback lasers. All measurement results are displayed at the top of the screen.

### DFB lasers are sensitive to reflections

To ensure accurate measurements, place an optical isolator or attenuator between the laser and the optical spectrum analyzer.

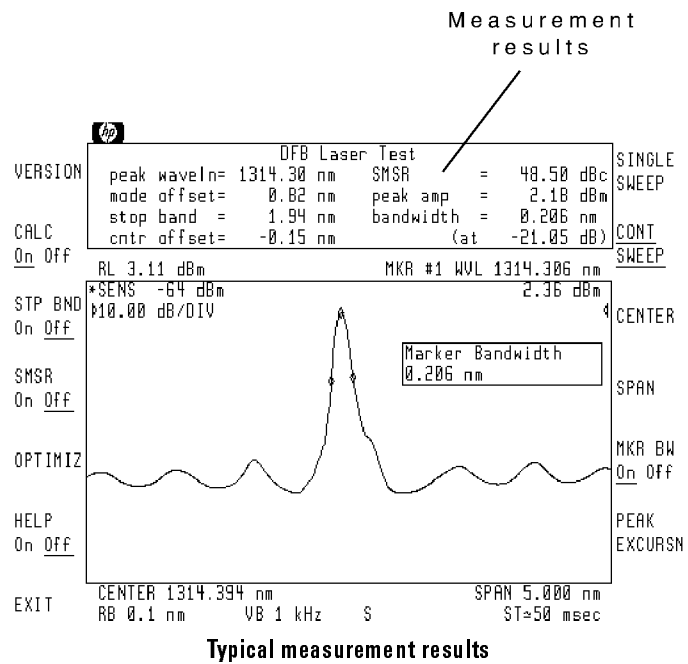

<b>DFB Measurements</b>	bandwidth	Displayed bandwidth of the main spectral component of the DFB laser. Due to the narrow line width of most DFB lasers, the result of this measurement for an unmodulated laser is the chosen resolution bandwidth of the optical spectrum analyzer.
	cntr offset	Indicates how well the main mode is centered in the stop band. This value equals the wavelength of the main spectral component minus the mean of the upper and lower stop band component wavelengths.
	mode offset	The wavelength separation (in nanometers) between the main spectral component and the next highest mode.
	peak amp	The power level of the laser's main spectral component.
	peak waveln	The wavelength of the main spectral component of the laser.
	SMSR	SMSR (side mode suppression ratio) is the amplitude difference between the main spectral component and the largest side mode.
	stop band	The wavelength spacing between the upper and lower side modes adjacent to the main mode.

**Reduce the bandwidth to measure chirp**

Due to the narrow line width of most DFB lasers, the bandwidth measurement for an unmodulated laser is the chosen resolution bandwidth of the optical spectrum analyzer. With modulation applied, lasers will chirp causing a spectral broadening. The resultant displayed waveform is the convolution of the optical spectrum analyzer's resolution bandwidth and the modulated laser's spectrum. When measuring the extent of chirp on a modulated laser, choose the narrowest resolution bandwidth available. (This is approximately 0.08 nm and can only be obtained by entering the value using the numeric keys.)

Measuring Signals  
**Characterizing DFB Lasers**

**Optimize the display for accuracy**

If you change any amplitude or wavelength settings while in the DFB Advanced-Measurement Program, be sure to press the **OPTIMIZ** softkey. This automatically optimizes the sensitivity setting to ensure that side modes are properly located and displayed. (The program automatically performs this optimization routine each time the program is started.)

**You can display the stop band**

The stop band is the wavelength spacing between the side modes that are adjacent to the main mode. As seen in the following figure, vertical lines can be displayed showing the actual trace data points used to calculate the stop band and center offset measurements. Press **STP BND On Off** to view the stop band.

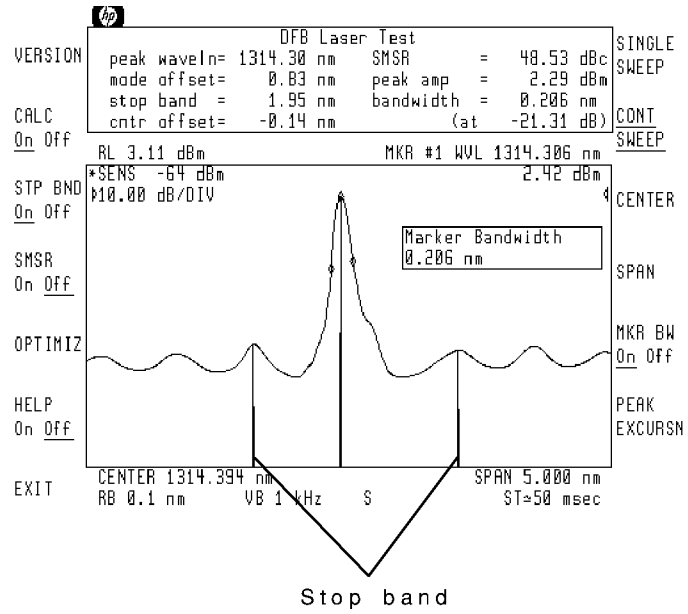

**SMSR trace shows side-mode used**

Side mode suppression ratio (SMSR) is the amplitude difference between the main mode and the largest side mode. As shown in the following figure, vertical lines can be displayed showing the actual trace data points used by the SMSR measurement. Press **SMSR On Off** to view the trace points used for the measurement.

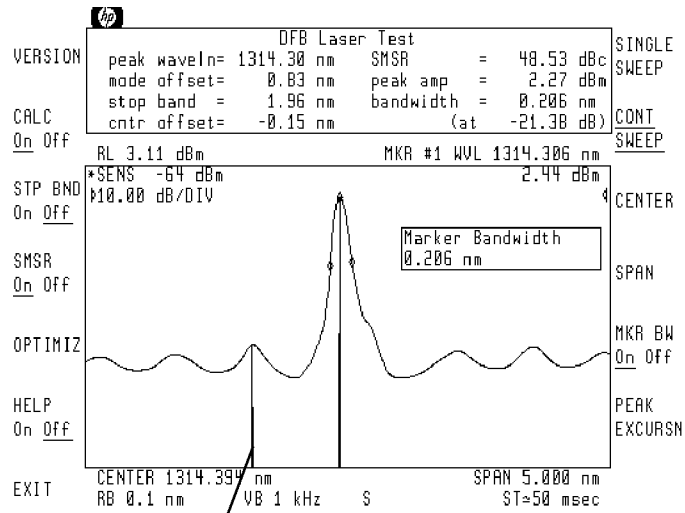

Side mode  
used for SMSR

**Characterizing DFB Lasers**

**Bandwidth measurement may require a reduced span**

One of the measurements is the bandwidth at the markers. By default, the bandwidth markers are placed 20 dB below the peak wavelength. (You can change this bandwidth position using the **MKR BW On Off** softkey.)

The accuracy of the bandwidth marker placement is affected by the following instrument settings:

- Wavelength span
- Bandwidth
- Trace length

If the wavelength span is too wide (or the bandwidth is too narrow), there may not be enough trace points to position the markers accurately. The following figures illustrate this point. In each case, the bandwidth markers are set to -20 dB. In the figure on the left, the span is 20 nm, and the measured bandwidth (displayed at the top of the screen) is 0.350 nm at -24.93 dB. In the figure on the right, the span is 3 nm, and the bandwidth markers are at -20.45 dB. This is much closer to our entered value of -20 dB. Notice how reducing the span increases the accuracy of the bandwidth marker placement. Increasing the trace length also increases marker placement accuracy.

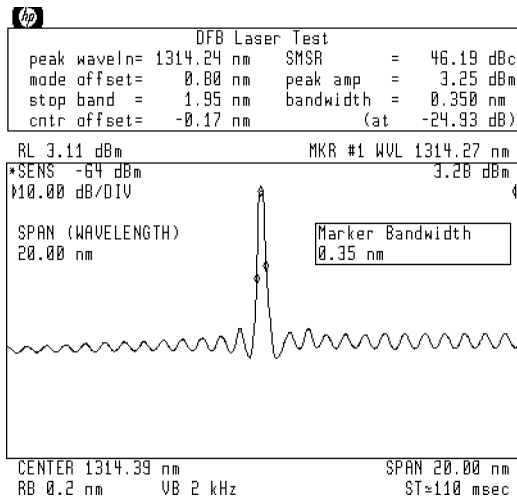

**20 nm span.**

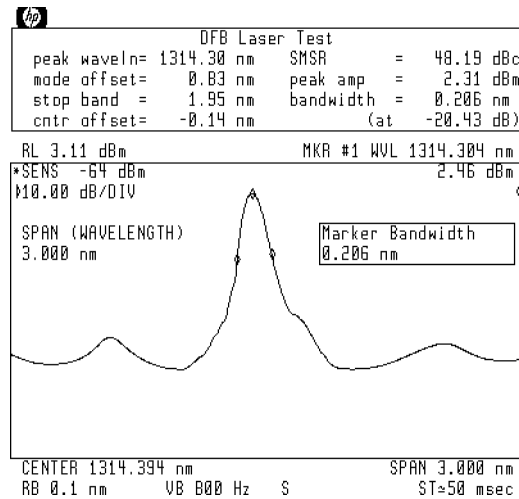

**3 nm span.**

**Peak excursion  
determines side modes**

The peak excursion value (in dB) determines which side modes are included in the measurements. To be accepted, each trace peak must rise, and then fall, by at least the peak excursion value about a given spectral component. The default value is 3 dB. Setting the value too high may result in not identifying a side mode. Setting the value too low may cause unwanted responses, including noise spikes, to be identified. Use the **STP BND On Off** softkey to display a trace showing which side modes are used in the measurements. Use **PEAK EXCURSN** to change the peak excursion value.

---

## To characterize a DFB laser

1. Press **AUTO MEAS** to locate and display the laser's response automatically.
2. Press **USER** and then **DFB** to measure the distributed feedback laser's characteristics.
3. If you want to stop the updating of measurement data with each sweep, press **CALC On Off** so that **Off** is underlined.
4. Pressing **HELP On Off** displays short definitions of important softkeys.

## To show the SMSR modes

1. Press **SMSR On Off** so that **On** is underlined.
2. If the side modes are not properly identified, perform the following:
  - a. Press **OPTIMIZ** if sensitivity needs to be adjusted.

This performs an automatic adjustment of the sensitivity.

- b. If the correct side modes are still not identified, press **PEAK EXCURSN**, and change the peak excursion value.

If the side modes have less than a 3 dB amplitude drop on either side, they will not be identified as a peak.

### **Trace data is overwritten**

When **SMSR On Off** is pressed so that **On** is underlined, any data in trace C is overwritten. This is because trace C is used as the SMSR trace.



---

## To show the stop-band

1. Press **STP BND On Off** so that **On** is underlined.
2. If the side modes are not properly identified, perform the following:
  - a. Press **OPTIMIZ** if sensitivity needs to be adjusted.

This performs an automatic adjustment of the sensitivity.

- b. If the correct side modes are still not identified, press **PEAK EXCURSN**, and change the peak excursion value.

If the side modes have less than a 3 dB amplitude drop on either side, they will not be identified as a peak.

### **Trace data is overwritten**

When **STP BND On Off** is pressed so that **On** is underlined, any data in trace B is overwritten. This is because trace B is used as the stop band trace.

# Characterizing Fabry-Perot (FP) Lasers

The FP Advanced-Measurement Program performs a series of automatic measurements on Fabry-Perot lasers. All measurement results are displayed at the top of the screen.

### Fabry-Perot lasers are sensitive to reflections

To ensure accurate measurements, place an optical isolator or attenuator between the laser and the optical spectrum analyzer.

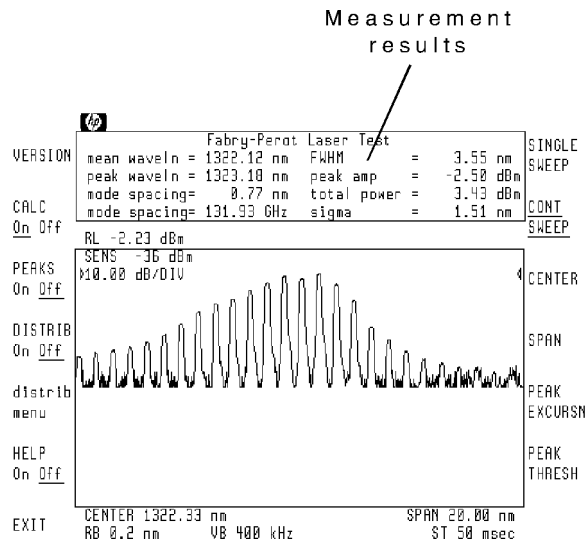

Typical measurement results

<b>FP Measurements</b>	envelope BW	This value is displayed only when envelope distribution is selected. The envelope bandwidth is the wavelength spacing of the two points on the envelope which are the <b>MKR BW</b> amplitude value (default value = -3 dB) from the highest point. The mean wavelength is the average of the two “n” dB down wavelengths.
	FWHM	FWHM (full width at half maximum) describes the spectral width of the half-power points of the laser, assuming a continuous, Gaussian power distribution. The half-power points are those where the power-spectral density is one-half that of the peak amplitude of the computed Gaussian curve.  $FWHM = 2.355 \sigma$ <p>where <math>\sigma</math> is sigma as defined below.</p>
	mean waveln	The wavelength representing the center of mass of selected peaks. The power and wavelength of each spectral component are used to calculate the mean wavelength.  $Mean\ Wavelength = \sum_{i=1}^N P_i \left( \frac{\lambda_i}{P_o} \right)$ <p>where <math>P_o</math> is total power as defined in this section.</p> <p>When envelope distribution is selected, the mean wavelength is defined as the average of the two “n” dB down wavelengths.</p>
	mode spacing	The average wavelength spacing between the individual spectral components of the laser. The display shows the mode spacing in both wavelength and frequency.
	peak amp	The power level of the peak spectral component of the laser.
	peak waveln	The wavelength of the peak spectral component.
	sigma	An rms calculation of the spectral width of the laser based on a Gaussian distribution. If a Lorentzian distribution is selected, sigma is not displayed. The power and wavelength of each spectral component is used to calculate mean wavelength.

**Characterizing Fabry-Perot (FP) Lasers**

$$sigma = \sqrt{\sum_{i=1}^N P_i \frac{(\lambda_i - \bar{\lambda})^2}{P_o}}$$

where:

$\bar{\lambda}$  is the mean wavelength (FWHM) as defined above.

$P_i$  is the power of a single peak.

$P_o$  is total power as defined in this section.

total power

The summation of the power in each of the selected peaks, or modes, that satisfy the peak-excursion and peak-threshold criteria.

$$Total\ Power = \sum_{i=1}^N P_i$$

**Distribution trace shows power distribution**

You can display a statistical curve showing the laser's power distribution. Use the distribution menu to select either the default Gaussian curve, a Lorentzian curve, or an envelope curve. Distributions can also be displayed with a linear amplitude scale. Use the optical spectrum analyzer's amplitude menu to select a linear scale.

When you select envelope distribution, a new right-side softkey appears. This softkey, **ENVLOPE MKR BW**, is used to position the displayed bandwidth markers. As a default, the markers are placed to measured the bandwidth at  $-3$  dB from the peak of the curve.

**Characterizing Fabry-Perot (FP) Lasers**

Fabry-Perot Laser Test			
mean waveln = 1304.97 nm	FWHM = 5.80 nm		
peak waveln = 1307.13 nm	peak amp = -2.78 dBm		
mode spacing = 0.91 nm	total power = 4.46 dBm		
mode spacing = 160.04 GHz	sigma = 2.46 nm		

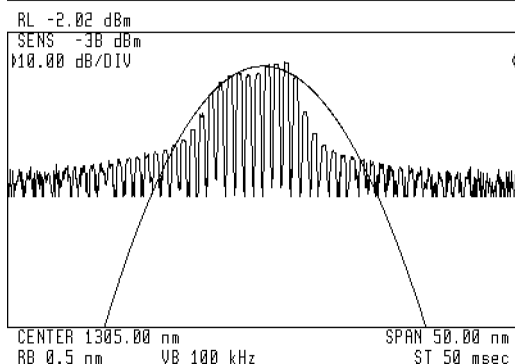

**Gaussian distribution trace.**

Fabry-Perot Laser Test			
mean waveln = 1305.06 nm	FWHM = 5.77 nm		
peak waveln = 1307.06 nm	peak amp = -2.68 dBm		
mode spacing = 0.91 nm	total power = 4.18 dBm		
mode spacing = 160.02 GHz			

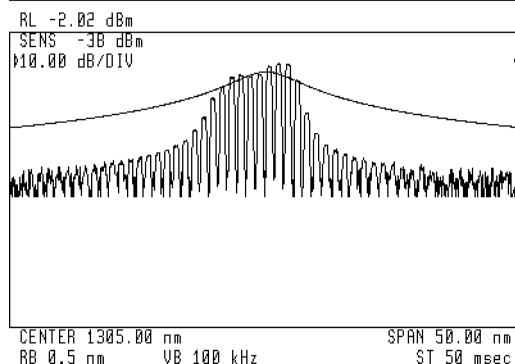

**Lorentzian distribution trace.**

Fabry-Perot Laser Test			
mean waveln = 1304.59 nm	envelope BW = 7.19 nm		
peak waveln = 1307.19 nm	peak amp = -2.34 dBm		
mode spacing = 6.25 nm	total power = 6.34 dBm		
mode spacing = 1101.08 GHz			

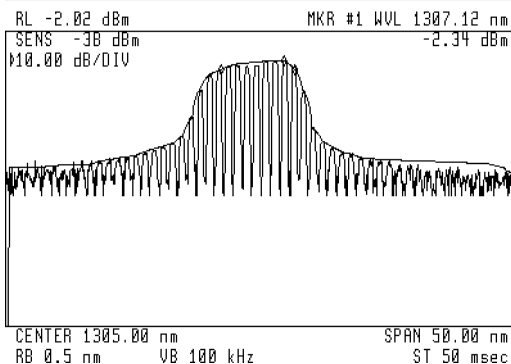

**Envelope distribution trace.**

**Characterizing Fabry-Perot (FP) Lasers**

**You select the modes included in the measurements**

Normally, measurement results are calculated using all laser modes within 90 dB of the peak response. As shown in the following figure, you can display a trace which identifies each peak used in the calculations. (Use the **PEAKS On Off** softkey.) A vertical line is drawn from the peak of the identified mode to the bottom of the display. The **PEAK THRESH** softkey can be used to change the threshold used to determine if a mode is included. In the following figure the threshold was changed from -90 dB to -20 dB.

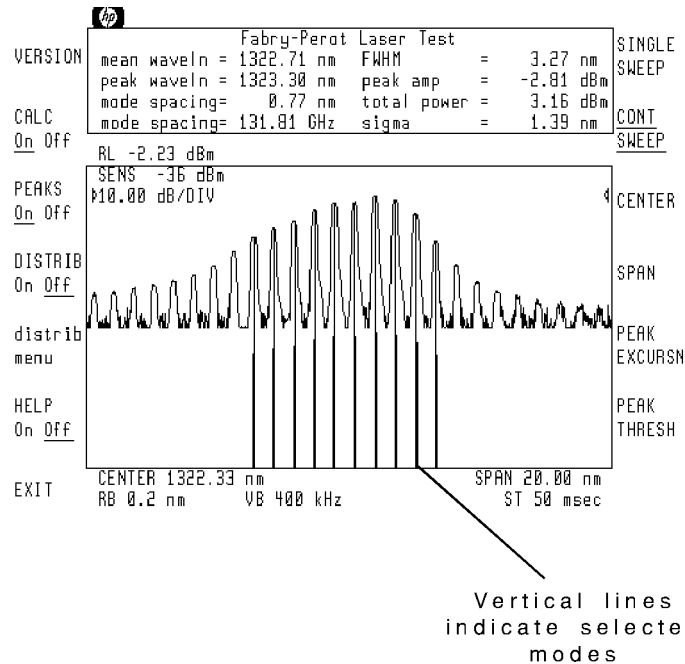

The peak excursion value (in dB) can also be used to determine which side modes are included in the measurements. To be accepted, each trace peak must rise, and then fall, by at least the peak excursion value about a given spectral component. Setting the peak-excursion value too high results in failure to include the smaller responses near the noise floor. Setting the value too low may cause unwanted responses, including noise spikes, to be identified. Use **PEAK EXCURSN** to change the peak excursion value.

---

## To characterize a Fabry-Perot laser

1. Press **AUTO MEAS** to locate and display the laser's response automatically.
2. Press **USER** and then **FP** to measure the Fabry-Perot laser's characteristics.
3. If you want to stop the updating of measurement data with each sweep, press **CALC On Off** so that **Off** is underlined.
4. Pressing **HELP On Off** displays short definitions of important softkeys.

---

## To show the power-distribution trace

1. Enter the FP Advanced-Measurement Program.
2. Press **DISTRIB On Off** so that **On** is underlined.

The default Gaussian distribution trace is displayed. This is also the distribution selected when **GAUSSIAN** is pressed.
3. To select a Lorentzian distribution, do the following:
  - a. Press **distrib menu** and then **LORENZ** to select a Lorentzian distribution.
  - b. Press **prev menu**.
4. To select Envelope distribution, do the following:
  - a. Press **distrib menu** and then **ENVLOPE** to select an Envelope distribution.

The envelope distribution is generated by straight line connections between selected peaks in linear format. The data used for the "envelope" is independent of log/linear modes. The envelope lines in log mode are the log of the straight lines in linear, therefore they look curved. The selected peaks are derived starting from the highest point,

### Characterizing Fabry-Perot (FP) Lasers

implementing the successive highest peak-to-the-left algorithm, until no more peaks are available. Next, the successive highest peak-to-the-right algorithm is carried out. Notice that the envelope skips peaks if the amplitudes fall then rise again, which is required for the monotonicity of the envelope.

- b. Press `prev menu`.

#### Trace data is overwritten

When `DISTRIB On Off` is pressed so that `On` is underlined, any data in trace C is overwritten. This is because trace C is used as the distribution trace.

---

## To show the modes used in measurements

- Press `PEAKS On Off` so that `On` is underlined.

For each mode used in the measurements, a vertical line is drawn from the peak of the mode to the bottom of the display.

#### Trace data is overwritten

When `PEAKS On Off` is pressed so that `On` is underlined, any data in trace B is overwritten. This is because trace B is used as the peak-identification trace.



## To select the modes used in measurements

1. Press **PEAKS On Off** so that **On** is underlined.

Each selected peak is identified by a vertical line.

2. Press **PEAK THRESH**, and increase the peak threshold value.

The peak threshold represents the amplitude value (relative to the highest mode) below which modes will not be identified. To avoid missing modes, the default value is  $-90$  dB.

3. Press **PEAK EXCURSN**, and adjust the peak excursion value.

Peak excursion determines how much a response must rise and then fall to be considered a peak.

# Characterizing LEDs

The LED Advanced-Measurement Program performs a series of automatic measurements on LEDs. All measurement results are displayed at the top of the screen. The LED measurement calculations compensate for the expected change in resolution bandwidth versus wavelength.

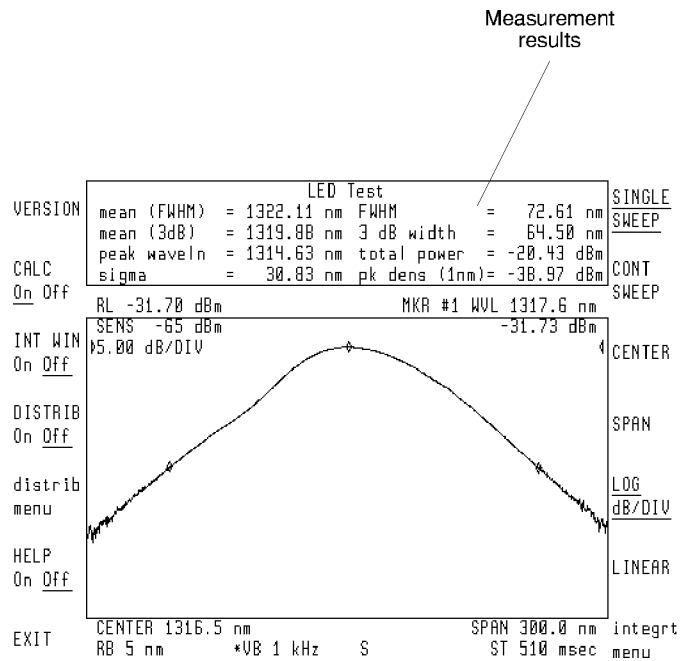

c3led1.cdr

Typical measurement results

<b>LED Measurements</b>	3 dB width	Describes the spectral width of the LED based on the separation of two wavelengths. Each wavelength has a power-spectral density equal to one-half the peak power-spectral density. The 3 dB width is determined by finding the peak of the LED spectrum, and dropping 3 dB on each side.
	FWHM	FWHM (full width at half maximum) describes the spectral width of the half-power (−3 dB) points of the LED, assuming a continuous, Gaussian power distribution. The half-power points are those where the power-spectral density is one-half that of the peak amplitude.  $FWHM = 2.355 \sigma$ <p>where <math>\sigma</math> is sigma as defined below.</p>
	mean (3 dB)	The average of the two wavelengths that are 3 dB (half-power) below the peak wavelength.
	mean (FWHM)	The wavelength representing the center of mass of the trace points. The power and wavelength of each trace point are used to calculate the mean (FWHM) wavelength.
		$Mean (FWHM) = \sum_{i=1}^N P_i \left( \frac{trace\ point\ spacing}{resolution\ bandwidth} \right) \left( \frac{\lambda_i}{P_o} \right)$ <p>where:</p> <p><math>\lambda_i</math> is the wavelength of a single trace point.</p> <p><math>P_i</math> is the power of a single trace point.</p> <p><math>P_o</math> is total power as defined in this section.</p>
	peak waveln	The wavelength at which the peak of the LED's spectrum occurs.
	PK dens (1 nm)	The power-spectral density (normalized to a 1 nm bandwidth) of the LED at the peak wavelength.
	sigma	An rms calculation of the spectral width of the led based on a Gaussian distribution. The power and wavelength of each trace point, between the displayed markers, are used to calculate sigma.

Measuring Signals  
**Characterizing LEDs**

$$\sigma = \sqrt{\sum_{i=1}^N P_i \left( \frac{\text{trace point spacing}}{\text{resolution bandwidth}} \right) \left[ \frac{(\lambda_i - \bar{\lambda})^2}{P_o} \right]}$$

where:

$\bar{\lambda}$  is mean wavelength (FWHM) as defined in this section.

$\lambda_i$  is the wavelength of a single trace point.

$P_i$  is the power of a single trace point.

$P_o$  is total power as defined in this section.

total power      The summation of the power at each trace point between the indicating markers, normalized by the ratio of the trace point spacing/resolution bandwidth. This normalization is required because the spectrum of the LED is continuous, rather than containing discrete spectral components (as a laser does).

$$\text{Total Power} = \sum_{i=1}^N P_i \left( \frac{\text{trace point spacing}}{\text{resolution bandwidth}} \right)$$

where:

$P_i$  is the power of a single trace point.

**Distribution trace to shows power distribution**

You can display a statistical curve that is based on the total power, power distribution, and mean wavelength of the LED. Use the distribution menu to select either the default Gaussian curve or a Lorentzian curve.

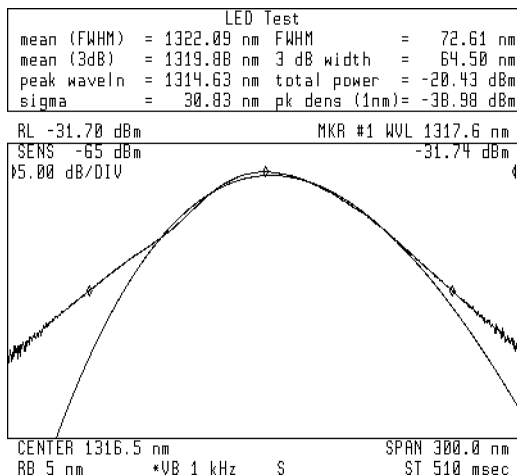

**Gaussian distribution trace.**

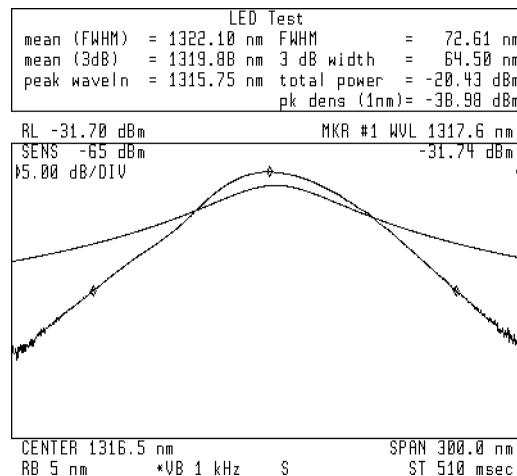

**Lorentzian distribution trace.**

Measuring Signals  
**Characterizing LEDs**

**Measurement  
integration window is  
adjustable**

The program calculates FWHM and total power based on the integration of a portion of the displayed response. By default, all trace points within 20 dB of the peak response are used in the integration. You can change this value using the Integration menu. Or, use the menu to define the starting and ending wavelength integration points. In the following figure the integration window was changed from -20 dB to -6 dB.

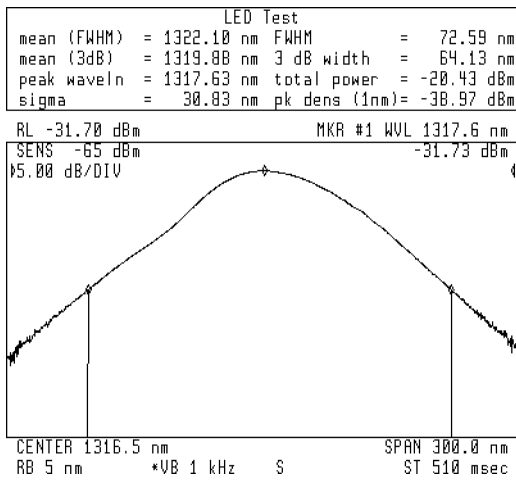

**-20 dB Integration window.**

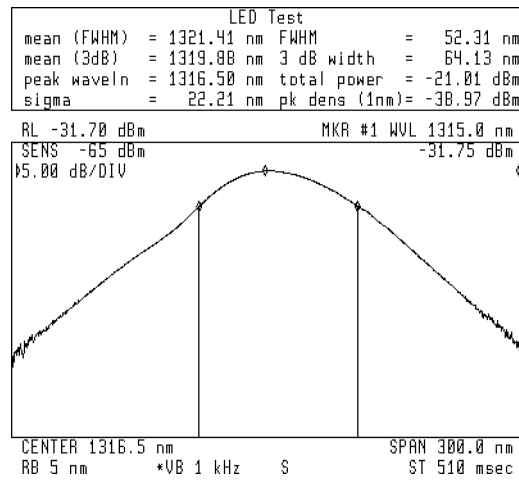

**-6 dB Integration window.**

---

## To characterize an LED

1. Press **AUTO MEAS** to locate and display the LED's response automatically.
2. Press **USER** and then **LED** to measure the LED's characteristics.
3. If you want to stop the updating of measurement data with each sweep, press **CALC On Off** so that **Off** is underlined.
4. Pressing **HELP On Off** displays short definitions of important softkeys.

---

## To show the power-distribution trace

1. Enter the LED Advanced-Measurement Program.
2. Press **DISTRIB On Off** so that **On** is underlined.

The default Gaussian distribution trace is displayed. This is also the distribution selected when **GAUSSIAN** is pressed.

3. To select a Lorentzian distribution, do the following:
  - a. Press **distrib menu** and then **LORENZ** to select a Lorentzian distribution.
  - b. Press **prev menu**.

### **Trace data is overwritten**

When **DISTRIB On Off** is pressed so that **On** is underlined, any data in trace C is overwritten. This is because trace C is used as the distribution trace.

## To change the integration window

1. Press **INT WIN On Off** so that **On** is underlined.

This displays the integration window trace that shows which trace points are included in the measurements.

2. Press **integr menu** to enter the Integration menu.
3. Perform one of the following to define the trace points included in the calculations:
  - Press **INTEGRT STRT WL**, and enter the starting wavelength. Then, press **INTEGRT STOP WL**, and enter the ending wavelength.
  - Press **INTEGRT FROM PK**, and enter an amplitude value specifying the desired range (relative to the peak response) for trace points included in the calculations.

The default value is  $-20$  dBc. Values are entered either in dBc or as a multiplier. For example, to include all the trace points within half the power level of the peak response, enter  $-3$  **dB** (dBc) or  $0.5$  **X**.

### **Trace data is overwritten**

When **INT WIN On Off** is pressed so that **On** is underlined, any data in trace B is overwritten. This is because trace B is used as the integration-window trace.





---

## Reinstalling Advanced-Measurement Programs

### **Programs can be copied from card or diskette**

Backup copies of the advanced-measurement programs are included in the following forms:

- Memory card.
- 3.5-inch diskette (HP-LIF format).

If your optical spectrum analyzer module is installed in an HP 70004A display, copy the advanced-measurement programs from the memory card. If you do not have an HP 70004A display, you must copy the programs either from a computer or directly from the an external HP-IB disk drive. The diskette containing the advanced-measurement programs uses the LIF format and cannot be directly read by MS-DOS based computers. The HP E2080A PC LIF utility can be used to transfer files between the HP-LIF and MS-DOS formats.

### **You must enter an external diskette drive's address**

The disk drive must be a 3.5 inch, CSS0-compatible drive, such as an HP 9122. When copying programs directly from an external diskette drive you must enter the drive's HP-IB address. The procedure in this chapter shows how to enter the address when cataloging the files. The default address is 0, unit 0, and volume 0. New addresses are entered in the following form:

*A.UV* where:

- A* is a digit from 1 to 7, representing the drive's HP-IB address.
- U* is a digit from 0 to 9, representing the unit number. The unit number is typically 0 or 1 and refers to an individual disk drive slot.
- V* is a digit from 0 to 9, representing the volume number. Volume numbers are used for hard disk drives. So, for reading diskettes, the volume number should be 0.

For example, entering *3.00* indicates an address of 3, a unit number of 0 and a volume number of 0. This accesses a diskette in the left drive of an external diskette drive at HP-IB address 3.

---

## To install from the memory card

1. Locate the memory card containing the advanced-measurement programs.
2. Locate the arrow printed on one end of the card.
3. Insert the card into the HP 70004A display's front-panel card slot. Match the card's arrow with the arrow printed above the card slot.

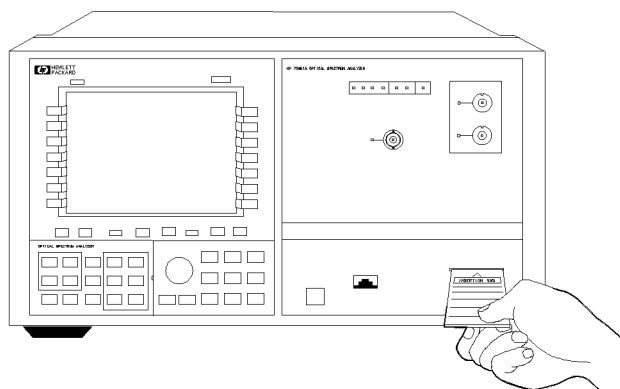

pkb7

4. Press **MENU** and then the left-side **Misc** softkey.
5. Press **MORE 1 of 3** and then **catalog & MSI**.
6. Press **HP-MSIB CARD** to display all files contained on the memory card.

### NOTE

If **2053 Storage device error** is displayed, either the card is missing, the card's write-protect switch is in the **SAFE** position, or the card's HP-MSIB address is listed incorrectly. The HP-MSIB address for the card is the same address as the display's HP-IB address and is normally set to 4. If the address is not correct, enter the correct address using the numeric keypad.

## Reinstalling Advanced-Measurement Programs

7. For each file on the card (DFB, FP, and LED) perform the following:
  - a. Press `LOAD FILE`.
  - b. Enter the file number, and press `ENTER` to reinstall the file. The front-panel LED next to the card slot lights indicating that the files are being copied into the `(USER)` menu.

---

### To install from a 3.5-inch diskette drive

1. Connect a 3.5-inch diskette drive to the MMS mainframe that contains the optical spectrum analyzer module. Use an HP-IB cable.
2. Insert the diskette containing the advanced-measurement programs into the diskette drive.
3. Press the left-side `Misc` softkey.
4. Press `MORE 1 of 3` and then `catalog & MSI`.
5. Press `HP DISK`, and use the numeric keypad to enter the diskette drive's address.

Refer to the introduction to this section for information on determining the code for the address.

6. Press the `ENTER` softkey.

If `2053 Storage device error` is displayed, either a diskette is not in the drive, or the drive's code is incorrectly entered.

7. For each file on the card perform the following:

Press `LOAD FILE`.

Enter the file number and press `ENTER` to reinstall the file.

---

## To install from a computer

1. Connect a computer to the MMS mainframe that contains the optical spectrum analyzer module. Use an HP-IB cable.

The computer must have a 3.5-inch diskette drive for reading LIF formatted diskettes.

2. Insert the diskette containing the advanced-measurement programs into the diskette drive.
3. Use your software to copy the files contained on the diskette to the optical spectrum analyzer module.

The optical spectrum analyzer module's default HP-IB address is 23. To display the address, perform the following:

- a. Press the left-side **State** softkey.
- b. Press **MORE 1 of 4** and then **MORE 2 of 4**.
- c. Press **show states** and then **CONFIG**.

## Measuring Signals

---

**Changing Instrument  
Modes**

---

## Changing Instrument Modes

Depending on the model number, HP 71450B/1B/2B optical spectrum analyzers provide up to six separate operating modes. Besides spectrum analysis, these modes perform the following tasks:

- Perform stimulus-response measurements.
- Perform fast pulse measurements.
- Measure broadband power. *(HP 71451B only)*
- Preselect (filter) a light source. *(HP 71451B only)*
- Test photodetector responsivity. *(HP 71451B only)*

### **User-calibrations are applied in all instrument modes**

User-calibration data is applied to the measurements performed during the modes described in this chapter. User-calibration can be performed only in the optical spectrum analyzer mode and the power-meter mode. Power-calibration data obtained in power-meter mode is used only in power-meter mode and photodetector test modes. Power-calibration data obtained in the optical spectrum analyzer mode is used in the other modes.

---

### **WARNING**

In preselector, stimulus response, and photodetector test modes, light energy input to the HP 71451B (70951B) front-panel MONOCHROMATOR INPUT connector can radiate from the front-panel MONOCHROMATOR OUTPUT connector. This radiated light passes through the internal monochromator and so is filtered and slightly attenuated.



**Contents**

Performing Stimulus-Response Measurements .....	5-4
To characterize a single-output device .....	5-9
To characterize a dual-output device .....	5-14
To display a trace of input power .....	5-16
To make measurements on a linear scale .....	5-16
To use alternative trace definitions .....	5-18
Making Fast Pulse Measurements .....	5-20
To measure fast pulses .....	5-20
Measuring Broadband Power .....	5-21
To measure broadband power .....	5-24
Preselecting a Light Source .....	5-26
To preselect a light source .....	5-29
To use a single mode output cable .....	5-31
Measuring Photodetector Responsivity .....	5-33
To measure photodetector responsivity .....	5-37
To display a trace of input power .....	5-41

## Performing Stimulus-Response Measurements

Stimulus-response measurements characterize optical components for loss (or gain) versus wavelength. You can characterize devices such as couplers, switches, filters, fibers, and amplifiers. The following figure shows the response of an optical coupler versus wavelength.

To perform stimulus-response measurements, you must have an amplitude-stable broadband light source. Although a white-light source provides the widest wavelength input for stimulus-response measurements, you can also use an LED or the spontaneous emission from an optical amplifier.

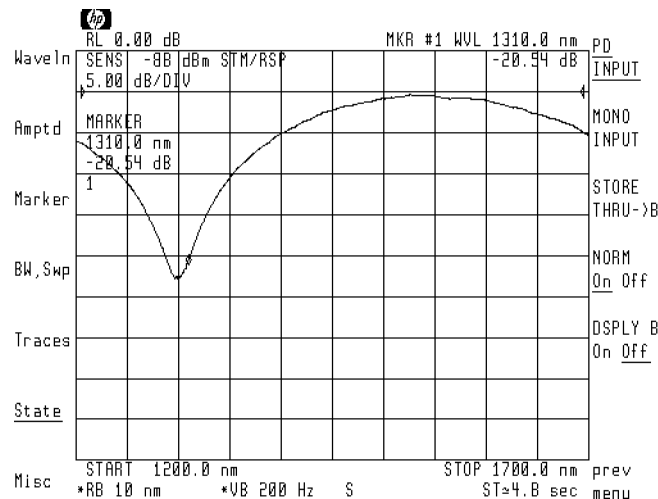

**Response of one output of an optical coupler.**

The displayed response is a convolution of the optical spectrum analyzer's resolution bandwidth and the amplitude response of the device being tested. Because of this convolution, the optical spectrum analyzer's resolution bandwidth affects both dynamic range and the ability to resolve fast amplitude changes versus wavelength. Wide resolution bandwidths improve dynamic range. Narrow resolution bandwidths increase the ability to resolve fast amplitude changes.

Changing Instrument Modes  
**Performing Stimulus-Response Measurements**

You can display two responses at the same time. The following figure shows the response of each of the outputs of an optical coupler versus wavelength.

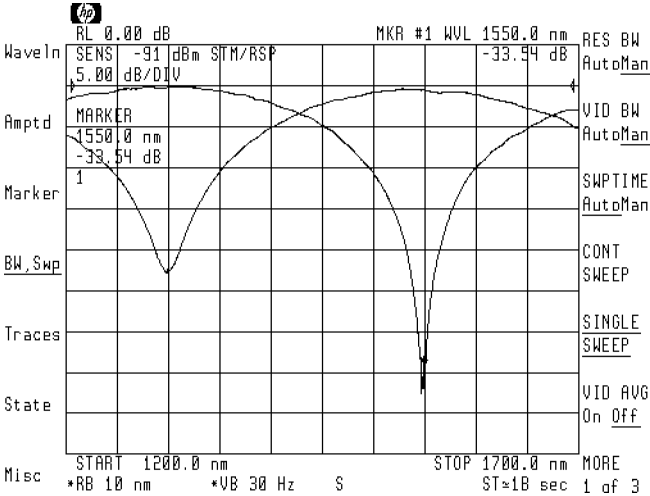

**Simultaneous display of both coupler outputs.**

**Performing Stimulus-Response Measurements**

**Block diagrams show light path**

The following block diagrams show the two instrument configurations available for stimulus-response testing. With the **PHOTODETECTOR INPUT** selected, the light from the light source first passes through the monochromator. This preselected light then passes through the device being tested before being detected by the optical spectrum analyzer.

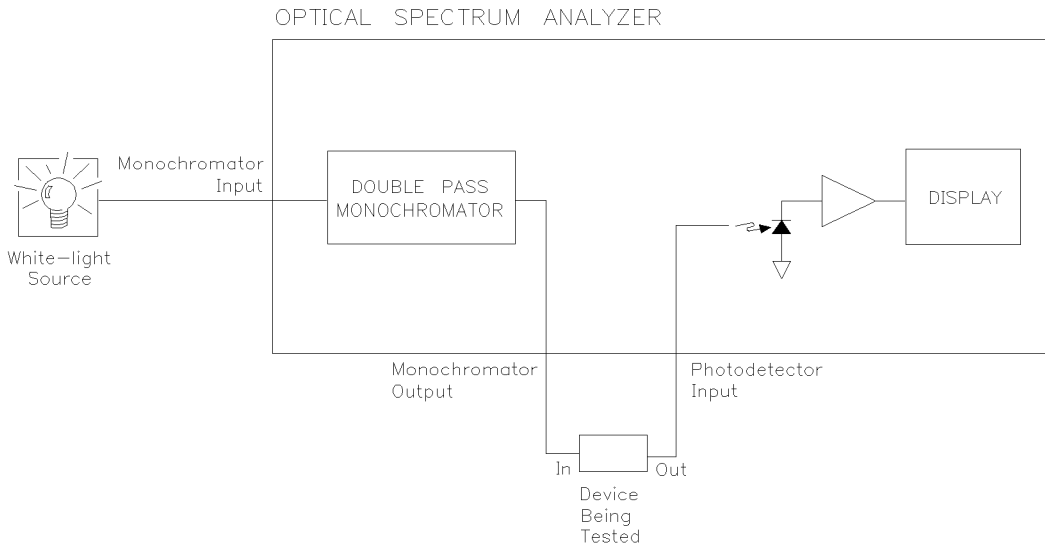

**Stimulus-response testing using photodetector input.**

With the **MONOCHROMATOR INPUT** selected, the light first passes through the device being tested. The output of the device being tested is connected to the monochromator input.

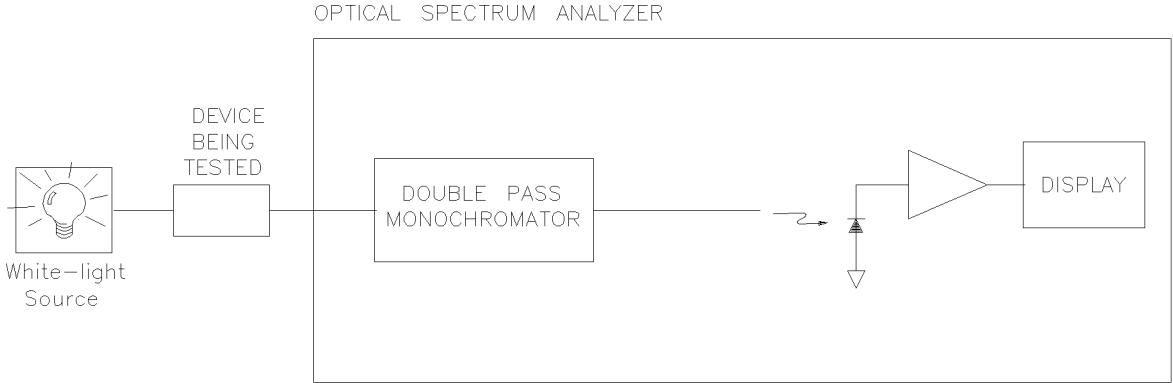

pkb21

**Stimulus-response testing using monochromator input.**

With both configurations, the analog output of the optical spectrum analyzer's detector and transimpedance amplifier is available at the rear-panel **ANALOG OUT** connector.

**Performing Stimulus-Response Measurements****Displayed response results from trace subtraction**

The displayed trace shows the ratio of the output power to the input power expressed as a logarithm (dB).

$$response (dB) = 10 \log \left( \frac{output\ power}{input\ power} \right)$$

The ratio is achieved through simple trace subtraction using logarithmic amplitude scales. This is possible because of the following logarithmic equality:

$$\log \left( \frac{A}{B} \right) = \log A - \log B$$

During a stimulus-response measurement, the trace of the input power is saved in trace B using the **STORE THRU→B** softkey. The power ratio is displayed by subtracting trace B from trace A using the **NORM On Off** softkey.

$$\log \left( \frac{trace\ A}{trace\ B} \right) = \log trace\ A - \log trace\ B$$

If there is no power loss (or gain) through a device, the power ratio is 1 and the trace is displayed at the reference position (0 dB).

$$10 \log 1 = 0\ dB$$

Loss or gain through the device under test offsets the trace below or above the 0 dB reference by the amount of the log of the loss or gain.

---

## To characterize a single-output device

As stated in the introduction to this section, there are two possible instrument configurations for this measurement. This example uses the configuration with the **PHOTODETECTOR INPUT**.

For best results, couple the light source to the monochromator using a short length of 62.5/125  $\mu$ m fiber-optic cable. This minimizes the sensitivity to optical alignments in the monochromator for 9/125  $\mu$ m device measurements and provides proper modal excitation for multimode fiber measurements.

Figures shown in this procedure display the characterization of an optical coupler.

1. Connect the light source to the optical spectrum analyzer's front-panel **MONOCHROMATOR INPUT** connector using a multimode fiber-optic cable.

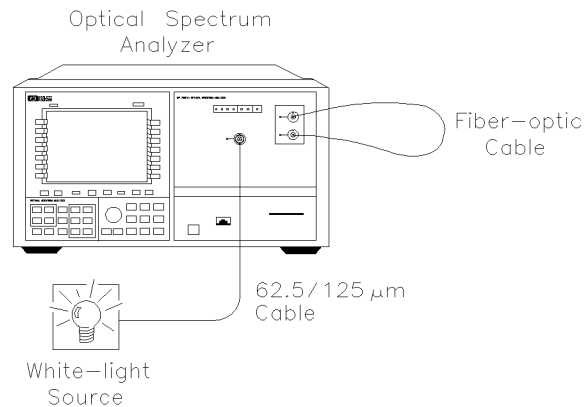

pkb20

2. Connect a fiber-optic cable, of the same diameter as in the device being tested, between the front-panel **MONOCHROMATOR OUTPUT** and **PHOTODETECTOR INPUT** connectors as shown in the preceding figure.
3. Press **(START)**, and enter the starting wavelength for the measurement.
4. Press **(STOP)**, and enter the ending wavelength for the measurement.

**Performing Stimulus-Response Measurements**

5. Press **RES BW** and enter a resolution bandwidth of 10 nm.  
 For the greatest measurement range and signal-to-noise ratio performance, it is recommended that the resolution bandwidth be set to 10 nm. Narrower bandwidths can be used if greater wavelength resolution is required.
6. Press the left-side **State** softkey.
7. Press **instr modes** and then **STM/RESP** to select stimulus-response mode.
8. Verify that **PD INPUT** is underlined.  
 This instrument configuration corresponds to the connection diagram shown in step 1.
9. Press **PEAK SEARCH** and then **TO REF LEVEL** to place the normalization response at the reference level.
10. Wait for one complete trace to be drawn on the display.

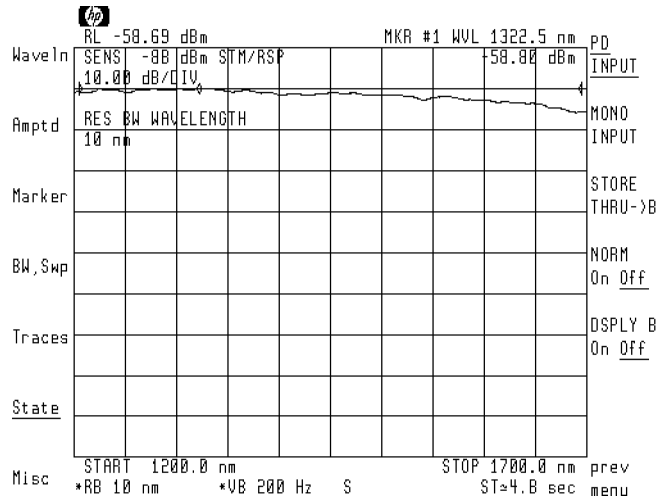

**Response of light path**

11. Press **STORE THRU->B** to store the response in trace B.



Changing Instrument Modes  
**Performing Stimulus-Response Measurements**

If changes to wavelength range or resolution bandwidth are made after this trace is stored, repeat this step.

12. Press **NORM On Off** to normalize the response at the reference position.

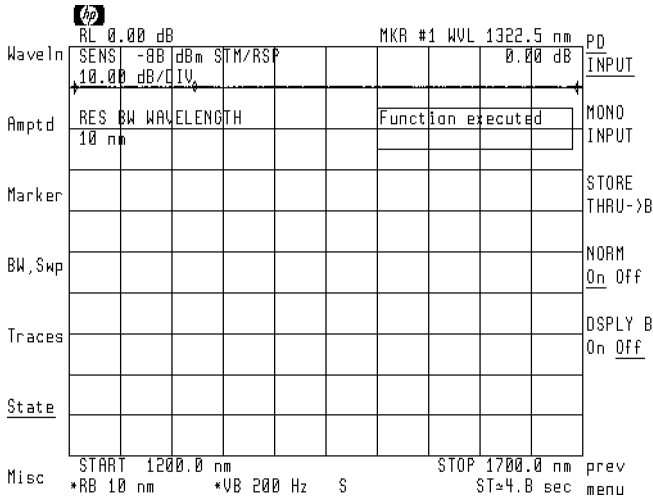

13. Insert the device being tested between the **PHOTODETECTOR INPUT** connector and the fiber-optic cable. See the following figure.

## Performing Stimulus-Response Measurements

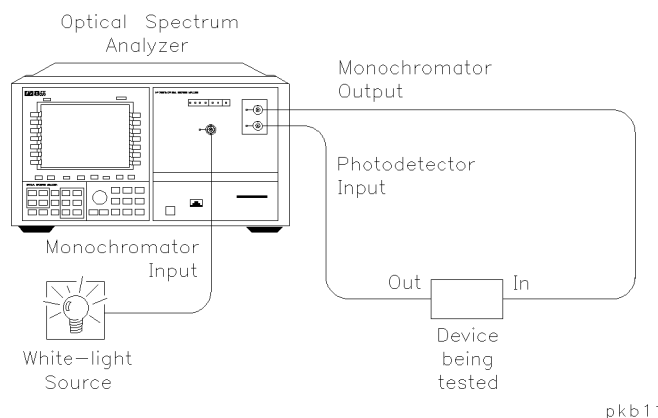

14. Press **NORMAL ON/OFF** to activate the markers.

The marker shows the insertion loss (or gain) of the device being tested at the marked wavelength. Use the front-panel knob to move the marker along the trace.

15. If you want to reduce the amplitude scale, perform the following steps:

- a. Press **PEAK SEARCH** and then **TO REF LEVEL**.

This places the response at the reference level. If you want to maintain a reference level of 0 dB, do not perform this step.

- b. Press the left-side **Amptd** softkey.
- c. Press **LOG dB/DIV**, and enter the desired logarithmic scale. For example, enter **5** dB.
- d. To return to the stimulus response menu, press **State**, **instr modes**, and then **STM/RESP**.

**Performing Stimulus-Response Measurements**

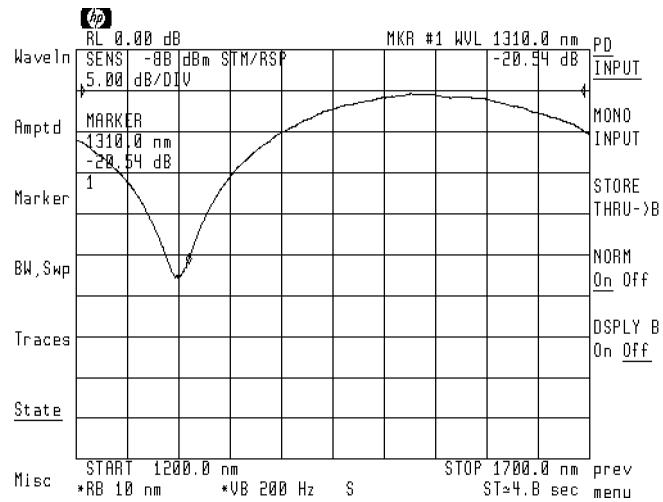

**Normalized response of coupler**

16. If you want to reduce displayed noise, perform the following steps:
  - a. Press the left-side **BW,Swp** softkey.
  - b. Press **VID BW AutoMan**, and reduce the video bandwidth.
  - c. To return to the stimulus response menu, press **State**, **instr modes**, and then **STM/RESP**.
17. Press **State**, **instr modes**, and then **OSA** to return to normal optical spectrum analyzer operation.

## To characterize a dual-output device

Devices such as optical couplers have two output ports. Use this procedure to display the normalized response of both outputs simultaneously.

1. Perform the previous procedure “To characterize a single-output device” to characterize one of the device’s outputs, but do not return to the OSA mode of operation at the end of the procedure.
2. Press the left-side **BW, Swp** softkey.
3. Press **SINGLE SWEEP**, and wait for one complete trace to be drawn on the display.

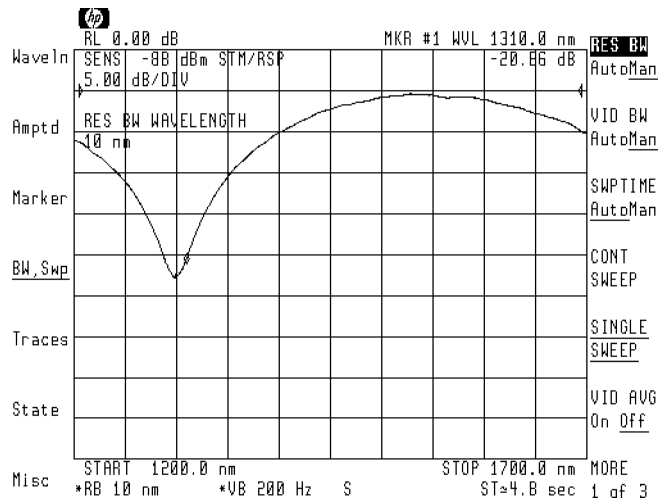

**Response of one of the coupler's outputs**

4. Press the left-side **Traces** softkey.
5. Press **MORE 1 of 4**, **oneshot math**, and then **A XCH C** to store trace A in trace C.
6. Press the left-side **Traces** softkey.

**Performing Stimulus-Response Measurements**

7. Press **trace A B C** so that **C** is selected.
8. Press **VIEW C BLANK C** so that **VIEW C** is underlined.
9. Press **trace A B C** so that **A** is selected.
10. Press **CLEAR WRT A**.
11. Disconnect the output of the device being tested from the front-panel **PHOTODETECTOR INPUT** connector.
12. Connect the device's second output to the front-panel **PHOTODETECTOR INPUT** connector.
13. Press the left-side **BW, Swp** softkey.
14. Press **SINGLE SWEEP** to show the response of the second output port.

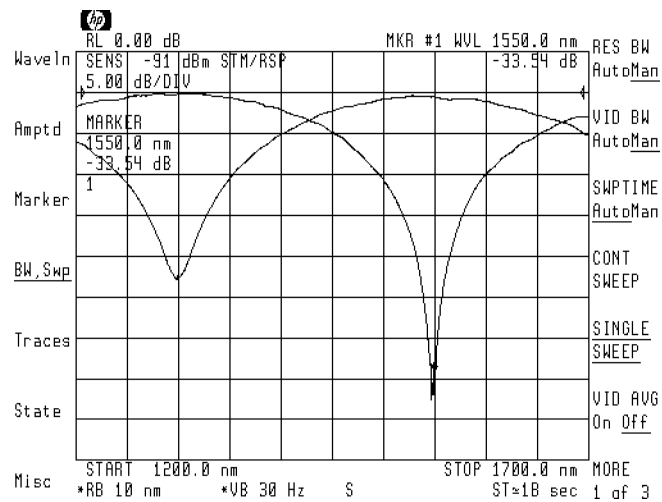

**Response of both coupler outputs**

---

## To display a trace of input power

After performing a stimulus-response measurement, trace B is the trace of the input light power over the selected wavelength range.

1. Press the left-side **State** softkey.
2. Press **instr modes** and then **STM/RESP**.
3. Press **DSPLY B On Off** so that **On** is underlined.
4. If the trace is not displayed, increase the amplitude scale.

---

## To make measurements on a linear scale

The stimulus-response measurements made in this section resulted in a logarithmic display of the results. The measurements can also be made with a linear amplitude scale. In order to do this, the amplitude scale must be changed to linear prior to saving the normalization trace.

In order to make the measurement with a linear scale, the procedure discussed earlier in this section can be used with the following exceptions:

1. After placing the normalization response at the reference level by pressing **PEAK SEARCH** and then **TO REF LEVEL**, change to a linear scale by pressing the left-side **Amptd** softkey and then **LINEAR**.
2. Prior to pressing **STORE THRU -> B** to save the normalization trace, reduce the noise on the trace by reducing the optical spectrum analyzer's video bandwidth:
  - a. Press the left-side **BW, Swp** softkey.
  - b. Press **VID BW AutoMan**.
  - c. Press **▼** until the trace appears to be free from noise.

**Performing Stimulus-Response Measurements**

- 3. After the normalization function has been activated, do not change the reference level, either manually or with the **PEAK SEARCH** and **TO REF LEVEL** functions as described for reducing the amplitude scale.

For this measurement, the amplitude scale must remain fixed at 0 (bottom) to 1.00 x (top).

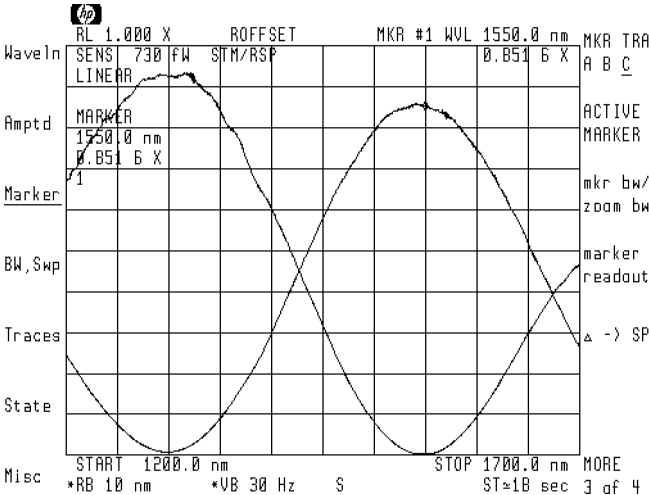

**WDM coupler's insertion loss characterized on a linear scale.**

---

## To use alternative trace definitions

The normalization function in the stimulus-response mode menu normalizes the measured data to a through reference trace. This uses the trace math of  $A-B \rightarrow A$  for logarithmic scales and  $A/B \rightarrow A$  for linear scales.

In some cases, other trace definitions are desired. Additional trace definitions are available in the traces menu under `trace logmath` (for measurements on a logarithmic scale) and `trace linmath` (for measurements on a linear scale). These definitions make use of various combinations of traces A, B, and C and, in some cases, the display line for a scaling factor. Traces B and C are used as stored reference traces and trace A is active, with the results being updated for each new measurement of trace A. In order to scale the resultant information for a result of 0 dB (or 1.00 x) to be at the reference level, the display line should be set to be equal to the reference level.

When using these trace definitions, it is not always necessary to use the stimulus-response instrument mode. Whether or not to use it depends on the instrument configuration being used. If the device being tested is to be placed between the light source output and the monochromator input, then activating the stimulus-response mode is not required. If the configuration in which the device being tested is placed between the monochromator output and the photodetector input is used, the stimulus-response mode must be activated in order to select the front-panel `PHOTODETECTOR INPUT (PD INPUT)`. If the stimulus-response instrument mode is not used, the optical spectrum analyzer's autorange function should be activated prior to beginning the measurement by pressing the left-side `Amptd` softkey followed by `MORE 1 of 4` and then `AUTORNG On Off` so that `On` is underlined.

Prior to saving any reference traces, it should be ensured that the optical spectrum analyzer is using sample, rather than peak, detection. This ensures greatest accuracy, and is indicated by an `S` character displayed at the bottom, center of the screen. This is accomplished by pressing `VID BW AutoMan` two times until `Man` is underlined, or pressing `VID BW AutoMan` one time and reducing the bandwidth by pressing `(▼)` at least one time. Additional video bandwidth reduction can be used to remove any unwanted noise on the trace.

One example use of the additional trace definitions is the linear characterization of a WDM coupler's coupling ratio. Coupling ratio is defined



as the ratio of the power at one output port to the sum of the power at all output ports. This is different than the standard insertion loss definition and requires a different trace definition. For a two output device, the equation  $A \leftarrow A*DL/(A+B)$  provides the proper definition. Trace A represents the power at the output under test, trace B represents the power at the other output, and A+B represents the total output power. In order to display the results on the same scale as the measured data, the display line is set equal to the reference level resulting in the value of  $A/(A+B) = 1$  being displayed at the reference level.

The linear measurement of a coupler's excess loss is also possible using one of the trace linmath equations. In this case, the equation  $A \leftarrow DL*(A+B)/C$  is used, where trace C is a measurement of the power at the device input and traces A and B are measurements of the power at each of the outputs. Again, the display line is set equal to the reference level for proper scaling.

---

## Making Fast Pulse Measurements

OSA pulse instrument mode provides the capability to accurately perform fast pulse measurements. This mode is identical to normal spectrum analyzer operation with one exception — the range of the instrument's internal transimpedance amplifier is limited in order to select wide bandwidth and fast settling characteristics.

Entering OSA pulse instrument mode, displays a menu from which you can conveniently access many of the pulse settings available with the optical spectrum analyzer. To learn more about these settings, refer to Chapter 3. You'll learn in Chapter 3, that you do not have to enter OSA pulse mode to use these settings.

One example of using OSA pulse mode is measuring the signal-to-noise ratio (SNR) of EDFA systems. This is accomplished by measuring the amplified spontaneous emission (ASE) level immediately ( $10\ \mu\text{s}$ ) after the source is turned off.

---

### To measure fast pulses

1. Press the left-side **State** softkey.
2. Press **MORE 1 of 4**, **instr modes**, and then **OSA PULSE**.
3. Select from the three display techniques described in Chapter 3.

## Measuring Broadband Power

### NOTE

This instrument mode is only available on HP 71451B/ HP 70951B optical spectrum analyzers.

Power-meter instrument mode displays the broadband power of the input light over time. The display's horizontal scale is calibrated in time rather than wavelength. This can be seen in the following figure. With power meter mode, you can perform the following:

- Measure total power of a broadband light source.
- Monitor power as a function of time to observe both long and short term drift.
- Monitor power to perform real-time adjustments.

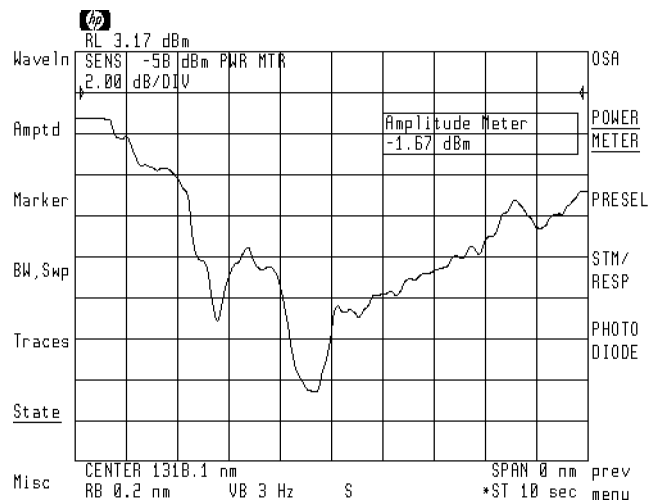

Display of broadband power versus time.

Changing Instrument Modes

**Measuring Broadband Power**

Power-meter instrument mode places the optical spectrum analyzer in the following settings:

Sweep time .....	10 s
Amplitude scale (if logarithmic) .....	5 dB/division
Video bandwidth .....	3 Hz

**Block diagram shows light path**

Because the input light is connected directly to the optical spectrum analyzer's photodetector, there is no filtering by the resolution bandwidth filters. Although the light does not pass through the monochromator, a center wavelength value should be entered. The center wavelength value selects the amplitude calibration factor used for the measurement.

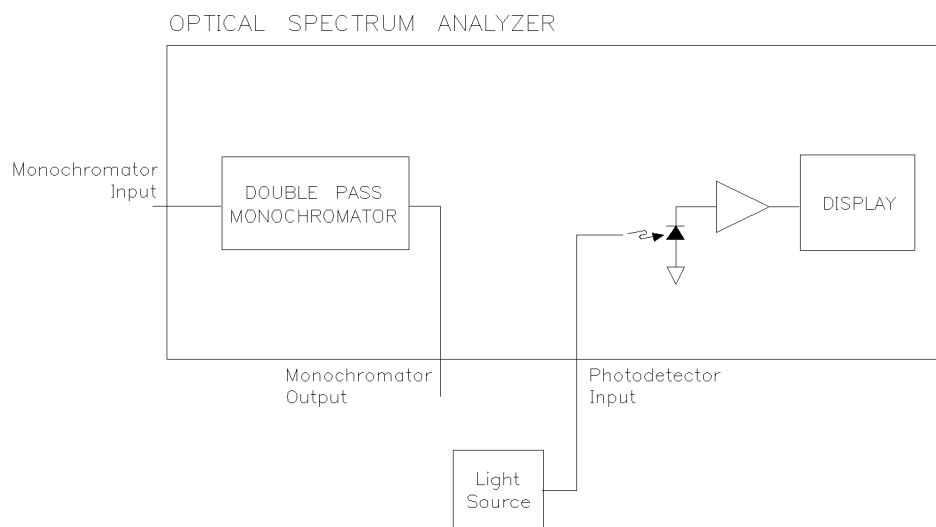

pkb18

**Block diagram of power-meter mode**

---

## To measure broadband power

User calibrations may be used to offset the amplitude in power-meter mode. A user power-calibration that is performed in optical spectrum analyzer mode is not used in power-meter mode. However, a user wavelength calibration performed in optical spectrum analyzer mode is applied in power-meter mode.

1. Connect the light source to the optical spectrum analyzer's front-panel **PHOTODETECTOR INPUT** connector as shown in the following figure.

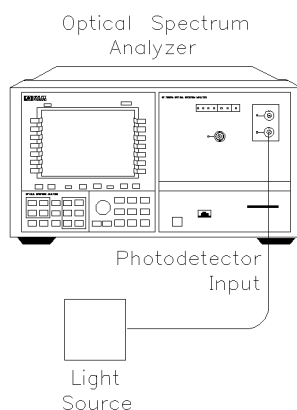

pkb14

2. Press the left-side **State** softkey.
3. Press **instr modes** and then **POWER METER** to select power meter mode.
4. Enter a center wavelength value to select the amplitude calibration factor for the power measurement.
5. If you need higher amplitude resolution, do the following:
  - a. Press **PEAK SEARCH** and then **TO REF LEVEL**.  
This places the response at the reference level.
  - b. Press the left-side **Amptd** softkey.

- c. Press **LOG dB/DIV**, and reduce the amplitude scale. For example, enter **1 dB**.
6. Press **State**, **instr modes**, and then **OSA** to return to normal optical spectrum analyzer operation.

**Zeroing may be required**

If the optical spectrum analyzer is left in power meter mode for long periods of time, the detector electronics may require zeroing for accurate measurements. To zero the detector, disconnect the input light and press the following softkeys: **Amptd**, **MORE 1 of 4**, **MORE 2 of 4**, **ZERO**.

---

## Preselecting a Light Source

**NOTE**

This instrument mode is only available on HP 71451B/ HP 70951B optical spectrum analyzers.

In preselector instrument mode, the optical spectrum analyzer acts as a fixed-tuned, variable wavelength, variable bandwidth, bandpass filter. It filters the input light at a specified wavelength. The filtered light is available at the front-panel **MONOCHROMATOR OUTPUT** connector. To change the amount of filtering, simply adjust the optical spectrum analyzer's resolution bandwidth. (Any of the resolution bandwidths may be chosen.) One application of preselector mode is the filtering (selecting) of one particular mode of a laser source.

When preselector mode is entered, the sweep stops with the optical spectrum analyzer fix tuned at the center wavelength. (If a marker is on, the optical spectrum analyzer is fix tuned at the marker wavelength.) The last trace remains displayed to show the input spectrum before the filtering. A marker shows the wavelength of the preselection. You can change the filtered output (preselection) wavelength by adjusting the marker's position. If the input spectrum changes, a softkey is provided for capturing a new sweep.



Changing Instrument Modes  
**Preselecting a Light Source**

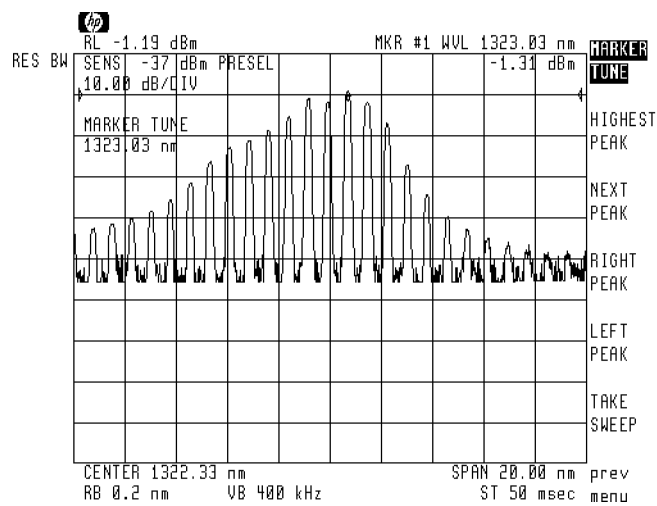

**Marker shows wavelength of preselection.**

Changing Instrument Modes

**Preselecting a Light Source**

If **RES BW** is selected for change, pressing one of the marker “peak” softkeys will not change the preselection tuning. (Although the marker will move.)

You must press **MARKER TUNE** to set the preselection wavelength to the value at the marker.

If the output light is directed into a  $9\mu$  fiber-optic cable, additional steps must be taken to ensure proper launching of the light into the cable. These additional steps are included in “To use a single mode output cable” in this section.

**Block diagram shows light path**

The following block diagram shows that the input light only passes through the internal monochromator. Thus, the bandwidth of the preselection is equal to the bandwidth of the selected resolution bandwidth filter.

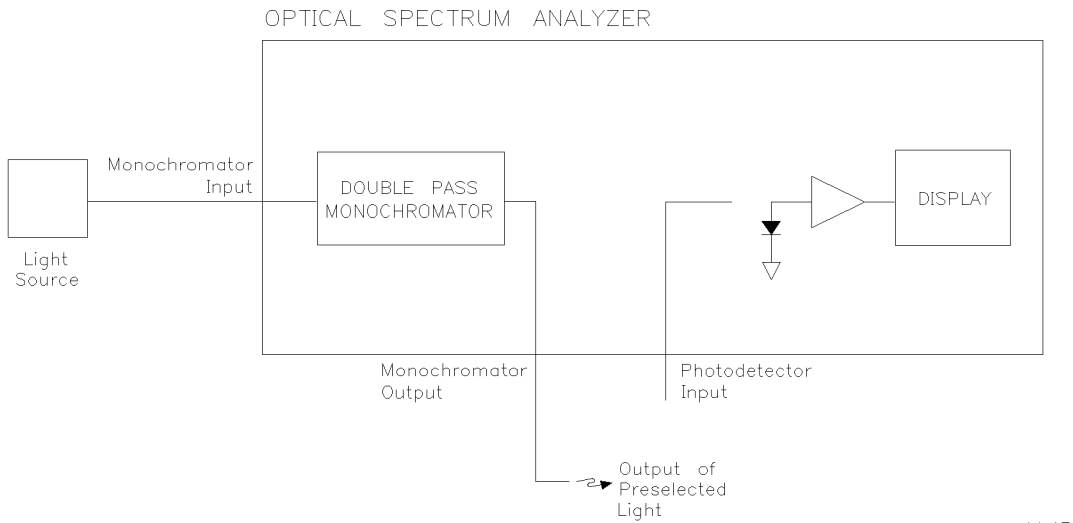

pkb 17

**Block diagram of preselection mode**

---

## To preselect a light source

1. Connect the light source to the optical spectrum analyzer's front-panel **MONOCHROMATOR INPUT** connector as shown in the following figure.

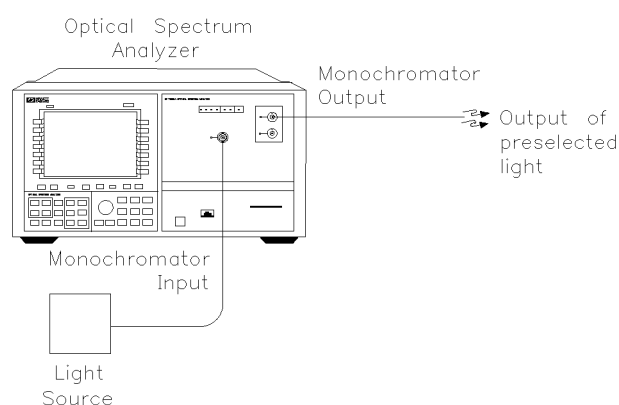

pkb15

2. Press **AUTO MEAS**. After the routine has finished, check that the display shows the wavelength range of interest. Adjust if necessary.
3. Press the left-side **State** softkey.
4. Press **instr modes** and then **PRESEL** to select preselector mode.
5. Press the left-side **RES BW** softkey.
6. Use the knob, step keys, or numeric keypad to enter the desired amount of resolution bandwidth filtering.
7. Press **TAKE SWEEP** to update the display to show the results of the new resolution bandwidth filtering.
8. The light is output from the optical spectrum analyzer's front-panel **MONOCHROMATOR OUTPUT** connector.

**Preselecting a Light Source**

This light is the filtered (by resolution bandwidth) and slightly attenuated (by monochromator loss) light input to the front-panel **MONOCHROMATOR INPUT** connector. Refer to Chapter 1 of the Reference manual for information on monochromator loss.

9. Press **MARKER TUNE**. Turn the front-panel knob to tune the preselector to any displayed wavelength.
10. If the input light changes, or if you change the span of the optical spectrum analyzer, press **TAKE SWEEP** to update the displayed trace with valid waveform data.
11. Press **prev menu** to return to normal optical spectrum analyzer operation.

---

## To use a single mode output cable

This procedure ensures the best launching of the output light from the  $62.5\mu$  **MONOCHROMATOR OUTPUT** connector into a  $9\mu$  fiber-optic cable.

1. Connect the light source to the optical spectrum analyzer's front-panel **MONOCHROMATOR INPUT** connector as shown in the following figure. Use a  $9\mu$  fiber-optic cable.

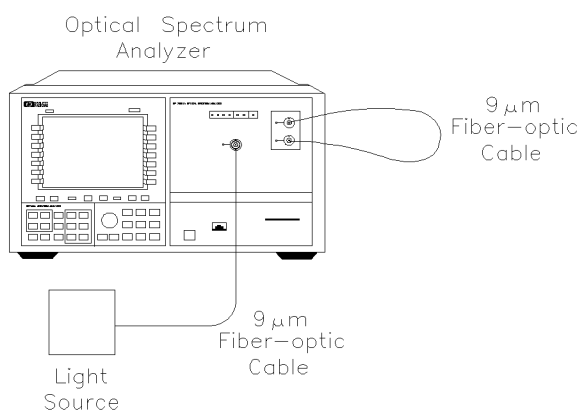

2. Connect a  $9\mu$  m fiber-optic cable between the front-panel **MONOCHROMATOR OUTPUT** and **PHOTODETECTOR INPUT** connectors as shown in the preceding figure.
3. Press **AUTO MEAS**. After the routine has ended, check that the display shows the wavelength range of interest. Adjust if necessary.

The light response to be preselected should be displayed on the screen.

4. Press the left-side **State** softkey.
5. Press **instr modes** and then **STM/RESP** to select stimulus-response mode.

Stimulus-response mode directs the light through the  $9\mu$  m fiber-optic cable.

**Preselecting a Light Source**

6. Wait for one complete trace to be drawn on the display.
7. Press **AUTO ALIGN**. Wait for the automeasurement routine to end.
8. Press the **prev menu** softkey.
9. Press **PRESEL** to select preselector mode.
10. Disconnect the 9 $\mu$  m fiber-optic cable from the front-panel **PHOTODETECTOR INPUT** connector.  
The output light is available at the loose end of this cable.
11. Press the left-side **RES BW** softkey.
12. Use the knob, step keys, or numeric keypad to enter the desired amount of resolution bandwidth filtering.
13. Press **TAKE SWEEP** to update the display to show the results of the new resolution bandwidth filtering.
14. Press **MARKER TUNE**. Turn the front-panel knob to tune the preselector to any displayed wavelength.
15. If the input light changes, or if you change the span or resolution bandwidth of the optical spectrum analyzer, press **TAKE SWEEP** to update the displayed trace with valid waveform data.
16. Press **prev menu** to return to normal optical spectrum analyzer operation.

---

## Measuring Photodetector Responsivity

**NOTE**

This instrument mode is only available on HP 71451B/ HP 70951B optical spectrum analyzers.

Photodiode instrument mode characterizes a photodetector's ability to convert light to electrical current. The displayed trace shows the ratio of the output current to the power of the input light expressed as a logarithm (dB). (The amplitude scale is amperes/watt.

$$response = 10 \log \left( \frac{output\ current\ in\ amperes}{input\ optical\ power\ in\ watts} \right)$$

To perform photodetector-responsivity measurements, you must have an amplitude-stable light source. Although a white-light source provides the widest wavelength input for photodetector-responsivity measurements, you can also use an LED or the spontaneous emission from an optical amplifier. Because of the low-level excitation provided by most white-light sources, proper shielding from light and electromagnetic interference must be maintained for accurate measurements.

The following figure shows the responsivity of a typical photodiode.

Changing Instrument Modes

**Measuring Photodetector Responsivity**

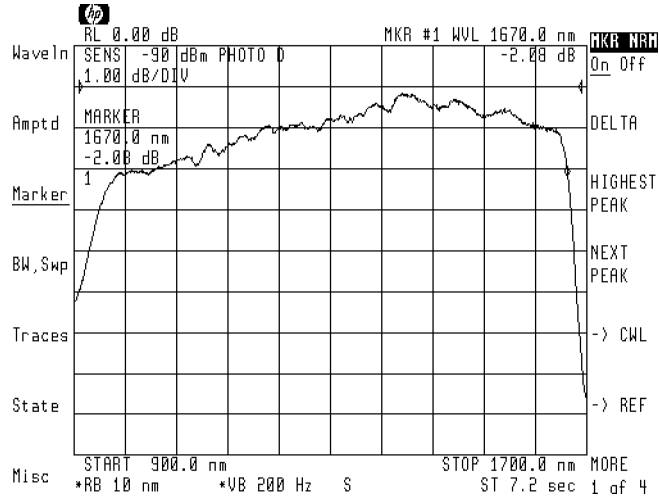

**Responsivity of a typical photodiode**



**Block diagram shows light path**

During photodetector-responsivity testing, the input light passes through the monochromator before being applied to the photodetector being tested. The optical spectrum analyzer processes the resulting photodetector current. The analog output of the optical spectrum analyzer's transimpedance amplifier is also available at the rear-panel **ANALOG OUT** connector.

The photodiode must be connected such that the photocurrent flows in the direction shown in the following figure. If the anode of the photodiode is connected to the **TRANS-Z** coaxial ground, the optical spectrum analyzer will measure the photodiode with zero volts bias.

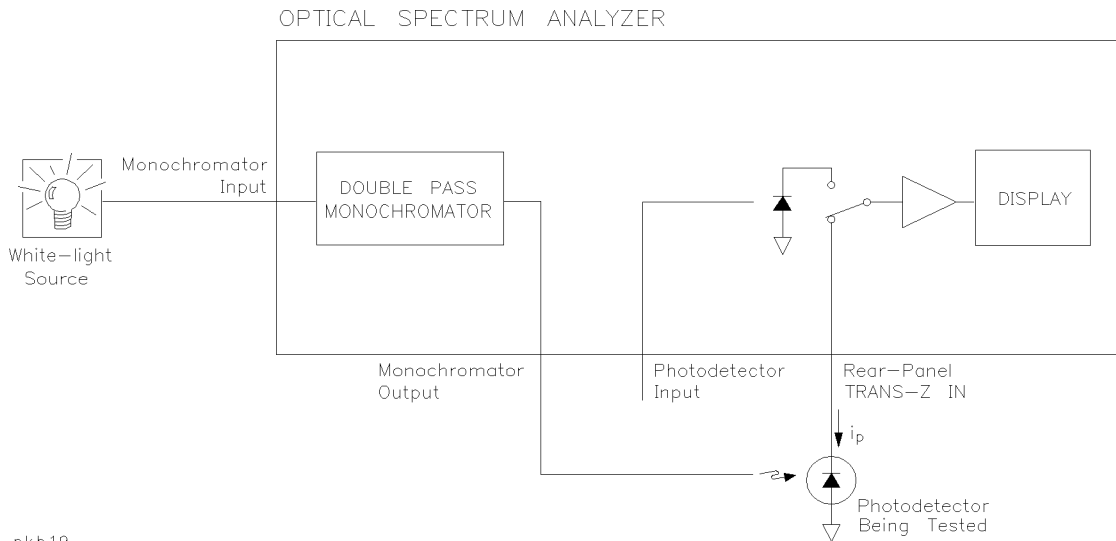

pkb19

**Block diagram of photodetector mode.**

**Measuring Photodetector Responsivity**

**Displayed response results from trace subtraction**

The displayed trace shows the ratio of the output current to the input light power expressed as a logarithm (dB).

$$response (dB) = 10 \log \left( \frac{amperes}{watts} \right)$$

The ratio is achieved through simple trace subtraction using logarithmic amplitude scales. This is possible because of the following logarithmic equality:

$$\log \left( \frac{A}{B} \right) = \log A - \log B$$

During photodiode mode, the trace of the input light power is saved in trace B using the **STORE THRU→B** softkey. The output current from the photodetector is then input to the optical spectrum analyzer and displayed on trace A. The ratio is displayed by subtracting trace B from trace A using the **NORM On Off** softkey.

$$\log \left( \frac{trace A}{trace B} \right) = \log trace A - \log trace B$$

If the ratio of the current to the light power is 1 amp/watt, the trace is displayed at the reference position (0 dB).

$$10 \log 1 = 0 dB$$

---

## To measure photodetector responsivity

For best results, couple the light source to the monochromator using a short length of 62.5/125  $\mu\text{m}$  fiber-optic cable. This minimizes the sensitivity to optical alignments in the monochromator for 9/125  $\mu\text{m}$  device measurements and provides proper modal excitation for multimode fiber measurements.

Figures shown in this procedure display the characterization of a typical photodiode.

1. Connect the light source to the optical spectrum analyzer's front-panel **MONOCHROMATOR INPUT** connector.

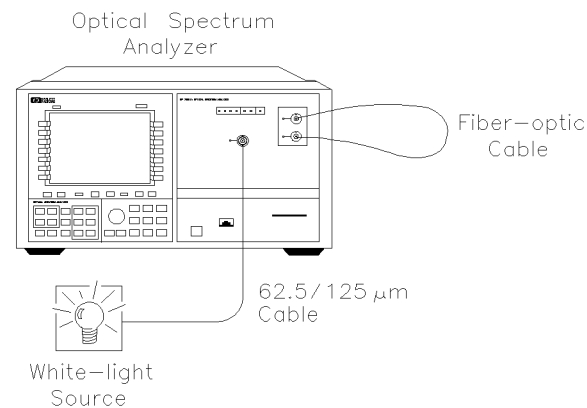

pkb20

2. Connect a fiber-optic cable between the front-panel **MONOCHROMATOR OUTPUT** and **PHOTODETECTOR INPUT** connectors as shown in the preceding figure.
3. Press **START**, and enter the starting wavelength for the measurement.
4. Press **STOP**, and enter the ending wavelength for the measurement.
5. Press **RES BW** and enter a resolution bandwidth of 10 nm.

For the greatest measurement range and signal-to-noise ratio performance, it is recommended that the resolution bandwidth be set

**Measuring Photodetector Responsivity**

to 10 nm. Narrower bandwidths can be used if greater wavelength resolution is required.

6. Press the left-side **State** softkey.
7. Press **instr modes** and then **PHOTO DIODE** to select stimulus-response mode.
8. Press **PEAK SEARCH** and **TO REF LEVEL** to place the normalization response at the reference level.
9. Wait for one complete trace to be drawn on the display.

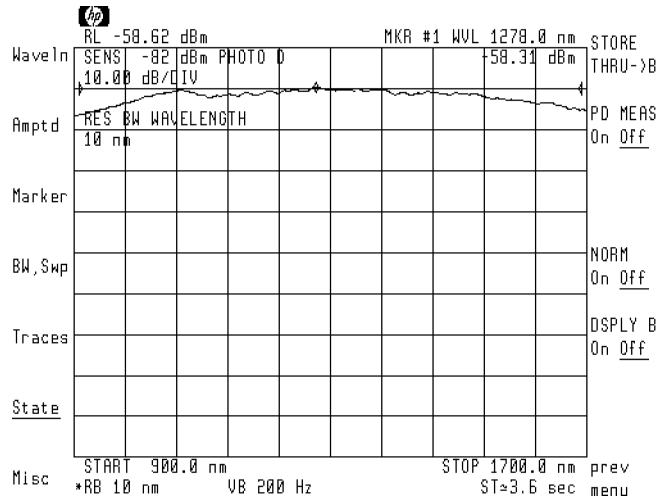

**Typical response of a light source**

10. Press **STORE THRU->B** to store the response in trace B.

If changes to wavelength range or resolution bandwidth are made after this trace is stored, repeat this step.

11. Disconnect the cable from the front-panel **PHOTODETECTOR INPUT** connector. Connect the cable to the photodetector being tested as shown in the following figure.

Changing Instrument Modes  
**Measuring Photodetector Responsivity**

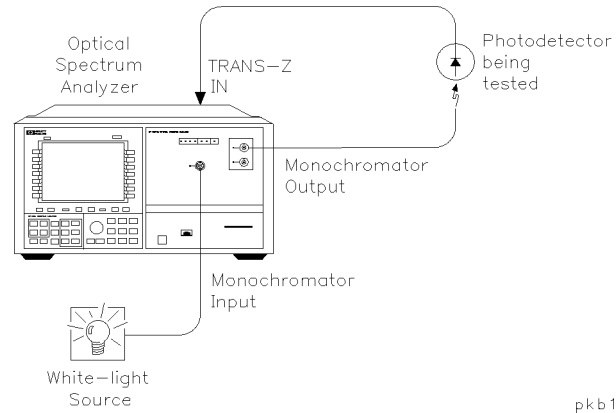

pkb12

12. Connect the output of the photodetector to the optical spectrum analyzer's rear-panel TRANS-Z IN connector.
13. Press **PD MEAS On Off** to turn on photodetector responsivity measurement.

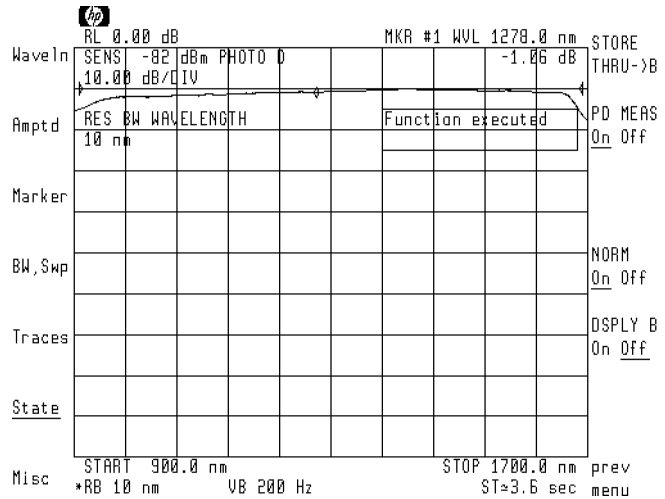

**Typical responsivity trace.**

## Changing Instrument Modes

14. If you want to reduce the amplitude scale, perform the following steps:
  - a. Press **PEAK SEARCH** and then **TO REF LEVEL**.  
This places the response at the reference level. If you want to maintain a reference level of 1 ampere/watt, do not perform this step.
  - b. Press the left-side **Amptd** softkey.
  - c. Press **LOG dB/DIV**, and enter the desired logarithmic scale. For example, enter **1** dB.
  - d. To return to the photodiode menu, press **State**, **instr modes**, and then **PHOTO DIODE**.

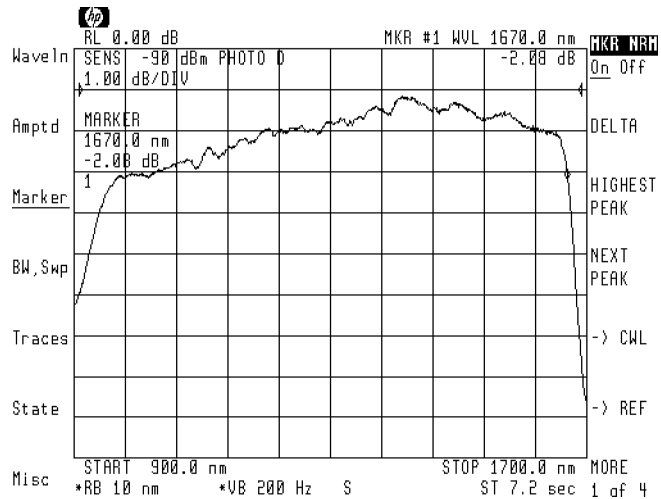

**Reduced amplitude scale.**

15. Press **State**, **instr modes**, and then **OSA** to return to normal optical spectrum analyzer operation.

---

## To display a trace of input power

Trace B is the trace of the input light power over the selected wavelength range.

1. Press **DSPLY B On Off** so that **On** is underlined.
2. If the trace is not displayed, increase the amplitude scale.

**Changing Instrument Modes**

---



**Using Option 002, Built-in  
White Light Source**

---

## Using Option 002, Built-in White Light Source

The information in this chapter introduces you to Option 002. The HP 71450B/1B/2B Option 002 provides a built-in white light source. Option 002 is a stable, broadband light source for swept-wavelength stimulus response testing from 900 nm to 1700 nm.

**Contents**

Operating the Light Source .....	6-4
To turn on the light source .....	6-4
Using the Light Source with the HP 71451B .....	6-5
Stimulus-Response Measurements with the HP 71450B/2B .....	6-6
To characterize a single-output device .....	6-10
To characterize a dual-output device .....	6-15
To display a trace of input power .....	6-17
To make measurements on a linear scale .....	6-17
To use alternative trace definitions .....	6-19
Replacing the Lamp .....	6-21
To replace the lamp .....	6-22

---

## Operating the Light Source

The output of the light source is accessed via the front-panel **LIGHT SOURCE OUTPUT** connector. The light is brought to this connector with a 62.5/125  $\mu$  m fiber. The standard connector interface is FC/PC, although other adapter interfaces are available.

### **Extending the lamp's lifetime**

Although the light source's lamp lasts an exceptionally long time, you can increase its life span by turning it off when it is not in use.

---

## To turn on the light source

1. Press the left-side **State** softkey.
2. Press **light source**.
3. Press **WHITE On Off** so that **On** is underlined.

To turn off the white light source, press **WHITE On Off** so that **Off** is underlined.

---

## Using the Light Source with the HP 71451B

Chapter 5 of this manual describes how to preselect light sources, perform stimulus-response measurements, and measure photodetector responsivity. The built-in white light source is an ideal source for these tasks. Use the short 62.5/125  $\mu\text{m}$  fiber provided with Option 002 to connect from the front-panel **LIGHT SOURCE OUTPUT** to **MONOCHROMATOR INPUT** connectors. A 9/125  $\mu\text{m}$  fiber is also provided for the normalization of measurements of single-mode fiber devices.

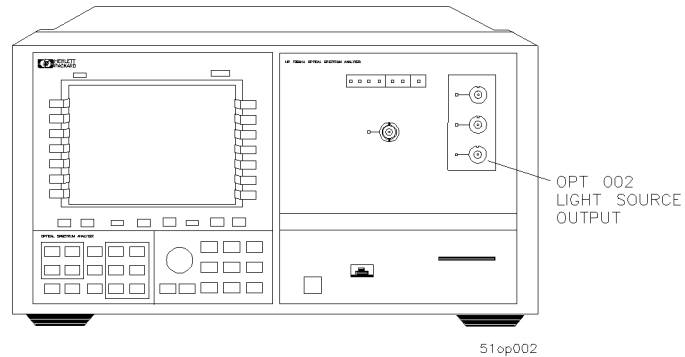

**HP 71451B with Option 002**

---

## Stimulus-Response Measurements with the HP 71450B/2B

The light source can be used as the source for stimulus response measurements with the HP 71450B/2B optical spectrum analyzer.

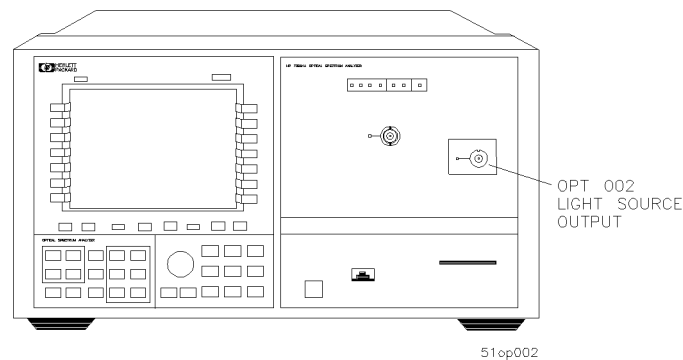

**HP 71450B/2B with Option 002**

Stimulus-response measurements characterize optical components for loss (or gain) versus wavelength. You can characterize devices such as couplers, switches, filters, and fibers. The following figure shows the response of one output of an optical coupler versus wavelength.

**Stimulus-Response Measurements with the HP 71450B/2B**

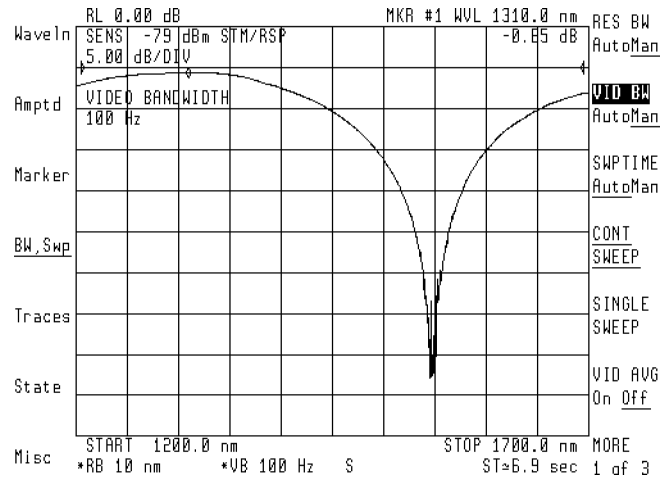

**Response of a coupler.**

The displayed response is a convolution of the optical spectrum analyzer's resolution bandwidth and the amplitude response of the device being tested. Because of this convolution, the optical spectrum analyzer's resolution bandwidth affects both dynamic range and the ability to resolve fast amplitude changes versus wavelength. Wide resolution bandwidths improve dynamic range. Narrow resolution bandwidths increase the ability to resolve fast amplitude changes.

Using Option 002, Built-in White Light Source

**Stimulus-Response Measurements with the HP 71450B/2B**

You can display two responses at the same time. The following figure shows the response of each of the outputs of an optical coupler versus wavelength.

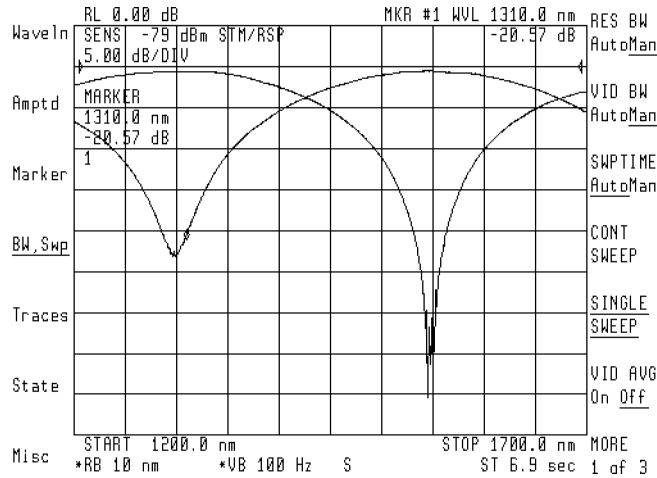

**Simultaneous display of both coupler outputs.**

**Block diagram shows light path**

During stimulus-response testing, the light from the light source first passes through the device under test and then into the optical spectrum analyzer. The analog output of the optical spectrum analyzer's detector and transimpedance amplifier is available at the rear-panel ANALOG OUT connector.

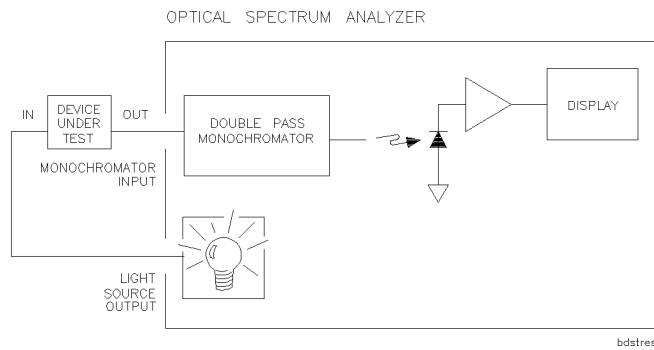

**Block diagram of stimulus-response measurement.**



**Displayed response results from trace subtraction**

The displayed trace shows the ratio of the output power to the input power expressed as a logarithm (dB).

$$response (dB) = 10 \log \left( \frac{output\ power}{input\ power} \right)$$

The ratio is achieved through simple trace subtraction using logarithmic amplitude scales. This is possible because of the following logarithmic equality:

$$\log \left( \frac{A}{B} \right) = \log A - \log B$$

During a stimulus-response measurement, the trace of the input power is saved in trace B. The power ratio is displayed by subtracting trace B from trace A using the **NORM On Off** softkey.

$$\log \left( \frac{trace\ A}{trace\ B} \right) = \log trace\ A - \log trace\ B$$

If there is no power loss (or gain) through a device, the power ratio is 1 (0 dB).

$$10 \log 1 = 0\ dB$$

Loss or gain through the device under test offsets the trace below or above 0 dB by the amount of the log of the loss or gain.

---

## To characterize a single-output device

Figures shown in this procedure display the characterization of an optical coupler.

1. Connect the optical spectrum analyzer's **LIGHT SOURCE OUTPUT** connector to the **OPTICAL INPUT** connector using a fiber size that matches the device under test.

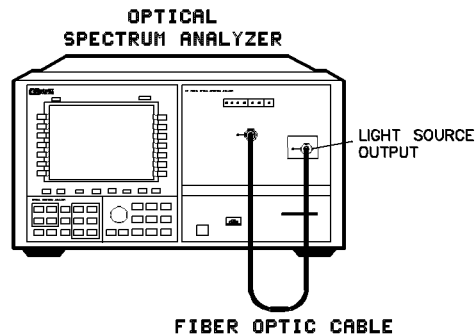

sglout

### Initial setup for single-output device test

2. Press the left-side **State** softkey.
3. Press **light source** and then **WHITE On Off** so that **On** is highlighted. This turns on the built-in white light source.
4. Press **(START)**, and enter the starting wavelength for the measurement.
5. Press **(STOP)**, and enter the ending wavelength for the measurement.
6. Press **(RES BW)** and enter a resolution bandwidth of 10 nm.

For the greatest measurement range and signal-to-noise ratio performance, it is recommended that the resolution bandwidth be set to 10 nm. Narrower bandwidths can be used if greater wavelength resolution is required.

7. Press the left-side **State** softkey.

Using Option 002, Built-in White Light Source  
**Stimulus-Response Measurements with the HP 71450B/2B**

8. Press **instr modes** and then **STM/RESP** to select stimulus-response mode.
9. Press **PEAK SEARCH** and then **TO REF LEVEL** to place the normalization response at the reference level.
10. Wait for one complete trace to be drawn on the display.

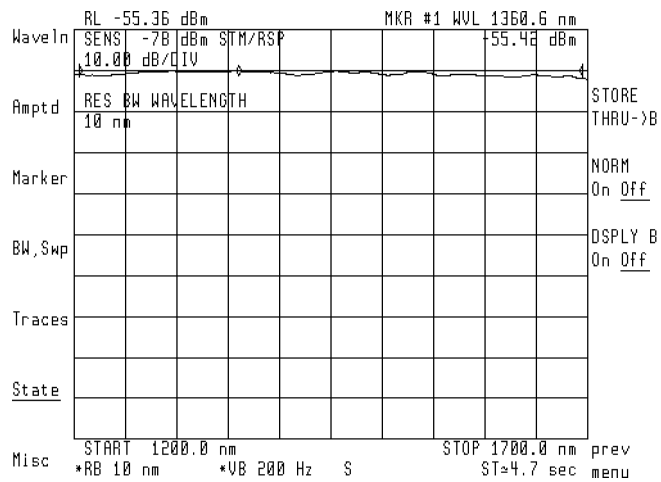

**Response of light path.**

11. Press **STORE THRU->B** to store the response in trace B.  
 If changes to wavelength range or resolution bandwidth are made after this trace is stored, repeat this step.
12. Press **NORM On Off** to normalize the response at the reference position.

Using Option 002, Built-in White Light Source

**Stimulus-Response Measurements with the HP 71450B/2B**

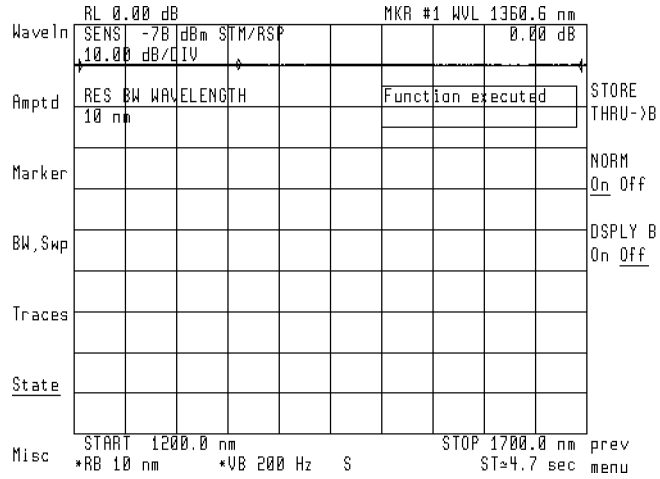

**Normalized response of light path.**

13. Insert the device being tested between the **OPTICAL INPUT** connector and the fiber-optic cable as shown in the following figure.

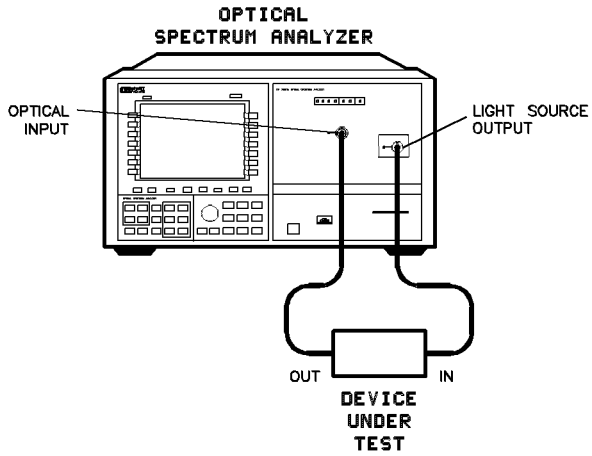

**Test setup for single-output device-under-test**

tssglout

**Stimulus-Response Measurements with the HP 71450B/2B**

14. Press **NORMAL ON/OFF** to activate the marker.

The marker shows the insertion loss (or gain) of the device being tested at the marked wavelength. Use the front-panel knob to move the marker along the trace.

15. If you want to reduce the amplitude scale, perform the following steps:
- Press **PEAK SEARCH** and then **TO REF LEVEL**. This places the response at the reference level. If you want to maintain a reference level of 0 dB, do not perform this step.
  - Press the left-side **Amptd** softkey.
  - Press **LOG dB/DIV**, and enter the desired logarithmic scale. For example, enter **5** dB.

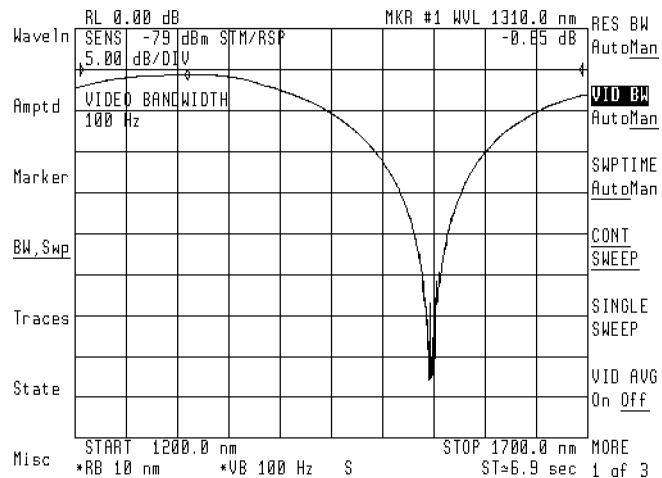

**Normalized response of coupler.**

16. If you want to reduce displayed noise, perform the following steps:
- Press the left-side **BW,Swp** softkey.
  - Press **VID BW AutoMan**, and reduce the video bandwidth.
  - To return to the stimulus response menu, press **State**, **instr modes**, and then **STM/RESP**.

Using Option 002, Built-in White Light Source

**Stimulus-Response Measurements with the HP 71450B/2B**

17. Press **State**, **instr modes**, and then **OSA** to return to normal optical spectrum analyzer operation.

## To characterize a dual-output device

Devices such as optical couplers have two output ports. Use this procedure to display the normalized response of both outputs simultaneously. Figures shown in this procedure display the characterization of an optical coupler.

1. Perform the previous procedure "To characterize a single-output device" to characterize one of the device's outputs, but do not return to the OSA mode of operation at the end of the procedure.
2. Press the left-side **BW, Swp** softkey.
3. Press **SINGLE SWEEP**, and wait for one complete trace to be drawn on the display.

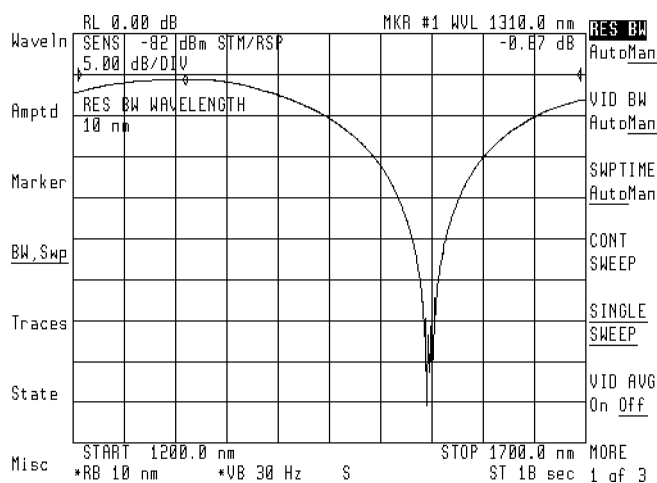

Response at one of the coupler's outputs.

4. Press the left-side **Traces** softkey.
5. Press **MORE 1 of 4**, **oneshot math**, then **A XCH C** to store trace A in trace C.

Using Option 002, Built-in White Light Source

### Stimulus-Response Measurements with the HP 71450B/2B

6. Press the left-side **Traces** softkey. Press **trace A B C** so that **C** is selected.
7. Press **VIEW C BLANK C** so that **VIEW C** is underlined.
8. Press **trace A B C** so that **A** is selected. Press **CLEAR WRT A**.
9. Disconnect the output of the device being tested from the front-panel **OPTICAL INPUT** connector.
10. Connect the device's second output to the front-panel **OPTICAL INPUT** connector.
11. Press the left-side **BW, Swp** softkey. Press **SINGLE SWEEP** to show the response of the second output port.

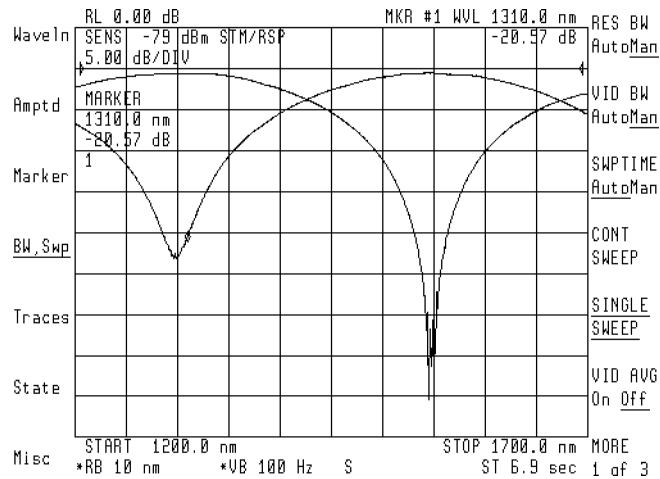

Response of both coupler outputs.



---

## To display a trace of input power

After performing a stimulus-response measurement, trace B is the trace of the input light power over the selected wavelength range.

1. Press the left-side **State** softkey.
2. Press **instr modes** and then **STM/RESP**.
3. Press **DSPLY B On Off** so that **On** is underlined.
4. If the trace is not displayed, increase the amplitude scale.

---

## To make measurements on a linear scale

The stimulus-response measurements made in this section resulted in a logarithmic display of the results. The measurements can also be made with a linear amplitude scale. In order to do this, the amplitude scale must be changed to linear prior to saving the normalization trace.

In order to make the measurement with a linear scale, the procedure discussed earlier in this section can be used with the following exceptions:

1. After placing the normalization response at the reference level by pressing **PEAK SEARCH** and then **TO REF LEVEL**, change to a linear scale by pressing the left-side **Amptd** softkey and then **LINEAR**.
2. Prior to pressing **STORE THRU -> B** to save the normalization trace, reduce the noise on the trace by reducing the optical spectrum analyzer's video bandwidth:
  - a. Press the left-side **BW,Swp** softkey.
  - b. Press **VID BW AutoMan**.
  - c. Press **▼** until the trace appears to be free from noise.

Using Option 002, Built-in White Light Source

### Stimulus-Response Measurements with the HP 71450B/2B

3. After the normalization function has been activated, do not change the reference level, either manually or with the **PEAK SEARCH** and **TO REF LEVEL** functions as described for reducing the amplitude scale.

For this measurement, the amplitude scale must remain fixed at 0 (bottom) to 1.00 x (top).

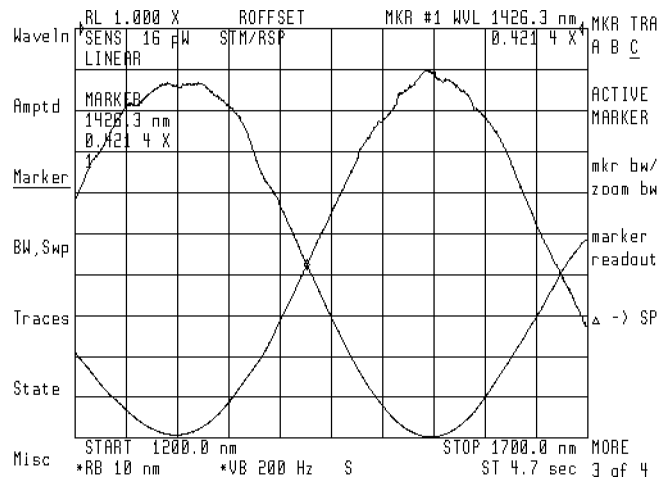

**WDM coupler characterized on a linear scale.**

---

## To use alternative trace definitions

The normalization function in the stimulus-response mode menu normalizes the measured data to a through reference trace. This uses the trace math of  $A-B \rightarrow A$  for logarithmic scales and  $A/B \rightarrow A$  for linear scales.

In some cases, other trace definitions are desired. Additional trace definitions are available in the traces menu under **trace logmath** (for measurements on a logarithmic scale) and **trace linmath** (for measurements on a linear scale). These definitions make use of various combinations of traces A, B, and C and, in some cases, the display line for a scaling factor. Traces B and C are used as stored reference traces and trace A is active, with the results being updated for each new measurement of trace A. In order to scale the resultant information for a result of 0 dB (or 1.00 x) to be at the reference level, the display line should be set to be equal to the reference level.

When using these trace definitions, it is not necessary to use the stimulus-response instrument mode. If the stimulus-response instrument mode is not used, the optical spectrum analyzer's autorange function should be activated prior to beginning the measurement by pressing the left-side **Amptd** softkey followed by **MORE 1 of 4** and then **AUTORNG On Off** so that **On** is underlined.

Prior to saving any reference traces, it should be ensured that the optical spectrum analyzer is using sample, rather than peak, detection. This ensures greatest accuracy, and is indicated by an **S** character displayed at the bottom, center of the screen. This is accomplished by pressing **VID BW AutoMan** two times until **Man** is underlined, or pressing **VID BW AutoMan** one time and reducing the bandwidth by pressing **(V)** at least one time. Additional video bandwidth reduction can be used to remove any unwanted noise on the trace.

One example use of the additional trace definitions is the linear characterization of a WDM coupler's coupling ratio. Coupling ratio is defined as the ratio of the power at one output port to the sum of the power at all output ports. This is different than the standard insertion loss definition and requires a different trace definition. For a two output device, the equation  $A \leftarrow A \cdot DL / (A+B)$  provides the proper definition. Trace A represents the power at the output under test, trace B represents the power at the other output, and A+B represents the total output power. In order to display the

Using Option 002, Built-in White Light Source

**Stimulus-Response Measurements with the HP 71450B/2B**

results on the same scale as the measured data, the display line is set equal to the reference level resulting in the value of  $A/(A+B) = 1$  being displayed at the reference level.

The linear measurement of coupler's excess loss is also possible using one of the trace linmath equations. In this case, the equation  $A \leftarrow DL*(A+B)/C$  is used, where trace C is a measurement of the power at the device input and traces A and B are measurements of the power at each of the outputs. Again, the display line is set equal to the reference level for proper scaling.

---

## Replacing the Lamp

Your Hewlett-Packard Sales and Service Office provides two replacement kits for the white-light source lamp assembly. One replacement kit, HP part number 70950-60026, contains a new lamp assembly. The other replacement kit, HP part number 5086-6913, contains a rebuilt lamp assembly. The rebuilt lamp assembly is provided as an exchange assembly; ordering an exchange assembly requires that you return the defective lamp assembly for credit.

### Contents of New Lamp Assembly Replacement Kit (HP part number 70950-60026)

Quantity	Description	Part Number
1	Installation Note	70951-90004
1	Light Source Lamp Assembly	5086-7913

---

#### **CAUTION**

Electrostatic discharge (ESD) can damage or destroy electronic components. For further information regarding ESD precautions, see the paragraph on ESD in the Service Manual for your instrument.

When installing the light source lamp replacement kit, use an approved static-free workstation to avoid component damage caused by ESD.

---

## Replacing the Lamp

---

### To replace the lamp

This procedure requires the use of the following tools:

- T-10 Torx driver
- 8 mm hex-ball driver
- Flat-blade screwdriver

#### **NOTE**

Other than the defective light-source assembly, all pieces of hardware are reused; keep the hardware together.

#### **Removing the module cover**

1. Set the mainframe LINE switch to OFF.
2. Remove any cables that are connected to the front- or rear-panels of the optical spectrum analyzer system.
3. Use and 8 mm hex-ball driver to remove the optical spectrum analyzer module from the mainframe.
4. Use the T-10 Torx-driver to remove the fourteen screws that attach the cover of the module to the module frame.

### Replacing the Lamp

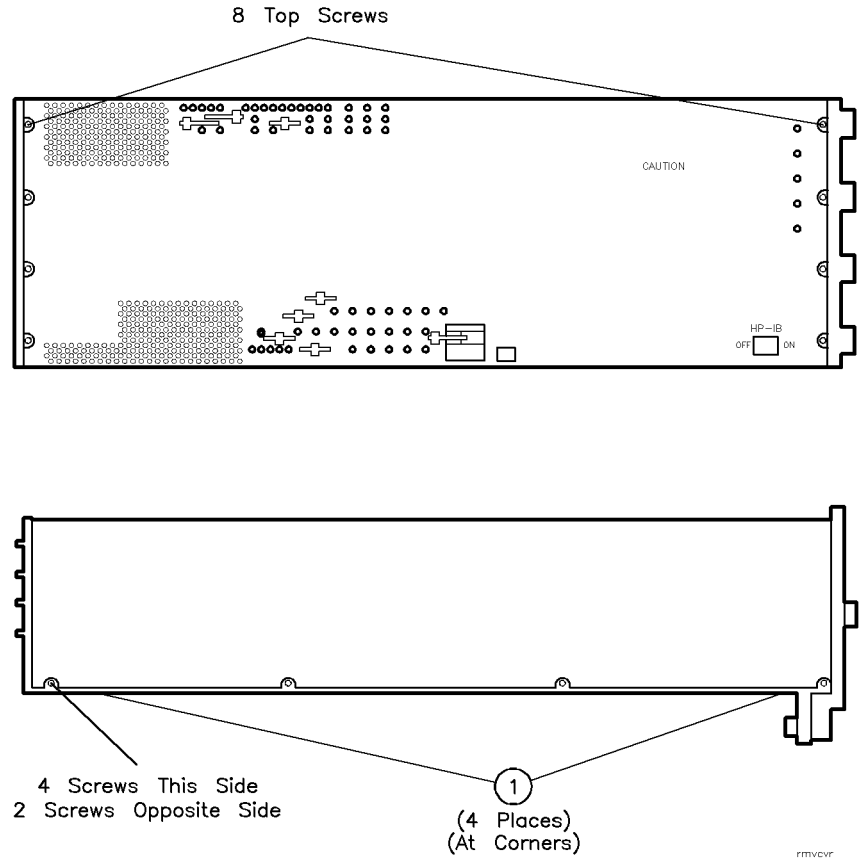

#### Removing the cover.

5. With the flat-blade screwdriver, gently pry at the four corners ① of the cover-bottom and module frame interface. Lift the cover off the frame.
6. Observe the position of the light-source assembly. The new assembly will be installed in an identical manner.
7. Locate the white-light source lamp assembly and remove the control cable ② from the X-Y control assembly.

#### Removing the white-light source assembly

### Replacing the Lamp

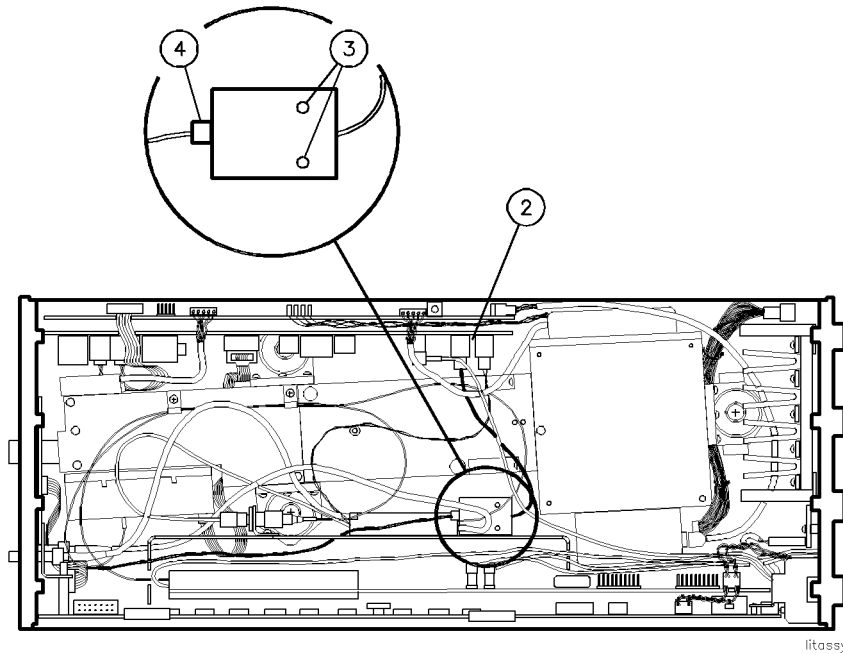

#### White light source lamp replacement.

8. Use the T-10 Torx-driver to remove the two screws ③ that hold the light source lamp assembly to the bracket and lift out the light source lamp assembly. These parts are used again to secure the new assembly.
9. Disconnect the optical fiber cable ④ from the light source lamp assembly. Install the new white-light source assembly as described in the next section.
10. Clean the optical fiber end that attaches to the light source assembly as explained in the following steps:
  - a. Apply isopropyl alcohol to a clean lint-free swab or lens paper.
    - Cotton swabs can be used as long as no cotton fibers remain on the fiber end after cleaning.

#### Cleaning the optical fiber cable



### Replacing the Lamp

- b. Clean the fiber end with the swab or lens paper. Move the swab or lens paper back and forth across the fiber end several times.
  - Some amount of wiping or mild scrubbing of the fiber end can help remove particles when application of alcohol alone can not.
  - The wiping technique can remove or displace particles smaller than one micron.
- c. Allow the connector to dry for about a minute. Or, use compressed air to dry it immediately.
  - Use compressed air to lessen the chance of deposits remaining on the fiber end.
  - Do not shake or tip the compressed air can. This action releases particles in the can into the air.
  - Direct the compressed air horizontally across the fiber end.
- d. As soon as the connector is dry, connect or cover it for later use.

#### **Reassembling the light-source and module**

11. Connect the optical fiber to the new light source lamp assembly as shown in ④ of the previous figure.
12. Attach the new light source lamp assembly to the bracket with the original screws ③.
13. Attach the control cable to the X-Y control assembly ②.
14. Position the module cover over the frame. Make sure that the sides are seated in the slots along the bottom of the cavity as shown in the following figure.

### Replacing the Lamp

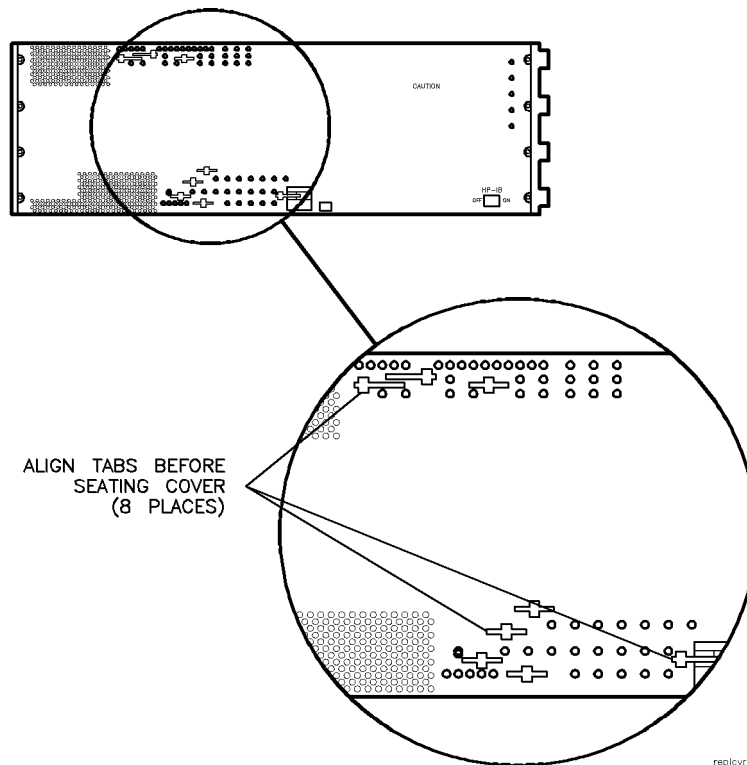

#### Replacing the cover.

15. Align the tabs with the slots on the top of the cover.
16. Attach four end screws, two to each end of the module, first.
17. Replace the remaining 10 screws, then tighten all fourteen screws to secure the cover to the frame.
18. Return the module to the mainframe.
19. Perform the "White Light Output Power Test" located in Chapter 5 of the *Installation and Verification Manual*.

---

Measuring Swept  
Polarization Dependent  
Loss

---

# Measuring Swept Polarization Dependent Loss

This chapter shows you how to perform polarization dependent loss (PDL) measurements on optical-to-optical and optical-to-electrical devices. These measurements require the following equipment:

- HP 71451B optical spectrum analyzer, (HP 70951B module).
- Option 002, built-in white light source.
- Option 003, swept polarization dependent loss kit.

Option 003 comes with an advanced-measurement program designed for characterizing PDL as a function of wavelength.

To begin the program, press **USER**, then **PDL**. If the program is unintentionally erased from memory, reinstall it using the procedure provided in Chapter 4, "Reinstalling the Advanced- Measurement Programs." A backup copy of the program is provided on both the memory card and the diskette. These are shipped with the swept polarization dependent loss kit.

## **Battery Power**

Automatic measurement programs are stored in battery powered memory. If the internal battery loses power, the programs are erased from memory. With normal use, the internal battery lasts for several years. To replace the internal battery, return the optical spectrum analyzer to a Hewlett-Packard service center.

---

## **WARNING**

During swept-polarization-loss measurements, light energy applied to the front-panel MONOCHROMATOR INPUT connector can radiate from the front-panel MONOCHROMATOR OUTPUT connector. This radiated light passes through the internal monochromator and so is filtered and slightly attenuated.

---

**Contents**

Characterizing Optical-to-Optical Devices .....	7-4
Preferred test setup (EXT photodetector).....	7-5
Simplified test setup (INT photodetector).....	7-7
To measure PDL .....	7-9
Characterizing Optical-to-Electrical Devices .....	7-15
To measure PDL .....	7-17

---

## Characterizing Optical-to-Optical Devices

This section presents a procedure for measuring the PDL of optical-to-optical devices such as filters, isolators, and couplers. In this procedure, you can use one of two test setups. One test setup uses an external detector. The other test setup uses the optical spectrum analyzer's internal detector. Using an external detector is the most accurate and preferred method. Using the internal detector is slightly less accurate, but has a simplified configuration.

Filtered, polarized, white light is applied to the input of the device being tested. The output spectrum is then viewed. The polarization of the filtered light is manually varied through all desired states of polarization. As the polarization is varied, the output spectrum changes, and the extreme power levels are recorded using maximum-hold and minimum-hold traces. The difference between the maximum and minimum traces represents the peak-to-peak polarization dependent loss of the device as a function of wavelength.

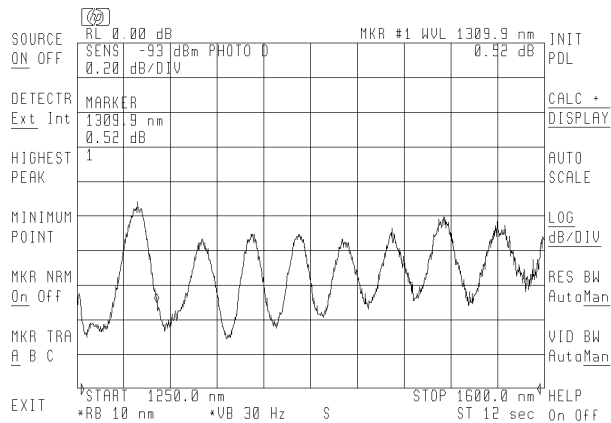

**Peak-to-peak PDL of an isolator (1250 to 1600 nm)**

## Preferred test setup (EXT photodetector)

The preferred method for making swept PDL measurements uses an external detector. The block diagram of the measurement is shown in the following figure.

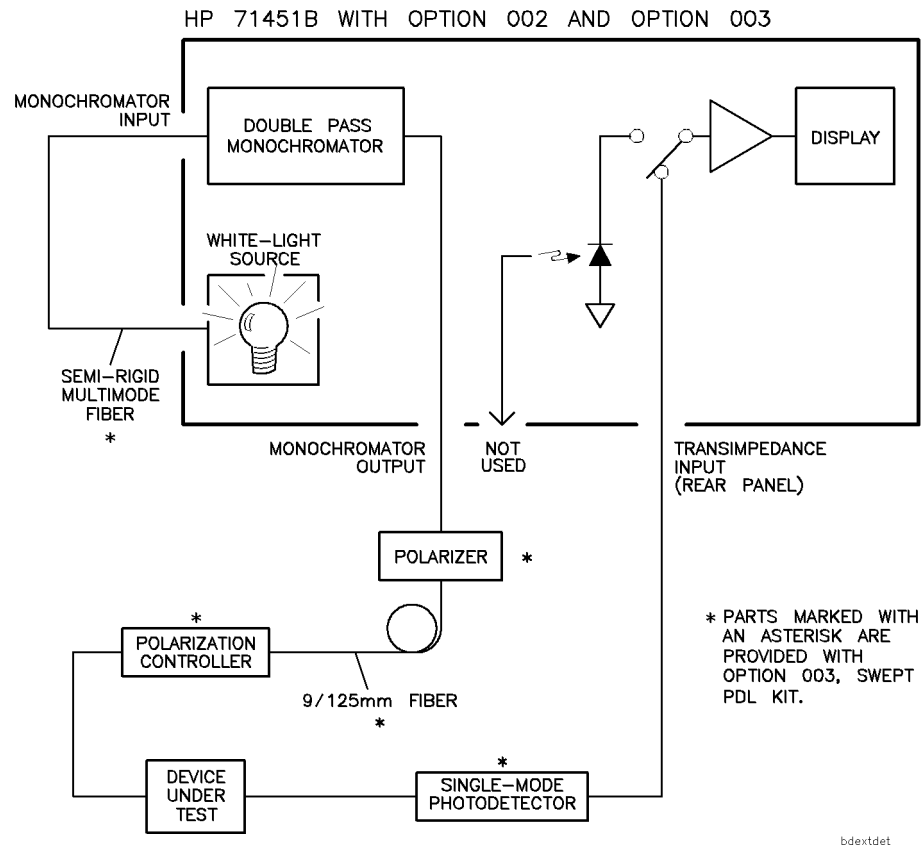

**Swept PDL Block Diagram Using the External Detector**

**Characterizing Optical-to-Optical Devices**

- This white light source is connected directly to the **MONOCHROMATOR INPUT** of the optical spectrum analyzer via a semi-rigid multimode fiber.
- The semi-rigid fiber is necessary to avoid measurement errors due to the fiber being moved during the measurement.
- The filtered light at the **MONOCHROMATOR OUTPUT** is applied to a polarizer connected directly to the **MONOCHROMATOR OUTPUT**.
- The output of the polarizer is connected to the polarization state controller via a single mode fiber.
- The input of the device under test is connected to the output of the polarization state controller.
- The output of the device under test is connected to the single-mode fiber photodetector that connects to the optical spectrum analyzer's rear-panel **TRANS-Z** transimpedance connector.

The external, single-mode photodetector is used to bypass the internal optical switch and multi-mode photodetector to minimize measurement errors. The polarization state controller output and the photodetector input are equipped with an FC/PC connector interface adapter. These adapters can be replaced with other adapter types.



## Simplified test setup (INT photodetector)

The simplified method for making swept PDL measurements uses the built-in detector. The block diagram of the measurement is shown in the following figure.

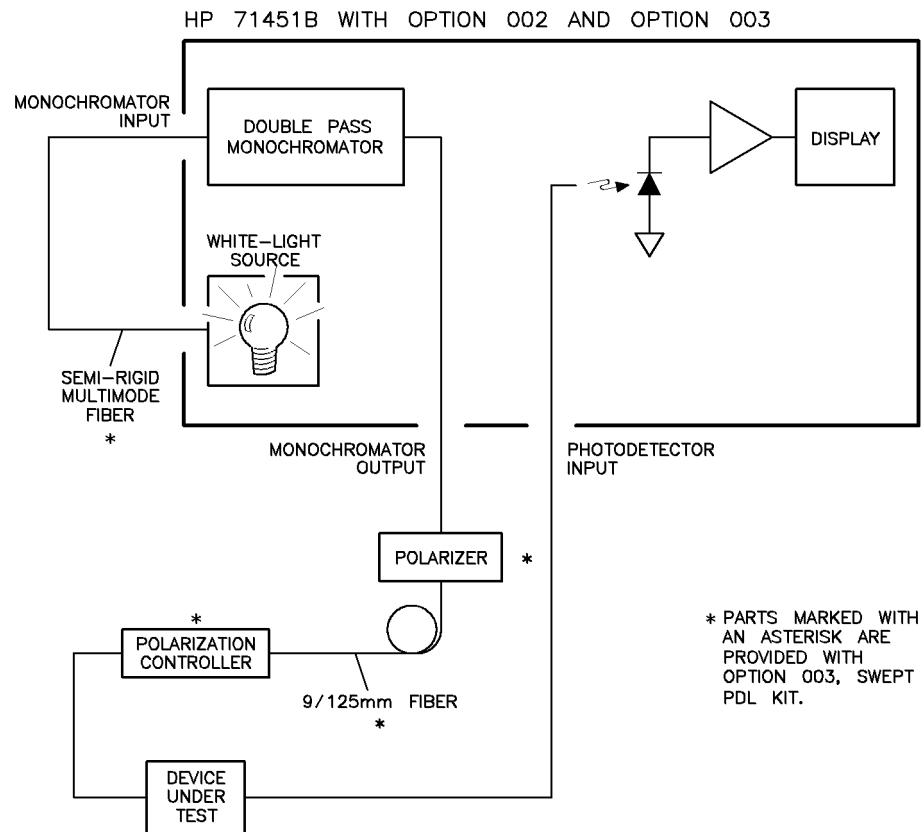

bdintdet

**Swept PDL Block Diagram Using the Internal Detector**

**Characterizing Optical-to-Optical Devices**

- The white light source is connected directly to the monochromator input of the optical spectrum analyzer via a semi-rigid multimode fiber.
- The semi-rigid fiber is necessary to avoid measurement errors due to the fiber being moved during the measurement.
- The filtered light at the **MONOCHROMATOR OUTPUT** is applied to a polarizer connected directly to the **MONOCHROMATOR OUTPUT**.
- The output of the polarizer is connected to the polarization state controller via a single mode fiber.
- The input of the device-under-test is connected to the output of the polarization state controller. The output of the device under test is connected to the optical spectrum analyzer's front-panel **PHOTODETECTOR INPUT** connector.

The polarization state controller output, and **PHOTODETECTOR INPUT** are equipped with FC/PC connector interface adapters. These adapters can be replaced with other adapter types.

---

## To measure PDL

In the this procedure, pay attention to the test setup and the measurement method (preferred or simplified) you plan to use. Only the equipment connections vary; the procedure is the same.

### Preparing for measurements

1. Turn the optical spectrum analyzer on, and allow it to warm up for one hour.
2. Connect the **LIGHT SOURCE OUTPUT** to the **MONOCHROMATOR INPUT** using the u-shaped, semi-rigid multimode fiber provided with the swept PDL kit.

---

### CAUTION

In order to avoid damage to the semi-rigid fiber, the end labeled **MONOCHROMATOR INPUT** must be attached to the optical spectrum analyzer's **MONOCHROMATOR INPUT** connector. Connection to any other port may damage the semi-rigid fiber.

3. Press the left-side **State** softkey.
4. Press **light source** and then **WHITE On Off** so that **On** is underlined.
5. Press the left-side **Marker** softkey.
6. Press **MKR NRM On Off** so that **On** is underlined.
7. Rotate the front-panel knob to place the marker at the wavelength of interest.
8. Press **(TO REF LEVEL)** to bring the light source output above the instrument's sensitivity level.
9. Press **(AUTO ALIGN)**.

Measuring Swept Polarization Dependent Loss  
**Characterizing Optical-to-Optical Devices**

- Connect the equipment** 10. Connect the rest of the equipment, provided with Option 003, as shown in either the preferred or simplified test setup diagrams:

The FC/PC (or other) connector interface on the **MONOCHROMATOR OUTPUT** must be removed prior to connecting the polarizer. This connector interface can then be used between the interface adapter and the output of the device under test.

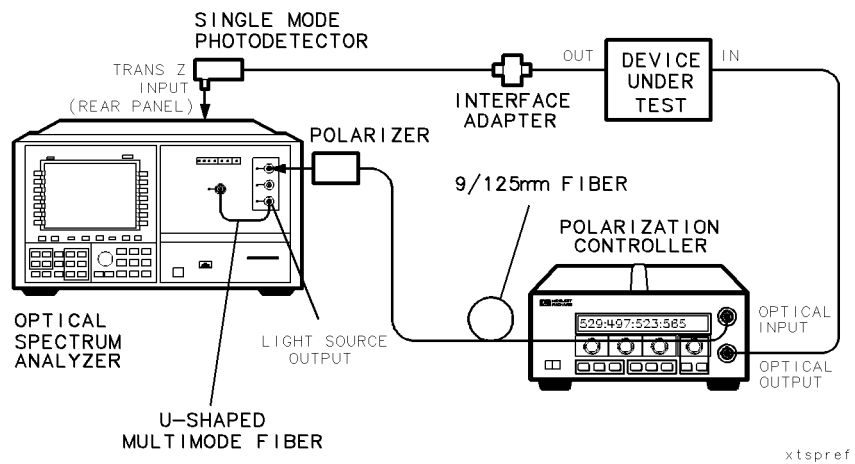

**Preferred test setup (Ext photodetector).**

Measuring Swept Polarization Dependent Loss  
**Characterizing Optical-to-Optical Devices**

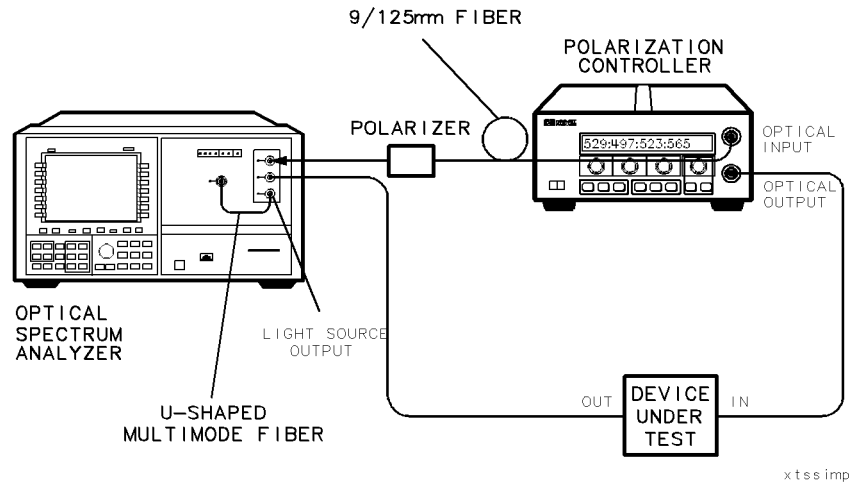

**Simplified test setup (Int photodetector)**

**Characterizing the device**

11. Activate the swept polarization dependent loss measurement personality by pressing **USER**, then press **PDL**.
12. Select either the external (preferred) or internal (simplified) detector mode.
  - Press **Detectr Int Ext** so that **Ext** is underlined to indicate that an external photodetector is being used.
  - Press **Detectr Int Ext** so that **Int** is underlined to indicate that an internal photodetector is being used.
13. Press **Source On Off** and underline **On** to turn on the white-light source.
14. Set the start- and stop-wavelengths for the measurement using the **START** and **STOP** keys on the keypad.

Measuring Swept Polarization Dependent Loss  
**Characterizing Optical-to-Optical Devices**

15. Set the resolution bandwidth using the **RES BW AutoMan** softkey.
  - For the greatest measurement range and signal-to-noise performance, set the resolution bandwidth to 10 nm.
  - Narrower bandwidths can be used if greater wavelength resolution is required.
16. After a sweep with the new resolution bandwidth has completed, press **AUTO SCALE**.

Pressing this key properly positions the signal on the display. If necessary, press **AUTO SCALE** during the measurement procedure to reposition the signal.
17. If the displayed trace appears to have a significant amount of noise compared to the expected polarization dependent loss of the device-under-test, reduce the noise by lowering the value of the video bandwidth filter.
  - Press **VID BW AutoMan**.
  - Press the down arrow key until the desired noise reduction is achieved.
  - Note that each decrease in the video bandwidth causes an increase in sweep time.

**Measuring PDL**

18. Start the PDL measurement by pressing **INIT PDL**.

Pressing **INIT PDL** activates the minimum- and maximum-hold traces, and begins the PDL measurement.

- Manually or automatically adjust the polarization state controller over all desired states of polarization while the optical spectrum analyzer is sweeping. The goal is to cover all desired states of polarization for each wavelength. Three traces are displayed on the optical spectrum analyzer as shown in the following figure.

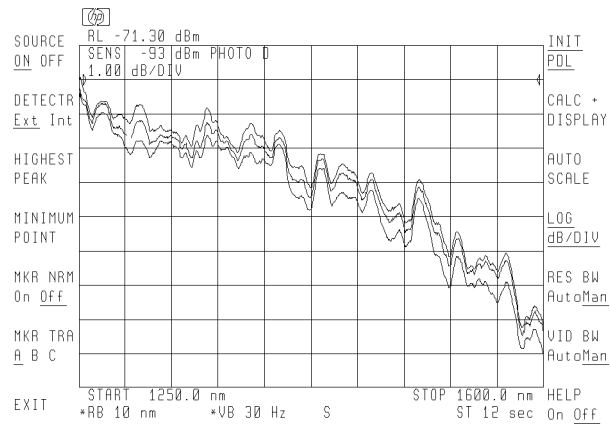

**Three traces displayed during PDL measurement.**

- After all adjustments are made, display the peak-to-peak polarization dependent loss by pressing **CALC+DISPLAY**. You can use the **AUTO SCALE** and marker functions on the results trace.

Measuring Swept Polarization Dependent Loss  
**Characterizing Optical-to-Optical Devices**

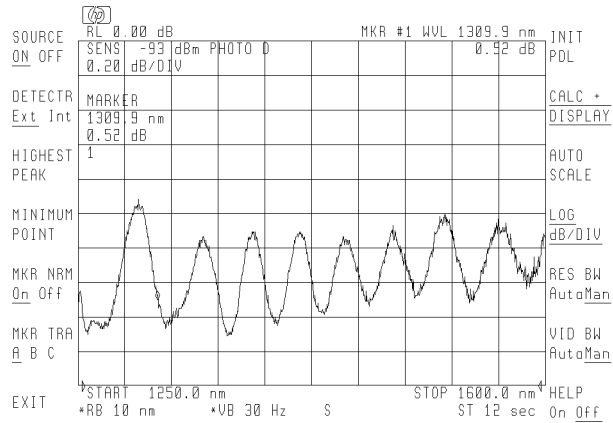

**PDL measurement results.**

- To start another measurement, press **INIT PDL**, and adjust the polarization state controller as explained in steps 18 through 20, above.



# Characterizing Optical-to-Electrical Devices

The method described in this section is for making swept polarization dependent loss measurements on optical-to-electrical devices such as photodetectors and receivers. The following figure shows the block diagram of the measurement.

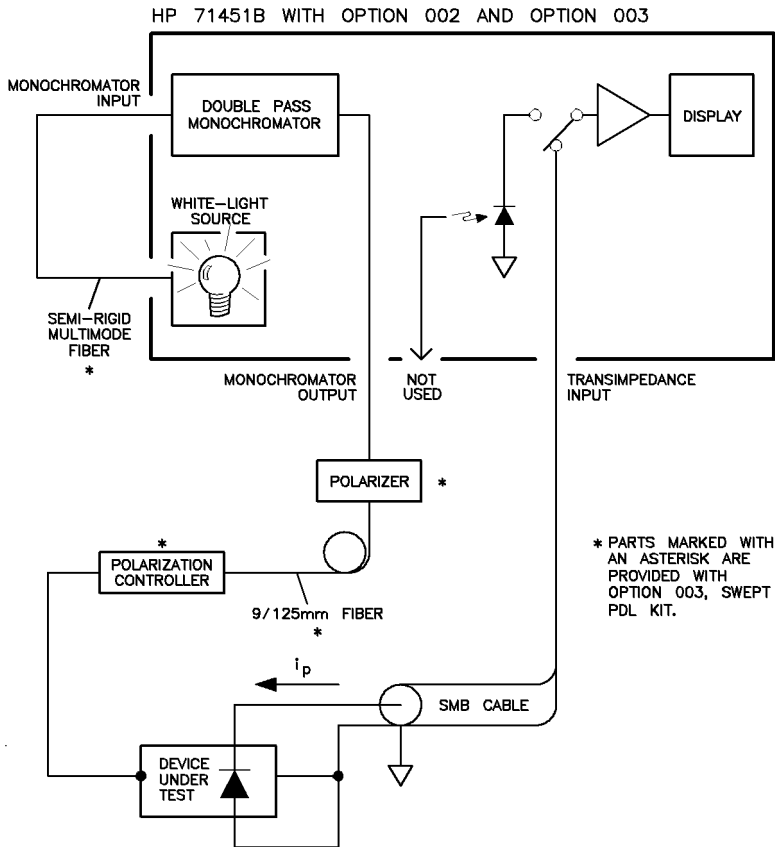

Swept PDL block diagram for optical-to-electrical device measurements

Measuring Swept Polarization Dependent Loss  
**Characterizing Optical-to-Electrical Devices**

Filtered, polarized, white light is applied to the input of the device being tested. The output of the device being tested is then viewed as a function of input wavelength. The polarization of the filtered light is manually varied through all desired states of polarization. As the polarization is varied, the output level changes, and the extreme power levels are recorded using maximum hold and minimum hold traces. The difference between the maximum and minimum traces represents the peak-to-peak polarization dependent loss of the device as a function of wavelength.

- The white light source is connected directly to the **MONOCHROMATOR INPUT** on the optical spectrum analyzer via a semi-rigid multimode fiber.
- The semi-rigid fiber is necessary to avoid measurement errors that are caused when the fiber is moved during a measurement.
- The filtered light at the **MONOCHROMATOR OUTPUT** is applied to a polarizer connected directly to the monochromator output.
- The output of the polarizer is connected to the polarization state controller via a single-mode fiber.
- The input of the device-under-test is connected to the output of the polarization state controller.
- The output of the device-under-test is connected to the transimpedance input on the rear panel of the optical spectrum analyzer using an SMB connector.

The device under test must be connected so that the output current flows from the center conductor of the transimpedance input to the device-under-test.

If the output of the device under test is a voltage rather than a current, place a series resistor at the output and consider the transimpedance input a virtual ground. The maximum current level *must not exceed 10 mA*.

The polarization state controller output is equipped with an FC/PC connector interface adapter. This adapter can be replaced with other adapter types.

---

**CAUTION**

---

This measurement is made with very small optical power and electrical current levels. Use care to ensure that room light and electromagnetic interference at the device under test do not affect the results.

---

## To measure PDL

### Preparing for measurements

1. Turn the optical spectrum analyzer on, and allow it to warm up for one hour.
2. Connect the **LIGHT SOURCE OUTPUT** to the **MONOCHROMATOR INPUT** using the u-shaped, semi-rigid multimode fiber provided with the swept PDL kit.

---

### CAUTION

In order to avoid damage to the semi-rigid fiber, the end labeled **MONOCHROMATOR INPUT** must be attached to the optical spectrum analyzer's **MONOCHROMATOR INPUT** connector. Connection to any other port may damage the semi-rigid fiber.

3. Press the left-side **State** softkey.
  4. Press **light source** and then **WHITE On Off** so that **On** is underlined.
  5. Press the left-side **Marker** softkey.
  6. Press **MKR NRM On Off** so that **On** is underlined.
  7. Rotate the front-panel knob to place the marker at the wavelength of interest.
  8. Press **(TO REF LEVEL)** to bring the light source output above the instrument's sensitivity level.
  9. Press **(AUTO ALIGN)**.
- Connect the equipment** 10. Connect the rest of the equipment provided, and the device under test, as shown in the following figure.

Measuring Swept Polarization Dependent Loss  
**Characterizing Optical-to-Electrical Devices**

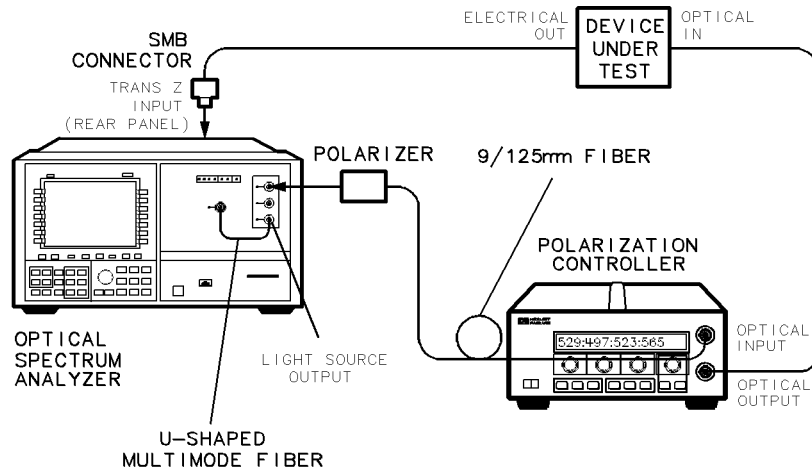

xtsswpt

**Test setup including device under test.**

**Characterizing the device**

11. Press **USER**.
12. Press **PDL** to activate the swept polarization dependent loss measurement personality.
13. Press **Detectr Int Ext** to underline **Ext** to indicate that an external photodetector is being used.
14. Press **Source On Off** and underline **On** to turn on the white-light source.
15. Set the start- and stop-wavelengths for the measurement using the **START** and **STOP** keys on the keypad.
16. Press **RES BW AutoMan** to set the measurement resolution bandwidth.
  - For the greatest measurement range and signal-to-noise performance, set the resolution bandwidth to 10 nm.
  - The narrower bandwidths can be used if greater wavelength resolution is required.

17. After a sweep with the new resolution bandwidth has completed, press **AUTO SCALE** to position the signal on display. If necessary, press **AUTO SCALE** during the measurement procedure to reposition the signal on the display.
18. If the displayed trace shows a significant amount of noise compared to the expected polarization dependent loss of the device under test, the noise can be reduced by lowering the value of the video bandwidth filter.
  - a. Press **VID BW AutoMan**.
  - b. Press the down-arrow key until the desired noise reduction is achieved.
  - c. Note that each decrease in the video bandwidth causes an increase in sweep time.

**Measuring PDL**

19. Press **INIT PDL** to start the PDL measurement.

When **INIT PDL** is pressed, the minimum hold and maximum hold traces are activated.

20. Adjust the polarization state controller over all desired states of polarization while the optical spectrum analyzer is sweeping. The goal is to cover all desired states of polarization for each wavelength. Three traces appear on the display as shown in the following figure.

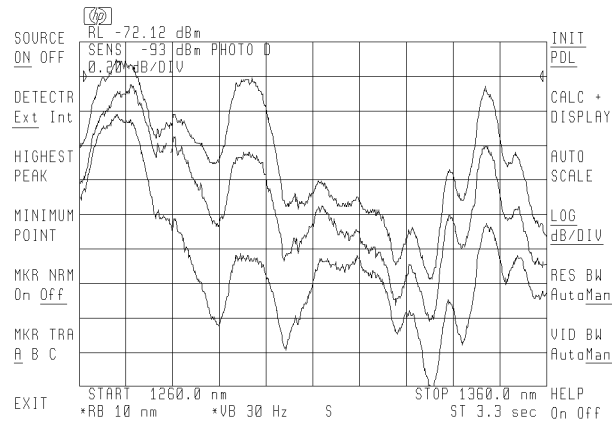

**Three traces displayed during PDL measurement.**

Measuring Swept Polarization Dependent Loss  
**Characterizing Optical-to-Electrical Devices**

21. After all adjustments are made, display the peak-to-peak polarization dependent loss by pressing **CALC+DISPLAY**. You can use the AUTO SCALE and marker functions on the results trace.

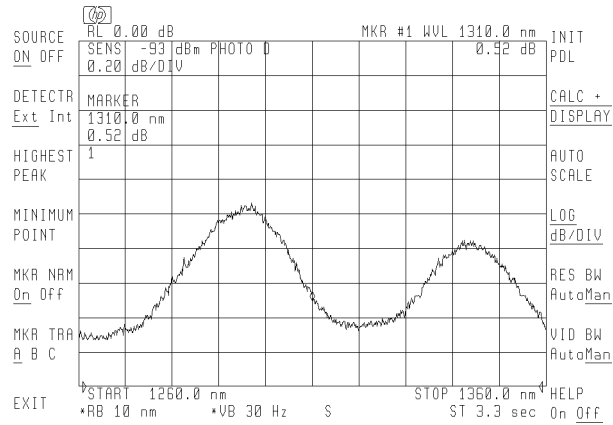

**PDL measurement results.**

22. To begin another measurement, press **INIT PDL** and adjust the polarization controller as explained in steps 19 through 21 above.

**Controlling Traces**

---

# Controlling Traces

Use the Traces menu to display and format traces. The optical spectrum analyzer displays up to three traces: A, B, and C. When the optical spectrum analyzer is first turned on, trace A is displayed, and traces B and C are blanked. A three-dimensional display allows you to see signal changes over time.

With trace math, you can perform many tasks including characterizing changes due to environmental stimulus and displaying the cumulative effect of multiple devices. The Traces menu allows you to save traces for recall at a later time.

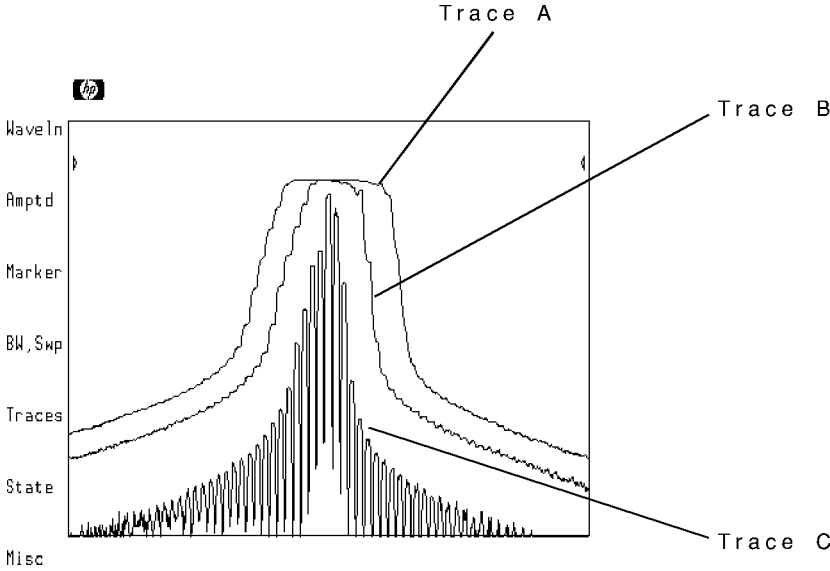

**Traces A, B, and C displayed.**



**Contents**

Displaying Traces .....	8-4
To display a trace .....	8-7
To blank a trace .....	8-7
To observe a drifting signal .....	8-8
To exchange trace data .....	8-10
To invoke default trace settings .....	8-11
Viewing Three-Dimensional Displays .....	8-12
To view the three-dimensional display .....	8-15
Reducing Noise with Video Averaging .....	8-16
To reduce displayed noise .....	8-17
Displaying a Moveable Display Line .....	8-18
To use the display line .....	8-19
Setting the Trace Threshold .....	8-20
To set the trace threshold .....	8-21
Simulating an Analog Display .....	8-22
To simulate an analog display .....	8-22
Comparing Traces with Trace Math .....	8-23
To compare responses .....	8-26
Changing Trace Length and Interpolation .....	8-30
To change the trace lengths .....	8-32
To disable trace A interpolation .....	8-33
Saving and Recalling Traces .....	8-34
To save trace A .....	8-34
To recall trace A .....	8-35

## Displaying Traces

The optical spectrum analyzer displays each trace in one of four possible methods:

- Clear writing
- Viewing
- Holding
- Blanking

Use the **trace A B C** softkey to select traces for trace operations. The optical spectrum analyzer displays each trace with a unique color. Notice that the **trace A B C** softkey label identifies the color assigned to each trace.

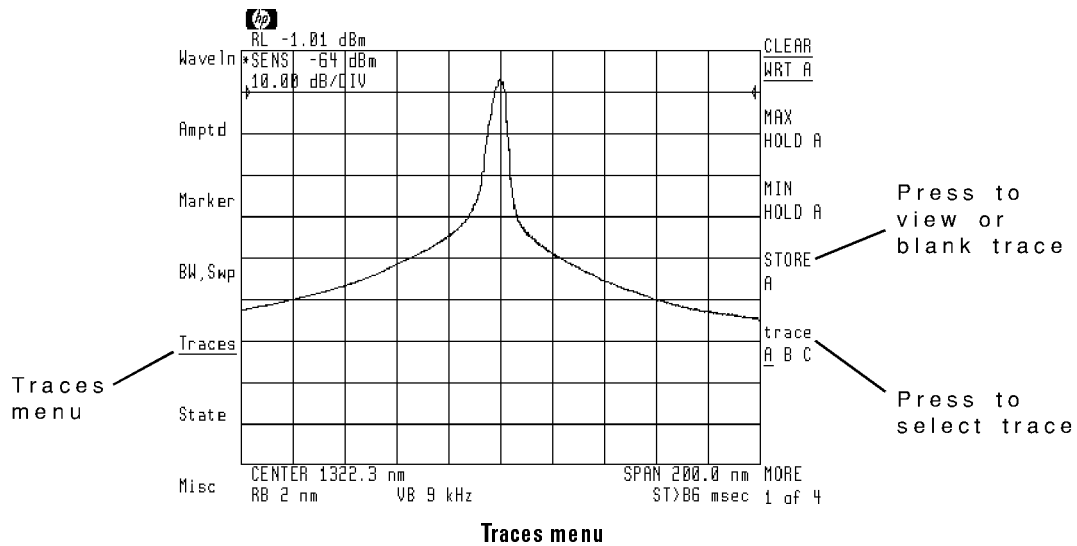

Clear-writing displays each trace value as it is acquired during each sweep. When first turned on, the optical spectrum analyzer clear writes Trace A. When you select trace viewing, the selected trace is not updated with each sweep. The result is a fixed trace on the screen. Blanking a trace prevents it from being displayed. Although viewed and blanked traces are not updated during sweeps, their data is still retained in the trace register and is available for trace math.

**Viewed trace storage**

Traces viewed by pressing the Trace menu's **STORE** and then **VIEW A BLANK A** softkeys are not stored in any file. Rather, the data is stored in temporary trace registers. To store traces in internal memory, on a RAM card, or on an external HP-IB disk, refer to "Storing and Recalling Traces" in this chapter.

Maximum and minimum trace holding retains the maximum (or minimum) detected trace values. During each sweep, new trace measurement points are displayed only if they show an increase (or decrease) from the previous value.

Controlling Traces  
**Displaying Traces**

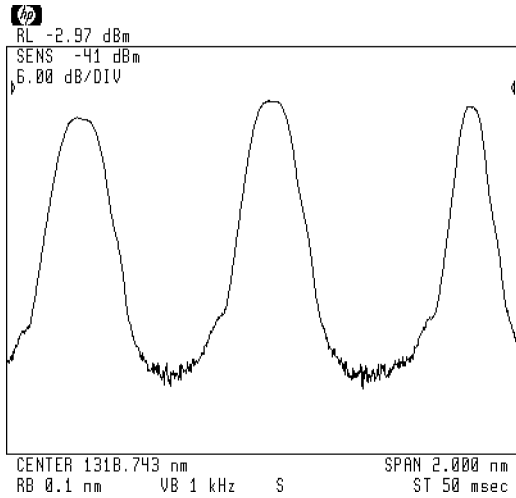

**Maximum holding.**

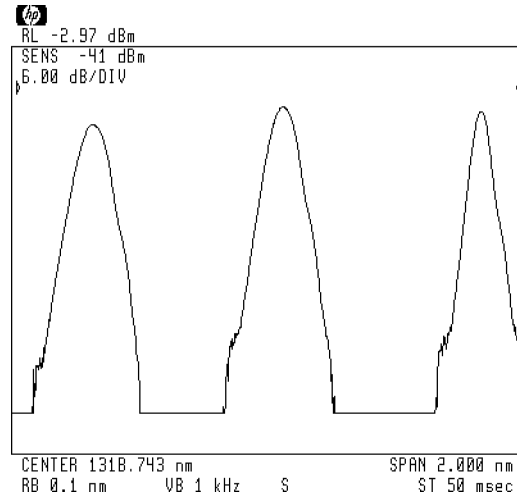

**Minimum holding.**

Some of the functions described in this chapter only work on trace A or trace B. For this reason, the **A XCH B**, **A XCH C**, and **B XCH C** softkeys are provided. (You'll find these softkeys in the **oneshot math** selection on page 2 of the Traces menu.) For example, only trace A can be saved in a file. Also, video averaging and trace line interpolation only work on trace A. So, if you want to perform these operations on trace B, you must first use the **A XCH B** softkey to exchange trace B data with trace A data.

---

## To display a trace

1. Press the left-side **Traces** softkey to enter the Traces menu.
2. Press the **trace A B C** softkey to select a trace.
3. Press the **STORE A** softkey if it is displayed.

Depending on the trace selected, this softkey will indicate trace A, B, or C.

4. Choose one of the following for the selected trace:
  - Press **CLEAR WRT A** to clear write the trace.
  - Press **MAX HOLD A** to hold maximum trace values.
  - Press **MIN HOLD A** to hold minimum trace values.
  - Press **VIEW A BLANK A** so that **VIEW A** is underlined to view the trace.

---

## To blank a trace

1. Press the left-side **Traces** softkey to enter the Traces menu.
2. Press the **trace A B C** softkey to select a trace.
3. Press the **STORE A** softkey if it is displayed.

Depending on the trace selected, this softkey will indicate trace A, B, or C.

4. Press **VIEW A BLANK A** so that **BLANK A** is underlined.

Controlling Traces  
**Displaying Traces**

---

## To observe a drifting signal

1. Change the optical spectrum analyzer's center wavelength and span values to observe a signal.
2. Press the **Traces** softkey to enter the Traces menu.
3. Press the **trace A B C** softkey so that trace B is selected.
4. Press the **CLEAR WRT B** softkey.

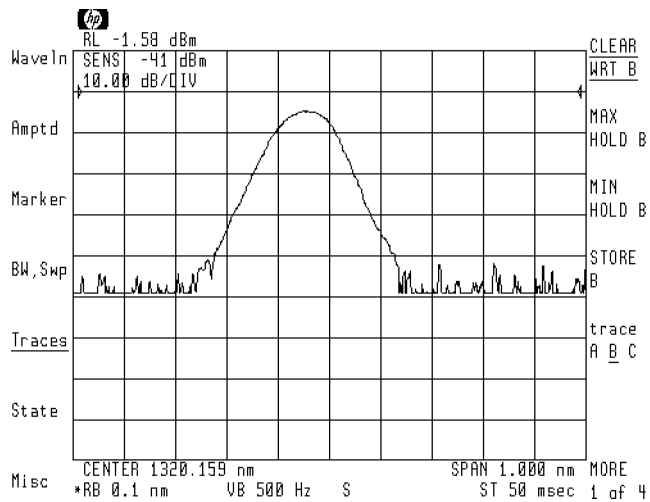

5. Press the **STORE B** softkey. Trace B is automatically placed in the view mode.
6. Press the **trace A B C** softkey so that trace A is selected.
7. Press the **MAX HOLD A** softkey.

Controlling Traces  
**Displaying Traces**

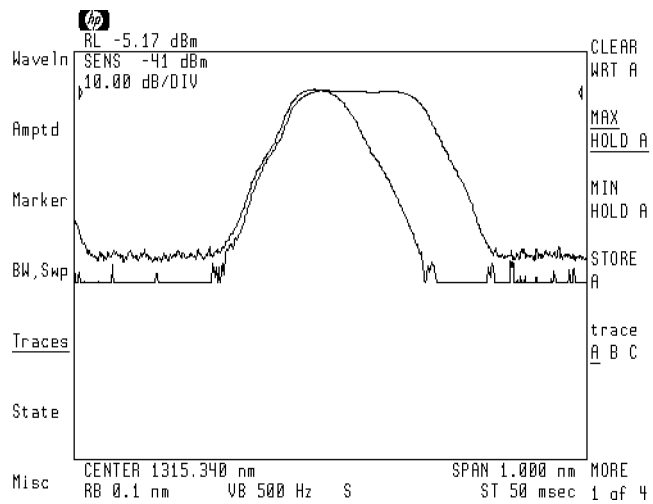

Trace B shows the signal at its starting position. Trace A shows the extent of signal wavelength and amplitude drift.

## To exchange trace data

1. Press the left-side **Traces** softkey to enter the Traces menu.
2. Press **MORE 1 of 4** and then **oneshot math**.
3. Press the **A XCH B** softkey to move trace A data to trace B and trace B data to trace A.
4. Press the **A XCH C** softkey to move trace A data to trace C and trace C data to trace A.
5. Press the **B XCH C** softkey to move trace B data to trace C and trace C data to trace B.

Pressing the exchange trace softkeys places both traces in the view mode where trace data is not updated with sweeps until the **CLEAR WRT** softkey is pressed.



---

## To invoke default trace settings

1. Press the left side **Traces** softkey to enter the Traces menu.
2. Press the **MORE 1 of 4** and then **MORE 2 of 4** softkeys.
3. Press the **TRACE PRESET** softkey.

All trace settings are returned to default conditions. Trace settings are identical to those achieved by pressing **(INSTR PRESET)**. All math functions are turned off, and normal video detection is used.

---

## Viewing Three-Dimensional Displays

Three dimensional displays offer a unique view of the input spectra over time. The optical spectrum analyzer displays successive traces with each trace slightly offset. The current sweep is placed at the front as older sweeps progressively move to the last background position. This gives a three-dimensional “look” with the third dimension showing changes in signal response with time.

Use the Traces menu's fourth page of softkeys to turn on the three-dimensional display.

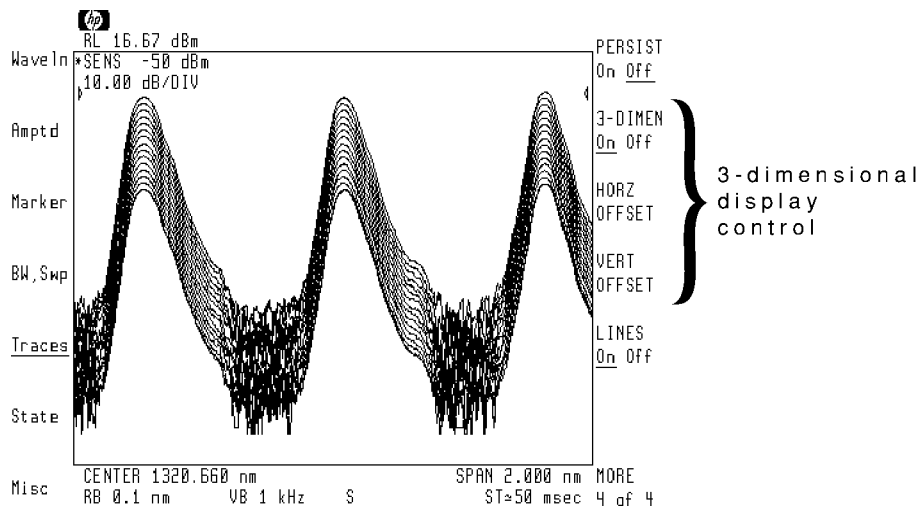

**Fast sweeps increase control**

With three-dimensional displays, front-panel control may appear sluggish. This is due to the additional time required to obtain and display the trace data. Use the fastest sweeps possible to increase the optical spectrum analyzer's response to front-panel controls. Decreasing the number of three-dimensional levels with the **3-DIMEN On Off** softkey also helps.

Normally, 16 traces are displayed to provide a proper three-dimensional view. However, you can increase or decrease the number of traces. The number of traces that can be displayed is limited by the amount of available internal memory. Viewing large numbers of traces may require that you increase internal memory by deleting files. If you need to increase memory to make more traces available, refer to "Increasing User Memory" in Chapter 13.

Changing the vertical and horizontal offsets between the traces helps to optimize the three-dimensional effect. Although offsets as large as 200 can be entered, it is recommended that values of 30 or less be used. The following figure shows the trace separation caused by a vertical offset of +100 and a horizontal offset of +50.

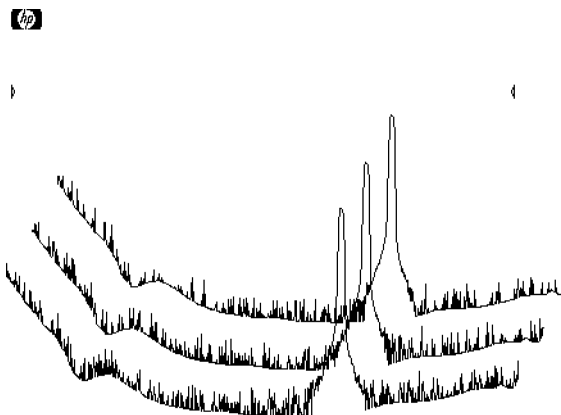

Controlling Traces

**Viewing Three-Dimensional Displays**

Both positive and negative offsets can be entered as shown in the following two figures.

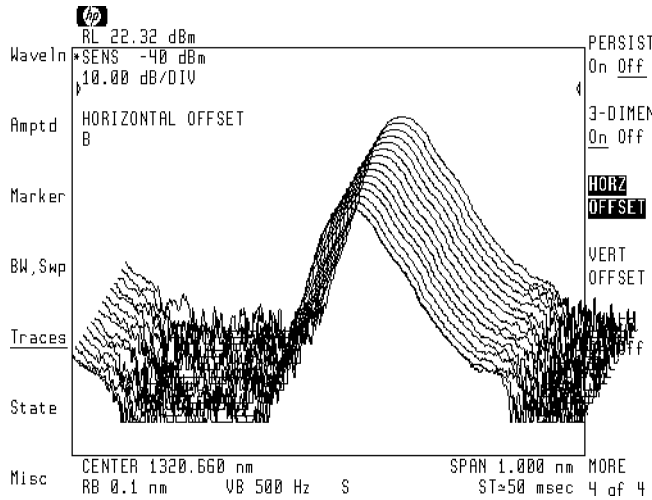

**Positive horizontal offset.**

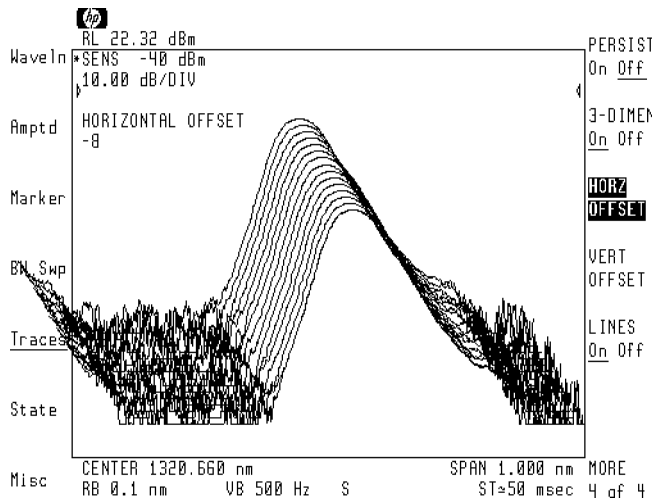

**Negative horizontal offset.**

---

## To view the three-dimensional display

1. Press the left-side **Traces** softkey to enter the Traces menu.
2. Press the **MORE 1 of 4**, **MORE 2 of 4**, and then **MORE 3 of 4** softkeys.
3. Press the **3-DIMEN On Off** softkey so that **On** is underlined.
4. Enter the amount of traces you want viewed in the three-dimensional display.

The number of traces that can be displayed is limited by the amount of available internal memory.

5. Optimize the three-dimensional effect using the following softkeys:
  - Press the **HORZ OFFSET**. Use the front-panel knob or numeric keypad to offset the displayed traces horizontally.
  - Press the **VERT OFFSET**. Use the front-panel knob or numeric keypad to offset the displayed traces vertically.

## Reducing Noise with Video Averaging

Use video averaging to observe signals that are within 6 dB of the displayed noise floor. This eliminates the need to increase sensitivity at the expense of longer sweeptimes. Video averaging reduces displayed noise by averaging the response of multiple trace sweeps. The resulting display shows the mean peak-value of the noise.

Video averaging operates on trace A; it does not affect traces B or C. A running average is kept using trace data from the number of sweeps you specify. The default average uses 100 sweeps. However, you can change the average from 1 to 10,000 traces. Use the front-panel keys to change the number of trace sweeps averaged.

Once started, you can restart averaging any time by turning video averaging off and then on again.

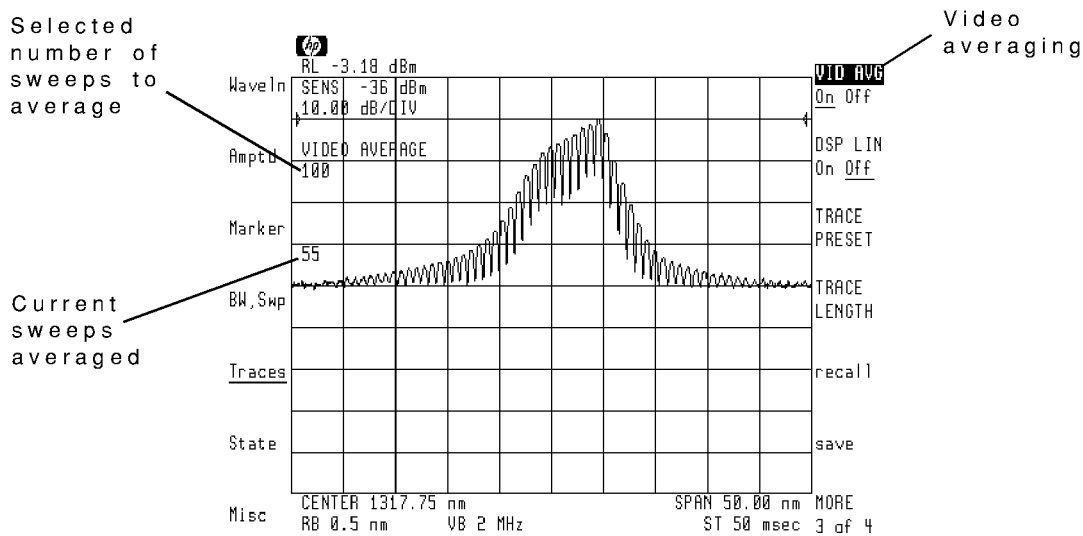

Page 3 of Traces Menu

## To reduce displayed noise

1. Press the left-side **Traces** softkey to enter the Traces menu. Trace A must be in the clear-write mode.
2. Press the **MORE 1 of 4** and then **MORE 2 of 4** softkeys.
3. Press the **VID AVG On Off** softkey so that **On** is underlined.
4. Enter the number of sweeps used in averaging the displayed trace.  
The default number of trace averages is 100.
5. Press the **VID AVG On Off** softkey to **Off** and then **On** to restart averaging at any time.

---

## Displaying a Moveable Display Line

The optical spectrum analyzer can display a moveable horizontal line called a display line. Use the display line to perform the following:

- Visually measure signal levels with direct readout.
- Establish a reference for signal comparisons.
- Position normalized traces.

In the following figure, the display line has been positioned at  $-50$  dBm using the front-panel knob. Notice that the display graticule is turned off to allow more easier viewing of the display line. Use the Misc menu to turn off the display graticule.

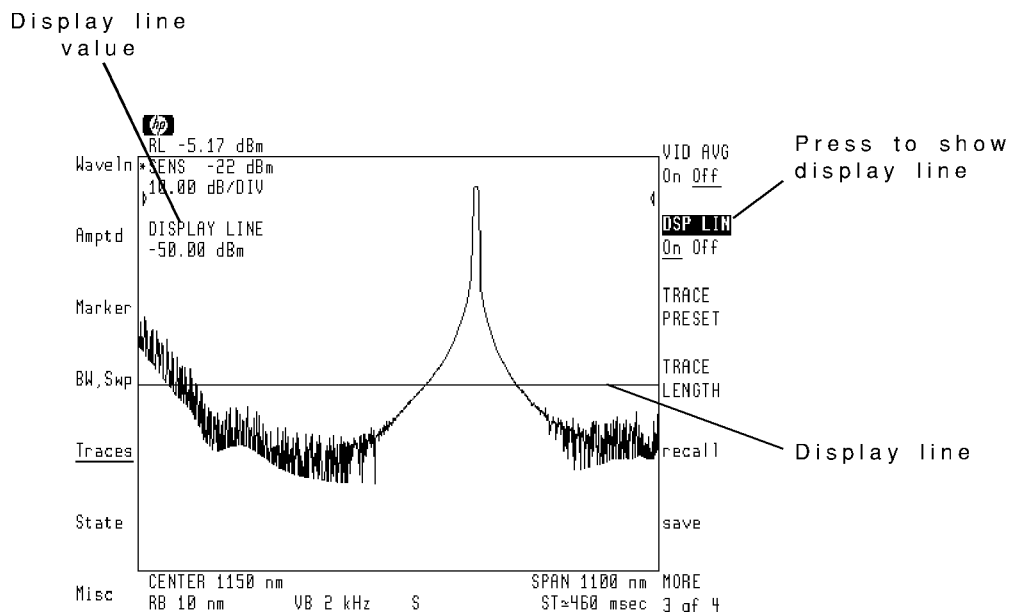



To position a normalized trace, refer to Chapter 5. To activate the display line, press the **DSP LIN On Off** softkey. You can access this softkey from page 3 of the **Traces** menu or page 1 of the **Misc** menu.

---

### To use the display line

1. Press the left-side **Traces** softkey to enter the Traces menu.
2. Press the **MORE 1 of 4** and then **MORE 2 of 4** softkeys.
3. Press the **DSP LIN On Off** softkey so that **On** is underlined.
4. Use the front-panel knob, step keys, or numeric keypad to position the display line on the screen.

Notice the display shows the amplitude value at the display line.

5. Press the **HOLD** softkey to prevent accidental changes to the display line's position.

## Setting the Trace Threshold

The trace threshold feature blanks all displayed trace information below the level you specify. Normally, the trace threshold is turned off. Trace threshold is only available from the Misc menu.

In the following figure, the threshold value has been set to blank all trace values below  $-50$  dBm. Notice that the display graticule is turned off to allow more easier viewing of the threshold. Use the Misc menu to turn off the display graticule.

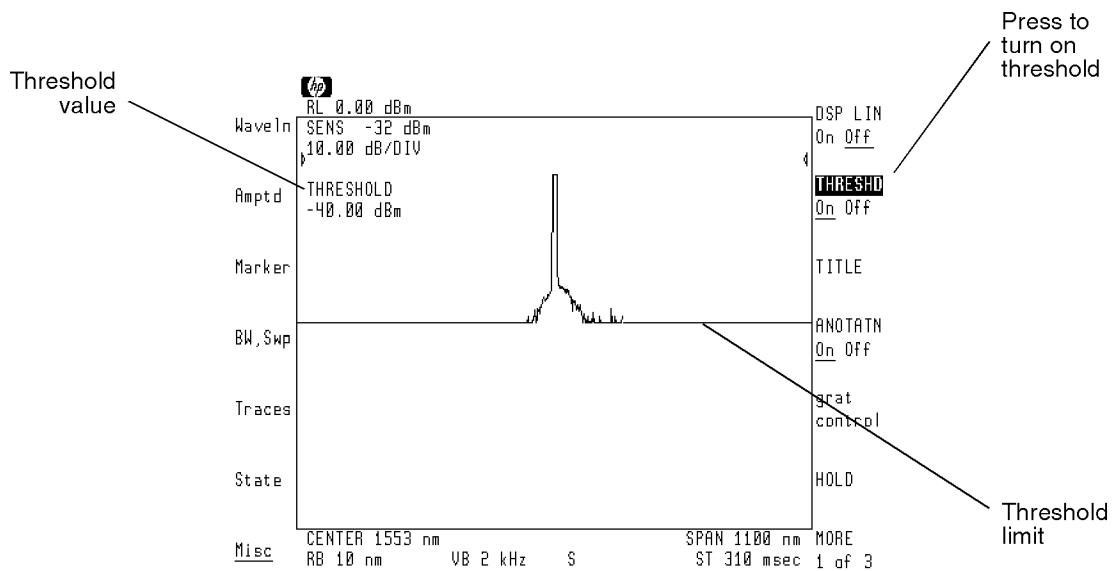

trmen7

---

## To set the trace threshold

1. Press the left-side **Misc** softkey to enter the Miscellaneous menu.
2. Press the **THRESHD On Off** softkey so that **On** is underlined.
3. Use the front-panel knob, keypad, or step keys to enter the threshold value.
4. Press the **HOLD** softkey to prevent accidental changes to the threshold value.

---

## Simulating an Analog Display

To simulate an analog display, use screen persistence. Persistence allows you to view transients or changes in the displayed response more easily. The trace for each sweep remains displayed for seven trace sweeps before being removed. Normally, trace persistence is off, and each trace is erased before a new one is drawn.

The display changes color to indicate persistence is turned on. Use the front-panel knob, step keys, or numeric keypad to change the amount of persistence used.

### **Persistence**

Screen persistence is only available with HP 70004 color displays. Information is stored in the display and is not available for manipulation.

---

### To simulate an analog display

1. Press the left-side **Traces** softkey to enter the Traces menu.
2. Press the **MORE 1 of 4**, **MORE 2 of 4**, and then **MORE 3 of 4** softkeys.
3. Press the **PERSIST On Off** softkey so that **On** is underlined.

---

## Comparing Traces with Trace Math

Trace math allows you to manipulate and compare traces by adding or subtracting trace-amplitude and display-line data. Trace math functions are provided in three menus:

- trace logmath menu

Use with logarithmic amplitude scales. Each math function, when turned on, is continuously applied to each new sweep of trace data.

- trace linmath menu

Use with linear amplitude scales. Each math function, when turned on, is continuously applied to each new sweep of trace data.

- oneshot math menu

Select for math functions that are performed once per key press. Traces are placed in “view” mode so that the data is not overwritten by the next sweep.

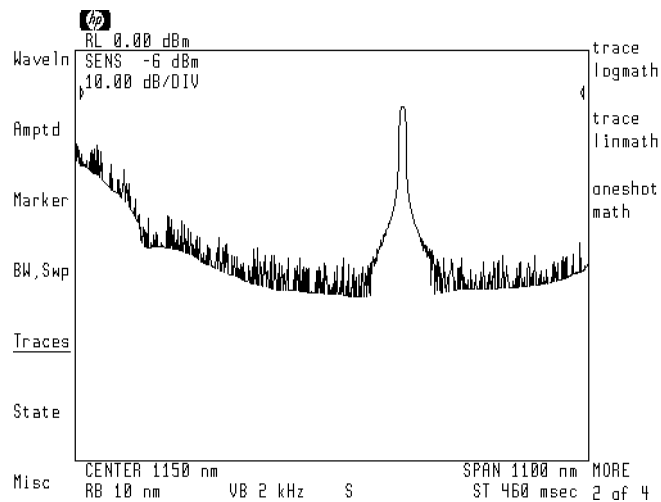

Page 2 of Traces menu

### Comparing Traces with Trace Math

The following list shows some of the tasks that are possible when using trace math:

- Characterizing changes due to environmental stimulus.
- Displaying the cumulative effect of multiple devices.
- Normalizing stimulus response measurements.

Refer to Chapter 4 to learn about using trace math to normalize stimulus response measurements. All trace exchange and math functions are located on page two of the Traces menu.

When trace math is performed between two traces, each measurement point on one trace is added to or subtracted from its corresponding measurement point on the other trace. Use the **A XCH B**, **A XCH C**, and **B XCH C** softkeys to exchange traces data between traces memories A, B, and C.

#### Trace lengths

Care must be used when applying trace math to traces having different lengths. (Trace lengths may be altered using the **TRACE LENGTH** softkey as described in this chapter.) Longer traces are truncated when operated on and stored in a trace of shorter length. Shorter traces are extended when operated on and stored in a trace of longer length. The last element of the shorter trace is duplicated to fill the longer trace length. Trace math computations are limited to the amplitude range of the graticule.

#### Amplitude scale and units

When using trace math, the traces must be obtained using identical scale and amplitude values. Any difference in reference level, amplitude units-per-division, or amplitude units invalidates any data resulting from trace math.

**Trace logmath functions subtract and add amplitude values**

Use trace subtraction to compare deviation between wavelength responses. If the responses stored in traces A and B are identical, the result of trace subtraction is a flat line at 0 dBm. However, any change in trace A results in deviation from this flat line. So, a 3 dB increase in amplitude in trace A results in a corresponding 3 dB increase in the displayed trace.

Logarithmic-scale trace subtraction uses amplitude log values; power is not added or subtracted. The following equation shows the results of trace subtraction using  $A \leftarrow A - B$ :

$$(-10 \text{ dBm}) - (-10 \text{ dBm}) = 0 \text{ dBm}$$

By adding the display line to the results of trace subtraction, you can position the trace on the display. For example, the following equation shows the result of using  $A \leftarrow A - B + DL$  to add a -6 dB display line to the previous equation. As you can see, the trace is moved down 6 dB on the screen.

$$(-10 \text{ dBm}) - (-10 \text{ dBm}) + (-6 \text{ dBm}) = -6 \text{ dBm}$$

**Trace linmath functions use positive-voltage units**

Linear-scale trace math (and oneshot math) uses positive-voltage units. So, using  $A \leftarrow A + B$  moves trace A data up the screen, while using  $A \leftarrow A - B$  moves trace A data down the screen. (This assumes trace B contains nonzero data.)

## To compare responses

The following figures show the effects of changing laser biasing. After normalization (using trace subtraction), the laser bias is increased. The resulting increase in laser amplitude across the wavelength span shows as deviation from the displayed flat line.

1. Connect a signal to the optical spectrum analyzer. Set the center wavelength, span, and sensitivity values for the desired display.

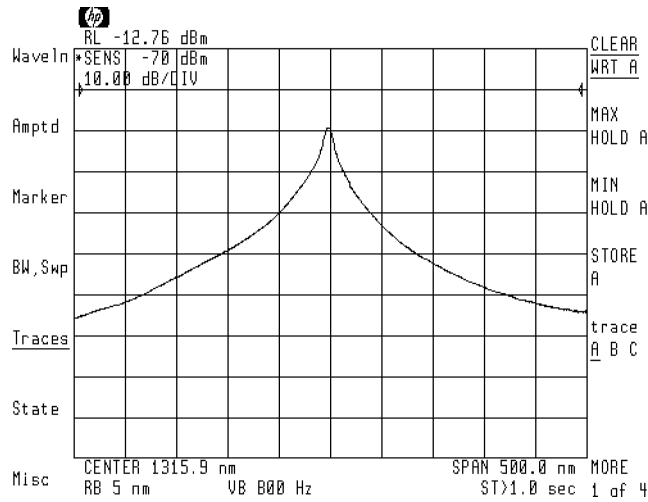

2. Press the left-side **Traces** softkey to enter the Traces menu.
3. Press the **MORE 1 of 4** and **MORE 2 of 4** softkeys.
4. Press the **DSP LIN On Off** softkey so that **On** is underlined.
5. Use the front-panel knob to position this line near the center of the display. In the following steps, the optical spectrum analyzer positions the normalized response at the display line's position.



Controlling Traces  
**Comparing Traces with Trace Math**

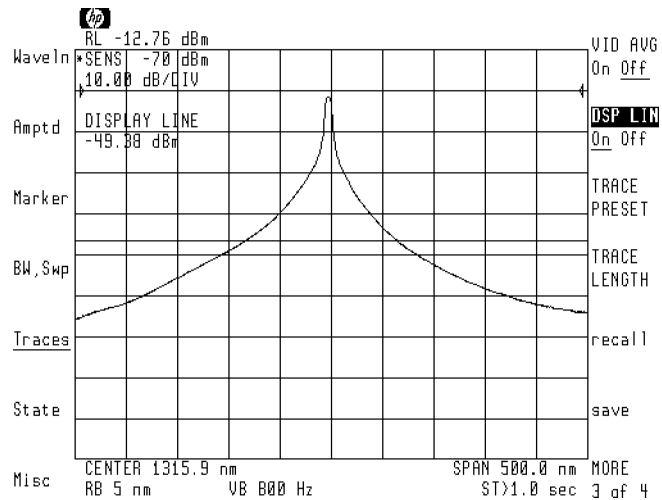

6. Press the left-side **Traces** softkey to return to the menu's first page.
7. Press the **MORE 1 of 4** and then **oneshot math** softkeys.
8. Press the **A XCH B** softkey to place the trace A data into trace B.

The optical spectrum analyzer automatically places trace A in view mode with trace B blanked.

9. Press **prev menu** and then **trace logmath**.
10. Press **A ← A-B+DL** softkey.
11. Press the left-side **Traces** softkey.
12. Press the **CLEAR WRT A** softkey to clear-write trace A.

Any deviation in laser output (from laser bias or environmental factors) causes changes to the normalized trace display.

Controlling Traces

**Comparing Traces with Trace Math**

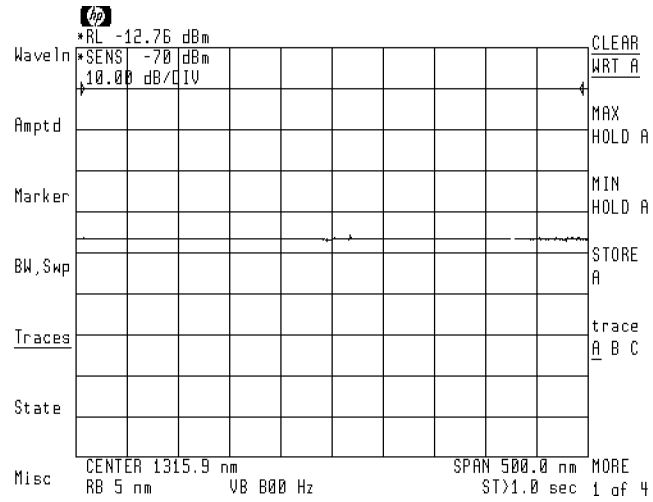

**Normalized display**

The normalized response is located at the display line. In the following figure, the laser's bias has been increased from  $-35$  mA to  $-100$  mA.

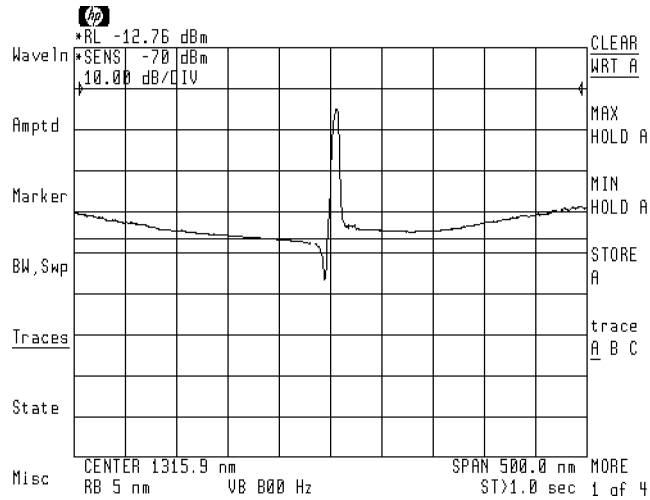

**Laser biased increased to  $-100$  mA**

- Change the display line to move the position of the response. You can use the normal amplitude functions including changing the amplitude scale and adding markers.

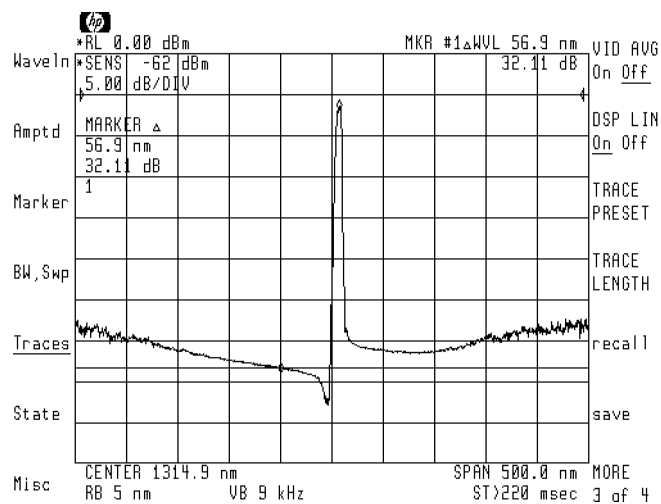

---

## Changing Trace Length and Interpolation

Each default trace consists of a series of 800 measurement points connected by interpolated lines. You can change the number of measurement points used for traces. Because the trace lengths of traces A, B, and C are all changed to the new value, any previous trace data is lost. So, if you change the trace length, be sure to do so before performing any trace math operations.

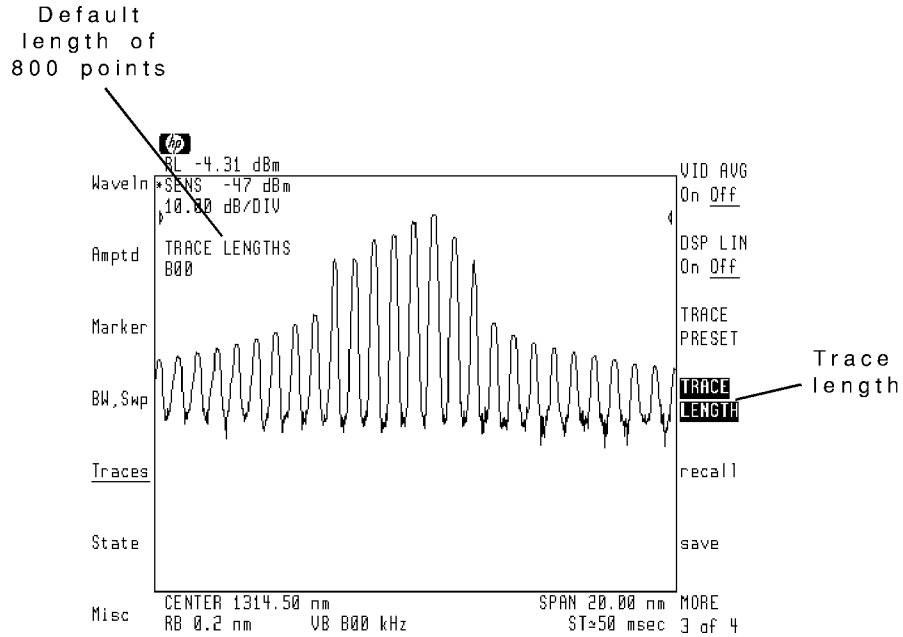

### Changing Trace Length and Interpolation

Trace lengths can range from 3 to 2048 measurement points. The default setting is 800. Increasing the number of measurement points slows the sweep speed but increases measurement resolution. Conversely, decreasing the measurement points results in faster sweeps with less resolution.

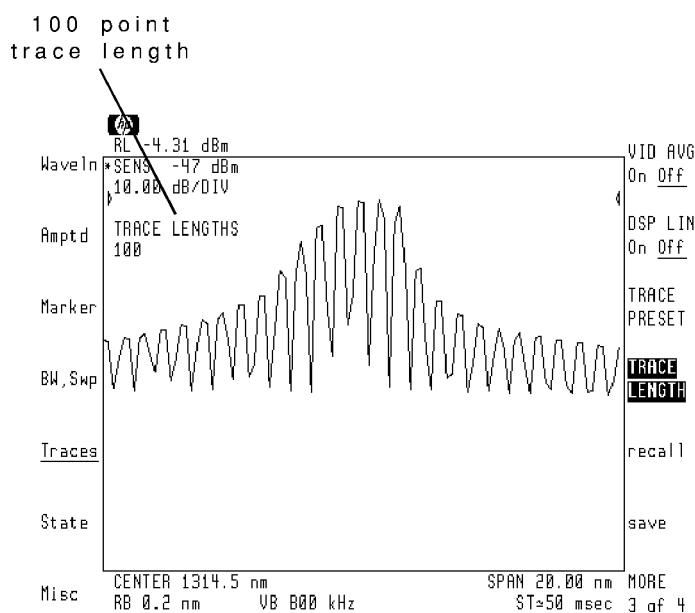

### Changing Trace Length and Interpolation

Normally all trace measurement points are connected by interpolated lines. You can turn off trace interpolation for trace A as shown in the following figure.

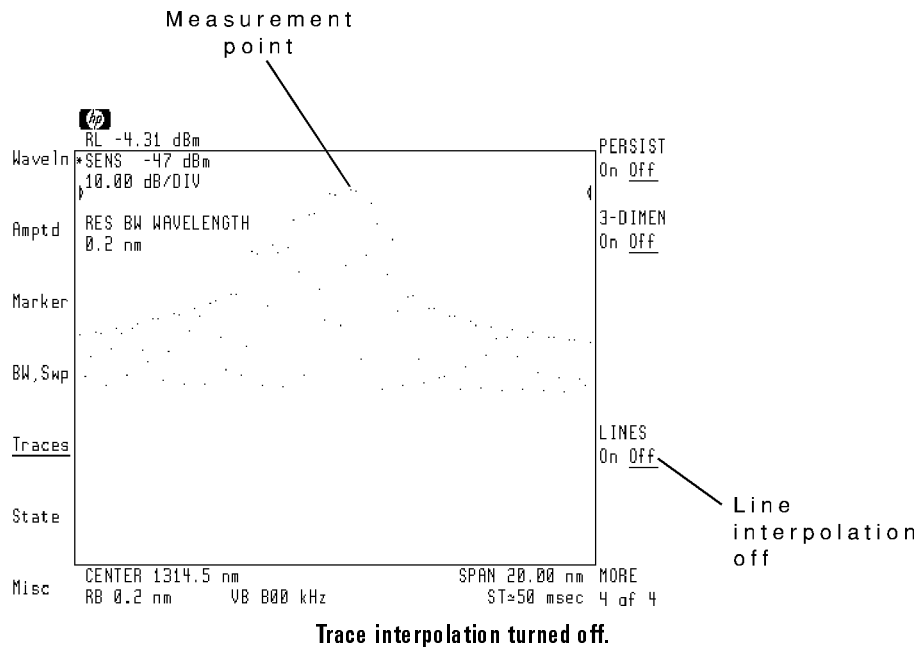

---

### To change the trace lengths

1. Press the left-side **Traces** softkey to enter the Traces menu.
2. Press the **MORE 1 of 4** and then **MORE 2 of 4** softkeys.
3. Press the **TRACE LENGTH** softkey.
4. Use the front-panel knob, numeric keypad, or step keys to enter the new trace length.

---

## To disable trace A interpolation

1. Press the left-side **Traces** softkey to enter the Traces menu.
2. Press the **MORE 1 of 4**, **MORE 2 of 4**, and then **MORE 3 of 4** softkeys.
3. Press the **LINES On Off** softkey so that **Off** is underlined.

---

## Saving and Recalling Traces

The following is a brief introduction on saving and recalling traces to memory. For a complete discussion on saving and recalling data, refer to Chapter 13. Chapter 13 includes information on selecting, formatting, and cataloging memory. Trace A can be saved or recalled from internal memory, memory cards, or an optional external HP-IB disk drive. Traces B and C can not be directly saved or recalled. They must first be copied to trace A using the **A XCH B** and **A XCH C** softkeys.

---

### To save trace A

1. Press the left-side **Traces** softkey to enter the Traces menu.
2. Press the **MORE 1 of 4** and then **MORE 2 of 4** softkeys.
3. Press the **save** softkey.
4. Press the **save to . . .** softkey, and select the memory location to save the trace:
  - **INTRNL MEMORY** indicates the optical spectrum analyzer's internal memory.
  - **HP-MSIB CARD** indicates a memory card plugged into the optical spectrum analyzer's front-panel card slot.
  - **HP-IB DISK** indicates an external HP-IB disk drive. Refer to Chapter 13 for information on connecting the disk drive.
5. Press the **prev menu** softkey.
6. Press the **SAVE TRACE A** softkey.
7. Use the front-panel numeric keypad to enter the file number.



## To recall trace A

1. Press the left-side **Traces** softkey to enter the Traces menu.
2. Press the **MORE 1 of 4** and then **MORE 2 of 4** softkeys.
3. Press the **recall** softkey.
4. Press the **recall from** softkey, and select the memory location to recall the trace from:
  - **INTRNL MEMORY** indicates the optical spectrum analyzer's internal memory.
  - **HP-MSIB CARD** indicates a memory card in the optical spectrum analyzer's front-panel card slot.
  - **HPIB DISK** indicates an external HP-IB disk drive. Refer to Chapter 13 for information on connecting the disk drive.
5. Press the **prev menu** softkey.
6. Press the **RECALL TRACE A** softkey.
7. Use the front-panel numeric keypad to enter the file number.

For example, in the following figure the file number is listed as 849.

# Controlling Traces

File name       CATALOG INTERNAL MEMORY  
                  WaveIn      Page 1 Prefix ''

File number      TOTAL MEM = 0917504  
                  Amptd      AVAIL MEM = 0912936  
                              CONFIG MEM = 0001750  
                              LARGEST MEM= 0912918  
                  Marker      049 1\_1      ASCII 02714

BW, Swp

Traces

State

Misc

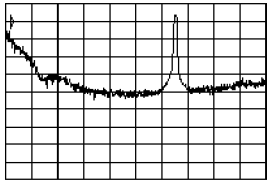

(END OF CATALOG)

catalog of internal memory

INTRNL MEMORY

HP-MSIB CARD

HPIB DISK

LOAD FILE

↓

NEXT PAGE

prev menu

CATALOG 1 of 2

**Using Markers**

---

## Using Markers

The optical spectrum analyzer provides markers for measuring absolute and relative values on traces A, B, and C. You can even use markers to locate signal peaks and change the displayed measurement range. Although the front-panel keypad allows you to position markers without having to enter the Marker menu, this chapter describes how to use the menu.

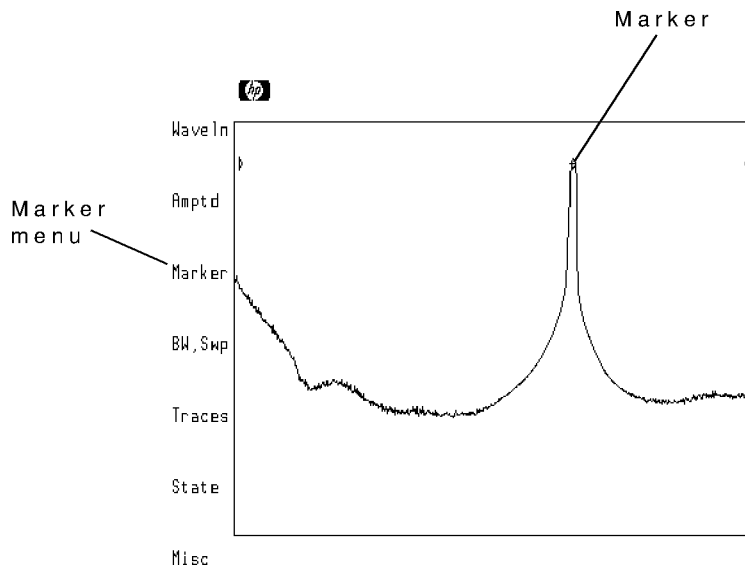

**Marker Displayed on Signal Peak**

<b>Contents</b>	
Selecting and Moving Markers	9-4
To display marker 1	9-7
To display markers 2 through 5	9-7
To move a marker to the next trace	9-8
To turn off the markers	9-8
Performing Marker Searches	9-9
To perform a peak search	9-13
To move marked signal to center screen	9-14
To move marked signal to reference level	9-14
To change the peak and pit definition	9-15
Using Delta Markers	9-16
To turn on a delta marker	9-19
To change wavelength span	9-19
To modify center-frequency step size	9-20
To measure bandwidth	9-20
To zoom to zero-span at marker	9-21
Tracking a Drifting Signal	9-22
To track a drifting signal	9-22
To define the tracking limit	9-23
Changing Marker Readout	9-24
To select the marker readout type	9-25
Stopping and Pausing the Sweep	9-26
To stop the sweep at the marker	9-27
To pause the sweep at the marker	9-27
Measuring Noise Level at Marker	9-28
To measure the noise level	9-28

## Selecting and Moving Markers

Press the left-side **Marker** softkey to display the Marker menu. If marker 1 is not already on, it is activated and placed on the trace's highest amplitude point. Use the front-panel knob, step keys, or numeric keypad to position the marker along the trace. Annotation shows the wavelength and amplitude value at the marker.

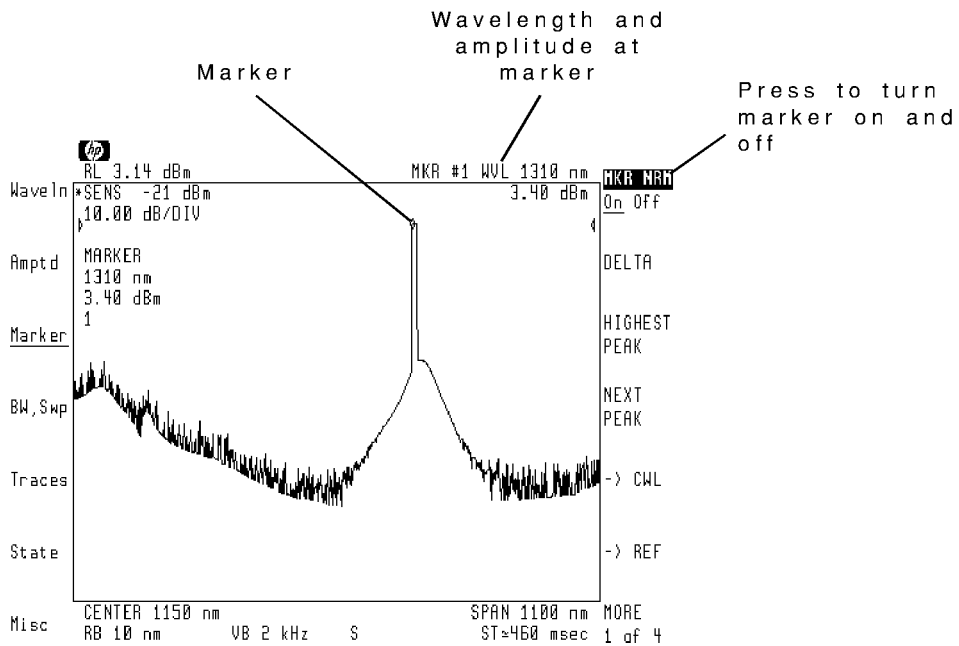

The **MKR NRM On Off** softkey turns all displayed markers off. You can not turn individual markers off. Marker positions can be protected from accidental changes caused by turning the front-panel knob accidentally. To protect the marker positions, press the front-panel **(HOLD)** key.

The optical spectrum analyzer displays up to five normal markers. Each marker can be positioned on any trace.

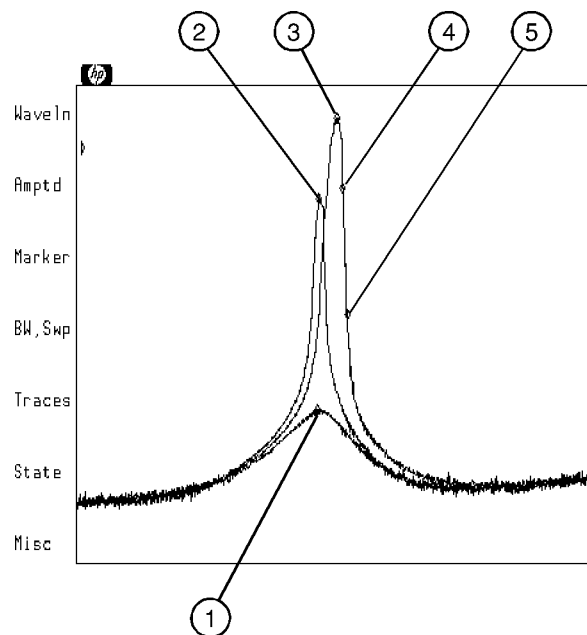

**Five markers on traces A, B, and C**

Using Markers

**Selecting and Moving Markers**

The marker functions listed in the Marker menu operate on the currently active marker. You activate a marker using the **ACTIVE MARKER** softkey located on page 3 of the Marker menu. Be sure to press **(HOLD)** after activating a marker.

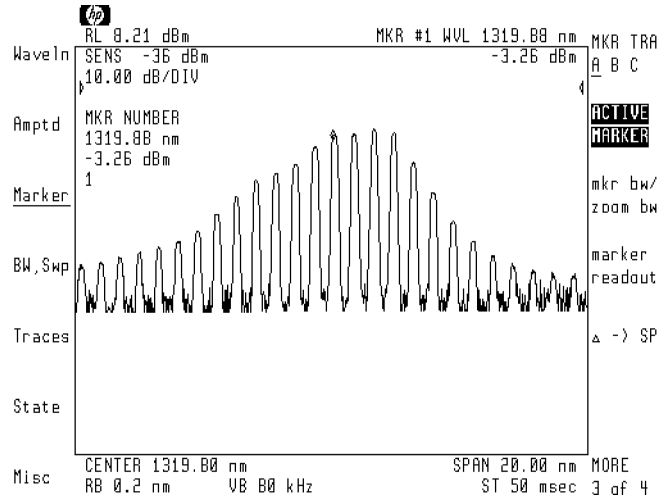



---

## To display marker 1

1. Press the left-side **Marker** softkey.

If not already turned on, Marker 1 is activated and placed on the peak amplitude of the trace.

2. Use the front-panel knob, step keys, or numeric keypad to position the marker along the trace.

---

## To display markers 2 through 5

1. Press the left-side **Marker** softkey.
2. Press **MORE 1 of 4**, **MORE 2 of 4**, and then **ACTIVE MARKER**.
3. Use the front-panel number keys to enter the number for the marker you want to display.

Press **2**, **3**, **4**, or **5** and then press **ENTER**.

4. Press the left-side **Marker** softkey.
5. Press the front-panel **(HOLD)** key.
6. Press **MKR NRM On Off** so that **On** is underlined to activate the marker.

---

## To move a marker to the next trace

1. Press the left-side **Marker** softkey.
2. Press **MORE 1 of 4**, **MORE 2 of 4**, and then **ACTIVE MARKER**.
3. Enter the number of the marker you want to move.  
Enter a 1, 2, 3, 4, or 5 and then press **ENTER**.
4. Press the front-panel **(HOLD)** key.
5. Press **MKR TRA A B C** to move the marker to the next trace.

---

## To turn markers off

1. Press the left-side **Marker** softkey.
2. Press **MKR NRM On Off** so that **Off** is underlined.

# Performing Marker Searches

Marker searches reduce the time required to locate and measure signals. With the press of a single function, you can place markers on displayed peaks, pits, and specific amplitude positions. Given the waveform displayed on this page, the marker could be positioned on the trace using the following functions in the order listed:

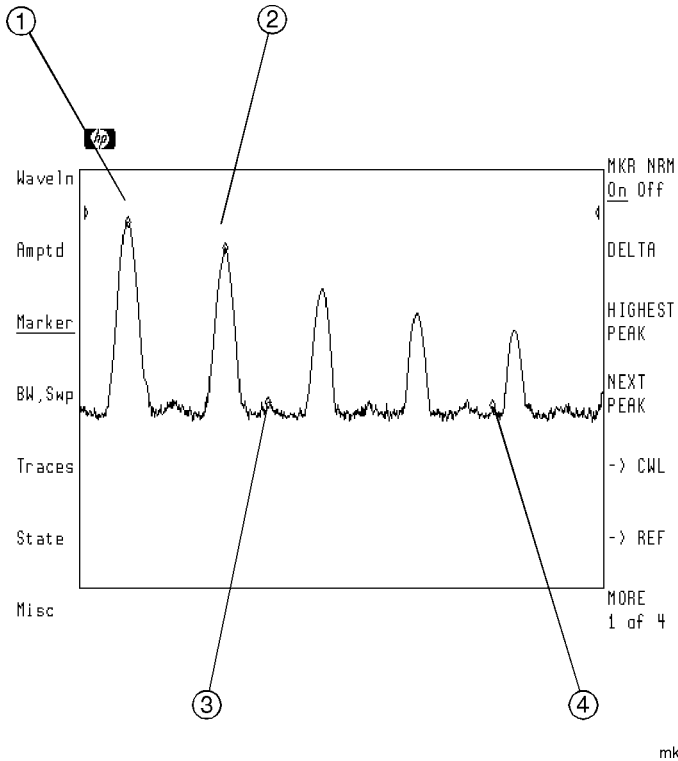

① HIGHEST PEAK	③ MORE 1 OF 4 RIGHT PEAK
② NEXT PEAK	④ MINIMUM PEAK

Using Markers

**Performing Marker Searches**

The following figure shows how markers can be used to locate minimum trace points. Use the pit,min markers menu that is located on page 4 of the Marker menu.

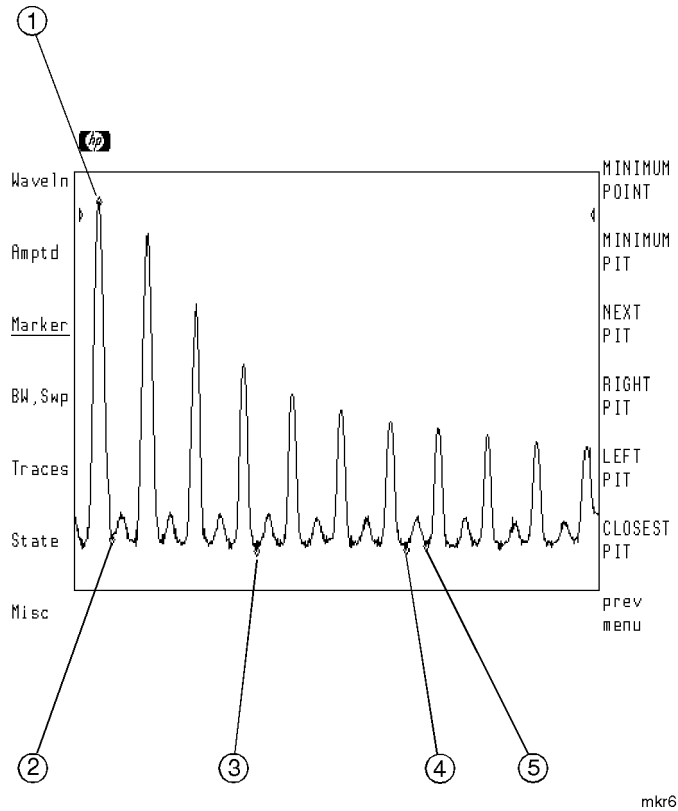

① PEAK SEARCH	④ NEXT PIT
② CLOSEST PIT	⑤ RIGHT PIT
③ MINIMUM POINT	

Notice that the pits located near figure callout ④ are not identified as pits with **CLOSEST PIT**. This is due to the method the optical spectrum analyzer uses to identify signal peaks and pits. Normally, any variation of 3 dB or more is considered a peak or pit. That is, the trace must increase by 3 dB and then decrease by 3 dB to be identified peak. This prevents the marker from identifying noise. You can change the amplitude variation required for signal peak identification. Signal pit identification works in a similar manner. For instructions on changing the peak and pit excursion values, refer to “To change the peak and pit definition” in this section.

**Changing the peak and pit excursion**

The peak and pit searches may not recognize valid signals near the noise floor when the peak or pit excursion definition is less than 3 dB. Thus, before performing peak and pit searches on signals near the noise floor, reduce the peak or pit excursion value. However, reducing the excursion value often causes peak and pit searches to identify noise spikes. To avoid this misidentification, use video averaging or video filtering to reduce the noise floor variance to a value less than the peak or pit excursion definition.

## Using Markers

### Performing Marker Searches

When used with the **-> CWL** and **-> REF** softkeys, peak searches provide a convenient method of centering waveforms on the display.

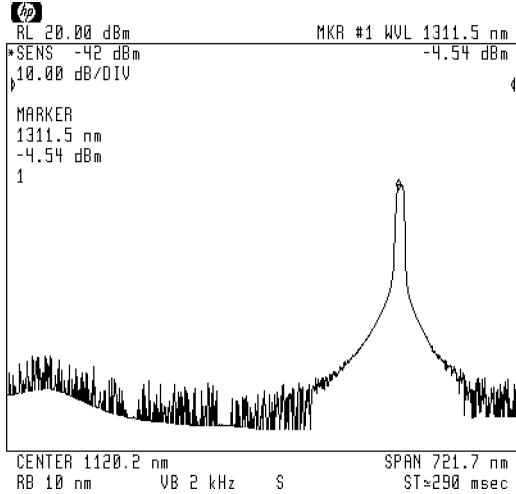

1. Place marker on peak.

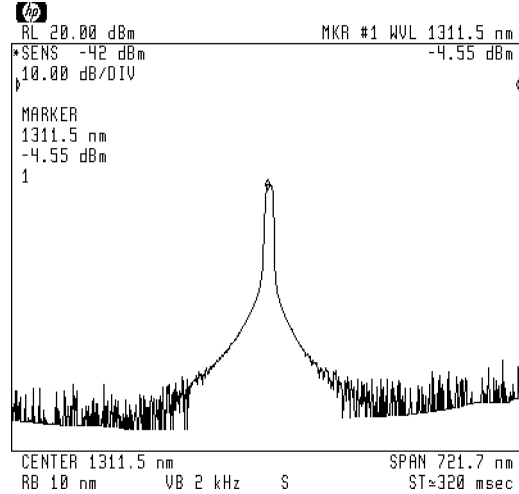

2. Press **-> CWL**.

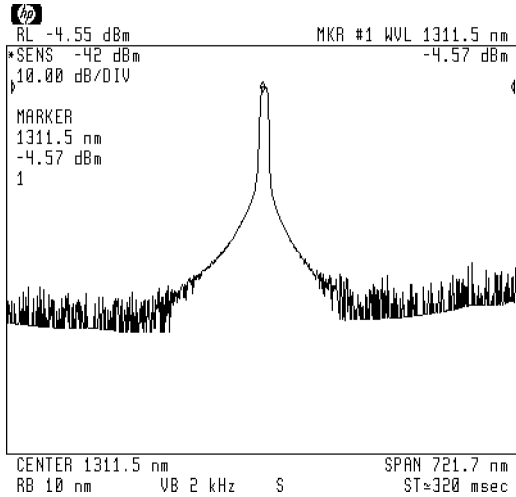

3. Press **-> REF**.

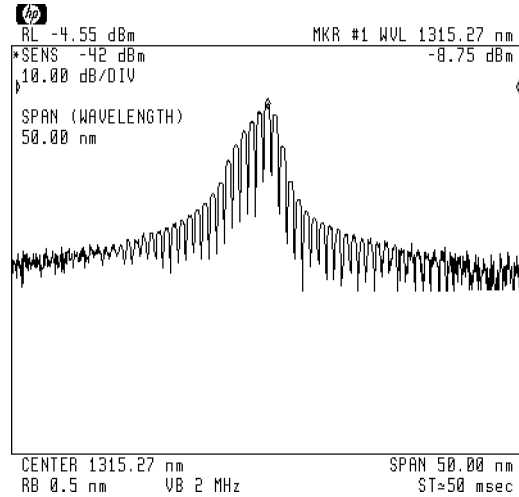

4. Press **SPAN** **5** **0** **nm**.

---

## To perform a peak search

1. Press the **Marker** softkey.
2. Position the active marker using the following softkeys:
  - **HIGHEST PEAK** to place the marker on the largest amplitude point on the trace.
  - **NEXT PEAK** to place the marker on the next largest peak.
  - **MORE 1 of 4** and then **RIGHT PEAK** to locate the next peak right of the marker.
  - **MORE 1 of 4** and then **LEFT PEAK** to locate the next peak left of the marker.
  - **MORE 1 of 4** and then **CLOSEST PEAK** to locate the next closest peak to the active marker.
  - **MORE 1 of 4**, **MORE 2 of 4**, **MORE 3 of 4**, and then **pit,min markers** for functions that are used to locate the lowest trace amplitudes and pits.

---

## To move a marked signal to center screen

### Single sweeps

If the optical spectrum analyzer is in single sweep mode, the displayed response will not change until a new sweep is triggered. This is because **→ CWL** changes the measurement range and not the measurement data.

1. Press the **Marker** softkey.
2. Place the marker on the peak of the signal.
3. Press **→ CWL**.

---

## To move a marked signal to the reference level

1. Press the **Marker** softkey.
2. Place the marker on the peak of the signal.
3. Press **→ REF**.



---

## To change the peak and pit definition

1. Press the **Marker** softkey.
2. Press **MORE 1 of 4**, **MORE 2 of 4**, and then **MORE 3 of 4**.
3. Press **marker excursn**.
4. Press **PEAK EXCURSN**, and enter the minimum trace excursion value that defines a peak.

The default trace excursion value is 3 dB.

5. Press **PIT EXCURSN**, and enter the minimum trace excursion value that defines a pit.

The default trace excursion value is 3 dB.

## Using Delta Markers

Delta markers allow you to measure relative values between any two trace points. For example, you can measure the wavelength separation of a laser's line modes. The active marker becomes the reference marker. Move the delta marker using the knob, step keys, or numeric keypad.

Convert the delta marker to normal marker at any time by pressing the **MKR NRM On Off** softkey so that **On** is highlighted in the softkey label.

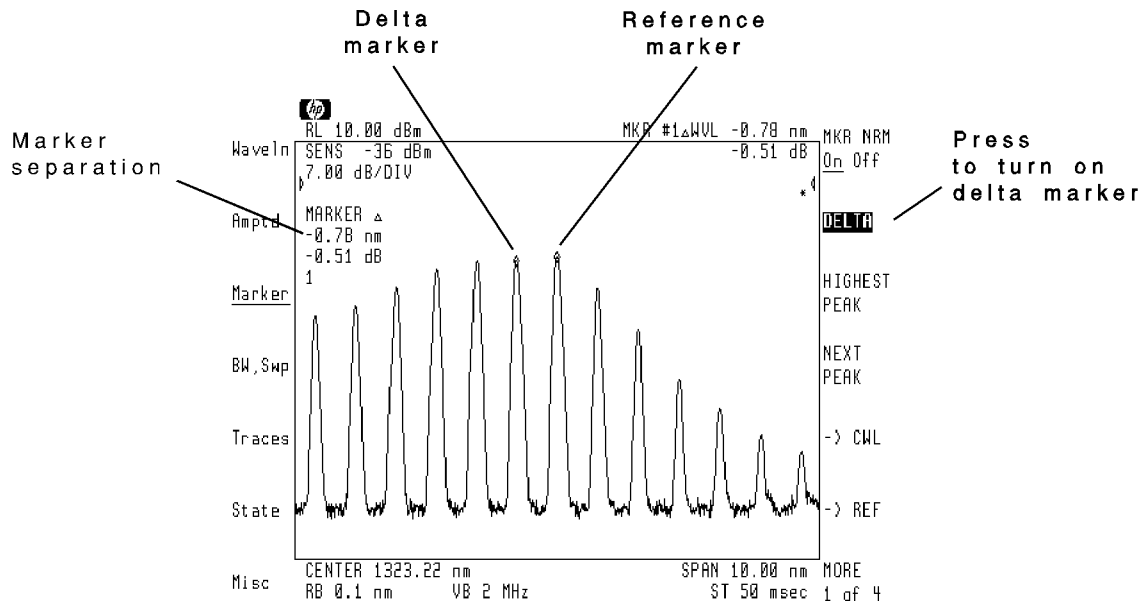

The wavelength separation between delta marker can be entered into the span. It can also be entered into the center frequency steps. When center wavelength is the active function, pressing the  $\blacktriangle$  and  $\blacktriangledown$  keys steps the center wavelength. The size of the steps can be set equal to the span between delta markers. This gives a convenient method of stepping the center frequency between laser modes.

The Marker menu provides a feature for automatically measuring a signal's bandwidth. Although the default bandwidth measured is 3 dB, you can specify other amplitude values.

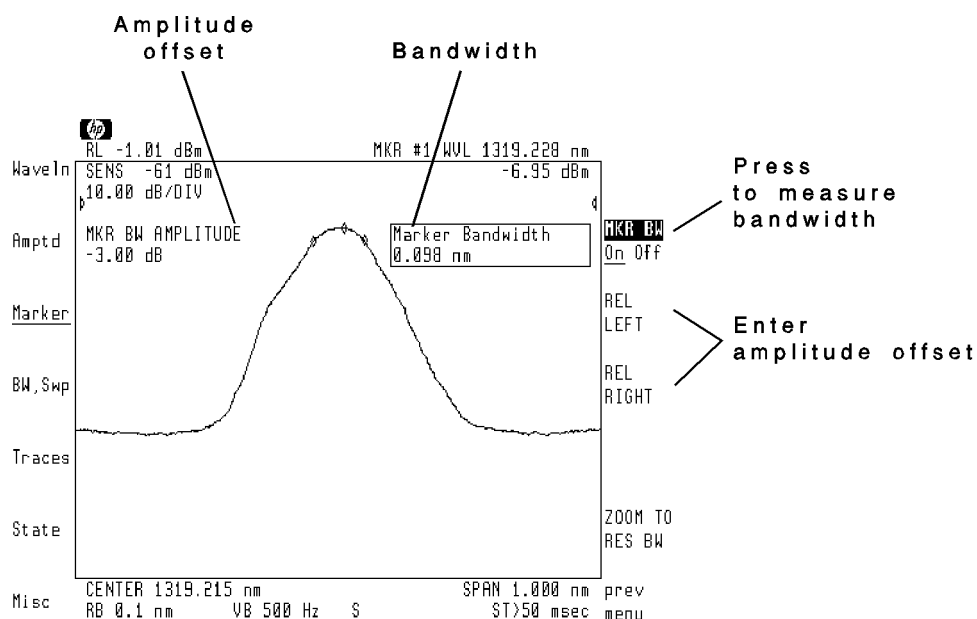

Using Markers  
**Using Delta Markers**

At times, you'll need to place the optical spectrum analyzer in zero span. The **ZOOM TO RES BW** function tunes the optical spectrum analyzer to the wavelength at the marker, places the analyzer in zero span, and then sets the resolution bandwidth to the desired setting.

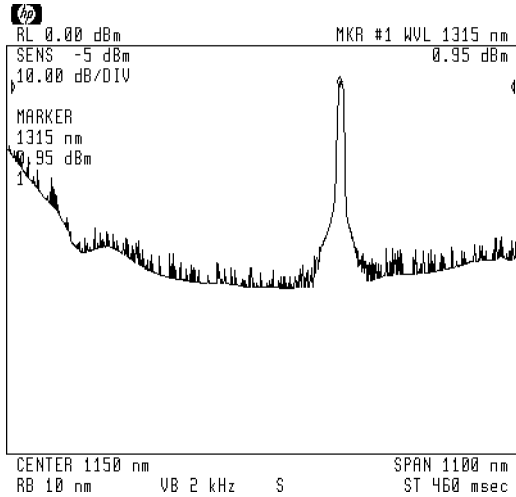

**Signal identified by marker.**

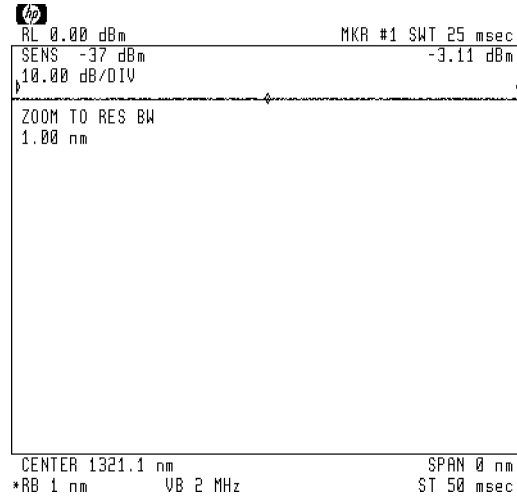

**Signal at 0 nm span.**

---

## To turn on a delta marker

1. Press the **Marker** softkey.
2. Press **MKR NRM On Off** so that **On** is underlined.
3. Use the front-panel knob to move the marker to a reference position.  
The peak search softkeys, for example **RIGHT PEAK**, will also move the marker.
4. Press **DELTA**, and use the front-panel knob to position the delta marker.  
The peak search softkeys, for example **HIGHEST PEAK**, will also move the delta marker.

---

## To change wavelength span

1. Press the left-side **Marker** softkey.
2. Press **MKR NRM On Off** so that **On** is underlined.
3. Use the front-panel knob, or other method, to move the marker to the desired starting wavelength.
4. Press **DELTA** to activate a delta marker.
5. Use the front-panel knob to position the delta marker at the stop wavelength.
6. Press **MORE 1 of 4**, **MORE 2 of 4**, and then  **$\Delta \rightarrow$  SP**.

---

## To modify center-frequency step size

1. Press the **Marker** softkey.
2. Use the front-panel knob, step keys, or numeric keypad to place the active reference marker at the desired trace position.
3. Press **DELTA** to display the delta marker.
4. Use the front-panel knob, step keys, or numeric keypad to place the delta marker at the desired trace position.
5. Press **MORE 1 of 4**, **MORE 2 of 4**, and then **Δ → CWL STEP**.

---

## To measure bandwidth

1. Press the left-side **Marker** softkey.
2. Press **MKR NRM On Off** so that **On** is underlined.
3. Place the marker on the signal's peak.
4. Press **MORE 1 of 4**, **MORE 2 of 4**, and then **mkr bw/ zoom bw**.
5. Press **MKR BW On Off** so that **On** is underlined. The bandwidth between the two delta markers is displayed.

The markers identify a default bandwidth of 3 dB. To change the default bandwidth, enter the new bandwidth using a minus sign. For example, to enter a 6 dB bandwidth press **⊖ 6 dB**. If the left and right amplitude offsets for measuring bandwidth need to be different from each other, use the **REL LEFT** and **REL RIGHT** softkeys to enter each value.

---

## To zoom to zero-span at marker

1. Press the left-side **Marker** softkey.
2. Press **MKR NRM On Off** so that **On** is underlined.
3. Place a marker on the signal's peak.
4. Press **MORE 1 of 4**, **MORE 2 of 4**, and then **mkw bw/ zoom bw**.
5. Press **ZOOM TO RES BW**, and use the numeric keypad to enter the desired resolution bandwidth.

The optical spectrum analyzer goes to zero span only after the resolution bandwidth has been entered. The resolution bandwidth can be set to the following values: 10, 5, 2, 1, 0.5, 0.2, 0.1, or 0.08 nanometers.

The optical spectrum analyzer automatically reduces the span at the marked signal to zero nanometers. The resolution bandwidth is set as requested. With the optical spectrum analyzer in zero span, the monochromator becomes fixed at one wavelength (the center wavelength). The resulting display shows signal amplitude versus time which is similar to an oscilloscope. Sweeptimes range from 40 ms (50  $\mu$ s per trace point) to 60s.

---

## Tracking a Drifting Signal

At times, it may be difficult to keep signals centered on the screen. For example, the signal may be drifting in wavelength. Or, you may be reducing the wavelength span. By using signal tracking, the optical spectrum analyzer automatically centers the signal after every sweep.

If multiple signals are present, limit the tracking range with **SIG TRK LIMIT** to ensure that the correct signal is centered. With tracking limiting, the optical spectrum analyzer continuously reevaluates the marker amplitude to see if the marker is still on the correct signal. The tracking-limit key controls the amplitude variation tolerated by signal-tracking.

---

### To track a drifting signal

1. Press the left-side **Marker** softkey and place the active marker on the signal peak.
2. Press **MORE 1 of 2** and then **SIG TRK On Off** so that **On** is underlined.



---

## To define the tracking limit

1. Press the left-side **Marker** softkey.
2. Press **MORE 1 of 4**, **MORE 2 of 4**, **MORE 3 of 4**, and then **SIG TRK LIMIT**.
3. Enter an amplitude limit for reidentifying the selected signal between sweeps.

The default limit is 5 dB. You can enter a limit from 0 to 300 dB.

---

## Changing Marker Readouts

Marker readouts can be changed to show any of the following trace values:

- Wavelength
- Frequency
- Period
- Sweeptime
- Inverse sweeptime (1/T)

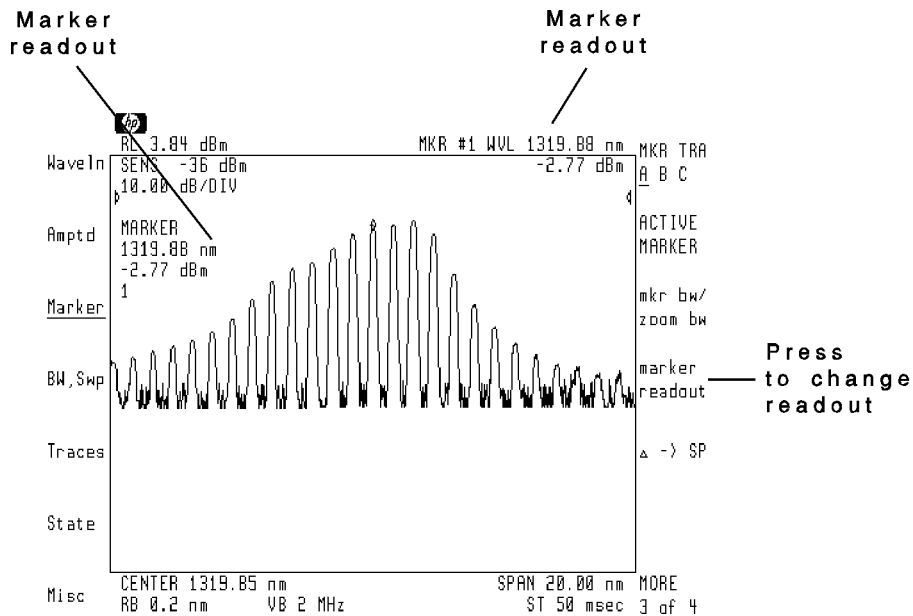

Normally, the optical spectrum analyzer automatically selects the appropriate readout value. For example, in zero span, the markers read out sweeptime. The display's left edge represents 0 seconds, and the right edge corresponds to the sweeptime. For example, a marker positioned at the center of the display when the sweeptime is 50 ms, shows a position value of 25 ms.

---

## To select the marker readout type

1. Press the left-side **Marker** softkey.
2. Press **MORE 1 of 4**, **MORE 2 of 4**, and then **marker readout**.
3. Select one of the following measurements:
  - **Auto** to enable automatic readout selection.
  - **FREQ** displays the frequency at the marker.
  - **WAVELEN** displays the wavelength at the marker.
  - **PERIOD** displays the period at the marker.
  - **SWPTIME** displays the sweeptime at the marker. The screen's left edge represents zero seconds.
  - **1/T** displays the inverse of the sweeptime at the marker.

---

## Stopping and Pausing the Sweep

The sweep can be stopped or paused at the marker position. Stopping the sweep at the marker reduces measurement times when extremely slow sweeps are used. While the trace is paused, the optical spectrum analyzer temporarily operates in zero-span for fix-tuned measurements. For example, with an HP 71451B optical spectrum analyzer, pausing the sweep at the marker allows a power measurement to be performed at the front-panel MONOCHROMATOR OUTPUT connector.

### **Inaccurate trace data**

The trace displayed to the right of the marker may be inaccurate when using the marker pause. When using the marker stop features, the portion of the trace displayed to the right of the marker is not updated.

---

## To stop the sweep at the marker

1. Press the left-side **Marker** softkey.
2. Press **MORE 1 of 4**, **MORE 2 of 4**, and then **MORE 3 of 4**.
3. Press **MK STOP On Off** so that **On** is underlined.

---

## To pause the sweep at the marker

1. Press the left-side **Marker** softkey.
2. Press the **MORE 1 of 4**, **MORE 2 of 4**, and then **MORE 3 of 4** softkeys.
3. Press **MKPAUSE On Off** so that **On** is underlined.
4. Enter a value in seconds to pause the sweep. For example, press **5 s**.

The sweep can be paused from 0 to 1000 seconds. The default value is 0 seconds.

---

## Measuring Noise Level at Marker

The optical spectrum analyzer can measure the rms noise level at the marker position. The rms noise level is normalized to a 1 nanometer bandwidth and is compensated for the following:

- The difference between the rms values of the noise-floor envelope (a narrowband response described by Rayleigh's distribution function) and the true rms value of the noise floor (which is a broadband response).
- Errors caused by the optical spectrum analyzer's internal video-bandwidth filters and log amplifiers.

---

### To measure the noise level

1. Press **Marker** and place the marker at the desired position for measurement.
2. Press **MORE 1 of 4**.
3. Press **MKNOISE On Off** so that **On** is underlined.

---

**Creating Limit Lines and  
Entering Amplitude  
Corrections**

## Creating Limit Lines and Entering Amplitude Corrections

Limit lines allow you to test the shape (wavelength and amplitude) of displayed responses. Because limit lines allow you to perform repetitive testing of response shapes, they are ideal for pass/fail testing on production lines. You design, create, save, recall, and edit limit lines using the Limit-lines menu. Access this menu from the page 2 of the Miscellaneous menu

Limit lines can also be used to create, save, recall, and edit amplitude correction factors. Use amplitude correction factors to compensate for wavelength-dependent amplitude variations in test setups. For example, you can use amplitude corrections to compensate for the wavelength response of an optical attenuator, switch, or other device.

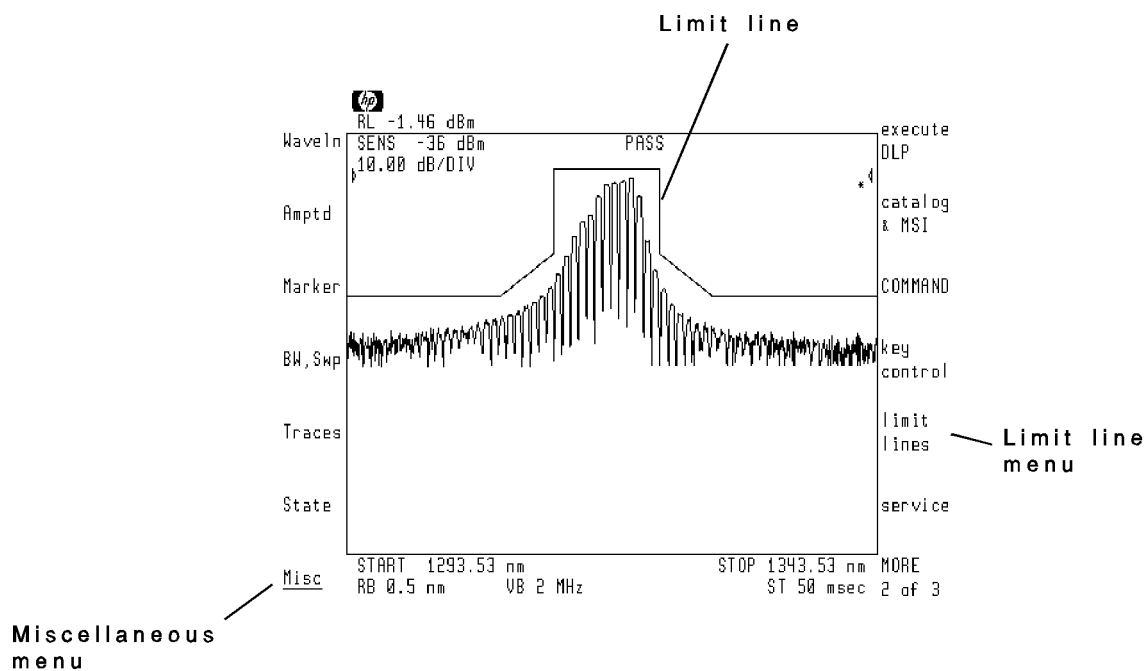

Second Page of Miscellaneous Menu



**Contents**

Creating Limit Lines .....	10-4
To enter the limit-lines menu .....	10-10
To create a limit line .....	10-10
To make limit lines relative or fixed .....	10-12
To turn on limit testing .....	10-12
To turn on the fail-limit beeper .....	10-12
To blank all traces .....	10-13
To erase the limit-line table .....	10-13
Saving and Recalling Limit Lines .....	10-14
To save a limit line .....	10-16
To list limit-line files in memory .....	10-16
To recall a limit line .....	10-17
Using Amplitude Corrections .....	10-18
To create amplitude corrections .....	10-21
To edit amplitude corrections .....	10-22
To increase the limit-line table size .....	10-23
To turn amplitude corrections on or off .....	10-24
To erase amplitude corrections .....	10-25
Tutorial: Using Limit Lines .....	10-26

---

## Creating Limit Lines

You can create limit lines that:

- Display at a fixed center wavelength and reference level.
- Display relative to the center wavelength and reference level.
- Define the upper response limit.
- Define the lower response limit.
- Define both lower and upper response limits.

If a displayed response is within your limit lines, a **PASS** message is displayed on the screen. If a displayed response is outside the limits, a **FAIL** message is displayed.

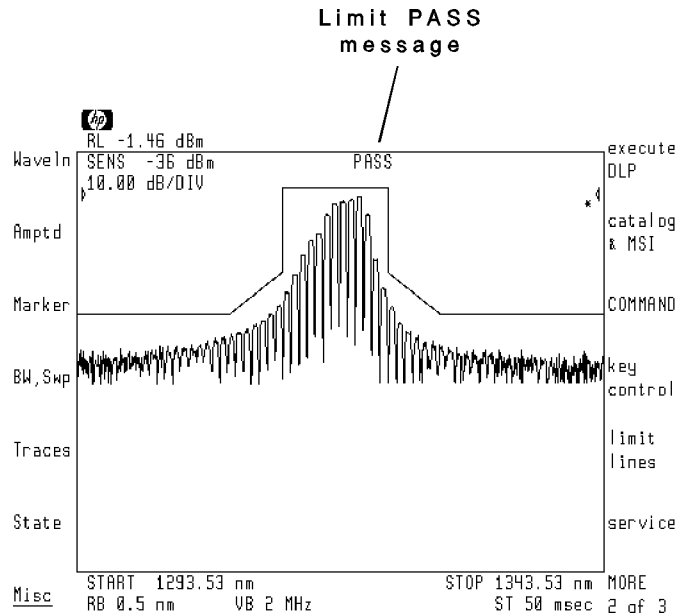

Limit lines may be fixed or relative with respect to the optical spectrum analyzer's wavelength and reference level. Relative limit lines do not change screen position if the wavelength or reference level are changed. However, fixed limit lines do change screen position as the wavelength and reference level are changed.

A tutorial, located at the end of this chapter, gives step-by-step instructions for creating an example limit line.

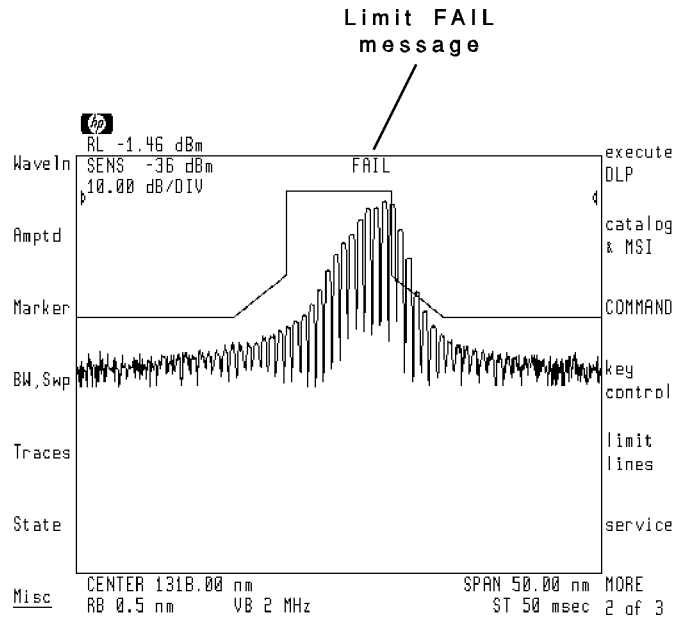

**Creating Limit Lines**

**Creating Limit Lines Using the Limit-Line Table**

Pressing the Miscellaneous menu's **limit lines** softkey places you in the Limit-lines menu. When you enter page 2 of the Limit-lines menu, a table automatically appears. You create limit lines by entering data in this table.

Limit lines are made by “drawing” lines between wavelength/amplitude points. Each line is called a segment. Segments begin at a starting wavelength and continue to the next segment. You enter each segment in a table displayed on the screen. Notice in the following figure that the limit lines are displayed along with the table. To make it easier to see the table, blank all displayed traces. Refer to “To blank all traces” in this section.

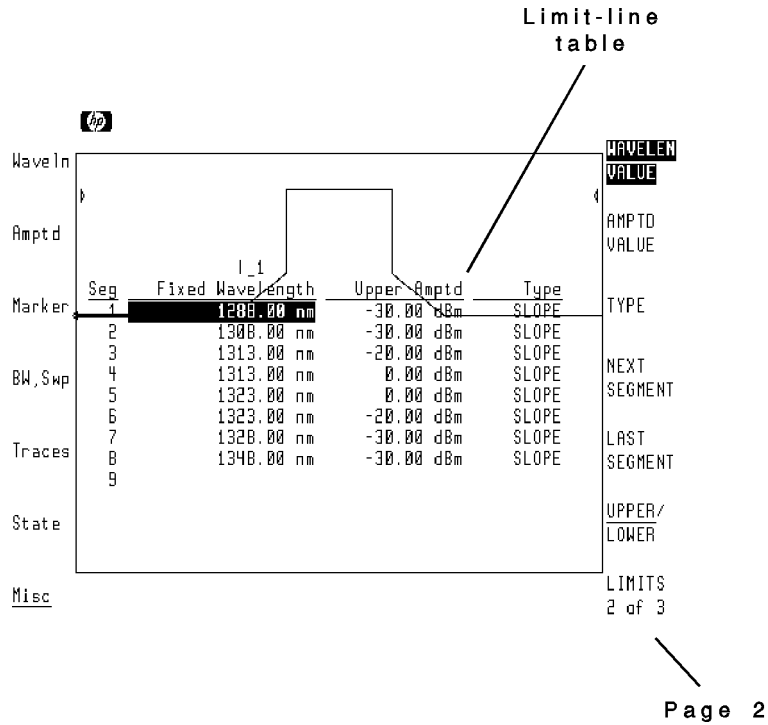

Limit-line table

**Missing limit lines**

If you cannot see any limit lines while constructing a limit-line table, there are two possible problems.

1. The **LIMITS On Off** softkey (on page 1 of the Limit-lines menu) must be set to **On**.
2. The optical spectrum analyzer may not be tuned to display the wavelengths listed in the limit-line table. Set the optical spectrum analyzer's center wavelength to the center wavelength of the limit line. Set the wavelength span to the span of the limit line.

The following figure shows the eight segment points defined in the table that is shown in the previous figure.

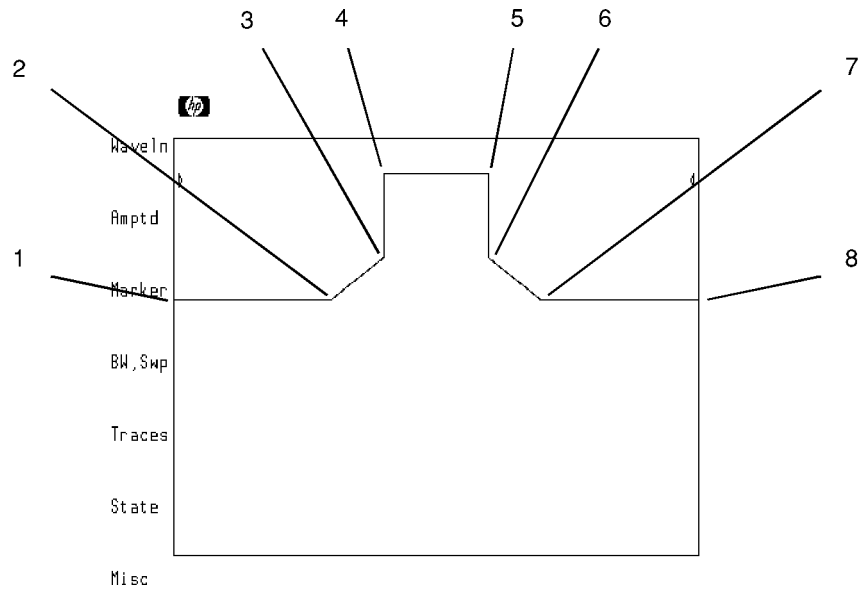

**Location of segment points**

**Creating Limit Lines**

In the table, a highlighted bar indicates the table data that is selected for entering or editing. A corresponding marker indicates the location of the selected segment point on the limit line.

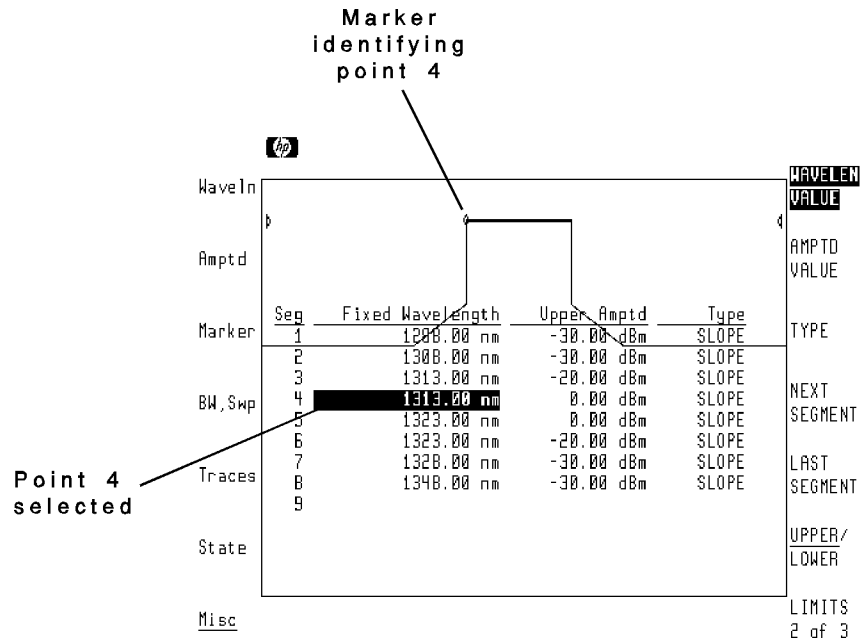

Segments can be one of three types: SLOPE, FLAT, or POINT. With slope types, segments with different amplitudes are connected using sloping lines. With flat types, segments remain constant in amplitude until the next segment's starting wavelength is reached. With point types, a segment's starting wavelength is not connected to the next segment; only the starting points are drawn.

The following figures illustrate difference between the three slope types. The limit-line table in each figure is identical except for the segment's type.

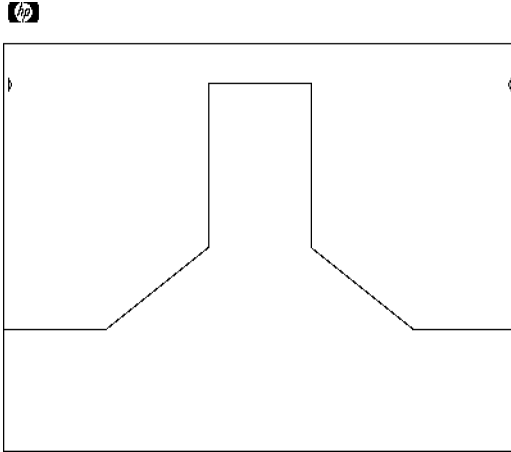

**SLOPE Segment Types.**

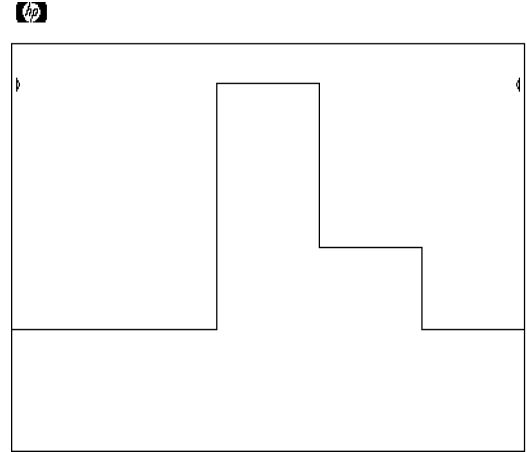

**FLAT Segment Types.**

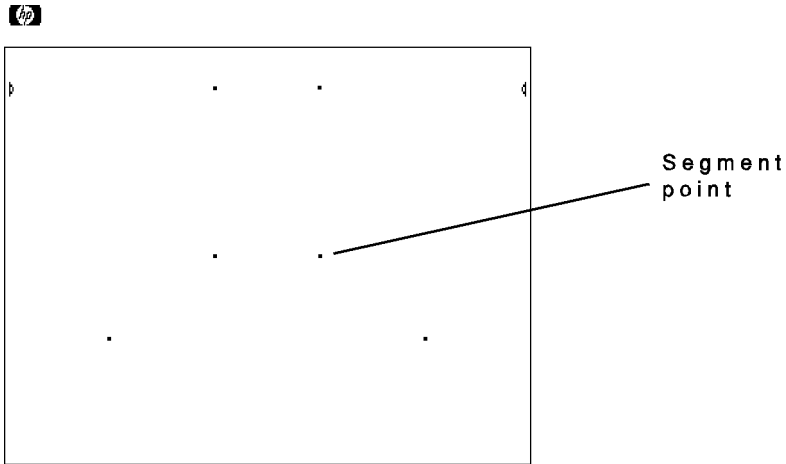

**POINT Segment Types.**

## Creating Limit Lines

---

### To enter the limit-lines menu

1. Press the left-side **Misc** softkey to enter the Miscellaneous menu.
  2. Press the **MORE 1 of 3** and then **limit lines** softkeys.
- 

### To create a limit line

1. Press the left-side **Misc** softkey to enter the Miscellaneous menu.
2. Press the **MORE 1 of 3** softkey.
3. Press the **limit lines** softkey to enter the Limit-lines menu.
4. Press the **LIMITS 1 of 3** and then **LIMITS 2 of 3** softkeys.

You can also press **enter limit** to view page 2 of the Limit-lines menu.

5. If any data is shown in the displayed table, erase the data by pressing **DELETE ALL** and then the **CONFIRM DELETE** softkeys.

All previously entered data will be lost! If you want to save the data, refer to “Saving and Recalling Limit Lines” in this chapter.

6. If any trace is displayed, press **BLANK TRACES** to prevent their display.
  7. Select relative or fixed wavelength limit lines. Press **RELATIV On Off** so that:
    - **Off** is underlined for fixed wavelength limit lines.
    - or,
    - **On** is underlined for relative wavelength limit lines.
  8. Press the **LIMITS 3 of 3** and then **LIMITS 1 of 3** softkeys.
-



9. Use the **WAVELEN VALUE** and **AMPTD VALUE** softkeys to enter the wavelength and amplitude of the first segment point.
10. Press the **NEXT SEGMENT** softkey to enter the values for the next segment.
11. Continue entering limit-line segments until all the line segments are entered. Press **NEXT SEGMENT** to begin each new line.
  - Line segments can be entered out of order. The table will automatically place the lines in their proper order starting from the shortest wavelength to the longest wavelength.
  - Use the **TYPE** softkey to select the line type of each segment. Choices are SLOPE, FLAT, and POINT. The **SELECT SEGMENT** softkey can be used to select a segment.
  - Press **NEXT SEGMENT** to select between segments already entered.
  - To delete a segment, use the **NEXT SEGMENT** softkey to highlight the segment, then press **LIMITS 2 of 3** and then **DELETE SEGMENT**.
  - **LAST SEGMENT** always enters a new segment at the end of the table.
12. To enter lower limit lines press the **UPPER/LOWER** softkey so that **LOWER** is underlined.

A new table appears for entering lower limit lines. Press **UPPER/LOWER** softkey to switch between upper and lower limit-line tables.
13. Limit testing is automatically turned on. Press a left-side softkey to exit the Miscellaneous menu and begin testing.

## Creating Limit Lines

---

### To make limit lines relative or fixed

1. Create a limit line in the Limit-lines menu.
  2. Display the Limit-lines menu's page 3 softkeys.
  3. Press the **RELATIV On Off** softkey so that:
    - **Off** is underlined for fixed wavelength limit lines.
    - or
    - **On** is underlined for relative wavelength limit lines.
- 

### To turn on limit testing

1. Create a limit line in the Limit-lines menu.
  2. Display the Limit-lines menu's page 1 softkeys.
  3. Press the **LIMITS On Off** softkey so that **On** is underlined.
- 

### To turn on the fail-limit beeper

1. Create a limit line in the Limit-lines menu.
2. Display the Limit-lines menu's page 1 softkeys.
3. Press the **BEEPER On Off** softkey so that **On** is underlined.

When the beeper is turned on, if the displayed signal fails the bounds indicated by the limit line, a beep sounds.

---

---

## To blank all traces

1. Enter the Limit-lines menu.
2. Display the Limit-lines menu's page 3 softkeys.
3. Press the **BLANK TRACES** softkey.

To display the traces again, press **BLANK TRACES** again.

Blanking the traces makes it easier to see the limit-line table for entering limit line data.

---

## To erase the limit-line table

1. Enter the Limit-lines menu.
2. Display the Limit-lines menu's page 3 softkeys.
3. Press **DELETE ALL** and then **CONFIRM DELETE**.

## Saving and Recalling Limit Lines

Limit lines can be saved in a file and recalled for later use. Although the limit-line table is not erased by pressing **INSTR PRESET** or by turning the optical spectrum analyzer off, it is still a good idea to save in a file any valuable limit lines.

Limit-line files can be cataloged and recalled using the Miscellaneous menu's **catalog & MSI** feature. (You can also recall limit-line files from the Limit-lines menu.) Each limit-line file has a file number and file name. The file name consists of the prefix *L\_* followed by a number. The prefix identifies the file as a limit line.

The file number is automatically assigned when the file is created. You provide the number in the file name when you save the limit line. For example, the two files in the following figure (L\_2 and L\_3) were saved as 2 and 3.

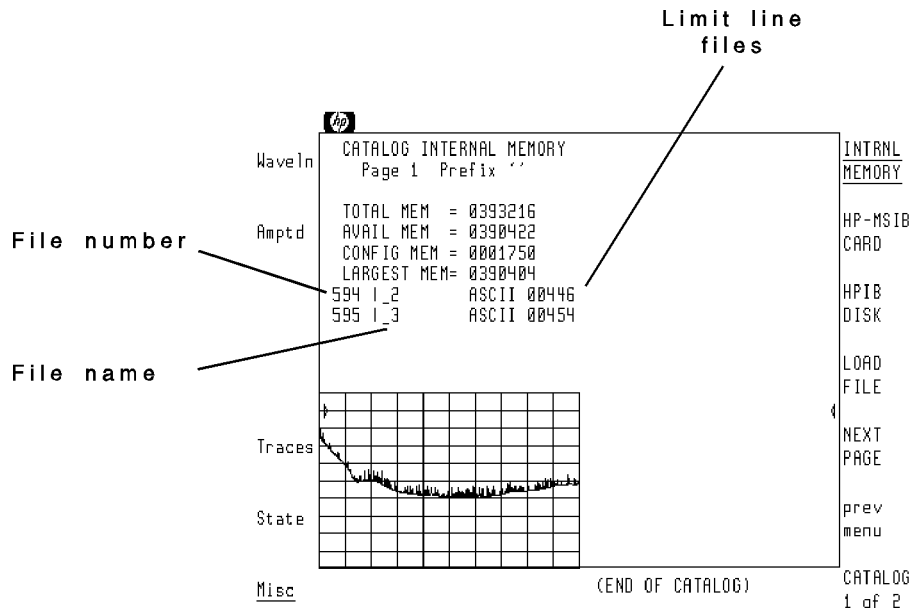

**Catalog of limit-line files in internal memory.**

Creating Limit Lines and Entering Amplitude Corrections  
**Saving and Recalling Limit Lines**

It's easy to load a limit-line file into the limit-line table for display. When loading from the catalog menu, press **LOAD FILE** and enter the file number. However, when loading from the Limit-lines menu, press **RECALL LIMIT**, and enter the number in the file name.

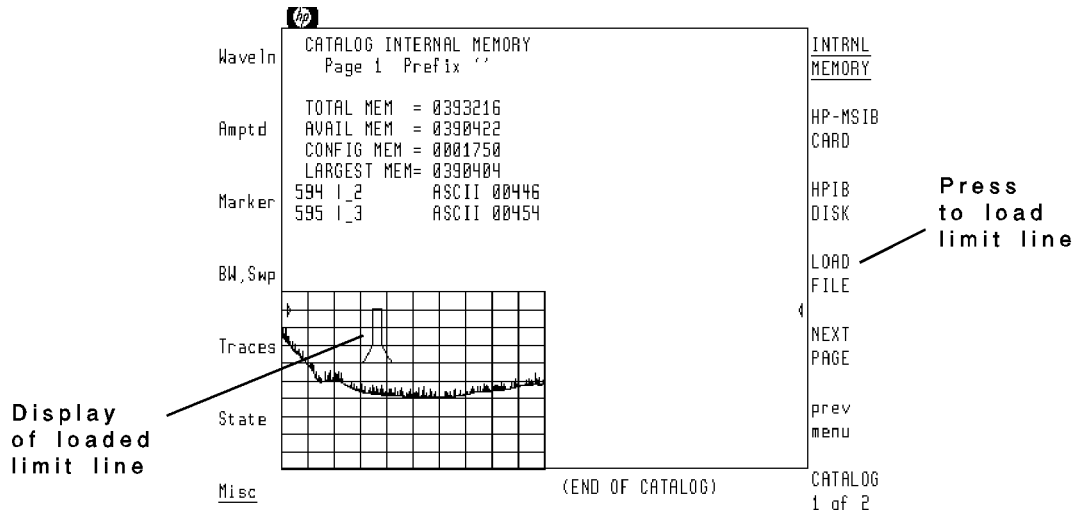

### **Saving and Recalling Limit Lines**

---

## To save a limit line

1. Create a limit line.
2. Display the Limit-lines menu's page 1 softkeys.

The Limit-lines menu is the menu you used to enter the limit-line table data.

3. Press the **SAVE LIMIT** softkey.
4. Use the numeric keypad to enter a file number. The number can be several digits depending on available memory.
5. Press the **ENTER** key.

---

## To list limit-line files in memory

1. Press the **Misc** softkey to enter the Miscellaneous menu.
2. Press the **MORE 1 of 3** and then **catalog & MSI** softkeys.

- Press **INTRNL MEMORY** to list the files stored in internal memory.
- Press **HP-MSIB CARD** to list the files stored on a memory card.

Remember to insert the card before pressing **HP-MSIB CARD**.

- Press **HPIB DISK** to list the files stored on an external HP-IB disk drive.
3. Locate the limit-line files. Limit-line file names start with the *l\_* prefix to help you locate the file.

If the displayed list of files does not fit on the display, press **NEXT PAGE** to view the additional files.

---

## To recall a limit line

You can recall files from either the Catalog & MSI menu or the Limit-lines menu. If you don't know the file name, recall the file from the Catalog & MSI menu.

- Recall from the Catalog & MSI menu with the following steps:
  1. Press the left-side **Misc** softkey.
  2. Press **MORE 1 of 3** and then **catalog & MSI**.
  3. Press **INTRNL MEMORY**, **HP-MSIB CARD**, or **HPIB DISK** to select the memory location of the file.
  4. Locate the limit-line file. Limit-line file names start with the *l\_* prefix to help you locate the file.
  5. Press **LOAD FILE**, and use the numeric keypad to enter the file number.

The file number is listed to the left of the file name.

6. Press **ENTER**.
- or
- Recall from the Limit-lines menu with the following steps:
    1. Press the left-side **Misc** softkey.
    2. Press **MORE 1 of 3** and then **limit lines**.
    3. Press **RECALL LIMIT**, and use the numeric keypad to enter the number associated with the file name.
    4. Press **ENTER**.

---

## Using Amplitude Corrections

Amplitude corrections give you the ability to compensate for the wavelength-dependent loss (or gain) of a device. For example, if an optical attenuator is placed between the optical spectrum analyzer and a laser, amplitude corrections can compensate for the attenuator's wavelength response. With amplitude corrections, amplitude levels (including markers) indicate the power at the laser's output. This effectively moves the measurement (or reference) point beyond the attenuator to the laser.

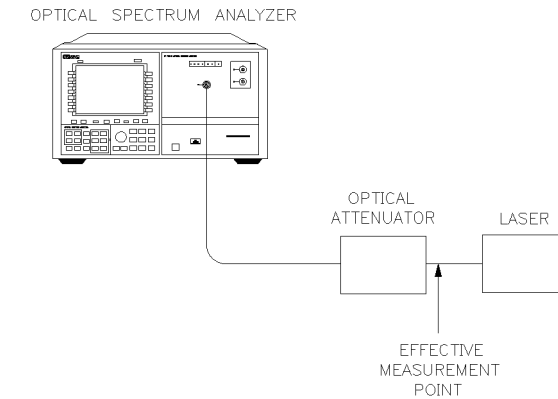

pkb8

**Amplitude corrections compensate for external device.**



The limit-line table allows you to work with amplitude corrections in the same manner as limit lines. This section shows you how to copy amplitude correction data to and from the limit-line table. It assumes you already know how to create, edit, save, and recall limit lines as shown in the first half of this chapter.

The amplitude correction factors, and their associated wavelength points, are stored in a special AMP\_COR file in internal memory. Pressing **INSTR PRESET** turns off the amplitude corrections.

Although you can create amplitude corrections using the limit-line table, it is easier to use a computer. Refer to the **AMPCOR** command in the *Programmer's Guide* for information on creating amplitude corrections via a computer.

Notice in the following figure that although the limit-line table contains 70 amplitude correction entries, the displayed trace can only show 20 at one time.

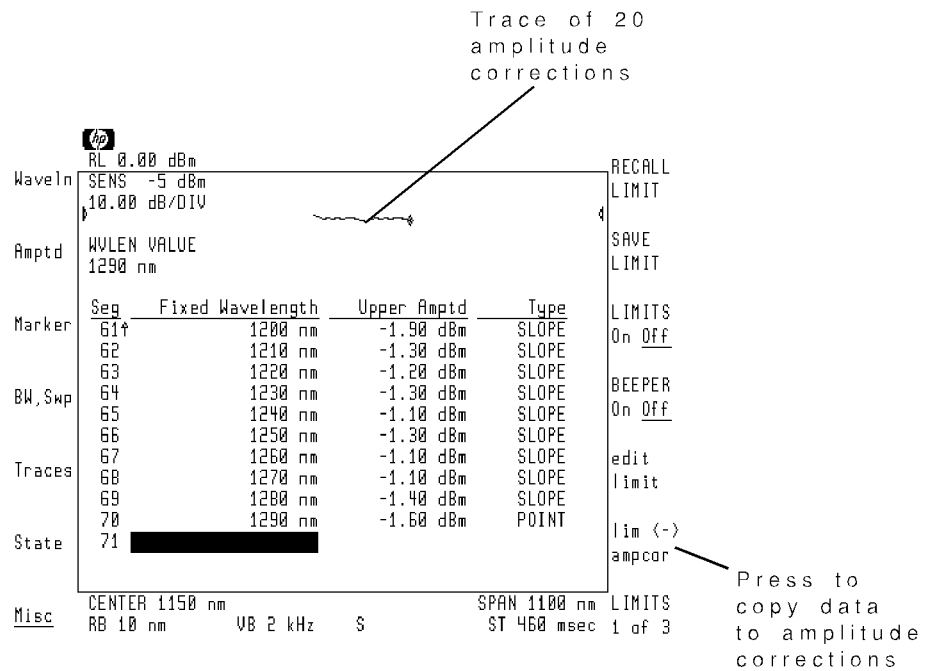

**Amplitude corrections loaded into table.**

## Using Amplitude Corrections

### Maximum entries in limit-line table

By default, the limit-line table can only display the first 20 amplitude correction factors. For example, if 50 amplitude correction factors are used during measurements, only the first 20 can be loaded into and displayed by the limit-line table. To increase the number of entries allowed in the table, use the **LIMLINE** programming command. Refer to “To increase the limit-line table size” in this section to learn how to issue this command from the front panel.

### Interpolation of amplitude corrections

When applying amplitude corrections, the optical spectrum analyzer linearly interpolates corrections that lie between the wavelength points that you enter. The wavelength endpoints are extended to the wavelength limits of the optical spectrum analyzer.

---

## To create amplitude corrections

- Send the amplitude correction data via computer to the optical spectrum analyzer. Use the **AMPCOR** command. Refer to the *Programmer's Guide*.  
or
- Use the limit-line table to enter wavelength/amplitude data. Then, copy the data into amplitude corrections with the following steps:
  1. Display page 1 of the Limit-lines menu.
  2. Press the **lim <-> ampcor** softkey.
  3. Press **UPPER -> AMPCOR** to copy the table data into amplitude corrections.

This copies upper limit-line data into amplitude corrections. Press **LOWER -> AMPCOR** to copy lower limit-line data into amplitude corrections.

---

## To edit amplitude corrections

1. If the amplitude correction data contains more than 20 corrections, increase the size of the limit-line table. Refer to “To increase limit-line table size” in this section.
2. Press the left-side **Misc** softkey to enter the Miscellaneous menu.
3. Press the **MORE 1 of 3** and then **limit lines** softkeys.
4. Press the **lim <-> ampcor** softkey.

---

### CAUTION

---

The following step loads the amplitude correction factors into the limit-line table. Any limit line data currently in the table is erased.

5. Press **AMPCOR -> UPPER** to load amplitude-correction values into the limit-line table's upper limits.  
You could also press **AMPCOR -> LOWER** to load the factors into the table's lower limits.
6. Press the **prev menu** softkey.
7. Press the **LIMITS 1 of 3** softkey, and use the displayed softkeys to edit any data in the table.  
Edit the data as you would any limit line. The first half of this chapter describes how to edit limit-line table data.
8. Press the **LIMITS 2 of 3** and **LIMITS 3 of 3** softkeys as needed to return to the **LIMITS 1 of 3** menu.
9. Press the **lim <-> ampcor** softkey.
10. Press **UPPER -> AMPCOR** to copy the table data into amplitude corrections.

This copies upper limit-line data into amplitude corrections. Press **LOWER -> AMPCOR** to copy lower limit-line data into amplitude corrections.

---

## To increase the limit-line table size

1. Press the **Misc** softkey to enter the Miscellaneous menu.
2. Press the **MORE 1 of 3** and then **COMMAND** softkeys.

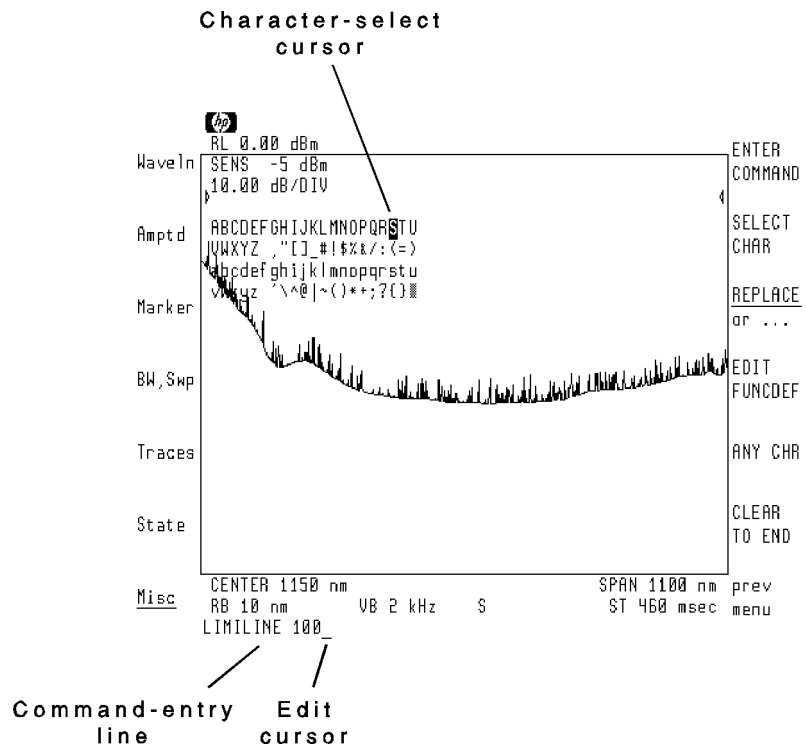

3. Use the front-panel knob and **SELECT CHAR** softkey to spell the command **LIMILINE 100** as shown in the figure.

This command sets the maximum size of the table to 100 entries. The default value is 20. The table can be set to a maximum of 400 entries. Refer to the boxed text in this procedure for instructions on using the editor.

### Using Amplitude Corrections

4. Press the **ENTER COMMAND** softkey.

#### Editing the COMMAND line

- Turn the front-panel knob to move the character-select cursor.
- Press the **▼** and **▲** keys (beneath the front-panel knob) to move the command-entry cursor.
- Press **SELECT CHAR** to enter a character at the character-select cursor.
- Press the numeric keypad to enter numbers or a minus sign.
- The **INSERT or . . .** softkey determines the action of the **SELECT CHAR** softkey. Choices are **INSERT** a character, **REPLACE** an existing character, or **DELETE** a character.
- Use the **CLEAR TO END** softkey to remove characters from the command-entry cursor to the end of the command.
- The space character is located after the **Z** character on the display.

---

## To turn amplitude corrections on and off

1. Press the left-side **Amptd** softkey to enter the Amplitude menu.
2. Press the **MORE 1 of 4**, **MORE 2 of 4**, and **MORE 3 of 4** softkeys.
3. Press the **AMPCOR On Off** softkey so that:
  - **On** is underlined to turn on amplitude corrections.
  - or
  - **Off** is underlined to turn off amplitude corrections.

---

## To erase amplitude corrections

1. Press the left-side **Misc** softkey to enter the Miscellaneous menu.
2. Press the **MORE 1 of 3** and then **limit lines** softkeys.
3. Press the **LIMITS 1 of 3** and then **LIMITS 2 of 3** softkeys.

---

### **CAUTION**

---

The following step erases any data contained in the limit-line table. If important data is in the table, save the limit line before continuing with the next step.

4. Press the **DELETE ALL** and then **CONFIRM DELETE** softkeys.
5. Press the **LIMITS 3 of 3** softkey.
6. Press the **lim <-> ampcor** softkey.
7. Press the **UPPER -> AMPCOR** softkey.

## Tutorial: Using Limit Lines

This example takes you step-by-step through the process of creating a limit line. We'll draw test limits around the response of a Fabry-Perot laser. This laser represents the ideal response that we would like to compare with other lasers. This procedure should take you about 20 minutes to perform.

The data entered to create the limit line is shown in the following table. As you can see, this is a relative limit line with values entered relative to the center wavelength. Notice that limit lines do not have to be symmetrical. In fact, you can be very creative in their design including adding lower limits.

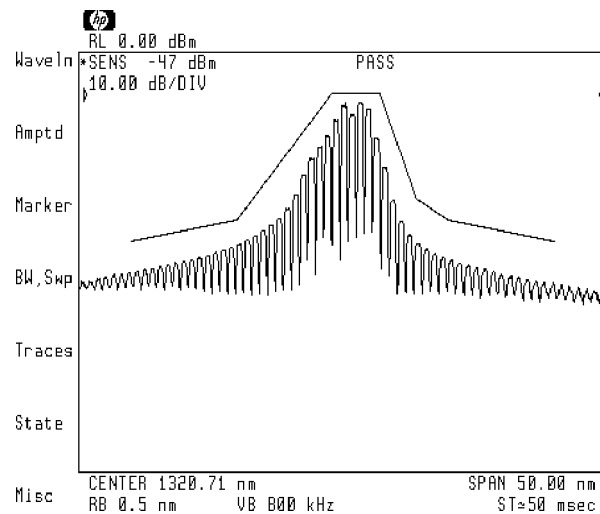

Segment	Relative Wavelength	Upper Amplitude	Type
1	-20.00 nm	-35.0 dBm	SLOPE
2	-10.00 nm	-30.0 dBm	SLOPE
3	-1.00 nm	-0.0 dBm	SLOPE
4	3.50 nm	-0.0 dBm	SLOPE
5	7.00 nm	-25.0 dBm	SLOPE
6	10.00 nm	-30.0 dBm	SLOPE
7	20.00 nm	-35.0 dBm	SLOPE



---

## Step 1. View the response

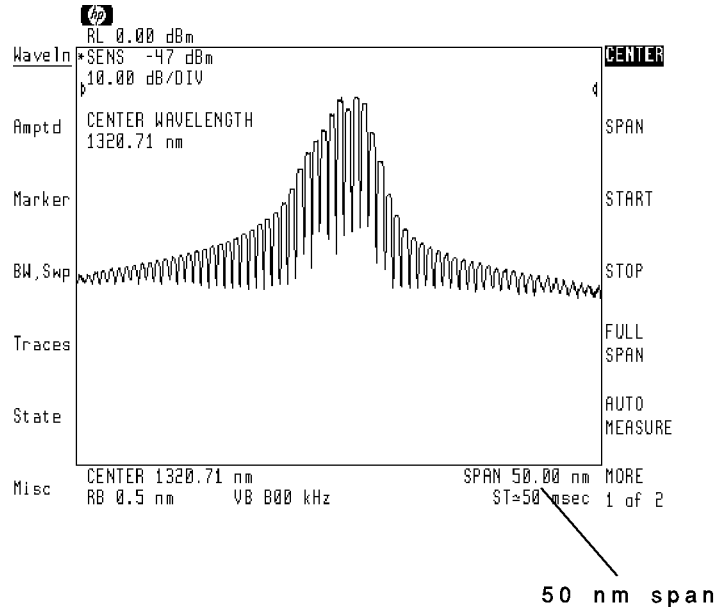

1. Connect the output of a Fabry-Perot laser to the front-panel **OPTICAL INPUT** connector.

On HP 71451B optical spectrum analyzers, the input connector is labeled **MONOCHROMATOR INPUT**. You may need to adjust the wavelengths and amplitude levels used in this procedure for your specific device.

2. Set the wavelength and span so that the desired wavelength range is viewed. Set the span to 50 nm so that the complete limit line will display.

Use the wavelength menu's **CENTER** and **SPAN** softkeys and the amplitude menu's **REF LVL** softkey.

**Tutorial: Using Limit Lines**

**Step 2. Display the limit-line table**

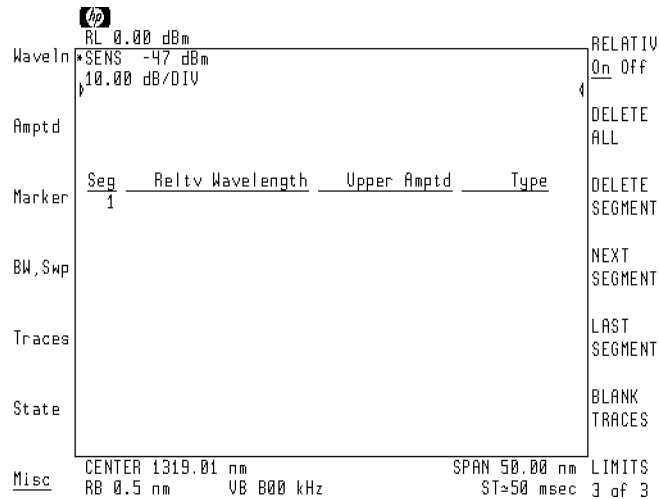

1. Press the left-side **Misc** softkey.
2. Press the **MORE 1 of 3** and then **limit lines** softkeys.
3. Press **LIMITS 1 of 3** and then **LIMITS 2 of 3**.
4. Press **DELETE ALL** and then **CONFIRM DELETE**.  
 This deletes any data that may already be in the table.
5. Press the **RELATIV On Off** softkey so that **On** is underlined.
6. Press **BLANK TRACES** to blank the trace if it helps you view the table. You can press **BLANK TRACES** again to view the trace.

### Step 3. Enter the first segment point

A total of seven segments will be used to define the limit line. This step enters the wavelength offset and amplitude for the first limit-line segment.

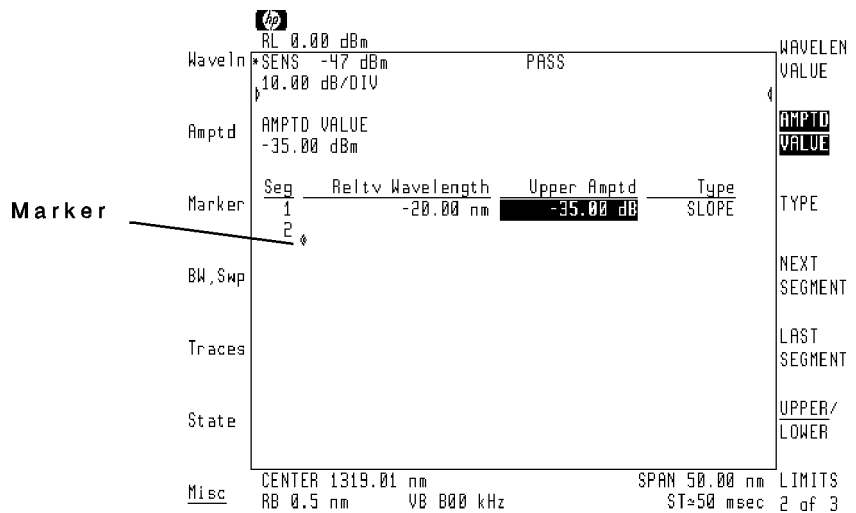

1. Press **LIMITS 3 of 3** to return to page 1 of the Limit-lines menu.
2. Press the **LIMITS 1 of 3** softkey.
3. Press **WAVELEN VALUE**, **(-)**, **(2)**, **(0)**, and then **nm**.

The highlighted bar shows the current table entry that has been selected for editing.

4. Press **AMPTD VALUE**, **(-)**, **(3)**, **(5)**, and then **dBm**.

Notice the marker displayed on the screen. This marker indicates the position of the segment point.

**Tutorial: Using Limit Lines**

**Step 4. Complete the table**

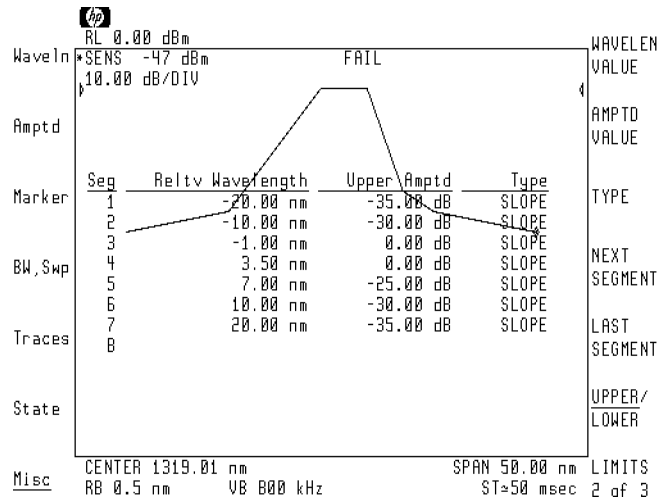

1. Press the **NEXT SEGMENT** softkey.
2. Use the **WAVELEN VALUE** and **AMPTD VALUE** softkeys to enter the next segment's values.  
 The figure on this page shows the completed table with the values for each segment. For example, segment 2 is -10 nm at -35 dBm.
3. Complete the table, pressing **NEXT SEGMENT** to add each new line of data.

## Step 5. Save the limit lines

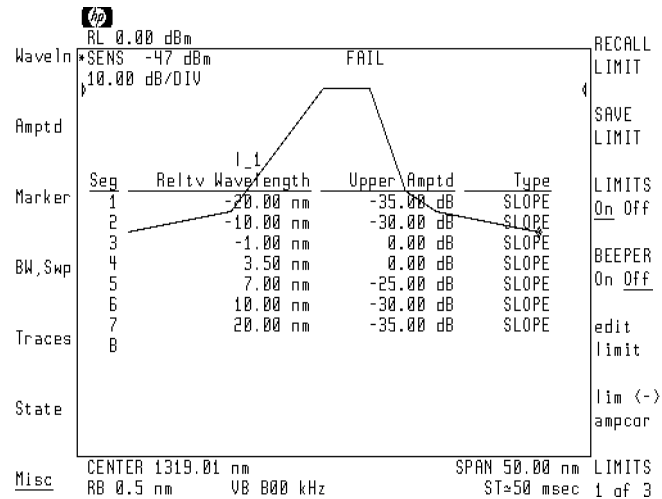

1. Press the **LIMITS 2 of 3** and then **LIMITS 3 of 3** softkey.
2. Press the **SAVE LIMIT** softkey.
3. Use the numeric keypad to enter a number for the file name. For example, press **1**.

Be sure there are no other limit-line files having the same number. If a limit-line file with this number already exists, the file's contents will be overwritten and the old data lost.

4. Press the **ENTER** key.

This step saves the limit-line table in a file on the default memory. Refer to the Miscellaneous menu's **catalog & MSI** feature for selecting default memory. Normally, it is set to the internal memory. After saving a limit-line file, you can recall it into the table at any time. If you need to recall the data, press the **RECALL LIMIT** softkey.

**Tutorial: Using Limit Lines**

**Step 6. Turn on limit-line testing**

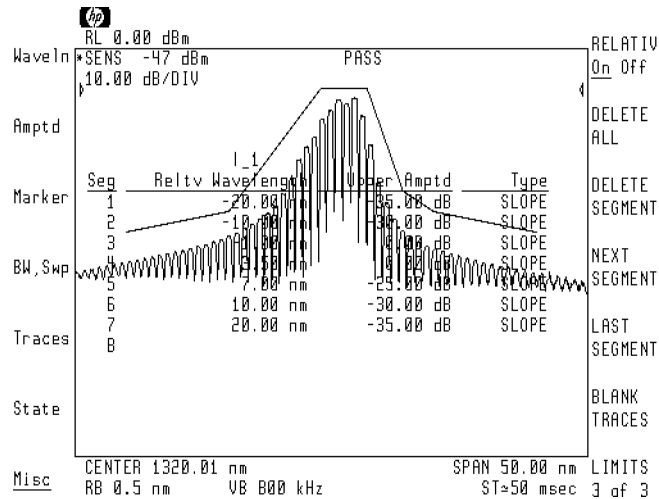

1. Press the **LIMITS On Off** softkey so that **On** is underlined.

Use this softkey to turn limit testing on and off.

2. Press the **BEEPER On Off** softkey so that **On** is underlined.

This feature causes an alarm to sound whenever the displayed response goes beyond the limit line. If you do not want to hear the alarm, press the softkey so that **Off** is underlined.

3. Press **LIMITS 1 OF 3** and then **LIMITS 2 OF 3**.

4. Press **BLANK TRACES** if the trace is not displayed.

---

## Step 7. Begin testing

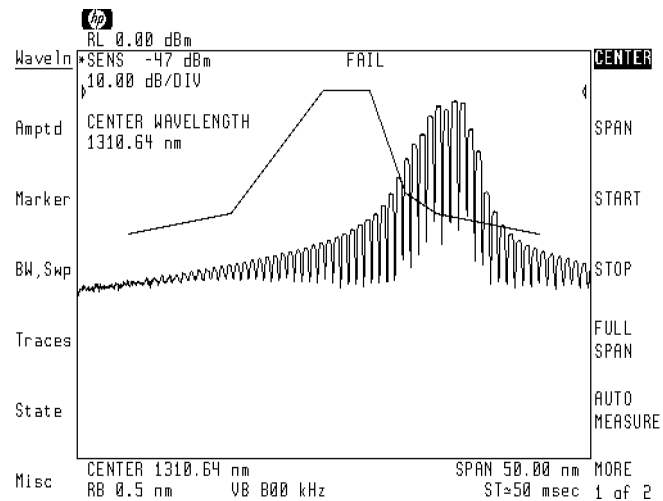

### Relative limit lines

Relative limit lines allow you to measure the shape of a response that may be located at different wavelengths.

1. Press the left-side **WaveIn** softkey to exit the Limit-lines menu.

Any left-side softkey will exit the menu. This removes the table from the display.

2. Rotate the front-panel knob.

**Tutorial: Using Limit Lines**

Because this is a relative limit line, the limit lines remain centered despite the change in center wavelength. You can tune the response to the limit line. Notice the displayed FAIL message indicating that the response is outside the limit line.

3. Recenter the signal in the limit line.



---

## Step 8. Make limit lines fixed

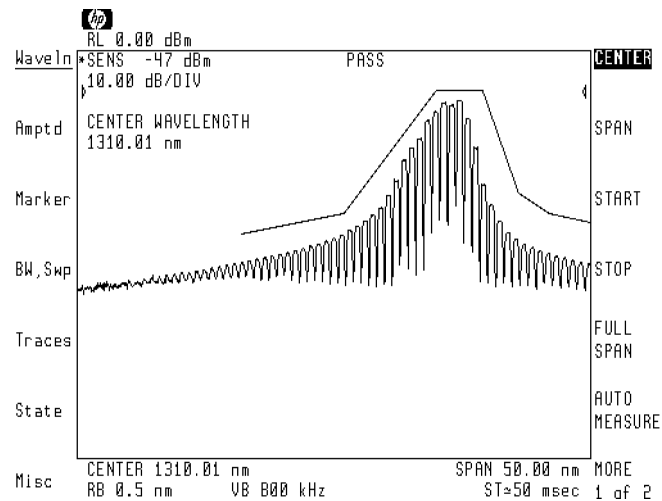

### Fixed limit lines

Fixed limit lines ensure that a response is located at a specific wavelength.

1. Press the left-side **Misc** softkey.
2. Press **MORE 1 of 3** and then **limit lines** to enter the Limit-lines menu.
3. Press the **LIMITS 1 of 3** and then **LIMITS 2 of 3** softkeys.
4. Press **RELATIV On Off** so that **Off** is underlined.

## Creating Limit Lines and Entering Amplitude Corrections

The limit lines are now fixed at a specific frequency. Notice that the values in the table change when you press this key from relative to fixed values. Limit lines can be moved by designating them as relative lines, tuning the center wavelength, and then changing the limit lines back to fixed values.

5. Press the left-side **WaveIn** softkey.
6. Rotate the front-panel knob to move the signal towards the side of the display.

As soon as you stop turning the knob, the limit line is redrawn. Because this is a fixed limit line, the limit lines stay at their assigned wavelength. Notice the displayed **PASS** message indicating that the response is within the limit line.

**Creating a User Menu**

---

## Creating a User Menu

User menus are custom softkey menus that you design. They allow you quickly to access your most frequently used optical spectrum analyzer softkeys and downloadable programs (DLPs). Downloadable programs are created from the front panel or created and loaded from an external computer. This chapter contains a brief introduction relating DLPs to the User menu. Refer to the *Programmer's Guide* for more information on creating DLPs.

After creating a User menu, simply press the **USER** key to use your menu. User menus, like measurement states and limit lines, can be saved as a file. Because menus can be saved and recalled at a later time, it's possible to create large numbers of custom menus. The optical spectrum analyzer saves menus in selected memory. Selected memory can be either internal RAM, memory card, or external HP-IB disk drive. Refer to chapter 13 to learn how to select the memory.

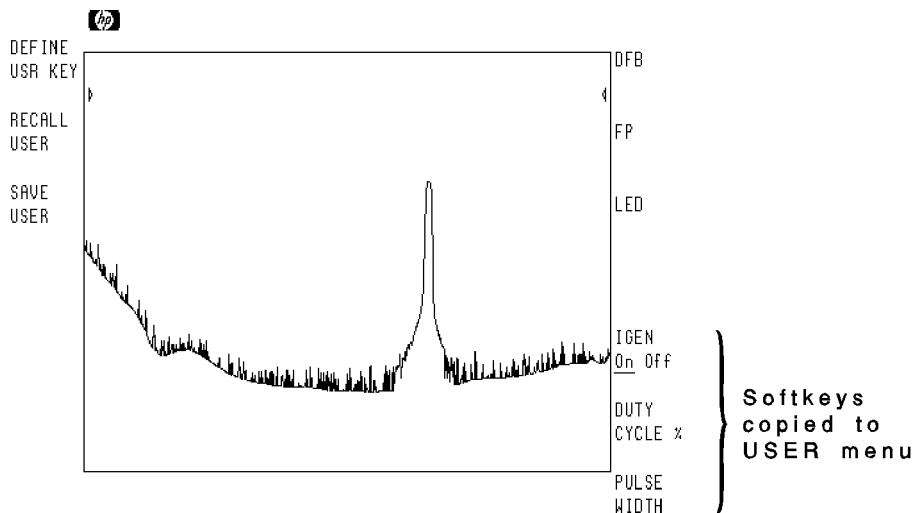

**Contents**

Designing User Menus ..... 11-4  
    To copy a MENU softkey to the User menu ..... 11-9  
    To add a softkey that starts a DLP ..... 11-9  
    To remove a softkey from the User menu ..... 11-10  
    To preset the User menu ..... 11-11  
    To delete a User menu file ..... 11-11  
    To enter a small DLP ..... 11-11  
    To edit a small DLP ..... 11-13  
Storing and Recalling User Menus ..... 11-14  
    To store and recall a User menu ..... 11-15

---

## Designing User Menus

You can build menus that:

- Contain any optical spectrum analyzer **(MENU)** softkey. The softkey is copied to the **(USER)** menu.
- Execute custom DLPs. The DLP's name is copied to the softkey position.

Up to 14 softkeys can be added to a menu (seven left-side softkeys and seven right-side softkeys). Turning the optical spectrum analyzer off or pressing the **(INSTR PRESET)** key does not erase custom **(USER)** menus.

When the optical spectrum analyzer is shipped from the factory, the **(USER)** menu contains the softkeys shown in the following figure. The three left-side softkeys control the User menu. The three right-side softkeys are factory-installed DLPs provided for automatic measurements. (Refer to Chapter 4 for information on using these measurement programs.) Additional softkeys may be present depending on what DLPs are loaded in memory.

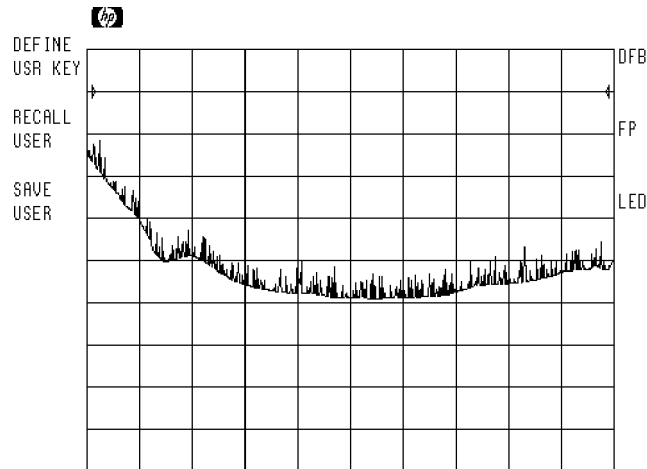

**Default User menu.**

**Limiting operation to the User menu**

To learn how to limit front-panel operation to the **(USER)** menu, refer to “Securing the optical spectrum analyzer” in Chapter 13. This prevents novice users from accessing optical spectrum analyzer softkeys. Limiting front-panel operation is especially useful in production-line settings.

**Use the key-control menu to manage the User menu**

You can manage **(USER)** menus using the Miscellaneous menu’s key-control menu. The key-control menu allows you to save, recall, dispose, and preset User menus. Presetting the **(USER)** menu deletes all copied softkeys. Softkeys for DLPs are not deleted. Disposing a **(USER)** menu deletes a User-menu file from memory. You must enter the file-name number to delete the file.

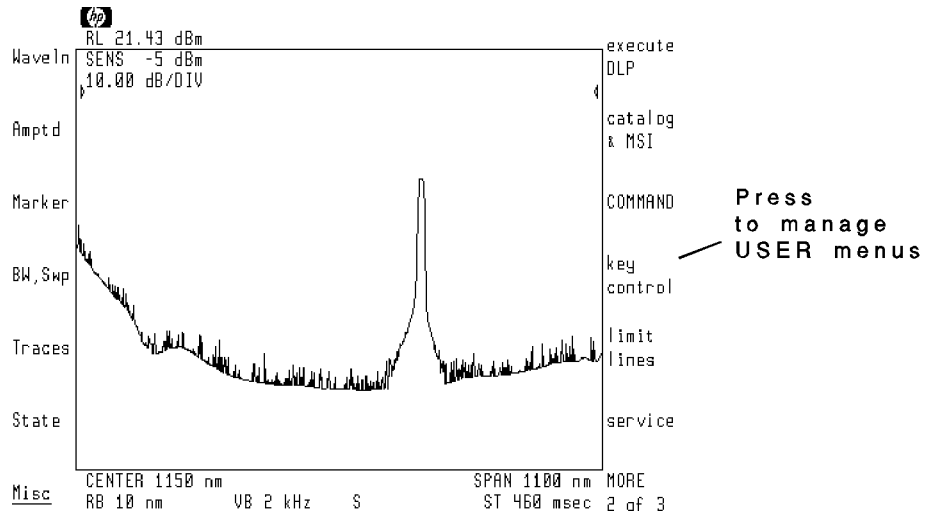

Creating a User Menu  
**Designing User Menus**

Many of the key-control menu functions can be accomplished from the **USER** menu. However, because these softkeys can be replaced by copied softkeys, the procedure in this section shows you how to use the key-control menu.

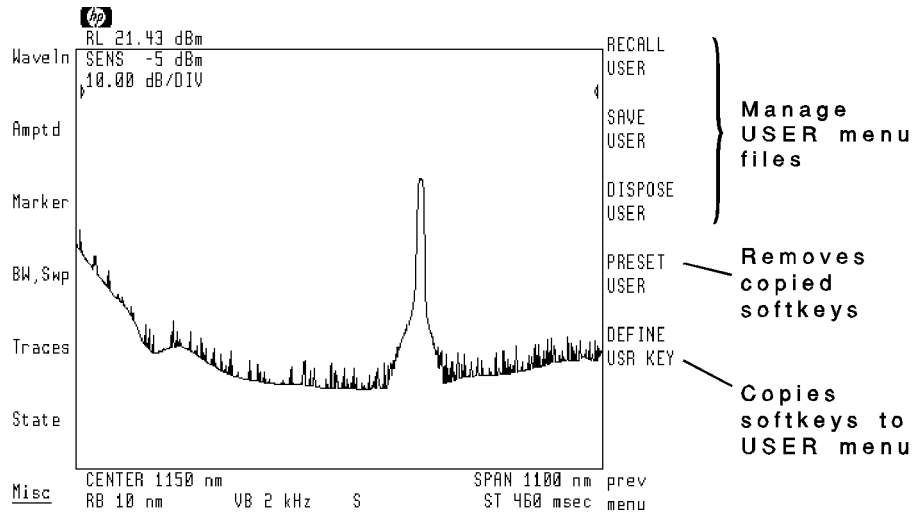

**Use a computer to add DLPs**

The *Programmer's Guide* explains how to create and save custom DLPs to the **USER** menu. It involves using the FUNCDEF command and then downloading the FUNCDEF over HP-IB to the optical spectrum analyzer module. If the last character in the FUNCDEF's name is an underscore character ("\_"), the optical spectrum analyzer automatically assigns the FUNCDEF to a **USER** menu softkey.

For example, you could create two simple DLPs for showing a border around the screen. (This is how many of the figures in this book were obtained.) One softkey turns off the graticule and turns on the border. Another softkey turns the border off. Refer to the *Programmer's Guide* for a complete explanation of programming the optical spectrum analyzer. The text that needs to be sent by a computer to the optical spectrum analyzer to accomplish this task is listed on the following page.



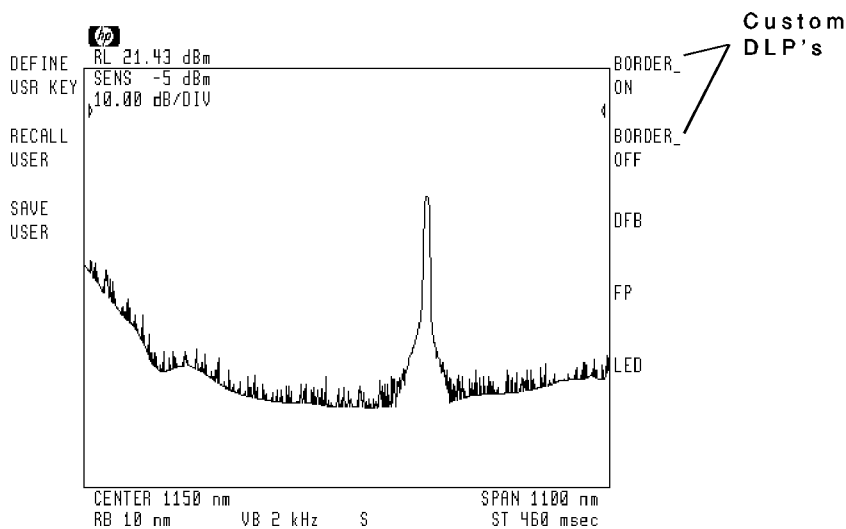

**DLPs added to User menu.**

```
FUNCDEF BORDER_ON_,@ Define first DLP.
IT 1;GRAT OFF;
PU;PA 0,90;
PD;PA 0,957,1000,957,1000,90,0,90;
@;
```

```
FUNCDEF BORDER_OFF_,@ Define second DLP.
IT 1;DELETE;
GRAT ON;
@;
```

If the DLP is less than 239 characters, you can create or edit it from the optical spectrum analyzer's front panel. Procedures in this section show how to enter and edit DLPs from the front panel using softkeys.

**Designing User Menus**

**HIL keyboard**

If you have an HIL keyboard, entering the text is much easier. Plug the keyboard into an HP-HIL connector located on the front-panel of HP 70004A displays. The keyboard and associated cable have the following part numbers:

HIL keyboard	.....	HP 46021A
keyboard cable	.....	46020-60001

In the Miscellaneous menu, there is a debug menu for debugging DLPs as they are downloaded from a computer. (Press **Misc**, **MORE 1 of 3**, **MORE 2 of 3**, and **debug** to access this menu.) For information on using this menu, refer to the *Programmer's Guide*. The *Programmer's Guide* includes information on the following softkeys: **DEBUG On Off**, **DEBUG SLOW**, **DEBUG FAST**, **PAUSE**, **STEP**, **CONT**, and **SERVICE REQUEST**.

---

## To copy a menu softkey to the user menu

1. Press the **Misc** softkey to enter the Miscellaneous menu.
2. Press the **MORE 1 of 3** and then **key control** softkeys.
3. Press the **DEFINE USR KEY** softkey.
4. You must press the softkey that you want to copy to the **(USER)** menu.
  - a. Press a left-side softkey to select an optical spectrum analyzer menu.
  - b. Press the right-side softkeys up to and including the softkey you want to add to the **(USER)** menu.

For example, to copy the **CENTER** softkey, press **WaveIn** and then **CENTER**.

5. Press the **(USER)** key.
6. Press the softkey corresponding to where you want the softkey copied.

---

## To add a softkey that starts a DLP

Use a computer to create a softkey for running a DLP. Refer to the *Programmer's Guide* for information on creating DLPs. However, if you have stored the DLP in internal memory, you can assign a **(USER)** softkey using the following steps.

1. Press the **Misc** softkey to enter the Miscellaneous menu.
2. Press the **MORE 1 of 3** and then **key control** softkeys.
3. Press the **DEFINE USR KEY** softkey.
4. Press the **prev menu** and then **execute DLP** softkeys. Notice that the display lists a softkey label for each DLP loaded in internal memory.

## Designing User Menus

5. Press the softkey for the desired DLP.

Some listed DLPs may actually be sub-routines. Be sure to select a valid DLP. Running a sub-routine causes erratic and unpredictable behavior. (Pressing **INSTR PRESET** returns the optical spectrum analyzer to normal operation.)

6. Press the **USER** key, then press the softkey corresponding to where you want the softkey label copied.

---

### To remove a softkey from the user menu

1. Press the **Misc** softkey to enter the Miscellaneous menu.
2. Press the **MORE 1 of 3** and then **key control** softkeys.
3. Press the **DEFINE USR KEY** softkey.
4. Press the sixth right-side softkey. The sixth softkey is located beneath the **DEFINE USR KEY** softkey; it does not have a softkey label.

Any blank softkey will work. The softkey in this example is easy to locate.

5. Press the **USER** key.
6. Press the softkey that you want to erase.

---

## To preset the User menu

1. Press the **Misc** softkey to enter the Miscellaneous menu.
2. Press the **MORE 1 of 3** and then **key control** softkeys.
3. Press the **PRESET USER** softkey.

---

## To delete a User menu file

1. Press the **Misc** softkey to enter the Miscellaneous menu.
2. Press the **MORE 1 of 3** and then **key control** softkeys.
3. Press the **DISPOSE USER** softkey.

---

## To enter a small DLP

This procedure shows how to enter a DLP using front-panel keys. For information on DLP syntax and using a computer, refer to the *Programmer's Guide*. The DLP entered using front-panel keys cannot be longer than 239 characters.

1. Press the left-side **Misc** softkey.
2. Press the **MORE 1 of 3** and then **COMMAND** softkeys.
3. Use the front-panel knob and **SELECT CHAR** softkey to spell the name of your DLP on the command-entry line. Refer to the boxed text in this procedure for instructions on using the editor.

## Designing User Menus

4. If you need more characters, or want to underline, invert video, or blink displayed text, use the **ANY CHR** softkey to enter the three-digit decimal code for the characters.

An ASCII table of codes for all available characters is located in the “Tables and Charts” chapter of the *Reference* manual. You’ll also find a table of character codes for underlining, inverting, and blinking text.

5. Press the **ENTER COMMAND** softkey to place the DLP in memory.

### Editing the **COMMAND** line

- Turn the front-panel knob to select a character.
- The space character is located after the **↵** character on the display.
- Press the **⏴** and **⏵** keys (beneath the front-panel knob) to move the command-entry cursor.
- Press **SELECT CHAR** to enter a character at the character-select cursor.
- Press the numeric keypad to enter numbers or a minus sign.
- The **INSERT or . . .** softkey determines the action of the **SELECT CHAR** softkey. Choices are **INSERT** a character, **REPLACE** an existing character, or **DELETE** a character.
- Use the **CLEAR TO END** softkey to remove characters from the command-entry cursor to the end of the command.
- The **ANY CHR** softkey can be used to enter the decimal value of characters from 32 through 255.

---

## To edit a small DLP

Do not use this procedure to edit DLPs larger than 239 characters.

1. Press the left-side **Misc** softkey.
2. Press the **MORE 1 of 3** and then **COMMAND** softkeys.
3. Enter the name of the DLP on the command-entry line. Using the knob, scroll the cursor to the desired letter; then press **SELECT CHAR** to place the character on the edit line. If needed, use the **▼** and **▲** keys to move the cursor on the command-entry line.
4. Press **EDIT FUNCDEF**. Then, use the displayed softkeys to edit the DLP. After editing, press **ENTER COMMAND**.

---

## Storing and Recalling User Menus

The following is a brief procedure for saving and recalling **(USER)** menus to memory. Storing menus allows you to create several different types of menus which you can recall when needed. For a complete discussion on managing memory, refer to Chapter 13. Chapter 13 includes information on selecting, formatting, and cataloging memory. **(USER)** menu can be saved or recalled from internal memory, memory cards, or an optional external HP-IB disk drive.

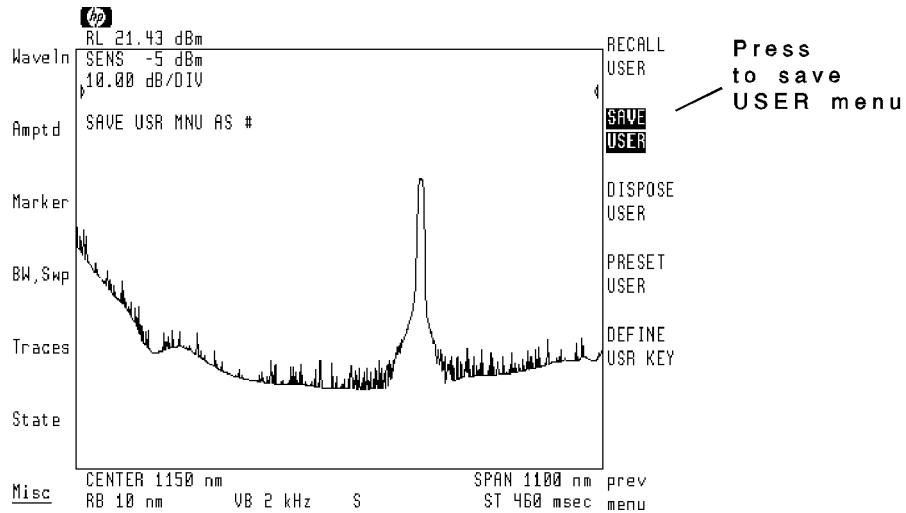



---

## To store and recall a User menu

1. Press the left-side **Misc** softkey to enter the Miscellaneous menu.
2. Press **MORE 1 of 3** and then **key control**.
3. To store a **(USER)** menu you have created, press the **SAVE USER** softkey, and use the front-panel numeric keypad to enter a number for the file name.
4. To recall a **(USER)** menu you have stored, press the **RECALL USER** softkey, and use the front-panel numeric keypad to enter the file name's number.

If you cannot remember the file's number, enter the Miscellaneous menu's **catalog & MSI** menu to recall the file. Refer to Chapter 13 for information on using the catalog menu.

If the **(USER)** menu contains the **SAVE USER** and **RECALL USER** softkeys, you can use them to save and recall your menus.

## Creating a User Menu

---

**Controlling Annotation,  
Printing, and Plotting**

---

## Controlling Annotation, Printing, and Plotting

In this chapter, you'll learn how to customize the annotation shown on the display. This includes displaying your own titles, setting the clock, and showing the ROM version. Once you have the correct annotation on the display, you can print the screen on a printer or plot the screen on a plotter.

**Contents**

Controlling Graticules, Annotation, and Titles .....	12-4
To place graticules relative to 0 dBm .....	12-6
To blank the screen graticule .....	12-6
To blank the screen annotation .....	12-7
To blank the clock display .....	12-8
To write a title on the screen .....	12-9
To remove a title from the screen .....	12-12
Controlling the System Clock .....	12-13
To blank the clock display .....	12-14
To set the clock .....	12-14
To select United States or European format .....	12-15
Displaying Information About the Instrument .....	12-16
To view the ROM version .....	12-17
To display the internal state of the instrument .....	12-18
Printing and Plotting .....	12-19
To print or plot the display .....	12-20
To enter the printer type and address .....	12-21
To enter the plotter type and address .....	12-22
To prevent softkey labels from printing or plotting .....	12-23

---

## Controlling Graticules, Annotation, and Titles

At times you may want to blank the graticules or annotation text to provide a less cluttered display. This can be very helpful when you are printing or plotting the display. The clock must be blanked separately from the annotation. Writing titles on the screen is easy using the Miscellaneous menu's **TITLE** feature. Titles are especially useful when identifying plotter and printer copies. Titles are considered part of the annotation.

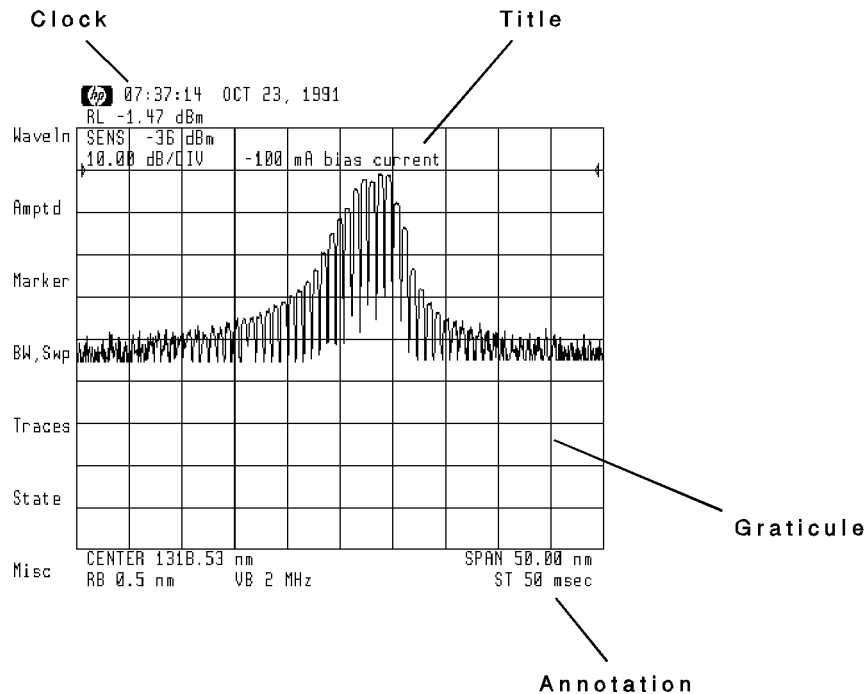

When displaying logarithmic amplitude scales, the optical spectrum analyzer places the horizontal graticule lines relative to the top-screen value. Using the **GRATSCR On Off** softkey, you can change this so that the graticules are placed relative to 0 dBm regardless of the top-screen value.

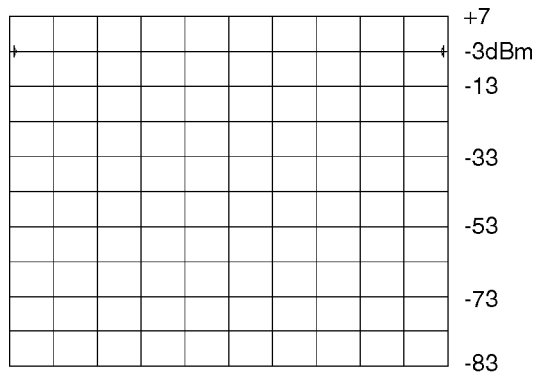

pp8

**GRATSCR On Off** function off.

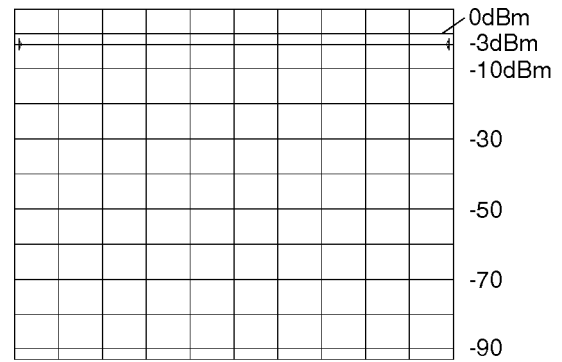

pp9

**GRATSCR On Off** function on.

**Settings: -3 dBm reference level, 10.00 dB/DIV amplitude scale**

---

## To place graticules relative to 0 dBm

1. Press the left-side **Misc** softkey to enter the Miscellaneous menu.
2. Press the **grat control** softkey.
3. Press the **GRATSCR On Off** softkey so that **Off** is underlined.

---

## To blank the screen graticule

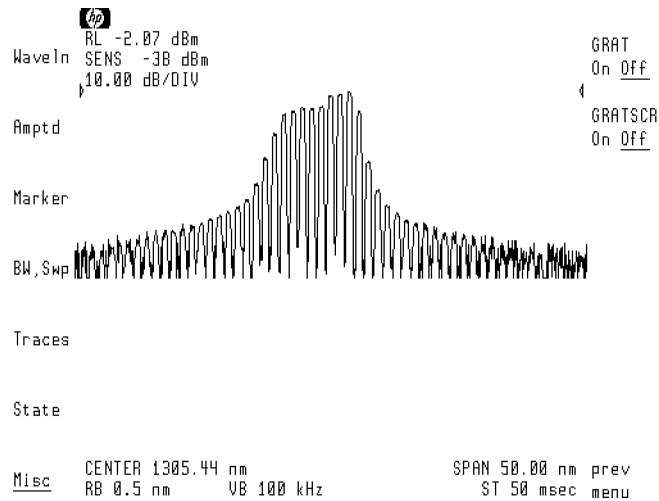

1. Press the left-side **Misc** softkey to enter the Miscellaneous menu.
2. Press the **grat control** softkey.
3. Press the **GRAT On Off** softkey so that **Off** is underlined.



---

## To blank the screen annotation

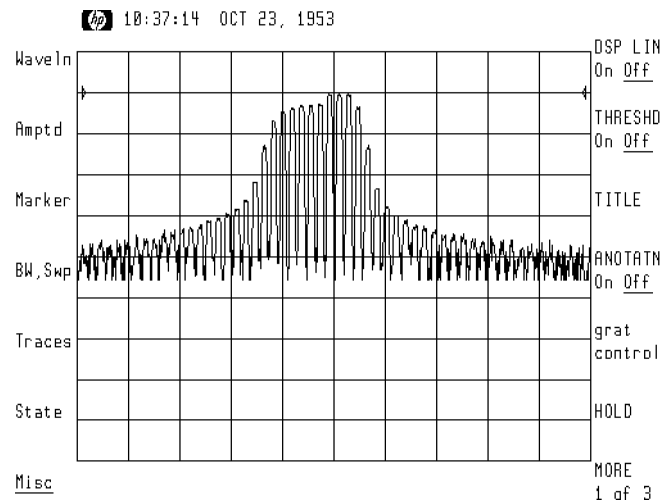

1. Press the left-side **Misc** softkey to enter the Miscellaneous menu.
2. Press the **ANOTATN On Off** softkey so that **Off** is underlined.

This procedure blanks any displayed title but does not blank the clock.

## To blank the clock display

The HP 70004A display's clock is displayed at the top of the screen. For your convenience, blanking the clock display is discussed here. If you need more detailed information, refer to the display's operating manual.

1. Press the front-panel **DISPLAY** key.
2. Press the left-side **Misc** softkey to enter the Miscellaneous menu.
3. Press the **clock** softkey.
4. Press the **CLOCK DISPLAY** softkey so that it is not underlined.

---

## To write a title on the screen

Because the title features are part of the annotation, be sure that the annotation is visible before beginning this procedure. An expanded set of characters and character control is available by changing from the title to the command menu. Instructions in this procedure explain how to do this.

### **HIL keyboard**

If you have a HIL keyboard, entering the text is much easier. The keyboard plugs into an HP-HIL connector on the front-panel of HP 70004A displays. The keyboard and associated cable have the following part numbers:

HIL keyboard	HP 46021A
keyboard cable	46020-60001

1. Press the left-side **Misc** softkey to enter the Miscellaneous menu.
2. Press the **TITLE** softkey to enter the Title menu.
3. Use the front-panel knob and **SELECT CHAR** softkey to spell your title on the title-entry line. See the following figure.

Refer to the boxed text at the end of this procedure for instructions on using the editor.

Controlling Annotation, Printing, and Plotting  
**Controlling Graticules, Annotation, and Titles**

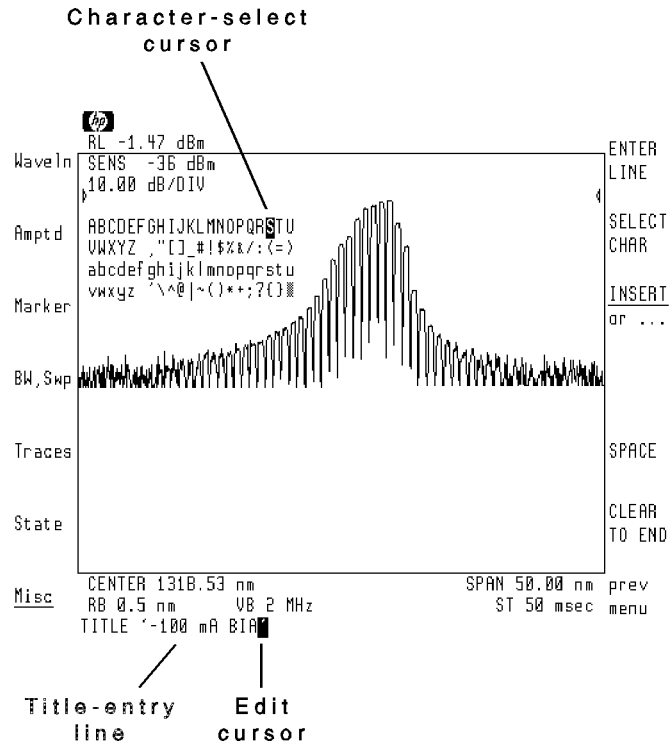

4. If you need more characters or want to underline, invert video, or blink the title, do the following:
  - a. Press **prev menu** and then **MORE 1 of 3**.
  - b. Press **COMMAND**.
  - c. Press the **▲** key to position the edit cursor.
  - d. Use the **ANY CHR** softkey to enter the three-digit decimal code for any characters not shown on the display.

An ASCII table of codes for all available characters is located in the "Tables and Charts" chapter of the *Reference* manual. You'll also find a table of character codes for underlining, inverting, and blinking text.

5. Press the **ENTER LINE** (or **ENTER COMMAND**) softkey to place the title on the screen.

#### **Editing the TITLE line**

- Turn the front-panel knob to select a character.
- Press the **▼** and **▲** keys (beneath the front-panel knob) to move the command-entry cursor.
- Press **SELECT CHAR** to enter a character at the character-select cursor.
- Press the numeric keypad to enter numbers or a minus sign.
- Press **SPACE** to add a space character.
- The **INSERT or . . .** softkey determines the action of the **SELECT CHAR** softkey. Choices are **INSERT** a character, **REPLACE** an existing character, or **DELETE** a character.
- Use the **CLEAR TO END** softkey to remove characters from the command-entry cursor to the end of the command.
- The space character is located after the **Z** character on the display.

## To remove a title from the screen

1. Press the **Misc** softkey to enter the Miscellaneous menu.
2. Press the **TITLE** softkey to enter the Title menu.
3. Press the **CLEAR TO END** and then **ENTER LINE** softkeys.

---

## Controlling the System Clock

The HP 70004A display's clock is displayed at the top of the screen. Often it is necessary to change or blank the clock display. For your convenience, a brief discussion of the procedure follows. If you need more detailed information, refer to the display's operating manual.

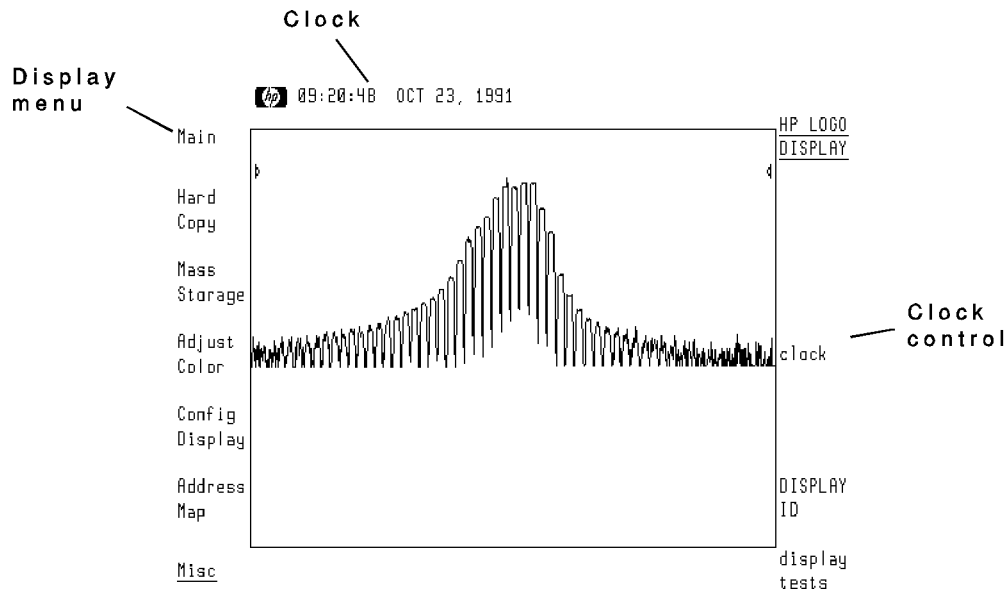

The clock keeps time even when the power is removed from the display. You can select from United States or European clock formats.

- US format: OCT 23, 1992 (Month-Day-Year)
- European format: 23.10.1992 (Day-Month-Year)

## Controlling the System Clock

---

### To blank the clock display

1. Press the front-panel **DISPLAY** key.
  2. Press the left-side **Misc** softkey to enter the Miscellaneous menu.
  3. Press the **clock** softkey.
  4. Press the **CLOCK DISPLAY** softkey so that it is not underlined.
- 

### To set the clock

1. Press the front-panel **DISPLAY** key.
2. Press the **Misc** softkey to enter the Miscellaneous menu.
3. Press the **clock** softkey.
4. Press the **set clock** softkey.
5. Press one of the right side softkeys, and then enter the number using the front-panel knob, step keys, or numeric keypad. If you use the front-panel knob or step keys, press the **←** key enter the value.
  - Enter hours in 24 hour time. (1:00 pm is entered as 13.)
  - Use the **RUN/STOP** softkey to temporarily stop the clock so that it can be synchronized with another clock.
6. Press the **MENU** key to return to the optical spectrum analyzer menus.



---

## To select United States or European clock format

1. Press the front-panel **DISPLAY** key.
2. Press the **Misc** softkey to enter the Miscellaneous menu.
3. Press the **clock** softkey.
4. To display the clock in US format, press the **US/EURO** softkey so that **US** is underlined.
5. To display the clock in European format, press the **US/EURO** softkey so that **EURO** is underlined.

---

## Displaying Information About the Instrument

In the Miscellaneous menu, you can view the version of the optical spectrum analyzer's ROM (read only memory). ROM memory contains the instructions for performing operation tasks. Knowing the ROM version can be important when communicating problems or questions to Hewlett Packard.

Using the State menu, you can display lists for obtaining knowledge about the following three conditions:

- System parameters
- Module level parameters
- Module HP-MSIB addresses

Interpreting some of the displayed parameters requires knowledge of the measurement techniques employed by the optical spectrum analyzer.

---

To view the ROM version

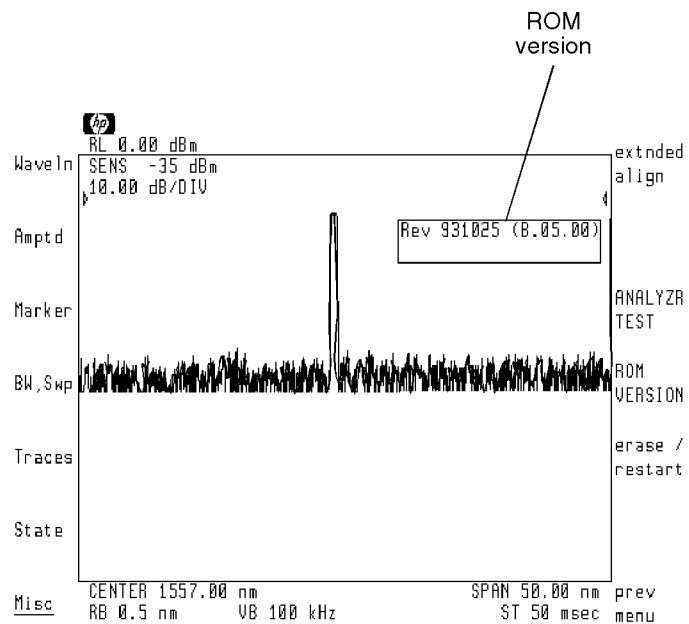

pp6

1. Press the **Misc** softkey to enter the Miscellaneous menu.
2. Press the **MORE 1 of 3** and then **service** softkeys.
3. Press the **ROM VERSION** softkey.

To display the internal state of the instrument

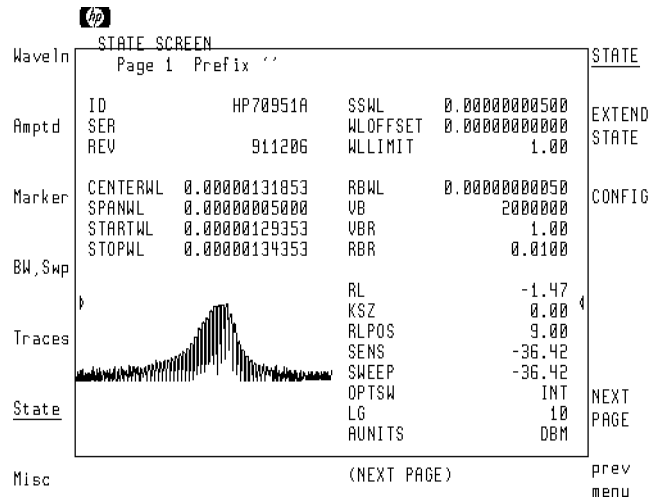

1. Press the **State** softkey to enter the State menu.
2. Press the **MORE 1 of 4** and then **MORE 2 of 4** softkeys.
3. Press the **show states** softkey.
  - Press **STATE** to view a table of system settings.  
System settings includes wavelength ranges, bandwidth settings, and offsets. The optical spectrum analyzer module's serial number and ROM revision is also listed.
  - Press **EXTEND STATE** to obtain additional technical information.
  - Press **CONFIG** to view the MSIB column and row address of the optical spectrum analyzer module and its ROM version number.
4. If more pages of information are available, press the **NEXT PAGE** softkey to view them.

---

## Printing and Plotting

Often, you'll need hard copies of the display for reports or records. Producing hard copies uses the print and plot capability of the HP 70004A display. If your optical spectrum analyzer is not installed in an HP 70004A display, the information in this chapter may not apply. If you need more detailed information, refer to the display's operating manual.

Plots can be made on any Hewlett Packard HPGL plotter. Prints can be made on any Hewlett Packard graphics printer that has an HP-IB connector. The following printers support the Hewlett Packard PCL printer language:

- ThinkJet
- PaintJet
- LaserJet printers

### **Printer connection**

Printers must be connected to the optical spectrum analyzer via an HP-IB cable. Because of this, the printer must have an HP-IB connector.

## To print or plot the display

1. Connect the printer or plotter to the display via the HP-IB.
2. Enter the printer or plotter address and type into the display.
3. Press the front-panel **PLOT** or **PRINT** keys.

If the plotter does not respond to pressing **PLOT**, try pressing **PLOT** again.

---

## To enter the printer type and address

This task applies to HP 70004A displays.

1. Press the front-panel **DISPLAY** key.
2. Press the **Hard Copy** softkey.
3. Press the **printer address** softkey.
  - To configure for a printer in talk/listen mode on the HP-IB, press **HP-IB TLK/LSN**, and use the numeric keypad to enter the printer's address.
  - To configure for a printer in listen-only mode on the HP-IB, press the **HP-IB L ONLY** softkey.
  - To configure for a printer via the HP-MSIB, enter its address using **HP-MSIB COLUMN** and **HP-MSIB ROW** softkeys.
4. Press the front-panel **←** key.
5. Press the **printer config** softkey.
6. Use the softkeys along the right side of the display to select the type of printer used.
7. Press the front-panel **←** key.
8. Press the **copy options** softkey, and then press the **COPY IS PRT/PLT** softkey so that **PRT** is underlined.
9. Press the front-panel **MENU** key to return to the optical spectrum analyzer's menu.
10. Reset the printer. This is usually accomplished by pressing a button on the printer. Refer to the printer's instruction manual.

## To enter the plotter type and address

This task applies to HP 70004A displays.

1. Press the front-panel **DISPLAY** key.
2. Press the **Hard Copy** softkey.
3. Press the **plotter address** softkey.
  - To configure the plotter in talk/listen mode on the HP-IB, use the **HP-IB TLK/LSN** softkeys to enter the plotter's address.
  - To configure the plotter in listen-only mode on the HP-IB, press the **HP-IB L ONLY** softkey.
  - To configure the plotter via the HP-MSIB, enter its address using **HP-MSIB COLUMN** and **HP-MSIB ROW** softkeys.
4. Press the front-panel **←** key.
5. Press the **plotter config** softkey.
6. Use the softkeys along the right side of the display to enter the plotter scaling points and select pen numbers.

Normally, the scaling points do not need to be changed from the default values.
7. Press the front-panel **←** key.
8. Press the **copy options** softkey, and then press the **COPY IS PRT/PLT** softkey so that **PLT** is underlined.
9. Press the front-panel **MENU** key to return to the optical spectrum analyzer's menu.



---

## To prevent softkey labels from printing or plotting

1. Press the front-panel **DISPLAY** key.
2. Press the **Hard Copy** softkey.
3. Press the **copy options** softkey.
4. Press the **KEY COPY** softkey so that it is not underlined.

**Controlling Annotation, Printing, and Plotting**

---

**Managing Memory**

---

## Managing Memory

Traces, measurement states, limit lines, User menus, and downloadable programs (DLPs) are all stored in either internal memory, a memory card, or a disk drive. Learning how to manage this memory is essential to obtaining the most benefit from your optical spectrum analyzer. This chapter helps you manage memory with its files. In addition to managing memory, this chapter shows you how to secure the optical spectrum analyzer for protection and declassification.

If you need to learn how to create measurement states, traces, limit lines, or user menus, refer to the following chapters:

Measurement states .....	Chapter 2
Traces .....	Chapter 8
Limit lines .....	Chapter 10
User menus .....	Chapter 11

**Contents**

Selecting and Formatting Memory .....	13-4
To insert a memory card .....	13-7
To select the default memory .....	13-8
To format memory .....	13-9
To change a card's battery .....	13-10
Working with Files .....	13-12
To catalog all files .....	13-16
To save a file .....	13-17
To recall a file .....	13-18
To copy internal memory .....	13-19
To erase a file .....	13-19
To erase all files .....	13-20
To modify file names .....	13-21
Increasing User Memory .....	13-23
To increase user memory .....	13-23
Securing the Optical Spectrum Analyzer .....	13-24
To prevent display of annotation .....	13-25
To restrict operation to (USER) menu .....	13-25
To restore operation of (MENU) menu .....	13-28
To erase internal memory partially .....	13-29
To erase internal memory fully .....	13-29
To recover from a full memory erase .....	13-30
Connecting an External HP-IB Disk Drive .....	13-34
To connect the disk drive .....	13-35

---

## Selecting and Formatting Memory

Measurement states, traces, limit lines, DLPs, and User menus can be saved in one of three memory locations:

- Internal memory
- Memory card
- Optional HP-IB disk drive

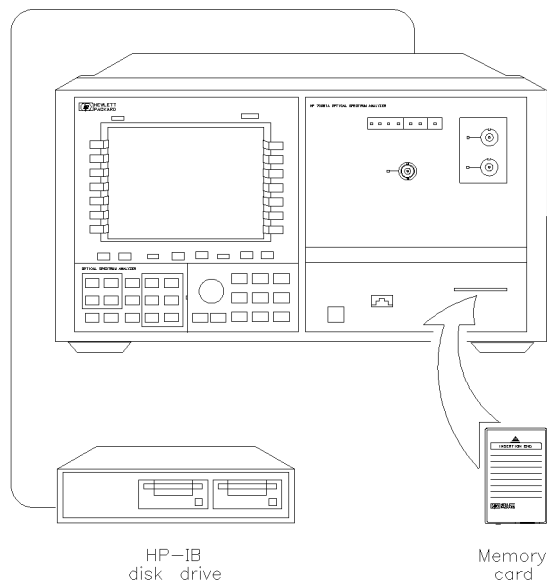

pkb6

You select which of these memory locations will be used to save and recall files. When first turned on, the optical spectrum analyzer automatically selects internal memory. You can save, recall, erase, and list (catalog) the files contained in selected memory. Files are cataloged using the Miscellaneous menu's catalog & MSI feature.

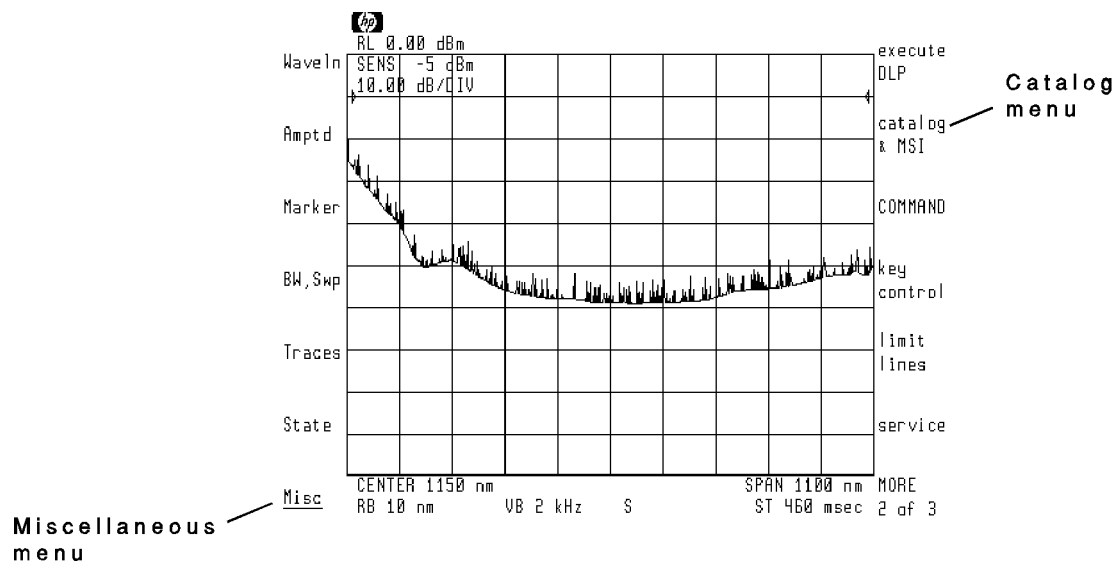

### Connecting HP-IB Disk Drives

HP-IB disk drives are connected via an HP-IB bus to the HP 70004A Display's rear panel. Refer to "Connecting an External HP-IB Disk Drive" in this chapter. Any computers attached to the HP-IB bus must be disconnected from the bus before attempting to use an external disk drive.

Memory cards and external HP-IB disks must be formatted before use. Formatting erases all data and initializes the memory for storing data. (Internal memory can also be formatted, although this is not required for first-time use.) Instructions in this section show you how to format memory.

## Selecting and Formatting Memory

### **Battery power**

Memory cards have a built-in battery to retain memory data. Data stored in the card remain as long as the card's battery has sufficient power. You should change the battery every two years using the procedure in this section.

On new cards, a special code is stamped on the card's side indicating the date it was installed. The first digit tells the year, and the next two digits the month. The third digit indicates the week. For example, 10C3 indicates the battery was installed during the third week of October in 1991.

### **Storage device error**

If no card is inserted in the front-panel card slot, and you attempt to read, write, or catalog a memory card, the optical spectrum analyzer displays the message `Storage device error`. Place a card in the card slot, and retry the operation.



---

## To insert a memory card

1. Locate the arrow printed on one end of the card.
2. Insert the card into the front-panel card slot with its arrow matching the arrow printed above the card slot.

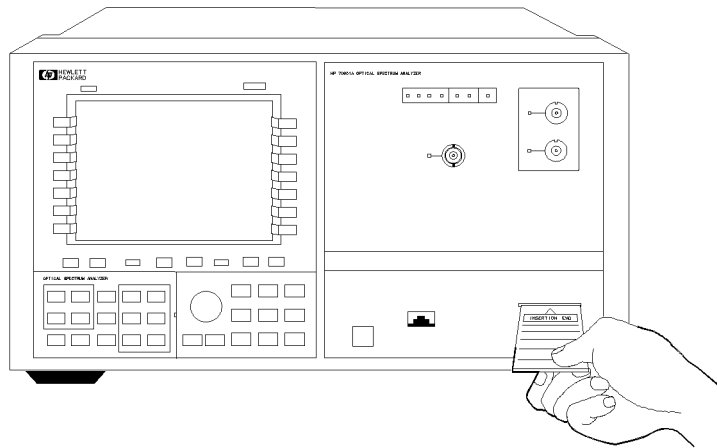

pkb7

---

## To select the default memory

1. Press the left-side **Misc** softkey.
2. Press **MORE 1 of 3** and then **catalog & MSI**.
3. Press a softkey to select the default memory:
  - **INTRNL MEMORY** indicates the optical spectrum analyzer's internal memory.
  - **HP-MSIB CARD** indicates a memory card in the optical spectrum analyzer's front-panel card slot.

Remember to insert the card before pressing **HP-MSIB CARD**. If **2053 Storage device error** is displayed, either the card is missing, the card's write-protect switch is in the SAFE position, or the card's HP-MSIB address is incorrectly listed. The HP-MSIB address for the card is the same address as the display's HP-IB address and is normally set to 4. If the address is not correct, enter the correct address using the numeric keypad.

- **HPIB DISK** indicates an external HP-IB disk drive. Refer to Chapter 1 for information on connecting the disk drive.

---

## To format memory

---

### **CAUTION**

---

This procedure erases all files at the default memory location. Calibration correction factors and serial-number identification in internal memory are not effected.

1. If you're formatting a memory card, place the card in the front-panel card slot. If you're formatting an external disk, place the disk in the HP-IB disk drive.
2. Press the left-side **Misc** softkey.
3. Press **MORE 1 of 3** and then **catalog & MSI**.
4. Press **INTRNL MEMORY**, **HP-MSIB CARD**, or **HPIB DISK** to select the memory to format.

Remember to insert the card before pressing **HP-MSIB CARD**. If **2053 Storage device error** is displayed, either the card is missing, the card's write-protect switch is in the SAFE position, or the card's HP-MSIB address is incorrectly listed. The HP-MSIB address for the card is the same address as the display's HP-IB address and is normally set to 4. If the address is not correct, enter the correct address using the numeric keypad.

5. Press the **CATALOG 1 of 2**, **FORMAT**, and then **CONFIRM FORMAT**.

---

## To change a card's battery

The memory card's battery is a lithium commercial CMOS type, part number CR 2016.

---

### CAUTION

The memory card should be installed when the battery is removed. If the battery is removed while the card is not installed, all data in the card will be lost. Store memory-card files on another device before changing the battery, when extra care is appropriate.

---

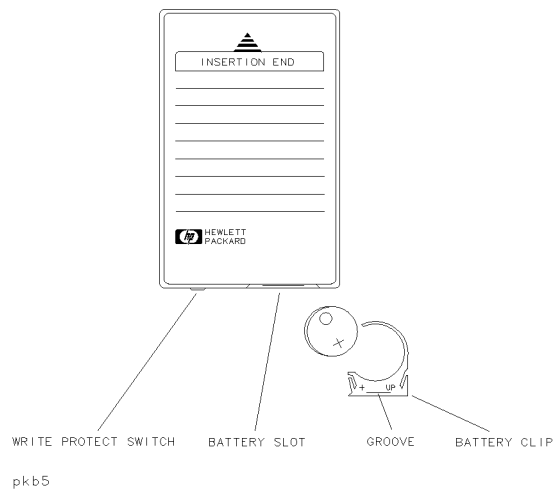

1. Install the memory card into the HP 70004A display.
2. On the front edge of the card, locate the groove of the battery clip.
3. Gently pry the battery clip out of the card. The battery fits inside the clip.
4. Replace the battery, making sure the plus (+) sign on the battery is on the same side as the plus sign on the clip.
5. Insert the battery clip into the memory card, holding the clip as oriented in the following figure. (Face the open edge of the clip toward the memory card's write-protect switch.)
6. Write the data that the battery was replaced on the card's label.

---

## Working with Files

Measurement states, traces, limit lines, DLPs, and User menus are all stored as files in memory. These files are retained even if power is removed from the optical spectrum analyzer. Files are identified by number and name. The optical spectrum analyzer arbitrarily assigns the file number when the file is created. The file name consists of a file-type prefix and an identifying number. When cataloged, the file listings show the file's data type and size in bytes.

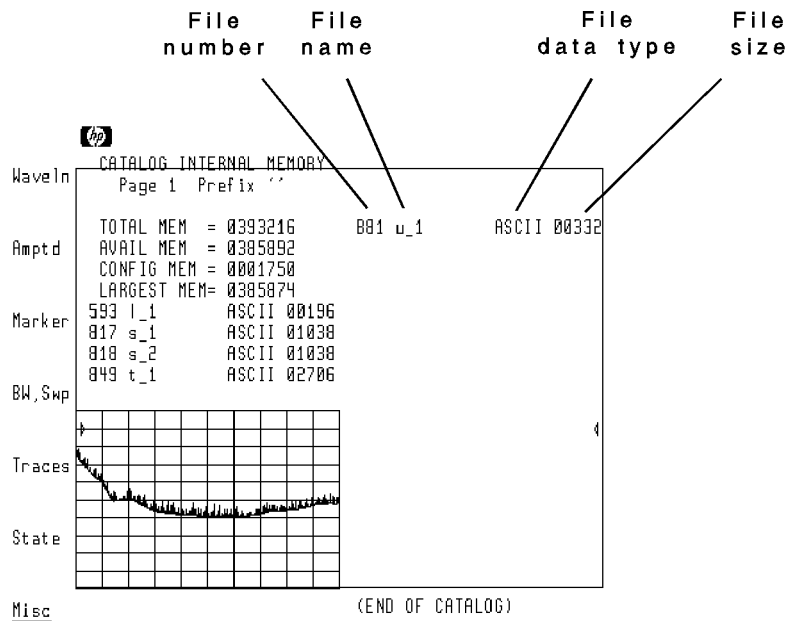

You assign the file's identifying number at the time you save it. Files saved and recalled using the front panel are labeled as ASCII. (ASCII files also include Downloadable Programs (DLPs) as described in the *Programmer's Guide*.) Non-ASCII files can be stored only in internal memory using programming commands.

Each file name contains one of five prefixes and a number. Prefixes are automatically appended to the number that you enter from the front panel. The following prefixes are used:

File Type	File Name Prefix
DLP	d_
Limit lines	l_
Measurement state	s_
Trace	t_
User menu	u_

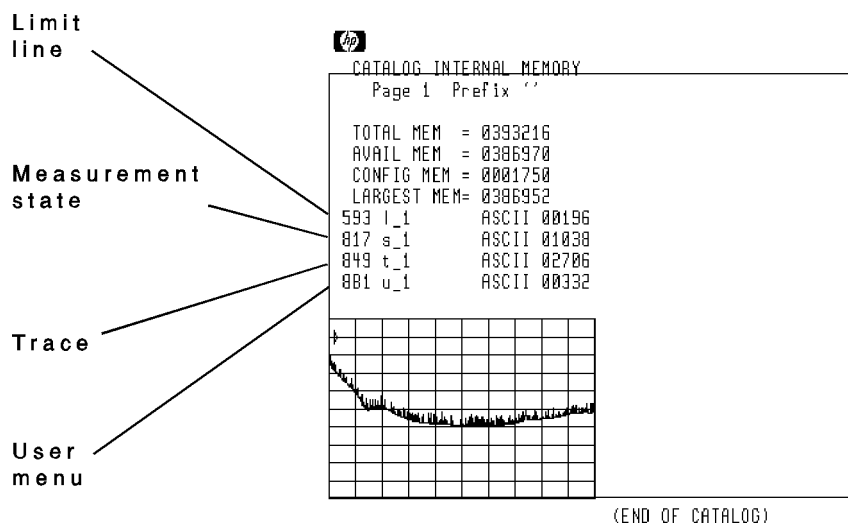

**File types.**

**Working with Files**

The following figure shows the prefix TRACE being constructed at the bottom of the display. For each of the five file types, the word TRACE will be appended to the file's prefix when the file is saved.

You can create custom file prefixes by appending text to the standard prefix. When you save a file, your custom prefix string is automatically appended to the prefix of each of the five file types. The prefix is appended regardless of whether you are saving a DLP, limit line, measurement state, trace, or User menu. The new prefix is used until it is erased or changed. You can add characters to the prefix of any file. This allows you to customize a file name so you can easily locate it.

For example, if you enter a custom prefix of TRACE and then save a trace, the following file will be saved in memory: tTRACE\_1

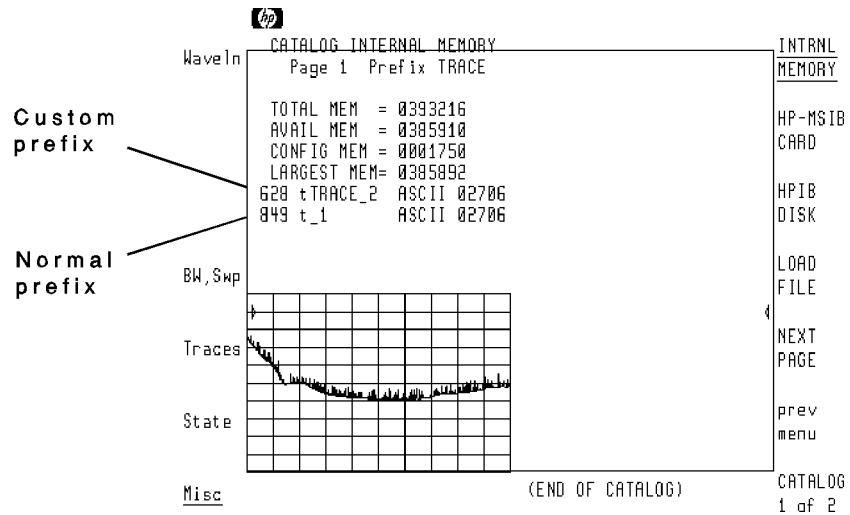



When you save a file, the optical spectrum analyzer displays a message indicating the current default memory and prefix.

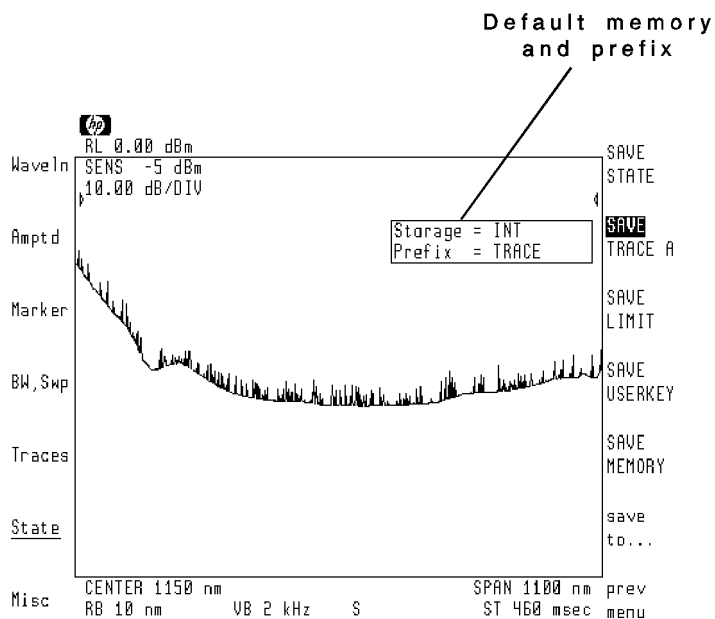

## To catalog all files

1. If you plan to catalog the files on a memory card, insert the card in the front-panel card slot.
2. Press the left-side **Misc** softkey.
3. Press **MORE 1 of 3** and then **catalog & MSI**.
  - Pressing **INTRNL MEMORY** lists the files stored in internal memory.
  - Pressing **HP-MSIB CARD** lists the files stored on a memory card.

If 2053 Storage device error is displayed, either the card is missing or the card's HP-MSIB address is incorrectly listed. The HP-MSIB address for the card is the same address as the display and is normally set to 4. If the address is not correct, enter the correct address using the numeric keypad.
  - Pressing **HPIB DISK** lists the files stored on an external HP-IB disk drive.
4. If the displayed list of files does not fit on the display, press **NEXT PAGE** to view additional files.
5. Locate the name of your file. Look for the correct file name prefix to help you locate the file. The following prefixes are used:

File Type	File Name Prefix
DLP	d_
Limit lines	l_
Measurement state	s_
Trace	t_
User menu	u_

---

## To save a file

Use this procedure to save a file in the default memory. To select default memory refer to “To select the default memory” in this chapter.

1. Press the left-side **State** softkey.
2. Press **save** and then press the softkey indicating the information you want to save:
  - Pressing **SAVE STATE** saves the current measurement state.
  - Pressing **SAVE TRACE A** saves trace A.
  - Pressing **SAVE LIMIT** saves a limit line.
  - Pressing **SAVE USERKEY** saves a User menu.
3. Use the front-panel numeric keypad to enter the file number.

## To recall a file

Use this procedure to recall a file from the default memory. To select default memory refer to “To select the default memory” in this section.

1. Press the left-side **State** softkey.
2. Press **recall** and then press the softkey indicating the information you want to save:
  - Pressing **RECALL STATE** saves the current measurement state.
  - Pressing **RECALL TRACE A** saves trace A.
  - Pressing **RECALL LIMIT** saves a limit line.
  - Pressing **RECALL USERKEY** saves a User menu.
3. If you know the number of the file you want to recall, press the recall softkey indicating the type of file, and then enter the file number.
4. If you do not know the number of the file you want to recall, do the following:
  - Press the **recall from** softkey to display a catalog of the default memory.

This step temporarily enters the Miscellaneous menu.
  - Locate the file you want to recall. Use the **NEXT PAGE** softkey if all the files are not displayed. Refer to this section’s introduction to learn how to identify files.
  - Press **LOAD FILE** and enter the number for the file to recall.

---

## To copy internal memory

Use this procedure to copy all internal memory files to default memory.

1. Press the left-side **State** softkey.
2. Press **save** and then **save to . . . .**.
3. Press one of the following softkeys to indicate the destination of the internal memory files:
  - Pressing **HP-MSIB CARD** selects a memory card. A card must be in the front-panel card slot before this key is pressed.
  - Pressing **HPIB DISK** selects an external disk drive.
4. Press **prev menu** and then **SAVE MEMORY**.

---

## To erase a file

Use this procedure to erase a file in the default memory. To select default memory refer to “To select the default memory” in this section.

1. Press the left-side **Misc** softkey.
2. Press **MORE 1 of 3**, **catalog & MSI**, and then **CATALOG 1 of 2**.

The files in the currently selected memory location will be displayed.

3. Locate the file you want to erase. Use the **NEXT PAGE** softkey if all the files are not displayed. Refer to this section’s introduction to learn how to identify files.
4. Press **PURGE FILE** and enter the number for the file to erase.

---

## To erase all files

---

### **CAUTION**

---

This procedure erases all internal volatile memory files. Measurement state files are erased even if state file protection is turned on using **P STATE On Off**.

1. Press the left-side **State** softkey.
2. Press **MORE 1 of 4**, **MORE 2 of 4**, **MORE 3 of 4**, **PARTIAL ERASE**, and then **CONFIRM ERASE**.

A **CANCEL** softkey is provided if you want to abort this procedure.

## To modify file names

The prefix length can be from 1 to 7 characters long. The following figure shows the prefix **TRACE** being constructed at the bottom of the display. For each of the five file types, the word **TRACE** will be appended to the file's prefix when the file is saved.

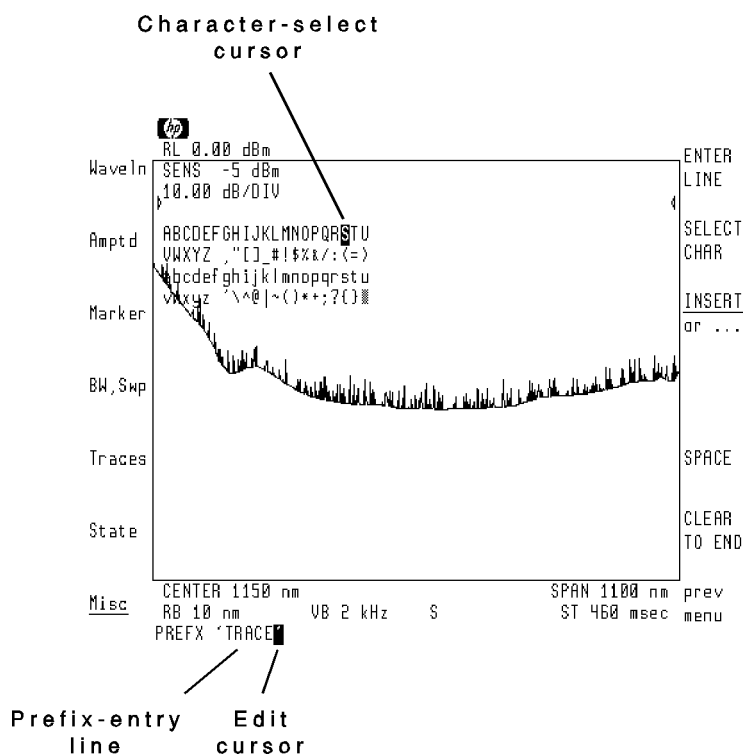

1. Press the left-side **Misc** softkey.
2. Press **MORE 1 of 3**, **catalog & MSI**, **CATALOG 1 of 2**, and then **CHANGE PREFIX**.

**Working with Files**

3. Use the front-panel knob and **SELECT CHAR** softkey to spell your prefix on the prefix-entry line. Refer to the boxed text in this procedure for instructions on using the editor.
4. Press **ENTER LINE** to place the title on the screen.

**Editing the prefix line**

- Turn the front-panel knob to select a character.
- Press the **▼** and **▲** keys (beneath the front-panel knob) to move the command-entry cursor.
- Press **SELECT CHAR** to enter a character at the character-select cursor.
- Press the numeric keypad to enter numbers or a minus sign.
- Press **SPACE** to add a space character.
- The **INSERT or . . .** softkey determines the action of the **SELECT CHAR** softkey. Choices are **INSERT** a character, **REPLACE** an existing character, or **DELETE** a character.
- Use the **CLEAR TO END** softkey to remove characters from the command-entry cursor to the end of the command.



---

## Increasing User Memory

The amount of available user memory is affected by the amount of memory reserved for measurement state files. Measurement state files require large amounts of memory. The procedure in this section increases user memory by limiting the amount of state files that can be saved. Of course, you can always delete unused files as explained in “To erase a file” in this chapter.

---

### To increase user memory

---

**CAUTION**

---

Decreasing the amount of state memory deletes any saved states that have file numbers greater than the new maximum state memory limit.

1. Press the left-side **State** softkey.
2. Press **MORE 1 of 4** and then **NO OF STATES**.
3. Enter the amount of memory to reserve for the maximum number of measurement states.

---

## Securing the optical spectrum analyzer

Sometimes it is important to prevent others from controlling or accessing optical spectrum analyzer data and settings. In this section, you'll learn how to perform these security tasks:

- Restrict optical spectrum analyzer operation to the **(USER)** and **(DISPLAY)** menus.
- Prevent the display of annotation and active-function readouts.
- Erase all memory including serial numbers and user-entered calibration factors.

Restricting operation to the **(DISPLAY)** and **(USER)** softkey menus prevents novice users from tampering with optical spectrum analyzer settings. Once operation is restricted, even the **(INSTR PRESET)** key is disabled. Turning the instrument off and then on again will not restore normal operation. To restore operation of the **(MENU)** softkeys, follow the instructions listed in “To restore operation of **(MENU)** softkeys” in this section.

The **LOCKOUT ANOTATN** softkey protects against unauthorized viewing of optical spectrum analyzer conditions. Once activated, annotation and active-function readouts cannot be viewed unless the **(INSTR PRESET)** key is pressed or the instrument is turned off and then turned on again. Even annotation for recalled measurement states will be blanked. If the **POWERON LAST** softkey is used before the power is turned off, the annotation remains blanked when power is reapplied.

For security reasons, you can perform a partial erase to remove all files in internal memory. This includes measurement state files protected with the **P STATE On Off** function. To ensure maximum security, perform a full erasure of internal memory. Full erasure also deletes serial number data for the optical spectrum analyzer module. A procedure in this section shows you how to reenter the serial number data.

---

## To prevent annotation from displaying

1. Press the left-side **Misc** softkey.
2. Press **MORE 1 of 3**, **MORE 2 of 3**, and then **LOCKOUT ANOTATN**.

The annotation cannot be turned on again until the **INSTR PRESET** key is pressed or the optical spectrum analyzer is turned off and then on again.

---

## To restrict operation to **USER** menu

---

### **CAUTION**

The following procedure ensures that your custom menu contains the **COMMAND** softkey. If the **COMMAND** softkey is not included, the only way to restore access to the optical spectrum analyzer's softkeys is to use a computer to send the **USERLOCK OFF** command over the HP-IB bus.

#### **HIL keyboard**

If you have a HIL keyboard, entering the text is much easier. The keyboard plugs into an HP-HIL connector on the front-panel of HP 70004A displays. The keyboard and associated cable have the following part numbers:

HIL keyboard	HP 46021A
keyboard cable	46020-60001

**Securing the optical spectrum analyzer**

1. Press the left-side **Misc** softkey, and then press **MORE 1 of 3**, **key control**, **DEFINE USR KEY**, **prev menu**, and then **COMMAND**.
2. Press **(USER)**, and then press the softkey where you want to copy the **COMMAND** softkey.
3. Press the new **COMMAND** softkey.
4. Use the front-panel knob and **SELECT CHAR** softkey to spell the command **USERLOCK ON** as shown at the bottom of the following figure. Refer to the boxed text following this procedure for instructions on using the editor.
5. Press **ENTER COMMAND**.

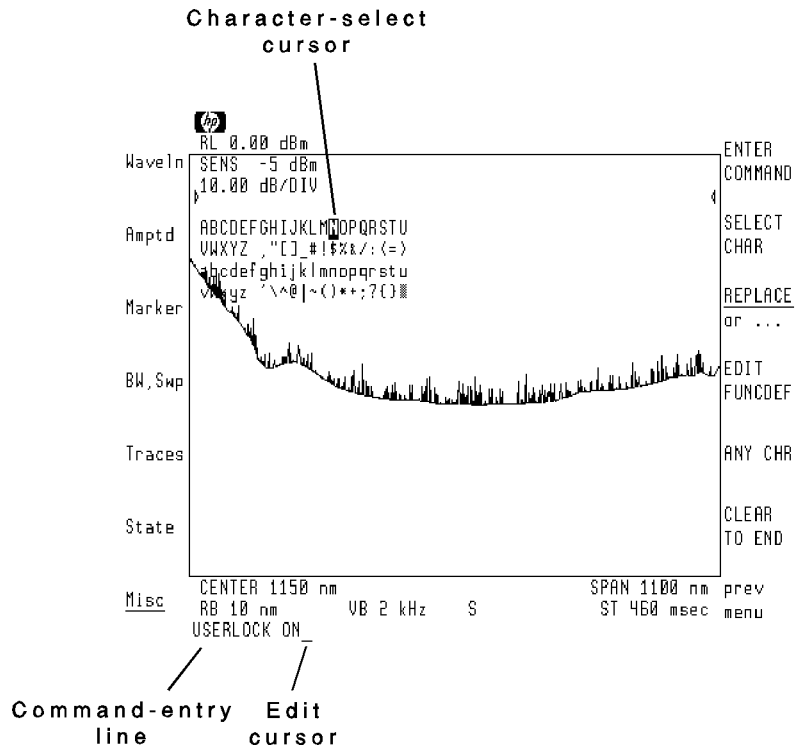

**Editing the COMMAND line**

- Turn the front-panel knob to select a character.
- Press the **▼** and **▲** keys (beneath the front-panel knob) to move the command-entry cursor.
- Press **SELECT CHAR** to enter a character at the character-select cursor.
- Press the numeric keypad to enter numbers or a minus sign.
- The space character is located after the **Z** character on the display.
- The **INSERT or . . .** softkey determines the action of the **SELECT CHAR** softkey. Choices are INSERT a character, REPLACE an existing character, or DELETE a character.
- Use the **CLEAR TO END** softkey to remove characters from the command-entry cursor to the end of the command.

---

## To restore operation of **MENU** menu

1. Press **USER** and then **COMMAND**.
2. Use the front-panel knob and **SELECT CHAR** softkey to spell the command **USERLOCK OFF** as shown in the following figure. Refer to the boxed text following this procedure for instructions on using the editor.
3. Press **ENTER COMMAND** and then the **MENU** key.

### Editing the **COMMAND** line

- Turn the front-panel knob to select a character.
- Press the **▼** and **▲** keys (beneath the front-panel knob) to move the command-entry cursor.
- Press **SELECT CHAR** to enter a character at the character-select cursor.
- Press the numeric keypad to enter numbers or a minus sign.
- The space character is located after the **Z** character on the display.
- The **INSERT or . . .** softkey determines the action of the **SELECT CHAR** softkey. Choices are **INSERT** a character, **REPLACE** an existing character, or **DELETE** a character.
- Use the **CLEAR TO END** softkey to remove characters from the command-entry cursor to the end of the command.

---

## To erase internal memory partially

---

### CAUTION

---

This procedure erases all internal memory except calibration correction offsets and serial-number identification. All files in internal memory are erased. This includes downloadable programs.

1. Press the left-side **State** softkey.
2. Press **MORE 1 of 4**, **MORE 2 of 4**, **MORE 2 of 4**, **PARTIAL ERASE** and then **CONFIRM ERASE**.

A **CANCEL** softkey is provided if you want to abort this procedure.

---

## To erase internal memory fully

---

### CAUTION

---

This procedure erases all internal memory including wavelength and amplitude calibration factors and serial-number identification.

1. Press the left-side **Misc** softkey.
2. Press **MORE 1 of 3**, **service**, **erase/restart**, **ERASE ALL**, and then **CONFIRM ERASE**.

A **CANCEL** softkey is provided if you want to abort this procedure.

3. Press **DISPLAY** and then **NEXT INSTR** to link the optical spectrum analyzer module to the display.

---

## To recover from a full memory erase

After a full memory erase, you must reenter the optical spectrum analyzer module's serial number using the **SER** command.

### HIL keyboard

If you have a HIL keyboard, entering the text is much easier. The keyboard plugs into an HP-HIL connector on the front-panel of HP 70004A displays. The keyboard and associated cable have the following part numbers:

HIL keyboard .....	HP 46021A
keyboard cable .....	46020-80001

1. Open the display's front-panel door to reveal the module's frame.

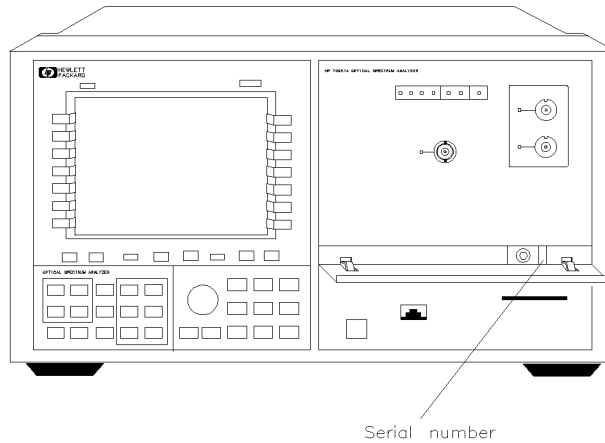

pkb4



**Securing the optical spectrum analyzer**

2. Read the serial number from a tag on the module's frame.
3. Press the left-side **Misc** softkey.
4. Press **MORE 1 of 3** and then **COMMAND**.
5. Use the front-panel knob and **SELECT CHAR** softkey to spell the command **SER"3141A00854"** as shown at the bottom of the following figure. (Of course, be sure to use the correct serial number from your optical spectrum analyzer module.) Refer to the boxed text following this procedure for instructions on using the editor.
6. Press **ENTER COMMAND**.

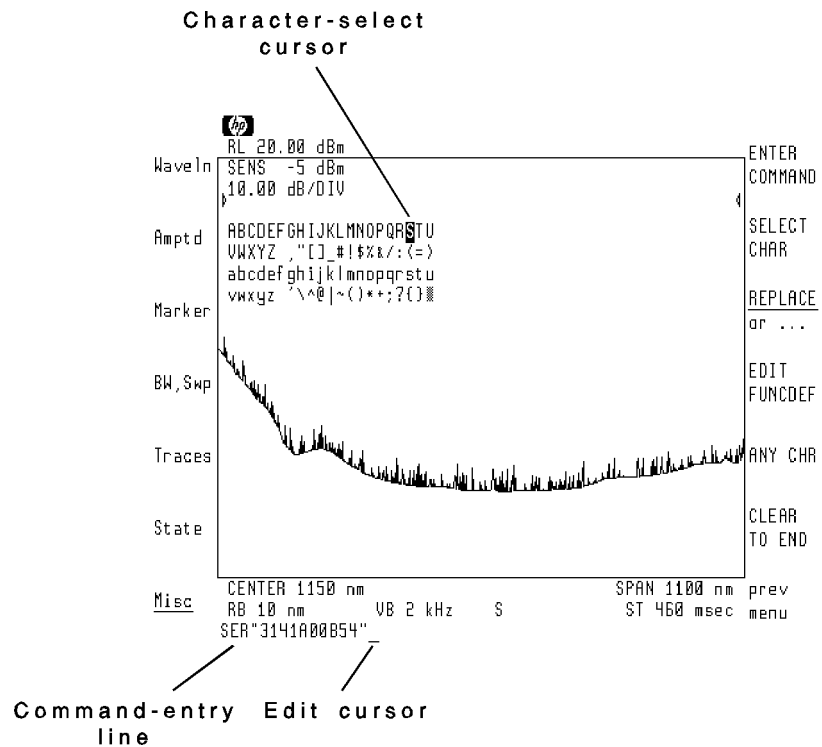

**Editing the COMMAND line**

- Turn the front-panel knob to select a character.
- Press the **▼** and **▲** keys (beneath the front-panel knob) to move the command-entry cursor.
- Press **SELECT CHAR** to enter a character at the character-select cursor.
- Press the numeric keypad to enter numbers or a minus sign.
- The **INSERT or . . .** softkey determines the action of the **SELECT CHAR** softkey. Choices are INSERT a character, REPLACE an existing character, or DELETE a character.
- Use the **CLEAR TO END** softkey to remove characters from the command-entry cursor to the end of the command.



---

## Connecting an External HP-IB Disk Drive

Measurement data and files can be saved on an external HP-IB disk drive. The disc drive must be a 3.5 inch, CS80 compatible, such as an HP 9122. To use the drive, you must connect it and enter its HP-IB address into the optical spectrum analyzer. The procedure in this section shows you how to do this.

The default HP-IB address used by the optical spectrum analyzer to locate the external disk drive is address 0, unit 0, and volume 0. You can enter a new address when **HPIB DISK** is pressed. New addresses are entered in the following form:

*A.UV* where:

- *A* is a digit from 1 through 7, representing the drive's HP-IB address.
- *U* is a digit from 0 through 9, representing the unit number. The unit number is typically 0 or 1 and refers to an individual disk drive slot.
- *V* is a digit from 0 through 9, representing the volume number. Volume numbers are used for hard disk drives. So, for reading diskettes, the volume number should be 0.

For example, entering 3.00 indicates an address of 3, unit number of 0 and a volume number of 0. This accesses a diskette in the left drive of an external diskette drive at HP-IB address 3.

---

## To connect the disk drive

1. Connect the HP-IB disk drive to the HP 70004A color display using an HP-IB cable.
2. Determine or set the HP-IB address of the disk drive. Refer to the user's manual for the disk drive for information on determining the disk drive's address.
3. Press the left-side **Misc** softkey.
4. Press **MORE 1 of 3**, **catalog & MSI**, and then **HPIB DISK**.

All measurement data and files will be saved and recalled from the disk until the **HP-MSIB CARD** or **INTRNL MEMORY** softkeys are pressed.

5. Use the numeric keypad to enter the code for the new address.

Refer to the introduction to this section for information on determining the code for the address.

6. Press **ENTER**.

## Managing Memory

---

**————— If You Have A Problem**

---

## If You Have A Problem

Your optical spectrum analyzer is built to provide dependable operation. It is unlikely you will experience a problem, but in the event something goes wrong, this chapter provides solutions to common problems.

Error messages can be displayed for a variety of reasons. Most messages indicate a harmless situation. For example, they may simply indicate that you attempted to enter a value that was out of a particular function's range. However, if an error message remains after pressing several keys it may indicate a more serious problem. Refer to the *Reference* manual for a complete list of definitions for all error messages.

If you cannot solve the problem with the information in this chapter, perform the following steps:

1. Toggle the test switch as described in "If operation is erratic" in this chapter.
2. Perform the self-test as described in this chapter.
3. Complete all the basic checks listed in the optical spectrum analyzer's installation and verification manual.
4. Call your nearest HP Sales and Service Office.



**Contents**

To perform the self-test routine ..... 14-4  
If operation is erratic ..... 14-5  
If displayed color, lines, and text are distorted ..... 14-7  
If advanced-measurement programs are missing ..... 14-8  
If UNCAL is displayed ..... 14-9  
If USERCAL is displayed ..... 14-10  
If ERR 2023 is displayed ..... 14-11  
If ERR 2037 is displayed ..... 14-12  
If ERR 2053 is displayed ..... 14-13  
If ERR 2057 is displayed ..... 14-15  
If ERR 2064 is displayed ..... 14-17

---

## To perform the self-test routine

1. Press the left-side **Misc** softkey.
2. Press **MORE 1 of 3** and then **service**.
3. Press **ANALYZR TEST**.

This automated self-test routine takes only one or two seconds to finish. Any errors are reported on the display screen.

---

## If operation is erratic

Illegal states or errors in memory cause erratic operation of the optical spectrum analyzer.

### Symptoms

- There exist multiple unrelated problems, or the instrument stops operating.
- Pressing **INSTR PRESET** does not fix the problem.
- Turning the instrument off and then on does not fix the problem.

### To solve this problem

#### User memory is erased

Performing the steps in this section erases all user memory. Any memory protection provided by other system softkey functions is disabled when this function is used. User calibrations and all DLPs, traces, measurement states, and limit lines are erased. Serial number information is also erased. The following steps show you how to reenter serial number information and the advanced-measurement programs.

- If you can use the softkeys, perform the following steps:
  1. Press **INSTR PRESET**.
  2. Press the left-side **Misc** softkey.
  3. Press **MORE 1 of 3**, **service**, **erase / restart** **ERASE ALL**, and then **CONFIRM ERASE**.
  4. Press the **LINE** switch off and then on.
  5. Press **DISPLAY** and then **NEXT INSTR**.
  6. Reenter the serial number. Refer to “To recover from a full memory erase” in Chapter 13.

If You Have A Problem

**If operation is erratic**

7. Reenter the advanced-measurement programs. Refer to “Reinstalling the Advanced-Measurement Programs” in Chapter 4.
- If you cannot use the softkeys, perform the following steps:
  1. Remove the optical spectrum analyzer module from the display.
  2. Locate the microswitches visible through a hole on the module’s top cover.
  3. Locate the switch labeled **TEST** and toggle the switch to its alternate position.
  4. Place the module back in the display, and turn the power on.
  5. After the module powers up, turn off the power, remove the module, and return the **TEST** switch to its original position.
  6. Replace the module, and turn the power on.
  7. Reenter the serial number. Refer to “To recover from a full memory erase” in Chapter 13.
  8. Reenter the advanced-measurement programs. Refer to “Reinstalling the Advanced-Measurement Programs” in Chapter 4.

---

## If displayed color, lines, and text are distorted

Placing the optical spectrum analyzer on a metal optical table can magnetize the display. Magnetized displays have distorted images due to irregular electron-beam deflection.

### **Symptoms**

- Displayed colors are irregular.
- Displayed graticule lines are not straight.
- Displayed text is not straight

### **To solve this problem**

1. Remove the optical spectrum analyzer from the table.
2. Use a degausser to demagnetize the display.

---

## If advanced-measurement programs are missing

The advanced-measurement programs are downloadable programs factory-installed in the **USER** menu. It is possible to erase these DLPs from memory. In the event that they are erased, they can be reloaded from the memory card (or disk) supplied with the optical spectrum analyzer.

### Symptoms

- Pressing **USER** displays only the following softkeys: **DEFINE USR KEY**, **RECALL USER**, or **SAVE USER**.

### To solve this problem

- Install the advanced-measurement programs as described in “Reinstalling the Advanced-Measurement Programs” in Chapter 4.

---

## If `UNCAL` is displayed

`UNCAL` indicates the display has become uncalibrated.

### Symptoms

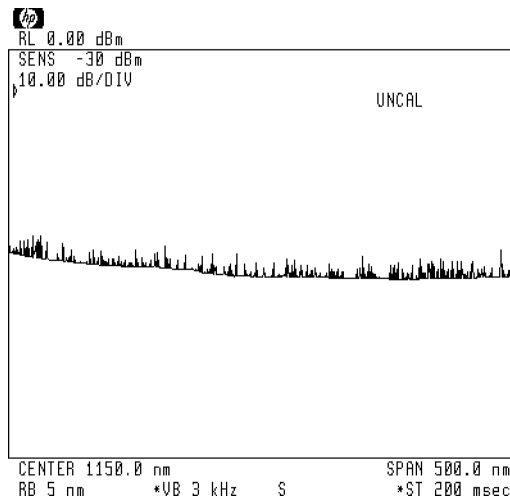

**UNCAL Displayed.**

### To solve this problem

This message normally occurs if instrument settings have been manually placed set unacceptable settings.

- Press `(NSTR PRESET)` to reset all instrument settings.
- or,
- Return any manual setting to its coupled setting by pressing its softkey so that `Auto` is underlined in the softkey's label.

---

## If USERCAL is displayed

USERCAL indicates that user calibrations are being applied to the measurements.

### Symptoms

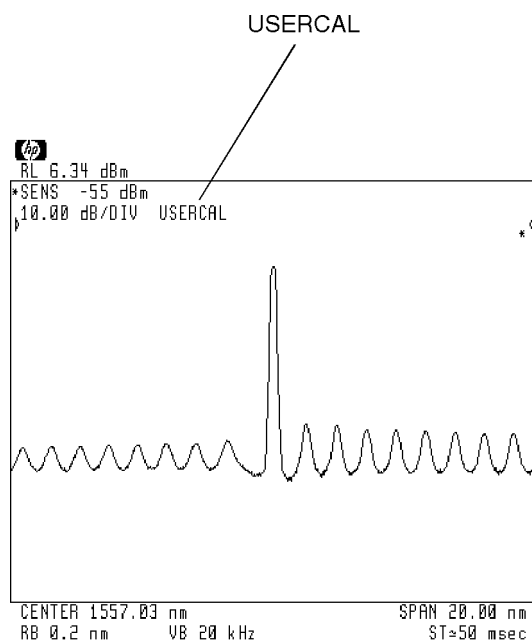

prob7

### USERCAL Displayed.

The USERCAL message does *not* indicate any problem. It is simply a reminder that user calibrations are being applied to the data. User calibrations are turned on or off using the **WL CAL On Off** and **PWR CAL On Off** softkeys. Locate these softkeys by pressing **Amptd**, **MORE 1 of 4**, and then **cal menu**. To learn how to perform user calibrations, refer to “Calibrating the Optical Spectrum Analyzer” located in Chapter 1.



---

## If ERR 2023 is displayed

ERR 2023 indicates the calibration signal is not within acceptable wavelength or amplitude tolerances.

### Symptoms

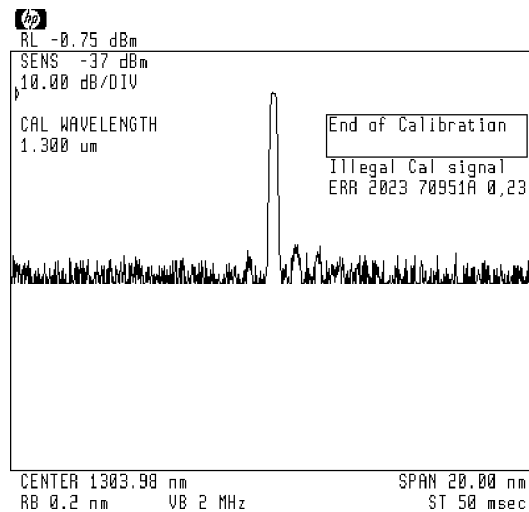

**Displayed error message 2023.**

### To solve this problem

The optical spectrum analyzer can compensate for about 2 nm of error between itself and the calibration laser.

- Confirm that the calibration laser's wavelength is accurately known and entered.
- The optical spectrum analyzer may need to be calibrated by the factory.

---

## If ERR 2037 is displayed

ERR 2037 indicates one of the following conditions has occurred:

- A external HP-IB disk drive is not connected via HP-IB to the optical spectrum analyzer.
- The disk drive's HP-IB address is incorrectly listed.

### Symptoms

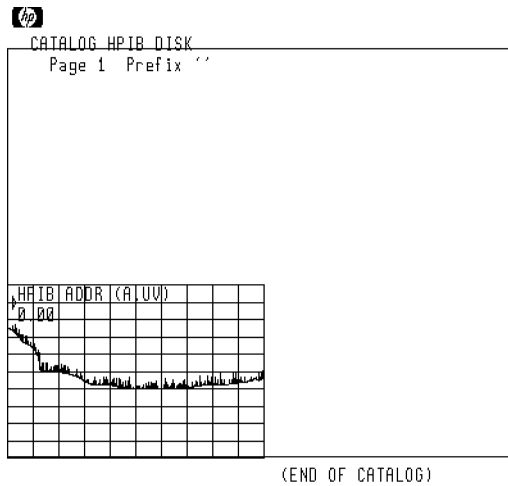

### Displayed error message 2037.

### To solve this problem

- Connect the disk drive to the optical spectrum analyzer using an HP-IB cable.
- Refer to “Connecting an External HP-IB Disk Drive” in Chapter 13 for information on entering the disk drives address.

---

## If ERR 2053 is displayed

ERR 2053 indicates one of the following conditions has occurred:

- A memory card is not in the front-panel card slot.
- The memory card's write-protect switch is in the SAFE position.
- The memory HP-MSIB address is incorrectly listed.

The HP-MSIB address for the card is the same address as the display and is normally set to 4. Use the numeric keypad to enter a new address. Changing the card's address is only used in rare instances when MMS systems are combined.

### Symptoms

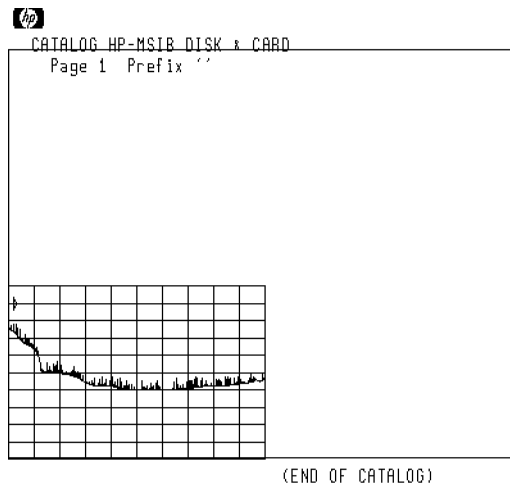

2053 Storage device error.

### Displayed error message 2053.

- To solve this problem**
- Place a memory card in the front-panel card slot.
  - Place memory card's write-protect switch in write-enable position.
  - Confirm the card's HP-MSIB address is incorrectly entered.

If You Have A Problem  
**If ERR 2053 is displayed**

**To enter the card's  
HP-MSIB address**

The HP-MSIB address for the card is the same address as the display's HP-IB address and is normally set to 4. Changing the card's address is only done in rare instances when MMS systems are combined.

1. Press the left-side **Misc** softkey.
2. Press **MORE 1 of 3**, **catalog & MSI**, and then **HP-MSIB CARD**.

The card's HP-MSIB address is shown on the screen.

3. If the card's address needs to be changed, use the front-panel knob, step keys, or numeric keypad to enter the new address number.

---

## If ERR 2057 is displayed

ERR 2057 indicates that there is not enough available default memory to hold additional files.

### Symptoms

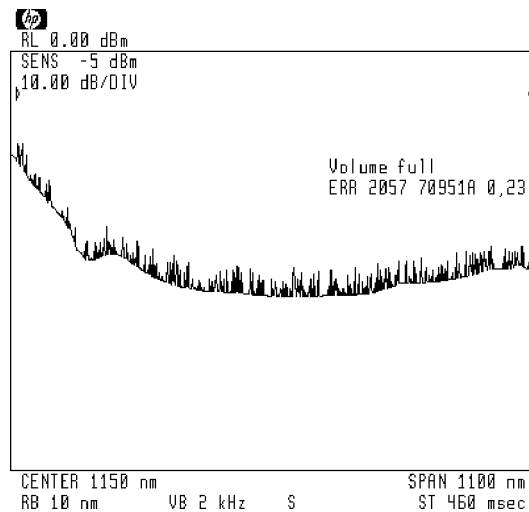

Displayed error message 2057.

- To solve this problem**
- Free additional memory or change default memory.
- To free additional user memory**
- Erase selected internal memory files as described in Chapter 13.
  - Erase all internal memory files as described in Chapter 13.
  - Decrease the amount of memory reserved for measurement states as described in “Increasing User Memory” in Chapter 13.
- To check available user memory**
1. Press the left-side **Misc** softkey.
  2. Press **MORE 1 of 3**, **catalog & MSI**, and then **INTRNL MEMORY** so that it is underlined.

If You Have A Problem  
If ERR 2057 is displayed

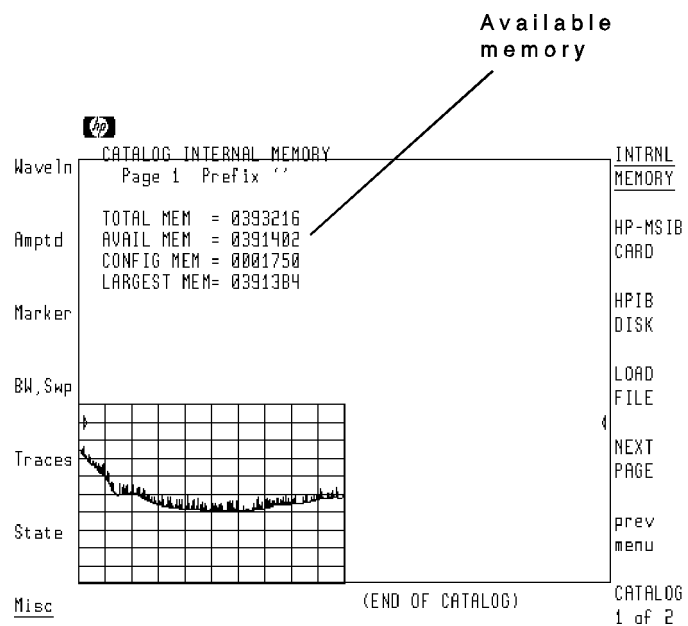

Available memory listed in bytes.

---

## If ERR 2064 is displayed

When ERR 2064 occurs, either an automatic measurement or an automatic alignment is attempted without a valid input signal.

### Symptoms

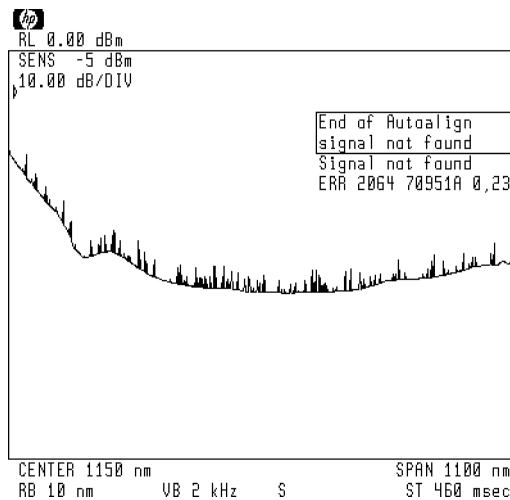

Displayed error message 2064.

### To solve this problem

1. Display a valid response within the 600 to 1700 nm input range.

The automatic alignment and measurement routines requires an LED or a single or multi-mode laser. The signal's power level must be rise at least 3 dB above the displayed noise floor.

2. To perform an automatic measurement, press the **AUTO MEAS** key or **AUTO MEASURE**.

**AUTO MEASURE** is located in the **WaveIn** menu.

3. To perform an automatic alignment, press **AUTO ALIGN** or the **Amptd** menu's **AUTO ALIGN** softkey.

**If You Have A Problem**

---





## Glossary

---

# Glossary

**absolute amplitude accuracy**

The degree of correctness or uncertainty (expressed in either percent or dB power). It includes relative uncertainties plus calibrator uncertainty. For improved accuracy, some spectrum analyzers specify frequency response relative to the calibrator as well as relative to the midpoint between peak-to-peak extremes.

**active function**

The active function is the instrument's feature currently selected for use. It may be a key selection or remote-programming command.

**active function readout**

The area of a display screen where the active function and its state are displayed. The active function is the one that was completed by the last key selection or remote-programming command.

**active marker**

The marker on a trace that can be repositioned by front-panel controls or programming commands.

**active trace**

The trace (commonly A, B, or C) that is being swept (updated) with incoming signal information.

**amplitude accuracy**

The general uncertainty of an amplitude measurement, whether relative or absolute.

**ASCII**

The acronym for American Standard Code for Information Interchange. It is an eight-bit code (7 bits plus parity check) used for data (information) interchange. An ASCII value is a specific combination of bits ranging from 0 to 255 that represent characters in machine language that computers and controllers can understand.

**attenuation**

A general term used to denote a decrease of signal magnitude in

transmission from one point to another. Attenuation may be expressed as a scalar ratio of the input to the output magnitude in decibels.

**autoranging**

Autoranging automatically adjusts the gain of the optical spectrum analyzer's internal transimpedance amplifier as the signal amplitude changes. The gain is changed to reposition a signal in the measurement range of the internal circuitry. When autoranging occurs during a sweep, a slight delay in the sweep results.

**battery-backed RAM**

Random access memory (RAM) data retained by a battery. RAM cards can contain data that is maintained with a battery. Refer also to **nonvolatile memory**.

**bit-error rate (BER)**

Bit-error rate is the percentage of bits that are transmitted incorrectly in a digital communications system.

**blank trace**

A function that stores any active trace in the optical spectrum analyzer's reserved memory and blanks the display. The stored trace may be A, B, or C.

**broadband response**

A signal whose spectrum is wider than the resolution bandwidth of the optical spectrum analyzer, and whose repetition frequency is lower than the bandwidth of the spectrum analyzer. Notice that it is a combination of signal and receiver characteristics that determines when a signal is classified as broadband. For refining incoming signal responses, select narrower spans and bandwidths.

**card reader**

See **memory card**.

**character set**

The set of elementary symbols. These normally include both alpha and numeric codes, plus punctuation or any other symbol which may be read, stored, or written and used for organization, control, or representation of data.

**characteristics**

Non-warranted operating information in the form of expected values for spectrum analyzer performance.

**chirp**

Chirp is the change in laser-diode wavelength caused when the diode is pulsed between two different optical power levels or intensity modulated. Chirp results from an increasing drive current that causes either a higher temperature or a change in the effective index of refraction, which increases the wavelength via the change of length of the laser's resonant cavity. Chirp effectively broadens the laser's spectral bandwidth, which results in a reduced system bandwidth because of chromatic dispersion.

**chop mode**

On an optical spectrum analyzer, chop mode is a method of compensating for the effects of stray light in the monochromator and to stabilize internal electronics during long sweeps. Chop mode reads and compensates for stray light and noise before reading the data for each trace point. This improves sensitivity stability and typically provides an increase in dynamic range of approximately 5 dB.

**chromatic dispersion**

Chromatic dispersion is pulse broadening due to the different velocities of different colors contained in the spectrum of the source. The pulse broadening depends directly on the spectral width of the source. Chromatic dispersion is basically a material property.

**clear-write trace**

An optical spectrum analyzer function that zeros specified trace A, B, or C memory, then updates the trace memory with each new sweep. The contents of trace memory are written to the display at a flicker-free rate.

**continuous sweep mode**

The optical spectrum analyzer condition where traces are automatically updated each time trigger conditions are met.

**correction factors**

Error coefficients stored in memory during a calibration. These coefficients are calculated into other measurements to minimize circuitry errors. This factor is the product of the ratio and phase-angle correction factors for the existing conditions of operation.

**default**

The preset conditions, options, or parameters of an instrument. The default state may be changed by choosing key selections or writing programming commands to use other conditions.

**delta marker**

An optical spectrum analyzer mode in which a fixed reference marker is established, then a second active marker becomes available so it can be placed anywhere along the trace. A readout indicates the relative wavelength separation and amplitude difference between the reference and active markers.

**display fidelity**

The measurement uncertainty of relative differences in amplitude at different power levels.

**display range**

The calibrated range of the display for a particular display mode or scale factor. Refer also to **linear display**, **log display**, and **scale factor**.

**distributed-feedback laser**

Distributed-feedback (DFB) lasers are a type of semiconductor diode laser capable of producing a single wavelength output.

**DLP**

The abbreviation for downloadable program. A single programming command or a sequence of programming commands used to perform specific operations. DLPs can be made up of several functions, variables, and traces. A DLP is generally created in a computer, then stored (downloaded into) in the analyzer's internal memory. Once downloaded, the DLP can be executed without a computer or controller.

**dynamic range**

A measure of an optical spectrum analyzer's ability to display a small signal in the presence of a larger signal. Stray light from the large signal raises the noise floor displayed on the screen. Dynamic range is determined primarily by the type of monochromator used, shape of the resolution bandwidth filtering, and spurious responses within the analyzer. A "chop" mode can be used to reduce the effects on dynamic range caused by stray light. In chop mode, the stray light is internally compensated for before acquiring each trace measurement point. This results in longer sweep times.

**EMC**

The abbreviation for electromagnetic compatibility. EMC is a condition of equipment tolerance to external electrical and magnetic fields.

**EMI**

The abbreviation for electromagnetic interference. An EMI measurement determines the degree to which potentially offending, undesirable signals emanate from a device.

**error message**

A message displayed on the screen indicating missing or failed hardware, improper user operation, or other conditions that require additional attention. Generally, the requested action or operation cannot be completed until the condition is resolved.

**extinction ratio**

The ratio of the high-level optical power to the low-level optical power in a transmission system is called the extinction ratio.

**FCC**

The abbreviation for the Federal Communications Commission. This is the part of the United States government that regulates EMI (electromagnetic interference).

**FDHM**

FDHM is an abbreviation for full-duration at half-maximum. FDHM describes the width of a response, identical to full-width at half-maximum (see FWHM).

**ferrule**

A tube which contains the optical fiber. The ferrule is necessary to keep the fiber aligned.

**FFT**

The abbreviation for fast Fourier transform. It is a mathematical operation performed on a time-domain signal to yield the individual spectral components that constitute the signal.

**firmware**

Instruction code that is integrated with the hardware to form a functional set that cannot be altered during normal operation. The instruction code, permanently installed in the circuitry of the instrument, is stored in ROM (read-only memory). Firmware determines the functional characteristics,

as opposed to the electrical or optical characteristics, of the instrument or equipment. Each firmware version is identified by a revision code number, or date code.

**firmware date code**

Indicates which revision of firmware (instrument software or ROM) resides in memory.

**flatness**

The peak-to-peak variation in the displayed signal amplitude over a specified center wavelength range. Flatness is typically specified in terms of  $\pm$ dB relative to the value midway between the extremes. It also may be specified relative to a calibrator wavelength.

**front-panel key**

Keys, typically labeled, and located on the front panel of an instrument. The key labels identify the function the key activities. Numeric keys and step keys are two examples of front-panel keys.

**FTZ**

The abbreviation for Fernmeldewesen Technischen Zentrum. This is the part of the German post office that regulates EMI (electromagnetic interference).

**full span**

Full span is a mode of operation in which the spectrum analyzer scans the entire wavelength range of an analyzer.

**function**

The action or purpose which a specific item is intended to perform or serve. The optical spectrum analyzer contains functions that can be executed via front-panel key selections, or through programming commands.

**FWHM**

FWHM is an abbreviation for full-width at half-maximum. Full-width at half-maximum describes the width of a response, identical to full-duration at half-maximum (see FDHM).

**gain compression**

The signal level at the optical spectrum analyzer's photodetector where the displayed amplitude of the signal is a specific number of dB too low, due to saturation.

**hard copy**

Information or data printed onto paper as opposed to its being stored on disk or in the instrument's memory.

**harmonic distortion**

Undesired wavelength components added to signals as a result of nonlinear behavior of the device (for example, an amplifier) through which signals pass. These unwanted components are harmonically related to the original signal.

**HP-IB**

The abbreviation for Hewlett-Packard interface bus. It is Hewlett-Packard's implementation of IEEE-488 (Standard Digital Interface for Programmable Instrumentation). Hewlett-Packard uses a parallel interface that allows you to "daisy-chain" more than one device to a port on a computer or instrument.

**IF gain/IF attenuation**

An analyzer control that adjusts the vertical position of displayed signals without affecting the signal level at the input. When changed, the value of the reference level is changed accordingly.

**input attenuator**

An attenuator between the optical spectrum analyzer's input connector and photodetector. The input attenuator is used to adjust the signal level in order to prevent gain compression due to high-level signals. It is also used to set the dynamic range by controlling the degree of internally-generated distortion.

**interface**

The place at which independent systems meet and interact. An operator's interaction with an instrument might occur at a keyboard. The keyboard then serves as part of the interface.

**interferometer**

See Mach-Zehnder interferometer (MZI).

**limit line**

A test limit made up of a series of line segments, positioned according to wavelength and amplitude within the optical spectrum analyzer's measurement range. Two defined limit lines may be displayed simultaneously. One sets an upper test limit, the other sets a lower test limit. Trace data can be compared with the limit lines as the spectrum



analyzer sweeps. If the trace data exceeds either the upper or lower limits, the spectrum analyzer displays a message or sounds a warning, indicating that the trace failed the test limits.

**limit-line file**

The user-memory file that contains the limit-line table entries. Limit lines are composed of wavelength and amplitude components that make up a trace array and this data is stored in the file. The limit-line file feature is available on spectrum analyzers that are capable of limit-line operation. Refer also to **limit line**.

**limit-line table**

The line segments of a limit line are stored in the limit-line table. The table can be recalled to edit the line segments, then restored in the limit-line file. Refer also to **limit line**.

**linear display**

The display mode in which the vertical scale is a linear function of the input-signal power. Amplitude values use measurement units of volts and watts.

**linewidth**

Linewidth refers to the spectral bandwidth of an individual mode (line) of a laser.

**log display**

The display mode in which the vertical scale is a logarithmic function of the input-signal power. The display calibration is set by selecting the value of the reference level and scale factor in dB per division.

**marker**

A visual indicator that can be placed anywhere along the displayed trace. A marker readout indicates the absolute value of the trace wavelength and amplitude at the marked point. The amplitude value is displayed with the currently selected units. Refer also to **delta marker** and **noise marker**.

**maximum input level**

The maximum, safe signal power that can be applied safely to the input of an optical spectrum analyzer.

**measurement range**

The ratio, expressed in dB, of the maximum signal level that can be measured (usually the maximum safe input level) to the lowest achievable average noise level. This ratio is almost always much greater than can be realized in a single measurement. Refer also to **dynamic range**.

**memory**

A storage medium, device, or recording medium into which data can be stored and held until some later time, and from which the entire original data may be retrieved.

**memory card**

A small, credit-card-shaped memory device that can store data or programs. The programs are sometimes called personalities and give additional capabilities to your instrument. Typically, there is only one personality per memory card. Refer also to **personality**.

**menu**

The optical spectrum analyzer functions that appear on the display and are selected by pressing front-panel keys. These selections may evoke a series of other related functions that establish groups called menus.

**monochromator**

An optical filter that can be tuned to various wavelengths. The monochromator uses a diffraction grating to separate an input signal into its different wavelength components. Multiple resolutions are generally available.

**noise marker**

A marker whose readout represents the noise density (or rather the noise level) in a 1 Hz bandwidth. When the noise marker is selected, the sample display detection mode is activated, the values of a number of consecutive trace points about the marker are averaged, and this average value is normalized to an equivalent value in a 1 Hz noise power bandwidth. The normalization process accounts for the effects of the detection and bandwidth and often the effect of the log amplifier when the log-display mode is selected.

**nonvolatile memory**

Memory data that is retained in the absence of an ac power source. This memory is typically retained with a battery. Refer also to **battery-backed RAM**.

**normalized reference level**

An amplitude level representing 0 dB deviation from a calibrated system's response. It is obtained by subtracting the system's response from itself.

**normalized reference position**

The position on a network analyzer's display of the normalized reference level.

**numerical aperture (NA)**

Numerical aperture and the core diameter determine how much power can be launched into an optical fiber. The numerical aperture is the sine of half the maximum angle of acceptance.

**parameter units**

Standard units of measure, which include the following:

Measured Parameter	Unit Name	Unit Abbreviation
electrical current	ampere	A
impedance  resistance	ohm	$\Omega$
power level	Watts	W
	decibel relative to milliwatts	dBm
power ratio	decibel	dB
time	second	s
voltage	volt	V
wavelength	hertz	Hz

**peak-detection mode**

For optical spectrum analyzers with digital displays, the display detection mode in which each displayed point indicates the maximum value of the video signal for that part of the wavelength span or time interval represented by the point.

**peak detector**

A detector that follows the peak of the signal applied to it. The standard detector for a spectrum analyzer with only one detection mode is a peak detector (envelope detector). MIL-STD EMI measurements usually call for positive peak detection.

**personality**

Applications software on a memory card or other electronic media that are downloaded into optical spectrum analyzer's RAM. The software directs spectrum analyzer operation so that complex measurements are initiated with front-panel selections and completed without connections to an external computer. Personalities can be designed to automate or simplify instrument operation.

**PIN photodetector**

The PIN photodetector is a detector type known for its simplicity, stability, and bandwidth. Its principle of operation is that whenever the energy of an entering photon is comparable to the band gap energy of the material, the photon energy is absorbed and an electron-hole pair is generated in the i-zone (intrinsic zone, a zone of low conductivity) of the photodetector. An ideal photodetector with negligible recombination would generate one electron-hole pair per photon.

**polarization insensitivity**

Polarization insensitivity indicates that changes in input signal polarization does not cause amplitude variations in measurements. Normally, light with different polarization input to a monochromator experiences differing degrees of attenuation.

**preselector**

A tunable bandpass filter. It tracks the appropriate input wavelength passing signals of the desired wavelength and reducing others. The optical spectrum analyzer's monochromator can be used as a preselector. Preselectors reduce multiple and image responses and, for certain signal conditions, improve dynamic range.

**RAM cards**

A software device used to save traces, states, limit lines, User menus, and software programs for the optical spectrum analyzer. RAM cards provide battery backed memory. If the battery is removed the data is lost. RAM cards can be written to or from. Refer also to personality and ROM cards.

**random-access memory**

RAM (random-access memory) or read-write memory. A storage area allowing access to any of its storage locations. Data can be written to or retrieved from RAM. User-generated information appearing on a display is typically RAM data.

**read-only memory**

ROM (read-only-memory) is the area in the optical spectrum analyzer that contains the analyzer's operation instructions (code). This memory cannot be changed. The data can be accessed (read), but not altered by the user.

**reference level**

The calibrated vertical position on the display used as a reference for amplitude measurement. The reference-level position is normally one of the top lines of the graticule. On some analyzers, it can be set anywhere on the display with front panel keys or remote commands. Refer also to scale factor.

**relative intensity noise (RIN)**

Relative intensity noise is a ratio of the fluctuations of a laser diode's optical power (intensity noise) at a given offset frequency or wavelength to the average power.

**residual responses**

Discrete responses seen on a optical spectrum analyzer display although no input signal is applied.

**resolution bandwidth**

Resolution bandwidth determines the ability to display two closely spaced signals as two distinct responses. This wavelength resolution is determined by the bandwidth of the optical filter located in the optical spectrum analyzer's monochromator. Changing the resolution bandwidth does not affect the displayed noise level.

**resolution**

Refer to **wavelength resolution**.

**responsivity**

The responsivity of a detector is the ratio of its output current to the incident optical power. The responsivity of an amplified lightwave converter is the ratio of its output voltage to the incident optical power.

**return loss**

A scalar measurement indicating how much less the reflected power is from the incident power on the line.

**ROM cards**

A software device used to contain software programs for downloading into a spectrum analyzer. Unlike RAM cards, ROM cards be only read from, not written to. Refer also to personality.

**scale factor**

The per-division calibration of the vertical axis of the display. Scales can be either linear or logarithmic.

**sensitivity**

Sensitivity is the defined as the minimum detectable signal. (It is set to six times the RMS noise level of the analyzer.) Sensitivity is directly coupled to video bandwidth and the gain of the internal transimpedance amplifier. Increasing the sensitivity decreases the video bandwidth and increases the sweep time and gain. (Sweep time is inversely proportional to the video bandwidth.)

**shape factor**

Refer to dynamic range.

**signal resolution**

The ability of the spectrum analyzer to resolve two separate input signals. Closely-spaced signals are more difficult to resolve than signals spaced far apart. Refer also to resolution bandwidth and shape factor.

**single-sweep mode**

That mode in which the spectrum analyzer sweeps once when trigger conditions are met. Each sweep is enabled (allowed to reoccur when trigger conditions are met) by pressing an appropriate front-panel key, or by sending a programming command.

**SMSR**

SMSR (side mode suppression ratio) is a measurement on distributed feedback (DFB) lasers. SMSR indicates the amplitude difference between the main spectral component and the largest side mode.

**softkey**

Key labels displayed on a screen or monitor which are activated by mechanical keys surrounding the display, or located on a keyboard. Softkey selections usually evoke menus that are written into the program software. Front-panel key selections determine which menu (set of softkeys) appears on the display.

**span**

Span equals the stop wavelength minus the start wavelength. The span setting determines the horizontal-axis scale of the spectrum analyzer display.

**span accuracy**

The uncertainty of the indicated wavelength separation of any two signals on the display.

**specifications**

Warranted operating performance. Spectrum analyzers are warranted to meet certain operating conditions. These conditions are typically listed in a table.

**spectrum**

An array of sine waves differing in wavelength, phase, and amplitude. Such an array completely determines a signal, such that a time-domain signal can be converted (mathematically) to a spectrum, and a spectrum can be converted to a time domain signal. Most spectrum analyzers do not measure the phase of the spectrum, only the amplitude and wavelength components. The amplitude spectrum cannot be restored to a time-domain signal without the phase information.



**optical spectrum analyzer**

A device that display the power distribution of a lightwave signal as a function of wavelength. Optical spectrum analyzers depend on either interferometer or grating designs to resolve individual light components.

**spurious response**

The undesired responses that appear on the optical spectrum analyzer's display as a result of the input signal. Internally generated distortion products are spurious responses, as are image and multiple responses.

**step key**

A key used to create an increment of change in an active optical spectrum analyzer setting. The front-panel  and  are called step keys.

**stimulus-response mode**

The operating state that allows the optical spectrum analyzer to make measurements similar to those of a network-analysis measurement system. A device can be characterized for its response to different input signal wavelengths. Measurement results are displayed in a

relative-amplitude scale resulting from a variation, plus or minus, from a reference (normalized) value stored in a trace.

**stop/start wavelength**

Terms used in association with the stop and start points of the wavelength measurement range. Together they determine the span of the measurement range.

**sweep time**

The time it takes the optical spectrum analyzer to tune across the selected span. Sweep time directly affects how long it takes to complete a measurement. It does not include the dead time between the completion of one sweep and the start of the next. It is the function of wavelength span, resolution bandwidth, and video bandwidth.

**syntax**

The grammar rules that specify how commands must be structured for an operating system, programming language, or applications.

**trace**

A trace is a displayed line representing the input spectrum. Traces are made up of a series of data points containing wavelength and amplitude information.

**transimpedance amplifier**

An amplifier used in an optical spectrum analyzer to transform current from a photodetector into voltage. The gain of the amplifier can be adjusted to maintain output voltages that are within the range of other internal circuits. If the range of the transimpedance amplifier is changed during a sweep, a slight pause in the sweep occurs.

**units**

Dimensions on the measured quantities. Units usually refer to amplitude quantities because they can be changed. Typical units are dBm (dB relative to 1 milliwatt) and watts.

**update**

To make existing information current; to bring information up to date.

**variable persistence**

A property of the display that allows the adjustment of the trace-fade rate which is created by the display's electron beam. It is a capability of



purely analog displays which provides flicker-free trace display regardless of sweep time.

**video**

A term describing the output of a spectrum analyzer's envelope detector.

**video average**

The digital averaging of spectrum analyzer trace information. It is available only on analyzers with digital displays. Each point on the display is averaged independently and the average is computed based on the number of sweeps selected by the user. The averaging algorithm applies a factor to the amplitude value of a given point on the current sweep ( $1/n$ , where  $n$  is the number of the current sweep); applies another factor to the previously stored average [ $(n - 1/n)$ ]; and combines the two for a current average. After the designated number of sweeps are completed, the factors remain constant, and the display becomes a running average.

**video bandwidth**

The cut-off wavelength (3 dB point) of an adjustable low-pass filter in the optical spectrum analyzer's video circuit. When the video bandwidth is equal to or less than the resolution bandwidth, the video circuit cannot fully respond to the more rapid fluctuations of the output of the envelope detector. The result is a smoothing of the trace, or a reduction in the peak-to-peak excursion, of broadband signals such as noise when viewed in broadband mode. The degree of averaging or smoothing is a function of the ratio of the video bandwidth to the resolution bandwidth.

**video filter**

A post-detection, low-pass filter that determines the bandwidth of the video amplifier. It is used to average or smooth a trace. Refer also to video bandwidth.

**wavelength**

The wavelength is the distance between two equal phase points on a wave in a dielectric material. The wavelength is equal to the phase velocity (the speed of light traveling in a dielectric material divided by the refractive index of the dielectric material) divided by the frequency.

**wavelength accuracy**

The uncertainty with which the wavelength of a signal or spectral component is indicated, either in an absolute sense or relative to some

other signal or spectral component. Absolute and relative wavelength accuracies are specified independently.

**wavelength range**

The range of wavelengths over which the optical spectrum analyzer performance is specified.

**wavelength repeatability**

Wavelength repeatability defines the accuracy to which the optical spectrum analyzer can be retuned to a given wavelength after a change in tuning.

**wavelength reproducibility**

Wavelength reproducibility refers to the amount of tuning drift in the optical spectrum analyzer. Reproducibility is measured during continuous sweep mode with no changes made to analyzer tuning. Reproducibility typically characterizes drift over a one-minute period.

**wavelength resolution**

The ability of a optical spectrum analyzer to separate closely spaced spectral components and display them individually. Resolution of equal amplitude components is determined by resolution bandwidth. Resolution of unequal amplitude signals is determined by resolution bandwidth and dynamic range.

**wavelength span**

The magnitude of the displayed wavelength component. Span is represented by the horizontal axis of the display. Generally, wavelength span is given as the total span across the full display. Some analyzers represent wavelength span (scan width) as a per-division value.

**zero span**

The case in which a spectrum analyzer becomes a fixed-tuned receiver. In this state, the bandwidth is equal to the resolution bandwidth. Signal-amplitude variations are displayed as a function of time. To avoid loss of signal information, the resolution bandwidth must be as wide as the signal bandwidth. To avoid any smoothing, the video bandwidth must be set wider than the resolution bandwidth.



Index

---

# Index

- 1 1/T softkey, 9-25
  
- 3 3-DIMEN On Off softkey, 8-13, 8-15
  
- 9 9 $\mu$  fiber-optic cable
  - advanced-measurement routines, 4-2
  - preselection instrument mode, 5-28
- 9 $\mu$  m fiber-optic cable
  - stimulus-response instrument mode, 5-9
  
- A A  $\leftarrow$  A-B + DL softkey, 8-25
- A  $\leftarrow$  A-B+DL softkey, 8-27
- A  $\leftarrow$  A-B softkey, 8-25
- active function, 1-6
- ACTIVE MARKER softkey, 9-6, 9-7, 9-8
- ADC SYNC OUT
  - connector, 3-4
  - softkey, 3-10
- ADCTRIG AC softkey, 3-15
- ADCTRIG DELAY softkey, 3-15
- ADCTRIG FREE softkey, 3-15
- ADCTRIG NEGEDGE softkey, 3-15
- ADCTRIG POSEDGE softkey, 3-15
- addresses, 12-16
- advanced-measurement programs, ix
  - amplitude accuracy, 4-2
  - installing, 14-8
  - missing, 4-2, 14-8
  - using, 4-2, 7-2
- advanced-measurement solutions, 4-2
- alignment, 1-28
  - recommended times, 1-28
  - removing offsets, 1-31
- ALIGN PRESET softkey, 1-31
- AMETER On Off softkey, 1-11
- AMPCOR  $\rightarrow$  LOWER softkey, 10-22
- AMPCOR  $\rightarrow$  UPPER softkey, 10-22
- AMPCOR On Off softkey, 10-24
- amplitude
  - calibrating, 1-37

- changing the scale, 1-21
- changing the units, 1-21
- offset, 1-12
- offsets, 1-7
- amplitude accuracy, v
  - advanced-measurement programs, 4-2
- amplitude corrections, 10-2, 10-18
  - creating, 10-21
  - editing, 10-22
  - erasing, 10-25
  - interpolation, 10-20
  - limit-line table size, 10-20
  - turning on and off, 10-24
- amplitude meter, 1-9, 1-11
- AMP REF OFFSET softkey, 1-12
- Amptd softkey, 1-6, 1-21
- AMPTD VALUE softkey, 10-11, 10-29
- analog display, 8-22
- ANALOG OUT connector, 5-7, 5-35, 6-8
- ANALYZR TEST softkey, 14-4
- annotation, xiv, 12-2
  - blinking, 12-7
  - marker readouts, 9-24
  - preventing display, 13-25
- ANOTATN On Off softkey, 12-7, 13-25
- ANY CHR softkey, 11-12, 12-10
- assembling light-source kit, 6-25
- AT MKR On Off softkey, 1-18
- A UNITS AutoMan softkey, 1-21
- autmeas state softkey, 1-17, 1-18, 1-19
- AUTO ALIGN**, v, 1-29
- AUTO ALIGN softkey, 1-29
- automatic alignment, v
  - error, 14-17
  - recommended times, v
- automatic measurement, viii
  - error, 14-17
  - AUTO MEAS**, viii, 1-16
    - to a fixed span, 1-17
    - to a specified log scale, 1-18
    - to a specified wavelength, 1-18
    - to optimize sensitivity, 1-19
- AUTO MEASURE
  - to a fixed span, 1-17
  - to a specified log scale, 1-18
  - to a specified wavelength, 1-18
  - to optimize sensitivity, 1-19
- AUTO MEASURE softkey, 1-16
- AUTOPTS ALIGN softkey, 1-31

- autoranging, 1-14
    - disabling, 1-15
  - AUTORNG On Off softkey, 1-15, 2-9
  - Auto softkey, 9-25
  - AUTZERO On Off softkey, 2-19, 2-21
  - averaging traces, 2-10, 8-16
  - A XCH B softkey, 8-6, 8-10, 8-24, 8-27, 8-34
  - A XCH C softkey, 8-6, 8-10, 8-34
- B**
- backspace , vi
  - bandwidth, measuring using markers, 9-17
  - battery
    - card, 13-6
    - changing in card, 13-10
    - optical spectrum analyzer, 4-2
  - BEEPER On Off softkey, 10-12
  - blanking
    - annotation, 12-4, 12-7
    - graticules, 12-4
    - trace, 8-7
    - traces, 8-5
  - BLANK TRACES softkey, 10-10, 10-13
  - broadband power, 5-21
  - BW,Swp softkey, 2-16
  - B XCH C softkey, 8-6, 8-10, 8-24
- C**
- CALC On Off softkey, 4-9, 4-25
  - calibration, 1-32
    - at STP, 1-35, 1-38
    - erasing user calibrations, 1-41
    - factory, 1-32
    - turning off user calibration, 1-40
    - user, 1-32
  - cal menu softkey, 1-40
  - CAL POWER softkey, 1-40
  - CAL WAVELEN softkey, 1-36, 1-40
  - CANCEL softkey, 13-20, 13-29
  - card, 13-4
    - battery, 13-6
    - changing battery, 13-10
    - write-protect switch, 13-9
  - CATALOG 1 of 2 softkey, 13-9
  - cataloging memory, 13-16
  - catalog & MSI softkey, 13-8, 13-16, 13-21
  - CENTER**, 1-7
  - center-frequency step size, changing, 9-20
  - CENTER softkey, 1-4, 4-4, 4-12, 4-20
  - center wavelength step size, 1-7, 1-12

- CHANGE PREFIX softkey, 13-21
- changing center wavelength using markers, 9-14
- changing file prefixes, 13-21
- changing reference level using markers, 9-14
- changing span using markers, 9-19
- changing the bandwidth to span ratio, 2-4
- changing trace length, 8-32
- chop mode, 2-12
  - disabling, 2-14
- CHOP On Off softkey, 2-14
- cleaning
  - adapters, 1-45
  - non-lensed connectors, 1-44
- cleaning fiber-optic connections, 1-42, 1-44
- CLEAR TO END softkey, 10-24, 11-12, 12-11, 12-12, 13-22, 13-27, 13-28, 13-32
- CLEAR WRT A softkey, 8-7
- CLEAR WRT B softkey, 8-8
- clock, 12-13
  - setting format, 12-15
  - setting the time, 12-14
- CLOCK DISPLAY softkey, 12-8, 12-14
- clock softkey, 12-14
- CLOSEST PEAK softkey, 9-13
- CLOSEST PIT softkey, 9-10
- COMMAND softkey, 11-11, 11-13, 13-25
- CONFIG softkey, 12-18
- configure
  - plotter, 12-22
  - printer, 12-21
- CONFIRM DELETE softkey, 10-10, 10-13, 10-25
- CONFIRM ERASE softkey, 13-20, 13-29
- CONFIRM FORMAT softkey, 13-9
- connector care, 1-42
- CONT softkey, 11-8
- CONT SWEEP softkey, 2-19, 4-4, 4-12, 4-20
- COPY IS PRT/PLT softkey, 12-21, 12-22
- copy options softkey, 12-21, 12-22, 12-23
- current source, 3-5
- CURRENT SOURCE connector, 3-4, 3-5, 3-11
- current source softkey, 3-10
- custom keypad, removing, xiii
- > CWL softkey , 9-12, 9-14
- > CWL STEP softkey , 9-20

- D DB/DIV AutoMan softkey, 1-18
- dBm softkey, 1-21
- DEBUG FAST softkey, 11-8
- DEBUG On Off softkey, 11-8
- DEBUG SLOW softkey, 11-8
- default memory, 13-8
- default trace settings, 8-11
- DEFINE USR KEY softkey, 11-9, 11-10
- delaying the sweep, 2-24, 2-26
- DELETE ALL softkey, 10-10, 10-13, 10-25
- DELETE or . . . softkey, 10-24, 11-12, 12-11, 13-22, 13-27, 13-28, 13-32
- DELETE SEGMENT softkey, 10-11
- delta markers, 9-16, 9-19
- DELTA softkey, 9-19, 9-20
- detection
  - sample, xiv
- DFB softkey, 4-2
  - installing, 14-8
  - missing, 4-2, 14-8
- diffraction-grating order, 1-25
  - changing, 1-25
- disk drive, 13-4
  - addressing, 4-28, 13-34
  - type, 4-28, 13-34
- display
  - annotation, xiv
  - clock, 12-13
  - distorted color, lines, and text, 14-7
  - instrument state, 12-16
  - persistence, 8-22
  - printing and plotting, 12-19
  - setting clock, 12-14
  - DISPLAY**, 12-14, 12-21
- displayed noise
  - effects of sensitivity, 2-8
  - effects of video averaging, 2-10
  - effects of video bandwidth, 2-9
  - reducing, 2-11
- displaying markers, 9-7
- display line, 8-18
- display readouts, 12-2
- DISPOSE USER softkey, 11-5, 11-11
- DISTRIB On Off softkey, 4-18, 4-25
- distributed-feedback lasers, measuring, 4-2
- downloadable programs, 11-2, 13-12
  - and User menus, 11-6
  - debugging, 11-8
  - editing, 11-13
  - entering, 11-11



- file prefix, 13-13
- related to User menus, 11-6
- drifting signals
  - measuring, 8-8
  - tracking, 9-22
- DSP LIN On Off softkey, 8-19, 8-26
- DSPLY B On Off softkey, 5-41
- DUTY CYCLE % softkey, 3-9, 3-10
- dynamic range, increasing, 2-12, 2-13

**E** EDIT FUNCDEF softkey, 11-13

- editing
  - command line, 11-12, 12-11
  - small DLPs, 11-13
- electrostatic discharge, iii
- ENTER COMMAND softkey, 10-24, 11-12, 12-11
- entering small DLPs, 11-11
- enter limit softkey, 10-10
- ENTER LINE softkey, 12-9, 12-11, 13-22
- ENTER softkey, 9-8
- envelope distribution, 4-14
- ENVLOPE MKR BW softkey, 4-14
- ENVLOPE softkey, 4-17
- ERR 2023, 14-11
- ERR 2037, 14-12
- ERR 2053, 13-6, 14-13
- ERR 2057, 14-15
- ERR 2064, 14-17
- error messages, 14-2
- exchanging traces, 8-10
- execute DLP softkey, 11-9
- EXTEND STATE softkey, 12-18
- external attenuation, 10-18
- external disk drive
  - addressing, 13-34
  - connecting, 13-34
- external triggering, 2-22, 2-26
  - accuracy, 3-14
  - pulsed measurements, 3-13
  - sweeps, 2-24
  - video bandwidth, 3-14
- EXT softkey, 2-26
- EXT TRIG IN connector, 2-24, 2-26, 3-13

- F** Fabry-Perot lasers, measuring, 4-2
- factory calibration, 1-35, 1-38
- FAIL message, 10-4
- fiber-optic cables
  - cleaning connections, 1-42
  - connecting, v
  - inspecting, 1-43
- files
  - cataloging, 13-16
  - changing prefixes, 13-22
  - custom prefixes, 13-13
  - erasing, 13-19
  - erasing all files, 13-20
  - managing, 13-12
  - modifying names, 13-21
  - name, 13-12
  - number, 13-12
  - prefixes, 13-13, 13-22
  - recalling, 13-18
  - saving, 13-17
  - suffix, 13-12
- firmware version, 12-16
- FLAT limit-line segments, 10-9
- FLAT softkey, 10-11
- FORMAT softkey, 13-9
- formatting memory, 13-9
- FP softkey, 4-2
  - installing, 14-8
  - missing, 4-2, 14-8
- freerun triggering, 2-22, 2-25
- FREQ softkey, 9-25
- front-panel connectors
  - HP-HIL, 11-8, 12-9, 13-25, 13-30
  - LIGHT SOURCE OUTPUT, 6-4
  - MONOCHROMATOR INPUT, iii, 5-2, 5-9, 5-29, 5-31, 5-37, 6-10, 10-27
  - MONOCHROMATOR OUTPUT, 5-2, 5-26, 9-26
  - OPTICAL INPUT, 10-27
  - PHOTODETECTOR INPUT, 5-11, 5-24, 6-12
- full erase, recovering from, 13-30
- full span, 1-10
- FULL SPAN softkey, 1-4, 1-10

- G** GATESWP On Off softkey, 3-16, 3-17
- GAUSSIAN softkey, 4-17, 4-25
- Gaussian distribution, 4-13, 4-14, 4-23
- graticules
  - blanking, 12-6
  - placement of, 12-5
- grating orders, 1-25
  - changing, 1-25
- GRAT On Off softkey, 12-6
- GRATSCRL On Off softkey, 12-5
- GRATSCR On Off softkey, 12-6
  
- H** hard-copy results, 12-19
- Hard Copy softkey, 12-22
- HELP On Off softkey, 4-9, 4-17, 4-25
- HIGHEST PEAK softkey, 9-9, 9-13
- HIL keyboard, 11-8, 12-9, 13-25, 13-30
- HOLD**, vi, 9-5
- holding trace values, 8-5
- HOLD softkey, 8-19, 8-21
- HORZ OFFSET softkey, 8-15
- HP DISK softkey, 4-30
- HP-IB DISK softkey, 4-28, 8-34, 13-16, 13-34, 13-35
- HP-IB L ONLY softkey, 12-21, 12-22
- HP-IB TLK/LSN softkey, 12-21, 12-22
- HP-LIF format, 4-28
- HP-MSIB CARD softkey, 8-34, 13-8
- HP-MSIB COLUMN softkey, 12-21, 12-22
- HP-MSIB ROW softkey, 12-21, 12-22
- HSWP IN/OUT connector, 3-17
- HYS LEVEL softkey, 2-25
  
- I** identifying a signal peak, 9-11
- IGEN LIMIT softkey, 3-10
- IGEN On Off softkey, 3-11
- increasing user memory, 13-23
- index-matching compounds, 1-42
- index matching gel, 1-42
- input connector, 1-42
- INSERT or . . . softkey, 10-24, 11-12, 12-11, 13-22, 13-27, 13-28, 13-32
- inspecting
  - cables, 1-43
- installing advanced-measurement programs, 14-8
- instr modes softkey, 5-10, 5-24, 5-25, 5-29, 5-32, 5-38
- INSTR PRESET**, 2-2, 8-11, 11-4
- instrument modes, x, 5-2
  - OSA pulse, 5-20

- photodiode, 5-33
- photodiode responsivity analyzer, x
- power meter, x, 5-21
- preselector, x, 5-26
- stimulus response, 5-4, 6-6
- stimulus-response analyzer, x
- instrument setups, saving, xii, 2-27
- instrument state, 12-16
  - protecting, 2-28
- INTEGRT FROM PK softkey, 4-26
- integrt menu softkey, 4-26
- INTEGRT STOP WL softkey, 4-26
- INTEGRT STRT WL softkey, 4-26
- internal memory, 13-4
  - copying to card, 13-19
- INTRNL MEMORY softkey, 8-34, 10-16, 13-8, 13-16
- INT WIN On Off softkey, 4-26

**K** keyboard, 11-8, 12-9, 13-25, 13-30

- key control softkey, 11-9
- KEY COPY softkey, 12-23

**L** lamp

- extending life of, 6-4
- replacing, 6-21

LAST SEGMENT softkey, 10-11

LEDs, measuring, 4-2

LED softkey, 4-2

- installing, 14-8
- missing, 4-2, 14-8

LEFT PEAK softkey, 9-9, 9-13

light source

- turning on, 6-4
- with HP 71450B/2B, 6-6
- with HP 71451B, 6-5

LIGHT SOURCE OUTPUT connector, 6-4, 6-5

light source softkey, 7-9, 7-17

limit lines, xii, 10-2, 13-12

- amplitude corrections, 10-18
- beeper, 10-12
- blanking traces, 10-13
- creating, 10-4
- entering, 10-10
- erasing, 10-13
- FAIL, 10-4
- file prefix, 13-13
- fixed, 10-5
- listing files in memory, 10-16

- menu, 10-10
- PASS, 10-4
- recalling, 10-14, 10-17
- relative, 10-5
- saving, 10-14, 10-16
- segments, 10-6
- segment types, 10-8
- table, 10-6
- turning on testing, 10-12
- tutorial, 10-26
- limit lines softkey, 10-6, 10-10
- LIMITS On Off softkey, 10-7, 10-12
- lim <-> ampcor softkey, 10-21, 10-22
- LINEAR softkey, 1-21, 4-20
- LINE softkey, 2-26
- LINES On Off softkey, 8-33
- line triggering, 2-22, 2-26
- LOAD FILE softkeys, 4-30, 10-17, 13-18
- LOCKOUT ANOTATN softkey, 13-24, 13-25
- LOG dB/DIV softkey, 1-21, 4-20
- Lorentzian distribution, 4-14, 4-23
- LORENZ softkey, 4-17, 4-25
- LOWER -> AMPCOR softkey, 10-21

**M** MANUAL ALIGN softkey, 1-29

- marker readout softkey, 9-25
- markers, 9-2
  - changing center-frequency step size, 9-20
  - changing peak definition, 9-15
  - changing wavelength span, 9-19
  - controlling sweep, 9-26
  - delta measurements, 9-16
  - displaying, 9-5, 9-7, 9-7
  - measuring bandwidth, 9-20
  - measuring noise level at, 9-28
  - moving between traces, 9-8
  - moving marked signals, 1-7, 9-14
  - peak identification, 9-11
  - peak search, 9-13
  - peak searches, 9-9
  - readouts, 9-24
  - turning off, 9-8
  - turning on delta markers, 9-19
  - zooming to zero span, 9-21
- marker softkey, 9-4
- MARKER TUNE softkey, 5-28, 5-30, 5-32
- MAX HOLD A softkey, 8-7, 8-8
- maximum input power, iii

- measurement points, displaying, 8-30
- measurement state
  - file prefix, 13-13
  - protecting, 2-27, 2-28
  - saving, 2-27
- measuring
  - bandwidth, 9-20
  - broadband power, 5-2
  - distributed-feedback lasers, 4-2
  - Fabry-Perot lasers, 4-2
  - fast pulse, 5-2, 5-20
  - LEDs, 4-2
  - noise, 9-28
  - noise level, 9-28
  - photodetectors, 5-33
  - power, 5-21
  - signal drift, 8-8
- mechanical alignment, 1-28
- memory
  - card, 13-4
  - cataloging, 13-16
  - checking available, 14-15
  - connecting external disk drive, 13-34
  - copying internal memory, 13-19
  - default, 13-8
  - disk drive, 13-4
  - erasing all files, 13-20
  - erasing files, 13-19
  - formatting, 13-5, 13-9
  - full erase, 13-29
  - increasing, 13-23
  - internal, 13-4
  - listing contents, 13-16
  - managing, 13-2
  - partial erase, 13-29
  - recovering from full erase, 13-30
  - selecting, 13-8
- memory card
  - battery, 13-6
  - changing battery, 13-10
  - inserting, 13-7
  - write-protect switch, 13-9
- MENU key, 13-28
- MENU softkeys
  - restoring operation of, 13-28
- MINIMUM POINT softkey, 9-10
- MIX HOLD A softkey, 8-7
- MKNOISE On Off softkey, 9-28
- MKPAUSE On Off softkey, 9-27

MKR BW On Off softkey, 4-8, 9-20  
mkr bw/ zoom bw softkey, 9-20, 9-21  
MKR NRM On Off softkey, 9-5, 9-7, 9-8  
MKR TRA A B C softkey, 9-8  
MK STOP On Off softkey, 9-27  
module HP-MSIB addresses, 12-16  
module level parameters, 12-16  
MONOCHROMATOR INPUT connector, iii, 10-27  
MONOCHROMATOR OUTPUT connector, iii, 5-26  
moving markers between traces, 9-8  
multiple images, 1-22  
    testing, 1-25, 1-26

**N** NEXT PAGE softkey, 12-18, 13-16  
NEXT PEAK softkey, 9-9, 9-13  
NEXT PIT softkey, 9-10  
NEXT SEGMENT softkey, 10-11, 10-30  
noise, measuring, 9-28  
NO OF STATES softkey, 13-23  
normalization, 8-2  
NORM On Off softkey, 5-8, 5-11, 5-36, 6-9, 6-11

**O** operation  
    erratic, 14-2, 14-5  
    preventing, 13-24, 13-25  
    restricting, 13-24, 13-25  
OPTICAL INPUT connector, 10-27  
optical-to-electrical device PDL measurement, 7-16  
optical-to-optical device PDL measurement, 7-4  
OPTIMIZ softkey, 4-6, 4-10  
Option 001, 3-5  
Option 002, 6-2  
    turning on, 6-4  
    wavelength range, 6-2  
    with HP 71450B/2B, 6-6  
    with HP 71451B, 6-5  
option 003, 7-2  
OPTSENS On Off softkey, 1-19  
ORDER AutoMan softkey, 1-25  
OSA pulse instrument mode, 5-20  
OSA softkey, 5-13, 5-25, 5-40

**P** PARTIAL ERASE softkey, 13-20, 13-29  
 pass/fail testing, 10-2  
 PASS message, 10-4  
 PAUSE softkey, 11-8  
 PD MEAS On Off softkey, 5-39  
 PEAK EXCURSN softkey, 4-9, 4-12, 4-16, 9-15  
**PEAK SEARCH**, 1-8  
 peak searches, 9-13  
 PEAKS On Off softkey, 4-16, 4-18  
 PEAK THRESH softkey, 4-12, 4-16  
 PERIOD softkey, 9-25  
 persistence, 8-22  
 PERSIST On Off softkey, 8-22  
 photodetector  
   measurements, 5-33  
   responsivity, 5-2  
   responsivity with built-in light source, 6-5  
 PHOTODETECTOR INPUT connector, 5-11, 5-24, 6-12  
 photodiode instrument mode, 5-33  
   block diagram, 5-35  
 photodiode responsivity analyzer, x  
 PHOTO DIODE softkey, 5-38  
 PIT EXCURSN softkey, 9-15  
**PLOT**, 12-20  
 plotter address, 12-22  
 plotter address softkey, 12-22  
 plotter config softkey, 12-22  
 plotting the display, 12-2, 12-19, 12-20  
   including softkey labels, 12-23  
 POINT limit-line segments, 10-9  
 POINT softkey, 10-11  
 polarization dependent loss, 7-2  
 power  
   calibrating, 1-37  
   maximum input, iii  
 POWER FOR CAL softkey, 1-35, 1-40  
 power meter instrument mode, x, 5-21  
   block diagram, 5-23  
   zeroing detector, 5-25  
 POWER METER softkey, 5-24  
 POWERON IP softkey, 2-28  
 POWERON LAST softkey, 2-28, 13-24  
 poweron menu softkey, 2-27  
 POWERON RECALL softkey, 2-28  
 power-on state, 2-28  
 preselection, 5-2, 5-26  
   with 9 $\mu$  cable, 5-28  
   with built-in light source, 6-5  
 preselector instrument mode, x, 5-26



- block diagram, 5-28
- PRESEL softkey, 5-29, 5-32
- PRESET USER softkey, 11-5, 11-11
- preventing operation, 13-24, 13-25
- PRINT**, 12-20
- printer
  - address, 12-21
  - connecting, 12-19
  - types of, 12-19
- printer address softkey, 12-21
- printer config softkey, 12-21
- printing the display, 12-2, 12-19, 12-20
  - including softkey labels, 12-23
- P STATE On Off softkey, 2-27, 2-28, 13-24
- pulsed light
  - measuring, 3-2
  - non-synchronized light, 3-16
  - synchronizing light source, 3-4
  - synchronizing the osa, 3-13
- pulsed measurements
  - selecting trigger type, 3-15
- PULSE WIDTH softkey, 3-9, 3-10
- pulsing light sources, 3-4
  - cables, 3-6
  - duty cycle, 3-6
  - pulse width, 3-6
  - pulse-width limitations, 3-7
- PURGE FILE softkey, 13-19
- PWR CAL On Off softkey, 1-40

**R** RB/SPAN RATIO softkey, 2-6

- readout options, 9-24
- rear-panel connectors, iii
  - ADC SYNC OUT, 3-4, 3-10
  - ANALOG OUT, 5-7, 5-35, 6-8
  - CURRENT SOURCE, 3-4, 3-11
  - EXT TRIG IN, 2-24, 3-13
  - HSWP IN/OUT, 3-17
  - TRANS-Z IN, 5-39
- recall from softkey, 8-35, 13-18
- recalling
  - limit lines, 10-14, 10-17
  - User menus, 11-14
- RECALL LIMIT softkey, 10-17, 13-18
- recall softkey, 2-27, 8-35, 13-18
- RECALL STATE softkey, 13-18
- RECALL TRACE A softkey, 8-35, 13-18
- RECALL USERKEY softkey, 13-18

- RECALL USER softkey, 11-15
- recovering from full erase, 13-30
- reducing noise with video averaging, 8-16, 8-17
- reference level
  - changing, 1-11
  - position, 1-5
- reference position, changing, 1-11
- REF LEVEL**, 1-7
- REF LVL POSN softkey, 1-11
- REF LVL softkey, 1-11
- > REF softkey, 9-12, 9-14
- RELATIV On Off softkey, 10-10, 10-12
- REL LEFT softkey, 9-20
- REL RIGHT softkey, 9-20
- removing
  - custom keypad, xiii
  - titles, 12-12
- REPLACE or . . . softkey, 10-24, 11-12, 12-11, 13-22, 13-27, 13-28, 13-32
- replacing the internal white-light lamp, 6-21
- RES BW AutoMan softkey, 2-6
- RES BW softkey, 5-29, 5-32
- resolution bandwidth
  - decreasing, 2-4
  - manual mode, 2-4
  - to span ratio, 2-6
- responses, multiple, 1-22
- RIGHT PEAK softkey, 9-9, 9-13
- RIGHT PIT softkey, 9-10
- ROM VERSION, 12-16
- ROM VERSION softkey, 12-17
- RUN/STOP softkey, 12-14

**S** sample detection, xiv

- S annotation, xiv
- SAVE LIMIT softkey, 10-16, 13-17
- SAVE MEMORY softkey, 13-19
- save softkey, 2-27, 8-34
- SAVE STATE softkey, 13-17
- save to . . . softkey, 8-34, 13-19
- SAVE TRACE A softkey, 8-34, 13-17
- SAVE USERKEY softkey, 13-17
- SAVE USER softkey, 11-15
- saving
  - and recalling traces, 8-34
  - instrument setups, xii, 2-27
  - limit lines, 10-14, 10-16
  - measurement states, 2-27
  - traces, 8-34

- User menus, 11-14
- screen
  - annotation, xiv
  - titles, 12-9
- security, 13-2, 13-24
  - erasing all memory, 13-24, 13-29
  - recovering from erasing all memory, 13-30
  - restricting operation, 13-24, 13-25
  - turning off annotation, 13-24, 13-25
- SELECT CHAR softkey, 11-12, 12-11, 13-32
- SELECT SEGMENT softkey, 10-11
- SENS**, 1-7
- SENS AutoMan softkey, 2-11
- sensitivity, 1-14
  - autoranging, 1-14
  - increasing, 1-15
  - increasing manually, 1-15
- SER command, 13-30
- SERVICE REQUEST softkey, 11-8
- service softkey, 12-17
- set clock softkey, 12-14
- setting the clock, 12-13
- show states softkey, 12-18
- side mode suppression ratio, 4-7
- signal not found, 14-17
- SIG TRK LIMIT softkey, 9-22, 9-23
- SIG TRK On Off softkey, 9-22
- SINGLE SWEEP softkey, 2-19, 4-4, 4-12, 4-20
- SLOPE limit-line segments, 10-9
- SLOPE softkey, 10-11
- SMSR On Off softkey, 4-10
- softkeys, vi
  - on-screen definitions, 4-9
- SPACE softkey, 12-11
- span
  - changing using markers, 9-19, 9-21
  - full, 1-10
  - SPAN**, 1-7, 1-8
  - SPAN AutoMan softkey, 1-17
  - SPAN softkey, 1-4, 4-4, 4-12, 4-20
- \*ST, 2-18
- standard temperature and pressure, 1-35, 1-38
- START**, 1-7
- START softkey, 1-4
- states, 13-12
- STATE softkey, 12-18
- step size, center wavelength, 1-7
- STEP softkey, 11-8
- stimulus-response analyzer, x

- stimulus-response instrument mode, 5-4, 6-6
- stimulus response instrument mode
  - block diagram, 5-6, 6-8
- stimulus-response measurements, 5-2, 5-4, 6-6
  - alternative trace definitions, 5-18
  - effects of resolution bandwidth, 5-4, 6-7
  - linear scale, 5-16, 6-17
  - with built-in light source, 6-5, 6-6
- stimulus response testing, 6-2
- STM/RESP softkey, 5-10, 5-32
- STOP**, 1-7
- STOP softkey, 1-4
- storage device error, 13-6, 13-9, 14-13
- STORE A softkey, 8-7
- STORE B softkey, 8-7, 8-8
- STORE C softkey, 8-7
- STORE THRU->B softkey, 5-8, 5-10, 5-36, 5-38, 6-9, 6-11
- STP BND On Off softkey, 4-9
- sweep
  - continuous, 2-18
  - controlling, 2-16
  - delaying, 2-24, 2-26
  - disabling, 2-19
  - pausing and stopping, 9-26
  - single, 2-18
  - speed versus trace length, 8-31
  - stopping, 2-20
  - triggering, 2-22
- SWEEP On Off softkey, 2-20
- sweep time
  - coupling, 2-16
  - manual control, 2-18
- Swept PDL Kit, 7-2
- SWPTIME AutoMan softkey, 2-13, 2-20
- SWPTIME softkey, 9-25
- sync out softkey, 3-9
- system parameters, 12-16

**T** TAKE SWEEP softkey, 5-30, 5-32

- temperature-drift compensation, 2-19
- test switch, 14-2
- three-dimensional displays, xi, 8-12
  - number of traces, 8-13
  - optimizing display of, 8-13
  - trace offsets, 8-13
  - viewing, 8-15
- THRESHD On Off softkey, 8-21
- time, 12-13

- format, 12-15
- setting, 12-13, 12-14
- titles, 12-9
  - removing, 12-12
- TITLE softkey, 12-9, 12-12
- TO CENTER**, 1-8
- TO REF LEVEL**, 1-8
- trace A B C softkey, 8-4, 8-7
- TRACE LENGTH softkey, 8-24, 8-32
- trace math, 8-24
  - amplitude scale and units, 8-24
  - length of traces, 8-24
  - subtraction, 5-8, 6-9
- TRACE PRESET softkey, 8-11
- traces, 8-2, 13-12
  - averaging, 2-10
  - blanking, 8-7
  - changing length, 8-32
  - comparing responses, 8-26
  - default length, 8-31
  - default settings, 8-11
  - displaying, 8-5
  - display line, 8-18
  - exchanging, 8-10
  - file prefix, 13-13
  - holding, 8-5
  - interpolation, 8-33
  - interpolation of measurement points, 8-31
  - length of, 8-24, 8-30
  - math, 8-23
  - measurement points, 8-30
  - saving and recalling, 8-34
  - simulate analog, 8-22
  - three-dimensional display, xi
  - three-dimensional trace offsets, 8-13
  - three-dimensional traces, 8-15
  - three-dimensional view, 8-12
  - threshold level, 8-20
  - video averaging, 8-16
  - viewing, 8-7
- traces softkey, 8-2
- Traces softkey, 8-7
- tracking limits, 9-23
- tracking signals, 9-22
- TRANS-Z IN connector, 5-39
- TRIGGER FREE softkey, 2-25
- triggering, 2-22
  - adding delay, 2-24, 2-26
  - external, 2-24, 2-26, 3-13

- freerun, 2-25
- line, 2-26
- video, 2-22, 2-25
- triggering the sweep, 2-22
- turning off markers, 9-8
- turning on light source, 6-4
- TYPE softkey, 10-11

**U**  $\Delta$   $\rightarrow$  SP softkey, 9-12, 9-19

- UNCAL, 2-2, 2-18, 2-20, 3-7, 14-9
- units
  - amperes/watt, 5-33
  - dBm, 1-21
  - watts, 1-21
- units menu softkey, 1-21
- UPPER/LOWER softkey, 10-11
- UPPER  $\rightarrow$  AMPCOR softkey, 10-21
- USER**, 11-2
  - factory-default softkeys, 11-5
- USERCAL, 1-40, 14-10
- user calibrations
  - instrument modes, 5-2
- USERCAL PRESET softkey, 1-41
- USER keys
  - installing, 14-8
  - missing, 4-2, 14-8
- USERLOCK OFF softkey, 13-25
- User menus, 11-2, 13-12
  - adding downloadable program names, 11-9
  - copying softkeys, 11-9
  - creating, 11-4
  - deleting, 11-11
  - file prefix, 13-13
  - limiting operation to, 11-5
  - presetting, 11-11
  - recalling, 11-14
  - removing softkeys, 11-10
  - restricting use to, 13-25
  - saving, 11-14
- US/EURO softkey, 12-15

- V**
  - VERSION softkey, 4-2
  - VERT OFFSET softkey, 8-15
  - VID AVG On Off softkey, 2-11, 2-13, 8-17
  - VID BW AutoMan softkey, 2-9, 2-11
  - video averaging, 2-10, 8-16
    - default number of trace averages, 8-17
  - video bandwidth
    - external adc triggering, 3-14
    - filtering, 2-9
    - manual mode, 2-9
    - pulsed mode, 3-8
  - VIDEO LEVEL softkey, 2-25
  - VIDEO softkey, 2-25
  - video triggering, 2-22, 2-25
    - hysteresis range, 2-23
    - level range, 2-23
  - VID LIN On Off softkey, 2-22, 2-25
  - VIEW A BLANK A softkey, 8-7
  - viewing a trace, 8-7
  - viewing three-dimensional traces, 8-15
  - volume full, 14-15
  
- W**
  - WATT softkey, 1-21
  - waveform math, 8-23
  - WAVELEN FOR CAL softkey, 1-35, 1-40
  - wavelength
    - calibrating, 1-35
    - extended range, 1-4, 1-10
    - full span, 1-10
    - menu, 1-6
    - offset, 1-12
    - offsets, 1-7
    - range, 1-4
    - resolution, 2-4, 2-6
    - setting, 1-4
  - wavelength range
    - optical spectrum analyzer, 1-4
    - Option 002, 6-2
  - wavelength response, compensating for, 10-18
  - WAVELEN OFFSET softkey, 1-12
  - WAVELEN softkey, 9-25
  - WAVELEN VALUE softkey, 10-11
  - WaveIn softkey, 1-6
  - white light source, 6-2
  - WHITE On Off softkey, 6-4, 7-9, 7-17
  - WL CAL On Off softkey, 1-40
  - W LIGHT ALIGN softkey, 1-30
  - WL LIM On Off softkey, 1-10

WL STEP AutoMan softkey, 1-12  
write-protect switch memory card, 13-9  
WVLEN VALUE softkey, 10-29

**X** X softkey, 4-26

**Z** ZERO softkey, 2-19, 5-25  
ZOOM TO RES BW softkey, 9-18, 9-21