

**Agilent
N1911A/1912A
P-Series Power
Meters**

User's Guide



Agilent Technologies

Notices

© Agilent Technologies, Inc. 2006–2013

No part of this manual may be reproduced in any form or by any means (including electronic storage and retrieval or translation into a foreign language) without prior agreement and written consent from Agilent Technologies, Inc. as governed by United States and international copyright laws.

Manual Part Number

N1912-90002

Edition

Eleventh Edition, December 10, 2013

Printed in Malaysia

Agilent Technologies, Inc.
3501 Stevens Creek Blvd.
Santa Clara, CA 95052 USA

Warranty

The material contained in this document is provided “as is,” and is subject to being changed, without notice, in future editions. Further, to the maximum extent permitted by applicable law, Agilent disclaims all warranties, either express or implied, with regard to this manual and any information contained herein, including but not limited to the implied warranties of merchantability and fitness for a particular purpose. Agilent shall not be liable for errors or for incidental or consequential damages in connection with the furnishing, use, or performance of this document or of any information contained herein. Should Agilent and the user have a separate written agreement with warranty terms covering the material in this document that conflict with these terms, the warranty terms in the separate agreement shall control.

Technology Licenses

The hardware and/or software described in this document are furnished under a license and may be used or copied only in accordance with the terms of such license.

Restricted Rights Legend

U.S. Government Restricted Rights. Software and technical data rights granted to the federal government include only those rights customarily provided to end user customers. Agilent provides this customary commercial license in Software and technical data pursuant to FAR 12.211 (Technical Data) and 12.212 (Computer Software) and, for the Department of Defense, DFARS 252.227-7015 (Technical Data - Commercial Items) and DFARS 227.7202-3 (Rights in Commercial Computer Software or Computer Software Documentation).

Safety Notices

CAUTION

A **CAUTION** notice denotes a hazard. It calls attention to an operating procedure, practice, or the like that, if not correctly performed or adhered to, could result in damage to the product or loss of important data. Do not proceed beyond a **CAUTION** notice until the indicated conditions are fully understood and met.

WARNING

A **WARNING** notice denotes a hazard. It calls attention to an operating procedure, practice, or the like that, if not correctly performed or adhered to, could result in personal injury or death. Do not proceed beyond a **WARNING** notice until the indicated conditions are fully understood and met.

Certification

Agilent Technologies certifies that this product met its published specifications at the time of shipment. Agilent further certifies that its calibration measurements are traceable to the United States National Institute of Standard and Technology (formerly National Bureau of Standards), to the extent allowed by that organization's calibration facility, and to the calibration facilities of other International Standards Organization members.

General Warranty

The material contained in this document is provided "as is," and is subject to being changed, without notice, in future editions. Further, to the maximum extent permitted by applicable law, Agilent disclaims all warranties, either express or implied with regard to this manual and any information contained herein, including but not limited to the implied warranties of merchantability and fitness for a particular purpose. Agilent shall not be liable for errors or for incidental or consequential damages in connection with the furnishing, use, or performance of this document or any information contained herein. Should Agilent and the user have a separate written agreement with warranty terms covering the material in this document that conflict with these terms, the warranty terms in the separate agreement shall control. Duration and conditions of warranty for this product may be superseded when the product is integrated into (becomes a part of) other Agilent products. During the warranty period, Agilent will, at its option, either repair or replace products which prove to be defective. The warranty period begins on the date of delivery or on the date of installation if installed by Agilent.

Warranty Service

For warranty service or repair, this product must be returned to a service facility designated by Agilent. For products returned to Agilent for warranty service, the Buyer shall prepay shipping charges to Agilent and Agilent shall pay shipping charges to return the product to the Buyer. However, the Buyer shall pay all shipping charges, duties, and taxes for products returned to Agilent from another country.

Limitation of Warranty

The foregoing warranty shall not apply to defects resulting from improper or inadequate maintenance by the Buyer, Buyer-supplied products or interfacing, unauthorized modification or misuse, operation outside of the environmental specifications for the product, or improper site preparation or maintenance.

The design and implementation of any circuit on this product is the sole responsibility of the Buyer. Agilent does not warrant the Buyer's circuitry or malfunctions of Agilent products that result from the Buyer's circuitry. In addition, Agilent does not warrant any damage that occurs as a result of the Buyer's circuit or any defects that result from Buyer-supplied products.

To the extent allowed by local law, Agilent makes no other warranty, expressed or implied, whether written or oral with respect to this product and specifically disclaims any implied warranty or condition of merchantability, fitness for a particular purpose or satisfactory quality.

Exclusive Remedies

To the extent allowed by local law, the remedies provided herein are the Buyer's sole and exclusive remedies. Agilent shall not be liable for any direct, indirect, special, incidental, or consequential damages (including lost profit or data), whether based on warranty, contract, tort, or any other legal theory.

Restricted Rights Legend

The Software and Documentation have been developed entirely at private expense. They are delivered and licensed as “commercial computer software” as defined in DFARS 252.227-7013 (Oct 1988), DFARS 252.211-7015 (May 1991), or DFARS 252.227-7014 (Jun 1995), as a “commercial item” as defined in FAR 2.101(a), or as “restricted computer software” as defined in FAR 52.227-19 (Jun 1987) (or any equivalent agency regulation or contract clause), whichever is applicable. You have only those rights provided for such Software and Documentation by the applicable FAR or DFARS clause or the Agilent standard software agreement for the product involved.

Technology Licenses

The hardware and/or software described in this document are furnished under a license and may be used or copied only in accordance with the terms of such license.

Safety Summary

The following general safety precautions must be observed during all phases of operation of this instrument. Failure to comply with these precautions or with specific warnings elsewhere in this manual violates safety standards of design, manufacture, and intended use of the instrument. Agilent Technologies, Inc. assumes no liability for the customer's failure to comply with these requirements.

Safety Notices

WARNING

A **WARNING** notice denotes a hazard. It calls attention to an operating procedure, practice, or the like that, if not correctly performed or adhered to, could result in personal injury or loss of life. Do not proceed beyond a **WARNING** notice until the indicated conditions are fully understood and met.

CAUTION

A **CAUTION** notice denotes a hazard. It calls attention to an operating procedure, practice, or the like that, if not correctly performed or adhered to, could result in damage to the product or loss of important data. Do not proceed beyond a **CAUTION** notice until the indicated conditions are fully understood and met.

Recommended Calibration Interval

Agilent Technologies recommends a two- years calibration cycle for the N1911A and N1912A P-Series power meter.

Safety Symbols

The following symbol on the instrument and in the documentation indicates precautions that must be taken to maintain safe operation of the instrument.



Caution, risk of danger.

The Instruction Documentation Symbol. The product is marked with this symbol when it is necessary for the user to refer to the instructions in the supplied documentation.



Alternating current (AC).



This symbol indicates the operating switch for 'Stand-by' mode. Note, the instrument is NOT isolated from the mains when the switch is pressed.

To isolate the instrument, the mains coupler (mains input cord) should be removed from the power supply.



Direct current (DC).



Both direct and alternating current.



Three-phase alternating current.

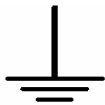

Earth (ground) TERMINAL.



PROTECTIVE CONDUCTOR TERMINAL.

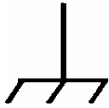

Frame or chassis TERMINAL.



Equipotentiality.



On (Supply).

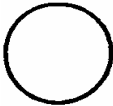

Off (Supply).

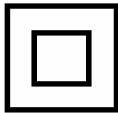

Equipment protected throughout by DOUBLE INSULATION or REINFORCED INSULATION.



Caution, risk of electric shock.



Caution, hot surface.



In position of bi-stable push control.

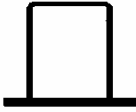

Out position of bi-stable push control.

General Safety Information

This is a Safety Class I instrument (provided with a protective earthing ground, incorporated in the power cord). The mains plug shall only be inserted in a socket outlet provided with a protective earth contact. Any interruption of the protective conductor inside or outside of the instrument is likely to make the instrument dangerous. Intentional interruption is prohibited.

WARNING

- **DO NOT operate the product in an explosive atmosphere or in the presence of flammable gasses or fumes.**
- **DO NOT use repaired fuses or short-circuited fuseholders: For continued protection against fire, replace the line fuse(s) only with fuse(s) of the same voltage and current rating and type.**
- **DO NOT perform procedures involving cover or shield removal unless you are qualified to do so: Operating personnel must not remove equipment covers or shields. Procedures involving the removal of covers and shields are for use by service-trained personnel only.**
- **DO NOT service or adjust alone: Under certain conditions, dangerous voltages may exist even with the equipment switched off. To avoid dangerous electrical shock, service personnel must not attempt internal service or adjustment unless another person, capable of rendering first aid and resuscitation, is present.**
- **DO NOT operate damaged equipment: Whenever it is possible that the safety protection features built into this product have been impaired, either through physical damage, excessive moisture, or any other reason, REMOVE POWER and do not use the product until safe operation can be verified by service-trained personnel. If necessary, return the product to a Agilent Technologies Sales and Service Office for service and repair to ensure the safety features are maintained.**
- **DO NOT substitute parts or modify equipment: Because of the danger of introducing additional hazards, do not install substitute parts or perform any unauthorized modification to the product. Return the product to a Agilent Technologies Sales and Service Office for service and repair to ensure the safety features are maintained.**

Environmental Conditions

This instrument is designed for indoor use. The table below shows the general environmental requirements for this instrument.

Environmental condition	Requirement
Temperature	Operating condition • 0 °C to 55 °C Storage condition • -40 °C to 70 °C
Humidity	Operating condition • Up to 95% RH at 40 °C (non-condensing) Storage condition • Up to 90% RH at 65 °C (non-condensing)
Altitude	Up to 3000 m
Pollution degree	2

Regulatory Information

The N1911/1912A P-Series power meters comply with the following safety and Electromagnetic Compatibility (EMC) compliances:





Safety compliance

- IEC 61010-1:2010/EN 61010-1:2010 (3rd Edition)
- Canada: CAN/CSA-C22.2 No. 61010-1-12
- USA: ANSI/UL 61010-1 (3rd Edition)

EMC compliance

- IEC 61326-1:2005/EN 61326-1:2006
- CISPR11:2003/EN 55011:2007, Group 1 Class A
- Canada: ICES/NMB-001:Issue 4, June 2006
- Australia/New Zealand: AS/NZS CISPR 11:2004

Regulatory Markings

	<p>The CE mark is a registered trademark of the European Community. This CE mark shows that the product complies with all the relevant European Legal Directives.</p>		<p>The C-tick mark is a registered trademark of the Spectrum Management Agency of Australia. This signifies compliance with the Australia EMC Framework regulations under the terms of the Radio Communication Act of 1992.</p>
<p>ICES/NMB-001</p>	<p>ICES/NMB-001 indicates that this ISM device complies with the Canadian ICES-001. Cet appareil ISM est conforme a la norme NMB-001 du Canada.</p>		<p>This instrument complies with the WEEE Directive (2002/96/EC) marking requirement. This affixed product label indicates that you must not discard this electrical or electronic product in domestic household waste.</p>
	<p>The CSA mark is a registered trademark of the Canadian Standards Association.</p>		<p>This symbol indicates the time period during which no hazardous or toxic substance elements are expected to leak or deteriorate during normal use. Forty years is the expected useful life of the product.</p>

Declaration of Conformity (DoC)

The Declaration of Conformity (DoC) for this instrument is available on the Agilent Web site. You can search the DoC by its product model or description at the Web address below.

<http://regulations.corporate.agilent.com/DoC/search.htm>

NOTE

If you are unable to search for the respective DoC, please contact your local Agilent representative.

In This Guide ...

- 1 Introduction** Chapter 1 introduces you to the front panel display and instrument Web browser of the P-Series power meter.
- 2 General Power Meter Functions** Chapter 2 describes the general operation of the P-Series power meter.
- 3 Using P-Series Power Sensor** Chapter 3 describes how to use your P-Series power sensor with your P-Series power meter.
- 4 Using E9320 E-Series Power Sensors** Chapter 4 describes how to use your E9320 E-Series power sensor with your P-Series power meter.
- 5 Using E9300 E-Series Power Sensors** Chapter 5 describes how to use your E9300 E-Series power sensor with your P-Series power meter.
- 6 Using E4410 E-Series Power Sensors** Chapter 6 describes how to use your E4410 E-Series power sensor with your P-Series power meter.
- 7 Using 8480 Series Power Sensors** Chapter 7 describes how to use your 8480 Series power sensor with your P-Series power meter.
- 8 Using N8480 Series Power Sensors** Chapter 8 describes how to use your N8480 Series power sensor with your P-Series power meter.
- 9 Complementary Cumulative Distribution Function (CCDF)** Chapter 9 describes the CCDF feature of the P-Series power meter.
- 10 Maintenance** Chapter 10 describes the built in tests, error messages and general maintenance.
- 11 Specifications and Characteristics** Chapter 11 describes the specifications and characteristics of your P-Series power meter.

Contents

Notices	ii
Certification	iii
General Warranty	iii
Warranty Service	iii
Limitation of Warranty	iv
Exclusive Remedies	iv
Restricted Rights Legend	v
Technology Licenses	v
Safety Summary	vi
Safety Notices	vi
Recommended Calibration Interval	vi
Safety Symbols	vii
General Safety Information	x
Environmental Conditions	xi
Regulatory Information	xi
Regulatory Markings	xii
Declaration of Conformity (DoC)	xiii
In This Guide ...	xiv

1 Introduction

LXI Class-C Compliant Power Meter	2
Rack Mounting	2
Power Meter and Sensor Capability	3
Conventions Used in this Guide	4
Front Panel Keys and Connections	5
The Display Layout	10
Window Symbols and Pop-ups	18
Using the Instrument Web Browser	22

2 General Power Meter Functions

Setting the Units of Measurement	30
Setting the Measurement Frequency	32
Setting the Resolution	33

Making Relative Measurements	34
Setting the Pulse Reference Levels	36
Setting Offsets	39
Setting Measurement Averaging	49
Step Detection	51
Setting the Video Averaging	52
Setting the Video Bandwidth	54
Setting Measurement Channel Gates	57
Setting up the Channel Trace	62
Setting the Trigger	66
Setting External Trigger for Normal and Average Power Measurement	72
Setting Measurement Limits	86
Setting the Measurement Display	90
Scaling the Analog Display	97
Recorder Output	99
Saving and Recalling Power Meter States	104
Zeroing and Calibrating the P-Series Sensor	107
Presetting the Power Meter	111

3 Using P-Series Power Sensor

Introduction	116
Configuring a Power Measurement	117
Setting the Trace Display	118

4 Using E9320 E-Series Power Sensors

Introduction	132
Power Meter Configuration	134
Configuring a Peak Power Measurement	135
Measurement Accuracy	136
Setting the Trace Display	138

5 Using E9300 E-Series Power Sensors

Introduction	152
Power Meter Configuration	153
Measurement Accuracy	155

Measuring Spread Spectrum and Multitone Signals	157
Measuring TDMA Signals	160
Electromagnetic Compatibility (EMC) Measurements	162
Measurement Accuracy and Speed	163

6 Using E4410 E-Series Power Sensors

Introduction	168
Power Meter Configuration	169
Measurement Accuracy	171

7 Using 8480 Series Power Sensors

Introduction	174
Power Meter Configuration	175
Measurement Accuracy	179
Frequency Specific Calibration Factors	180
Sensor Calibration Tables	184

8 Using N8480 Series Power Sensors

Introduction	196
Power Meter Configuration Changes	198
Default Channel Setup	199
N8480 Series Sensors Connection Requirements	200
N8480 Series Power Sensors (excluding Option CFT)	201
N8480 Series Power Sensors with Option CFT	203

9 Complementary Cumulative Distribution Function (CCDF)

Introduction	218
Setting the CCDF Table	219
Setting the CCDF Trace	222

10 Maintenance

Self Test	228
Error Messages	232
Operator Maintenance	243

Contacting Agilent Technologies	245
Erasing Memory Data	248
Returning Your Power Meter for Service	249
Agilent Sales and Service Offices	251

11 Specifications and Characteristics

Introduction	254
Power Meter Specifications	256
Measurement Characteristics	259
Rear Panel Inputs and Output Connections	262
1 mW Power Reference	263
Environmental Conditions	264
Physical Characteristics	265
Regulatory Information	266
System Specifications and Characteristics	267

List of Figures

Figure 1-1	Dual numeric display	10
Figure 1-2	Single numeric and analog display	12
Figure 1-3	Full screen numeric display	13
Figure 1-4	Trace display in both windows	14
Figure 1-5	Trace display in single enlarged window in markers mode	15
Figure 1-6	Trace display in single enlarged window in trigger delay mode	16
Figure 1-7	Trace display in single enlarged window in trace control mode	17
Figure 1-8	Opening the instrument Web interface.	22
Figure 1-9	N1912A P-Series power meter Web browser (Welcome Page)	23
Figure 1-10	Status message before Toggle ID is selected.	24
Figure 1-11	Status message when Toggle ID is selected.	24
Figure 1-12	Example of Lan Status message.	25
Figure 1-13	Viewing LAN configuration settings from the Web interface.	26
Figure 1-14	Password security dialog box.	27
Figure 1-15	Changing the instrument LAN interface configuration	28
Figure 2-16	Frequency pop-up	32
Figure 2-17	Typical relative measurement display	34
Figure 2-18	Numeric display	35
Figure 2-19	Measurement configuration screen	36
Figure 2-20	Pulse duration measurement between two reference levels	37
Figure 2-21	Trace Ref Lvl 1 pop-up	37
Figure 2-22	Trace Ref Lvl 2 pop-up	38
Figure 2-23	Pulse Duration Ref Lvl pop-up	38
Figure 2-24	Simplified measurement path	39
Figure 2-25	Typical channel offset display	40
Figure 2-26	Channel offset indicator	41
Figure 2-27	Typical display offset display	42
Figure 2-28	Frequency dependent offset tables display	44
Figure 2-29	Frequency dependent offset indicator	45
Figure 2-30	“Edit Offset” display with data added	46
Figure 2-31	Edit table title pop-up	47
Figure 2-32	Typical averaged readings	49
Figure 2-33	Meas Avg Count pop-up	50

Figure 2-34	Video Avg Count pop-up	53
Figure 2-35	Bandwidth filter shapes	55
Figure 2-36	Video bandwidth pop-up	56
Figure 2-37	Example of measurement gates	57
Figure 2-38	Gate Setup screen	58
Figure 2-39	Time Gating Start pop-up	59
Figure 2-40	Time Gating Length pop-up	59
Figure 2-41	Auto Gate Settings display	60
Figure 2-42	Marker 1 Ref Percentage pop-up	60
Figure 2-43	Marker 2 Ref Percentage pop-up	61
Figure 2-44	The placement of gates (markers) in Auto Gating mode	61
Figure 2-45	Trace setup display	62
Figure 2-46	Trace Start Time pop-up	63
Figure 2-47	X Scale/Division pop-up	63
Figure 2-48	Trace Units pop-up	64
Figure 2-49	Y scale maximum value pop-up	64
Figure 2-50	Y Scale/Division pop-up	65
Figure 2-51	Trigger menu - free run mode	66
Figure 2-52	Trigger Setting Menu 1 of 2	67
Figure 2-53	Trigger Level pop-up	68
Figure 2-54	Trigger Delay pop-up	69
Figure 2-55	Trigger setting menu 2 of 2	69
Figure 2-56	Trigger Holdoff pop-up	70
Figure 2-57	Trigger Hysteresis pop-up	71
Figure 2-58	TRIG IN and TRIG OUT connection diagram between power meter and power source.	74
Figure 2-59	Channel Setup display	74
Figure 2-60	Sensor Mode pop-up.	75
Figure 2-61	Trigger setting menu 1 of 2	76
Figure 2-62	Trigger setting menu 2 of 2	76
Figure 2-63	Limits checking applications	86
Figure 2-64	Limits checking results	86
Figure 2-65	Minimum limit pop-up	88
Figure 2-66	Limit failures	89
Figure 2-67	Sixteen measurements per channel	90

Figure 2-68	Measurement feed example	91
Figure 2-69	Measurement Setup showing single configuration	92
Figure 2-70	Function pop-up	93
Figure 2-71	Measurement type pop-up	93
Figure 2-72	Gating Number pop-up	94
Figure 2-73	Measurement Setup showing combined configuration	95
Figure 2-74	Measurement example display	96
Figure 2-75	Maximum limit pop-up	97
Figure 2-76	Minimum limit pop-up	97
Figure 2-77	Increment and decrement multiplier	98
Figure 2-78	Recorder Minimum pop-up	100
Figure 2-79	Recorder Maximum pop-up	100
Figure 2-80	Increment and decrement multiplier	102
Figure 2-83	Save/Recall screen	104
Figure 2-84	Save confirm pop-up	105
Figure 2-85	File name pop-up	105
Figure 2-86	Recall pop-up	106
Figure 2-87	Zeroing pop-up	107
Figure 2-88	Calibration wait pop-up	108
Figure 2-89	Please zero and calibrate window	110
Figure 2-90	Preset display options	111
Figure 3-92	P-Series sensor default channel setup	119
Figure 3-93	Trace display in dual channel power meter	120
Figure 3-94	Trace display in single enlarged window	121
Figure 3-95	Trace display with gate control menu	122
Figure 3-96	Trace display with trigger delay menu	123
Figure 3-97	Trace display with trace control menu	125
Figure 3-98	Trace display in full screen	126
Figure 3-99	P-Series power sensor default channel setup	127
Figure 3-100	Channel offset display	128
Figure 4-101	Bandwidth Filter Shapes	133
Figure 4-102	E-Series E9320 power sensor default channel setup	134
Figure 4-104	E-Series E9320 power sensor channel setup when trigger is selected	140
Figure 4-105	Trace display in dual channel power meter	140
Figure 4-106	Trace display in single enlarged window	141

[Figure 4-107](#) Trace display with gate control menu 142
[Figure 4-108](#) Trace display with trigger delay menu 143
[Figure 4-109](#) Trace display with trace control menu 145
[Figure 4-110](#) Trace display in full screen 146
[Figure 4-111](#) E-Series E9320 power sensor default channel setup 147
[Figure 4-112](#) Channel offset display 148
[Figure 5-113](#) E9300 E-Series auto-averaging settings 153
[Figure 5-114](#) E9300 E-Series sensor default channel setup 154
[Figure 5-115](#) Frequency pop-up 156
[Figure 5-116](#) Spread spectrum signal 157
[Figure 5-117](#) Wideband CDMA error of E-Series E9300 power sensor versus corrected CW sensor. 158
[Figure 5-118](#) CDMA (IS-95A): 9Ch Fwd 158
[Figure 5-119](#) Calibration factors versus frequency 159
[Figure 6-120](#) E-Series CW sensor auto-averaging settings 169
[Figure 6-121](#) E-Series E4410 sensor default channel setup 170
[Figure 6-122](#) Frequency pop-up 172
[Figure 7-123](#) 8480 Series auto-averaging settings 175
[Figure 7-124](#) 8480 Series sensor default channel setup 176
[Figure 7-125](#) Reference Calibration Factor pop-up window 181
[Figure 7-126](#) Calibration factor pop-up window 182
[Figure 7-127](#) Calibration factor display 182
[Figure 7-128](#) Sensor table selected 185
[Figure 7-129](#) Frequency dependent offset indicator 185
[Figure 7-130](#) Frequency/calibration table display 186
[Figure 7-131](#) “Sensor Tbls” screen 188
[Figure 7-132](#) “Edit Cal” display 189
[Figure 7-133](#) Edit table title pop-up 189
[Figure 8-134](#) Auto-averaging settings 198
[Figure 8-135](#) N8480 Series sensor (excluding Option CFT) default channel setup 199
[Figure 8-137](#) Frequency pop-up 202
[Figure 8-138](#) Reference calibration factor pop-up window 204
[Figure 8-139](#) Calibration factor pop-up window 205
[Figure 8-140](#) Calibration factor displayed 206
[Figure 8-141](#) Sensor table selected 209

[Figure 8-142](#) Frequency dependent offset indicator 210
[Figure 8-143](#) Frequency/calibration table display 211
[Figure 8-144](#) “Sensor Tbls” screen 213
[Figure 8-145](#) “Edit Cal” display 214
[Figure 8-146](#) Edit table title pop-up 214
[Figure 9-147](#) CCDF table in windowed display 219
[Figure 9-148](#) CCDF table in expanded display 220
[Figure 9-149](#) CCDF table in full-screen display 221
[Figure 9-150](#) Trace Display Select control menu 222
[Figure 9-151](#) CCDF trace display with Marker Trace menu 223
[Figure 9-152](#) Scale/Div pop-up 225
[Figure 9-153](#) Selection of CCDF trace to be stored as a reference trace 226
[Figure 10-154](#) Self test complete 229
[Figure 10-155](#) Error indicator position 232
[Figure 10-156](#) Replacing the fuse 244
[Figure 10-157](#) Secure erase status pop-up 248
[Figure 11-158](#) Measured rise time percentage error versus signal under test rise time 261
[Figure 11-159](#) P-Series sensor error in peak-to-average measurements for a two-tone input 268

THIS PAGE HAS BEEN INTENTIONALLY LEFT BLANK.

List of Tables

Table 1-1	Type of Lan Status message.	25
Table 2-2	Measurement units - Single channel meters	30
Table 2-3	Measurement units - Dual channel meters	30
Table 2-4	P-Series Sensor Video Bandwidth Setting	54
Table 2-5	Power and frequency sweep mode compatibility table	72
Table 2-6	Power and frequency sweep measurement functions table	73
Table 2-7	Range of values for window limits	87
Table 2-8	Ranges of recorder output setting	101
Table 2-9	Preset compatibility matrix for E-Series E9320 power sensor	112
Table 4-10	Sensor Bandwidth	132
Table 5-11	Power sensor connection requirements	155
Table 7-12	8480 Series connection requirements	177
Table 7-13	Installed power sensor models	187
Table 8-14	Power range in the Range setting	196
Table 8-15	N8480 Series connection requirements	200
Table 8-16	Installed power sensor models	212

THIS PAGE HAS BEEN INTENTIONALLY LEFT BLANK.



1 Introduction

LXI Class-C Compliant Power Meter	2
Rack Mounting	2
Power Meter and Sensor Capability	3
Conventions Used in this Guide	4
Front Panel Keys and Connections	5
The Display Layout	10
Window Symbols and Pop-ups	18
Using the Instrument Web Browser	22

This chapter introduces you to the front panel display and instrument Web browser of the P-Series power meter.



LXI Class-C Compliant Power Meter



P-Series power meter is a **LXI Class C** compliant instrument, developed using LXI Technology. LXI, an acronym for LAN eXtension for Instrumentation, is an instrument standard for devices that use the Ethernet (LAN) as their primary communication interface.

Hence, it is an easy-to-use instrument especially with the usage of an integrated Web browser that provides a convenient way to configure the instrument's functionality.

Rack Mounting

The N1911A/1912A can be mounted in a standard 19-inch rack. Rack mount kits are available as listed below. Support rails are also required for rack mounting. These are normally supplied with the rack and are not included with the rack mount options.

If you are installing an instrument on top of the N1911A/1912A, ensure that the instrument does not obstruct the ventilation holes at the top of the N1911A/1912A. If required, use a filler panel above the N1911A/1912A to ensure adequate space for air circulation.

Option	Description
N1911A Option 908	Rack mount kit for one instrument
N1911A Option 909	Rack mount kit for two instruments
N1912A Option 908	Rack mount kit for one instrument
N1912A Option 909	Rack mount kit for two instruments

Power Meter and Sensor Capability

Your P-Series power meter is compatible with Agilent P-Series, E-Series E9320, E-Series E9300, E-Series E4410, 8480 Series and the N8480 Series power sensors. However, not all sensor and meter combinations have the same features or capabilities. The main differences are as below:

Features	P-Series N1920	E-Series E9320	E-Series E9300	E-Series E4410	8480 Series	N8480 Series
Average power of CW signal	•	•	•	•	•	•
Average power of modulated signal	•	•	•		•	•
Peak power	•	•				
Cal factors stored on EEPROM	•	•	•	•		• ¹
≥200 readings/sec	•	•	•	•		
Peak/burst average power	•	•				
Time gated measurements	•	•				
Rising edge trigger	•	•				
Falling edge trigger	•	•				

¹ Not applicable for N8480 Series power sensors with Option CFT

NOTE

- The E-Series, 8480 Series and N8480 Series power sensors require N1917A/B/C cables when connected to the P-Series power meters.
- The N8480 Series power sensors used in this user's guide is referring to all sensors from the N8480 Series unless otherwise stated.

Specifications

The specifications for the power meter are listed in [Chapter 11](#), "Specifications and Characteristics," starting on page 253.

Conventions Used in this Guide

The following conventions are used throughout this guide.





	This symbol and text represents a labeled key on the power meter front panel.
Softkey	This symbol and text represents a labeled softkey and is used to indicate you should press the unmarked key beside the displayed text.
Message	This text represents a displayed message.
Parameter	This is used to represent a parameter, value, or title.
“Channel”	<p>This User’s Guide describes the operation for both the single channel and the dual channel power meter. To identify channels on a dual channel meter a Channel softkey on an N1911A meter becomes Channel A and Channel B on N1912A.</p> <p>When you are asked to press “the channel” Softkey in a procedure, make sure you select the relevant channel.</p>

Front Panel Keys and Connections

This section briefly describes the functions of the front panel keys and connectors.



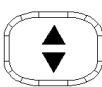





These keys are located to the left of the display.

Key	Function
	Press this key to preset the power meter. An option list of pre-installed measurement configurations is presented. Select an option and press the confirm key.
	Press this key to control the power meter from the front panel when it is operating via the remote interfaces (when Local Lock Out is not enabled).
	Press this key to select the upper or lower measurement window. The selected window is highlighted by a blue line on the right side of the window. Any measurement setup you create is performed in the selected window.
	Press this key to choose windowed, expanded, or full-screen display of a numeric measurement. It also provides quick access to the Gate Control screen and menu when a trace window is selected.
	Press this key to switch the meter between on and standby. When power is supplied, the background LED is red. Pressing the key, switches the power meter on and the background LED is green.



These keys are located along the lower edge of the display.

Key	Function
	Press this key to access general configuration-menus, such as GPIB address. You can also access the Self-Test and Table entry menus. The measurement screen remains visible.
	Press this key to access the channel configuration menus. Channel parameters such as averaging and offsets are configured from this menu.
	Press this key to access the triggering menu. Unless a P-Series or an E-Series E9320A Sensor is connected, all the menu keys are disabled (grayed out).
	Press this key to setup relative measurements or set display offsets.
	Press this key to access the measurement display menu. You can choose the displayed measurement resolution, units and display format.
	Use this key together with  to configure measurement displays.





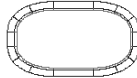
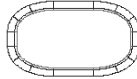
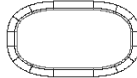
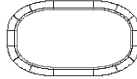
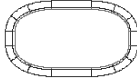

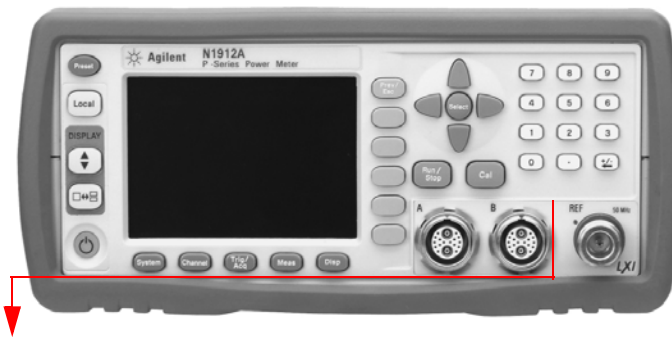

These keys are all associated with the menu labels and data entry. They are located to the right of the display.

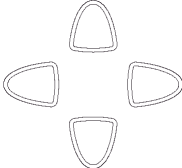
Key	Function
	Press this key to return to the previous screen. This key also cancels pop-up entry.
	These unmarked keys are called 'softkeys' and are referred to by the text on the display next to them. For example, during a Preset, you are given an option to confirm the command. Press to continue, that is, press the softkey beside the displayed word 'confirm'.
	
	
	
	The lowest of the unmarked softkeys is used when there is a two page menu to be displayed. For example, a 1 of 2 is displayed beside the key indicating the first page of a two page menu. Press the key to access the next page or second page. (A 2 of 2 is displayed).



These keys and connectors are associated with the measurement channels and are located on the right-hand side of the front panel.

Key	Function
	The arrow keys are used for navigation around the parameter entry screens. The up and down arrows are used for selecting values from a pop-up list, they can also be used for stepping two values, X Scale and Y Scale. They are also used to enter text, for example, table names.
	Press this key to select a highlighted field to allow data entry, check a checkbox and terminate entry of a pop up list.
	Press this key to access the zero and calibration menus.
	Press this key to start and stop the acquisition of the measurement.
	Press these keys to enter numeric values in the pop-up fields, for example, the offset values. To complete the entry use the softkey.

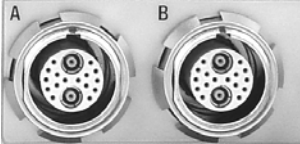
Connector	Function
	<p>The power reference is a 1 mW (0 dBm) 50 MHz signal available from a 50 Ω type-N connector. It is used for calibrating an 8480, E-Series or N8480 Series power sensor and meter system. If the meter is configured with Option 003, the connector is fitted to the rear panel. The Green LED beside the connector is lit when the calibrator is turned on.</p>
	<p>The sensor input connectors (N1912A shown, the N1911A has one input). If the meter is configured with Option 003, the connectors are fitted to the rear panel.</p>

The Display Layout

Figure 1-1 shows the display layout when two windows are configured in dual numeric mode.

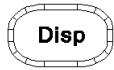
Pressing , **Disp Type** the other display formats are available.

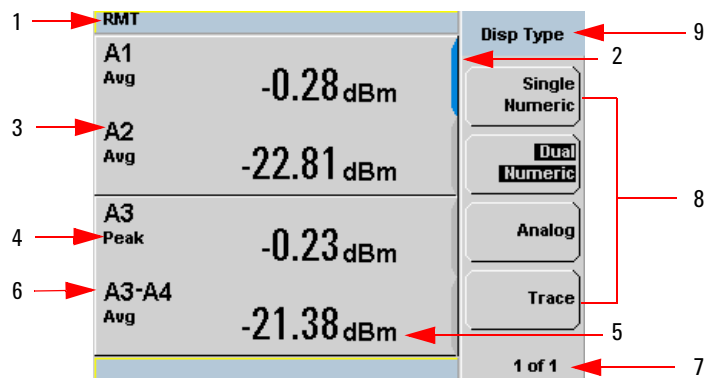



Figure 1-1 Dual numeric display

- 1 The status reporting line displays messages and the control status of the power meter. For example, the status can be either **RMT** (remote, GPIB, USB or LAN operation) or **LCL** (local, front panel operation).
The message fields indicate **ERR** for any error conditions that occur or informing you to **Please Zero** the power sensor.
- 2 The blue highlight on the right hand side of the window shows it is the currently selected measurement display line. This measurement line is the Upper Window/Upper Measurement.
- 3 The measured channel is shown. With a P-Series or an E-Series E9320 power sensor connected, and channel in trigger mode, the associated gate number is shown.
- 4 The associated measurement type is shown below the channel and gate number.

- 5 This displays the measurement units, either dBm, dB, Watts, or percent (%).

NOTE

With a P-Series or an E-Series E9320 power sensor connected, a measurement result of -270 dBm indicates the input power level is beyond the sensitivity of the sensor.

- 6 With a P-Series or an E-Series E9320 power sensor connected, you can make combined measurements with a single channel meter. A dual channel meter extends this feature across both channels.
- 7 This displays the number of pages in the current menu. For example, **1 of 2** indicates that there are two pages in the menu and the first page is currently displayed. Pressing the softkey displays the next page, indicated by **2 of 2**. (Press the softkey to display the previous menu page.)
- 8 The available softkey labels are displayed in these four fields. Additionally, settings associated with the labeled function are displayed under the label.
- 9 This field displays the menu title. For example, **Channel Setup** or press  and the **Zero/Cal** menu is displayed.

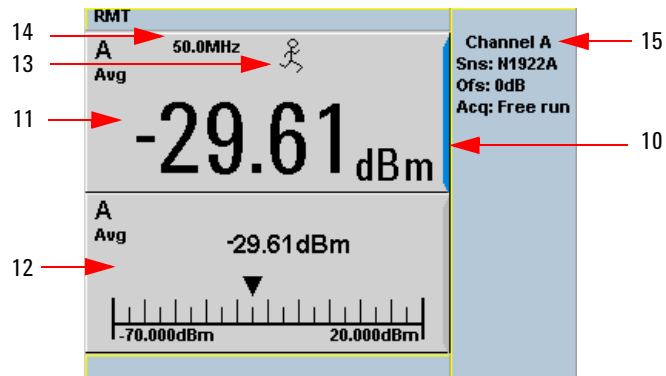





Figure 1-2 Single numeric and analog display





10 Figure 1-2 shows the default display mode of two measurement windows. The upper measurement window has a blue highlight on the right hand side of the window showing it has been selected.

Using the , , or  keys you can change the selection of the measurement window.

Using the  key on numeric measurement results window you can choose either two rectangular windows, a single enlarged window, or a full screen display by pressing. The display style is applied to the currently selected window or measurement line.

11 The upper window is configured to show a single numeric display.

12 The lower window is configured to show an analog meter which displays the measurement result and the meter scaling.

13 With a P-Series or an E-Series E9320 power sensor connected, the symbol shows the trigger state  (Free Run),  (Stopped),  (Negative Slope), or  (Positive Slope).

14 The channel measurement frequency.

15 This displays the connected sensor, the offset value, and the acquisition mode on the channel. On dual channel models it shows for both channels.

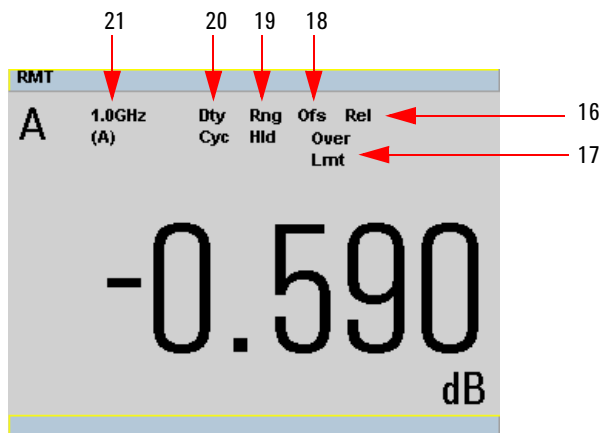

Figure 1-3 Full screen numeric display

16 Figure 1-3 shows a single numeric full screen displaying a relative result.

This field displays **Rel** if relative mode is on.

17 This field indicates the measurement result is beyond the configured upper or lower limit. If the measurement is within the limits this field is empty. If the measurement result is less than the minimum limit set, **Undr Lmt** is displayed. If the measurement result is more than the maximum limit set, **Over Lmt** is displayed.

18 This field displays **Ofs** if an offset is set.

19 This field displays **Rng Hld** if a range is selected.

20 This field displays **Dty Cyc** if a duty cycle is set.

21 The information in this field is displayed on two lines and depends on the sensor type, sensor calibration table, frequency dependent offset table currently selected, and the measurement frequency.

NOTE

The following trace displays are only available when a P-Series or an E-Series E9320 power sensor is connected.



Figure 1-4 Trace display in both windows

22 Figure 1-4 shows both windows configured to trace display mode. This is only available with an P-Series or an E-Series E9320 power sensor is connected. The captured trace, channel, and scaling are displayed. The lower window is the selected window.

23 The  indicates the point on the trace where trigger event occurs.

NOTE

Single or continuous triggering (**Sing Trig** or **Cont Trig**) must be selected from the **Acqn** menu to view a trace window. The **Acqn** menu is accessed by pressing  , **Trigger** . **Trace** is disabled when **Free Run** is selected.

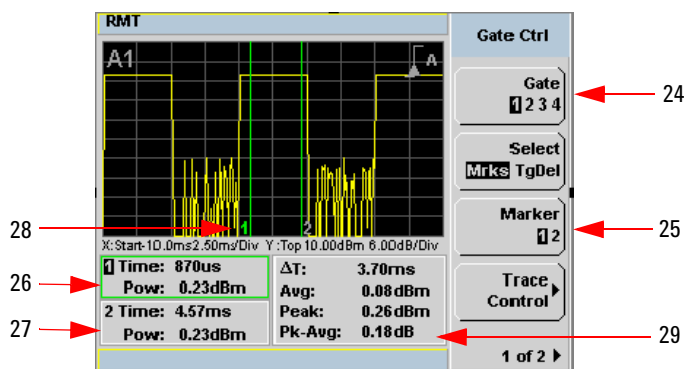



Figure 1-5 Trace display in single enlarged window in markers mode

Figure 1-5 shows a single enlarged window with the **Gate Ctrl** menu and associated tables and markers. The **Gate Control** is the default display when using trace display.

24 Pressing **Gate** scrolls through the 4 gates available for each channel.

25 The markers, **1** and **2**, indicate the start and end points of the selected gate. Pressing **Marker** toggles between the two markers. You can use the  and  keys to move the active marker along the trace.

26 The highlighted table, with the green border, shows the time (**Time:**) and the instantaneous power level (**Pow:**) of the active marker at the configured point. A negative time value indicates a measurement before the trigger point.

NOTE

Gate timing parameters are all related to your chosen trigger point. This may be different from the timing of the triggering event if you have configured a trigger delay. Refer to item No 30 for more information.

27 This table shows the time (**Time:**) and the instantaneous power level (**Pow:**) of the inactive marker at the configured point.

28 The highlighted marker shows the active marker at the configured point.

29 This table shows the width of the gate **ΔT:**(time between the markers), the average, peak, and peak-to-average ratio power measurements within the active gate.

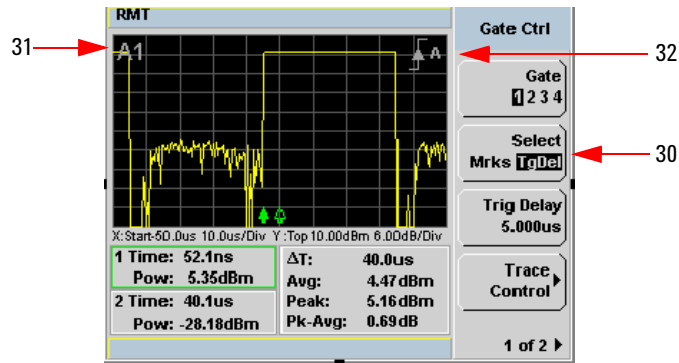

Figure 1-6 Trace display in single enlarged window in trigger delay mode

Figure 1-6 shows a single enlarged window with the **Gate Ctrl** menu and associated tables and trigger delay.

30 Pressing **Select TgDel** removes the gate markers and displays the trigger marker(s). The \blacktriangle indicates when the trigger event occurs, whilst \blacktriangleleft shows the delayed trigger point. When the two points coincide only the \blacktriangle trigger is shown.

In the example shown in Figure 1-6, the \blacktriangleleft appears ahead of the \blacktriangle as a trigger delay of $-5.00 \mu\text{s}$ has been configured, placing the measurement trigger before the trigger event. You can configure the trigger delay by pressing and entering a numeric value.

To indicate an off-screen trigger event, \blacktriangleleft is displayed. To indicate an off-screen trigger point, \blacktriangleleft is displayed.

31 The selected channel and gate number is displayed.

32 The trigger setting and slope is displayed. Examples shown in Figure 1-6 are Internal Channel A and a Positive Slope.

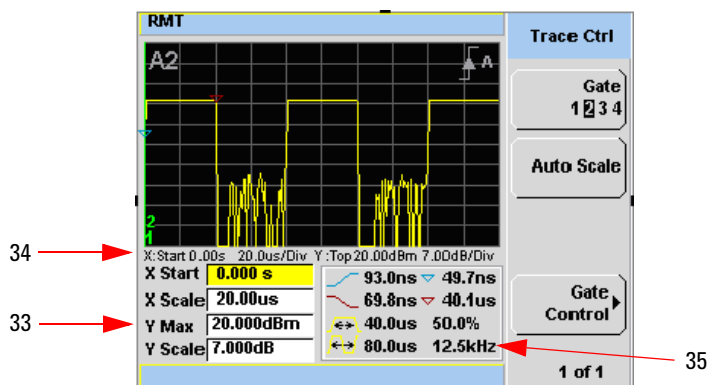

Figure 1-7 Trace display in single enlarged window in trace control mode

Figure 1-7 shows a single enlarged window with the **Trace Ctrl** menu with information on the pulse and associated X and Y control.

- 33** This is the X and Y trace setup fields. Using the or keys you can highlight the item and change its value.
- 34** The current settings of the X and Y scale are displayed in this reporting line.
- 35** This table shows 8 automatic time measurements performed on the first complete captured pulse after the trigger. The 8 measurements are rise time , fall time , time to positive occurrence , time to negative occurrence , pulse period , pulse width , duty cycle **50.0 %** and pulse repetitive frequency **12.5 kHz**.

Window Symbols and Pop-ups

There are several different graphic symbols and pop-up windows that can occur on the power meter display. These can occur for a variety of reasons, for example:

- An error or warning occurs
- You are required to wait while the power meter carries out a procedure
- You are required to select an entry from a list
- You are required to enter a numeric value

There are three different colors used to signify the pop-up status:

- Green - used to allow data entry
- Orange - used to display information
- Red - used to display an error

Warning Symbol Pop-up

The warning symbol is displayed either in a pop-up window or directly in the measurement window when such an event occurs. A pop-up window is displayed for approximately two seconds. The text in the pop-up window gives details of the warning type, for example, to indicate that a power sensor has insufficient bandwidth or a previous entered frequency value in a table. Depending on the severity of the warning, the pop-up may be displayed in Orange or Red.

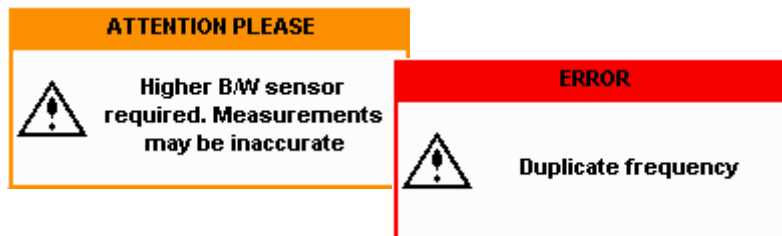

Wait Symbol Pop-up

The wait symbol is displayed when the power meter is carrying out a procedure and no action is required from you. The symbol appears in a pop-up window. It may appear, for example, during a calibration.



Confirm Symbol Pop-up

This type of pop-up window is displayed when you are required to press **Confirm** to verify your previous selection. For example, prior to a **Save** being carried out.

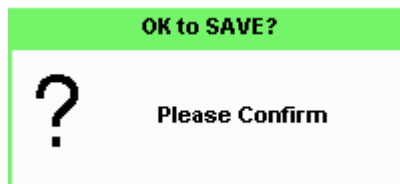

Numeric Entry Pop-up

This type of pop-up window is displayed when you need to modify numeric data. The numeric keys allow you to enter the value.

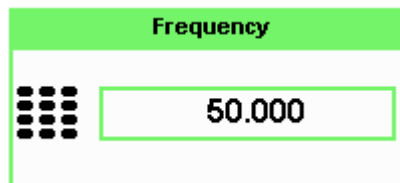

Text Entry Pop-up

This type of pop-up window is displayed when you need to modify alphanumeric data, for example, table names. The up/down arrow keys increment and decrement the alphanumeric digit that the cursor is currently positioned. The left/right arrow keys move the cursor to another alphanumeric digit.

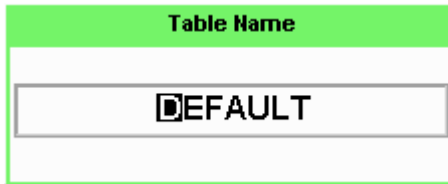

Trace Scaling Pop-up

This pop-up window is displayed when you are in the **Trace Control** menu and you can either use the up/down arrow keys for increment and decrement, or the numeric keys to set, the values of the X scale and Y scale.

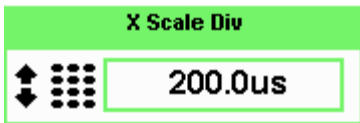

List Pop-up

This pop-up window is displayed when you are required to select an entry from a list. Use the up/down arrow keys to highlight your choice. Press select to complete the entry.

Video Avg Count
1
2
4
8
16
32
64
128
256

Using the Instrument Web Browser

P-Series power meters network settings can be configured using its Web-based interface (Web browser). The instrument's Web browser can be opened from Agilent Connection Expert as shown in [Figure 1-8](#).

NOTE

Alternatively, the instrument's Web-based interface can also be opened directly from a Web browser by entering the instrument's IP address or hostname in the browser's 'address' window.

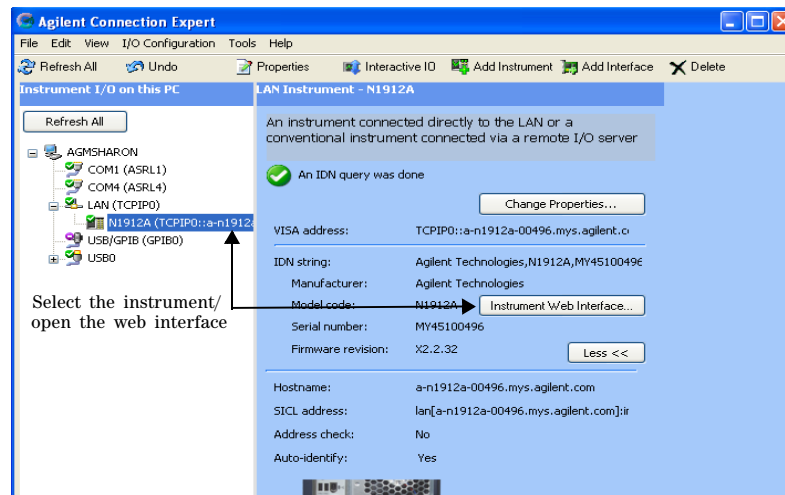

Figure 1-8 Opening the instrument Web interface.

An example of the Web browser is shown in “N1912A P-Series power meter Web browser (Welcome Page)” on page 23.

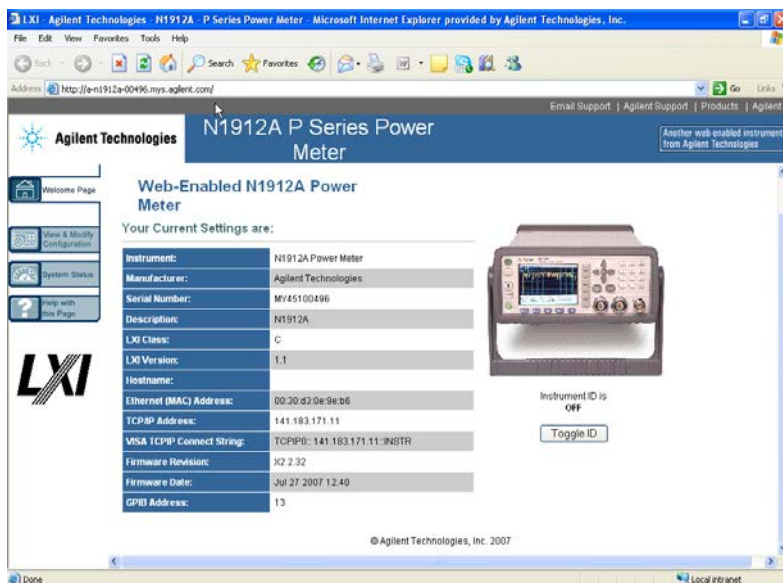



Figure 1-9 N1912A P-Series power meter Web browser (Welcome Page)

Instrument on the network can be physically identified through the **Status** message on **Remote Interfaces** screen by clicking **Toggle ID** within the Web browser. This changes the status of the **Instrument ID** to **ON** or **OFF**.

Before the instrument identification starts, press  **Remote Interfaces** to view the **Status** message.

When **Instrument ID** is toggled to **ON**, this causes the **Status** message “LAN identify start” in **Remote Interface** screen on the front panel to blink 3 times. When the **Toggle ID** is selected again, the default **Status** message “Running” is returned. See [Figure 1-10](#) and [Figure 1-11](#).

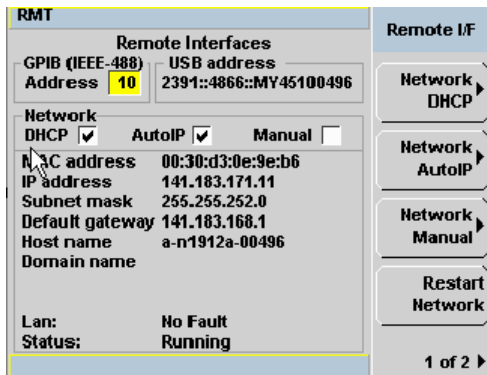
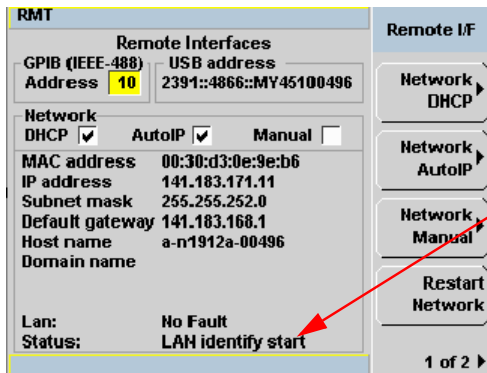

Figure 1-10 Status message before Toggle ID is selected.



Status message "LAN identity start" to blink 3 times when Toggle ID is selected.

Figure 1-11 Status message when Toggle ID is selected.

When power meter is configured to LAN, the **Lan Status** on **Remote Interfaces** screen will show the LAN error condition and status of the LAN configuration connection. There are six types of **Lan Status** messages that may occur. See [Table 1-1](#). See also [Figure 1-12](#) for the example of **Lan Status** message.

Table 1-1 Type of Lan Status message.

Type of message	Description
Lan: No Fault Status: Initialized	<ul style="list-style-type: none"> A valid IP address is successfully obtained using selected LAN configuration and the network state is initialized.
Lan: No Fault Status: Running	<ul style="list-style-type: none"> A valid IP address is successfully obtained using selected LAN configuration, while network is running.
Lan: Fault Status: Initialization failed	<ul style="list-style-type: none"> IP conflict occurs, or IP address failed to be obtained using selected LAN configuration, or No LAN configuration is selected.
Lan: Fault Status: Disconnected	<ul style="list-style-type: none"> LAN cable is unplugged.
Lan: – Status: Restarting	<ul style="list-style-type: none"> Restart the network and try to obtain an IP address using selected LAN configuration.
Lan: DHCP Not Available Status: Running	<ul style="list-style-type: none"> Unable to obtain IP address from DHCP server (if user select DHCP configuration) IP address obtained from Auto-IP or manual configuration.

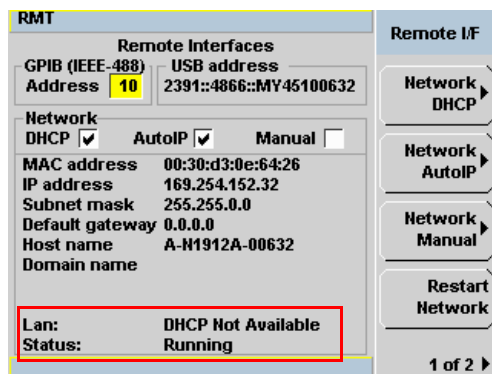

Figure 1-12 Example of Lan Status message.

NOTE

For more details on remote interface configuration, refer to *P-Series Power Meters Installation Guide*.

Editing the Instrument's LAN Settings

Once communication path to the instrument has been established, the instrument's LAN configuration can be viewed and modified using the Web browser.

On the Welcome Page, click **View and Modify Configuration**. This opens the configuration window shown in [Figure 1-13](#).

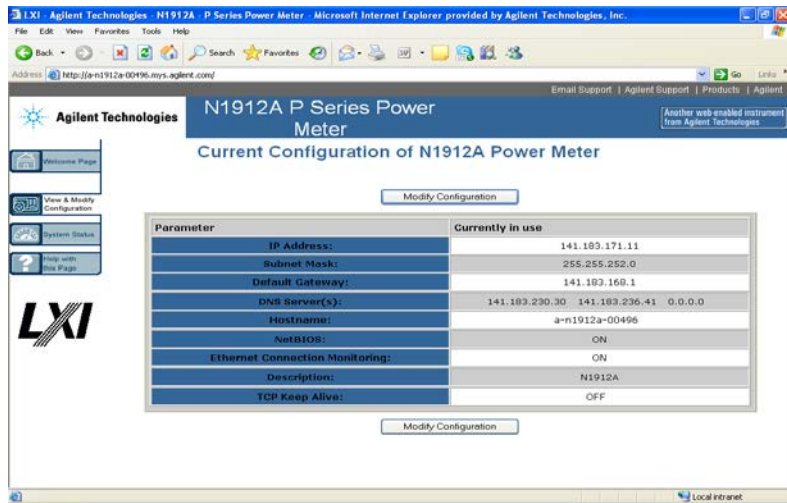

Figure 1-13 Viewing LAN configuration settings from the Web interface.

To edit parameters shown, click **Modify Configuration**. The **Enter Password** dialog box appears as shown in [Figure 1-14](#).



Figure 1-14 Password security dialog box.

Click the **Submit** (accept the default password) and the window opens as shown in [Figure 1-15](#). The default password is “**agilent**”.

NOTE

For P-Series power meters with latest firmware upgrade to be LXI-C compliant, a LAN reset needs to be performed to ensure that the password is reset to default. See LAN reset procedure as below.

Procedure:

- 1 Press  , **Remote Interfaces** to display the **Remote Interfaces** screen.
- 2 Press **1 of 2** softkey to display the second page of the **Remote I/F** menu.
- 3 Press **LAN Reset** softkey to reset the LAN settings to default.

NOTE

When **LAN Reset** softkey is pressed, it will also change the GPIB address to default.

NOTE

You can change the password from the **Configuring your N1912A Power Meter** window as shown in [Figure 1-15](#). Scroll down the **Parameter** column until you locate the **Change Password** parameter.

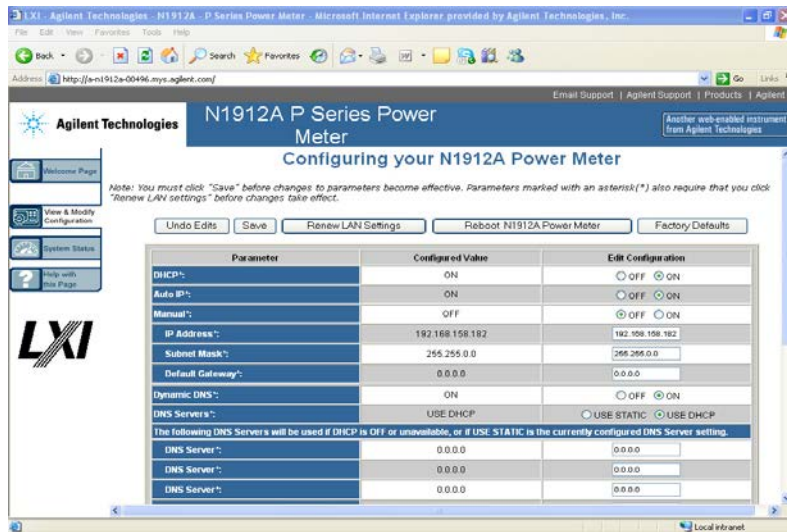
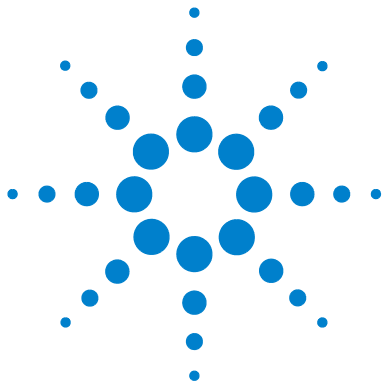

Figure 1-15 Changing the instrument LAN interface configuration



2 General Power Meter Functions

Setting the Units of Measurement	30
Setting the Measurement Frequency	32
Setting the Resolution	33
Making Relative Measurements	34
Setting the Pulse Reference Levels	36
Setting Offsets	39
Setting Measurement Averaging	49
Step Detection	51
Setting the Video Averaging	52
Setting the Video Bandwidth	54
Setting Measurement Channel Gates	57
Setting up the Channel Trace	62
Setting the Trigger	66
Setting External Trigger for Normal and Average Power Measurement	72
Setting Measurement Limits	86
Setting the Measurement Display	90
Scaling the Analog Display	97
Recorder Output	99
Saving and Recalling Power Meter States	104
Zeroing and Calibrating the P-Series Sensor	107
Presetting the Power Meter	111
Setting the Cable Short/Long	113

This chapter describes the general operation of the P-Series power meter.



Setting the Units of Measurement

The **Units** menu is used to select the measurement units for the currently selected window. These can either be logarithmic (dBm or dB) or linear

(Watt or %) units. Presetting () the power meter sets the measurement units to dBm (logarithmic units). [Table 2-2](#) and [Table 2-3](#) show units that are applicable to each measurement mode.

Press , **Units**. Select the unit of measurement from **dBm**, **W**, **dB**, and **%**. Softkeys which cannot be selected in your particular mode of operation are grayed out.

NOTE

When the measurement unit is set to Watt (W), it is possible that negative power results are displayed when measuring low power levels.

Table 2-2 Measurement units - Single channel meters

Measurement Mode	Relative Mode Off	Relative Mode On
Log	dBm	dB
Linear	Watt	%

Table 2-3 Measurement units - Dual channel meters

Measurement Mode	Relative Mode Off	Relative Mode On
Ratio	Log	dB
	Linear	%
Difference	Log	dB
	Linear	Watt

Selecting Units of Measurement from the Softkeys

In some menus, for example, units in the **Trace Setup** menu, you are required to enter the units of measurement for power. In some cases, due to the availability of wide power range, the following menu is displayed:

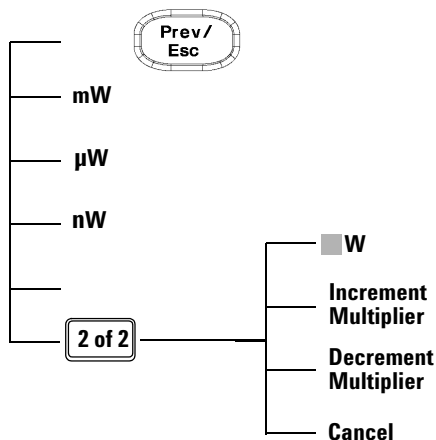

Pressing **Increment Multiplier** or **Decrement Multiplier** increases or decreases the multiplier shown in front of **W**. Pressing **W** after the correct multiplier has been selected confirms the entry.

NOTE





Invalid softkeys are grayed out so the value cannot be entered.

Setting the Measurement Frequency

Entering the frequency of the RF signal you are measuring optimizes the accuracy and minimizes measurement uncertainty, especially when making comparative measurements between signals.

Procedure

Set the measurement frequency as follows:

- 1 Press . On dual channel meters select the required channel.
- 2 Use the  and  keys to highlight the **Frequency** value field and press  to display the **Frequency** pop-up. Use the numeric keypad to enter the required value in the **Frequency** pop-up window.

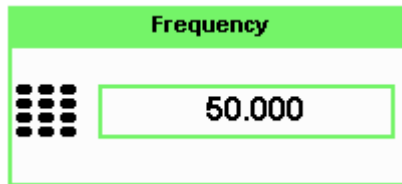



Figure 2-16 Frequency pop-up

- 3 Confirm your choice by pressing **MHz** or **GHz**.
- 4 Press  key to close the **Channel Setup** screen.

Setting the Resolution

The resolution of each of the power meter's numeric type windows can be set to four different levels (1, 2, 3 or 4).

These four levels represent:

- 1, 0.1, 0.01, 0.001 dB respectively if the measurement suffix is dBm or dB.
- 1, 2, 3 or 4 significant digits respectively if the measurement suffix is W or %.

The default value is 0.01 dB (3 digits).



To set the resolution on the currently selected window:

- 1 Press . The current setting of the resolution is highlighted under the **Resolution** softkey.
- 2 To change this setting, press **Resolution** repeatedly until the required resolution setting is highlighted.

Making Relative Measurements

Relative mode enables comparison of a measurement result to a reference value. The relative reading, or difference, can be displayed in either dB or % terms. When the measurement result is displayed in % a prefix multiplier may be shown.

Procedure

- 1 Press  to display the **Measurement Setup** menu.
- 2 Select the window you wish to set a reference value on by pressing the **Meas Select** key. The currently selected window/measurement is displayed.
- 3 Use the  and  keys to highlight the **Relative** setting field.

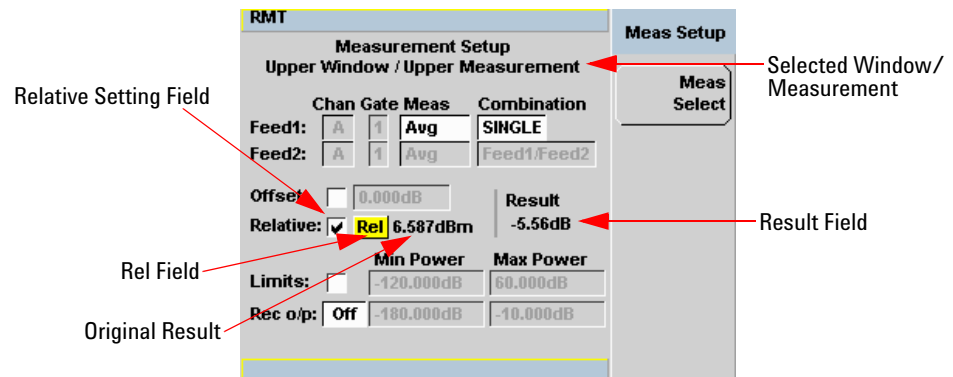





Figure 2-17 Typical relative measurement display

- 4 Press  to check the **Relative** setting field.
- 5 Confirm that the power meter is measuring the signal you want to use as the reference. This is displayed under the **Result** field.

6 Press the , , key to highlight the **Rel** field.

7 Press  and the original result value will appear on the right hand side of the **Rel** check field.

8 The relative value displayed under **Result** field will change as the measured signal varies.

NOTE

If you return the power meter to display the numeric display, a **Rel** symbol will be displayed in the measurement window it is applied to.

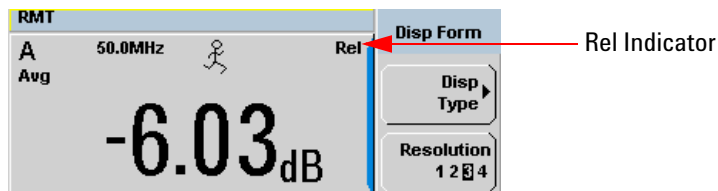



Figure 2-18 Numeric display

NOTE

The **Rel** symbol is not displayed when the associated measurement is displayed in **Dual Numeric** or **Analog** format.

Setting the Pulse Reference Levels

- Press  and proceed to the second page of **Sys/Inputs** menu by pressing the **1 of 2** softkey.
- Press **Meas Config** softkey to display the **Measurement Configuration** screen.
- Press the **Channel A B** softkey to select the desired channel for a dual channel power meter (N1912A).

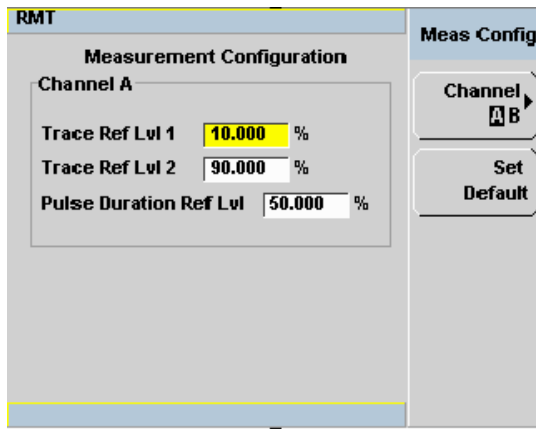

Figure 2-19 Measurement configuration screen

NOTE

Trace Ref Lvl 1 and Trace Ref Lvl 2 are used in calculation of transition durations and occurrences.

NOTE

Pulse Duration Ref Lvl allows pulse duration measurements between non-standard reference levels.

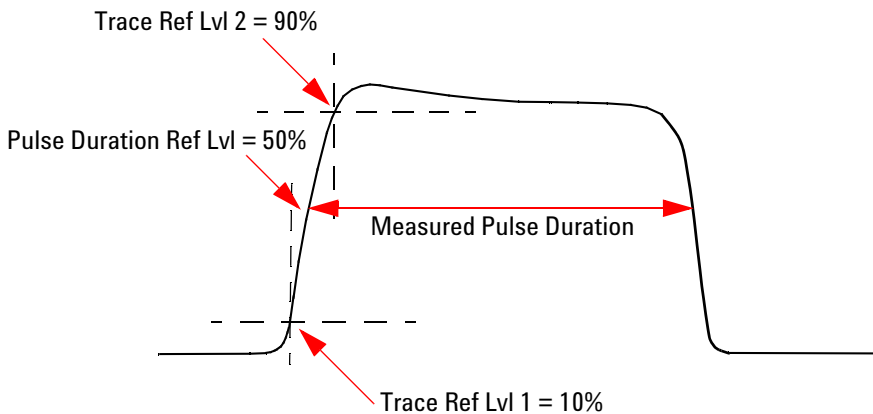





Figure 2-20 Pulse duration measurement between two reference levels

- 1 Use the  and  keys to highlight the **Trace Ref Lvl 1** field.
- 2 Press  to display the **Trace Ref Lvl 1** pop-up, and use the numeric keypad to enter the intended value in the **Trace Ref Lvl 1** pop-up window.

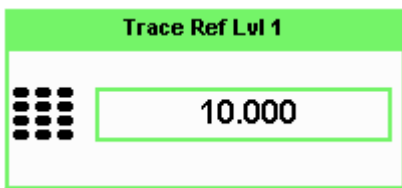





Figure 2-21 Trace Ref Lvl 1 pop-up

- 3 Complete the entry by pressing the  softkey.
- 4 Use the  and  keys to highlight the **Trace Ref Lvl 2** field.

2 General Power Meter Functions

- 5 Press  to display the **Trace Ref Lvl 2** pop-up, and use the numeric keypad to enter the intended value in the **Trace Ref Lvl 2** pop-up window.

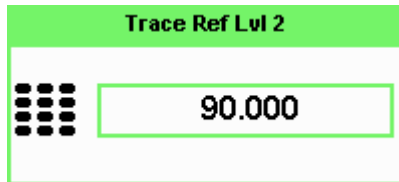





Figure 2-22 Trace Ref Lvl 2 pop-up

- 6 Complete the entry by pressing the **%** softkey.
- 7 Use the  and  keys to highlight the **Pulse Duration Ref Lvl** field.
- 8 Press  to display the **Pulse Duration Ref Lvl** pop-up, and use the numeric keypad to enter the intended value in the **Pulse Duration Ref Lvl** pop-up.

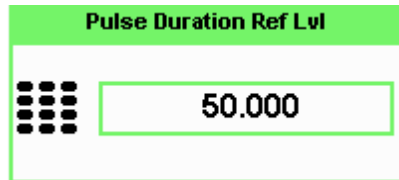

Figure 2-23 Pulse Duration Ref Lvl pop-up

- 9 Complete the entry by pressing the **%** softkey.

NOTE

By default, the **Trace Ref Lvl 1**, **Trace Ref Lvl 2** and **Pulse Duration Ref Lvl** settings are set to 10 %, 90 % and 50 % respectively.

Setting Offsets

The power meter can be configured to compensate for a signal loss or gain in your test setup. The power meter allows you to apply offsets at three different points in the measurement path.

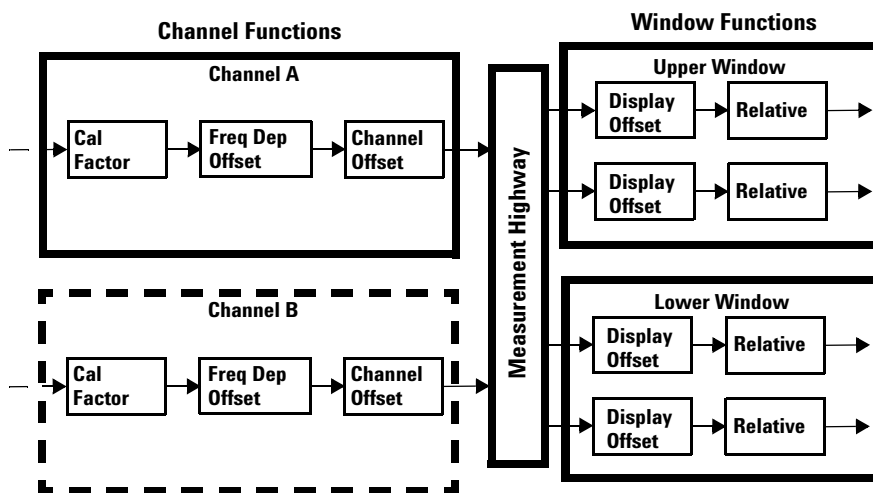

Figure 2-24 Simplified measurement path

Figure 2-24 shows that how you can apply a **Channel Offset** or a **Frequency Dependent Offset** prior to any mathematical functions. These allow you to compensate each channel individually. An overall offset can be applied if required using the **Display Offset**.

Setting Channel Offsets





This gain or loss is applied to the measured power before any mathematical functions, display offsets or relative functions are included.

Offsets are entered in dB and the range is -100 dB to +100 dB.

A positive value compensates for a loss and a negative value compensates for a gain.

Procedure

To enter a channel offset:

- 1 Press  to display the **Channel Setup** screen. Confirm the channel requiring setup is displayed.
- 2 Press **Offsets** to display the **Offsets Setup**.
- 3 Use the  and  keys to highlight the **Offset** setting field.
- 4 Press  to check the **Offset** setting field.

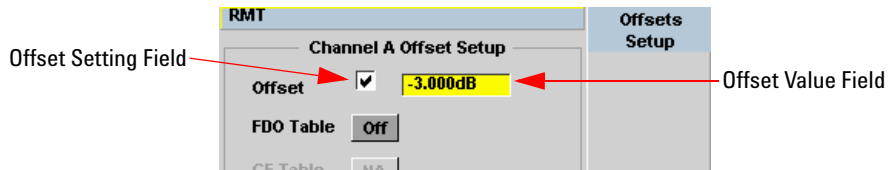





Figure 2-25 Typical channel offset display

- 5 Press  to highlight the **Offset** value field and press  to display the **Offset** pop-up. Use the numeric keypad to enter the required value in the **Offset** pop-up window.
- 6 Confirm your choice by pressing **dB**.
- 7 Press  key to complete the offset entry. If either a channel or a display offset is set, the **Ofs** indicator is displayed.

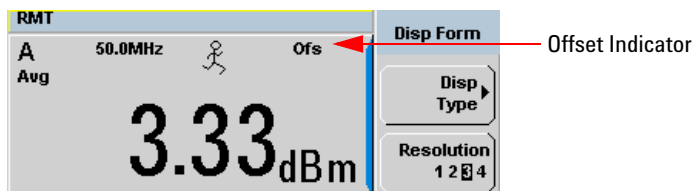

Figure 2-26 Channel offset indicator

NOTE

The **Ofs** symbol is not displayed when the associated measurement is displayed in Dual Numeric or Analog format.





Setting Display Offsets

This gain or loss is applied to the measured power after any channel offsets or mathematical functions have been included.

Offsets are entered in dB and the range of values is -100 dB to $+100$ dB. A positive value compensates for a loss, and a negative value compensates for a gain.

Procedure

Enter a display offset on the currently selected window:

- 1 Press  to display the **Measurement Setup** screen.
- 2 Select the window you wish to set the offset value on by pressing the **Meas Select** key. The currently selected window/measurement is displayed.
- 3 Use the  and  keys to highlight the **Offset** setting field.
- 4 Press  to check the **Offset** setting field.

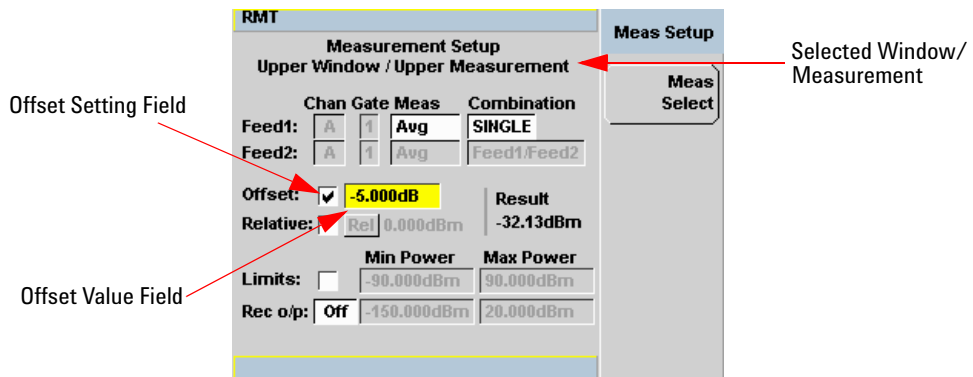





Figure 2-27 Typical display offset display

- 5 Press  to highlight the **Offset** value field and press  to display the **Display Offset** pop-up. Use the numeric keypad to enter the required value in the **Offset** pop-up window.
- 6 Confirm your choice by pressing **dB**. Press  key to complete the offset entry.

NOTE

The **Ofs** indicator is displayed if Display Offset is selected.

Setting Frequency Dependent Offsets

Frequency dependent offset tables provide a quick and convenient method of compensating for frequency related changes in the response of your test system. Note that when selected, frequency dependent offset corrections are applied IN ADDITION to any correction for sensor frequency response.

The power meter is capable of storing 10 frequency dependent offset tables with a maximum of 80 frequency points each.

To use frequency dependent offset tables:





- 1 Select the table to be applied to a channel. Refer to “[Setting Frequency Dependent Offsets](#)” on page 42 for further information. If you require to edit the table refer to “[Editing Frequency Dependent Offset Tables](#)” on page 45 for further information.
- 2 If using an 8480 Series, N8480 Series or an E-Series sensor, zero and calibrate the power meter. The reference calibration factor used during the calibration is automatically set by the power meter from the sensor calibration table (if selected).
- 3 Specify the frequency of the signal you want to measure. The calibration factor/offset is automatically set by the power meter from the sensor calibration table (if selected) and the frequency dependent offset table. Refer to “[Procedure](#)” on page 44 for further information.
- 4 Make the measurement.

Selecting a Frequency Dependent Offset Table

You can select a frequency dependent offset table from the  key menu followed by **Tables** and **Freq. Dep. Offset**.

The State column indicates if any frequency dependent offset tables are currently selected. The **Offset Tables** screen is shown in [Figure 2-28](#).

NOTE

You can also view which FDO table is being used by pressing the , **Offsets** and use the  and  keys to highlight the **FDO Table** setting field and press  to display the table.

Procedure

Select an offset table as follows:

1 Press, either:

a.  , **Tables** , **Freq. Dep. Offset** .



b.  , **Offsets** and use the  and  keys to highlight the **FDO Table**

setting field and press  to display the table.

RMT			Offset Tbls
Tbl Name	State	Pts	
A CUSTOM_A	off	1	Edit Table
B CUSTOM_B	on	1	
C CUSTOM_C	off	0	Table Off On
D CUSTOM_D	off	0	
E CUSTOM_E	off	0	Done
F CUSTOM_F	off	0	
G CUSTOM_G	off	0	
H CUSTOM_H	off	0	
I CUSTOM_I	off	0	
J CUSTOM_J	off	0	

1 of 1

Figure 2-28 Frequency dependent offset tables display

2 Use the  and  keys to highlight one of the 10 table titles and press **Table** to highlight **On**.

NOTE

When no data is contained in the highlighted table, the **Table** key is disabled (grayed out).

3 Press **Done** to complete the selection of the offset table.

4 Press **Done** again to display the measurement screen. [Figure 2-29](#) shows which offset table is selected.

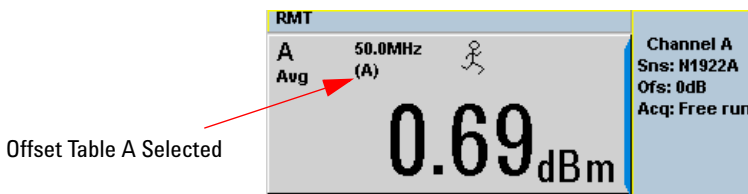





Figure 2-29 Frequency dependent offset indicator

- 5 To change the frequency, press  and use the  and  keys to highlight the **Frequency** field.
- 6 Press  to display the **Frequency** pop-up window. Use the numeric keypad to enter the required value in the **Frequency** pop-up window.
- 7 To confirm your choice, press the appropriate unit softkey.
- 8 Connect the power sensor to the signal to be measured.
- 9 The measurement result, including offset, is now displayed.

NOTE

If the measurement frequency does not correspond directly to a frequency in the sensor calibration table (if selected) and the frequency dependent offset table being used, the power meter calculates the calibration factor and offset using linear interpolation. If you enter a frequency outside the frequency range defined in the sensor calibration table or the frequency dependent offset table, the power meter uses the highest or lowest frequency point in the appropriate table to set the calibration factor and offset.

Editing Frequency Dependent Offset Tables

There are ten frequency dependent offset tables named **CUSTOM_A** through **CUSTOM_J**. They are empty of any data when the power meter is shipped from the factory.

You cannot delete any of the 10 existing frequency dependent offset tables or create any additional tables. However, you can enter values into the 10 existing tables. Each frequency dependent offset table can contain a maximum of 80 frequency points.

2 General Power Meter Functions

To view the frequency dependent offset tables currently stored in the power meter, press , **Tables**, **Freq. Dep. Offset**. The **Frequency Dependent Offset Tables** screen is displayed as shown in [Figure 2-28](#).

Editing frequency dependent offset tables requires the following steps:



- 1 Identify and select the table you want to edit
- 2 Rename the table
- 3 Enter the frequency and offset pairs
- 4 Save the table

Procedure

First select the table you want to edit as follows:







NOTE

A frequency in the range of 0.001 MHz to 1000.0 GHz can be entered. A calibration factor in the range of 1 % to 150 % can be entered.

- 1 Press , **Tables**, **Freq. Dep. Offset** to display the **Offset Tbls** screen.
- 2 Choose the table you want to edit using the  and  keys. Press **Edit Table** to display the **Edit Offset** screen as shown in [Figure 2-30](#).

RMT		Edit Offset	
Name: CUSTOM_C		Change	
Freq	Offset	Insert	
1kHz	125.0%	Delete	
5kHz	150.0%	Done	
200kHz	96.0%	1 of 1	
10.000MHz	90.0%		
10.000GHz	100.0%		
600.000GHz	99.0%		
1000.000GHz	40.0%		

Figure 2-30 “Edit Offset” display with data added

- 3 Highlight the table title using the  and  keys. Press **Change** and use the , ,  and  keys to select and change the characters in the **Table Name** pop-up to create the name you want to use.

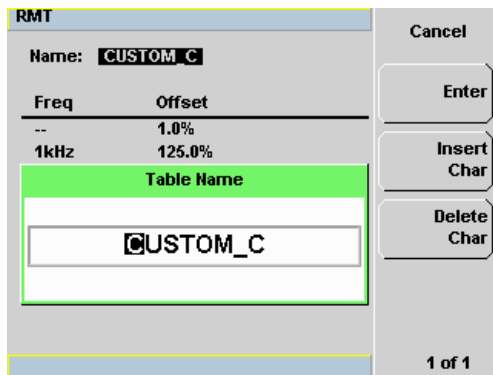

Figure 2-31 Edit table title pop-up

- Pressing **Insert Char** adds a new character to the right of the selected character.
- Pressing **Delete Char** removes the selected character.

- 4 Press **Enter** to complete the entry.

NOTE

The following rules apply to naming sensor calibration tables:

- The name must consist of no more than 12 characters.
- All characters must be upper or lower case alphabetic characters, or numeric (0-9), or an underscore (_).
- No other characters are allowed.
- No spaces are allowed in the name.

2 General Power Meter Functions

Enter (or edit) the frequency and offset pairs as follows:

- 1 Press **Insert** to add a new frequency value (or press **Change** to edit). Use the numeric keypad to enter the required value in the **Frequency** pop-up window. Complete the entry by pressing the **GHz**, **MHz** keys.
- 2 Enter the new offset value (or press **Change** to edit). Use the numeric keypad to enter the required value in the Offset pop-up window. Complete the entry by pressing the **%** key.
- 3 Continue adding/editing values until you have entered all the data you require.
- 4 When you have finished editing the table press **Done** to save the table.

NOTE

If you measure a signal with a frequency outside the frequency range defined in the frequency dependent offset table, the power meter uses the highest or lowest frequency point in the frequency dependent offset table to calculate the offset

Setting Measurement Averaging

The power meter uses a digital filter to average power readings. The number of readings averaged can range from 1 to 1024. This filter is used to reduce noise, obtain the desired resolution and to reduce the jitter in the measurement results. Increasing the value of the measurement average reduces measurement noise. However, the measurement time is increased. You can manually select the measurement average or you can set the power meter to auto measurement average mode. The default is **AUTO**.

When the auto measurement average mode is enabled, the power meter automatically sets the number of readings averaged together to satisfy the filtering requirements for most power measurements. The number of readings averaged together depends on the resolution setting and the power level currently being measured.

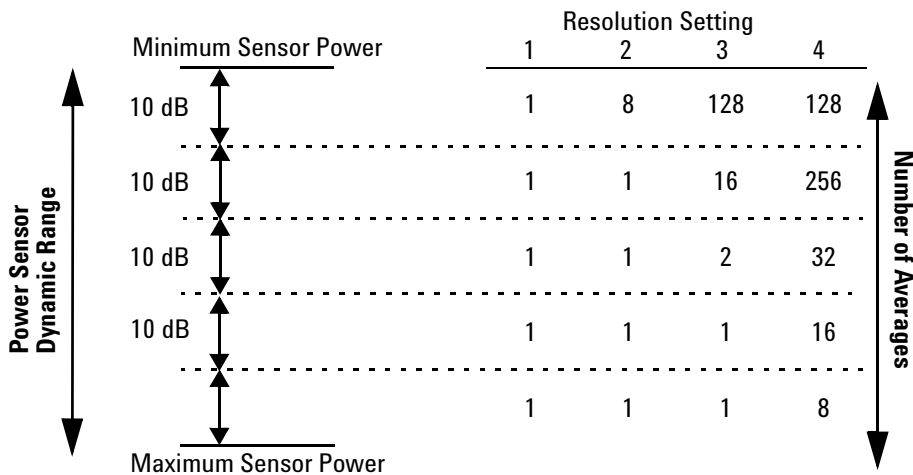

Figure 2-32 Typical averaged readings

Figure 2-32 shows the typical number of averages for each range and resolution when the power meter is in auto filter mode and is set to normal speed mode. P-Series power meters recognize different sensor types when they are connected, and configure suitable averaging automatically.



Resolution is a measurement display function and not a channel function. In the case where a channel is set up in both the upper and lower window and the resolution settings are different, the highest resolution setting is taken to calculate the averaging number.



These four resolution levels represent:

- 1, 0.1, 0.01, 0.001 dB respectively if the measurement suffix is dBm or dB.
- 1, 2, 3 or 4 significant digits respectively if the measurement suffix is W or %.



Procedure

Set measurement averaging as follows:

- 1 Press . On dual channel meters select the required channel. The current setting is shown in the Meas Avg field (**AUTO**, **MAN**, or **OFF**) on the **Channel Setup** screen. The default is **AUTO**.
- 2 Use the  and  keys to select the Filter setting field.

- 3 Press  and use the  and  to step through the available settings.

If you have selected **AUTO** or **OFF** proceed at step 7. If you have selected **MAN** proceed as follows:

- 4 Use the  key to select the **Meas Avg:** value field.
- 5 Press  to display the **Meas Avg Count** pop-up.

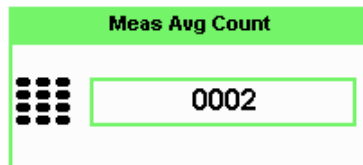



Figure 2-33 Meas Avg Count pop-up





- 6 Use the numeric keys to enter the required value and press **Enter**.
- 7 Press  key to close the **Channel Setup** screen.

Step Detection

To reduce the filter settling time after a significant step in the measured power the filter can be set to re-initialize upon detection of a step increase or decrease in the measured power. Step detection can be set in both manual and automatic measurement average modes.

Procedure

Set step detection as follows:

- 1 Press . On dual channel meters select the required channel.
- 2 Use the  and  keys to select the **Step Detect** setting field.
- 3 Press  to check the step detection to on or off.
- 4 Press  key to close the **Channel Setup** screen.

Setting the Video Averaging







NOTE

This feature is only available when a P-Series or an E-Series E9320 power sensor is connected.

Video averaging uses a digital filter to average repetitions of a triggered signal. The number of acquisitions averaged can range from 1 to 256, in multiples of 2^n . With video averaging the average of a number of acquisitions is calculated to smooth the displayed trace and reduce apparent noise. The measurement requires a continuously repeating signal. Increasing the value of this filter reduces noise but increases the time required to make the measurement.

Procedure

Set the video average as follows:

- 1 Press . On dual channel meters select the required channel.
- 2 Use the  and  keys to select the **Video Avg** setting field.
- 3 Press  to check the video averaging to on or off.
- 4 Use the  key to select the **Video Avg:** value field.
- 5 Press  to display the **Video Avg Count** pop-up.

Video Avg Count
1
2
4
8
16
32
64
128
256

Figure 2-34 Video Avg Count pop-up

6 Use the  and  keys to highlight the required **Video Avg Count** value

and press  .

7 Press  key to close the **Channel Setup** screen.

Setting the Video Bandwidth

NOTE

This feature is only available when a P-Series or an E-Series E9320 power sensor is connected.

Selecting a bandwidth value close to or slightly greater than required by the modulating signal bandwidth can help reduce noise and improve accuracy on peak measurements (see [Table 2-4](#)). It can however, reduce the processing speed for long acquisition times.

Table 2-4 P-Series Sensor Video Bandwidth Setting

Low:	Medium:	High:	Off
5.0 MHz	15.0 MHz	30.0 MHz	>30.0 MHz

The Low, Medium, and High pass band shapes achieved by the video bandwidth settings provide flat filter responses with very sharp cut-off points by applying digital signal processing techniques to ensure accurate power measurement within the specified band.

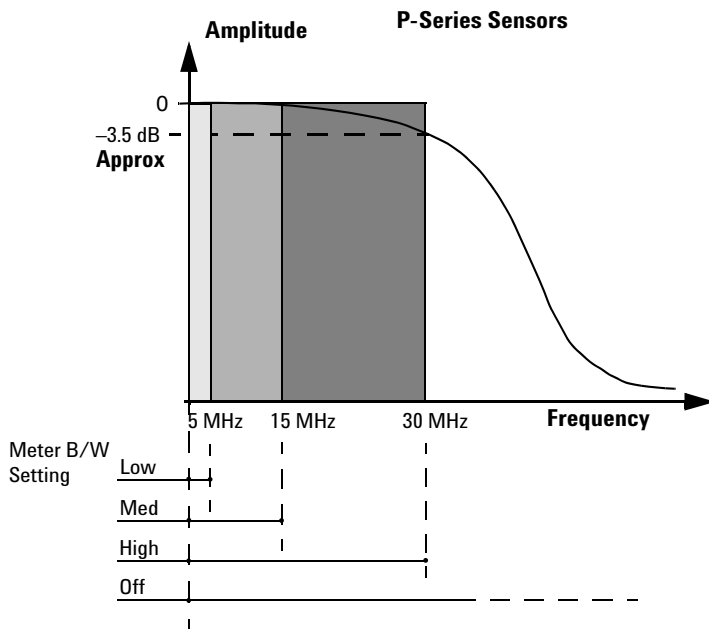





Figure 2-35 Bandwidth filter shapes

When video bandwidth is set to Off, it removes all digital signal conditioning. This provides approximately 3 dB roll off at the maximum sensor's bandwidth and is best suited for accurate trace capture, minimizing overshoot, and removing any ringing effects caused by the sharp cut-off filters used in the Low, Med and High settings. [Figure 2-35](#) shows the filter shapes associated with the P-Series wideband power sensors.

Procedure

Set the video bandwidth as follows:

- 1 Press . On dual channel meters select the required channel.
- 2 Use the  and  keys to select the **Video B/W** setting field.
- 3 Press  to display the **Video B/W** pop-up.

2 General Power Meter Functions

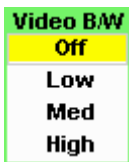



Figure 2-36 Video bandwidth pop-up

4 Use the  and  keys to highlight the required **Video Bandwidth** setting

and press  .

5 Press  key to close the **Channel Setup** screen.

Setting Measurement Channel Gates

NOTE

This feature is only available when a P-Series or an E-Series E9320 power sensor is connected.

A system of gates, controlled by and referenced to a trigger point, is used to obtain measurement data from a captured trace. The trace data within each gate period is subsequently used for the individual measurement calculations. Up to 4 gates can be set up for each channel. [Figure 2-37](#) shows an example of 4 gates setup to perform the following measurements simultaneously:

- Average power level of the pulse:
Gate 1, average measurement
- Average “off” power level ahead of the pulse:
Gate 2, average measurement
- Peak to average ratio:
Gate 1, peak-to-average measurement
- Pulse drop:
Gate 3, average measurement, minus Gate 4, average measurement

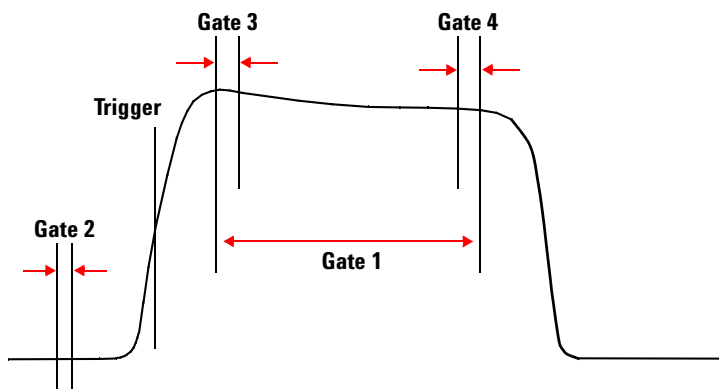

Figure 2-37 Example of measurement gates

NOTE

Figure 2-37 shows measurement results using this example of the gates placement.

Procedure





NOTE

This procedure uses the **Gates Setup** under the **Channel Setup** menu. Alternatively, you can use a more visual method, when in the Graphical Trace Mode (Gate Control Menu), to set the channel's Gate Control. (See "Setting the Trace Display" on page 118).

- Press **Gates Setup**. The **Channel Gate Setup** screen is displayed.

Channel A Gate Setup	
Gate 1 Start:	0.000 s Length: 100.0us
Gate 2 Start:	0.000 s Length: 0.000 s
Gate 3 Start:	0.000 s Length: 0.000 s
Gate 4 Start:	0.000 s Length: 0.000 s

Figure 2-38 Gate Setup screen

- 1 Highlight the **Gate Start** you want to configure using the , ,  and  keys.

NOTE

The gate start time is relative to the trigger event. Positive values set a measurement gate, to a maximum time of 1 second, after the trigger. Negative time gate start values set a measurement gate, to a maximum time of 1 second, before the trigger.





- 2 Press  and use the numeric keypad to enter the required value in the **Time Gating Start** pop-up window.



Figure 2-39 Time Gating Start pop-up

- 3 Complete the entry by pressing the required second, millisecond, microsecond or nanosecond (**s**, **ms**, **us** or **ns**) softkey.
- 4 Highlight the **Gate Length** you want to configure using the , , , and  keys.

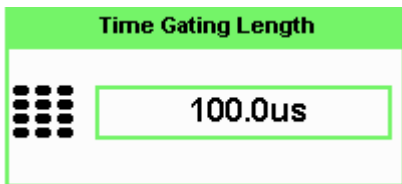

Figure 2-40 Time Gating Length pop-up

- 5 Complete the entry by pressing the required second, millisecond, or microsecond or nanosecond (**s**, **ms**, **us** or **ns**) softkey.
- 6 Repeat this process until you have setup all the required gates.

Auto Gate

This feature will automatically set the gates (start and stop times of the user defined time interval) for each measurement relative to the rising and falling edges' trigger point.

- Proceed to the second page of **Gate Ctrl** menu and press **Auto Gate** softkey.

2 General Power Meter Functions

- To change the **Auto Gate** setup:
 - 1 Press **Auto Gate Settings** softkey.

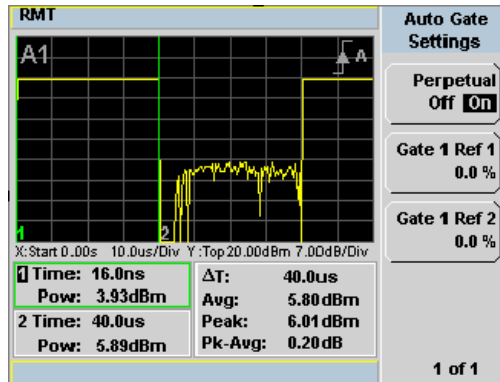

Figure 2-41 Auto Gate Settings display

NOTE

Auto Gate Settings enables the placing of markers (gates) at different positions.

- 2 Press **Gate 1 Ref 1 0.0%** softkey. The **Marker 1 Ref Percentage** pop-up is displayed.

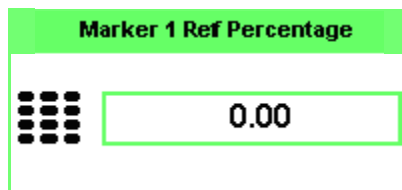

Figure 2-42 Marker 1 Ref Percentage pop-up

- 3 Use the numeric keys to complete the entry and press **%** softkey.
- 4 Press **Gate 1 Ref 2 0.0%** softkey. The **Marker 2 Ref Percentage** pop-up is displayed.

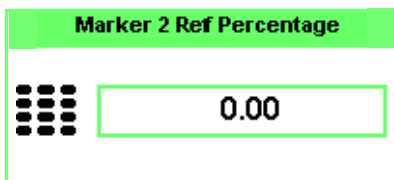

Figure 2-43 Marker 2 Ref Percentage pop-up

- 5 Use the numeric keys to complete the entry and press **%** softkey.

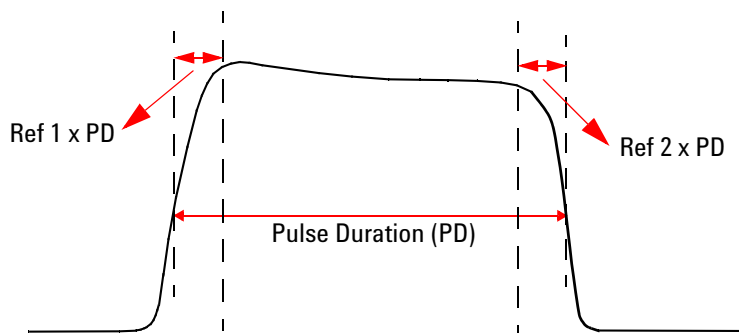

Figure 2-44 The placement of gates (markers) in Auto Gating mode

NOTE

Enabling the **Perpetual Off On** softkey allows the gates to be repositioned automatically according to the changes of pulse duration.

Setting up the Channel Trace

NOTE

This feature is only available when a P-Series or an E-Series E9320 power sensor is connected.

NOTE

The **Trace Setup** is the only location where you can change the Y-axis units from **dBm** to **Watts**.

Procedure

NOTE

This procedure uses the **Trace Setup** under the **Channel Setup** menu. Alternatively, you can use a more visual method, when in the Graphical Trace Mode (Trace Control Menu), to set the channel's Trace Control. (See [“Setting the Trace Display”](#) on page 118).

- 1 Press  , **Trace Setup** to display the **Trace Setup** menu.

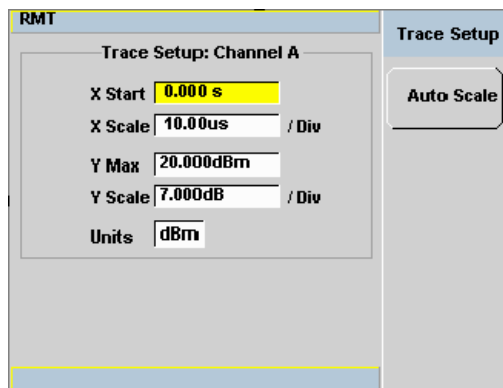





Figure 2-45 Trace setup display

- 2 Use the  and  keys to highlight the **X Start** field.

- 3 Press  to display the **Trace Start Time** pop-up and use the numeric keypad to enter the required value in the **Trace Start Time** pop-up window.

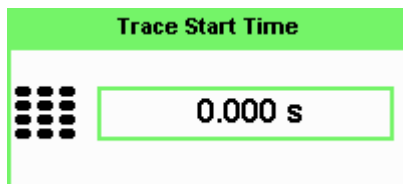







Figure 2-46 Trace Start Time pop-up

- 4 Complete the entry by pressing the required second, millisecond, microsecond or nanosecond (**s**, **ms**, **us** or **ns**) softkey.
- 5 Use the  and  keys to highlight the **X Scale** field.

- 6 Press  to display the **X Scale/Division** pop-up.
- Use the numeric keypad to enter the required value in the **X Scale/Division** pop-up window.
 - Use the  and  keys to increase or decrease the value.

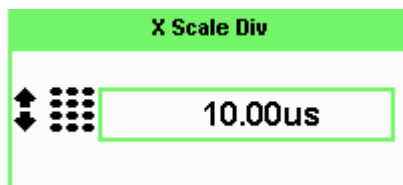



Figure 2-47 X Scale/Division pop-up

- 7 Complete the entry by pressing:
- The required second, millisecond, microsecond or nanosecond (**s**, **ms**, **us** or **ns**) softkey.
 - The **Enter** softkey.

2 General Power Meter Functions

- 8 Use the  and  keys to highlight the **Units** field.

If you want to view the trace in linear scale, use this field. Otherwise the default scale is in logarithmic.







- 9 Press  to display the Units pop-up, and use the  and  to highlight **Watt** or **dBm**.



Figure 2-48 Trace Units pop-up

- 10 Press  to complete the entry.

- 11 Use the  and  keys to highlight the **Y Max** field.

- 12 Press  to display the **Trace Maximum** pop-up, and use the numeric keypad to enter the required value in the **Trace Maximum** pop-up window.

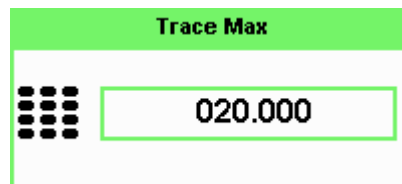







Figure 2-49 Y scale maximum value pop-up

- 13 Complete the entry by pressing the **dBm** or the linear value.

- 14 Use the  and  keys to highlight the **Y Scale** field.

- 15 Press  to display the **Y Scale/Division** pop-up.
- Use the numeric keypad to enter the required value in the **Y Scale/Division** pop-up window.
 - Use the  and  keys to increase or decrease the value.

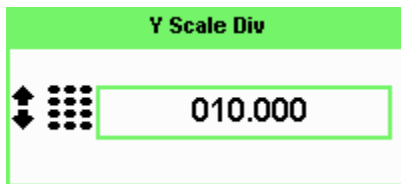

Figure 2-50 Y Scale/Division pop-up

16 Complete the entry by pressing the **dB** or the linear value.

17 Press  key to complete the setup and display the measurements results.

Auto Scale

Auto Scale automatically configures the window's X-axis and Y-axis to best display the input trace.

- 1** Press **Trace Control** softkey under **Gate Ctrl** menu.
- 2** **Auto Scale** softkey is pressed to accomplish auto scaling.

NOTE

This feature will work reliably with well behaved pulses. Modulated pulses may cause the meter to auto-scale on the details within the pulse envelope.

Setting the Trigger

NOTE

This feature is only available when a P-Series power sensor is connected.

The trigger can be taken from a rising or falling measured power level or controlled externally using the Ext Trig input. Additional control features such as; hold-off, hysteresis, and delay are provided to help you achieve a stable and reliable trigger. To use the measurement gates, the power meter must be triggered.

- Press . The **Trigger** menu is displayed.

The trigger status is displayed below the **Acqn** label in the **Trigger** menu. [Figure 2-51](#) shows the power meter display in **Free Run** mode. In this mode the meter is not synchronized to any modulated RF signal at the sensor input. Consequently, power levels within the configured time gates are random and the displayed measurement results are not valid.

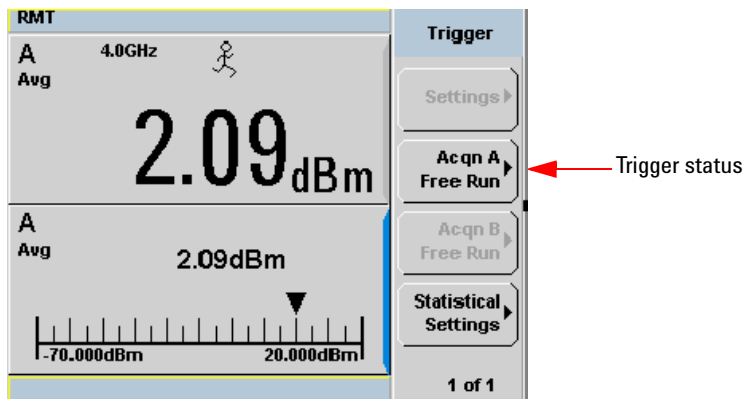



Figure 2-51 Trigger menu - free run mode

NOTE

The  symbol in the upper window indicates the power meter is in free run mode.

Procedure

- 1 Press **Acqn** softkey to configure a trigger.
- 2 Select either **Sing Trig** or **Cont Trig**.
 - **Sing Trig** is a single shot mode. After triggering, the measurement is halted, the **⊗** symbol is displayed. You can start another measurement by pressing the **Run/Stop** key.
 - **Cont Trig** is a continuous trigger mode. The symbol **⌋** or **⌋** is displayed.
- 3 Press **Settings** to configure the remaining trigger parameters. The trigger **Settings** menu have two pages. [Figure 2-52](#) shows page one and [Figure 2-55](#) shows page two.

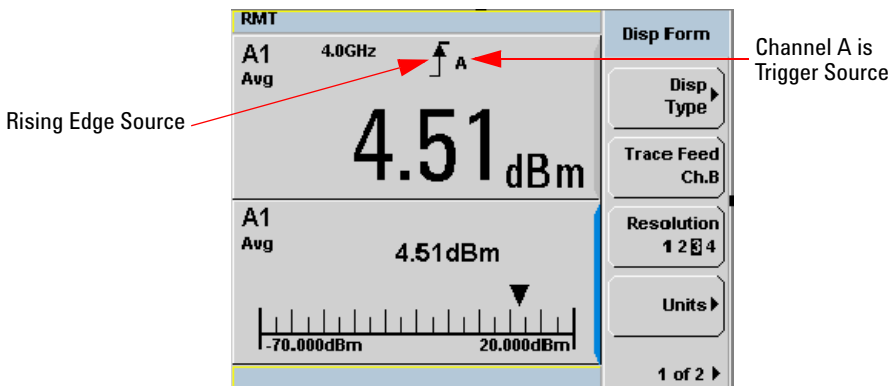

Figure 2-52 Trigger Setting Menu 1 of 2

To help you quickly check the triggering setup, the current settings for all the trigger parameters are shown with their respective softkey labels.

Source The current setting is shown below the **Source** label.

To change the setting press **Source** and choose **Ext** or **Int**.

The trigger source is shown beside the trigger symbol when a measurement window is configured in single numeric mode. When an external trigger (**Ext**) is selected, the power meter can be triggered via the Ext Trig input.

NOTE

For N1912A, by pressing **Source**, you can choose your source through the three different softkeys: **Ext**, **Ch.A**, and **Ch.B**.

Mode The **Mode** key is only available when trigger **Source Int** is selected.

To change the setting press **Mode** and choose **Norm** or **AutoLvl**.

The current setting is displayed below the label. When **Norm** is selected you can choose the RF power level transition used as the trigger. The power meter automatically finds a triggering power level transition when **AutoLvl** is selected.

Level **Level** is only available when **Norm** trigger mode has been selected. The current value is shown below the **Level** label. The minimum power level you can enter is limited to 40 dB below the maximum sensor power. To change the setting press **Level** and use the numeric keypad to enter the required value in the **Trigger Level** pop-up window to enter the new value.

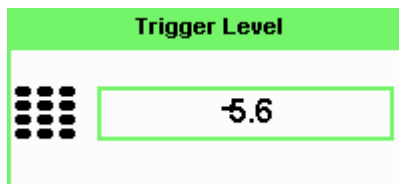

Figure 2-53 Trigger Level pop-up

Complete the entry by pressing **dBm**.

Delay The current setting is displayed below the **Delay** label. The delay time is applied between the trigger event and all the gate start times. This allows you to time-shift all the gates by the same amount with one setting change. A delay of up to 1 second can be entered. To enter or change the setting press **Delay** and use the numeric keypad to enter the required value in the **Trigger Delay** pop-up window to enter the new value.

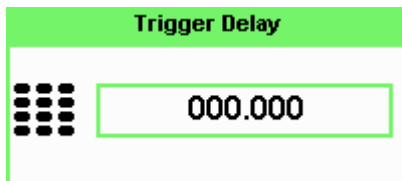

Figure 2-54 Trigger Delay pop-up

Complete the entry by pressing the required second, millisecond, microsecond or nanosecond (**s** , **ms** , **us** or **ns**) softkey.

NOTE

The trigger delay time can also be entered or changed in the Trace Display mode when the **Gate Control** menu is displayed. See “[Setting the Trace Display](#)” on page 118 for further detail.

Press **1 of 2** to display the second menu page.

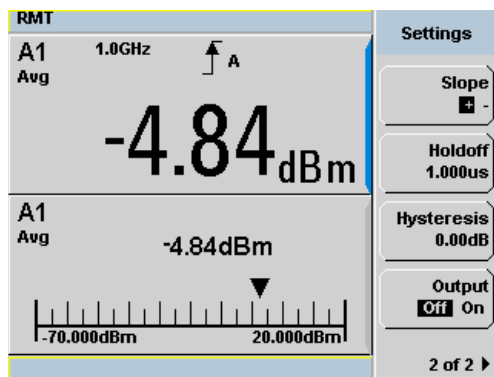

Figure 2-55 Trigger setting menu 2 of 2

2 General Power Meter Functions

Slope The current setting is displayed below the **Slope** label and the ↓ or ↑ symbol is displayed in single numeric display mode. + (and ↑) is used to generate the trigger from an increasing power level. Similarly, - (and ↓) is used to generate the trigger from a decreasing power level. To change the setting, press **Slope** to highlight + or - as required.

Holdoff The current setting is displayed below the **Holdoff** label. After a trigger event occurs, the trigger mechanism is disabled for the configured time period. This allows stable triggering to be achieved even when a signal has multiple edges, for example, a TDMA signal with non-constant amplitude modulation. Values up to 400 ms can be configured.

To change the setting press **Holdoff** and use the numeric keypad to enter the required value in the **Trigger Holdoff** pop-up window to enter the new value.

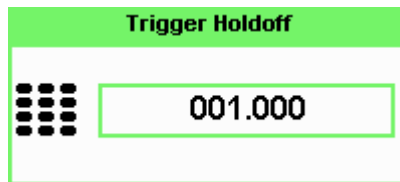

Figure 2-56 Trigger Holdoff pop-up

Complete the entry by pressing **ms**, **us** or **ns**.

Hysteresis **Hysteresis** is only available when **Norm** trigger mode has been selected. The current setting is displayed below the **Hysteresis** label. You can use the hysteresis function to help generate a more stable trigger by preventing triggering unless the RF power level achieves the trigger level and the additional hysteresis value. It can be applied to both rising and falling edge trigger generation. A maximum of 3 dB hysteresis can be entered.

Rising Edge

When a rising power transition triggers the power meter, the triggering system is disabled. The power meter does not trigger again if another rising power transition is presented. The triggering system is re-armed only when the input power falls below a level equal to the trigger level minus the configured hysteresis value.

Falling Edge

When a falling power transition triggers the power meter, the triggering system is disabled. The power meter does not trigger again if another falling power transition is presented. The triggering system is rearmed only when the input power rises above a level equal to the trigger level plus the configured hysteresis value.

To change the setting, press **Hysteresis** and use the numeric keypad to enter the required value in the **Trigger Hysteresis** pop-up window to enter the new value.

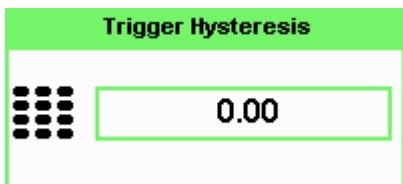

Figure 2-57 Trigger Hysteresis pop-up

Complete the entry by pressing **dB**.

Output The current setting is displayed below the **Output** label. A TTL level high is produced at the rear panel **TRIG OUT BNC** connector when the power meter is triggered when **On** is configured.

To change the setting, press **Output** to highlight **On** or **Off** as required.

Setting External Trigger for Normal and Average Power Measurement

There are two modes featured in peak and average power measurement

- Power sweep mode
- Frequency sweep mode

These modes are used to eliminate the need for lengthy test routines, while increasing measurement throughput by reducing overhead of communication with the controller. The sweep feature allows you to make power measurement by quickly stepping through a series of frequencies or power levels. Configuration shown in [Figure 2-58](#) illustrates the triggering connection required to synchronize power meter measurement to the power source settings.

[Table 2-5](#) below shows the power and frequency sweep mode compatibility in normal and average mode. Measurement averaging and trace display will be turned OFF in E-Series E9320 and P-Series N1920 power sensors while performing power or frequency sweep during normal mode.

Table 2-5 Power and frequency sweep mode compatibility table

Sensor	Normal Mode	Average Mode
848x	—	✓
E441x	—	✓
E930x	—	✓
E932x	✓	✓
N848x	—	✓
N192x	✓	✓(emulated*)

* Average only mode measurement is calculated based on peak measurement operation for the P-Series N1920 power sensor.

NOTE

Auto CAL will be temporary disabled in P-Series N1920 power sensors during power or frequency sweep.

Table 2-6 shows the available measurement functions during normal and average mode when in power or frequency sweep.

Table 2-6 Power and frequency sweep measurement functions table

Measurement functions	Normal Mode	Average Mode
Hold off	✓	—
Trigger delay	✓	—
Measurement averaging	—	✓
Gate setting	✓	—
Channel offset	—	✓
Hysteresis	—	—
Measurement types supported	Peak, peak-to-average, average, minimum power	Average only

NOTE

Refer to the P-Series Power Meters Programming Guide for the commands usage details. Example of command set:
SENSe:BUFFer:MTYPe "PEAK"

Power Sweep Mode

Power sweep is generally used in power level calibration setup where the frequency is fixed, and the amplitude of the power source signal is swept. This mode can be used to characterize the flatness, linearity or gain compression of a device under test.

NOTE

This feature is applicable for 8480 Series, N8480 Series, E-Series E4410, E-Series E9300, E-Series E9320 or P-Series N1920 sensor when connected.

Procedures

- 1 Connect sensor to a power source.
- 2 Connect power meter **TRIG OUT** to power source **TRIG IN** using a BNC cable. The same connection is applied for power source **TRIG OUT** to power meter **TRIG IN**. See [Figure 2-58](#) on page 84.

2 General Power Meter Functions

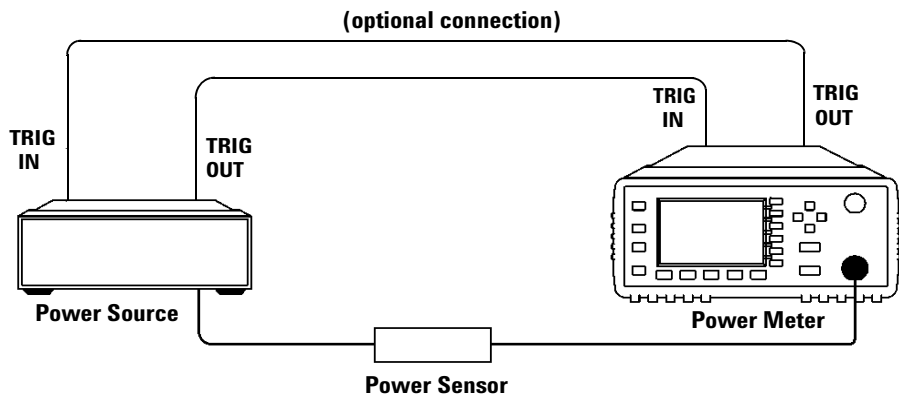

Figure 2-58 TRIG IN and TRIG OUT connection diagram between power meter and power source.

- 3 Press . The **Channel Setup** screen displays as below.

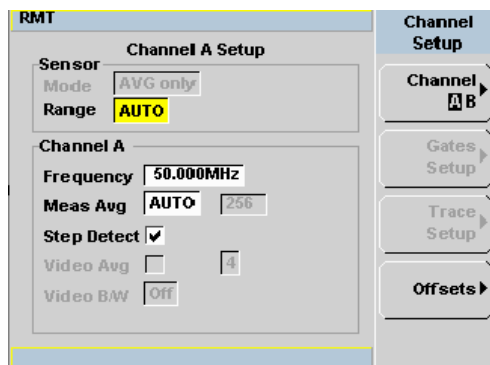

Figure 2-59 Channel Setup display





NOTE

When 8480 Series, N8480 Series, E-Series E4410 or E-Series E9300 sensor is connected, **Sensor Mode** is set to **AVG** only by default.

NOTE

When E-Series E9320 or P-Series N1920 sensor is connected, the default sensor mode is **Normal**. User can use this **Normal** mode to perform power or frequency sweep, or change the mode to **AVG** only to perform power or frequency sweep. Refer [Table 2-6](#) on the differences in measurement functions supported under these two modes.

To change the sensor mode from the default **Normal** mode to **AVG** only mode, follow the instructions below:

- Press . Use the  and  keys to highlight the **Sensor Mode** field.
- Press  to display the **Sensor Mode** pop-up.

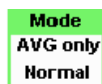





Figure 2-60 Sensor Mode pop-up.

- Use the  and  keys to highlight the **AVG** and press .



4 Press . The **Trigger** menu is displayed.

5 Press **Acqn** softkey to configure the trigger.

6 Select either **Sing Trig** or **Cont Trig**.

- **Sing Trig** is a single shot mode. After triggering, the measurement is halted, and the  symbol is displayed. You can start another

measurement by pressing the  key.

- **Cont Trig** is a continuous trigger mode. The symbol  or  is displayed.

2 General Power Meter Functions

- 7 Press **Settings** to configure the remaining trigger parameters. The trigger **Settings** menu consists of two pages. **Figure 2-61** shows page 1 and **Figure 2-62** shows page 2.

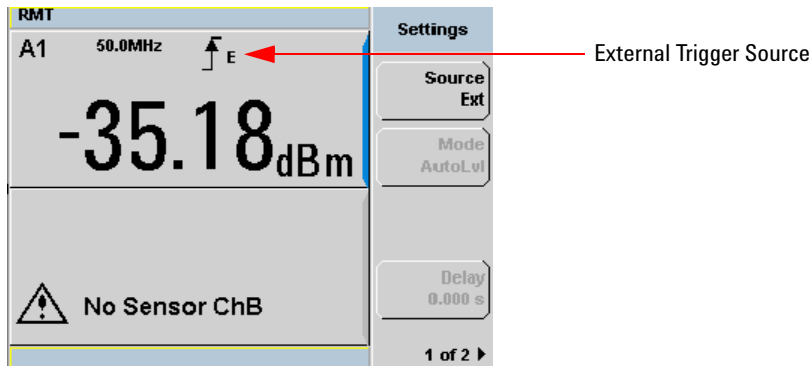

Figure 2-61 Trigger setting menu 1 of 2



Figure 2-62 Trigger setting menu 2 of 2

- 8 Press **Source** and **Ext** will be automatically enabled.
- 9 Press **1 of 2**, select **Output On** to allow a TTL level high to be produced at the rear panel **TRIG OUT** BNC port upon the meter completed a measurement. Refer to note on page 87 for details.

NOTE

In both power sweep and frequency sweep mode, the meter **TRIG OUT** to power source **TRIG IN** connection is optional. If this connection was not setup previously, you need to setup the proper Dwell time. You may choose to setup the Dwell time in the power source step setting to cater the maximum settling time required by the power meter. However, to achieve maximum speed in power sweep, this setup is recommended. Once the power reading is settled, the meter will output a TTL signal at the **TRIG OUT** to the power source **TRIG IN** to trigger the power source to step to the next point.

10 Press **Slope** and select **+** or **-** to set the trigger edge.

11 Set the trigger buffer size by sending `SENSE:BUFFer:COUNT <buffer_size>` command to meter using remote interface.

NOTE



Refer to the *P-Series Power Meters Programming Guide* for the commands usage details.

Example of command set:

```
SENSE:BUFFer:COUNT 20
```

NOTE

The power meter can be remotely controlled by LAN, USB and GPIB (IEEE488) programming interfaces. Refer to *P-Series Power Meters Installation Guide* for details.

12 Press  or  to setup measurement setting such as measurement averaging, measurement frequency, offsets, duty cycle and so forth. Refer to “[General Power Meter Functions](#)” on page 29 for the setup procedures.

13 Send `*OPC` (Operation Complete) command to meter to set the operation complete bit in the Standard Event Status register when all pending device operations are completed.

14 Set the meter to continuous trigger mode by sending `INITiate:CONTinuous ON` command to meter.

15 Configure and set the required power sweep range and step on the power source accordingly.

16 Set the power source trigger input and trigger output, then start sweeping.

17 Poll the status of the power meter by sending *ESR?. *ESR? will return a 1 when buffering is completed. Use FETCh? to retrieve all the buffered measurement.

Example of SCPI commands set

Refer to the following SCPI commands for normal and average mode in power sweep measurement.

NOTE

Refer to the *P-Series Power Meters Programming Guide* for the commands usage details.

Normal mode

This feature is applicable for E9320 and N1920 Series power sensor when connected. Below are examples of SCPI commands when used in normal mode. Send the SCPI commands below to meter using remote interface.

- SENS:DET:FUNC NORM
- TRIG:SOUR EXT
- SENS:BUFF:COUN 2048

Optional measurement configurations:

- TRIG:DEL 1ms
- TRIG:HOLD 10us
- OUTP:TRIG ON
- SENS:SWE1:OFFS:TIME 100us
- SENS:SWE1:TIME 100us
- INIT:CONT ON
- *OPC
- *ESR?
- FETC?

Average mode

This feature is applicable for 8480 Series, N8480 Series, E-Series E4410, E-Series E9300, E-Series E9320 or P-Series N1920 sensor when connected. Below are examples of SCPI commands when used in average mode. Send the SCPI commands below to meter using remote interface.

- SENS:DET:FUNC AVER
- TRIG:SOUR EXT
- SENS:BUFF:COUN 2048

Optional measurement configurations:

- OUTP:TRIG ON
- SENS:MRAT DOUB
- SENS:AVER:COUN 128
- INIT:CONT ON
- *OPC
- *ESR?
- FETC?

Frequency Sweep Mode

Frequency sweep is generally used in a frequency response calibration system where the amplitude is fixed, and the frequency of the power source signal is swept. This mode can be used to determine the frequency response of a device under test.

NOTE

This feature is only available when N8480 Series, E-Series E4410, E-Series E9300, E-Series E9320 or P-Series N1920 sensor is connected.

Procedures

- 1 Connect sensor to a power source.
- 2 Connect power meter **TRIG OUT** to power source **TRIG IN** using a BNC cable. The same connection is applied for power source **TRIG OUT** to power meter **TRIG IN**. See [Figure 2-58](#).
- 3 Press . The **Channel Setup** displays as shown in [Figure 2-59](#).









NOTE

When N8480 Series, E-Series E4410 or E-Series E9300 sensor is connected, **Sensor Mode** is set to **AVG** only by default.

NOTE

When E-Series E9320 or P-Series N1920 sensor is connected, the default sensor mode is **Normal**. User can use this **Normal** mode to perform power or frequency sweep, or change the mode to **AVG** only to perform power or frequency sweep. Refer [Table 2-6](#) on the differences in measurement functions supported under these two modes.



To change the sensor mode from the default **Normal** mode to **AVG** only mode, follow the instructions below:

- Press . Use the  and  keys to highlight the **Sensor Mode** field.
 - Press  to display the **Sensor Mode** pop-up.
 - Use the  and  keys to highlight the **AVG** and press .
-
- 4 Press . The **Trigger** menu is displayed.
 - 5 Press **Acqn** softkey to configure a trigger.
 - 6 Select either **Sing Trig** or **Cont Trig**.
 - 7 Press **Settings** to configure the remaining trigger parameters. The trigger **Settings** menu consists of two pages. [Figure 2-61](#) shows page 1 and [Figure 2-62](#) shows page 2.
 - 8 Press **Source** and **Ext** will be automatically enabled.
 - 9 Press **1 of 2**, select **Output On** to allow a TTL level high to be produced at the rear panel **TRIG OUT** BNC port upon the meter completed a measurement. Refer to note below for details.

NOTE

In both power sweep and frequency sweep mode, the meter **TRIG OUT** to power source **TRIG IN** connection is optional. If this connection was not setup previously, you need to setup the proper Dwell time. You may choose to setup the Dwell time in the power source step setting to cater the maximum settling time required by the power meter. However, to achieve maximum speed in frequency sweep, this setup is recommended. Once the power reading is settled, the meter will output a TTL signal at the **TRIG OUT** to the power source **TRIG IN** to trigger the power source to step to the next point.

2 General Power Meter Functions

- 10** Press  or  to setup measurement settings such as measurement averaging, measurement frequency, offsets, duty cycle and so forth. Refer to “General Power Meter Functions” on page 29 for the setup procedures.
- 11** Set the frequency range and step by sending the below commands to meter using remote interface.
- SENSE:FREQUENCY:START <start_frequency><frequency_unit>
 - SENSE:FREQUENCY:STOP <stop_frequency><frequency_unit>
 - SENSE:FREQUENCY:STEP <frequency_step_size>

NOTE

Refer to the *P-Series Power Meters Programming Guide* for the commands usage details.

Example of commands set:

```
SENSE:FREQUENCY:START 10MHz
```

```
SENSE:FREQUENCY:STOP 500MHz
```

```
SENSE:FREQUENCY:STEP 10
```

NOTE

The power meter can be remotely controlled by LAN, USB and GPIB (IEEE488) programming interfaces. Refer to *P-Series Power Meters Installation Guide* for details.

- 12** Send *OPC (Operation Complete) command to meter; to set the operation complete bit in the Standard Event Status register when all pending device operations are completed.
- 13** Set the meter to continuous trigger cycles by sending INITiate:CONTinuous ON command to meter.
- 14** Configure and set the required frequency sweep range and frequency step size of the power source.
- 15** Set the power source trigger input and trigger output.
- 16** Set the power source to sweep.
- 17** Poll the status of the power meter by sending *ESR?. *ESR? will return a 1 when buffering is completed. Use FETCh? to retrieve all the buffered measurement.

Example of SCPI commands set

Refer to the following SCPI commands set for normal mode and average mode in frequency sweep measurement.

NOTE

Refer to the *P-Series Power Meters Programming Guide* for the commands usage details.

Normal mode

This feature is applicable for E9320 and N1920 Series power sensor when connected. Below are examples of SCPI commands when used in normal mode. Send the SCPI commands below to meter using remote interface.

- SENS:DET:FUNC NORM
- TRIG:SOUR EXT
- SENS:FREQ:START 50 MHz
- SENS:FREQ:STOP 4 GHz
- SENS:FREQ:STEP 2048

Optional measurement configurations:

- TRIG:DEL 1ms
- TRIG:HOLD 10us
- OUTP:TRIG ON
- SENS:SWE1:OFFS:TIME 100us
- SENS:SWE1:TIME 100us
- INIT:CONT ON
- *OPC
- *ESR?
- FETC?

Average mode

This feature is applicable for 8480 Series, N8480 Series, E-Series E4410, E-Series E9300, E-Series E9320 or P-Series N1920 sensor when connected. Below are examples of SCPI commands when used in average mode. Send the SCPI commands below to meter using remote interface.

- SENS:DET:FUNC AVER
- TRIG:SOUR EXT
- SENS:FREQ:START 50 MHz
- SENS:FREQ:STOP 4 GHz
- SENS:FREQ:STEP 2048

Optional measurement configurations:

- OUTP:TRIG ON
- SENS:MRAT DOUB
- SENS:AVER:COUN 128
- INIT:CONT ON
- *OPC
- *ESR?
- FETC?

Determine the Right Step to be Set

Number of frequency step can be calculated by using equation below:

$$\text{Step} = \frac{f_{\text{stop}} - f_{\text{start}} + \text{Interval}}{\text{Interval}}$$

where,

Step = Number of frequency step

f_{start} = Frequency sweep's start point

f_{stop} = Frequency sweep's stop point

Interval = Frequency step size

Example

When $f_{\text{start}} = 1$ GHz and $f_{\text{stop}} = 5$ GHz with given interval of 0.5 GHz, the Step should be set to

$$\begin{aligned} \text{Step} &= \frac{f_{\text{stop}} - f_{\text{start}} + \text{Interval}}{\text{Interval}} \\ &= \frac{5 \text{ GHz} - 1 \text{ GHz} + 0.5 \text{ GHz}}{0.5 \text{ GHz}} \\ &= \underline{\underline{9}} \end{aligned}$$

Setting Measurement Limits

You can configure the power meter to detect when a measurement has crossed over a predefined upper and/or lower limit value.

Limits are boundaries set for a certain power range and it can be applied to power, ratio or difference measurement.

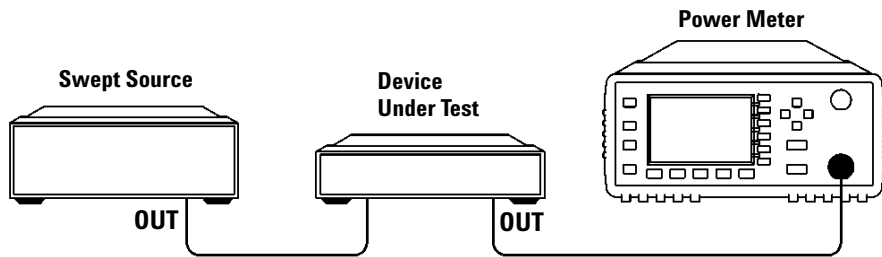

Figure 2-63 Limits checking applications

In this application a swept frequency signal is applied to the input of the Device Under Test. The power meter measures the output power. The limits have been set at +4 dBm and +10 dBm. A fail occurs each time the output power is outside these limits as shown in Figure 2-64.

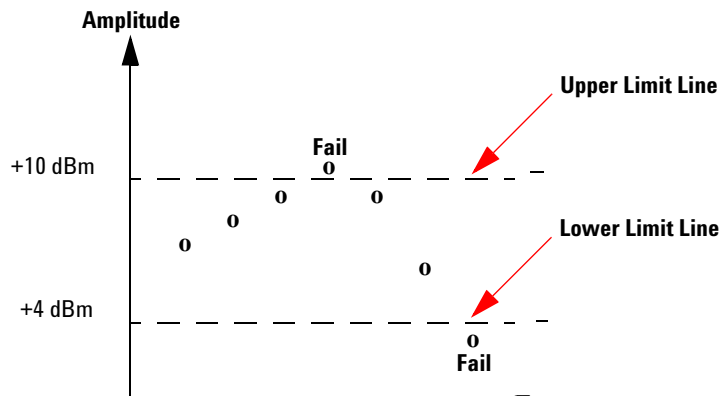

Figure 2-64 Limits checking results

Setting Limits

The power meter can be configured to verify the current measurement in any measurement line against predefined upper and/or lower limit values. The range of values that can be set for the upper and lower limits and the default values depends on the measurement units in the currently selected measurement line (see Table 2-7).

Table 2-7 Range of values for window limits





Window Units	Maximum	Minimum	Default Maximum	Default Minimum
dB	+200 dB	-180 dB	60 dB	-120 dB
dBm	+230 dBm	-150 dBm	90 dBm	-90 dBm
%	999.9 X%	100.0 a%	100.0 M%	100.0 p%
W	100.000 XW	1.000 aW	1.000 MW	1.000 pW

Procedure

Set the limits as follows:

NOTE

Ensure you have selected the channel you wish to set up.

- 1 Press , **Meas Select** to display the **Measurement Setup** menus.
- 2 Use the  and  keys to highlight the **Limits:** setting field.
- 3 Press  to check the **Limits:** setting field.
- 4 Use the  key to highlight the **Minimum Limits:** value field.

2 General Power Meter Functions

- 5 Press  to display the **Minimum Limit** pop-up.

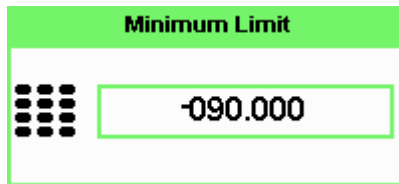





Figure 2-65 Minimum limit pop-up

- 6 Use the numeric keys to enter the required value and press **dBm**.
- 7 Use the  key to highlight the **Maximum Limits:** value field.
- 8 Press  to display the **Maximum Limit** pop-up.
- 9 Use the numeric keys to enter the required value and press **dBm**.
- 10 Press  key to close the **Measurement Setup** screen.

NOTE

The Limits can be disabled and re-enabled by checking the **Limits:** setting field.

Checking for Limit Failures

Limit failures are displayed in the appropriate field in the measurement window on the power meter's display as shown in [Figure 2-66](#).

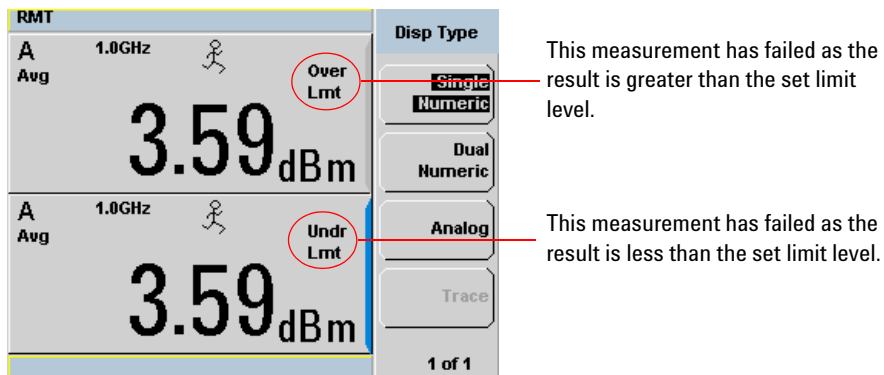

Figure 2-66 Limit failures

Setting the Measurement Display

Using the gate settings, up to four measurements or a combination of measurements can be shown on the display. Any of the 4 measurement display lines can show any of the measurement results from any of the 4 gates, allowing you complete control of the displayed information.

The power meter cannot display all 16 (or 32) measurements simultaneously.

Average, peak, peak-to-average ratio, and minimum measurements are made within each gate period generating possible measurement results per channel as shown in [Figure 2-67](#).

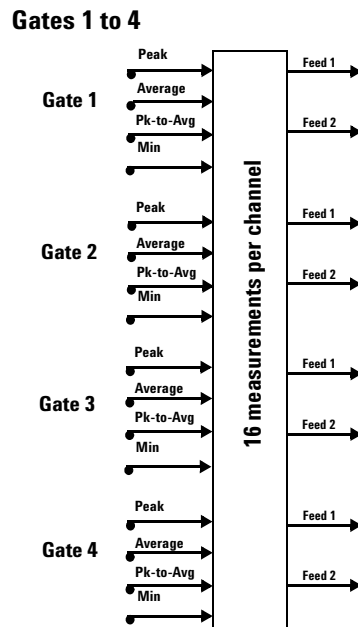

Figure 2-67 Sixteen measurements per channel

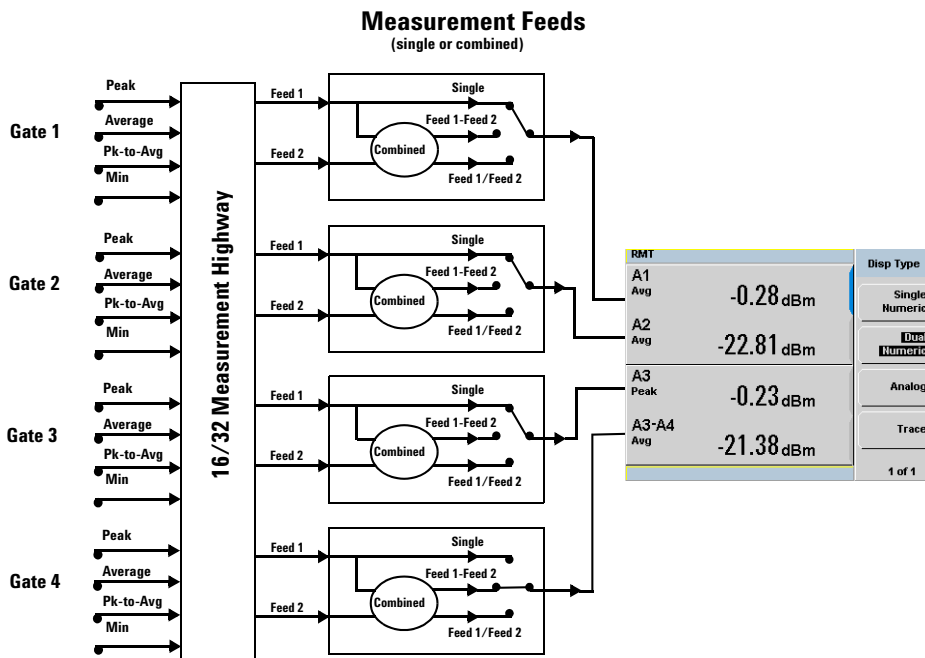



Figure 2-68 Measurement feed example

Each displayed line has a measurement feed. Each measurement feed has two independent inputs, Feed 1 and Feed 2. The two Feeds, 1 and 2, can carry any of the 16 measurement results from the 4 gates. (32 measurements from 8 gates in the dual channel N1912A). Only Feed 1 can be displayed in Single Mode. In Combined Mode, Feed 1 - Feed 2 or Feed 1 / Feed 2 can be displayed.

Numeric Format

Configure a measurement displayed in **Single Numeric** or **Dual Numeric** format as follows:

- Press  , **Meas Select** to select the measurement window or measurement line you want to configure.

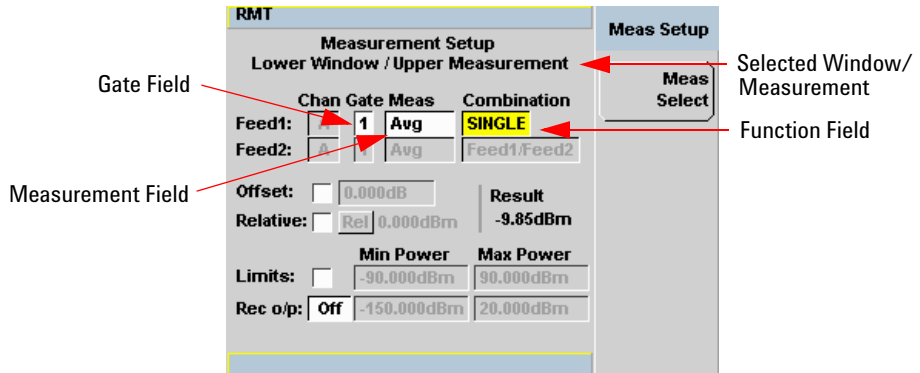

Figure 2-69 Measurement Setup showing single configuration

Single Function Measurement

Figure 2-69 shows Gate 1 with an average measurement assigned in the upper measurement line of the lower window. (For single channel power meter (N1911A), the **Channel** field will be disabled, as shown in Figure 2-69).

NOTE

The gate field is disabled if trigger acquisition is Free Run.

- Use the , , , , to highlight the **Combination** function field.











- 2 Press  to display the Function pop-up, and use the  and  to highlight **Single**.



Figure 2-70 Function pop-up

- 3 Press  to complete the entry.
- 4 Use the , , , , to highlight the measurement type field.
- 5 Press  to display the **Feed Measurement** pop-up, and use the  and  in assign a measurement type.

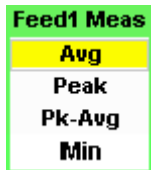







Figure 2-71 Measurement type pop-up

- 6 Press  to complete the entry.
- 7 Use the , , , , to highlight the **Gate** field.

2 General Power Meter Functions

- 8 Press  to display the **Gate Number** pop-up, and use the numeric keypad to enter the required value in the **Gate Number** pop-up window.

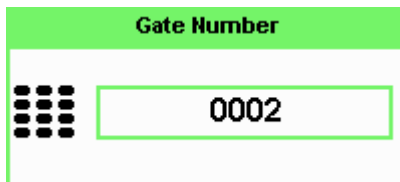



Figure 2-72 Gating Number pop-up

- 9 Press **Enter** to complete the entry.
- 10 Repeat this process until you have setup all the required gates and measurements.
- 11 Press  key to complete the setup and display the measurement results.

Combined Measurement

Figure 2-73 shows a Combined Measurement configuration; Channel A, gate 1 peak power minus gate 3 peak power, to be displayed in the lower measurement line of the lower display window. (For single channel power meter (N1911A), the **Channel** field will be disabled, as shown in Figure 2-73).

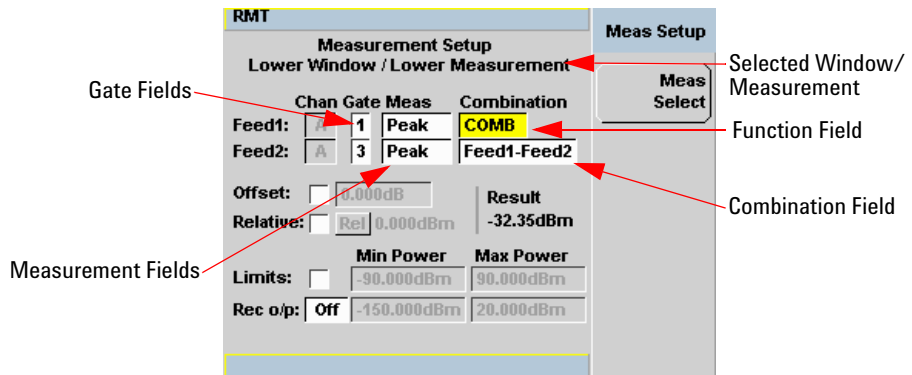













Figure 2-73 Measurement Setup showing combined configuration

NOTE

The **Gate** field is disabled if Trigger Acquisition is Free Run.

- 1 Use the , , , , to highlight the **Combination** function field.
- 2 Press  to display the **Function** pop-up (see Figure 2-70) and use the  and  to highlight **Combined**.
- 3 Press  to complete the entry.
- 4 Use the , , , , to highlight the measurement type field.











- 5 Press  to display the **Feed Measurement** pop-up (see [Figure 2-71](#)) and use the  and  to assign a measurement type.
- 6 Press  to complete the entry.
- 7 Use the , , , , to highlight the **Gate** field.
- 8 Press  to display the **Gate Number** pop-up, see [Figure 2-72](#), and use the numeric keypad to enter the required value in the **Gate Number** pop-up window.
- 9 Press **Enter** to complete the entry.
- 10 Repeat this process until you have setup all the required gates and measurements.
- 11 Press  key to complete the setup and display the measurements results.





Figure 2-74 Measurement example display

Scaling the Analog Display

NOTE

Ensure you have highlighted an Analog window.

Use the , , or  keys to select the analog measurement window.

Press **dBm**, **mW**, **uW**, or **nW**, to complete the entry.

Configure a measurement displayed in **Analog** format as follows:

- 1 Press , **Anlg Mtr Scaling** to display the **Analog Scaling** softkeys.

The **Max** and **Min** scale values are shown on the analog display and adjacent to the softkey labels.

- 2 Press **Max** to display the **Meter Maximum** pop-up.

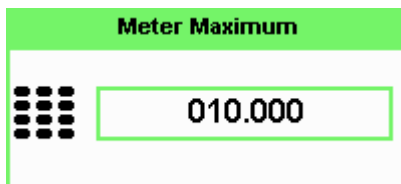

Figure 2-75 Maximum limit pop-up

- 3 Use the numeric keys to enter the required value and press **dB**.
- 4 Press **Min** to display the **Meter Minimum** pop-up.

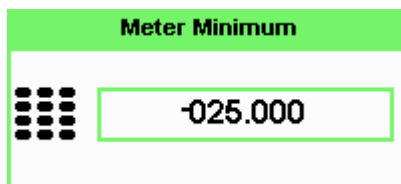

Figure 2-76 Minimum limit pop-up

- 5 Use the numeric keys to enter the required value and press **dB**.

2 General Power Meter Functions

Tip If you have selected linear scaling for the analog measurement and the units you require are beyond the range of the displayed menu, an additional menu is available. When the pop-up is displayed, you can press 1 of 2 to access the increment/decrement multiplier menu.

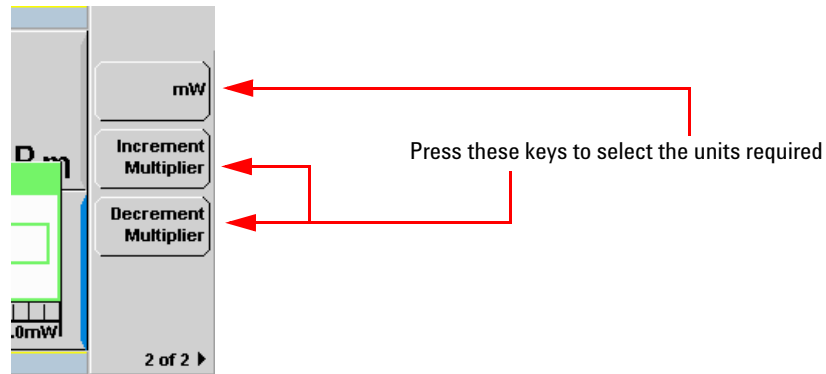

Figure 2-77 Increment and decrement multiplier

Use the **Increment Multiplier** or **Decrement Multiplier** to display the required units.

Press the units softkey (**xW**) to complete the entry.

Recorder Output

The rear panel **Recorder Output** connectors (1 and 2) produce a dc voltage that corresponds to the power level in Watts of the channel depending on the measurement mode. This dc voltage ranges from 0 to +1 Vdc. The output impedance is typically 1 k Ω . Channel and display offsets, and duty cycle have no effect on the Recorder Outputs.

For example, the Recorder Outputs can be used to:

- Record swept measurements
- Level an output from a source using external leveling
- Monitor the output power





To access the **Recorder** menu press , and enable Rec o/p. This allows you to switch the Recorder Output signal either on or off. The **Max Power** and **Min Power** softkeys allow you to scale the power levels to represent the 1 Vdc maximum and 0 Vdc minimum output voltage of the Recorder Output.

Procedure



Set the recorder output as follows:

NOTE

Ensure you have selected the channel you want to set up.

- 1 Press , **Meas Select** to display the **Measurement Setup** menus.
- 2 Use the  and  keys to highlight the **Rec o/p**: setting field.
- 3 Press  to reveal the **Recorder** option menu.

2 General Power Meter Functions

4 Use the  and  keys to highlight the option you require.

- The N1911A has only two options, **On** or **Off**.
- The N1912A have three options: 1, 2 or Off.

5 Press  .

6 Use the  key to highlight the **Recorder Minimum:** value field.

7 Press  to display the **Recorder Minimum** pop-up.

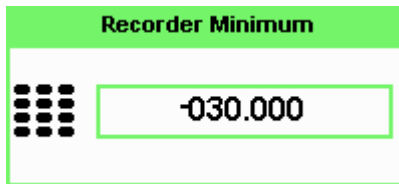



Figure 2-78 Recorder Minimum pop-up

8 Use the numeric keys to enter the power level you want to generate a 1 Vdc output in the **Recorder Maximum** pop-up and press **dBm**.

9 Use the  key to highlight the **Recorder Maximum:** value field.

10 Press  to display the **Recorder Maximum** pop-up.

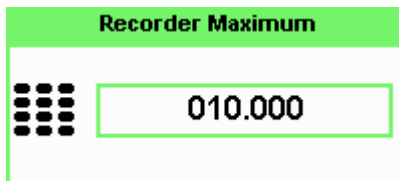



Figure 2-79 Recorder Maximum pop-up

11 Use the numeric keys to enter the power level you want to generate a 0 Vdc output in the **Recorder Minimum** pop-up and press **dBm**.

12 Press  key to close the **Measurement Setup** screen.

NOTE

The recorder output can be disabled and re-enabled by checking the **Rec o/p:** setting field.

NOTE

The highest power you are going to measure is used to determine the value which you should set for the **Recorder Output** maximum setting. For example, if you are measuring a power less than 1 mW and greater than 100 μ W, then set the recorder maximum value to 1 mW.

Table 2-8 Ranges of recorder output setting

Log	50	40	30	20	10	0
Lin	100 W	10 W	1 W	100 mW	10 mW	1 mW
Log	-10	-20	-30	-40	-50	-60
Lin	100 mW	10 mW	1 mW	100 nW	10 nW	1 nW

Tip If you have selected linear scaling for the recorder output and the units you require are beyond the range of the displayed menu, an additional menu is available. When the pop-up is displayed, you can press 1 of 2 to access the increment/decrement multiplier menu.

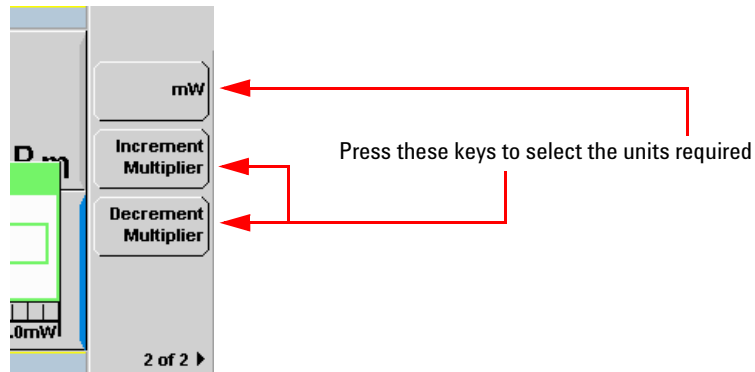

Figure 2-80 Increment and decrement multiplier

Use the **Increment Multiplier** or **Decrement Multiplier** to display the required units. Press the units softkey (**xW**) to complete the entry.

N1911A/N1912A Option H02

NOTE

N1911A/N1922A Option H01 replaces the recorder output on the rear panel with video output. The video output is the direct signal output detected by the sensor diode, with no correction applied. The video output provides a DC voltage proportional to the measured input power through a BNC connector on the rear panel. The DC voltage can be displayed on an oscilloscope for time measurement. The video output impedance is 50 Ω .

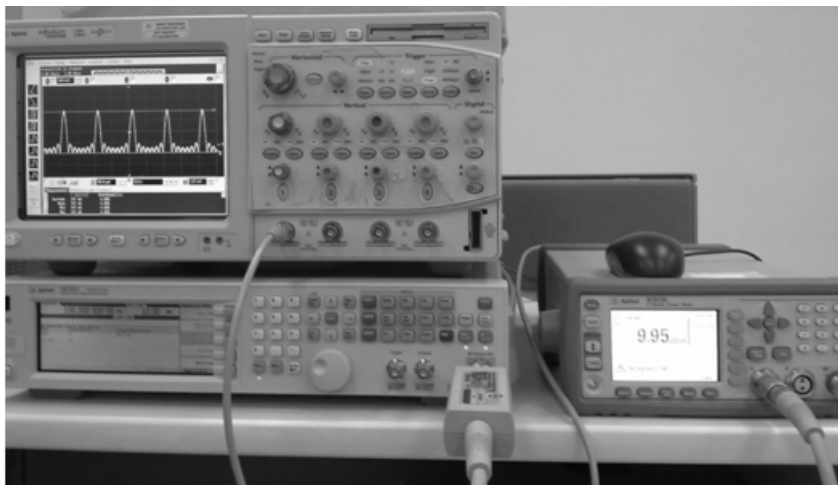

Figure 2-81 Measurement example for Option H02

Measurement example for Option H02

For this example, N1912A P-Series power sensors, MXG N5182A signal generator, and Infiniium 54832D oscilloscope will be used.

- 1 Connect the power sensor input to the RF input of the signal generator.
- 2 Connect the video output of the power meter (Option H02) to the channel 1 of the oscilloscope with a BNC cable.
- 3 Generate an RF Multitone waveform from the signal generator.
- 4 Set the oscilloscope to **Auto Trigger** mode to capture the waveform.

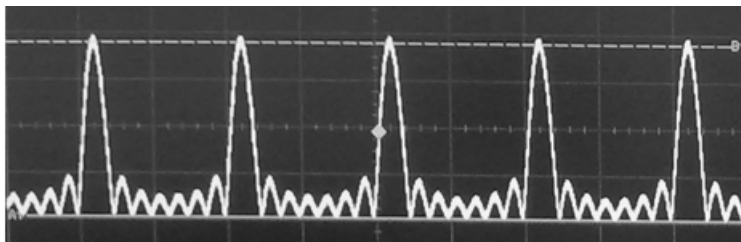



Figure 2-82 Example screenshot of the RF Multitone waveform

Saving and Recalling Power Meter States

To reduce repeated setup sequences, you can save a maximum of ten power meter states in the non-volatile memory.

The save/recall functions are part of the **Sys/Inputs** menu, accessed by pressing the  key.

NOTE

Your power meter has measurement configurations suitable for common wireless communication and radar (pulse) formats already saved as Instrument Presets. These require P-Series or E-Series E9320 power sensors.

To save a measurement setup:

- 1 Press , **Save/Recall** to display the **Save/Recall** screen as shown in [Figure 2-83](#).

RMT		Save/Recall
Reg	Name	Status
1	State1	Available
2	State2	Available
3	State3	Available
4	State4	Available
5	State5	Available
6	State6	Available
7	State7	Available
8	State8	Available
9	State9	Available
10	State10	Available

Save



Recall

Edit Name

Done

1 of 1

Figure 2-83 Save/Recall screen

- 2 Using the  and  keys, select an available name from the displayed list. To change the name of a register - See [Chapter 2](#), “Editing a Register’s Name,” starting on page 105, otherwise press **Save**.

- 3 The power meter prompts you to press **Confirm** to proceed.



Figure 2-84 Save confirm pop-up

Editing a Register's Name

- 1 If you have not already done so, press **System**, **Save/Recall**.
- 2 Use the **Up** and **Down** keys to select the required register and press **Edit Name**. The selected name is displayed in a pop-up window. Modify this as required:

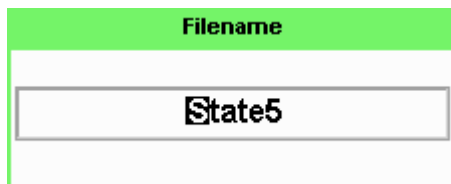





Figure 2-85 File name pop-up

- 3 Use **Up** and **Down** keys to modify the character on which the cursor is currently positioned.
- 4 Use **Left** or **Right** to move to other characters.
- 5 Use **Insert Char** and **Delete Char** as required.
- 6 To confirm your choice press **Enter**.

Recalling a Measurement Setup

- 1 Press , **Save/Recall**.
- 2 Use the  and  keys to select the required register and press **Recall**.

The **Recall** key is disabled (grayed out) when an unused register is selected.

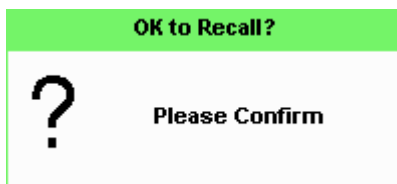

Figure 2-86 Recall pop-up

- 3 Press **Confirm**.

Zeroing and Calibrating the P-Series Sensor

This section describes how to zero and calibrate the power meter when using a P-Series wideband power sensor.

Zeroing

Zeroing adjusts the power meter for a zero power reading on each power meter channel and P-Series sensor combination. This is achieved without removing it from a power source. The power meter can be set to automatically zero *on-the-fly* while you are using it. Alternatively, you can perform a zero at your preference. During zeroing a wait symbol is displayed.



Figure 2-87 Zeroing pop-up

When the P-Series power sensor is initially connected to the power meter, it automatically performs a Zero and Calibration routine.

When to Zero?

Zeroing of the power meter is recommended:

- When a 5 °C change in temperature occurs.
- Every 24 hours.
- Prior to measuring low level signals. For example, 10 dB above the lowest specified power for your power sensor.

Automatic Zero

The automatic zero can be enabled as follows:

- Press , **1 of 2** and toggle the **Auto Zero A** to On.

The **Zeroing** pop-up is displayed when a zero occurs.

NOTE

When you are performing measurements, this may cause delays in obtaining results. During this time, it is recommended to disable the automatic zeroing.

Manual Zeroing

To manually zero the power meter and sensor:

- Press  and the channel **Zero** softkey.

The **Zeroing** pop-up is displayed.

NOTE

On dual channel meters you can zero each channel independently or both channels sequentially by pressing the **Zero** softkey - choosing **Zero A**, **Zero B** or **Zero Both**

Calibration

Calibration sets the gain of each power meter channel and P-Series sensor combination. This is achieved without the need to connect it to the 1.0 mW Power Reference. The power meter can be set to automatically calibrate *on-the-fly* while you are using it. Alternatively, you can perform the calibration manually. The reference calibration factor is automatically set for all P-Series power sensors.

During calibration, the wait symbol is displayed.



Figure 2-88 Calibration wait pop-up

Offset and relative settings are ignored during calibration.

Manual Calibration

To manually calibrate the power meter and sensor combination:

- 1 Press  and the channel **Cal** softkey to start the calibration routine.

The **Calibrating** pop-up is then displayed.

NOTE

For N1912A, you calibrate each channel independently by pressing the **Cal** softkey by choosing **Cal A** or **Cal B**.

Tip You can reduce the steps required to carry out the manual zero and calibration procedure as follow:

Press  and **Zero + Cal**. (For dual channel meters, press **Zero + Cal**, **Zero + Cal A** or **Zero + Cal B** as required).

Zero/Cal Lockout

The Zero/Cal Lockout facility can help you make sure that a measurement cannot be made until the power meter and sensor combination has been zeroed and calibrated.

When the Zero/Cal Lockout facility is enabled and a sensor is initially connected, the message **Please Zero and Cal** is displayed.

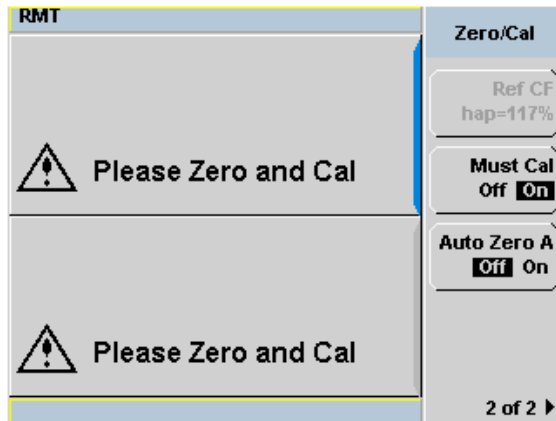



Figure 2-89 Please zero and calibrate window

When you zero the sensor the message changes to **Please Cal**. If you calibrate the sensor before zeroing it, the message changes to **Please Zero**.

Dual channel meters display channel specific messages when a sensor is connected. The Zero/Cal Lockout configuration is applied to both channels - it cannot be applied to one channel only.

You can enable and disable the Zero/Cal Lockout facility from the System menu or the Cal menu as follow:

Press , **1 of 2**, **Must Cal** **Off** or **On**.

Similarly,

press , **1 of 2**, **Must Cal** **Off** or **On**.

Presetting the Power Meter

This section details the power meter's preset conditions.

Press the  to display the preset options as shown in [Figure 2-90](#).

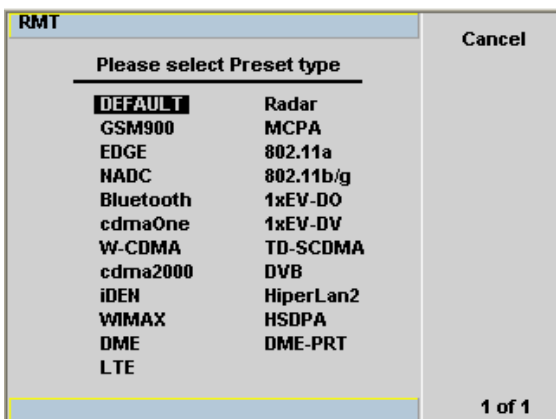

Figure 2-90 Preset display options

The remote addresses, the data stored in the sensor calibration tables, the calibration table selected, and the zeroing and calibration data are not affected by a preset.

For presetting with E-Series E9320 power sensors, refer to [Table 2-9](#).

Table 2-9 Preset compatibility matrix for E-Series E9320 power sensor

Preset	Compatible E-Series E9320 Sensors
GSM900	E9321A/E9322A/E9323A/E9325A/E9326A/E9327A
EDGE	E9321A/E9322A/E9323A/E9325A/E9326A/E9327A
NADC	E9321A/E9322A/E9323A/E9325A/E9326A/E9327A
Bluetooth	E9322A/E9323A/E9326A/E9327A
cdmaOne	E9322A/E9323A/E9326A/E9327A
W-CDMA	E9323A/E9327A
cdma2000	E9323A/E9327A
iDEN	E9321A/E9322A/E9323A/E9325A/E9326A/E9327A
Radar	E9321A/E9322A/E9323A/E9325A/E9326A/E9327A
MCPA	E9321A/E9322A/E9323A/E9325A/E9326A/E9327A
802.11a	Not applicable
802.11b/g	Not applicable
1*EV-DO	E9321A/E9322A/E9323A/E9325A/E9326A/E9327A
1*EV-DV	E9321A/E9322A/E9323A/E9325A/E9326A/E9327A
TD-SCDMA	E9321A/E9322A/E9323A/E9325A/E9326A/E9327A
DVB	E9323A/E9327A
HyperLan2	Not applicable
WIMAX	E9323A/E9327A
HSDPA	E9323A/E9327A
DME	E9323A/E9327A
DME-PRT	E9323A/E9327A
LTE	E9323A/E9327A

NOTE

For all preset states, total of two windows are displayed.

Setting the Cable Short/Long

When connecting the power sensor with any Agilent power sensor cable with length of 10 m (32 ft) and above, you are required to change the cable setting from **Short** (default setting) to **Long**, or an error will occur when the power sensor is connected.

Short

This is the default setting and for sensor cable length less than or equal to 10 m (32 ft).

Long

This setting is for sensor cable length more than 10 m (32 ft). The maximum supported sensor cable length is 31 m (100 ft).

To access the cable setting,

- 1 Press , **1 of 2** and select **Service**.
- 2 In the **Service** menu, press **1 of 2** and select **Cable Short/Long** to toggle between the short or long cable options.

The **LCB** indicator will appear in blue at the bottom of the display to indicate that the long cable option is selected as shown in [Figure 2-91](#).

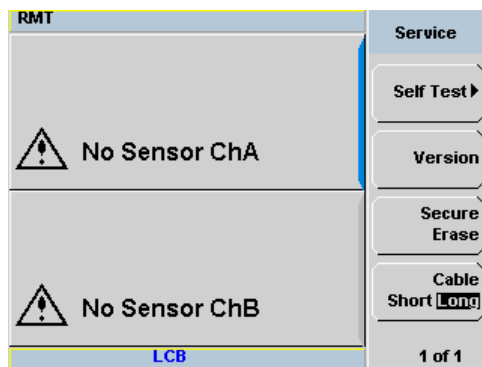

Figure 2-91 Short/long cable option

THIS PAGE HAS BEEN INTENTIONALLY LEFT BLANK.



3 Using P-Series Power Sensor

Introduction 116
Configuring a Power Measurement 117
Setting the Trace Display 118

This chapter describes how to use your P-Series power sensors (N1921A, N1922A, N1923A^[1], N1924A^[1]) with your P-Series power meters.

[1] The N1923/24A power sensors can be used with the P-Series power meters but there will be some compromise on the rise/fall time measurement capability.



Introduction

The P-Series wideband power sensor's mode of operation is optimized to measure the peak and average power of pulsed or modulated signals with a wide bandwidth.

The power meter automatically recognizes a P-Series wideband power sensor when it is connected. The sensor's calibration data, characterizing the sensor output versus input power, frequency and temperature, is automatically read by the power meter. After the sensor's data is read, the power meter automatically performs a zero and calibration, this process is described in [“Zeroing and Calibrating the P-Series Sensor”](#) on page 107.

The power meter and P-Series wideband power sensor continuously sample the RF signal at a 100 mega-samples per second. Similarly, the dual channel meter samples both channels at the same rate.

The instantaneous power of an RF signal can be detected with up to 30 MHz of video^[1] bandwidth (modulation bandwidth).

The triggering methods used by the system (power meter and sensor) enable the continuous measurement of modulated signals or single events. A trigger can be taken from a rising or falling edge of an RF signal pulse or controlled externally.

NOTE

Maximum dynamic range is related to the maximum sensor bandwidth. Refer to the documentation supplied with your P-Series wideband power sensor for specification information.

[1]The term *video* is applied to a signal that has been amplitude demodulated from an RF carrier, but contains components in the RF part of the spectrum. For a power meter it refers to the output of the sensor diodes.

Configuring a Power Measurement

While the P-Series power meter may at first seem complex, configuring a measurement and displaying the results can be quickly achieved.

You can configure the required measurements using the data entry from the channel setup gate and trace menus.

However, it is easier using the trace display's **Gate Control** and **Trace Control** menus to configure your initial set up, as it is a more interactive process and may require less iterations between channel, triggering, gate, and display functions to make a measurement.

Before configuring the measurements, you should have some information about the signal you want to measure. For example, the following information can help you quickly establish stable triggering and reliable measurement data:

- The Center Frequency (CF)
- The bandwidth of any modulating signal
- The expected maximum and minimum power levels
- Timing information for any pulsed signals

Setting the Trace Display

The P-Series power meter is optimized to operate in the trace display mode when measuring a pulsed signal.

The swiftest method to get the power meter into a trace display is described in the following procedure:

NOTE

The procedure assumes you are starting from a default preset.

- 1 Connect the power sensor to the power meter and connect it to the power source
- 2 Set the **Channel Frequency**
- 3 Set the **Trigger** to **Continuous**
- 4 Set the **Display** to **Trace**
- 5 Expand window and use the **Gate** control and **Trace** control menus to set the gate markers, trigger delay, and scale.

NOTE

You can return to other menus later to add more accuracy on the measurement, for example, **Channel Setup**, to set the measurement average, the video average and the bandwidth of a modulating signal.

- 6 When you are satisfied with the configuration you may want to save it for future use. See [“Saving and Recalling Power Meter States”](#) on page 104 for further information.







Step 1. Connecting the Power Sensor

When you initially connect a P-Series wideband power sensor to the power meter, the sensor's calibration data is automatically read by the power meter. After the sensor's data is read, the power meter automatically performs a zero and calibration, see [“Zeroing and Calibrating the P-Series Sensor”](#) on page 107 for further information.

Connect the sensor to the power source.

Step 2. Setting the Channel Frequency

- Press . The **Channel Setup** screen is displayed. If using an N1912A, select the channel you want to configure.

1. Press  the , , , and  keys to highlight the frequency field. Press  to configure the setting. See [“Setting the Measurement Frequency”](#) on page 32 for further information.

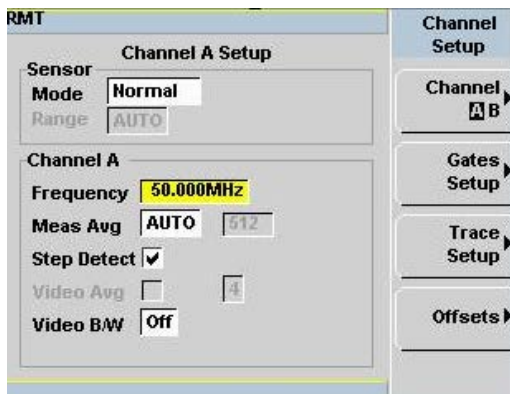

Figure 3-92 P-Series sensor default channel setup

NOTE

By default the sensor mode is set to **Normal**, users are allowed to change to **AVG** only mode whereby all the peak power measurement functions will be disabled.

When you have completed the procedure you can return to this menu later to add more accuracy to the measurement.

Step 3. Setting the Trigger

To use the measurement gates the power meter must be triggered.

A trigger can be taken from a rising or falling measured power level or controlled externally using the Ext Trig input.

- Press . The **Trigger** menu is displayed.

The trigger status is displayed below the **Acqn** label in the **Trigger** menu. Press the **Acqn** softkey and select **Cont Trig** to configure continuous triggering.

When you have completed the procedure you may return to the **Trigger** menu later to add more accuracy to the remaining trigger parameters, to help you achieve a stable and reliable trigger.

Step 4. Setting the Display to Trace

Using trace display provides a visual representation of the signal of interest.

- Press , **Disp Type**, **Trace** to display the Trace window.

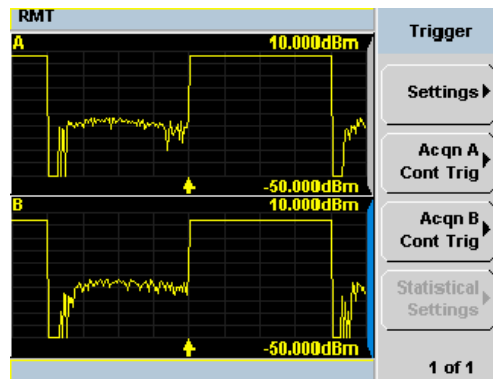





Figure 3-93 Trace display in dual channel power meter

- Use the , , or  keys to select a measurement window. Choose the type of display you require from the menu.

Step 5. Expanding the Trace Display

Expanding the trace to display a **Single Enlarged Window** provides a more detailed visual representation of the signal of interest and display of the measured results. [Figure 3-94](#) is an example of this display. This display type also provides a visual method of setting up the gate, trigger delay, and trace controls.

Use the  key to configure the display from two rectangular windows to a single enlarged window, or a full screen display by pressing repeatedly. The display style is applied to the currently highlighted window.

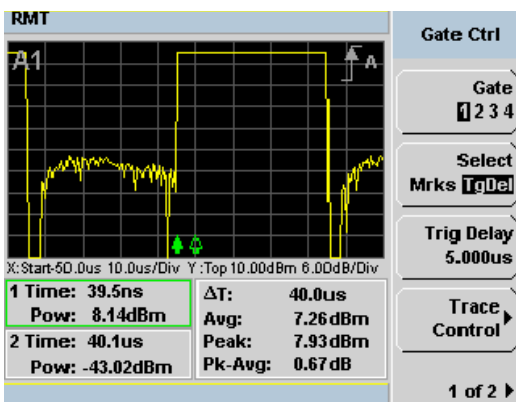





Figure 3-94 Trace display in single enlarged window

NOTE

When you alter a parameter in another menu, you are returned to a two window

display. Use the , , or  keys to highlight the trace measurement window and

use the  key to enlarge the display.

NOTE

If the bandwidth of a modulated signal is unknown, you may discover that during the set up process, a power sensor of lesser or greater bandwidth is required.

After you have completed this initial set up, you can, if required, return to the following setup to improve your measurement results:

- The **Channel Setup** to configure any averaging and offsets.
- The **Trigger** setup to configure any additional setting there.
- The **Meas Setup** to configure any additional setting there.

Gate Control in a Single Enlarged Window

When you initially display a Single Enlarged Window, the **Gate Control** menu is available. Setting the gate features are described in greater detail in “Setting Measurement Channel Gates” on page 57. However, the following sections are to give you an overview of the control and their impact on the displayed results.

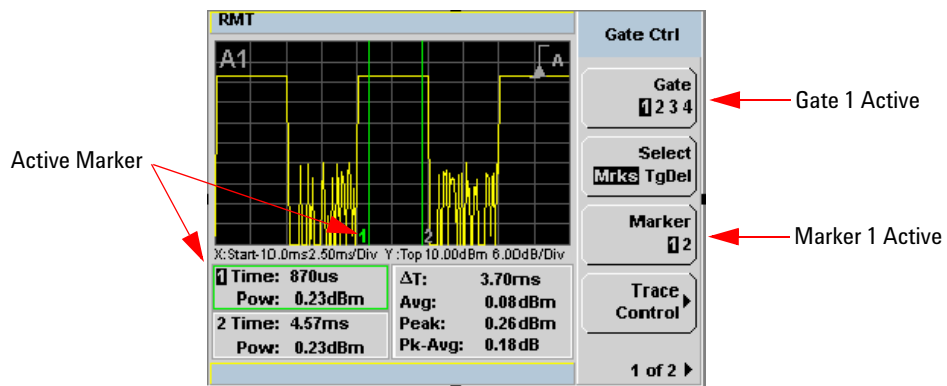

Figure 3-95 Trace display with gate control menu

Gate Pressing **Gate** scrolls through the 4 gates available for each channel. The gate displayed is highlighted below the **Gate** softkey. It is also displayed in the channel/gate annotation in the top left of the screen.

Select Pressing **Select Mrks TgDel** displays the gate markers or trigger markers.

Markers When **Mrks** is selected, Markers 1 and 2 indicate the start and end points of the selected measurement gate. Pressing **Marker** toggles between the two markers, the highlighted marker is the currently active marker. Use the **←** and **→** keys to move the markers left or right across the display.

The tables on the lower left of the screen show the time (**Time:**) and the instantaneous power level (**Pow:**) of the markers at their configured points. The table highlighted with the green border represents the active marker, also highlighted in green. A negative time value indicates a measurement before the trigger point. (See [Figure 3-95](#)).

NOTE

Gate timing parameters are all related to your chosen trigger point. This may be different from the timing of the triggering event if you have configured a trigger delay.

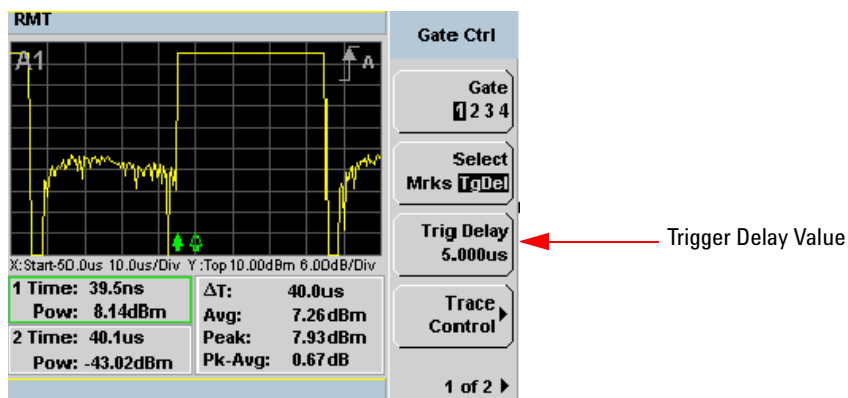



Figure 3-96 Trace display with trigger delay menu

TgDel When **TgDel** is selected you can adjust the trigger delay. The display changes to remove the gate markers and displays the trigger marker(s). The **▲** indicates when the trigger event occurs, whilst **⬇** shows the delayed trigger point. When the two points coincide, only the **▲**

3 Using P-Series Power Sensor

trigger is shown.

The configured value is displayed below the **Trig Delay** softkey. This value is shown in [Figure 3-96](#).

To indicate an off-screen trigger event,  is displayed. To indicate an off-screen trigger point,  is displayed.

NOTE

Your chosen trigger point is used as the reference point for the timing of all the measurement gates.

Trig Delay The trigger delay value is shown below the **Trig Delay** softkey. You configure the trigger delay by pressing **Trig Delay** and entering a numeric value in the pop-up window.

Pressing **Select** highlights **Mrks** to display the trace markers again.

NOTE

You can also setup the trigger delay in the **Trigger** menu, by pressing **Settings**, **Delay** and entering a value in the pop-up window.

Trace Control Press **Trace Control** to display the **Trace Control** menu. Setting the trace features are described in greater details in [“Setting up the Channel Trace”](#) on page 62.

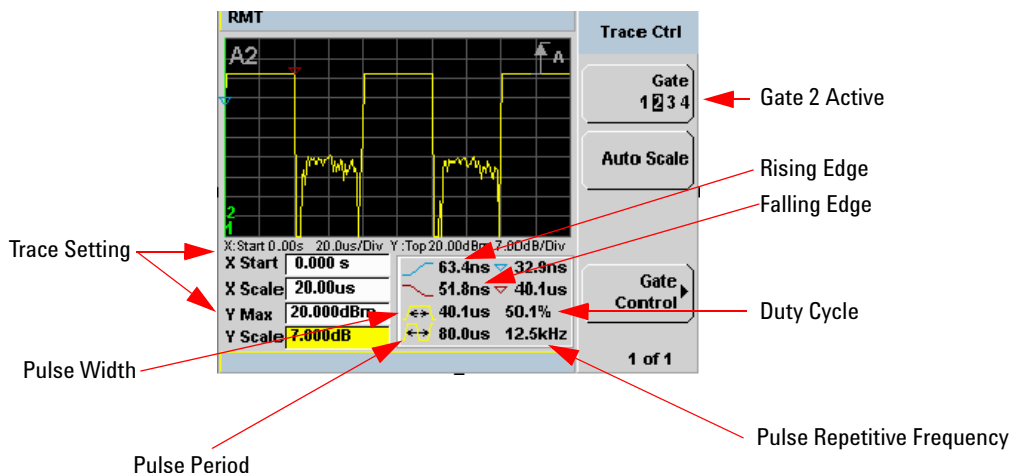

Figure 3-97 Trace display with trace control menu

The fields on the lower left of the screen are the X and Y trace setup fields. Using the \uparrow or \downarrow keys you can highlight the item and change its value. (See [Figure 3-97](#))

The table on the lower right of the screen shows the eight automatic time measurements performed on the first complete captured pulse after the trigger. The eight measurements are rise time, fall time, time to positive occurrence, time to negative occurrence, pulse width, pulse period (pulse repetitive interval), pulse repetitive frequency and duty cycle.

The current settings of the X and Y scale are displayed on the reporting line above both tables.

NOTE

If you want to view the trace in linear mode, the **Trace Setup** is the only location where you can change the Y-scale units from **dBm** to **Watts**; otherwise the default unit is in logarithmic.

Gate Control Press **Gate Control** to display the **Gate Ctrl** menu. Setting the gate features are described in greater details in “[Gate Control in a Single Enlarged Window](#)” on page 122”.

Viewing the Results in a Full Screen Window

Use the  key to display the trace in a full screen window display. This provides a better resolution on the display. You can press **Trace Meas** or **Gate Meas** to display the results as set in **Single Enlarged Window** mode. The current settings of the X and Y scale are displayed on the reporting line above

the results. You need to toggle the  key to allow the softkeys to be displayed.

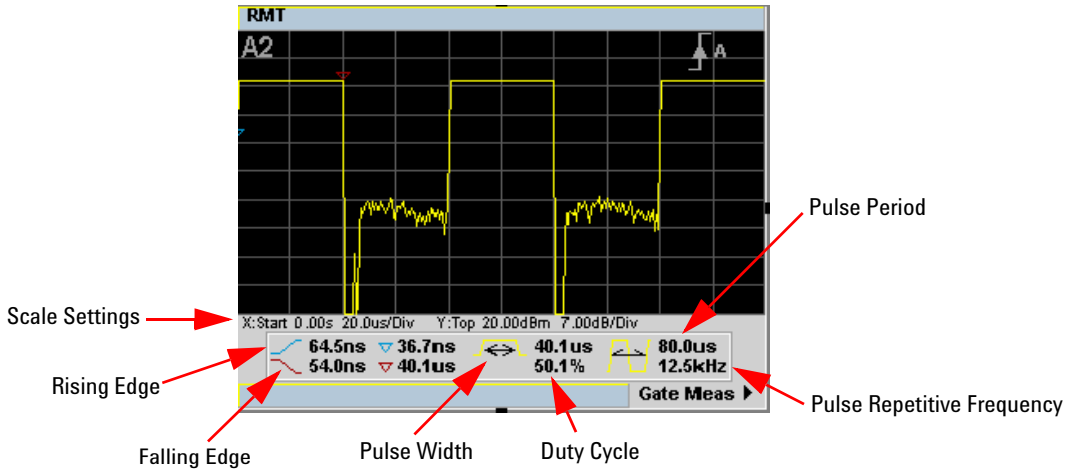



Figure 3-98 Trace display in full screen

Improving the Accuracy with Additional Settings

You can now return to the setup menus and adjust the default setting to obtain greater measurement accuracy.

Channel Setup

- Press . The **Channel Setup** screen is displayed. If using an N1912A, select the channel you want to configure.

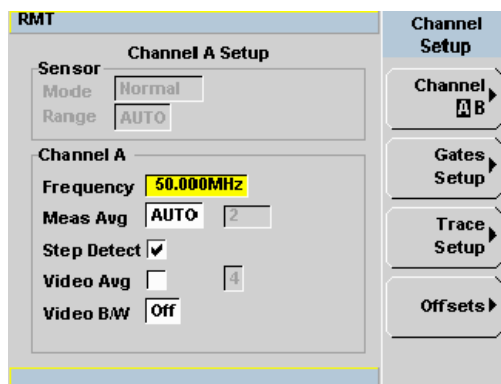





Figure 3-99 P-Series power sensor default channel setup

NOTE

For E-Series E9320 power sensors range settings, only UPPER and LOWER ranges are available in Normal and Triggered mode.

Use the , , , and  keys to highlight the setting field and press



to configure the setting. For further detail on these settings, refer to the appropriate sections.

- **Meas Avg:** [“Setting Measurement Averaging”](#) on page 49
- **Video Avg:** [“Setting the Video Averaging”](#) on page 52
- **Step Detect:** [“Step Detection”](#) on page 51

- **Video B/W:** “Setting the Video Bandwidth” on page 54

Setting Offsets

Press **Offsets**. The **Offsets Setup** screen is displayed.

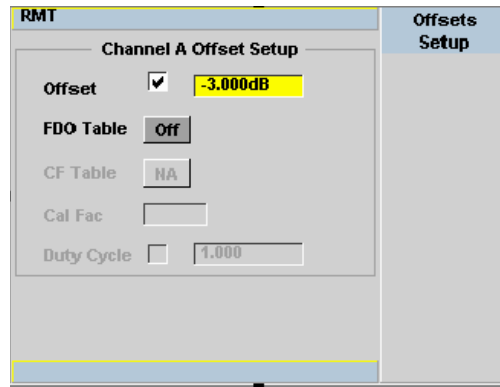







Figure 3-100 Channel offset display

Use the , , , and  keys to highlight any parameters you want to change. Press  to configure the required settings. For further detail on setting these, refer to the appropriate section.

- **Offset:** “Setting Channel Offsets” on page 39
- **FDO Table:** “Setting Frequency Dependent Offsets” on page 42

Trigger Setup

Press . The **Trigger** menu is displayed.





The trigger status is displayed below the **Acqn** label in the **Trigger** menu.

Press the **Settings** softkey and add more accuracy to the remaining trigger parameters, for example, hold-off and hysteresis, to help you achieve a stable and reliable trigger. Hence, this ensures that the gates you have set up are capturing the required signal information. See [Chapter 2](#), “Setting

the Trigger,” starting on page 66 for further information.

Measurement Setup

Press . The **Measurement Setup** menu is displayed.

Use the , , , and  keys to highlight the setting field and press



to configure the setting.

When you have configured the measurements gates, you can assign the measurement feed and display the results in numeric formats. For example, dual numeric display with Gate 1 peak measurement minus Gate 3 peak measurement. Also, from this menu you can add offsets and measurement limits. For further detail on these settings, refer the appropriate section.

- **Feed1/2** [“Setting the Measurement Display”](#) on page 90
- **Offset** [“Setting Display Offsets”](#) on page 41
- **Limits** [“Setting Measurement Limits”](#) on page 86

Display

Press . The **Display Form** menu is displayed.

Choose the display format to present the measurements results. The options, other than trace, are as follows:

Single Numeric If you need to configure the numeric format when using a P-Series sensor, refer to [“Numeric Format”](#) on page 91 for more details.

Dual Numeric If you need to configure the numeric format when using a P-Series sensor, refer to [“Numeric Format”](#) on page 91 for more details.

Analog If you need to configure the analog format when using a P-Series sensor refer to [“Scaling the Analog Display”](#) on page 97 for more details.

THIS PAGE HAS BEEN INTENTIONALLY LEFT BLANK.



4 Using E9320 E-Series Power Sensors

Introduction	132
Power Meter Configuration	134
Configuring a Peak Power Measurement	135
Measurement Accuracy	136
Setting the Trace Display	138

This chapter describes how to use your E9320 E-Series power sensors with P-Series power meter.



Introduction

The E9320 E-Series power sensors have dual modes of operation.

- The normal mode is optimized for a wider bandwidth but with reduced dynamic range. The instantaneous power of an RF signal can be detected with, depending on the sensor type, up to 5 MHz of video bandwidth (modulation bandwidth). Use this mode to measure the peak and average power of pulsed or modulated signals.
- The *average-only* mode is optimized for high accuracy and wide dynamic range. Use this mode to measure the average power of signals below the dynamic range of normal mode.

NOTE

The term 'video' is applied here to a signal that has been amplitude demodulated from an RF carrier but contains components in the RF part of the spectrum. For a power meter it refers to the output of the sensor diodes in normal mode.

In normal mode the P-Series power meters and E9320 E-Series power sensors continuously sample the RF signal at a 20 Msamples/s rate. A trigger can be taken from a rising or falling edge of an RF signal pulse or controlled externally via GPIB or TTL input.

Table 4-10 Sensor Bandwidth

Sensor	Video Bandwidth Setting			
	Low	Medium	High	Off
E9321A E9325A	30 kHz	100 kHz	300 kHz	300 kHz*
E9322A E9326A	100 kHz	300 kHz	1.5 MHz	1.5 MHz*
E9323A E9327A	300 kHz	1.5 MHz	5 MHz	5 MHz*

* The Low, Medium, and High settings provide flat filter responses with very sharp cutoff points by applying digital signal processing techniques. The Off setting removes all signal conditioning. Refer to [Figure 4-101](#).

NOTE

Maximum dynamic range is related to the maximum sensor bandwidth. Please refer to the documentation supplied with your E-Series E9320 power sensor for specification information.

Figure 4-101 shows the filter shapes associated with the E9323A and E9327A power sensors

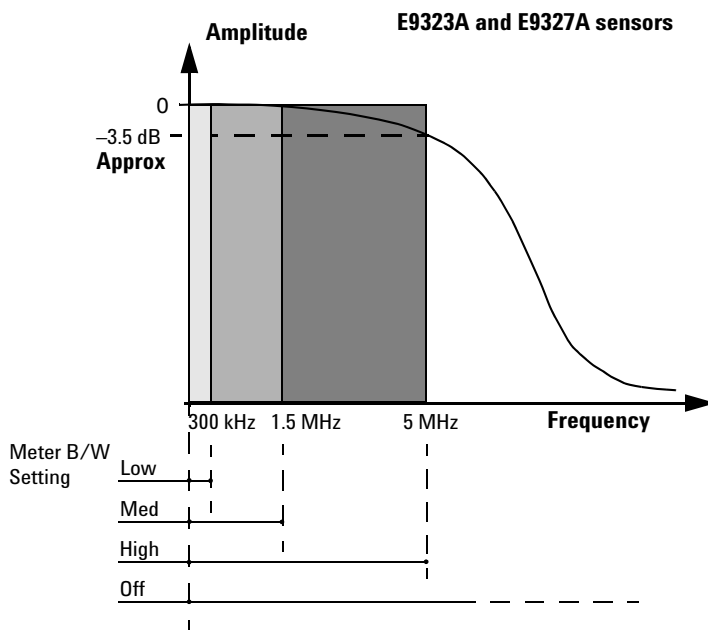

Figure 4-101 Bandwidth Filter Shapes

Power Meter Configuration

The P Series power meters automatically recognize an E-Series E9320 power sensor when it is connected. The sensor calibration data, characterizing the sensor output versus input power, frequency, and temperature, is automatically read by the power meter.

Default Channel Setup

When an E-Series E9320 power sensor is connected the following Channel Setup is automatically configured. Carrying out a Preset returns the power meter to this configuration.

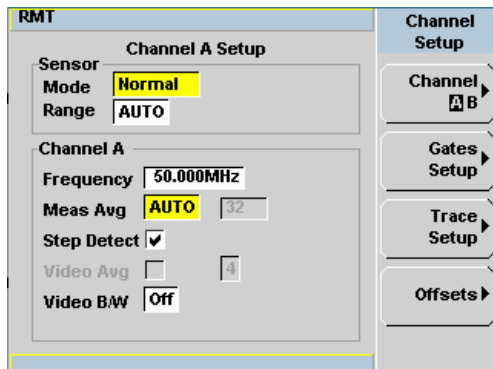

Figure 4-102 E-Series E9320 power sensor default channel setup

Configuring a Peak Power Measurement

While the P-Series power meter may at first seem complex, configuring a measurement and displaying the results are quickly achieved using trace markers or by following a step-by-step process of numeric data entry.

Before configuring the measurements, you should have some information about the signal you want to measure. The following information for example, can help you quickly establish stable triggering and reliable measurement data:

- the Center Frequency (CF)
- the bandwidth of any modulating signal
- the expected maximum and minimum power levels
- timing information for any pulsed signals

You can configure the required measurements using numeric data entry from the keypad or remote interface or, by manually positioning trace markers using the front panel controls.

Setting up the power meter using the trace markers is a more interactive process and may require more iterations between channel, triggering, gate, and display functions to make a measurement. However, it is ideally suited to measuring an unknown signal.

TIP If pulsed signal timing information is unavailable or incomplete, you may prefer to use the trace and marker functions to configure your measurement.

NOTE

You must select continuous or single triggered mode to enable the use of trace markers.

Measurement Accuracy

Power sensors have small errors in their response over frequency. The response of each sensor is measured during manufacture (and during periodic calibration). With E-Series power sensors, the resulting frequency compensation information is written into Electrically Erasable Programmable Read Only Memory (EEPROM). This allows the frequency and calibration data to be downloaded to the power meter automatically.

Using calibration factors enables you to achieve improved measurement accuracy. This section describes making continuous wave measurements using the E9320 E-Series power sensors.

Making a measurement requires the following steps:

- 1 Zero and calibrate the power meter/sensor combination.
- 2 Set the frequency for the signal you want to measure.
- 3 Make the measurement.

Procedure

First zero and calibrate the power meter/sensor combination.

- 1 Ensure the power sensor is disconnected from any signal source.

- 2 Press  and the channel **Zero** softkey. The **Zeroing** pop-up is displayed.

- 3 Connect the power sensor to the POWER REF output.





- 4 Press  and the channel **Cal** softkey to start the calibration routine. The **Calibrating** pop-up is then displayed.

NOTE

You can reduce the steps required to carry out the zero and calibration procedure as follows:

- 1 Connect the power sensor to the POWER REF output.
- 2 Press  and **Zero + Cal**. (For dual channel meters, press **Zero + Cal**, **Zero + Cal A** or **Zero + Cal B** as required).

Now set the frequency of the signal you want to measure. The power meter automatically selects the appropriate calibration factor.

- 5 Press . On dual channel meters select the required channel.
- 6 Use the  and  keys to highlight the **Frequency** value field and press  to display the **Frequency** pop-up. Use the numeric keypad to enter the required value in the **Frequency** pop-up window.

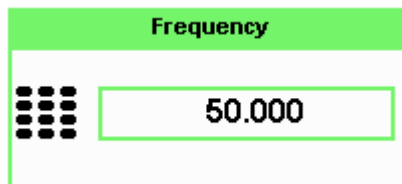



Figure 4-103 Frequency pop-up

- 7 Confirm your choice by pressing **MHz** or **GHz**.
- 8 Press  key to close the **Channel Setup** screen.

Now make the measurement.

- 9 Connect the power sensor to the signal to be measured. The corrected measurement result is displayed.

Setting the Trace Display

The P-Series power meter is optimized to operate in the trace display mode when measuring a pulsed signal.

The swiftest method to get the power meter into a trace display is described in the following procedure:

NOTE

The procedure assumes you are starting from a default preset.

- 1 Connect the power sensor to the power meter and connect it to the power source
- 2 Set the **Channel Frequency**
- 3 Set the **Trigger** to **Continuous**
- 4 Set the **Display** to **Trace**
- 5 Expand window and use the **Gate** control and **Trace** control menus to set the gate markers, trigger delay, and scale.

NOTE

You can return to other menus later to add more accuracy on the measurement, for example, **Channel Setup**, to set the measurement average, the video average and the bandwidth of a modulating signal.







- 6 When you are satisfied with the configuration you may want to save it for future use. See [“Saving and Recalling Power Meter States”](#) on page 104 for further information.

Step 1. Connecting the Power Sensor

When you initially connect an E-Series E9320 power sensor to the power meter, the sensor's calibration data is automatically read by the power meter. After every power cycle, the E9320 must perform zero and calibration as the P-Series power meters do not retain the states and settings upon power cycle (warm start feature).

Connect the sensor to the power source.

Step 2. Setting the Channel Frequency

- Press . The **Channel Setup** screen is displayed. If using an N1912A, select the channel you want to configure.
- Use the , , , and  keys to highlight the frequency field. Press  to configure the setting. See [“Setting the Measurement Frequency”](#) on page 32 for further information.

When you have completed the procedure you can return to this menu later to add more accuracy to the measurement.

Step 3. Setting the Trigger

To use the measurement gates the power meter must be triggered.

A trigger can be taken from a rising or falling measured power level or controlled externally using the Ext Trig input.

- Press . The **Trigger** menu is displayed.

The trigger status is displayed below the **Acqn** label in the **Trigger** menu. Press the **Acqn** softkey and select **Cont Trig** to configure continuous triggering.

When you have completed the procedure you may return to the **Trigger** menu later to add more accuracy to the remaining trigger parameters, to help you achieve a stable and reliable trigger.

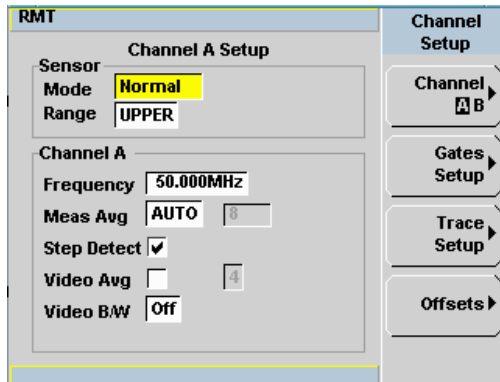

Figure 4-104 E-Series E9320 power sensor channel setup when trigger is selected

Step 4. Setting the Display to Trace

Using trace display provides a visual representation of the signal of interest.





- Press , **Disp Type**, **Trace** to display the Trace the highlighted window.



Figure 4-105 Trace display in dual channel power meter

- Use the , , or  keys to select a measurement window. Choose the type of display you require from the menu.

Step 5. Expanding the Trace Display

Expanding the trace to display a **Single Enlarged Window** provides a more detailed visual representation of the signal of interest and display of the measured results. Figure 4-106 is an example of this display. This display type also provides a visual method of setting up the gate, trigger delay, and trace controls.

Use the  key to configure the display from two rectangular windows to a single enlarged window, or a full screen display by pressing repeatedly. The display style is applied to the currently highlighted window.

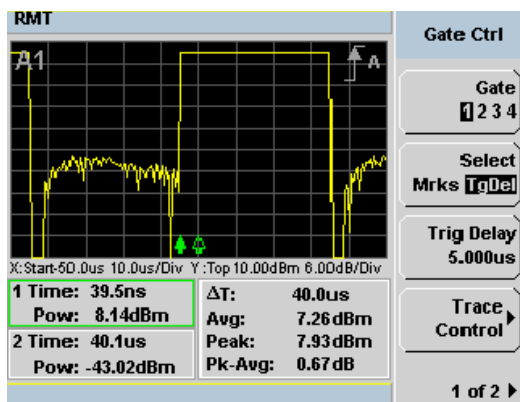





Figure 4-106 Trace display in single enlarged window

NOTE

When you alter a parameter in another menu, you are returned to a two window

display. Use the , , or  keys to highlight the trace measurement window and

use the  key to enlarge the display.

NOTE

If the bandwidth of a modulated signal is unknown, you may discover that during the set up process, a power sensor of lesser or greater bandwidth is required.

After you have completed this initial set up, you can, if required, return to the following setup to improve your measurement results:

- The **Channel Setup** to configure any averaging and offsets.
- The **Trigger** setup to configure any additional setting there.
- The **Meas Setup** to configure any additional setting there.

Gate Control in a Single Enlarged Window

When you initially display a single enlarged window, the **Gate Control** menu is available. Setting the gate features are described in greater detail in “Setting Measurement Channel Gates” on page 57. However, the following sections are to give you an overview of the control and their impact on the displayed results.

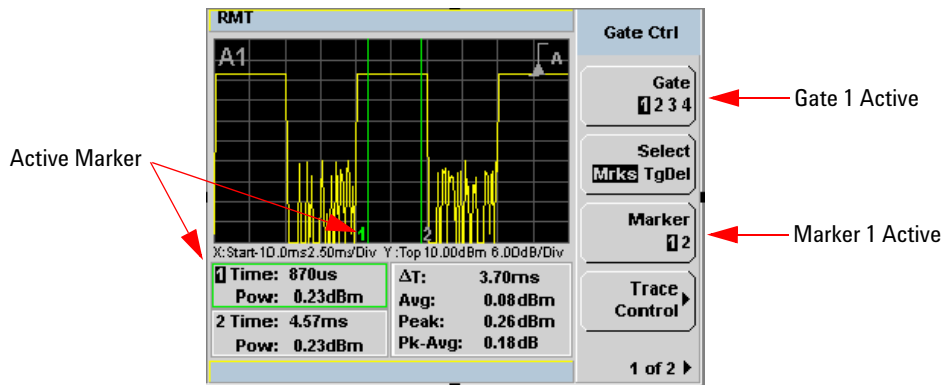



Figure 4-107Trace display with gate control menu

Gate Pressing **Gate** scrolls through the 4 gates available for each channel. The gate displayed is highlighted below the **Gate** softkey. It is also displayed in the channel/gate annotation in the top left of the screen.

Select Pressing **Select Mrks TgDel** displays the gate markers or trigger markers.

Markers When **Mrks** is selected, Markers **1** and **2** indicate the start and end points of the selected measurement gate. Pressing **Marker** toggles between the two markers, the highlighted marker is the currently active marker. Use the  and  keys to move the markers left or right across the display.

The tables on the lower left of the screen show the time (**Time:**) and the instantaneous power level (**Pow:**) of the markers at their configured points. The table highlighted with the green border represents the active marker, also highlighted in green. A negative time value indicates a measurement before the trigger point. (See [Figure 4-107](#)).

NOTE

Gate timing parameters are all related to your chosen trigger point. This may be different from the timing of the triggering event if you have configured a trigger delay.

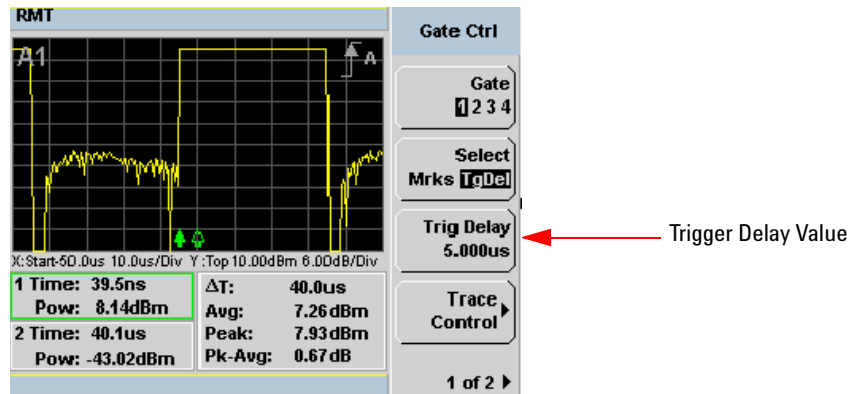







Figure 4-108 Trace display with trigger delay menu

TgDel When **TgDel** is selected you can adjust the trigger delay. The display changes to remove the gate markers and displays the trigger marker(s). The  indicates when the trigger event occurs, whilst  shows the delayed trigger point. When the two points coincide, only the  trigger is shown.

The configured value is displayed below the **Trig Delay** softkey. This value is shown in [Figure 4-108](#).

To indicate an off-screen trigger event,  is displayed. To indicate an off-screen trigger point,  is displayed.

NOTE

Your chosen trigger point is used as the reference point for the timing of all the measurement gates.

Trig Delay The trigger delay value is shown below the **Trig Delay** softkey. You configure the trigger delay by pressing **Trig Delay** and entering a numeric value in the pop-up window.

Pressing **Select** highlights **Mrks** to display the trace markers again.

NOTE

You can also setup the trigger delay in the **Trigger** menu, by pressing **Settings**, **Delay** and entering a value in the pop-up window.

Trace Control Press **Trace Control** to display the **Trace Control** menu. Setting the trace features are described in greater details in [“Setting up the Channel Trace”](#) on page 62.

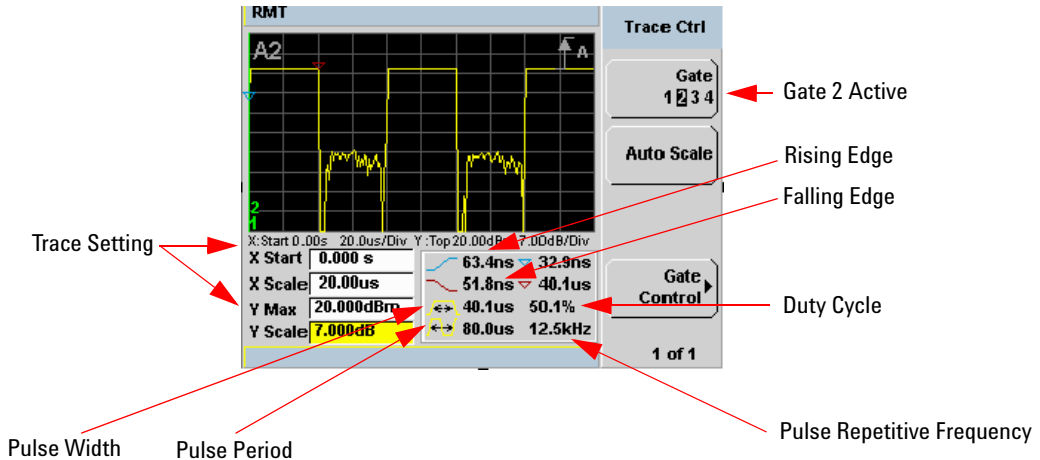

Figure 4-109 Trace display with trace control menu

The fields on the lower left of the screen are the X and Y trace setup fields. Using the or keys you can highlight the item and change its value. (See [Figure 4-109](#))

The table on the lower right of the screen shows the 8 automatic time measurements performed on the first complete captured pulse after the trigger. The 8 measurements are rise time, fall time, time to positive occurrence, time to negative occurrence, pulse width, pulse period (pulse repetitive interval), pulse repetitive frequency and duty cycle.

The current settings of the X and Y scale are displayed on the reporting line above both tables.

NOTE

If you want to view the trace in linear mode, the **Trace Setup** is the only location where you can change the Y-scale units from **dBm** to **Watts**; otherwise the default unit is in logarithmic.

Gate Control Press **Gate Control** to display the **Gate Ctrl** menu. Setting the gate features are described in greater details in “[Gate Control in a Single Enlarged Window](#)” on page 142”.

Viewing the Results in a Full Screen Window

Use the  key to display the trace in a full screen window display. This provides a better resolution on the display. You can press **Trace Meas** or **Gate Meas** to display the results as set in **Single Enlarged Window** mode. The current settings of the X and Y scale are displayed on the reporting line above

the results. You need to toggle the  key to allow the softkeys to be displayed.

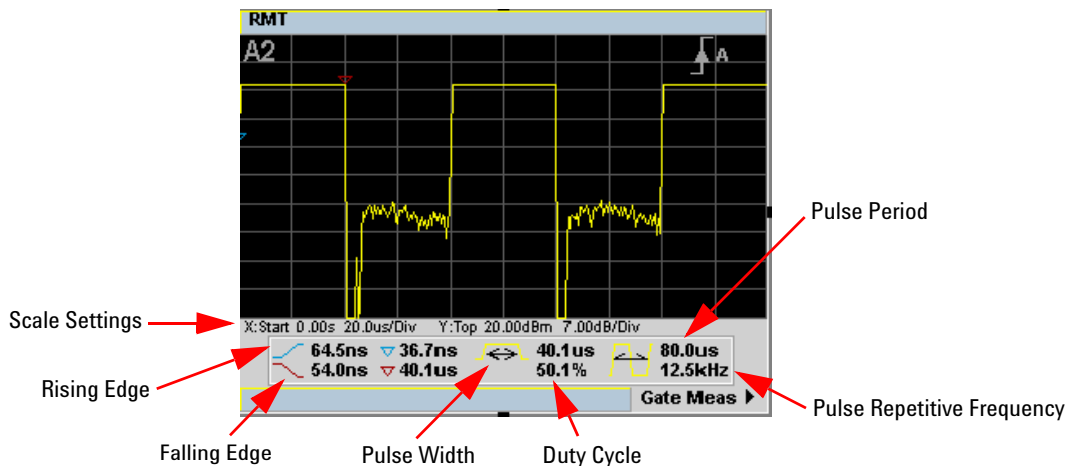



Figure 4-110 Trace display in full screen

Improving the Accuracy with Additional Settings

You can now return to the setup menus and adjust the default setting to obtain greater measurement accuracy.

Channel Setup

- Press . The **Channel Setup** screen is displayed. If using an N1912A, select the channel you want to configure.

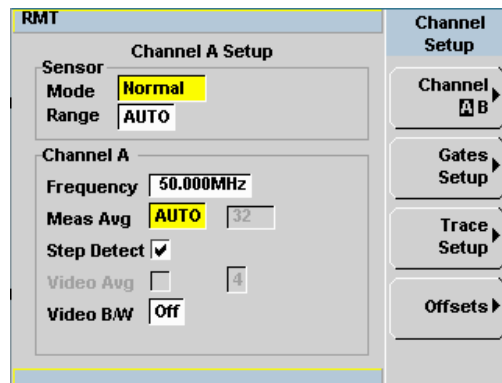





Figure 4-111E-Series E9320 power sensor default channel setup

NOTE

For range settings, only UPPER and LOWER ranges are available in Normal and Triggered mode.

Use the , , , and  keys to highlight the setting field and press



to configure the setting. For further detail on these settings, refer to the appropriate sections.

- **Meas Avg:** [“Setting Measurement Averaging”](#) on page 49
- **Video Avg:** [“Setting the Video Averaging”](#) on page 52
- **Step Detect:** [“Step Detection”](#) on page 51
- **Video B/W:** [“Setting the Video Bandwidth”](#) on page 54

Setting Offsets

Press **Offsets**. The **Offsets Setup** screen is displayed.

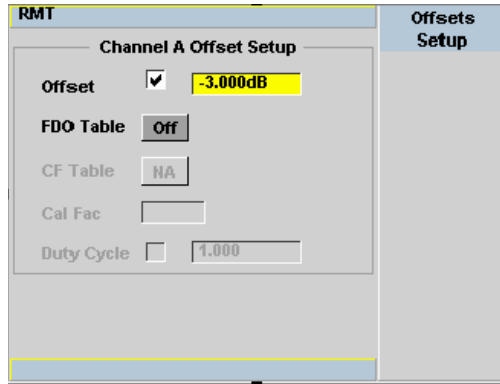







Figure 4-112 Channel offset display

Use the , , , and  keys to highlight any parameters you want to change. Press  to configure the required settings. For further detail on setting these, refer to the appropriate section.

- **Offset:** “Setting Channel Offsets” on page 39
- **FDO Table:** “Setting Frequency Dependent Offsets” on page 42

Trigger Setup





Press . The **Trigger** menu is displayed.

The trigger status is displayed below the **Acqn** label in the **Trigger** menu.

Press the **Settings** softkey and add more accuracy to the remaining trigger parameters, for example, hold-off and hysteresis, to help you achieve a stable and reliable trigger. Hence, this ensures that the gates you have set up are capturing the required signal information. See [Chapter 2](#), “Setting the Trigger,” starting on page 66 for further information.

Measurement Setup

Press . The **Measurement Setup** menu is displayed.

Use the , , , and  keys to highlight the setting field and press  to configure the setting.

When you have configured the measurements gates, you can assign the measurement feed and display the results in numeric formats. For example, dual numeric display with Gate 1 peak measurement minus Gate 3 peak measurement. Also, from this menu you can add offsets and measurement limits. For further detail on these settings, refer the appropriate section.

- **Feed1/2** “[Setting the Measurement Display](#)” on page 90
- **Offset** “[Setting Display Offsets](#)” on page 41
- **Limits** “[Setting Measurement Limits](#)” on page 86

Display

Press . The **Display Form** menu is displayed.

Choose the display format to present the measurements results. The options, other than trace, are as follows:

Single Numeric If you need to configure the numeric format when using a P-Series sensor, refer to “[Numeric Format](#)” on page 91 for more details.

Dual Numeric If you need to configure the numeric format when using a P-Series sensor, refer to “[Numeric Format](#)” on page 91 for more details.

Analog If you need to configure the analog format when using a P-Series sensor refer to “[Scaling the Analog Display](#)” on page 97 for more details.

THIS PAGE HAS BEEN INTENTIONALLY LEFT BLANK.



5 Using E9300 E-Series Power Sensors

Introduction	152
Power Meter Configuration	153
Measurement Accuracy	155
Measuring Spread Spectrum and Multitone Signals	157
Measuring TDMA Signals	160
Electromagnetic Compatibility (EMC) Measurements	162
Measurement Accuracy and Speed	163

This chapter describes how to use your E9300 E-Series power sensors with P-Series power meter.



Introduction

The E9300 E-Series power sensors are true average, wide dynamic range RF microwave power sensors. They are based on a dual sensor diode pair/attenuator/diode pair. This technique ensures the diodes in the selected signal path are kept in their square law region, thus the output current (and voltage) is proportional to the input power. The diode pair/attenuator/diode pair assembly can yield the average of complex modulation formats across a wide dynamic range, irrespective of signal bandwidth. Further refinements are included to improve power handling allowing accurate measurement of high level signals with high crest factors without incurring damage to the sensor.

These sensors measure average RF power on a wide variety of modulated signals and are independent of the modulation bandwidth. They are ideally suited to the average power measurement of multi-tone and spread spectrum signals such as CDMA, W-CDMA and digital television formats.

Please refer to the documentation supplied with your E-Series E9300 power sensor for specification and calibration information.

Power Meter Configuration

The P-Series power meters automatically recognize an E-Series E9300 power sensor when it is connected. The sensor calibration data is automatically read by the power meter. The power meter also configures the auto-averaging settings shown in Figure 5-113 to suit the power sensor characteristics.

	E9300/1/4A	E9300/1H	E9300/1B	Maximum Sensor Power	Resolution Setting				Number of Averages
					1	2	3	4	
Sensor Dynamic Range	Upper Range	10 dBm	20 dBm	40 dBm	1	1	1	4	Number of Averages
		2 dBm	12 dBm	32 dBm	1	1	4	16	
		-4 dBm	6 dBm	26 dBm	1	1	8	32	
		-10 dBm	0 dBm	20 dBm	1	4	16	128	
					1	16	64	128	
	Lower Range	-20 dBm	-10 dBm	10 dBm	1	1	1	4	
		-30 dBm	-20 dBm	0 dBm	1	1	2	16	
		-40 dBm	-30 dBm	-10 dBm	1	2	16	64	
					4	16	128	256	
		-50 dBm	-40 dBm	-20 dBm	32	64	256	256	
			Minimum Sensor Power						

Figure 5-113 E9300 E-Series auto-averaging settings

NOTE

These values are valid only for the power meter channel connected with E-Series E9300 power sensor. You can also configure the settings manually – refer to “Achieving Stable Results with TDMA Signals” on page 160 if required.

Default Channel Setup

When an E-Series E9300 power sensor is connected the following **Channel Setup** is automatically configured. Carrying out a Preset returns the power meter to this configuration.

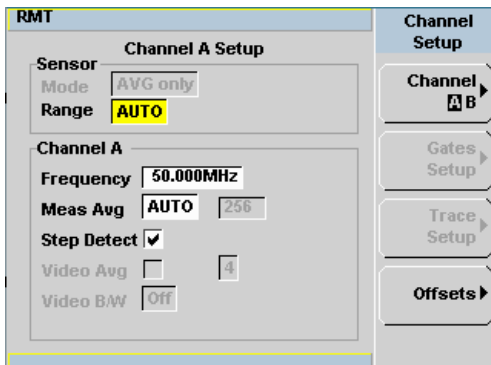

Figure 5-114 E9300 E-Series sensor default channel setup

Measurement Accuracy

Power sensors have small errors in their response over frequency. The response of each sensor is measured during manufacture to determine correction factors. With E-Series power sensors, correction factors are held in Electrically Erasable Programmable Read Only Memory (EEPROM) and are downloaded to the power meter automatically.

Using calibration factors enables improved measurement accuracy. This section describes making average power measurements using the E9300 E-Series power sensors.

Making a measurement requires the following steps:

- 1 Zero and calibrate the power meter/sensor combination.
- 2 Set the frequency for the signal you want to measure.
- 3 Make the measurement.

Table 5-11 Power sensor connection requirements

Sensor	Connection Requirements
E9300A E9300H E9301A E9301H E9304A	These power sensors connect directly to the POWER REF.
E9300B E9301B	These power sensors are configured with an attenuator. Prior to calibration this attenuator must be removed. Replace the attenuator before making measurements.

Procedure

First zero and calibrate the power meter/sensor combination.

- 1 Ensure the power sensor is disconnected from any signal source.
- 2 Press  and the channel **Zero** softkey. The **Zeroing** pop-up is displayed.
- 3 Connect the power sensor to the POWER REF output.





- 4 Press  and the channel **Cal** softkey to start the calibration routine. The **Calibrating** pop-up is then displayed.

NOTE

You can reduce the steps required to carry out the zero and calibration procedure as follows:

- 1 Connect the power sensor to the POWER REF output.
- 2 Press  and **Zero + Cal**. (For dual channel meters, press **Zero + Cal**, **Zero + Cal A** or **Zero + Cal B** as required).

Now set the frequency of the signal you want to measure. The power meter automatically selects the appropriate calibration factor.

- 5 Press . On dual channel meters select the required channel.
- 6 Use the  and  keys to highlight the **Frequency** value field and press  to display the **Frequency** pop-up. Use the numeric keypad to enter the required value in the **Frequency** pop-up window.

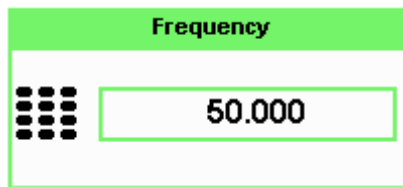



Figure 5-115 Frequency pop-up

- 7 Confirm your choice by pressing **MHz** or **GHz**.
- 8 Press  key to close the **Channel Setup** screen.

Now make the measurement.

- 9 Reconnect any required attenuators or adaptors and connect the power sensor to the signal to be measured.

The corrected measurement result is displayed.

Measuring Spread Spectrum and Multitone Signals

To achieve high data transfer rates within a given bandwidth, many transmission schemes are based around phase and amplitude (I and Q) modulation. These include CDMA, W-CDMA and digital television. The signals are characterized by their appearance on a spectrum analyzer display – a high amplitude noise-like signal of bandwidths up to 20 MHz. An 8 MHz bandwidth digital television signal is shown in [Figure 5-116](#).

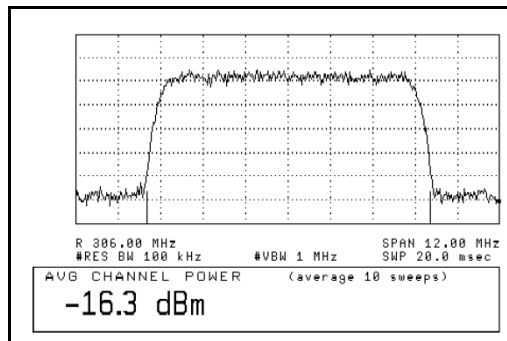

Figure 5-116 Spread spectrum signal

The diode pair/attenuator/diode pair architecture of the E9300 E-Series power sensors is ideally suited to the average power measurement of these signals. The sensors have wide dynamic range (80 dB max, sensor dependent) and are bandwidth independent.

Some signal modulation formats such as orthogonal-frequency-division multiplexing (OFDM) and CDMA have large crest factors. The E-Series E9300/1/4A power sensors can measure +20 dBm average power even in the presence of +13 dB peaks but the peak pulse duration must be less than 10 microseconds. For high power applications, such as base-station testing, the E9300/1B and E9300/1H are recommended.

CDMA Signal Measurements

Figure 5-117 and Figure 5-118 show typical results obtained when measuring a CDMA signal. In these examples, the error is determined by measuring the source at the amplitude of interest, with and without CDMA modulation, adding attenuation until the difference between the two values stops changing. The CW sensor in Figure 5-117 uses correction factors to correct for power levels beyond its square law operating region.

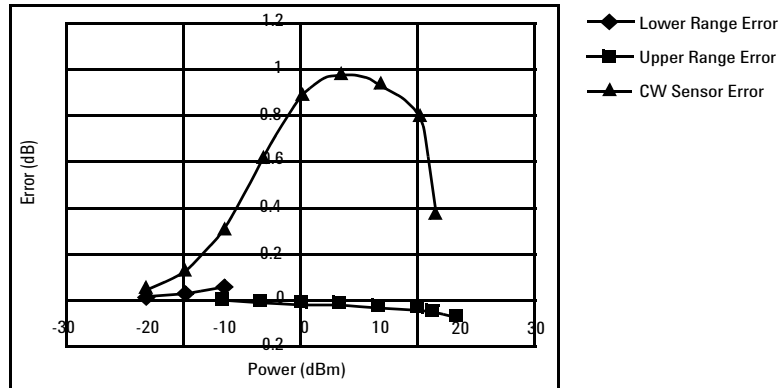

Figure 5-117 Wideband CDMA error of E-Series E9300 power sensor versus corrected CW sensor.

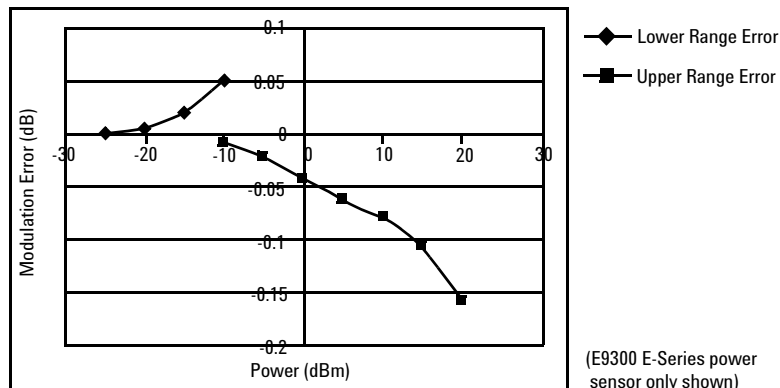

Figure 5-118 CDMA (IS-95A): 9Ch Fwd

Multitone Signal Measurements

In addition to wide dynamic range, the E9300 E-Series power sensors also have an exceptionally flat calibration factor versus frequency response as shown in [Figure 5-119](#). This is ideal for amplifier intermodulation distortion measurements where the components of the two-tone or multitone test signal can be separated by hundreds of MHz.

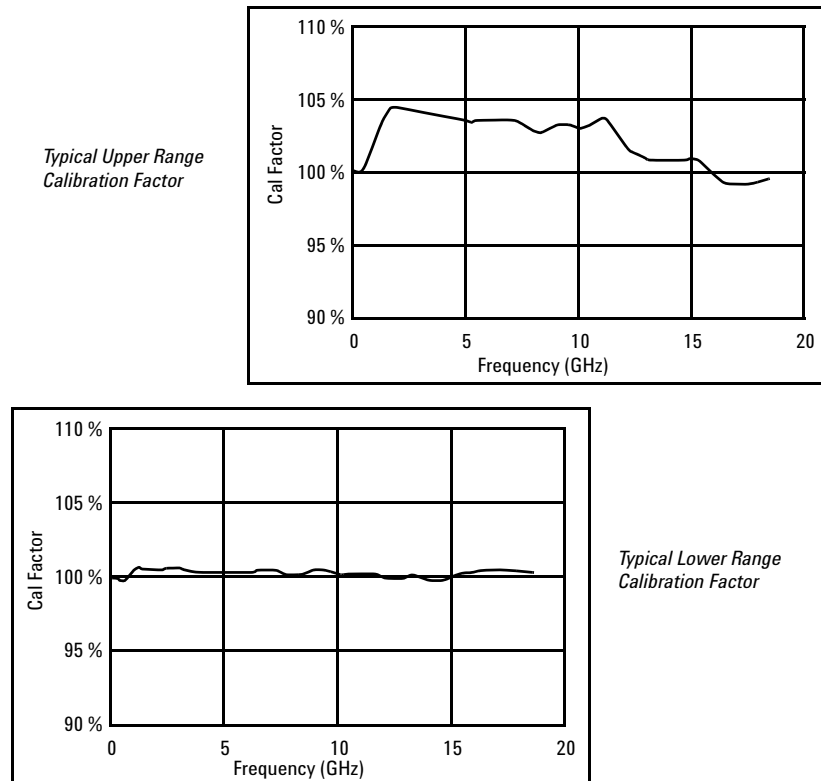

Figure 5-119 Calibration factors versus frequency

Measuring TDMA Signals

Power Meter and Sensor Operation

The voltages generated by the diode detectors in the power sensor can be very small. Gain and signal conditioning are required to allow accurate measurement. This is achieved using a 440 Hz square wave output from the power meter to drive a chopper-amplifier in the power sensor. Digital Signal Processing (DSP) of the generated square wave is used by the power meter to recover the power sensor output and accurately calculate the power level.







The chopper-amplifier technique provides noise immunity and allows large physical distances between power sensor and power meter (Agilent 11730 Series cables available up to 61 metres). Additional averaging helps reduce noise susceptibility.

Achieving Stable Results with TDMA Signals

The averaging settings in the power meter are designed to reduce noise when measuring continuous wave (CW) signals. Initial measurement of a pulsed signal may appear unstable with jitter on the less significant displayed digits. With pulsed signals the averaging period must be increased to allow measurement over many cycles of the pulsed signal.

Procedure

Set the averaging as follows:

- 1 Press . On dual channel meters, select the required channel.
- 2 Use the  and  keys to select the **Filter** setting field.
- 3 Press  and use the  and  keys to step through the available settings. Select **MAN**.
- 4 Use the  key to select the **Meas Avg:** value field.





- 5 Press  to display the **Meas Avg Count** pop-up.
- 6 Use the numeric keys to enter the required value.
- 7 Press **Enter** to complete the entry.

NOTE

You should also ensure the filter is not reset when a step increase or decrease in power is detected by switching the step detection off.

Procedure

Switch off step detection as follows:

- 1 Press . On dual channel meters, select the required channel.
- 2 Use the  and  keys to select the **Step Detect** setting field.
- 3 Press  to check the step detection to **Off**.
- 4 Press  key to close the **Channel Setup** screen.

Achieving Stable Results with GSM Signals

Signals with a pulse repetition frequency (PRF) close to a multiple or sub-multiple of the 440 Hz chopper-amplifier signal generate a beat note at a frequency between the PRF and 440 Hz. Control over the filter settings is again required to obtain stable results.

- TIP** The PRF of a GSM signal is approximately 217 Hz and thus requires more averaging than most other TDMA signals. To achieve a stable measurement use the filter setting procedures to set the **Length**. Experimentally, a **Length** setting of 148 gives optimum results although settings in the order of 31 or 32 give acceptable results if a faster measurement is required.

Electromagnetic Compatibility (EMC) Measurements

The low frequency range of the E9304A make it the ideal choice for making EMC measurements to CISPR (Comite International Special Perturbations Radioelectriques) requirements, and electromagnetic interference (EMI) test applications such as the radiated immunity test (IEC61000-4-3).

DC coupling of the E9304A input allows excellent low frequency coverage. However, the presence of any dc voltages mixed with the signal has an adverse effect on the accuracy of the power measurement.

CAUTION

The E9304A sensor is DC coupled. DC voltages in excess of the maximum value (5 Vdc) can damage the sensing diode.

Measurement Accuracy and Speed

The power meter has no internal ranges. The only ranges you can set are those of the E9300 E-Series power sensors (and other Agilent Technologies E-Series power sensors). With an E-Series E9300 power sensor the range can be set either automatically or manually. Use autoranging when you are not sure of the power level you are about to measure.

CAUTION

To prevent damage to your sensor do not exceed the power levels specified in the sensor user's guide.

The E9304A sensor is DC coupled. DC voltages in excess of the maximum value (5 Vdc) can damage the sensing diode.

Setting the Range

There are two manual settings, **LOWER** and **UPPER**. The **LOWER** range uses the more sensitive path and the **UPPER** range uses the attenuated path in the E9300 E-Series power sensors.







Sensor	LOWER range	UPPER range
E9300/1/4A	-60 dBm to -10 dBm	-10 dBm to +20 dBm
E9300/1B	-30 dBm to +20 dBm	+20 dBm to +44 dBm
E9300/1H	-50 dBm to 0 dBm	0 dBm to +30 dBm

The default is **AUTO**. In **AUTO** the range crossover value depends on the sensor model being used.

E9300/1/4A	E9300/1B	E9300/1H
-10 dBm \pm 0.5 dBm	+20 dBm \pm 0.5 dBm	0 dBm \pm 0.5 dBm

Procedure

Set the range as follows:

- 1 Press . On dual channel meters, select the required channel.
- 2 Use the  and  keys to select the **Range:** setting field.
- 3 Press  to display the **Range** pop-up.
- 4 Use the  and  keys to select the required setting.
- 5 Press  to complete the entry.

Measurement Considerations

While autoranging is a good starting point, it is not ideal for all measurements. Signal conditions such as crest factor or duty cycle may cause the power meter to select a range which is not the optimum configuration for your specific measurement needs. Signals with average power levels close to the range switch point require you to consider your needs for measurement accuracy and speed. For example, using an E9300/1/4A sensor, where the range switch point is -10 ± 0.5 dBm in a pulsed signal configured as follows:

Characteristic	Value
Peak Amplitude	-6 dBm
Duty Cycle	25%

The calculated average power is -12 dBm.

Accuracy

The value of -12 dBm lies in the lower range of the E-Series E9300 power sensor. In autoranging mode (“**AUTO**”), the power meter determines the average power level is below -10 dBm and selects the low power path. However, the peak amplitude of -6 dBm is beyond the specified, square law response range of the low power path diodes. The high power path (-10 dBm to $+20$ dBm) should be used to ensure a more accurate measurement of this signal. However, range holding in “**UPPER**” (the high power path), for a more accurate measurement, results in considerably more filtering.

Speed and Averaging

The same signal also requires that consideration is given to measurement speed. As shown above, in autoranging mode the power meter selects the low power path in the E-Series E9300 power sensor. With auto-averaging also configured, minimal filtering is applied. Values of 1 to 4 for average power levels above -20 dBm are used in the low power path. (Refer to “[E9300 E-Series auto-averaging settings](#)” on page 153.)

If the range is held in “**UPPER**” for more accuracy, the measurement is slower. More filtering is applied due to the increase in noise susceptibility at the less sensitive area of the high power path. Values of 1 to 128 for average power levels less than -10 dBm are used. (Again, refer to “[E9300 E-Series auto-averaging settings](#)” on page 153.) Manually lowering the filter settings speeds up the measurement but can result in an unwanted level of jitter.

Summary

Attention must be paid to signals whose average power levels are in the low power path range whilst their peaks are in the high power path range. You can achieve best accuracy by selecting the high power path or best speed by selecting the low power path.

THIS PAGE HAS BEEN INTENTIONALLY LEFT BLANK.



6 Using E4410 E-Series Power Sensors

Introduction 168
Power Meter Configuration 169
Measurement Accuracy 171

This chapter describes how to use your E4410 E-Series power sensors with P-Series power meter.



Introduction

The E4410 E-Series power sensors are diode based power sensors. They are intended for the measurement of CW microwave power levels in a wide dynamic range from -70 dBm to $+20$ dBm (100 pW to 100 mW). These are high-speed power sensors, and do not incorporate narrow-bandwidth averaging used in average-power sensors. Signals with digital, pulse, or other forms of amplitude modulation may introduce measurement errors.

Multi-tone signals (containing multiple frequency components), or signals with significant harmonic content (> -45 dBc) may introduce measurement errors at high power levels.

Please refer to the documentation supplied with your E-Series E4410 power sensor for specification and calibration information.

Power Meter Configuration

The P-Series power meters automatically recognize an E-Series E4410 power sensor when it is connected. The sensor calibration data is automatically read by the power meter. Also, the power meter automatically configures the averaging as shown in [Figure 6-120](#).

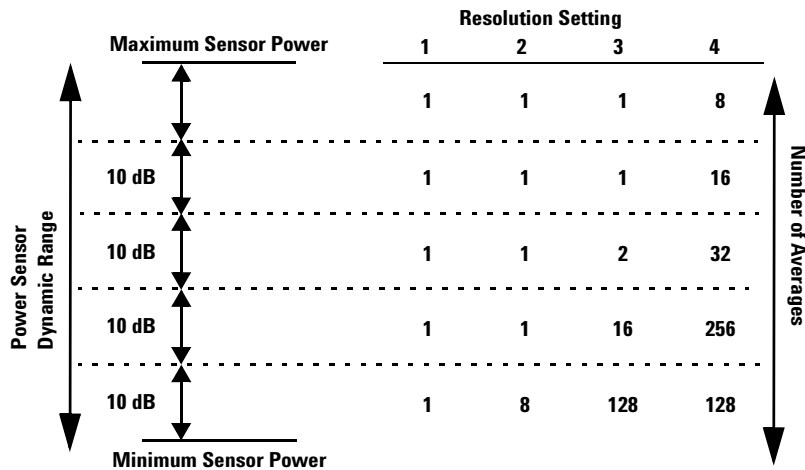

Figure 6-120E-Series CW sensor auto-averaging settings

NOTE

These values are valid only for the power meter channel connected with E-Series E4410 power sensor. Averaging settings can also be manually configured.

Default Channel Setup

When an E-Series E4410 power sensor is connected the following **Channel Setup** is automatically configured. Carrying out a Preset returns the channel to this configuration.

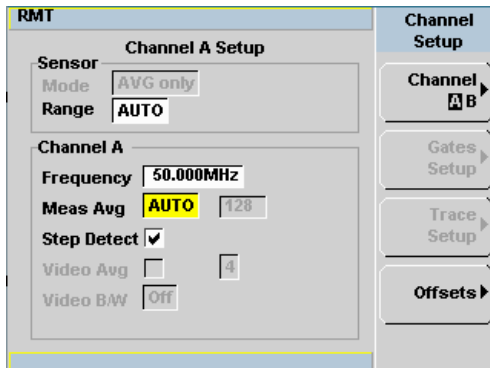

Figure 6-121 E-Series E4410 sensor default channel setup

Measurement Accuracy

Power sensors have small errors in their response over frequency. The response of each sensor is measured during manufacture (and during periodic calibration). With E-Series power sensors, the resulting frequency compensation information is written into Electrically Erasable Programmable Read Only Memory (EEPROM). This allows the frequency and calibration data to be downloaded to the power meter automatically.



Using calibration factors enables you to achieve improved measurement accuracy. This section describes making continuous wave measurements using the E4410 E-Series power sensors.

Making a measurement requires the following steps:

- 1 Zero and calibrate the power meter/sensor combination.
- 2 Set the frequency for the signal you want to measure.
- 3 Make the measurement.

Procedure

First zero and calibrate the power meter/sensor combination.





- 1 Ensure the power sensor is disconnected from any signal source.
- 2 Press  and the channel **Zero** softkey. The **Zeroing** pop-up is displayed.
- 3 Connect the power sensor to the POWER REF output.
- 4 Press  and the channel **Cal** softkey to start the calibration routine. The **Calibrating** pop-up is then displayed.

NOTE

You can reduce the steps required to carry out the zero and calibration procedure as follows:

- 1 Connect the power sensor to the POWER REF output.
- 2 Press  and **Zero + Cal**. (For dual channel meters, press **Zero + Cal**, **Zero + Cal A** or **Zero + Cal B** as required).

Now set the frequency of the signal you want to measure. The power meter automatically selects the appropriate calibration factor.

- 5 Press . On dual channel meters select the required channel.
- 6 Use the  and  keys to highlight the **Frequency** value field and press  to display the **Frequency** pop-up. Use the numeric keypad to enter the required value in the **Frequency** pop-up window.

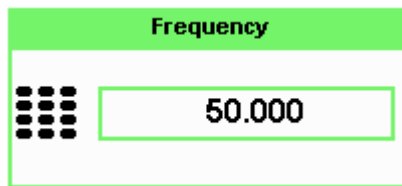

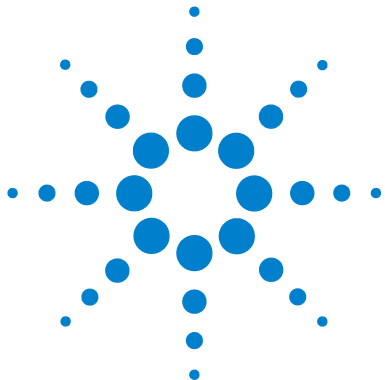

Figure 6-122 Frequency pop-up

- 7 Confirm your choice by pressing **MHz** or **GHz**.
- 8 Press  key to close the **Channel Setup** screen.

Now make the measurement.

- 9 Connect the power sensor to the signal to be measured. The corrected measurement result is displayed.



7 Using 8480 Series Power Sensors

Introduction	174
Power Meter Configuration	175
Measurement Accuracy	179
Frequency Specific Calibration Factors	180
Sensor Calibration Tables	184

This chapter describes how to use your 8480 Series power sensors with P-Series power meter.



Introduction

The 8480 Series offers a wide range of both thermocouple and diode based power sensors. Many have very specific applications, for example the 110GHz W8486A or the +44 dBm 8482B. However, they do not have their calibration factors stored in EEPROM, unlike all E-Series, and require that you use default calibration tables or manually enter the required correction factors. Likewise, they cannot be used to make peak or time gated measurements.

Please refer to the documentation supplied with your Agilent 8480 Series power sensors for specification and calibration information.

Power Meter Configuration

The P-Series power meters automatically recognize an 8480 Series power sensor when it is connected. The averaging settings shown in Figure 7-123 are automatically configured.

	Maximum Sensor Power	Resolution Setting				Number of Averages
		1	2	3	4	
		1	1	1	8	
10 dB		1	1	1	16	
10 dB		1	1	2	32	
10 dB		1	1	16	256	
10 dB		1	8	128	128	
	Minimum Sensor Power					

Figure 7-123 8480 Series auto-averaging settings

NOTE

These values are valid only for the power meter channel connected with Agilent 8480 Series power sensors. Averaging settings can also be manually configured.

Default Channel Setup

Figure 7-124 shows the **Channel Setup** configured automatically. Presetting returns the power meter to this configuration.

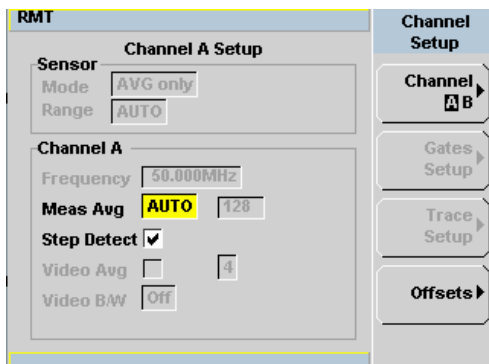

Figure 7-124 8480 Series sensor default channel setup

8480 Series Sensors Connection Requirements

Table 7-12 8480 Series connection requirements

Sensor	Connection Requirements
8481A 8481H 8482A 8482H	These power sensors connect directly to the POWER REF.
8481D 8484A	Prior to calibration, an Agilent 11708A 30 dB reference attenuator should be connected between the power sensor and the POWER REF. Remove this attenuator from the power sensor input before making measurements.
8483A	This power sensor requires a 75 Ω (f) to 50 Ω (m) N-Type adapter (1250-0597) to connect to the POWER REF. Remove this adapter before making measurements.
R8486A Q8486A V8486A W8486A R8486D Q8486D	These waveguide power sensors have two connectors. Use the N-Type connector to calibrate the power meter.
8481B 8482B	These power sensors are configured with an attenuator. Prior to calibration this attenuator must be removed. Replace the attenuator before making measurements.
8485A	This power sensor requires an APC 3.5 (f) to 50 Ω (m) N-Type adapter (08485-60005) to connect to the POWER REF. Remove this adapter before making measurements.
8485D	Prior to calibration, an Agilent 11708A 30 dB reference attenuator and an APC 3.5 (f) to 50 Ω (m) N-Type adapter (08485-60005) should be connected between the power sensor and the POWER REF. Remove this attenuator and adaptor before making measurements.

7 Using 8480 Series Power Sensors

Sensor	Connection Requirements
8487A	This sensor requires an APC 2.4 (f) to 50 Ω (m) N-Type adapter (08487-60001) to connect to the POWER REF. Remove this adapter before making measurements.
8487D	Prior to calibration, an Agilent 11708A 30 dB reference attenuator and an APC 2.4 (f) to 50 Ω (m) N-Type adapter (08487-60001) should be connected between the power sensor and the Power Ref. Remove this adapter before making measurements.

Measurement Accuracy

Power sensors have small errors in their response over frequency. The response of each sensor is measured during manufacture (and during periodic calibration) and the resulting frequency compensation information is supplied in the form of calibration factors. Using calibration factors enables you to achieve improved measurement accuracy. The P-Series power meters provide two methods of using the calibration factors:

- inputting the individual calibration factor for a frequency prior to making the measurement, or
- using sensor calibration tables.

If you are making most of your measurements at a single frequency, or in a narrow range of frequencies, entering a specific calibration factor is a more effective method. Only a minimal amount of data entry is required.

However, if you are making measurements on a wide range of signal frequencies, a sensor table is more effective as you only need to enter the frequency of the signal you are measuring. The power meter automatically selects and applies the calibration factor from the selected table.

Frequency Specific Calibration Factors

This section shows you how to make a measurement using the calibration factor for the frequency of the signal you want to measure.

TIP This method is best suited to making several measurements at one frequency as you need only enter a small amount of data.

Using this method requires the following steps:

- 1 Zero and calibrate the power meter/sensor combination.
- 2 Set the calibration factor value for the frequency of the signal you want to measure.
- 3 Make the measurement.

Procedure

First select and enter the reference calibration factor for the sensor you are using as follows:

- 1 Ensure the power sensor is disconnected from any signal source.
- 2 Refer to the connection requirements in [Table 7-12](#) and ensure the sensor is ready for connection to the Power Reference.
- 3 (), **REF CFs**. The value is displayed under the channel **Ref CF** softkey.

Does this setting match the value for the sensor? (The power sensor reference calibration factor can normally be found above the calibration factors table on the power sensor body.)

- 4 To change the settings, press the channel **REF CF**. The reference calibration factor pop up window is displayed as shown in [Figure 7-125](#). Use the numeric keypad to enter the required value in the **Ref Cal Factor** pop-up menu.

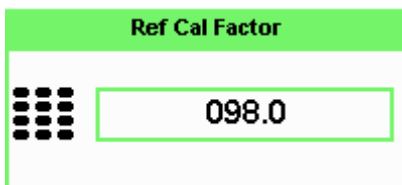

Figure 7-125 Reference Calibration Factor pop-up window

- 5 Press **%** to complete the entry.

Now zero and calibrate the power meter/sensor combination as follows:

- 6 Press **Cal** and the channel **Zero** softkey. The **Zeroing** pop-up is displayed.
- 7 Connect the power sensor to the POWER REF output.
- 8 Press **Cal** and the channel **Cal** softkey to start the calibration routine. The **Calibrating** pop-up is then displayed.

NOTE

You can reduce the steps required to carry out the zero and calibration procedure as follows:

- 1 Connect the power sensor to the POWER REF output.
- 2 Press **Cal** and **Zero + Cal**. (For dual channel meters, press **Zero + Cal**, **Zero + Cal A** or **Zero + Cal B** as required).

Now set the sensor calibration factor for the frequency of the signal you want to measure.

- 9 Press **Channel**, **Offset**. The value is displayed on the **Cal Fac** field.

Does this setting match the value for the sensor? (The power sensor reference calibration factor can normally be found above the calibration factors table on the power sensor body.)

10 To change the settings, use the  and  keys to highlight the **Cal Fac**

value field and press  to display the **Cal Factor** pop-up. Use the numeric keypad to enter the required value in the **Cal Factor** pop-up window.

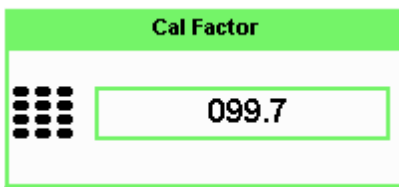

Figure 7-126 Calibration factor pop-up window

11 Press  to complete the entry.

12 Connect the power sensor to the signal to be measured.

13 The corrected measurement result is displayed.

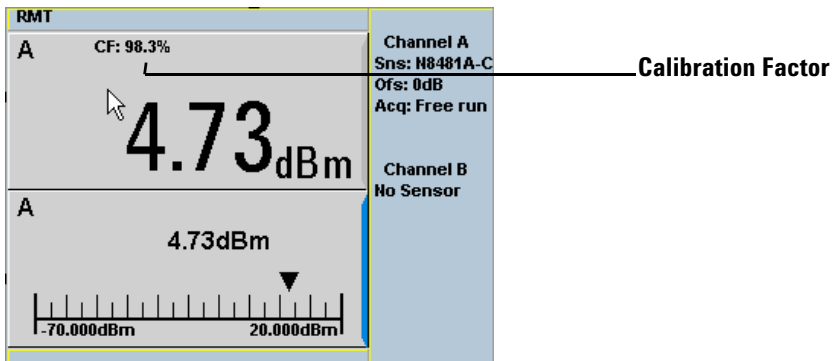









Figure 7-127 Calibration factor display

Example

To make a measurement on channel A with a power sensor which has a reference calibration factor of 99.8% and a calibration factor of 97.6% at the measurement frequency.

- Disconnect the power sensor from any signal source.
- Press , **REF CFs** and the channel **REF CF** softkey.
- Use the numeric keypad to enter 99.8 in the **Ref Cal Factor** pop-up window.
- Press **%** to complete the entry.
- Press  and the channel **Zero** softkey. The **Zeroing** pop-up is displayed.
- Connect the power sensor to the POWER REF output.
- Press  and the channel **Cal** softkey to start the calibration routine. The **Calibrating** pop-up is then displayed.
- Press , **Offset**. The value is displayed on the **Cal Fac** field.
- Press  and  and  keys to highlight the **Cal Fac** value field and press  to display the **Cal Factor** pop-up. Use the numeric keypad to enter 97.6 in the **Cal Factor** pop-up window.
- Press **%** to complete the entry.
- Connect the power sensor to the signal to be measured.
- The corrected measurement result is displayed.

NOTE

When no sensor tables are selected and **Single Numeric** display mode is chosen, the calibration factor used for the measurement is displayed in the upper window as shown in [Figure 7-127](#).

Sensor Calibration Tables

This section describes how to use sensor calibration tables. Sensor calibration tables store the measurement calibration factors, for a power sensor model or for a specific power sensor, in the power meter. They are used to correct measurement results.

Use sensor calibration tables when you want to make power measurements over a range of frequencies using one or more power sensors.

The P-Series power meters are capable of storing 20 sensor calibration tables each containing up to 80 frequency points. The power meter is supplied with a set of 9 predefined sensor calibration tables plus a “100%” default table. The data in these tables is based on statistical averages for a range of Agilent Technologies power sensors. Your own sensor will most likely differ from the typical to some degree. If you require best accuracy, create a custom table for each sensor you use as shown in [“Editing/Generating Sensor Calibration Tables”](#) on page 187.

To use calibration factor tables:

- 1 Select the sensor calibration table to be applied to a channel.
- 2 Zero and calibrate the power meter. The reference calibration factor used during the calibration is automatically set by the power meter from the sensor calibration table.
- 3 Specify the frequency of the signal you want to measure. The calibration factor is automatically set by the power meter from the sensor calibration table.
- 4 Make the measurement.

Procedure

First select the table for the sensor you are using as follows:

- 1 Press **System**, **Tables**, **Sensor Cal Tables**.
- 2 Use the **▲** and **▼** keys to highlight one of the 20 table titles and press **Table** to highlight **On**.

RMT			Sensor Tbls
Tbl Name	State	Pts	
0 DEFAULT	A	2	Edit Table
1 8481A	off	17	
2 8482A	off	12	A Table Off On
3 8483A	off	10	
4 8481D	off	21	B Table Off On
5 8485A	off	22	
6 R8486A	off	17	Done
7 Q8486A	off	19	
8 R8486D	off	17	
9 8487A	off	53	

1 of 1

Figure 7-128 Sensor table selected

NOTE

When no data is contained in the highlighted table, the **Table** key is disabled (grayed out).

- 3 Press **Done** to complete the selection of the calibration factor table.
- 4 Press **Done** again to display the measurement screen. Figure 7-129 shows which offset table is selected.

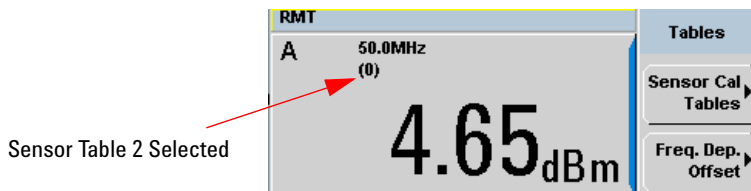





Figure 7-129 Frequency dependent offset indicator

- 5 To change the frequency, press  and use the  and  keys to highlight the **Frequency** field.
- 6 Press  to display the **Frequency** pop-up window. Use the numeric keypad to enter the required value in the **Frequency** pop-up window.
- 7 To confirm your choice, press the appropriate unit softkey.
- 8 Connect the power sensor to the signal to be measured.
- 9 The corrected measurement result is now displayed.

NOTE

If the measurement frequency does not correspond directly to a frequency in the sensor calibration table, the power meter calculates the calibration factor using linear interpolation.

If you enter a frequency outside the frequency range defined in the sensor calibration table, the power meter uses the highest or lowest frequency point in the sensor calibration table to set the calibration factor.

NOTE

When **Single Numeric** display mode is chosen, the frequency you entered and the

sensor table identifier is displayed in the upper window. Also, pressing , **Offset** displays the frequency you entered and calibration factor for each channel derived from the selected sensor tables.

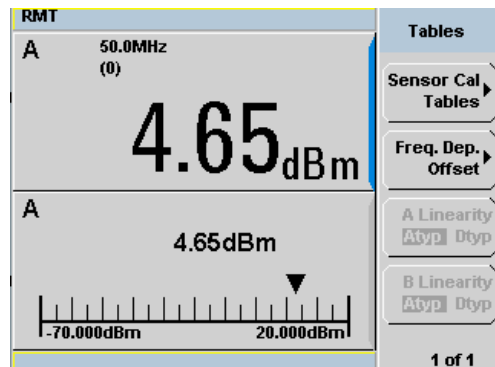

Figure 7-130 Frequency/calibration table display

Editing/Generating Sensor Calibration Tables

To help achieve the best accuracy in your measurement you can enter the values supplied for the sensors you are using by editing the installed sensor calibration tables or by generating your own custom tables.

You cannot delete any of the 20 existing calibration tables or create any additional tables. However, you can edit or delete the content of each table. If you need another table you should edit and re-name one of the tables. Each calibration table can contain a maximum of 80 frequency points.

To view the calibration tables currently stored in the power meter, press



, **Tables**, **Sensor Cal Tables**. The **Sensor Tbls** screen is displayed as shown in [Figure 7-128](#).

Table 7-13 Installed power sensor models

Table	Sensor Model	Table	Sensor Model
0	DEFAULT ¹	5	8485A
1	8481A	6	R8486A
2	8482A ²	7	Q8486A
3	8483A	8	R8486D
4	8481D	9	8487A

¹ DEFAULT is a sensor calibration table where the reference calibration factor and calibration factors are 100%. This sensor calibration table can be used during the performance testing of the power meter.

² The Agilent 8482B and Agilent 8482H power sensors use the same data as the Agilent 8482A.

There are also ten sensor calibration tables named **CUSTOM_0** through **CUSTOM_9**. These tables do not contain any data when the power meter is shipped from the factory.

Editing frequency dependent offset tables requires the following steps:

- 1 Identify and select the table you want to edit
- 2 Rename the table
- 3 Enter the frequency and offset pairs
- 4 Save the table

Procedure



First select the table you want to edit as follows:

- 1 Press , **Tables**, **Sensor Cal Tables** to display the **Sensor Tbls** screen.

RMT			Sensor Tbls
Tbl Name	State	Pts	
0 DEFAULT	off	2	Edit Table
1 8481A	off	17	
2 8482A	off	12	A Table Off On
3 8483A	off	10	
4 8481D	off	21	
5 8485A	off	22	
6 R8486A	off	17	B Table Off On
7 Q8486A	off	19	
8 R8486D	off	17	
9 8487A	off	53	Done







1 of 1

Figure 7-131 “Sensor Tbls” screen

- 2 Choose the table you want to edit using the  and  keys. Press **Edit Table** to display the **Edit Cal** screen as shown in [Figure 7-132](#).

RMT		Edit Cal
Name:	8481A	Change
Ref CF:	90.0%	
Freq	Cal Fac	Insert
100.000MHz	99.7%	
2.000GHz	98.0%	Delete
3.000GHz	97.7%	
4.000GHz	97.4%	Done
5.000GHz	97.0%	
6.000GHz	96.9%	1 of 1
7.000GHz	96.4%	
8.000GHz	96.0%	

Figure 7-132 “Edit Cal” display

- 3 Highlight the table title using the  and  keys. Press **Change** and use the , ,  and  keys to select and change the characters in the **Table Name** pop-up to create the name you want to use.

RMT		Cancel
Name:	8481A	%
Ref CF:	90.0%	
Freq	Cal Fac	Cal Factor
100.000MHz	99.7%	
2.000GHz	98.0%	099.7
		
		1 of 1

Figure 7-133 Edit table title pop-up

- Pressing **Insert Char** adds a new character to the right of the selected character.
- Pressing **Delete Char** removes the selected character.

- 4 Press **Enter** to complete the entry.

NOTE

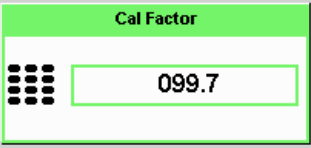
A calibration factor in the range of 1 % to 150 % can be entered.

The following rules apply to naming sensor calibration tables:

- The name must consist of no more than 12 characters.
- All characters must be upper or lower case alphabetic characters, or numeric (0-9), or an underscore (_).
- No other characters are allowed.
- No spaces are allowed in the name.

Enter (or edit) the frequency and cal factor pairs as follows:

- 1 Press **Insert** to add a new frequency value (or press **Change** to edit). Use the numeric keypad to enter the required value in the **Frequency** pop-up window. Complete the entry by pressing the **GHz**, **MHz** keys.
- 2 Enter the new cal factor value (or press **Change** to edit). Use the numeric keypad to enter the required value in the **Cal Factor** pop-up window. Complete the entry by pressing the **%** key.
- 3 Continue adding/editing values until you have entered all the data you require.
- 4 When you have finished editing the table press **Done** to save the table.

NOTE

Ensure that the frequency points you use cover the frequency range of the signals you want to measure. If you measure a signal with a frequency outside the frequency range defined in the sensor calibration table, the power meter uses the highest or lowest frequency point in the sensor calibration table to calculate the offset

Pre-installed Calibration Table Contents

The following lists detail the contents of the installed sensor calibration tables.

DEFAULT	
RCF	100
0.1 MHz	100
110 GHz	100
Agilent 8481A	
RCF	100
50 MHz	100
100 MHz	99.8
2 GHz	99
3 GHz	98.6
4 GHz	98
5 GHz	97.7
6 GHz	97.4
7 GHz	97.1
8 GHz	96.6
9 GHz	96.2
10 GHz	95.4
11 GHz	94.9
12.4 GHz	94.3
13 GHz	94.3
14 GHz	93.2
15 GHz	93
16 GHz	93
17 GHz	92.7
18 GHz	91.8
Agilent 8482A	
RCF	98
0.1 MHz	98
0.3 MHz	99.5
1 MHz	99.3
3 MHz	98.5
10 MHz	98.5
30 MHz	98.1
100 MHz	97.6
300 MHz	97.5
1 GHz	97
2 GHz	95
3 GHz	93

Agilent 8483A	
RCF	94.6
0.1 MHz	94
0.3 MHz	97.9
1 MHz	98.4
3 MHz	98.4
10 MHz	99.3
30 MHz	98.7
100 MHz	97.8
300 MHz	97.5
1 GHz	97.2
2 GHz	96.4
3 GHz	93
4 GHz	91
Agilent 8481D	
RCF	99
50 MHz	99
500 MHz	99.5
1 GHz	99.4
2 GHz	99.5
3 GHz	98.6
4 GHz	98.6
5 GHz	98.5
6 GHz	98.5
7 GHz	98.6
8 GHz	98.7
9 GHz	99.5
10 GHz	98.6
11 GHz	98.7
12 GHz	99
12.4 GHz	99.1
13 GHz	98.9
14 GHz	99.4
15 GHz	98.9
16 GHz	99.1
17 GHz	98.4
18 GHz	100.1

7 Using 8480 Series Power Sensors

4.2 GHz	91
---------	----

--	--

Agilent R8486A	
RCF	100
50 MHz	100
26.5 GHz	94.9
27 GHz	94.9
28 GHz	95.4
29 GHz	94.3
30 GHz	94.1
31 GHz	93.5
32 GHz	93.7
33 GHz	93.7
34 GHz	94.9
34.5 GHz	94.5
35 GHz	94.4
36 GHz	93.7
37 GHz	94.9
38 GHz	93.5
39 GHz	93.9
40 GHz	92.3
Agilent 8485A	
RCF	100
50 MHz	100
2 GHz	99.5
4 GHz	98.9
6 GHz	98.5
8 GHz	98.3
10 GHz	98.1
11 GHz	97.8
12 GHz	97.6
12.4 GHz	97.6
14 GHz	97.4
16 GHz	97

Agilent N8485A continued	
17 GHz	96.7
18 GHz	96.6
19 GHz	96
20 GHz	96.1
21 GHz	96.2
22 GHz	95.3
23 GHz	94.9
24 GHz	94.3
25 GHz	92.4
26 GHz	92.2
26.5 GHz	92.1
Agilent R8486D	
RCF	97.6
50 MHz	97.6
26.5 GHz	97.1
27 GHz	95.3
28 GHz	94.2
29 GHz	94.5
30 GHz	96.6
31 GHz	97.6
32 GHz	98
33 GHz	98.9
34 GHz	99.5
34.5 GHz	99
35 GHz	97.6
36 GHz	99
37 GHz	98.2
38 GHz	97.4
39 GHz	97.6
40 GHz	100

Agilent 8487A	
RCF	100
50 MHz	100
100 MHz	99.9
500 MHz	98.6
1 GHz	99.8
2 GHz	99.5
3 GHz	98.9
4 GHz	98.8
5 GHz	98.6
6 GHz	98.5
7 GHz	98.4
8 GHz	98.3
9 GHz	98.3
10 GHz	98.3
11 GHz	98.1
12 GHz	97.9
13 GHz	98
14 GHz	98.2
15 GHz	97.7
16 GHz	96.8
17 GHz	97
18 GHz	96.3
19 GHz	95.9
20 GHz	95.2
21 GHz	95.6
22 GHz	95.5
23 GHz	95.4
24 GHz	95
25 GHz	95.4
26 GHz	95.2
27 GHz	95.1
28 GHz	95
29 GHz	94.4
30 GHz	94
31 GHz	93.7
32 GHz	93.8
33 GHz	93
34 GHz	93.2

Agilent 8487A continued	
34.5 GHz	93.5
35 GHz	93.1
36 GHz	92
37 GHz	92.4
38 GHz	90.9
39 GHz	91.3
40 GHz	91.4
41 GHz	90.6
42 GHz	89.9
43 GHz	89.1
44 GHz	88.1
45 GHz	86.9
46 GHz	85.8
47 GHz	85.4
48 GHz	83.2
49 GHz	81.6
50 GHz	80.2
Agilent 08486A	
RCF	100
50 MHz	100
33.5 GHz	91.3
34.5 GHz	92
35 GHz	91.7
36 GHz	91.5
37 GHz	92.1
38 GHz	91.7
39 GHz	91
40 GHz	90.7
41 GHz	90.3
42 GHz	89.5
43 GHz	88.5
44 GHz	88.7
45 GHz	88.2
46 GHz	87
47 GHz	86.4
48 GHz	85.3
49 GHz	84.7
50 GHz	82.9

THIS PAGE HAS BEEN INTENTIONALLY LEFT BLANK.



8 Using N8480 Series Power Sensors

Introduction	196
Power Meter Configuration Changes	198
Default Channel Setup	199
N8480 Series Sensors Connection Requirements	200
N8480 Series Power Sensors (excluding Option CFT)	201
N8480 Series Power Sensors with Option CFT	203

This chapter describes how to use your N8480 Series power sensors with P-Series power meter.



Introduction

The N8480 Series power sensors is a replacement for the 8480 Series power sensors (excluding the D-model sensors) with build-in **Electrically Erasable Programmable Read-Only Memory (EEPROM)**¹.

The N8480 Series power sensors is used for measuring the average power supplied by RF or microwave source or a device-under-test (DUT). The N8480 Series power sensors places a 50 ohm load on the RF or microwave source. The power meter indicates the power dissipated in this load in W or dBm.

The N8480 sensors (excluding Option CFT) measure power levels from -35 dBm to $+20$ dBm (316 nW to 100 mW), at frequencies from 10 MHz to 33 GHz and have two independent power measurement path (upper and lower range).

Table 8-14 Power range in the Range setting

Sensor	Range Setting	Lower Range	Upper Range
N8481/2/5/7/8A and N8486AQ/AR excluding Option CFT	AUTO (Default)	-35 dBm to -1 dBm	-1 dBm to $+20$ dBm
	LOWER	-35 dBm to -1 dBm	-
	UPPER ²	-	-35 dBm to $+20$ dBm
N8481/2B excluding Option CFT	AUTO (Default)	-5 dBm to $+29$ dBm	$+29$ dBm to $+44$ dBm
	LOWER	-5 dBm to $+29$ dBm	-
	UPPER ²	-	$+29$ dBm to $+44$ dBm
N8481/2H excluding Option CFT	AUTO (Default)	-15 dBm to $+17$ dBm	$+17$ dBm to $+35$ dBm
	LOWER	-15 dBm to $+17$ dBm	-
	UPPER ²	-	$+17$ dBm to $+35$ dBm

Meanwhile, the N8480 sensors with Option CFT only measure power levels from -35 dBm to $+20$ dBm (1 μ W to 100 mW) in single range.

Similar to the E-Series power sensors, the N8480 Series power sensors are also equipped with EEPROM to store sensor's characteristics such as model number, serial number, linearity, temperature compensation, calibration factor¹ and so forth. However, the calibration factor table stored in EEPROM is not applicable for N8480 Series power sensors with

Option CFT, and require that you use default calibration tables or manually enter the required correction factors. Likewise, they cannot be used to make peak or time gated measurements.

The N8480 Series power sensors consist of four sensor model types with respective power range:

- A-models (–35 dBm to +20 dBm)
 - N8481A, N8482A, N8485A, N8487A, and N8488A
- B-models (–5 dBm to +44 dBm)
 - N8481B and N8482B
- H-models (–15 dBm to +35 dBm)
 - N8481H and N8482H
- Waveguide-models (–35 dBm to +20 dBm)
 - N8486AQ and N8486AR

Please refer to the documentation supplied with your Agilent N8480 Series power sensors for specification and calibration information.

¹ The calibration factor table stored in the EEPROM is not applicable for N8480 Series sensors with Option CFT.

² Recommended for pulse signals measurement with period of more than one second.

Power Meter Configuration Changes

The Agilent P-Series power meter recognizes when an Agilent N8480 Series power sensor is connected. The N8480 Series power sensors (excluding Option CFT) sensor calibration data is automatically read by the power meter. In addition, the auto-averaging settings shown in [Figure 8-134](#) are automatically configured.

	N8481/2/5/7A			Maximum Sensor Power	Resolution Setting				Number of Averages
	N8486AQ/AR	N8481/2B	N8481/2H		1	2	3	4	
	0 dBm	30 dBm	20 dBm		1	1	2	8	
	-1 dBm	29 dBm	17 dBm		2	2	4	32	
	-10 dBm	20 dBm	10 dBm		2	2	4	32	
	-20 dBm	10 dBm	0 dBm		2	2	16	256	
	-30 dBm	0 dBm	-10 dBm		2	8	128	128	
					4	64	256	512	
				Minimum Sensor Power					

Figure 8-134 Auto-averaging settings

NOTE

These values are valid only for the power meter channel connected to an Agilent N8480 Series power sensor. Averaging settings can also be manually configured. Refer to [“Setting Measurement Averaging”](#) on page 49 for more details.

Default Channel Setup

When a N8480 Series power sensor is connected, the following Channel Setup is automatically configured. Carrying out a Preset returns the channel to this configuration.

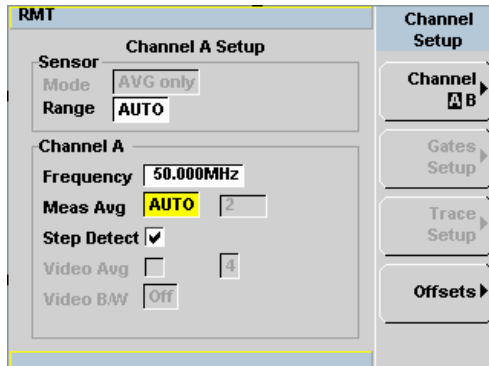

Figure 8-135 N8480 Series sensor (excluding Option CFT) default channel setup

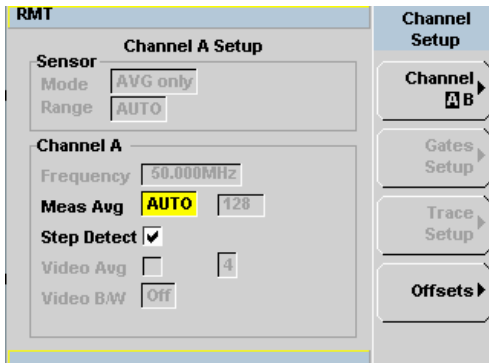

Figure 8-136 N8480 Series sensor with Option CFT default channel setup

N8480 Series Sensors Connection Requirements

Table 8-15 N8480 Series connection requirements

Sensor	Connection Requirements
N8481A N8481H N8482A N8482H	These power sensors connect directly to the POWER REF.
N8481B N8482B	These power sensors are configured with an attenuator. Prior to calibration this attenuator must be removed. Replace the attenuator before making measurements.
N8485A	This power sensor requires an APC 3.5 (f) to 50 Ω (m) N-Type adapter (08485-60005) to connect to the POWER REF. Remove this adapter before making measurements.
N8486AR N8486AQ	These waveguide power sensors have two connectors. Use the N-Type connector to calibrate the power meter.
N8487A N8488A	This sensor requires an APC 2.4 (f) to 50 Ω (m) N-Type adapter (08487-60001) to connect to the POWER REF. Remove this adapter before making measurements.

N8480 Series Power Sensors (excluding Option CFT)



Power sensors have small errors in their response over frequency. The response of each sensor is measured during manufacture (and during periodic calibration). With N8480 Series power sensors (excluding Option CFT), the resulting frequency compensation information is written into Electrically Erasable Programmable Read Only Memory (EEPROM). This allows the frequency and calibration data to be downloaded to the power meter automatically.

Using calibration factors enables you to achieve improved measurement accuracy. This section describes making continuous wave measurements using the N8480 Series power sensors (excluding Option CFT).

Making a measurement requires the following steps:

- 1 Zero and calibrate the power meter/sensor combination.
- 2 Set the frequency for the signal you want to measure.
- 3 Make the measurement.

Procedure



- 1 First zero and calibrate the power meter/sensor combination.
- 2 Ensure the power sensor is disconnected from any signal source.
- 3 Press  and the channel **Zero** softkey. The **Zeroing** pop-up is displayed.
- 4 Connect the power sensor to the POWER REF output.
- 5 Press  and the channel **Cal** softkey to start the calibration routine. The **Calibrating** pop-up is then displayed.

NOTE

You can reduce the steps required to carry out the zero and calibration procedure as follows:

- 1 Connect the power sensor to the POWER REF output.
- 2 Press  and **Zero + Cal**. (For dual channel meters, press **Zero + Cal**, **Zero + Cal A** or **Zero + Cal B** as required).

Now set the frequency of the signal you want to measure. The power meter automatically selects the appropriate calibration factor.

- 6 Press . On dual channel meters select the required channel.
- 7 Use the  and  keys to highlight the **Frequency** value field and press



to display the **Frequency** pop-up. Use the numeric keypad to enter the required value in the **Frequency** pop-up window.

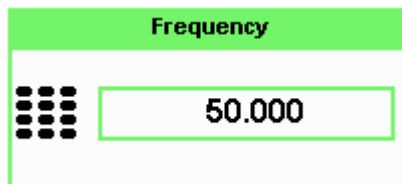



Figure 8-137 Frequency pop-up

- 8 Confirm your choice by pressing **MHz** or **GHz**.
- 9 Press  key to close the **Channel Setup** screen.

Now make the measurement.

- 10 Connect the power sensor to the signal to be measured.

The corrected measurement result is displayed.

N8480 Series Power Sensors with Option CFT

Power sensors have small errors in their response over frequency. The response of each sensor is measured during manufacture (and during periodic calibration). The calibration factor table written into Electrically Erasable Programmable Read Only Memory (EEPROM) is not applicable for N8480 Series power sensors with Option CFT. Therefore, the response of each sensor is measured during manufacture (and during periodic calibration) and the resulting frequency compensation information is supplied in the form of calibration factors. The P-Series power meters provide two methods of using the calibration factors:

- inputting the individual calibration factor for a frequency prior to making the measurement, or
- using sensor calibration tables.

If you are making most of your measurements at a single frequency, or in a narrow range of frequencies, entering a specific calibration factor is a more effective method. Only a minimal amount of data entry is required.

However, if you are making measurements on a wide range of signal frequencies, a sensor table is more effective as you only need to enter the frequency of the signal you are measuring. The power meter automatically selects and applies the calibration factor from the selected table.

Frequency Specific Calibration Factors

This section shows you how to make a measurement using the calibration factor for the frequency of the signal you want to measure.

Tip This method is best suited to making several measurements at one frequency as you need only enter a small amount of data.

Using this method requires the following steps:

- 1 Zero and calibrate the power meter/sensor combination.
- 2 Set the calibration factor value for the frequency of the signal you want to measure.
- 3 Make the measurement

Procedure

- 1 Ensure the power sensor is disconnected from any signal source.
- 2 Refer to the connection requirements in [Table 8-15](#) and ensure the sensor is ready for connection to the Power Reference.
- 3 Press the **Cal** softkey, **REF CFs**. The value is displayed under the channel **Ref CF** softkey.

Does this setting match the value for the sensor? (The power sensor reference calibration factor can normally be found above the calibration factors table on the power sensor body.)

- 4 To change the settings, press the channel **REF CF**. The reference calibration factor pop up window is displayed as shown in [Figure 8-138](#). Use the numeric keypad to enter the required value in the **Ref Cal Factor** pop-up menu.

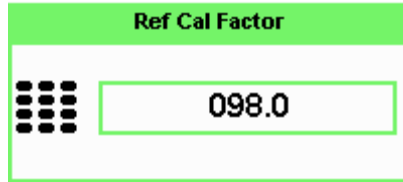

Figure 8-138Reference calibration factor pop-up window

- 5 Press **%** to complete the entry.

Now zero and calibrate the power meter/sensor combination as follows:

- 6 Press the **Cal** softkey and the channel **Zero** softkey. The **Zeroing** pop-up is displayed.
- 7 Connect the power sensor to the POWER REF output.
- 8 Press the **Cal** softkey and the channel **Cal** softkey to start the calibration routine. The **Calibrating** pop-up is then displayed.

NOTE

You can reduce the steps required to carry out the zero and calibration procedure as follows:

- 1 Connect the power sensor to the POWER REF output.
- 2 Press  and **Zero + Cal**. (For dual channel meters, press **Zero + Cal**, **Zero + Cal A** or **Zero + Cal B** as required).

Now set the sensor calibration factor for the frequency of the signal you want to measure.

- 9 , **Offset**. The value is displayed on the **Cal Fac** field.

Does this setting match the value for the sensor? (The power sensor reference calibration factor can normally be found above the calibration factors table on the power sensor body.)

- 10 To change the settings, use the  and  keys to highlight the **Cal Fac**

value field and press  to display the **Cal Factor** pop-up. Use the numeric keypad to enter the required value in the **Cal Factor** pop-up window.

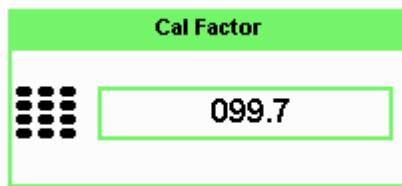

Figure 8-139 Calibration factor pop-up window

- 11 Press **%** to complete the entry.
- 12 Connect the power sensor to the signal to be measured.
- 13 The corrected measurement result is displayed.

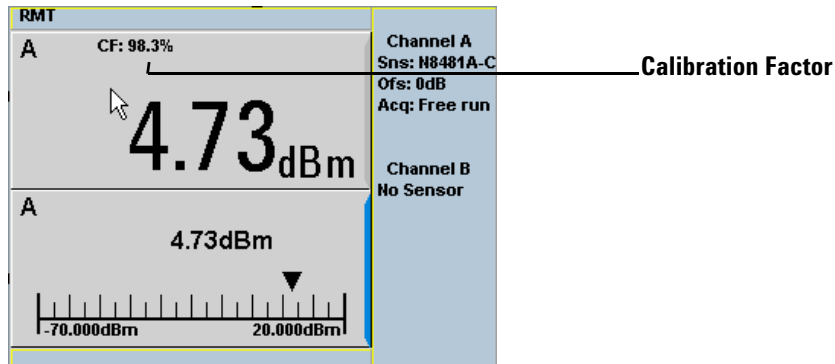











Figure 8-140 Calibration factor displayed

Example

To make a measurement on channel A with a power sensor which has a reference calibration factor of 99.8% and a calibration factor of 97.6% at the measurement frequency.

- Disconnect the power sensor from any signal source.
- Press , **REF CFs** and the channel **REF CF** softkey.
- Use the numeric keypad to enter 99.8 in the **Ref Cal Factor** pop-up window.
- Press **%** to complete the entry.
- Press  and the channel **Zero** softkey. The **Zeroing** pop-up is displayed.
- Connect the power sensor to the POWER REF output.
- Press  and the channel **Cal** softkey to start the calibration routine. The **Calibrating** pop-up is then displayed.
- Press , **Offset**. The value is displayed on the **Cal Fac** field.

- Press the  key, the  and  keys to highlight the **Cal Fac** value field and press  to display the **Cal Factor** pop-up. Use the numeric keypad to enter 97.6 in the **Cal Factor** pop-up window.
- Press  to complete the entry.
- Connect the power sensor to the signal to be measured.
- The corrected measurement result is displayed.

NOTE

When no sensor tables are selected and **Single Numeric** display mode is chosen, the calibration factor used for the measurement is displayed in the upper window as shown in [Figure 8-140](#).

Sensor Calibration Tables

This section describes how to use sensor calibration tables. Sensor calibration tables store the measurement calibration factors, for a power sensor model or for a specific power sensor, in the power meter. They are used to correct measurement results.

Use sensor calibration tables when you want to make power measurements over a range of frequencies using one or more power sensors.

The P-Series power meters are capable of storing 20 sensor calibration tables each containing up to 80 frequency points. The power meter is supplied with a set of 9 predefined sensor calibration tables plus a “100%” default table. The data in these tables is based on statistical averages for a range of Agilent Technologies power sensors. Your own sensor will most likely differ from the typical to some degree. If you require best accuracy, create a custom table for each sensor you use as shown in [“Editing/Generating Sensor Calibration Tables”](#) on page 212.

To use calibration factor tables:

- 1 Select the sensor calibration table to be applied to a channel.
- 2 Zero and calibrate the power meter. The reference calibration factor used during the calibration is automatically set by the power meter from the sensor calibration table.
- 3 Specify the frequency of the signal you want to measure. The calibration factor is automatically set by the power meter from the sensor calibration table.
- 4 Make the measurement.





Selecting a Sensor Calibration Table

You can select a calibration factor table from the  key menu followed by **Tables** and **Sensor Cal Table**.

The State column indicates if any calibration factor tables are currently selected. The **Sensor Tbls** screen is shown in [Figure 8-141](#).



NOTE

You can also view which sensor table is being used by pressing the , **Offset** and

 the  and  keys to highlight the **CF Table** setting field and press  to display the table.

Procedure

Select sensor calibration table as follows:

- 1 Press , **Tables**, **Sensor Cal Tables**.
- 2 Use the  and  keys to highlight one of the 20 table titles and press **Table** to highlight **On**.

RMT				Sensor Tbls	
Tbl Name	State	Pts			
0 DEFAULT	A	2	Edit Table		
1 8481A	off	17	A Table		
2 8482A	off	12	Off On		
3 8483A	off	10	B Table		
4 8481D	off	21	Off On		
5 8485A	off	22	Done		
6 R8486A	off	17			
7 Q8486A	off	19			
8 R8486D	off	17			
9 8487A	off	53			
				1 of 1	

Figure 8-141 Sensor table selected

NOTE

When no data is contained in the highlighted table, the **Table** key is disabled (grayed out).

- 3 Press **Done** to complete the selection of the calibration factor table.
- 4 Press **Done** again to display the measurement screen. [Figure 8-142](#) shows which offset table is selected.

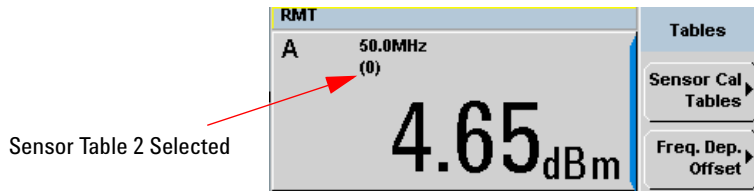





Figure 8-142 Frequency dependent offset indicator

- 5 To change the frequency, press  and use the  and  keys to highlight the **Frequency** field.
- 6 Press  to display the **Frequency** pop-up window. Use the numeric keypad to enter the required value in the **Frequency** pop-up window.
- 7 To confirm your choice, press the appropriate unit softkey.
- 8 Connect the power sensor to the signal to be measured.
- 9 The corrected measurement result is now displayed.

NOTE

If the measurement frequency does not correspond directly to a frequency in the sensor calibration table, the power meter calculates the calibration factor using linear interpolation.

If you enter a frequency outside the frequency range defined in the sensor calibration table, the power meter uses the highest or lowest frequency point in the sensor calibration table to set the calibration factor.

NOTE

When **Single Numeric** display mode is chosen, the frequency you entered and the

sensor table identifier is displayed in the upper window. Also, pressing  , **Offset** displays the frequency you entered and calibration factor for each channel derived from the selected sensor tables.

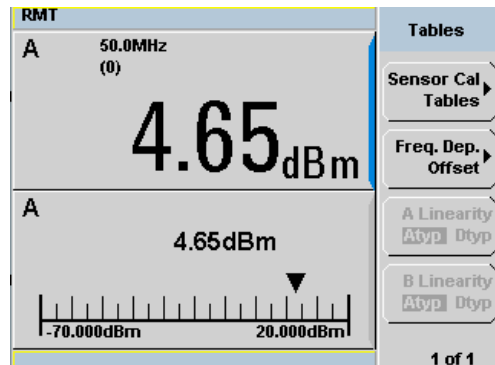

Figure 8-143 Frequency/calibration table display

Editing/Generating Sensor Calibration Tables

NOTE

Predefined sensor calibration factor table stored in power meter is not applicable for Agilent N8480 Series power sensors with Option CFT. Therefore, users are required to create a new sensor calibration table for the sensors when a sensor calibration table is needed.

To help achieve the best accuracy in your measurement you can enter the values supplied for the sensors you are using by editing the installed sensor calibration tables or by generating your own custom tables.

You cannot delete any of the 20 existing calibration tables or create any additional tables. However, you can edit or delete the content of each table. If you need another table you should edit and re-name one of the tables. Each calibration table can contain a maximum of 80 frequency points.

To view the calibration tables currently stored in the power meter, press



, **Tables**, **Sensor Cal Tables**. The **Sensor Tbls** screen is displayed as shown in [Figure 8-141](#).

Table 8-16 Installed power sensor models

Table	Sensor Model	Table	Sensor Model
0	DEFAULT ¹	5	8485A
1	8481A	6	R8486A
2	8482A ²	7	Q8486A
3	8483A	8	R8486D
4	8481D	9	8487A

¹ DEFAULT is a sensor calibration table where the reference calibration factor and calibration factors are 100%. This sensor calibration table can be used during the performance testing of the power meter.

²The Agilent 8482B and Agilent 8482H power sensors use the same data as the Agilent 8482A.

There are also ten sensor calibration tables named **CUSTOM_0** through **CUSTOM_9**. These tables do not contain any data when the power meter is shipped from the factory.

Editing frequency dependent offset tables requires the following steps:

- 1 Identify and select the table you want to edit
- 2 Rename the table
- 3 Enter the frequency and offset pairs
- 4 Save the table



Procedure

First select the table you want to edit as follows:

- 1 Press , **Tables**, **Sensor Cal Tables** to display the **Sensor Tbls** screen.

RMT			Sensor Tbls	
Tbl Name	State	Pts		
0 DEFAULT	off	2	Edit Table	
1 8481A	off	17	A Table	
2 8482A	off	12	Off On	
3 8483A	off	10	B Table	
4 8481D	off	21	Off On	
5 8485A	off	22	Done	
6 R8486A	off	17		
7 Q8486A	off	19		
8 R8486D	off	17		
9 8487A	off	53		
			1 of 1	

Figure 8-144 “Sensor Tbls” screen

- 2 Choose the table you want to edit using the  and  keys. Press **Edit Table** to display the **Edit Cal** screen as shown in [Figure 8-145](#).

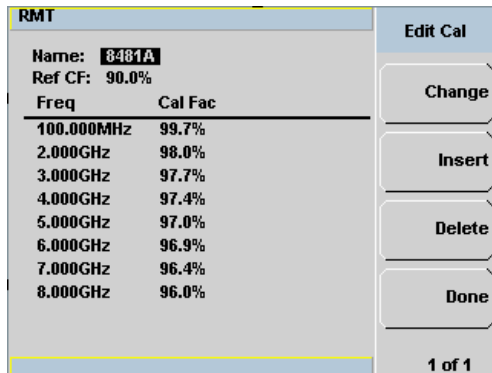

Figure 8-145 “Edit Cal” display

- Highlight the table title using the and keys. Press **Change** and use the , , and keys to select and change the characters in the **Table Name** pop-up to create the name you want to use.

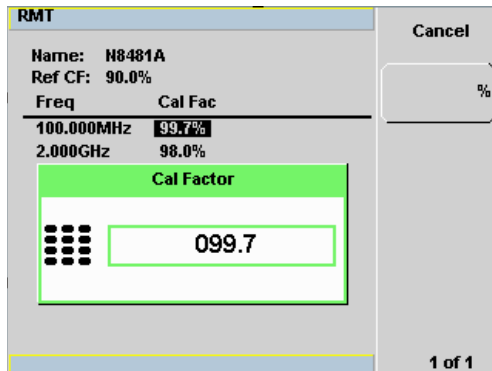

Figure 8-146 Edit table title pop-up

- Pressing **Insert Char** adds a new character to the right of the selected character.
- Pressing **Delete Char** removes the selected character.

- 4 Press **Enter** to complete the entry.

NOTE

A calibration factor in the range of 1 % to 150 % can be entered.

The following rules apply to naming sensor calibration tables:

- The name must consist of no more than 12 characters.
- All characters must be upper or lower case alphabetic characters, or numeric (0-9), or an underscore (_).
- No other characters are allowed.
- No spaces are allowed in the name.

Enter (or edit) the frequency and cal factor pairs as follows:

- 1 Press **Insert** to add a new frequency value (or press **Change** to edit). Use the numeric keypad to enter the required value in the **Frequency** pop-up window. Complete the entry by pressing the **GHz**, **MHz** keys.
- 2 Enter the new cal factor value (or press **Change** to edit). Use the numeric keypad to enter the required value in the **Cal Factor** pop-up window. Complete the entry by pressing the **%** key.
- 3 Continue adding/editing values until you have entered all the data you require.
- 4 When you have finished editing the table press **Done** to save the table.

NOTE

Ensure that the frequency points you use cover the frequency range of the signals you want to measure. If you measure a signal with a frequency outside the frequency range defined in the sensor calibration table, the power meter uses the highest or lowest frequency point in the sensor calibration table to calculate the offset

THIS PAGE HAS BEEN INTENTIONALLY LEFT BLANK.



9 Complementary Cumulative Distribution Function (CCDF)

Introduction 218

Setting the CCDF Table 219

This chapter describes the CCDF feature of the P-Series power meter.



Introduction

Many of the present digitally modulated signals now look noise-like in the time and frequency domains. This means that statistical measurements of the signals can be a useful characterization. Power Complementary Cumulative Distribution Function (CCDF) curves characterize the higher level power statistics of a digitally modulated signal. The curves can be useful in determining design parameters for digital communication systems.



A CCDF curve is defined by how much time the waveform spends at or above a given power level. This is expressed in dB relative to the average power. A CCDF curve is a plot of relative power levels versus probability where the X-axis represents the dB above the average signal power, while the Y-axis represents the percent of time the signal spends at or above the power level specified by the X-axis.

The most important application of power CCDF curves is to specify, completely and without ambiguity, the power characteristics of the signals that will be mixed, amplified, and decoded in communication systems. For example, baseband DSP signal designers can completely specify the power characteristics of signals to the RF designers by using CCDF curves. This helps avoid costly errors at system integration time. Similarly, system manufacturers can avoid ambiguity by completely specifying the test signal parameters to their amplifier suppliers.

CCDF curves apply to many design applications. Some of these applications are:

- Visualizing the effects of modulation formats.
- Combining multiple signals via system's components (for example, amplifiers).
- Evaluating spread-spectrum systems.
- Designing and testing RF components.

Setting the CCDF Table

To view the CCDF table, press , **Disp Type**, **1 of 2**, and **CCDF Table**. In the CCDF table, you can view the data in 3 ways - windowed, expanded and full screen. The CCDF table is shown in windowed format by default. However you can press  once for expanded format and twice for full-screen.

NOTE

CCDF is only allowed in Free Run mode, it cannot be used in Triggered mode. CCDF is only applicable to P-Series wideband power sensors (N192xA family).

Windowed CCDF Table

The CCDF table is shown in windowed format by default.

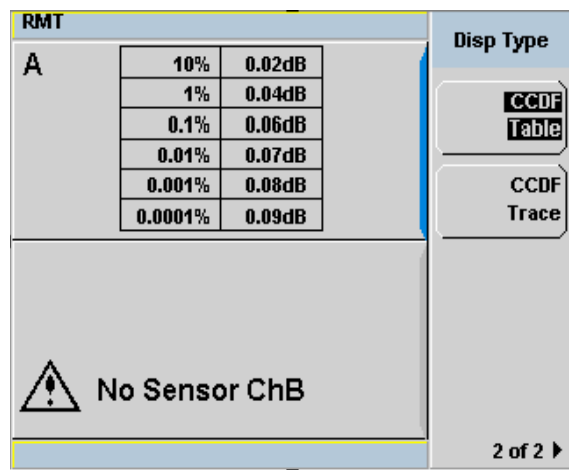



Figure 9-147 CCDF table in windowed display

Expanded CCDF Table

Press  once for an expanded view of the CCDF table.

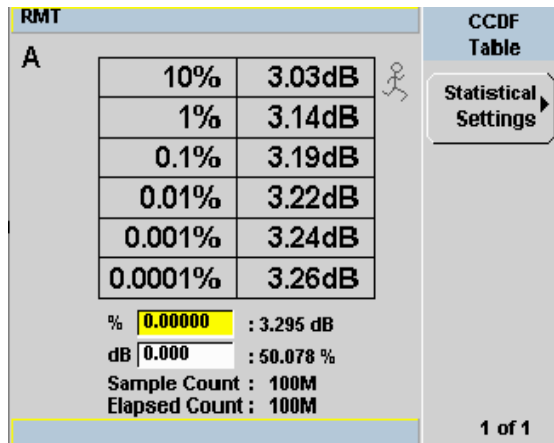

Figure 9-148 CCDF table in expanded display

In expanded format, you are allowed to query the power (dB) and the probability (%) based on your input. You can also vary the sample count of the CCDF table.

To set the sample count, press **Statistical Settings** then **Counts 100.0M**. You can also set the mode to single or continuous. In single mode, the graph and table readings will stop refreshing after the desired elapsed count is acquired. In continuous mode, the graph and table readings will reset after each cycle of elapsed count.

The mode can be set by pressing **Mode Single Cont**.

NOTE

The minimum elapsed count is 100 M, while the maximum is 10 G.

NOTE

Statistical Settings can also be accessed in **Marker Ctrl** menu.

Full Screen CCDF Table

Press  twice for a full-screen view of the CCDF table.

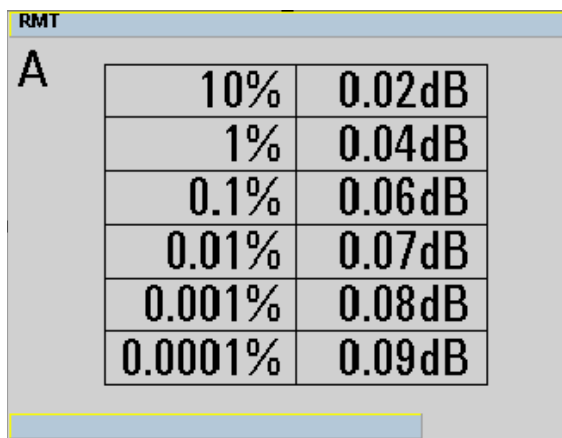

Percentage	dB Value
10%	0.02dB
1%	0.04dB
0.1%	0.06dB
0.01%	0.07dB
0.001%	0.08dB
0.0001%	0.09dB

Figure 9-149 CCDF table in full-screen display

Setting the CCDF Trace

The CCDF Trace display allows you to view the CCDF traces for Channel A, Channel B, Gaussian and Reference. You can read the data by moving the markers on the trace. In addition, the difference between markers on Channel A, Channel B, Gaussian and Reference traces can be observed.

To view the CCDF trace, press , **Disp Type** and **CCDF Trace**.

Step 1: Display the Trace

- Press **Trace Control**, **Trace Display** and select the trace that you wish to display. The trace which is not selected is grayed out, as in [Figure 9-150](#).

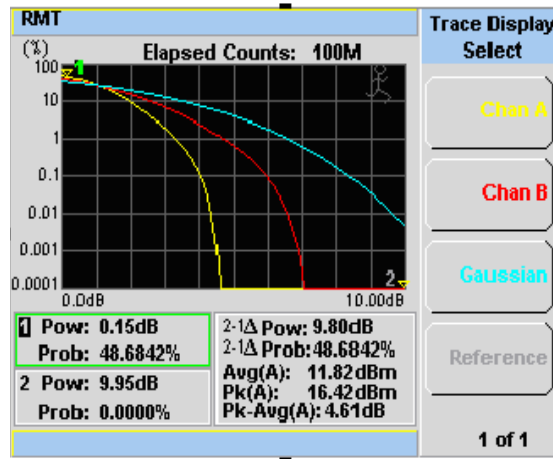

Figure 9-150 Trace Display Select control menu

NOTE

Yellow - Channel A, Red - Channel B, Turquoise - Gaussian and Pink - Reference.

Step 2: Setting the Marker

By using the marker, you can retrieve the data in between the limits of the X-axis that have been set.

- Return to **Marker Ctrl** menu.
- Press **Marker Trace**.
- Press **▲** and **▼** to select Marker 1 or Marker 2.
- Press **Chan A**, **Chan B**, **Gaussian**, or **Reference** to select the trace that you wish the marker to be placed on.

NOTE

Selected marker will have a green line outlining either Row 1 or Row 2.

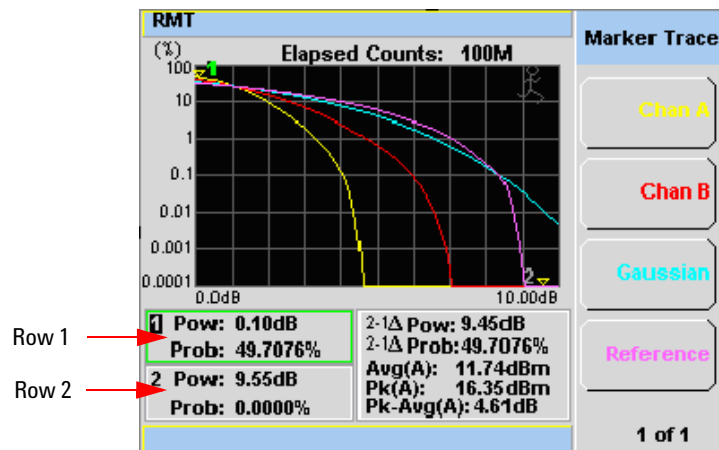

Figure 9-151 CCDF trace display with Marker Trace menu

- Press **Prev/Esc** to return to the **Marker Ctrl** menu.
- Press **Marker 1 2** to select the marker.
- Press **←** and **→** to move the marker to get to the required location.

While the marker is moving along the trace, the power (dB) and the probability (%) will be reflected at the lower left corner as shown in [Figure 9-151](#). Row 1 shows the reading for Marker 1 while row 2 shows the reading for Marker 2. The lower right corner shows the delta reading for Marker 2-Marker 1, average measurement, peak measurement and the peak-to-average ratio for the respective channel that you have selected.

NOTE

The alphabet in the parenthesis after Average, Peak and Peak-Average measurements represents: (A) - Channel A, (B) - Channel B, (G) - Gaussian, and (R) - Reference.

NOTE

Press  once to view the displayed trace in full-screen.

NOTE

Marker control menu is also accessible in the **Trace Control** menu.

Step 3: Setting the Scale/Div

- You are allowed to optimize the view of the trace by setting the appropriate scale/div. The lowest limit is 0.1 dB while the highest limit is 50 dB. A warning message will appear if the lower or upper limit has been exceeded.

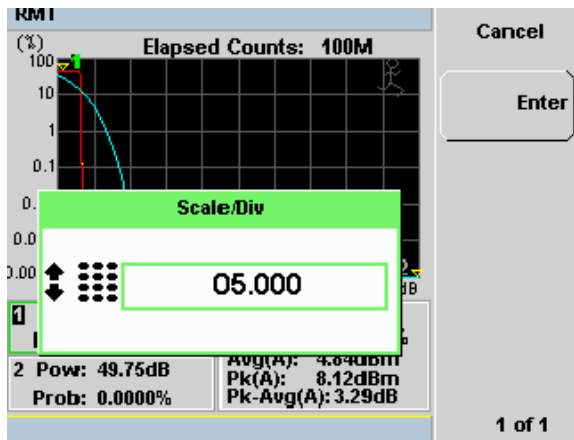

Figure 9-152 Scale/Div pop-up

Step 4: Store the Trace for Reference

- The function of **Store to Reference** is to save the trace of either Channel A or Channel B into the volatile memory of the power meter.
- Press **Reference** under the **Trace Display** menu to retrieve the stored trace.

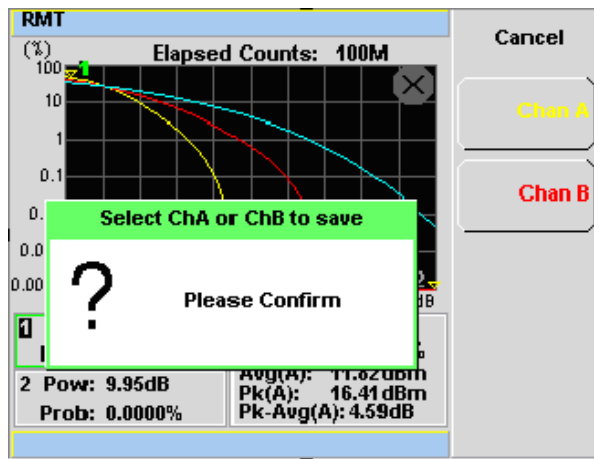

Figure 9-153 Selection of CCDF trace to be stored as a reference trace



10 Maintenance

Self Test	228
Error Messages	232
Operator Maintenance	243
Contacting Agilent Technologies	245
Erasing Memory Data	248
Returning Your Power Meter for Service	249
Agilent Sales and Service Offices	251

This chapter describes the built in tests, error messages and general maintenance.



Self Test

The power meter has two self test modes:

- Power on self test - occurs automatically when you turn on the power meter.
- Troubleshooting mode - accessed via the front panel or remotely. The front panel softkey menu allows you to run individual tests, whereas the remote command runs a complete series of tests as listed in “Remote Testing” on page 230.

Power On Self Test

The power on self test is performed automatically when the power meter is turned on and takes approximately 10 seconds to complete.

As the power on self test occurs, the message “**Testing...**” appears next to the name of the test which is being performed. When each test is complete, the message **Testing...** is replaced by either the message **Passed** or **Failed**. If a failure occurs the message **Power-up H/W Err** appears. Any errors are also written to the error queue and can be examined in

the **Errors** screen by pressing , **Error List**.

Front Panel Selection of Self Tests

Press , **1 of 2**, **Service**, **Self Test** to access the **Self Test** menu consisting of the following:

- Instrument Self Test
- Keyboard
- Bitmaps Displays

Instrument Self Test

If **Self Test** is selected, the following tests are run: (These are the same tests which are run using the *TST? command.)

- Test Point Voltages
- Calibrator
- Fan
- Battery
- Channel Peak Path
- Channel CW Path
- Channel DAP Check

As each test takes place, the name of the test is listed on the screen. While a test is running, the message **Testing...** appears beside the name of the test. As each stage of the test is completed, the **Testing...** message is replaced by either **Passed** or **Failed**.

RMT		Self Test
TEST	RESULT	
Test Point Voltages	Passed	
Calibrator	Passed	
Fan	Passed	
Battery	Passed	
ChA Peak Path	Passed	
ChA CW Path	Passed	
ChA DAP Check	Passed	
ChB Peak Path	Passed	
ChB CW Path	Passed	
ChB DAP Check	Passed	
		Done

Figure 10-154Self test complete

When the test is complete, the result is displayed. Press **Done** to return to the **Service** menu.

If the self test failed, information about the failure is displayed on the screen.

Remote Testing

To invoke the remote self test, the IEEE 488.1 compliant standard command, *TST? is used. This command runs a full self test and returns one of the following codes:

- 0 - no tests failed
- 1 - one or more tests failed

The remote self test consists of the following tests:

The communications assembly is tested implicitly, in that the command will not be accepted or return a result unless the remote interface is functioning correctly.

Refer to [“Test Descriptions”](#) on page 230 if you require a description of each individual test.

When the *TST? command is executed, the screen is cleared. As each test takes place, the name of the test is listed on the screen. While a test is running, the message **Testing...** appears beside the name of the test. As each stage of the test is completed, the message **Testing...** is replaced by either the message **Passed** or **Failed**.

Test Descriptions

This section specifies what is actually checked by each of the tests. Some of the tests may only be applicable to one method of invocation (for example, from the front panel). If this is the case, it is specified in the test description. Most of the tests have an associated error message which is added to the error queue if the test fails. The exception to this is the bitmap display test. Refer to [“Error Messages”](#) on page 232 for more details.

Fan

This test confirms that the internal cooling fan is operating.

Calibrator

The reference calibrator is turned on (indicated by the POWER REF LED)

and measured internally. A pass or fail result is returned.

Display

Three tests are available for the display: the display assembly, display RAM and bitmap display.

A read/write is performed on the display RAM. If the value which is written is read back correctly, a pass is recorded, otherwise a fail is recorded.

The liquid crystal display/ light emitting diode (LCD/LED) control circuits are tested by making separate voltage measurements via the multiplexer and digital signal processor. If the expected voltages are measured, a pass is recorded, otherwise a fail is recorded. The three circuits tested are the LCD contrast control, the LED brightness control, and the display temperature sensing diode.

Error Messages

Introduction

This section contains information about error messages. It explains how to read the power meter's error queue and lists all error messages and their probable causes.

When there is a hardware related problem, for example, a power sensor overload, the error message is displayed on the status line at the top of the display. In addition, the errors are also written to the error queue. If there are any errors in the error queue the front panel error indicator is displayed as shown in [Figure 10-155](#).

Other errors can also be generated when the power meter is being operated over the remote interface. These errors also display the error indicator and are written to the error queue.

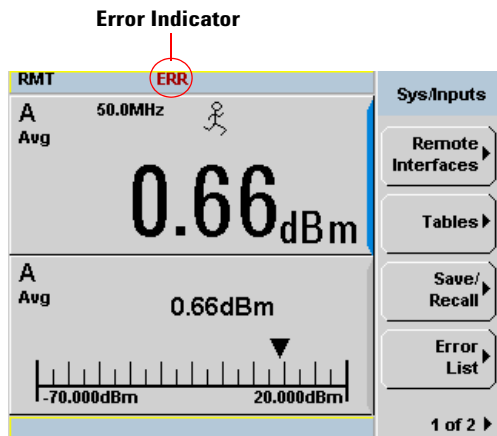

Figure 10-155 Error indicator position

To read the error queue from the front panel:

- Press **System**, **1 of 2**, **Service**, **Error List** and use **Next** to scroll through each error message.

To read the error queue from the remote interface use:

- the `SYSTEM:ERROR?` command.

Error queue messages have the following format:

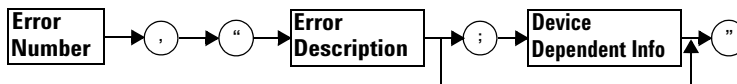

Error Queue Message

For example, -330, “Self-test Failed;Battery Fault”.

Errors are retrieved in a first in first out (FIFO) order. If more than 30 errors occur, the error queue overflows and the last error in the queue is replaced with error -350, “Queue Overflow”. Any time the queue overflows the most recent error is discarded.

When the errors are read they are removed from the error queue. This opens a position at the end of the queue for a new error message, if one is subsequently detected. When all errors have been read from the queue, further error queries return +0, “No errors”.

To delete all the errors in the queue from the front panel press:

- Press , **1 of 2**, **Service**, **Error List** and use **Clear Errors**.

To delete all the errors in the queue remotely use:

- the `*CLS` (clear status) command.

The error queue is also cleared when the instrument power has been switched off.

Error Message List

-101	Invalid character
	An invalid character was found in the command string. You may have inserted a character such as #, \$, or % in the command header or within a parameter. For example, LIM:LOW 0#.
-102	Syntax error
	Invalid syntax was found in the command string. For example, LIM:CLE:AUTO, 1 or LIM:CLE: AUTO 1.
-103	Invalid separator
	An invalid separator was found in the command string. You may have used a comma instead of a colon, semicolon, or blank space; or you may have used a blank space instead of a comma. For example, OUTP:ROSC,1.
-105	GET not allowed
	A Group Execute Trigger (GET) is not allowed within a command string.
-108	Parameter not allowed
	More parameters were received than expected for the command. You may have entered an extra parameter, or added a parameter to a command that does not accept a parameter. For example, CAL 10.
-109	Missing parameter
	Fewer parameters were received than expected for the command. You omitted one or more parameters that are required for this command. For example, AVER:COUN.
-112	Program mnemonic too long
	A command header was received which contained more than the maximum 12 characters allowed. For example, SENSEAVERAgeCOUNt 8.

-113	Undefined header
	<p>A command was received that is not valid for this power meter. You may have misspelled the command, it may not be a valid command or you may have the wrong interface selected. If you are using the short form of the command, remember that it may contain up to four letters.</p> <p>For example, TRIG:SOUR IMM.</p>
-121	Invalid character in number
	<p>An invalid character was found in the number specified for a parameter value.</p> <p>For example, SENS:AVER:COUN 128#H.</p>
-123	Exponent too large
	<p>A numeric parameter was found whose exponent was larger than 32,000.</p> <p>For example, SENS:COUN 1E34000.</p>
-124	Too many digits
	<p>A numeric parameter was found whose mantissa contained more than 255 digits, excluding leading zeros.</p>
-128	Numeric data not allowed
	<p>A numeric value was received within a command which does not accept a numeric value.</p> <p>For example, MEM:CLE 24.</p>
-131	Invalid suffix
	<p>A suffix was incorrectly specified for a numeric parameter. You may have misspelled the suffix.</p> <p>For example, SENS:FREQ 200KZ.</p>
-134	Suffix too long
	<p>A suffix used contained more than 12 characters.</p> <p>For example, SENS:FREQ 2MHZZZZZZZZZZ.</p>
-138	Suffix not allowed
	<p>A suffix was received following a numeric parameter which does not accept a suffix.</p> <p>For example, INIT:CONT 0Hz.</p>

-148	Character data not allowed
	A discrete parameter was received but a character string or a numeric parameter was expected. Check the list of parameters to verify that you have used a valid parameter type. For example, MEM:CLE CUSTOM_1.
-151	Invalid string data
	An invalid string was received. Check to see if you have enclosed the character string in single or double quotes. For example, MEM:CLE "CUSTOM_1.
-158	String data not allowed
	A character string was received but is not allowed for the command. Check the list of parameters to verify that you have used a valid parameter type. For example, LIM:STAT 'ON'.
-161	Invalid block data
	A block data element was expected but was invalid for some reason. For example, *DDT #15FET. The 5 in the string indicates that 5 characters should follow, whereas in this example there are only 3.
-168	Block data not allowed
	A legal block data element was encountered but not allowed by the power meter at this point. For example, SYST:LANG #15FETC?.
-178	Expression data not allowed
	A legal expression data was encountered but not allowed by the power meter at this point. For example, SYST:LANG (5+2).
-211	Trigger ignored
	Indicates that <GET> or *TRG, or TRIG:IMM was received and recognized by the device but was ignored because the power meter was not in the wait for trigger state.

-213	<p>Init ignored</p> <p>Indicates that a request for a measurement initiation was ignored as the power meter was already initiated.</p> <p>For example, INIT:CONT ON INIT.</p>
-214	<p>Trigger deadlock</p> <p>TRIG:SOUR was set to HOLD or BUS and a READ? or MEASure? was attempted, expecting TRIG:SOUR to be set to IMMEDIATE.</p>
-220	<p>Parameter error;Frequency list must be in ascending order.</p> <p>Indicates that the frequencies entered using the MEMory:TABLE:FREQuency command are not in ascending order.</p>
-221	<p>Settings conflict</p> <p>This message occurs under a variety of conflicting conditions. The following list gives a few examples of where this error may occur:</p> <p>If the READ? parameters do not match the current settings.</p> <p>If you are in fast mode and attempting to switch on for example, averaging, duty cycle or limits.</p> <p>Trying to clear a sensor calibration table when none is selected.</p>
-222	<p>Data out of range</p> <p>A numeric parameter value is outside the valid range for the command.</p> <p>For example, SENS:FREQ 2 KHZ.</p>
-224	<p>Illegal parameter value</p> <p>A discrete parameter was received which was not a valid choice for the command. You may have used an invalid parameter choice.</p> <p>For example, TRIG:SOUR EXT.</p>
-226	<p>Lists not same length</p> <p>This occurs when SENSE:CORRection:CSET[1] CSET2:STATe is set to ON and the frequency and calibration/offset lists do not correspond in length.</p>

-230	Data corrupt or stale This occurs when a FETC? is attempted and either a reset has been received or the power meter state has changed such that the current measurement is invalidated (for example, a change of frequency setting or triggering conditions).
-230	Data corrupt or stale;Please zero and calibrate Channel A When CAL[1 2]:RCAL is set to ON and the sensor currently connected to Channel A has not been zeroed and calibrated, then any command which would normally return a measurement result (for example FETC?, READ?, or MEAS?) will generate this error message.
-230	Data corrupt or stale;Please zero and calibrate Channel B When CAL[1 2]:RCAL is set to ON and the sensor currently connected to Channel B has not been zeroed and calibrated, then any command which would normally return a measurement result (for example FETC?, READ?, or MEAS?) will generate this error message.
-230	Data corrupt or stale;Please zero Channel A When CAL[1 2]:RCAL is set to ON and the sensor currently connected to Channel A has not been zeroed, then any command which would normally return a measurement result (for example FETC?, READ?, or MEAS?) will generate this error message.
-230	Data corrupt or stale;Please zero Channel B When CAL[1 2]:RCAL is set to ON and the sensor currently connected to Channel B has not been zeroed, then any command which would normally return a measurement result (for example FETC?, READ?, or MEAS?) will generate this error message
-230	Data corrupt or stale;Please calibrate Channel A When CAL[1 2]:RCAL is set to ON and the sensor currently connected to Channel B has not been calibrated, then any command which would normally return a measurement result (for example FETC?, READ?, or MEAS?) will generate this error message
-230	Data corrupt or stale;Please calibrate Channel B When CAL[1 2]:RCAL is set to ON and the sensor currently connected to Channel B has not been calibrated, then any command which would normally return a measurement result (for example FETC?, READ?, or MEAS?) will generate this error message

-231	Data questionable;CAL ERROR Power meter calibration failed. The most likely cause is attempting to calibrate without applying a 1 mW power to the power sensor.
-231	Data questionable;CAL ERROR ChA Power meter calibration failed on Channel A. The most likely cause is attempting to calibrate without applying a 1 mW power to the power sensor.
-231	Data questionable;CAL ERROR ChB Power meter calibration failed on Channel B. The most likely cause is attempting to calibrate without applying a 1 mW power to the power sensor.
-231	Data questionable;Input Overload The power input to Channel A exceeds the power sensor's maximum range.
-231	Data questionable;Input Overload ChA The power input to Channel A exceeds the power sensor's maximum range.
-231	Data questionable;Input Overload ChB The power input to Channel B exceeds the power sensor's maximum range.
-231	Data questionable;Lower window log error This indicates that a difference measurement in the lower window has given a negative result when the units of measurement were logarithmic.
-231	Data questionable;Upper window log error This indicates that a difference measurement in the upper window has given a negative result when the units of measurement were logarithmic.
-231	Data questionable;ZERO ERROR Power meter zeroing failed. The most likely cause is attempting to zero when some power signal is being applied to the power sensor.
-231	Data questionable;ZERO ERROR ChA Power meter zeroing failed on Channel A. The most likely cause is attempting to zero when some power signal is being applied to the power sensor.

-231	Data questionable;ZERO ERROR ChB Power meter zeroing failed on Channel B. The most likely cause is attempting to zero when some power signal is being applied to the power sensor.
-241	Hardware missing The power meter is unable to execute the command because either no power sensor is connected or it expects an E-series power sensor and one is not connected.
-310	System error;Dty Cyc may impair accuracy with ECP sensor This indicates that the sensor connected is for use with CW signals only.
-310	System error;Ch A Dty Cyc may impair accuracy with ECP sensor This indicates that the sensor connected to Channel A is for use with CW signals only.
-310	System error;Ch B Dty Cyc may impair accuracy with ECP sensor This indicates that the sensor connected to Channel B is for use with CW signals only.
-310	System error;Sensor EEPROM Read Failed - critical data not found or unreadable This indicates a failure with your E-Series or N8480 Series power sensor. Refer to your power sensor manual for details on returning it for repair.
-310	System error;Sensor EEPROM Read Completed OK but optional data block(s) not found or unreadable This indicates a failure with your E-Series or N8480 Series power sensor. Refer to your power sensor manual for details on returning it for repair.
-310	System error;Sensor EEPROM Read Failed - unknown EEPROM table format This indicates a failure with your E-Series or N8480 Series power sensor. Refer to your power sensor manual for details on returning it for repair.
-310	System error;Sensor EEPROM < > data not found or unreadable Where < > refers to the sensor data block covered, for example, Linearity, Temp - Comp (temperature compensation). This indicates a failure with your E-Series or N8480 Series power sensor. Refer to your power sensor manual for details on returning it for repair.

-310	<p>System error;Sensors connected to both front and rear inputs.</p> <p>You cannot connect two power sensors to the one channel input. In this instance the power meter detects power sensors connected to both it's front and rear channel inputs.</p>
-321	<p>Out of memory</p> <p>The power meter required more memory than was available to run an internal operation.</p>
-330	<p>Self-test Failed;</p> <p>The -330, "Self-test Failed" errors indicate that you have a problem with your power meter. Refer to "Contacting Agilent Technologies" on page 245 for details of what to do with your faulty power meter.</p>
-330	Self-test Failed;Measurement Channel Fault
-330	Self-test Failed;Measurement Channel A Fault
-330	Self-test Failed;Measurement Channel B Fault
-330	<p>Self-test Failed;Calibrator Fault</p> <p>Refer to "Calibrator" on page 230 if you require a description of the calibrator test.</p>
-330	Self-test Failed;ROM Check Failed
-330	Self-test Failed;RAM Check Failed
-330	<p>Self-test Failed;Display Assy. Fault</p> <p>Refer to "Display" on page 231 if you require a description of the Display test.</p>
-350	<p>Queue overflow</p> <p>The error queue is full and another error has occurred which could not be recorded.</p>
-361	<p>Parity error in program</p> <p>The serial port receiver has detected a parity error and consequently, data integrity cannot be guaranteed.</p>

-362	Framing error in program The serial port receiver has detected a framing error and consequently, data integrity cannot be guaranteed.
-363	Input buffer overrun The serial port receiver has been overrun and consequently, data has been lost.
-410	Query INTERRUPTED A command was received which sends data to the output buffer, but the output buffer contained data from a previous command (the previous data is not overwritten). The output buffer is cleared when power has been off, or after *RST (reset) command has been executed.
-420	Query UNTERMINATED The power meter was addressed to talk (that is, to send data over the interface) but a command has not been received which sends data to the output buffer. For example you may have executed a CONFigure command (which does not generate data) and then attempted to read data from the remote interface.
-430	Query DEADLOCKED A command was received which generates too much data to fit in the output buffer and the input buffer is also full. Command execution continues but data is lost.
-440	Query UNTERMINATED after indefinite response The *IDN? command must be the last query command within a command string.

Operator Maintenance

This section describes how to replace the power line fuse and clean the power meter. If you need additional information about replacing parts or repairing the power meter, refer to the *P-Series Power Meter Service Guide*.

To clean the power meter, disconnect its supply power and wipe with a damp cloth only.

The power line fuse is located within the power meter's fuse holder assembly on the rear panel. For all voltages the power meter uses a 250 V, F3.15 AH, 20 mm fast blow fuse with high breaking capacity (Agilent part number 2110-0957).

NOTE

The power meter also has an internal fuse. If you suspect that this fuse needs to be replaced, it must be done by trained service personnel. Please refer to [“Returning Your Power Meter for Service”](#) on page 249.

Replacing the Power Line Fuse

- 1 Slide the fuse holder assembly from the rear panel as shown in [Figure 10-156](#).
- 2 Install the correct fuse in the “In line” position as shown in [Figure 10-156](#). (A spare fuse can be stored in the fuse holder assembly.)
- 3 Replace the fuse holder assembly in the rear panel.

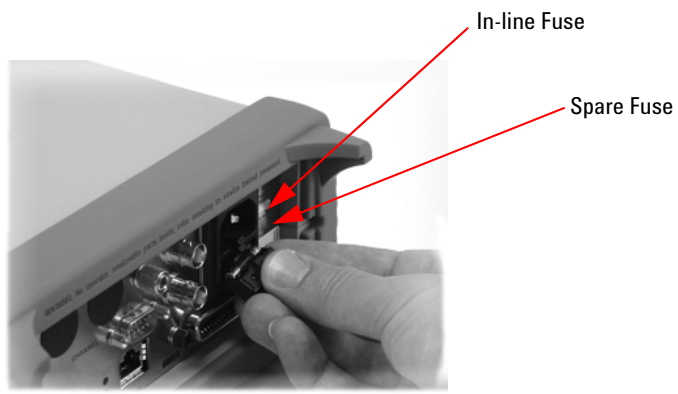

Figure 10-156 Replacing the fuse

Contacting Agilent Technologies

This section details what to do if you have a problem with your power meter.

If you have a problem with your power meter, first refer to the section [“Before calling Agilent Technologies”](#). This chapter contains a checklist that will help identify some of the most common problems.

If you wish to contact Agilent Technologies about any aspect of the power meter, from service problems to ordering information, refer to [“Agilent Sales and Service Offices”](#) on page 251.

If you wish to return the power meter to Agilent Technologies refer to [“Returning Your Power Meter for Service”](#) on page 249.

Before calling Agilent Technologies

Before calling Agilent Technologies or returning the power meter for service, please make the checks listed in [“Check the Basics”](#) on page 245. If you still have a problem, please read the warranty printed at the front of this guide. If your power meter is covered by a separate maintenance agreement, please be familiar with the terms.

Agilent Technologies offers several maintenance plans to service your power meter after warranty expiration. Call your Agilent Technologies Sales and Service Center for full details.

If the power meter becomes faulty and you wish to return the faulty instrument, follow the description on how to return the faulty instrument in the section [“Contacting Agilent Technologies”](#) on page 245.

Check the Basics

Problems can be solved by repeating what was being performed when the problem occurred. A few minutes spent in performing these simple checks may eliminate time spent waiting for instrument repair. Before calling Agilent Technologies or returning the power meter for service, please make the following checks:

- Check that the line socket has power.
- Check that the power meter is plugged into the proper ac power source.
- Check that the power meter is switched on.
- Check that the line fuse is in working condition.
- Check that the other equipment, cables, and connectors are connected properly and operating correctly.
- Check the equipment settings in the procedure that was being used when the problem occurred.
- Check that the test being performed and the expected results are within the specifications and capabilities of the power meter.
- Check the power meter display for error messages.
- Check operation by performing the self tests.
- Check with a different power sensor.

Instrument serial numbers

Agilent Technologies makes frequent improvements to its products to enhance their performance, usability and reliability. Agilent Technologies service personnel have access to complete records of design changes for each instrument. The information is based on the serial number and option designation of each power meter.

Whenever you contact Agilent Technologies about your power meter have a complete serial number available. This ensures you obtain the most complete and accurate service information. The serial number can be obtained by:

- interrogating the power meter over the remote interface using the *IDN? command.
- from the front panel by pressing  , **1 of 2** , **Service** , **Version** .
- from the serial number label.

The serial number label is attached to the rear of each Agilent Technologies instrument. This label has two instrument identification entries. The first provides the instruments serial number and the second provides the identification number for each option built into the instrument.

The serial number is divided into two parts: the prefix (two letters and the first four numbers), and the suffix (the last four numbers).

- The prefix letters indicate the country of manufacture. This code is based on the ISO international country code standard, and is used to designate the specific country of manufacture for the individual product. The same product number could be manufactured in two different countries. In this case the individual product serial numbers would reflect different country of manufacture codes. The prefix also consists of four numbers. This is a code identifying the date of the last major design change.
- The suffix indicates an alpha numeric code which is used to ensure unique identification of each product throughout Agilent Technologies.

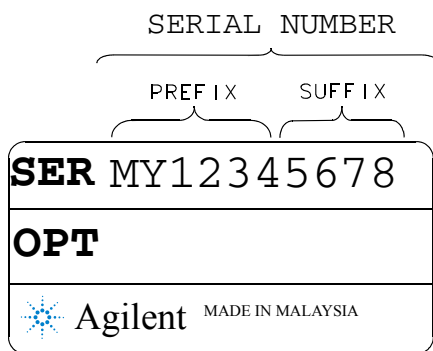

Erasing Memory Data

If you need to erase the P-Series power meter's memory, for example, before you return it to Agilent Technologies for repair or calibration, of all data stored in it.

The memory data erased includes the save/recall states and power on last states.

The following procedure explains how to do this.

1. Press the  key.
2. Press **1 of 2**.
3. Press **Service**.
4. Press **Secure Erase**.
5. If you are sure, press the **Confirm** key.
6. A pop-up appears, as shown in [Figure 10-157](#) informing you of the status of the procedure.

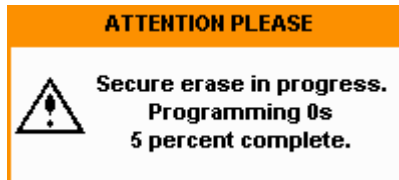

Figure 10-157Secure erase status pop-up

Returning Your Power Meter for Service

Use the information in this section if you need to return your power meter to Agilent Technologies.

Packaging the Power Meter for Shipment

Use the following steps to package the power meter for shipment to Agilent Technologies for service:

- Fill in a blue service tag (available at the end of this guide) and attach it to the power meter. Please be as specific as possible about the nature of the problem. Send a copy of any or all of the following information:
 - Any error messages that appeared on the power meter display.
 - Any information on the performance of the power meter.

CAUTION

Power meter damage can result from using packaging materials other than those specified. Never use styrene pellets in any shape as packaging materials. They do not adequately cushion the power meter or prevent it from shifting in the carton. Styrene pellets cause power meter damage by generating static electricity and by lodging in the rear panel.

-
- Use the original packaging materials or a strong shipping container that is made of double-walled, corrugated cardboard with 159 kg (350 lb) bursting strength. The carton must be both large enough and strong enough to accommodate the power meter and allow at least 3 to 4 inches on all sides of the power meter for packing material.
 - Surround the power meter with at least 3 to 4 inches of packing material, or enough to prevent the power meter from moving in the carton. If packing foam is not available, the best alternative is SD-240 Air Cap™ from Sealed Air Corporation (Commerce, CA 90001). Air Cap looks like a plastic sheet covered with 1-1/4 inch air filled bubbles. Use the pink Air Cap to reduce static electricity. Wrap the power meter several times in the material to both protect the power meter and prevent it from moving in the carton.

10 Maintenance

- Seal the shipping container securely with strong nylon adhesive tape.
- Mark the shipping container “FRAGILE, HANDLE WITH CARE” to ensure careful handling.
- Retain copies of all shipping papers.

Agilent Sales and Service Offices

In any correspondence or telephone conversations, refer to the power meter by its model number and full serial number. With this information, the Agilent representative can quickly determine whether your unit is still within its warranty period.

UNITED STATES	Agilent Technologies (tel) 1 800 829 4444
CANADA	Agilent Technologies Canada Inc. Test & Measurement (tel) 1 877 894 4414
EUROPE	Agilent Technologies Test & Measurement European Marketing Organization (tel) (31 20) 547 2000
JAPAN	Agilent Technologies Japan Ltd. (tel) (81) 426 56 7832 (fax) (81) 426 56 7840
LATIN AMERICA	Agilent Technologies Latin America Region Headquarters, USA (tel) (305) 267 4245 (fax) (305) 267 4286
AUSTRALIA and NEW ZEALAND	Agilent Technologies Australia Pty Ltd. (tel) 1-800 629 4852 (Australia) (fax) (61 3) 9272 0749 (Australia) (tel) 0-800 738 378 (New Zealand) (fax) (64 4) 802 6881 (New Zealand)
ASIA PACIFIC	Agilent Technologies, Hong Kong (tel) (852) 3197 7777 (fax) (852) 2506 9284

Or visit Agilent's Website at <http://www.agilent.com/find/assist>.

THIS PAGE HAS BEEN INTENTIONALLY LEFT BLANK.



11 Specifications and Characteristics

Introduction	254
Power Meter Specifications	256
Measurement Characteristics	259
Rear Panel Inputs and Output Connections	262
1 mW Power Reference	263
Environmental Conditions	264
Physical Characteristics	265
Regulatory Information	266
System Specifications and Characteristics	267

This chapter describes the specifications and characteristics of your P-Series power meter.



Introduction

This chapter details the P-Series power meters's specifications and supplemental characteristics. Information contained in this chapter refers to operation with P-Series wideband power sensors.

Specification Definitions

There are two types of product specifications:

- Warranted specifications
- Characteristic specifications

Warranted specifications

Warranted specifications are covered by the product warranty and apply over 0 °C to 55 °C, unless otherwise noted. Warranted specifications include Measurement Uncertainty calculated with 95 % confidence.

Characteristic specifications

Characteristic specifications are not warranted. They describe product performance that is useful in the application of the power sensors by giving typical, but non-warranted performance parameters. These characteristics are shown in *italics* or denoted as “*typical*”, “*nominal*” or “*approximate*”.

Characteristic information is representative of the product. In many cases, it may also be supplemental to a warranted specification. Characteristic specifications are not verified on all power sensors. The types of characteristic specifications can be placed in two groups:

- The first group of characteristic types describes 'attributes' common to all products of a given model or option.

Examples of characteristics that describe 'attributes' are product weight, and 50 Ω input Type-N connector. In these examples product weight is an *approximate* value and a 50 Ω input is *nominal*. These two terms are most widely used when describing a product's 'attributes'.

- The second group of characteristic types describes 'statistically' the aggregate performance of the population of products.

These characteristics describe the expected behavior of the population of products. They do not guarantee the performance of any individual product. No measurement uncertainty value is accounted for in the specification. These specifications are referred to as *typical*.

Conditions

The power meter and sensor meet its specifications when:

- Stored for a minimum of two hours at a stable temperature within the operating temperature range, and turned on for at least 30 minutes.
- The power meter and power sensor are within their recommended calibration periods.
- Used in accordance to the information provided in the power meter's user's guide.

Measurement uncertainties

For information on measurement uncertainty calculations, refer to Agilent AN 1449-1 to Agilent AN 1449-4 "Fundamentals of RF and Microwave Power Measurements", Literature Number 5988-9213EN to 5988-9216EN.

Power Meter Specifications

Number of Channels

- N1911A P-Series power meter, single channel
- N1912A P-Series power meter, dual channel

Frequency Range

- N1921A P-Series wideband power sensor, 50 MHz to 18 GHz
- N1922A P-Series wideband power sensor, 50 MHz to 40 GHz

Dynamic Range

- -35 dBm to +20 dBm (> 500 MHz)
- -30 dBm to +20 dBm (50 MHz -500 MHz)

Measurements

The following Power measurements are provided with free-run or time gated definition.

- Average
- Peak
- Minimum
- Peak-to-Average

Time parameter measurements of pulse rise time, fall time, pulse width, time to positive occurrence, time to negative occurrence, pulse repetitive frequency and duty cycle are also provided.

Power Sensors Compatibility

P-Series power meters are compatible with all Agilent P-Series wideband power sensors.

The P-Series power meters also operates with N8480 Series power sensors and the existing 8480 Series and E-Series (E4410, E9300, and E9320) ranges of power sensors.¹

Meter Uncertainty

Instrumentation Linearity	±0.8 %
---------------------------	--------

Average Power Measurement Accuracy²

- N1921A: $\leq \pm 0.2$ dB or ± 4.5 %
- N1922A: $\leq \pm 0.3$ dB or ± 6.7 %

¹ For specifications when using an 8480, N8480 Series and E-Series sensors (except E9320A range), refer to Lit Number 5965-6382E. For specifications when using an E932XA sensors, refer to Lit Number 5980-1469E.

² Specification is valid over -15 to $+20$ dBm, and a frequency range 0.5 to 10 GHz, DUT Max. SWR < 1.27 for the N1921A, and a frequency range 0.5 to 40 GHz, DUT Max. SWR < 1.2 for the N1922A. Averaging set to 32, in Free Run mode.

Remote Programming

Interface:	GPIB interface operates to IEEE 488.2 and IEC-625 10/100BaseT Lan Interface USB 2.0 Interface
Command Language:	SCPI standard interface commands ³
GPIB Compatibility:	SH1, AH1, T6, TE0, L4, LE0, SR1, RL1, PP1, DC1, DT1, C0

³ The P-Series power meters are not compatible with the 436A, 437B, or the 438A power meter command sets.

Timebase

Timebase Range	<i>2 ns to 100 msec/div</i>
Accuracy	± 10 ppm
Jitter	≥ 1 ns

Bandwidth

Video Bandwidth	≥ 30 MHz
Single Shot Bandwidth	≥ 30 MHz

NOTE

The video bandwidth represents the ability of the power sensor and meter to follow the power envelope of the input signal. The power envelope of the input signal is, in some cases, determined by the signal's modulation bandwidth, hence, video bandwidth is sometimes referred to as modulation bandwidth.

Measurement Characteristics

Trigger

Internal Trigger	Range: -20 to $+20$ dBm Resolution: 0.1 dB Level Accuracy: ± 0.5 dB Latency: ⁴ 160 ns ± 10 ns Jitter: ≤ 5 ns rms
External TTL Trigger Input	High: >2.4 V Low: <0.7 V Latency: ⁴ 90 ns ± 10 ns Minimum trigger pulse width: 15 ns Minimum trigger repetition period: 50 ns Impedance: 50 Ω Jitter: ≤ 5 ns rms
External TTL Trigger Output	<i>Low to High transition on trigger event.</i> High: >2.4 V Low: <0.7 V Latency: ⁴ 30 ns ± 10 ns Impedance: 50 Ω Jitter: ≤ 5 ns rms
Trigger Delay	Delay range: ± 1.0 s, maximum Delay resolution: 1 % of delay setting <i>(10 ns maximum)</i>
Trigger Hold-off	Range: 1 μ s to 400 ms Resolution: 1 % of selected value <i>(to a minimum of 10 ns)</i>
Trigger Level Threshold Hysteresis	Range: ± 3 dB Resolution: 0.05 dB

⁴ Latency is defined as the delay between the applied RF crossing the trigger level and the power meter switching into the triggered state.

Measurement Speed

Measurement speed using remote interface	≥ 1500 readings per second
---	---------------------------------

Pulse Characteristic

These pulse characteristics are only applicable when a P-Series wideband sensor is used.

Rise Time and Fall Time	≤ 13 ns ^{5,6}
Minimum Pulse Width	50 ns ⁷
Overshoot	≤ 5 %
Maximum Pulse Repetition Rate	10 MHz ⁸

⁵ Applies to frequencies >500 MHz (See [Figure 11-158](#)).

⁶ Applies only when **Off** is selected for video bandwidth.

⁷ The **Minimum Pulse Width** is the recommended minimum pulse width viewable on the power meter, where power measurements are meaningful and accurate, but not warranted.

⁸ Based on 10 samples per period.

Maximum Sample Rate and Capture Length

Maximum Sampling Rate	100 Msamples/second, continuous sampling
Maximum Capture Length	1 second

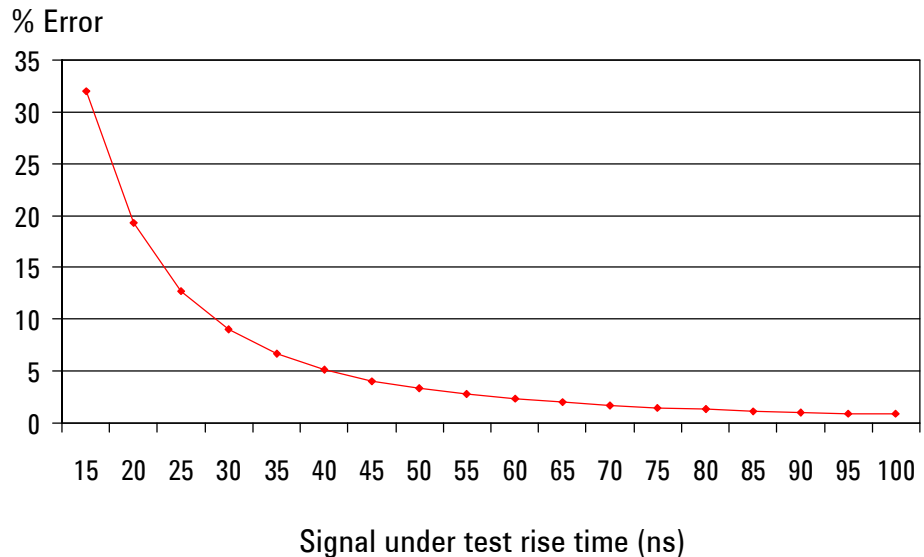

Figure 11-158 Measured rise time percentage error versus signal under test rise time

Although the rise time specification is ≤ 13 ns, this does not mean that the P-Series meter and sensor combination can accurately measure a signal with a known rise time of 13 ns. The measured rise time is the root sum of the squares (RSS) of the signal under test rise time and the system rise time (13 ns).

$$\sqrt{((\text{SignalUnderTestRiseTime})^2 + (\text{SystemRiseTime})^2)}$$

$$\frac{(\text{MeasuredRiseTime} - \text{SignalUnderTestRiseTime})}{(\text{SignalUnderTestRiseTime})} \times 100$$

Rear Panel Inputs and Output Connections

Recorder Output(s): ⁹	Analog 0 to 1 V, 1 kW output impedance, BNC connector
GPIB USB 2.0 10/100BaseT LAN	Interfaces allow communication with an external controller
Trigger Input:	Input has TTL compatible logic levels and uses a BNC connector
Trigger Out:	Output provides TTL compatible logic levels and uses a BNC connector
Ground:	Binding post, accepts 4 mm plug or bare wire connection

⁹ Two recorder outputs are available on the dual channel N1912A P-Series power meter.

Line Power

Input Voltage Range	100 to 240 Vac 100 to 120 Vac Automatic voltage selection Fluctuations not exceeding $\pm 10\%$
Input Frequency Range	50 to 60 Hz (100 to 240 Vac) 440 Hz (100 to 120 Vac)
Power Requirement	70 VA (maximum)

1 mW Power Reference

NOTE

The **1mW Power Reference** is provided for calibration of the E-Series, 8480 Series and the N8480 Series power sensors. The P-Series sensors are automatically calibrated, hence, do not need this power reference for calibration.

Power Output:	1.00 mW (0.0 dBm) Factory set to $\pm 0.4\%$ traceable to the National Physical Laboratories (NPL), UK
Accuracy: (over 2-years)	$\pm 1.2\%$ (0 - 55 °C) $\pm 0.4\%$ (25 \pm 10 °C)
Frequency:	<i>50 MHz nominal</i>
SWR:	1.08 (0 - 55 °C) <i>1.05 typical</i>
Connector Type:	Type N (f), 50 Ω

Environmental Conditions

General

Complies with the requirements of the EMC Directive 89/336/EEC.

Operating Environment

Temperature:	0 °C to 55 °C
Maximum Humidity:	95 % at 40 °C (non-condensing)
Minimum Humidity:	15 % at 40 °C (non-condensing)
Maximum Altitude:	3,000 meters (9,840 feet)

Storage Conditions

Non-Operating Storage Temperature:	-40 °C to +70 °C
Non-Operating Maximum Humidity:	90 % at 65 °C (non-condensing)
Non-Operating Maximum Altitude:	15,240 meters (50,000 feet)

Physical Characteristics

Dimensions

The following dimensions exclude front and rear panel protrusions:

- 88.5 mm H x 212.6 mm W x 348.3 mm D (3.5 in x 8.5 in x 13.7 in)

Weight

Weight (Net):	<i>N1911A: ≤ 3.5 kg (7.7 lb) approximately</i>
	<i>N1912A: ≤ 3.7 kg (8.1 lb) approximately</i>
Weight (Shipping):	<i>N1911A: ≤ 7.9 kg (17.4 lb) approximately</i>
	<i>N1912A: ≤ 8.0 kg (17.6 lb) approximately</i>

Regulatory Information

Electromagnetic Compatibility

This product complies with the protection requirements of European Council Directive 89/336/EEC for Electromagnetic Compatibility (EMC).

The conformity assessment requirements have been met using the technical construction file route to compliance, using EMC test specifications EN 55011:1991 (Group 1, Class A) and EN 50082-1:1992. In order to preserve the EMC performance of the product, any cable which becomes worn or damaged must be replaced with the same type and specification.

The product also meets the following EMC standards:

- IEC 61326-1:2005/EN61326-1:2006
- CISPR11:2003/EN55011:2007, Group 1 Class A
- Canada: ICES/NMB-001:Issue 4, June 2006
- Australia/New Zealand: AS/NZS CISPR 11:2004

Product Safety

This product conforms to the requirements of the following safety standards:

- IEC 61010-1:2010/EN 61010-1:2010 (3rd Edition)
- Canada: CAN/CSA-C22.2 No. 61010-1-12
- USA: ANSI/UL 61010-1 (3rd Edition)

Low Voltage Directive

This product conforms to the requirements of European Council Directive 73/23/EEC.

System Specifications and Characteristics

The video bandwidth in the meter can be set to High, Medium, Low and Off. The video bandwidths stated in the table below are not the 3 dB bandwidths, as the video bandwidths are corrected for optimal flatness (except the Off filter). Refer to [Figure 11-159](#) for information on the flatness response of the High, Medium, Low and Off filters. The Off video bandwidth setting provides the warranted rise time and fall time specification and is the recommended setting for minimizing overshoot on pulse signals.

Rise Time, Fall Time, and Overshoot versus Video Bandwidth Settings

Parameter	Video Bandwidth Setting				
	Low: 5 MHz	Medium: 15 MHz	High: 30 MHz	Off	
				< 500 MHz	> 500 MHz
Rise Time/ Fall Time ⁹	< 56 ns	< 25 ns	≤ 13 ns	< 36 ns	≤ 13 ns
Overshoot ¹⁰	-	-	-	< 5 %	< 5 %

⁹ Specified as 10 % to 90 % for rise time and 90 % to 10 % for fall time on a 0 dBm pulse.

¹⁰ Specified as the overshoot relative to the settled pulse top power.

NOTE

For option 107 (10 m cable), add 5 ns to the rise time and fall time specifications.

Characteristic Peak Flatness

The peak flatness is the flatness of a peak-to-average ratio measurement for various tone-separations for an equal magnitude two-tone RF input. [Figure 11-159](#) refers to the relative error in peak-to-average ratio measurements as the tone separation is varied. The measurements were performed at -10 dBm with power sensors with 1.5 m cable lengths.

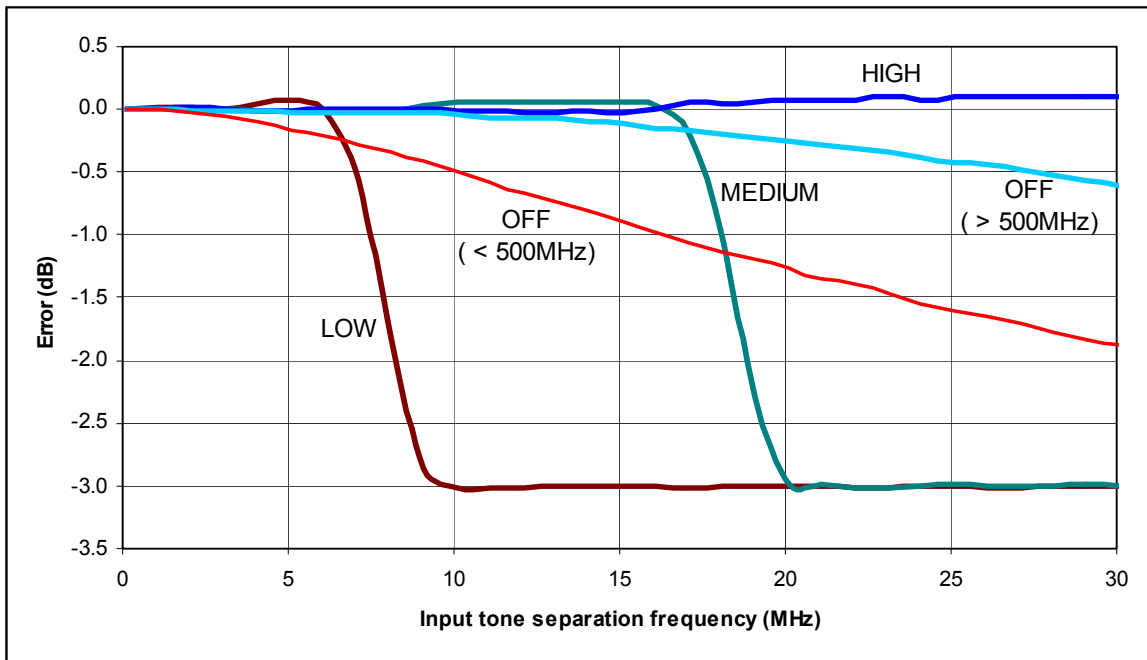

Figure 11-159P-Series sensor error in peak-to-average measurements for a two-tone input

Noise and Drift

Sensor Model	Zeroing	Zero Set		Zero Drift ¹¹	Noise per Sample	Measurement Noise (Free Run) ¹²
		<500 MHz	> 500 MHz			
N1921A / N1922A	No RF at input	200 nW		100 nW	2 μ W	50 nW
	RF Present	550 nW	200 nW			

¹¹ Within 1 hour after a zero, at a constant temperature, after 24 hour warm-up of the power meter. This component can be disregarded with Auto-zero mode set to ON.

¹² Measured over a one-minute interval, at a constant temperature, two standard deviations, with averaging set to 1.

Measurement Average Setting	1	2	4	8	16	32	64	128	256	512	1024
Free Run Noise Multiplier	1	0.9	0.8	0.7	0.6	0.5	0.45	0.4	0.3	0.25	0.2

Video BW setting		Low 5 MHz	Medium 15 MHz	High 30 MHz	Off
Noise per Sample Multiplier	< 500 MHz	0.5	1	2	1
	\geq 500 MHz	0.45	0.75	1.1	1

Effect of Video Bandwidth Setting:

The noise per sample is reduced by applying the meter video bandwidth filter setting (High, Medium or Low). If averaging is implemented, this will dominate any effect of changing the video bandwidth.

Effect of time-gating on measurement noise

The measurement noise on a time-gated measurement depends on the time gate length. 100 averages are carried out every 1 μ s of gate length. The Noise-per-Sample contribution in this mode can approximately be reduced by $\div(\text{gate length} / 10 \text{ ns})$ to a limit of 50 nW.

www.agilent.com

Contact us

To obtain service, warranty, or technical support assistance, contact us at the following phone numbers:

United States:

(tel) 800 829 4444 (fax) 800 829 4433

Canada:

(tel) 877 894 4414 (fax) 800 746 4866

China:

(tel) 800 810 0189 (fax) 800 820 2816

Europe:

(tel) 31 20 547 2111

Japan:

(tel) (81) 426 56 7832 (fax) (81) 426 56 7840

Korea:

(tel) (080) 769 0800 (fax) (080) 769 0900

Latin America:

(tel) (305) 269 7500

Taiwan:

(tel) 0800 047 866 (fax) 0800 286 331

Other Asia Pacific Countries:

(tel) (65) 6375 8100 (fax) (65) 6755 0042

Or visit Agilent World Wide Web at:

www.agilent.com/find/assist

Product specifications and descriptions in this document are subject to change without notice. Always refer to the English version at the Agilent Web site for the latest revision.

© Agilent Technologies, Inc. 2006–2013

Printed in Malaysia
Eleventh Edition, December 10, 2013

N1912-90002