



# **Agilent EPM-P Series Peak and Average Power Meters**

## **User's Guide**



**Agilent Technologies**

# Notices

© Agilent Technologies, Inc. 2000–2013

No part of this manual may be reproduced in any form or by any means (including electronic storage and retrieval or translation into a foreign language) without prior agreement and written consent from Agilent Technologies, Inc. as governed by United States and international copyright laws.

## Manual Part Number

E4416-90023

## Edition

Sixth Edition, April 5, 2013

Printed in Malaysia

Agilent Technologies, Inc.  
3501 Stevens Creek Blvd.  
Santa Clara, CA 95052 USA

## Warranty

**The material contained in this document is provided “as is,” and is subject to being changed, without notice, in future editions. Further, to the maximum extent permitted by applicable law, Agilent disclaims all warranties, either express or implied, with regard to this manual and any information contained herein, including but not limited to the implied warranties of merchantability and fitness for a particular purpose. Agilent shall not be liable for errors or for incidental or consequential damages in connection with the furnishing, use, or performance of this document or of any information contained herein. Should Agilent and the user have a separate written agreement with warranty terms covering the material in this document that conflict with these terms, the warranty terms in the separate agreement shall control.**

## Technology Licenses

The hardware and/or software described in this document are furnished under a license and may be used or copied only in accordance with the terms of such license.

## Restricted Rights Legend

U.S. Government Restricted Rights. Software and technical data rights granted to the federal government include only those rights customarily provided to end user customers. Agilent provides this customary commercial license in Software and technical data pursuant to FAR 12.211 (Technical Data) and 12.212 (Computer Software) and, for the Department of Defense, DFARS 252.227-7015 (Technical Data - Commercial Items) and DFARS 227.7202-3 (Rights in Commercial Computer Software or Computer Software Documentation).

## Safety Notices

### CAUTION

A **CAUTION** notice denotes a hazard. It calls attention to an operating procedure, practice, or the like that, if not correctly performed or adhered to, could result in damage to the product or loss of important data. Do not proceed beyond a **CAUTION** notice until the indicated conditions are fully understood and met.

---

### WARNING

A **WARNING** notice denotes a hazard. It calls attention to an operating procedure, practice, or the like that, if not correctly performed or adhered to, could result in personal injury or death. Do not proceed beyond a **WARNING** notice until the indicated conditions are fully understood and met.

---

## Certification

Agilent Technologies certifies that this product met its published specifications at the time of shipment from the factory. Agilent Technologies further certifies that its calibration measurements are traceable to the United States National Institute of Standards and Technology, to the extent allowed by the Institute's calibration facility, and to the calibration facilities of other International Standards Organization members.

## Warranty

This Agilent Technologies instrument product is warranted against defects in material and workmanship for a period of 3 years from date of shipment. During the warranty period, Agilent Technologies will at its option, either repair or replace products which prove to be defective. For warranty service or repair, this product must be returned to a service facility designated by Agilent Technologies. Buyer shall prepay shipping charges to Agilent Technologies and Agilent Technologies shall pay shipping charges, duties, and taxes for products returned to Agilent Technologies from another country. Agilent Technologies warrants that its software and firmware designated by Agilent Technologies for use with an instrument will execute its programming instructions when properly installed on that instrument. Agilent Technologies does not warrant that the operation of the instrument, or firmware will be uninterrupted or error free.

## Limitation of Warranty

The foregoing warranty shall not apply to defects resulting from improper or inadequate maintenance by Buyer, Buyer-supplied software or interfacing, unauthorized modification or misuse, operation outside of the environmental specifications for the product, or improper site preparation or maintenance. NO OTHER WARRANTY IS EXPRESSED OR IMPLIED. AGILENT TECHNOLOGIES SPECIFICALLY DISCLAIMS THE IMPLIED WARRANTIES OF MERCHANTABILITY AND FITNESS FOR A PARTICULAR PURPOSE.

## Exclusive Remedies

THE REMEDIES PROVIDED HEREIN ARE BUYER'S SOLE AND EXCLUSIVE REMEDIES. AGILENT TECHNOLOGIES SHALL NOT BE LIABLE FOR ANY DIRECT, INDIRECT, SPECIAL, INCIDENTAL, OR CONSEQUENTIAL DAMAGES, WHETHER BASED ON CONTRACT, TORT, OR ANY OTHER LEGAL THEORY.

## Warnings and Cautions

This guide uses warnings and cautions to denote hazards.

### **WARNING**

**A warning calls attention to a procedure, practice or the like, which, if not correctly performed or adhered to, could result in injury or the loss of life. Do not proceed beyond a warning until the indicated conditions are fully understood and met.**

---

### **CAUTION**

A caution calls attention to a procedure, practice or the like which, if not correctly performed or adhered to, could result in damage to or the destruction of part or all of the equipment. Do not proceed beyond a caution until the indicated conditions are fully understood and met.

---

## Recommended Calibration Interval

Agilent Technologies recommends a two- years calibration cycle for the E4416A and E4417A EPM-P Series power meter.

## Safety Symbols

The following symbol on the instrument and in the documentation indicates precautions that must be taken to maintain safe operation of the instrument.



Caution, risk of danger.  
The Instruction Documentation Symbol. The product is marked with this symbol when it is necessary for the user to refer to the instructions in the supplied documentation.



Alternating current (AC).



This symbol indicates the operating switch for 'Stand-by' mode. Note, the instrument is NOT isolated from the mains when the switch is pressed. To isolate the instrument, the mains coupler (mains input cord) should be removed from the power supply.



This symbol indicates the operating switch for 'On' mode.

---

## **General Safety Considerations**

The following general safety precautions must be observed during all phases of operation, service, and repair of this instrument. Failure to comply with these precautions or with specific warnings elsewhere in this manual violates safety standards of design, manufacture, and intended use of the instrument. Agilent Technologies assumes no liability for the customer's failure to comply with these requirements.

**WARNING**

This is a Safety Class I instrument (provided with a protective earthing ground, incorporated in the power cord). The mains plug shall only be inserted in a socket outlet provided with a protective earth contact. Any interruption of the protective conductor inside or outside of the instrument is likely to make the instrument dangerous. Intentional interruption is prohibited.

- **DO NOT** operate the product in an explosive atmosphere or in the presence of flammable gasses or fumes.
  - **DO NOT** use repaired fuses or short-circuited fuseholders: For continued protection against fire, replace the line fuse(s) only with fuse(s) of the same voltage and current rating and type.
  - **DO NOT** perform procedures involving cover or shield removal unless you are qualified to do so: Operating personnel must not remove equipment covers or shields. Procedures involving the removal of covers and shields are for use by service-trained personnel only.
  - **DO NOT** service or adjust alone: Under certain conditions, dangerous voltages may exist even with the equipment switched off. To avoid dangerous electrical shock, service personnel must not attempt internal service or adjustment unless another person, capable of rendering first aid and resuscitation, is present.
  - **DO NOT** operate damaged equipment: Whenever it is possible that the safety protection features built into this product have been impaired, either through physical damage, excessive moisture, or any other reason, **REMOVE POWER** and do not use the product until safe operation can be verified by service-trained personnel. If necessary, return the product to a Agilent Sales and Service Office for service and repair to ensure the safety features are maintained.
  - **DO NOT** substitute parts or modify equipment: Because of the danger of introducing additional hazards, do not install substitute parts or perform any unauthorized modification to the product. Return the product to a Agilent Sales and Service Office for service and repair to ensure the safety features are maintained.
-

**THIS PAGE HAS BEEN INTENTIONALLY LEFT BLANK.**



# Contents

Notices	ii
Certification	iii
Warranty	iii
Limitation of Warranty	iii
Exclusive Remedies	iv
Warnings and Cautions	iv
Safety Symbols	v
General Safety Considerations	vi

## 1 Introduction

Welcome	2
Conventions Used in this Guide	4
Power Meter and Sensor Capability	5
1 Not applicable for N8480 Series power sensors with Option CFT	5
Front Panel Keys and Connections	6
The Display Layout	10
Window Symbols	17
Confirmation Pop-Up	17
Wait Symbol	18
One of Many Entry Pop-Up	18
Configuration Conflict Pop-Up	18
Numeric or Alphanumeric Entry Pop-Up	19

## 2 General Power Meter Functions

Zeroing and Calibrating	22
Zeroing	22
Calibration	23
Calibration with E-Series Power Sensors and N8480 Series Power Sensors (Excluding Option CFT)	24
Calibration with 8480 Series Power Sensors and N8480 Series Power Sensors with Option CFT	25
Zero/Cal Lockout	29
Zeroing and Calibrating Using TTL Inputs	30
Setting the Units of Measurement	34
Selecting Units of Measurement from the Softkeys	35

Setting the Resolution	36
Making Relative Measurements	37
Setting Offsets	39
Setting Channel Offsets	39
Setting Display Offsets	41
Setting Frequency Dependent Offsets	43
Setting Averaging	49
Step Detection	51
Setting Measurement Limits	52
Setting Limits	53
Checking for Limit Failures	57
Setting the Range	59
Scaling the Analog Display	61
Recorder Output	63
Saving and Recalling Power Meter Configurations	66
Measuring Pulsed Signals	68
Presetting the Power Meter	71
Preset Conditions	71

### **3 Using E9320 E-Series Power Sensors**

Introduction	76
Power Meter Configuration	78
Default Channel Setup	78
Measurement Method	79
Measurement Display	80
Configuring a Peak Power Measurement	82
The Set Up Process	83
Setting Up Using Data Entry	83
Setting Up Using Trace Markers	103
Measurement Example	110
Using Preinstalled Measurement Setups	115
Measuring GSM	116
Measuring EDGE	119
Measuring NADC	122
Measuring iDEN	126
Measuring Bluetooth	129

- Measuring cdmaOne 133
- Measuring W-CDMA 136
- Measuring cdma2000 139

## **4 Using E9300 E-Series Power Sensors**

- Introduction 144
- Power Meter Configuration 145
  - Default Channel Setup 146
- Measurement Accuracy 147
- Measuring Spread Spectrum and Multitone Signals 149
  - CDMA Signal Measurements 150
  - Multitone Signal Measurements 151
- Measuring TDMA Signals 152
  - Power Meter and Sensor Operation 152
  - Achieving Stable Results with TDMA Signals 152
  - Achieving Stable Results with GSM Signals 153
- Electromagnetic Compatibility (EMC) Measurements 155
- Measurement Accuracy and Speed 156
  - Setting the Range 156
  - Measurement Considerations 157

## **5 Using E4410 E-Series Power Sensors**

- Introduction 160
- Power Meter Configuration 161
  - Default Channel Setup 162
- Measurement Accuracy 163

## **6 Using 8480 Series Power Sensors**

- Introduction 166
- Power Meter Configuration 167
  - Default Channel Setup 167
- Measurement Accuracy 169
- Frequency Specific Calibration Factors 170
- Sensor Calibration Tables 176
  - Editing/Generating Sensor Calibration Tables 180
  - Preinstalled Calibration Table Contents 184

## **7 Using N8480 Series Power Sensors**

- Introduction 188

Power Meter Configuration	190
Default Channel Setup	191
Measurement Accuracy	192
N8480 Series Power Sensors (excluding Option CFT)	192
N8480 Series Power Sensors with Option CFT	194
Frequency Specific Calibration Factors	195
Sensor Calibration Tables	199
Editing/Generating Sensor Calibration Tables	202

## **8 Maintenance**

Self Test	208
Power On Self Test	208
Front Panel Selection of Self Tests	209
Remote Testing	211
Test Descriptions	212
Error Messages	215
Introduction	215
Error Message List	217
Operator Maintenance	226
Replacing the Power Line Fuse	226
Contacting Agilent Technologies	228
Before calling Agilent Technologies	228
Check the Basics	229
Instrument serial numbers	229
Sales and Service Offices	231
Returning Your Power Meter for Service	232

## **9 Specifications and Characteristics**

Introduction	236
Power Meter Specifications	237
Video Bandwidth/ Dynamic Range Optimization	238
Accuracy	239
1 mW Power Reference	240
Measurement Characteristics	241
Sampling Characteristics	243
Rear Panel Inputs/Outputs	243
Remote Programming	244

Physical Specifications	244
Environmental Specifications	245
Operating Environment	245
Storage Conditions	245
Regulatory Information	246
Electromagnetic Compatibility	246
Product Safety	246

**THIS PAGE HAS BEEN INTENTIONALLY LEFT BLANK.**

## Figures

- Figure 2-1 Reference Calibration Factor Pop-Up Window 26
- Figure 2-2 Rmt I/O Port TTL Inputs 30
- Figure 2-3 Rel Indicator 37
- Figure 2-4 Simplified Measurement Path 39
- Figure 2-5 Offset Applied 40
- Figure 2-6 Offset Applied 40
- Figure 2-7 Offset applied 42
- Figure 2-8 Offset Tables 44
- Figure 2-9 Frequency Dependent Offset Table Selected 45
- Figure 2-10 Frequency Dependent Offset Configured 46
- Figure 2-11 “Edit Offset” Screen with Some Added Data 48
- Figure 2-12 Averaged Readings 49
- Figure 2-13 Filter Length Pop-Up 50
- Figure 2-14 Limits Checking Application 52
- Figure 2-15 Limits Checking Results 53
- Figure 2-16 Setting Maximum Limit 54
- Figure 2-17 Remote I/O TTL Outputs 55
- Figure 2-18 TTL Output Pop-up 56
- Figure 2-19 Example of TTL Disconnect Warning Message 56
- Figure 2-20 TTL Limits Pop-Up 57
- Figure 2-21 Limit Failures 58
- Figure 2-22 Channel Setup - Range 59
- Figure 2-23 Analog Display in Lower Window 61

Figure 2-24 Meter Maximum Pop-Up	61
Figure 2-25 Meter Minimum Pop-Up	62
Figure 2-26 Recorder Maximum Pop-Up	64
Figure 2-27 Recorder Minimum Pop-Up	64
Figure 2-28 Save/Recall Screen	66
Figure 2-29 “Save” Pop-Up	67
Figure 2-30 “Recall” Pop-Up	67
Figure 2-31 Pulsed Signal	69
Figure 2-32 Duty Cycle: Off	69
Figure 2-33 Duty Cycle Pop-Up	70
Figure 2-34 Duty Cycle: On, 50%	70
Figure 3-1 E-Series E9320 Power Sensor Default Channel Setup	78
Figure 3-2 Measurement Gates	79
Figure 3-3 Twelve Measurements per Channel	80
Figure 3-4 E-Series E9320 Power Sensor Default Channel Setup	84
Figure 3-5 Bandwidth Filter Shapes	87
Figure 3-6 Gates screen	88
Figure 3-7 Time Gating Start Pop-Up	88
Figure 3-9 Trigger Menu - Free Run Mode	90
Figure 3-10 Trigger Setting Menu 1 of 2	91
Figure 3-11 Trigger Level Pop-Up	92
Figure 3-12 Trigger Delay Pop-Up	93
Figure 3-13 Trigger Setting Menu 2 of 2	93
Figure 3-14 Trigger Holdoff Pop-Up	94
Figure 3-15 Trigger Hysteresis Pop-Up	95
Figure 3-16 Display Type Menu	96



Figure 3-17 Lower Window/Lower Measurement Setup	98
Figure 3-18 Measurement Set-Up Example	99
Figure 3-19 Measurement Example Display	99
Figure 3-20 Analog Display in Lower Window	100
Figure 3-21 Meter Maximum Pop-Up	100
Figure 3-22 Meter Minimum Pop-Up	101
Figure 3-23 Trace Display in Lower Window	102
Figure 3-24 Trace Maximum Pop-Up	102
Figure 3-25 Gate Control Menu and Display	103
Figure 3-26 E-Series E9320 Power Sensor Default Channel Setup	104
Figure 3-27 Trigger Menu - Free Run Mode	105
Figure 3-28 Gate Control Menu and Display	105
Figure 3-29 Trigger Marker - Negative Delay	106
Figure 3-30 Trace Control Display	108
Figure 3-31 Bluetooth Signal with Markers Shown	109
Figure 3-32 Measurement Example Measurement Display	114
Figure 3-33 Preset Selection Display	115
Figure 3-34 GSM Measurement Display	116
Figure 3-35 EDGE Measurement Display	119
Figure 3-36 Full Rate Frame	122
Figure 3-37 NADC Measurement Display	123
Figure 3-38 Bluetooth Measurement Display	129
Figure 3-39 Markers on a Bluetooth Measurement	132
Figure 3-40 cdmaOne Measurement Display	133
Figure 3-41 W-CDMA Measurement Display	136
Figure 3-42 Typical cdma2000 Measurement Display	139

Figure 4-1 E9300 E-Series Auto-Averaging Settings	145
Figure 4-2 E9300 E-Series Sensor Default Channel Setup	146
Figure 4-3 Frequency Pop-Up Window	148
Figure 4-4 Spread Spectrum Signal	149
Figure 4-5 Wideband CDMA Error of E-Series E9300 power sensor versus corrected CW sensor.	150
Figure 4-6 CDMA (IS-95A): 9Ch Fwd	150
Figure 4-7 Calibration Factors versus Frequency	151
Figure 5-1 E-Series CW sensor Auto-averaging settings	161
Figure 5-2 E-Series CW sensor default Channel Setup	162
Figure 5-3 Frequency Pop-up Window	164
Figure 6-1 8480 Series Auto-Averaging Settings	167
Figure 6-2 8480 Series Sensor Default Channel Setup	168
Figure 6-3 Reference Calibration Factor Pop-Up Window	171
Figure 6-4 Calibration Factor Pop-Up Window	172
Figure 6-5 Calibration Factor Displayed	173
Figure 6-6 Sensor Table Selected	177
Figure 6-7 Frequency Pop-Up Window	178
Figure 6-8 Frequency/Calibration Table Display	179
Figure 6-9 “Sensor Tbls” Screen	181
Figure 6-10 “Edit Cal” Screen	182
Figure 7-1 N8480 Series Auto-Averaging Settings	190
Figure 7-2 N8480 Series Sensor (excluding Option CFT) Default Channel Setup	191
Figure 7-3 N8480 Series Sensor with Option CFT Default Channel Setup	191
Figure 7-4 Frequency Pop-Up Window	194
Figure 7-5 Reference Calibration Factor Pop-Up Window	196

Figure 7-6 Calibration Factor Pop-Up Window	197
Figure 7-7 Calibration Factor Displayed	198
Figure 7-8 Sensor Table Selected	200
Figure 7-9 Frequency Pop-Up Window	200
Figure 7-10 Frequency/Calibration Table Display	201
Figure 7-11 "Sensor Tbls" Screen	203
Figure 7-12 "Edit Cal" Screen	204
Figure 8-1 Self Test in Progress	210
Figure 8-2 Error Indicator Position	215
Figure 8-3 Error Queue Message	216
Figure 8-4 Replacing the Fuse	227

**THIS PAGE HAS BEEN INTENTIONALLY LEFT BLANK.**

## Tables

Table 2-1 Power Sensor Connection Requirements	27
Table 2-2 TTL Input Control Logic	30
Table 2-3 TTL Inputs Timing Diagram 1	31
Table 2-4 TTL Inputs Timing Diagram 2	33
Table 2-5 Measurement Units - Single Channel Meters	34
Table 2-6 Measurement Units - Dual Channel Meters	34
Table 2-7 Range of Values for Window Limits	53
Table 3-1 Sensor Bandwidth	76
Table 3-2 Measurement Example Channel Setup	110
Table 3-3 Measurement Example Gate Configurations	111
Table 3-4 Measurement Example Trigger Configurations	112
Table 3-5 Trace Setup Parameters	114
Table 3-6 GSM900 Configurations	117
Table 3-7 EDGE Configurations	120
Table 3-8 NADC Configurations	124
Table 3-9 iDEN Configuration	127
Table 3-10 Bluetooth Configurations	130
Table 3-11 cdmaOne Configurations	134
Table 3-12 W-CDMA Configurations	137
Table 4-1 Power Sensor Connection Requirements	147
Table 6-1 8480 Series Connection Requirements	173
Table 6-2 Installed Power Sensor Models	180
Table 7-1 Power Range in Power Meter Range Setting	188
Table 7-2 N8480 Series Power Sensors Connection Requirements	193

[Table 7-3 Installed Power Sensor Models](#) 202

[Table 9-1 Video Bandwidth vs. Peak Power Dynamic Range](#) 239



# 1 Introduction

Welcome	2
Conventions Used in this Guide	4
Power Meter and Sensor Capability	5
Front Panel Keys and Connections	6
The Display Layout	10
Window Symbols	17



## Welcome

Welcome to the EPM-P Series power meter *user's guide*! Together with the E9320 E-Series power sensors, the EPM-P Series power meters can measure complex modulation formats such as TDMA, CDMA and W-CDMA. Preinstalled measurement setups for GSM900, EDGE, NADC, iDEN, Bluetooth, cdmaOne, W-CDMA, and cdma2000 help reduce the time required to measure these common wireless communications formats. Power measurements include peak, peak-to-average ratio and average power of RF and microwave signals. Extensive triggering features such as continuous, level, external TTL, and GPIB, are available for making time gated measurements. In addition, the EPM-P power meters are compatible with E9300 E-Series, E-Series E4410, 8480 Series, and N8480 Series power sensors giving you additional choice for conventional, average power measurements.

### NOTE

The N8480 Series power sensors used in this user's guide is referring to all sensors from the N8480 Series unless otherwise stated.

### Documentation Information

As shown in the installation guide, this guide is only part of the information supplied. The documentation consists of:

- The installation guide – Shows you how to check your power meter, switch it on and connect it to an Agilent power sensor. This information is presented in English, French, German, Italian, Japanese, and Spanish languages.
- The user's guide – Shows you how to operate your power meter from the front panel interface to make measurements using the Agilent E-Series E9320, E-Series E9300, E-Series E4410, 8480 Series, and N8480 Series power sensors. You can find the user's guide as Adobe Acrobat PDF (Portable Document Format) file on the supplied CD-ROM in English, French, German, Italian, Japanese, and Spanish languages.
- The programming guide – Shows you how to operate your power meter using the remote interfaces. You can find the programming guide as an Adobe Acrobat PDF file on the supplied CD-ROM in English language only.



Printed Guides available by ordering the following options:

- English language user's guide – Option OBK
- French language user's guide – Option ABF
- German language user's guide – Option ABD
- Italian language user's guide – Option ABZ
- Japanese language user's guide – Option ABJ
- Spanish language user's guide – Option ABE

**NOTE**

The programming guide is supplied in english language only.

**What You'll Find in this Guide**

This user's guide shows you how to operate your EPM-P Series power meter using the front panel interface to make measurements with the E9320 E-Series, E9300 E-Series, E4410 E-Series, 8480 Series, and N8480 Series power sensors.

Some EPM-P Series power meter features and capabilities depend on the type of power sensor connected. Other features are general and independent of the power sensor. This user's guide is there for divided into three main blocks.

- Chapters 1 and 2 show you the main EPM-P power meter functions. These functions are typically independent of the connected sensor type.
- Chapters 3, 4, 5, 6, and 7 show you how to use the EPM-P power meters with each of the five sensor families.
- Chapters 8 and 9 describe general maintenance and specifications.

For remote programming information, refer to the *EPM-P Series Power Meter Programming Guide*.

## Conventions Used in this Guide

The following conventions are used throughout this guide.



This symbol and text represents a labeled key on the power meter front panel.



This symbol and text represents a labeled softkey and is used to indicate you should press the unmarked key beside the displayed text.



This symbol and text represents a displayed message.

### Parameter

This is used to represent a parameter, value, or title.

### "Channel"

This user's guide describes the operation for both the single channel E4416A and the dual channel E4417A. To identify channels on a dual channel meter, a **Channel** softkey on an E4416A meter becomes **Channel A** and **Channel B** to an E4417A.

When you are asked to press "the channel" **Softkey** in a procedure, make sure you select the relevant channel.

## Power Meter and Sensor Capability

Your E4416A or E4417A power meter is compatible with E9320 E-Series, E9300 E-Series, E4410 E-Series, 8480 Series, and N8480 Series power sensors. However, not all sensor and meter combinations have the same features or capabilities. The main differences are:

Features	E9320 E-Series	E9300 E-Series	E-4410 E-Series	8480 Series	N8480 Series
Average Power of CW Signal	•	•	•	•	•
Cal Factors on EEPROM	•	•	•		• <sup>1</sup>
>200 Readings per second	•	•	•		
Average Power of modulated signal	•	•		•	•
Peak/Burst Average Power	•				
Time Gated Measurements	•				

<sup>1</sup> Not applicable for N8480 Series power sensors with Option CFT

## Specifications





The specifications for the power meter are listed in [Chapter 1](#).

## Front Panel Keys and Connections

This section briefly describes the functions of the front panel keys and connectors. The user's guide shows you how to use them in more detail.



These keys are located to the left of the display.

Key	Function
	Press this key to switch the meter between on and standby. When power is supplied, the orange LED above the key is lit. Press the key to switch on the meter. The green LED lights.
	Press this key to select the upper or lower measurement window. The selected window is highlighted by a shadowed box. Any measurement setup you create is implemented in the selected window.
	Press this key to choose windowed, expanded, or full screen display of a numeric measurement. It also provides quick access to the Gate Control screen and menu when a trace window is selected.
	Press this key to preset the power meter when it is operating in local mode (front panel operation) or to select a preinstalled measurement configuration. A pop-up window is displayed asking you to confirm the command. It also enables you to take control of the meter from the front panel when operating via the remote interfaces (when Local Lock Out is not enabled).













These keys are located along the lower edge of the display.

Key	Function
System	Press this key to access general configuration menus, such as GPIB address. You can also access some measurement configuration menus. The measurement screen remains visible.
Channel	Press this key to access the channel configuration tables and menus. Channel parameters such as averaging and offsets are configured from this menu.
Trigger	Press this key to access the triggering menu. Unless an E9320A E-Series sensor is connected, all the menu keys are disabled (greyed out).
Meas Setup	Press this key to setup relative measurements or set display offsets.
Meas Display	Press this key to access the measurement display menu. You can choose the displayed measurement resolution, units and display format.



These keys are all associated with the menu labels and data entry. They are located to the right of the display.

<b>Key</b>	<b>Function</b>
	Press this key to access the next pages of a menu. For example, <b>1 of 2</b> displayed beside the  key indicates page one of a two page menu is displayed. Press  to access the second page. ( <b>2 of 2</b> is displayed.)
	Press this key to access the previous pages of a menu. For example, <b>2 of 2</b> displayed beside the  key indicates page two of a two page menu is displayed. Press  to access the previous page. ( <b>1 of 2</b> is displayed).
   	These unmarked keys are called ‘softkeys’ and are referred to by the text on the display beside them. For example, during a Preset, a pop-up window asks you to confirm the command. Press <b>Confirm</b> to continue, that is, press the softkey beside the displayed word ‘confirm’. Similarly, pressing <b>Cancel</b> (the softkey beside the word ‘cancel’) stops the Preset.
	The arrow keys are used to select and change parameters such as instrument state names and offset values.



These keys and connectors are associated with the measurement channels and are located on the right-hand side of the front panel.

### Key

### Function

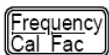

Press this key to access the input frequency, and sensor calibration factor menus. Use these functions to improve the accuracy of your measurement.

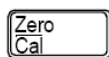

Press this key to access the zero and calibration menus. Use these functions to improve the accuracy of your measurement.

### Connector

### Function

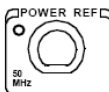

The power reference is a 1 mW (0 dBm) 50 MHz signal available from a 50  $\Omega$  type-N connector. It is used for calibrating the sensor and meter system. If the meter is configured with Option 003, the connector is fitted to the rear panel. The Green LED beside the connector is lit when the calibrator is turned on.

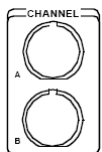

The sensor input connectors. The E4417A has two inputs, the E4416A has one input as shown in the photograph. If the meter is configured with Option 002 or Option 003, the connectors are fitted to the rear panel.

## The Display Layout

The following figure details the display layout when the two windows are configured in the dual numeric mode. Other display formats are available by

pressing , .

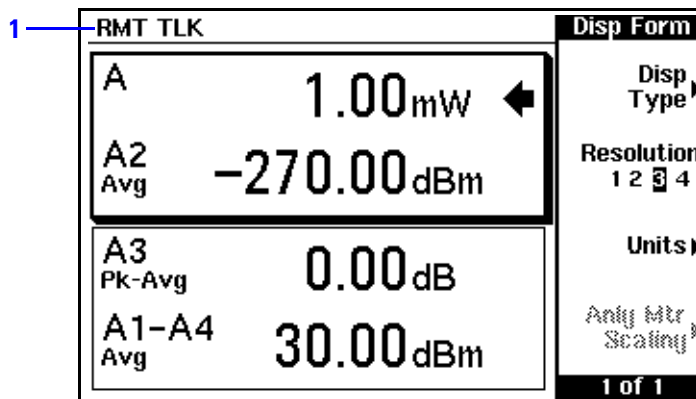

- The status reporting line displays five fields, three associated with either GPIB, RS232 or RS422 status and two associated with error and warning conditions. The first field displays either **RMT** (remote, GPIB, RS232 or RS422 operation) or **LCL** (local, front panel operation).





For GPIB operation, the second field displays **TLK** if the power meter is addressed to talk or **LSN** if it is addressed to listen. The third field indicates an **SRQ** (service request).

For RS232 and RS422 operation, the second field displays **RX** when data is being received. The third field displays **TX** when the power meter is transmitting data.

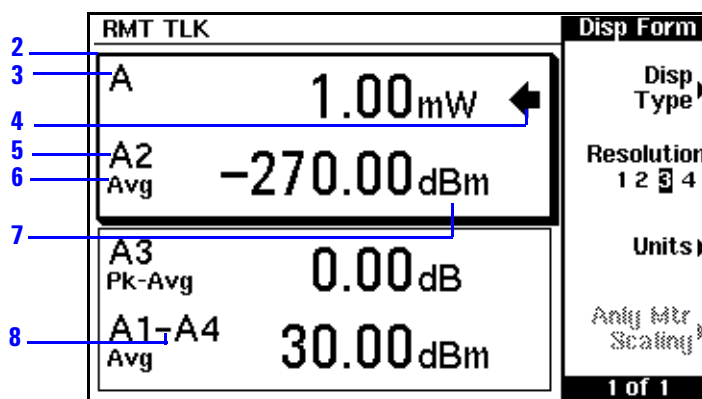
The fourth field indicates **ERR** for any error conditions. The last field is used to report error and warning messages.





- 2 There are two measurement windows. This is the upper measurement window. The shading around the window indicates it has been selected (using the ,  or  keys). With numeric measurement results, you can choose either two rectangular windows, a single enlarged window, or a full screen display by pressing . The display style is applied to the currently selected window or measurement line.
- 3 This field displays the channel being measured. This measurement line is the Upper Window/Upper Measurement.
- 4 The arrow indicates the currently selected measurement display line.
- 5 With an E-Series E9320 power sensor connected, the channel and associated gate number are shown.
- 6 With an E-Series E9320 power sensor connected, the associated measurement type is shown below the channel and gate number.
- 7 This field displays the measurement units, either dBm, dB, Watts, or percent (%).

**NOTE**



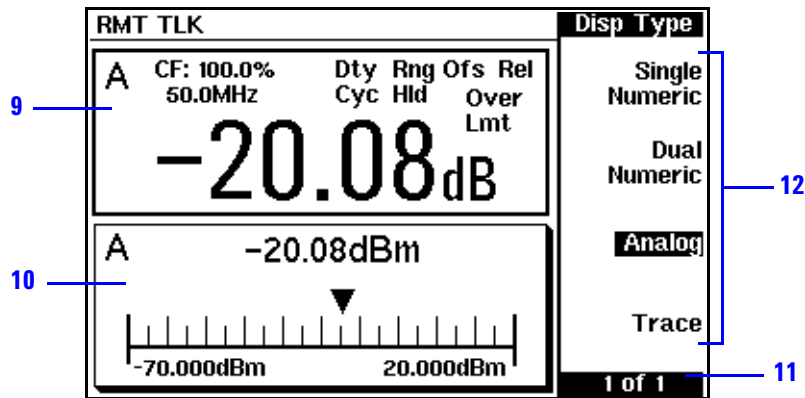

With an E-Series E9320 power sensor connected, a measurement result of  $-270$  dBm indicates the input power level is outwith the sensitivity of the sensor.

- 8 With an E-Series E9320 power sensor connected, you can make combined measurements with a single channel meter. A dual channel meter extends this feature across both channels.

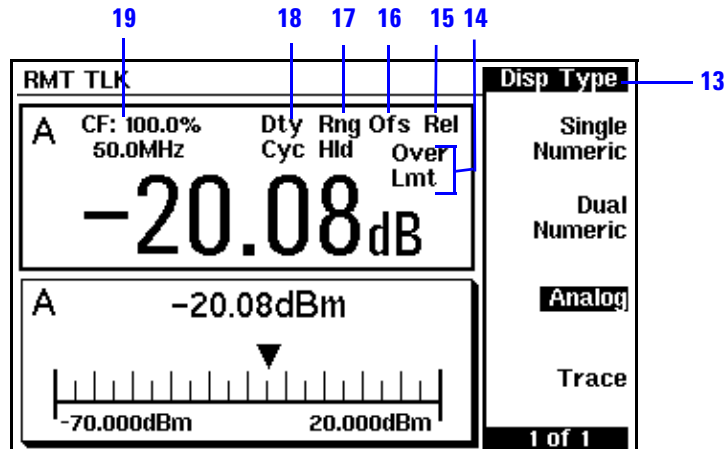

- 9 This window is configured to show a single numeric display.
- 10 This window is configured to show an analog meter which displays the measurement result and the meter scaling.
- 11 This field displays the number of pages in the current menu. For example, 1 of 2 indicates that there are two pages in the menu and the first page is currently displayed. Pressing  displays the next page, indicated by 2 of 2. ( displays the previous menu page.)
- 12 The available softkey labels are displayed in these four fields. Additionally, settings associated with the labelled function are displayed.



- 13** This field displays the menu title. For example, when the power meter is initially switched on, the **Contrast** menu is displayed, and if for example, you press , the **Zero/Cal** menu is displayed.
- 14** This field indicates the measurement result is out with any configured upper or lower limits. If the measurement is within the limits, this field is empty. If the measurement result is less than the minimum limit set, **Undr Lmt** is displayed. If the measurement result is more than the maximum limit set, **Over Lmt** is displayed.
- 15** This field displays **Rel** if relative mode is on.
- 16** This field displays **Ofs** if an offset is set.
- 17** This field displays **Rng Hld** if a range is selected.
- 18** This field displays **Dty Cyc** if a duty cycle is set. With an E-Series E9320 power sensor connected, the field shows , , , or , depending on the trigger state.
- 19** The information in this field is displayed on two lines and depends on the sensor type, sensor calibration table, frequency dependent offset table currently selected, and the measurement frequency.

**NOTE**

The following trace displays are only available when an E-Series E9320 power sensor is connected.

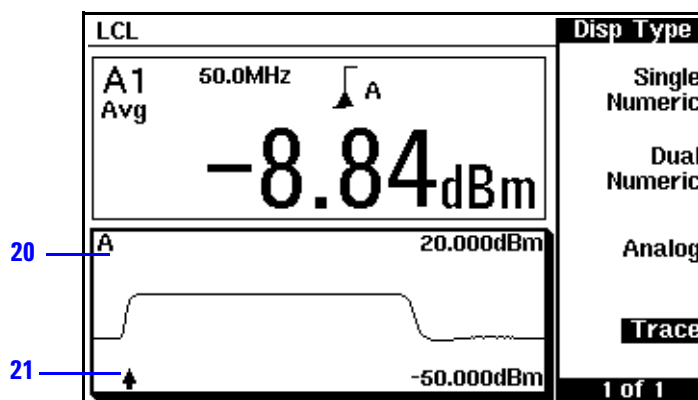

20 This window is configured to show a trace display. This is only available with an E-Series E9320 power sensor connected. The captured trace and scaling are displayed.

21 The  indicates the point on the trace where trigger event occurs.

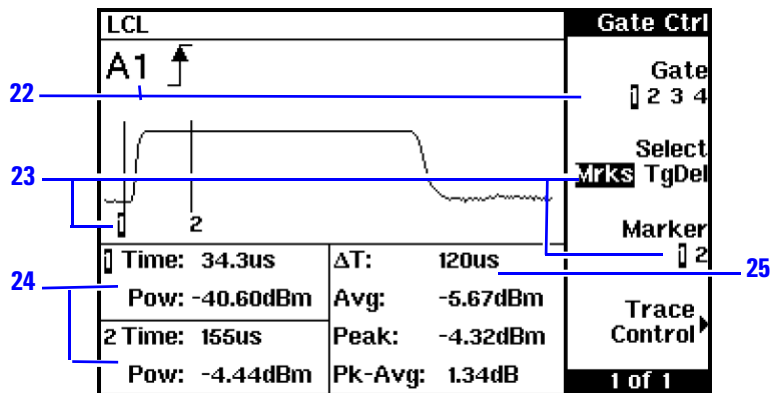

**NOTE**

Single or continuous triggering (**Sing Trig** or **Cont Trig**) must be selected from the **Acqn** menu to view a trace window. The **Acqn** menu is accessed by pressing , **Acqn**. **Trace** is disabled when **Free Run** is selected.



This display shows the **Gate Ctrl** menu, associated tables and markers. The **Gate Ctrl** screen is accessed by pressing **Gate Control** from the **Trace Ctrl** menu or by pressing **Gate Control** from the **Gates** menu.

22 Pressing **Gate** scrolls through the four gates available for each channel. The selected gate number is repeated in the upper left corner of the window.

23 The markers **1** and **2**, indicate the start and end points of the selected gate. Pressing **Marker 1 2** toggles between the two markers. You can use the  and  keys to move the active marker along the trace.

24 This table shows the time (**Time:**) from the configured trigger point and the instantaneous power level (**Pow:**) for both markers. A negative time value indicates a measurement before the trigger point.

**NOTE**

Gate timing parameters are all related to your chosen trigger point. This may be different from the timing of the triggering event if you have configured a trigger delay. Refer to item 26 for more information.



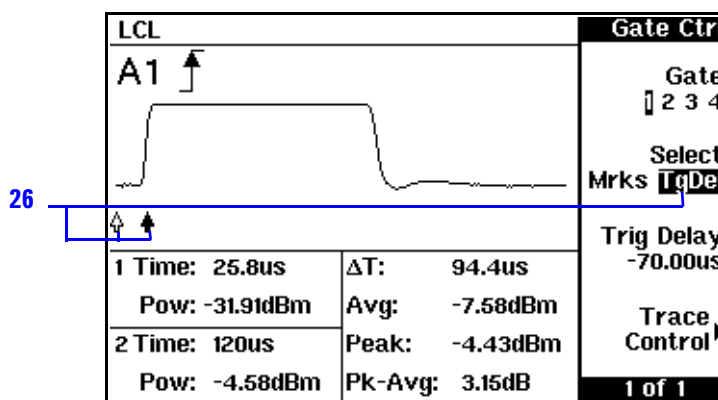

- 25 This table shows the width of the gate  $\Delta T$ : (time between the markers), and the average, peak, and peak-to-average ratio power measurements within the gate.



- 26 Pressing **Select TgDel** hides the gate markers and displays the trigger marker(s).  $\uparrow$  indicates when the trigger event occurs, whilst  $\uparrow$  shows the delayed trigger point. When the two points coincide, only the delayed trigger  $\uparrow$  is shown.

In the example displayed, the  $\uparrow$  appears ahead of the  $\uparrow$  as a trigger delay of  $-70.00 \mu\text{s}$  has been configured, placing the measurement trigger before the trigger event. You can configure the trigger delay by pressing **Select TgDel** and entering a numeric value or by pressing the  $\leftarrow$  or  $\rightarrow$  keys.

Gate and trigger markers are moved one pixel when the  $\leftarrow$  or  $\rightarrow$  keys are pressed and released. They are moved up to five pixels at a time when the keys are pressed and held. To reduce the time interval represented by one pixel, decrease the length of the displayed trace.





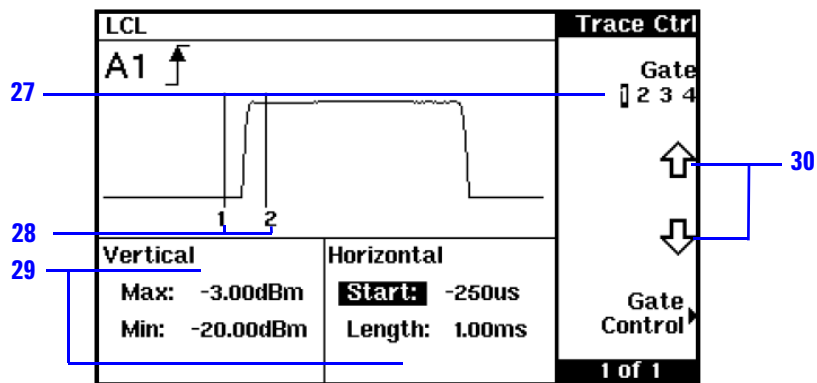

To indicate an off-screen trigger event,  or  is displayed. To indicate an off-screen trigger point,  or  is displayed.

**NOTE**

Gate timing parameters are all related to your chosen trigger point. This may be different from the timing of the triggering event if you have configured a trigger delay. Refer to item 26 for more information.



The **Trace Ctrl** screen is accessed by pressing **Trace Control** from the **Gate Ctrl** menu or by pressing **Trace Control** from the **Trace Setup** menu.

- 27 Pressing **Gate** scrolls through the four gates available for each channel. The selected gate number is repeated in the upper left corner of the window.
- 28 The markers **1** and **2**, indicate the start and end points of the selected gate.
- 29 The vertical table shows the amplitude scaling of the trace display. The horizontal table shows the scale and start point, relative to the measurement trigger of the trace.
- 30 You can change any of the horizontal or vertical trace values using the  or  softkeys having first selected the parameter using the , , , and  keys.

## Window Symbols

There are a number of different graphic symbols and pop-up windows that can occur on the power meter display. These can occur for a variety of reasons such as when:

- an error or warning occurs.
- a confirmation is required.
- you are required to wait while the power meter carries out a procedure.
- you are required to select an entry from a list.
- you are required to enter an alphanumeric value.

### Warning Symbol

The warning symbol is displayed either directly in the measurement window or in a pop-up window when such an event occurs. A pop-up window is displayed for approximately two seconds. The text in the pop-up window gives details of the warning type. This symbol may also appear on a measurement window, for example, to indicate that a power sensor is not connected.



### Confirmation Pop-Up

This pop-up window is displayed when you are required to press

**Confirm** to verify your

previous

selection. For

a  (Pre

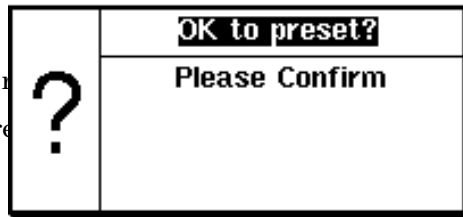



## Wait Symbol

The wait symbol is displayed when the power meter is carrying out a procedure but no action is required from you. The symbol appears in a pop-up window. It may appear, for example, during zeroing or calibration.



## One of Many Entry Pop-Up

This pop-up window is displayed when you are required to select an entry using  and  from the list.

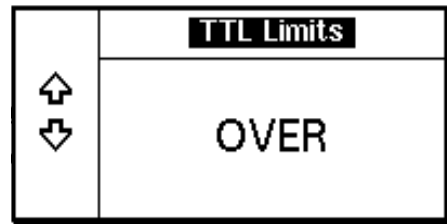





## Configuration Conflict Pop-Up

This pop-up window is displayed when you make a configuration that conflict with a previous setup. The previous setup is lost





## Numeric or Alphanumeric Entry Pop-Up

This pop-up window is displayed when you are required to modify numeric or alphanumeric data. The  and  keys move the position of the cursor. The  and  keys increment and decrement the alphanumeric digit on which the cursor is currently positioned.

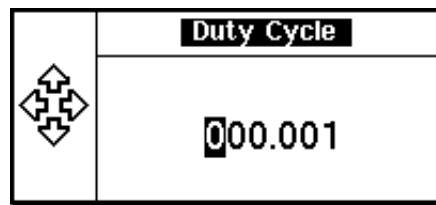

**THIS PAGE HAS BEEN INTENTIONALLY LEFT BLANK.**



## 2 General Power Meter Functions

Zeroing and Calibrating	22
Setting the Units of Measurement	34
Setting the Resolution	36
Making Relative Measurements	37
Setting Offsets	39
Setting Averaging	49
Step Detection	51
Setting Measurement Limits	52
Setting the Range	59
Scaling the Analog Display	61
Recorder Output	63
Saving and Recalling Power Meter Configurations	66
Measuring Pulsed Signals	68
Presetting the Power Meter	71



## Zeroing and Calibrating

This section describes how to zero and calibrate the power meter and sensor combination. You should always zero the power meter prior to calibrating it.

### Zeroing

Zeroing adjusts the power meter for a zero power reading with no power applied to the power sensor. During zeroing, the wait symbol is displayed.

To zero the power meter and sensor:

Press  and the channel **Zero** softkey. The **Zeroing** message and wait symbol are displayed. On dual channel meters, you can zero both channels sequentially by pressing **Zero Both**. During zeroing, the wait symbol is displayed.

#### When to zero?

Zeroing of the power meter is recommended:

- when a 5 °C change in temperature occurs.
- when you change the power sensor.
- every 24 hours.
- prior to measuring low level signals. For example, 10 dB above the lowest specified power for your power sensor.

## Calibration

Calibration sets the gain of each power meter channel and sensor combination using a 50 MHz 1 mW (0 dBm) signal. Use the power meter's POWER REF as a traceable power reference or a suitable external reference signal. An essential part of calibrating is setting the correct reference calibration factor for the power sensor you are using. You must manually enter the reference calibration factor for an 8480 Series power sensor or N8480 Series power sensor with Option CFT. The reference calibration factor is automatically set for all E-Series sensors and N8480 Series sensors (excluding Option CFT).

During calibration, the wait symbol is displayed. Offset, relative, and duty cycle settings are ignored during calibration. Some power sensors require adaptors or attenuator pads to enable connection to the POWER REF output. Refer to [Table 2-1](#) on page 27 for details.

### NOTE

During calibration, the power meter automatically switches the power reference calibrator on (if it is not already on). After calibration, it switches it back to the state it was in prior to calibration.

---

## Calibration with E-Series Power Sensors and N8480 Series Power Sensors (Excluding Option CFT)

This section describes the calibration procedure for E-Series power sensors and N8480 Series power sensors (excluding Option CFT). The power meter identifies that an E-Series power sensors and N8480 Series power sensors (excluding Option CFT) is connected and automatically downloads the calibration table. Since there is no requirement to enter any calibration factors, the channel **Ref CF %** and **Cal Fac** softkeys are disabled. (These softkey labels are still visible but appear grayed out.)

### Procedure

Zero and calibrate the power meter/sensor combination as follows:

- 1 Ensure the power sensor is disconnected from any signal source.
- 2 Refer to the connection requirements in [Table 2-1](#) and ensure the sensor is ready for connection to the power reference.
- 3 Press  and the channel **Zero** softkey to zero the channel. The **Zeroing** message and wait symbol are displayed.
- 4 Connect the power sensor to the POWER REF output.
- 5 Press the channel **Cal** softkey to start the calibration routine. The **Calibrating** message and wait symbol are displayed.

The power meter and sensor are now ready for use.

**TIP** You can reduce the steps required to carry out the zero and calibration procedure as follows:

- Connect the power sensor to the POWER REF output.
- Press  and **Zero + Cal**. (For dual channel meters, press **Zero + Cal**, **Zero + Cal A**, or **Zero + Cal B** as required.)

### NOTE

Following calibration, ensure you remove/reattach any attenuators or adaptors before making a measurement.

## Calibration with 8480 Series Power Sensors and N8480 Series Power Sensors with Option CFT

This section describes the calibration procedure for Agilent 8480 Series power sensors and N8480 Series power sensors with Option CFT. The reference calibration factor is entered manually.

### NOTE



#### V8486A and W8486A sensors

For most 8480 Series sensors, the correct (A type or D type) linearity correction table is automatically selected. The linearity-type field on the measurement screen is grayed out. Under the gray-out condition, the selected linearity correction table that is displayed on the screen is irrelevant to the correct linearity correction table that is automatically selected by power meter firmware.

However, for the V8486A and W8486A sensors (**V8486A and W8486A sensors only**), the automatic selection must be overridden by selecting the D type linearity. Subsequent connection of another A type sensor while the D type is selected will result in a warning message stating that “Linearity Override May be Required”.

“V8486A and W8486A sensors” on page 26 show you how to change the linearity configuration.

### Procedure





- 1 Ensure the power sensor is disconnected from any signal source.
- 2 Refer to the connection requirements in [Table 2-1](#) and ensure the sensor is ready for connection to the Power Reference.
- 3 Check the current reference calibration factor setting by pressing , . The value is displayed under the channel **Ref CF %** softkey.

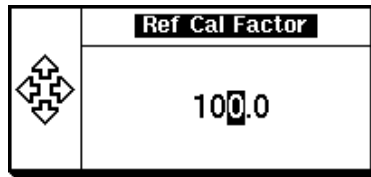



Does this setting match the value for the sensor? (The power sensor reference calibration factor can normally be found above the calibration factors table on the power sensor body.)

- 4 If required, change this setting by pressing the channel **Ref CF**. The reference calibration factor pop-up window is displayed as shown in [Figure 2-1](#).

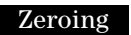

**Figure 2-1** Reference Calibration Factor Pop-Up Window

Use the , , , and  keys to select and change the values as required.

- 5 Confirm your choice by pressing .
- 6 Press  and the channel  softkey to zero the channel. The  message and wait symbol are displayed.
- 7 Connect the power sensor to the POWER REF output.
- 8 Press the channel  softkey to start the calibration routine. The  message and wait symbol are displayed.





### NOTE

Following calibration, ensure you remove/reattach any attenuators or adaptors before making a measurement.

### V8486A and W8486A sensors

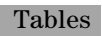
V8486A and W8486A sensors require that you manually select D type linearity correction. Subsequent connection of another A type sensor will result in a warning message . You must then manually select A type correction.

Select the linearity to be applied as follows:

Press ,  and press the channel  softkey to highlight  or .

Linearity can be manually configured for each channel. For example, to set D type linearity on channel B:



Press , **Tables** and press **B Linearity** to highlight **Dtyp**.

**Table 2-1** Power Sensor Connection Requirements

<b>Sensor</b>	<b>Connection requirements</b>
<b>8481A</b> <b>8481H</b> <b>8482A</b> <b>8482H</b> <b>N8481A</b> <b>N8481H</b> <b>N8482A</b> <b>N8482H</b> <b>E4412A</b> <b>E930xA</b> <b>E930xH</b> <b>E9304 H18</b> <b>E9304 H19</b> <b>E932xA</b>	These power sensors connect directly to the reference calibrator.
<b>8481D</b> <b>8484A</b>	Prior to the power meter calibration, an Agilent 11708A 30 dB reference attenuator should be connected between the power sensor and the reference calibrator. Remove this attenuator from the power sensor input before making measurements.
<b>8483A</b>	This power sensor requires a 75 $\Omega$ (f) to 50 $\Omega$ (m) N-Type adapter (1250-0597) to connect to the POWER REF. Remove this adapter from the power sensor input before making measurements.
<b>R8486A</b> <b>Q8486A</b> <b>V8486A</b> <b>W8486A</b> <b>R8486D</b> <b>Q8486D</b>	These waveguide power sensors have two connectors. Use the N-Type connector to calibrate the power meter.
<b>8481B</b> <b>8482B</b> <b>N8481B</b> <b>N8481B</b> <b>E930xB</b>	These power sensors are configured with an attenuator. Prior to calibration, this attenuator must be removed. The attenuator must be reconnected prior to making measurements.

**Table 2-1** Power Sensor Connection Requirements

Sensor	Connection requirements
<b>8485A</b> <b>N8485A</b> <b>E4413A</b> <b>E9300A H24</b> <b>E9300A H25</b>	This power sensor requires an APC 3.5 (f) to 50 $\Omega$ (m) N-Type adapter (08485-60005) to connect to the reference calibrator. Remove this adapter before making measurements.
<b>8485D</b>	Prior to calibration, an Agilent 11708A 30 dB reference attenuator and an APC 3.5 (f) to 50 $\Omega$ (m) N-Type adapter (08485-60005) should be connected between the power sensor and the reference calibrator. Remove this attenuator from the power sensor input before making measurements.
<b>8487A</b> <b>N8487A</b> <b>N8488A</b>	This sensor requires an APC 2.4 (f) to 50 $\Omega$ (m) N-Type adapter (08487-60001) to connect to the power meter. Remove this adapter before making measurements.
<b>8487D</b>	Prior to the power meter calibration, an Agilent 11708A 30 dB reference attenuator and an APC 2.4 (f) to 50 $\Omega$ (m) N-Type adapter (08487-60001) should be connected between the power sensor and the reference calibrator. Remove this attenuator from the power sensor input before making measurements.
<b>N8486AR</b> <b>N8486AQ</b>	These waveguide power sensors have two connectors. Use the N-Type connector to calibrate the power meter.

## Zero/Cal Lockout

The Zero/Cal Lockout facility can help you make sure that a measurement cannot be made until the power meter/sensor combination has been zeroed and calibrated.

When the Zero/Cal Lockout facility is enabled and a sensor is first connected, the message **Please Zero and Cal** is displayed.

When you zero the sensor, the message changes to **Please Cal**. If you calibrate the sensor before zeroing it, the message changes to **Please Zero**.

### Dual Channel

Dual channel meters display channel specific messages when a sensor is connected. The Zero/Cal Lockout configuration is applied to both channels - it cannot be applied to one channel only.

You can enable and disable the Zero/Cal Lockout facility from the System menu or the Zero/ Cal menu as follows:

Press , , **Must Cal** **Off** or **On**.

Similarly,

press , , **Must Cal** **Off** or **On**.

## Zeroing and Calibrating Using TTL Inputs

You can use the TTL inputs on the rear panel Rmt I/O port to initiate zero and calibration cycles on the power meter. The connector is an RJ-45 Series shielded modular jack with the TTL input pins connected as shown in [Figure 2-2](#).

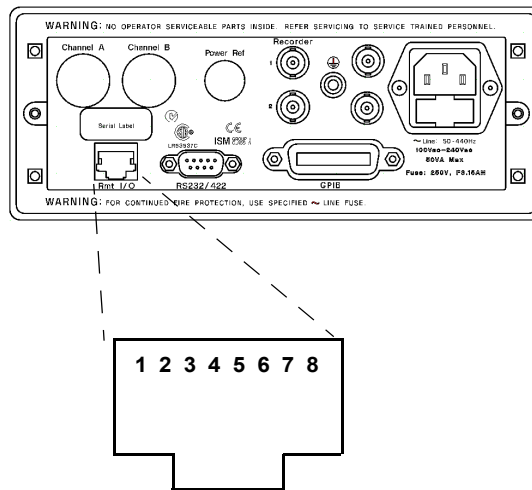

Pin number	Connection
1	none
2	Ground
3	Upper Window TTL Output
4	Lower Window TTL Output
5	TTL Input 1
6	TTL Input 2
7	Ground
8	Ground

**Figure 2-2** Rmt I/O Port TTL Inputs

The TTL inputs are active low and control the zero and calibration functions as shown in [Table 2-2](#).

**Table 2-2** TTL Input Control Logic

Input 1	Input 2	Single channel	Dual channel
1	1	None	None
1	0	CAL	CAL A
0	1	ZERO	ZERO BOTH
0	0	CAL	CAL B

Effective control of the zero and calibration cycles using the TTL inputs depends on correct timing of the input signals as shown in Table 2-3 and Table 2-4.

**Table 2-3** TTL Inputs Timing Diagram 1

Timing of zero/cal inputs for conditions “01” and “10”.

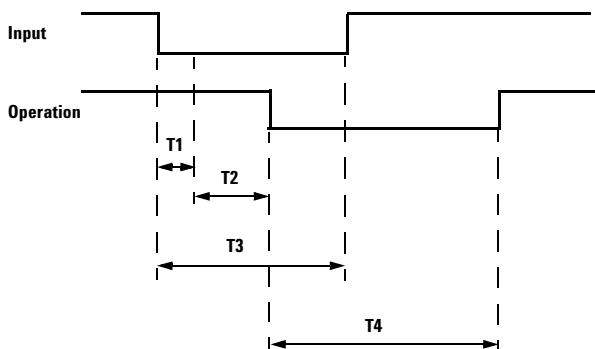

Time	Description	Value
T1	Minimum width of input	300 ms
T2	Time between input detection and start of zero/cal cycle. This is determined by the number of averages x sample rate, or if there is an existing zero/cal operation in progress, the time for this current operation to complete. Note that the worst case is 1024 averages x 50 ms = 51.2 s. For front panel operation (in free run mode), the time is 1 x 50 ms.	Max: 50 ms (typical) Min.: 0 ms
T3	Maximum width of input. Longer inputs may cause a subsequent zero/cal operation some time after the current one is complete.	4 s
T4	Time for zero/cal operation to complete.  Zero Both (dual channel meters) is a sequential operation and requires double that of single channel meters.	Zero: 10 s (8480 Series) 12 s (E-Series) 45 s (E9320 Series) 22 s (N8480 Series excluding Option CFT) 8 s (N8480 Series with Option CFT)

## 2 General Power Meter Functions

**Table 2-3** TTL Inputs Timing Diagram 1

Timing of zero/cal inputs for conditions "01" and "10".

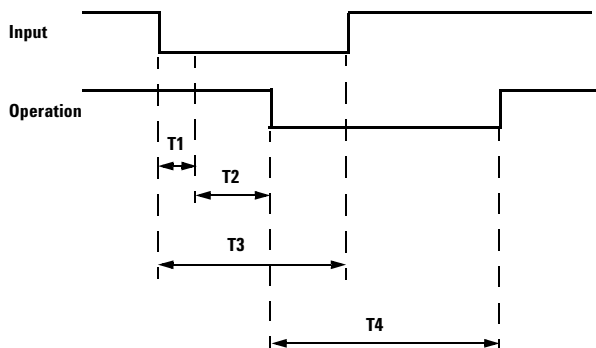

Cal: 6 s (8480 Series)  
7 s (E-Series)  
15 s (E9320 Series)  
10 s (N8480 Series  
excluding Option  
CFT)  
7 s (N8480 Series  
with Option CFT)

All timings based on 100 ms firmware polling.

**Table 2-4** TTL Inputs Timing Diagram 2

Timing of zero/cal inputs for condition "00".

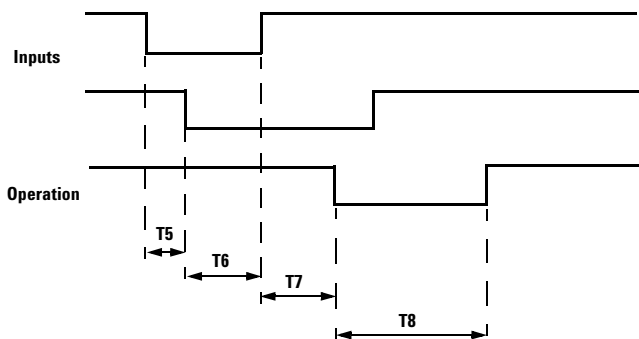



Time	Description	Value
T5	Maximum time between inputs going low.	100 ms
T6	Minimum overlap of low inputs.	200 ms
T7	Time between input detection and start of zero/cal cycle. This is determined by the number of averages x sample rate, or if there is an existing zero/cal operation in progress, the time for this current operation to complete. Note that the worst case is 1024 averages x 50 ms = 51.2 s. For front panel operation (in free run mode), the time is 1 x 50 ms.	4 s
T8	Time for cal operation to complete.	Cal: 6 s (8480 Series) 7 s (E-Series) 30 s (E9320 Series) 10 s (N8480 Series excluding Option CFT) 7 s (N8480 Series with Option CFT)

All timings based on 100 ms firmware polling.

If both TTL inputs are simultaneously low under any circumstances other than those shown above, the operation is undefined.

## Setting the Units of Measurement

The **Units** menu is used to select the measurement units for the currently selected window. These can either be logarithmic (dBm or dB) or linear (Watt or %) units. Presetting (  ) the power meter sets the measurement units to dBm (logarithmic units). [Table 2-5](#) and [Table 2-6](#) show the units applicable to each measurement mode.

Press , **Units**. Select the unit of measurement from **dBm**, **W**, **dB**, and **%**. Softkeys which cannot be selected in your particular mode of operation are grayed out.

### NOTE

When the unit of measurement is set to Watt, it is possible that negative power measurements may be displayed when measuring low power levels.

**Table 2-5** Measurement Units - Single Channel Meters

Measurement mode	Relative mode off	Relative mode on
Log	dBm	dB
Linear	Watt	%

**Table 2-6** Measurement Units - Dual Channel Meters

Measurement mode		Relative mode off	Relative mode on
<b>Ratio</b>	Log	dB	dB
	Linear	%	%
<b>Difference</b>	Log	dBm	dB
	Linear	Watt	%



## Selecting Units of Measurement from the Softkeys

In some menus, you are required to enter the units of measurement for power. In some cases, due to the wide power range available, the following menu is displayed:

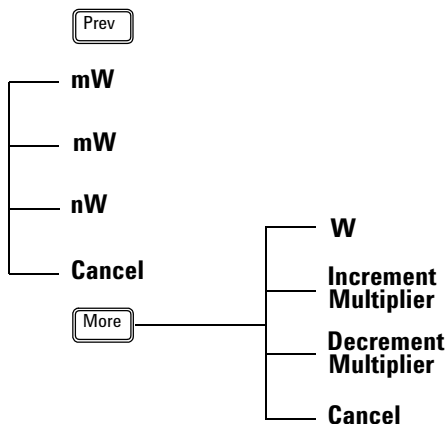

### NOTE

Some softkeys may be grayed out so that an invalid value cannot be entered.

Pressing **Increment Multiplier** or **Decrement Multiplier** increases or decreases the multiplier shown in front of **W**. Pressing **W** after the correct multiplier has been selected confirms the entry.

## Setting the Resolution

The resolution of each of the power meter's windows can be set to four different levels (1, 2, 3 or 4).

These four levels represent:

- 1, 0.1, 0.01, 0.001 dB respectively if the measurement suffix is dBm or dB.
- 1, 2, 3 or 4 significant digits respectively if the measurement suffix is W or %.

The default value is 0.01 dB (three digits).

To set the resolution on the currently selected window:

- 1 Press . The current setting of the resolution is highlighted under the **Resolution** softkey.
- 2 To change this setting, press **Resolution** until the required resolution setting is highlighted.

## Making Relative Measurements

Relative mode enables comparison of a measurement result to a reference value. The relative reading, or difference, can be displayed in either dB or % terms. When the measurement result is displayed in % a prefix multiplier may be shown.

### Procedure

To set a reference value on the currently selected window:

- 1 Press **Meas Setup**, **Rel/Offset** to display the **Rel/Offset** menu.
- 2 Confirm the power meter is measuring the signal you want to use as the reference.
- 3 Press **Rel** to use the current reading as the reference value. You can compare the measurement result in dB or percentage (%). **Rel Off On** is automatically set to **On** when **Rel** is pressed.
- 4 To change the measurements, press **Meas Display**, **Units**. Press **dB** or **%** as required.
- 5 Successive measurements are now displayed relative to the reference value. The relative mode can be disabled and reenabled by pressing **Meas Display**, **Rel/Offset**, to select **Off**.

**Rel** is displayed in the window when the measurement line it is applied to is displayed (see [Figure 2-3](#))

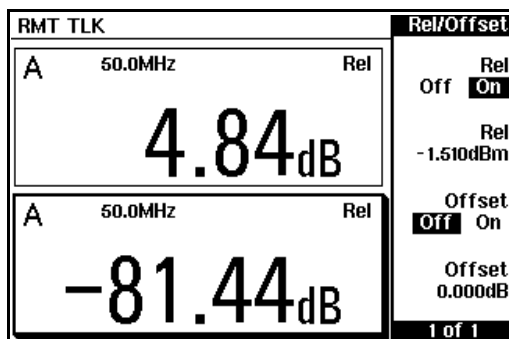

Figure 2-3 Rel Indicator

## 2 General Power Meter Functions

### NOTE

The **Rel** symbol is not displayed when the associated measurement is displayed in **Dual Numeric** or **Analog** format.

---

## Setting Offsets

The power meter can be configured to compensate for a signal loss or gain in your test setup. The power meter allows you to apply offsets at three different points in the measurement path as shown in Figure 2-4.

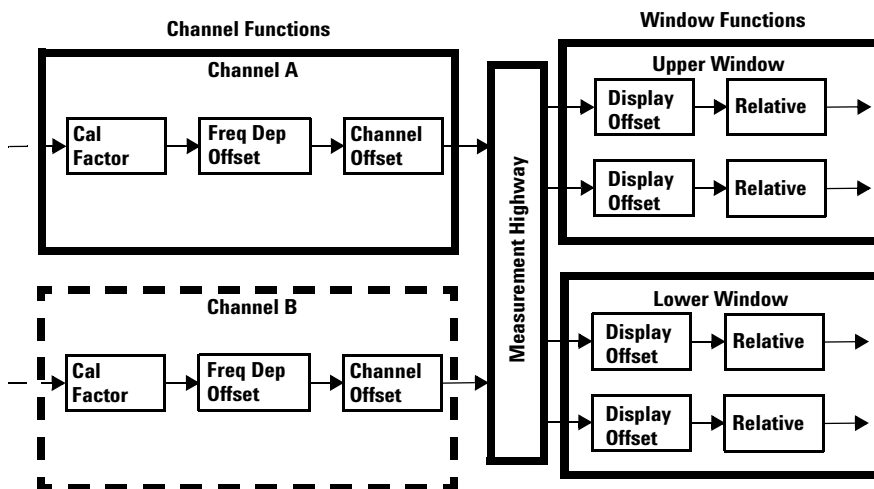

**Figure 2-4** Simplified Measurement Path

Applying a Channel Offset or a Frequency Dependent Offset allows you to compensate each channel individually prior to any mathematical functions. An overall offset can then be applied if required using the Display Offset.

## Setting Channel Offsets

This gain or loss is applied to the measured power before any mathematical functions, display offsets or relative functions are included.

Offsets are entered in dB. The allowable range of values is -100 dB to +100 dB. A positive value compensates for a loss, and a negative value compensates for a gain.

## 2 General Power Meter Functions

To enter a channel offset:

- 1 Press **Channel** to display the Channel Setup screen. Confirm the required channel setup is displayed. Press **Channel Ch.** to change channel if required.
- 2 Use the **↑** and **↓** keys to highlight the **Offset:** setting.
- 3 Press **Change** to select **On**.

Press **→** to highlight the **Offset:** value and press **Change** to display the **Offset** pop-up. Use the **←**, **→**, **↑**, and **↓** keys to select and change the values as required.

- 4 Confirm your choice by pressing **dB**.
- 5 Press **Done** to complete the offset entry.

If either a channel or a display offset is set, **Ofs** is displayed.

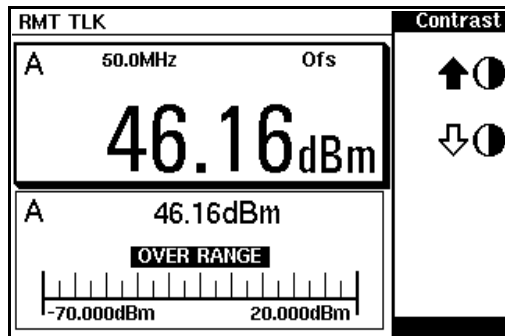

**Figure 2-5** Offset Applied

### NOTE

The **Ofs** symbol is not displayed when the associated measurement is displayed in **Dual Numeric** or **Analog** format.

## Setting Display Offsets

This gain or loss is applied to the measured power after any channel offsets or mathematical functions have been included.

Offsets are entered in dB. The allowable range of values is -100 dB to +100 dB. A positive value compensates for a loss, and a negative value compensates for a gain.

### Procedure

Enter a display offset on the currently selected window:

- 1 Press **Meas Setup**, **Rel/Offset** to display the **Rel/Offset** menu.
- 2 Press **Offset** to highlight **On**.
- 3 Press **Offset** to display the **Offset** pop-up. (The current offset value is shown below the **Offset** softkey.)

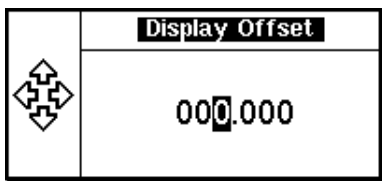

**Figure 2-6** Offset Pop-Up

Use the **←**, **→**, **↑**, and **↓** keys to select and change the values as required.

- 4 Confirm your choice by pressing **dB**.
- 5 Press **Done** to complete the offset entry.

If either a channel or a display offset is set, **Ofs** is displayed.

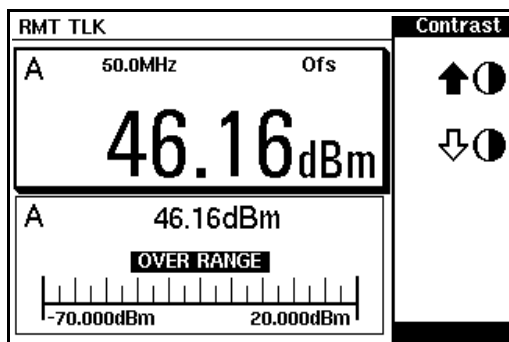

Figure 2-7 Offset applied

### NOTE

The **Ofs** symbol is not displayed when the associated measurement is displayed in **Dual Numeric, Trace, or Analog format**.

The display offset is a function of the window. Any of the four measurement display lines can have its own offset.



## Setting Frequency Dependent Offsets



Frequency dependent offset tables provide a quick and convenient method of compensating for frequency related changes in the response of your test system. Note that when selected, frequency dependent offset corrections are applied IN ADDITION to any correction for sensor frequency response.

The power meter is capable of storing 10 frequency dependent offset tables of up to 80 frequency points each.

To use frequency dependent offset tables:

- 1** Select the table to be applied to a channel. Refer to [“Selecting a Frequency Dependent Offset Table”](#) on page 44 for further information. If you require to edit the table refer to [“Editing Frequency Dependent Offset Tables”](#) on page 46 for further information.
- 2** Zero and calibrate the power meter. The reference calibration factor used during the calibration is automatically set by the power meter from the sensor calibration table (if selected).
- 3** Specify the frequency of the signal you want to measure. The calibration factor/offset is automatically set by the power meter from the sensor calibration table (if selected) and the frequency dependent offset table. Refer to [“Procedure”](#) on page 44 for further information.
- 4** Make the measurement.

### Selecting a Frequency Dependent Offset Table

You can select a frequency dependent offset table from the  key menu or the . The **State** column indicates if any frequency dependent offset tables are currently selected. The **Offset Tbls** screen is shown in Figure 2-8.

RMT TLK		Offset Tbls	
Tbl	Name	State	Pts
A	CUSTOM_A	off	5
B	CUSTOM_B	off	0
C	CUSTOM_C	off	0
D	CUSTOM_D	off	0
E	CUSTOM_E	off	0
F	CUSTOM_F	off	0
G	CUSTOM_G	off	0
H	CUSTOM_H	off	0
I	CUSTOM_I	off	0
J	CUSTOM_J	off	0

Edit Table ▾

Table

**Off** On





Done

1 of 1

Figure 2-8 Offset Tables

### Procedure

Select an offset table as follows:

- 1 Ensure the power meter/sensor combination has been zeroed and calibrated.
- 2 Press:
  - , **Tables**, **Freq.Dep.Offset** or,
  - press  and after selecting the required channel, use the  and  keys to select **FDO Table**, and press **Change**.

The **Offset Tbls** screen is displayed.

- 3 Use the  and  keys to highlight one of the 10 table titles and press **Table** to highlight **On**.



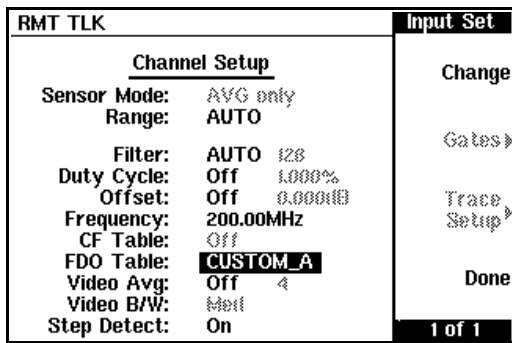

**NOTE**

When no data is contained in the highlighted table, the **Table** key is disabled (greyed out).

- 4 Press **Done** to complete the selection of the offset table.



**Figure 2-9** Frequency Dependent Offset Table Selected

- 5 Press **Done** again to display the measurement screen.
- 6 Press **Frequency Cal Fac**. The current setting of the frequency is displayed under the channel **Freq** softkey.
- 7 To change the frequency, press the channel **Freq** softkey. The frequency is displayed in a pop-up window. Use the , , , and  keys to select and change the values as required.
- 8 To confirm your choice, press the appropriate unit softkey.
- 9 Connect the power sensor to the signal to be measured.
- 10 The measurement result, including offset, is now displayed.

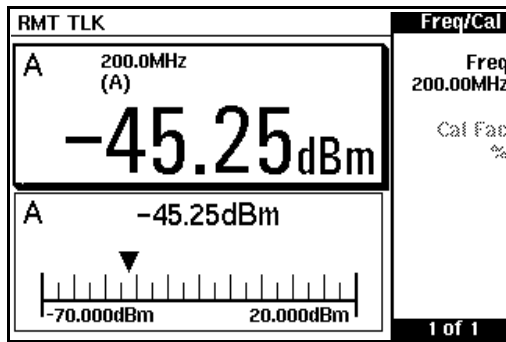

Figure 2-10 Frequency Dependent Offset Configured

**NOTE**

If the measurement frequency does not correspond directly to a frequency in the sensor calibration table (if selected) and the frequency dependent offset table being used, the power meter calculates the calibration factor and offset using linear interpolation. If you enter a frequency outside the frequency range defined in the sensor calibration table or the frequency dependent offset table, the power meter uses the highest or lowest frequency point in the appropriate table to set the calibration factor and offset.

**Editing Frequency Dependent Offset Tables**

There are ten frequency dependent offset tables named CUSTOM\_A through CUSTOM\_J. They do not contain any data when the power meter is shipped from the factory.

You cannot delete any of the 10 existing frequency dependent offset tables or create any additional tables. However, you can enter values into the 10 existing tables. Each frequency dependent offset table can contain a maximum of 80 frequency points.

To view the frequency dependent offset tables currently stored in the power meter, press **System**, **Tables**, **Freq.Dep.Offset**. The **Offset Tbls** screen is displayed as shown in Figure 2-8 on page 44.

Creating frequency dependent offset tables requires the following steps:









- 1 Identify and select the table you want to edit.
- 2 Rename the table.

3 Enter the frequency and calibration factor data pairs.

4 Save the table.

### Procedure

First select the table you want to edit as follows:

- 1 Press **System**, **Tables**, **Freq.Dep.Offset** to display the **Offset Tbls** screen.
- 2 Choose the table you want to edit using the  and  keys. Press **Edit table** to display the **Edit Offset** screen as shown in [Figure 2-11](#).
- 3 Highlight the table title using the  and  keys. Press **Change** and use the , , , and  keys to select and change the characters to create the name you want to use.
  - Pressing **Insert Char** adds a new character to the right of the selected character.
  - Pressing **Delete Char** removes the selected character.
- 4 Press **Enter** to complete the entry.

### NOTE













A frequency in the range of 0.001 MHz to 999.999 GHz can be entered. A calibration factor in the range of 1% to 150% can be entered. The following rules apply to naming sensor calibration tables:

- The name must consist of no more than 12 characters.
- All characters must be upper or lower case alphabetic characters, or numeric (0 to 9), or an underscore (\_).
- No other characters are allowed.
- No spaces are allowed in the name.

RMT TLK		Edit Offset
Name: <b>CUSTOM_A</b>		Change
Freq	Offset	Insert
5.000MHz	90.0%	Delete
6.000MHz	80.0%	
7.000MHz	70.0%	
8.000MHz	60.0%	
9.000MHz	50.0%	
		Done
		1 of 1

Figure 2-11 “Edit Offset” Screen with Some Added Data

Enter (or edit) the frequency and offset pairs as follows:

- 5 Press **Insert** to add a new frequency value or use the , , , and  keys to select the frequency value in the table.
- 6 Enter the value or press **Change** and use the , , , and  keys to enter the required frequency. Complete the entry by pressing the **GHz**, **MHz** keys.
- 7 Enter the offset using the , , , and  keys. Complete the entry by pressing the **%** key.

Continue adding/editing values until you have entered all the data you require.

- 8 When you have finished editing the table, press **Done** to save the table.

**NOTE**

Both single and dual channel power meters with variety of rear panel configurations have been used for the illustrations in this guide. Your power meter may differ in detail to those shown.

## Setting Averaging

The power meter uses a digital filter to average power readings. The number of readings averaged can range from 1 to 1024. This filter is used to reduce noise, obtain the desired resolution and to reduce the jitter in the measurement results. Increasing the value of the filter length reduces measurement noise. However, the time to take the measurement is increased. You can select the filter length or you can set the power meter to auto filter mode. The default is **AUTO**.

When the auto filter mode is enabled, the power meter automatically sets the number of readings averaged together to satisfy the filtering requirements for most power measurements. The number of readings averaged together depends on the resolution and the power level currently being measured.

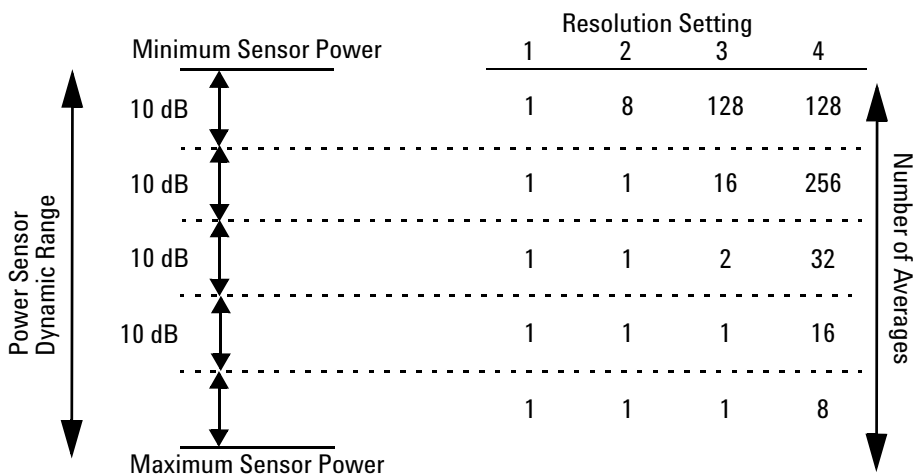

**Figure 2-12** Averaged Readings

Figure 2-12 shows the typical number of readings averaged for each range and resolution when the power meter is in auto filter mode and is set to normal speed mode. The EPM-P Series power meters recognize different sensor types when they are connected and configure suitable averaging automatically.





Resolution is a measurement display function and not a channel function. In the case where a channel is set up in both the upper and lower window and the resolution settings are different, the highest resolution setting is taken to calculate the averaging number.

These four resolution levels represent:

- 1, 0.1, 0.01, 0.001 dB respectively if the measurement suffix is dBm or dB.
- 1, 2, 3 or 4 significant digits respectively if the measurement suffix is W or %.

### Procedure

Set averaging as follows:

- 1 Press  and select the channel you want to set up. The current **Filter:** setting (**AUTO**, **MAN**, or **OFF**) is shown on the **Channel Setup** screen.
- 2 Use the , , , and  keys to select the **Filter:** setting.
- 3 Press **Change** to step through the available settings.

If you have selected **AUTO** or **OFF** proceed at step 7. If you have selected **MAN** proceed as follows:

- 4 Use the , , , and  keys to select the **Filter:** value.
- 5 Press **Change** to display the Filter Length pop-up.

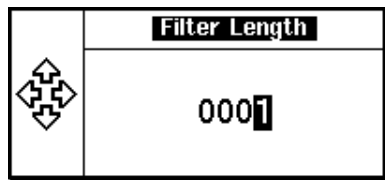

**Figure 2-13** Filter Length Pop-Up

- 6 Use the , , , and  keys to enter the required value and press **Enter**.
- 7 Press **Done** to close the **Channel Setup** screen.







## Step Detection

To reduce the filter settling time after a significant step in the measured power the filter can be set to reinitialize upon detection of a step increase/decrease in the measured power. Step detection can be set in both manual and automatic filter modes.

### Procedure

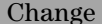
Set step detection as follows:

- 1 Press . On dual channel meters, select the required channel.
- 2 Use the  and  keys to select the **Step Detect** setting.
- 3 Press  to set step detection **On** or **Off** as required.
- 4 Press .

## Setting Measurement Limits

You can configure the power meter to detect when a measurement is out with a predefined upper and/or lower limit value.

Limits are windows or measurement display line based and can be applied to power, ratio or difference measurements. In addition, the limits can be set to output a TTL logic level at the rear panel Rmt I/O port when the predefined limits are exceeded.

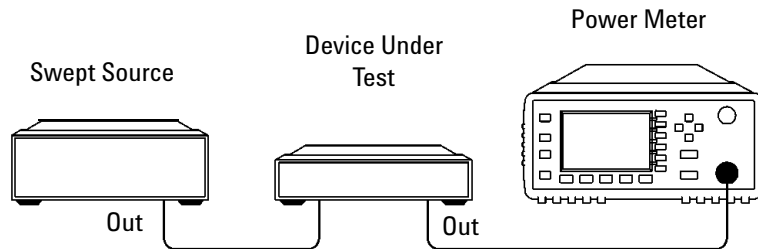

**Figure 2-14** Limits Checking Application

In this application, a swept frequency signal is applied to the input of the Device Under Test. The power meter measures the output power. The limits have been set at +4 dBm and +10 dBm. A fail occurs each time the output power is outside these limits as shown in [Figure 2-15](#).

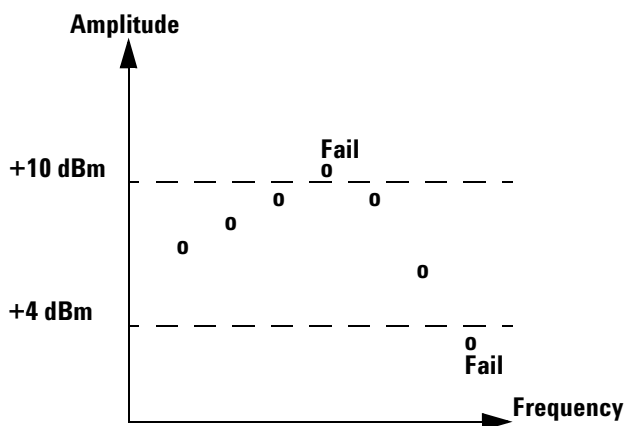

Figure 2-15 Limits Checking Results

## Setting Limits

The power meter can be configured to verify the current measurement in any measurement line against predefined upper and/or lower limit values. The range of values that can be set for the upper and lower limits and the default values depends on the measurement units in the currently selected measurement line, see [Table 2-7](#).

Table 2-7 Range of Values for Window Limits

Window units	Max	Min	Default	
			Max	Min
dB	+ 200 dB	- 180 dB	60 dB	- 120 dB
dB m	+ 230 dBm	- 150 dBm	90 dBm	- 90 dBm
%	10.0 Z%	100.0 a%	100.0 M%	100.0 p%
W	100.000 XW	1.000 aW	1.000 MW	1.000 pW

### Procedure

Set the limits as follows:

- 1 Press **Meas Setup**, **Limits**. The current setting of the maximum and minimum limits for the selected measurement line are displayed under the **Max** and **Min** softkeys respectively.
- 2 Use the **↑** and **↓** keys to select the measurement line you want to configure.
- 3 Change these settings by pressing **Max** or **Min** and use the **←**, **→**, **↑**, and **↓** keys to set the required values in the pop-up windows.

Complete the entry by pressing the required power unit softkey.

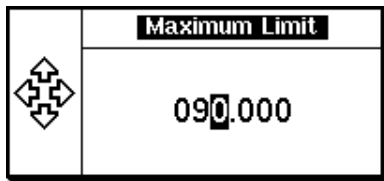

**Figure 2-16** Setting Maximum Limit

- 4 To enable limit checking, press **Limits** to select On.
- 5 Repeat this process for each required measurement line.

Limits can be disabled and reenabled simply by pressing **Limits Off On**.

### TTL outputs

The limits can also be set to output a TTL logic level at the rear panel Rmt I/O port when the predefined limits are exceeded. You can switch the rear panel TTL outputs on or off; set the TTL output level to active high or low; and determine whether the TTL output represents an over limit condition, under limit condition or both. Any two of the four measurement line limit conditions can be connected to either TTL output line.

The TTL connector is an RJ-45 Series shielded modular jack assembly with the TTL output pins connected as shown in [Figure 2-17](#).

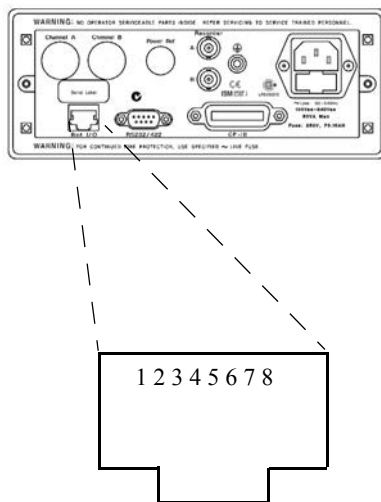

Pin number	Connection
1	None
2	Ground
3	TTL Output 1
4	TTL Output 2
5	TTL Input 1
6	TTL Input 2
7	Ground
8	Ground

**Figure 2-17** Remote I/O TTL Outputs



### Procedure

Set the TTL Output as follows:

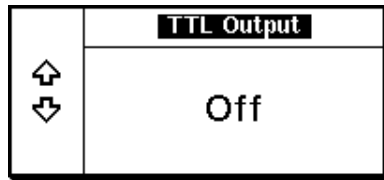
- 1 Press **Meas Setup**, **Limits** **TTL Output**.
- 2 Use the **↑** and **↓** keys to select the measurement line you want to configure.
- 3 Press **TTL Output**.



**Figure 2-18** TTL Output Pop-up

- 4 Use the  and  keys to select TTL Output line 1, 2, or Off. Press **Enter** to confirm your choice. The new setting appears under the **TTL Output** softkey.



### NOTE

If you have selected a TTL Output line previously configured for another measurement, a warning message is displayed



**Figure 2-19** Example of TTL Disconnect Warning Message

Your new connection overrides the previous configuration which is now disconnected.

- 5 Press **Limits**. The TTL output can indicate an over limit condition, under limit condition or both. Use the  and  keys to select your choice from the pop-up. Press **Enter** to confirm your choice.

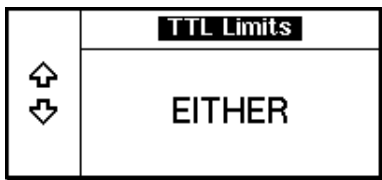
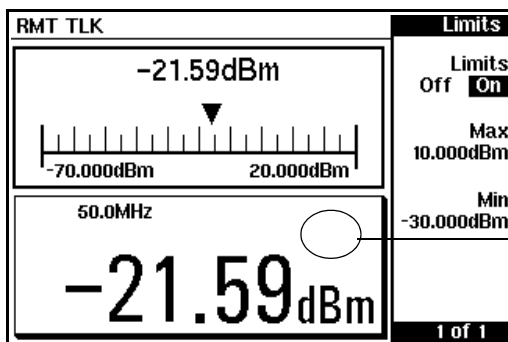

Figure 2-20 TTL Limits Pop-Up

- 6 You can choose a high or low level TTL output to represent a limits failure. Press **Fail O/P** to select **High** or **Low** to set a logical '1' or logical '0' for a limits failure.

## Checking for Limit Failures

Limit failures are displayed in the appropriate field in the measurement window on the power meter's display as shown in Figure 2-21.



This measurement has passed. This is indicated by the empty limit field.

## 2 General Power Meter Functions

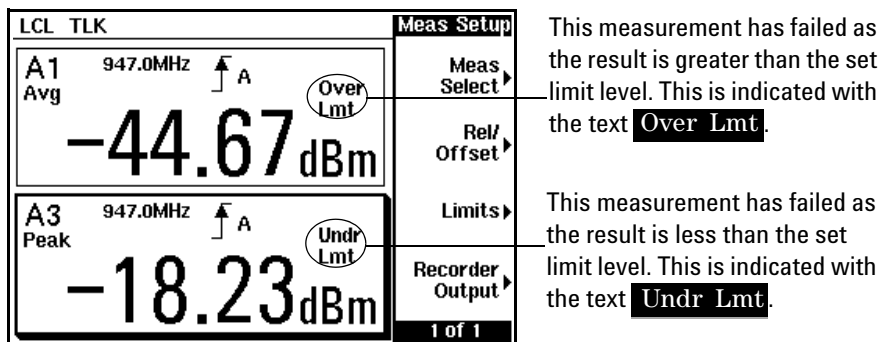

Figure 2-21 Limit Failures



## Setting the Range

The power meter has no internal ranges. The only ranges that can be set are those of the E-Series and N8480 Series power sensors. With an E-Series or N8480 Series power sensor (excluding Option CFT), the range can be set either automatically or manually. There are two manual settings, **LOWER** and **UPPER**. The lower range is more sensitive than the higher range. Use autorange when you are not sure of the power level you will be measuring. Use a manually configured range when you want to ensure there is no range switching during the measurement. The default is **AUTO**.

### Procedure

Set the range as follows:

- 1 Press **Channel** to display the **Channel Setup** screen. The current **Range:** setting is displayed.
- 2 Use the **↑** and **↓** keys to select the **Range:** setting.

RMT TLK		Input Set
<b>Channel Setup</b>		Change
Sensor Mode:	Normal	
Range:	<b>AUTO</b>	
Filter:	AUTO 2	Gates▶
Duty Cycle:	Off 1.000%	
Offset:	Off 0.000dB	Trace Setup▶
Frequency:	50.000MHz	
CF Table:	Off	
FDO Table:	Off	Done
Video Avg:	Off 4	
Video B/W:	Med	
Step Detect:	On	
		1 of 1

**Figure 2-22** Channel Setup - Range

- 3 Press **Change** and choose **AUTO**, **LOWER**, or **UPPER** as required.
- 4 Press **Done** to confirm your choice.

## **2 General Power Meter Functions**

## Scaling the Analog Display

Configure a measurement displayed in **Analog** format as follows:

- 1 Press **Meas Display**.
- 2 Use the **Left Arrow**, **Right Arrow**, and **Up/Down Arrow** keys to select the analog measurement window.
- 3 Press **Anlg Mtr Scaling**.

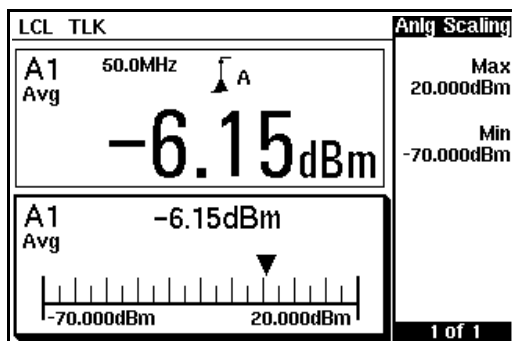

**Figure 2-23** Analog Display in Lower Window



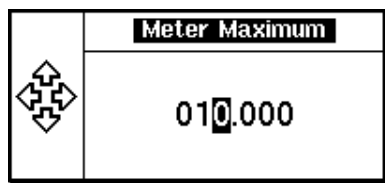

The **Max** and **Min** scale values are shown on the analog display and adjacent to the softkey labels.

- 4 Press **Max** and use the **Left Arrow**, **Right Arrow**, **Up Arrow**, and **Down Arrow** keys to configure the required value in the Meter Maximum pop-up window. Press **dBm**, **mW**, **uW**, or **nW**, to complete the entry.



**Figure 2-24** Meter Maximum Pop-Up

## 2 General Power Meter Functions

- 5 Similarly, press **Min** and use the , , , and  keys to configure the required value in the Meter Minimum pop-up window. Press **dBm**, **mW**, **uW**, or **nW**, to complete the entry.

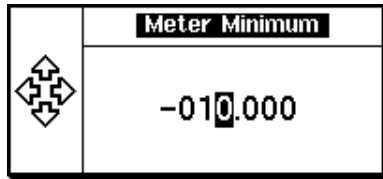

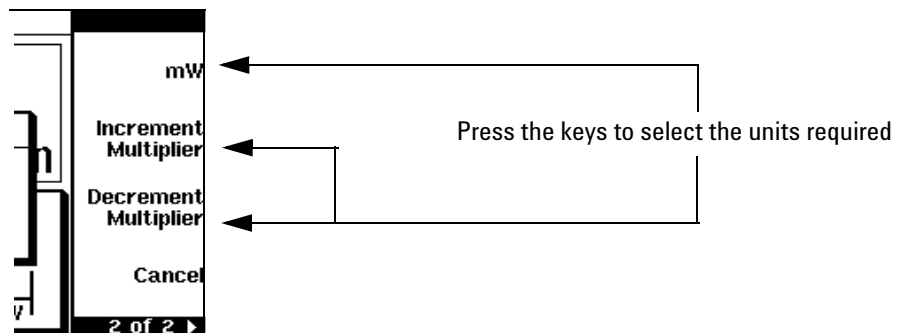

Figure 2-25 Meter Minimum Pop-Up

**TIP** If you have selected linear scaling for the analog measurement and the units you require are outwith the range of the displayed menu, an additional menu is available. When the pop-up is displayed, you can press  to access the increment/decrement multiplier menu. Use the **Increment Multiplier** or **Decrement Multiplier** to display the required units. Press the units softkey () to complete the entry.



## Recorder Output

The rear panel Recorder Output connectors (A and B) produce a DC voltage that corresponds to the power level in Watts of the channel, depending on the measurement mode. This DC voltage ranges from 0 to +1 Vdc. The output impedance is typically 1 kW. Channel and display offsets, and duty cycle have no effect on the Recorder Outputs.









For example, the Recorder Outputs can be used to:

- record swept measurements
- level an output from a source using external leveling, or
- monitor the output power

To access the Recorder menu, press , **Recorder Output**. This menu allows you to switch the Recorder Output signal either on or off. The **Max Power** and **Min Power** softkeys allow you to scale the power levels to represent the 1 Vdc maximum and 0 Vdc minimum output voltage of the Recorder Output.

### Procedure

Configure the recorder output as follows:

- 1 From a measurement display screen, use the , , and  keys to select the measurement window or measurement display line you want to connect to the recorder output.
- 2 Press , **Recorder Output** and **Output** to select On.
- 3 Press **Max Power** and **Min Power** use the , , , and  keys to enter the power level you want to generate a 1 Vdc output in the Recorder Maximum pop-up. Press **dBm**, **mW**, **uW**, or **nW**, to complete the entry.

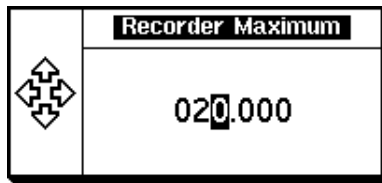





Figure 2-26 Recorder Maximum Pop-Up

- 4 Similarly, press **Min Power** and use the , , , and  keys to enter the power level you want to generate a 0 Vdc output in the Recorder Minimum pop-up. Press **dBm**, **mW**, **uW**, or **nW**, to complete the entry.

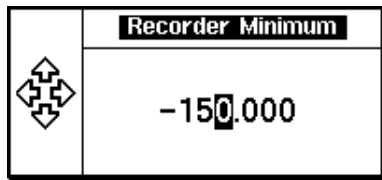

Figure 2-27 Recorder Minimum Pop-Up

**NOTE**

The highest power you are going to measure is used to determine the value which you should set for the Recorder Output maximum setting. For example, if you are measuring a power less than 1 mW and greater than 100 mW, then set the recorder maximum value to 1 mW.

Log	50	40	30	20	10	0
Lin	100 W	10 W	1 W	100 mW	10 mW	1 mW

Log	-10	-20	-30	-40	-50	-60
Lin	100 mW	10 mW	1 mW	100 nW	10 nW	1 nW

**TIP** If you have selected linear scaling for the analog measurement and the units you require are outwith the range of the displayed menu, an additional menu is available. When the pop-up is displayed, you can press **More** to access the increment/decrement multiplier menu. Use the **Increment Multiplier** or **Decrement Multiplier** to display the required units. Press the units softkey (**xW**) to complete the entry.

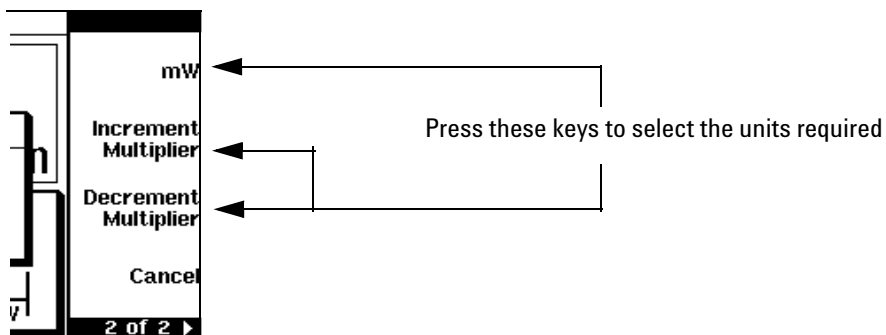

## Saving and Recalling Power Meter Configurations

To reduce repeated setup sequences, up to ten power meter configurations can be stored in nonvolatile memory.

The save/recall functions are part of the Sys/Inputs menu, accessed by pressing the  key.

To save a measurement setup:

- 1 Press , **Save/Recall** to display the Save/Recall screen as shown in [Figure 2-28](#).

RMT TLK		Save/Recall
Reg	Name	Status
1	State1	Available
2	State2	Available
3	<b>State3</b>	Available
4	State4	Available
5	State5	Available
6	State6	Available
7	State7	Available
8	State8	Available
9	State9	Available
10	State10	Available

Save  
Recall  
Edit Name  
Done  
1 of 1

**Figure 2-28** Save/Recall Screen

### NOTE

Your power meter has been shipped with measurement configurations suitable for common wireless communication formats already saved as Instrument States. These require E9320 E-Series power sensors. Refer to [Chapter 3](#) for more information.



- 2 Using the  and  keys, select an available name from the displayed list. To change the name of a register, proceed from step 4, otherwise press **Save**.
- 3 The power meter prompts you to press **Confirm** to proceed.





Figure 2-29 “Save” Pop-Up

If you need to modify a name:

- 4 If you have not already done so, press **System**, **Save/Recall**.
- 5 Use the **Left Arrow** and **Right Arrow** keys to select the required register and press **Edit Name**. The selected name is displayed in a pop-up window. Modify this as required:
  - Use **Up Arrow** and **Down Arrow** keys to modify the character on which the cursor is currently positioned.
  - Use **Left Arrow** or **Right Arrow** to move to other characters.
  - Use **Insert Char** and **Delete Char** as required.
- 6 To confirm your choice, press **Enter**.

To recall a measurement setup:

- 1 Press **System**, **Save/Recall**.
- 2 Use the **Up Arrow** and **Down Arrow** keys to select the required register and press .

## NOTE

The key is disabled (greyed out) when an unused register is selected.

- 3 Press **Confirm**.

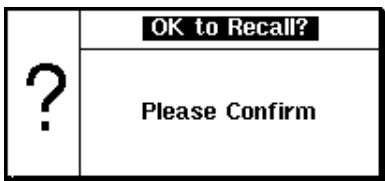

Figure 2-30 “Recall” Pop-Up

## Measuring Pulsed Signals

**TIP**

The E-Series E9320 power sensors are best suited for peak and pulse power measurement.

However, the E9300 E-Series, 8480 Series and N8480 Series power sensors can be used to measure the power of a pulsed signal.

The measurement result is a mathematical representation of the pulse power rather than an actual measurement (assumes constant peak power). The power meter measures the average power of the pulsed input signal and then divides the measurement result by the duty cycle value to obtain the pulse power reading. The allowable range of values is 0.001% to 100%. The default value is 1.000%.

If duty cycle is enabled and the channel is setup in single numeric display format, the message **Dty Cyc** is displayed.

**NOTE**

Pulse measurements are not recommended using Agilent E4412A and E4413A power sensors.

---

An example of a pulsed signal is shown in Figure 2-31.

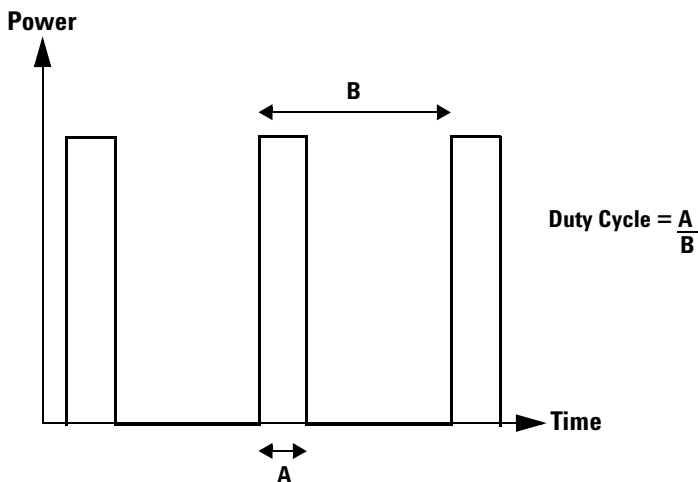

Figure 2-31 Pulsed Signal

**Procedure**





Set the duty cycle as follows:

- 1 Press Channel. Select the channel you want to configure. The current setting of the duty cycle is displayed in the channel setup table.
- 2 Use the ←, →, ↑, and ↓ keys to select the duty cycle setting and press Change to select On.

RMT TLK		Input Set
<b>Channel Setup</b>		<b>Change</b>
Sensor Mode:	AVG only	
Range:	AUTO	
Filter:	AUTO 128	Gates▶
Duty Cycle:	<b>Off</b> 1.000%	
Offset:	Off 0.000dB	Trace Setup▶
Frequency:	947.00MHz	
CF Table:	Off	
FDO Table:	Off	
Video Avg:	Off 4	Done
Video B/W:	Med	
Step Detect:	Off	
		1 of 1

Figure 2-32 Duty Cycle: Off

## 2 General Power Meter Functions

- Use the , , , and  keys to select the duty cycle value and press **Change**.

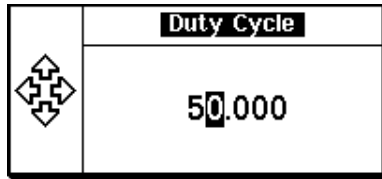





Figure 2-33 Duty Cycle Pop-Up

- Again use the , , , and  keys to select and change the values as required. Complete the entry by pressing **%**.

LCL TLK	Input Set
<b>Channel Setup</b>	
Sensor Mode: AVG only	Change
Range: AUTO	
Filter: AUTO 128	Gates>
Duty Cycle: On 50.000%	
Offset: Off 0.000dB	Trace Setup>
Frequency: 947.00MHz	
CF Table: Off	
FDO Table: Off	
Video Avg: Off 4	Done
Video B/W: Mod	
Step Detect: Off	1 of 1

Figure 2-34 Duty Cycle: On, 50%

- Press **Done**.

### NOTE

Pulse power averages out any aberrations in the pulse such as overshooting or ringing. For this reason, it is called pulse power and not peak power or peak pulse power.

In order to ensure accurate pulse power readings, the input signal must be pulsed with a rectangular pulse. Other pulse shapes (such as triangle, chirp or Gaussian) will cause erroneous results.

The pulse power on/off ratio must be much greater than the duty cycle ratio.



## Presetting the Power Meter

This section details the power meter's preset conditions.

The GPIB address, the data stored in the sensor calibration tables, and the zeroing and calibration data are not affected by a  (Preset). The calibration table selected is not affected.

### Preset Conditions

The number of windows displayed is two.

	Select Interface	is not affected.
	GBIP Addr	is not affected.
	Baud Rate	is not affected.
	Word Size	is not affected.
	Stop Bits	is not affected.
	Parity	is not affected.
	Pacing	is not affected.
	Echo	is not affected.
	Sensor Cal Tables	channel  is not affected.
	Freq.Dep.Offset	channel  is not affected.
	Linearity	is set to <b>Atype</b> .
	Power Ref	is set to <b>Off</b> .
	Must Cal	is not affected

Channel

<b>Sensor Mode:</b>	Is active and set to <b>Normal</b> mode only when an E9320A E-Series sensor is connected, otherwise inactive and greyed out in AVG only setting.
<b>Range:</b>	Is active and set to <b>Auto</b> only when an E9320A E-Series, E9300 E-Series sensor or N8480 Series sensor (excluding Option CFT) is connected, otherwise inactive and greyed out in <b>Auto</b> setting.
<b>Filter:</b>	Is set to <b>Auto</b> .
<b>Duty Cycle:</b>	Is set to <b>Off</b> . Is inactive and greyed out when an E9320 E-Series sensor is connected and in normal mode.
<b>Offset:</b>	Is set to <b>Off</b> .
<b>Frequency:</b>	Is only available when an E-Series sensor or N8480 Series sensor (excluding Option CFT) is connected and is set to 50.000 MHz.
<b>Cal Fac:</b>	Is only available when an 8480 Series sensor or N8480 Series sensor with Option CFT is connected and is set to 100%.
<b>CF Table:</b>	Is not affected when an 8480 Series sensor or N8480 Series sensor with Option CFT is connected, otherwise inactive and greyed out in the <b>Off</b> setting.
<b>FDO Table:</b>	Is not affected.
<b>Video Avg:</b>	Is set to <b>Off</b> when and E9320A E-Series sensor is connected otherwise greyed out in the <b>Off</b> setting.
<b>Video B/W:</b>	Is set to <b>Off</b> when and E9320A E-Series sensor is connected otherwise greyed out in the <b>Off</b> setting.
<b>Step Detect:</b>	Is set to <b>On</b> .
<b>Gates</b>	Is only available when an E9320A E-Series power sensor is connected.
<b>Gate Start:</b>	All gates are set to <b>0.0000 s</b> .
<b>Gate Length:</b>	Gate 1 is set to <b>100.00 <math>\mu</math>s</b> . Gates 2, 3, and 4 are set to <b>0.0000 s</b> .
<b>Trace Setup</b>	Is only available when an E9320A E-Series power sensor is connected.
<b>Start:</b>	Is set to <b>0.0000 s</b> .

<b>Length:</b>	Is set to <b>100.00 <math>\mu</math>s.</b>
<b>Max:</b>	Is set to <b>20.000 dBm.</b>
<b>Min:</b>	Is set to <b>-50.000 dBm.</b>
<b>Min:</b>	Is set to <b>dBm.</b>

**Trigger**

All Trigger configurations are inactive and greyed out unless an E9320A E-Series power sensor is connected.

**Acqn**

Is set to **Free Run.**

**Stop Run**

Is set to **Run.**

**Source**

Is set to **Int.**

**Mode**

Is set to **AutoLvl.**

**Delay**

Is set to **0.0000 s.**

**Slope**

Is set to **+**.

**Holdoff**

Is set to **1.0000  $\mu$ s.**

**Hysteresis**

Is set to **0.000 dB.**

**Output**

Is set to **Off.**

**Meas Setup**

**Chan**, **Gate**, and **Meas** are all inactive and greyed out, regardless of sensor type.

**Function**

Is set to **Single.**

**Rel**

Is set to **Off.**

**Rel**

Is set to **0.000 dBm.**

**Offset**

Is set to **Off.**

**Offset**

Is set to **0.000 dB.**

**Limits**

Is set to **Off.**

**Max**

Is set to **90.000 dBm.**

## 2 General Power Meter Functions

<b>Min</b>	Is set to <b>-90.000 dBm</b> .
<b>TTL Output</b>	Is set to <b>Off</b> .
<b>Meas Display</b>	<b>Disp Type</b> Upper window is set to <b>Single Numeric</b> and the Lower window to <b>Analog</b> .
<b>Resolution</b>	Is set to <b>3</b> .
<b>Unit</b>	Is set to <b>dBm</b> .
<b>Frequency Cal Fac</b>	<b>Freq</b> Is only available when an E-Series sensor or N8480 Series sensor (excluding Option CFT) is connected and is set to 50.000 MHz
<b>Cal Fac</b>	Is only available when an 8480 Series sensor or N8480 Series sensor with Option CFT is connected and is set to <b>100%</b>
<b>Zero Cal</b>	<b>Power Ref</b> Is set to <b>Off</b> .





## 3 Using E9320 E-Series Power Sensors

Introduction	76
Power Meter Configuration	78
Configuring a Peak Power Measurement	82
The Set Up Process	83
Measurement Example	110
Using Preinstalled Measurement Setups	115



## Introduction

The E9320 E-Series power sensors have dual modes of operation.

- The normal mode is optimized for a wider bandwidth but with reduced dynamic range. The instantaneous power of an RF signal can be detected with, depending on the sensor type, up to 5 MHz of video bandwidth (modulation bandwidth). Use this mode to measure the peak and average power of pulsed or modulated signals.
- The *average-only* mode is optimized for high accuracy and wide dynamic range. Use this mode to measure the average power of signals below the dynamic range of normal mode.

### NOTE

The term 'video' is applied here to a signal that has been amplitude demodulated from an RF carrier but contains components in the RF part of the spectrum. For a power meter it refers to the output of the sensor diodes in normal mode.

In normal mode the EPM-P Series power meters and E9320 E-Series power sensors continuously sample the RF signal at a 20 Msample/s rate. A trigger can be taken from a rising or falling edge of an RF signal pulse or controlled externally via GPIB or TTL input.

**Table 3-1** Sensor Bandwidth

Sensor	Video bandwidth setting			
	Low	Medium	High	Off
E9321A E9325A	30 kHz	100 kHz	300 kHz	300 kHz*
E9322A E9326A	100 kHz	300 kHz	1.5 MHz	1.5 MHz*
E9323A E9327A	300 kHz	1.5 MHz	5 MHz	5 MHz*

\* The Low, Medium, and High settings provide flat filter responses with very sharp cutoff points by applying digital signal processing techniques. The Off setting removes all signal conditioning. Refer to [Figure 3-5](#).

**NOTE**

Maximum dynamic range is related to the maximum sensor bandwidth. Please refer to the documentation supplied with your E-Series E9320 power sensor for specification information.

---

## Power Meter Configuration

The EPM-P Series power meters automatically recognize an E-Series E9320 power sensor when it is connected. The sensor calibration data, characterizing the sensor output versus input power, frequency, and temperature, is automatically read by the power meter.

### Default Channel Setup

When an E-Series E9320 power sensor is connected, the following Channel Setup is automatically configured. Carrying out a Preset returns the power meter to this configuration.

Any changes made to the Channel Setup are retained after a power cycle.

RMT TLK		Input Set
<b>Channel Setup</b>		Change
Sensor Mode:	<b>Normal</b>	Gates ▶
Range:	AUTO	Trace Setup ▶
Filter:	AUTO 256	Done
Duty Cycle:	Off 1000%	
Offset:	Off 0.000100	
Frequency:	50.000MHz	
CF Table:	Off	
FDO Table:	Off	
Video Avg:	Off 4	
Video B/W:	Off	
Step Detect:	On	
		1 of 1

**Figure 3-1** E-Series E9320 Power Sensor Default Channel Setup

## Measurement Method

The E4416A meter and E9320 E-Series power sensors continuously sample the RF signal at a 20 MHz rate. Similarly, the E4417A samples both channels at the same rate. Various trigger methods enable the measurement of continuously modulated signals or single events.

### Measurement Gates

A system of gates, controlled by and referenced to a trigger point, is used to extract measurement data from the captured trace. The trace data within each gate period is subsequently used for the individual measurement calculations. Up to four gates can be set up for each channel (Refer to [Figure 3-2](#).)

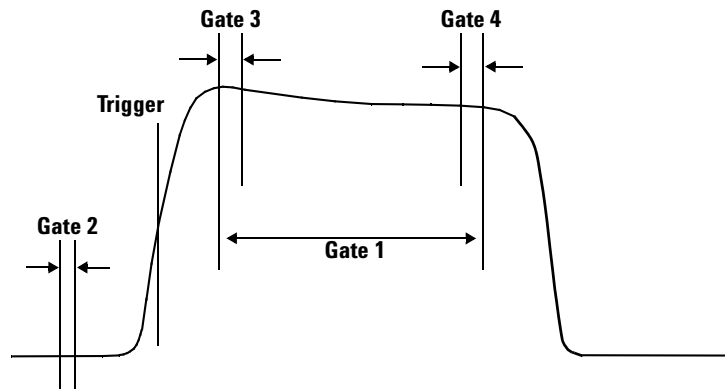

**Figure 3-2** Measurement Gates

With the gates setup as shown in [Figure 3-2](#) for example, you can simultaneously measure:

- The average power level of the pulse: Gate 1, average measurement
- The Peak to average ratio: Gate 1, peak-to-average measurement
- The Pulse droop: Gate 3, average measurement, minus Gate 4, average measurement
- The average "off" power level ahead of the pulse: Gate 2, average measurement.

## Measurement Display

Average, peak, and peak-to-average ratio measurements are made within each gate period generating 12 possible measurement results per channel as shown in Figure 3-3.

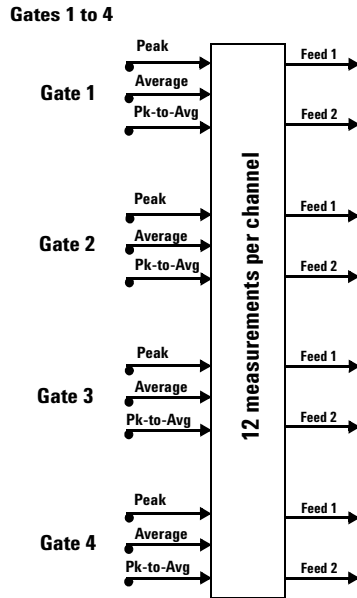
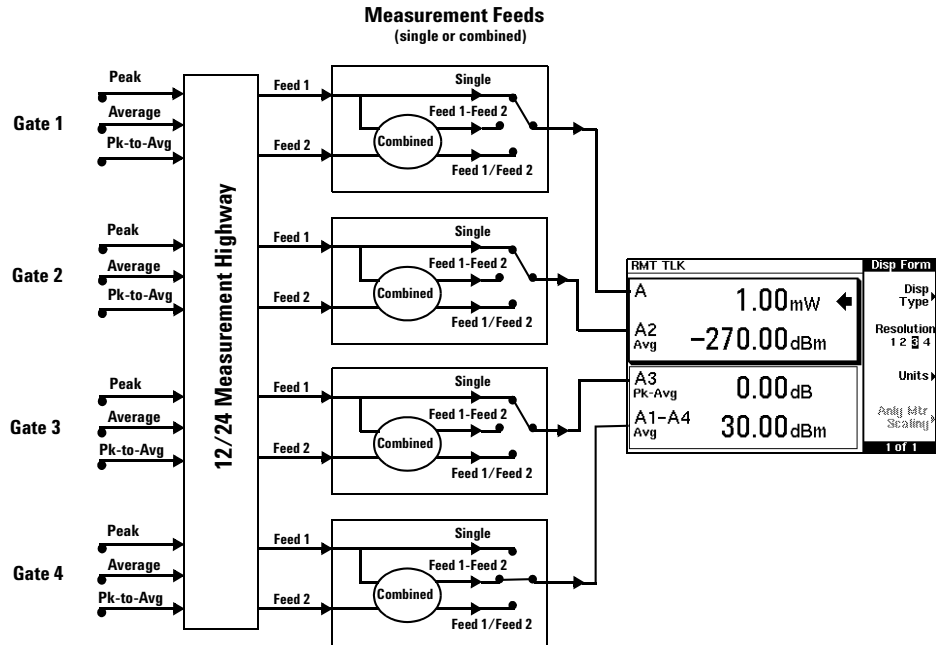

**Figure 3-3** Twelve Measurements per Channel

The EPM-P power meters cannot display all 12 (or 24) measurements simultaneously. However, up to four measurements or a combination of measurements and traces can be shown on the display. Any of the four measurement display lines can show any of the measurement results from any of the four gates allowing you complete control of the displayed information.

Each displayed line has a measurement feed. Each measurement feed has two independent inputs, Feed 1 and Feed 2. The two Feeds, 1 and 2, can carry any of the 12 measurement results from the 4 gates.

(24 measurements from eight gates in the dual channel E4417A.) Only Feed 1 can be displayed in Single Mode. In Combined Mode, Feed 1 – Feed 2 or Feed 1 / Feed 2 can be displayed.

**NOTE**

When selected, the trace display should be used only as an indication. It is representative of the measurement trace but the resolution is constrained by the limitations of the display.

You can configure the trace start and length parameters in a similar manner to setting up a gate. In addition, you can configure the amplitude scaling.

## Configuring a Peak Power Measurement

While the EPM-P may at first seem complex, configuring a measurement and displaying the results are quickly achieved using trace markers or by following a step-by-step process of numeric data entry.

Before configuring the measurements, you should have some information about the signal you want to measure. The following information for example, can help you quickly establish stable triggering and reliable measurement data:

- the Center Frequency (CF)
- the bandwidth of any modulating signal
- the expected maximum and minimum power levels
- timing information for any pulsed signals

You can configure the required measurements using numeric data entry from the keypad or remote interface or, by manually positioning trace markers using the front panel controls.

Setting up the power meter using the trace markers is a more interactive process and may require more iterations between channel, triggering, gate, and display functions to make a measurement. However, it is ideally suited to measuring an unknown signal.

**TIP** If pulsed signal timing information is unavailable or incomplete, you may prefer to use the trace and marker functions to configure your measurement.

### NOTE

You must select continuous or single trigger mode to enable the use of trace markers.



# The Set Up Process

## Setting Up Using Data Entry

Using the data entry method, the following steps are required to set-up one or several measurements.

- 1 Channel Setup** – choose the sensor mode and range, configure filtering, averaging, bandwidth, and the RF frequency.
- 2 Gate Setup** – configure the timing of gates for the signal you want to measure.
- 3 Trigger Setup** – configure the trigger to ensure the gates you have set up are capturing the required signal information.
- 4 Display Setup** – choose the display format for the measurements you want to make.
- 5 Measurement Setup** – assign the measurements to the displays you have set up.

**Step 1. The Channel Setup**

- Press Channel.

The Channel Setup screen is displayed. Select the channel you want to configure and use the ←, →, ↑, and ↓ keys to select any parameters you want to change. Press Change to configure the required settings.

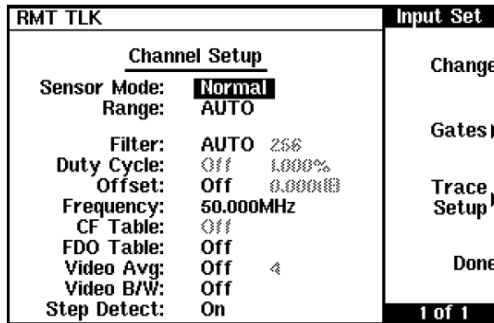

**Figure 3-4** E-Series E9320 Power Sensor Default Channel Setup

**Sensor Mode:** **Normal** enables peak, peak-to-average, and average measurements and is suitable for making time gated measurements. **AVG** only is suitable for measuring the average power of a lower level signal only. If used above -20 dBm, it will give accurate results for CW signals only.

- Range:** The power sensors have a high and low range. When in autorange mode, the correct range for the measurement is selected automatically. In Free Run acquisition mode, the range is selected to be suitable for the input signal. If the signal rises sharply through a range threshold while a measurement is being made, the range is changed and a new measurement made.
- In a triggered acquisition mode, (**Cont Trig** or **Sing Trig**) the sensor may switch range from low to high on the rising edge of a pulse, or from high to low on the trailing edge. The time delay for this process, 4  $\mu$ s with **Video B/W** set to **Off**, 8  $\mu$ s using **High**, **Med**, and **Low** settings, may impair your measurement. By using the upper or lower settings to hold the sensor in a specific range, the switching delay is removed.
- Filter:** The power meter uses a digital filter to average power readings. The filtering is applied only to an average measurement in the selected gates when in normal mode or to the average-only mode measurement. The number of readings averaged can range from 1 to 1024. This filter is used to reduce noise, obtain the desired resolution and to reduce the jitter in the measurement results. Increasing the value of the filter length reduces measurement noise but increases the time to make the measurement.
- Offset:** If your test setup has known gains or losses, you can remove these from the displayed measurement results by setting up an Offset as described in “[Setting Offsets](#)” on page 39
- Frequency:** The E9320 E-Series power sensors are fully corrected for calibration factor and frequency dependent linearity errors. Correction data is downloaded to the meter when a sensor is connected. It is important, for best accuracy, to enter the frequency of the RF signal you are measuring.

**TIP** Entering the frequency, especially when making comparative measurements between signals, greatly reduces measurement uncertainty.

**FDO Table:** If your test setup has known frequency dependant amplitude variations, you can remove these errors from the displayed measurement results by setting up and using a Frequency Dependant Offset table. Refer to “[Setting Offsets](#)” on page 39.

**Video Avg:** Video averaging uses a digital filter to average to average repetitions of a triggered signal. The number of acquisitions averaged can range from 1 to 256. With video averaging the average of a number of acquisitions is calculated to smooth the displayed trace and reduce apparent noise. The measurement requires a continuously repeating signal. Increasing the value of the filter reduces noise but increases the time required to make the measurement.

**Video B/W:**

Select a value close to or greater than that of the modulating signal bandwidth. Note that this varies between sensors (See [Table 3-1](#) on page 76). The pass band shapes achieved by the video bandwidth settings are flat with very sharp cutoffs to ensure accurate power measurement within the specified band.

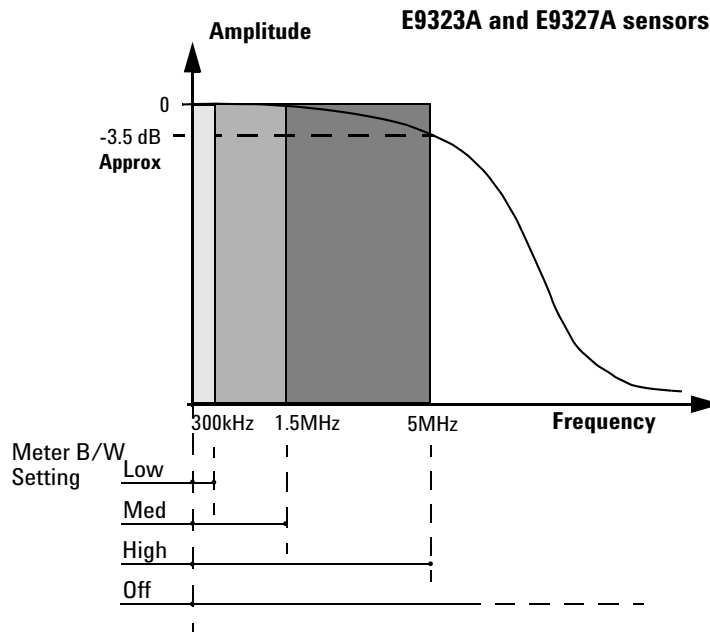

**Figure 3-5** Bandwidth Filter Shapes

A fourth, filter Off, setting is provided. This provides approximately 3 dB roll off at the maximum sensor bandwidth and is best suited for accurate trace capture, removing any ringing effects caused by the sharp cut-off filters used in the Low, Med and High settings. [Figure 3-5](#) shows the filter shapes associated with the E9323A and E9327A power sensors. [Table 3-1](#) on page 76 lists all the bandwidth settings. Selecting a bandwidth only slightly higher than required by your signal can help reduce noise and improve accuracy on peak measurements. It can however, reduce the processing speed for long acquisition times.

**Step Detect:** To reduce the filter settling time after a significant step in the measured power, the filter can be set to reinitialise upon detection of a step increase/decrease in the measured power. Step detection can be set in both manual and automatic filter modes.



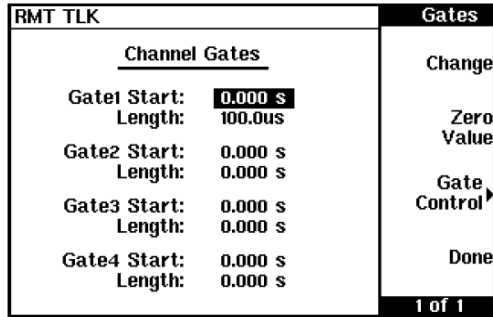

### Step 2. The Gate Setup

- Press **Gates**.

The **Channel Gates** screen is displayed.







**Figure 3-6** Gates screen

- First select the **Gate Start** value for the gate you want to configure using the , , , and  keys.



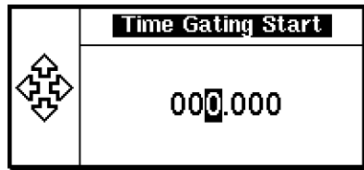

**NOTE**

The gate start time is relative to the trigger event. Positive values open a measurement gate up to one second after the trigger. Use a negative Time Gate Start value to open a gate up to one second before the trigger.

- Press **Change** and again use the , , , and  keys to configure the required value in the Time Gating Start pop-up window.



**Figure 3-7** Time Gating Start Pop-Up

- Complete the entry by pressing the required second, millisecond, or microsecond (**s**, **ms**, or **us**) softkey.
- Select the Gate Length parameter and press **Change**. Use the , , , and  keys to configure the required value in the Time Gating Length pop-up window. A maximum of one second can be entered.

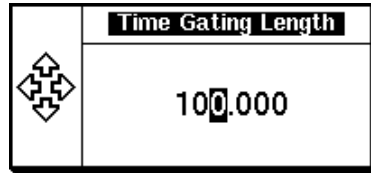

**Figure 3-8** Time Gating Length Pop-Up

- Complete the entry by pressing the required second, millisecond, or microsecond (**s**, **ms**, or **us**) softkey.
- Repeat this process until you have setup all the required gates.

#### NOTE

The gate length is the length of time from the gate start. It can only have positive values.

### Step 3. The Trigger Setup

- Press **Trigger**.

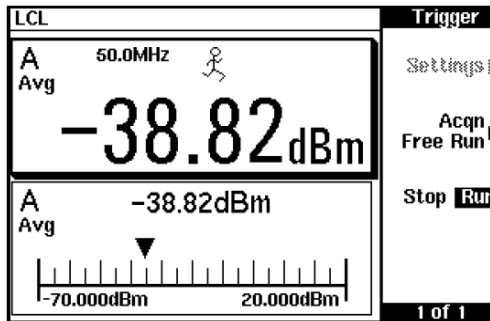

The **Trigger** menu is displayed. (The **Trigger** menu is disabled when the **Sensor Mode** is set to **AVG** only in the **Channel Setup**.)

The trigger status is also displayed below the **Acqn** label in the Trigger menu. **Table 3-9** on page 90 shows the power meter display in Free Run mode. In this mode, the meter is not synchronized to any modulated RF signal at the sensor input. Consequently, power levels within the configured time gates are random and the displayed measurement results are not valid.



**Figure 3-9** Trigger Menu - Free Run Mode

**NOTE**

The  symbol in the upper window indicates the power meter is in free run mode. The  symbol is replaced by  and the measurement halted when **Stop Run** is pressed to select **Stop**.

To make use of the measurement gates, the power meter must be triggered. The trigger can be taken from a rising or falling measured power level or controlled externally via the Ext Trig input or GPIB. Additional features such as holdoff, hysteresis, and delay are additional control features provided to help you achieve a stable and reliable trigger.



- Press **Acqn** to configure a trigger.
- Select either **Sing Trig** or **Cont Trig**. **Sing Trig** is a single shot mode.

After triggering, the measurement is halted, the **⊗** symbol is displayed and **Stop** is highlighted. You can start another measurement by pressing **Stop Run** to select **Run**, and wait for the next trigger.

- Press **Settings** to configure the remaining trigger parameters.

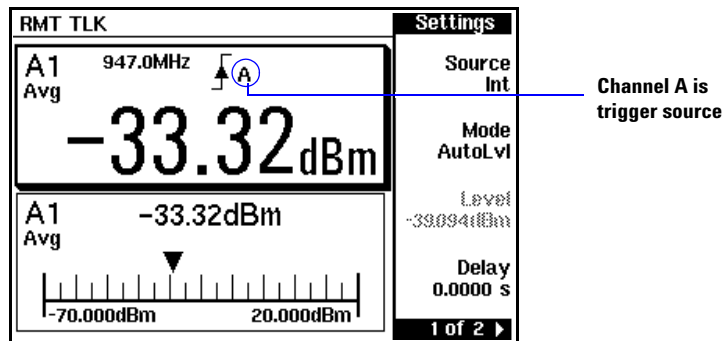

**Figure 3-10** Trigger Setting Menu 1 of 2

There are two pages for the trigger Settings menu. [Figure 3-10](#) shows page 1.

**TIP** To help you quickly check the triggering setup, the current settings for all the trigger parameters are shown below the respective softkey labels.





**Source** The current setting is shown below the **Source** label. Also, the trigger source is shown beside the trigger symbol when a measurement window is configured in single numeric mode. When an external trigger (**Ext**) is selected, the power meter can be triggered via the Ext Trig (TTL transition edge) input or a remote command.

To change the setting, press **Source** and choose **Ext** or **Int**.

**Mode** The **Mode** key is only available when trigger **Source Int** is selected. Again, the current setting is displayed below the label. When **Norm** is selected, you can choose the RF power level transition used as the trigger. The power meter automatically finds a triggering power level transition when **AutoLvl** is selected.

To change the setting, press **Mode** and choose **Norm** or **AutoLvl**.

**Level** **Level** is only available when **Norm** trigger has been selected. The current value is shown below the **Level** label. The minimum power level you can enter is limited to 40 dB below the maximum sensor power. To change the setting, press **Level**

and use the , , , and  keys to enter the new value.

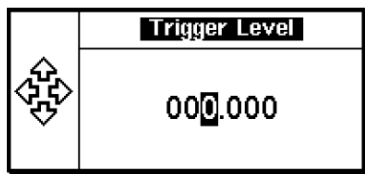





**Figure 3-11** Trigger Level Pop-Up

Complete the entry by pressing **dBm**.

**Delay**

The current setting is displayed below the **Delay** label. The delay time is applied between the trigger event and all the gate start times. This allows you to timeshift all the gates by the same amount with one setting change. A delay of up to one second can be entered. To change the setting, press **Delay**

and use the , , , and  keys to enter the new value.

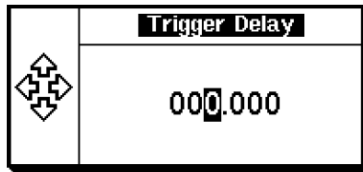

**Figure 3-12** Trigger Delay Pop-Up

Complete the entry by pressing **s**, **ms**, or **us**.

Press **More** to display the second menu page.

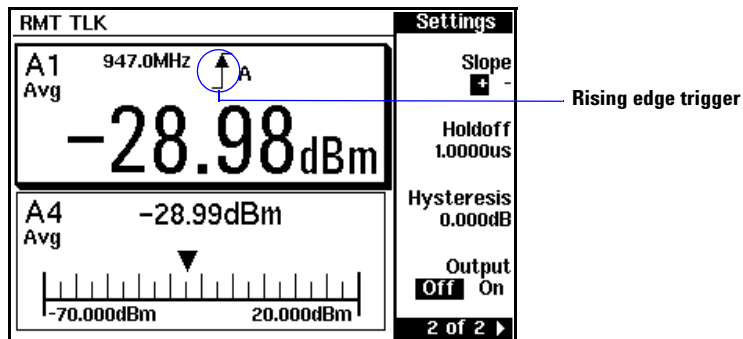

**Figure 3-13** Trigger Setting Menu 2 of 2

#### Slope

The current setting is displayed below the **Slope** label and the  $\downarrow$  or  $\uparrow$  symbol is displayed in single numeric display mode.  $+$  (and  $\uparrow$ ) is used to generate the trigger from an increasing power level. Similarly,  $-$  (and  $\downarrow$ ) is used to generate the trigger from a decreasing power level or external TTL transition.

To change the setting, press **Slope** to highlight  $+$  or  $-$  as required.

#### Holdoff

The current setting is displayed below the **Holdoff** label. After a trigger event occurs, the trigger mechanism is disabled for the configured time period. This allows stable triggering to be achieved even when a signal has multiple edges, for example, a TDMA signal with nonconstant amplitude modulation. Values up to 400 ms can be configured.

To change the setting, press **Holdoff** and use the  $\leftarrow$ ,  $\rightarrow$ ,  $\uparrow$ , and  $\downarrow$  keys to enter the new value.

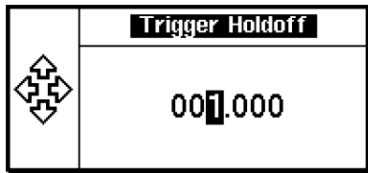

**Figure 3-14** Trigger Holdoff Pop-Up

Complete the entry by pressing **s**, **ms**, or **us**.

#### Hysteresis

The current setting is displayed below the **Hysteresis** label. You can use the hysteresis function to help generate a more stable trigger by preventing triggering unless the RF power level achieves the trigger level and the additional hysteresis value. It can be applied to both rising and falling edge trigger generation. A maximum of 3 dB hysteresis can be entered.

**Rising Edge:**

When a rising power transition triggers the power meter, the triggering system is disabled. The power meter does not trigger again if another rising power transition is presented. The triggering system is rearmed only when the input power falls below a level equal to the trigger level minus the configured hysteresis value.

**Falling edge:**

When a falling power transition triggers the power meter, the triggering system is disabled. The power meter does not trigger again if another falling power transition is presented. The triggering system is rearmed only when the input power rises above a level equal to the trigger level plus the configured hysteresis value.

To change the setting, press **Hysteresis** and the , , , and  keys to enter the new value.

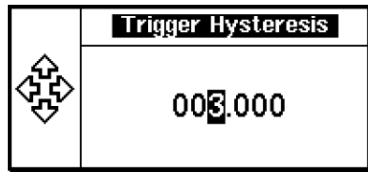

**Figure 3-15** Trigger Hysteresis Pop-Up

Complete the entry by pressing **dB**.

**Output**

The current setting is displayed below the **Output** label. A TTL level high is produced at the rear panel TRIG OUT BNC connector when the power meter is triggered when **On** is configured.

To change the setting, press **Output** to highlight **On** or **Off** as required.

### Step 4. The Display Setup

This step requires that you first check the power meter is set-up to show the measurement results in the display format you require.

- Press **Meas Display**, **Disp Type** to display the first page of the display format menu.

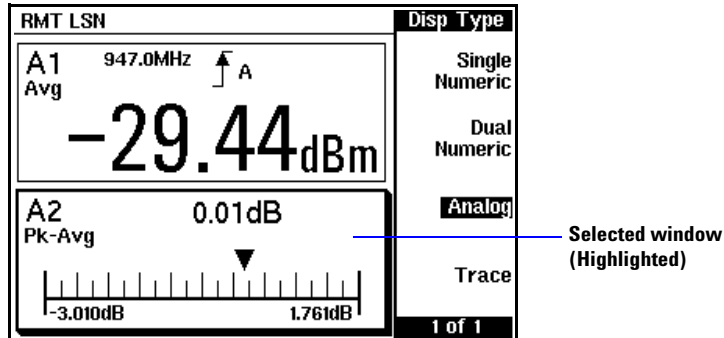
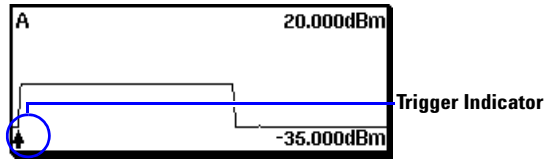

Figure 3-16 Display Type Menu

- Use the **Up** and **Down** or **Left/Right** keys to select a measurement window. Choose the type of display you require from the menu.



Trace



## Step 5. The Measurement Setup

### Numeric Format

Configure a measurement displayed in **Single Numeric** or **Dual Numeric** format as follows:

- Press **Meas Setup** and use the , , or  keys to select the measurement window or measurement line you want to configure.
- Press **Meas Select**.

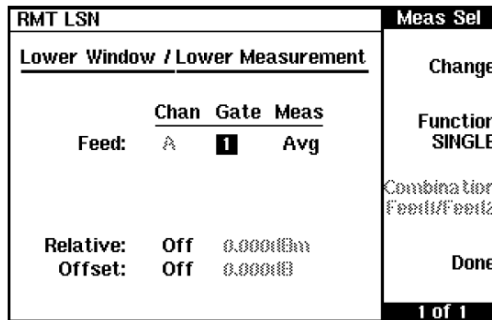

Figure 3-17 Lower Window/Lower Measurement Setup

### Single Function Measurement







- Press **Function** to select SINGLE.
- Use the , , , and  and **Change** keys to assign a measurement type to a gate number as required.

Figure 3-17 shows an average measurement assigned to Gate 1 in the lower measurement line of the lower window. (The Channel label is disabled as a single channel meter is shown.)

- Press **Done** to complete the set-up and display the measurements results screen.
- Use the , , or  keys to select the next measurement window or measurement line you want to configure.



### Combined Measurement





- Press to select COMB.
- Use the , , , and  and **Change** keys to assign a measurement type to a gate number as required.

Figure 3-18 shows a Combined Measurement configuration; channel A, gate 1 peak power minus gate 3 peak power, with a 3 dB display offset, to be displayed in the upper measurement line of the lower display window. (Again, the Channel label is disabled as a single channel meter is shown.)

RMT TLK			Meas Sel
<u>Lower Window / Upper Measurement</u>			Change
	<u>Chan</u>	<u>Gate</u>	<u>Meas</u>
Feed1:	A	1	Peak
Feed2:	A	3	Peak
Relative:	Off	0.000dBm	
Offset:	On	3.000dB	
			Function COMB
			Combination Feed1-Feed2
			Done
			1 of 1

**Figure 3-18** Measurement Set-Up Example

Press to complete the setup. The measurement configuration is also displayed with the results. Figure 3-19 shows both the previously configured measurements in the Lower Window.



A1-A3 Peak	-33.74dBm	←
A1 Avg	-0.03dBm	

**Figure 3-19** Measurement Example Display

Continue this process until you have configured all the required numeric displays.

### Analog Format



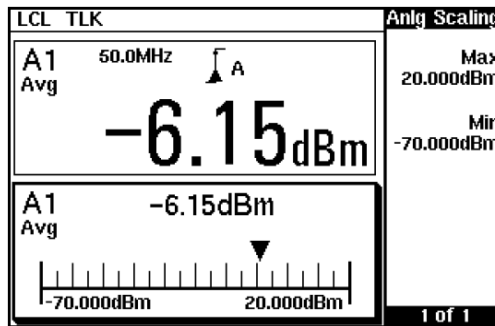

Configure a measurement displayed in **Analog** format as follows:

- Press **Meas Display**.
- Use the , , or  keys to select the analog measurement window.
- Press **Anlg Mtr Scaling**.





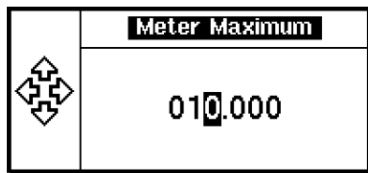

**Figure 3-20** Analog Display in Lower Window

The **Max** and **Min** scale values are shown on the analog display and adjacent to the softkey labels.

- Press **Max** and use the , , , and  keys to configure the required value in the Meter Maximum pop-up window. Press **dBm**, **mW**, **uW**, or **nW**, to complete the entry.



**Figure 3-21** Meter Maximum Pop-Up

- Similarly, press **Min** and use the , , , and  keys to configure the required value in the **Meter Minimum** pop-up window. Press **dBm**, **mW**, **uW**, or **nW**, to complete the entry.

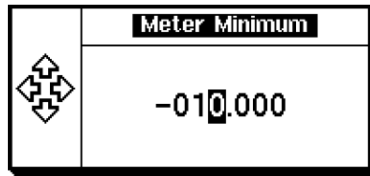

**Figure 3-22** Meter Minimum Pop-Up

**TIP** If you have selected linear scaling for the analog measurement and the units you require are outwith the range of the displayed menu, an additional menu is available. When the pop-up is displayed, you can press **More** to access the increment/decrement multiplier menu. Use the **Increment Multiplier** or to display the required units. Press the units softkey (**xW**) to complete the entry.

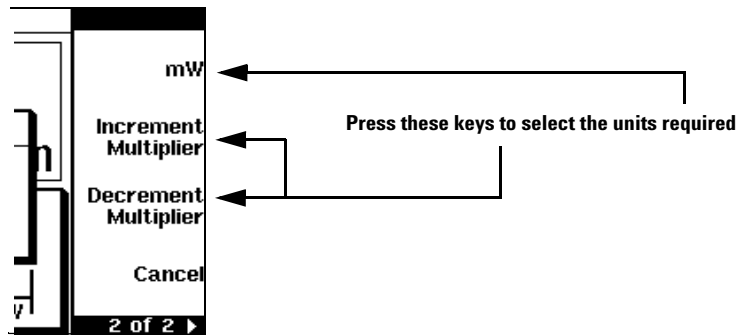

### Trace Format

Configure a measurement displayed in **Trace** format as follows:

- Press **Meas Display** and use the **↑**, **↓**, or **↕** keys to select the trace window.
- Press **Channel**, **Trace Setup** to display the Trace Setup menu.

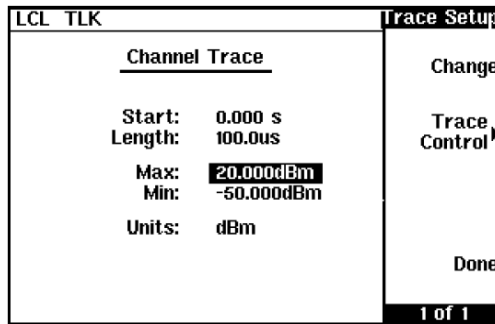

**Figure 3-23** Trace Display in Lower Window

- Use the **←**, **→**, **↑**, and **↓** keys to select the required parameter.
- Press **Change** and configure the required value in the pop-up window. Press **dBm** to complete the entry.

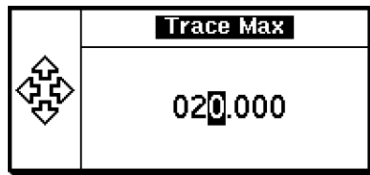

**Figure 3-24** Trace Maximum Pop-Up

- Similarly, select each parameter as required, completing the entry by pressing the appropriate units key.

**NOTE**

The trace start time is relative to your selected trigger point. Positive values start the trace up to one second after the trigger event. Use a negative value to start the trace up to one second before the trigger.

## Setting Up Using Trace Markers

Setting up a measurement using the trace markers requires less information about the signal you are measuring than the data entry method. Similar steps are required but in a different and less ordered manner. More iteration between the power meter controls may be required to complete the measurement set up.

While you can configure the display with several measurement results, there are some occasions where the information presented, as shown in [Figure 3-25](#), is sufficient and additional display set ups are not required.

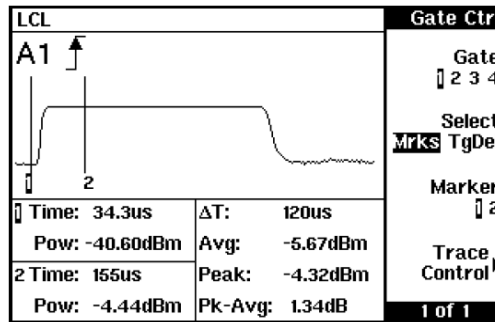

**Figure 3-25** Gate Control Menu and Display

**NOTE**

If the bandwidth of a modulated signal is unknown, you may discover during the set-up process, that a power sensor of lesser or greater bandwidth is required.

Loosely follow this process until you are familiar with the trace and marker controls.

- Channel – choose the sensor mode and range, configure filtering, averaging, bandwidth, and the RF frequency.
- Trigger – configure the trigger to ensure the meter is triggering on the required event.
- Gate – use the **Gate Ctrl** and **Trace Ctrl** menus to configure the timing of gates and trigger point on the displayed signal.
- Display – choose the display format for the measurements you want to make.
- Measurement Setup – assign the measurements to the displays you have set up.

#### Channel

Press Channel. Refer to “[Step 1. The Channel Setup](#)” on page 84 and configure the Channel Setup table with as much information as you have available. Confirm the **Video B/W:** and **Video Avg:** are set to **Off**. Bandwidth, filtering, and averaging can be readjusted later to improve measurement accuracy.

RMT TLK	Input Set
<b>Channel Setup</b>	Change
Sensor Mode: <b>Normal</b>	Gates ▶
Range: AUTO	Trace Setup ▶
Filter: AUTO 25%	Done
Duty Cycle: Off 1.000%	
Offset: Off 0.000dB	
Frequency: 50.000MHz	
CF Table: Off	
FDO Table: Off	
Video Avg: Off ◀	
Video B/W: Off	
Step Detect: On	1 of 1

**Figure 3-26** E-Series E9320 Power Sensor Default Channel Setup

#### NOTE

The Sensor Mode: must be set to Normal to allow access to the gate and trace control screens.

**Trigger** The power meter must be in a triggered mode to allow access to the gate and trace control screens.

Press **Trigger** and refer to “[Step 3. The Trigger Setup](#)” on page 90 to configure a suitable trigger. You can also configure trigger delay timing using markers.

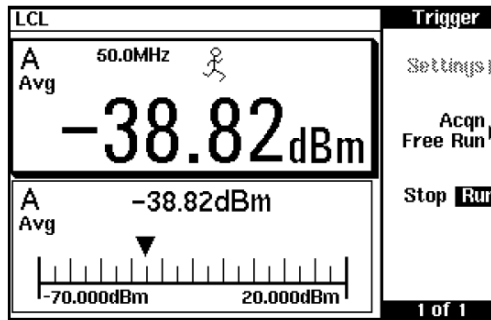

**Figure 3-27** Trigger Menu - Free Run Mode

**Gate** To access the gate control menu, press **Channel**, **Gates**, **Gate Control**.

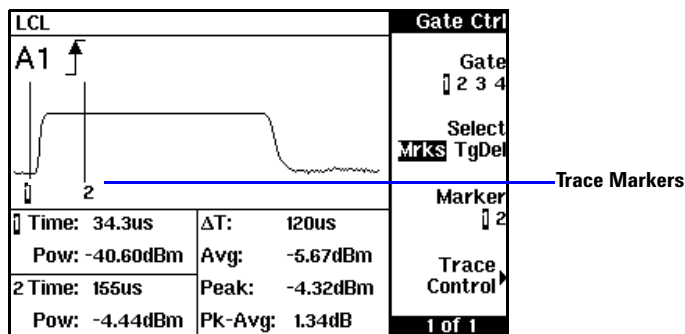
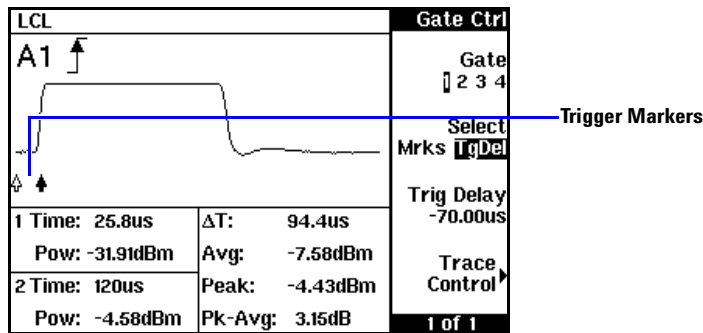

**Figure 3-28** Gate Control Menu and Display

- Gate** Pressing **Gate** scrolls through the four gates available for each channel. The gate displayed is highlighted below the **Gate** softkey and also in the channel/gate annotation in the top left of the display.
- Select** Pressing **Select** displays the gate or trigger markers.
- Mrks** When **Mrks** is selected, markers 1 and 2 indicate the start and end points of the measurement gate.
- Tgdel** When **Tgdel** is selected you can adjust the trigger delay. Again, refer to “[Step 3. The Trigger Setup](#)” on page 90 for more detail.

#### NOTE

Your chosen trigger point is used as the reference point for the timing of all the measurement gates.



**Figure 3-29** Trigger Marker - Negative Delay



Pressing the and hardkeys decreases or increases the trigger delay. Your chosen trigger point is indicated by . The trigger event is indicated by . The configured value is displayed below the **Trig Delay** softkey.





**Trig Delay** The trigger delay value is shown below the **Trig Delay** softkey.

You can also setup the trigger delay by pressing **Trig Delay** and entering a value in the pop-up window.







Pressing **Select** highlights **Mrks** to display the trace markers again.

**Marker 1 2** Press **Marker** to select the required marker. Press the  and  keys to move the selected marker.

## NOTE

Gate and trigger markers are moved one pixel when the  or  keys are pressed and released. They are moved up to five pixels at a time when the keys are pressed and held. To reduce the time interval represented by one pixel, decrease the length of the displayed trace.

**Trace Control** Press **Trace Control** to display the Trace Ctrl menu.

The vertical and horizontal parameters of the displayed trace are shown in a table. The , , , and  keys are used to select a parameter. Use the  or  softkeys to increase or decrease the selected parameter. Position and scale the trace display as required to ease setting up the gate markers.

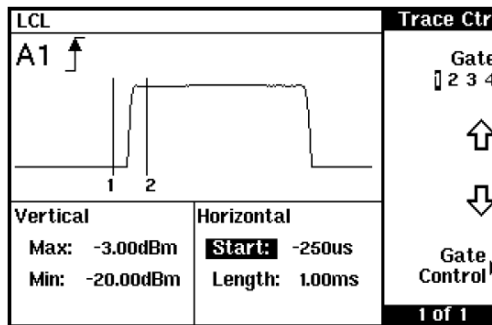

Figure 3-30 Trace Control Display

**TIP** To zoom in on a gate, first adjust the **Start:** parameter to place the gate markers at the left of the display. Next reduce the value of the **Length:** parameter. Readjust the **Start:** parameter as required. As the marker timings are related to the trigger point, they remain in a fixed position on the trace. Adjustments to the gate markers require the **Gate Ctrl** menu.

**Gate Control** Press **Gate Control** to display the **Gate Ctrl** screen and continue with the gate setup.

Repeat this process until you have configured all the gates required.

### Display

Now configure the display to show the measurement results you require by pressing **Meas Display**. Refer to “[Step 4. The Display Setup](#)” on page 96 for more information.

**TIP** If you choose to configure one of the windows with a trace display, you can quickly redisplay the Gate Ctrl screen by pressing **Meas Display**.

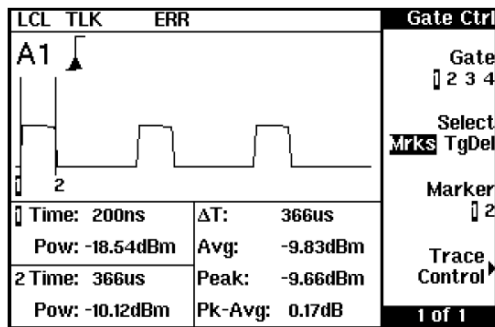

**Figure 3-31** Bluetooth Signal with Markers Shown





### Measurement Setup

When you have configured both windows with the required displays, set up the measurements as shown in “[Step 5. The Measurement Setup](#)” on page 98.

## Measurement Example

This measurement example configures the power meter to measure an Enhanced Data for Global Evolution (or Enhanced Data for GSM Evolution) signal. Triggering is achieved using the rising edge of the burst. As the power meter triggers during the rising power transition, the measurement gate is configured to measure the average power in a 520  $\mu$ s period, 20  $\mu$ s after triggering. The display is configured to show the peak and peak-to-average results in the lower window in numeric format, while the upper window shows the power trace starting 40  $\mu$ s before the trigger.

### Step 1. The Channel Setup

- 1 Press . The **Channel Setup** screen is displayed.
- 2 Select the channel you want to configure.
- 3 Use the , , ,  and **Change** keys to configure the settings listed in [Table 3-2](#).

**Table 3-2** Measurement Example Channel Setup

Parameter	Setting
Sensor Mode:	Normal
Range:	AUTO
Filter:	AUTO
Offset:	Off
Frequency:	900 MHz
FDO Table:	Off
Video Avg:	Off
Video B/W:	E9321A*, E9325A* – High E9322A, E9326A – Med E9323A, E9327A – Low
Step Detect:	On





\* The E9321A and E9325A sensors are best suited as they have the optimum dynamic range and low-level stability in the 300 kHz bandwidth.

**NOTE**

After a Preset, Video B/W defaults to High for all sensors.

**Step 2. The Gate Setup**

Only one gate is to be set up, starting 20  $\mu\text{s}$  after the trigger for a duration of 520  $\mu\text{s}$ .

- 1 Press **Gates**. The **Channel Gates** screen is displayed.
- 2 Use the , , , , and **Change** keys to configure the settings listed in [Table 3-3](#).

**Table 3-3** Measurement Example Gate Configurations

Parameter	Setting
Gate1 Start:	20 $\mu\text{s}$
Length:	520 $\mu\text{s}$
Gate2 Start:	0
Length:	0
Gate3 Start:	0
Length:	0
Gate4 Start:	0
Length:	0













### Step 3. The Trigger Setup

The trigger is now configured for a power level of  $-20$  dBm on a rising edge. A trigger hold off is also setup for  $4275$   $\mu$ s, disabling the trigger and ensuring the same time slot is measured at the next frame. Also, trigger hysteresis is included to prevent small power transitions during the burst causing retriggering.

Configure the Trigger as shown in [Table 3-4](#).







**Table 3-4** Measurement Example Trigger Configurations

Parameter	Setting
Acqn:	Cont Trig
Source:	Int (internal)
Trigger Level:	$-20$ dBm
Slope:	+ (rising)
Holdoff:	$4275$ $\mu$ s
Hysteresis:	$3.0$ dB
Output:	Off

- 1 Press **Trigger**. The **Trigger** menu is displayed.
- 2 Press **Acqn**, **Cont Trig**.
- 3 Press **Settings**, **Source**, **Int**.
- 4 Press **Mode**, **Norm**.
- 5 Press **Level**. Use the the , , , and  keys to set the trigger level to  $-20$  dBm.
- 6 Press **More** to access the second page of the menu.
- 7 Press **Slope** to select **+**.
- 8 Press **Holdoff**. Use the , , , and  keys to enter a value of  $4275$   $\mu$ s.
- 9 Press **Hysteresis**. Use the , , , and  keys to enter a value of  $3$  dBm.





















#### Step 4. The Display Setup

Before configuring the measurement, first setup the display for a dual numeric window and a trace window. Configure the display as follows:

- 1 Press . The **Disp Form** menu is displayed.
- 2 Use the , , or  keys to select the upper window.
- 3 Press **Disp Type**, **Trace**.
- 4 Use the , , or  keys to select the lower window.
- 5 Press **Dual Numeric**.

#### Step 5. The Measurement Setup

The dual numeric window is now configured to display the average power, and the peak to average ratio, in Gate 1. The trace window is configured to show the RF burst from 20  $\mu$ s ahead of the trigger for a duration of 700  $\mu$ s. Configure the Measurements as follows:

- 1 Press .
- 2 Use the , , or  keys to select the upper measurement in the lower window.
- 3 Press **Meas Select**. Use the , , , and  keys to setup an average measurement in Gate 1.
- 4 Press **Done**.
- 5 Use the , , or  keys to select the lower measurement in the lower window.
- 6 Press **Meas Select**. Use the , , , and  keys to setup a peak-to-average measurement in Gate 1.
- 7 Press **Done**.
- 8 Press .
- 9 Use the , , or  keys to select the upper window.
- 10 Press , and setup the parameters as follows:

**Table 3-5** Trace Setup Parameters

Parameters	Setting
Max	+20 dBm
Min	-35 dBm
Start	-40 $\mu$ s
Length	700 $\mu$ s

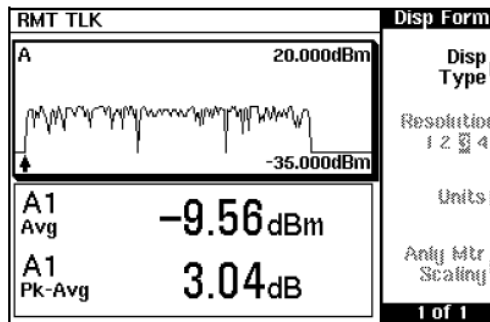

**Figure 3-32** Measurement Example Measurement Display

**TIP** If you require faster measurement speed, set the **Filter:** to **MAN** (Channel Setup screen) and reduce the filter value. Conversely, if you are measuring low power levels and want to improve the stability of the measurements, increase the filter value. Increasing the filter value however, reduces the measurement speed.

The maximum power level for the E9320 E-Series power sensors is +20 dBm.

Attenuation may be required when directly measuring transmitter output. Enter the value of the attenuation as an **Offset:** (Meas Setup, Meas Select) to correct the displayed measurement result.



## Using Preinstalled Measurement Setups

Preinstalled measurement setups for GSM900, EDGE, NADC, iDEN, Bluetooth, cdmaOne, W-CDMA, and cdma2000 help reduce the time required to measure these common wireless communications formats. They are accessed quickly by pressing the  key and using the cursor keys to select the required format from the displayed list.

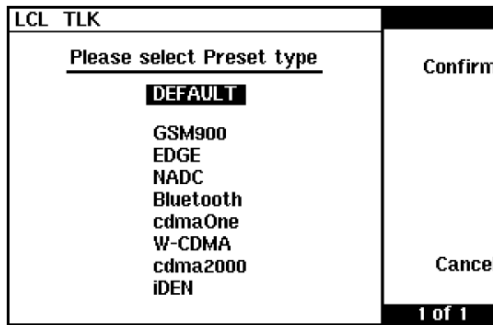



**Figure 3-33** Preset Selection Display

If required, you can modify the setups to suit your own needs and save them using [“Saving and Recalling Power Meter Configurations”](#) on page 66.

### NOTE

- When there are no power sensors connected, or sensors other than E9320 E-Series power sensors, the preinstalled setups menu keys are disabled.
- When an E-Series E9320 power sensor and a non E-Series E9320 power sensor are connected to a dual channel meter, only the channel connected to the E-Series E9320 power sensor is configured. The other channel is configured with default settings.
- When two E9320 E-Series power sensors are connected to a dual channel meter, both channels are configured with the same values, differing only when the desired bandwidth requires an appropriate setting for each sensor.

## Measuring GSM

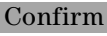
The GSM900 configuration is available by pressing  and using the ,  keys to select **GSM900**. Pressing  completes the process. The preinstalled setup configures the power meter for an average power measurement in a GSM RF burst. Triggering is achieved using the rising edge of the burst. The 'useful' part of the GSM burst lasts for 542.8  $\mu$ s with a rise time of 28  $\mu$ s. As the power meter triggers during the rising power transition, the measurement gate is configured to measure the average power in a 520  $\mu$ s period, 20  $\mu$ s after triggering.

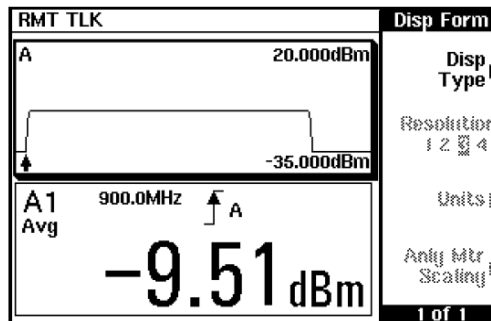

The display ([Figure 3-34](#)) is configured to show the average power in the lower window in numeric format, while the upper window shows the power trace starting 40  $\mu$ s before the trigger. [Table 3-6](#) shows the configuration.



**Figure 3-34** GSM Measurement Display

**Table 3-6** GSM900 Configurations

	Parameters	Setting
Channel	The E9321A and E9325A sensors are best suited as they have the optimum dynamic range and low-level stability in the 300 kHz bandwidth. (After a Preset, <b>Video B/W</b> defaults to <b>High</b> for all sensors.)	
	Sensor Mode:	Normal
	Range:	AUTO
	Filter:	AUTO
	Offset:	Off
	Frequency:	900 MHz
	FDO Table:	Off
	Video Avg:	Off
	Video B/W:	E9321A, E9325A – High E9322A, E9326A – Med E9323A, E9327A – Low
	Step Detect:	On
	Gates	Only one gate is set-up, starting 20 $\mu$ s after the trigger for a duration of 520 $\mu$ s.
Gate1 Start:		20 $\mu$ s
Length:		520 $\mu$ s
Gate2 Start:		0
Length:		0
Gate3 Start:		0
Length:		0
Gate4 Start:		0
Length:	0	
Trigger	The trigger is configured for –20 dBm on a rising edge. A trigger hold off is also setup for 4275 $\mu$ s, disabling the trigger for 7.5 time slots, ensuring the same time slot is measured in the next frame. Also, trigger hysteresis is included to prevent small power transitions during the burst causing re-triggering.	
	Acqn:	Cont Trig
	Source:	Int (internal)
	Level:	–20 dBm

	Parameters	Setting
	Mode:	Normal
	Slope:	+ (rising)
	Delay:	20 $\mu$ s
	Holdoff:	4275 $\mu$ s
	Hysteresis:	0.0 dB
	Output:	Off
	The display is setup for a single numeric window and a trace window.	
	Upper Window:	Trace
	Lower Window:	Single Numeric
	The trace window is configured to show the RF burst from 40 $\mu$ s ahead of the trigger for a duration of 700 $\mu$ s. The single numeric window is configured to display the average power in gate 1.	
Upper Window: (Trace)		
	Max	+20 dBm
	Min	-35 dBm
	Start	-40 $\mu$ s
	Length	700 $\mu$ s
Lower Window:		
	Upper Line: Gate 1:	Average measurement
	Lower Line: Gate 1:	Peak-to-average measurement



**TIP** If you require faster measurement speed, set the **Filter:** to **MAN** (Channel Setup screen) and reduce the filter value. Conversely, if you are measuring low power levels and want to improve the stability of the measurements, increase the filter value. Increasing the filter value however, reduces the measurement speed.

The maximum power level for the E9320 E-Series power sensors is +20 dBm.

Attenuation may be required when directly measuring GSM transmitter output.

Enter the value of the attenuation as an **Offset:** (, **Meas Select**) to correct the displayed measurement result.

## Measuring EDGE

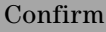
The EDGE configuration is available by pressing  and using the  and  keys to select EDGE. Pressing  completes the process.

Enhanced Data for Global Evolution or Enhanced Data for GSM Evolution is an enhancement of the GSM standard. The modulation scheme is 8PSK. As Edge does not have constant amplitude GMSK modulation like GSM, peak-to-average ratio may be of interest.

The preinstalled setup configures the power meter for average and peak-to-average power measurements in a GSM RF burst. Triggering is achieved using the rising edge of the burst. The 'useful' part of the GSM burst lasts for 542.8  $\mu$ s with a rise time of 28  $\mu$ s. As the power meter triggers during the rising power transition, the measurement gate is configured to measure the average power in a 520  $\mu$ s period, 20  $\mu$ s after triggering.

The display ([Figure 3-35](#)) is configured to show the peak and peak-to-average results in the lower window in numeric format while the upper window shows the power trace starting 40  $\mu$ s before the trigger.

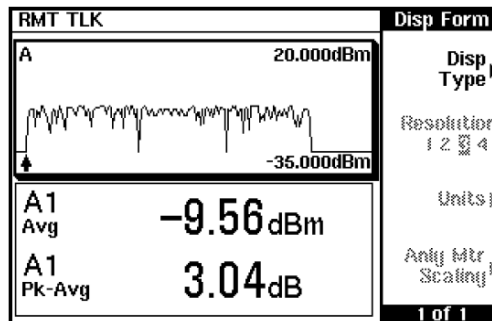

**Figure 3-35** EDGE Measurement Display

**Table 3-7** EDGE Configurations

	Parameters	Setting
Channel	The E9321A and E9325A sensors are best suited as they have the optimum dynamic range and low-level stability in the 300 kHz bandwidth. (After a Preset, <b>Video B/W</b> defaults to <b>High</b> for all sensors.)	
	Sensor Mode:	Normal
	Range:	AUTO
	Filter:	AUTO
	Offset:	Off
	Frequency:	900 MHz
	FDO Table:	Off
	Video Avg:	Off
	Video B/W:	E9321A, E9325A – High E9322A, E9326A – Med E9323A, E9327A – Low
	Step Detect:	On
Gates	Only one gate is set-up, starting 20 $\mu$ s after the trigger for a duration of 520 $\mu$ s.	
	Gate1 Start:	20 $\mu$ s
	Length:	520 $\mu$ s
	Gate2 Start:	0
	Length:	0
	Gate3 Start:	0
	Length:	0
	Gate4 Start:	0
	Length:	0
Trigger	The trigger is configured for –20 dBm on a rising edge. A trigger hold off is also setup for 4275 $\mu$ s, disabling the trigger for 7.5 time slots, ensuring the same time slot is measured in the next frame. Also, trigger hysteresis is included to prevent small power transitions during the burst causing re-triggering.	
	Acqn:	Cont Trig
	Source:	Int (internal)
	Level:	–20 dBm

Parameters	Setting
Mode:	Normal
Slope:	+ (rising)
Delay:	0
Holdoff:	4275 $\mu$ s
Hysteresis:	0.0 dB
Output:	Off

Meas  
Display

The display is setup for a dual numeric window and a trace window.

Upper Window:	Trace
Lower Window:	Dual Numeric

Meas  
Setup

The trace window is configured to show the RF burst from 40  $\mu$ s ahead of the trigger for a duration of 700  $\mu$ s. The single numeric window is configured to display the average power in gate 1.

Upper Window: (Trace)

Max	+20 dBm
Min	-35 dBm
Start	-40 $\mu$ s
Length	700 $\mu$ s

Lower Window:

Upper Line: Gate 1:	Average measurement
Lower Line: Gate 1:	Peak-to-average measurement

**TIP** If you require faster measurement speed, set the **Filter:** to **MAN** (Channel Setup screen) and reduce the filter value. Conversely, if you are measuring low power levels and want to improve the stability of the measurements, increase the filter value. Increasing the filter value however, reduces the measurement speed.

The maximum power level for the E9320 E-Series power sensors is +20 dBm.

Attenuation may be required when directly measuring transmitter output.

Enter the value of the attenuation as an **Offset:** (Meas Setup), (Meas Select) to correct the displayed measurement result.

## Measuring NADC

The NADC configuration is available by pressing (Preset Local) and using the the (Up) and (Down) keys to select NADC. Pressing (Confirm) completes the process.

The preinstalled setup configures the power meter for average power measurements of both active time slots in NADC or IS-136 'full rate' transmission. This assumes that there are two time slots in each frame to be measured, for example, time slots 0 in [Figure 3-36](#).

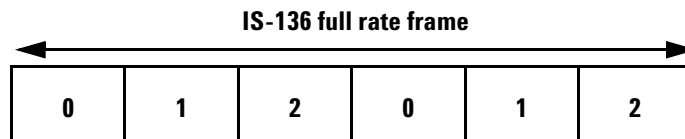

**Figure 3-36** Full Rate Frame

Triggering is achieved using the rising edge of the burst. The measurement gates are configured to measure the average power in two NADC time slots, separated by two inactive time slots. The rise time of an NADC TDMA burst is approximately 123.5  $\mu$ s (6 bits) and the 'useful' part of the



burst lasts approximately 6.4 ms. Gate 1 is configured to measure the average power in a 6.4 ms period, 123.5  $\mu$ s after triggering. Gate 2 is configured to measure the average power in a 6.4ms period, 20.123 ms (3 time slots plus rise times) after triggering.

The display (Figure 3-37) is configured to show the Gate 1 and Gate 2 average results in the lower window in numeric format, while the upper window shows the power trace starting 0.2 ms before the trigger.

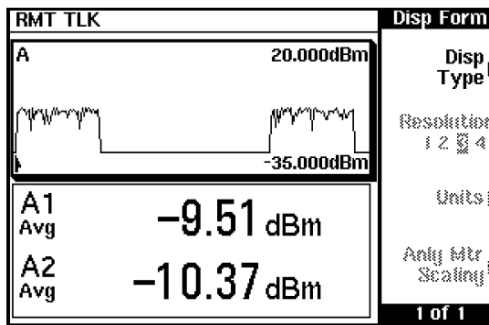

**Figure 3-37** NADC Measurement Display

**Table 3-8** NADC Configurations

Parameters	Setting
<b>Channel</b>	The narrow bandwidth of the NADC signal requires only the 30 kHz bandwidth of the E9321A and E9325A sensors in the Low setting and these are best suited. Other E9320 sensors may be used in their lowest setting but they provide less dynamic range and low-level stability. (After a Preset, <b>Video B/W</b> defaults to <b>High</b> for all sensors.)
Sensor Mode:	Normal
Range:	AUTO
Filter:	AUTO
Offset:	Off
Frequency:	800 MHz
FDO Table:	Off
Video Avg:	Off
Video B/W:	E9321A, E9325A – Low E9322A, E9326A – Low E9323A, E9327A – Low
Step Detect:	On
<b>Gates</b>	Two gates are configured as follows.
Gate1 Start:	123.5 $\mu$ s
Length:	6.46 $\mu$ s
Gate2 Start:	20.123 ms
Length:	6.46 ms
Gate3 Start:	0
Length:	0
Gate4 Start:	0
Length:	0
<b>Trigger</b>	The trigger is configured for a power level of $-20$ dBm on a rising edge. A trigger hold off is also setup for 30 ms, disabling the trigger for 4.5 time slots, ensuring the same time slot is measured each time.
Acqn:	Cont Trig
Source:	Int (internal)

Parameters	Setting
Level:	-20 dBm
Mode:	Normal
Slope:	+ (rising)
Delay:	0
Holdoff:	30 ms
Hysteresis:	0.0 dB
Output:	Off

Meas  
Display

The display is setup for a dual numeric window and a trace window.

Upper Window:	Trace
Lower Window:	Dual Numeric

Meas  
Setup

The dual numeric window is configured to display the average power in gate 1 and the average power in gate 2. The trace window is configured to show the RF burst from 0.2 ms ahead of the trigger for a duration of 28 ms.

Upper Window:

Max	+20 dBm
Min	-35 dBm
Start	-0.2 ms
Length	28 ms



Lower Window:

Upper Line: Gate 1:	Average measurement
Lower Line: Gate 2:	Average measurement





**TIP** If you require faster measurement speed, set the **Filter:** to **MAN** (Channel Setup screen) and reduce the filter value. Conversely, if you are measuring low power levels and want to improve the stability of the measurements, increase the filter value. Increasing the filter value however, reduces the measurement speed.

The maximum power level for the E9320 E-Series power sensors is +20 dBm.

Attenuation may be required when directly measuring GSM transmitter output.

Enter the value of the attenuation as an **Offset:** (, ) to correct the displayed measurement result.

## Measuring iDEN

The iDEN configuration is available by pressing  and using the  and  keys to select iDEN. Pressing  completes the process.

The preinstalled setup configures the power meter for average power and the peak-to-average power ratio measurements in one iDEN training and data pulse, and the average power in a 90 ms iDEN frame. Triggering is achieved using the rising edge of the training burst. Time gating is used to measure the average power in the following 15 ms pulse. The display is configured to show the peak-to-average ratio within the data pulse and the average power in the entire 90 ms frame on two display lines in the lower window while the upper window shows the average power in a 15 ms data pulse. All displays are numeric.

**Table 3-9** iDEN Configuration

	Parameters	Setting
Channel	The narrow bandwidth of the iDEN signal requires only the 30 kHz bandwidth of the E9321A and E9325A sensors in the Low setting and these are best suited. Other E9320 sensors may be used in their lowest setting but they provide less dynamic range and low-level stability.	
	Sensor Mode:	Normal
	Range:	AUTO
	Filter:	AUTO
	Offset:	Off
	Frequency:	800 MHz
	FDO Table:	Off
	Video Avg:	Off
	Video B/W:	E9321A, E9325A – Low E9322A, E9326A – Low E9323A, E9327A – Low
	Step Detect:	On
Gates	Two gates are configured as follows.	
	Gate1 Start:	10 $\mu$ s
	Length:	15 ms
	Gate2 Start:	0 s
	Length:	90 ms
	Gate3 Start:	0
	Length:	0
	Gate4 Start:	0
Length:	0	
Trigger	The trigger is now configured for a power level of –20 dBm on a rising edge. Auto-level triggering is also be used. A trigger hold off is also setup to ensure the power meter is not re triggered by the data pulse following the training pulse.	
	Acqn:	Cont Trig
	Source:	Int (internal)
	Level:	–20 dBm

Parameters	Setting
Mode:	Normal
Slope:	+ (rising)
Delay:	0
Holdoff:	20 ms
Hysteresis:	0.0 dB
Output:	Off

Meas Display

The display is setup for a dual numeric window and a single numeric window.

Upper Window: Single Numeric

Lower Window: Dual Numeric

Meas Setup

The dual numeric window is configured to display the peak-to-average ratio in gate 1 and the average power in gate 2. The single numeric window is configured to display the average power in gate 1.

Upper Window:

Gate 1: Average measurement

Lower Window:

Upper Line: Gate 1: Peak-to-average measurement

Lower Line: Gate 2: Average measurement



**TIP** If you require faster measurement speed, set the **Filter:** to **MAN** (Channel Setup screen) and reduce the filter value. Conversely, if you are measuring low power levels and want to improve the stability of the measurements, increase the filter value. Increasing the filter value however, reduces the measurement speed.

The maximum power level for the E9320 E-Series power sensors is +20 dBm.

Attenuation may be required when directly measuring GSM transmitter output.

Enter the value of the attenuation as an **Offset:** ( Meas Setup ), **Meas Select**) to correct the displayed measurement result.

## Measuring Bluetooth

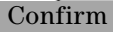
The Bluetooth configuration is available by pressing  and using the  and  keys to select **Bluetooth**. Pressing  completes the process.

The preinstalled setup configures the power meter for peak and average power measurements in a single Bluetooth DH1 data burst. Triggering is achieved using the rising edge of the burst. The measurement gate is configured to measure the peak and average power in a 366  $\mu$ s period, 0.2  $\mu$ s after the trigger.

The display ([Figure 3-38](#)) is configured to show the peak and average power in the lower window in numeric format, while the upper window shows the power trace over 6 time slots starting 50  $\mu$ s before the trigger.

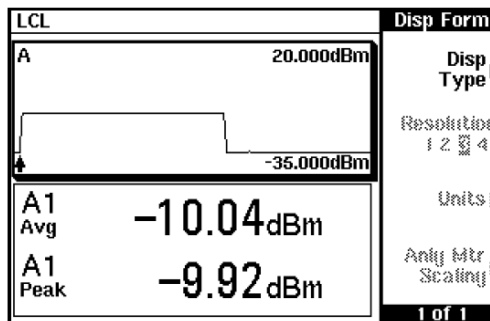

**Figure 3-38** Bluetooth Measurement Display

**Table 3-10** Bluetooth Configurations

	Parameters	Setting
Channel	The E9321A and E9325A are not recommended due to lack of bandwidth. (After a Preset, <b>Video B/W</b> defaults to <b>High</b> for all sensors.)	
	Sensor Mode:	Normal
	Range:	AUTO
	Filter:	AUTO
	Offset:	Off
	Frequency:	2400 MHz
	FDO Table:	Off
	Video Avg:	Off
	Video B/W:	E9322A, E9326A – Low E9323A, E9327A – Low
	Step Detect:	On
Gates	Only one gate is set up.	
	Gate1 Start:	0.2 $\mu$ s
	Length:	366 $\mu$ s
	Gate2 Start:	0
	Length:	0
	Gate3 Start:	0
	Length:	0
	Gate4 Start:	0
	Length:	0
Trigger	The trigger is now configured for a power level of $-20$ dBm on a rising edge. A trigger hold off is also setup for 650 $\mu$ s, disabling the trigger until the current time slot is measured.	
	Acqn:	Cont Trig
	Source:	Int (internal)
	Level:	$-20$ dBm
	Mode:	Normal
	Slope:	+ (rising)
	Delay:	0
	Holdoff:	650 $\mu$ s



Parameters	Setting
Hysteresis:	0.0 dB
Output:	Off

	The display is setup for a dual numeric window and a trace window.	
	Upper Window:	Trace
	Lower Window:	Dual Numeric

  

	The dual numeric window is configured to display the average power in gate 1 and the peak power in gate 1. The trace window is configured to show the RF burst from 50 $\mu$ s ahead of the trigger for a duration of 3.8 ms.	
	Upper Window:	
	Max	+20 dBm
	Min	-35 dBm
	Start	-50 $\mu$ s
	Length	3.8 ms
Lower Window:		
Upper Line: Gate 1:	Average measurement	
Lower Line: Gate 1:	Peak measurement	

**TIP** If you require faster measurement speed, set the **Filter:** to **MAN** (Channel Setup screen) and reduce the filter value. Conversely, if you are measuring low power levels and want to improve the stability of the measurements, increase the filter value. Increasing the filter value however, reduces the measurement speed.

The maximum power level for the E9320 E-Series power sensors is +20 dBm.

Attenuation may be required when directly measuring GSM transmitter output.

Enter the value of the attenuation as an **Offset:** (, **Meas Select**) to correct the displayed measurement result.

### 3 Using E9320 E-Series Power Sensors

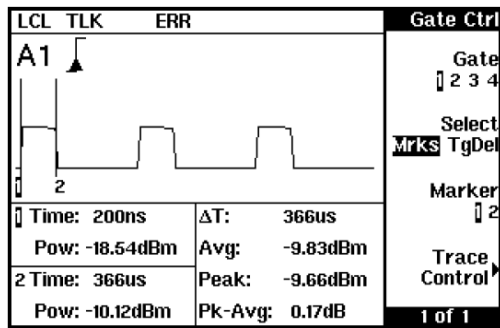



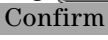

Figure 3-39 Markers on a Bluetooth Measurement

## Measuring cdmaOne

The cdmaOne configuration is available by pressing  and using the  and  keys to select cdmaOne. Pressing  completes the process.

The preinstalled setup configures the power meter for a continuous measurement on a cdmaOne signal. Peak and peak-to-average power measurements are made over a defined and statistically valid number of samples. With gated 10 ms measurements, corresponding to 200,000 samples, there is less than a 0.01% probability that there are no peaks above the measured peak value.

The display ([Figure 3-40](#)) is configured to show the peak, the average and the peak-to-average ratio.

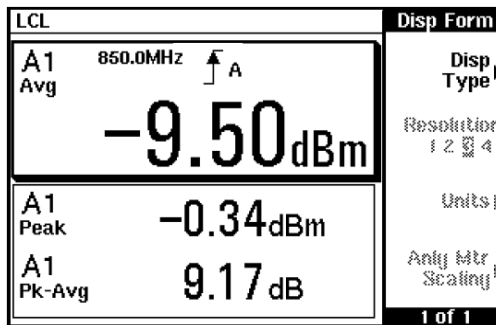

**Figure 3-40** cdmaOne Measurement Display

**Table 3-11** cdmaOne Configurations

	Parameters	Setting
Channel	The E9322A and E9326A sensors are best suited due to their 1.5 MHz bandwidth. The E9321A and E9325A are not recommended due to their lack of bandwidth. (After a Preset, <b>Video B/W</b> defaults to <b>High</b> for all sensors.)	
	Sensor Mode:	Normal
	Range:	AUTO
	Filter:	AUTO
	Offset:	Off
	Frequency:	8500 MHz
	FDO Table:	Off
	Video Avg:	Off
	Video B/W:	E9322A, E9326A – High E9323A, E9327A – Medium
	Step Detect:	On
Gates	Only one gate is set up, starting 1 $\mu$ s after the trigger for a duration of 10 ms.	
	Gate1 Start:	0 s
	Length:	10 ms
	Gate2 Start:	0
	Length:	0
	Gate3 Start:	0
	Length:	0
	Gate4 Start:	0
Length:	0	
Trigger	The trigger is configured for continuous triggering on a rising edge at $-10$ dBm. This results in continuously updated results based on a 10 ms period relating to a position beyond 0.01% on the CCDF curve.	
	Acqn:	Cont Trig
	Source:	Int (internal)
	Level:	$-10$ dBm
	Mode:	Auto Level
	Slope:	+ (rising)
	Delay:	0

Parameters	Setting
Holdoff:	0
Hysteresis:	0.0 dB
Output:	Off

Meas  
Display

The display is setup for a single numeric and a dual numeric window.

Upper Window: Single Numeric

Lower Window: Dual Numeric

Meas  
Setup

The single numeric window is configured to display the average power. The dual numeric window is configured to show the peak power and the peak-to-average ratio.

Upper Window:

Gate 1: Average measurement

Lower Window:

Upper Line: Gate 1: Average measurement

Lower Line: Gate 1: Ppeak-to-average measurement



**TIP** If you require faster measurement speed, set the **Filter:** to **MAN** (Channel Setup screen) and reduce the filter value. Conversely, if you are measuring low power levels and want to improve the stability of the measurements, increase the filter value. Increasing the filter value however, reduces the measurement speed.

The maximum power level for the E9320 E-Series power sensors is +20 dBm.

Attenuation may be required when directly measuring GSM transmitter output.

Enter the value of the attenuation as an **Offset:** (Meas Setup), Meas Select) to correct the displayed measurement result.

## Measuring W-CDMA

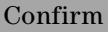
The W-CDMA configuration is available by pressing  and using the  and  keys to select W-CDMA. Pressing  completes the process.

The preinstalled setup configures the power meter for a continuous power measurement on a W-CDMA signal. Peak and peak-to-average power measurements are made over a defined and statistically valid number of samples. With gated 10 ms measurements, corresponding to 200,000 samples, there is less than a 0.01% probability that there are no peaks above the measured peak value.

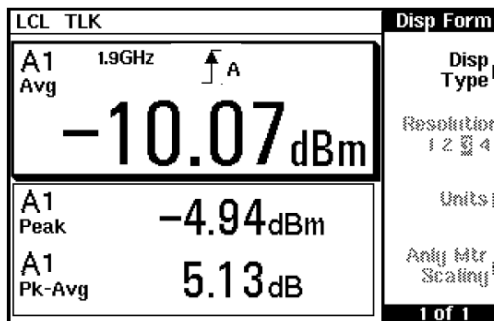

The display ([Figure 3-41](#)) is configured to show the peak, the average and the peak-to-average ratio.



**Figure 3-41** W-CDMA Measurement Display

**Table 3-12** W-CDMA Configurations

Parameters	Setting
<b>Channel</b>	With 5 MHz bandwidth, the E9323A and E9327A sensors are best suited. The E9321A, E9322A, E9325A, and E9326A sensors are not recommended due to their lack of bandwidth (5 MHz required). (After a Preset, <b>Video B/W</b> defaults to <b>High</b> for all sensors.)
Sensor Mode:	Normal
Range:	AUTO
Filter:	AUTO
Offset:	Off
Frequency:	1900 MHz
FDO Table:	Off
Video Avg:	Off
Video B/W:	E9323A, E9327A - High
Step Detect:	On
<b>Gates</b>	Only one gate is set up, starting 1 $\mu$ s after the trigger for a duration of 10 ms.
Gate1 Start:	0 s
Length:	10 ms
Gate2 Start:	0
Length:	0
Gate3 Start:	0
Length:	0
Gate4 Start:	0
Length:	0
<b>Trigger</b>	The trigger is configured for continuous triggering on a rising edge at $-10$ dBm. This results in continuously updated results based on a 10 ms period relating to a position beyond 0.01% on the CCDF curve.
Acqn:	Cont Trig
Source:	Int (internal)
Level:	$-10$ dBm
Mode:	Auto Level
Slope:	+ (rising)
Delay:	0

	Parameters	Setting
	Holdoff:	0
	Hysteresis:	0.0 dB
	Output:	Off
	The display is setup for a single numeric and a dual numeric window.	
	Upper Window:	Single Numeric
	Lower Window:	Dual Numeric
	The single numeric window is configured to display the average power. The dual numeric window is configured to show the peak power and the peak-to-average ratio.	
	Upper Window:	
	Gate 1:	Average measurement
	Lower Window:	
	Upper Line: Gate 1:	Peak measurement
	Lower Line: Gate 1:	Peak-to-average measurement

**TIP** If you require faster measurement speed, set the **Filter:** to **MAN** (Channel Setup screen) and reduce the filter value. Conversely, if you are measuring low power levels and want to improve the stability of the measurements, increase the filter value. Increasing the filter value however, reduces the measurement speed.

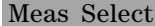

The maximum power level for the E9320 E-Series power sensors is +20 dBm.

Attenuation may be required when directly measuring GSM transmitter output.

Enter the value of the attenuation as an **Offset:** (, ) to correct the displayed measurement result.

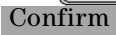

## Measuring cdma2000

The cdma2000 configuration is available by pressing  and using the  and  keys to select cdma2000. Pressing  completes the process.

The preinstalled setup configures the power meter for a continuous power measurement on a cdma2000 signal. Peak and peak-to-average power measurements are made over a defined and statistically valid number of samples. With gated 10 ms measurements, corresponding to 200,000 samples, there is less than a 0.01% probability that there are no peaks above the measured peak value.

The display ([Figure 3-42](#)) is configured to show the peak, the average and the peak-to-average ratio.

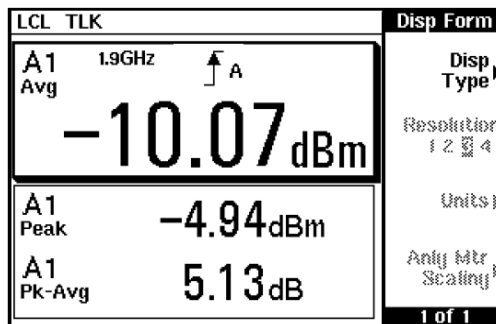

**Figure 3-42** Typical cdma2000 Measurement Display

**Table 3-13** cdma2000 Configurations

Parameters	Setting
<b>Channel</b>	With 5 MHz bandwidth, the E9323A and E9327A sensors are best suited. The E9321A, E9322A, E9325A, and E9326A sensors are not recommended due to their lack of bandwidth (5 MHz required). (After a Preset, <b>Video B/W</b> defaults to <b>High</b> for all sensors.)
Sensor Mode:	Normal
Range:	AUTO
Filter:	AUTO
Offset:	Off
Frequency:	1900 MHz
FDO Table:	Off
Video Avg:	Off
Video B/W:	E9323A, E9327A – High
Step Detect:	On
<b>Gates</b>	Only one gate is set up, starting 1 $\mu$ s after the trigger for a duration of 10 ms.
Gate1 Start:	0 s
Length:	10 ms
Gate2 Start:	0
Length:	0
Gate3 Start:	0
Length:	0
Gate4 Start:	0
Length:	0
<b>Trigger</b>	The trigger is configured for continuous triggering on a rising edge at –10 dBm. This results in continuously updated results based on a 10 ms period relating to a position beyond 0.01% on the CCDF curve.
Acqn:	Cont Trig
Source:	Int (internal)
Level:	–10 dBm
Mode:	Auto Level
Slope:	+ (rising)
Delay:	0

Parameters	Setting
Holdoff:	0
Hysteresis:	0.0 dB
Output:	Off

Meas  
Display

The display is setup for a single numeric and a dual numeric window.

Upper window:	Single Numeric
Lower Window:	Dual Numeric

Meas  
Setup

The single numeric window is configured to display the average power. The dual numeric window is configured to show the peak power and the peak-to-average ratio.

Upper Window:

Gate 1:	Average measurement
---------	---------------------

Lower Window:

Upper Line: Gate 1:	Peak measurement
Lower Line: Gate 1:	Peak-to-average measurement

**TIP** If you require faster measurement speed, set the **Filter:** to **MAN** (Channel Setup screen) and reduce the filter value. Conversely, if you are measuring low power levels and want to improve the stability of the measurements, increase the filter value. Increasing the filter value however, reduces the measurement speed.

The maximum power level for the E9320 E-Series power sensors is +20 dBm.

Attenuation may be required when directly measuring GSM transmitter output.

Enter the value of the attenuation as an **Offset:** (  , **Meas Select** ) to correct the displayed measurement result.

**THIS PAGE HAS BEEN INTENTIONALLY LEFT BLANK.**



## 4 Using E9300 E-Series Power Sensors

Introduction	144
Power Meter Configuration	145
Measurement Accuracy	147
Measuring Spread Spectrum and Multitone Signals	149
Measuring TDMA Signals	152
Electromagnetic Compatibility (EMC) Measurements	155
Measurement Accuracy and Speed	156



## Introduction

The E9300 E-Series power sensors are true average, wide dynamic range RF microwave power sensors. They are based on a dual sensor diode pair/attenuator/diode pair. This technique ensures the diodes in the selected signal path are kept in their square law region, thus the output current (and voltage) is proportional to the input power. The diode pair/attenuator/diode pair assembly can yield the average of complex modulation formats across a wide dynamic range, irrespective of signal bandwidth. Further refinements are included to improve power handling allowing accurate measurement of high level signals with high crest factors without incurring damage to the sensor.

These sensors measure average RF power on a wide variety of modulated signals and are independent of the modulation bandwidth. They are ideally suited to the average power measurement of multi-tone and spread spectrum signals such as CDMA, W-CDMA and digital television formats.

Please refer to the documentation supplied with your E-Series E9300 power sensor for specification and calibration information.

## Power Meter Configuration

The EPM-P Series power meters automatically recognize an E-Series E9300 power sensor when it is connected. The sensor calibration data is automatically read by the power meter. The power meter also configures the auto-averaging settings shown in Figure 4-1 to suit the power sensor characteristics.

	E9300/1/4A	E9300/1H	E9300/1B	Maximum Sensor Power	Resolution Setting				Number of Averages
					1	2	3	4	
Sensor Dynamic Range	Upper Range	10 dBm	20 dBm	40 dBm	1	1	1	4	
		2 dBm	12 dBm	32 dBm	1	1	4	16	
		-4 dBm	6 dBm	26 dBm	1	1	8	32	
		-10 dBm	0 dBm	20 dBm	1	4	16	128	
					1	16	64	128	
	Lower Range	-20 dBm	-10 dBm	10 dBm	1	1	1	4	
		-30 dBm	-20 dBm	0 dBm	1	1	2	16	
		-40 dBm	-30 dBm	-10 dBm	1	2	16	64	
					4	16	128	256	
		-50 dBm	-40 dBm	-20 dBm	32	64	256	256	
			Minimum Sensor Power						

**Figure 4-1** E9300 E-Series Auto-Averaging Settings

### NOTE

These values are valid only for the power meter channel connected to the E-Series E9300 power sensor and only while the sensor is connected. You can also configure the settings manually – refer to “Achieving Stable Results with TDMA Signals” on page 152 if required.

## Default Channel Setup

When an E-Series E9300 power sensor is connected the following, **Channel Setup** is automatically configured. Carrying out a Preset returns the power meter to this configuration.

Any changes made to the **Channel Setup** are retained after a power cycle.

RMT TLK	Input Set
<b>Channel Setup</b>	
Sensor Mode: <i>AVG only</i>	<b>Change</b>
Range: <b>AUTO</b>	Gates▶
Filter: <b>AUTO</b> 128	Trace▶
Duty Cycle: <b>Off</b> 1.000%	Setup▶
Offset: <b>Off</b> 0.000dB	<b>Done</b>
Frequency: <b>50.000MHz</b>	
CF Table: <b>Off</b>	
FDO Table: <b>Off</b>	
Video Avg: <b>Off</b> 4	
Video B/W: <b>Off</b>	
Step Detect: <b>On</b>	<b>1 of 1</b>

**Figure 4-2** E9300 E-Series Sensor Default Channel Setup



## Measurement Accuracy

Power sensors have small errors in their response over frequency. The response of each sensor is measured during manufacture to determine correction factors. With E-Series power sensors, correction factors are held in Electrically Erasable Programmable Read Only Memory (EEPROM) and are downloaded to the power meter automatically.

Using calibration factors enables improved measurement accuracy. This section describes making average power measurements using the E9300 E-Series power sensors.

Making a measurement requires the following steps:

- 1 Zero and calibrate the power meter/sensor combination.
- 2 Set the frequency for the signal you want to measure.
- 3 Make the measurement.

**Table 4-1** Power Sensor Connection Requirements

Sensor	Connection requirements
E9300A E9300H E9301A E9301H E9304A	These power sensors connect directly to the POWER REF.
E9300B E9301B	These power sensors are configured with an attenuator. Prior to calibration this attenuator must be removed. Replace the attenuator before making measurements.

### Procedure

First zero and calibrate the power meter/sensor combination.

- 1 Ensure the power sensor is disconnected from any signal source.
- 2 Press  and the channel **Zero** softkey to zero the channel. The **Zeroing** message and wait symbol are displayed.
- 3 Connect the power sensor to the POWER REF output using the connection method specified in [Table 4-1](#) on page 147.

- 4 Press the channel **Cal** softkey to start the calibration routine. The **Calibrating** message and wait symbol are displayed.

**TIP** You can reduce the steps required to carry out the zero and calibration procedure as follows:

- Connect the power sensor to the POWER REF output.
- Press **Zero Cal** and **Zero + Cal**. (For dual channel meters, press **Zero + Cal**, **Zero + Cal A** or **Zero + Cal B** as required.)

Now set the frequency of the signal you want to measure. The power meter automatically selects the appropriate calibration factor.

- 5 Press **Frequency Cal Fac** and the channel **Freq** softkey to display the **Frequency** pop-up window.

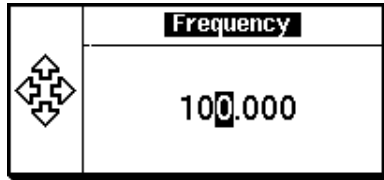

**Figure 4-3** Frequency Pop-Up Window

Use the **←**, **→**, **↑**, and **↓** keys to enter the frequency of the signal you want to measure.

- 6 Press **GHz** or **MHz** as required to complete the entry.

Now make the measurement.

- 7 Reconnect any required attenuators or adaptors and connect the power sensor to the signal to be measured.

The corrected measurement result is displayed.

## Measuring Spread Spectrum and Multitone Signals

To achieve high data transfer rates within a given bandwidth, many transmission schemes are based around phase and amplitude (I and Q) modulation. These include CDMA, W-CDMA and digital television. The signals are characterized by their appearance on a spectrum analyzer display – a high amplitude noise-like signal of bandwidths up to 20 MHz. An 8 MHz bandwidth digital television signal is shown in [Figure 4-4](#).

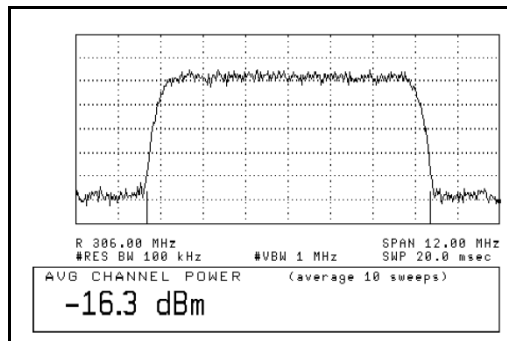

**Figure 4-4** Spread Spectrum Signal

The diode pair/attenuator/diode pair architecture of the E9300 E-Series power sensors is ideally suited to the average power measurement of these signals. The sensors have wide dynamic range (80 dB max, sensor dependent) and are bandwidth independent.

Some signal modulation formats such as orthogonal-frequency-division multiplexing (OFDM) and CDMA have large crest factors. The E-Series E9300/1/4A power sensors can measure +20 dBm average power even in the presence of +13 dB peaks but the peak pulse duration must be less than 10 microseconds. For high power applications, such as base-station testing, the E9300/1B and E9300/1H are recommended.

## CDMA Signal Measurements

Figure 4-5 and Figure 4-6 show typical results obtained when measuring a CDMA signal. In these examples, the error is determined by measuring the source at the amplitude of interest, with and without CDMA modulation, adding attenuation until the difference between the two values stops changing. The CW sensor in Figure 4-5 uses correction factors to correct for power levels beyond its square law operating region.

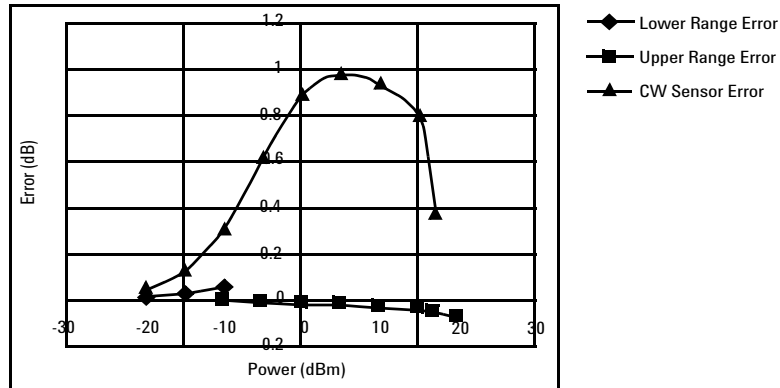

**Figure 4-5** Wideband CDMA Error of E-Series E9300 power sensor versus corrected CW sensor.

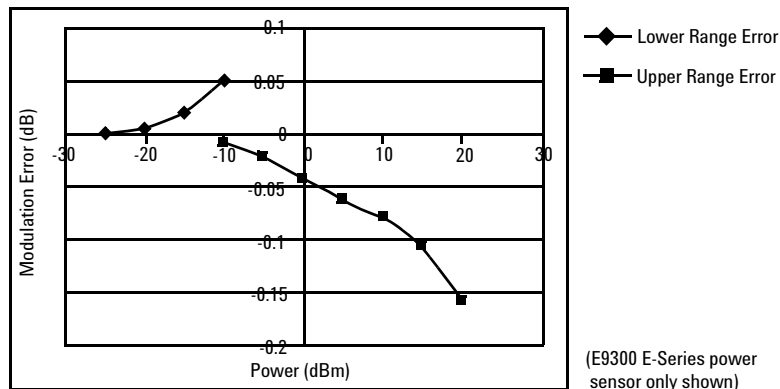

**Figure 4-6** CDMA (IS-95A): 9Ch Fwd

## Multitone Signal Measurements

In addition to wide dynamic range, the E9300 E-Series power sensors also have an exceptionally flat calibration factor versus frequency response as shown in Figure 4-7. This is ideal for amplifier intermodulation distortion measurements where the components of the two-tone or multitone test signal can be separated by hundreds of MHz.

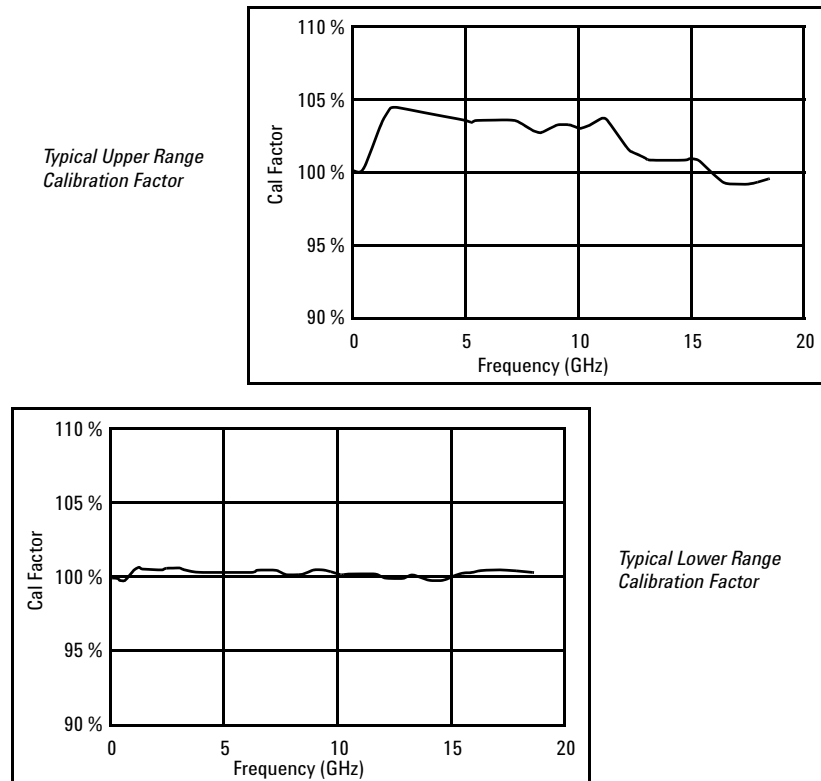

**Figure 4-7** Calibration Factors versus Frequency

Simply select a suitable single calibration factor frequency for your measurement using the  key on the power meter.

## Measuring TDMA Signals

### Power Meter and Sensor Operation

The voltages generated by the diode detectors in the power sensor can be very small. Gain and signal conditioning are required to allow accurate measurement. This is achieved using a 440 Hz square wave output from the power meter to drive a chopper-amplifier in the power sensor. Digital Signal Processing (DSP) of the generated square wave is used by the power meter to recover the power sensor output and accurately calculate the power level.



The chopper-amplifier technique provides noise immunity and allows large physical distances between power sensor and power meter (Agilent 11730 Series cables available up to 61 metres). Additional averaging helps reduce noise susceptibility.



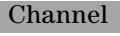

### Achieving Stable Results with TDMA Signals

The averaging settings in the power meter are designed to reduce noise when measuring continuous wave (CW) signals. Initial measurement of a pulsed signal may appear unstable with jitter on the less significant displayed digits. With pulsed signals, the averaging period must be increased to allow measurement over many cycles of the pulsed signal.

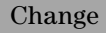
#### Procedure

Set the averaging as follows:

- 1 Press  to display the **Channel Setup** screen. In addition, on dual channel meters, you may need to press  to display the **Channel Setup** for the channel you want to use.
- 2 If **Filter: MAN** is not configured use  or  to highlight the **Filter:** setting.
- 3 Repeatedly press  to scroll through the choices; **AUTO**, **MAN**, and **OFF**. Choose **MAN**.

- 4 With **MAN** selected, use  to select the filter length value and press **Change**.
- 5 Use , , , and  to select and change the values as required.

Confirm your entry by pressing **Enter**.

(You can delete any changes and return to the Channel Setup simply by pressing **Cancel**.)



- 6 Press **Done** to complete the procedure.

## NOTE

You should also ensure the filter is not reset when a step increase or decrease in power is detected by switching the step detection off.

### Procedure

Switch off step detection as follows:

- 1 Press  to display the **Channel Setup**. In addition, on dual channel meters, you may need to press **Channel** to display the **Channel Setup** for the channel you want to use.
- 2 If **Step Detect:Off** is not configured use  or  to highlight the **Step Detect:** setting.
- 3 Press **Change** to select **Off**.
- 4 Press **Done** to complete the procedure.

## Achieving Stable Results with GSM Signals

Signals with a pulse repetition frequency (PRF) close to a multiple or sub-multiple of the 440 Hz chopper-amplifier signal generate a beat note at a frequency between the PRF and 440 Hz. Control over the filter settings is again required to obtain stable results.

**TIP** The PRF of a GSM signal is approximately 217 Hz and thus requires more averaging than most other TDMA signals. To achieve a stable measurement, use the filter setting procedures to set the **Length**. Experimentally, a **Length** setting of 148 gives optimum results although settings in the order of 31 or 32 give acceptable results if a faster measurement is required.



## Electromagnetic Compatibility (EMC) Measurements

The low frequency range of the E9304A make it the ideal choice for making EMC measurements to CISPR (Comite International Special Perturbations Radioelectriques) requirements, and electromagnetic interference (EMI) test applications such as the radiated immunity test (IEC61000-4-3).

DC coupling of the E9304A input allows excellent low frequency coverage. However, the presence of any dc voltages mixed with the signal has an adverse effect on the accuracy of the power measurement.

**CAUTION**

The E9304A sensor is DC coupled. DC voltages in excess of the maximum value (5 Vdc) can damage the sensing diode.

---

## Measurement Accuracy and Speed

The power meter has no internal ranges. The only ranges you can set are those of the E9300 E-Series power sensors (and other Agilent Technologies E-Series power sensors). With an E-Series E9300 power sensor the range can be set either automatically or manually. Use autorange when you are not sure of the power level you are about to measure.

### CAUTION

To prevent damage to your sensor, do not exceed the power levels specified in the sensor user's guide.

The E9304A sensor is DC coupled. DC voltages in excess of the maximum value (5 Vdc) can damage the sensing diode.

## Setting the Range

There are two manual settings, **LOWER** and **UPPER**. The **LOWER** range uses the more sensitive path and the **UPPER** range uses the attenuated path in the E9300 E-Series power sensors.

Sensor	LOWER range	UPPER range
E9300/1/4A	-60 dBm to -10 dBm	-10 dBm to +20 dBm
E9300/1B	-30 dBm to +20 dBm	+20 dBm to +44 dBm
E9300/1H	-50 dBm to 0 dBm	0 dBm to +30 dBm

The default is **AUTO**. In **AUTO**, the range crossover value depends on the sensor model being used.

E9300/1/4A	E9300/1B	E9300/1H
-10 dBm $\pm$ 0.5 dBm	+20 dBm $\pm$ 0.5 dBm	0 dBm $\pm$ 0.5 dBm

## Procedure

Set the range as follows:

- 1 Press **Channel** to display the **Channel Setup**. In addition, on dual channel meters, you may need to press **Channel** to display the **Channel Setup** for the channel you want to use.
- 2 Use **↑** or **↓** to highlight the **Range:** setting.
- 3 Press **Change** to scroll through the choices **AUTO**, **LOWER** or **UPPER** and choose as required.

Press **Done** to complete the procedure.

## Measurement Considerations

While autorange is a good starting point, it is not ideal for all measurements. Signal conditions such as crest factor or duty cycle may cause the power meter to select a range which is not the optimum configuration for your specific measurement needs. Signals with average power levels close to the range switch point require you to consider your needs for measurement accuracy and speed. For example, using an E9300/1/4A sensor, where the range switch point is  $-10 \pm 0.5$  dBm in a pulsed signal configured as follows:

Characteristic	Value
Peak Amplitude	-6 dBm
Duty Cycle	25%

The calculated average power is -12 dBm.

### Accuracy

The value of  $-12$  dBm lies in the lower range of the E-Series E9300 power sensor. In autorange mode (“**AUTO**”), the power meter determines the average power level is below  $-10$  dBm and selects the low power path. However, the peak amplitude of  $-6$  dBm is beyond the specified, square law response range of the low power path diodes. The high power path ( $-10$  dBm to  $+20$  dBm) should be used to ensure a more accurate measurement of this signal. However, range holding in “**UPPER**” (the high power path), for a more accurate measurement, results in considerably more filtering.

### Speed and Averaging

The same signal also requires that consideration is given to measurement speed. As shown above, in autorange mode the power meter selects the low power path in the E-Series E9300 power sensor. With auto-averaging also configured, minimal filtering is applied. Values of 1 to 4 for average power levels above  $-20$  dBm are used in the low power path. (Refer to “[E9300 E-Series Auto-Averaging Settings](#)” on page 145.)

If the range is held in “**UPPER**” for more accuracy, the measurement is slower. More filtering is applied due to the increase in noise susceptibility at the less sensitive area of the high power path. Values of 1 to 128 for average power levels less than  $-10$  dBm are used. (Again, refer to “[E9300 E-Series Auto-Averaging Settings](#)” on page 145.) Manually lowering the filter settings speeds up the measurement but can result in an unwanted level of jitter.

### Summary

Attention must be paid to signals whose average power levels are in the low power path range whilst their peaks are in the high power path range. You can achieve best accuracy by selecting the high power path or best speed by selecting the low power path.



## 5 Using E4410 E-Series Power Sensors

Introduction 160  
Power Meter Configuration 161  
Measurement Accuracy 163



## Introduction

The E4410 E-Series power sensors are diode based power sensors. They are intended for the measurement of CW microwave power levels in a wide dynamic range from  $-70$  dBm to  $+20$  dBm (100 pW to 100 mW). These are high-speed power sensors, and do not incorporate narrow-bandwidth averaging used in average-power sensors. Signals with digital, pulse, or other forms of amplitude modulation may introduce measurement errors.

Multi-tone signals (containing multiple frequency components), or signals with significant harmonic content ( $> -45$  dBc) may introduce measurement errors at high power levels.

Please refer to the documentation supplied with your E-Series E4410 power sensor for specification and calibration information.

## Power Meter Configuration

The EPM-P Series power meters automatically recognize an E-Series E4410 power sensor when it is connected. The sensor calibration data is automatically read by the power meter. Also, the power meter automatically configures the averaging as shown in [Figure 5-1](#).

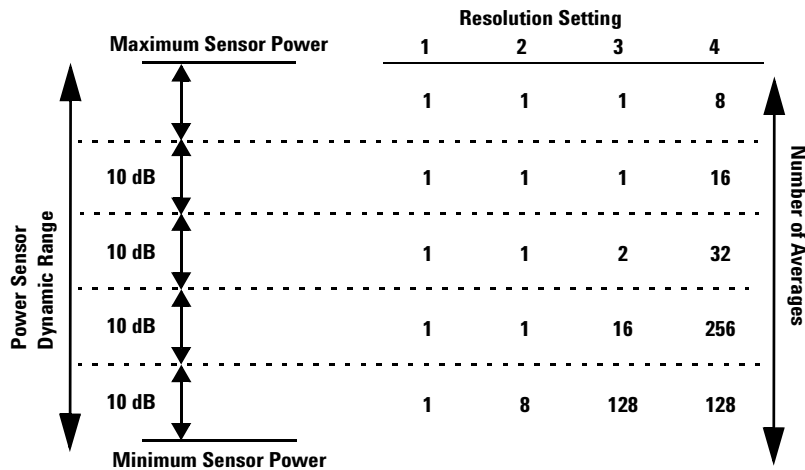

**Figure 5-1** E-Series CW sensor Auto-averaging settings

### NOTE

These values are valid only for the power meter channel connected to the E-Series E4410 power sensor and only while the sensor is connected. Averaging settings can also be manually configured.

## Default Channel Setup

When an E-Series E4410 power sensor is connected the following **Channel Setup** is automatically configured. Carrying out a Preset returns the channel to this configuration.

Any changes made to the **Channel Setup** are retained through a power cycle.

RMT TLK		Input Set
<u>Channel Setup</u>		Change
Sensor Mode:	AVG only	
Range:	<b>AUTO</b>	
Filter:	AUTO 128	Gates >
Duty Cycle:	Off 1000%	
Offset:	Off 0.000000	Trace
Frequency:	50.000MHz	Setup >
CF Table:	Off	
FDO Table:	Off	
Video Avg:	Off 4	Done
Video B/W:	Off	
Step Detect:	On	
		1 of 1

Figure 5-2 E-Series CW sensor default Channel Setup



## Measurement Accuracy

Power sensors have small errors in their response over frequency. The response of each sensor is measured during manufacture (and during periodic calibration). With E-Series power sensors, the resulting frequency compensation information is written into Electrically Erasable Programmable Read Only Memory (EEPROM). This allows the frequency and calibration data to be downloaded to the power meter automatically.

Using calibration factors enables you to achieve improved measurement accuracy. This section describes making continuous wave measurements using the E4410 E-Series power sensors.

Making a measurement requires the following steps:

- 1 Zero and calibrate the power meter/sensor combination.
- 2 Set the frequency for the signal you want to measure.
- 3 Make the measurement.

### Procedure

First zero and calibrate the power meter/sensor combination.

- 1 Ensure the power sensor is disconnected from any signal source.
- 2 Press  and the channel **Zero** softkey to zero the channel. The **Zeroing** message and wait symbol are displayed.
- 3 Connect the power sensor to the POWER REF output.
- 4 Press the channel **Cal** softkey to start the calibration routine. The **Calibrating** message and wait symbol are displayed.

**TIP** You can reduce the steps required to carry out the zero and calibration procedure as follows:



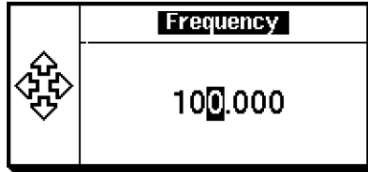

- Connect the power sensor to the POWER REF output.
- Press  and **Zero + Cal**. (For dual channel meters, press **Zero + Cal**, **Zero + Cal A** or **Zero + Cal B** as required.)

Now set the frequency of the signal you want to measure. The power meter automatically selects the appropriate calibration factor.

- 5 Press  and the channel **Freq** softkey to display the **Frequency** pop-up window.



**Figure 5-3** Frequency Pop-up Window

- 6 Use the , , , and  keys to enter the frequency of the signal you want to measure.
- 7 Press **GHz** or **MHz** as required to complete the entry.

Now make the measurement.

- 8 Connect the power sensor to the signal to be measured.

The corrected measurement result is displayed.



## 6 Using 8480 Series Power Sensors

Introduction	166
Power Meter Configuration	167
Measurement Accuracy	169
Frequency Specific Calibration Factors	170
Sensor Calibration Tables	176



## Introduction

The 8480 Series offers a wide range of both thermocouple and diode based power sensors. Many have very specific applications, for example the 110 GHz W8486A or the +44 dBm 8482B. However, they do not have their calibration factors stored in EEPROM, unlike all E-Series and N8480 Series power sensors (excluding Option CFT), which require that you use default calibration tables or manually enter the required correction factors. Likewise, they cannot be used to make peak or time gated measurements.

Please refer to the documentation supplied with your Agilent 8480 Series power sensors for specification and calibration information.

## Power Meter Configuration

The EPM-P Series power meters automatically recognize an 8480 Series power sensor when it is connected. The averaging settings shown in Figure 6-1 are automatically configured.

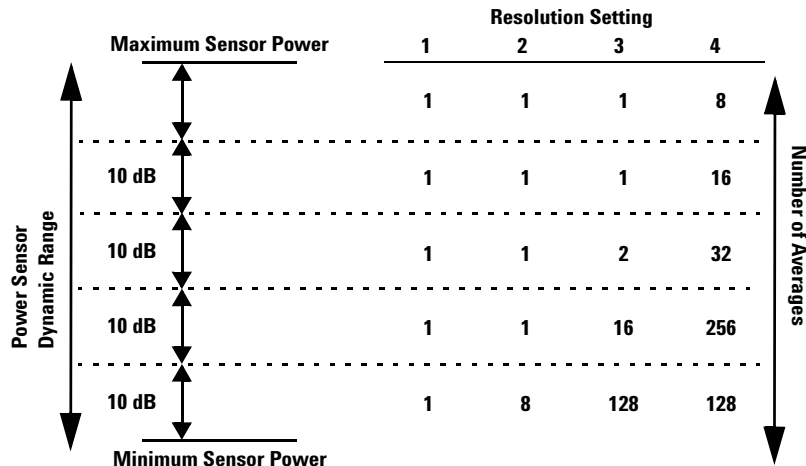

**Figure 6-1** 8480 Series Auto-Averaging Settings

### NOTE

These values are valid only for the power meter channel connected to the Agilent 8480 Series power sensors and only while the sensor is connected. Averaging settings can also be manually configured.

## Default Channel Setup

Figure 6-2 shows the **Channel Setup** configured automatically. Presetting returns the power meter to this configuration.

Any changes made to the **Channel Setup** are retained after a power cycle.

RMT TLK	Please Zero	Input Set
<b>Channel Setup</b>		<b>Change</b>
Sensor Mode:	AVG only	
Range:	AUTO	
Filter:	<b>AUTO</b> 128	Gates →
Duty Cycle:	Off 1.000%	
Offset:	Off 0.000dB	Trace Setup →
Cal Fac:	100.0%	
CF Table:	DEFAULT	
FDO Table:	Off	<b>Done</b>
Video Avg:	Off 4	
Video B/W:	Off	
Step Detect:	On	
		<b>1 of 1</b>

Figure 6-2 8480 Series Sensor Default Channel Setup

## Measurement Accuracy

Power sensors have small errors in their response over frequency. The response of each sensor is measured during manufacture (and during periodic calibration) and the resulting frequency compensation information is supplied in the form of calibration factors. Using calibration factors enables you to achieve improved measurement accuracy. The EPM-P Series peak power meters provide two methods of using the calibration factors:

- inputting the individual calibration factor for a frequency prior to making the measurement, or
- using sensor calibration tables.

If you are making most of your measurements at a single frequency, or in a narrow range of frequencies, entering a specific calibration factor is a more effective method. Only a minimal amount of data entry is required.

However, if you are making measurements on a wide range of signal frequencies, a sensor table is more effective as you only need to enter the frequency of the signal you are measuring. The power meter automatically selects and applies the calibration factor from the selected table.

## Frequency Specific Calibration Factors

This section shows you how to make a measurement using the calibration factor for the frequency of the signal you want to measure.



**TIP** This method is best suited to making several measurements at one frequency as you need only enter a small amount of data.

Using this method requires the following steps:

- 1 Zero and calibrate the power meter/sensor combination.
- 2 Set the calibration factor value for the frequency of the signal you want to measure.
- 3 Make the measurement.

### Procedure

First select and enter the reference calibration factor for the sensor you are using as follows:

- 1 Ensure the power sensor is disconnected from any signal source.
- 2 Refer to the connection requirements in [Table 6-1](#) and ensure the sensor is ready for connection to the Power Reference.
- 3 Check the current reference calibration factor setting by pressing , . The value is displayed under the channel  softkey.

Does this setting match the value for the sensor? (The power sensor reference calibration factor can normally be found above the calibration factors table on the power sensor body.)

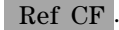
- 4 If required, change this setting by pressing the channel . The reference calibration factor pop-up window is displayed as shown in [Figure 6-3](#)



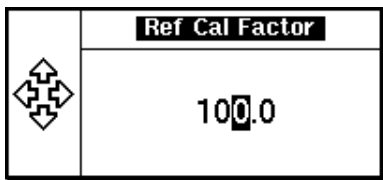

**Figure 6-3** Reference Calibration Factor Pop-Up Window

Modify this (see below) as required.

- Use or to highlight the digit you want to change.
- Use or to increment or decrement the highlighted digit.

**5** Confirm your choice by pressing .

Now zero and calibrate the power meter/sensor combination as follows:

- 6** Press and the channel softkey to zero the channel. The message and wait symbol are displayed.
- 7** Connect the power sensor to the POWER REF output.
- 8** Press the channel softkey to start the calibration routine. The message and wait symbol are displayed.

Now set the sensor calibration factor for the frequency of the signal you want to measure.

- 9** Check the current calibration factor setting by pressing . The value is displayed under the channel softkey.



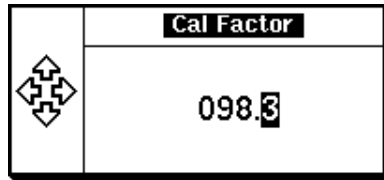

Does this setting match the value for the sensor at the frequency of the signal you want to measure? (The calibration factors are presented in table form on the power sensor body. You may need to interpolate between values if the specific frequency is not listed)

- 10** If required, change this setting by pressing the channel . The calibration factor pop-up window is displayed as shown in [Figure 6-4](#).



**Figure 6-4** Calibration Factor Pop-Up Window

Modify this (see below) as required.

- Use  or  to highlight the digit you want to change.
- Use  or  to increment or decrement the highlighted digit.

Confirm your choice by pressing .

Now make the measurement as follows:

**11** Connect the power sensor to the signal to be measured.

**12** The corrected measurement result is displayed.

**NOTE**

When no sensor tables are selected and **Single Numeric** display mode is chosen, the calibration factor used for the measurement is displayed in the upper window as shown in [Figure 6-5](#).

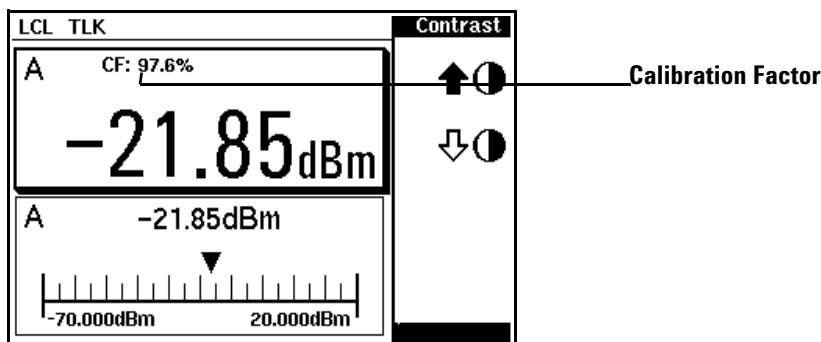

**Figure 6-5** Calibration Factor Displayed

**Table 6-1** 8480 Series Connection Requirements

Sensor	Connection requirements
<b>8481A</b> <b>8481H</b> <b>8482A</b> <b>8482H</b>	These power sensors connect directly to the POWER REF.
<b>8481D</b> <b>8484A</b>	Prior to calibration, an Agilent 11708A 30 dB reference attenuator should be connected between the power sensor and the POWER REF. Remove this attenuator from the power sensor input before making measurements.
<b>8483A</b>	This power sensor requires a 75 $\Omega$ (f) to 50 $\Omega$ (m) N-Type adapter (1250-0597) to connect to the POWER REF. Remove this adapter before making measurements.
<b>R8486A</b> <b>Q8486A</b> <b>V8486A</b> <b>W8486A</b> <b>R8486D</b> <b>Q8486D</b>	These waveguide power sensors have two connectors. Use the N-Type connector to calibrate the power meter.
<b>8481B</b> <b>8482B</b>	These power sensors are configured with an attenuator. Prior to calibration this attenuator must be removed. Replace the attenuator before making measurements.





**Table 6-1** 8480 Series Connection Requirements

Sensor	Connection requirements
<b>8485A</b>	This power sensor requires an APC 3.5 (f) to 50 $\Omega$ (m) N-Type adapter (08485-60005) to connect to the POWER REF. Remove this adapter before making measurements.
<b>8485D</b>	Prior to calibration, an Agilent 11708A 30 dB reference attenuator and an APC 3.5 (f) to 50 $\Omega$ (m) N-Type adapter (08485-60005) should be connected between the power sensor and the POWER REF. Remove this attenuator and adaptor before making measurements.
<b>8487A</b>	This sensor requires an APC 2.4 (f) to 50 $\Omega$ (m) N-Type adapter (08487-60001) to connect to the POWER REF. Remove this adapter before making measurements.
<b>8487D</b>	Prior to calibration, an Agilent 11708A 30 dB reference attenuator and an APC 2.4 (f) to 50 $\Omega$ (m) N-Type adapter (08487-60001) should be connected between the power sensor and the Power Ref. Remove this adapter before making measurements.

### Example

To make a measurement on channel A with a power sensor which has a reference calibration factor of 99.8% and a calibration factor of 97.6% at the measurement frequency.

- Disconnect the power sensor from any signal source.
- Press **Zero Cal**, **More**, **Ref CF %**.
- Use the **←**, **→**, **↑**, and **↓** keys to select and change the digits to display 99.8 in the pop-up window.
- Complete the entry by pressing **%**.
- Press **More** and the channel **Zero** softkey to zero the channel.
- When the zeroing routine is complete, connect the power sensor to the POWER REF output.
- Press the channel **Cal** softkey to start the calibration routine.
- When the calibration routine is complete press **Frequency Cal Fac**, **Cal Fac %**.

- Use the , , , and  keys to select and change the digits to display 97.6 in the pop-up window.
- Complete the entry by pressing .
- Connect the power sensor to the signal to be measured.
- The corrected measurement result is displayed.

## Sensor Calibration Tables

This section describes how to use sensor calibration tables. Sensor calibration tables store the measurement calibration factors, for a power sensor model or for a specific power sensor, in the power meter. They are used to correct measurement results.

**TIP** Use sensor calibration tables when you want to make power measurements over a range of frequencies using one or more power sensors.

The EPM-P Series power meters are capable of storing 20 sensor calibration tables each containing up to 80 frequency points. The power meter is supplied with a set of 9 predefined sensor calibration tables plus a “100%” default table. The data in these tables is based on statistical averages for a range of Agilent Technologies power sensors. Your own sensor will most likely differ from the typical to some degree. If you require best accuracy, create a custom table for each sensor you use as shown in [“Editing/Generating Sensor Calibration Tables”](#) on page 180.

Using power sensor tables require the following steps:

- 1 Choose the sensor table for the power sensor you are using and allocate it to the associated power meter channel.
- 2 Zero and calibrate the power meter. The reference calibration factor used during the calibration is automatically set by the power meter from the sensor calibration table.
- 3 Specify the frequency of the signal you want to measure. The calibration factor is automatically selected by the power meter from the sensor calibration table.
- 4 Make the measurement.

## Procedure

First select the table for the sensor you are using as follows:

- 1 Press **System**, **Tables**, **Sensor Cal Tables** to display the **Sensor Tbls** screen. The selected sensor table is indicated in the **State** column as shown in [Figure 6-6](#). The sensors are listed 1 to 9 with a further 10 (10 to 19) available as custom tables. The **Pts** column shows the number of data points in the table.
- 2 Use the **↑** and **↓** keys to select the sensor model you are using.
- 3 Press **Table On Off** to highlight **On**. The **State** changes to **on** as shown in [Figure 6-6](#).

LCL TLK				Sensor Tbls
Tbl	Name	State	Pts	
0	DEFAULT	off	2	
1	<b>HP8481A</b>	<b>on</b>	19	
2	HP8482A	off	12	
3	HP8483A	off	10	
4	HP8481D	off	21	
5	HP8485A	off	22	
6	R8486A	off	17	
7	Q8486A	off	19	
8	R8486D	off	17	
9	HP8487A	off	54	

Edit Table	Table
Off	<b>On</b>
Done	
<b>1 of 1</b>	

**Figure 6-6** Sensor Table Selected



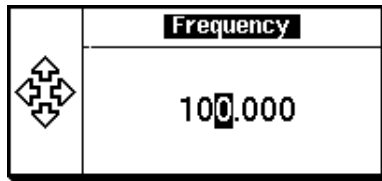

- 4 Press **Done** to complete the process.

Now enter the frequency of the signal you want to measure as follows:

- 5 Press **Frequency Cal Fac** and the channel **Freq** softkey to display the **Frequency** pop-up window.



**Figure 6-7** Frequency Pop-Up Window

6 Use the , , , and  keys to select and change the digits to match the frequency of the signal you want to measure.

7 Press **GHz** or **MHz** as required to complete the entry.

Now make the measurement.

8 Connect the power sensor to the signal to be measured.

9 The corrected measurement result is displayed.

**NOTE**

If the measurement frequency does not correspond directly to a frequency in the sensor calibration table, the power meter calculates the calibration factor using linear interpolation.

If you enter a frequency outside the frequency range defined in the sensor calibration table, the power meter uses the highest or lowest frequency point in the sensor calibration table to set the calibration factor.

**NOTE**

When **Single Numeric** display mode is chosen, the frequency you entered and the

sensor table identifier is displayed in the upper window. Also, pressing  displays the frequency you entered and calibration factor for each channel derived from the selected sensor tables.



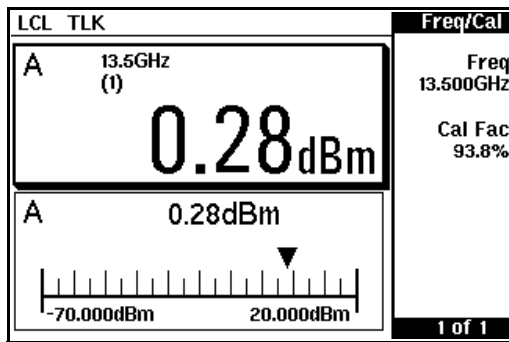

**Figure 6-8** Frequency/Calibration Table Display

## Editing/Generating Sensor Calibration Tables

To help achieve the best accuracy in your measurement, you can enter the values supplied for the sensors you are using by editing the installed sensor calibration tables or by generating your own custom tables. While you cannot delete any of the 20 sensor calibration tables, you can edit or delete their contents. If you need another table, you should edit and rename one of the tables. A maximum of 80 frequency/calibration factor data points can be stored in each table.

You can view the installed sensor tables by pressing **System**, **Tables**, **Sensor Cal Tables** to display the **Sensor Tbls** screen as shown in [Figure 6-6](#).

These power sensors are:

**Table 6-2** Installed Power Sensor Models

Table	Sensor model	Table	Sensor model
0	DEFAULT <sup>1</sup>	5	8485A
1	8481A	6	R8486A
2	8482A <sup>2</sup>	7	Q8486A
3	8483A	8	R8486D
4	8481D	9	8487A

<sup>1</sup> DEFAULT is a sensor calibration table where the reference calibration factor and calibration factors are 100%. This sensor calibration table can be used during the performance testing of the power meter.

<sup>2</sup> The Agilent 8482B and Agilent 8482H power sensors use the same data as the Agilent 8482A.

There are also ten sensor calibration tables named **CUSTOM\_0** through **CUSTOM\_9**. These tables do not contain any data when the power meter is shipped from the factory.

Editing or generating power sensor tables requires the following steps:

- 1 Identify and select the sensor table you want to edit or create.
- 2 Rename the table.
- 3 Edit/enter the frequency and calibration factor data pairs.
- 4 Save the table.



### Procedure

First select the table you want to edit or create as follows:

- 1 Press , **Tables**, **Sensor Cal Tables** to display the **Sensor Tbls** screen.

RMT TLK			Sensor Tbls
Tbl	Name	State Pts	
0	<b>DEFAULT</b>	off 2	<b>Edit Table</b> →
1	HP8481A	off 19	Table
2	HP8482A	off 12	<b>Off</b> On
3	HP8483A	off 10	
4	HP8481D	off 21	
5	HP8485A	off 22	
6	R8486A	off 17	
7	Q8486A	off 19	
8	R8486D	off 17	Done
9	HP8487A	off 54	
			<b>1 of 1</b>

**Figure 6-9** “Sensor Tbls” Screen

- 2 Choose the table you want to edit using the  and  keys. Press **Edit Table** to display the **Edit Cal** screen as shown in [Figure 6-10](#).

RMT TLK		Edit Cal
Name: <b>HP8481A</b>		Change
Ref CF: 100.0%		
Freq	Cal Fac	Insert
50.000MHz	100.0%	
100.000MHz	99.8%	
2.000GHz	99.0%	Delete
3.000GHz	98.6%	
4.000GHz	98.0%	
5.000GHz	97.7%	Done
6.000GHz	97.4%	
7.000GHz	97.1%	
		1 of 1







Figure 6-10 “Edit Cal” Screen

**NOTE**

A frequency in the range of 0.001 MHz to 999.999 GHz can be entered. A calibration factor in the range of 1% to 150% can be entered. The following rules apply to naming sensor calibration tables:

- The name must consist of no more than 12 characters.
- All characters must be upper or lower case alphabetic characters, or numeric (0 – 9), or an underscore (\_).
- No other characters are allowed.
- No spaces are allowed in the name.







Now change the title of the table as follows:

- 3 Highlight the table title using the  and  keys. Press **Change** and use the , , , and  keys to select and change the characters create the name you want to use.









- Pressing **Insert Char** adds a new character to the right of the selected character.
- Pressing **Delete Char** removes the selected character.

Press **Enter** to complete the entry.

Enter the reference calibration factor as follows:

- 4 Using the  and  keys, select the reference calibration factor value and press **Change**. Use the , , , and  keys to change the value to match the power sensor. Press **%** to complete the entry.

Edit and/or enter the frequency and calibration factor pairs as follows:

- 5 Use the , , , and  keys to select the frequency or calibration factors in the table.
- 6 Press **Change** and edit the value to match the sensor you want to use. Complete the entry by pressing the **%**, **GHz** or **MHz** keys.
- 7 Enter additional frequency/calibration factor pairs by pressing **Insert** when the **Edit Cal** screen is displayed. You are prompted to enter the frequency first followed by the respective calibration factor. The power meter automatically sets up the table in frequency ascending order.
- 8 When you have finished editing the table, press **Done**.
- 9 Use the , , , and  keys and the channel **Table Off On** to allocate the new table to the measurement channel.
- 10 Press **Done** to complete the editing process and save the table.

## NOTE

Ensure that the frequency points you use cover the frequency range of the signals you want to measure. If you measure a signal with a frequency outside the frequency range defined in the sensor calibration table, the power meter uses the highest or lowest frequency point in the sensor calibration table to calculate the calibration factor.

## Preinstalled Calibration Table Contents

The following lists detail the contents of the installed sensor calibration tables.

DEFAULT	
RCF	100
0.1 MHz	100
110 GHz	100
Agilent 8481A	
RCF	100
50 MHz	100
100 MHz	99.8
2 GHz	99
3 GHz	98.6
4 GHz	98
5 GHz	97.7
6 GHz	97.4
7 GHz	97.1
8 GHz	96.6
9 GHz	96.2
10 GHz	95.4
11 GHz	94.9
12.4 GHz	94.3
13 GHz	94.3
14 GHz	93.2
15 GHz	93
16 GHz	93
17 GHz	92.7
18 GHz	91.8
Agilent 8482A	
RCF	98
0.1 MHz	98
0.3 MHz	99.5
1 MHz	99.3
3 MHz	98.5
10 MHz	98.5
30 MHz	98.1
100 MHz	97.6
300 MHz	97.5
1 GHz	97
2 GHz	95
3 GHz	93

Agilent 8483A	
RCF	94.6
0.1 MHz	94
0.3 MHz	97.9
1 MHz	98.4
3 MHz	98.4
10 MHz	99.3
30 MHz	98.7
100 MHz	97.8
300 MHz	97.5
1 GHz	97.2
2 GHz	96.4
3 GHz	93
4 GHz	91
Agilent 8481D	
RCF	99
50 MHz	99
500 MHz	99.5
1 GHz	99.4
2 GHz	99.5
3 GHz	98.6
4 GHz	98.6
5 GHz	98.5
6 GHz	98.5
7 GHz	98.6
8 GHz	98.7
9 GHz	99.5
10 GHz	98.6
11 GHz	98.7
12 GHz	99
12.4 GHz	99.1
13 GHz	98.9
14 GHz	99.4
15 GHz	98.9
16 GHz	99.1
17 GHz	98.4
18 GHz	100.1

4.2 GHz	91
---------	----

--	--

<b>Agilent R8486A</b>	
RCF	100
50 MHz	100
26.5 GHz	94.9
27 GHz	94.9
28 GHz	95.4
29 GHz	94.3
30 GHz	94.1
31 GHz	93.5
32 GHz	93.7
33 GHz	93.7
34 GHz	94.9
34.5 GHz	94.5
35 GHz	94.4
36 GHz	93.7
37 GHz	94.9
38 GHz	93.5
39 GHz	93.9
40 GHz	92.3
<b>Agilent 8485A</b>	
RCF	100
50 MHz	100
2 GHz	99.5
4 GHz	98.9
6 GHz	98.5
8 GHz	98.3
10 GHz	98.1
11 GHz	97.8
12 GHz	97.6
12.4 GHz	97.6
14 GHz	97.4
16 GHz	97

<b>Agilent 8485A continued</b>	
17 GHz	96.7
18 GHz	96.6
19 GHz	96
20 GHz	96.1
21 GHz	96.2
22 GHz	95.3
23 GHz	94.9
24 GHz	94.3
25 GHz	92.4
26 GHz	92.2
26.5 GHz	92.1
<b>Agilent R8486D</b>	
RCF	97.6
50 MHz	97.6
26.5 GHz	97.1
27 GHz	95.3
28 GHz	94.2
29 GHz	94.5
30 GHz	96.6
31 GHz	97.6
32 GHz	98
33 GHz	98.9
34 GHz	99.5
34.5 GHz	99
35 GHz	97.6
36 GHz	99
37 GHz	98.2
38 GHz	97.4
39 GHz	97.6
40 GHz	100

<b>Agilent 8487A</b>	
RCF	100
50 MHz	100
100 MHz	99.9
500 MHz	98.6
1 GHz	99.8
2 GHz	99.5
3 GHz	98.9
4 GHz	98.8
5 GHz	98.6
6 GHz	98.5
7 GHz	98.4
8 GHz	98.3
9 GHz	98.3
10 GHz	98.3
11 GHz	98.1
12 GHz	97.9
13 GHz	98
14 GHz	98.2
15 GHz	97.7
16 GHz	96.8
17 GHz	97
18 GHz	96.3
19 GHz	95.9
20 GHz	95.2
21 GHz	95.6
22 GHz	95.5
23 GHz	95.4
24 GHz	95
25 GHz	95.4
26 GHz	95.2
27 GHz	95.1
28 GHz	95
29 GHz	94.4
30 GHz	94
31 GHz	93.7
32 GHz	93.8
33 GHz	93
34 GHz	93.2

<b>Agilent 8487A continued</b>	
34.5 GHz	93.5
35 GHz	93.1
36 GHz	92
37 GHz	92.4
38 GHz	90.9
39 GHz	91.3
40 GHz	91.4
41 GHz	90.6
42 GHz	89.9
43 GHz	89.1
44 GHz	88.1
45 GHz	86.9
46 GHz	85.8
47 GHz	85.4
48 GHz	83.2
49 GHz	81.6
50 GHz	80.2
<b>Agilent Q8486A</b>	
RCF	100
50 MHz	100
33.5 GHz	91.3
34.5 GHz	92
35 GHz	91.7
36 GHz	91.5
37 GHz	92.1
38 GHz	91.7
39 GHz	91
40 GHz	90.7
41 GHz	90.3
42 GHz	89.5
43 GHz	88.5
44 GHz	88.7
45 GHz	88.2
46 GHz	87
47 GHz	86.4
48 GHz	85.3
49 GHz	84.7
50 GHz	82.9





## 7 Using N8480 Series Power Sensors

Introduction 188  
Power Meter Configuration 190  
Measurement Accuracy 192



## Introduction

The N8480 Series power sensors is a replacement for the 8480 Series power sensors (excluding the D-model sensors) with built-in **Electrically Erasable Programmable Read-Only Memory (EEPROM)**<sup>1</sup>.

The N8480 Series power sensors is used for measuring the average power supplied by RF or microwave source or device-under-test (DUT). The N8480 Series power sensors places a 50 ohm load on the RF or microwave source. The power meter indicates the power dissipated in this load in W or dBm.

The N8480 sensors (excluding Option CFT) measure power levels from  $-35$  dBm to  $+20$  dBm ( $316$  nW to  $100$  mW), at frequencies from  $100$  kHz to  $33$  GHz and have two independent power measurement range (upper and lower range).

**Table 7-1** Power Range in Power Meter Range Setting

Sensor	Range Setting	Lower Range	Upper Range
N8481/2/5/7/8A and N8486AQ/AR excluding Option CFT	AUTO (Default)	$-35$ dBm to $-1$ dBm	$-1$ dBm to $+20$ dBm
	LOWER	$-35$ dBm to $-1$ dBm	-
	UPPER <sup>2</sup>	-	$-30$ dBm to $+20$ dBm
N8481/2B excluding Option CFT	AUTO (Default)	$-5$ dBm to $+29$ dBm	$+29$ dBm to $+44$ dBm
	LOWER	$-5$ dBm to $+29$ dBm	-
	UPPER <sup>2</sup>	-	$0$ dBm to $+44$ dBm
N8481/2H excluding Option CFT	AUTO (Default)	$-15$ dBm to $+17$ dBm	$+17$ dBm to $+35$ dBm
	LOWER	$-15$ dBm to $+17$ dBm	-
	UPPER <sup>2</sup>	-	$+10$ dBm to $+35$ dBm

Meanwhile, the N8480 sensors with Option CFT only measure power levels from  $-30$  dBm to  $+20$  dBm ( $1$   $\mu$ W to  $100$  mW) in single range.

Similar to the E-Series power sensors, the N8480 Series power sensors are also equipped with EEPROM to store sensor's characteristics such as model number, serial number, linearity, temperature compensation, calibration factor<sup>1</sup> and so forth. However, the calibration factor table stored in the EEPROM is not applicable for N8480 Series power sensors

with Option CFT. Therefore, you are required to use the default calibration tables or manually enter the required correction factors. Likewise, they cannot be used to make peak or time gated measurements.

The N8480 Series power sensors consist of four sensor model types with respective power range:

- A-models (–35 dBm to +20 dBm)
  - N8481A, N8482A, N8485A, N8487A, and N8488A
- B-models (–5 dBm to +44 dBm)
  - N8481B and N8482B
- H-models (–15 dBm to +35 dBm)
  - N8481H and N8482H
- Waveguide-models (–35 dBm to +20 dBm)
  - N8486AQ and N8486AR

Please refer to the documentation supplied with your Agilent N8480 Series power sensors for specification and calibration information.

<sup>1</sup> The calibration factor table stored in the EEPROM is not applicable for N8480 Series power sensors with Option CFT.

<sup>2</sup> Recommended for pulse signals measurement with period of more than one second.

## Power Meter Configuration

The EPM-P Series power meters automatically recognize an N8480 Series power sensor when it is connected. The averaging settings shown in Figure 7-1 are automatically configured.

	N8481/2/5/7A			Maximum Sensor Power	Resolution Setting			
	N8486AQ/AR	N8481/2B	N8481/2H		1	2	3	4
	0 dBm	30 dBm	20 dBm	↕	1	1	2	8
	-1 dBm	29 dBm	17 dBm	↕	2	2	4	32
	-10 dBm	20 dBm	10 dBm	↕	2	2	4	32
	-20 dBm	10 dBm	0 dBm	↕	2	2	16	256
	-30 dBm	0 dBm	-10 dBm	↕	2	8	128	128
				↕	4	64	256	512
				Minimum Sensor Power				

Sensor Dynamic Range (outermost vertical arrow)  
 Lower Range (middle-left vertical arrow)  
 Upper Range (middle-right vertical arrow)  
 Number of Averages (rightmost vertical arrow)

**Figure 7-1** N8480 Series Auto-Averaging Settings

### NOTE

These values are valid only for the power meter channel connected to the Agilent N8480 Series power sensors and only while the sensor is connected. Averaging settings can also be manually configured.

## Default Channel Setup

Figure 7-2 shows the **Channel Setup** configured automatically. Presetting returns the power meter to this configuration.

Any changes made to the **Channel Setup** are retained after a power cycle.

RMT TLK		Input Set
<b>Channel Setup</b>		
Sensor Mode:	AVG only	Change  Gates →  Trace Setup →  Done  1 of 1
Range:	<b>AUTO</b>	
Filter:	<b>AUTO</b> 256	
Duty Cycle:	Off 1.000%	
Offset:	Off 0.0001dB	
Frequency:	50.000MHz	
CF Table:	Off	
FDO Table:	Off	
Video Avg:	Off 4	
Video B/W:	Off	
Step Detect:	On	

Figure 7-2 N8480 Series Sensor (excluding Option CFT) Default Channel Setup

RMT TLK		Please Zero	Input Set
<b>Channel Setup</b>			
Sensor Mode:	AVG only	Change  Gates →  Trace Setup →  Done  1 of 1	
Range:	<b>AUTO</b>		
Filter:	<b>AUTO</b> 128		
Duty Cycle:	Off 1.000%		
Offset:	Off 0.0001dB		
Cal Fac:	100.0%		
CF Table:	DEFAULT		
FDO Table:	Off		
Video Avg:	Off 4		
Video B/W:	Off		
Step Detect:	On		

Figure 7-3 N8480 Series Sensor with Option CFT Default Channel Setup

## Measurement Accuracy

### **N8480 Series Power Sensors (excluding Option CFT)**

Power sensors have small errors in their response over frequency. The response of each sensor is measured during manufacture (and during periodic calibration). With N8480 Series power sensors (excluding Option CFT), the resulting frequency compensation information is written into Electrically Erasable Programmable Read Only Memory (EEPROM). This allows the frequency and calibration data to be downloaded to the power meter automatically.

Using calibration factors enables you to achieve improved measurement accuracy. This section describes making continuous wave measurements using the N8480 Series power sensors (excluding Option CFT).

Making a measurement requires the following steps:

- 1** Zero and calibrate the power meter/sensor combination.
- 2** Set the frequency for the signal you want to measure.
- 3** Make the measurement.

**Table 7-2** N8480 Series Power Sensors Connection Requirements

Sensor	Connection Requirements
N8481A N8481H N8482A N8482H	These power sensors connect directly to the POWER REF.
N8481B N8482B	These power sensors are configured with an attenuator. Prior to calibration this attenuator must be removed. Replace the attenuator before making measurements.
N8485A	This power sensor requires an APC 3.5 (f) to 50 $\Omega$ (m) N-Type adapter (08485-60005) to connect to the POWER REF. Remove this adapter before making measurements.
N8486AR N8486AQ	These waveguide power sensors have two connectors. Use the N-Type connector to calibrate the power meter.
N8487A N8488A	This sensor requires an APC 2.4 (f) to 50 $\Omega$ (m) N-Type adapter (08487-60001) to connect to the POWER REF. Remove this adapter before making measurements.

### Procedure

First zero and calibrate the power meter/sensor combination.

- 1 Ensure the power sensor is disconnected from any signal source.
- 2 Press  and the channel **Zero** softkey to zero the channel. The **Zeroing** message and wait symbol are displayed.
- 3 Connect the power sensor to the POWER REF output.
- 4 Press the channel **Cal** softkey to start the calibration routine. The **Calibrating** message and wait symbol are displayed.

**TIP** You can reduce the steps required to carry out the zero and calibration procedure as follows:



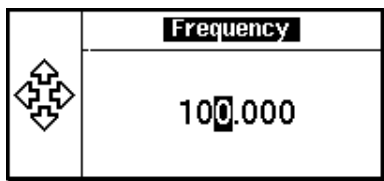

- Connect the power sensor to the POWER REF output.
- Press  and **Zero + Cal**. (For dual channel meters, press **Zero + Cal**, **Zero + Cal L**, or **Zero + Cal I** as required.)

Now set the frequency of the signal you want to measure. The power meter automatically selects the appropriate calibration factor.

- 5 Press  and the channel **Freq** softkey to display the **Frequency** pop-up window.



**Figure 7-4** Frequency Pop-Up Window

- 6 Use the , , , and  keys to enter the frequency of the signal you want to measure.
- 7 Press **GHz** or **MHz** as required to complete the entry.

Now make the measurement.

- 8 Connect the power sensor to the signal to be measured.

The corrected measurement result is displayed.

### N8480 Series Power Sensors with Option CFT

Similar to the 8480 Series sensors, the N8480 Series power sensors with Option CFT needs to apply corrections when making measurements across frequency as well. Therefore, you are required to enter calibration factor manually.

The calibration factor table written into Electrically Erasable Programmable Read Only Memory (EEPROM) is not applicable for N8480 Series power sensors with Option CFT. Therefore, the response of each sensor is measured during manufacture (and during periodic calibration) and the resulting frequency compensation information is supplied in the form of calibration factors. The EPM-P Series peak power meters provide two methods of using the calibration factors:

- inputting the individual calibration factor for a frequency prior to making the measurement, or



- using sensor calibration tables.

If you are making most of your measurements at a single frequency, or in a narrow range of frequencies, entering a specific calibration factor is a more effective method. Only a minimal amount of data entry is required.

However, if you are making measurements on a wide range of signal frequencies, a sensor table is more effective as you only need to enter the frequency of the signal you are measuring. The power meter automatically selects and applies the calibration factor from the selected table.

### Frequency Specific Calibration Factors

This section shows you how to make a measurement using the calibration factor for the frequency of the signal you want to measure.



**TIP** This method is best suited to making several measurements at one frequency as you need only enter a small amount of data.

Using this method requires the following steps:

- 1 Zero and calibrate the power meter/sensor combination.
- 2 Set the calibration factor value for the frequency of the signal you want to measure.
- 3 Make the measurement.

### Procedure

First select and enter the reference calibration factor for the sensor you are using as follows:

- 1 Ensure the power sensor is disconnected from any signal source.
- 2 Refer to the connection requirements in [Table 7-2](#) and ensure the sensor is ready for connection to the Power Reference.
- 3 Check the current reference calibration factor setting by pressing , . The value is displayed under the channel **Ref CF %** softkey.

Does this setting match the value for the sensor? (The power sensor reference calibration factor can normally be found above the calibration factors table on the power sensor body.)

- 4 If required, change this setting by pressing the channel **Ref CF**. The reference calibration factor pop-up window is displayed as shown in Figure 7-5.

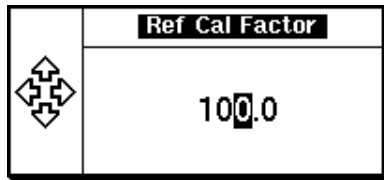

**Figure 7-5** Reference Calibration Factor Pop-Up Window

Modify this (see below) as required.

- Use or to highlight the digit you want to change.
- Use or to increment or decrement the highlighted digit.

- 5 Confirm your choice by pressing **%**.

Now zero and calibrate the power meter/sensor combination as follows:

- 6 Press and the channel **Zero** softkey to zero the channel. The **Zeroing** message and wait symbol are displayed.
- 7 Connect the power sensor to the POWER REF output.
- 8 Press the channel **Cal** softkey to start the calibration routine. The **Calibrating** message and wait symbol are displayed.

Now set the sensor calibration factor for the frequency of the signal you want to measure.

- 9 Check the current calibration factor setting by pressing . The value is displayed under the channel **Cal Fac %** softkey.



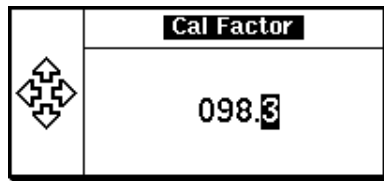

Does this setting match the value for the sensor at the frequency of the signal you want to measure? (The calibration factors are presented in table form on the power sensor body. You may need to interpolate between values if the specific frequency is not listed.)

**10** If required, change this setting by pressing the channel **Cal Fac %**. The calibration factor pop-up window is displayed as shown in [Figure 7-6](#).



**Figure 7-6** Calibration Factor Pop-Up Window

Modify this (see below) as required.

- Use  or  to highlight the digit you want to change.
- Use  or  to increment or decrement the highlighted digit.

Confirm your choice by pressing **%**.

Now make the measurement as follows:

**11** Connect the power sensor to the signal to be measured.

**12** The corrected measurement result is displayed.

#### NOTE

When no sensor tables are selected and **Single Numeric** display mode is chosen, the calibration factor used for the measurement is displayed in the upper window as shown in [Figure 7-7](#).

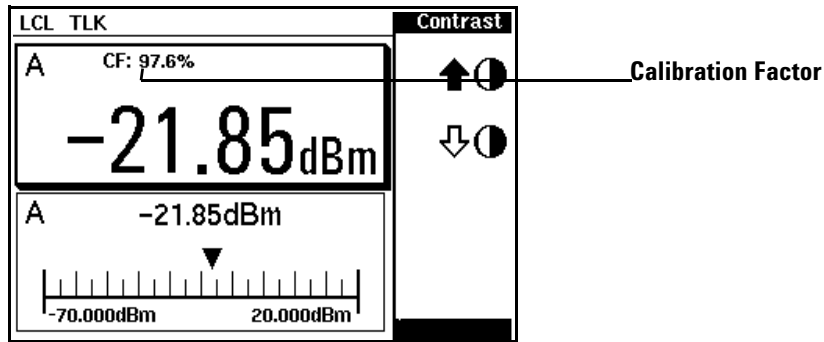

Figure 7-7 Calibration Factor Displayed

### Example

To make a measurement on channel A with a power sensor which has a reference calibration factor of 99.8% and a calibration factor of 97.6% at the measurement frequency.

- Disconnect the power sensor from any signal source.
- Press **Zero Cal**, **More**, **Ref CF %**.
- Use the **←**, **→**, **↑**, and **↓** keys to select and change the digits to display 99.8 in the pop-up window.
- Complete the entry by pressing **%**.
- Press **More** and the channel **Zero** softkey to zero the channel.
- When the zeroing routine is complete connect the power sensor to the POWER REF output.
- Press the channel **Cal** softkey to start the calibration routine.
- When the calibration routine is complete press **Frequency Cal Fac**, **Cal Fac %**.
- Use the **←**, **→**, **↑**, and **↓** keys to select and change the digits to display 97.6 in the pop-up window.
- Complete the entry by pressing **%**.
- Connect the power sensor to the signal to be measured.

- The corrected measurement result is displayed.

### Sensor Calibration Tables

This section describes how to use sensor calibration tables. Sensor calibration tables store the measurement calibration factors, for a power sensor model or for a specific power sensor, in the power meter. They are used to correct measurement results.

**TIP** Use sensor calibration tables when you want to make power measurements over a range of frequencies using one or more power sensors.

The EPM-P Series power meters are capable of storing 20 sensor calibration tables each containing up to 80 frequency points. The power meter is supplied with a set of 9 predefined sensor calibration tables plus a “100%” default table. The data in these tables is based on statistical averages for a range of Agilent Technologies power sensors. Your own sensor will most likely differ from the typical to some degree. If you require best accuracy, create a custom table for each sensor you use as shown in [“Editing/Generating Sensor Calibration Tables”](#) on page 202.

Using power sensor tables require the following steps:

- 1 Choose the sensor table for the power sensor you are using and allocate it to the associated power meter channel.
- 2 Zero and calibrate the power meter. The reference calibration factor used during the calibration is automatically set by the power meter from the sensor calibration table.
- 3 Specify the frequency of the signal you want to measure. The calibration factor is automatically selected by the power meter from the sensor calibration table.
- 4 Make the measurement.

**Procedure**

First select the table for the sensor you are using as follows:

- 1 Press **System**, **Tables**, **Sensor Cal Tables** to display the **Sensor Tbls** screen. The selected sensor table is indicated in the **State** column as shown in **Figure 7-8**. The sensors are listed 1 to 9 with a further 10 (10 to 19) available as custom tables. The **Pts** column shows the number of data points in the table.
- 2 Use the **Up** and **Down** keys to select the sensor model you are using.
- 3 Press **Table On Off** to highlight **On**. The **State** changes to **on** as shown in **Figure 7-8**.

LCL TLK				Sensor Tbls
Tbl	Name	State	Pts	
0	DEFAULT	off	2	
1	<b>HP8481A</b>	<b>on</b>	19	
2	HP8482A	off	12	
3	HP8483A	off	10	
4	HP8481D	off	21	
5	HP8485A	off	22	
6	R8486A	off	17	
7	Q8486A	off	19	
8	R8486D	off	17	
9	HP8487A	off	54	

Edit Table	Table
Off	<b>On</b>
Done	
<b>1 of 1</b>	

**Figure 7-8** Sensor Table Selected



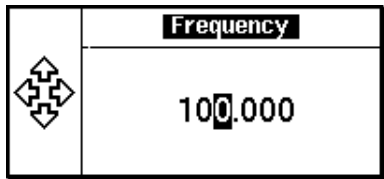

- 4 Press **Done** to complete the process.

Now enter the frequency of the signal you want to measure as follows:

- 5 Press **Frequency Cal Fac** and the channel **Freq** softkey to display the **Frequency** pop-up window.



**Figure 7-9** Frequency Pop-Up Window

- 6 Use the , , , and  keys to select and change the digits to match the frequency of the signal you want to measure.
  - 7 Press **GHz** or **MHz** as required to complete the entry.
- Now make the measurement.
- 8 Connect the power sensor to the signal to be measured.
  - 9 The corrected measurement result is displayed.

**NOTE**

If the measurement frequency does not correspond directly to a frequency in the sensor calibration table, the power meter calculates the calibration factor using linear interpolation.

If you enter a frequency outside the frequency range defined in the sensor calibration table, the power meter uses the highest or lowest frequency point in the sensor calibration table to set the calibration factor.

**NOTE**

When **Single Numeric** display mode is chosen, the frequency you entered and the

sensor table identifier is displayed in the upper window. Also, pressing  displays the frequency you entered and calibration factor for each channel derived from the selected sensor tables.

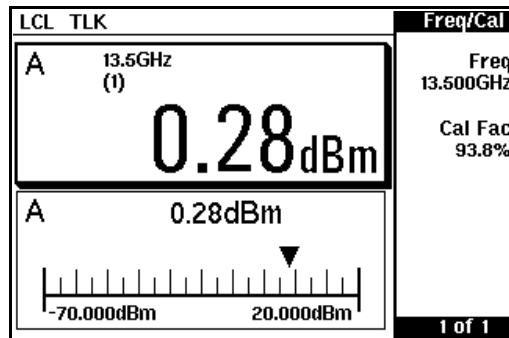



**Figure 7-10** Frequency/Calibration Table Display

## Editing/Generating Sensor Calibration Tables

### NOTE

Predefined sensor calibration factor table stored in power meter is not applicable for Agilent N8480 Series power sensors with Option CFT. Therefore, users are required to create a new sensor calibration table for the sensors when a sensor calibration table is needed.

To help achieve the best accuracy in your measurement, you can enter the values supplied for the sensors you are using by editing the installed sensor calibration tables or by generating your own custom tables. While you cannot delete any of the 20 sensor calibration tables, you can edit or delete their contents. If you need another table you should edit and re-name one of the tables. A maximum of 80 frequency/calibration factor data points can be stored in each table.

You can view the installed sensor tables by pressing , ,  to display the **Sensor Tbls** screen as shown in [Figure 7-8](#).

These power sensors are:

**Table 7-3** Installed Power Sensor Models

Table	Sensor model	Table	Sensor model
0	DEFAULT <sup>1</sup>	5	8485A
1	8481A	6	R8486A
2	8482A <sup>2</sup>	7	Q8486A
3	8483A	8	R8486D
4	8481D	9	8487A

<sup>1</sup> DEFAULT is a sensor calibration table where the reference calibration factor and calibration factors are 100%. This sensor calibration table can be used during the performance testing of the power meter.

<sup>2</sup> The Agilent 8482B and Agilent 8482H power sensors use the same data as the Agilent 8482A.



There are also ten sensor calibration tables named **CUSTOM\_0** through **CUSTOM\_9**. These tables do not contain any data when the power meter is shipped from the factory.

Editing or generating power sensor tables requires the following steps:

- 1 Identify and select the sensor table you want to edit or create.
- 2 Rename the table.
- 3 Edit/enter the frequency and calibration factor data pairs.
- 4 Save the table.

### Procedure

First select the table you want to edit or create as follows:

- 1 Press **System**, **Tables**, **Sensor Cal Tables** to display the **Sensor Tbls** screen.

RMT TLK			Sensor Tbls	
Tbl	Name	State	Pts	
0	DEFAULT	off	2	
1	HP8481A	off	19	
2	HP8482A	off	12	
3	HP8483A	off	10	
4	HP8481D	off	21	
5	HP8485A	off	22	
6	R8486A	off	17	
7	Q8486A	off	19	
8	R8486D	off	17	
9	HP8487A	off	54	

Edit  
Table →

Table

Off On

Done

1 of 1

**Figure 7-11** “Sensor Tbls” Screen

- 2 Choose the table you want to edit using the **↑** and **↓** keys. Press **Edit Table** to display the **Edit Cal** screen as shown in [Figure 7-12](#).

RMT TLK		Edit Cal
Name: <b>HP8481A</b>		Change
Ref CF: 100.0%		
Freq	Cal Fac	Insert
50.000MHz	100.0%	
100.000MHz	99.8%	
2.000GHz	99.0%	Delete
3.000GHz	98.6%	
4.000GHz	98.0%	
5.000GHz	97.7%	Done
6.000GHz	97.4%	
7.000GHz	97.1%	
		1 of 1







Figure 7-12 “Edit Cal” Screen

**NOTE**







A frequency in the range of 0.001 MHz to 999.999 GHz can be entered. A calibration factor in the range of 1% to 150% can be entered. The following rules apply to naming sensor calibration tables:

- The name must consist of no more than 12 characters.
- All characters must be upper or lower case alphabetic characters, or numeric (0 – 9), or an underscore (\_).
- No other characters are allowed.
- No spaces are allowed in the name.









Now change the title of the table as follows:

- 3 Highlight the table title using the  and  keys. Press **Change** and use the , , , and  keys to select and change the characters to create the name you want to use.
  - Pressing **Insert Char** adds a new character to the right of the selected character.
  - Pressing **Delete Char** removes the selected character.
 Press **Enter** to complete the entry.

Enter the reference calibration factor as follows:

- 4 Using the  and  keys, select the reference calibration factor value and press **Change**. Use the , , , and  keys to change the value to match the power sensor. Press **%** to complete the entry.

Edit and/or enter the frequency and calibration factor pairs as follows:

- 5 Use the , , , and  keys to select the frequency or calibration factors in the table.
- 6 Press **Change** and edit the value to match the sensor you want to use. Complete the entry by pressing the **%**, **GHz**, or **MHz** keys.
- 7 Enter additional frequency/calibration factor pairs by pressing **Insert** when the **Edit Cal** screen is displayed. You are prompted to enter the frequency first followed by the respective calibration factor. The power meter automatically sets up the table in frequency ascending order.
- 8 When you have finished editing the table press **Done**.
- 9 Use the , , , and  keys and the channel **Table Off Or** to allocate the new table to the measurement channel.
- 10 Press **Done** to complete the editing process and save the table.

## NOTE

Ensure that the frequency points you use cover the frequency range of the signals you want to measure. If you measure a signal with a frequency outside the frequency range defined in the sensor calibration table, the power meter uses the highest or lowest frequency point in the sensor calibration table to calculate the calibration factor.

**THIS PAGE HAS BEEN INTENTIONALLY LEFT BLANK.**



## 8 Maintenance

Self Test [208](#)

Error Messages [215](#)

Operator Maintenance [226](#)

Contacting Agilent Technologies [228](#)



## Self Test

The power meter has two self test modes:



- Power on self test – occurs automatically when you turn on the power meter.
- Troubleshooting mode – accessed via the front panel or remotely. The front panel softkey menu allows you to run individual tests, whereas the remote command runs a complete series of tests as listed in “[Remote Testing](#)” on page 211.

### Power On Self Test

The power on self test is performed automatically when the power meter is turned on and takes approximately 10 seconds to complete. The power on self test checks following components:

- Lithium Battery
- Calibrator
- Measurement Assembly (Both assemblies on dual channel meters.)
- Fan
- Serial Interface

Refer to see “[Test Descriptions](#)” on page 212 if you require a description of each individual test.

As the power on self test takes place, the message **Testing...** appears next to the name of the test which is being performed. When each test is complete, the message **Testing...** is replaced by either the message **Passed** or **Failed**. If a failure occurs the message Power-up H/W Err appears. Any errors are also written to the error queue and can be examined in the Errors screen by pressing , .

## Front Panel Selection of Self Tests

Press **System**, **More**, **Service**, **Self Test** to access the Self Test menu consisting of the following:

- Instrument Self Test
- Individual, accessing the following tests:
  - Keyboard
  - Fan
  - Display bitmaps
  - Serial Interface, accessing the following tests:
    - UART Configuration
    - Local Loop Back
    - RS232 Loop Back
    - RS422 Loop Back

**More** accesses:

- Trigger Loop back
- Time base
- Fast Path Accuracy

### NOTE

The RS232 and RS422 loop back tests require a specially wired connector – refer to the *EPM-P Series power meter service guide*.

Each of these tests can be run individually. Information on the instrument self test and confidence check are described in “[Instrument Self Test](#)” on page 210. Refer to “[Test Descriptions](#)” on page 212 if you require a description of the other tests.

### Instrument Self Test

If **Instrument Self Test** is selected, the following tests are run: (These are the same tests which are run using the \*TST? command.)

- ROM checksum
- RAM
- Lithium Battery
- Display Assembly
- Calibrator
- Measurement Assemblies
- Fan
- Serial Interface

As each test takes place, the name of the test is listed on the screen. While a test is running, the message **Testing...** appears beside the name of the test. As each stage of the test is completed, the **Testing...** message is replaced by either **Passed** or **Failed**.

RMT TLK		Self Test ▶
TEST	RESULT	
ROM	Passed	
RAM	Passed	
RAM Battery	Passed	
Display Assy.	Passed	
Calibrator	Passed	
Meas. Assy.	Passed	
Serial Interface	Testing...	
		Done

**Figure 8-1** Self Test in Progress

When the test is complete, the result is displayed until **Done** is selected. If the self test failed, information about the failure is displayed on the screen.



## Remote Testing

To invoke the remote self test, the IEEE 488.1 compliant standard command, \*TST? is used. This command runs a full self test and returns one of the following codes:

- 0 – no tests failed
- 1 – one or more tests failed

The remote self test consists of the following tests:

- ROM checksum
- RAM
- Lithium Battery
- Display Assembly
- Calibrator
- Measurement Assemblies
- Communications Assembly (Implicit)

The communications assembly is tested implicitly, in that the command will not be accepted or return a result unless the GPIB interface is functioning correctly.

Refer to see “[Test Descriptions](#)” on page 212 if you require a description of each individual test.

When the \*TST? command is executed, the screen is cleared. As each test takes place, the name of the test is listed on the screen. While a test is running, the message **Testing...** appears beside the name of the test. As each stage of the test is completed, the message **Testing...** is replaced by either the message **Passed** or **Failed**.

## Test Descriptions

This section specifies what is actually checked by each of the tests. Some of the tests may only be applicable to one method of invocation (for example, from the front panel). If this is the case, it is specified in the test description. Most of the tests have an associated error message which is added to the error queue if the test fails. The exception to this is the bitmap display test. Refer to [“Error Messages”](#) on page 215 for more details.

### ROM Checksum

This test calculates the checksum of the firmware and checks it against the predefined checksum stored on the ROM. A pass or a fail result is returned.

### RAM

This test carries out a read and write test on the instrument RAM.

### Lithium Battery

When the firmware is first downloaded, a known value is written into a batterybacked memory location. This test verifies that the value is still resident. It returns a pass if the value is still present, otherwise it returns a fail.

### Measurement Assemblies

A measurement assembly is requested to automatically run a self test. This self test returns either a pass or a fail. A fail can either be produced by the measurement assembly self test failing or by the measurement assembly not responding.

### Fan

This test confirms that the internal cooling fan is operating.

## Serial Interface

Four tests are available for the serial interface: UART configuration, local loop back, RS232 loop back and RS422 loop back. Both the RS232 and RS422 loop back tests require a specially wired connector – refer to the *EPM-P Series Power Meter Service Guide*.

- UART Configuration – confirms that the baud rate, stop bits and parity settings are correctly configured on the UART.
- Local Loop Back – Tx and Rx on the UART are internally connected and a test message is sent to confirm correct operation.
- RS232/RS422 Loop Back – A message is sent via the UART and transceivers using an external loop back connector (refer to the *EPM-P Series Power Meter Service Guide*).

## Calibrator

The reference calibrator is turned on (indicated by the POWER REF LED) and measured internally. A pass or fail result is returned.

## Display

Three tests are available for the display: the display assembly, display RAM and bitmap display.

A read or write is performed on the display RAM. If the value which is written is read back correctly, a pass is recorded, otherwise a fail is recorded.

The liquid crystal display or light emitting diode (LCD/LED) control circuits are tested by making separate voltage measurements via the multiplexer and digital signal processor. If the expected voltages are measured, a pass is recorded, otherwise a fail is recorded. The three circuits tested are the LCD contrast control, the LED brightness control, and the display temperature sensing diode.

## Trigger Loop Back

This test generates a level on the trigger output and verifies that it can be seen on the trigger input. You are required to make the connection between the trigger input and output connectors (BNC).

### **Time Base**

This test routes the 10 MHz internal time base signal to the trigger output connector where frequency verification can be made. When the power meter is preset or power cycled, the routing is removed.

### **Fast Path Accuracy**

This test requires specialized test equipment and is beyond the scope of this guide. Please refer to the *EPM-P Series Power Meters Service Guide*.

# Error Messages

## Introduction

This section contains information about error messages. It explains how to read the power meter's error queue and lists all error messages and their probable causes.

When there is a hardware related problem, for example, a power sensor overload, the error message is displayed on the status line at the top of the display. In addition, the errors are also written to the error queue. If there are any errors in the error queue the front panel error indicator is displayed as shown in [Figure 8-2](#).

Other errors can also be generated when the power meter is being operated over the remote interface. These errors also display the error indicator and are written to the error queue.

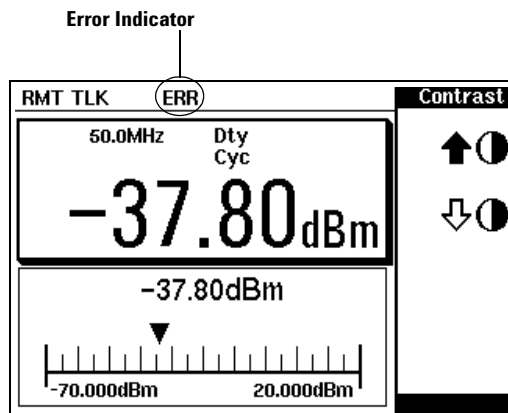

**Figure 8-2** Error Indicator Position

To read the error queue from the front panel:

- Press **System**, **Error List** and use **Next** to scroll through each error message.

To read the error queue from the remote interface use:

- the `SYSTem:ERRor?` command.

Error queue messages have the following format:

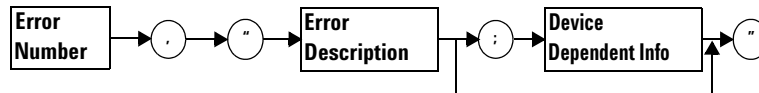

**Figure 8-3** Error Queue Message

For example, `-330, "Self-test Failed;Battery Fault"`.

Errors are retrieved in a first in first out (FIFO) order. If more than 30 errors occur, the error queue overflows and the last error in the queue is replaced with error `-350, "Queue Overflow"`. Any time the queue overflows the most recent error is discarded.

When the errors are read they are removed from the error queue. This opens a position at the end of the queue for a new error message, if one is subsequently detected. When all errors have been read from the queue, further error queries return `+0, "No errors"`.

To delete all the errors in the queue from the front panel press:

- **System**, **Error List**, and use **Clear Errors**.

To delete all the errors in the queue remotely use:

- the `*CLS` (clear status) command.

The error queue is also cleared when the instrument power has been switched off.

## Error Message List

-101	<p><b>Invalid character</b></p> <p>An invalid character was found in the command string. You may have inserted a character such as #, \$, or % in the command header or within a parameter.</p> <p>For example, LIM:LOW O#.</p>
-102	<p><b>Syntax error</b></p> <p>Invalid syntax was found in the command string.</p> <p>For example, LIM:CLE:AUTO, 1 or LIM:CLE: AUTO 1.</p>
-103	<p><b>Invalid separator</b></p> <p>An invalid separator was found in the command string. You may have used a comma instead of a colon, semicolon, or blank space; or you may have used a blank space instead of a comma.</p> <p>For example, OUTP:ROSC, 1.</p>
-105	<p><b>GET not allowed</b></p> <p>A Group Execute Trigger (GET) is not allowed within a command string.</p>
-108	<p><b>Parameter not allowed</b></p> <p>More parameters were received than expected for the command. You may have entered an extra parameter, or added a parameter to a command that does not accept a parameter.</p> <p>For example, CAL 10</p>
-109	<p><b>Missing parameter</b></p> <p>Fewer parameters were received than expected for the command. You omitted one or more parameters that are required for this command.</p> <p>For example, AVER:COUN.</p>
-112	<p><b>Program mnemonic too long</b></p> <p>A command header was received which contained more than the maximum 12 characters allowed.</p> <p>For example, SENSEAVERageCOUNT 8.</p>

---

-113	<b>Undefined header</b>  A command was received that is not valid for this power meter. You may have misspelled the command, it may not be a valid command or you may have the wrong interface selected. If you are using the short form of the command, remember that it may contain up to four letters.  For example, <code>TRIG:SOUR IMM</code> .
-121	<b>Invalid character in number</b>  An invalid character was found in the number specified for a parameter value.  For example, <code>SENS:AVER:COUN 128#H</code> .
-123	<b>Exponent too large</b>  A numeric parameter was found whose exponent was larger than 32,000.  For example, <code>SENS:COUN 1E34000</code> .
-124	<b>Too many digits</b>  A numeric parameter was found whose mantissa contained more than 255 digits, excluding leading zeros.
-128	<b>Numeric data not allowed</b>  A numeric value was received within a command which does not accept a numeric value.  For example, <code>MEM:CLE 24</code> .
-131	<b>Invalid suffix</b>  A suffix was incorrectly specified for a numeric parameter. You may have misspelled the suffix.  For example, <code>SENS:FREQ 200KZ</code> .
-134	<b>Suffix too long</b>  A suffix used contained more than 12 characters.  For example, <code>SENS:FREQ 2MHZZZZZZZZZZZZ</code> .
-138	<b>Suffix not allowed</b>  A suffix was received following a numeric parameter which does not accept a suffix.  For example, <code>INIT:CONT 0Hz</code> .

---



---

-148	<b>Character data not allowed</b>  A discrete parameter was received but a character string or a numeric parameter was expected. Check the list of parameters to verify that you have used a valid parameter type.  For example, <code>MEM:CLE CUSTOM_1</code> .
-151	<b>Invalid string data</b>  An invalid string was received. Check to see if you have enclosed the character string in single or double quotes.  For example, <code>MEM:CLE "CUSTOM_1"</code> .
-158	<b>String data not allowed</b>  A character string was received but is not allowed for the command. Check the list of parameters to verify that you have used a valid parameter type.  For example, <code>LIM:STAT 'ON'</code> .
-161	<b>Invalid block data</b>  A block data element was expected but was invalid for some reason. For example, <code>*DDT #15FET</code> . The 5 in the string indicates that 5 characters should follow, whereas in this example there are only 3.
-168	<b>Block data not allowed</b>  A legal block data element was encountered but not allowed by the power meter at this point.  For example <code>SYST:LANG #15FETC?</code> .
-178	<b>Expression data not allowed</b>  A legal expression data was encountered but not allowed by the power meter at this point.  For example <code>SYST:LANG (5+2)</code> .
-211	<b>Trigger ignored</b>  Indicates that <code>&lt;GET&gt;</code> or <code>*TRG</code> , or <code>TRIG:IMM</code> was received and recognized by the device but was ignored because the power meter was not in the wait for trigger state.

---

-213	<p><b>Init ignored</b></p> <p>Indicates that a request for a measurement initiation was ignored as the power meter was already initiated.</p> <p>For example, <code>INIT:CONT ON</code> <code>INIT.</code></p>
-214	<p><b>Trigger deadlock</b></p> <p><code>TRIG:SOUR</code> was set to <code>HOLD</code> or <code>BUS</code> and a <code>READ?</code> or <code>MEASure?</code> was attempted, expecting <code>TRIG:SOUR</code> to be set to <code>IMMediate</code>.</p>
-220	<p><b>Parameter error;Frequency list must be in ascending order.</b></p> <p>Indicates that the frequencies entered using the <code>MEMory:TABLE:FREQuency</code> command are not in ascending order.</p>
-221	<p><b>Settings conflict</b></p> <p>This message occurs under a variety of conflicting conditions. The following list gives a few examples of where this error may occur:</p> <ul style="list-style-type: none"> <li>• If the <code>READ?</code> parameters do not match the current settings.</li> <li>• If you are in fast mode and attempting to switch on for example, averaging, duty cycle or limits.</li> <li>• Trying to clear a sensor calibration table when none is selected.</li> </ul>
-221	<p><b>Settings conflict; DTR/DSR not available on RS422</b></p> <p>DTR/DSR is only available on the RS232 interface.</p>
-222	<p><b>Data out of range</b></p> <p>A numeric parameter value is outside the valid range for the command. For example, <code>SENS:FREQ 2KHZ</code>.</p>
-224	<p><b>Illegal parameter value</b></p> <p>A discrete parameter was received which was not a valid choice for the command. You may have used an invalid parameter choice.</p> <p>For example, <code>TRIG:SOUR EXT</code>.</p>
-226	<p><b>Lists not same length</b></p> <p>This occurs when <code>SENSe:CORRection:CSET[1]   CSET2:STATe</code> is set to <code>ON</code> and the frequency and calibration/offset lists do not correspond in length.</p>

-230	<p><b>Data corrupt or stale</b></p> <p>This occurs when a FETC? is attempted and either a reset has been received or the power meter state has changed such that the current measurement is invalidated (for example, a change of frequency setting or triggering conditions).</p>
-230	<p><b>Data corrupt or stale;Please zero and calibrate Channel A</b></p> <p>When CAL [1   2] :RCAL is set to ON and the sensor currently connected to channel A has not been zeroed and calibrated, then any command which would normally return a measurement result (for example FETC?, READ?, or MEAS?) will generate this error message</p>
-230	<p><b>Data corrupt or stale;Please zero and calibrate Channel B</b></p> <p>When CAL [1   2] :RCAL is set to ON and the sensor currently connected to channel B has not been zeroed and calibrated, then any command which would normally return a measurement result (for example FETC?, READ?, or MEAS?) will generate this error message.</p>
-230	<p><b>Data corrupt or stale;Please zero Channel A</b></p> <p>When CAL [1   2] :RCAL is set to ON and the sensor currently connected to channel A has not been zeroed, then any command which would normally return a measurement result (for example FETC?, READ?, or MEAS?) will generate this error message.</p>
-230	<p><b>Data corrupt or stale;Please zero Channel B</b></p> <p>When CAL [1   2] :RCAL is set to ON and the sensor currently connected to channel B has not been zeroed, then any command which would normally return a measurement result (for example FETC?, READ?, or MEAS?) will generate this error message</p>
-230	<p><b>Data corrupt or stale;Please calibrate Channel A</b></p> <p>When CAL [1   2] :RCAL is set to ON and the sensor currently connected to channel B has not been calibrated, then any command which would normally return a measurement result (for example FETC?, READ?, or MEAS?) will generate this error message</p>
-230	<p><b>Data corrupt or stale;Please calibrate Channel B</b></p> <p>When CAL [1   2] :RCAL is set to ON and the sensor currently connected to channel B has not been calibrated, then any command which would normally return a measurement result (for example FETC?, READ?, or MEAS?) will generate this error message</p>

-231	<b>Data questionable;CAL ERROR</b> Power meter calibration failed. The most likely cause is attempting to calibrate without applying a 1 mW power to the power sensor.
-231	<b>Data questionable;CAL ERROR ChA</b> Power meter calibration failed on channel A. The most likely cause is attempting to calibrate without applying a 1 mW power to the power sensor.
-231	<b>Data questionable;CAL ERROR ChB</b> Power meter calibration failed on channel B. The most likely cause is attempting to calibrate without applying a 1 mW power to the power sensor.
-231	<b>Data questionable;Input Overload</b> The power input to Channel A exceeds the power sensor's maximum range.
-231	<b>Data questionable;Input Overload ChA</b> The power input to Channel A exceeds the power sensor's maximum range.
-231	<b>Data questionable;Input Overload ChB</b> The power input to Channel B exceeds the power sensor's maximum range.
-231	<b>Data questionable;Lower window log error</b> This indicates that a difference measurement in the lower window has given a negative result when the units of measurement were logarithmic.
-231	<b>Data questionable;Upper window log error</b> This indicates that a difference measurement in the upper window has given a negative result when the units of measurement were logarithmic.
-231	<b>Data questionable;ZERO ERROR</b> Power meter zeroing failed. The most likely cause is attempting to zero when some power signal is being applied to the power sensor.
-231	<b>Data questionable;ZERO ERROR ChA</b> Power meter zeroing failed on channel A. The most likely cause is attempting to zero when some power signal is being applied to the power sensor.
-231	<b>Data questionable;ZERO ERROR ChB</b> Power meter zeroing failed on channel B. The most likely cause is attempting to zero when some power signal is being applied to the power sensor.

-241	<b>Hardware missing</b>
	The power meter is unable to execute the command because either no power sensor is connected or it expects an Agilent E-Series or N8480 Series power sensor and one is not connected.
-310	<b>System error;Dty Cyc may impair accuracy with ECP sensor</b>
	This indicates that the sensor connected is for use with CW signals only.
-310	<b>System error;Ch A Dty Cyc may impair accuracy with ECP sensor</b>
	This indicates that the sensor connected to channel A is for use with CW signals only.
-310	<b>System error;Ch B Dty Cyc may impair accuracy with ECP sensor</b>
	This indicates that the sensor connected to channel B is for use with CW signals only.
-310	<b>System error;Sensor EEPROM Read Failed – critical data not found or unreadable</b>
	This indicates a failure with your Agilent E-Series or N8480 Series power sensor. Refer to your power sensor manual for details on returning it for repair.
-310	<b>System error;Sensor EEPROM Read Completed OK but optional data block(s) not found or unreadable</b>
	This indicates a failure with your Agilent E-Series or N8480 Series power sensor. Refer to your power sensor manual for details on returning it for repair.
-310	<b>System error;Sensor EEPROM Read Failed - unknown EEPROM table format</b>
	This indicates a failure with your Agilent E-Series or N8480 Series power sensor. Refer to your power sensor manual for details on returning it for repair.
-310	<b>System error;Sensor EEPROM &lt; &gt; data not found or unreadable</b>
	Where < > refers to the sensor data block covered, for example, Linearity, Temp – Comp (temperature compensation).
	This indicates a failure with your Agilent E-Series or N8480 Series power sensor. Refer to your power sensor manual for details on returning it for repair.
-310	<b>System error;Sensors connected to both front and rear inputs.</b>
	You cannot connect two power sensors to the one channel input. In this instance the power meter detects power sensors connected to both it's front and rear channel inputs.

-321	<p><b>Out of memory</b></p> <p>The power meter required more memory than was available to run an internal operation.</p>
-330	<p><b>Self-test Failed;</b></p> <p>The -330, "Self-test Failed" errors indicate that you have a problem with your power meter. Refer to see <a href="#">“Contacting Agilent Technologies”</a> on page 228 for details of what to do with your faulty power meter.</p>
-330	<p><b>Self-test Failed;Measurement Channel Fault</b></p> <p>Refer to see <a href="#">“Measurement Assemblies”</a> on page 212 if you require a description of the Measurement Assembly test.</p>
-330	<p><b>Self-test Failed;Measurement Channel A Fault</b></p> <p>Refer to see <a href="#">“Measurement Assemblies”</a> on page 212 if you require a description of the Measurement Assembly test.</p>
-330	<p><b>Self-test Failed;Measurement Channel B Fault</b></p> <p>Refer to see <a href="#">“Measurement Assemblies”</a> on page 212 if you require a description of the Measurement Assembly test.</p>
-330	<p><b>Self-test Failed;Lithium Battery Fault</b></p> <p>Refer to see <a href="#">“Lithium Battery”</a> on page 212 if you require a description of the battery test.</p>
-330	<p><b>Self-test Failed;Calibrator Fault</b></p> <p>Refer to see <a href="#">“Calibrator”</a> on page 213 if you require a description of the calibrator test.</p>
-330	<p><b>Self-test Failed;ROM Check Failed</b></p> <p>Refer to see <a href="#">“ROM Checksum”</a> on page 212 if you require a description of the ROM Checksum test.</p>
-330	<p><b>Self-test Failed;RAM Check Failed</b></p> <p>Refer to see <a href="#">“RAM”</a> on page 212 if you require a description of the RAM test.</p>
-330	<p><b>Self-test Failed;Display Assy. Fault</b></p> <p>Refer to see <a href="#">“Display”</a> on page 213 if you require a description of the Display test.</p>

-330	<p><b>Self-test Failed;Serial Interface Fault</b></p> <p>Refer to see “<a href="#">Serial Interface</a>” on page 213 if you require a description of this test.</p>
-350	<p><b>Queue overflow</b></p> <p>The error queue is full and another error has occurred which could not be recorded.</p>
-361	<p><b>Parity error in program</b></p> <p>The serial port receiver has detected a parity error and consequently, data integrity cannot be guaranteed.</p>
-362	<p><b>Framing error in program</b></p> <p>The serial port receiver has detected a framing error and consequently, data integrity cannot be guaranteed.</p>
-363	<p><b>Input buffer overrun</b></p> <p>The serial port receiver has been overrun and consequently, data has been lost.</p>
-410	<p><b>Query INTERRUPTED</b></p> <p>A command was received which sends data to the output buffer, but the output buffer contained data from a previous command (the previous data is not overwritten). The output buffer is cleared when power has been off, or after *RST (reset) command has been executed.</p>
-420	<p><b>Query UNTERMINATED</b></p> <p>The power meter was addressed to talk (that is, to send data over the interface) but a command has not been received which sends data to the output buffer. For example you may have executed a CONFigure command (which does not generate data) and then attempted to read data from the remote interface.</p>
-430	<p><b>Query DEADLOCKED</b></p> <p>A command was received which generates too much data to fit in the output buffer and the input buffer is also full. Command execution continues but data is lost.</p>
-440	<p><b>Query UNTERMINATED after indefinite response</b></p> <p>The *IDN? command must be the last query command within a command string.</p>

## Operator Maintenance

This section describes how to replace the power line fuse and clean the power meter. If you need additional information about replacing parts or repairing the power meter, refer to the *EPM-P Series Power Meter Service Guide*.

To clean the power meter, disconnect its supply power and wipe with a damp cloth only.

The power line fuse is located within the power meter's fuse holder assembly on the rear panel. For all voltages the power meter uses a 250 V, F3.15AH, 20 mm fast blow fuse with high breaking capacity (Agilent part number 2110-0957).

### NOTE

The power meter also has an internal fuse. If you suspect that this fuse needs replaced it must be done by trained service personnel. Please refer to [“Returning Your Power Meter for Service”](#) on page 232.

---

## Replacing the Power Line Fuse

- 1 Remove the power cord from the power meter.
- 2 Slide the fuse holder assembly from the rear panel as shown in [Figure 8-4](#).
- 3 Install the correct fuse in the "In line" position as shown in [Figure 8-4](#). (A spare fuse can be stored in the fuse holder assembly.)
- 4 Replace the fuse holder assembly in the rear panel.



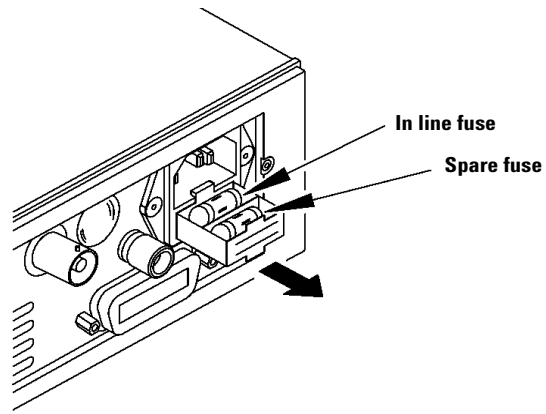

**Figure 8-4** Replacing the Fuse

## Contacting Agilent Technologies

This section details what to do if you have a problem with your power meter.

If you have a problem with your power meter, first refer to the section [“Before calling Agilent Technologies”](#). This chapter contains a checklist that will help identify some of the most common problems.

If you wish to contact Agilent Technologies about any aspect of the power meter, from service problems to ordering information, refer to see [“Sales and Service Offices”](#) on page 231.

If you wish to return the power meter to Agilent Technologies refer to see [“Returning Your Power Meter for Service”](#) on page 232.

### Before calling Agilent Technologies

Before calling Agilent Technologies or returning the power meter for service, please make the checks listed in see [“Check the Basics”](#) on page 229. If you still have a problem, please read the warranty printed at the front of this guide. If your power meter is covered by a separate maintenance agreement, please be familiar with the terms.

Agilent Technologies offers several maintenance plans to service your power meter after warranty expiration. Call your Agilent Technologies Sales and Service Center for full details.

If the power meter becomes faulty and you wish to return the faulty instrument, follow the description on how to return the faulty instrument in the section see [“Sales and Service Offices”](#) on page 231.

## Check the Basics

Problems can be solved by repeating what was being performed when the problem occurred. A few minutes spent in performing these simple checks may eliminate time spent waiting for instrument repair. Before calling Agilent Technologies or returning the power meter for service, please make the following checks:

- Check that the line socket has power.
- Check that the power meter is plugged into the proper AC power source.
- Check that the power meter is switched on.
- Check that the line fuse is in working condition.
- Check that the other equipment, cables, and connectors are connected properly and operating correctly.
- Check the equipment settings in the procedure that was being used when the problem occurred.
- Check that the test being performed and the expected results are within the specifications and capabilities of the power meter.
- Check the power meter display for error messages.
- Check operation by performing the self tests.
- Check with a different power sensor.

## Instrument serial numbers

Agilent Technologies makes frequent improvements to its products to enhance their performance, usability and reliability. Agilent Technologies service personnel have access to complete records of design changes for each instrument. The information is based on the serial number and option designation of each power meter.

Whenever you contact Agilent Technologies about your power meter have a complete serial number available. This ensures you obtain the most complete and accurate service information. The serial number can be obtained by:

- interrogating the power meter over the GPIB using the \*IDN? command.

- from the front panel by selecting **System**, **More**, **Service**, **Version**.
- from the serial number label.

The serial number label is attached to the rear of each Agilent Technologies instrument. This label has two instrument identification entries. The first provides the instruments serial number and the second provides the identification number for each option built into the instrument.

The serial number is divided into two parts: the prefix (two letters and the first four numbers), and the suffix (the last four numbers).

- The prefix letters indicate the country of manufacture. This code is based on the ISO international country code standard, and is used to designate the specific country of manufacture for the individual product. The same product number could be manufactured in two different countries. In this case the individual product serial numbers would reflect different country of manufacture codes. The prefix also consists of four numbers. This is a code identifying the date of the last major design change.
- The suffix indicates an alpha numeric code which is used to ensure unique identification of each product throughout Agilent Technologies.

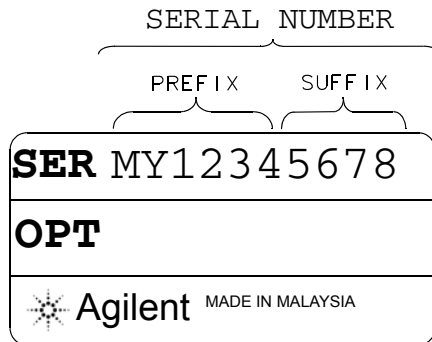

## Sales and Service Offices

For more information about Agilent Technologies test and measurement products, applications, services, and for a current sales office listing, visit our web site: <http://www.agilent.com>.

You can also contact one of the following centers and ask for a test and measurement sales representative.

<b>UNITED STATES</b>	(tel) 800 829 4444 (fax) 800 829 4433
<b>CANADA</b>	(tel) 877 894 4414 (fax) 800 746 4866
<b>EUROPE</b>	(tel) 31 20 547 2111
<b>JAPAN</b>	(tel) (81) 426 56 7832 (fax) (81) 426 56
<b>LATIN AMERICA</b>	(tel) (305) 269 7500
<b>ASIA PACIFIC</b>	(tel) (65) 6375 8100 (fax) (65) 6755 0042

In any correspondence or telephone conversations, refer to the power sensor by its model number and full serial number. With this information, the Agilent Technologies representative can quickly determine whether your unit is still within its warranty period.

## Returning Your Power Meter for Service

Use the information in this section if you need to return your power meter to Agilent Technologies.

### Package the Power Meter For Shipment

Use the following steps to package the power meter for shipment to Agilent Technologies for service:

- 1 Fill in a blue service tag (available at the end of this guide) and attach it to the power meter. Please be as specific as possible about the nature of the problem. Send a copy of any or all of the following information:
  - Any error messages that appeared on the power meter display.
  - Any information on the performance of the power meter.

#### CAUTION

Power meter damage can result from using packaging materials other than those specified. Never use styrene pellets in any shape as packaging materials. They do not adequately cushion the power meter or prevent it from shifting in the carton. Styrene pellets cause power meter damage by generating static electricity and by lodging in the rear panel.

- 2 Use the original packaging materials or a strong shipping container that is made of double-walled, corrugated cardboard with 159 kg (350 lb) bursting strength. The carton must be both large enough and strong enough to accommodate the power meter and allow at least 3 to 4 inches on all sides of the power meter for packing material.

- 3** Surround the power meter with at least 3 to 4 inches of packing material, or enough to prevent the power meter from moving in the carton. If packing foam is not available, the best alternative is SD-240 Air Cap™ from Sealed Air Corporation (Commerce, CA 90001). Air Cap looks like a plastic sheet covered with 1-1/4 inch air filled bubbles. Use the pink Air Cap to reduce static electricity. Wrap the power meter several times in the material to both protect the power meter and prevent it from moving in the carton.
- 4** Seal the shipping container securely with strong nylon adhesive tape.
- 5** Mark the shipping container "FRAGILE, HANDLE WITH CARE" to ensure careful handling.
- 6** Retain copies of all shipping papers.

**THIS PAGE HAS BEEN INTENTIONALLY LEFT BLANK.**





## 9 Specifications and Characteristics

Introduction	236
Power Meter Specifications	237
Measurement Characteristics	241
Environmental Specifications	245
Regulatory Information	246



## Introduction

This chapter details the power meter's specifications and supplemental characteristics.

**Specifications** – describe the warranted performance and apply after a 30 minutes warm-up. These specifications are valid over the power meter's operating and environmental range unless otherwise stated and after performing a zero and calibration procedure.

**Supplemental characteristics** – *shown in italics*, are intended to provide information useful in applying the power meter by giving typical (expected), but nonwarranted performance parameters. These characteristics are shown in italics or denoted as “typical”, “nominal” or “approximate”.

**Measurement uncertainties** – for information on measurement uncertainty calculations, refer to Agilent Application Note 64-1, “*Fundamentals of RF and Microwave Power Measurements*”, Literature Number 5965-6380E.

**Compatibility** – the EPM-P Series power meters operate with the E9320 E-Series family of power sensors for peak, average and time gated measurements. The EPM-P Series meters also operate with existing 8480 Series, E4410 E-Series, E9300 E-Series and N8480 Series ranges of power sensors for average power measurements.

**Measurement Modes** – the EPM-P Series power meters have two measurement modes:

- *Normal* mode – (default mode using E9320 E-Series sensors) for peak, average and time related measurements.
- *Average-only* mode – this mode is primarily for average power measurements on low level signals, when using E9320 E-Series sensors, and is the mode used with 8480 Series, E4410 E-Series, E9300 E-Series and N8480 Series range of power sensors.

## Power Meter Specifications

### Frequency Range

9 kHz to 110 GHz, power sensor dependent.

### Power Range

-70 dBm to +44 dBm (100 pW to 25 W), power sensor dependent.

### Power Sensors

Compatible with all Agilent 8480 Series power sensors, Agilent E-Series power sensors and Agilent N8480 Series power sensors.

### Single Sensor Dynamic Range

#### E9320 E-Series peak and average sensors:

70 dB maximum (*Normal mode*)

85 dB maximum (*Average-only mode*)

#### E4410 E-Series sensors:

90 dB

#### E9300 E-Series average sensors:

80 dB maximum

#### 8480 Series sensors:

50 dB maximum

#### N8480 Series sensors (excluding Option CFT):

55 dB maximum

#### N8480 Series sensors with Option CFT:

50 dB maximum

### Display Units

#### Absolute:

Watts or dBm

#### Relative:

Percent or dB

### Display Resolution

Selectable resolution of:

1.0, 0.1, 0.01 and 0.001 dB in logarithmic mode, or  
1, 2, 3 and 4 significant digits in linear mode

### Default Resolution

0.01 dB in logarithmic mode  
Three digits in linear mode

### Offset Range

±100 dB in 0.001 dB increments, to compensate for external loss or gain.

### Video Bandwidth (Modulation Bandwidth)

*5 MHz (set by meter and is sensor dependent)*

#### NOTE

The video bandwidth represents the ability of the power sensor and meter to follow the power envelope of the input signal. The power envelope of the input signal is, in some cases, determined by the signal's modulation bandwidth, and hence video bandwidth is sometimes referred to as modulation bandwidth.

### Video Bandwidth/ Dynamic Range Optimization

The power measurement system, comprising the sensor and meter, has its maximum video bandwidth defined by the E9320 E-Series power sensor. To optimize the system's dynamic range for peak power measurements, the Video Bandwidth in the meter can be set to **High**, **Medium**, or **Low** as detailed in [Table 9-1](#). The filter video bandwidths stated in the table are not the 3 dB bandwidth as the video bandwidths are corrected for optimal flatness. Refer to the E9320 *E-Series Power Sensor Operating and Service Guide* for information on the sensor's peak flatness response. A filter **Off** mode is also provided.

**Table 9-1** Video Bandwidth vs. Peak Power Dynamic Range

Video bandwidth / Maximum peak power dynamic range				
Sensor	Off	High	Medium	Low
E9321A	300 kHz/ -40 dBm to 20 dBm	300 kHz/ -42 dBm to 20 dBm	100 kHz/ -43 dBm to 20 dBm	30 kHz/ -45 dBm to 20 dBm
E9322A	1.5 MHz/ -36dBm to +20 dBm	1.5 MHz/ -37 dBm to 20 dBm	300 kHz/ -38 dBm to 20 dBm	100 kHz/ -39 dBm to 20 dBm
E9323A	5 MHz/ -32 dBm to 20 dBm	5 MHz/ -32 dBm to 20 dBm	1.5 MHz/ -34 dBm to 20 dBm	300 kHz/ -36 dBm to 20 dBm

**Accuracy**

**Instrumentation**

Please add the corresponding power sensor linearity percentage (Refer to the Specifications section in the user's guide supplied with your power sensor).

**(Average-only Mode):**

<b>Absolute:</b>	Logarithmic $\pm 0.02$ dB
	Linear $\pm 0.5\%$
<b>Relative:</b>	Logarithmic $\pm 0.04$ dB
	Linear $\pm 1.0\%$

	Calibration temperature <sup>1</sup> $\pm 5$ °C	Temperature 0 to 55 °C
<b>Absolute accuracy (log)</b>	$\pm 0.04$ dB	$\pm 0.08$ dB
<b>Absolute accuracy (linear)</b>	$\pm 0.8\%$	$\pm 1.7\%$
<b>Relative accuracy (log)</b>	$\pm 0.08$ dB	$\pm 0.16$ dB
<b>Relative accuracy (linear)</b>	$\pm 1.6\%$	$\pm 3.4\%$

<sup>1</sup> Power meter is within  $\pm 5$  °C of its calibration temperature.

**Time Base:** 0.01%

***Zero Set, Zero Drift, and Measurement Noise:***

For E9320 E-Series sensors, refer to the Specifications Section in the *E-Series E9320 Power Sensors Operating and Service Guide*.

**1 mW Power Reference**

**Power Output:** 1.00 mW (0.0 dBm). Factory set to  $\pm 0.4\%$

\*\* Traceable to National Physical Laboratories (NPL), UK.

**Accuracy:** (for two years)  $\pm 0.9\%$  (0 to 55 °C)  
 $\pm 0.6\%$  (25  $\pm$  10 °C)  
 $\pm 1.03\%$  (23  $\pm$  3 °C)

**Frequency:** 50 MHz nominal

**SWR:** 1.06 maximum (1.08 maximum for Option 003)

**Connector Type:** Type-N (f), 50  $\Omega$

## Measurement Characteristics

### Measurement Characteristics:

**Measurements:** Average Power  
Peak Power  
Peak-to-Average ratio  
Measurements between two time offsets (time gating)

**Averaging:** Averaging over 1 to 1024 readings is available for reducing noise

### Measurement Speed (GPIB):

Over the GPIB, three measurement modes are available - Normal, X2 and Fast. The typical maximum speed for each mode is shown in the table below:

Sensor type		Measurement speed (readings per second)		
		Normal	x2	Fast <sup>1,2</sup>
E9320 E-Series peak and average sensors	Average-only mode	20	40	400
	Normal mode <sup>3</sup>	20	40	1000
E4410 E-Series and E9300 E-Series average power sensors		20	40	400
8480 Series power sensors		20	40	N/A
N8480 Series power sensors		20	40	N/A

<sup>1</sup> Fast speed not available for 8480 Series and N8480 Series sensors.

<sup>2</sup> Maximum measurement speed is obtained by using binary output in free run trigger mode.

<sup>3</sup> For E9320 E-Series sensors maximum speed is achieved using binary output in free run acquisition.

<b>Channel Functions:</b>	A, B, A/B, B/A, A-B, B-A, and relative
<b>Storage Registers:</b>	10 instrument states can be saved via Save/Recall menu.
<b>Predefined setups:</b>	For common wireless standards (GSM900, EDGE, NADC, iDEN, Bluetooth, IS-95 CDMA, WCDMA and cdma2000), predefined setups are provided.

### Trigger

<b>Sources:</b>	Internal, External TTL, GPIB, and RS232/422.
<b>Time Resolution:</b>	50 ns
<b>Delay Range:</b>	$\pm 1.0$ s
<b>Delay Resolution:</b>	50 ns for delays < $\pm 50$ ms otherwise 200 ns
<b>Hold-off:</b>	<b>Range:</b> 1 $\mu$ s to 400 ms <b>Resolution:</b> 1% of selected value (minimum of 100 ns)
<b>Internal Trigger:</b>	<b>Range:</b> -20 to +20 dBm <b>Level Accuracy:</b> $\pm 0.5$ dB <b>Resolution:</b> 0.1 dB <b>Latency:</b> 500 ns $\pm$ 100 ns

Latency is defined as the delay between the applied RF crossing the trigger level and the power meter switching into the triggered state.

<b>External Trigger Range:</b>	<i>High</i> >2.0 V, <i>Low</i> <0.8 V; BNC connector; rising or falling edge triggered; input impedance >1 kW
<b>Trigger Out:</b>	Output provides TTL compatible levels ( <i>High</i> >2.4 V, <i>Low</i> <0.4 V) and uses a BNC connector



**Sampling Characteristics**

<b>Sampling Rate:</b>	20 MSa/s
<b>Sampling Technique:</b>	Continuous sampling

**Rear Panel Inputs/Outputs**

<b>Recorder Output(s):</b>	Analog 0 to 1 V, 1 kW output impedance, BNC connector. (Two outputs are available on the E4417A, Channel A and B.)
<b>Remote Input/Output:</b>	<p><b>TTL Output:</b> used to signal when measurement has exceeded a defined limit</p> <p><b>TTL Input:</b> initiates zero and calibration routine <b>Connector type:</b> RJ-45 series shielded modular jack assembly</p> <p><b>TTL Output:</b> <i>high = 4.8 V max, low = 0.2V max</i></p> <p><b>TTL Input:</b> <i>high = 3.5 V min., 5 V max; low = 1 V max, -0.3 V min.</i></p>
<b>RS-232/422 Interface:</b>	Serial interface for communication with an external controller, Male/Plug 9-pin D-subminiature connector
<b>Trigger In:</b>	Accepts a TTL signal for initiating measurements, BNC connector
<b>Trigger Out:</b>	Outputs a TTL signal for synchronizing with external equipment, BNC connector
<b>Ground:</b>	Binding post, accepts 4 mm plug or bare wire connection
<b>Power:</b>	<p><b>Input Voltage Range:</b> 85 to 264 Vac, automatic selection</p> <p><b>Input Frequency Range:</b> 47 to 440 Hz</p> <p><b>Power Requirement:</b> <math>\approx</math> 50 VA (14 Watts)</p>

### Remote Programming

<b>Interface:</b>	GPIB interface operates to IEEE 488.2 and IEC-625 RS-232 and RS-422 interfaces are supplied as standard
<b>Command Language:</b>	SCPI standard interface commands
<b>GPIB Compatibility:</b>	SH1, AH1, T6, TE0, L4, LE0, SR1, RL1, PP1, DC1, DT1, C0

## Physical Specifications

### Dimensions:

The following dimensions exclude front and rear panel protrusions:  
212.6 mm W x 88.5 mm H x 348.3 mm D  
(8.5 in x 3.5 in x 13.7 in)

<b>Weight (Net):</b>	<b>E4416A:</b> 4.0 Kg (8.8 lb) <i>approximately</i> <b>E4417A:</b> 4.1 Kg (9.0 lb) <i>approximately</i>
<b>Weight (Shipping):</b>	<b>E4416A:</b> 7.9 Kg (17.4 lb) <i>approximately</i> <b>E4417A:</b> 8.0 Kg (17.6 lb) <i>approximately</i>

## Environmental Specifications

### Operating Environment

<b>Temperature:</b>	0 °C to 55 °C
<b>Maximum Humidity:</b>	95% at 40 °C (non-condensing)
<b>Minimum Humidity:</b>	15% at 40 °C
<b>Maximum Altitude:</b>	3000 meters (9840 feet)

### Storage Conditions

<b>Storage Temperature:</b>	-20 °C to +70 °C
<b>Non-Operating Maximum Humidity:</b>	90% at 65 °C (non-condensing)
<b>Non-Operating Maximum Altitude:</b>	15240 meters (50000 feet)

## Regulatory Information

### Electromagnetic Compatibility

This product conforms with the protection requirements of European Council Directive 89/336/EEC for Electromagnetic Compatibility (EMC). The conformity assessment requirements have been met using the technical construction file route to compliance, using EMC test specifications EN 55011:1991 (Group 1, Class A) and EN 50082-1:1992. In order to preserve the EMC performance of the product, any cable which becomes worn or damaged must be replaced with the same type and specification.

### Product Safety

This product conforms to the requirements of European Council Directive 73/23/EEC, and meets the following safety standards:

- IEC61010-1(1990) + A1 (1992) + A2 (1995)/EN 61010-1 (1993)
- IEC 825-1(1993)/EN 60825-1 (1994)
- Canada / CSA C22.2 No. 1010.1-93

**www.agilent.com**

### **Contact us**

To obtain service, warranty, or technical support assistance, contact us at the following phone numbers:

United States:

(tel) 800 829 4444 (fax) 800 829 4433

Canada:

(tel) 877 894 4414 (fax) 800 746 4866

China:

(tel) 800 810 0189 (fax) 800 820 2816

Europe:

(tel) 31 20 547 2111

Japan:

(tel) (81) 426 56 7832 (fax) (81) 426 56 7840

Korea:

(tel) (080) 769 0800 (fax) (080) 769 0900

Latin America:

(tel) (305) 269 7500

Taiwan:

(tel) 0800 047 866 (fax) 0800 286 331

Other Asia Pacific Countries:

(tel) (65) 6375 8100 (fax) (65) 6755 0042

Or visit Agilent World Wide Web at:

[www.agilent.com/find/assist](http://www.agilent.com/find/assist)

Product specifications and descriptions in this document are subject to change without notice. Always refer to the Agilent Web site for the latest revision.

© Agilent Technologies, Inc. 2000–2013

Printed in Malaysia  
Sixth Edition, April 5, 2013

E4416-90023



**Agilent Technologies**