



# **Agilent N8480 Series Power Sensors**

## **Operating and Service Guide**



**Agilent Technologies**

# Notices

© Agilent Technologies, Inc. 2008–2014

No part of this manual may be reproduced in any form or by any means (including electronic storage and retrieval or translation into a foreign language) without prior agreement and written consent from Agilent Technologies, Inc. as governed by United States and international copyright laws.

## Manual Part Number

N8481-90000

## Edition

Tenth Edition, January 9, 2014

Printed in Malaysia

Agilent Technologies, Inc.  
5301 Stevens Creek Blvd.  
Santa Clara, CA 95051 USA

## Warranty

**The material contained in this document is provided “as is,” and is subject to being changed, without notice, in future editions. Further, to the maximum extent permitted by applicable law, Agilent disclaims all warranties, either express or implied, with regard to this manual and any information contained herein, including but not limited to the implied warranties of merchantability and fitness for a particular purpose. Agilent shall not be liable for errors or for incidental or consequential damages in connection with the furnishing, use, or performance of this document or of any information contained herein. Should Agilent and the user have a separate written agreement with warranty terms covering the material in this document that conflict with these terms, the warranty terms in the separate agreement shall control.**

## Technology Licenses

The hardware and/or software described in this document are furnished under a license and may be used or copied only in accordance with the terms of such license.

## Restricted Rights Legend

U.S. Government Restricted Rights. Software and technical data rights granted to the federal government include only those rights customarily provided to end user customers. Agilent provides this customary commercial license in Software and technical data pursuant to FAR 12.211 (Technical Data) and 12.212 (Computer Software) and, for the Department of Defense, DFARS 252.227-7015 (Technical Data - Commercial Items) and DFARS 227.7202-3 (Rights in Commercial Computer Software or Computer Software Documentation).

## Safety Notices

### CAUTION

A **CAUTION** notice denotes a hazard. It calls attention to an operating procedure, practice, or the like that, if not correctly performed or adhered to, could result in damage to the product or loss of important data. Do not proceed beyond a **CAUTION** notice until the indicated conditions are fully understood and met.

---


















### WARNING

A **WARNING** notice denotes a hazard. It calls attention to an operating procedure, practice, or the like that, if not correctly performed or adhered to, could result in personal injury or death. Do not proceed beyond a **WARNING** notice until the indicated conditions are fully understood and met.




---

## Safety Symbols

The following symbol on the instrument and in the documentation indicates precautions that must be taken to maintain safe operation of the instrument.

	Direct current (DC)		Off (supply)
	Alternating current (AC)		On (supply)
	Both direct and alternating current		Caution, risk of electric shock
	Three-phase alternating current		Caution, risk of danger (refer to this manual for specific Warning or Caution information)
	Earth (ground) terminal		Caution, hot surface
	Protective conductor terminal		Out position of a bi-stable push control
	Frame or chassis terminal		In position of a bi-stable push control
	Equipotentiality		Equipment protected throughout by double insulation or reinforced insulation
	<p>This symbol indicates that a device, or part of a device, may be susceptible to electrostatic discharges (ESD) which can result in damage to the product.</p> <p>Observe ESD precautions given on the product, or its user documentation, when handling equipment bearing this mark.</p>		

## Regulatory Markings

 <p><b>CE</b> <b>ISM 1-A</b></p>	<p>The CE mark shows that the product complies with all the relevant European legal Directives (if accompanied by a year, it signifies when the design was proven).</p>	 <p><b>C</b> <b>N10149</b></p>	<p>The C-tick mark is a registered trademark of the Spectrum management Agency of Australia. This signifies compliance with the Australian EMC Framework regulations under the terms of the Radio Communications Act of 1992.</p>
<p><b>ICES/NMB-001</b></p>	<p>This ISM device complies with the Canadian ICES-001, Cet appareil ISM est conforme à la norme NMB-001 du Canada.</p>		<p>This product complies with the WEEE Directive (2002/96/EC) marking equipment. The affixed product label indicates that you must not discard this electrical/electronic product in domestic household waste.</p>

## General Safety Information

The following general safety precautions must be observed during all phases of operation, service, and repair of this instrument. Failure to comply with these precautions or with specific warnings elsewhere in this manual violates safety standards of design, manufacture, and intended use of the instrument. Agilent Technologies assumes no liability for the customer's failure to comply with these requirements.

### WARNING

**Before connecting the power sensor to other instruments ensure that all instruments are connected to the protective (earth) ground. Any interruption of the protective earth grounding will cause a potential shock hazard that could result in personal injury.**

---

### CAUTION

- Use the instrument with the cables provided.
  - Repair or service that is not covered in this manual should only be performed by qualified personnels.
-

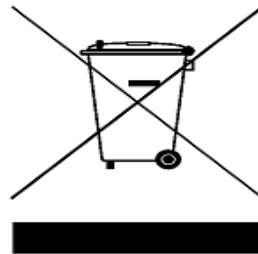
## Waste Electrical and Electronic Equipment (WEEE) Directive 2002/96/EC

This instruction complies with the WEEE Directive (2002/96/EC) marking requirement. This affixed product label indicates that you must not discard this electrical/electronic product in domestic household waste.

Product Category:

With reference to the equipment types in the WEEE directive Annex 1, this instrument is classified as a “Monitoring and Control Instrument” product.

The affixed product label is shown as below:



### **Do not dispose in domestic household waste**

To return this unwanted instrument, contact your nearest Agilent office, or visit

[www.agilent.com/environment/product](http://www.agilent.com/environment/product)

for more information.

## Environmental Conditions

This instrument is designed for indoor use only. The table below shows the general environmental requirements for the product.

### Operating Environment

Environmental Conditions	Requirements
Temperature	0 °C to 55 °C (Operating)
Humidity	Maximum: 95% at 40 °C Minimum: 15% at 40 °C
Altitude	Operating up to 4,600 metres (15,000 feet)

### Storage Conditions

Environmental Conditions	Requirements
Temperature	-40 °C to 70 °C (Non-operating)
Humidity	Non-operating up to 90% at 65 °C (Non-condensing)
Altitude	Non-operating up to 7,620 metres (25,000 feet)

#### CAUTION

The N8480 Series power sensors complies with the following EMC requirements:

- IEC 61326-1:2005/EN 61326-1:2006
  - Canada: ICES/NMB-001:2004
  - Australia/New Zealand: AS/NZS CISPR11:2004
-

## Declaration of Conformity (DoC)

The Declaration of Conformity (DoC) for this instrument is available on the Web site. You can search the DoC by its product model or description.

<http://regulations.corporate.agilent.com/DoC/search.htm>

### NOTE

If you are unable to search for the respective DoC, please contact your local Agilent representative.

---



## In This Guide ...

- 1 Introduction** Chapter 1 introduces the overview and operation of the N8480 Series power sensors.
- 2 Specifications and Characteristics** Chapter 2 describes the specifications and characteristics of the N8480 Series power sensors.
- 3 Service** Chapter 3 elaborates on the information about principle of operations, troubleshooting, and repair of the N8480 Series power sensors.

**THIS PAGE HAS BEEN INTENTIONALLY LEFT BLANK.**

# Contents

Notices	ii
Safety Symbols	iii
Safety Symbols	iii
Regulatory Markings	iv
General Safety Information	v
Waste Electrical and Electronic Equipment (WEEE) Directive 2002/96/EC	vi
Environmental Conditions	vii
In This Guide ...	ix

## 1 Introduction

General Information	2
Initial Inspections	3
Accessories Shipped with the Instrument	3
Original Packaging	3
Power Meter and Sensor Cable Requirements	4
Interconnection and Calibration	5
Recommended Calibration Interval	6
Temperature Sensitivity	6
Operating Instructions	7
Modulation Effect	8
Torque	8
Overview of the N8480 Series Power Sensors	9
N8485A Power Sensor	12
N8487A Power Sensor	12
N8488A Power Sensor	13
B-models and H-models Information	13
Waveguide-models Information	14
Options	15
Power Meter Firmware Compatibility	16
Power Meter Configuration Changes	17
Measurement Accuracy and Speed	18
Measurement Considerations	18

## **2 Specifications and Characteristics**

Specification Definitions	20
Warranted Specifications	20
Characteristic Specifications	20
Conditions	21
Specifications	22
Frequency and Dynamic Power Range	22
Damage Level	23
Maximum SWR	24
Power Linearity	31
Switching Point	35
Zero Set, Zero Drift and Measurement Noise	36
Settling Time	37
Calibration Factor and Reflection Coefficient	38
Calibration Factor Uncertainty	39
Supplemental Characteristics	43
Physical Characteristics	44

## **3 Service**

Cleaning	46
Connector Care	46
Principle of Operations	47
Performance Test	48
Standing Wave Ratio (SWR) and Reflection Coefficient (Rho) Performance Test	48
Zero Set Performance Test	51
Replaceable Parts	53
Troubleshooting	59
Repair	59
Diassembly/Reassembly Procedures	60
Diassembly Procedure	60
Reassembly Procedure	60

## List of Figures

- Figure 1-1 N8480 Series power sensors 2
- Figure 1-2 Connecting a sensor cable to power meter 5
- Figure 1-3 Connecting waveguide flange to the N8486AQ power sensor 7
- Figure 1-4 N8480 Series power sensor simplified block diagram 11
- Figure 1-5 N8485A power sensor with adapter 12
- Figure 1-6 N8487A power sensor with adapter 12
- Figure 1-7 N8488A power sensor with adapter 13
- Figure 1-8 Auto-averaging settings 17
- Figure 2-1 Typical SWR, 10 MHz to 18 GHz (25 °C ±10 °C) for N8481A power sensor 25
- Figure 2-2 Typical SWR, 100 kHz to 6 GHz (25 °C ±10 °C) for N8482A power sensor 26
- Figure 2-3 Typical SWR, 10 MHz to 26.5 GHz (25 °C ±10 °C) for N8485A power sensor 26
- Figure 2-4 Typical SWR, 50 MHz to 50 GHz (25 °C ±10 °C) for N8487A power sensor 27
- Figure 2-5 Typical SWR, 10 MHz to 70 GHz (25 °C ±10 °C) for N8488A power sensor 27
- Figure 2-6 Typical SWR, 33 MHz to 50 GHz (25 °C ±10 °C) for N8486AQ power sensor 28
- Figure 2-7 Typical SWR, 26.5 GHz to 40 GHz (25 °C ±10 °C) for N8486AR power sensor 28
- Figure 2-8 Typical SWR, 10 MHz to 18 GHz (25 °C ±10 °C) for N8481B power sensor 29
- Figure 2-9 Typical SWR, 100 kHz to 6 GHz (25 °C ±10 °C) for N8482B power sensor 29
- Figure 2-10 Typical SWR, 10 MHz to 18 GHz (25 °C ±10 °C) for N8481H power sensor 30
- Figure 2-11 Typical SWR, 100 kHz to 6 GHz (25 °C ±10 °C) for N8482H power sensor 30
- Figure 2-12 Typical N8481/2/5/7/8A and N8486AR/AQ power linearity at 25 °C, after zero and calibration with associated measurement uncertainty 32
- Figure 2-13 Typical N8481/2B power linearity at 25 °C, after zero and calibration with associated measurement uncertainty 33
- Figure 2-14 Typical N8481/2H power linearity at 25 °C, after zero and calibration with associated measurement uncertainty 34
- Figure 2-15 Autofilter, default resolution, 10 dB decreasing power step (not across the switching point) 37
- Figure 2-16 Typical cal factor and SWR vs. frequency 43
- Figure 3-1 Illustrated Parts Breakdown 54
- Figure 3-2 Removing power sensor shell 60

**THIS PAGE HAS BEEN INTENTIONALLY LEFT BLANK.**

## List of Tables

Table 1-1	Power sensor cable options	4
Table 1-2	RF connector type, wrench size, and torque values	8
Table 1-3	Power range in range setting	10
Table 1-4	Power meter firmware	16
Table 2-1	Frequency and dynamic power range	22
Table 2-2	Damage level at average and peak power	23
Table 2-3	Maximum SWR	24
Table 2-4	Power linearity	31
Table 2-5	Switching point hysteresis	35
Table 2-6	Zero set, zero drift and measurement noise	36
Table 2-7	Settling time in normal and x2 mode	37
Table 2-8	Calibration factor uncertainty at 25 °C ± 3 °C	39
Table 2-9	Calibration factor uncertainty at 25 °C ± 10 °C	40
Table 2-10	Calibration factor uncertainty at 0 °C to 55 °C	42
Table 2-11	Physical dimensions	44
Table 3-1	Reflection coefficient for N8480 Series power sensors (25 °C ± 10 °C)	49
Table 3-2	Replaceable parts list for standard N8480 Series power sensors	55
Table 3-3	Replaceable parts list for N8480 Series power sensors with Option CFT	57
Table 3-4	Replacement part list for adapters used on N8480 Series power sensors	58

**THIS PAGE HAS BEEN INTENTIONALLY LEFT BLANK.**





# 1 Introduction

General Information	2
Initial Inspections	3
Accessories Shipped with the Instrument	3
Original Packaging	3
Power Meter and Sensor Cable Requirements	4
Interconnection and Calibration	5
Recommended Calibration Interval	6
Temperature Sensitivity	6
Operating Instructions	7
Modulation Effect	8
Torque	8
Overview of the N8480 Series Power Sensors	9
N8485A Power Sensor	12
N8487A Power Sensor	12
N8488A Power Sensor	13
B-models and H-models Information	13
Waveguide-models Information	14
Options	15
Power Meter Firmware Compatibility	16
Power Meter Configuration Changes	17
Measurement Accuracy and Speed	18

This chapter contains information about initial inspection and overview of the Agilent N8480 Series power sensors.



## General Information

This guide contains information about the initial inspection, connections, specifications, operation, and performance tests of the N8480 Series power sensors. You can also find a copy of this guide on the *EPM and EPM-P Series Power Meter Documentation CD* supplied with the power meter.



**Figure 1-1** N8480 Series power sensors

## Initial Inspections

- 1 Inspect the shipping container for damage. Signs of damage may include a dented or torn shipping container or cushioning material that shows signs of unusual stress or compacting.
- 2 Carefully remove the contents from the shipping container and verify that your order is complete.

### NOTE

- If the shipping container or packaging material is damaged, it should be kept until the contents have been checked mechanically and electrically. If there is mechanical damage, notify the nearest Agilent Technologies office. Keep the damaged shipping materials (if any) for inspection by the carrier and Agilent representative. If required, you can find a list of Agilent Sales and Service Offices on the last page of this guide.
  - Ensure you have read and understand the preceding safety information before proceed.
- 

## Accessories Shipped with the Instrument

The following items are shipped with every purchase of N8480 Series power sensor:

- Certificate of Calibration
- Product Reference CD

Verify that any options ordered are included with the shipment by checking the packing list included with the shipment.

## Original Packaging

Containers and materials identical to those used in the factory packaging are available through Agilent Technologies office. If the instrument is being returned to Agilent Technologies for servicing, attach a tag indicating the type of service required, return address, model number, and serial number. Also mark the container FRAGILE to assure careful handling. In any correspondence, refer to the instrument by model number and serial number.

## Power Meter and Sensor Cable Requirements

Table 1-1 lists the length of cable option for the N8480 Series power sensors.

**Table 1-1** Power sensor cable options

Power Sensor Cable Option	Description	Supported Power Meter
<b>11730 Family Sensor Cables (Grey)</b> 11730A 11730B 11730C 11730D 11730E 11730F <sup>1</sup>	1.5 m (5-ft) cable length 3 m (10-ft) cable length 6.1 m (20-ft) cable length 15.2 m (50-ft) cable length 30.5 m (100-ft) cable length 61 m (200-ft) cable length (operate up to 45 °C)	EPM Series power meters
<b>E9288 Family Sensor Cables (Blue)</b> E9288A E9288B E9288C	1.5 m (5-ft) cable length 3 m (10-ft) cable length 10 m (31-ft) cable length	EPM Series power meters <sup>1</sup> EPM-P Series power meters
<b>N1917 Family Sensor Cable Adapter</b> N1917A N1917B N1917C	1.5 m (5-ft) cable length 3 m (10-ft) cable length 10 m (31-ft) cable length	P-Series power meters

<sup>1</sup> Only applicable for E4418B and E4419B power meters.

## Interconnection and Calibration

Connect one end of the supported sensor cable to the N8480 Series power sensor and connect the other end of the cable to the power meter's channel input. Allow approximately four seconds for the power meter to download the data from the power sensor's EEPROM.



**Figure 1-2** Connecting a sensor cable to power meter

### NOTE

- For B-models power sensors, you must disconnect the attached attenuator before connecting it to the power meter for zero and calibration.
- The waveguide-models power sensors have two inputs:
  - Type-N connector — for a 50 MHz 1 mW calibration signal generated by the power meter
  - Waveguide flange — to be connected to the test port during actual measurement.

### CAUTION

For power sensors with Type-N connector, connect the power sensor to the power meter by turning the nut only. The power sensor can be damaged if the torque is applied to the power sensor's body.

### WARNING

**Before connecting the power sensor to other instruments, ensure that all instruments are connected to the protective (earth) ground. Any interruption of the protective earth grounding will cause a potential shock hazard that could result in personal injury.**

To carry out a zero and calibration cycle required by the power meter, refer to the respective power meter's *User's Guide* for details of the power sensor's zero and calibration procedures.

For new connections and measurements below  $-25$  dBm (applicable for N8487A with serial number MY48700101 to MY54089999 and N8488A with serial number MY50230001 to MY54089999 only), it is recommended to perform the following steps.

- 1 Connect the power sensor to the test port.
- 2 Allow the power sensor to settle for at least 20 minutes with no RF power.
- 3 Perform zeroing with the power sensor still connected to the test port.

### NOTE

It is recommended to perform frequent zeroing when performing measurements below  $-25$  dBm.

## Recommended Calibration Interval

Agilent Technologies recommends a one year calibration cycle for the N8480 Series power sensors.

## Temperature Sensitivity

The sensitivity of the power sensor is influenced by ambient temperature. The sensor should be recalibrated at each change in temperature to obtain the most accurate results. The sensor has a built-in temperature compensation that ensures the accuracy of measurement carried out within  $0$  to  $55$  °C, refer to [Table 2-4](#) for details. For measurement below  $-25$  dBm, it is recommended to re-apply zero procedure when there has been a temperature variation of more than  $\pm 5$  °C since the last zeroing.

## Operating Instructions

To operate the power sensors, refer to the operating instructions in the respective power meter's *User's Guide*.

### CAUTION

#### For N8486AQ power sensor only.

When connecting the waveguide flange to the power sensor, make sure you follow the following procedures to avoid any damage to the precision waveguide flange:

- 1 Torque the waveguide flange's screws to < 3.75 lb-in (maximum).
- 2 Insert the two screws as indicated in [Figure 1-3](#) located at the side of the flange. Insert the remaining two screws to either side of the flange. Tighten the four screws until finger tight.
- 3 Tighten the flange using a calibrated torque wrench by going back and forth between each screws that are opposite to each others. Tighten each screw with a small incremental torque until the desired torque is achieved.  
If you are using the hex ball driver, hold the driver with your thumb and forefinger to avoid excess torque. You must extremely carefull not to over-torque when using the hex ball driver, and do not fully torque one screw before tightening the others.



**Figure 1-3** Connecting waveguide flange to the N8486AQ power sensor

## Modulation Effect

When measuring RF or microwave sources that are modulated at the chopper frequency (nominally 440 Hz), at the first or second harmonic or submultiples of the chopper frequency, beat notes may occur. Unless these beat notes are exactly the chopper frequency, they can usually be eliminated by averaging (filtering) since the amplitudes are plus and minus the actual power. These frequencies may also be avoided by changing the modulation frequency slightly, if possible.

Refer to the respective power meter's *User's Guide* for information on setting the averaging (filtering).

## Torque

Table 1-2 shows the connector type (for connection to DUT) for the power sensor models. A torque wrench must be used to tighten these connectors. Only use a wrench set to the correct torque value.

**Table 1-2** RF connector type, wrench size, and torque values

Model	Option	RF Connector	Wrench Size	Torque Value
N8481A	N8481A-100	Type-N (male)	3/4 inch open end	12 lb-in
	N8481A-200	APC-7		
N8482A	N8482A-100	Type-N (male)		
N8481B	N8481B-100			
N8482B	N8482B-100			
N8481H	N8481H-100			
N8482H	N8482H-100			
N8485A	N8485A-100	3.5 mm (male)	3/4 inch or 20 mm open end	8 lb-in
N8487A	N8487A-100	2.4 mm (male)	5/16 inch open end	8 lb-in
N8488A	N8488A-100	1.85 mm (male)	4/5 inch open end	8 lb-in
N8486AQ	N8486AQ-100	Waveguide Flange UG-383/U	3/32 inch Balldriver-Hex <sup>1</sup>	3.75 lb-in
N8486AR	N8486AR-100	Waveguide flange UG-599/U	3/32 inch Balldriver-Hex <sup>1</sup>	3.75 lb-in

<sup>1</sup> Balldriver is used to tighten the screws, instead of the connector.



## Overview of the N8480 Series Power Sensors

The N8480 Series power sensors are high accuracy thermocouple power sensors that allow direct measurement of RF or microwave power through the heating effect it has on a terminating load. All calibration data for the N8480 Series power sensors is stored in EEPROM<sup>1</sup> and is downloaded to the power meter when the sensor is connected. In terms of functionality and performance, they<sup>2</sup> replace and surpass the popular 8480 thermocouple power sensors.

The N8480 Series power sensors are used for measuring the average power supplied by an RF or microwave source or a device-under-test (DUT). In use, the power sensor is connected to the RF or microwave source and to a compatible power meter. The N8480 Series power sensors are compatible with the EPM Series power meters (E4418B, E4419B, N1913A, and N1914A), EPM-P Series power meters (E4416A and E4417A), and P-Series power meters (N1911A and N1912A) only. The N8480 Series power sensors place a 50  $\Omega$  load on the RF or microwave source. The power meter indicates the power dissipated in this load in mW or dBm.

The N8480 Series power sensors consist of four sensor model types with respective power range:

- A-models (–35 dBm to +20 dBm)
  - N8481A, N8482A, N8485A, N8487A, and N8488A<sup>3</sup>
- B-models (–5 dBm to +44 dBm)
  - N8481B and N8482B
- H-models (–15 dBm to +35 dBm)
  - N8481H and N8482H
- Waveguide-models (–35 dBm to +20 dBm)
  - N8486AQ and N8486AR

<sup>1</sup> The calibration factor table stored in the EEPROM is not applicable for N8480 Series sensors with Option CFT.

<sup>2</sup> Except for N8488A power sensor. N8488A power sensor is a newly introduced high frequency sensor. It is not meant to replace any of the existing 8480 thermocouple power sensors.

<sup>3</sup> Option CFT is not available for N8488A power sensor.

**NOTE**

For B-models power sensors, the calibration factor data is valid only when the sensor is used with the supplied attenuator.

**Table 1-3** Power range in range setting

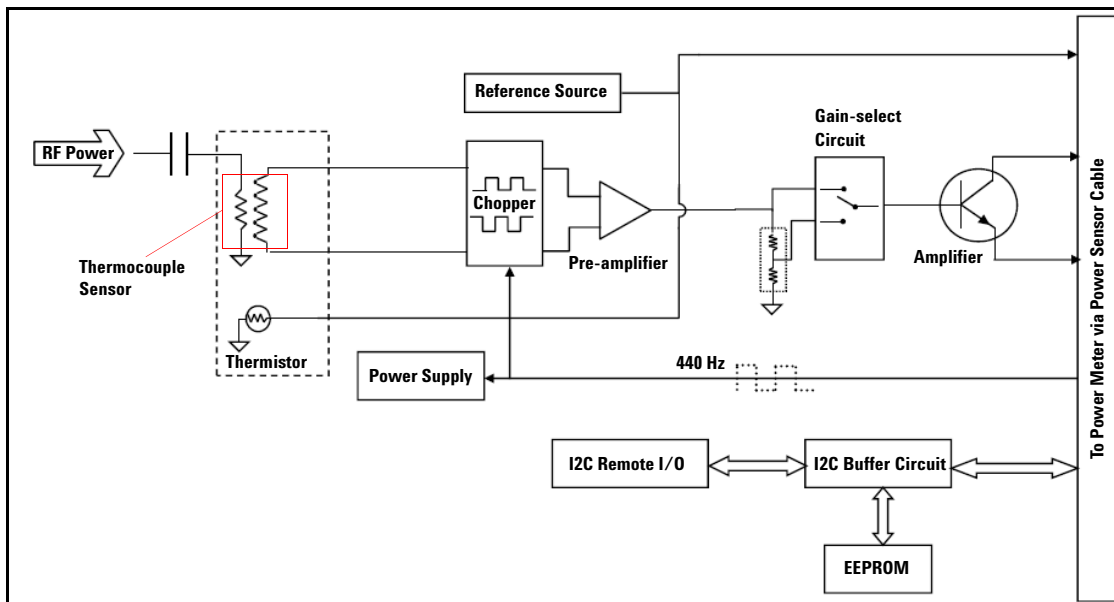
Sensor	Range Setting	Lower Range	Upper Range
N8481/2/5/7/8A and N8486AQ/AR excluding Option CFT	AUTO (Default)	-35 dBm to -1 dBm	-1 dBm to +20 dBm
	LOWER	-35 dBm to -1 dBm	-
	UPPER <sup>1</sup>	-	-30 dBm to +20 dBm
N8481/2B excluding Option CFT	AUTO (Default)	-5 dBm to +29 dBm	+29 dBm to +44 dBm
	LOWER	-5 dBm to +29 dBm	-
	UPPER <sup>1</sup>	-	0 dBm to +44 dBm
N8481/2H excluding Option CFT	AUTO (Default)	-15 dBm to +17 dBm	+17 dBm to +35 dBm
	LOWER	-15 dBm to +17 dBm	-
	UPPER <sup>1</sup>	-	-10 dBm to +35 dBm

<sup>1</sup> Recommended for pulse signals measurement with period of more than one second.

The N8480 Series power sensors (excluding Option CFT) measure power levels from -35 dBm to +44 dBm (316 nW to 25.1 W), at frequencies from 100 kHz to 67 GHz and have two independent power measurement range (upper and lower range).

Meanwhile, the N8480 sensors with Option CFT (except for N8488A) only measure power levels from -30 dBm to +44 dBm (1  $\mu$ W to 25.1 W) in single range. Similar to the E-Series power sensors, the N8480 Series power sensors are also equipped with EEPROM to store sensor's characteristics such as model number, serial number, linearity, temperature compensation, calibration factor, and so forth.

This feature ensures the correct calibration data is applied by any compatible power meter connected with N8480 Series power sensor, and to ensure the accuracy of the measurements.



**Figure 1-4** N8480 Series power sensor simplified block diagram

Figure 1-4 illustrates a basic power sensor block diagram for thermocouple power sensing elements. From the RF or microwave signal input, the thermocouple detector mounts generate a very low voltage – in the order of nV. As the DC voltage is very low, it requires amplification before it can be transferred to the power meter on the standard cables.

The amplification is provided by an input amplifier assembly that consists of a balanced chopper and an AC coupled low-noise amplifier. The DC voltage is routed through gold wires to the chopper circuit, which converts the low-level DC voltage to an AC voltage. To do this, the chopper is controlled by a 440 Hz square-wave generated by the power meter (the chop signal). The result is an AC output signal proportional to the DC input. The AC signal is then amplified to a relatively high-level AC signal that can be routed to the power meter by standard cables (Agilent 11730 Series cables are available up to 61 metres from  $-5\text{ }^{\circ}\text{C}$  to  $45\text{ }^{\circ}\text{C}$ ).

## N8485A Power Sensor

The N8485A power sensor is fitted with 3.5 mm (m) connectors as standard. To convert the 3.5 mm (m) connector for calibration, an adapter (3.5 mm (f) to Type-N (m)) is included with the power sensor. See [Figure 1-5](#).



**Figure 1-5** N8485A power sensor with adapter

**NOTE**

The 3.5 mm to Type-N adapter is intended for the use of 1 mW, 50 MHz power reference of the power meter only. Its function as a calibration reference may be compromised if it is used for other purpose.

## N8487A Power Sensor

The N8487A power sensor is fitted with 2.4 mm (m) connector as standard. To convert the 2.4 mm (m) connector for calibration, an adapter (2.4 mm (f) to Type-N (m)) is included with the power sensor. See [Figure 1-6](#).



**Figure 1-6** N8487A power sensor with adapter

**NOTE**

The 2.4 mm to Type-N adapter is intended for the use of 1 mW, 50 MHz power reference of the power meter only. Its function as a calibration reference may be compromised if it is used for other purpose.

## N8488A Power Sensor

The N8488A power sensor is calibrated to measure power levels in 10 MHz to 67 GHz frequency range. This sensor is functional up to 70 GHz; with typical specifications ranging from *67 GHz to 70 GHz*.

The N8488A power sensor is fitted with 1.85 mm (m) connector as standard. To convert the 1.85 mm (m) connector for calibration, an adapter (2.4 mm (f) to Type-N (m)) is included with the power sensor. See [Figure 1-7](#).



**Figure 1-7** N8488A power sensor with adapter

### NOTE

- The 2.4 mm to Type-N adapter is intended for the use of 1 mW, 50 MHz power reference of the power meter only. Its function as a calibration reference may be compromised if it is used for other purpose.
- According to *IEEE Standard for Precision Coaxial 1.85 mm Slash Sheet*, the 1.85 mm (m) connector is compatible with the 2.4 mm (f) connector. Hence, the adapter (2.4 mm (f) to Type-N (m)) can be used to convert the 1.85 mm (m) connector for calibration.

## B-models and H-models Information

The B-models (with 30 dB removable attenuator) or H-models (with 20 dB attenuator) power sensor is a calibrated combination of an attenuator assembly and a sensor assembly.

The attenuator and sensor assemblies are calibrated as a set and must be used together when a specified accuracies are to be obtained. These combination is referred to as a power sensor.

### NOTE

#### For B-models power sensors only

- Removal of D-ring from the sensor assembly will void the warranty.
  - The D-ring that is available on the input connector; located on the sensor is used to prevent the sensor from being connected to a high power source when an attenuator is not attached. The sensors must only be connected to the power meter for calibration or to a high power attenuator for any RF measurements.
- 

### WARNING

- **For B-models power sensors only. The high power attenuator contains a substrate of beryllium oxide. Beryllium oxide in powder form is a hazardous material and may be harmful to your health if inhaled. Do not perform any operation on the beryllium oxide that might generate dust.**
  - **Defective attenuator should be returned to Agilent Technologies for proper disposal.**
- 

## Waveguide-models Information

The waveguide power sensors (excluding Option CFT) measure power levels from -35 dBm to +20 dBm at frequencies from 26.5 GHz to 50 GHz. They consist of a multi-stepped coax which adapt the 50  $\Omega$  thermocouple impedance to the desired waveguide impedance, and hence provide a very low SWR up to 40 or 50 GHz.

## Options

### N8481A Option 200

The N8481A power sensor is fitted with Type-N (m) connector as standard. Users can choose the sensor to be fitted with APC-7 connector by choosing the Option 200.

### N8485A Option 033

The N8485A power sensor with Option 033 is calibrated to measure power levels in the 10 MHz to 33 GHz frequency range.

---

**NOTE**

The N8485A Option 033 power sensor is fitted with a 3.5 mm(m) connector.

---

### N8480 Series power sensors with Option CFT

The N8480 Series power sensors with Option CFT covers  $-30$  dBm to  $+20$  dBm in a single power range and allows users to use the calibration factor in two methods:

- manually enter the calibration factor for a particular frequency prior to make a measurement; or
- manually enter the sensors calibration factor table and select the frequency of the signal to be measured

The calibration factor data is provided on the label attached to the power sensor's cover. This calibration factor is used to make frequency dependent efficiency correction and it is unique to each sensors.

For Option CFT specifications and characteristics, see [Chapter 2](#), "Specifications and Characteristics."

---

**NOTE**

- The calibration factor table stored in the EEPROM is not applicable for N8480 Series power sensors with Option CFT.
- Please refer to the respective power meter's *User's Guide* on how to make a measurement using the calibration factor table.

## Power Meter Firmware Compatibility

Before using the N8480 Series power sensors, make sure the power meter is using the latest firmware as shown in [Table 1-4](#). This is to ensure that the power meter is compatible with N8480 Series power sensors.

**Table 1-4** Power meter firmware

Power Meter	Model Number	Compatible Firmware Revision
EPM Series power meters	E4418B	A1.09.01 and above
	E4419B	A2.09.01 and above
	N1913A	A.01.00 and above
	N1914A	
EPM-P Series power meters	E4416A	A1.05.01 and above
	E4417A	A2.05.01 and above
P-Series power meters	N1911A	A.05.02 and above
	N1912A	

For detailed information on the firmware installation, refer to the respective power meter Web site located at [www.agilent.com](http://www.agilent.com) under **Technical Support > Drivers & Software > Firmware Update**.

### NOTE

You can also find the compatible power meter's firmware as well as the firmware upgrade procedures in *N8480 Series Power Sensors Product Reference CD*.



## Power Meter Configuration Changes

The Agilent EPM Series, EPM-P Series, or P-Series power meters recognize the Agilent N8480 Series power sensor when it is connected. The N8480 Series power sensors (excluding Option CFT) calibration data is automatically read by the power meter. In addition, the auto-averaging settings shown in [Figure 1-8](#) are also automatically configured.

	N8481/2/5/7/8A			Maximum Sensor Power	Resolution Setting				Number of Averages
	N8486AQ/AR	N8481/2B	N8481/2H		1	2	3	4	
	0 dBm	30 dBm	20 dBm	-----	1	1	2	8	Number of Averages
	-1 dBm	29 dBm	17 dBm	-----	2	2	4	32	
	-10 dBm	20 dBm	10 dBm	-----	2	2	4	32	
	-20 dBm	10 dBm	0 dBm	-----	2	2	16	256	
	-30 dBm	0 dBm	-10 dBm	-----	2	8	128	128	
				-----	4	64	256	512	
				Minimum Sensor Power					

**Figure 1-8** Auto-averaging settings

### NOTE

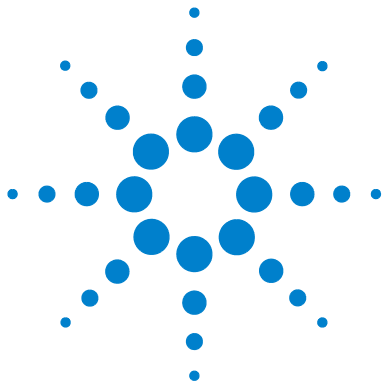
These values are valid only for the power meter channel connected to an Agilent N8480 Series power sensor. Averaging settings can also be manually configured. Refer to the respective power meter's *User's Guide* for information on setting the averaging (filtering).

## Measurement Accuracy and Speed

The power meter has no internal ranges. The only ranges you can set are those of the Agilent N8480 Series power sensors and other Agilent E-Series power sensors. With an Agilent N8480 Series power sensor (excluding Option CFT) or E-Series power sensor, the range can be set either automatically or manually. Use autoranging when you are not sure of the power level you are about to measure.

### Measurement Considerations

While autoranging is a good starting point, it is not ideal for all measurements. Signal characteristics such as crest factor or duty cycle may cause the power meter to select a range which is not the optimum configuration for your specific measurement needs. Signals with average power levels close to the range switch point require you to consider your needs for measurement accuracy. When measuring pulse signals, you are recommended to select manual filtering. This allows you to choose the averaging to cover the many periods of the pulse signal instead of having it determined by measurement noise. Selecting manual filtering also changes the behaviour of the autoranging to help prevent frequency range changes due to pulses. For a very long pulse periods (more than one second), it may be better to select UPPER range as this will prevent any possibility of range changes upsetting the measurement.



## 2 Specifications and Characteristics

Specification Definitions	20
Warranted Specifications	20
Characteristic Specifications	20
Conditions	21
Specifications	22
Frequency and Dynamic Power Range	22
Damage Level	23
Maximum SWR	24
Power Linearity	31
Switching Point	35
Zero Set, Zero Drift and Measurement Noise	36
Settling Time	37
Calibration Factor and Reflection Coefficient	38
Calibration Factor Uncertainty	39
Supplemental Characteristics	43
Physical Characteristics	44

This chapter contains information about specifications and characteristics of the Agilent N8480 Series power sensors.



# Specification Definitions

There are two types of product specifications:

- warranted specifications
- characteristic specifications

## Warranted Specifications

Warranted specifications are covered by the product warranty and apply over 0 °C to 55 °C, unless otherwise noted. Warranted specifications include measurement uncertainty calculated with 95% confidence.

## Characteristic Specifications

Characteristic specifications are not warranted. They describe product performance that is useful in the application of the power sensors by giving typical, but non-warranted performance parameters. These characteristics are shown in *italics* or denoted as “*typical*”, “*nominal*” or “*approximate*”.

Characteristic information is representative of the product. In many cases, it may also be supplemental to a warranted specification.

Characteristic specifications are not verified on all power sensors. The types of characteristic specifications can be placed in two groups:

- The first group of characteristic types describes 'attributes' common to all products of a given model or option.

Examples of characteristics that describe 'attributes' are product weight, and 50 Ω input Type-N connector. In these examples product weight is an *approximate* value and a 50 Ω input is *nominal*. These two terms are most widely used when describing a product's 'attributes'.

- The second group of characteristic types describes 'statistically' the aggregate performance of the population of products.

These characteristics describe the expected behavior of the population of products. They do not guarantee the performance of any individual product. No measurement uncertainty value is accounted for in the specification. These specifications are referred to as *typical*.

- *Typical plots* are derived from a population mean from production testing. Plot shown may vary from unit to unit and is not warranted.

For warranted specifications, refer to the individual tables.

## Conditions

The power meter and power sensor meet its specifications when:

- Stored for a minimum of two hours at a stable temperature within the operating temperature range, and turned on for at least 30 minutes.
- The power meter and power sensor are within their recommended calibration periods.
- Used in accordance to the information provided in the power meter's *User's Guide*.

## Specifications

**NOTE**

- Specifications stated in this chapter refer to all N8480 Series power sensors unless otherwise stated.
- The term “standard” used in table under the Sensor Option column is referring to all N8480 Series power sensors except Option CFT.

### Frequency and Dynamic Power Range

**Table 2-1** Frequency and dynamic power range

Sensor Option	Sensor Model	Frequency Range	Dynamic Power Range
Standard	N8481A	10 MHz to 18 GHz	-35 dBm to +20 dBm
	N8482A	100 kHz to 6 GHz	
	N8485A	10 MHz to 26.5 GHz	
	N8485A Option 033	10 MHz to 33 GHz	
	N8487A	50 MHz to 50 GHz	
	N8488A	10 MHz to 67 GHz <i>67 GHz to 70 GHz</i>	
	N8486AR	26.5 GHz to 40 GHz	
	N8486AQ	33 GHz to 50 GHz	
	N8481B	10 MHz to 18 GHz	-5 dBm to +44 dBm
	N8482B	100 kHz to 6 GHz	
	N8481H	10 MHz to 18 GHz	-15 dBm to +35 dBm
	N8482H	100 kHz to 6 GHz	

**Table 2-1** Frequency and dynamic power range

Sensor Option	Sensor Model	Frequency Range	Dynamic Power Range
Option CFT	N8481A	10 MHz to 18 GHz	-30 dBm to +20 dBm
	N8482A	100 kHz to 6 GHz	
	N8485A	10 MHz to 26.5 GHz	
	N8485A Option 033	10 MHz to 33 GHz	
	N8487A	50 MHz to 50 GHz	
	N8486AR	26.5 GHz to 40 GHz	
	N8486AQ	33 GHz to 50 GHz	0 dBm to +44 dBm
	N8481B	10 MHz to 18 GHz	
	N8482B	100 kHz to 6 GHz	
	N8481H	10 MHz to 18 GHz	-10 dBm to +35 dBm
	N8482H	100 kHz to 6 GHz	

## Damage Level

**Table 2-2** Damage level at average and peak power

Sensor Model	Damage Level (Average Power)	Damage Level (Peak Power)
N8481A N8482A N8485A N8487A N8488A N8486AR N8486AQ	+25 dBm	15 W/2 $\mu$ s
N8481B N8482B	+49 dBm	500 W/1 $\mu$ s
N8481H N8482H	+40 dBm	100 W/1 $\mu$ s

## Maximum SWR

**NOTE**

For overlapping frequency points, refer to the lower SWR specification.

**Table 2-3** Maximum SWR

Sensor Model	Frequency Band	Maximum SWR	
		(25 °C ± 10 °C)	(0 °C to 55 °C)
N8481A	10 MHz to 30 MHz	1.37	1.57
	30 MHz to 50 MHz	1.14	1.16
	50 MHz to 2 GHz	1.08	1.11
	2 GHz to 12.4 GHz	1.16	1.16
	12.4 GHz to 18 GHz	1.23	1.25
N8482A	100 kHz to 300 kHz	1.54	1.57
	300 kHz to 1 MHz	1.17	1.17
	1 MHz to 2 GHz	1.06	1.06
	2 GHz to 6 GHz	1.07	1.08
N8485A	10 MHz to 50 MHz	1.33	1.53
	50 MHz to 100 MHz	1.08	1.11
	100 MHz to 2 GHz	1.05	1.07
	2 GHz to 12.4 GHz	1.14	1.14
	12.4 GHz to 18 GHz	1.19	1.20
	18 GHz to 26.5 GHz	1.26	1.28
26.5 GHz to 33 GHz <sup>1</sup>	1.32	1.36	
N8487A	50 MHz to 100 MHz	1.08	1.10
	100 MHz to 2 GHz	1.05	1.07
	2 GHz to 12.4 GHz	1.10	1.10
	12.4 GHz to 18 GHz	1.16	1.16
	18 GHz to 26.5 GHz	1.22	1.22
	26.5 GHz to 40 GHz	1.30	1.30
40 GHz to 50 GHz	1.34	1.33	
N8488A	10 MHz to 100 MHz	1.08	1.08
	100 MHz to 2.4 GHz	1.08	1.08
	2.4 GHz to 12.4 GHz	1.10	1.10
	12.4 GHz to 18 GHz	1.12	1.14
	18 GHz to 26.5 GHz	1.21	1.23
	26.5 GHz to 40 GHz	1.30	1.31
	40 GHz to 67 GHz	1.46	1.47
67 GHz to 70 GHz	1.48	1.50	

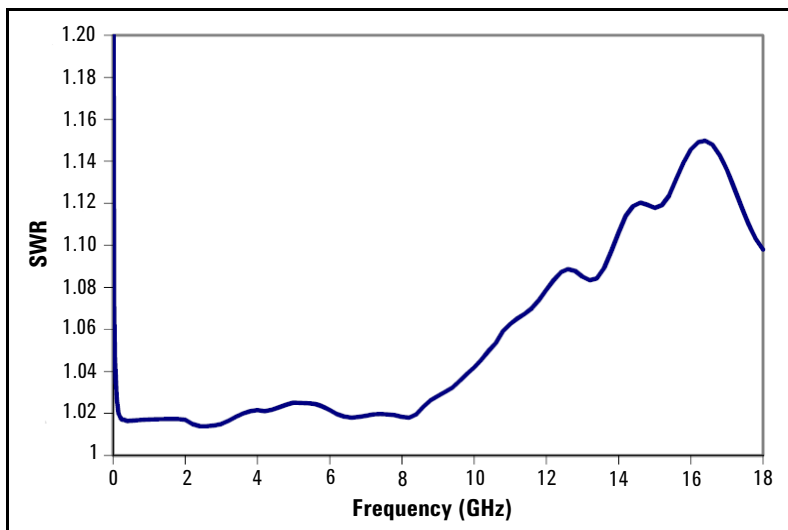


**Table 2-3** Maximum SWR

Sensor Model	Frequency Band	Maximum SWR	
		(25 °C ± 10 °C)	(0 °C to 55 °C)
N8486AR	50 MHz <sup>2</sup>	1.17	1.20
	26.5 GHz to 40 GHz	1.40	1.40
N8486AQ	50 MHz <sup>2</sup>	1.17	1.20
	33 GHz to 50 GHz	1.50	1.50
N8481B	10 MHz to 2 GHz	1.09	1.10
	2 GHz to 12.4 GHz	1.14	1.18
	12.4 GHz to 18 GHz	1.23	1.28
N8482B	100 kHz to 2 GHz	1.08	1.10
	2 GHz to 6 GHz	1.16	1.18
N8481H	10 MHz to 8 GHz	1.16	1.16
	8 GHz to 12.4 GHz	1.22	1.22
	12.4 GHz to 18 GHz	1.32	1.41
N8482H	100 kHz to 6 GHz	1.13	1.14

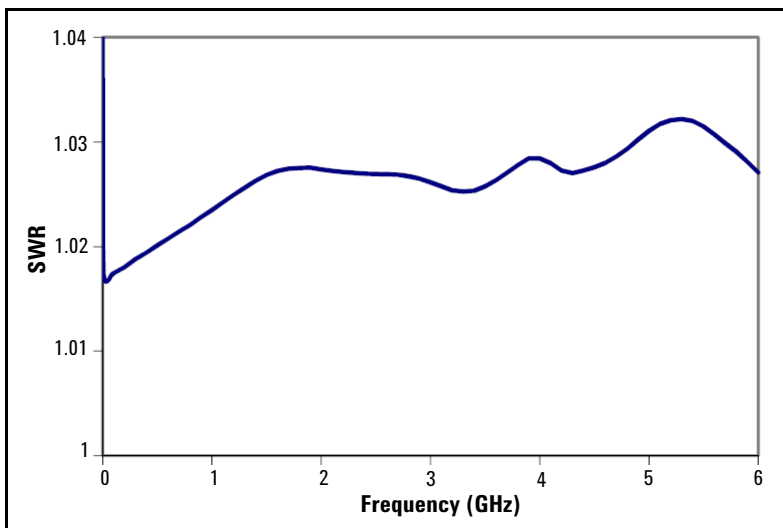
<sup>1</sup> Only applicable for N8485A Option 033.

<sup>2</sup> SWR for 50 MHz calibration port . Type-N (m) coaxial connector is used in the 50 MHz calibration.

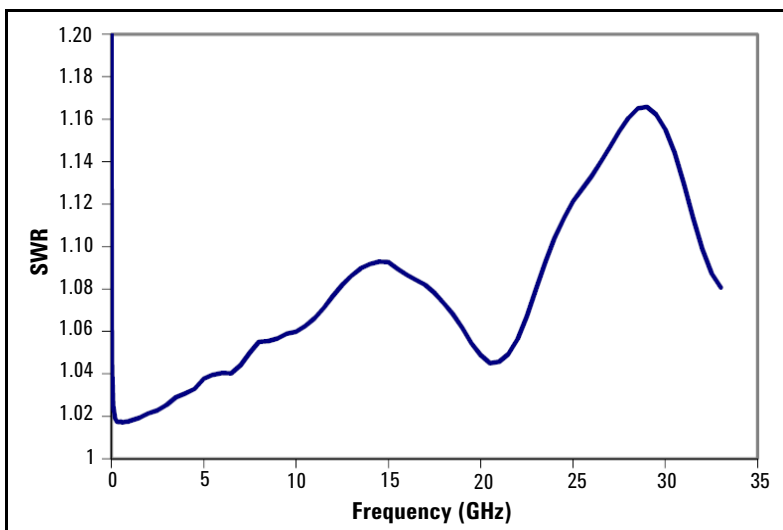


**Figure 2-1** Typical SWR, 10 MHz to 18 GHz (25 °C ±10 °C) for N8481A power sensor

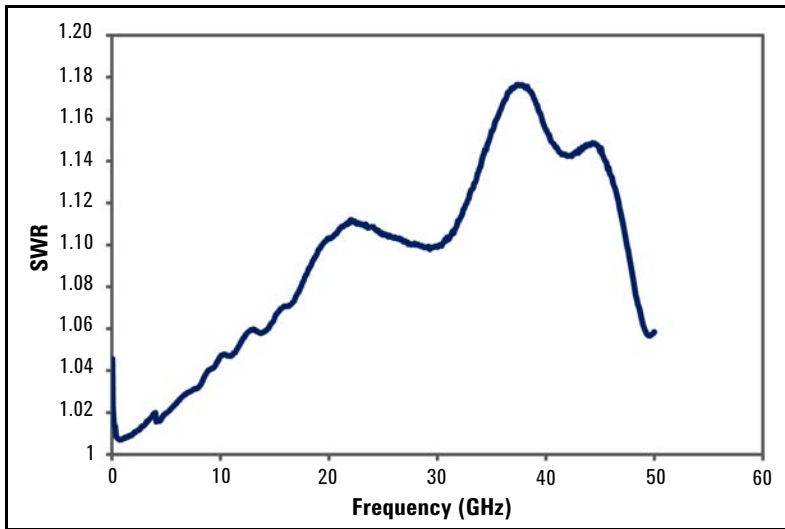
## 2 Specifications and Characteristics



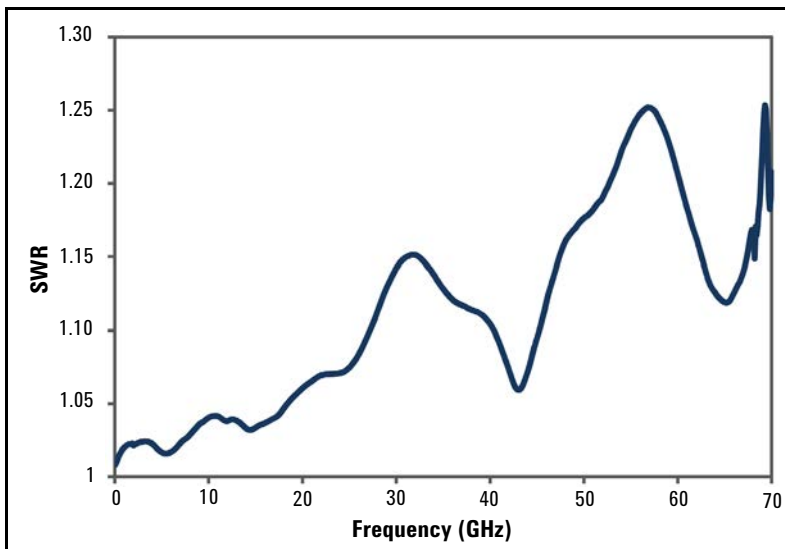
**Figure 2-2** Typical SWR, 100 kHz to 6 GHz (25 °C ±10 °C) for N8482A power sensor



**Figure 2-3** Typical SWR, 10 MHz to 26.5 GHz (25 °C ±10 °C) for N8485A power sensor

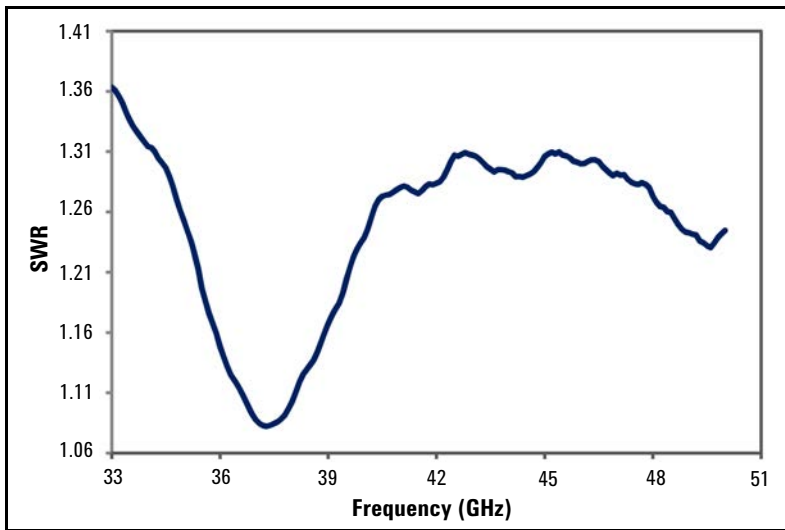


**Figure 2-4** Typical SWR, 50 MHz to 50 GHz (25 °C ±10 °C) for N8487A power sensor

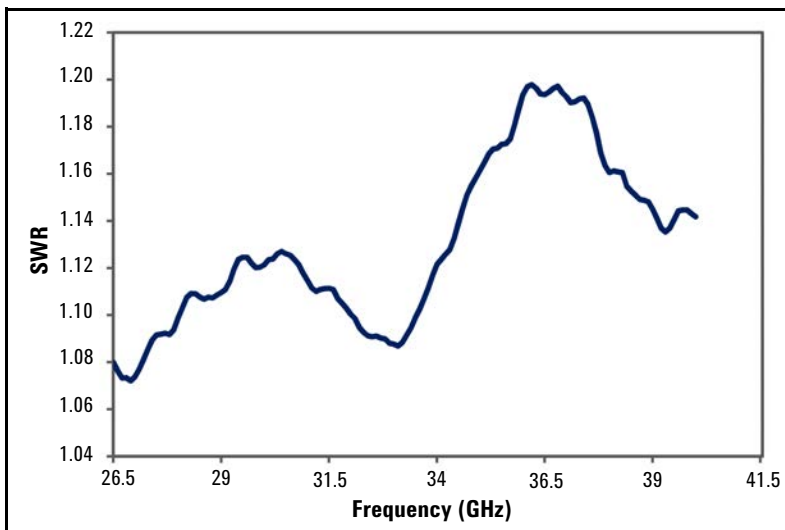


**Figure 2-5** Typical SWR, 10 MHz to 70 GHz (25 °C ±10 °C) for N8488A power sensor

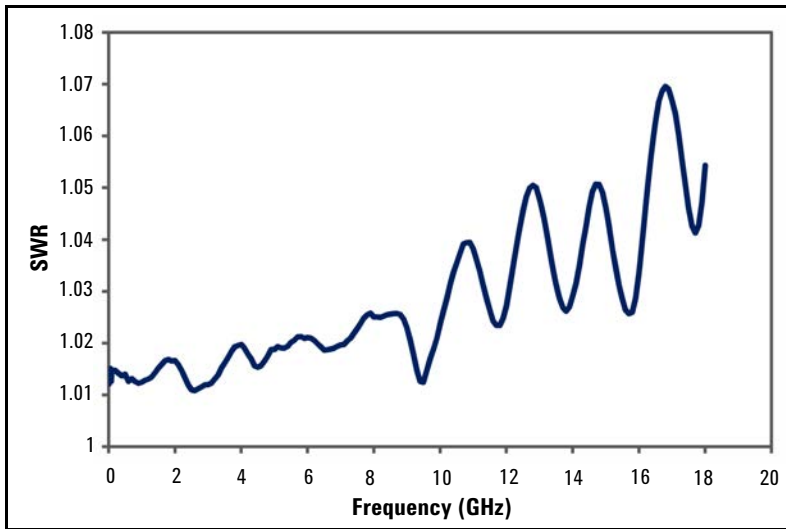
## 2 Specifications and Characteristics



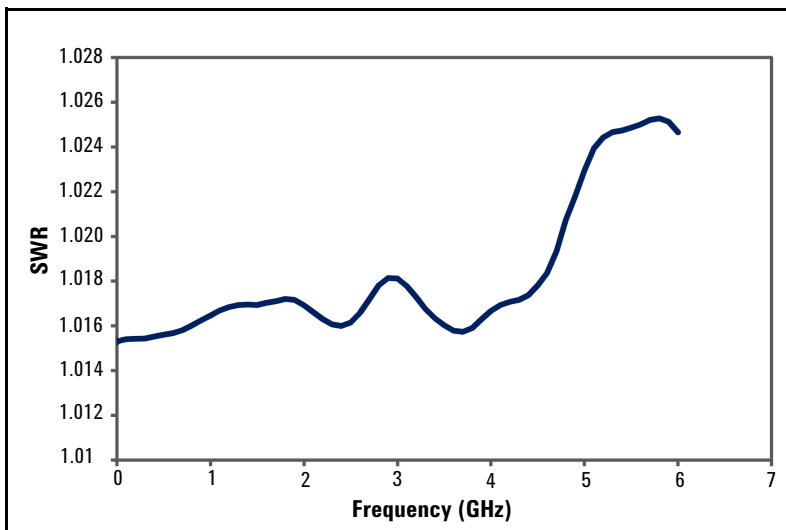
**Figure 2-6** Typical SWR, 33 MHz to 50 GHz (25 °C ±10 °C) for N8486AQ power sensor



**Figure 2-7** Typical SWR, 26.5 GHz to 40 GHz (25 °C ±10 °C) for N8486AR power sensor

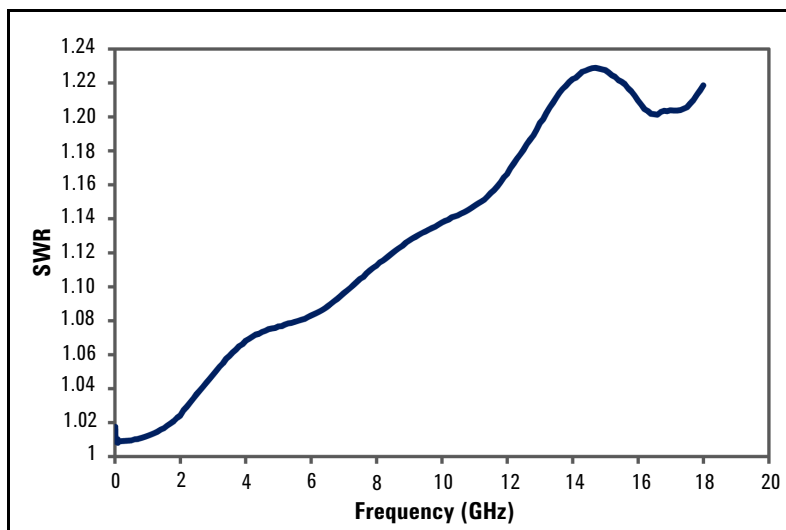


**Figure 2-8** Typical SWR, 10 MHz to 18 GHz (25 °C ±10 °C) for N8481B power sensor

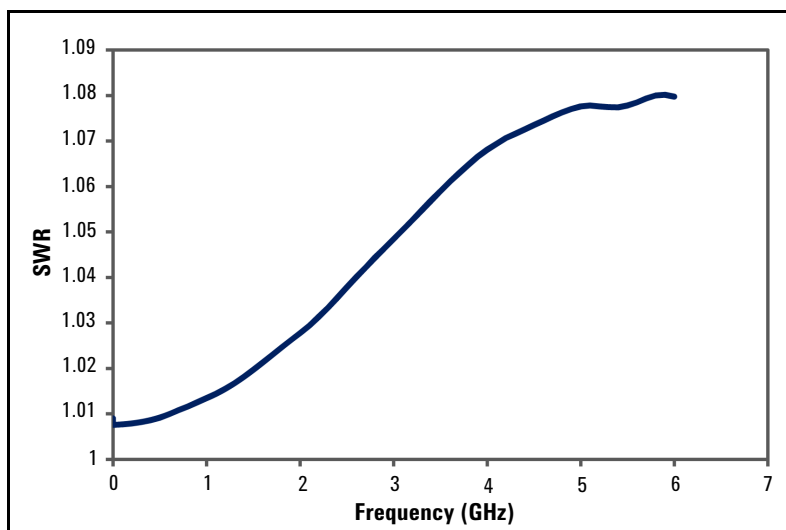


**Figure 2-9** Typical SWR, 100 kHz to 6 GHz (25 °C ±10 °C) for N8482B power sensor

## 2 Specifications and Characteristics



**Figure 2-10** Typical SWR, 10 MHz to 18 GHz (25 °C ±10 °C) for N8481H power sensor



**Figure 2-11** Typical SWR, 100 kHz to 6 GHz (25 °C ±10 °C) for N8482H power sensor

## Power Linearity

After zero and calibration at ambient environment conditions.

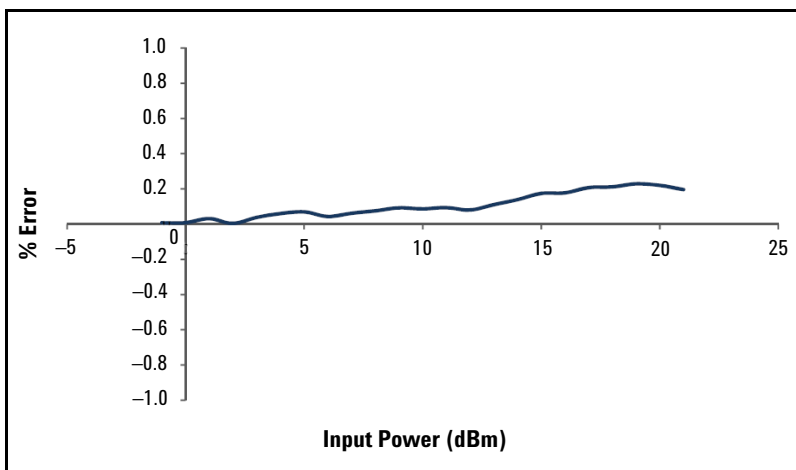
### NOTE

The N8480 Series power sensors' linearity is negligible except for the power range specified in [Table 2-4](#).

**Table 2-4** Power linearity

Sensor Model	Power Range	Linearity (25°C ± 10 °C )	Linearity (0 °C to 55 °C )
N8481A N8482A N8485A N8487A N8488A N8486AR N8486AQ	-1 dBm to +15 dBm	±0.52%	±0.80%
	+15 dBm to +20 dBm	±0.80%	±1.90%
N8481B	+29 dBm to +39 dBm	±0.52%	±0.80%
N8482B	+39 dBm to +44 dBm	±1.66%	±2.75%
N8481H	+17 dBm to +30 dBm	±0.77%	±1.05%
N8482H	+30 dBm to +35 dBm	±2.84%	±3.93%

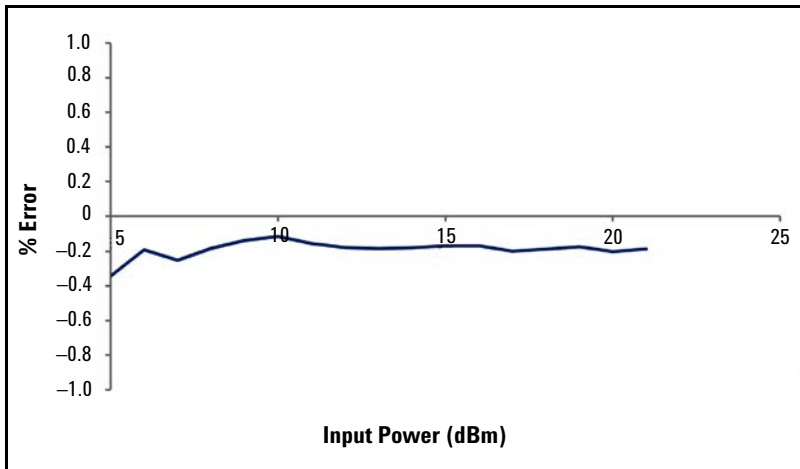
## 2 Specifications and Characteristics



**Figure 2-12** Typical N8481/2/5/7/8A and N8486AR/AQ power linearity at 25 °C, after zero and calibration with associated measurement uncertainty

N8481/2/5/7/8A and N8486AR/AQ	-1 dBm to +10 dBm	+10 dBm to +15 dBm	+15 dBm to +20 dBm
Measurement Uncertainty (%)	±0.35	±0.35	±0.35

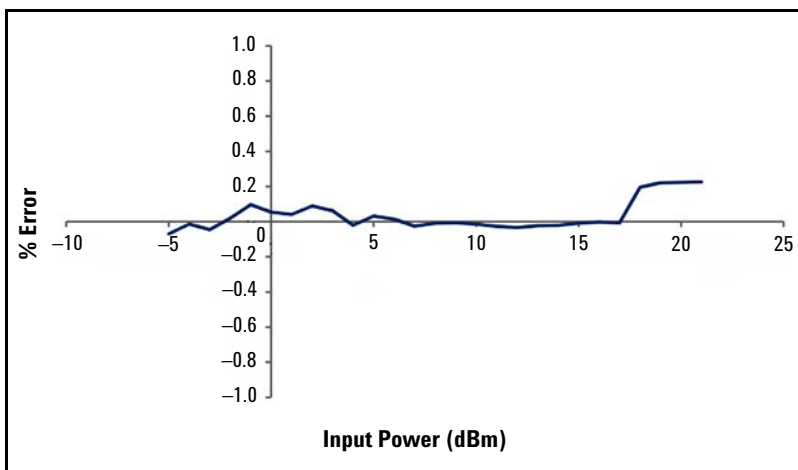




**Figure 2-13** Typical N8481/2B power linearity at 25 °C, after zero and calibration with associated measurement uncertainty

N8481/2B	+29 dBm to +40 dBm	+40 dBm to +44 dBm
Measurement Uncertainty (%)	$\pm 0.35$	$\pm 1.21$

## 2 Specifications and Characteristics



**Figure 2-14** Typical N8481/2H power linearity at 25 °C, after zero and calibration with associated measurement uncertainty

N8481/2H	+17 dBm to +30 dBm	+30 dBm to +35 dBm
Measurement Uncertainty (%)	$\pm 0.60$	$\pm 2.39$

## Switching Point

### NOTE

Switching point is applicable for standard N8480 Series power sensors only.

The N8480 Series power sensors have two power measurement ranges; a lower range and upper range. The power meter automatically selects the proper power range. To avoid unnecessary switching when the power level is near switching point, a **Switching Point Hysteresis** has been added.

**Table 2-5** Switching point hysteresis

Switching point hysteresis	0.5 dB
----------------------------	--------

### **N8481/2/5/7/8A and N8486AQ/AR power sensors**

This hysteresis causes the lower range to remain selected until approximately  $-0.5$  dBm as the power level is increased, above this power the upper range is selected.

The upper range remains selected until approximately  $-1.5$  dBm as the signal level decreases, below this power the lower range is selected.

### **N8481/2B power sensors**

This hysteresis causes the lower range to remain selected until approximately 29.5 dBm as the power level is increased, above this power the upper range is selected.

The upper range remains selected until approximately 28.5 dBm as the signal level decreases, below this power the lower range is selected.

### **N8481/2H power sensors**

This hysteresis causes the lower range to remain selected until approximately 17.5 dBm as the power level is increased, above this power the upper range is selected.

The upper range remains selected until approximately 16.5 dBm as the signal level decreases, below this power the lower range is selected.

## Zero Set, Zero Drift and Measurement Noise

**Table 2-6** Zero set, zero drift and measurement noise

Sensor Model	Sensor Option	Range	Conditions (RH) <sup>1</sup>	Zero Set <sup>4</sup>	Zero Drift <sup>2, 4</sup>	Measurement Noise <sup>3, 4</sup>
N8481A N8482A N8485A N8486AR N8486AQ N8487A	Standard	Upper	20% to 70%	±63 nW	< ±7 nW	< 114 nW
		Lower	20% to 70%	±25 nW	< ±3 nW	< 80 nW
	Option CFT	N/A <sup>5</sup>	20% to 70%	±63 nW	< ±7 nW	< 114 nW
N8488A	Standard	Upper	20% to 70%	±63 nW	< ±7 nW	< 114 nW
		Lower	20% to 70%	±25 nW	< ±3 nW	< 80 nW
	Option CFT	N/A <sup>5</sup>	N/A <sup>5</sup>	N/A <sup>5</sup>	N/A <sup>5</sup>	N/A <sup>5</sup>
N8481B N8482B	Standard	Upper	20% to 70%	±63 μW	< ±7 μW	< 114 μW
		Lower	20% to 70%	±25 μW	< ±3 μW	< 80 μW
	Option CFT	N/A <sup>5</sup>	20% to 70%	±63 μW	< ±7 μW	< 114 μW
N8481H N8482H	Standard	Upper	20% to 70%	±6.3 μW	< ±0.7 μW	< 11.4 μW
		Lower	20% to 70%	±2.5 μW	< ±0.3 μW	< 8 μW
	Option CFT	N/A <sup>5</sup>	20% to 70%	±6.3 μW	< ±0.7 μW	< 11.4 μW

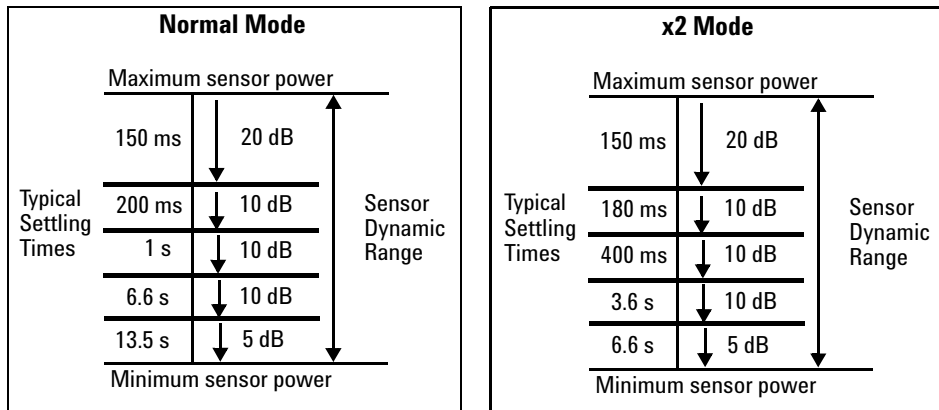
- 1 RH is the abbreviation for relative humidity.
- 2 Average hourly drift, at constant temperature. It is recommended to wait for 3 minutes and perform zeroing before taking the measurement. For N8487A with serial number MY48700101 to MY54089999 and N8488A with serial number MY50230001 to MY54089999, it is recommended to wait for 30 minutes and perform zeroing before taking the measurement.
- 3 The number of averages at 16 for normal mode and 32 for x2 mode, at a constant temperature, measured over one minute interval and two standard deviations.
- 4 The zero set, zero drift, and measurement noise specifications are tested at 50 MHz.
- 5 N/A is the abbreviation for “not applicable”.

## Settling Time

In normal and x2 mode, manual filter, 10 dB decreasing power step (not across the switching point), the settling time is shown in [Table 2-7](#).

**Table 2-7** Settling time in normal and x2 mode

Number of Averages	1	2	4	8	16	32	64	128	256	512	1024
Settling Time (s) (Normal mode)	0.15	0.2	0.3	0.5	1.1	1.9	3.4	6.6	13	27	57
Response Time (s) (x2 mode)	0.15	0.18	0.22	0.35	0.55	1.1	1.9	3.5	6.9	14.5	33



**Figure 2-15** Autofilter, default resolution, 10 dB decreasing power step (not across the switching point)

## Calibration Factor and Reflection Coefficient

Calibration Factor (CF) and Reflection Coefficient (Rho) data are provided on a data sheet included with the power sensor. This data is unique to each power sensor. If you have more than one power sensor, match the serial number on the data sheet with the serial number on the power sensor you are using. The CF corrects for the frequency response of the power sensor. The Agilent EPM Series, EPM-P Series, or P-Series power meters automatically read the CF data stored in the power sensor's EEPROM and use it to make the corrections.

Reflection Coefficient (Rho, or  $\rho$ ) relates to the SWR according to the following formula:

$$\text{SWR} = \frac{1 + \rho}{1 - \rho}$$

Typical measurement uncertainties of the Calibration Factor (CF) are listed in the following tables. There is only one set of CF data used for both high and low range of each power sensors. Therefore, there is only one set of measurement uncertainty data available. The typical measurement uncertainty data listed in this guide is meant to help users on the measurement uncertainty estimation. These values are only a guideline and are not to be used in any accurate uncertainty calculations. For accurate measurement uncertainty values, please refer to the measurement report<sup>1</sup> of the specific power sensor.

### NOTE

Do not assume the typical measurement uncertainty listed in this guide as the maximum calibration factor measurement uncertainty.

<sup>1</sup> Only applicable with the purchase of Option 1A7 or Option A6J.

## Calibration Factor Uncertainty

**Table 2-8** Calibration factor uncertainty at 25 °C ± 3 °C

Frequency	25 °C ± 3 °C					
	N8481A	N8481B	N8481H	N8482A	N8482B	N8482H
100 kHz to 10 MHz	-	-	-	0.91	1.48	0.89
10 MHz to 30 MHz	0.82	1.42	0.77	0.78	1.43	0.79
30 MHz to 500 MHz	0.77	1.48	0.89	0.77	1.49	0.89
500 MHz to 1.2 GHz	0.78	1.48	0.89	0.78	1.49	0.89
1.2 GHz to 6 GHz	0.91	1.58	1.06	0.89	1.56	1.02
6 GHz to 14 GHz	1.26	1.77	1.46	-	-	-
14 GHz to 18 GHz	1.59	1.92	1.73	-	-	-

**Table 2-8** Calibration factor uncertainty at 25 °C ± 3 °C (continued)

Frequency	25 °C ± 3 °C			
	N8485A	N8487A	N8486AR	N8486AQ
100 kHz to 10 MHz	-	-	-	-
10 MHz to 30 MHz	0.82	-	-	-
30 MHz to 500 MHz	1.24	1.33	-	-
500 MHz to 1.2 GHz	1.26	1.35	-	-
1.2 GHz to 6 GHz	1.35	1.41	-	-
6 GHz to 14 GHz	1.66	1.61	-	-
14 GHz to 18 GHz	1.83	1.73	-	-
18 GHz to 26.5 GHz	2.67	2.26	-	-
26.5 GHz to 33 GHz	3.32	2.58	2.68	-
33 GHz to 34 GHz	-	2.80	3.19	3.14
34 GHz to 35 GHz	-	2.80	3.19	3.40
35 GHz to 40 GHz	-	2.80	3.19	3.14
40 GHz to 45 GHz	-	3.66	-	3.19
45 GHz to 50 GHz	-	4.23	-	3.26

## 2 Specifications and Characteristics

**Table 2-8** Calibration factor uncertainty at 25 °C ± 3 °C (continued)

Frequency	25 °C ± 3 °C
	N8488A
10 MHz to 50 MHz	1.70
50 MHz to 100 MHz	1.60
100 MHz to 2 GHz	1.58
2 GHz to 12.4 GHz	1.75
12.4 GHz to 18 GHz	1.92
18 GHz to 26.5 GHz	2.43
16.5 GHz to 50 GHz	4.56
50 GHz to 67 GHz	5.30
67 GHz to 70 GHz	5.81

**Table 2-9** Calibration factor uncertainty at 25 °C ± 10 °C

Frequency	25 °C ± 10 °C					
	N8481A	N8481B	N8481H	N8482A	N8482B	N8482H
100 kHz to 10 MHz	-	-	-	1.28	2.40	0.99
10 MHz to 30 MHz	1.47	1.98	1.39	1.03	1.84	0.86
30 MHz to 500 MHz	1.03	1.91	1.10	1.03	1.83	0.98
500 MHz to 1.2 GHz	0.97	1.91	1.15	1.08	1.94	1.00
1.2 GHz to 6 GHz	1.23	1.97	1.42	1.81	2.68	1.19
6 GHz to 14 GHz	1.85	2.69	3.87	-	-	-
14 GHz to 18 GHz	2.17	3.20	7.01	-	-	-



**Table 2-9** Calibration factor uncertainty at 25 °C ± 10 °C (continued)

Frequency	25 °C ± 10 °C			
	N8485A	N8487A	N8486AR	N8486AQ
100 kHz to 10 MHz	-	-	-	-
10 MHz to 30 MHz	<i>0.94</i>	-	-	-
30 MHz to 500 MHz	<i>1.43</i>	<i>1.84</i>	-	-
500 MHz to 1.2 GHz	<i>1.52</i>	<i>2.10</i>	-	-
1.2 GHz to 6 GHz	<i>1.68</i>	<i>2.36</i>	-	-
6 GHz to 14 GHz	<i>2.26</i>	<i>2.87</i>	-	-
14 GHz to 18 GHz	<i>2.47</i>	<i>3.14</i>	-	-
18 GHz to 26.5 GHz	<i>3.75</i>	<i>3.77</i>	-	-
26.5 GHz to 33 GHz	<i>4.79</i>	<i>4.17</i>	<i>3.48</i>	-
33 GHz to 34 GHz	-	<i>4.55</i>	<i>4.07</i>	<i>5.02</i>
34 GHz to 35 GHz	-	<i>4.55</i>	<i>4.07</i>	<i>4.99</i>
35 GHz to 40 GHz	-	<i>4.55</i>	<i>4.07</i>	<i>5.02</i>
40 GHz to 45 GHz	-	<i>5.40</i>	-	<i>5.17</i>
45 GHz to 50 GHz	-	<i>6.02</i>	-	<i>5.20</i>

**Table 2-9** Calibration factor uncertainty at 25 °C ± 10 °C (continued)

Frequency	25 °C ± 3 °C
	N8488A
10 MHz to 50 MHz	<i>2.83</i>
50 MHz to 100 MHz	<i>1.98</i>
100 MHz to 2 GHz	<i>1.84</i>
2 GHz to 12.4 GHz	<i>2.45</i>
12.4 GHz to 18 GHz	<i>2.89</i>
18 GHz to 26.5 GHz	<i>3.52</i>
16.5 GHz to 50 GHz	<i>4.99</i>
50 GHz to 67 GHz	<i>6.46</i>
<i>67 GHz to 70 GHz</i>	<i>7.29</i>

## 2 Specifications and Characteristics

**Table 2-10** Calibration factor uncertainty at 0 °C to 55 °C

Frequency	0 °C to 55 °C					
	N8481A	N8481B	N8481H	N8482A	N8482B	N8482H
100 kHz to 10 MHz	-	-	-	1.59	2.67	1.41
10 MHz to 30 MHz	4.46	3.64	2.83	0.91	1.73	0.86
30 MHz to 500 MHz	1.57	2.22	1.44	1.16	1.77	1.03
500 MHz to 1.2 GHz	1.65	2.49	1.60	1.54	2.12	1.07
1.2 GHz to 6 GHz	2.04	2.85	1.96	1.99	3.91	1.40
6 GHz to 14 GHz	2.62	3.81	4.81	-	-	-
14 GHz to 18 GHz	3.27	4.30	9.74	-	-	-

**Table 2-10** Calibration factor uncertainty at 0 °C to 55 °C (continued)

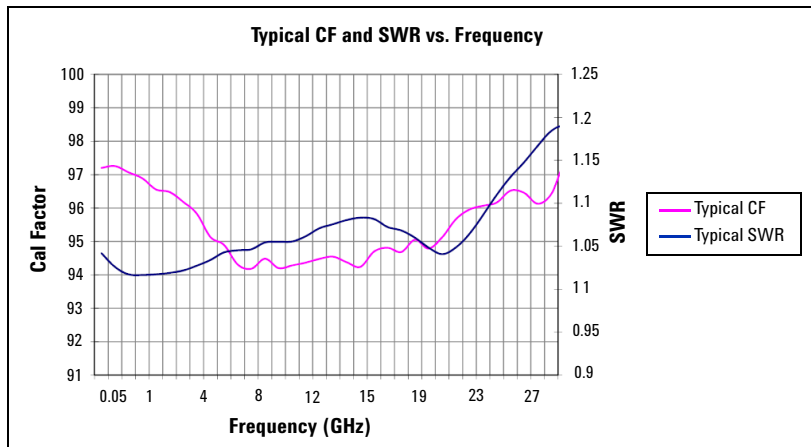
Frequency	0 °C to 55 °C			
	N8485A	N8487A	N8486AR	N8486AQ
100 kHz to 10 MHz	-	-	-	-
10 MHz to 30 MHz	1.25	-	-	-
30 MHz to 500 MHz	1.98	2.14	-	-
500 MHz to 1.2 GHz	2.07	2.45	-	-
1.2 GHz to 6 GHz	2.40	2.65	-	-
6 GHz to 14 GHz	2.99	3.17	-	-
14 GHz to 18 GHz	3.35	3.41	-	-
18 GHz to 26.5 GHz	4.70	4.04	-	-
26.5 GHz to 33 GHz	6.41	4.43	3.76	-
33 GHz to 34 GHz	-	4.84	4.25	6.04
34 GHz to 35 GHz	-	4.84	4.25	6.04
35 GHz to 40 GHz	-	4.84	4.25	6.04
40 GHz to 45 GHz	-	5.70	-	5.86
45 GHz to 50 GHz	-	6.19	-	6.59

**Table 2-10** Calibration factor uncertainty at 0 °C to 55 °C (continued)

Frequency	25 °C ± 3 °C
	N8488A
10 MHz to 50 MHz	3.69
50 MHz to 100 MHz	2.63
100 MHz to 2 GHz	2.40
2 GHz to 12.4 GHz	2.61
12.4 GHz to 18 GHz	3.15
18 GHz to 26.5 GHz	4.50
16.5 GHz to 50 GHz	5.67
50 GHz to 67 GHz	7.18
67 GHz to 70 GHz	8.69

## Supplemental Characteristics

Supplemental characteristics are intended to provide additional information, useful in applying the power sensor by giving a typical but not warranted performance parameters.



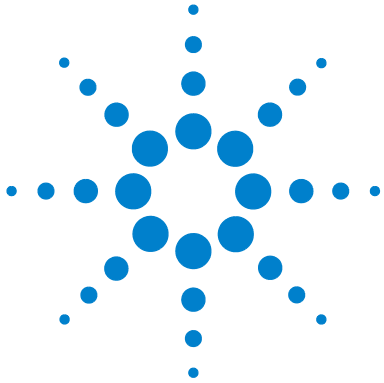
**Figure 2-16** Typical cal factor and SWR vs. frequency

## Physical Characteristics



**Table 2-11** Physical dimensions

Sensor Model	Dimensions	Weight
N8481A N8482A	38 mm W x 30 mm H x 130 mm L (1.5 in X 1.2 in X 5.1 in)	Net: 0.181 kg (0.40 lb) Shipping: 0.90 kg (1.98 lb)
N8485A	38 mm W x 30 mm H x 121 mm L (1.5 in X 1.2 in X 4.75 in)	Net: 0.183 kg (0.40 lb) Shipping: 0.90 kg (1.98 lb)
N8487A	38 mm W x 30 mm H x 121 mm L (1.5 in X 1.2 in X 4.75 in)	Net: 0.154 kg (0.34 lb) Shipping: 0.874 kg (1.92 lb)
N8488A	38 mm W x 30 mm H x 115 mm L (1.5 in X 1.2 in X 4.5 in)	Net: 0.162 kg (0.36 lb) Shipping: 0.881 kg (1.94 lb)
N8486AR	38 mm W x 62 mm H x 152 mm L (1.5 in X 2.4 in X 6.0 in)	Net: 0.202 kg (0.45 lb) Shipping: 0.922 kg (2.03 lb)
N8486AQ	38 mm W x 62 mm H x 152 mm L (1.5 in X 2.4 in X 6.0 in)	Net: 0.204 kg (0.45 lb) Shipping: 0.924 kg (2.03 lb)
N8481B N8482B	83 mm W x 114 mm H x 283 mm L (3.2 in X 4.5 in X 11.1 in)	Net: 0.684 kg (1.51 lb) Shipping: 1.404 kg (3.09 lb)
N8481H N8482H	38 mm W x 30 mm H x 174 mm L (1.5 in X 1.2 in X 6.8 in)	Net: 0.234 kg (0.52 lb) Shipping: 0.954 kg (2.10 lb)



## 3 Service

Cleaning	46
Connector Care	46
Principle of Operations	47
Performance Test	48
Standing Wave Ratio (SWR) and Reflection Coefficient (Rho) Performance Test	48
Zero Set Performance Test	51
Replaceable Parts	53
Troubleshooting	59
Repair	59
Diassembly/Reassembly Procedures	60
Diassembly Procedure	60
Reassembly Procedure	60

This chapter contains information about principle of operations, troubleshooting, and repair of the Agilent N8480 Series power sensors.



## Cleaning

Use a clean, damp cloth to clean the body of the N8480 Series power sensors.

### Connector Care

A solution of pure isopropyl or ethyl alcohol can be used to clean connectors but make sure to keep in mind on its flammable nature.

#### CAUTION

- The RF connector bead deteriorates when contacted with any chlorinated or aromatic hydrocarbon such as acetone, trichlorethane, carbon tetrachloride, and benzene.
- Do not attempt to clean connectors with anything metallic such as pins or paper clips.

---

Clean the connector only at a static free workstation. Electrostatic discharge to the center pin of the connector will render the power sensor inoperative.

Clean the connector face by first using a blast of compressed air. If the compressed air fails to remove contaminants, use a cotton swab dipped in isopropyl or ethyl alcohol. If the swab is too big, use a round wooden toothpick wrapped in a lint free cloth dipped in isopropyl or ethyl alcohol.

## Principle of Operations

The A1 module assembly (refer to [Figure 3-1](#)) on the Agilent N8480 Series power sensors provides a 50  $\Omega$  load to the RF signal applied to the power sensor. A thermocouple assembly in the bulkhead converts the applied RF to produce DC voltages which vary with the RF power across the 50  $\Omega$  load.

The low-level DC voltages from the bulkhead assembly are amplified before they are transferred on standard cables to the power meter. The amplification is provided by an input amplifier assembly which consists of a chopper (sampling gate) and an input amplifier. The chopper circuit converts the DC voltages to AC voltages. The chopper is controlled by a 440 Hz square wave generated by the power meter. The amplitude of the sampling gate output is a 440 Hz square wave which varies with the RF power input. The 440 Hz AC output is applied to an amplifier which provides the input to the power meter.

The Agilent EPM Series, EPM-P Series, or P-Series power meters automatically detects the power sensor when an Agilent N8480 Series power sensor is connected and downloads the correction data from the sensor's EEPROM. The auto-averaging settings are also configured automatically for use with Agilent N8480 Series power sensors. This configures the power meter to operate over the range with that particular sensor's unique correction data applied.

## Performance Test

### Standing Wave Ratio (SWR) and Reflection Coefficient (Rho) Performance Test

This section does not establish preset SWR test procedures since there are several test methods and different equipment available for testing the SWR or reflection coefficient. Therefore, the actual accuracy of the test equipment must be accounted for when measuring against instrument specifications to determine a pass or fail condition. The test system used must not exceed the system Rho uncertainties shown in [Table 3-1](#) when testing the N8480 Series power sensors.

To check the calibration factor, the power sensor should be compared with another recently calibrated power sensor. The source should be leveled with a reference coupler that has low SWR and high directivity to monitor or level the incident power.

For calibration factor and error analysis, refer to Agilent Application Note AN1449-1 to AN1449-4 (Part 1 to Part 4), “Fundamentals of RF and Microwave Power Measurement”.

#### NOTE

#### Waveguide power sensors only (N8486AR and N8486AQ)

- While the flange of the N8486AR is similar to the one described in MIL F-3922/54C-003, the N8486AQ is modified to mate with the greater precision of MIL-3922/67B-006 flanges. The true position of the holes relative to each other are held to a diameter tolerance of 0.0254 mm (0.001 in). The holes are held to 1.664 mm (0.0655 in) minimum diameter while the pins are held to 1.61 mm (0.0634 in) maximum diameter.



**Table 3-1** Reflection coefficient for N8480 Series power sensors (25 °C ± 10 °C)

Sensor Model	Frequency	System Rho Uncertainty	Actual Measurement	Maximum Rho
N8481A	10 MHz to 30 MHz	±0.007		0.157
	30 MHz to 50 MHz	±0.005		0.067
	50 MHz to 2 GHz	±0.005		0.040
	2 GHz to 12.4 GHz	±0.012		0.073
	12.4 GHz to 18 GHz	±0.013		0.105
N8482A	100 kHz to 300 kHz	±0.007		0.212
	300 kHz to 1 MHz	±0.005		0.077
	1 MHz to 2 GHz	±0.008		0.030
	2 GHz to 6 GHz	±0.009		0.035
N8485A	10 MHz to 50 MHz	±0.011		0.143
	50 MHz to 100 MHz	±0.006		0.038
	100 MHz to 2 GHz	±0.005		0.025
	2 GHz to 12.4 GHz	±0.009		0.064
	12.4 GHz to 18 GHz	±0.011		0.085
	18 GHz to 26.5 GHz	±0.014		0.114
	26.5 GHz to 33 GHz	±0.020		0.139
N8487A	50 MHz to 100 MHz	±0.013		0.038
	100 MHz to 2 GHz	±0.011		0.026
	2 GHz to 12.4 GHz	±0.011		0.049
	12.4 GHz to 18 GHz	±0.014		0.072
	18 GHz to 26.5 GHz	±0.022		0.099
	26.5 GHz to 40 GHz	±0.039		0.130
	40 GHz to 50 GHz	±0.055		0.144

**Table 3-1** Reflection coefficient for N8480 Series power sensors (25 °C ± 10 °C)

Sensor Model	Frequency	System Rho Uncertainty	Actual Measurement	Maximum Rho
N8488A	10 MHz to 100 MHz	±0.005		0.016
	100 MHz to 2.4 GHz	±0.004		0.018
	2.4 GHz to 12.4 GHz	±0.004		0.043
	12.4 GHz to 18 GHz	±0.005		0.056
	18 GHz to 26.5 GHz	±0.007		0.099
	26.5 GHz to 40 GHz	±0.011		0.133
	40 GHz to 67 GHz	±0.022		0.190
	67 GHz to 70 GHz	±0.026		0.200
N8486AR	26.5 GHz to 40 GHz	±0.021		0.168
N8486AQ	33 GHz to 50 GHz	±0.054		0.200
N8481B	10 MHz to 2 GHz	±0.007		0.042
	2 GHz to 12.4 GHz	±0.018		0.066
	12.4 GHz to 18 GHz	±0.023		0.102
N8482B	100 kHz to 2 GHz	±0.011		0.041
	2 GHz to 6 GHz	±0.013		0.074
N8481H	10 MHz to 8 GHz	±0.015		0.075
	8 GHz to 12.4 GHz	±0.021		0.099
	12.4 GHz to 18 GHz	±0.046		0.140
N8482H	100 kHz to 6 GHz	±0.012		0.063

## Zero Set Performance Test

This performance test is carried out to verify that a minimal amount of residual offset error is present after zeroing has been performed. The offset error is caused by contamination from several sources including the noise of the device-under-test (DUT) itself. Zero set is the difference between the power levels indicated by the DUT, after executing zeroing and the true zero power. Ideally, this difference should be zero.

This performance test requires a compatible Agilent power meter with the DUT and a computer with the Agilent IO Libraries Suite installed.

System specification:  $\pm 25$  nW, tested at 50 MHz

Recommended power meter: N1913A, N1914A

Recommended 50 MHz, 50  $\Omega$  load: 85138B

### Procedure

- 1 Connect the DUT (N8480 Series) to the power meter (N1913A) as shown in the following diagram. Then, launch the Agilent IO Libraries Suite on the computer.



- 2 Warm up the DUT for approximately an hour.
- 3 Launch the Interactive IO on the Agilent IO Libraries Suite to send SCPI commands to the DUT.
- 4 Connect the DUT to the power meter 1 mW calibrator and perform zeroing for the DUT by sending "CAL:ZERO:AUTO ONCE".
- 5 Perform calibration for the DUT by sending "CAL:AUTO ONCE".
- 6 Set the frequency of the DUT to 50 MHz by sending "FREQ 50MHz".
- 7 Enable auto-averaging for the DUT by sending "AVER:COUN:AUTO ON".
- 8 Change the power measurement unit of the DUT to watt by sending "UNIT:POW W".

- 9** Disconnect the DUT from the power meter 1 mW calibrator.
- 10** Terminate the DUT with the 50 MHz, 50  $\Omega$  load.  
(This step is compulsory for N8488A but optional for N8481A, N8481B, N8481H, N8482A, N8482B, N8482H, N8485A, N8487A, N8486AR, and N8486AQ.)
- 11** Perform zeroing for the DUT by sending “CAL:ZERO:AUTO ONCE”.
- 12** Set the DUT to the single trigger mode by sending “INIT:CONT OFF”.
- 13** Read the noise level of the DUT by sending “READ?” and then record the reading.
- 14** Repeat step 13 for 10 times and then calculate the mean value of the readings.
- 15** Compare the calculated mean value to the system specification. If the test fails, refer to “[Repair](#)” on page 59.

## Replaceable Parts

Figure 3-1 illustrates the parts breakdown of the N8480 Series power sensors that identifies all the replaceable parts. If you want to order a part, quote the Agilent part number, specify the quantity required, and address the order to the nearest Agilent office.

**NOTE**

If you are located within United States, you are advised to order directly from the Agilent Parts Center in Roseville, California.

Ask your nearest Agilent office for ordering information and forms for the “Direct Mail Order System”. Information such as toll free telephone number will be provided.

---

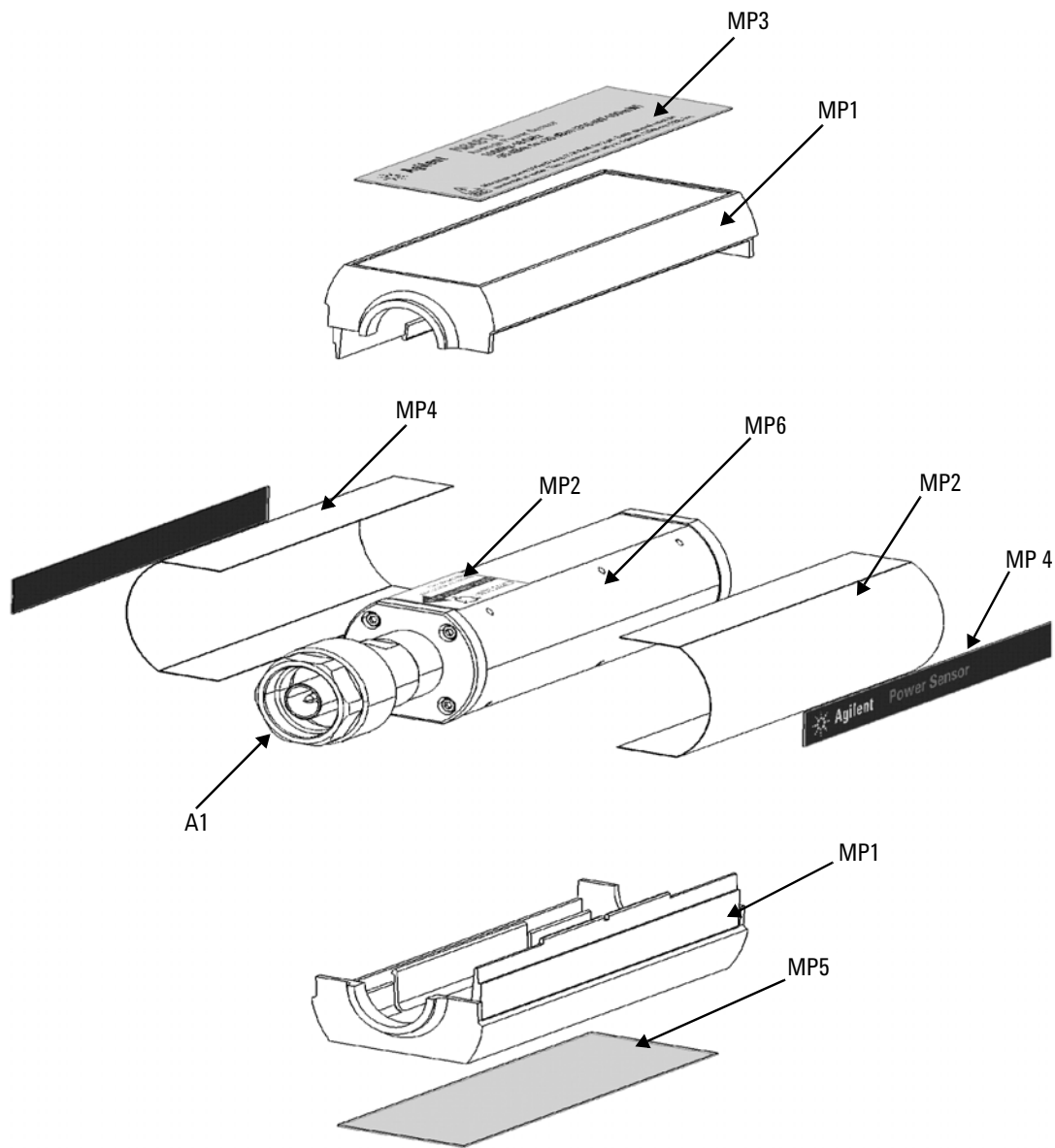


Figure 3-1 Illustrated Parts Breakdown

**Table 3-2** Replaceable parts list for standard N8480 Series power sensors

Reference Designaton	Option	Part Number	Quantity	Description
<b>A1</b>				
N8481A	N8481A-100	N8481-60007	1	N8481A (Type-N) replacement module
	N8481A-200	N8481-60008	1	N8481A (APC-7) replacement module
N8482A	N8482A-100	N8482-60002	1	N8482A (Type-N) replacement module
N8485A	N8485A-100	N8485-60002	1	N8485A (3.5 mm) replacement module
N8487A	N8487A-100	N8487-60005	1	N8487A (2.4 mm) replacement module
N8488A	N8488A-100	N8488-60006	1	N8488A (1.85 mm) replacement module
N8481B	N8181B-100	N8481-60012	1	N8481B (Type-N) replacement module
N8482B	N8482B-100	N8482-60008	1	N8482B (Type-N) replacement module
N8481H	N8481H-100	N8481-60014	1	N8481H (Type-N) replacement module
N8482H	N8482H-100	N8482-60010	1	N8482H (Type-N) replacement module
N8486AR	N8486AR-100	N8486-60010	1	N8486AR (Waveguide flange UG-599/U) replacement module
N8486AQ	N8486AQ-100	N8486-60008	1	N8486AQ (Waveguide flange UG-383/U) replacement module
<b>Chassis Parts</b>				
MP1	-	E9321-40001	2	Plastic shell
MP2	-	E9321-00001	2	Shield
MP3	-	N8481-84301	1	Label-ID top (N8481A)
MP3	-	N8482-84301	1	Label-ID top (N8482A)
MP3	-	N8485-84301	1	Label-ID top (N8485A)

**Table 3-2** Replaceable parts list for standard N8480 Series power sensors

Reference Designaton	Option	Part Number	Quantity	Description
MP3	-	N8485-84303	1	Label-ID top (N8485A Option 033)
MP3	-	N8487-84301	1	Label-ID top (N8487A)
MP3	-	N8488-84301	1	Label-ID top (N8488A)
MP3	-	N8486-84301	1	Label-ID top (N8486AR)
MP3	-	N8486-84302	1	Label-ID top (N8486AQ)
MP3	-	N8481-84302	1	Label-ID top (N8481B)
MP3	-	N8482-84302	1	Label-ID top (N8482B)
MP3	-	N8481-84303	1	Label-ID top (N8481H)
MP3	-	N8482-84303	1	Label-ID top (N8482H)
MP4	-	N8481-84304	2	Label-Side
MP5	-	N8481-84305	1	Label-Cert. bottom
MP6	-	00346-80011	1	Label-Information



**Table 3-3** Replaceable parts list for N8480 Series power sensors with Option CFT

Reference Designaton	Option	Part Number	Quantity	Description
<b>A1</b>				
N8481A	N8481A-100	N8481-60009	1	N8481A (Type-N) replacement module, CFT Option
	N8481A-200	N8481-60010	1	N8481A (APC-7) replacement module, CFT Option
N8482A	N8482A-100	N8482-60007	1	N8482A (Type-N) replacement module, CFT Option
N8485A	N8485A-100	N8485-60003	1	N8485A (3.5 mm), replacement module, CFT Option
N8487A	N8487A-100	N8487-60006	1	N8487A (2.4 mm) replacement module, CFT Option
N8481B	N8181B-100	N8481-60013	1	N8481B (Type-N) replacement module, CFT Option
N8482B	N8482B-100	N8482-60009	1	N8482B (Type-N) replacement module, CFT Option
N8481H	N8481H-100	N8481-60015	1	N8481H (Type-N) replacement module, CFT Option
N8482H	N8482H-100	N8482-60011	1	N8482H (Type-N) replacement module, CFT Option
N8486AR	N8486AR-100	N8486-60011	1	N8486AR (Waveguide flange UG-599/U) replacement module, CFT Option
N8486AQ	N8486AQ-100	N8486-60009	1	N8486AQ (Waveguide flange UG-383/U) replacement module, CFT Option
<b>Chassis Parts</b>				
MP1	-	E9321-40001	2	Plastic shell
MP2	-	E9321-00001	2	Shield
MP3	-	N8481-84307	1	Label-ID top (N8481A)
MP3	-	N8482-84306	1	Label-ID top (N8482A)
MP3	-	N8485-84302	1	Label-ID top (N8485A)
MP3	-	N8485-84304	1	Label-ID top (N8485A Option 033)
MP3	-	N8487-84302	1	Label-ID top (N8487A)
MP3	-	N8486-84303	1	Label-ID top (N8486AR)

**Table 3-3** Replaceable parts list for N8480 Series power sensors with Option CFT

Reference Designaton	Option	Part Number	Quantity	Description
MP3	-	N8486-84304	1	Label-ID top (N8486AQ)
MP3	-	N8481-84310	1	Label-ID top (N8481B)
MP3	-	N8482-84309	1	Label-ID top (N8482B)
MP3	-	N8481-84311	1	Label-ID top (N8481H)
MP3	-	N8482-84310	1	Label-ID top (N8482H)
MP4	-	N8481-84304	2	Label-Side
MP5	-	N8481-84306	1	Label ID Certification Bottom - CFT Option
MP6	-	00346-80011	1	Label-Information

**Table 3-4** Replacement part list for adapters used on N8480 Series power sensors

Model	Part Number	Quantity	Description
N8485A	08485-60005	1	3.5 mm to N(m) Coax Adapter
N8487A	08487-60001	1	2.4 mm to N(m) Coax Adapter

## Troubleshooting

Troubleshooting information is intended to first isolate the power sensor, cable, or power meter as the defective component. When the power sensor is isolated, an appropriate sensor module must be used for repair. See [Table 3-2](#) and [Table 3-3](#).

If error message 241 or 310 is displayed on the power meter, suspect a power sensor failure. Error 241 will occur if the power sensor is missing. A supported cable must be used to connect the N8480 Series power sensors to a power meter.

If no error message is displayed, but a problem occurs when making a measurement, try replacing the cable from the power meter to the power sensor. If the problem still exists, try using a different power sensor to determine if the problem is in the power meter or in the power sensor.

Electrostatic discharge will render the power sensor inoperative. Do not, under any circumstances, open the power sensor unless you and the power sensor are in a static free environment.

## Repair

There is no serviceable parts inside the N8480 Series power sensors. If the power sensor is defective, send it back to the nearest Agilent Service Center for repair. The entire “module” of the defective power sensor will be replaced with an appropriate replacement module listed in [Table 3-2](#) and [Table 3-3](#).

## Diassembly/Reassembly Procedures

### Diassembly Procedure

Disassemble the power sensor by performing the following steps:

- Diassemble the power sensor only in a static free workstation. Electrostatic discharge renders the power sensor inoperative.
- At the rear of the power sensor, insert the blade of a screwdriver between the plastic shells (See [Figure 3-2](#)). To prevent damage to the plastic shells use a screwdriver blade as wide as the slot between the two shells.
- Pry alternately at both sides of the connector until the plastic shells are apart. Remove the shells and the magnetic shields.



**Figure 3-2** Removing power sensor shell

### Reassembly Procedure

Replace the magnetic shields and the plastic shells. Snap the plastic shells together.

**www.agilent.com**

### **Contact us**

To obtain service, warranty, or technical support assistance, contact us at the following phone numbers:

United States:

(tel) 800 829 4444 (fax) 800 829 4433

Canada:

(tel) 877 894 4414 (fax) 800 746 4866

China:

(tel) 800 810 0189 (fax) 800 820 2816

Europe:

(tel) 31 20 547 2111

Japan:

(tel) (81) 426 56 7832 (fax) (81) 426 56 7840

Korea:

(tel) (080) 769 0800 (fax) (080) 769 0900

Latin America:

(tel) (305) 269 7500

Taiwan:

(tel) 0800 047 866 (fax) 0800 286 331

Other Asia Pacific Countries:

(tel) (65) 6375 8100 (fax) (65) 6755 0042

Or visit Agilent World Wide Web at:

[www.agilent.com/find/assist](http://www.agilent.com/find/assist)

Product specifications and descriptions in this document are subject to change without notice. Always refer to the English version at the Agilent Web site for the latest revision.

© Agilent Technologies, Inc. 2008–2014

Printed in Malaysia  
Tenth Edition, January 9, 2014

N8481-90000



**Agilent Technologies**