

Agilent U1271A/U1272A Handheld Digital Multimeter

User's Guide



Agilent Technologies

Notices

© Agilent Technologies, Inc. 2010-2013

No part of this manual may be reproduced in any form or by any means (including electronic storage and retrieval or translation into a foreign language) without prior agreement and written consent from Agilent Technologies, Inc. as governed by United States and international copyright laws.

Manual Part Number

U1271-90010

Edition

Eighth Edition, September 13, 2013

Agilent Technologies, Inc.
5301 Stevens Creek Blvd.
Santa Clara, CA 95051 USA

Warranty

The material contained in this document is provided “as is,” and is subject to change, without notice, in future editions. Further, to the maximum extent permitted by the applicable law, Agilent disclaims all warranties, either express or implied, with regard to this manual and any information contained herein, including but not limited to the implied warranties of merchantability and fitness for a particular purpose. Agilent shall not be liable for errors or for incidental or consequential damages in connection with the furnishing, use, or performance of this document or of any information contained herein. Should Agilent and the user have a separate written agreement with warranty terms covering the material in this document that conflict with these terms, the warranty terms in the separate agreement shall control.

Technology Licenses

The hardware and/or software described in this document are furnished under a license and may be used or copied only in accordance with the terms of such license.

Restricted Rights Legend

U.S. Government Restricted Rights. Software and technical data rights granted to the federal government include only those rights customarily provided to end user customers. Agilent provides this customary commercial license in Software and technical data pursuant to FAR 12.211 (Technical Data) and 12.212 (Computer Software) and, for the Department of Defense, DFARS 252.227-7015 (Technical Data - Commercial Items) and DFARS 227.7202-3 (Rights in Commercial Computer Software or Computer Software Documentation).

Safety Notices

CAUTION









A **CAUTION** notice denotes a hazard. It calls attention to an operating procedure, practice, or the likes of that, if not correctly performed or adhered to, could result in damage to the product or loss of important data. Do not proceed beyond a **CAUTION** notice until the indicated conditions are fully understood and met.

WARNING

A **WARNING** notice denotes a hazard. It calls attention to an operating procedure, practice, or the likes of that, if not correctly performed or adhered to, could result in personal injury or death. Do not proceed beyond a **WARNING** notice until the indicated conditions are fully understood and met.

Safety Symbols

The following symbols on the instrument and in the documentation indicate precautions which must be taken to maintain safe operation of the instrument.

	Direct current (DC)		Caution, risk of electric shock
	Alternating current (AC)		Caution, risk of danger (refer to this manual for specific Warning or Caution information)
	Both direct and alternating current	CAT III 1000 V	Category III 1000 V overvoltage protection
	Earth (ground) terminal	CAT IV 600 V	Category IV 600 V overvoltage protection
	Equipment protected throughout by double insulation or reinforced insulation		Caution, risk of hazardous voltage (icon appears on the instrument screen)

Safety Considerations

Read the information below before using this multimeter. The descriptions and instructions in this manual apply to the Agilent U1271A and U1272A Handheld Digital Multimeters (hereafter referred to as the multimeter). The model U1272A appears in all illustrations.

CAUTION

- Disconnect circuit power and discharge all high-voltage capacitors before testing resistance, continuity, diodes, or capacitance.
 - Use the proper terminals, function, and range for your measurements.
 - This device is for use at altitudes of up to 2,000 m.
 - Never measure voltage when current measurement is selected.
 - Always use the specified battery type. The power for the meter is supplied with four standard AAA 1.5 V batteries. Observe the correct polarity markings before you insert the batteries to ensure proper insertion of the batteries in the meter.
-

WARNING

- **Do not use the multimeter if it is damaged. Before you use the multimeter, inspect the case. Look for cracks or missing plastic. Pay particular attention to the insulation surrounding the connectors.**
 - **Inspect the test leads for damaged insulation or exposed metal. Check the test leads for continuity. Replace damaged test leads before you use the multimeter.**
 - **Do not operate the multimeter around explosive gas, vapor, or wet environments.**
 - **Do not apply more than the rated voltage (as marked on the multimeter) between terminals, or between terminal and earth ground.**
 - **Never use the multimeter in wet conditions or when there is water on the surface. If the multimeter is wet, ensure that the multimeter is dried only by trained personnel.**
-

WARNING

- **Before use, verify the multimeter's operation by measuring a known voltage.**
 - **When measuring current, turn off the circuit power before connecting the multimeter in the circuit. Remember to place the multimeter in series with the circuit.**
 - **When servicing the multimeter, use only the specified replacement parts.**
 - **Use caution when working above 60 V DC, 30 V AC RMS, or 42.4 V peak. Such voltages pose a shock hazard.**
 - **Be aware of the presence of hazardous AC voltage before using the Low Pass Filter (LPF) function for AC voltage measurement. Voltages measured are usually greater than what indicated on the multimeter as the AC voltages with higher frequencies have been filtered through the LPF function.**
 - **Do not use the Z_{LOW} (low input impedance) function (U1272A only) to measure voltages in circuits that could be damaged by this function's low input impedance of 2 k Ω .**
 - **When using the probes, keep your fingers behind the finger guards on the probes.**
 - **Connect the common test lead before you connect the live test lead. When you disconnect the leads, disconnect the live test lead first.**
 - **Remove the test leads from the multimeter before you open the battery cover.**
 - **Do not operate the multimeter with the battery cover or portions of the cover removed or loosened.**
 - **To avoid false readings, which may lead to possible electric shock or personal injury, replace the battery as soon as the low battery indicator appears and flashes.**
-

Environmental Conditions

This instrument is designed for indoor use and in an area with low condensation. The table below shows the general environmental requirements for this instrument.





Environmental conditions	Requirements
Operating temperature	Full accuracy from $-20\text{ }^{\circ}\text{C}$ to $55\text{ }^{\circ}\text{C}$
Operating humidity	Full accuracy up to 80% RH (relative humidity) for temperature up to $30\text{ }^{\circ}\text{C}$, decreasing linearly to 50% RH at $55\text{ }^{\circ}\text{C}$
Storage temperature	$-40\text{ }^{\circ}\text{C}$ to $70\text{ }^{\circ}\text{C}$
Altitude	Up to 2000 meters
Pollution degree	Pollution degree II

NOTE

The U1271A/U1272A Handheld Digital Multimeter complies with the following safety and EMC requirements:

- EN/IEC 61010-1:2001
- ANSI/UL 61010-1:2004
- CAN/CSA-C22.2 No. 61010-1-04
- Commercial limits compliance with EN61326-1

Regulatory Markings

	<p>The CE mark is a registered trademark of the European Community. This CE mark shows that the product complies with all the relevant European Legal Directives.</p>		<p>The C-tick mark is a registered trademark of the Spectrum Management Agency of Australia. This signifies compliance with the Australia EMC Framework regulations under the terms of the Radio Communication Act of 1992.</p>
<p>ICES/NMB-001</p>	<p>ICES/NMB-001 indicates that this ISM device complies with the Canadian ICES-001. Cet appareil ISM est conforme a la norme NMB-001 du Canada.</p>		<p>This instrument complies with the WEEE Directive (2002/96/EC) marking requirement. This affixed product label indicates that you must not discard this electrical or electronic product in domestic household waste.</p>
	<p>The CSA mark is a registered trademark of the Canadian Standards Association.</p>		<p>This symbol indicates the time period during which no hazardous or toxic substance elements are expected to leak or deteriorate during normal use. Forty years is the expected useful life of the product.</p>

Waste Electrical and Electronic Equipment (WEEE) Directive 2002/96/EC

This instrument complies with the WEEE Directive (2002/96/EC) marking requirement. This affixed product label indicates that you must not discard this electrical or electronic product in domestic household waste.

Product Category:

With reference to the equipment types in the WEEE directive Annex 1, this instrument is classified as a “Monitoring and Control Instrument” product.

The affixed product label is as shown below.



Do not dispose in domestic household waste.

To return this unwanted instrument, contact your nearest Agilent Service Centre, or visit

www.agilent.com/environment/product

for more information.

Declaration of Conformity (DoC)

The Declaration of Conformity (DoC) for this instrument is available on the Agilent Web site. You can search the DoC by its product model or description at the Web address below.

<http://regulations.corporate.agilent.com/DoC/search.htm>

NOTE

If you are unable to search for the respective DoC, please contact your local Agilent representative.

THIS PAGE HAS BEEN INTENTIONALLY LEFT BLANK.

Table of Contents

1 Introduction

About This Manual	2
Documentation map	2
Safety notes	2
Preparing Your Multimeter	3
Check the shipment	3
Install the batteries	3
Turn on your multimeter	6
Automatic power-off	6
Enabling the backlight	7
Selecting the range	7
Alerts and warnings during measurement	8
Adjusting the tilt stand	10
Connecting the IR-USB cable	10
Power-on options	12
Your Multimeter in Brief	13
Dimensions	13
Overview	15
Rotary switch	17
Keypad	21
Display screen	25
Input terminals	31
Cleaning Your Multimeter	33

2 Making Measurements

Crest Factor	36
Measuring AC Voltage	37
Using the LPF (Low Pass Filter) Function for AC measurements	39

Measuring DC Voltage	40
Using the Filter Function for DC measurement	43
Measuring AC and DC Signals (U1272A only)	44
Using the LPF (Low Pass Filter) Function for AC+DC measurements	45
Making dB Measurements (U1272A only)	46
Using Z_{LOW} for Voltage Measurements (U1272A only)	48
Using Qik-V for Voltage Measurements (U1271A only)	50
Measuring Resistance	51
Measuring Conductance	53
Testing for Continuity	54
Using Smart Ω for Resistance Measurements (U1272A only)	57
Testing Diodes	60
Using Auto-diode for Diode Tests (U1272A only)	64
Measuring Capacitance	66
Measuring Temperature	68
Measuring AC or DC Current	73
% Scale of 4-20 mA or 0-20 mA	78
Frequency Test Mode	81
Measuring frequency	82
Measuring pulse width	84
Measuring duty cycle	85

3 Multimeter Features

Making Relative Measurements (Null)	88
Making Scale Transfers (Scale)	90
Capturing Maximum and Minimum Values (MaxMin)	92

Capturing Peak Values (Peak)	94
Freezing the Display (TrigHold and AutoHold)	95
Recording Measurement Data (Data Logging)	96
Performing manual logs (HAnd)	97
Performing interval logs (AUto)	98
Performing event logs (triG)	100
Reviewing Previously Recorded Data (View)	102

4 Multimeter Setup Options

Using the Setup Menu	106
Editing numerical values	107
Setup Menu Summary	108
Setup Menu Items	110
Changing the beep frequency	110
Enabling and disabling the Filter	111
Changing the variation count	113
Changing the recording option	114
Changing the sample interval duration	115
Changing the decibel display (U1272A only)	116
Setting a custom dBm reference impedance (U1272A only)	117
Changing the auto power-off and backlight timeouts	118
Enabling and disabling the overvoltage alert	120
Changing the % scale range	121
Changing the thermocouple type (U1272A only)	122
Changing the minimum measurable frequency	123
Changing the baud rate	124
Changing the data bits	125
Changing the parity check	126
Enabling and disabling the backlight alert	127
Enabling smooth mode	128

Changing the user scale conversion value and unit	129
Resetting the multimeter's setup options	130
Changing the temperature unit	131

5 Characteristics and Specifications

Product Characteristics	134
Specification Assumptions	136
Measurement Category	136
Measurement category definition	136
Electrical Specifications	138
DC specifications	138
AC specifications	141
AC+DC specifications for U1272A	145
Capacitance specifications	147
Temperature specifications	148
Frequency specifications	149
Duty cycle and pulse width specifications	149
Frequency sensitivity specifications	151
Peak hold specifications	152
Decibel (dB) specifications for U1272A	153
Measurement rate (approximate)	154

A Shift Functions Using the Shift Key

B Dual Display Combinations Using the Dual Key

List of Figures

Figure 1-1	Installing the batteries	4
Figure 1-2	Start-up display	6
Figure 1-3	Input warning display	9
Figure 1-4	Tilt-stand adjustment and IR cable connection	10
Figure 1-5	Agilent GUI Data Logger Software	11
Figure 1-6	Width dimensions	13
Figure 1-7	Height and depth dimensions	14
Figure 1-8	Front panel	15
Figure 1-9	Rear panel	16
Figure 1-10	U1271A rotary switch	18
Figure 1-11	U1272A rotary switch	19
Figure 1-12	Keys	21
Figure 1-13	Display screen	25
Figure 1-14	Connector terminals	31
Figure 2-1	AC voltage display	37
Figure 2-2	Measuring AC voltage	38
Figure 2-3	AC voltage with LPF display	39
Figure 2-4	DC voltage display	40
Figure 2-5	Measuring DC voltage	42
Figure 2-6	Filter for DC voltage measurements	43
Figure 2-7	AC+DC voltage display	44
Figure 2-8	Low Pass Filter(LPF) for AC+DC voltage measurements	45
Figure 2-9	dBm display	46
Figure 2-10	dBV display	47
Figure 2-11	Z _{LOW} display	49
Figure 2-12	Qik-V display	50
Figure 2-13	Resistance display	51
Figure 2-14	Measuring resistance	52
Figure 2-15	Continuity operation	55
Figure 2-16	Testing for continuity	56
Figure 2-17	Smart Ω (with bias voltage) display	58
Figure 2-18	Measuring leakage current	59
Figure 2-19	Diode display	60
Figure 2-20	Open diode display	61

Figure 2-21	Testing forward bias diode	62
Figure 2-22	Testing reverse bias diode	63
Figure 2-23	Auto-diode display - Good status	65
Figure 2-24	Auto-diode display - nGood status	65
Figure 2-25	Capacitance display	66
Figure 2-26	Measuring capacitance	67
Figure 2-27	Temperature display	68
Figure 2-28	Measuring surface temperature	69
Figure 2-29	Temperature measurement without ambient compensation	72
Figure 2-30	DC current display	74
Figure 2-31	Measuring DC current	75
Figure 2-32	Measuring AC current	76
Figure 2-33	Current measurement setup	77
Figure 2-34	4-20 mA % Scale display	78
Figure 2-35	Measuring DC current using the 4-20 mA % scale	80
Figure 2-36	Functions allowing frequency measurement	81
Figure 2-37	Frequency, pulse width, and duty cycle measurements	82
Figure 2-38	Frequency display	83
Figure 2-39	Pulse width display	84
Figure 2-40	Duty cycle display	85
Figure 3-1	Null display	88
Figure 3-2	Null operation	89
Figure 3-3	Scale operation	91
Figure 3-4	MaxMin display	93
Figure 3-5	Peak display	94
Figure 3-6	Manual log display	97
Figure 3-7	Interval log display	99
Figure 3-8	Event log display	101
Figure 3-9	View display	102
Figure 3-10	Empty view display	102
Figure 4-1	bEEP display	110
Figure 4-2	FiLtEr display	113
Figure 4-3	AHOLd display	114
Figure 4-4	d-LoG display	115
Figure 4-5	L-tiME display	116
Figure 4-6	dCibEL display	117

Figure 4-7	dbrEF display	118
Figure 4-8	APo display	119
Figure 4-9	bLit display	119
Figure 4-10	ALert display	120
Figure 4-11	PErCEn display	121
Figure 4-12	CoUPLE display	122
Figure 4-13	FrEq display	123
Figure 4-14	bAUd display	124
Figure 4-15	dAtAb display	125
Figure 4-16	PAritY display	126
Figure 4-17	A-bLit display	127
Figure 4-18	SMootH display	128
Figure 4-19	SMootH display	129
Figure 4-20	rESEt display	130
Figure 4-21	t-Unit display	131

THIS PAGE HAS BEEN INTENTIONALLY LEFT BLANK.

List of Tables

Table 1-1	Battery level indicator	5
Table 1-2	Power-on options	12
Table 1-3	Front panel parts	15
Table 1-4	Rear panel parts	16
Table 1-5	U1271A rotary switch functions	18
Table 1-6	U1272A rotary switch functions	19
Table 1-7	Keypad functions	22
Table 1-8	General annunciators	25
Table 1-9	Measurement units display	29
Table 1-10	Analog bar graph display	30
Table 1-11	Terminal connections for different measuring functions	32
Table 2-1	Threshold resistance values	54
Table 2-2	Auto-diode voltage thresholds	64
Table 2-3	% Scale measurement range	79
Table 3-1	Available scale conversions	90
Table 3-2	Data logging maximum capacity	96
Table 3-3	Event log trigger conditions	100
Table 4-1	Setup menu key functions	106
Table 4-2	Setup menu item descriptions	108
Table 4-3	Filter (LPF) options	112
Table 4-4	Firmware version 2.00 or older	112
Table 4-5	Firmware version 2.04 or newer	112
Table 5-1	DC specifications	138
Table 5-2	U1271A true rms AC voltage specifications	141
Table 5-3	U1271A true rms AC current specifications	142
Table 5-4	U1272A true rms AC voltage specifications	143
Table 5-5	U1272A true rms AC current specifications	144
Table 5-6	U1272A true rms AC+DC voltage specifications	145
Table 5-7	U1272A true rms AC+DC current specifications	146
Table 5-8	Capacitance specifications	147
Table 5-9	Temperature specifications	148
Table 5-10	Frequency specifications	149
Table 5-11	Duty cycle and pulse width specifications	149
Table 5-12	Duty cycle and pulse width calculation example	150

Table 5-13	Frequency sensitivity and trigger level specifications for voltage measurements	151
Table 5-14	Frequency sensitivity specifications for current measurements	151
Table 5-15	Peak hold specifications for DC voltage and current measurements	152
Table 5-16	U1272A decibel specifications	153
Table 5-17	U1272A decibel accuracy specifications for DC voltage measurements	153
Table 5-18	Measurement rate (approximate)	154
Table A-1	U1271A default and shift functions	156
Table A-2	U1272A default and shift functions	157
Table B-1	U1271A dual display combinations	160
Table B-2	U1272A dual display combinations	162



1 Introduction

About This Manual	2
Documentation map	2
Safety notes	2
Preparing Your Multimeter	3
Check the shipment	3
Install the batteries	3
Turn on your multimeter	6
Automatic power-off	6
Enabling the backlight	7
Selecting the range	7
Alerts and warnings during measurement	8
Adjusting the tilt stand	10
Connecting the IR-USB cable	10
Power-on options	12
Your Multimeter in Brief	13
Dimensions	13
Overview	15
Rotary switch	17
Keypad	21
Display screen	25
Input terminals	31
Cleaning Your Multimeter	33

This chapter lists the package contents for each multimeter model, and teaches you how to set up your multimeter for the first time. An introduction to all the features of the multimeter is also given. This introduction does not cover all of the capabilities of the multimeter but gives basic examples to help you perform basic operations on your multimeter.



About This Manual

Documentation map

The following manuals and software are available for your multimeter. For the very latest version, please visit our Web site at: <http://www.agilent.com/find/hhTechLib>.

Check the manual revision on the first page of each manual.

- **User's Guide.** This manual.
- **Quick Start Guide.** Printed copy for outdoor use, included with shipment.
- **Service Guide.** Free download at the Agilent Web site.
- **Agilent GUI Data Logger Software, Help, and Quick Start Guide.** Free download at the Agilent Web site.

Safety notes

The following safety notes are used throughout this manual. Familiarize yourself with each of the notes and its meaning before operating your multimeter. More pertinent safety notes for using this product are located under the “[Safety Symbols](#)” section.

CAUTION

Caution denotes a hazard. It calls attention to a procedure that, if not correctly performed or adhered to, could result in damage to or destruction of the product. Do not proceed beyond a caution notice until the indicated conditions are fully understood and met.

WARNING

Warning denotes a hazard. It calls attention to a procedure which, if not correctly performed or adhered to, could result in injury or loss of life. Do not proceed beyond a warning note until the indicated conditions are fully understood and met.

Preparing Your Multimeter

Check the shipment

When you receive your multimeter, check the shipment according to the following procedure.

- 1 Inspect the shipping container for damage. Signs of damage may include a dented or torn shipping container or cushioning material that indicates signs of unusual stress or compacting. Save the packaging material in case the multimeter needs to be returned.
- 2 Carefully remove the contents from the shipping container, and verify that the standard accessories and your ordered options are included in the shipment according to the *Included Accessories* list located at the side of the box.
- 3 For any question or problems, refer to the Agilent contact numbers on the back of this manual.

Install the batteries

Your multimeter is powered by four 1.5 V AAA alkaline batteries (included with the shipment). When you receive your multimeter, the AAA alkaline batteries are not installed.

Use the following procedure to install the batteries.

CAUTION

Before you proceed with the batteries installation, remove all cable connections to the terminals and ensure that the rotary switch is at the OFF position. Use only the battery type specified in the “[Product Characteristics](#)” on page 134.

- 1 Open the battery cover.** Lift the tilt stand and loosen the screws with a suitable Phillips screwdriver and remove the battery cover as shown in [Figure 1-1](#).
- 2 Insert the battery.** Observe the proper battery polarity. The terminal ends of each battery are indicated inside the battery compartment.
- 3 Close the battery cover.** Place the battery cover back in its original position and tighten the screws.

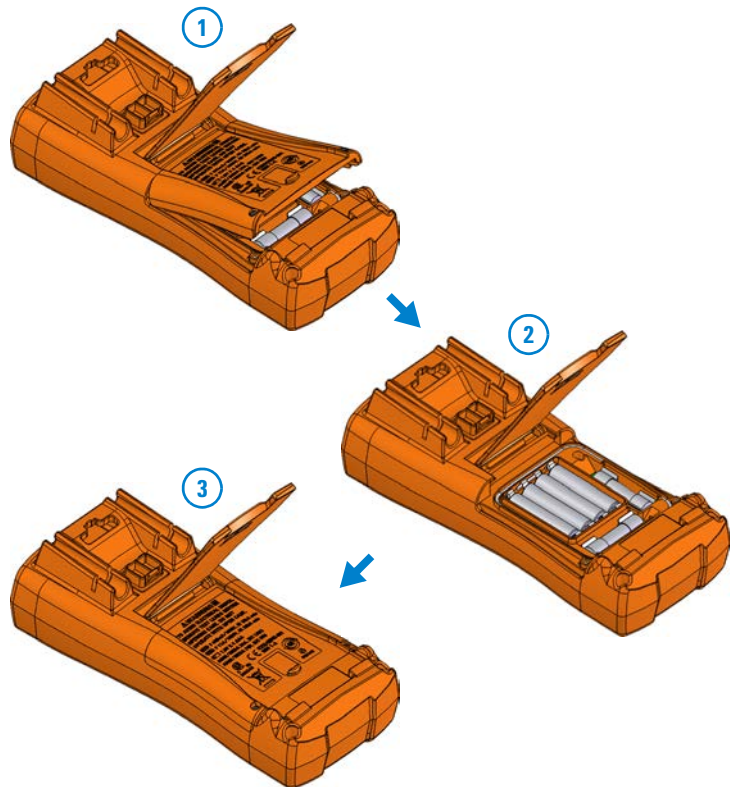





Figure 1-1 Installing the batteries

The battery level indicator in the lower left-hand corner of the display indicates the relative condition of the batteries. [Table 1-1](#) describes the various battery levels the indicator represents.

Table 1-1 Battery level indicator

Indication	Battery capacity
	Full capacity
	2/3 capacity
	1/3 capacity
 <i>(Flashing periodically)</i>	Almost empty (less than one day)

WARNING

To avoid false readings, which could lead to possible electric shock or personal injury, replace the battery as soon as the low battery indicator appears. Do not discharge the battery by shorting the battery or reverse the battery polarity in any of the subjects.

CAUTION

To avoid instruments being damage from battery leakage:

- Always remove dead batteries immediately.
- Always remove the batteries and store them separately if the multimeter is not going to be used for a long period.

Turn on your multimeter

To power ON your multimeter, turn the rotary switch to any other position. The model number of your multimeter will be shown on the display briefly.

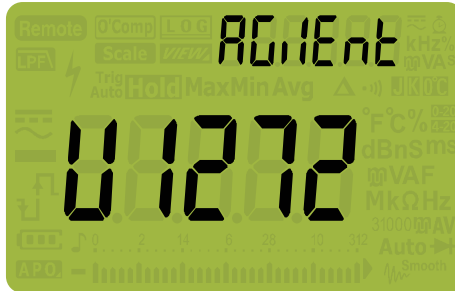

Figure 1-2 Start-up display

To power OFF your multimeter, turn the rotary switch to the **OFF**/**OFF** position.

Automatic power-off

Your multimeter automatically turns off if the rotary switch is not moved or a key is not pressed for 15 minutes (default). Pressing any key will turn the multimeter back on after it is powered off automatically.

To change the timeout period or completely disable the automatic power-off, refer to [“Changing the auto power-off and backlight timeouts”](#) on page 118.

Enabling the backlight

If viewing the display becomes difficult in low-light conditions, press  to activate the LCD backlight.

To conserve battery life, a user-adjustable timeout controls how long the backlight stays on. The default timeout is 15 seconds. To change the backlight timeout refer to “[Changing the auto power-off and backlight timeouts](#)” on page 118.

Selecting the range

The multimeter’s selected range is always displayed above the right-hand end of the bar graph, as the range indicator. Pressing  switches the multimeter between manual and autoranging. It also cycles through the available multimeter ranges when manual ranging is enabled.

Autoranging is convenient because the multimeter automatically selects an appropriate range for sensing and displaying each measurement. However, manual ranging results in better performance, since the multimeter does not have to determine which range to use for each measurement.

NOTE

The range is fixed for diode tests, temperature, Qik-V, and Z_{LOW} measurements.

In autorange, the multimeter selects the lowest range to display the highest available precision (resolution) for the input signal. If manual range is already enabled, press  for more than 1 second to enter the autoranging mode.

If autoranging is enabled, press  to enter the manual range mode.

Each additional press of  sets the multimeter to the next higher range, unless it is already in the highest range, at which point the range switches to the lowest range.

Alerts and warnings during measurement

Voltage alert

WARNING

For your own safety, please do not ignore the voltage alert. When the multimeter cautions you with a voltage alert, immediately remove the test leads from the source being measured.

Your multimeter provides a voltage alert for voltage measurements in both autoranging and manual range modes. The multimeter starts beeping periodically once the measured voltage exceeds the **Alert** value (regardless of polarity) set in the Setup mode. Immediately remove the test leads from the source being measured.

By default, this feature is turned off. Be sure to set the alert voltage according to your test requirements. To change the alert voltage level, refer to [“Enabling and disabling the overvoltage alert”](#) on page 120.

Hazardous voltage indication

The multimeter will also display the hazardous voltage (⚡) symbol as an early precaution when the measured voltage is equal to or greater than 30 V in all voltage measurement modes.

Input warning

CAUTION

To avoid circuit damage and possibly blowing the multimeter’s current fuse, do not place the probes across (in parallel with) a powered circuit when a lead is plugged into a current terminal. This causes a short circuit because the resistance through the multimeter’s current terminals is very low.

The multimeter emits a continuous beep and displays **Err** or **Err** when the test lead is inserted into the **μA mA** or **A** input terminal but the rotary switch is not set to the correct current position.



Figure 1-3 Input warning display

This warning is intended to stop you from attempting to measure voltage, continuity, resistance, capacitance, diode, or temperature values when the leads are plugged into a current terminal.

Adjusting the tilt stand

To adjust the multimeter to a 60° standing position, pull the tilt-stand outward to its maximum reach.

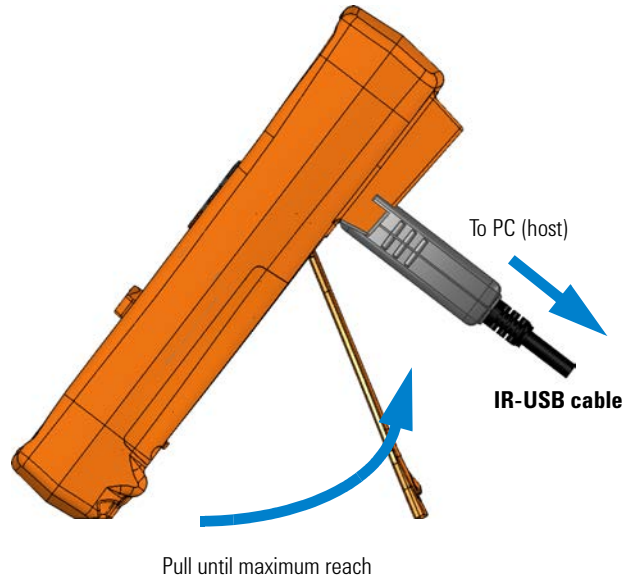

Figure 1-4 Tilt-stand adjustment and IR cable connection

Connecting the IR-USB cable

You can use the IR communication link (IR communication port, located at the rear panel) and the Agilent GUI Data Logger software to control your multimeter remotely, perform data logging operations, and transfer the contents of your multimeter's memory to a PC.

Ensure that the Agilent logo on the U1173A IR-USB cable (purchased separately) connected to the multimeter is facing up. Firmly push the IR head into the multimeter's IR communication port until it snaps into place (see [Figure 1-4](#)).

Refer to the *Agilent GUI Data Logger Software Help* and *Quick Start Guide* for more information on the IR communication link and the Agilent GUI Data Logger software.



Figure 1-5 Agilent GUI Data Logger Software







The Agilent GUI Data Logger software and its supporting documents (Help and Quick Start Guide) are available for free download at <http://www.agilent.com/find/hhTechLib>.

You may purchase a U1173A IR-USB cable from an Agilent Sales Office nearest to you.

Power-on options

Some options can be selected only while you turn the multimeter on. These power-on options are listed in the table below. To select a power-on option, press and hold the specified key while turning the rotary switch to any other position (OFF to ON). Power-on options remain selected until the multimeter is turned off.

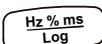
Table 1-2 Power-on options

Key	Description
	Check firmware version. The multimeter's firmware version will be shown on the primary display. Press any key to exit this mode.
	LCD test. All annunciators are displayed in the LCD. Press any key to exit this mode.
	Smooth is enabled until the multimeter is turned off. To permanently enable Smooth, see "Enabling smooth mode" on page 128.
	Auto Power-Off (APO) is disabled until the multimeter is turned off. To permanently disable APO, see "Changing the auto power-off and backlight timeouts" on page 118.
	Simulates the Auto Power-Off (APO) mode. Press any key to turn the multimeter back on and resume normal operation.
	Backlight test. LCD backlight is activated. Press any key to exit this mode.

Your Multimeter in Brief

Dimensions

Front view



Figure 1-6 Width dimensions

Rear and side view

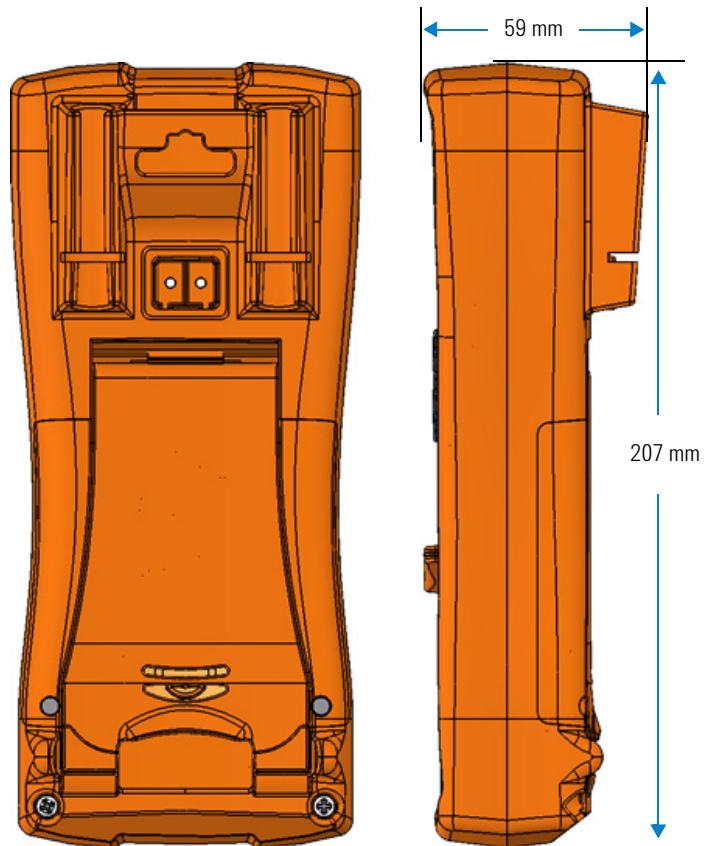

Figure 1-7 Height and depth dimensions

Overview

Front panel

The front panel parts of your multimeter are described in this section. Click the respective “Learn more” pages for more information on each part.



Figure 1-8 Front panel

Table 1-3 Front panel parts

Legend	Description	Learn more on:
1	Display screen	page 25
2	Keypad	page 21
3	Rotary switch for U1271A	page 18
4	Terminals	page 31
5	Rotary switch for U1272A	page 19

Rear panel

The rear panel parts of your multimeter are described in this section. Click the respective “Learn more” pages for more information on each part.

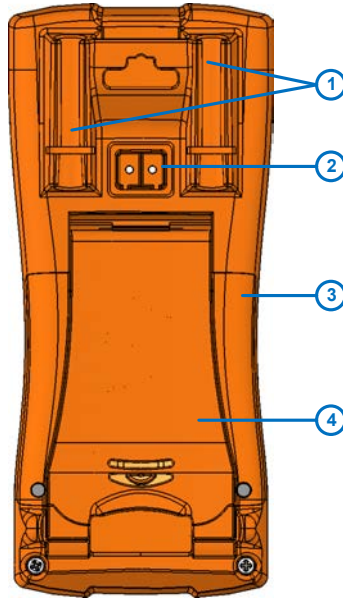

Figure 1-9 Rear panel

Table 1-4 Rear panel parts

Legend	Description	Learn more on:
1	Test probe holders	-
2	IR communication port	page 10
3	Battery and fuse access cover	page 3
4	Tilt stand	page 10

Rotary switch

The measurement functions for each rotary switch position are described in [Table 1-5 \(U1271A\)](#) and [Table 1-6 \(U1272A\)](#). Turning the rotary switch changes the measurement function and resets all other measurement options.

The U1272A model offers four additional rotary switch functions:



- Z_{LOW} (low input impedance) voltage measurements,
- Smart Ω (offset compensation) measurements,
- Auto-diode test, and
- AC+DC voltage and current measurements.

The U1271A has one differing rotary switch function:

- Qik-V test.

Click the respective “Learn more” pages for more information on each function.

NOTE

Some rotary switch positions have a *shifted* function printed in **orange**. Press  to switch between the shifted and regular function. See [page 24](#) for more information on the  key.

WARNING

Remove the test leads from the measuring source or target before changing the rotary switch position.

1 Introduction

Your Multimeter in Brief

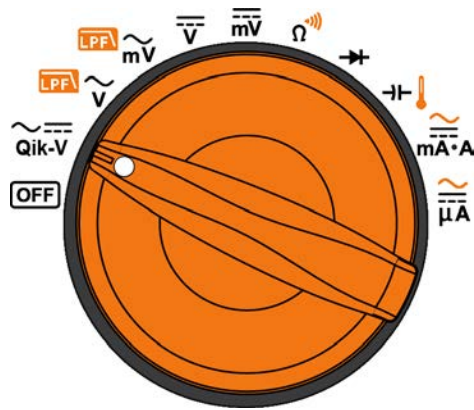





Figure 1-10 U1271A rotary switch

Each position of the U1271A rotary switch (shown in [Figure 1-10](#)) is described in [Table 1-5](#).

Table 1-5 U1271A rotary switch functions

Legend	Description	Learn more on:
OFF	Off	page 5
Qik-V	AC or DC voltage measurement for signal identification	page 50
LPF V	AC voltage measurement with Low Pass Filter	page 36 and page 39
LPF mV	AC voltage measurement (up to millivolts) with Low Pass Filter	
V	DC voltage measurement	page 40
mV	DC voltage measurement (up to millivolts)	
Ω	Resistance measurement or Continuity test	page 51 and page 54
→+	Diode test	page 60

Table 1-5 U1271A rotary switch functions (continued)

Legend	Description	Learn more on:
	Capacitance or Temperature measurement	page 66 and page 68
	AC or DC current measurement	page 73
	AC or DC current measurement (up to microamperes)	

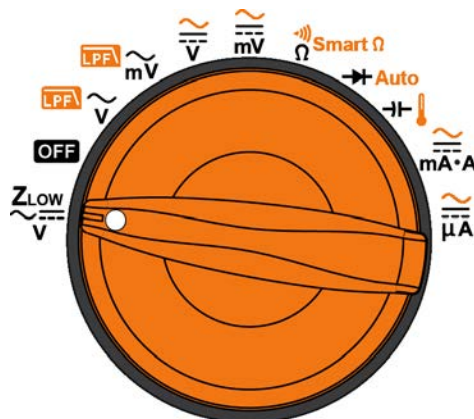

Figure 1-11 U1272A rotary switch

Each position of the U1272A rotary switch (shown in [Figure 1-11](#)) is described in [Table 1-6](#).

Table 1-6 U1272A rotary switch functions











Legend	Description	Learn more on:
	Low impedance AC or DC voltage measurement for eliminating ghost voltages	page 48
OFF	Off	page 5

Table 1-6 U1272A rotary switch functions (continued)

Legend	Description	Learn more on:
	AC voltage measurement with Low Pass Filter	page 36 and page 39
	AC voltage measurement (up to millivolts) with Low Pass Filter	
	AC, DC, or AC+DC voltage measurement	page 40 and page 44
	AC, DC, or AC+DC voltage measurement (up to millivolts)	
	Resistance measurement, Continuity test, or Resistance measurement with offset compensation	page 51 , page 54 , and page 57
	Diode test or Auto-diode test	page 60 and page 64
	Capacitance or Temperature measurement	page 66 and page 68
	AC, DC, or AC+DC current measurement	page 73 and page 44
	AC, DC, or AC+DC current measurement (up to microamperes)	

Keypad

The operation of each key is explained below. Pressing a key enables a function, displays a related symbol, and emits a beep. Turning the rotary switch to another position resets the current operation of the key. Click the respective “Learn more” pages for more information on each function.

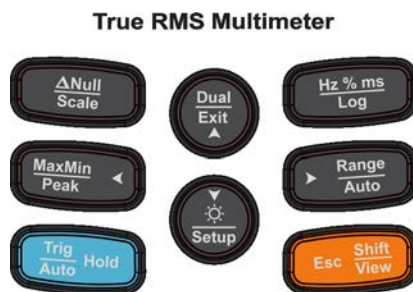

Figure 1-12 Keys

Table 1-7 Keypad functions











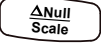



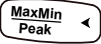

Legend	Function when pressed for:		Learn more on:
	Less than 1 second	More than 1 second	
	<p>Sets the Null/Relative mode.</p> <ul style="list-style-type: none"> The displayed value is saved as a reference to be subtracted from subsequent measurements. While in Null mode, press  again to view the stored reference value that has been saved. The display will return to normal after 3 seconds. Pressing  while the relative value is being displayed will cancel the Null mode. 	<p>Sets the Scale mode for the specified ratio and unit display. (Only applicable for voltage measurements.)</p> <ul style="list-style-type: none"> The most recently saved (or default) ratio and unit will be shown on the primary and secondary displays. Press  while the Scale symbol is flashing to cycle through the available ratio and unit displays. Press  while the Scale symbol is flashing to save the selected ratio and unit and to start the conversion, or While the Scale symbol is flashing, if no activity is detected after 3 seconds, the conversion will begin (with the specified ratio and unit shown on the primary display). Press  for more than 1 second to cancel the Scale transfer mode. 	<p>page 88 and page 90</p>
	<p>Starts and stops the MaxMin recording.</p> <ul style="list-style-type: none"> Press  again to cycle through maximum (Max), minimum (Min), average (Avg), and present (MaxMinAvg) readings. Press  for more than 1 second to exit this mode. 	<p>Starts and stops the Peak recording.</p> <ul style="list-style-type: none"> Press  again to switch between the maximum (Hold Max) and minimum (Hold Min) peak readings. Press  for more than 1 second to exit this mode. 	<p>page 92 and page 94</p>
	<p>Freezes the present reading in the display (Trig Hold mode).</p> <ul style="list-style-type: none"> In TrigHold mode, press  to manually trigger the holding of the next measured value. Press  for more than 1 second to exit this mode. 	<p>Automatically freezes the present reading once the reading is stable (Auto Hold mode)</p> <ul style="list-style-type: none"> In AutoHold mode, the reading is updated automatically once the reading is stable and the count setting is exceeded. Press  for more than 1 second to exit this mode. 	<p>page 95</p>
	<p>Switches between the dual-combination displays (if available).</p>	<p>Exits the Hold, Null, MaxMin, Peak, frequency test, and dual display modes.</p>	<p>page 159</p>

Table 1-7 Keypad functions (continued)



















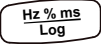









Legend	Function when pressed for:		Learn more on:
	Less than 1 second	More than 1 second	
	<p>Turns the backlight on or off.</p>	<p>Enters or exits the Setup mode.</p> <ul style="list-style-type: none"> In the Setup mode, press  or  to navigate through the menu pages. Press  or  to cycle through the available settings, or to edit the existing values. Press  to save the new settings or values and exit the editing mode, or press  to exit the editing mode without saving. Press  for more than 1 second to exit this mode. 	<p>page 7 and page 105</p>
	<p>Frequency test mode for current or voltage measurements is enabled.</p> <ul style="list-style-type: none"> Press  to scroll through the frequency (Hz), pulse width (ms), and duty cycle (%) measurements. In duty cycle and pulse width measurements, press  to switch between the positive or negative edge trigger. Press  for more than 1 second to exit this mode. 	<p>Starts and stops the Data Logging.</p> <ul style="list-style-type: none"> If data logging is set as Hand (manual data logging), pressing  for more than 1 second will log the present reading into the memory. The display will return to normal after a short while (≈ 1 second). To manually log another reading, press  again for more than 1 second. If data logging is set as Auto (automatic data logging), pressing  for more than 1 second will enter the automatic data logging mode, where data is logged at the interval defined in the multimeter's Setup. If data logging is set as Event (event data logging), pressing  for more than 1 second will enter the event data logging mode, where data is logged each time a triggering condition is satisfied. Press  for more than 1 second to exit the automatic or event data logging mode. 	<p>page 81 and page 96</p>

Table 1-7 Keypad functions (continued)

Legend	Function when pressed for:		Learn more on:
	Less than 1 second	More than 1 second	
	<ul style="list-style-type: none"> Sets a manual range and disables autoranging. Press  again to cycle through each available measurement range. During temperature measurements, if Celsius-Fahrenheit (°C - °F) or Fahrenheit-Celsius (°F - °C) is selected as the default temperature unit, pressing  changes the temperature measurement unit between Celsius (°C) and Fahrenheit (°F). See “Changing the default temperature unit” on page 70 for more information. 	<p>Enables autoranging.</p>	<p>page 7 and page 70</p>
	<p>Switches between the regular and <i>shifted</i> measurement function (icon printed in orange above the rotary switch position — if available). Press  again to switch back to the regular measurement function.</p>	<p>Enters the Log Review menu.</p> <ul style="list-style-type: none"> Press  again to cycle through the previously recorded manual (H), interval (A), or event (E) logging data. Press  or  to view first or last logged data respectively. Press  or  to scroll through the logged data. Press  for more than 1 second to clear all the logged data for the selected logging mode. Press  for more than 1 second to exit this mode. 	<p>page 17 and page 102</p>

Display screen

The display annunciators of your multimeter are described in this section. See also “[Measurement units](#)” on page 29 for a list of available measurement signs and notations and “[Analog bar graph](#)” on page 30 for a tutorial on the analog bar graph located at the bottom of your display screen.

General display annunciators

The general display annunciators of your multimeter are described in the table below. Click the respective “Learn more” pages for more information on each annunciator.

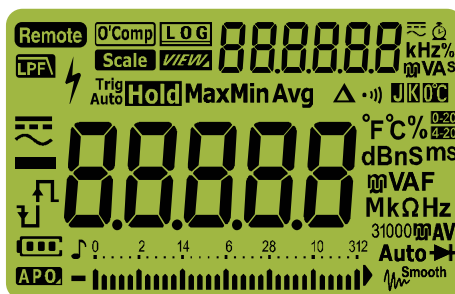

Figure 1-13 Display screen

Table 1-8 General annunciators

Legend	Description	Learn more on:
Remote	Remote control enabled	page 10
O'Comp	Offset compensation (Smart Ω) for resistance measurement enabled	page 57
LOG	Data logging in progress	page 96
Scale	Scale transfer enabled	page 90
VIEW	View mode for reviewing previously logged data	page 102

Table 1-8 General annunciators

Legend	Description	Learn more on:
	Secondary measurement display	-
	AC, DC, and AC+DC indication for secondary display	page 48 , page 50 , and page 81
	Elapsed time for Peak and Recording mode	page 94 and page 96
	Measuring units for the secondary display	page 29
	Low pass filter enabled for AC measurement Filter enabled for DC measurement	page 39 page 43
	Hazardous voltage sign for measuring voltage ≥30 V or overload	page 8
	Trigger hold enabled	page 95
	Auto hold enabled	
	Peak hold (maximum value) enabled	page 94
	Peak hold (minimum value) enabled	
	Maximum reading shown on primary display	
	Minimum reading shown on primary display	page 92
	Averaged reading shown on primary display	
	Present reading shown on primary display	
	Relative (Null) enabled	page 88
	Audible continuity test selected	page 54

Table 1-8 General annunciators





















Legend	Description	Learn more on:
	J-type thermocouple selected	page 70
	K-type thermocouple selected	
	Temperature measurement without ambient compensation selected	page 72
	4-20 mA % scale mode selected	
	0-20 mA % scale mode selected	page 78
	DC (direct current)	page 40 and page 73
	AC (alternating current)	page 36 and page 73
	AC+DC	page 44
	<ul style="list-style-type: none"> • Capacitor is charging (during capacitance measurement) • Positive slope for pulse width (ms) and duty cycle (%) measurements 	page 66 and page 81
	<ul style="list-style-type: none"> • Capacitor is discharging (during capacitance measurement) • Negative slope for pulse width (ms) and duty cycle (%) measurements 	
	Primary measurement display	-
	Measuring units for the primary display	page 29
	Measurement range selected	page 7
	Battery capacity indication	page 5

Table 1-8 General annunciators

Legend	Description	Learn more on:
	APO (Auto Power-Off) enabled	page 6
	Tone enabled	-
	Analog bar graph	page 30
Auto	Autoranging enabled or Auto-diode enabled	page 7
	Diode test selected	page 60
 Smooth	Smooth mode enabled	page 12 and page 128
	Overload (the reading exceeds the display range)	-

Measurement units

The available signs and notations for each measurement function in your multimeter are described in [Table 1-9](#). The units listed below are applicable to the primary display and secondary display measurements of your multimeter.

Table 1-9 Measurement units display

Sign/Notation	Description
M	Mega 1E+06 (1000000)
k	kilo 1E+03 (1000)
n	nano 1E-09 (0.000000001)
μ	micro 1E-06 (0.000001)
m	milli 1E-03 (0.001)
dBm	Decibel unit relative to 1 mW
dBV	Decibel unit relative to 1 V
mV, V	Voltage units for voltage measurement
A, mA, μA	Ampere units for current measurement
nF, μF, mF	Farad units for capacitance measurement
Ω, kΩ, MΩ	Ohm units for resistance measurement
MHz, kHz, Hz	Hertz units for frequency measurement
ms	Millisecond, unit for pulse width measurement
%	Percent, unit for duty cycle measurement
°C	Degree Celsius, unit for temperature measurement
°F	Degree Fahrenheit, unit for temperature measurement
s	Seconds, unit for Peak and Recording mode elapsed time

Analog bar graph



The analog bar emulates the needle on an analog multimeter, without displaying the overshoot. When measuring peak or null adjustments and viewing fast-changing inputs, the bar graph provides a useful indication because it has a faster updating rate^[1] to cater for fast-response applications.

For frequency, duty cycle, pulse width, 4-20 mA % scale, 0-20 mA % scale, dBm, dBV, and temperature measurements, the bar graph does not represent the primary display value.

For example, when frequency, duty cycle, or pulse width is displayed on the primary display during voltage or current measurement, the bar graph represents the voltage or current value (not the frequency, duty cycle, or pulse width value). Another example is when 4-20 mA % scale or 0-20 mA % scale is displayed on the primary display, the bar graph represents the current value and not the percentage value.

The “+” or “-” sign indicates whether the measured or calculated value is positive or negative. Each segment represents 1000 or 500 counts depending on the range indicated on the peak bar graph.

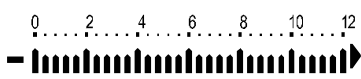
Table 1-10 Analog bar graph display

Range	Counts/ Segments	Used for the function
	500	V, A, Ω, \rightarrow +
	1000	V, A, Ω, \rightarrow +

An unstable bar graph and unmatched primary display when measuring DC voltage usually means the presence of AC voltages in the circuit.

[1] The analog bar graph measurement rate is approximately 50 times/second for DC voltage, current, and resistance measurements.

Input terminals

The terminal connections for the different measurement functions of your multimeter are described in the table below. Observe the rotary switch position of your multimeter before connecting the test leads to the connector terminals.

WARNING

Ensure that the terminal connections are correct for that particular measurement function before starting any measurement.

CAUTION

To avoid damaging this device, do not exceed the rated input limit.

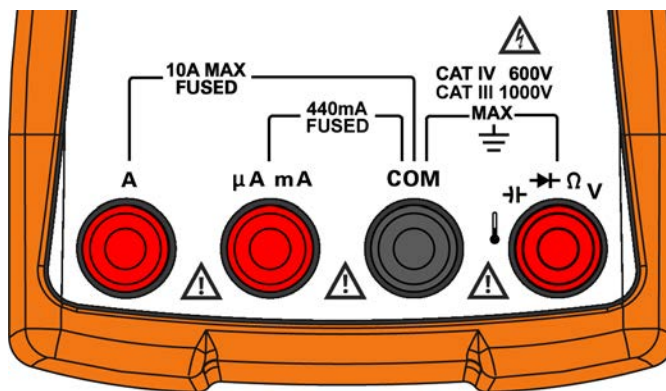







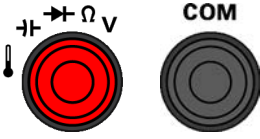









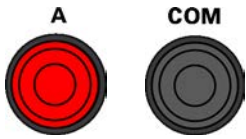

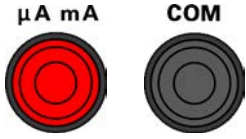



Figure 1-14 Connector terminals

1 Introduction

Your Multimeter in Brief

Table 1-11 Terminal connections for different measuring functions

Rotary switch position		Input terminals	Overload protection
U1271A	U1272A		
 Qik-V	 Z ^{LOW} V		
 LPP V	 LPP V		1000 Vrms
 LPP mV	 LPP mV		
 V	 V		
 mV	 mV		
 Ω	 Smart Ω		1000 Vrms for short circuit <0.3 A
 →	 → Auto		
 T	 T		
 mA·A	 mA·A		11 A/1000 V, fast-acting fuse
 mA·A	 mA·A		440 mA/1000 V, fast-acting fuse
 μA	 μA		

Cleaning Your Multimeter

WARNING

To avoid electrical shock or damage to the multimeter, ensure that the insides of the casing stay dry at all times.

Dirt or moisture in the terminals can distort readings. Follow the steps below to clean your multimeter.

- 1 Turn the multimeter off and remove the test leads.
- 2 Turn the multimeter over and shake out any dirt that may have accumulated in the terminals.

Wipe the case with a damp cloth and mild detergent – do not use abrasives or solvents. Wipe the contacts in each terminal with a clean swab dipped in alcohol.

1 Introduction
Cleaning Your Multimeter

THIS PAGE HAS BEEN INTENTIONALLY LEFT BLANK.



2 Making Measurements

Crest Factor	36
Measuring AC Voltage	37
Using the LPF (Low Pass Filter) Function for AC measurements	39
Measuring DC Voltage	40
Using the Filter Function for DC measurement	43
Measuring AC and DC Signals (U1272A only)	44
Using the LPF (Low Pass Filter) Function for AC+DC measurements	45
Making dB Measurements (U1272A only)	46
Using Z_{LOW} for Voltage Measurements (U1272A only)	48
Using Qik-V for Voltage Measurements (U1271A only)	50
Measuring Resistance	51
Measuring Conductance	53
Testing for Continuity	54
Using Smart Ω for Resistance Measurements (U1272A only)	57
Testing Diodes	60
Using Auto-diode for Diode Tests (U1272A only)	64
Measuring Capacitance	66
Measuring Temperature	68
Measuring AC or DC Current	73
% Scale of 4-20 mA or 0-20 mA	78
Frequency Test Mode	81
Measuring frequency	82
Measuring pulse width	84
Measuring duty cycle	85

The following sections describe how to take measurements with your multimeter.



Crest Factor

The crest factor may be determined by using this formula:

$$\text{Crest factor} = \frac{\text{Peak value}}{\text{True RMS value}}$$

You may refer to “[Capturing Peak Values \(Peak\)](#)” on page 94 on how to obtain the peak values.



The crest factor may be up to 3.0 at full-scale except for the 1000 V range where it is 1.5 at full scale, as explained in the table below:

Voltage range	Crest factor	Maximum input (V_{peak})
30 mV	3	+/- 90 mV
300 mV	3	+/- 900 mV
3 V	3	+/- 9 V
30 V	3	+/- 90 V
300 V	3	+/- 900 V
1000 V	1.5	+/- 1500 V

Measuring AC Voltage

AC voltage measurements measured with this multimeter are returned as true rms (root mean square) readings. These readings are accurate for sine waves and other wave forms (with no DC offset) such as square waves, triangle waves, and staircase waves.

For measuring AC voltage signals with DC offset (U1272A only), refer to the “[Measuring AC and DC Signals \(U1272A only\)](#)” section later in this manual.

- 1 Rotate the multimeter’s rotary switch to  (or  (or , U1272A only).
- 2 Set up your multimeter to measure AC voltage as shown in [Figure 2-2](#).
- 3 Probe the test points and read the display.

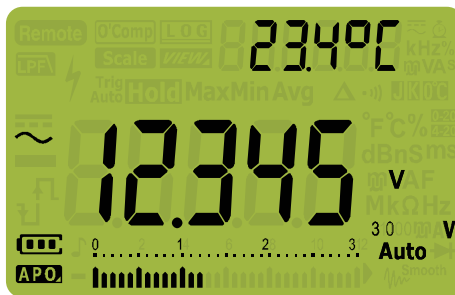



Figure 2-1 AC voltage display

NOTE

- Press  to cycle through the available dual display combinations. See [Appendix B](#), “Dual Display Combinations Using the Dual Key,” starting on page 159 to learn more.
- Press  to enable the frequency test mode for voltage measurements. See “[Frequency Test Mode](#)” on page 81 to learn more.

2 Making Measurements

Measuring AC Voltage



Figure 2-2 Measuring AC voltage

Using the LPF (Low Pass Filter) Function for AC measurements

Your multimeter is equipped with an AC low pass filter to help reduce unwanted electronic noise when measuring AC voltage or AC frequency.

- 1 Rotate the multimeter's rotary switch to $\text{LPA} \sim / \text{LPA} \sim \text{mV}$.
- 2 Press $\text{Shift} \text{Esc}$ to activate the low pass filter function (LPA). Your multimeter continues measuring in the chosen AC mode, but now the signal diverts through a filter that blocks unwanted voltages above 1 kHz.



Figure 2-3 AC voltage with LPF display

WARNING

- To avoid possible electric shock or personal injury, do not use the Low Pass Filter option to verify the presence of hazardous AC voltages. AC voltage values greater than what are indicated may be present when the Low Pass Filter is enabled.
- First, make an AC voltage measurement with the filter OFF to detect the possible presence of hazardous voltages. Then, select the filter function if required for measurement stability and response speed.

The low pass filter can improve measurement performance on composite sine waves that are typically generated by inverters and variable frequency motor drives.

Measuring DC Voltage

This multimeter displays DC voltage values as well as their polarity. Negative DC voltages will return a negative sign on the left of the display.

- 1 To measure a DC voltage with your multimeter, rotate the rotary switch to $\overline{\sim}$ / $\overline{\sim}$ or $\overline{\sim}$ / $\overline{\sim}$ and set up your multimeter as shown in [Figure 2-4](#).
- 2 Probe the test points and read the display.

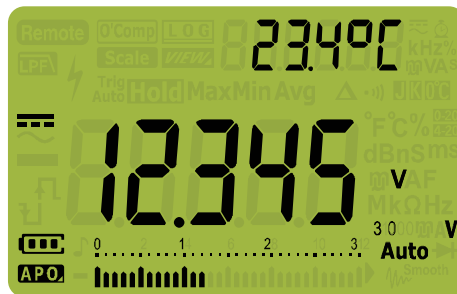



Figure 2-4 DC voltage display

NOTE

- For firmware version 2.00 and below, the Filter function is switched off by default. Customers are advised to update their products to the latest firmware version to take advantage of the latest safety features and measurement improvements.
- Press  to cycle through the available dual display combinations. See [Appendix B](#), “Dual Display Combinations Using the Dual Key,” starting on page 159 to learn more.
- Press  to enable the frequency test mode for voltage measurements. See “[Frequency Test Mode](#)” on page 81 to learn more.

CAUTION

- For measuring AC voltage signals with a DC offset, refer to the [“Measuring AC and DC Signals \(U1272A only\)”](#) on page 44.
 - For measuring DC voltage from a mixed signal in DC measurement mode, ensure that the Filter is enabled (Refer to [“Enabling and disabling the Filter”](#) on page 111).
 - To avoid possible electric shock or personal injury, enable the Low Pass Filter to verify the presence of hazardous DC voltages. Displayed DC voltage values can be influenced by high frequency AC components and must be filtered to assure an accurate reading.
-

2 Making Measurements

Measuring DC Voltage



Figure 2-5 Measuring DC voltage

Using the Filter Function for DC measurement

Turn on the Filter Function when measuring DC voltage and/or current from a mixed signal (AC+DC components) in the DC voltage measurement mode. See “[Enabling and disabling the Filter](#)” on page 111 for more information.

The Filter Function blocks and attenuates AC signals to help you read the DC measurement from a mixed signal. For instance, a DC offset with an AC voltage signal presence (for example, AC 100 V/220 V applied to the 3 V range).

The **LPF** will appear if the Filter is enabled in the multimeter’s Setup.



Figure 2-6 Filter for DC voltage measurements

WARNING

- To avoid possible electric shock or personal injury, enable the Filter to verify the presence of hazardous DC voltages. Displayed DC voltage values can be influenced by high frequency AC components and must be filtered to assure an accurate reading.
- Do not enable any of the dual display options when performing measurements to verify the presence of hazardous DC voltages. (U1272A only)

2 Making Measurements

Measuring AC and DC Signals (U1272A only)

Measuring AC and DC Signals (U1272A only)

Your multimeter is capable of displaying both AC and DC signal components, voltage or current, as two separate readings or one AC+DC (rms) value combined.



- 1 Set up your multimeter according to your desired measurement. Set the rotary switch to:
 - i For voltage measurements: \tilde{V} or \tilde{mV} .
 - ii For current measurements: \tilde{mA} or $\tilde{\mu A}$.
- 2 Press the  key twice to cycle the measurement function to the AC+DC mode ($\tilde{\ominus}$). Probe the test points and read the display.



Figure 2-7 AC+DC voltage display

For better accuracy when measuring the DC offset of an AC voltage, measure the AC voltage first. Note the AC voltage range, then manually select a DC voltage range equal to or higher than the AC range. This procedure improves the accuracy of the DC measurement by ensuring that the input protection circuits are not activated.

NOTE

- Press  to cycle through the available dual display combinations. See [Appendix B](#), “Dual Display Combinations Using the Dual Key,” starting on page 159 to learn more.
- Press  to enable the frequency test mode for voltage measurements. See “[Frequency Test Mode](#)” on page 81 to learn more.

Using the LPF (Low Pass Filter) Function for AC+DC measurements

Your multimeter is equipped with an AC low pass filter to help reduce unwanted electronic noise when measuring a mixed signal.

- 1 Enable the LPF (You may refer to “[Enabling and disabling the Filter](#)” on page 111).
- 2 Rotate the multimeter’s rotary switch to .
- 3 Your multimeter continues measuring in the AC+DC mode, but now the signal diverts through a filter that blocks unwanted voltages above 1 kHz



Figure 2-8 Low Pass Filter(LPF) for AC+DC voltage measurements

2 Making Measurements

Making dB Measurements (U1272A only)

Making dB Measurements (U1272A only)

Your multimeter is capable of displaying voltage as a dB value, either relative to 1 milliwatt (dBm) or a reference voltage of 1 volt (dBV).

Displaying dBm values

A dBm measurement must use a reference impedance (resistance) to calculate a dB value based on 1 milliwatt. The reference impedance is set to 50 Ω by default. To select another reference value, see the “[Setting a custom dBm reference impedance \(U1272A only\)](#)” on page 117.

- 1 To set the multimeter to display values in dBm, first set the rotary switch to $\text{L.P.F.} \sim \text{V}$, $\text{L.P.F.} \sim \text{mV}$, $\sim \text{V}$, or $\sim \text{mV}$.
- 2 Press Dual Exit until the voltage measurements are displayed as a dBm value, as shown in [Figure 2-9](#).

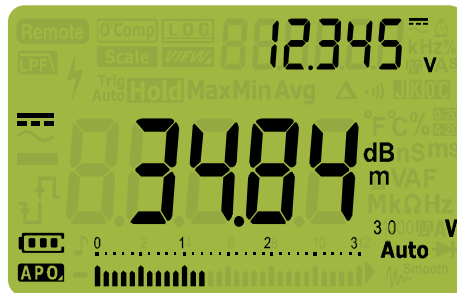

Figure 2-9 dBm display

Press Dual Exit for more than 1 second to exit the dBm function. Selecting the frequency test mode, Hz \% rms Log also cancels the dBm function.

Displaying dBV values

A dBV measurement uses a 1 volt reference voltage to compare the present measurement against a stored relative value. The difference between the two AC signals is displayed as a dBV value. The reference impedance setting is not part of a dBV measurement.

- 1 To make a dBV measurement, first set the rotary switch to $\overset{\sim}{\text{V}}$, $\overset{\sim}{\text{mV}}$, $\overset{\sim}{\text{V}}$, or $\overset{\sim}{\text{mV}}$.
- 2 Press Setup for more than 1 second to enter the multimeter's Setup mode.
- 3 Press Range Auto until dB is shown on the secondary display. Press Setup until dBV is shown on the primary display.
- 4 Press Hz \% ms Log to save the changes. Press and hold Setup until the multimeter restarts.
- 5 Press Dual Exit until the voltage measurements are displayed as a dBV value, as shown in [Figure 2-10](#).



Figure 2-10 dBV display

To make the multimeter display dBm values again, repeat [step 2](#) to [step 4](#) and select dBm instead. See “[Changing the decibel display \(U1272A only\)](#)” on page 116 to learn more.

Press Dual Exit for more than 1 second to exit the dBV function. Selecting the frequency test mode, Hz \% ms Log also cancels the dBV function.

2 Making Measurements

Using Z_{LOW} for Voltage Measurements (U1272A only)

Using Z_{LOW} for Voltage Measurements (U1272A only)

CAUTION

Do not use the Z_{LOW} function to measure voltages in circuits that could be damaged by this function's low impedance ($\approx 2 \text{ k}\Omega$).

Use the Z_{LOW} (low input impedance) function to remove ghost or induced voltages from your measurements.

Ghost voltages are voltages present on a circuit that should not be energized. Ghost voltages can be caused by capacitive coupling between energized wiring and adjacent unused wiring.

Z_{LOW} can remove ghost voltages from your measurements by dissipating the coupling voltage. Use Z_{LOW} to reduce the possibility of false readings in areas where the presence of ghost voltages are suspected.

The Z_{LOW} function in your multimeter presents a low impedance across the leads to obtain a more accurate measurement.

- 1 To make a Z_{LOW} measurement, rotate the multimeter's rotary switch to $\frac{Z_{LOW}}{V}$.
- 2 Probe the test points and read the display. The AC voltage measurement is shown in the primary display and the DC voltage measurement is shown in the secondary display. Press  to exchange the AC and DC voltage indication on the primary and secondary displays.

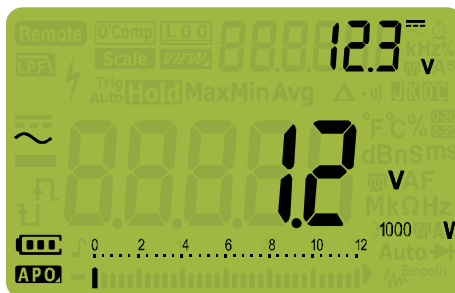

Figure 2-11 Z_{LOW} display

During Z_{LOW} measurements, autoranging is disabled and the multimeter's range is set to 1000 volts in the manual ranging mode.

Use Z_{LOW} to test a battery's health

Aside from reading a battery's voltage level using the DC voltage measurement function, you can also use the Z_{LOW} function to test a battery's health.

If you detect that the measured battery's voltage shown in the Z_{LOW} function is declining gradually, this means that the capacity of battery-under-test is not enough to support regular functions. Use this simple and quick test to determine if a battery has enough voltage capacity to support regular activities.

NOTE

Prolonged used of the Z_{LOW} function will consume the capacity of the battery-under-test.

2 Making Measurements

Using Qik-V for Voltage Measurements (U1271A only)

Using Qik-V for Voltage Measurements (U1271A only)

Use the Qik-V function to help you check for the presence of either or both AC and DC voltages before you set a precise range for a more accurate reading.

- 1 To quickly identify the measured signal type, rotate the multimeter's rotary switch to $\tilde{\text{Qik-V}}$.
- 2 Probe the test points and read the display. The AC voltage measurement is shown in the primary display and the DC voltage measurement is shown in the secondary display. Press Dual/Exit to exchange the AC/DC and DC voltage indication on the primary and secondary displays.

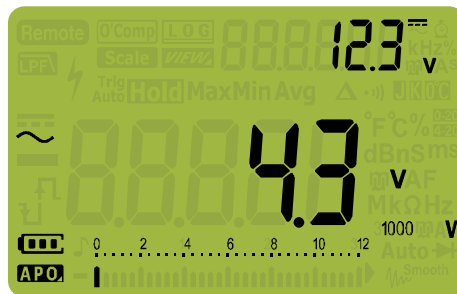

Figure 2-12 Qik-V display

Once the signal type is identified (AC, DC, or AC+DC voltage), select the appropriate voltage measurement function by turning the rotary switch to an appropriate position and function (AC, DC, or AC+DC) for a more accurate reading.

Measuring Resistance

CAUTION

To avoid possible damage to your multimeter or to the equipment under test, disconnect the circuit power and discharge all high-voltage capacitors before measuring resistance.

Resistance (opposition to the current flow) is measured by sending a small current out through the test leads to the circuit under test. Because this current flows through all possible paths between the leads, the resistance reading represents the total resistance of all paths between the leads. Resistance is measured in ohms (Ω).

- 1 To measure resistance, set the multimeter's rotary switch to Ω Smart Ω / Ω and set up your multimeter as shown in Figure 2-14.
- 2 Probe the test points and read the display.

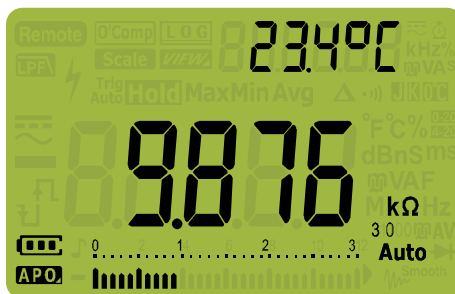

Figure 2-13 Resistance display

Keep the following in mind when measuring resistance.

- The test leads can add 0.1 Ω to 0.2 Ω of error to resistance measurements. To test the leads, touch the probe tips together and read the resistance of the leads. To remove lead resistance from the measurement, hold the test lead tips together and press Δ Null Scale. Now the resistance at the probe tips will be subtracted from all future display readings.

2 Making Measurements

Measuring Resistance

- Because the multimeter's test current flows through all possible paths between the probe tips, the measured value of a resistor in a circuit is often different from the resistor's rated value.



The resistance function can produce enough voltage to forward-bias silicon diode or transistor junctions, causing them to conduct. If this is suspected, press  to apply a lower current in the next higher range.



Figure 2-14 Measuring resistance

Measuring Conductance

Conductance is the reciprocal of resistance. High values of conductance correspond to low values of resistance. Conductance is measured in Siemens (S). The 300 nS range measures conductance in nano-Siemens (1 nS = 0.000000001 Siemens). Because small conductance values correspond to extremely high resistance values, the nS range allows you to easily calculate and determine the resistance of components up to 100 G Ω (0.01 nS resolution).

- 1 To measure conductance, set the multimeter's rotary switch to Ω Smart Ω / Ω and set up your multimeter as shown in [Figure 2-14](#).
- 2 Press  until the conductance measurement is selected (**nS** unit shown). Probe the test points and read the display.

High-resistance readings are susceptible to electrical noise. Use averaging to smooth out most of the noisy readings. Refer to [“Capturing Maximum and Minimum Values \(MaxMin\)”](#) on page 92.

Testing for Continuity

CAUTION

To avoid possible damage to your multimeter or to the equipment under test, disconnect the circuit power and discharge all high-voltage capacitors before testing for continuity.

Continuity is the presence of a complete path for current flow. The continuity test features a beeper that sounds and a backlight that flashes as long as a circuit is complete or broken. The audible and visual alert allows you to perform quick continuity tests without having to watch the display.



In continuity, a short means a measured value is less than the threshold resistance values listed in [Table 2-1](#).

Table 2-1 Threshold resistance values

Measuring range	Threshold resistance
30.000 Ω	$<25 \pm 10 \Omega$
300.00 Ω	$<25 \pm 10 \Omega$
3.0000 k Ω	$<250 \pm 100 \Omega$
30.000 k Ω	$<2.5 \pm 1 \text{ k}\Omega$
300.00 k Ω	$<25 \pm 10 \text{ k}\Omega$
3.0000 M Ω	$<120 \pm 60 \text{ k}\Omega$
30.000 M Ω	$<120 \pm 60 \text{ k}\Omega$
300.00 M Ω	$<120 \pm 60 \text{ k}\Omega$

You can set the beeper to sound and the backlight to flash as a continuity indication whether the circuit-under-test is less than (short) or more than or equal to (open) the threshold resistance.

Press  to switch between short and open states for checking normal open (—|—) and normal close (—|—) contacts.

- 1 To perform a continuity test, position the rotary switch to  and set up your multimeter as shown in Figure 2-14.
- 2 Press  to enable the continuity test function (•••).
- 3 Press  to switch between the short and open state.

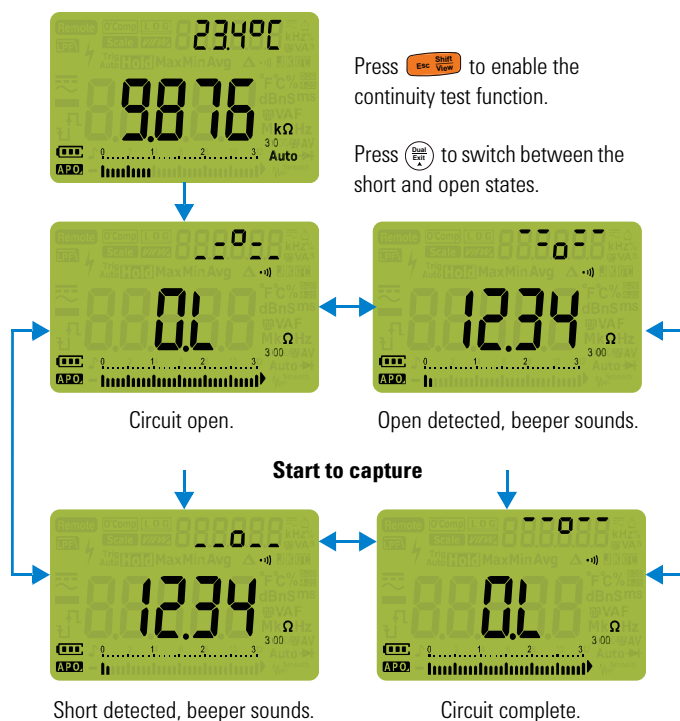

Figure 2-15 Continuity operation

- 4 Probe the test points and read the display.

The continuity function detects intermittent shorts and opens lasting as short as 1 ms. A brief short or open causes the multimeter to emit a short beep and flash.

2 Making Measurements

Testing for Continuity

You can enable or disable the audible and visual alert via the multimeter's Setup. See “[Changing the beep frequency](#)” on page 110 and “[Enabling and disabling the backlight alert](#)” on page 127 for more information on the audible and visual alert options.

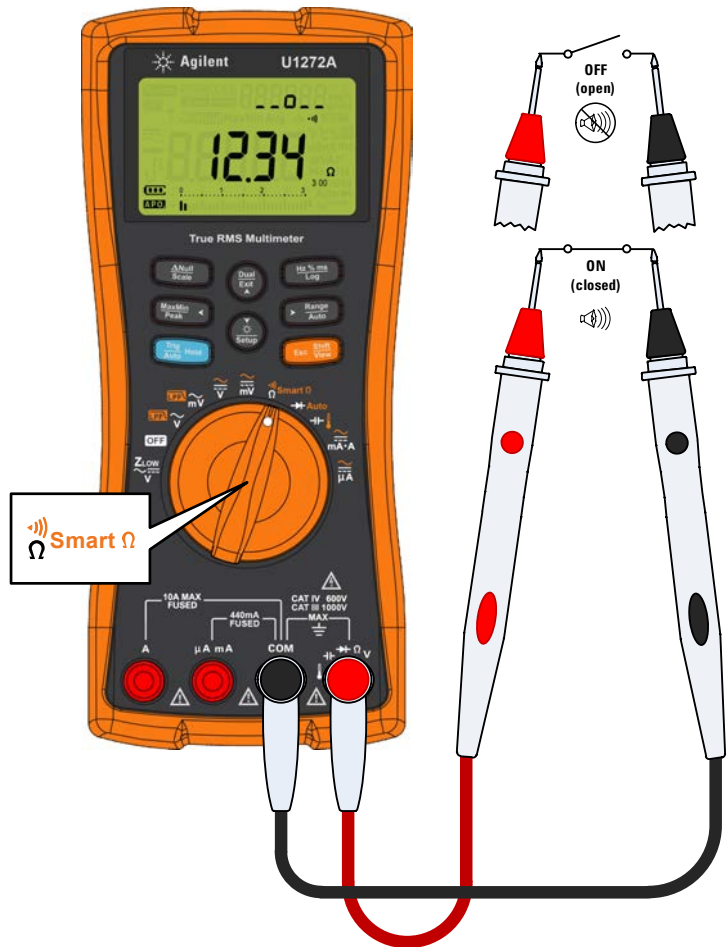

Figure 2-16 Testing for continuity

Using Smart Ω for Resistance Measurements (U1272A only)

Smart Ω (offset compensation) removes unexpected DC voltages within instrument, at the input or at the circuit being measured, which will add to resistance measurement errors. The bias voltage or leakage current is shown on the secondary display.

Using the offset compensation method, the multimeter takes the difference between two resistance measurements when two different test currents are applied to determine if there are any offset voltages in the input circuitry. The resultant displayed measurement corrects this offset, giving a more accurate resistance measurement.

NOTE

The Smart Ω is applicable for the 30 Ω , 300 Ω , 3 k Ω , 30 k Ω , and 300 k Ω resistance range only. The maximum correctable offset/bias voltage is +50 mV/–30 mV for the 30 Ω range and +1.0 V/–0.2 V for the 300 Ω , 3 k Ω , 30 k Ω , and 300 k Ω ranges.

If the DC voltage on the resistor is over the maximum correctable offset/bias voltage, ∞ is shown on the secondary display.

- 1 To use the Smart Ω function, rotate the multimeter's rotary switch to Ω Smart Ω and press  until Ω Comp is shown on the display.
- 2 Probe the test points and read the display. The resistance measurement and the bias voltage measurement is shown in the primary and secondary displays respectively.

Press  to switch between the leakage (μ A) and bias (mV) display.

2 Making Measurements

Using Smart Ω for Resistance Measurements (U1272A only)

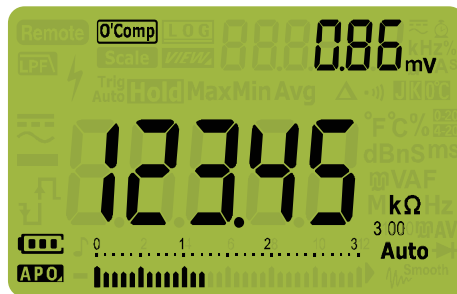

Figure 2-17 Smart Ω (with bias voltage) display

Use Smart Ω to measure the resistance of a thermocouple sensor

It is useful to measure the resistance of a thermocouple temperature sensor. The thermovoltage is proportional to the temperature and the impact of the resistance measurement. Using the Smart Ω function will help you achieve precise readings regardless of the temperature.

Use Smart Ω to measure leakage current

Use the Smart Ω function to measure leakage current or reverse current for junction diodes. Such leakage currents are negligible, and are usually measured in units of μA or nA . Instead of having to source a high precision multimeter with 1 nA or 0.1 nA or a precision shunt, you can measure the leakage current using the Smart Ω function with just a resistor from 100 $\text{k}\Omega$ to 300 $\text{k}\Omega$.

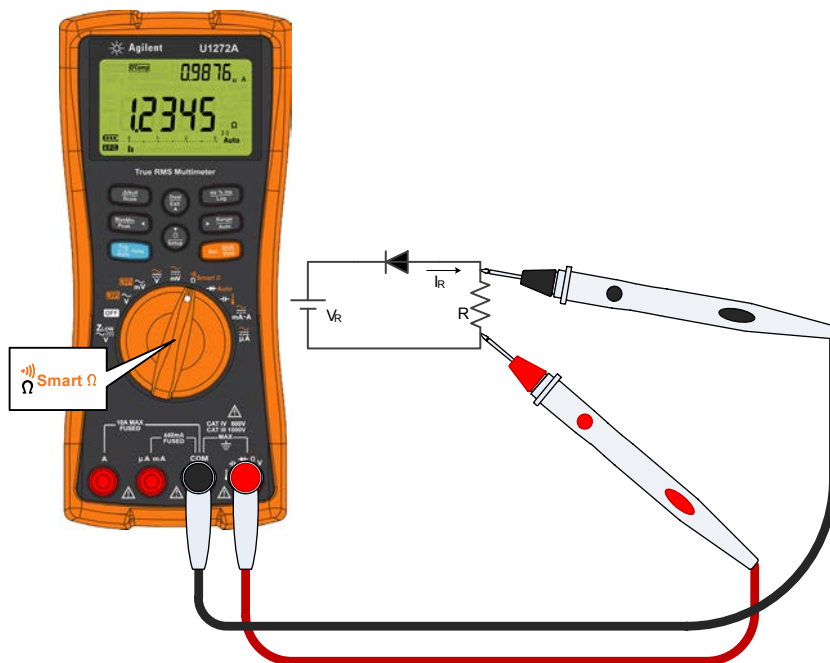

Figure 2-18 Measuring leakage current

Testing Diodes

CAUTION

To avoid possible damage to your multimeter or to the equipment under test, disconnect the circuit power and discharge all high-voltage capacitors before testing diodes.

Use the diode test to check diodes, transistors, silicon controlled rectifiers (SCRs), and other semiconductor devices. A good diode allows current to flow in one direction only.

This test sends a current through a semiconductor junction, and then measures the junction's voltage drop. A typical junction drops 0.3 V to 0.8 V.

- 1 To test a diode out of a circuit, position the rotary switch to \rightarrow/\rightarrow Auto and set up your multimeter as shown in Figure 2-21.
- 2 Probe the test points and read the display.

NOTE

Connect the red test lead to the positive terminal (anode) of the diode and the black test lead to the negative terminal (cathode). The cathode of a diode is indicated with a band.

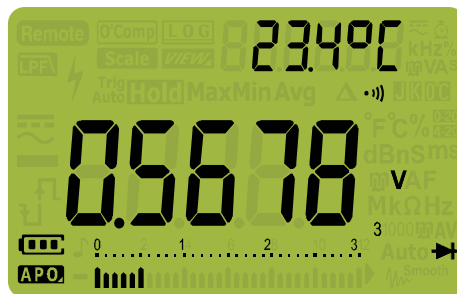

Figure 2-19 Diode display

Your multimeter can display diode forward bias of up to approximately 3.1 V. The forward bias of a typical diode is within the range of 0.3 V to 0.8 V; however, the reading can vary depending on the resistance of other pathways between the probe tips.

- 3** Reverse the probes (as shown in [Figure 2-22](#)) and measure the voltage across the diode again. Assess the diode according to the following guidelines:
- A diode is considered good if the multimeter displays $\overline{\text{OL}}$ in reverse bias mode.
 - A diode is considered shorted if the multimeter displays approximately 0 V in both forward and reverse bias modes, and the multimeter beeps continuously.
 - A diode is considered open if the multimeter displays $\overline{\text{OL}}$ in both forward and reverse bias modes.

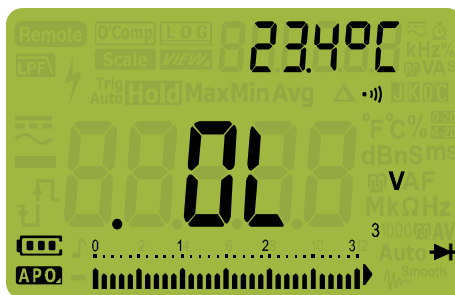

Figure 2-20 Open diode display

If the beeper is enabled during diode test, the multimeter will beep briefly for a normal junction and sound continuously for a shorted junction, below 0.050 V. See [“Changing the beep frequency”](#) on page 110 to disable the beeper.

2 Making Measurements

Testing Diodes



Figure 2-21 Testing forward bias diode

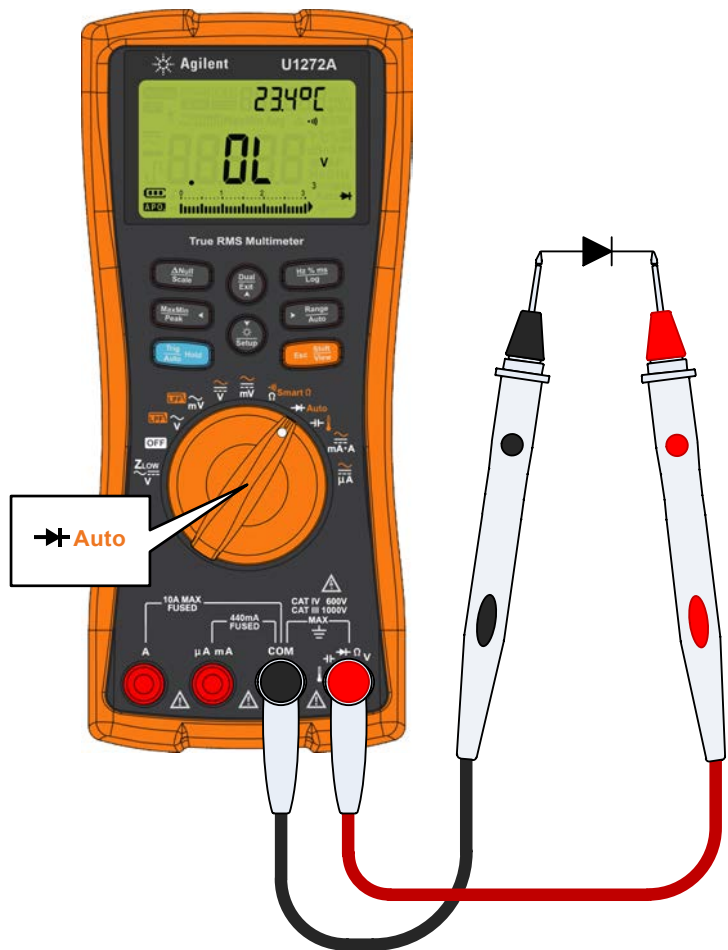

Figure 2-22 Testing reverse bias diode

2 Making Measurements

Using Auto-diode for Diode Tests (U1272A only)

Using Auto-diode for Diode Tests (U1272A only)

The auto-diode function will help you test both forward bias and reverse bias directions simultaneously. You do not need to change the measuring direction to identify the diode's status.

Table 2-2 Auto-diode voltage thresholds

Forward voltage	Reverse voltage	Diode status	
		Good	No Good
Primary display	Secondary display		
OL or <0.3 V or >0.8 V	-OL or >-0.3 V or <-0.8 V		✗
Within 0.3 V to 0.8 V	-OL	✓	
OL	Within -0.3 V to -0.8 V	✓	

NOTE

The open condition will not be alerted as OL on both directions if the auto-diode function is used.

- 1 Rotate the multimeter's rotary switch to **→Auto** and set up your multimeter as shown in [Figure 2-21](#).
- 2 Press  to activate the auto-diode function (**Auto▶**).

The primary display shows the forward bias voltage value. The reverse bias voltage value is shown in the secondary display.

- $\overline{0000}$ is shown briefly (along with a single beep) on the secondary display if the diode is in a good condition.
- $\overline{0000}$ is shown briefly (along with two beeps) if the diode is out of the thresholds.

Measuring Capacitance

CAUTION

To avoid possible damage to the multimeter or to the equipment under test, disconnect circuit power and discharge all high-voltage capacitors before measuring capacitance. Use the DC voltage function to confirm that the capacitor is fully discharged.

The multimeter measures capacitance by charging the capacitor with a known current for a known period of time, measuring the resulting voltage, and then calculating the capacitance.

- 1 To measure capacitance, position the rotary switch to $\rightarrow \text{C}$ and set up your multimeter as shown in Figure 2-26.
- 2 Probe the test points and read the display. $\uparrow \sqcap$ is shown on the bottom left of the display when the capacitor is charging, and $\downarrow \sqcap$ is shown when the capacitor is discharging.



Figure 2-25 Capacitance display

NOTE

To improve measurement accuracy of small value capacitors, press Δ with the test leads open to subtract the residual capacitance of the multimeter and leads.

NOTE

For measuring capacitance values greater than 1000 μF , discharge the capacitor first, then select a suitable range for measurement. This will speed up the measurement time and also ensure that the correct capacitance value is obtained.

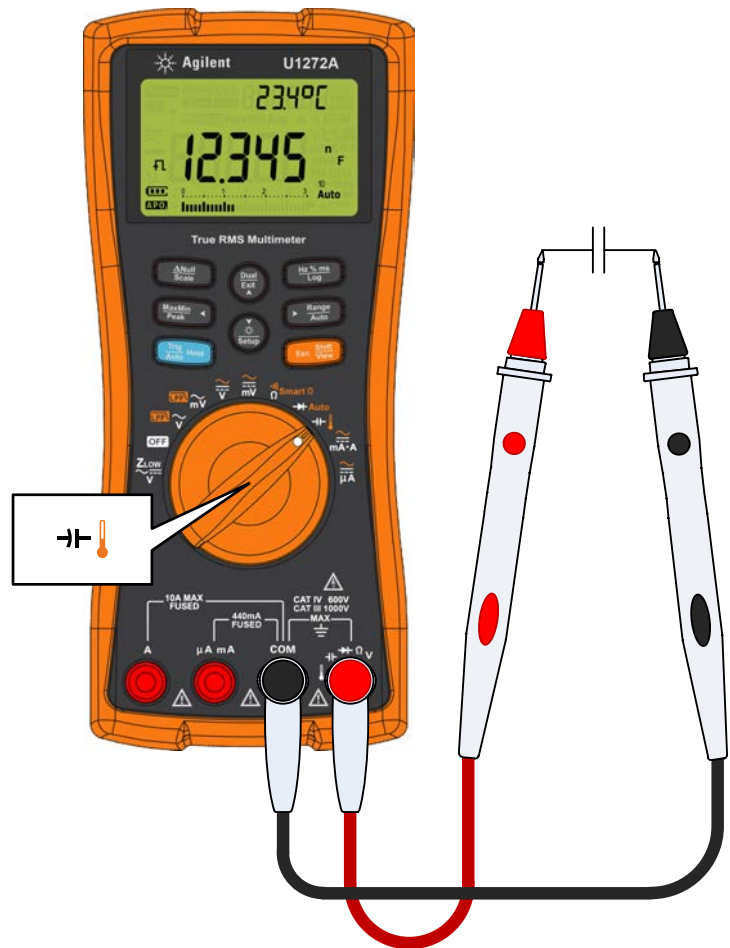

Figure 2-26 Measuring capacitance

Measuring Temperature

WARNING

Do not connect the thermocouple to electrically live circuits. Doing so will potentially cause fire or electric shock.

CAUTION

Do not bend the thermocouple leads at sharp angles. Repeated bending over a period of time can break the leads.

The multimeter uses a type-K (default setting) temperature probe for measuring temperature.



- 1 To measure temperature, position the rotary switch to \rightarrow and press  once. Set up your multimeter as shown in [Figure 2-29](#).
- 2 Probe the test points and read the display. The primary display normally shows temperature or the message  (open thermocouple). The open thermocouple message may be due to a broken (open) probe or because no probe is installed into the input jacks of the multimeter.



Figure 2-27 Temperature display

Press  to change the temperature units between $^{\circ}\text{C}$ or $^{\circ}\text{F}$ (you must first change the temperature unit to switch between $^{\circ}\text{C}$ and $^{\circ}\text{F}$ or $^{\circ}\text{F}$ and $^{\circ}\text{C}$). See [“Changing the default temperature unit”](#) on page 70 for more information.

CAUTION

Always set the temperature unit display per the official requirements and in compliance with the National laws of your region.

NOTE

Shorting the ! terminal to the **COM** terminal will display the temperature at the multimeter's terminals.

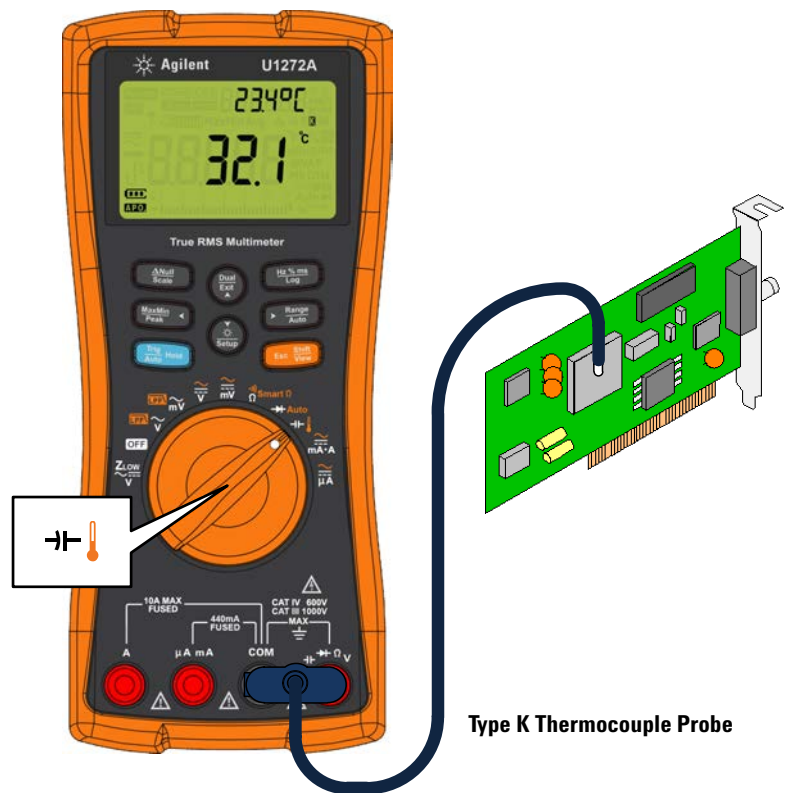







Figure 2-28 Measuring surface temperature

Changing the default thermocouple type (U1272A only)

You can change the thermocouple type (J or K) by accessing the multimeter's Setup.





- 1 Press  for more than 1 second to enter the multimeter's Setup mode.
- 2 Press  until **COUPLE** is shown on the secondary display. Press  or  to change the thermocouple type.

Available options: **TYPE K** or **TYPE J**.



- 3 Press  to save the changes. Press and hold  until the multimeter restarts.



Changing the default temperature unit

You can change the temperature unit (degree Celsius, Celsius/Fahrenheit, Fahrenheit, or Fahrenheit/Celsius) by accessing the multimeter's Setup.

- 1 Press  for more than 1 second to enter the multimeter's Setup mode.
- 2 Press  for more than 1 second until **TEMP** is shown on the secondary display. Press  or  to change the temperature unit.



Available options:

- **°C** - Temperature measured in °C.
- **°C - °F** - During temperature measurements, press  to switch between °C and °F.
- **°F** - Temperature measured in °F.
- **°F - °C** - During temperature measurements, press  to switch between °F and °C.

- 3 Press  to save the changes. Press and hold  until the multimeter restarts.

The bead-type thermocouple probe is suitable for measuring temperatures from $-40\text{ }^{\circ}\text{C}$ to $204\text{ }^{\circ}\text{C}$ ($399\text{ }^{\circ}\text{F}$) in PTFE-compatible environments. Above this temperature range, the probe may emit toxic gas. Do not immerse this thermocouple probe in any liquid. For best results, use a thermocouple probe designed for each specific application – an immersion probe for liquid or gel, and an air probe for air measurement.

Observe the following measurement techniques:

- Clean the surface to be measured and ensure that the probe is securely touching the surface. Remember to disable the applied power.
- When measuring above ambient temperatures, move the thermocouple along the surface until you get the highest temperature reading.
- When measuring below ambient temperatures, move the thermocouple along the surface until you get the lowest temperature reading.
- Place the multimeter in the operating environment for at least 1 hour as the multimeter is using a non-compensation transfer adapter with miniature thermal probe.
- For quick measurement, use the  compensation to view the temperature variation of the thermocouple sensor. The  compensation assists you in measuring relative temperature immediately.

Temperature measurement without ambient compensation

If you are working in a constantly varying environment, where ambient temperatures are not constant, do the following:



- 1 Press  to select  compensation. This allows a quick measurement of the relative temperature.
- 2 Avoid contact between the thermocouple probe and the surface to be measured.
- 3 After a constant reading is obtained, press  to set the reading as the relative reference temperature.
- 4 Touch the surface to be measured with the thermocouple probe and read the display.



Figure 2-29 Temperature measurement without ambient compensation

Measuring AC or DC Current

WARNING

Never attempt an in-circuit current measurement where the open-circuit potential to earth is greater than 1000 V. Doing so will cause damage to the multimeter and possible electric shock or personal injury.

CAUTION

To avoid possible damage to the multimeter or to the equipment under test:

- Check the multimeter's fuses before measuring current.
 - Use the proper terminals, function, and range for your measurement.
 - Never place the probes across (in parallel with) any circuit or component when the leads are plugged into the current terminals.
-

To measure current, you must open the circuit under test, then place the multimeter in series with the circuit.

To measure AC or DC current, proceed as follows:

- 1 Turn off power to the circuit. Discharge all high-voltage capacitors. Insert the black test lead into the **COM** terminal. Insert the red test lead in an input appropriate for the measurement range.
 - i If you are using the **A** terminal, set the rotary switch to $\overset{\sim}{\text{mA}}\cdot\text{A}$.
 - ii If you are using the **μA mA** terminal, set the rotary switch to $\overset{\sim}{\mu\text{A}}$ for currents below 5000 μA (5 mA), or $\overset{\sim}{\text{mA}}\cdot\text{A}$ for currents above 5000 μA .

NOTE

To avoid blowing the multimeter's 440 mA fuse, use the **μA mA** terminal only if you are sure the current is less than 400 mA. See [Figure 2-33](#) for test lead connections and function selection. Refer to the "Input warning" section for information on the alerts the multimeter uses when leads are not used correctly for current measurements.

2 Making Measurements

Measuring AC or DC Current

- Press  to cycle between DC (—), AC (∩), AC+DC (⊖), or % scale (%_{0.20} or %_{0.20}) current measurements.
- Open the circuit path to be tested. Probe the test points and read the display.



Figure 2-30 DC current display



NOTE

Reversing the leads will produce a negative reading, but will not damage the multimeter.

CAUTION

- For measuring AC current signals with a DC offset (U1272A only), refer to the “[Measuring AC and DC Signals \(U1272A only\)](#)” on page 44.
- For measuring DC current from a mixed signal in DC measurement mode, ensure that the Filter is enabled (Refer to “[Enabling and disabling the Filter](#)” on page 111).

NOTE

- Press  to cycle through the available dual display combinations. See [Appendix B](#), “Dual Display Combinations Using the Dual Key,” starting on page 159 to learn more.
- Press  to enable the frequency test mode for voltage measurements. See “[Frequency Test Mode](#)” on page 81 to learn more.

CAUTION

Placing the probes across (in parallel with) a powered circuit when a lead is plugged into a current terminal can damage the circuit you are testing and blow the multimeter's fuse. This happens because the resistance through the multimeter's current terminals are very low, resulting in a short circuit.

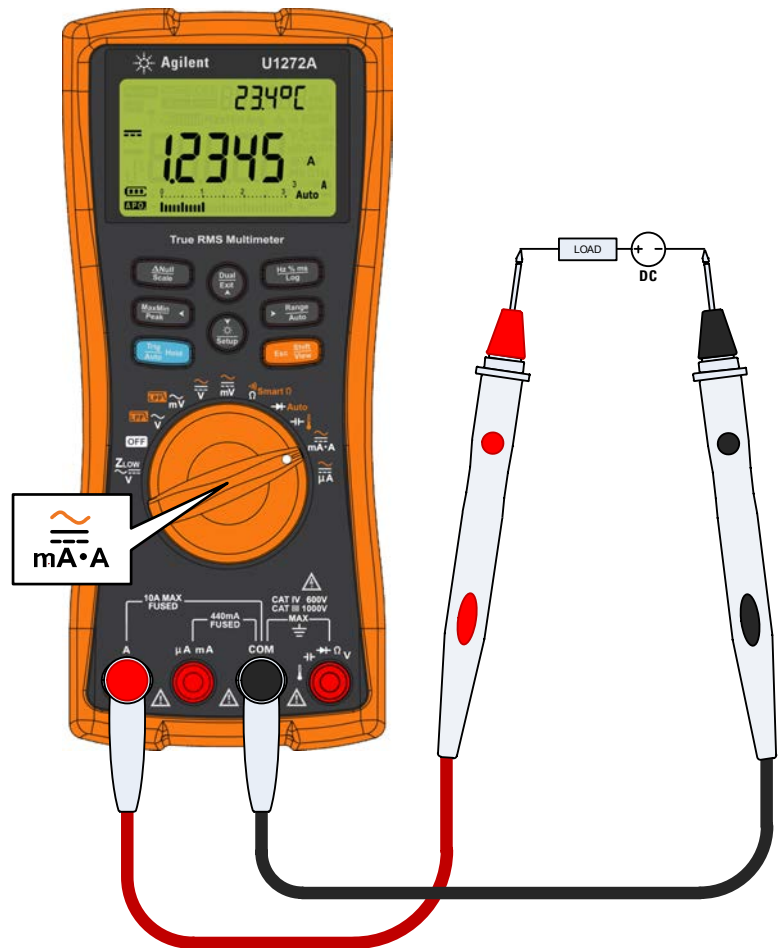

Figure 2-31 Measuring DC current

2 Making Measurements

Measuring AC or DC Current

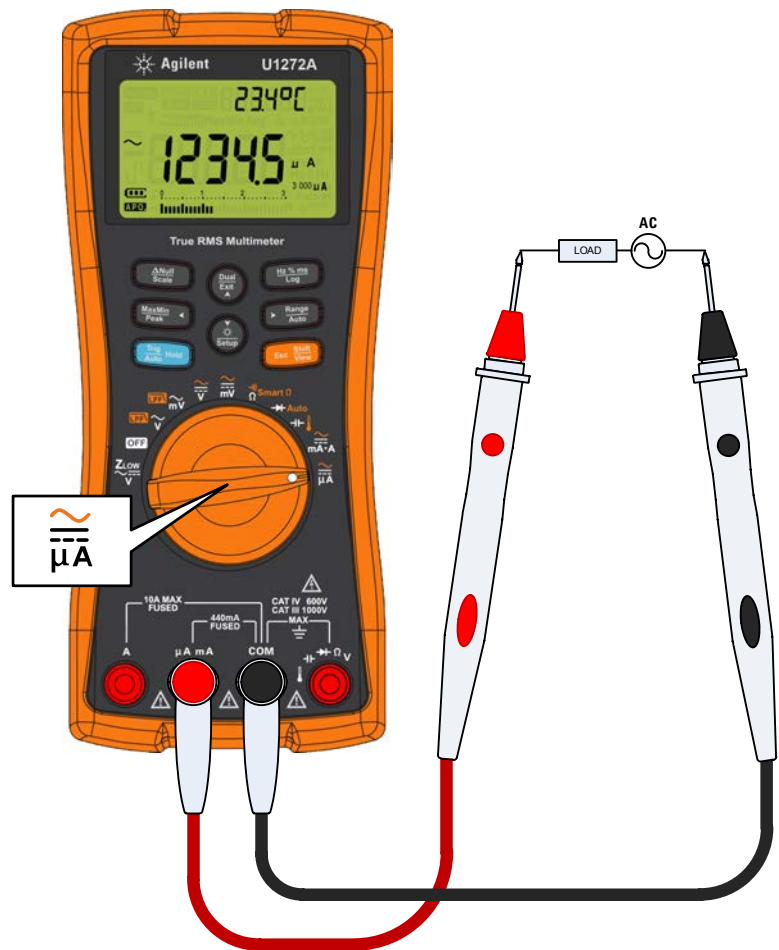

Figure 2-32 Measuring AC current

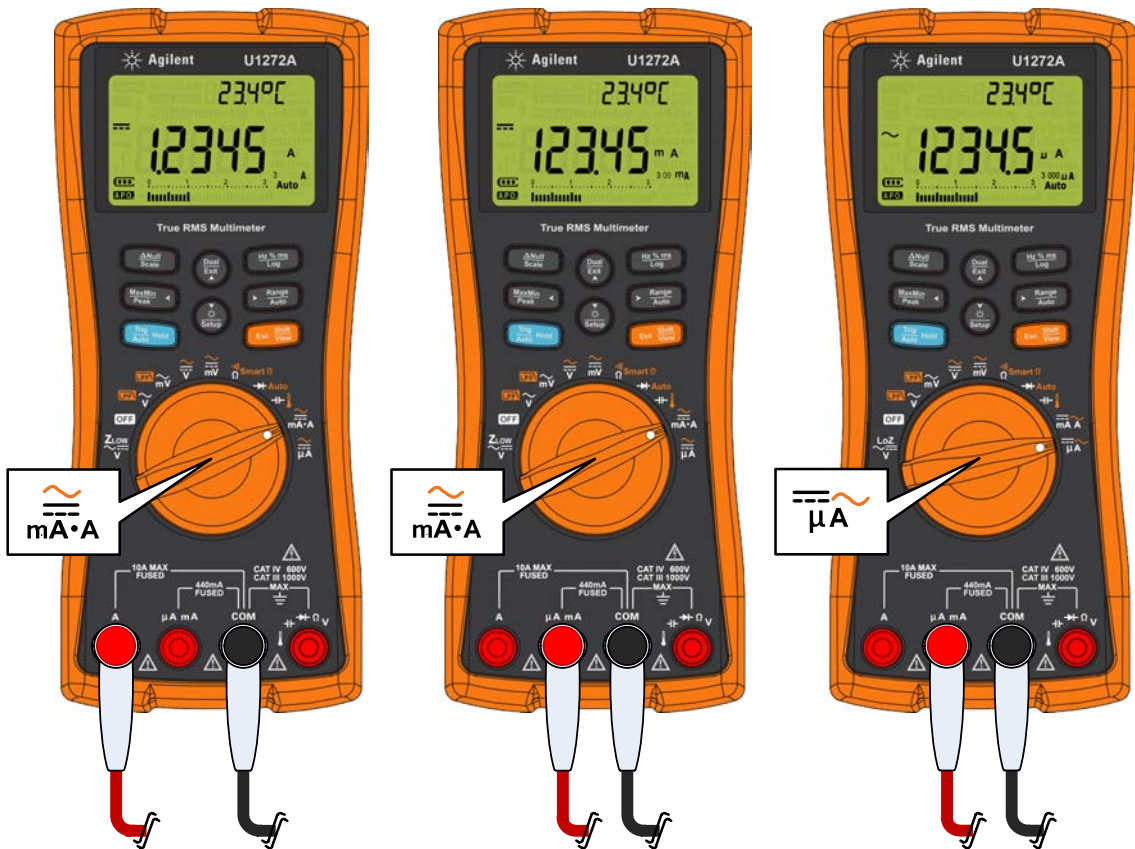



Figure 2-33 Current measurement setup

% Scale of 4-20 mA or 0-20 mA

The 4-20 mA current loop output from a transmitter is a type of electrical signal that is used in a series circuit to provide a robust measurement signal that is proportional to the applied pressure, temperature, or flow in process control. The signal is a current loop where 4 mA represents the zero percent signal and 20 mA represents the 100 percent signal.

The % scale for 4-20 mA or 0-20 mA in this multimeter is calculated using its corresponding DC mA measurement. The multimeter will automatically optimize the best resolution for the selected measurement. Two ranges are available for the % scale as shown in [Table 2-3](#).

To display the current measurement in % scale:

- 1 Position your multimeter's rotary switch position to $\tilde{\sim}$ mA·A. Set up your multimeter to measure DC current by following the steps listed in the “[Measuring AC or DC Current](#)” section.
- 2 Press  until $\%_{4-20}$ (or $\%_{0-20}$) is shown on the right side of the display. Probe the test points and read the display.

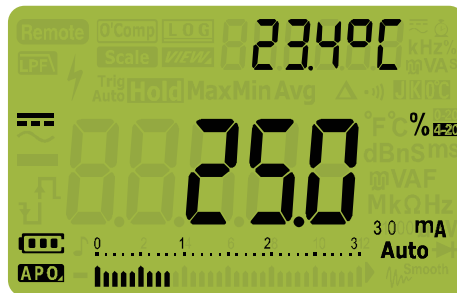

Figure 2-34 4-20 mA % Scale display

The analog bar graph displays the current measurement value. (In the example above, 8 mA is represented as 25% in the 4-20 mA % scale.)







Table 2-3 % Scale measurement range

% Scale of 4-20 mA or 0-20 mA	DC mA measurement range
999.99%	30 mA or 300 mA ^[1]
9999.9%	

[1] Applies to both autoranging and manual range selection.

Changing the % scale range

You can change the % scale range (4-20 mA or 0-20 mA) by accessing the multimeter's Setup.

- 1 Press  for more than 1 second to enter the multimeter's Setup mode.
- 2 Press  until *PERCENT* is shown on the secondary display. Press  or  to change the current % scale range. Available options: *4-20 mA*, *0-20 mA*, or *OFF*.
- 3 Press  to save the changes. Press and hold  until the multimeter restarts.

Use the % scale with a pressure transmitter, a valve positioner, or other output actuators to measure pressure, temperature, flow, pH, or other process variables.

2 Making Measurements

Measuring AC or DC Current

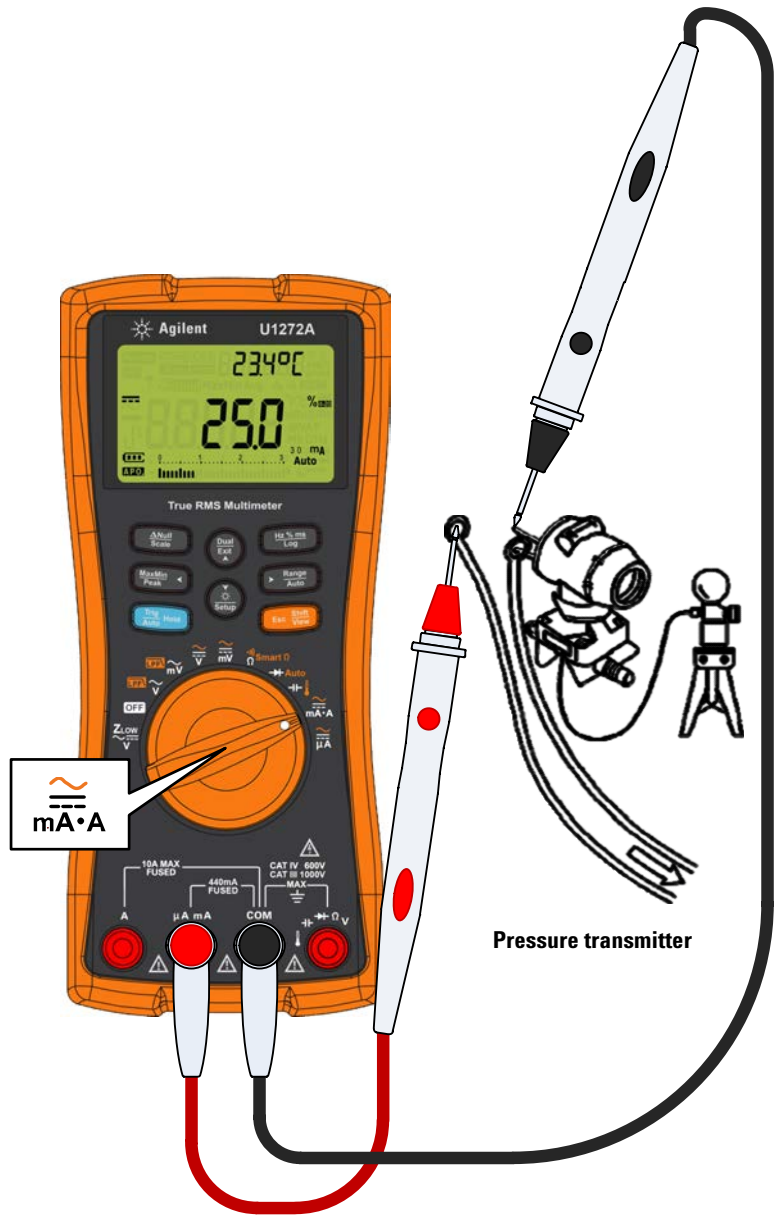

Figure 2-35 Measuring DC current using the 4-20 mA % scale

Frequency Test Mode

WARNING

Never measure the frequency where the voltage or current level exceeds the specified range. Manually set the voltage or current range if you want to measure frequencies below 20 Hz.

Measuring the frequency of a signal helps detect the presence of harmonic currents in neutral conductors and determines whether these neutral currents are the result of unbalanced phases or non-linear loads.

Your multimeter allows simultaneous monitoring of real-time voltage or current with frequency, duty cycle, or pulse width measurements. Figure 2-36 highlights the primary functions allowing frequency measurements in your multimeter.

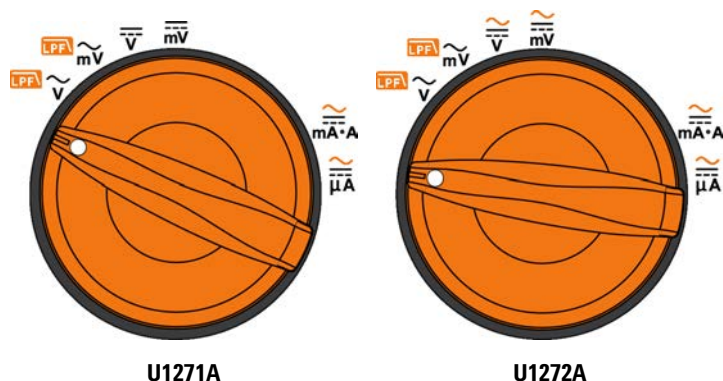

Figure 2-36 Functions allowing frequency measurement

Measuring frequency

Frequency is the number of cycles a signal completes each second. Frequency is defined as $1/\text{Period}$. Period is defined as the time between the middle threshold crossings of two consecutive, like-polarity edges, as shown in [Figure 2-37](#).

The multimeter measures the frequency of a voltage or current signal by counting the number of times the signal crosses a threshold level within a specified period of time.

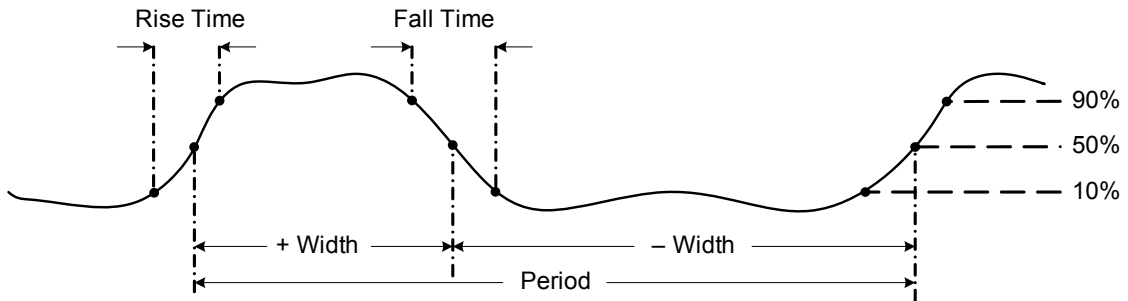



Figure 2-37 Frequency, pulse width, and duty cycle measurements

Pressing  controls the input range of the primary function (voltage or ampere) and not the frequency range.

1 To measure frequency, rotate the switch to one of the primary functions allowing frequency measurements highlighted in [Figure 2-36](#).

NOTE

To obtain the best measuring results for frequency measurements, please use the AC measuring path.

2 Press . Probe the test points and read the display.





Figure 2-38 Frequency display

The frequency of the input signal is shown in the primary display. The voltage or ampere value of the signal is shown in the secondary display. The bar graph does not indicate frequency but indicates the voltage or ampere value of the input signal.

Observe the following measurement techniques:

- If a reading shows as 0 Hz or is unstable, the input signal may be below or near the trigger level. You can usually correct these problems by manually selecting a lower input range, which increases the sensitivity of the multimeter.
- If a reading seems to be a multiple of what you expect, the input signal may be distorted. Distortion can cause multiple triggerings of the frequency counter. Selecting a higher voltage range might solve this problem by decreasing the sensitivity of the multimeter. In general, the lowest frequency displayed is the correct one.

Press  to cycle through the frequency, pulse width, and duty cycle measurements.

Press  for more than 1 second to exit the frequency measurement function.

Measuring pulse width

The pulse width function measures the amount of time a signal is high or low, as shown in Figure 2-37. It is the time from the middle threshold of the rising edge to the middle threshold of the next falling edge. The measured waveform must be periodic; its pattern must repeat at equal time intervals.





- 1 To measure pulse width, position the rotary switch to one of the functions allowing frequency measurements shown in Figure 2-36.
- 2 Press  until the measurements are shown in the millisecond (ms) unit. Probe the test points and read the display.



Figure 2-39 Pulse width display

The pulse width of the input signal is shown in the primary display. The voltage or ampere value of the signal is shown in the secondary display. The bar graph does not indicate duty cycle but indicates the voltage or ampere value of the input signal.

The pulse width polarity is displayed to the left of the duty cycle value.  indicates a positive pulse width and  indicates a negative pulse width. To change the polarity being measured, press .

Press  to cycle through the frequency, pulse width, and duty cycle measurements.

Press  for more than 1 second to exit the pulse width measurement function.

Measuring duty cycle

The duty cycle (or duty factor) of a repetitive pulse train is the ratio of the positive or negative pulse width to the period expressed as a percentage, as shown in [Figure 2-37](#).

The duty-cycle function is optimized for measuring the on or off time of logic and switching signals. Systems such as electronic fuel injection systems and switching power supplies are controlled by pulses of varying width, which can be checked by measuring duty cycle.

- 1 To measure duty cycle, position the rotary switch on one of the functions allowing frequency measurements shown in [Figure 2-36](#).
- 2 Press  until the measurements are displayed as a percentage (%). Probe the test points and read the display.







Figure 2-40 Duty cycle display

The duty cycle percentage of the input signal is shown in the primary display. The voltage or ampere value of the signal is shown in the secondary display. The bar graph does not indicate duty cycle but indicates the voltage or ampere value of the input signal.

2 Making Measurements

Frequency Test Mode

The pulse polarity is displayed to the left of the duty cycle value.  indicates a positive pulse and  indicates a negative pulse. To change the polarity being measured, press .

Press  to cycle through the frequency, pulse width, and duty cycle measurements.

Press  for more than 1 second to exit the duty cycle measurement function.



3 Multimeter Features

Making Relative Measurements (Null)	88
Making Scale Transfers (Scale)	90
Capturing Maximum and Minimum Values (MaxMin)	92
Capturing Peak Values (Peak)	94
Freezing the Display (TrigHold and AutoHold)	95
Recording Measurement Data (Data Logging)	96
Performing manual logs (HAnd)	97
Performing interval logs (AUto)	98
Performing event logs (triG)	100
Reviewing Previously Recorded Data (View)	102

The following sections describe the additional features available in your multimeter.



Making Relative Measurements (Null)

When making null measurements, also called relative, each reading is the difference between a stored (selected or measured) null value and the input signal.

One possible application is to increase the accuracy of a resistance measurement by nulling the test lead resistance. Nulling the leads is also particularly important prior to making capacitance measurements.

NOTE

Null can be set for both auto and manual range settings, but not in the case of an overload.

- 1 To activate the relative mode, press the  key. The measurement value at the time that when Null (Δ) is enabled, is stored as the reference value.

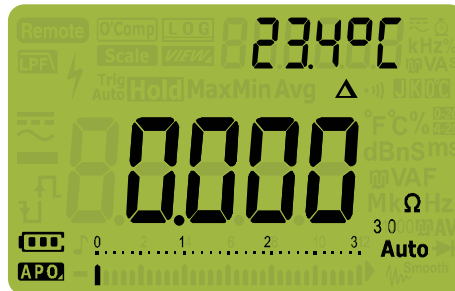







Figure 3-1 Null display

- 2 Press  again to view the stored reference value. The display will return to normal after 3 seconds.
- 3 To disable the Null function, press  while the stored reference value is shown (step 2).

For any measurement function, you can directly measure and store the null value by pressing  with the test leads open (nulls the test lead capacitance), shorted (nulls the test lead resistance), or across a desired null value circuit.

NOTE

- In resistance measurement, the multimeter will read a non-zero value even when the two test leads are in direct contact, because of the resistance of these leads. Use the null function to zero-adjust the display.
- For DC voltage measurements, the thermal effect will influence the accuracy of the measurements. Short the test leads and press  when the displayed value is stable to zero-adjust the display.

Press  to enable the Null function.

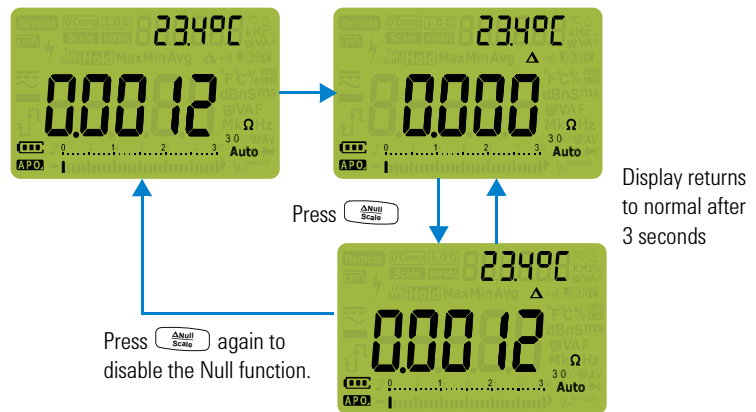

Figure 3-2 Null operation

Making Scale Transfers (Scale)





The Scale operation emulates a transducer by helping you to convert the measured readings proportionally to the specified ratio and unit display. Use Scale to transfer voltage readings to proportional readings when using clamp-on current probes or high voltage probes. The available scale conversions are shown in the table below.

Table 3-1 Available scale conversions



Scale conversion		Multiplier ^[1]	Unit	Related units
1 kV/V ^[2]	1000 V/V	1000.0	V	V, kV
1 A/mV	1000 A/V	1000.0	A	A, kA
1 A/10 mV	100A/V	100.0	A	A, kA
1 A/100 mV	10 A/V	10.0	A	mA, A, kA

[1] The transfer formula used is: Display = Multiplier × Measurement

[2] This value and unit can be adjusted from the multimeter's Setup. See ["Changing the user scale conversion value and unit"](#) on page 129 for more information.

- 1 Press and hold  for more than 1 second to enable the Scale operation.
- 2 The most recently saved (default: 1 kV/V, ×1000.0) ratio and unit will be shown on the primary and secondary displays. Press  while the **Scale** symbol is flashing to cycle through the available ratio and unit displays.
- 3 Press  while the **Scale** symbol is flashing to save the selected ratio and unit and start the conversion. The selected ratio and unit will be used as the default ratio and unit the next time Scale is enabled.
- 4 Or, while the **Scale** symbol is flashing, if no activity is detected after 3 seconds, the conversion will begin (with the specified ratio and unit shown on the primary display).
- 5 Press and hold  for more than 1 second to cancel the Scale operation.

NOTE

The  is disabled during Scale operations. Press  to enable the frequency test mode for voltage and current measurements during Scale operations.

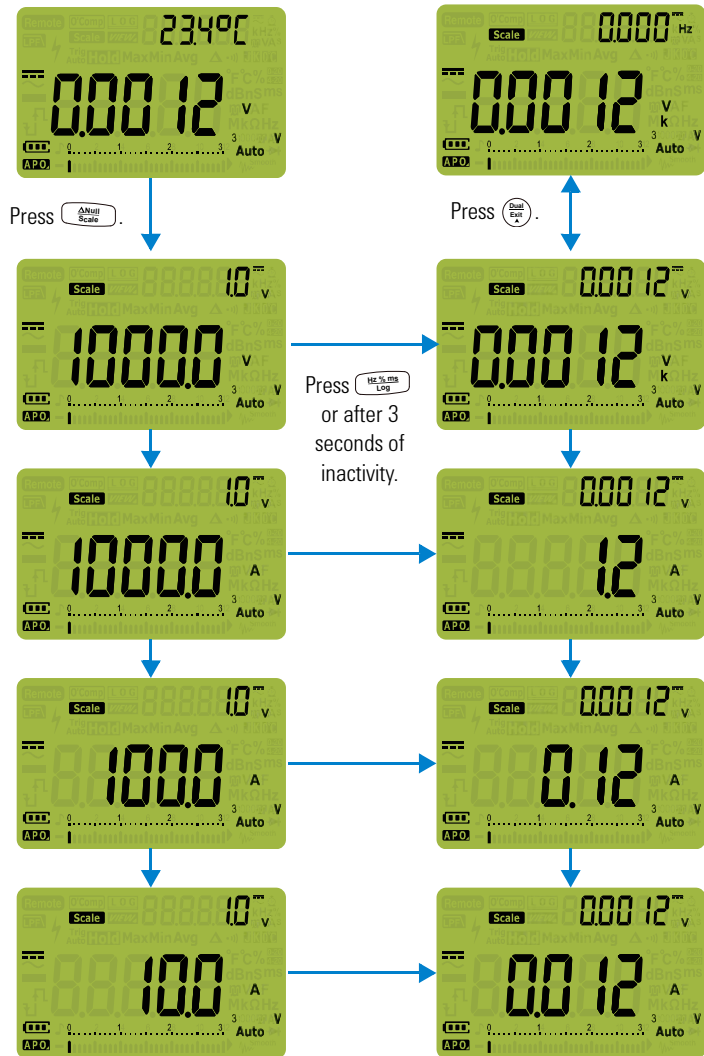

Figure 3-3 Scale operation

Capturing Maximum and Minimum Values (MaxMin)

The MaxMin operation stores the maximum, minimum, and average input values during a series of measurements.



When the input goes below the recorded minimum value or above the recorded maximum value, the multimeter beeps and records the new value. The elapsed time since the recording session was started is stored and shown on the display at the same time. The multimeter also calculates an average of all readings taken since the MaxMin mode was activated.

From the multimeter's display, you can view the following statistical data for any set of readings:

- Max: highest reading since the MaxMin function was enabled
- Min: lowest reading since the MaxMin function was enabled
- Avg: average or mean of all readings since the MaxMin function was enabled
- MaxMinAvg: present reading (actual input signal value)

NOTE

This function is applicable to all measurements except for continuity and diode tests.

- 1 Press  to enable the MaxMin operation.
- 2 Press  again to cycle through the Max, Min, Avg, or present (MaxMinAvg) input values.

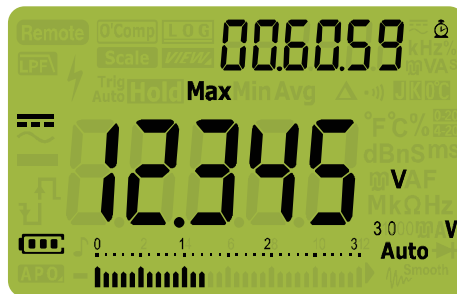





Figure 3-4 MaxMin display

3 The elapsed time is shown on the secondary display. Press  to restart the recording session.

NOTE

- Changing the range manually will also restart the recording session.
- If an overload is recorded, the averaging function will be stopped.  is shown in place of the average value.
- The APO (auto power-off) function is disabled when MaxMin is enabled.
- The maximum recording time is 99.59.59 (hh.mm.ss).  is shown if the recording exceeds the maximum time.

4 Press  for more than 1 second to disable the MaxMin function.

This mode is useful for capturing intermittent readings, recording minimum and maximum readings unattended, or recording readings while equipment operation keeps you from observing the multimeter display.

The true average value displayed is the arithmetic mean of all readings taken since the start of recording. The average reading is useful for smoothing out unstable inputs, calculating power consumption, or estimating the percentage of time a circuit is active.

Capturing Peak Values (Peak)

This function allows the measurement of peak voltage for analysis of such components as power distribution transformers and power factor correction capacitors.







- 1 To activate the peak mode, press the  key for more than 1 second.
- 2 Press  again to display the maximum (HoldMax) or minimum (HoldMin) peak values along with their respective time stamps.



Figure 3-5 Peak display

- 3 If  (overload) is shown, press the  key to change the measurement range. This action will also restart the recording session.
- 4 Press  to restart the recording session without changing the measurement range.
- 5 Press  or  for more than 1 second to disable the Peak function.

When the peak value of the input signal goes below the recorded minimum value or above the recorded maximum value, the multimeter beeps and records the new value. At the same time, the elapsed time since the peak recording session was started is stored as the recorded value's time stamp.



NOTE

The APO (auto power-off) function is disabled when Peak is enabled.

Freezing the Display (TrigHold and AutoHold)

TrigHold operation

To freeze the display for any function, press the  key.







If  is pressed while a MaxMin, Peak, or Data Logging recording session is in progress, the display freezes but the data acquisition continues in the background. Pressing  again updates the display to reflect data that was acquired during the hold.

AutoHold operation

Pressing the  for more than 1 second activates the AutoHold if the multimeter is not in the MaxMin, Peak, or Data Logging recording modes.

AutoHold operation monitors the input signal and updates the display and, if enabled, emits a beep, whenever a new stable measurement is detected. A stable measurement is one that does not vary more than a selected adjustable (AutoHold threshold) variation count for at least one second (default 500 counts). Open lead conditions are not included in the update.

Changing the default AutoHold threshold count

- 1 Press  for more than 1 second to enter the multimeter's Setup mode.
- 2 **AHOLD** should be shown on the secondary display. (If not, press  or  until it is shown.)
- 3 Press  or  to edit the value shown on the primary display.
- 4 Press  to save the changes. Press and hold  until the multimeter restarts.

NOTE

If the reading value is unable to reach a stable state (when exceeding the preset variation), the reading value will not be updated.

Recording Measurement Data (Data Logging)

The Data Logging function provides you the convenience of recording test data for future review or analysis. Since data is stored in the nonvolatile memory, the data remains saved even when the multimeter is turned OFF or if the battery is replaced.

The Data Logging feature collects measurement information over a user-specified duration. There are three data logging options that can be used to capture measurement data: manual (HRnd), interval (RUtd), or event (tr, ũ).





- A manual log stores an instance of the measured signal each time  is pressed. See [page 97](#).
- An interval log stores a record of the measured signal at a user-specified interval. See [page 98](#).
- An event log stores a record of the measured signal each time a trigger condition is satisfied. See [page 100](#).

Table 3-2 Data logging maximum capacity



Data logging option	Maximum capacity for saving	
	U1271A	U1272A
Manual (HRnd)	100	100
Interval (RUtd)	200	10000
Event (tr, ũ)	<i>Shares the same memory with Interval logging</i>	

Before starting a recording session, set up the multimeter for the measurements to be recorded.

Select the data logging option

- 1 Press  for more than 1 second to enter the multimeter's Setup mode.
- 2 Press  until *d-LOG* is shown on the secondary display. Press  or  to change the data logging option.

Available options: *HRnd*, *Auto*, or *LOG*.

- 3 Press  to save the changes. Press and hold  until the multimeter restarts.

Performing manual logs (HAnd)

Ensure that *HRnd* is selected as the data logging option in the multimeter's Setup.

- 1 Press  for more than 1 second to store the present input signal value.

LOG and the log entry number are displayed at the top of the display. The display will return to normal after a short while (around 1 s).

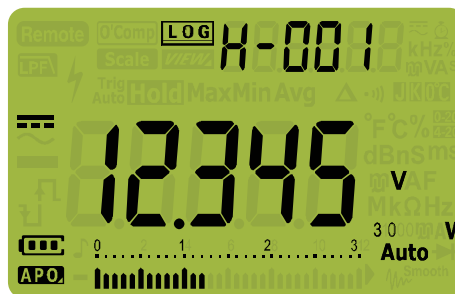



Figure 3-6 Manual log display

- 2 Repeat [step 1](#) again to save the next input signal value.

3 Multimeter Features

Recording Measurement Data (Data Logging)







The maximum number of readings that can be stored for the manual log is 100 entries. When all entries are occupied, **H-FULL** will be shown when  is pressed.

See the “[Reviewing Previously Recorded Data \(View\)](#)” section later in this manual to review or erase the recorded entries.

Performing interval logs (AUto)

Ensure that **AUto** is selected as the data logging option in the multimeter’s Setup.

Set the recording interval duration

- 1 Press  for more than 1 second to enter the multimeter’s Setup mode.
- 2 Press  until **L-t, nE** is shown on the secondary display. Press  or  to change the duration or a recording interval from 1 to 99999 seconds (default 1 second).
- 3 Press  to save the changes. Press and hold  until the multimeter restarts.

The duration set in the steps above will determine how long each recording interval takes. The input signal value at the end of each interval will be recorded and saved into the multimeter’s memory.

Start the interval log mode

- 1 Press  for more than 1 second to start interval log mode.

LOG and the log entry number are displayed at the top of the display. Subsequent readings are automatically recorded into the multimeter’s memory at the interval specified in the Setup mode.

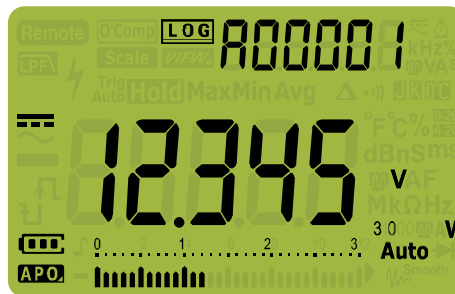





Figure 3-7 Interval log display

- 2 Press  for more than 1 second to exit the interval log mode.

The maximum number of readings that can be stored for the interval log is 10000 entries for the U1272A and 200 entries for the U1271A. When all entries are occupied,  will be shown when  is pressed.

The interval and event log share the same memory buffer (total combined: 10000 entries for U1272A and 200 entries for U1271A). Increased usage of the interval log entries will lead to the decrease of the maximum entries for the event log, and vice versa.

See the “[Reviewing Previously Recorded Data \(View\)](#)” section later in this manual to review or erase the recorded entries.

NOTE

When the interval log recording session is running, all other keypad operations are disabled; except for , which, when pressed for more than 1 second, will stop and exit the recording session. Furthermore, APO (auto power-off) is disabled during the recording session.

Performing event logs (triG)

Ensure that triG is selected as the data logging option in the multimeter's Setup.

Event logs are used only with the following modes:

- TrigHold and AutoHold (page 95)
- MaxMin recording (page 92)
- Peak recording (page 94)

Event records are triggered by the measured signal satisfying a trigger condition set by the measurement function used in the following modes:

Table 3-3 Event log trigger conditions

Modes	Trigger condition
	<i>The input signal value is recorded:</i>
TrigHold	Each time  is pressed.
AutoHold	When the input signal varies more than the variation count.
MaxMin	When a new maximum (or minimum) value is recorded. The average and present readings are not recorded in the Event log.
Peak	When a new peak (maximum or minimum) value is recorded.

Start the event log mode



- 1 Select one of the four modes stated in Table 3-3.
- 2 Press  for more than 1 second to start event log mode.

LOG and the log entry number are displayed at the top of the display. Subsequent readings are automatically recorded into the multimeter's memory every time the trigger condition specified in Table 3-3 is satisfied.



Figure 3-8 Event log display

- 3 Press  for more than 1 second to exit the event log mode.

The maximum number of readings that can be stored for the event log is 10000 entries for the U1272A and 200 entries for the U1271A. When all entries are occupied,  will be shown when  is pressed.

The event and interval log share the same memory buffer (total combined: 10000 entries for U1272A and 200 entries for U1271A). Increased usage of the event log entries will lead to the decrease of the maximum entries for the interval log, and vice versa.

See the “[Reviewing Previously Recorded Data \(View\)](#)” section later in this manual to review or erase the recorded entries.

NOTE

APO (auto power-off) is disabled during the recording session.

3 Multimeter Features

Reviewing Previously Recorded Data (View)

Reviewing Previously Recorded Data (View)

Viewing data stored in the multimeter's memory is performed through the  key.



- 1 Press  for more than 1 second to enter the multimeter's View mode. Press  again to cycle through the manual (H), interval (A), or event (E) previously stored records.









Figure 3-9 View display

If nothing has been recorded, *H-Err*, *A-Err*, or *E-Err* will be displayed instead.



Figure 3-10 Empty view display

- 2 Select the desired recording category to view its entries.
 - i Press  to jump to the first stored entry.
 - ii Press  to jump to the last stored entry.
 - iii Press  to view the next stored entry. The index number increases by one.
 - iv Press  to view the previous stored entry. The index number decreases by one.
 - v Press  for more than 1 second to clear all entries for the selected log type.
- 3 Press  for more than 1 second to exit the View mode.

3 Multimeter Features

Reviewing Previously Recorded Data (View)

THIS PAGE HAS BEEN INTENTIONALLY LEFT BLANK.



4 Multimeter Setup Options

Using the Setup Menu	106
Editing numerical values	107
Setup Menu Summary	108
Setup Menu Items	110
Changing the beep frequency	110
Enabling and disabling the Filter	111
Changing the variation count	113
Changing the recording option	114
Changing the sample interval duration	115
Changing the decibel display (U1272A only)	116
Setting a custom dBm reference impedance (U1272A only)	117
Changing the auto power-off and backlight timeouts	118
Enabling and disabling the overvoltage alert	120
Changing the % scale range	121
Changing the thermocouple type (U1272A only)	122
Changing the minimum measurable frequency	123
Changing the baud rate	124
Changing the data bits	125
Changing the parity check	126
Enabling and disabling the backlight alert	127
Enabling smooth mode	128
Changing the user scale conversion value and unit	129
Resetting the multimeter's setup options	130
Changing the temperature unit	131

The following sections describe how to change the preset features of your multimeter.

















Using the Setup Menu

The multimeter’s setup menu allows you to change a number of nonvolatile preset features. Modifying these settings affects the general operation of your multimeter across several functions. Select a setting to edit to perform one of the following:

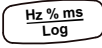

- Switch between two values, such as on or off.
- Cycle through multiple values from a predefined list.
- Decrease or increase a numerical value within a fixed range.



To contents of the setup menu are summarized in [Table 4-2](#) on page 108.



Table 4-1 Setup menu key functions



Legend	Description
	<p>Press  for more than 1 second to access the setup menu.</p> <p>Press and hold  until the multimeter restarts to exit the setup menu.</p>
	<p>Press  or  to step through the menu items.</p>
	<p>Press  or  at each menu item to change the preset settings. The menu item (in the secondary display) will flash to indicate that you can now change the values shown in the primary display.</p> <p>Press  or  again to switch between two values, to cycle through multiple values from a list, or to decrease or increase a numerical value.</p>
	<p>While the menu item is flashing, press  to save your changes.</p>
	<p>While the menu item is flashing, press  to discard your changes.</p>



Editing numerical values

When editing numerical values, use the  and  to position the cursor on a numerical digit.

- Press  to move the cursor to the left, and
- Press  to move the cursor to the right.

When the cursor is positioned over a digit, use the  and  keys to change the numerical digit.

- Press  to increment the digit, and
- Press  to decrement the digit.

When you have completed your changes, save the new numerical value by pressing . (Or alternatively, if you wish to discard the changes you made, press .)

4 Multimeter Setup Options

Setup Menu Summary

Setup Menu Summary

The Setup menu items are summarized in the table below. Click the respective “Learn more” pages for more information on each menu item.

Table 4-2 Setup menu item descriptions

Legend	Available settings	Description	Learn more on:
BEeP	3200 Hz, 3491 Hz, 3840 Hz, 4267 Hz, or <i>oFF</i>	Set the multimeter’s beep frequency from 3200 Hz to 4267 Hz or off. Default is 3491 Hz.	page 110
FILtEr	<i>dC</i> , <i>dCRc</i> , or <i>oFF</i>	Enable the LPA for DC, AC, and AC+DC(U1272A only) voltage and current measuring paths. Default is dC.	page 39 and page 111
hOULd	0050 to 9999 counts	Set the multimeter’s AutoHold threshold count from 50 to 9999 counts. Default is 500 counts.	page 95 and page 113
d-LoG	<i>HAnd</i> , <i>Auto</i> , or <i>Er</i> , <i>G</i>	Set the multimeter’s data logging option (manual log, interval log, or event log). Default is manual log (HAnd).	page 96 and page 114
L-t, nE	00001 to 99999 s	Set the logging duration for interval logs from 1 to 99999 seconds (1 day, 3 hours, 46 minutes, 39 seconds). Default is 1 second.	page 98 and page 115
dC, dBEL	<i>on dBm</i> , <i>on dBV</i> , or <i>oFF</i>	U1272A only — Set the multimeter to display voltage as a dB value (dBm/dBV) or off. Default is dBm.	page 46 and page 116
dBref	0001 to 9999 Ω	U1272A only — Set the dBm reference impedance value from 1 Ω to 9999 Ω. Default is 50 Ω.	page 46 and page 117
APo	01 to 99 minutes or <i>oFF</i>	Set the auto power-off timeout period from 1 to 99 minutes (1 hour, 39 minutes) or off. Default is 15 minutes.	page 6 and page 118
bL, t	01 to 99 s or <i>oFF</i>	Set the LCD backlight timeout period from 1 to 99 seconds (1 minute, 39 seconds) or off. Default is 15 seconds.	page 7 and page 118
ALert	0000.1 to 10100 V or <i>oFF</i>	Set the multimeter’s voltage alert value from 0.1 V to 1010 V or off. Default is off.	page 8 and page 120
PERcEn	0-20 mA, 4-20 mA, or <i>oFF</i>	Set the multimeter’s % scale selection (0-20 mA/4-20 mA) or off. Default is 4-20 mA.	page 78 and page 121
COUPLE	<i>TYPE</i> <input type="checkbox"/> or <i>TYPE</i> <input checked="" type="checkbox"/>	U1272A only — Set the multimeter’s thermocouple type (type J or type K). Default is type K.	page 68 and page 122

Table 4-2 Setup menu item descriptions (continued)

Legend	Available settings	Description	Learn more on:
<i>FREQ</i>	0.5 Hz or 10 Hz	Set the minimum measurement frequency (0.5 Hz or 10 Hz). Default is 0.5 Hz.	page 81 and page 123
<i>BAUD</i>	9600 or 19200	Set the baud rate for remote communication with a PC (9600, or 19200). Default is 9600.	page 10 and page 124
<i>DATAB</i>	7-bit or 8-bit	Set the data bit length for remote communication with a PC (7-bit or 8-bit). Default is 8-bit.	page 10 and page 125
<i>PARITY</i>	none, En, or odd	Set the parity bit for remote communication with a PC (none, even, or odd). Default is none.	page 10 and page 126
<i>ALERT</i>	off or on	Set the multimeter to flash the backlight during alerts. Default is on.	page 54 and page 127
<i>SMOOTH</i>	0001d to 9999d or 0001E to 9999E	Set the primary display's settling value from (0001.d) to (9999.d) or (0001.E) to (9999.E). Default is disabled (0009.d).	page 12 and page 128
<i>USER</i>	(0000.1 to 100000) V/V, A/V, or 000 (no unit)/V	Set the scale conversion value from (0000.1) to (1000.0). The scale conversion unit can be set to V/V, A/V, or 000 (no unit)/V. Default is (1000.0) V/V.	page 90 and page 129
<i>RESET</i>	DEFAULT	Reset the multimeter to its factory default settings.	page 130
<i>TEMP</i>	°C, °C-°F, °F, or °F-°C	Set the multimeter's temperature unit (Celsius, Celsius/Fahrenheit, Fahrenheit, Fahrenheit/Celsius). Default is °C (Celsius).	page 68 and page 131

Setup Menu Items

Changing the beep frequency

The multimeter's beeper alerts users to the presence of circuit continuities, operator errors such as incorrect lead connections for the selected function, and newly sensed values for MaxMin and Peak recordings.

Parameter	Range	Default setting
bEEP	3200 Hz, 3491 Hz, 3840 Hz, 4267 Hz, or Off	3491 Hz

To change the beep frequency:









- 1 Press  for more than 1 second to enter the multimeter's setup menu.
- 2 Press  or  until **bEEP** is shown on the secondary display.



Figure 4-1 bEEP display

- 3 Press  or  to change the beep frequency. Select **OFF** to disable the beeper feature.
- 4 Press  to save your changes or press  to discard your changes.

- 5 Press and hold  until the multimeter restarts to return to normal operation.

Enabling and disabling the Filter

There are two Filter () options within the design of the multimeter:

- In AC/AC+DC measurement mode, the Filter works as a low pass filter and attenuates signals with frequencies of more than 1 kHz
- In DC measurement mode, the Filter will block AC signals

Only one of the two filters can be in the signal path at any point in time. The possible scenarios are:

- Only the AC Low Pass Filter is enabled
- Only the DC Filter is enabled
- No Filter in the signal path

The  icon appears when either of the filter circuits are enabled. When either LPF is enabled, the measurement speed (response time) will be impacted.

NOTE

The DC Filter cannot be used when the dual display mode is enabled where AC and DC voltages are measured.

Table 4-3 Filter (LPF) options

Measurement	Filter setting		
	DC ^[1]	DCAC	OFF
AC/AC+DC ^[2]	OFF	Low Pass Filter	OFF
DC	Filter (blocks AC)	Filter (blocks AC)	OFF
Dual display	OFF	Low Pass Filter	OFF

[1] The Filter (DC) will be set to ON as the factory default. You may change it to an alternate setting, and the multimeter will remember the chosen setting for consecutive uses.

[2] The AC+DC measurement mode is only valid for the U1272A only.

You may enable the Filter for DC coupling of voltage and/or current measurements. The  icon will be shown during the measurement.

Table 4-4 Firmware version 2.00 or older

Parameter	Range	Default setting
FiLtEr	on or oFF	oFF



Table 4-5 Firmware version 2.04 or newer

Parameter	Range	Default setting
FiLtEr	dC, dCAC, or oFF	dC

CAUTION

To avoid possible electric shock or personal injury, enable the Filter(LPF) to verify the presence of hazardous DC voltages. Displayed DC voltage values can be influenced by high frequency AC components and must be filtered to assure an accurate reading.

To enable/disable the Filter:

- 1 Press  for more than 1 second to enter the multimeter's setup menu.
- 2 Press  or  until *FILtEr* is shown on the secondary display.

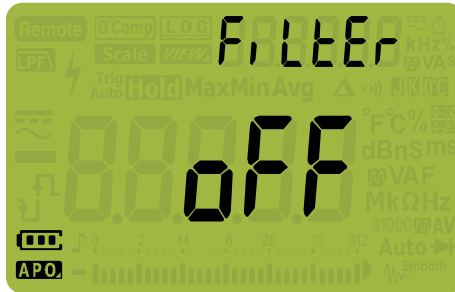







Figure 4-2 FilteR display

- 3 Press  or  to enable the filters (*ON* is selected). Select *OFF* to disable the filters.
- 4 Press  to save your changes or press  to discard your changes.
- 5 Press and hold  until the multimeter restarts to return to normal operation.

Changing the variation count



This setting is used with the multimeter's AutoHold feature (see [page 95](#)). When the variation of the measured value exceeds the value of the variation count, the AutoHold feature will be ready to trigger.

Parameter	Range	Default setting
AHoLd	(50 to 9999) counts	500 counts

4 Multimeter Setup Options

Setup Menu Items

To change the variation count:

- 1 Press  for more than 1 second to enter the multimeter's setup menu.
- 2 Press  or  until **AHOLD** is shown on the secondary display.

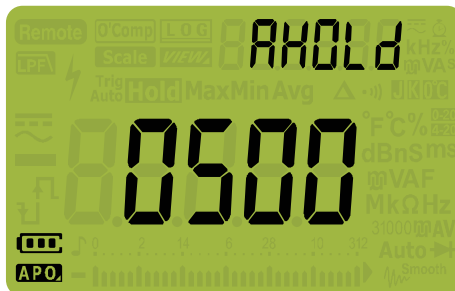







Figure 4-3 AHOLD display

- 3 Press  or  to set the variation count.
- 4 Press  to save your changes or press  to discard your changes.
- 5 Press and hold  until the multimeter restarts to return to normal operation.

Changing the recording option

This setting is used with the multimeter's Data Logging feature (see [page 96](#)). There are three available recording options for the multimeter's Data Logging feature.

Parameter	Range	Default setting
d-LoG	HAnd, AUto, or TriG	HAnd

To change the recording option:









- 1 Press  for more than 1 second to enter the multimeter's setup menu.
- 2 Press  or  until **d-LoG** is shown on the secondary display.



Figure 4-4 d-LoG display

- 3 Press  or  to set the recording option.
- 4 Press  to save your changes or press  to discard your changes.
- 5 Press and hold  until the multimeter restarts to return to normal operation.

Changing the sample interval duration

This setting is used with the multimeter's Interval Data Logging feature (see [page 98](#)). The multimeter will record a measurement value at the beginning of every sample interval.

Parameter	Range	Default setting
L-tiME	(1 to 99999) s	1 s

4 Multimeter Setup Options

Setup Menu Items

To change the sample interval duration:









- 1 Press  for more than 1 second to enter the multimeter's setup menu.
- 2 Press  or  until $L-ti\bar{n}\bar{E}$ is shown on the secondary display.



Figure 4-5 L-tiME display

- 3 Press  or  to set the sample interval duration.
- 4 Press  to save your changes or press  to discard your changes.
- 5 Press and hold  until the multimeter restarts to return to normal operation.

Changing the decibel display (U1272A only)

This setting is used with dB measurements (see [page 46](#)). You can enable the multimeter to display voltage as a dB value, either relative to 1 milliwatt (dBm) or a reference voltage of 1 volt (dBV).

Parameter	Range	Default setting
dCibEL	On dBm, On dBV, or Off	On dBm

To change the decibel display:









- 1 Press  for more than 1 second to enter the multimeter's setup menu.
- 2 Press  or  until $dCibEL$ is shown on the secondary display.



Figure 4-6 dCibEL display

- 3 Press  or  to change the decibel display. Select off to disable dB measurements.
- 4 Press  to save your changes or press  to discard your changes.
- 5 Press and hold  until the multimeter restarts to return to normal operation.

Setting a custom dBm reference impedance (U1272A only)

This setting is used with dB measurements (see [page 46](#)). The dBm function is logarithmic, and is based on a calculation of power delivered to a reference impedance (resistance), relative to 1 mW.

Parameter	Range	Default setting
dbrEF	(1 to 9999) Ω	50 Ω

To change the dBm reference impedance value:









- 1 Press  for more than 1 second to enter the multimeter's setup menu.
- 2 Press  or  until *dbrEF* is shown on the secondary display.



Figure 4-7 dbrEF display



- 3 Press  or  to set the dBm reference impedance value.
- 4 Press  to save your changes or press  to discard your changes.
- 5 Press and hold  until the multimeter restarts to return to normal operation.

Changing the auto power-off and backlight timeouts

The multimeter's automatic power-off (see [page 6](#)) and backlight (see [page 7](#)) features use timers to determine when to turn off the backlight and when to automatically turn the multimeter off.

Parameter	Range	Default setting
APo	(1 to 99) minutes or Off	15 minutes
bLit	(1 to 99) s or Off	15 s

To change the auto power-off and backlight timeout periods:

- 1 Press  for more than 1 second to enter the multimeter's setup menu.
- 2 Press  or  until AP_o or $bLit$ is shown on the secondary display.

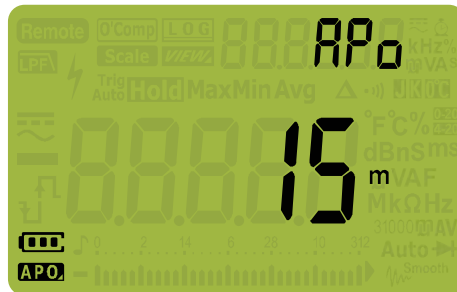

Figure 4-8 APo display

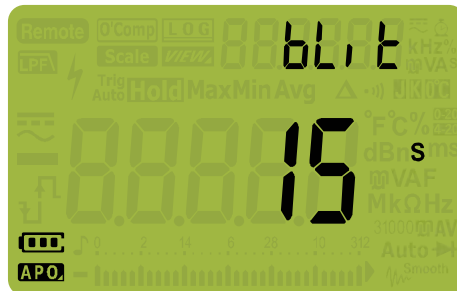







Figure 4-9 bLit display



- 3 Press  or  to change the timeout period. Select off to disable the timeout feature.
- 4 Press  to save your changes or press  to discard your changes.
- 5 Press and hold  until the multimeter restarts to return to normal operation.

Enabling and disabling the overvoltage alert

This setting is used with the multimeter's overvoltage alert (see [page 8](#)). The multimeter's will start beeping periodically once the measured voltage exceeds the value set, regardless of polarity.

Parameter	Range	Default setting
ALert	(0.1 to 1010) V or Off	Off

To enable the overvoltage's alert:

- 1 Press  for more than 1 second to enter the multimeter's setup menu.
- 2 Press  or  until **ALert** is shown on the secondary display.

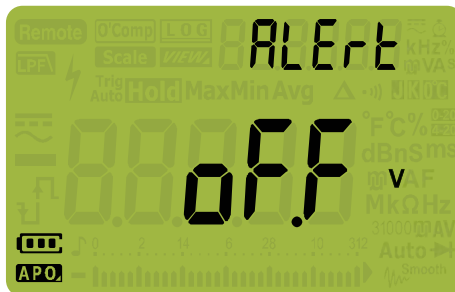







Figure 4-10 ALert display

- 3 Press  or  to set the overvoltage alert level. Select **off** to disable the overvoltage alert feature.
- 4 Press  to save your changes or press  to discard your changes.
- 5 Press and hold  until the multimeter restarts to return to normal operation.

Changing the % scale range

This setting is used with % scale current measurements (see page 78). The multimeter converts DC current measurements to a percentage scale readout of 0% to 100% based on the selected range in this menu. For example, a 25% readout represents a DC current of 8 mA on the 4-20 mA % scale, or a DC current of 5 mA on the 0-20 mA % scale.

Parameter	Range	Default setting
PErCEn	4-20 mA, 0-20 mA, or Off	4-20 mA

To change the % scale range:









- 1 Press  for more than 1 second to enter the multimeter's setup menu.
- 2 Press  or  until PErCEn is shown on the secondary display.



Figure 4-11 PErCEn display

- 3 Press  or  to change the % scale range. Select **OFF** to disable the % scale readout.
- 4 Press  to save your changes or press  to discard your changes.
- 5 Press and hold  until the multimeter restarts to return to normal operation.

Changing the thermocouple type (U1272A only)

This setting is used with temperature measurements (see [page 68](#)). Select a thermocouple type that matches the thermocouple sensor you are using for temperature measurements.

Parameter	Range	Default setting
CoUPLE	tYPE K or tYPE J	tYPE K

To change the thermocouple type:









- 1 Press  for more than 1 second to enter the multimeter's setup menu.
- 2 Press  or  until **CoUPLE** is shown on the secondary display.



Figure 4-12 CoUPLE display



- 3 Press  or  to change the thermocouple type.
- 4 Press  to save your changes or press  to discard your changes.
- 5 Press and hold  until the multimeter restarts to return to normal operation.

Changing the minimum measurable frequency

This setting is used with frequency tests (see [page 81](#)). Changing the minimum measurable frequency will influence the measurement rates for frequency, duty cycle, and pulse width measurements. The typical measurement rate as defined in the specification is based on a minimum measurable frequency of 10 Hz.

Parameter	Range	Default setting
FrEq	0.5 Hz or 10 Hz	0.5 Hz

To change the minimum measurable frequency:

- 1 Press  for more than 1 second to enter the multimeter's setup menu.
- 2 Press  or  until *FrEq* is shown on the secondary display.

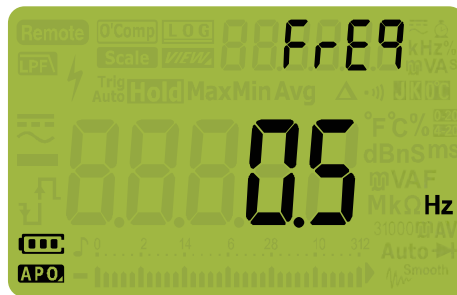







Figure 4-13 FrEq display

- 3 Press  or  to change the frequency value.
- 4 Press  to save your changes or press  to discard your changes.
- 5 Press and hold  until the multimeter restarts to return to normal operation.

Changing the baud rate

This setting changes the baud rate for remote communications with a PC.

Parameter	Range	Default setting
bAUd	(9600 or 19200) bits/second	9600 bits/second

To change the baud rate:









- 1 Press  for more than 1 second to enter the multimeter's setup menu.
- 2 Press  or  until **bAUd** is shown on the secondary display.



Figure 4-14 bAUd display

- 3 Press  or  to change the baud rate.
- 4 Press  to save your changes or press  to discard your changes.
- 5 Press and hold  until the multimeter restarts to return to normal operation.

Changing the data bits

This setting changes the number of data bits (data width) for remote communications with a PC. The number of stop bit is always 1, and this cannot be changed.

Parameter	Range	Default setting
dAtAb	8-bit or 7-bit	8-bit

To change the data bit:









- 1 Press  for more than 1 second to enter the multimeter's setup menu.
- 2 Press  or  until **dAtAb** is shown on the secondary display.



Figure 4-15 dAtAb display



- 3 Press  or  to change the data bit.
- 4 Press  to save your changes or press  to discard your changes.
- 5 Press and hold  until the multimeter restarts to return to normal operation.

Changing the parity check

This setting changes the parity check for remote communications with a PC.

Parameter	Range	Default setting
PAritY	nonE, En, or odd	nonE

To change the data bit:

- 1 Press  for more than 1 second to enter the multimeter's setup menu.
- 2 Press  or  until PAritY is shown on the secondary display.

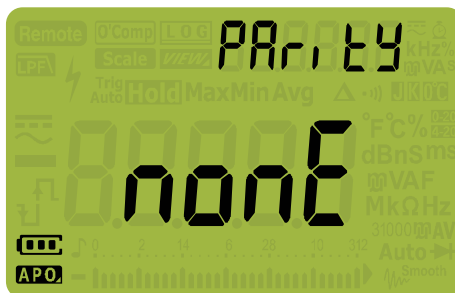







Figure 4-16 PAritY display

- 3 Press  or  to change the parity check.
- 4 Press  to save your changes or press  to discard your changes.
- 5 Press and hold  until the multimeter restarts to return to normal operation.

Enabling and disabling the backlight alert

The multimeter's backlight will flash to alert users to the presence of circuit continuities and operator errors such as incorrect lead connections for the selected function.

Parameter	Range	Default setting
A-bLit	on or Off	on

To enable the backlight alert:









- 1 Press  for more than 1 second to enter the multimeter's setup menu.
- 2 Press  or  until **A-bLit** is shown on the secondary display.



Figure 4-17 A-bLit display

- 3 Press  or  to enable or disable the backlight alert feature.
- 4 Press  to save your changes or press  to discard your changes.
- 5 Press and hold  until the multimeter restarts to return to normal operation.

Enabling smooth mode

Smooth is used to smoothen the refresh rate of the readings in order to reduce the impact of unexpected noise and to help you achieve a stable reading. You can enable Smooth by holding  while turning on the multimeter (“Power-on options” on page 12). This method however is temporary and Smooth will be turned off when you cycle the multimeter’s power. You can permanently enable Smooth from the Setup mode.

Parameter	Range	Default setting
SMoothH	(0001.d to 9999.d) or (0001.E to 9999.E)	0009.d (disabled)

To enable Smooth:









- 1 Press  for more than 1 second to enter the multimeter’s setup menu.
- 2 Press  or  until **SñoothH** is shown on the secondary display.



Figure 4-18 SMoothH display

- 3 Press  or  to set the Smooth refresh rate. To permanently enable Smooth, change the last digit shown from **d** (disabled) to **E** (enabled).
- 4 Press  to save your changes or press  to discard your changes.

- 5 Press and hold  until the multimeter restarts to return to normal operation.

Changing the user scale conversion value and unit

You can set the user scale conversion value and unit. The ratio can be set from 0000.1 to 1000.0 and the unit can be set to V/V, A/V, or 000 (no unit)/V. The default is 1000 V/V. See “[Making Scale Transfers \(Scale\)](#)” on page 90 for more information on the Scale operation.

Parameter	Range	Default setting
Scale USEr	(0000.1 to 1000.0) V/V, A/V, or 000 (no unit)/V	(1000.0) V/V

To set the user scale conversion value and unit:





- 1 Press  for more than 1 second to enter the multimeter’s setup menu.
- 2 Press  or  until **USEr** is shown on the secondary display.





Figure 4-19 SMooth display

- 3 Press  or  to set the scale conversion value. Move the cursor to the unit indicator (right-most) to change the scale conversion unit.

4 Multimeter Setup Options

Setup Menu Items

- 4 Press  to save your changes or press  to discard your changes.
- 5 Press and hold  until the multimeter restarts to return to normal operation.

Resetting the multimeter's setup options

The multimeter's setup options can be reset to its default values through the setup menu.

Parameter	Range	Default setting
rESEt	dEFAU	dEFAU



- 1 Press  for more than 1 second to enter the multimeter's setup menu.
- 2 Press  until rESEt is shown on the secondary display.





Figure 4-20 rESEt display

- 3 Press and hold  for more than 1 second to perform the reset. The multimeter will beep once and return to the first setup menu item (bEEP).



Changing the temperature unit

This setting is used with temperature measurements (see page 68). Four combinations of displayed temperature unit(s) are available:

- Celsius only: Temperature measured in °C.
- Celsius/Fahrenheit: During temperature measurements, press  to switch between °C and °F.
- Fahrenheit only: Temperature measured in °F.
- Fahrenheit/Celsius: During temperature measurements, press  to switch between °F and °C.

Parameter	Range	Default setting
t-Unit	°C, °C-°F, °F, or °F-°C	°C

To change the temperature unit:

- 1 Press  for more than 1 second to enter the multimeter's setup menu.
- 2 Press  for more than 1 second until **t-Unit** is shown on the secondary display.

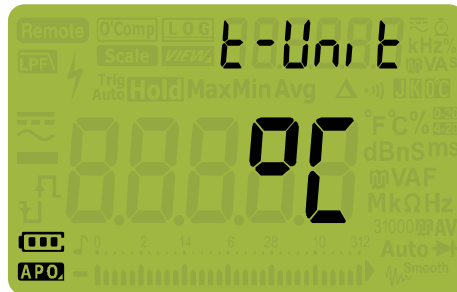









Figure 4-21 t-Unit display

- 3 Press  or  to change the temperature unit.
- 4 Press  to save your changes or press  to discard your changes.

4 Multimeter Setup Options

Setup Menu Items

- 5 Press  or  to continue browsing through the other menu items or press and hold  until the multimeter restarts to return to normal operation.

CAUTION

Always set the temperature unit display per the official requirements and in compliance with the National laws of your region.



5 Characteristics and Specifications

Product Characteristics	134
Specification Assumptions	136
Measurement Category	136
Measurement category definition	136
Electrical Specifications	138
DC specifications	138
AC specifications	141
AC+DC specifications for U1272A	145
Capacitance specifications	147
Temperature specifications	148
Frequency specifications	149
Duty cycle and pulse width specifications	149
Frequency sensitivity specifications	151
Peak hold specifications	152
Decibel (dB) specifications for U1272A	153
Measurement rate (approximate)	154

This chapter lists the characteristics, assumptions, and specifications of the U1271A and U1272A handheld digital multimeters.



Product Characteristics

NOTE

Product characteristics specified in the table below are applicable for both U1271A and U1272A models unless stated otherwise.

POWER SUPPLY

Battery type:

- 4 × 1.5 V Alkaline battery (ANSI/NEDA 24A or IEC LR03), or
- 4 × 1.5 V Zinc Chloride battery (ANSI/NEDA 24D or IEC R03)

Battery life:

- 300 hours typical (based on new Alkaline batteries for DC voltage measurement)
- Low battery indicator will flash when the battery voltage drops below 4.4 V (approximately)

POWER CONSUMPTION

460 mVA maximum (with backlight enabled)

FUSE

- 10 × 35 mm 440 mA/1000 V fast-acting fuse
- 10 × 38 mm 11 A/1000 V fast-acting fuse

DISPLAY

Liquid crystal display (LCD) (with maximum reading of 33000 counts)

INPUT IMPEDANCE AT OFF MODE (U1272A only)

1.67 k Ω (protected by positive temperature coefficient resistor)

OPERATING ENVIRONMENT

- Operating temperature from –20 °C to 55 °C, 0% to 80% RH
- Full accuracy up to 80% RH for temperatures up to 30 °C, decreasing linearly to 50% RH at 55 °C
- Altitude up to 2000 meters
- Pollution degree II

STORAGE COMPLIANCE

–40 °C to 70 °C, 0% to 80% RH

SAFETY COMPLIANCE

EN/IEC 61010-1:2001, ANSI/UL 61010-1:2004, and CAN/CSA-C22.2 No. 61010-1-04

MEASUREMENT CATEGORY

CAT III 1000 V/CAT IV 600 V

ELECTROMAGNETIC COMPATIBILITY (EMC)

Commercial limits compliance with EN61326-1

IP RATING

IP-54

TEMPERATURE COEFFICIENT

$0.05 \times (\text{specified accuracy}) / ^\circ\text{C}$ (from -20°C to 18°C , or 28°C to 55°C)

COMMON MODE REJECTION RATIO (CMRR)

>120 dB at DC, 50/60 Hz $\pm 0.1\%$ (1 k Ω unbalanced)

NORMAL MODE REJECTION RATIO (NMRR)

>60 dB at 50/60 Hz $\pm 0.1\%$

DIMENSIONS (W \times H \times D)

92 \times 207 \times 59 mm

WEIGHT

- U1271A: 518 grams (with batteries)
 - U1272A: 520 grams (with batteries)
-

WARRANTY

Please refer to http://www.agilent.com/go/warranty_terms

- Three years for the product
 - Three months for the product's standard accessories, unless otherwise specified
 - Please take note that for the product, the warranty does not cover:
 - Damage from contamination
 - Normal wear and tear of mechanical components
 - Manuals, fuses, and standard disposable batteries
-

CALIBRATION CYCLE

One year

Specification Assumptions

- Accuracy is given as \pm (% of reading + counts of least significant digit) at $23\text{ }^{\circ}\text{C} \pm 5\text{ }^{\circ}\text{C}$, with relative humidity less than 80% RH.
- AC V and AC $\mu\text{A}/\text{mA}/\text{A}$ specifications are AC coupled, true RMS and are valid from 5% of range to 100% of range.
- The crest factor may be up to 3.0 at full-scale except for the 1000 V range where it is 1.5 at full scale.
- For non-sinusoidal waveforms, add (2% reading + 2% full scale) typical, for crest factors up to 3.
- After Z_{LOW} (low input impedance) voltage measurements, wait at least 20 minutes for thermal impact to cool before proceeding with any other measurement.

Measurement Category

The Agilent U1271A/U1272A Handheld Digital Multimeters have a safety rating of CAT III, 1000 V and CAT IV, 600 V.

Measurement category definition

Measurement CAT I are for measurements performed on circuits not directly connected to the AC mains. Examples are measurements on circuits not derived from the AC mains and specially protected (internal) mains-derived circuits.

Measurement CAT II are measurements performed on circuits directly connected to a low-voltage installation. Examples are measurements on household appliances, portable tools, and similar equipment.

Measurement CAT III are measurements performed in the building installation. Examples are measurements on distribution boards, circuit- breakers, wiring, including cables, bus-bars, junction boxes, switches, socket outlets in the fixed installation, and equipment for industrial use, and some other equipment including stationary motors with permanent connection to the fixed installation.

Measurement CAT IV are measurements performed at the source of the low-voltage installation. Examples are electricity meters and measurements on primary over current protection devices and ripple control units.

Electrical Specifications

NOTE

Specification assumptions are given on [page 136](#).

DC specifications

Table 5-1 DC specifications

Function	Range	Resolution	Accuracy		Test current	Burden voltage	Input impedance
			U1271A	U1272A			
Voltage	30 mV ^[1]	0.001 mV	-	0.05% + 20	-	-	10 MΩ
	300 mV ^[1]	0.01 mV	0.05% + 5	0.05% + 5	-	-	10 MΩ
	3 V	0.0001 V	0.05% + 5	0.05% + 5	-	-	11.11 MΩ
	30 V	0.001 V	0.05% + 2	0.05% + 2	-	-	10.1 MΩ
	300 V	0.01 V	0.05% + 2	0.05% + 2	-	-	10 MΩ
	1000 V	0.1 V	0.05% + 2	0.05% + 2	-	-	10 MΩ
	Z _{LOW} (low input impedance) enabled, applicable for 1000 V range and resolution only ^[2]			-	1% + 20	-	-

Notes for DC voltage specifications:

- 1 The accuracy of the 30 mV to 300 mV range is specified after the Null function is used to subtract the thermal effect (by shorting the test leads).
- 2 For Z_{LOW} measurements, autoranging is disabled and the multimeter's range is set to 1000 V in the manual ranging mode.

Table 5-1 DC specifications (continued)

Function	Range	Resolution	Accuracy		Test current	Burden voltage	Input impedance
			U1271A	U1272A			
Resistance	30 Ω	0.001 Ω	-	0.2% + 10	0.65 mA	-	-
	300 Ω ^[4]	0.01 Ω	0.2% + 5	0.2% + 5	0.65 mA	-	-
	3 kΩ ^[4]	0.0001 kΩ	0.2% + 5	0.2% + 5	65 μA	-	-
	30 kΩ	0.001 kΩ	0.2% + 5	0.2% + 5	6.5 μA	-	-
	300 kΩ	0.01 kΩ	0.5% + 5	0.2% + 5	0.65 μA	-	-
	3 MΩ	0.0001 MΩ	0.6% + 5	0.6% + 5	93 nA// 10 MΩ	-	-
	30 MΩ ^[5]	0.001 MΩ	1.2% + 5	1.2% + 5	93 nA// 10 MΩ	-	-
	100 MΩ ^{[5][6]}	0.01 MΩ	2.0% + 10	-	93 nA// 10 MΩ	-	-
	300 MΩ ^{[6][7]}	0.01 MΩ	-	2.0% + 10 @ <100 MΩ 8.0% + 10 @ >100 MΩ	93 nA// 10 MΩ	-	-
	300 nS	0.01 nS	1% + 10	1% + 10	93 nA// 10 MΩ	-	-

Notes for resistance specifications:

- 1** Overload protection: 1000 Vrms for short circuits with <0.3 A current.
- 2** Maximum open voltage is <+3.3 V
- 3** Built-in buzzer beeps when the resistance measured is less than 25 Ω ± 10 Ω. The multimeter can capture intermittent measurements longer than 1 ms.
- 4** The accuracy of the 30 Ω to 3 kΩ range is specified after the Null function is used to subtract the test lead resistance and thermal effect (by shorting the test leads).
- 5** For the ranges of 30 MΩ and 100 MΩ, the RH is specified for <60%.
- 6** The accuracy for ranges <50 nS is specified after the Null function is used on an open test lead.
- 7** The temperature coefficient of the 100 MΩ and 300 MΩ range is 0.1 × (specified accuracy)/°C (from -20 °C to 18 °C or 28 °C to 55 °C)

5 Characteristics and Specifications

Electrical Specifications

Table 5-1 DC specifications (continued)

Function	Range	Resolution	Accuracy		Test current	Burden voltage	Input impedance
			U1271A	U1272A			
Diode	3 V ^[3]	0.0001 V	0.5% + 5	0.5% + 5	Approx. 1 mA to 2 mA	-	-
	Auto ^[4]	0.0001 V	-	0.5% + 5	Approx. 0.1 mA to 0.3 mA	-	-

Notes for diode specifications:

- 1 Overload protection: 1000 Vrms for short circuits with <0.3 A current.
- 2 Built-in buzzer beeps continuously when the voltage measured is less than 50 mV and beeps once for forward-biased diode or semiconductor junctions measured between 0.3 V and 0.8 V ($0.3\text{ V} \leq \text{reading} \leq 0.8\text{ V}$).
- 3 Open voltage for diode: <+3.3 V DC
- 4 Open voltage for Auto-diode: <+2.5 V DC and >-1.0 V DC

Current	300 μA ^[1]	0.01 μA	0.2% + 5	0.2% + 5	-	<0.04 V	-
	3000 μA ^[1]	0.1 μA	0.2% + 5	0.2% + 5	-	<0.4 V	-
	30 mA ^[1]	0.001 mA	0.2% + 5	0.2% + 5	-	<0.08 V	-
	300 mA ^{[1][3]}	0.01 mA	0.2% + 5	0.2% + 5	-	<1.00 V	-
	3 A ^[2]	0.0001 A	0.3% + 10	0.3% + 10	-	<0.1 V	-
	10 A ^{[2][4]}	0.001 A	0.3% + 10	0.3% + 10	-	<0.3 V	-

Notes for DC current specifications:

- 1 Overload protection for 300 μA to 300 mA range: 0.44 A/1000 V; 10 \times 35 mm fast-acting fuse
- 2 Overload protection for 3 A to 10 A range: 11 A/1000 V; 10 \times 38 mm fast-acting fuse
- 3 Specification for 300 mA range: 440 mA continuous.
- 4 Specification for 10 A range: 10 A continuous. Add 0.3% to the specified accuracy when measuring signals >10 A to 20 A for 30 seconds maximum. After measuring currents >10 A, cool down the multimeter for twice the duration of the measured time before proceeding with low current measurements.

AC specifications

AC specifications for U1271A

Table 5-2 U1271A true rms AC voltage specifications

Function	Range	Resolution	Accuracy			
			45 Hz to 65 Hz	30 Hz to 45 Hz 65 Hz to 1 kHz	1 kHz to 5 kHz	5 kHz to 20 kHz
Voltage	300 mV	0.01 mV	0.7% + 20	1.0% + 25	2.0% + 25	2.0% + 40
	3 V	0.0001 V	0.7% + 20	1.0% + 25	2.0% + 25	2.0% + 40
	30 V	0.001 V	0.7% + 20	1.0% + 25	2.0% + 25	2.0% + 40
	300 V	0.01 V	0.7% + 20	1.0% + 25	2.0% + 25	-
	1000 V	0.1 V	0.7% + 20	1.0% + 25	-	-
		LPF (low pass filter) enabled, applicable for all voltage ranges and resolution		0.7% + 20	1.0% + 25 @ <200 Hz 5.0% + 25 @ <440 Hz	-

Notes for U1271A AC voltage specifications:

- 1 Overload protection: 1000 Vrms. For millivolt measurements, 1000 Vrms for short circuits with <0.3 A current.
- 2 Input impedance: 10 MΩ (nominal) in parallel with <100 pF.

5 Characteristics and Specifications

Electrical Specifications

Table 5-3 U1271A true rms AC current specifications

Function	Range	Resolution	Accuracy	Burden voltage
			45 Hz to 2 kHz	
Current	300 μ A ^[1]	0.01 μ A	0.9% + 25	<0.04 V
	3000 μ A ^[1]	0.1 μ A	0.9% + 25	<0.4 V
	30 mA ^[1]	0.001 mA	0.9% + 25	<0.08 V
	300 mA ^{[1][3]}	0.01 mA	0.9% + 25	<1.00 V
	3 A ^[2]	0.0001 A	1.0% + 25	<0.1 V
	10 A ^{[2][4]}	0.001 A	1.0% + 25	<0.3 V

Notes for U1271A AC current specifications:

- 1 Overload protection for 300 μ A to 300 mA range: 0.44 A/1000 V; 10 \times 35 mm fast-acting fuse
- 2 Overload protection for 3 A to 10 A range: 11 A/1000 V; 10 \times 38 mm fast-acting fuse
- 3 Specification for 300 mA range: 440 mA continuous.
- 4 Specification for 10 A range: 10 A continuous. Add 0.3% to the specified accuracy when measuring signals >10 A to 20 A for 30 seconds maximum. After measuring currents >10 A, cool down the multimeter for twice the duration of the measured time before proceeding with low current measurements.

AC specifications for U1272A

Table 5-4 U1272A true rms AC voltage specifications

Function	Range	Resolution	Accuracy				
			45 Hz to 65 Hz	20 Hz to 45 Hz 65 Hz to 1 kHz	1 kHz to 5 kHz	5 kHz to 20 kHz	20 kHz to 100 kHz ^[5]
Voltage	30 mV	0.001 mV	0.6% + 20	0.7% + 25	1.0% + 25	1.0% + 40	3.5% + 40
	300 mV	0.01 mV	0.6% + 20	0.7% + 25	1.0% + 25	1.0% + 40	3.5% + 40
	3 V	0.0001 V	0.6% + 20	1.0% + 25	1.5% + 25	2.0% + 40	3.5% + 40
	30 V	0.001 V	0.6% + 20	1.0% + 25	1.5% + 25	2.0% + 40	3.5% + 40
	300 V	0.01 V	0.6% + 20	1.0% + 25	1.5% + 25	2.0% + 40	-
	1000 V	0.1 V	0.6% + 20	1.0% + 25	1.5% + 25	-	-
	LPF (low pass filter) enabled, applicable for all voltage ranges and resolution		0.6% + 20	1.0% + 25 @ <200 Hz 5.0% + 25 @ <440 Hz	-	-	-
	Z _{LOW} (low input impedance) enabled, applicable for 1000 V range and resolution only ^[4]		2% + 40	2% + 40 @ <440 Hz	-	-	-

Notes for U1272A AC voltage specifications:

- 1 Overload protection: 1000 Vrms. For millivolt measurements, 1000 Vrms for short circuits with <0.3 A current.
- 2 Input impedance: 10 MΩ (nominal) in parallel with <100 pF.
- 3 The input signal is lower than the product of 20,000,000 V×Hz.
- 4 Z_{LOW} impedance: 2 kΩ (nominal). For Z_{LOW} measurements, autoranging is disabled and the multimeter's range is set to 1000 V in the manual ranging mode.
- 5 For 20 kHz to 100 kHz accuracy: Three counts of the LSD per kHz of additional error is to be added for frequencies >20 kHz and signal inputs <10% of range.

5 Characteristics and Specifications

Electrical Specifications

Table 5-5 U1272A true rms AC current specifications

Function	Range	Resolution	Accuracy		Burden voltage
			45 Hz to 65 Hz	20 Hz to 45 Hz	
				65 Hz to 2 kHz	
Current	300 μA ^[1]	0.01 μA	0.6% + 25	0.9% + 25	<0.04 V
	3000 μA ^[1]	0.1 μA	0.6% + 25	0.9% + 25	<0.4 V
	30 mA ^[1]	0.001 mA	0.6% + 25	0.9% + 25	<0.08 V
	300 mA ^{[1][3]}	0.01 mA	0.6% + 25	0.9% + 25	<1.00 V
	3 A ^[2]	0.0001 A	0.8% + 25	1.0% + 25	<0.1 V
	10 A ^{[2][4]}	0.001 A	0.8% + 25	1.0% + 25	<0.3 V

Notes for U1272A AC current specifications:

- 1 Overload protection for 300 μA to 300 mA range: 0.44 A/1000 V; 10 \times 35 mm fast-acting fuse
- 2 Overload protection for 3 A to 10 A range: 11 A/1000 V; 10 \times 38 mm fast-acting fuse
- 3 Specification for 300 mA range: 440 mA continuous.
- 4 Specification for 10 A range: 10 A continuous. Add 0.3% to the specified accuracy when measuring signals >10 A to 20 A for 30 seconds maximum. After measuring currents >10 A, cool down the multimeter for twice the duration of the measured time before proceeding with low current measurements.

AC+DC specifications for U1272A

Table 5-6 U1272A true rms AC+DC voltage specifications

Function	Range	Resolution	Accuracy				
			45 Hz to 65 Hz	20 Hz to 45 Hz 65 Hz to 1 kHz	1 kHz to 5 kHz	5 kHz to 20 kHz	20 kHz to 100 kHz ^[3]
Voltage	30 mV	0.001 mV	0.7% + 40	0.8% + 45	1.1% + 45	1.1% + 60	3.6% + 60
	300 mV	0.01 mV	0.7% + 25	0.8% + 30	1.1% + 30	1.1% + 45	3.6% + 45
	3 V	0.0001 V	0.7% + 25	1.1% + 30	1.6% + 30	2.1% + 45	3.6% + 45
	30 V	0.001 V	0.7% + 25	1.1% + 30	1.6% + 30	2.1% + 45	3.6% + 45
	300 V	0.01 V	0.7% + 25	1.1% + 30	1.6% + 30	2.1% + 45	-
	1000 V	0.1 V	0.7% + 25	1.1% + 30	1.6% + 30	-	-

Notes for U1272A AC+DC voltage specifications:

- 1 Overload protection: 1000 Vrms. For millivolt measurements, 1000 Vrms for short circuits with <0.3 A current.
- 2 Input impedance: 10 MΩ (nominal) in parallel with <100 pF.
- 3 For 20 kHz to 100 kHz accuracy: Three counts of the LSD per kHz of additional error is to be added for frequencies >20 kHz and signal inputs <10% of range.

5 Characteristics and Specifications

Electrical Specifications

Table 5-7 U1272A true rms AC+DC current specifications

Function	Range	Resolution	Accuracy		Burden voltage
			45 Hz to 65 Hz	20 Hz to 45 Hz	
				65 Hz to 2 kHz	
Current	300 μA ^[1]	0.01 μA	0.8% + 30	1.1% + 30	<0.04 V
	3000 μA ^[1]	0.1 μA	0.8% + 30	1.1% + 30	<0.4 V
	30 mA ^[1]	0.001 mA	0.8% + 30	1.1% + 30	<0.08 V
	300 mA ^{[1][3]}	0.01 mA	0.8% + 30	1.1% + 30	<1.00 V
	3 A ^[2]	0.0001 A	0.9% + 35	1.3% + 35	<0.1 V
	10 A ^{[2][4]}	0.001 A	0.9% + 35	1.3% + 35	<0.3 V

Notes for U1272A AC+DC current specifications:

- 1 Overload protection for 300 μA to 300 mA range: 0.44 A/1000 V; 10 \times 35 mm fast-acting fuse
- 2 Overload protection for 3 A to 10 A range: 11 A/1000 V; 10 \times 38 mm fast-acting fuse
- 3 Specification for 300 mA range: 440 mA continuous.
- 4 Specification for 10 A range: 10 A continuous. Add 0.3% to the specified accuracy when measuring signals >10 A to 20 A for 30 seconds maximum. After measuring currents >10 A, cool down the multimeter for twice the duration of the measured time before proceeding with low current measurements.

Capacitance specifications

Table 5-8 Capacitance specifications

Range	Resolution	Accuracy		Measuring rate (at full scale)
		U1271A	U1272A	
10 nF	0.001 nF	1% + 5	1% + 5	4 times/second
100 nF	0.01 nF	1% + 2	1% + 2	
1000 nF	0.1 nF	1% + 2	1% + 2	
10 μF	0.001 μF	1% + 2	1% + 2	
100 μF	0.01 μF	1% + 2	1% + 2	0.5 times/second
1000 μF	0.1 μF	1% + 2	1% + 2	
10 mF	0.001 mF	1% + 2	1% + 2	0.3 times/second

Notes for capacitance specifications:

- 1 Overload protection: 1000 Vrms for short circuits with <0.3 A current.
- 2 The accuracy of for all ranges is specified based on a film capacitor or better, and after the Null function is used to subtract the residual values (by opening the test leads).

Temperature specifications

Table 5-9 Temperature specifications

Thermal type	Range	Resolution	Accuracy	
			U1271A	U1272A
K	-200 °C to 1372 °C	0.1 °C	1% + 1 °C	1% + 1 °C
	-328 °F to 2502 °F	0.1 °F	1% + 1.8 °F	1% + 1.8 °F
J	-200 °C to 1200 °C	0.1 °C	-	1% + 1 °C
	-328 °F to 2192 °F	0.1 °F	-	1% + 1.8 °F

Notes for temperature specifications:

- 1 The specifications above is specified after 60 minutes of warm-up time.
- 2 The accuracy does not include the tolerance of the thermocouple probe.
- 3 Do not allow the temperature sensor to contact a surface that is energized above 30 Vrms or 60 V DC. Such voltages poses a shock hazard.
- 4 Ensure that the ambient temperature is stable within ± 1 °C and that the Null function is used to reduce the test lead's thermal effect and temperature offset. Before using Null function, set the multimeter to measure temperature without ambient compensation (OFF) and keep the thermocouple probe as close to the multimeter as possible (avoid contact with any surface that has a different temperature from the ambient temperature).
- 5 When measuring temperature with respect to any temperature calibrator, try to set both the calibrator and multimeter with an external reference (without internal ambient compensation). If both the calibrator and multimeter are set with internal reference (with internal ambient compensation), some deviations may show between the readings of the calibrator and multimeter, due to differences in ambient compensation between the calibrator and multimeter. Keeping the multimeter close to the output terminal of calibrator will help reduce the deviation.
- 6 The temperature calculation is specified according to the safety standards of EN/IEC-60548-1 and NIST175.

Frequency specifications

Table 5-10 Frequency specifications

Range	Resolution	Accuracy	Minimum input frequency
99.999 Hz	0.001 Hz	0.02% + 5	0.5 Hz
999.99 Hz	0.01 Hz	0.005% + 5	
9.9999 kHz	0.0001 kHz	0.005% + 5	
99.999 kHz	0.001 kHz	0.005% + 5	
999.99 kHz	0.01 kHz	0.005% + 5	
>1 MHz	0.1 kHz	0.005% + 5 @ <1 MHz	

Notes for frequency specifications:

- 1 Overload protection: 1000 V; input signal is $<20,000,000 \text{ V} \times \text{Hz}$ (product of voltage and frequency).
- 2 The frequency measurement is susceptible to error when measuring low-voltage, low-frequency signals. Shielding inputs from external noise pickup is critical for minimizing measurement errors. Turning on the low pass filter may help you to filter out the noise and achieve a stable reading.

Duty cycle and pulse width specifications

Table 5-11 Duty cycle and pulse width specifications

Function	Mode	Range	Resolution	Accuracy at full scale
Duty cycle	DC coupling	99.99%	-	0.3% per kHz + 0.3%
	AC coupling	99.99%	-	0.3% per kHz + 0.3%

Notes for duty cycle specifications:

- 1 The accuracy for duty cycle and pulse width measurements is based on a 3 V square wave input to the DC 3 V range. For AC couplings, the duty cycle range can be measured within the range of 10% to 90% for signal frequencies $>20 \text{ Hz}$.
- 2 The range of the duty cycle is determined by the frequency of the signal:
 $\{10 \mu\text{s} \times \text{frequency} \times 100\% \}$ to $\{[1 - (10 \mu\text{s} \times \text{frequency})] \times 100\% \}$.

5 Characteristics and Specifications

Electrical Specifications

Table 5-11 Duty cycle and pulse width specifications

Function	Mode	Range	Resolution	Accuracy at full scale
Pulse width	-	999.99 ms	0.01 ms	(duty cycle accuracy/frequency) + 0.01 ms
	-	2000.0 ms	0.1 ms	(duty cycle accuracy/frequency) + 0.1 ms

Notes for pulse width specifications:

- 1 The accuracy for duty cycle and pulse width measurements is based on a 3 V square wave input to the DC 3 V range.
- 2 The pulse width (positive or negative) must be $>10 \mu\text{s}$. The range of the pulse width is determined by the frequency of the signal.

Calculation example

Table 5-12 Duty cycle and pulse width calculation example

Frequency	Duty cycle range ^[1]		Accuracy	
	From	To	Duty cycle ^[2]	Pulse width ^[3]
100 Hz	0.1%	99.9%	0.33%	0.043 ms
1 kHz	1%	99%	0.6%	0.016 ms

Notes for duty cycle and pulse width calculation example:

- 1 The range of the duty cycle is determined from this equation:
 $\{10 \mu\text{s} \times \text{frequency} \times 100\% \}$ to $\{[1 - (10 \mu\text{s} \times \text{frequency})] \times 100\% \}$.
- 2 The accuracy of the duty cycle is determined from this equation: $[0.3\% \times (\text{frequency kHz})] + 0.3\%$
- 3 The accuracy of the pulse width is determined from this equation: (duty cycle accuracy/frequency) + 0.01 ms.

Frequency sensitivity specifications

For voltage measurements

Table 5-13 Frequency sensitivity and trigger level specifications for voltage measurements

Input range ^[1]	Minimum sensitivity (RMS sine wave)			Trigger level for DC coupling	
	15 Hz to 100 kHz	0.5 Hz to 15 Hz		0.5 Hz to 200 kHz	
		100 kHz to 200 kHz	Up to 1 MHz ^[3]	U1271A	U1272A
30 mV ^[2]	3 mV	3 mV	-	-	5 mV
300 mV	6 mV	8 mV	40m V	10 mV	15 mV
3 V	0.12 V	0.2 V	0.4 V	0.15 V	0.15 V
30 V	0.6 V	0.8 V	2.6 V	1.5 V	1.5 V
300 V	6 V	8 V @ <100 kHz	-	9 V @ <100 kHz	9 V @ <100 kHz
1000 V	50 V	50 V @ <100 kHz	-	90 V @ <100 kHz	90 V @ <100 kHz

Notes for frequency sensitivity and trigger level specifications for voltage measurements:

- 1 Maximum input for specified accuracy, refer to “AC specifications” on page 141.
- 2 30 mV range applicable for U1272A only.
- 3 200 kHz to 1 MHz minimum sensitivity range applicable for U1272A only.

For current measurements

Table 5-14 Frequency sensitivity specifications for current measurements

Input range ^[1]	Minimum sensitivity (RMS sine wave)
	2 Hz to 30 kHz
300 μ A	100 μ A
3000 μ A	70 μ A
30 mA	1.2 mA

Notes for frequency sensitivity specifications for current measurements:

- 1 Maximum input for specified accuracy, refer to “AC specifications” on page 141.

5 Characteristics and Specifications

Electrical Specifications

Table 5-14 Frequency sensitivity specifications for current measurements (continued)

Input range ^[1]	Minimum sensitivity (RMS sine wave)
	2 Hz to 30 kHz
300 mA	12 mA
3 A	0.12 A
10 A	1.2 A

Notes for frequency sensitivity specifications for current measurements:

- 1 Maximum input for specified accuracy, refer to “AC specifications” on page 141.

Peak hold specifications

Table 5-15 Peak hold specifications for DC voltage and current measurements

Signal width	Accuracy for DC voltage and current
Single event >1 ms	Specified accuracy + 400
Repetitive >250 μ s	Specified accuracy + 1000

Decibel (dB) specifications for U1272A

Table 5-16 U1272A decibel specifications

dB base	Reference	Default reference
1 mW (dBm)	1 Ω to 9999 Ω	50 Ω
1 V (dBV)	1 V	1 V

Notes for U1272A decibel specifications:

- 1 The reading of dBm is indicated in decibels of power above or below 1 mW, or decibels of voltage above or below 1 V. The formula is calculated according to the voltage measurement and specified reference impedance. Its accuracy is depended on the accuracy of the voltage measurement. See [Table 5-17](#).
- 2 Auto-ranging mode is used.
- 3 The bandwidth is according to voltage measurements.

Decibel (dBV) accuracy specifications

Table 5-17 U1272A decibel accuracy specifications for DC voltage measurements

Range	dBV range		Accuracy				
	Minimum	Maximum	45 Hz to 65 Hz	20 Hz to 45 Hz 65 Hz to 1 kHz	1 kHz to 5 kHz	5 kHz to 20 kHz	20 kHz to 100 kHz
30 mV	-56.48	-30.46	0.06	0.07	0.09	0.1	0.32
300 mV	-36.48	-10.46	0.06	0.07	0.09	0.1	0.32
3 V	-16.48	+9.54	0.06	0.09	0.14	0.19	0.32
30 V	+3.52	+29.54	0.06	0.09	0.14	0.19	0.32
300 V	+23.52	+49.54	0.06	0.09	0.14	0.19	-
1000 V	+33.98	+60	0.06	0.09	0.14	-	-

5 Characteristics and Specifications

Electrical Specifications

Measurement rate (approximate)

Table 5-18 Measurement rate (approximate)

Function	Times/second	
	U1271A	U1272A
AC V (V or mV)	7	7
DC V (V or mV)	7	7
Ω	14	14
Ω with offset compensation	-	3
Diode	14	14
Auto-diode	-	3
Capacitance	4 (<100 μ F)	4 (<100 μ F)
DC A (μ A, mA, or A)	7	7
AC A (μ A, mA, or A)	7	7
Temperature	7	7
Frequency	2 (>10 Hz)	2 (>10 Hz)
Duty cycle	1 (>10 Hz)	1 (>10 Hz)
Pulse width	1 (>10 Hz)	1 (>10 Hz)

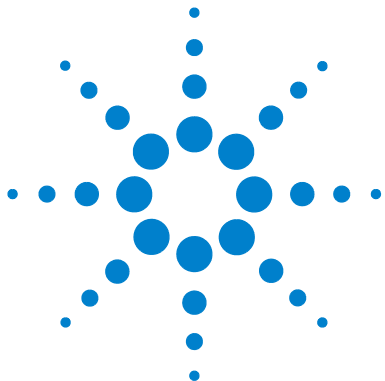



Appendix A

Shift Functions Using the Shift Key

Table A-1 U1271A default and shift functions 156













Table A-2 U1272A default and shift functions 157

The tables below list the function shown in the primary display when the  key is pressed, with respect to the multimeter's rotary switch position. Press  to cycle through the available shift functions.



A Shift Functions Using the Shift Key

Table A-1 U1271A default and shift functions

Rotary switch position	Function shown in the primary display:	
	Default	When  is pressed
	AC voltage measurement; DC voltage measurement shown on secondary display (AC/DC V) ^[1]	-
	AC voltage measurement (AC V)	AC voltage measurement (AC V) with low pass filter (LPF)
	AC voltage measurement (AC mV)	AC voltage measurement (AC mV) with low pass filter (LPF)
	DC voltage measurement (DC V)	-
	DC voltage measurement (DC mV)	-
	Resistance measurement (Ω)	Continuity test () Ω
	Diode test (V)	-
	Capacitance measurement (F)	Temperature measurement ($^{\circ}\text{C}$ or $^{\circ}\text{F}$)
		AC current measurement (AC mA)
With the positive probe inserted into the μA mA terminal	DC current measurement (DC mA)	% (0-20 or 4-20) DC mA
		AC current measurement (AC A)
With the positive probe inserted into the A terminal	DC current measurement (DC A)	% (0-20 or 4-20) DC A
	DC current measurement (DC μA)	AC current measurement (AC μA)















[1] Press  to switch the function shown in the primary display (AC V) with the function shown in the secondary display (DC V). Press  for more than 1 second to switch back the displays.



Table A-2 U1272A default and shift functions

Rotary switch position	Function shown in the primary display:	
	Default	When  is pressed
	Low impedance (Z_{LOW}) AC or DC voltage measurement (AC/DC V) ^[1]	-
	AC voltage measurement (AC V)	AC voltage measurement (AC V) with low pass filter (LPF)
	AC voltage measurement (AC mV)	AC voltage measurement (AC mV) with low pass filter (LPF)
	DC voltage measurement (DC V)	AC voltage measurement (AC V)
		AC+DC voltage measurement (AC+DC V)
	DC voltage measurement (DC mV)	AC voltage measurement (AC mV)
		AC+DC voltage measurement (AC+DC mV)
	Resistance measurement (Ω)	Continuity test (••) Ω
		Resistance measurement (Ω) with offset compensation (Smart Ω)
	Diode test (V)	Auto-diode test (V)
	Capacitance measurement (F)	Temperature measurement ($^{\circ}$ C or $^{\circ}$ F)
 With the positive probe inserted into the μ A mA terminal	DC current measurement (DC mA)	AC current measurement (AC mA)
		AC+DC current measurement (AC+DC mA)
 With the positive probe inserted into the A terminal	DC current measurement (DC A)	% (0-20 or 4-20) mA
		AC current measurement (AC A)
		AC+DC current measurement (AC+DC A)
		% (0-20 or 4-20) A

A Shift Functions Using the Shift Key

Table A-2 U1272A default and shift functions (continued)

Rotary switch position	Function shown in the primary display:	
	Default	When  is pressed
U1272A		
	DC current measurement (DC μA)	AC current measurement (AC μA)
		AC+DC current measurement (AC+DC μA)



[1] Press  to switch the function shown in the primary display (AC V) with the function shown in the secondary display (DC V). Press  again to switch back the displays.



Appendix B Dual Display Combinations Using the Dual Key

Table B-1 U1271A dual display combinations 160

Table B-2 U1272A dual display combinations 162

The tables below list the function shown in the secondary display when the  key is pressed, with respect to the multimeter's rotary switch position. Press  to cycle through the available dual display combinations. Press  for more than 1 second to return to the default secondary display function (ambient temperature measurement).



B Dual Display Combinations Using the Dual Key

Table B-1 U1271A dual display combinations



















Rotary switch position	Function shown (when  is pressed) in the:	
U1271A	Primary display	Secondary display
	AC voltage measurement (AC V)	DC voltage measurement (AC V)
	<i>Press  to switch the function shown on the primary display (AC V) with the function shown on the secondary display (DC V). Press  again to switch back the functions.</i>	
	AC voltage measurement (AC V)	AC coupling frequency measurement (Hz)
	AC voltage measurement (AC V) with low pass filter (LPF)	
	AC voltage measurement (AC mV)	AC coupling frequency measurement (Hz)
	AC voltage measurement (AC mV) with low pass filter (LPF)	
	DC voltage measurement (DC V)	DC coupling frequency measurement (Hz)
	DC voltage measurement (DC mV)	DC coupling frequency measurement (Hz)
	Resistance measurement (Ω)	Ambient temperature ($^{\circ}\text{C}$) ^[1]
	Continuity test (••) Ω	<i>Press  to switch between the short or open state.</i>
	Diode test (V)	Ambient temperature ($^{\circ}\text{C}$) ^[1]
	Capacitance measurement (F)	Ambient temperature ($^{\circ}\text{C}$) ^[1]
	Temperature measurement ($^{\circ}\text{C}$ or $^{\circ}\text{F}$)	Ambient temperature ($^{\circ}\text{C}$) ^[2]
	DC current measurement (DC mA)	DC coupling frequency measurement (Hz)
		AC current measurement (AC mA)
With the positive probe inserted into the μA mA terminal	AC current measurement (AC mA)	AC coupling frequency measurement (Hz)
		DC current measurement (DC mA)
	% (0-20 or 4-20) DC mA	DC current measurement (DC mA) ^[1]

Table B-1 U1271A dual display combinations (continued)

Rotary switch position	Function shown (when  is pressed) in the:	
U1271A	Primary display	Secondary display
 With the positive probe inserted into the A terminal	DC current measurement (DC A)	DC coupling frequency measurement (Hz) AC current measurement (AC A)
	AC current measurement (AC A)	AC coupling frequency measurement (Hz) DC current measurement (DC A)
	% (0-20 or 4-20) DC A	DC current measurement (DC A) ^[1]
	DC current measurement (DC µA)	DC coupling frequency measurement (Hz) AC current measurement (AC µA)
	AC current measurement (AC µA)	AC coupling frequency measurement (Hz) DC current measurement (DC µA)

[1] Alternative dual display combination not available for this function.

[2] When  is pressed, temperature measurement without ambient compensation () is enabled.

B Dual Display Combinations Using the Dual Key

WARNING

In the dual display DC voltage decibel and DC voltage measurement mode, the ⚡ icon will not appear on the screen regardless of voltage.

Table B-2 U1272A dual display combinations



















Rotary switch position	Function shown (when  is pressed) in the:	
U1272A	Primary display	Secondary display
	Low impedance (Z_{LOW}) AC voltage measurement (V)	Low impedance (Z_{LOW}) DC voltage measurement (V)
	<i>Press  to switch the function shown on the primary display (AC V) with the function shown on the secondary display (DC V). Press  again to switch back the functions.</i>	
	AC voltage measurement (AC V)	AC coupling frequency measurement (Hz)
	AC voltage decibel display (dBm) is enabled when  is pressed.	AC voltage measurement (AC V)
	AC voltage measurement (AC V) with low pass filter (LPF)	AC coupling frequency measurement (Hz)
	AC voltage decibel display (dBm) with low pass filter (LPF) is enabled when  is pressed.	AC voltage measurement (AC V) with low pass filter (LPF)
	AC voltage measurement (AC mV)	AC coupling frequency measurement (Hz)
	AC voltage decibel display (dBm) is enabled when  is pressed.	AC voltage measurement (AC mV)
	AC voltage measurement (AC mV) with low pass filter (LPF)	AC coupling frequency measurement (Hz)
	AC voltage decibel display (dBm) with low pass filter (LPF) is enabled when  is pressed.	AC voltage measurement (AC mV) with low pass filter (LPF)

Table B-2 U1272A dual display combinations (continued)

Rotary switch position	Function shown (when  is pressed) in the:	
U1272A	Primary display	Secondary display
	DC voltage measurement (DC V)	DC coupling frequency measurement (Hz) AC voltage measurement (AC V)
	DC voltage decibel display (dBm) is enabled when  is pressed. ^[1]	DC voltage measurement (DC V)
	AC voltage measurement (AC V)	AC coupling frequency measurement (Hz) DC voltage measurement (DC V)
	AC voltage decibel display (dBm) is enabled when  is pressed.	AC voltage measurement (AC V)
	AC+DC voltage measurement (AC+DC V)	AC coupling frequency measurement (Hz) AC voltage measurement (AC V) DC voltage measurement (DC V)
	AC+DC voltage decibel display (dBm) is enabled when  is pressed.	AC+DC voltage measurement (AC+DC V)
	DC voltage measurement (DC mV)	DC coupling frequency measurement (Hz) AC voltage measurement (AC mV)
	DC voltage decibel display (dBm) is enabled when  is pressed. ^[1]	DC voltage measurement (DC mV)
	AC voltage measurement (AC mV)	AC coupling frequency measurement (Hz) DC voltage measurement (DC mV)
	AC voltage decibel display (dBm) is enabled when  is pressed.	AC voltage measurement (AC mV)
	AC+DC voltage measurement (AC+DC mV)	AC coupling frequency measurement (Hz) AC voltage measurement (AC mV) DC voltage measurement (DC mV)
	AC+DC voltage decibel display (dBm) is enabled when  is pressed.	AC+DC voltage measurement (AC+DC V)

B Dual Display Combinations Using the Dual Key

Table B-2 U1272A dual display combinations (continued)













Rotary switch position	Function shown (when  is pressed) in the:	
U1272A	Primary display	Secondary display
	Resistance measurement (Ω)	Ambient temperature ($^{\circ}\text{C}$) ^[2]
	Continuity test (••) Ω	Press  to switch between the short or open state.
	Resistance measurement (Ω) with offset compensation (Smart Ω)	Press  to switch between the leakage and bias display.
	Diode test (V)	Ambient temperature ($^{\circ}\text{C}$) ^[2]
	Auto-diode test (V)	
	Capacitance measurement (F)	Ambient temperature ($^{\circ}\text{C}$) ^[2]
	Temperature measurement ($^{\circ}\text{C}$ or $^{\circ}\text{F}$)	Ambient temperature ($^{\circ}\text{C}$) ^[3]
 With the positive probe inserted into the μA mA terminal	DC current measurement (DC mA)	DC coupling frequency measurement (Hz)
		AC current measurement (AC mA)
	AC current measurement (AC mA)	AC coupling frequency measurement (Hz)
		DC current measurement (DC mA)
	AC+DC current measurement (AC+DC mA)	AC coupling frequency measurement (Hz)
		AC current measurement (AC mA)
		DC current measurement (DC mA)
% (0-20 or 4-20) DC mA	DC current measurement (DC mA) ^[2]	
 With the positive probe inserted into the A terminal	DC current measurement (DC A)	DC coupling frequency measurement (Hz)
		AC current measurement (AC A)
	AC current measurement (AC A)	AC coupling frequency measurement (Hz)
		DC current measurement (DC A)
	AC+DC current measurement (AC+DC A)	AC coupling frequency measurement (Hz)
		AC current measurement (AC A)
		DC current measurement (DC A)
% (0-20 or 4-20) DC A	DC current measurement (DC A) ^[2]	

Table B-2 U1272A dual display combinations (continued)

Rotary switch position	Function shown (when  is pressed) in the:	
U1272A	Primary display	Secondary display
	DC current measurement (DC μA)	DC coupling frequency measurement (Hz)
		AC current measurement (AC μA)
	AC current measurement (AC μA)	AC coupling frequency measurement (Hz)
		DC current measurement (DC μA)
	AC+DC current measurement (AC+DC μA)	AC coupling frequency measurement (Hz)
		DC current measurement (DC μA)

[1] In this measurement mode, the  icon will not appear on the screen regardless of voltage.

[2] Alternative dual display combination not available for this function.

[3] When  is pressed, temperature measurement without ambient compensation () is enabled.

B Dual Display Combinations Using the Dual Key

THIS PAGE HAS BEEN INTENTIONALLY LEFT BLANK.

www.agilent.com

Contact us

To obtain service, warranty, or technical assistance, contact us at the following phone or fax numbers:

United States:

(tel) 800 829 4444 (fax) 800 829 4433

Canada:

(tel) 877 894 4414 (fax) 800 746 4866

China:

(tel) 800 810 0189 (fax) 800 820 2816

Europe:

(tel) 31 20 547 2111

Japan:

(tel) (81) 426 56 7832 (fax) (81) 426 56 7840

Korea:

(tel) (080) 769 0800 (fax) (080) 769 0900

Latin America:

(tel) (305) 269 7500

Taiwan:

(tel) 0800 047 866 (fax) 0800 286 331

Other Asia Pacific Countries:

(tel) (65) 6375 8100 (fax) (65) 6755 0042

Or visit Agilent World Wide Web at:

www.agilent.com/find/assist

Product specifications and descriptions in this document are subject to change without notice. Always refer to the English version on the Agilent Web site for the latest revision.

© Agilent Technologies, Inc., 2010-2013

Eighth Edition, September 13, 2013
U1271-90010



Agilent Technologies