

Errata

Title & Document Type: 3478A Multimeter Operator's Manual

Manual Part Number: 03478-90009

Revision Date: January 1, 1988

HP References in this Manual

This manual may contain references to HP or Hewlett-Packard. Please note that Hewlett-Packard's former test and measurement, semiconductor products and chemical analysis businesses are now part of Agilent Technologies. We have made no changes to this manual copy. The HP XXXX referred to in this document is now the Agilent XXXX. For example, model number HP8648A is now model number Agilent 8648A.

About this Manual

We've added this manual to the Agilent website in an effort to help you support your product. This manual provides the best information we could find. It may be incomplete or contain dated information, and the scan quality may not be ideal. If we find a better copy in the future, we will add it to the Agilent website.

Support for Your Product

Agilent no longer sells or supports this product. You will find any other available product information on the Agilent Test & Measurement website:

www.tm.agilent.com

Search for the model number of this product, and the resulting product page will guide you to any available information. Our service centers may be able to perform calibration if no repair parts are needed, but no other support from Agilent is available.



HEWLETT-PACKARD

HP 3478A Multimeter Operating Manual

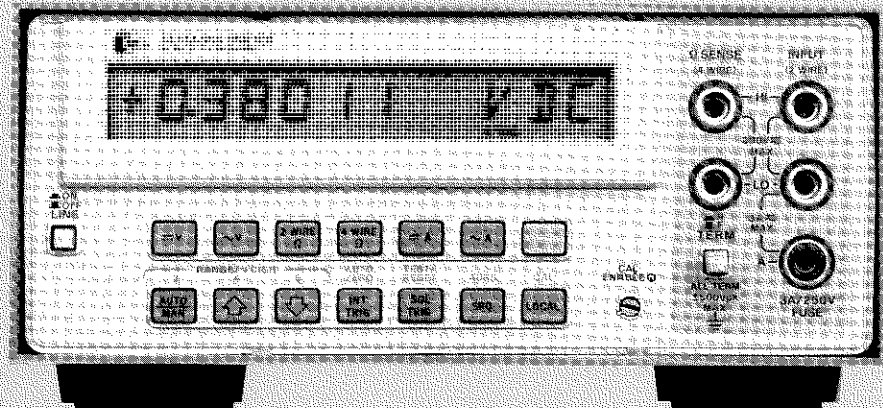

HP 3478A Multimeter Operator's Manual

RESTRICTED RIGHTS LEGEND

Use, duplication, or disclosure by the Government is subject to restrictions as set forth in subdivision (b)(3)(ii) of the Rights in Technical Data and Computer Software clause at 52.227-7013.

Hewlett-Packard Company
3000 Hanover Street, Palo Alto, California 94304

Copyright © Hewlett-Packard Company, 1988

Manual Part Number: 03478-90009
Microfiche Part Number: 03478-99009

Printed: JANUARY 1988 Edition 2
Printed in U.S.A. E1287

Printing History

New editions are complete revisions of the manual. Update packages, which are issued between editions, contain additional and replacement pages to be merged into the manual by the customer. The dates on the title page change only when a new edition or a new update is published. No information is incorporated into a reprinting unless it appears as a prior update; the edition does not change when an update is incorporated.

Many product updates and fixes do not require manual changes and, conversely, manual corrections may be done without accompanying product changes. Therefore, do not expect a one-to-one correspondence between product updates and manual updates.

Edition 1 (Part Number 03478-90005) FEBRUARY 1983
Edition 2 (Part Number 03478-90009) JANUARY 1988

CERTIFICATION

Hewlett-Packard Company certifies that this product met its published specifications at the time of shipment from the factory. Hewlett-Packard further certifies that its calibration measurements are traceable to the National Institute of Standards and Technologies, to the extent allowed by the the Institute's calibration facility, and to the calibration facilities of other International Standards Organization members.

WARRANTY

This Hewlett-Packard instrument product is warranted against defects in materials and workmanship for a period of one year from date of shipment [except that in the case of certain components listed in Section I of this manual, the warranty shall be for the specified period]. During the warranty period, Hewlett-Packard Company will, at its option, either repair or replace products which prove to be defective.

For warranty service or repair, this product must be returned to a service facility designated by -hp-. Buyer shall prepay shipping charges to -hp- and -hp- shall pay shipping charges to return the product to Buyer. However, Buyer shall pay all shipping charges, duties, and taxes for products returned to -hp- from another country.

Duration and conditions of warranty for this instrument may be superceded when the instrument is integrated into (becomes a part of) other -hp- instrument products.

Hewlett-Packard warrants that its software and firmware designated by -hp- for use with an instrument will execute its programming instructions when properly installed on that instrument. Hewlett-Packard does not warrant that the operation of the instrument, or software, or firmware will be uninterrupted or error free.

LIMITATION OF WARRANTY

The foregoing warranty shall not apply to defects resulting from improper or inadequate maintenance by Buyer, Buyer-supplied software or interfacing, unauthorized modification or misuse, operation outside of the environmental specifications for the product, or improper site preparation or maintenance.

NO OTHER WARRANTY IS EXPRESSED OR IMPLIED. HEWLETT-PACKARD SPECIFICALLY DISCLAIMS THE IMPLIED WARRANTIES OF MERCHANTABILITY AND FITNESS FOR A PARTICULAR PURPOSE.

EXCLUSIVE REMEDIES

THE REMEDIES PROVIDED HEREIN ARE BUYER'S SOLE AND EXCLUSIVE REMEDIES. HEWLETT-PACKARD SHALL NOT BE LIABLE FOR ANY DIRECT, INDIRECT, SPECIAL, INCIDENTAL, OR CONSEQUENTIAL DAMAGES, WHETHER BASED ON CONTRACT, TORT, OR ANY OTHER LEGAL THEORY.

ASSISTANCE

Product maintenance agreements and other customer assistance agreements are available for Hewlett-Packard products.

For any assistance, contact your nearest Hewlett-Packard Sales and Service Office. Addresses are provided at the back of this manual.



SAFETY SUMMARY

The following general safety precautions must be observed during all phases of operation, service, and repair of this instrument. Failure to comply with these precautions or with specific warnings elsewhere in this manual violates safety standards of design, manufacture, and intended use of the instrument. Hewlett-Packard Company assumes no liability for the customer's failure to comply with these requirements. This is a Safety Class 1 instrument.

GROUND THE INSTRUMENT

To minimize shock hazard, the instrument chassis and cabinet must be connected to an electrical ground. The instrument is equipped with a three-conductor ac power cable. The power cable must either be plugged into an approved three-contact electrical outlet or used with a three-contact to two-contact adapter with the grounding wire (green) firmly connected to an electrical ground (safety ground) at the power outlet. The power jack and mating plug of the power cable meet International Electrotechnical Commission (IEC) safety standards.

DO NOT OPERATE IN AN EXPLOSIVE ATMOSPHERE

Do not operate the instrument in the presence of flammable gases or fumes. Operation of any electrical instrument in such an environment constitutes a definite safety hazard.

KEEP AWAY FROM LIVE CIRCUITS

Operating personnel must not remove instrument covers. Component replacement and internal adjustments must be made by qualified maintenance personnel. Do not replace components with power cable connected. Under certain conditions, dangerous voltages may exist even with the power cable removed. To avoid injuries, always disconnect power and discharge circuits before touching them.

DO NOT SERVICE OR ADJUST ALONE

Do not attempt internal service or adjustment unless another person, capable of rendering first aid and resuscitation, is present.

DO NOT SUBSTITUTE PARTS OR MODIFY INSTRUMENT

Because of the danger of introducing additional hazards, do not install substitute parts or perform any unauthorized modification to the instrument. Return the instrument to a Hewlett-Packard Sales and Service Office for service and repair to ensure that safety features are maintained.

DANGEROUS PROCEDURE WARNINGS

Warnings, such as the example below, precede potentially dangerous procedures throughout this manual. Instructions contained in the warnings must be followed.

WARNING

Dangerous voltages, capable of causing death, are present in this instrument. Use extreme caution when handling, testing, and adjusting.

SAFETY SYMBOLS

General Definitions of Safety Symbols Used On Equipment or In Manuals.



Instruction manual symbol: the product will be marked with this symbol when it is necessary for the user to refer to the instruction manual in order to protect against damage to the instrument.



Indicates dangerous voltage (terminals fed from the interior by voltage exceeding 1000 volts must be so marked).

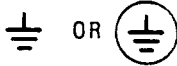

Protective conductor terminal. For protection against electrical shock in case of a fault. Used with field wiring terminals to indicate the terminal which must be connected to ground before operating equipment.



Low-noise or noiseless, clean ground (earth) terminal. Used for a signal common, as well as providing protection against electrical shock in case of a fault. A terminal marked with this symbol must be connected to ground in the manner described in the installation (operating) manual, and before operating the equipment.

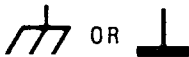

Frame or chassis terminal. A connection to the frame (chassis) of the equipment which normally includes all exposed metal structures.



Alternating current (power line).



Direct current (power line).



Alternating or direct current (power line).

WARNING

The WARNING sign denotes a hazard. It calls attention to a procedure, practice, condition or the like, which, if not correctly performed or adhered to, could result in injury or death to personnel.

CAUTION

The CAUTION sign denotes a hazard. It calls attention to an operating procedure, practice, condition or the like, which, if not correctly performed or adhered to, could result in damage to or destruction of part or all of the product.

NOTE :

The NOTE sign denotes important information. It calls attention to procedure, practice, condition or the like, which is essential to highlight.



Herstellerbescheinigung

Hiermit wird bescheinigt, daß das Gerät/System HP 3478A
in Übereinstimmung mit den Bestimmungen von Postverfügung 1046/84 funkentstört ist.

Der Deutschen Bundespost wurde das Inverkehrbringen dieses Gerätes/Systems angezeigt und die Berechtigung zur Überprüfung der Serie auf Einhaltung der Bestimmungen eingeräumt.

Zusatzinformation für Meß- und Testgeräte

Werden Meß- und Testgeräte mit ungeschirmten Kabeln und/oder in offenen Meßaufbauten verwendet, so ist vom Betreiber sicherzustellen, daß die Funk-Entstörbestimmungen unter Betriebsbedingungen an seiner Grundstücksgrenze eingehalten werden.

Manufacturer's declaration

This is to certify that the equipment HP 3478A
is in accordance with the Radio Interference Requirements of Directive FTZ 1046/84. The German Bundespost was notified that this equipment was put into circulation, the right to check the series for compliance with the requirements was granted.

Additional Information for Test- and Measurement Equipment

If Test- and Measurement Equipment is operated with unshielded cables and/or used for measurements on open set-ups, the user has to assure that under operating conditions the Radio Interference Limits are still met at the border of his premises.

TABLE OF CONTENTS

Chapter	Page	REMOTE PROGRAMMING (Cont'd)	Page
I. MEET THE 3478A	1	Trying Out a Command	35
Introduction	1	Addressing	36
How to Use This Manual	2	Sending Instructions to the 3478A	37
Simplified Operation	5/6	Home Commands	39
Chapter	Page	Programming Hints	40
II. USING THE 3478A	7	Receiving Data from the 3478A	41
Introduction	7	3478A Bus Capabilities	42
Detailed Operating Instructions	7	CLEAR	43
Operating Characteristics	7	Examples	43
AUTOZERO	8	Comments	43
What is Autozero?	8	LOCAL	44
How it Affects Measurements	8	Examples	44
CALIBRATE	10	Comments	44
What is Electronic Calibration?	10	LOCAL LOCKOUT	44
Calibrate Enable	10	Example	44
CURRENT	11	Comments	44
Measuring Current	11	REMOTE	45
DISPLAY	12	Examples	45
How it is Used	12	Comments	45
Normal	12	REQUIRE SERVICE (SRQ)	46
Message	13	How to use SRQ	46
User Generated Message	15	Status Register and Status Byte	47
Changing the Number of Digits		Setting the SRQ Mask	47
Displayed	15	SPOLL	50
Annunciators	17	Example	50
OPTIMIZING READING RATES	18	Comments	50
Why Optimize?	18	TRIGGER	53
Your Signal Environment	18	Examples	53
Integration Times	18	Comments	53
Autozero	19	Topics in Advanced Programming	54
Other Factors Influencing the		TEMPERATURE MEASUREMENTS	54
Reading Rate	19	EXTENDED OHMS	55
RANGING	20	dBm MEASUREMENTS	56
What About Ranging?	20	MAXIMUM READING RATE	57
Reading the Display	20	STATUS BYTE COMMAND	58
Autorange	21	3478A Programming Commands	59
Manual Ranging	22	Chapter	Page
REAR PANEL	23	IV. OPERATORS MAINTENANCE	63
What is on the Rear Panel?	23	Introduction	63
The Rear Panel Switches	23	Accessories	63
RESISTANCE MEASUREMENTS	25	Initial Inspection	64
Measuring Resistance	25	Preparation for Use	64
How Resistances are Measured	25	Safety Considerations	66
Other Considerations	28	Environmental Requirements	67
TEST/RESET	29	Specifications	67
What it Does	29	Interface Connections	67
TRIGGER MODES	30	Fuse Replacement	68
What is Triggering?	30	In Case of Trouble	70
Trigger Indicator	30	Warranty Information	73
VOLTAGE MEASUREMENTS	32	How to Obtain Repair Service	74
Measuring Voltages	32	Serial Number	74
VOLTMETER COMPLETE	34	General Shipping Instructions	74
What is Voltmeter Complete?	34	Further Considerations	75
Using the Voltmeter Complete Pulse	34	3478A Verification Program	76
Chapter	Page	Specifications	81
III. REMOTE PROGRAMMING	35	APPENDICES	
Introduction	35	A.	85
Scope	35	B.	93

Chapter 1

Meet The 3478A

Introduction

Your new 3478A is a fully programmable HP-IB* digital multimeter. In an automatic test or on the bench, the 3478A offers 3 1/2 to 5 1/2 digit resolution for measuring dc volts, true RMS ac volts, 2- and 4- wire ohms, and dc and RMS ac current. The 3478A offers dc voltage performance from 100 nanovolt sensitivity up to 300 volts (full scale), true RMS capability up to 300 kHz, and resistance measurements from 100 $\mu\Omega$ sensitivity to 30M Ω (full scale). Its dc and true RMS ac current measuring capability is from 1 μ A sensitivity up to 3A. The fast autorange capability of the 3478A allows you to make measurements over a wide dynamic range without sacrificing throughput rates.

By selecting the number of digits displayed and using the autozero feature, the 3478A allows you flexibility in measurement speed and accuracy. Up to 71 readings per second can be made with the 3478A in the 3 1/2 digit mode. The 3478A has a fast trigger mode which lets you bypass the built-in settling time delay to make fast true RMS ac measurements in systems applications.

The alphanumeric Liquid Crystal Display (LCD) gives you measurement units as part of the reading for easy-to-read, unambiguous answers. The HP-IB talk, listen, remote, and SRQ status information is also available with LCD annunciators. The SRQ button can be used to flag or interrupt your computer from the front panel of the 3478A.

Other system features of the 3478A include the Voltmeter Complete signal and External Trigger input, both available on the rear panel, to synchronize with scanners or to other external devices. The switchable front/rear inputs let you easily connect to the 3478A for either bench or systems operation. The systems package of the 3478A offers convenient rack mounting in a system.

Furthermore, to lower your cost of ownership, the 3478A is calibrated electronically, either manually from the front panel or remotely in an automatic calibration system. There are no internal adjustments and the calibration of all functions is done without the removal of covers. The self-test function verifies most of the internal circuitry of the 3478A for an indication of the proper operation of the multimeter.

* HP-IB (Hewlett-Packard Interface Bus) is Hewlett-Packard's implementation of IEEE Standard 488-1978 and ANSI MC1.1.

How to Use This Manual

This Operators Manual has been designed with you the operator in mind; to serve as a complete reference document for using the 3478A as a solution to your measurement needs. It covers both bench use and remote programming. Maintenance procedures, such as installation, were intentionally placed later in the manual -Chapter 4 - because this information is seldom referred to. If, however, you have just received your 3478A you may want to read that information. A separate service manual for the 3478A contains the information on calibration, performance testing, and service.

Familiarize yourself with the 3478A by looking through this manual. The best way to feel at ease with the instrument is to sit down with this manual and the 3478A and key in the examples shown. It won't take long to become familiar with the instrument and its many features.

The next four paragraphs describe the remaining chapters and appendix in this Operators Manual. Read through these paragraphs to acquaint yourself with the organization of the manual prior to using your new -hp-Model 3478A.

Using the 3478A, Chapter II

Chapter II begins where Chapter I closes by discussing each function and feature of the 3478A in much more detail. This chapter also covers topics such as optimizing reading rates, alternate triggering modes, the rear panel features, and the display. The topics are alphabetically arranged for easy reference. Most of the information in this chapter will prove to be very helpful when you are remote programming the 3478A.

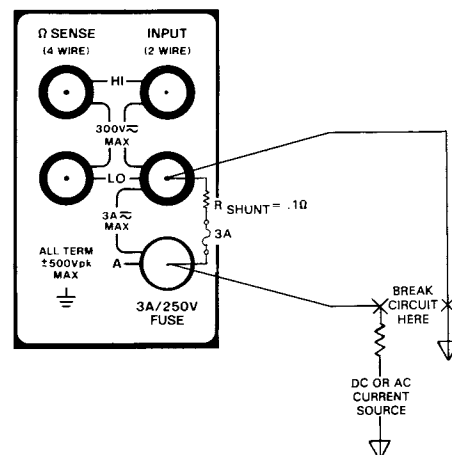

```

10  ! Temperature measurement
20  ! -hp- series 200/300 BASIC
30  !
40  Dvm=723
50  CLEAR Dvm
60  DISP "Clearing HP 3478A..."
70  WAIT 2
80  OUTPUT Dvm;"F3R4N4Z1T1"
90
100 !OUTPUT Dvm;"F4R4N4Z1T1"
110
120 Q1=.001286
130 Q2=.00023595
140 Q3=.0000000941
150 LOOP
160  ENTER Dvm;B
170  Q4=LOG(B)
180  P=1/(Q1+Q4*(Q2+Q4*Q4*Q3))-273.15
190  DISP "The temperature is ";P;" deg. C"
200 END LOOP
210 END

```

Operator's Maintenance, Chapter IV

Operator's maintenance information is found in Chapter IV. This chapter addresses installation procedures, a complete table of specifications, what to do if you suspect problems with the 3478A, and many other items of special interest to the operator.

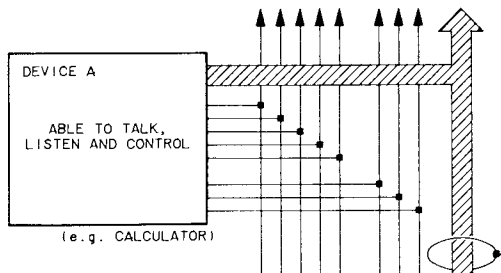

Remote Programming, Chapter III

If your needs are in the area of remote programming the 3478A, then Chapter III is where you need to look for programming information. Numerous examples are given to enhance the programming discussion. At the end of this Chapter are several application program examples designed to solve frequently encountered measurement problems. Remember that you will want to read Chapter II prior to beginning Chapter III.

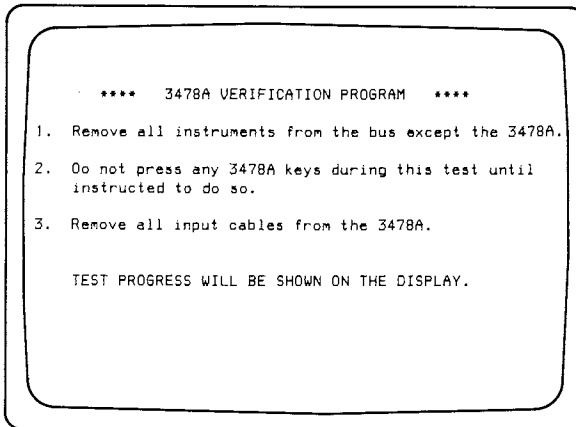

HP-IB Description, Appendix A

HP-IB is Hewlett-Packard's implementation of IEEE standard 488-1978 Standard Digital Interface for Programmable Instrumentation. Appendix A provides a general description of the HP-IB Interface. This information is controller independent, but gives specific information about the 3478A as it relates to HP-IB.

Turning it On

Before applying ac power to the 3478A, check the rear panel line voltage option label to be certain the instrument is set for the nominal line voltage in your area. If necessary, refer to the installation information in Chapter 4. As you press the line switch, carefully watch the display as the 3478A goes through a complete internal self test and displays its HP-IB address.

DISPLAY



34780P-SLFTST



34780P-SLFTSTOK

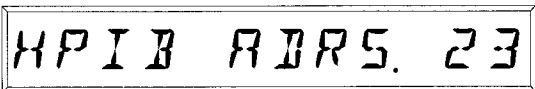

34780P-HP1BADR

RESULT

The 3478A displays "SELF TEST" during the period of time it is performing the tests. It will then display "SELF TEST OK" or an appropriate error message upon completion of the Self Test.

The message shown here affirms that the 3478A is ready for measurements.

The factory preset HP-IB address for the 3478A is "23". This address may be easily changed to fit your system needs by means of five switches on the rear panel. The 3478A may also be set for TALK-ONLY, in which case the display would indicate: HPIB ADRS.T.O. Note, if the self test does not pass, this message would be replaced by an error message.

This entire process takes only a moment to complete. At this point the 3478A is ready to use and is set to the following state:

Function: DC Volts
Range: Autorange on
Display: 5 1/2 Digits of Display
Trigger: Internal Trigger
Auto-zero: On

NOTE

Most 3478A's produced prior to January 1983 will not display "SELF TEST OK." This is normal.

Test/Reset

Even though the 3478A went through its Self Test during Turn-on, let's go through it manually. As we do, carefully watch the display, especially the 12 annunciators along the bottom. Every segment in the display (except for the top dot in the colon) is turned on for as long as you hold the Self Test button down. When the button is released, the display will remain for approximately 2 seconds while the Self Test is performed. The 3478A is then reset and returns to its turn-on state. A more complete description of the Self Test is found in Chapter II. Should any of the five elements of the self test fail, a message will be displayed identifying the general circuit area where the failure occurred. This can greatly reduce initial troubleshooting time.

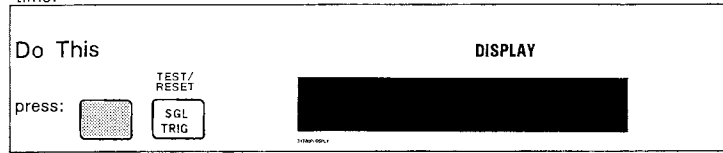

NOTE

Most 3478A's produced prior to January 1983 will turn on every display segment for the duration of the Self Test (approximately 2 seconds) regardless of how long the Self Test button is depressed.

Simplified Operation

The front panel of the 3478A is designed for ease of use by logically grouping keys that are functionally related. This chapter is intended to provide a basic working knowledge of the 3478A in making typical measurements.

Measurement Function Keys

Use the first six keys along the top row to select the type of measurement you want to make.

- [DC V] DC Voltage
- [AC V] AC Voltage
- [DC A] DC Current
- [AC A] AC Current
- [2 WIRE Ω] 2-Wire Ohms
- [4 WIRE Ω] 4-Wire Ohms

Number of Digits Displayed

The "SHIFTED" functions of the range keys are used to select alternate numbers of display digits. This feature is provided as a means to increase reading rates, but with a trade-off of noise rejection and resolution. Be sure to read DISPLAY and OPTIMIZING READING RATES in Chapter II.

- [3] 3 1/2 digit mode, (fastest reading rate, least resolution and little noise rejection).
- [4] 4 1/2 digit mode.
- [5] 5 1/2 digit mode, (best noise rejection, slowest reading rate)

Display

12 character alphanumeric display with 12 dedicated annunciators. The display is read directly in engineering units, i.e., MV for milli-volts, MOHM for Meg-ohm resistance, etc.

Blue Key

[shift] pressed before another key executes the function shown above that key.

ΩSense

These terminals are used for the voltmeter sense leads when making 4-wire ohms measurements.

Input

These are the voltmeter and 2-wire ohms input, 4-wire ohms source current terminals.

Front / Rear

When this switch is out, the front panel input terminals are selected. If the switch is in, the rear panel terminals are used.

A

This is the Amps input terminal and is used with the INPUT LOW terminal. (3 Amp fuse protected)

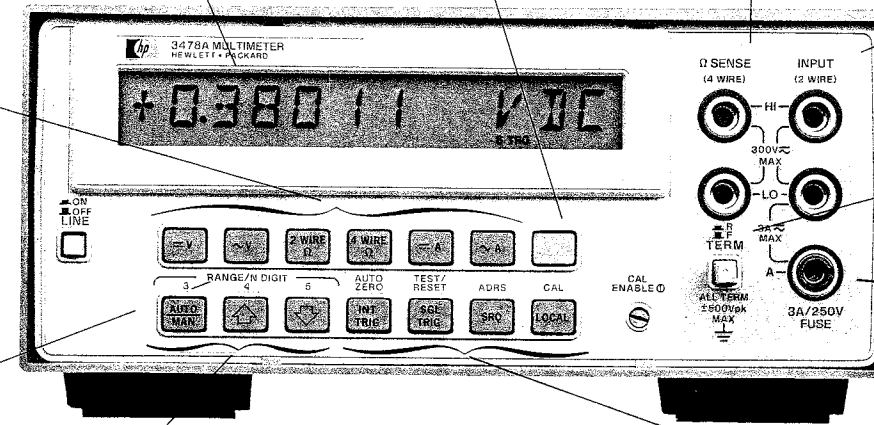

Range Keys

The range keys, as the name implies, are used to select the proper range for the measurement. Press any of the keys to select the manual range mode. Note the M RNG annunciator in the display. The AutoMan key will return the meter to autorange.

- [AUTO MAN] Pressing this key toggles between Auto and Manual ranging.
- [↑] Up-ranging.
- [↓] Down-ranging.

These keys are used to select special operating features of the 3478A. The next two chapters provide a detailed explanation of these keys. The blue shift key allows for selecting the "SHIFTED" functions of the bottom row of keys. You can always tell when you have pressed the Shift key; the SHIFT annunciator will appear in the display. It will disappear when the function is executed or shift is pressed again.

- [INT TRIG] Internal Trigger is selected by this key. In this mode, the 3478A triggers itself for the fastest possible reading rate.

Additional Feature Keys

Autozero is a function that allows you to enable or disable the internal zero correction circuitry. Turning Autozero off increases the reading rate with a trade-off of long term stability.

Pressing the **Single Trigger** key causes the 3478A to take one reading and wait for the next trigger impulse. This impulse can come from either the Single Trigger key or the External Trigger input (rear panel BNC).

Test/Reset performs an internal self test then resets the 3478A to its turn-on state. Any errors in the self test are noted in the display.

The front panel **SRQ** (Service Request) key is an HP-IB operation that enables you to manually interrupt the controller. This key is enabled by setting the SRQ mask.

The 3478A HP-IB **Address** is displayed in response to the Address key.

Another HP-IB operation, **Local** returns the 3478A to front panel control from the REMOTE mode.

The 3478A features total electronic calibration. The **Cal** key is used as part of that procedure. See the 3478A Service Manual, -hp- part number 03478-90001.

Chapter II

Using The 3478A

Introduction

The -hp- Model 3478A Digital Multimeter is a very powerful bench instrument equally at home in the lab or production areas. In the first chapter you saw the very basic features of the 3478A; in this chapter you will learn to use those features to solve your measurement needs. The detailed operating information in this chapter presents the most comprehensive instruction about all of the multimeter's functions. Whether you use your 3478A as a stand alone bench instrument or coupled with a computer for a measurement system, the information in this chapter will prove invaluable.

Detailed Operating Instructions

The goal of this chapter is to provide easy to find answers to the vast majority of questions you may have about using your 3478A. To this end, this chapter is divided into 12 major subject headings. Each subject presents the most comprehensive information about a particular feature or function of the 3478A. At the end of most subjects will be a short list of HP-IB remote programming commands that pertain to that subject. For more information on remote programming, refer to Chapter III.

Operating Characteristics

The Operating Characteristics of the 3478A are detailed in Table 2-1. This table is not the comprehensive table of specifications, but rather an abbreviated set. You will probably find that this table answers most of your questions about the capabilities of the multimeter without poring over several pages of specifications. Should you ever need to refer to them, the complete Table of Specifications for the 3478A is given in Chapter 4.

Table 2-1. Operating Characteristics

<p>DC VOLTS 100 nanovolt resolution (30mv range) to 300V Full Scale Z_{in}: $> 10^{10}\Omega$, 30mV, 300mV, and 3V range $10\text{ M}\Omega \pm 1\%$, 30V and 300V range</p>	<p>AC AMPS $1\mu\text{A}$ resolution (300mA range) to 3A Full Scale Maximum Shunt Resistance = $.3\Omega$ Maximum Burden at Full Scale = $< 900\text{mV}$ Bandwidth: 20Hz - 20kHz</p>
<p>AC VOLTS $1\mu\text{V}$ resolution (300mV range) to 300V full scale True RMS Responding, Crest Factor = 4:1 at full scale Bandwidth: 20Hz to 100KHz (300KHz on 30V range) Z_{in}: $1\text{ M}\Omega \pm 1\%$, in parallel with 75pF</p>	<p>OHMS $100\mu\Omega$ resolution (30 ohm range) to 30 megohms Full Scale Open Circuit Voltage: $< 6.3\text{V}$ Current through Rx: 30Ω, 300Ω, 3KΩ range -1mA 30KΩ range - 100μA 300KΩ range - 10μA 3MΩ range - 1μA 30MΩ range - 100 nA</p>
<p>DC AMPS $1\mu\text{A}$ resolution (300mA range) to 3A full scale Maximum Shunt Resistance = $.3\Omega$ Maximum Burden at Full Scale = $< 900\text{ mV}$</p>	

AUTOZERO

What is Autozero?

The autozero key allows the user to selectively enable or disable the internal zeroing technique used in the 3478A. Enabling autozero insures the user that any offset errors generated internal to the 3478A are continuously nulled with each reading. This renders the most accuracy. There are, however, many applications where disabling the autozero is advantageous. With autozero off, the internal reading rate nearly doubles. This would be important in programmable applications where speed is critical. Furthermore, the 3478A input circuitry remains in a completely static state with autozero off. This is useful when making measurements in extremely high impedance circuits where the internal switching transients of the 3478A may affect the reading accuracy. Of course, any range or function change that takes place with autozero off is automatically accompanied with an autozero update. The thermal stability of the measurement environment is the most important factor in deciding whether or not to turn autozero off. By simply keeping the temperature of the 3478A at a fixed value, you can turn autozero off without adverse effects.

How it Affects Measurements

DC Voltage and Current

Do This

Turn the 3478A off, then on again.

press:

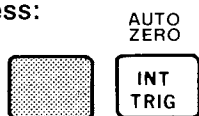

Notice that the display is being updated more frequently, indicating a faster reading rate. Also notice that the AZ OFF annunciator is on in the display. The Autozero feature is now turned off. Pressing the key sequence again will turn Autozero back on.

Autozero is used to correct for small offsets (thermal, etc) in the DC input amplifier circuitry of the multimeter. With the Autozero feature enabled (Autozero is enabled at power turn-on) the 3478A takes two measurements per reading: a "zero" measurement and a measurement of the input voltage. The displayed reading is the algebraic difference between the two measurements. The 3478A makes the zero measurement by disconnecting the multimeter's input terminals, and then shorting the internal input circuitry to circuit common. It then switches back for an input voltage measurement. All switching is internal and is automatic.

AUTOZERO (Cont'd)

With autozero turned off, whenever a new function or range is selected the 3478A immediately takes one final zero measurement and stores the results in its internal memory. Subsequent measurements of the input voltage subtract this one zero measurement to correct the reading. Since only the input voltage is measured, the reading rate almost doubles.

AC Volts and Current

AC voltage and current measurements use different input circuitry than dc voltage and current measurements. However, with autozero on, a zero measurement is made to null any errors in the A/D converter. Turning autozero off has the same effect as on dc volts and current.

Resistance Measurements

For 2-wire ohms measurements the autozero feature performs just as it does for DC voltage measurements. Resistance measurements using the 4-wire mode require different considerations.

The zero measurement is normally made with the input amplifier shorted to circuit ground. In the 4-Wire ohms mode, the input amplifier is shorted to the 4-Wire SENSE LO terminal for the zero measurement. With autozero "ON", the zero reading is updated for each measurement cycle. With autozero "OFF", the reading is not updated and may cause an ohms measurement error if the resistance of the test leads change. To prevent this error, a new zero reading should be taken by changing or updating the state of the 3478A anytime test leads are changed.

See Also: Display (Integration Time) and Optimizing Reading Rates



Commands

- Z0 Turns autozero off
- Z1 Turns autozero on

CALIBRATE

What is Electronic Calibration?

One of the many features of the 3478A is electronic calibration. This represents a totally new concept in Hewlett-Packard voltmeters. Before, voltmeters had to be removed from their mounting, have their covers removed, and mechanical adjustments made. Then the voltmeter had to be reassembled and installed. But now, calibration may be done by pressing a front panel button and there is absolutely no disassembly required. It is beyond the scope of this section to present the entire calibration procedure. For complete calibration information refer to the 3478A Service Manual, -hp- part number 03478-90008.

Briefly, Electronic Calibration is done by applying a known voltage (or resistance or current) to the voltmeter and telling it the exact value of that voltage. The voltmeter then takes ten readings and compares the average of those readings to the known value. A "CALIBRATION CONSTANT" is calculated to correct the reading to the known value and then stored in the voltmeter's memory. These Calibration Constants are generated for each range and function of the meter. All subsequent measurements are corrected by the constants. The Calibration Constant memory is backed-up by a long life battery to maintain the constants when power is turned off.

Calibrate Enable

On the front panel of the 3478A is a small rotary switch labeled CAL. This switch, when rotated so that the slot is vertical, enables the calibration procedure of the 3478A. This switch should not be turned except when qualified service trained personnel are to perform the calibration procedures. Enabling the CAL switch may cause loss of calibration if proper procedures are not followed carefully.



Commands

C Calibrate
(see the 3478A Service Manual)

CURRENT

Measuring Current

Your 3478A has the capability of measuring DC or True RMS AC Currents up to 3 amps in two ranges. The current function is protected by a 3 Amp, 250V fuse. If the fuse opens, refer to Chapter IV before replacing. The illustration below shows the internal current shunt and fuse used in the 3478A. The unknown current flowing through the current shunt produces a voltage which can then be measured.

Current inputs of greater than 1 amp may cause the current shunt to change value slightly due to self heating (somewhat like a thermistor). This may cause inaccuracies in the measurement. Sufficient time should be allowed for the circuitry to settle after the measurement is complete, before other critical current measurements are made.

DC Current 

Press the DC Amps key and select the appropriate range (or let the 3478A autorange). When measuring currents, remove all other test leads from the 3478A front panel. There are two ranges available for current measurements: the 300 milliamp range and the 3 amp range. Up to 10 microamps of noise may be seen on the 300 milliamp range.

AC Current 

Measuring ac current is identical to dc current, except that you use the AC Amps key to select the measurement function. The specified range of the AC ammeter is 30 milliamps to 3 amps. Lower accuracy readings down to 1 milliamp may be taken on the 300 milliamp range. Up to several hundred counts of residual offset may be seen on the 5½ digit display with the input open.



Commands

- F5 Selects DC Current mode (also H5)
- F6 Selects AC Current mode (also H6)

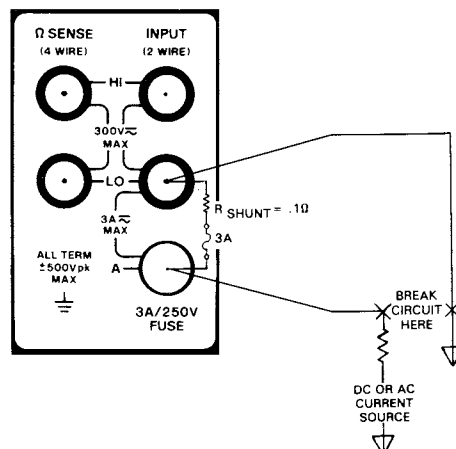

Figure 2-1. Current Measurements

DISPLAY

How it is Used

Another of the unique features of the 3478A is the 12 character alphanumeric display with 12 dedicated annunciators. The alphanumeric display may be used in one of three modes: NORMAL, MESSAGE, or USER GENERATED MESSAGE. The annunciators are used to indicate the current state of the multimeter's features (SRQ, autozero, 2- or 4- wire ohms, etc.).

Do This

press:



TEST/
RESET

SGL
TRIG

This puts the 3478A in its SELF TEST mode. For now, just watch the display and notice the 12 characters in the display and the 12 annunciators.

Normal

In the NORMAL mode of operation the display is used to indicate the results of the measurement, whether dc voltage or ohms, etc. The measurement is displayed in the 2nd through 7th characters in the display. The first digit displays the polarity (+ or -) of the reading. The measurement function (and, in some instances, an indication of range) is given in the last four characters of the display. The maximum display is 303099 with the decimal point appropriately placed for the range.

Do This

press:



This puts the meter in the dc volts function, manual range mode. Note the M RNG annunciator in the display.

press:



OR



Press these keys several times and watch the display as the decimal point moves across, and as the display indicates MVDC for milli-volts DC, and then VDC for Volts DC. The display is always read directly. Do the same in the 2-wire ohms mode. Watch as the display indicates OHM, KOHM (kil-ohms) and MOHM (Meg-ohms).

DISPLAY (Cont'd)



Abnormal Multimeter Readings

If a reading is larger than a particular range can display, the display will indicate an OVLD with the measurement function and decimal point still displayed.

If the A-D convertor is inoperative, the display will indicate "A-D TEST FAIL" or "A-D LINK FAIL". The 3478A will continue to try to make a reading, and if it succeeds, it will display the reading.

Message

It was demonstrated in the last two paragraphs that the 3478A is capable of displaying error messages. There are several other messages the 3478A may display. For example:

<p>Do This</p> <p>press:</p> 	<p>The display should now indicate "ENABLE CAL". This message indicates that the calibration switch must be set to the calibrate position before the instrument can be calibrated.</p>
<p>OR</p> 	<p>The display now shows the HP-IB address of the 3478A.</p>

These are two more examples of messages which the 3478A may display. Other possible messages will fall into one of three categories:

Table 2-2. 3478A Messages

ERROR MESSAGES (see Self Test)
U.C. RAM FAIL The 3478A has failed its internal RAM self test.
U.C. ROM FAIL The 3478A has failed its ROM self test, indicating an error in the ROM.
CAL RAM FAIL An attempt to write to the calibration RAM during calibration was unsuccessful.
UNCALIBRATED The CAL RAM has an incorrect checksum. The calibration of the 3478A is suspect.

DISPLAY (Cont'd)

Table 2-2. 3478A Messages (Cont'd)

A:D LINK FAIL

The internal processor is unable to communicate with the A/D convertor.

A:D SLOPE ERR

The A/D convertor is not able to converge upon a result properly.

A:D TEST FAIL

The A/D convertor has failed its self test.

CALIBRATION MESSAGE (see the 3478A Service Manual)

CALIBRATING

The CAL key has been pressed and a calibration is in progress.

CAL ABORTED

Either an invalid key was pressed, an overload was detected, or an A/D convertor error was detected. The calibration is aborted.

CAL FINISHED

A calibration cycle has been successfully completed.

ENABLE CAL

The CAL ENABLE switch must be turned to the CAL (vertical) position in order to do a calibration.

VALUE ERROR

The 3478A is unable to calibrate to the requested value. This message would result if:

- a. A zero calibration is attempted and the 3478A reads a raw value outside the range of +50000 to -40000 (assumes 5 1/2 digit mode)
- b. A gain calibration is attempted with a negative applied voltage.
- c. A gain calibration is attempted which is outside the range available, approximately $\pm 7\%$ of full scale.
- d. An AC voltage calibration is attempted and the applied voltage is not 3VAC.
- e. A calibration is attempted via the bus with the "C" command, and a valid target number was not found in the display.

ACI VALUE ERR

At the end of an AC voltage calibration when the 3478A attempted to compute the calibration constant for AC current, it computed a number outside of the allowed range. This could be caused by an invalid calibration constant on either the 300mV DC range or the 3A DC range. The ac voltage calibration is valid however.

GENERAL USAGE MESSAGE

HPIB ADRSxx

This is the HP-IB address of the 3478A. xx indicates the actual address of the instrument (decimal) and may be altered by the address switches on the rear panel.

OVLD

This stands for overload and indicates that the input is too great for that particular range.

DISPLAY (Cont'd)

User Generated Message

Under computer control the 3478A can display your own user messages of up to 12 characters. Refer to Section III, Remote Programming, for more information on this.



Commands

- D2text Places the message "text" into the display
- D3text Places "text" into display but the display is not updated.
- D1 Returns the 3478A to NORMAL display.

Changing the Number of Digits Displayed

When you are displaying measurement results (NORMAL mode), you also have a choice of the number of digits displayed, i.e., resolution of the reading. This not only has a great effect on the reading rate but also affects the Normal Mode Rejection (NMR).

Do This

press:



This puts the 3478A into the 3 1/2 digit display mode. This mode has the fastest reading rate but the lowest resolution and little noise rejection. The integration time in this mode is .1 power line cycle.

OR



This is the 4 1/2 digit display mode. This mode provides 59 db NMR with an integration time of 1 power line cycle (16.66 mS at 60Hz, 20 mS at 50Hz).

OR



The 5 1/2 digit display mode provides the best resolution and greatest amount of noise rejection. In this mode, 10 readings are taken, each with 1 power line cycle integration time, and averaged together. This provides 80 db of noise rejection.

DISPLAY (Cont'd)

Integration Times

As mentioned above, changing the number of display digits does more than merely change the resolution of the multimeter. It actually changes the "INTEGRATION TIME", which determines the reading rate. This in turn will greatly affect the Normal Mode Rejection (NMR) of the 3478A. The 3478A uses an integration type of A/D converter. Integration is a process where the effects of line related noise are averaged to zero over the period of an integral number of power line cycles (PLC's) during an A/D conversion. The integration time is not the same as the time for one measurement. The integration time is the time period, in PLC's, during which the input voltage is sampled by the voltmeter. At 4 1/2 digit display, the time required for one integration cycle is one PLC: 16.66 mS at 60Hz line frequency, 20 mS for 50Hz. The 3478A determines the line frequency by the setting of the 50/60Hz switch on the rear panel. In the 3 1/2 digit mode, the integration time is .1 PLC. Normal Mode Rejection (NMR) is the ability of a voltmeter to accurately measure dc voltages in the presence of ac voltages at power line frequencies. The 3478A has much better NMR at 4 1/2 digit display than it does at 3 1/2 digit display (59 db vs. 0db). The greatest amount of NMR is available from the 5 1/2 digit mode (80 db) where ten (10) readings are taken at 1 PLC integration time and averaged together.



Commands

- N3 Selects 3½ digit display
- N4 Selects 4½ digit display
- N5 Selects 5½ digit display

DISPLAY (Cont'd)

Annunciators

The 12 display annunciators, located along the bottom of the display, are used to indicate the state of the 3478A.

Table 2-3. Annunciators

<u>Annunciator</u>	<u>Indication</u>
SRQ	The SRQ annunciator indicates that the 3478A is trying to request service from the controller. Refer to Chapter III.
LSTN	The LSTN (LISTEN) annunciator turns on when the 3478A is addressed to listen via the HP-IB.
TLK	The TLK annunciator means that the 3478A has been addressed to talk via the HP-IB.
RMT	RMT indicates that the 3478A is under bus control, that is, it is under remote operation. The front panel keyboard is inactive except for the LOCAL and SRQ keys (see LOCAL and LOCAL LOCKOUT in the next chapter).
MATH	MATH is not used on the 3478A.
AZ OFF	The Autozero feature of the 3478A is disabled.
2 Ω	The 3478A is in the 2-wire ohms mode.
4 Ω	The 3478A is in the 4-wire ohms mode.
M RNG	This annunciator indicates that the 3478A is in the manual ranging mode; auto-range is inactive.
S TRIG	Single trigger means that the internal trigger is disabled. The voltmeter idles until either an external trigger pulse is received, the single trigger key is pressed again, or a TRIGGER message is received over the Bus.
CAL	The CAL annunciator will blink if the 3478A requires calibration in the selected range and function.
SHIFT	This annunciator indicates that the [SHIFT] key has been pressed, enabling the shifted functions. The annunciator will go off when either the function is executed or the [SHIFT] key is pressed again.

OPTIMIZING READING RATES

Why Optimize?

There are several reasons why you would want to optimize the rate at which readings are taken by the 3478A. Perhaps you are using a scanner to measure a large number of points where a faster reading rate would mean a better picture of what is happening at a single point in time. Or maybe you need to read fast so that you don't waste valuable computer time waiting for a measurement result. Whatever your reason for optimizing reading rates, the 3478A can solve many of these application problems. Your maximum reading rate with the 3478A is influenced by several factors. These include the signal environment (line related and broadband noise, thermals, etc.), the desired accuracy, and convenience features such as autorange or autozero. The speed and timing of the A/D process is dependent upon a number of factors. The number of digits of resolution selected, whether or not the autozero feature is enabled, and the selected function determine how long it takes for the A/D to make a conversion. The reading speed is also affected by the value of the measured voltage (or current or resistance) and whether the display is turned on or off (HP-IB D3 command turns the display off, see Chapter 3).

Your Signal Environment

The signal that you are trying to measure is subject to line related and broadband noise which can interfere with your measurement. The 3478A works to reduce or reject this kind of noise by using a form of Analog to Digital (A/D) conversion called integration. Integration is a process where the effect of line related noise is averaged to zero over the period of an integral number of power line cycles (PLC's) during an A/D conversion. The measure of the ability of the multimeter to measure dc voltages in the presence of ac voltages (at power line frequencies) is called Normal Mode Rejection (NMR). The NMR of the 3478A is largely dependent upon the number of digits displayed. An important part of this process is to make certain that the 50/60 Hz line switch (S1 on the rear panel) is set properly: up for 50Hz line frequency and down for 60 Hz.

Integration Times

Changing the number of digits of display does more than change the resolution of the reading. It actually changes the "INTEGRATION TIME" which determines the reading rate. The integration time is not the same as the time for one measurement, the integration time is the time period, in PLC's, during which the voltmeter samples the input voltage. At 4 1/2 digits of display, the time required for one integration period is one PLC: 16 2/3 mS at 60Hz line frequency or 20mS at 50Hz.

At 3 1/2 digits of display, the integration time is .1 PLC. Normal Mode Rejection (NMR) is a measure of the ability of the voltmeter to accurately measure dc voltages in the presence of ac voltages at power line frequencies. The 3478A has much better NMR at the 4 1/2 digits of display (60 db) than at 3 1/2 digits (0db) because of the integration times. At 5 1/2 digits of display, the 3478A takes ten (10) readings from the 4 1/2 digit mode and averages them together. This provides the greatest amount of noise rejection (80db).

Autozero

The thermal stability of the measurement environment is also a very important consideration. By simply keeping the temperature of the 3478A at a fixed value, you can nearly double your reading rate by turning autozero off, without adverse effects. Although the 3478A is slightly less accurate, the faster reading rate may be worth it. In addition, any range or function change that takes place is automatically accompanied by an autozero update which removes any accumulated offsets. If the measurement environment is quiet enough to disregard NMR then only accuracy and resolution are the measurement speed factors and autozero may be turned off.

Other Factors Influencing the Reading Rate



1. You can speed the reading rate by selecting a fixed range instead of allowing the multimeter to autorange every reading.
2. AC voltage measurements have a built-in 600mS settling time. Resistance measurements can be made as fast as DC voltage measurements except on the 3Mohm and 30Mohm ranges where a settling time (30mS and 300mS respectively) is needed for stable measurements. The T5 Fast Trigger command (HP-IB) is the same as the T3 command except that the delay is omitted. If more than one reading is required because of autoranging, etc, the delay will occur normally.
3. Consider the time it takes to transfer data over the HP-IB. For example, the TRANSFER command is much faster than the ENTER or RETURN commands on -hp-computers.
4. The maximum possible reading rate is with 3 1/2 digits displayed, autozero off, any DC voltage function, 60 Hz power selected, manual range, display turned off (see HP-IB command D3), a positive voltage measured, and internal trigger selected.

RANGING

What About Ranging?

The task of selecting the proper range on the 3478A may be done either automatically by the multimeter, or manually with the front panel keys.

Reading the Display

<p>Do This</p>	<p>Short the 3478A's input terminals.</p>
<p>press:</p> 	<p>Notice that the M RNG annunciator turns on in the display. This indicates that the meter is in the manual range mode. Pressing this key again returns the meter to the autorange mode.</p>
<p>press:</p>  OR 	<p>Press each of these keys several times. Watch the decimal point as it moves across the display. Also notice the range annunciator in the display. For example, if the meter is in the DC Volts function, the display should indicate MVDC or VDC depending upon the range selected. Try this in the other measurement modes.</p>

The display is always read directly and gives an indication of the range as a combination of decimal point and function display. Try connecting a variable dc power supply to the multimeter. Make sure that the meter is in the DC volts function and autorange mode. As you adjust the power supply, watch the display. The display will momentarily go blank as the meter changes ranges. You might see a reading such as 47.215 MVDC. Reading the display directly, this would indicate a measurement of 47.215 milli-volts dc (.047215 volts). It should be apparent that the multimeter is in the 300 milli-volt range; the reading is too large to be read on the 30 milli-volt range.

RANGING (Cont'd)

Table 2-4. Valid 3478A Ranges

Function	Ranges	Display Indication	HP-IB Code
DC Volts	30mV, 300mV	MVDC	R-2,R-1
	3V,30V,300V	VDC	R0,R1,R2
AC Volts	300mV	MVAC	R-1
	3V,30V,300V	VAC	R0,R1,R2
DC Current	300mA	MADC	R-1
	3A	ADC	R0
AC Current	300mA	MAAC	R-1
	3A	AAC	R0
Resistance	30 Ω , 300 Ω	OHM	R1,R2
	3K Ω , 30K Ω ,300K Ω	KOHM	R3,R4,R5
	3M Ω , 30M Ω	MOHM	R6,R7

If the multimeter is in the manual range mode, the display will indicate an OVLD when the input is greater than the particular range can handle. R-2 selects the most sensitive range on any function.

Autorange

Autoranging on the 3478A is done by taking readings in the 4 1/2 digit mode on successive ranges until it finds the proper range that will allow for a display between full scale (303099 counts) and approximately 9% of full scale (027000 counts).



Command

RA Selects autorange mode

Autorange Hysteresis

In the autorange mode, the multimeter will up range (go to a higher range) if the display reading exceeds (\pm) 303099 counts or it will down range (go to the next lower range) if the display reading decreases below (\pm) 027000 counts. This assumes a 5 1/2 digit mode. These numerical autorange points are irrespective of decimal point placement. The difference between the two points is called the autorange hysteresis and is illustrated in Figure 2-2 for DC Volts. Autoranging in other functions is similar.

RANGING (Cont'd)

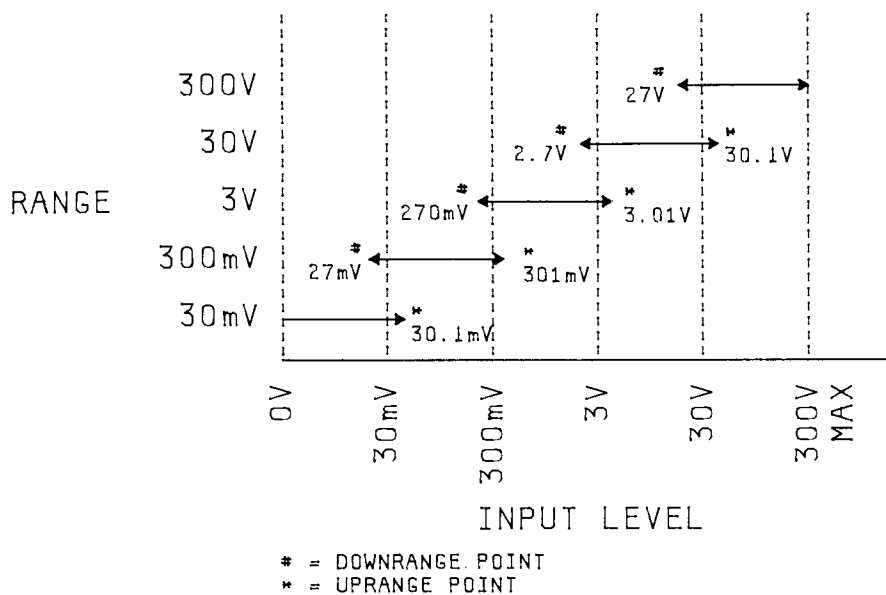

3478A-2-2

Figure 2-2. Autorange Hysteresis

Manual Ranging



The 3478A is put in the manual range mode in one of three ways: pressing the AUTO/MAN (Autorange/Manual range) key, which will cause the meter to maintain its present range; the UP-ARROW key, which will cause the meter to go to the next higher range; or the DOWN-ARROW key to go to a lower range. In any case, when the 3478A is in the manual range mode, the M RNG annunciator is on in the display. Pressing the AUTO/MAN key restores autoranging.

The highest or lowest possible range depends on the function selected. For example, 30 mV is the lowest DC voltage range but 300mV is the lowest AC voltage range. If the 3478A were set to the 30mV DC range and you pressed the AC Volts key, the meter would default to the nearest valid range, i.e., 300mV. The meter will default to the nearest valid range when a function change is made.



Command

See Table 2-4.

REAR PANEL

What is on the Rear Panel?

Figure 2-3 illustrates the rear panel of the 3478A. The Rear Panel input terminals are selected by the F/R switch on the instrument front panel. There are two BNC connectors. One is for outputting a Voltmeter complete pulse at the end of an A/D conversion. The second BNC connector is used to input an external trigger pulse. See VOLTMETER COMPLETE and TRIGGER for more information on these connectors. And of course there is the HP-IB connector.

The Rear Panel Switches

Also on the rear panel of the 3478A is a set of 8 switches. See Figure 2-3. These switches are "on", or in the "1" position when they are up. Switch number 1, farthest to the left, is the 50Hz/60Hz select switch. This switch should be in the up position if a power line with 50Hz frequency is being used, or down if a 60Hz power line is used. This switch changes the integration period (see OPTIMIZING READING RATES) of the A/D converter so as to obtain the greatest AC NMR and CMR rejection at the line frequency used. The reading rate is slightly slower when 50Hz is selected. This switch is read approximately once each minute and at power-on/reset.

Switch number 2 is not used.

Switch number 3 is used to select the Power-on SRQ (PWR ON SRQ) feature. When this feature is enabled, i.e., the switch is up, the 3478A will generate an SRQ (Request Service HP-IB message) whenever the power is lost and then returned, such as a momentary power blackout.

Switches 4 through 8 are used to select the HP-IB talk/listen address for the 3478A. The factory preset positions for these switches are, from left to right: up, down, up, up, up for a selected address of "23". In order to select the talk-only mode, all five switches must be in the "on" or up position. For more information on the HP-IB address switches refer to Appendix A.

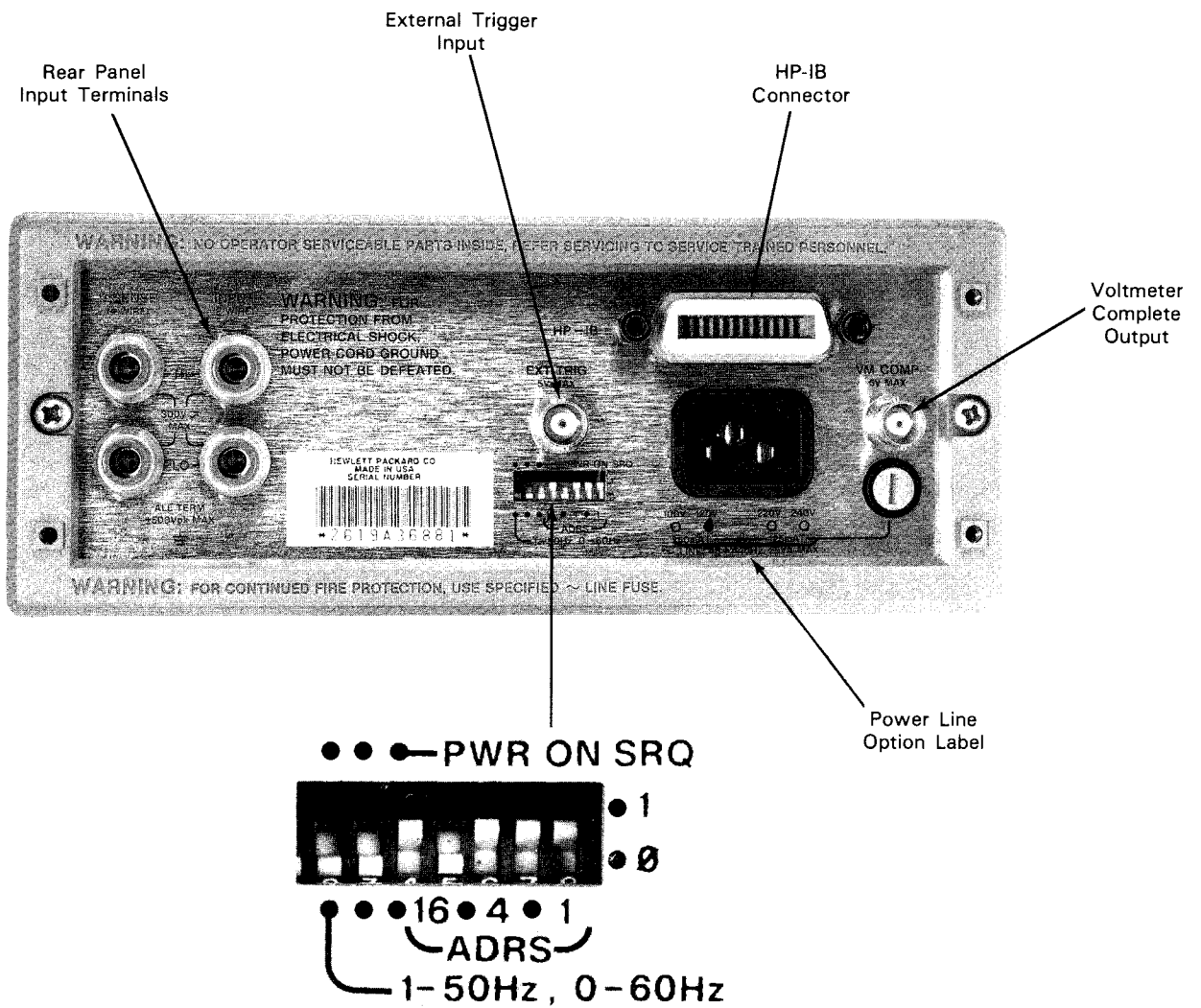

Figure 2-3. 3478A Rear Panel and Switches

RESISTANCE MEASUREMENTS

Measuring Resistance

The 3478A is capable of measuring resistance from 30 milliohm to 30 Megohms in seven ranges. Resistance measurements may be made in either 2- or 4- wire ohms configuration. The illustrations in Figure 2-4 show how resistance measurements are made. A known current is supplied by the 3478A and flows through the unknown resistance. The DC voltmeter measures the attendant voltage drop. The 3478A is factory calibrated in the 4-wire ohms mode. If most or all of your resistance measurements will be made in the 2-wire ohms mode, the 3478A may be recalibrated in the 2-wire ohms mode. See the 3478A Service Manual. Resistances in excess of 30 Megohms may be measured using the extended ohms mode (remote operation only, see Chapter 3).

How Resistances are Measured

Resistances are measured by the 3478A sourcing a known current through the unknown resistance. A dc voltage measurement is made across the resistance. The value of the resistance can then be determined (Ohm's Law, Resistance = Voltage/Current). Figure 2-4 shows the current source and the voltmeter connections for both 2- and 4- wire ohms measurements. Table 2-5 shows the nominal current through the unknown resistance for the individual ohms ranges. Variations in currents are compensated for by the calibration constants.

Table 2-5. Nominal Currents through Unknown Resistance

Range	Current Through Unknown	Maximum Open Circuit Voltage
30 Ω	1mA	6.3 V
300 Ω	1mA	6.3 V
3K Ω	1mA	6.3 V
30K Ω	100uA	5.8 V
300K Ω	10uA	5.8 V
3M Ω	1uA	5.8 V
30M Ω	100nA	5.8 V

There are two situations in which the 3478A may indicate a negative (minus) resistance: either small negative voltages may exist on the circuit under test, or the inputs to the 4-WIRE SENSE and the INPUT leads are inverted from each other in the 4-wire ohms function.

In the 5½ digit mode, the 3478A may show 10 counts or more of noise on the 30 ohm and 30 Megohm ranges. If the 3½ digit mode is used on the 30 Megohm range, special grounding and shielding may be required (due to the absence of AC normal mode rejection).

RESISTANCE MEASUREMENTS (Cont'd)

2-Wire Ohms

The two wire ohms mode is used most commonly when the resistance of the test leads is not critical. Inaccurate results may occur when using the 2-wire ohms mode if the resistance of the test leads is very high, i.e., long test leads. Suppose you are making temperature measurements with a type 44004 thermistor. Refer to Figure 2-4. At 20°C, 40 feet of #24 A.W.G. copper wire has a resistance of 1.02 ohms. Two such wires would have a total resistance of 2.04 ohms. With a type 44004 thermistor this would result in an error of .1%.



Command

F3 Selects 2-wire ohms mode (also H3)

4-Wire Ohms

The use of 4-wire ohms measurements alleviates the errors caused by the effects of test lead resistance. Figure 2-4 illustrates this point. The current through the thermistor is the same regardless of the lead resistance, and the voltmeter measures only the voltage across the thermistor, not across the combined lead resistance. The 4-wire resistance measurements are essential when highest accuracy is required, or where long lead lengths are present.



Command

F4 Selects 4-wire ohms mode (also H4)

Extended Ohms

The extended ohms feature of the 3478A is available only via the F7 remote programming command. With extended ohms, the 3478A can be used to measure resistances in excess of 30 Mohms. When in the extended ohms mode, the 3478A goes to the 30 Mohm range, 2-wire mode. An internal resistance of approximately 10 Mohms is placed in parallel with the input terminals. If this resistance is measured first and then your unknown resistor connected to the input terminals; the parallel combination can be measured and a calculation performed to determine the approximate value of the unknown resistance. The formula for the calculation is:

$$R_x = \frac{R_i * R_t}{R_i - R_t}$$

RESISTANCE MEASUREMENTS (Cont'd)

R_x is the unknown resistance, R_i is the measured value of the internal 10 Mohm resistor and R_t is the measured value of the parallel combination. The test leads used should be very short, preferably a shielded twisted pair, to minimize noise pick up.

A program to make the necessary measurements, perform the calculations, and display the value of the unknown resistor is given in Chapter III.



Command

- F7 Selects the Extended Ohms function (also H7)
(2- wire mode)

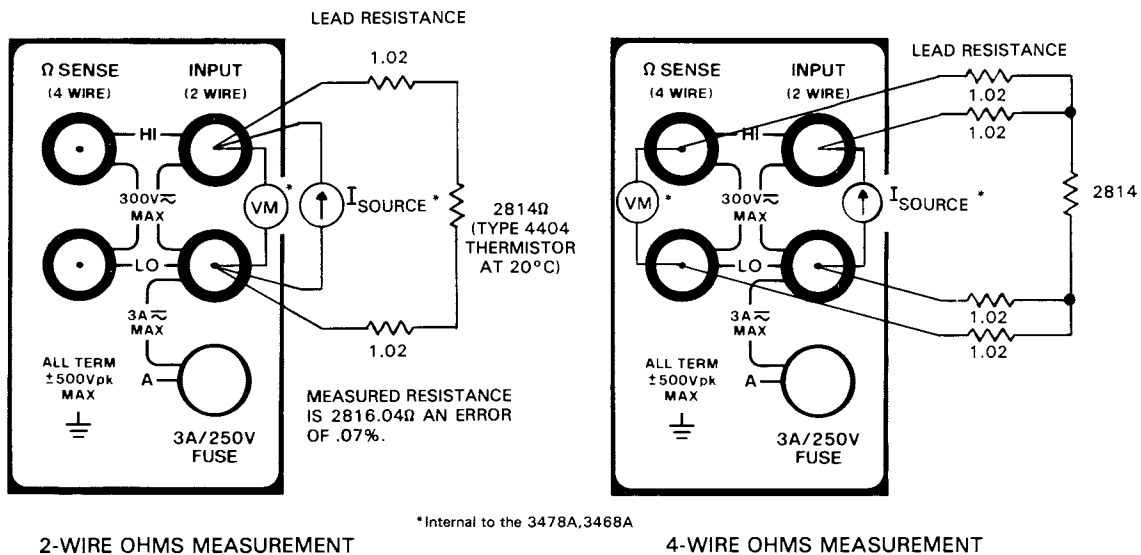

Figure 2-4. Resistance Measurements

RESISTANCE MEASUREMENTS (Cont'd)

Other Considerations

1. Always use the shortest possible test leads, especially at the higher resistance ranges. Ideally, the test leads should be a shielded, twisted pair to reduce noise pick-up.

2. For best results, especially at 3 1/2 digits display, the input LO terminal should be connected to the 3478A chassis (earth ground).

3. Additional settling time may be required when using the higher ohms ranges under program control. This is important if there is more than 200pF shunt capacitance connected externally as might be the case if you were using the 3478A with a scanner. Theoretically, the settling time necessary is:

$$-RC \cdot \ln(P/100)$$

Where R is the resistance being measured, C is equal to 620pF plus any external capacitance, and P is the desired percentage of step accuracy. For example, lets say we want to measure a 3.0 Mohm resistor through a scanner with 1200pF capacitance (High-to-Lo terminals). If a short was previously applied (short to 3.0 Mohms = step) and a .001% reading is desired, the settling time necessary is:

$$-(3 \cdot 10^6) \cdot (1200 + 620) \cdot (10^{-12}) \cdot (\ln(.001/100)) = 63\text{mS}$$

Since on the 3 Mohm range there is an internal delay of 30mS, an additional delay of 30 to 35 mS should be allowed. The 30 Mohm range has an internal delay of 300 mS.

TEST/RESET

What it Does

The 3478A self test performs several checks on the digital and A/D converter circuitry of the instrument. A failure in any of these four areas is indicated by an error message in the display. When the self test is complete, the 3478A resets to its turn-on state.

Do This

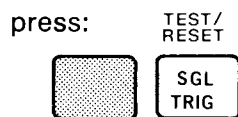

This initiates the functional tests of the digital circuitry in the 3478A. The SELF TEST starts by turning every segment in the display on (except the top dot on the colon). These segments will remain on for as long as the Self Test button is held down. When the button is released, the display will remain for approximately 2 seconds as the self test is performed. It will then display "SELF TEST OK" or an appropriate error message. If the self test passed the HP-IB address will be displayed and the 3478A returns to its power-on state. If an error was detected, and the error message displayed, the HP-IB address will not be displayed but the 3478A will attempt to operate normally.

Table 2-6. Self Test Error Messages

U.C. RAM FAIL	- This indicates that the micro-computer's internal RAM (not CAL RAM) has failed its self test.
U.C. ROM FAIL	- The 3478A internal ROM has failed its self test. This indicates an error in the ROM.
UNCALIBRATED	- The random access memory that contains the calibration constants has an incorrect checksum. The calibration of the 3478A is suspect.
A:D TEST FAIL	- The A/D converter has failed its self test.
A:D LINK FAIL	- The microcomputer is unable to communicate with the A/D converter.

For all failures refer to the 3478A Service Manual.



Command

Use the HP-IB CLEAR command.
(See Chapter III)

TRIGGER MODES

What is Triggering?

Triggering is simply the process that causes the 3478A to take a reading. There are three basic triggering modes available on the 3478A. These three modes are described after we look at the trigger indicator.

Trigger Indicator

The decimal point that is farthest right in the display will blink every time a reading is completed. If a colon or comma is placed there by a remote operation (D2 command, see Chapter III), the display will alternate between a comma and a colon.

Internal Trigger

In the internal trigger mode the 3478A triggers itself to take readings at the maximum possible rate. This mode is automatically selected at instrument turn-on and after performing Self Test. A settling delay has been added before each A/D conversion in the ac volts and current and the two highest ohms ranges to ensure accurate readings.



Command

T1 Selects the internal trigger mode

Single Trigger

The single trigger mode allows you to manually trigger the voltmeter from its front panel. The first time you press the Single Trigger key the 3478 will take one reading, display the results, and go to the single trigger mode. Subsequently, each time the key is pressed the multimeter will make one reading, display the result, and then sit idle, waiting for another trigger.

This sample and hold feature is useful when you're taking measurements in tight areas where the probe must not slip. What you do is this: press the Single Trigger key and position your finger to press the key again. You can then place the probe, press the Single Trigger key, and then remove the probe, all without taking your eyes off of the probe. With the probe safely removed, the measurement is still held on the display.

TRIGGER MODES (Cont'd)

When the 3478A is in the Single Trigger mode and you attempt to change ranges or change function, the left hand portion of the display will go blank (with the exception of the decimal point) until another trigger impulse is received.



Command

T3 Selects the Single Trigger Mode

External Trigger

The external trigger mode is enabled by the single trigger key and is identical to the single trigger mode except that the triggering impulse is applied to a BNC connector on the rear panel of the 3478A. The External Trigger input is TTL logic compatible or may be actuated by a simple switch closure. The 3478A is triggered on the negative edge of the TTL pulse which must be a minimum of 100nS duration. If a trigger pulse is received while a reading is in progress, the impulse is ignored.



Command

T2 Selects the External trigger mode

Associated HP-IB Commands

T4 Selects the Trigger Hold Mode

T5 Fast Trigger. Same as T3 except that the settling delay is omitted on AC Volts and current, and the two highest ohms ranges

NOTE

From any trigger mode, readings may also be initiated by the HP-IB GET command. External trigger is disabled by the T1, T3, T4, or T5 command.

VOLTAGE MEASUREMENTS

Measuring Voltages

Whether you use your 3478A on the bench or as part of a sophisticated test system, probably most of your measurements will be voltage measurements. If you have special requirements in taking voltage measurements, be sure to read the sections on Optimizing Reading Rates, Display, Autozero, and Triggering modes. A complete Table of Specifications is given in Chapter 4 of this manual.

DC Voltage Measurements

DC voltages measured on the 3478A are both simple and straightforward. Press the DC Voltage key and either select the appropriate range or allow the multimeter to autorange. Read the display directly (no multiplying the reading by the range, etc.) for the measured voltage. Up to 1 microvolt of noise may be seen on the 30 millivolt range.



Command

F1 Selects the DC Volts mode (also H1)

AC Voltage Measurements

Like DC voltage measurements, AC measurements are very straightforward. Press the AC Voltage key and appropriate range key(s). The display is read directly for the measured voltage.

The 3478A uses a True RMS to DC converter for AC voltage and current measurements. Unlike multimeters that use an average detector, the True RMS converter allows accurate measurement of voltages that are often noisy, non-periodic or non-sinusoid. The RMS converter will accurately measure the True RMS value of sawtooth or triangle waveforms; squarewaves; or low repetition rate, high crest factor (ratio of peak to RMS) pulse trains.

VOLTAGE MEASUREMENTS (Cont'd)

RMS measurements are made by calculating the instantaneous square of the input signal, averaging it and taking the square root of the result. This provides a DC voltage that is proportional to the RMS value of the waveform. A DC voltage measurement is then made by the A/D converter.

It should be noted that the AC voltmeter accuracy is specified only for inputs greater than 10% of full scale. Hence the specified range is 30 millivolts to 300 volts. The 300 millivolt range is useful for lower accuracy readings down to 1 millivolt. Up to several hundred counts of residual offset may be seen on the 5½ digit display with the input shorted.



Command

F2 Selects the AC Volts mode (also H2)

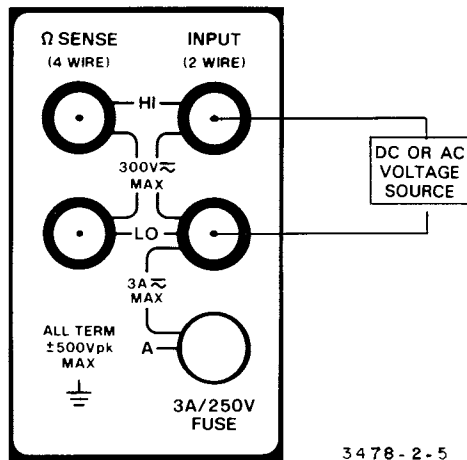

Figure 2-5. Voltage Measurements

VOLTMETER COMPLETE

What is Voltmeter Complete?

The Voltmeter Complete BNC connector on the rear panel of the 3478A provides a pulse at the completion of every A/D cycle. This pulse is used to indicate that the 3478A is ready to output an answer or be retriggered. The pulse is a negative going TTL compatible pulse of about $1\mu\text{S}$ duration.

Using the Voltmeter Complete Pulse

The following illustration shows one way to use the Voltmeter Complete and External Increment feature of the 3478A in conjunction with the -hp- Model 3852A Data Acquisition/Control Unit. Once the connections are made, the 3852A advances to the next channel with each Voltmeter Complete pulse.

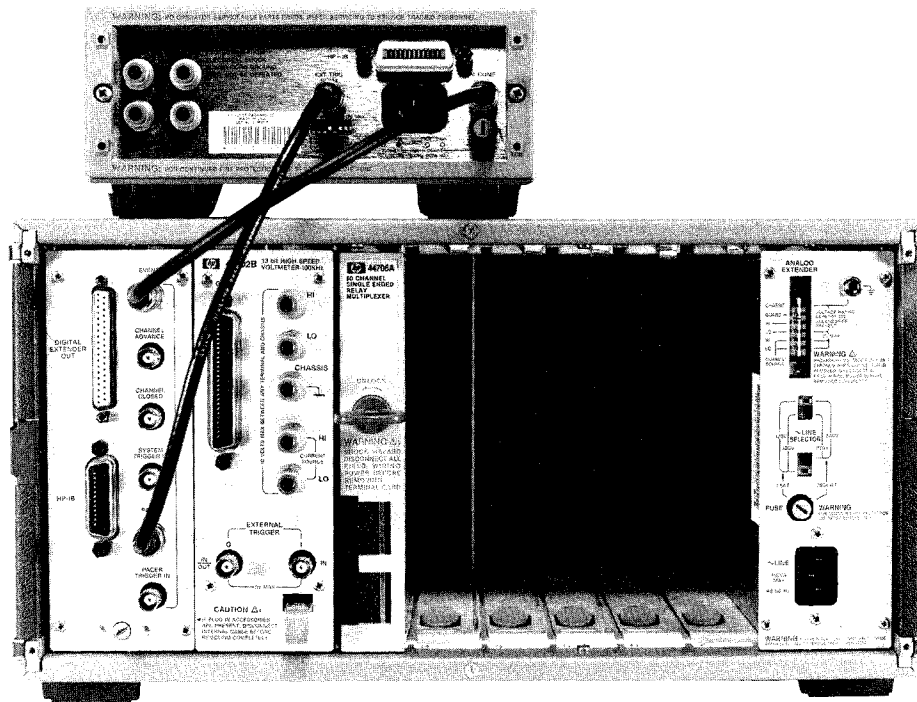

Figure 2-6. Using Voltmeter Complete

Chapter III

Remote Programming

Introduction

In this chapter you will learn about remote programming your 3478A over the Hewlett-Packard Interface Bus (HP-IB) using a computer / controller. If you are not familiar with HP-IB or some of the terms used in this chapter, Appendix A contains a concise description of HP-IB. Be sure that you have read through or at least familiarized yourself with Chapter 2 of this manual before starting this chapter. You will need to understand the operating characteristics of the 3478A before you begin programming it.

Scope

The descriptions presented in this chapter are in general terms to optimize the flow of information regardless of the type of controller you are using. This means that both the inexperienced user as well as the experienced programmer will be programming the 3478A efficiently and productively with minimum instruction time. There are, however, many example programs given to enhance the discussion, most of which are given in HP BASIC for -hp- Series 200/300 computers.

Trying Out a Command

Before we actually begin the programming discussion, let's look at a simple example that displays your name on the 3478A display. If you have one of the controllers shown below, type in the commands as shown. Even if you don't have one of the controllers listed, read through this section anyway as it provides a basis for later discussions. Enter the command exactly as shown using your own name capital letters - in place of "your name".

Computer	Type The Message:	Press:
-hp- 9825	wrt 723,"D2your name"	[EXECUTE]
-hp- series 200/300, 85	OUTPUT 723;"D2your name"	[RETURN] (on the -hp- 85, PRESS [END LINE])

Actually, any message of up to 12 characters may be displayed in this manner. The command "D2your name" tells the 3478A to display the message "your name" in its display; "D2" is called the "COMMAND CODE". The 3478A cannot display lowercase letters, it displays unusual symbols instead. It can display, however, special characters such as \$, %, &, #, etc. Try these characters in place of "your name".

At the end of this chapter are several blue pages that describes each of the program commands the 3478A will respond to, and how they are used. As an added plus, at the back of the manual is a Command Quick Reference Guide that you can tear out and keep with your 3478A.

Addressing

Do This

press: ADRS

LOCAL		SRQ
-------	--	-----

The 3478A will display its HP-IB address in the form: HPIB ADRS XX. XX represents the actual address which is factory preset to 23.

Each instrument that you connect to the interface bus has a unique "address", and the 3478A is no different. The address provides a way for the controller to send or receive data from one instrument on the bus when actually there are several instruments connected together. In the previous example, where you displayed your name, we used the statement "OUTPUT 723". The "723" refers to the controller interface select code (isc) which is 7 and the 3478A factory preset address which is 23. If you need to change the address of the 3478A refer to the installation information in Chapter 4. All the examples in this chapter assume that the 3478A will be addressed at 723 (which is also called the device select code, dsc).

When the controller tells a particular instrument to talk, i.e., send data over the Interface Bus, we say that the instrument has been "Addressed to Talk". Likewise, when the controller tells an instrument to listen, i.e., receive data or instructions from the Bus, the instrument is said to have been "Addressed to Listen". The 3478A is capable of both talking and listening or it may be set to Talk-only, in which case it cannot listen to instructions or data coming over the Bus. There can be only one instrument addressed to talk on the Bus at any one time.

Sending Instructions to the 3478A

The Instruction Message is one specific form of an HP-IB Data message (see Appendix A). It is used to cause the 3478A to change states, i.e., make an ac measurement instead of a dc measurement, or perform a particular operation such as output status information, etc. Look at the blue pages at the end of this chapter. They describe each of the Instruction Messages the 3478A will respond to and how they are used. An abbreviated table is given in the Command Quick Reference Guide.

Look at Figure 3-1. The instruction message may contain from one to three parts as shown: the Operation Mnemonic, Qualifier, and Data. The Operation Mnemonic is a single letter which is always used. The Qualifier and Data portion of the message are used as defined by the operation to be performed. An example of a command which requires only the operation mnemonic is the "S" command. A function or range command requires the mnemonic plus a qualifier, e.g., "F2" or R-1. The "D2" or "D3" commands require the mnemonic "D", a qualifier (either 2 or 3), and data, which is the text to be displayed. The diagram also shows that instructions may be linked together forming a string of instructions.

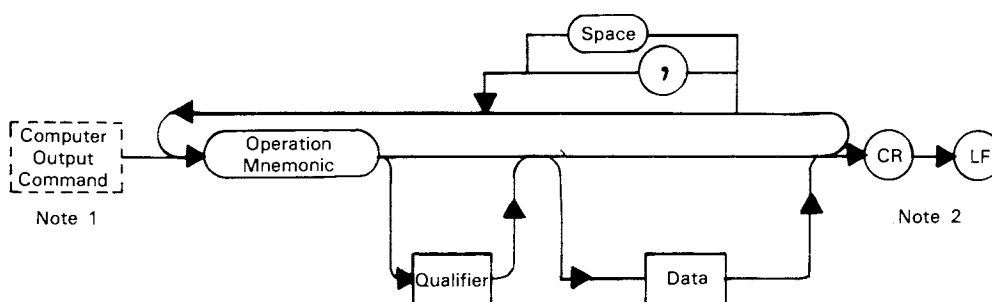

Note 1. The computer or controller output command as shown in the figure includes the HP-IB address of the instrument to which the Instruction Message is being directed, i.e., 723. It also includes any delimiters required by the computer language syntax. A delimiter is a character that is used either to separate one expression from another, or to terminate a list. Delimiters include semicolons, quotation marks, commas, spaces, etc. When linking instructions it is not necessary to add delimiters between instructions.

Note 2. Some computers and controllers generate a Carriage Return/Line Feed (CR/LF) automatically as part of the output command. Check the output command syntax for your specific computer. The CR/LF is a delimiter that terminates a list. The 3478A ignores the CR/LF except in the D2 or D3 commands.

Figure 3-1. Sending Instructions

Procedure

Decide what you want the instrument to do and determine the appropriate Operation Mnemonic(s). For example, the Operation Mnemonic for function codes is F, the Mnemonic for range codes is R, etc. Specify the Qualifier and Data as necessary. Let's look at an example and break down the instruction message. To set the 3478A to the DC Volts function and 30 volt range, the following message would be sent:

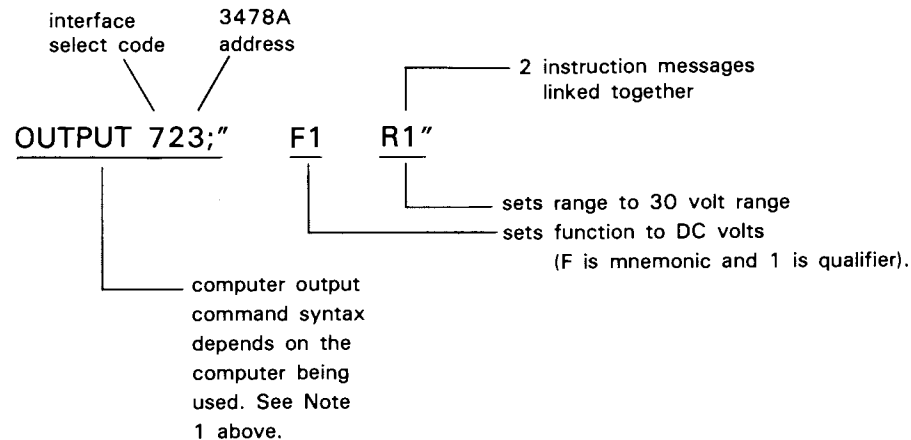

Figure 3-2. Instruction Example

As you can see from the example, more than one instruction may be sent to the 3478A at one time; any number of instructions may be included in the command string. In the next section we will look at the HOME commands of the 3478A. Each HOME command is actually made up of several instructions. But for now, let's take another look at using multiple instructions.

Sample Problem

We want to make an ac voltage measurement that we know to be between .20 volts and 1 volt. We also want Autozero on and the measurement to be made in the 4 1/2 digit mode. What series of instructions will achieve this?

First, it is an ac voltage measurement, therefore instruction "F2" (Function 2) is used. We don't know exactly what range to use, so let's use the autorange feature, "RA" (Range Auto). The instruction for autozero on is "Z1" (Zero 1), and for the 4 1/2 digit mode, "N4" (Number of digits 4). Our command string now looks like:

"F2RAZ1N4"

Since we know the voltage to be measured is small, let's set the 3478A to a low range before we autorange. The instruction "R-2" (Range -2) will do this for us. Furthermore, if we want the meter to only take one reading we could add the instruction "T3" (Triger mode 3) to the end of the string. By adding it at the end, the meter is set up for the measurement before the reading is actually triggered. The complete string, along with the OUTPUT statement is:

OUTPUT 723; "F2R-2RAZ1N4T3"

Instructions are implemented as they are received over the Bus. In other words, the 3478A will go to the ac volts mode before it goes to the lowest range. It will go to the lowest range before autorange, it will autorange before turning autozero on, etc. The last thing it will do is trigger for the measurement.

A very important matter to keep in mind is to use the proper computer syntax. Remember that the examples given in this chapter were written for a computer such as the -hp- 85F. Check your computer I/O manual for the correct syntax and in the examples given, use that syntax.

Home Commands

There is a series of eight preset commands conveniently provided in the 3478A which greatly ease programming. These commands, called HOME commands, set the 3478A to predetermined states as defined in Table 3-1. In the sample program given earlier, we ended with a string of six commands which could actually be replaced with one HOME command, "H2".

Table 3-1. Home Commands

<u>Command</u>	<u>Description</u>
H0	HOME Command. The 3478A is placed into the DC volts function (F1), autorange (RA), trigger hold (T4), 4 1/2 digit display (N4), and autozero on (Z1). Any result ready to be output to the bus or display is erased. External trigger input is disabled. This command is equal to: "F1T4R-2RAZ1N4". The meter will wait for a trigger command such as T3 or T5.
H1	Measure DC Volts. This function is the same as the H0 command except that a single trigger occurs, and if the 3478A is addressed to talk will output the reading. This command is equivalent to: "F1R-2RAZ1N4T3"
H2	Measure AC Volts. This command is the same as H1 except that an AC Voltage measurement is taken. Equivalent to: "F2R-2RAZ1N4T3"
H3	Measure 2-Wire Ohms. Identical to H1 except takes a 2-wire ohms measurement.
H4	Measure 4-Wire Ohms. Identical to H1 except takes a 4-wire ohms measurement.
H5	Measure DC Current. Identical to H1 except takes a DC Current measurement.
H6	Measure AC Current. Identical to H1 except takes an AC Current measurement.
H7	Measure Extended Ohms. Identical to H1 except take an extended ohms measurement.

Using the Home Commands

You can use the HOME commands just as they are or combined with other commands. For example:

```
OUTPUT 723; "H1"
```

would set the 3478A to the DC Volts function and take one reading. If you want the 3478A to be in the internal trigger mode you could send:

```
OUTPUT 723; "H1T1"
```

In order for "T1" to be in effect, it must follow the "H1" command, otherwise the "H1" command will put "T3" in effect.

Programming Hints

When more than one command is sent to the 3478A in one "OUTPUT" instruction statement, the commands are executed as they arrive. Therefore it is best to make the trigger statement the last statement in the command string so that the 3478A will be set up for the measurement before it triggers. If you send the command "T3T1", the "T1" command is the last one received and will be in effect.

Instructions are sent to the 3478A as a series of 7-bit ASCII characters (parity bit is ignored). All lowercase letters, spaces, commas, and semicolons are ignored and may be freely used to format commands for easy readability. All null characters, carriage return, line feed, form feed, and vertical and horizontal tab characters are also ignored. All other characters and sequences not explicitly allowed (see the Command Table) will result in an error. Errors will be discussed later. For example, sending the message:

```
OUTPUT 723;"Function 1 Range 1"
```

would be the same as:

```
OUTPUT 723;"F1R1"
```

When a multicharacter command is received, if a character is received which does not fit into the syntax of the command, the command will be aborted and an error will be generated. An attempt is made to process the character as if it were the first character of another command. For example, the command "FR3" will cause a syntax error but then go on to range 3 (that is, "R3"). See Require Service, Status Register.

Commands which accept binary arguments (represented by x in the command table) and the D2 and D3 commands are exceptions to the above rules. Any of the 256 possible 8-bit bytes may be sent as a binary argument, any ASCII character greater than 31 (decimal) may be sent as part of a text message (see Appendix B). Note, however, that lowercase alpha characters are not represented as alpha characters in the display.

Receiving Data from the 3478A

The 3478A has the ability to talk to the computer or other instruments, giving the results of measurements or status information. This is another specific form of the HP-IB Data Message. The controller must tell or "address" the 3478A to talk in order for it to send data.

Example. From the last section we saw how to make the voltmeter go to the DC Volts function and 30V range. Now we will see how to read back the measured voltage.

```
10 OUTPUT 723;"F1R1"    (from the last section)
20 ENTER 723; A$
30 DISP A$
40 END
```

The 3478A is addressed to talk by the ENTER 723 command in the second line. The measurement result is stored in the string variable A\$ and displayed on the controller's display. Remember that the actual computer syntax used (i.e., ENTER, OUTPUT, DISPLAY, etc.) is dependent on the computer that you are using and may be different than the examples given. You should refer to your computer's I/O programming manual.

Let's try another very simple example. You can use your controller to determine the setting of the 3478A's Front /Rear switch. This is done by sending the program command "S" and then reading the output.

Do This

Enter the following program and run it.

```
10 OUTPUT 723; "S"
20 ENTER 723; S1
30 DISP S1
40 END
```

If the value read back from the 3478A (variable S1 in the example shown) is "0" the rear panel terminals are selected. If the value is "1" the front panel terminals are selected. Try this program with the switch in both positions. If the 3478A is in the single trigger mode (S TRIG annunciator on) this program will not work. Either press [LOCAL] [INT TRIG] keys or reset the voltmeter.

Output Format

Messages are sent by the 3478A as 13 bytes in the following formats:

Voltmeter Reading: $\pm d.dddddE\pm d$ CR LF
Overload: $+9.99999E+9$ CR LF

The character "d" represents a single digit. If the 3478A is in the 4 1/2 digit mode, the last digit returned before the "E" will be a "0". In the 3 1/2 digit mode the last 2 digits will be "0"'s.

3478A Bus Capabilities

So far we have seen how to program the 3478A for specific operations and how to read back the data. But now it is time to move on and look at special HP-IB commands and advanced programming topics.

Talk Only Mode

Many applications of the 3478A, a simple data logger for example, may require that the instrument take readings and output them to some device such as a printer. All this is to be done without the aid of a controller. The 3478A's TALK ONLY mode allows this type of transaction to occur.

The 3478A is set to the talk only mode by setting the 5 HP-IB address switches, on the 3478A rear panel, to the "1" (up) position. Refer to Chapter 4. Measurement data is output after each completed reading. Function and range settings, etc., are done from the front panel keyboard.

3478A Response to Bus Messages

The following topics, arranged in alphabetical order, deal with HP-IB commands (see Appendix A) and the way the 3478A responds to them. Refer to the I/O programming manual of your controller for specific information on syntax and actions taken by the HP-IB interface when sending the message. The examples given apply to the -hp- 85, 9835, 9845 and 200/300 series computers, except where noted.

CLEAR

Examples

```
CLEAR 7      (device clear)
CLEAR 723    (selected device clear)
```

Comments

Upon receiving the CLEAR message, the 3478A will be placed into its test/reset routine. The routine starts with the 3478A performing its internal self test and reading its rear panel HP-IB address switches. Any errors in the self test will be noted in the voltmeter display and will cause the hardware error bit to be "set" in the status register and the appropriate bits to be set in the error register. If there are no errors, the HP-IB address will be displayed for approximately 2 seconds. The power-on state for the 3478A is: DC Volts function, Autorange, Internal Trigger, Autozero On, and 5 1/2 digit mode.

LOCAL

Examples

```
LOCAL 7  
LOCAL 723
```

Comments

The LOCAL 723 message clears the 3478A from the REMOTE operation mode and reenables front panel control. Pressing the front panel LOCAL key accomplishes the same thing, provided the key has not been disabled by the LOCAL LOCKOUT Message. LOCAL 7 removes every instrument on interface 7 from the remote mode.

If the 3478A is in Remote with Local Lockout set, the only way to return to front panel control is to either turn power off and then on again or execute the Clear Lockout / Set Local (CL/SL) message. For many controllers this is the same as the LOCAL command, i.e., LOCAL 7. The command LOCAL 7 takes all instruments out of Local Lockout that are on that bus. The command LOCAL 723 would return the 3478A to front panel control but a subsequent REMOTE command (or OUTPUT 723) would return it to LOCAL LOCKOUT.

LOCAL LOCKOUT

Example

```
LOCAL LOCKOUT 7
```

Comments

The LOCAL LOCKOUT message locks out the 3478A's front panel keys, including the LOCAL and SRQ keys. The lockout will remain in effect until it is cleared over the interface bus by sending the LOCAL message to the multimeter or cycling the 3478A's power.

REMOTE

Examples

```
REMOTE 7  
REMOTE 723
```

Comments

The REMOTE command is used to enable the 3478A to switch from local front panel control to remote program control. The 3478A must actually be addressed before it will go into its Remote state.

The Remote state for the 3478A means that the front panel keyboard (except the LOCAL and SRQ keys) is disabled. The REM annunciator in the display is turned on. The 3478A remains in the same state after it receives the REMOTE command that it was in before receiving it. To disable the LOCAL and SRQ keys use the LOCAL LOCKOUT command.

You will seldom find it necessary to execute the REMOTE command. The REMOTE message is independent of other HP-IB activity and is sent on a single Interface Bus line called REN (see Appendix A). Some controllers set the REN line true at power-on, or when reset, which has the same effect as sending the Remote message with only the interface select code, i.e., REMOTE 7. Before any instrument will actually go into the Remote state it must be addressed. Therefore, when the 3478A is first addressed, such as OUTPUT 723, it will actually go to the remote state.

REQUIRE SERVICE (SRQ)

Another important feature of the 3478A is that you can program it to interrupt the controller when certain conditions are met. Of course, the controller must also be programmed to respond to the interrupt. The Require Service (SRQ) message is used to implement this and is independent of all other HP-IB activity. SRQ is sent on a single Interface Bus line called the SRQ line (see Appendix A). The 3478A **MUST BE PROGRAMMED** for the interrupt before the interrupt will take place. The following list gives the possible causes of interrupt that the 3478A can be programmed for.

1. Power-on/ Reset. The 3478A will interrupt the controller when the 3478A power is turned on, it received a Device CLEAR or Selected Device CLEAR, or the 3478A was reset.
2. CAL Failure. The 3478A will interrupt the controller if an attempted calibration failed.
3. Front Panel Keyboard. You can use the front panel SRQ key on the 3478A to interrupt the controller.
4. Hardware Error. If a hardware error occurs, the controller would be interrupted.
5. Syntax Error. If the controller sent an invalid instruction, the 3478A would interrupt the controller.
6. Data Ready. The 3478A would interrupt the controller after each completed measurement.

How to use SRQ

When the Require Service message (SRQ) is sent, the computer must determine first which instrument is requesting service. This is done by conducting a SERIAL POLL (SPOLL) of every device on the bus which is capable of requesting service. When an instrument is polled, it responds by sending a "STATUS BYTE" which indicates whether it requested service, and if so, the nature of the request. If the Status Byte for the instrument polled indicates that it was not requesting service, the computer would continue to poll the other instruments on the bus until the proper one is located. This, of course assumes that the controller has been programmed to respond to the SRQ interrupt.

Status Register and Status Byte

The status register is used to monitor the six possible interrupt conditions. It is possible for one or more bits of the status register to be true without the 3478A causing an interrupt. The interrupt will only occur when the SRQ mask has been set for particular conditions. Refer to Figure 3-3. If the SRQ mask is set for certain conditions and one or more of those conditions occur, bit 6 of the status register will go true (true being a "1"), the SRQ annunciator in the display will turn on, and the HP-IB SRQ message will be sent. The controller must be programmed to respond to the SRQ message.

The Status Byte is an 8-bit byte that may be used to determine the current status of the 3478A regardless of whether an interrupt (SRQ) has occurred. The Status Byte comes from the status register and is output in response to a serial poll which is described in the next section.

Bit 7	Bit 6	Bit 5	Bit 4	Bit 3	Bit 2	Bit 1	Bit 0
power-on Reset	SRQ	Cal Failed	Front Panel SRQ	Hardware Error	Syntax Error	N/A (always 0)	Data Ready

Figure 3-3. Status Register

Setting the SRQ Mask

The SRQ mask can only be set to mask bits 0-5 on the Status Register. Default mask value is 00. To set the mask first determine which conditions you want to interrupt the controller, e.g., data ready, calibration procedure failed, syntax error, etc. Determine the two digit octal code for those conditions. Then, output the "M" instruction mnemonic followed by the octal code as the qualifier, that is: "Mxx", where xx is the octal code. Think of the SRQ mask as a mask that sits over the lower six bits of the status register and masks out those conditions you don't want to cause an interrupt. Figure 3-4 shows the status register and the SRQ mask set for bit 0, Data Ready.

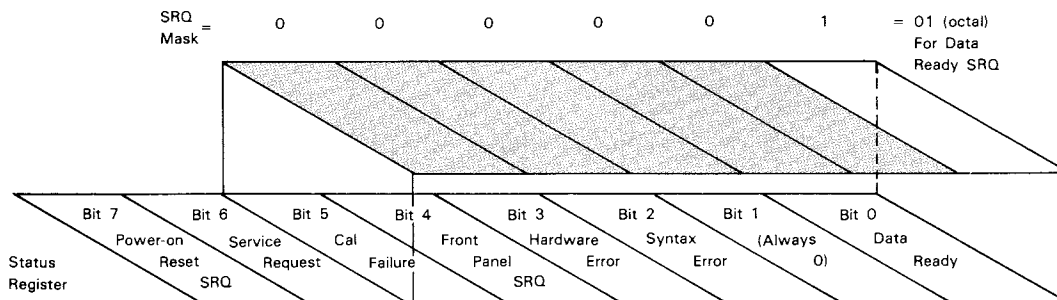

Figure 3-4. Status Byte and SRQ Mask

Example 1. Data Ready SRQ

Data Ready is a feature of the 3478A that allows it to interrupt the controller after each completed measurement (data ready). This means that the controller doesn't waste valuable computing time waiting for measurement data but proceeds with its work until interrupted. To enable the data ready feature on the 3478A, bit 0 on the SRQ mask must be set. Remember that bit 0 will be true in the status register anytime data is ready but for the SRQ to occur the mask must be set. The bit pattern for the mask would look like:

bit #:	5	4	3	2	1	0
value:	0	0	0	0	0	1
	└──────────┘			└──────────┘		
	0			1		

01 is the octal representation
(see also Figure 3-4)

Consequently, we would use the command: `OUTPUT 723;"M01"` to set the mask for Data Ready. Therefore, whenever the 3478A has data ready it will interrupt the controller via the SRQ line. The controller will only be interrupted if bit 0 is true, meaning that data is ready. Bits 1 through 5 will not interrupt the controller if they go true because the mask was not set for those bits. When data becomes ready, the SRQ annunciator turns on in the display, and remains on, until the controller responds by doing a serial poll, executing the `CLEAR` command, outputting the "K" instruction, or entering a measurement from the 3478A.

```

10 ! DATA READY EXAMPLE
20 ! -hp- 85 VERSION
30 ! 3478A AT ADDRESS 723
40 OUTPUT 723 ;"KM01"
50 ON INTR 7 GOSUB 1000
60 ENABLE INTR 7,8
70 ! The body of the program goes
   here
990 END
1000 P=SPOLL(723)
1010 STATUS 7,1 ; A
1020 ENTER 723 ; R
1030 DISP R
1040 RETURN

```

Line	Description
40	Outputs the SRQ mask. The "K" command clears the status register (except bit 0).
50	Instructs the computer where to go (line 1000) when an interrupt (SRQ) occurs on interface 7.
60	ENABLE INTR7;8 actually enables the -hp-85 to respond to the SRQ. SRQ is octal code "8" in the -hp- 85 control register.
70-990	These lines contain the main body of the program
1000	This is the start of the interrupt subroutine. SPOLL returns the 3478A status byte to variable "P". It also resets bit 6, if it was set, of the status register.
1010	The STATUS command reads and clears the -hp- 85 Status/Control register so that it can respond to the next interrupt.
1020-1040	Line 1010 reads the data and resets bit 0 of the status register. Line 1020 displays the data. Line 1030 returns program control to where the program was interrupted.

Example 2. Front Panel SRQ

The front panel SRQ feature of the 3478A provides you with a way of manually interrupting the controller from the multimeter front panel. This feature is enabled by setting bit 4 of the SRQ mask, command "M20". Once this is done, pressing the 3478A front panel SRQ key causes the 3478A to request service (SRQ) from the controller. The SRQ annunciator turns on in the display until the controller responds by doing a serial poll (or the CLEAR command, or "K" instruction).

Line	Description
10 ! FRONT PANEL SRQ EXAMPLE	
20 ! -hp- 85 VERSION	
30 ! 3478A AT ADDRESS 723	
40 OUTPUT 723 ;"KM20"	
50 ON INTR 7 GOSUB 1000	
60 ENABLE INTR 7;8	
70 ! The body of the program goes here	
990 END	
1000 STATUS 7.1 ; A	
1010 P=SPOLL(723)	
1020 IF BIT(P,4) THEN DISP "SRQ KEY PRESSED"	
1030 RETURN	
40	The "M20" statement sets the 3478A to respond to the front panel SRQ key. The "K" clears the status register, except bit 0.
50	This tells the computer where to go (line 1000) when an SRQ interrupt occurs.
60	ENABLE INTR actually allows the controller to respond to interrupts.
70-990	These lines contain the body of the program.
1000	Line 1000 is the beginning of the interrupt subroutine. The STATUS command reads and clears the -hp- 85 Status/ Control register so that it can respond to the next interrupt.
1010	SPOLL returns 3478A status byte to variable P. It also clears the status register.
1020	Bit 4 of the status byte (P) is checked to make sure it is a "1". If it is, the message SRQ KEY PRESSED is displayed. If it isn't, then something else caused the interrupt.
1030	This line returns program control to where it was interrupted.

SPOLL

Example

```
SPOLL (723)          (-hp- 85, 200/300 series computers)
STATUS 723;P        (-hp- 9835, 9845A/B)
```

Comments

Serial poll allows you to determine the current status of the 3478A. When the 3478A receives the serial poll message, it returns its status byte (status register). Many controllers will display the byte as the sum of the values of the individual bits that are set. If bits 7 and 0 are set, for example, the value would be shown as 129 (129 = 128 + 1). The 8 bits of the status byte and their respective values are shown in Figure 3-5, followed by a description of the bits.

	Bit 7	Bit 6	Bit 5	Bit 4	Bit 3	Bit 2	Bit 1	Bit 0
	power-on Reset	SRQ	Cal Failed	Front Panel SRQ	Hardware Error	Syntax Error	N/A (always 0)	Data Ready
Decimal Value	128	64	32	16	8	4	2	1

Figure 3-5. Status Byte

- Data Ready
Bit 0 When this bit is set to 1, it indicates that the 3478A will output a reading if it is addressed to talk. This bit will return to 0 when the controller begins to accept the reading, or when some change in the programmed state of the 3478A causes the reading to be no longer available.

- Bit 1 This bit is always 0.

- Syntax Error
Bit 2 When set to 1 this bit indicates that a command has been received over the HP-IB that is syntactically incorrect.

- Hardware Error
Bit 3 This bit, when it is set to 1, indicates that a hardware error of some sort has occurred. This may be the failure of a self test routine, a problem with the A/D converter, or a checksum error in the calibration RAM. More information can be obtained about the error by reading the 3478A error register (see the B and E bus commands). The calibration RAM checksum is checked every time a reading is made.

SPOLL (Cont'd)

Front Panel Bit 4	SRQ When this bit is set to a 1 it indicates that the front panel SRQ button has been pressed.
Calibration Fail Bit 5	This bit is used to indicate that an attempted calibration has failed. The bit will be set to 1 under this condition.
Service Request Bit 6	This bit indicates that the 3478A has requested service via the SRQ line. The bit is set to 1 whenever one of the events specified for bits 0 through 5 above occurs at the same time that the corresponding bit in the mask register is set. The bit is also set at power-on time if the PWR ON SRQ switch on the rear panel is turned on. This bit is reset by a serial poll.
Power-on Reset Bit 7	This bit is set to 1 when a power-on reset has occurred. If switch 3 on the rear panel block of switches is set to the "1" or up position, bit 6 will be true and the SRQ message is sent. Bit 7 will be cleared if a reset due to the HP-IB CLEAR command occurs or the TEST/RESET key is pressed. It is also cleared when the 3478A is Serial Polled.

All status register bits described above are reset by a Device Clear Message. Bits 2 through 7 are also reset by a serial poll if bit 6 was read as a 1. If bit 6 is read as a 0, indicating that the 3478A was not generating an SRQ, no bits are changed. See also the K command in the Quick Reference Guide.

Try this simple exercise.

1. Reset the 3478A. This should be done by cycling the LINE switch. Without setting the SRQ mask, perform a serial poll on the 3478A. Remember to check the command structure for the controller you are using. The status byte returned by the 3478A should indicate that bits 0 and 7 are true. Many controllers will show a value of "129". Looking at Figure 3-5 we can see that the value 129 is equal to the sum of the decimal values of bits 0 and 7. Bit 7 is true because of the power-on/reset that occurred. Bit 0 indicates that a measurement has been made and data is ready. This step of the exercise simply serves to show that bits in the status register may be true without causing the Service Request message to be sent. Remember that when Service Request is sent, the SRQ annunciator turns on.

SPOLL (Cont'd)

2. Now turn the 3478A off. On the rear panel find the bank of 8 switches and set switch 3, Power-on SRQ, to the up (1) position. When you turn the 3478A back on, the SRQ annunciator should be on in the display. Now do a serial poll. The status byte returned by the 3478A shows a value of 193. This means that bits 7, 6, and 1 were true ($128+64+1=193$). Bit 6 is true because of the power-on SRQ condition. Bit 7 is true, as in the first step, because a power-on reset occurred. Because the Power-on SRQ switch was "SET", when the 3478A was turned on, it sent the Service Request message (SRQ). After you do the serial poll, the SRQ annunciator will turn off.

3. Finally, turn the 3478A off and return switch 3 to the down position. Turn the 3478A on, notice that the SRQ annunciator is not on, and send it the message "M01". M01 sets the SRQ mask for the data ready condition. In just a moment the SRQ annunciator will turn on in the display. Again do a serial poll. The value returned should again be 193 (bits 7, 6, 1). This time the SRQ occurred because the SRQ Mask was set for bit 0, Data Ready. Do another Serial Poll and notice that the SRQ annunciator goes off momentarily until new data is available. The value returned from this second Serial Poll is 65 because bit 7 was cleared by the first poll.

The previous section on Service Request gave two example programs demonstrating SRQ interrupts. Look at the second program, FRONT PANEL SRQ. Change line 70 to read: 70 GOTO 60 and run the program. Line 40 sets the SRQ mask to front panel SRQ. Line 1000 performs a serial poll when, and only when, an SRQ condition occurs (i.e., when you press the 3478A SRQ key). Line 1010 looks at bit 4 of the Status Byte to verify that it was the front panel SRQ key that caused the interrupt.

TRIGGER

Examples

```
TRIGGER 7  
TRIGGER 723
```

Comments

If the 3478A has been addressed to listen, the TRIGGER message (also known as GET, for Group Execute Trigger) will trigger the multimeter for a new reading. If a reading is in progress at the time the TRIGGER message is received, the reading will be aborted and a new reading started. If a reading is in progress when the TRIGGER message is received, there may be a delay (up to 1/2 second) for the previous A/D cycle to be aborted and the new reading to commence.

Topics in Advanced Programming

The following five programs illustrate the flexibility and measurement power of the 3478A. The programs include using a thermistor to accurately measure temperature, achieving the maximum reading rate, using the 3478A Status Bytes, and more. Although the programs were developed on an -hp- series 200/300 computer they may easily be modified to run on any other controller. In many cases, suggestions are made for modifying the programs to suit your individual needs.

TEMPERATURE MEASUREMENTS

The program shown in the following figure computes the temperature, in °C, corresponding to the resistance of a thermistor. The program has been designed to work with thermistors exhibiting a 5.000 K Ω resistance at 25°C, such as a type 44007 (-hp- part number 0837-0164) or equivalent.

The program gives you the option of selecting either 2-wire or 4-wire ohms measurements to be made on the thermistor. As it stands, the program sets the 3478A for a 2-wire measurement which gives suitable results if the thermistor is used at a temperature where its resistance is much greater than the resistance of the test leads. For greatest accuracy from a thermistor, a 4-wire resistance measurement should be used. To change to a 4-wire resistance measurement, delete the first exclamation mark (!) from line 100. The program is useful over a temperature range of -80°C to +150°C.

```
10    ! Temperature measurement with type 44007 thermistor
20    ! -hp- series 200/300 BASIC
30    !
40    Dvm=723                ! Factory set address is 723
50    CLEAR Dvm             ! Set DVM to known state
60    DISP "Clearing HP 3478A..."! Inform operator of operations
70    WAIT 2                ! Wait for DVM to finish reset
80    OUTPUT Dvm;"F3R4N4Z1T1" ! Set DVM to 2-wire ohms, 30Kohm range,
90                                ! 4.5 digits, Azero on, Internal trigger
100 !OUTPUT Dvm;"F4R4N4Z1T1" ! Set DVM to 4-wire ohms, 30Kohm range,
110                                ! 4.5 digits, Azero on, Internal trigger
120 Q1=.001286              ! Type 44007 thermistor constant
130 Q2=.00023595           ! Type 44007 thermistor constant
140 Q3=.0000000941         ! Type 44007 thermistor constant
150 LOOP                    ! Start continuous measurements
160  ENTER Dvm;B            ! Enter DVM reading
170  Q4=LOG(B)              ! Calculate Q4
180  P=1/(Q1+Q4*(Q2+Q4*Q4*Q3))-273.15 ! Calculate temperature (P)
190  DISP "The temperature is ";P;" deg. C" ! Display temperature (P)
200 END LOOP
210 END
```

EXTENDED OHMS

The extended ohms feature is available only via the HP-IB F7 or H7 commands. With extended ohms you can measure resistances above 30 Mohms. When in the Extended Ohms mode, the 3478A goes to the 30 Mohm range, 2wire mode. An internal resistance of approximately 10 Mohms is placed in parallel with the inputs. If this resistance is measured first and then the unknown resistor connected to the inputs, the parallel combination can be measured and a calculation performed to determine the approximate value of the unknown resistance. The formula for the calculation is:

$$R_x = \frac{R_i * R_t}{R_i - R_t}$$

R_x is the unknown resistance, R_i is the measured value of the internal 10 Mohm resistor and R_t is the measured value of the parallel combination. The test leads should be a very short shielded twisted pair to not pick up radiated noise.

A program that will make the necessary measurements, perform the calculations, and display the value for the unknown resistor, is given in the following figure.

```
10      ! Extended ohms measurement example
20      ! -hp- series 200/300 BASIC
30      !
40      Dvm=723                ! Factory set address is 723
50      PRINTER IS CRT
60      OUTPUT Dvm;"D2OPEN TERMS." ! Operator prompt on DVM display
70      PRINT "Extended ohms is a 2-wire measurement"
80      PRINT "used for measurements above 30 Mohms."
90      PRINT "Open the HP 3478A input terminals"
100     DISP "Press <continue> to begin..."
110     PAUSE
120     DISP " "                ! Clear DVM display
130     OUTPUT Dvm;"H7"        ! Measure R1 (DVM's internal 10M resistor)
140     ENTER Dvm;R1           ! Enter R1 value from DVM
150     OUTPUT Dvm;"D2ADD RESISTOR"! Operator prompt on DVM display
160     PRINT "Connect the unknown resistance."
170     DISP "Press <contnue> to proceed..."
180     PAUSE
190     DISP " "                ! Clear DVM display
200     OUTPUT Dvm;"H7"        ! Measure R2 (parallel resistance of
210                                ! DVM's internal 10M resistor-R1-and
220                                ! Unknown resistor-R3)
230     ENTER Dvm;R2           ! Enter R2 value from DVM
240     R3=R1*R2/(R1-R2)       ! Calculate unknown resistance R3
250     DISP "The resistance is ";R3/(10^6);" Mohms"
260     END
```

dBm MEASUREMENTS

The dBm Program is used to calculate a power ratio using a 50Ω impedance as the reference. The dBm equation is:

$$\text{dBm} = 10 * \text{LOG}[(X^2/R)/1\text{mw}]$$

where X is the measured value, R is the impedance reference (50Ω) and 1mw is the OdBm reference.

```
10    ! dBm measurement example
20    ! -hp- series 200/300 BASIC
30    !
40    Dvm=723                                ! Factory set address is 723
50    OUTPUT Dvm;"H2T1"                      ! Set DVM to AC volts, Autorange,
60                                           ! Azero on, 4.5 digits, Int trigger
70    LOOP                                    ! Start continuous measurements
80    ENTER Dvm;Reading                      ! Enter a DVM reading
90    Dbm=10*LG(Reading^2/50/.001)          ! Calculate power ratio
100   DISP "The reading is ";Dbm;" dBm"     ! Display dBm value
110   END LOOP
120   END
```

MAXIMUM READING RATE

The maximum possible reading rate is with 3 1/2 digits selected, autozero off, display off, manual ranging, the line frequency switch (3478A rear panel) set to the 60Hz position, and positive dc voltages, current and resistance measurements. Remember though, there is a settling delay on the two highest ohms ranges.

The program in the following figure sets the 3478A for these conditions with two exceptions. First, you must manually set the 50/60 Hz line switch to the 60Hz position. This switch is on the rear panel of the 3478A. Second, the program sets the 3478A to the autorange mode. If you know the approximate value of the voltage to be measured you can change the "RA" command in line 70 to reflect an appropriate range.

The program instructs the 3478A to take 100 readings and transfer the readings to the computer. The program then calculates how long it took to complete the 100 measurements and transfer the data (usually about 1.2 seconds).

```
10   ! Maximum reading rate example
20   ! -hp- series 200/300 BASIC
30   !
40   REAL B(1:100)
50   PRINTER IS CRT
60   ASSIGN @Dvm TO 723           ! Factory set address is 723
70   OUTPUT @Dvm;"F1RAN3Z0T1D3" ! Set DVM to DCvolts, Autorange,
80                                   ! 3.5 digits, Azero off,
90                                   ! Internal Trigger, Display text
100  T1=TIMEDATE
110  T2=TIMEDATE
120  FOR I=1 TO 100
130    ENTER @Dvm;B(I)           ! Enter 100 DVM readings
140  NEXT I
150  T3=TIMEDATE
160  T3=T3-T2-(T2-T1)           ! Calculate time for 100 readings
170  PRINT USING "30A,DD.DD,42A";"Total time for 100 readings = ";T3;
    " seconds. Press CONTINUE to list readings."
180  PAUSE
190  FOR I=1 TO 100
200    PRINT "Reading ";I;" = ";B(I) ! List the 100 readings
210  NEXT I
220  END
```

STATUS BYTE COMMAND

There are 5 bytes, each 8 bit wide, which may be used to determine the current state of the 3478A. If the multimeter is addressed to talk after reception of the "B" command it will output the 5 bytes. The meaning of the individual bytes is given in the table of 3478A programming commands.

The first of the following two programs demonstrates how to get the binary representation of the 5 bytes. The second program shows how the first three bits of the first byte may be used to indicate the measurement function the 3478A is set to. Similar steps may be used on the remaining bits and the other 4 bytes.

```
10 ! Binary status example
20 ! -hp- series 200/300 BASIC
30 !
40 INTEGER B(4)
50 Dvm=723 ! Factory set address is 723
60 PRINTER IS CRT
70 OUTPUT Dvm;"B" ! DVM outputs binary status
80 ENTER Dvm USING "B";B(*)
90 FOR I=0 TO 4
100 PRINT "Byte ";I;" = ";
110 PRINT BIT(B(I),7);BIT(B(I),6);BIT(B(I),5);
120 PRINT BIT(B(I),4);BIT(B(I),3);BIT(B(I),2);
130 PRINT BIT(B(I),1);BIT(B(I),0)
140 PRINT
150 NEXT I
160 END
```

```
10 ! HP 3478A State Program
20 ! -HP- Series 200/300 BASIC
30 !
40 INTEGER State
50 Dvm=723 ! Factory set address is 723
60 Func=0
70 OUTPUT Dvm;"B" ! DVM output binary status
80 ENTER Dvm USING "B";State ! Enter the DVM's status
90 IF BIT(State,7) THEN Func=4
100 IF BIT(State,6) THEN Func=Func+2
110 IF BIT(State,5) THEN Func=Func+1
120 IF Func=1 THEN Func$="DC Volts"
130 IF Func=2 THEN Func$="AC Volts"
140 IF Func=3 THEN Func$="2-Wire Ohms"
150 IF Func=4 THEN Func$="4-Wire Ohms"
160 IF Func=5 THEN Func$="DC Amps"
170 IF Func=6 THEN Func$="AC Amps"
180 IF Func=7 THEN Func$="Extended Ohms"
190 DISP "the HP 3478A function is ";Func$
200 END
```

3478A Programming Commands

Type	Command	Explanation
Measurement Function	F1 F2 F3 F4 F5 F6 F7	DC Volts function AC Volts function 2-wire ohms function 4-wire ohms function DC Current function AC Current function Extended ohms function
Range	R-2 R-1 R0 R1 R2 R3 R4 R5 R6 R7 RA	30mV DC range 300mV AC or DC range or the 300mA AC or DC range 3V AC or DC range or 3A AC or DC range 30V AC or DC range or the 30 ohm range 300V DC or AC range or the 300 ohm range 3K ohm range 30K ohm range 300K ohm range 3M ohm range 30M ohm range Selects Autorange
<p>An invalid range for a given function defaults to the most sensitive range if the range specified is too low, or the least sensitive range if the specified range is too high</p>		
Display	N3 N4 N5	Selects the 3 1/2 digit display. Fastest reading but little noise rejection. .1 Power Line Cycle integration. Selects the 4 1/2 digit display. 1 PLC integration. Selects the 5 1/2 digit display. Best resolution and greatest noise rejection. 10 PLC integration.
Trigger	T1 T2 T3 T4 T5	Internal trigger External trigger. Any reading in progress is aborted, and the 3478A waits for an external trigger pulse to occur. Triggering occurs on the negative going edge of the pulse. Readings may also be initiated by an HP-IB GET command. Single Trigger. This causes a single measurement to commence. Further readings may be initiated by an HP-IB GET command, but not an external trigger pulse. Trigger Hold. Any reading in progress is aborted and the 3478A remains idle. The 3478A will still respond to an HP-IB GET command but not to an external trigger. Fast Trigger. Fast Trigger works the same as T3, except that in AC Volts, AC Current, or the two highest ohms range the initial settling delay is omitted. If more than one reading is necessary because of auto-ranging or if the DMM must change ranges or functions to perform the measurement, the delay will occur normally.

3478A Programming Commands (Cont'd)

Type	Command	Explanation
Autozero	Z0 Z1	Autozero off Autozero on
Write To Display	D1 D2text D3text	Return from D2 or D3 to NORMAL DISPLAY. The "D2" command places the message "text" into the 3478A display. The message can contain any of the 64 ASCII characters from decimal 32 through 95, inclusive. The message may be as long as necessary to fill up the 12 characters in the display. Note that the period, comma, and semicolon go between characters. This command is terminated by any control character, such as a <CR>. If more than 12 characters are sent, the extra characters are ignored until a control character is received. If the terminating control character is anything but an HT, LF, VT, FF, or CR, it will result in a syntax error. This command also locks the display until an error occurs, a D1 command is received, a device clear is received, or a front panel key is pressed. Like the D2 command above, this places the message "text" into the display. It also turns off all dedicated annunciators and then stops updating the display. This command takes about 30mS to complete, after which the considerable overhead of updating the display is bypassed (means a faster reading rate). This enables the 3478A to respond to commands more rapidly in certain conditions. If the display is not updated for about ten minutes, it will blank out completely. The display can be restored by pressing the "LOCAL" key, or by executing a D1, D2, or D3 command.
Preset Commands	H0 H1 H2 H3 H4 H5 H6 H7	Home command. This command places the 3478A into the DC Volts function, Auto-Range, Single Trigger state, 4 1/2 digit display, with Auto-Zero on. Any result ready to be output to the bus or display is erased. The external trigger input is disabled. This command is equivalent to "F1T4R-2RAZ1N4". Measure DC Volts. This command causes one DC Voltage measurement to be made, following which an enter command from the controller will access the result. This command is like the H0 command except that a trigger occurs. This command is equivalent to "F1R-2RAZ1N4T3". Measure AC Volts. Identical to H1 except for the function. Measure 2-wire Ohms. Identical to H1 except for the function. Measure 4-wire Ohms. Identical to H1 except for the function. Measure DC Current. Identical to H1 except for the function. Measure AC Current. Identical to H1 except for the function. Measure Extended Ohms. Identical to H1 except for the function

3478A Programming Commands (Cont'd)

Type	Command	Explanation
Binary Status	B	<p>Binary Status. If the 3478A is addressed to talk after reception of the "B" command, it will output five bytes which indicate its currently programmed state. This command also clears the error register (byte 4). The meaning of the five bytes is:</p> <p>Byte 1: Function, Range, and Number of Digits.</p> <p>If Octal value of bits 7,6,5</p> <ul style="list-style-type: none"> = 1 then DC Volts = 2 then AC Volts = 3 then 2-wire Ohms = 4 then 4-wire Ohms = 5 then DC Current = 6 then AC Current = 7 then Extended Ohms <p>If Octal value of bits 4,3,2</p> <ul style="list-style-type: none"> = 1 then 30mV DC, 300mV AC, 30 ohm, 300mA AC or DC, Extended Ohms = 2 then 300mV DC, 3V AC, 300 ohm 3A AC or DC = 3 then 3V DC, 30V AC, 3K ohm = 4 then 30V DC, 300V AC, 30K ohm = 5 then 300V DC, 300K ohm = 6 then 3M ohm = 7 then 30M ohm <p>IF Octal value of bits 1,0</p> <ul style="list-style-type: none"> = 1 then 5 1/2 digit mode = 2 then 4 1/2 digit mode = 3 then 3 1/2 digit mode <p>Byte 2: Status Bits</p> <ul style="list-style-type: none"> Bit 7 = Always zero Bit 6 = 1 then External trigger enabled Bit 5 = 1 then Cal RAM enabled Bit 4 = 1 then Front/Rear switch is in the front position Bit 3 = 1 then 3478A is set up for 50Hz operation Bit 2 = 1 then Auto-Zero is enabled Bit 1 = 1 then Auto-Range is enabled Bit 0 = 1 then Internal trigger is enabled <p>Byte 3: Serial Poll Mask (SRQ)</p> <ul style="list-style-type: none"> Bit 7 = 1 then PON SRQ switch was on the last time power was turned on or a device clear message was received Bit 6 = Always zero Bit 5 = 1 then SRQ if CAL procedure failed Bit 4 = 1 then SRQ if keyboard SRQ is pressed Bit 3 = 1 then SRQ if hardware error occurs Bit 2 = 1 then SRQ if syntax error occurs Bit 1 = not used Bit 0 = 1 then SRQ as every reading is available to the bus

3478A Programming Commands (Cont'd)

Type	Command	Explanation
Binary Status (Cont'd)		<p>Byte 4: Error Information</p> <ul style="list-style-type: none"> Bit 7 = Always zero Bit 6 = Always zero Bit 5 = 1 then There has been a failure in the A/D link Bit 4 = 1 then The A/D has failed its internal Self Test Bit 3 = 1 then There has been an A/D slope error Bit 2 = 1 then The ROM self test has failed Bit 1 = 1 then The RAM self test has failed Bit 0 = 1 then This bit is set by the self test routine if any of the CAL RAM locations have bad checksums, or if a range with a bad checksum is selected. <p>Byte 5: DAC Value</p> <p>This byte will contain a value between 0 and 63 (decimal). This represents the setting of the internal Digital to Analog Converter (DAC), and is primarily for diagnostic purposes.</p>
	K	Clear the Serial Poll Register. This command clears bits 1-5 and 7 in the Serial Poll Register. Bit 0 always represents the current status and is unaffected by this command. Bit 6 is either set (1) or cleared (0) depending upon the binary AND of bit 0 in the status register and the SRQ mask. Bit 6 is reset by a Serial Poll.
	E	Error Register. This command enables the controller to read the 3478A Error Register. See Byte 4 in the "B" command above for an explanation of this register. Unlike the "B" command, the "E" command outputs the Error Register as two octal digits, followed by a CR, LF. The "E" command also clears the Error Register.
	Mxx	Set the SRQ Mask to octal value xx. The parameter xx must be two digits exactly. Bits 0 through 5 of the binary representation of xx are used to set the appropriate mask bits.
	S	Return the Front/Rear switch position. If the 3478A is addressed to talk after receiving the "S" command, it will output either a "1" or a "0" <CR> <LF> depending on whether the front/rear switch was in the front or rear position, respectively. The position of the switch is read only when a reading is taken, and thus returns the position of the switch at time of the last reading.
Calibrate	C	Calibrate. See the 3478A Service Manual.

Chapter IV

Operator's Maintenance

Introduction

Your 3478A Digital Multimeter was thoughtfully engineered for ease of use, accuracy, and perhaps most important, reliability. The instrument was carefully inspected before shipping and should be free of mechanical and electrical flaws and should be in proper electrical working condition.

The information in this chapter covers the initial setup and installation of the 3478A and should be read before the 3478A is installed for use. This chapter also includes the specification table, warranty information, instructions about what to do if you suspect the multimeter is malfunctioning, obtaining repair service, cleaning, etc.

Accessories

Table 4-1 lists the available accessories for your 3478A. These accessories are offered to help you maximize the usability and convenience of your 3478A.

Table 4-1. Accessories

Accessory Number	Description
10833A	HP-IB Cable, 1 Meter (39.37 inches)
10833B	HP-IB Cable, 2 Meters (78.74 inches)
10833C	HP-IB Cable, 4 Meters (157.48 inches)
10833D	HP-IB Cable, 0.5 Meters (19.69 inches)
11002A	Test Leads, Dual banana to dual alligator
11003A	Test Leads, Dual banana to probe and alligator
11096B	RF Probe
34111A	High Voltage Probe, DC 40kV
34118A	Test Leads, banana to probes with safety guard rings
34119A	High Voltage Probe, AC or DC 5kV
Option 907 (5061-9688)	Front Handle Kit
Option 908 (5061-9672)	Rack Mounting Kit
Option 910	Additional Operators Manual and Service Manual, -hp- Part Number 03478-90009, 03478-90008

Initial Inspection

Your 3478A was carefully inspected before it left the factory. It should be free of marks or scratches and in proper working order upon receipt. You should, however, inspect the instrument for any damage that may have occurred in transit. If the shipping container or cushioning material is damaged, it should be kept until the contents of the shipment have been checked for completeness and the instrument has been mechanically and electrically inspected. Procedures for checking the electrical performance of the 3478A are given in the 3478A SERVICE MANUAL (-hp-part number 03478-90008). If there is any mechanical damage or the contents are incomplete, or the instrument does not pass its performance tests, notify the nearest Hewlett-Packard office (a list of the -hp- Sales and Service Offices is located in the back of this manual). If the shipping container is damaged, or the cushioning material shows signs of stress, notify the carrier as well as the Hewlett-Packard office. Save the shipping materials for the carrier.

Preparation for Use

Power Requirements

The 3478A Digital Multimeter requires a power source of 100, 120, 220, or 240 Vac (-10%, +5%), 48 Hz to 440 Hz single phase. Maximum power consumption is 25 VA.

Line Voltage Selection

Refer to the rear panel of the 3478A for the line voltage option label. Make certain that the option marked on the label is the same as the nominal line voltage for your area. Also check the left most switch (50/60Hz switch) for the proper setting, i.e., up for 50Hz and down for 60Hz. Table 4-2 lists the available power options.

Table 4-2. Line Voltage Options

Option No.	Line Voltage	Frequency	Power Line Fuse
315	100	50	250 mA (-hp- part number 2110-0201)
316	100	60	250 mA
325	120	50	250 mA
326	120	60	250 mA
335	220	50	125 mA (-hp- part number 2110-0318)*
336	220	60	125 mA
345	240	50	125 mA
346	240	60	125 mA

* slo-blo fuse

CAUTION

Before connecting the multimeter to an ac power source, verify that the ac power source matches the power requirements of the multimeter as marked on the option label on the rear panel of the instrument. Only qualified service trained personnel are allowed to reconfigure the 3478A for the different line voltage options.

Power Cords and Receptacles

Figure 4-1 illustrates the different power cord configurations that are available to provide ac power to the 3478A. The -hp- part number shown directly below the individual power plug drawing is the part number for the power cord set equipped with the appropriate mating plug for that receptacle. If the appropriate power cord is not included with the instrument, notify the nearest -hp- Sales and Service office.

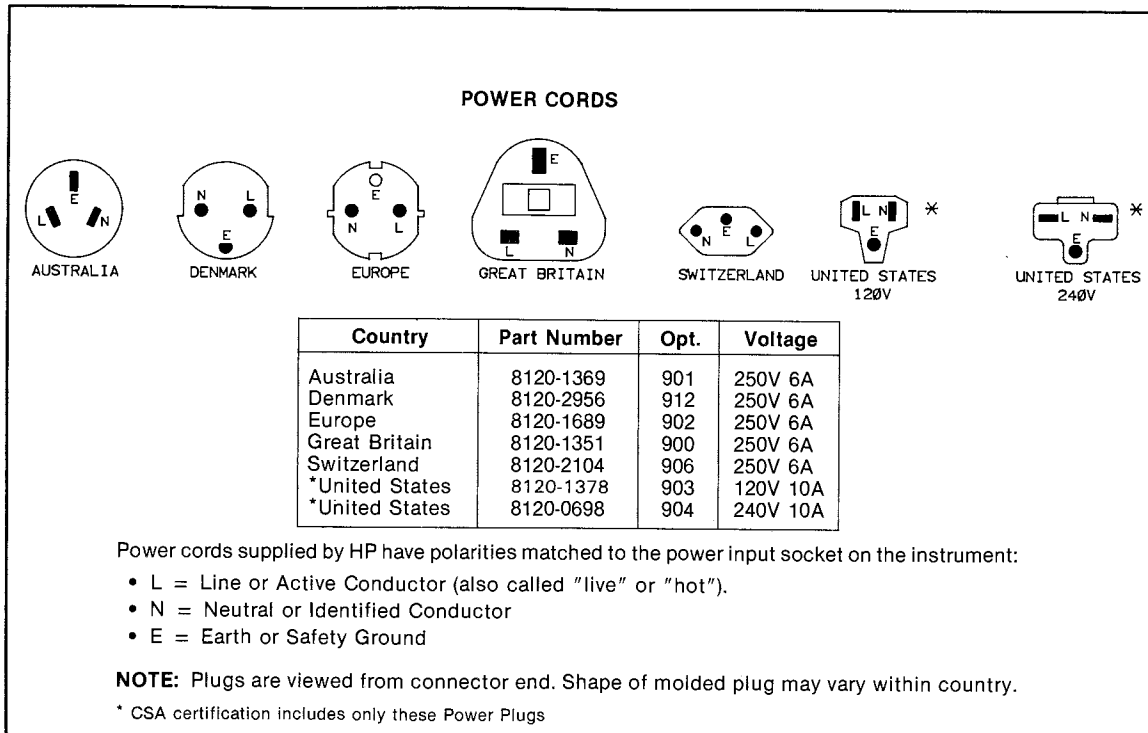

Figure 4-1. Power Cables

Grounding Requirements

To minimize shock hazard, the instrument chassis and cabinet must be connected to an electrical ground. The instrument is equipped with a three-conductor ac power cable. The power cable must either be plugged into an approved three-contact electrical outlet or used with a three-contact to two-contact adapter with the grounding wire (green) firmly connected to an electrical ground (safety ground) at the power outlet. The power jack and mating plug of the supplied power cable meet International Electrotechnical Commission (IEC) safety standards.

Safety Considerations

General safety precautions must be adhered to during all phases of operation of the 3478A. Failure to comply with these precautions or with specific warnings elsewhere in this manual, violates safety standards of design, manufacture, and intended use of the instrument. Hewlett-Packard company assumes no liability for the customer's failure to comply with these requirements. This is a Safety Class 1 instrument.

Operating personnel must not remove instrument covers. Component replacement must be made by qualified maintenance personnel. Do not operate the instrument in the presence of flammable gases or fumes. Operation of any electrical instrument in such an environment constitutes a definite safety hazard.

Warnings or cautions precede any potentially dangerous procedures throughout this manual. Instructions contained in the warnings and cautions must be followed. Safety Symbols used on the instrument or in the manual include the following:

WARNING The WARNING sign denotes a hazard. It calls attention to a procedure, practice, condition, or the like, which, if not correctly performed or adhered to, could result in injury or death to personnel.

CAUTION The CAUTION sign denotes a hazard. It calls attention to an operating procedure, practice, condition, or the like, which, if not correctly performed or adhered to could result in damage or destruction to all or part of the product.

NOTE The NOTE sign denotes important information. It calls attention to a procedure, practice, condition, or the like, which is essential to highlight.



Instruction Manual Symbol: the product will be marked with this symbol when it is necessary for the user to refer to the instruction manual in order to protect against damage to the instrument.



Indicates dangerous voltage (terminals fed from the interior by voltage exceeding 1000 volts must be so marked).



Alternating current.



Direct current.

Environmental Requirements

When the 3478A is calibrated, careful note should be taken of the ambient temperature. In order to meet and maintain the specifications listed in Table 4-3, the 3478A should be operated within $\pm 5^{\circ}\text{C}$ ($\pm 9^{\circ}\text{F}$) of the calibration temperature, also called the reference temperature. As it comes from the factory, the 3478A should be operated within an ambient temperature range of $23^{\circ}\text{C} \pm 5^{\circ}\text{C}$ ($73^{\circ}\text{F} \pm 9^{\circ}\text{F}$). The instrument may be operated within an ambient temperature range of 0°C to 55°C ($+32^{\circ}\text{F}$ to 131°F) but with reduced accuracy.

WARNING

To prevent potential electrical or fire hazard, do not expose the multimeter to rain or moisture.

Specifications

The specifications for the 3478A are the performance characteristics of the instrument which are certified. These specifications are listed in Table 4-3, and are the performance standards or limits against which the multimeter is tested. Included in the table are some supplemental characteristics of the 3478A and should be considered as additional and general information for you, the user. Because of the many operational capabilities of the 3478A, exercise care when checking the instruments specifications.

Any changes in the specifications due to manufacturing changes, design, or traceability to the National Bureau of Standards will be covered in a manual change supplement.

Interface Connections

The -hp- 3478A is compatible with the Hewlett-Packard Interface Bus (HP-IB). HP-IB is Hewlett-Packard's implementation of IEEE Std. 488-1978, "Standard Digital Interface for Programmable Instrumentation." Refer to Appendix A for specific information regarding HP-IB.

The 3478A's HP-IB connection is made by an HP-IB Interface cable to the 24 pin HP-IB connector located on the rear panel. A typical interconnection of HP-IB is shown in Figure 4-2 in which system interconnection is made by three interface cables. The ends of the cables have both a male and a female connector to enable connections to other instruments and cables. As many as 15 instruments can be connected by the same interface bus. However, the maximum length of cable that can effectively be used to connect a group of instruments should not exceed 2 meters (6.5 feet) times the number of instruments to be connected, or 20 meters (65.6 feet) total, whichever is less.

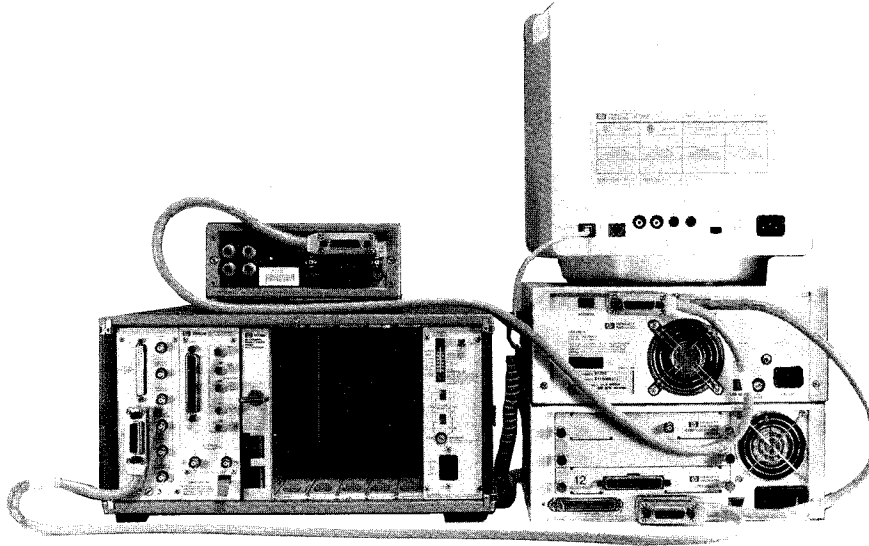

Figure 4-2. Typical HP-IB System Interconnection

Address Selection

The HP-IB address of the 3478A is determined by the setting of the five right-most switches on the rear panel. These switches are read at power-on, whenever the ADRS key is pressed, or whenever an HP-IB CLEAR message is received over the bus. Turning on (up) all five switches selects the 3478A Talk-Only mode. The 3478A normally leaves the factory with the address switches set to decimal code "23". The corresponding ASCII code is a listen address code of "7" and a talk code of "W". Refer to Figure 4-3 for the factory address switch setting.

Fuse Replacement

Amps Terminal Fuse

The Amps terminal fuse is located physically inside the Amps (A) terminal on the multimeter front panel. To replace the fuse, first remove the cable from the Amps terminal and then turn the power off to the multimeter. Use the side slots on the "A" terminal to rotate the terminal counterclockwise. The terminal and fuse will

protrude from the front panel. Remove the terminal and fuse, replace the fuse with a 3A/250V rated fuse, -hp- part number 2110-0003. Return the terminal and fuse to the front panel.

Power Line Fuse

The power line fuse is located on the rear panel of the 3478A in the lower right corner. To replace the fuse, turn the multimeter's power switch off and remove the power cord from the rear of the instrument. With a small flatblade screwdriver rotate the fuse terminal counterclockwise. Replace the fuse with the appropriate fuse as shown in Table 4-2. Reinstall the fuse and terminal and apply power.

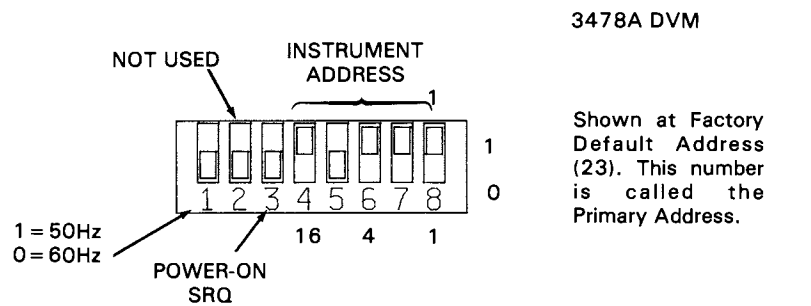

ASCII Code Character		Address Switches					5-bit
Listen	Talk	A4	A5	A6	A7	A8	Decimal Code
SP	@	0	0	0	0	0	00
!	A	0	0	0	0	1	01
"	B	0	0	0	1	0	02
#	C	0	0	0	1	1	03
\$	D	0	0	1	0	0	04
%	E	0	0	1	0	1	05
&	F	0	0	1	1	0	06
'	G	0	0	1	1	1	07
(H	0	1	0	0	0	08
)	I	0	1	0	0	1	09
*	J	0	1	0	1	0	10
+	K	0	1	0	1	1	11
,	L	0	1	1	0	0	12
-	M	0	1	1	0	1	13
.	N	0	1	1	1	0	14
/	O	0	1	1	1	1	15
0	P	1	0	0	0	0	16
1	Q	1	0	0	0	1	17
2	R	1	0	0	1	0	18
3	S	1	0	0	1	1	19
4	T	1	0	1	0	0	20
5	U	1	0	1	0	1	21
6	V	1	0	1	1	0	22
7	W	1	0	1	1	1	23 ← Factory Default
8	X	1	1	0	0	0	24
9	Y	1	1	0	0	1	25
:	Z	1	1	0	1	0	26
;	[1	1	0	1	1	27
<]	1	1	1	0	0	28
=	~	1	1	1	0	1	29
>	~	1	1	1	1	0	30
	Talk Only	1	1	1	1	1	

Select Codes can be any integer 1 thru 12. Primary Addresses can be any integer 0 thru 30. 31 is not a valid HP-IB address.

Figure 4-3. 3478A Address Codes

In Case of Trouble

If at any time you suspect that the 3478A is malfunctioning, perform the self test as follows:



This initiates the functional self test of the 3478A. The self test starts by turning on every segment in the display (except the top dot on the colon) for about 2 seconds. Following this the self test actually begins with any discrepancies noted in the display. If there are no self test failures, the HP-IB address is displayed and the 3478A returns to its power-on state. The following is a list of possible self test failures:

- U.C. RAM FAIL - This indicates the internal microcomputer (U.C.) RAM (not CAL RAM) has failed its self test.
- U.C. ROM FAIL - The 3478A has failed its internal ROM self test.
- UNCALIBRATED - The RAM that contains the calibration constants has an incorrect checksum, the calibration of the 3478A is suspect
- A:D TEST FAIL - The A/D converter has failed its self test.
- A:D LINK FAIL - The microprocessor cannot communicate with the A/D converter.

If the Voltmeter self test fails, or the display is blank, or it will not respond to the front panel keys (3478A not in REMOTE mode), turn the multimeter off and perform the following steps.

1. Remove the HP-IB connector, External Trigger, Voltmeter Complete and power cables.
2. Check the Line Voltage option marking on the rear panel of the 3478A to ensure that it is set to the correct nominal line voltage in your area (i.e., 110, 120, 220, or 240 Vac).
3. Ensure that the correct power line fuse is installed and that it is intact.
4. Check the AC power cord and plug it into the AC receptacle on the 3478A.

5. Turn the 3478A on. Watch the display. At turn-on the multimeter will display SELF TEST, then the HP-IB address, and then start taking readings in the dc volts mode. If any part of the self test should fail an error message will be shown in the display instead of the HP-IB address.

6. If the display does not return or if the self test fails again, the 3478A requires service. Notify your local -hp- Sales and Service Office for specific information on where to send the instrument for repair.

Remote

At the end of this chapter is a program that you can use to verify the operational readiness of the 3478A. The program was not designed to troubleshoot the 3478A but the information gathered by running the program can be a great help in troubleshooting.

Before running the program make certain that the 3478A is the only instrument on the Bus. Remove the test leads and external trigger and VM complete cables. Follow the instructions given on the CRT.

Response: Press Continue softkey (F2) or type CONT to continue.

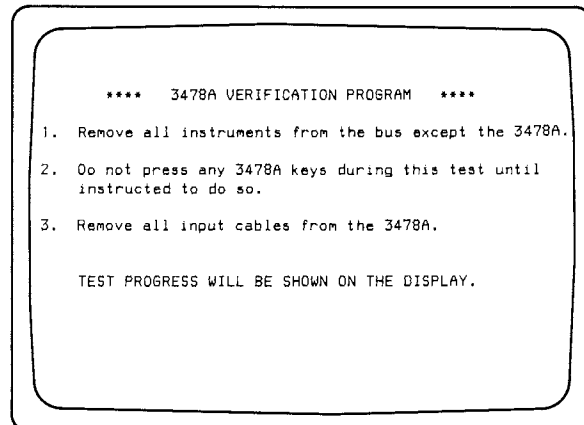

Response: If the 3478A address is 723, press the RETURN key. If the 3478A address is not 723, then enter the correct address and press RETURN.

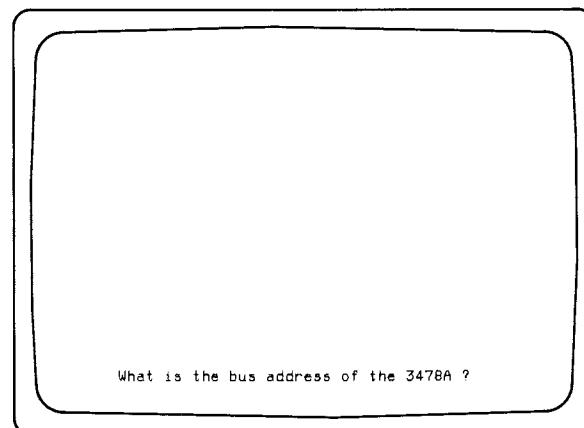

Response: Press the 3478A front panel SRQ key. The computer will beep every 5 seconds and will abort the program if you have not pressed SRQ within 10 seconds.

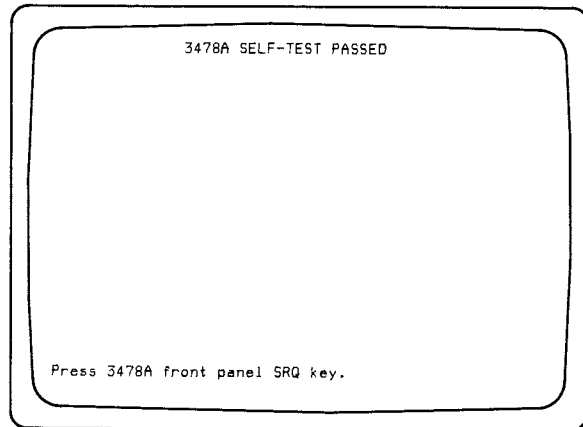

Response: After the 3478A front panel SRQ key is pressed, the 3478A verification is completed. Results are listed on the computer display.

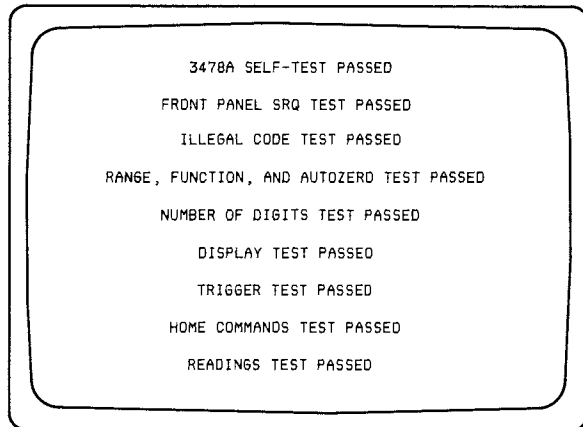

What the Test Does

Test 1. SELF TEST.

This test verifies that the 3478A responds to the HP-IB CLEAR command and performs its internal self test.

Test 2. PROGRAM CODES.

The test starts by verifying that the 3478A can send an SRQ and that the computer will respond to it. Next, an illegal code is sent to the 3478A to be certain that it rejects it. Then, all possible combinations of autozero, function and range codes are sent to the 3478A. In addition, all display modes, trigger modes and the preset commands are tested. Finally, two readings are taken. One from the the 300V dc range that is checked to be sure there are no offsets. The second reading checks for an overload condition from the 2-wire ohms mode.

Warranty Information

Certification

Hewlett-Packard Company certifies that this product met its published specifications at the time of shipment from the factory. Hewlett-Packard further certifies that its calibration measurements are traceable to the United States National Bureau of Standards, to the extent allowed by the Bureau's calibration facility, and to the calibration facilities of other International Standards Organization members.

Warranty

This Hewlett-Packard product is warranted against defects in material and workmanship for a period of one year from date of shipment. During the warranty period, Hewlett-Packard Company will, at its option, either repair or replace products which prove to be defective.

For warranty service or repair, this product must be returned to a service facility designated by -hp-. Buyer shall prepay shipping charges to -hp- and -hp- shall pay shipping charges to return the product to Buyer. However, Buyer shall pay all shipping charges, duties, and taxes for products returned to -hp- from another country.

Hewlett-Packard warrants that its software and firmware designated by -hp- for use with an instrument will execute its programming instructions when properly installed on that instrument. Hewlett-Packard does not warrant that the operation of the instrument, or software, or firmware will be uninterrupted or error free.

Limitation of Warranty

The foregoing warranty shall not apply to defects resulting from improper or inadequate maintenance by Buyer, Buyer-supplied software or interfacing, unauthorized modification or misuse, operation outside of the environmental specifications for the product, or improper site preparation or maintenance.

NO OTHER WARRANTY IS EXPRESSED OR IMPLIED. HEWLETT-PACKARD SPECIFICALLY DISCLAIMS THE IMPLIED WARRANTIES OF MERCHANTABILITY AND FITNESS FOR A PARTICULAR PURPOSE.

Exclusive Remedies

THE REMEDIES PROVIDED HEREIN ARE BUYER'S SOLE AND EXCLUSIVE REMEDIES. HEWLETT-PACKARD SHALL NOT BE LIABLE FOR ANY DIRECT, INDIRECT, SPECIAL, INCIDENTAL, OR CONSEQUENTIAL DAMAGES, WHETHER BASED ON CONTRACT, TORT, OR ANY OTHER LEGAL THEORY.

Assistance

Product maintenance agreements and other customer assistance agreements are available for Hewlett-Packard products.

For any assistance, contact your nearest Hewlett-Packard Sales and Service Office. Addresses are provided in the back of this manual.

How to Obtain Repair Service

Contact your local -hp- sales office for specific information on where to send the instrument for repair. This will substantially reduce turn-around time. You may have your 3478A repaired by Hewlett-Packard anytime it needs service, whether it is under warranty or not. There is a charge for repairs after the warranty period. A list of sales offices is conveniently provided in the back of this manual. Outside of the United States, repair service may be obtained at your local -hp- service center.

Serial Number

Each 3478A multimeter carries its own serial number on a plate on the rear panel. It is recommended that owners keep a separate record of this number. Should your unit be lost or stolen, the complete serial number is often necessary for tracing and recovery, as well as any insurance claims.

General Shipping Instructions

Should you ever need to ship your 3478A, be sure it is packaged in a protective package (use the original shipping container and cushioning material) to avoid in-transit damage. Such damage is not covered by the warranty. Hewlett-Packard suggests that you always insure shipments. Attach a tag to the instrument identifying the owner and indicating the service or repair needed. Include the model number and full serial number of the instrument. In any correspondence, identify the instrument by model number and full serial number.

Further Considerations

Cleaning

Disconnect the 3478A from its ac power source before cleaning. The multimeter can be cleaned with a soft cloth dampened either in clean water or in water containing a mild detergent. Do not use an excessively wet cloth, or allow water inside the instrument. Do not use any abrasive cleaners, especially on the display. Do not press too hard on the display. The panel area surrounding the input terminals should not be touched because oils on the surface caused by finger prints may cause leakage paths and decrease the input impedance. To maintain the high input impedance of the multimeter, the input terminal area should be cleaned periodically with a cotton swab dipped in isopropyl alcohol.

3478A Verification Program

```
10  !   *** 3478A VERIFICATION PROGRAM ***
20  !
30  ! This program does a quick check of the 3478A's functionality
40  ! over the bus. It does not do any specification testing.
50  !
60  PRINTER IS CRT
70  !
80  ! GIVE USER INSTRUCTIONS AND GET ADDRESS OF 3478A
90  !
100 OUTPUT KBD USING "#,K";"K"      ! Clear the CRT
110 FOR I=1 TO 5
120   PRINT
130 NEXT I
140 PRINT "          **** 3478A VERIFICATION PROGRAM ****"
150 PRINT
160 PRINT "          1. Remove all instruments from the bus except the 3478A."
170 PRINT
180 PRINT "          2. Do not press any 3478A keys during this test until"
190 PRINT "             instructed to do so."
200 PRINT
210 PRINT "          3. Remove all input cables from the 3478A."
220 PRINT
230 PRINT
240 PRINT "          TEST PROGRESS WILL BE SHOWN ON THE DISPLAY."
250 PRINT
260 PRINT
270 PRINT
280 PRINT "Press Continue (F2) Softkey or type CONT to continue."
290 PAUSE
300 !
310 Start:  !
320 OUTPUT KBD USING "#,K";"K"      ! Clear the CRT
330 OUTPUT KBD USING "#,K";"723BB"  ! Prompt for HP 3478A address
340 INPUT "What is the bus address of the 3478A ? Factory address = 23",Adr$
350 IF Adr$<>" " THEN Adr=VAL(Adr$)
360 Adr_hpib=Adr DIV 100             ! Address of HPIB interface
370 IF Adr_hpib<3 OR Adr_hpib>10 THEN Input_error
380 IF Adr MOD 100>30 OR Adr MOD 100<0 THEN Input_error
390 Adr_78=Adr                      ! Address of HP 3478A
400 GOTO Selftest
410 Input_error: !
420 BEEP
430 DISP " !!! INVALID INPUT !!!"
440 WAIT 1
450 GOTO Start
460 !
470 !*****
480 !***** PERFORM 3478A SELF TEST *****
490 !*****
500 !
510 Selftest:  !
520 ON TIMEOUT Adr_hpib,2 GOTO Dead
530 OUTPUT KBD USING "#,K";"K"      ! Clear the CRT
```

3478A Verification Program (Cont'd)

```

540 PRINT
550 PRINT
560 CLEAR Adr_78                ! Clear the DVM
570 WAIT 3                      ! Wait for Self Test to finish
580 OUTPUT Adr_78;"E"
590 ENTER Adr_78;Stat          ! Read DVM Error Register
600 IF Stat=0 THEN GOTO Good
610 !
620 IF BIT(Stat,0) THEN PRINT "          CAL RAM FAILURE"
630 IF BIT(Stat,1) THEN PRINT "          CPU RAM FAILURE"
640 IF BIT(Stat,2) THEN PRINT "          ROM FAILURE"
650 IF BIT(Stat,3) THEN PRINT "          A/D SLOPE ERROR"
660 IF BIT(Stat,4) THEN PRINT "          A/D SELF TEST ERROR"
670 IF BIT(Stat,5) THEN PRINT "          A/D LINK FAILURE"
680 PRINT
690 PRINT "          SELF TEST FAILED, Please see the 3478A Service Manual"
700 PRINT
710 PRINT "          ***** VERIFICATION ABORTED *****"
720 GOTO Done
730 !
740 Dead: !
750 PRINT "          The 3478A at address "&VAL$(Adr_78)&" does not respond."
760 PRINT
770 PRINT "          Check for power and proper HPiB address. Then run      "
780 PRINT "          program again."
790 PRINT
800 PRINT "          ***** VERIFICATION ABORTED *****"
810 GOTO Done
820 !
830 Good: !
840 PRINT "          3478A SELF-TEST PASSED"
850 GOTO Codes
860 !
870 !*****
880 !***** CHECK PROGRAM CODES *****
890 !*****
900 !
910 Codes: !
920 ! Testing Front Panel SRQ
930 !
940 OUTPUT Adr_78;"KM20"        ! Enable DVM's front panel SRQ
950 ON INTR Adr_hpib GOTO Srq
960 ON DELAY 15 GOTO Not_pressed ! Controller must receive an SRQ
970                               ! within 10 seconds
980 ENABLE INTR Adr_hpib;2      ! Allow controller to be interrupted
990                               ! by an SRQ signal on the bus
1000 DISP "Press 3478A front panel SRQ key."
1010 BEEP
1020 WAIT 5                      ! Wait for SRQ button to be pushed
1030 GOTO 1010
1040 !
1050 Srq: !                      Controller received an SRQ signal from the bus
1060 OFF DELAY
1070 STATUS Adr_hpib,1;A

```

3478A Verification Program (Cont'd)

```
1080 OUTPUT Adr_78;"B"
1090 ENTER Adr_78 USING "3(B)";B1,B2,B3 ! Get HP 3478A status
1100 IF BIT(B3,4) THEN GOTO Passed ! Is SRQ bit set ?
1110 PRINT
1120 PRINT " Front panel SRQ did not set bit in "
1130 PRINT " 3478A Status Register "
1140 PRINT
1150 PRINT " ***** VERIFICATION ABORTED *****"
1160 GOTO Done
1170 !
1180 Not_pressed: ! ! Controller did not get SRQ signal
1190 PRINT
1200 PRINT " The 3478A front panel SRQ button was not pushed."
1210 PRINT
1220 PRINT " ***** VERIFICATION ABORTED ***** "
1230 GOTO Done
1240 Passed:!
1250 P=SPOLL(Adr_78) ! Clear the HP 3478A status register
1260 PRINT
1270 PRINT " FRONT PANEL SRQ TEST PASSED "
1280 !
1290 ! Test for Illegal Program Codes
1300 !
1310 OUTPUT Adr_78;"KM04" ! Enable syntax error SRQ
1320 ON INTR Adr_hpib GOTO Caught
1330 ENABLE INTR Adr_hpib;2 ! Allow controller to be interrupted
1340 OUTPUT Adr_78;"Q3" ! Send an illegal code to DVM
1350 WAIT 2
1360 PRINT
1370 PRINT " Sent an illegal program code to the 3478A"
1380 PRINT " and it accepted it without SRQing."
1390 PRINT
1400 PRINT " ***** VERIFICATION ABORTED *****"
1410 !
1420 Caught: !
1430 STATUS Adr_hpib,1;A
1440 P=SPOLL(Adr_78) ! Clear the DVM Status Register
1450 PRINT
1460 PRINT " ILLEGAL CODE TEST PASSED"
1470 !
1480 ! Now see if the HP 3478A will accept all normal program codes
1490 !
1500 DISP " Watch the 3478A display. "
1510 ON INTR Adr_hpib GOTO Failure
1520 ENABLE INTR Adr_hpib;2 ! Allow SRQ to interrupt controller
1530 !
1540 Group=1 ! Autozero, Function, Range tests
1550 FOR Z=0 TO 1 ! Autozero
1560 FOR F=1 TO 7 ! Function
1570 FOR R=-3 TO 7 ! Range
1580 OUTPUT Adr_78;"Z";Z;"F";F;"R";R
1590 NEXT R
1600 NEXT F
1610 NEXT Z
```

3478A Verification Program (Cont'd)

```
1620 PRINT
1630 PRINT "          RANGE, FUNCTION, AND AUTOZERO TEST PASSED"
1640 !
1650 Group=2          ! Number of Digits test
1660 FOR N=3 TO 5
1670   OUTPUT Adr_78;"F1RAN";N
1680 NEXT N
1690 PRINT
1700 PRINT "          NUMBER OF DIGITS TEST PASSED"
1710 !
1720 Group=3          ! Display tests
1730 OUTPUT Adr_78;"D1"
1740 OUTPUT Adr_78;"D2DISPLAY TEST"
1750 WAIT .75
1760 OUTPUT Adr_78;"D3DISPLAY TEST"
1770 WAIT .75
1780 PRINT
1790 PRINT "          DISPLAY TEST PASSED"
1800 !
1810 Group=4          ! Trigger tests
1820 FOR T=1 TO 5
1830   OUTPUT Adr_78;"F1RAD1N5T";T
1840 NEXT T
1850 PRINT
1860 PRINT "          TRIGGER TEST PASSED"
1870 !
1880 Group=5          ! 'HOME' tests
1890 FOR H=7 TO 0 STEP -1
1900   OUTPUT Adr_78;"H";H
1910 NEXT H
1920 PRINT
1930 PRINT "          HOME COMMANDS TEST PASSED"
1940 !
1950 GOTO Readings
1960 !
1970 Failure:!          One of the program code tests failed
1980 STATUS Adr_hpib,1;A
1990 P=SPOLL(Adr_78)
2000 PRINT
2010 IF BIT(P,2) THEN PRINT "          Program codes test failed--s
2020 BEEP
2030 SELECT Group
2040   CASE 1
2050     PRINT "   Function code =F";F;"Range code =R";R;"Autozero =Z";Z
2060   CASE 2
2070     PRINT "   Display digits = N";N-1
2080   CASE 3
2090     PRINT "   Display commands failure"
2100   CASE 4
2110     PRINT "   Trigger command = T";T
2120   CASE 5
2130     PRINT "   Preset code = H";H
2140 END SELECT
2150 PRINT
```

3478A Verification Program (Cont'd)

```
2160 PRINT "          ***** VERIFICATION ABORTED *****"
2170 GOTO Done
2180 !*****
2190 !***** READING TESTS *****
2200 !*****
2210 !
2220 Readings: !
2230 DISP "          "
2240 OUTPUT ADR_78;"F1R2N5T1"
2250 ENTER ADR_78;Volts
2260 IF ABS(Volts)<=.002 THEN GOTO Ohms
2270 PRINT
2280 PRINT "          !! Zero error on the 30V range. !!"
2290 PRINT
2300 PRINT "          Program not aborted "
2310 Ohms: !
2320 OUTPUT ADR_78;"F3RA"
2330 ENTER ADR_78;Ohm
2340 IF Ohm<>9999990000 THEN
2350     PRINT
2360     PRINT "          !! Ohms overload error !!"
2370     PRINT
2380     PRINT "          Program not aborted"
2390 END IF
2400 OUTPUT ADR_78;"F1RAN5T1"
2410 PRINT
2420 PRINT "          READINGS TEST PASSED"
2430 Done: !
2440 DISP "3478A verification program done."
2450 END
```

Table 4-3. Specifications

DC VOLTAGE				
Input Characteristics:				
Range	Maximum Reading (5½ Digit)	Resolution		
		5½ Digit	4½ Digit	3½ Digit
30mV	± 30.3099mV	100nV	1µV	10µV
300mV	± 303.099mV	1µV	10µV	100µV
3 V	± 3.03099 V	10µV	100µV	1mV
30 V	± 30.3099 V	100µV	1mV	10mV
300 V	± 303.099 V	1mV	10mV	100mV
Input Resistance:				
30mV, 300mV, 3V ranges: > 10 ¹⁰ Ω				
30V, 300V ranges: 10MΩ ± 1%				
Maximum Input Voltage: (non-destructive)				
Hi to Lo: 303V rms or 450V peak				
Hi or Lo to Earth Ground: ± 500V peak				
Measurement Accuracy:				
± (% of reading + number of counts)				
Auto-zero ON				
5½ Digit Mode:				
Range	Cal. Temp ±1°C	Cal. Temp. ±5°C		
	24 Hours	90 Day	1 Year	
30mV	0.025 + 40	0.0275 + 40	0.035 + 40	
300mV	0.004 + 4	0.005 + 5	0.007 + 5	
3 V	0.003 + 2	0.004 + 2	0.006 + 2	
30 V	0.004 + 3	0.005 + 4	0.007 + 4	
300 V	0.004 + 2	0.005 + 2	0.007 + 2	
4½ and 3½ Digit Mode:				
Accuracy is the same as 5½ digit mode for % of reading; use 1 count for number of counts on all ranges except 30mV range use 4 counts.				
The Cal. Temp. (Calibration Temperature) is the temperature of the environment where the 3478A was calibrated. Calibration should be performed with the temperature of the environment between 20°C and 30°C.				
Auto-Zero Off:				
(5½ digit) for a stable environment (± 1°C), for < 24 hrs., add 110 counts to accuracy specification for 30mV range, 11 counts for 300mV and 30V ranges, 3 counts for 3V and 300V range.				
Temperature Coefficient:				
0°C to 55°C				
5½ digit display, auto-zero ON				
± (% of reading + number of counts)/°C				
Range	Temperature Coefficient			
30mV	0.0028 + 5.0			
300mV	0.0005 + 0.5			
3 V	0.0004 + 0.05			
30 V	0.0006 + 0.5			
300 V	0.0004 + 0.05			
Noise Rejection:				
In dB, with 1kΩ imbalance in Lo lead. AC rejection for 50, 60Hz ± 0.1%. Auto-zero ON.				
Display	AC NMR	AC ECMR	DC CMR	
5½ digits	80	150	140	
4½ digits	59	130	140	
3½ digits	0	70	140	
Maximum Reading Rates: (readings/sec)				
First reading is correct when triggered coincident with step input.				
The reading rates are dependent on the speed of the controller being used.				
Line Frequency	Auto Zero	3½ Digits	4½ Digits	5½ Digits
60Hz	Off	90	35	4.4
	On	60	20	2.3
50Hz	Off	85	30	3.7
	On	50	17	1.9
AC VOLTAGE (true rms responding)				
Input Characteristics:				
Range	Maximum Reading (5½ Digit)	Resolution		
		5½ Digit	4½ Digit	3½ Digit
300mV	303.099mV	1µV	10µV	100µV
3 V	3.03099 V	10µV	100µV	1mV
30 V	30.3099 V	100µV	1mV	10mV
300 V	303.099 V	1mV	10mV	100mV
Input Impedance:				
1MΩ ± 1% shunted by < 60pF				
Maximum Input Voltage: (non-destructive)				
Hi to Lo: 303Vrms or 450V peak				
Hi or Lo to Earth Ground: ± 500V peak				
Measurement Accuracy:				
± (% of reading + number of counts)				
Auto-zero ON. 5½ digit display. Accuracy is specified for sine-wave inputs only, > 10% of full scale.				
1 Year, Cal. Temp. ± 5°C				
Input Frequency	300mV	Ranges 3V, 30V	300V	
20Hz-50Hz	1.14 + 163	1.14 + 102	1.18 + 102	
50Hz-100Hz	0.46 + 163	0.46 + 103	0.50 + 102	
100Hz-20kHz	0.20 + 120	0.20 + 70	0.24 + 70	
20kHz-50kHz	0.38 + 205	0.26 + 140	0.42 + 140	
50kHz-100kHz	1.20 + 840	0.87 + 780	0.98 + 780	
100kHz-300kHz		10.1 + 3720	(30V Range Only)	

Table 4-3. Specifications (Cont'd)

Auto Zero Off:

(5½ digits) for a stable environment ($\pm 1^\circ\text{C}$), for <24 hrs., add 10 counts to accuracy specifications for all ranges.

Temperature Coefficient:

0°C to 55°C
 5½ digit display, auto-zero ON.
 For frequencies <20kHz, $\pm(0.016\%$ of reading + 10 counts)/°C
 For frequencies >20kHz, $\pm(0.04\%$ of reading + 10 counts)/°C

Crest Factor:

>4:1 at full scale.

Common Mode Rejection:

With 1kΩ imbalance in Lo lead, >70dB, at 60Hz.

Maximum Reading Rates: (readings/sec)

First reading is correct within 70 counts of final value, when on correct range, triggered coincident with step input. Add 0.6 seconds for each range change.

Reading rates are the same as dc volts using fast trigger (T5). Using Normal Trigger (T1, T2, T3):

For 50 or 60Hz operation, auto-zero ON or OFF.
 3½ or 4½ digits: 1.4
 5½ digits: 1.0

RESISTANCE (2-wire Ω, 4-wire Ω)

Input Characteristics:

Range	Maximum Reading (5½ Digit)	Resolution		
		5½ Digit	4½ Digit	3½ Digit
30 Ω	30.3099 Ω	100 μΩ	1 mΩ	10 mΩ
300 Ω	303.099 Ω	1 mΩ	10 mΩ	100 mΩ
3 kΩ	3.03099 kΩ	10 mΩ	100 mΩ	1 Ω
30 kΩ	30.3099 kΩ	100 mΩ	1 Ω	10 Ω
300 kΩ	303.099 kΩ	1 Ω	10 Ω	100 Ω
3MΩ	3.03099MΩ	10 Ω	100 Ω	1 kΩ
30MΩ	30.3099MΩ	100 Ω	1 kΩ	10 kΩ

Input Protection: (non-destructive)

Hi source to Lo source: $\pm 350\text{V}$ peak
 Hi sense to Lo sense: $\pm 350\text{V}$ peak
 Hi or Lo to Earth Ground: $\pm 500\text{V}$ peak

Measurement Accuracy:

\pm (% of reading + number of counts)
 Auto-zero ON, 4-wire ohms.
 Maximum INPUT LO impedance is 3.3% of full scale.

5½ Digit Mode:

Range	Cal. Temp $\pm 1^\circ\text{C}$ 24 Hours	Cal. Temp. $\pm 5^\circ\text{C}$	
		90 Day	1 Year
30Ω	0.023 + 35	0.027 + 41	0.034 + 41
300Ω	0.0045 + 4	0.012 + 5	0.017 + 5
3k-300kΩ	0.0035 + 2	0.011 + 2	0.016 + 2
3 MΩ	0.0052 + 2	0.011 + 2	0.016 + 2
30MΩ	0.036 + 2	0.066 + 2	0.078 + 2

Note

>30 M ohm Range accuracy is approximately 0.002%/M ohm.

2-Wire Ohms Accuracy:

Same as 4-wire ohms, except add a maximum of 200mΩ off-set. On the 3M ohm Range, add .0016% of reading and on the 30M ohm Range, add .0083%.

Auto-Zero Off:

(5½ digit) for a stable environment ($\pm 1^\circ\text{C}$), for <24 hrs., add 110 counts to accuracy specification for 30Ω range, 11 counts for 300Ω, 3 counts for 3KΩ through 300KΩ ranges, 8 counts for 3MΩ range, and 33 counts for 30MΩ range.

Temperature Coefficient:

0°C to 55°C
 5½ digit display, auto-zero ON
 \pm (% of reading + number of counts)/°C

Range	Temperature Coefficient
30Ω	0.003 + 5
300Ω	0.0009 + .5
3k-300kΩ	0.0009 + .05
3MΩ	0.0021 + .05
30MΩ	0.021 + .05

Current Through Unknown:

Range	Current
30 ohm	1mA
300 ohm	1mA
3K ohm	1mA
30K ohm	100μA
300K ohm	10μA
3M ohm	1μA
30M ohm	100nA

Maximum Open Circuit Voltage:

6.5V

Maximum Reading Rates:

Same as dc volts, except for 3MΩ and 30MΩ ranges. For 3MΩ range, add 30ms; for 30MΩ range, add 300ms per reading.

DC CURRENT

Input Characteristics:

Range	Maximum Reading (5½ Digit)	Resolution		
		5½ Digit	4½ Digit	3½ Digit
300mA	$\pm 303.099\text{mA}$	1μA	10μA	100μA
3 A	$\pm 3.03099 A$	10μA	100μA	1mA

Maximum Input: (non-destructive)

3A from <250V source; fuse protected

Measurement Accuracy:

\pm (% of reading + number of counts)
 Auto-zero ON, 5½ digit display.

Range	Cal. Temp. $\pm 5^\circ\text{C}$	
	90 Days	1 Year
300mA	0.11 + 40	0.15 + 40
3A, <1A input	0.14 + 6	0.17 + 6
3A, >1A input	1.0 + 30	1.0 + 30

Table 4-3. Specifications (Cont'd)

Auto-Zero Off:

(5 1/2 digit) for a stable environment ($\pm 1^\circ\text{C}$), for <24 hrs., add 110 counts to accuracy specification for 300mA range, 11 counts for 3A range.

Temperature Coefficient:

0°C to (Cal. Temp. -5°C), (Cal. Temp. $+5^\circ\text{C}$) to 55°C
 5 1/2 digit display, auto-zero ON
 \pm (% of reading + number of counts)/°C

Range	Temperature Coefficient
300mA	0.012 + 5
3 A	0.012 + 0.5

Maximum Burden at Full Scale:

1V

Maximum Reading Rates:

Same as dc volts

AC CURRENT (true rms responding)

Input Characteristics:

Range	Maximum Reading (5 1/2 Digit)	Resolution		
		5 1/2 Digit	4 1/2 Digit	3 1/2 Digit
300mA	303.099mA	1µA	10µA	100µA
3 A	3.03099 A	10µA	100µA	1mA

Maximum Input: (non-destructive)

3A from <250V source; fuse protected

Measurement Accuracy:

\pm (% of reading + number of counts)
 Auto-zero ON, 5 1/2 digit display, accuracy specified for sine-wave inputs only >10% of full scale.
 1 YEAR, CAL. TEMP. $\pm 5^\circ\text{C}$

Frequency	Ranges	
	300mA	3A
20Hz - 50Hz	1.54 + 163	2.24 + 163
50Hz - 1kHz	0.81 + 163	1.5 + 163
1kHz - 10kHz	0.72 + 163	1.42 + 163
10kHz - 20kHz	0.86 + 163	1.56 + 163

Auto-zero Off:

(5 1/2 digits) for a stable environment ($\pm 1^\circ\text{C}$), for <24 hrs., add 10 counts to accuracy specification.

Temperature Coefficient:

0°C to 55°C.
 5 1/2 digits, auto-zero ON.
 \pm (0.021% of reading + 10 counts)/°C

Maximum Burden at Full Scale:

1V

Crest Factor:

>4:1 at full scale

Maximum Reading Rates:

Same as ac volts

GENERAL INFORMATION

Operating Temperature:

0 to 55°C

Humidity Range:

95% R.H., 0 to 40°C

Storage Temperature:

-40°C to 75°C

Warm-up Time:

1 hr. to meet all specifications.

Integration Time:

Number of Digits	Line Frequency	
	50Hz	60Hz
5 1/2	200ms	166.7ms
4 1/2	20ms	16.67ms
3 1/2	2ms	1.667ms

Power:

AC Line 48 - 440Hz; 86 - 250V, (see configuration)

Maximum Power:

<25 watts

Size:

102mm H x 215mm W x 356mm D
 (4 in H x 8 in W x 14 in D)

Weight:

3Kg (6.5 lbs.)

APPENDIX A

Introduction

This appendix contains a general description of the Hewlett-Packard Interface Bus (HP-IB). HP-IB is Hewlett-Packard's implementation of IEEE Standard 488-1978, "Standard Digital Interface for Programmable Instrumentation". The information is non-controller dependent but, where appropriate, is dependent on the 3478A.

General HP-IB Description

The Hewlett-Packard Interface Bus (HP-IB) is a carefully defined interface which simplifies the integration of various instruments, calculators, and computers into systems. The interface provides for messages in digital form to be transferred between two or more HP-IB compatible devices. A compatible device can be an instrument, calculator, computer, or peripheral device that is designed to be interfaced using the HP-IB.

The HP-IB is a parallel bus of 16 active signal lines grouped into three sets, according to function, to interconnect up to 15 instruments. Figure A-1 provides a pictorial view of the HP-IB connector and its pin designation. A diagram of the Interface Connections and Bus Structure is shown in Figure A-2.

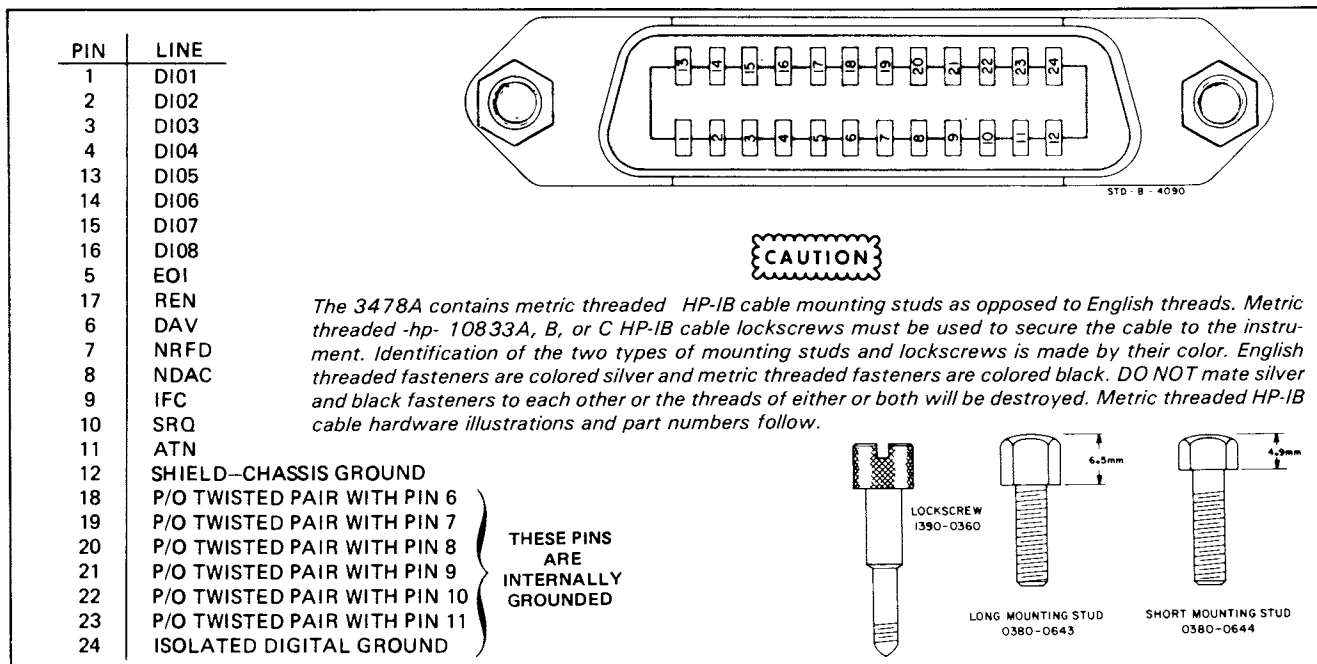

Figure A-1. HP-IB Connector

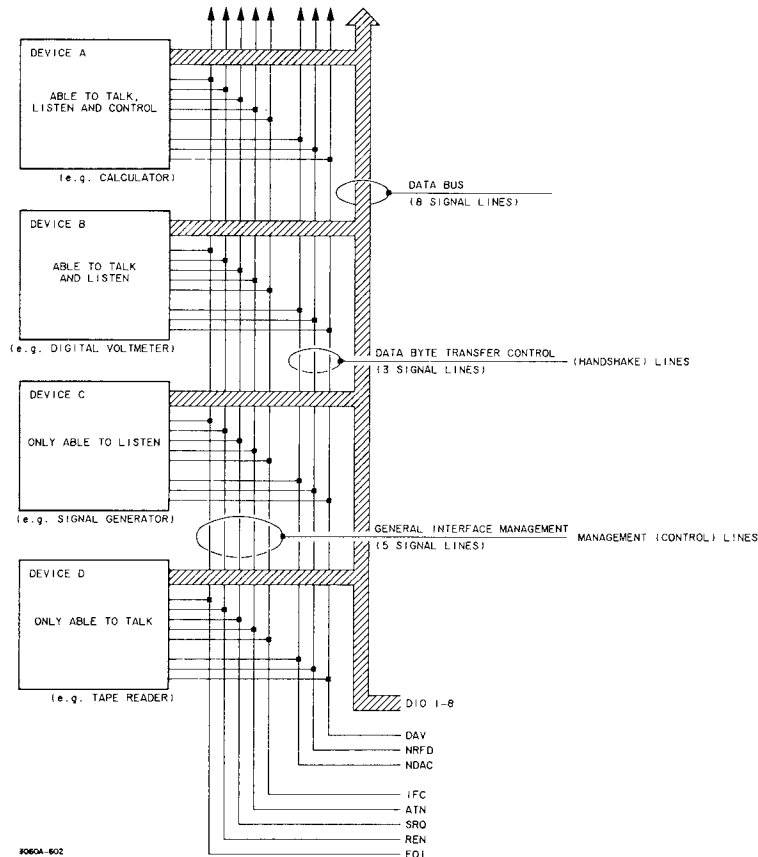

Figure A-2. Interface Connection and Bus Structure

Eight Signal lines, termed as DATA Lines, are in the first set. The Data Lines are used to transmit data in the form of coded messages. These messages are used to program the instrument function, transfer measurement data, coordinate instrument operation, and to manage the system. This allows you to set-up the instrument and read its measurement data. Input and Output of messages, in bit parallel byte serial form, are also transferred in the Data Lines. A 7-bit ASCII code normally represents each piece of data.

Data is transferred by means of an interlocking "handshake" technique which permits data transfer (asynchronously) at the rate of the slowest active device used in that particular transfer. The three DATA BYTE CONTROL lines coordinate the transfer and form the second set of lines.

The remaining five GENERAL INTERFACE MANAGEMENT lines are used to manage the devices on the HP-IB. This includes activating all connected devices at once, clearing the interface, and others. For more details on HP-IB order HP part number 59401-90030. This is a condensed description of the Hewlett-Packard Interface Bus.

HP-IB System Overview

The following paragraphs define the terms and concepts used to describe HP-IB (Bus) system operations.

HP-IB System Terms

a. **Address:** The characters sent by a controlling device to specify which device will send information on the HP-IB and which device(s) will receive that information. Addressing may also be accomplished by hardwiring a device to only send information or only receive information.

b. **Byte:** A unit of information consisting of 8 binary digits (bits).

c. **Device:** A unit that is compatible with the IEEE Standard 488-1978.

d. **Device Dependent:** An action a device performs in response to information sent over the HP-IB. The action is characteristic of an individual device and may vary from device to device.

e. **Polling:** This process typically is used by a controller to locate a device that needs to interact with the controller. There are two types of polling, as follows:

1. **Serial Poll:** This method obtains one byte of operational information about an individual device in the system. The process must be repeated for each device from which information is desired.

2. **Parallel Poll:** This method obtains information about a group of devices simultaneously. The 3478A does not respond to a Parallel Poll.

Basic Device Communication Capabilities

Devices which communicate along the interface bus can be classified into three basic categories:

a. **Talker:** Any device that is able to send information over the HP-IB when it has been addressed. Only one talker may be active at a time; usually the one that is currently directed to send data. All HP-IB type calculators and computers are generally talkers.

b. **Listener:** Devices which receive information over the HP-IB, when they have been addressed. A device may or may not be both a talker and a listener. Calculators and computers are generally both a talker and a listener (at different times).

c. Controller: The device that can specify which device(s) on the bus is a talker or listener. There can be two types of controllers, an Active Controller and a System Controller. The Active Controller is the current controlling device. The System Controller can, however, take control of the HP-IB even if it is not the Active Controller. There can also be only one Active Controller at a time, even if several controllers are on the Bus.

HP-IB Messages

Different types of information can be passed over the HP-IB to one or more devices. Some of this information is in the form of messages, most of which can be separated into two parts. One part can be classified as the address portion specified by the controller and the information that comprises the messages. The second part can be classified as HP-IB management messages. These messages are comprised of twelve messages and are called Bus messages.

a. Data: The actual information (binary bytes) sent by a talker to one or more listeners. The information (data) can either be in numeric form or a character string.

b. Trigger: The Trigger message causes the listening device or devices to perform a device dependent action when addressed.

c. Clear: The Clear message causes the listening device(s) or all the devices on the HP-IB to return to their predefined device-dependent state.

d. Remote: This message causes the listening device(s) to switch from local front panel control to remote program control when addressed to listen.

e. Local: This message clears the REMOTE message from the listening device(s) and returns the device(s) to local front panel control.

f. Local Lockout: This message prevents a device operator from manually inhibiting remote program control.

g. Clear Lockout and Set Local: With this message, all devices are removed from the local lockout mode and revert to local. The remote message is also cleared for all devices.

h. Require Service: A device can send this message at any time to signify the device needs some type of interaction with the controller. This message is cleared by the device's STATUS BYTE message if the device no longer requires service.

i. Status Byte: A byte that represents the current status of a single device on the HP-IB. One bit indicates whether the device sent the require sevice message and the remaining seven bits indicate optional conditions defined by the device. This byte is sent from the talking device in response to a "Serial Poll" operation performed by the controller.

j. Status Bit: A byte that represents the operational conditions of a group of devices on the HP-IB. Each device responds on a particular bit of the byte thus identifying a device dependent condition. This bit is typically sent by devices in response to a parallel poll operation.

k. Pass Control: The bus management responsibility is transferred from the active controller to another controller by this message.

l. Abort: The system controller sends this message to unconditionally assume control of the HP-IB from the active controller. The message will terminate all bus communication but does not implement the CLEAR message.

3478A Bus Capabilities

The 3478A interfaces to the HP-IB as defined by the IEEE Standard 488-1978. The interface functional subset which the 3478A implements is specified in Table A-1.

Table A-1. 3478A Device Capability

SH1	Source Handshake complete capability
AH1	Acceptor Handshake complete capability
T5	Basic talker, with serial poll, talk only mode, and unaddress with MLA.
TE0	No extended talker
L4	Basic listener, unaddress when MTA
LE0	No extended listener
SR1	Service request complete capability
RL1	Remote-Local complete capability
PPO	No parallel poll capability
DC1	Device Clear complete capability
DT1	Device Trigger complete capability
CO	No controller capability

HP-IB Worksheet

The HP-IB worksheet (Table A-2) can be used to determine the HP-IB capabilities of the other HP-IB compatible instruments in a system. The sheet may be filled in with the bus message applicability for your controller and for each HP-IB device. The bus capability for the 3478A has already been filled in. Refer to your controller manual and the manual(s) of your other device(s) for their Bus Message capabilities. Once the sheet is filled out, you should then have the HP-IB capabilities of your device(s).

Table A-2 HP-IB Worksheet

Message	Device						
	MODEL 3478A				MODEL		
INSTRUMENT IDENTIFICATION	MODEL 3478A				MODEL		
AND	LISTEN YES				LISTEN		
HP-IB ADDRESS	TALK YES				TALK		
	5 BIT VALUE 23				5 BIT VALUE		
DATA	S & R						
TRIGGER	R						
CLEAR	R						
LOCAL	R						
REMOTE	R						
LOCAL LOCKOUT	R						
CLEAR LO & SET LOCKOUT	R						
REQUIRE SERVICE	S						
STATUS BYTE	S						
STATUS BIT	N						
PASS CONTROL	N						
ABORT	N						

S = SEND ONLY R = RECEIVE ONLY S & R = SEND AND RECEIVE N = NOT IMPLEMENTED

Bus Message Implementation

The following eleven figures provide a description of the implementation of the Bus Messages using the 3478A. The codes used in the figures are:

T = True
 F = False
 X = Don't Care
 oct = Octal Code

Data Message (Controller to 3478A).

To send Data from the controller to the 3478A, first:

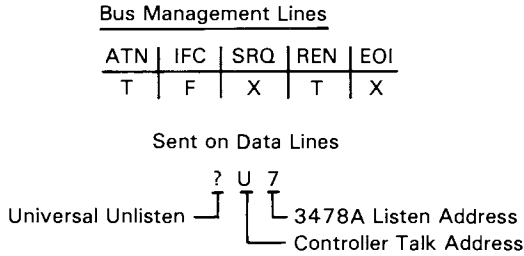

then:

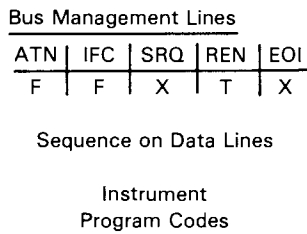

Data Message (3478A to Controller or Other Device(s)).

To send Data from the 3478A to the controller, first:

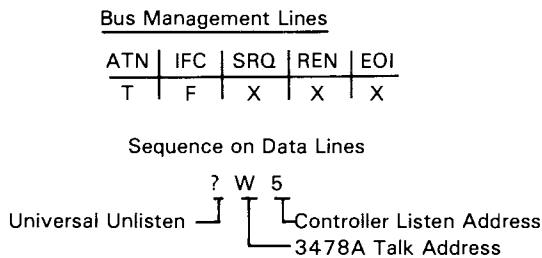

then:

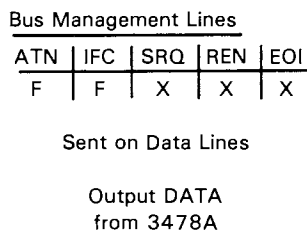

Trigger Message (from Controller to Device(s))

To send the TRIGGER Message (Group Execute Trigger):

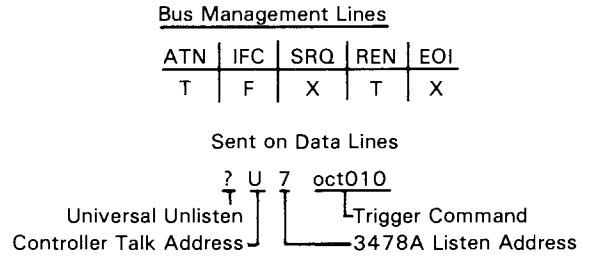

Remote Message

To Enter the REMOTE Mode:

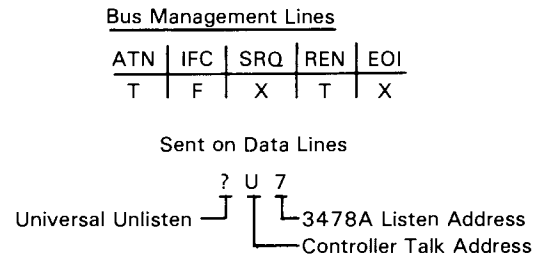

To Remain in the REMOTE Mode:

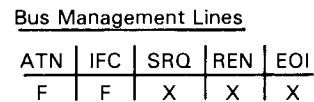

Local Message

To enter the LOCAL Mode:

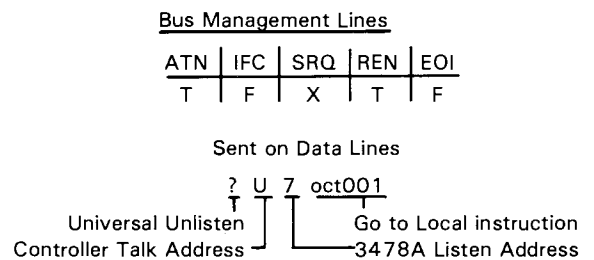

Bus Message Implementation (Cont'd)

Clear Message

To send the CLEAR Message:

Bus Management Lines				
ATN	IFC	SRQ	REN	EOI
T	F	X	X	X

Sent on Data Lines



To send the CLEAR MESSAGE Only to the 3478A:

Bus Management Lines				
ATN	IFC	SRQ	REN	EOI
F	F	X	T	X

Sent on Data Lines

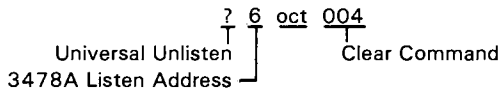

Status Byte Message

To Serial POLL the 3478A (obtain Status Byte):

Bus Management Lines				
ATN	IFC	SRQ	REN	EOI
T	F	X	X	F

Sent on Data Lines

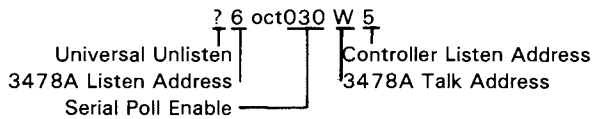

then:

Bus Management Lines				
ATN	IFC	SRQ*	REN	EOI
F	F	X	X	F

Sent on Data Lines

3478A Status Byte

*If SRQ was true, it will switch to the false state.

and finally:

Bus Management Lines				
ATN	IFC	SRQ	REN	EOI
T	F	F	X	F

Sent on Data Lines



Require Service Message

To send REQUIRE SERVICE MESSAGE:

Bus Management Lines				
ATN	IFC	SRQ	REN	EOI
X	X	T	X	X

Local Lockout Message

To enable LOCAL LOCKOUT:

Bus Management Lines				
ATN	IFC	SRQ	REN	EOI
T	F	X	T	F

Sent on Data Lines



to maintain LOCAL LOCKOUT:

Bus Management Lines				
ATN	IFC	SRQ	REN	EOI
X	X	X	T	X

Clear Lockout/Set Local Message

To CLEAR LOCAL LOCKOUT and set LOCAL:

Bus Management Lines				
ATN	IFC	SRQ	REN	EOI
X	X	X	T	X

Abort Message

To send the ABORT Message:

Bus Management Lines				
ATN	IFC	SRQ	REN	EOI
X	T	X	X	X

APPENDIX B

ASCII Character Codes

ASCII Char.	EQUIVALENT FORMS			ASCII Char.	EQUIVALENT FORMS			ASCII Char.	EQUIVALENT FORMS			ASCII Char.	EQUIVALENT FORMS		
	Binary	Octal	Dec.		Binary	Octal	Dec.		Binary	Octal	Dec.		Binary	Octal	Dec.
NULL	00000000	000	0	space	00100000	040	32	@	01000000	100	64	'	01100000	140	96
SOH	00000001	001	1	!	00100001	041	33	A	01000001	101	65	a	01100001	141	97
STX	00000010	002	2	"	00100010	042	34	B	01000010	102	66	b	01100010	142	98
ETX	00000011	003	3	#	00100011	043	35	C	01000011	103	67	c	01100011	143	99
EOT	00000100	004	4	\$	00100100	044	36	D	01000100	104	68	d	01100100	144	100
ENQ	00000101	005	5	%	00100101	045	37	E	01000101	105	69	e	01100101	145	101
ACK	00000110	006	6	&	00100110	046	38	F	01000110	106	70	f	01100110	146	102
BELL	00000111	007	7	'	00100111	047	39	G	01000111	107	71	g	01100111	147	103
BS	00001000	010	8	(00101000	050	40	H	01001000	110	72	h	01101000	150	104
HT	00001001	011	9)	00101001	051	41	I	01001001	111	73	i	01101001	151	105
LF	00001010	012	10	*	00101010	052	42	J	01001010	112	74	j	01101010	152	106
V_TAB	00001011	013	11	+	00101011	053	43	K	01001011	113	75	k	01101011	153	107
FF	00001100	014	12	,	00101100	054	44	L	01001100	114	76	l	01101100	154	108
CR	00001101	015	13	-	00101101	055	45	M	01001101	115	77	m	01101101	155	109
SO	00001110	016	14	.	00101110	056	46	N	01001110	116	78	n	01101110	156	110
SI	00001111	017	15	/	00101111	057	47	O	01001111	117	79	o	01101111	157	111
DLE	00010000	020	16	0	00110000	060	48	P	01010000	120	80	p	01110000	160	112
DC ₁	00010001	021	17	1	00110001	061	49	Q	01010001	121	81	q	01110001	161	113
DC ₂	00010010	022	18	2	00110010	062	50	R	01010010	122	82	r	01110010	162	114
DC ₃	00010011	023	19	3	00110011	063	51	S	01010011	123	83	s	01110011	163	115
DC ₄	00010100	024	20	4	00110100	064	52	T	01010100	124	84	t	01110100	164	116
NAK	00010101	025	21	5	00110101	065	53	U	01010101	125	85	u	01110101	165	117
SYNC	00010110	026	22	6	00110110	066	54	V	01010110	126	86	v	01110110	166	118
ETB	00010111	027	23	7	00110111	067	55	W	01010111	127	87	w	01110111	167	119
CAN	00011000	030	24	8	00111000	070	56	X	01011000	130	88	x	01111000	170	120
EM	00011001	031	25	9	00111001	071	57	Y	01011001	131	89	y	01111001	171	121
SUB	00011010	032	26	:	00111010	072	58	Z	01011010	132	90	z	01111010	172	122
ESC	00011011	033	27	;	00111011	073	59	[01011011	133	91	{	01111011	173	123
FS	00011100	034	28	<	00111100	074	60	\	01011100	134	92		01111100	174	124
GS	00011101	035	29	=	00111101	075	61]	01011101	135	93	}	01111101	175	125
RS	00011110	036	30	>	00111110	076	62	^	01011110	136	94	~	01111110	176	126
US	00011111	037	31	?	00111111	077	63	_	01011111	137	95	DEL	01111111	177	127

COMMAND QUICK REFERENCE GUIDE

Function Code		Range Code										
		R-2	R-1	R0	R1	R2	R3	R4	R5	R6	R7	RA (Autorange)
DC Volts	F1	30mV	300mV	3V	30V	300V	+	+	+	+	+	
AC Volts	F2	*	300mV	3V	30V	300V	+	+	+	+	+	
2-W Ohm	F3	*	*	*	30Ω	300Ω	3KΩ	30KΩ	300kΩ	3MΩ	30MΩ	
4-W Ohm	F4	*	*	*	30Ω	300Ω	3KΩ	30KΩ	300KΩ	3MΩ	30MΩ	
DC Amps	F5	*	300mA	3A	+	+	+	+	+	+	+	
AC Amps	F6	*	300mA	3A	+	+	+	+	+	+	+	
Enhanced Ohms	F7											

Notes:

- * indicates that the range code selects the lowest (most sensitive) range for that function
- + indicates that the range code selects the highest (least sensitive) range for that function

Other Program Codes:

Function Mnemonic	Qualifier	Description	Example
N	3,4,5	Selects the number of digits of display	N3 selects the 3 1/3 digit display
T	1-5	Trigger mode; Internal External, Single, Hold, Fast	T2 selects external trigger
Z	0,1	Autozero	Z0 turns Autozero off Z1 turns Autozero on
D	1-3	Display	D1 selects normal display D2text prints message "text" on display.
H	0-7	Home (preset) H0 = F1T4R-2RAZ1N4 H1 = F1R-2RAZ1N4T3 H2 = F2R-2RAZ1N4T3 H3 = F3R-2RAZ1N4T3 H4 = F4R-2RAZ1N4T3 H5 = F5R-2RAZ1N4T3 H6 = F6R-2RAZ1N4T3 H7 = F7R-2RAZ1N4T3	
B		Output Binary status	
C		Calibrate (see service manual)	
K		Clear serial poll register	
E		read and clear error register	
Mxx	0 to 77 (octal)	Set SRQ mask to octal value xx	
S		Return value of Front/Rear switch	

INDEX

	Page		Page
A		H	
ABORT message	89,92	Hints, programming	40
Abnormal multimeter readings	13	Home commands	39
Accessories	63	see also Table 3-1, and Quick Reference	
AC		Guide	
current	11	HP-IB	
volts	32	general description	85
Address (HP-IB)	4,36,37,68	interface connections	67,85
Amps terminal	11	program codes	59
Annunciators	17		
ASCII character set	93	I	
Autorange	21	Input terminals	5/6
hysteresis	21	Integration	16,18
Autozero	8,19	Internal trigger	30
C			
Calibration	10	L	
Cleaning	75	Line voltage selection	64
CLEAR	43,88,92	LOCAL	44,88,91
Clear Lockout/Set Local	44,88,92	LOCAL LOCKOUT	44,88,92
Current measurements	11		
D		M	
Data	88,91	Manual ranging	22
message	37	Measurement Function keys	5/6
ready SRQ	48	Messages	
dBm measurement program	56	display	13
DC		HP-IB	88,91
current	11	self test	4,29
volts	32	user generated	15
Display	4,12,20	N	
digits	15	Normal display	12
messages	13,29	O	
normal	12	Operating characteristics	7,81
user generated messages	15	Operation mnemonic	37
E		Optimizing reading rates	18
Environment		program for maximum rate	57
environmental requirements	67	Output format	42
signal environments	18		
Extended Ohms	26,55	P	
External Trigger	31	Programming Commands	59
F		Programming hints	40,54
Format, output	42	Q	
Four-wire ohms measurements	26	Qualifier	37
Front/rear switch	4		
Fuse replacement	68		

INDEX (Cont'd)

R	Page	T	Page
Range (ranging)	20	Talk-only mode	42
key	20	Temperature measurement program	54
Reading rate	18	Test/reset	29
program for maximum rate	57	Trigger	30,53,88,91
Rear panel	23	external	31
switches	23,68	indicator	30
REMOTE	45,88,91	internal	30
REQUIRE SERVICE (SRQ)	46,88,92	modes	30
Repair Service	74	single	30
Resistance measurements	25	Trouble, in case of	70
2-wire	26	TURNING IT ON	4
4-wire	26	Two-wire ohms measurements	26
extended ohms	26		
		U	
S		User generated messages	15
Safety considerations	66	V	
SENSE terminals	5/6	Verification program	76
SERIAL POLL (SPOLL)	46-49, 50	Voltage measurements	32
Shift	5/6	Voltmeter complete	34
Signal environment	18		
Single trigger	30	W	
Specifications	67, 81-83	Warranty	73
SRQ	46		
key	5/6		
mask	47		
Status byte	47,58,89,92		
Status register	47		



03478-90009

Printed in U.S.A.