

Agilent 4263B LCR Meter
User's Guide



Agilent Technologies
Innovating the HP Way

Agilent Part No. 04263-90022
Printed in JAPAN December 2000

Fourth Edition

Documentation Map

- *User's Guide* ⇐ This book

Is a handy reference to help you to get started using your 4263B, basic measurements and commonly used features are explained.

- *Operation Manual* (Furnished with the 4263B.)

Provides information on initial inspection, how to operate the 4263B, in-depth reference information, general information, and maintenance information.

In *User's Guide*.

- Chapter 1, Preparation for Use

For initial turn ON of the 4263B

- Chapter 2, Operating the 4263B

Basic Measurement operation

Getting acquired with the 4263B : for beginners

Handy reference for measurement task : for all users

- Chapter 3, Measurement Example

Measurement examples for typical 4263B applications

Capacitor measurement

Inductor measurement

Transformer measurement

In the *User's Guide*, information on the following subjects is not discussed:

- Initial Inspection
- GPIB Remote Control
- Handler Interface
- Maintenance
- Specification
- Error Messages

For detailed information on these subjects, refer to the *Operation Manual*.

Contents

1. Preparation for Use	
In This Chapter	1-1
Power Requirements	1-1
To Set Power LINE Voltage	1-1
To Set Power LINE Frequency	1-3
2. Operating the 4263B	
In This Chapter	2-1
Resetting 4263B to its Default Settings	2-2
Connecting Test Fixture	2-2
Setting the Cable Length	2-3
Selecting the Measurement Parameter	2-3
Setting the Test Signal Frequency	2-4
Setting the Test Signal Level	2-4
Setting the DC Bias Source Voltage	2-5
Selecting the Measurement Time Mode	2-5
Setting the Averaging Rate	2-5
Selecting the Measurement Range	2-6
Auto Range mode —Automatically Selecting the Optimum Measurement Range	2-6
Hold Range mode—Selecting the Measurement Range of Your Choice	2-6
Selecting the Trigger Mode	2-7
Setting the Trigger Delay Time	2-7
Performing the OPEN Correction	
—Canceling the stray admittance in parallel with the DUT	2-8
Performing the SHORT Correction	
—Canceling the residual impedance in series with the DUT	2-9
Using the Comparator Function	2-10
Setting the Limit Values	2-10
Starting the Sort	2-10
Using the Contact Check Function	
—Monitoring the connection of test electrodes and DUT	2-11
Using the Deviation Measurement Function	2-11
Setting the Deviation Reference Values	2-11
Selecting the Deviation Mode	2-12
Selecting the Display Mode	2-13
Using the Level Monitor Function	2-14
Selecting the Beeper Mode	2-15
Setting the Printer—Printing the measurement data	2-15
Connecting the DUT	2-16
Applying the DC Bias	2-17
Making a Measurement	2-17
Verification of Current Settings	2-17
If You Have a Problem	2-18
Reference	2-19
Default Settings	2-19
Measurement Parameters	2-19

Accessories Available	2-20
16064B LED Display/Trigger Box	2-20
Test Fixtures and Test Leads	2-20
Accessories List	2-22
Measurement Range Setting	2-23
Other Topics	2-23

3. Measurement Examples

In This Chapter	3-1
Electrolytic Capacitor Measurement—For High Capacitance	3-2
DUT	3-2
Requirements	3-2
Measurement Setup	3-2
Measurement Procedure	3-2
For More Information	3-5
Inductor Measurement—Versatile measurement parameters	3-6
DUT	3-6
Requirements	3-6
Test Fixture	3-6
Measurement Setup	3-6
Measurement Procedure	3-6
For More Information	3-10
Transformer Measurement (Option 001 Only)	3-11
DUT	3-11
Requirements	3-11
Measurement Setup	3-11
Measurement Procedure	3-11
For More Information	3-14

Figures

2-1. Connecting a Test Fixture	2-2
2-2. Printer Output	2-16
2-3. Connecting the DUT	2-16

Tables

1-1. Line Voltage Selection	1-2
---------------------------------------	-----

Preparation for Use

In This Chapter

First you must set the 4263B to match the available power LINE voltage, before turning the 4263B ON.

If the 4263B's power LINE voltage and frequency are properly set and ready to use, you can skip this chapter.

Power Requirements

The 4263B's power source requirements are as follows:

LINE Voltage : 100 / 120 / 220 / 240 V ac ($\pm 10\%$)

LINE Frequency : 47 to 66 Hz

Power Consumption : 45 VA maximum

To Set Power LINE Voltage

1. Confirm that the power cable is disconnected.
2. Slide the LINE Voltage selector on the rear panel to match the ac LINE voltage which will be used (see Table 1-1).

Table 1-1. Line Voltage Selection

Voltage Selector	Line Voltage	Required Fuse
(a) 115 V	100 / 120 V	T 0.5 A 250 V (Agilent part number 2110-0202)
(b) 230 V	220 / 240 V	T 0.25 A 250 V (Agilent part number 2110-0201)

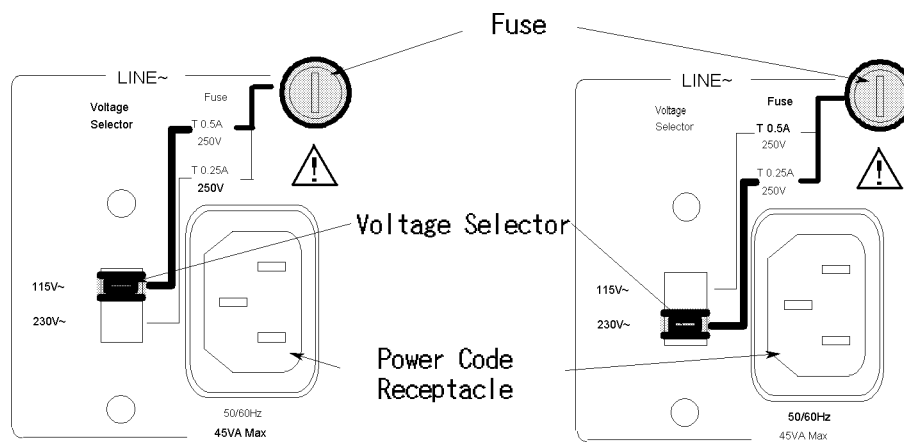



To Set Power LINE Frequency

Note In this manual, the BLUE shift key is expressed as  , the top of the key is not labeled “blue”.



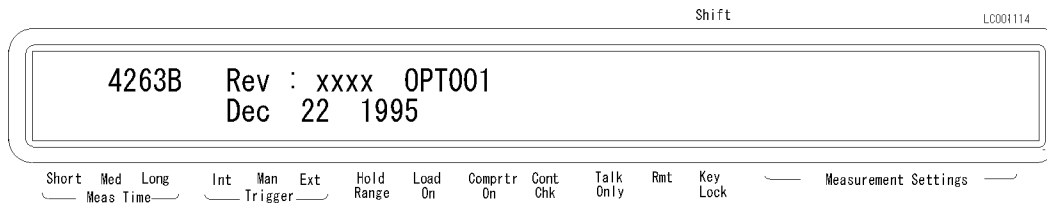

1. Connect the power cable to the power cord receptacle on the rear panel.
2. Push the LINE switch in and the 4263B will emit a beep when it turns ON, and the self tests will be performed. (If any message is displayed, see “Error Messages” at the back of Operation manual.) The 4263B will be ready for operation after a message like the following is displayed.



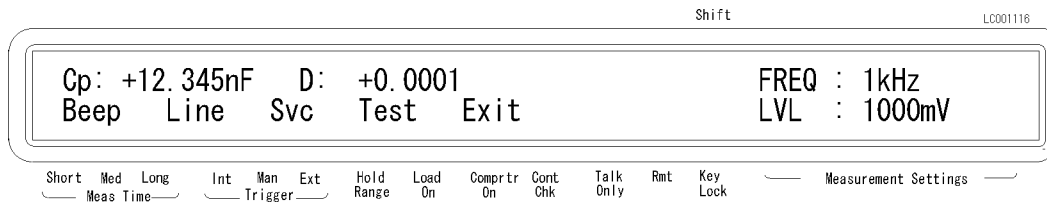

3. Press   . The following configuration menu is displayed.

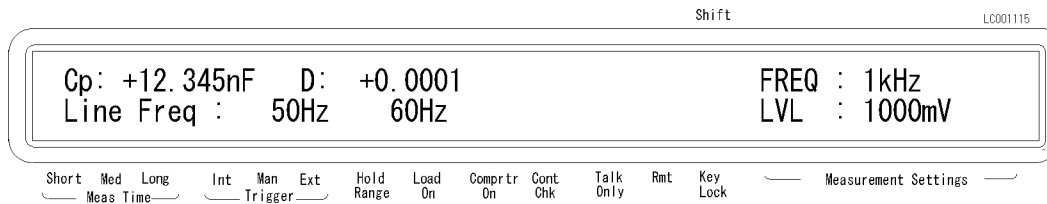

4. Press  until Line blinks, then press  .



A blinking item means that it is currently selected.

5. If the setting does not match the ac line frequency, press  to toggle the setting between 50 HZ and 60 HZ.
6. Press  to set the line frequency.

7. Exit the configuration menu by selecting **Exit**.

Note



The power line frequency setting is stored and is not changed after reset or power-off. Once you set it, you do not need to set the line frequency again as long as the same power line frequency is being used.

Operating the 4263B



In This Chapter

Basic operation of the 4263B is explained.

Resetting 4263B to its Default Settings

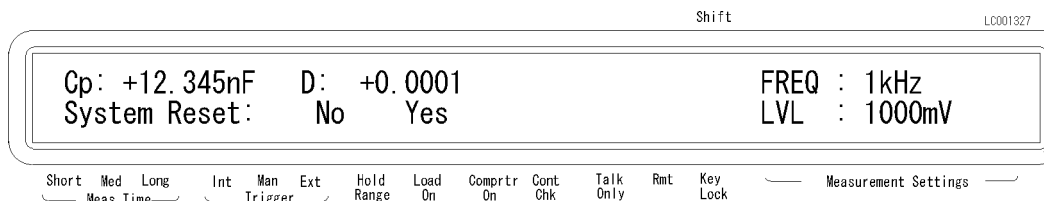
1. Press   to select the reset menu.



2. Select Yes using  or , and press .

The 4263B will be reset to its default settings. For more information about the default settings, see “Default Settings” later in this chapter.

Connecting Test Fixture

Connect the test fixture to the UNKNOWN terminals as follows:

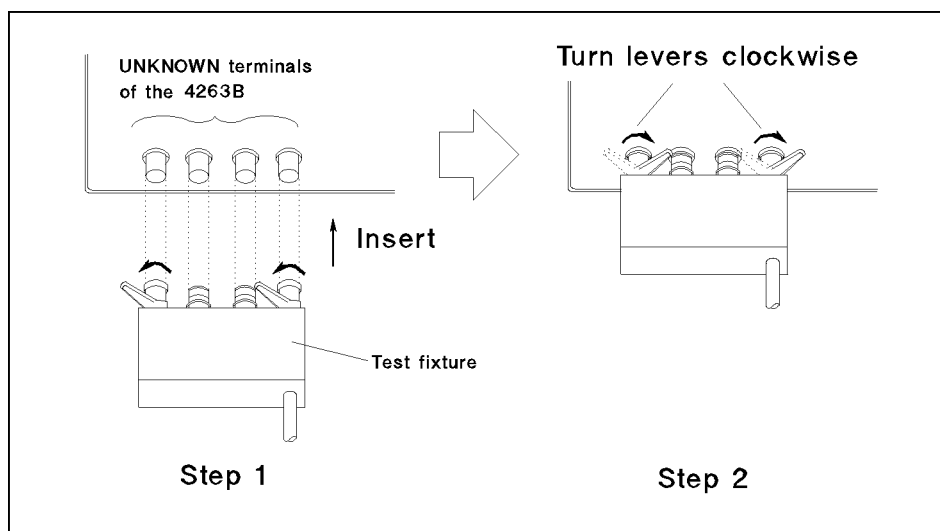



Figure 2-1. Connecting a Test Fixture

See information on available test fixtures, “Accessories Available” later in this chapter.



Setting the Cable Length

The cable length correction function cancels the phase shift error caused by the cable length. When using the Agilent test leads, perform the cable length correction as follows:

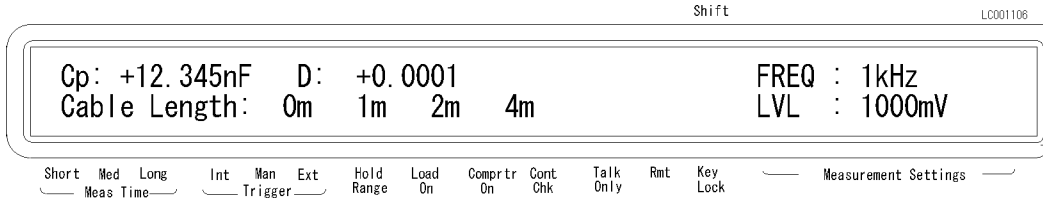
1. Press   . Cable lengths 0 m, 1 m, 2 m, and 4 m will be displayed.







The blinking cable length is the current setting.

2. Select the desired cable length using  or  . To determine which length you should select, see “Accessories Available” later in this chapter.
3. Press  .

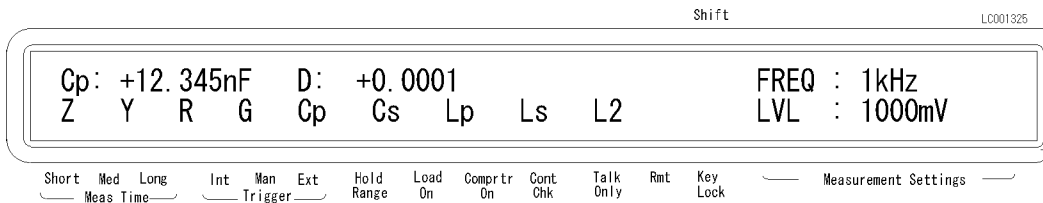
Selecting the Measurement Parameter



1. Press  . The primary measurement parameters are displayed.



2. Select the desired primary parameter using  or  , and press  .
3. Then the secondary parameters are displayed in the same manner as above.

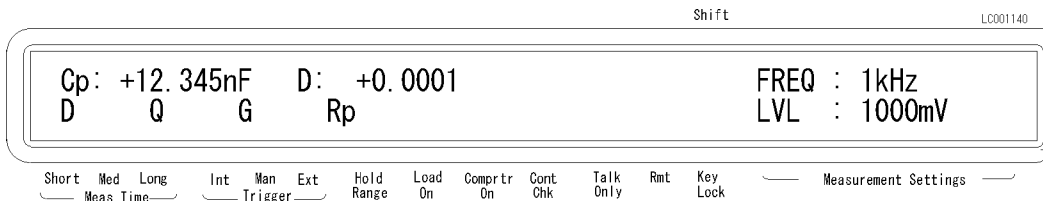

The secondary parameters which can be selected differ depending on the primary parameter. Refer to “Measurement Parameters” later in this chapter.



4. Select the desired secondary parameter using  or  , and press  .

Setting the Test Signal Frequency

Press . The test signal frequency selection menu is displayed.

Select the desired frequency using  or , and press .



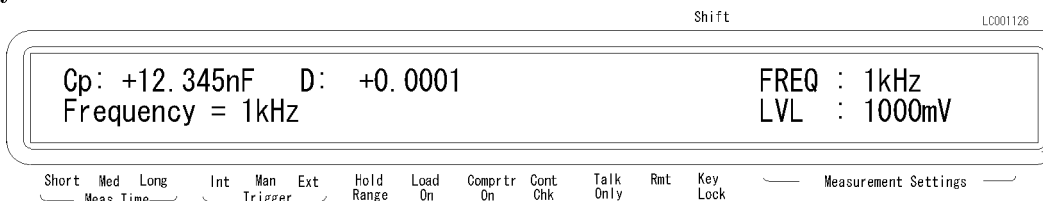





You can also select the test signal frequency by pressing  until the desired frequency is displayed.





Note that the 10 kHz and 20 kHz (Option 002 only) test frequency are not available when the cable length setting is 4 m, and the 100 kHz test frequency is not available when the cable length setting is 2 m or 4 m.

Setting the Test Signal Level

1. Press . The test signal level selection menu is displayed.

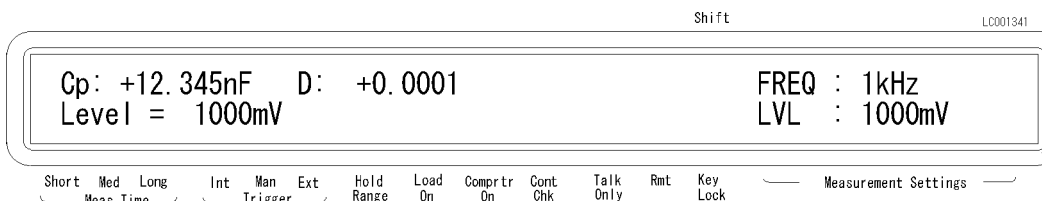

2. Enter the desired value using the numeric keys and the engineering key . For example, to set the level to 245 mV, press     (or press    ).

You can also set the value using  or .





3. Press  to set the test signal level.

Setting the DC Bias Source Voltage

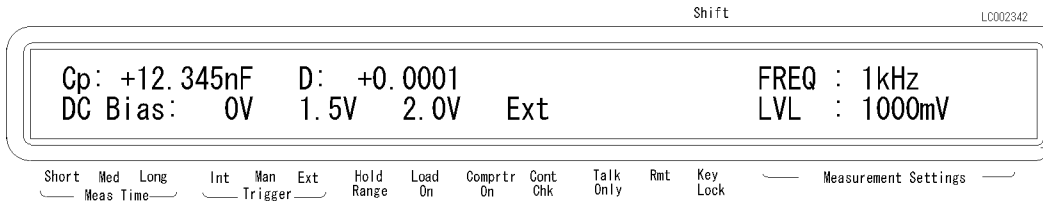
1. Press  . The DC bias setting menu is displayed.



2. Select the desired DC bias voltage value using  or , and press .

Now the DC bias source is selected. For how to apply the DC bias voltage, see “Applying the DC Bias”, later in this chapter.



Selecting the Measurement Time Mode

1. Press  to select the measurement time mode (Short, Med or Long). The **Meas Time** annunciator (▼) displays the measurement time setting.

Setting the Averaging Rate

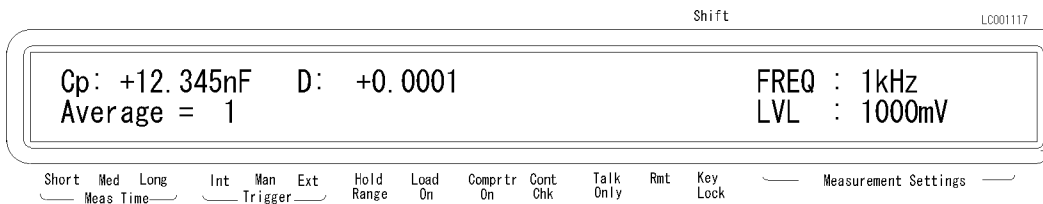
1. Press  .





2. Enter the averaging rate using the numeric keys. You can enter integer values from 1 to 256. Also, you can increase or decrease the value using  or .
3. Press  to set the value and to exit.

Selecting the Measurement Range

Auto Range mode

—Automatically Selecting the Optimum Measurement Range



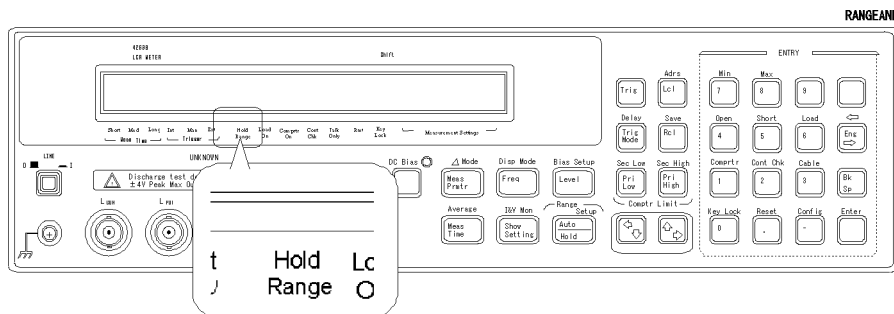

Press . The 4263B's range mode is changed from “Hold” to “Auto”, or from “Auto” to “Hold”. When the **Hold Range** annunciator() is OFF, the 4263B is set to the auto range mode.

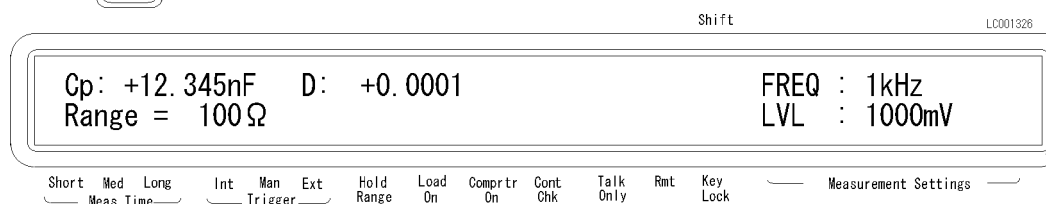

Hold Range mode—Selecting the Measurement Range of Your Choice

1. Press .



2. Press  or  until the desired range is displayed. Or, input the impedance value to be measured using the numeric keys and the engineering key . The 4263B will select the optimum measurement range setting.
3. Press  to set the measurement range.

The available ranges are 0.1 Ω, 1 Ω, 10 Ω, 100 Ω, 1 kΩ, 10 kΩ, 100 kΩ, and 1 MΩ. To determine which measurement range you should select, see “Measurement Range Setting” later in this chapter.

Selecting the Trigger Mode

Press  until the **Trigger** annunciator (▼) points to the desired trigger mode (Int, Man or Ext).

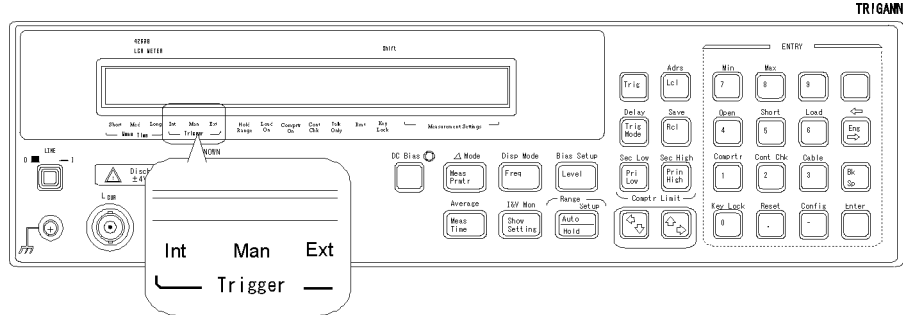



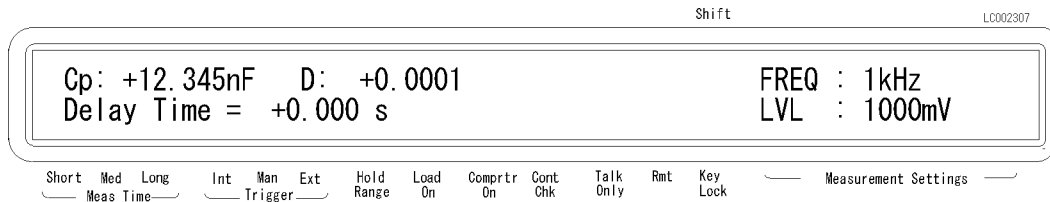

To trigger a measurement in each mode, see “Making a Measurement” later in this chapter.

Setting the Trigger Delay Time

1. Press  .





2. Enter the desired trigger delay time using the numeric keys. (For example, to set 0.5 sec, press    0 . 5 .) You can set the trigger delay time from 0.000 sec to 9.999 sec.



You can also set the trigger delay time using  or  ;

3. Press  .

Performing the OPEN Correction —Canceling the stray admittance in parallel with the DUT

1. Confirm that the test fixture is connected to the UNKNOWN terminals without a DUT connected.
2. Press   . The OPEN correction menu is displayed.



Press  or  until Openmeas blinks, and press  . The OPEN correction is performed. During that time, the following message is displayed.

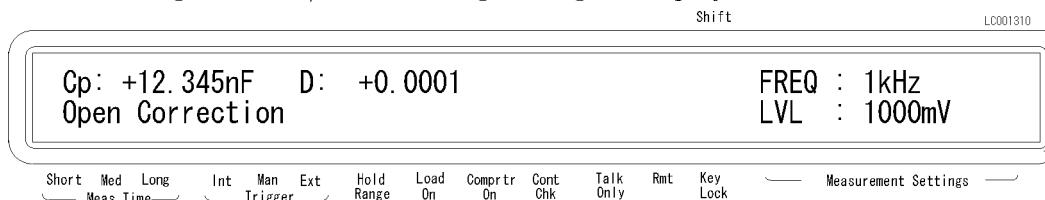



After a while, the 4263B completes OPEN correction with the message `Open Correction Complete`, and returns to the measurement state.

If “Out Of Limit”, a WARNING message, is displayed, the OPEN admittance is so high that it would be unsuitable for OPEN correction data. This is only a WARNING, the OPEN correction data will still be used. However, you must verify the test fixture connection to the UNKNOWN terminals and the procedure used to perform the OPEN correction.



- Verify that the test fixture is correctly connected to the UNKNOWN terminal.
- Verify that nothing is connected to the test fixture’s test electrode.

Perform OPEN correction again after verifying the above items.

Performing the SHORT Correction —Canceling the residual impedance in series with the DUT

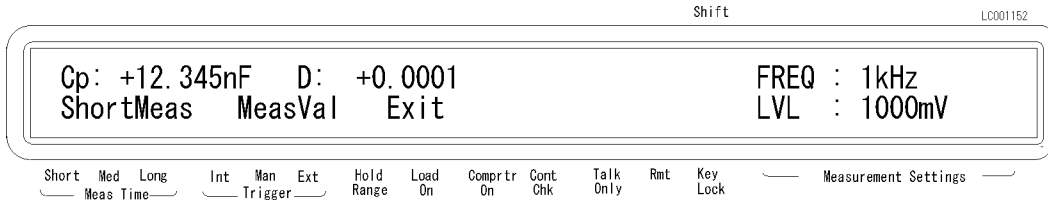
1. Configure the test electrodes in a SHORT configuration by connecting the High and Low electrodes to each other or by connecting a shorting bar to the test fixture.
2. Press  . The SHORT correction menu is displayed.



3. Press  or  until Shortmeas blinks, and press . SHORT correction is performed. During that time, the following message is displayed.

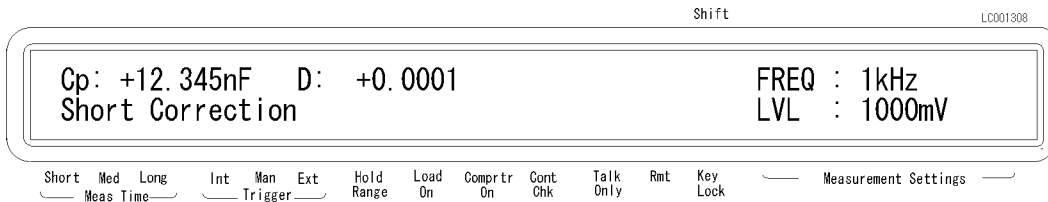

After a while, the 4263B completes SHORT correction with the message Short Correction Complete, and returns to the measurement state.





If “Out Of Limit”, a WARNING message, is displayed, the SHORT impedance is so high that it would be unsuitable for SHORT correction data. This is only a WARNING, the SHORT correction data will still be used. However, you must verify the test fixture connection to the UNKNOWN terminals and the procedure used to perform the SHORT correction.

- Verify that the test fixture is correctly connected to the UNKNOWN terminal.
- Verify that the test fixture’s test electrodes are correctly shorted.

Perform SHORT correction again after verifying the above items.

Using the Comparator Function

Setting the Limit Values

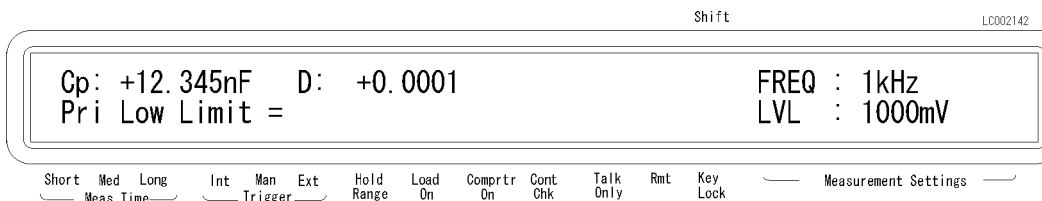

- Press  to set the lower limit of the primary parameter, and  to set the higher limit. Press  to set the lower limit of the secondary parameter, and  to set the higher limit.
For example, the following menu is displayed when  is pressed.

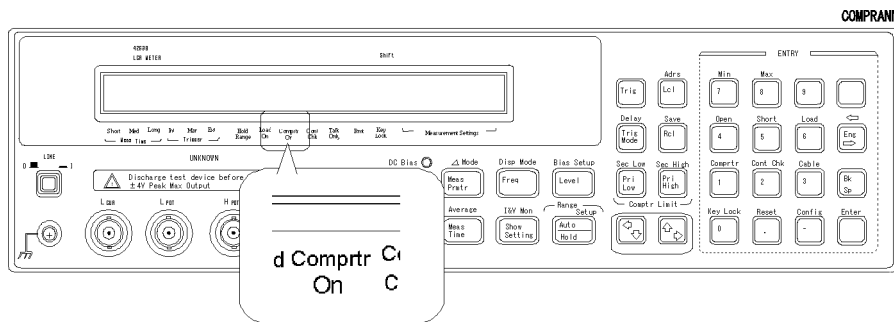

- Enter the value using the numeric keys, then press  to set the value. You can set the value from -999.99×10^{14} to 999.99×10^{14} .

Starting the Sort



- Press  . The **Comprtr On** annunciator() turns ON, and the comparator function is turned ON.

The sorting results are HIGH, IN, and LOW.

Where,

HIGH greater than the higher limit
 IN between the higher and lower limits
 LOW less than the lower limit

The 4263B shows the comparison results using the display, beeper, printer, and 16064B LED Display/Trigger Box.

- For result output to the display, see “Selecting the Display Mode” later in this chapter.
- For result output to the beeper, see “Selecting the Beeper Mode” later in this chapter.
- For result output to the printer, see “Setting the Printer—Printing the measurement data” later in this chapter.
- For result output to the 16064B, see “Accessories Available” later in this chapter.

Using the Contact Check Function —Monitoring the connection of test electrodes and DUT

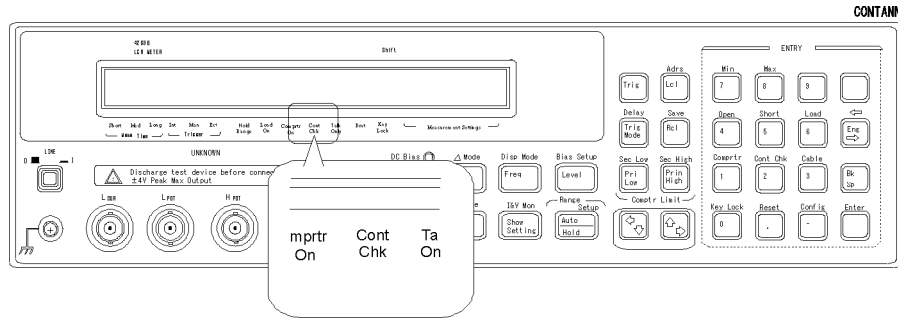

Press   , and the **Cont Chk** annunciator(▼) turns ON.



When the contact check result is Fail, the 4263B displays N.C. (No-Contact).

Using the Deviation Measurement Function

Setting the Deviation Reference Values

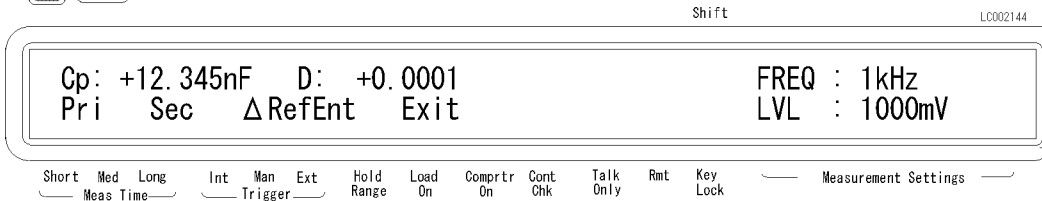
1. Press   .



Press  or  until ΔRefEnt blinks, and press  .

2. You can now input the primary parameter's reference value. Enter the reference value with the numeric keys, and press  to set the value.

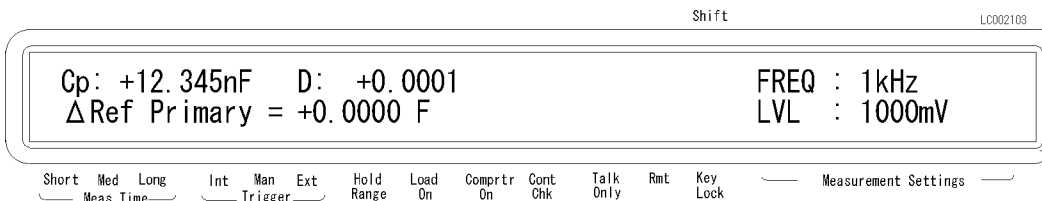



3. Then the 4263B displays the menu for setting the secondary parameter's reference value. Enter the reference value with the numeric keys, and press  to set the value.



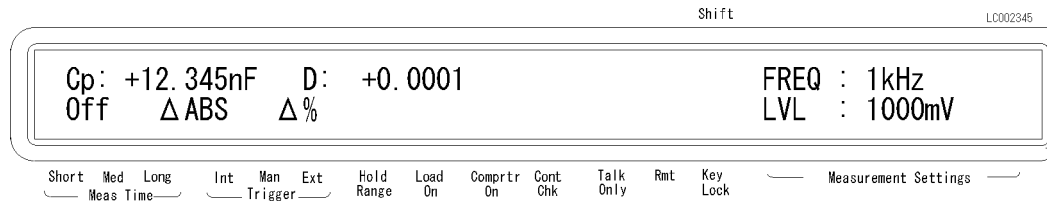

Selecting the Deviation Mode

4. The primary parameter's mode can be set by selecting **Pri** and pressing  .



Δ ABS	Measured value–Reference
Δ %	$(\text{Measured value} - \text{Reference}) / \text{Reference} \times 100 \%$
Off	Turning the deviation mode OFF.



Select the deviation measurement mode with  or  , and press  .

5. The secondary parameter's mode can be set by selecting **Sec** and pressing  in the same manner as the primary. Select the desired mode with  or  , and press  .

Selecting the Display Mode

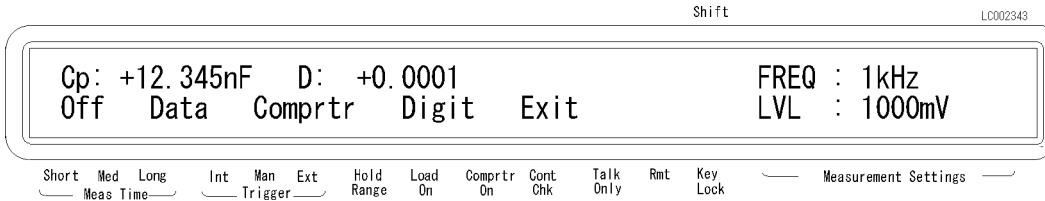
Press  



Press  or  to select Data, Cmprtr, Digit or Off, and press .

- The Measurement Display mode (Data) shows the measurement data:

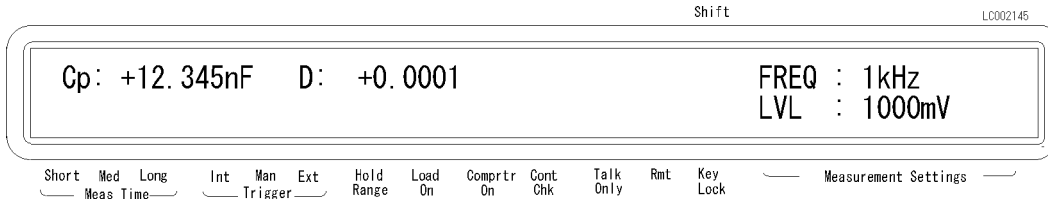

- The Comparison Display mode (Cmprtr) shows the comparison results:

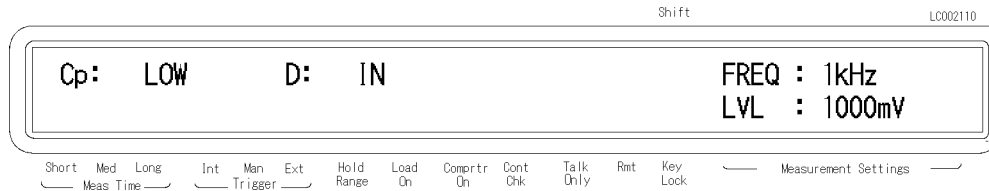

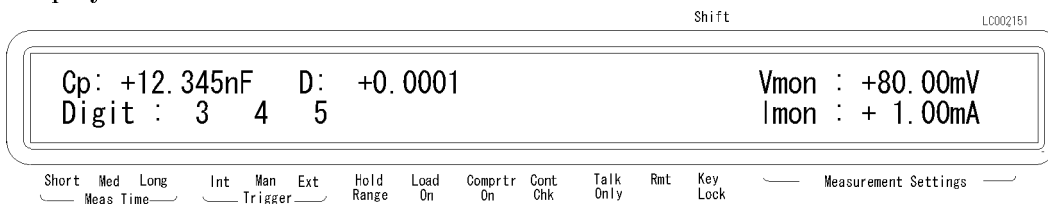

- When Digit is selected, the following menu is displayed, allowing you to set the number of digits displayed for the measured value.





- When Off is selected, the 4263B will not display the measurement results (Display OFF mode).

Using the Level Monitor Function

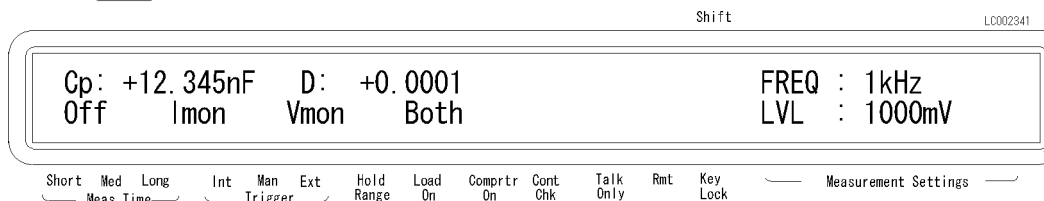
1. Press  , and the following menu is displayed.



2. Select Off, Imon, Vmon or Both using  .

- When Imon is selected, the 4263B will monitor the actual signal current flowing through the DUT.
- When Vmon is selected, the 4263B will monitor the actual signal voltage across the DUT.
- When Both is selected, the 4263B will monitor both current and voltage.
- When Off is selected, the level monitor function is turned OFF.

3. Press .

You can see the level monitor values on the LCD display by pressing  several times;

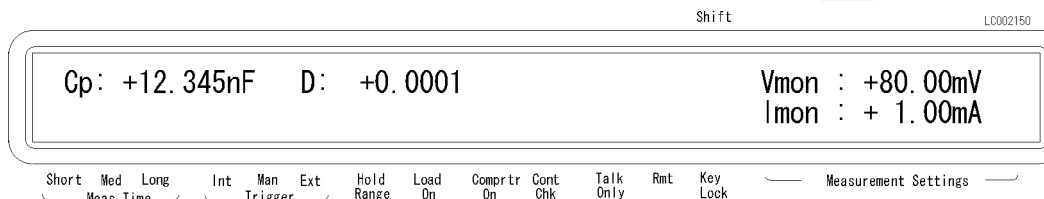



Selecting the Beeper Mode

To change the beeper mode for the comparator result reporting:

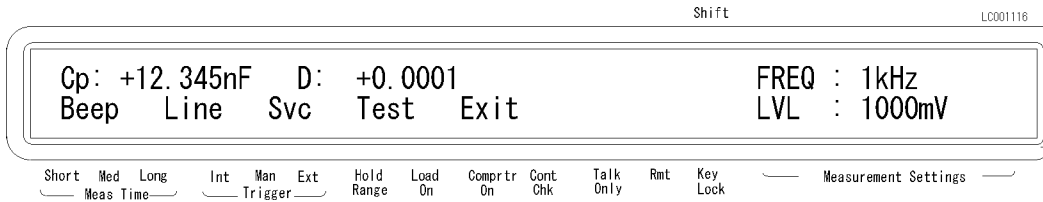

1. Press  .

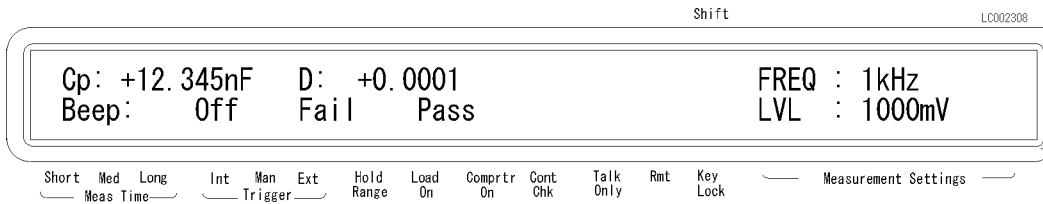

2. Select Beep using  or , and press .









3. Select the beep mode using  or , and press .

4. Select Exit using  or , and press .

Setting the Printer—Printing the measurement data

1. Use an GPIB compatible printer, set to the Listen Always mode.
2. Connect the printer to the 4263B's GPIB port on the rear panel.
3. Turn the printer ON.
4. Set the 4263B to talk only mode (Set the 4263B's GPIB address to 31).

- a. Press    . Or press  or  to change the value.

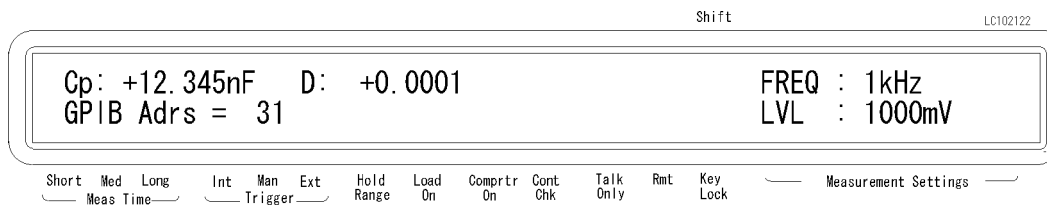

- b. Press . The **Talk Only** annunciator(▼) turns ON, and the printer begins printing the measurement data.

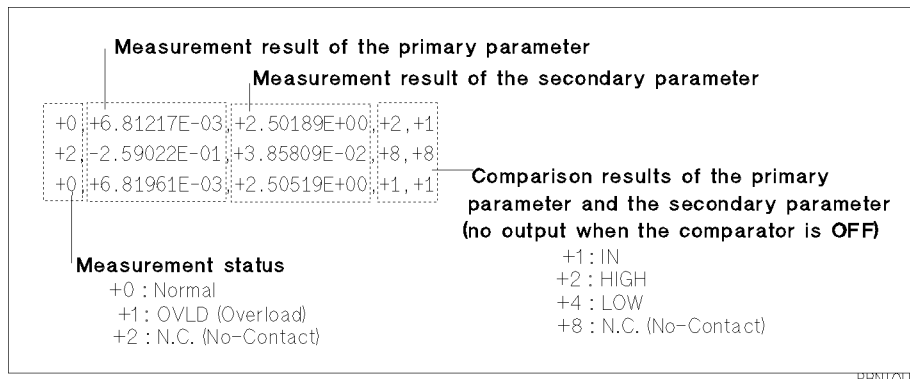

Figure 2-2. Printer Output

When you want to disable printing, change the GPIB address to an address other than 31 (for example, 17, which is the default setting).

Connecting the DUT

Connect the DUT to the test electrodes.

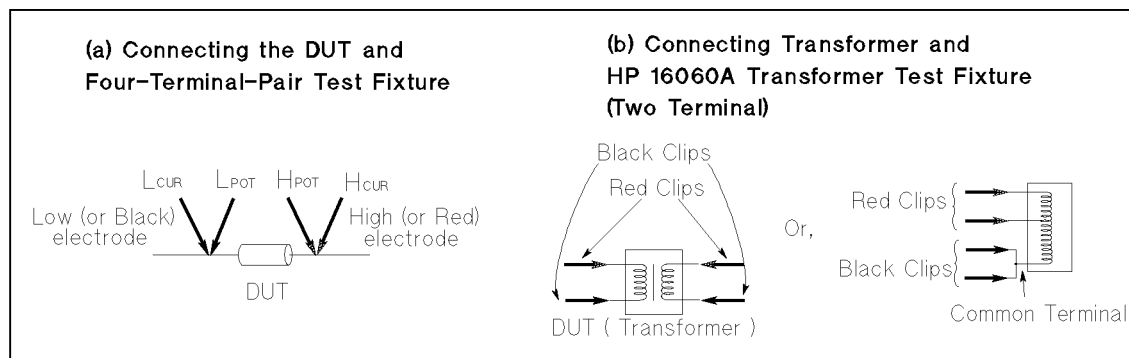
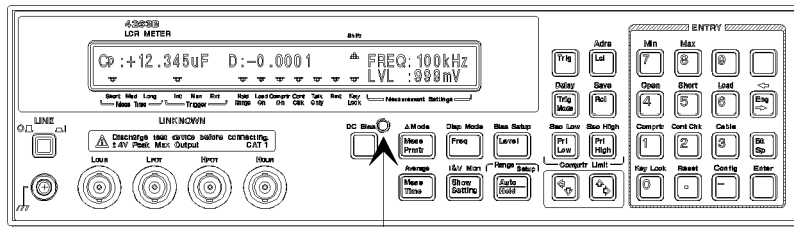



Figure 2-3. Connecting the DUT

Applying the DC Bias



DC Bias ON/OFF Indicator

Press  to apply the DC bias. The **DC Bias ON/OFF indicator** is ON.

(Press  again to turn OFF the DC bias. The **DC Bias ON/OFF indicator** is OFF.)

Making a Measurement

- In the internal trigger mode— The 4263B makes continuous free-running measurements.
- In the manual trigger mode— Press  when you want to trigger a measurement.
- In the external trigger mode— Connect the external trigger source to the EXT TRIGGER terminal on the 4263B's rear panel, and apply a TTL level trigger signal to trigger a measurement. (For details, see *Operation Manual*.)
Note that it must be set to the external trigger mode to trigger from an external handler or the 16064B LED Display/Trigger Box.

Verification of Current Settings

Press .

The display on the right side of the LCD changes, and each time  is pressed, the next current setting is displayed.



1. Test signal frequency and Test signal level
2. DC bias setting and Averaging rate
3. Trigger delay time and Cable length
4. Comparator limits for primary parameter
5. Comparator limits for secondary parameter
6. Level monitor value

If You Have a Problem

If any of the problems listed below occur, follow the instructions described.



- If you find yourself lost when operating the 4263B, you can get back on track by:

To return to the measurement mode, press  several times.

To return to the default settings, press  . (If the reset not accepted, confirm that the **Key Lock** annunciator is turned ON. See next.)

- If the 4263B does not accept key input:

- Check whether or not the **Key Lock** annunciator(▼) is ON. If so,



- Press  . The **Key Lock** annunciator(▼) turns OFF and the front-panel keys are unlocked.

- Check that the 16064B LED display/trigger box is connected to the 4263B and it is set to lock out the keys. If so, unlock the keys from the 16064B.

- If the 4263B does not display measurement results:

The display mode is set to the Display OFF mode.

1. If the 4263B is in the key lockout mode, cancel the key lockout mode. (See previous description.)

2. Press   to change the display mode to a mode other than Display OFF.

- If ----- or OVLD is displayed:

The measurement result is out of the measurable range. Check the DUT and make sure the measurement range is properly set.

Reference

Default Settings

- Frequency : 1 kHz
- Test voltage level : 1 Vrms
- DC Bias : OFF
- DC Bias source : 0 V
- Measurement parameter : Cp-D
- Deviation measurement : OFF
- Measurement range : Auto
- Measurement time : MEDium
- Averaging rate : 1
- Trigger mode : Internal
- Trigger delay : 0 ms
- Comparator : OFF
- Contact check : OFF
- Display mode : Measurement mode
- Beep mode : FAIL mode
- Cable length : 0 m
- Display digits : 5
- Level monitor : OFF
- OPEN/SHORT correction data is cleared

Measurement Parameters

Primary Parameter	Secondary Parameters Which May Be Selected For This Primary Parameter	
Z	θ	Z : impedance (absolute value)
Y	θ	Y : admittance (absolute value)
R	X	θ : phase angle
G	B	R : resistance
Cp	D Q G Rp	Ls : equivalent series inductance
Cs	D Q Rs	Lp : equivalent parallel inductance
Lp	D Q G Rp Rdc	Cs : equivalent series capacitance
Ls	D Q Rs Rdc	Cp : equivalent parallel capacitance
L2	N 1/N M R2	Q : quality factor
		D : dissipation Factor
		G : conductance
		X : reactance
		B : susceptance
		Rp : equivalent parallel resistance
		Rs : equivalent series resistance
		Rdc :dc resistance
		N : turns ratio of transformer ¹
		M :mutual inductance ¹
		L2 : inductance ¹
		R2 : dc resistance ¹

¹ This parameter is measured using the transformer measurement configuration (two-terminal measurement configuration).

Note

Primary parameter L2 and secondary parameters Rdc, N, M, and R2 can only be used with Option 001 (N / M / DCR measurement function addition). These parameters are not displayed on the menu if the 4263B is not equipped with Option 001.

To measure the primary parameter L2, the transformer measurement configuration is required. So use the 16060A Transformer Test Fixture.

Accessories Available**16064B LED Display/Trigger Box**

The 16064B LED Display/Trigger Box triggers a measurement when its trigger key is pressed, and displays the contact check and comparison results using LEDs. It allows you to manually operate the comparator function of the 4263B.

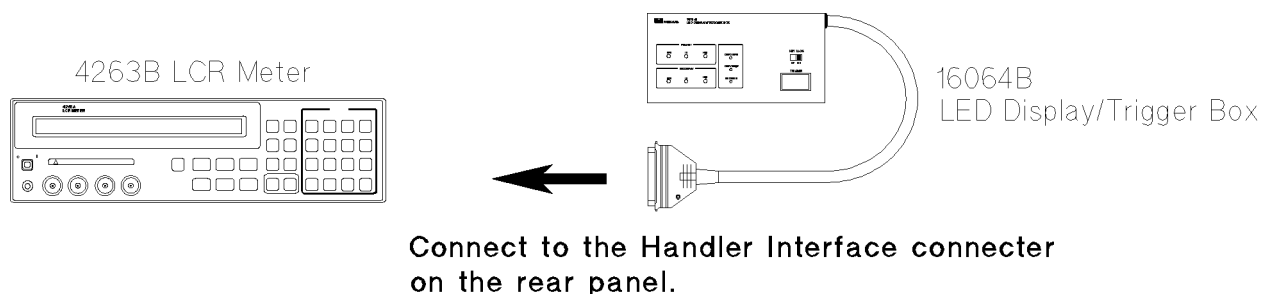
**Test Fixtures and Test Leads**

For measurement versatility, various types of test fixtures and test leads are available for the 4263B. In this section, main test fixtures and test leads are described using figures. When using these test fixtures and test leads, set the 4263B to the corresponding cable length of the test fixture or test leads being used.

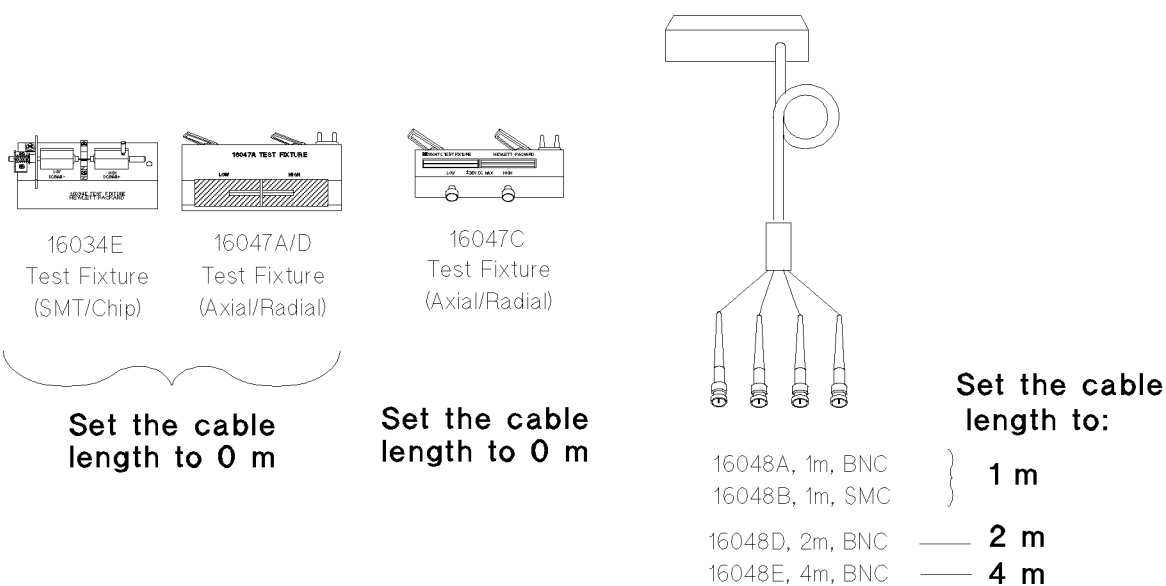

4263B

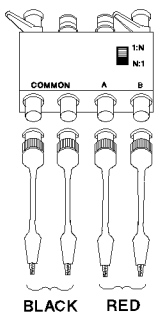

HP 16060A
Transformer
Test Fixture

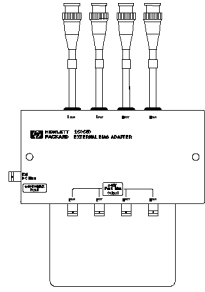

HP 16065C
External
Bias Adapter

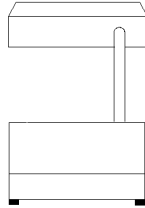

HP 16065A
EXT Voltage
Bias Fixture

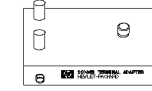

HP 16085B
Terminal Adapter
(4TP to APC 7)

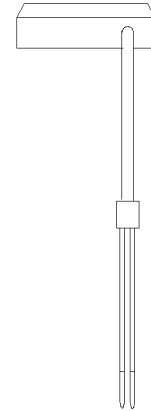

HP 16334A
Test Fixture
(Tweezer)

Set the cable length to 0 m

Set the cable length to 1 m

Set the cable length to 0 m

Set the cable length to 1 m

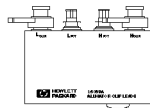

HP 16089A
Kelvin Clip Leads
Large clip, 1 m length

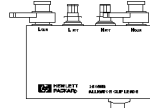

HP 16089B
Kelvin Clip Meads
Medium clip, 1 m length

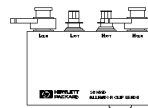

HP 16089C
Kelvin IC Clip Leads
IC Package clip, 1 m length

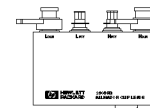

HP 16089D
Alligator Clip Leads
Four clips, 1 m length

Set the cable length to 1 m

Accessories List

16034E	Test Fixture (For SMD or Chip type DUT)
16047A	Test Fixture (For Axial or Radial DUT)
16047B	Test Fixture (For Axial or Radial DUT)
16047C	HF Test Fixture (For Axial or Radial DUT)
16047D	Test Fixture (For Axial or Radial DUT)
16048A	Test Leads (1 m, BNC)
16048B	Test Leads (1 m, SMC)
16048D	Test Leads (2 m, BNC)
16048E	Test Leads (4 m, BNC)
16060A	Transformer Test Fixture
16065A	External Bias Test Fixture
16065C	External Bias Adapter
16085B	Terminal Adapter: Converts 4 terminal pair connector to APC7 connector.
16089A	Kelvin Clip Leads (1 m, two large clips)
16089B	Kelvin Clip Leads (1 m, two medium clips)
16089C	Kelvin Clip Leads (1 m, two IC clips)
16089D	Alligator Clip Leads (1 m, four medium clips)
16089E	Kelvin Clip Leads (1 m, two large clips)
16092A ¹	RF Spring Clip: Axial Radial and SMD
16093A ¹	RF Two-Terminal Binding Post
16093B ¹	RF Three-Terminal Binding Post
16094A ^{1,2}	RF Probe Tip/Adapter
16095A ³	LF Probe Adapter
16191A ¹	Side Electrode SMD Test Fixture
16192A ¹	Parallel Electrode SMD Test Fixture
16193A ¹	Small Side Electrode SMD Test Fixture
16194A ¹	Wide Temperature SMD Test Fixture
16314A	50Ω/4-Term Converter 100Hz-10MHz
16334A	Test Fixture (For SMD or Chip type DUT)
16451B	Dielectric Test Fixture
16452A	Magnetic Test Fixture
16064B	LED Display/Trigger Box (with GO/NO-GO display and trigger button)

1 16085B adapter required.

2 Cables adapted to APC7 on each end required.

3 Don't connect ground-lead to 4263B.

Note



There is some possibility that available accessories are changed. Refer to latest accessories catalogue about the latest information.

Measurement Range Setting

Range Setting	Optimum Measurement Range
0.1 Ω ¹	$ Z \leq 100 \text{ m}\Omega$
1 Ω	$100 \text{ m}\Omega < Z \leq 1 \Omega$
10 Ω	$1 \Omega < Z \leq 10 \Omega$
100 Ω	$10 \Omega < Z < 1 \text{ k}\Omega$
1 $\text{k}\Omega$	$1 \text{ k}\Omega \leq Z < 10 \text{ k}\Omega$
10 $\text{k}\Omega$	$10 \text{ k}\Omega \leq Z < 100 \text{ k}\Omega$
100 $\text{k}\Omega$ ²	$100 \text{ k}\Omega \leq Z < 1 \text{ M}\Omega$
1 $\text{M}\Omega$ ²	$1 \text{ M}\Omega \leq Z < 10 \text{ M}\Omega$

¹ This range is available when the test level settings is higher than 315 mV.

² This range is not available for the 100 kHz test frequency setting.

Other Topics

For details on these functions, see the *Operation Manual*.

- Initial Inspection — Chapter 1 of the *Operation Manual*
- Load correction — Chapter 1, Chapter 3 and Chapter 7 of the *Operation Manual*
- Key Lock Function — Chapter 2 and Chapter 3 of the *Operation Manual*
- GPIB — Chapter 4 and Chapter 5 of the *Operation Manual*
- Handler Interface — Chapter 3, Chapter 6, and Appendix B of the *Operation Manual*
- Save / Recall — Chapter 2 and Chapter 3 of the *Operation Manual*
- Backup Function — Chapter 3 of the *Operation Manual*
- Specification — Chapter 8 of the *Operation Manual*
- Maintenance — Chapter 9 of the *Operation Manual*
- Error Messages — “Error Messages” in back of the *Operation Manual*

Measurement Examples

In This Chapter

This chapter provides the typical measurement examples

Electrolytic Capacitor Measurement—For High Capacitance

The 4263B's measurement accuracy and wide measurement range are the right tools to make precise measurements of electrolytic capacitor parameters.

Electrolytic capacitors are generally high capacitance, so their impedance is low. The 4263B has the 100 mΩ measurement range, and keeps its high measurement accuracy when measuring low impedance. For example, the 4263B measures an aluminum electrolytic capacitor, 22,000 μF, at the test frequency of 120 Hz, with about 0.5 % accuracy. You can try this measurement using the following procedure.

DUT

Aluminum electrolytic capacitor (22,000 μF ± 20 %)

Requirements

Test Fixture : 16089B Kelvin Clip Leads

Measurement Setup

Measurement parameter : Cs-D¹
 Test frequency : 120 Hz
 Test signal level : 1 Vrms²

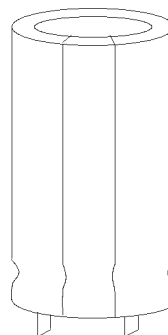

- 1 For high capacitance measurement, equivalent series parameter Cs-D is commonly used.
- 2 Even though LVL:1 Vrms is set, less than 0.5Vrms which is maximum applicable voltage for testing electrolytic capacitors in accordance to JIS standard, will be applied to the Aluminum electrolytic capacitor under test.

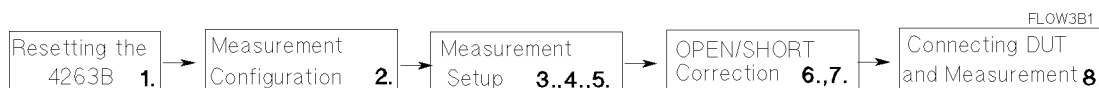

Measurement Procedure

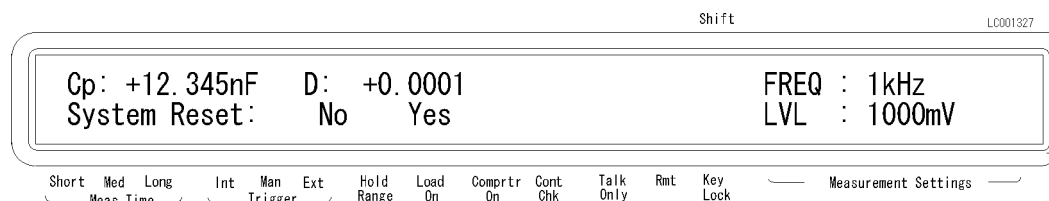

1. Reset the 4263B.

- a. Press   .



- b. Press  until Yes blinks, and press  .

3-2 Measurement Examples

4263B

2. Connect test fixture to the UNKNOWN terminals as follows.

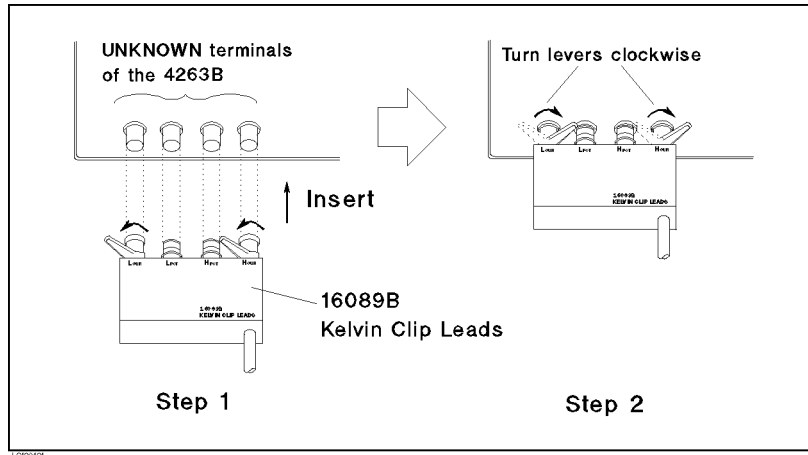

3. Set the cable length to 1 m.

a. Press **3** .

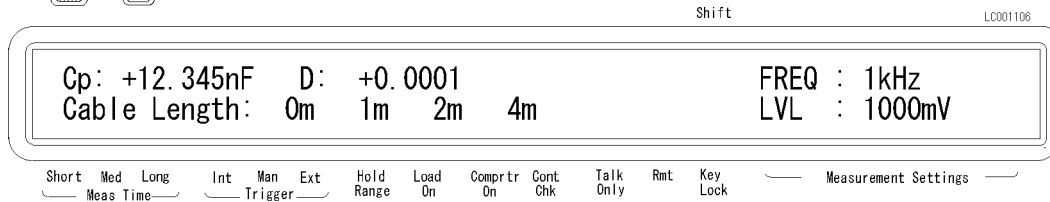

b. Select 1 m using or , and press .

4. Set measurement parameter to Cs-D.

a. Press **Meas Prmr** , and the following menu is displayed.

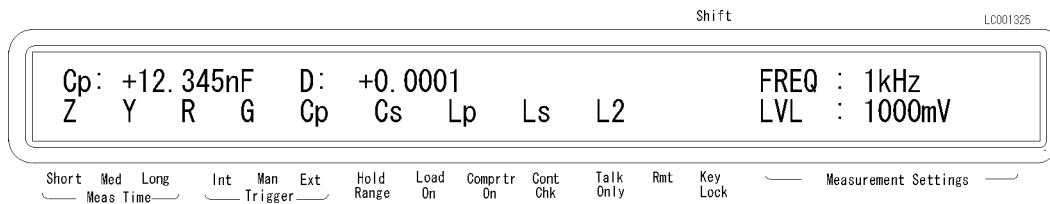

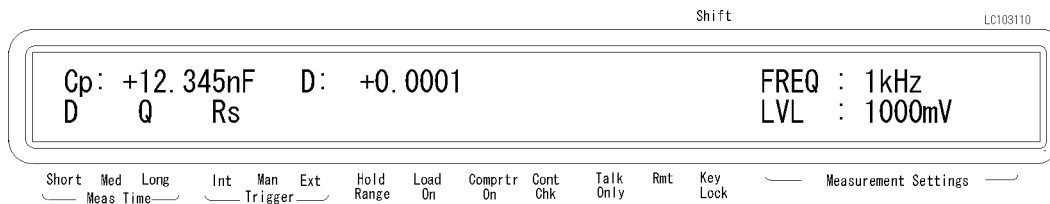

b. Select Cs using or , and press .



c. Select D using or , and press .



5. Set the test frequency to 120 Hz.

Press  .

Press  or  to set the frequency to 120Hz, and press  .

6. Perform the OPEN correction.

a. Separate the test lead clips (Nothing must be connected to the test lead clips).

b. Press   and the following menu is displayed.

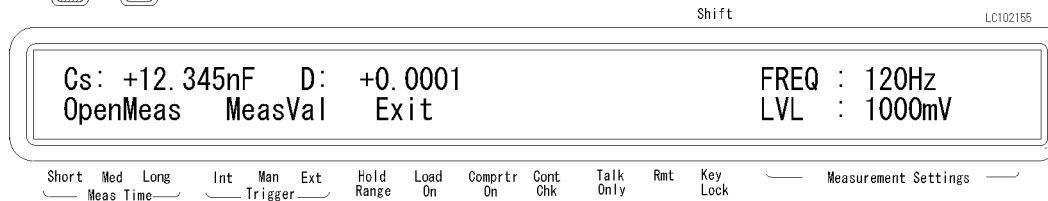

c. Select OpenMeas using  or  , and press  .

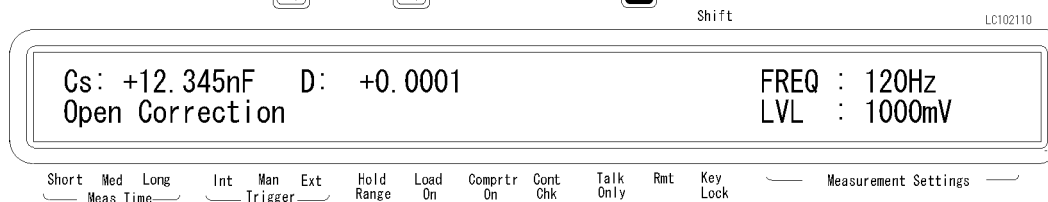



After a while, the OPEN correction is completed. (If Out Of Limit is displayed, see “Performing the OPEN Correction –Canceling the stray admittance in parallel with the DUT” in Chapter 2.)

7. Perform the SHORT correction.

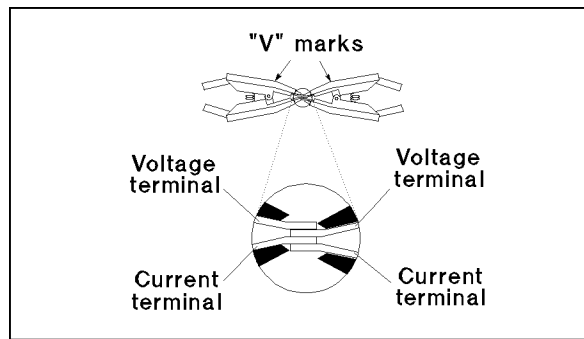
a. Short the electrodes of the test fixture as shown in the following figure.



4263B

b. Press  , and the following menu is displayed.

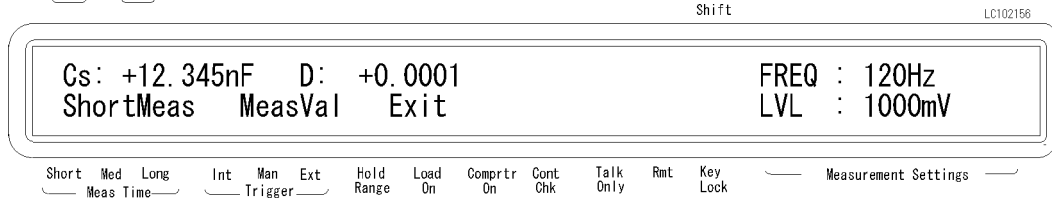

c. Select ShortMeas using  or , and press .

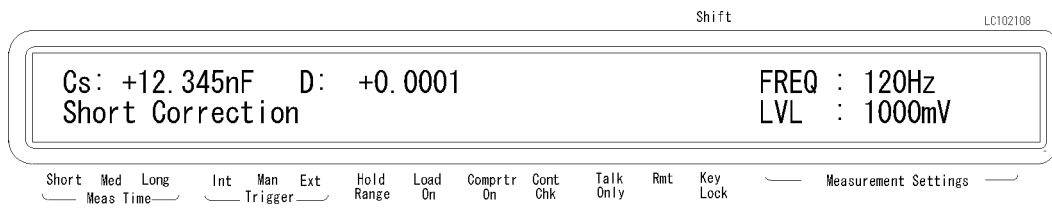

After a while, the SHORT correction is completed. (If Out Of Limit is displayed, see “Performing the SHORT Correction —Canceling the residual impedance in series with the DUT” in Chapter 2.)

8. Connect the DUT to the test fixture, and the measurement result will be displayed.

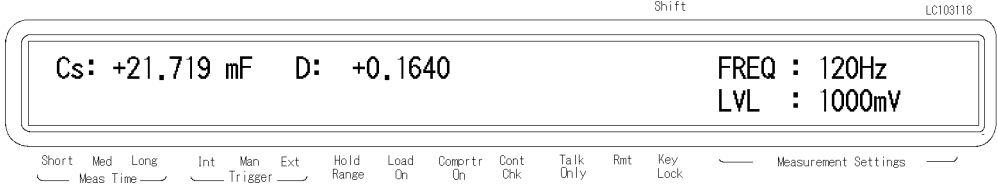

For More Information

- To apply the DC bias — See “Setting the DC Bias Source Voltage” in Chapter 2.
- To print out the measurement result — See “Setting the Printer—Printing the measurement data” in Chapter 2

Inductor Measurement—Versatile measurement parameters

The 4263B offers many kinds of measurement parameters for LCR measurement. In addition to these parameters, Option 001 adds ability to make turns ratio (N), mutual inductance (M), DC resistance (DCR) measurements.

This example shows a basic measurement for an inductor, and its DCR. You can measure both inductance and DCR without resetting the measurement configuration.

DUT

Coil (220 μ H \pm 5 % @ 100kHz)

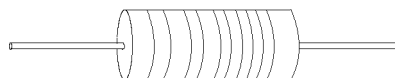

Requirements

Test Fixture : 16047A

Test Fixture

16047A

Measurement Setup

Measurement parameter : Lp-Q and Lp-Rdc
 Test frequency : 100 kHz
 Test signal level : 100 mVrms

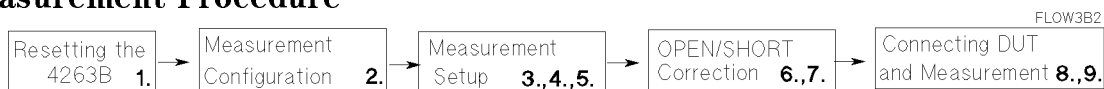

Measurement Procedure

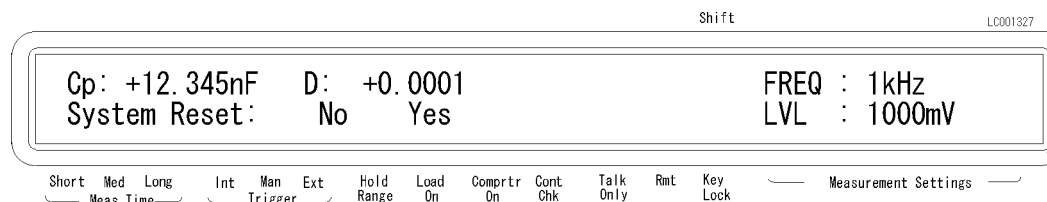

1. Reset the 4263B.

a. Press   .



b. Press  until Yes blinks, and press  .

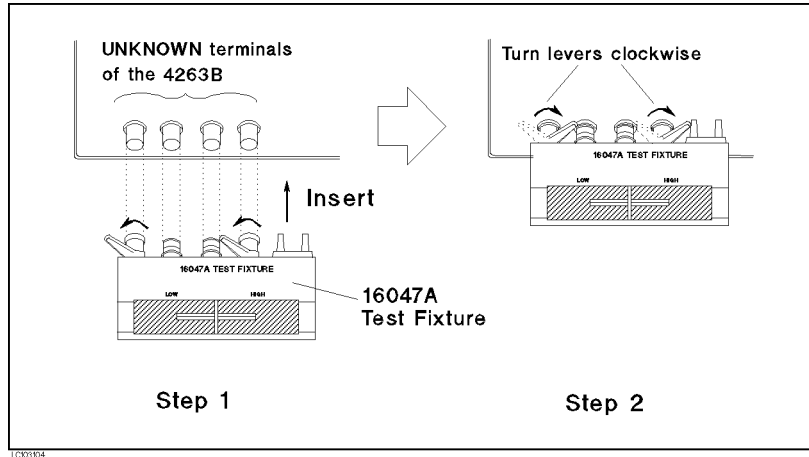

2. Connect the test fixture to the UNKNOWN terminals.





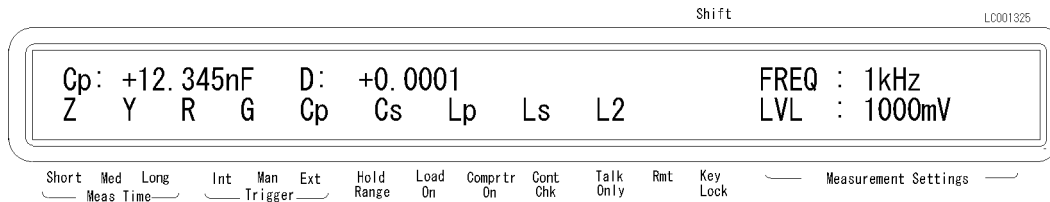

3. Select measurement parameter Lp-Q.

a. Press  and the following menu is displayed.

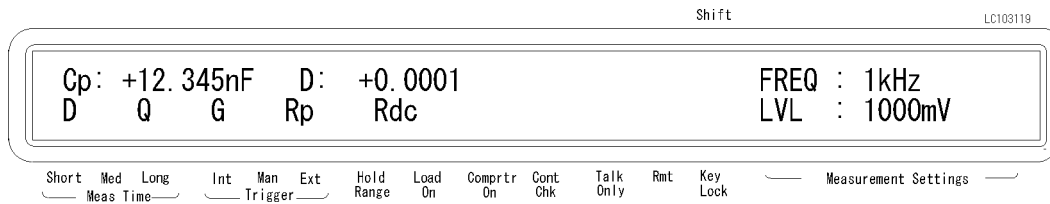



b. Select Lp using  or , and press .



c. Select Q using  or , and press .

4. Set the test signal frequency to 100 kHz.

Press  .

Set the frequency to 100 kHz using  or , and press .



5. Set the test signal level to 100 mV.

Press .

Set the level to 100 mV using the numeric keys or  , and press .

6. Perform the OPEN correction.

- a. Remove any device inserted in the test electrodes to create an OPEN condition (Nothing should be connected to the test electrodes).

- b. Press  , and the following menu is displayed.

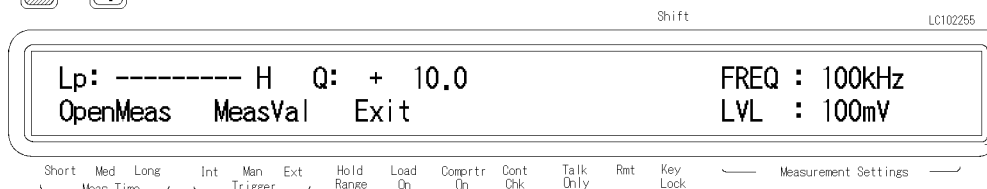

- c. Select OpenMeas using  or , and press .

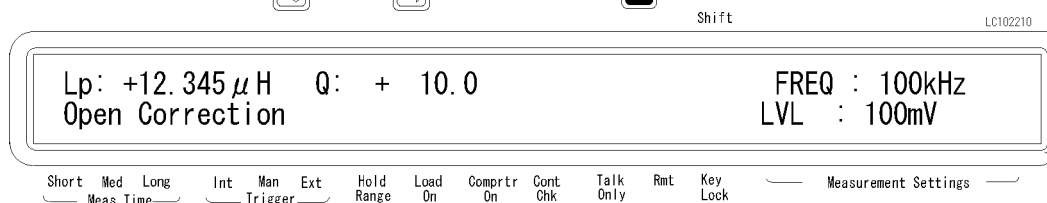

After a while, the OPEN correction is completed. (If Out Of Limit is displayed, see “Performing the OPEN Correction –Canceling the stray admittance in parallel with the DUT” in Chapter 2.)

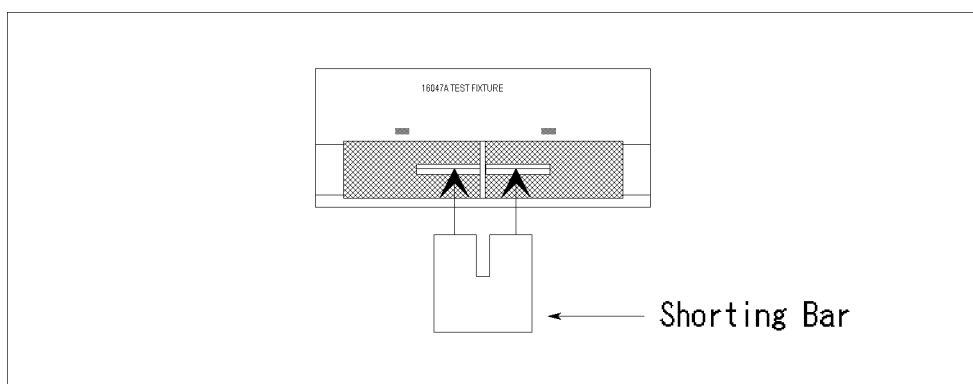

7. Perform the SHORT correction.

- a. Insert the shorting plate to the test fixture as shown in the following figure:



LC103122

4263B

b. Press  , and the following menu is displayed.

Shift LC102256

Lp: +12.345 μ H Q: + 10.0 FREQ : 100kHz
 ShortMeas MeasVal Exit LVL : 100mV

Short Med Long Int Man Ext Hold Load Comprtr Cont Talk Rmt Key
 — Meas Time — — Trigger — Range On On Chk Only Lock

Measurement Settings

c. Select ShortMeas using  or , and press .

Shift LC102208

Lp: +12.345 μ H Q: + 10.0 FREQ : 100kHz
 Short Correction LVL : 100mV

Short Med Long Int Man Ext Hold Load Comprtr Cont Talk Rmt Key
 — Meas Time — — Trigger — Range On On Chk Only Lock

Measurement Settings

After a while, the SHORT correction is completed. (If Out Of Limit is displayed, see “Performing the SHORT Correction —Canceling the residual impedance in series with the DUT” in Chapter 2.)

8. Connect the DUT to the test fixture and the measurement result will be displayed.

Shift LC109120

Lp: +216.55 μ H Q: + 18.6 FREQ : 100kHz
LVL : 100mV

Short Med Long Int Man Ext Hold Load Comprtr Cont Talk Rmt Key
 — Meas Time — — Trigger — Range On On Chk Only Lock

Measurement Settings

Note Step 9 is for an 4263B with Option 001 only.



9. Change the measurement parameter to Lp-Rdc.

a. Press  and the following menu is displayed.

Shift LC102125

Lp: +216.55 μ H Q: +18.6 FREQ : 100kHz
 Z Y R G Cp Cs Lp Ls L2 LVL : 100mV

Short Med Long Int Man Ext Hold Load Comprtr Cont Talk Rmt Key
 — Meas Time — — Trigger — Range On On Chk Only Lock

Measurement Settings



b. Press  to select Lp.

Shift LC109112

Lp: +216.55 μ H Q: +18.6 FREQ : 100kHz
 D Q G Rp Rdc LVL : 100mV

Short Med Long Int Man Ext Hold Load Comprtr Cont Talk Rmt Key
 — Meas Time — — Trigger — Range On On Chk Only Lock

Measurement Settings

- c. Select Rdc using  or , and press . The measurement result will be displayed.

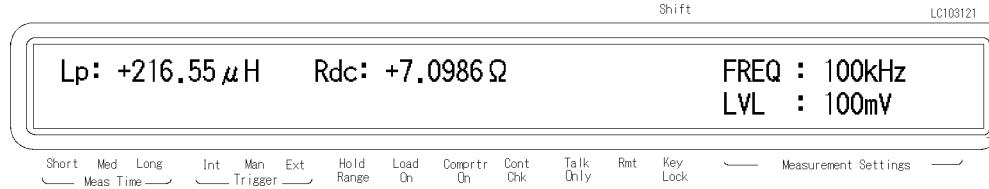

For More Information

- To select other measurement parameters — See “Selecting the Measurement Parameter” in Chapter 2.
- To print out the measurement result — See “Setting the Printer—Printing the measurement data” in Chapter 2

Transformer Measurement (Option 001 Only)

With the 4263B's ability to measure turns ratio (N), mutual inductance (M), and DC resistance (DCR), transformer-parameter calculations are no longer time-consuming tasks. Moreover the 16060A Transformer Test Fixture makes it easy to setup transformer measurement configurations.

The following example shows how easy it is to measure turns ratio (N), mutual inductance (M), and dc resistance (DCR) measurement of transformer.

DUT

Transformer (1 : 8)

Requirements

Test Fixture : 16060A Transformer Test Fixture

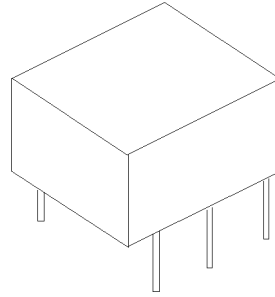

Measurement Setup

Measurement : L2-N and L2-R2
parameter
Test frequency : 100 kHz
Test signal Level : 100 mVrms

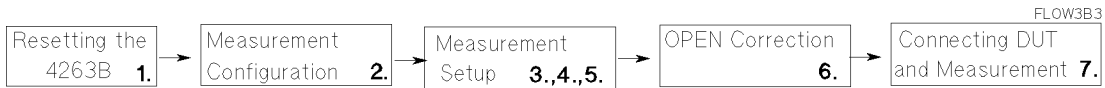

Measurement Procedure

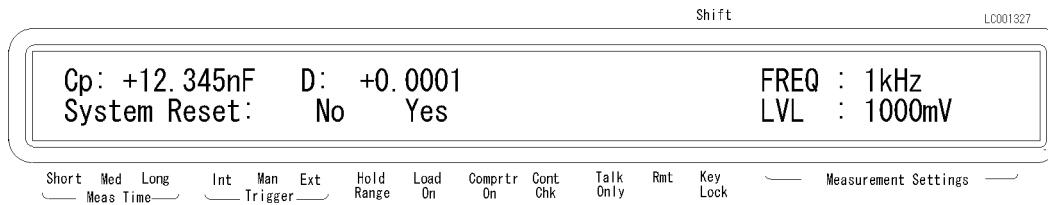

1. Reset the 4263B.

a. Press   .



b. Press  until Yes blinks, and press  .

2. Connect the test fixture to the UNKNOWN terminals.

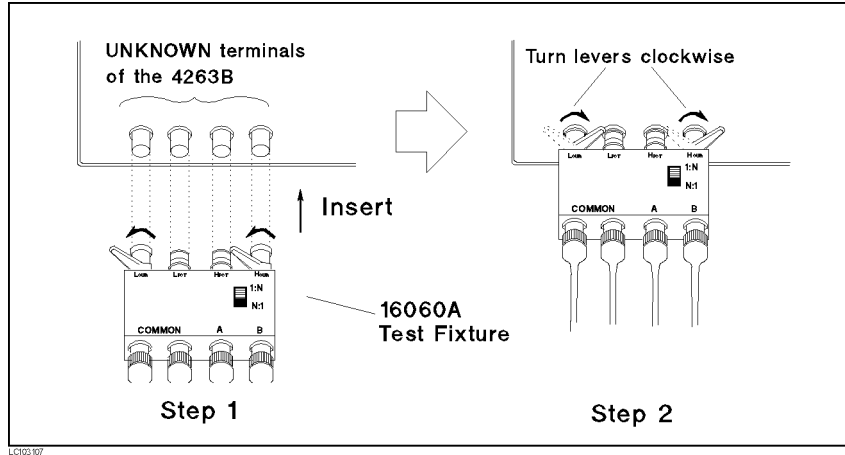

3. Set the measurement parameter to L2-N.

a. Press and the following is displayed.

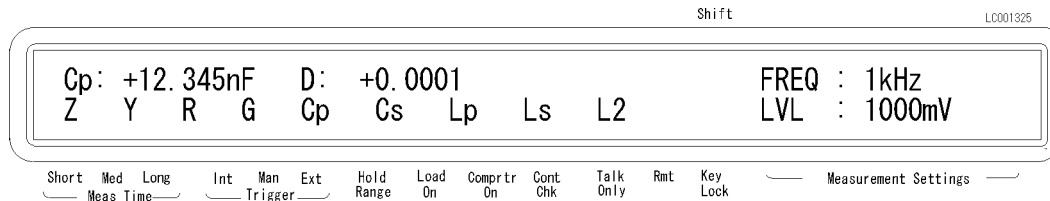

b. Select L2 using or , and press .

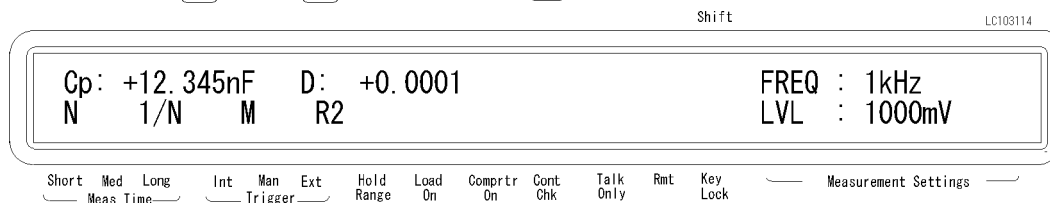

c. Select N using or , and press .

4. Set the test frequency to 100 kHz.

Press .

Set the frequency to 100 kHz using , and press .

5. Set the test signal level to 100 mVrms.

Press .

Set the level to 100 mV using the numeric keys or , and press .

4263B

6. Perform the OPEN correction.

- a. Short the red clips together and short the black clips together, then separate the shorted red and black sets of clips from each other. (See the following figure.)

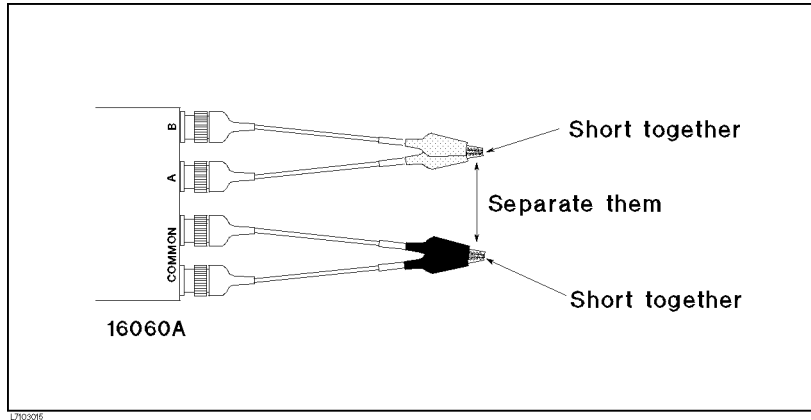

- b. Press , and the following menu is displayed.

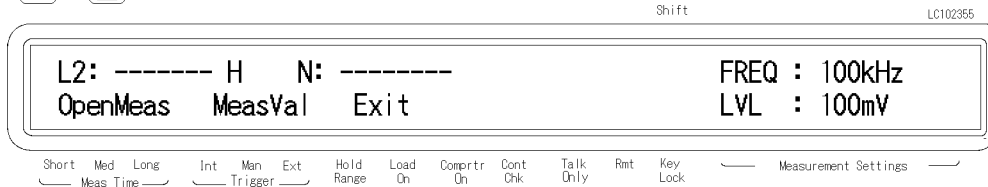

- c. Select OpenMeas using or , and press .

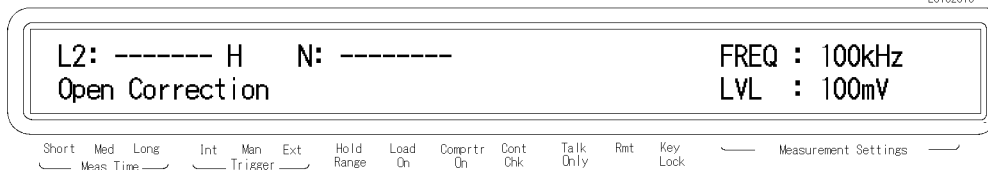

After a while, the OPEN correction is completed. (If OUT OF LIMIT is displayed, see “Performing the OPEN Correction –Canceling the stray admittance in parallel with the DUT” in Chapter 2.)

Note



Do not use the SHORT correction function of the 4263B when the L2-N, L2-1/N, L2-M, or L2-R2 measurement parameters are selected.

7. Connect the DUT to the test fixture and the measurement result will be displayed.

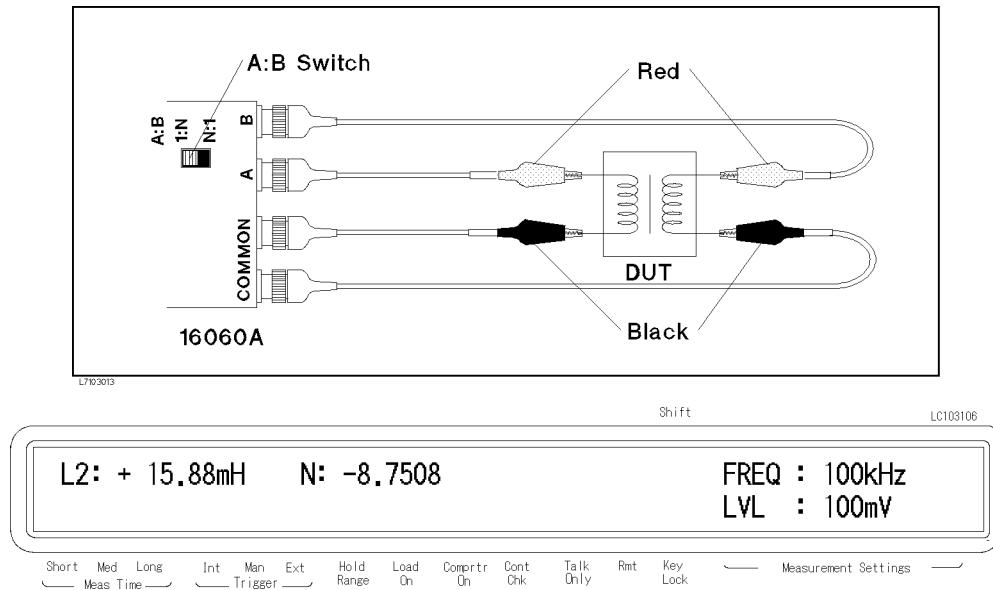

Set the switch to the opposite position if the 4263B displays 0VLD as the measured value of N . The 4263B cannot measure a value of N less than 0.9, and 0VLD means that the measurement result is out of range.

The leading sign of N indicates the polarity of transformer as follows:

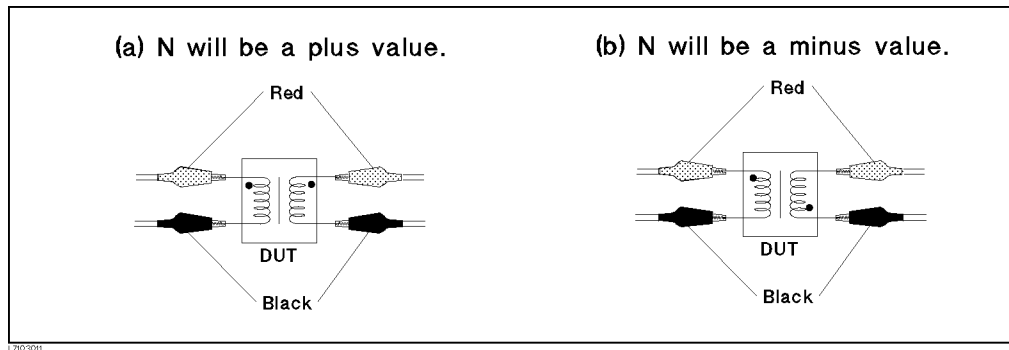

For More Information

- To select other parameters — You can measure L2-M (mutual inductance) and L2-R2 (dc resistance) without changing the measurement configuration. To change the measurement parameter, see “Selecting the Measurement Parameter” in Chapter 2.
- To print out the measurement result — See “Setting the Printer—Printing the measurement data” in Chapter 2