



ROHDE & SCHWARZ

Test and Measurement
Division

Operating Manual

SIGNAL GENERATOR

SMT

1039.2000.02/03/06

Printed in the Federal
Republic of Germany

Tabbed Divider Overview

Contents

Data Sheets

Safety Instructions
Certificate of quality
EC Certificate of Conformity
List of R & S Representatives

Tabbed Divider

1	Chapter 1: Preparation for Use
2	Chapter 2: Manual Operation
3	Chapter 3: Remote Control
4	Chapter 4: Maintenance and Troubleshooting
5	Chapter 5: Testing the Rated Specifications
6	Annex A: IEC/IEEE-Bus Interface
7	Annex B: List of Error Messages
8	Annex C: List of Commands
9	Annex D: Programming Examples
10	Index

Contents

Data Sheet

	Page
1	Preparation for Use
1.1	Putting into Operation 1.1
1.1.1	Supply Voltage 1.1
1.1.2	Switching On/Off the Instrument 1.1
1.1.3	Initial Status 1.2
1.1.4	Setting Contrast and Brightness of the Display 1.2
1.1.5	RAM With Battery Back-Up 1.2
1.1.6	Preset Setting 1.3
1.2	Functional Test 1.3
1.3	Fitting the Options 1.4
1.3.1	Opening the Casing 1.4
1.3.2	Overview of the Slots 1.5
1.3.3	Option SM-B1 – Reference Oscillator OCXO 1.5
1.3.4	Option SM-B2 – LF Generator 1.6
1.3.5	Options SM-B3, SM-B8, and SM-B – Pulse Modulator 1.5, 3 and 6 GHz 1.6
1.3.6	Option SM-B4 – Pulse Generator 1.7
1.3.7	Option SM-B6 – Multifunction Generator 1.7
1.3.8	Option SMT-B19 – Rear Panel Connections for RF and LF 1.7
1.3.9	Cabling of the 50-MHz Reference (REF50) 1.8
1.4	Mounting into a 19" Rack 1.8
2	Operation
2.1	Explanation of Front and Rear Panel 2.1
2.1.1	Elements of the Front Panel 2.1
2.1.1.1	Display 2.1
2.1.1.2	Controls 2.3
2.1.1.3	Inputs/Outputs 2.11
2.1.2	Elements of the Rear Panel 2.13
2.2	Operating Concept 2.18
2.2.1	Display 2.18
2.2.2	Basic Operating Steps 2.19
2.2.2.1	Calling the Menus 2.19
2.2.2.2	Selection and Change of Parameters 2.20
2.2.2.3	Triggering Action 2.21

2.2.2.4	Quick Selection of Menu (QUICK SELECT)	2.21
2.2.2.5	Use of [FREQ] and [LEVEL] Keys	2.22
2.2.2.6	Use of [RF ON/OFF] and [MOD ON/OFF] Keys	2.22
2.2.2.7	Changing Unit of Level	2.22
2.2.2.8	Correction of Input	2.22
2.2.3	Sample Setting for First Users	2.23
2.2.4	List Editor	2.26
2.2.4.1	Select and Generate List – SELECT LIST	2.27
2.2.4.2	Deletion of Lists – DELETE LIST	2.28
2.2.4.3	Edition of Lists	2.29
2.2.4.4	Pattern Setting to Operate the List Editor	2.34
2.2.5	Save/Recall – Storing/Calling of Instrument Settings	2.37
2.3	Menu Summary	2.38
2.4	RF Frequency	2.39
2.4.1	Frequency Offset	2.40
2.5	RF Level	2.40
2.5.1	Level Offset	2.42
2.5.2	Interrupt-free Level Setting	2.42
2.5.3	Switching On/Off Internal Level Control	2.42
2.5.4	Internal Level Control – Bandwidth Selection	2.43
2.5.5	User Correction (UCOR)	2.43
2.5.6	EMF	2.45
2.5.7	[RF ON/OFF] Key	2.45
2.5.8	Reset Overload Protection	2.45
2.6	Modulation	2.46
2.6.1	Modulation Sources	2.46
2.6.1.1	Simultaneous Modulation	2.47
2.6.1.2	Alternate Switching Off of Modulations	2.47
2.6.1.3	[MOD ON/OFF] Key	2.48
2.6.1.4	LF-Generator	2.49
2.6.2	Amplitude Modulation	2.50
2.6.3	Frequency Modulation	2.51
2.6.3.1	FM Deviation Limits	2.52
2.6.4	Phase Modulation	2.53
2.6.4.1	PM Deviation Limits	2.54
2.6.5	Pulse Modulation	2.54
2.6.5.1	Pulse Generator	2.54
2.6.6	STEREO Modulation	2.57
2.6.7	VOR-/ILS Test Signals	2.58
2.6.7.1	VOR Modulation	2.58
2.6.7.2	ILS-Glide Slope Modulation (ILS-GS)	2.61
2.6.7.3	ILS-Localizer Modulation (ILS-LOC)	2.64
2.6.7.4	Marker Beacon	2.67

2.7	LF-Output	2.68
2.8	Sweep	2.70
2.8.1	Setting the Sweep Range (START, STOP, CENTER and SPAN)	2.70
2.8.2	Selecting the Sweep Run (SPACING LIN, LOG)	2.71
2.8.3	Operating Modes (MODE)	2.71
2.8.4	Trigger Input	2.71
2.8.5	Sweep Outputs	2.71
2.8.6	RF-Sweep	2.73
2.8.7	LEVEL Sweep	2.74
2.8.8	LF-Sweep	2.75
2.9	Memory Sequence	2.77
2.10	Utilities	2.80
2.10.1	IEC-Bus Address (SYSTEM-GPIB)	2.80
2.10.2	Parameter of the RS232 Interface (SYSTEM RS232)	2.81
2.10.3	Suppressing Indications and Deleting Memories (SYSTEM-SECURITY) ...	2.82
2.10.4	Indication of the IEC-Bus Language (SYSTEM-LANGUAGE)	2.82
2.10.5	Reference Frequency Internal/External(REF OSC)	2.83
2.10.6	Phase of the Output Signal (PHASE)	2.84
2.10.7	Password Input with Functions Protected (PROTECT)	2.85
2.10.8	Calibration (CALIB)	2.86
2.10.9	Indication of Module Variants (DIAG-CONFIG)	2.90
2.10.10	Voltage Indication of Test Points (DIAG-TPOINT)	2.91
2.10.11	Indication of Service Data (DIAG-PARAM)	2.92
2.10.12	Test (TEST)	2.92
2.10.13	Assign Modulations to the [MOD ON/OFF] Key (MOD-KEY)	2.93
2.10.14	Set Auxiliary Inputs/Outputs (AUX I/O)	2.94
2.10.15	Switching On/Off Beeper (BEEPER)	2.95
2.11	The Help System	2.96
2.12	Status	2.96
2.13	Error Messages	2.97

3	Remote Control	
3.1	Introduction	3.1
3.2	Brief Instructions	3.1
3.3	Switchover to Remote Control	3.2
3.3.1	Remote Control via IEC Bus	3.3
3.3.1.1	Setting the Device Address	3.3
3.3.1.2	Indications during Remote Control	3.3
3.3.1.3	Return to Manual Operation	3.3
3.3.2	Remote Control vis RS-232 Interface	3.4
3.3.1.1	Setting the Transmission Parameters	3.4
3.3.1.2	Indications during Remote Control	3.4
3.3.1.3	Return to Manual Operation	3.4
3.4	IEC-Bus Messages	3.4
3.4.1	Interface Messages	3.4
3.4.2	Device Messages (Commands and Device Responses)	3.5
3.5	Structure and Syntax of the Device Messages	3.5
3.5.1	SCPI Introduction	3.5
3.5.2	Structure of a Command	3.6
3.5.3	Structure of a Command Line	3.8
3.5.4	Responses to Queries	3.8
3.5.5	Parameters	3.9
3.5.6	Overview of Syntax Elements	3.10
3.6	Description of Commands	3.11
3.6.1	Notation	3.11
3.6.2	Common Commands	3.13
3.6.3	ABORt System	3.16
3.6.4	CALibration System	3.16
3.6.5	DIAGnostic System	3.19
3.6.6	DISPlay System	3.21
3.6.7	FORMat System	3.22
3.6.8	MEMory System	3.23
3.6.9	OUTPut System	3.23
3.6.10	OUTPut2 System	3.25
3.6.11	SOURce System	3.26
3.6.11.1	SOURce:AM Subsystem	3.26
3.6.11.2	SOURce:CORREction Subsystem	3.28
3.6.11.3	SOURce:FM Subsystem	3.29
3.6.11.4	SOURce:FREQuency Subsystem	3.31
3.6.11.5	SOURce:ILS Subsystem	3.34
3.6.11.6	SOURce:MARKer Subsystem	3.39
3.6.11.7	SOURce:MBEacon Subsystem	3.41
3.6.11.8	SOURce:PHASe Subsystem	3.42
3.6.11.9	SOURce:PM Subsystem	3.43
3.6.11.10	SOURce:POWer Subsystem	3.45
3.6.11.11	SOURce:PULM Subsystem	3.48
3.6.11.12	SOURce:PULSe Subsystem	3.49

3.6.11.13	SOURce:ROSCillator Subsystem	3.50
3.6.11.14	SOURce:STEReo Subsystem	3.51
3.6.11.15	SOURce:SWEEP Subsystem	3.54
3.6.11.16	SOURce:VOR Subsystem	3.57
3.6.12	SOURce0 2 System	3.60
3.6.12.1	SOURce0 2:FREQuency Subsystem	3.60
3.6.12.2	SOURce0 2:FUNcTion Subsystem	3.61
3.6.12.3	SOURce2:MARKer Subsystem	3.62
3.6.12.4	SOURce2:SWEEP Subsystem	3.63
3.6.13	STATus System	3.65
3.6.14	SYSTem System	3.67
3.6.15	TEST System	3.72
3.6.16	TRIGger System	3.74
3.6.17	UNIT System	3.76
3.7	Instrument Model and Command Processing	3.77
3.7.1	Input Unit	3.77
3.7.2	Command Recognition	3.78
3.7.3	Data Set and Instrument Hardware	3.78
3.7.4	Status Reporting System	3.78
3.7.5	Output Unit	3.79
3.7.6	Command Sequence and Command Synchronization	3.79
3.8	Status Reporting System	3.80
3.8.1	Structure of an SCPI Status Register	3.80
3.8.2	Overview of the Status Registers	3.82
3.8.3	Description of the Status Registers	3.83
3.8.3.1	Status Byte (STB) and Service Request Enable Register (SRE)	3.83
3.8.3.2	IST Flag and Parallel Poll Enable Register (PPE)	3.84
3.8.3.3	Event Status (ESR) and Event Status Enable Register (ESE)	3.84
3.8.3.4	STATus:OPERation Register	3.85
3.8.3.5	STATus:QUEStionable Register	3.85
3.8.4	Application of the Status Reporting System	3.86
3.8.4.1	Service Request, Making Use of the Hierarchy Structure	3.86
3.8.4.2	Serial Poll	3.86
3.8.4.3	Parallel Poll	3.87
3.8.4.4	Query by Means of Commands	3.87
3.8.4.5	Error-Queue Query	3.87
3.8.5	Resetting Values of the Status Reporting System	3.88
4	Maintenance and Troubleshooting	
4.1	Maintenance	4.1
4.1.1	Cleaning the Outside	4.1
4.1.2	Storage	4.1
4.1.3	Exchange of the Lithium Battery	4.1
4.2	Functional Test	4.4

5	Testing the Rated Specifications	
5.1	Test Instruments and Utilities	5.1
5.1.1	Test Systems to Measure Modulation Characteristics	5.3
5.1.1.1	Standard Test System	5.3
5.1.1.2	Test System with Audio Analyzer	5.3
5.1.1.3	Test System for Broadband FM	5.3
5.1.1.4	Test System for Pulse Modulation	5.4
5.2.	Test Procedure	5.5
5.2.1	Display and Keyboard	5.5
5.2.2	Frequency Setting	5.5
5.2.3	Settling Time	5.6
5.2.4	Reference Frequency	5.8
5.2.5	Harmonics Suppression	5.8
5.2.6	Suppression of Nonharmonics	5.9
5.2.7	SSB Phase Noise	5.10
5.2.8	Broadband Noise	5.11
5.2.9	Residual FM	5.12
5.2.10	Residual AM	5.13
5.2.11	Output Level	5.13
5.2.12	Output Reflection Coefficient	5.15
5.2.13	Interrupt-free Level Setting (ATTEN FIXED)	5.16
5.2.14	Overvoltage Protection	5.17
5.2.15	Testing Level Monitoring at Input EXT1	5.17
5.2.16	Modulation Depth of AM	5.17
5.2.17	AM Frequency Response	5.18
5.2.18	AM Distortion Factor	5.18
5.2.19	Residual Φ_M with AM	5.18
5.2.20	Testing Level Monitoring at Input EXT2 (Option SM-B5)	5.19
5.2.21	FM Deviation Setting	5.19
5.2.22	FM Frequency Response	5.20
5.2.22.1	FM Frequency Response up to 100 kHz	5.20
5.2.22.2	FM Frequency Response up to 8 MHz	5.20
5.2.23	FM Distortion Factor	5.21
5.2.24	Residual AM with FM	5.21
5.2.25	Carrier Frequency Deviation with FM	5.21
5.2.26	FM Stereo Modulation	5.22
5.2.27	Φ_M Deviation Setting	5.22
5.2.28	Φ_M Frequency Response	5.23
5.2.28.1	Φ_M Frequency Response with a PM bandwidth of 100 kHz	5.23
5.2.28.2	Φ_M Frequency Response with a PM bandwidth of 2 MHz	5.23
5.2.29	Φ_M Distortion Factor	5.24
5.2.30	Internal Modulation Generator	5.24
5.2.31	Pulse Modulation (Option SM-B3/B8)	5.24
5.2.31.1	ON/OFF-Ratio	5.24
5.2.31.2	Dynamic Characteristics	5.25
5.2.32	LF Generator (Option SM-B2)	5.25
5.2.32.1	Frequency Error	5.25
5.2.32.2	Frequency Response	5.26
5.2.33	Pulse Generator (Option SM-B4)	5.26

5.2.34	Multi-Function Generator (Option SM-B6)	5.27
5.2.34.1	Frequency Error, Distortion Factor and Level	5.27
5.2.34.2	Frequency Response	5.28
5.2.34.3	Distortion Factor and Crosstalk Attenuation Stereo	5.28
5.2.34.4	Pilot-Tone Level	5.28
5.3	Test Report	5.29
6	Annex A	IEC/IEEE-Bus Interface
7	Annex B	List of Error Messages
8	Annex C	List of Commands (with SCPI Conformity Information)
9	Annex D	Programming Examples
10	Index	

Tables

Table 2-1	Input sockets for the different types of modulation	2.45
Table 2-2	Status messages in the case of a deviation from the rated value at the external modulation input	2.46
Table 2-3	Modulations which cannot be operated simultaneously	2.47
Table 2-4	Modulation generators as component parts	2.48
Table 2-5	MEMORY SEQUENCE; Example of a list	2.76
Table 3-1	Device Response to *OPT?	3.13
Table 3-2	Synchronization using *OPC, *OPC? and *WAI	3.79
Table 3-3	Meaning of the bits used in the status byte	3.83
Table 3-4	Meaning of the bits used in the event status register	3.84
Table 3-5	Meaning of the bits used in the STATus:OPERation register	3.85
Table 3-6	Meaning of the bits used in the STATus:QUESTionable register	3.85
Table 3-7	Resetting instrument functions	3.88
Table 5-1	Test instruments and utilities	5.1
Table 5-2	Changeover limits of the SMT	5.5
Table 5-3	Test report	5.29

Figures

Fig. 1-1	SMT – View from the front	1.5
Fig. 2-1	Front panel view	2.2
Fig. 2-2	Rear panel view	2.12
Fig. 2-3	Design of the display	2.18
Fig. 2-4	MODULATION AM menu	2.19
Fig. 2-5	Display after AM setting	2.24
Fig. 2-6	Display after pattern setting	2.25
Fig. 2-7	OPERATION page of the MEM SEQ menu	2.26
Fig. 2-8	SELECT LIST selection window	2.27
Fig. 2-9	DELETE LIST selection window	2.28
Fig. 2-10	Edit function EDIT/VIEW	2.29
Fig. 2-11	Block function FILL: Input window	2.30
Fig. 2-12	Edit function INSERT: Input window	2.32
Fig. 2-13	Edit function DELETE: Input window	2.33
Fig. 2-14	Starting point of pattern setting - Edition of a list	2.34
Fig. 2-15	Pattern setting – Edition of a list	2.36
Fig. 2-16	Menu FREQUENCY (preset setting)	2.39
Fig. 2-17	Example of a circuit with frequency offset	2.40
Fig. 2-18	Menu LEVEL (preset setting)	2.41
Fig. 2-19	Example of a circuit with level offset	2.42
Fig. 2-20	Menu LEVEL ALC (preset setting)	2.43
Fig. 2-21	Menu LEVEL UCOR – OPERATION page	2.44
Fig. 2-22	Menu LEVEL UCOR – EDIT page	2.44
Fig. 2-23	Menu LEVEL EMF (preset setting)	2.45
Fig. 2-24	Menu MODULATION AM (preset setting),	2.50
Fig. 2-25	Menu MODULATION FM (preset setting),	2.51
Fig. 2-26	Dependency of the FM maximal deviation on the RF frequency set	2.52
Fig. 2-27	Menu MODULATION PM (preset setting)	2.53
Fig. 2-28	Dependency of the PM maximal deviation on the RF frequency set	2.54
Fig. 2-29	Signal example 1: single pulse, TRIGGER MODE = AUTO	2.55
Fig. 2-30	Signal example 2: double pulse, TRIGGER MODE = EXT, SLOPE = POS	2.55
Fig. 2-31	Menu MODULATION PULSE (preset setting)	2.56
Fig. 2-32	Menu MODULATION STEREO (preset setting)	2.57
Fig. 2-33	Menu MODULATION VOR (preset setting)	2.59
Fig. 2-34	Menu MODULATION ILS-GS (preset setting)	2.61
Fig. 2-35	Menu MODULATION ILS-LOC (preset setting)	2.64
Fig. 2-36	Menu MODULATION MKR-BCN (preset setting)	2.67
Fig. 2-37	Menu LF OUTPUT (preset setting)	2.68
Fig. 2-38	Signal example sweep: MODE = AUTO, BLANK TIME = NORMAL	2.72
Fig. 2-39	Signal example sweep: MODE = SINGLE, BLANK TIME = LONG	2.72
Fig. 2-40	Menu SWEEP - FREQ	2.73
Fig. 2-41	Menu SWEEP - LEVEL	2.74
Fig. 2-42	Menu SWEEP - LF GEN	2.75
Fig. 2-43	Menu MEM SEQ — OPERATION page (preset setting)	2.78
Fig. 2-44	Menu MEM SEQ — EDIT page	2.79
Fig. 2-45	Menu UTILITIES SYSTEM - GPIB	2.80
Fig. 2-46	Menu UTILITIES SYSTEM - RS232	2.81
Fig. 2-47	Menu UTILITIES SYSTEM-SECURITY	2.82



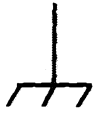



Fig. 2-48	Menu UTILITIES REF-OSC (preset setting)	2.82
Fig. 2-49	Menu UTILITIES PHASE (preset setting)	2.83
Fig. 2-50	Menu UTILITIES PROTECT (preset setting)	2.84
Fig. 2-51	Menu UTILITIES CALIB-VCO SYN	2.85
Fig. 2-52	Menu UTILITIES CALIB-LEV PRESET	2.86
Fig. 2-53	Menu UTILITIES CALIB-FM	2.87
Fig. 2-54	Menu UTILITIES CALIB-PULSE GEN	2.88
Fig. 2-55	Menu UTILITIES DIAG-CONFIG	2.89
Fig. 2-56	Menu UTILITIES DIAG-TPOINT	2.90
Fig. 2-57	Menu UTILITIES DIAG-PARAM	2.91
Fig. 2-58	Menu UTILITIES MOD KEY (preset setting)	2.92
Fig. 2-59	Menu UTILITIES AUX I/O	2.93
Fig. 2-60	Menu UTILITIES BEEPER	2.94
Fig. 2-61	STATUS page	2.95
Fig. 2-62	ERROR page	2.96
Fig. 3-1	Tree structure of the SCPI command systems	3.5
Fig. 3-2	Instrument model if remote control is carried out by the IEC bus	3.77
Fig. 3-3	The status register model	3.80
Fig. 3-4	Overview of the status registers	3.82
Fig. 4-1	Menu UTILITIES - TEST	4.2

Safety Instructions

This unit has been designed and tested in accordance with the EC Certificate of Conformity and has left the manufacturer's plant in a condition fully complying with safety standards.

To maintain this condition and to ensure safe operation, the user must observe all instructions and warnings given in this operating manual.

Safety-related symbols used on equipment and documentation from R&S:

							
Observe operating instructions	Weight indication for units >18 kg	PE terminal	Ground terminal	Danger! Shock hazard	Warning! Hot surfaces	Ground	Attention! Electrostatic sensitive devices require special care

1. The unit may be used only in the operating conditions and positions specified by the manufacturer. Unless otherwise agreed, the following applies to R&S products:
Pollution severity 2, overvoltage category 2, IP degree of protection 2X, altitude max. 2000 m.
The unit may be operated only from supply networks fused with max. 16 A.
2. For measurements in circuits with voltages $V_{rms} > 30 V$, suitable measures should be taken to avoid any hazards.
(using, for example, appropriate measuring equipment, fusing, current limiting, electrical separation, insulation).
3. If the unit is to be permanently wired, the PE terminal of the unit must first be connected to the PE conductor on site before any other connections are made (installation and cabling of the unit to be performed only by qualified technical personnel).
4. For permanently installed units without built-in fuses, circuit breakers or similar protective devices, the supply circuit must be fused such as to provide suitable protection for the users and equipment.
5. Prior to switching on the unit, it must be ensured that the nominal voltage set on the unit matches the nominal voltage of the AC supply network.
If a different voltage is to be set, the power fuse of the unit may have to be changed accordingly.
6. Units of protection class I with disconnectible AC supply cable and appliance connector may be operated only from a power socket with earthing contact and with the PE conductor connected.
7. It is not permissible to interrupt the PE conductor intentionally, neither in the incoming cable nor on the unit itself as this may cause the unit to become electrically hazardous.
Any extension lines or multiple socket outlets used must be checked for compliance with relevant safety standards at regular intervals.
8. If the unit has no power switch for disconnection from the AC supply, the plug of the connecting cable is regarded as the disconnecting device. In such cases it must be ensured that the power plug is easily reachable and accessible at all times (length of connecting cable approx. 2 m). Functional or electronic switches are not suitable for providing disconnection from the AC supply.
If units without power switches are integrated in racks or systems, a disconnecting device must be provided at system level.
9. Applicable local or national safety regulations and rules for the prevention of accidents must be observed in all work performed.
Prior to performing any work on the unit or opening the unit, the latter must be disconnected from the supply network.
Any adjustments, replacements of parts, maintenance or repair may be carried out only by authorized R&S technical personnel.
Only original parts may be used for replacing parts relevant to safety (eg power switches, power transformers, fuses). A safety test must be performed after each replacement of parts relevant to safety.
(visual inspection, PE conductor test, insulation-resistance, leakage-current measurement, functional test).

continued overleaf

Safety Instructions

10. Ensure that the connections with information technology equipment comply with IEC950/EN60950.
11. Lithium batteries must not be exposed to high temperatures or fire.
Keep batteries away from children.
If the battery is replaced improperly, there is danger of explosion. Only replace the battery by R&S type (see spare part list)
Lithium batteries are suitable for environmentally-friendly disposal or specialized recycling. Dispose them into appropriate containers, only.
Do not short-circuit the battery.
12. Equipment returned or sent in for repair must be packed in the original packing or in packing with electrostatic and mechanical protection.
13. Electrostatics via the connectors may damage the equipment. For the safe handling and operation of the equipment, appropriate measures against electrostatics should be implemented.
14. Any additional safety instructions given in this manual are also to be observed.

Patent Information

This product contains technology licensed by Marconi Instruments LTD. under US patents 4609881 and 4870384 and under corresponding patents in Germany and elsewhere.

Certified Quality System ISO 9001

DQS REG. NO 1954-04

Qualitätszertifikat

Sehr geehrter Kunde,

Sie haben sich für den Kauf eines Rohde & Schwarz-Produktes entschieden. Hiermit erhalten Sie ein nach modernsten Fertigungsmethoden hergestelltes Produkt. Es wurde nach den Regeln unseres Qualitätsmanagementsystems entwickelt, gefertigt und geprüft. Das Rohde & Schwarz-Qualitätsmanagementsystem ist nach ISO 9001 zertifiziert.

Certificate of quality

Dear Customer,

You have decided to buy a Rohde & Schwarz product. You are thus assured of receiving a product that is manufactured using the most modern methods available. This product was developed, manufactured and tested in compliance with our quality management system standards.

The Rohde & Schwarz quality management system is certified according to ISO 9001.

Certificat de qualité

Cher client,

Vous avez choisi d'acheter un produit Rohde & Schwarz. Vous disposez donc d'un produit fabriqué d'après les méthodes les plus avancées. Le développement, la fabrication et les tests respectent nos normes de gestion qualité.

Le système de gestion qualité de Rohde & Schwarz a été homologué conformément à la norme ISO 9001.



ROHDE & SCHWARZ

Support Center

Telefon / Telephone: (0180) 512 42 42

Fax: (++)89) 41 29 - 137 77

e-mail: CustomerSupport@rsd.rohde-schwarz.com

Für technische Fragen zu diesem Rohde & Schwarz-Gerät steht Ihnen ab sofort unsere Hotline der Rohde & Schwarz Vertriebs-GmbH, Support Center, zur Verfügung.

Unser Team bespricht mit Ihnen Ihre Fragen und sucht Lösungen für Ihre Probleme.

Die Hotline ist Montag bis Freitag von 8.00 bis 17.00 Uhr besetzt.

Bei Anfragen außerhalb der Geschäftszeiten hinterlassen Sie bitte eine Nachricht oder senden Sie eine Notiz per Fax oder e-mail. Wir setzen uns dann baldmöglichst mit Ihnen in Verbindung.

Should you have any technical questions concerning this Rohde & Schwarz product, please contact the hotline of Rohde & Schwarz Vertriebs-GmbH, Support Center.

Our hotline team will answer your questions and find solutions to your problems.

You can reach the hotline Monday through Friday from 8:00 until 17:00.

If you need assistance outside office hours, please leave a message or send us a fax or e-mail. We will contact you as soon as possible.



ROHDE & SCHWARZ



ROHDE & SCHWARZ
EC Certificate of Conformity



Certificate No.: 960011

This is to certify that:

Equipment type	Order No.	Designation
SMTxx	1039.2000.xx	Signal Generator

complies with the provisions of the Directive of the Council of the European Union on the approximation of the laws of the Member States

- relating to electrical equipment for use within defined voltage limits
(73/23/EEC revised by 93/68/EEC)
- relating to electromagnetic compatibility
(89/336/EEC revised by 91/263/EEC, 92/31/EEC, 93/68/EEC)

Conformity is proven by compliance with the following standards:

EN61010-1 : 1991
EN50081-1 : 1992
EN50082-1 : 1992

Affixing the EC conformity mark as from 1996

ROHDE & SCHWARZ GmbH & Co. KG
Mühldorfstr. 15, D-81671 München

Munich, 08.02.96

Central Quality Management FS-QZ / Becker

Adressen/Addresses

FIRMENSITZ/HEADQUARTERS

Telefon/Phone
Telefax
E-mail

ROHDE & SCHWARZ GmbH & Co. KG

Mühlendorfstraße 15 · 81671 München +49 89 41 29-0
Postfach 801469 · 81614 München +49 89 41 29-12164
Internet: www.rohde-schwarz.com -

WERKE/PLANTS

ROHDE & SCHWARZ Messgerätebau GmbH

Riedbachstraße 58 · 87700 Memmingen +49 83 31 10 8-0
Postfach 16 52 · 87686 Memmingen +49 83 31 10 81 124 -

ROHDE & SCHWARZ GmbH & Co. KG

Werk Teisnach +49 99 23 8 57-0
Kaikenrieder Straße 27 · 94244 Teisnach +49 99 23 8 571-1 74
Postfach 11 49 · 94240 Teisnach -

ROHDE & SCHWARZ GmbH & Co. KG · Werk Köln

Graf-Zeppelin-Straße 18 · 51147 Köln +49 22 03 49-0
Postfach 98 02 60 · 51130 Köln +49 22 03 49-51 3 08 -

TOCHTERUNTERNEHMEN/SUBSIDIARIES

ROHDE & SCHWARZ Vertriebs-GmbH

Mühlendorfstraße 15 · 81671 München +49 89 4129-120 07
Postfach 801469 · 81614 München +49 89 4129-135 67
customersupport@rohde-schwarz.com

ROHDE & SCHWARZ International GmbH

Mühlendorfstraße 15 · 81671 München +49 89 4129-120 05
Postfach 80 14 60 · 81614 München +49 89 4129-135 97 -

ROHDE & SCHWARZ Engineering and Sales GmbH

Mühlendorfstraße 15 · 81671 München +49 89 4129-137 11
Postfach 80 14 29 · 81614 München +49 89 4129-137 23 -

R&S BICK Mobilfunk GmbH

Im Landerfeld 7 · 31848 Bad Münder +49 50 42 9 98-0
Postfach 20 62 · 31844 Bad Münder +49 50 42 9 98-105
rsbick@rsbick.rohde-schwarz.com

ROHDE & SCHWARZ FTK GmbH

Wendenschloßstraße 168, Haus 28 +49 30 6 58 91-122
12557 Berlin +49 30 65 550-221 -

SIT Gesellschaft für Systeme

der Informationstechnik mbH +49 30 6 58 84-2 22
Wendenschloßstraße 168, Haus 28 +49 30 6 58 84-1 83
12557 Berlin sit.info@sit.rohde-schwarz.com

Zweigniederlassungen der Rohde & Schwarz Vertriebs-GmbH/Branch offices of Rohde & Schwarz Vertriebs-GmbH

Zweigniederlassung Berlin

Ernst-Reuter-Platz 10 · 10587 Berlin (+49 30) 34 79 48-0
Postfach 100620 · 10566 Berlin (+49 30) 34 79 48-48
customersupport@rohde-schwarz.com

Zweigniederlassung Büro Bonn

Josef-Wirmer-Straße 1-3 · 53123 Bonn (+49 2 28) 918 90-0
Postfach 140264 · 53057 Bonn (+49 2 28) 25 50 87
customersupport@rohde-schwarz.com

Zweigniederlassung Hamburg

Steilshooper Allee 47 · 22309 Hamburg (+49 40) 63 29 00-0
Postfach 602240 · 22232 Hamburg (+49 40) 630 78 70
customersupport@rohde-schwarz.com

Zweigniederlassung Köln

Graf-Zeppelin-Straße 18 · 51147 Köln (+49 22 03) 807-0
Postfach 900149 · 51111 Köln (+49 22 03) 807-50
customersupport@rohde-schwarz.com

Zweigniederlassung Mitte

Siemensstraße 20 (+49 61 02) 20 07-0
63263 Neu-Isenburg (+49 61 02) 80 00 40
customersupport@rohde-schwarz.com

Zweigniederlassung München

Mühlendorfstraße 15 · 81671 München (+49 89) 41 86 95-0
Postfach 801449 · 81614 München (+49 89) 40 47 64
customersupport@rohde-schwarz.com

Zweigniederlassung Nürnberg

Donastraße 36 (+49 9 11) 64203-0
90451 Nürnberg (+49 9 11) 64203-33
customersupport@rohde-schwarz.com

Zweigniederlassung Telekommunikation

Siemensstraße 20 (+49 61 02) 20 07-0
63263 Neu-Isenburg (+49 61 02) 20 07-12
customersupport@rohde-schwarz.com

ADRESSEN WELTWEIT/ADDRESSES WORLDWIDE

Algeria

ROHDE & SCHWARZ Bureau d'Alger (2) 59 24 53
5 B, Place de Laperrine (2) 69 46 08
16035 Hydra-Alger -

Argentina

Precisión Electrónica SRL (14) 331 16 85
Av. Julio A. Roca 710 - Piso 6 (14) 334 51 11
1067 Buenos Aires preelctr@satlink.com

Australia

ROHDE & SCHWARZ Sales (2) 8845 4100
(AUSTRALIA) Pty. Ltd. (2) 9738 3988
Unit 6, 2-8 South Street Service (2) 8845 4188
Rydalmere, N.S.W. 2116 (2) 9638 0832
sales@rsaus.rohde-schwarz.com
service@rsaus.rohde-schwarz.com

Austria

ROHDE & SCHWARZ-ÖSTERREICH (1) 6 02 61 41
Ges. m. b. H. (1) 6 02 61 41-14
Sonnleithnergasse 20 office@rsoe.rohde-schwarz.com
1100 Wien

Azerbaijan

ROHDE & SCHWARZ Azerbaijan 12 93 31 38
Liaison Office Baku 12 93 03 14
Azerbaijan Avenue 35 -
370139 Baku

Baltic

Countries siehe/see Denmark

Bangladesh

Business International Ltd. (2) 881 06 53
Corporation Office (2) 882 82 91
House No: 95/A, Block 'F'
Road No: 4, Banani
Dhaka - 1213 -

Belgium

ROHDE & SCHWARZ BELGIUM N.V. (2) 7 21 50 02
Excelsiorlaan 31 Bus 1 (2) 7 25 09 36
1930 Zaventem info@rsb.rohde-schwarz.com

Bolivia

siehe auch/see also Argentina

RIBCO LTDA. (2) 32 84 03
Av. Mariscal Santa Cruz 1392 (2) 39 30 47
Ed. Cámara Nacional gibatta@caoba.entelnet.bo
de Comercio
Piso 10, Of.1010-1011
La Paz

Brazil

ROHDE & SCHWARZ DO BRASIL LTDA.
Av. Alfredo Egidio de (11) 56 41 12 00
Souza Aranha, 177 (11) 56 41 78 10
1º andar - Santo Amaro
04726-170 São Paulo- SP

Adressen/Addresses

Brunei	GKL Equipment PTE. Ltd. #11-01 BP Tower 396, Alexandra Road Singapore 119954 Republic of Singapore	276 06 26 276 06 29 gkleqpt@signet.com.sg	Finland	Orbis Oy P.O. B. 15 00421 Helsinki	(9) 47 88 30 (9) 53 16 04 info@orbis.fi
Bulgaria	ROHDE & SCHWARZ Representation Office Bulgaria 39, Fridtjof Nansen Blvd. 1000 Sofia	(2) 963 43 34 (2) 963 21 97 rohdebg@rsoe.com	France	ROHDE & SCHWARZ FRANCE Immeuble "Le Newton" 9-11, rue Jeanne Braconnier 92366 Meudon-la-Forêt Cédex	(1) 41 36 10 00 (1) 41 36 11 10 -
Canada	Kommunikationstechnik/Communications Equipment: ROHDE & SCHWARZ CANADA Inc. 555 March Rd. Kanata, Ontario K2K 2M5	(613) 592 80 00 (613) 592 80 09 -		Niederlassung/Subsidiary Rennes: ROHDE & SCHWARZ FRANCE Sigma 1 Rue du Bignon 35135 Chantepie	(2) 99 51 97 00 (2) 99 41 91 31 -
	Messtechnik/T & M Equipment: TEKTRONIX CANADA, Inc. 3280 Langstaff Road, Unit 1 Concord, Ontario L4K 5B6	(416) 747 50 00 (905) 760 72 41 -		Niederlassung/Subsidiary Toulouse: ROHDE & SCHWARZ FRANCE Technoparc 3 B.P.501 31674 Labège Cédex Büros/Offices: Aix-en-Provence	(5) 61 39 10 69 (5) 61 39 99 10 -
Chile	DYMEQ Ltda. Avenida Larrain 6666 Santiago	(2) 277 50 50 (2) 227 87 75 dymeq@entelchile.net		Lyon Nancy	(4) 94 07 39 94 (4) 94 07 55 11 (4) 78 29 88 10 (4) 78 29 94 71 (3) 83 54 51 29 (3) 83 55 39 51
China	ROHDE & SCHWARZ Representative Office Beijing Parkview Center, Room 602 No. 2 Jiangtai Road, Chao Yang District Beijing 100016, P. R. China	(10) 64 31 28 28 (10) 64 37 98 88 -	Ghana	KOP Engineering Ltd. P.O. Box 11012 3rd Floor Akai House, Osu Accra	(21) 77 99 13 (21) 22 47 69
Colombia	Ferrostaal de Colombia Av. Eldorado Nro. 97-03 Interior 2 Santafé de Bogotá, D.C.	(1) 415 77 00 (1) 413 18 06 mc_fsc@multiphone.net.co	Greece	MERCURY SA. 6, Loukianou Str. 10675 Athens	(1) 722 92 13 (1) 721 51 98 mercury@hol.gr
Costa Rica	siehe/see Mexico (EPSA)		Guatemala	siehe/see Mexico (EPSA)	
Croatia	siehe/see Austria		Honduras	siehe/see Mexico (EPSA)	
Republic of Cyprus	HINIS TELECAST LTD. Agiou Thoma 18 Kiti Larnaca 7550	(4) 42 51 78 (4) 42 46 21	Hong Kong	Schmidt & Co. (HK) Ltd. 9/F North Somerset House Taikoo Place 979 King's Road Quarry Bay, Hong Kong	25 07 03 33 28 27 56 56 frankwong@shk.schmidtgroup.com
Czech Republic	ROHDE & SCHWARZ – Praha, s.r.o. Pod Kastany 3 160 00 Praha 6	(2) 24 32 20 14 (2) 24 31 70 43 rohdecz@rsoe.com	Hungary	ROHDE & SCHWARZ Budapesti Iroda Etele ut. 68 1115 Budapest	(1) 203 02 82 (1) 203 02 82 rohdehu@rsoe.com
Denmark	ROHDE & SCHWARZ DANMARK A/S Ejby Industrivej 40 2600 Glostrup	43 43 66 99 43 43 77 44 RSDK@post1.tele.dk	Iceland	siehe/see Denmark	
Ecuador	REPRESENTACIONES MANFRED WEINZIERL Guanguiltagua 72 (39-93) Urbanización Jardines del Batán Quito	(2) 25 22 51 (2) 25 22 51 mweinzierl@accessinter.net	India	ROHDE & SCHWARZ India Pvt. Ltd. 244, Okhla Industrial Estate Phase - III New Delhi 110 020	(11) 683 74 84 rsindiad@vsnl.com
Egypt	U.A.S. Universal Advanced Systems 31 Manshiet El Bakry St., Heliopolis 11341 Cairo	(202) 455 67 44 (202) 256 17 40 uas@intouch.com	Indonesia	P.T. REKANUSA SOLUSI Menara Rajawali, 24th floor Jl Mega Kuningan Lot # 5.1 Kawasan Mega Kuningan Jakarta 12950	(21) 576 16 02 (21) 576 16 04 -
El Salvador	siehe/see Mexico (EPSA)		Iran	ROHDE & SCHWARZ IRAN Liaison Office - Reg. N° RFC 1947 Dr. Beheschty Ave., Pakistan Ave., 12th Street N° 1 Tehran 15317	(21) 8 73 02 82 (21) 8 73 02 83 -
Estonia	ROHDE & SCHWARZ DANMARK A/S Estonian Branch Office Narva mnt. 13 10151 Tallinn	(6) 14 31 20 (6) 14 31 21			

Adressen/Addresses

Ireland	siehe/see Great Britain		
Italy	ROHDE & SCHWARZ ITALIA S.p.a. Via Tiburtina 1182 00156 Roma	(6) 41 59 81 (6) 41 59 82 70 -	
	Centro Direzionale Lombardo Via Roma 108 20060 Cassina de' Pecchi (MI)	(2) 95 70 41 (2) 95 30 27 72	
Japan	ADVANTEST Corporation RS Sales Department Shinjuku-NS Building, 4-1 Nishi-Shinjuku Tokyo 163-08, Japan	(3) 33 42 75 53 (3) 53 22 72 70 yoshimu@inst.advantest.co.jp	
Jordan	Middle East Development c/o Jordan Crown Engineering & Trading Co. P.O. Box 830414 Amman, 11183	(6) 465 96 71 (6) 465 96 72	
Kazakhstan	ROHDE & SCHWARZ Kazakhstan Liaison Office Almaty Pl. Respubliki 15 480013 Almaty	32 72 63 55 55 32 72 63 46 33 -	
Kenya	Excel Enterprises Limited Dunga Road P.O. Box 42 788 Nairobi	(2) 55 80 88 (2) 54 46 79	
Korea	Hana Technica Corp. Seoul Kangnam, P.O. Box 1458 Young Dong Bldg. 4F 63-16 Nonhyun-Dong, Kang Nam-Ku Seoul	(2) 514 45 46 (2) 514 45 49 hanateco@unitel.co.kr	
Kuwait	Group Five Trading & Contracting Co. P.O. Box 26645 Safat 13127 State of Kuwait	244 91 72 244 95 28	
Latvia	Rohde & Schwarz Danmark A/S Latvian Branch Office Merkela iela 21-301 1050 Riga	(7) 50 23 55 (7) 50 23 60 rsdk@rsdk.rohde-schwarz.com	
Lebanon	Rohde & Schwarz International Liaison Office Riyadh PO Box 361 c/o Haji Abdullah Alireza & Co. Riyadh 11411 - KSA	(1) 465 64 28 Ext. 303 (1) 465 64 28 Ext. 229	
Liechtenstein	siehe/see Switzerland		
Lithuania	Rohde & Schwarz Danmark A/S Lithuanian Office Lukiskiu 5-228 2600 Vilnius	222 46 62 222 46 62	
Luxembourg	siehe/see Belgium		
Malaysia	DAGANG TEKNIK SDN. BHD. No. 9, Jalan SS 4D/2 Taman People's Park 47301 Petaling Jaya Selangor Darul Ehsan	(3) 7035503/7035568 (3) 7 03 34 39 danik@tm.net.my	
Malta	ITEC - International Technology Ltd. B'Kara Road San Gwann	37 43 00 37 43 53 itec@keyworld.net	
Mexico	Vertrieb Kommunikationstechnik/ Sales of Communications Equipment: ELECTROINGENIERIA de Precisión S.A. (EPSA) Uxmal 520 Colonia Vertiz Narvarte 03600 Mexico DF		(5) 559 76 77 (5) 575 33 81 epsa@compuserve.com
	Vertrieb Messtechnik/Sales of T&M Equipment: Tektronix S.A. de C.V. Periférico Sur 5000, 8° Piso Col. Insurgentes Cuicuilco Del. Coyoacán 04530 Mexico, D.F.		(5) 666 63 33 (5) 666 63 36
Nepal	Abishek Trade Links (P) Ltd. P.O.B. 9700 Kathmandu	(1) 25 69 30 (1) 24 25 73 Durbar@hotel.mos.com.np	
Netherlands	ROHDE & SCHWARZ NEDERLAND B.V. Perkinsbaan 1 3439 ND Nieuwegein	(30) 600 17 00 (30) 600 17 99 Rob.DenHartog@rsn.rohde-schwarz.com	
New Zealand	Nichecom Level 1 Tawa Plaza 210 Main Rd / P.O.B. 56-045 Tawa, Wellington	(4) 232 32 33 (4) 232 32 30 ISDN (4) 237 30 10 robin.hodgson@nichecom.co.nz	
Nicaragua	siehe/see Mexico (EPSA)		
Nigeria	Ferrostaal (Nigeria) Ltd. 27/29 Adeyemo Alkaija Street P.O. Box 72021 Victoria Island Lagos	(1) 262 00 60 (1) 262 00 64	
Norway	ROHDE & SCHWARZ NORGE Østensjøveien 36, P.O.B. 103 BRYN 0611 Oslo	23 17 22 50 23 17 22 69 -	
Oman	T&M Equipment and Broadcasting: Mustafa & Jawad Science & Industry Co. Ltd. P.O. Box 3340 Post Code 112 Ruwi Sultanate of Oman	60 20 09 60 70 66	
Pakistan	TelcoNet Communications & Engineering 213/D, Ordnance Road Rawalpindi-Pakistan-46000	(51) 26 30 72 (51) 26 32 11 tnc@meganet.com.pk	
Panama	siehe auch/see also Mexico (EPSA)		
	ELECTRONICO BALBOA S.A. Av. El Paical, Edif. El Dorado Urb. Los Angeles Panama City	614 93 64 236 18 20 pdubois@ebsa.com	
Papua- New Guinea	siehe/see Australia		
Peru	siehe auch/see also Argentina		
	BMP INGENIEROS S.A. Av. José Gálvez Barrenechea 645 Urb. Corpac - San Borja Lima 41	(1) 225 40 30 (1) 475 15 13 wmgelgarejo@bmp.com.pe	

Adressen/Addresses

Philippines	MARCOM Industrial Equipment, Inc. MCC P.O.Box 2307 6-L Mezzanine Suite, Vernida I Condominium 120 Amorsolo St. Legaspi Village Makati City/Philippines 3117	(2) 8 13 29 31 (2) 8 17 05 07	12830 Skarpnäck info@rss.rohde-schwarz.com
Poland	ROHDE & SCHWARZ Oddzial w Polsce ul. Stawki 2, Pietro 28 00-193 Warszawa	(22) 860 64 90 (22) 860 64 99 rohdepl@rsoe.com	Switzerland Roschi Rohde & Schwarz AG Papiermühlestrasse 145, Postfach 3063 Ittigen -
Portugal	TELERUS Sistemas de Telecomunicações, S.A. Rua General Ferreira Martins, Lote 6,2.ºB 1495 Algés	(21) 412 35 90 (21) 412 36 00 telerus@mail.telepac.pt	Syria Electro Scientific Office Baghdad Street Dawara Clinical Lab. Building P.O.B. 8162 Damascus
Romania	ROHDE & SCHWARZ Representation Office Bucharest Uranus 98 Bloc U8, scara 2, etaj 5, ap. 36 76102 Bucuresti	(1) 410 68 46 (1) 411 20 13 rohdero@rsoe.com	Tanzania Security Systems (T) Ltd. P.O. Box 7512 Dar Es Salaam
Russian Federation	ROHDE & SCHWARZ Representative Office Moscow Kazachy per. 7 109017 Moscow	(095) 234 49 62 (095) 234 49 63 rohderus@rsoe.com	Taiwan Lancer Communication Co., LTD. 16F, No. 30, Pei-Ping East Road Taipei rosa.ho@lancercomm.com.tw
Saudi Arabia	Rohde & Schwarz Liaison Office c/o Haji Abdullah Alireza Co. Ltd. P.O.B. 361 Riyadh 11411	(1) 465 64 28 (1) 465 07 82 -	Thailand Vertrieb Kommunikationstechnik/Sales Communications Equipment: TPP Operation Co., Ltd. (2) 880 93 45 41/5 MoobanTarinee Boromrajchonnee Rd. (2) 880 93 47 Talingchan, Bangkok 10170 -
Singapore	Vertrieb/Sales: INFOTEL TECHNOLOGIES LTD. 19 Tai Seng Drive Kinergy Building # 06-00 Singapore 535222	287 68 22 284 95 55 general@infotel.com.sg	Vertrieb Messtechnik/Sales T & M Equipment: Schmidt Scientific (Thailand) Ltd. (2) 643 13 30-9 212 Government Housing Bank Bldg. (2) 643 13 40 Tower II, 19th Floor, Rama 9 Rd., Huaykwang, Bangkapi, Bangkok 10320 -
	Service: Rohde & Schwarz Support Centre Asia Pte. Ltd. 1 Kaki Bukit View #04-05/07 Techview Singapore 415941	846 37 10 846 00 29 rssca@mbox4.singnet.com.sg	Turkey ROHDE & SCHWARZ Liaison Office Istanbul Bagdad Cad. 191/3, Ard. 81030 Selamicesme-Istanbul
Slovak Republic	Specialne systémy a software, a.s. Svrčic ul 84104 Bratislava	(7) 65 42 25 29 (7) 65 42 07 68 3s@internet.sk	Ukraine ROHDE & SCHWARZ Representative Office Kiev ul. Patrisa Loumoumba, 4 252042 Kiev
Slovenia	ROHDE & SCHWARZ Representation Ljubljana Koprska 92 1000 Ljubljana	(61) 123 46 51 (61) 123 46 11 rohdesi@rsoe.com	United Arab Emirates Service-Center für den Mittleren Osten/ Service Center for the Middle East: ROHDE & SCHWARZ Emirates L.L.C. P.O.B. 31156 Abu Dhabi -
South Africa	Protea Data Systems (Pty) Ltd Communications & Measurement Division Private Bag X19 Bramley 2018	(11) 786 36 47 (11) 786 58 91 Colin.Forbes@protea.co.za	ROHDE & SCHWARZ Liaison Office Middle East P.O. Box 311 56 Abu Dhabi -
Spain	ROHDE & SCHWARZ ESPAÑA Salcedo, 11 28034 Madrid	(91) 334 10 70 (91) 729 05 06 rema@rsd.rohde-schwarz.com	Vertrieb/Sales: ROHDE & SCHWARZ Liaison Office Dubai (4) 39 44 829 P.O.B. 53726 (4) 39 44 794 Dubai -
Sri Lanka	LANKA AVIONICS 658/1/1, Negombo Road Mattumagala Ragama	(1) 95 66 78 (1) 95 83 11 -	R&S BICK Mobile Communication P.O.B. 17466 (4) 81 36 75 JAFZ, LOB 04-028 (4) 81 36 76 Dubai -
Sudan	SolarMan Co. Ltd. P.O. Box 11 545 Karthoum	(11) 47 31 08 (11) 78 17 25	United Kingdom ROHDE & SCHWARZ UK Ltd. Ancells Business Park Fleet, Hampshire GU 13 8UZ -
Sweden	ROHDE & SCHWARZ SVERIGE AB Flygfältsgatan 15	(8) 605 19 00 (8) 605 19 80	Uruguay siehe auch/see also Argentina

Adressen/Addresses

AEROMARINE S.A. (2) 400 39 62
Cerro Largo 1497 (2) 401 85 97
11200 Montevideo aeromar@adinet.com.uy

USA Kommunikationstechnik/Communications Equipment:
ROHDE & SCHWARZ, Inc. (301) 459 88 00
4425 Nicole Drive (301) 459 28 10
Lanham, MD 20706 -

Messtechnik/T & M Equipment:
TEKTRONIX Inc. (800) 835 9433 Ext. 6630
P.O.B. 500, M/S 50-216 (800) 835 7732
Beaverton, OR 97076 -

Venezuela EQUILAB TELECOM C.A. (2) 34 46 26
Centro Seguros La Paz (2) 239 52 05
Piso 6, Local E-61 r_ramire@equilabtelecom.com.ve
Ava. Francisco de Miranda
Boleita, Caracas 1070

Military customers only:
REPRESENTACIONES BOPIC S.A. (2) 985 21 29
Av. Diego Cisneros (2) 985 39 94
Centro Empresarial Los Ruices incotr@cantv.net
Of. 119, 1er piso
Los Ruices
Caracas

Vietnam Schmidt Vietnam Co., Ltd. (4) 834 61 86
8/F, Schmidt Tower, Hanoi (4) 834 61 88
Intern. Technology Centre svnhn@schmidt group.com
Cau Giay, Tu Liem, IPO Box 89
Hanoi

Yugoslavia see/siehe Austria

Nicht aufgeführte Länder/Countries not listed:
ROHDE & SCHWARZ INTERNATIONAL GmbH
P.O.B. 80 14 69
81614 München / Germany
Please fax to +49 89 41 29 136 62

**Supplement B
to Operating Manual
SIGNAL GENERATOR
SMT**

Correction of Data Sheet, Number 0196

Spectral purity

Harmonics

With pulse modulator on:

Level \leq 5 dBm < -30 dBc
Level without overrange < -26 dBc

Model SMT03

Amplitude modulation:

AM distortion factor at 1 kHz
Applies to levels \leq 7dBm

1 Preparation for Use

1.1 Putting into Operation

Before putting the SMT into operation, please make sure that

- the covers of the casing are put on and screwed,
- the ventilation openings are free,
- no signal voltage levels exceeding the permissible limits are applied at the inputs,
- the outputs of the instrument are not overloaded or connected incorrectly.

If these points are not observed, the instrument might be damaged.

1.1.1 Supply Voltage

The SMT can be operated at a.c. systems from 90 to 132 V and 180 to 265 V at system frequencies from 47 to 440 Hz. The power supply socket is situated at the rear of the instrument. The instrument automatically sets itself to the voltage applied within the permissible voltage ranges. It is not necessary to set the instrument to a certain supply voltage.

1.1.2 Switching On/Off the Instrument

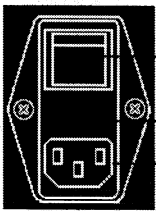

- Power switch
- Fuse holder
- Power supply socket

Power switch at the rear of the instrument

- Switch on/off:
- ▶ Press power switch at the top/bottom
- When the instrument is switched off, the marking "O" is visible at the top of the power switch.

The power switch can remain switched on permanently. Switching off is only necessary when the instrument is to be completely disconnected from the mains.



- Standby check LED

On/off switch at the front of the instrument

- Switch on:
- ▶ Press switch.
- The instrument is ready for operation.
- Switch off:
- ▶ Release switch.
- The instrument assumes the STANDBY mode.

1.1.3 Initial Status

Upon switching on, the instrument either automatically assumes the status set when it was switched off (parameter POWER-ON STATE PREVIOUS SETTING in LEVEL-LEVEL menu) or the RF output is disconnected (POWER-ON STATE RF OFF).

If the instrument need not be operated from the initial status any further, a defined default status should be established by pressing the [PRESET] key prior to making further settings.

STANDBY Mode

In the STANDBY mode the optional reference oscillator (option SM-B1) remains switched on, which increases frequency accuracy.

Frequency accuracy after switching on when the oven-controlled reference oscillator is fitted (option SM-B1)

When switching on from the STANDBY mode, the specified frequency accuracy is reached immediately. If the power switch was switched off, the reference oscillator needs some minutes of warm-up time to reach its nominal frequency. During this period of time, the output frequency does not yet reach its final value either. In the status line in the header field of the display the message "OVEN COLD" is displayed for this time.

1.1.4 Setting Contrast and Brightness of the Display

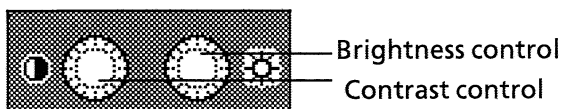

Contrast and brightness of the display can be set by means of the contrast and brightness controls situated below the display.

1.1.5 RAM With Battery Back-Up

The SMT has a static read-write memory (CMOS-RAM) with battery back-up, in which 50 different complete settings of the instrument can be stored (cf. Chapter 2, section "Storing and Calling of Instrument Settings"). In addition, all data and/or lists the user enters himself, such as for memory sequence and user correction of the level, are stored in the RAM. Further, all data of the calibrations running within the instrument in the SMT are stored in the RAM (cf. Chapter 2, section "Calibration").

A lithium battery with a service life of approx. 5 years serves to supply the RAM with power. When the battery is discharged, the data stored will be lost. Exchanging the battery is described in service manual.

1.1.6 Preset Setting

A defined setting status is achieved by pressing the [PRESET] key.

Preset Status:

RF frequency	100 MHz
RF level	-30 dBm
Reference frequency	internal, adjustment off
Offsets	0
Modulations	switched off
Transient-free level setting	switched off, level attenuator mode: AUTO
Internal level control	level ALC: ON
User correction	level Ucor: OFF
LF output	switched off
Sweep	switched off
Memory sequence	switched off
Suppression of indications	system security: unaltered
Protection of calibration data	protection lock: unaltered
Settings stored	unaltered
Data, lists etc. stored	unaltered
IEC-bus address	unaltered
Beeper	unaltered
Power-on state	unaltered

All parameters and circuit states, even those of operating modes which are not activated, are preset by means of Preset.

The presettings going beyond the above list can be seen from the menu representations as of Section 2.4 which each indicate the Preset setting status.

1.2 Functional Test

On switching on the instrument and permanently during operation, the SMT carries out a selftest. The ROM contents as well as the battery of the non-volatile RAM are checked on switching on the instrument and the RAM contents with every calling the memory. The most important instrument functions are automatically monitored during operation.

If an error is detected, the message "ERROR" is displayed in the status line. For further identification of the error, press the [ERROR] key. Thereupon a description of the error/s is displayed (cf. Chapter 2, Section "Error Messages"). Return to the menu exited by pressing the [RETURN] key.

If required, the selftests can be induced purposefully. See Chapter 2, Section "Functional Test". Further, internal test points can be polled by the user and the results be read out and displayed. See Chapter 2, Section "Voltage Display of Test Points".

1.3 Fitting the Options

Due to its variety of options, the SMT offers the possibility of providing the instrument with the equipment exactly corresponding to the application. Newly fitted options are automatically recognized and the relevant parameters added in the menu.

After every change of the instrument configuration, the CMOS RAM has to be cleared as the storage data shift:

- ▶ Switch off the instrument
- ▶ Switch the instrument on again with the [PRESET] key pressed

The internal calibration routines VCO SYN, LEV PRESET, PULSE GEN and FM now have to be called up again to restore the cleared calibration values.

These routines are accessible via menu UTILITIES-CALIB (see also Chapter 2, section "calibration"). The calibration routines have to be carried out in the following order:

1. VCO SYN (synthesizer)
2. LEV PRESET
3. PULSE GEN (if installed)
4. FM (synthesizer)

1.3.1 Opening the Casing



Caution: Prior to opening the SMT unplug the power connector.

Remove paneling

- ▶ Remove four screws in the two tilt feet at the rear of the instrument.
- ▶ Remove the upper paneling towards the top and rear.
- ▶ Turn the instrument.
- ▶ Remove the lower paneling towards the top and rear.

Open ventilation ducts

When an option is fitted at a slot which has not been used up to now, the appropriate ventilation duct of the plexiglass plate at the left in the casing frame must be opened. The openings are pre-punched so that the respective part is easy to break out.

1.3.2 Overview of the Slots

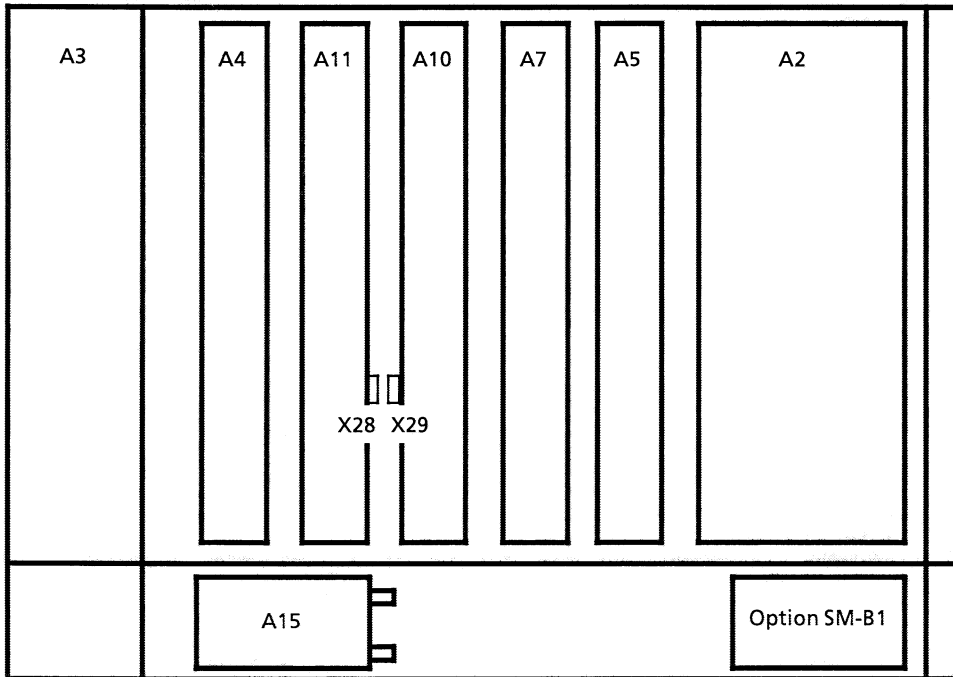

- | | |
|-------------------|--------------------------------|
| A2 = power supply | A7 = synthesizer |
| A3 = front unit | A10 = output unit, 1.5 GHz |
| A4 = option | A11 = output unit, 3 GHz/6 GHz |
| A5 = option | A15 = attenuator |

Fig. 1-1 SMT – View from the top

1.3.3 Option SM-B1 – Reference Oscillator OCXO

Fitting the option

- ▶ Fasten the option at the back end of the lateral opening by means of the screw threads provided there.
If slots A5 and A6 are both occupied, one of these modules must be removed temporarily.
- ▶ Feed ribbon cable W710 through the rear square cut-out to the motherboard, insert into connector X22 and snap in the locking.
- ▶ Feed coaxial cable W710 from socket X711 of the option through the second cut-out along the rear transverse panel to connector X74 at the A7 module, synthesizer, via the motherboard and insert there. Fasten the cable at the transverse panel using the cable ties attached.

Set tuning voltage and calibrate OCXO

The crystal oscillator was factory-tuned to nominal frequency and the appropriate tuning voltage indicated on the cover of the module. The calibration value now has to be calculated from this value and transferred to the memory of the signal generator.

Calculate calibration value

The tuning voltage is generated by a 12b-bit-D/A converter which is scaled such that a tuning voltage of 12 volts is generated with calibration value (CALIBRATION DATA) 4000. The calibration value is thus calculated from the tuning voltage (V_{tun}) as follows

$$\text{CALIBRATION DATA} = V_{\text{tun}} \times 4096 / 12$$

For checking purposes, the voltage at pin 16 of plug X22 on the motherboard can be remeasured and corrected if necessary. A check by means of frequency measurement may only be made after a warm-up of 2 hours and against a calibrated reference.

Store calibration value

- ▶ Call menu UTILITIES-CALIB-REF OSC.
- ▶ Enter the calculated calibration voltage with CALIBRATION DATA by means of the rotary knob or keypad.
- ▶ Select STORE CALIBRATION DATA
- ▶ Terminate entry using the [SELECT] key
The new calibration value is stored in the EPROM.

Note: *The flash EPROM does not permit the deletion of individual data. Thus new memory space is occupied for each calibration. If there is no memory space available any more, the EPROM must be cleared by an authorized service shop and be written into anew. Thus a calibration should only be made if necessary.*

1.3.4 Option SM-B2 – LF Generator

Fitting as 1st generator

As 1st generator, the LF generator is fitted at one of the rear slots A5.

- ▶ Withdraw jumper X29 at the front top of the motherboard.
- ▶ Plug jumper X3 at position 2-3 (on the right) on the option (to the right of multipoint connector X50).

Fitting as 2nd generator

If there already is a generator at one of the slots A5, the LF generator is mounted at slot A4.

- ▶ Withdraw jumper X28 on the motherboard.
- ▶ Plug jumper X3 at position 1-2 on the option.

1.3.5 Options SM-B3, SM-B8, and SM-B9 – Pulse Modulator 1.5, 3, and 6 GHz

When fitting this option, the RF characteristics of the instrument change to such an extent that the output level has to be calibrated. This requires calibrated test instruments, a control processor and service kit SM-Z2. For this reason, fitting should be carried out at an authorized R&S service shop. Fitting is described in the service manual (stock number 1039.3359.24).

1.3.6 Option SM-B4 – Pulse Generator

The pulse generator is fitted within module A4, pulse modulator.

- Fitting the option
- ▶ Open module A4.
 - ▶ Fasten the pulse generator board by means of 4 screws.
 - ▶ Plug in connectors W10 and W11.
 - ▶ Screw on cover again.
 - ▶ Establish the following RF connections at the pulse generator:

Cable	From	To	Signal
W43	A4-X43	Rear panel	VIDEO
W44	A4-X44	Rear panel	SYNC

- ▶ Cable 50-MHz reference, cf. Section 1.3.12

- Calibrating pulse generator
- ▶ Call menu UTILITIES/ CALIB /PULSE GEN
 - ▶ Select action CALIBRATE ▶ and activate using the [SELECT] key
The start and end of the calibration are displayed. Calibration only takes a few seconds.

Note: *The calibration data are stored in the RAM, thus the calibration can be repeated as often as required.*

1.3.7 Option SM-B6 – Multifunction Generator

The multifunction generator is fitted at slot A5.

Remove jumper X29 at the motherboard.

For cabling the 50-MHz reference, cf. Section 1.3.9.

1.3.8 Option SMT-B19 – Rear Panel Connections for RF and LF

The SMT can be retrofitted to match rear panel connections for RF and LF for mounting into a 19" rack by means of option SMT-B19. The mounting instructions are attached to the option.

1.3.9 Cabling of the 50-MHz Reference (REF50)

Instrument with option
multifunction generator

Cable	From	To
W172	A7-X72	A5-X53

Instrument with option
pulse generator

Cable	From	To
W41	A7-X72	A4-X41

Instrument with options
multifunction generator
and pulse generator

Cable	From	To
W172	A7-X72	A5-X53
W41	A5-X51	A4-X41

1.4 Mounting into a 19" Rack

Caution: *Ensure free air inlet at the perforation of the side walls and air outlet at the rear of the instrument in rack mounting.*

The SMT can be mounted into a 19" rack by means of rack adapter ZZA-94 (stock no. 396.4905.00). The mounting instructions are attached to the adapter.

2 Operation

2.1 Explanation of Front and Rear Panel

2.1.1 Elements of the Front Panel

2.1.1.1 Display

(cf. Fig. 2-1, A Front panel view, display)

1

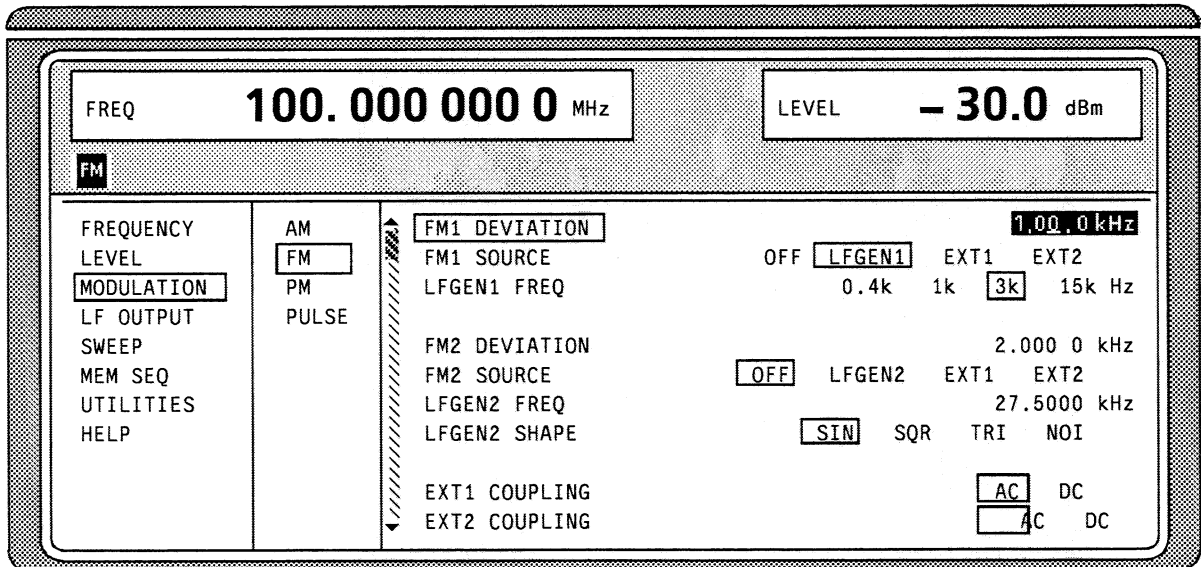

The display shows in the header field:

- the current frequency and level settings.
- status messages.
- error messages.

menu field:

- the main menu and the submenus selected with the current settings.

Parameters can be selected and changed in the menus indicated.

see as well
Section 2.2.1, Display

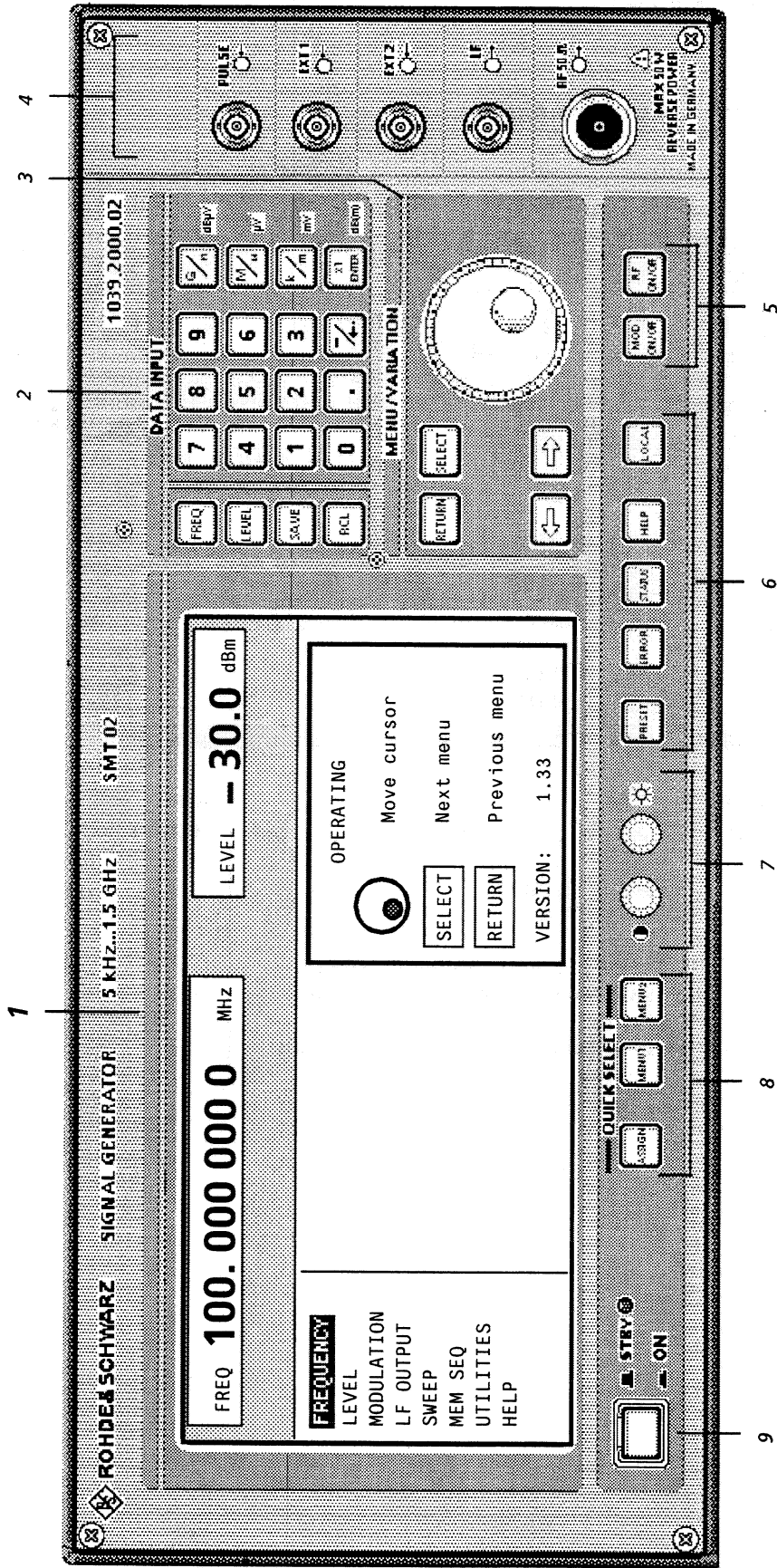

Fig. 2-1, A Front panel view, display

2.1.1.2 Controls

(cf. Fig. 2-1, B front panel view, controls)

2 DATA INPUT

Parameter field

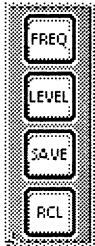

Parameters RF frequency and RF level can be entered directly by means of the parameter keys, alternatively to menu operation. The input value (indicated in the header field) considers the offset, see Sections 2.4 and 2.5. Further, complete instrument settings can be stored and called.

- FREQ** Opens the setting of the RF frequency via value input or variation by means of a rotary knob. The current menu is maintained. Return to the menu by means of the [RETURN] key. (Setting of the RF frequency also in the FREQUENCY menu).
- LEVEL** Opens the setting of the RF level via value input or variation by means of a rotary knob. The current menu is maintained. Return to the menu by means of the [RETURN] key. (Setting of the RF level also in the LEVEL menu).
- SAVE** Opens the storing of the current instrument setting. Memory selection is effected by entering a number (1 to 50) and is finished by means of the [ENTER] key.
- RCL** Opens the calling of an instrument setting stored. Memory selection is effected by entering a number (1 to 50) and is finished by means of the [ENTER] key.

see as well

Section 2.2.2.5,
Use of [FREQ] and
[LEVEL] Keys

Section 2.4,
RF Frequency

Section 2.5,
RF Level

Section 2.2.5,
Storing and Calling
of Instrument
Settings

Numeric input field

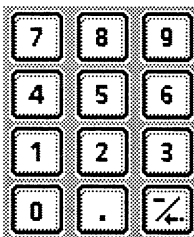

Numeric values, decimal point and minus sign can be entered by means of the digital keys.

- 0...9** Enters the digit.
- .** Enters the decimal point.
- /←** Enters the minus sign.
Deletes the last input (digit, sign or decimal point) – key [BACKSPACE].

see as well

Section 2.2.2,
Basic Operating
Steps

2 DATA INPUT

Unit keys with enter function

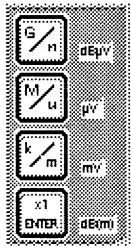

The unit keys terminate the input of values and specify the multiplication factor for the respective basic unit. The basic units are displayed next to the input field while numbers are entered. In the case of level settings, the unit keys specify the unit.

G/n	dBµV	Selects Giga/nano, with RF level dBµV, with RF level dB.
M/µ	µV	Selects Mega/micro, with level µV.
k/m	mV	Selects kilo/milli, with level mV.
1x ENTER	dB(m)	Terminates entries in the basic unit and value inputs without unit. Selects with level dBm Selects with level offset and level step width dB.

In order to change to another level unit, simply press the unit key desired. Parameter LEVEL must be activated, e.g. by pressing the [LEVEL] key.

see as well
Section 2.2.2,
Basic Operating
Steps

Section 2.2.2.7,
Change Unit of Level

3 MENU / VARIATION

Menu keys

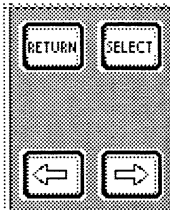

The menu keys access the menus and settings within the menus.

RETURN	Returns the menu cursor to the next higher menu level.
SELECT	Acknowledges the choice marked by the menu cursor
←	Moves the digit cursor to the left by one position in the marked value indication. Moves the menu cursor to the left by one position in a 1-out-of-n selection.
⇒	Moves the digit cursor to the right by one position in the marked value indication. Moves the menu cursor to the right by one position in a 1-out-of-n selection.

see as well
Section 2.2.2,
Basic Operating Steps

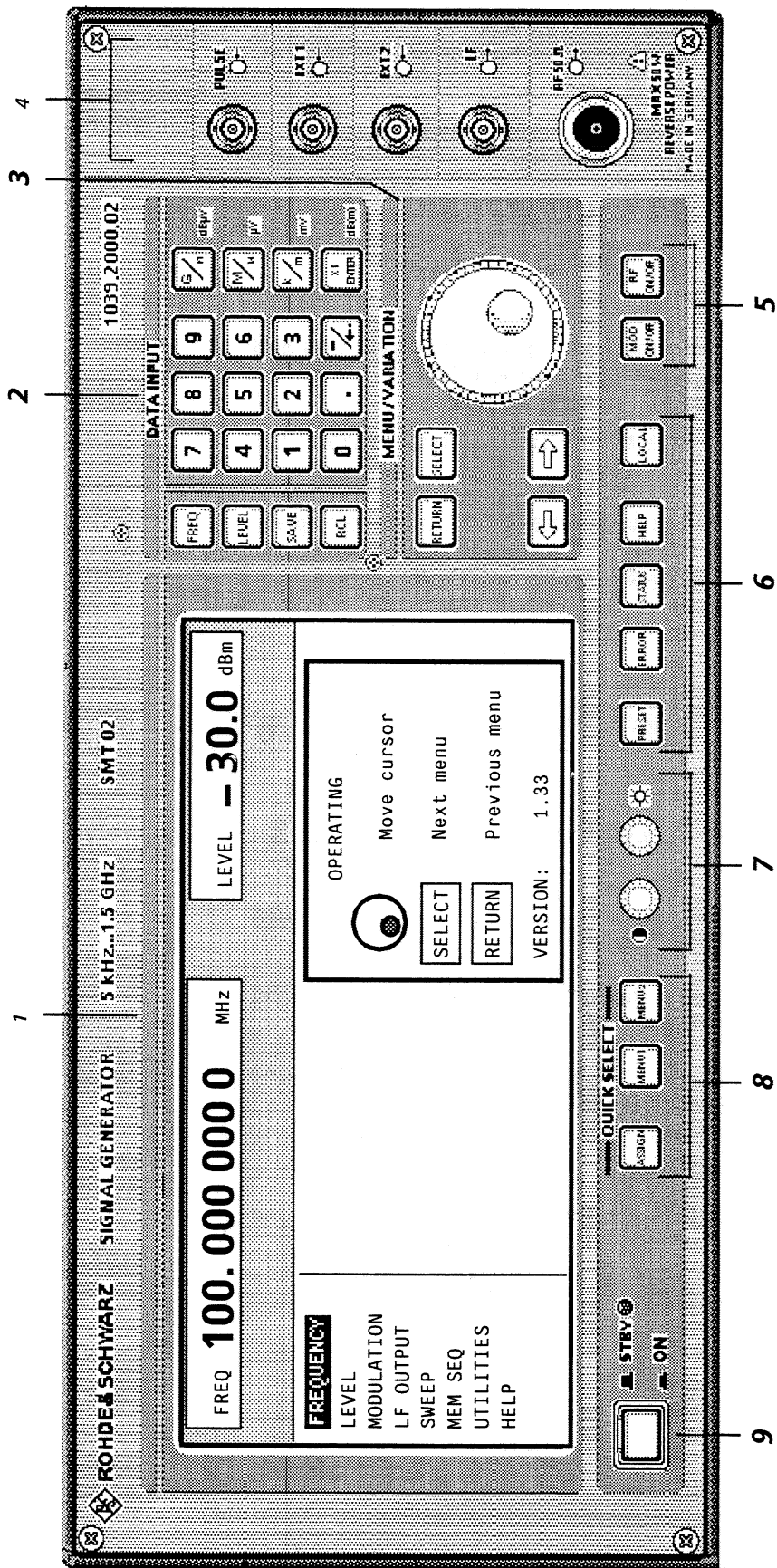
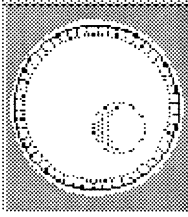

Fig. 2-1, B Front panel view, controls

3 MENU / VARIATION

Rotary knob



The rotary knob moves the menu cursor over the positions of a menu level to choose from or varies the value of a parameter. The variation is either effected in steps of one or in a step width that can be specified at will.

See as well
Section 2.2.2,
Basic Operating Steps

Section 2.2.3,
Sample Setting for
First Users

4

See Section 2.1.1.3, page 2.11, Inputs/Outputs.

5

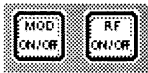

RF ON/OFF	Switches on/off the RF signal.
MOD ON/OFF	Switches on/off the modulation selected in the UTILITIES MOD KEY menu.

See as well
Section 2.2.2.6,
Use of [RF ON /OFF]
and [MOD ON /OFF]
Keys

6



PRESET	Establishes a defined instrument status.
ERROR*	Indicates error and caution messages.
STATUS*	Indicates the instrument status.
HELP*	Indicates context-sensitive auxiliary text.
LOCAL	Switches the instrument from the REMOTE mode (remote control) to the LOCAL mode (manual control).

* Exit the menus using the [RETURN] key.

See as well
Section 1.1.7,
Preset Setting

Section 2.11,
Help System

Section 2.12,
Status

Section 2.13,
Error Messages

Section 3,
Remote Control

7



Brightness and contrast of the display can be set using the rotary knobs.

	Contrast
	Brightness

See as well
Section 1.1.5, Setting
of Contrast and
Brightness of the
Display

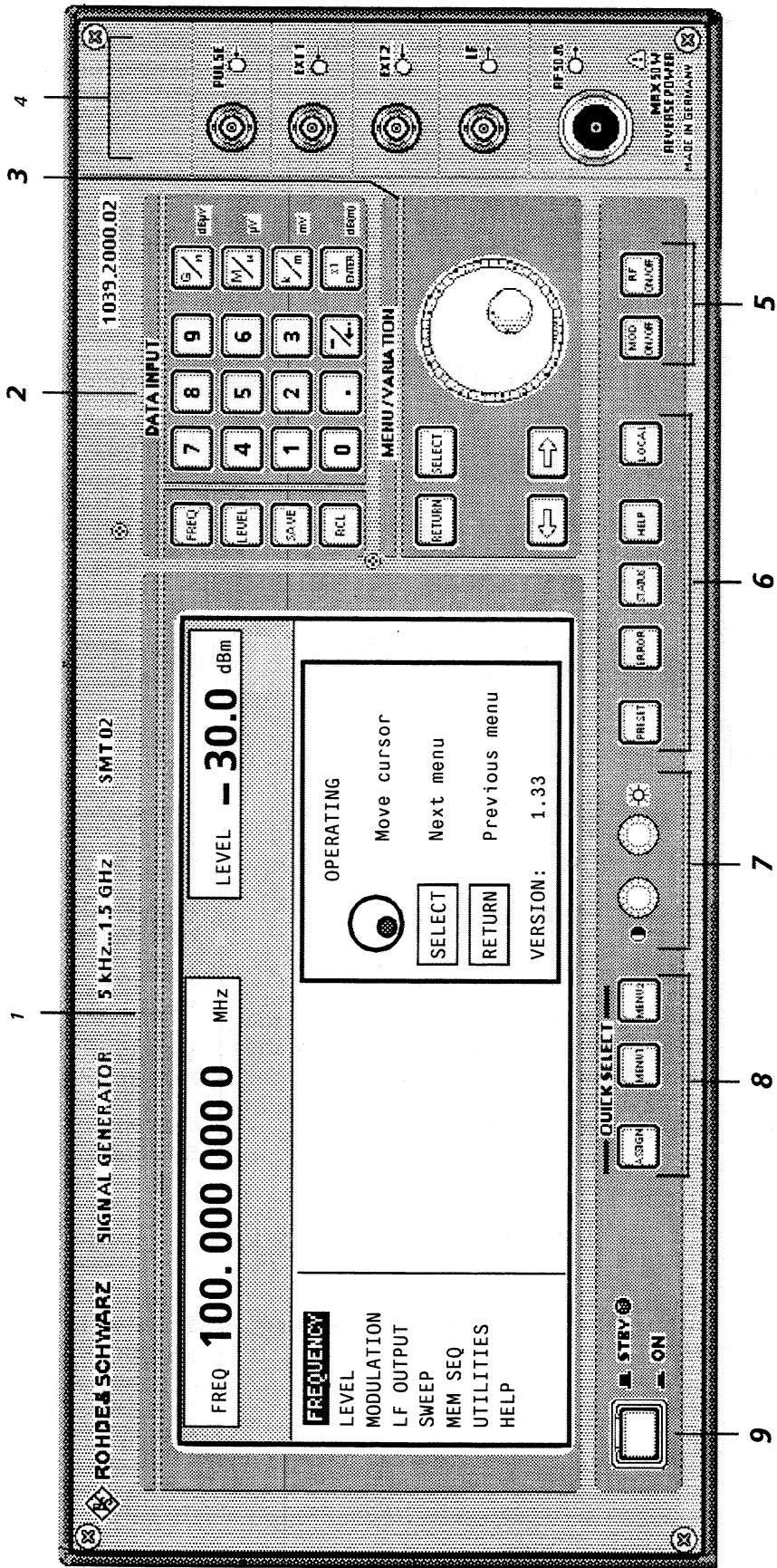

Fig. 2-1, B Front panel view, controls

7 QUICK SELECT



The menu-quick-selection keys permit fast access to two menus selected.

ASSIGN Stores the current menu as menu1 when the MENU1 key is pressed afterwards or as menu2 when the MENU2 key is pressed afterwards.

MENU1 Activates menu1 stored.

MENU2 Activates menu2 stored.

See as well
Section 2.2.2,
Basic Operating Steps

8 Switching On/Off

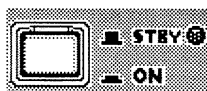

The On/Off switch switches the instrument from the standby mode to the ready-for-operation status. Prerequisite: The power switch at the rear of the instrument must be switched on.

STBY LED is illuminated in the standby mode.

See as well
Section 1.1.3,
Switching On/Off
the Instrument

Section 2.1.2,
Elements of the
Rear Panel, Power
Switch

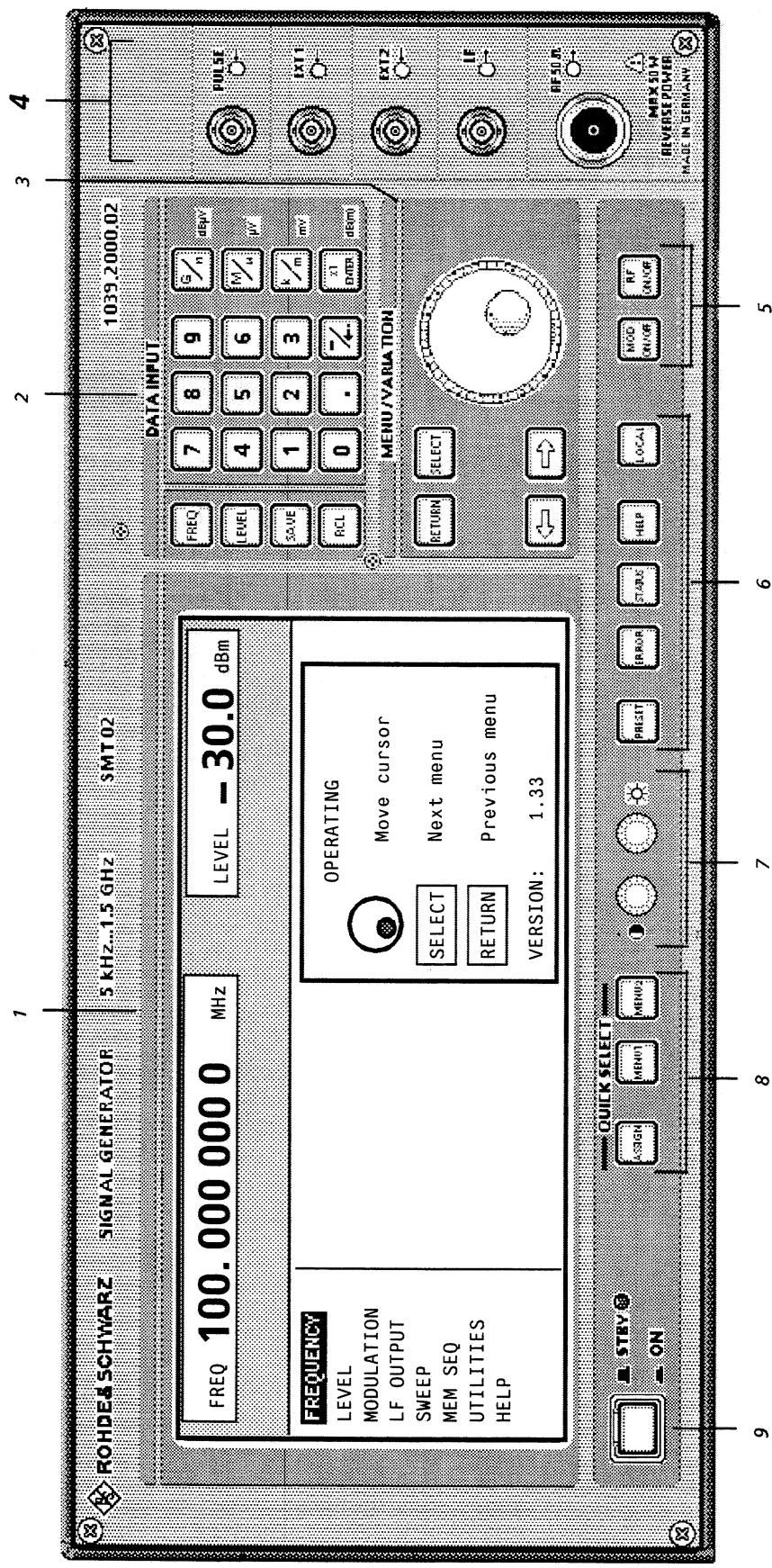

Fig. 2-1, C Front panel view, inputs/outputs

2.1.1.3 Inputs/Outputs

(Cf. Fig. 2-1, C Front panel view, Inputs/Outputs)

4

Inputs/Outputs

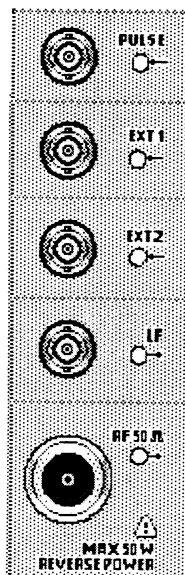

PULSE	Input* to trigger the pulse generator or to directly control the pulse modulation. Level: TTL. Input resistance 50 Ω/10 kΩ, selectable. Maximal permissible overvoltage: ± 2V	See as well Section 2.6.5, Pulse Modulation
EXT1	Input external modulation signal, alternatively for AM or FM (PM). Input resistance > 100 kΩ. Nominal voltage V_S : 1 V Maximal permissible overvoltage: ± 15V	Section 2.6.1, Modulation Sources
EXT2	Input external modulation signal for FM (PM). Input resistance > 100 kΩ. Nominal voltage V_S : 1 V Maximal permissible overvoltage: ± 15V	Section 2.6.1, Modulation Sources
LF	Output** LF-signal of the internal LF-generators LFGEN 1 and LFGEN 2. Source resistance < 10 Ω.	Section 2.7, LF output
RF	Output RF signal. Source resistance 50 Ω.	Section 2.2.2.6, Use of [RF ON / OFF] and [MOD ON / OFF] Key
*	Options: SM-B3, SM-B4, SM-B8	
**	Options: SM-B2, SM-B6	

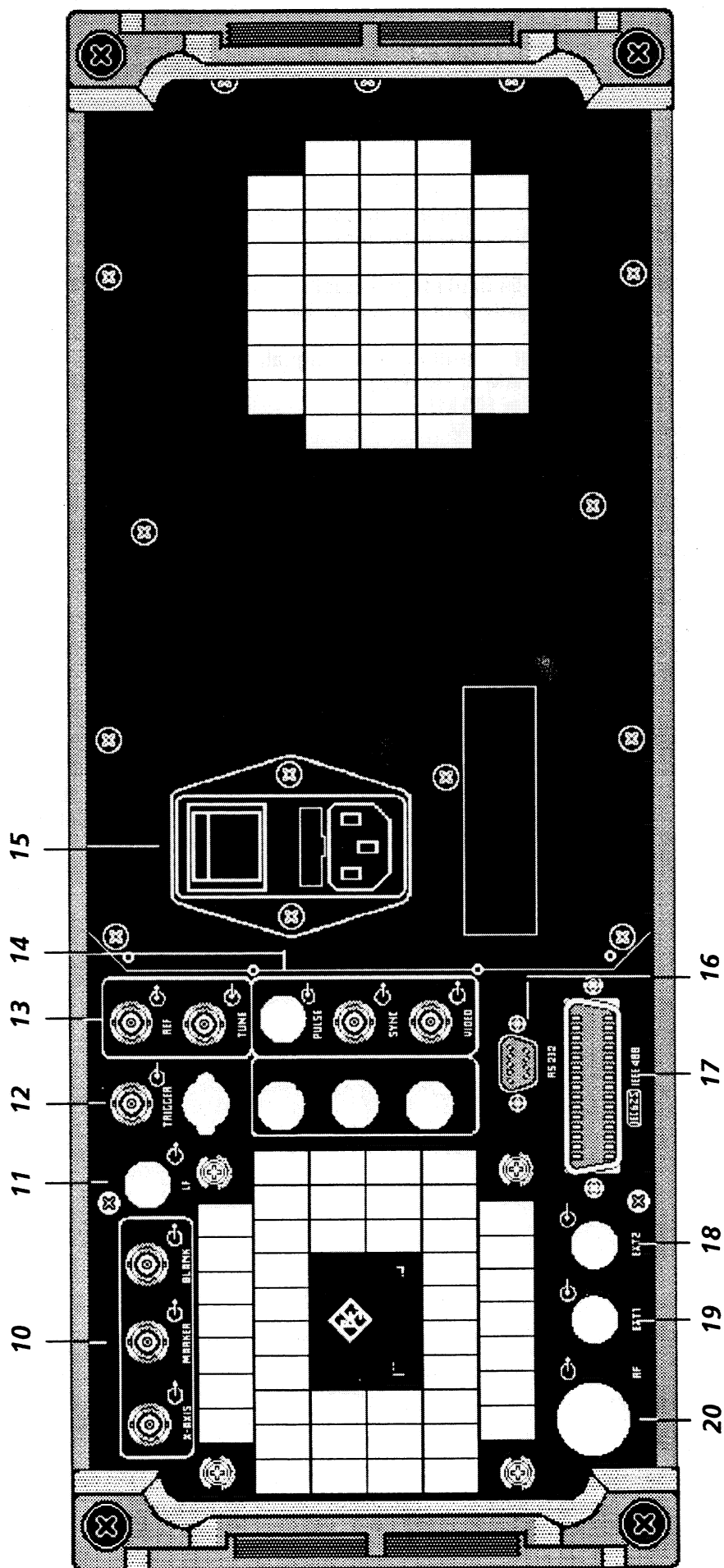

Fig. 2-2 Rear panel view

2.1.2 Elements of the Rear Panel

(Cf. Fig. 2-2, Rear panel view)

10



Outputs for control and triggering in the sweep mode.

X-AXIS Level: 0 to 10 V.

MARKER Level: TTL

BLANK Level: TTL

See as well
Section 2.8,
Sweep

11



LF Cut-out, provided to relocate the LF output at the front to the rear of the instrument.

12



TRIGGER Input to trigger sweep and memory sequence.
Level: TTL

See as well
respective sections as
to menus and
Section 2.10.14,
Input/Output
Settings (AUX I/O)

13



REF Output of the internal 10-MHz reference signal with reference internal.
Source resistance 50 Ω .
Input for external reference frequency 5 or 10 MHz in operating mode external reference.
Input resistance 200 Ω .

TUNE Tuning input for the internal reference frequency. Voltage range $\pm 10V$, pulling range $\pm 1 \cdot 10^{-6}$.

See as well
Section 2.10.5,
Reference Frequency
int/ext

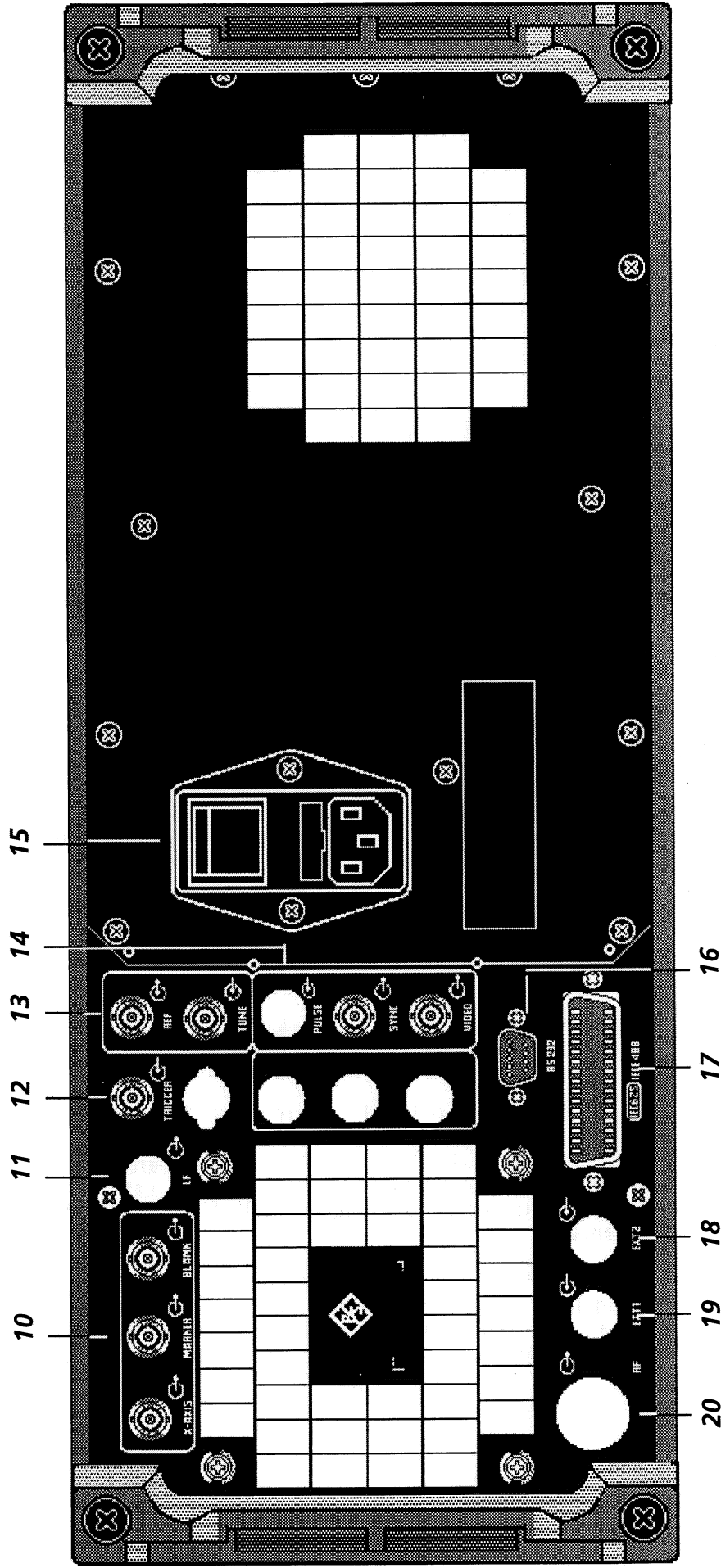
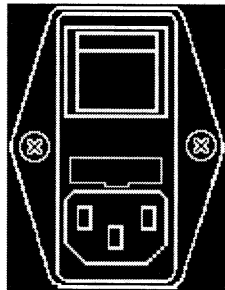

Fig. 2-2 Rear panel view



PULSE	Cut-out, provided to relocate the PULSE input at the front to the rear of the instrument.
SYNC	Output SYNC signal with pulse modulation. Level: TTL
VIDEO	Output video signal with pulse modulation. The signal is synchronous with the RF pulse. Level: TTL

See as well
Section 2.6.5,
Pulse Modulation



Power switch	On when pressed at the top
Fuse holder	F1 and F2
Power supply connection	

See as well
Section 1.1.1,
Supply Voltage
Section 1.1.2,
Power Fuses
Section 1.1.3,
Switching On/Off
the Instrument



RS-232	RS-232 interface, used for software update and the loading of calibration data. The pin assignment corresponds to the pin assignment of a PC.
--------	---

See as well
Section 3,
Remote Control

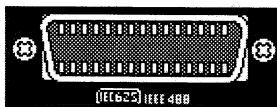

IEC 625 IEEE 488	IEC-Bus (IEEE 488) Remote-control interface
---------------------	--

See as well
Section 3,
Remote Control

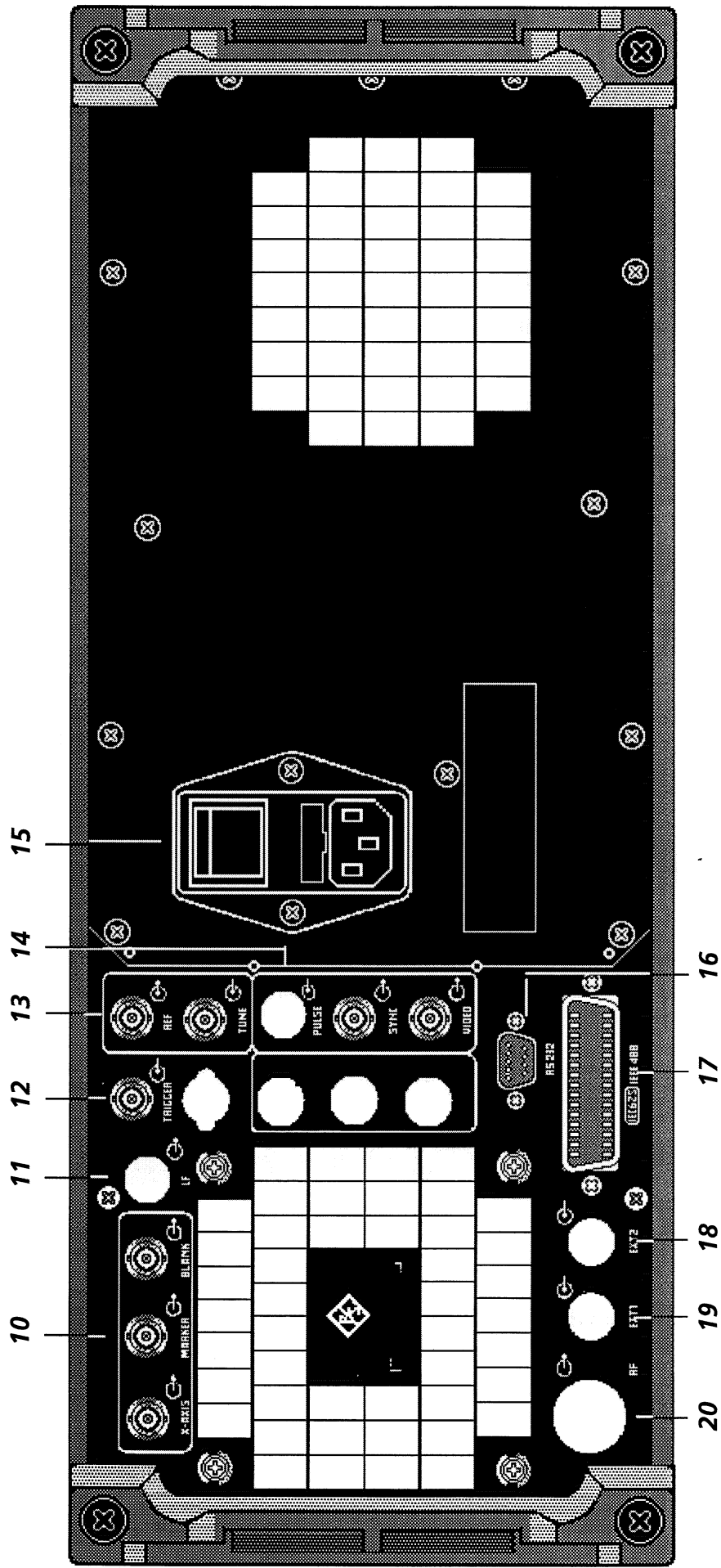

Fig. 2-2 Rear panel view

18



EXT2

Cut-out, provided to relocate the EXT2 input at the front to the rear of the instrument.

19



EXT1

Cut-out, provided to relocate the EXT1 input at the front to the rear of the instrument.

20



RF

Cut-out, provided to relocate the RF output at the front to the rear of the instrument.

2.2 Operating Concept

2.2.1 Display

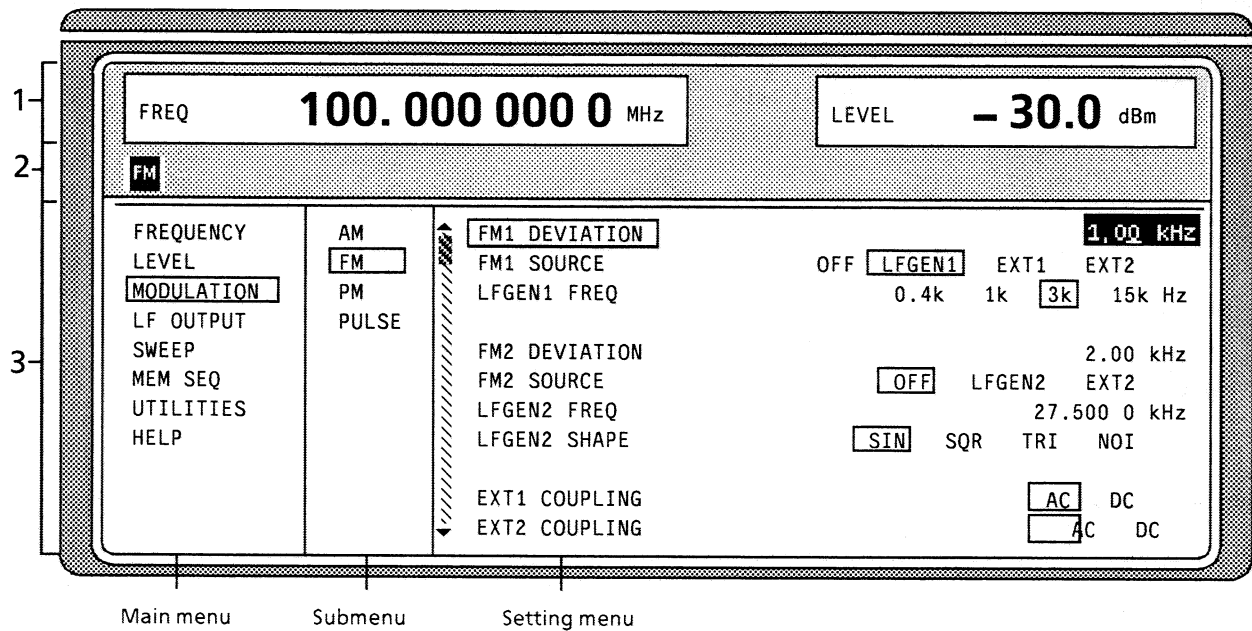

- 1 Header field
- 2 Status line
- 3 Menu fields

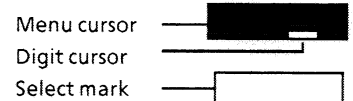

Fig. 2-3 Design of the display

Header field (1) The header field of the display indicates frequency and level of the RF output signal which considers the offset value. In the RF-sweep operating mode, the start and stop frequencies are displayed in two lines one above the other. The start and stop levels are indicated in the LEVEL-sweep operating mode correspondingly.

Status line (2) The status line below describes operating mode and operating state of the instrument. Error messages and notes for caution are also displayed in the status line.

Menu fields (3) The indication fields below the header field are reserved for the menu representations. The image contents of these fields change as a function of the menu selected. The field at the left-hand display margin is occupied with the main menu, the topmost level of the menu structure. The main menu is always faded in.

Each further field adjacent at the right contains submenus.

The field ending with the right-hand display margin shows the setting menu. In this menu all setting values and setting states connected with the menu selected are indicated. When accessing submenus, the higher-order menus remain in the display. The current menu path is evident through the select marks.

Menu cursor The menu cursor shows the user at which position in the menu he is. The position of the menu cursor is evident from the inverse notation of the term (white characters on a black background)

Digit cursor As an underscore, the digit cursor marks the position which can be varied by means of the rotary knob in a value indication.

Select mark The frame around a term marks current menus or valid settings in the setting menu.

2.2.2 Basic Operating Steps

The operating principle is explained in this section. For better understanding, please read sections "Display" (Section 2.2.1) and "Sample Setting for First Users" (Section 2.2.3) in addition.

To operate the instrument, menus are called in the display. All setting possibilities and the current setting status are evident from the menus. All settings can be made by accessing the menus.

RF frequency and RF level can also be set without menu operation using keys [FREQ] and [LEVEL]. RF signal and modulation can also be switched on/off without menu operation using keys [RF ON/OFF] and/or [MOD ON/OFF].

2.2.2.1 Calling the Menus

Accessing the menus is effected using rotary knob [VARIATION], [SELECT] key and [RETURN] key.

Rotary knob Rotary knob [VARIATION] moves the menu cursor over the positions of a menu level to be selected.

If a scrollbar is visible at the left-hand margin of a menu, the menu is larger than the screen window. If the menu cursor is moved to the margin of the screen window, the covered lines become visible.

[SELECT] key The [SELECT] key acknowledges the selection marked by means of the menu cursor.

[RETURN] key The [RETURN] key

- returns the menu cursor to the next higher menu level.
The menu cursor is shifted to the left into the preceding column of the menu structure.
- resets the menu cursor from frequency or level value indication in the header field into the menu field to the menu called last.
- closes the display pages called using keys [STATUS], [HELP] and [ERROR] again.

Settings are accessed in the setting menus ending with the right-hand display margin.

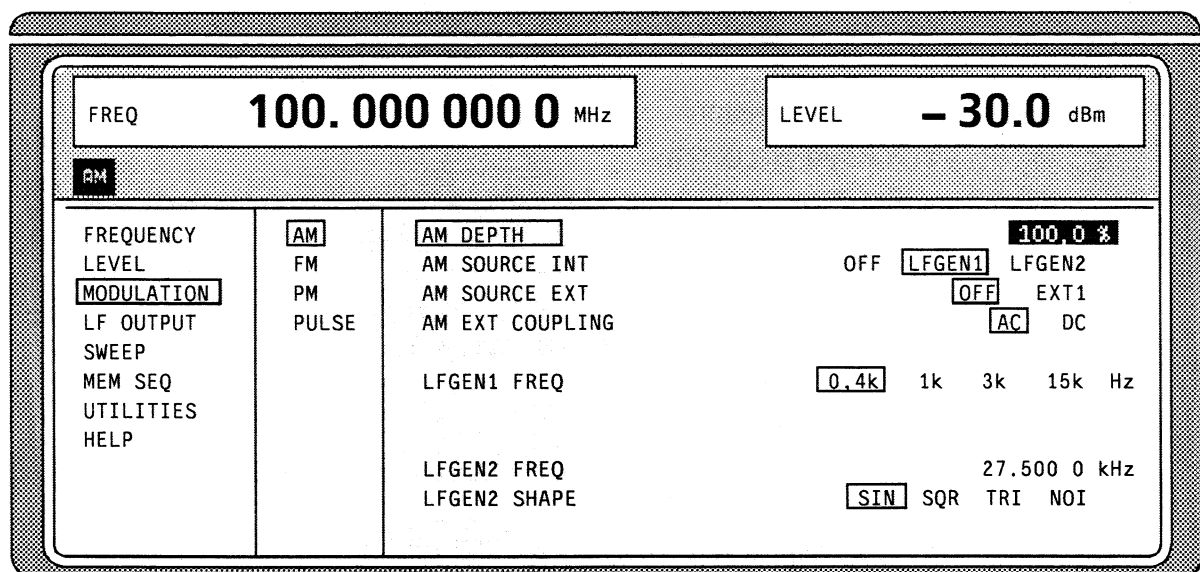

Fig. 2-4 MODULATION-AM menu

2.2.2.2 Selection and Change of Parameters

Select

parameter

- ▶ Set the menu cursor to the name of the parameter desired using the rotary knob, e.g. to AM DEPTH in the AM menu, Fig. 2.4.

Change setting value

via value inputs

- ▶ Press the first digit of the new value or minus sign.
The old value is deleted, the entry is indicated in the marked field.
- ▶ Enter further digits.
- ▶ Terminate the input using a unit key or, in the case of inputs in the base unit or in the case of inputs without unit, using the [1x/Enter] key.
- ▶ Press the [RETURN] key.
The menu cursor wraps back to the appropriate parameter.

using rotary knob

- ▶ Press the [SELECT] key.
The menu cursor changes from the parameter selected in the left-hand column of the setting menu to the setting value on the right, e.g. from AM DEPTH to 100%, Fig. 2-4.
- ▶ Set the underscore to the position of the setting value to be varied using keys [→] [←].
- ▶ Turn the rotary knob.
The position underscored is varied in steps of 1.

Note: RF frequency and RF level can also be varied in a step width which can be defined arbitrarily using the rotary knob. In the respective setting menu (FREQUENCY or LEVEL) the step width is entered as KNOB STEP USER and the KNOB STEP set from DECIMAL to USER. To point to the fact that the step width has been converted to the value programmed, the underscore as a symbol of the digit cursor disappears in the respective value indication.

1-out-of-n selection

- ▶ Select parameters.
- ▶ Press the [SELECT] key.
The menu cursor changes from the parameter selected in the left-hand column of the setting menu to the current selection on the right, e.g. from LFGEN1 FREQ to 0.4 kHz, Fig. 2-4.
- ▶ Set the menu cursor to the position desired within the 1-out-of-n selection using the rotary knob or cursor keys [→] [←].
- ▶ Press the [SELECT] key.
The setting is made.
The selection mark which has marked the setting valid up to now wraps to the new position.
- ▶ Press the [RETURN] key.
The menu cursor wraps back to the respective parameter.

Quick selection of a parameter

The quick selection of a parameter reduces the number of operating steps if several parameters are set successively. The menu cursor can directly be set further from line to line in the column of the setting values.

- ▶ Press the [SELECT] key.

The menu cursor wraps from the setting value of a parameter to the setting value of the parameter in the next line.

The following

- is true:
- The column of the setting values can be exited at each position by pressing the [RETURN] key.

2.2.2.3 Triggering Action

Lines in the setting menu which are marked with the "▶" symbol at the end of the line qualify an action which can be carried out. Instruction SEARCH ONCE ▶ in the LEVEL-ALC menu, e.g., switches on level control for level calibration for a short period of time.

Trigger action

- ▶ Set the menu cursor to the respective instruction.

- ▶ Press the [SELECT] key.

The action is triggered.

While the action is carried out, the instruction remains framed by the selection mark.

2.2.2.4 Quick Selection of Menu (QUICK SELECT)

The keys of the QUICK SELECT control field are used to call selected menus quickly by one keystroke.

Store menus

- ▶ Establish the desired operating status of the current menu.

- ▶ Press the [ASSIGN] key.

- ▶ Press key [MENU1] or [MENU2].

The current menu is stored as menu1 or menu2. That is to say, 2 menus can be stored in total.

Call menus

- ▶ Press key [MENU1] or [MENU2].

Menu1 or menu2 stored is displayed. Exactly the operating status which was current at the point of time of storing is reconstructed.

2.2.2.5 Use of [FREQ] and [LEVEL] Keys

RF frequency and RF level can be set without menu operation as well using direct keys [FREQ] and [LEVEL]. The input value considers the offset, see Sections 2.4 and 2.5.

- Key [FREQ]/ [LEVEL]**
- ▶ Press the [FREQ] or [LEVEL] key.
 - The frequency and/or the level indication in the header field of the display is marked.
 - The current menu at the display is maintained.
 - ▶ Alter the value via a value input or the rotary knob.
 - ▶ Press the [RETURN] key.
 - The menu cursor wraps to the position marked last in the menu.

2.2.2.6 Use of [RF ON / OFF] and [MOD ON / OFF] Keys

RF signal and modulation can be switched on/off without menu operation as well using direct keys [RF ON / OFF] and/or [MOD ON / OFF] (see Section 2.6.1.3, [MOD ON/OFF] key as well).

- Key [RF ON / OFF] /**
- ▶ Press the [RF ON / OFF] key.
 - The RF output signal is switched on/off.
 - IEC--bus short command: : *OUTP OFF*
- Key [MOD ON / OFF]**
- ▶ Press the [MOD ON / OFF] key.
 - ▶ A direct IEC-bus command is not available. The modulations have to be switched on/off on and off in the respective modulation submenus.

2.2.2.7 Changing Unit of Level

For the level, the unit of the value set can be changed without a new value input.

- Change level unit**
- ▶ Activate LEVEL parameter.
 - Press the [LEVEL] key or
 - set the menu cursor in the LEVEL menu to the setting value of the AMPLITUDE parameter.
 - ▶ Press the unit key with the desired level unit.
 - The level is indicated in the desired unit.

2.2.2.8 Correction of Input

Digital entries can be corrected by one of the Unit/Enter keys before terminating the input.











- Key [- /←]** The backspace key deletes the value entered digit by digit. When the last digit is deleted, the previous value is displayed.
- Key [RETURN]** Pressing the [RETURN] key deletes the entire entry and results in the previous value being indicated again.
For a subsequent new input in the setting menu, the first digit of the new value is to be entered.
For a subsequent new input via the [FREQ] or [LEVEL] keys, the respective key has to be pressed again.
- Key [FREQ]/ [LEVEL]** In the case of a frequency or level input by means of the [FREQ] or [LEVEL] keys, pressing the [FREQ] and/or [LEVEL] key again deletes the entire input.

2.2.3 Sample Setting for First Users

First users most quickly become familiar with the operation of the instrument if they execute the pattern setting of this section.





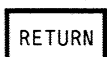



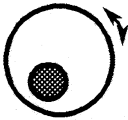

First frequency and level of the RF output signal are set via keys [FREQ] and [LEVEL] in the DATA INPUT field:

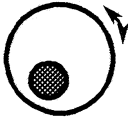
- Frequency 250 MHz
- Level 10 dBm

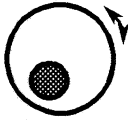
Operating steps	Explanations
	Reset the instrument to the defined state.
    	Set the frequency to 250 MHz. The menu cursor marks the permanent frequency indication.
   	Set the level to 10 dBm. The menu cursor marks the permanent level indication.
	Reset the menu cursor to the menu field.

The output signal is to be amplitude-modulated next.

- AM modulation depth 15.5 %
- AM signal 3-kHz sine

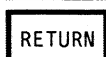
Operating steps	Explanations
 MODULATION 	Select MODULATION menu. ▶ Set menu cursor to MODULATION using the rotary knob and subsequently press [SELECT] key. The submenu is displayed.
 AM 	Select AM submenu. The AM setting menu is displayed.
 AM DEPTH 	Select AM DEPTH parameter. The menu cursor marks the setting value .
    	Enter modulation depth 15.5% and acknowledge.
	Reset menu cursor to AM DEPTH.

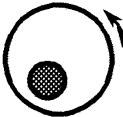
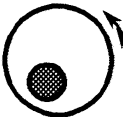
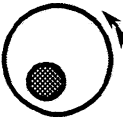
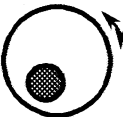
Operating steps	Explanations
 AM SOURCE INT <input type="checkbox"/> SELECT	Select AM SOURCE INT. The menu cursor marks the current 1-out-of-n selection.
 . LFGEN1 . <input type="checkbox"/> SELECT	Select LF generator1 as modulation source. The selection mark marks LFGEN1. AM is faded in the status line as a hint that AM is switched on.
<input type="checkbox"/> RETURN	Reset menu cursor to AM SOURCE INT.
 LFGEN1 FREQ <input type="checkbox"/> SELECT	Select parameter LFGEN1 FREQ. The menu cursor marks the current frequency selection.
 . 3k . <input type="checkbox"/> SELECT	Set the frequency of LF generator1 to 3 kHz. The selection mark marks 3 kHz. The indications on the display are represented in Fig. 2-5.

The AM modulation setting is completed.

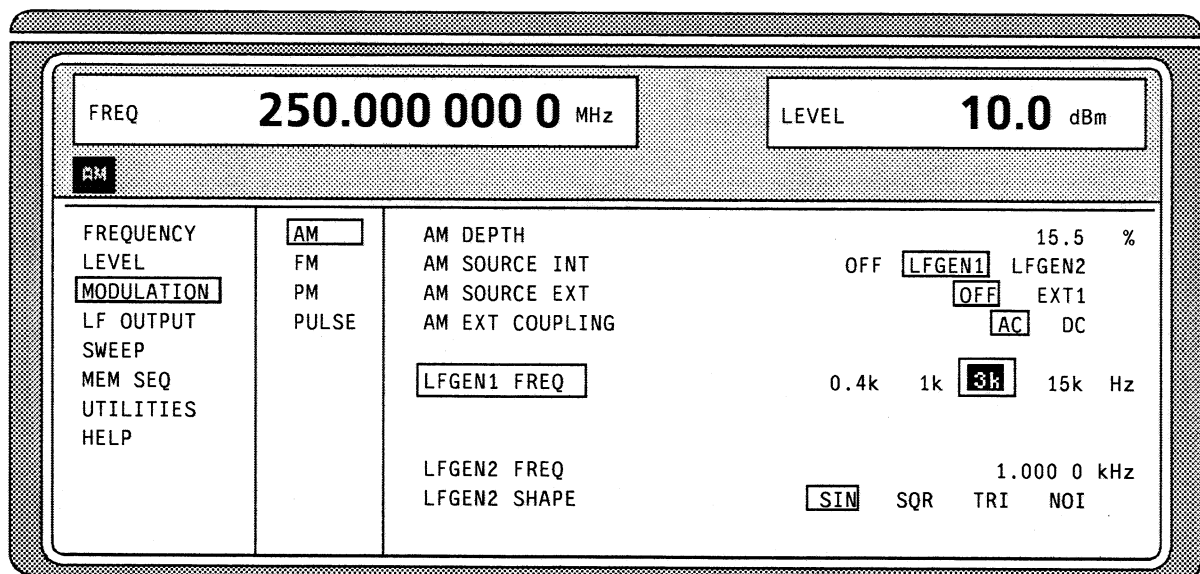

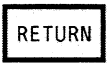
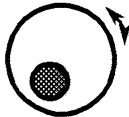

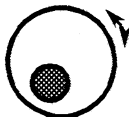
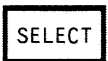















Fig. 2-5 Display after AM setting

Subsequently to the above setting, 420 MHz as new RF frequency and 12.5 kHz as the step width for the RF frequency variation are set in the following. Parameter quick select is used, which reduces the number of operating steps.

Operating steps	Explanations
  	Reset the menu cursor to the main menu in 3 steps.
 FREQUENCY 	Select FREQUENCY menu. The frequency setting menu is displayed.
 FREQUENCY 	Select FREQUENCY parameter. The menu cursor marks the setting value.
   	Enter frequency 420 MHz and acknowledge.
 	Set menu cursor to the setting value of parameter KNOB STEP USER.
    	Enter step width 12.5 kHz.
	Set menu cursor to the current KNOB STEP selection.
 . USER . 	Select USER (user-defined step width) The selection mark marks USER. This results in step width 12.5 kHz being used in the case of variation using the rotary knob.



Bild 2-6 Display after pattern setting

2.2.4 List Editor

The SMT offers the possibility of generating lists. Lists are used for setting sequences (memory sequence) or for level correction which can be defined by the user (UCOR). They consist of elements which are defined by an index and at least one parameter per index. Each list is marked by a separate name and can be selected via this name. The lists are accessed in the menus assigned in each case, e.g. to the settings sequences of stored instrument settings in the MEM SEQ menu. However, the lists are always generated and processed in the same way and the procedures are hence explained in detail by the example of the memory sequence mode (menu MEM SEQ) in this section. A pattern setting at the end of this section allows the user to become familiar with the operation of the list editor.

Setting menus providing list processing are structured in two pages:

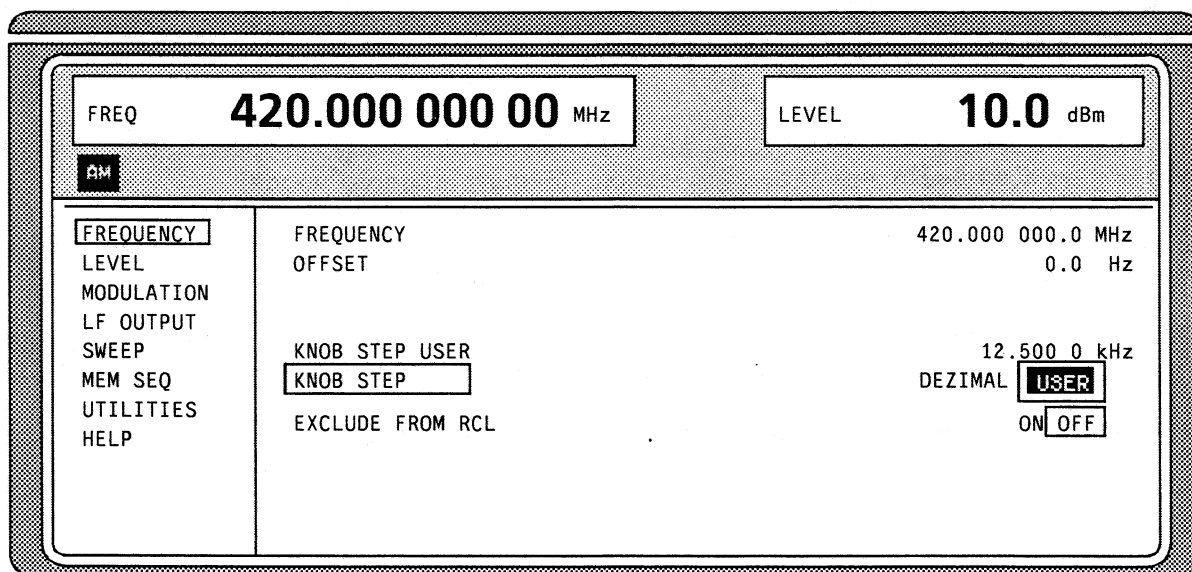
The first page, called OPERATION page in the following contains the general configuration parameter for processing a list. Further, the general list functions such as selecting and deleting the list as well as calling an editing mode are provided. The second page, the EDIT page, is automatically displayed when calling an edit function and serves to enter and modify the parameters of the list.

The OPERATION page has a similar arrangement with all list editors. As an example, the OPERATION page of the MEM SEQ menu is shown:

Menu selection: MEM SEQ

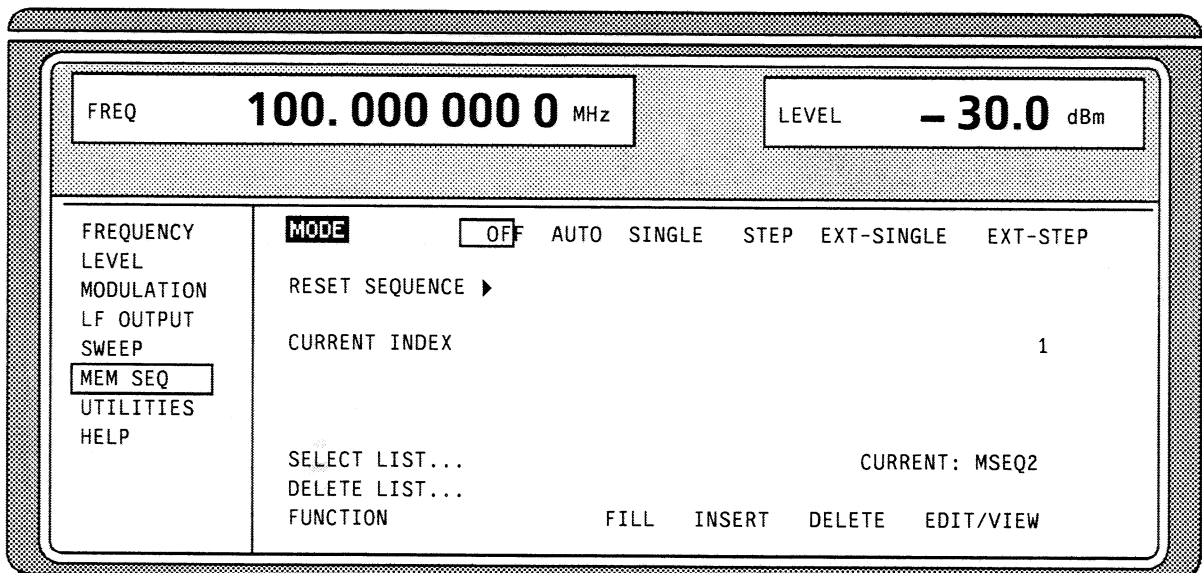

Fig. 2-7 OPERATION page of the MEM SEQ menu

The settings for MODE, CURRENT INDEX, etc. are irrelevant for the general description of the list editors and are described in greater detail in Section "Memory Sequence" mode.

The last three menu lines of the OPERATION page always exist and are reserved for selecting and deleting lists as well as for calling the edit functions (and hence the EDIT page).

SELECT LIST Opens a selection window in which a list can be selected from the existing lists or a new, empty list can be generated. In this line the active list is always displayed.

DELETE LIST Opens a selection window in which the list to be deleted can be selected.

- FUNCTION** Selection of the edit function for processing the lists. The EDIT page is automatically called through the selection (cf. Section 2.2.4.3).
- FILL Filling a list with elements.
 - INSERT Insertion of elements into a list.
 - DELETE Deletion of elements of a list.
 - EDIT/VIEW Processing the individual elements.

2.2.4.1 Select and Generate List — SELECT LIST

SELECT LIST opens a selection window in which either an existing list can be selected or a new, empty list can be generated (cf. Fig. 2-8). By pressing the [RETURN] key, the selection window is closed without changing the setting.

- Select list
- ▶ Mark the list desired using the rotary knob.
 - ▶ Press [SELECT] key.
The selected list is included in the instrument setting. The selection window is closed. The selected list is displayed under CURRENT.
- Generate list
- ▶ Mark CREATE NEW LIST ▶ using rotary knob.
 - ▶ Press [SELECT] key.
A new empty list is automatically generated which can be filled using functions FILL or EDIT. The selection window is closed. The new list is displayed under CURRENT.
- No modification of the setting
- ▶ Press [RETURN] key.

Selection: SELECT LIST

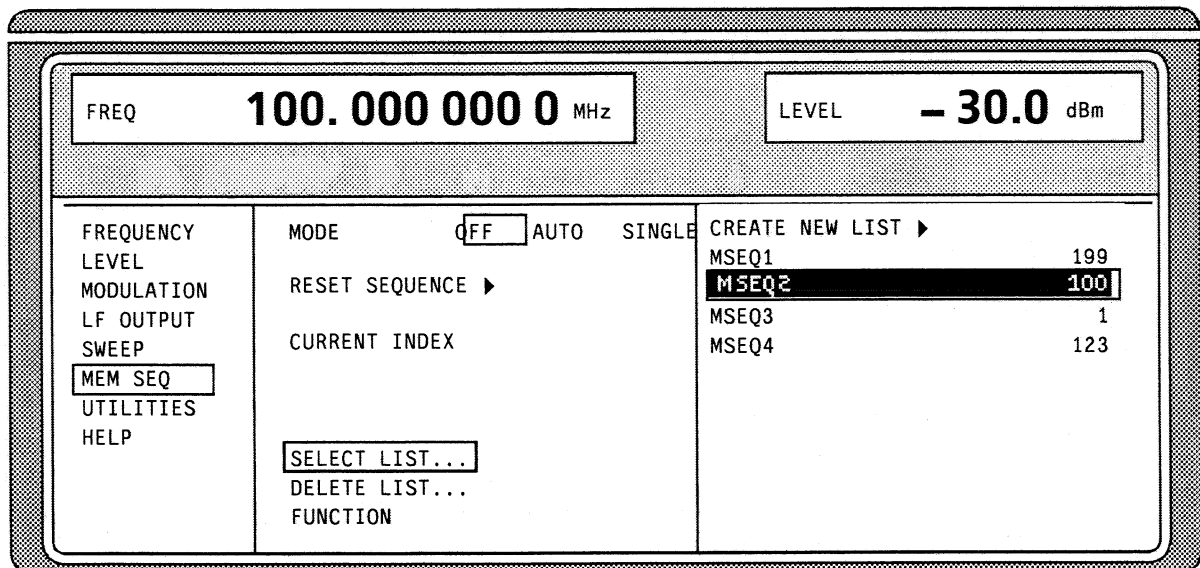

Fig. 2-8 SELECT-LIST selection window

CREATE NEW LIST ▶

Generating a new list. The name of the list cannot be selected freely in the case of manual control. A definite list name is automatically generated in the following form:

MSEQ<n>, with <n> ∈ {0..9}, e.g. MSEQ1 (with memory sequence).

This applies correspondingly to the other operating modes. In the case of level correction, UCOR1 would be generated for example. If a list is created via IEC bus, an arbitrary list name can be given (cf. Section 3). Unrestricted access is also possible by means of the selection window.

MSEQ2 100

The list currently set is marked in the selection window by means of the selection mark, here MSEQ2. In addition to the list name, the length of the list is given, here 100 elements.

2.2.4.2 Deletion of Lists – DELETE LIST

DELETE LIST opens a selection window in which the list to be deleted can be selected. The lists are represented together with their name and their length (cf. Fig. 2-9). By pressing the [RETURN] key the selection window is exited without deleting a list.

Delete list

- ▶ Mark desired list using the rotary knob.
- ▶ Press [SELECT] key.
The prompt "enter [SELECT] to delete list/sequence" is displayed
- ▶ Press [SELECT] key.
The list is deleted. If the prompt is acknowledged with the [RETURN] key, however, the list is not deleted. The selection window is automatically closed due to the acknowledgement of the prompt.

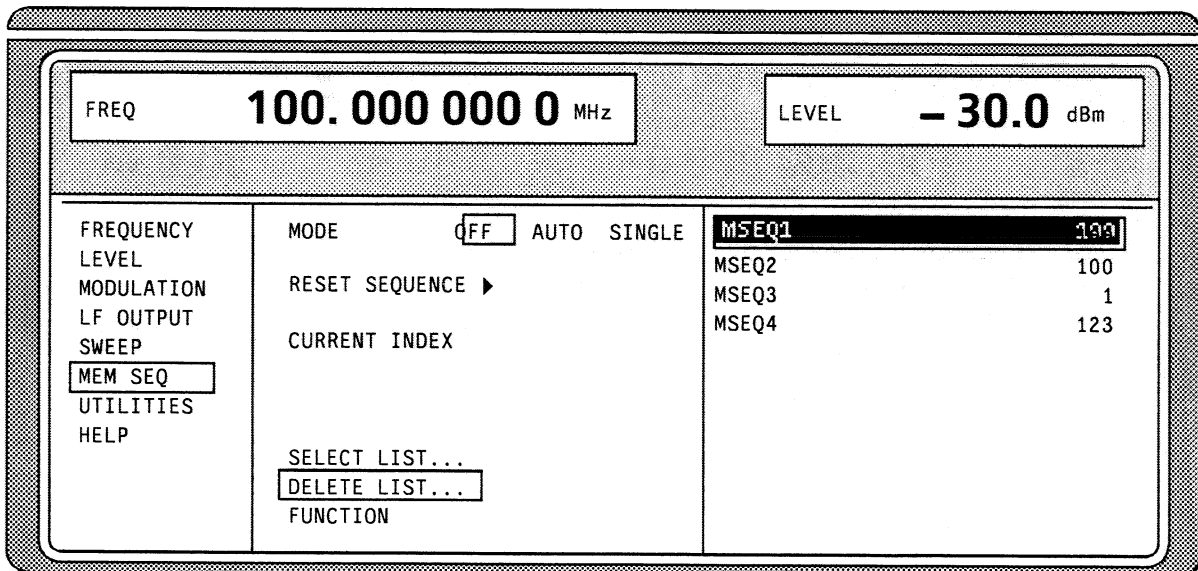

Fig. 2-9 DELETE-LIST selection window

2.2.4.3 Edition of Lists

Due to the selection of an edit mode on the OPERATION page the EDIT page is automatically activated. When the EDIT/VIEW function is selected, the largest possible section of the list is displayed (cf. Fig. 2-10). In the case of block functions FILL, INSERT and DELETE, an input window is additionally displayed (cf. Fig. 2-11 to 2-13).

Functions SELECT LIST and FUNCTION are available on the EDIT page as on the OPERATION page.

Return to the OPERATION page is effected by pressing the [RETURN] key twice.

Single-value function EDIT/VIEW

By selecting the EDIT/VIEW function, the entire list can be viewed or modifications of single values be carried out.

If the cursor marks a value in the INDEX column of the list, the EDIT mode is exited by pressing the [RETURN] key. The menu cursor then marks FUNCTION again.

There is no separate function for storing the list. This means that every modification of the list is transferred to the internal data set and has an effect on exiting the EDIT/VIEW function.

Selection: FUNCTION EDIT/VIEW

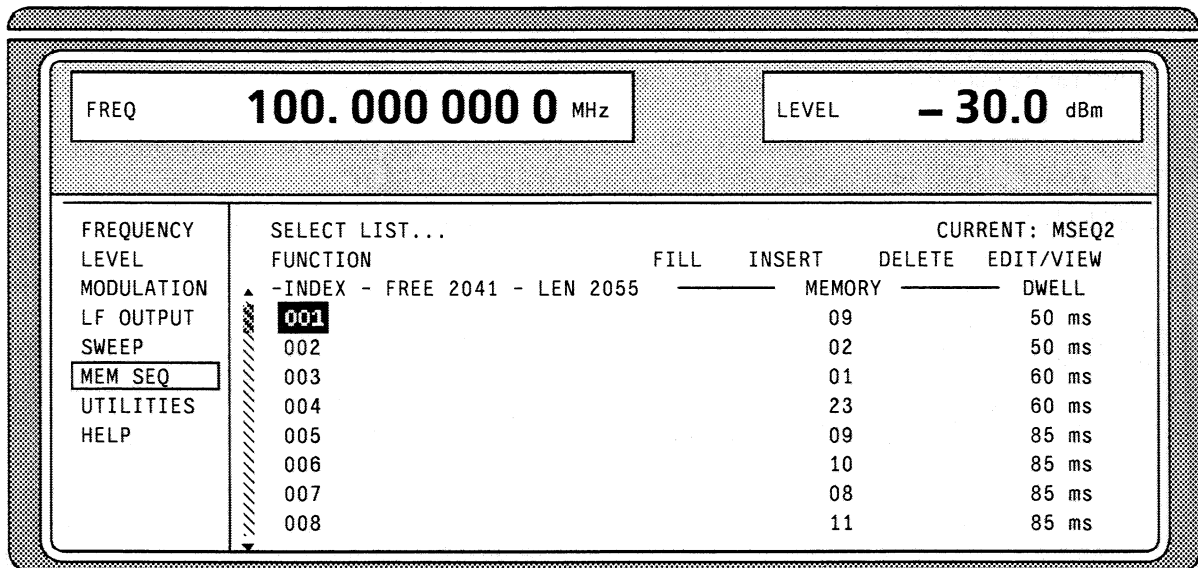

Fig. 2-10 Edit function EDIT/VIEW

- INDEX** Identification of the column below, here position in the list.
- FREE** Space available. FREE 2041 means that space for 2041 parameter elements is available in the list memory in total.
- LEN** Occupied space. LEN 2055 means that the current list occupies 2055 elements in the list memory.
- MEMORY** Identification of the column below, here memory location number.
- DWELL** Identification of the column below, here dwell time

- Select parameters
 - ▶ Mark the index associated to the parameter using the rotary knob or directly enter the value of the index via the numeric keys.
 - ▶ Press [SELECT] key.
Parameter MEMORY is marked. If the second parameter DWELL is to be marked, press the [SELECT] key again.

- Modify parameters
 - ▶ Vary the value of the parameter selected using the rotary knob or enter the value directly using numeric keys.
 - ▶ Press the [ENTER] key or unit keys.
The value is included in the data set. The menu cursor marks the value of the next column. In the last column, the menu cursor then marks the next line of column MEMORY.
 - ▶ Press the [RETURN] key.
The menu cursor wraps back to the INDEX column. The EDIT mode is exited by repeatedly pressing the [RETURN] key (cf. Section 2.2.4.4).

Block function FILL

Using function FILL, a parameter, e.g. MEMORY, is overwritten with constant or linearly increasing/decreasing values within a defined range. The input window is exited by pressing the [RETURN] key without a modification being carried out.

If the filling range exceeds the end of the list, the list is automatically extended.

The list entry, in the example for MEMORY, with index [AT + n] is calculated as follows from the information AT, RANGE, starting value (MEMORY) and WITH INCREMENT:

$$\text{MEMORY[AT + n]} = \text{starting value (MEMORY)} + n \cdot \text{increment} \quad | \quad (0 \leq n \leq \text{RANGE} - 1)$$

Selection: FUNCTION-FILL

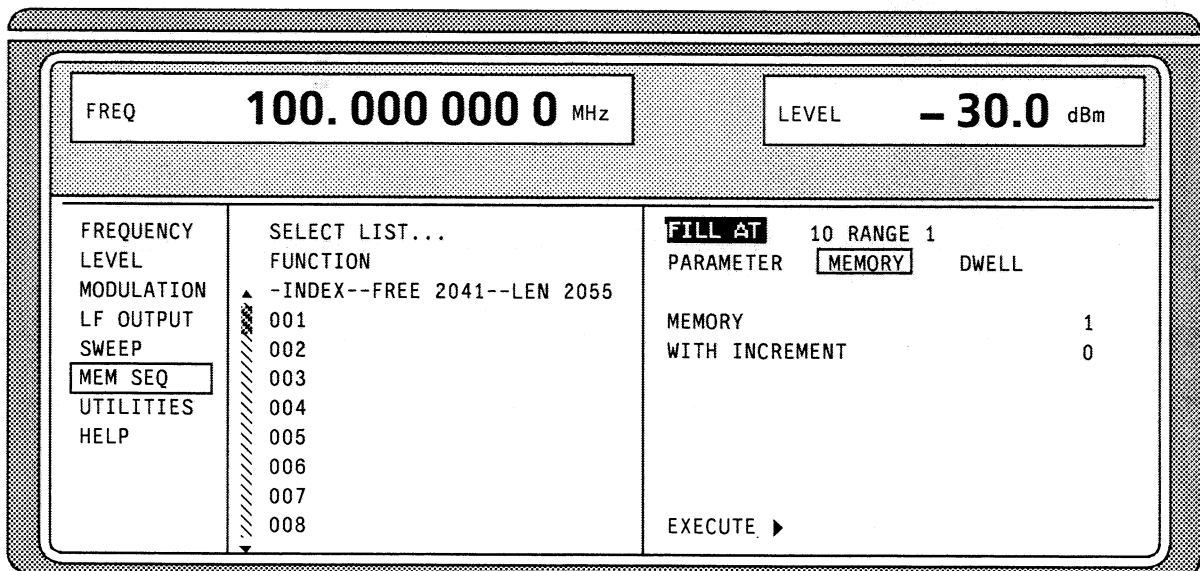

Fig. 2-11 Block function FILL: Input window

FILL AT	Setting the filling range. AT Lower limit (index) RANGE Number of elements to be filled.
PARAMETER	Selection on which of the parameters the filling function is to have an effect. This menu option is eliminated if the list only includes elements with one parameter.
MEMORY or DWELL	Input of the starting value for the parameter selected. This option is only displayed if a selection has been made under PARAMETER MEMORY or DWELL.
WITH INCREMENT	Input of the increment between two successive values. If 0 is entered as increment, a filling procedure with constant values is achieved. This option is only displayed if a selection has been made under PARAMETER MEMORY or DWELL.
EXECUTE ▶	Starts the filling sequence. After the function has been executed, the input window is automatically exited. The current index points to the first element after the processed range..

- Filling a list
- After selection of function FILL, the menu cursor marks FILL AT.
- ▶ Press the [SELECT] key.
The menu cursor marks the value at AT.
 - ▶ Vary index value using the rotary knob or enter using the numeric keys and the [ENTER] key.
 - ▶ Press the [SELECT] key.
The menu cursor marks the value at RANGE.
 - ▶ Vary value using the rotary knob or enter using the numeric keys and the [ENTER] key.
 - ▶ Press the [SELECT] key.
The menu cursor marks MEMORY or DWELL in input line PARAMETER.
 - ▶ Select MEMORY using the rotary knob (if not yet marked) and press the [SELECT] key.
The menu cursor marks the value in input line MEMORY.
 - ▶ Vary starting value for column MEMORY using the rotary knob or enter using the numeric keys and the [ENTER] key.
 - ▶ Press the [SELECT] key.
The menu cursor marks the value in input line WITH INCREMENT.
 - ▶ Vary the value of the increment desired using the rotary knob or enter using the numeric keys and the [ENTER] key.
 - ▶ Press the [RETURN] key.
 - ▶ Mark the action EXECUTE ▶.
 - ▶ Press the [SELECT] key.
The filling sequence is initiated. After the function has been carried out, the input window is automatically exited. The menu cursor marks FUNCTION. The EDIT page shows the end of the range that has been filled right now.

Block function INSERT

Function INSERT inserts the desired number of elements with constant or linearly increasing/decreasing values before the element with the given starting index. All elements which had been stored from the starting index are shifted to the end of the range to be inserted.

Input is effected analogously to filling a list.

By pressing the [RETURN] key the input window is exited without a modification being effected. The menu cursor then marks FUNCTION.

The list entry, in the example for MEMORY, with index [AT + n] is calculated as follows from the information AT, RANGE, starting value (MEMORY) and WITH INCREMENT:

$$\text{MEMORY}[AT + n] = \text{starting value (MEMORY)} + n \cdot \text{Increment} \quad | \quad (0 \leq n \leq \text{RANGE} - 1)$$

Selection: FUNCTION INSERT:

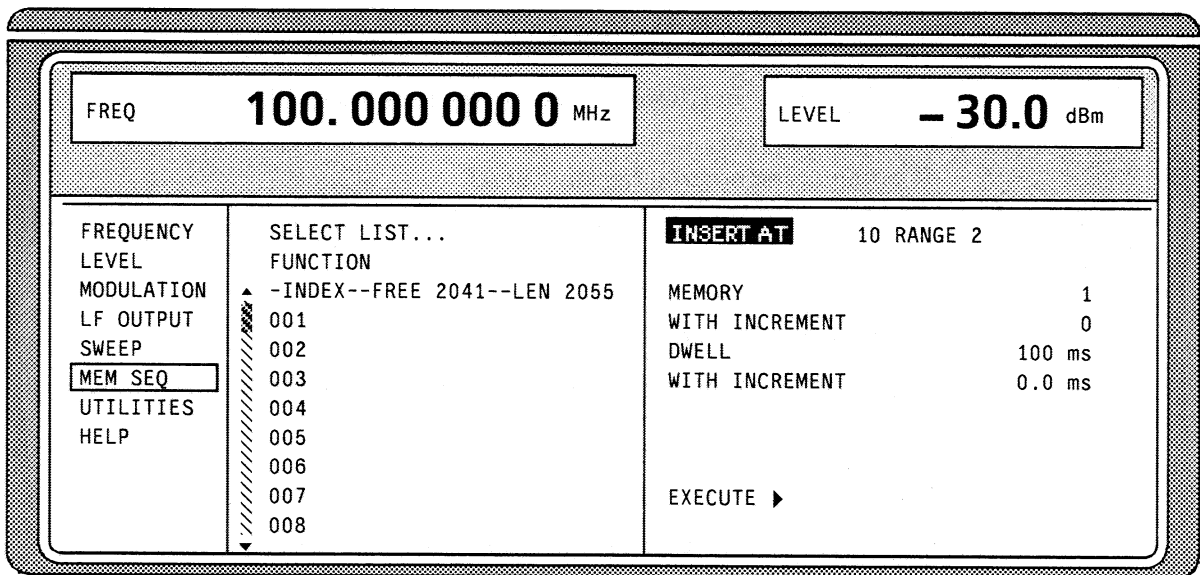

Fig. 2-12 Edit function INSERT: Input window

- INSERT AT** Input of the starting index and the number of the elements to be inserted.
 AT Starting index before which the insert operation is to be effective.
 RANGE Number of the elements to be inserted
- MEMORY** Input of the starting value for MEMORY.
- DWELL** Input of the starting value for DWELL.
- WITH INCREMENT** Input of the increment between two successive values for MEMORY or DWELL. If 0 is indicated as increment, constant values are achieved to be inserted RANGE times.
- EXECUTE ▶** Starts the inserting sequence. After the function has been executed, the input window is automatically exited. The menu cursor marks FUNCTION. The EDIT page shows the beginning of the range that has moved forward.

Block function DELETE

Function DELETE deletes the elements of the range indicated. This does not leave a gap in the list but the remaining elements move forward. If the given range exceeds the end of the list, deletion until the end of the list is effected.

Input is analog to filling a list.

By pressing the [RETURN] key, the input window is exited without a modification being carried out. The menu cursor then marks FUNCTION.

Selection: FUNCTION DELETE

The screenshot shows a terminal window with the following content:

```
FREQ      100.000 000 0 MHz      LEVEL     - 30.0 dBm
```

FREQUENCY	SELECT LIST...	DELETE AT	10 RANGE 2
LEVEL	FUNCTION		
MODULATION	-INDEX--FREE 2041--LEN 2055		
LF OUTPUT	001		
SWEEP	002		
MEM SEQ	003		
UTILITIES	004		
HELP	005		
	006		
	007		
	008		

EXECUTE ►

Fig. 2-13 Edit function DELETE: Input window

DELETE AT Input of the block of the list to be deleted
AT Lower limit (INDEX)
RANGE Number of elements to be deleted.

EXECUTE ► Starts the deletion. After the function has been executed, the input window is automatically exited. The menu cursor marks FUNCTION. The EDIT page shows the beginning of the range that has moved forward.

2.2.4.4 Pattern Setting to Operate the List Editor

The user can become familiar with the operation of the list editor by means of the following pattern setting in the MEM SEQ menu. A list has to be generated and filled with values by using the single-value function EDIT/VIEW:

- Memory location number of the first element 20
- Dwell time of the first element 15s
- Memory location number of the second element 1.

When the setting has been terminated, return to the OPERATION page of the MEM SEQ menu.

At the beginning of the operation sequence, menu MEM SEQ is called. List MSEQ2 is active. The menu cursor marks a parameter of the setting menu on the OPERATION page (c.f. Fig. 2-14).

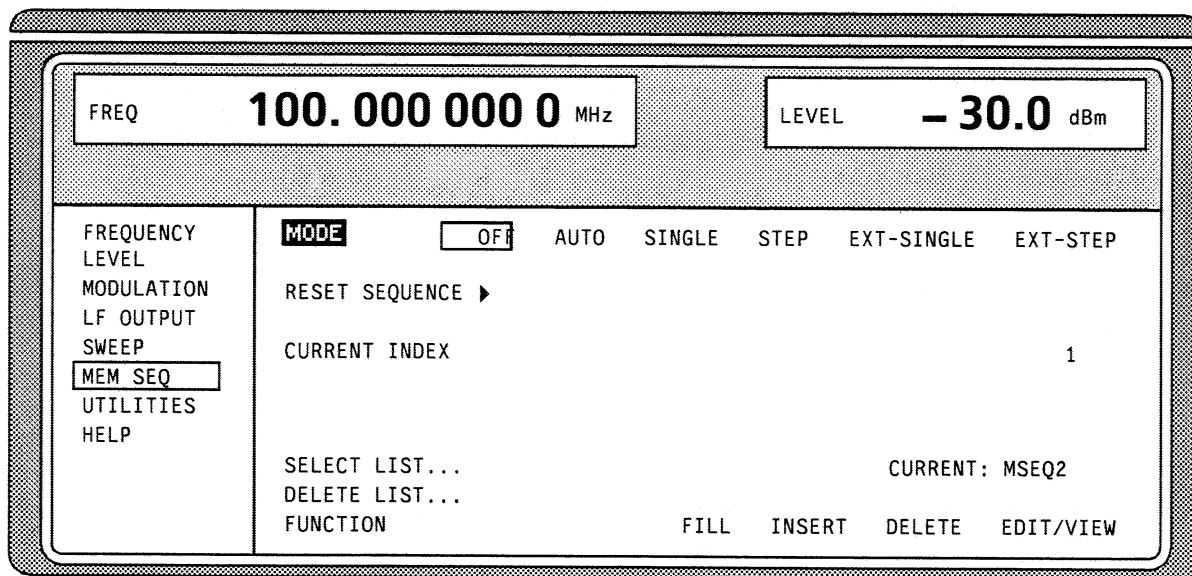
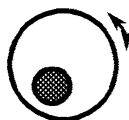
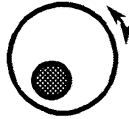
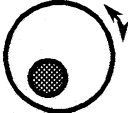
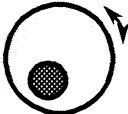

Fig. 2-14 Starting point of the pattern setting

Operating steps		Explanations
	SELECT LIST... SELECT	Select the SELECT LIST menu item.
	CREATE NEW LIST ... SELECT	A new list MSEQ0 is generated. The menu cursor is reset to SELECT LIST....

Operating steps	Explanations
 FUNCTION <input type="button" value="SELECT"/>	Select the FUNCTION menu item.
 . EDIT/VIEW . <input type="button" value="SELECT"/>	Select single-value function EDIT/VIEW. The EDIT page of the MEM SEQ menu is called. The menu cursor marks the index of the first element of list MSEQ0.
<input type="button" value="SELECT"/>	Set the menu cursor to the memory location number value of the first element (c.f. Fig. 2-15,A).
<input type="button" value="2"/> <input type="button" value="0"/> <input type="button" value="1x ENTER"/>	Enter MEMORY 20. The menu cursor automatically wraps to the DWELL value of the first element (Fig. 2-15,B). (default value is 100 ms).
<input type="button" value="1"/> <input type="button" value="5"/> <input type="button" value="1x ENTER"/>	Enter DWELL 15 s. The menu cursor automatically wraps to the MEMORY value of the second element.
<input type="button" value="1"/> <input type="button" value="1x ENTER"/>	Enter MEMORY 1. The menu cursor automatically wraps to the DWELL value of the second element. (default value is 100 ms).
<input type="button" value="RETURN"/>	Reset the menu cursor to the index.
<input type="button" value="RETURN"/>	Reset the menu cursor to the FUNCTION menu item of the EDIT page of menu MEM SEQ (c.f. Fig. 2-15,C).
<input type="button" value="RETURN"/>	Reset the menu cursor to the FUNCTION menu item of the OPERATION page of menu MEM SEQ.

Note: With the return to the OPERATION page the operation of the list editor is finished.

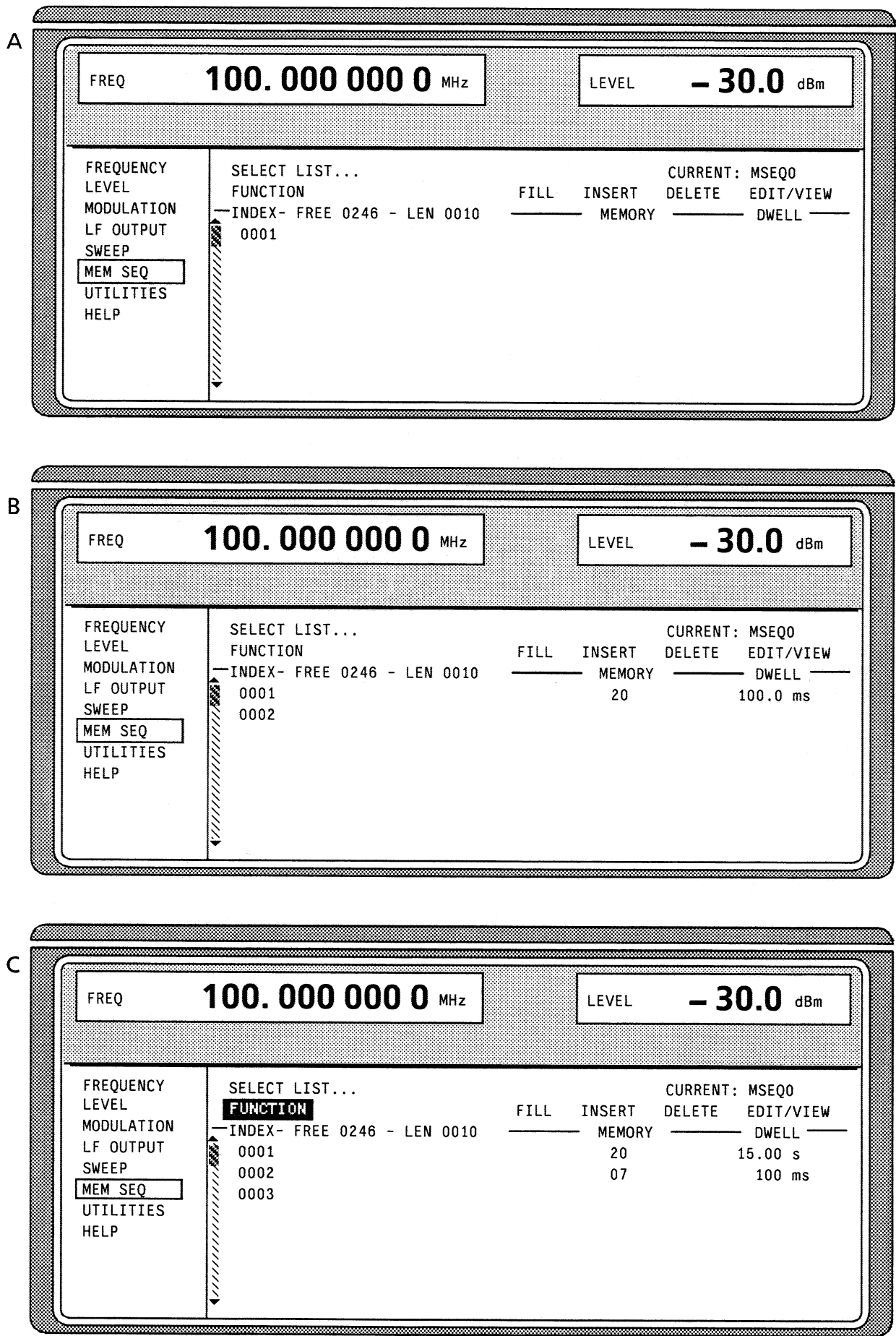









Fig. 2-15, A to C Pattern setting – Edition of a list

2.2.5 Save/Recall - Storing/Calling of Instrument Settings

50 complete instrument settings can be stored in memory locations 1 to 50.

Operating steps	Explanations
   	Store current instrument setting in memory location 12.
   	Call instrument setting of memory location 12.

The digital display during a save or recall entry is faded in a window.

Memory location 0 has a special function. Here the instrument setting which was current prior to the last memory recall and prior to a preset setting is automatically stored. This permits the resetting of instrument settings which have inadvertently been deleted using Recall 0.

If an instrument setting is stored in which a sweep was switched on, the sweep is started using the recall.

Store IEC-bus command: "***SAV 12**"

Call IEC-bus command: "***RCL 12**"

Notes: *The contents of lists, as they are used for memory sequence or for user correction (UCOR), is not saved in the SAVE memory. It is stored under the respective list name and can be called. If instrument settings are called which go back to list data such as level setting using UCOR, the current list contents is used. If this has been altered, it is not identical to the list contents at the point of storing any more.*

Memory Sequence is dealt with in Section 2.9.

2.3 Menu Summary

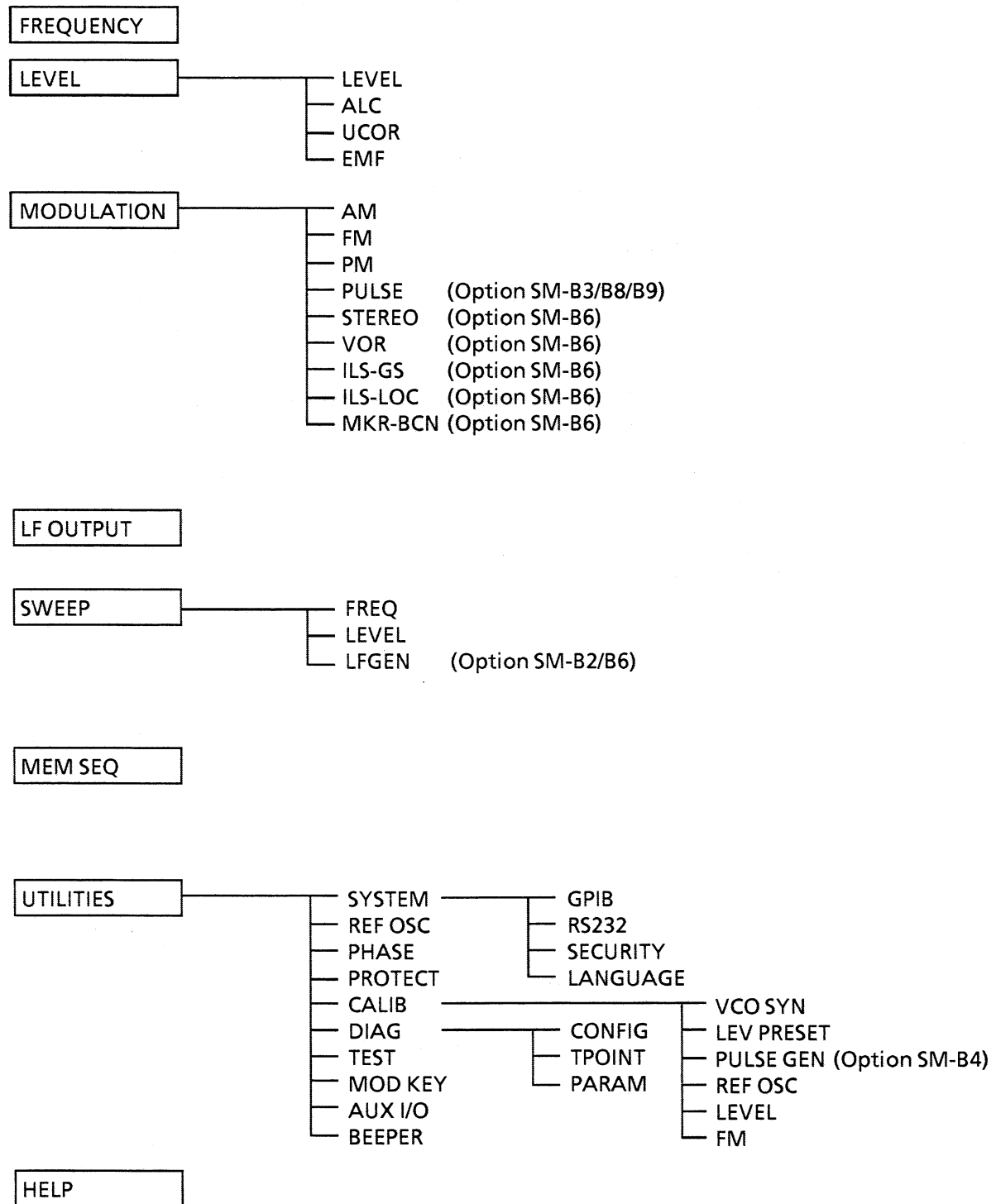

2.4 RF Frequency

The frequency of the RF output signal can be set directly using the [FREQ] key (cf. Section 2.2.2.5) or by accessing menu FREQUENCY.

In the header field of the display, the frequency of the RF output signal is indicated under FREQ.

In the case of frequency settings opened by means of the [FREQ] key, the value entered directly is the frequency of the RF output signal.

The input value of frequency settings effected in the FREQUENCY menu considers the offset in calculation (cf. Section 2.4.1). This offers the possibility of entering the desired output frequency of possibly series-connected instruments such as mixers in the menu.

Note: Further settings: Frequency sweep Menu SWEEP
 LF frequency Menu MODULATION
 int./ext. reference frequency Menu LF OUTPUT
 Phase of the output signal Menu UTILITIES-REF OSC
 Menu UTILITIES-PHASE

Menu selection: FREQUENCY

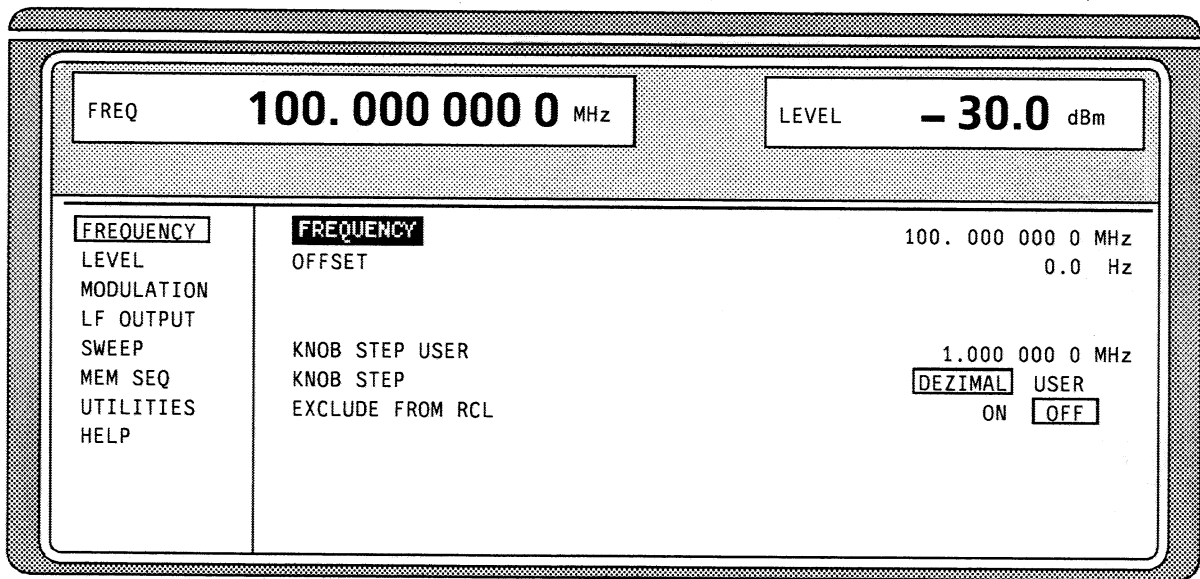

Fig. 2-16 Menu FREQUENCY (preset setting)

FREQUENCY Input value of the RF frequency considering the OFFSET input value. The frequency of the RF output signal is determined by input values FREQUENCY and OFFSET (cf. Section 2.4.1 Frequency Offset).

IEC-bus short command :FREQ 100E6

OFFSET Input value of a frequency offset, e.g., of a series-connected mixer (cf. Section 2.4.1, Frequency Offset).

IEC-bus short command :FREQ:OFFS 0

KNOB STEP USER Input value of the step width for frequency variation using the shaft encoder. The RF frequency is varied in the step width entered if KNOB STEP is set to USER.

IEC-bus short command :FREQ:STEP 1MHz

KNOB STEP DECIMAL: Variation step width corresponding to the position of the digit cursor.

USER: "User Defined", variation step width as entered under KNOB STEP USER.

EXCLUDE FROM RCL OFF The saved frequency is loaded when instrument settings are loaded with the [RECALL] key or with a memory sequence.

IEC-bus short command :FREQ:RCL INCL

ON The RF frequency is not loaded when instrument settings are loaded, the current settings are maintained.

IEC-bus short command :FREQ:RCL EXCL

2.4.1 Frequency Offset

The SMT offers the possibility of entering an offset (OFFSET) of possibly series-connected instruments in the FREQUENCY menu. The indication/input value under FREQUENCY considers this input and represents the frequency value of the RF signal at the output of these instruments (cf. Fig. 2-17).

Input values FREQUENCY and OFFSET in the FREQUENCY menu have the following connection with the frequency of the RF output signal:

$\text{FREQUENCY} - \text{OFFSET} = \text{output frequency}$

An offset input does not cause a variation of the RF output frequency, but only a variation of indication value FREQUENCY in the FREQUENCY menu.

The RF output frequency of the SMT is indicated in the header field of the display. It can be entered directly, i.e. without considering the offset using the [FREQ] key.

The offset setting also remains effective with the frequency sweep.

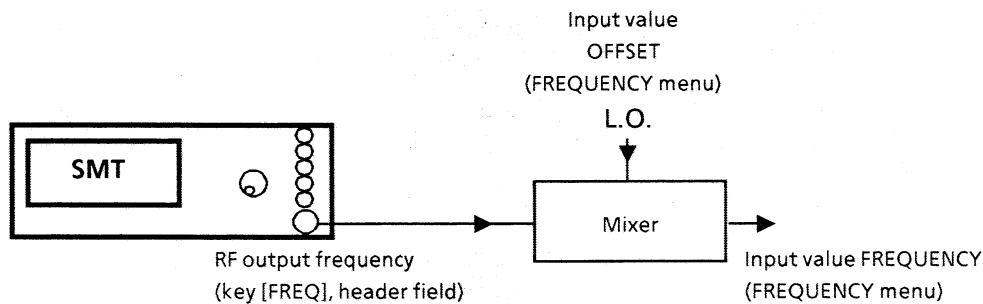

Fig. 2-17 Example of a circuit with frequency offset

2.5 RF Level

The RF output level can be set directly using the [LEVEL] key (cf. Section 2.2.2.5) or by accessing the LEVEL menu.

In the header field of the display, the set RF output level is indicated under LEVEL.

The input value of level settings opened using the [LEVEL] key directly corresponds to the RF output level.

The input value of the level settings effected in the LEVEL-LEVEL menu mathematically considers the offset of an attenuation/amplification element which is possibly series-connected (cf. Section 2.5.1). This offers the possibility of entering the desired level at the output of series-connected instruments, the SMT then alters the RF output level correspondingly. The offset can also be entered in the LEVEL-LEVEL menu.

dBm, dB μ V, mV and μ V can be used as level units. The 4 unit keys are directly labelled with these units. In order to change to another level unit, simply press the desired unit key.

- Notes:**
- The message *UNLEVELED* is displayed in the status line if the level set in the overrange is not reached.
 - Further settings: *Level sweep* menu *SWEEP*

Menu selection: LEVEL - LEVEL

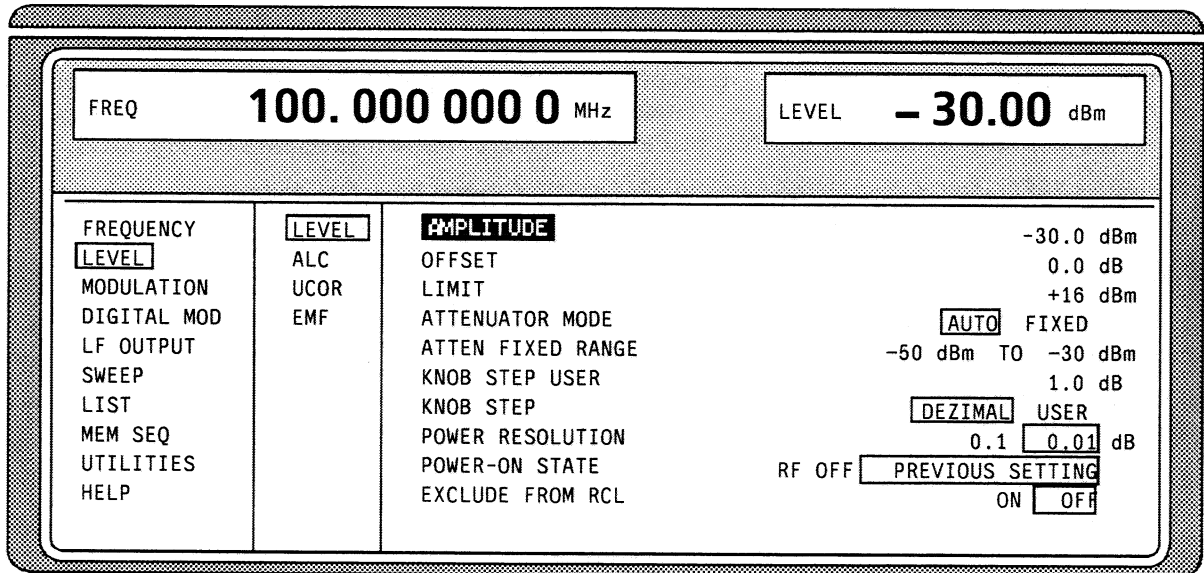

Fig. 2-18 Menu LEVEL (preset setting), POWER RESOLUTION is set to 0.01 dB

- AMPLITUDE** Input value of the RF level considering the OFFSET input value. The level of the RF output signal is determined by input values AMPLITUDE and OFFSET (cf. Section 2.5.2, Level Offset).
IEC-bus short command :*POW -30*
- OFFSET** Input value of the level offset of the RF output level compared to the input value of the RF level indicated in the LEVEL menu. Input in dB (cf. Section 2.5.1, Level Offset).
IEC-bus short command :*POW:OFFS 0*
- LIMIT** Input value of level limitation. This value indicates the upper limit of the level at the RF output connector. If a level above this limit is attempted to be set, a warning is displayed in the status line.
IEC-bus short command :*POW:LIM 16 dBm*
- ATTENUATOR MODE** AUTO Normal operation. The attenuator switching mechanically switches in steps of 5 dB, the switching points being fixed.
IEC-bus short command :*OUTP:AMOD AUTO*
- FIXED Level settings are effected without switching the attenuator (cf. Section 2.5.2, Interrupt-free Level Setting).
IEC-bus short command :*OUTP:AMOD FIX*
- ATTEN FIXED RANGE** Indication of the level range in which the level is set without interruption in the "ATTENUATOR MODE FIXED" operating mode.
- KNOB STEP USER** Input value of the step width for level variation using the rotary knob. The RF level is varied in the step width entered if KNOB STEP is set to USER.
IEC-bus short command :*POW:STEP 1*
- KNOB STEP** DECIMAL Variation step width according to the position of the digit cursor.
USER User Defined, variation step width as entered under KNOB STEP USER.
- POWER RESOLUTION** Selection of resolution of LEVEL display. For level range -99.9 dBm to +16 dBm the resolution for the level display can be set to 0.1 dB or 0.01 dB.
- POWER-ON STATE** Selection of the state the RF output is to assume after power-on of the unit.
RF OFF Output is switched off
PREVIOUS SETTING Same state as before switch-off
IEC-bus short command :*OUTP:PON UNCH*

EXCLUDE FROM RCL OFF The saved RF level is loaded when instrument settings are loaded with the [RECALL] key or with a memory sequence.
 ON The RF level is not loaded when instrument settings are loaded, the current settings are maintained.
 IEC-bus short command :*POW:RCL EXCL*

2.5.1 Level Offset

The SMT offers the possibility of entering the offset (OFFSET) of a possibly series-connected attenuator/amplification element in the LEVEL-LEVEL menu. The indication/input value under AMPLITUDE considers this input (see below) and represents the level value of the signal at the output of the series-connected instrument (cf. Fig. 2-19).

Input values LEVEL and OFFSET in the LEVEL menu have the following connection with the RF output level:

$$\text{LEVEL} - \text{OFFSET} = \text{output level}$$

An offset input does not effect an alteration of the RF output level, but only an alteration of the LEVEL indication value in the LEVEL menu. The offset is to be entered in dB.

The RF output level of the SMT is indicated in the header fields of the display. It can be entered directly, i.e. without considering an offset, using the [LEVEL] key.

The offset setting also remains effective in the ATTENUATOR MODE FIXED operating mode and with level sweep.

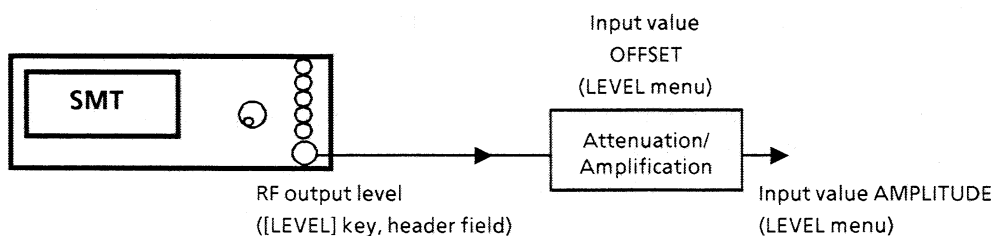

Fig. 2-19 Example of a circuit with level offset

2.5.2 Interrupt-free Level Setting

In the ATTENUATOR MODE FIXED operating mode, level settings are carried out without interruption. An electronic attenuation setting is used instead of the interrupting attenuator. The 20-dB range of the level which can be set interrupt-free extends from the level set on switching on the ATTENUATOR FIXED MODE until 20 dB below. Within this 20-dB range, the level can be set via the keyboard, via the rotary knob or via the IEC bus.

2.5.3 Switching On/Off Internal Level Control

Menu LEVEL-ALC offers access to settings for level control.

Level control can be deactivated and various bandwidths of the level control can be switched on.

Switching off level control (ALC STATE OFF) switches over the internal level control into a sample-and-hold operation. In this operating mode, level control is automatically switched on for a short period of time after every level and frequency setting, and then the level control is held at the value achieved. Switching off the level control is used with multi-transmitter measurements to achieve a larger intermodulation ratio.

Bandwidth setting influences the AM noise of the output signal. The bandwidth of the level control has the same effect as a filter of the same bandwidth.

Menu selection: LEVEL - ALC

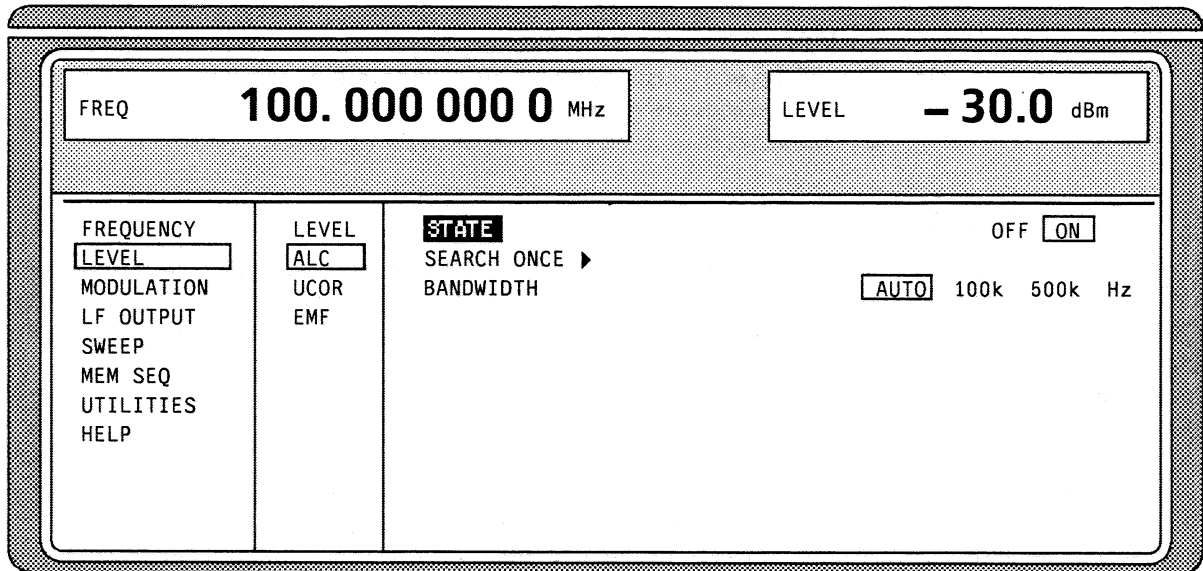

Fig. 2-20 Menu LEVEL-ALC (preset setting)

STATE ON Normal state. Internal level control is permanently switched on.
IEC-bus short command :*POW:ALC ON*

OFF Internal level control is deactivated. In this state no AM is possible.
IEC-bus short command :*POW:ALC OFF*

SEARCH ONCE ▶ Manual short-time switching on of the level control for level calibration in the ALC STATE OFF operating mode.
IEC-bus short command :*POW:ALC ON; ALC OFF*

2.5.4 Internal Level Control – Bandwidth Selection

BANDWIDTH Selection of the bandwidth of the level control.

AUTO The bandwidth is automatically adapted to the operating conditions.
IEC-bus short command :*POW:ALC:BAND:AUTO ON*

100 kHz Bandwidth narrow. This setting improves AM noise with carrier offset > 100 kHz. However, the AM bandwidth is restricted.
IEC-bus short command :*POW:ALC:BAND 100kHz;BAND:AUTO OFF*

500 kHz Full bandwidth
IEC-bus short command :*POW:ALC:BAND 500kHz;BAND:AUTO OFF*

2.5.5 User Correction (UCOR)

Function "User Correction" can be used to create and activate lists in which arbitrary RF frequencies are assigned level correction values. Up to 10 lists with a total of 160 correction values can be compiled. For frequencies which are not included in the list the level correction is determined by means of interpolation of the nearest correction values.

When user correction is switched on, the LEVEL indication is completed by the indication UCOR (User Correction) in the header field of the display. The RF output level is the sum of both values.

$$\text{LEVEL} + \text{UCOR} = \text{output level}$$

If the offset setting is used at the same time, the LEVEL indication value is the difference of the input values AMPLITUDE and OFFSET of the menu LEVEL.

$$\text{AMPLITUDE} - \text{OFFSET} = \text{LEVEL}$$

The user correction is effective in all operating modes if switched on.

Menu selection: LEVEL - UCOR

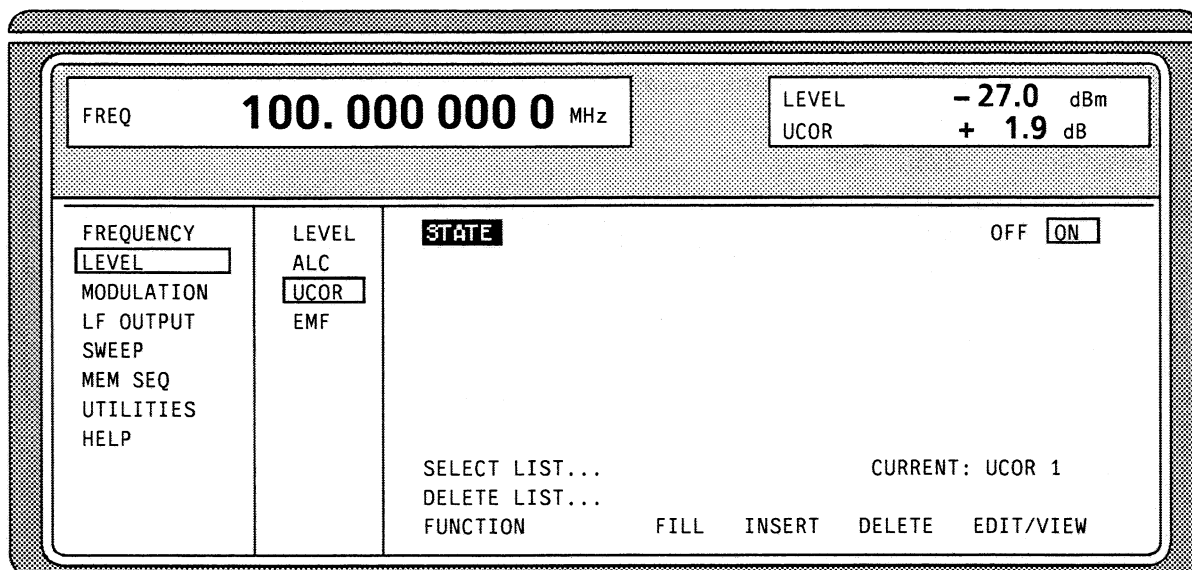

Fig. 2-21 Menu LEVEL-UCOR – OPERATION page

- STATE** Switching on/off user correction.
IEC-bus short command :CORR ON
- SELECT LIST...** Selection of a list or generation of a new list (cf. Section 2.2.4, List Editor).
IEC-bus short command :CORR:CSET "UCOR1"
- DELETE LIST...** Deletion of a list (cf. Section 2.2.4, List Editor).
IEC-bus short command :CORR:CSET:DEL "UCOR1"
- FUNCTION** Selection of the editing mode to process the selected list (cf. Section 2.2.4, List Editor).
IEC-bus short command :CORR:CSET:DATA:FREQ 100MHz, 102MHz,...
 :CORR:CSET:DATA:POW 1dB, 0.8dB,...

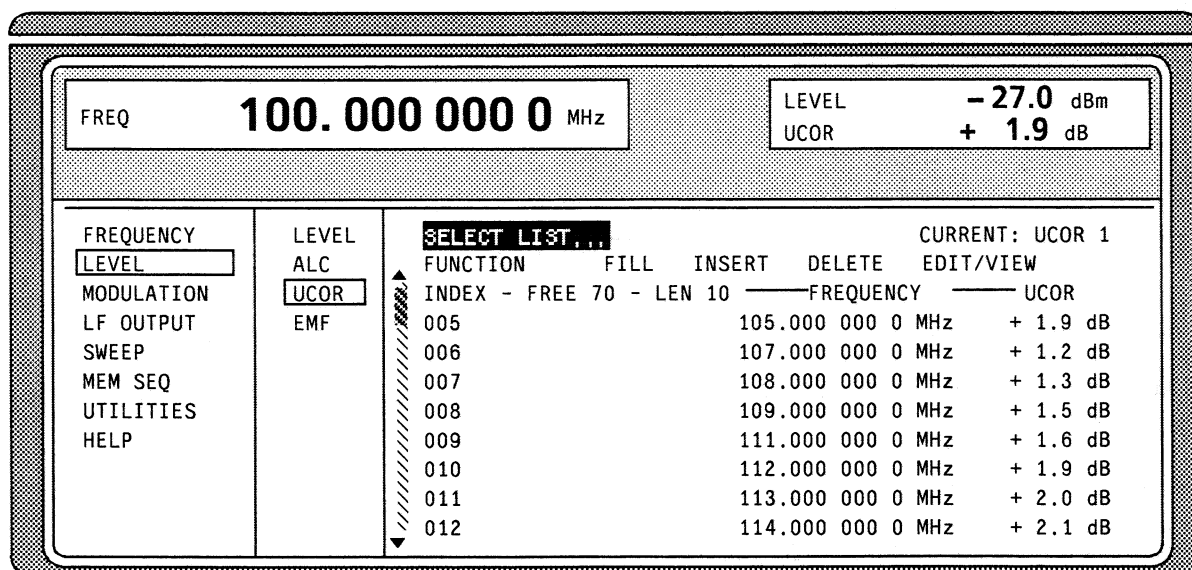

Fig. 2-22 Menu LEVEL-UCOR – EDIT page

2.5.6 EMF

The signal level can also be set and indicated as the voltage of EMF (open-circuit voltage).

EMF is displayed in the header field of the display after the unit of the level indication if one of units dB μ V, mV or μ V is selected.

Menu selection: LEVEL - EMF

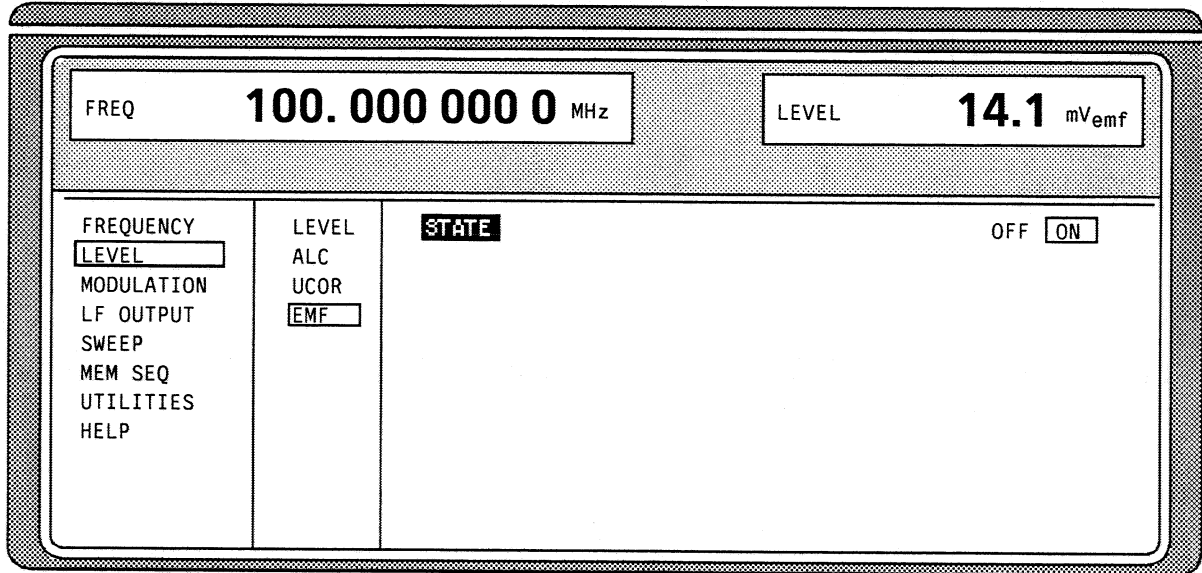

Fig. 2-23 Menu LEVEL-EMF (preset setting)

STATE	ON	Voltage value of the level is the voltage of EMF.
	OFF	Voltage value of the level is voltage at 50 Ω .

2.5.7 [RF ON / OFF] Key

The RF output signal is switched on and off again using the [RF ON / OFF] key. This does not influence the current menu. When the output signal is switched off, the message "RF OFF" is displayed in the LEVEL indication of the header field. If RF OFF is displayed, the 50- Ω source resistance is maintained.

IEC-bus short command :*OUTP OFF*

2.5.8 Reset Overload Protection (SMT02/03 only)

SMT02 and SMT03 are protected against overload by an external signal which is fed into the RF output. If an external signal is too high, the overload protection responds. This state is indicated by means of the message "RF OFF" in the LEVEL indication in the header field and the message "OVERLOAD" in the status line. SMT06 is not protected against overload, the IEC/IEEE-Bus command being ignored

- ▶ Reset the overload protection by pressing the [RF ON / OFF] key.

IEC-bus short command :*OUTP:PROT:CLE*

The SMT06 doesn't have an overload protection.

2.6 Modulation

The SMT offers the following modulations:

- Amplitude modulation (AM)
- Frequency modulation (FM)
- Phase modulation (PM)
- Pulse modulation (PULSE) *
- FM-stereo modulation (STEREO) *
- VOR/ILS modulation (VOR, ILS-GS, ILS-LOC, MKR BCN) * * Only with option

Internal or external modulation sources can be used for all modulations.

2.6.1 Modulation Sources

Internal Modulation Sources

Internal modulation generators LF GEN1 and LF GEN2 are available for AM, FM and PM depending on the equipment. For a more detailed description, cf. Section 2.6.2.1, LF Generator.

For internal pulse modulation, the instrument can be equipped with a pulse generator (option SM-B4). For a more detailed description, cf. Section 2.6.5.1, Pulse Generator.

External Modulation Sources

The appropriate input sockets to the different modulations in the case of external supply can be taken from table 2-1. External AM, FM and PM can be AC or DC-coupled.

Table 2-1 Input sockets for the different types of modulation

Modulation	Inputs		
	EXT1	EXT2	PULSE
AM	x		
FM1	x	x	
FM2		x	
PM1	x	x	
PM2		x	
PULSE			x

The external modulation signal must show a voltage of $V_s = 1 \text{ V}$ ($V_{\text{eff}} = 0.707 \text{ V}$) in order to maintain the modulation depth or deviation indicated. Deviations of more than $\pm 3 \%$ are signalled in the status line by means of the following messages (cf. table 2-2). Monitoring is only active if the inputs are AC-coupled.

Table 2-2 Status messages in the case of a deviation from the rated value at the external modulation input

Message	Deviation
EXT1-HIGH	Voltage at EXT1 too high
EXT1-LOW	Voltage at EXT1 too low
EXT2-HIGH	Voltage at EXT2 too high
EXT2-LOW	Voltage at EXT2 too low
EXT-HI/HI	Voltage at EXT1 and EXT2 too high
EXT-LO/LO	Voltage at EXT1 and EXT2 too low
EXT-HI/LO	Voltage at EXT1 too high and EXT2 too low
EXT-LO/HI	Voltage at EXT1 too low and EXT2 too high

2.6.1.1 Simultaneous Modulation

Basically, every combination of AM, FM and pulse modulation is possible. Instead of FM, phase modulation (PM) can be switched on as well. There are only restrictions for modulations of the same kind and for the multiple use of the 2nd LF generator (cf. table 2-3).

Two-tone AM is possible by simultaneously switching on the external and internal source.

Two-tone FM or two-tone PM is possible by simultaneously switching on FM1 and FM2 or PM1 and PM2. For FM1 and FM2 (PM1 and PM2) separate deviations can be set and separate sources switched on.

Note: *With two-tone modulation please observe that the set deviation or modulation depth is valid for one signal and the sum deviation or sum modulation depth is determined by adding both signals. This results in overmodulation if the maximal value for deviation or modulation depth is exceeded.
To guarantee a deviation error of max. 3%, the ratio of the two deviations has to be < 100 with dual sound FM/PM.*

2.6.1.2 Alternate Switching Off of Modulations

Due to the multiple use of some functional modules in the instrument some modulations cannot be set at the same time (cf. table 2-3). In the case of manual control, incompatible modulations deactivate one another, a short-time warning is displayed in the status line.

Note: *The IEC-bus control according to SCPI forbids the mutual influence of types of modulation on one another. In the case of remote control, an error message is outputted when the attempt is made to switch on incompatible types of modulation (cf. annex B).*

Table 2-3 Modulations which cannot be operated simultaneously.

	AM INT1	AM INT2	AM EXT1	FM1 INT1	FM1 EXT1,2	FM2 INT2	FM2 EXT1,2	PM1 INT1	PM1 EXT1,2	PM2 INT2	PM2 EXT1,2	Stereo	VOR	ILS	MCR-BCN
AM INT1													×	×	×
AM INT2												×	×	×	×
AM EXT1													☒	☒	×
FM1 INT1					□			×	×	×	×				
FM1 EXT1,2				□				×	×	×	×				
FM2 INT2							□	×	×	×	×	×	×	×	×
FM2 EXT1,2						□		×	×	×	×	×			
PM1 INT1				×	×	×	×		□			×			
PM1 EXT1,2				×	×	×	×	□				×			
PM2 INT2				×	×	×	×				□	×	×	×	×
PM2 EXT1,2				×	×	×	×			□		×			
Stereo		×				×	×	×	×	×	×		×	×	×
VOR	×	×	☒			×				×		×		×	×
ILS	×	×	☒			×				×		×	×		×
MCR-BCN	×	×	×			×				×		×	×	×	

- × Mutual switching off in the case of manual control
- ☒ In the VOR- (ILS..) menu AM EXT can be added as an own parameter
- Switching off by means of 1-out-of-n selection

2.6.1.3 [MOD ON/OFF] Key

The modulations can directly be switched on/off using the key or by accessing the MODULATION menu. When switching on using the [MOD ON/OFF] key, the modulation sources which are set in the modulation menus are used.

The [MOD ON/OFF] key can either be effective for all modulations or for a selected modulation. The selection for which modulation the [MOD ON/OFF] key is effective is made in the UTILITIES-MOD KEY menu. (cf. Section "Assigning Modulation to [MOD ON/OFF] Key").

When selecting a certain type of modulation, each pressing the [MOD ON/OFF] key switches on or off the modulation selected.

In the case of selection "all modulations", the [MOD ON/OFF] key has the following effect:

- At least one modulation is active:
Pressing the [MOD ON/OFF] key switches off all active modulations. Which modulations were active is stored.
- No modulation is active:
Pressing the [MOD ON/OFF] key switches on the modulations which were last switched off using the [MOD ON/OFF] key.

2.6.1.4 LF-Generator

The SMT is equipped with a fixed-frequency generator as internal modulation source as a standard. The generator supplies sinusoidal signals of the frequencies of 0.4, 1, 3 and 15 kHz. In addition to the standard equipment, the SMT can be equipped with the following optional LF modulation sources:

- LF-generator, option SM-B2
- Multifunction generator, option SM-B6

It is possible to fit two optional modulation sources unless option SM-B3, pulse modulator, is fitted. If two options are fitted, the access to the internal standard generator is eliminated. The different possibilities of modulation generator fitting are visible from table 2-4:

Table 2-4 Modulation generators as component parts

LF-Generator 1	LF-Generator 2
Standard generator	—
Standard generator	Option SM-B2, LF-generator
Standard generator	Option SM-B6, multifunction generator
Option SM-B2, LF-generator	Option SM-B2, LF-generator
Option SM-B2, LF-generator	Option SM-B6, multifunction generator

The selection of the waveform and frequency of the internal modulation signals can be made in one of the modulation menus (AM, FM, PM) as well as in the LF-output menu.

- Notes:**
- *In conformance to the possibilities of the modulation generator options fitted, there are differences in the modulation menus for AM, FM and PM.*
 - *The settings LFGEN SHAPE NOI and LF sweep deactivate one another.*

2.6.2 Amplitude Modulation

Menu MODULATION-AM offers access to settings for amplitude modulation.

- Notes:**
- In the level range from 7 dBm to 13 dBm, the specified AM data are only guaranteed for a linearly decreasing modulation depth with a rising level. When a modulation depth is set that is too high, "WARNING" is displayed in the status line or the message "WARN -221 Settings conflict; AM forces level into overrange" is displayed after pressing the ERROR key.
 - Modulations AM, VOR, ILS and MKR BCN deactivate one another.
Settings AM SOURCE INT = LFGEN2 and STEREO deactivate one another as well.

Menu selection: MODULATION- AM

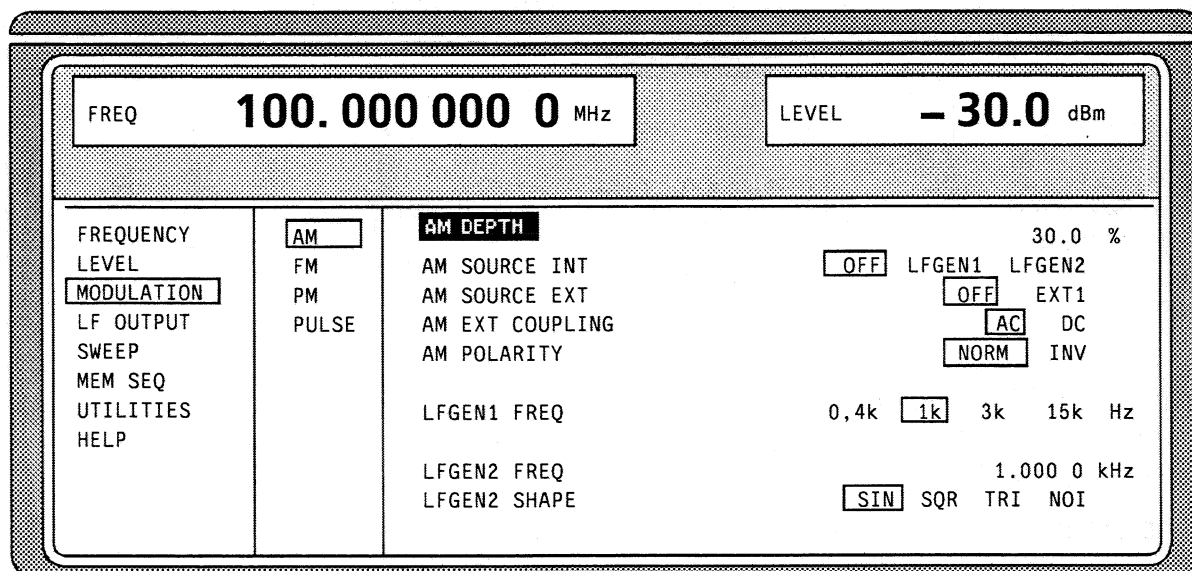

Fig. 2-24 Menu MODULATION-AM (preset setting), fitted with option SM-B2, LF-generator (LFGEN2)

- AM DEPTH** Input value of the modulation depth.
IEC-bus short command :AM 30PCT
- AM SOURCE INT** Selection of the internal source.
IEC-bus short command :AM:SOUR INT1; STAT ON
- AM SOURCE EXT** Selection of the external source.
IEC-bus short command :AM:SOUR EXT; STAT ON
- AM EXT COUPLING** Selection of the kind of coupling AC or DC with external supply.
IEC-bus short command :AM:EXT:COUP AC
- AM POLARITY** Selection of the polarity of amplitude modulation.
NORM A positive modulation voltage generates a higher output level.
INV The AM polarity is inverted.
IEC-bus short command :AM:POL NORM
- LFGEN1 FREQ** Selection of the frequency of the 1st LF generator.
IEC-bus short command :AM:INT1:FREQ 1kHz
- LFGEN2 FREQ** Input value of the frequency of the 2nd LF generator.
IEC-bus short command :AM:INT2:FREQ 1kHz
- LFGEN2 SHAPE** Selection of the waveform of the 2nd LF generator.
IEC-bus short command :SOUR2:FUNC SIN

2.6.3 Frequency Modulation

Menu MODULATION-FM offers access to settings for frequency modulation.

Note: *The following modulations cannot be set simultaneously and deactivate one another: FM and PM; FM2 and STEREO; FM2 SOURCE = LFGEN2 and VOR, ILS, MKR BCN*

Menu selection: MODULATION-FM

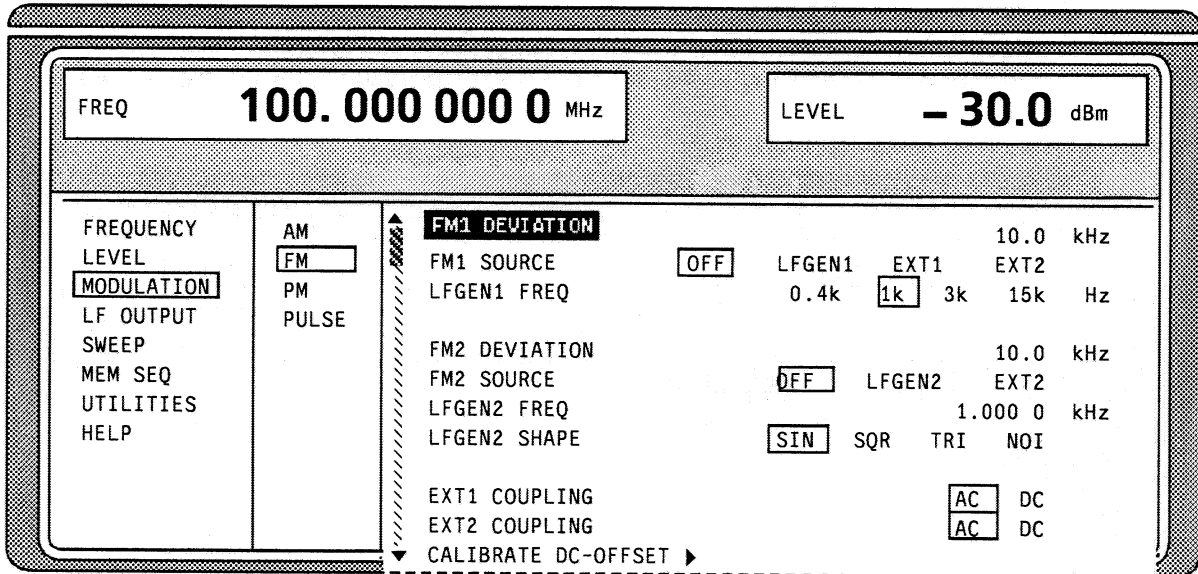

Fig. 2-25 Menu MODULATION-FM (preset setting), fitted with option SM-B2, LF-generator (LFGEN2).

- | | |
|----------------------|--|
| FM1 DEVIATION | Input value of the deviation for FM1.
IEC-bus short command : <i>FM1 10kHz</i> |
| FM1 SOURCE | Switching on and off FM1 and selection of the modulation source.
IEC-bus short commands : <i>FM1:SOUR INT; STAT ON</i> |
| LFGEN1 FREQ | Selection of the frequency of the 1st LF generator.
IEC-bus short command : <i>FM1:INT:FREQ 1kHz</i> |
| FM2 DEVIATION | Input value of the deviation for FM2.
IEC-bus short command : <i>FM2 10kHz</i> |
| FM2 SOURCE | Switching on and off FM2 and selection of the modulation source.
IEC-bus short command : <i>FM2:STAT OFF</i> |
| LFGEN2 FREQ | Input value of the LFGEN2 frequency.
IEC-bus short command : <i>FM2:INT:FREQ 1kHz</i> |
| LFGEN2 SHAPE | Selection of the waveform of the 2nd LF generator.
IEC-bus short command : <i>SOUR2:FUNC SIN</i> |
| EXT1 COUPLING | Selection of the type of coupling AC or DC for the external input EXT1.
IEC-bus short command : <i>FM1:EXT1:COUP AC</i> |
| EXT2 COUPLING | Selection of the type of coupling AC or DC for the external input EXT2.
IEC-bus short command : <i>FM1:EXT2:COUP AC</i> |

CALIBRATE DC-OFFSET ▶ Triggers the calibration of the carrier mean frequency. DC offsets in the modulation path and of the source are compensated for.

Caution: *In the case of an AC-coupling of the modulator, CALIBRATE DC-OFFSET ▶ is not possible. The modulator is DC-coupled with settings EXT1 DC and EXT2 DC, also in combination with other inputs.*

IEC-bus short command :CAL:FM:OFFS?

2.6.3.1 FM Deviation Limits

The maximal deviation depends on the RF frequency set (cf. Fig. 2-26). It is possible to enter a deviation that is too high for a certain RF frequency or to vary the RF frequency to a range in which the deviation can no longer be set. In this case the maximally possible deviation is set and an error message is displayed.

In the RF range 93.75 MHz to 130 MHz a different synthesis range is selected depending on the deviation set. If the deviation is smaller than 80 kHz, the synthesizer is in the division range with optimal spectral purity. If the deviation set is larger than 80 kHz, the extended heterodyne band is automatically selected.

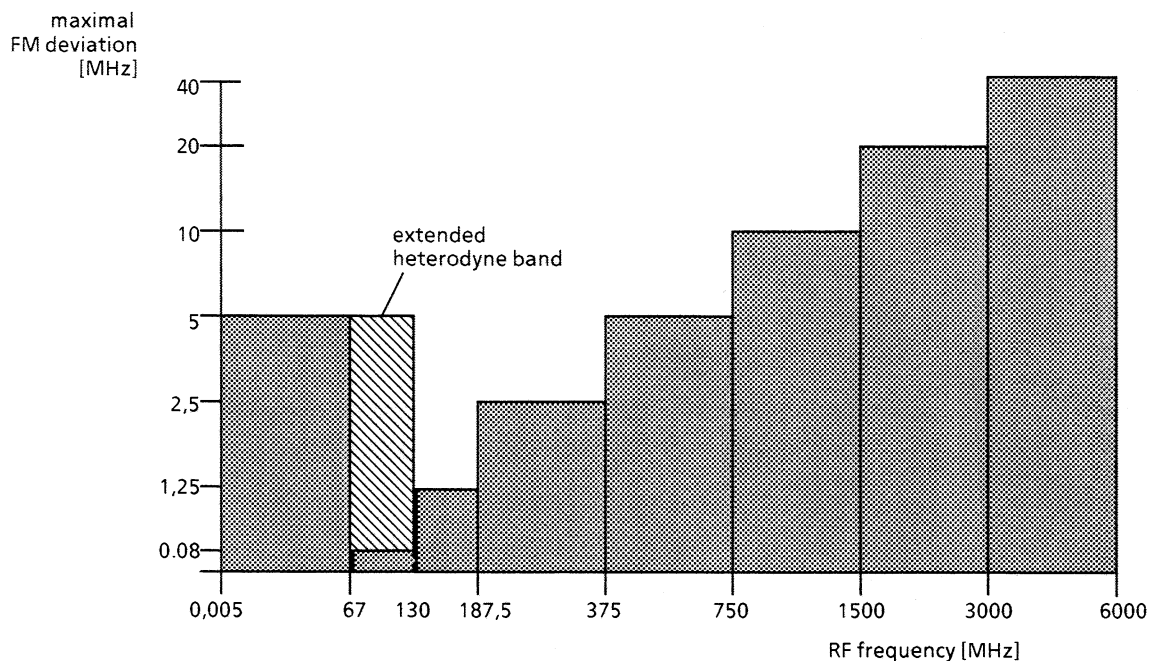

Fig. 2-26 Dependency of the FM maximal deviation on the RF frequency set

2.6.4 Phase Modulation

The PM menu offers access to settings for phase modulation.

Note: The following modulations cannot be set simultaneously and deactivate one another:
 PM and FM
 PM and STEREO
 PM2 SOURCE = LFGEN2 and VOR, ILS, MKR BCN

Menu selection: MODULATION - PM

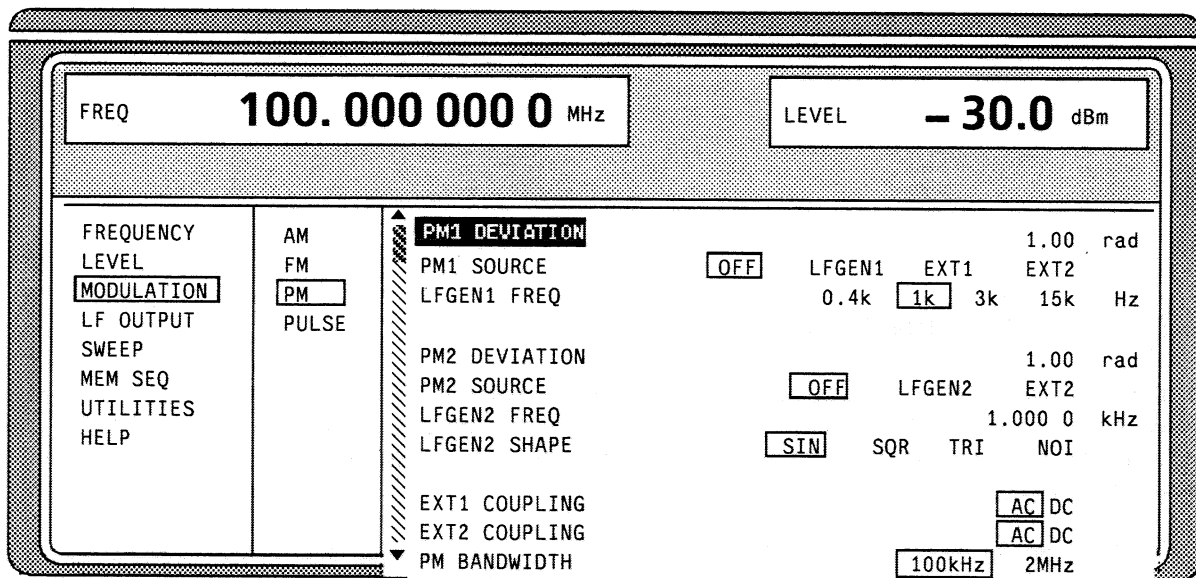

Fig. 2-27 Menu MODULATION-PM (preset setting), fitted with option SM-B2, LF generator (LFGEN2).

- PM1 DEVIATION** Input value of the deviation for PM1 (cf. Section 2.6.4.1, PM Deviation Limits).
 IEC-bus short command :PM1 1RAD
- PM1 SOURCE** Switching on and off PM1 and selection of the modulation source.
 IEC-bus short command :PM1:SOUR:INT;STAT ON
- LFGEN1 FREQ** Selection of the frequency of the 1st LF generator.
 IEC-bus short command :PM1:INT:FREQ 1kHz
- PM2 DEVIATION** Input value of the deviation for PM2 (cf. Section 2.6.4.1, PM Deviation Limits).
 IEC-bus short command :PM2 1RAD
- PM2 SOURCE** Switching on and off PM2 and selection of the modulation source.
 IEC-bus short command :PM2:SOUR INT;STAT ON
- LFGEN2 FREQ** Input value of the LFGEN2 frequency.
 IEC-bus short command :PM2:INT:FREQ 1kHz
- LFGEN2 SHAPE** Selection of the waveform of the 2nd LF generator.
 IEC-bus short command :SOUR2:FUNC SIN
- EXT COUPLING** Selection of the type of coupling AC or DC for external input EXT1.
 IEC-bus short command :PM:EXT1:COUP AC
- EXT2 COUPLING** Selection of the type of coupling AC or DC for external input EXT2.
 IEC-bus short command :PM:EXT2:COUP AC
- PM BANDWIDTH** Selection of the modulation bandwidth.
 IEC-bus short command :PM:BAND 100kHz

2.6.4.1 PM Deviation Limits

The maximal deviation depends on the RF frequency set and on the PM bandwidth (cf. Fig. 2-28). It is possible to enter a deviation that is too high for a certain RF frequency or to vary the RF frequency to a range in which the deviation can no longer be set. In this case the maximally possible deviation is set and an error message displayed.

In the RF range 67 MHz to 130 MHz a different synthesis range is selected depending on the deviation set. If the deviation is small, the synthesizer is in the division range with optimal spectral purity. If the deviation is large (shaded area), the extended heterodyne band is automatically selected.

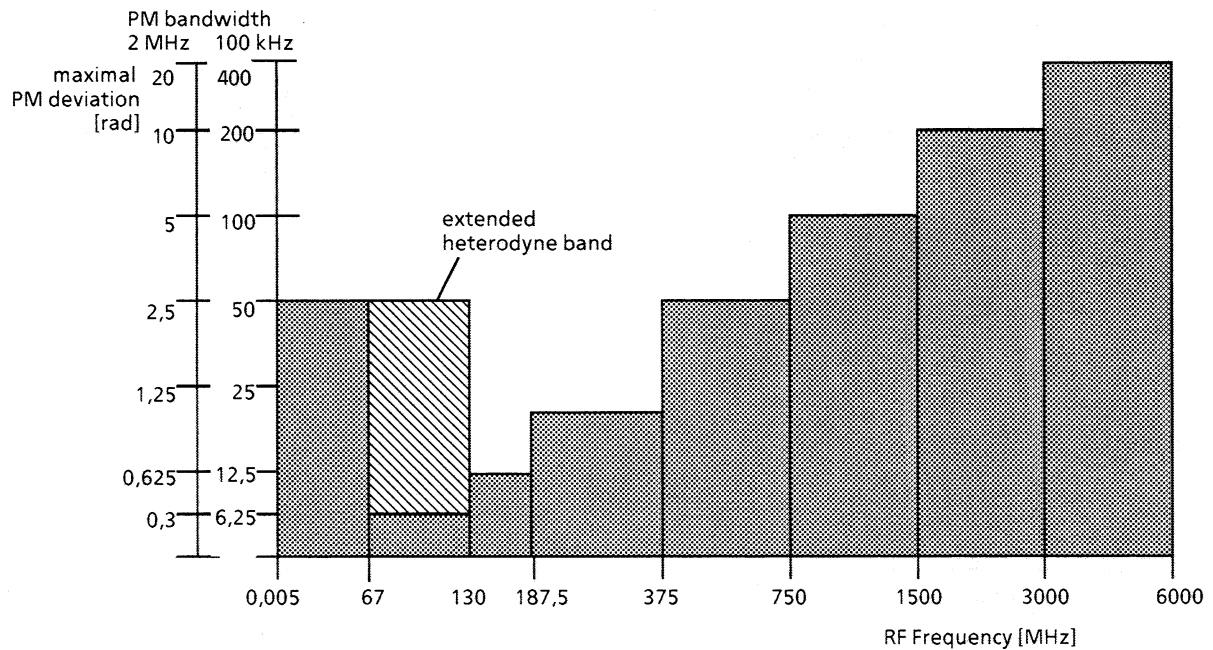

Fig. 2-28 Dependency of the PM maximal deviation on the RF frequency set

2.6.5 Pulse Modulation

The pulse modulator can be controlled by an external source as well as by the internal pulse generator. In the case of external control, the external source directly feeds the pulse modulator. The envelope of the RF is identical to the control signal. In the case of control by the internal pulse generator, the pulse form of the pulse generator determines the envelope of the RF. Pulse delay, pulse width and period can be set.

The polarity of the pulse modulation is selectable. With POLARITY = NORM, the RF level is on with HIGH level at modulation input PULSE. The input resistance is selectable between 50 Ω and 10 k Ω .

2.6.5.1 Pulse Generator

As an internal modulation source, the pulse generator offers the possibility to set single and double pulses with variable pulse delay, pulse width and period. The pulse generator can be triggered internally or by means of an external signal at the PULSE input. The internal triggering is derived from the reference frequency and hence very stable. In trigger mode EXT, the positive or the negative edge can be used to trigger the pulse generator.

The pulse generator can also be operated as an independent function without the pulse modulator being controlled if the pulse modulation source SOURCE is switched to OFF or EXT. The pulse can be tapped at the VIDEO output.

The PULSE input is at the front of the instrument. The SYNC and VIDEO output are at the rear of the instrument.

Signal examples:

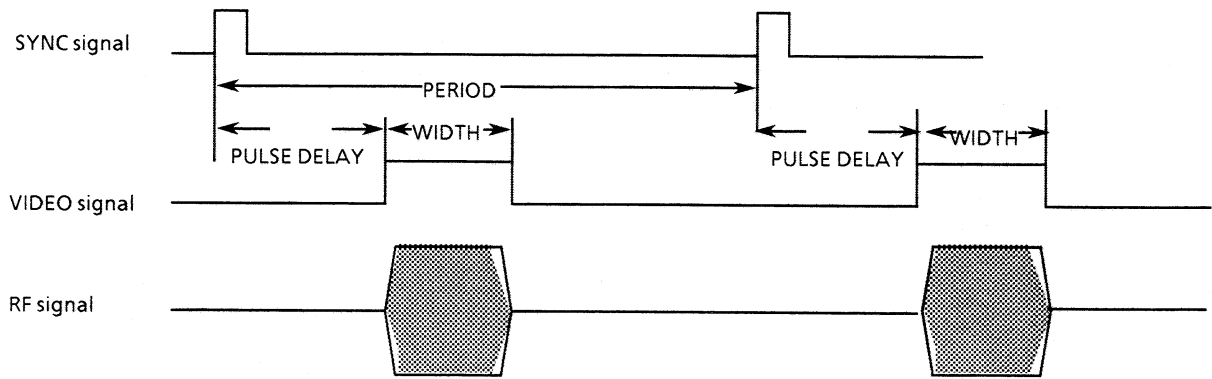

Fig. 2-29 Signal example 1: single pulse, TRIGGER MODE = AUTO

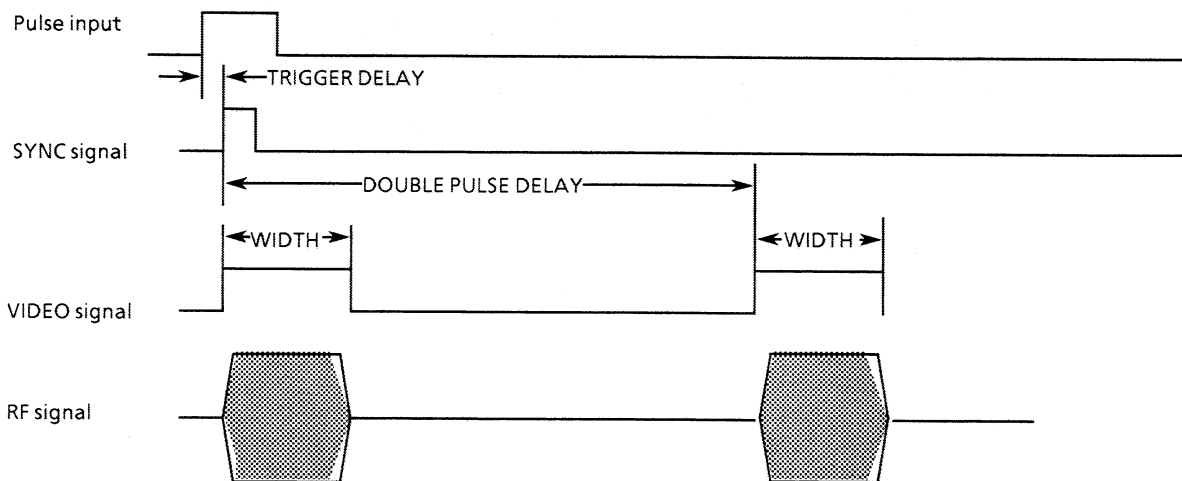

Fig. 2-30 Signal example 2: double pulse, TRIGGER MODE = EXT, SLOPE = POS

The PULSE menu offers access to settings for pulse modulation and to the pulse generator. If only option SM-B3, pulse modulator, is fitted, only the first 3 lines are displayed in the setting menu.

Menu selection: MODULATION - PULSE

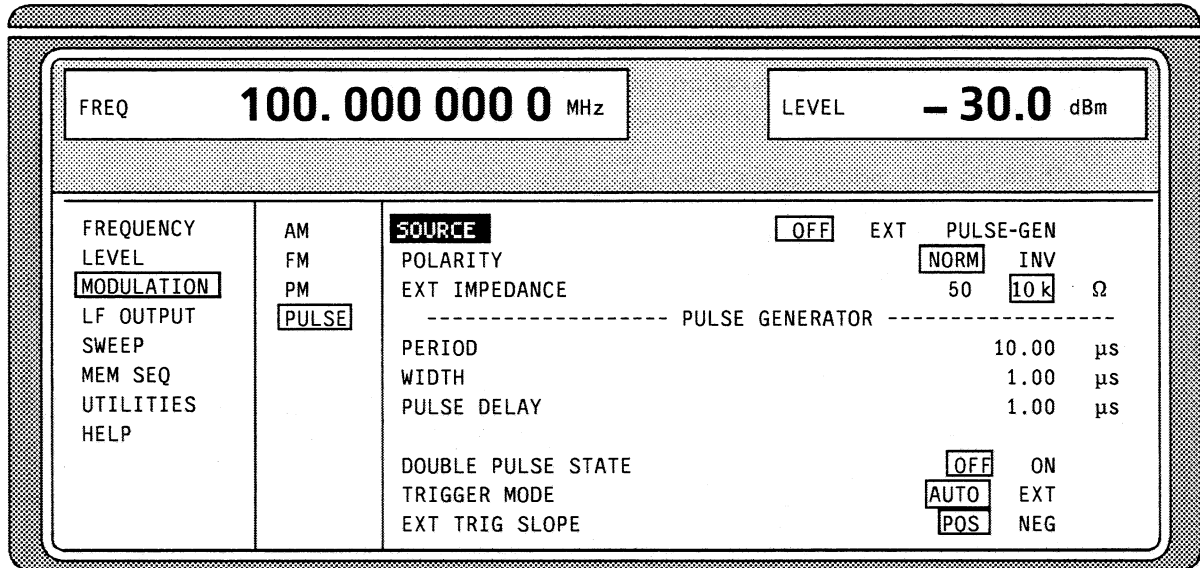

Fig. 2-31 Menu MODULATION-PULSE (preset setting), fitted with option SM-B3, pulse modulator, and SM-B4, pulse generator.

- SOURCE** Selection of the modulation source.
IEC-bus short command :*PULM:SOUR INT; STAT ON*
- POLARITY** Selection of the polarity of the modulation signal.
NORM The RF signal is on during high level.
INV The RF signal is suppressed during high level.
IEC-bus short command :*PULM:POL NORM*
- EXT IMPEDANCE** Selection of the input resistance 50 Ω or 10 kΩ.
IEC-bus short command :*PULM:EXT:IMP 50*
- PERIOD** Input value of the period.
IEC-bus short command :*PULS:PER 10us*
- WIDTH** Input value of the pulse width.
IEC-bus short command :*PULS:WIDT 1us*
- PULSE DELAY** Input value of the single-pulse delay. Is only displayed if DOUBLE PULSE STATE is set to be OFF.
IEC-bus short command :*PULS:DEL 1 us*
- DOUBLE PULSE DELAY** Input value of the double-pulse delay.
IEC-bus short command :*PULS:DOUB:DEL 1us*
- DOUBLE PULSE STATE** Switching on/off the double pulses.
ON Double pulse is switched on
OFF Single pulse
IEC-bus short command :*PULS:DOUB ON*
- TRIGGER MODE** Selection of the trigger mode.
AUTO Period as entered under PERIOD.
EXT Period is determined by the external signal at the PULSE input.
IEC-bus short command :*TRIG:PULS:SOUR AUTO*
- EXT TRIG SLOPE** Selection of the active edge of the external trigger signal.
POS Pulse generator triggers on positive edge of the external signal.
NEG Pulse generator triggers on negative edge of the external signal.
IEC-bus short command :*TRIG:PULS:SLOP POS*

2.6.6 STEREO Modulation

By means of option SM-B6, multifunction generator, STEREO multiplex signals conforming to standards can be generated according to the pilot-tone method.

Note: The following modulations cannot be set simultaneously and deactivate one another:

- STEREO and FM
- STEREO and PM
- STEREO and AM if SOURCE AM = LFGEN2

Menu selection: MODULATION:STEREO

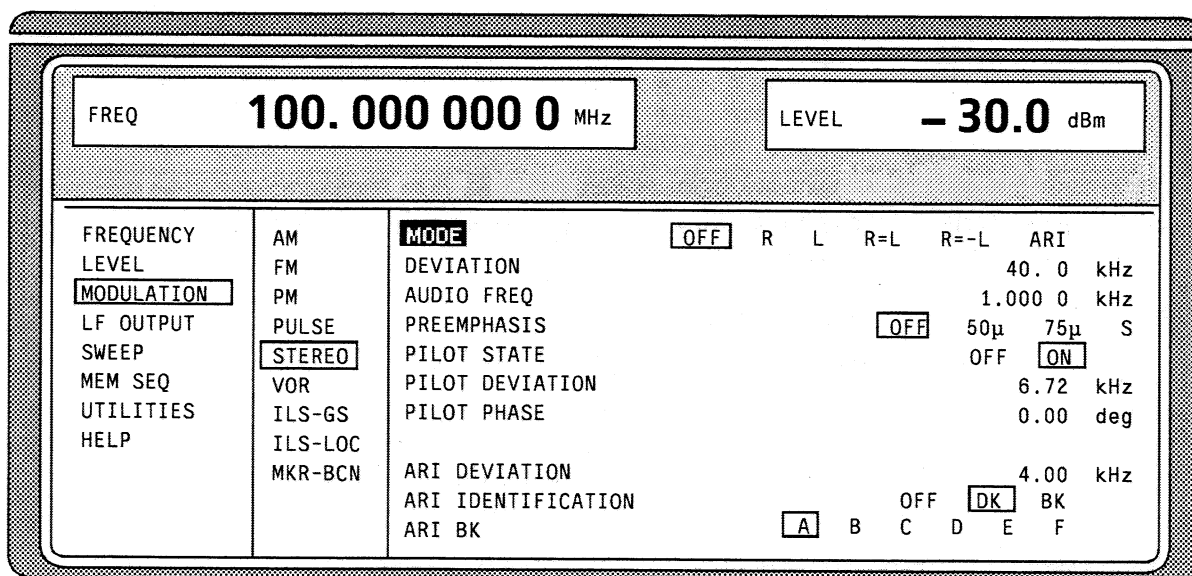

Fig. 2-32 Menu MODULATION-STEREO (preset setting), fitted with option SM-B6, multifunction generator

MODE

Selection of the operating mode.

- OFF The stereo signal is switched off.
- R Audio signal only in the right-hand channel.
- L Audio signal only in the left-hand channel.
- R = L Audio signals of same frequency and phase in both channels.
- R = - L Audio signals of same frequency but opposite phase in both channels.
- ARI Generation of 19-kHz pilot tone and ARI traffic channel signals.

IEC-bus short command :STER:STAT ON; SIGN AUD; AUD:MODE LEFT

DEVIATION

Input value of the frequency deviation of the STEREO-MPX signal without considering the pilot-tone content.

IEC-bus short command :STER 40kHz

AUDIO FREQ

Input value of the frequency of the audio signal.

IEC-bus short command :STER:AUD:FREQ 1kHz

PREEMPHASIS

Selection of the preemphasis of the audio signal.

- 50 us Preemphasis 50 µs
- 75 us Preemphasis 75 µs
- OFF Preemphasis switched off

IEC-bus short command :STER:AUD:PRE OFF

PILOT STATE	Switching on/off the pilot tone. IEC-bus short command :STER:PIL:STAT OFF
PILOT DEVIATION	Input value of the pilot deviation. IEC-bus short command :STER:PIL 6270
PILOT PHASE	Input value of the phase of the pilot tone. The zero point of the suppressed 38-kHz subcarrier of the STEREO multiplex signal serves as phase reference. IEC-bus short command :STER:PIL:PHAS 0
ARI DEVIATION	Input value of the deviation content of the unmodulated 57-kHz-ARI subcarrier in the ARI operating mode. IEC-bus short command :STER:ARI 4kHz
ARI IDENTIFICATION	Selection between ARI broadcasting code (DK) and traffic area code (BK). OFF The area code and the broadcasting code are switched off. DK The broadcasting code is activated. The AM modulation depth of the broadcasting code (125 Hz) on the ARI subcarrier is $m = 0.3$. BK The area code is activated. The AM modulation depth of the area code chosen under ARI BK is $m = 0.6$. IEC-bus short commands :STER:SIGN ARI; ARI:TYPE DK
ARI BK	Selection of the standard traffic area codes. A Traffic area code A, 23.7500 Hz B Traffic area code B, 28.2738 Hz C Traffic area code C, 34.9265 Hz D Traffic area code D, 39.5833 Hz E Traffic area code E, 45.6731 Hz F Traffic area code F, 53.9773 Hz IEC-bus short commands :STER:SIGN ARI; ARI:TYPE BK; ARI:BK A

2.6.7 VOR / ILS Test Signals

By means of option SM-B6, multifunction generator, test signals for avionics systems

- VOR (VHF Omnidirectional Range),
- ILS (Instrument Landing System) and
- MKR-BCN (Marker Beacon) can be generated.

2.6.7.1 VOR Modulation

- Notes:**
- The following modulations cannot be set simultaneously and deactivate one another:
VOR and AM
VOR and PM if SOURCE PM = LFGEN2
VOR and FM if SOURCE FM = LFGEN2
 - In the AM, FM, PM and LF-output menu the message "VOR" is displayed under LFGEN2 if the VOR modulation is activated.

Menu selection: MODULATION-VOR

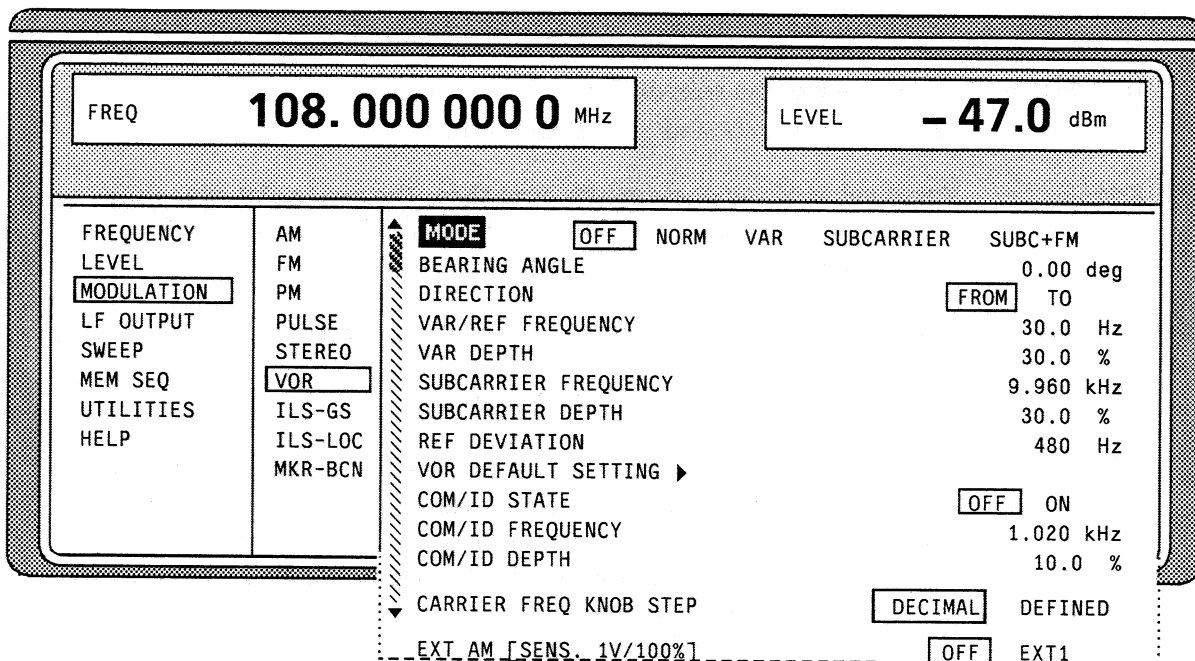

Fig. 2-33 Menu MODULATION-VOR (preset setting), fitted with option SM-B6, multifunction generator

- MODE** Selection of the VOR operating mode.
- OFF VOR modulation is switched off. In menus AM, FM, PM and LF-OUTPUT, the original setting is displayed under LFGEN2, the message "VOR" is eliminated.
 - NORM VOR modulation is activated.
 - VAR Amplitude modulation of the output signal with the 30-Hz signal content of the VOR signal. The modulation depth of the 30-Hz signal corresponds to the value set under VAR DEPTH.
 - SUBCARRIER Amplitude modulation of the output signal with the unmodulated 9960-Hz FM carrier of the VOR signal. The modulation depth corresponds to the value set under SUBCARRIER DEPTH.
 - SUBC + FM Amplitude modulation of the output signal with the frequency-modulated 9960-Hz carrier of the VOR signal. The frequency deviation corresponds to the value set under REF DEVIATION, the modulation depth to the value set under SUBCARRIER DEPTH.
- IEC-bus short command :VOR:STAT ON; MODE NORM
- BEARING ANGLE** Input value of the phase angle between the 30-Hz VAR signal and the 30-Hz reference signal.
- IEC-bus short command :VOR 0deg
- DIRECTION** Selection of the reference position of the phase information.
- FROM Selection of the beacon as a reference position. The angle set under BEARING ANGLE corresponds to the angle between the true north and the connection line between beacon and airplane.
 - TO Selection of the airplane position as a reference position. The angle set under BEARING ANGLE corresponds to the angle between the true north and the connection line between airplane and beacon.
- IEC-bus short command :VOR:DIR FROM
- VAR/REF FREQUENCY** Input value of the frequency of the VAR and the REF signal.
- IEC-bus short command :VOR:VAR:FREQ 30

- VAR DEPTH** Input value of the AM modulation depth of the (30-Hz) VAR signal.
IEC-bus short command :VOR:VAR 30PCT
- SUBCARRIER FREQUENCY** Input value of the frequency of the FM carrier.
IEC-bus short command :VOR:SUBC 9960
- SUBCARRIER DEPTH** Input value of the AM modulation depth of the FM carrier.
IEC-bus short command :VOR:SUBC:DEPT 30PCT
- REF DEVIATION** Input value of the frequency deviation of the REF signal on the FM carrier.
IEC-bus short command :VOR:REF 480
- VOR DEFAULT SETTING** Call the VOR default setting.
The default setting corresponds to the setting represented in Fig. 2-33 except for the MODE setting (= NORM). The selection of the CARRIER FREQ KNOB STEP parameters is not changed by calling this function.
IEC-bus short command :VOR:PRES
- COM/ID STATE** Switching on/off an additional communication/identification signal (COM/ID signal).
IEC-bus short command :VOR:COM ON
- COM/ID FREQUENCY** Input value of the frequency of the COM/ID signals.
IEC-bus short command :VOR:COM:FREQ 1020
- COM/ID DEPTH** Input value of the AM modulation depth of the COM/ID signals.
IEC-bus short command :VOR:COM:DEPT 10PCT
- CARRIER FREQ KNOB STEP** Selection of the variation of the carrier frequency via the rotary knob.
DECIMAL Decimal variation according to the current cursor position.
DEFINED Variation in predefined steps according to the standardized VOR transmitting frequencies (see table, values in MHz).
- Note:** If DEFINED is selected, the current RF frequency is automatically switched over to the next VOR transmitting frequency according to the table when switching on modulation VOR.

108.00	109.40	110.80	112.10	112.80	113.50	114.20	114.90	115.60	116.30	117.05	117.75
108.05	109.45	110.85	112.15	112.85	113.55	114.25	114.95	115.65	116.35	117.10	117.80
108.20	109.60	111.00	112.20	112.90	113.60	114.30	115.00	115.70	116.40	117.15	117.85
108.25	109.65	111.05	112.25	112.95	113.65	114.35	115.05	115.75	116.45	117.20	117.90
108.40	109.80	111.20	112.30	113.00	113.70	114.40	115.10	115.80	116.50	117.25	117.95
108.45	109.85	111.25	112.35	113.05	113.75	114.45	115.15	115.85	116.55	117.30	
108.60	110.00	111.40	112.40	113.10	113.80	114.50	115.20	115.90	116.60	117.35	
108.65	110.05	111.45	112.45	113.15	113.85	114.55	115.25	115.95	116.65	117.40	
108.80	110.20	111.60	112.50	113.20	113.90	114.60	115.30	116.00	116.75	117.45	
108.85	110.25	111.65	112.55	113.25	113.95	114.65	115.35	116.05	116.80	117.50	
108.00	110.40	111.80	112.60	113.30	114.00	114.70	115.40	116.10	116.85	117.55	
109.05	110.45	111.85	112.65	113.35	114.05	114.75	115.45	116.15	116.90	117.60	
109.20	110.60	112.00	112.70	113.40	114.10	114.80	115.50	116.20	116.95	117.65	
109.25	110.65	112.05	112.75	113.45	114.15	114.85	115.55	116.25	117.00	117.70	

EXT AM [SENS. 1V/100%] Switching on/off an external modulation signal via socket EXT1.

OFF External AM input (EXT1) switched off.

ON External AM input (EXT1) activated.

The sensitivity is 10 mV per percent modulation depth.

IEC-bus short command :VOR:SOUR INT2,EXT

Note: As automatic level monitoring of the external modulation signal is switched off in this operating mode, there can be an overmodulation as a function of the level of the external signal without a corresponding caution message being generated. In order to avoid an overmodulation, the peak value of the external signal is to be delimited corresponding to the sum of the modulation depths of the remaining VOR signal components.

2.6.7.2 ILS-Glide Slope Modulation (ILS-GS)

- Notes:**
- The following modulations cannot be set simultaneously and deactivate one another:
 ILS-GS and AM
 ILS-GS and PM if SOURCE PM = LFGEN2
 ILS-GS and FM if SOURCE FM = LFGEN2
 - In the AM, FM, PM and LF-output menu the message "ILS-GS" is displayed under LFGEN2 if the ILS-GS modulation is activated.
 - With setting CARRIER FREQ KNOB STEP = DEFINED, a change to modulation ILS-LOC automatically causes the RF frequency to be adapted to the localizer value which is coupled to the glide-slope setting.

Menu selection: MODULATION- ILS-GS

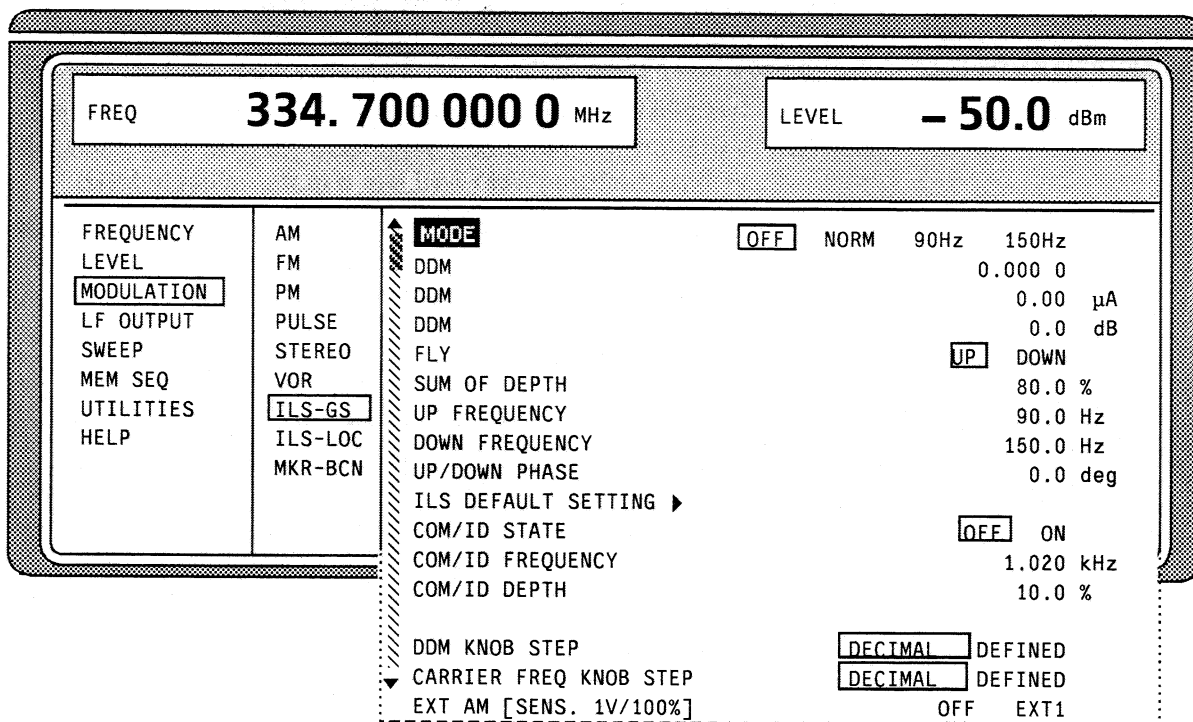

Fig. 2-34 Menu MODULATION-ILS-GS (preset setting), fitted with option SM-B6, multifunction generator

- MODE** Selection of the ILS-GS operating mode.
- OFF ILS-GS modulation is switched off.
 In menus AM, FM, PM and LF-OUTPUT, the original setting is displayed under LFGEN2, the message "ILS-GS" is eliminated.
 - NORM ILS-GS modulation is activated.

90 Hz Amplitude modulation of the output signal with the 90-Hz signal content of the ILS-GS signal. The modulation depth of the 90-Hz signal results from the settings of parameters SUM OF DEPTH (SOD) and DDM according to:

$$AM(90\text{ Hz}) = 0.5 \times (\text{SOD} + \text{DDM} \times 100\%)$$

150 Hz Amplitude modulation of the output signal with the 150-Hz signal content of the ILS-GS signal. The modulation depth of the 150-Hz signal results from the settings of parameters SUM OF DEPTH (SOD) and DDM acc. to:

$$AM(150\text{ Hz}) = 0.5 \times (\text{SOD} - \text{DDM} \times 100\%)$$

IEC-bus short command :*ILS:STAT ON; TYPE GS; MODE NORM*

DDM Difference in Depth of Modulation. Input value of the difference in depth of modulation between the 90-Hz and the 150-Hz tone of the ILS-GS modulation signal. The DDM value is calculated to formula (parameter UP/DOWN = DOWN):

$$\text{DDM} = [\text{AM}(90\text{ Hz}) - \text{AM}(150\text{ Hz})] / 100\%$$

A variation of the DDM value automatically leads to a variation of the value of the instrument current and the DDM value in dB.

IEC-bus short command :*ILS:DDM 0*

DDM Input value of the current of the ILS indicating instrument corresponding to the DDM value. A variation of the value of the instrument current automatically leads to a variation of the DDM value and the DDM value in dB. The value of the instrument current is calculated according to:

$$\text{DDM } \mu\text{A} = \text{DDM} \times 857.1 \mu\text{A}$$

IEC-bus short command :*ILS:DDM:CURR 0*

DDM Input of the DDM value in dB. A variation of the value automatically leads to a variation of the DDM value and the value of the instrument current. The dB value is calculated according to:

$$\text{DDM dB} = 20 \times \text{LOG} [(\text{SOD} + \text{DDM} \times 100\%) / (\text{SOD} - \text{DDM} \times 100\%)]$$

IEC-bus short command :*ILS:DDM:LOG 0*

FLY Selection between ILS-GS operating modes UP and DOWN. A change of the setting automatically changes the sign of the DDM value.

UP In operating mode UP, the 150-Hz modulation signal is predominant, the DDM value is positive.

DOWN In operating mode DOWN, the 90-Hz modulation signal is predominant, the DDM value is negative.

IEC-bus short command :*ILS:DDM:DIR UP*

SUM OF DEPTH Input value of the arithmetic sum of the modulation depths of the 90-Hz and 150-Hz ILS-GS signal contents. The RMS modulation depth of the sum signal depends on the phase setting of both modulation tones.

IEC-bus short command :*ILS:SOD 80PCT*

UP FREQ Input value of the modulation frequency of the antenna lobe arranged at the top.

IEC-bus short command :*ILS:ULOB 90*

DOWN FREQ Input value of the modulation freq. of the antenna lobe arranged at the bottom.

IEC-bus short command :*ILS:LLOB 150*

Note: *A variation of one of the two modulation frequencies causes an automatic adaptation of the other modulation frequency in such a way that a frequency-response ratio of 3:5 or 5:3 is maintained.*

UP/DOWN PHASE Input value of the phase between the modulation signals of the upper and lower antenna lobe. The zero point of the 150-Hz signal serves as a reference. The input is effected in degrees of the 150-Hz signal.

IEC-bus short command :*ILS:PHAS 0deg*

DEFAULT SETTING

Call the ILS-GS default setting. The default setting corresponds to the setting represented in Fig. 2-34 except for the MODE setting (= NORM). The selection of the CARRIER FREQ KNOB STEP parameter is not changed by calling this function.

IEC-bus short command :ILS:PRES

COM/ID STATE

Switching on/off an additional communication/identification signal (COM/ID-Signal).

IEC-bus short command :ILS:COM ON

COM/ID FREQUENCY

Input value of the frequency of the COM/ID signal.

IEC-bus short command :ILS:COM:FREQ 1020

COM/ID DEPTH

Input value of the AM modulation depth of the COM/ID signal.

IEC-bus short command :ILS:COM:DEPT 10PCT

DDM KNOB STEP

Selection of the variation of the DDM value via the rotary knob.

DECIMAL Decimal variation according to the current cursor position.

DEFINED Variation between the predefined DDM values:

- 0.4000
- 0.1750 (glide sector)
- 0.0910, - 0.0450
- 0.0000 (glide path)
- + 0.0450, + 0,0910
- + 0.1750 (glide sector)
- + 0.4000

CARRIER FREQ KNOB STEP

Selection of the variation of the carrier frequency via the rotary knob. The selection is effective for both ILS modulations.

DECIMAL Decimal variation according to the current cursor position.

DEFINED Variation in predefined steps according to the standardized GLIDE-SLOPE transmitting frequencies (see table).

Note: *If DEFINED is selected, the current RF frequency is automatically switched over to the next GLIDE-SLOPE transmitting frequency acc. to the table when switching on the modulation.*

LOC / GS (MHz)	LOC / GS (MHz)	LOC / GS (MHz)	LOC / GS (MHz)	LOC / GS (MHz)	LOC / GS (MHz)	LOC / GS (MHz)
108.10 / 334.70	108.70 / 330.50	109.30 / 332.00	109.90 / 333.80	110.50 / 329.60	111.10 / 331.70	111.70 / 333.50
108.15 / 334.55	108.75 / 330.35	109.35 / 331.85	109.95 / 333.65	110.55 / 329.45	111.15 / 331.55	111.75 / 333.35
108.30 / 334.10	108.90 / 329.30	109.50 / 332.60	110.10 / 334.40	110.70 / 330.20	111.30 / 332.30	111.90 / 331.10
108.35 / 333.95	108.95 / 329.15	109.55 / 332.45	110.15 / 334.25	110.75 / 330.05	111.35 / 332.15	111.95 / 330.95
108.50 / 329.90	109.10 / 331.40	109.70 / 333.20	110.30 / 335.00	110.90 / 330.80	111.50 / 332.90	
108.55 / 329.75	109.15 / 331.25	109.75 / 333.05	110.35 / 334.85	110.95 / 330.65	111.55 / 332.75	

EXT AM [SENS. 1V/100%]

Switching on/off an external modulation signal via socket EXT1.

OFF External AM input EXT1 switched off.

ON External AM input EXT1 activated.

The sensitivity is 10 mV per percent of modulation depth.

IEC-bus short command :ILS:SOUR INT2, EXT

Note: *As the automatic level monitoring of the external modulation signal is switched off in this operating mode, there can be an overmodulation as a function of the level of the external signal without a corresponding caution message being generated.*

In order to avoid an overmodulation, the peak value of the external signal is to be delimited corresponding to the sum of the modulation depths of the remaining ILS signal components.

2.6.7.3 ILS-Localizer Modulation (ILS-LOC)

- Notes:**
- The following modulations cannot be set simultaneously and deactivate one another:
ILS-LOC and AM
ILS-LOC and PM if SOURCE PM = LFGEN2
ILS-LOC and FM if SOURCE FM = LFGEN2
 - In the AM, FM, PM and LF-output menu the note "ILS-LOC" is displayed under LFGEN2 if the ILS-LOC modulation is activated.
 - With setting CARRIER FREQ KNOB STEP = DEFINED, a change to modulation ILS-GS automatically causes the RF frequency to be adapted to the glide-slope value which is coupled to the localizer setting.

Menu selection: MODULATION ILS-LOC

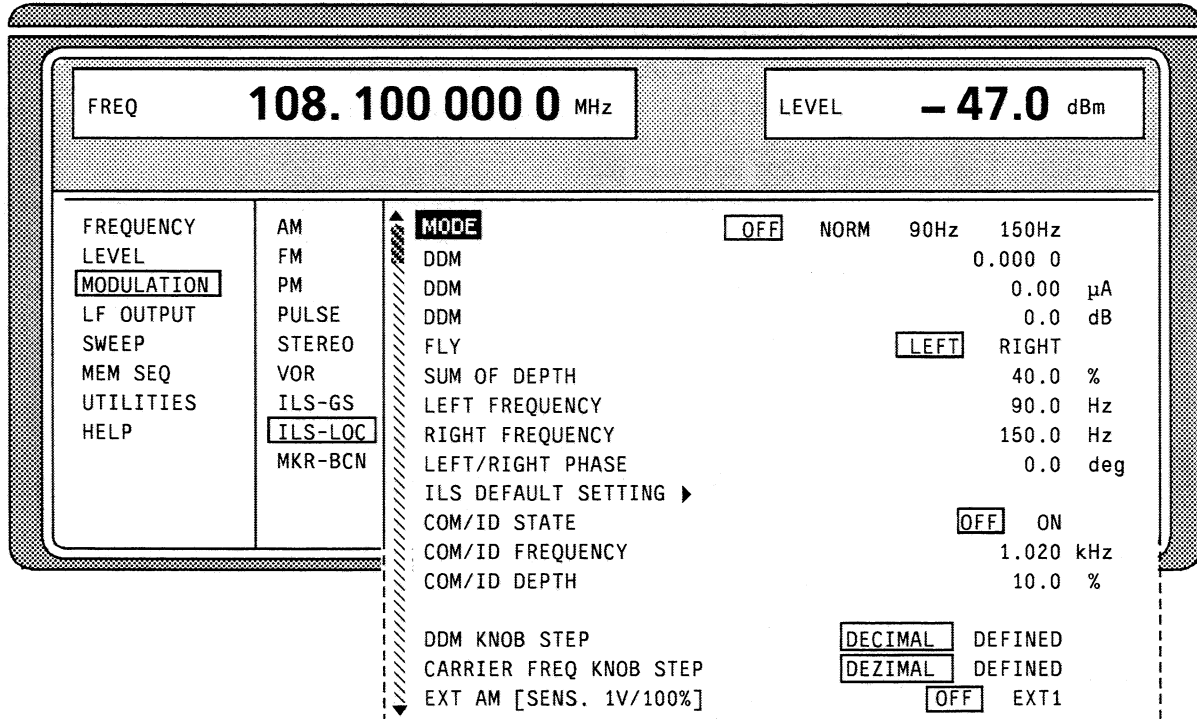

Fig. 2-35 Menu MODULATION-ILS-LOC (preset setting), fitted with option SM-B6, multifunction generator

MODE

Selection of the ILS-LOC operating mode.

OFF ILS-LOC modulation is switched off.
 In menus AM, FM, PM and LF-OUTPUT the original setting is displayed under LFGEN2, the note "ILS-LOC" is eliminated.

NORM ILS-LOC modulation is activated.

90 Hz Amplitude modulation of the output signal with the 90-Hz signal content of the ILS-LOC signal. The modulation depth of the 90-Hz signal is calculated from the settings of parameters SUM OF DEPTH (SOD) and DDM according to:

$$AM(90\text{ Hz}) = 0.5 \times (SOD + DDM \times 100\%)$$

150 Hz Amplitude modulation of the output signal with the 150-Hz signal content of the ILS-LOC signal. The modulation depth of the 150-Hz signal results from the settings of parameters SUM OF DEPTH (SOD) and DDM according to:

$$AM(150\text{ Hz}) = 0.5 \times (SOD - DDM \times 100\%)$$

IEC-bus short command :ILS:STAT ON; TYPE LOC; LOC:MODE NORM

DDM	<p><u>D</u>ifference in <u>D</u>epth of <u>M</u>odulation. Input value of the difference in depth of modulation between the 90-Hz and the 150-Hz tone of the ILS-LOC modulation signal. The DDM value is calculated according to the following formula (parameter LEFT/RIGHT = RIGHT) :</p> $\text{DDM} = [\text{AM}(90 \text{ Hz}) - \text{AM}(150 \text{ Hz})] / 100\%$ <p>If LEFT of parameter LEFT/RIGHT is selected, negative DDM values result with otherwise same setting. A variation of the DDM value automatically leads to a variation of the DDM value in dB and the value of the instrument current.</p> <p>IEC-bus short command :ILS:LOC:DDM 0</p>
DDM	<p>Input value of the current of the ILS indicating instrument corresponding to the DDM value. A variation of the value of the instrument current automatically leads to a variation of the DDM value and the DDM value in dB. The value of the instrument current is calculated according to:</p> $\text{DDM } \mu\text{A} = \text{DDM} \times 857.1 \mu\text{A}$ <p>IEC-bus short command :ILS:LOC:DDM:CURR 0</p>
DDM	<p>Input of the DDM value in dB. A variation of the DDM value in dB automatically leads to a variation of the value of the instrument current and of the DDM value. The dB value is calculated according to:</p> $\text{DDM dB} = 20 \times \text{LOG} [(\text{SOD} + \text{DDM} \times 100\%) / (\text{SOD} - \text{DDM} \times 100\%)]$ <p>IEC-bus short command :LOC:DDM:LOG 0</p>
FLY	<p>Selection between ILS-LOC operating modes LEFT and RIGHT. A change of the setting automatically changes the sign of the DDM value.</p> <p>LEFT In the LEFT operating mode, the content of the 150-Hz modulation signal is predominant. The DDM value is negative.</p> <p>RIGHT In the RIGHT operating mode, the content of the 90-Hz modulation signal is predominant. The DDM value is positive.</p> <p>IEC-bus short command :ILS:LOC:DDM:DIR LEFT</p>
SUM OF DEPTH	<p>Input value of the arithmetic sum of the modulation depths of 90-Hz and 150-Hz ILS-LOC signal contents. The RMS modulation depth depends on the phase setting of both modulation tones.</p> <p>IEC-bus short command :ILS:LOC:SOD 40PCT</p>
LEFT FREQUENCY	<p>Input value of the modulation frequency of the antenna lobe arranged at the left viewed from the plane.</p> <p>IEC-bus short command :ILS:LOC:LLOB 90</p>
RIGHT FREQUENCY	<p>Input value of the modulation frequency of the antenna lobe arranged at the right viewed from the plane.</p> <p>IEC-bus short command :ILS:LOC:RLOB 150</p> <p>Note: <i>A variation of one of the two modulation frequencies causes an automatic adaptation of the other modulation frequency in such a way that a frequency-response ratio of 3:5 or 5:3 is maintained.</i></p>
LEFT/RIGHT PHASE	<p>Input value of the phase between the modulation signals of the left-hand and right-hand antenna lobe. The zero point of the 150-Hz signal serves as a reference. The input is effected in degrees of the 150-Hz signal.</p> <p>IEC-bus short command :ILS:LOC:PHAS 0deg</p>

ILS DEFAULT SETTING	<p>Call the ILS-LOC default setting. The default setting corresponds to the setting represented in Fig. 2-35 except for the MODE setting (= NORM). The selection of the CARRIER FREQ KNOB STEP parameter is not changed by calling this function. IEC-bus short command :<i>ILS:LOC:PRES</i></p>
COM/ID STATE	<p>Switching on/off an additional communication/identification signal (COM/ID-Signal). IEC-bus short command :<i>ILS:LOC:COM ON</i></p>
COM/ID FREQUENCY	<p>Input value of the frequency of the COM/ID signal. IEC-bus short command :<i>ILS:LOC:COM:FREQ 1020</i></p>
COM/ID DEPTH	<p>Input value of the AM modulation depth of the COM/ID signal. IEC-bus short command :<i>ILS:LOC:COM:DEPT 10PCT</i></p>
DDM KNOB STEP	<p>Selection of the variation of the DDM value via the rotary knob.</p> <p>DECIMAL Decimal variation according to the current cursor position.</p> <p>DEFINED Variation between the predefined DDM values: - 0.2000, - 0.1550 (course sector) - 0.0930, - 0.0460 0.0000 (course line) + 0.0460, + 0.0930 + 0.1550 (course sector) + 0.2000</p>
CARRIER FREQ KNOB STEP	<p>Selection of the variation of the carrier frequency via the rotary knob. The selection is effective on both ILS modulations.</p> <p>DECIMAL Decimal variation according to the current cursor position.</p> <p>DEFINED Variation in predefined steps according to the standardized ILS-LOCALIZER transmitter frequencies (see table ILS-GS modulation).</p> <p>Note: <i>If DEFINED is selected, the current RF frequency is automatically switched over to the next LOCALIZER transmitter frequency according to the table when switching on the modulation.</i></p>
EXT AM [SENS. 1 V/100%]	<p>Switching on/off an external modulation signal via socket EXT1.</p> <p>OFF External AM input EXT1 switched off.</p> <p>ON External AM input EXT1 activated. The sensitivity is 10 mV per percent modulation depth. IEC-bus short command :<i>ILS:SOUR INT2, EXT</i></p> <p>Note: <i>As automatic level monitoring of the external modulation signal is switched off in this operating mode, there can be an overmodulation as a function of the level of the external signal without a corresponding caution message being generated. In order to avoid an overmodulation, the peak value of the external signal is to be delimited corresponding to the sum of the modulation depths of the remaining ILS signal components.</i></p>

2.6.7.4 Marker Beacon

- Notes:**
- The following modulations cannot be set simultaneously and deactivate one another:
 MKR-BCN and AM, MKR-BCN and PM if SOURCE PM = LFGEN2
 MKR-BCN and FM if SOURCE FM = LFGEN2
 - In the AM, FM, PM and LF-output menu the note "MKR-BCN" is displayed under LFGEN2 if the MKR-BCN modulation is activated.

Menu selection: MODULATION-MKR-BCN

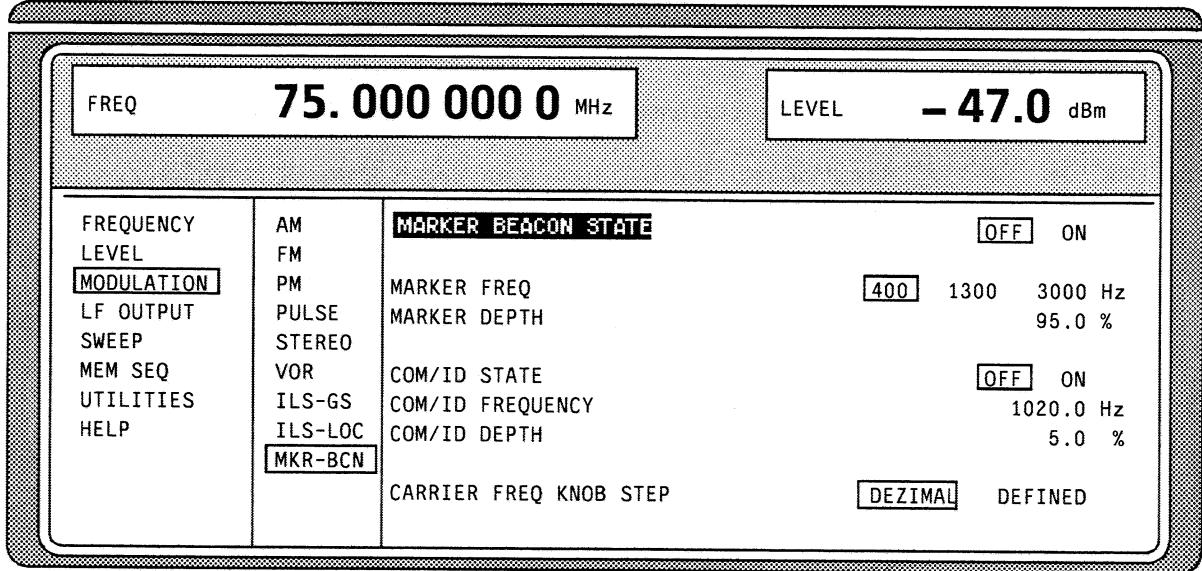

Fig. 2-36 Menu MODULATION-MKR-BCN (preset settings), fitted with option SM-B6, multifunction generator.

- MARKER BEACON STATE** Switching on and off the marker-beacon signal.
 IEC-bus short command :*MBE:STAT ON*
- MARKER FREQ** Selection of the frequency of the marker-beacon signal.
 IEC-bus short command :*MBE:FREQ 400*
- MARKER DEPTH** Input value of the modulation depth of the marker-beacon signal.
 IEC-bus short command :*MBE:DEPT 95PCT*
- COM/ID STATE** Switching on and off an additional communication/identification signal (COM/ID signal).
 IEC-bus short command :*MBE:COM ON*
- COM/ID FREQUENCY** Input value of the frequency of the COM/ID signal.
 IEC-bus short command :*MBE:COM:FREQ 1020*
- COM/ID DEPTH** Input value of the AM modulation depth of the COM/ID signal.
 IEC-bus short command :*MBE:COM:DEPT 5PCT*
- CARRIER FREQ KNOB STEP** Selection of the variation of the carrier frequency via the rotary knob.
 DECIMAL Decimal variation according to the current cursor position.
 DEFINED Variation in predefined steps according to the standardized marker beacon transmitter frequencies (s. table, value in MHz).
- Note:** If *DEFINED* is selected, the current RF frequency is automatically switched over to the next marker beacon transmitter frequency when switching on the modulation.

74.600	75.675	74.750	74.825	74.900	74.975	75.050	75.125	75.200	75.275	75.350
74.625	74.700	74.775	74.850	74.925	75.000	75.075	75.150	75.225	75.300	75.375
74.650	74.725	74.800	74.875	74.950	75.025	75.100	75.175	75.250	75.325	75.400

2.7 LF-Output

Depending on which options are fitted (cf. table 2-4), internal LF generator 1 and/or 2 are available as a signal source for the LF output.

Menu LF OUTPUT offers access to the settings of the LF output.

- Notes:**
- An alteration of the waveform or frequency of the internal modulation generators in the LF-output menu has a parallel effect on the modulation for which the respective generator has been selected as modulation source.
 - The SWEEP function of LF generator 2 can be activated in menu SWEEP-LF-GEN2.
 - Key [G/n] dB μ V switches the unit of the display / LF level output voltage setting to dBu.

Menu selection: LF OUTPUT

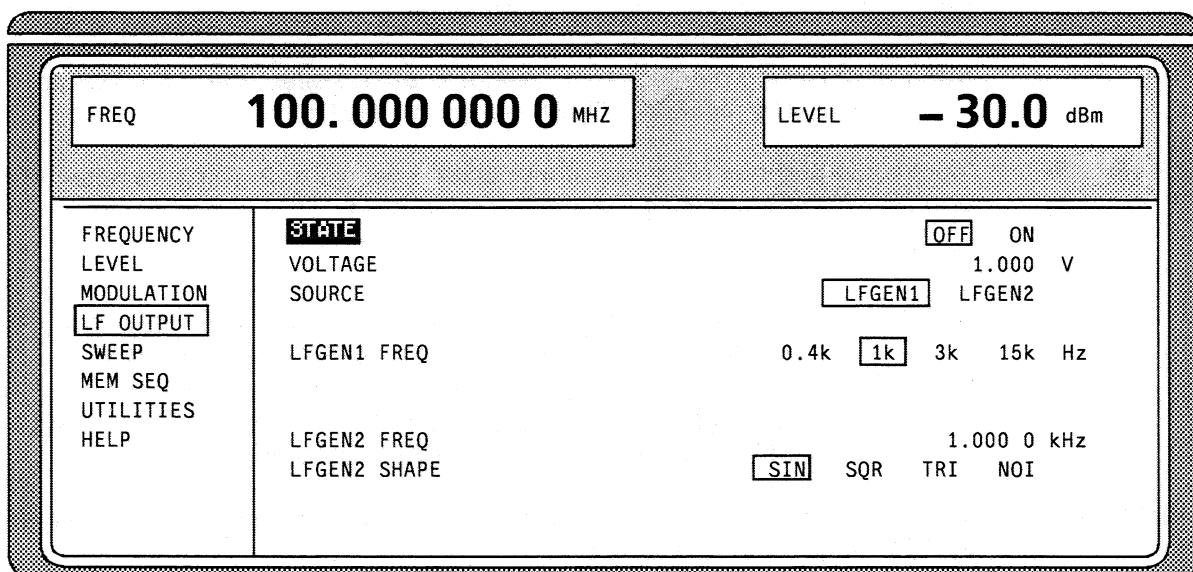

Fig. 2-37 Menu LF OUTPUT (preset setting), fitted with option SM-B6, multifunction generator

STATE Switching on/off the LF output. Parameter LF STATE has no influence on the modulation settings.

IEC-bus short command :OUTP2 ON

VOLTAGE Input value of the output voltage of the LF output. The input is effected in the form of a peak voltage. If no LF generator option is fitted, the constant output voltage of the standard generator ($V_S = 1\text{ V}$) is indicated.

IEC-bus short command :OUTP2: VOLT 1V

Notes: If LF generator 2 (LFGEN2) is selected as source and

- STEREO operating mode is activated, the voltage of the LF output depends on the setting of the wanted and the pilot deviation and cannot be changed in this menu. The output voltage is 6 dBu (1.55 V_{RMS} at 600 Ω) per 40 kHz of set sum deviation. The following is displayed:

VOLTAGE (STEREO) 6dBu / 40 kHz

- one of operating modes VOR, ILS-GS or ILS-LOC is activated, the input of the output voltage of the LF output is effected relative to the set sum modulation depth. The following is displayed, e.g. in the case of VOR modulation:

VOLTAGE (VOR/ILS) per 100% DEPTH 1.000 V

LF SOURCE	<p>Selection of the signal source for the LF output.</p> <p>IEC-bus short command :<i>OUTP2:SOUR 0</i> (Selection of LF generator 1) :OUTP2:SOUR 2 (Selection of LF generator 2)</p>
LFGEN1 FREQ	<p>Input value of the frequency of internal modulation generator 1.</p> <p>IEC-bus short command :<i>SOUR0:FREQ 1kHz</i></p>
LFGEN1 SHAPE	<p>Input value of the signal shape for modulation generator 1. The signal shape of modulation generator 1 can only be set if two modulation generator options are fitted.</p> <p>IEC-bus short command :<i>SOUR0:FUNC SIN</i></p>
LFGEN2 FREQ	<p>Input value of the frequency of internal modulation generator 2. This parameter is only displayed if a modulation generator option is fitted.</p> <p>IEC-bus short command :<i>SOUR2:FREQ 1kHz</i></p> <p><i>Note: In operating modes Stereo, VOR, ILS.. or LF-Sweep, the value indication is replaced by "STEREO", "VOR", "ILS.." or "SWEEP".</i></p>
LFGEN2 SHAPE	<p>Input value of the signal shape of modulation generator 2. This parameter is only displayed if a modulation generator option is fitted.</p> <p>IEC-bus short command :<i>SOUR2:FUNC SIN</i></p> <p>Notes:</p> <ul style="list-style-type: none"> - A selection of signal shape NOI in the LF-SWEEP operating mode automatically leads to this operating mode being aborted. - In operating modes STEREO, VOR, ILS.. an indication of this parameter is eliminated. Instead, a selection between STEREO OUTPUT MPX and PILOT is possible (see below).
STEREO OUTPUT	<p>Selection of the stereo signal at the LF output. This parameter is only displayed if STEREO modulation is activated.</p> <p>MPX Output of the complete STEREO-MPX signal.</p> <p>PILOT Output of the pilot tone.</p> <p>IEC-bus short commands :<i>STER:STAT ON;</i> :<i>OUTP2:SOUR 2;</i> :<i>OUTP2:STER MPX</i></p>

2.8 Sweep

The SMT offers a digital step-by-step sweep for parameters:

- RF frequency
- LF frequency
- RF level

In addition to the digital step-by-step sweep, an analog sweep for RF frequency and RF level is possible by switching on frequency or amplitude modulation with an internal saw tooth.

Setting a sweep is effected in five basic steps which are shown in the following example, the setting of a frequency sweep:

1. Set sweep range (START and STOP or CENTER and SPAN).
2. Select linear or logarithmic sequence (SPACING).
3. Set step width (STEP) and dwell time (DWELL).
4. Activate marker if desired (MARKER).
5. Switch on sweep (MODE set to AUTO, SINGLE or STEP).

2.8.1 Setting the Sweep Range (START, STOP, CENTER and SPAN)

The sweep range of the RF sweep can be entered in two different ways. Either by entering the START and STOP value or by entering CENTER and SPAN. Please observe that the two parameter sets influence one another. The influence is exerted in the following way:

- START frequency altered:
STOP = unaltered
CENTER = $(START + STOP)/2$
SPAN = $(STOP - START)$
- STOP frequency altered:
START = unaltered
CENTER = $(START + STOP)/2$
SPAN = $(STOP - START)$
- CENTER frequency altered:
SPAN = unaltered
START = $(CENTER - SPAN/2)$
STOP = $(CENTER + SPAN/2)$
- SPAN frequency altered:
CENTER = unaltered
START = $(CENTER - SPAN/2)$
STOP = $(CENTER + SPAN/2)$

2.8.2 Selecting the Sweep Run (SPACING LIN, LOG)

The sweep run, linear or logarithmic, can be selected using SPACING. For the RF and LF sweep, a linear or logarithmic run is possible. For level sweep, only the logarithmic run is possible.

With the logarithmic sweep, step width STEP is equal to a constant fraction of the present setting. The logarithmic step width is entered in unit % with RF or LF sweep, in unit dB with level sweep.

2.8.3 Operating Modes (MODE)

The following operating modes are available:

AUTO	<p>Sweep from the starting point to the stop point, with automatic restart at the starting point. If another sweep operating mode was activated prior to the AUTO operating mode, continuation is made from the current sweep setting (cf. Fig. 2-38). IEC-bus short commands:</p> <table border="0"> <tr> <td>RF sweep:</td> <td>LF sweep:</td> <td>Level sweep:</td> </tr> <tr> <td><i>FREQ:MODE SWE</i></td> <td><i>SOUR2:FREQ:MODE SWE</i></td> <td><i>POW:MODE SWE</i></td> </tr> <tr> <td><i>SWE:MODE AUTO</i></td> <td><i>SOUR2:SWE:MODE AUTO</i></td> <td><i>SWE:POW:MODE AUTO</i></td> </tr> <tr> <td><i>TRIG:SOUR AUTO</i></td> <td><i>TRIG2:SOUR AUTO</i></td> <td><i>TRIG:SOUR AUTO</i></td> </tr> </table>	RF sweep:	LF sweep:	Level sweep:	<i>FREQ:MODE SWE</i>	<i>SOUR2:FREQ:MODE SWE</i>	<i>POW:MODE SWE</i>	<i>SWE:MODE AUTO</i>	<i>SOUR2:SWE:MODE AUTO</i>	<i>SWE:POW:MODE AUTO</i>	<i>TRIG:SOUR AUTO</i>	<i>TRIG2:SOUR AUTO</i>	<i>TRIG:SOUR AUTO</i>
RF sweep:	LF sweep:	Level sweep:											
<i>FREQ:MODE SWE</i>	<i>SOUR2:FREQ:MODE SWE</i>	<i>POW:MODE SWE</i>											
<i>SWE:MODE AUTO</i>	<i>SOUR2:SWE:MODE AUTO</i>	<i>SWE:POW:MODE AUTO</i>											
<i>TRIG:SOUR AUTO</i>	<i>TRIG2:SOUR AUTO</i>	<i>TRIG:SOUR AUTO</i>											
SINGLE	<p>Single run from the starting point to the stop point. If SINGLE is selected, the run is not started yet. Function EXECUTE SINGLE SWEEP ▶ to be executed, which can be used to start the run, is displayed below the MODE line (cf. Fig. 2-39). IEC-bus short commands:</p> <table border="0"> <tr> <td>RF sweep:</td> <td>LF sweep:</td> <td>Level sweep:</td> </tr> <tr> <td><i>FREQ:MODE SWE</i></td> <td><i>SOUR2:FREQ:MODE SWE</i></td> <td><i>POW:MODE SWE</i></td> </tr> <tr> <td><i>SWE:MODE AUTO</i></td> <td><i>SOUR2:SWE:MODE AUTO</i></td> <td><i>SWE:POW:MODE AUTO</i></td> </tr> <tr> <td><i>TRIG:SOUR SING</i></td> <td><i>TRIG2:SOUR SING</i></td> <td><i>TRIG:SOUR SING</i></td> </tr> </table>	RF sweep:	LF sweep:	Level sweep:	<i>FREQ:MODE SWE</i>	<i>SOUR2:FREQ:MODE SWE</i>	<i>POW:MODE SWE</i>	<i>SWE:MODE AUTO</i>	<i>SOUR2:SWE:MODE AUTO</i>	<i>SWE:POW:MODE AUTO</i>	<i>TRIG:SOUR SING</i>	<i>TRIG2:SOUR SING</i>	<i>TRIG:SOUR SING</i>
RF sweep:	LF sweep:	Level sweep:											
<i>FREQ:MODE SWE</i>	<i>SOUR2:FREQ:MODE SWE</i>	<i>POW:MODE SWE</i>											
<i>SWE:MODE AUTO</i>	<i>SOUR2:SWE:MODE AUTO</i>	<i>SWE:POW:MODE AUTO</i>											
<i>TRIG:SOUR SING</i>	<i>TRIG2:SOUR SING</i>	<i>TRIG:SOUR SING</i>											
STEP	<p>Step-by-step, manual run within the sweep limits. Activating STEP stops a running sweep and the cursor wraps to the indication value of CURRENT. The sweep run can now be controlled upwards or downwards in discrete steps using the rotary knob or the numeric keys. IEC-bus short commands:</p> <table border="0"> <tr> <td>RF sweep:</td> <td>LF sweep:</td> <td>Level sweep:</td> </tr> <tr> <td><i>FREQ:MODE SWE</i></td> <td><i>SOUR2:FREQ:MODE SWE</i></td> <td><i>POW:MODE SWE</i></td> </tr> <tr> <td><i>SWE:MODE STEP</i></td> <td><i>SOUR2:SWE:MODE STEP</i></td> <td><i>SWE:POW:MODE STEP</i></td> </tr> <tr> <td><i>TRIG:SOUR SING</i></td> <td><i>TRIG2:SOUR SING</i></td> <td><i>TRIG:SOUR SING</i></td> </tr> </table>	RF sweep:	LF sweep:	Level sweep:	<i>FREQ:MODE SWE</i>	<i>SOUR2:FREQ:MODE SWE</i>	<i>POW:MODE SWE</i>	<i>SWE:MODE STEP</i>	<i>SOUR2:SWE:MODE STEP</i>	<i>SWE:POW:MODE STEP</i>	<i>TRIG:SOUR SING</i>	<i>TRIG2:SOUR SING</i>	<i>TRIG:SOUR SING</i>
RF sweep:	LF sweep:	Level sweep:											
<i>FREQ:MODE SWE</i>	<i>SOUR2:FREQ:MODE SWE</i>	<i>POW:MODE SWE</i>											
<i>SWE:MODE STEP</i>	<i>SOUR2:SWE:MODE STEP</i>	<i>SWE:POW:MODE STEP</i>											
<i>TRIG:SOUR SING</i>	<i>TRIG2:SOUR SING</i>	<i>TRIG:SOUR SING</i>											
EXT-SINGLE	<p>Single run from the starting point to the stop point as in the case of SINGLE, but triggered by an external trigger signal. IEC-bus short commands:</p> <table border="0"> <tr> <td>RF sweep:</td> <td>LF sweep:</td> <td>Level sweep:</td> </tr> <tr> <td><i>FREQ:MODE SWE</i></td> <td><i>SOUR2:FREQ:MODE SWE</i></td> <td><i>POW:MODE SWE</i></td> </tr> <tr> <td><i>SWE:MODE AUTO</i></td> <td><i>SOUR2:SWE:MODE AUTO</i></td> <td><i>SWE:POW:MODE AUTO</i></td> </tr> <tr> <td><i>TRIG:SOUR EXT</i></td> <td><i>TRIG2:SOUR EXT</i></td> <td><i>TRIG:SOUR EXT</i></td> </tr> </table>	RF sweep:	LF sweep:	Level sweep:	<i>FREQ:MODE SWE</i>	<i>SOUR2:FREQ:MODE SWE</i>	<i>POW:MODE SWE</i>	<i>SWE:MODE AUTO</i>	<i>SOUR2:SWE:MODE AUTO</i>	<i>SWE:POW:MODE AUTO</i>	<i>TRIG:SOUR EXT</i>	<i>TRIG2:SOUR EXT</i>	<i>TRIG:SOUR EXT</i>
RF sweep:	LF sweep:	Level sweep:											
<i>FREQ:MODE SWE</i>	<i>SOUR2:FREQ:MODE SWE</i>	<i>POW:MODE SWE</i>											
<i>SWE:MODE AUTO</i>	<i>SOUR2:SWE:MODE AUTO</i>	<i>SWE:POW:MODE AUTO</i>											
<i>TRIG:SOUR EXT</i>	<i>TRIG2:SOUR EXT</i>	<i>TRIG:SOUR EXT</i>											
EXT-STEP	<p>Step-by-step run by means of the external trigger signal. Each trigger event triggers a single step. IEC-bus short commands:</p> <table border="0"> <tr> <td>RF sweep:</td> <td>LF sweep:</td> <td>Level sweep:</td> </tr> <tr> <td><i>FREQ:MODE SWE</i></td> <td><i>SOUR2:FREQ:MODE SWE</i></td> <td><i>POW:MODE SWE</i></td> </tr> <tr> <td><i>SWE:MODE STEP</i></td> <td><i>SOUR2:SWE:MODE STEP</i></td> <td><i>SWE:POW:MODE STEP</i></td> </tr> <tr> <td><i>TRIG:SOUR EXT</i></td> <td><i>TRIG2:SOUR EXT</i></td> <td><i>TRIG:SOUR EXT</i></td> </tr> </table>	RF sweep:	LF sweep:	Level sweep:	<i>FREQ:MODE SWE</i>	<i>SOUR2:FREQ:MODE SWE</i>	<i>POW:MODE SWE</i>	<i>SWE:MODE STEP</i>	<i>SOUR2:SWE:MODE STEP</i>	<i>SWE:POW:MODE STEP</i>	<i>TRIG:SOUR EXT</i>	<i>TRIG2:SOUR EXT</i>	<i>TRIG:SOUR EXT</i>
RF sweep:	LF sweep:	Level sweep:											
<i>FREQ:MODE SWE</i>	<i>SOUR2:FREQ:MODE SWE</i>	<i>POW:MODE SWE</i>											
<i>SWE:MODE STEP</i>	<i>SOUR2:SWE:MODE STEP</i>	<i>SWE:POW:MODE STEP</i>											
<i>TRIG:SOUR EXT</i>	<i>TRIG2:SOUR EXT</i>	<i>TRIG:SOUR EXT</i>											
OFF	<p>The sweep operating mode is switched off. IEC-bus short commands:</p> <table border="0"> <tr> <td>RF sweep:</td> <td>LF sweep:</td> <td>Level sweep:</td> </tr> <tr> <td><i>FREQ:MODE CW</i></td> <td><i>SOUR2:FREQ:MODE CW</i></td> <td><i>POW:MODE CW</i></td> </tr> </table>	RF sweep:	LF sweep:	Level sweep:	<i>FREQ:MODE CW</i>	<i>SOUR2:FREQ:MODE CW</i>	<i>POW:MODE CW</i>						
RF sweep:	LF sweep:	Level sweep:											
<i>FREQ:MODE CW</i>	<i>SOUR2:FREQ:MODE CW</i>	<i>POW:MODE CW</i>											

2.8.4 Trigger Input

An external signal at the rear input triggers the sweep in the EXT-SINGLE and EXT-STEP operating modes. The polarity of the active trigger edge can be set in menu UTILITIES - AUX I/O EXT TRIG SLOPE .

2.8.5 Sweep Outputs

Outputs X-AXIS, BLANK and MARKER are available at the rear of the instrument to control and trigger oscilloscopes or XY recorders.

X-AXIS With sweep switched on, this output supplies a voltage ramp of 0...10 V for the X-deflection of an oscilloscope or an XY recorder.

BLANK This output supplies a signal (0V/5V) to trigger and blank an oscilloscope or for the PEN LIFT control of an XY recorder. The polarity and the period of the signal can be set under UTILITIES - AUX I/O - BLANK POLARITY and - BLANK TIME.

MARKER This output becomes active when the sweep run has reached the mark. The MARKER signal can be used for the brightness control of an oscilloscope. Up to three marks can be set in order to mark certain positions in the sweep run. The polarity of the signal can be set in menu UTILITIES - AUX I/O - MARKER POLARITY. The period of the active signal is equal to the dwell time (DWELL) of a step.

Signal examples:

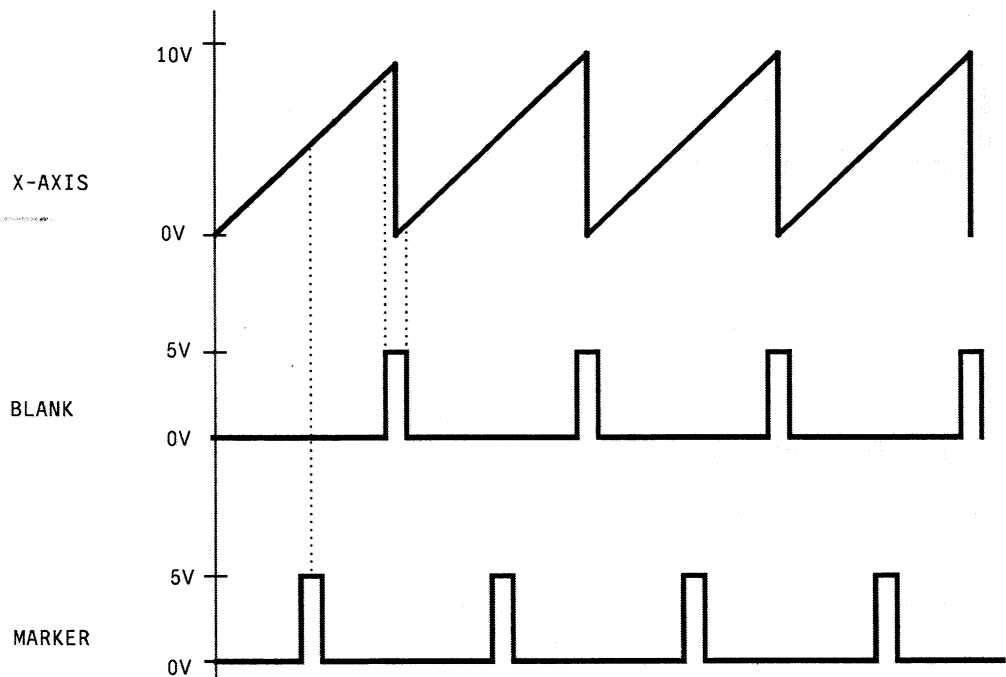

Fig. 2-38 Signal example sweep: MODE = AUTO, BLANK TIME = NORMAL

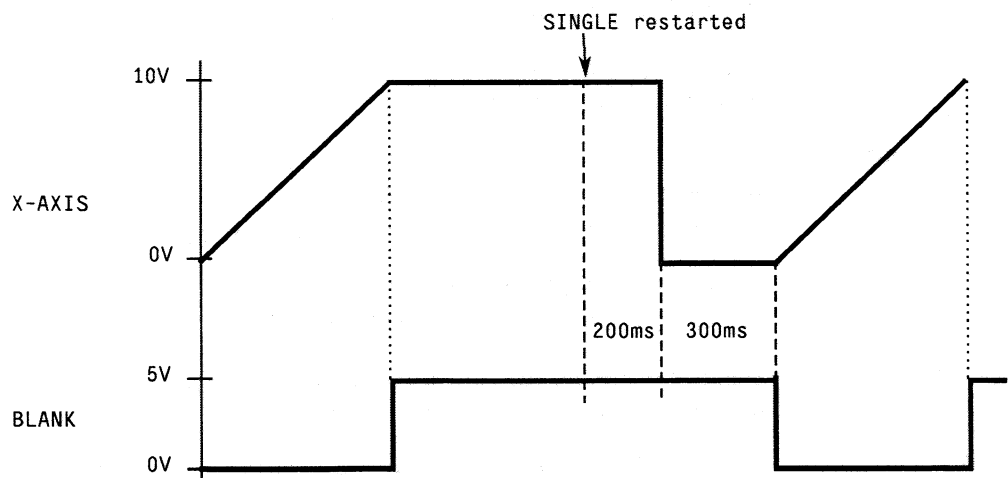

Fig. 2-39 Signal example sweep: MODE = SINGLE, BLANK TIME = LONG

2.8.6 RF-Sweep

Menu SWEEP - FREQ offers access to settings for RF sweep.

Menu selection: SWEEP - FREQ

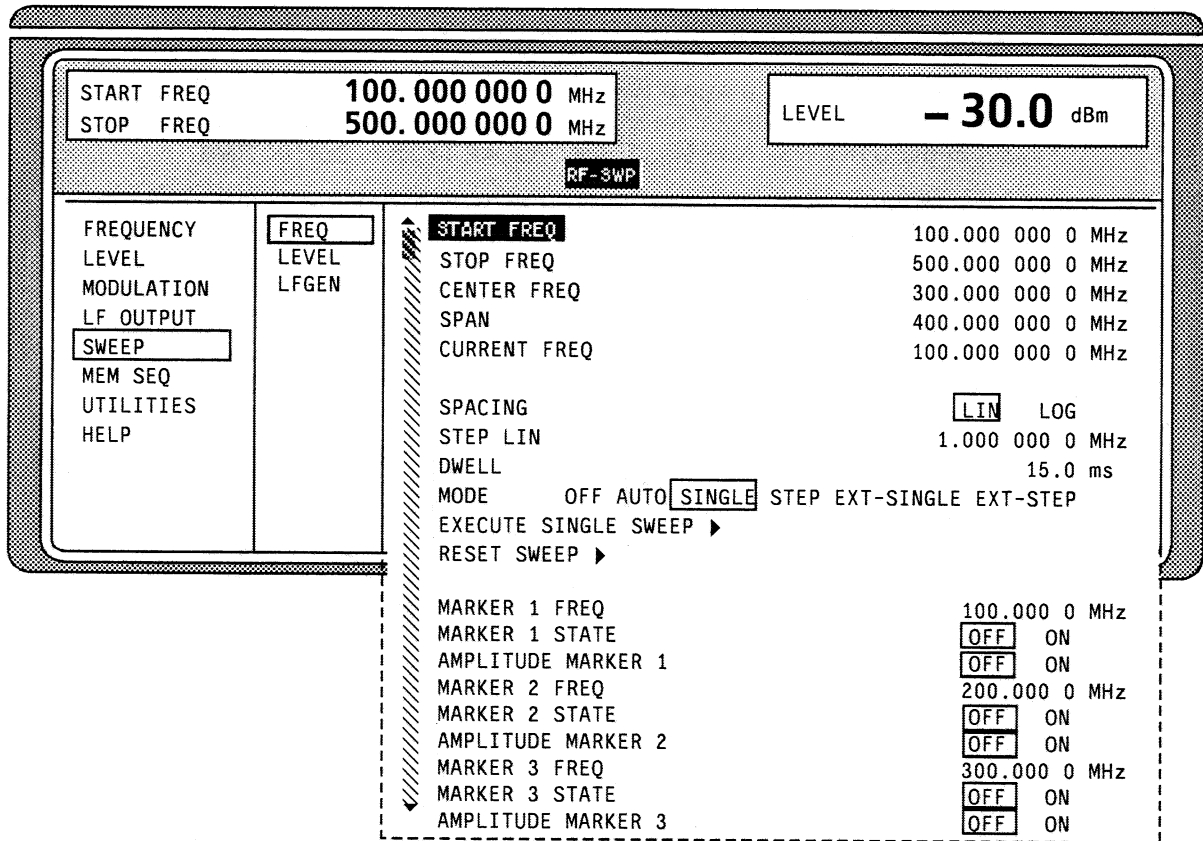

Fig. 2-40 Menu SWEEP - FREQ

- START FREQ** Input value of the starting frequency.
IEC-bus short command :FREQ:STAR 100MHz
- STOP FREQ** Input value of the stop frequency.
IEC-bus short command :FREQ:STOP 500MHz
- CENTER FREQ** Input value of the center frequency.
IEC-bus short command :FREQ:CENT 300MHz
- SPAN** Input value of the span.
IEC-bus short command :FREQ:SPAN 100MHz
- CURRENT FREQ** Indication of the current frequency value.
Operating mode STEP: Input value of frequency.
- STEP LIN (LOG)** Input value of the step width. Depending on whether SPACING LIN or LOG is selected, STEP LIN or LOG is displayed.
IEC-bus short command :SWE:STEP:LIN 1MHz
- DWELL** Input value of the dwell time per step
IEC-bus short command :SWE:DWEL 10ms
- SPACING** Selection of the sweep run, linear or logarithmic.
IEC-bus short command :SWE:SPAC LIN
- MODE** Selection of the sweep operating mode (cf. Section 2.8.3).
IEC-bus short command :FREQ:MODE SWE; :SWE:MODE AUTO
:TRIG:SOUR SING

- EXECUTE SINGLE SWEEP ▶** Starts a single sweep run. This action to be executed is only indicated and is only effective if MODE SINGLE has been selected.
IEC-bus short command :TRIG
- RESET ▶** Sets the starting frequency.
IEC-bus short command :ABOR
- MARKER 1 FREQ**
MARKER 2 FREQ
MARKER 3 FREQ Input value of the frequency for the marker selected.
IEC-bus short command :MARK1:FREQ 100MHZ
- MARKER 1 STATE**
MARKER 2 STATE
MARKER 3 STATE Switching on/off the marker selected.
IEC-bus short command :MARK1 OFF
- AMPLITUDE MARKER 1**
AMPLITUDE MARKER 2
AMPLITUDE MARKER 3 Switching on/off the amplitude marker selected.
OFF Amplitude marker is switched off.
ON Amplitude marker is switched on. On reaching the mark the output level is reduced by 1 dB.
IEC-bus short command :MARK1:AMPL OFF

2.8.7 LEVEL Sweep

Menu SWEEP - LEVEL offers access to settings for LEVEL sweep.

Menu selection: SWEEP - LEVEL

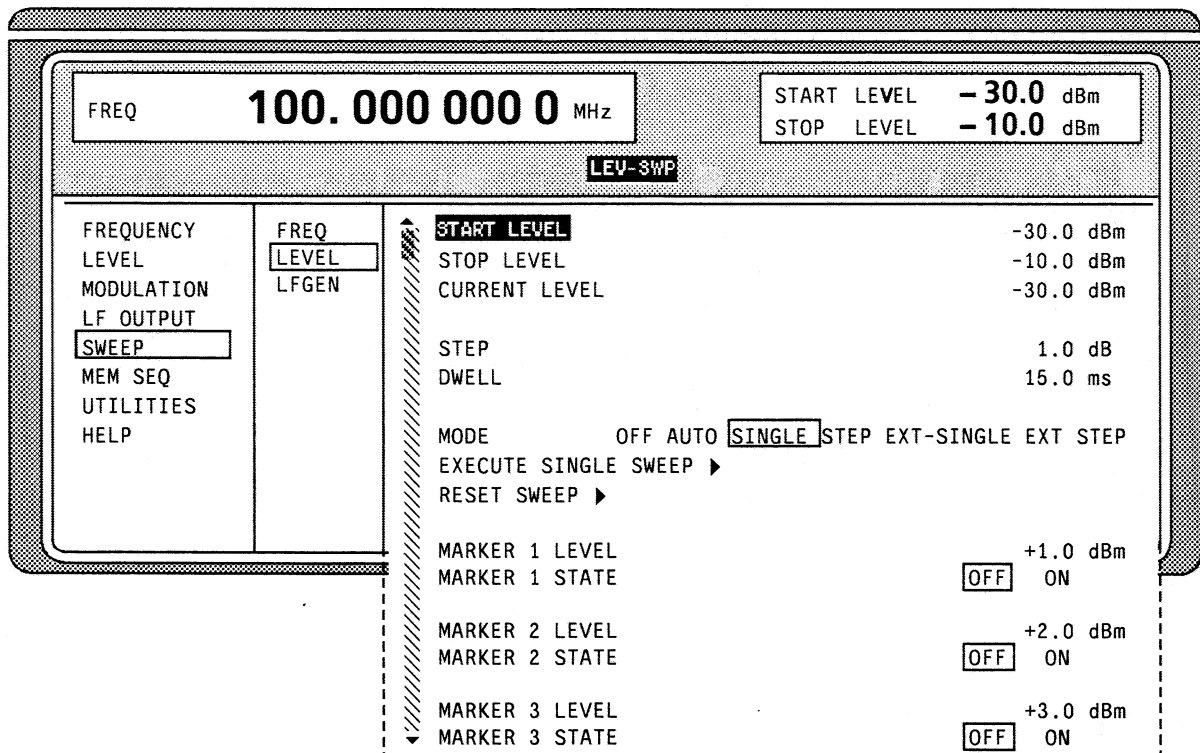

Fig. 2-41 Menu SWEEP - LEVEL

- START LEVEL** Input value of the starting level.
IEC-bus short command :POW:STAR -30DBM
- STOP LEVEL** Input value of the stop level.
IEC-bus short command :POW:STOP -10DBM

CURRENT LEVEL	Indication of the current level Operating mode STEP: Input value of level.
STEP	Input value of the step width. IEC-bus short command :SWE:POW:STEP 1DB
DWELL	Input value of the dwell time per step. IEC-bus short command :SWE:POW:DWEL 10ms
MODE	Selection of the sweep operating mode (cf. Section 2.8.3). IEC-bus short command :POW:MODE SWE; :SWE:POW:MODE AUTO; :TRIG:SOUR SING
EXECUTE SINGLE SWEEP ▶	Starts a single sweep run. This action to be executed is only indicated and is only effective if MODE SINGLE is selected. IEC-bus short command :TRIG
RESET ▶	Sets the starting level. IEC-bus short command :ABOR
MARKER 1 LEVEL MARKER 2 LEVEL MARKER 3 LEVEL	Input value of the level for the marker selected. IEC-bus short command :MARK1:PSW:POW 0dBm
MARKER 1 STATE MARKER 2 STATE MARKER 3 STATE	Switching on/off the marker selected. IEC-bus short command :MARK1:PSW OFF

2.8.8 LF-Sweep

Menu SWEEP - LF GEN2 offers access to settings for LF sweep.

Note: Settings LF SWEEP and SOURCE LFGEN2 SHAPE NOI deactivate one another.

Menu selection: SWEEP - LF GEN2

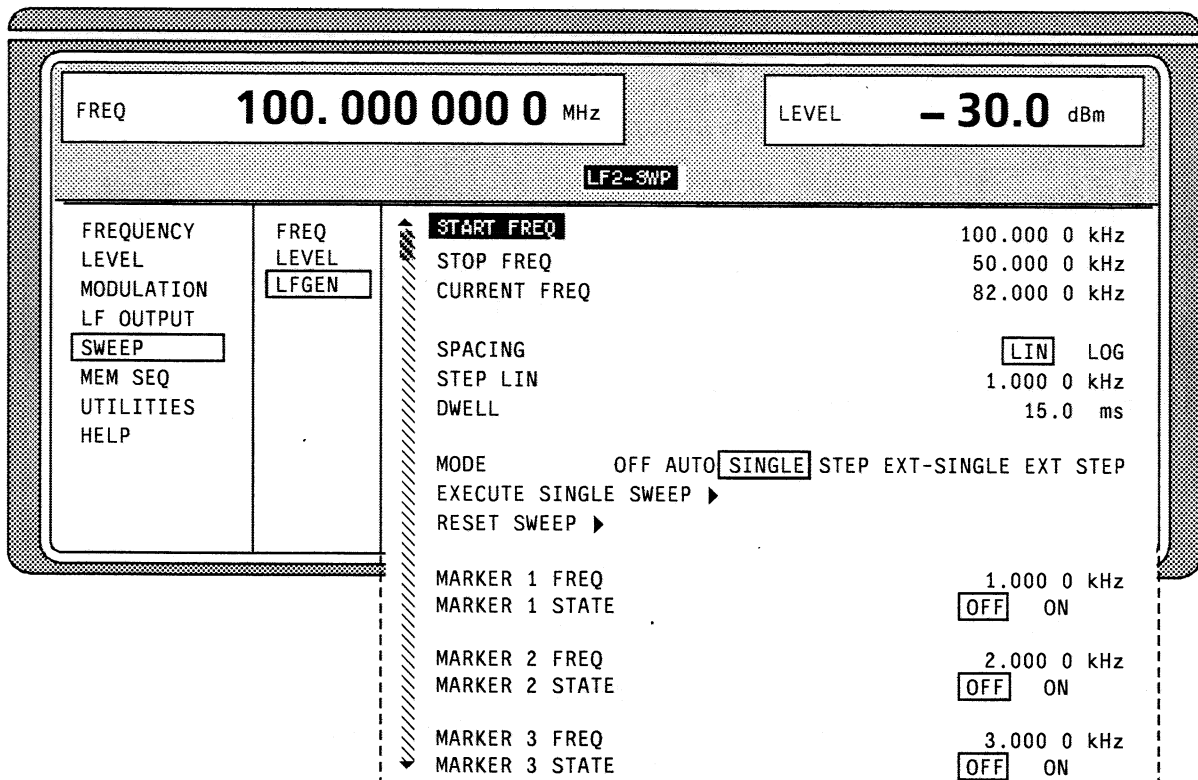

Fig. 2-42 Menu SWEEP - LF GEN

START FREQ	Input value of the starting frequency. IEC-bus short command : <i>SOUR2:FREQ:STAR 100kHz</i>
STOP FREQ	Input value of the stop frequency. IEC-bus short command : <i>SOUR2:FREQ:STOP 50kHz</i>
CURRENT FREQ	Indication of the current frequency value. Operating mode STEP: Input value of frequency.
STEP	Input value of the step width. IEC-bus short command : <i>SOUR2:SWE:STEP:LIN 1kHz</i>
DWELL	Input value of the dwell time per step. IEC-bus short command : <i>SOUR2:SWE:DWEL 10ms</i>
SPACING	Selection of the sweep run, linear or logarithmic. IEC-bus short command : <i>SOUR2:SWE:SPAC LIN</i>
MODE	Selection of the sweep operating mode (cf. Section 2.8.3). IEC-bus short command : <i>SOUR2:SWE:MODE AUTO; :TRIG:SOUR SING</i>
EXECUTE SINGLE SWEEP ▶	Starts a single sweep run. This action to be executed is only indicated and is only effective if MODE SINGLE is selected. IEC-bus short command : <i>TRIG</i>
RESET SWEEP ▶	Sets the starting frequency. IEC-bus short command : <i>ABOR</i>
MARKER 1 FREQ MARKER 2 FREQ MARKER 3 FREQ	Input value of the frequency for the marker selected. IEC-bus short command : <i>SOUR2:MARK1:FREQ 1kHz</i>
MARKER 1 STATE MARKER 2 STATE MARKER 3 STATE	Switching on/off the marker selected, IEC-bus short command : <i>SOUR2:MARK1 OFF</i>

2.9 Memory Sequence

In the memory-sequence operating mode the instrument automatically services a list with stored instrument settings. Memory locations 1 to 50, which are loaded using SAVE and whose stored settings are called either separately using RECALL or automatically and subsequently in the SEQUENCE mode, are available.

The list is continuously serviced from the beginning to the end with a continual index. The order of the memories to be passed through is arbitrary. Each setting can be assigned a freely selectable dwell time. The dwell time determines the duration of the setting, its minimal value is 50 ms, its maximal value 60 sec.

The list is divided up into 3 columns for list index, memory location number (Memory) and dwell time (Dwell). The beginning of the list has index 1.

Table 2-5 MEMORY SEQUENCE; Example of a list

Index	Memory	Dwell
001	09	50.0 ms
002	02	50.0 ms
003	01	75.0 ms
004	10	75.0 ms
...

Up to 10 sequence lists can be created. The total number of possible list elements is maximally 256. I.e., a list can have 256 entries at the most, or less if several lists have been created.

Each list is identified by a separate name and selected via this name. A detailed description how to process the lists can be found in Section 2.2.4, List Editor.

Note: *Frequently changing the level in the operating mode MEMORY SEQUENCE can stress the mechanically switched attenuator. The attenuator is also actuated when AM is switched on or off. For this reason we recommend that you make use of the non-interrupting level setting as much as possible and that you use the setting AM 0% instead of switching AM off.*

Operating Modes (MODE)

The following operating modes are available:

AUTO Run from the beginning to the end of the list with automatic restart at the beginning. If another mode was activated prior to the AUTO operating mode, continuation is made from the current index.

IEC-bus short commands `SYST:MODE MSEQ; :SYST:MSEQ:MODE AUTO`
`TRIG:MSEQ:SOUR AUTO`

SINGLE Single run from the beginning to the end of the list. If SINGLE is selected, the run is not yet started. Below the MODE line, function EXECUTE SINGLE SEQUENCE ▶ to be executed is displayed which can be used to start the run.

IEC-bus short commands `SYST:MODE MSEQ; :SYST:MSEQ:MODE AUTO`
`TRIG:MSEQ:SOUR SING`

- EXECUTE SINGLE SEQUENCE ▶** Starts the single run of a memory sequence. This menu option is only visible if **MODE SINGLE** is selected.
IEC-bus short command :*TRIG:MSEQ*

- RESET ▶** Wrap to the beginning of the list.
IEC-bus short command :*ABOR:MSEQ*

- CURRENT INDEX** Indication of the current list index. Setting value of the current list index in the **MODE STEP** operating mode.

- SELECT LIST...** Selection of a list or generation of a new list (cf. Section 2.2.4, List Editor).
IEC-bus short command :*SYST:MSEQ:SEL "MSEQ1"*

- DELETE LIST...** Deletion of a list (cf. Section 2.2.4, List Editor).
IEC-bus short command :*SYST:MSEQ:DEL "MSEQ2"*

- FUNCTION** Selection of the editor functions to process the selected list (cf. Section 2.2.4, List Editor).
IEC-bus short command :*SYST:MSEQ 2, 4...; DWEL 50ms, 60ms...*

The second page of menu **MEM SEQ**, the **EDIT** page, is automatically activated if one of the editor functions of the **FUNCTION** line is selected. The list which is entered as **CURRENT LIST** in the **SELECT LIST** line is shown.

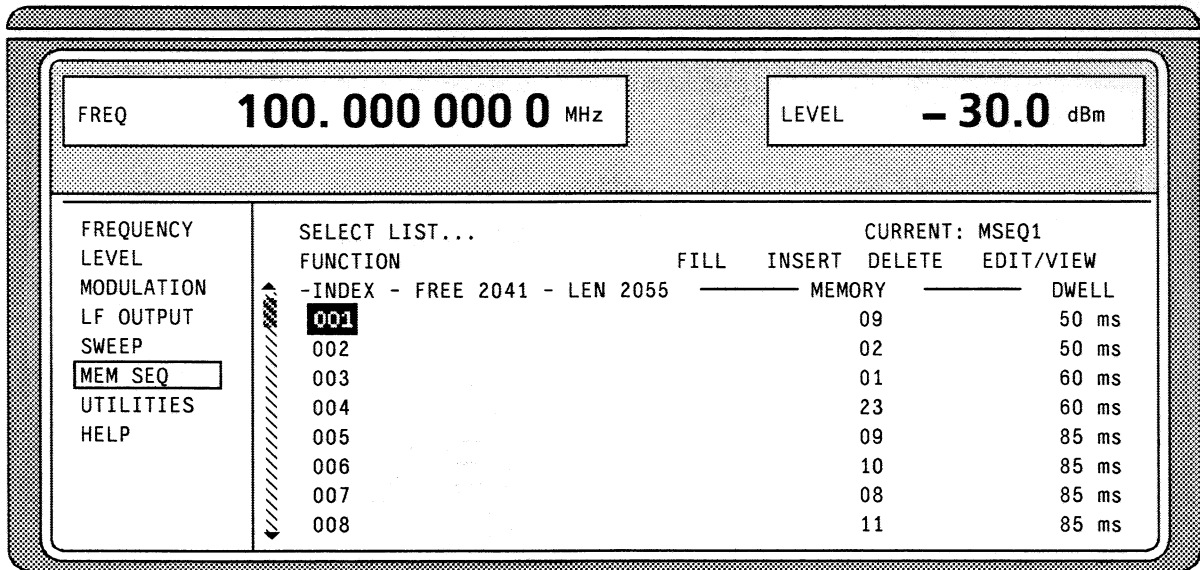

Fig. 2-44 Menu **MEM SEQ** — **EDIT** page

- INDEX** Index of the list.

- FREE** Indication of the list entries still vacant.

- LEN** Length of the current list.

- MEMORY** Parameter: number of memory location; range 1 to 50.

- DWELL** Parameter: dwell time; specified range 50 ms to 60 sec, step width 1 ms.

2.10 Utilities

The UTILITIES menu contains submenus for general functions which do not directly relate to the signal generation.

2.10.1 IEC-Bus Address (SYSTEM-GPIB)

Submenu SYSTEM-GPIB offers access to the remote-control address. The setting range is 0 to 30. At the point of delivery address 28 is set.

Menu selection: UTILITIES - SYSTEM - GPIB

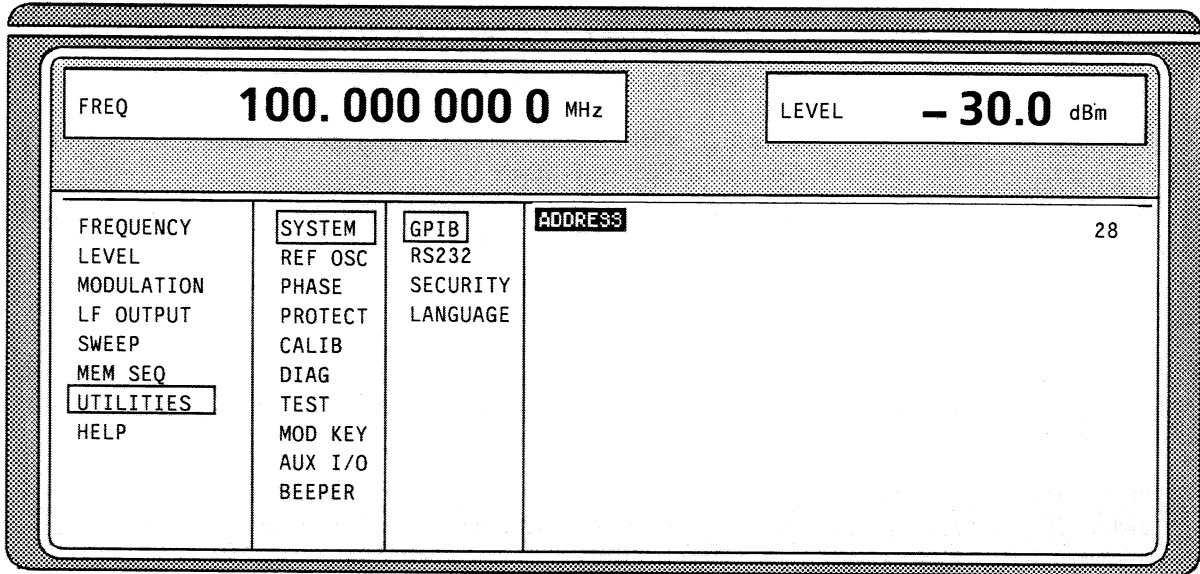

Fig. 2-45 Menu UTILITIES - SYSTEM - GPIB

ADDRESS Input value of the IEC-bus address
IEC-bus short command :SYST:COMM:GPIB:ADDR 25

2.10.2 Parameter of the RS232 Interface (SYSTEM RS232)

Submenu SYSTEM-RS232 offers access to the configuration of the RS-232 interface. The pin assignment of the interface corresponds to the one of a PC.

Menu selection: UTILITIES - SYSTEM-RS232

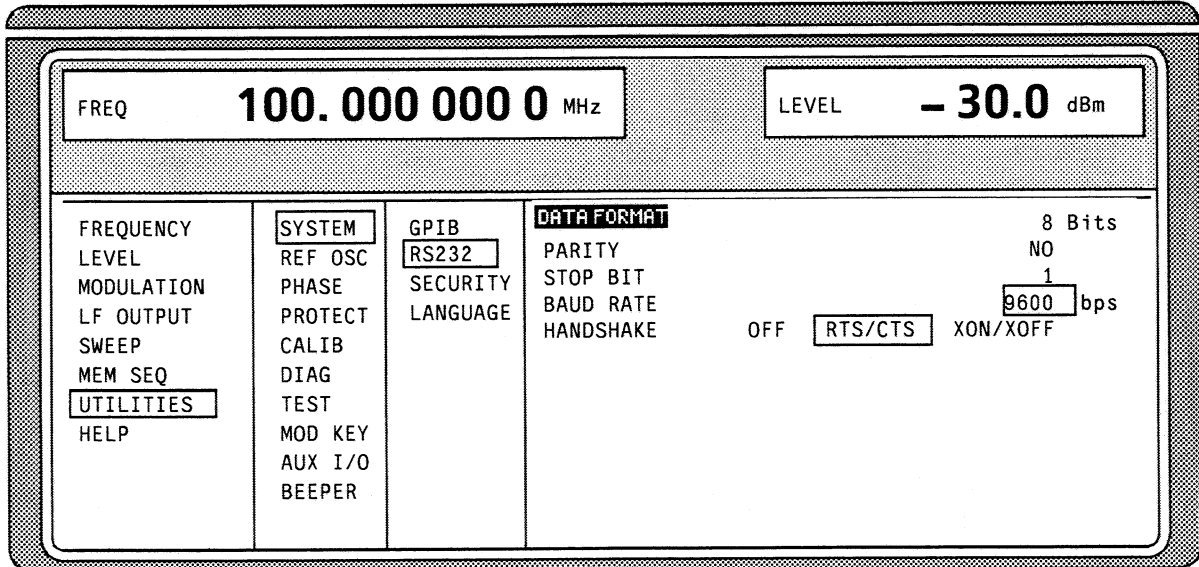

Fig. 2-46 Menu UTILITIES - SYSTEM - RS232

DATA FORMAT	Indication of the number of data bits. This value cannot be changed.
PARITY	Indication of parity. This value cannot be changed.
STOP BIT	Indication of the number of stop bits. This value cannot be changed.
BAUD RATE	Selection of the baud rate. IEC-bus short command : <i>SYST:COMM:SER:BAUD 9600</i>
HANDSHAKE	Selection of the handshake. OFF No handshake IEC-bus short commands : <i>SYST:COMM:SER:PACE NONE</i> : <i>SYST:COMM:SER:CONT:RTS ON</i> RTS/CTS Hardware handshake using the interface lines RTS and CTS. This mode always is to be preferred to XON/XOFF mode, if permitted by the configuration of the host computer. IEC-bus short command : <i>SYST:COMM:SER:CONT:RTS RFR</i> XON/XOFF Software handshake using the ASCII codes 11h <XON> and 13h <XOFF>. This mode is not recommended for binary data and for baud rates above 9600 baud. IEC-bus short command : <i>SYST:COMM:SER:PACE XON</i>

2.10.3 Suppressing Indications and Deleting Memories (SYSTEM-SECURITY)

For security interests, indications can be suppressed and memories deleted in the SYSTEM-SECURITY submenu.

Menu selection: UTILITIES - SYSTEM - SECURITY

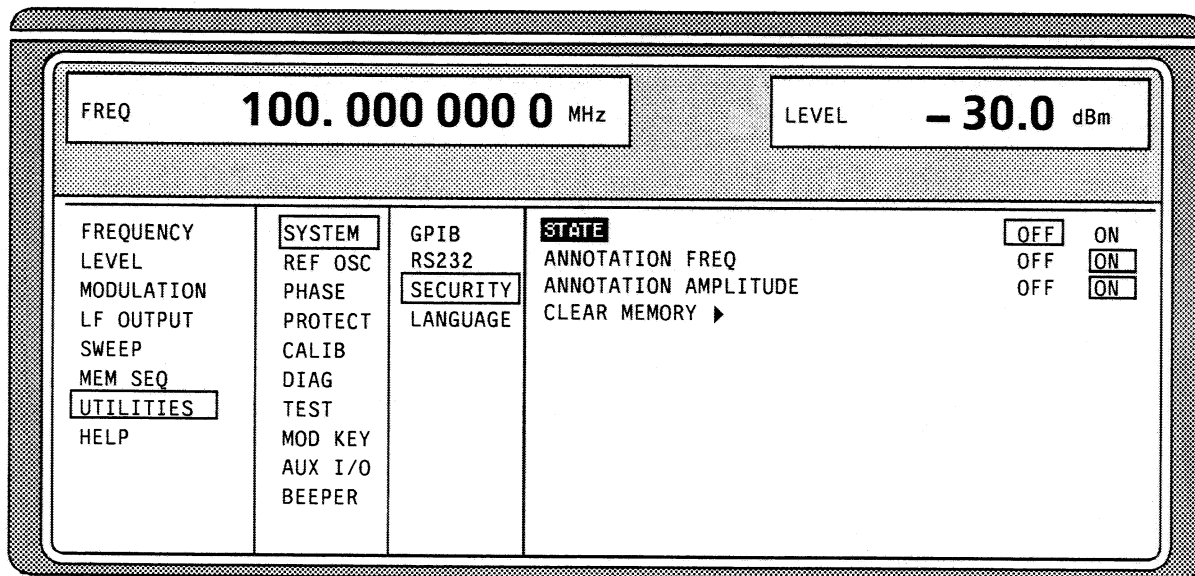

Fig. 2-47 Menu UTILITIES-SYSTEM-SECURITY

- STATE** Selection of the SECURITY state
- ON Locks the suppression of the indications. Can only be set via IEC bus.
 - OFF Deactivates the interlock of the indication suppression. The preset state is set in the transition ON→OFF, and all data stored such as settings, user correction and memory sequence settings stored are deleted. Can only be set via IEC bus.
- IEC-bus short command :SYST:SEC OFF
- ANNOTATION FREQ**
- OFF All frequency indications are suppressed.
 - ON The frequency setting is displayed.
- IEC-bus short command :DISP:ANN:FREQ ON
- ANNOTATION AMPLITUDE**
- OFF All level indications are suppressed.
 - ON The level setting is displayed.
- IEC-bus short command :DISP:ANN:AMPL ON
- CLEAR MEMORY ▶** Deletion of all data stored such as settings, user correction and memory sequence settings stored.
- For this action, two commands are necessary at the IEC bus:
- IEC-bus short command :SYST:SEC ON; SEC OFF

2.10.4 Indication of the IEC-Bus Language (LANGUAGE)

Submenu UTILITIES-SYSTEM LANGUAGE indicates the IEC-bus language and the current SCPI version.

2.10.5 Reference Frequency Internal/External (REF OSC)

In the internal-reference operating mode, the internal reference signal at a frequency of 10 MHz is available at the REF socket (rear of the instrument).

Signal level: V_{eff} (EMF, sine) = 1 V.

The frequency of the internal reference oscillator can be detuned via the TUNE input (rear of the instrument). Input voltage range ± 10 V, pulling range $\pm 1 \times 10^{-6}$.

The external detuning is possible in both states of the ADJUSTMENT STATE (ON or OFF) unless option SM-B1, reference oscillator OCXO, is fitted. If option SM-B1, reference oscillator OCXO, is fitted, the detuning via the TUNE input is only possible if the ADJUSTMENT STATE selection has been switched to ON in the UTILITIES-REF OSC menu.

In the external-reference operating mode, an external signal at a frequency of 5 MHz or 10 MHz is to be fed into socket REF. Synchronization to 5 or 10 MHz is effected automatically.

The message "EXT REF" is displayed in the status line in the header field of the display in the external-reference operating mode.

The REF OSC menu offers access to the settings of the reference frequency.

Menu selection: UTILITIES-REF OSC

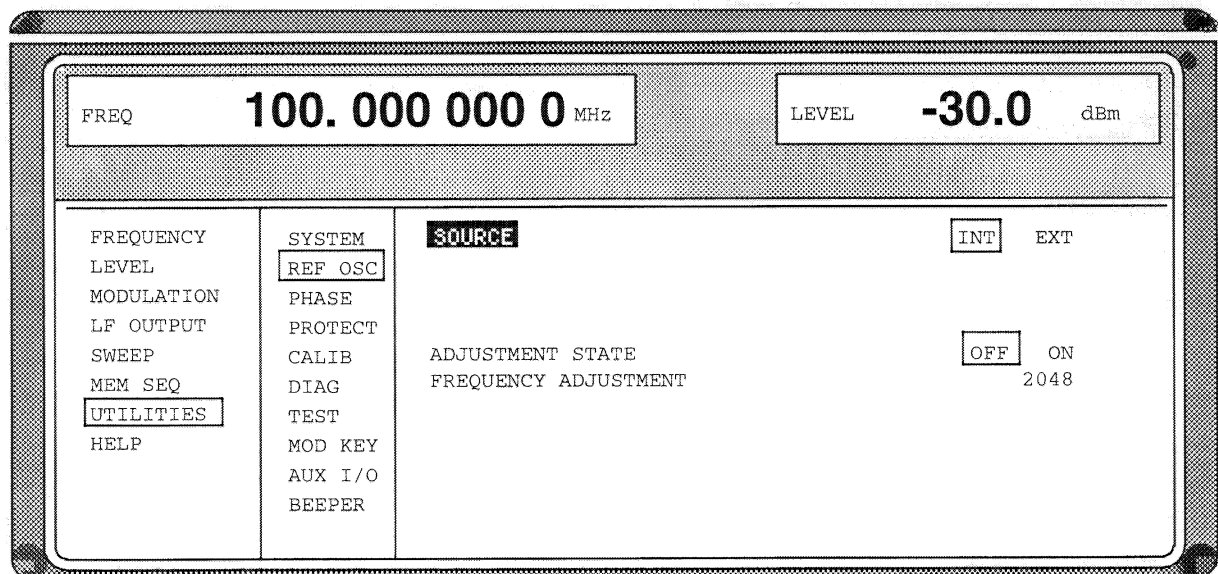

Fig. 2-48 Menu UTILITIES-REF-OSC (preset setting)

SOURCE

Selection of the operating mode.

INT Internal-reference operating mode

EXT External-reference operating mode

IEC-bus short command :ROSC:SOUR INT

ADJUSTMENT STATE

OFF Tuning value of the internal reference frequency as calibrated (cf. menu UTILITIES-CALIB)

ON Tuning value according to setting value FREQUENCY ADJUSTMENT. Option SM-B1, reference oscillator OCXO, is switched off. Only the standard reference oscillator is in operation.

IEC-bus short command :ROSC:ADJ:STAT ON

FREQUENCY ADJUSTMENT

Input value in the range 0 to 4095 to set the internal reference frequency. Pulling range $\pm 4 \times 10^{-6}$.

IEC-bus short command :ROSC:ADJ:VAL 2048

2.10.6 Phase of the Output Signal (PHASE)

Menu UTILITIES-PHASE offers access to the phase setting of the RF output signal with respect to a reference signal of the same frequency.

Menu selection: UTILITIES-PHASE

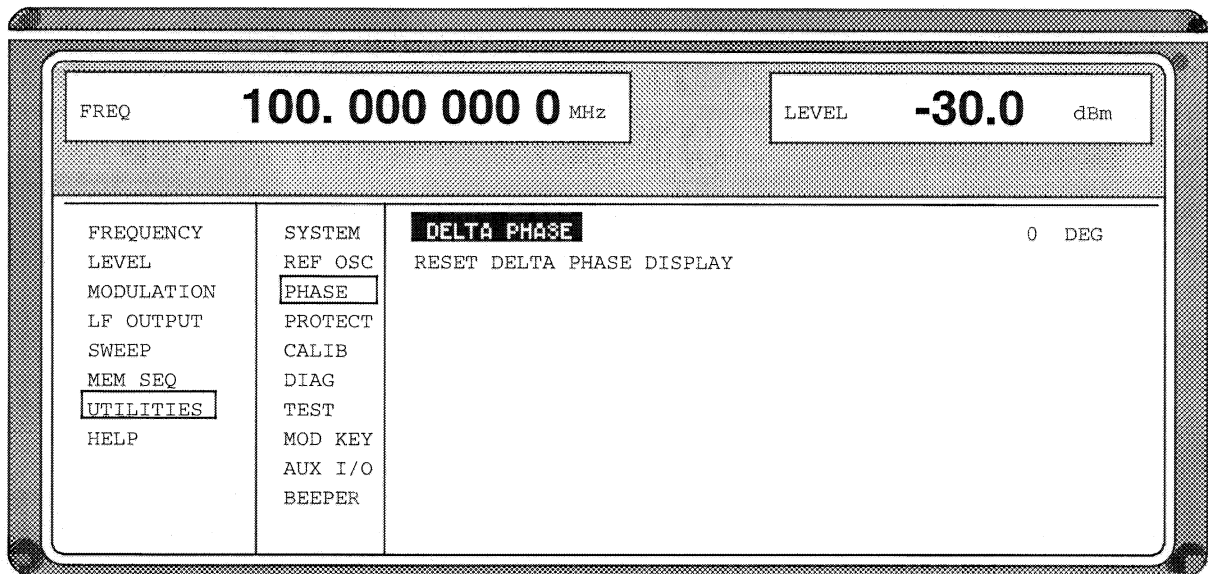

Fig. 2-49 Menu UTILITIES-PHASE (preset setting)

DELTA PHASE

Setting value of the phase

IEC-bus short command :PHAS 0

RESET DELTA PHASE DISPLAY

Sets the display of the DELTA PHASE to 0 without the phase of the output signal being influenced.

IEC-bus short command :PHAS:REF

2.10.7 Password Input With Functions Protected (PROTECT)

The execution of calibrating and service functions is protected by a password. To unlock the lock-out, the correct password, a 6-digit number, has to be entered and then the [ENTER] key has to be pushed. After the instrument has been switched on, the lock-out is automatically activated.

Password 1 unlocks the lock-out for calibrations LEV PRESET, VCO SYN, FM and PULSE GEN.

Password 2 unlocks the lock-out for calibration REF OSC.

Password 3 permits the input of the serial number and the value of the counter for POWER ON, operating hours and attenuator circuits.

Menu UTILITIES-PROTECT offers access to the unlocking of protected functions.

Menu selection: UTILITIES - PROTECT

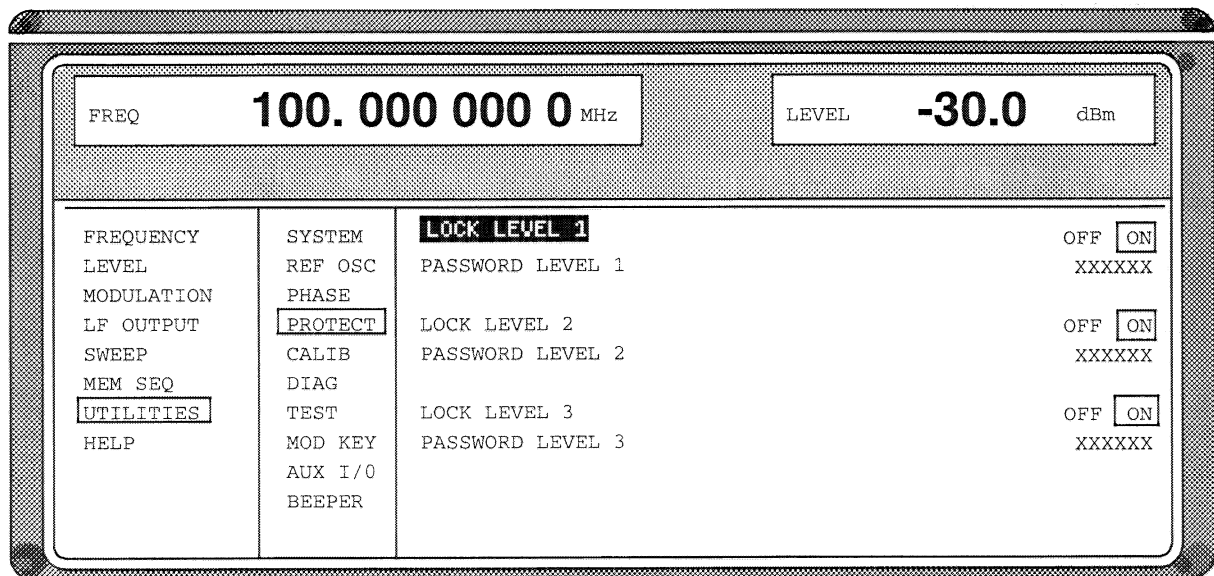

Fig. 2-50 Menu UTILITIES-PROTECT (preset setting)

LOCK LEVEL x

Activating/deactivating the lock-out.

ON The lock-out is activated.

OFF The cursor automatically wraps to the input of the password. After the password has been entered, the lock-out is deactivated.

IEC-bus short command `:SYST:PROT1 ON`

PASSWORD LEVEL x

Input of the password; termination with [ENTER] key.

IEC-bus short command `:SYST:PROT1 OFF, 123456`

2.10.8 Calibration (CALIB)

The following menus offer access to calibrating routines and correction values:

```

UTILITIES - CALIB -VCO SYN
    LEV PRESET
    REF OSC      (cf. service manual)
    LEVEL       (cf. service manual)
    FM
    PULSE GEN
  
```

Internal calibration routines LEV PRESET, VCO SYN, FM and PULSE GEN are protected by a password. They can only be executed if the lock-out in the UTILITIES - PROTECT menu has been unlocked. The password is PASSWORD LEVEL 1 = "123456".

Caution: Execute calibration routines only when the instrument has warmed up.

Calibration routines LEVEL and REF OSC are described in the service manual (stock no. 1039.3359.24).

Calibration VCO SYN

In order to accelerate settling, the oscillator of the synthesizer is preset via a D/A converter. The presetting values are stored in a table and can be renewed using internal calibration routine VCO SYN. The calibration routine needs only be executed after a data loss in the RAM or after an exchange of modules.

Function: In a 10-MHz division scale, the VCOs are synchronized with the rated frequency and the presetting voltage readjusted until the difference to the tuning voltage becomes minimal. The value hence achieved is entered into the table. The routine takes approx. 20 seconds.

Menu selection: UTILITIES - CALIB - VCO SYN

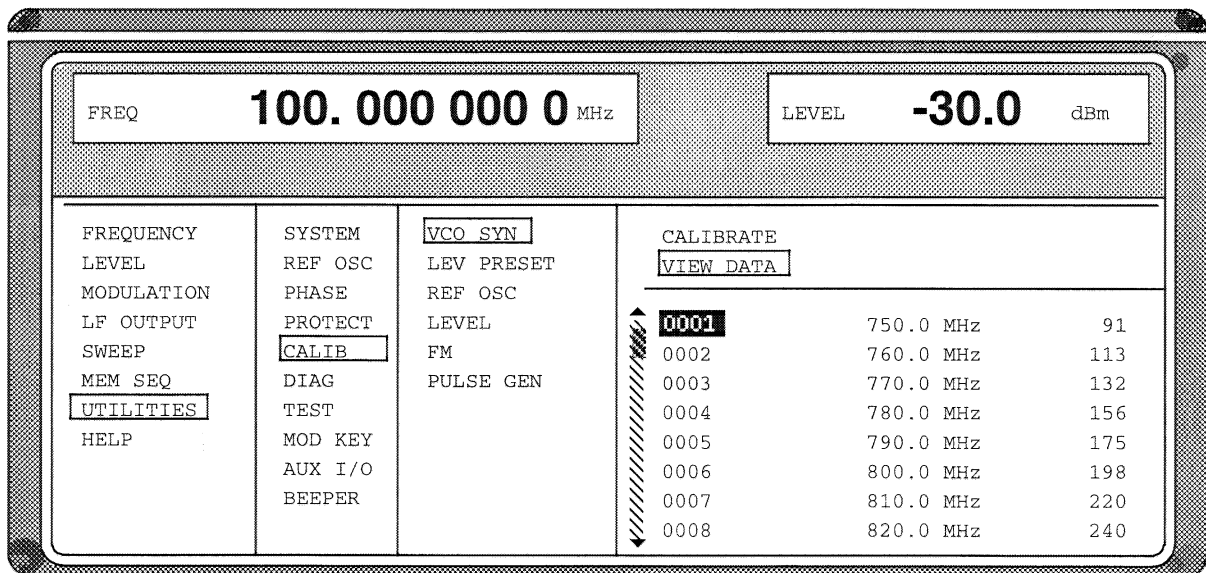

Fig. 2-51 Menu UTILITIES-CALIB-VCO SYN

CALIBRATE Triggers the calibration for the synthesizer PLL.
IEC-bus short command :CAL:VSYN?

VIEW DATA

Indication of the list of presetting values.

The cursor wraps to index 1 of the list. The list can be executed using the rotary knob. This line is the first to be indicated in the segment by means of a value entry of the index using the digit block.

IEC-bus short command :CAL:VSYN:DATA?

Calibration LEV PRESET

In order to hold the amplitude modulator in the optimal working point with all frequency and level settings, a second control element is mounted by means of which the level before the modulator is set in such a way that the modulator always works in the best part of its characteristic. The setting values for the second control element are stored in a table and can be renewed using internal calibration routine LEV PRESET. The calibration routine needs only be executed in the case of a data loss in the RAM or after an exchange of modules.

Function: By alternately adjusting the two level control elements, the calibration routine determines the value for the presetting in which the amplitude modulator is operated at the attenuation demanded. The calibration is executed according to a given frequency table at levels of 13dBm to -2dBm in steps of 3 dB. The routine takes approx. 4 min.

Menu selection: UTILITIES - CALIB - LEV PRESET

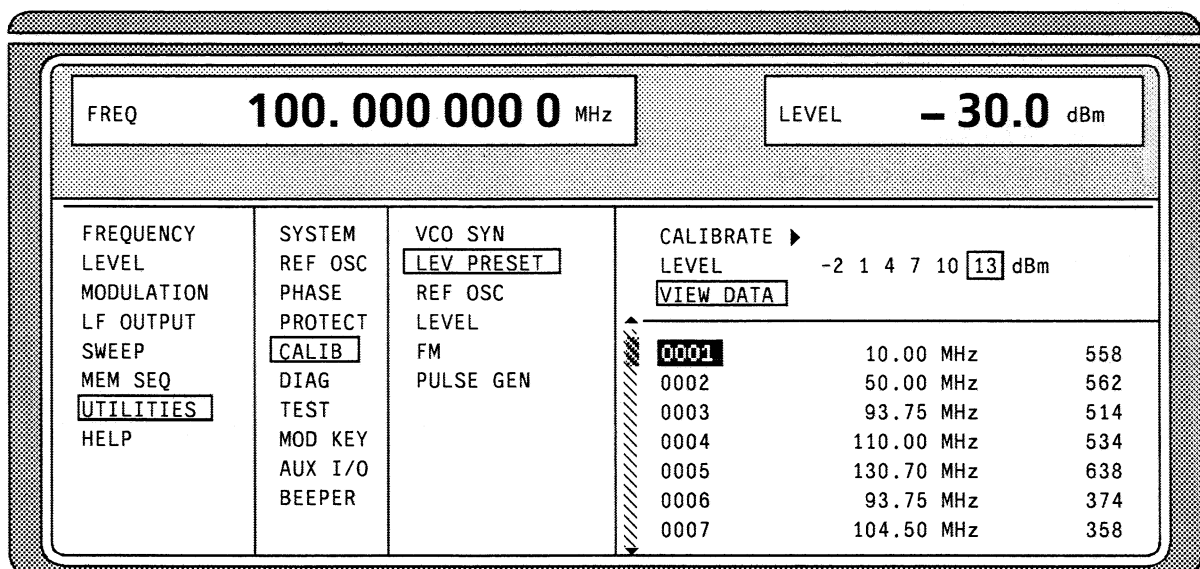

Fig. 2-52 Menu UTILITIES-CALIB-LEV PRESET

CALIBRATE ►

Triggers the calibration for level preset.

IEC-bus short command :CAL:LPR?

LEVEL

Selection of the level for which the correction values are indicated.

VIEW DATA

The cursor wraps to index 1 of the list. The list can be executed using the rotary knob. This line is the first to be indicated in the segment by means of a value entry of the index using the digit block.

IEC-bus short command :CAL:LPR:DATA?

Calibration FM

The frequency modulation is generated via two paths by modulation of the division factor of the PLL as well as by the direct modulation of the oscillator. The modulation sensitivity of the oscillator is frequency-dependent. The calibration routine determines correction factors to balance the fluctuating modulation sensitivity in steps of 10 MHz. The routine is to be executed in the case of larger variations of the temperature, data loss in the RAM or an exchange of modules. It takes approx. 1 min.

Menu selection: UTILITIES - CALIB - FM

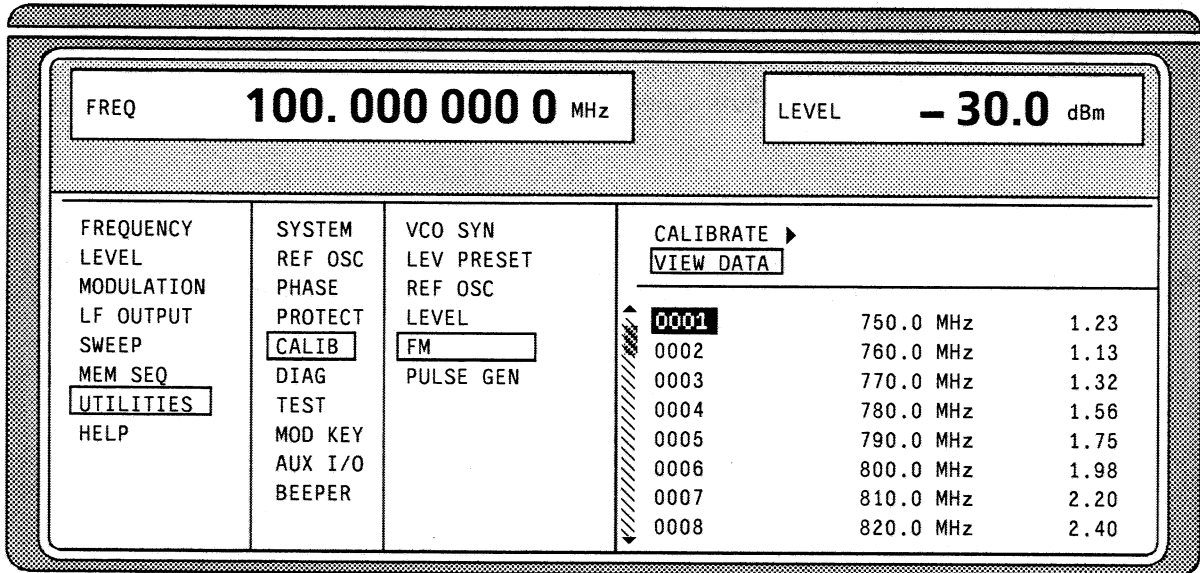

Fig. 2-53 Menu UTILITIES-CALIB-FM

CALIBRATE ▶

Triggers the calibration for the FM.

IEC-bus short command :CAL:FM?

VIEW DATA

Indication of the list of correction values.

The cursor wraps to index 1 of the list. The list can be executed using the rotary knob. This line is the first to be indicated in the segment by means of a value entry of the index using the digit block.

IEC-bus short command :CAL:FM:DATA?

Calibration PULSE GEN

A programmable oscillator determines the accuracy of the pulse width and the pulse delay of the pulse generator. To compensate for the temperature dependence of the oscillator (approx. 0.2%/degree) an internal calibration is offered. The adjustment accuracy is approx. ±0.5%. The calibration routine is to be executed even after a data loss in the RAM or after an exchange of modules.

Function: The frequency of the oscillator is measured using a counter which is synchronized with the crystal reference. The oscillator is readjusted until the deviation is minimized. The calibration value thus achieved is stored.

Menu selection: UTILITIES - CALIB - PULSE GEN

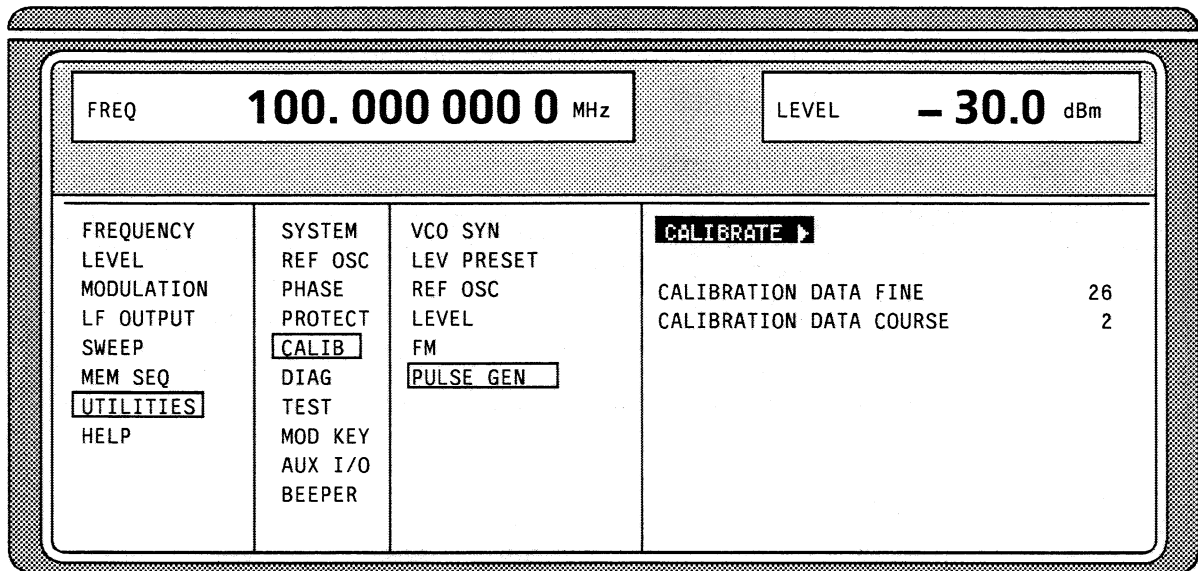

Fig. 2-54 Menu UTILITIES-CALIB-PULSE GEN

- CALIBRATE ▶** Triggers the calibration for the pulse generator.
IEC-bus short command :CAL:PULS?
- CALIBRATION DATA FINE** Indication of the fine adjustment in decimal form.
IEC-bus short command :CAL:PULS:DATA?
- CALIBRATION DATA COURSE** Indication of the coarse adjustment in decimal form.
IEC-bus short command :CAL:PULS:DATA?

2.10.9 Indication of Module Variants (DIAG-CONFIG)

For service purposes, the modules installed can be indicated with their variants and states of modification. Submenu DIAG-CONFIG offers access to the module indication.

IEC-bus short command :DIAG:INFO:MOD?

Menu selection: UTILITIES - DIAG - CONFIG

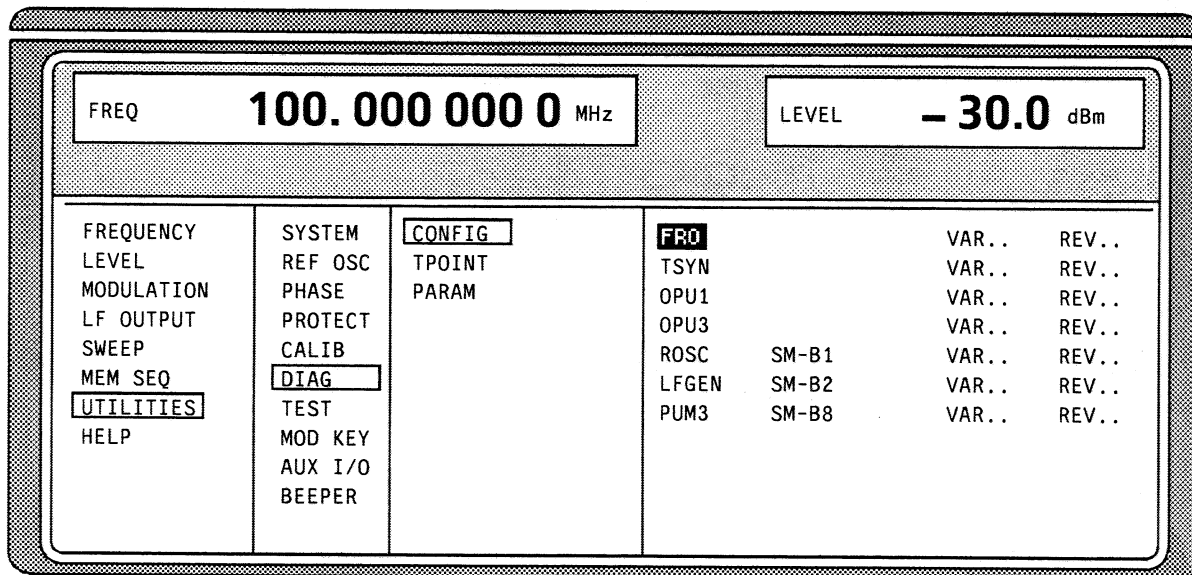

Fig. 2-55 Menu UTILITIES-DIAG-CONFIG

2.10.10 Voltage Indication of Test Points (DIAG-TPOINT)

Submenu DIAG-TPOINT offers access to internal test points. If a test point is switched on, the voltage indication is displayed in a window in the header field. For greater detail, see service manual (stock no. 1039.3359.24).

Menu selection: UTILITIES - DIAG - TPOINT

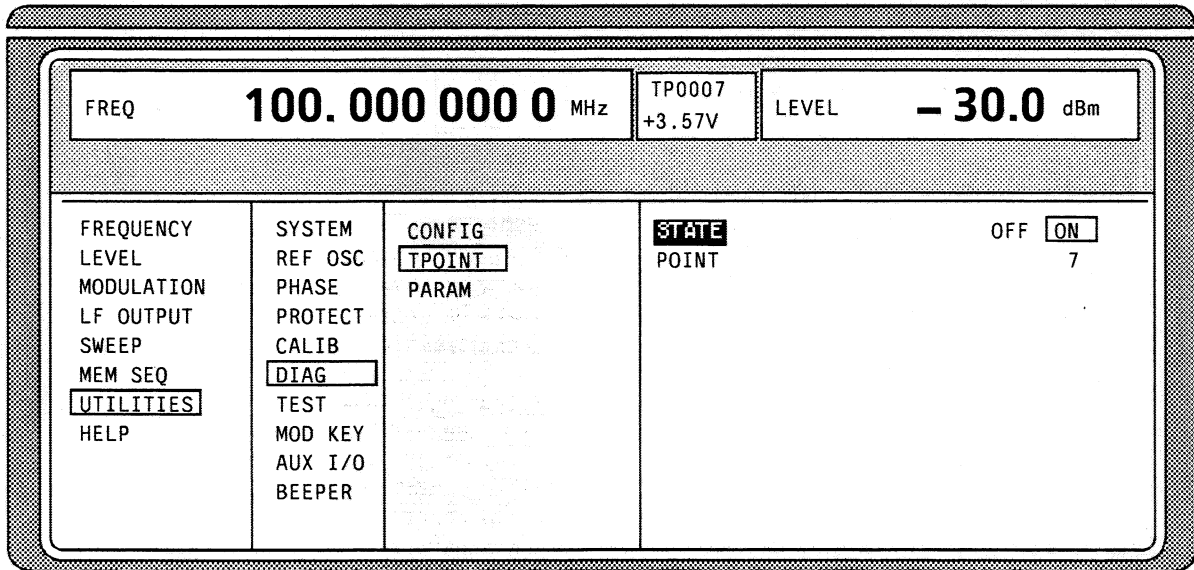

Fig. 2-56 Menu UTILITIES-DIAG-TPOINT

STATE

Switching on/off the voltage indication.

POINT

Input value of the test point.

IEC-bus short command :DIAG:POINxx?

2.10.11 Indication of Service Data (DIAG-PARAM)

Submenu DIAG-PARAMETER offers access to different parameters such as serial number, software version, operating-hours counter and attenuator circuits.

Menu selection: UTILITIES - DIAG - PARAM

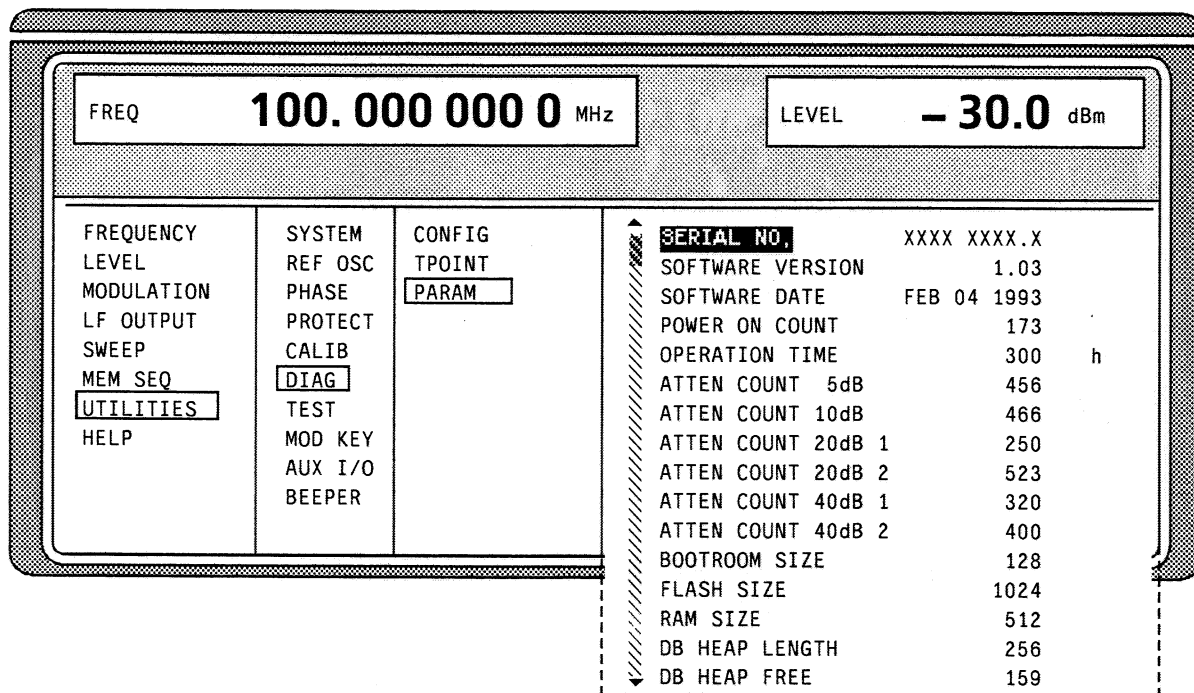

Fig. 2-57 Menu UTILITIES-DIAG-PARAM

For IEC-bus commands, cf. Section 3.6.5, DIAGnostic System.

2.10.12 Test (TEST)

(cf. Section 4.2, Functional Test)

2.10.13 Assign Modulations to the [MOD ON/OFF] Key (MOD-KEY)

The modulations can be switched on/off in the individual modulation menus and parallelly by means of the [MOD ON/OFF] key.

For which modulations the [MOD ON/OFF] key is effective can be defined in the UTILITIES-MOD KEY menu. The key can either be effective for all modulations or for a selected one.

Function of the [MOD ON/OFF] key if effective for a type of modulation:

- ▶ Every pressing a key alters the state (ON or OFF) of the selected modulation.

Function of the [MOD ON/OFF] key if effective for all types of modulation (ALL):

- ▶ If at least one modulation is switched on, pressing the [MOD ON/OFF] key switches the modulation/s off. Which modulations were switched on is stored.
- ▶ If no modulation is switched on, pressing the [MOD ON/OFF] key switches on the modulations which were last switched off using the [MOD ON/OFF] key.

On switching on using the [MOD ON/OFF] key, the modulation sources are used as defined in the modulation menus.

Access to the selection of the modulation to be switched using the [MOD ON/OFF] key is possible in the UTILITIES-MOD KEY menu.

Menu selection: UTILITIES - MOD KEY

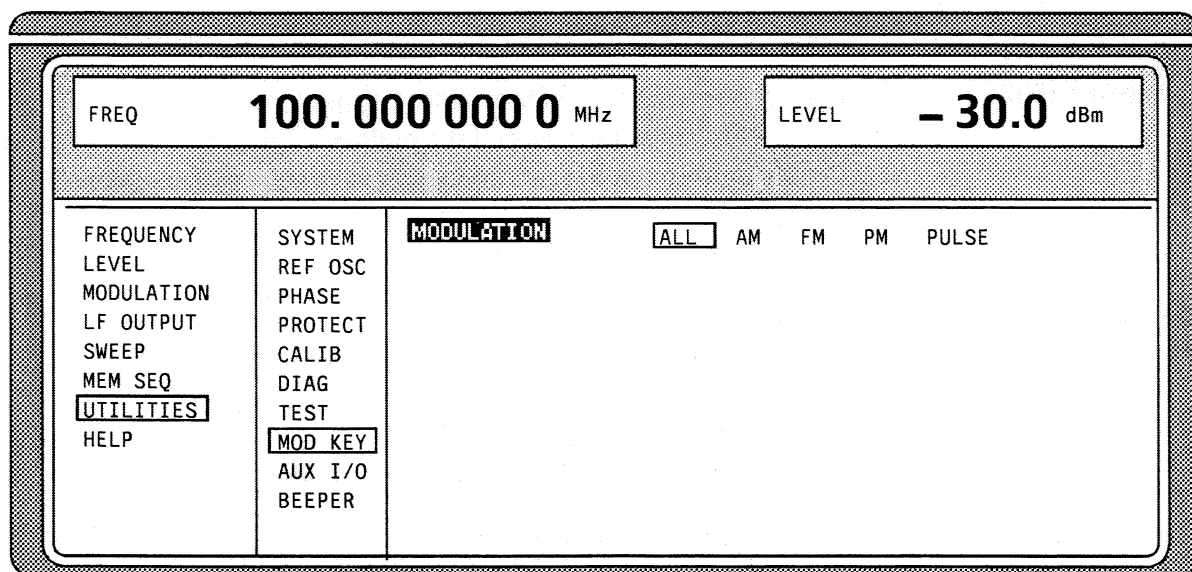

Fig. 2-58 Menu UTILITIES-MOD KEY (preset setting)

MODULATION Selection for which modulation the [MOD ON/OFF] key is to be effective.

Note: Preset switches off all modulations, sets the selection to ALL and stores AM 30%, AM SOURCE INT: LF GEN1 as default setting.

2.10.14 Set Auxiliary Inputs/Outputs (AUX I/O)

Menu UTILITIES - AUX I/O offers access to settings for the TRIGGER input, BLANK output and MARKER output. Sections Sweep and Memory Sequence provide further information.

Menu selection: UTILITIES - AUX I/O

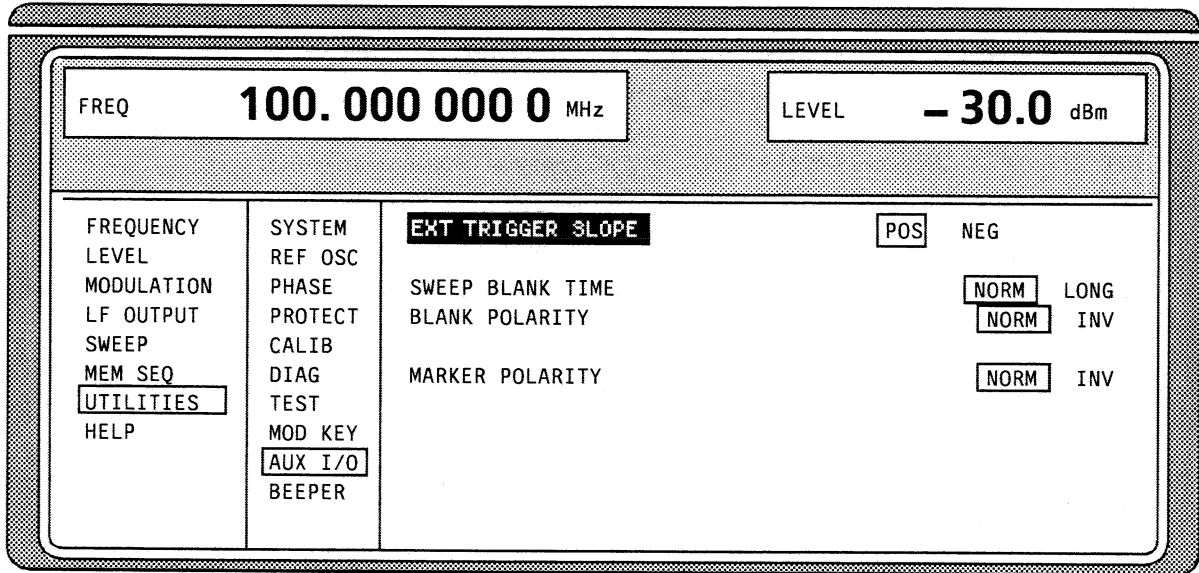

Fig. 2-59 Menu UTILITIES - AUX I/O

EXT TRIGGER SLOPE

Selection of the active edge of the external trigger signal.

POS The instrument triggers on the positive edge of the external signal.

NEG The instrument triggers on the negative edge of the external signal.

IEC-bus short command :TRIG:SLOP POS

SWEEP BLANK TIME

Selection of the blank duration.

NORM BLANK duration is set to the shortest duration possible.

LONG The BLANK duration is set for the PEN LIFT control of an XY recorder (approx. 500ms).

IEC-bus short command :SOUR2:SWE:BTIM NORM

BLANK POLARITY

Selection of the polarity for the blank signal.

NORM With active BLANK, the output signal is HIGH.

INV Polarity is inverted.

IEC-bus short command :OUTP:BLAN NORM

MARKER POLARITY

Selection of the polarity for the marker signal.

NORM The output signal is HIGH when the sweep cycle reaches the mark.

INV Polarity is inverted.

IEC-bus short command :MARK:POL NORM

2.10.15 Switching On/Off Beeper (BEEPER)

Menu UTILITIES-BEEPER offers access to the switching on/off of the beeper.

Note: Preset does not alter the current state (ON or OFF).

Menu selection: UTILITIES -BEEPER

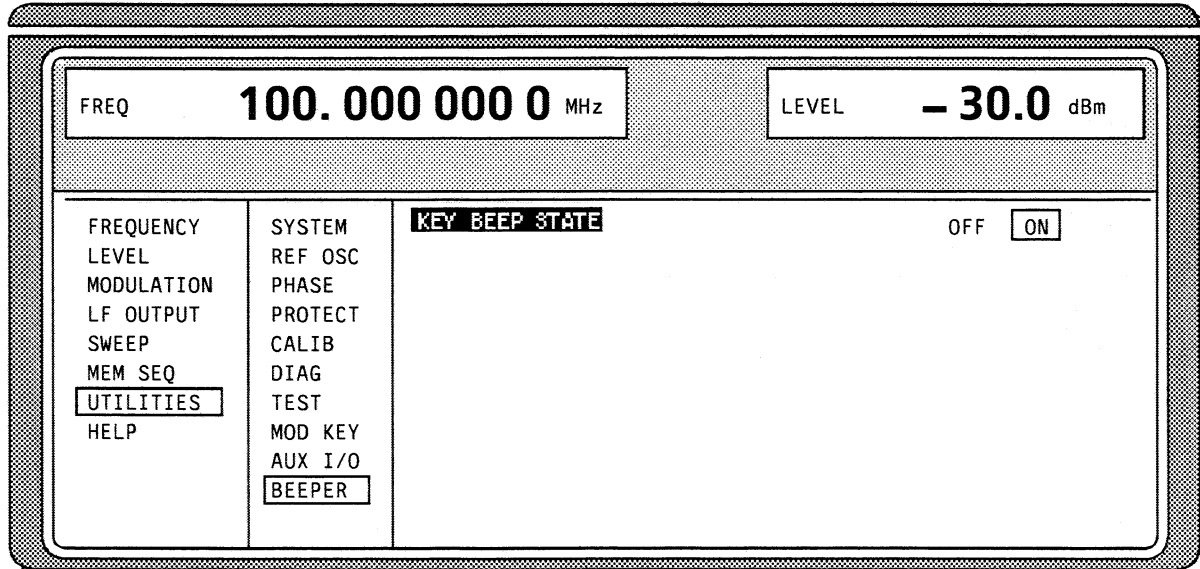

Fig. 2-60 Menu UTILITIES - BEEPER

KEY BEEP STATE Switching on/off the beeper
IEC-BUS command :SYST:BEEP:STAT ON

2.11 The Help System

The SMT has two help systems. On the one hand the context-sensitive help which is called by means of the HELP key and which gives information on the current menu. On the other hand, auxiliary texts can be selected according to headwords in alphabetical order by accessing menu HELP.

HELP Key

The yellow HELP key can be pressed at any point in time. The current setting menu is faded out and context-sensitive text faded in. The help panel can be exited by means of the RETURN key.

Menu HELP

After calling the help menu, access to all auxiliary texts is possible via an index. Operation is analog to menu operation.

- ▶ Set the menu cursor to the index desired using the shaft encoder.
- ▶ Press the [SELECT] key.
The information for the index marked is displayed.
- ▶ Press the [RETURN] key to exit the menu.

2.12 Status

By means of a STATUS page, the SMT permits an overview over all settings of the instrument. The settings are displayed in an abbreviated form. The STATUS page is called by pressing the [STATUS] key. Return to the preceding menu is effected using the [RETURN] key.

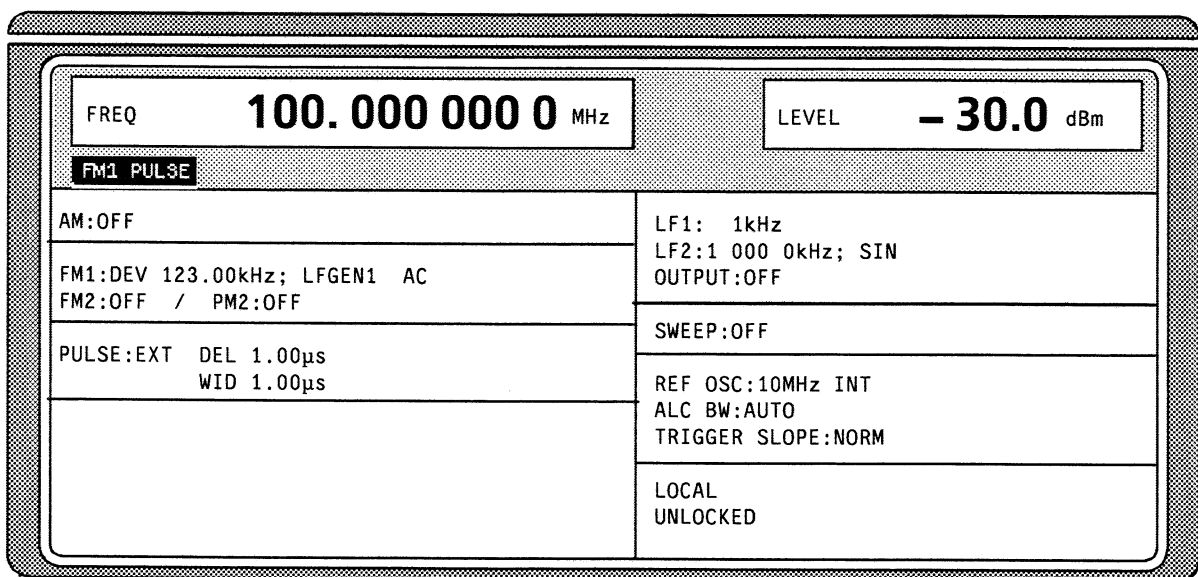

Fig. 2-61 STATUS page

2.13 Error Messages

The SMT displays error and caution messages in a different manner, depending on how long, for a short period of time or permanently, the cause exists.

Short-term message The short-term message is displayed in the status line. Part of it overwrites the status indications and disappears after approx. 2 seconds or in the case of a new entry.

The instrument shows, e.g., short-term messages if the attempt is made to enter an overrange or if incompatible operating modes deactivate one another.

Long-term message The long-term message is displayed in the status line by means of the message "WARNING" or "ERROR". Pressing the [ERROR] key calls the ERROR page in which the messages are entered. Several messages can be entered at the same time. The long-term message remains existing until there is no cause any more. The ERROR page is exited using the [RETURN] key.

The instrument displays, e.g., the long-term message "ERROR" if there is a hardware error or "WARNING" if overrange settings have been made.

Notes: – An error message "ERROR" does not necessarily point to a defect instrument. There are various operating states which can cause an ERROR message. E. g. if the instrument is set to external reference but no external reference is connected.

- Error 313 indicates the loss of calibration data and is also applicable in case of a cold start (key [PRESET] is pressed during switch-on). The calibration values can be restored with internal calibration routines. These routines are accessible via menu UTILITIES-CALIB (see section on calibration).

The ERROR page offers access to long-term messages if the [ERROR] key is pressed.

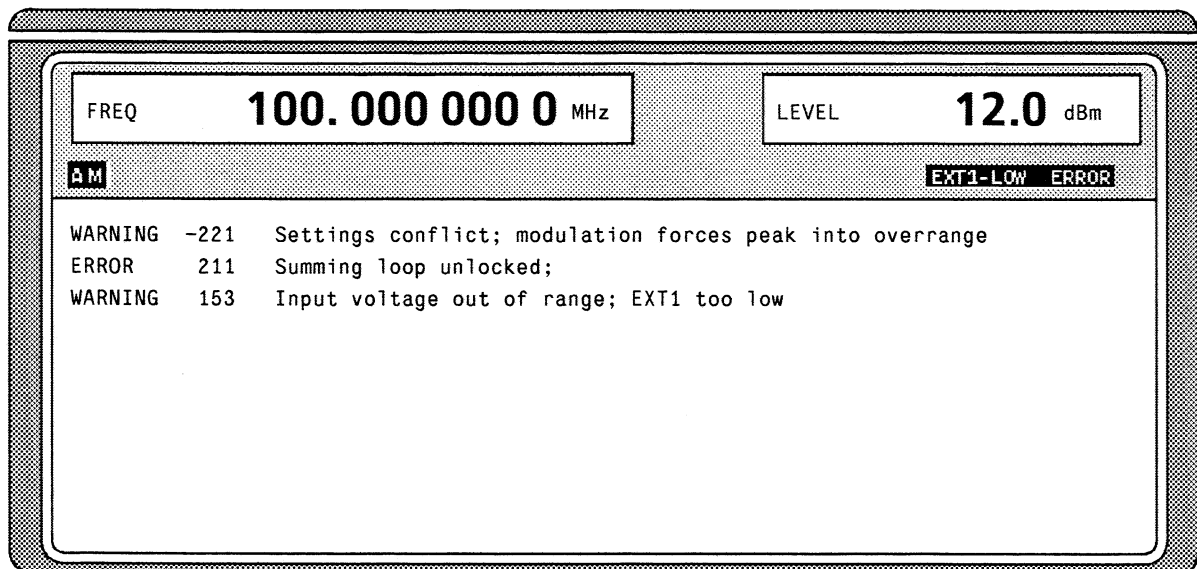

Fig. 2-62 ERROR page

A list of the possible error messages is to be found in annex B.

3 Remote Control

3.1 Introduction

The instrument is equipped with an IEC-bus interface according to standard IEC 625.1/IEEE 488.2, and a RS-232 interface. The connector is located at the rear of the instrument and permits connecting a controller for remote control. The instrument supports the SCPI version 1994.0 (Standard Commands for Programmable Instruments). The SCPI standard is based on standard IEEE 488.2 and aims at the standardization of device-specific commands, error handling and the status registers (see Section 3.5.1).

This section assumes basic knowledge of IEC-bus programming and operation of the controller. A description of the interface commands is to be obtained from the relevant manuals.

The requirements of the SCPI standard placed on command syntax, error handling and configuration of the status registers are explained in detail in the respective sections. Tables provide a fast overview of the commands implemented in the instrument and the bit assignment in the status registers. The tables are supplemented by a comprehensive description of every command and the status registers. Detailed program examples of the main functions are to be found in annex D. The program examples for IEC-bus programming are all written in Quick BASIC.

Note:

*In contrast to manual control, which is intended for maximum possible operating convenience, the priority of remote control is the predictability of the device status. This means that when incompatible settings (eg activation of PM and FM at the same time) are attempted, the command is ignored and the device status remains unchanged, ie is not adapted to other settings. Therefore, IEC/IEEE-bus control programs should always define an initial device status (eg with command *RST) and then implement the required settings.*

3.2 Brief Instructions

The short and simple operating sequence given below permits fast putting into operation of the instrument and setting of its basic functions.

3.2.1 IEC Bus

It is assumed that the IEC-bus address, which is factory-set to 28 has not yet been changed.

1. Connect instrument and controller using IEC-bus cable.
2. Write and start the following program on the controller:

CALL IBFIND("DEV1", generator%)	Open port to the instrument
CALL IBPAD(generator%, 28)	Inform controller about instrument address
CALL IBWRT(generator%, "*RST;*CLS")	Reset instrument
CALL IBWRT(generator%, "FREQ 50MHz")	Set frequency to 50 MHz
CALL IBWRT(generator%, "POW -7.3dBm")	Set output level -7.3 dBm
CALL IBWRT(generator%, "AM:SOUR INT1")	Set AM modulation source LFGEN1
CALL IBWRT(generator%, "AM:INT1:FREQ 15kHz")	Set modulation frequency 15 kHz
CALL IBWRT(generator%, "AM 30PCT")	Set AM modulation depth 30%
CALL IBWRT(generator%, "AM:STAT ON")	Switch on AM
CALL IBWRT(generator%, "OUTPUT:STATE ON")	Switch on RF output

An amplitude-modulated signal is now applied at the output of the instrument.

3. To return to manual control, press the LOCAL key at the front panel

3.2.2 RS-232 Interface

It is assumed that the configuration of the RS-232 interface at the unit has not yet been changed.

1. Connect unit and controller using the 0-modem cable
2. Enter the following command at the controller to configure the controller interface:

```
mode com1: 9600, n, 8, 1
```

3. Create the following ASCII file:

*RST; *CLS	Switch instrument to remote control (Return key)
FREQ 50MHz	Reset instrument
POW -7.3dBm	Set frequency 50 MHz
OUTP:STAT ON	Set output level -7.3 dBm
AM:SOUR INT1	Switch on RF output
AM:INT1:FREQ 15kHz	Set AM modulation source LFGEN1
AM 30PCT	Set modulation frequency 15 kHz
AM:STAT ON	Set AM modulation depth 30%
	Switch on AM
	(Return key)

4. Transfer ASCII file to unit via RS-232 interface. Enter the following command at the controller:
copy <filename> com1:
An amplitude-modulated signal is now applied at the output of the instrument.
5. To return to manual control, press the [LOCAL] key at the front panel.

3.3 Switchover to Remote Control

On power-on, the instrument is always in the manual operating state ("LOCAL" state) and can be operated via the front panel.

The instrument is switched to remote control ("REMOTE" state)

IEC bus as soon as it receives an addressed command from a controller.

RS-232 as soon as it receives either a carriage return <CR> (=0Dh) or a line feed <LF> (0Ah) from a controller.

During remote control, operation via the front panel is disabled. The instrument remains in the remote state until it is reset to the manual state via the front panel or via IEC bus (see Sections 3.3.1.3 and 3.3.2.3). Switching from manual operation to remote control and vice versa does not affect the remaining instrument settings.

3.3.1 Remote Control via IEC Bus

3.3.1.1 Setting the Device Address

The IEC-bus address of the instrument is factory-set to 28. It can be changed manually in the UTILITIES-SYSTEM-GPIB-ADDRESS menu or via IEC bus. Addresses 0 to 30 are permissible.

- Manually:**
- ▶ Call UTILITIES-SYSTEM-GPIB-ADDRESS menu
 - ▶ Enter desired address
 - ▶ Terminate input using the [1x/ENTER] key

- Via IEC bus:**
- | | |
|---|-------------------------------------|
| <pre>CALL IBFIND("DEV1", generator%)</pre> | Open port to the instrument |
| <pre>CALL IBPAD(generator%, 28)</pre> | Inform controller about old address |
| <pre>CALL IBWRT(generator%, "SYST:COMM:GPIB:ADDR 20")</pre> | Set instrument to new address |
| <pre>CALL IBPAD(generator%, 20)</pre> | Inform controller about new address |

3.3.1.2 Indications during Remote Control

The state of the remote control is evident by the words "IEC REMOTE" or "LOCAL" on the STATUS page. The STATUS page is always displayed in the REMOTE state. LOCKED indicates that the key [LOCAL] is disabled, ie switchover to manual operation is only possible via IEC/IEEE bus. With UNLOCKED indicated, switchover to manual control is possible via the key [LOCAL] (see also section 3.3.1.3).

3.3.1.3 Return to Manual Operation

Return to manual operation is possible via the front panel or the IEC bus.

- Manually:**
- ▶ Press the [LOCAL] key.
- Notes:**
- Before switchover, command processing must be completed as otherwise switchover to remote control is effected immediately.
 - The [LOCAL] key can be disabled by the universal command LLO (see annex A) in order to prevent unintentional switchover. In this case, switchover to manual mode is only possible via the IEC bus.
 - The [LOCAL] key can be enabled again by deactivating the REN control line of the IEC bus (see annex A).

- Via IEC bus:**
- | | |
|-----------------------------------|-------------------------------------|
| <pre>...</pre> | |
| <pre>CALL IBLOC(generator%)</pre> | Set instrument to manual operation. |

3.3.2 Remote Control via RS-232-Interface

3.3.2.1 Setting the Transmission Parameters

To enable an error-free and correct data transmission, the parameters of the unit and the controller should have the same setting. To prevent any problems during binary data transmission, the RS-232 interface is set for 8 data bits, no parity and 1 stop bit. This data format corresponds to the current IEEE P1174 standard. Parameters baud rate and handshake can be manually changed in menu UTILITIES-SYSTEM-RS-232.

- ▶ Call UTILITIES-SYSTEM-GPIB-RS232 menu
- ▶ Select desired baudrate and handshake
- ▶ Terminate input using the [1x/ENTER] key

3.3.2.2 Indications during Remote Control

The state of the remote control is evident by the words "RS-232 REMOTE" or "LOCAL" on the STATUS page. The STATUS page is always displayed in the REMOTE state.

3.3.2.3 Return to Manual Operation

Return to manual operation is possible via the front panel.

- ▶ Press the [LOCAL] key.

Note: – *Before switchover, command processing must be completed as otherwise switchover to remote control is effected immediately.*

3.4 Messages

The messages transferred via the data lines of the IEC bus (see annex A) can be divided into two groups:

- **interface messages** and
- **device messages.**

For the RS-232 interface, no interface messages are defined.

3.4.1 Interface Messages

Interface messages are transferred on the data lines of the IEC bus, the "ATN" control line being active. They are used for communication between controller and instrument and can only be sent by a controller which has the IEC-bus control. Interface commands can be subdivided into

- **universal commands** and
- **addressed commands.**

Universal commands act on all devices connected to the IEC bus without previous addressing, addressed commands only act on devices previously addressed as listeners. The interface messages relevant to the instrument are listed in annex A.

Some control characters are defined for the control of the RS-232-interface (see annex A).

3.4.2 Device Messages (Commands and Device Responses)

Device messages are transferred on the data lines of the IEC bus, the "ATN" control line not being active. ASCII code is used. The device messages are largely identical for the two interfaces. A distinction is made according to the direction in which they are sent on the IEC bus:

- **Commands** are messages the controller sends to the instrument. They operate the device functions and request informations. The commands are subdivided according to two criteria:
 1. According to the effect they have on the instrument:
 - Setting commands** cause instrument settings such as reset of the instrument or setting the output level to 1 volt.
 - Queries** cause data to be provided for output on the IEC-bus, e.g. for identification of the device or polling the active input.
 2. According to their definition in standard IEEE 488.2:
 - Common Commands** are exactly defined as to their function and notation in standard IEEE 488.2. They refer to functions such as management of the standardized status registers, reset and selftest.
 - Device-specific commands** refer to functions depending on the features of the instrument such as frequency setting. A majority of these commands has also been standardized by the SCPI committee.
- **Device responses** are messages the instrument sends to the controller after a query. They can contain measurement results, instrument settings and information on the instrument status (cf. Section 3.5.4).

Structure and syntax of the device messages are described in Section 3.5. The commands are listed and explained in detail in Section 3.6.

3.5 Structure and Syntax of the Device Messages

3.5.1 SCPI Introduction

SCPI (Standard Commands for Programmable Instruments) describes a standard command set for programming instruments, irrespective of the type of instrument or manufacturer. The goal of the SCPI consortium is to standardize the device-specific commands to a large extent. For this purpose, a model was developed which defines the same functions inside a device or for different devices. Command systems were generated which are assigned to these functions. Thus it is possible to address the same functions with identical commands. The command systems are of a hierarchical structure. Fig. 3-1 illustrates this tree structure using a section of command system SOURCE, which operates the signal sources of the devices. The other examples concerning syntax and structure of the commands are derived from this command system.

SCPI is based on standard IEEE 488.2, i.e. it uses the same syntactic basic elements as well as the common commands defined in this standard. Part of the syntax of the device responses is defined with greater restrictions than in standard IEEE 488.2 (see Section 3.5.4, Responses to Queries).

3.5.2 Structure of a Command

The commands consist of a so-called header and, in most cases, one or more parameters. Header and parameter are separated by a "white space" (ASCII code 0 to 9, 11 to 32 decimal, e.g. blank). The headers may consist of several key words. Queries are formed by directly appending a question mark to the header.

Note: *The commands used in the following examples are not in every case implemented in the instrument.*

Common commands

Common commands consist of a header preceded by an asterix "*" and one or several parameters, if any.

Examples: **RST* RESET, resets the device
**ESE 253* EVENT STATUS ENABLE, sets the bits of the event status enable register
**ESR?* EVENT STATUS QUERY, queries the contents of the event status register.

Device-specific commands

Hierarchy: Device-specific commands are of hierarchical structure (see Fig. 3-1). The different levels are represented by combined headers. Headers of the highest level (root level) have only one key word. This key word denotes a complete command system..

Example: *SOURce* This key word denotes the command system SOURce.

For commands of lower levels, the complete path has to be specified, starting on the left with the highest level, the individual key words being separated by a colon ":".

Example: *SOURce:FM:EXTernal:COUpling AC*

This command lies in the fourth level of the SOURce system. It sets the coupling of the external signal source to AC.

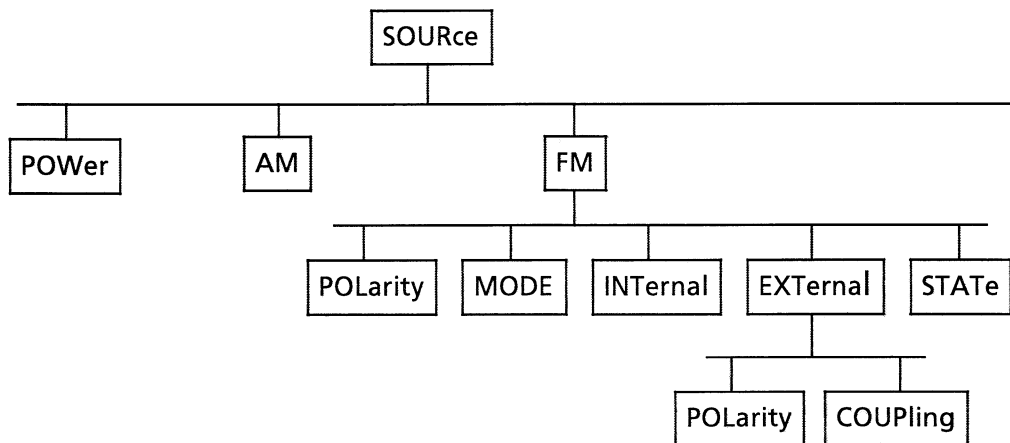

Fig. 3-1 Tree structure of the SCPI command systems using the SOURce system by way of example

Some key words occur in several levels within one command system. Their effect depends on the structure of the command, that is to say, at which position in the header of a command they are inserted.

Example: *SOURce:FM:POLarity NORMal*

This command contains key word POLarity in the third command level. It defines the polarity between modulator and modulation signal.

SOURce:FM:EXTernal:POLarity NORMal

This command contains key word POLarity in the fourth command level. It defines the polarity between modulation voltage and the resulting direction of the modulation only for the external signal source indicated.

Optional key words: Some command systems permit certain key words to be optionally inserted into the header or omitted. These key words are marked by square brackets in the description. The full command length must be recognized by the instrument for reasons of compatibility with the SCPI standard. Some commands are considerably shortened by these optional key words.

Example: *[SOURce]:POWer[:LEVel][:IMMEDIATE]:OFFSet 1*

This command immediately sets the offset of the signal to 1 volt. The following command has the same effect:

POWer:OFFSet 1

Note: *An optional key word must not be omitted if its effect is specified in detail by a numeric suffix.*

Long and short form: The key words feature a long form and a short form. Either the short form or the long form can be entered, other abbreviations are not permissible.

Example: *STATus:QUESTionable:ENABLE 1 = STAT:QUES:ENAB 1*

Note: *The short form is marked by upper-case letters, the long form corresponds to the complete word. Upper-case and lower-case notation only serve the above purpose, the instrument itself does not make any difference between upper-case and lower-case letters.*

Parameter: The parameter must be separated from the header by a "white space". If several parameters are specified in a command, they are separated by a comma ",". A few queries permit the parameters MINimum, MAXimum and DEFault to be entered. For a description of the types of parameter, refer to Section 3.5.5.

Example: *SOURce:POWer:ATTenuation? MAXimum Response: 60*
This query requests the maximal value for the attenuation.

Numeric suffix: If a device features several functions or features of the same kind, e.g. inputs, the desired function can be selected by a suffix added to the command. Entries without suffix are interpreted like entries with the suffix 1.

Example: *SOURce:FM:EXTernal2:COUpling AC*

This command sets the coupling of the second external signal source.

3.5.3 Structure of a Command Line

A command line may consist of one or several commands. It is terminated by a <New Line>, a <New Line> with EOI or an EOI together with the last data byte. QuickBASIC automatically produces an EOI together with the last data byte.

Several commands in a command line are separated by a semicolon ";". If the next command belongs to a different command system, the semicolon is followed by a colon.

Example: *CALL IBWRT(generator%, "SOURCE:POWER:CENTer MINimum;:OUTPut:ATTenuation 10")*

This command line contains two commands. The first command is part of the SOURCE system and is used to specify the center frequency of the output signal. The second command is part of the OUTPut system and sets the attenuation of the output signal.

If the successive commands belong to the same system, having one or several levels in common, the command line can be abbreviated. To this end, the second command after the semicolon starts with the level that lies below the common levels (see also Fig. 3-1). The colon following the semicolon must be omitted in this case.

Example:

CALL IBWRT(generator%, "SOURCE:FM:MODE LOCKed; :SOURCE:FM:INTernal:FREQuency 1kHz")

This command line is represented in its full length and contains two commands separated from each other by the semicolon. Both commands are part of the SOURCE command system, subsystem FM, i.e. they have two common levels.

When abbreviating the command line, the second command begins with the level below SOURCE:FM. The colon after the semicolon is omitted.

The abbreviated form of the command line reads as follows:

CALL IBWRT(generator%, "SOURCE:FM:MODE LOCKed; INTernal:FREQuency 1kHz")

However, a new command line always begins with the complete path.

Example: *CALL IBWRT(generator%, "SOURCE:FM:MODE LOCKed")*
CALL IBWRT(generator%, "SOURCE:FM:INTernal:FREQuency 1kHz")

3.5.4 Responses to Queries

A query is defined for each setting command unless explicitly specified otherwise. It is formed by adding a question mark to the associated setting command. According to SCPI, the responses to queries are partly subject to stricter rules than in standard IEEE 488.2.

1. The requested parameter is transmitted without header.
Example: *SOURCE:EXTernal:COUPling?* Response: *AC*
2. Maximum values, minimum values and all further quantities, which are requested via a special text parameter are returned as numerical values.
Example: *FREQuency? MAX* Response: *10E3*
3. Numerical values are output without a unit. Physical quantities are referred to the basic units or to the units set using the Unit command.
Example: *FREQuency?* Response: *1E6* for 1 MHz
4. Truth values <Boolean values> are returned as 0 (for OFF) and 1 (for ON).
Example: *OUTPut:STATE?* Response: *1*
5. Text (character data) is returned in a short form (see also Section 3.5.5.5).
Example: *SOURCE:FM:SOURce?* Response: *INT1*

3.5.5 Parameters

Most commands require a parameter to be specified. The parameters must be separated from the header by a "white space". Permissible parameters are numerical values, Boolean parameters, text, character strings and block data. The type of parameter required for the respective command and the permissible range of values are specified in the command description (see Section 3.6).

Numerical values Numerical values can be entered in any form, i.e. with sign, decimal point and exponent. Values exceeding the resolution of the instrument are rounded up or down. The mantissa may comprise up to 255 characters, the exponent must lie inside the value range -32000 to 32000. The exponent is introduced by an "E" or "e". Entry of the exponent alone is not permissible. In the case of physical quantities, the unit can be entered. Permissible unit prefixes are G (giga), MA (mega), MOHM and MHZ are also permissible), K (kilo), M (milli), U (micro) and N (nano). If the unit is missing, the basic unit is used.

Example: *SOURce:FREQuency 1.5 kHz = SOURce:FREQuency 1.5E3*

Special numerical values The texts MINimum, MAXimum, DEFault, UP and DOWN are interpreted as special numerical values.

In the case of a query, the numerical value is provided.

Examples: Setting command: *SOURce:VOLTage MAXimum*

Query: *SOURce:VOLTage?* Response: *15*

- MIN/MAX MINimum and MAXimum denote the minimum and maximum value.
- DEF DEFault denotes a preset value which has been stored in the EPROM. This value conforms to the default setting, as it is called by the *RST command.
- UP/DOWN UP, DOWN increases or reduces the numerical value by one step. The step width can be specified via an allocated step command (see annex C, List of Commands) for each parameter which can be set via UP, DOWN.
- INF/NINF INFINITY, Negative INFINITY (NINF) represent the numerical values -9.9E37 or 9.9E37, respectively. INF and NINF are only sent as device responses.
- NAN Not a Number (NAN) represents the value 9.91E37. NAN is only sent as device response. This value is not defined. Possible causes are the division of zero by zero, the subtraction of infinite from infinite and the representation of missing values.

Boolean Parameters Boolean parameters represent two states. The ON state (logically true) is represented by ON or a numerical value unequal to 0. The OFF state (logically untrue) is represented by OFF or the numerical value 0. 0 or 1 is provided in a query.

Examples: Setting command: *SOURce:FM:STATe ON*

Query: *SOURce:FM:STATe?* Response: *1*

Text Text parameters observe the syntactic rules for key words, i.e. they can be entered using a short or long form. Like any parameter, they have to be separated from the header by a white space. In the case of a query, the short form of the text is provided.

Example: Setting command: *OUTPut:FILTer:TYPE EXTernal*

Query: *OUTPut:FILTer:TYPE?* Response: *EXT*

Strings

Strings must always be entered in quotation marks (' or ").

Example: *SYSTem:LANGuage "SCPI" or SYSTem:LANGuage 'SCPI'*

Block data

Block data are a transmission format which is suitable for the transmission of large amounts of data. A command using a block data parameter has the following structure:

Example: *HEADer:HEADer #45168xxxxxxx*

ASCII character # introduces the data block. The next number indicates how many of the following digits describe the length of the data block. In the example the 4 following digits indicate the length to be 5168 bytes. The data bytes follow. During the transmission of these data bytes all End or other control signs are ignored until all bytes are transmitted. Data elements comprising more than one byte are transmitted with the byte being the first which was specified by SCPI command *"FORMat:BORDER"*.

3.5.6 Overview of Syntax Elements

The following survey offers an overview of the syntax elements.

- :** The colon separates the key words of a command.
In a command line the colon after the separating semicolon marks the uppermost command level.
- ;** The semicolon separates two commands of a command line. It does not alter the path.
- ,** The comma separates several parameters of a command.
- ?** The question mark forms a query.
- *** The asterisk marks a common command.
- "** Quotation marks introduce a string and terminate it.
- #** ASCII character # introduces block data.
- A "white space" (ASCII-Code 0 to 9, 11 to 32 decimal, e.g. blank) separates header and parameter.

3.6 Description of Commands

3.6.1 Notation

In the following sections, all commands implemented in the instrument are first listed in tables and then described in detail, separated according to the command system. The notation corresponds to the one of the SCPI standards to a large extent. The SCPI conformity information can be taken from the list of commands in annex C.

Table of Commands

- Command: In the command column, the table provides an overview of the commands and their hierarchical arrangement (see indentations).
- Parameter: In the parameter column the requested parameters are indicated together with their specified range.
- Unit: The unit column indicates the basic unit of the physical parameters.
- Remark: In the remark column an indication is made on
- whether the command does not have a query form,
 - whether the command has only one query form ,
 - whether this command is implemented only with a certain option of the instrument.

Indentations

The different levels of the SCPI command hierarchy are represented in the table by means of indentations to the right. The lower the level is, the farther the indentation to the right is. Please observe that the complete notation of the command always includes the higher levels as well.

Example: `:SOURce:FM:MODE` is represented in the table as follows:

<code>:SOURce</code>	first level
<code>:FM</code>	second level
<code>:MODE</code>	third level

In the individual description, the hierarchy is represented in the corresponding way. That is to say, for each command all key words above up to the left-hand margin must be considered. An example for each command is written out at the end of the individual description.

Upper/lower case notation Upper/lower case letters serve to mark the long or short form of the key words of a command in the description (see Section 3.5.2). The instrument itself does not distinguish between upper and lower case letters.

Special characters

- | A selection of key words with an identical effect exists for several commands. These key words are indicated in the same line, they are separated by a vertical stroke. Only one of these key words has to be indicated in the header of the command. The effect of the command is independent of which of the key words is indicated.

Example: `:SOURce`
`:FREQuency`
`:CW|:FIXed`

The two following commands of identical meaning can be formed. They set the frequency of the constantly frequent signal to 1 kHz:

`:SOURce:FREQuency:CW 1E3=:SOURce:FREQuency:FIXed 1E3`

A vertical stroke in indicating the parameters marks alternative possibilities in the sense of "or". The effect of the command is different, depending on which parameter is entered.

Example: Selection of the parameters for the command
`:SOURce:COUPling AC|DC`

If parameter AC is selected, only the AC content is fed through, in the case of DC, the DC as well as the AC content.

- [] Key words in square brackets can be omitted when composing the header (cf. Section 3.5.2, Optional Keywords). The full command length must be accepted by the instrument for reasons of compatibility with the SCPI standards.
Parameters in square brackets can optionally be incorporated in the command or omitted as well.
- { } Parameters in braces can optionally be incorporated in the command either not at all, once or several times.

3.6.2 Common Commands

The common commands are taken from the IEEE 488.2 (IEC 625-2) standard. Same commands have the same effect on different devices. The headers of these commands consist of an asterix "*" followed by three letters. Many common commands refer to the status reporting system which is described in detail in Section 3.8.

Command	Parameter	Unit	Remark
*CLS			no query
*ESE	0 to 255		
*ESR?			only query
*IDN?			only query
*IST?			only query
*OPC			
*OPT?			only query
*PRE	0 to 255		
*PSC	0 1		
*RCL	0 to 50		no query
*RST			no query
*SAV	1 to 50		no query
*SRE	0 to 255		
*STB?			only query
*TRG			no query
*TST?			only query
*WAI			

*CLS

CLEAR STATUS sets the status byte (STB), the standard event register (ESR) and the EVENT-part of the QUESTIONABLE and the OPERATION register to zero. The command does not alter the mask and transition parts of the registers. It clears the output buffer.

*ESE 0 to 255

EVENT STATUS ENABLE sets the event status enable register to the value indicated. Query *ESE? returns the contents of the event status enable register in decimal form.

*ESR?

STANDARD EVENT STATUS QUERY returns the contents of the event status register in decimal form (0 to 255) and subsequently sets the register to zero.

*IDN?

IDENTIFICATION QUERY queries the instrument identification.

The device response is for example: *"Rohde&Schwarz, SMT03,00000001, 1.03"*

03 = variant identification

00000001 = serial number

1.03 = firmware version number

***IST?**

INDIVIDUAL STATUS QUERY returns the contents of the IST flag in decimal form (0 | 1). The IST flag is the status bit which is sent during a parallel poll (cf. Section 3.8.3.2).

***OPC**

OPERATION COMPLETE sets bit 0 in the event status register when all preceding commands have been executed. This bit can be used to initiate a service request (cf. Section 3.7).

***OPC**

OPERATION COMPLETE QUERY writes message "1" into the output buffer as soon as all preceding commands have been executed (cf. Section 3.7).

***OPT?**

OPTION IDENTIFICATION QUERY queries the options included in the instrument and returns a list of the options installed. The options are separated from each other by means of commas. For every option, a fixed position is provided in the response.

Table 3-1 Device Response to *OPT?

Position	Option
1	SM-B1 Reference oscillator OCXO
2	SM-B2 LF generator
3	SM-B2 2nd LF generator
4	SM-B3 Pulse modulator 1.5 GHz
5	SM-B4 Pulse generator
6	reserved
7	SM-B6 Multifunction generator
8	SM-B8 Pulse modulator 3GHz
9	reserved

Example for a device response: 0,SM-B2,0,0,0,SM-B5,0,0,0

***PRE 0 to 255**

PARALLEL POLL REGISTER ENABLE sets the parallel poll enable register to the value indicated. Query *PRE? returns the contents of the parallel poll enable register in decimal form.

***PSC 0 | 1**

POWER ON STATUS CLEAR determines whether the contents of the ENABLE registers is maintained or reset in switching on.

*PSC = 0 causes the contents of the status registers to be maintained. Thus a service request can be triggered in switching on in the case of a corresponding configuration of status registers ESE and SRE.

*PSC ≠ 0 resets the registers.

Query *PSC? reads out the contents of the power-on-status-clear flag. The response can be 0 or 1.

***RCL 0 to 50**

RECALL calls the instrument state which was stored under the number supplied using command *SAV. 50 instrument states can be stored.

***RST**

RESET sets the instrument to a defined default status. The command essentially corresponds to pressing the [PRESET] key. The state of the RF-output is an exception: The RF-output ist deactivated after *RST, however, it is activated after the [RESET] key has been pressed. The default setting is indicated in the description of the commands.

***SAV 1 to 50**

SAVE stores the current instrument state under the number indicated (cf. *RCL as well).

***SRE 0 to 255**

SERVICE REQUEST ENABLE sets the service request enable register to the value indicated. Bit 6 (MSS mask bit) remains 0. This command determines under which conditions a service request is triggered. Query *SRE? reads the contents of the service request enable register in decimal form. Bit 6 is always 0.

***STB?**

READ STATUS BYTE QUERY reads out the contents of the status byte in decimal form.

***TRG**

TRIGGER triggers all actions waiting for a trigger event. Special trigger events can be started by command system "TRIGger" (see section "TRIGger System").

***TST?**

SELF TEST QUERY triggers all selftests of the instrument indicated in Section 4.4, Functional Test and outputs an error code in decimal form.

***WAI**

WAIT-to-CONTINUE only permits the servicing of the subsequent commands after all preceding commands have been executed and all signals have settled (cf. Section 3.7 and "*OPC" as well).

3.6.3 ABORt System

The ABORt system contains the commands to abort actions triggered. After an action has been aborted, it can be triggered again at once. All commands trigger an event, thus they have no *RST value.

Further commands for the trigger system of the SMT can be found in the TRIGger system, Section 3.6.16.

Command	Parameter	Default Unit	Remarks
:ABORt [:SWEep] :MSEquence			No query No query

:ABORt

[:SWEep]

The command aborts a sweep.

Example: :ABOR:SWE

:MSEquence

The command aborts a Memory Sequence.

Example: :ABOR:MSEQ

3.6.4 CALibration System

The CALibration system contains the commands to calibrate the SMT. On triggering the calibration by means of :MEASure, response, "0" displays a faultless calibration, response "1" means that an error has occurred during calibration. As to the meaning of the data in the case of query :DATA?, cf. Chapter 2, Section "Calibration".

Command	Parameter	Default Unit	Remark
:CALibration :FM [:MEASure]? :DATA? :OFFSet? :LEVel :DATA? :FRANge :PMODulator :STATe :LPReset [:MEASure]? :DATA? :PULSe [:MEASure]? :DATA? :ROSCillator [:DATA] :VSYNthesis [:MEASure]? :DATA?	NORMa MIXer ON OFF ON OFF 0 to 4095		Query only Query only Query only Query only Query only Query only Option SM-B4 Query only Query only Query only Query only

:CALibration
:FM

The commands to calibrate the DC offset voltage to zero as well as the commands to calibrate the FM accuracy (slope of deviation) are under this node.

[:MEASure]

The command triggers a calibration measurement of the FM accuracy. The command triggers an event and thus has no *RST value.

Example: `:CAL:FM:MEAS?`

:DATA?

The command queries the calibration data of the FM accuracy. It returns all calibration data in the format specified in the FORMat system.

Example: `:CAL:FM:DATA?`

:OFFSet?

The command triggers a calibration measurement of the offset voltage to zero. Data which can be read out are not generated, thus there is no appropriate DATA? command. The command triggers an event and thus has no *RST value.

Example: `:CAL:FM:OFFS?`

:LEVel

This node provides the commands for the management of the level correction table. The corresponding data are permanently stored in the instrument and cannot be changed. The instrument includes different level correction tables. The tables to be used are selected depending on the set frequency and the pulse modulator switched on (internal or external). The :FRANge and :PMODulator commands select the level correction tables to be read out using the DATA? command. These commands simulate the current instrument status but do not have any influence on the instrument setup. The :STATe ON command activates the level correction table corresponding to the real instrument setup.

:FRANge NORMal|MIXer

The command selects the level correction table valid for a frequency in the NORMal or in the MIXer range. *RST value is NOR

Example: `:CAL:LEV:FRAN NORM`

:PMODulator ON|OFF

The command selects the level correction table valid for an instrument setup with the pulse modulator ON or OFF.

Example: `:CAL:LEV:PMOD OFF` *RST value is OFF

:DATA?

The command queries the level correction data. It returns all level correction data in the format fixed in the :FORMat system. The other commands under this node determine the list that is returned.

Example: `:CAL:LEV:DATA?`

:STATe ON|OFF

The command switches on or off internal level correction. *RST value is ON.

Example: `:CAL:LEV:STAT OFF`

:CALibration

:CALibration

:LPRreset

The commands to measure the values for the level presetting table are under this node (Level Preset).

[[:MEASure]]?

The command triggers a calibration measurement. The command triggers an event and thus has no *RST value.

Example: :CAL:LPR:MEAS? Response: 0

:DATA?

The command queries the correction data. It returns all correction data in the format fixed in the :FORMat system.

Example: :CAL:LPR:DATA?

:PULSe

The commands to calibrate the pulse generator are under this node (option SM-B4).

[[:MEASure]]?

The command triggers a calibration measurement. The command triggers an event and thus has no *RST value.

Example: :CAL:PULS:MEAS? Response: 0

:DATA?

The command queries the correction data. It returns the correction data as two integers separated by a comma. The first number indicates the fine adjustment, the second the coarse adjustment.

Example: :CAL:PULS:DATA? Response: 26,2

:ROSCillator

The commands to calibrate the reference oscillator are under this node.

[[:DATA]] 0 to 4095

The command enters the correction data. For an exact definition of the calibration value, cf. Chapter 2, Section "Calibration".

Example: :CAL:ROSC:DATA 2048

:VSYNthesis

The commands to determine the sampling points for the frequency setting are under this node.

[[:MEASure]]?

The command triggers a calibration measurement. The command triggers an event and thus has no default setting value.

Example: :CAL:VSYN:MEAS? Response: 0

:DATA?

The command queries the calibration data. It returns all calibration data in the format which was set in the FORMat system.

Example: :CAL:VSYN:DATA?

3.6.5 DIAGnostic System

The DIAGnostic system contains the commands for diagnostic test and service of the instrument. SCPI does not define DIAGnostic commands, the commands listed here are SMT-specific. All DIAGnostic commands are queries which are not influenced by *RST. Hence no default setting values are stated.

Command	Parameter	Default Unit	Remark
:DIAGnostic :INFO :CCOunt :ATTenuator1 2 3 4 5 6? :POWer? :MODules? :OTIMe? :SDATe? [:MEASure] :POINt?			Query only Query only Query only Query only Query only Query only

:DIAGnostic
:INFO

The commands which can be used to query all information which does not require hardware measurement are under this node.

:CCOunt

The commands which can be used to query all counters in the instrument are under this node (Cycle COunt).

:ATTenuator 1 | 2 | 3 | 4 | 5 | 6?

The command queries the number of switching processes of the different attenuator stages. The stages are designated with Z1 to Z6 within the instrument. In this command they are differentiated by a numeric suffix whose name corresponds to the number. Hence the following assignment is true:

Suffix	Name	Function
1	Z1	40-dB stage
2	Z2	20-dB stage
3	Z3	5-dB stage
4	Z4	20-dB stage
5	Z5	10-dB stage
6	Z6	40-dB stage

Example: :DIAG:INFO:CCO:ATT1?

Response: 1487

:DIAGnostic

:DIAGnostic

:INFO

:CCOunt

:POWer?

The command queries the number of switch-on processes.

Example: `:DIAG:INFO:CCO:POW?`

Response: 258

:MODules?

The command queries the modules existing in the instrument with their model and state-of-modification numbers. The response supplied is a list in which the different entries are separated by commas. The length of the list is variable and depends on the equipment of the instrument. Each entry consists of three parts which are separated by means of blanks:

1. Name of module
2. Variant of module in the form VarXX (XX = 2 digits)
3. Revision of module in the form RevXX (XX = 2 digits)

Example: `:DIAG:INFO:MOD?`

Response: *FRO Var01 Rev00,
DSYN Var03 Rev12,
ROSC Var01 Rev03*

:OTIMe?

The command reads out the internal operating-hours counter (Operation TIME). The response supplies the number of hours the instrument has been in operation up to now.

Example: `:DIAG:INFO:OTIM?`

Response: 19

:SDATe?

The command queries the date of software creation. The response is returned in the form year, month, day.

Example: `:DIAG:INFO:SDAT?`

Response: 1992, 12, 19

[:MEASure]

The commands which trigger a measurement in the instrument and return the measured value are under this node.

:POINT?

The command triggers a measurement at a measuring point and returns the voltage measured. The measuring point is specified by a numeric suffix (cf. service manual, stock no. 1039.3359.24).

Example: `:DIAG:MEAS:POIN2?`

Response: 3.52

3.6.6 DISPlay System

This system contains the commands to configure the screen. If system security is activated using command *SYSTem:SECurity ON*, the display cannot be switched on and off arbitrarily (cf. below).

Command	Parameter	Default Unit	Remark
:DISPlay :ANNotation [:ALL] :AMPLitude :FREQUency	ON OFF ON OFF ON OFF		

:DISPlay :ANNotation

The commands determining whether frequency and amplitude are indicated are under this node.

Caution: *With SYSTem:SECurity ON, the indications cannot be switched from OFF to ON. In this case *RST does not influence the ANNotation settings either. With SYSTem:SECurity OFF, the *RST value is ON for all ANNotation parameters.*

[:ALL] ON | OFF

The command switches the frequency and amplitude indication on or off.

Command *:DISPlay:ANNotation:ALL ON* can only be executed if *SYSTem:SECurity* is set to *OFF*.

With *SYSTem:SECurity OFF* – *RST value is ON.

Example: *:DISP:ANN:ALL ON*

AMPLitude ON | OFF

The command switches on or off the amplitude indication.

Command *:DISPlay:ANNotation:AMPLitude ON* can only be executed if *SYSTem:SECurity* is set to *OFF*.

With *SYSTem:SECurity OFF* – *RST value is ON.

Example: *:DISP:ANN:AMPL ON*

FREQUency ON | OFF

The command switches the frequency indication on or off.

Command *:DISPlay:ANNotation:FREQUency ON* can only be executed if *SYSTem:SECurity* is set to *OFF*.

With *SYSTem:SECurity OFF* – *RST value is ON.

Example: *:DISP:ANN:FREQ ON*

3.6.7 FORMat System

This system contains the commands determining the format of the data the SMT returns to the controller. All queries returning a list of numeric data or a binary block are concerned. With each of these commands, this connection is pointed to in the description.

Command	Parameter	Default Unit	Remark
:FORMat [:DATA]	ASCIi REAL [,32 64] PACKed		

:FORMat

[:DATA] ASCIi | REAL [,32 | 64] | PACKed

The command specifies the data format.

Note: *Settings using the FORMat:DATA command are only effective for commands with which this is stated in the command description.*

ASCIi Numeric data are transmitted in plain text, separated by commas.

REAL Numeric data are transmitted as block data. 8 (4 with setting 32, see below) successive bytes are interpreted as a double-precision floating point number (in accordance with IEEE 754). The number indicates the length of an integer in bits; 32 and 64 are valid values, 64 is preset.

PACKed Numerical data are transmitted as binary block data. The format of the binary data itself is command-specific. Its description can be found by the respective command.

*RST value is ASCIi

Example: *:FORM:DATA ASCIi*

3.6.8 MEMory System

This system contains the commands for the memory management of the SMT.

Commands	Parameter	Default Unit	Remark
:MEMory :NSTates?			Query only

:MEMory
:NSTates?

The command returns the number of *SAV/*RCL memories available. The SMT has 50 *SAV/*RCL memories in total.

Example: :MEM:NST?

Response: 50

3.6.9 OUTPut System

This system contains the commands specifying the characteristics of the RF output socket and the blank socket. The characteristics of the LF socket are specified in the OUTPut2 system.

Command	Parameter	Default Unit	Remark
:OUTPut :AMODe :BLANK :POLarity :IMPedance? :PROTection :CLEar :TRIPped? [:STATE] :PON	AUTO FIXEd NORMAl INVVerted ON OFF OFF UNCHanged		Query only SMT02 and SMT03 Query only

:OUTPut

:AMODe AUTO | FIXEd

The command switches over the operating mode of the attenuator at the RF output (Attenuator MODe).

AUTO The attenuator is switched whenever possible.

FIXEd The attenuator is switched when certain fixed levels are exceeded/fallen below. *RST value is AUTO

Example: :OUTP:AMOD AUTO

:OUTPut

:OUTPut**:BLANk**

The commands determining the characteristics of the BLANk output are under this node.

:POLarity NORMal | INVerted

The command sets the polarity of the BLANk signal.

NORMal The active BLANk state is indicated by the more positive or higher output voltage.

INVers The active BLANk state is indicated by the more negative or lower output voltage. *RST value is NORM

Example: `:OUTP:BLAN:POL NORM`

:IMPedance?

The command queries the impedance of the RF output. This permits converting the output level between units V and W. The impedances cannot be changed. With the SMT, this is the fixed value of 50 Ohm for the RF output.

Example: `:OUTP:IMP?`

Response: 50

:PROTection

The commands to configure the protective circuit of SMT02/03 are under this node. The RF output is protected by a protective circuit which deactivates the output if an overvoltage is supplied from outside. This does not change the value of `OUTPut:STATe`.

:CLEar

The command resets the protective circuit after it has been triggered. The state of the output is determined by `OUTPut:STATe` again. The command triggers an event and hence has no default setting value.

Example: `:OUTP:PROT:CLE`

:TRIPped?

The command queries the state of the protective circuit. The responses mean:

"0" The protective circuit has not responded

"1" The protective circuit has responded

Example: `:OUTP:PROT:TRIP?`

Response: 1

:STATe ON | OFF

The command switches on or off the RF output. The RF output can also be switched off by the response of the protective circuit. But this has no influence on this parameter.

Note: In contrast to the PRESET key, command *RST sets this value to OFF, the output is deactivated.

*RST value is OFF

Example: `:OUTP:STAT ON`

:PON OFF | UNChanged

This command selects the RF output is assume after power-on of the unit.

OFF Output is switched off

UNChanged Same state as before switch-off

It only exists for the RF output

*RST does not influence the set value.

Example: `:OUTP:PON OFF`

3.6.10 OUTPut2 System

This system contains the commands specifying the characteristics of the LF output socket.

Command	Parameter	Default Unit	Remark
:OUTPut2 :SOURce :STEReo [:STATe] :VOLTage	0 2 MPX PIlot ON OFF 0 V to 4 V	V	Option SM-B2/SM-B6 Option SM-B2/SM-B6

:OUTPut2

:SOURce 0 | 2

This command selects which LF generator is connected with the LF output socket (only with option SM-B2 and SM-B6).

0 LF generator 1

2 LF generator 2

*RST value is 0, LF generator 1 is connected at the output.

Example: :OUTP2:SOUR 2

:STEReo MPX | PIlot

The command determines whether the complete stereo multiplex signal (MPX) or only the pilot tone is output. The command is only effective if LF generator2 is in the STEREO operating mode and if LF generator2 is selected for OUTPut2:SOURce as well.

*RST value is MPX

Example: :OUTP2:SOUR:STER MPX

[:STATe] ON | OFF

The command switches the LF output on or off.

*RST value is OFF

Example: :OUTP2:STAT ON

:VOLTage 0V to 4V

The command sets the voltage of the LF output. The voltage is a characteristic of the output, not the source. I.e., it is maintained even if another LF generator is connected to the output.

*RST value is 1 V

Example: :OUTP2:VOLT 3.0V

3.6.11 SOURce System

This system contains the commands to configure the RF signal source. Keyword SOURce is optional, i.e., it can be omitted. The LF signal sources (options SM-B2 and SM-B6) are configured in the SOURce0|2 system (cf. Section 3.6.12).

The following subsystems are realized in the instrument:

Subsystem	Setting
[:SOURce] :AM :CORRection :FM :FREQuency :ILS :MARKer :MBE :PHASe :PM :POWER :PULM :PULSe :ROSCillator :STEReo :SWEep :VOR	Amplitude modulation Correction of the output level Frequency modulation Frequencies including sweep Test signals for ILS (Instrument Landing System) Marker generation with sweeps Marker signals (Marker Beacon) Phase between output signal and reference oscillator signal Phase modulation Output level, level control and level correction Pulse modulation Pulse generator Reference oscillator Stereo modulation Sweeps Test signals for VOR (VHF Omnidirectional Range)

3.6.11.1 SOURce:AM Subsystem

This subsystem contains the commands to control the amplitude modulation. Up to two LF generators which serve as internal modulation sources can be fitted in the instrument (options SM-B2 and SM-B6). Part of their settings is effected under SOURce0|2.

Command	Parameter	Default Unit	Remark
[:SOURce] :AM [:DEPTH] :EXTeRnal :COUPLing :INTeRnal 1 2 :FREQuency :POLarity :SOURce :STATe	0 to 100PCT AC DC 400 Hz 1 kHz 3 kHz 15 kHz or 0.1 Hz to 500 kHz or 0.1 Hz to 1 MHz NORMal INVeRted INT1 2 EXT INT1 2, EXT ON OFF	PCT Hz	 Option SM-B2 Option SM-B6

**:SOURce
:AM****[:DEPT h]** 0 to 100PCT

The command sets the modulation depth in percent.

*RST value is 30PCT

Example: `:SOUR:AM:DEPT 15PCT`**:EXTernal**

The commands to set the external AM input are under this node.

:COUpling AC | DC

The command selects the type of coupling for the external AM input.

AC The d.c. voltage content is separated from the modulation signal.

DC The modulation signal is not altered.

*RST value is AC

Example: `:SOUR:AM:EXT:COUP AC`**:INTernal 1 | 2**

The settings for the internal AM inputs are effected under this node.

INT1 is LF generator 1,

INT2 is LF generator 2.

Here the same hardware is set for AM, PM, FM and SOURce0|2. This means that, for example, the following commands are coupled with each other and have the same effect:

`SOUR:AM:INT2:FREQ``SOUR:FM2:INT:FREQ``SOUR:PM2:INT:FREQ``SOUR2:FREQ:CW`**:FREQuency** 400 Hz | 1 kHz | 3 kHz | 15 kHz or 0,1 Hz to 500 kHz or 0,1 Hz to 1 MHz

The command sets the modulation frequency. Only certain specified ranges are permissible depending on the equipment of the instrument.

If neither SM-B2 nor SM-B6 are fitted, only INT1 is permissible and values 400 Hz, 1 kHz, 3 kHz and 15 kHz are true. With option SM-B2, the specified range from 0.1 Hz to 500 kHz is true, with SM-B6, from 0.1 Hz to 1 MHz.

*RST value is 1 kHz

Example: `:SOUR:AM:INT:FREQ 15kHz`**:POLarity** NORMal | INVerted

The command selects the polarity of the AM.

NORMal A positive modulation voltage generates a higher output level.

INVerted The AM polarity is inverted.

Example: `:SOUR:AM:POL NORM`

*RST value is NORMal

:SOURce INT1|2 | EXT | INT1|2 ,EXT

The command selects the modulation source. INT1 is LF generator 1, INT2 LF generator 2 (option SM-B2 or SM-B6). An external and an internal modulation source can be indicated at the same time (see example).

*RST value is INT1

Example: `:SOUR:AM:SOUR INT1,EXT`**:STATe** ON | OFF

The command switches amplitude modulation on or off.

*RST value is OFF

Example: `:SOUR:AM:STAT ON`

3.6.11.2 SOURce:CORRection Subsystem

The CORRection subsystem permits a correction of the output level. The correction is effected by adding user-defined table values to the output level as a function of the RF frequency. In the SMT, this subsystem serves to select, transmit and switch on USER-CORRECTION tables (see Chapter 2, Section "User Correction (UCOR)" as well).

Command	Parameter	Default Unit	Remark
[[:SOURce] :CORRection [:STATe] :CSET :CATalog? [:SElect] :DATA :FREQuency :POWer :DElete	ON OFF "Name of table" 5 kHz to 1,5 GHz {,5 kHz to 1,5 GHz} - 40 dB to + 6 dB {,-40 dB to + 6 dB} "Name of table"	 Hz dB	 Query only SMT03/06: to 3/6 GHz

[[:SOURce]

:CORRection

[:STATe] ON | OFF

The command switches the table selected using *SOURce:CORRection:CSET* on or off.

Example: :SOUR:CORR:STAT ON

*RST value is OFF

:CSET The commands to select and edit the UCOR lists are under this node. These commands have no *RST value.

:CATalog?

The command queries the tables available. It returns a list, the entries are separated by means of commas.

Example: :SOUR:CORR:CSET:CAT? Response: "UCOR1", "UCOR2", "UCOR3"

[:SElect] "Name of table"

The command selects a correction table. This command alone does not yet effect a correction. First the table selected must be activated (cf. *:SOURce:CORRection:STATe*). If there is no table of this name (max. 7 letters), a new table is created.

Example: :SOUR:CORR:CSET:SEL "UCOR1"

:DATA The commands to edit the UCOR tables are under this node.

:FREQuency 5 kHz to 1,5 GHz {,5 kHz to 1,5 GHz} / SMT03: 5 kHz to 3 GHz / SMT06: 5 kHz to 6 GHz. The command transmits the frequency data for the table selected using *:SOURce:CORRection:CSET*.

Note: The frequency values must be inputed in ascending order.

Example: :SOUR:CORR:CSET:DATA:FREQ 100MHz,102MHz,103MHz

:POWer - 40 dB to + 6 dB {,-40 dB to + 6 dB }

The command transmits the level data for the table selected using *:SOURce:CORRection:CSET*.

Example: :SOUR:CORR:CSET:DATA:POWer 1dB, 0,8dB, 0,75dB

:DElete "Name of table"

The command deletes the table indicated from the instrument memory.

Example: :SOUR:CORR:CSET:DEL "UCOR2"

3.6.11.3 SOURce-FM-Subsystem

This subsystem contains the commands to check the frequency modulation and to set the parameters of the modulation signal. The SMT is equipped with two independent frequency modulators. They are differentiated by a suffix after FM.

SOURce:FM1

SOURce:FM2

Command	Parameter	Default Unit	Remark
[:SOURce] :FM1 2			
[:DEVIation]	0 to 10 MHz;	Hz	SMT03: 20 Hz SMT06: 40 Hz
:EXTernal1 2 :COUpling	AC DC		
:INTernal :FREquency	400 Hz 1 kHz 3 kHz 15 kHz or 0.1 Hz to 500 kHz or 0.1 Hz to 1 MHz	Hz	Option SM-B2 Option SM-B6
:SOURce :STATe	INT EXT1 EXT2 ON OFF		

[:SOURce]

:FM 1 | 2

[:DEVIation] 0 to 10 MHz; SMT03: 0 to 20 MHz / SMT06: 0 to 40 MHz

The command specifies the frequency variation caused by the FM. Although the LF generators are used as modulation sources, the frequency variation is independent of the voltage at the LF output. The maximally possible DEVIation depends on *SOURce:FREquency* (cf. data sheet).

*RST value is 10 kHz

Example: :SOUR:FM1:DEV 5kHz

:EXTernal 1 | 2

The commands to set the external FM input are under this node. The settings under EXTernal for modulations AM, FM and PM are independent of each other. The settings are always related to the socket which is determined by the numeric suffix after EXTernal. The suffix after FM is ignored then. With the following commands, e.g., the settings are both related to socket EXT2:

:SOUR:FM1:EXT2:COUP AC

:SOUR:FM2:EXT2:COUP AC

A command without suffix is interpreted like a command with suffix 1.

:COUpling AC | DC

The command selects the type of coupling for the external FM input.

AC The d.c. voltage content is separated from the modulation signal.

DC The modulation signal is not altered.

*RST value is AC

Example: :SOUR:FM:EXT:COUP AC

:SOURce:FM

[:SOURce]**:FM1|2****:INTernal**

The settings for the internal FM generators are effected under this node. For FM1, this is always LF generator 1, for FM2, always LF generator 2. Here the same hardware is set for FM1, PM1, AM:INT1 as well as SOURce0, just like for FM2, PM2 and AM:INT2 as well as SOURce2. This means that, e.g., the following commands are coupled with each other and have the same effect:

SOUR:AM:INT2:FREQ

SOUR:FM2:INT:FREQ

SOUR:PM2:INT:FREQ

SOUR2:FREQ:CW

:FREQuency 400 Hz | 1 kHz | 3 kHz | 15 kHz or 0.1 Hz to 500 kHz or 0.1 Hz to 1MHz

The command sets the modulation frequency. There are different specified ranges depending on the equipment of the instrument:

If neither SM-B2 nor SM-B6 are fitted, only FM 1 is permissible and values 400 Hz, 1 kHz, 3 kHz and 15 kHz are valid. With option SM-B2, the specified range from 0.1 Hz to 500 kHz is valid, with SM-B6, from 0.1 Hz to 1 MHz. *RST value is 1 kHz

Example: *:SOUR:FM:INT:FREQ 10kHz*

:SOURce INTernal | EXTernal1 | EXTernal2

The command selects the modulation source. A command without suffix is interpreted like a command with suffix 1. LF generator 1 is INT for FM1, LF generator2 for FM2. Several modulation sources can be active at the same time (cf. example)

*RST value for FM1: INT
for FM2:EXT2

Example: *:SOUR:FM:SOUR INT1,EXT2*

:STATe ON | OFF

The command switches the frequency modulation on or off.

*RST value is OFF.

Example: *SOUR:FM:STAT OFF*

3.6.11.4 SOURce:FREQUENCY Subsystem

This subsystem contains the commands for the frequency setting of the RF source including the sweeps.

Command	Parameter	Default Unit	Remark
[[:SOURce]			
:FREQUENCY			
:CENTer	5 kHz to 1.5 GHz	Hz	SMT03/06: to 3/6 GHz
[[:CW :FIXed]	5 kHz to 1.5 GHz	Hz	SMT03/06: to 3/6 GHz
:RCL	INCLude EXCLude		
:MANual	5 kHz to 1.5 GHz	Hz	SMT03/06: to 3/6 GHz
:MODE	CW FIXed SWEEp		
:OFFSet	-50 GHz to 50 GHz	Hz	
:SPAN	0 to 1.5 GHz	Hz	SMT03/06: to 3/6 GHz
:START	5 kHz to 1.5 GHz	Hz	SMT03/06: to 3/6 GHz
:STOP	5 kHz to 1.5 GHz	Hz	SMT03/06: to 3/6 GHz
:STEP			
[[:INCRement]	0 to 1 GHz	Hz	

[[:SOURce]

:FREQUENCY

:CENTer 5 kHz to 1.5 GHz (SMT03: 5 kHz to 3 GHz / SMT06: 5 kHz to 6 GHz)

The command sets the sweep range by means of the center frequency. This command is coupled to commands *:SOURce:FREQUENCY:START* and *:SOURce:FREQUENCY:STOP*.

The OFFSet value is considered with this command as with the FREQUENCY input value in the FREQUENCY menu. Thus the specified range indicated is only valid for OFFSet = 0. The specified range with other OFFSet values can be calculated according to the following formula (cf. Section 2.4.1, Frequency Offset, as well):

$$5 \text{ kHz} + \text{OFFSet} \dots 1.5 \text{ GHz} + \text{OFFSet}$$

Example: *:SOUR:FREQ:CENT 100kHz* *RST value is (START + STOP)/2

[[:CW|:FIXed] 5 kHz to 1.5 GHz (SMT03: 5 kHz to 3 GHz / SMT06: 5 kHz to 6 GHz)

The command sets the frequency for CW operation. This value is coupled to the current sweep frequency. In addition to a numeric value, UP and DOWN can be indicated. The frequency is increased or reduced by the value set under *:SOURce:FREQUENCY:STEP*. (As to specified range, cf. *FREQUENCY:CENTer*)

Example: *:SOUR:FREQ:CW 100kHz* *RST value is 100 MHz

:RCL INCLude | EXCLude

The command determines the effect of the recall function on the frequency. *RST value has no effect to this setting.

INCLude The saved frequency is loaded when instrument settings are loaded with the [RECALL] key or with a memory sequence.

EXCLude The RF frequency is not loaded when instrument settings are loaded, the current settings are maintained.

Example: *:SOUR:FREQ:RCL INCL*

:MANual 5 kHz to 1.5 GHz (SMT03: 5 kHz to 3 GHz / SMT06: 5 kHz to 6 GHz)

The command sets the frequency if *SOURce:SWEEp:MODE MANual* and *SOURce:FREQUENCY:MODE SWEEp* are set. Only frequency values between the settings with *:SOURce:FREQUENCY:START* and *:SOURce:FREQUENCY:STOP* are permitted. (As to specified range, cf. *FREQUENCY:CENTer*)

Example: *:SOUR:FREQ:MAN 500MHz* *RST value is 100 MHz

[[:SOURce]**:FREQuency****:MODE** CW | FIXed | SWEep

The command specifies the operating mode and hence also specifies which commands check the FREQuency subsystem. The following allocations are valid:

CW|FIXed CW and FIXed are synonyms. The output frequency is specified by means of *:SOURce:FREQuency:CW|FIXed*.

SWEep The instrument operates in the SWEep operating mode. The frequency is specified by means of commands *SOURce:FREQuency:START; STOP; CENTer; SPAN; MANual*. *RST value is CW.

Example: *:SOUR:FREQ:MODE SWE*

:OFFSet –50 to +50 GHz

The command sets the frequency offset of an instrument possibly series-connected, e.g., of a mixer. If a frequency offset is entered, the frequency entered using *SOURce:FREQuency* does no longer conform to the RF output frequency. The following connection is true:

$SOURce:FREQuency = \text{RF output frequency} + OFFSet$.

Entering an offset does not vary the RF output frequency, but the query value of *SOURce:FREQuency* (cf. Section 2.4.1, Frequency Offset). *RST value is 0

Example: *:SOUR:FREQ:OFFS 100MHz*

:SPAN 0 to 1.5 GHz (SMT03: 5 kHz to 3 GHz / SMT06: 5 kHz to 6 GHz)

This command indicates the frequency range for the sweep. This parameter is coupled to the start and stop frequency. Negative values for SPAN are permitted, then $START > STOP$ is true. There is the following connection:

$START = CENTer - SPAN/2$

$STOP = CENTer + SPAN/2$

*RST value is (STOP–START)

Example: *:SOUR:FREQ:SPAN 1GHz*

:START 5 kHz to 1.5 GHz (SMT03: 5 kHz to 3 GHz / SMT06: 5 kHz to 6 GHz)

This command indicates the starting value of the frequency for the sweep operation. Parameters *START*, *STOP*, *SPAN* and *CENTer* are coupled to each other. *START* may be larger than *STOP*. (As to the specified range, cf. *FREQ:CENT*). *RST value is 100MHz

Example: *:SOUR:FREQ:STAR 1MHz*

:STOP 5 kHz to 1.5 GHz (SMT03: 5 kHz to 3 GHz / SMT06: 5 kHz to 6 GHz)

This command indicates the final value of the frequency for the sweep operation (see *START* as well). (As to specified range, cf. *FREQ:CENT*). *RST value is 500MHz

Example: *:SOUR:FREQ:STOP 100MHz*

:STEP

The command to enter the step width for the frequency setting if frequency values UP or DOWN are used is under this node. This command is coupled to the *KNOB STEP* command in manual control. Only linear step widths can be set.

[[:INCRement]] 0 to 1 GHz

The command sets the step width for the frequency setting.

*RST value is 1MHz

Example: *:SOUR:FREQ:STEP:INCR 1MHz*

3.6.11.5 SOURCE:ILS Subsystem

This subsystem contains the commands to control the characteristics of the test signals for ILS (Instrument Landing System) (option SM-B6, multifunction generator).

Command	Parameter	Default Unit	Remark
[:SOURCE] :ILS			Option SM-B6
:STATe	ON OFF		
:SOURce	INT2 INT2, EXT		
:TYPE	GS GSLope LOCALizer		
[:GS GSLope]			
:MODE	NORM ULOBe LLOBe		
:COMid			
[:STATe]	ON OFF		
:FREQUENCY	0.1 to 20 000 Hz	Hz	
:DEPTH	0 to 100 PCT	PCT	
:DDM			
:CURRENT	– 685 uA to + 685 uA	A	
[:DEPTH]	–0.8 to + 0.8 PCT	PCT	
:DIRection	UP DOWN		
:LOGarithmic	–999.9 to + 999.9		
:LLOBe			
[:FREQUENCY]	100 to 200 Hz	Hz	
:ULOBe			
[:FREQUENCY]	60 to 120 Hz	Hz	
:PHASe	0 to 120 deg	rad	No query
:PRESet			
:SODEpth	0 to 100 PCT	PCT	
:LOCALizer			
:MODE	NORM LLOBe RLOBe		
:COMid			
[:STATe]	ON OFF		
:FREQUENCY	0.1 to 20 000 Hz	Hz	
:DEPTH	0 to 100 PCT	PCT	
:DDM			
:CURRENT	–387 to +387 uA	A	
[:DEPTH]	–0.4 to +0.4 PCT	PCT	
:DIRection	LEFT RIGHT		
:LOGarithmic	–999.9 to + 999.9		
:LLOBe			
[:FREQUENCY]	60 to 120 Hz	Hz	
:RLOBe			
[:FREQUENCY]	100 to 200 Hz	Hz	No query
:PHASe	0 to 120 deg	rad	
:PRESet			
:SODEpth	0 to 100 PCT	PCT	

[:SOURCE]

:ILS

:STATe ON | OFF

The command switches the generation of ILS signals on or off. STATe ON is only possible if no amplitude modulation is switched on. Modulation generator 2 must not be switched simultaneously as a source for PM or FM either.

Example: :SOURCE:ILS:STAT ON

*RST value is OFF

:SOURCE INT2 | INT2, EXT

This command determines the signal sources of the test signal.

INT2 The test signal used for ILS is generated internally by LF generator 2.

INT2, EXT A signal from input EXT1 is added to the internal signal in addition. Switching off the internal source is not possible.

Example: :SOURCE:ILS:SOURCE INT2

*RST value is INT2

[[:SOURce]**:ILS****:TYPE** GS|GSLope | LOCalizer

The command switches over between the two components of the ILS method. The configuration of the signals is effected under the respective node GSLObe or LOCalizer.

GS|GSLope Vertical component (Glide Slope)LOCalizer Horizontal component (LOCalizer)Example: **:SOUR:ILS:TYPE GS**

*RST value is GS

[[:GS]GSLope]

The commands to specify the characteristics of the glide slope signal are under this node. Whether this signal is output, however, is determined by command **SOURce:ILS:TYPE**.

:MODE NORM | ULOBe | LLOBe

The command specifies the type of the ILS-GS signal generated.

NORM ILS-GS signal

ULOBe (Upper LOBe) Amplitude modulation of the output signal using the **SOURce:ILS:GS:ULOBe:FREQuency** signal component (generally 90 Hz) of the ILS-GS signal. The modulation depth for **SOURce:ILS:GS:DDM:DIR DOWN** results from

$$AM(90Hz) = 0.5 * (ILS:GS:SODepth + ILS:GS:DDM * 100\%)$$

and for **SOURce:ILS:GS:DDM:DIR UP** from

$$AM(90Hz) = 0.5 * (ILS:GS:SODepth - ILS:GS:DDM * 100\%)$$

LLOBe (Lower LOBe) Amplitude modulation of the output signal using the **SOURce:ILS:GS:LLOBe:FREQuency** signal component (generally 150 Hz) of the ILS-GS signal. The modulation depth for **SOURce:ILS:GS:DDM:DIR DOWN** results from

$$AM(150Hz) = 0.5 * (ILS:GS:SODepth + ILS:GS:DDM * 100\%)$$

and for **SOURce:ILS:GS:DDM:DIR UP** from

$$AM(150Hz) = 0.5 * (ILS:GS:SODepth - ILS:GS:DDM * 100\%)$$

Example: **:SOUR:ILS:GS:MODE ULOB**

*RST value is NORM

:COMid

The commands to set the ComId content (communication/identification signal) of the ILS-GS signal are under this node.

[[:STATE] ON | OFF

The command activates or deactivates the ComId signal.

*RST value is OFF

Example: **:SOUR:ILS:GS:COM:STAT ON****:FREQuency** 0.1 to 20 000 Hz

The command sets the frequency of the ComId signal.

*RST value is 1020 Hz

Example: **:SOUR:ILS:GS:COM:FREQ 1020****:DEPT**h 0 to 100 PCT

The command sets the AM modulation depth of the ComId signal.

Example: **:SOUR:ILS:GS:COM:DEPT 10PCT**

*RST value is 10 PCT

:DDM

(Difference in Depth of Modulation) The commands to set the modulation depth difference between the signal of the upper lobe (90 Hz) and the lower lobe (150 Hz) are under this node.

[:SOURce]**:ILS****[:GS | GSLOpe]****:DDM****:CURRent** -685 uA to + 685 uA

The command enters the DDM value alternatively as a current by means of the ILS indicating instrument. This parameter is coupled with *SOURce:ILS:GS:DDM:DEPT*h.

Example: *:SOUR:ILS:GS:DDM:CURR 0* *RST value is 0

[:DEPTH] -0.8 to +0.8 PCT

The command sets the difference of the modulation depth. This parameter is coupled with *SOURce:ILS:GS:DDM:CURRent*.

The following is true for *SOURce:ILS:GS:DDM:DIRrection DOWN*

$$ILS:GS:DDM:DEPT\text{h} = (AM(90\text{Hz}) - AM(150\text{Hz}))/100\%$$

and for *SOURce:ILS:GS:DDM:DIRrection UP*

$$ILS:GS:DDM:DEPT\text{h} = (AM(150\text{Hz}) - AM(90\text{Hz}))/100\%$$

Example: *:SOUR:ILS:GS:DDM:DEPT 0PCT* *RST value is 0PCT

:DIRrection UP | DOWN

The command indicates the direction in which the pilot has to correct the course. By calculation, this setting has the same effect as a reverse of the sign of the *SOURce:ILS:GS:DDM:DEPT*h value.

UP The airplane is too low, it must climb.

DOWN The airplane is too high, it must descend.

Example: *:SOUR:ILS:GS:DDM:DIR DOWN* *RST value is UP

:LOGarithmic -999.9 dB ... + 999.9 dB

The command enters the DDM value in dB. This parameter is coupled with *SOURce:ILS:GS:DDM:DEPT*h and *:CURRent*. *RST value is 0.0 dB

Example: *:SOUR:ILS:GS:DDM:LOG 0*

:LLOBe The commands to configure the signal of the lower ILS-GS antenna lobe are under this node (Lower LOBe).

[:FREQuency] 100 to 200 Hz

The command sets the frequency. Normally, it is 150 Hz. This parameter is coupled with *SOURce:ILS:GS:ULOBe:FREQuency*. As the ratio of *ULOBe:FREQuency* and *LLOBe:FREQuency* must always be 3/5, *ULOBe:FREQuency* is readjusted accordingly.

Example: *:SOUR:ILS:GS:LLOB:FREQ 150* *RST value is 150 Hz

:ULOBe The commands to configure the signal of the upper ILS-GS antenna lobe (Upper LOBe) are under this node.

[:FREQuency] 60 to 120 Hz

The command sets the frequency. Normally, it is 90 Hz. This parameter is coupled with *SOURce:ILS:GS:LLOBe:FREQuency*. As the ratio of *ULOBe:FREQuency* and *LLOBe:FREQuency* must always be 3/5, *LLOBe:FREQuency* is readjusted accordingly.

Example: *:SOUR:ILS:GS:ULOB:FREQ 90* *RST value is 90 Hz

PHASe 0 to 120 deg

The command sets the phase between the modulation signals of the upper and the lower antenna lobe. The zero crossing of the signal of the lower lobe serves as a reference. The angle is related to the period of the signal of the lower antenna lobe.

Example: *:SOUR:ILS:GS:PHAS 0deg* *RST value is 0

[:SOURce]

:ILS

[:GS | GSLObe]

:PRESet

This command is equivalent to the following command sequence:

```
:ILS:SOUR INT2  
:ILS:STAT ON  
:ILS:TYPE GS  
:ILS:GS:MODE NORM  
:ILS:GS:COM OFF  
:ILS:GS:COM:FREQ 1020Hz  
:ILS:GS:COM:DEPT 10PCT  
:ILS:GS:DDM 0.0  
:ILS:GS:DDM:DIR UP  
:ILS:GS:SOD 80PCT  
:ILS:GS:ULOB 90Hz  
:ILS:GS:LLOB 150Hz  
:ILS:GS:PHAS 0
```

The values set correspond to the state after *SYSTEM:PRESET* or **RST*. The command neither has a query form nor an **RST* value.

Example: *:SOUR:ILS:GS:PRES*

:SODepth 0 to 100 PCT

The command indicates the sum of the modulation depths of the signals of the lower lobe (90 Hz) and the upper lobe (150 Hz). **RST* value is 80PCT

Example: *:SOUR:ILS:GS:SOB 80PCT*

:LOCALizer

The commands to specify the characteristics of the LOCALizer signal are under this node. Whether this signal is output, however, is determined by command *SOURce:ILS:TYPE*.

:MODE NORM | LLOBe | RLOBe

The command specifies the type of the ILS-LOC signal generated.

NORM ILS-LOC signal

LLOBe (Left LOBe) Amplitude modulation of the output signal using the *SOURce:ILS:LOC:LLOBe:FREQuency* signal component (generally 90 Hz) of the ILS-LOC signal. The modulation depth

for *SOURce:ILS:GS:DDM:DIR RIGHT* results from

$$AM(90Hz) = 0.5 * (ILS:LOC:SODepth + ILS:LOC:DDM * 100\%)$$

and for *SOURce:ILS:GS:DDM:DIR LEFT* from

$$AM(90Hz) = 0.5 * (ILS:LOC:SODepth - ILS:LOC:DDM * 100\%)$$

RLOBe (Right LOBe) Amplitude modulation of the output signal using the *SOURce:ILS:LOC:RLOBe:FREQ* signal component (generally 150 Hz) of the ILS-LOC signal. The modulation depth

for *ILS:LOC:DDM:DIR RIGHT* results from

$$AM(150Hz) = 0.5 * (ILS:LOC:SODepth + ILS:LOC:DDM * 100\%)$$

and for *ILS:LOC:DDM:DIR LEFT* from

$$AM(150Hz) = 0.5 * (ILS:LOC:SODepth - ILS:LOC:DDM * 100\%)$$

Example: *:SOUR:ILS:LOC:MODE LLOB* **RST* value is NORM

[:SOURce]
:ILS

:LOCALizer
:COMid

The commands to set the ComId content (communication/identification signal) of the ILS-LOC signal are under this node.

[:STATE] ON | OFF

The command activates or deactivates the ComId signal. *RST value is OFF

Example: **:SOUR:ILS:LOC:COM:STAT ON**

:FREQuency 0.1 to 20 000 Hz

The command sets the frequency of the ComId signal. *RST value is 1020 Hz

Example: **:SOUR:ILS:LOC:COM:FREQ 1020**

:DEPTH 0 to 100 PCT

The command sets the AM modulation depth of the ComId signal.

Example: **:SOUR:ILS:LOC:COM:DEPT 10PCT** *RST value is 10 PCT

:DDM

(Difference in Depth of Modulation) The commands to set the modulation depth difference between the signal of the left lobe (90 Hz) and the right lobe (150 Hz) are under this node.

:CURRENT -387 to +387 uA

The command alternatively enters the DDM value as a current by means of the ILS indicating instrument. This parameter is coupled with **SOURce:ILS:LOC:DDM:DEPTH**.

Example: **:SOUR:ILS:LOC:DDM:CURR 0** *RST value is 0 A

[:DEPTH] -0.4 to +0.4 PCT

The command sets the difference of the modulation depth. This parameter is coupled with **SOURce:ILS:LOC:DDM:CURRent**. The following is true:

for **SOURce:ILS:LOC:DDM:DIRectioN RIGHT**

$$ILS:LOC:DDM:DEPTH = (AM(90Hz) - AM(150Hz))/100\%$$

and for **SOURce:ILS:LOC:DDM:DIRectioN LEFT**

$$ILS:LOC:DDM:DEPTH = (AM(150Hz) - AM(90Hz))/100\%$$

Example: **:SOUR:ILS:LOC:DDM:DEPT 0PCT** *RST value is 0PCT

:DIRectioN LEFT | RIGHT

The command indicates the direction in which the pilot has to correct the course. By calculation, this setting has the same effect as a reverse of the sign of the **SOURce:ILS:LOC:DDM:DEPTH** value.

LEFT The airplane is too much to the right, it must turn to the left.

RIGHT The airplane is too much to the left, it must turn to the right.

Example: **:SOUR:ILS:LOC:DDM:DIR LEFT** *RST value is LEFT

:LOGarithmic -999.9 dB ... +999.9 dB

The command enters the DDM value in dB. This parameter is coupled with **SOURce:ILS:LOC:DDM:DEPTH** and **:CURRent**.

Example: **:SOUR:ILS:LOC:DDM:LOG 0** *RST value is 0.0 dB

[[:SOURce]

:ILS

:LOCalizer

:LLOBe

The commands to configure the signals of the left ILS-LOC antenna lobe (Left LOBe) are under this node.

[[:FREQUENCY] 60 to 120 Hz

The command sets the frequency. Normally, it is 90 Hz. This parameter is coupled with *SOURce:ILS:LOC:RLOBe:FREQUENCY*. As the ratio of *LLOBe:FREQUENCY* and *RLOBe:FREQUENCY* must always be 3/5, *RLOBe:FREQUENCY* is readjusted accordingly.

Example: *:SOUR:ILS:LOC:LLOB:FREQ 90** RST value is 90 Hz

:RLOBe

The commands to configure the signal of the right ILS-LOC antenna lobe (Right LOBe) are under this node.

[[:FREQUENCY] 100 to 200 Hz

The command sets the frequency. Normally, it is 150 Hz. This parameter is coupled with *SOURce:ILS:LOC:LLOBe:FREQUENCY*. As the ratio of *LLOBe:FREQUENCY* and *RLOBe:FREQUENCY* must always be 3/5, *LLOBe:FREQUENCY* is readjusted accordingly. *RST value is 150 Hz

Example: *:SOUR:ILS:LOC:RLOB:FREQ 150*

:PHASe 0 to 120 deg

The command sets the phase between the modulation signals of the left and the right antenna lobe. The zero crossing of the signal of the right lobe serves as a reference. The angle relates to the period of the signal of the right antenna lobe.

Example: *:SOUR:ILS:LOC:PHAS 0deg* *RST value is 0

:PRESet

This command is equivalent to the following command sequence:

```
:ILS:SOUR INT2  
:ILS:STAT ON  
:ILS:TYPE LOC  
:ILS:LOC:MODE NORM  
:ILS:LOC:COM OFF  
:ILS:LOC:COM:FREQ 1020Hz  
:ILS:LOC:COM:DEPT 10PCT  
:ILS:LOC:DDM 0.0  
:ILS:LOC:DDM:DIR LEFT  
:ILS:LOC:SOD 40PCT  
:ILS:LOC:LLOB 90Hz  
:ILS:LOC:RLOB 150Hz  
:ILS:LOC:PHAS 0
```

The values set correspond to the state after *SYSTEM:PRESET* or **RST*. The command neither has a query form nor an **RST* value.

Example: *:SOUR:ILS:LOC:PRES*

:SODePTH 0 to 100 PCT

The command indicates the sum of modulation depths of the signals of the left lobe (90 Hz) and the right lobe (150 Hz).

Example: *:SOUR:ILS:LOC:SOB 40PCT* *RST value is 40PCT

3.6.11.6 SOURce:MARKer Subsystem

This subsystem contains the commands to check the marker generation with sweeps. The SMT has three markers each for frequency and level sweeps which are differentiated by a numeric suffix after MARKer. The settings for frequency sweep and level sweep marker are independent of each other.

Command	Parameter	Default Unit	Remark
[:SOURce] :MARKer 1 2 3 [:FSWweep] :AMPLitude :AOFF :FREQUency [:STATe] :PSWweep :AOFF :POWer [:STATe] :POLarity	ON OFF 5 kHz to 1.5 GHz ON OFF –144 to +16 dBm ON OFF NORMal INVerted	Hz dBm	No query SMT03/06: 5 kHz to 3/6 GHz No query

[:SOURce]
:MARKer 1 | 2 | 3
[:FSWweep]

The commands for the markers with frequency sweep are under this node. Keyword :FSWweep can be omitted, then the command conforms to SCPI regulations.

:AMPLitude ON | OFF

The command specifies whether the marker influences the signal level.

ON The output level is reduced by a constant value when the marker frequency is executed.

OFF The output level remains unchanged. *RST value is OFF

Example: :SOUR:MARK1:FSW:AMP ON

:AOFF

Command (All markers off) switches off all frequency markers. This command triggers an event, thus it has no *RST value and no query form.

Example: :SOUR:MARK:FSW:AOFF

:FREQUency 5 kHz to 1.5 GHz (SMT03: 5 kHz to 3 GHz / SMT06: 5 kHz to 6 GHz)

The command sets the marker selected by the numeric suffix with MARKer to the frequency indicated.

The OFFSet value of the subsystem (menu) FREQUency is considered with this command as with the MARKer input value in menu SWEEP-FREQ. Thus the specified range indicated is only valid for SOURce:FREQUency:OFFSet 0. The specified range with other OFFset values can be calculated according to the following formula (cf. Section 2.4.1, Frequency Offset as well):

$$5 \text{ kHz} - \text{OFFSet} \dots 1.5 \text{ GHz} - \text{OFFSet}$$

*RST value for MARK1: 100MHz
MARK2: 200MHz
MARK3: 300MHz

Example: :SOUR:MARK1:FSW:FREQ 30MHz

[[:SOURce]

:MARKer1|2|3

[[:FSWweep]

[[:STATe] ON | OFF

The command switches the marker selected by the numeric suffix with MARKer on or off. *RST value is OFF

Example: `:SOUR:MARK1:FSW:STAT ON`

:PSWweep

The commands for the markers with level sweep are under this node (Power sweep). The three markers are differentiated by a numeric suffix after MARKer.

:AOFF

The command switches all level markers off. This command is an event and thus has no *RST value and no query form.

Example: `:SOUR:MARK:PSW:AOFF`

:POWER -144 dBm to +16dBm

The command sets the marker selected by the numeric suffix with MARKer to the level indicated.

The OFFSet value of the subsystem (menu) POWER (LEVEL) is considered with this command by analogy with the MARKer input value in the SWEEP-LEVEL menu. Thus the specified range indicated is only valid for *SOURce:POWER:OFFSet 0*. The specified range with other OFFSet values can be calculated according to the following formula (cf. Section 2.5.1, Level Offset, as well):

$$-144\text{dBm} - \text{OFFSet} \dots 16\text{dBm} - \text{OFFSet}$$

*RST value for MARK1: 1dBm
MARK2: 2dBm
MARK3: 3dBm

Example: `:SOUR:MARK1:PSW:POW -2dBm`

[[:STATe] ON | OFF

The command switches the marker selected by the numeric suffix with MARKer on or off. *RST value is OFF

Example: `:SOUR:MARK1:PSW:STAT ON`

:POLarity NORMal | INVerted

The command specifies the polarity of the marker signal.

NORMal When running through the marker condition, TTL level is applied at the marker output, otherwise 0 V.

INVerted When running through the marker condition, 0 V is applied at the marker output, otherwise TTL level. *RST value is NORM

Example: `:SOUR:MARK:POL INV`

3.6.11.7 SOURCE:MBEacon Subsystem

This subsystem contains the commands to control the characteristics of the marker signals (Marker B_Eacon) as they are used to mark the distance in the approach range of airports (option SM-B6, multifunction generator).

Command	Parameter	Default Unit	Remark
[:SOURCE] :MBEacon :STATE [:MARKer] :FREQuency :DEPT _h :COMid [:STATe] :FREQuency :DEPT _h	ON OFF 400 Hz 1300 Hz 3000 Hz 0 to 100 PCT ON OFF 0.1 to 20 000 Hz 0 to 100 PCT	Hz PCT Hz PCT	Option SM-B6

[:SOURCE]

:MBEacon

:STATE ON | OFF

The command switches on or off the generation of marker beacon signals. STATE ON is only possible if no amplitude modulation is switched on. Modulation generator 2 must not be inserted simultaneously as a source for PM or FM either.

*RST value is OFF

Example: :SOUR:MBE:STAT ON

[:MARKer]

The commands to set the marker signal are under this node.

:FREQuency 400 Hz | 1300 Hz | 3000 Hz

The command selects the frequency of the marker signal.

*RST value is 400 Hz

Example: :SOUR:MBE:MARK:FREQ 400

:DEPT_h 0 to 100 PCT

The command sets the modulation depth of the marker signal.

*RST value is 95 PCT

Example: :SOUR:MBE:MARK:DEPT 95PCT

:COMid

The commands to set the ComId content (communication/identification signal) of the ILS signal are under this node.

[:STATe] ON | OFF

The command activates or deactivates the ComId signal.

*RST value is OFF

Example: :SOUR:MBE:COM:STAT ON

:FREQuency 0.1 to 20 000 Hz

The command sets the frequency of the ComId signal.

*RST value is 1020 Hz

Example: :SOUR:MBE:COM:FREQ 1020

:DEPT_h 0 to 100 PCT

The command sets the AM modulation depth of the ComId signal.

*RST value is 5 PCT

Example: :SOUR:MBE:COM:DEPT 5PCT

3.6.11.8 SOURce:PHASe Subsystem

Command	Parameter	Default Unit	Remark
[:SOURce] :PHASe [:ADJust] :REFerence	-360 deg to 360 deg	rad	No query

[:SOURce]

:PHASe

[:ADJust] -360 to +360 deg

The command indicates the phase between output signal and reference oscillator signal. This setting is only accepted using *SOURce:PHASe:REFerence* (cf. below). An indication in RADian is possible. *RST value is 0.0 DEG.

Example: :*SOUR:PHAS:ADJ 2DEG*
 :*SOUR:PHAS:ADJ 0.1RAD*

:REFerence

The command accepts the phase set using *SOURce:PHASe:ADJust* as a new reference phase. The command has no *RST value.

Example: :*SOUR:PHAS:REF*

3.6.11.9 SOURce:PM Subsystem

This subsystem contains the commands to check the phase modulation and to set the parameters of the modulation signal. The SMT is equipped with two independent phase modulators, PM1 and PM2. They are differentiated by a suffix after PM.

SOURce:PM1

SOURce:PM2

Command	Parameter	Default Unit	Remark
[:SOURce] :PM 1 2 [:DEVIation] :BANDwidth :EXTernal 1 2 :COUPling :INTernal :FREQUency :SOURce :STATe	-360 to +360 deg 100 kHz 2 MHz AC DC 400 Hz 1 kHz 3 kHz 15 kHz or 0.1 Hz ... 100 kHz or 0.1 Hz to 1 MHz INT EXT1 2 INT, EXT1 2 ON OFF	rad Hz Hz	 Option SM-B2 Option SM-B6

[:SOURce]

:PM 1 | 2

[:DEVIation] -360 to +360deg

The command sets the modulation depth in Radian (cf. Section 2.6.4.1, PM Deviation Limits). DEGREE are accepted. *RST value is 1 rad

Example: *SOUR:PM:DEV 20DEGR*

:BANDwidth 100 kHz | 2 MHz

The command sets the bandwidth of the phase modulation. *RST value is 100 kHz

Example: *SOUR:PM:BAND 100 kHz*

:EXTernal 1 | 2

The commands to check the external input of the PM modulators are under this node. The settings under EXTernal for modulations AM, FM and PM are independent of each other. The settings are always related to the socket determined by the suffix after EXTernal. The suffix after PM is ignored then. With the following commands, e.g., the settings are both related to socket EXT2:

:SOUR:PM1:EXT2:COUP AC

:SOUR:PM2:EXT2:COUP AC

A command without suffix is interpreted like a command with suffix 1.

:COUPling AC | DC

The command selects the type of coupling for the external PM input.

AC The d.c. voltage content is separated from the modulation signal.

DC The modulation signal is not changed.

*RST value is AC

Example: *:SOUR:PM:COUP DC*

[[:SOURce]

:PM1|2

:INTernal

The settings for the internal PM generators are effected under this node. For PM1, this is always LF generator 1, for PM2, always LF generator 2. Here the same hardware is set for FM1, PM1, AM::INT1 as well as SOURce0, for FM2, PM2 and AM:INT2 and SOURce2 as well. This means that, e.g., the following commands are coupled with each other and have the same effect:

SOUR:AM:INT2:FREQ

SOUR:FM2:INT:FREQ

SOUR:PM2:INT:FREQ

SOUR2:FREQ:CW

:FREQuency 400 kHz | 1 kHz | 3 kHz | 15 kHz or 0.1 Hz...100 kHz or 0.1 Hz...1 MHz

The command sets the modulation frequency. There are different specified ranges depending on the equipment of the instrument:

If neither SM-B2 nor SM-B6 are fitted, only INT1 is permissible and values 400 Hz, 1 kHz, 3 kHz and 15 kHz are valid. With option SM-B2, the specified range from 0.1 Hz to 500 kHz is valid, with SM-B6 from 0.1 to 1 MHz. *RST value is 1 kHz

Example: *:SOUR:PM:INT:FREQ 10kHz*

:SOURce INTernal | EXTernal1|2 | INTernal, EXTernal1|2

The command selects the modulation source. A command without suffix is interpreted like a command with suffix 1. LF generator 1 is INTernal for PM1, LF generator2 for PM2. Several modulation sources can be active at the same time (see example)

*RST value for PM1: INT

for PM2:EXT2

Example: *:SOUR:PM:SOUR INT,EXT2*

:STATe ON | OFF

The command switches the phase modulation selected by the numeric suffix with PM on or off. *RST value is OFF

Example: *:SOUR:PM1:STAT OFF*

3.6.11.10 SOURce:POWer Subsystem

This subsystem contains the commands to set the output level, the level control and the level correction of the RF signal. Other units can be used instead of dBm:

- by indication directly after the numeric value (example :*POW* 0.5V),
- by altering the DEFault unit in the UNIT system (cf. UNIT:POWER, Section 3.6.17)

Command	Parameter	Default Unit	Remark
[:SOURce] : POWer : ALC : BANDwidth BWIDth : AUTO [:STATe] [:LEVel] [:IMMediate] [AMPLitude] : OFFSet : RCL : LIMit [:AMPLitude] : MANual : MODE : START : STOP : STEP [:INCRement]	100 Hz 500 kHz ON OFF ONCE ON OFF –144 to +16 dBm –100 to +100 dB INCLude EXCLude –144 to +16dBm –144 to +16dBm FIXed SWEEp –144 to +16 dBm –144 to +16 dBm 0.1 to 10 dB	Hz dBm dB dBm dBm dBm dBm dB	

[**:SOURce**]
 :**POWer**
 :**ALC**

The commands checking the automatic level control are under this node.

:BANDwidth | **BWIDth** 100 Hz | 500 kHz

The command sets the bandwidth of the level control.

*RST value is 100 kHz

Example: :*SOUR:POW:ALC:BAND 100kHz*

:AUTO ON | OFF | ONCE

The command determines the mode in adapting the bandwidth.

ON The bandwidth is automatically adapted.

OFF No bandwidth adaptation.

ONCE The bandwidth is adapted once, then AUTO is automatically set to OFF.

Example: :*SOUR:POW:ALC:BAND:AUTO ON*

*RST value is ON

[**:STATe**] ON | OFF

The command switches level control on or off.

On Level control is permanently switched on.

OFF Level control is switched on for a short period of time if the level changes.

*RST value is ON

Example: :*SOUR:POW:ALC:STAT ON*

[[:SOURce]

:POWer

[[:LEVel]

[[:IMMediate]

The commands to set the output level with operating modes CW and Sweep are under these nodes.

[[:AMPLitude] –144 to +16 dBm

The command sets the RF output level in operating mode CW. UP and DOWN can be indicated in addition to numeric values. Then the level is increased or reduced by the value indicated under **:SOURce:POWer:STEP**.

The OFFSet value is considered with this command as with the AMPLITUDE input value in menu LEVEL-LEVEL. Thus the specified range indicated is only valid for **:POWer:OFFSet 0**. The specified range with other OFFSet values can be calculated according to the following formula (cf. Chapter 2, Section "Level Offset", as well):

$-144\text{dBm} + \text{OFFSet} \dots 16\text{dBm} + \text{OFFSet}$

The keywords of this command are optional to a large extent, thus the long as well as the short form of the command is shown in the example. *RST value is –30 dBm

Example: **:SOUR:POW:LEV:IMM:AMPL –15** or
:POW –15

:OFFSet –100 to +100 dB

The command sets the constant level offset of a series-connected attenuator/amplifier (cf. Chapter 2, Section "Level Offset"). If a level offset is entered, the level entered using **POWer:AMPLitude** does no longer conform to the RF output level. The following connection is true:

$\text{:POWer:AMPLitude} = \text{RF output level} + \text{:POWer:OFFSet}$.

Entering a level offset does not change the RF output level but only the query value of **:POWer:AMPLitude**.

Only dB is permissible as a unit here, linear units (V, W etc.) are not permitted.

Caution: *The level offset is also valid in the case of level sweeps!*

Example: **:SOUR:POW:LEV:IMM:OFFS 0** or ***RST value is 0**
:POW:OFFS 0

:RCL INCLude | EXCLude

The command determines the effect of the recall function on the RF level.*RST value has no effect to this setting.

INCLude The saved RF level is loaded when instrument settings are loaded with the [RECALL] key or with a memory sequence.

EXCLude The RF level is not loaded when instrument settings are loaded, the current settings are maintained.

Example: **:SOUR:POW:LEV:IMM:RCL INCL**

:LIMit

[[:AMPLitude] –144 to +16 dBm

The command limits the maximum Rf output level in operating mode CW and SWEEP. It does not influence the display LEVEL and the answer to query **POW?**.

Example: **:SOUR:POW:LIM –15dBm** *RST value is +16 dBm

[:SOURce]**:POWer****:MANual** -144 to +16 dBm

The command sets the level if *SOURce:POWer:MODE* is set to *SWEep* and *SOURce:SWEep:MODE* to *MANual*. Only level values between *START* and *STOP* are permissible. (As to the specified range, cf. *:POWer:AMPLitude*).

*RST value is -30 dBm

Example: *:SOUR:POW:MAN 1dBm*

:MODE *FIXed* | *SWEep*

The command specifies the operating mode and thus also by means of which commands the level setting is checked.

FIXed The output level is specified by means of commands under *:SOURce:POWer:LEVel*.

SWEep The instrument operates in the *SWEep* mode. The level is specified by means of *:SOURce:POWer;START; STOP; CENTER; SPAN* and *MANual*.

*RST value is *FIXed*

Example: *:SOUR:POW:MODE FIX*

:START -144 to +16 dBm

The command sets the starting value for a level sweep. *START* may be larger than *STOP*, then the sweep runs from the high to the low level. (As to the specified range, cf. *:POWer:AMPLitude*).

*RST value is -30dBm

Example: *:SOUR:POW:STAR -20*

:STOP -144 to +16dBm

The command sets the final value for a level sweep. *STOP* may be smaller than *START*. (As to the specified range, cf. *:POWer:AMPLitude*).

*RST value is -10 dBm

Example: *:SOUR:POW:STOP 3*

:STEP

The commands to set the step width are under this node.

[:INCRement] 0.1to 10 dB

The command sets the step width with the level setting if *UP* and *DOWN* are used as level values. The command is coupled with *KNOB STEP* in the manual control, i.e., it also specifies the step width of the shaft encoder.

Only dB is permissible as a unit here, the linear units (V, W etc.) are not permitted.

*RST value is 1 dB

Example: *:SOUR:POW:STEP:INCR 2*

3.6.11.11 SOURce:PULM Subsystem

This subsystem contains the commands to check the pulse modulation and to set the parameters of the modulation signal. The internal pulse generator (option SM-B3 and SM-B4) is set in the SOURce:PULSe subsystem.

Command	Parameter	Default Unit	Remark
[[:SOURce] :PULM EXTernal :IMPedance :INTernal :FREQuency :POLarity :SOURce :STATe	50 Ohm 10 kOhm 0.01176 Hz to 10 MHz NORMal INVerted INTernal EXTernal ON OFF	Ohm	Option SM-B3, SM-B4 and SM-B8 SM-B9

[[:SOURce]

:PULM

:EXTernal

The commands to check the external pulse generator input socket are under this node.

:IMPedance 50 Ohm| 10 kOhm

The command sets the impedance of the input socket for the external pulse generator. The pulse generator has an own input socket, hence this setting is independent of the corresponding settings under PM and FM.

*RST value is 10 kOhm

Example: :*SOUR:PULM:EXT:IMP 10E3*

:INTernal

The commands to check the internal modulation source are under this node.

:FREQuency 0.01176 Hz to 10 MHz

The command sets the frequency of the pulse generator. This parameter is coupled with *SOURce:PULSe:PERiod*.

*RST value is 100 kHz

Example: :*SOUR:PULM:INT:FREQ 1MHz*

:POLarity NORMal | INVerted

The command specifies the polarity between modulating and modulated signal.

NORMal The RF signal is suppressed during the interpulse period.

INVerted The RF signal is suppressed during the pulse.

*RST value is NORMal

Example: :*SOUR:PULM:POL INV*

:SOURce EXTernal | INTernal

The command selects the source of the modulating signal.

INTernal Internal pulse generator (option SM-B4).

EXTernal Signal fed externally

*RST value is INTernal

Example: :*SOUR:PULM:SOUR INT*

:STATe ON | OFF

The command switches on or off the pulse modulation.

*RST value is OFF

Example: :*SOUR:PULM:STAT ON*

3.6.11.12 SOURce:PULSe Subsystem

This subsystem contains the commands to set the pulse generator (option SM-B3 and SM-B4). The pulse generation is triggered on principle, with the trigger certainly being able to be set to "free run" using TRIGger:PULSe: SOURce AUTO as well.

Command	Parameter	Default Unit	Remark
[[:SOURce] :PULSe			Option SM-B3, SM-B4 and SM-B8
:DELay	40 ns to 1 s	s	
:DOUBle			
:DELay	60 ns to 1 s	s	
[[:STATe]	ON OFF		
:PERiod	100 ns to 85 s	s	
:WIDTh	20 ns to 1 s	s	

[:SOURce]

:PULSe

:DELay 40 ns to 1 s

The command specifies the time from the start of the period to the first edge of the pulse. Due to the construction of the instrument, this parameter is set to 0 if :SOURce:PULSe:DOUBle:STATe is set to ON. The old value is activated again as soon as the double pulse has been switched off. *RST value is 1 μ s

Example: :SOUR:PULS:DEL 10 μ s

:DOUBle

The commands to check the second pulse are under this node. If :SOURce:PULSe:DOUBle:STATe is set to ON, a second pulse whose width (WIDTh) is identical to the first pulse is generated in every period.

:DELay 60 ns to 1 s

The command sets the time from the start of the pulse period to the first edge of the second pulse. *RST value is 1 μ s

Example: :SOUR:PULS:DOUB:DEL 10 μ s

[:STATe] ON | OFF

The command switches the second pulse on or off.

ON

The second pulse is switched on.

Parameter :SOURce:PULSe:DELay is set to 0 and cannot be changed. WIDTh > (PULSe:PERiod – PULSe:DOUBle:DELay)/2 results in error message –221, "Settings conflict".

OFF

The second pulse is switched off.

*RST value is OFF

Example: :SOUR:PULS:DOUB:STAT OFF

:PERiod 100 ns to 85 s

The command sets the pulse period.

The pulse period is the reciprocal value of the pulse frequency, thus this command is coupled to command :SOURce:PULM:INTernal:FREQUENCY. *RST value is 10 μ s

Example: :SOUR:PULS:PER 2s

:WIDTh 20 ns to 1 s

The command sets the pulse width.

*RST value is 1 μ s

Example: :SOUR:PULS:WIDT 0.1s

3.6.11.13 SOURce:ROSCillator Subsystem

This subsystem contains the commands to set the external and internal reference oscillator.

Command	Parameter	Default Unit	Remark
[[:SOURce] :ROSCillator [:INTernal] :ADJust [:STATe] :VALue :SOURce	ON OFF 0 to 4095 INTernal EXTernal		

[[:SOURce]

:ROSCillator

[:INTernal]

The commands to set the internal reference oscillator are under this node.

:ADJust

The commands for frequency correction (fine adjustment of the frequency) are under this node.

[:STATe] ON | OFF

The command switches the fine adjustment of the frequency on or off.

*RST value is OFF

Example: **:SOUR:ROSC:INT:ADJ:STAT ON**

:VALue 0 to 4095

The command indicates the frequency correction value. For a detailed definition, cf. Chapter 2, section "Reference Frequency Internal/External".

*RST value is 2048

Example: **:SOUR:ROSC:INT:ADJ:VAL 2048**

:SOURce INTernal | EXTernal

The command selects the reference source.

INTernal The internal oscillator is used.

EXTernal The reference signal is fed externally.

*RST value is INTernal

Example: **:SOUR:ROSC:SOUR EXT**

3.6.11.14 SOURce-STEReo Subsystem

This subsystem contains the commands to generate FM stereo multiplex signals conforming to standards according to the pilot-tone method (option SM-B6). The modulation signal is output in addition at the LF output socket (cf. Section 3.6.10, OUTPut2 system as well).

Command	Parameter	Default Unit	Remark
[:SOURce] :STEReo			Option SM-B6
:STATe	ON OFF		
[:DEVIation]	0 Hz to 100 kHz	Hz	
:SIGNal	AUDio ARI		
:AUDio			
[:FREQuency]	0.1 Hz to 15 kHz	Hz	
:PREemphasis	OFF 50 us 75 us		
:MODE	RIGHt LEFT RELeft REMLeft		
:PILot			
:STATe	ON OFF		
[:DEVIation]	0 Hz to 10 kHz	Hz	
:PHASe	0 deg to 360 deg	rad	
:ARI			
:STATe	ON OFF		
[:DEVIation]	0 Hz to 10 kHz	Hz	
:TYPE	BK DK OFF		
:BK			
[:CODE]	A B C D E F		

[:SOURce]

:STEReo

:STATe ON | OFF

The command switches on or off the stereo signal.

*RST value is OFF

Example: :SOUR:STER:STAT ON

[:DEVIation] 0 Hz to 100 kHz

The command sets the frequency deviation of the FM stereo multiplex signal without considering the pilot-tone content.

*RST value is 40 kHz

Example: :SOUR:STER:DEV 40kHz

:SIGNal AUDio | ARI

The command selects which signals are generated, simulated audio signals or ARI traffic channel signals with a 19-kHz pilot tone.

AUDio Audio signals are generated, ARI is switched off.

ARI ARI signals are generated.

*RST value is AUDio

Example: :SOUR:STER:SIGN AUD

:AUDio

The commands to set the characteristics of the audio signals generated by the SMT are under this node.

[:FREQuency] 0.1 Hz to 15 kHz

The command sets the frequency of the audio signal. The frequency applies to both channels at the same time.

*RST value is 1 kHz

Example: :SOUR:STER:AUD 1kHz

:SOURce:STEReo

[[:SOURce]**:STEReo****:AUDio****:PREemphasis** OFF | 50 us | 75 us

The command selects the preemphasis of the audio signal.

OFF Preemphasis is switched off.

50 us 50 μ s preemphasis75us 75 μ s preemphasis

*RST value is OFF

Example: *:SOUR:STER:AUD:PRE 50us***:MODE** RIGHT | LEFT | RELeft | REMLeft

The command selects the operating mode in which the two channels operate.

RIGHT Audio signal only in the right channel

LEFT Audio signal only in the left channel

RELeft (Right Equals Left) Audio signals of same frequency and phase in both channelsREMLeft (Right Equals Minus Left) Audio signals of same frequency but opposite phase in both channels.

*RST value is RELeft

Example: *:SOUR:STER:AUD:MODE RIGH***:PILot**

The commands to set the characteristics of the 19-kHz pilot-tone signal are under this node.

:STATe ON | OFFThe command activates or deactivates the pilot tone. The pilot tone can be activated or deactivated independently of the setting of *SOURce:STEReo:SIGNal*.

*RST value is ON

Example: *:SOUR:STER:PIL:STAT ON***[[:DEViation]** 0 Hz to 10 kHz

The command sets the frequency deviation of the pilot tone. *RST value is 6.72 kHz

Example: *:SOUR:STER:PIL:DEV 6720***:PHASe** 0 deg to 360 deg

The command sets the phase of the pilot tone. The zero crossing of the suppressed 38-kHz auxiliary carrier of the stereo multiplex signal serves as a phase reference.

*RST value is 0 deg

Example: *:SOUR:STER:PIL:PHAS 10deg*

**[:*SOURce*]
:*STEReo*
:*ARI***

The commands to specify the characteristics of the ARI traffic channel signal are under this node.

[:*DEViation*] 0 Hz to 10 kHz

The command sets the deviation content of the unmodulated 57-kHz ARI auxiliary carrier.

*RST value is 4 kHz

Example: :*SOUR:STER:ARI:DEV 4kHz*

:*TYPE* BK | DK | OFF

The command specifies which identification is generated.

BK Area code. The AM modulation depth of the area code on the ARI auxiliary carrier, which has been selected under *SOURce:STEReo:ARI:BK:CODE* is $m = 0.6$.

DK Broadcasting code. The AM modulation depth of the broadcasting code (125 Hz) on the ARI auxiliary carrier is $m = 0.3$.

OFF Area and broadcasting code are deactivated.

*RST value is DK

Example: :*SOUR:STER:ARI:TYPE BK*

:*BK*

The commands to specify the characteristics of the BK signal are under this node.

[:*CODE*] A | B | C | D | E | F

The command specifies the area code.

A Traffic area code A 23.7500 Hz

B Traffic area code B 28.2738 Hz

C Traffic area code C 34.9265 Hz

D Traffic area code D 39.5833 Hz

E Traffic area code E 45.6731 Hz

F Traffic area code F 53.9773 Hz

*RST value is A

Example: :*SOUR:STER:ARI:BK A*

3.6.11.15 SOURce:SWEEp Subsystem

This subsystem contains the commands to check the RF sweep, i.e., sweeps of the RF generators. Sweeps are triggered on principle. The frequency sweep is activated by command *SOURce:FREQuency:MODE SWEEp*, the level sweep by command *SOURce:POWer:MODE SWEEp*.

Command	Parameter	Default Unit	Remark
[[:SOURce]] :SWEEp :BTIMe [:FREQuency] :DWELI :MODE :POINts :SPACing :STEP [:LINear] :LOGarithmic :POWer :DWELI :MODE :POINts :SPACing :STEP :LOGarithmic	NORMAl LONG 10 ms to 5 s AUTO MANUal STEP Number LINear LOGarithmic 0 to 1 GHz 0.01 to 50PCT 10 ms to 5 s AUTO MANUal STEP Number LOGarithmic 0 to 10 dB	 s Hz PCT s dB	

[[:SOURce]]

:SWEEp

:BTIMe NORMAl | LONG

The command sets the blank time (Blank TIME) of the sweep. The setting is valid for all sweeps, i.e., also for LF sweeps.

NORMAl Blank time as short as possible.

LONG Blank time long enough to permit an XY recorder to return to 0.

Example: :SOUR:SWEE:BTIM LONG *RST value is NORM

[[:FREQuency]]

The commands to set the frequency sweeps are under this node. Keyword [[:FREQuency]] can be omitted (cf. examples). The commands are SCPI compatible then unless stated otherwise.

:DWELI 10 ms to 5 s

The command sets the time per frequency step (dwell).

Example: :SOUR:SWEE:DWEL 10ms *RST value is 15 ms

:MODE AUTO | MANUal | STEP

The command specifies the run of the sweep.

AUTO Each trigger triggers exactly one entire sweep cycle.

MANUal Each frequency step of the sweep is triggered by means of manual control or a *SOURce:FREQuency:MANUal* command, the trigger system is not active. The frequency increases or decreases (depending on the direction of the shaft encoder) by the value indicated under *:SOURce:FREQuency:STEP:INCRement*.

STEP Each trigger triggers only one sweep step (single-step mode). The frequency increases by the value indicated under *:SOURce:SWEEp:STEP:LOGarithmic*. *RST value is AUTO

Example: :SOUR:SWEE:MODE AUTO

[:*SOURce*]
:*SWEEp*
[:*FREQuency*]

:*POINts* Number

The command determines the number of steps in a sweep.

Instead of this command, commands *SOURce:SWEEp:FREQuency:STEP:LINear* and *SOURce:SWEEp:FREQuency:STEP:LOGarithmic* should be used, as *SOURce:SWEEp:FREQuency:POINts* has been adapted to the instrument characteristics in comparison to the SCPI command.

The value of *POINts* depends on *SPAN* and *STEP* according to the following formulas.

The following is true for linear sweeps : $POINts = SPAN / STEP:LIN + 1$

The following is true for logarithmic sweeps and *START* < *STOP*:

$$POINts = ((\log STOP - \log START) / \log (1 + STEP:LOG))$$

Two independent *POINts* values are used for *SPACing LOG* and *SPACing LIN*. I.e., before *POINts* is changed, *SPACing* must be set correctly. A change of *POINts* results in an adaptation of *STEP*, but not of *START*, *STOP* and *SPAN*.

Example: *:SOUR:SWEE:POIN 100*

:*SPACing* LINear | LOGarithmic

The command selects whether the steps have linear or logarithmic spacings.

*RST value is *LINear*

Example: *:SOUR:SWEE:SPAC LIN*

:*STEP*

The commands to set the step width with linear and logarithmic sweeps are under this node. The settings of *STEP:LIN* and *STEP:LOG* are independent of each other.

[:*LINear*] 0 to 1 GHz

The command sets the step width with the linear sweep. If *STEP[:LINear]* is changed, the value of *POINts* valid for *SPACing:LINear* also changes according to the formula stated under *POINts*. A change of *SPAN* does not result in a change of *STEP[:LINear]*. Keyword *[:LINear]* can be omitted, then the command conforms to SCPI regulations (see example).

*RST value is 1 MHz

Example: *:SOUR:SWEE:STEP 1MHz*

:*LOGarithmic* 0.01 to 50 PCT

The command indicates the step width factor for logarithmic sweeps. The next frequency value of a sweep is calculated according to

new frequency = prior frequency + *STEP:LOG* x prior frequency (if *START* < *STOP*)

STEP:LOG indicates the fraction of the prior frequency by which this is increased for the next sweep step. Usually *STEP:LOG* is indicated in percent, with the suffix *PCT* having to be used explicitly. If *STEP:LOG* is changed, the value of *POINts* valid for *SPAC:LOG* also changes according to the formula stated under *POINts*. A change of *START* or *STOP* does not result in a change of *STEP:LOG*.

*RST value is 1 PCT

Example: *:SOUR:SWEE:STEP:LOG 10PCT*

[:SOURce]
:SWEep
:POWer

The commands to set the level sweeps are under this node.

:DWELI 10 ms to 5 s

The command sets the time per level step (dwell).

*RST value is 15 ms

Example: `:SOUR:SWE:POW:DWEL 12ms`

:MODE AUTO | MANual | STEP

The command specifies the run of the sweep.

AUTO Each trigger triggers exactly one entire sweep cycle.

MANual Each level step of the sweep is triggered by means of manual control or a `SOURce:POWer:MANual` command, the trigger system is not active. The level increases or decreases (depending on the direction of the shaft encoder) by the value stated under `:SOURce:POWer:STEP:INCRement`.

STEP Each trigger triggers only one sweep step (single-step mode). The level increases by the value indicated under `:SOURce:POWer:STEP:INCRement`. *RST value is AUTO

Example: `:SOUR:SWE:POW:MODE AUTO`

:POINTs Number

The command determines the number of steps in a sweep. Instead of this command, command `SOURce:SWEep:POWer:STEP:LOGarithmic` should be used, as `POINTs` has been adapted to the instrument characteristics in comparison to the SCPI command.

The value of `:POINTs` depends on `.SPAN` and `:STEP` according to the following formulas:

$$\text{POINTs} = ((\log \text{STOP} - \log \text{START}) / \log \text{STEP:LOG}) + 1$$

A change of `POINTs` results in an adaptation of `STEP` but not of `START`, `STOP` and `SPAN`.

Example: `:SOUR:SWE:POW:POIN 100`

:SPACing LOGarithmic

The command specifies that the steps have logarithmic spacings. It permits the query of `SPACing`. *RST value is LOGarithmic

Example: `:SOUR:SWE:POW:SPAC LOG`

:STEP

The commands to set the step width with the sweep are under this node.

:LOGarithmic 0 to 10 dB

The command indicates the step width factor for logarithmic sweeps. The next level value of a sweep is calculated according to

$$\text{new level} = \text{prior level} + \text{STEP:LOG} \times \text{prior level}$$

`STEP:LOG` indicates the fraction of the prior level by which this is increased for the next sweep step. Usually `STEP:LOG` is indicated in dB, with suffix dB having to be used explicitly. If `STEP:LOG` is changed, the value of `POINTs` also changes according to the formula indicated under `POINTs`. A change of `START` or `STOP` does not result in a change of `STEP:LOG`. Keyword `:LOG` can be omitted, then the command conforms to SCPI regulation (see example). *RST value is 1dB

Example: `:SOUR:SWE:STEP 10dB`

3.6.11.16 SOURce:VOR-Subsystem

This subsystem contains the commands to control the characteristics of the test signals for VOR (VHF Omnidirectional Range) (option SM-B6, multifunction generator).

Command	Parameter	Default Unit	Remark
[:SOURce] :VOR			Option SM-B6
:STATe	ON OFF		
:SOURce	INT2 INT2, EXT		
:MODE	NORM VAR SUBCarrier FMSubcarrier		
[:BANGLE]	0 to 360 deg	rad	
:DIRection	FROM TO		
:VAR			
[:DEPTH]	0 to 100 PCT	PCT	
:FREQuency	20 to 40 Hz	Hz	
:SUBCarrier			
:DEPTH	0 to 100 PCT	PCT	
[:FREQuency]	5 to 15 kHz	Hz	
:REFerence			
[:DEViation]	0 to 960 Hz	Hz	
:PRESet			
:COMid			No query
[:STATe]	ON OFF		
:FREQuency	0.1 to 20 000 Hz	Hz	
:DEPTH	0 to 100 PCT	PCT	

[:SOURce]

:VOR

:STATe ON | OFF

The command switches on or off the generation of VOR signals. STATe ON is only possible if no amplitude modulation is switched on. Modulation generator 2 must not be switched simultaneously as a source for PM or FM either.

*RST value is OFF

Example: :SOUR:VOR:STAT ON

:SOURce INT2 | INT2, EXT

This command determines the signal sources of the test signal.

INT2 The test signal used for VOR is generated internally by LF generator 2 (SOURce INT2).

INT2, EXT A signal from input EXT1 is added to the internal signal in addition. Switching off the internal source is not possible.

*RST value is INT2

Example: :SOUR:VOR:SOUR INT2

:SOURce:VOR

[[:SOURce]**:VOR****:MODE** NORM | VAR | SUBCarrier | FMSubcarrier

The command specifies the type of VOR signal generated.

NORM VOR signal

VAR Amplitude modulation of the output signal with the *SOURce:VOR:VAR:FREQuency* signal content (usually 30 Hz) of the VOR signal. The modulation depth is set under *SOURce:VOR:VAR:DEPT*h.SUBCarrier Amplitude modulation of the output signal with the unmodulated *SOURce:VOR:SUBCarrier:FREQuency*-FM carrier (usually 9960 Hz) of the VOR signal. The modulation depth is set under *SOURce:VOR:SUBCarrier:DEPT*h.FMSubcarrier (FM-modulated subcarrier) Amplitude modulation of the output signal with the frequency-modulated *SOURce:VOR:SUBCarrier: FREQuency--FM* carrier (usually 9960 Hz) of the VOR signal. The frequency deviation is set under *SOURce:VOR:REFerence:DEViation*, the modulation depth under *SOURce:VOR:SUBCarrier:DEPT*h.

*RST value is NORM

Example: *:SOUR:VOR:MODE VAR***[[:BANGLE] 0 to 360 deg**The command sets the bearing angle (Bearing ANGLE) between the VAR signal and the reference signal. The orientation of the angle depends on the setting under *SOURce:VOR:BANGLE:DIRection*.

*RST value is 0 Grad

Example: *:SOUR:VOR:BANG 0deg***:DIRection** FROM | TO

The command determines the orientation of the bearing angle.

FROM The bearing angle is measured between the geographic north and the connection line from beacon to airplane.

TO The bearing angle is measured between the geographic north and the connection line from airplane to beacon.

*RST value is FROM

Example: *:SOUR:VOR:BANG:DIR TO***:VAR**

The commands to specify the characteristics of the VAR signal are under this node.

[[:DEPT] 0 to 100 PCT

The command sets the AM modulation depth of the VAR signal. *RST value is 30PCT

Example: *:SOUR:VOR:VAR:DEPT 30PCT***:FREQuency 20 to 40 Hz**

The command sets the frequency of the VAR signal. As VAR and reference signal must always have the same frequency, this setting is also valid for the reference signal.

*RST value is 30 Hz

Example: *:SOUR:VOR:VAR:FREQ 30*

[[:SOURce]**:VOR****:SUBCarrier**

The commands to specify the characteristics of the FM carrier are under this node (subcarrier).

[[:FREQuency] 5 to 15 kHz

The command sets the frequency of the FM carrier.

*RST value is 9960 Hz

Example: **:SOUR:VOR:SUBC:FREQ 9960**

:DEPTH 0 to 100 PCT

The command sets the AM modulation depth of the FM carrier.

*RST value is 30PCT

Example: **:SOUR:VOR:SUBC:DEPT 30PCT**

:REFerence

The commands to specify the characteristics of the reference signal are under this node.

[[:DEViation] 0 to 960 Hz

The command sets the frequency deviation of the reference signal on the FM carrier.

*RST value is 480 Hz

Example: **:SOUR:VOR:REF:DEV 480**

:PRESet

This command is equivalent to the following command sequence:

:VOR:MODE NORM

:VOR:SOUR INT2

:VOR 0deg

:VOR:DIRection FROM

:VOR:VAR:FREQ 30Hz

:VOR:VAR 30PCT

:VOR:SUBC 9960Hz

:VOR:SUBC:DEPTH 30PCT

:VOR:REF:DEV 480Hz

:VOR:COM OFF

:VOR:COM:FREQ 1020Hz

:VOR:COM:DEPTH 10PCT

The values set correspond to the state after **SYSTEM:PRESET** or ***RST**. The command neither has a query form nor an ***RST** value.

Example: **:SOUR:VOR:PRES**

:COMid

The commands to set the ComId component (communication/identification signal) of the VOR signal are under this node.

[[:STATe] ON | OFF

The command activates or deactivates the ComId signal.

*RST value is OFF

Example: **:SOUR:VOR:COM:STAT ON**

:FREQuency 0.1 to 20 000 Hz

The command sets the frequency of the ComId signal.

*RST value is 1020 Hz

Example: **:SOUR:VOR:COM:FREQ 1020**

:DEPTH 0 to 100 PCT

The command sets the AM modulation depth of the ComId signal.

*RST value is 10PCT

Example: **:SOUR:VOR:COM:DEPT 10PCT**

3.6.12 SOURce0|2 System

The SOURce0|2 system contains the commands to configure the LF signal sources. The following allocation is valid:

- SOURce0: Standard generator.
 Designated as INT1 if used as a modulation source (cf. command *SOURce:AM:SOURce INT1*, e.g.). The numbering as SOURce0 is different from the manual control.
 Second optional LF generator (option SM-B2).
 Replaces the standard generator which is cut out by this option. Is designated as INT1 if it is used as a modulation source; if it is used as an LF generator, it is designated as SOURce0 differently from the numbering of the manual control.
- SOURce2 First optional LF or modulation generator (option SM-B2 or SM-B6).
 Is designated as INT2 if used as a modulation source; if it is used as an LF generator, it is designated as SOURce2.

The commands to set the output voltage of the LF generators are in the OUTPut2 system (see Section 3.6.10)

Sub systems	Setting
:SOURce0 2 :FREQuency :FUNctIon :MARKer :SWEep	Frequency with CW and sweep operation Waveform of the output signal Marker for LF sweeps (only possible using SOURce2) LF sweep (only possible using SOURce2)

3.6.12.1 SOURce0|2:FREQuency Subsystem

This subsystem contains the commands for the frequency settings in operating modes CW and SWEep. Only command *SOURce0:FREQuency:CW|FIXed* is effective for the standard LF generator (SOURce0). For LF generator2 (SOURce2), sweep commands are effective as well.

Commands	Parameter	Default Unit	Remark
:SOURce0 2 :FREQuency [:CW :FIXed]	400 Hz 1 kHz 3 kHz 15 kHz or 0.1Hz to 500 kHz or 0.1Hz to 1MHz	Hz	Option SM-B2 or B6
:MANual	0.1Hz to 500 kHz or 0.1Hz to 1MHz	Hz	Option SM-B2 or B6
:MODE	CW FIXed SWEep		
:STARt	0.1Hz to 500 kHz or 0.1Hz to 1MHz	Hz	Option SM-B2 or B6
:STOP	0.1Hz to 500 kHz or 0.1Hz to 1MHz	Hz	Option SM-B2 or B6

- :SOURce0|2
 :FREQuency
 [:CW|:FIXed] 400 Hz | 1 kHz | 3 kHz | 15 kHz or 0.1 Hz to 500 kHz or 0.1 Hz to 1MHz
 The command sets the frequency for the CW mode.
 If neither SM-B2 nor SM-B6 are fitted, the values 400 Hz, 1 kHz, 3 kHz and 15 kHz are permissible for SOURce0. With option SM-B2, values from 0.1 Hz to 500 kHz are permissible, with SM-B6 from 0.1 Hz to 1 MHz. RST value is 1kHz
 Example: :SOUR2:FREQ:CW 1kHz

:SOURce0|2

:FREQUENCY

:MANual 0.1 Hz to 500 kHz or 0.1 Hz to 1MHz

The command sets the frequency if *SOURce2:SWEep:MODE MANual* and *SOURce2:FREQUENCY: MODE SWEep* are set. In this case, only frequency values between the settings *SOURce2: FREQUENCY:START* and ... :STOP are allowed. (For range of values see *FREQUENCY:CENTer*).

Example: :SOUR2:FREQ:MAN 1kHz

*RST value is 1 kHz

:MODE CW|FIXed | SWEep

The command specifies the operating mode and hence by means of which commands the FREQUENCY subsystem is checked. The following allocations are valid:

CW|FIXed CW and FIXed are synonyms. The output frequency is specified by means of *SOURce0|2:FREQUENCY:CW |FIXed*.

SWEep The generator operates in the SWEep mode. The frequency is specified by means of commands *SOURce2:FREQUENCY:START; STOP; MANual*. The SWEep setting is only possible for SOURce2.

RST value is CW

Example: :SOUR0:FREQ:MODE CW

:START 0.1 Hz to 500 kHz (option SM-B2) or 0.1 Hz to 1 MHz (option SM-B6)

This command indicates the starting value of the frequency for the sweep.

*RST value is 1kHz

Example: :SOUR2:FREQ:STAR 100kHz

:STOP 0.1 Hz to 500 kHz (option SM-B2) bzw. 0.1 Hz to 1 MHz (option SM-B6)

This command indicates the end value of the frequency for the sweep.

*RST value is 100kHz

Example: :SOUR2:FREQ:STOP 200 kHz

3.6.12.2 SOURce 0|2:FUNCTION Subsystem

This subsystem contains the commands specifying the waveform of the output signal.

Command	Parameter	Default Unit	Remark
:SOURce0 2 :FUNCTION [:SHAPE]	SINusoid SQUare TRIangle PRNoise SAWTooth		

:SOURce0|2

:FUNCTION

[:SHAPE] SINusoid | SQUare | TRIangle | PRNoise

The command specifies the waveform of the output signal. In the case of the standard generator, the waveform is specified to be sine. The optional LF generator (*SOURce2*, option SM-B2 or SM-B6) can be converted to all signal forms. If two options SM-B2 are installed, *SOURce0* can be set to all signal forms as well.

SINusoid Sine

SQUare Square

TRIangle Triangle

PRNoise Periodic noise.

SAWTooth Sawtooth

*RST value is SIN

Example: :SOUR2:FUNC:SHAP SQU

3.6.12.3 SOURce2:MARKer Subsystem

This subsystem contains the commands to check the marker generation in the case of LF sweeps. Operating mode SWEEP is only possible for SOURce2. The three markers existing are differentiated by a numeric suffix after marker.

Command	Parameter	Default Unit	Remark
:SOURce2 :MARKer [:FSWEEP] :AOFF :FREQuency [:STATe] :POLarity	0.1 Hz to 500 kHz ON OFF NORMal INVerted	Hz	Option SM-B2 or SM-B6 No query

:SOURce2
:MARKer 1 | 2 | 3
[:FSWEEP]

The commands for the markers with the LF frequency sweep (Frequency SWEEP) are under this node. Keyword [:FSWEEP] can also be omitted, then the command conforms to SCPI regulation (see examples).

:AOFF

The command switches off all LF frequency markers. This command triggers an event, thus it has no *RST value and no query form.

Example: :SOUR2:MARK:AOFF

:FREQuency 0.1Hz to 500 kHz

The command sets the marker selected by the numeric suffix at MARKer to the frequency indicated.

*RST value for MARK1: 100kHz
MARK2: 10kHz
MARK3: 1kHz

Example: :SOUR2:MARK1:FREQ 9000

[:STATe] ON | OFF

The command switches on or off the marker selected by the numeric suffix at MARKer.

*RST value is OFF

Example: :SOUR2:MARK1:STAT ON

:POLarity NORMal | INVerted

The command specifies the polarity of the marker signal as follows:

NORMal When running through the marker condition, TTL level is applied at the marker output, otherwise 0 V.

INVers When running through the marker condition, 0 V is applied at the marker output, otherwise TTL level.

*RST value is NORM

Example: :SOUR2:MARK1:POL INV

3.6.12.4 SOURce2:SWEep Subsystem

This subsystem contains the commands to check the LF sweep of SOURce2. Sweeps are triggered on principle. Command *SOURce2:FREQUENCY:MODE SWEep* activates the LF sweep.

Command	Parameter	Default Unit	Remark
:SOURce2 :SWEep :BTIME [:FREQUENCY] :DWELL :MODE :POINTS :SPACING :STEP [:LINEar] :LOGarithmic	NORMal LONG 10 ms to 5 s AUTO MANual STEP Number LINear LOGarithmic 0 to 500 kHz 0.01 to 50 PCT	 s Hz PCT	Option SM-B2 oder SM-B6

:SOURce2

:SWEep

:BTIME NORMal | LONG

The command sets the blank time (Blank TIME) of the sweep. The setting is valid for all sweeps, i.e., also for RF sweeps.

NORMal Blank time as short as possible.

LONG Blank time long enough to permit an X/Y recorder to return to 0.

*RST value is NORM

Example: :SOUR2:SWE:BTIM LONG

[:FREQUENCY]

The commands to set the frequency sweeps are under this node. Keyword [:FREQUENCY] can be omitted. Then the commands are SCPI-compatible unless stated otherwise (see examples).

:DWELL 10 ms to 5 s

The command sets the time per frequency step (dwell).

*RST value is 15 ms

Example: :SOUR2:SWE:DWEL 20ms

:MODE AUTO | MANual | STEP

The command specifies the run of the sweep.

AUTO Each trigger triggers exactly one entire sweep cycle.

STEP Each trigger triggers only one sweep step (single-step mode). The frequency increases by the value indicated under :SOURce2:SWEep :STEP.

*RST value is AUTO

Example: :SOUR2:SWE:MODE AUTO

:SOURce2

:SWEep

[:FREQuency]

:POINts Number

The command determines the number of steps in a sweep. Instead of this command, commands **:SOURce2:FREQuency:STEP:LINear** and **:SOURce2:FREQuency:STEP:LOGarithmic** should be used, as **:SOURce2:SWEep:FREQuency:POINts** has been adapted to the instrument characteristics in comparison to the SCPI command. The value of **POINts** depends on **SPAN** and **STEP** according to the following formulas.

The following is true of linear sweeps: $POINts = SPAN / STEP:LIN + 1$

The following is true of logarithmic sweeps and **START** < **STOP**:

$$POINts = ((\log STOP - \log START) / \log STEP:LOG) + 1$$

Two independent **POINts** values are used for **SPACing LOG** and **SPACing LIN**. That is to say, before **POINts** is changed, **SPACing** must be set correctly. A change of **POINts** causes an adaption of **STEP**, but not of **START**, **STOP** and **SPAN**.

Example: **:SOUR2:SWE:POIN 50**

:SPACing LINear | LOGarithmic

The command selects whether the steps have linear or logarithmic spacings.

*RST value is LINear

Example: **:SOUR2:SWE:SPAC LOG**

:STEP

The commands to set the step width with linear and logarithmic sweeps are under this node. The settings of **STEP:LIN** and **STEP:LOG** are independent of each other.

[:LINear] 0 to 500 kHz

The command sets the step width with the linear sweep. If **STEP:LINear** is changed, the value of **POINts** valid for **SPACing:LINear** also changes according to the formula indicated under **POINts**. A change of **SPAN** does not cause a change of **STEP:LINear**. Keyword **[:LINear]** can be omitted, then the command conforms to SCPI regulation (see example).

*RST value is 1 kHz

Example: **:SOUR2:SWE:STEP 10kHz**

:LOGarithmic 0.01 to 50 PCT

The command indicates the step width factor for logarithmic sweeps. The next frequency value of a sweep is calculated according to (if **START** < **STOP**):

$$\text{new frequency} = \text{prior frequency} + STEP:LOG \times \text{prior frequency}$$

Thus **STEP:LOG** indicates the fraction of the prior frequency by which this is increased for the next sweep step. Usually **STEP:LOG** is indicated in percent, with the suffix **PCT** having to be used explicitly. If **STEP:LOG** is changed, the value of **POINts** valid for **SPACing:LOGarithmic** also changes according to the formula stated under **POINts**. A change of **START** or **STOP** does not cause a change of **STEP:LOGarithmic**.

*RST value is 1 PCT

Example: **:SOUR2:SWE:STEP:LOG 5PCT**

3.6.13 STATus System

This system contains the commands for the status reporting system (c.f. Section 3.8, Status Reporting System). *RST has no influence on the status registers.

Command	Parameter	Default Unit	Remark
:STATus			
:OPERation			
[:EVENT]?			Query only
:CONDition?			Query only
:PTRansition	0 to 32767		
:NTRansition	0 to 32767		
:ENABLE	0 to 32767		
:PRESet			No query
:QUESTionable			
[:EVENT]?			Query only
:CONDition?			Query only
:PTRansition	0 to 32767		
:NTRansition	0 to 32767		
:ENABLE	0 to 32767		
:QUEue			
[:NEXT]?			Query only

:STATus

:OPERation

The commands for the STATus:OPERation register are under this node.

[:EVENT]?

The command queries the content of the EVENT part of the STATus:OPERation register. In reading out, the content of the EVENT part is deleted.

Example: :STAT:OPER:EVEN?

Response: 17

:CONDition?

The command queries the content of the CONDition part of the STATus:OPERation register. In reading out, the content of the CONDition part is not deleted. The value returned directly reflects the current hardware state.

Example: :STAT:OPER:COND?

Response: 1

:PTRansition 0 to 32767

The command (Positive Transition) sets the edge detectors of all bits of the STATus:OPERation register from 0 to 1 for the transitions of the CONDition bits.

Example: :STAT:OPER:PTR 32767

:NTRansition 0 to 32767

The command (Negative Transition) sets the edge detectors of all bits of the STATus:OPERation register from 1 to 0 for the transitions of the CONDition bit.

Example: :STAT:OPER:NTR 0

:STATus

:STATus**:OPERation****:ENABLE** 0 to 32767

The command sets the bits of the ENABLE register. This register selectively enables the individual events of the appropriate status event register for the sum bit in the status byte.

Example: `:STAT:OPER:ENAB 1`

:PRESet

The command resets the edge detectors and ENABLE parts of all registers to a defined value. All PTRansition parts are set to FFFFh, i.e., all transitions from 0 to 1 are detected. All NTRansition parts are set to 0, i.e., a transition from 1 to 0 in a CONDition bit is not detected. The ENABLE parts of STATus:OPERation and STATus:QUESTionable are set to 0, i.e., all events in these registers are not passed on.

Example: `:STAT:PRES`

:QUESTionable

The commands for the STATus:QUESTionable register are under this node.

[:EVENT]?

The command queries the content of the EVENT part of the STATus:QUESTionable register. In reading out, the content of the EVENT part is deleted.

Example: `:STAT:QUES:EVEN?` Response: 1

:CONDition?

The command queries the content of the CONDition part of the STATus:QUESTionable register. In reading out, the content of the CONDition part is not deleted.

Example: `:STAT:QUES:COND?` Response: 2

:PTRansition 0 to 32767

The command (Positive Transition) sets the edge detectors of all bits of the STATus:QUESTionable register from 0 to 1 for transitions of the CONDition bit.

Example: `:STAT:QUES:PTR 32767`

:NTRansition 0 to 32767

The command (Negative Transition) sets the edge detectors of all bits of the STATus:QUESTionable register from 1 to 0 for transitions of the CONDition bit.

Example: `:STAT:QUES:NTR 0`

:ENABLE 0 to 32767

The command sets the bits of the ENABLE part of the STATus:QUESTionable register. This part selectively enables the individual events of the appropriate EVENT part for the sum bit in the status byte.

Example: `:STAT:QUES:ENAB 1`

:QUEue[:NEXT]?

The command queries the entry that has been in the error queue for the longest time and thus deletes it. Positive error numbers denote errors specific of the instrument, negative error numbers error messages specified by SCPI (see annex B). If the error queue is empty, error number 0, "No error", is returned. The command is identical to `SYSTem:ERRor?`.

Example: `STATus:QUEue:NEXT?` Response: -221, "Settings conflict"

3.6.14 SYSTem System

In this system, a number of commands for general functions which are not immediately related to signal generation, are combined.

Command	Parameter	Default Unit	Remark
:SYSTem			
:BEEPer			
:STATe	ON OFF		
:COMMunicate			
:GPIB			
[:SELF]			
:ADDRes	0 to 30		
:SERial			
:CONTRol			
:RTS	ON IBFull RFR		
:BAUD	1200 2400 4800 9600 19200 38400 57600 115200		
:PACE	XON NONE		
:ERRor?			Query only
:KLOCK	ON OFF		
:MODE	FIXed MSEQUence		
:MSEQUence			
:CATalog?			
:DElete	"Name of sequence"	s	
:ALL			
:DWELl	50 ms to 60 s {,50 ms to 60 s}		
:FREE?			Query only
:MODE	AUTO STEP		
[:RCL]			
:POINts?	1 to 50 {,1 to 50}		Query only
:SElect	"Name of sequence"		
:PRESet			
:PROTect			
[:STATe]	ON OFF , password		
:SECurity			
[:STATe]	ON OFF		
:SERRor?			Query only
:VERSion?			Query only

:SYSTem

:BEEPer This node contains the commands to set the beeper fitted.

:STATe ON | OFF

The command switches the beeper on or off.

*RST value is OFF

Example: `:SYST:BEEP:STAT OFF`

:COMMunicate

The commands to set the remote control interface are under this node.

:GPIB The commands to check the IEC bus are under this node (GPIB = General Purpose Interface Bus).

[:SELF]

:ADDRes 1 to 30

The command sets the IEC-bus instrument address.

*RST value is 28

Example: `:SYST:COMM:GPIB:ADDR 1`

:SYSTem

:SYSTem

:COMMunication

:SERial

The command to set the serial interface are under this node. The data format is fixedly set to 8 data bits, no parity and 1 stop bit. These values cannot be changed. The device represents a DTE (Data Terminal Equipment) in relation to the serial interface. Therefore the the controller must be connected via a 0-modem.

:BAUD 1200| 2400| 4800| 9600| 19200| 38400| 57600| 115200

The commands sets the baud rate for both the transmit and the receive direction. *RST has no influence on this parameter.

Example: `:SYST:COMM:SER:CONT:BAUD 9600`

*RTS value is 9600

:CONTrol

:RTS ON | IBFull | RFR

The commands sets the hardware handshake. *RST has no influence on this parameter.

ON Interface line RTS is always active.

IBFull | RFR Input Buffer Full | Ready For Receiving

Interface line RTS remains active as long as the instrument is ready to receive data.

Example: `:SYST:COMM:SER:CONT:RTS ON`

*RST value is RFR

:PACE XON | NONE

The command sets the software handshake. *RST has no influence on this parameter.

XON Software handshake using the ASCII codes 11h (XON) and 13h (XOFF).

Note: *This mode is not recommended for binary data and for baud rates above 9600 bauds.*

NONE No software handshake.

Example: `:SYST:COMM:SER:PACE NONE`

*RST value is NONE

:ERRor?

The command queries the entry that has been in the error queue for the longest time. Positive error numbers denote errors specific of the instrument, negative error numbers denote error messages specified by SCPI (see annex B3). If the error queue is empty, 0, "No error", is returned. The command is identical to `STATus:QUEue:NEXT?`

Example: `:SYST:ERR?`

Response: `-221, "Settings conflict"`

:KLOCK ON | OFF

The command (Keyboard LOCK) disables the keyboard of the SMT including the [LOCAL] key or enables it again (OFF).

Caution: *If :SYSTem:SECurity is ON, the keyboard cannot be enabled, i.e., :SYSTem:KLOCK OFF is not accepted. If the disabling of the command is released by switching over to :SYSTem:SECurity OFF, data will be lost.*

Example: `:SYST:KLOC ON`

*RST value is OFF

:SYSTem**:MODE** *FIXed* | *MSEquence*

The command sets the operating mode of the instrument.

FIXed The overall instrument state can only be switched over using **RCL*.

MSEquence The instrument successively sets the instrument states indicated under
:SYSTem:MSEquence:RCL. *RST value is *FIXed*

Example: *:SYST:MODE FIX*

:MSEquence

This node contains the commands to manage the memory sequences. Memory sequences each consist of a list of instrument state numbers and a time list. If *:SYSTem:MODE* is switched to *MSEquence*, the instrument states stated in the list selected are set successively for the time stated in the time list in each case.

:CATalog?

The command queries the memory sequences available. It returns a list, the entries are separated by means of commas.

Example: *:SYST:MSEQ:CAT?* Response: "SEQ1", "DEMO", "SEQA"

:DElete "Name of sequence"

The command deletes the memory sequence indicated. This must not be selected.

Example: *:SYST:MSEQ:DEL "SEQ1"*

:ALL

The command deletes all memory sequences. The memory-sequence mode must be switched off (*:SYSTem:MODE FIXed*) as a selected sequence cannot be deleted.

Example: *:SYST:MSEQ:DEL:ALL*

:DWELl 50 ms to 60 s {,50 ms to 60 s}

For the memory sequence which has currently been selected, the command transmits a list indicating the time for which an instrument setting is "held" in each case before the instrument proceeds to the next setting. If *DWELl* indicates only one parameter, every item of the instrument state list is set for the same, indicated time. Lists are not influenced by **RST*.

Example: *:SYST:MSEQ:DWEL 1s*

:FREE?

The command queries the space available for memory sequences. It returns two values. The first value indicates the space still vacant, the second the space already occupied.

Example: *:SYST:MSEQ:FREE?* Response: 20, 236

:MODE *AUTO* | *STEP*

The command indicates in which way the memory sequence is to be processed (by analogy with *:SOURce:SWEep:MODE*).

AUTO Each trigger event triggers a complete cycle of the memory sequence selected.

STEP Each trigger event only triggers one step in processing the memory sequence. *RST value is *AUTO*

Example: *:SYST:MSEQ:MODE AUTO*

:SYSTem

:MSEQence

[**:RCL**] 1 to 50 {,1 to 50}

The command transmits the list of the instrument states to be assumed successively. The list contains integers denoting the states stored by means of *SAV. These instrument states are set successively using a simulated *RCL (thus the name of the list). The values of the list are between 1 and 50 (number of memory locations to be called). Lists are not influenced by *RST.

Example: :SYST:MSEQ:RCL 30,31,32,32,32,33

:POINts?

The command queries the length of the RCL list selected. The RCL list is user-defined and of variable length (see above). The maximal length can be queried by means of :SYSTem:MSEQence:FREE? (addition of the two values).

Example: :SYST:MSEQ:RCL:POIN? Response: 17

:SElect "Name of sequence"

The command selects a memory sequence. The name of the sequence may be an arbitrary character string of up to 7 letters. If there is no memory sequence of the name indicated, the command creates it, i.e., this command can be used to generate new lists.

Example: :SYST:MSEQ:SEL "SEQA"

:PRESet

The command triggers an instrument reset. It has the same effect as the RESET key of the manual control or as command *RST. This command triggers an event and hence has no *RST value.

Example: :SYST:PRES

:PROTect 1 | 2 | 3

The commands to disable certain instrument functions are under this node. A list of the functions concerned can be found in the manual control (Chapter 2, Section "Password Input with Functions Protected"). There are three protection levels which are differentiated by means of a suffix after PROTect. *RST has no effects on the disabling/enabling of the instrument functions.

[**:STATe**] ON | OFF, password

The command switches a protection level on or off. The passwords are 6-digit numbers. They are fixedly stored in the firmware. The password for the first level is 123456.

ON disables the functions belonging to this protection level. A password need not be indicated.

OFF deactivates the disabling again if the correct password is indicated. Otherwise an error - 224, "Illegal parameter value" is generated and STATe remains ON.

Example: :SYST:PROT1:STAT OFF,123456

:SYSTem

:SECurity

The commands setting the security characteristics of the instrument are under this node.

[[:STATE]] ON|OFF

The command switches the security state on or off.

ON The following commands cannot be executed:

:DISPlay:ANNotation:ALL ON

:DISPlay:ANNotation:FREQuency ON

:DISPlay:ANNotation:AMPLitude ON

:SYSTem:KLOCK OFF

OFF In the transition from ON to OFF all data existing in the instrument except for the calibrating data are deleted, especially all status registers, all instrument states and all lists.

The command is not influenced by *RST and *RCL.

Example: :SYST:SEC:STAT ON

:SERRor?

This command returns a list of all errors existing at the point of time of the query. This list corresponds to the indication on the ERROR page with manual control (cf. Section 2.14, Error Messages).

Example: :SYST:SERR?

Response: -221, "Settings conflict", 153, "Input voltage out of range"

:VERSion?

The command returns the SCPI version number the instrument acts in accordance with. This command is a query and thus has no *RST value.

Example: :SYST:VERS?

Response: 1994.0

3.6.15 TEST System

This system contains the commands to execute the selftest routines (*RAM?*, *ROM?* and *BATTery?*) as well as to directly manipulate the hardware modules (*:TEST:DIRect*). The selftests return a "0" if the test has been executed successfully, otherwise a value unequal to "0". All commands of this system do not have an *RST value.

Caution: *The commands under node :TEST:DIRect directly act on the respective hardware module circumventing any security mechanisms. They are provided for service purposes and should not be used by the user. Improper use of the commands may damage the module.*

Command	Parameter	Default Unit	Remark
:TEST :DIRect :ATTC :LFGENA :LFGENB :MGEN :OPU1M :OPU3M :OPU6M :PUM :TSYN :ROSC :RAM? :ROM? :BATTery?	 Subaddress, hex data string Subaddress, hex data string Subaddress, hex data string Subaddress, hex data string Subaddress, hex data string Subaddress, hex data string Subaddress, hex data string Subaddress, hex data string Subaddress, hex data string Subaddress, hex data string		 Query only Query only Query only Query only

:TEST
 :DIRect

This node contains the commands directly acting on the respective hardware module circumventing any security mechanisms. The commands under this node have no short form.

:ATTC Subaddress, hex data string
The command directly acts on module ATTC. A subaddress (0 or 1) must be indicated as a parameter. The data are indicated as a <string> (i.e., an ASCII character string enclosed in quotation marks) representing hexadecimal numbers. Thus characters 0 to 9 A to F may occur in the character string.

Example: `:TEST:DIR:ATTC 0, "0010AF1F"`

:TEST**:DIRect**

:LFGENA Subaddress, hex data string
The command acts on module LFGENA. (cf. *:TEST:DIR:ATTC*)

:LFGENB Subaddress, hex data string
The command acts on module LFGENB. (cf. *:TEST:DIR:ATTC*)

:MGEN Subaddress, hex data string
The command acts on module MGEN. (cf. *:TEST:DIR:ATTC*)

:OPU1M Subaddress, hex data string
The command acts on module OPU1. (cf. *:TEST:DIR:ATTC*)

:OPU3M Subaddress, hex data string
The command acts on module OPU3. (cf. *:TEST:DIR:ATTC*)

:OPU6M Subaddress, hex data string
The command acts on module OPU6. (cf. *:TEST:DIR:ATTC*)

:PUM Subaddress, hex data string
The command acts on module PUM. (cf. *:TEST:DIR:ATTC*)

:TSYN Subaddress, hex data string
The command acts on module TSYN. (cf. *:TEST:DIR:ATTC*)

:ROSC Subaddress, hex data string
The command acts on module ROSC. (cf. *:TEST:DIR:ATTC*)

:RAM?

The command triggers a test of the EPROMS (see table).

:ROM?

The command triggers a test of the main memory (see table).

:BATTery?

The command triggers a test of the battery voltage (see table).

3.6.16 TRIGger System

The TRIGger system contains the commands to select the trigger source and to configure the external trigger socket. The suffix is only important for the SWEEP subsystem and conforms to the numbering of the SOURce system:

TRIGger1 = RF generator

TRIGger2 = LFGEN2

The trigger system of the SMT is a simplified implementation of the SCPI trigger system. Compared to SCPI, the TRIGger system shows the following differences:

- No INITiate command, the instrument behaves as if *INITiate:CONTinuous ON* was set.
- There are several subsystems denoting the different parts of the instrument under TRIGger (SWEep, PULSe, MSEquence).

Further commands as to the trigger system of the SMT can be found in the ABORt system.

Command	Parameter	Default Unit	Remark
:TRIGger1 2 [:SWEep] [:IMMEDIATE] :SOURce	SINGLE EXTernal AUTO		No query
:MSEquence [:IMMEDIATE] :SOURce	SINGLE EXTernal AUTO		No query
:PULSe :SOURce :SLOPe :SLOPe	EXTernal AUTO POSitive NEGative POSitive NEGative EITHER		

:TRIGger1|2
[:SWEep]

All commands to trigger a sweep are under this node. The settings here act on level and frequency sweeps for RF generator (TRIG1) and LF generator (TRIG2).

[:IMMEDIATE]

The command immediately starts a sweep. Which sweep is executed depends on the respective MODE setting, e.g. *:SOURce:FREQuency:MODE SWEep*. The command corresponds to manual-control command EXECUTE SINGLE SWEEP. This command is an event and thus has no *RST value.

Example: *:TRIG:SWE:IMM*

:TRIGger1|2

[:SWEep]

:SOURce SINGLE | EXTernal | AUTO

The command specifies the trigger source.

The naming of the parameters directly corresponds to the different settings with manual control. SCPI uses other designations for the parameters the instrument accepts as well. These designations are to be preferred if compatibility is important. The following table provides an overview:

SMT designation	SCPI designation	Command with manual control
SINGLE	BUS	MODE SINGLE or STEP
EXTernal	EXTernal	MODE EXT TRIG SINGLE or EXT TRIG STEP
AUTO	IMMEDIATE	MODE AUTO

SINGLE Triggering is effected by means of IEC-bus commands :TRIGger:SWEep :IMMEDIATE or *TRG. If :SOURce:SWEep:MODE is set to STEP, a step, in the case of the AUTO setting a complete sweep, is executed.

EXTernal Triggering is effected from outside via the EXT.TRIG. socket or by the GET command via IEC/IEEE-bus (see annex A). The action triggered depends on the setting of the sweep mode as in the case of SINGLE.

AUTO The trigger is free-running, i.e., the trigger requirement is permanently met. As soon as a sweep has been terminated, the next one is started.

Example: :TRIG:SWE:SOUR AUTO *RST value is SINGLE

:MSEquence

This node contains all commands to trigger a memory sequence. The commands are only valid for TRIGger1.

[:IMMEDIATE]

The command immediately starts a memory sequence. It corresponds to the EXECUTE SINGLE MODE command of the manual control in the MEMORY SEQUENCE menu. This command is an event and thus has no *RST value.

Example: :TRIG:MSEQ:IMM

:SOURce SINGLE | EXTernal | AUTO

The command specifies the trigger source (cf. :TRIGger:SWEep:SOURce)

Example: :TRIG:MSEQ:SOUR AUTO *RST value is SINGLE

:PULSE

This node contains all commands to trigger the pulse generator (option SM-B4). The commands are only valid for TRIGger1.

:SOURce EXTernal | AUTO

The command specifies the trigger source.

EXTernal Triggering is effected from outside via the PULSE socket.

AUTO Trigger is free-running (see above) *RST value is AUTO

Example: :TRIG:PULS:SOUR AUTO

:SLOPe POSitive | NEGative

The command indicates whether the action triggered is triggered at the positive or the negative edge of the trigger signal. *RST value is POSitive

Example: :TRIG:PULS:SLOP NEG

:TRIGger1:UNIT

:TRIGger

:SLOPe POSitive | NEGative | EITHer

The command indicates whether the external trigger input only responds to the positive, the negative or to both edges of the trigger signal. The command acts on *TRIGger1|2:SWEEp* and *TRIGger1:MSEQuence*. The pulse generator has an own trigger input and thus also an own SLOPe command.

*RST value is POSitiv

Example: **:TRIG:SLOP NEG**

3.6.17 UNIT System

This system contains the commands specifying which units are valid if no unit is indicated in a command. These settings are valid for the entire instrument.

Command	Parameter	Default Unit	Remark
:UNIT :ANGLE :POWer	DEGRee DEGree RADian DBM DBW DBMW DBUW DBV DBMV DBUV V		

:UNIT

:ANGLE DEGRee | DEGree | RADian

The command indicates the unit for angles.

*RST value is RADian

Example: **:UNIT:ANGL DEGR**

:POWer DBM | DBW | DBMW | DBUW | DBV | DBMV | DBUV | V

The command indicates the unit for power.

*RST value is DBM

Example: **:UNIT:POW V**

3.7 Instrument Model and Command Processing

The instrument model shown in Fig. 3.2 has been made viewed from the standpoint of the servicing of IEC-bus commands. The individual components work independently of each other and simultaneously. They communicate by means of so-called "messages".

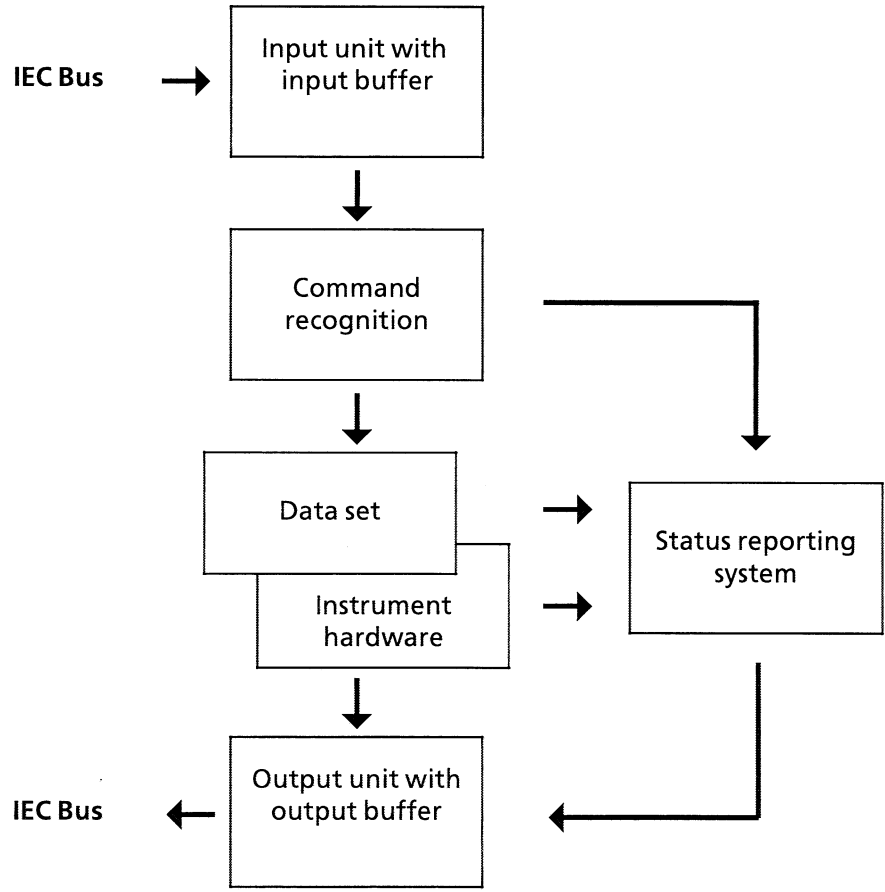

Fig. 3-2 Instrument model in the case of remote control by means of the IEC bus

3.7.1 Input Unit

The input unit receives commands character by character from the IEC bus and collects them in the input buffer. The input buffer has a size of 1024 characters. The input unit sends a message to the command recognition as soon as the input buffer is full or as soon as it receives a delimiter, <PROGRAM MESSAGE TERMINATOR>, as defined in IEEE 488.2, or the interface message DCL. If the input buffer is full, the IEC-bus traffic is stopped and the data received up to then are processed. Subsequently the IEC-bus traffic is continued. If, however, the buffer is not yet full when receiving the delimiter, the input unit can already receive the next command during command recognition and execution. The receipt of a DCL clears the input buffer and immediately initiates a message to the command recognition.

3.7.2 Command Recognition

The command recognition analyses the data received from the input unit. It proceeds in the order in which it receives the data. Only a DCL is serviced with priority, a GET (Group Execute Trigger), e.g., is only executed after the commands received before as well. Each recognized command is immediately transferred to the data set but without being executed there at once.

Syntactical errors in the command are recognized here and supplied to the status reporting system. The rest of a command line after a syntax error is analysed further if possible and serviced.

If the command recognition recognizes a delimiter or a DCL, it requests the data set to set the commands in the instrument hardware as well now. Subsequently it is immediately prepared to process commands again. This means for the command servicing that further commands can already be serviced while the hardware is still being set ("overlapping execution").

3.7.3 Data Set and Instrument Hardware

Here the expression "instrument hardware" denotes the part of the instrument fulfilling the actual instrument function - signal generation, measurement etc. The controller is not included.

The data set is a detailed reproduction of the instrument hardware in the software.

IEC-bus setting commands lead to an alteration in the data set. The data set management enters the new values (e.g. frequency) into the data set, however, only passes them on to the hardware when requested by the command recognition. As this is always only effected at the end of a command line, the order of the setting commands in the command line is not relevant.

The data are only checked for their compatibility among each other and with the instrument hardware immediately before they are transmitted to the instrument hardware. If the detection is made that an execution is not possible, an "execution error" is signalled to the status reporting system. All alterations of the data set are cancelled, the instrument hardware is not reset. Due to the delayed checking and hardware setting, however, it is permissible to set impermissible instrument states within one command line for a short period of time without this leading to an error message (example: simultaneous activation of FM and PM). At the end of the command line, however, a permissible instrument state must have been reached again.

Before passing on the data to the hardware, the settling bit in the STATus:OPERation register is set (cf. Section 3.8.3.4). The hardware executes the settings and resets the bit again as soon as the new state has settled. This fact can be used to synchronize command servicing.

IEC-bus queries induce the data set management to send the desired data to the output unit.

3.7.4 Status Reporting System

The status reporting system collects information on the instrument state and makes it available to the output unit on request. The exact structure and function are described in Section 3.8.

3.7.5 Output Unit

The output unit collects the information requested by the controller, which it receives from the data set management. It processes it according to the SCPI rules and makes it available in the output buffer. The output buffer has a size of 1024 characters. If the information requested is longer, it is made available "in portions" without this being recognized by the controller.

If the instrument is addressed as a talker without the output buffer containing data or awaiting data from the data set management, the output unit sends error message "Query UNTERMINATED" to the status reporting system. No data are send on the IEC bus, the controller waits until it has reached its time limit. This behaviour is specified by SCPI.

3.7.6 Command Sequence and Command Synchronization

What has been said above makes clear that all commands can potentially be carried out overlapping. Equally, setting commands within one command line are not absolutely serviced in the order in which they have been received.

In order to make sure that commands are actually carried out in a certain order, each command must be sent in a separate command line, that is to say, with a separate IBWRT()-call.

In order to prevent an overlapping execution of commands, one of commands *OPC, *OPC? or *WAI must be used. All three commands cause a certain action only to be carried out after the hardware has been set and has settled. By a suitable programming, the controller can be forced to wait for the respective action to occur (cf. table 3-2).

Table 3-2 Synchronization using *OPC, *OPC? and *WAI

Com-mand	Action after the hardware has settled	Programming the controller
*OPC	Setting the operation-complete bit in the ESR	<ul style="list-style-type: none"> – Setting bit 0 in the ESE – Setting bit 5 in the SRE – Waiting for service request (SRQ)
*OPC?	Writing a "1" into the output buffer	Addressing the instrument as a talker
*WAI	Executing the next command Note: The IEC-bus handshake is not stopped	Sending the next command

An example as to command synchronization can be found in annex D "Program Examples".

3.8 Status Reporting System

The status reporting system (cf. Fig. 3-4) stores all information on the present operating state of the instrument, e.g. that the instrument presently carries out an AUTORANGE and on errors which have occurred. This information is stored in the status registers and in the error queue. The status registers and the error queue can be queried via IEC bus.

The information is of a hierarchical structure. The register status byte (STB) defined in IEEE 488.2 and its associated mask register service request enable (SRE) form the uppermost level. The STB receives its information from the standard event status register (ESR) which is also defined in IEEE 488.2 with the associated mask register standard event status enable (ESE) and registers STATus:OPERation and STATus:QUEStionable which are defined by SCPI and contain detailed information on the instrument.

The IST flag ("Individual Status") and the parallel poll enable register (PPE) allocated to it are also part of the status reporting system. The IST flag, like the SRQ, combines the entire instrument status in a single bit. The PPE fulfills an analog function for the IST flag as the SRE for the service request.

The output buffer contains the messages the instrument returns to the controller. It is not part of the status reporting system but determines the value of the MAV bit in the STB and thus is represented in Fig. 3.4.

3.8.1 Structure of an SCPI Status Register

Each SCPI register consists of 5 parts which each have a width of 16 bits and have different functions (cf. Fig. 3-3). The individual bits are independent of each other, i.e. each hardware status is assigned a bit number which is valid for all five parts. For example, bit 3 of the STATus:OPERation register is assigned to the hardware status "wait for trigger" in all five parts. Bit 15 (the most significant bit) is set to zero for all parts. Thus the contents of the register parts can be processed by the controller as positive integer.

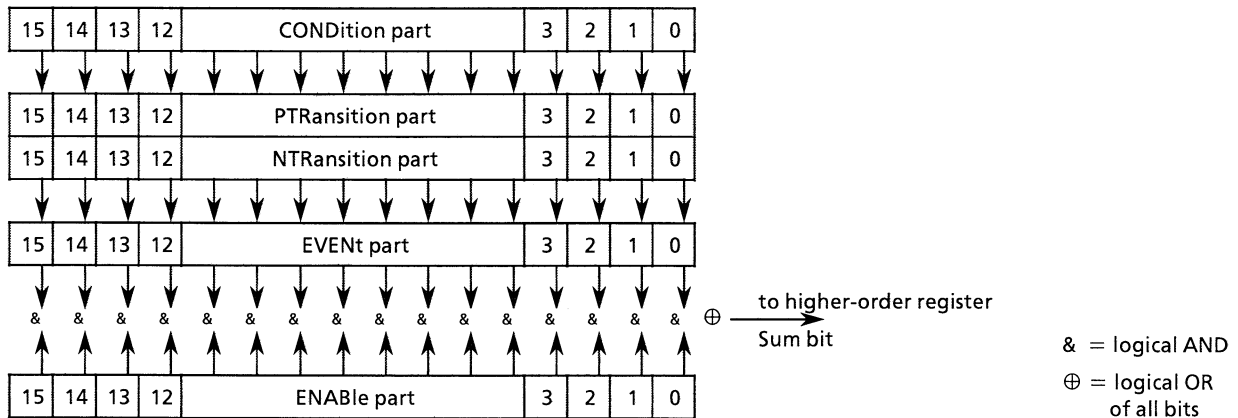

Fig. 3-3 The status-register model

CONDition part	The CONDition part is directly written into by the hardware or the sum bit of the next lower register. Its contents reflects the current instrument status. This register part can only be read, but not written into or cleared. Its contents is not affected by reading.
PTRansition part	The <u>Positive-TR</u> ansition part acts as edge detector. When a bit of the CONDition part is changed from 0 to 1, the associated PTR bit decides whether the EVENT bit is set to 1. PTR bit = 1: the EVENT bit is set. PTR bit = 0: the EVENT bit is not set. This part can be written into and read at will. Its contents is not affected by reading.
NTRansition part	The <u>Negative-TR</u> ansition part also acts as edge detector. When a bit of the CONDition part is changed from 1 to 0, the associated NTR bit decides whether the EVENT bit is set to 1. NTR bit = 1: the EVENT bit is set. NTR bit = 0: the EVENT bit is not set. This part can be written into and read at will. Its contents is not affected by reading.
	With these two edge register parts the user can define which state transition of the condition part (none, 0 to 1, 1 to 0 or both) is stored in the EVENT part.
EVENT part	The EVENT part indicates whether an event has occurred since the last reading, it is the "memory" of the condition part. It only indicates events passed on by the edge filters. It is permanently updated by the instrument. This part can only be read by the user. During reading, its contents is set to zero. In linguistic usage this part is often equated with the entire register.
ENABLE part	The ENABLE part determines whether the associated EVENT bit contributes to the sum bit (cf. below). Each bit of the EVENT part is ANDed with the associated ENABLE bit (symbol '&'). The results of all logical operations of this part are passed on to the sum bit via an OR function (symbol '+'). ENAB bit = 0: the associated EVENT bit does not contribute to the sum bit ENAB bit = 1: if the associated EVENT bit is "1", the sum bit is set to "1" as well. This part can be written into and read by the user at will. Its contents is not affected by reading.
Sum bit	As indicated above, the sum bit is obtained from the EVENT and ENABLE part for each register. The result is then entered into a bit of the CONDition part of the higher-order register. The instrument automatically generates the sum bit for each register. Thus an event, e.g. a PLL that has not locked, can lead to a service request throughout all levels of the hierarchy.

Note: *The service request enable register SRE defined in IEEE 488.2 can be taken as ENABLE part of the STB if the STB is structured according to SCPI. By analogy, the ESE can be taken as the ENABLE part of the ESR.*

3.8.2 Overview of the Status Registers

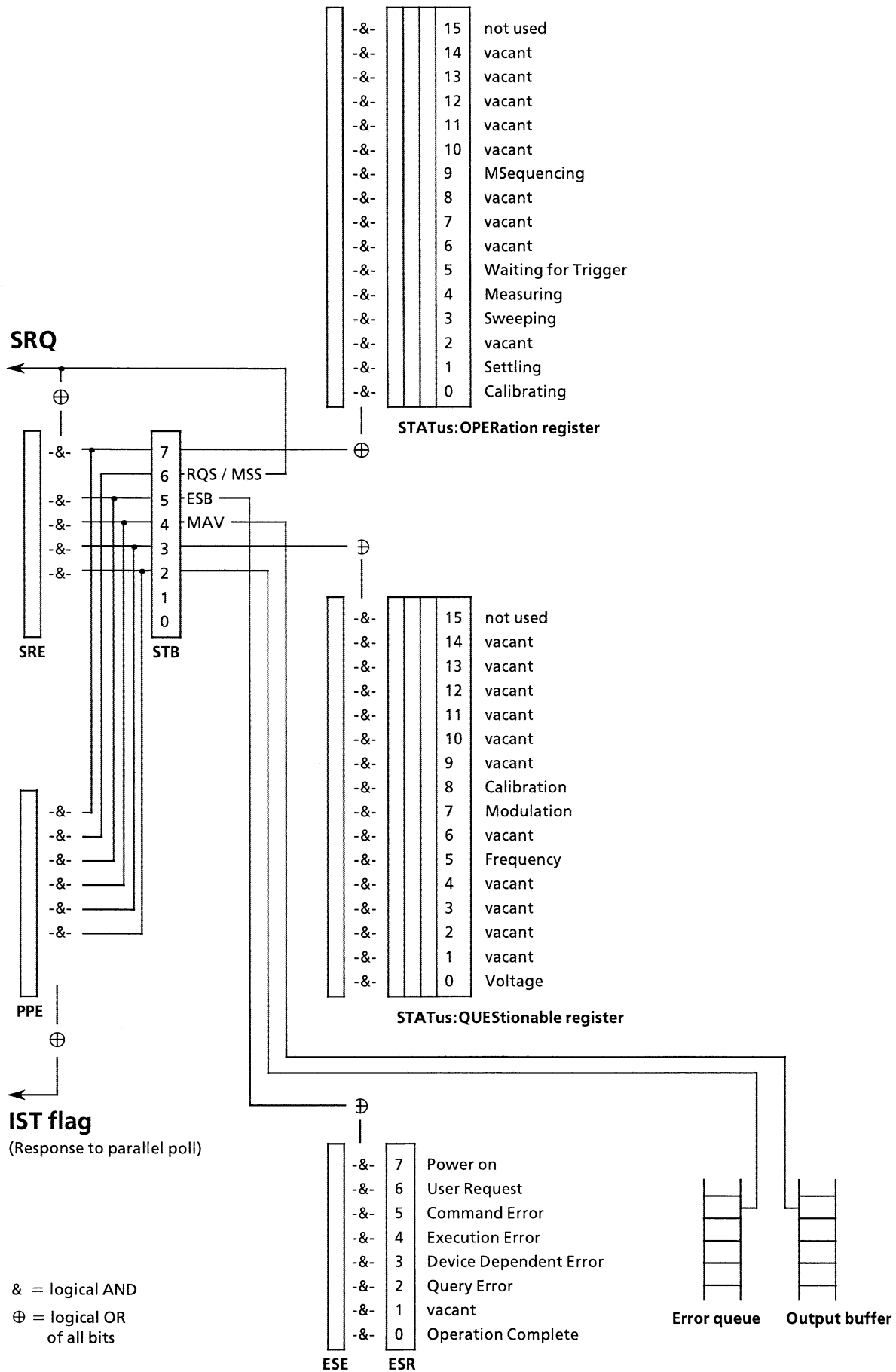

Fig. 3-4 Overview of the status registers

3.8.3 Description of the Status Registers

3.8.3.1 Status Byte (STB) and Service Request Enable Register (SRE)

The STB is already defined in IEEE 488.2. It provides a rough overview of the instrument status by collecting the pieces of information of the lower registers. It can thus be compared with the CONDition part of an SCPI register and assumes the highest level within the SCPI hierarchy. A special feature is that bit 6 acts as the sum bit of the remaining bits of the status byte.

The STATUS BYTE is read out using the command "**STB?*" or a serial poll.

The STB implies the SRE. It corresponds to the ENABle part of the SCPI registers as to its function. Each bit of the STB is assigned a bit in the SRE. Bit 6 of the SRE is ignored. If a bit is set in the SRE and the associated bit in the STB changes from 0 to 1, a Service Request (SRQ) is generated on the IEC bus, which triggers an interrupt in the controller if this is appropriately configured and can be further processed there.

The SRE can be set using command "**SRE*" and read using "**SRE?*".

Table 3-3 Meaning of the bits used in the status byte

Bit no.	Meaning
2	<p>Error Queue not empty</p> <p>The bit is set when an entry is made in the error queue.</p> <p>If this bit is enabled by the SRE, each entry of the error queue generates a Service Request. Thus an error can be recognized and specified in greater detail by polling the error queue. The poll provides an informative error message. This procedure is to be recommended since it considerably reduces the problems involved with IEC-bus control.</p>
3	<p>QUESTionable status sum bit</p> <p>The bit is set if an EVENT bit is set in the QUESTionable-Status register and the associated ENABle bit is set to 1.</p> <p>A set bit indicates a questionable instrument status, which can be specified in greater detail by polling the QUESTionable-Status register.</p>
4	<p>MAV bit (message available)</p> <p>The bit is set if a message is available in the output buffer which can be read.</p> <p>This bit can be used to enable data to be automatically read from the instrument to the controller (cf. annex D, program examples).</p>
5	<p>ESB bit</p> <p>Sum bit of the event status register. It is set if one of the bits in the event status register is set and enabled in the event status enable register.</p> <p>Setting of this bit implies a serious error which can be specified in greater detail by polling the event status register.</p>
6	<p>MSS bit (master status summary bit)</p> <p>The bit is set if the instrument triggers a service request. This is the case if one of the other bits of this register is set together with its mask bit in the service request enable register SRE.</p>
7	<p>OPERation status register sum bit</p> <p>The bit is set if an EVENT bit is set in the OPERation-Status register and the associated ENABle bit is set to 1.</p> <p>A set bit indicates that the instrument is just performing an action. The type of action can be determined by polling the OPERation-Status register.</p>

3.8.3.2 IST Flag and Parallel Poll Enable Register (PPE)

By analogy with the SRQ, the IST flag combines the entire status information in a single bit. It can be queried by means of a parallel poll (cf. Section 3.8.4.3) or using command `"*IST?"`.

The parallel poll enable register (PPE) determines which bits of the STB contribute to the IST flag. The bits of the STB are ANDed with the corresponding bits of the PPE, with bit 6 being used as well in contrast to the SRE. The Ist flag results from the ORing of all results. The PPE can be set using commands `"*PRE"` and read using command `"*PRE?"`.

3.8.3.3 Event Status Register (ESR) and Event Status Enable Register (ESE)

The ESR is already defined in IEEE 488.2. It can be compared with the EVENT part of an SCPI register. The event status register can be read out using command `"*ESR?"`.

The ESE is the associated ENABLE part. It can be set using command `"*ESE"` and read using command `"*ESE?"`.

Table 3-4 Meaning of the bits used in the event status register

Bit No.	Meaning
0	Operation Complete This bit is set on receipt of the command <code>*OPC</code> exactly when all previous commands have been executed.
2	Query Error This bit is set if either the controller wants to read data from the instrument without having sent a query, or if it does not fetch requested data and sends new instructions to the instrument instead. The cause is often a query which is faulty and hence cannot be executed.
3	Device-dependent Error This bit is set if a device-dependent error occurs. An error message with a number between -300 and -399 or a positive error number, which denotes the error in greater detail, is entered into the error queue (cf. annex B, Error Messages).
4	Execution Error This bit is set if a received command is syntactically correct, however, cannot be performed for other reasons. An error message with a number between -200 and -300, which denotes the error in greater detail, is entered into the error queue (cf. annex B, Error Messages).
5	Command Error This bit is set if a command which is undefined or syntactically incorrect is received. An error message with a number between -100 and -200, which denotes the error in greater detail, is entered into the error queue (cf. annex B, Error Messages).
6	User Request This bit is set on pressing the LOCAL key, i.e., when the instrument is switched over to manual control.
7	Power On (supply voltage on) This bit is set on switching on the instrument.

3.8.3.4 STATus:OPERation Register

In the CONDition part, this register contains information on which actions the instrument is being executing or, in the EVEnt part, information on which actions the instrument has executed since the last reading. It can be read using commands "STATus:OPERation:CONDition?" or "STATus:OPERation[:EVEnt]?".

Table 3-5 Meaning of the bits used in the STATus:OPERation register

Bit No.	Meaning
0	CALibrating This bit is set as long as the instrument is performing a calibration.
1	SETTLing This bit is set as long as the new status is settling after a setting command. It is only set if the settling time is longer than the command processing time.
3	SWEeping This bit is set while the instrument is performing a sweep.
4	MEASuring This bit is set while the instrument is performing a measurement.
5	WAIT for TRIGGER This bit is set as long as the instrument is waiting for a trigger event.
9	MSequencing This bit is set while the instrument is performing a memory sequence.

3.8.3.5 STATus:QUEStionable Register

This register contains information on questionable instrument states. They can occur, e.g. if the instrument is operated out of its specifications. It can be queried using commands "STATus:QUEStionable:CONDition?" or "STATus:QUEStionable[:EVEnt]?".

Table 3-6 Meaning of the bits used in the STATus:QUEStionable register

Bit No.	Meaning
0	VOLTage This bit is set if the voltage at an output connector is not correct, if the voltage is above or below the specified limit values, if the level limit has responded, if the overvoltage protection has responded.
5	FREQuency The bit is set if a frequency at the RF output is not correct or if it is lower or higher than the specified values.
7	MODulation The bit is set if a modulation is not correct or is operated outside the specifications.
8	CALibration The bit is set if a calibration is not performed properly.

3.8.4 Application of the Status Reporting System

In order to be able to effectively use the status reporting system, the information contained there must be transmitted to the controller and further processed there. There are several methods which are represented in the following. Detailed program examples are to be found in annex D, Program Examples.

3.8.4.1 Service Request, Making Use of the Hierarchy Structure

Under certain circumstances, the instrument can send a service request (SRQ) to the controller. Usually this service request initiates an interrupt at the controller, to which the control program can react with corresponding actions. As evident from Fig. 3.4 (Section 3.8.2), an SRQ is always initiated if one or several of bits 2, 3, 4, 5 or 7 of the status byte are set and enabled in the SRE. Each of these bits combines the information of a further register, the error queue or the output buffer. The corresponding setting of the ENABLE parts of the status registers can achieve that arbitrary bits in an arbitrary status register initiate an SRQ. In order to make use of the possibilities of the service request, all bits should be set to "1" in enable registers SRE and ESE.

Examples (cf. Fig. 3.4, Section 3.8.2 and Program Examples, annex D as well):

Use of command "**OPC*" to generate an SRQ

- ▶ Set bit 0 in the ESE (Operation Complete)
- ▶ Set bit 5 in the SRE (ESB)

After its settings have been completed, the instrument generates an SRQ.

Indication of the end of a sweep by means of an SRQ with the controller

- ▶ Set bit 7 in the SRE (sum bit of the STATus:OPERation register)
- ▶ Set bit 3 (sweeping) in the STATus:OPERation:ENABLE.
- ▶ Set bit 3 in the STATus:OPERation:NTRansition so as to make sure that the transition of sweeping bit 3 from 1 to 0 (sweep end) is recorded in the EVENT part as well.

After a sweep has been completed, the instrument generates an SRQ.

The SRQ is the only possibility for the instrument to become active on its own. Each controller program should set the instrument such that a service request is initiated in the case of malfunction. The program should react appropriately to the service request. A detailed example for a service request routine is to be found in annex D, Program Examples.

3.8.4.2 Serial Poll

In a serial poll, just as with command "**STB*", the status byte of an instrument is queried. However, the query is realized via interface messages and is thus clearly faster. The serial-poll method has already been defined in IEEE 488.1 and used to be the only standard possibility for different instruments to poll the status byte. The method also works with instruments which do not adhere to SCPI or IEEE 488.2.

The quick-basic command for executing a serial poll is "*IBRSP()*". Serial poll is mainly used to obtain a fast overview of the state of several instruments connected to the IEC bus.

3.8.4.3 Parallel Poll

In a parallel poll, up to eight instruments are simultaneously requested by the controller by means of a single command to transmit 1 bit of information each on the data lines, i.e., to set the data line allocated to each instrument to logically "0" or "1". By analogy to the SRE register which determines under which conditions an SRQ is generated, there is a parallel poll enable register (PPE) which is ANDed with the STB bit by bit as well considering bit 6. The results are ORed, the result is then sent (possibly inverted) as a response in the parallel poll of the controller. The result can also be queried without parallel poll by means of command *"*IST"*.

The instrument first has to be set for the parallel poll using quickBASIC command *"IBPPC()"*. This command allocates a data line to the instrument and determines whether the response is to be inverted. The parallel poll itself is executed using *"IBRPP()"*.

The parallel-poll method is mainly used in order to quickly find out after an SRQ which instrument has sent the service request if there are many instruments connected to the IEC bus. To effect this, SRE and PPE must be set to the same value. A detailed example as to the parallel poll is to be found in annex D, Program Examples.

3.8.4.4 Query by Means of Commands

Each part of every status register can be read by means of queries. The individual commands are indicated in the detailed description of the registers in Section 3.8.3. What is returned is always a number which represents the bit pattern of the register queried. Evaluating this number is effected by the controller program.

Queries are usually used after an SRQ in order to obtain more detailed information on the cause of the SRQ.

3.8.4.5 Error-Queue Query

Each error state in the instrument leads to an entry in the error queue. The entries of the error queue are detailed plain-text error messages which can be looked at in the ERROR menu via manual control or queried via the IEC bus using command *"SYSTem:ERRor?"*. Each call of *"SYSTem:ERRor?"* provides an entry from the error queue. If no error messages are stored there any more, the instrument responds with 0, "No error".

The error queue should be queried after every SRQ in the controller program as the entries describe the cause of an error more precisely than the status registers. Especially in the test phase of a controller program the error queue should be queried regularly since faulty commands from the controller to the instrument are recorded there as well.

3.8.5 Resetting Values of the Status Reporting System

Table 3-7 comprises the different commands and events causing the status reporting system to be reset. None of the commands, except for **RST* and *SYSTEM:PRESet* influences the functional instrument settings. In particular, *DCL* does not change the instrument settings.

Table 3-7 Resetting instrument functions

Event Effect	Switching on supply voltage		DCL, SDC (Device Clear, Selected Device Clear)	*RST or SYSTEM:PRESet	STATus:PRESet	*CLS
	Power-On-Status-Clear					
	0	1				
Clear STB, ESR	—	yes	—	—	—	yes
Clear SRE, ESE	—	yes	—	—	—	—
Clear PPE	—	yes	—	—	—	—
Clear EVENT parts of the registers	—	yes	—	—	—	yes
Clear Enable parts of all OPERATION and QUESTIONable registers, Fill Enable parts of all other registers with "1".	—	yes	—	—	yes	—
Fill PTRansition parts with "1", Clear NTRansition parts	—	yes	—	—	yes	—
Clear error queue	yes	yes	—	—	—	yes
Clear output buffer	yes	yes	yes	1)	1)	1)
Clear command processing and input buffer	yes	yes	yes	—	—	—

- 1) Every command being the first in a command line, i.e., immediately following a <PROGRAM MESSAGE TERMINATOR> clears the output buffer.

4 Maintenance and Troubleshooting

The instrument does not need a periodic maintenance. What is necessary is essentially the cleaning of the instrument. However, it is recommended to check the rated data from time to time.

4.1 Maintenance

4.1.1 Cleaning the Outside

The outside of the instrument is suitably cleaned using a soft, line-free dustcloth.

Caution! *Do not use solvents such as thinners, acetone and similar things in any case, because otherwise the front panel labeling or plastic parts will be damaged.*

4.1.2 Storage

The storage temperature range of the instrument is -40 to +70 degrees Celsius. If the instrument is to be stored for a longer period of time, it must be protected against dust.

4.2 Functional Test

The SMT carries out a selftest on switching on the instrument and permanently during operation. On switching on, the RAM and ROM contents are checked and the battery of the non-volatile RAMs tested. If an error is detected, this is indicated through a corresponding error message. The most important instrument functions are automatically monitored during operation.

If a faulty function is detected in the selftest, ERROR is displayed in the status line. To identify the error, the ERROR menu, in which the error messages are entered, can be called by pressing the [ERROR] key (cf. Chapter 2, Section "Error Messages").

The tests can additionally be called via the menu.

Access to the tests is offered by the UTILITIES-TEST menu.

Menu selection: UTILITIES - TEST

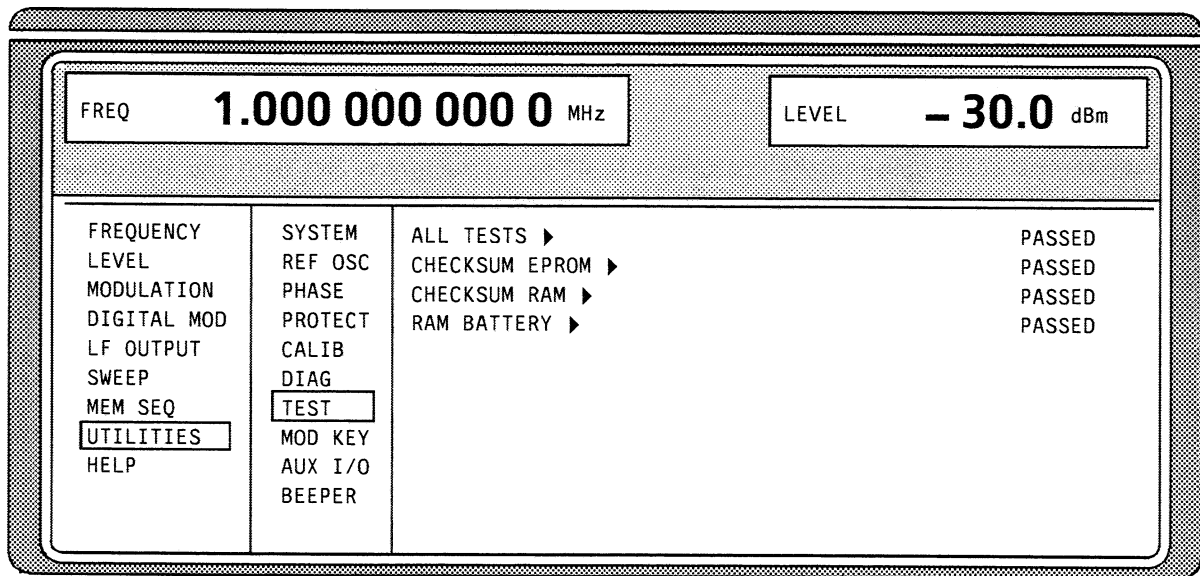

Fig. 4-1 Menu UTILITIES-TEST

ALL TESTS > All tests are executed.

CHECKSUM EPROM > Tests the EPROM checksum.

CHECKSUM RAM > Tests the RAM checksum.

RAM BATTERY > Tests the RAM battery.

5 Testing the Rated Specifications

5.1 Test Instruments and Utilities

Table 5-1 Test instruments and utilities

Item	Type of instrument	Specifications required	Suitable instrument	R&S order no.	Application
1	Frequency counter (included in item 2)	1 Hz to 1.5 GHz (SMT02) 1 Hz to 3 GHz (SMT03), 1 Hz to 6 GHz (SMT06), Resolution 0.1 Hz			5.2.2 5.2.4
2	RF spectrum analyzer	100 Hz to 5 GHz (SMT02/03), 100 Hz to 18 GHz (SMT06) synthesizer tuning, dynamic range > 80 dB	FSB FSM	848.0020.52 1020.7020.52	5.1.1.3 5.2.3 5.2.5 5.2.6 5.2.7 5.2.8 5.2.11 5.2.12 5.2.28 5.2.31
3	Storage oscilloscope	100-M samples/s, averaging function			5.2.3
4	Controller	Industrial standard PC/XT/AT with IEC-625 interface,	PSA 15	1012.1003.03	5.2.3
5	Signal generator of high spectral purity	0.1 MHz to 1.5 GHz (SMT02) 0.1 MHz to 3 GHz (SMT03), 0.1 MHz to 6 GHz (SMT06), SSB noise level < -126 dBc with 1GHz/20 kHz FM-d.c.	SME02, SME03, SME06, SMGU, SMHU	1038.6002.02, 1038.6002.03, 1038.6002.06, 819.0010.52, 835,8011.52	5.1.1.4 5.2.7 5.2.8 5.2.12 5.2.14
6	Phase noise test setup	Mixer: 10 MHz to 1.5 GHz (SMT02) 10 MHz to 3 GHz (SMT03), 10 MHz to 6 GHz (SMT06), separating filter 2 MHz, preamplifier with 40-dB changeover switch, input noise < 2nV (1Hz) output for FM-d.c.			5.2.7 5.2.8
7	Oscilloscope	Bandwidth > 100 MHz, two channels with D. C. coupling			5.1.1.3, 5.1.1.4 5.2.7 5.2.8 5.2.33
8	RF power meter	5 kHz to 1.5 GHz (SMT02) 5 kHz to 3 GHz (SMT03) 5 kHz to 6 GHz (SMT06)	NRVS with NRVS-Z51	1020.1809.02 857.9004.02	5.2.11 5.2.13
9	Precision attenuation set	Attenuation 0 to 120 dB, resolution 5 dB	DPSP RSG	8334.6010.02 1009.4505.02	5.2.11

Item	Type of instrument	Specifications required	Suitable instrument	R&S order no.	Application
10	Low-noise preamplifier	5 kHz to 1.5 GHz (SMT02) 5 kHz to 3 GHz (SMT03), 5 kHz to 6 GHz (SMT06) amplification > 20 dB, noise factor < 10 dB			5.2.11
11	VSWR bridge	1 MHz to 1.5 GHz (SMT02) 1 MHz to 3 GHz (SMT03), directivity > 40 dB	ZRC	1039.9492.55/52	5.2.12
12	D.c. voltage source	Setting range 0 to 10 V	NGT 20	117.7133.02	5.2.14
13	RF power amplifier	10 MHz to 1.5 GHz (SMT02) 10 MHz to 3 GHz (SMT03), Power > 1W			5.2.14
14	Audio analyzer	Generator up to 100 kHz, level meter, distortion meter	UPD	1030.7500.04 1030.7500.05	5.1.1.2 5.2.30 5.2.32
15	Modulation analyzer	100 kHz to 1.5 GHz (SMT02) 100 kHz to 3 GHz (SMT03/06) AM, FM, PhiM, stereo coder, stereo decoder, distortion meter, weighting filter CCIR, CCITT	FMB	856.5005.52	5.1.1.1 5.1.1.2 5.1.1.5
16	Mixer	10 MHz to 1.5 GHz (SMT02) 10 MHz to 3 GHz (SMT03), 10 MHz to 6 GHz (SMT06), "high level"			5.1.1.4
17	Pulse generator	Pulse repetition frequency up to 10 MHz, level TTL	AFG, AFGU	377.2100.02, 377.5000.02	5.1.1.4 5.2.31 5.2.33
18	Sine-wave generator	10 Hz to 8 MHz, 1 V (U peak)	AFG	377.2100.02	5.1.1.3 5.2.28
19	AC voltmeter	10 Hz to 8 MHz	URE3	350.5315.03	5.2.32
20	Broadband FM demodulator	Delay line discriminator, input frequency 140 MHz, demodulation bandwidth 10 MHz			5.1.1.3
21	RF attenuator pad	1.5 GHz (SMT02) 3 GHz (SMT03) 6 GHz (SMT06) 3 dB			5.1.1.4
22	Lowpass filter	Attenuation up to 50 MHz < 1 dB with 100 MHz > 20 dB with 200 MHz > 40 dB			5.1.1.4
23	VSWR directional coupler	3 GHz to 6 GHz (SMT036), directivity > 40 dB			5.2.12
24	RF attenuator pad	6 GHz (SMT06) 20 dB			5.1.1.5

5.1.1 Test Systems to Measure Modulation Characteristics

5.1.1.1 Standard Test System

Test equipment – Modulation analyzer (Section 5.1, item 15)

Test setup

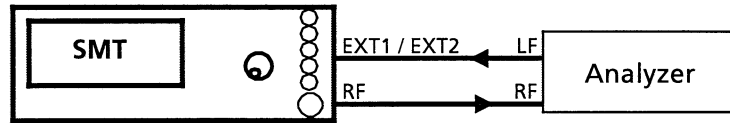

5.1.1.2 Test System with Audio Analyzer

Test equipment – Modulation analyzer (Section 5.1, item 15)
– Audio analyzer (Section 5.1, item 14)

Test setup

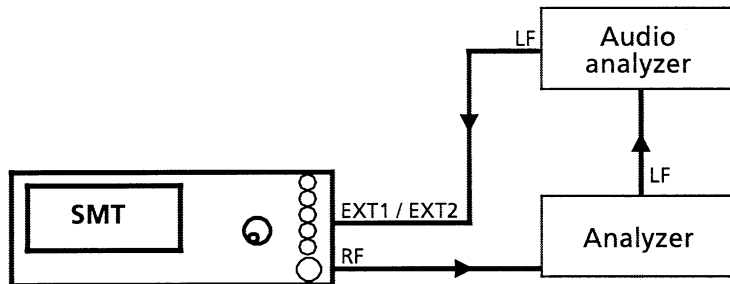

5.1.1.3 Test System for Broadband FM

Test equipment – Spectrum analyzer (Section 5.1, item 2)
– Oszilloscope (Section 5.1, item 7)
– Sine-wave generator (Section 5.1, item 18)
– Broadband FM demodulator (Section 5.1, item 20)

Test setup

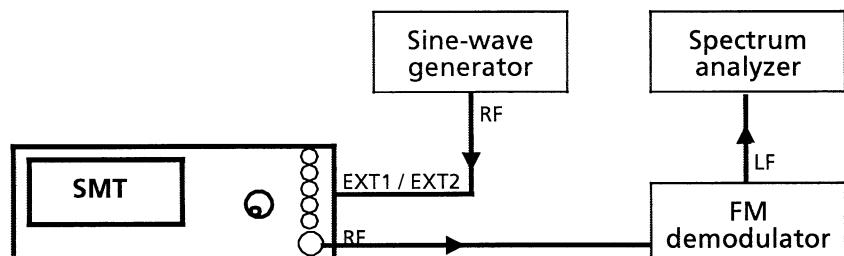

5.1.1.4 Test System for Pulse Modulation

Test equipment

- Second signal generator (Section 5.1, item 5)
- Oscilloscope (Section 5.1, item 7)
- Mixer (Section 5.1, item 16)
- Pulse generator (Section 5.1, item 17)
- RF attenuator pad (Section 5.1, item 21)
- Lowpass filter (Section 5.1, item 23)

Test setup

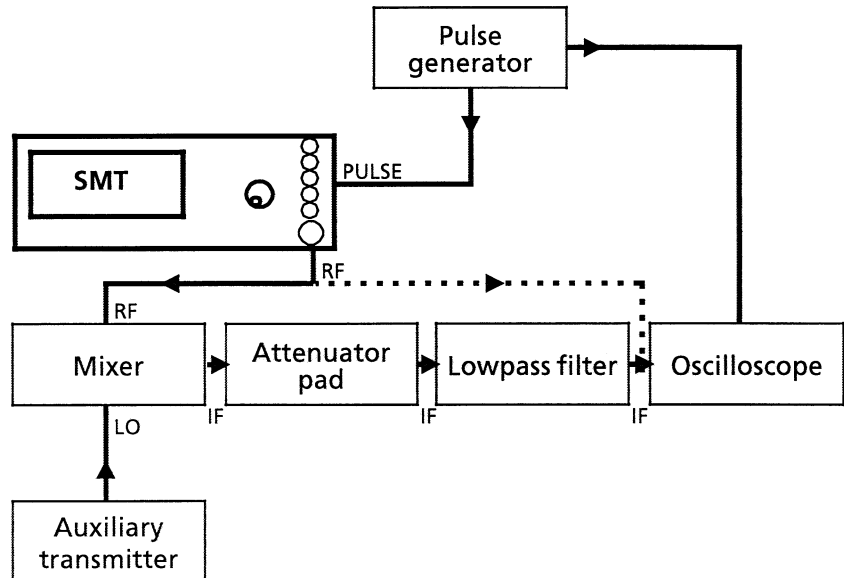

5.1.1.5 Meßplatz-Erweiterung durch Abmischen

Test equipment

- Second signal generator (Section 5.1, item 5)
- Mixer (Section 5.1, item 16)
- RF attenuator pad (Section 5.1, item 21)
- RF attenuator pad (Section 5.1, item 24)
- Lowpass filter (Section 5.1, item 22)

Test setup

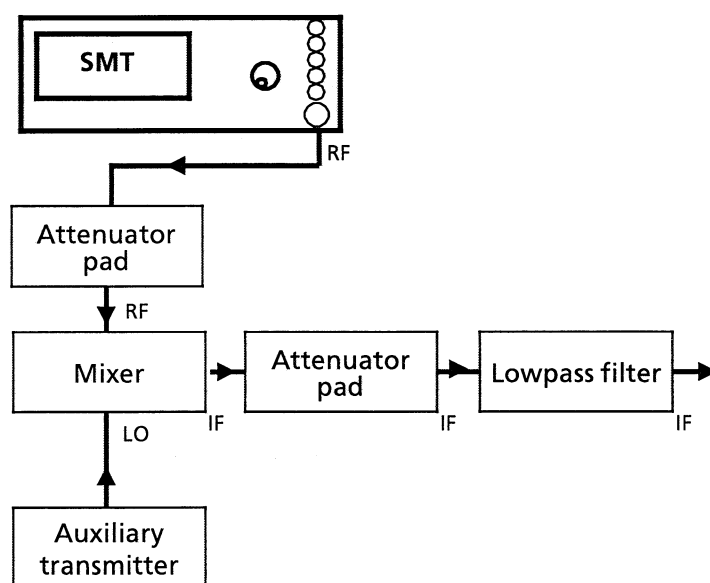

5.2 Test Procedure

The rated specifications of the generator are tested after the instrument has warmed up for at least 30 minutes and a total calibration has been carried out (c.f. Chapter 2, Section "Calibration"). This is the only way to make sure that the guaranteed data are observed. The values in the following sections are not guaranteed; only the technical data in the data sheet are binding.

5.2.1 Display and Keyboard

- Testing
- Display
 - ▶ Switch on instrument.
The basic menu is displayed after several seconds.
 - ▶ Rotate contrast control (left-hand potentiometer at the lower edge).
The contrast is varied from dark to bright.
 - ▶ Rotate brightness control (right-hand potentiometer at the lower edge).
The brightness of the background illumination is varied.
 - Keyboard
 - ▶ Press keys and check response at the display.

5.2.2 Frequency Setting

- Test equipment Frequency counter (Section 5.1, item 1)
- Test principle The frequency setting is checked using a frequency counter whose reference frequency is synchronized with the one of the SMT.
- Measurement ▶ Setting at the SMT
 - Test frequency unmodulated,
 - Level 0 dBm
 The values measured must be exact within the frame of the counter resolution.

Test frequencies recommended see table 5-2

Table 5-2 shows the synthesis-dependent changeover limits. In order to fully test the function of the instrument, we recommend measurements at these range limits.

Table 5-2, A Changeover limits of the SMT

Range	from	to
Doubler 2 (SMT06)	3000.000 000 1 MHz	6000.000 000 0 MHz
Doubler 1 (SMT03)	1500.000 000 1 MHz	3000.000 000 0 MHz
Synthesis octave	750.000 000 1 MHz	1500.000 000 0 MHz
Divider :2	375.000 000 1 MHz	750.000 000 0 MHz
Divider :4	187.500 000 1 MHz	375.000 000 0 MHz
Divider :8	93.750 000 1 MHz	187.500 000 0 MHz
Divider: 16	67.500 000 1 MHz	93.750 000 1 MHz
Mixer range	0.001 000 0 MHz	93.750 000 0 MHz
Mixer range with a large deviation	0.001 000 0 MHz	130.700 000 0 MHz

Table 5-2, B Changeover limits of the SMT — further hardware limits

Range		from	to
Lowpass filters OPU1	No. 0	1045.600 000 1 MHz	1500.000 000 0 MHz
	1	750.000 000 1 MHz	1045.600 000 0 MHz
	2	522.800 000 1 MHz	750.000 000 0 MHz
	3	375.000 000 1 MHz	522.800 000 0 MHz
	4	261.400 000 1 MHz	375.000 000 0 MHz
	5	187.500 000 1 MHz	261.400 000 0 MHz
	6	130.700 000 1 MHz	187.500 000 0 MHz
	7	93.750 000 1 MHz	130.700 000 0 MHz
	8	63.500 000 1 MHz	93.750 000 0 MHz
Bandpass filters OPU3/6 (SMT03/06)	No. 1	1500.000 000 1 MHz	1885.200 000 0 MHz
	2	1885.200 000 1 MHz	2297.200 000 0 MHz
	3	2297.200 000 1 MHz	3000.000 000 0 MHz
Bandpass filters OPU6 (SMT06)	Nr. 4	3000.000 000 1 MHz	3770.400 000 1 MHz
	5	3770.400 000 1 MHz	4594.400 000 1 MHz
	6	4594.400 000 1 MHz	6000.000 000 0 MHz
Oscillators SUM	No. 1	750.000 000 1 MHz	1100.000 000 0 MHz
	2	1100.000 000 1 MHz	1250.000 000 1 MHz
	3	1250.000 000 1 MHz	1500.000 000 0 MHz
Rectifier	before mixer	0.001 000 0 MHz	9.362 500 0 MHz
	at output OPU1	9.362 500 1 MHz	1500.000 000 0 MHz
	at output OPU3 (SMT03)	1500.000 000 1 MHz	3000.000 000 0 MHz
	at output OPU6 (SMT06)	1500.000 000 1 MHz	6000.000 000 0 MHz

5.2.3 Settling time

Test equipment

- Spectrum analyzer with video output (Section 5.1, item 2)
- Storage oscilloscope (Section 5.1, item 3)
- Controller (Section 5.1, item 4)

Test principle

The spectrum analyzer is operated as an edge demodulator with a 0-Hz span. A controller transmits starting and stop frequency via the IEC bus. The storage oscilloscope is connected to the video output of the analyzer and triggered by the positive edge on the EOI line of the IEC bus. If the controller switches over from the starting to the stop frequency, the settling procedure is displayed on the screen of the storage oscilloscope.

Test setup

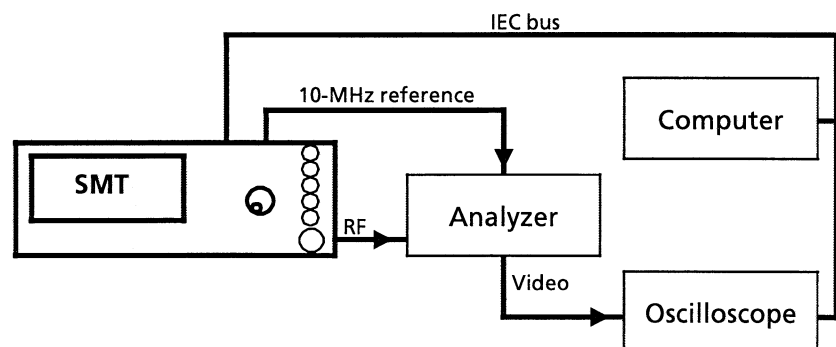

Preparing measurement

- ▶ Synchronize the reference frequencies of SMT and analyzer.
- ▶ Establish IEC bus and RF connections
- ▶ Connect storage oscilloscope to the video output of the analyzer.
- ▶ Apply trigger connection to the EOI-line (pin 5) of the IEC bus.
- ▶ Settings at the SMT
 - Stop frequency unmodulated
 - Level 0 dBm
- ▶ Settings at the storage oscilloscope
 - Time base 2 ms/div
 - Sensitivity corresponding to the video output of the analyzer,
 - Trigger free-running with respect to calibration.
- ▶ Settings at the spectrum analyzer
 - Reference level –5 dBm,
 - Amplitude scale 1 dB/div,
 - Resolution bandwidth to 1 kHz,
 - Video bandwidth 100 kHz,
 - Span 10 kHz.
- ▶ Now increase the center frequency, starting from the stop frequency, until the visible filter edge runs through the central point of the screen.
- ▶ The span can now be reduced to 0 Hz and the frequency scale be calibrated at the (free-running) oscilloscope by means of steps of 100 Hz at the SMT.

Measurement

- ▶ Setting at the storage oscilloscope
 - Time base 2 ms/div
 - Sensitivity corresponding to the video output of the analyzer
 - Triggering externally by the positive edge at 1.5 V.
- ▶ Send the starting frequency first and then the stop frequency from the controller.
The settling curve is displayed on the screen of the oscilloscope triggered externally.
Relative deviation from the rated frequency after 25 ms . . . $< 1E-7$
- ▶ Repeat measurement with exchanged starting and stop frequencies.

Recommended measuring frequencies

Starting frequency	Stop frequency
999 MHz	1001 MHz
1249 MHz	1251 MHz
749 MHz	751 MHz
60 MHz	1001 MHz
1001 MHz	60 MHz
751 MHz	3000 MHz (SMT03)
751 MHz	6000 MHz (SMT06)

Basic program for the controller

```

CLS
iec address% = 28 '
CALL IBFIND("DEV1", generator%) '
CALL IBPAD(generator%, iec address%) '
iecterm% = &HA '
CALL IBEOS(generator%, iec term% + &H800)
CALL IBWRT(generator%, "POW 0dBm")
DO
  INPUT "Starting frequency in MHz";F1$
  INPUT "Stop frequency in MHz";F2$
  DO
    CALL IBWRT(generator%, "FREQ" + F1$ + "MHz")
    PRINT "Frequency:";F1$; "MHz"
    DO '
      kbd$ = INKEY$
      LOOP UNTIL LEN(kbd$)
      SWAP F1$, F2$
      LOOP UNTIL kbd$ = CHR$(27) '
      INPUT "Repetition (y/n)"; w$
      LOOP UNTIL NOT UCASES$(w$) = "Y"
    END
  
```

IEC-bus address of the SMT (28)
Open DEV1 and obtain access number
Set IEC-bus address of the DEV1 to 28
Set EOS to LINE FEED

wait for key

Exit using ESCAPE

5.2.4 Reference Frequency

Caution: Allow the SMT to warm up for at least 2 hours before measurement.

Test equipment	Frequency counter (Section 5.1, item 1)
Test setup	Connect a calibrated frequency counter to output REF (socket at the rear).
Measurement	<ul style="list-style-type: none"> ▶ Measure frequency. Relative frequency error in the rated temperature range with standard equipment < 1E-6, per year of service period + 2E-6 with option SM-B1 < 1E-9, per day of service period + 5E-8

5.2.5 Harmonics Suppression / Subharmonics

Hinweis: Die Messung der Subharmonischen gilt nur für SMT03 und SMT06, da Subharmonische nur bei Frequenzen > 1,5 GHz auftreten.

Test equipment	Spectrum analyzer (Section 5.1, item 2)
Test setup	Connect the spectrum analyzer to the RF output of the SMT.
Measurement	<ul style="list-style-type: none"> SMT02 ▶ Settings at the SMT02 <ul style="list-style-type: none"> – Test frequencies of 5 kHz to 1500 MHz, unmodulated – Level 13 dBm or 10 dBm. SMT03 ▶ Settings at the SMT03 <ul style="list-style-type: none"> – Test frequencies of 5 kHz to 3000 MHz, unmodulated – Level 13 dBm or 10 dBm. SMT06 ▶ Settings at the SMT06 <ul style="list-style-type: none"> – Test frequencies of 5 kHz to 6000 MHz, unmodulated – Level 13 dBm or 10 dBm.

- ▶ Check the harmonics suppression using the spectrum analyzer. Make sure that the spectrum analyzer is not overdriven.
 - Harmonics level at level 10 dBm max.–30 dBc
 - Harmonics level at level 13 dBm max.–26 dBc
- ▶ Check the subharmonics using the spectrum analyzer. Make sure that the spectrum analyzer is not overdriven (SMT03/06 only).
 - Subharmonics level $f > 1.5$ GHz max.–40 dBc
 - Subharmonics level $f > 3$ GHz max.–34 dBc

5.2.6 Suppression of Nonharmonics

Test equipment and setup See Section 5.2.5, Harmonics Suppression.
The test level should be 8.1 dBm unmodulated.

Measurement Nonharmonics level with

- Frequency settings ≤ 1.5 GHz < -80 dBc
- Frequency settings > 1.5 GHz (SMT03) < -74 dBc
- Frequency settings > 3.0 GHz (SMT06) < -68 dBc

Recommended settings at the spectrum analyzer

- Span 1 kHz,
- Resolution bandwidth 10 Hz,
- Video bandwidth 30 Hz,
- Synchronize reference frequencies of analyzer and test object.

Recommended test and search frequencies

Nonharmonics of the step synthesis

Setting at the SMT	Search in the ratio
600.005 MHz	10 kHz
760.01 MHz	10 kHz
870.01 MHz	10 kHz
875.02 MHz	10 kHz
990.01 MHz	10 kHz
1120.01 MHz	10 kHz
1124.02 MHz	10 kHz
1200.00333333 MHz	10 kHz
1200.01 MHz	10 kHz
1200.005 MHz	10 kHz
1370.01 MHz	10 kHz
1374.02 MHz	10 kHz

Mixer nonharmonics
of the output part 1.5 GHz

Setting at the SMT	Search at frequency
67 MHz	17 MHz
67 MHz	57 MHz
67 MHz	77 MHz
67 MHz	117 MHz
67 MHz	131 MHz

5.2.7 SSB Phase Noise

Test equipment

- Second signal generator (Section 5.1 item 5),
- Phase noise test system, consisting of mixer with lowpass filter and preamplifier (Section 5.1 item 6),
- Oscilloscope (Section 5.1 item 7)
- Spectrum analyzer (Section 5.1 item 2).

Test principle

The two signal generators are set to the test frequency and synchronized with a phase offset of 90 deg (phase quadrature). Mixing to 0 Hz suppresses the RF carrier and due to the phase quadrature the mixer supplies a voltage corresponding to the phase difference between the input signals. This is measured by the LF spectrum analyzer and can be converted into SSB phase noise.

Test setup

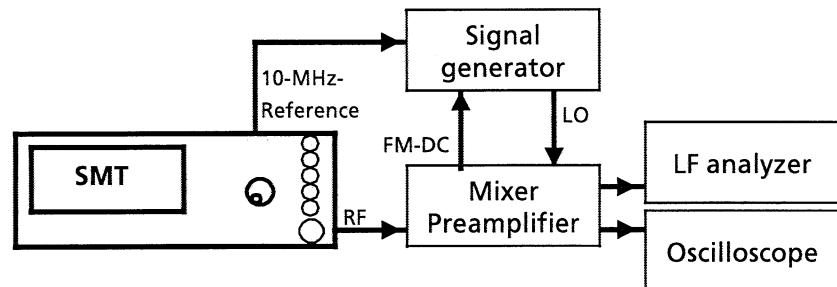

Measurement

- ▶ Set the levels of the two signal generators according to the specifications of the mixer used (unmodulated)
- ▶ For calibration, set the preamplifier to 0 dB and detune a signal generator by 20 kHz. Measure and note down the reference value at 20 kHz at the analyzer.
- ▶ Cancel the detuning and make the phase quadrature. Switch on test transmitter FM-DC with a deviation of 5 kHz to this effect. The output voltage of the mixer must become 0.
- ▶ Set the preamplifier to 40 dB and read the noise voltage at the analyzer, normalized to a bandwidth of 1 Hz (noise level).

Evaluation

- ▶ Subtract from the reference value and add 6 dB for the second side band measured (correlated) and 40 dB for the amplification switchover to the ratio found. If the signal-to-noise ratio of the second signal generator is not better than the one of the test object by at least 10dB, the noise component of the reference transmitter must be determined and subtracted as well.

Example: Let the reference level be measured to be 12 dBm. A noise level of -78 dBm (1H z) is determined at 20 kHz. The difference is 90dB, in addition to the correction for the second side band (6 dB) and the amplification switchover (40 dB) there is a signal-to-noise ratio of 136dB or a noise level of -136 dBc (dB with respect to the carrier power). If two identical signal transmitters have been used, the result must be decreased by 3 dB for the (uncorrelated) noise power of the reference transmitter. The final result is then -139 dBc.

The following noise levels should be measured and/or not be exceeded:

Test frequency	Noise in 20-kHz ratio
6000 MHz	-103 dBc (only SMT06)
3000 MHz	-109 dBc (only SMT03/06)
2000 MHz	-110 dBc (only SMT03/06)
1000 MHz	-116 dBc
500 MHz	-122 dBc
250 MHz	-128 dBc
125 MHz	-134 dBc
80 MHz	-139 dBc
< 67.5 MHz	-120 dBc

5.2.8 Broadband Noise

Test equipment Broadband noise is measured using the test setup of 5.2.7 (SSB Phase Noise).

Test principle Calibration is effected in the same way as in Section 5.2.7, SSB Phase Noise. For measurement, the signal generators are detuned until the difference frequency falls into the stop band of the lowpass filter (> 10 MHz). A 1-MHz section of the sum of the broadband noise powers of both signal generators is to be measured at the spectrum analyzer then, which corresponds to the carrier frequency offset from the difference frequency up to the difference frequency minus 1MHz. Due to the mirror inversion of the spectrum at the zero line, the power measured must be halved.

Measurement

- ▶ Calibration see Section 5.2.7.
- ▶ Increase the detuning to the measurement offset frequency, (recommended offset frequency 10 MHz).
- ▶ Set the preamplifier to 40 dB and read the noise voltage at the analyzer at a center frequency of approx. 100 kHz, normalized to a bandwidth of 1 Hz (noise level).

Evaluation

- ▶ Subtract from the reference level and add 43 dB for the amplification switchover and the mirror image. The measured value is the sum of the noise powers of both signal generators. If the signal-to-noise ratio of the second signal generator is not better than the one of the test object by at least 10 dB, the noise component of the reference transmitter must be determined and subtracted as well. In the case of two identical transmitters, the correction is further 3 dB.
- Corrected measured value ≤ -140 dBc

Recommended test frequencies see table 5-2.

5.2.9 Residual FM

Test equipment

Test system 5.1.1.1
Testsystem 5.1.1.5 (SMT06 only)

Measurement

- ▶ Settings at the SMT
 - Test frequencies, unmodulated,
 - Level 8.1dBm.
- ▶ Setting at the analyzer
 - FM, RMS value

The residual FM measured must not exceed the values according to the table.

Test Frequency	Residual FM 30 Hz to 23 kHz	Residual FM CCITT
< 67.5 MHz	10 Hz	4 Hz
80 MHz	1,5 Hz	1 Hz
125 MHz	3 Hz	1 Hz
250 MHz	5 Hz	2 Hz
500 MHz	10 Hz	4 Hz
751 MHz	20 Hz	8 Hz
1000 MHz	20 Hz	8 Hz
1001 MHz	20 Hz	8 Hz
1250 MHz	20 Hz	8 Hz
1251 MHz	20 Hz	8 Hz
1500 MHz	20 Hz	8 Hz
2000 MHz	40 Hz (only SMT03/06)	16 Hz
3000 MHz	40 Hz (only SMT03/06)	16 Hz
6000 MHz	80 Hz (only SMT06)	32 Hz

5.2.10 Residual AM

Test equipment	Test system 5.1.1.1
Measurement	See Section 5.2.9, but demodulation AM Residual AM with a measuring bandwidth of 30 Hz to 23 kHz $\leq 0.02\%$

5.2.11 Output Level

Test equipment	<ul style="list-style-type: none">- Power meter (Section 5.1, item 8)- Precision attenuator (Section 5.1, item 9)- Spectrum analyzer (Section 5.1, item 2)- Low-noise preamplifier (Section 5.1, item 10)
----------------	--

Test Methods for Level in the Measuring Range of the Power Meter

Test setup	Connect power meter to the RF output socket.
Measurement	<ul style="list-style-type: none">▶ Setting at the SMT<ul style="list-style-type: none">- RF level to be measured (see below), unmodulated.▶ Measure the level at output frequencies of 5 kHz to 1500 MHz (3000/6000 MHz with SMT03/06). Deviation of the output level from the rated value<ul style="list-style-type: none">at $f \leq 3$ GHz max. ≤ 1 dBat $f > 3$ GHz max. ≤ 2 dB Frequency response at 0 dBm (Difference between the lowest and the highest level) max. ≤ 1 dB
Recommended test level	13, 10, 8, 7.9, 5, 0, -5, -10, -20, -30 dBm

Test Methods for Low Levels

Test principle	Levels below the measuring range of the power meter can be carried out by means of a comparison measurement using a precision attenuator and a sensitive test receiver or spectrum analyzer.
Test setup	Connect a precision attenuator to the RF output of the SMT and a spectrum analyzer with screened RF measurement cables to its output.

Measurement

- ▶ Settings at the SMT
 - Test frequency
 - Level 10 dBm, unmodulated
- ▶ Setting at the analyzer
 - Test frequency
- ▶ Setting at the attenuator
 - Attenuation 130 dB. 2
- ▶ Read the level at the analyzer and note down as a reference value. It should be approx. –110 dBm. Select the measurement bandwidth small enough to ensure an exact reading.
- ▶ Now repeat the measurement with the settings given in the table. Deviation of the indication at the analyzer from the reference value, in each case max. 1dB

Settings

Level at the SMT	Attenuation of the attenuator
10 dBm	120 dB
5 dBm	115 dB
0 dBm	110 dB
–10 dBm	100 dB
–30 dBm	80 dB
–50 dBm	60 dB
–70 dBm	40 dB
–90 dBm	20 dB
–110 dBm	0 dB

Measurement of Lowest Levels

Caution: No RF leakage of the components used is the prerequisite for a correct measurement

Test setup

- ▶ Insert a low-noise preamplifier between SMT and precision attenuator.

Measurement

- ▶ Perform a subsequent calibration with a level already measured (–30 dBm). This allows measuring levels up to the lower setting limit of the SMT.

5.2.12 Output Reflection Coefficient

Test equipment

- VSWR bridge (Section 5.1, item 11)
- VSWR directional coupler for SMT06 (Section 5.1, item 23)
- Second signal generator (Section 5.1, item 5)
- Spectrum analyzer (Section 5.1, item 2) .

Test setup

Notes: -

- *The test port of the bridge must be directly screwed to the test object .*

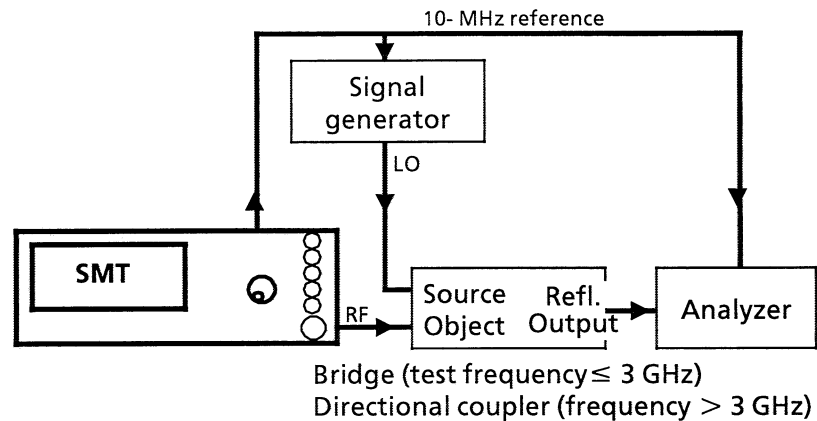

Measurement

- ▶ Settings at the SMT
 - Test level
 - Test frequency, unmodulated.
- ▶ Settings at the spectrum analyzer
 - Test frequency
 - Test level
 - Resolution and video bandwidth 10 kHz,
 - Span 0 Hz,
 - linear scale
 - Sweep time 30 ms.
- ▶ Settings at the second signal generator
 - Detune by 100 Hz compared to the test frequency,
 - first minimal level, unmodulated.
- ▶ At the spectrum analyzer, now bring the line indicated approx. into the center of the screen by varying the reference level and read and note down the level as a reference level.
- ▶ Screw off the bridge or the directional coupler from the SMT and increase the level at the second signal generator until the reference level is measured again at the analyzer.
- ▶ Screw the bridge or the directional coupler onto the SMT again.
- ▶ A more or less wavy line representing the VSWR of the SMT is to be seen now at the spectrum analyzer. The VSWR is to be calculated from the maximal and the minimal voltage according to
$$VSWR = u_{max}/u_{min}.$$

VSWR	f ≤ 3 GHz	3 GHz < f ≤ 5 GHz	f > 5 GHz
Level > 0 dBm	< 2	< 2	< 2
Level > 0 dBm with Option SM-B9	< 2	< 2	< 2,5
Level ≤ 0 dBm	< 1,5	< 2	< 2

Passive measurement of the VSWR
with output levels of the SMT
below –30 dBm

- ▶ Settings at the second signal generator
 - Test frequency
 - Level 10 dBm.
- ▶ Screw off VSWR bridge or the directional coupler from the test object and note down the level measured at the analyzer as a reference value.
- ▶ Screw on the bridge or the directional coupler again and determine the new level at the analyzer.

The output reflection coefficient r of the test object is the voltage ratio test level/reference level. It serves to determine the voltage standing wave ratio (VSWR) according to the formula

$$VSWR = (1 + r)/(1 - r).$$

5.2.13 Interrupt-free Level Setting (ATTEN FIXED)

Test equipment

Power meter (Section 5.1, item 8)

Test setup

Connect the power meter to the RF output of the SMT.

Measurement

- ▶ Settings at the SMT
 - 1000 MHz, unmodulated,
 - Level 8.0 dBm,
 - Select FIXED in the LEVEL/LEVEL ATTEN menu.
- ▶ Note down the level read at the power meter as a reference level or set the power meter to 0 dB for relative measurement.
- ▶ Now reduce the level in steps of 5 dB at the SMT.

The following deviations should not be exceeded:

Attenuation	Tolerance
–5 dBm	±0.2 dB
–10 dBm	±0.4 dB
–15 dBm	±0.6 dB
–20 dBm	±0.8 dB

5.2.14 Overvoltage Protection (only for SMT02 and 03)



Caution: *SMT06 is not protected against overvoltage. To prevent damages to be unit*
 – never apply a DC voltage to the RF output connector,
 – never apply more than the maximum permissible RF power (30 dBm) to the RF output connector.

Test equipment	<ul style="list-style-type: none"> – Adjustable d.c. voltage source (Section 5.1, item 12) – Signal generator (Section 5.1, item 5) – Power amplifier (Section 5.1, item 13)
Test setup	Connect an adjustable d.c. voltage source to the RF output socket of the SMT via a 50-Ohm resistor or a signal generator with a subsequent power amplifier with a power output of more than 1 Watt.
Testing	<ul style="list-style-type: none"> ▶ Settings at the SMT <ul style="list-style-type: none"> – 100 MHz, unmodulated, – Level –120 dBm. ▶ Apply the d.c. voltage via the 50-Ohm resistance. The overvoltage protection must respond at a voltage of >4V and <7V with both polarities. ▶ Connect the signal generator to the RF output socket of the SMT via the power amplifier and feed frequencies of up to 1500 MHz (in the case of SMT03 3000 MHz). The overvoltage protection must respond at a supplied RF power of 0.5 to 1W.

5.2.15 Testing Level Monitoring at Input EXT1

Test equipment	Test system 5.1.1.2.
Test setup	Connect the generator output of the audio analyzer to external modulation input EXT1.
Testing	<ul style="list-style-type: none"> ▶ Setting at the SMT <ul style="list-style-type: none"> – Select EXT1 in the MODULATION/AM/AM SOURCE menu. <p>Generator level under $0.97 \pm 0.01 V(u_{peak})$... indication EXT1 LOW Generator level over $1.03 \pm 0.01 V(u_{peak})$... indication EXT1 HIGH Generator level between 0.99 and $1.01 V(u_{peak})$ no indication</p>

5.2.16 Modulation Depth of AM

Test equipment	Test system 5.1.1.1 Test system 5.1.1.5 (SMT06).
Measurement	<ul style="list-style-type: none"> ▶ Settings at the SMT <ul style="list-style-type: none"> – Level 0 dBm – Select LFGEN1 in the MOD/AM/AM SOURCE INT menu, – Modulation depth 0.1% to 80% (recommended values 30% and 80%) – Modulation frequency 1 kHz . ▶ Vary the carrier frequency from 9 MHz to 1500 MHz (3000/6000 MHz with SMT03/06). For recommended setting values, see table 5-2. ▶ Read off the modulation depth at the modulation analyzer. Deviation of the modulation depth measured from the setting value max. 4 % of the indication + 1 % absolutely

5.2.17 AM Frequency Response

Test equipment	Test system 5.1.1.2 Test system 5.1.1.5 (SMT06).
Measurement	<ul style="list-style-type: none"> ▶ Settings at the SMT <ul style="list-style-type: none"> – Level 0 dBm, – Select EXT1 in the MODULATION/AM/AM SOURCE menu, – Modulation depth 60%. ▶ Vary the carrier frequency from 5 kHz to 1500 MHz (3000/6000 MHz with SMT03/06). For recommended setting values, see table 5-2. ▶ Setting at the audio analyzer <ul style="list-style-type: none"> – Generator level 1 V(u_{peak}). ▶ Determine the modulation frequency response (difference between the highest and the lowest modulation depth) by varying the generator frequency. Modulation frequency response from 20 Hz to 50 kHz .. max.1dB

Note: *If option SM-B2 LF generator is fitted, LFGEN2 can be selected in the MODULATION/AM/AM SOURCE menu and the test frequency be set using the internal generator for this measurement.*

5.2.18 AM Distortion Factor

Test equipment	Test system 5.1.1.1 Test system 5.1.1.5 (SMT06).
Measurement	<ul style="list-style-type: none"> ▶ Settings at the SMT <ul style="list-style-type: none"> – Level 0 dBm – Select LFGEN1 in the MODULATION/AM/AM SOURCE INT menu, – Modulation depth 30% – Modulation frequency 1 kHz. ▶ Vary the carrier frequency from 9 MHz to 1500 MHz (3000/6000 MHz with SMT03/06). For recommended setting values, see table 5-2. ▶ Read off the distortion factor at the modulation analyzer. Distortion factor max. 1% ▶ Repeat measurement with an AM of 80%. Distortion factor max.2%

5.2.19 Residual PhiM with AM

Test equipment	Test system 5.1.1.1 Test system 5.1.1.5 (SMT06).
Measurement	<ul style="list-style-type: none"> ▶ Settings at the SMT <ul style="list-style-type: none"> – Various test frequencies (for recommended setting values, see table 5-2) – Level 0 dBm – Select LFGEN1 in the MODULATION/AM/AM SOURCE INT menu, – Modulation depth 30% – Modulation frequency 1 kHz. ▶ Measure the phase modulation resulting by means of a 23-kHz lowpass filter and peak weighting at the modulation analyzer. Unwanted modulation with carrier frequencies ≤ 3 GHz max.0.2 rad Unwanted modulation with carrier frequencies > 3 GHz max.2 rad

5.2.20 Testing Level Monitoring at Input EXT2 (Option SM-B5)

- Test equipment Test system 5.1.1.2.
- Test setup Connect the generator output of the audio analyzer to external modulation input EXT2.
- Testing ▶ Setting at the SMT
 – Select EXT2 in the MODULATION/FM/FM1 SOURCE menu.
 Generator level under $0.97 \pm 0.01 V(u_{peak})$.. indication EXT2 LOW
 Generator level over $1.03 \pm 0.01 V(u_{peak})$... indication EXT2 HIGH
 Generator level between 0.99 and $1.01 V(u_{peak})$ no indication

5.2.21 FM Deviation Setting

- Test equipment Test system 5.1.1.1.
- Measurement ▶ Settings at the SMT
 – Different test frequencies (cf. below)
 – Level 0 dBm
 – Select LFGEN1 in the MODULATION/FM/FM1 SOURCE menu,
 – Modulation frequency 1 kHz
 – FM Deviation 30 Hz to 600 kHz (see below).
 ▶ Read off the deviation at the modulation analyzer.

Recommended setting values,
 maximum deviation

FM Deviation	Test Frequency	Deviation _{peak}
30 Hz	1000 MHz	10 to 50 Hz
100 Hz	1000 MHz	80 to 120 Hz
300 Hz	1000 MHz	275 to 325 Hz
1 kHz	1000 MHz	950 to 1050 Hz
3 kHz	1000 MHz	2.9 to 3.1 kHz
10 kHz	1000 MHz	9.7 to 10.3 kHz
30 kHz	1000 MHz	29.1 to 30.9 kHz
100 kHz	1000 MHz	97 to 103 kHz
300 kHz	1000 MHz	291 to 309 kHz
100 kHz	70 MHz	97 to 103 kHz
300 kHz	70 MHz	291 to 309 kHz
600 kHz	70 MHz	582 to 618 kHz

5.2.22 FM Frequency Response

5.2.22.1 FM Frequency Response up to 100 kHz

Test equipment	Test system 5.1.1.2.
Measurement	<ul style="list-style-type: none">▶ Settings at the SMT<ul style="list-style-type: none">– Test frequency 100 MHz– Level 0 dBm– Select EXT1 in the MODULATION/FM/FM1 SOURCE menu,– Deviation 50 kHz .▶ Setting at the audio analyzer<ul style="list-style-type: none">– Generator level 1 V(u_{peak}) .▶ Determine the modulation frequency response (difference between the highest and lowest modulation depth) by varying the generator frequency of the audio analyzer from 10 Hz to 100 kHz. Modulation frequency response max.0.5 dB▶ Repeat measurement when frequency is fed at socket EXT2 and with setting MODULATION/FM/FM2 SOURCE EXT2.

Note: *If option SM-B2 LF generator is fitted, LFGEN2 can be selected in the MODULATION/FM FM2 SOURCE menu and the test frequency be set using the internal generator for this measurement.*

5.2.22.2 FM Frequency Response up to 8 MHz

Test equipment	Test system 5.1.1.3.
Measurement	<ul style="list-style-type: none">▶ Setting at the SMT<ul style="list-style-type: none">– Test frequency 140 MHz– Level 13 dBm– Select EXT2 in the MODULATION/FM/FM1/SOURCE menu.▶ Setting at the sine-wave generator<ul style="list-style-type: none">– Generator level 1 V(u_{peak}) .▶ Connect an oscilloscope to the output of the frequency discriminator.▶ Setting at the frequency discriminator<ul style="list-style-type: none">– Set an output voltage of 0 V with the RF frequency of the SMT (step width 10 kHz).▶ Remove the oscilloscope and connect a spectrum analyzer to the output of the frequency discriminator.▶ Setting at the SMT<ul style="list-style-type: none">– Deviation 500 kHz▶ Setting at the spectrum analyzer<ul style="list-style-type: none">– Operating mode MAX HOLD▶ Vary the frequency from 100 kHz to 8 MHz at the sine-wave generator and measure the modulation frequency response (difference between the largest and the smallest modulation depth). Modulation frequency response max.3 dB

5.2.23 FM Distortion Factor

Test equipment	Test system 5.1.1.1.
Measurement	<ul style="list-style-type: none"> ▶ Settings at the SMT <ul style="list-style-type: none"> – Carrier frequencies 187.5 to 375 MHz – Level 0 dBm – Select INT in the MODULATION/FM/FM1 SOURCE menu, – Deviation 250 kHz – Modulation frequency 1 kHz. ▶ Read off distortion factor at the modulation analyzer. Distortion factor max. 0.5%
Recommended setting values	187.5000001 MHz, 193.75 MHz, 200 MHz, 206.25 MHz, 212.5 MHz, 218.75 MHz, 225 MHz, 231.25 MHz, 237.5 MHz, 243.75 MHz, 250 MHz, 250.0000001 MHz, 256.25 MHz, 262.5 MHz, 268.75 MHz, 275 MHz, 281.25, 287.5 MHz, 293.75 MHz, 300 MHz, 306.25 MHz, 312.5 MHz, 312.5000001 MHz, 318.75 MHz, 325 MHz, 331.25 MHz, 337.5 MHz, 343.75 MHz, 350 MHz, 356.25 MHz, 362.5 MHz, 368.75 MHz, 375 MHz.

5.2.24 Residual AM with FM

Test equipment	Test system 5.1.1.1.
Measurement	<ul style="list-style-type: none"> ▶ Settings at the SMT <ul style="list-style-type: none"> – Various test frequencies > 10 MHz (for recommended settings, see table 5-2) – Level 0 dBm, – Select LFGEN1 in the MODULATION/FM/FM1 SOURCE menu, – Deviation 40 kHz , – Modulation frequency 1 kHz. ▶ Measure the amplitude modulation resulting by means of a 23-kHz lowpass filter and peak weighting at the modulation analyzer. Unwanted modulation measured max.0.1%

5.2.25 Carrier Frequency Deviation with FM

Test equipment	Test system 5.1.1.1.
Measurement	<ul style="list-style-type: none"> ▶ Settings at the SMT <ul style="list-style-type: none"> – 1 GHz – Level 0 dBm – Select FM1 DEVIATION 1MHz, FM1 SOURCE EXT1, EXT1 COUPLING DC in the MODULATION/FM menu. ▶ Setting at the modulation analyzer <ul style="list-style-type: none"> – Counter function ▶ Observe change when switching on and off FM. Frequency deviation when switching on FM < 1 kHz.

5.2.26 FM Stereo Modulation

Test equipment	Test system 5.1.1.1.
Test setup	Connect the stereo coder output of the modulation analyzer with socket EXT1 of the SMT.
Measurement	<ul style="list-style-type: none">▶ Settings at the SMT<ul style="list-style-type: none">– Carrier frequencies 10.7 MHz and 85 MHz to 108 MHz– Select FM1 DEVIATION 46 kHz, FM1 SOURCE EXT1, EXT1 COUPLING DC in the MODULATION/FM menu.▶ Setting at the stereo coder<ul style="list-style-type: none">– Set the level such that neither EXT1 HIGH nor EXT1 LOW is indicated.▶ Modulate both channels with 1 kHz, determine the distortion factor of both channels using the distortion meter in the modulation analyzer. Distortion factor < 0.2%▶ Switch over deviation measurement to relative measurement and operate both channels without a signal.▶ Measure the Signal to noise ratio in both channels according to CCIR. The unweighed signal to noise ratio must be more than 73 dB. The weighted signal to noise ratio must be more than 66 dB.▶ Modulate only one channel with 1 kHz. Measure the crosstalk modulation in the unmodulated channel. It should be more than 50 dB under the reference value of the wanted modulation.

5.2.27 PhiM Deviation Setting

Test equipment	Test system 5.1.1.1.
Measurement	<ul style="list-style-type: none">▶ Settings at the SMT<ul style="list-style-type: none">– Carrier frequency 1000 MHz– Level 0 dBm– Select INT in the MODULATION/PM/PM1 SOURCE menu,– Deviation 0.01 to 100 rad (see below)– Modulation frequency 1 kHz.▶ Read off PhiM deviation at the modulation analyzer. Deviation of the deviation measured from the setting value max. 3% of the indication +0.01 rad▶ Repeat measurement with a PM bandwidth of 2 MHz and a deviation of 0.01 to 5 rad. Deviation of the deviation measured from the setting value max. 3% of the display +0.01 rad
Recommended setting values	0.01, 0.03, 0.1, 0.3, 1, 3, 10, 30, 100 rad

5.2.28 PhiM Frequency Response

Note: *If option SM-B2 LF generator is fitted, LFGEN2 can also be selected in the MODULATION/PM PM2 SOURCE menu and the test frequency be set using the internal generator for this measurement.*

5.2.28.1 PhiM Frequency Response with a PM Bandwidth of 100 kHz

Test equipment	Test system 5.1.1.2
Measurement	<ul style="list-style-type: none">▶ Settings at the SMT<ul style="list-style-type: none">– Carrier frequency 140 MHz,– Level 0 dBm– Select PM DEVIATION 5 rad, PM1 SOURCE EXT1, EXT1 COUPLING AC in the MODULATION/PM menu,– Deviation 5 rad.▶ Setting at the audio analyzer<ul style="list-style-type: none">– Generator level 1 V(u_{peak}).▶ Determine the modulation frequency response (difference between the highest and lowest modulation depth) by varying the generator frequency of the analyzer. Modulation frequency response 10 Hz to 100 kHz max. 3 dB▶ Repeat measurement using setting PM2 SOURCE EXT2.

5.2.28.2 PhiM Frequency Response with a PM Bandwidth of 2 MHz

Test equipment	<ul style="list-style-type: none">– Spectrum analyzer (Section 5.1, pos. 2)– Signal generator (Section 5.1, pos. 18)
Test principle	The level of the modulation sidebands ($-20 \log(\text{PhiM}/2)$) and thus the modulation index in the modulation frequency range indicated is measured using a spectrum analyzer.
Test setup	<ul style="list-style-type: none">▶ Connect spectrum analyzer to the RF output of the SMT.▶ Connect modulation generator to input EXT2 of the SMT.
Measurement	<ul style="list-style-type: none">▶ Settings at the SMT<ul style="list-style-type: none">– Carrier frequency 140 MHz,– Level 0 dBm– in menu MODULATION/PM select PM DEVIATION 0.2 rad, PM2 SOURCE EXT2 and EXT2 COUPLING AC,▶ Setting at the signal generator (connected to EXT2)<ul style="list-style-type: none">– Generator level 1 V(u_{peak}).▶ Setting at the spectrum analyzer<ul style="list-style-type: none">– Operating mode MAX HOLD▶ Determine the modulation frequency response (difference between the largest and the smallest modulation depth) by varying the generator frequency from 100 kHz to 2 MHz. Modulation frequency response 100 kHz to 1 MHz max. 1 dB Modulation frequency response 1 MHz to 2 MHz max. 3 dB

5.2.29 PhiM Distortion Factor

Test equipment	Test system 5.1.1.1
Measurement	<ul style="list-style-type: none">▶ Settings at the SMT<ul style="list-style-type: none">– Carrier frequency 140 MHz– Level 0 dBm– Select INT in the MODULATION/PM/PM1 SOURCE menu,– Deviation 12.5 rad– Modulation frequency 1 kHz.▶ Read off the distortion factor at the modulation analyzer. Distortion factor max. 0.5%

5.2.30 Internal Modulation Generator

Test equipment	Audio analyzer (Section 5.1, item 14)
Test setup	<ul style="list-style-type: none">▶ Connect an audio analyzer to socket LF of the SMT to test the internal modulation generator.
Measurement	<ul style="list-style-type: none">▶ Settings at the SMT<ul style="list-style-type: none">– Select LFGEN1 in the LF OUTPUT/SOURCE menu,– Level 1 V,– subsequently all 4 frequencies of the internal generator.▶ Read off the actual frequency at the audio analyzer. Deviation compared to the rated value <3%▶ Read off output voltage at the audio analyzer. Output voltage 990 to 1010 mV (peak value)

5.2.31 Pulse Modulation (Option SM-B3/B8/B9)

5.2.31.1 ON/OFF - Ratio

Test equipment	<ul style="list-style-type: none">– Spectrum analyzer (Section 5.1, item 2)– Pulse generator (Section 5.1, item 17)
Test setup	<ul style="list-style-type: none">▶ Connect a spectrum analyzer to the RF output socket of the SMT▶ Connect a pulse generator to socket PULSE at the rear panel of the SMT.
Measurement	<ul style="list-style-type: none">▶ Setting at the SMT<ul style="list-style-type: none">– Select EXT1 in the MODULATION/PULSE/SOURCE menu.▶ Determine the output level of the SMT with a present "high" and "low" signal with various carrier frequencies. Difference of the output level with a "high" and "low" signal >80 dB

5.2.31.2 Dynamic Characteristics

Test equipment	Test system 5.1.1.4.						
Measurement	<ul style="list-style-type: none"> ▶ Simultaneously display the input signal from the pulse generator and the (down-converted) output signal on the dual-trace oscilloscope (triggering on the input signal). ▶ Settings at the pulse generator <ul style="list-style-type: none"> – Square-wave pulse sequence at a frequency of approx. 10 MHz, TTL level. ▶ Settings at the SMT <ul style="list-style-type: none"> – Carrier frequencies > 5 MHz – Option SM-B3: level 10 dBm. – Option SM-B8: level 9 dBm. – Option SM-B9: level 8 dBm. ▶ With carrier frequencies > 50 MHz, use mixer and set an IF of approx. 50 MHz using the auxiliary transmitter. ▶ Evaluate the modulated RF signal at the oscilloscope. Rising time = the time between 10% and 90% of the RF amplitude Fall time = the time between 90% and 10% of the RF amplitude Pulse delay time = the time between 50% of the input pulse amplitude and 50% of the RF amplitude <table border="0" style="margin-left: 20px; width: 100%;"> <tr> <td>Rising time</td> <td>< 10 ns</td> </tr> <tr> <td>Fall time</td> <td>< 10 ns</td> </tr> <tr> <td>Pulse delay time</td> <td>< 70 ns</td> </tr> </table> 	Rising time	< 10 ns	Fall time	< 10 ns	Pulse delay time	< 70 ns
Rising time	< 10 ns						
Fall time	< 10 ns						
Pulse delay time	< 70 ns						

5.2.32 LF Generator (Option SM-B2)

5.2.32.1 Frequency Error

Test equipment	Audio analyzer (Section 5.1, item 14)	
Test setup	Connect the audio analyzer to the LF socket of the SMT.	
Measurement	<ul style="list-style-type: none"> ▶ Settings at the SMT <ul style="list-style-type: none"> – Select SOURCE LFGEN2, VOLTAGE 1V in menu LF OUTPUT , – Vary LFGEN2 FREQUENCY from 20 Hz to 100 kHz. ▶ Read off the actual frequency at the audio analyzer. Deviation from the rated value	< 1E-4
	<ul style="list-style-type: none"> ▶ Read off the distortion factor at the audio analyzer. Rated value	< 0.1%
	<ul style="list-style-type: none"> ▶ Settings at the SMT <ul style="list-style-type: none"> – Set LFGEN2 FREQUENCY 1 kHz in menu LF OUTPUT – Vary VOLTAGE from 1 mV to 4 V. ▶ Measure the output level using the audio analyzer. Deviation from the rated value	max. 1% + 1mV.
Recommended settings	3 mV, 10 mV, 30 mV, 100 mV, 300 mV, 1 V, 2 V, 4 V.	

5.2.32.2 Frequency Response

Test equipment	AC voltmeter (Section 5.1, item 19)				
Test setup	Connect AC voltmeter to the LF socket of the SMT.				
Measurement	<ul style="list-style-type: none"> ▶ Settings at the SMT <ul style="list-style-type: none"> – Select SOURCE LFGEN2 in menu LF OUTPUT, – Vary LFGEN2 FREQUENCY from 10 Hz to 500 kHz. <p>Frequency response (difference between the highest and lowest level)</p> <table border="0" style="margin-left: 20px;"> <tr> <td>up to 100 kHz</td> <td>< 0.3 dB</td> </tr> <tr> <td>up to 500 kHz</td> <td>< 0.5 dB</td> </tr> </table>	up to 100 kHz	< 0.3 dB	up to 500 kHz	< 0.5 dB
up to 100 kHz	< 0.3 dB				
up to 500 kHz	< 0.5 dB				

Note: *The setting time is a mere time the computer requires and thus needs not to be re-measured.*

5.2.33 Pulse Generator (Option SM-B4)

Test equipment	<ul style="list-style-type: none"> – Oscilloscope (Section 5.1, item 7) – Pulse generator (Section 5.1, item 17)
Test setup	<ul style="list-style-type: none"> ▶ Connect the pulse generator to the PULSE socket. ▶ Connect sockets SYNC and VIDEO to the two channels of the oscilloscope. ▶ Switch on an input resistance of 50 Ohm at the oscilloscope or use feed-through termination.
Measurement Single pulses	<ul style="list-style-type: none"> ▶ Settings at the SMT <ul style="list-style-type: none"> In menu MODULATION/PULSE – SOURCE PULSE-GEN, – PERIOD 100 ns, – WIDTH 20 ns, – PULSE DELAY 20 ns, – DOUBLE PULSE STATE OFF, – TRIGGER MODE AUTO, – EXT TRIGGER SLOPE POS. ▶ Settings at the oscilloscope <ul style="list-style-type: none"> – Time base 20 ns/div, – both channels 2 V/div, – Triggering from the SYNC signal. <p>SYNC output Pulse sequence with a pulse width of 40 ns ± 10 ns VIDEO output Pulse sequence with a pulse width of 20 ns ± 4 ns, the first edge appears after the first edge of the SYNC signal by the pulse delay of 20 ns (–11 ns, + 21 ns). SYNC and VIDEO output Period 100 ns,</p>

Note: *The period is derived from the internal reference frequency and has its accuracy. There must be no error within the frame of the measuring accuracy of the oscilloscope.*

- Double pulses ▶ Settings at the SMT
In menu MODULATION/PULSE
 - DOUBLE PULSE STATE ON,
 - WIDTH 20 ns,
 - DOUBLE PULSE DELAY 60 ns
 VIDEO output second pulse with a width of 20 ns \pm 4 ns,
 Spacing to the first pulse 60 ns (+ 23ns, – 13ns) .
- Ext. triggering ▶ Setting at the SMT
In menu MODULATION/PULSE
 - TRIGGER MODE EXT
 ▶ Settings at the pulse generator
 - TTL pulse sequence at 10 MHz
 The pulse sequence at the oscilloscope must not change.
 Trigger the oscilloscope on the PULSE input.
 The pulse sequence may be offset by maximally 50 ns.
- ▶ Repeat the measurements with pulse periods of up to 85s and pulse widths, pulse delays and double pulse spacings of up to 1s.

5.2.34. Multi-Function Generator (Option SM-B6)

5.2.34.1 Frequency Error, Distortion Factor and Level

Test equipment	Audio analyzer (Section 5.1, item 14)
Test setup	Connect the audio analyzer to the LF output of the SMT.
Measurement	<ul style="list-style-type: none"> ▶ SMT settings In menu LF OUTPUT <ul style="list-style-type: none"> – VOLTAGE 1 V – SOURCE LFGEN2 – LFGEN2 SHAPE SIN – Vary LFGEN2 FREQ 20 Hz to 1 MHz. ▶ Read off the actual frequency at the audio analyzer. The values measured have to be precise within the scope of the counter resolution (error < 0.1 Hz). ▶ Read off distortion factor at the audio analyzer. Rated value up to 100 kHz < 0.1 % ▶ SMT settings Menu LF OUTPUT <ul style="list-style-type: none"> – SOURCE LFGEN2 – LFGEN2 FREQ 1 kHz – LFGEN2 SHAPE SIN – Vary VOLTAGE from 3mV to 4 V (see below) ▶ Measure the output level using the audio analyzer. Deviation from rated value max. 1% + 1mV.
Recommended settings	3 mV, 10 mV, 30 mV, 100 mV, 300 mV, 1 V, 2 V, 4 V.

5.2.34.2 Frequency Response

Test equipment	AC voltmeter (Section 5.1, item 19)
Test setup	Connect the AC voltmeter to the LF socket of the SMT.
Measurement	<ul style="list-style-type: none">▶ SMT settings In menu LF OUTPUT<ul style="list-style-type: none">– SOURCE LFGEN2,– Vary LFGEN2 FREQUENCY from 10 Hz to 500 kHz. Frequency response (difference between the smallest and largest level)
	up to 100 kHz < 0.3 dB
	up to 500 kHz < 0.5 dB

Note: The setting time is a mere computer time and thus need not be remeasured.

5.2.34.3 Distortion Factor and Crosstalk Attenuation Stereo

Test equipment	Modulation analyzer (Section 5.1, item 15)
Test setup	Connect modulation analyzer to the LF output of the SMT.
Measurement	<ul style="list-style-type: none">▶ SMT settings In menu MODULATION STEREO<ul style="list-style-type: none">– MODE R,– AUDIO FREQ 1kHz,In menu LF OUTPUT<ul style="list-style-type: none">– STEREO OUTPUT MPX.▶ Read distortion factor at the modulation analyzer (signal R) Rated value▶ Measure the modulated signal of the right channel, note down value▶ Measure the demodulated signal of the left channel Difference between modulated and demodulated signal▶ Repeat measurement using setting MODE L
	< 0.1%
	> 60 dB

5.2.34.4 Pilot Tone Level

Test equipment	AC voltmeter (Section 5.1, item 15)
Test setup	Connect AC voltmeter to the LF output of the SMT.
Measurement	<ul style="list-style-type: none">▶ SMT settings In menu MODULATION STEREO<ul style="list-style-type: none">– PILOT STATE ON–In menu LF OUTPUT<ul style="list-style-type: none">– STEREO OUTPUT PILOT– LF VOLTAGE 1V▶ Read AC voltage of the pilot tone Rated value
	$0.707 V_{\text{eff}} \pm 14mV_{\text{eff}}$

5.3 Test Report

ROHDE & SCHWARZ	SIGNAL GENERATOR SMT	1039.2000.0_
Serial number:		
Person testing:		
Date:		
Signature:		

Table 5-3 Test report

Item	Characteristic	Measurem. acc. to Section	Min.	Actual	Max.	Unit
1	Display and keyboard	5.2.1	checked	—	—
2	Frequency setting	5.2.2	checked	—	—
3	Settling time	5.2.3	—	10	ms
4	Reference frequency	5.2.4	—	—	—
5	Harmonics at 10 dBm Harmonics at 13 dBm Subharmonics (f > 1.5 GHz) Subharmonics (f > 3 GHz)	5.2.5	— — — —	-30 -40 -40 -34	dBc dBc dBc dBc
6	Spuriae RF > 3 GHz (SMT06) RF > 1.5 GHz (SMT03) RF ≤ 1.5 GHz	5.2.6	— — —	-68 -74 -80	dBc dBc dBc
7	SSB phase noise ratio 20 kHz RF < 67.5 MHz RF = 80 MHz RF = 125 MHz RF = 250 MHz RF = 500 MHz RF = 1000 MHz RF = 2000 MHz (SMT03706) RF = 3000 MHz (SMT03/06) RF = 6000 MHz (SMT06)	5.2.7	— — — — — — — — — —	-120 -139 -134 -128 -122 -116 -110 -109 -103	dBc (1 Hz) dBc (1 Hz) dBc (1 Hz) dBc (1 Hz) dBc (1 Hz) dBc (1 Hz) dBc (1 Hz) dBc (1 Hz) dBc (1 Hz)
8	Broadband noise	5.2.8	—	-140	dBc (1 Hz)
9	Residual FM _{eff} (0.02 to 20 kHz/CCITT) RF < 67.5 MHz RF 67.5 to 187.5 MHz RF 187.5 to 375 MHz RF 375 to 750 MHz RF 750 to 1500 MHz RF 1500 to 3000 MHz (SMT03/06) RF 3000 to 6000 MHz (SMT06)	5.2.9	— — — — — — —	10 / 4 3 / 1 5 / 2 10 / 4 20 / 8 40 / 16 80 / 32	Hz Hz Hz Hz Hz Hz Hz

Continuation: Test report

Item	Characteristic	Measur. acc. to Section	Min.	Actual	Max.	Unit
10	Residual AM	5.2.10	—	0.02	%
11	Output level, Frequency response Deviation from the rated value f ≤ 3 GHz f > 3 GHz	5.2.11	—	1	dB
			—	1	dB
			—	2	dB
12	Output reflection coeff. Test level ≤ 0 dBm, f ≤ 3 GHz Test level ≤ 0 dBm, f > 3 GHz Test level > 0 dBm Test level > 0 dBm, f > 5 GHz with SM-B9	5.2.12	—	1,5	(VSWR)
			—	2,0	(VSWR)
			—	2,0	(VSWR)
			—	2,5	(VSWR)
13	Interrupt-free level setting – 5 dB –10 dB –15 dB –20 dB	5.2.13	– 5.1	–4.9	dB
			–10.2	–9.8	dB
			–15.3	–14.7	dB
			–20.4	–19.6	dB
14	Overvoltage protection (SMT02/03) D.c. voltage RF supply	5.2.14	4	7	V
			0.5	1	W
15	Level monitoring EXT1 lower limit upper limit	5.2.15	0.97	0.99	V
			1.01	1.03	V
16	AM modulation depth 80% 30 %	5.2.16	75.8	84.2	%
			27.8	32.2	%
17	AM frequency response 20 Hz to 50 kHz	5.2.17	—	1	dB
18	AM distortion factor with AM 30% with AM 80%	5.2.18	—	1	%
			—	2	%
19	Residual PhiM with AM, f ≤ 3 GHz Residual PhiM with AM, f > 3 GHz	5.2.19	—	0.2	rad
			—	2.0	rad
20	Level monitoring EXT2 lower limit upper limit	5.2.20	0.97	0.99	V
			1.01	1.03	V

Continuation: Test report

Item	Characteristic	Measur. acc. to Section	Min.	Actual	Max.	Unit
21	FM deviation setting	5.2.21			
	RF= 1 GHz				
	with 30 Hz		10	50	Hz
	with 100 Hz		77	123	Hz
	with 300 Hz		271	329	Hz
	with 1 kHz		0.95	1.05	kHz
	with 3 kHz		2.89	3.11	kHz
	with 10 kHz		9.68	10.32	kHz
	with 30 kHz		29.08	30.92	kHz
	with 100 kHz		96.98	103.02	kHz
	with 300 kHz		291	309	kHz
	RF= 70 MHz				
with 100 kHz	96.98	103.02	kHz		
with 300 kHz	291	309	kHz		
with 600 kHz	582	618	kHz		
22	FM frequency response	5.2.22			
	FM1, EXT1 10 Hz to 100 kHz		—	0.5	dB
	FM1, EXT2 10 Hz to 100 kHz		—	0.5	dB
	FM2, EXT1 10 Hz to 100 kHz		—	0.5	dB
	FM2, EXT2 10 Hz to 8 MHz		—	3	dB
23	FM distortion factor	5.2.23	—	0.3	%
24	Residual AM with FM	5.2.24	—	0.1	%
25	Frequency deviation with FM Deviation 1 MHz	5.2.25	—	1	kHz
26	FM stereo modulation	5.2.26			
	Distortion factor		—	0.2	%
	External voltage suppression		73	—	dB
	Noise voltage suppression		66	—	dB
	Channel separation		50	—	dB
27	PhiM deviation setting	5.2.27				
	PM BANDWIDTH 100 kHz					
	with 30 mrad		20	40	mrad
	with 0.1 rad		0.087	0.113	rad
	with 0.3 rad		0.281	0.319	rad
	with 1.0 rad		0.969	1.031	rad
	with 3.0 rad		2.90	3.10	rad
	with 10 rad		9.69	10.31	rad
	with 30 rad		29	31	rad
	with 100 rad		96.9	103.1	rad
	PM BANDWIDTH 2 MHz					
	with 30 mrad		20	40	mrad
	with 0.1 rad		0.087	0.113	rad
	with 0.3 rad		0.281	0.319	rad
	with 1.0 rad		0.969	1.031	rad
with 3.0 rad	2.90	3.10	rad		

Continuation: Test report

Item	Characteristic	Measur. acc. to Section	Min.	Actual	Max.	Unit
28	PhiM frequency response	5.2.28				
	PM BANDWIDTH 100 kHz					
	PM1, EXT1, 10Hz...100 kHz		—	3	dB
	PM1, EXT2, 10Hz...100 kHz		—	3	dB
	PM2, EXT1, 10Hz...100 kHz		—	3	
	PM BANDWIDTH 2 MHz					dB
	PM2, EXT2, 10 Hz...1 MHz		—	1	dB
PM2, EXT2, 1 MHz...2 MHz	—	3	dB		
29	PhiM distortion factor	5.2.29	—	0.5	%
30	Int. modulation generator	5.2.30				
	Frequency 400 Hz		388	412	Hz
	Frequency 1 kHz		970	1030	Hz
	Frequency 3 kHz		2910	3090	Hz
	Frequency 15 kHz		14.55	15.45	kHz
Level	990	1010	mV		
31	Pulse modulation	5.2.31				
	ON/OFF ratio		80	—	dB
	Rising time		—	10	ns
	Fall time		—	10	ns
Delay time	—	70	ns		
32	LF generator	5.2.32				
	Frequency error		—	1E0-4	—
	Distortion factor		—	0.1	%
	Level					
	3 mV		2	4	mV
	10 mV		8.9	11.1	mV
	30 mV		28.7	31.3	mV
	100 mV		98.0	101.0	mV
	300 mV		296	304	mV
	1 V		0.989	1.011	V
	2 V		1.979	2.021	V
4 V	3.959	4.041	V		
Frequency response up to 100 kHz	—	0.3	dB		
Frequency response up to 400 kHz	—	0.5	dB		
33	Pulse generator	5.2.33				
	Pulse period		checked	—	
	Pulse width		-5% -3 ns	+5% +3 ns	% / ns
	Pulse delay		-5% -3 ns	+5% +3 ns	% / ns
	Double pulse spacing		-5% -10 ns	+5% +20 ns	% / ns
	Trigger delay		—	50 ns	ns

Continuation: Test report

Item	Characteristic	Measurem. acc. to Section	Min.	Actual	Max.	Unit
34	Multi-function generator	5.2.33				
	Frequency error		—	1E0-4	—
	Distortion factor		—	0.1	%
	Level				
	3 mV		2	4	mV
	10 mV		8.9	11.1	mV
	30 mV		28.7	31.3	mV
	100 mV		98.0	101.0	mV
	300 mV		296	304	mV
	1 V		0.989	1.011	V
	2 V		1.979	2.021	V
	4 V		3.959	4.041	V
	Frequency response up to 100 kHz		—	0.3	dB
	Frequency response up to 500 kHz		—	0.5	dB
	Stereo				
	Crosstalk attenuation		60	—	dB
	Distortion factor		—	0.1	%
	Pilot-tone level		0.693	0.721	V

Annex A3

IEC/IEEE-Bus Interface

The instrument is equipped with an IEC/IEEE-bus connection as a standard. The mating connector according to IEEE 488 is at the rear of the instrument. A controller for remote control can be connected via the interface. The connection is effected using a shielded cable.

Characteristics of the Interface

- 8-bit parallel data transfer
- bidirectional data transfer
- three line handshake
- high data transfer rate of max. 350 kByte/s
- up to 15 devices can be connected
- maximal length of the connecting cables 15 m (single connection 2m)
- wired OR if several instruments are connected in parallel.

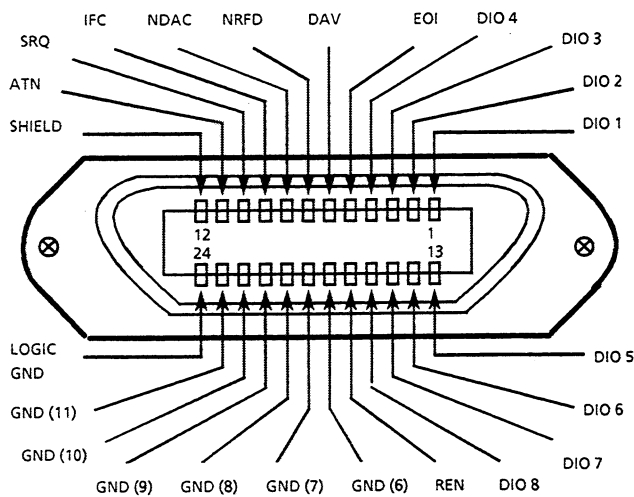

Fig. A-1 Contact Assignment of the IEC-bus socket

Bus Lines

1. Data bus with 8 lines DIO 1 to DIO 8.

The transmission is bit-parallel and byte-serial in the ASCII/ISO code. DIO1 is the bit of lowest order, DIO8 the bit of highest order.

2. Control bus with 5 lines.

IFC (Interface Clear),
active low resets the interfaces of the instruments connected to the default setting.

ATN (Attention),
active low signals the transmission of interface messages
inactive high signals the transmission of device-dependent messages.

SRQ (Service Request),
active low enables a device connected to send a service request to the controller.

REN (Remote Enable),
active low permits the switchover to remote control.

EOI (End or Identify),
has two functions in connection with ATN:
active low marks the end of data transmission with ATN = high
active low triggers a parallel poll with ATN = low.

3. Handshake bus with three lines.

DAV (Data Valid),
active low signals a valid data byte on the data bus.

NRFD (Not Ready For Data),
active low signals that one of the device connected is not ready for data transfer .

NDAC (Not Data Accepted),
active low as long as the instrument connected is accepting the data present on the data bus.

Interface Functions

Instruments which can be remote-controlled via IEC bus can be equipped with different interface functions. Table A-1 lists the interface functions appropriate for the instrument.

Table A-1 Interface functions

Control character	Interface function
SH1	Handshake source function (source handshake)
AH1	Handshake drain function (acceptor handshake)
L4	Listener function.
T6	Talker function, ability to respond to serial poll
SR1	Service request function (Service Request)
PP1	Parallel poll function
RL1	Remote/Local switchover function
DC1	Resetting function (Device Clear)
DT1	Trigger function (Device Trigger)

Interface Messages

Interface messages are transmitted to the instrument on the data lines, with the attention line being active (LOW). They serve to communicate between instrument and controller.

Common Commands

The common commands are encoded in the range 10 through 1F hex. They are effective for all instruments connected to the bus without addressing them before.

Table A-2 Common Commands

Command	QuickBASIC command	Effect on the instrument
DCL (Device Clear)	IBCMD (controller%, CHR\$(20))	Aborts the processing of the commands just received and sets the command processing software to a defined initial state. Does not change the instrument setting.
IFC (Interface Clear)	IBSIC (controller%)	Resets the interfaces to the default setting.
LLO (Local Lockout)	IBCMD (controller%, CHR\$(17))	The LOC/IEC ADDR key is disabled.
SPE (Serial Poll Enable)	IBCMD (controller%, CHR\$(24))	Ready for serial poll
SPD (Serial Poll Disable)	IBCMD (controller%, CHR\$(25))	End of serial poll
PPU (Parallel Poll Unconfigure)	IBCMD (controller%, CHR\$(21))	End of the parallel-poll polling state

Addressed Commands

The addressed commands are encoded in the range 00 through 0F hex. They are only effective for instruments addressed as listeners.

Table A-3 Addressed Commands

Command	QuickBASIC command	Effect on the instrument
SDC (Selected Device Clear)	IBCLR (device%)	Aborts the processing of the commands just received and sets the command processing software to a defined initial state. Does not change the instrument setting.
GET (Group Execute Trigger)	IBTRG (device%)	Triggers a previously active device function (eg a sweep). The effect of the command is the same as with that of a pulse at the external trigger signal input.
GTL (Go to Local)	IBLOC (device%)	Transition to the "Local" state (manual control)
PPC (Parallel Poll Configure)	IBPPC (device%, data%)	Configure instrument for parallel poll. The QuickBASIC command additionally executes PPE / PPD.

RS-232-C Interface

The instrument is fitted with an RS-232-C interface as standard. The 9-pin connector is at the rear panel. A controller can be connected via this interface for remote control.

Interface characteristics

- Serial data transmission in asynchronous mode
- Bidirectional data transmission via two separate lines
- Transmission rate selectable from 1200 to 115200 baud
- Logic 0 signal from + 3 V to + 15 V
- Logic 1 signal from -15 V to -3 V
- An external instrument (controller) can be connected
- Software handshake (XON, XOFF)
- Hardware handshake

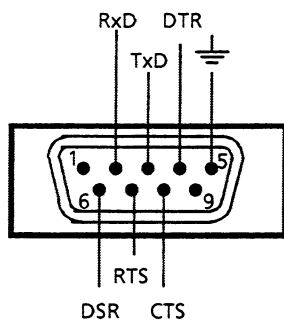

Fig. A-2 Pin assignment of RS-232-C connector

Signal lines

RxD (Receive Data),

Data line, transmission from external controller to instrument.

TxD (Transmit Data),

Data line, transmission from instrument to external controller.

DTR (Data terminal ready)

Output (log. 0 = active). With DTR, the instrument indicates that it is ready to receive data. The DTR line controls whether the instrument is ready for reception or not.

GND,

Interface ground, connected to instrument ground.

DSR (Data Set Ready),

(Instead of the CTS line, the DSR connector is used for instruments with a VAR2 REV3 front module.)

RTS (Request To Send),

Output (log 0 = active). With RTS, the instrument indicates that it is ready to receive data. The RTS line controls whether the instrument is ready for reception or not.

CTS (Clear to send),

Input (log 0 = active). CTS tells the instrument that the opposite station is ready to receive data.

Transmission parameters

To ensure an error-free and correct data transmission, the parameters of the instrument and the controller should have the same settings. The parameters are set in menu UTILITIES-SYSTEM-RS232.

Transmission rate (baud rate)

The following baud rates can be set in the instrument:
1200, 2400, 4800, 9600, 19200, 38400, 57600, 115200.

Data bits

Data transmission is in 8-bit ASCII code. The first bit transmitted is the LSB (Least Significant Bit).

Start bit

Each data byte begins with a start bit. The falling edge of the start bit indicates the beginning of the data byte.

Parity bit

A parity bit is not used.

Stop bits

The transmission of a data byte is terminated by a stop bit.

Example: Transmission of character A (41 hex) in the 8-bit ASCII code.

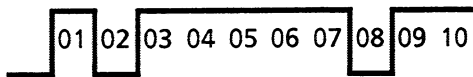

Bit 01 = Start bit, Bit 02...09 = Data bits,
Bit 10 = Stop bit.

Bitduration = 1/baud rate

Interface functions

For interface control, some control characters defined from 0 to 20 hex of the ASCII code can be transmitted via the interface (see Table A-4).

Table A-4 Interface functions

Control character	Interface function
<Ctrl Q> 11 hex	Enables character output (XON)
<Ctrl S> 13 hex	Inhibits character output (XOFF)
Break (at least 1 character only log 0)	Reset instrument
0Dhex, 0Ahex	Terminator <CR>, <LF> Switchover between local/remote

Handshake

Software handshake

The software handshake with the XON/XOFF protocol controls data transmission. If the receiver wishes to inhibit data entry, it sends XOFF to the transmitter. The transmitter then interrupts the data output until it receives a XON. The same function is provided at the transmitter side (controller).

Note: *Software handshake is not suitable for transmission of binary data. Use the hardware handshake.*

Hardware handshake

In case of a hardware handshake the instrument signals that it is ready for reception via line DTR and RTS. A logic 0 means "ready" and a 1 means "not ready". Whether the controller is ready for reception or not is signalled to the instrument via lines CTS or DSR (see signal lines). The transmitter of the instrument is switched on by a 0 and off by a 1. Line RTS remains active as long as the serial interface is active. Line DTR controls whether the instrument is ready for reception or not.

Connection between instrument and controller

Connection of the instrument with the controller is via a so-called 0-modem cable. In this case, the data, control and signalling lines have to be cross-connected. For a controller with a 9-pin or 25-pin connector the following circuit diagram applies.

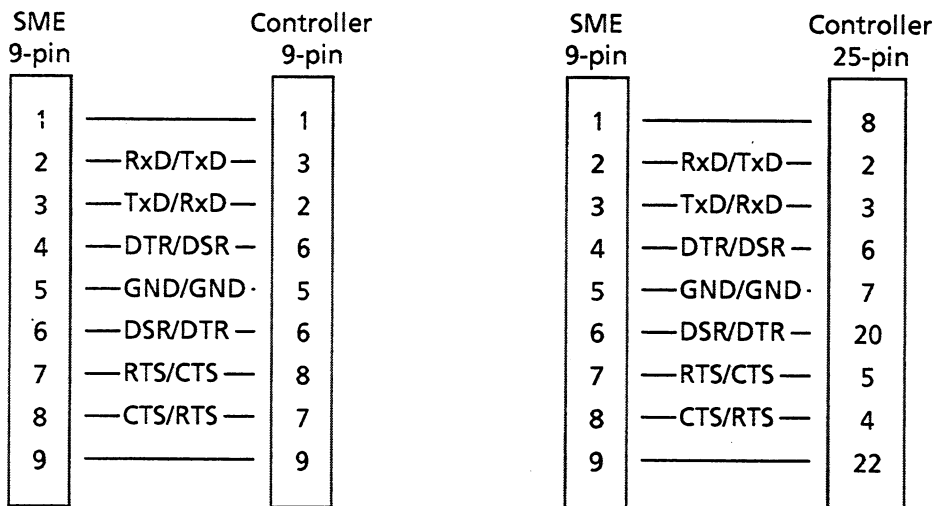

Fig. A-3 Wiring of data, control and signalling lines for hardware handshake

Annex B

List of Error Messages

The following list contains all error messages for errors occurring in the instrument. The meaning of negative error codes is defined in SCPI, positive error codes mark errors specific of the instrument.

The table contains the error code in the left-hand column. In the right-hand column the error text being entered into the error/event queue or being displayed is printed in bold face. Below the error text, there is an explanation as to the respective error.

SCPI-Specific Error Messages

No Error

Error code	Error text in the case of queue poll Error explanation
0	No error This message is output if the error queue does not contain entries.

Command Error — Faulty command; sets bit 5 in the ESR register.

Error code	Error text in the case of queue poll Error explanation
-100	Command Error The command is faulty or invalid.
-101	Invalid Character The command contains an invalid sign. Example: A header contains an ampersand, "SOURCE&".
-102	Syntax error The command is invalid. Example: The command contains block data the instrument does not accept.
-103	Invalid separator The command contains an impermissible sign instead of a separator. Example: A semicolon is missing after the command.
-104	Data type error The command contains an invalid value indication. Example: ON is indicated instead of a numeric value for frequency setting.
-105	GET not allowed A Group Execute Trigger (GET) is within a command line.
-108	Parameter not allowed The command contains too many parameters. Example: Command SOURce:FM:INTernal:FREQuency permits only one frequency indication.
-109	Missing parameter The command contains too few parameters. Example: Command SOURce:FM:INTernal:FREQuency requires a frequency indication.

Continuation: Command Error

Error code	Error text in the case of queue poll Error explanation
- 112	Program mnemonic too long The header contains more than 12 signs.
- 113	Undefined header The header is not defined for the instrument. Example: *XYZ is undefined for every instrument.
- 114	Header suffix out of range The header contains an impermissible numeric suffix. Example: SOURce3 does not exist in the instrument.
- 123	Exponent too large The absolute value of the exponent is larger than 32000.
- 124	Too many digits The number contains too many digits.
- 128	Numeric data not allowed The command contains a number which is not allowed at this position. Example: Command SOURce:FREQuency:MODE requires the indication of a text parameter.
- 131	Invalid suffix The suffix is invalid for this instrument. Example: nHz is not defined.
- 134	Suffix too long The suffix contains more than 12 signs.
- 138	Suffix not allowed A suffix is not allowed for this command or at this position of the command. Example: Command *RCL does not permit indicating a suffix.
- 141	Invalid character data The text parameter either contains an invalid sign or it is invalid for this command. Example: write error with parameter indication; SOURce:FREQuency:MODE FIXSED.
- 144	Character data too long The text parameter contains more than 12 signs.
- 148	Character data not allowed The text parameter is not allowed for this command or at this position of the command. Example: Command *RCL requires a number to be indicated.
- 158	String data not allowed The command contains a valid character string at a position which is not allowed. Example: A text parameter is set in quotation marks, SOURce:FREQuency:MODE "FIXed"
- 161	Invalid block data The command contains faulty block data. Example: An END message was received before the expected number of data had been received.
- 168	Block data not allowed The command contains valid block data at an impermissible position. Example: Command *RCL requires a number to be indicated.
- 178	Expression data not allowed The command contains a mathematical expression at an impermissible position.

Execution Error — Error in executing the command; sets bit 4 in the ESR register

Error code	Error text in the case of queue poll Error explanation
- 203	<p>Command protected</p> <p>The desired command could not be executed as it was protected with a password. Use command SYSTem:PROTeCt OFF, <password> to enable the command. Beispiel: The command CALibrate:PULSe:MEASure? is protected with a password.</p>
- 211	<p>Trigger ignored</p> <p>The trigger (GET, *TRG or trigger signal) was ignored due to device timing considerations Example: The instrument was not ready to respond.</p>
- 221	<p>Settings conflict</p> <p>There is a settings conflict between two parameters. Example: FM1 and PM1 cannot be switched on at the same time.</p>
- 222	<p>Data out of range</p> <p>The parameter value is out of the range permitted by the instrument. Example: Command *RCL only permits entries in the range of 0 to 50</p>
- 223	<p>Too much data</p> <p>The command contains too many data. Example: The instrument does not have sufficient storage space.</p>
- 224	<p>Illegal parameter value</p> <p>The parameter value is invalid. Example: An invalid text parameter is indicated, TRIGger:SWEep:SOURce TASTe</p>
- 225	<p>Out of memory</p> <p>The storage space available in the instrument is exhausted. Example: An attempt is made to create more than 10 Memory Sequence lists.</p>
- 226	<p>Lists not same length</p> <p>The parts of a list have different lengths. This error message is also displayed if only a part of a list has been transmitted via IEC bus. All parts have to be transmitted always before the command is executed. Example: The DWELI list is longer than the RCL list, or only the DWELI list is transmitted</p>
- 230	<p>Data corrupt or stale</p> <p>The data are incomplete or invalid. Example: The instrument has aborted a measurement.</p>
- 240	<p>Hardware error</p> <p>The command cannot be executed due to problems with the instrument hardware.</p>
- 241	<p>Hardware missing</p> <p>The command cannot be executed due to missing hardware. Example: An option is not fitted.</p>
- 255	<p>Directory full</p> <p>The list management cannot accept any more lists as the maximum number of lists has already be attained. Example: Only 10 Memory Sequence lists can be created.</p>

Device Specific Error — sets bit 3 in the ESR register.

Error code	Error text in the case of queue poll Error explanation
- 310	System error This error message suggests an error within the instrument. Please inform the R&S Service.
- 311	Memory error Error in the instrument memory.
- 313	Calibration memory lost Loss of calibration data stored. The calibration data of VCO SYN, LEV PRESET and PULSE GEN can be restored by internal routines (See Chapter 2, Section "Calibration")
- 314	Save/recall memory lost Loss of the non-volatile data stored using *SAV? command.
- 315	Configuration memory lost Loss of the non-volatile configuration data stored by the instrument.
- 330	Self-test failed The selftest could not be executed.
- 350	Queue overflow This error code is entered into the queue instead of the actual error code if the queue is full. It indicates that an error has occurred but not been accepted. The queue can accept 5 entries.
- 360	Communication error An error has occurred during the transmission or reception of data on the IEC/IEEE bus or via the RS-232 interface.

Query Error — Error in data request; sets bit 2 in the ESR register.

Error code	Error text in the case of queue poll Error explanation
- 410	Query INTERRUPTED The query has been interrupted. Example: After a query, the instrument receives new data before the response has been sent completely.
- 420	Query UNTERMINATED The query is incomplete. Example: The instrument is addressed as a talker and receives incomplete data.
- 430	Query DEADLOCKED The query cannot be processed. Example: The input and output buffers are full, the instrument cannot continue operation.

SMT-Specific Error Messages

Device-dependent Error — device-specific error; sets bit 3 in the ESR register.

Error code	Error text in the case of queue poll Error explanation
105	Frequency underrange The frequency is below the limit value guaranteed.
106	Frequency overrange The frequency is beyond the limit value guaranteed.
110	Output unlevelled The level control loop is deactivated.
115	Level overrange The level is above the limit value guaranteed.
116	Level underrange The level is below the limit value guaranteed.
117	Dynamic level range exceeded The difference between the maximal and the minimal value of a level list is above 20 dBm. An exact level setting is no longer guaranteed.
131	AM modulation frequency out of range The AM modulation frequency is out of the permissible range.
132	PM modulation frequency out of range The PM modulation frequency is out of the permissible range.
140	This modulation forces other modulations OFF A modulation has been switched on which cannot be used at the same time as an already active modulation. The previous modulation has been witted off.
152	Input voltage out of range; EXT1 too high The input voltage at the EXT1 socket is too high.
153	Input voltage out of range; EXT1 too low The input voltage at the EXT1 socket is too low.
154	Input voltage out of range; EXT2 too high The input voltage at the EXT2 socket is too high.
155	Input voltage out of range; EXT2 too low The input voltage at the EXT2 socket is too low.
161	Output protection tripped The overvoltage protection has responded (cf. Section 2.5.8).
162	LF output overdriven The dependency of the LF output voltage on other parameters in stereo operation has caused that the LF output would have to supply more than 4 volts. However, the voltage has been limited to 4 volts.
171	Oven cold The reference oscillator has not yet reached its operating temperature.
180	Calibration failed Calibration could not be executed.
181	REF OSC calibration data not used because ADJUSTMENT STATE is ON The reference-oscillator calibration data are not used as long as ADJUSTMENT STATE is activated.
182	Calibration data missing Calibration data are missing in the device memory. The calibration data have to be generated first by an internal or external calibration or to be loaded into the device.

Continuation: Device-dependent Error

Error code	Error text in the case of queue poll Error explanation
200	Cannot access hardware The data transmission to a module was unsuccessful.
201	Function not supported by this hardware revision A later version of certain parts of the instrument is necessary to execute the function selected.
202	Diagnostic A/D converter failure Diagnostic A/D converter has failed.
222	Synthesizer loop unlocked The PLL of the synthesizer has not locked.
241	No list defined There is no list defined.
243	Dwell time adjusted A dwell time given on a list cannot be processed by the unit. The setting was automatically adjusted.
251	No User Correction Table; zero assumed An attempt has been made to switch on user correction, but no UCOR table has been stored in the instrument yet. The instrument behaves as if a table was called which only contains 0-values.
260	Invalid keyboard input ignored An invalid input via the keyboard is not considered.
265	This parameter is read only An attempt has been made to change a fixedly specified value.
270	Data output aborted Data output was aborted on the IEC/IEEE-bus. Example: The key [LOCAL] was pressed.
304	String too long A character string which is too long was received via the IEC bus. The names of lists may have a length of maximally seven letters.
305	Fill pattern too long; truncated More data have been entered with block function FILL in the list editor than the filling range (RANGE) set permits. The exceeding data are ignored.
306	No fill pattern specified An attempt was made to execute a filler function without having to indicate a filler pattern.

Annex C

List of Commands (with SCPI Conformity Information)

The SMT supports SCPI version 1994.0.

For remote control, commands which were specified or accepted in this SCPI version have been used to a large extent. Commands which are not part of the SCPI specification are marked "not SCPI" in the SCPI info.

Command	Parameter	Page	SCPI-Info
:ABORt [:SWEp]		3.16	not SCPI
:ABORt :MSEquence		3.16	not SCPI
:CALibration :FM [:MEASure]?		3.17	not SCPI
:CALibration :FM :DATA?		3.17	not SCPI
:CALibration :FM :OFFSet?		3.17	not SCPI
:CALibration :LEVel :DATA?		3.17	not SCPI
:CALibration :LEVel :FRANge	NORMAl MIXer	3.17	not SCPI
:CALibration :LEVel :PMODulator	ON OFF	3.17	not SCPI
:CALibration :LEVel :STATe	ON OFF	3.17	not SCPI
:CALibration :LPReset [:MEASure]?		3.18	not SCPI
:CALibration :LPReset :DATA?		3.18	not SCPI
:CALibration:PULSe [:MEASure]?		3.18	not SCPI
:CALibration :PULSe :DATA?		3.18	not SCPI
:CALibration :ROSCillator [:DATA]	0 to 4095	3.18	not SCPI
:CALibration :VSYNthesis [:MEASure]?		3.18	not SCPI
:CALibration :VSYNthesis :DATA?		3.17	not SCPI
:DIAGnostic :INFO :CCOunt :ATTenuator1 2 3 4 5 6?		3.19	
:DIAGnostic :INFO :CCOunt :POWer?		3.20	
:DIAGnostic :INFO :MODules?		3.20	
:DIAGnostic :INFO :OTIME?		3.20	
:DIAGnostic :INFO :SDATE?		3.20	
:DIAGnostic [:MEASure] :POINt?		3.20	
:DISPlay :ANNOtation [:ALL]	ON OFF	3.21	
:DISPlay :ANNOtation :AMPLitude	ON OFF	3.21	
:DISPlay :ANNOtation :FREQuency	ON OFF	3.21	

Command	Parameter	Page	SCPI-Info
:FORMat [:DATA]	ASCIi REAL[, 32 64] PACKed	3.22	
:MEMory :NSTates?		3.23	
:OUTPut :AMODE	AUTO FIXed	3.24	not SCPI
:OUTPut :BLANK [:POLarity]	NORMal INVerted	3.24	not SCPI
:OUTPut :IMPedance?		3.24	
:OUTPut :PROTection:CLEar		3.24	
:OUTPut :PROTection:TRIPped?		3.24	
:OUTPut [:STATE]	ON OFF	3.24	
:OUTPut [:STATE] :PON	OFF UNChanged	3.24	not SCPI
:OUTPut2 :SOURce	0 2	3.25	not SCPI
:OUTPut2 :SOURce :STEReo	MPX PILot	3.25	not SCPI
:OUTPut2 [:STATE]	ON OFF	3.25	
:OUTPut2 :VOLTage	0 V to 4 V	3.25	not SCPI
[:SOURce] :AM [:DEPTH]	0 to 100 PCT	3.27	
[:SOURce] :AM :EXTernal :COUPLing	AC DC	3.27	
[:SOURce] :AM :INTernal1 2:FREQuency	400 Hz 1 kHz 3 kHz 15 kHz / 0.1 Hz to 500 kHz / 0.1 Hz to 1 MHz	3.27	
[:SOURce] :AM :POLarity	NORMal INVerted	3.27	
[:SOURce] :AM :SOURce	INT1 2 EXT INT1 2 , EXT	3.27	
[:SOURce] :AM :STATE	ON OFF	3.27	
[:SOURce] :CORRection [:STATE]	ON OFF	3.28	
[:SOURce] :CORRection :CSET :CATalog?		3.28	not SCPI
[:SOURce] :CORRection :CSET [:SElect]	"Name"	3.28	
[:SOURce] :CORRection :CSET :DATA:FREQ	5kHz..1.5GHz {,5kHz..1.5GHz} SMT03/06: 5kHz ...3/6 GHz	3.28	not SCPI
[:SOURce] :CORRection :CSET :DATA:POWer	- 40... + 6dB {, - 40... + 6dB}	3.28	not SCPI
[:SOURce] :CORRection :CSET :DElete	"Name"	3.28	not SCPI
[:SOURce] :FM1 2 [:DEVIation]	0 to 10 MHz, SMT03/06: 0 to 20/40 MHz	3.29	
[:SOURce] :FM1 2 :EXTernal1 2 :COUPLing	AC DC	3.29	
[:SOURce] :FM1 2 :INTernal :FREQuency	400 Hz 1 kHz 3 kHz 15 kHz / 0.1 Hz to 500 kHz / 0.1 Hz to 1 MHz	3.30	
[:SOURce] :FM1 2 :SOURce	INT EXT1 EXT2	3.30	
[:SOURce] :FM1 2 :STATE	ON OFF	3.30	

Command	Parameter	Page	SCPI-Info
[[:SOURce]:FREQUency:CENTer	5 kHz to 1.5 GHz (SMT03/06: 3/6 GHz)	3.31	
[[:SOURce]:FREQUency[:CW :FIXed]	5 kHz to 1.5 GHz (SMT03/06: 3/6 GHz)	3.31	
[[:SOURce]:FREQUency[:CW :FIXed]:RCL	INCLude EXCLude	3.31	
[[:SOURce]:FREQUency:MANual	5 kHz to 1.5 GHz (SMT03/06: 3/6 GHz)	3.31	
[[:SOURce]:FREQUency:MODE	CW FIXed SWEEp	3.32	
[[:SOURce]:FREQUency:OFFSet	- 50 to + 50 GHz	3.32	
[[:SOURce]:FREQUency:SPAN	0 to 1.5 GHz	3.32	
[[:SOURce]:FREQUency:STARt	5 kHz to 1.5 GHz (SMT03/06: 3/6 GHz)	3.32	
[[:SOURce]:FREQUency:STOP	5 kHz to 1.5 GHz (SMT03/06: 3/6 GHz)	3.32	
[[:SOURce]:FREQUency:STEP[:INCRement]	0 to 1 GHz	3.32	
[[:SOURce]:ILS:STATe	ON OFF	3.33	not SCPI
[[:SOURce]:ILS:SOURce	INT2 INT2, EXT	3.33	not SCPI
[[:SOURce]:ILS:TYPE	GS GSLobe LOCALizer	3.34	not SCPI
[[:SOURce]:ILS[:GS GSLope]:MODE	NORM ULobe LLOBe	3.34	not SCPI
[[:SOURce]:ILS[:GS GSLope]:COMid[:STATe]	ON OFF	3.34	not SCPI
[[:SOURce]:ILS[:GS GSLope]:COMid:FREQUency	0.1 to 20 000 Hz	3.34	not SCPI
[[:SOURce]:ILS[:GS GSLope]:COMid:DEPTH	0 to 100 PCT	3.34	not SCPI
[[:SOURce]:ILS[:GS GSLope]:DDM[:DEPTH]	- 0.8 to + 0.8 PCT	3.35	not SCPI
[[:SOURce]:ILS[:GS GSLope]:DDM:DIRectioN	UP DOWN	3.35	not SCPI
[[:SOURce]:ILS[:GS GSLope]:DDM:CURREnt	- 685 to + 685 uA	3.35	not SCPI
[[:SOURce]:ILS[:GS GSLope]:DDM:LOGarithmic	- 999.9 to + 999.9	3.35	not SCPI
[[:SOURce]:ILS[:GS GSLope]:LLOBe[:FREQUency]	100 to 200 Hz	3.35	not SCPI
[[:SOURce]:ILS[:GS GSLope]:ULobe[:FREQ]	60 to 120 Hz	3.35	not SCPI
[[:SOURce]:ILS[:GS GSLope]:PHASe	0 to 120 deg	3.35	not SCPI
[[:SOURce]:ILS[:GS GSLope]:PRESet		3.36	not SCPI
[[:SOURce]:ILS[:GS GSLope]:SODEpth	0 to 100 PCT	3.36	not SCPI
[[:SOURce]:ILS:LOCALizer:MODE	NORM LLOBe RLOBe	3.36	not SCPI
[[:SOURce]:ILS:LOCALizer:COMid[:STATe]	ON OFF	3.37	not SCPI
[[:SOURce]:ILS:LOCALizer:COMid:FREQUency	0.1 to 20 000 Hz	3.37	not SCPI
[[:SOURce]:ILS:LOCALizer:COMid:DEPTH	0 to 100 PCT	3.37	not SCPI
[[:SOURce]:ILS:LOCALizer:DDM[:DEPTH]	- 0.4 to + 0.4 PCT	3.37	not SCPI
[[:SOURce]:ILS:LOCALizer:DDM:DIRectioN	LEFT RIGHT	3.37	not SCPI
[[:SOURce]:ILS:LOCALizer:DDM:CURREnt	- 387 to + 387 uA	3.37	not SCPI
[[:SOURce]:ILS:LOCALizer:DDM:LOGarithmic	- 999.9 to + 999.9	3.37	not SCPI
[[:SOURce]:ILS:LOCALizer:LLOBe[:FREQUency]	60 to 120 Hz	3.38	not SCPI
[[:SOURce]:ILS:LOCALizer:RLOBe[:FREQUency]	100 to 200 Hz	3.38	not SCPI
[[:SOURce]:ILS:LOCALizer:PHASe	0 to 120 deg	3.38	not SCPI
[[:SOURce]:ILS:LOCALizer:PRESet		3.38	not SCPI
[[:SOURce]:ILS:LOCALizer:SODEpth	0 to 100 PCT	3.38	not SCPI

Command	Parameter	Page	SCPI-Info
[[:SOURce]:MARKer1 2 3[:FSWeep]:AMPL [:SOURce]:MARKer1 2 3[:FSWeep]:AOFF [:SOURce]:MARKer1 2 3[:FSWeep]:FREQUency	ON OFF 5 kHz to 1.5 GHz (SMT03/06:3/6 GHz)	3.39 3.39 3.39	
[[:SOURce]:MARKer1 2 3[:FSWeep]:STATe]	ON OFF	3.40	not SCPI
[[:SOURce]:MARKer1 2 3:PSWeep:AOFF [:SOURce]:MARKer1 2 3:PSWeep:POWer [:SOURce]:MARKer1 2 3:PSWeep:STATe]	 – 144 to + 16 dBm ON OFF	3.40 3.40 3.40	not SCPI not SCPI
[[:SOURce]:MARKer:POLarity]	NORMAL INVERTed	3.40	
[[:SOURce]:MBEacon:STATe [:SOURce]:MBEacon[:MARKer]:FREQUency [:SOURce]:MBEacon[:MARKer]:DEPTH [:SOURce]:MBEacon:COMid[:STATe] [:SOURce]:MBEacon:COMid:FREQUency [:SOURce]:MBEacon:COMid:DEPTH]	ON OFF 400 Hz 1300 Hz 3000 Hz 0 to 100 PCT ON OFF 0.1 to 20 000 Hz 0 to 100 PCT	3.41 3.41 3.41 3.41 3.41	not SCPI not SCPI not SCPI not SCPI not SCPI
[[:SOURce]:PHASe[:ADJust] [:SOURce]:PHASe:REFerence]	– 360 to + 30 deg	3.42 3.42	
[[:SOURce]:PM1 2[:DEViation] [:SOURce]:PM1 2:BANDwidth [:SOURce]:PM1 2:EXTernal1 2:COUPLing [:SOURce]:PM1 2:INTernal:FREQUency [:SOURce]:PM1 2:SOURce [:SOURce]:PM1 2:STATe]	– 360 to + 360 deg 100 kHz 2 MHz AC DC 400 Hz 1kHz 3kHz 15kHz 0.1 Hz to 500 kHz / 0.1Hz to 1 MHz INT EXT1 2 INT, EXT1 2 ON OFF	3.43 3.43 3.43 3.44 3.44 3.44	
[[:SOURce]:POWer:ALC:BANDwidth [:SOURce]:POWer:ALC:BANDwidth:AUTO [:SOURce]:POWer:ALC[:STATe] [:SOURce]:POWer[:LEVel][:IMMEDIATE]:AMPL [:SOURce]:POWer[:LEVel][:IMMEDIATE]:OFFSet [:SOURce]:POWer[:LEVel][:IMMEDIATE]:RCL [:SOURce]:POWer:LIMit[AMPLitude] [:SOURce]:POWer:MANual [:SOURce]:POWer:MODE [:SOURce]:POWer:STARt [:SOURce]:POWer:STOP [:SOURce]:POWer:STEP[:INCRement]	100 Hz 500 kHz ON OFF ONCE ON OFF – 144 to + 16 dBm – 100 to 100 dB INCLude EXCLude – 144 to + 16 dBm – 144 to + 16 dBm FIXed SWEEp – 144 to + 16 dBm – 144 to + 16 dBm 0.1 to 10 dB	3.45 3.45 3.45 3.46 3.46 3.46 3.46 3.46 3.47 3.47 3.47 3.47	

Command	Parameter	Page	SCPI-Info
[[:SOURce]:PULM:EXTernal:IMPedance	50 Ohm 10 kOhm	3.48	
[[:SOURce]:PULM:INTernal:FREQuency	0.01176 Hz to 10 MHz	3.48	
[[:SOURce]:PULM:POLarity	NORMal INVerted	3.48	
[[:SOURce]:PULM:SOURce	INTernal EXTernal	3.48	
[[:SOURce]:PULM:STATE	ON OFF	3.48	
[[:SOURce]:PULSe:DELay	40 ns to 1 s	3.49	
[[:SOURce]:PULSe:DOUBle:DELay	60 ns to 1 s	3.49	
[[:SOURce]:PULSe:DOUBle[:STATE]	ON OFF	3.49	
[[:SOURce]:PULSe:PERiod	100 ns to 85 s	3.49	
[[:SOURce]:PULSe:WIDTh	20 ns to 1 s	3.49	
[[:SOURce]:ROSCillator[:INTernal]:ADJust:STATE	ON OFF	3.50	not SCPI
[[:SOURce]:ROSCillator[:INTernal]:ADJust:VALue	0 to 4095	3.50	not SCPI
[[:SOURce]:ROSCillator:SOURce	INTernal EXTernal	3.50	
[[:SOURce]:STEReo:STATE	ON OFF	3.51	not SCPI
[[:SOURce]:STEReo[:DEViation]	0 Hz to 100 kHz	3.51	not SCPI
[[:SOURce]:STEReo:SIGNAL	AUDio ARI	3.51	not SCPI
[[:SOURce]:STEReo:AUDio[:FREQuency]	0.1 Hz to 15 kHz	3.51	not SCPI
[[:SOURce]:STEReo:AUDio:PREemphasis	OFF 50 us 75 us	3.52	not SCPI
[[:SOURce]:STEReo:AUDio:MODE	RIGHT LEFT RELeft REMLeft	3.52	not SCPI
[[:SOURce]:STEReo:PILot:STATE	ON OFF	3.52	not SCPI
[[:SOURce]:STEReo:PILot[:DEViation]	0 Hz to 10 kHz	3.52	not SCPI
[[:SOURce]:STEReo:PILot:PHASe	0 to 360 deg	3.52	not SCPI
[[:SOURce]:STEReo:ARI[:DEViation]	0 Hz to 10 kHz	3.53	not SCPI
[[:SOURce]:STEReo:ARI:TYPE	BK DK	3.53	not SCPI
[[:SOURce]:STEReo:ARI:BK:TYPE	A B C D E F	3.53	not SCPI
[[:SOURce]:SWEep:BTIME	NORMal LONG	3.54	not SCPI
[[:SOURce]:SWEep[:FREQuency]:DWELI	10 ms to 5 s	3.54	not SCPI
[[:SOURce]:SWEep[:FREQuency]:MODE	AUTO MANual STEP	3.54	not SCPI
[[:SOURce]:SWEep[:FREQuency]:POINts	Number	3.55	not SCPI
[[:SOURce]:SWEep[:FREQuency]:SPACing	LINear LOGarithmic	3.55	not SCPI
[[:SOURce]:SWEep[:FREQuency]:STEP[:LINear]	0 to 1 GHz	3.55	not SCPI
[[:SOURce]:SWEep[:FREQuency]:STEP:LOG	0.01 to 50 PCT	3.55	not SCPI
[[:SOURce]:SWEep:POWER:DWELI	10 ms to 5 s	3.56	not SCPI
[[:SOURce]:SWEep:POWER:MODE	AUTO MANual STEP	3.56	not SCPI
[[:SOURce]:SWEep:POWER:POINts	Number	3.56	not SCPI
[[:SOURce]:SWEep:POWER:SPACing	LOGarithmic	3.56	not SCPI
[[:SOURce]:SWEep:POWER:STEP:LOGarithmic	0 to 10 dBm	3.56	not SCPI

Command	Parameter	Page	SCPI-Info
[:SOURce] :VOR :STATe	ON OFF	3.57	not SCPI
[:SOURce] :VOR :SOURce	INT2 INT2, EXT	3.57	not SCPI
[:SOURce] :VOR :MODE	NORM VAR SUBCarrier FMSubcarrier	3.58	not SCPI
[:SOURce] :VOR [:BANGle]	0 to 360 deg	3.58	not SCPI
[:SOURce] :VOR [:BANGle] :DIRectiOn	FROM TO	3.58	not SCPI
[:SOURce] :VOR :VAR [:DEPTh]	0 PCT to 100 PCT	3.58	not SCPI
[:SOURce] :VOR :VAR :FREQuency	20 to 40 Hz	3.58	not SCPI
[:SOURce] :VOR :SUBCarrier :DEPTh	0 to 100 PCT	3.59	not SCPI
[:SOURce] :VOR :SUBCarrier [:FREQuency]	5 to 15 kHz	3.59	not SCPI
[:SOURce] :VOR :REFerence [:DEViatiOn]	0 to 960 Hz	3.59	not SCPI
[:SOURce] :VOR :PRESet		3.59	not SCPI
[:SOURce] :VOR :COMid [:STATe]	ON OFF	3.59	not SCPI
[:SOURce] :VOR :COMid :FREQuency	0.1 Hz to 20 kHz	3.59	not SCPI
[:SOURce] :VOR :COMid :DEPTh	0 to 100 PCT	3.59	not SCPI
:SOURce0 2 :FREQuency [:CW :FIXed]	0.1Hz to 500kHz or 1MHz	3.60	
:SOURce0 2 :FREQuency :MANual	0.1Hz to 500kHz or 1MHz	3.61	
:SOURce0 2 :FREQuency :MODE	CW FIXed SWEep	3.61	
:SOURce2 :FREQuency :STARt	0.1Hz to 500kHz / 0.1 Hz to 1MHz	3.61	
:SOURce2 :FREQuency :STOP	0.1Hz to 500kHz / 0.1 Hz to 1MHz	3.61	
:SOURce0 2 :FUNCTiOn [:SHAPE]	SINusoid SQUARE TRIangle PRNoise SAWTooth	3.61	
:SOURce2 :MARKer [:FSWEEP] :AOff		3.62	not SCPI
:SOURce2 :MARKer [:FSWEEP] :FREQuency	0.1 Hz to 500 kHz	3.62	not SCPI
:SOURce2 :MARKer [:FSWEEP] [:STATe]	ON OFF	3.62	not SCPI
:SOURce2 :MARKer :POLarity	NORMAL INVERTed	3.62	not SCPI
:SOURce2 :SWEep :BTIME	NORMAL LONG	3.63	not SCPI
:SOURce2 :SWEep [:FREQuency] :DWELl	10 ms to 5 s	3.63	not SCPI
:SOURce2 :SWEep [:FREQuency] :MODE	AUTO STEP	3.63	not SCPI
:SOURce2 :SWEep [:FREQuency] :POINts	Number	3.64	not SCPI
:SOURce2 :SWEep [:FREQuency] :SPACing	LINear LOGarithmic	3.64	not SCPI
:SOURce2 :SWEep [:FREQuency] :STEP [:LIN]	0 to 500 kHz	3.64	not SCPI
:SOURce2 :SWEep [:FREQuency] :STEP :LOG	0.01 to 50 PCT	3.64	not SCPI
:STATus :OPERation [:EVENT]?		3.65	
:STATus :OPERation :CONDitiOn?		3.65	
:STATus :OPERation :PTRansiOn	0 to 32767	3.65	
:STATus :OPERation :NTRansiOn	0 to 32767	3.65	
:STATus :OPERation :ENABle	0 to 32767	3.66	

Command	Parameter	Page	SCPI-Info
:STATus:PRESet		3.66	
:STATus:QUESTionable[:EVENT]?		3.66	
:STATus:QUESTionable:CONDition?		3.66	
:STATus:QUESTionable:PTRansition	0...32767	3.66	
:STATus:QUESTionable:NTRansition	0...32767	3.66	
:STATus:QUESTionable:ENABLE	0...32767	3.66	
:STATus:QUEue[:NEXT]?		3.66	
:SYSTem:BEEPer:STATe	ON OFF	3.68	
:SYSTem:COMMunicate:GPIB[:SELF]:ADDRess	1 to 30	3.67	
:SYSTem:COMMunicate:SERial:CONTRol:RTS	ON IBFull RFR	3.68	
:SYSTem:COMMunicate:SERial:BAUD	1200 2400 4800 9600 19200 38400 57600 115200	3.68	
:SYSTem:COMMunicate:SERial:PACE	XON NONE	3.68	
:SYSTem:ERRor?		3.68	
:SYSTem:KLOCK	ON OFF	3.68	
:SYSTem:MODE	FIXed MSEQUence	3.69	not SCPI
:SYSTem:MSEQUence:CATalog?		3.69	not SCPI
:SYSTem:MSEQUence:DELeTe	"Name of sequence"	3.69	not SCPI
:SYSTem:MSEQUence:DELeTe:ALL		3.69	not SCPI
:SYSTem:MSEQUence:DWELL	Number {,number}	3.69	not SCPI
:SYSTem:MSEQUence:FREE?		3.69	not SCPI
:SYSTem:MSEQUence:MODE	AUTO STEP	3.690	not SCPI
:SYSTem:MSEQUence[:RCL]	1 to 50 {,1 to 50}	3.70	not SCPI
:SYSTem:MSEQUence[:RCL]:POINts?		3.70	not SCPI
:SYSTem:MSEQUence:SELeCt	"Name of sequence"	3.70	not SCPI

Command	Parameter	Page	SCPI-Info
:SYSTem :PRESet		3.70	
:SYSTem :PROTect1 2 3 [:STATe]	ON OFF [,password]	3.70	not SCPI
:SYSTem :SECurity [:STATe]	ON OFF	3.70	
:SYSTem :SERRor?		3.71	
:SYSTem :VERsion?		3.71	
:TEST :DIRect :ATTC	Subaddress {,hex data string}	3.72	
:TEST :DIRect :LFGENA	Subaddress {,hex data string}	3.73	
:TEST :DIRect :LFGENB	Subaddress {,hex data string}	3.73	
:TEST :DIRect :MGEN	Subaddress {,hex data string}	3.73	
:TEST :DIRect :OPU1M	Subaddress {,hex data string}	3.73	
:TEST :DIRect :OPU3M	Subaddress {,hex data string}	3.73	
:TEST :DIRect :OPU6M	Subaddress {,hex data string}	3.73	
:TEST :DIRect :PUM	Subaddress {,hex data string}	3.73	
:TEST :DIRect :TSYN	Subaddress {,hex data string}	3.73	
:TEST :DIRect :ROSC	Subaddress {,hex data string}	3.73	
:TEST :RAM?		3.73	
:TEST :ROM?		3.73	
:TEST :BATTery?		3.73	
:TRIGger1 2 [:SWEep] [:IMMediate]		3.74	not SCPI
:TRIGger1 2 [:SWEep] :SOURce	SINGle EXTernal AUTO	3.75	not SCPI
:TRIGger :MSEQuence [:IMMediate]		3.75	not SCPI
:TRIGger :MSEQuence :SOURce	SINGle EXTernal AUTO	3.75	not SCPI
:TRIGger :PULSe :SOURce	EXTernal AUTO	3.76	not SCPI
:TRIGger :PULSe :SLOPe	POSitive NEGative	3.76	not SCPI
:TRIGger :SLOPe	POSitive NEGative EITHer	3.76	not SCPI
:UNIT :ANGLE	DEGRee DEGree RADian	3.76	
:UNIT :POWer	DBM DBW DBMW DBUW DBV DBMV DBUV V	3.76	

Annex D

Programming Examples

The examples explain the programming of the instrument and can serve as a basis to solve more complex programming tasks.

QuickBasic has been used as programming language. However, the programs can be translated into other languages.

1. Including IEC-Bus Library for QuickBasic

```
REM ----- Include IEC-bus library for quickbasic -----  
'$INCLUDE: 'c:\qbasic\qbdecl4.bas'
```

2. Initialization and Default Status

The IEC bus as well as the settings of the instrument are brought into a defined default status at the beginning of every program. Subroutines "InitController" and "InitDevice" are used to this effect.

2.1. Initiate Controller

```
REM ----- Initiate controller -----  
REM InitController  
ieaddress% = 28 'IEC-bus address of the instrument  
CALL IBFIND("DEV1", generator%) 'Open port to the instrument  
CALL IBPAD(generator%, ieaddress%) 'Inform controller on instrument address  
CALL IBTMO(generator%, 11) 'Response time to 1 sec  
REM *****
```

2.2. Initiate Instrument

The IEC-bus status registers and instrument settings of the SMT are brought into the default status.

```
REM ----- Initiate instrument -----  
REM InitDevice  
CALL IBWRT(generator%, "*cls") 'Reset status register  
CALL IBWRT(generator%, "*rst") 'Reset instrument  
CALL IBWRT(generator%, "OUTPUT ON") 'Switch on RF output  
REM *****
```

3. Transmission of Instrument Setting Commands

Output frequency, output level and AM modulation are set in this example. The settings correspond to the sample setting for first users in manual control. By analogy to the step width setting of the rotary knob, the step width is additionally set for the alteration of the RF frequency in the case of UP and DOWN.

```
REM ----- Instrument setting commands -----
CALL IBWRT(generator%, "FREQUENCY 250E6")      'RF frequency 250 MHz
CALL IBWRT(generator%, "POWER 10")            'Output power -10 dBm
CALL IBWRT(generator%, "AM 80")               'AM with modulation index of 80%
CALL IBWRT(generator%, "AM:INTERNAL1:FREQUENCY 3KHZ") 'Modulation frequency 3 kHz
CALL IBWRT(generator%, "AM:SOURCE INT1")      'Modulation source LF generator 1
CALL IBWRT(generator%, "FREQUENCY:STEP 12500") 'Step width RF frequency 12.5 kHz
REM *****
```

4. Switchover to Manual Control

```
REM ----- Switch instrument over to manual control -----
CALL IBLOC(generator%)                        'Set instrument to Local state
REM *****
```

5. Reading out Instrument Settings

The settings made in example 3 are read out here. The abbreviated commands are used.

```
REM ----- Reading out instrument settings -----
Rffrequency$ = SPACES$(20)                   'Provide text variables with 20 characters
CALL IBWRT(generator%, "FREQ?")              'Request frequency setting
CALL IBRD(generator%, Rffrequency$)          'Read value

RFlevel$ = SPACES$(20)                       'Provide text variables with 20 characters
CALL IBWRT(generator%, "POW?")               'Request level setting
CALL IBRD(generator%, RFlevel$)              'Read value

AMmodulation depth$ = SPACES$(20)            'Provide text variables with 20 characters
CALL IBWRT(generator%, "AM?")                'Request setting of modulation depth
CALL IBRD(generator%, AMmodulation depth$)   'Read value

AMfrequency$ = SPACES$(20)                   'Provide text variables with 20 characters
CALL IBWRT(generator%, "AM:INT1:FREQ?")     'Request modulation frequency setting
CALL IBRD(generator%, AMfrequency$)         'Read value

Step width$ = SPACES$(20)                    'Provide text variables with 20 characters
CALL IBWRT(generator%, "FREQ:STEP?")        'Request step width setting
CALL IBRD(generator%, step width$)          'Read value

REM ----- Display values on the screen -----
PRINT "RF frequency:      "; Rffrequency$,
PRINT "RF level:         "; RFlevel$,
PRINT "AM modulation depth:"; AMmodulation depth$,
PRINT "AM frequency:     "; AMfrequency$,
PRINT "Step width:       "; step width$
REM *****
```

6. List Management

```
REM ----- Example of list management -----
CALL IBWRT(generator%, "SYST:MSEQ:SELECT "+CHR$(34)+"MSEQ1"+CHR$(34))
                                'Select list "MSEQ1". is generated if necessary
CALL IBWRT(generator%, "SYST:MSEQ 1,3,7,2,5,7,7")
                                'Fill recall list with values
CALL IBWRT(generator%, "SYST:MSEQ:DWELL 0.2")      '200ms per recall
CALL IBWRT(generator%, "TRIGGER:MSEQ:SOURCE AUTO")
                                'Permanently repeat memory sequence automatically
CALL IBWRT(generator%, "SYST:MODE MSEQ")          'Switch over instrument to memory sequence mode
REM *****
```

7. Command synchronization

The possibilities for synchronization implemented in the following example are described in Section 3.7.6, Command Order and Command Synchronization.

```
REM ----- Examples of command synchronization -----
REM Command ROSCILLATOR:SOURCE INT has a relatively long execution time
REM (over 300ms). It is to be ensured that the next command is only executed
REM when the reference oscillator has settled.

REM First possibility: Use of *WAI -----
CALL IBWRT(generator%, "ROSCILLATOR:SOURCE INT; *WAI; :FREQUENCY 100MHZ")

REM Second possibility: Use of *OPC? -----
OpcOk$ = SPACE$(2)                'Space for *OPC? - Provide response
CALL IBWRT(generator%, "ROSCILLATOR:SOURCE INT; *OPC?")
REM ----- here the controller can service other instruments -----
CALL IBRD(generator%, OpcOk$)      'Wait for "1" from *OPC?

REM Third possibility: Use of *OPC
REM In order to be able to use the service request function in conjugation with a National
REM Instruments GPIB driver, the setting "Disable Auto Serial Poll" must be changed to "yes"
REM by means of IBCONF.
CALL IBWRT(generator%, "*SRE 32")  'Permit service request for ESR
CALL IBWRT(generator%, "*ESE 1")  'Set event-enable bit for operation-complete bit
ON PEN GOSUB OpcReady             'Initialization of the service request routine
PEN ON
CALL IBWRT(generator%, "ROSCILLATOR:SOURCE INT; *OPC")
REM Continue main program here
STOP                              'End of program

OpcReady:
REM As soon as the reference oscillator has settled, this subroutine is activated
REM Program suitable reaction to the OPC service request.
ON PEN GOSUB OpcReady             'Enable SRQ routine again
RETURN
REM *****
```

8. Service Request

The service request routine requires an extended initialization of the instrument in which the respective bits of the transition and enable registers are set.

In order to be able to use the service request function in conjugation with a National Instruments GPIB driver, the setting "Disable Auto Serial Poll" must be changed to "yes" by means of IBCONF.

```
REM ----- Example of initialization of the SRQ in the case of errors -----
CALL IBWRT(generator%, "*CLS")           'Reset status reporting system
CALL IBWRT(generator%, "*SRE 168")      'Permit service request for
                                        STAT:OPER-, STAT:QUES- and ESR register
CALL IBWRT(generator%, "**ESE 60")      'Set event-enable bit for
                                        command, execution, device-dependent
                                        and query error
CALL IBWRT(generator%, "STAT:OPER:ENAB 32767") 'Set OPERation enable bit for all
                                        events
CALL IBWRT(generator%, "STAT:OPER:PTR 32767") 'Set appropriate OPERation Ptransition
                                        bits
CALL IBWRT(generator%, "STAT:OPER:ENAB 32767") 'Set questionable enable bits for all
                                        events
CALL IBWRT(generator%, "STAT:OPER:PTR 32767") 'Set appropriate questionable
                                        Ptransition bits
ON PEN GOSUB Srq                        'Initialization of the service request routine
PEN ON
REM Continue main program here
STOP                                    'End of program
```

A service request is then processed in the service request routine.

Note: The variables *userN%* and *userM%* must be pre-assigned usefully.

```
Srq:
REM ----- Service request routine -----
DO
  SRQFOUND% = 0
  FOR I% = userN% TO userM%              'Poll all bus users
    ON ERROR GOTO nouser                 'No user existing
    CALL IBRSP(I%, STB%)                 'Serial poll, read status byte
    IF (STB% AND 64) > 0 THEN             'This instrument has bits set in the STB
      SRQFOUND% = 1
      IF (STB% AND 16) > 0 THEN GOSUB Outputqueue
      IF (STB% AND 4) > 0 THEN GOSUB Failure
      IF (STB% AND 8) > 0 THEN GOSUB Questionablestatus
      IF (STB% AND 128) > 0 THEN GOSUB Operationstatus
      IF (STB% AND 32) > 0 THEN GOSUB Esrread
    END IF
  NEXT I%
LOOP UNTIL SRQFOUND% = 0
ON ERROR GOTO error handling
ON PEN GOSUB Srq: RETURN                 'Enable SRQ routine again;
                                        'End of SRQ routine
```

Reading out the status event registers, the output buffer and the error/event queue is effected in subroutines.

```
REM ----- Subroutines for the individual STB bits -----
```



```

Outputqueue:                                'Reading the output buffer
Message$ = SPACE$(100)                       'Make space for response
CALL IBRD(generator%, Message$)
PRINT "Message in output buffer :"; Message$
RETURN
Failure:                                     'Read error queue
ERROR$ = SPACE$(100)                         'Make space for error variable
CALL IBWRT(generator%, "SYSTEM:ERROR?")
CALL IBRD(generator%, ERROR$)
PRINT "Error text :"; ERROR$
RETURN

```

```

Questionablestatus:                         'Read questionable status register
Ques$ = SPACE$(20)                          'Preallocate blanks to text variable
CALL IBWRT(generator%, "STATus:QUESTionable:EVENT?")
CALL IBRD(generator%, Ques$)
IF (VAL(Ques$) AND 128) > 0 THEN PRINT "Calibration ?" 'Calibration is questionable
IF (VAL(Ques$) AND 1) > 0 THEN PRINT "Voltage ?"      'Output level is questionable
RETURN

```

```

Operationstatus:                            'Read operation status register
Oper$ = SPACE$(20)                          'Preallocate blanks to text variable
CALL IBWRT(generator%, "STATus:OPERation:EVENT?")
CALL IBRD(generator%, Oper$)
IF (VAL(Oper$) AND 1) > 0 THEN PRINT "Calibration"
IF (VAL(Oper$) AND 2) > 0 THEN PRINT "Settling"
IF (VAL(Oper$) AND 4) > 0 THEN PRINT "Ranging"
IF (VAL(Oper$) AND 8) > 0 THEN PRINT "Sweeping"
IF (VAL(Oper$) AND 32) > 0 THEN PRINT "Wait for trigger"
RETURN

```

```

Esrread:                                    'Read event status register
Esr$ = SPACE$(20)                           'Preallocate blanks to text variable
CALL IBWRT(generator%, "*ESR?")             'Read ESR
CALL IBRD(generator%, Esr$)
IF (VAL(Esr$) AND 1) > 0 THEN PRINT "Operation complete"
IF (VAL(Esr$) AND 4) > 0 THEN GOTO Failure
IF (VAL(Esr$) AND 8) > 0 THEN PRINT "Device dependent error"
IF (VAL(Esr$) AND 16) > 0 THEN GOTO Failure
IF (VAL(Esr$) AND 32) > 0 THEN GOTO Failure
IF (VAL(Esr$) AND 64) > 0 THEN PRINT "User request"
IF (VAL(Esr$) AND 128) > 0 THEN PRINT "Power on"
RETURN
REM *****

```

```

REM ----- Error routine -----
Error handling:
PRINT "ERROR"                               ' Output error message
STOP                                         ' Stop software

```

Index

A

Aborting triggered actions 3.16
 Addressed commands 3.4, 6A.3
 Airplane position 2.59, 3.58
 Alternate Switching Off of Modulations 2.47
 AM Distortion Factor 5.18
 AM Frequency Response 5.18
 AM noise 2.42
 Amplitude
 – marker 2.74, 3.39
 – modulation 2.50, 3.26
 – modulator 2.87
 Antenna lobe 2.62, 2.65, 3.35, 3.37
 Area code (BK) 2.58, 3.53
 ARI auxiliary carrier 2.58, 3.53
 ARI traffic channel signal 2.57, 3.51
 Asterix 3.10
 Attenuator 1.5, 2.41, 3.23
 Attenuator circuits 2.85, 2.92
 Audio signal 2.57, 3.51
 Automatic
 level monitoring 2.45, 2.60, 2.63, 2.66, 3.24, 5.17, 5.19
 Avionic systems 2.58

B

Bandwidth of the level control 2.42, 3.45
 Basic unit 3.8
 Battery 1.2, 4.1
 Bearing angle (VOR) 2.59, 3.58
 Beeper 2.95, 3.67
 BK signal (area code) 2.58, 3.53
 Blank duration 2.94, 3.54, 3.63
 BLANK output 2.13, 2.72, 2.94, 3.24
 Block data 3.10, 3.22
 Boolean parameters 3.8
 Braces 3.12
 Brightness
 – display 1.2
 – oscilloscope 2.72
 Broadband noise 5.11
 Broadcasting code (DK) 2.58, 3.53
 Baud rate 2.81, 3.68, 6A.5

C

Calibration
 – FM 2.88, 3.17
 – password 2.85, 3.70
 – level 2.86, 3.17
 – level preset 2.87, 3.18
 – pulse generator 2.89, 3.18
 – reference oscillator 2.86, 3.18
 – VCO SYN 2.86, 3.18
 Calling menus 2.21
 Carrier frequency deviation with FM 5.21
 Caution messages 2.97
 Center frequency 2.73, 3.31
 Changing the level unit 2.22, 3.76
 Character data 3.8
 CMOS-RAM 1.2
 Colon 3.10
 Com/Id signal
 – ILS test signals 2.63, 2.66, 3.38
 – Marker Beacon signals 2.67, 3.41
 – VOR test signals 2.60, 3.59
 Comma 3.7
 Command
 – line 3.8
 – recognition 3.78
 – sequence 3.79
 – synchronization 3.79, 9D.3
 Common commands 3.5, 3.13

Com/Id signal
 – ILS-GS test signals 2.63, 3.34
 – ILS-LOC test signals 2.66, 3.37
 – Marker-Beacon test signals 2.67, 3.41
 – VOR test signals 2.60, 3.59
 Condition register 3.81
 Configure the screen 3.21
 Contrast 1.2
 Control signal 2.54
 Correction
 – input 2.22
 – output level 2.43, 3.28
 Counter 2.85, 3.19
 Coupling
 – external AM input 2.50, 3.27
 – external FM input 2.51, 3.29
 – external PM input 2.53, 3.43
 Course line/sector 2.66
 Current of ILS indicating instrument 2.62, 2.65, 3.35, 3.37

D

Data
 – bit 2.81, 3.67, 6A.5
 – format 3.22
 – lines 3.4, 6A.1
 – loss 2.82, 3.71
 – set 3.78
 Date of software creation 3.20
 DDM value
 – ILS-GS 2.62, 3.34
 – ILS-LOC 2.65, 3.36
 Decimal point 2.3, 3.9
 Default setting 1.3, 2.7, 3.15, 3.70, 3.88
 Delay time
 – double pulse 2.56, 3.49
 Deletion
 – all data stored 2.82, 3.71
 – lists 2.28, 3.28, 3.69
 – input 2.22
 Delimiter 3.77
 Delta phase 2.84, 3.42
 Deviation
 – frequency modulation 2.51, 3.29
 – phase modulation 2.53, 3.43
 – pilot tone 2.58, 3.52
 – reference signal (VOR) 2.60, 3.59
 – stereo multiplex signal 2.57, 3.51
 Device message 3.5
 Device response 3.5
 Diagnostic test 2.92, 3.19
 Difference in depth of modulation 2.62, 2.65, 3.34, 3.36
 Digit cursor 2.18
 Disabling
 – calibrations 2.85, 3.70
 – certain instrument functions 3.71
 – keyboard 3.3, 3.70
 Display 1.2, 2.1
 DK (broadcasting code) 2.58, 3.53
 Double pulse 2.56, 3.49
 Dwell list 2.79, 3.69
 Dwell time
 – level sweep 2.75, 3.56
 – LF-sweep 2.76, 3.63
 – RF-sweep 2.73, 3.54
 – memory sequence 2.79, 3.68
 Dynamic characteristics 5.25

E

Editing	
– input value	2.20
– list	2.26, 3.28, 3.69
Edge of external trigger signal	
– PULSE input	2.56, 3.75
– TRIGGER input	2.94, 3.76
EMF	2.45
Enable register	3.81
Envelope	2.54
EOI	3.8
ESE	3.13, 3.84
ESR	3.13, 3.84
Error messages	2.97, 7B.1
Error queue	3.87
Event register	3.81
Event status register	3.13, 3.84
Event status enable register	3.13, 3.84
Exponent	3.9
EXT1 / EXT2 inputs	2.11, 2.46
External detuning	2.83, 3.50
External modulation sources	2.47
External trigger	
– active edge	2.56, 2.78, 2.94, 3.76
– memory sequence	2.78, 3.76
– pulse modulation	2.56, 3.75
– sweep	2.71, 3.76

F

Filling a list	2.31
FM	
– deviation limits	2.52
– deviation setting	5.20
– distortion factor	5.21
– frequency response	5.20
– generator	2.51, 2.68, 3.30
– stereo multiplex signal	2.69, 3.25, 3.51, 5.22
– subcarrier (VOR)	2.60, 3.59
Frequency	
– amplitude modulation	2.50, 3.27
– antenna lobe	2.62, 2.65, 3.35, 3.37
– audio signal	2.57, 3.51
– Com/Id signal (ILS-GS)	2.63, 3.34
– Com/Id signal (ILS-LOC)	2.66, 3.37
– Com/Id signal (marker beacon)	2.67, 3.41
– Com/Id signal (VOR)	2.60, 3.59
– FM carrier	2.60, 3.59
– frequency modulation	2.51, 3.29
– LF generator	2.68, 3.60
– LF sweep	2.76, 3.60, 3.62
– marker beacon signal	2.67, 3.41
– phase modulation	2.53, 3.43
– pulse modulation	2.54, 3.48
– RF signal	2.30, 3.31
– RF sweep	2.73, 3.32
– VAR signal	2.60, 3.58
Frequency accuracy	1.2, 5.5
Frequency deviation	
– frequency modulation	2.51, 3.29
– stereo multiplex signal	2.57, 3.51
– pilot tone	2.58, 3.52
– reference signal (VOR)	2.60, 3.59
Frequency indications	2.18, 2.82, 3.21
Frequency marker	
– LF-sweep	2.76, 3.62
– RF-sweep	2.74, 3.39
Frequency offset	2.40, 3.32
Frequency sweep	
– LF	2.76, 3.63
– RF	2.73, 3.54
Front unit	1.5

G

Generating a list	2.27
GET (Group Execute Trigger)	3.78
Glide path / sector	2.63
Glide slope signal	2.61, 3.34

H

Harmonics suppression	5.8
Header	3.6
Header field of the display	2.18
Heterodyne band	2.52, 2.54

I

IEC-bus	
– address	2.80, 3.67
– control	3.1
– interface	3., 1, 6A.1
ILS-Glide Slope modulation	2.61, 3.34
ILS-Localizer modulation	2.64, 3.36
Impedance	
– PULSE input	2.11, 3.48
– RF output	.11, 3.24
Incompatible types of modulation	2.47
Initial status	1.2
Input	2.13
– EXT1 / EXT1	2.11, 2.46
– PULSE	2.11, 2.54, 3.75
– REF	2.13, 2.83, 3.50
– TRIGGER	2.13, 2.71, 2.78, 2.94, 3.74
– TUNE	2.13, 2.83
Input buffer	3.77
Input resistance	2.11, 2.13
Input sockets for the different types of modulation	2.46
Inserting sequence	2.32
Instrument current	2.62, 2.65, 3.35, 3.37
INT1 / INT2	3.27, 3.60
Interface message DCL	3.77
Interface messages	3.4, 6A.3
Intermodulation ratio	2.42
Interrupt-free level setting	2.42, 3.23, 5.16
IST flag	3.14, 3.84

K

Key word	3.6
Key	
– [1x/ENTER]	2.5, 2.20
– [ASSIGN]	2.9, 2.21
– [ERROR]	1.3, 2.7, 2.97
– [FREQ]	2.3, 2.22, 2.39
– [HELP]	2.7, 2.96
– [LEVEL]	2.3, 2.40
– [LOKAL]	2.7, 3.3
– [MENU1]	2.9, 2.21
– [MOD ON/OFF]	2.7, 2.48, 2.93
– [PRESET]	1.3, 2.7, 3.15
– [RCL]	2.3, 2.37
– [RETURN]	2.6, 2.19
– [RF ON / OFF]	2.7, 2.22, 2.45
– [SAVE]	2.3, 2.37
– [SELECT]	2.7, 2.19
– [STATUS]	2.7, 2.96
– [- / ←]	2.3, 2.22
– [→] [←]	2.6, 2.20

L

Level	
– control	2.42, 3.45
– correction	2.43, 3.28
– indications	2.18, 2.45, 2.82, 3.21
– marker	2.75, 3.40
– monitoring	2.45, 2.60, 3.24, 5.17
– offset	2.42, 3.46
– range	2.41
– sweep	2.74, 3.47, 3.56
– unit	2.22, 2.40, 3.76
LF	
– generator	2.49, 5.25
– output	1.6, 2.68, 3.25, 3.60
– sweep	2.75, 3.63
List editor	2.26
List	
– level correction (UCOR)	2.44, 3.28
– memory sequence (MEM SEQ)	2.77, 3.69
Listener	3.4
Localizer signal	2.66, 3.36
Lock-out	
– calibration	2.85, 3.70
– keyboard	3.3, 3.69
– instrument functions	3.71
Long form of commands	3.7
Lower-case notation	3.7

M

Mantissa	3.9
Marker	
– level sweep	2.75, 3.40
– LF sweep	2.76, 3.62
– RF sweep	2.74, 3.39
Marker beacon signal	2.67, 3.41
MARKER output	2.13, 2.72, 2.94, 3.40, 3.37
Maximal deviation	
– frequency modulation	2.52
– phase modulation	2.54
Maximum value	3.9
Measuring point	2.91, 3.20
Memory	
– deletion	2.82, 3.70
– location	2.37, 2.77, 3.23
Memory sequence	2.29, 2.77, 3.69
Menu cursor	2.18
Menu	
– FREQUENCY	2.37
– HELP	2.96
– LEVEL-ALC	2.42
– LEVEL-LEVEL	2.40
– LEVEL-EMF	2.45
– LEVEL-UCOR	2.43
– LF-OUTPUT	2.68
– MEM SEQ	2.78
– MODULATION -AM	2.50
– MODULATION -FM	2.51
– MODULATION -ILS-GS	2.61
– MODULATION -ILS-LOC	2.64
– MODULATION -MRK-BCN	2.67
– MODULATION -PM	2.53
– MODULATION -PULSE	2.55
– MODULATION -STEREO	2.57
– MODULATION -VOR	2.59
– SWEEP - FREQ	2.73
– SWEEP - LEVEL	2.74
– SWEEP - LF GEN	2.75
– UTILITIES - AUX I/O	2.94
– UTILITIES - BEEPER	2.95
– UTILITIES - CALIB	2.86
– UTILITIES - DIAG - CONFIG	2.90
– UTILITIES - DIAG - TPOINT	2.91
– UTILITIES - DIAG - PARAM	2.92
– UTILITIES - MOD KEY	2.93

– UTILITIES - PHASE	2.84
– UTILITIES - PROTECT	2.85
– UTILITIES - REF OSC	2.83
– UTILITIES - SYTEM-GPIB	2.80
– UTILITIES - SYSTEM-LANGUAGE	2.82
– UTILITIES - SYSTEM-RS232	2.81
– UTILITIES - SYSTEM-SECURITY	2.82
– UTILITIES - TEST	2.92
Minimum values	3.7
Minus sign	2.3
Modulation depth	
– amplitude modulation	2.50, 3.27
– area code (BK)	2.58, 3.52
– broadcasting code (DK)	2.58, 3.53
– Com/Id signal	2.60, 2.63, 2.66, 2.67, 3.247, 3.41, 3.59
– FM carrier (VOR)	2.60, 3.59
– marker beacon signal	2.67, 3.41
– 30 Hz VAR signal (VOR)	2.60, 3.58
Modulation generators	2.46, 5.24
Modulation source	
– overview	2.46
– amplitude modulation	2.50, 3.27
– frequency modulation	2.51, 3.29
– ILS test signals	2.63, 2.66, 3.33
– marker beacon signal	2.67, 3.41
– phase modulation	2.53, 3.43
– pulse modulation	2.56, 3.48
– stereo modulation	2.57, 3.51
– VOR test signals	2.60, 3.57
Module indication	2.90, 3.20
Multi-transmitter measurements	2.42
Multifunction generator	1.7, 2.49, 5.27

N

Name of memory sequence	3.70
NAN	3.9
Negative transition register	3.81
NINF	3.9
Nominal frequency	1.5
Nonharmonics level	5.9
Number of switch-on processes	2.92, 3.20
Numeric suffix	3.6
Numeric values	2.3, 3.8

O

ON/OFF - ratio	5.24
Open-circuit voltage	2.45
Operating-hours counter	2.92, 3.20
Option	
– SM-B1	1.2, 1.5, 2.83
– SM-B2	1.6, 2.49
– SM-B3	1.6, 2.55
– SM-B4	1.7, 2.54
– SM-B6	1.7, 2.49
– SM-B8	1.6, 2.54
– SMT-B19	1.7
Output	
– BLANK	2.13, 2.72, 2.94, 3.24
– LF	2.11, 2.68, 3.25
– MARKER	2.13, 2.72, 2.94, 3.40, 3.62
– REF	2.13, 2.83, 3.50
– RF	2.11, 2.39, 2.45, 3.23
– SYNC	2.15, 2.55
– VIDEO	2.15, 2.54
– X--AXIS	2.13, 2.71
Output buffer	3.79
Output level	2.40, 3.45, 5.13
Output reflection coefficient	5.16
Output unit (command processing)	3.79
Output unit (1.5 GHz and 3 GHz)	1.5
Output voltage of the LF output	2.68, 3.25
OVEN COLD	1.2
Overlapping execution	3.78

OVERLOAD	2.45	Responses to Queries	3.8
Overload protection	2.45, 3.24, 5.17	RF	
Overmodulation	2.47, 2.52, 2.60, 2.63, 2.66	– frequency	2.39, 3.31
P		– level	2.40, 3.45
Paneling	1.4	– output	2.11, 2.39, 2.40, 2.45, 3.23
Parallel poll	3.87	– sweep	2.73, 3.54
Parallel poll enable register	3.14, 3.84	RF OFF	2.45
Parameter (commands)	3.6	Root level	3.6
Parameter (menu)	2.20	Rotary knob	2.7, 2.19
Password	2.85, 3.70	RS-232 interface	2.15, 2.81, 3.67, 6A.4
Path	3.6	S	
Period	2.56, 3.49	Sample-and-hold operation	2.42
Phase		SCPI	
– angle	2.59, 3.58	– conformance information	8C.1
– antenna lobe	2.62, 2.65, 3.35, 3.38	– introduction	3.5
– control	2.84, 3.42	– status register	3.80
– modulation	2.53, 3.43	– version	3.1, 8C.1
– pilot tone	2.58, 3.52	Scrollbar	2.19
– RF- output signal	2.84, 3.42	Security state	2.85, 3.71
PhiM		Select	
– deviation setting	5.22	– list	2.27
– distortion factor	5.24	– mark	2.18
– frequency response	5.23	– parameter	2.20
Pilot tone	2.57, 2.69, 3.25, 3.52	– 1-out-of-n	2.20
PM		Selftest	1.3, 3.15, 3.72, 4.2
– deviation limits	2.54	Semicolon	3.10
– generator	2.53, 3.44	Sequence name (memory sequence)	2.77, 3.70
– modulator	2.53, 3.43	Serial number	2.92, 3.20
Polarity		Serial poll	3.83, 3.86
– BLANK signal	2.94, 3.24	Service request	3.86
– marker signal	2.94, 3.40, 3.62	Service request enable register	3.15, 3.83
– pulse modulation	2.56, 3.48	Setting commands	3.5
Positive transition register	3.81	Settling bit	3.78
Power		Short form (command)	3.7
– fuses	1.1	Signal shape	
– supply	1.5	– AM	2.50, 3.61
– switch	1.1	– FM	2.51, 3.61
Preemphasis of the audio signal	2.57, 3.52	– PM	2.53, 3.61
Preset	1.3, 2.7, 3.15, 3.70, 3.88	– LF output	2.69, 3.61
Protection level	2.85, 3.70	Simultaneous modulation	2.47
Protective circuit	2.45, 3.24	Slots	1.5
PULSE input	2.11, 2.54, 3.75	Software version	2.92, 3.20
Pulse		SOURCE0 / 2	3.60
– generator	1.7, 2.54, 2.89, 3.49, 5.26	Special characters	3.12
– modulation	2.54, 3.48	Spectral purity	2.52, 2.54
– modulator	1.6, 2.54, 3.48	Square brackets	3.7, 3.12
– period	2.56, 3.49	SRE (Service request enable register)	3.15, 3.83
– width	2.56, 2.89, 3.49	SRQ (Service request)	3.86
Q		SSB phase noise	5.10
Queries	3.5	Standby mode	1.1, 2.9
Question mark	3.10	Starting frequency	
Quick selection (menu)	2.21	– LF sweep	2.75, 3.61
Quotation marks	3.10	– RF sweep	2.73, 3.32
R		Starting level	2.74, 3.47
Rack, 19"	1.10	Status byte	3.15, 3.83
RCL list	2.77, 3.70	Status line	2.18, 2.97
Recall	2.37, 2.77	Status page	2.96
Reference		Status reporting system	3.13, 3.80
– external	2.83, 3.50	Status operation register	3.65, 3.85
– internal	2.83, 3.50, 5.8	Status questionable register	3.64, 3.85
– phase	2.84, 3.42	STB (Status byte)	3.15, 3.83
– 50 MHz	1.8	Step width	
– 10 MHz	2.13	– command parameters UP/DOWN	3.9
– VOR	2.60, 3.59	– level sweep	2.75, 3.56
Reference oscillator OCXO	1.2, 1.5, 2.83, 3.50	– LF sweep	2.76, 3.64
Resetting values of the status reporting System	3.88	– RF sweep	2.73, 3.55
Residual AM	5.13	– rotary knob (DDM value)	2.63, 2.66
Residual AM with FM	5.21	– rotary knob (frequency)	2.39
Residual FM	5.12	– rotary knob (level)	2.41
Residual PhiM with AM	5.18	– rotary knob (carrier frequency VOR)	2.60
		– rotary knob (carrier frequency ILS-GS)	2.63
		– rotary knob (carrier frequency ILS-LOC)	2.66
		Stereo modulation	2.57, 3.51
		Stereo multiplex signal	2.57, 2.69, 3.25, 3.51

Stop bit	2.81, 3.67, 6A.5
Stop frequency	
– LF sweep	2.76, 3.61
– RF sweep	2.73, 3.32
Stop level	2.74, 3.47
Storage temperature	4.1
Storing	
– menu	2.21
– list	2.29
– instrument setting	2.37, 3.15
Strings	3.10
Structure	
– command	3.6
– command line	3.8
Sum bit	3.81
Sum deviation	2.47, 2.68
Sum modulation depth	2.47, 2.68
– ILS-GS	2.62, 3.35
– ILS-LOC	2.65, 3.37
Supply voltage	1.1
Sweep	
– level	2.74, 3.47, 3.56
– LF	2.75, 3.61, 3.63
– RF	2.73, 3.32, 3.55
Switchover output	2.15, 2.55
Synchronize command servicing	3.79
Syntax elements	3.10
Synthesis range	2.52, 2.54
Synthesizer	1.5

T

Test point	2.91, 3.20
Text parameters	3.8
Traffic area code (BK)	2.58, 3.53
Trigger input	2.13, 2.71, 2.78, 2.94, 3.74
Trigger	
– pulse modulation	2.56, 3.75
– sweeps	2.74, 3.74
– memory sequence	2.78, 3.75
TUNE input	2.13, 2.83
Tuning voltage	1.5, 2.86, 3.50
Two-tone modulation	2.47

U

Unit	2.5, 2.20, 3.8, 3.76
Universal commands	3.4, 6A.3
UNLEVELED	2.40
User correction (UCOR)	2.43, 3.28

V

VAR signal	2.59, 3.58
Ventilation ducts	1.4
Vertical stroke	3.12
VOR Modulation	2.58, 3.57

W

WARNING	2.97
Waveform	2.50, 2.51, 2.53, 2.69, 3.61
White space	3.10
Working point (level preset)	2.87

X

X-AXIS output	2.13, 2.72
XY recorder	2.71, 2.94, 3.24

