



ROHDE & SCHWARZ

Test and Measurement
Division

Software Manual

OFDM Signal Generation

AMIQ/SMIQ-K15

1122.2803.02

1105.1535.02

*Printed in the Federal
Republic of Germany*

1105.1590.42-04-

Table of Contents

	<i>Page</i>
1 Introduction	1-1
System Requirements	1-1
Installation	1-1
Transferring Data to WinIQSIM and AMIQ	1-2
What is OFDM Modulation?	1-2
The WinIQOFDM System Model	1-5
Signal Structure	1-5
Alternate User	1-6
2 Panels and their Functions	2-1
General Operation	2-1
Operating Panels	2-1
Online Help	2-1
Main Panel	2-2
File Menu	2-2
Edit Modes Menu	2-2
Minimize All!	2-4
Help Menu	2-5
Controls and Indicators	2-6
Data Sources, Alternate User Data Sources	2-7
Controls and Indicators	2-8
Modulators	2-13
Controls and Indicators	2-14
Pilot	2-23
Controls and Indicators	2-24
OFDM Symbols	2-25
OFDM Symbols Menu	2-26
Pool Menu	2-27
Current Symbol	2-27
Physical Parameters	2-27
Subcarrier Edit	2-29
Subcarrier List	2-31
Spectrum Display	2-31
Bursts/PLCP-Frames	2-32
Bursts Menu	2-33
Edit Payload Menu	2-33
Pool Menu	2-34
General Settings Block	2-34

Payload List	2-36
Payload Edit Block.....	2-37
Frames	2-39
Frames Menu	2-40
Pool Menu.....	2-40
General Settings Block.....	2-41
Burst List.....	2-42
Burst List Edit Block.....	2-43
Sequence	2-44
General Settings Block.....	2-45
Frame List.....	2-45
Frame List Edit Block.....	2-46
3 Applications.....	3-1
Generating HiperLAN/2 Signals with WinIQOFDM.....	3-1
Generating IEEE 802.11a Signals with WinIQOFDM	3-3
Generating DVB Signals with WinIQOFDM.....	3-4
4 Glossary of Terms.....	4-1
5 Index.....	5-1

1 Introduction

System Requirements

WinIQOFDM is intended to run together with WinIQSIM (version 3.40 or higher) on one PC. The requirements concerning the PC system are the same as for WinIQSIM. Make sure you have a TCP/IP interface installed.

There are several options how the signals computed by WinIQOFDM can actually be generated physically. RF signals can be generated either by an SMIQ (version 5.40 or higher) with options B60 and K15, or by a combination of an AMIQ (version 3.03 or higher) with option K15 and an SMIQ. For signal generation in the baseband, an AMIQ (version 3.03 or higher) with option K15 is sufficient.

Installation

During the setup process, the user may change two path names, the directory name for the installation of WinIQOFDM (default: c:\WinIQOFDM) and the path name for LabWindows/CVI RunTime Engine. This software is required for WinIQOFDM and WinIQSIM but need not be copied again if it is already installed.

Installation from CD

To install WinIQOFDM on your PC, close all applications currently running on your PC, especially the ones that use LabWindows' CVI runtime engine. Then insert the enclosed CD into your CD-ROM drive. A file is now automatically displayed allowing you to install the WinIQOFDM software on your computer. A setup program that is launched from this file guides you through the rest of the installation.

If the AutoRun function is deactivated in Windows, open the WinIQOFDM CD-Rom and double-click on *Start.pdf* to start the setup process. Alternatively, you can use *Start => Run...* from the taskbar.

If Windows then displays the *Open With* window, the Adobe Acrobat Reader program for reading the *Start.pdf* file is not yet installed. In this case, start the *Setup.exe* program in the *AcroRd32* folder.

Installation from floppy

If the computer does not have a CD-ROM drive, the required data can also be copied on several floppies. Copy the following files on floppy 1 from the *W-IQQOFDM\Install* directory:

- *Setup.exe*
- *ofdm.001*
- *History.txt*
- *Readme<nn>.txt.*

File *ofdm.002* is copied on floppy2,
ofdm.003 on floppy3, etc.

Then insert floppy 1 into the drive and start the *setup.exe* program by clicking *Start => Run...* in the taskbar or by a double-click on *setup.exe* on your workstation 3 1/2" floppy (A:).

The icon for the deinstallation of the WinIQOFDM program is part of the WinIQOFDM program group. The directory tree is not cleared if it contains user files.

Transferring Data to WinIQSIM and AMIQ

After the signal has been computed in WinIQOFDM, it is transferred to WinIQSIM for further treatment (filtering etc.) and to be loaded into the AMIQ. This is done through a TCP/IP interface. All you have to do is to start both programs and to select **Import** from WinIQSIM's **System!** menu to connect the two programs. The black "TCP/IP Connected" LED on WinIQOFDM's main panel will indicate a successful connection.

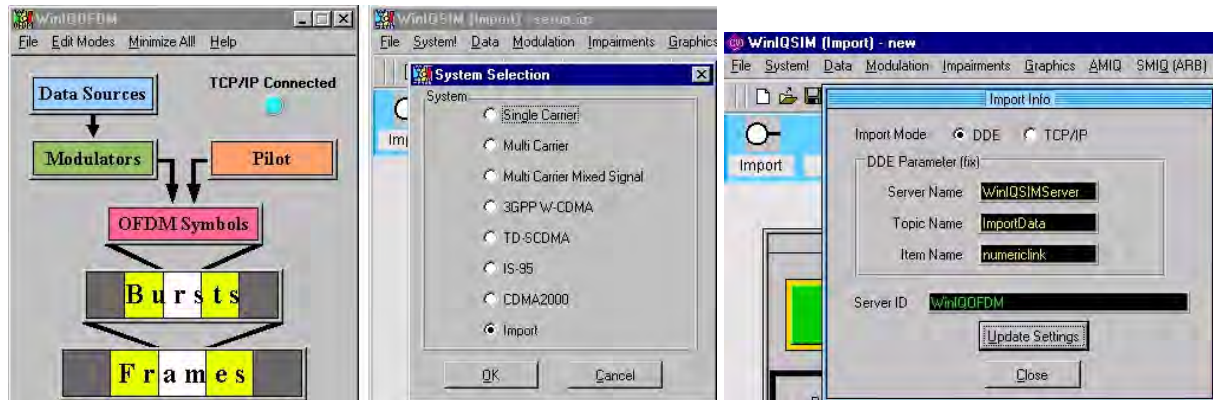

Fig. 1-1

Now, WinIQSIM automatically asks WinIQOFDM for new signal data every time before it performs a calculation. Notice that WinIQSIM does not initiate the generation of a new signal in WinIQOFDM. You have to do this manually by pressing the **Generate Signal** button.

The data transfer to the AMIQ or to the SMIQ with option B60 via an IEC bus connection is done through the WinIQSIM menu items **AMIQ | Transmission** and **SMIQ | Transmission**. Please, refer to the WinIQSIM manual for details.

What is OFDM Modulation?

(C)OFDM is the abbreviation for *(Coded) Orthogonal Frequency Division Multiplexing*, and describes a digital modulation scheme that distributes a single data stream over a large number of carriers for parallel transmission. These carriers are called the subcarriers of the signal. In the frequency domain, they are equally spaced around a central RF carrier, so the frequency $f_{n,rf}$ of the n th subcarrier out of N can be expressed as

$$f_{n,rf} = f_c + n \cdot f_d,$$

with

$$n \in \left[-\frac{N-1}{2}, \frac{N-1}{2}\right]$$

if N is odd, and

$$n \in \left[-\frac{N}{2}, \frac{N}{2} - 1\right]$$

if N is even.

f_d is the frequency spacing between the subcarriers and f_c is the center frequency of the OFDM signal. In the baseband, we obtain

$$f_n = n \cdot f_d,$$

with

$$n \in \left[-\frac{N-1}{2}, \frac{N-1}{2} \right]$$

and

$$n \in \left[-\frac{N}{2}, \frac{N}{2} - 1 \right]$$

for odd and even N s, respectively, where f_n is the baseband frequency of the n th subcarrier. The subcarriers $\exp(2\pi i n f_d t)$ build an orthogonal set of functions, hence the name of the modulation. Each of these subcarriers is modulated separately. The modulation symbols result from encoding the binary data using traditional PSK or QAM mappings. Let us assume we want to transmit 128 bits simultaneously on $N = 64$ QPSK modulated subcarriers ($n = -32, -31, \dots, +31$). Then for example the subcarrier with index -32 may carry the first pair of bits, the subcarrier with index -31 would carry the second pair, and so on. The last two bits would then be assigned to the subcarrier with index +31.

So, within one OFDM symbol, each subcarrier has its own phase p_n and amplitude a_n . The whole baseband signal looks like this:

$$s = \sum_{n=n_{\min}}^{n_{\max}} a_n \cdot e^{ip_n} \cdot f_n = \sum_{n=n_{\min}}^{n_{\max}} c_n \cdot n \cdot f_d,$$

where n_{\min} and n_{\max} set the range for n as in the above formulas. We can interpret this as the discrete Fourier transform (DFT) of the OFDM symbol to generate. Consequently, instead of really modulating all 64 subcarriers, the discrete time domain signal is calculated by applying to s an inverse DFT of length N . The result is a series of samples that represent one period of a signal that has the same spectrum as the desired OFDM symbol. The sampling frequency is $f_s = N \cdot f_d$. One period of the calculated series yields all amplitude and phase information contained in s . The minimum OFDM Symbol duration is thus

$$T_u = \frac{N}{f_d}.$$

If N is chosen to be power of 2, an inverse fast Fourier transform (FFT) can be used instead of the more time consuming DFT. Notice that the DFT is defined for signals that are periodic in the time domain as well as in the frequency domain. The alias spectra are eliminated through (digital) baseband filtering. Therefore, it is necessary to leave some empty space at the high and low end of the DFT spectrum s for the filter to cut in. Thus, only a subset of the N maximum possible subcarriers will actually be modulated, the others have zero amplitude.

Furthermore, the OFDM symbols have to be stretched by a guard interval in order to overcome multipath propagation. The guard interval is a cyclic continuation of the time domain representation of s located at the beginning of the symbol.



Fig. 1-2

So, an OFDM symbol falls into a so-called "useful part" containing all necessary data and a guard interval. The actual symbol duration becomes

$$T_{sym} = T_g + T_u.$$

The guard time T_g is given by the largest difference in traveling time to be expected between two propagation paths. It is necessary that at least one period of the above waveform is received without intersymbol interference (ISI). If T_g is chosen too short to guarantee this, no successful transmission is

possible. Valid T_g s are generally long enough for transients that occur between consecutive symbols to fade away.

From the receiver's point of view, without additional information, it is completely unclear at what point in time the useful part of an incoming OFDM symbol starts and where it ends. Clear OFDM spectra will more or less appear and then fade back into intersymbol interference noise, without the receiver being able to tell the absolute phase of the just received symbol. This is why some carriers called "pilots" carry reference information, i.e. they have a known amplitude and phase, to enable the receiver to tell the absolute amplitudes and phases of all subcarriers by analyzing the pilots. There are various concepts how pilots can be defined. Quite frequently, OFDM systems also employ differential modulation schemes to overcome broadband fading in the transmission channel. While the phase deviation between the ends of the spectrum may be large, it is assumed to be small - and can thus be compensated - between neighboring subcarriers.

The following figure shows an OFDM spectrum as generated by a HiperLAN/2 system. HL/2 employs a 64 FFT with 48 modulated subcarriers. The picture on the left shows a CW version of this spectrum, i.e. 48 unmodulated subcarriers, no guard interval, whereas the picture on the right shows the spectrum that results from an actual data transmission.

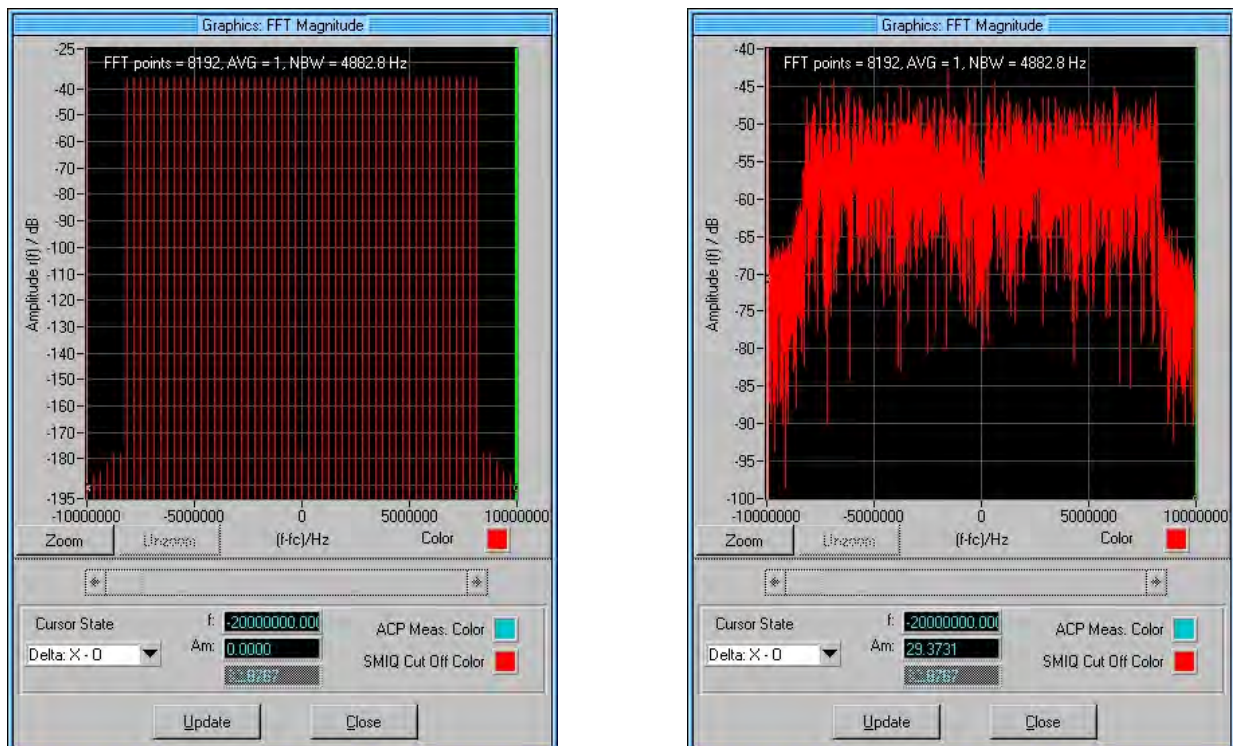

Fig. 1-3

Just like in any other digital communications scheme, OFDM symbols can be grouped together, e.g. in bursts and frames, to form a hierarchical time structure. Quite frequently, bursts start with a preamble that facilitates system timing, channel measurements, etc.

The WinIQOFDM System Model

WinIQOFDM is a very general tool that simulates most OFDM systems currently in use or under development within one unified system model. For proper simulation, the user is required to project the layout of his system onto this unified model, i.e. express his system specifications in terms of a WinIQOFDM configuration. For example, not every OFDM transmission will be organized in "bursts" and "frames". Some systems may call them "frames" and "superframes", and some may not have a double hierarchy at all. It is thus very important for the user to have a thorough understanding of the WinIQOFDM system model, as well as of the OFDM system he is trying to implement, to be able to set up this software correctly. For some systems, example setups are provided with the software that can be used as a starting point for your own configurations. For HiperLAN/2 type systems, a special edit mode was introduced, that makes sure that all edits up to OFDM symbol level comply with the HiperLAN/2 standard. This section gives an overview of WinIQOFDM's system model, refer to chapter "Panels and their Functions" for details.

Signal Structure

The main panel reflects the basic system layout.

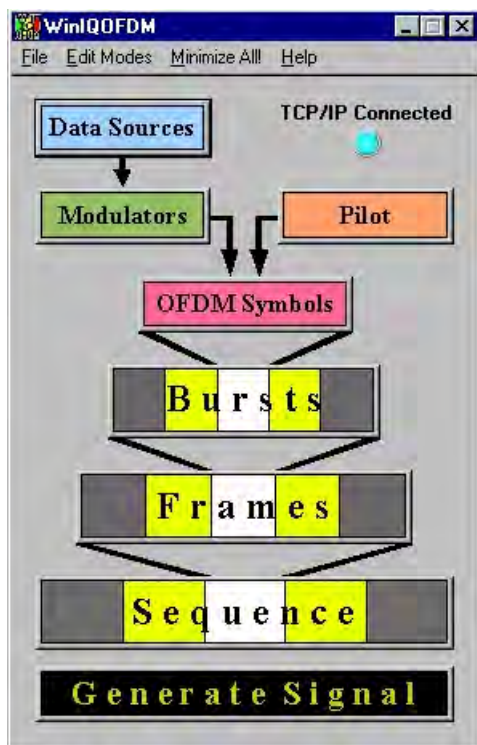

Fig. 1-4

The components of the virtual OFDM system you are intending to build can basically be regarded as independent pieces of hardware that are plugged together. Their interoperation involves no additional intelligence.

There are 8 data sources and modulators that can be freely combined with each other. WinIQOFDM offers a selection of commonly used PRBS type data generators, including a user PRBS, as well as a data file option to import user data that was generated offline. The modulators encode this data into phases and amplitudes.

A special pair of data generator and modulator is the pilot that can be accessed directly from the main panel. It does not differ from the standard components but rather emphasizes the pilot's special role within an OFDM symbol. If an OFDM system uses more than one pilot, the additional pilots will have to be generated by regular data sources and modulators.

The next level in the system specification is the definition of OFDM symbols. This is where data sources and modulators are coupled together. You can define and configure any number of OFDM symbols, together with a preguard interval, simply by assigning a data source and modulator to each subcarrier. The FFT length and sampling rate are the same for all OFDM symbols.

The time structure of the generated signal is organized in a hierarchy of bursts, frames and a sequence, where the sequence represents the final signal to be computed. It consists of frames that in turn contain a series of bursts. A burst is a concatenation of an optional preamble, a number of OFDM symbols, and an optional postamble. Any number of bursts and frames can be defined and kept in a pool. The handling of this structure is designed in a way that consistently avoids conflicts between different levels within this hierarchy throughout the configuration process.

Through the *alternate user*, WinIQOFDM can simulate two independent groups of users that both contribute to the generated sequence. For more details on this concept, refer to Alternate User.

Alternate User

A special feature of the WinIQOFDM system model is the Alternate User. This means that the whole mechanism for OFDM signal generation is implemented twice in the software. For every burst within a frame, you can decide whether it has to be generated by the main or the alternate user.

The alternate and the main users' signal structures are generally identical up to OFDM symbol level, except for the data source configurations, so all other edits you make are applied to both user groups. Although they are configured identically, their pilots and modulators operate independently of each other.

The alternate and main user's data sources are configured separately, so that you can assign different types of data streams, like e.g. a data file for the alternate and a PRBS 9 for the main user (see Data Source Types).

What can you do with this feature? Suppose you want to simulate a TDD system where a frame consists of bursts that all stem from different mobile terminals. The DUT has to pick and demodulate one of these signals. So, what you need is one self-consistent signal that is actually demodulated by the DUT, along with a number of "dummy" signals that belong to other terminals and that can carry any data. Since all terminals are alike, their signals have the same structure. A very convenient way of obtaining this scenario is to set up WinIQOFDM to generate the necessary bursts once, and then switch the bursts you actually want to demodulate to "alternate user" within the frame panel. These bursts will then contain their own self-consistent data sequence.

2 Panels and their Functions

General Operation

Operating Panels

WinQOFDM is operated from the Main Panel that serves as a control board for the program. All other panels are opened by clicking on the corresponding items in the main panel's system diagram.

A panel can be closed by pressing its *OK* button. Since all settings you made in the panel were executed immediately, no more action is taken upon *OK*. Alternatively, the *Cancel* button can be used. This button also closes the panel, but all settings that were made since it was called are rejected. The status of the panel before the call is restored.

Instead of clicking the *OK* and *Cancel* buttons, you can also just hit the *Enter* and *Esc* keys on the keyboard, respectively.

Out of all open panels, only one can be active at a time. The active panel's title bar is highlighted according to your Windows configuration.

Online Help

An overview of the online help contents is accessed from the main panel through the menu item **Help | Contents** or the *F1* key. A keyword search within the help function is available at the **Help | Search** menu item. The contents of the help function are to a large extent identical with those of the operating manual.

Main Panel

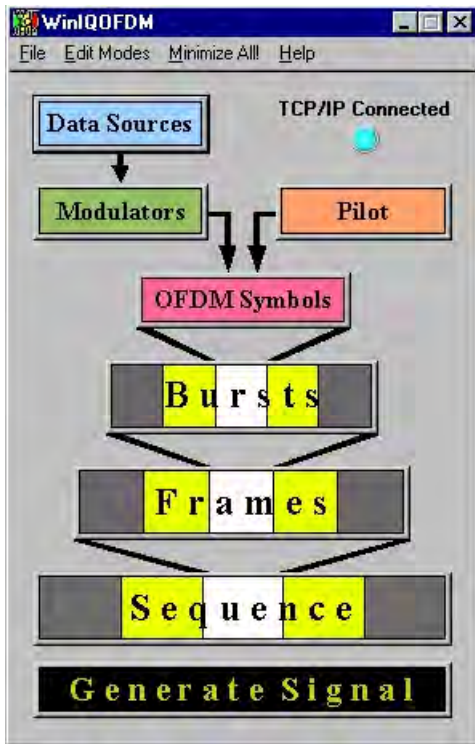

Fig. 2-1

The Main Panel serves as a control board for all other panels. These are opened and closed by clicking on the corresponding elements in the system diagram. Apart from this, the main panel performs file operations, switches between edit modes, and starts the signal generation.

File Menu

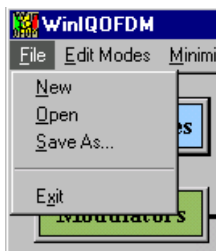

Fig. 2-2

New Selecting **New** initializes WinIQOFDM's settings to the factory default:

- data sources: All 0
- modulators: BPSK
- OFDM Symbols: 1 subcarrier in "Off" state
- bursts, frames and sequence: empty.

Make sure that you saved the current state of you work into a backup file, since all setup

data is going to be lost during initialization.

- Open** Select **Open** to load a new setup into WinIQOFDM. The extension for WinIQOFDM setup files is *.iqo.
- Save As...** Select **Save As...** to save your setup into a file. The extension for WinIQOFDM setup files is *.iqo.
- Exit** Select **Exit** to quit WinIQOFDM.

Edit Modes Menu



Fig. 2-3

The different Edit Modes in WinIQOFDM facilitate the configuration of the program for certain known OFDM systems. The panels are modified, and some controls will change their behavior, in order to only allow for settings that comply with the standard concerned. Whenever you switch to an edit mode other than "Generic", the current configuration will be overwritten with a default setup. So it is advisable to save your work before you change the edit mode. In order to switch between different system specific edit modes, you always have to return into Generic edit mode, first.

- Generic** This is WinIQOFDM's most general edit mode that leaves you the greatest freedom in configuring the program. All parameters are accessible. Unlike other edit modes, this one does not load a default setting when being called, so your settings will not be overwritten when you switch to "Generic".
- HiperLAN/2** This edit mode restricts your configuration options to HiperLAN/2 compliant settings up to the level of OFDM symbol definition. Parameters that don't apply are dimmed in this mode. In the OFDM Symbols panel, a change of data source or modulator affects all 48 data carriers within a symbol. Only the first four modulators can be accessed, and they are set up to provide the four modulation schemes defined in HiperLAN/2. The pilot carriers are assigned automatically according to the standard. Although they cannot be programmed separately, single subcarriers can still be switched on and off by themselves.

When entering HiperLAN/2 edit mode, your settings will be overwritten by a default configuration that includes preset OFDM symbol structures and sample HiperLAN/2 PDUs. So, unless you have special requirements on the data you want to transmit, you can go right ahead with the configuration of the HiperLAN/2 MAC frames and the sequence you want to compute.
- IEEE 802.11a** This edit mode provides an easy way of generating signals according to IEEE 802.11a. Up to OFDM symbol level, all settings are restricted to compliant values. Parameters that don't apply are dimmed in this mode. In the OFDM Symbols panel, a change of data source or modulator affects all 48 data carriers within a symbol. Only the first four modulators can be accessed, and they are set up to provide the four modulation schemes defined in IEEE 802.11a. The pilot carriers are assigned automatically according to the standard. Although they cannot be programmed separately, single subcarriers can still be switched on and off by themselves.

IEEE 802.11a signals are organized in frames with no further subdivision into bursts. So, in IEEE 802.11a edit mode, OFDM symbols are directly used together with a preamble to construct frames that in turn are used to build the sequence. Yet, the structure of the frames is similar to WinIQOFDM bursts, not frames, so the IEEE 802.11a frame panel corresponds to the Bursts panel in Generic Edit Mode. The IEEE 802.11a sequence panel is the same as in Generic edit mode with an additional User switch that is used to assign frames to the main and the Alternate User, respectively.

When entering IEEE 802.11a edit mode, your settings will be overwritten by a default configuration that includes preset OFDM symbol structures. So, unless you have special requirements on the data you want to transmit, you can go right ahead with the configuration of the IEEE 802.11a frames and the sequence you want to compute.

Minimize All!

Hides the WinIQOFDM application from your desktop. You can show it again by clicking on the **WinIQOFDM** icon on the taskbar.

Help Menu

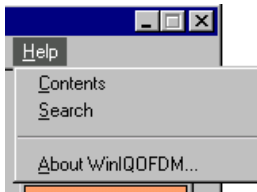

Fig. 2-4

- | | |
|---------------------------|---|
| Contents | Search WinIQOFDM's online help by contents. |
| Search | Search WinIQOFDM's online help by keyword. |
| About WinIQOFDM... | Displays general information on the currently installed version of WinIQOFDM. |

Controls and Indicators

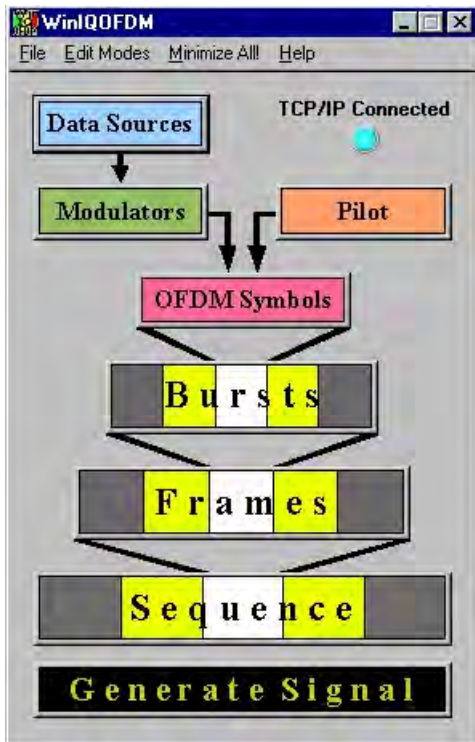

Fig. 2-5

TCP/IP Connection Indicator



The blue TCP/IP Connection Indicator LED is lit while WinIQOFDM is connected to a TCP/IP server like WinIQSIM.

Data Sources

Click on the **Data Sources** button to open the Data Sources panel.

Modulators

Click on the **Modulators** button to open the Modulators panel.

Pilot

Click on the **Pilot** button to open the Pilot panel.

OFDM Symbols

Click on the **OFDM Symbols** button to open the OFDM Symbols panel.

Bursts

Click on the **Bursts** button to open the Bursts panel.

Frames

Click on the **Frames** button to open the Frames panel.

Sequence

Click on the **Sequence** button to open the Sequence panel.

Generate Signal

Click on the **Generate Signal** button to compute a new IQ output signal that can be transferred to WinIQSIM via TCP/IP.

Data Sources, Alternate User Data Sources

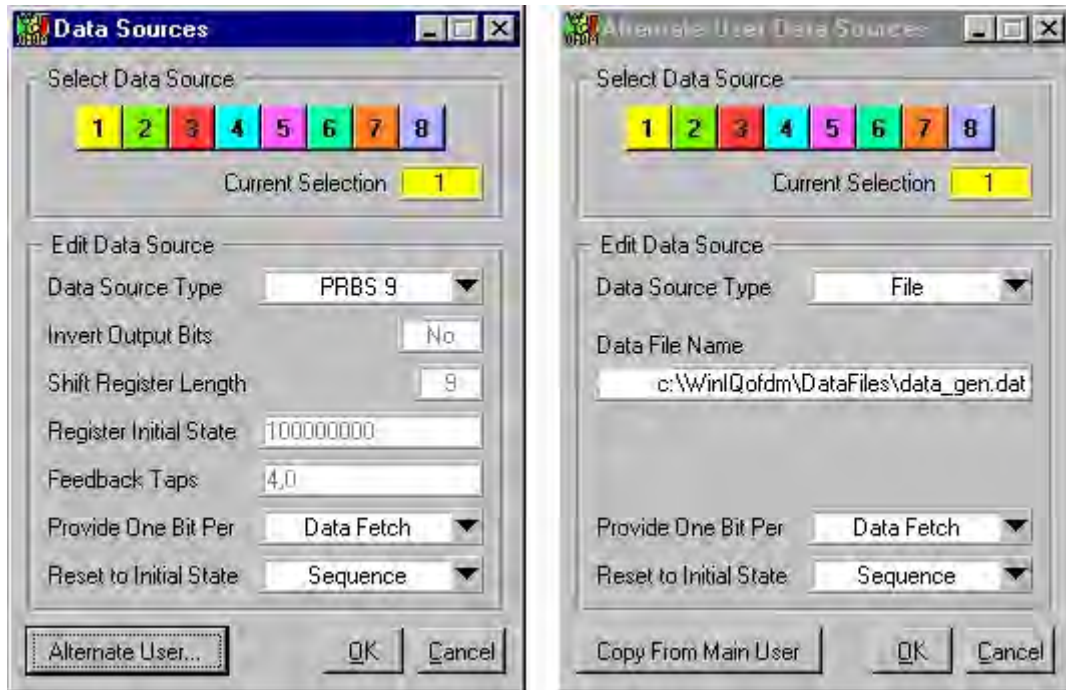

Fig. 2-6

In these two panels, you can configure the data sources used in the simulation. WinIQOFDM offers two sets of data generators that are assigned to the main and the alternate user, respectively (see Alternate User). Each of these sets comprises eight independent data sources. These are freely configurable, either as binary feedback shift register type PRBS generators, or as a file interface that can read data streams from ASCII files provided by the user. The *Alternate User Data Sources* panel is accessed through the *Data Sources* panel by clicking on the *Alternate User...* button. In the *Alternate User Data Sources* panel, you can make the same settings as in the *Data Sources* panel, except that they apply for the alternate user instead of the main user.

Controls and Indicators

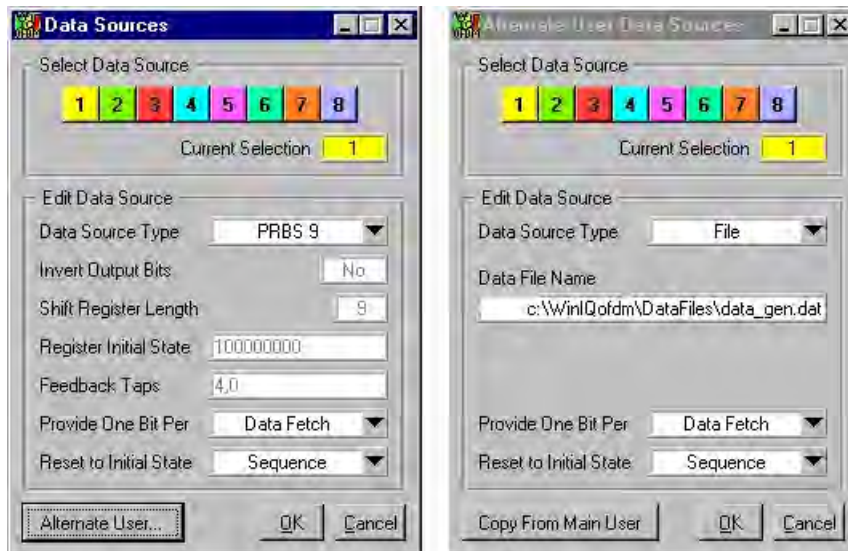

Fig. 2-7

Note that, while editing the data sources, the panels adapt to the type of data source that is currently selected. Not all parameters are accessible at all times. Parameters that do not apply are hidden. Settings that cannot be edited are printed in gray. A list of appropriate parameters is given in the description of each generator type.

Data Source Selector



Fig. 2-8

WinIQOFDM provides eight independent data sources per user. The currently edited data source is selected by clicking on one of the eight selector buttons. It is shown by the *Current Selection* indicator. The data sources are color coded, to make them easier to identify within the setups shown in the "OFDM Symbols" panel.

Data Source Type

This parameter determines the kind of data generator that is simulated by the selected source. WinIQOFDM offers the following selection:

All 0 The source generates binary zeroes only.

Parameters: none

All 1 The source generates binary ones only.

Parameters: none

PRBS 7 - 23

These feedback shift register type data generators are defined according to CCITT V.52 and Rec. 0.151, respectively, and their structure cannot be edited by the user. To use these standard PRBS sources as a base for user defined generators, simply select them before switching the source to *User PRBS*. The number behind the name "PRBS" indicates the length of the generating shift register. For example, in order to produce a PRBS 16, a 16 state shift register is required. This figure shows the schematic of such a PRBS 9 shift register.

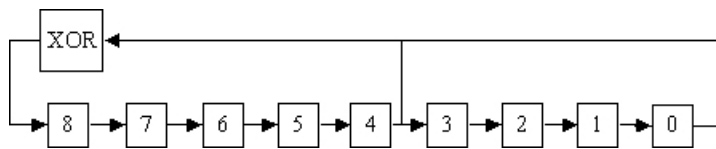

Fig. 2-9

The following table lists the generator data for the types of PRBSs implemented in WinIQOFDM. The initial state is always a 1 in register No. 0, and 0 in all other registers. According to CCITT V.52, the output bits of some PRBS generators are inverted. Since all PRBSs in this table are designed to have maximum length, their lengths are given by

$$2^n - 1$$

for a PRBS *n*.

Generator Type	Sequence Length in Bit	Feedback Taps at Registers No.	Inverted Output
PRBS 7	127	1, 0	No
PRBS 9	511	4, 0	No
PRBS 11	2047	2, 0	No
PRBS 15	32767	1, 0	Yes
PRBS 16	65535	5, 3, 2, 0	No
PRBS 20	1048575	3, 0	No
PRBS 21	2097151	2, 0	No
PRBS 23	8388607	5, 0	Yes

Parameters: Provide One Bit Per...
Reset to Initial State...

User PRBS

A User PRBS generator has the same basic layout as the default generators PRBS 7 - 23, but all Parameters, such as feedback taps, initial state, and inverted output, can be set by the user. When switching to *User PRBS* from any other data source type, the settings of the previously selected generator are kept as starting point for your edits.

*Parameters: Invert Output Bits
Register Initial State
Feedback Taps
Provide One Bit Per...
Reset to Initial State...*

HiperLAN/2 Pilot The pilot proposed by the HiperLAN/2 standard is modulated by a special PRBS of length 7. The HiperLAN/2 pilot is defined for a shift register structure that is different, but equivalent to the one implemented in WinIQOFDM. The program uses the same generator layout as for regular PRBS 7 - 23, and for this layout, the definition of the HiperLAN/2 pilot PRBS generator becomes:

Register Length	Sequence Length in Bit	Feedback Taps at Registers No.	Register Initial State	Invert Output
7	127	3, 0	0000111	Yes (in connection with HL/2 BPSK modulation)

Every new OFDM symbol, one new bit is produced.

*Parameters: Provide One Bit Per...
Reset to Initial State...*

Fixed Pattern It is possible to directly type the sequence to be generated at the *Fixed Pattern* input (only '0's and '1's, no separators). The data source will then generate a cyclic extension of this pattern. This is only convenient for short patterns, e.g. 0011 0011 0..., for longer patterns, using a data file may be the better choice. When changing from any PRBS to *Fixed Pattern*, the initial state of the generator becomes the initial pattern.

*Parameters: Pattern
Provide One Bit Per...
Reset to Initial State...*

File WinIQOFDM's data sources can also read binary sequences from files and use them for signal generation. Valid files can be obtained easily from standard Mathematical tools (numbers in float ASCII form, separated by spaces). The default file extension is *.dat. The numbers in the files are interpreted as follows:

0.0 and -1.0: logical 0
1.0: logical 1

Files are not allowed to contain any other numbers, so its contents may look like this:

```
1.0000000e+000    1.0000000e+000    0.0000000e+000
0.0000000e+000    1.0000000e+000    0.0000000e+000 ...
```

or:

```
1.0000000e+000    1.0000000e+000    -1.0000000e+000
-1.0000000e+000    1.0000000e+000    -1.0000000e+000 ...
```

The data sources read the data files cyclically, i.e. when the end of a data file is reached during a simulation, WinIQOFDM will start over from the beginning of the file.

*Parameters: Data File Name
Provide One Bit Per...
Reset to Initial State...*

Invert Output Bits Decides whether the feedback shift register's output is inverted.

Shift Register Length

Displays the length in bits of the shift register that is currently used as a PRBS generator. This parameter is read-only. The shift register length is determined by the initial state.

Pattern Length

Displays the length in bits of the fixed pattern produced by the currently edited data source. This parameter is read-only. The pattern length is determined by the current pattern.

Register Initial State

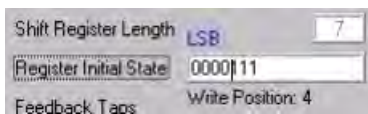

Fig.: 2-10

Displays or sets the initial state of the currently selected shift register, i.e. the binary values that the register contains at the start of a simulation and after every reset (see Data Source Type). The initial states of WinIQOFDM's preset PRBSs are part of their definition and cannot be edited. If, for example, you want to implement a standard PRBS 9 with an initial state other than 00000001, select *PRBS 9* as your data source type first, in order to get the basic settings, and then switch to *User PRBS* to edit the initial state. Note that the initial state is read from left to right, so the LSB is the bit located at the leftmost position.

Feedback Taps

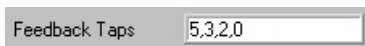

Fig. 2-11

Displays or sets the position of the currently selected shift register's feedback taps (see Data Source Type). The feedback taps of WinIQOFDM's preset PRBSs are part of their definition and cannot be edited. If you want to change the feedback taps of such a PRBS, you have to set the data source type to *User PRBS* first.

Pattern



Fig. 2-12

Here, you type the binary pattern that will be produced by a data source of type *Fixed Pattern*. Note that the pattern will be read from left to right, so the bit in the leftmost position is the first one to be generated.

Data File Name

For data sources of type *File* (see Data Source Type), this field shows the name of the selected data file. Click on the name to choose another file. This will open a dialog box.

Provide One Bit Per

This switch determines when the data source will produce a new bit. This setting does not depend upon whether this bit is used and encoded by a modulator or not. This parameter is used to implement counters, or data streams that occur identically on more than one subcarrier. There are three settings:

Provide One Bit Per...

Used Subcarrier: This setting is used to implement a "subcarrier counter". One bit is generated for every subcarrier that is not switched *off* in the OFDM Symbols panel, no matter if it is accessed by a modulator or not. This is the correct operation mode of the continual and scattered pilots used in DAB.

Data Fetch: A new bit is generated whenever a modulator reads a bit from the source, so that a continuous data stream is provided. This is the behavior you would expect from a regular data generator, and it is the default setting for most data source types.

OFDM Symbol: This setting is used to implement an "OFDM symbol counter". One bit is generated per OFDM symbol. The bit can be read several times by modulators. Pilots in HiperLAN/2 and TPS pilots in DAB operate this way. This is the default setting for the *HiperLAN/2* data source type.

Reset to Initial State

Here, you select when the data source has to be reset in the course of a simulation. After a reset, the PRBS generated by the data source will start over from the top. So, for a feedback shift register, this means that the initial state is written back into the register, a *file* type data source will simply jump back to the top of the data file. There are four possibilities:

Every OFDM Symb.: reset at the beginning of every new OFDM symbol

Every Burst: reset at the beginning of every new burst

Every Frame: reset at the beginning of every new frame

Sequence: reset only at the beginning of the simulation, i.e. at the start of the sequence

Alternate User...

Opens the *Alternate User Data Source* panel, where you can configure the data sources for this user group. For more details about the Alternate User concept, please refer to Alternate User.

Copy from Main User

Click on this button in the Alternate User panel, to copy the configuration of the main user's data sources into the alternate user's data sources. So, if you don't need to make different settings for the two user groups, this is a convenient way of programming the alternate user's data sources without having to set every parameter twice. For more details about the Alternate User concept, please refer to Alternate User.

Modulators

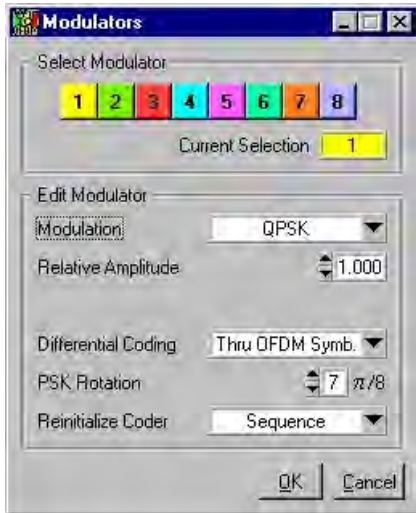

Fig. 2-13

In this panel, you can configure the modulators used in the simulation. WinIQOFDM offers two sets of eight modulators for the alternate user and for the main user, respectively. Since the modulator settings are always identical for both user groups, unlike the data source settings, there is only one panel to edit both sets at a time.

The modulators are freely configurable to provide a large variety of both differential and non-differential PSK and QAM modulation schemes.

Controls and Indicators

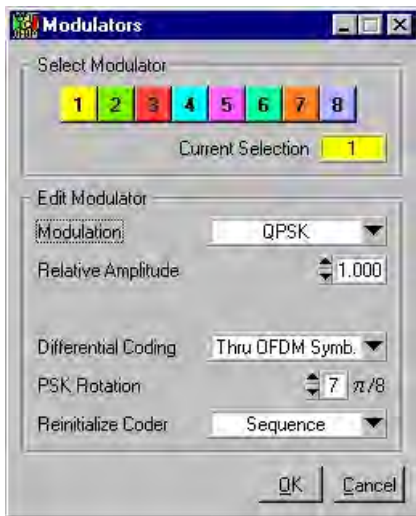

Fig. 2-14

Note that, while editing the modulators, the panel adapts to the modulation scheme that is currently selected. Not all parameters are accessible at all times. Parameters that do not apply are hidden. The descriptions of the modulation schemes include a list of appropriate parameters.

Modulator Selector



Fig. 2-15

WinIQOFDM provides eight independent modulators per user. The currently edited modulator is selected by clicking on one of the eight selector buttons. It is shown by the *Current Selection* indicator. The modulators are color coded, to make them easier to identify within the setups shown in the "OFDM Symbols" panel.

Modulation

BPSK

BPSK is a modulation scheme, where every bit in the data stream is simply assigned a (sub-)carrier phase of either 0° or 180°. This results in the following constellation.

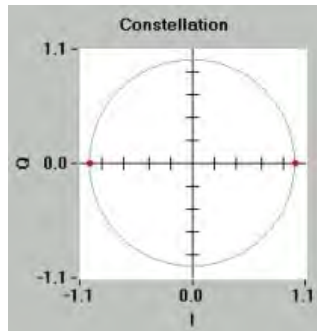

Fig. 2-16 WinIQOFDM offers these two BPSK mappings:

Data Symbol	0	1
BPSK	0°	180°
BPSK HL/2 (HiperLAN/2 type BPSK)	180°	0°

Parameters: Relative Amplitude
Differential Coding (PSK Rotation, Reset Coder)

QPSK

QPSK is a modulation scheme that assigns one out of four discrete (sub-) carrier phases to pairs of consecutive bits in the data stream. This results in the following constellation.

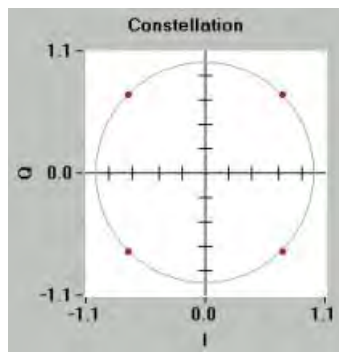

Fig.: 2-17

WinIQOFDM offers a choice of three different QPSK Mappings:

Data Symbol	00	01	10	11
QPSK	45°	135°	225°	315°
QPSK HL/2	225°	135°	315°	45°
QPSK DVB	45°	315°	135°	225°

Parameters: *Relative Amplitude*
Differential Coding (PSK Rotation, Reset Coder)

8 PSK

8 PSK is a modulation scheme that assigns one out of eight discrete (sub-)carrier phases to three consecutive bits in the data stream. This results in the following constellation.

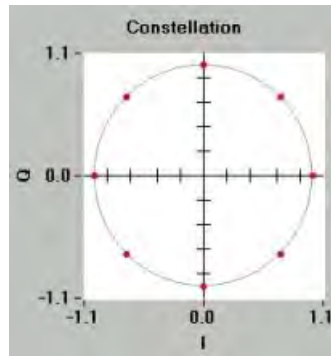

Fig. 2-18

This is the mapping implemented in WinIQOFDM:

Data Symbol	8 PSK
000	0°
001	45°
010	90°
011	135°
100	180°
101	225°
110	270°
111	315°

Parameters: *Relative Amplitude*
Differential Coding (PSK Rotation, Reset Coder)

16 QAM

16 QAM is a modulation scheme where phase and amplitude modulation are employed to map 4 consecutive bits in the data stream to one out of 16 discrete points in the complex signal space. The constellation is as follows:

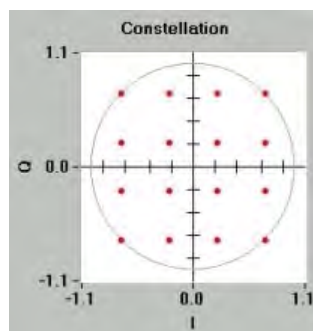

Fig. 2-19

Although basically, the signal constellation in 16 QAM is always like this, systems that use PSK as well as QAM modulation usually employ some amplitude normalization in order to obtain an average signal power from the QAM mapping, that corresponds to the (constant) power that results from PSK modulation. The normalization factors used differ between standards. WinIQOFDM provides the 16 QAM schemes used in HiperLAN/2 and DVB, the necessary normalizations are thereby included in the 16 QAM mapping. So there is no need to adjust the Relative Amplitude parameter.

DVB also makes use of a so-called Alpha value to modify its QAM constellations. The assignment between data bits and constellation points remains unchanged in a general manner. These variations are also available as presets.

The following table shows the QAM mappings offered by WinIQOFDM. The DVB mapping is only given for $\alpha = 1$. For $\alpha = 2$ or $\alpha = 4$, the factor $\sqrt{1/10}$ must be replaced by $\sqrt{1/20}$ and $\sqrt{1/52}$, respectively.

Data Symbol	HiperLAN/2	DVB (alpha = 1)
0000	$\sqrt{1/10} * (-3-3j)$	$\sqrt{1/10} * (3+3j)$
0001	$\sqrt{1/10} * (-3-1j)$	$\sqrt{1/10} * (3+1j)$
0010	$\sqrt{1/10} * (-3+3j)$	$\sqrt{1/10} * (1+3j)$
0011	$\sqrt{1/10} * (-3+1j)$	$\sqrt{1/10} * (1+1j)$
0100	$\sqrt{1/10} * (-1-3j)$	$\sqrt{1/10} * (3-3j)$
0101	$\sqrt{1/10} * (-1-1j)$	$\sqrt{1/10} * (3-1j)$
0110	$\sqrt{1/10} * (-1+3j)$	$\sqrt{1/10} * (1-3j)$
0111	$\sqrt{1/10} * (-1+1j)$	$\sqrt{1/10} * (1-1j)$
1000	$\sqrt{1/10} * (3-3j)$	$\sqrt{1/10} * (-3+3j)$
1001	$\sqrt{1/10} * (3-1j)$	$\sqrt{1/10} * (-3+1j)$
1010	$\sqrt{1/10} * (3+3j)$	$\sqrt{1/10} * (-1+3j)$
1011	$\sqrt{1/10} * (3+1j)$	$\sqrt{1/10} * (-1+1j)$
1100	$\sqrt{1/10} * (1-3j)$	$\sqrt{1/10} * (-3-3j)$
1101	$\sqrt{1/10} * (1-1j)$	$\sqrt{1/10} * (-3-1j)$
1110	$\sqrt{1/10} * (1+3j)$	$\sqrt{1/10} * (-1-3j)$
1111	$\sqrt{1/10} * (1+1j)$	$\sqrt{1/10} * (-1-1j)$

Parameters:
Relative Amplitude
Alpha
Differential Coding (Reset Coder)

64 QAM

64 QAM is a modulation scheme where phase and amplitude modulation are employed to map 6 consecutive bits in the data stream to one out of 64 discrete points in the complex signal space. The constellation is as follows:

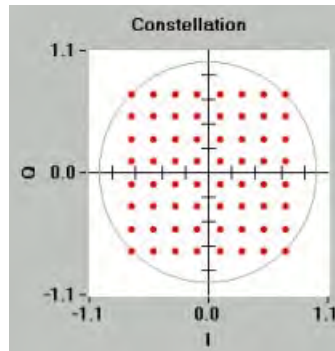

Fig. 2–20

Although basically, the signal constellation in 64 QAM is always like this, systems that use PSK as well as QAM modulation usually employ some amplitude normalization in order to obtain an average signal power from the QAM mapping, that corresponds to the (constant) power that results from PSK modulation. The normalization factors used differ between standards. WinIQOFDM provides the 64 QAM schemes used in HiperLAN/2 and DVB, the necessary normalizations are thereby included in the 64 QAM mapping. So there is no need to adjust the Relative Amplitude parameter.

DVB also makes use of a so-called Alpha parameter to modify its QAM constellations. The assignment between data bits and constellation points remains unchanged in a general manner. These variations are also available as presets.

The following table shows the QAM mappings offered by WinIQOFDM. The DVB mapping is only given for $\alpha = 1$. For $\alpha = 2$ or $\alpha = 4$, the factor $\sqrt{1/42}$ must be replaced by $\sqrt{1/60}$ and $\sqrt{1/108}$, respectively.

Data Symbol	HiperLAN/2	DVB (alpha = 1)	Data Symbol	HiperLAN/2	DVB (alpha = 1)
000000	$\sqrt{1/42}*(-7-7j)$	$\sqrt{1/42}*(7+7j)$	100000	$\sqrt{1/42}*(7-7j)$	$\sqrt{1/42}*(-7+7j)$
000001	$\sqrt{1/42}*(-7-5j)$	$\sqrt{1/42}*(7+5j)$	100001	$\sqrt{1/42}*(7-5j)$	$\sqrt{1/42}*(-7+5j)$
000010	$\sqrt{1/42}*(-7-1j)$	$\sqrt{1/42}*(5+7j)$	100010	$\sqrt{1/42}*(7-1j)$	$\sqrt{1/42}*(-5+7j)$
000011	$\sqrt{1/42}*(-7-3j)$	$\sqrt{1/42}*(5+5j)$	100011	$\sqrt{1/42}*(7-3j)$	$\sqrt{1/42}*(-5+5j)$
000100	$\sqrt{1/42}*(-7+7j)$	$\sqrt{1/42}*(7+1j)$	100100	$\sqrt{1/42}*(7+7j)$	$\sqrt{1/42}*(-7+1j)$
000101	$\sqrt{1/42}*(-7+5j)$	$\sqrt{1/42}*(7+3j)$	100101	$\sqrt{1/42}*(7+5j)$	$\sqrt{1/42}*(-7+3j)$
000110	$\sqrt{1/42}*(-7+1j)$	$\sqrt{1/42}*(5+1j)$	100110	$\sqrt{1/42}*(7+1j)$	$\sqrt{1/42}*(-5+1j)$
000111	$\sqrt{1/42}*(-7+3j)$	$\sqrt{1/42}*(5+3j)$	100111	$\sqrt{1/42}*(7+3j)$	$\sqrt{1/42}*(-5+3j)$
001000	$\sqrt{1/42}*(-5-7j)$	$\sqrt{1/42}*(1+7j)$	101000	$\sqrt{1/42}*(5-7j)$	$\sqrt{1/42}*(-1+7j)$
001001	$\sqrt{1/42}*(-5-5j)$	$\sqrt{1/42}*(1+5j)$	101001	$\sqrt{1/42}*(5-5j)$	$\sqrt{1/42}*(-1+5j)$
001010	$\sqrt{1/42}*(-5-1j)$	$\sqrt{1/42}*(3+7j)$	101010	$\sqrt{1/42}*(5-1j)$	$\sqrt{1/42}*(-3+7j)$
001011	$\sqrt{1/42}*(-5-3j)$	$\sqrt{1/42}*(3+5j)$	101011	$\sqrt{1/42}*(5-3j)$	$\sqrt{1/42}*(-3+5j)$
001100	$\sqrt{1/42}*(-5+7j)$	$\sqrt{1/42}*(1+1j)$	101100	$\sqrt{1/42}*(5+7j)$	$\sqrt{1/42}*(-1+1j)$
001101	$\sqrt{1/42}*(-5+5j)$	$\sqrt{1/42}*(1+3j)$	101101	$\sqrt{1/42}*(5+5j)$	$\sqrt{1/42}*(-1+3j)$
001110	$\sqrt{1/42}*(-5+1j)$	$\sqrt{1/42}*(3+1j)$	101110	$\sqrt{1/42}*(5+1j)$	$\sqrt{1/42}*(-3+1j)$
001111	$\sqrt{1/42}*(-5+3j)$	$\sqrt{1/42}*(3+3j)$	101111	$\sqrt{1/42}*(5+3j)$	$\sqrt{1/42}*(-3+3j)$
010000	$\sqrt{1/42}*(-1-7j)$	$\sqrt{1/42}*(7-7j)$	110000	$\sqrt{1/42}*(1-7j)$	$\sqrt{1/42}*(7-7j)$
010001	$\sqrt{1/42}*(-1-5j)$	$\sqrt{1/42}*(7-5j)$	110001	$\sqrt{1/42}*(1-5j)$	$\sqrt{1/42}*(7-5j)$
010010	$\sqrt{1/42}*(-1-1j)$	$\sqrt{1/42}*(5-7j)$	110010	$\sqrt{1/42}*(1-1j)$	$\sqrt{1/42}*(5-7j)$
010011	$\sqrt{1/42}*(-1-3j)$	$\sqrt{1/42}*(5-5j)$	110011	$\sqrt{1/42}*(1-3j)$	$\sqrt{1/42}*(5-5j)$
010100	$\sqrt{1/42}*(-1+7j)$	$\sqrt{1/42}*(7-1j)$	110100	$\sqrt{1/42}*(1+7j)$	$\sqrt{1/42}*(7-1j)$
010101	$\sqrt{1/42}*(-1+5j)$	$\sqrt{1/42}*(7-3j)$	110101	$\sqrt{1/42}*(1+5j)$	$\sqrt{1/42}*(7-3j)$
010110	$\sqrt{1/42}*(-1+1j)$	$\sqrt{1/42}*(5-1j)$	110110	$\sqrt{1/42}*(1+1j)$	$\sqrt{1/42}*(5-1j)$
010111	$\sqrt{1/42}*(-1+3j)$	$\sqrt{1/42}*(5-3j)$	110111	$\sqrt{1/42}*(1+3j)$	$\sqrt{1/42}*(5-3j)$
011000	$\sqrt{1/42}*(-3-7j)$	$\sqrt{1/42}*(1-7j)$	111000	$\sqrt{1/42}*(3-7j)$	$\sqrt{1/42}*(-1-7j)$
011001	$\sqrt{1/42}*(-3-5j)$	$\sqrt{1/42}*(1-5j)$	111001	$\sqrt{1/42}*(3-5j)$	$\sqrt{1/42}*(-1-5j)$
011010	$\sqrt{1/42}*(-3-1j)$	$\sqrt{1/42}*(3-7j)$	111010	$\sqrt{1/42}*(3-1j)$	$\sqrt{1/42}*(-3-7j)$
011011	$\sqrt{1/42}*(-3-3j)$	$\sqrt{1/42}*(3-5j)$	111011	$\sqrt{1/42}*(3-3j)$	$\sqrt{1/42}*(-3-5j)$
011100	$\sqrt{1/42}*(-3+7j)$	$\sqrt{1/42}*(1-1j)$	111100	$\sqrt{1/42}*(3+7j)$	$\sqrt{1/42}*(-1-1j)$
011101	$\sqrt{1/42}*(-3+5j)$	$\sqrt{1/42}*(1-3j)$	111101	$\sqrt{1/42}*(3+5j)$	$\sqrt{1/42}*(-1-3j)$
011110	$\sqrt{1/42}*(-3+1j)$	$\sqrt{1/42}*(3-1j)$	111110	$\sqrt{1/42}*(3+1j)$	$\sqrt{1/42}*(-3-1j)$
011111	$\sqrt{1/42}*(-3+3j)$	$\sqrt{1/42}*(3-3j)$	111111	$\sqrt{1/42}*(3+3j)$	$\sqrt{1/42}*(-3-3j)$

Parameters: *Relative Amplitude*
Alpha
Differential Coding (Reset Coder)

Relative Amplitude

This parameter determines the overall output level of the modulators. It can be used to normalize constellations to levels other than the presets. The complex coordinates $\mathbf{c}(i)$ of all points contained in the constellation are multiplied by this factor A_{rel} . So, the modified constellation becomes

$$\mathbf{c}'_i = A_{rel} \cdot \mathbf{c}_i.$$

Note that some constellations (especially QAM) may by default include some kind of normalization. Since these normalizations are part of the definitions of the corresponding modulation schemes, they are already included in the $\mathbf{c}(i)$ for $A_{rel} = 1$. They are not shown in the panel.

Alpha

The parameter *alpha* is used in DVB to obtain "non-uniform-QAM". The quadrants of a regular "uniform" QAM constellation are shifted apart along the bisectors of the quadrants concerned. The relative distances between points within the same quadrant are maintained. Let $\mathbf{c}(i,j)$ be the complex coordinates that constitute a uniform QAM constellation, where the index i denotes the four quadrants, and where the $\mathbf{c}(i,0)$ are the points within these quadrants that are closest to the origin. Then the $\mathbf{c}'(i,j)$ of the corresponding non-uniform QAM constellation are calculated

$$\mathbf{c}'_{i,j} = \mathbf{c}_{i,j} + (\alpha - 1) \cdot \mathbf{c}_{i,0}.$$

The uniform distribution of the constellation points within the I-Q-plane is lost. For *alpha* = 1, the constellation remains unchanged. The figure shows an example of this for 16 QAM.

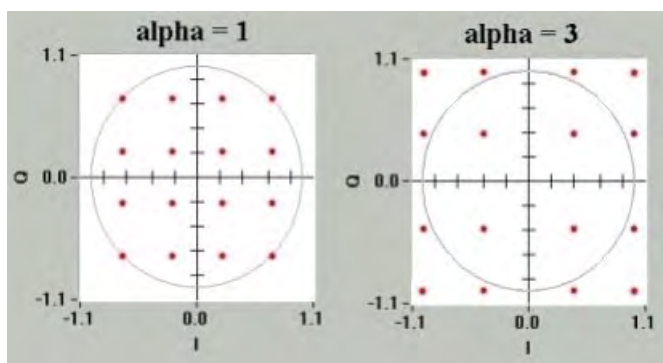

Fig. 2-21

Differential Coding

Differential coding is available for PSK as well as for QAM modulations, yet the effect of this parameter is different depending on the selected modulation type.

For PSK modulation, differential coding means that the modulator does not output the phase that corresponds to the encoded data symbol directly, but rather uses it as an increment to the previous output phase. So, for an All 0 data source and differential QPSK (without PSK rotation), the output is calculated as follows: The 00 data symbols are routed to a phase of 45° throughout. Since this phase is used as an increment, the phases accumulate and result in these phases at the output of the modulator: 45°, 90°, 135°, 180°, 225°, 270°, 315°, 0°...

For QAM modulation, the differential coding is applied to the incoming data stream. The numerical values of the binary data symbols are accumulated modulo the number of mapping points in the constellation. The modulator output is the constellation point that corresponds to the result of the accumulation. In other words, for a data symbol with the numerical value *n*, the modulator will count on *n* entries in its mapping table instead of producing the I-Q-symbol with index *n*.

Let us illustrate this by an example: After initialization, the content of the accumulator is 0. Now the following data symbols are modulated using differential 16 QAM HL/2:

0011, 0101, 0000, 0110, 0111... (binary) = 3, 5, 0, 6, 7... (decimal).

The modulator will now do the following operations:

Data Symbols	Accumulated Data	I-Q Symbols
0011b = 3	$(0 + 3) \bmod 16 = 3 = 0011b$	$\text{sqrt}(1/10) + (-3+1j)$
0101b = 6	$(3 + 6) \bmod 16 = 9 = 1001b$	$\text{sqrt}(1/10) + (3-1j)$
0000b = 0	$(9 + 0) \bmod 16 = 9 = 1001b$	$\text{sqrt}(1/10) + (3-1j)$
0110b = 6	$(9 + 6) \bmod 16 = 15 = 1111b$	$\text{sqrt}(1/10) + (1+1j)$
0111b = 7	$(15 + 7) \bmod 16 = 6 = 0110b$	$\text{sqrt}(1/10) + (-1+3j)$
...

Note that HiperLAN/2 and IEEE 802.11a do not use differential modulation schemes.

In OFDM systems, there are two ways of applying these concepts. One possibility is to have differential coding separately for each subcarrier, so that the reference is always the state of that same subcarrier in the previous OFDM symbol. For this mode select **Differential Coding | Per Subcarrier**.

The other option is to refer to the state of the last subcarrier that was modulated by the same modulator. Typically, this will be the neighboring subcarrier with lower index within the same OFDM symbol. For this mode select **Differential Coding | Thru OFDM Symb**.

It is very clear for both modes what happens as long as all subcarriers are assigned to the same modulator, or rather, as long as a continuous chain of differential references is provided for the modulation. But what happens if the chain is broken by subcarriers that have been assigned to other modulators? The solution is simple: Since in WinIQOFDM the modulators operate independently of one another, they will simply refer to the subcarriers that they modulated last and use the state they left them in. They fully ignore what other modulators may have done in the meantime.

The following figure illustrates the behavior for the two modes of operation.

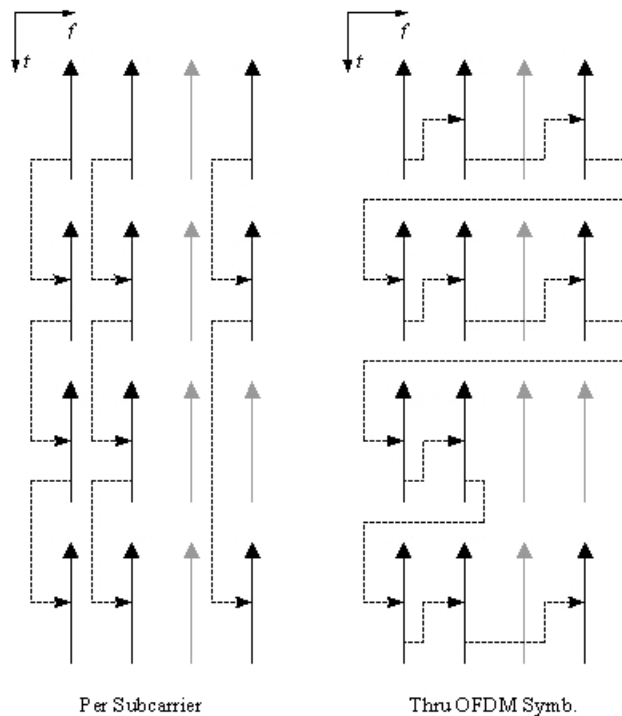

Fig. 2-22

It shows the subcarriers (f-axis) of four consecutive OFDM symbols (t-axis) with FFT length 4. The black subcarriers are assigned to a modulator that performs a differential modulation, the gray subcarriers belong to other modulators. The dashed arrows indicate what subcarrier in what OFDM symbol is used as reference for the currently modulated subcarriers. For *Differential Coding Per Subcarrier*, the reference is always the last subcarrier with the same index that was assigned to the same modulator as the subcarrier in question. If *Differential Coding Thru OFDM Symb.* is selected, the reference is the last subcarrier modulated by the same modulator, no matter what index it has and what OFDM symbol it belongs to. If the chain of references is broken, as it is for example on the rightmost subcarrier in the third OFDM symbol, the differential coding will simply "jump" all subcarriers that were assigned to other modulators.

WinIQOFDM also features a *Reinitialize Coder* parameter that determines reset events for the differential coding (and PSK Rotation).

PSK Rotation

PSK rotation is only offered in connection with differential PSK modulations. This parameter introduces a phase shift of $(k * \text{PI})/8 = k * 22.5^\circ$ between consecutive PSK symbols, where $k = 0, 1, 2, \dots, 15$. So, let us assume you selected differential 8 PSK and an All 0 data source. Without PSK rotation, the phase at the modulator output should thus be 0° throughout. Now you select a PSK rotation of $6\text{PI}/8 = 135^\circ$. The phases you will observe at the modulator output are: $0^\circ, 135^\circ, 270^\circ, 45^\circ, 180^\circ, 315^\circ, 90^\circ, 225^\circ \dots$

Reinitialize Coder

This parameter determines when the differential coder has to be reset. "Reset" means that the reference for Differential Coding and the PSK Rotation are reset to 0, so that the data symbol that follows a reset is coded/modulated non-differentially.

Pilot



Fig.: 2-22

The pilot consists of a regular data source and modulator that are coupled together by default. It was introduced to emphasize the special role the pilot plays in most OFDM systems.

In the OFDM Symbols panel, you can assign the pilot to any subcarrier, just like any other combination of data source and modulator. The only difference is that you have a choice between assigning the pilot "as is" or with all pilot bits inverted. This is a special feature that makes it easier to obtain configurations like in HiperLAN/2 that uses an inverted pilot on the 21st subcarrier without having to sacrifice an extra data source and modulator. The color codes are white-red for the pilot "as is" and white-green for the inverted pilot.

Apart from this, the parameters offered in the *Pilot* panel are the same as the ones you find in the panels *Data Sources*, *Alternate User Data Sources* and *Modulators*. There is no *Alternate User Pilot* panel since the pilot configuration is assumed the same for both user groups. However, the alternate user has its own pilot generator that is configured along with the main setup.

If one pilot per user is not enough, or if you need more flexibility than you can obtain from a fixed couple of data source and modulator, you can always "misuse" the regular data sources and modulators to generate the pilot you want.

Controls and Indicators

Data Source Type	This parameter is identical to the Data Source Type parameter in the <i>Data Sources</i> panel.
Invert Output Bits	This parameter is identical to the Invert Output Bits parameter in the <i>Data Sources</i> panel.
Shift Register Length	This parameter is identical to the Shift Register Length in the <i>Data Sources</i> panel.
Pattern Length	This parameter is identical to the Pattern Length parameter in the <i>Data Sources</i> panel.
Register Initial State	This parameter is identical to the Register Initial State parameter in the <i>Data Sources</i> panel.
Feedback Taps	This parameter is identical to the Feedback Taps parameter in the <i>Data Sources</i> panel.
Pattern	This parameter is identical with the Pattern parameter in the <i>Data Sources</i> panel.
Data File Name	This parameter is identical to the Data File Name parameter in the <i>Data Sources</i> panel.
Provide One Bit Per	This parameter is identical to the Provide One Bit Per parameter in the <i>Data Sources</i> panel.
Reset to Initial State	This parameter is identical to the Reset to Initial State parameter in the <i>Data Sources</i> panel.
Modulation	This parameter is identical to the Modulation parameter in the <i>Modulators</i> panel.
Relative Amplitude	This parameter is identical to the Relative Amplitude parameter in the <i>Modulators</i> panel.
Alpha	This parameter is identical to the Alpha parameter in the <i>Modulators</i> panel.
Differential Coding	This parameter is identical to the Differential Coding parameter in the <i>Modulators</i> panel.
PSK Rotation	This parameter is identical to the PSK Rotation parameter in the <i>Modulators</i> panel.
Reinitialize Coder	This parameter is identical to the Reinitialize Coder parameter in the <i>Modulators</i> panel.

OFDM Symbols

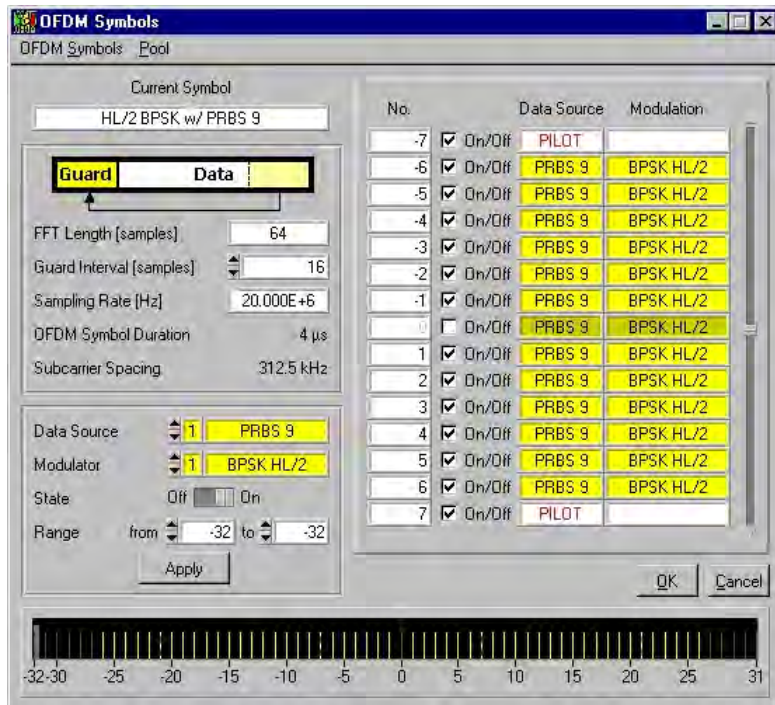

Fig.: 2-23

In the *OFDM Symbols* panel, you configure the OFDM symbol structure of the communications system you want to simulate. You set the system-wide sampling rate and FFT length, i.e. the number of available subcarriers. Then you define prototypes of the OFDM symbols you are going to generate. These prototypes are kept in a pool and can be used to construct bursts in the Bursts panel. Their definition covers the structure of the OFDM symbols in time and frequency domain, as well as what data sources and modulators are associated with the subcarriers. It does not include any information about the actual data encoded into the symbol. The latter is not generated until during the simulation. For simplicity, we will not differentiate between the terms *OFDM symbol* and *OFDM symbol prototype* in the following.

Every OFDM symbol prototype in the pool has its own name, guard interval and subcarrier setup. A *subcarrier setup* contains the assignment of data sources, modulators, and pilots to the subcarriers of the symbol. Not all carriers have to be used. A subcarrier that is switched off has a constant zero amplitude and is ignored by data sources and modulators.

The *OFDM Symbols* panel falls into the following blocks:

- Current Symbol (Symbol Name), top left
- Physical Parameters, upper middle left
- Subcarrier Edit, lower middle left
- Subcarrier List, top right
- Spectrum Display, bottom

OFDM Symbols Menu



Fig.: 2-24

New OFDM Symbol

At this tap, you can create new OFDM symbol prototypes. The currently edited symbol will be kept in the pool. Note that WinIQOFDM can only restore the symbol that is currently selected, so you have to confirm for your edits to be kept before creating a new OFDM symbol. The new symbol will be called "NONAME" by default. There are several options for the initial configuration of the new symbol.

New Default OFDM Symbol

Creates a new empty OFDM symbol. The guard interval is of length zero. All subcarriers are inactive. This option is not available in the HiperLAN/2 edit mode.

New Default HiperLAN/2 Symbol

Creates a new OFDM symbol that complies with the HiperLAN/2 standard. WinIQOFDM looks for the modulator with the lowest index that performs a modulation featured by the standard. This modulator and the data source with the same index will be assigned to the 48 data carriers used in HiperLAN/2. If no such modulator can be found, the default index is 1. HiperLAN/2 compliance also requires some other parameters to be set up according to the standard. If it was not properly configured, WinIQOFDM will either propose to make the necessary changes, or, depending on the actual problem, abort the creation of the new symbol. In any case, dialog boxes will report the inconsistencies encountered.

Copy Current OFDM Symbol

Creates a new OFDM symbol with the same parameter settings as the currently selected one.

Delete OFDM Symbol

Removes the currently selected OFDM symbol from the pool.

Pool Menu

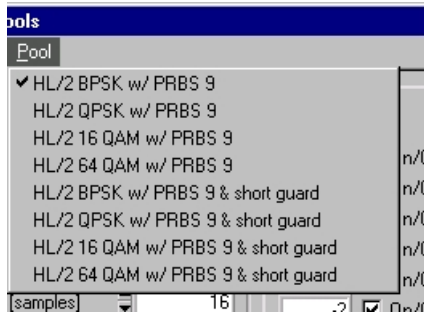

Fig. 2-25

The pool menu shows all OFDM symbol prototypes that are currently in memory. By checking one of the menu items, you can select the symbol you want to edit and bring it on the display.

Current Symbol

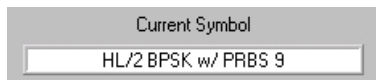

Fig.: 2-26

Displays the name of the OFDM symbol prototype that you are currently editing. You can also enter a new name.

Physical Parameters

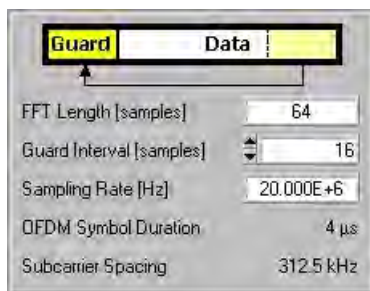

Fig.: 2-27

In the *physical parameters* block, you make settings that influence the overall shape of the OFDM symbols you want to create, regardless of the transmitted data and modulation schemes. You determine the number of subcarriers (FFT length), the sampling rate, and the guard interval. From this follow the OFDM symbol duration and the subcarrier spacing in the frequency domain. Note that the FFT length and the sampling rate are global settings that influence all OFDM symbol prototypes, instead of only the one that is currently displayed. Modifications of these global parameters cannot be undone.

FFT Length

Here, you can set the FFT length in samples, i.e. the number of available subcarriers in the OFDM symbols. This is a system-wide parameter, a change of the FFT length affects all OFDM symbol prototypes in the pool and cannot be undone.

Note that the FFT length has a direct influence on the length of the prototype bursts defined in the Bursts panel. And these are used to construct frames. So, if a burst is already used within a frame, an extended FFT length may cause it to either overlap with the burst that follows or to exceed the length of that frame. In other words, this may lead to a conflict in the configuration that cannot be resolved automatically. In these cases, WinIQOFDM will not carry out the attempted modifications. Instead, it will give you a description of the problem along with a list of the frames concerned.

Guard Interval

The guard interval (in samples) can be set separately for every OFDM symbol prototype in the pool. It is inserted at the beginning of every OFDM symbol and contains the selected number of samples that are copied from the end of the symbol's useful part. Thus, a periodic extension of the OFDM symbol is obtained.

The duration of that interval, the guard time, must be long enough for all echoes that stem from previously transmitted OFDM symbols to fade away. Therefore, in an OFDM system design, the minimum length of the guard interval is given by the longest difference in traveling time to be expected between two multipath propagation paths.

Note that the guard interval has a direct influence on the length of the prototype bursts defined in the Bursts panel. And these are again used to construct frames. So, if a burst is already used within a frame, a longer guard interval may cause it to either overlap with the burst that follows or to exceed the length of that frame. In other words, this may lead to a conflict in the configuration that cannot be resolved automatically. In these cases, WinIQOFDM will not carry out the attempted modifications. Instead, it will give you a description of the problem along with a list of the frames concerned.

Sampling Rate

Here you can set the sampling frequency for the generation of the simulated signal. The sampling rate is a system-wide parameter, yet it does not concern the calculations performed in WinIQOFDM, at all. But it is passed on to WinIQSIM, and from there, it affects the settings of AMIQ or SMIQ B60, respectively. The sampling rate can be changed at any time.

OFDM Symbol Duration

This read-only parameter is displayed for your information only. It is calculated from the other physical parameters according to

OFDM symbol duration = (FFT length [samples] + guard interval [samples]) / sampling frequency.

Subcarrier Spacing

This read-only parameter is displayed for your information only. It is calculated from the other physical parameters according to

$$\text{subcarrier spacing} = \text{sampling frequency} / \text{FFT length [samples]}.$$

Subcarrier Edit



Fig.: 2-28

In the subcarrier edit block, you decide for every subcarrier within the currently edited OFDM symbol whether it is active ("On") or inactive ("Off"), and what data source and modulator it is assigned to.

This is done by first selecting the edit range, i.e. the minimum and maximum subcarrier index that will be affected by the edits. Then you select the data source, the modulator, and the on/off state you want to assign to these carriers. Finally click the *Apply* button to carry out the selected modifications.

Note that in an HiperLAN/2 configuration, all active data carriers within each OFDM symbol must be assigned to the same data source and modulator. This is why in the *HiperLAN/2 edit mode*, these selectors are excluded from the range selection.

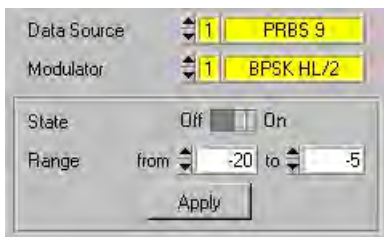

Fig.: 2-29

Any data source or modulator you select will be immediately assigned to all data carriers in the OFDM symbol. The pilot and inactive carriers are always set up according to the HiperLAN/2 standard. You can still use the rest of the subcarrier edit block to deactivate the normally active subcarriers in the selected range.

Data Source

Here, you choose the data source that you want to assign to the subcarriers within the edit range. Use the up/down arrows to select either one of the eight generators in the (*alternate*) *data sources* panel or the pilot. The number and type of the data source are shown. The control changes its color according to the current selection.

The pilot is selected by scrolling all the way down. The panel will then change, and show a selector that determines whether the pilot has to be inverted or not. Note that you cannot choose a modulator anymore. The pilot modulator is assigned implicitly.

Modulator

Here, you choose the modulator that you want to assign to the subcarriers within the selected range. Use the up/down arrows to select one of the eight modulators in the *modulators* panel. The number and type of the modulator are shown. The control changes its color according to the current selection. The pilot modulator cannot be selected. It is assigned automatically along with the pilot data source.

On/off State

Here, you can switch the on/off state of subcarriers. A subcarrier in *Off* state is inactive. It produces a constant zero amplitude and is completely ignored by data sources and modulators.

Thus, there is a difference between a subcarrier with no power and a subcarrier in *Off* state. A subcarrier with no power is still modulated and draws bits from its data source. A subcarrier in *Off* state is somewhat nonexistent, it is simply assigned a zero amplitude during signal generation. As of now, subcarriers with zero power can only be simulated by sacrificing a "dummy" modulator with a relative amplitude of zero that can be assigned to the carriers concerned.

Subcarrier List

No.		Data Source	Modulation
-7	<input checked="" type="checkbox"/> On/Off	PILOT	
-6	<input checked="" type="checkbox"/> On/Off	PRBS 9	BPSK HL/2
-5	<input checked="" type="checkbox"/> On/Off	PRBS 9	BPSK HL/2
-4	<input checked="" type="checkbox"/> On/Off	PRBS 9	BPSK HL/2
-3	<input checked="" type="checkbox"/> On/Off	PRBS 9	BPSK HL/2
-2	<input checked="" type="checkbox"/> On/Off	PRBS 9	BPSK HL/2
-1	<input checked="" type="checkbox"/> On/Off	PRBS 9	BPSK HL/2
0	<input type="checkbox"/> On/Off	PRBS 9	BPSK HL/2
1	<input checked="" type="checkbox"/> On/Off	PRBS 9	BPSK HL/2
2	<input checked="" type="checkbox"/> On/Off	PRBS 9	BPSK HL/2
3	<input checked="" type="checkbox"/> On/Off	PRBS 9	BPSK HL/2
4	<input checked="" type="checkbox"/> On/Off	PRBS 9	BPSK HL/2
5	<input checked="" type="checkbox"/> On/Off	PRBS 9	BPSK HL/2
6	<input checked="" type="checkbox"/> On/Off	PRBS 9	BPSK HL/2
7	<input checked="" type="checkbox"/> On/Off	PILOT	

Fig.: 2-30

The subcarrier list contains detailed information on how all subcarriers in the currently edited OFDM symbol are configured. You can scroll through the list and verify the data sources and modulators associated with the carriers. A double-click on one of the lines in the table automatically selects the corresponding carrier for edits.

The leftmost column shows the index number of the subcarriers. The indices are printed in black on a white background – or vice versa for subcarriers within the selected edit range. Subcarriers in *Off* state have gray index numbers.

The second left column contains check boxes for the On/off State of the subcarriers. Active carriers are checked. Here, you can directly (de)activate carriers without using the subcarrier edit block.

The second right column contains the data source information of the subcarrier. The color code indicates the data source that is currently assigned, the text shows the selected generator type. Inactive subcarriers are dimmed. Use the subcarrier edit block to change the assignments.

The rightmost column contains the modulator information of the subcarrier. The color code indicates the modulator that is currently assigned, the text shows the selected modulation scheme. Inactive subcarriers are dimmed. Use the subcarrier edit block to change the assignments.

Spectrum Display



Fig. 2-31

The spectrum display is a graphical representation of the currently edited OFDM symbol prototype. The subcarriers in *On* state appear as lines in the colors of the associated modulators. Subcarriers in *Off* state are shown in dark gray. Pilot subcarriers are white with stripes in red (non-inverted pilots) or green (inverted pilots). The range selected in the Subcarrier Edit block is marked by a gray background.

Bursts/PLCP-Frames

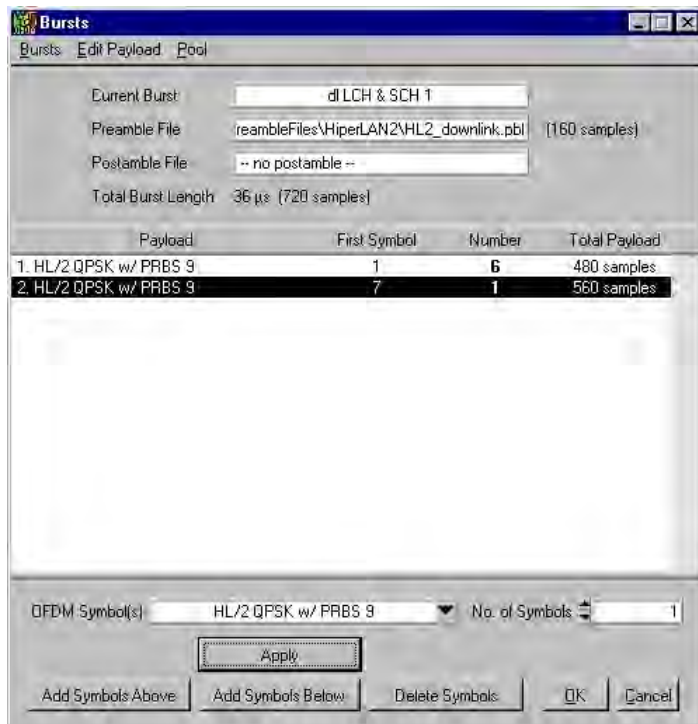

Fig.: 2-32

In the WinIQOFDM system model, a burst is defined as a seamless concatenation of a preamble, a series of OFDM symbols referred to as *payload*, and a postamble. Bursts are the first layer of organization within the time structure of the signal to generate. They are used to construct Frames.

All building parts are optional, so a valid burst may also just contain a preamble. Just like with OFDM symbols, the configuration of a burst does not include its data content, but rather its structure, a *prototype*. For simplicity, we will not differentiate between the terms *burst* and *burst prototype*.

Note: In IEEE 802.11a edit mode, the *Bursts* panel is replaced by a *PLCP Frames* panel with identical functionality. So, if you are currently editing in this mode, and you are looking for information on the *PLCP Frames* panel, you should refer to this chapter.

Bursts Menu



Fig.: 2-33

The *Bursts* menu provides functions to create and delete burst prototypes.

New Burst

At this tap, you can create new burst prototypes. The currently edited burst will be kept in the pool. Note that WinIQOFDM can only restore the burst that is currently selected, so you have to confirm for your edits to be kept before creating a new burst. The new burst will be called "NONAME" by default. There are several options for the initial configuration of the new burst.

Copy Current Burst Creates a new burst prototype that is identical to the currently selected one.

New Empty Burst Creates a new burst prototype of length zero that does not contain any preamble, postamble or OFDM symbols.

Delete Burst

Removes the currently selected burst from the pool.

Edit Payload Menu

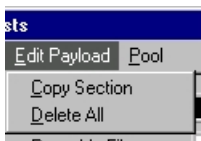

Fig.: 2-34

Copy Section

This menu item allows you to copy a section of your currently edited burst's payload as a whole. A popup opens, where you can select what part of the current payload you want to copy, how many copies to make, and where to insert them.

Delete All

Removes all bursts from the payload of the currently edited burst. The preamble and postamble remain.

Pool Menu

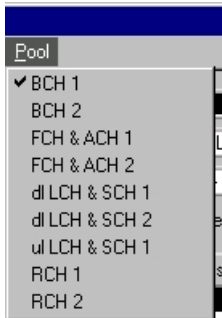

Fig.: 2-35

The pool menu shows all burst prototypes that are currently in memory. Checking a burst, selects it for edits and brings it on the display.

General Settings Block

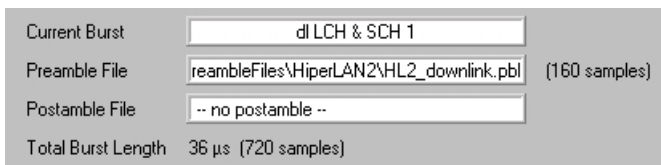

Fig.: 2-36

This block gives access to the parameters that do not concern the payload of the burst, i.e. the burst name, and the preamble and postamble files.

Current Burst Displays the name of the burst prototype that you are currently editing. You can also enter a new name.

Preamble File Shows the name of the preamble file assigned to the currently edited burst. Since in many OFDM systems burst preambles are generated with algorithms that differ from the ones that are normally used for OFDM symbol generation, WinIQOFDM features a file interface to simply read burst preambles from a file and insert them into the signal. These files contain directly the complex samples that constitute the preamble. Valid files can be obtained easily from standard Mathematical tools (numbers in float ASCII form, separated by spaces, I- and Q-components alternate). The default file extension is *.pbl. Here is an example of a correct *.pbl file:

I[1] Q[1]:	-9.1997509024248380e-002	-6.9388939039072280e-018
I[2] Q[2]:	-9.4440956821414020e-002	-4.1397785354800700e-002
I[3] Q[3]:	-1.2020053815196320e-001	-3.5205922522437700e-002
I[4] Q[4]:	1.3736669523554450e-002	1.1789091851599240e-001
I[5] Q[5]:	1.3010412496663320e-001	1.3877787807814460e-017
I[6] ...	1.3736669523554470e-002	...

Double-click on the preamble file display to select a new preamble. The display reads -- no preamble -- if no file is currently selected. WinIQOFDM automatically detects the length of the preamble, i.e. number of IQ-samples

contained in the file, and shows it next to the preamble file name. It is also added to the total burst length. Files with an odd number of float values will not be accepted.

Postamble File

Shows the name of the postamble file assigned to the currently edited burst. Since in many OFDM systems burst postambles are generated with algorithms that differ from the ones that are normally used for OFDM symbol generation, WinIQOFDM features a file interface to simply read burst postambles from a file and insert them into the signal. These files contain directly the complex samples that constitute the postamble. Valid files can be obtained easily from standard Mathematical tools (numbers in float ASCII form, separated by spaces, I- and Q-components alternate). The default file extension is *.pbl. Here is an example of a correct *.pbl file:

I[1] Q[1]:	-9.1997509024248380e-002	-6.9388939039072280e-018
I[2] Q[2]:	-9.4440956821414020e-002	-4.1397785354800700e-002
I[3] Q[3]:	-1.2020053815196320e-001	-3.5205922522437700e-002
I[4] Q[4]:	1.3736669523554450e-002	1.1789091851599240e-001
I[5] Q[5]:	1.3010412496663320e-001	1.3877787807814460e-017
I[6] ...	1.3736669523554470e-002	...

Double-click on the postamble file display to select a new postamble. The display reads -- *no postamble* -- if no file is currently selected. WinIQOFDM automatically detects the length of the *postamble*, i.e. number of IQ-samples contained in the file, and shows it next to the *postamble* file name. It is also added to the total burst length. Files with an odd number of float values will not be accepted.

Total Burst Length

This indicator shows the total length of the currently selected burst in terms of duration and number of samples. This includes the preamble and postamble, as well as the payload.

Payload List

Payload	First Symbol	Number	Total Payload
3. Symbol Test Src 5, 3 ERR	5	2	1152 samples
4. Symbol Test Src 2	7	4	1920 samples
5. Symbol Test Src 8, 2 ERR	11	1	2112 samples
6. Symbol Test Src 4, 1 ERR	12	1	2304 samples
7. Symbol Test Src 1	13	10	4224 samples
8. Symbol Test Src 1	23	3	4800 samples
9. Symbol Test Src 3	26	1	4992 samples
10. Symbol Test Src 5, 3 ERR	27	2	5376 samples
11. Symbol Test Src 2	29	4	6144 samples
12. Symbol Test Src 8, 2 ERR	33	1	6336 samples
13. Symbol Test Src 4, 1 ERR	34	1	6528 samples
14. Symbol Test Src 1	35	10	8448 samples
15. Symbol Test Src 1	45	3	9024 samples
16. Symbol Test Src 3	48	1	9216 samples
17. Symbol Test Src 5, 3 ERR	49	2	9600 samples

Fig.: 2-37

This display shows a sorted list of all OFDM symbols in the currently edited burst. Every row may represent one or a whole group of similar symbols within the payload. 'Similar' means that all symbols in one group refer to the same prototype. From left to right the columns show

- the group indices
- the names of the OFDM symbols assigned to the groups
- the indices of the first symbols within every group with respect to the whole payload
- the number of OFDM symbols contained in the groups
- the total length in samples of the payload at the end of the groups.

No changes can be made directly in the payload list. The Payload Edit Block or the Edit Payload Menu must be used for modifications. The line that is currently selected for edits is printed white on black. A line is selected by clicking on it, a double click selects a line and moves its settings into the payload edit block.

Payload Edit Block

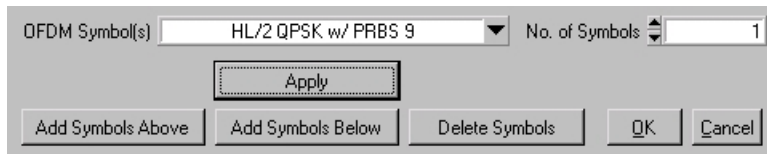

Fig.: 2-38

This is the bottom part of the Bursts panel. In this block, you can add and edit entries in the Payload List. First, you select the desired OFDM symbol prototype and number of symbols. Then you use the buttons to either apply these settings to the currently selected line in the payload list, add a list entry with these settings above or below that line, or to delete the selected line from the list.

OFDM Symbol(s)

Here, you select the OFDM symbol prototype you want to assign either to a new group of symbols or to the currently selected one. The choice is of all the symbols from the pool in the OFDM Symbols panel.

Note that the length of the symbol you select directly influences the burst's total length. So, if a burst is already used within a frame, this may cause it to either overlap with the burst that follows or to exceed the length of that frame. In other words, assigning another symbol prototype may lead to a conflict in the configuration that cannot be resolved automatically. In these cases, WinIQOFDM will not carry out the attempted modifications. Instead, it will give you a description of the problem along with a list of the frames concerned.

No. of Symbols

Here, you select the number of symbols you want to assign either to a new group of symbols or to the currently selected one.

Note that the number of symbols has a direct influence on the burst's total length. So, if a burst is already used within a frame, a larger number of symbols may cause it to either overlap with the burst that follows or to exceed the length of that frame. In other words, it may lead to a conflict in the configuration that cannot be resolved automatically. In these cases, WinIQOFDM will not carry out the attempted modifications. Instead, it will give you a description of the problem along with a list of the frames concerned.

Apply

Assigns the selected OFDM symbol prototype and number of symbols to the group of symbols that is currently marked in the Payload List.

If this would lead to a conflict within a frame, e.g. burst overlaps, the attempted modifications are not carried out. Instead, WinIQOFDM will give you a description of the problem along with a list of the frames concerned.

Add Symbols Above

Adds a new group of symbols to the payload containing the selected OFDM symbol prototype and number of symbols above the currently edited line in the Payload List. In the list, the newly added group will appear as a new line.

Note that adding symbols to a burst will increase its length. So, if a burst is already used within a frame, a larger number of symbols may cause it to either overlap with the burst that follows or to exceed the length of that frame. In other words, it may lead to a

conflict in the configuration that cannot be resolved automatically. In these cases, WinIQOFDM will not carry out the attempted modifications. Instead, it will give you a description of the problem along with a list of the frames concerned.

Add Symbols Below

Adds a new group of symbols to the payload containing the selected OFDM symbol prototype and number of symbols below the currently edited line in the Payload List. In the list, the newly added group will appear as a new line.

Note that adding symbols to a burst will increase its length. So, if a burst is already used within a frame, a larger number of symbols may cause it to either overlap with the burst that follows or to exceed the length of that frame. In other words, it may lead to a conflict in the configuration that cannot be resolved automatically. In these cases, WinIQOFDM will not carry out the attempted modifications. Instead, it will give you a description of the problem along with a list of the frames concerned.

Delete Symbols

Deletes the currently selected group of OFDM symbols from the payload list.

Frames

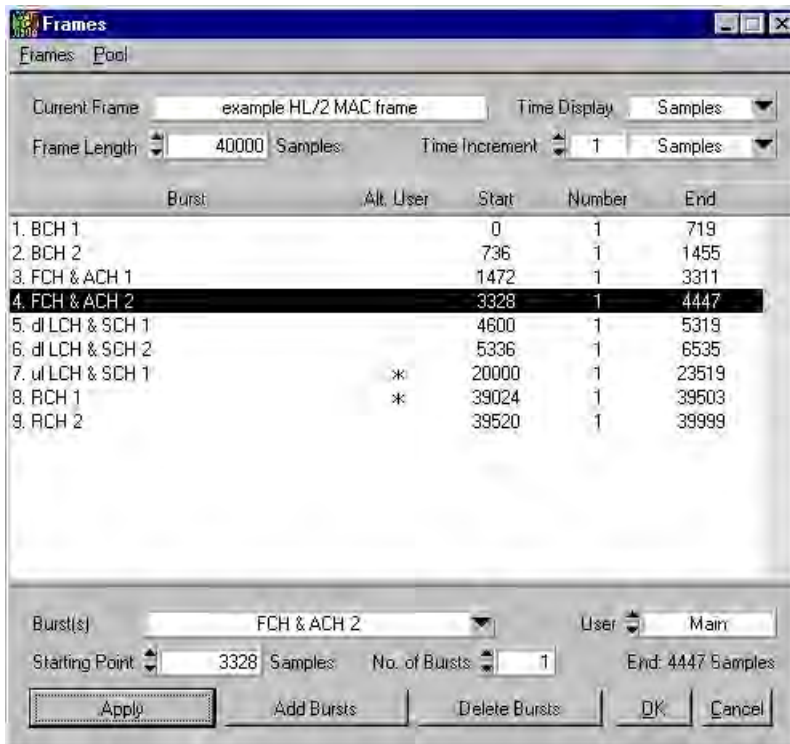

Fig.: 2-39

In the WinIQOFDM system model, a frame is defined as a certain time span that is filled with bursts. Frames are the second layer of organization within the time structure of the signal to generate. They are used to construct the Sequence.

The bursts, or rather burst prototypes, all have their own arbitrary starting point within a frame. A frame does not have to be filled up completely, it may contain empty spaces where no signal will be generated (constant zero output). In fact, it is even possible to set up a completely empty frame. Since such a configuration is rather pointless, WinIQOFDM will give a warning. The only thing that is not allowed to happen is an overlap between bursts within a frame.

Just like with bursts, the configuration of a frame does not include its data content, but rather its structure, a *prototype*. For simplicity, we will not differentiate between the terms *frame* and *frame prototype*.

Note: The *PLCP Frames* panel in IEEE 802.11a edit mode corresponds in functionality to the *Bursts* panel in other edit modes. So, if you are currently editing in this mode, you should refer to chapter *Bursts Panel* for a description.

Frames Menu



Fig.: 2-40

The *Frames* menu provides functions to create and delete frame prototypes.

New Frame

At this tap, you can create new frame prototypes. The currently edited frame will be kept in the pool. Note that WinIQOFDM can only restore the frame that is currently selected, so you have to confirm that your edits be kept before creating a new frame. The new frame will be called "NONAME" by default. There are several options for the initial configuration of the new frame.

Copy Current Frame

Creates a new frame prototype that is identical to the currently selected one.

New Empty Frame

Creates a new frame prototype of length zero that does not contain any bursts.

Delete Frame

Removes the currently selected frame from the pool.

Pool Menu

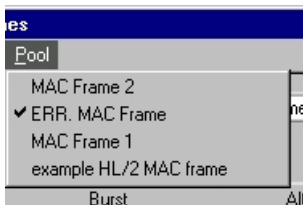

Fig.: 2-41

The pool menu shows all frame prototypes that are currently in memory. Checking a frame, selects it for edits and brings it on the display.

General Settings Block

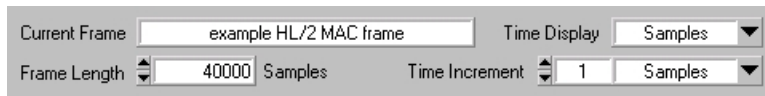

Fig.: 2-42

This block gives access to the more general parameters of the frame that do not concern its content, i.e. the frame's name and length. Apart from this, it features some additional options for the handling of the *Frames* panel.

- | | |
|-----------------------|---|
| Current Frame | Displays the name of the frame prototype that you are currently editing. You can also enter a new name. |
| Frame Length | Here, you set the total length of the frame you are currently editing. The frame length is a 'hard limit', meaning that bursts within a frame cannot be extended beyond the frame's length. The length is a frame property and may differ among the frames contained in the pool. |
| Time Display | Decides whether the internal timing of frames (e.g. starting points of bursts) is given in terms of samples or absolute time. This is merely a display option that does not affect WinIQOFDM's configuration. |
| Time Increment | Here, you select the time increment for the Starting Point control in the Burst List Edit Block. You can enter any number of samples or bursts. If <i>Bursts</i> is selected, the reference for the increment is always the burst prototype the Burst(s) control is set to. |

Burst List

Burst	Alt. User	Start	Number	End
2. HL/2 BCH w/ broadcast preamble		736	1	1455
3. HL/2 downlink preamble		1472	1	1631
4. HL/2 FCH		1632	2	3071
5. HL/2 ACH		3072	1	3311
6. HL/2 downlink preamble		3328	1	3487
7. HL/2 FCH		3488	1	4207
8. HL/2 ACH		4208	1	4447
9. HL/2 downlink preamble		4600	1	4759
10. HL/2 LCH (QPSK, CR 3/4)		4760	1	5239
11. HL/2 SCH (QPSK, CR 3/4)		5240	1	5319
12. HL/2 downlink preamble		5336	1	5495
13. HL/2 LCH (16 QAM, CR 3/4)		5496	2	5975
14. HL/2 SCH (QPSK, CR 3/4)		5976	1	6055
15. HL/2 LCH (16 QAM, CR 3/4)		6056	1	6295
16. HL/2 SCH (QPSK, CR 3/4)		6296	3	6535

Fig. 2–43

This display shows a sorted list of all bursts in the currently edited frame. Every row may represent one or a whole group of similar bursts. 'Similar' means that all bursts in one group refer to the same prototype. From left to right the columns show

- the group indices
- the names of the bursts assigned to the groups
- the association of the groups with the main or alternate user
- the beginning of the groups with respect to the frame
- the number of bursts contained in the groups
- the end of the groups with respect to the frame.

No changes can be made directly in the burst list. The Burst List Edit Block must be used for modifications. The entry that is currently selected for edits is printed white on black. An entry is selected by clicking on it, a double click selects an entry and moves the settings into the burst list edit block.

Sequence

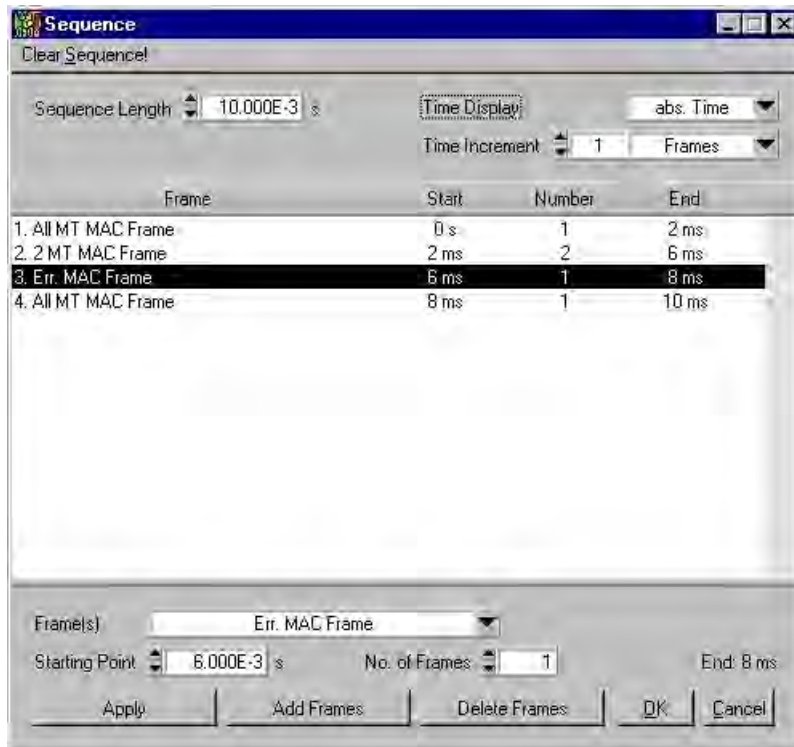

Fig.: 2-45

In the WinIQOFDM system model, the final signal to generate is called the *sequence*. So, the sequence is the highest layer of organization within the signal's time structure. It is defined as a time span of given length that is filled with Frames.

The frames, or rather frame prototypes, all have their own freely configurable starting point within the sequence. The sequence may contain empty spaces where no signal will be generated (constant zero amplitude). In fact, it is even possible to set up a totally empty sequence. WinIQOFDM will give a warning, though. The only thing that is not allowed to happen is an overlap between frames within the sequence.

Just like with frames, the configuration of a sequence does not include its data content, but rather its structure, a *prototype*. For the sake of simplicity, this text will not differentiate between the terms *sequence* and *sequence prototype*.

Clear Sequence!

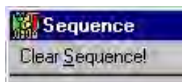

Fig.: 2-46

This menu item removes all frames from the sequence. The length of the sequence remains unchanged.

General Settings Block

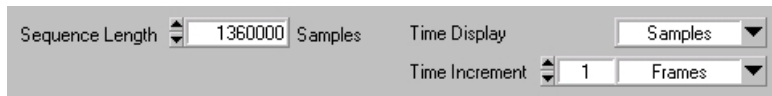

Fig.: 2-47

Sequence Length

Here, you set the total length of the sequence. The sequence length is a 'hard limit', meaning that frames within a sequence cannot be extended beyond the sequence length.

Time Display

Decides whether the internal timing of the sequence (e.g. starting points of frames) is given in terms of samples or absolute time. This is merely a display option that does not affect WinIQOFDM's configuration.

Time Increment

Here, you select the time increment for the Starting Point control in the Burst List Edit Block. You can enter any number of samples or bursts. If *Bursts* is selected, the reference for the increment is always the burst prototype the Burst(s) control in the Burst List Edit Block is set to.

Frame List

Frame	Start	Number	End
2. ERR. MAC Frame	40000	1	79999
3. MAC Frame 2	120000	3	239999
4. MAC Frame 1	240000	2	319999
5. example HL/2 MAC frame	320000	1	359999
6. example HL/2 MAC frame	360000	1	399999
7. ERR. MAC Frame	400000	2	479999
8. MAC Frame 2	480000	2	559999
9. MAC Frame 1	560000	3	679999
10. example HL/2 MAC frame	680000	5	879999
11. MAC Frame 2	1040000	1	1079999
12. ERR. MAC Frame	1080000	1	1119999
13. ERR. MAC Frame	1120000	1	1159999
14. ERR. MAC Frame	1160000	1	1199999
15. MAC Frame 2	1200000	2	1279999
16. MAC Frame 1	1280000	2	1359999

Fig.: 2-48

This display shows a sorted list of all frames in the sequence. Every row may represent one or a whole group of similar frames. 'Similar' means that all frames in one group refer to the same prototype. From left to right the columns show

- the group indices
- the names of the frames assigned to the groups
- the beginning of the groups with respect to the sequence
- the number of frames contained in the groups
- the end of the groups with respect to the sequence.

No changes can be made directly in the frame list. The Frame List Edit Block must be used for modifications. The entry that is currently selected for edits is printed white on black. An entry is selected by clicking on it, a double click selects an entry and moves the settings into the frame list edit block.

Frame List Edit Block

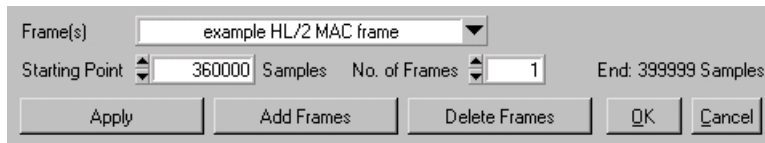

Fig.: 2-49

Frame(s)	Here, you select the frame prototype you want to assign either to a new group of frames in the sequence or to the currently selected one. The choice is of all the frames from the pool in the Frames panel.
Starting Point	Here, you select the starting point you want to assign either to a new group of frames in the sequence or to the currently selected one.
No. of Frames	Here, you select the number of frames you want to assign either to a new group of frames in the sequence or to the currently selected one.
End	Indicates the end of the currently selected group of frames.
User	In IEEE 802.11a edit mode, the Frame List edit block features an additional User selector that lets you decide whether the currently selected group of frames is going to be generated by the main or the alternate user.
Apply	Assigns the settings made above in the Frame List Edit Block to the group of frames that is currently selected in the Frame List. If this would lead to an overlap with other frames, or if the frame would exceed the length of the sequence, the modifications are not carried out.
Add Frames	Adds a new group of frames to the sequence content. The new group of frames is configured with the settings made above in the Frame List Edit Block. If this would lead to an overlap with other frames, or if the new frame would exceed the length of the sequence, the modifications are not carried out.
Delete Frames	Deletes the currently selected group of frames from the sequence.

3 Applications

Generating HiperLAN/2 Signals with WinIQOFDM

HiperLAN/2 uses an IFFT of length 64 to generate its OFDM symbols. The sampling rate is 20 MHz. Only the subcarriers with indices -26 through -1 and 1 through 26 are actually in use. The ones with indices -21 , -7 , 7 , and 21 carry pilot signals, the others carry data. The guard interval is 16 samples long. There is an option for a “short guard interval” that only comprises 8 samples, as well. OFDM symbols cannot be divided to transmit more than one data stream together in parallel. This means that all data carriers within one symbol have to be fed from the same data source. The channel coded and interleaved data is assigned sequentially to the data carriers starting at index -26 and going on in ascending order to carrier No. 26. How many data bits are encoded per subcarrier depends on the type of modulation used. As far as the design of the OFDM symbols is concerned, the European HiperLAN/2 standard is very similar to the American IEEE 802.11a specification (see Generating IEEE 802.11a Signals with WinIQOFDM). The time structure on the burst level or above is entirely different, though.

Four non-differential modulation schemes are employed: BPSK HL/2, QPSK HL/2, 16 QAM HL/2, and 64 QAM HL/2 (optional). The pilots are always modulated with BPSK HL/2 (see below). The other subcarriers can be assigned any of these modulation schemes, but there is always just one scheme per burst, and, thus, per OFDM symbol, as well. The HiperLAN/2 standard contains restrictions as to what modulation schemes are allowed to be used in what kind of burst.

All four pilots obtain their data from one special PRBS with shift register length 7. This PRBS is transmitted “as is” on the first three pilots in parallel, the pilot data at subcarrier index 7 is inverted. The pilot data sequence is initialized at the beginning of every Burst. As mentioned above, the pilots are modulated using the HL/2 BPSK mapping. In order to obtain those pilots from WinIQOFDM, you have to make the following settings: Select **Data Source Type|HiperLAN/2 Pilot** in the *Pilot* panel, the parameters **Provide One Bit Per|OFDM Symbol** and **Reset to Initial State|every Burst** will be set as defaults automatically. Then select **Modulation|BPSK HL/2** with **Differential Coding|disabled**. Then what you still have to do in every OFDM symbol is to assign the subcarriers -21 , -7 , 7 and 21 to *Pilot as is* and *Pilot inverted*, respectively.

Although you could make all necessary settings in the *Generic* edit mode, the aforementioned conventions up to OFDM symbol level are met automatically if you select WinIQOFDM's *HiperLAN/2* edit mode in the main panel (**Edit Modes|HiperLAN/2**). This edit modes prevents all settings that are illegal in *HiperLAN/2* and loads a pool of OFDM symbols filled with all structures that can occur in this system.

A *HiperLAN/2* burst corresponds to one PDU (Protocol Data Unit). It consists of a preamble and a number of OFDM symbols that are attached to it. Preamble files for *HiperLAN/2* can be found in the folder *PreambleFiles/HiperLAN2/* in the install directory. The attached OFDM symbols contain the PDUs. All these PDUs have a given length that depends on the channel coding and modulation used. A further explanation of this is beyond the scope of this document. Please refer to the DLC part of the *HiperLAN/2* specifications for a closer description of how to construct valid PDUs.

There is also a frame structure in *HiperLAN/2*. A MAC frame has a length of 2ms, or 40 000 samples. The locations of bursts inside a frame are rather free. Basically, bursts can start at any sample whose index is a multiple of 8. The actual starting points are contained in the broadcast bursts at the beginning of every MAC frame. So, in order to create frames that can actually be demodulated, the data file import has to be used to fill the broadcast burst with valid data.

The files *HL2_Example_MAC_frame_1* and *HL2_Example_MAC_frame_2* contain two examples of how to configure WinIQOFDM in order to implement *HiperLAN/2* MAC frames. The files can be found in the folder *Setups/Examples/* in the install directory. Both files produce the same signal.

The first file shows an approach where complete valid bursts have been set up in the *Bursts* panel on an OFDM symbol basis. These bursts are simply assigned to their positions in the MAC frame in the *Frames* panel. This concept is most suitable if the simulated system is seen from a PHY layer point of view. The frame setup is very clearly structured, yet, it does not contain any information about the actual PDUs contained in the bursts. In fact, the PDU structure can only be recovered by analyzing the kind, number and order of the OFDM symbols contained in every burst and comparing it to the *HiperLAN/2* specifications. On the other hand, this is very easy to do for somebody who has read the standard.

The configuration found in the second file reflects more of the signal structure on DLC layer level. The *Bursts* panel is not used to define complete bursts, but contains a pool of all possible PDUs in *HiperLAN/2* (only with regular guard intervals) together with bursts that only contain the preambles of the bursts to be constructed. The PDUs and preambles are then concatenated in the *Frames* panel to obtain the burst structure within the MAC frame. The preambles mark the beginning of every new burst. So, the actual structure of the PDU train is clearly visible in the *Frames* panel, and it is easy to add new bursts, simply by picking preambles and PDUs from the “toolbox” created in the *Bursts* panel.

Which one of these two implementations you prefer is up to you, after all. Anyway, these examples give a good idea of how WinIQOFDM's system model can be used to easily create *HiperLAN/2* signals.

Generating IEEE 802.11a Signals with WinIQOFDM

IEEE 802.11a is one of the physical layers proposed to provide a data link according to the IEEE 802.11a standard. On the physical layer, the American IEEE 802.11a is very similar to European HiperLAN/2 (see Generating HiperLAN/2 Signals with WinIQOFDM).

IEEE 802.11a uses an IFFT of length 64 to generate its OFDM symbols. The sampling rate is 20 MHz. Only the subcarriers with indices -26 through -1 and 1 through 26 are actually in use. The ones with indices -21 , -7 , 7 , and 21 carry pilot signals, the others carry data. The guard interval is 16 samples long. OFDM symbols cannot be divided to transmit more than one data stream together in parallel. This means that all data carriers within one symbol have to be fed from the same data source. The channel coded and interleaved data is assigned sequentially to the data carriers starting at index -26 and going on in ascending order to carrier No. 26. How many data bits are encoded per subcarrier depends on the type of modulation used.

Four non-differential modulation schemes are employed: BPSK HL/2, QPSK HL/2, 16 QAM HL/2, and 64 QAM HL/2. The pilots are always modulated with BPSK HL/2 (see below). The other subcarriers can be assigned any of these modulation schemes, but there is always just one scheme per OFDM symbol. Yet, the first symbol of a frame must be completely BPSK modulated.

All four pilots obtain their data from one special PRBS with shift register length 7. This PRBS is transmitted "as is" on the first three pilots in parallel, the pilot data at subcarrier index 7 is inverted. The pilot data sequence is initialized at the beginning of every PLCP frame (see below). As mentioned above, the pilots are modulated using the HL/2 BPSK mapping. In order to obtain those pilots from WinIQOFDM, you have to make the following settings: Select **Data Source Type|HiperLAN/2 Pilot** in the *Pilot* panel, the parameters **Provide One Bit Per|OFDM Symbol** and **Reset to Initial State|every Burst** will be set as defaults automatically. Then select **Modulation|BPSK HL/2 with Differential Coding|disabled**. Then what you still have to do in every OFDM symbol is to assign the subcarriers -21 , -7 , 7 and 21 to *Pilot as is* and *Pilot inverted*, respectively.

IEEE 802.11a signals are organized in PLCP frames that cannot be broken down further into bursts. One such PLCP frame falls into three parts:

- a *PLCP preamble* with a length of 12 OFDM symbol durations
- a BPSK modulated OFDM symbol called *signal* that contains information on the frame length and the modulation scheme used by the following symbols
- an arbitrary number of OFDM symbols that carry the data to be transmitted.

The data symbols may be modulated by any one of the above schemes, but the same scheme must be maintained throughout one frame.

Although you could make all necessary settings in Generic edit mode, it is much more convenient to use WinIQOFDM's built-in *IEEE 802.11a* edit mode (in the Main Panel select **Edit Modes|IEEE 802.11a**). This edit mode prevents all settings that do not comply with the standard and at the same time creates a pool of OFDM symbols containing all symbol structures that can occur in that system. There is one Symbol with BPSK HL/2, QPSK HL/2, 16 QAM HL/2 and 64 QAM HL/2 modulation, respectively, plus one symbol with BPSK HL/2 modulation that is assigned to a different data source than the other symbols. It is intended to be the first symbol of a PLCP frame and may carry true reference information if the corresponding data source reads from a data file with proper content.

PLCP frames in IEEE802.11a diction correspond roughly to WinIQOFDM bursts. Yet, there is no additional hierarchy above them like the frames in WinIQOFDM. Consequently, in IEEE802.11a edit mode, WinIQOFDM's user interface is changed to construct PLCP frames directly from OFDM symbols. The PLCP Frames panel has the same functionality as the Bursts panel in Generic edit mode and is thus operated the same way. In this panel, you can build a pool of IEEE 802.11a PLCP frames according to your needs. The PLCP preamble file can be found in the folder *PreambleFiles/IEEE 802.11a*. A preset model frame is already provided when you switch to IEEE 802.11a edit mode. Finally, you combine the frames in the Sequence panel to form the signal you want to generate. The Sequence panel features an additional User selector in the Frame List edit block that lets you decide whether the currently selected group of frames is going to be generated by the main or the alternate user.

Generating DVB Signals with WinIQOFDM

This section gives a short overview of the DVB standard (ETSI EN 300 744 V1.2.1), along with a proposal how a DVB signal can be obtained from WinIQOFDM.

Let us start off with the basic signal structure. According to the standard, DVB signal is organized in *frames* and *super-frames*, where a super-frame consists of four frames, and a frame comprises 68 OFDM symbols in turn. So, DVB frames correspond to WinIQOFDM bursts and DVB super-frames correspond to WinIQOFDM frames. There are two modes, the *8K mode* and the *2K mode* with FFT lengths of 8192 and 2048, respectively. In the 8K mode, 6817 subcarriers are used (indices –3408 through 3408), and 1705 in the 2K mode (indices –852 through 852). There are three sampling frequencies depending on the aimed channel bandwidth.

Table 3-1

Channel bandwidth	Sampling rate
8 MHz	64/7 MHz
7 MHz	8 MHz
6 MHz	48/7 MHz

The guard time can be 1/4, 1/8, 1/16, or 1/32 of the duration of an OFDM symbol's useful part. All OFDM symbols contain data and reference information (*scattered pilots*, *continual pilots*, and *TPS carriers*).

The payload can be modulated with QPSK, 16 QAM, or 64 QAM. For the QAM schemes, the alpha value can be 1, 2, or 4. In WinIQOFDM, these modulations are named *QPSK DVB*, *16 QAM DVB a1*, *16 QAM DVB a2*, *16 QAM DVB a4*, *16 QAM DVB a1*, *16 QAM DVB a2*, and *16 QAM DVB a4*. One of these modulation schemes is used for all subcarriers during a transmission.

The transmission parameters remain unchanged at least during one super-frame.

All of the above said can be easily obtained from WinIQOFDM by choosing the desired type of data generator and modulation in the corresponding panels, say as data source and modulator No. 1, and setting the correct sampling rate and FFT length in the OFDM Symbols panel. Then, this data generator and modulator can be assigned to all data subcarriers. Unused subcarriers must be switched to the *off* state.

The trickier part is the configuration of the pilots and the TPS carriers. The reference sequence carried by the scattered and continual pilots is obtained from one PRBS 11 shift register with initial state 11111111111 that is configured as a subcarrier counter and reset every OFDM symbol. The TPS carriers use this same sequence to initialize their differential modulation (see below), so it is better to use a regular data source, e.g. source No. 8, instead of WinIQOFDM's pilot to generate the sequence.

So, what you need to do so far in the data sources panel is to make source No. 8 a *User PRBS*, and make the following settings:

Table 3-2

Invert Output Bits	No
Register Initial State	11111111111
Feedback Taps	2, 0
Provide One Bit Per	Active Subcarrier
Reset to Initial State	Every OFDM Symb.

The resulting Shift Register Length should be 11.

The pilots are BPSK modulated and transmitted with relative amplitude 4/3. So, assign these settings to modulator No. 8 in the modulators panel.

There are two types of pilots in DVB, the *scattered pilots* and the *continual pilots*. The difference is that the continual pilots have fixed locations within the OFDM symbols, whereas there are four patterns for the distribution of the scattered pilots that are switched cyclically every symbol. Please consult the DVB standard for more details. The only way to realize this cyclic switch in WinIQOFDM is to define four separate OFDM symbols with the four pilot distributions and make sure that in all bursts these symbols follow one another in the correct order.

The TPS is transmitted in parallel on 17 TPS subcarriers in 2K mode and on 68 subcarriers in 8K mode, i.e. all TPS carriers in a symbol convey the same bit. The locations of the TPS carriers are the same throughout all OFDM symbols. The TPS contains signalling parameters related to the transmission scheme. One TPS message is 68 bits long, i.e. one TPS message is transmitted during one frame.

The modulation scheme used for the TPS carriers is differential BPSK per subcarrier with relative amplitude 1. The differential modulation is reinitialized every frame. The first bit in a frame encoded on the TPS carriers is taken from the PRBS 11 generator used for the pilots.

The conclusion is that in order to generate a DVB signal, five OFDM symbols need to be defined, four with the different distribution patterns of the scattered pilots, and one *TPS init symbol* with the first pilot distribution and the TPS carriers all assigned to the pilot data source. This symbol has to be used as the first symbol of a DVB frame (WinIQOFDM burst). The rest of the frame has to be filled with the other four OFDM symbols according to this pattern: 2, 3, 4, 1, 2, 3, 4, 1, 2, 3, 4... This can be done rather quickly by help of the Copy Section command.

Then the TPS data source must be set up to produce one bit per OFDM symbol. If you are planning to transmit valid TPS data, note that the first bit of every TPS block is generated by the TPS data source, although the bits that are encoded are taken from the pilot generator. So, every TPS message starts off with an unused dummy bit.

The DVB super-frames are then constructed in WinIQOFDM's frames panel. The sequence is a concatenation of super-frames.

If more than one set of transmission parameters has to be realized in one simulation, a set of symbols and bursts as described above has to be created for every one of them.

4 Glossary of Terms

DFT	Discrete Fourier Transform
FFT	Fast Fourier Transform
IFFT	Inverse Fourier Transform
PLCP	Physical Layer Convergence Procedure
TPS	Transmission Parameter Signalling
DVB	Digital Video Broadcasting (digital terrestrial television)
HiperLAN	High PERformance Local Area Network
PRBS	Pseudo Random Binary Sequence
QAM	Quadrature Amplitude Modulation
PRBS	Pseudo Random Binary Sequence
8 PSK	8 Phase Shift Keying
QPSK	Quadrature Phase Shift Keying
BPSK	Binary Phase Shift Keying
PDU	Protocol Data Unit

5 Index

*

- *.dat file 2-10
- *.pbl file 2-34, 2-35

1

- 16 QAM 2-16

6

- 64 QAM 2-17

8

- 8 PSK 2-16
- 802.11a 2-3, 2-32, 2-39, 2-46, 3-1, 3-3

A

- about WinIQOFDM... 2-5
- add bursts 2-43
- alpha 2-20, 2-24
- alternate user 1-6, 2-7, 2-12, 2-13, 2-23
- applications 3-1

B

- BPSK 2-15
- burst 1-6, 2-25, 2-28, 2-32, 2-33, 2-37, 2-43
- burst list 2-42
- burst list edit 2-43
- burst pool 2-34
- bursts menu 2-33

C

- Cancel button 2-1
- clear sequence! 2-44
- contents 2-5
- copy current burst 2-33
- copy from main user 2-12
- copy section 2-33
- current symbol 2-27

D

- data file name 2-12, 2-24
- data source 1-5, 1-6, 2-2, 2-7, 2-8, 2-10, 2-12, 2-23, 2-25, 2-30, 3-4
- data source selector 2-8
- data source type 2-9, 2-24
- delete all 2-33
- delete burst 2-33
- delete bursts 2-43
- differential coding 2-21
- Differential Coding 2-24
- differential coding per subcarrier 2-22
- differential coding thru OFDM symb 2-22
- DVB 3-4

E

- edit modes menu 2-3
- edit payload menu 2-33
- exit 2-3

F

- feedback shift register 2-9
- feedback taps 2-9, 2-11, 2-24
- FFT length 2-28
- file menu 2-2
- frame 1-6, 2-39
- frame list 2-45
- frame list edit 2-46
- frame pool 2-40
- frames menu 2-40

G

- generic edit mode 2-3
- guard interval 1-3, 2-28
- guard time 1-3

H

- help 2-1, 2-5
- help menu 2-5
- HiperLAN/2 3-1, 3-3
- HiperLAN/2 edit mode 2-3, 2-29

I

IEEE 802.11a..... 2-3, 2-32, 2-39, 2-46, 3-1, 3-3
 IEEE 802.11a edit mode 2-3
 installation 1-1
 invert output bits..... 2-10, 2-24
 inverted output 2-9

M

main panel..... 2-2
 main user 2-7, 2-13
 minimize all! 2-4
 modulation..... 2-15, 2-24
 modulator 1-5, 2-13, 2-30
 modulator selector 2-14

N

new burst..... 2-33
 new empty burst..... 2-33
 new OFDM symbol 2-26

O

OFDM modulation 1-2
 OFDM symbol 1-6, 2-25, 2-36
 OFDM symbol duration 2-28
 OFDM symbol name 2-27
 OFDM symbol pool 2-27
 OFDM symbols menu 2-26
 OK button 2-1
 online help..... 2-1, 2-5
 open 2-3
 operating panels 2-1

P

pattern 2-11, 2-24
 pattern length 2-11, 2-24
 payload..... 2-32, 2-37
 payload list 2-36
 pilot 1-6, 2-23, 2-30, 2-31
 PLCP frame..... 2-32
 pool menu 2-27, 2-34, 2-40
 postamble..... 2-32
 PRBS 2-9
 preamble 2-32
 provide one bit per 2-12, 2-24
 PSK rotation 2-22

Q

QPSK..... 2-15

R

register initial state 2-11, 2-24
 reinitialize coder 2-22, 2-24
 relative amplitude 2-20, 2-24
 reset to initial state 2-12, 2-24

S

sampling rate 2-28
 save as..... 2-3
 search..... 2-5
 select data source 2-8
 select modulator 2-14
 sequence 1-6, 2-44
 sequence length 2-45
 shift register length 2-11, 2-24
 spectrum..... 1-4, 2-31
 spectrum display 2-31
 subcarrier 1-2
 subcarrier edit..... 2-29
 subcarrier list 2-31
 subcarrier spacing 2-29
 system requirements 1-1

T

time display 2-45
 time increment..... 2-41, 2-45
 transferring data to WinIQSIM and AMIQ 1-2

U

useful part..... 1-3

W

WinIQOFDM system model..... 1-5, 1-6