

Keysight Microwave Signal Generators

9 kHz to 70 GHz and multipliers up to 1.1 THz



E8267D PSG vector
E8257D PSG analog
N5183B MXG analog
N5173B EXG analog



Summary of Key Specifications

Specifications	PSG vector	PSG analog	MXG analog	EXG analog
Model number	E8267D	E8257D	N5183B	N5173B
Frequency range (min. to max.)	100 kHz to 44 GHz	100 kHz to 70 GHz	9 kHz to 40 GHz	9 kHz to 40 GHz
Frequency switching (list mode)	9 ms	9 ms	600 μ s	600 μ s
Sweep mode	Step, list, ramp	Step, list, ramp	Step, list	Step, list
Output power (at 20 GHz)	-130 to +22 dBm	-135 to +26 dBm	-135 to +20 dBm	-135 to +20 dBm
Level accuracy (at 20 GHz)	\pm 0.8 dB	\pm 0.8 dB	\pm 0.7 dB	\pm 0.7 dB
SSB phase noise (at 10 GHz; 10 kHz offset)	-126 dBc/Hz	-126 dBc/Hz	-124 dBc/Hz	-101 dBc/Hz
Harmonics (at 10 GHz)	-55 dBc	-55 dBc	-55 dBc	-55 dBc
Non-harmonics (at 1 GHz)	-88 dBc	-88 dBc	-100 dBc	-72 dBc
AM rate	DC to 100 kHz	DC to 100 kHz	DC to 100 kHz	DC to 100 kHz
FM deviation (maximum)	1 to 128 MHz	1 to 128 MHz	1 to 128 MHz	2.5 to 320 MHz
PM phase deviation (maximum in normal mode)	1 to 800 rad	1 to 1280 rad	0.5 to 64 rad	1.25 to 160 rad
Narrow pulse width	20 ns	20 ns	20 ns	20 ns
EVM (LTE)	0.8%	-	-	-
ACPR (16QAM,10 GHz)	-64 dBc	-	-	-
Internal baseband generator RF BW	80 MHz	-	-	-
External I/Q modulator RF BW	Up to 4 GHz	-	-	-
Waveform playback memory	64 Msa	-	-	-
Baseband generator mode	Waveform playback and real-time IQ	-	-	-

Generate Trusted Performance

When you describe the demands on your newest programs, the urgency is clear—that’s what keeps Keysight Technologies, Inc. innovating in microwave signal generators. Our foundation is the PSG, with its metrology-grade performance and versatile capabilities. Complementing the PSG, the MXG and EXG offer alternatives in size, speed, and cost.

As you pursue mission success, Keysight can help you generate trusted performance. Our microwave signal generators are an essential part of today’s most advanced measurement systems. They reliably provide the signal purity, output power, and modulation you need to keep pushing the envelope.

- Drive advanced designs forward with the high output power and extremely low phase noise of the E8267D and E8257D PSG
- Get the right mix of speed, performance, and size with the pure and precise N5183B MXG
- Balance performance needs and budget realities with the cost-effective N5173B EXG
- Lower your cost-of-ownership with signal generators that deliver proven reliability and support for cost-effective calibration, service, and repair

Migrate from legacy signal generators

Carefully planned instrument migration and modernization can maximize your test-system efficiency, performance, and readiness, while minimizing risk and potential disruptions, so you can keep your programs running smoothly. Keysight microwave signal generators are designed as evolutionary replacements to their in-class predecessors. Take advantage of code compatibility and increased performance, flexibility, speed, and compact size by replacing legacy equipment.

www.keysight.com/find/Microwave_SigGen_Migration



PSG MW vector
E8267D
100 kHz to 44 GHz

- E8267C**
- 8780A**
- E2500B**



PSG MW analog
E8257D
100 kHz to 70 GHz

- 8340 Series**
8340 to 8341A/B
- 8360 Series**
83620 to 83624A/B/L
83630 to 83650B/L
- 8370 Series**
83711 to 83712A/B
83731 to 83732A/B
83751 to 83752A/B



MXG/EXG MW analog
N5183B/N5173B
9 kHz to 40 GHz

- N5183A**
8672/73A/B/C/D
- 8340 Series**
8340 to 8341A/B
- 8360 Series**
83620 to 83624A/B/L
83630 to 83650B/L
- 8370 Series**
83711 to 83712A/B
83731 to 83732A/B
83751 to 83752A/B



Stay Ahead with Metrology-Grade Signal Generation

The PSG is the industry's most trusted microwave signal generator, with thousands of units deployed in hundreds of programs around the world. With metrology-grade performance and evolving capabilities, it continues to enable new designs that stay ahead of emerging threats.

PSG signal generators offer a versatile platform with room to grow—serving your test needs now and in the future. The highly flexible option structure enables you to configure the PSG to accommodate your specific test applications as well as your budget requirements. Tailor the performance of the PSG, such as frequency range, output power, phase noise, types of modulation, and more. Many options can be retrofitted yourself or at a Keysight Service Center, so you can quickly and easily adapt to new test programs.

Address your toughest requirements with PSG analog

The E8257D PSG analog signal generator combines metrology-grade frequency and level accuracy with excellent distortion and spurious characteristics to test your most advanced devices with the highest quality signals. Meet test system needs across a wide frequency range with 20, 31.8, 40, 50, and 67 GHz models available and the ability to add frequency extender modules to cover up to 1.1 THz.

Extend coverage up to 1.1 THz

Easily extend the frequency range of your PSG, MXG, or EXG signal generators with multiplier modules from Keysight partners. The E8257D-Vxx-Series of external, high-power, frequency-banded millimeter-wave source modules from VDI provide synthesized frequency performance and millimeter-wave test signals for waveguide bands from 50 to 1.1 THz.

For the PSG, Keysight also offers the E8257DSxx-Series frequency multipliers up to 500 GHz, from OML Inc., which draw their power directly from the signal generator and require no external power supply.



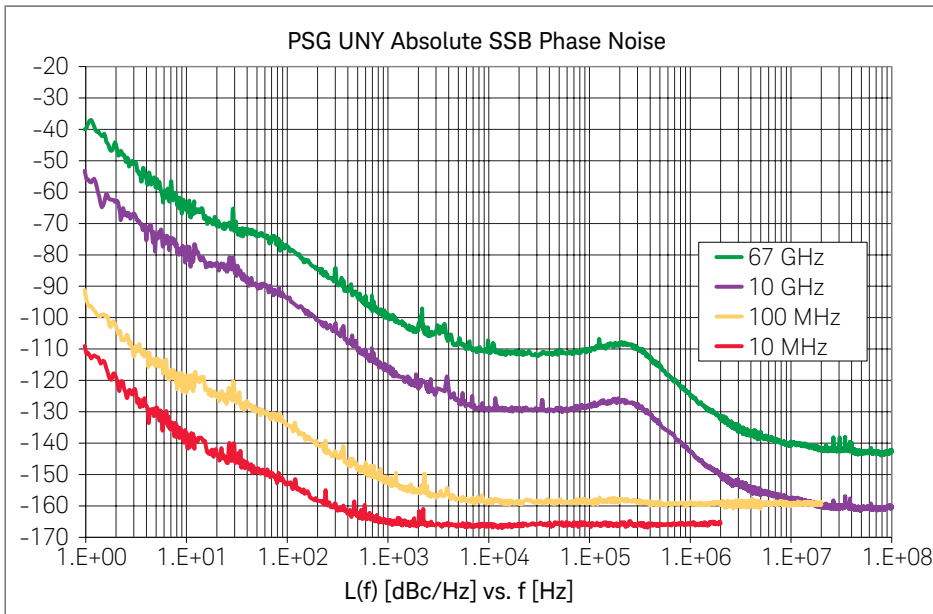

Increase receiver sensitivity with extremely low phase noise: -91 dBc/Hz at 100 Hz offset and -126 dBc/Hz at 10 kHz offset (10 GHz)

Apply metrology-grade phase noise to your most demanding tests

Boasting the widest frequency range and industry-leading spectral purity, the PSG analog is ideal for local oscillator (LO) substitution and low jitter clock replacement. Address the demanding needs of Doppler radar and receiver-blocking tests with extremely low phase noise: -91 dBc/Hz at 100 Hz offset and -126 dBc/Hz at 10 kHz offset (10 GHz) to maximize receiver sensitivity. Combine this with low spurious performance to minimize distortion translated to mixer products for improved signal quality and increased test accuracy. In addition, the PSG provides superior system clock performance with integrated frequency dividers that deliver extremely low jitter for analog to digital converters (ADC) and digital to analog converters (DAC) operating from MHz to GHz clock ranges.

Achieve even lower phase noise

If you are looking to improve close-in phase noise at the sub 1 Hz to 1 kHz offset, the PSG and MXG with Option UNY provide an ultra-clean 10 MHz reference input path, allowing you to reduce phase noise even further than with the internal high-performance oven-controlled crystal oscillators (OCXO). Achieve up to 10 dB improvement at offsets < 100 Hz across the full frequency range. To enable metrology-grade traceability, the PSG also offers residual phase noise specifications at multiple offsets.

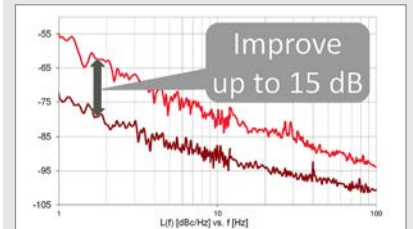

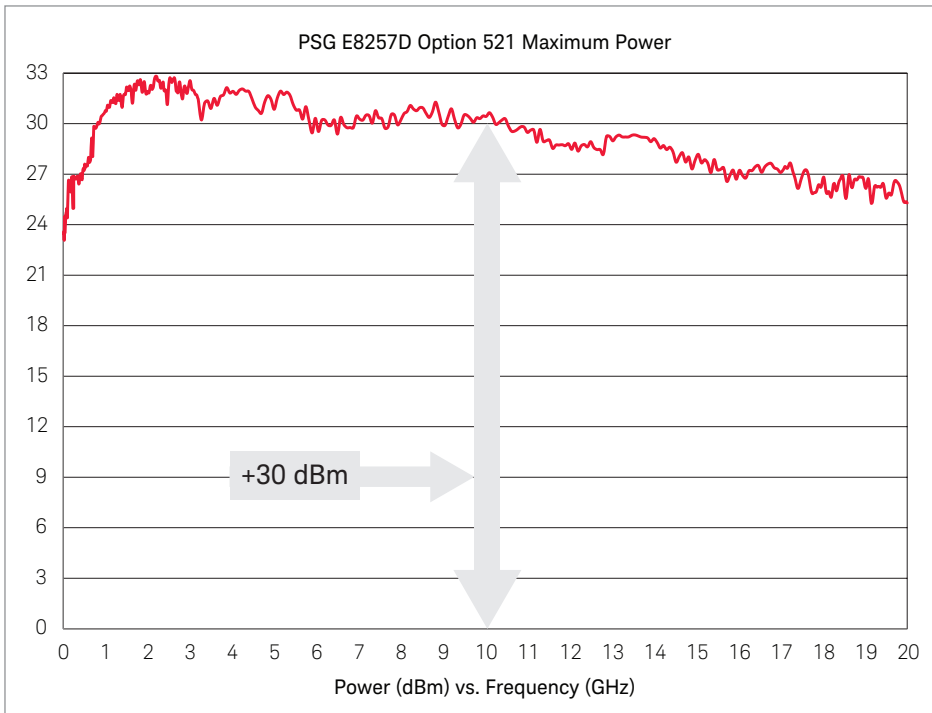

Drive high-power signals in test environments prone to signal loss

Option 521 is capable of generating more than 1 W (+30 dBm) of output power to drive high-power signals and overcome test system losses. Eliminate external amplifiers and improve calibration accuracy and repeatability with automatic level control and step attenuation at high power levels.

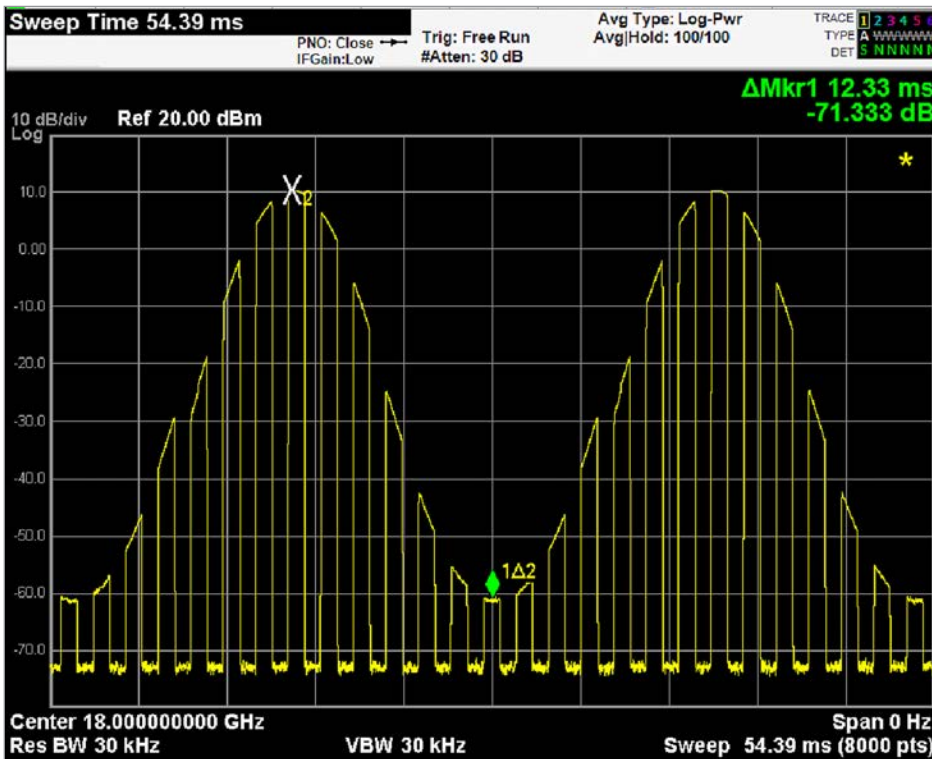

Simulate deep scanning radar

Simulate a moving radar antenna beam when you add Option 1SM scan modulation to the PSG. With this option, you can realize up to 60 dB of modulation depth and more dynamic range for power sweep applications.

Benefit from unrivaled component analysis

For component stimulus/response applications, PSG signal generators offer high output power, outstanding level accuracy, low harmonics and spurious distortion, and analog and digital sweep of frequency and power. Analog (AM, FM, and Φ M) and pulse modulators can also be applied during sweep operation. Using the PSG in combination with a spectrum analyzer for swept scalar analysis, you will realize the benefits of economy, convenience, and extended dynamic range in one measurement system.

Use as a tracking generator with the X-Series signal analyzers

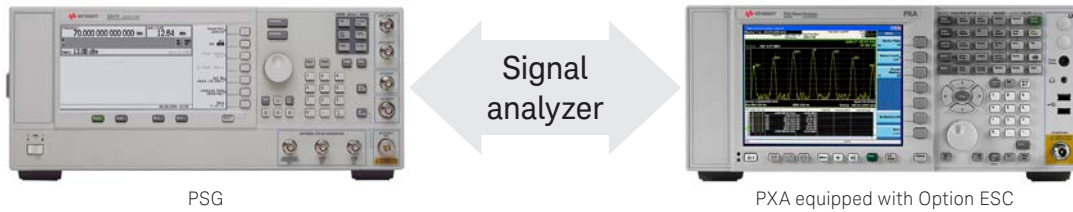

Obtain high-phase stability at different frequencies

To support unique research applications, you can share a common 1 GHz reference between two or more PSG signal generators with Option H1S, providing increased relative phase stability at two or more different frequencies. For example, you can set one source at 10 GHz and the other at 18 GHz with a phase relationship that is highly stable.

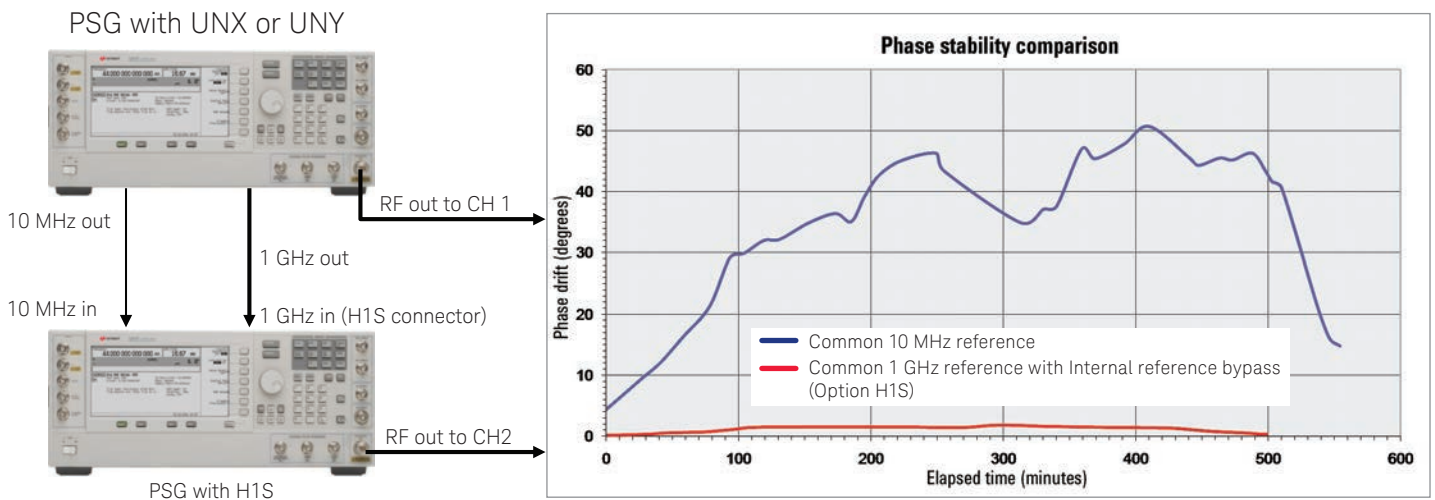



Master the most complex signals with PSG vector

The E8267D PSG vector signal generator is the highest performance, fully-integrated microwave vector signal generator from 100 kHz to 44 GHz, allowing you to create realistic wideband radar, electronic warfare (EW), and satellite communications (SATCOM) waveforms. The flexible, integrated 80 MHz arbitrary waveform generator (AWG) and real-time baseband generator simulates cellular, wireless, GPS, and custom communications using Signal Studio, SystemVue, or MATLAB. For advanced military or research test systems, add the Keysight M8190A wideband AWG for up to 4 GHz modulation bandwidth. You can also simulate multiple radar transmissions and multi-emitter threats for algorithm verification or array calibration with a phase coherent configuration.

Accelerate receiver baseband development and test

The PSG vector equipped with optional 80 MHz, 64 Msample internal baseband generator (Option 602) combines arbitrary waveform generation (ARB mode) with sophisticated real-time I/Q symbol generation (real-time mode). Real-time mode is ideal for receiver tests requiring very long or untruncated data payloads such as in satellite testing. Take advantage of deep sequencing and a memory compression engine to create long, non-repeating patterns of waveforms. Alternatively, you can pair the PSG with the N5102A digital signal interface module for direct digital IQ output or input. In output mode, directly stimulate field-programmable gate arrays (FPGA) or DAC with streaming serial or parallel IQ. In input mode, upconvert digital IQ streams from your FPGA or ADC to calibrated analog IF, RF, or microwave frequencies.

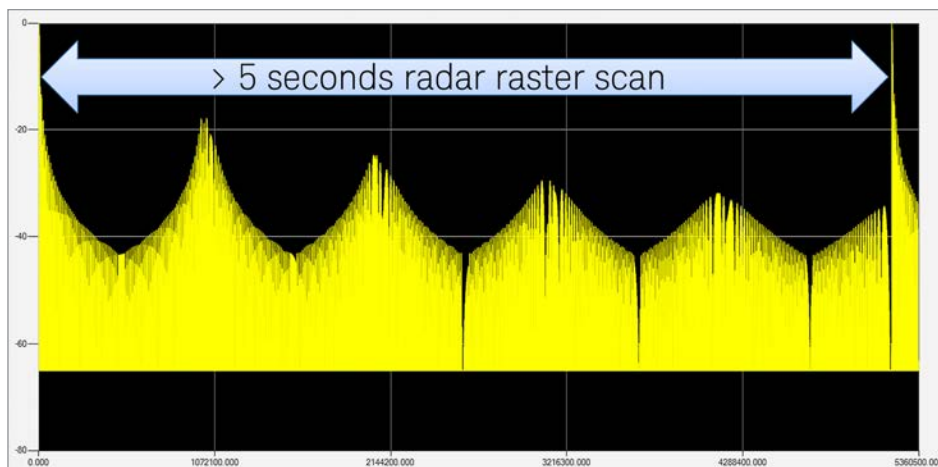

Long bidirectional raster scan radar pattern using memory compression sequencing and Signal Studio for pulse building

Simplify signal creation with Signal Studio software

Connect the PSG vector to Signal Studio and simplify signal creation. Whether you are testing single-channel radar, satellite links, or multiple emitter types for EW jammer receiver test, easy access to the right test signals streamlines validation and ensures correct operation. Configure Signal Studio to match your requirements by choosing from basic or advanced levels of capability with a scalable option structure. Signal Studio also offers software control with .NET API to support automated testing.



Detection, positioning, tracking, and navigation

- Pulse building for radar
- GPS, GLONASS, Galileo, Beidou, SBAS, QZSS

General purpose

- Multitone, NPR
- Real-time AWGN
- Custom modulation: QAM, PSK, ASK, MSK, and custom IQ maps
- Jitter injection

Communications

- LTE FDD/TDD, W-CDMA/HSPA+, cdma2000®, 1xEV-DO, GSM/EDGE, and more
- WLAN, WiMAX™, Bluetooth®, and more
- ATSC, DVB, S-DMB, FM Stereo, and more

www.keysight.com/find/SignalStudio

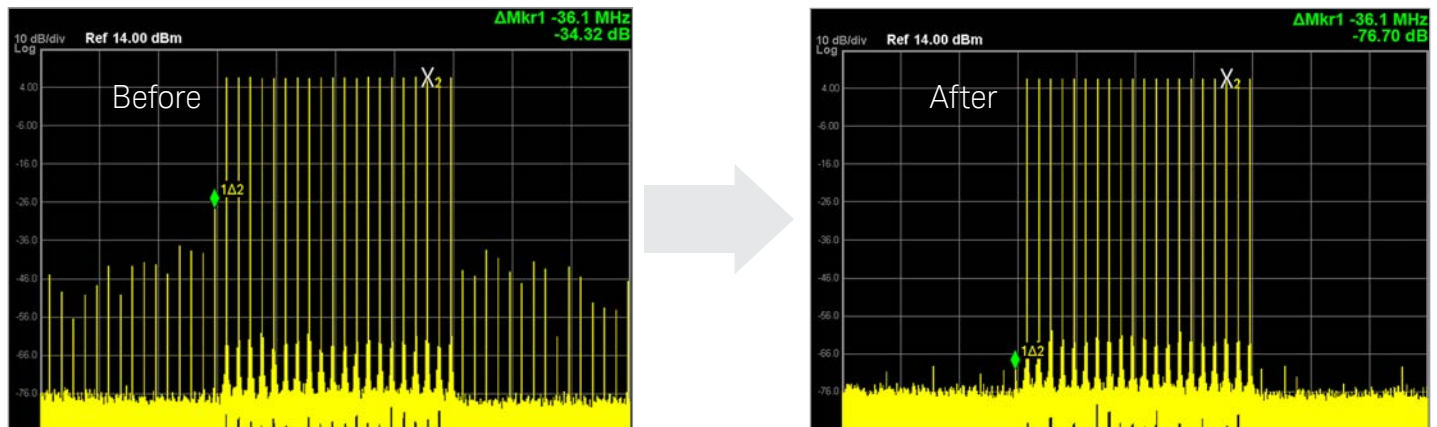

Signal Studio for multi-tone distortion enables pre-distorted, multi-tone signals with -76 dBc intermodulation distortion products

Design more realistic waveforms using wideband external inputs

High bandwidth, sample rate, and bit resolution allow more realistic waveforms for accurate testing of wideband communications, radar, EW, satellite, and frequency-agile systems. The PSG vector equipped with Option 016 enables up to 4 GHz RF modulation bandwidth (for carriers > 3.2 GHz). Add special Option H18 to extend wide modulation bandwidth for carriers < 3.2 GHz.

For complex wideband signal generation at microwave frequencies, Keysight N824xA and M8190A AWGs deliver unprecedented performance, with each channel providing up to 5 GHz of modulation bandwidth and greater than -68 dBc dynamic range. When the AWGs are used with the PSG vector's wideband I/Q modulator, you can realize authentic signal simulations with RF modulation bandwidth of up to 4 GHz for IF and RF subsystem test.

www.keysight.com/find/AWG

Get millimeter-wave upconversion for advanced wideband measurements

Conduct research or meet test requirements in wideband millimeter-wave applications such as WiGig, 5G, automotive radar, or imaging using the PSG vector and N5152A upconverter with an analog PSG, MXG, or EXG. This configuration allows you to realize up to 2 GHz wideband IQ upconversion to millimeter-wave frequencies from 57 to 64 GHz. Contact Keysight to create a customized solution to meet your bandwidth and frequency coverage needs.

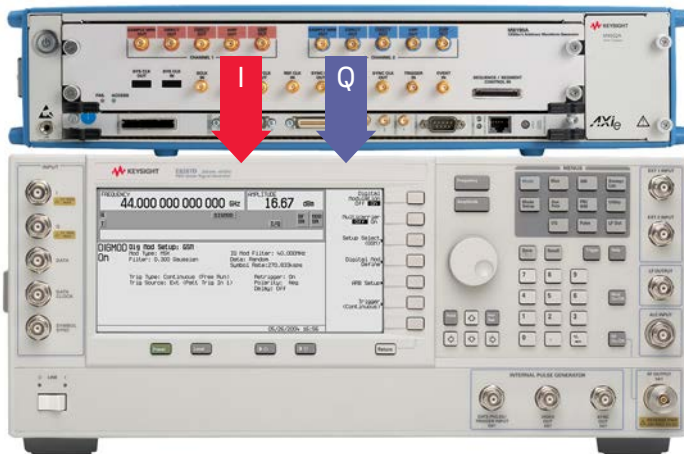
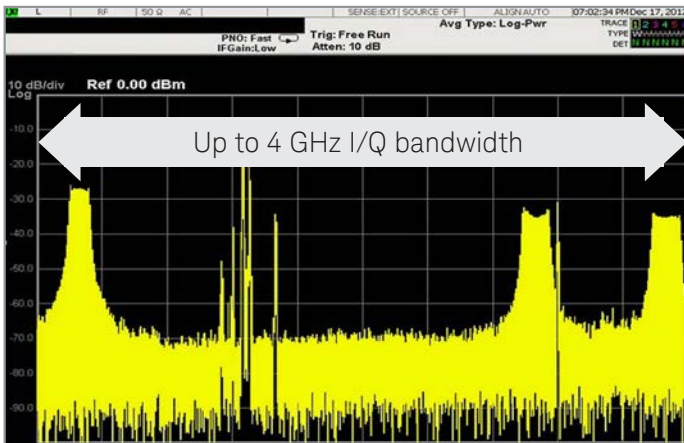

Simulate simultaneous multiple emitters with up to 4 GHz modulation bandwidth using E8267D, M8190A AWG, and external IQ inputs Option 016

Generate up to 16 phase-coherent signals

Testing multi-receiver systems used in phased-array radar, communications networks, and direction finding has traditionally been difficult and expensive. Field testing, while perhaps necessary for final system verification, is an expensive method for the design phase. The phase-coherent simulation system, which consists of up to 16 PSG signal generators configured with special options, provides a more repeatable, configurable alternative for the laboratory or the flight line. The system provides the full-phase coherency that is mandatory for testing multi-receiver systems, as well as full control over time, phase, amplitude, and frequency.

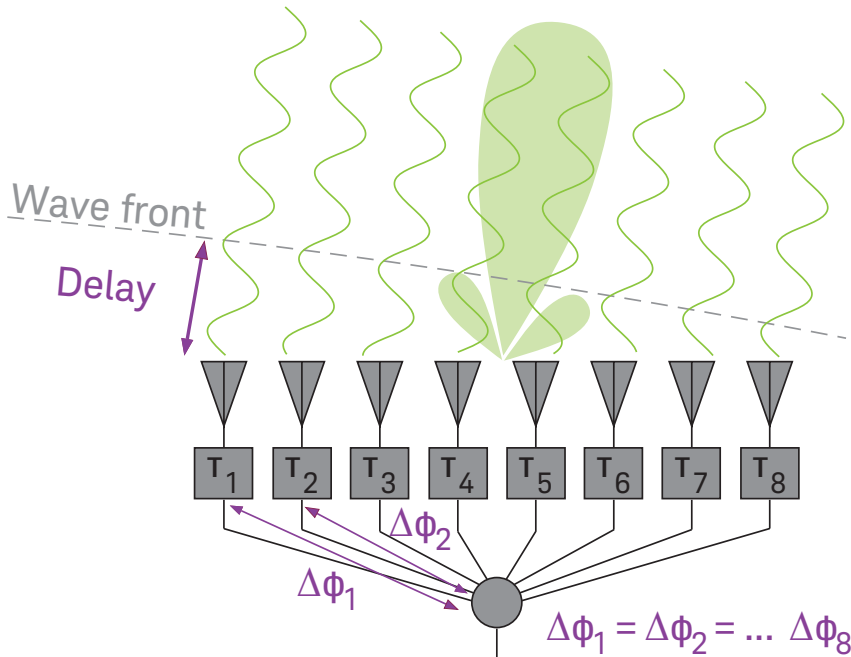
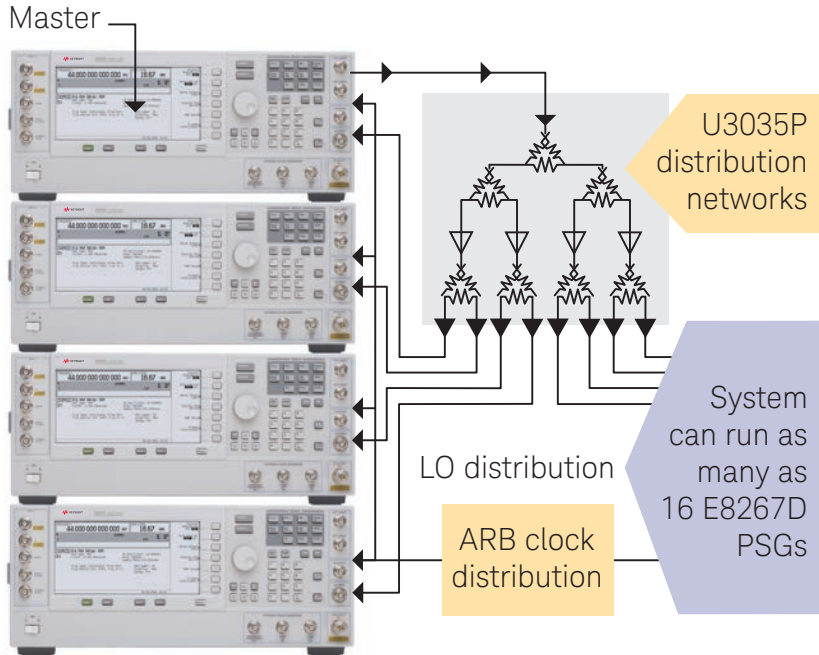

Lock up to 16 PSG vector signal generators to achieve phase coherency with special Option HCC



Choose Alternatives in Size, Speed, and Cost

With increased vigilance on program efficiencies placing constraints on budget and space, the MXG and EXG microwave analog signal generators offer alternatives in size, speed, and cost. Crafted to create signals capable of testing your most advanced systems or components, these signal generators offer industry-leading performance and low cost of ownership. A proven, scalable platform combined with cost-effective calibration and internal diagnostics allows you to buy the capabilities you need today and easily upgrade to meet future requirements.

Maximize speed and rack space with MXG

The N5183B MXG microwave analog signal generator is the pure and precise alternative to the PSG analog, with advantages in size and speed. It delivers the performance you need—spectral purity, output power, and more—to perform module- and system-level testing.

Save space and maintain test rigor with near-PSG performance levels in just two rack units. Available in 13, 20, 31.8, or 40 GHz models, the MXG microwave allows you to address demanding tests of radar modules and systems offering best-in-class phase noise of ≤ -124 dBc/Hz (10 kHz offset) with -75 dBc spurious (at 10 GHz). Use the MXG to accelerate your calibration process with best-in-class switching speed of less than 600 μ s.

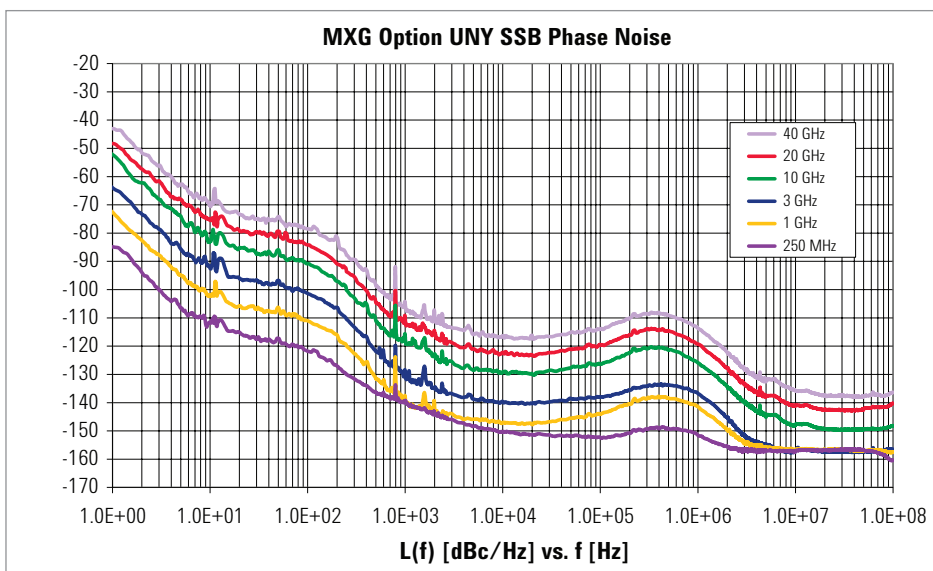

Enhanced phase noise with triple-loop synthesis

The MXG implements a new triple-loop phased-lock loop (PLL) design and frequency plan that results in substantial phase noise improvements close to the carrier and at wide offsets. The frequency plan addresses several key attributes: the choice of oscillator and reference frequencies in the synthesizer and the associated frequency conversion (mixers and multipliers) and filtering.

The triple-loop approach allows optimized frequency spacing that ensures effective filtering of nonlinear artifacts, such as images, by pushing them outside the bandwidth of the synthesizer circuits. In the MXG, the plan arranges the frequency references and conversions such that the largest nonlinearities are far from the desired frequencies and modest filtering can heavily attenuate the remaining spurious signals.

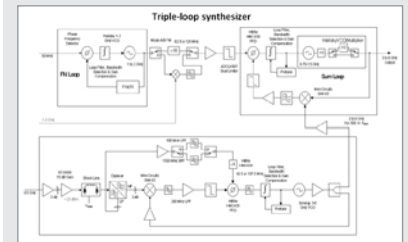

Best-in-class phase noise

The MXG offers best-in-class phase noise to maximize receiver sensitivity testing.

Balance budget and performance with EXG

The N5173B EXG microwave analog signal generator is the cost-effective choice when you need to balance budget and performance. In two rack units, it provides the essential signals that address parametric testing of broadband filters, amplifiers, receivers, and more.

Perform basic LO upconversion or CW blocking with low-cost coverage to 13, 20, 31.8, or 40 GHz. Characterize broadband microwave components such as filters and amplifiers with the best combination of output power (+20 dBm at 20 GHz), low harmonics (≤ -55 dBc), and full step attenuation. Use as a high-stability system reference with standard high-performance OCXO at an aging rate of less than ± 5 parts per billion per day.

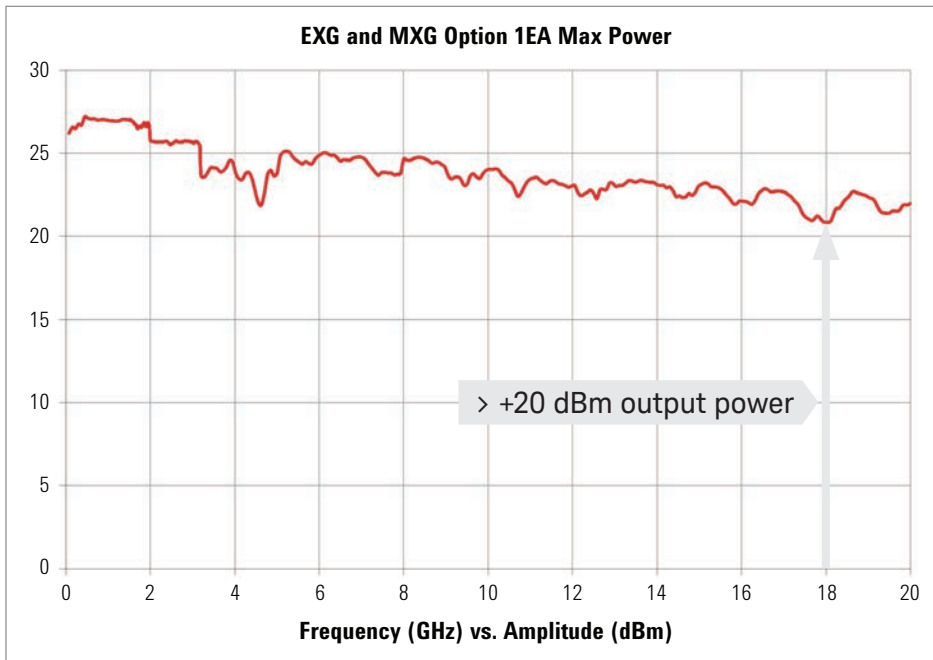

Best-in-class output power

The EXG offers the best combination of specified output power, low harmonics, and full step attenuation, so you do not have to compromise performance.

FREQUENCY 2.140 000 000 00 GHz	AMPLITUDE/POWER METER -44.00 dBm	ChA: -47.25 dBm ChB: 10.20 dBm	ChA Settings External Power Meter Channel 8
Power Meter Measurements			Channel Frequency Settings
ChA (N1914A, N1950000651) Power Meter -47.25 dBm 50.000 MHz	ChB (U2002A, N1951310025) Power Meter 10.20 dBm 50.000 MHz	Channel Offset 0.000 dB	
		Averaging (Auto)	
		Measurement Units dBm W	



Shrink your test stand further with optional integrated multifunction generator and USB power sensor interface

Create complex analog modulation combinations

The MXG and EXG can simulate complex combinations of analog signals, serving as a cost-effective alternative to vector microwave sources. With Option 303, you get seven waveform generators that can be set independently, with up to five simultaneously using the composite modulation features in AM, FM/PM, and LF out. In addition, the function generators can be synchronized and run in parallel with the internal pulse generator (Option UNW) and list sweep. These capabilities provide you with the flexibility to test receivers with more complex modulation—such as frequency switching FM chirp—with low rate frequency and amplitude drift using a low-cost analog microwave source.

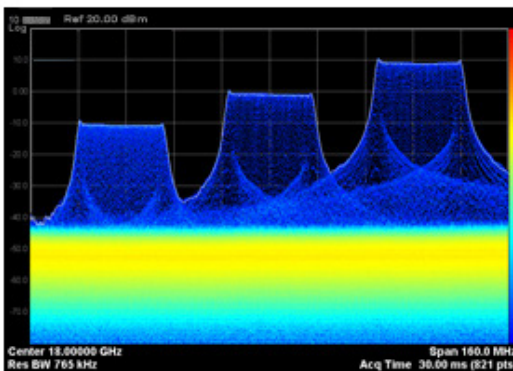
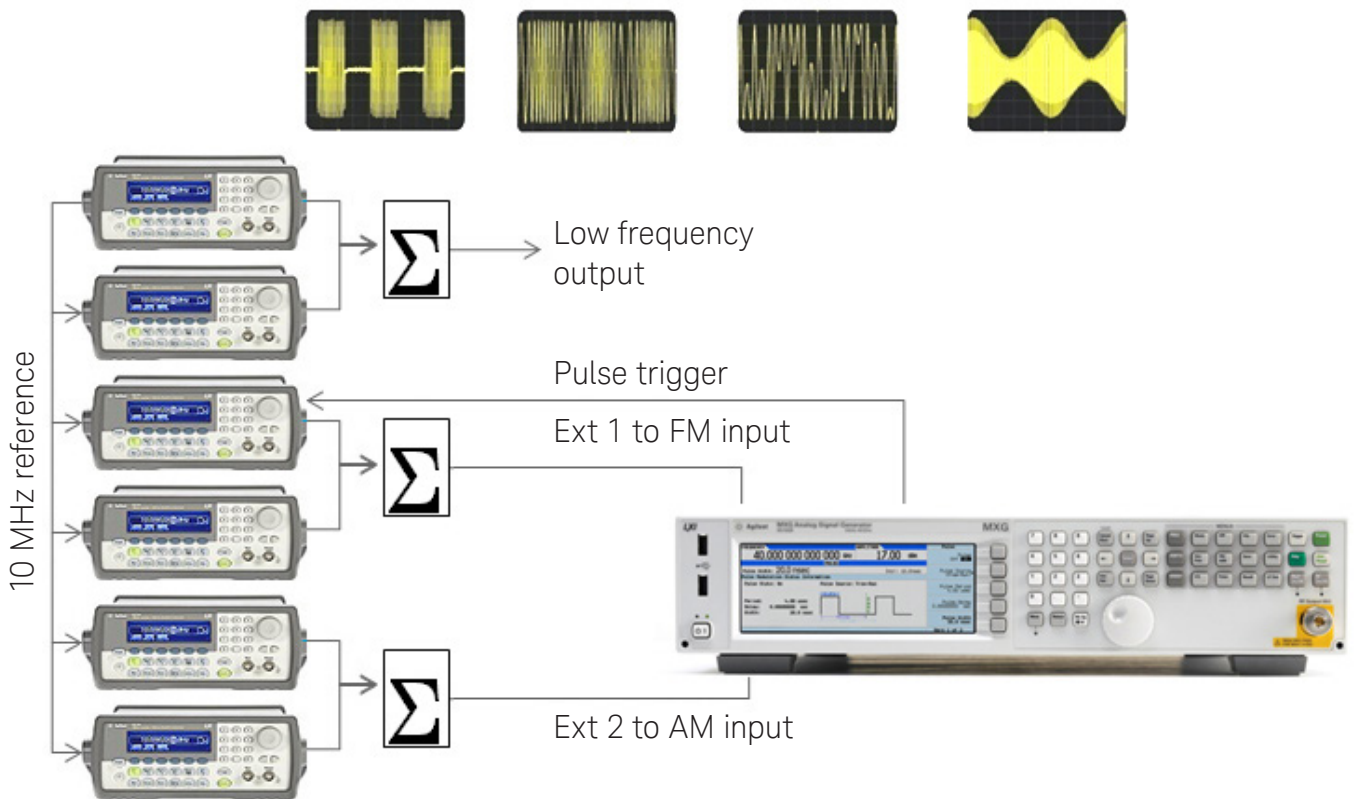

FREQUENCY	AMPLITUDE	Setup	SweepGen
20.000 000 000 000 GHz	18.00 dBm		F1 Sweep Waveform (Pos Ramp)
AM/FM/PULSE	LF		F1 Sweep Shape (Sawtooth)
Analog Modulation Status Information			
AM1	FuncGen2	Depth:50.0%	Wfn: Sine(400.0Hz)
AM2	NoiseGen1	Depth:10.0%	Type:Gaussian
F1	SweepFuncGen	Dev:50.000000MHz	Shape:Sawtooth
	Coupled:R/A	Start:4.000000Hz	Stop:400.0Hz
		Wfn:PosRamp	F1 Start Freq 400.0 Hz
F12	FuncGen1	Dev:1.000000MHz	Wfn:Sine(400.0Hz)
F12-HB1	FuncGen1	Dev:10.000rad	Wfn:Sine(1.0000+Hz)
F12-HB2	FuncGen1	Dev:0.000rad	Wfn:Sine(400.0Hz)
LFOut	DualFuncGen	amp1:2.5000	Wfn1:PosRamp(400.0Hz)
		tone2amp1:65.0%	Wfn2:Sine(1.0000kHz)
			F1 Sweep Trigger (Int)

FM chirp radar simulation with AM and FM drift and AM noise added using multi-function generator Option 303

Simulate radar signals with variable pulses

Create variable pulsed signals, customizing up to 2047 pulses from the MXG or EXG front panel, with Option 320 pulse train generator. Import and export signal parameters with comma separated variables or ASCII files via USB. This integrated flexibility allows you to simulate simple radar ranging measurements, pulse groups with staggered or stepped pulse repetition interval (PRI) for acquisition testing, pulse code modulated (PCM) for distance measurement equipment (DME) patterns, interrogate friend or foe (IFF) patterns, or telemetry waveforms.

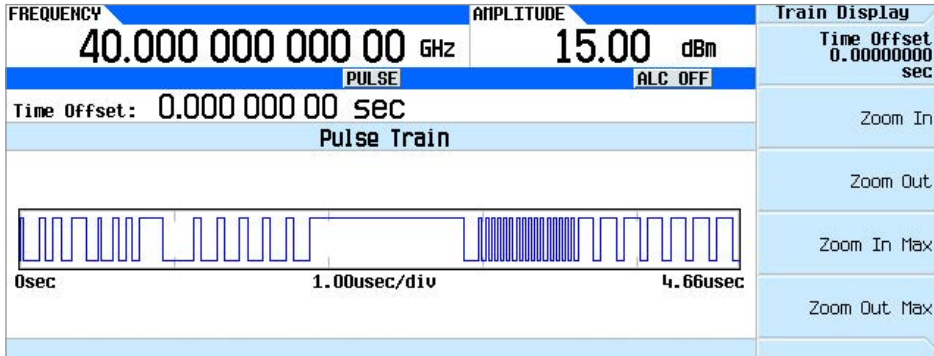

FREQUENCY		AMPLITUDE		Train Display	
40.000 000 000 00 GHz		15.00 dBm		Time Offset 0.0000000 sec	
PULSE		ALC OFF		Zoom In	
Time Offset: 0.000 000 00 sec					
Pulse Train					
0sec 1.00usec/div 4.66usec					
FREQUENCY		AMPLITUDE		Pulse Train	
40.000 000 000 00 GHz		15.00 dBm		Edit Item	
PULSE		ALC OFF		Insert Row	
Pulse Train					
	On Time	Off Time	Repeat		
1	20 ns	100 ns	2		
3	40 ns	50 ns	9		
12	60 ns	60 ns	1		
13	100 ns	70 ns	500		
513	20 ns	80 ns	200		
713	40 ns	40 ns	1	Go To Row	
714	40 ns	50 ns	1		
715	150 ns	200 ns	1	Display Pulse Train	
716	50 ns	100 ns	1		
717	50 ns	100 ns	1		
				More 1 of 2	

View pulse train pattern on front panel display

Enhance security

Working on classified or high-security projects poses additional test challenges. When your instrument needs to be removed or shared, you need to be confident that sensitive information is not accessible.

Option 006 for the MXG and EXG and Option 009 on PSG provides removable external memory, including memory management features to erase and sanitize all memory locations inside the instrument.



Calibrate your device with automatic leveling

MXG and EXG microwave signal generators allow you to use external power sensors for automatic leveling. This capability is ideal in test environments with external amplifiers or at microwave frequencies where cable loss and impedance mismatch can create a significant amount of amplitude error. With a USB power sensor and coupler, the MXG or EXG will automatically adjust output power near the device under test (DUT) to the desired level in real-time across all frequency and power ranges supported to best characterize or calibrate your device.

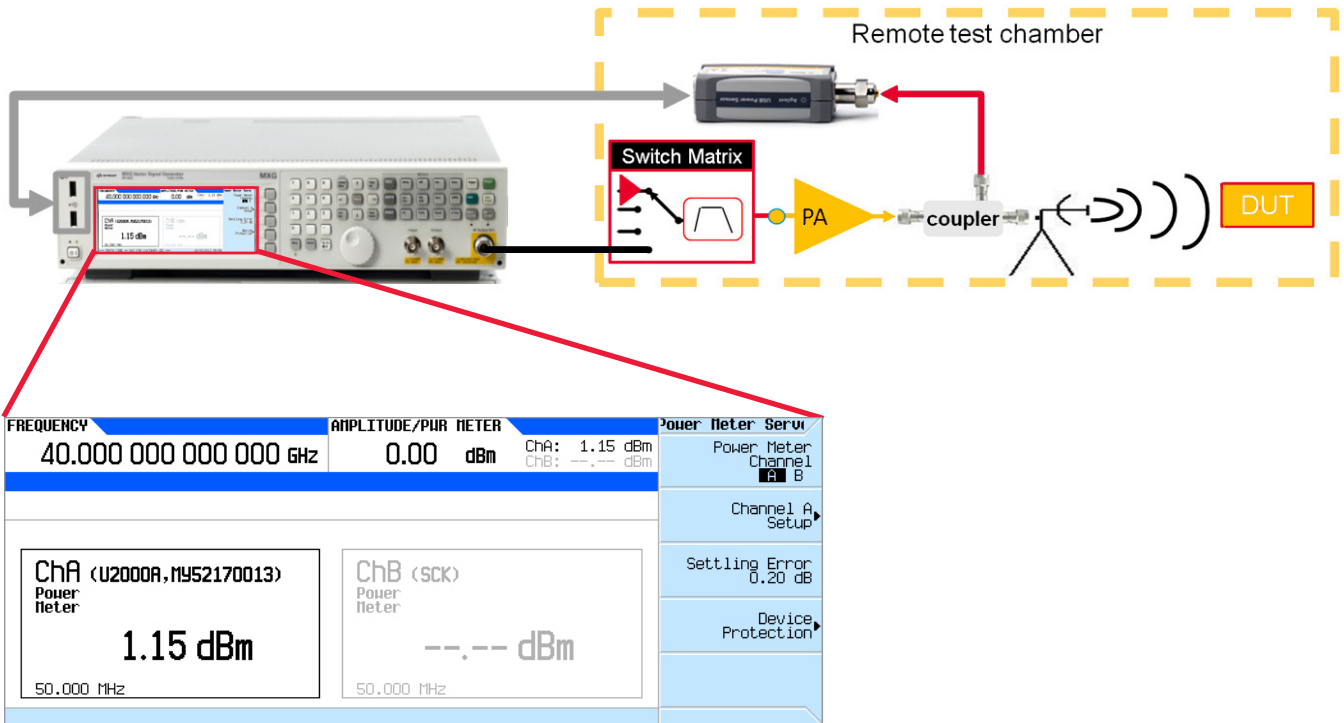

Use automatic leveling on the MXG or EXG to calibrate your device

Lower operating costs

To reduce your total cost-of-ownership, the MXG and EXG are designed for high reliability as well as fast, easy, and cost-effective calibration, service, and repair. To maximize uptime, today's MXG and EXG signal generators leverage technology used in the previous-generation MXG, which has a high mean time between failures (MTBF).

To help you minimize downtime and service costs, the MXG and EXG include advanced self-maintenance capabilities such as full internal root-cause self-diagnostics. The recommended three-year calibration cycle and self-maintenance strategy will help reduce support costs and increase instrument uptime. If onsite repairs are ever needed, they can be completed in about one day with the Keysight pre-calibrated refurbished parts exchange program.

FREQUENCY		AMPLITUDE		Self Test	
40.000 000 000 00 GHz		17.00 dBm		View Details ▶	
ATTNHOLD					
Test Editor					
Sel	ID#	Test Name	Status		
--- RF: Digital Self Tests ---					
x	101	Digital FPGA Test	PASSED	Self-diagnostics ▶	
x	102	Digital JTAG Test	PASSED		
x	103	Digital Voltages Test	PASSED		
x	104	Board Temperature Test	PASSED		
x	105	Sweep Out Test	PASSED		
--- RF: Reference Self Tests ---					
x	201	Reference Voltages Test	PASSED		
x	202	Reference 100MHz Tank DAC Test	PASSED		
x	203	Reference Tuning Voltage Test	PASSED		
Page 1 of 2					

Self-diagnostics helps reduce support costs and increases uptime

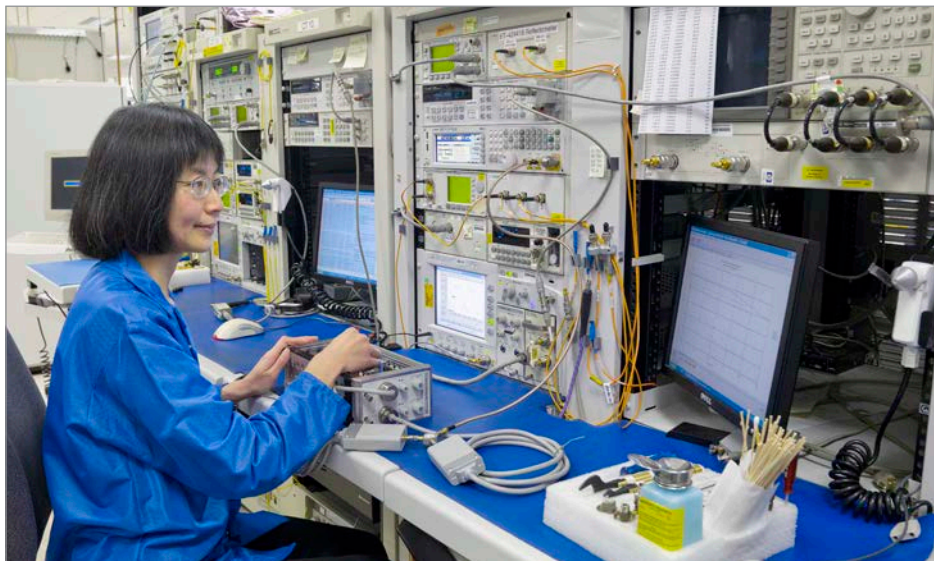

Simplified self-maintenance

Simplified self-maintenance for the MXG and EXG is an alternative to traditional maintenance and repair. Maintaining the instrument in-house empowers you to actively manage downtime, while maximizing uptime and reducing your total cost of ownership.

Quick calibration

Using a spectrum analyzer, a power meter, and Keysight's TME calibration software, you can calibrate the MXG and EXG in less than four hours.

Onsite repair

Should a failure occur, the MXG and EXG are quick and easy to repair. Repair assemblies are field-orderable and come fully adjusted and certified. Onsite repair can be done in as little as one day.

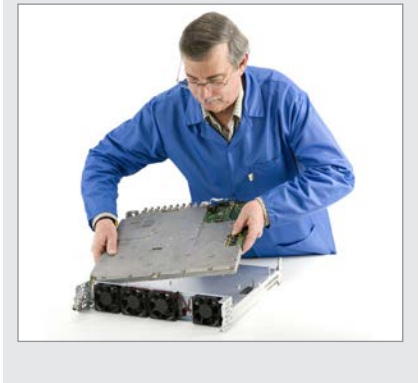

PSG Front and Rear Panels

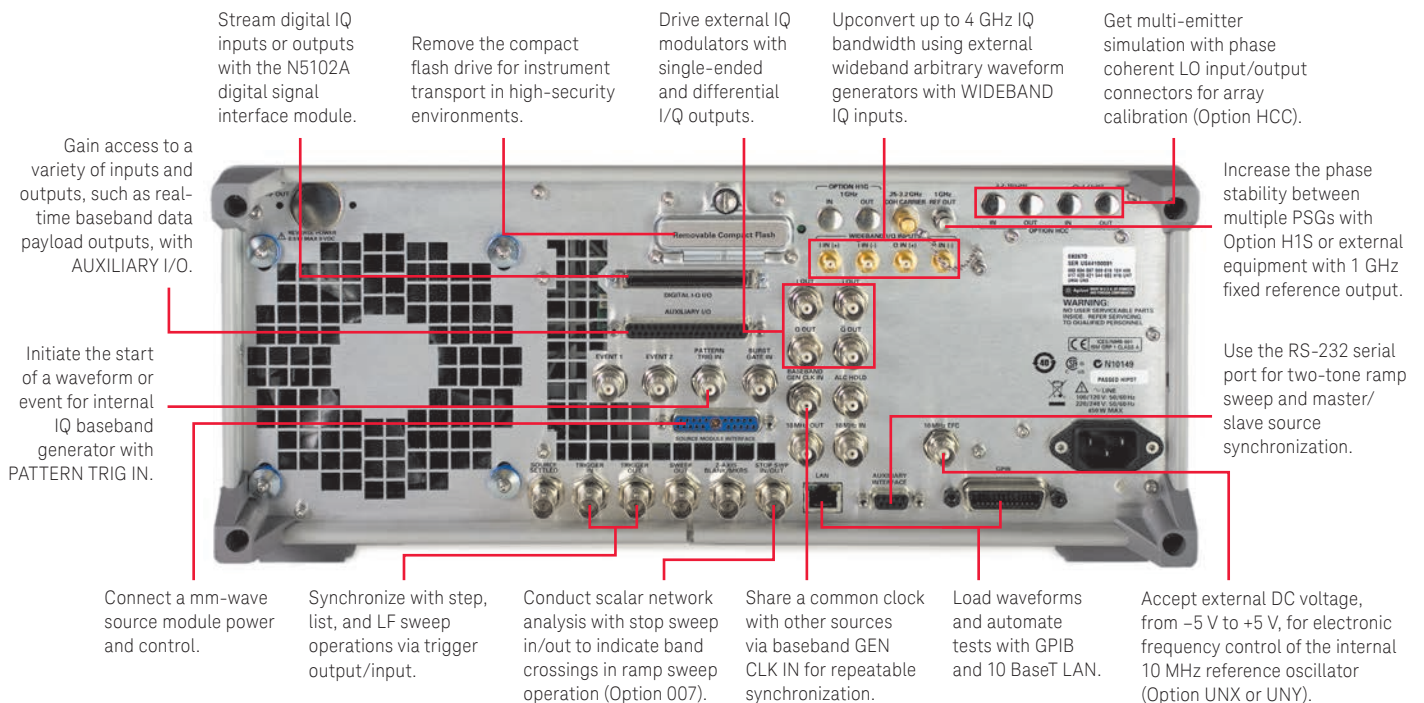
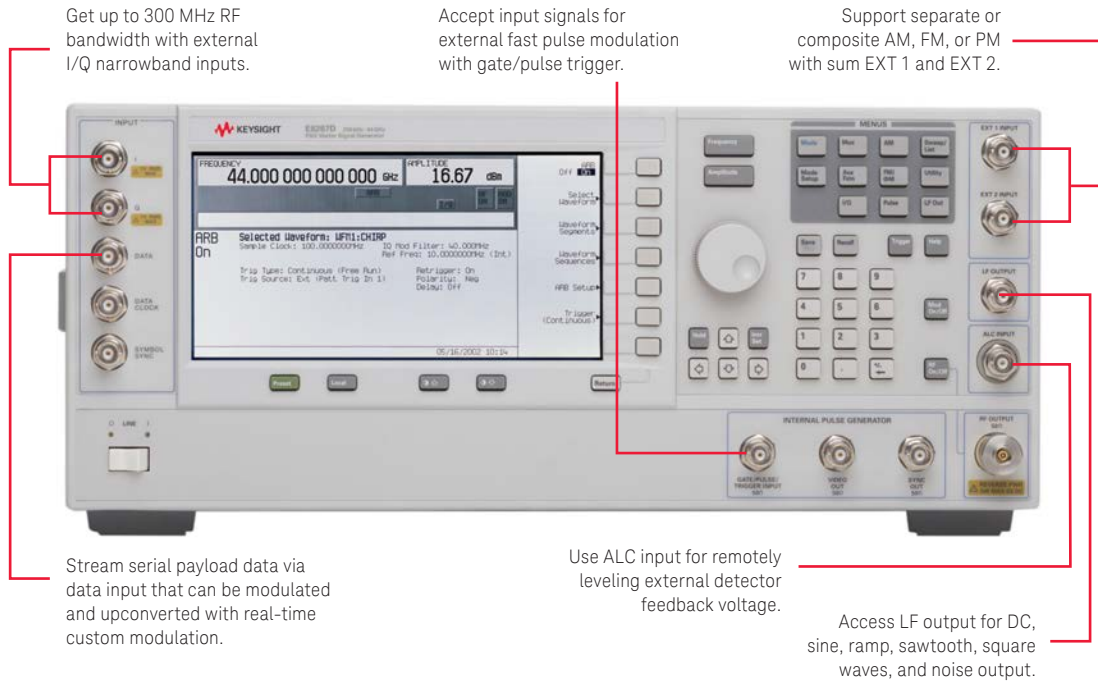

Note: Available connectors vary depending on the PSG model and option structure configuration

MXG/EXG Front and Rear Panels

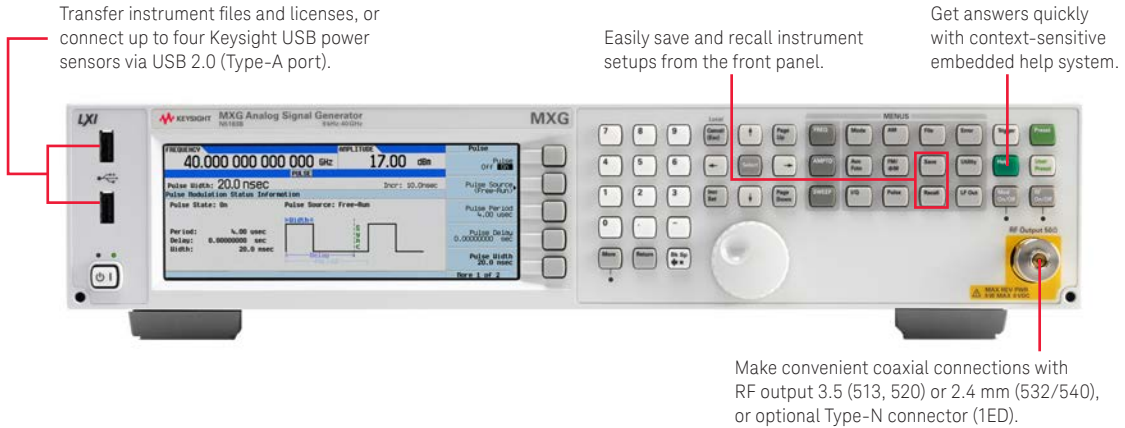

Sum EXT 1 and 2 inputs for composite analog modulation of AM or FM/PM or digitally sum with Option 303.

Access LF output for DC, sine, ramp, sawtooth, and square waves, or generate up to 10 MHz waveforms with Option 303 multifunction generator.

Synchronize external devices with +10 V output proportional step sweeps.

Conduct scalar network analysis with markers and band switches using the Z-axis output.

Use automatic level control input for remotely leveling external detector feedback voltage.

Transfer instrument files and licenses, or connect up to four Keysight USB power sensors via USB 2.0 (Type-A port).



Supply input-pulsed TTL or CMOS signals < 20 ns for pulse modulation.

Configure TRIG 1 or 2 for inputs such as sweep triggering or outputs such as source settled, pulse video, or pulse synchronization.

Increase frequency precision with high-performance 10 MHz OCXO reference input/output.

Control and download files remotely over 1000 Base-T LAN, GPIB, or USB (Type-B port).

Enhance instrument security with removable solid-state drive (Option 006).

Evolving Since 1939

Our unique combination of hardware, software, services, and people can help you reach your next breakthrough. We are unlocking the future of technology.

From Hewlett-Packard to Agilent to Keysight.

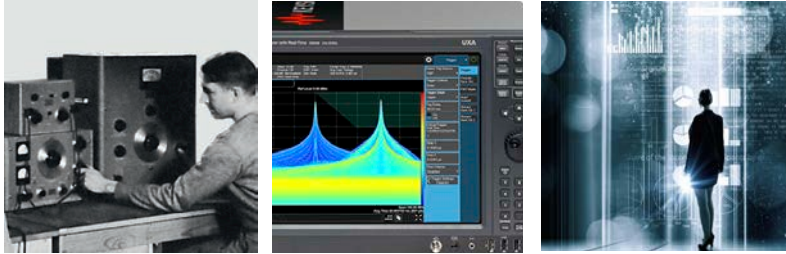

myKeysight

myKeysight

www.keysight.com/find/mykeysight

A personalized view into the information most relevant to you.

www.keysight.com/find/emt_product_registration

Register your products to get up-to-date product information and find warranty information.

KEYSIGHT SERVICES

Accelerate Technology Adoption.
Lower costs.

Keysight Services

www.keysight.com/find/service

Keysight Services can help from acquisition to renewal across your instrument's lifecycle. Our comprehensive service offerings—one-stop calibration, repair, asset management, technology refresh, consulting, training and more—helps you improve product quality and lower costs.



Keysight Assurance Plans

www.keysight.com/find/AssurancePlans

Up to ten years of protection and no budgetary surprises to ensure your instruments are operating to specification, so you can rely on accurate measurements.

Keysight Channel Partners

www.keysight.com/find/channelpartners

Get the best of both worlds: Keysight's measurement expertise and product breadth, combined with channel partner convenience.

www.keysight.com/find/microwavesigGens

For more information on Keysight Technologies' products, applications or services, please contact your local Keysight office. The complete list is available at:

www.keysight.com/find/contactus

Americas

Canada	(877) 894 4414
Brazil	55 11 3351 7010
Mexico	001 800 254 2440
United States	(800) 829 4444

Asia Pacific

Australia	1 800 629 485
China	800 810 0189
Hong Kong	800 938 693
India	1 800 11 2626
Japan	0120 (421) 345
Korea	080 769 0800
Malaysia	1 800 888 848
Singapore	1 800 375 8100
Taiwan	0800 047 866
Other AP Countries	(65) 6375 8100

Europe & Middle East

Austria	0800 001122
Belgium	0800 58580
Finland	0800 523252
France	0805 980333
Germany	0800 6270999
Ireland	1800 832700
Israel	1 809 343051
Italy	800 599100
Luxembourg	+32 800 58580
Netherlands	0800 0233200
Russia	8800 5009286
Spain	800 000154
Sweden	0200 882255
Switzerland	0800 805353
	Opt. 1 (DE)
	Opt. 2 (FR)
	Opt. 3 (IT)
United Kingdom	0800 0260637

For other unlisted countries:

www.keysight.com/find/contactus
(BP-9-7-17)

DEKRA Certified
ISO 9001 Quality Management System

www.keysight.com/go/quality

Keysight Technologies, Inc.
DEKRA Certified ISO 9001:2015
Quality Management System



This information is subject to change without notice.

© Keysight Technologies, 2014-2017

Published in USA, December 1, 2017

5991-4876EN

www.keysight.com