

X-Series Signal Generators

N5181B/N5171B Analog

N5182B/N5172B Vector

- 9 kHz to 6 GHz frequency range
- Industry-leading performance
- Sophisticated real-time applications
- Low cost of ownership



Discover X-Series signal generation

Industry-leading performance

From 9 kHz to 6 GHz, the analog and vector MXG and EXG signal generators deliver unmatched performance in five key categories: phase noise and spectral purity, bandwidth, EVM, ACPR, and output power.

Advanced real-time applications

Perform advanced receiver testing compatible with the latest standards using the MXG or EXG and Signal Studio software: define signal parameters, transfer them to the instrument, and use closed-loop or interactive control during signal generation.

Lower cost-of-ownership

X-Series signal generators are designed for high reliability and simplified service. One key example is the self-maintenance strategy: if onsite repairs are ever needed, they can be completed in less than two hours with our refurbished-parts exchange program.

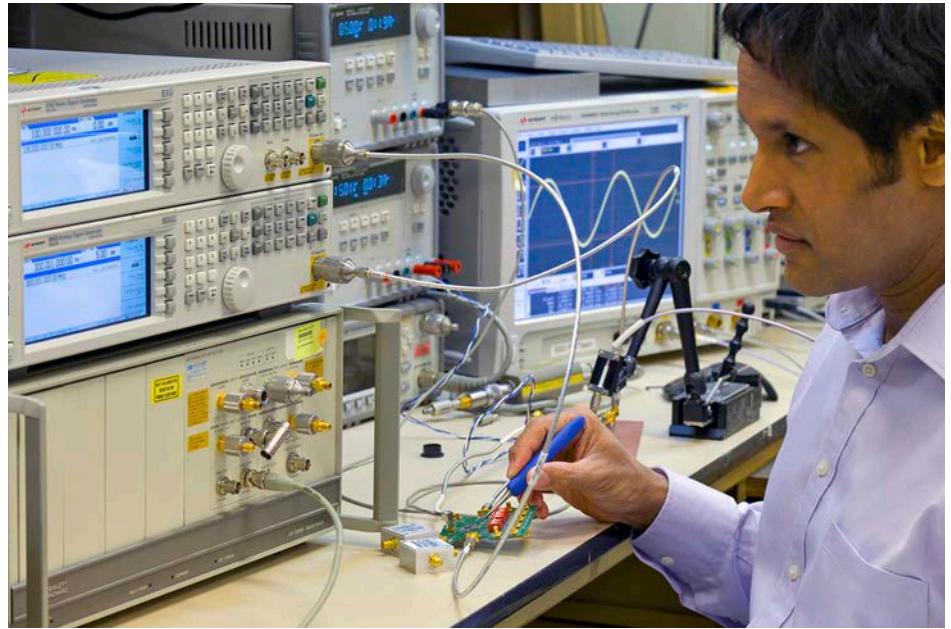

Summary of Key Specifications

	MXG	EXG
Frequency ranges	9 kHz to 6 GHz	9 kHz to 6 GHz
Phase noise @ 1 GHz, 20 kHz offset	-146 dBc/Hz	-122 dBc/Hz
Spurious @ 1 GHz (nonharmonics)	-96 dBc	-72 dBc
Output power @ 1 GHz	+27 dBm	+27 dBm
ACPR (vector) W-CDMA 64 DPCH	-73 dBc	-73 dBc
EVM (vector) 802.11ac/LTE	0.4 percent	0.4 percent
Bandwidth (vector)	160 MHz	120 MHz
Arbitrary waveform memory (vector)	1024 MSa	512 MSa

www.keysight.com/find/X-Series_SG

Generate True Performance



Internal channel corrections enhance bandwidth and accuracy

The EXG and MXG provide modulation bandwidths to 120 or 160 MHz, respectively. This wide modulation bandwidth is available with EVM up to 0.4 percent and flatness up to ± 0.2 dB, ample performance for even the most demanding design tasks.

The X-Series achieves this combination of bandwidth and accuracy through the use of a proprietary baseband ASIC and a factory-calibrated channel correction technique that extend from the baseband I/Q modulator to the RF output. Together, these technologies minimize I/Q errors to provide high modulation accuracy plus wide modulation bandwidth without user intervention such as manual I/Q adjustment.

To know your device's behavior, you'll take many paths. That's the idea behind the Keysight Technologies, Inc. X-Series signal generators. They produce the signals you need—from simple to complex, from clean to dirty—to test your design within and beyond its limits.

The X-Series is crafted to create signals capable of testing your very best devices. From the pure and precise MXG to the cost-effective EXG, the X-Series helps you generate true performance.

To help you quickly create signals that meet the needs of specific standards and measurements, the MXG and EXG are compatible with Keysight Signal Studio software. Its suite of signal-creation tools addresses cellular communications, wireless connectivity, audio, video, positioning, tracking, and general-purpose applications.

To reduce cost of ownership, the X-Series signal generators are designed for high reliability and fast, easy calibration, service, and repair. Today's MXG and EXG leverage technology used in previous-generation MXG signal generators, which are among the most reliable signal sources ever offered by Keysight.

Take Your Devices to the Limit



Industry-leading phase noise

The MXG implements a new triple-loop phased-lock loop (PLL) design and “frequency plan” that results in substantial phase noise improvements close to the carrier and at wide offsets. The frequency plan addresses several key attributes: the choice of oscillator and reference frequencies in the synthesizer and the associated frequency conversion (mixers and multipliers) and filtering.

The triple-loop approach allows optimized frequency spacing that ensures effective filtering of nonlinear artifacts such as images by pushing them outside the bandwidth of the synthesizer circuits. In the MXG, the plan arranges the frequency references and conversions such that the largest are far from the desired frequencies and modest filtering can heavily attenuate the remaining spurious signals.

Pure and precise MXG

On the path to better performance, the pure and precise MXG X-Series signal generators are fine-tuned to be your “golden transmitter” in R&D. Whether you’re pushing for a linear RF chain or an optimized link budget, the analog and vector MXG models deliver the performance and capabilities you need: phase noise, ACPR, channel coding, and more.

Use the MXG to test radar receiver sensitivity, characterize ADC or mixer SNR, or find receiver out-of-band rejection capability. You’ll get excellent results with industry-leading phase noise of -146 dBm at 1 GHz and spurious performance of -96 dBc at 1 GHz. You can also drive power amplifiers and characterize nonlinear behavior with industry-leading output power of $+27$ dB and ACPR of -73 dBc (W-CDMA test mode 1, 64 DPCH).

With EVM up to 0.4 percent (802.11ac and LTE) and factory-equalized 160 MHz RF bandwidth with flatness of less than ± 0.2 dB, the MXG enables testing and characterization of multicarrier power amplifiers or wideband receivers and components, such as those used in 802.11ac WLAN designs.

Meet your toughest requirements

The MXG is designed to keep pace with your ongoing search for greater performance. In consumer wireless, military communications, or radar, performance gains can help you mitigate interference, accelerate data throughput, or enhance receiver sensitivity.



Overcome interference problems

In wireless, interference mitigation is becoming more difficult with the proliferation of users, devices, and standards. In the development of power amplifiers, the MXG helps minimize interference with less distortion by providing -73 dBc ACPR (W-CDMA test model 1, 64 DPCH) and $+27$ dBm output power.

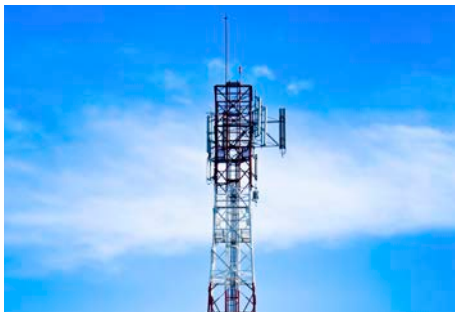

Accelerate data throughput

Meeting throughput expectations at the edge of the network is becoming more challenging with LTE-Advanced and 802.11ac WLAN. With 160-MHz bandwidth and EVM up to 0.4 percent, the MXG helps you keep pace with present and emerging standards.



Enhance receiver sensitivity

With the latest generation of radar systems, the challenge is to locate small, low-mobility targets—and one of the keys is enhanced receiver sensitivity. By providing unsurpassed phase noise of -146 dBc/Hz (1 GHz, 20 kHz offset) and spurious of -96 dBc (1 GHz) the MXG makes it possible to see the true performance of advanced radar systems.



Get the Right Performance at the Right Price

Lower operating costs

To reduce your total cost-of-ownership, the X-Series is designed for high reliability as well as fast, easy, and cost-effective calibration, service, and repair. To maximize uptime, today's MXG and EXG signal generators leverage technology used in the previous-generation MXG, which has a mean time between failures (MTBF) of 116,000 hours.

To help you minimize downtime and service costs, the MXG and EXG include advanced self-maintenance capabilities such as full internal root-cause self-diagnostics. The recommended three-year calibration cycle and self-maintenance strategy will help reduce support costs and increase instrument uptime. If onsite repairs are ever needed, they can be completed in less than two hours (and no post repair calibration needed) with our refurbished-parts exchange program.



Cost-effective EXG

On the path to faster throughput and greater uptime, the cost-effective EXG is optimized for manufacturing test. Analog and vector models provide the signals you need for basic parametric testing of components, functional verification of receivers, and virtually anything in between.

Accurately verify performance fast

Check component performance with +27 dBm output power and -73 dBc ACPR (W-CDMA test model 1, 64 DPCH). With 900- μ s simultaneous switching of frequency, power, and waveform type, you can also maximize test throughput.

Reduce total cost of test

To help you manage costs, the X-Series is scalable: buy the performance and capabilities you need today and easily upgrade later. You can also purchase only the waveforms you need with 5-pack and 50-pack licensing.

When space is at a premium, the EXG is just 2U high and offers options such as an integrated multi-function generator and a USB power-sensor interface.

Easily Migrate from the ESG or First-Generation MXG



If you're already using the ESG or a first-generation MXG, we've made it easy to migrate to the new MXG and EXG.

The new MXG exceeds ESG performance in every important category. It also provides a larger set of applications that cover the latest standards. In automated test systems, extensive backward compatibility enables drop-in replacement without rewriting code or integrating new drivers.

Compared to the first-generation MXG, the EXG provides similar performance and significant enhancements. It starts with an attractive entry price and more capability in areas such as output power, ACPR, bandwidth, and memory. To meet evolving test requirements, you can scale up EXG performance and capability as needed: add higher output power, a real-time baseband generator, or a built-in multi-function generator.

For more information go to:
www.keysight.com/find/ESG2MXG

Enhanced security

Working on classified or high-security projects poses additional challenges. When your instrument needs to be removed or shared, you need to be confident that sensitive information is not accessible.

Option 006 for the X-Series signal generators provides removable external memory, including memory management features to erase and sanitize all memory locations inside the instrument.



Simplify Signal Creation with Signal Studio

Choose basic or advanced options

Basic options support creation of partially coded, statistically correct signals for stimulus/response measurements. For example, you can perform component-level parametric testing of amplifiers, modulators, filters, and so on. You can also verify the performance of transmitters, receivers, and RF subsystems.

Advanced options enable creation of fully channel-coded signals for analysis of receiver BER, FER, BLER, and PER. This enables verification of baseband subsystem coding in ASICs, DSPs, and more. It also supports testing of receiver performance and functionality during RF/baseband integration or system-level test.



Whether you're working on a single radio format or integrating multiple formats into a single device, easy access to the right test signals streamlines validation and helps ensure interoperability. Accelerate your work with Signal Studio software, a flexible suite of signal-creation tools that reduces the time you spend on signal simulation. Its performance-optimized reference signals—validated by Keysight—enhance the characterization and verification of your devices.

Signal Studio is scalable to meet a wide range of requirements in component and receiver testing. It starts with a choice of two operating modes: waveform playback mode and real-time mode. Waveform playback mode supports two levels of functionality, basic and advanced. Real-time mode provides advanced capabilities such as closed-loop control during signal generation. This level of flexibility helps you optimize the cost and capability of the Signal Studio configuration that's right for you.

Signal Studio covers the latest technologies such as LTE-Advanced, Multi-Standard Radio (MSR) 802.11ac WLAN, and GNSS, and delivers a wide range of applications in the following categories:

- General purpose
- Cellular communications
- Wireless connectivity
- Audio/video broadcasting
- Detection, positioning, tracking, and navigation

For more information, go to: www.keysight.com/find/SignalStudio

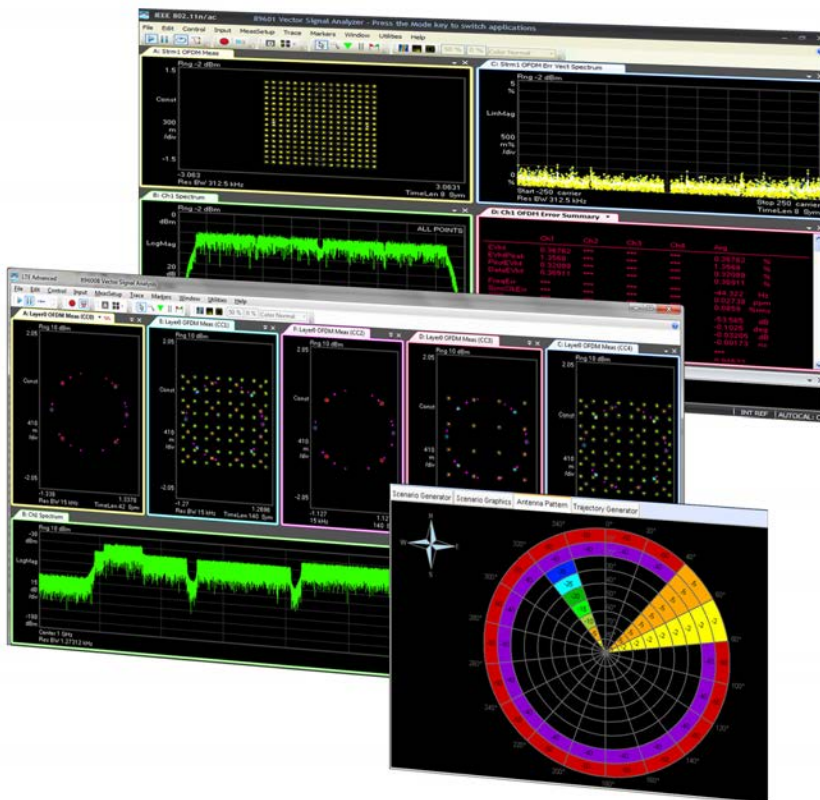

Simulate real-world signals with real-time mode

LTE receiver performance test with real-time signal generation

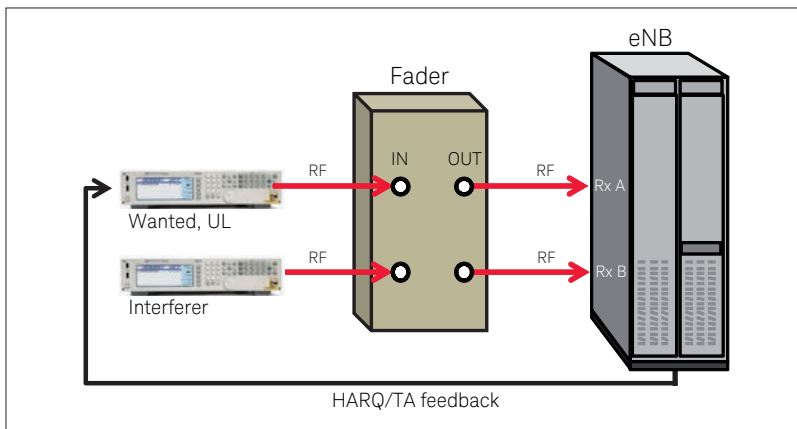

In Signal Studio, real-time mode is used to define the parameters of nonrepeating signals needed for receiver testing. Its graphical interface provides a direct instrument connection for parameter transfer and closed-loop or interactive control during signal generation. Real-time capabilities are currently available in versions of Signal Studio that address the following standards:

- LTE FDD/TDD
- W-CDMA/HSPA+
- GSM/EDGE
- cdma2000®
- GNSS
- Digital video

Real-time generation supports creation of complex signal scenarios of extremely long durations. In satellite navigation applications, an MXG or EXG can generate up to 32 line-of-site and multipath channels with greater than 24 hours duration. In DVB applications, this solution supports up to two hours of playback or continuous PN23 data sequences.

Closed-loop testing is becoming increasingly important with the latest digital wireless standards, especially during throughput testing of real-world channels. In LTE applications, Signal Studio plus an X-Series signal generator supports full conformance testing with BTS loopback performance testing.

Deep arbitrary waveform memory

The replay of an arbitrary waveform file is often an easier way to handle non-standard or classified signal-simulation applications. In such cases, an important but simple technical advance is deep waveform memory: the MXG has up to 1 GSa and the EXG has up to 512 MSa.

With 1 GSa, the MXG can provide a minimum of five seconds and as much as hours of a continuous signal without repeating, depending on sample rate. This capability can, in some cases, provide an alternative to real-time signal generation.

Analog Front and Rear Panels

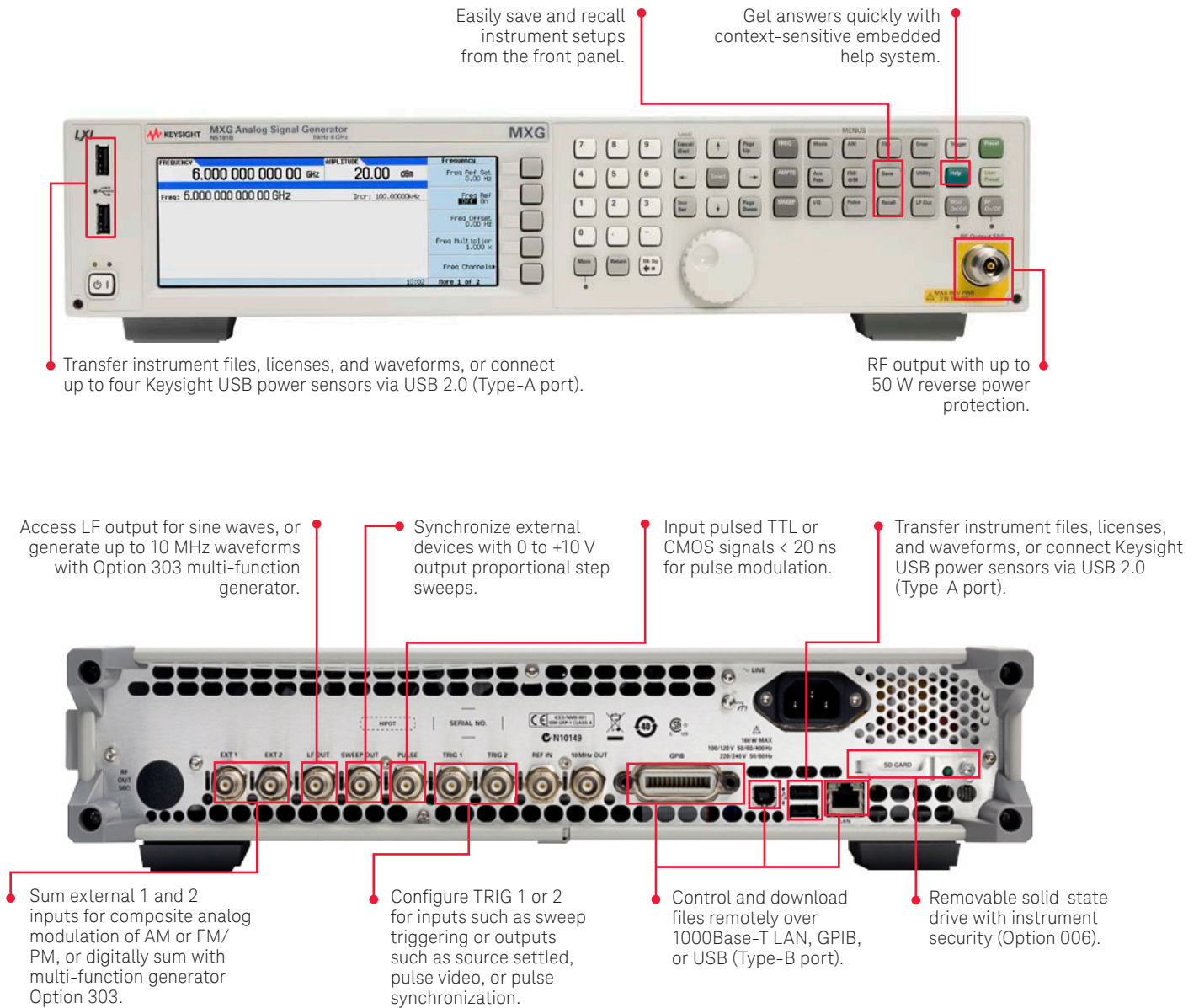

Note: The MXG and EXG X-Series analog signal generators have the same connector layout.

Vector Front and Rear Panels

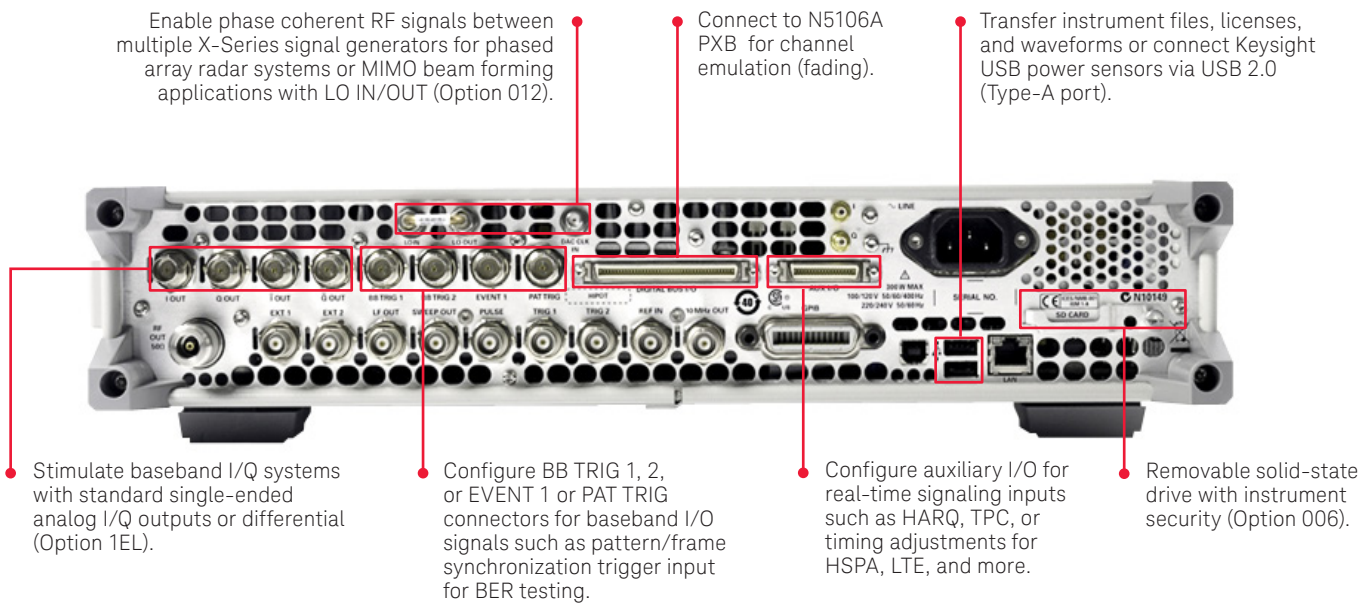
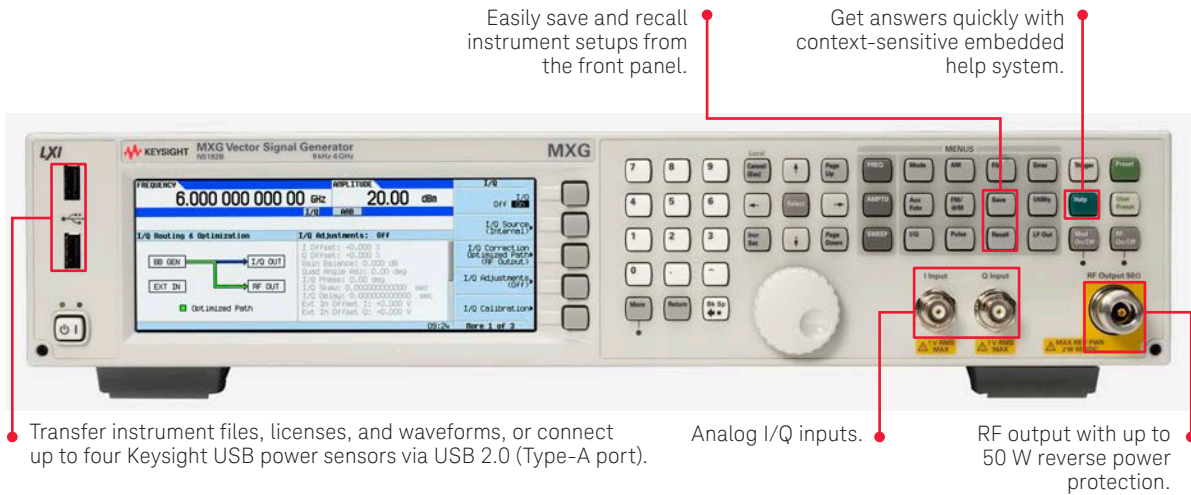

Note: The MXG and EXG X-Series vector signal generators have the same connector layout.

Related Literature

Keysight X-Series Signal Generators	Publication number
MXG Data Sheet	5991-0038EN
MXG Configuration Guide	5990-9959EN
EXG Data Sheet	5991-0039EN
EXG Configuration Guide	5990-9958EN
Signal Studio Software Brochure	5989-6448EN

Learn more at: www.keysight.com

For more information on Keysight Technologies' products, applications or services, please contact your local Keysight office. The complete list is available at: www.keysight.com/find/contactus

