

# User's Guide

## Agilent Technologies E4428C/38C ESG Signal Generators

This guide applies to the following signal generator models:

**E4428C ESG Analog Signal Generator**

**E4438C ESG Vector Signal Generator**

Due to our continuing efforts to improve our products through firmware and hardware revisions, signal generator design and operation may vary from descriptions in this guide. We recommend that you use the latest revision of this guide to ensure you have up-to-date product information. Compare the print date of this guide (see bottom of page) with the latest revision, which can be downloaded from the following website:

*<http://www.agilent.com/find/esg>*



**Agilent Technologies**

**Manufacturing Part Number: E4400-90503**

**Printed in USA**

**March 2013**

© Copyright 2001-2013 Agilent Technologies, Inc.

---

## Notice

The material contained in this document is provided “as is”, and is subject to being changed, without notice, in future editions.

Further, to the maximum extent permitted by applicable law, Agilent disclaims all warranties, either expressed or implied with regard to this manual and to any of the Agilent products to which it pertains, including but not limited to the implied warranties of merchantability and fitness for a particular purpose. Agilent shall not be liable for errors or for incidental or consequential damages in connection with the furnishing, use, or performance of this document or any of the Agilent products to which it pertains. Should Agilent have a written contract with the User and should any of the contract terms conflict with these terms, the contract terms shall control.

<b>1. E4428C Analog Signal Generator Overview</b> .....	<b>1</b>
Standard Analog Signal Generator Features .....	2
Options .....	3
Firmware Upgrades .....	3
To Upgrade Firmware .....	3
Calibration .....	4
Modes of Operation .....	5
Continuous Wave .....	5
Swept Signal .....	5
Analog Modulation .....	5
Front Panel Overview .....	6
1. Display .....	6
2. Softkeys .....	6
3. Frequency Key .....	7
4. Amplitude Key .....	7
5. Knob .....	7
7. Save Key .....	7
7. Menu Keys .....	7
8. Recall Key .....	7
9. EXT 1 INPUT Connector .....	8
10. EXT 2 INPUT Connector .....	8
11. Help Key .....	8
12. Trigger Key .....	8
13. LF OUTPUT Connector .....	8
14. RF OUTPUT Connector .....	9
15. Mod On/Off Key .....	9
16. RF On/Off Key .....	9
17. Numeric Keypad .....	9
18. Incr Set Key .....	9
19. Arrow Keys .....	10
20. Hold Key .....	10
21. Return Key .....	10
22. Display Contrast Increase Key .....	10
23. Display Contrast Decrease Key .....	10
24. Local Key .....	10
25. Preset Key .....	10
26. Standby LED .....	10
27. Line Power LED .....	10

---

# Contents

28. Power Switch . . . . .	11
Front Panel Display . . . . .	12
1. Frequency Area . . . . .	12
2. Annunciators . . . . .	13
3. Amplitude Area . . . . .	15
4. Softkey Label Area . . . . .	15
5. Error Message Area . . . . .	15
6. Text Area . . . . .	15
7. Active Function Area . . . . .	15
Rear Panel Overview . . . . .	16
1. AC Power Receptacle . . . . .	17
2. GPIB Connector . . . . .	17
3. RS 232 Connector . . . . .	17
4. LAN Connector . . . . .	18
5. TRIG OUT Connector . . . . .	18
6. TRIG IN Connector . . . . .	18
7. 10 MHz IN Connector . . . . .	18
8. SWEEP OUT Connector . . . . .	18
9. 10 MHz OUT Connector . . . . .	18
<b>2. E4438C Vector Signal Generator Overview . . . . .</b>	<b>19</b>
Standard Vector Signal Generator Features . . . . .	20
Options . . . . .	21
Understanding Baseband Generator Options . . . . .	21
Firmware Upgrades . . . . .	22
To Upgrade Firmware . . . . .	22
Calibration . . . . .	23
Modes of Operation . . . . .	24
Continuous Wave . . . . .	24
Swept Signal . . . . .	24
Analog Modulation . . . . .	24
Digital Modulation . . . . .	24
Front Panel Overview . . . . .	26
1. Display . . . . .	26
2. Softkeys . . . . .	26
3. Frequency Key . . . . .	26
4. Amplitude Key . . . . .	27
5. Knob . . . . .	27

6. Menu Keys .....	27
7. Save Key .....	27
8. Recall Key .....	27
9. EXT 1 INPUT Connector .....	28
10. EXT 2 INPUT Connector .....	28
11. Help Key .....	28
12. Trigger Key .....	28
13. LF OUTPUT Connector .....	29
14. RF OUTPUT Connector .....	29
15. Mod On/Off Key .....	29
16. RF On/Off Key .....	29
17. Numeric Keypad .....	29
18. Incr Set Key .....	30
19. Arrow Keys .....	30
20. Hold Key .....	30
21. Return Key .....	30
22. Display Contrast Increase Key .....	30
23. Display Contrast Decrease Key .....	30
24. Local Key .....	30
25. Preset Key .....	30
26. Standby LED .....	31
27. Line Power LED .....	31
28. Power Switch .....	31
29. SYMBOL SYNC Connector (Option 001/601 or 002/602) .....	31
30. DATA CLOCK Connector (Option 001/601 or 002/602) .....	31
31. DATA Connector (Option 001/601 or 002/602) .....	32
32. Q Connector .....	32
33. I Connector .....	32
Front Panel Display .....	33
1. Frequency Area .....	33
2. Annunciators .....	34
3. Digital Modulation Annunciators .....	36
4. Amplitude Area .....	36
5. Softkey Label Area .....	36
6. Error Message Area .....	36
7. Text Area .....	36
8. Active Function Area .....	36
Rear Panel Overview .....	37

---

# Contents

1. 321.4 IN Connector (Option 300) . . . . .	38
2. BER GATE IN Connector (Option UN7) . . . . .	38
3. BER CLK IN Connector (Option UN7) . . . . .	38
4. BER DATA IN Connector (Option UN7) . . . . .	38
5. I-bar OUT Connector (Option 001/601 or 002/602) . . . . .	38
6. I OUT Connector (Option 001/601 or 002/602) . . . . .	39
7. COH CARRIER Output Connector . . . . .	39
8. Q OUT Connector (Option 001/601 or 002/602) . . . . .	39
9. Q-bar OUT Connector (Option 001/601 or 002/602) . . . . .	40
10. EVENT 1 Connector (Option 001/601 or 002/602) . . . . .	40
11. EVENT 2 Connector (Option 001/601 or 002/602) . . . . .	40
12. PATT TRIG IN Connector (Option 001/601 or 002/602) . . . . .	41
13. AUX I/O Connector . . . . .	41
14. DIGITAL BUS . . . . .	43
15. AC Power Receptacle . . . . .	43
16. GPIB Connector . . . . .	44
17. RS 232 Connector . . . . .	44
18. LAN Connector . . . . .	44
19. TRIG OUT Connector . . . . .	45
20. BURST GATE IN Connector (Option 001/601 or 002/602) . . . . .	45
21. TRIG IN Connector . . . . .	45
22. 10 MHz IN Connector . . . . .	45
23. SWEEP OUT Connector . . . . .	45
24. 10 MHz OUT Connector . . . . .	46
25. BASEBAND GEN REF IN Connector (Option 001/601 or 002/602) . . . . .	46
<b>3. Basic Operation . . . . .</b>	<b>47</b>
Using Table Editors . . . . .	48
Table Editor Softkeys . . . . .	49
Modifying Table Items in the Data Fields . . . . .	49
Configuring the RF Output . . . . .	50
Configuring a Continuous Wave RF Output . . . . .	50
Configuring a Swept RF Output . . . . .	53
Generating the Modulation Format . . . . .	58
Modulating the Carrier Signal . . . . .	60
To Turn the Modulation On . . . . .	60
To Turn the Modulation Off . . . . .	60
Creating and Applying User Flatness Correction . . . . .	61

Creating a User Flatness Correction Array . . . . .	61
Using the Memory Catalog . . . . .	68
Viewing Stored Files . . . . .	68
Storing Files . . . . .	69
Using the Instrument State Registers . . . . .	70
Saving an Instrument State . . . . .	71
Recalling an Instrument State . . . . .	72
Saving an Instrument State for a Waveform File . . . . .	72
Recalling an Instrument State for a Waveform File . . . . .	73
Deleting Registers and Sequences . . . . .	74
Using Security Functions . . . . .	75
Understanding Memory Types . . . . .	75
Removing Sensitive Data from Memory . . . . .	78
Using the Secure Display . . . . .	82
Enabling Options (E4438C Only) . . . . .	84
Enabling a Software Option . . . . .	84
Using the Web Server . . . . .	85
Activating the Web Server . . . . .	85
<b>4. Basic Digital Operation (Option 001/601 or 002/602) . . . . .</b>	<b>89</b>
Custom Modulation . . . . .	91
Custom ARB Waveform Generator . . . . .	91
Custom Real Time I/Q Baseband . . . . .	92
Arbitrary (ARB) Waveform File Headers . . . . .	93
Creating a File Header . . . . .	93
Modifying Header Information . . . . .	95
Dual ARB Player Waveform Sequence File Headers . . . . .	101
Editing and Viewing File Headers in the Dual ARB Player . . . . .	101
Playing a Waveform File containing a Header . . . . .	105
Using the Dual ARB Waveform Player . . . . .	107
Accessing the Dual ARB Player . . . . .	107
Creating Waveform Segments . . . . .	108
Creating a Waveform Sequence . . . . .	109
Playing a Waveform Sequence . . . . .	110
Editing a Waveform Sequence . . . . .	111
Adding Real Time Noise to a Dual ARB Waveform (Option 403) . . . . .	112
Storing and Loading Waveform Segments . . . . .	113
Understanding the I/Q Modulator Filter . . . . .	115

---

# Contents

Applying An I/Q Modulator Filter .....	116
Local Settings for ARB Waveform Formats and the Dual ARB Player .....	117
I/Q Attenuator and Filters Settings .....	117
Waveform Runtime Scaling .....	119
High Crest Mode .....	119
ARB Sample Clock .....	119
Waveform Markers .....	120
Using Waveform Markers .....	124
Waveform Marker Concepts .....	125
Accessing Marker Utilities .....	129
Viewing Waveform Segment Markers .....	130
Clearing Marker Points from a Waveform Segment .....	131
Setting Marker Points in a Waveform Segment .....	132
Controlling Markers in a Waveform Sequence (Dual ARB Only) .....	134
Viewing a Marker Pulse .....	136
Using the RF Blanking Marker Function .....	137
Setting Marker Polarity .....	139
Triggering Waveforms .....	140
Source .....	141
Mode and Response .....	141
Accessing Trigger Utilities .....	142
Setting the Polarity of an External Trigger .....	143
Using Gated Triggering .....	143
Using Segment Advance Triggering .....	145
Using External Triggering .....	146
Using Waveform Clipping .....	149
How Power Peaks Develop .....	149
How Peaks Cause Spectral Regrowth .....	151
How Clipping Reduces Peak-to-Average Power .....	152
Configuring Circular Clipping .....	155
Configuring Rectangular Clipping .....	156
Using Waveform Scaling .....	157
How DAC Over-Range Errors Occur .....	157
How Scaling Eliminates DAC Over-Range Errors .....	158
Scaling a Currently Playing Waveform (Runtime Scaling) .....	159
Scaling a Waveform File in Volatile Memory .....	160
Using Customized Burst Shape Curves .....	161
Understanding Burst Shape .....	161



Creating a User-Defined Burst Shape Curve .....	163
Storing a User-Defined Burst Shape Curve .....	166
Recalling a User-Defined Burst Shape Curve.....	166
Generating the Waveform .....	167
Configuring the RF Output .....	167
Using Finite Impulse Response (FIR) Filters .....	168
Creating a User-Defined FIR Filter Using the FIR Table Editor .....	168
Modifying a FIR Filter Using the FIR Table Editor.....	173
Loading the Default Gaussian FIR File.....	173
Modifying the Coefficients .....	174
Storing the Filter to Memory.....	174
Differential Encoding .....	175
Differential Data Encoding .....	176
How Differential Encoding Works .....	177
Using Differential Encoding .....	179
User-Defined I/Q Maps.....	183
Creating a User-Defined I/Q Map.....	183
Storing a User-Defined I/Q Map File .....	185
Moving I/Q Symbols.....	185
User-Defined FSK Modulation.....	187
Modifying a Default FSK Modulation .....	187
Storing an FSK Modulation .....	188
Creating a User-Defined FSK Modulation .....	188
Creating and Using Bit Files.....	190
Creating a User File.....	190
Renaming and Saving a User File.....	192
Recalling a User File.....	193
Modifying an Existing User File.....	193
Applying Bit Errors to a User File .....	194
Waveform Licensing for Firmware Version $\geq$ C.05.23.....	195
Understanding Waveform Licensing.....	195
Installing an E4438C Option 22x or E4438C Option 25x .....	195
Licensing a Signal Generator Waveform File.....	196
Using Waveform 5-Pack Licensing (Options 221-229) for Firmware Version $<$ C.05.23 .....	197
Understanding Waveform 5-Pack Licensing.....	197
Installing an E4438C Option 22x Waveform 5-Pack License .....	198
Licensing a Signal Generator Waveform File.....	198
Using Waveform 5-Pack History .....	200

---

# Contents

Waveform 5-Pack Warning Messages .....	202
Waveform Licenses (Signal Studio “A” Versions) .....	203
<b>5. AWGN Waveform Generator (Option 403) .....</b>	<b>205</b>
Configuring the AWGN Generator. ....	206
Arb Waveform Generator AWGN .....	206
Real Time I/Q Baseband AWGN .....	207
<b>6. Analog Modulation .....</b>	<b>209</b>
Analog Modulation Waveforms .....	210
Configuring AM .....	211
Setting the Carrier Frequency .....	211
Setting the RF Output Amplitude .....	211
Setting the AM Depth and Rate .....	211
Turning on Amplitude Modulation .....	211
Wideband AM (E4438C) .....	212
Configuring FM .....	213
Setting the RF Output Frequency .....	213
Setting the RF Output Amplitude .....	213
Setting the FM Deviation and Rate .....	213
Activating FM .....	213
Configuring $\Phi$ M .....	214
Setting the RF Output Frequency .....	214
Setting the RF Output Amplitude .....	214
Setting the FM Deviation and Rate .....	214
Activating FM .....	214
Configuring Pulse Modulation .....	215
Setting the RF Output Frequency .....	215
Setting the RF Output Amplitude .....	215
Setting the Pulse Period and Width .....	215
Activating Pulse Modulation .....	215
Configuring the LF Output .....	216
Configuring the LF Output with an Internal Modulation Source .....	217
Configuring the LF Output with a Function Generator Source .....	218
<b>7. Digital Signal Interface Module .....</b>	<b>219</b>
Clock Timing .....	220
Clock and Sample Rates .....	220

Clock Source . . . . .	223
Common Frequency Reference . . . . .	224
Clock Timing for Parallel Data . . . . .	227
Clock Timing for Parallel Interleaved Data . . . . .	230
Clock Timing for Serial Data . . . . .	232
Clock Timing for Phase and Skew Adjustments . . . . .	232
Connecting the Clock Source and the Device Under Test . . . . .	234
Data Types . . . . .	236
Output Mode . . . . .	236
Input Mode . . . . .	236
Operating the N5102A Module in Output Mode . . . . .	238
Setting up the Signal Generator Baseband Data . . . . .	238
Accessing the N5102A Module User Interface . . . . .	238
Choosing the Logic Type and Port Configuration . . . . .	239
Selecting the Output Direction . . . . .	240
Selecting the Data Parameters . . . . .	240
Configuring the Clock Signal . . . . .	242
Generating Digital Data . . . . .	246
Operating the N5102A Module in Input Mode . . . . .	247
Accessing the N5102A Module User Interface . . . . .	247
Selecting the Input Direction . . . . .	248
Choosing the Logic Type and Port Configuration . . . . .	248
Configuring the Clock Signal . . . . .	249
Selecting the Data Parameters . . . . .	253
Digital Data . . . . .	255
<b>8. Bluetooth Signals (Option 406) . . . . .</b>	<b>257</b>
Accessing the Bluetooth Setup Menu on the ESG . . . . .	258
Setting Up Packet Parameters . . . . .	259
Setting up Impairments . . . . .	261
Using Burst . . . . .	263
Setting the Burst Power Ramp . . . . .	263
Using Clock/Gate Delay . . . . .	264
Turning On a Bluetooth Signal . . . . .	265
<b>9. BERT (Options UN7 and 300) . . . . .</b>	<b>267</b>
Setting Up a PHS Bit Error Rate Test (BERT) . . . . .	268
Required Equipment . . . . .	268

---

# Contents

Connecting the Test Equipment . . . . .	269
Setting the Carrier Frequency and Power Level . . . . .	270
Selecting the Radio Data Format . . . . .	270
Setting the Radio to a Receiver Mode . . . . .	271
Selecting the BERT Data Pattern and Total Bits . . . . .	271
Selecting the BERT Trigger . . . . .	271
Starting BERT measurements . . . . .	272
Measuring RF Loopback BERT with Option 300 . . . . .	273
Required Equipment . . . . .	273
Connecting the Test Equipment . . . . .	273
Configuring GSM Mode on the Agilent Technologies E4406A VSA Series Transmitter Tester . . . . .	275
Configuring GSM Mode on the ESG Vector Signal Generator . . . . .	276
Synchronizing to the BCH Then the TCH . . . . .	279
Synchronizing to the TCH . . . . .	281
Making Loopback BERT Measurements . . . . .	282
Using Amplitude Sensitivity Search . . . . .	284
Using the External Frame Trigger Function with the EDGE Format . . . . .	288
Measuring the Initial Delay Value . . . . .	288
Adjusting the Delay Value . . . . .	289
Bit Error Rate Tester–Option UN7 . . . . .	292
Block Diagram . . . . .	292
Clock Gate Function . . . . .	292
Clock/Gate Delay Function . . . . .	293
Clock Delay Function . . . . .	294
Gate Delay Function in the Clock Mode . . . . .	296
Triggering . . . . .	296
Data Processing . . . . .	299
Repeat Measurements . . . . .	300
Testing Signal Definitions . . . . .	301
RF Loopback BER–Option 300 . . . . .	303
Synchronization . . . . .	303
Erased Frame Detection . . . . .	304
Downlink Errors . . . . .	304
Frame Structure . . . . .	304
Verifying BERT Operation . . . . .	306
Verification Setup . . . . .	306

---

## **10. CDMA Digital Modulation (Option 401) . . . . . 311**

cdma2000 Forward Link Modulation for Component Test .....	312
Activating a Predefined CDMA Forward Link State .....	312
Creating a User-Defined CDMA Forward Link State.....	313
cdma2000 Reverse Link Modulation for Component Test.....	316
Activating a Predefined cdma2000 Reverse Link State .....	316
Creating a User-Defined cdma2000 Reverse Link State.....	317
Storing a Component Test Waveform to Memory .....	320
Recalling a Component Test Waveform .....	321
Creating a Custom Multicarrier cdma2000 Waveform.....	322
Opening the Multicarrier cdma2000 Setup Table Editor .....	322
Modifying a Multicarrier cdma2000 4-Carrier Template .....	323
Activating a Custom Multicarrier cdma2000 Setup .....	324
cdma2000 Forward Link Modulation for Receiver Test.....	326
Editing the Base Station Setup .....	326
Editing Channel Setups.....	326
Adjusting Code Domain Power.....	328
Managing Noise .....	329
Generating the Baseband Signal .....	330
Configuring the RF Output .....	331
cdma2000 Reverse Link Modulation for Receiver Test.....	332
Editing the Mobile Setup.....	332
Editing Channel Setups.....	332
Adjusting Code Domain Power.....	334
Managing Noise .....	335
Generating the Baseband Signal .....	336
Configuring the RF Output .....	337
Forward and Reverse Link I/O Signal Descriptions and Timing Relationships.....	338
Front Panel Inputs .....	338
Rear Panel Inputs .....	339
Rear Panel Outputs .....	339
Forward Link I/O Timing Relationships.....	341
Reverse Link I/O Timing Relationships .....	343
Applying a User-Defined FIR Filter to a cdma2000 Waveform.....	347
IS-95A Modulation.....	349
Creating a Predefined CDMA State .....	349
Creating a User-Defined CDMA State .....	350
Applying Changes to an Active CDMA State.....	352
Creating a User-Defined Multicarrier CDMA State .....	352

---

# Contents

Applying Changes to an Active Multicarrier CDMA State .....	354
<b>11. GPS Modulation (Option 409) .....</b>	<b>355</b>
Real Time MSGPS .....	357
Signal Generation Block Diagram .....	358
Scenario Files .....	359
RF Power Level Considerations .....	360
Generating a Real Time MSGPS Signal .....	362
Configuring the External Reference Clock .....	363
Real Time GPS .....	364
Real Time GPS Introduction .....	365
Setting Up the Real Time GPS Signal .....	370
Configuring the External Reference Clock .....	371
Testing Receiver Sensitivity .....	373
Setting Up a GPS Bit Error Rate Test .....	374
<b>12. Multitone Waveform Generator (Options 001/601 or 002/602) .....</b>	<b>379</b>
Creating a Custom Multitone Waveform .....	380
Initializing the Multitone Setup Table Editor .....	380
Configuring Tone Powers and Tone Phases .....	380
Removing a Tone .....	380
Generating the Waveform .....	381
Configuring the RF Output .....	381
Applying Changes to an Active Multitone Signal .....	382
Storing a Multitone Waveform .....	382
Recalling a Multitone Waveform .....	383
<b>13. Custom Digital Modulation (Options 001/601 or 002/602) .....</b>	<b>385</b>
Using the Arbitrary Waveform Generator .....	386
Using Predefined Custom TDMA Digital Modulation .....	386
Creating a Custom TDMA Digital Modulation State .....	387
Storing a Custom TDMA Digital Modulation State .....	388
Recalling a Custom TDMA Digital Modulation State .....	388
Creating a Custom Multicarrier TDMA Digital Modulation State .....	389
Storing a Custom Multicarrier TDMA Digital Modulation State .....	391
Applying Changes to an Active Multicarrier TDMA Digital Modulation State .....	391
Using the Real Time I/Q Baseband Generator .....	392
Selecting Predefined Custom Modulation Modes .....	392

Creating User-Defined Custom Modulation . . . . .	393
<b>14. Real Time TDMA Formats (Option 402) . . . . .</b>	<b>395</b>
EDGE Framed Modulation . . . . .	396
Understanding External Data Connections . . . . .	396
Activating Framed Data Format . . . . .	397
Configuring the EDGE Timeslots . . . . .	397
Configuring GMSK Timeslots . . . . .	397
Disabling Timeslot Ramping . . . . .	398
Generating the Baseband Signal . . . . .	398
Configuring the RF Output . . . . .	398
Adjusting the Power Level Between Timeslots . . . . .	398
GSM Framed Modulation . . . . .	400
Activating Framed Data Format . . . . .	400
Configuring the First Timeslot . . . . .	400
Configuring the Second Timeslot . . . . .	400
Configuring the Third Timeslot . . . . .	400
Disabling Timeslot Ramping . . . . .	401
Generating the Baseband Signal . . . . .	401
Configuring the RF Output . . . . .	401
Adjusting the Power Level Between Timeslots . . . . .	401
Enhanced Observed Time Difference (E-OTD) . . . . .	402
Overview . . . . .	402
Basic GSM Frame Structure . . . . .	402
E-OTD Measurement System Synchronization . . . . .	408
Sample SCPI Command Scripts . . . . .	411
DECT Framed Modulation . . . . .	415
Activating Framed Data Format . . . . .	415
Configuring the First Timeslot . . . . .	415
Configuring the Second Timeslot . . . . .	415
Generating the Baseband Signal . . . . .	415
Configuring the RF Output . . . . .	416
PHS Framed Modulation . . . . .	417
Activating Framed Data Format . . . . .	417
Configuring the First Timeslot . . . . .	417
Configuring the Second Timeslot . . . . .	417
Generating the Baseband Signal . . . . .	417
Configuring the RF Output . . . . .	418

---

# Contents

PDC Framed Modulation . . . . .	419
Activating Framed Data Format . . . . .	419
Configuring the First Timeslot . . . . .	419
Configuring the Second Timeslot . . . . .	419
Generating the Baseband Signal . . . . .	419
Configuring the RF Output . . . . .	420
NADC Framed Modulation . . . . .	421
Activating Framed Data Format . . . . .	421
Configuring the First Timeslot . . . . .	421
Configuring the Second Timeslot . . . . .	421
Generating the Baseband Signal . . . . .	421
Configuring the RF Output . . . . .	422
TETRA Framed Modulation . . . . .	423
Activating Framed Data Format . . . . .	423
Configuring the First Timeslot . . . . .	423
Configuring the Second Timeslot . . . . .	423
Generating the Baseband Signal . . . . .	423
Configuring the RF Output . . . . .	424
<b>15. W-CDMA Digital Modulation for Component Test (Option 400) . . . . .</b>	<b>425</b>
W-CDMA Downlink Modulation . . . . .	426
Activating a Predefined W-CDMA Downlink State . . . . .	426
Creating a User-Defined W-CDMA Downlink State . . . . .	427
Storing a W-CDMA Downlink/Uplink State . . . . .	431
Recalling a W-CDMA Downlink/Uplink State . . . . .	432
Creating a User-Defined Multicarrier W-CDMA State . . . . .	433
Storing a Multicarrier W-CDMA State . . . . .	436
Recalling a Multicarrier W-CDMA State . . . . .	437
W-CDMA Uplink Modulation . . . . .	438
Creating a Predefined W-CDMA Uplink State . . . . .	438
Creating a User-Defined W-CDMA Uplink State . . . . .	439
W-CDMA Concepts . . . . .	443
Understanding TPC Values . . . . .	445
Understanding TFCI, TPC, and Pilot Power Offsets . . . . .	446
Calculating Downlink Scramble Codes . . . . .	448
W-CDMA Frame Structures . . . . .	452
Downlink PICH Frame Structure . . . . .	452
Downlink PCCPCH + SCH Frame Structure . . . . .	453



Downlink DPCCH/DPDCH Frame Structure .....	454
Uplink DPCCH/DPDCH Frame Structure .....	456
<b>16. W-CDMA Uplink Digital Modulation for Receiver Test (Option 400) .....</b>	<b>459</b>
Equipment Setup .....	461
ESG and Agilent E4440A PSA Spectrum Analyzer Setup .....	461
ESG and Base Transceiver Station (BTS) Setup .....	461
Understanding the PRACH .....	463
Overview .....	463
Access Slots .....	463
Preamble .....	464
Message Part .....	465
Power Control .....	467
Power Control Modes .....	473
Generating a Single PRACH Signal .....	476
Configuring the RF Output .....	476
Selecting the PRACH and Single PRACH Modes .....	476
Selecting a Rear Panel Output Trigger .....	476
Generating the Baseband Signal .....	477
Setting Up the E4440A PSA for the PRACH Signal .....	477
Modifying the PRACH Physical and Transport Layers .....	478
Viewing the Modified PRACH Signal .....	482
Generating the AICH for the PRACH Message Transmission .....	482
Viewing the PRACH Message Using an AICH Trigger .....	485
Using the AICH Feature with a Base Transceiver Station .....	486
Multiple PRACH Overview .....	488
Understanding the 80 ms Transmission/Time Period .....	488
Understanding the Power Offset Between the Carrier and the Multiple PRACH .....	491
Setting Up a Multiple PRACH Signal .....	493
Configuring the RF Output .....	493
Selecting the PRACH and Multiple PRACH Modes .....	494
Selecting the Rear Panel Output Trigger .....	494
Generating the Baseband Signal .....	495
Configuring the PRACH Code Setup .....	495
Configuring the PRACH Power Setup .....	501
Configuring the PRACH Timing Setup .....	504
Viewing a Multiple PRACH Signal .....	509
Connecting the ESG to a Base Station .....	510

---

# Contents

Overload Testing with Multiple PRACHs—Multiple ESGs . . . . .	511
Connecting the ESG to the Base Transceiver Station . . . . .	513
Configuring the ESGs . . . . .	514
Setting Up the LF Output as the PRACH Start Trigger Signal . . . . .	517
DPCH . . . . .	518
Generating a DPCCH/DPDCH with a Reference Measurement Channel . . . . .	518
Configuring the E4440A PSA for Viewing the DPCCH/DPDCH Output . . . . .	519
Modifying the DPCCH/DPDCH Physical and Transport Layers . . . . .	520
Configuring the E4440A PSA for Viewing Additive Noise . . . . .	524
Adding Noise . . . . .	524
Using the Transmit Power Control . . . . .	527
Compressed Mode Single Transmission Gap Pattern Sequence (TGPS) Overview . . . . .	531
Setting Up Compressed Mode for a Single TGPS Transmission . . . . .	533
Equipment Setup . . . . .	533
Configuring the RF Output . . . . .	533
Accessing the W-CDMA Modulation Format and Selecting Uplink . . . . .	534
Setting UP the W-CDMA Signal Parameters . . . . .	534
Generating the Baseband Signal . . . . .	535
Configuring Compressed Mode . . . . .	535
Viewing and Adjusting the Compressed Mode Signal . . . . .	539
Compressed Mode Multiple Transmission Gap Pattern Sequence (TGPS) Overview . . . . .	542
Understanding Multiple TGPS Compressed Frame Alignment . . . . .	542
Setting Up Compressed Mode for a Multiple TGPS Transmission . . . . .	545
Equipment Setup . . . . .	545
Configuring the RF Output . . . . .	545
Accessing the W-CDMA Modulation Format and Selecting Uplink . . . . .	546
Setting UP the W-CDMA Signal Parameters . . . . .	546
Selecting the Rear Panel Output Trigger . . . . .	547
Generating the Baseband Signal . . . . .	547
Configuring TGPSI 1 . . . . .	548
Configuring TGPSI 2 . . . . .	551
Viewing the Multiple TGPSI Signal . . . . .	554
Configuring the UE Setup . . . . .	556
Locating Rear Panel Input Signal Connectors . . . . .	557
Configuring Rear Panel Output Signals . . . . .	559
Accessing the Output Trigger Signal Menu . . . . .	559
Selecting an Output Signal . . . . .	559
Deselecting an Output Signal . . . . .	561

Adjusting Code Domain Power .....	562
Scaling to 0 dB .....	562
Setting Equal Channel Powers .....	563
W-CDMA Uplink Concepts .....	564
Data Channel Air Interface Block Diagram .....	564
Reference Measurement Channels (RMC) .....	564
Transition between Normal Frame and Compressed Frame .....	565
Settling Time during User Event for DPCH Compressed Mode .....	566
Connecting the ESG to a W-CDMA Base Station .....	566
Connector Assignments for W-CDMA Uplink .....	567
Signal Descriptions for W-CDMA Uplink .....	571
Synchronization Diagrams .....	576
Frame Sync Trigger Status Indicator .....	581
Special Power Control Considerations When Using DPCCCH/DPDCH in Compressed Mode or PRACH .....	584
W-CDMA AWGN Measurements and Bandwidths .....	585
DPCH Transmit Power Control by an External Signal .....	587
DPCCCH/DPDCH Frame Structure .....	589
<b>17. W-CDMA Downlink Digital Modulation for Receiver Test (Option 400) .....</b>	<b>591</b>
Using W-CDMA Downlink .....	592
Configuring the Base Station Setup .....	592
Configuring the Physical Layer .....	593
Configuring the Transport Layer .....	594
Adjusting Code Domain Power .....	595
Managing Noise .....	597
Generating the Baseband Signal .....	598
Applying New Settings .....	598
Configuring the RF Output .....	599
Transmit Diversity Overview .....	600
Configuring for Transmit Diversity and BERT .....	603
Equipment Set Up .....	603
Configuring the RF Output for both ESGs .....	604
Accessing the W-CDMA Modulation Format and Selecting Downlink .....	605
Setting UP Antenna One (ESG One) .....	605
Setting UP Antenna Two (ESG Two) .....	609
Generating the Baseband Signals and Synchronizing the ESG Transmissions .....	611
Configuring the UE .....	611

---

# Contents

Making the BERT Measurement . . . . .	612
Out-of-Synchronization Testing Overview . . . . .	614
Configuring for Out-of-Synchronization Testing . . . . .	615
Equipment Set up . . . . .	615
Setting the RF Output . . . . .	616
Accessing the W-CDMA Modulation Format and Selecting Downlink . . . . .	617
Setting UP the W-CDMA Signal Parameters . . . . .	617
Selecting the Input DTX Gating Signal Trigger Polarity . . . . .	618
Generating the Baseband Signal and Activating the Out-Of-Synchronization Test Feature . . . . .	619
Configuring the UE . . . . .	619
Setting Up the Spectrum Analyzer for Detecting the UE DTX . . . . .	619
Configuring the DPCH DTX Gating Trigger Signal . . . . .	620
Compressed Mode Overview . . . . .	621
Setting Up for a Compressed Mode Signal . . . . .	624
Equipment Setup . . . . .	624
Setting the RF Output . . . . .	626
Accessing the W-CDMA Modulation Format and Selecting Downlink . . . . .	627
Setting Up the W-CDMA Signal Parameters . . . . .	627
Generating the Baseband Signal . . . . .	628
Configuring Compressed Mode . . . . .	628
Making Compressed Mode Signal Measurements . . . . .	633
Measuring the DPCH Symbol Power . . . . .	633
Making the BERT Measurement . . . . .	637
Locating Rear Panel Input Signal Connectors . . . . .	639
Configuring Rear Panel Output Signals . . . . .	641
Accessing the Rear Panel Output Signal Menu . . . . .	641
Selecting an Output Signal . . . . .	641
Deselecting an Output Signal . . . . .	642
Rear Panel Output Signal Descriptions . . . . .	643
W-CDMA Downlink Concepts . . . . .	646
DPCH Coding Block Diagram . . . . .	646
Reference Measurement Channels . . . . .	646
Scramble Codes . . . . .	648
W-CDMA AWGN Measurements and Bandwidths . . . . .	649
Special Power Control Considerations When Using Compressed Mode . . . . .	652
W-CDMA Frame Structures . . . . .	653
Downlink PICH Frame Structure . . . . .	653
Downlink PCCPCH + SCH Frame Structure . . . . .	654

Downlink DPCCH/DPDCH Frame Structure . . . . .	655
<b>18. Troubleshooting . . . . .</b>	<b>657</b>
Basic Signal Generator Operations . . . . .	658
Cannot Turn Off Help Mode . . . . .	658
No RF Output . . . . .	658
Signal Loss While Working with Mixers . . . . .	659
Signal Loss While Working with Spectrum Analyzers . . . . .	660
RF Output Power too Low . . . . .	662
No Modulation at the RF Output . . . . .	663
Sweep Appears to be Stalled . . . . .	663
Cannot Turn Off Sweep Mode . . . . .	663
Incorrect List Sweep Dwell Time . . . . .	664
List Sweep Information is Missing from a Recalled Register . . . . .	664
Data Storage . . . . .	665
Signal Generator Lock-Up . . . . .	666
Fail-Safe Recovery Sequence . . . . .	666
Error Messages . . . . .	668
Error Message File . . . . .	668
Error Message Format . . . . .	669
Error Message Types . . . . .	670
Upgrading Firmware . . . . .	671
Returning a Signal Generator to Agilent Technologies . . . . .	672
Contacting Agilent Sales and Service Offices . . . . .	673

---

# Contents

# Documentation Overview

## Installation Guide

- Safety Information
- Getting Started
- Operation Verification
- Regulatory Information

## User's Guide

- E4428C Analog Signal Generator Overview
- E4423C Analog Signal Generator Overview
- Basic Operation
- Basic Digital Operation
- AWGN Waveform Generator
- Analog Modulation
- Digital Signal Interface Module
- Bluetooth Signals
- BERT
- CDMA Digital Modulation
- GPS Modulation
- Multitone Waveform Generator
- Custom Digital Modulation
- Real Time TDMA Formats
- W-CDMA Digital Modulation for Component Test
- W-CDMA Uplink Digital Modulation for Receiver Test
- W-CDMA Downlink Digital Modulation for Receiver Test
- Troubleshooting

## Programming Guide

- Getting Started with Remote Operation
- Using IO Interfaces
- Programming Examples
- Programming the Status Register System
- Creating and Downloading Waveform Files
- Creating and Downloading User-Data Files

## **SCPI Reference**

### Volume 1:

- SCPI Basics
- Basic Function Commands
- System Commands
- Analog Commands
- Component Test Digital Commands

### Volume 2:

- Digital Signal Interface Module Commands
- Bit Error Rate Test (BERT) Commands
- Receiver Test Digital Commands

### Volume 3:

- Receiver Test Digital Commands (continued)

## **Compatibility with E44xxB SCPI Commands**

- Overview
- E4428C/38C SCPI Commands
- ESG E44xxB Commands
- 8648A/B/C/D Commands
- 8658B, 8657A/B/D/J Programming Codes

## **Service Guide**

- Troubleshooting
- Replaceable Parts
- Assembly Replacement
- Post-Repair Procedures
- Safety and Regulatory

## **Key and Data Field Reference**

### Volume 1:

- Symbols, Numerics, A-H

### Volume 2:

- Volume 2: I-Z



---

# 1 E4428C Analog Signal Generator Overview

The following list shows the topics covered in this chapter:

- “Standard Analog Signal Generator Features” on page 2
- “Options” on page 3
- “Firmware Upgrades” on page 3
- “Calibration” on page 4
- “Modes of Operation” on page 5
- “Front Panel Overview” on page 6
- “Front Panel Display” on page 12
- “Rear Panel Overview” on page 16

## Standard Analog Signal Generator Features

- CW output from 250 kHz to 3 or 6 GHz; the high-end frequency is dependent on the frequency option purchased with your signal generator
- list and step sweep of frequency and amplitude, with multiple trigger sources
- user flatness correction
- automatic leveling control (ALC) on and off modes; power calibration in ALC-off mode is available, even without power search
- 10 MHz reference oscillator with external output
- GPIB, RS-232, and 10Base-T LAN interfaces
- closed-loop AM
- dc-synthesized FM to 10 MHz rates; maximum deviation depends on the carrier frequency
- phase modulation
- pulse modulation
- a function generator that includes the following features:
  - 50 $\Omega$  low frequency output, 0 to 3 V<sub>p</sub>
  - selectable waveforms: sine, square, ramp, triangle, noise, swept-sine, dual-sine, and pulse
  - variable frequency modulation rates
  - variable triggering in list and step sweep modes: auto, external, single, or remote
- a pulse generator that includes the following features:
  - external pulse
  - internal square wave
  - internal pulse sources: internal square, internal pulse, external 1 dc-coupled, and external 2 dc-coupled
  - adjustable pulse width
  - adjustable pulse period
  - adjustable pulse rate
- external modulation inputs for AM, FM, and  $\Phi$ M
- simultaneous modulation configurations

## Options

ESG signal generators have hardware, firmware, software, and documentation options. The data sheet shipped with your signal generator provides an overview of available options. For more information, visit the Agilent ESG web page at <http://www.agilent.com/find/esg>, selected the desired ESG model, and then click the **Options** tab.

---

## Firmware Upgrades

You can upgrade the firmware in your signal generator whenever new firmware is released. New firmware releases, which can be downloaded from the Agilent website, may contain signal generator features and functionality not available in previous firmware releases.

To determine the availability of new signal generator firmware, visit the Signal Generator Firmware Upgrade Center web page at <http://www.agilent.com/find/upgradeassistant>, or call the number listed at <http://www.agilent.com/find/assist>.

### To Upgrade Firmware

The following procedure shows you how to download new firmware to your ESG using a LAN connection and a PC. For information on equipment requirements and alternate methods of downloading firmware, such as GPIB, refer to the *Firmware Upgrade Guide*, which can be accessed at <http://www.agilent.com/find/upgradeassistant>.

1. Note the IP address of your signal generator. To view the IP address on the ESG, press **Utility > GPIB/RS-232 LAN > LAN Setup**.
2. Use an internet browser to visit <http://www.agilent.com/find/upgradeassistant>.
3. Scroll down to the “Documents and Downloads” table and click the link in the “Latest Firmware Revision” column for the E4428C/38C ESG.
4. In the File Download window, select **Run**.
5. In the Welcome window, click **Next** and follow the on-screen instructions. The firmware files download to the PC.
6. In the “Documents and Downloads” table, click the link in the “Upgrade Assistant Software” column for the E4428C/38C ESG to download the PSG/ESG Upgrade Assistant.
7. In the File Download window, select **Run**.
8. In the Welcome window, click **OK** and follow the on-screen instructions.

### Calibration

- At the desktop shortcut prompt, click **Yes**.
- Once the utility downloads, close the browser and double-click the **PSG/ESG Upgrade Assistant** icon on the desktop.
- In the upgrade assistant, set the connection type you wish to use to download the firmware, and the parameters for the type of connection selected. For LAN, enter the instrument's IP address, which you recorded in [step 1](#).

---

**NOTE** If the PSG's dynamic host configuration protocol (DHCP) is enabled, the network assigns the instrument an IP address at power on. Because of this, when DHCP is enabled, the IP address may be different each time you turn on the instrument. DHCP does *not* affect the hostname.

---

- Click **Browse**, and double-click the firmware revision to upgrade your signal generator.
- In the Upgrade Assistant, click **Next**.
- Once connection to the instrument is verified, click **Next** and follow the on-screen prompts.

---

**NOTE** Once the download starts, it cannot be aborted.

---

---

**NOTE** When the User Attention message appears, you must *first* cycle the instrument's power, *then* click OK.

---

When the upgrade completes, the Upgrade Assistant displays a summary.

- Click **OK** and close the Upgrade Assistant.

---

## Calibration

Agilent Technologies recommends calibrating the E4428C ESG Signal Generator every two years.

## **Modes of Operation**

The ESG signal generator provides three modes of operation:

- continuous wave (CW)
- swept signal
- analog modulation

### **Continuous Wave**

In this mode, the signal generator produces a CW signal. The signal generator is set to a single frequency and power level.

### **Swept Signal**

In this mode, the signal generator sweeps over a range of frequencies and/or power levels. Both list and step sweep functionality is available.

### **Analog Modulation**

In this mode, the signal generator modulates the CW signal using one of four analog modulation types:

- AM (two paths)
- FM (two paths)
- $\Phi$ M (normal and high bandwidth)
- Pulse modulation

## Front Panel Overview

Figure 1-1 shows the signal generator front panel. This interface enables you to define, monitor, and manage input and output characteristics.

Figure 1-1 Front Panel Feature Overview

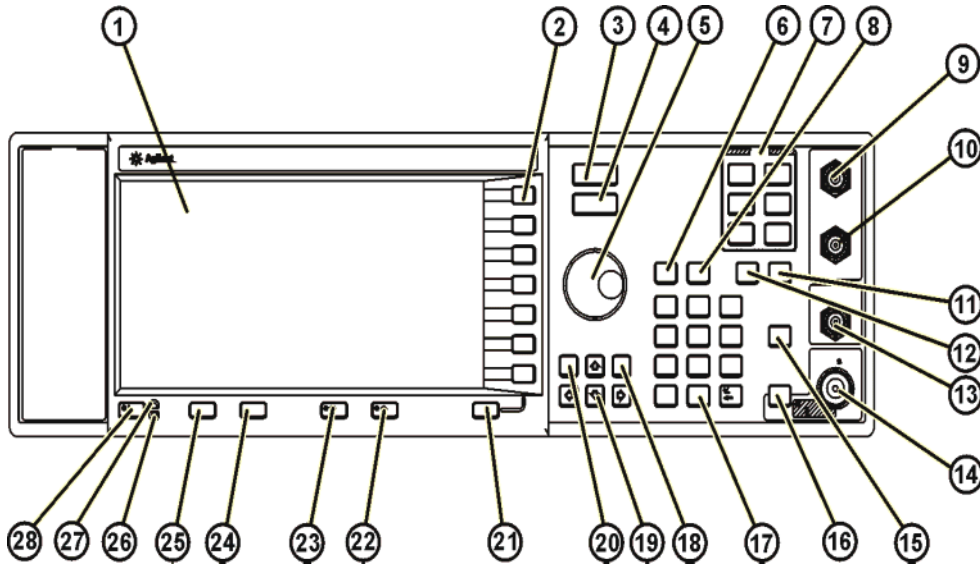

### 1. Display

The LCD screen provides information on the current function. Information can include status indicators, frequency and amplitude settings, and error messages. Labels for the softkeys are located on the right-hand side of the display. For further description of the front panel display, refer to “[Front Panel Display](#)” on page 12.

### 2. Softkeys

Softkeys activate the function indicated by the displayed label to the left of each key.

### 3. Frequency Key

Pressing this hardkey makes frequency the active function. You can change the RF output frequency or use the menus to configure frequency attributes such as frequency multiplier, offset, and reference.

### 4. Amplitude Key

Pressing this hardkey activates the amplitude function. You can change the RF output amplitude or use the menus to configure amplitude attributes such as power search, user flatness, and ALC BW.

### 5. Knob

Rotating the knob increases or decreases a numeric value or changes a highlighted digit or character. You can also use the knob to step through lists or select items in a row. The knob uses the **Incr Set** value in conjunction with the knob ratio (set with the **Step/Knob Ratio** softkey) to determine how much each turn of the knob changes the active function value. For example, if the **Incr Set** value for the active function is 10 dB and the knob ratio is 50 to 1, then each turn of the knob changes the active function by 0.2 dB (1/50th of 10 dB). By modifying either value or both, you change the amount for each turn of the knob. For more information on softkeys, refer to the *E4428C/38C ESG Signal Generators Key and Data Field Reference*.

### 7. Save Key

This hardkey accesses a menu of softkeys enabling you to save data to the signal generator's instrument state memory register. The instrument state register is a section of memory divided into 10 sequences numbered 0 through 9. Each sequence contains 100 registers numbered 00 through 99.

The **Save** hardkey provides a quick alternative to reconfiguring the signal generator via the front panel or with SCPI commands when switching between different configurations. The **Recall** hardkey recalls a saved instrument state.

Refer to “[Saving an Instrument State](#)” on page 71 for more information on the save operation.

### 7. Menu Keys

These hardkeys access softkey menus enabling configuration of list and step sweeps, utility functions, the LF output, and various analog modulation types. For detailed information on these keys, refer to the *E4428C/38C ESG Signal Generators Key and Data Field Reference*.

### 8. Recall Key

This hardkey restores any instrument state that you previously saved in a instrument state memory register.

## 9. EXT 1 INPUT Connector

This BNC input connector accepts an input signal for use with AM, FM,  $\Phi$ M, and pulse modulation. The damage levels are  $5 V_{\text{rms}}$  and  $10 V_{\text{p}}$ .

AM, FM,  $\Phi$ M       $\pm 1 V_{\text{p}}$  produces the indicated deviation or depth. When using the AC coupled input selection with a signal that has a peak input voltage that differs from  $1 V_{\text{p}}$  by more than 3%, the signal generator displays HI/LO annunciator.

Pulse Modulation    +1 V is on and 0 V is off

On signal generators with Option 1EM, this input is relocated to a female BNC connector on the rear panel.

## 10. EXT 2 INPUT Connector

This BNC input connector accepts an input signal for use with AM, FM,  $\Phi$ M, and pulse modulation. The damage levels are  $5 V_{\text{rms}}$  and  $10 V_{\text{p}}$ .

AM, FM,  $\Phi$ M       $\pm 1 V_{\text{p}}$  produces the indicated deviation or depth. When using the AC coupled input selection with a signal that has a peak input voltage that differs from  $1 V_{\text{p}}$  by more than 3%, the signal generator displays HI/LO annunciator.

Pulse Modulation    +1 V is on and 0 V is off

On signal generators with Option 1EM, this input is relocated to a female BNC connector on the rear panel.

## 11. Help Key

Press this key to display a short description of any hardkey or softkey. There are two help modes available: single and continuous. Single mode is the factory preset condition. To toggle between single and continuous mode, press **Utility > Instrument Info/Help Mode > Help Mode Single Cont.**

Single Mode      The help text is provided for the next key you press without activating the key's function. Any key pressed afterward exits the help mode and activates the key's function

Continuous Mode    The help text is provided for each subsequent key press until you either press the **Help** key again, or change to single mode. In continuous mode, pressing the **Help** key also activates the key's function (except for the **Preset** key).

## 12. Trigger Key

This hardkey initiates an immediate trigger event for a function such as a list or step sweep. The trigger mode must be set to **Trigger Key** prior to initiating a trigger event with this hardkey.

## 13. LF OUTPUT Connector

This BNC connector is the output for modulation signals generated by the low frequency (LF) source function generator. This output is capable of driving  $3 V_{\text{p}}$  (nominal) into a  $50\Omega$  load.

On signal generators with Option 1EM, this output is relocated to a rear-panel female BNC connector.



## 14. RF OUTPUT Connector

This female Type-N connector is the output for RF signals. The source impedance is 50Ω. For Options 501, 502, 503, and 504 the damage levels are 50 Vdc, 50 W at ≤ 2 GHz, and 25 W at > 2 GHz maximum. For Options 501, 502, 503, and 504 the reverse power protection circuit will trip, however, at nominally 1 W.

---

**CAUTION** E4428C and E4438C signal generators with Option 506 are not equipped with reverse power protection circuits.

---

On signal generators with Option 1EM, this output is relocated to a rear-panel female Type-N connector.

## 15. Mod On/Off Key

Pressing this hardkey enables or disables all active modulation formats (AM, FM, ΦM, or Pulse) that are applied to the output carrier signal.

This hardkey does not set up or activate an AM, FM, ΦM, or Pulse format; each individual modulation format must still be set up and activated (for example, **AM > AM On**) or nothing will be applied to the output carrier signal when the **Mod On/Off** hardkey is enabled.

The MOD ON/OFF annunciator, which is always present on the display, indicates whether active modulation formats have been enabled or disabled with the **Mod On/Off** hardkey.

## 16. RF On/Off Key

This hardkey toggles the operating state of the RF signal present at the RF OUTPUT connector. The RF On/Off annunciator is always visible in the display to indicate whether the RF is turned on or off.

## 17. Numeric Keypad

The numeric keypad consists of the 0 through 9 hardkeys, a decimal point hardkey, and a backspace hardkey (  ). The backspace hardkey enables you to backspace or specify a negative value. When specifying a negative numeric value, the negative sign must be entered prior to entering the numeric value.

## 18. Incr Set Key

This hardkey enables you to set the increment value of the current active function. When this hardkey is pressed, the increment value of the current active function appears as the active entry for the display. Use the numeric keypad, arrow hardkeys, or the knob to adjust the increment value. Changing the Incr Set hardkey's value also affects how much each turn of the knob changes an active function's value according to the knob's current ratio setting. For more information on softkeys, refer to the *E4428C/38C ESG Signal Generators Key and Data Field Reference*.

## 19. Arrow Keys

The up and down arrow hardkeys are used to increase or decrease a numeric value, step through displayed lists, or select items in a row of a displayed list. Individual digits or characters may be highlighted using the left and right arrow hardkeys. Once an individual digit or character is highlighted, its value can be changed using the up and down arrow hardkeys.

## 20. Hold Key

This hardkey blanks the softkey label area, the active function area, and the text areas of the display. Softkeys, arrow hardkeys, the knob, the numeric keypad, and the **Incr Set** hardkey have no effect once this hardkey is pressed. Press any other hardkey to end the hold mode.

## 21. Return Key

This hardkey enables you to retrace your key presses. When in a menu with more than one level (More 1 of 3, More 2 of 3, etc.), the **Return** key will always return you to the first level of the menu.

## 22. Display Contrast Increase Key

This hardkey, when pressed or held, causes the display background to darken.

## 23. Display Contrast Decrease Key

This hardkey, when pressed or held, causes the display background to lighten.

## 24. Local Key

This hardkey is used to deactivate remote operation and return the signal generator to front panel control.

## 25. Preset Key

This hardkey is used to set the signal generator to a known state (factory or user-defined).

## 26. Standby LED

This yellow LED indicates when the signal generator power switch is set to the standby condition.

## 27. Line Power LED

This green LED indicates when the signal generator power switch is set to the on position.

## **28. Power Switch**

This switch activates full power to the signal generator when set to the on position, and deactivates all signal generator functions when in standby mode. In standby mode, the signal generator remains connected to the line power, and power is supplied to some internal circuits.

## Front Panel Display

Figure 1-2 shows the front panel display. The LCD screen displays data fields, annotations, key press results, softkey labels, error messages, and annunciators that represent various active functions.

Figure 1-2 Front Panel Display

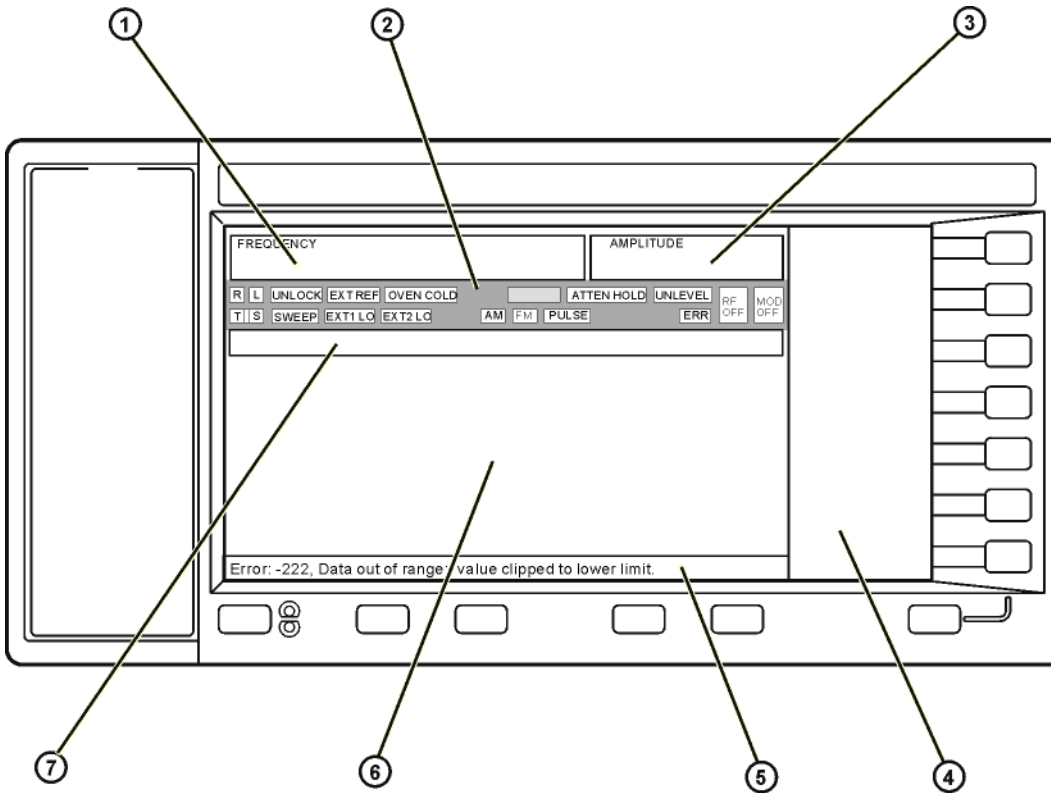

### 1. Frequency Area

The current frequency setting is shown in this portion of the display. In this same area, the ESG displays the indicators for frequency offset (OFFS) and multiplier (MULT) functions. In addition, REF appears when you enable the frequency reference mode and CHANNEL is turned on when you turn on a frequency channel (**Freq Channels Off On** softkey).

## 2. Annunciators

The display annunciators show the status of some of the signal generator functions, and indicate error conditions. An annunciator position may be used by more than one function. This does not create a problem, because only one function that shares an annunciator position can be active at a given time.

$\Phi$ M	This annunciator appears when phase modulation is turned on. If frequency modulation is turned on, the FM annunciator will replace $\Phi$ M.
ALC OFF	This annunciator appears when the ALC circuit is disabled. A second annunciator, UNLEVEL, will appear in the same position if the ALC is enabled and is unable to maintain the output level.
AM	This annunciator appears when amplitude modulation is turned on.
ARMED	This annunciator appears when a sweep has been initiated and the signal generator is waiting for the sweep trigger event.
ATTEN HOLD	This annunciator appears when the attenuator hold function is turned on. When this function is on, the attenuator is held at its current setting.
ERR	This annunciator appears when an error message is placed in the error queue. This annunciator will not turn off until you have viewed all of the error messages or cleared the error queue. You can access error messages by pressing <b>Utility &gt; Error Info</b> .
EXT1 LO/HI	This annunciator is displayed as either EXT1 LO or EXT1 HI. This annunciator appears when the ac-coupled signal to the EXT 1 INPUT is less than $0.97 V_p$ or greater than $1.03 V_p$ .
EXT2 LO/HI	This annunciator is displayed as either EXT2 LO or EXT2 HI. This annunciator appears when the ac-coupled signal to the EXT 2 INPUT is less than $0.97 V_p$ or greater than $1.03 V_p$ .
EXT REF	This annunciator appears when an external frequency reference is applied.
FM	This annunciator appears when frequency modulation is turned on. If phase modulation is turned on, the $\Phi$ M annunciator will replace FM.
L	This annunciator appears when the signal generator is in listener mode and is receiving information or commands over the GPIB, RS-232, or VXI-11/Sockets (LAN) interface.

### Front Panel Display

MOD ON/OFF	<p>This annunciator indicates if the RF carrier is modulated (MOD ON while there is an active modulation format), or if the modulation is off (MOD OFF). Either condition of this annunciator is always visible in the display.</p> <p>The MOD ON annunciator may be showing even when there are no active modulation formats. This merely indicates that the carrier signal will be modulated when a modulation format is enabled.</p>
OVEN COLD	<p>This annunciator appears when the temperature of the internal oven reference oscillator has dropped below an acceptable level. When this annunciator is on, frequency accuracy is degraded. This condition should occur for several minutes after the signal generator is first connected to line power. The annunciator is timed, and automatically turns off after a specified period.</p>
PULSE	<p>This annunciator appears when pulse modulation is turned on.</p>
R	<p>This annunciator appears when the signal generator is remotely controlled over the GPIB, RS-232, or VXI-11/sockets (LAN) interface.</p>
RF ON/OFF	<p>This annunciator indicates when the RF signal is present (RF ON) at the RF OUTPUT, or if the RF signal is not present (RF OFF) at the RF OUTPUT. Either condition of this annunciator is always visible in the display.</p>
S	<p>This annunciator appears when the signal generator has generated a service request (SRQ) over the GPIB, RS-232, or VXI-11/sockets (LAN) interface.</p>
SWEEP	<p>This annunciator appears when the signal generator is sweeping in list or step mode.</p>
T	<p>This annunciator appears when the signal generator is in talker mode and is transmitting information over the GPIB, RS-232, or VXI-11/sockets (LAN) interface.</p>
UNLEVEL	<p>This annunciator appears when the signal generator is unable to maintain the correct output level. The UNLEVEL annunciator is not necessarily an indication of instrument failure. Unleveled conditions can occur during normal operation. A second annunciator, ALC OFF, will appear in the same position when the ALC circuit is disabled.</p>
UNLOCK	<p>This annunciator appears when any of the phase locked loops are unable to maintain phase lock. You can determine which loop is unlocked by examining the error messages.</p>

### 3. Amplitude Area

The current output power level setting is shown in this portion of the display. When active, the following functions also display indicators in the amplitude area:

- Amplitude offset (OFFS)
- Amplitude reference mode (REF)
- Alternate Amplitude ( $\Delta = 0.00$  dB)
- User flatness (UF)

### 4. Softkey Label Area

The labels in this area define the function of the softkeys located immediately to the right of the label. The softkey label will change depending upon the function selected. For detailed softkey descriptions, refer to the *E4428C/38C ESG Signal Generators Key and Data Field Reference*.

### 5. Error Message Area

Abbreviated error messages are reported in this space. When multiple error messages occur, only the most recent message remains displayed. Reported error messages with details can be viewed by pressing **Utility > Error Info**.

### 6. Text Area

This area of the display is used to show status information about the signal generator such as the modulation status, sweep lists, and file catalogs. This area also enables you to perform functions such as managing information, entering information, and displaying or deleting files.

### 7. Active Function Area

The current active function is shown in this area. For example, if frequency is the active function, the current frequency setting will be displayed here. If the current active function has an increment value associated with it, that value is also displayed.

## Rear Panel Overview

The signal generator rear panel (Figure 1-3) provides input, output, and remote interface connections. Figure 1-4 shows a portion of the rear panel for signal generators with Option 1EM, which moves front panel connectors to the rear panel. For Option 1EM connectors not described in this section, see “Front Panel Overview” on page 6.

Figure 1-3 Rear Panel Feature Overview

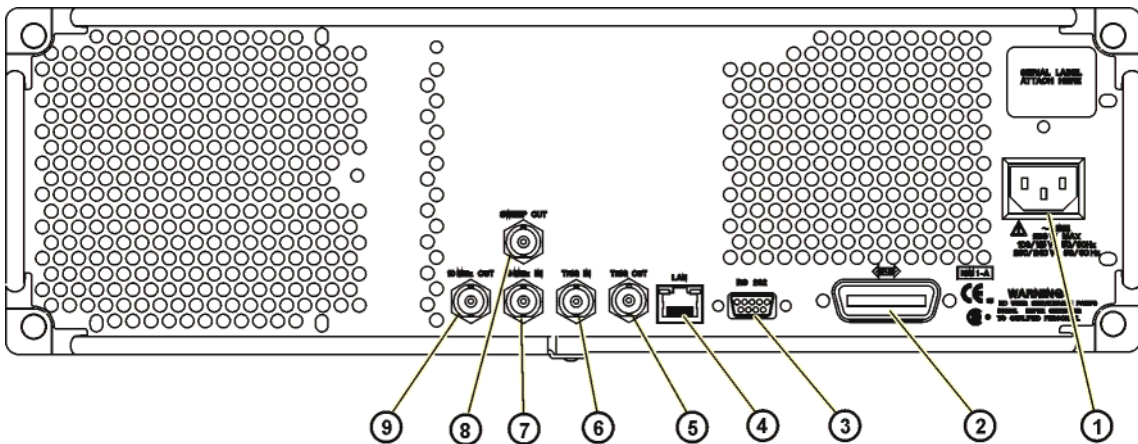
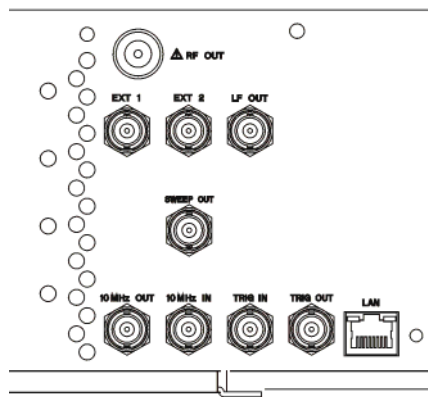

Figure 1-4





## 1. AC Power Receptacle

The power cord receptacle accepts a three-pronged cable that is shipped with the signal generator. The line voltage is connected here.

## 2. GPIB Connector

The GPIB connector allows communications with compatible devices such as external controllers. It is functionally equivalent to the LAN and RS 232 connectors.

## 3. RS 232 Connector

This female DB-9 connector is an RS-232 serial port that can be used for controlling the signal generator remotely. It is functionally equivalent to the GPIB and LAN connectors. The following table shows the description of the pinouts. [Figure 1-5](#) shows the pin configuration.

**Table 1-1 RS 232 Connector**

Pin Number	Signal Description	Signal Name
1	No Connection	
2	Receive Data	RECV
3	Transmit Data	XMIT
4	+5 V	
5	Ground, 0 V	
6	No Connection	
7	Request to Send	RTS
8	Clear to Send	CTS
9	No Connection	

**Figure 1-5**

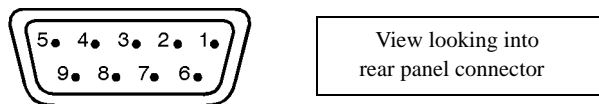

## 4. LAN Connector

LAN based communication is supported by the signal generator via the LAN (local area network) connector. The LAN connector enables the signal generator to be remotely programmed by a LAN-connected computer. The distance between a computer and the signal generator is limited to 100 meters (10Base-T) on a single cable. For more information about the LAN, refer to the *E4428C/38C ESG Signal Generators Programming Guide*.

## 5. TRIG OUT Connector

This female BNC connector outputs a TTL signal that is asserted high at the start of a dwell sequence, or at the start of waiting for the point trigger in manual sweep mode. It is asserted low when the dwell is over, when the point trigger is received, or once per sweep during an LF sweep. The logic polarity can be reversed.

## 6. TRIG IN Connector

This female BNC connector accepts a CMOS signal for triggering operations, such as point-to-point in manual sweep mode or an LF sweep in external sweep mode. Triggering can occur on either the positive or negative edge. The damage levels are  $> +5.5$  volts and  $< -0.5$  volts.

## 7. 10 MHz IN Connector

This female BNC connector accepts a  $-3.5$  to  $+20$  dBm signal from an external timebase reference that is 1, 2, 5, or 10 MHz  $\pm 0.2$  ppm. The nominal input impedance is  $50\Omega$ . The signal generator detects when a valid reference signal is present at this connector and automatically switches from internal to external reference operation. The signal generator will only automatically switch from internal to external reference operation when the instrument is in its factory default mode where the **Ref Oscillator Source Auto Off On** softkey is set to on.

## 8. SWEEP OUT Connector

This female BNC connector provides a voltage range of 0 to  $+10$  V. When the signal generator is sweeping, the SWEEP OUT signal ranges from 0 V at the beginning of the sweep to  $+10$  V at the end of the sweep regardless of the sweep width. In CW mode this connector has no output. The output impedance is less than  $1\Omega$  and can drive  $2$  k $\Omega$ .

## 9. 10 MHz OUT Connector

This female BNC connector provides a nominal signal level of  $+3.9$  dBm  $\pm 2$  dB, and an output impedance of  $50\Omega$ . The accuracy is determined by the timebase used.

---

## 2 E4438C Vector Signal Generator Overview

The following list shows the topics covered in this chapter:

- “Standard Vector Signal Generator Features” on page 20
- “Options” on page 21
- “Firmware Upgrades” on page 22
- “Calibration” on page 23
- “Modes of Operation” on page 24
- “Front Panel Overview” on page 26
- “Front Panel Display” on page 33
- “Rear Panel Overview” on page 37

## **Standard Vector Signal Generator Features**

- CW output from 250 kHz to 1, 2, 3, 4 or 6 GHz; the high-end frequency is dependent on the frequency option purchased with your signal generator
- list and step sweep of frequency and amplitude, with multiple trigger sources
- user flatness correction
- automatic leveling control (ALC) on and off modes; power calibration in ALC-off mode is available, even without power search
- 10 MHz reference oscillator with external output
- GPIB, RS-232, and 10Base-T LAN interfaces
- closed-loop AM
- dc-synthesized FM to 10 MHz rates; maximum deviation depends on the carrier frequency
- phase modulation
- pulse modulation
- a function generator that includes the following features:
  - 50 $\Omega$  low frequency output, 0 to 3 V<sub>p</sub>
  - selectable waveforms: sine, square, ramp, triangle, noise, swept-sine, dual-sine, and pulse
  - variable frequency modulation rates
  - variable triggering in list and step sweep modes: auto, external, single, or remote
- a pulse generator that includes the following features:
  - external pulse
  - internal square wave
  - internal pulse sources: internal square, internal pulse, external 1 dc-coupled, and external 2 dc-coupled
  - adjustable pulse width
  - adjustable pulse period
  - adjustable pulse rate
- external modulation inputs for AM, FM,  $\Phi$ M, and I/Q modulation
- simultaneous modulation configurations

---

## Options

ESG signal generators have hardware, firmware, software, and documentation options. The data sheet shipped with your signal generator provides an overview of available options. For more information, visit the Agilent ESG web page at <http://www.agilent.com/find/esg>, selected the desired ESG model, and then click the **Options** tab.

### Understanding Baseband Generator Options

Your E4438C can have one of four baseband generator options, depending upon when you first purchased the instrument and whether or not the baseband generator has been upgraded to a newer version. The options consist of the following:

- Option 001            internal baseband generator with 8 megasample memory (no longer available)
- Option 002            internal baseband generator with 32 megasample memory (no longer available)
- Option 601            internal baseband generator with 8 megasample memory and digital bus capability
- Option 602            internal baseband generator with 64 megasample memory and digital bus capability

These four baseband generators are similar in some respects, and very different in others. They are similar in that all four versions support the same signal generation formats, such as W-CDMA, cdma2000, WLAN, and many others. All four versions offer both arbitrary waveform capability and real-time baseband generation capability.

The first obvious difference between these four baseband generators is that they offer different playback memory sizes. This is primarily important to users providing their own arbitrary waveform files, since these may be very large in size. Of the signal creation personalities offered by Agilent, currently only Signal Studio for WLAN and Signal Studio for Pulse Building are capable of creating waveforms that can exceed the 8 megasample memory of the Option 001/601 models.

The second important difference between these baseband generators is that only Option 601 and 602 offer digital bus capability. This proprietary digital bus is used for communication with the Agilent Baseband Studio suite of products. Baseband Studio products provide a range of baseband signal processing functions, including baseband digital outputs, fading, and hard drive waveform streaming. These functions are not compatible with Options 001 or 002. An upgrade kit is available, however, if you want to add Option 601 or 602 to your existing E4438C ESG.

## Firmware Upgrades

You can upgrade the firmware in your signal generator whenever new firmware is released. New firmware releases, which can be downloaded from the Agilent website, may contain signal generator features and functionality not available in previous firmware releases.

To determine the availability of new signal generator firmware, visit the Signal Generator Firmware Upgrade Center web page at <http://www.agilent.com/find/upgradeassistant>, or call the number listed at <http://www.agilent.com/find/assist>.

### To Upgrade Firmware

The following procedure shows you how to download new firmware to your ESG using a LAN connection and a PC. For information on equipment requirements and alternate methods of downloading firmware, such as GPIB, refer to the *Firmware Upgrade Guide*, which can be accessed at <http://www.agilent.com/find/upgradeassistant>.

1. Note the IP address of your signal generator. To view the IP address on the ESG, press **Utility** > **GPIB/RS-232 LAN** > **LAN Setup**.
2. Use an internet browser to visit <http://www.agilent.com/find/upgradeassistant>.
3. Scroll down to the “Documents and Downloads” table and click the link in the “Latest Firmware Revision” column for the E4428C/38C ESG.
4. In the File Download window, select **Run**.
5. In the Welcome window, click **Next** and follow the on-screen instructions. The firmware files download to the PC.
6. In the “Documents and Downloads” table, click the link in the “Upgrade Assistant Software” column for the E4428C/38C ESG to download the PSG/ESG Upgrade Assistant.
7. In the File Download window, select **Run**.
8. In the Welcome window, click **OK** and follow the on-screen instructions.
9. At the desktop shortcut prompt, click **Yes**.
10. Once the utility downloads, close the browser and double-click the **PSG/ESG Upgrade Assistant** icon on the desktop.
11. In the upgrade assistant, set the connection type you wish to use to download the firmware, and the parameters for the type of connection selected. For LAN, enter the instrument’s IP address, which you recorded in [step 1](#).

---

**NOTE** If the PSG's dynamic host configuration protocol (DHCP) is enabled, the network assigns the instrument an IP address at power on. Because of this, when DHCP is enabled, the IP address may be different each time you turn on the instrument. DHCP does *not* affect the hostname.

---

12. Click **Browse**, and double-click the firmware revision to upgrade your signal generator.
13. In the Upgrade Assistant, click **Next**.
14. Once connection to the instrument is verified, click **Next** and follow the on-screen prompts.

---

**NOTE** Once the download starts, it cannot be aborted.

---

---

**NOTE** When the User Attention message appears, you must *first* cycle the instrument's power, *then* click OK.

---

When the upgrade completes, the Upgrade Assistant displays a summary.

15. Click **OK** and close the Upgrade Assistant.

---

## Calibration

Agilent Technologies recommends calibrating the E4438C ESG Signal Generator every two years.

## Modes of Operation

The ESG signal generator provides four modes of operation:

- continuous wave (CW)
- swept signal
- analog modulation
- digital modulation

### Continuous Wave

In this mode, the signal generator produces a CW signal. The signal generator is set to a single frequency and power level.

### Swept Signal

In this mode, the signal generator sweeps over a range of frequencies and/or power levels. Both list and step sweep functionality is available.

### Analog Modulation

In this mode, the signal generator modulates the CW signal using one of four analog modulation types:

- AM (two paths and wideband)
- FM (two paths)
- $\Phi$ M (normal and high bandwidth)
- Pulse modulation

Some of these modulation types can be used together.

### Digital Modulation

In this mode, the signal generator modulates a CW signal with either a real-time I/Q signal or arbitrary I/Q waveform. I/Q modulation is only available on the E4438C. An optional internal baseband generator (Option 001/601 002/602) adds the following digital modulation formats:

- *Custom Arb Waveform Generator* mode can produce a single-modulated carrier or multiple-modulated carriers. Each modulated carrier waveform must be calculated and generated before it can be output; this signal generation occurs on the internal baseband generator. Once a waveform has been created, it can be stored and recalled, which enables repeatable playback of test signals. To learn more, refer to [“Using the Arbitrary Waveform Generator” on page 386](#).



- *Custom Real Time I/Q Baseband* mode produces a single carrier, but it can be modulated with real-time data that allows real-time control over all of the parameters that affect the signal. The single-carrier signal that is produced can be modified by applying various data patterns, filters, symbol rates, modulation types, and burst shapes. To learn more, refer to [“Using the Real Time I/Q Baseband Generator” on page 392](#).
- *Multitone* mode produces up to 64 continuous wave signals (or tones) with adjustable amplitude and frequency spacing. To learn more, refer to [“Multitone Waveform Generator \(Options 001/601 or 002/602\)” on page 379](#).
- *Dual ARB* mode is used to control the playback sequence of waveform segments that have been written into the ARB memory located on the internal baseband generator. These waveforms can be generated by the internal baseband generator using any of the Arb modulation formats, or downloaded through a remote interface into the ARB memory. To learn more, refer to [“Using the Dual ARB Waveform Player” on page 107](#).

## Front Panel Overview

Figure 2-1 shows the signal generator front panel. This interface enables you to define, monitor, and manage input and output characteristics.

Figure 2-1 Front Panel Feature Overview

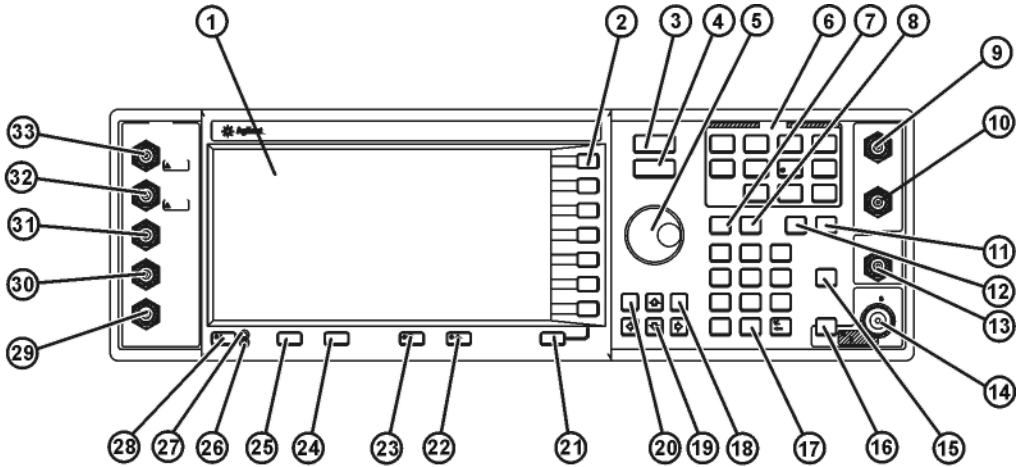

pk701c

### 1. Display

The LCD screen provides information on the current function. Information can include status indicators, frequency and amplitude settings, and error messages. Labels for the softkeys are located on the right-hand side of the display. For further description of the front panel display, refer to “[Front Panel Display](#)” on page 33.

### 2. Softkeys

Softkeys activate the function indicated by the displayed label to the left of each key.

### 3. Frequency Key

Pressing this hardkey makes frequency the active function. You can change the RF output frequency or use the menus to configure frequency attributes such as frequency multiplier, offset, and reference.

## 4. Amplitude Key

Pressing this hardkey activates the amplitude function.

When active, the following functions also display indicators in the amplitude area:

- Amplitude offset (OFFS)
- Amplitude reference mode (REF)
- Alternate Amplitude ( $\Delta = 0.00$  dB)
- User flatness (UF)

## 5. Knob

Rotating the knob increases or decreases a numeric value or changes a highlighted digit or character. You can also use the knob to step through lists or select items in a row. The knob uses the **Incr Set** value in conjunction with the knob ratio (set with the **Step/Knob Ratio** softkey) to determine how much each turn of the knob changes the active function value. For example, if the **Incr Set** value for the active function is 10 dB and the knob ratio is 50 to 1, then each turn of the knob changes the active function by 0.2 dB (1/50th of 10 dB). By modifying either value or both, you change the amount for each turn of the knob. For more information on softkeys, refer to the *E4428C/38C ESG Signal Generators Key and Data Field Reference*.

## 6. Menu Keys

These hardkeys access softkey menus enabling configuration of list and step sweeps, utility functions, the LF output, and various analog and digital modulation types. For detailed information on these keys, refer to the *E4428C/38C ESG Signal Generators Key and Data Field Reference*.

## 7. Save Key

This hardkey accesses a menu of softkeys enabling you to save instrument settings to the signal generator's instrument state memory register. The instrument state register is a section of memory divided into 10 sequences numbered 0 through 9. Each sequence contains 100 registers numbered 00 through 99.

The **Save** hardkey provides a quick alternative to reconfiguring the signal generator via the front panel. The **Recall** hardkey recalls a saved instrument state.

Refer to [“Saving an Instrument State” on page 71](#) for more information on the save operation.

## 8. Recall Key

This hardkey restores any instrument state that you previously saved in a instrument state memory register. When you load the waveform file from NVWFM into waveform memory (WFM1), and then use the **Recall** softkey to recall the signal generator settings associated with the file.

## 9. EXT 1 INPUT Connector

This BNC input connector accepts an input signal for use with AM, FM,  $\Phi$ M, and pulse modulation, or as the linear control for a burst envelope. The damage levels are  $5 V_{\text{rms}}$  and  $10 V_p$ .

AM, FM,  $\Phi$ M       $\pm 1 V_p$  produces the indicated deviation or depth. When using the AC coupled input selection with a signal that has a peak input voltage that differs from  $1 V_p$  by more than 3%, the signal generator displays the HI/LO annunciator.

Pulse Modulation    +1 V is on and 0 V is off

Burst Envelope      Provides linear control:  $-1 V = 0\%$  amplitude and  $0 V = 100\%$  amplitude

On signal generators with Option 1EM, this input is relocated to a rear panel, male SMB connector.

## 10. EXT 2 INPUT Connector

This BNC input connector accepts an input signal for use with AM, FM,  $\Phi$ M, and pulse modulation. The damage levels are  $5 V_{\text{rms}}$  and  $10 V_p$ .

AM, FM,  $\Phi$ M       $\pm 1 V_p$  produces the indicated deviation or depth. When using the AC coupled input selection with a signal that has a peak input voltage that differs from  $1 V_p$  by more than 3%, the signal generator displays HI/LO annunciator.

Pulse Modulation    +1 V is on and 0 V is off

If you configure your signal generator with Option 1EM, this input is relocated to an SMB connector on the rear panel.

## 11. Help Key

Press this key to display a short description of any hardkey or softkey. There are two help modes available: single and continuous. Single mode is the factory preset condition. To toggle between single and continuous mode, press **Utility** > **Instrument Info/Help Mode** > **Help Mode Single Cont.**

Single Mode        The help text is provided for the next key you press without activating the key's function. Any key pressed afterward exits the help mode and activates the key's function

Continuous Mode    The help text is provided for each subsequent key press until you either press the **Help** key again, or change to single mode. In continuous mode, pressing the **Help** key also activates the key's function (except for the **Preset** key).

## 12. Trigger Key

This hardkey initiates an immediate trigger event for a function such as a list or step sweep. The trigger mode must be set to **Trigger Key** prior to initiating a trigger event with this hardkey.

### 13. LF OUTPUT Connector

This BNC connector is the output for modulation signals generated by the low frequency (LF) source function generator. This output is capable of driving  $3 V_p$  (nominal) into a  $50\Omega$  load.

On signal generators with Option 1EM, this output relocated to a rear-panel SMB connector.

### 14. RF OUTPUT Connector

This female Type-N connector is the output for RF signals. The source impedance is  $50\Omega$ . For Options 501, 502, 503, and 504 the damage levels are 50 Vdc, 50 W at  $\leq 2$  GHz, and 25 W at  $> 2$  GHz maximum. For Options 501, 502, 503, and 504 the reverse power protection circuit will trip, however, at nominally 1 W.

---

**CAUTION** E4428C and E4438C signal generators with Option 506 are not equipped with reverse power protection circuits.

---

On signal generators with Option 1EM, this output relocated to a rear-panel female Type-N connector.

### 15. Mod On/Off Key

Pressing this hardkey enables or disables all active modulation formats (AM, FM,  $\Phi$ M, Pulse, or I/Q) that are applied to the output carrier signal.

This hardkey does not set up or activate an AM, FM,  $\Phi$ M, Pulse, or I/Q format; each individual modulation format must still be set up and activated (for example, **AM > AM On**) or nothing will be applied to the output carrier signal when the **Mod On/Off** hardkey is enabled.

The MOD ON/OFF annunciator, which is always present on the display, indicates whether active modulation formats have been enabled or disabled with the **Mod On/Off** hardkey.

### 16. RF On/Off Key

This hardkey toggles the operating state of the RF signal present at the RF OUTPUT connector. The RF On/Off annunciator is always visible in the display to indicate whether the RF is turned on or off.

### 17. Numeric Keypad

The numeric keypad consists of the 0 through 9 hardkeys, a decimal point hardkey, and a backspace hardkey (). The backspace hardkey enables you to backspace or specify a negative value. When specifying a negative numeric value, the negative sign must be entered prior to entering the numeric value.

## 18. Incr Set Key

This hardkey enables you to set the increment value of the current active function. When this hardkey is pressed, the increment value of the current active function appears as the active entry for the display. Use the numeric keypad, arrow hardkeys, or the knob to adjust the increment value. Changing the Incr Set hardkey's value also affects how much each turn of the knob changes an active function's value according to the knob's current ratio setting. For more information on softkeys, refer to the *E4428C/38C ESG Signal Generators Key and Data Field Reference*.

## 19. Arrow Keys

The up and down arrow hardkeys are used to increase or decrease a numeric value, step through displayed lists, or select items in a row of a displayed list. Individual digits or characters may be highlighted using the left and right arrow hardkeys. Once an individual digit or character is highlighted, its value can be changed using the up and down arrow hardkeys.

## 20. Hold Key

This hardkey blanks the softkey label area, the active function area, and the text areas of the display. Softkeys, arrow hardkeys, the knob, the numeric keypad, and the **Incr Set** hardkey have no effect once this hardkey is pressed. Press any other hardkey to end the hold mode.

## 21. Return Key

This hardkey enables you to retrace your key presses. When in a menu with more than one level (More 1 of 3, More 2 of 3, etc.), the **Return** key will always return you to the first level of the menu.

## 22. Display Contrast Increase Key

This hardkey, when pressed or held, causes the display background to darken.

## 23. Display Contrast Decrease Key

This hardkey, when pressed or held, causes the display background to lighten.

## 24. Local Key

This hardkey is used to deactivate remote operation and return the signal generator to front panel control.

## 25. Preset Key

This hardkey is used to set the signal generator to a known state (factory or user-defined).

## 26. Standby LED

This yellow LED indicates when the signal generator power switch is set to the standby condition.

## 27. Line Power LED

This green LED indicates when the signal generator power switch is set to the on position.

## 28. Power Switch

This switch activates full power to the signal generator when set to the on position, and deactivates all signal generator functions when in standby mode. In standby mode, the signal generator remains connected to the line power, and power is supplied to some internal circuits.

## 29. SYMBOL SYNC Connector (Option 001/601 or 002/602)

This female BNC input connector accepts an externally supplied symbol sync signal for use with digital modulation applications. The expected input is a CMOS bit clock signal. It may be used in two modes. When used as a symbol sync in conjunction with a data clock, the signal must be high during the first data bit of the symbol. The signal must be valid during the falling edge of the data clock signal and may be a single pulse or continuous. When the SYMBOL SYNC itself is used as the (symbol) clock, the CMOS falling edge is used to clock the DATA signal.

The maximum clock rate is 50 MHz. The damage levels are  $> +5.5$  volts and  $< -0.5$  volts.

On signal generators with Option 1EM, this input is relocated to a rear panel SMB connector.

When using the real-time W-CDMA uplink personality, this connector should *not* be used to connect the external baseband generator data clock. The BASEBAND GEN REF IN connector should be used instead.

## 30. DATA CLOCK Connector (Option 001/601 or 002/602)

The female BNC input connector accepts a CMOS externally supplied CMOS compatible signal data-clock input used with digital modulation applications. The expected input is a CMOS bit clock signal where the rising edge is aligned with the beginning data bit. The falling edge is used to clock the DATA and SYMBOL SYNC signals.

The maximum clock rate is 50 MHz. The damage levels are  $> +5.5$  volts and  $< -0.5$  volts.

On signal generators with Option 1EM, this input is relocated to a rear panel SMB connector.

### 31. DATA Connector (Option 001/601 or 002/602)

The female BNC input connector accepts a CMOS externally supplied CMOS compatible signal data input used with digital modulation applications. The expected input is a CMOS signal where a CMOS high is equivalent to a data 1 and a CMOS low is equivalent to a data 0.

The maximum input data rate is 50 Mb/s. The data must be valid on the DATA CLOCK falling edges. The damage levels are  $> +5.5$  volts and  $< -0.5$  volts.

On signal generators with Option 1EM, this input is relocated to a rear panel SMB connector.

### 32. Q Connector

This female BNC input connector accepts an externally supplied, analog, quadrature-phase component of I/Q modulation. The signal level is  $\sqrt{I^2+Q^2} = 0.5 V_{\text{rms}}$  for a calibrated output level. The input impedance is  $50\Omega$ . The damage level is  $1 V_{\text{rms}}$  and 10 volts peak.

To activate a signal applied to this connector, press **Mux > I/Q Source 1** or **I/Q Source 2** and then select either **Ext 50 Ohm** or **Ext 600 Ohm**. On signal generators with Option 1EM, this input is relocated as an SMB to the rear panel.

### 33. I Connector

This female BNC input connector accepts an externally supplied, analog, in-phase component of I/Q modulation. The signal level is  $\sqrt{I^2+Q^2} = 0.5 V_{\text{rms}}$  for a calibrated output level. The input impedance is  $50\Omega$ .

To activate the in-phase component of the I/Q signal applied to this connector, press **Mux > I/Q Source 1** or **I/Q Source 2** and then select either **Ext 50 Ohm** or **Ext 600 Ohm**.

This input connector also accepts the modulating signal for use with the wideband AM selection. The wideband AM signal depth is a linear function of the I INPUT signal voltage:

- 0.25 volts = 50%
- 0.5 volts = 100%

When turned on, wideband AM automatically selects the I INPUT and configures it for  $50\Omega$ . This setting is independent of the **MUX > I/Q Source** setting.

The damage level for this connector is  $1 V_{\text{rms}}$  and 10 volts peak. On signal generators with Option 1EM, this input is relocated as an SMB to the rear panel.



## Front Panel Display

Figure 2-2 shows the front panel display. The LCD screen displays data fields, annotations, key press results, softkey labels, error messages, and annunciators that represent various active functions.

**Figure 2-2** Front Panel Display

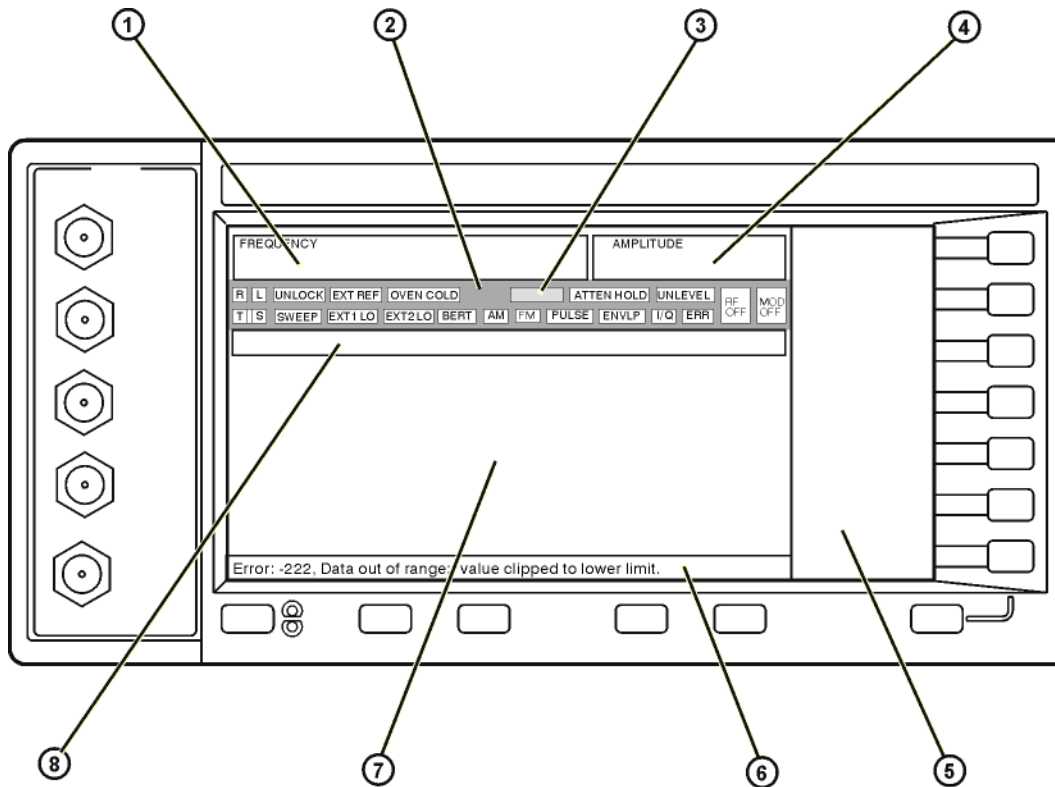

pk702c

### 1. Frequency Area

The current frequency setting is shown in this portion of the display. In this same area, the ESG displays the indicators for frequency offset (OFFS) and multiplier (MULT) functions. In addition, REF appears when you enable the frequency reference mode and CHANNEL is turned on when you turn on a frequency channel (**Freq Channels Off On** softkey).

## 2. Annunciators

The display annunciators show the status of some of the signal generator functions, and indicate error conditions. An annunciator position may be used by more than one function. This does not create a problem, because only one function that shares an annunciator position can be active at a given time.

ΦM	This annunciator appears when phase modulation is turned on. If frequency modulation is turned on, the FM annunciator will replace ΦM.
ALC OFF	This annunciator appears when the ALC circuit is disabled. Two other annunciators appear in the same position: UNLEVEL when the ALC is enabled and is unable to maintain the output level, and BBG DAC when the waveform data exceeds the DAC range.
AM	This annunciator appears when amplitude modulation is turned on.
ARMED	This annunciator appears when a sweep has been initiated and the signal generator is waiting for the sweep trigger event.
ATTEN HOLD	This annunciator appears when the attenuator hold function is turned on. When this function is on, the attenuator is held at its current setting.
BERT	This annunciator appears when the Option UN7 bit error rate test (BERT) functions are turned on.
ENVLP	This annunciator appears if the burst envelope modulation is turned on.
ERR	This annunciator appears when an error message is placed in the error queue. This annunciator will not turn off until you have viewed all of the error messages or cleared the error queue. You can access error messages by pressing <b>Utility &gt; Error Info</b> .
EXT1 LO/HI	This annunciator is displayed as either EXT1 LO or EXT1 HI. This annunciator appears when the ac-coupled signal to the EXT 1 INPUT is less than $0.97 V_p$ or greater than $1.03 V_p$ .
EXT2 LO/HI	This annunciator is displayed as either EXT2 LO or EXT2 HI. This annunciator appears when the ac-coupled signal to the EXT 2 INPUT is less than $0.97 V_p$ or greater than $1.03 V_p$ .
EXT REF	This annunciator appears when an external frequency reference is applied.
FM	This annunciator appears when frequency modulation is turned on. If phase modulation is turned on, the ΦM annunciator will replace FM.
L	This annunciator appears when the signal generator is in listener mode and is receiving information or commands over the GPIB, RS-232, or VXI-11/Sockets (LAN) interface.

MOD ON/OFF	<p>This annunciator indicates if the RF carrier is modulated (MOD ON while there is an active modulation format), or if the modulation is off (MOD OFF). Either condition of this annunciator is always visible in the display.</p> <p>The MOD ON annunciator may be showing even when there are no active modulation formats. This merely indicates that the carrier signal will be modulated when a modulation format is enabled.</p>
OVEN COLD	<p>This annunciator appears when the temperature of the internal oven reference oscillator has dropped below an acceptable level. When this annunciator is on, frequency accuracy is degraded. This condition should occur for several minutes after the signal generator is first connected to line power. The annunciator is timed, and automatically turns off after a specified period.</p>
PULSE	<p>This annunciator appears when pulse modulation is turned on.</p>
R	<p>This annunciator appears when the signal generator is remotely controlled over the GPIB, RS-232, or VXI-11/Sockets (LAN) interface.</p>
RF ON/OFF	<p>This annunciator indicates when the RF signal is present (RF ON) at the RF OUTPUT, or if the RF signal is not present (RF OFF) at the RF OUTPUT. Either condition of this annunciator is always visible in the display.</p>
S	<p>This annunciator appears when the signal generator has generated a service request (SRQ) over the GPIB, RS-232, or VXI-11/Sockets (LAN) interface.</p>
SWEEP	<p>This annunciator appears when the signal generator is sweeping in list or step mode.</p>
T	<p>This annunciator appears when the signal generator is in talker mode and is transmitting information over the GPIB, RS-232, or VXI-11/Sockets (LAN) interface.</p>
UNLEVEL	<p>This annunciator appears when the signal generator is unable to maintain the correct output level. The UNLEVEL annunciator is not necessarily an indication of instrument failure. Unleveled conditions can occur during normal operation. Two other annunciators appear in the same position: ALC OFF when the ALC circuit is disabled and BBG DAC when the waveform data exceeds the DAC range.</p>
BBG DAC	<p>This annunciator appears when the waveform data exceeds the range of the DAC, which causes a DAC over-range error. It remains illuminated until the condition is corrected by scaling the data. It appears in the same location as the UNLEVEL and ALC OFF annunciators, and is the dominant annunciator. For example, if an unleveled condition exists at the same time as a DAC over-range condition, the DAC over-range annunciator remains until corrected. Once corrected, the UNLEVEL annunciator appears.</p>
UNLOCK	<p>This annunciator appears when any of the phase locked loops are unable to maintain phase lock. You can determine which loop is unlocked by examining the error messages.</p>

### 3. Digital Modulation Annunciators

All digital modulation annunciators appear in this location. These annunciators appear only when the modulation is active, and only one digital modulation can be active at any given time.

### 4. Amplitude Area

The current output power level setting is shown in this portion of the display. When active, the following functions also display indicators in the amplitude area:

- Amplitude offset (OFFS)
- Amplitude reference mode (REF)
- Alternate Amplitude ( $\Delta = 0.00$  dB)
- User flatness (UF)

### 5. Softkey Label Area

The labels in this area define the function of the softkeys located immediately to the right of the label. The softkey label will change depending upon the function selected. For detailed softkey descriptions, refer to the *E4428C/38C ESG Signal Generators Key and Data Field Reference*.

### 6. Error Message Area

Abbreviated error messages are reported in this space. When multiple error messages occur, only the most recent message remains displayed. Reported error messages with details can be viewed by pressing **Utility > Error Info**.

### 7. Text Area

This area of the display is used to show status information about the signal generator such as the modulation status, sweep lists, and file catalogs. This area also enables you to perform functions such as managing information, entering information, and displaying or deleting files.

### 8. Active Function Area

The current active function is shown in this area. For example, if frequency is the active function, the current frequency setting will be displayed here. If the current active function has an increment value associated with it, that value is also displayed.

## Rear Panel Overview

The signal generator rear panel (Figure 2-3) provides input, output, and remote interface connections. Figure 2-4 shows a portion of the rear panel for signal generators with Option 1EM, which moves front panel connectors to the rear panel. For Option 1EM connectors not described in this section, see “Front Panel Overview” on page 26.

**Figure 2-3 Rear Panel Feature Overview**

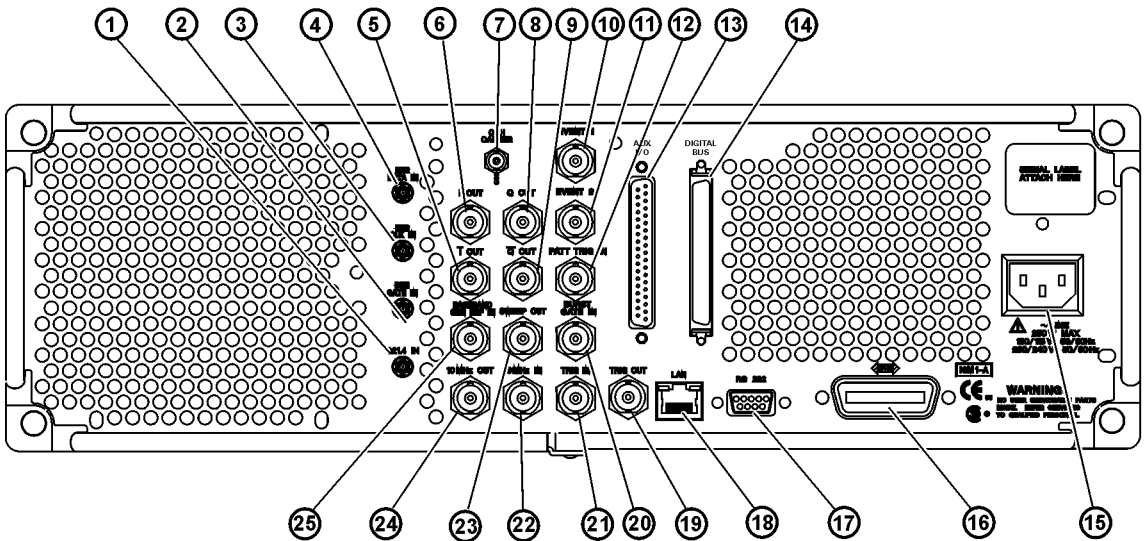

**Figure 2-4**

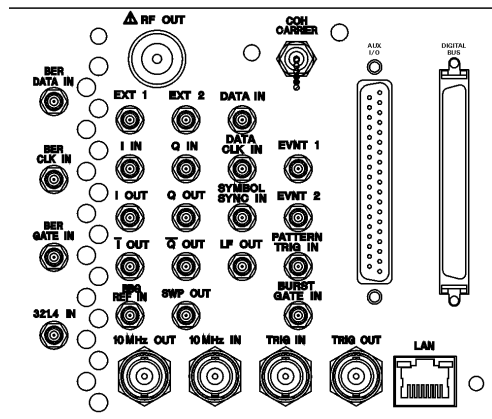

### 1. 321.4 IN Connector (Option 300)

Use this female SMB connector to input a downconverted 321.4 MHz GSM/EDGE signal for base transceiver station (BTS) loopback measurements. (Option 300 also requires Options UN7, 001/601 or 002/602, and 402).

### 2. BER GATE IN Connector (Option UN7)

Use this female SMB connector to input the clock gate signal for the bit-error-rate measurements. The clock signal to the BER CLK IN connector is valid only when the signal to this connector is a high or low, depending on your softkey selection or SCPI command. The damage levels are  $> +5.5$  volts and  $< -0.5$  volts. This connector accepts a high impedance TTL-compatible signal or a  $75\Omega$  input. It can be enabled or disabled by a softkey or a SCPI command.

### 3. BER CLK IN Connector (Option UN7)

Use this female SMB connector to input the clock signal for the bit-error-rate measurements. The rising (positive) or falling (negative) edge of the signal (selected either by softkey or SCPI command) causes data on the BER DATA IN connector to be sampled. The damage levels are  $> +5.5$  volts and  $< -0.5$  volts. This connector accepts a high impedance TTL-compatible signal or a  $75\Omega$  input.

### 4. BER DATA IN Connector (Option UN7)

Use this female SMB connector to input the data streams for the bit-error-rate measurements. The rising (positive) or falling (negative) edge of the BER CLK IN signal (selected by the softkey or the SCPI command) is used to trigger the reading of the data. The damage levels are  $> +5.5$  volts and  $< -0.5$  volts. This connector accepts a high impedance TTL-compatible signal or a  $75\Omega$  input.

### 5. I-bar OUT Connector (Option 001/601 or 002/602)

This female BNC connector is used in conjunction with the I OUT connector to provide a balanced baseband stimulus. Balanced signals are signals present in two separate conductors that are symmetrical relative to ground, and are opposite in polarity (180 degrees out of phase). The nominal output impedance of this connector is  $50\Omega$ , DC-coupled. The damage levels are  $> +2$  V and  $< -2$  V. The DC origin offset is typically  $< 10$  mV. The output signal levels into a  $50\Omega$  load are as follows:

- $0.5 V_{pk}$ , typical, corresponds to one unit length of the I/Q vector.
- $0.69 V_{pk}$  (2.84 dB), typical, maximum crest factor for peaks for  $\pi/4$  DQPSK with  $\alpha = 0.5$ .
- $0.71 V_{pk}$  (3.08 dB), typical, maximum crest factor for peaks for  $\pi/4$  DQPSK with  $\alpha = 0.35$ .
- Typically  $1 V_{p-p}$  maximum (Option 001/601 or 002/602 only).

If you configure your signal generator with Option 1EM, this output is relocated and changed from a BNC to an SMB connector.

## 6. I OUT Connector (Option 001/601 or 002/602)

This female BNC connector outputs the analog, in-phase component of I/Q modulation from the internal baseband generator. The nominal output impedance of this connector is  $50\Omega$ , DC-coupled. The damage levels are  $> +3.5$  V and  $< -3.5$  V. The DC origin offset is typically  $< 10$  mV. The output signal levels into a  $50\Omega$  load are as follows:

- $0.5 V_{pk}$ , typical, corresponds to one unit length of the I/Q vector.
- $0.69 V_{pk}$  (2.84 dB), typical, maximum crest factor for peaks for  $\pi/4$  DQPSK with  $\alpha = 0.5$ .
- $0.71 V_{pk}$  (3.08 dB), typical, maximum crest factor for peaks for  $\pi/4$  DQPSK with  $\alpha = 0.35$ .
- Typically  $1 V_{p-p}$  maximum.

If you configure your signal generator with Option 1EM, this output is relocated from a BNC to an SMB connector.

## 7. COH CARRIER Output Connector

The coherent carrier connector outputs RF that is modulated with FM or  $\Phi$ M. The output power is nominally  $-2$  dBm  $\pm 5$  dB. The output frequency range is from 249.99900001 MHz to the maximum specified frequency of your signal generator or 4 GHz for Option 506 instruments. If the RF output frequency is below this range, the coherent carrier output signal will have the following frequency: Frequency of coherent carrier =  $(1E9 - \text{Frequency of RF output})$  in Hz. The damage levels are 20 Vdc and 13 dBm reverse RF power.

## 8. Q OUT Connector (Option 001/601 or 002/602)

This female BNC connector outputs the analog, quadrature-phase component of I/Q modulation from the internal baseband generator. The nominal output impedance of this connector is  $50\Omega$ , DC-coupled. The damage levels are  $> +3.5$  V and  $< -3.5$  V. The DC origin offset is typically  $< 10$  mV. The output signal levels into a  $50\Omega$  load are as follows:

- $0.5 V_{pk}$ , typical, corresponds to one unit length of the I/Q vector.
- $0.69 V_{pk}$  (2.84 dB), typical, maximum crest factor for peaks for  $\pi/4$  DQPSK with  $\alpha = 0.5$ .
- $0.71 V_{pk}$  (3.08 dB), typical, maximum crest factor for peaks for  $\pi/4$  DQPSK with  $\alpha = 0.35$ .
- Typically  $1 V_{p-p}$  maximum.

If you configure your signal generator with Option 1EM, this output is relocated from a BNC to an SMB connector.

## 9. Q-bar OUT Connector (Option 001/601 or 002/602)

This female BNC connector is used in conjunction with the Q OUT connector to provide a balanced baseband stimulus. Balanced signals are signals present in two separate conductors that are symmetrical relative to ground, and are opposite in polarity (180 degrees out of phase). The nominal output impedance of this connector is  $50\Omega$ , DC-coupled. The damage levels are  $> +2$  V and  $< -2$  V. The DC origin offset is typically  $< 10$  mV. The output signal levels into a  $50\Omega$  load are as follows:

- $0.5 V_{pk}$ , typical, corresponds to one unit length of the I/Q vector.
- $0.69 V_{pk}$  (2.84 dB), typical, maximum crest factor for peaks for  $\pi/4$  DQPSK with  $\alpha = 0.5$ .
- $0.71 V_{pk}$  (3.08 dB), typical, maximum crest factor for peaks for  $\pi/4$  DQPSK with  $\alpha = 0.35$ .
- Typically  $1 V_{p-p}$  maximum.

If you configure your signal generator with Option 1EM, this output is relocated from a BNC to an SMB connector.

## 10. EVENT 1 Connector (Option 001/601 or 002/602)

This female BNC connector outputs a pulse that can be used to trigger the start of a data pattern, frame, or timeslot. It is adjustable to within plus or minus one timeslot with one bit of resolution. With Option 401 installed, an even second output is generated. A marker is output every two seconds indicating the beginning of each short code sequence for use in synchronizing CDMA analysis instruments.

There is a marker on/off condition associated with each waveform point. The marker 1 level is  $+3.3$  V CMOS high when positive polarity is selected;  $-3.3$  V CMOS low when negative polarity is selected. The output on the EVENT 1 connector occurs whenever Marker 1 is turned on in the waveform. (Markers are automatically turned on whenever you set them in a waveform segment. When you combine waveform segments that contain Marker 1 into a sequence, the markers are automatically turned off until you toggle them on in either the Edit Selected Waveform Sequence menu or in the Build New Waveform Sequence menu.)

The damage levels for the Event 1 connector are  $> +8$  V and  $< -4$  V. On signal generators with Option 1EM, this output is changed from a BNC to an SMB connector. With Option 401 you can select from several different output signals for this connector.

## 11. EVENT 2 Connector (Option 001/601 or 002/602)

This female BNC connector outputs a data enable signal for gating external equipment. The output is applicable when the external data is clocked into internally generated timeslots. Data is enabled when the signal is low. With Option 401 installed, a marker is output on the EVENT 2 connector every 26.67 milliseconds, corresponding to the start of each short code.

There is a marker on/off condition associated with each waveform point. The marker 2 level is  $+3.3$  V CMOS high when positive polarity is selected;  $-3.3$  V CMOS low when negative polarity is selected. The



output on the EVENT 1 connector occurs whenever Marker 1 is turned on in the waveform. The output on the EVENT 2 connector occurs whenever Marker 2 is turned on in the waveform. (Markers are automatically turned on whenever you set them in a waveform segment. When you combine waveform segments that contain Marker 2 into a sequence, the markers are automatically turned off until you toggle them on in either the Edit Selected Waveform Sequence menu or in the Build New Waveform Sequence menu.)

The damage levels are  $> +8\text{ V}$  and  $< -4\text{ V}$ . On signal generators with Option 1EM, this output is changed from a BNC to an SMB connector. With Option 401 this connector is used for system reset output.

## 12. PATT TRIG IN Connector (Option 001/601 or 002/602)

This female BNC input connector can accept either a CMOS low to CMOS high, or CMOS high to CMOS low edge trigger. The minimum trigger input pulse width, high or low, is 100 ns. The damage levels are  $> +5.5\text{ volts}$  and  $< -0.5\text{ volts}$ . If you configure your signal generator with Option 1EM, this input is changed from a BNC to an SMB connector.

The input to the PATT TRIG IN connector is used to trigger the internal digital modulation pattern generator to start a single pattern output or to stop and re-synchronize a pattern that is being continuously output. The trigger edge is latched and then sampled by the falling edge of the internal data bit clock to synchronize the trigger with the data bit clock timing. The minimum delay from the trigger edge to the first bit of the frame is 1.5 to 2.5 bit clock periods.

This connector is the source for the external trigger for all of the ARB waveform generator triggers. With Option 401, this connector is used for even second synchronization input.

## 13. AUX I/O Connector

This female 37-pin connector is active only on instruments with an internal baseband generator (Option 001/601 or 002/602). On signal generators without one of these options, this connector is non-functional. This connector provides access to the inputs and outputs described in the following table and shown in [Figure 2-5](#).

Connector Pin	Description
ALT PWR IN	Pin-16 is used with an internal baseband generator. This pin accepts a CMOS signal for synchronization of external data and alternate power signal timing. Damage levels are $> +5.5\text{ volts}$ and $< -0.5\text{ volts}$ .
DATA CLK OUT	Pin-6 is used with an internal baseband generator. This pin relays a CMOS bit clock signal for synchronizing serial data. Damage levels are $> +5.5\text{ volts}$ and $< -0.5\text{ volts}$ .
DATA OUT	Pin-7 is used with an internal baseband generator. This pin outputs data (CMOS) from the internal data generator or the externally supplied signal at data input. Damage levels are $> +5.5\text{ volts}$ and $< -0.5\text{ volts}$ .

Connector Pin	Description (Continued)
EVENT 3	<p>Pin-19 is used with an internal baseband generator. In arbitrary waveform mode, this pin outputs a timing signal generated by Marker 3.</p> <p>The marker 3 output level is +3.3 V CMOS regardless of marker polarity settings. The reverse damage levels for this connector pin are &gt; +5.5 volts and &lt; -0.5 volts.</p>
EVENT 4	<p>Pin-18 is used with an internal baseband generator. In arbitrary waveform mode, this pin outputs a timing signal generated by Marker 4.</p> <p>The marker 4 output level is +3.3 V CMOS regardless of marker polarity settings. The reverse damage levels for this connector pin are &gt; +5.5 volts and &lt; -0.5 volts.</p>
PATT TRIG IN 2	<p>Pin-17 accepts a signal that triggers an internal pattern or frame generator to start single pattern output. Minimum pulse width is 100 ns. Damage levels are &gt; +5.5 and &lt; -0.5 V.</p>
SYM SYNC OUT	<p>Pin-5 is used with an internal baseband generator. This pin outputs the CMOS symbol clock for symbol synchronization, one data clock period wide. Damage levels are &gt; +5.5 volts and &lt; -0.5 volts.</p>
BER MEAS TRIG/BER NO DATA	<p>Pin-22 is used for bit error rate testing (Option UN7). Damage levels are &gt; +5.5 volts and &lt; -0.5 volts.</p>
BER ERR OUT	<p>Pin-21 is used for bit error rate testing (Option UN7). Damage levels are &gt; +5.5 volts and &lt; -0.5 volts</p>
BER TEST OUT	<p>Pin-20 is used for bit error rate testing (Option UN7). Damage levels are &gt; +5.5 volts and &lt; -0.5 volts</p>
BER SYNC LOSS	<p>Pin-4 is used for bit error rate testing (Option UN7). Damage levels are &gt; +5.5 volts and &lt; -0.5 volts.</p>
BER MEAS END	<p>Pin-1 is used for bit error rate testing (Option UN7). Damage levels are &gt; +5.5 volts and &lt; -0.5 volts.</p>

**Figure 2-5 AUX I/O Pin Configuration**

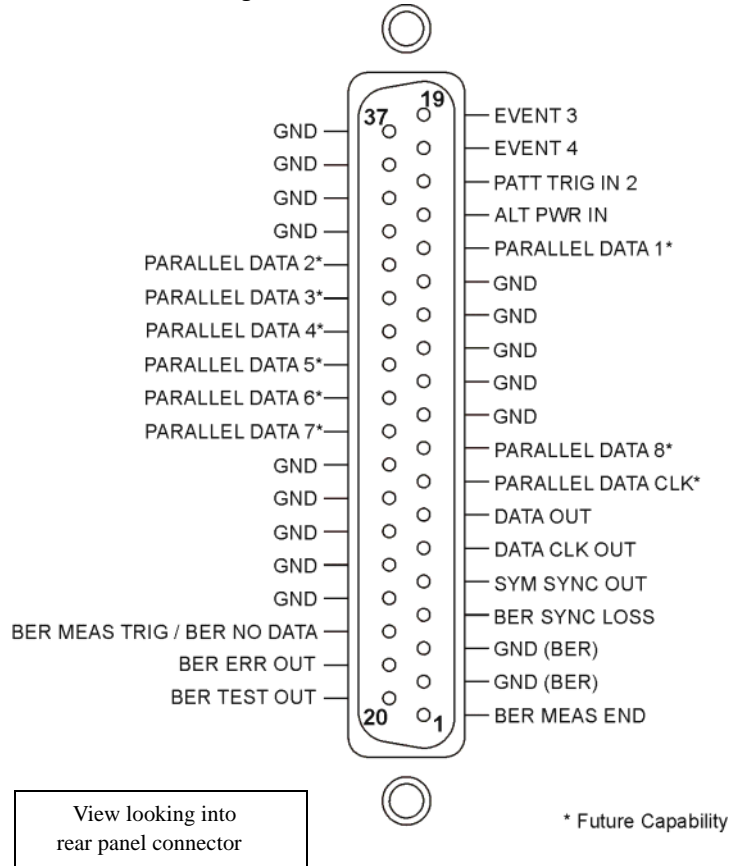

## 14. DIGITAL BUS

This is a proprietary bus used for Agilent Baseband Studio products, which require Option 601 or 602. This connector is not operational for general purpose customer use. Signals are present only when a Baseband Studio option is installed (for details, refer to [www.agilent.com/find/basebandstudio](http://www.agilent.com/find/basebandstudio)).

## 15. AC Power Receptacle

The power cord receptacle accepts a three-pronged cable that is shipped with the signal generator. The line voltage is connected here.

## 16. GPIB Connector

The GPIB connector allows communications with compatible devices such as external controllers. It is functionally equivalent to the LAN and RS 232 connectors.

## 17. RS 232 Connector

This female DB-9 connector is an RS-232 serial port that can be used for controlling the signal generator remotely. It is functionally equivalent to the GPIB and LAN connectors. The following table shows the description of the pinouts. [Figure 2-6](#) shows the pin configuration.

**Table 2-1 RS 232 Connector**

Pin Number	Signal Description	Signal Name
1	No Connection	
2	Receive Data	RECV
3	Transmit Data	XMIT
4	+5 V	
5	Ground, 0 V	
6	No Connection	
7	Request to Send	RTS
8	Clear to Send	CTS
9	No Connection	

**Figure 2-6**

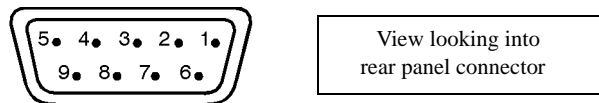

## 18. LAN Connector

LAN based communication is supported by the signal generator via the LAN (local area network) connector. The LAN connector enables the signal generator to be remotely programmed by a LAN-connected computer. The distance between a computer and the signal generator is limited to 100 meters (10Base-T) on a single cable. For more information about the LAN, refer to the E4428C/38C ESG Signal Generators Programming Guide.

## 19. TRIG OUT Connector

This female BNC connector outputs a TTL signal that is asserted high at the start of a dwell sequence, or at the start of waiting for the point trigger in manual sweep mode. It is asserted low when the dwell is over, when the point trigger is received, or once per sweep during an LF sweep. The logic polarity can be reversed.

## 20. BURST GATE IN Connector (Option 001/601 or 002/602)

The female BNC connector accepts a CMOS signal for gating burst power in digital modulation applications. The burst gating is used when you are externally supplying data and clock information. The input signal must be synchronized with the external data input that will be output during the burst. The burst power envelope and modulated data are internally delayed and re-synchronized. The input signal must be CMOS high for normal burst RF power or CW RF output power and CMOS low for RF off. The leading edges must be synchronous with the DATA CLOCK rising edges. The damage levels are  $> +5.5$  volts and  $< -0.5$  volts.

If you configure your signal generator with Option 1EM, this output is changed from a BNC to an SMB connector. With Option 401, this connector is used for system reset trigger input.

## 21. TRIG IN Connector

This female BNC connector accepts a CMOS signal for triggering operations, such as point-to-point in manual sweep mode or an LF sweep in external sweep mode. Triggering can occur on either the positive or negative edge. The damage levels are  $> +5.5$  volts and  $< -0.5$  volts.

## 22. 10 MHz IN Connector

This female BNC connector accepts a  $-3.5$  to  $+20$  dBm signal from an external timebase reference that is 1, 2, 5, or 10 MHz  $\pm 0.2$  ppm. The nominal input impedance is  $50\Omega$ . The signal generator detects when a valid reference signal is present at this connector and automatically switches from internal to external reference operation. The signal generator will only automatically switch from internal to external reference operation when the instrument is in its factory default mode where the **Ref Oscillator Source Auto Off On** softkey is set to on.

## 23. SWEEP OUT Connector

This female BNC connector provides a voltage range of 0 to  $+10$  V. When the signal generator is sweeping, the SWEEP OUT signal ranges from 0 V at the beginning of the sweep to  $+10$  V at the end of the sweep regardless of the sweep width. In CW mode this connector has no output. The output impedance is less than  $1\Omega$  and can drive  $2\text{ k}\Omega$ .

## 24. 10 MHz OUT Connector

This female BNC connector provides a nominal signal level of +3.9 dBm  $\pm$ 2 dB, and an output impedance of 50 $\Omega$ . The accuracy is determined by the timebase used.

## 25. BASEBAND GEN REF IN Connector (Option 001/601 or 002/602)

The BASEBAND GEN REF IN connector accepts a 0 to +20 dBm sine wave or TTL square wave signal from an external timebase reference. This digital modulation reference clock is used by the internal baseband generator for both component and receiver test applications (only the *internal* baseband generator can be locked to this external reference; the RF frequency remains locked to the 10 MHz reference). The nominal input impedance is 50 $\Omega$  at 13 MHz, AC-coupled.

This connector accepts a TTL or  $> -10$  dBm sine wave external reference at rates from 250 kHz through 100 MHz. The internal clock for the arbitrary waveform generator is locked to this signal when external reference is selected in the ARB setup. The minimum pulse width must be  $> 10$  ns. The damage levels are  $> +8$  V and  $< -8$  V.

This female BNC connector is provided only on signal generators with Options 001/601 and 002/602. On signal generators with Option 1EM, this output is changed from a BNC to an SMB connector.

When using the real-time W-CDMA uplink personality, this connector is used to connect the external baseband generator data clock.

---

## 3 Basic Operation

The following list shows the topics covered in this chapter:

- “Using Table Editors” on page 48
- “Configuring the RF Output” on page 50
- “Generating the Modulation Format” on page 58
- “Modulating the Carrier Signal” on page 60
- “Creating and Applying User Flatness Correction” on page 61
- “Using the Memory Catalog” on page 68
- “Using the Instrument State Registers” on page 70
- “Using Security Functions” on page 75
- “Enabling Options (E4438C Only)” on page 84
- “Using the Web Server” on page 85

## Using Table Editors

The signal generator table editors enable you to simplify configuration tasks, such as creating a list sweep. This section familiarizes you with basic table editor functionality using the List Mode Values table editor as an example.

Press **Preset > Sweep/List > Configure List Sweep**.

The signal generator displays the List Mode Values table editor, as shown below.

**Figure 3-1**

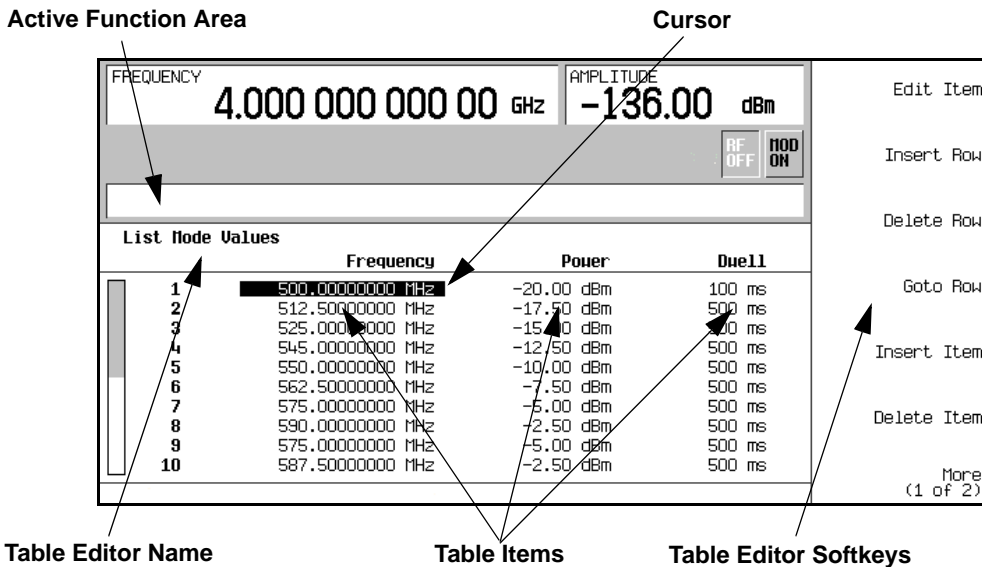

Active Function Area

displays the active table item while its value is edited.

Cursor

an inverse video identifier used to highlight specific table items for selection and editing.

Table Editor Softkeys

select table items, preset table values, and modify table structures.

Table Items

values arranged in numbered rows and titled columns (The columns are also known as data fields. For example, the column below the Frequency title is known as the Frequency data field).



## Table Editor Softkeys

The following table editor softkeys are used to load, navigate, modify, and store table item values. Press **More (1 of 2)** to access **Load/Store** and its associated softkeys.

<b>Edit Item</b>	displays the selected item in the active function area of the display where the item's value can be modified.
<b>Insert Row</b>	inserts an identical row of table items above the currently selected row.
<b>Delete Row</b>	deletes the currently selected row.
<b>Goto Row</b>	opens a menu of softkeys ( <b>Enter</b> , <b>Goto Top Row</b> , <b>Goto Middle Row</b> , <b>Goto Bottom Row</b> , <b>Page Up</b> , and <b>Page Down</b> ) used to quickly navigate through the table items.
<b>Insert Item</b>	inserts an identical item in a new row below the currently selected item.
<b>Delete Item</b>	deletes the item from the bottom row of the currently selected column.
<b>Page Up</b> and <b>Page Down</b>	displays table items that occupy rows outside the limits of the ten-row table display area.
<b>Load/Store</b>	opens a menu of softkeys ( <b>Load From Selected File</b> , <b>Store To File</b> , <b>Delete File</b> , <b>Goto Row</b> , <b>Page Up</b> , and <b>Page Down</b> ) used to load table items from a file in the memory catalog, or to store the current table items as a file in the memory catalog. The signal generator accepts a file name with a maximum length of 23 characters (alphanumeric and special characters).

## Modifying Table Items in the Data Fields

To modify existing table items:

1. Use the arrow keys or the knob to move the table cursor over the desired item. In [Figure 3-1 on page 48](#), the first item in the Frequency data field has been selected.
2. Press **Edit Item**.

The selected item is displayed in the active function area of the display.

3. Use the knob, arrow keys, or the numeric keypad to modify the value.
4. Press **Enter**.

The modified item is now displayed in the table.

## Configuring the RF Output

This section will show you how to create continuous wave and swept RF outputs.

### Configuring a Continuous Wave RF Output

Using these procedures, you will learn how to set the following parameters:

- RF output frequency
- frequency reference and frequency offset
- RF output amplitude
- amplitude reference and amplitude offset

#### Setting the RF Output Frequency

1. Press **Preset**.

This returns the signal generator to the factory-defined state.

---

**NOTE** You can change the preset condition of the signal generator to a user-defined state. For these examples, however, use the factory-defined preset state (the **Preset Normal User** softkey in the Utility menu must be set to Normal).

---

2. Observe the **FREQUENCY** area of the display (in the upper left-hand corner).

The value displayed is the maximum specified frequency of the signal generator.

3. Press **RF On/Off**.

The **RF On/Off** hardkey must be pressed before the RF signal is available at the RF OUTPUT connector. The display annunciator changes from RF OFF to RF ON. The maximum specified frequency is now being output at the RF OUTPUT connector (at the signal generator's minimum power level).

4. Press **Frequency > 700 > MHz**.

The 700 MHz RF frequency is now displayed in the **FREQUENCY** area of the display and also in the active entry area.

5. Press **Frequency > Incr Set > 1 > MHz**.

This changes the frequency increment value to 1 MHz.

6. Press the up arrow key.

Each press of the up arrow key increases the frequency by the increment value last set with the **Incr Set** hardkey. The increment value is displayed in the active entry area.

7. The down arrow decreases the frequency by the increment value set in the previous step. Practice stepping the frequency up and down in 1 MHz increments.

You can also adjust the RF output frequency using the knob. As long as frequency is the active function (the frequency is displayed in the active entry area), the knob will increase and decrease the RF output frequency.

8. Use the knob to adjust the frequency back to 700 MHz.

### Setting the Frequency Reference and Frequency Offset

The following procedure sets the RF output frequency as a reference frequency to which all other frequency parameters are relative. The frequency initially shown on the display will be 0.00 Hz (the frequency output by the hardware minus the reference frequency). Although the display changes, the frequency output does not change. Any subsequent frequency changes are shown as incremental or decremental to 0 Hz.

1. Press **Preset**.
2. Press **Frequency > 700 > MHz**.
3. Press **Freq Ref Set**.

This activates the frequency reference mode and sets the current output frequency (700 MHz) as the reference value. The **FREQUENCY** area displays 0.00 Hz, which is the frequency output by the hardware (700 MHz) minus the reference value (700 MHz). The **REF** indicator is activated and the **Freq Ref Off On** softkey has toggled to On.

4. Press **RF On/Off**.

The display annunciator has changed from **RF OFF** to **RF ON**. The RF frequency at the **RF OUTPUT** connector is 700 MHz.

5. Press **Frequency > Incr Set > 1 > MHz**.

This changes the frequency increment value to 1 MHz.

6. Press the up arrow key.

This increments the output frequency by 1 MHz. The **FREQUENCY** area display changes to show 1.000 000 00 MHz, which is the frequency output by the hardware (700 MHz + 1 MHz) minus the reference frequency (700 MHz). The frequency at the **RF OUTPUT** changes to 701 MHz.

## Configuring the RF Output

7. Press **Freq Offset > 1 > MHz.**

This enters a 1 MHz offset. The FREQUENCY area displays 2.000 000 00 MHz, which is the frequency output by the hardware (701 MHz) minus the reference frequency (700 MHz) plus the offset (1 MHz). The OFFS indicator is activated. The frequency at the RF OUTPUT connector is still 701 MHz.

### Setting the RF Output Amplitude

1. Press **Preset.**
2. Observe the AMPLITUDE area of the display.

The display reads the minimum power level of the signal generator. This is the normal preset RF output amplitude.

3. Press **RF On/Off.**

The display annunciator changes from RF OFF to RF ON. The RF signal is now being output at the minimum power level at the RF OUTPUT connector.

4. Press **Amplitude > -20 > dBm.**

This changes the amplitude to -20 dBm. The new -20 dBm RF output power is now displayed in the AMPLITUDE area of the display and also in the active entry area.

Amplitude is still the active function until you press another front panel function key. You can also change the amplitude using the up and down arrow keys and the knob.

### Setting the Amplitude Reference and Amplitude Offset

The following procedure sets the RF output power as an amplitude reference to which all other amplitude parameters are relative. The amplitude initially shown on the display will be 0 dB (the power output by the hardware minus the reference power). Although the display changes, the output power does not change. Any subsequent power changes are shown as incremental or decremental to 0 dB.

1. Press **Preset.**
2. Press **Amplitude > -20 > dBm.**
3. Press **More (1 of 2) > Ampl Ref Set.**

This activates the amplitude reference mode and sets the current output power (-20 dBm) as the reference value. The AMPLITUDE area displays 0.00 dB, which is the power output by the hardware (20 dBm) minus the reference value (-20 dBm). The REF indicator is activated and the **Ampl Ref Off On** softkey has toggled to On.

4. Press **RF On/Off**.

The display annunciator has changed from RF OFF to RF ON. The power at the RF OUTPUT connector is  $-20$  dBm.

5. Press **Incr Set > 10 > dB**.

This changes the amplitude increment value to 10 dB.

6. Use the up arrow key to increase the output power by 10 dB.

The AMPLITUDE area displays 10.00 dB, which is the power output by the hardware ( $-20$  dBm plus 10 dB) minus the reference power ( $-20$  dBm). The power at the RF OUTPUT connector changes to  $-10$  dBm.

7. Press **Ampl Offset > 10 > dB**.

This enters a 10 dB offset. The AMPLITUDE area displays 20.00 dB, which is the power output by the hardware ( $-10$  dBm) minus the reference power ( $-20$  dBm) plus the offset (10 dB). The OFFS indicator is activated. The power at the RF OUTPUT connector is still  $-10$  dBm.

## Configuring a Swept RF Output

The signal generator has two sweep types: step and list.

---

**NOTE** List sweep data cannot be saved within an instrument state, but *can* be saved to the memory catalog. For instructions on saving list sweep data, see “Storing Files” on page 69.

During swept RF output, the FREQUENCY and AMPLITUDE areas of the signal generator’s display are deactivated, depending on what is being swept.

---

This section provides an explanation of the differences between step sweep and list sweep. You will learn two ways to configure the signal generator’s RF output to sweep a defined set of frequency and amplitude points. You will create a step sweep and then you will use these points as the basis for a new list sweep.

### Step Sweep

When a step sweep is activated, the signal generator sweeps the RF output based on the values entered for RF output start and stop frequencies and amplitudes, a number of equally spaced points (steps) to dwell upon, and the amount of dwell time at each point. The frequency, amplitude, or frequency *and* amplitude of the RF output will sweep from the start amplitude/frequency to the stop amplitude/frequency, dwelling at equally spaced intervals defined by the **# Points** softkey value.

Step sweep provides a linear progression through the start-to-stop frequency and/or amplitude values. You can toggle the direction of the sweep, up or down. When the **Sweep Direction Down Up** softkey is set to Up,

values are swept from the start frequency/amplitude to the stop frequency/amplitude. When set to Down, values are swept from the stop frequency/amplitude to the start frequency/amplitude.

### Configuring and Activating a Single Step Sweep

In this procedure, you will create a step sweep with nine, equally spaced points and the following parameters:

- frequency range from 500 MHz to 600 MHz
- amplitude from -20 dBm to 0 dBm
- dwell time 500 ms at each point

1. Press **Preset**.
2. Press **Sweep/List**.

This opens a menu of sweep softkeys.

3. Press **Sweep Repeat Single Cont**.

This toggles the sweep repeat from continuous to single.

4. Press **Configure Step Sweep**.

5. Press **Freq Start > 500 > MHz**.

This changes the start frequency of the step sweep to 500 MHz.

6. Press **Freq Stop > 600 > MHz**.

This changes the stop frequency of the step sweep to 600 MHz.

7. Press **Ampl Start > -20 > dBm**.

This changes the amplitude level for the start of the step sweep.

8. Press **Ampl Stop > 0 > dBm**.

This changes the amplitude level for the end of the step sweep.

9. Press **# Points > 9 > Enter**.

This sets the number of sweep points to nine.

10. Press **Step Dwell > 500 > msec**.

This sets the dwell time at each point to 500 milliseconds.

11. Press **Return > Sweep > Freq & Ampl.**

This sets the step sweep to sweep both frequency and amplitude data. Selecting this softkey returns you to the previous menu and turns on the sweep function.

12. Press **RF On/Off.**

The display annunciator changes from RF OFF to RF ON.

13. Press **Single Sweep.**

A single sweep of the frequencies and amplitudes configured in the step sweep is executed and available at the RF OUTPUT connector. On the display, the SWEEP annunciator appears for the duration of the sweep, and a progress bar shows the progression of the sweep. The **Single Sweep** softkey can also be used to abort a sweep in progress.

### Activating Continuous Step Sweep

Press **Sweep Repeat Single Cont.**

This toggles the sweep from single to continuous. A continuous repetition of the frequencies and amplitudes configured in the step sweep are now available at the RF OUTPUT connector. The SWEEP annunciator appears on the display, indicating that the signal generator is sweeping, and progression of the sweep is shown by a progress bar.

### List Sweep

List sweep allows you to create a list of arbitrary frequency, amplitude, and dwell time values and sweep the RF output based on the entries in the List Mode Values table.

Unlike a step sweep that contains linear ascending/descending frequency and amplitude values spaced at equal intervals throughout the sweep, list sweep frequencies and amplitudes can be entered at unequal intervals, nonlinear ascending/descending, or random order.

For convenience, the List Mode Values table can be copied from a previously configured step sweep. Each step sweep point's associated frequency, amplitude and dwell time values are entered into a row in the List Mode Values table, as the following example illustrates.

### Configuring a List Sweep Using Step Sweep Data

In this procedure, you will leverage the step sweep points and change the sweep information by editing several points in the List Mode Values table editor. For information on using table editors, see [“Using Table Editors” on page 48.](#)

1. Press **Sweep Repeat Single Cont.**

This toggles the sweep repeat from continuous to single. The SWEEP annunciator is turned off. The sweep will not occur until it is triggered.

## Configuring the RF Output

2. Press **Sweep Type List Step**.

This toggles the sweep type from step to list.

3. Press **Configure List Sweep**.

This opens another menu displaying softkeys that you will use to create the sweep points. The display shows the current list data. (When no list has been previously created, the default list contains one point set to the signal generator's maximum frequency, minimum amplitude, and a dwell time of 2 ms.)

4. Press **More (1 of 2) > Load List From Step Sweep > Confirm Load From Step Sweep**.

The points you defined in the step sweep are automatically loaded into the list.

### Editing List Sweep Points

1. Press **Return > Sweep > Off**.

Turning the sweep off allows you to edit the list sweep points without generating errors. If sweep remains on during editing, errors occur whenever one or two point parameters (frequency, power, and dwell) are undefined.

2. Press **Configure List Sweep**.

This returns you to the sweep list table.

3. Use the arrow keys to highlight the dwell time in row 1.

4. Press **Edit Item**.

The dwell time for point 1 becomes the active function.

5. Press **100 > msec**.

This enters 100 ms as the new dwell time value for row 1. Note that the next item in the table (in this case, the frequency value for point 2) becomes highlighted after you press the terminator softkey.

6. Using the arrow keys, highlight the frequency value in row 4.

7. Press **Edit Item > 545 > MHz**.

This changes the frequency value in row 4 to 545 MHz.

8. Highlight any column in the point 7 row and press **Insert Row**.

This adds a new point between points 7 and 8. A copy of the point 7 row is placed between points 7 and 8, creating a new point 8, and renumbering the successive points.



9. Highlight the frequency item for point 8, then press **Insert Item**.

Pressing **Insert Item** shifts frequency values down one row, beginning at point 8. Note that the original frequency values for both points 8 and 9 shift down one row, creating an entry for point 10 that contains only a frequency value (the power and dwell time items do not shift down).

The frequency for point 8 is still active.

10. Press **590 > MHz**.

11. Press **Insert Item > -2.5 > dBm**.

This inserts a new power value at point 8 and shifts down the original power values for points 8 and 9 by one row.

12. Highlight the dwell time for point 9, then press **Insert Item**.

A duplicate of the highlighted dwell time is inserted for point 9, shifting the existing value down to complete the entry for point 10.

### Activating List Sweep for a Single Sweep

1. Press **Return > Sweep > Freq & Ampl**

This turns the sweep on again. No errors should occur if all parameters for every point have been defined in the previous editing process.

2. Press **Single Sweep**.

The signal generator will single sweep the points in your list. The SWEEP annunciator activates during the sweep.

3. Press **More (1 of 2) > Sweep Trigger > Trigger Key**.

This sets the sweep trigger to occur when you press the **Trigger** hardkey.

4. Press **More (2 of 2) > Single Sweep**.

This arms the sweep. The ARMED annunciator is activated.

5. Press the **Trigger** hardkey.

The signal generator will single sweep the points in your list and the SWEEP annunciator will be activated during the sweep.

## Generating the Modulation Format

The modulation format can be turned on prior to or after setting your signal parameters. Perform the following steps to turn the modulation format on:

1. Access the first menu within the modulation format.

This menu will show a softkey that has the format's name associated with off and on. For example, **AM Off On**. For some formats, the off/on key may appear in additional menus other than the first one.

2. Press the modulation format off/on key until On is highlighted.

Figure 3-2 shows the AM modulation format's first menu with off as the format status, and Figure 3-3 shows an example of the ESG display when the format is active.

The modulation format is now generated, however the carrier signal is not modulated until the **Mod On/Off** key has been set to on. Depending on the modulation format, the signal generator may require a few seconds to build the signal. Within the digital formats, you may see a BaseBand Reconfiguring status bar appear on the display. Once the signal is generated, an annunciator showing the name of the format will appear on the display indicating that the modulation format is active. For digital formats, the I/Q annunciator will appear in addition to the name of the modulation format.

**Figure 3-2 Modulation Format Off**

Modulation Status		Information			
Mod	State	Depth/Dev	Source	Rate	Waveform
AM 1	Off	0.1%	Internal	400.0Hz	Sine
AM 2	Off	0.1%	Internal	400.0Hz	Sine
AM WB	Off	0.3V=100%	I Input		
FM 1	Off	1.0000kHz	Internal	400.0Hz	Sine
FM 2	Off	1.0000kHz	Internal	400.0Hz	Sine
PM 1	Off	0.000rad	Internal	400.0Hz	Sine
PM 2	Off	0.000rad	Internal	400.0Hz	Sine
LFOut	Off	0.000Vp	Internal		
Pulse	Off	40.0usec	Internal	80.0usec	Pulse
Burst	Off		Ext1 DC		
I/Q	Off		Ext 50 Ohm		

First AM Menu  
Modulation Format is Off

**Figure 3-3 Modulation Format On**

Active Modulation Format Annunciator

FREQUENCY 20.000 000 000 000 GHz AMPLITUDE -135.00 dBm

AM

Mod	State	Depth/Dev	Source	Rate	Waveform
AM 1	On	0.1%	Internal	400.0Hz	Sine
AM 2	Off	0.1%	Internal	400.0Hz	Sine
AM WB	Off	0.3V=100%	I Input		
FM 1	Off	1.0000kHz	Internal	400.0Hz	Sine
FM 2	Off	1.0000kHz	Internal	400.0Hz	Sine
PM 1	Off	0.000rad	Internal	400.0Hz	Sine
PM 2	Off	0.000rad	Internal	400.0Hz	Sine
LFOut	Off	0.000Vp	Internal		
Pulse	Off	40.0usec	Internal	80.0usec	Pulse
Burst	Off		Ext. DC		
I/Q	Off		Ext. 50 Ohm		

AM Path 2

Off AM On

AM Depth 0.1 %

AM Source (Internal)

AM Rate 400.0 Hz

AM Waveform (Sine)

AM Depth Couple On

First AM Menu  
 Modulation format is On

## Modulating the Carrier Signal

The carrier signal is modulated when the **Mod On/Off** key is set to on and a modulation format is active. When the key is set to on, the MOD ON annunciator shows in the display. The MOD OFF annunciator appears when the key is set to off. The MOD ON annunciator may be showing even when there are no active modulation formats. This just indicates that the carrier signal will be modulated when a modulation format is turned on.

### To Turn the Modulation On

Press the **Mod On/Off** key until the MOD ON annunciator appears in the display.

The carrier signal is now modulated with all active modulation formats. This is the factory default.

### To Turn the Modulation Off

Press the **Mod On/Off** key until the MOD OFF annunciator appears in the display.

The carrier signal is no longer modulated or capable of being modulated when a modulation format is active.

**Figure 3-4 Carrier Signal Modulation Status**

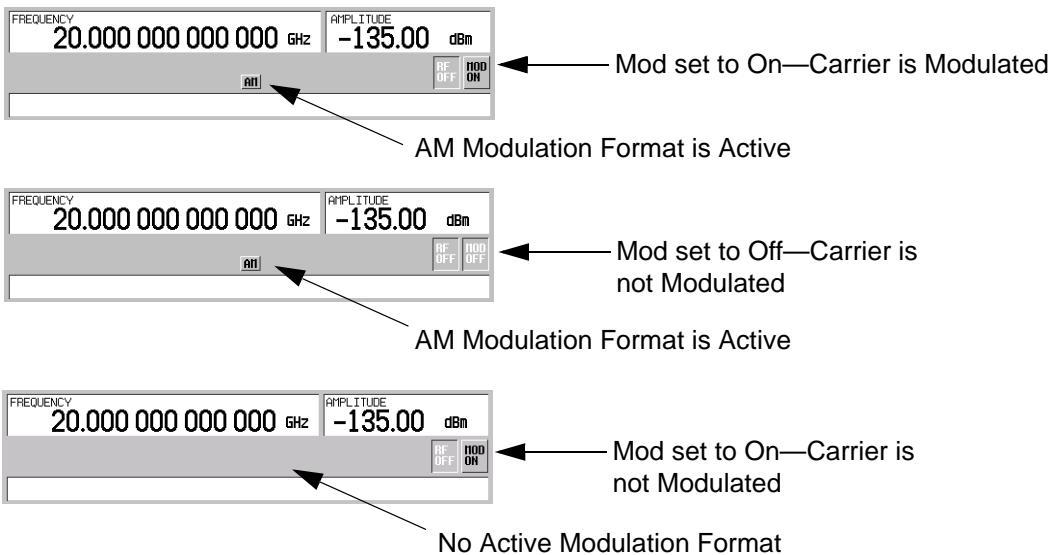

## Creating and Applying User Flatness Correction

User flatness correction allows the digital adjustment of RF output amplitude for up to 1601 frequency points in any frequency or sweep mode. Using an Agilent E4416A/17A or E4418B/19B power meter (controlled by the signal generator through GPIB) to calibrate the measurement system, a table of power level corrections is created for frequencies where power level variations or losses occur. These frequencies may be defined in sequential linear steps or arbitrarily spaced.

If you do not have an Agilent E4416A/17A or E4418B/19B power meter, or if your power meter does not have a GPIB interface, the correction values can be manually entered into the signal generator.

To allow different correction arrays for different test setups or different frequency ranges, you may save individual user flatness correction tables to the signal generator's memory catalog and recall them on demand.

Follow the steps in the next sections to create and apply user flatness correction to the signal generator's RF output.

Afterward, follow the steps in [“Recalling and Applying a User Flatness Correction Array” on page 66](#) to recall a user flatness file from the memory catalog and apply it to the signal generator's RF output.

### Creating a User Flatness Correction Array

In this example, you will create a user flatness correction array. The flatness correction array contains ten frequency correction pairs (amplitude correction values for specified frequencies), from 500 MHz to 1 GHz.

An Agilent E4416A/17A/18B/19B power meter (controlled by the signal generator via GPIB) and E4413A power sensor are used to measure the RF output amplitude at the specified correction frequencies and transfer the results to the signal generator. The signal generator reads the power level data from the power meter, calculates the correction values, and stores the correction pairs in the user flatness correction array.

If you do not have the required Agilent power meter, or if your power meter does not have a GPIB interface, you can enter correction values manually.

#### Required Equipment

- Agilent E4416A/17A/18B/19B power meter
- Agilent E4413A E Series CW power sensor
- GPIB interface cable
- adapters and cables, as required

## Creating and Applying User Flatness Correction

### Configure the Power Meter

1. Select SCPI as the remote language for the power meter.
2. Zero and calibrate the power sensor to the power meter.
3. Enter the appropriate power sensor calibration factors into the power meter as appropriate.
4. Enable the power meter's cal factor array.

---

**NOTE** For operating information on your particular power meter/sensor, refer to its operating guide.

---

### Connect the Equipment

Connect the equipment as shown in [Figure 3-5 on page 63](#).

---

**NOTE** During the process of creating the user flatness correction array, the power meter is controlled by the signal generator via GPIB. No other controllers are allowed on the GPIB interface.

---

Figure 3-5

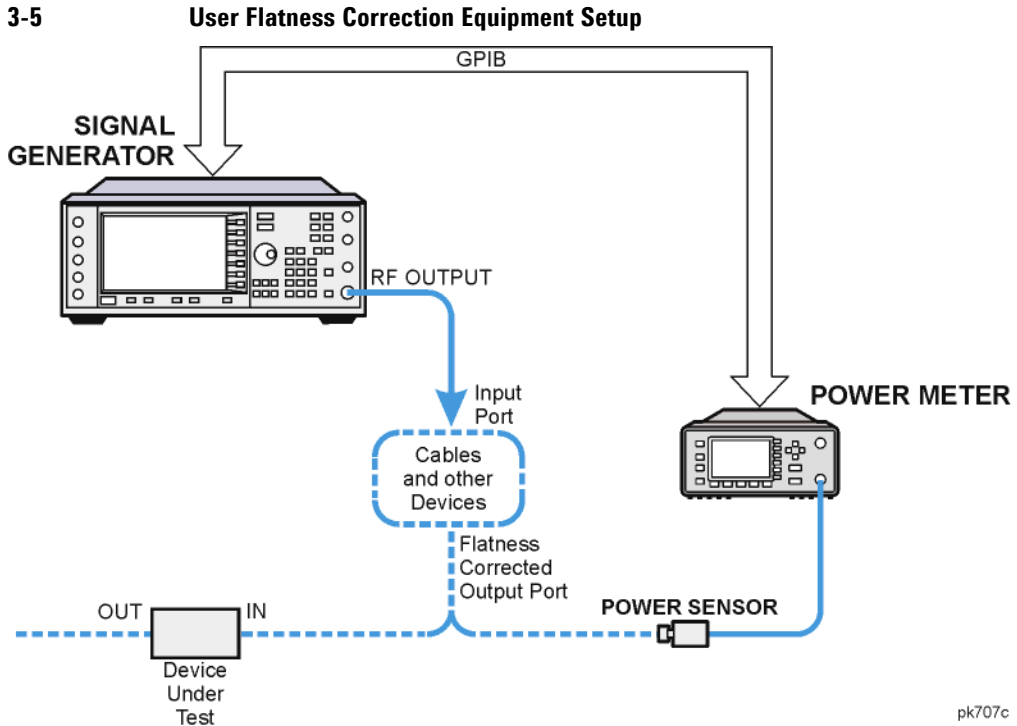

pk707c

### Configure the Signal Generator

1. Press **Preset**.
2. Configure the signal generator to interface with the power meter.
  - a. Press **Amplitude > More (1 of 2) > User Flatness > More (1 of 2) > Power Meter > E4416A, E4417A, E4418B, or E4419B**.
  - b. Press **Meter Address >** enter the power meter's GPIB address **> Enter**.
  - c. For E4417A and E4419B power meters, press **Meter Channel A B** to select the power meter's active channel.
  - d. Press **Meter Timeout** to adjust the length of time before the instrument generates a timeout error if unsuccessfully attempting to communicate with the power meter.
3. Press **More (2 of 2) > Configure Cal Array > More (1 of 2) > Preset List > Confirm Preset**.

This opens the User Flatness table editor and presets the cal array frequency/correction list.

## Basic Operation

### Creating and Applying User Flatness Correction

4. Press **Configure Step Array**.

This opens a menu for entering the user flatness step array data.

5. Press **Freq Start > 500 > MHz**.
6. Press **Freq Stop > 1 > GHz**.
7. Press **# of Points > 10 > Enter**.

Steps 4, 5, and 6 enter the desired flatness-corrected frequencies into the step array.

8. Press **Return > Load Cal Array From Step Array > Confirm Load From Step Sweep**.

This populates the user flatness correction array with the frequency settings defined in the step array.

9. Press **Amplitude > 0 > dBm**.
10. Press **RF On/Off**.

This activates the RF output and the RF ON annunciator is displayed on the signal generator.

### Perform the User Flatness Correction

---

**NOTE** If you are not using an Agilent E4416A/17A/18B/19B power meter, or if your power meter does not have a GPIB interface, you can perform the user flatness correction manually. For instructions, see [“Performing the User Flatness Correction Manually” on page 65](#).

---

1. Press **More (1 of 2) > User Flatness > Do Cal**.

This creates the user flatness amplitude correction value table entries. The signal generator enters the user flatness correction routine and a progress bar is shown on the display.

2. When prompted, press **Done**.

This loads the amplitude correction values into the user flatness correction array.

If desired, press **Configure Cal Array**.

This opens the user flatness correction array, where you can view the stored amplitude correction values. The user flatness correction array title displays **User Flatness: (UNSTORED)** indicating that the current user flatness correction array data has not been saved to the memory catalog.



### Performing the User Flatness Correction Manually

If you are not using an Agilent E4416A/17A/18B/19B power meter, or if your power meter does not have a GPIB interface, complete the steps in this section and then continue with the user flatness correction tutorial.

1. Press **More (1 of 2) > User Flatness > Configure Cal Array**.

This opens the User Flatness table editor and places the cursor over the frequency value (1 GHz) for row 1. The RF output changes to the frequency value of the table row containing the cursor and 1.000 000 000 00 is displayed in the FREQUENCY area of the display.

2. Observe and record the measured value from the power meter.
3. Subtract the measured value from 0 dBm.
4. Move the table cursor over the correction value in row 1.
5. Press **Edit Item** > enter the difference value from step 3 > **dB**.  
The signal generator adjusts the RF output amplitude based on the correction value entered.
6. Repeat steps 2 through 5 until the power meter reads 0 dBm.
7. Use the down arrow key to place the cursor over the frequency value for the next row. The RF output changes to the frequency value of the table row containing the cursor, as shown in the FREQUENCY area of the display.
8. Repeat steps 2 through 7 for every entry in the User Flatness table.

### Save the User Flatness Correction Data to the Memory Catalog

This process allows you to save the user flatness correction data in the signal generator's memory catalog. With several user flatness correction files saved to the memory catalog, any file can be recalled, loaded into the correction array, and applied to the RF output to satisfy specific RF output flatness requirements.

1. Press **Load/Store**.
2. Press **Store to File**.
3. Enter the file name FLATCAL1 using the alphanumeric softkeys, numeric keypad, or the knob.  
The maximum file name length is 23 characters (alphanumeric and special characters).
4. Press **Enter**.

The user flatness correction array file FLATCAL1 is now stored in the memory catalog as a UFLT file.

### Applying a User Flatness Correction Array

Press **Return** > **Return** > **Flatness Off On**.

This applies the user flatness correction array to the RF output. The UF indicator is activated in the AMPLITUDE section of the signal generator's display and the frequency correction data contained in the correction array is applied to the RF output amplitude.

### Recalling and Applying a User Flatness Correction Array

Before performing the steps in this section, complete [“Creating a User Flatness Correction Array” on page 61](#).

1. Press **Preset**.
2. Press **Amplitude** > **More (1 of 2)** > **User Flatness** > **Configure Cal Array** > **More (1 of 2)** > **Preset List** > **Confirm Preset**.
3. Press **More (2 of 2)** > **Load/Store**.
4. Ensure that the file `FLATCAL1` is highlighted.
5. Press **Load From Selected File** > **Confirm Load From File**.

This populates the user flatness correction array with the data contained in the file `FLATCAL1`. The user flatness correction array title displays `User Flatness: FLATCAL1`.

6. Press **Return** > **Flatness Off On**.

This applies the user flatness correction data contained in `FLATCAL1`.

### Returning the Signal Generator to GPIB Listener Mode

During the user flatness correction process, the power meter is controlled by the signal generator via GPIB, and no other controllers are allowed on the GPIB interface. The signal generator operates in GPIB talker mode, as a device controller for the power meter. In this operating mode, it cannot receive SCPI commands via GPIB.

---

**NOTE** Before interfacing the signal generator to a remote controller, the signal generator must be in GPIB listener mode. Press the **GPIB Listener Mode** softkey to return the signal generator to GPIB listener mode from GPIB talker mode.

If an RF carrier has been previously configured, you must save the present instrument state before returning the signal generator to GPIB listener mode.

---

1. Save your instrument state to the instrument state register.

For instructions, see [“Saving an Instrument State” on page 71](#).

2. Press  **GPIB Listener Mode**.

This presets the signal generator and returns it to GPIB listener mode. The signal generator can now receive remote commands executed by a remote controller connected to the GPIB interface.

3. Recall your instrument state from the instrument state register.

For instructions, see [“Recalling an Instrument State”](#) on page 72.

## Using the Memory Catalog

The signal generator's interface for stored files is the memory catalog. From the memory catalog, you can view, store, and save files using the signal generator's front panel or a remote controller. For more information on the memory catalog and performing these tasks remotely, see the *E4428C/38C ESG SCPI Command Reference* and the *E4428C/38C ESG Vector Signal Generator Programming Guide*.

The memory catalog may contain the following file types and their associated data:

BIN	binary data
LIST	sweep data from the List Mode Values table including frequency, amplitude, and dwell time
STAT	instrument state data (controlling instrument operating parameters, such as frequency, amplitude, and mode)
UFLT	user flatness calibration correction pair data (user-defined frequency and corresponding amplitude correction values)

---

**NOTE** You may have additional file types depending on which options you have installed in your signal generator.

---

### Viewing Stored Files

1. Press **Utility > Memory Catalog > Catalog Type**.

All files in the memory catalog are listed in alphabetical order, regardless of which catalog type you select. File information appears on the display and includes the file name, file type, file size, and the file modification date and time.

2. Press **List**

The Catalog of List Files is displayed.

3. Press **Catalog Type > State**.

The Catalog of State Files is displayed.

4. Press **Catalog Type > User Flatness**.

The Catalog of USERFLAT Files is displayed.

## Storing Files

To store a file to the memory catalog, first create a file. For this example, use the default list sweep table.

1. Press **Preset**.
2. Press **Sweep/List > Configure L1ist Sweep > More (1 of 2) > Load/Store**.

This opens the Catalog of List Files.

3. Press **Store to File**.

This displays a menu of alphabetical softkeys for naming the file. `Store to:` is displayed in the active function area.

4. Enter the file name `LIST1` using the alphabetical softkeys and the numeric keypad.

The maximum file name length is 23 characters (alphanumeric and special characters).

5. Press **Enter**.

The file is now displayed in the Catalog of List Files, showing the file name, file type, file size, and the date and time the file was modified.

---

## Using the Instrument State Registers

The instrument state memory is a section of memory divided into 10 sequences (numbered 0 through 9). Each sequence consists of 100 registers (numbered 00 through 99). Instrument state sequences and registers save and recall signal generator settings, and provide a quick way to reconfigure the signal generator when switching between different instrument and signal configurations.

The signal generator with Option 005 (internal hard drive) has approximately 4 GB available for storing instrument state files, as well as other user data. Without Option 005, the signal generator has 20 MB available for data and instrument state storage. Instrument state files vary in length, depending on the signal generator's configuration.

Data, such as waveform files, arb settings, and table entries, are not stored in instrument state memory. Store these data types to the signal generator's memory. Instrument state memory only saves settings such as frequency, attenuation, power, and so forth.

The following list shows additional signal generator settings that are *not* saved with the save operation.

FM Deviation	List Mode Freq	Hostname	FTP Server
RS-232 Baud Rate	List Mode Power	IP Address	Web Server (HTTP)
Remote Language	List Mode Dwell	Subnet Mask	Sockets SCPI (TELNET)
System Security Level	List Mode Sequence	Default Gateway	VXI-11 SCPI
System Security Level Display	Display State On/Off	MAC	
System Security Level State	PM Deviation	Manual DHCP	

Waveform data is stored in NVWFM. If you have a waveform file and want to save signal generator settings associated with that file, you must first select the waveform in volatile waveform memory (WFM1). When you save the signal generator settings associated with that file to instrument state memory, a reference to the waveform file name will also be saved. Refer to [“Storing and Loading Waveform Segments” on page 113](#) for information on saving waveform files.

For more information on storing file data, such as waveform files, arb setups, and table entries, refer to [“Storing Files” on page 69](#). Refer to the *E4428C/38C ESG Signal Generator Programming Guide* and the *E4428C/38C ESG Signal Generator Key and Data Field Reference* for more information on the save and recall function.

The following procedure demonstrates saving settings to the instrument state memory.

## Saving an Instrument State

1. Preset the signal generator, then turn on amplitude modulation (the AM annunciator will turn on):
  - a. Press **Frequency > 800 > MHz.**
  - b. Press **Amplitude > 0 > dBm.**
  - c. Press **AM > AM Off On.**
2. (Optional) If you want to associate these settings with a waveform file, load the waveform file into WFM1 and select it. Refer to “[Storing and Loading Waveform Segments](#)” on page 113 for information on loading waveform files into WFM1.
3. Press **Save > Select Seq > 1 > Enter.**

The sequence number becomes the active function. The signal generator displays the last sequence used. Using the arrow keys, set the sequence to 1.
4. Press **Select Reg > 1 > Enter.**

The register number in sequence 1 becomes the active function. The signal generator displays either the last register used accompanied by the text: ( in use ), or (if no registers are in use) register 00 accompanied by the text: ( available ). Use the arrow keys to select register 01.
5. Press **Save Seq[1] Reg[01].**

This saves the instrument state, configured in step 1, to sequence 1, register 01 of the instrument state register. If a waveform is selected or being played, then the name of the waveform file will also be saved in sequence 1, register 01 of the instrument state register.
6. Press **Add Comment to Seq[1] Reg[01].**

This enables you to add a descriptive comment to sequence 1 register 01. The comment appears in the Saved States list when the **Recall** hardkey is pressed. If you have a waveform associated with the instrument state, enter the name of the waveform in the comment field. You can then easily identify the name of the waveform and associated instrument state when the **Recall** hardkey is pressed.
7. Using the letter softkeys, front panel knob, or numeric keypad, enter a comment and press **Enter.**
8. Press **Edit Comment In Seq[1] Reg[01].**

If you wish, you can now change the descriptive comment for sequence 1 register 01.

Changes to a previously saved instrument state, for example an instrument state saved in Seq n, Reg nn, can be re-saved by highlighting that register and pressing **Re-SAVE Seq[n] Reg[nn]**. The re-save function overwrites previously saved instrument state settings, with the new settings configuration.

## Recalling an Instrument State

Using this procedure, you will learn how to recall instrument settings saved to an instrument state register. Refer to the “[Recalling an Instrument State for a Waveform File](#)” on page 73 for recalling a waveform file and associated signal generator settings.

1. Press **Preset**.
2. Press the **Recall** hardkey.

Notice that the **Select Seq** softkey shows sequence 1. (This is the last sequence that you used.)

3. Press **RECALL Reg**.

The register to be recalled in sequence 1 becomes the active function. Press the up arrow key once to select register 1. Your stored instrument state settings are recalled.

## Saving an Instrument State for a Waveform File

This procedure applies to the E4438C with Option 001/601 or 002/602 and demonstrates saving signal generator settings associated with a waveform file.

---

**NOTE** The save function saves only a reference to a waveform file name; no waveform data is stored. Use Save function to save signal generator settings and use the Store function to save waveform data.

---

Signal generator settings such as frequency, power, attenuator level, and so forth, are not saved when a waveform file is saved. Signal generator settings, associated with the waveform file, must be saved to the instrument state memory. If there is no waveform file in NVWFM, create one using the procedure, “[Creating Waveform Segments](#)” on page 108.

You can save signal generator settings, associated with a waveform file, so that when you load the waveform from NVWFM and play it, the same signal generator settings can be recalled and re-applied to the waveform file.

## Set Up the Signal Generator

1. Press **Preset**.
2. Press **Frequency > 2 > GHz**.
3. Press **Amplitude > -30 > dBm**.
4. Press **Mode > Dual ARB > Waveform Segments**.
5. Scroll and highlight a waveform file in NVWFM.



6. Press **Load Segment From NVWFM Memory > Return**.
7. Scroll to the waveform selected in step 3.
8. Press **Select Waveform > ARB Off On** to on. This causes the signal generator to play the waveform.

### **Saving the Instrument State**

Instrument states can be saved to any one of the 10 sequences and 100 registers in instrument state memory. In this procedure, sequence 01 and register 02 are used to store the signal generator settings associated with the waveform file. The Save function saves instrument settings and the waveform file name but does not save waveform data. Waveform data can only be saved to NVWFM with the Store function.

1. Press **Save > Select Seq > 01 > Select Reg > 02 > Save Reg**.

The signal generator settings associated with the waveform file and the name of the waveform file are now saved in the instrument state memory. The section [“Recalling an Instrument State for a Waveform File” on page 73](#) describes how to recall this instrument state and associated waveform file.

### **Recalling an Instrument State for a Waveform File**

This procedure applies to signal generators with Option 001/601 or 002/602 and demonstrates recalling signal generator settings associated with a waveform file. This procedure uses the same signal generator settings and waveform file used in the previous section, [“Saving an Instrument State for a Waveform File”](#).

1. Press **Mode > Dual ARB > Waveform Segments**.
2. Scroll and select the waveform file used in the previous section.
3. Press **Load Segment From NVWFM Memory > Return > Select Waveform**
4. Highlight the file selected in step 3.
5. Press **Select Waveform**.

The next step recalls the signal generator settings associated with the waveform file. These settings were saved to Seq 01 and Reg 02 in the previous procedure.

6. Press **Recall > Select Seq > 01**
7. Press **RECALL Reg > 01 > Enter**.

The signal generator is now setup with the same settings associated with the waveform previously saved to NVWFM.

## Deleting Registers and Sequences

These procedures describe how to delete registers and sequences saved to an instrument state register.

### Deleting a Specific Register within a Sequence

1. Press **Preset**.
2. Press the **Recall** or **Save** hardkey.  
Notice that the **Select Seq** softkey shows the last sequence that you used.
3. Press **Select Seq** and enter the sequence number containing the register you want to delete.
4. Press **Select Reg** and enter the register number you want to delete.  
Notice that the **Delete Seq[n] Reg[nn]** should be loaded with the sequence and register you want to delete.
5. Press **Delete Seq[n] Reg[nn]**.  
This deletes the chosen register.

### Deleting All Registers within a Sequence

1. Press **Preset**.
2. Press the **Recall** or **Save** hardkey.  
Notice that the **Select Seq** softkey shows the last sequence that you used.
3. Press **Select Seq** and enter the sequence number containing the registers you want to delete.
4. Press **Delete all Regs in Seq[n]**.  
This deletes all registers in the selected sequence.

### Deleting All Sequences

---

**CAUTION** Be sure you want to delete the contents of *all* registers and *all* sequences in the instrument state register.

---

1. Press **Preset**.
2. Press the **Recall** or **Save** hardkey.  
Notice that the **Select Seq** softkey shows the last sequence that you used.
3. Press **Delete All Sequences**.  
This deletes all of the sequences saved in the instrument state register.

## Using Security Functions

**CAUTION** Do not use the following functions with signal generator firmware revisions C.04.84, C.04.86, or C.04.95:

- **Erase All**
- **Erase and Sanitize All**
- **Erase and Overwrite All**

If you have one of the stated revisions installed, please upgrade *immediately* to firmware revision C.04.96 or later.

This section describes how to use the ESG security functions to protect and remove classified proprietary information stored or displayed in the instrument. All security functions described in this section also have an equivalent SCPI command for remote operation. (Refer to the “System Subsystem (:SYSTEM)” chapter of the *E4428C/38C ESG Signal Generators SCPI Command Reference* for more information.)

### Understanding Memory Types

The ESG comprises several memory types, each used for storing a specific type of data. Before removing sensitive data, it is important to understand how each memory type is used in the signal generator. The following tables describe each memory type used in the base instrument, optional baseband generator, and optional hard disk.

**Table 3-1 Base Instrument Memory**

Memory Type and Size	Writable During Normal Operation?	Data Retained When Powered Off?	Purpose/Contents	Data Input Method	Location in Instrument and Remarks
Main Memory (SDRAM) 64 MB	Yes	No	firmware operating memory	operating system (not user)	CPU board, not battery backed.

**Table 3-1 Base Instrument Memory (Continued)**

Memory Type and Size	Writable During Normal Operation?	Data Retained When Powered Off?	Purpose/Contents	Data Input Method	Location in Instrument and Remarks
Main Memory (Flash) 20 MB	Yes	Yes	factory calibration/configuration data  user file system, which includes instrument status backup, flatness calibration, IQ calibration, instrument states, waveforms (including header and marker data), modulation definitions, and sweep lists	firmware upgrades and user-saved data	CPU board (same chip as firmware memory, but managed separately)  User data is not stored in this memory if hard disk (Option 005) is installed.  Because this 32-MB memory chip contains 20 MB of user data (described here) and 12 MB of firmware memory, a selective chip erase is performed. User data areas are selectively and completely sanitized when you perform the <b>Erase and Sanitize</b> function.
Firmware Memory (Flash) 12 MB	No	Yes	main firmware image	factory installed or firmware upgrade	CPU board (same chip as main flash memory, but managed separately)  During normal operation, this memory cannot be overwritten except for LAN configuration. It is only overwritten during the firmware installation or upgrade process.
	Yes	Yes	LAN configuration	front panel entry or remotely	Because this 32-MB memory chip contains 20 MB of user data and 12 MB of firmware memory (described here), a selective chip erase is performed. User data areas are selectively and completely sanitized when you perform the <b>Erase and Sanitize</b> function.
Battery Backed Memory (SRAM) 512 kB	Yes	Yes	user-editable data (table editors)  last instrument state, last instrument state backup, persistent instrument state and instrument status	firmware operations	CPU board  The battery can be removed to sanitize the memory, but must be reinstalled for the instrument to operate. The battery is located on the motherboard.
Bootrom Memory (Flash) 128 kB	No	Yes	CPU bootup program and firmware loader/updater	factory programmed	CPU board  During normal operation, this memory cannot be overwritten or erased. This read-only data is programmed at the factory.

**Table 3-1 Base Instrument Memory (Continued)**

Memory Type and Size	Writable During Normal Operation?	Data Retained When Powered Off?	Purpose/Contents	Data Input Method	Location in Instrument and Remarks
Calibration Backup Memory (Flash) 512 KB	No	Yes	factory calibration/configuration data backup no user data	factory or service only	motherboard
Boards Memory (Flash) 512 Bytes	No	Yes	factory calibration and information files, code images, and self-test limits no user data	factory or service only	all RF boards, baseband generator, and motherboard
Micro-processor Cache (SRAM) 3 kB	Yes	No	CPU data and instruction cache	memory is managed by CPU, not user	CPU board, not battery backed.

**Table 3-2 Baseband Generator Memory (Options 001/601 and 002/602)**

Memory Type and Size	Writable During Normal Operation?	Data Retained When Powered Off?	Purpose/Contents	Data Input Method	Remarks
Waveform Memory (SDRAM) 40–320 MB	Yes	No	waveforms (including header and marker data) and PRAM	normal user operation	User data is completely sanitized when you perform the <b>Erase and Sanitize</b> function. Not battery backed.
BBG Firmware Memory (Flash) 32 MB	No	Yes	firmware image for baseband generator	firmware upgrade	

**Table 3-2 Baseband Generator Memory (Options 001/601 and 002/602) (Continued)**

Memory Type and Size	Writable During Normal Operation?	Data Retained When Powered Off?	Purpose/Contents	Data Input Method	Remarks
Coprocessor Memory (SRAM) 32 MB	Yes	No	operating memory of baseband coprocessor CPU	During normal operation, some user information, such as payload data, can remain in the memory.	This memory is used during normal baseband generator operation. It is not directly accessible by the user. Not battery backed.
Buffer Memory (SRAM) 5 x 512 kB	No	No	support buffer memory for ARB and real time applications	normal user operation	This memory is used during normal baseband generator operation. It is not directly accessible by the user. Not battery backed.

**Table 3-3 Hard Disk Memory (Option 005)**

Memory Type and Size	Writable During Normal Operation?	Data Retained When Powered Off?	Purpose/Contents	Data Input Method	Remarks
Media Storage (Built-in Hard Disk) 6 GB or 10 GB (4 GB usable in both cases)	Yes	Yes	user files, including flatness calibrations, IQ calibration, instrument states, waveforms (including header and marker data), modulation definitions, and sweep lists	user-saved data	The magnetic residue requires several rewrite cycles or drive removal and destruction.  The hard disk is an option and is therefore not installed in some instruments. If it is installed, these files are stored on the hard disk instead of in flash memory.  User data is completely sanitized when you perform the <b>Erase and Sanitize</b> function.
Buffer Memory (DRAM) 512 kB	No	No	buffer (cache) memory	normal operation through hard disk	

### Removing Sensitive Data from Memory

When moving the signal generator from a secure development environment, you can remove any classified proprietary information stored in the instrument. This section describes several security functions you can use to remove sensitive data from your instrument.

---

## Erase All

---

**CAUTION** Do not use this function with signal generator firmware revisions C.04.84, C.04.86, or C.04.95. If you have one of these revisions installed, please upgrade *immediately* to revision C.04.96 or later.

---

This function removes all user files, user flatness calibrations, user I/Q calibrations, and resets all table editors with original factory values, ensuring that user data and configurations are not accessible or viewable. The instrument appears as if it is in its original factory state, however, the memory is not sanitized. This action is relatively quick, taking less than one minute (the exact time depends on the number of files).

To carry out this function, press **Utility > Memory Catalog > More (1 of 2) > Security > Erase All > Confirm Erase**.

---

**NOTE** This function is different than pressing **Utility > Memory Catalog > More (1 of 2) > Delete All Files**, which deletes all user files, but does not reset the table editors.

---

## Erase and Overwrite All

---

**CAUTION** Do not use this function with signal generator firmware revisions C.04.84, C.04.86, or C.04.95. If you have one of these revisions installed, please upgrade *immediately* to revision C.04.96 or later.

---

This function performs the same actions as [Erase All](#) and then clears and overwrites the various memory types in accordance with Department of Defense (DoD) standards, as described below.

---

SRAM	All addressable locations are overwritten with random characters.
CPU Flash	All addressable locations are overwritten with random characters and then the flash blocks are erased. This accomplishes the same purpose of a chip erase, however, only the areas that are no longer in use are erased and the factory calibration files are left intact. System files are restored after erase.
DRAM	All addressable locations are overwritten with random characters.
Hard Disk	All addressable locations are overwritten with a single character. (This is insufficient for top secret data, according to DoD standards. For top secret data, the hard drive must be removed and destroyed.)

---

To carry out this function, press **Utility > Memory Catalog > More (1 of 2) > Security > Erase and Overwrite All > Confirm Overwrite**.

## Erase and Sanitize All

---

**CAUTION** Do not use this function with signal generator firmware revisions C.04.84, C.04.86, or C.04.95. If you have one of these revisions installed, please upgrade *immediately* to revision C.04.96 or later.

---

This function performs the same actions as [Erase and Overwrite All](#) and then adds more overwriting actions. After executing this function, you must manually perform some additional steps for the sanitization to comply with Department of Defense (DoD) standards. These actions and steps are described below.

---

SRAM	All addressable locations are overwritten with random characters.
DRAM	All addressable locations are overwritten with a single character. You must then power off the instrument to purge the memory contents.
Hard Disk	All addressable locations are overwritten with a single character and then a random character. (This is insufficient for top secret data, according to DoD standards. For top secret data, the hard drive must be removed and destroyed.)

---

To carry out this function, press **Utility > Memory Catalog > More (1 of 2) > Security > Erase and Sanitize All > Confirm Sanitize**.

## Removing Persistent State Information Not Removed During Erase

### Persistent State

The persistent state settings contain instrument setup information that can be toggled within predefined limits such as display intensity, contrast and the GPIB address. In vector models, the user IQ Cal is also saved in this area.

The following key presses or SCPI commands can be used to clear the IQ cal file and to set the operating states that are not affected by a signal generator power-on, preset, or \*RST command to their factory default:

### Instrument Setup

- On the front panel, press: **Utility > Power On/Preset > Restore System Defaults > Confirm Restore Sys Defaults**
- Or send the command: `:SYSTEM:PRESet:PERSistent`

### LAN Setup

The LAN setup (hostname, IP address, subnet mask, and default gateway) information is not defaulted with a signal generator power-on or \*RST command. This information can only be changed or cleared by entering new data.



### User IQ Cal File (Vector Models Only)

When a user-defined IQ calibration has been performed, the cal file data is removed by setting the cal file to default, as follows:

1. On the front panel, press: **I/Q > I/Q Calibration > Revert to Default Cal Settings**
2. Send these commands:
  - :CAL:IQ:DEF
  - :CAL:WBIQ:DEF

### Using the Secure Mode

The secure mode automatically applies the selected **Security Level** action the next time the instrument's power is cycled.

### Setting the Secure Mode Level

---

**CAUTION** Do not use the functions **Erase**, **Overwrite**, or **Sanitize** with signal generator firmware revisions C.04.84, C.04.86, or C.04.95. If you have one of these revisions installed, please upgrade *immediately* to revision C.04.96 or later.

---

1. Press **Utility > Memory Catalog > More (1 of 2) > Security > Security Level**.
2. Choose from the following selections:
  - None** – equivalent to a factory preset, no user information is lost
  - Erase** – equivalent to **Erase All**
  - Overwrite** – equivalent to **Erase and Overwrite All**
  - Sanitize** – equivalent to **Erase and Sanitize All**

### Activating the Secure Mode

---

**CAUTION** Once you activate secure mode (by pressing **Confirm**), you cannot deactivate or decrease the security level; the erasure actions for that security level execute at the next power cycle. Once you activate secure mode, you can only increase the security level until you cycle power. For example, you can change **Erase** to **Overwrite**, but not the reverse.

After the power cycle, the security level selection remains the same, but the secure mode is not activated.

---

Press **Utility > Memory Catalog > More (1 of 2) > Security > Enter Secure Mode > Confirm**.

The **Enter Secure Mode** softkey changes to **Secure Mode Activated**.

### If Your Instrument is Not Functioning

If the instrument is not functioning and you are unable to use the security functions, you must physically remove the processor board and optional hard disk, if installed, from the instrument. Once these assemblies are removed, proceed as follows:

For the processor board, choose one of the following options:

- Discard the processor board and send the instrument to a repair facility. A new processor board will be installed and the instrument will be repaired and calibrated. If the instrument is still under warranty, you will not be charged for the new processor board.
- If you have another working instrument, install the processor board into that instrument and erase the memory. Then reinstall the processor board back into the non-working instrument and send it to a repair facility for repair and calibration. If you discover that the processor board does not function in the working instrument, discard the processor board and note that it caused the instrument failure on the repair order. If the instrument is still under warranty, you will not be charged for the new processor board.

For the optional hard disk, choose one of the following options:

- Discard the hard disk and send the instrument to a repair facility. Indicate on the repair order that the hard disk was removed and must be replaced. A new hard disk will be installed and the instrument will be repaired and calibrated. If the instrument is still under warranty, you will not be charged for the new hard disk.
- Keep the hard disk and send the instrument to a repair facility. When the instrument is returned, reinstall the hard disk.

For procedures on removing and replacing the processor board and hard disk, refer to the *E4428C/38C ESG Signal Generators Service Guide*.

### Using the Secure Display

This function prevents unauthorized personnel from reading the instrument display and tampering with the current configuration through the front panel. The display is blanked, except for the message **\*\*\* SECURE DISPLAY ACTIVATED \*\*\*** (see [Figure 3-6 on page 83](#)), and the front panel keys are disabled. Once this function is activated, the power must be cycled to re-enable the display and front panel keys.

To apply this function, press **Utility > Display > More (1 of 2) > Activate Secure Display > Confirm Secure Display**

**Figure 3-6** ESG Screen with Secure Display Activated

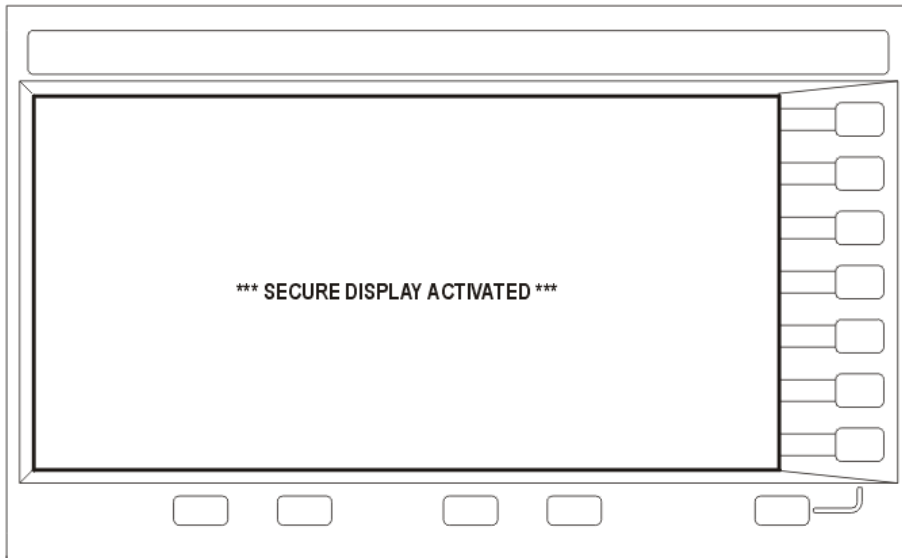

## Enabling Options (E4438C Only)

You can retrofit a signal generator after purchase to add new capabilities. Some new optional features are implemented in hardware that you must install. Some options are implemented in software but require the presence of optional hardware in the instrument. This example shows you how to enable software options.

### Enabling a Software Option

A license key (provided on the license key certificate) is required to enable each software option.

1. Access the Software Options menu:

**Utility > Instrument Adjustments > Instrument Options > Software Options**

The following is an example of the signal generator display, which lists any enabled software options, and the software options that can be enabled:

FREQUENCY <b>1.000 000 000 00</b> GHz		AMPLITUDE <b>-136.00</b> dBm	Modify License Key
		RF OFF    MOD ON	
<b>Software Option Selection</b>		Host ID = 7414ce76	
<b>Option License Key</b>	<b>Description</b>		
400 C9CF137379CB ✓	3GPP FDD		
401 C4D1127279C8 ✓	CDMA2000 AND IS95A		
402 C5CB11716FCD ✓	TDMA SUITE (GSM/EDGE/NDAC/PDC/PHS/TETRA/DECT)		
403 C6CD107075CA ✓	AJIGN		
404 BFD717777BC7 ✓	1XEV		
405 C0D9167681C4 ✓	802.11B/HYPERLAN		
406 C1D3157577C9 ✓	BLUETOOTH		
407 C2D514747DC6 ✓	3GPP TDD		
408 B8DF1B7B83C3 ✓	MMDS		
409 BCE11A7A89C0 ✓	GPS		

Proceed With Reconfiguration

2. Verify that the host ID shown on the display matches the host ID on the license key certificate. The host ID is unique for each instrument. If the host ID on the license key certificate does not match your instrument, the license key cannot enable the software option.
3. Verify that any required hardware is installed. Software options are linked to specific hardware options, so before a software option can be enabled, the appropriate hardware option must be installed. For example, Option 400, W-CDMA, requires Option 001/601 or 002/602, Internal Baseband Generator. If the software option that you intend to install is listed in a grey font, the required hardware may not be installed (in the Hardware Options menu, look for an X in the “Selected” column of the appropriate hardware option).

4. Enable the software option:
  - a. Highlight the desired option.
  - b. Press **Modify License Key**, and enter the 12-character license key (from the license key certificate).
  - c. Verify that you want to reconfigure the signal generator with the new option:  
**Proceed With Reconfiguration > Confirm Change**  
The instrument enables the option and reboots.

---

## Using the Web Server

You can communicate with the signal generator using the Web Server. This service uses TCP/IP (Transmission Control Protocol/Internet Protocol) to communicate with the signal generator over the internet.

The Web Server uses a client/server model where the client is the web browser on your PC or workstation and the server is the signal generator. When you enable the Web Server, you can access a web page that resides on the signal generator.

The Web-Enabled ESG web page, shown in [Figure 3-7](#), provides general information on your signal generator and a means to control the instrument by using a remote front panel interface or using SCPI (Standard Communication for Programmable Instruments) commands. The web page also has links to Agilent's products, support, manuals, and website.

---

**NOTE** The Web Server service is compatible with the latest version of the Microsoft® Internet Explorer web browser.<sup>1</sup>

---

The Signal Generator Web Control menu button on the Web-Enabled ESG web page will access a second web page. This web page, shown in [Figure 3-8](#), provides a virtual instrument interface that can be used to control the signal generator. You can use the mouse to click on the signal generator's front panel hardkeys, softkeys and number pad. There is also a text box that can be used to send SCPI commands to the instrument.

## Activating the Web Server

Perform the following steps to access the Web Server.

1. Turn on the Web Server by pressing **Utility > GPIB/RS-232 LAN > LAN Services Setup > Web Server On**.

---

1. Microsoft is a registered trademark of Microsoft Corp.

## Basic Operation

### Using the Web Server

2. Press the **Proceed With Reconfiguration** softkey.
3. Press the **Confirm Change** (Instrument will Reboot) softkey. The signal generator will reboot.
4. Launch your PC or workstation web browser.

5. Enter the IP address of the signal generator in the web browser address field. For example, `http://101.101.101.101`. Replace 101.101.101.101 with your signal generator's IP address. Press the Enter key on the computer's keyboard.

---

**NOTE** The IP (Internet Protocol) address can change depending on your LAN configuration. Use the **LAN Config Manual DHCP** softkey to select a Manual or DHCP (dynamic host communication protocol) LAN configuration. Refer to *E4428C/38C ESG Signal Generator Key and Data Field Reference* for more information.

---

6. Press the enter key on the computer's keyboard. The web browser will display the signal generator's homepage as shown below in [Figure 3-7](#). This web page displays information about the signal generator and provides access to Agilent's website.

**Figure 3-7** Signal Generator Web Page

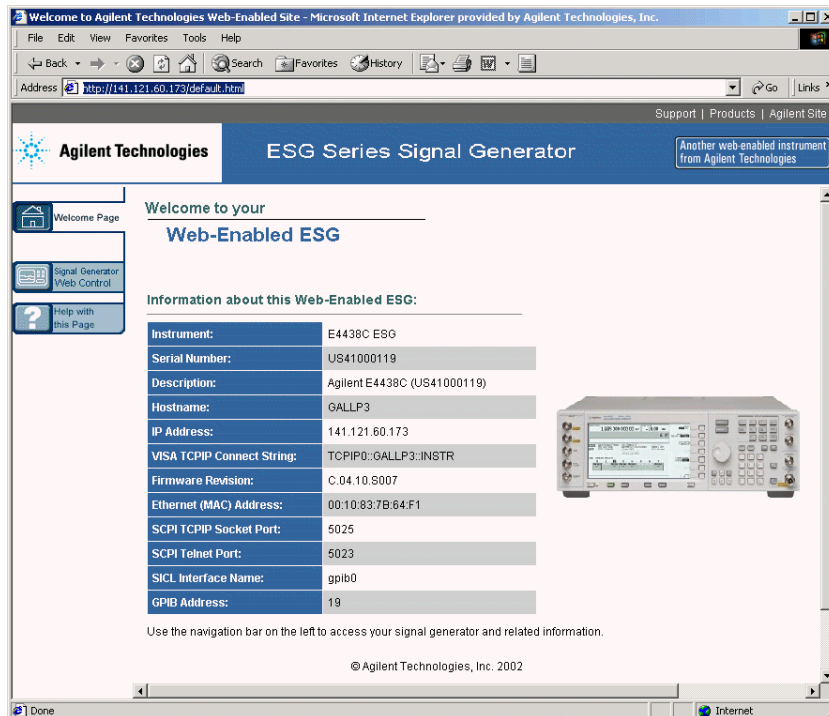

- Click the Signal Generator Web Control menu button on the left of the page. A new web page will be displayed as shown below in [Figure 3-8](#).

**Figure 3-8** Web Page Front Panel

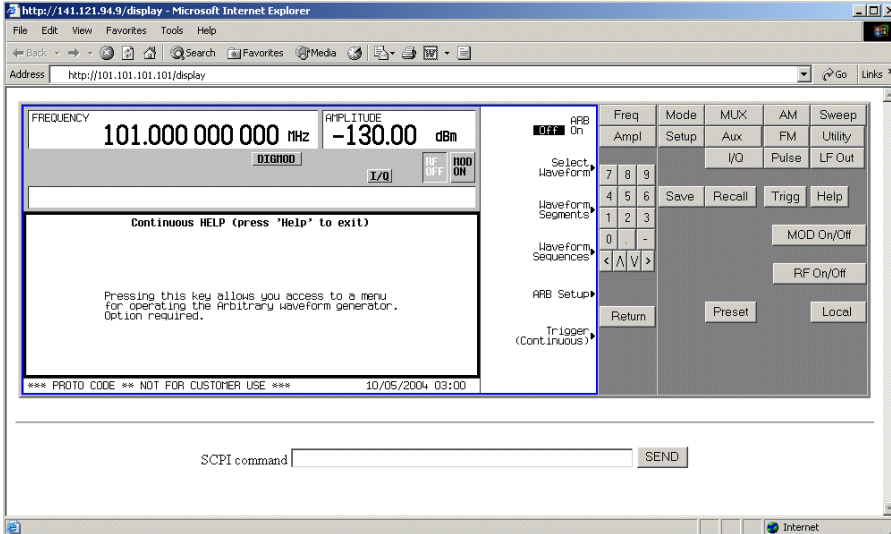

This web page remotely accesses all signal generator functions and operations. Use the mouse pointer to click on the signal generator’s hardkeys and softkeys. The results of each mouse click selection will be displayed on the web page. For example, click on the Frequency hardkey then use the front panel key pad to enter a frequency. You can also use the up and down arrow keys to increase or decrease the frequency.

You can use the SCPI Command text box at the bottom of the front panel display to send commands to the signal generator. Enter a valid SCPI command, then click the SEND button. The results of the command will be displayed on a separate web page titled, “SCPI Command Processed”. You can continue using this web page to enter SCPI commands or you can return to the front panel web page.

---

**NOTE** It may be necessary to use the web browser Refresh function if the web page does not update with new settings.

---



---

## 4 Basic Digital Operation (Option 001/601 or 002/602)

The following list shows the topics covered in this chapter:

- “Custom Modulation” on page 91
- “Arbitrary (ARB) Waveform File Headers” on page 93
- “Using the Dual ARB Waveform Player” on page 107
- “Understanding the I/Q Modulator Filter” on page 115
- “Local Settings for ARB Waveform Formats and the Dual ARB Player” on page 117
- “Using Waveform Markers” on page 124
- “Triggering Waveforms” on page 140
- “Using Waveform Clipping” on page 149
- “Using Waveform Scaling” on page 157
- “Using Customized Burst Shape Curves” on page 161
- “Using Finite Impulse Response (FIR) Filters” on page 168
- “Modifying a FIR Filter Using the FIR Table Editor” on page 173
- “Differential Encoding” on page 175
- “User-Defined I/Q Maps” on page 183
- “User-Defined FSK Modulation” on page 187
- “Creating and Using Bit Files” on page 190
- “Waveform Licensing for Firmware Version <sup>3</sup> C.05.23” on page 195

## Basic Digital Operation (Option 001/601 or 002/602)

- “Using Waveform 5-Pack Licensing (Options 221-229) for Firmware Version < C.05.23” on page 197
- “Waveform Licenses (Signal Studio “A” Versions)” on page 203

---

## Custom Modulation

For creating custom modulation, the signal generator offers two modes of operation: the ARB waveform generator mode and the real time I/Q baseband mode. The ARB waveform generator mode has built-in modulation formats such as NADC or GSM and pre-defined modulation types such as BPSK and 16QAM that can be used to create a signal. The real time I/Q baseband mode can be used to create custom data formats using built-in PN sequences or custom-user files along with various modulation types and different built-in filters such as Gaussian or Nyquist.

Both modes of operation are used to build complex, digitally modulated signals that simulate communication standards with the flexibility to modify existing digital formats, define or create digitally modulated signals, and add signal impairments.

### Custom ARB Waveform Generator

The signal generator's ARB waveform generator mode is designed for out-of-channel test applications. This mode can be used to generate data formats that simulate random communication traffic and can be used as a stimulus for component testing. Other capabilities of the ARB waveform generator mode include:

- configuring single or multicarrier signals (up to 100 carriers)
- creating waveform files using the signal generator's front panel interface

The waveform files, when created as random data, can be used as a stimulus for component testing where device performance such as adjacent channel power (ACP) can be measured. The `AUTOGEN_WAVEFORM` file, that is automatically created when you turn the ARB waveform generator on, can be renamed and stored in the signal generator's non-volatile memory. This file can later be loaded into volatile memory and played using the dual ARB waveform player.

For more information, refer to the sections [“Using the Dual ARB Waveform Player” on page 107](#) and [“Modes of Operation” on page 24](#).

## Custom Modulation

### Custom Real Time I/Q Baseband

The real time mode simulates single-channel communication using user-defined modulation types along with custom FIR filters, and symbol rates. Data can be downloaded from an external source into PRAM memory or supplied as real time data using an external input. The real time I/Q baseband mode can also generate pre-defined data formats such as PN9 or FIX4. A continuous data stream generated in this mode can be used for receiver bit error analysis. This mode is limited to a single carrier. The real time I/Q baseband mode:

- has more data and modulation types available than the ARB waveform generator mode
- supports custom I/Q constellation formats
- has the capability to generate continuous PN sequences for bit error rate testing (BERT)
- needs no waveform build time when signal parameters are changed.

For more information, refer to the custom arb section [“Using the Arbitrary Waveform Generator” on page 386](#), the custom real time section [“Using the Real Time I/Q Baseband Generator” on page 392](#) and the section on [“Digital Modulation” on page 24](#).

---

## Arbitrary (ARB) Waveform File Headers

ARB file headers are used to save a modulation format's signal generator settings and parameters so that the waveform can be replicated when it is again played back by the dual ARB player. Once a modulation format, such as Custom real time, has been turned off, the waveform file is available only to the dual ARB player.

File header settings and parameters can be defined and saved along with the waveform file in the signal generator's non-volatile waveform memory (NVWFM). When you load a stored waveform file into volatile waveform memory (WFM1), the file header information will be used to configure the ESG so that the dual ARB player is set up the same way each time that the waveform file is played.

A default file header is automatically created whenever a waveform is generated (turning on a modulation format), a waveform sequence created, or a waveform file downloaded to the ESG (Refer to the *E4428C/38C ESG Signal Generators Programming Guide* for details on downloading files).

The following ESG setting and parameter information can be saved to the file header:

- ARB sample clock rate
- Runtime scaling (only in the dual ARB player)
- Marker 1–4 settings and routing functions ([page 124](#))
  - Polarity
  - ALC hold
  - RF blanking
- High crest mode (only in the dual ARB player)
- Modulator attenuation
- Modulator filter
- I/Q output filter (used when routing signals to the rear panel I/Q outputs)
- Other instrument optimization settings (for files generated by the ESG) that cannot be set by the user.

File headers can also store a user-defined 32-character text description of the waveform or sequence file. For details on the file header settings and parameters, refer to “[File Header Description](#)” on [page 96](#).

### Creating a File Header

When you turn a modulation format on, the ESG automatically generates a temporary waveform file along with a default marker file and default file header. The temporary waveform file resides in volatile waveform memory (WFM1) and is named AUTOGEN\_WAVEFORM. The default file header has no signal generator settings saved to it and the default marker file consists of all zeros. Refer to the *E4428C/38C ESG Signal*

## Arbitrary (ARB) Waveform File Headers

*Generators Programming Guide* for more information on marker files.

When you turn the modulation format off, the AUTOGEN\_WAVEFORM file remains in volatile waveform memory (WFM1) and can be selected again for playing only by the dual ARB player. If you turn on another Arb modulation format or change ESG parameters and settings, the AUTOGEN\_WAVEFORM file will be overwritten by a new AUTOGEN\_WAVEFORM, file header, and marker file.

If you want to keep the configuration setup in the AUTOGEN\_WAVEFORM file, save it, using a different name, to NVWFM. The associated file header and marker file will automatically be saved. For information on storing files after the modulation format is turned off, see “[Storing Waveform Segments to Non-Volatile Memory](#)” on page 113.

---

**NOTE** Each time an ARB modulation format is turned on, a new AUTOGEN\_WAVEFORM along with a default marker and default file header are generated which overwrites the previous AUTOGEN\_WAVEFORM file, marker file and file header.

---

When the waveform file is stored to non-volatile memory (NVWFM), the associated file header information is automatically saved to the signal generator’s /USER/HEADER directory and the marker file is automatically saved to the signal generator’s /USER/MARKERS directory. When a waveform file, residing in WFM1, is *selected* for playback, the file header settings along with the marker file settings are automatically applied to the ESG.

The following procedure will generate an AUTOGEN\_WAVEFORM file and file header using the ARB CDMA2000 modulation format. This procedure for generating an AUTOGEN\_WAVEFORM file and file header applies to all the Arb formats.

1. Turn on the ESG and then press **Preset**.
2. Press **Mode > CDMA > Arb CDMA2000 > CDMA2000 Off On** to On. See [Figure 4-1](#) below.

The ESG creates the AUTOGEN\_WAVEFORM file along with a default file header and default marker file when the modulation format, CDMA2000 in this example, is turned on. At this time, the file header does not have signal generator settings or parameters for the currently playing AUTOGEN\_WAVEFORM file. You must modify the default file header settings and parameters for the active modulation and then save the file header information using the **Save Setup To Header** softkey.

**Figure 4-1 First-Level Softkey Menu**

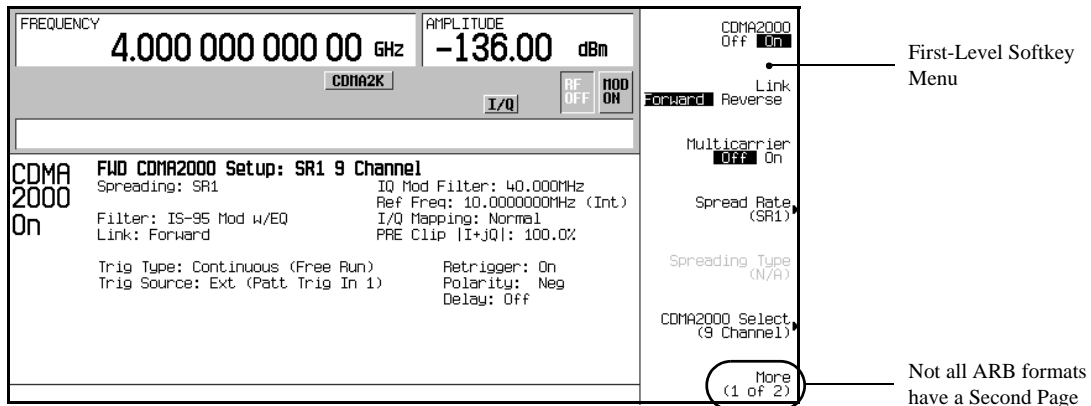

## Modifying Header Information

This procedure builds on the previous procedure, explaining the different fields of a file header, and showing how to access, modify, and save changes to the file header information.

In a modulation format, you can access a file header only while the modulation format is active (on). All ARB modulation formats and the dual ARB player access the file header the same way, except that in some modulation formats, the menu may be on page two of the first-level softkey menu.

1. From the first-level softkey menu (shown in [Figure 4-1](#)), open the Header Utilities menu:  
 Press **More (1 of 2) > ARB Setup > Header Utilities**

[Figure 4-2 on page 96](#) shows the default file header for the AUTOGEN\_WAVEFORM CDMA2000 digital modulation waveform. The Header Field column names the parameters for the file header. The Saved Header Settings column, shows that the signal generator settings for the active format are Unspecified, meaning that no settings have been saved to the file header.

The Current Inst. Settings column shows the current signal generator settings for the active modulation. These settings become the saved header settings when they are saved to the file header (as demonstrated in [Step](#) ).

Basic Digital Operation (Option 001/601 or 002/602)  
**Arbitrary (ARB) Waveform File Headers**

**Figure 4-2 CDMA2000 Default Header Display**

Let's you Enter/Edit the Description Field

Clears the Saved Header Settings Column to Default Settings

Saves the Current Inst. Settings Column to the Saved Header Settings Column

Current Signal Generator Settings

Page Up

Page Down

Page 1

Page 2

Default Header Settings

Header Field	Saved Header Settings	Current Inst. Settings
Description		
Sample Rate	Unspecified	11.0592000 MHz
Runtime Scaling	Unspecified	92.00 %
Marker 1 Polarity	Unspecified	Pos
Marker 2 Polarity	Unspecified	Pos
Marker 3 Polarity	Unspecified	Pos
Marker 4 Polarity	Unspecified	Pos
ALC Hold Routing	Unspecified	None
Alt Ampl. Routing	Unspecified	None
RF Blank Routing	Unspecified	None
High Crest Mode	Unspecified	Off
Mod Attenuation	Unspecified	Auto
I/Q Mod Filter	Unspecified	Auto
I/Q Output Filter	Unspecified	Auto

**NOTE** If a setting is unspecified in the file header, the signal generator's current value for that setting does not change when you select and play the waveform in the future.

- Save the information in the Current Inst. Settings column to the file header:  
 Press **Save Setup To Header**.

Both the Saved Header Settings column and the Current Inst. Settings column now display the same settings; the Saved Header Settings column lists the settings saved in the file header.

**File Header Description**

The file header contains the following information:

- 32-Character Description:** A description entered for the header, such as a the waveform's function (saved/edited with the **Edit Description** softkey, see [Figure 4-2](#)). You can use the displayed alpha/symbol softkeys and the numeric keypad to enter information.
- Sample Rate:** The ARB sample clock rate.



Runtime Scaling:	The Runtime scaling value. Runtime scaling is applied in real time while the waveform is playing. This setting can be changed only for files playing in the dual ARB player.
Marker 1...4 Polarity:	The marker polarity, positive or negative (described on <a href="#">page 139</a> ).
ALC Hold Routing:	Which marker, if any, implements the ESG's ALC hold function (described on <a href="#">page 126</a> ). The ALC hold function holds the ALC at its current level when the marker signal is low. All waveforms generated in the ESG have a marker on the first sample point. In order to see the results from the three routing selections, you may need to select a range of sample (marker) points. Setting the marker points is accomplished using the <b>Set Marker on Range of Points</b> softkey located in the <b>Marker Utilities</b> softkey menu. See " <a href="#">Setting Marker Points in a Waveform Segment</a> " on <a href="#">page 132</a> for more information.
Alt Ampl. Routing	This will display which marker, if any, triggers the ESG's alternate amplitude feature when the marker signal is low. When the marker signal goes high, the trigger is terminated, disengaging alternate amplitude. You still need to configure the alternate amplitude parameters located in the <b>Amplitude</b> hardkey menu.
RF Blank Routing:	Which marker, if any, implements the ESG's RF blanking function (described on <a href="#">page 137</a> ) when the marker signal is low. RF blanking also uses ALC hold. There is no need to select the ALC Hold Routing for the same marker when you are using the RF Blank Routing function. When the marker signal goes high, RF blanking is discontinued.
High Crest Mode	This field displays the status of the high crest mode for the dual ARB player. The high crest mode reduces ALC levels while playing ARB waveform files, resulting in the maximum output level but reducing power level accuracy. This setting can only be changed for files in the dual ARB player.
Mod Attenuation:	The I/Q modulator attenuation setting.
I/Q Mod Filter:	The I/Q modulator filter setting. The modulator filter affects the I/Q signal modulated onto the RF carrier.
I/Q Output Filter:	The I/Q output filter setting. The I/Q output filter is used for I/Q signals routed to the rear panel I and Q outputs.

3. Return to the ARB Setup menu: Press **Return**.

You are now in the **ARB Setup** softkey menu. From this menu you can access all the signal generator settings that are saved to the file header. However, not all ESG settings are saved to the file header. For example, the **ARB Reference Ext Int** softkey selection is not part of the saved header settings. [Figure 4-3](#) shows the ARB Setup softkey menu and the softkey paths used in steps four through nine.

Arbitrary (ARB) Waveform File Headers

Figure 4-3 ARB Setup Softkey Menu and Marker Utilities

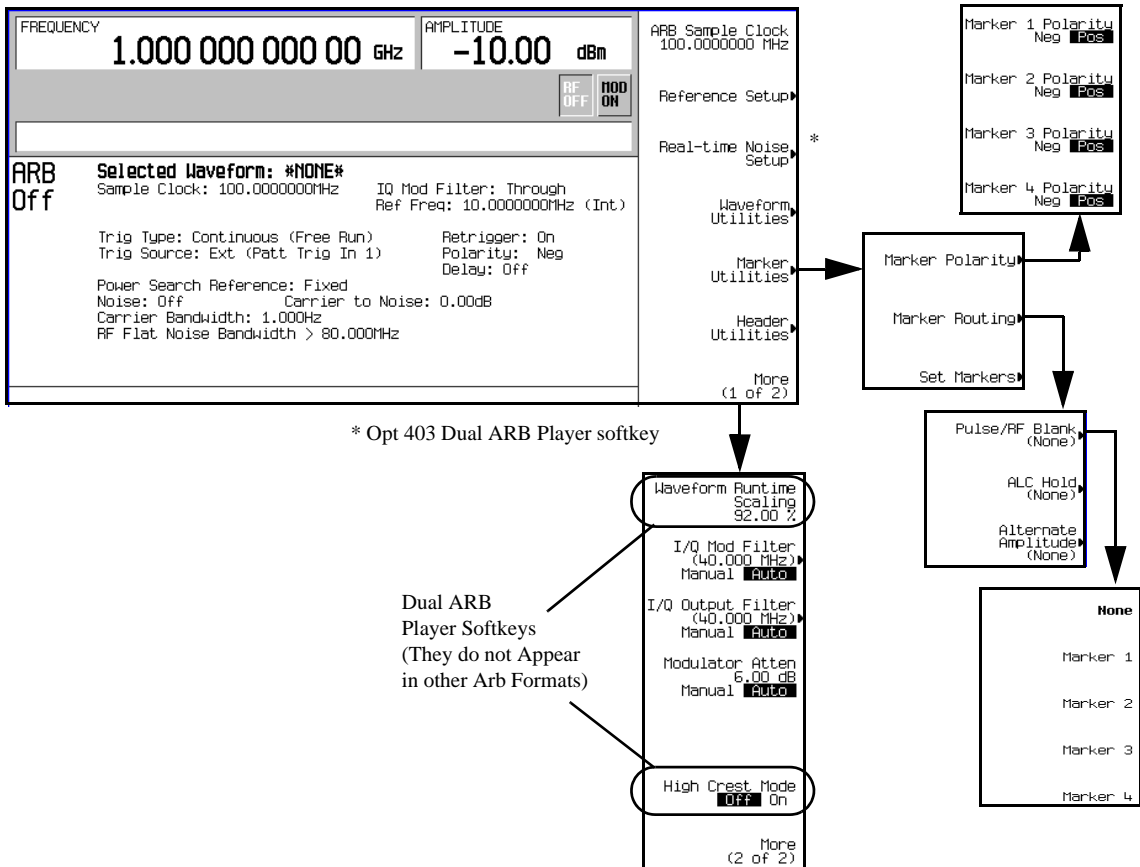

4. Set the ARB sample clock to 5 MHz: Press **ARB Sample Clock > 5 > MHz**.
5. Set the modulator attenuation to 15 dB:  
Press **More (1 of 2) > Modulator Atten n.nn dB Manual Auto** to **Manual > 15 > dB**.
6. Set the I/Q modulation filter to a through:  
Press **I/Q Mod Filter Manual Auto** to **Manual > Through**.
7. Set marker one to blank the RF output at the set marker point(s):  
Press **More (2 of 2) > Marker Utilities > Marker Routing > Pulse/RF Blank > Marker 1**.  
For information on setting markers, see [“Using Waveform Markers”](#) on page 124.
8. Set the polarity of Marker 1 negative:  
Press **Return > Marker Polarity > Marker 1 Polarity Neg Pos** to **Neg**.

- Return to the Header Utilities menu: Press **Return** > **Return** > **Header Utilities**.

Notice that the Current Inst. Settings column now reflects the changes made in steps 4 through 8 to the current signal generator setup, but that the saved header values have not changed (as shown in [Figure 4-4](#) below).

**Figure 4-4 Differing Values between Header and Current Setting Columns**

The screenshot displays the 'File Header Information' menu for 'UFI1:AUTOGEN\_WAVEFORM'. It features a table comparing 'Saved Header Settings' and 'Current Inst. Settings'. The 'Current Inst. Settings' column shows updated values for Sample Rate (5.000000 MHz), Marker 1 Polarity (Neg), and Marker 1 (Marker 1), which differ from the 'Saved Header Settings' (11.0592 MHz, Positive, None). The interface also includes navigation buttons like 'Page Up', 'Page Down', and 'Page 1', 'Page 2'.

Header Field	Saved Header Settings	Current Inst. Settings
Description		
Sample Rate	11.0592 MHz	5.000000 MHz
Runtime Scaling	92.00 %	92.00 %
Marker 1 Polarity	Positive	Neg
Marker 2 Polarity	Positive	Pos
Marker 3 Polarity	Positive	Pos
Marker 4 Polarity	Positive	Pos
ALC Hold Routing	None	None
Alt Amp1. Routing	None	None
RF Blank Routing	None	Marker 1
High Crest Mode	Off	Off
Mod Attenuation	Auto	15.00 dB
I/Q Mod Filter	Auto	2.100 MHz
I/Q Output Filter	Auto	Auto

- Save the current settings to the file header: Press the **Save Setup To Header** softkey.

The settings from the Current Inst. Settings column now appear in the Saved Header Settings column. The file header has been modified and the current instrument settings saved. This is shown in [Figure 4-5](#).

Arbitrary (ARB) Waveform File Headers

Figure 4-5 Saved File Header Changes

The screenshot displays the 'File Header Information' for a waveform file named 'AUTOGEN\_WAVEFORM'. At the top, the frequency is set to 4.000 000 000 00 GHz and the amplitude is -136.00 dBm. Below this, there are control buttons for 'CDMA2K', 'I/Q', 'RF OFF', and 'MOD ON'. The main part of the interface is a table with three columns: 'Header Field', 'Saved Header Settings', and 'Current Inst. Settings'. The table is divided into two pages. Page 1 includes fields for 'Description', 'Sample Rate', 'Runtime Scaling', and four 'Marker' polarities. Page 2 includes 'RF Blank Routing', 'High Crest Mode', 'Mod Attenuation', 'I/Q Mod Filter', and 'I/Q Output Filter'. On the right side of the table, there are navigation buttons: 'Edit Description', 'Clear Header', 'Save Setup To Header', 'Page Up', and 'Page Down'. Arrows point from 'Page 1' and 'Page 2' labels to the corresponding sections of the table.

Header Field	Saved Header Settings	Current Inst. Settings
Description		
Sample Rate	5.0000 MHz	5.0000000 MHz
Runtime Scaling	92.00 %	92.00 %
Marker 1 Polarity	Negative	Neg
Marker 2 Polarity	Positive	Pos
Marker 3 Polarity	Positive	Pos
Marker 4 Polarity	Positive	Pos
ALC Hold Routing	None	None
Alt Ampl. Routing	None	None
RF Blank Routing	Marker 1	Marker 1
High Crest Mode	Off	Off
Mod Attenuation	15.000 dB	15.00 dB
I/Q Mod Filter	2.1000 MHz	2.100 MHz
I/Q Output Filter	Auto	Auto

While a modulation format is active (on), the AUTOGEN\_WAVEFORM waveform file plays and you can modify the header information. Once you turn the modulation format off, the header information is available only through the dual ARB player.

---

**NOTE** If you turn the modulation format off and then on, you overwrite the previous AUTOGEN\_WAVEFORM file and its file header. To avoid this, rename the file before you turn the modulation format back on (see [“Storing Waveform Segments to Non-Volatile Memory”](#) on page 113).

---

## Dual ARB Player Waveform Sequence File Headers

When you create a waveform sequence (described on [page 109](#)), the ESG automatically creates a default file header, which takes priority over the headers for the waveform segments that compose the waveform sequence. During a waveform sequence playback, the waveform segment headers are ignored (except to verify that all required options are installed). When you store the waveform sequence, its file header is stored with it.

Follow the procedure “[Creating a Waveform Sequence](#)” on [page 109](#) to generate a waveform sequence file header.

## Editing and Viewing File Headers in the Dual ARB Player

Before you can edit a file header in the dual ARB player, the associated waveform file must reside in volatile waveform memory (WFM1). In addition, you cannot edit the AUTOGEN\_WAVEFORM file header in the dual ARB player if the AUTOGEN\_WAVEFORM file is currently being played by another modulation format such as Custom real time. Turn off the modulation format then play the AUTOGEN\_WAVEFORM file using the dual ARB player. You can then modify the file header.

If you want to edit a file header for a waveform file that resides in non-volatile memory (NVWFM), move it to WFM1 and then play it. Refer to “[Loading Waveform Segments from Non-Volatile Memory](#)” on [page 114](#) for information on loading files from NVWFM.

Edits to file headers can only be performed when the waveform file is playing. After making changes to the signal generator settings and parameters, you can apply these new settings to the waveform by pressing the **Save Setup To Header** softkey and then reselecting the waveform file for playback. When you do this, you will see the values from the Saved Header Settings column overwrite the settings in the Current Inst. Settings column. For information on selecting and playing waveform files, see “[Playing a Waveform Sequence](#)” on [page 110](#).

---

**NOTE** Edits to file headers can only be performed when the waveform file is playing.

---

## Modifying File Header Information

All file header descriptions listed in the procedure “[Modifying Header Information](#)” on [page 95](#) are valid in the dual ARB player. The following procedure selects a waveform file, accesses its file header, and then refers you back to the aforementioned procedure to perform the edits. This procedure assumes there is an a user-defined waveform file or an AUTOGEN\_WAVEFORM file in WFM1. For information on creating the AUTOGEN\_WAVEFORM file and associated file header, refer to “[Creating a File Header](#)” on [page 93](#).

1. Press **Mode > Dual ARB > Select Waveform**.
2. Using the arrow keys, highlight the waveform file that needs its file header edited.

## Arbitrary (ARB) Waveform File Headers

3. Press the **Select Waveform** softkey.
4. Press **ARB Off On** to On.
5. Press **ARB Setup > Header Utilities**.
6. Edit the file header.
  - a. If you have a default file header, go to [“Modifying Header Information” on page 95](#), read the additional information for step one, and then perform the rest of the steps in the procedure.
  - b. If you need to edit an existing file header, start with step three in the [“Modifying Header Information”](#) procedure on [page 95](#).

### Viewing the file header with the Dual ARB Player Off

One of the differences between the dual ARB player and other Arb formats is that you can view a file header without the dual ARB being on (ARB Off On softkey set to Off). However, you cannot edit the displayed file header. This was done to prevent an accidental change to a file header for an AUTOGEN\_WAVEFORM file that may be playing in a modulation format. With the dual ARB player turned off, perform the following steps.

1. Press **Mode > Dual ARB > Select Waveform**.
2. Using the arrow keys, highlight the desired waveform file.
3. Press the **Select Waveform** softkey.
4. Press **ARB Setup > Header Utilities**.

The file header is displayed in the ESG display and you can see that the file header editing softkeys are grayed-out (inactive) as shown in [Figure 4-6 on page 103](#).

**Figure 4-6 Viewing a File Header**

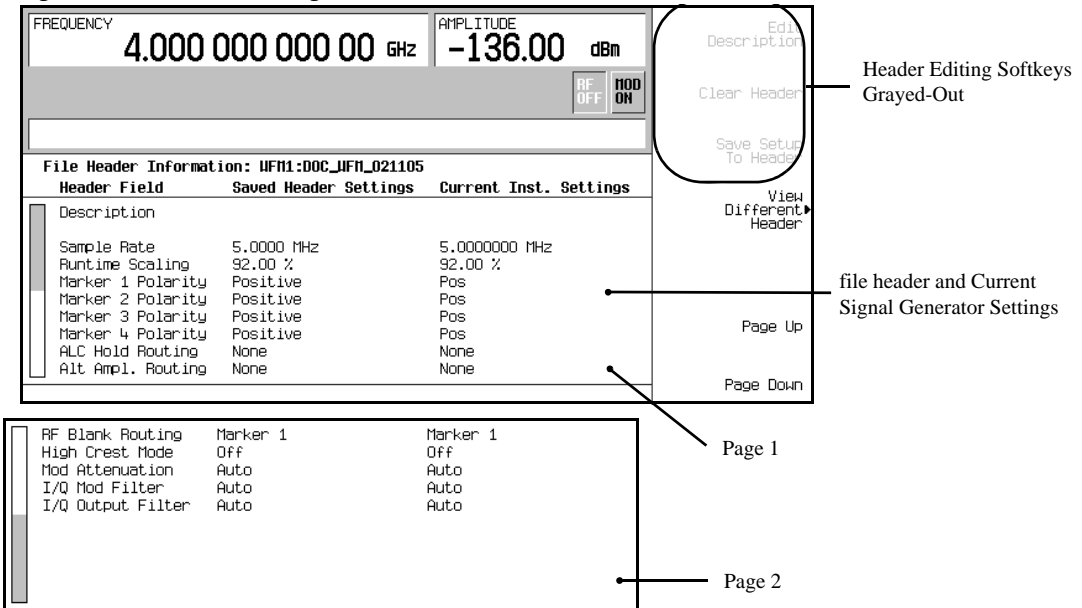

### Viewing a Different File Header

You can view file headers for other waveform files, even while the dual ARB player has a waveform playing. However, you can edit a file header only when the associated waveform file is being played by the dual ARB player. When you select another file header for viewing, the header editing softkeys are grayed-out as shown in [Figure 4-6](#).

This procedure will guide you through the available viewing choices.

1. Press **Mode > Dual ARB > ARB Setup > Header Utilities > View Different Header**

Notice that the waveform files in the table are listed in alphabetical order.

Arbitrary (ARB) Waveform File Headers

Figure 4-7 Waveform File List for Viewing a Different Header

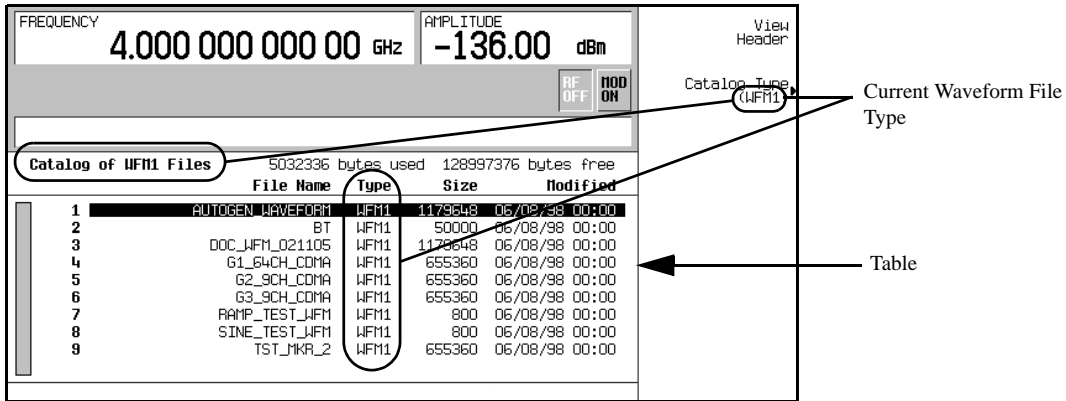

2. Press the **Catalog Type** softkey.

Now you have a choice of three waveform file types that can be displayed in the table accessed in step one. These choices are shown in Figure 4-8.

Figure 4-8 Waveform File Type Selection

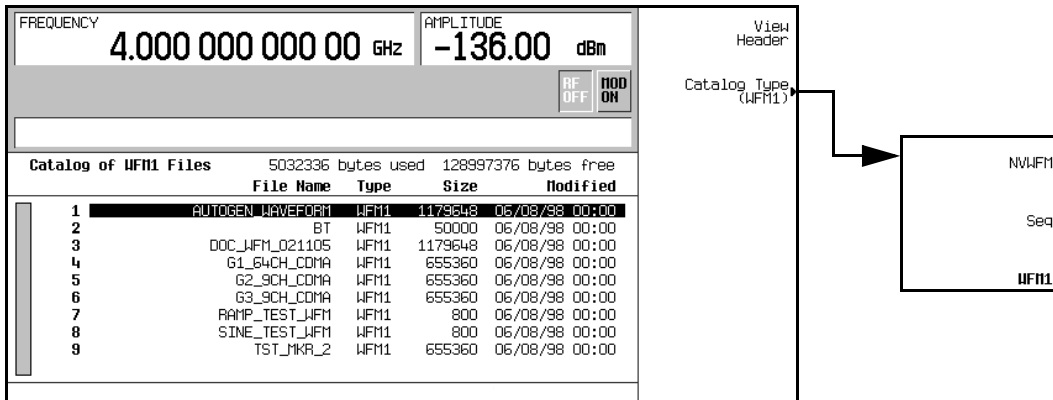

**NWFM1**

This choice will display all of the waveform segments currently stored in non-volatile memory.

**Seq**

This choice will display all of the waveform sequence files.



**WFM1** This choice will display all of the waveform segments that currently reside in volatile memory.

3. Press the **NVWFM** softkey.

After pressing the softkey, you are returned to the waveform file listing table that now displays the waveform files from non-volatile memory. This is shown in [Figure 4-9](#).

**Figure 4-9 NVWFM Waveform Files Showing**

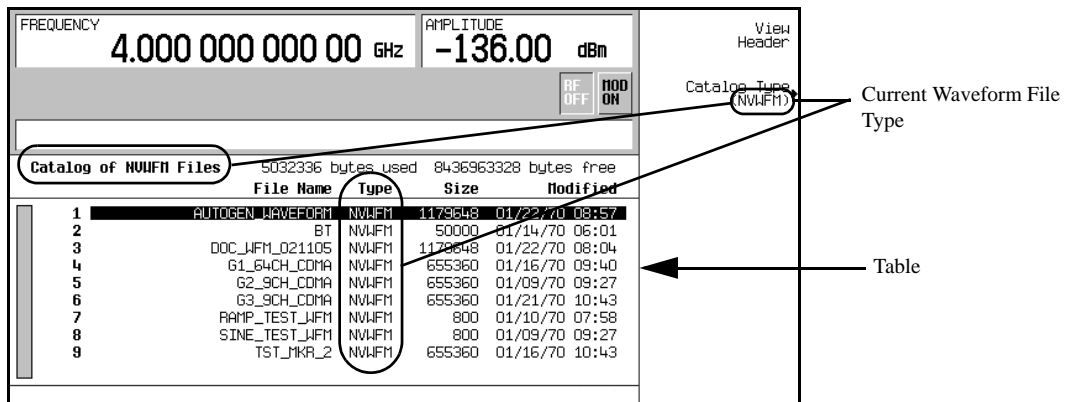

4. Highlight a waveform file.
5. Press the **View Header** softkey.

The file header for the selected waveform file is shown in the ESG display. If there was a waveform playing, its header information is removed from the ESG display, but its settings are still used by the signal generator. There are two ways to return to the header information for the playing waveform. One way is to press the **View Different Header**, select the current playing waveform file, and press **View Header**. The second way is to press **Return** and then **Header Utilities**.

### Playing a Waveform File containing a Header

After a waveform file (AUTOGEN\_WAVEFORM) has been generated by a modulation format and the format is turned off, the AUTOGEN\_WAVEFORM file is accessible to and can be played back only in the dual ARB player. This is also true for downloaded waveform files.

The file header settings, associated with the waveform file, are used to configure signal generator settings and parameters when the waveform is selected for playback in the dual ARB. Some of these settings will appear as part of the softkey labels. In addition, some of the saved header settings will appear on the dual ARB summary display. This is shown in [Figure 4-10 on page 106](#). Follow the procedure “[Playing a Waveform Sequence](#)” on [page 110](#) to apply file header settings and to play back a waveform.

Basic Digital Operation (Option 001/601 or 002/602)  
**Arbitrary (ARB) Waveform File Headers**

**Figure 4-10 File Header Settings Applied**

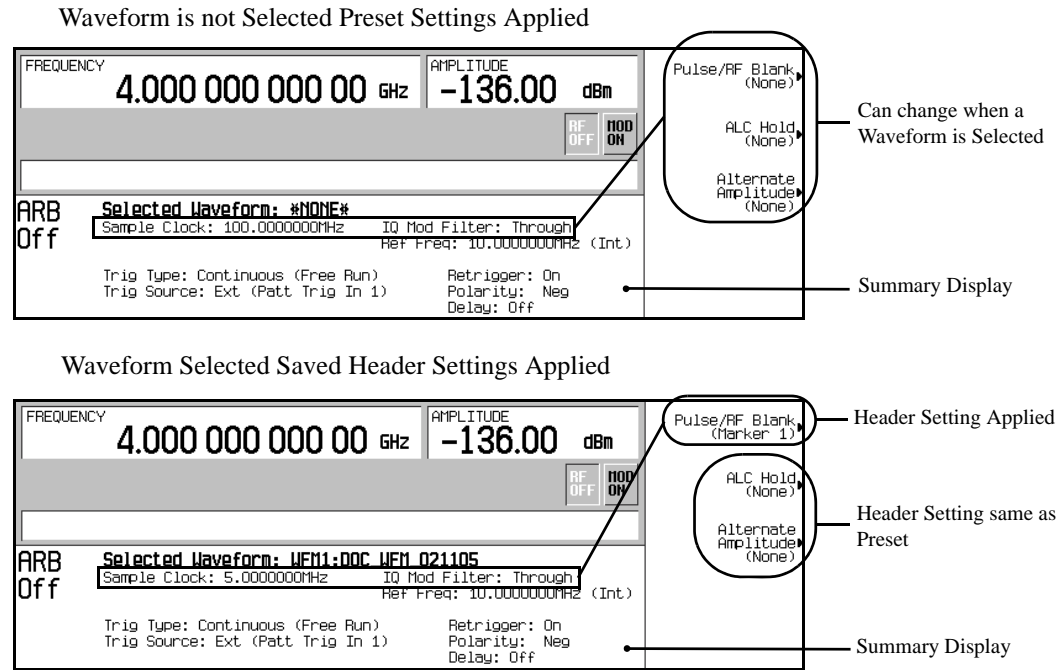

If you change any of the signal generator settings listed in the file header after the waveform file is selected, the changed setting(s) will appear in the file header's Current Inst. Settings column and they will be applied to the signal generator instead of the saved header settings. To reapply the saved header settings, reselect the waveform for playback.

---

**NOTE** The signal generator used to play back a stored waveform file must have the same options as are required to generate the file.

---

## Using the Dual ARB Waveform Player

The dual arbitrary (ARB) waveform player is used to play back waveform files. There are two types of waveform files: segments and sequences. A segment is a waveform file that is created using one of the signal generator's pre-defined ARB formats (Custom, W-CDMA, CDMA2000, etc.). A sequence can be described as several segments strung together to create one waveform file. Waveform files can also be created remotely using another signal generator or using computer programs and downloaded to the ESG for playback by the dual ARB waveform player. For information on downloading waveforms, refer to the *E4428C/38C ESG Signal Generator Programming Guide*. The dual ARB player is used to rename and store waveform files and to load waveform files from the signal generator's memory.

A waveform file is automatically generated whenever an ARB modulation format is turned on. This automatically generated file is named AUTOGEN\_WAVEFORM. Because this default file name is shared among all ARB formats, it must be renamed if you want to save the information contained in the file. If the file is not renamed, it will be overwritten when another ARB format is turned on.

Before you can play or edit any waveform file, it must reside in volatile waveform memory. The signal generator has two types of memory, WFM1 (volatile waveform memory) and NVWFM (non-volatile waveform memory). Load a stored waveform file from NVWFM into volatile memory (WFM1) where it can be edited or played by the ARB waveform player.

The dual ARB waveform player provides markers ([page 124](#)), triggering ([page 140](#)), and clipping ([page 149](#)) capabilities.

## Accessing the Dual ARB Player

Press **Mode** > **Dual ARB**.

The first-level softkey menu is shown in the following figure. Most procedures start from this menu.

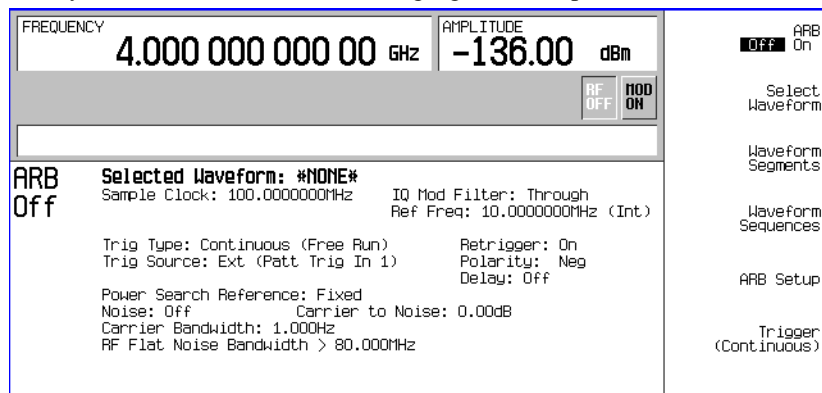

## Creating Waveform Segments

There are two ways to provide waveform segments for use by the waveform sequencer. You can either download a waveform via the remote interface, or generate a waveform using one of the Arb modulation formats. For information on downloading waveforms via the remote interface, see the *E4428C/38C ESG Signal Generator Programming Guide*.

The following procedure describes how to create waveform segments using IS-95A CDMA waveforms. In this procedure, you generate two IS-95A CDMA waveforms, a predefined 64 channel forward CDMA state and a predefined 9 channel forward CDMA state. After the two waveform segments are named and stored in memory, they are used to build a waveform sequence in the procedure, “[Creating a Waveform Sequence](#)” on [page 109](#).

1. Generate the first waveform:

- a. Press **Preset**.
- b. Press **Mode > CDMA > Arb IS-95A**.
- c. Press **Setup Select > 64 Ch Fwd**.
- d. Press **CDMA Off On** until On is highlighted.

This generates a waveform named AUTOGEN\_WAVEFORM with the predefined 64 channel forward link CDMA configuration. The 64 channel forward link AUTOGEN\_WAVEFORM is stored in volatile waveform memory (WFM1). During waveform generation, the CDMA and I/Q annunciators are shown on the ESG’s front panel display.

- e. Press **CDMA Off On** until Off is highlighted.

The AUTOGEN\_WAVEFORM file is in use while the ARB modulation format is on; preventing you from performing the modifications to the file as required in the following steps. When the modulation format is turned off the AUTOGEN\_WAVEFORM file remains in WFM1 and can be modified and saved using a different file name.

2. Create the first waveform segment.

The AUTOGEN\_WAVEFORM, created in the previous step, will be renamed and become the first waveform segment.

- a. Press **Mode > Dual ARB > Waveform Segments > Load Store** to Store.
- b. Highlight the default AUTOGEN\_WAVEFORM file using the front panel arrow keys.
- c. Press **Rename Segment > Editing Keys > Clear Text**.
- d. Enter a file name (for example, FWDCH\_64), and press **Enter > Store Segment To NVWFM Memory**. This renames the waveform segment, and stores a copy in non-volatile memory (NVWFM).

---

**NOTE** Because there can be only one AUTOGEN\_WAVEFORM waveform in WFM1 at any given time, you must rename this file to clear the way for a second waveform.

---

3. Generate the second waveform:
  - a. Press **Mode > CDMA > Arb IS-95A**.
  - b. Press **Setup Select > 9 Ch Fwd**.
  - c. Press **CDMA Off On** until On is highlighted.
  - d. Press **CDMA Off On** until Off is highlighted.

4. Create the second waveform segment:

Repeat Step 2, giving this segment a different descriptive name (for example, FWDCH\_9).

## Creating a Waveform Sequence

A waveform sequence is made up of segments but can also contain other sequences. Any number of segments, up to 32768, can be used to create a sequence. This limit count is determined by the number of segments in the waveform sequence. Segments and sequences can be repeated within a waveform sequence and the total of all segments and repeated segments cannot exceed the limit count. [Figure 4-11](#) shows a waveform sequence made up of two sequences and three segments. In this example the segment count is eleven.

**Figure 4-11** Waveform Sequence Diagram

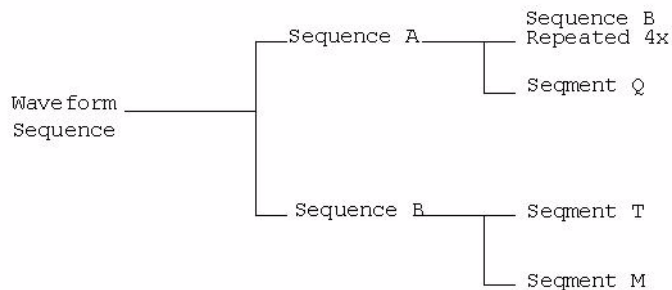

## Building a Waveform Sequence

The following procedure shows how to create, edit, and store a waveform sequence using the two waveform segments created in the section “[Creating Waveform Segments](#)” on page 108. This procedure assumes that the waveform segments FWDCH\_64 and FWDCH\_9 are present in WFM1. To use a segment in a sequence, the segment must reside in volatile memory; for information on loading waveform segments from non-volatile to volatile memory, see [page 114](#).

1. Select the waveform segments:

Define a sequence as one repetition of the FWDCH\_64 segment followed by one repetition of the FWDCH\_9 waveform segment.

## Using the Dual ARB Waveform Player

- a. Press **Mode > Dual ARB > Waveform Sequences > Build New Waveform Sequence > Insert Waveform.**
  - b. Highlight the FWDCH\_64 waveform segment and press **Insert Selected Waveform.**
  - c. Highlight the FWDCH\_9 waveform segment and press **Insert Selected Waveform.**
  - d. Press **Done Inserting**
2. **Optional:** Enable markers as desired for the segments in the new sequence: see [page 134](#).
3. Name and store the waveform sequence to the Catalog of Seq Files in the memory catalog:
- a. Press **Name and Store.**
  - b. Enter a file name (for example, FWDCH\_64+FWDCH\_9).
  - c. Press **Enter.**

## Playing a Waveform Sequence

You can play a waveform sequence or a waveform segment using this procedure. Both waveform types use the same process.

If you have not created waveform segments and used them to build and store a waveform sequence, complete the steps in the previous procedures, “[Creating Waveform Segments](#)” on [page 108](#) and “[Creating a Waveform Sequence](#)” on [page 109](#).

---

**NOTE** A waveform segment must reside in volatile memory (WFM1) before it can be played individually or as part of a waveform sequence. Refer to “[Loading Waveform Segments from Non-Volatile Memory](#)” on [page 114](#) for more information.

---

1. Select a waveform sequence:
  - a. Press **Mode > Dual ARB > Select Waveform.**
  - b. Highlight a waveform sequence (for this example, FWDCH\_64+FWDCH\_9) from the Sequence column of the Select Waveform catalog, and press **Select Waveform.**

The display shows the currently selected waveform (for example, Selected Waveform: SEQ:FWDCH\_64+FWDCH\_9).

2. Generate the waveform:  
Press **ARB Off On** to On.

This plays the waveform sequence created in the previous procedures. During the waveform sequence generation, the ARB and I/Q annunciator are displayed. The waveform is now modulating the RF carrier.

3. Configure the RF Output:
  - a. Set the RF carrier frequency.
  - b. Set the RF output amplitude.
  - c. Turn on the RF output.

The waveform sequence is now available at the signal generator's RF OUTPUT connector.

## Editing a Waveform Sequence

This procedure shows how to edit waveform segments within a waveform sequence, and then save the edited sequence with the segment changes. Within the editing display, you can change the number of times each segment plays (repetitions), delete segments from a sequence, add segments to a sequence, toggle markers on and off (described on [page 134](#)), and save changes. There are two ways to save changes, they can be saved to the current waveform sequence or they can be saved using a different waveform sequence name.

---

**NOTE** If you do not store changes to the waveform sequence before exiting the waveform sequence editing display, changes will not be made.

---

## Modifying the Sequence

1. Press **Waveform Sequences**.
2. Highlight the waveform sequence (for example, FWDCH\_64+FWDCH\_9).
3. Press **Edit Selected Waveform Sequence**.
4. Highlight the first waveform entry (for example, WFM1:FWDCH\_64).
5. Press **Edit Repetitions > 100 > Enter**.

The number of repetitions for the first waveform entry changes to 100 and the cursor moves to the next entry.

6. Press **Edit Repetitions > 200 > Enter**.

You have now changed the number of repetitions for each waveform segment entry from 1 to 100 and 200, respectively. The following procedures show how to save these changes.

## Saving Changes to the Current Sequence Name

Press **Name and Store > Enter**

You have now changed the number of repetitions for each waveform segment entry from 1 to 100 and 200,

## Using the Dual ARB Waveform Player

respectively. The sequence with the changes is stored under the same name to the Catalog of Seq Files in the signal generator's memory catalog.

### Saving Changes to a Different Sequence Name

1. Press **Name and Store**.
2. Press **Editing Keys > Clear Text**.
3. Enter a file name (for example, CH64\_100+CH9\_200) using the alpha/symbol softkeys and the numeric keypad.
4. Press **Enter**.

A new waveform sequence, CH64\_100+CH9\_200 is now defined based on the original sequence. It is a copy of the original sequence, FWDCH\_64+FWDCH\_9.

### Adding Real Time Noise to a Dual ARB Waveform (Option 403)

The signal generator with option 403 can apply additive white gaussian noise (AWGN) to a carrier in real time while the modulating waveform file is being played by the dual ARB waveform player. The AWGN can be configured using front panel softkeys. The **Carrier to Noise Ratio** softkey allows you to specify the amount of noise power relative to carrier power that is applied to the signal. The **Carrier Bandwidth** softkey sets the bandwidth over which the noise is integrated and the **Noise Bandwidth Factor** softkey allows you to select a flat noise bandwidth. Refer to the *E4428C/38C ESG SCPI Command Reference* for remote operation commands and the *E4428C/38C ESG Signal Generator Key and Data Field Reference* for key descriptions.

The following procedure sets up a carrier and modulates it using the pre-defined SINE\_TEST\_WFM waveform file. AWGN is then applied to the carrier.

### Configuring AWGN

1. Preset the signal generator. Press the **Preset** hardkey.
2. Press the **Frequency** hardkey and enter 1.5 GHz.
3. Press the **Amplitude** hardkey and enter -10 dBm.
4. Press **RF On Off** to On.
5. Press **Mode > Dual ARB > Select Waveform** and highlight the SINE\_TEST\_WFM waveform.
6. Press **Select Waveform**.
7. Press **ARB Off On** to On.
8. Press **ARB Setup > ARB Sample Clock** enter 50 MHz.
9. Press **Real-time Noise Setup > Carrier to Noise Ratio** and enter 30 dB.
10. Press **Carrier Bandwidth** and enter 40 MHz.
11. Press **Real-time Noise Off On** to On.

This procedure applies AWGN to the 1.5 GHz carrier. The displayed power level of the signal generator, -10 dBm, will include the noise power which is set as a carrier to noise ratio (C/N) of 30 dB. Noise power,



for the purpose of C/N, is applied across a carrier bandwidth of 40 MHz. The default noise bandwidth factor is 1, which provides a flat noise signal bandwidth of a least 0.8 times the 50 MHz sample rate.

## Storing and Loading Waveform Segments

Waveform segments can reside in volatile memory (WFM1), or they can be stored in non-volatile memory (NVWFM), or both. However, to play or edit a waveform file, the file must reside in WFM1. Because files stored in volatile memory do not survive a power cycle, it is a good practice to store waveform files to non-volatile memory and load them to volatile memory whenever you want to use them.

### Storing Waveform Segments to Non-Volatile Memory

Recall that there are two types of files used in the dual ARB player, segments (a single waveform file) and sequences (a series of waveform files). A sequence is comprised of multiple segments and may include other sequences. Refer to “[Creating a Waveform Sequence](#)” on page 109 for more information on segments and sequences.

The segments that compose a waveform sequence are not stored when the waveform sequence is stored. You must save any segment or segments used to create a waveform sequence. Storing just the waveform sequence will result in losing the waveform segments when the signal generator is turned off or rebooted during an ESG firmware upgrade. When this occurs, you cannot play the waveform sequence until the segments are recreated using the same file names that the sequence expects. If you attempt to play the sequence without the segments, an error, **ERROR: 629, File format invalid** will be reported, since the dual ARB player can no longer find the waveform segments that make up the sequence.

Waveform segments must reside in volatile memory (WFM1) to be edited or played individually and all components, such as segments and other sequences, of a sequence must reside in WFM1.

The following example demonstrates storing waveform segments. If you have not created waveform segments, complete the steps in the previous section, “[Creating Waveform Segments](#)” on page 108. In this example, the sequence is stored to the Catalog of Seq Files and the segments are stored to the Catalog of NVWFM files.

1. Press **Mode > Dual ARB > Waveform Segments**.
2. Press **Load Store** to Store.
3. Highlight the waveform segment you want to store.
4. If the waveform segment needs to be renamed, follow steps a through d, if not, proceed to step five.
  - a. Press **Rename Segment > Editing Keys > Clear Text**.
  - b. Enter a name for the waveform segment using the displayed alpha/symbol softkeys along with the numeric keypad. The maximum length for a file name is 23 characters (alphanumeric and special characters).

## Using the Dual ARB Waveform Player

- c. Press **Enter**.
  - d. Highlight the waveform segment that was renamed.
5. Press **Store Segment to NVWFM Memory**.
  6. Repeat steps three through five for all segments that you want to store.

In addition to the above method for saving segments to NVWFM, the signal generator allows you to store all files, residing in WFM1, into NVWFM. This is accomplished using the **Store All to NVWFM Memory** softkey.

### Loading Waveform Segments from Non-Volatile Memory

Waveform segments must reside in volatile memory (WFM1) before they can be played, edited, or be included in a sequence. In addition, you need to load segments into WFM1 whenever power is cycled to the ESG or an action initiated that causes the ESG to reboot.

1. Press **Mode > Dual ARB > Waveform Segments**.
2. Highlight the waveform segment you want to load.
3. Press **Load Segment From NVWFM Memory**.

In addition to the above method, the signal generator allows you to load all files, residing in NVWFM, into WFM1. This is accomplished using the **Load All From NVWFM Memory** softkey.

## Understanding the I/Q Modulator Filter

The I/Q modulator filter (**I/Q Mod Filter Manual Auto** softkey) lets you select either post-reconstruction low pass filtering that has a narrower bandwidth than that of the reconstruction filter, or no post-reconstruction filtering. It can be used with both real time and ARB signals.

There are two modes for the I/Q modulator filter: auto or manual. With auto, the signal generator automatically selects either filtering (2.1 MHz or 40 MHz) or no filtering depending on the signal configuration. With manual, the user can select a 2.1 MHz filter, a 40 MHz filter, or no filter.

The low pass filter selections are fifth order elliptic filters that exhibit very low passband ripple. These filters are positioned before the I/Q modulator, so the filtering is applied separately to the I and Q paths. Since they are post-reconstruction filters, they do not apply any oversampling.

Because the filters are for the I and Q signals and not the modulated signal, they are filtering the I/Q bandwidth, which has up to 40 MHz for I and 40 MHz for Q (80 MHz total I/Q bandwidth). This means that when viewed through the RF output, the filter size appears to be twice the size of the selected filter. For example, the 2.1 MHz I/Q bandwidth filter shows as a 4.2 MHz filter in the RF bandwidth.

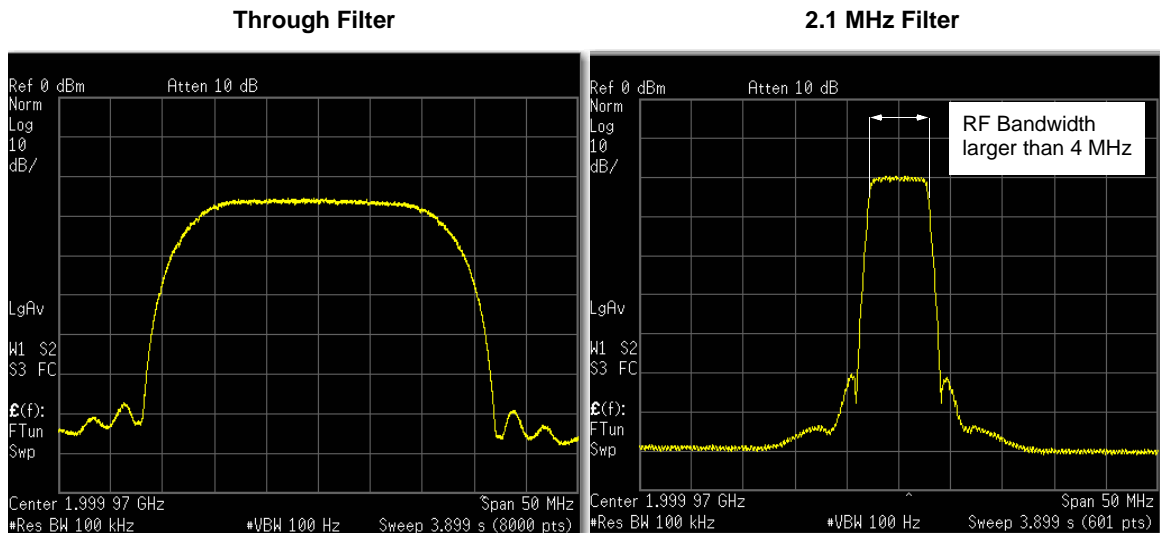

The 2.1 MHz filter is for improving the ACPR on single carrier wideband signals such as W-CDMA. The 40 MHz filter is best used to eliminate spurious events. As with any filter, the I/Q modulator filters do add some group delay. To determine whether the filters may be contributing to distortion or some unexpected signal artifact, select the through path and view the signal. If there is no change in the signal, then the I/Q modulator filter is not the cause.

## **Applying An I/Q Modulator Filter**

### **Real Time Signals**

1. Configure the signal.
2. Set the I/Q modulator filter:
  - a. Press **I/Q > More (1 of 2) > I/Q Mod Filter Manual Auto**.

This key is active only when using a real time signal. When using an ARB signal, the **I/Q Mod Filter Manual Auto** softkey within the I/Q menu grays out.

- b. In the filter menu, select **Through, 2.1 MHz, 40 MHz, or Auto**.
3. If not already done, turn on the modulation format.
4. Turn on the RF output.

### **ARB Signal**

The I/Q modulator filter selections reside within the modulation format menu, instead of in the I/Q menu as for the real time signals. For more information, see [“I/Q Attenuator and Filters Settings” on page 117](#).

1. Configure the signal.
2. Within the ARB modulation format menu, set the I/Q modulator filter:
  - a. Press **ARB Setup > more (1 of 2) > I/Q Mod Filter Manual Auto**.  
The **more (1 of 2)** softkey may not appear in all menus.
  - b. In the filter menu, select **Through, 2.1 MHz, 40 MHz, or Auto**.
3. If not already done, turn on the modulation format.
4. Turn on the RF output.

---

## Local Settings for ARB Waveform Formats and the Dual ARB Player

To provide you with the greatest convenience in optimizing and replicating waveforms for playback in the dual ARB player, settings that were previously (pre-C.03.10 firmware release) found in only the dual ARB player have now been incorporated into each of the ARB modulation formats. In addition, some of the I/Q waveform settings previously found in the I/Q and MUX hardkey menus are also present in the ARB modulation formats and the dual ARB player. These settings are shown in the following list, and explained in the sections that follow:

- I/Q output filter
- I/Q modulator filter
- I/Q modulator attenuator
- Waveform runtime scaling
- High crest mode
- ARB sample clock
- Markers

### I/Q Attenuator and Filters Settings

The I/Q output filter, modulator attenuator, and the I/Q modulator filter parameters are now set locally within each ARB modulation format (W-CDMA, CDMA2000, AWGN, Multitone, etc.) and the dual ARB player. When you set these signal generator parameters within one modulation format, they will not apply to the others. These settings are applied to the signal generator when the modulation format is turned on or the saved waveform is selected in the dual ARB player. They can also be saved to the file header. The I/Q output attenuator (I/Q Output Atten softkey located in the I/Q hardkey menu) still maintains its original behavior in that it is a global setting (applies to all signal generator formats).

### Front Panel Changes

In pre-C.03.10 firmware releases, the I/Q output filter, modulator attenuator, and the I/Q modulator filter parameters were set globally from the **I/Q** and/or the **Mux** hardkey menus using the **I/Q Mod Filter Manual Auto**, **Modulator Atten nnn dB Manual Auto**, **I/Q Output Filter Manual Auto**, and the **I/Q Mod Filter Manual Auto** softkeys. These three softkeys now appear in each of the ARB formats and the dual ARB player. This enables you to set these parameters locally within each ARB format and the dual ARB player.

The three softkeys in the I/Q and mux menus now apply only to the real time formats and externally applied I/Q signals. The real time formats are the ones preceded with real time on the ESG softkey labels and usually have BBG as one of the SCPI command mnemonics. When an ARB format or the dual ARB player is active, the three softkeys in the I/Q and mux menus are grayed-out indicating that they do not apply to the ARB

**Local Settings for ARB Waveform Formats and the Dual ARB Player**

format or the dual ARB player.

Setting the three parameters, for the ARB formats or the dual ARB player, are accomplished by accessing the **ARB Setup** softkey menu located in each of the ARB formats and the dual ARB player. The location of this softkey menu is shown in **Figure 4-12**.

When you save the signal generator setup using the front panel **Save** hardkey function with an ARB format or the dual ARB player, the local settings for the three parameters are also saved.

**Figure 4-12 ARB I/Q Filters and Attenuator Softkey Location**

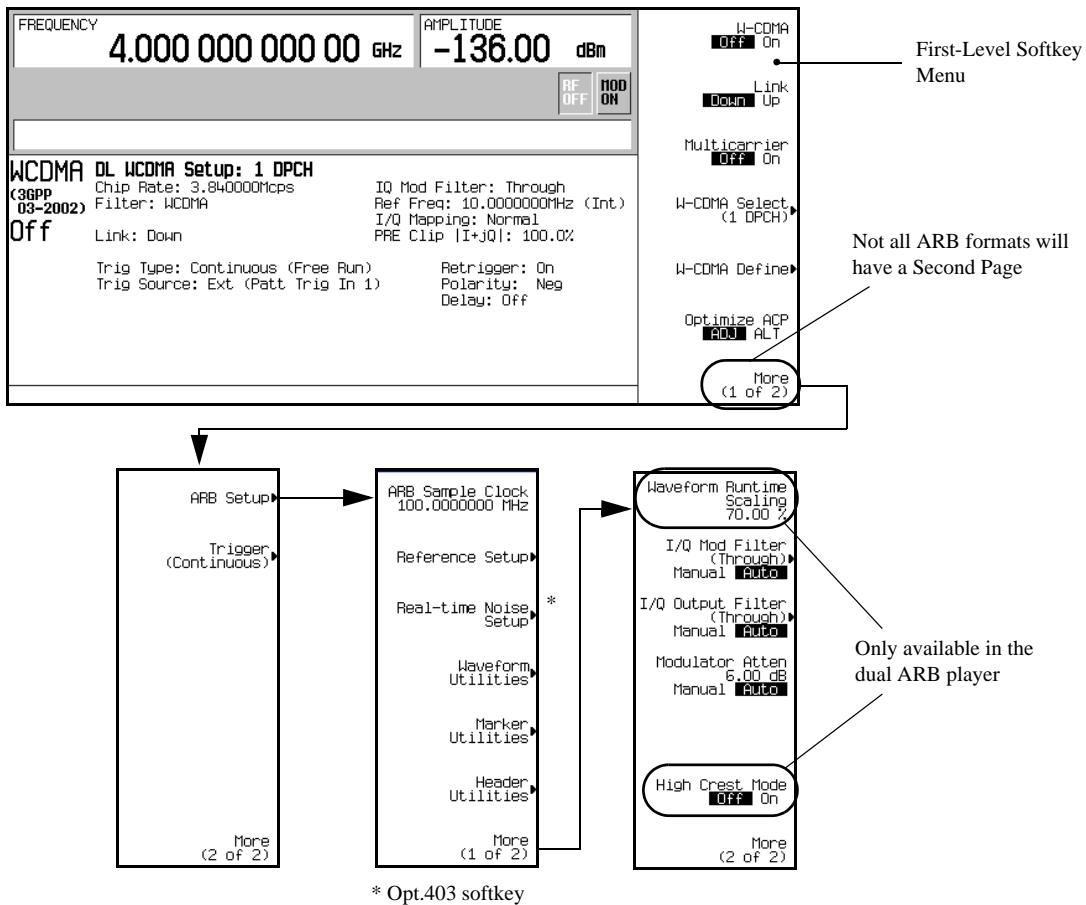

## SCPI Command Changes

New SCPI commands have been developed and included in the C.03.10 and later versions of the firmware. These new commands allow you to set the three parameters discussed earlier for each of the ARB modulation formats and the dual ARB player. Commands have also been changed for the three parameters in the Digital Modulation subsystem to accommodate the local setting feature.

These new commands duplicate the behavior of the softkeys discussed in the previous section. The main difference is that now you can set new values for the three parameters (available in the I/Q and/or MUX menus) while an ARB modulation format is active and playing. However, the new settings will not be applied until the ARB format is turned off. Then they are used only if a real time modulation format is turned on or an external I/Q signal is applied to the ESG.

The pre-C.03.10 Digital Modulation subsystem filter and attenuator commands will still work and have the same behavior, in that they apply changes globally. This means that if you configure a local setting for an ARB format using the new commands, and then executed the older commands from the Digital Modulation subsystem, the older commands would override the local settings.

## Waveform Runtime Scaling

Waveform runtime scaling enables you to set the scaling value that is applied to the waveform while it is playing.

You can set waveform runtime scaling in the **ARB Setup** softkey menu located in the dual ARB player. The location of this softkey is shown in [Figure 4-12](#). This setting is only available for the dual ARB player.

When you save the signal generator setup using the front panel **Save** hardkey function with the dual ARB player, the local setting for waveform runtime scaling is also saved.

## High Crest Mode

High crest mode reduces ALC levels while processing ARB waveform files, resulting in signals with less distortion and improved EVM. However, in the high crest mode, the maximum output level is reduced and power level accuracy is degraded.

You can set this parameter by in the **ARB Setup** softkey menu located in the dual ARB player. The location of this softkey is shown in [Figure 4-12](#). This setting is only available in the dual ARB player.

When you save the signal generator setup using the front panel **Save** hardkey function with the dual ARB player, the local setting for high crest mode is also saved.

## ARB Sample Clock

Each ARB modulation format and the dual ARB player incorporate a local ARB sample clock parameter. For example, you can set the ARB CDMA2000 modulation format's ARB sample rate to 5 MHz, and this parameter would apply only to the ARB CDMA2000 waveform that is currently playing. The 5 MHz setting would not be used in any of the other ARB modulation formats or the dual ARB player. If you were to turn

off the CDMA2000 ARB format and then turn it back on, the factory setting would be applied until you once again change the ARB sample clock value. This setting can be saved to the file header. In this way you can set the ARB sample clock while in the ARB modulation player format, and have that same setting applied when the waveform is selected for playback in the dual ARB player.

The accessibility and setting of the ARB sample clock differs between the ARB modulation formats and the dual ARB player. Within the ARB formats, this parameter can be changed only when the format is active (on). Any value you enter while the format is active, will be replaced with the factory optimized value when the format is turned off and then back on. While the ARB format is off, the **ARB Sample Clock** softkey is grayed-out. In the dual ARB player, the ARB sample clock setting is accessible even when the dual ARB is off. You can also set the ARB sample clock when the dual ARB is off and the new setting is applied when the dual ARB player is turned on. This setting will survive toggling the dual ARB player off and on.

[Figure 4-12 on page 118](#) shows the location for the **ARB Sample Clock** softkey which is on the first page of the **ARB Setup** softkey menu. Even though the figure is for the ARB W-CDMA modulation format, the key path is the same for all ARB formats and the dual ARB player.

## Waveform Markers

Waveform markers are used to mark specific points on a waveform and are available for use in all ARB modulation formats. The signal generator provides four markers. Each marker can be associated with the RF blanking function, the ALC hold function, and the alternate amplitude triggering function. A marker can implement one or all three functions. For more information, refer to the section, [“Using Waveform Markers” on page 124](#).

---

**NOTE** In the Bluetooth modulation format, markers one and two are automatically set when payload data types are selected and the waveform is generated. See [“Bluetooth Marker Behavior” on page 123](#) for more information.

---

You can set each marker’s polarity and the marker points (first sample point or a range of sample points). Each marker provides a rear panel output signal using the event connector (EVENT 1, 2, 3, or 4) that corresponds to the marker number. The EVENT 3 and 4 connectors are actually pins located on the AUX I/O connector. For more information on the AUX I/O connector, see [“Rear Panel Overview” on page 37](#).

The ALC hold marker function holds the ALC modulator at its current level when the marker signal is low. When the marker signal goes high, the ALC hold function is discontinued.

ALC hold is automatically incorporated in the RF blanking marker function. So if you select the RF blanking marker function (**Pulse/RF Blank** softkey), there is no need to select the ALC hold marker function for the same marker number. You can use the ALC hold function by itself when you have a waveform signal that incorporates idle periods or when the increased dynamic range encountered with RF blanking is not desired. The ALC hold should only be used for short periods of time of less than 100 ms. Extended periods of using the ALC hold feature may affect the waveform’s output amplitude.



**Local Settings for ARB Waveform Formats and the Dual ARB Player**

The alternate amplitude marker function triggers the Alternate Amplitude feature located in the **Amplitude** hardkey menu. You still need to set up the alternate amplitude parameters. The trigger selection for the alternate amplitude feature in the Amplitude hardkey menu should be set to internal. When the marker signal goes low, the alternate amplitude function is triggered. When the marker signal goes high, the trigger is terminated disengaging alternate amplitude.

Marker settings are located in the **Marker Utilities** softkey menu. The location of this softkey and the marker softkey menus are shown in [Figure 4-13](#). Even though the figure is for the ARB W-CDMA modulation format, the key path is the same for all ARB formats and the dual ARB player.

Basic Digital Operation (Option 001/601 or 002/602)  
**Local Settings for ARB Waveform Formats and the Dual ARB Player**

**Figure 4-13 ARB Marker Location and Softkey Menus**

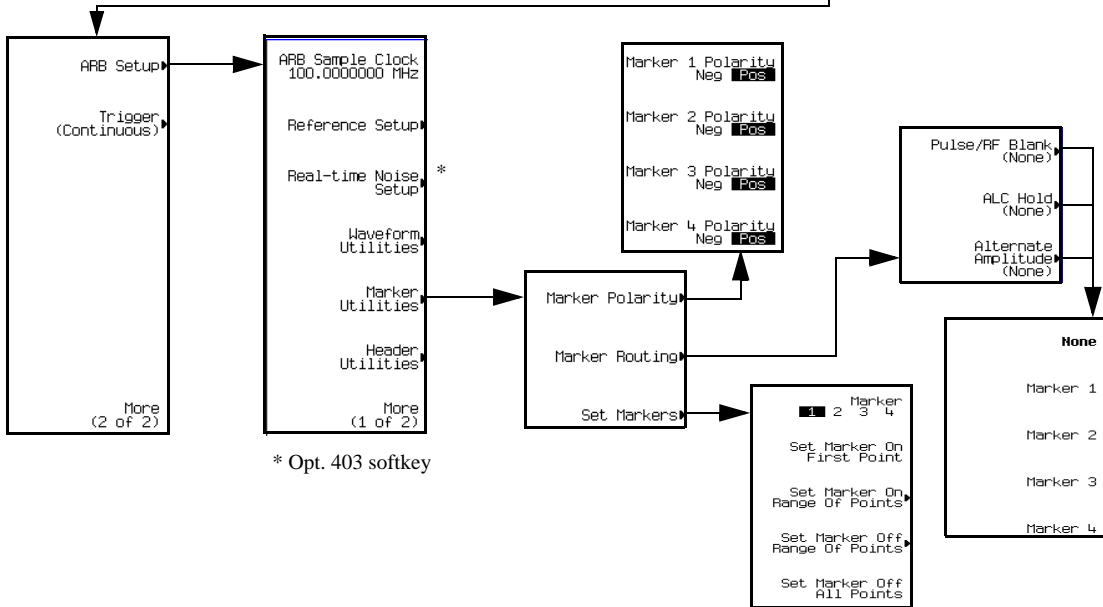
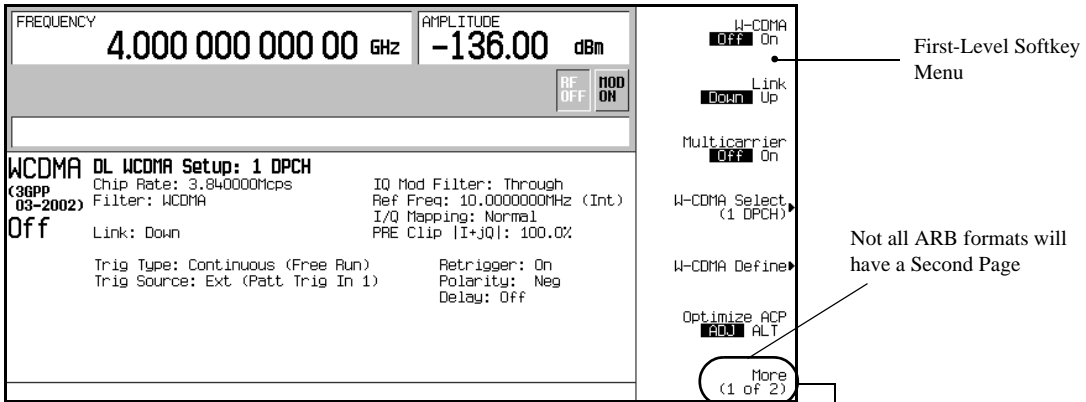

### Bluetooth Marker Behavior

Bluetooth markers one and two have predetermined settings that are implemented when a payload data type is selected and the waveform is generated. A waveform is regenerated when a new payload data type is selected while the modulation format is on. These predetermined settings will override the current marker settings if they are different. However they do not affect the ALC hold and the alternate amplitude marker functions. But they will affect the RF blanking function. After the waveform has been generated/regenerated, you can modify the predetermined settings to suit your measurement needs. The following list explains the predetermined settings for marker one and two according to the selected payload data type:

Truncated PN9 or 8-bit pattern	Marker one outputs a five-sample-point wide pulse (500 ns) at the EVENT 1 rear panel connector, and marker two implements RF blanking during the time that the Bluetooth signal is low.
Continuous PN9	Marker one outputs a 1 MHz clock signal at the EVENT 1 rear panel connector, and marker two outputs a 216 $\mu$ s gated pulse signal at the EVENT 2 rear panel connector that aligns with the transmission of the payload data.

## Using Waveform Markers

The signal generator provides four waveform markers to mark specific points on a waveform *segment*. When the signal generator encounters an enabled marker, an auxiliary output signal is routed to the rear panel event connector (described in the “[Rear Panel Overview](#)” on page 37) that corresponds to the marker number. You can use this auxiliary output signal to synchronize another instrument with the waveform, or as a trigger signal to start a measurement at a given point on a waveform.

You can also configure markers to initiate ALC hold, or RF Blanking (which includes ALC hold). Refer to “[Waveform Markers](#)” on page 120 for more information.

Creating a waveform segment (page 108) also creates a marker file that places a marker point on the first sample point of the segment for markers one and two. When a waveform file is downloaded that does not have a marker file associated with it, the signal generator creates a marker file without any marker points. Factory-supplied segments have a marker point on the first sample for all four markers.

The following procedures demonstrate how to use markers while working in the dual ARB player, but the process is the same when working in any ARB format.

These procedures also discuss two types of points: a *marker point* and a *sample point*. A *marker point* is a point at which a given marker is set on a waveform; you can set one or more marker points for each marker. A *sample point* is one of the many points that compose a waveform.

There are three basic steps to using waveform markers:

“[Clearing Marker Points from a Waveform Segment](#)” on page 131

“[Setting Marker Points in a Waveform Segment](#)” on page 132

“[Controlling Markers in a Waveform Sequence \(Dual ARB Only\)](#)” on page 134

This section also provides the following information:

- “[Waveform Marker Concepts](#)” on page 125
- “[Accessing Marker Utilities](#)” on page 129
- “[Viewing Waveform Segment Markers](#)” on page 130
- “[Viewing a Marker Pulse](#)” on page 136
- “[Using the RF Blanking Marker Function](#)” on page 137
- “[Setting Marker Polarity](#)” on page 139

## Waveform Marker Concepts

The signal generator's ARB formats provide four waveform markers to mark specific points on a waveform segment. You can set each marker's polarity and marker points (on a single sample point or over a range of sample points). Each marker can also perform ALC hold or RF Blanking and ALC hold.

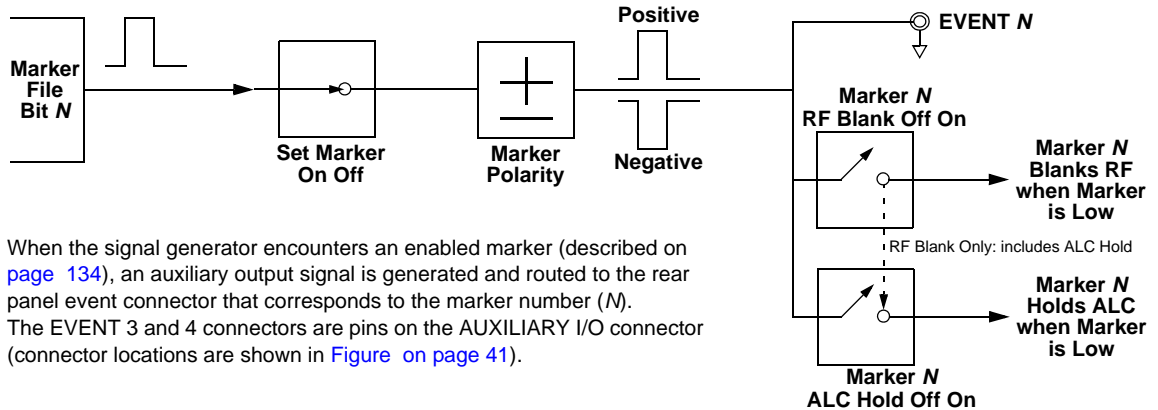

When the signal generator encounters an enabled marker (described on [page 134](#)), an auxiliary output signal is generated and routed to the rear panel event connector that corresponds to the marker number ( $N$ ). The EVENT 3 and 4 connectors are pins on the AUXILIARY I/O connector (connector locations are shown in [Figure on page 41](#)).

## Marker File Generation

Generating a waveform segment (see [page 108](#)) automatically creates a marker file that places a marker point on the first sample point of the segment for markers one and two.

Downloading a waveform file (as described in the *E4428C/38C ESG Signal Generators Programming Guide*) that does not have a marker file associated with it causes the signal generator to automatically create a marker file but does *not* place any marker points.

## Marker Point Edit Requirements

Before you can modify a waveform segment's marker points, the segment must reside in volatile memory (WFM1). Refer to the section, "Loading Waveform Segments from Non-Volatile Memory" on [page 114](#) for more information.

In the dual ARB player, you can modify a waveform segment's marker points either without playing the waveform, or while playing the waveform in an ARB modulation format. In an ARB modulation format, you must play the waveform before you can modify a segment's marker points.

## Saving Marker Polarity and Routing Settings

Marker polarity and routing settings remain until you reconfigure them, preset the signal generator, or cycle the ESG power. To ensure that a waveform uses the correct settings when it is played, set the marker polarities or routing (RF Blanking and ALC Hold), and save the information to the file header ([page 93](#)). This is especially important when the segment plays as part of a sequence because the previously played

## Using Waveform Markers

segment could have different marker and routing settings.

### ALC Hold Marker Function

While you can set a marker function (described as Marker Routing on the softkey label) either before or after you set marker points (page 132), setting a marker function before setting marker points may cause power spikes or loss of power at the RF output.

Use the ALC hold function by itself when you have a waveform signal that incorporates idle periods, or when the increased dynamic range encountered with RF blanking (page 137) is not desired.

The ALC hold marker function holds the ALC circuitry at the *average* (RMS) value of the sampled points set by the marker(s). For both positive and negative marker polarity, the ALC samples the RF output signal (the carrier plus any modulating signal) when the marker signal goes high:

Positive: The signal is sampled during the on marker points.

Negative: The signal is sampled during the off marker points.

The marker signal has a minimum of a two sample point delay in its response relative to the waveform signal response. To compensate for the marker signal delay, offset marker points from the waveform sample at which you want the ALC sampling to begin.

---

**NOTE** Because it can affect the waveform's output amplitude, do not use the ALC hold for longer than 100 ms. For longer time intervals, refer to "Power Search Mode" on page 661.

---

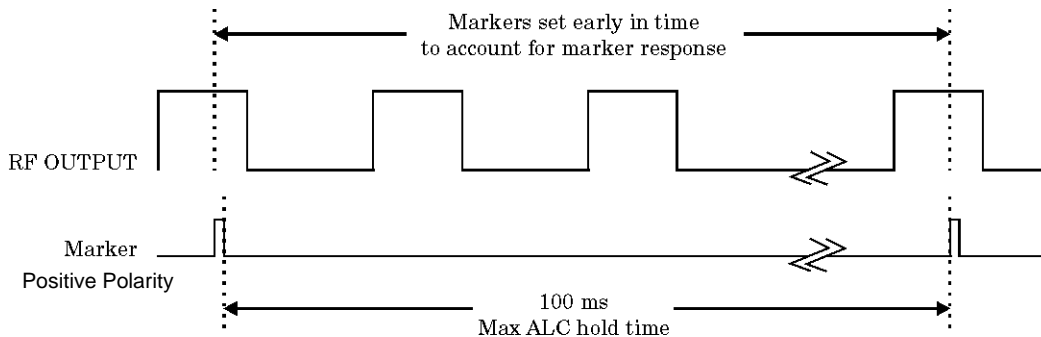

---

**CAUTION** Incorrect ALC sampling can create a sudden unlevelled condition that may create a spike in the RF output, potentially damaging a DUT or connected instrument. To prevent this condition, ensure that you set markers to let the ALC sample over an amplitude that accounts for the higher power levels encountered within the signal.

---

### Example of Correct Use

Waveform: 1022 points  
Marker range: 95-97  
Marker polarity: Positive

This example shows a marker set to sample the waveform's area of highest amplitude. Note that the marker is set well before the waveform's area of lowest amplitude. This takes into account the response difference between the marker and the waveform signal.

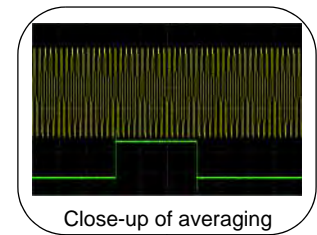
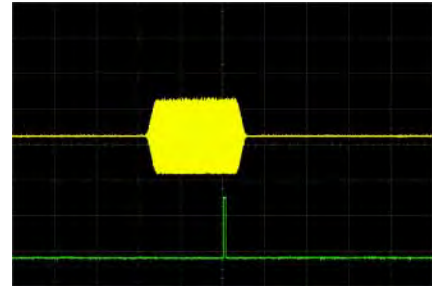

The ALC samples the waveform when the marker signal goes high, and uses the average of the sampled waveform to set the ALC circuitry.

Here the ALC samples during the *on* marker points (positive polarity).

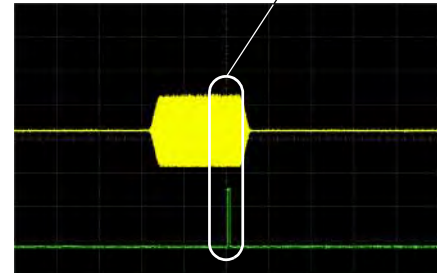

### Example of Incorrect Use

Waveform: 1022 points  
Marker range: 110-1022  
Marker polarity: Positive

This example shows a marker set to sample the low part of the same waveform, which sets the ALC modulator circuitry for that level; this usually results in an unlevelled condition for the signal generator when it encounters the high amplitude of the pulse.

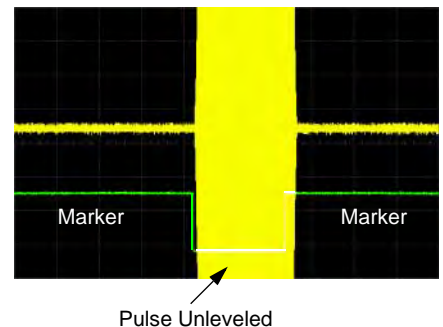

Using Waveform Markers

Example of Incorrect Use

Waveform: 1022 points  
Marker range: 110-1022  
Marker polarity: Negative

This figure shows that a negative polarity marker goes low during the marker *on* points; the marker signal goes high during the *off* points. The ALC samples the waveform during the *off* marker points.

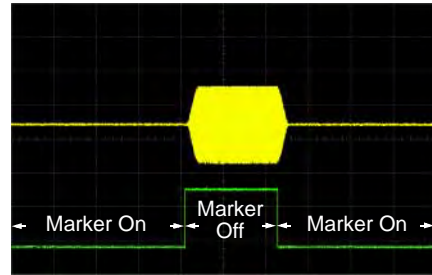

Sample range begins on first point of signal

Sampling both on and off time sets the modulator circuitry incorrectly for higher signal levels. Note the increased amplitude at the beginning of the pulse.

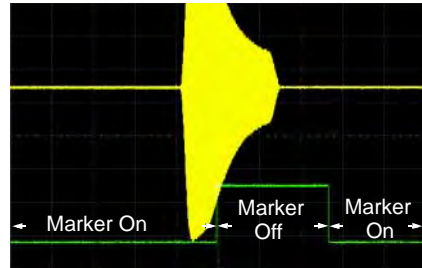

Negative range set between signal and off time



## Accessing Marker Utilities

Use the following procedure to display the marker parameters. This procedure uses the dual ARB player, but you can access the marker utilities through the ARB Setup softkey in all ARB formats.

1. Select the ARB waveform player:  
press **Mode** > **Dual ARB**
2. Press **ARB Setup** > **Marker Utilities**.

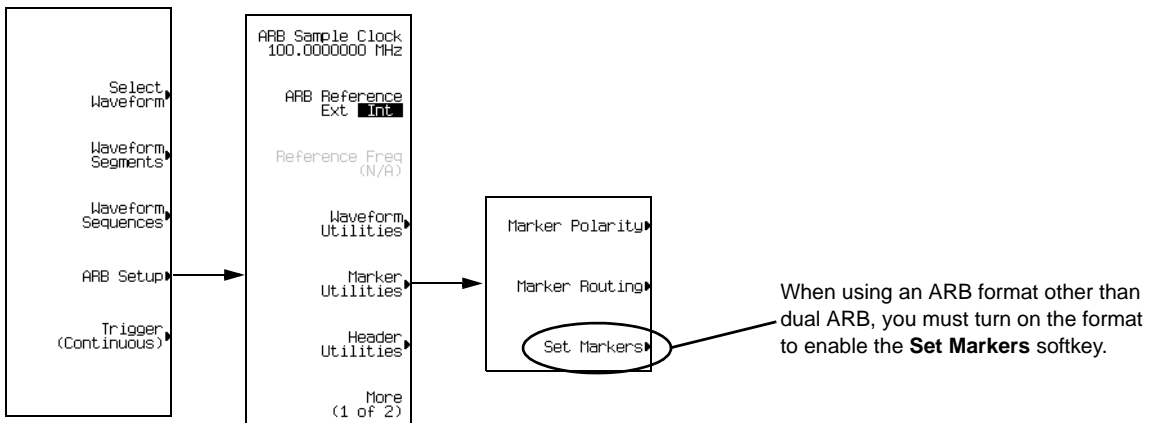

---

**NOTE** Most of the procedures in this section begin at the **Marker Utilities** softkey menu.

---

Using Waveform Markers

Viewing Waveform Segment Markers

Markers are applied to waveform segments. Use the following steps to view the markers set for a segment (this example uses the factory-supplied segment, SINE\_TEST\_WFM).

1. In the Marker Utilities menu (page 129), press **Set Markers**.
2. Highlight the desired waveform segment. In an ARB format such as Custom Arb Waveform Generator, there is only one file (AUTOGEN\_WAVEFORM) and it is highlighted.
3. Press **Display Markers > Zoom in Max**. The maximum zoom in range is 28 points.

Experiment with the Zoom functions to see how they display the markers.

The display can show a maximum of 460 points; displayed waveforms with a sample point range greater than 460 points may not show the marker locations.

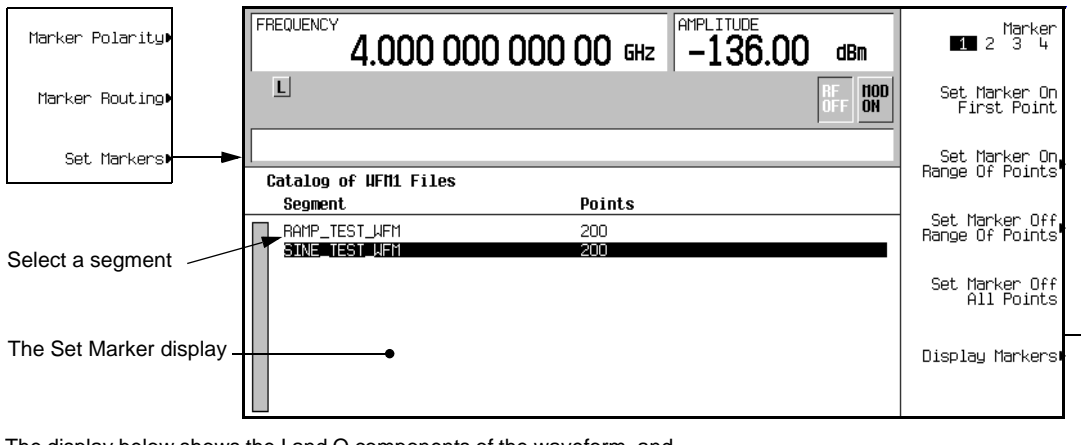

The display below shows the I and Q components of the waveform, and the marker points set in a factory-supplied segment.

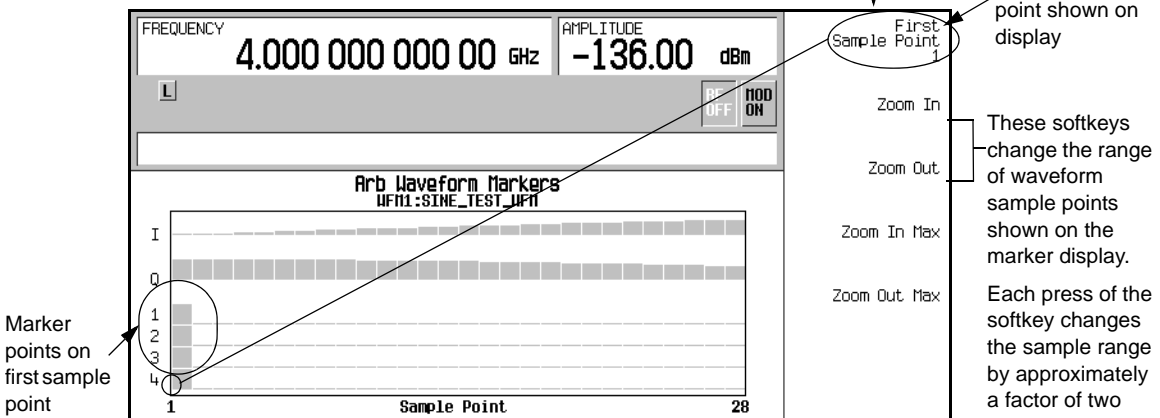

## Clearing Marker Points from a Waveform Segment

When you set marker points they do not replace points that already exist, but are set *in addition* to existing points. Because markers are cumulative, before you set points, view the segment ([page 130](#)) and remove any unwanted points. With all markers cleared, the level of the event output signal is 0V.

### Clearing All Marker Points

1. In the Marker Utilities menu ([page 129](#)), press **Set Markers**.
2. Highlight the desired waveform segment.  
In an ARB format, there is only one file (AUTOGEN\_WAVEFORM) and it is already highlighted.
3. Highlight the desired marker number:  
Press **Marker 1 2 3 4**.
4. For the selected marker number, remove all marker points in the selected segment:  
Press **Set Marker Off All Points**.
5. Repeat from [Step 3](#) for any remaining marker points that you want to remove.

### Clearing a Range of Marker Points

The following example uses a waveform with marker points (Marker 1) set across points 10–20. This makes it easy to see the affected marker points. The same process applies whether the existing points are set over a range or as individual points ([page 125](#)).

1. In the Marker Utilities menu ([page 129](#)), select the desired marker (for this example, Marker 1).
2. Set the first sample point that you want off (for this example, 13):  
Press **Set Marker Off Range Of Points > First Mkr Point > 13 > Enter**.
3. Set the last marker point in the range that you want off to a value less than or equal to the number of points in the waveform, *and* greater than or equal to the value set in [Step 2](#) (for this example, 17):  
Press **Last Mkr Point > 17 > Enter > Apply To Waveform > Return**.

This turns off all marker points for the active marker within the range set in [Steps 2](#) and [3](#), as shown in the following figure.

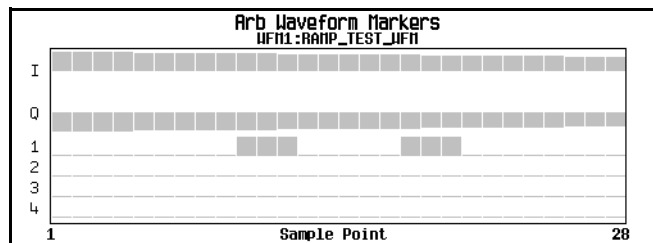

Viewing markers is described on [page 130](#)

## Using Waveform Markers

### Clearing a Single Marker Point

Use the steps described in “Clearing a Range of Marker Points” on page 131, but set both the first and last marker point to the value of the point you want to clear. For example, if you want to clear a marker on point 5, set both the first and last value to 5.

### Setting Marker Points in a Waveform Segment

To set marker points on a segment, the segment must reside in volatile memory (page 114).

When you set marker points, they do not replace points that already exist, but are set *in addition* to existing points. Because markers are cumulative, before you set marker points within a segment, view the segment (page 130) and remove any unwanted points (page 125).

### Placing a Marker Across a Range of Points

1. In the **Marker Utilities** menu (page 129), press **Set Markers**.
2. Highlight the desired waveform segment.  
In an ARB format, there is only one file (AUTOGEN\_WAVEFORM) and it is already highlighted.
3. Highlight the desired marker number:  
Press **Marker 1 2 3 4**
4. Set the first sample point in the range (in this example, 10):  
Press **Set Marker On Range Of Points > First Mkr Point > 10 > Enter**.
5. Set the last marker point in the range to a value less than or equal to the number of points in the waveform, *and* greater than or equal to the first marker point (in this example, 20):  
Press **Last Mkr Point > 20 > Enter**.
6. Press **Apply To Waveform > Return**.

This sets a range of waveform marker points. The marker signal starts on sample point 10, and ends on sample point 20, as shown in the following figure.

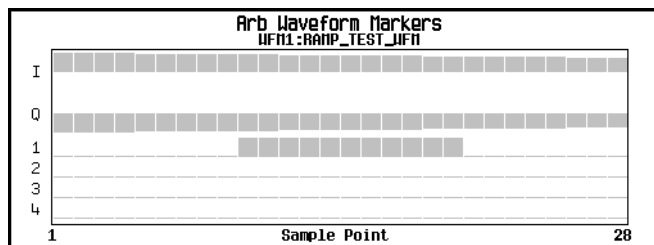

Viewing markers is described on page 130

## Placing a Marker on a Single Point

### *On the First Point*

1. In the **Marker Utilities** menu (page 129), press **Set Markers**.
2. Highlight the desired waveform segment.  
In an ARB format, there is only one file (AUTOGEN\_WAVEFORM) and it is already highlighted.
3. Highlight the desired marker number:  
Press **Marker 1 2 3 4**.
4. Press **Set Marker On First Point**.

This sets a marker on the first point in the segment for the marker number selected in [Step 3](#).

### *On Any Point*

Use the steps described in “[Setting Marker Points in a Waveform Segment](#)” on page 132, but set both the first and last marker point to the value of the point you want to set. For example, if you want to set a marker on point 5, set both the first and last value to 5.

## Placing Repetitively Spaced Markers

The following example sets markers across a range of points and specifies the spacing (skipped points) between each marker. You must set the spacing *before* you apply the marker settings; you cannot apply skipped points to a previously set range of points.

1. Remove any existing marker points (page 125).
2. In the **Marker Utilities** menu (page 129), press **Set Markers**.
3. Highlight the desired waveform segment.  
In ARB formats there is only one file (AUTOGEN\_WAVEFORM) and it is already highlighted.
4. Highlight the desired marker number: Press **Marker 1 2 3 4**.
5. Set the first sample point in the range (in this example, 5):  
Press **Set Marker On Range Of Points > First Mkr Point > 5 > Enter**.
6. Set the last marker point in the range to a value less than the number of points in the waveform, *and* greater than or equal to the first marker point (in this example, 25):  
Press **Last Mkr Point > 25 > Enter**.
7. Enter the number of sample points that you want skipped (in this example, 1):  
Press **# Skipped Points > 1 > Enter**.

## Using Waveform Markers

8. Press **Apply To Waveform** > **Return**.

This causes the marker to occur on every other point (one sample point is skipped) within the marker point range, as shown below.

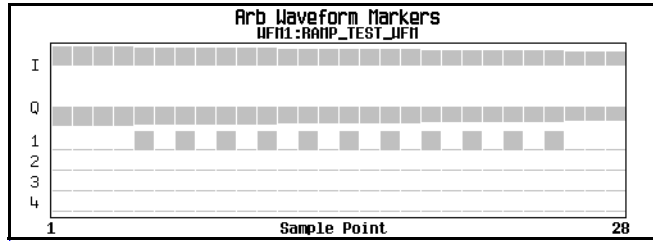

Viewing markers is described on [page 130](#)

One application of the skipped point feature is the creation of a clock signal as the auxiliary output.

## Controlling Markers in a Waveform Sequence (Dual ARB Only)

In a waveform segment, an enabled marker point generates an auxiliary output signal that is routed to the rear-panel event connector (described in “[Rear Panel Overview](#)” on [page 37](#)) corresponding to that marker number. For a waveform sequence, you enable or disable markers on a segment-by-segment basis; this enables you to output markers for some segments in a sequence, but not for others. Unless you change the marker settings or cycle the power, the setting remains the same for the next loaded sequence.

### As You Create a Waveform Sequence

After you select the waveform segments to create a waveform sequence, and *before* you name and save the sequence, you can enable or disable each segment’s markers independently. Enabling a marker that has no marker points ([page 132](#)) has no effect on the auxiliary outputs.

1. Select the waveform segments ([Step 1](#) on [page 109](#)).
2. Toggle the markers as desired:
  - a. Highlight the first waveform segment.
  - b. Press **Enable/Disable Markers**.
  - c. As desired, press **Toggle Marker 1**, **Toggle Marker 2**, **Toggle Marker 3**, and **Toggle Marker 4**.  
Toggling a marker that has no marker points ([page 132](#)) has no effect on the auxiliary outputs.

An entry in the **Mkr** column (see figure below) indicates that the marker is enabled for that segment; no entry in the column means that all markers are disabled for that segment.

- d. In turn, highlight each of the remaining segments and repeat [Step c](#).
3. Press **Return**.

- Name and store the waveform sequence “Storing Waveform Segments to Non-Volatile Memory” on page 113.

The following figure shows a sequence built reusing the same factory-supplied waveform segment; a factory-supplied segment has a marker point on the first sample for all four markers. In this example, Marker 1 is enabled for the first segment, Marker 2 is enable for the second segment, and markers 3 and 4 are enabled for the third segment.

(1/2)	Segment	SINE_TEST_WFM Sequence	(UNSTORED) (1/1)	Waveform	Reps	filcr	Toggle Marker 3
	AUTOGEN_PPRM_1	2KKL2KKM		WFM1:SINE_TEST_WFM	1	1	Toggle Marker 4
	RAMP_TEST_WFM	A		WFM1:SINE_TEST_WFM	1	2	
	SINE_TEST_WFM	AR2		WFM1:SINE_TEST_WFM	1	3	
		B					
		COMPLEX					

Sequence Marker Column  
This entry shows that markers 3 and 4 are enabled for this segment.

For each segment, only the markers enabled for that segment produce a rear-panel auxiliary output signal. In this example, the Marker 1 auxiliary signal appears only for the first segment, because it is disabled for the remaining segments. The Marker 2 auxiliary signal appears only for the second segment, and the marker 3 and 4 auxiliary signals appear only for the third segment.

### In an Existing Waveform Sequence

If you have not already done so, create and store a waveform sequence that contains at least three segments (page 109). Ensure that the segment or segments are available in volatile memory (page 114).

- Press **Mode > Dual ARB > Waveform Sequences**, and highlight the desired waveform sequence.
- Press **Edit Selected Waveform Sequence**, and highlight the first waveform segment.
- Press **Enable/Disable Markers > Toggle Marker 1, Toggle Marker 2, Toggle Marker 3, and Toggle Marker 4**. Toggling a marker that has no marker points (page 132) has no effect on the auxiliary outputs.

An entry in the **Mkr** column indicates that the marker is enabled for that segment; no entry in the column means that all markers are disabled for that segment

- Highlight the next waveform segment and toggle the desired markers (in this example, markers 1 and 4).
- Repeat [Step 4](#) as desired (for this example, select the third segment and toggle marker 3).

Using Waveform Markers

6. Press **Return** > **Name And Store** > **Enter**.

The markers are enabled or disabled per your selections, and the changes have been saved to the selected sequence file.

(1/1) Segment	RAMP_TEST_WFM Sequence	(UNSTORED) Waveform	Reps	UNTITLED Marker
RAMP_TEST_WFM	FWDCH_64+FWDCH_9	WF11:RAMP_TEST_WFM	1 1234	
SINE_TEST_WFM	RQ_DATA	WF11:SINE_TEST_WFM	1 1 4	
	RQ_S	SEQ:RQ_DATA	1	3
	TGR_TST_2			
	TST_GW			

Viewing a Marker Pulse

When a waveform plays (page 110), you can detect a set and enabled marker’s pulse at the rear panel event connector that corresponds to that marker number. This example demonstrates how to view a marker pulse generated by a waveform segment that has at least one marker point set (page 132). The process is the same for a waveform sequence.

This procedure uses the factory-supplied segment, SINE\_TEST\_WFM in the dual ARB Player. Factory-supplied segments have a marker point on the first sample point for all four markers, as shown.

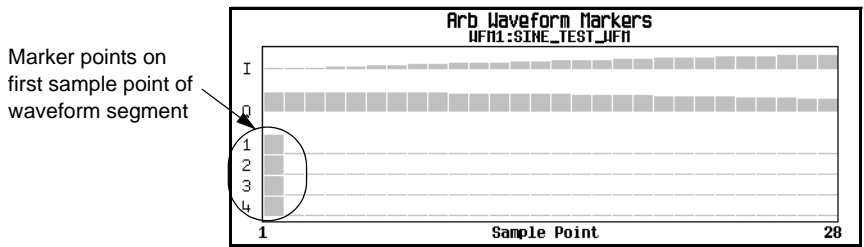

Viewing markers is described on page 130

1. Press **Mode** > **Dual ARB** > **Select Waveform**, and highlight the SINE\_TEST\_WFM segment.
2. Press **ARB Off On** to On.
3. Connect the ESG’s rear-panel Q OUT output to the oscilloscope’s channel 1 input.



4. Connect the ESG's rear-panel EVENT 1 output to the oscilloscope's channel 2 input. When marker 1 is present, the ESG outputs a signal on the EVENT 1 connector as shown in the following example.

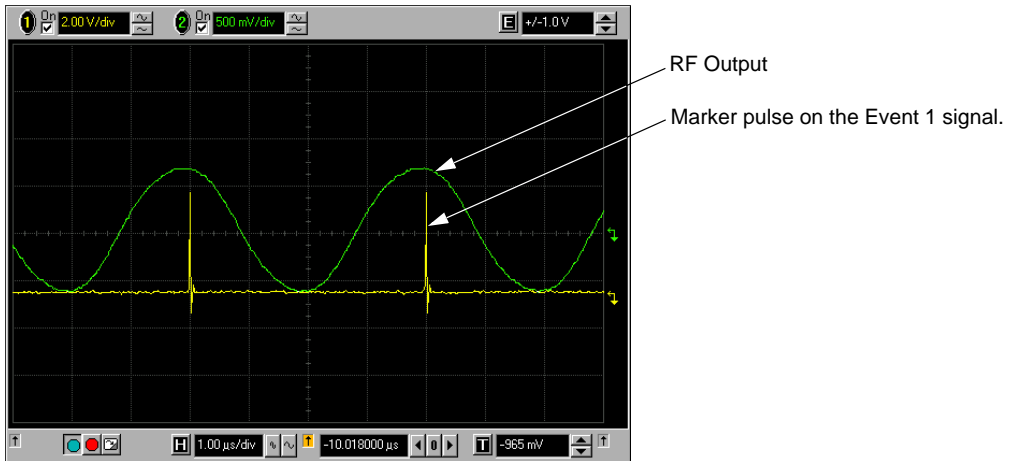

## Using the RF Blanking Marker Function

While you can set a marker function (described as **Marker Routing** on the softkey label) either before or after setting the marker points ([page 132](#)), setting a marker function before you set marker points may change the RF output. RF Blanking includes ALC hold (described on [page 126](#), note **Caution** regarding unleveled power). The signal generator blanks the RF output when the marker signal goes low.

1. Using the factory-supplied segment SINE\_TEST\_WFM, set Marker 1 across points 1–180 ([page 132](#)).
2. From the **Marker Utilities** menu ([page 129](#)), assign RF Blanking to Marker 1:

Using Waveform Markers

Press **Marker Routing > Pulse/RF Blank > Marker 1**.

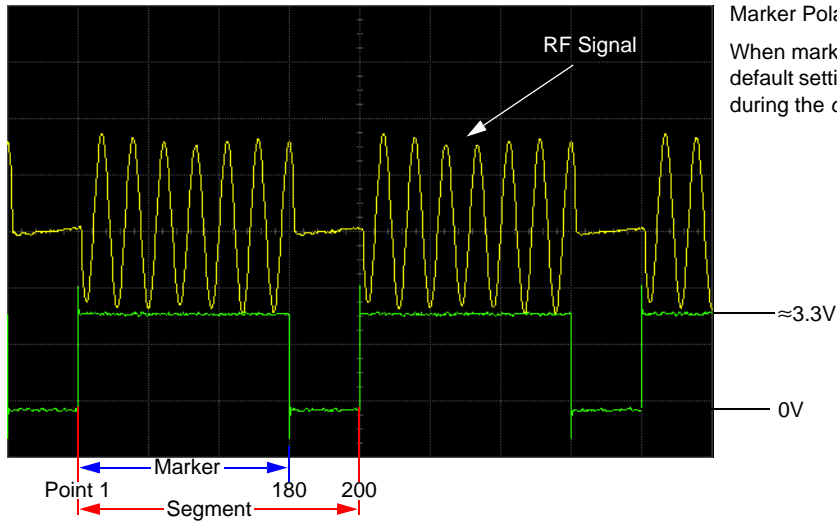

Marker Polarity = Positive

When marker polarity is positive (the default setting), the RF output is blanked during the *off* marker points.

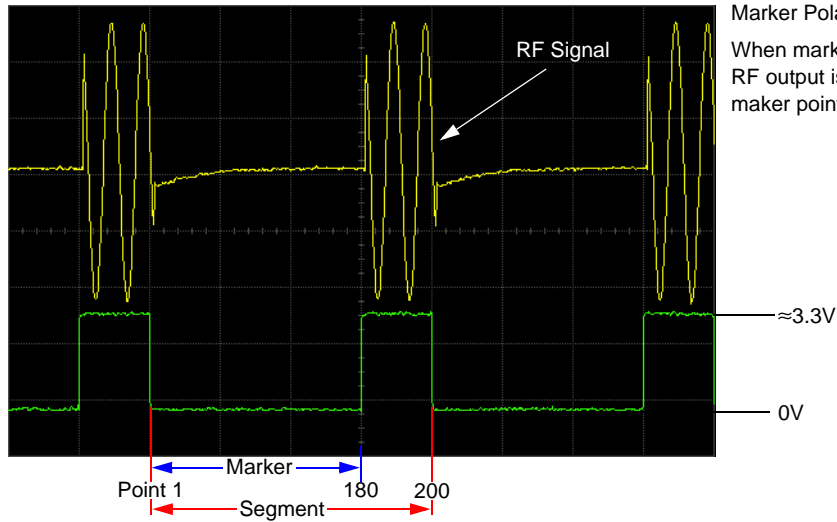

Marker Polarity = Negative

When marker polarity is negative, the RF output is blanked during the *on* marker points

## Setting Marker Polarity

Setting a negative marker polarity inverts the marker signal.

1. In the **Marker Utilities** menu ([page 129](#)), press **Marker Polarity**.
2. Select the marker polarity as desired for each marker number.

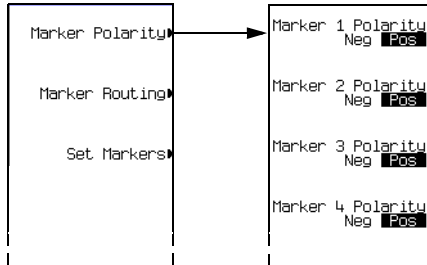

Default Marker Polarity = Positive

Set each marker polarity independently.

See Also: [“Saving Marker Polarity and Routing Settings” on page 125.](#)

As shown on [page 137](#):

Positive Polarity: *On* marker points are high ( $\approx 3.3V$ ).

Negative Polarity: *On* marker points are low (0V).

## Triggering Waveforms

Triggering is available in both ARB and real time formats. ARB triggering controls the playback of a waveform file; real time custom triggering controls the transmission of a data pattern. The examples and discussions in this section use the dual ARB Player, but the functionality and methods of access (described on [page 142](#)) are similar in all ARB and real time formats.

Triggers control data transmission by telling the ESG when to transmit the modulating signal. Depending on the trigger settings, the data transmission may occur once, continuously, or the ESG may start and stop the transmission repeatedly (Gated mode).

A trigger signal comprises both positive and negative signal transitions (states), which are also called high and low periods; you can configure the ESG to trigger on either state. It is common to have multiple triggers, also referred to as trigger occurrences or trigger events, occur when the signal generator requires only a single trigger. In this situation, the ESG recognizes the first trigger event and ignores the rest.

When you select a trigger mode, you may lose the signal (carrier plus modulation) from the RF output until you trigger the modulating signal. This is because the ESG sets the I and Q signals to zero volts prior to the first trigger event, which suppresses the carrier. If you create a data pattern with the initial I and Q voltages set to values other than zero, this does not occur. After the first trigger event, the signal's final I and Q levels determine whether you see the carrier signal or not (zero = no carrier, other values = visible carrier). At the end of most data patterns, the final I and Q points are set to a value other than zero.

There are four parts to configuring a waveform trigger:

- *Source* determines how the ESG receives the trigger that initiates waveform play.
- *Mode* determines the waveform's overall behavior when it plays.
- *Response* determines the specifics of how the waveform responds to a trigger.
- *Polarity* determines the state of the trigger to which the waveform responds (used only with an external trigger source); you can set either negative, or positive.

## Source

The figure below shows the dual ARB mode trigger menu.

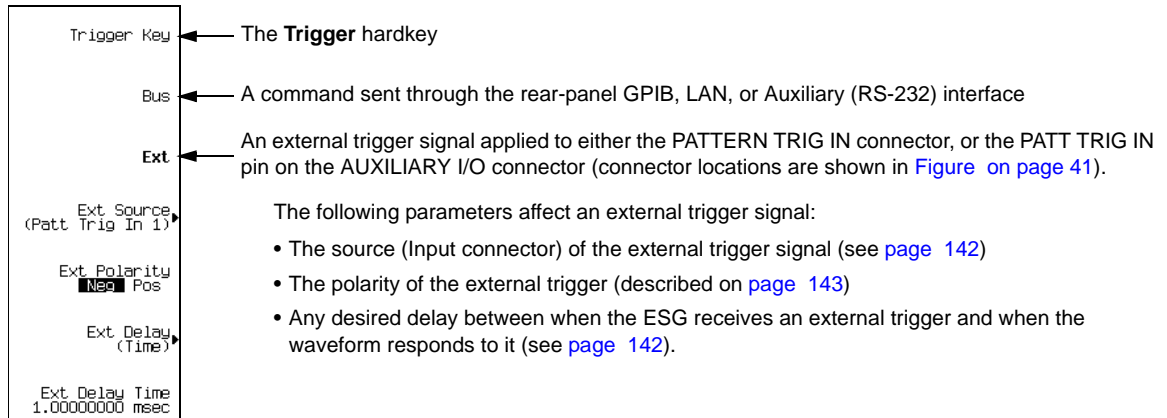

## Mode and Response

The arbitrary waveform player provides four trigger *modes*; each mode has one or more possible *responses*:

- **Single** plays the waveform once. *Arb formats* have the following re-triggering options:
  - **Off** ignores triggers received during play; a trigger received after playback completes restarts the playback.
  - **On** causes a trigger received during play to repeat the waveform after the current play completes.
  - **Immediate** causes a trigger received during play to immediately restart the waveform.
- **Gated** causes the waveform to wait for the first active trigger signal state to begin transmission, then repeatedly starts and stops in response to an externally applied gating signal (example on [page 143](#)). You select the active state with the **Gate Active Low High** softkey (see [page 143](#)).

In an ARB format, the waveform plays during the *inactive* state, and stops during the *active* state.

In real time Custom, behavior depends on whether the signal uses framed or unframed data.

Because the ESG provides only unframed data, to transmit a framed data signal you must create an external file that incorporates the framing and download it to the ESG (see the *E4428C/38C ESG Signal Generators Programming Guide*).

- *Unframed data* transmits during active states, and stops during inactive states. The signal stops at the last transmitted symbol and restarts at the next symbol.
- *Framed data* starts transmitting at the beginning of a frame during active states, and stops at the end of a frame when the end occurs during inactive states. If the end of the frame extends into the next active state, the signal transmits continuously.

## Triggering Waveforms

- Segment Advance** (dual ARB only) causes a segment in a sequence to require a trigger to play. The *trigger source* controls how play moves from segment to segment (example on [page 145](#)). A trigger received during the last segment loops play to the *first* segment in the sequence. You have two choices as to how the segments play:
  - **Single** causes a segment in a sequence to play once, after which the dual ARB player stops and waits for a trigger before advancing to the next segment, and playing that segment to completion. Triggers received during play cause the current segment to finish, the dual ARB player advances to the next segment, and plays that segment to completion.
  - **Continuous** causes a segment in a sequence to play continuously until the waveform receives another trigger. Triggers received during play cause the current segment to finish, then play advances to the next segment, which plays continuously.
- Continuous** repeats the waveform until you turn the signal off or select another waveform, trigger mode, or response. Continuous has the following functions:
  - **Free Run** immediately triggers and plays the waveform; triggers received during play are ignored.
  - **Trigger & Run** plays the waveform when a trigger is received; subsequent triggers are ignored.
  - **Reset & Run** (not available in real time Custom) plays the waveform when a trigger is received; subsequent triggers restart the waveform.

## Accessing Trigger Utilities

The following figures show the menus for the trigger parameters. These figures show the dual ARB player, but you can access the trigger utilities through the **Trigger** softkey in all ARB formats, and the **Pattern Trigger** softkey in the Real Time I/Q Baseband (Custom) format.

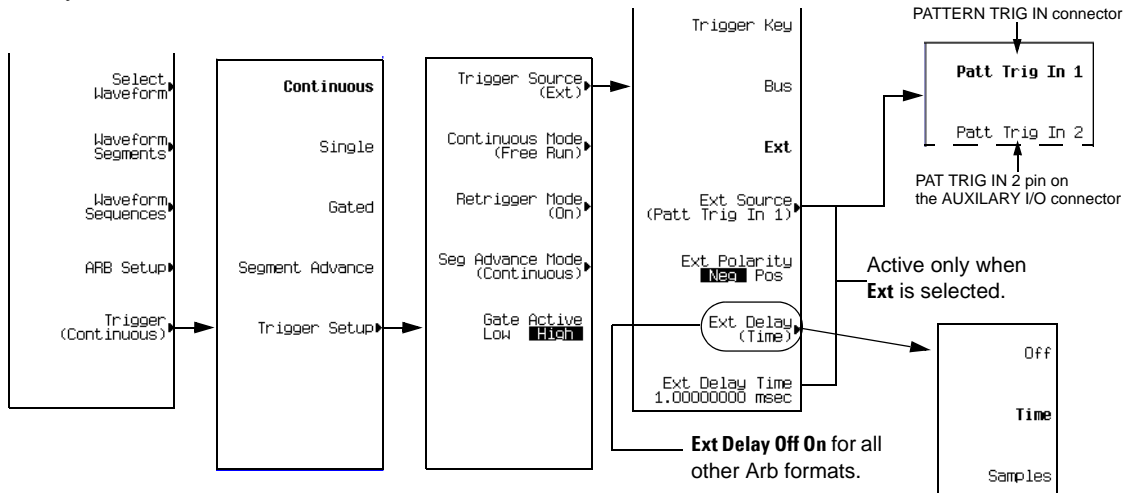

- To display the trigger modes, press **Mode > Dual ARB > Trigger**.

- To display the response selections available for a given trigger mode, press **Trigger Setup**, then select the desired trigger mode. To see the selections for Single mode in an ARB format, select **Retrigger Mode**; in real time Custom, selecting Single mode causes the data pattern to play once when triggered.
- To display the trigger source options, press **Trigger Setup > Trigger Source**.

## Setting the Polarity of an External Trigger

### Gated Mode

The selections available with the gate active parameter refer to the low and high states of an external trigger signal. For example, when you select High, the active state occurs during the high of the trigger signal.

**ARB Formats** When the active state occurs, the ESG *stops* the waveform file playback at the last played sample point, and restarts the playback at the next sample point when the inactive state occurs.

**Real Time Custom** When the active state occurs, the ESG *transmits* the data pattern. When the inactive state occurs, the transmission stops at the last transmitted symbol, and restarts at the next symbol when the active state occurs.

### Continuous, Single, or Segment Advance Modes

The **Ext Polarity Neg Pos** softkey selections refer to the low (negative) and high (positive) states of an external trigger. With Neg selected (the default), the ESG responds during the low state of the trigger signal.

## Using Gated Triggering

Gated triggering enables you to define the on (playback) and off states of a modulating waveform. This example uses the factory supplied segment, `SINE_TEST_WFM`.

1. Connect the output of a function generator to the signal generator's rear-panel PATTERN TRIG IN, as shown in the following figure.

## Triggering Waveforms

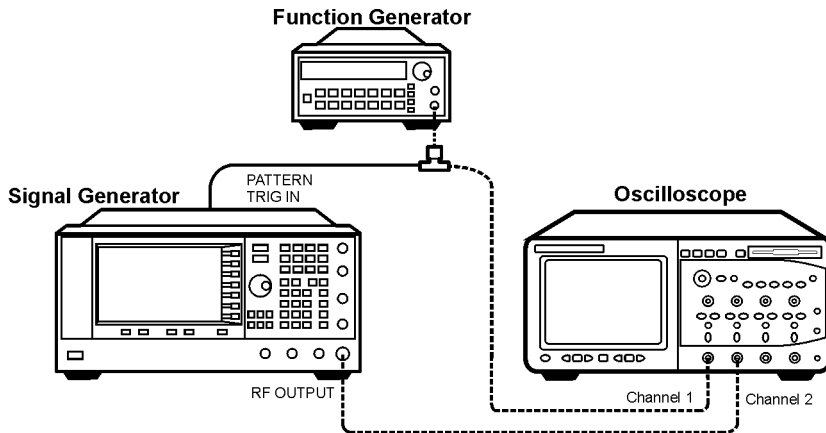

This connection is applicable to all external triggering methods. The optional oscilloscope connection enables you to see the effect that the trigger signal has on the RF output.

2. Preset the signal generator.
3. Configure the carrier signal output:
  - Set the desired frequency.
  - Set the desired amplitude.
  - Turn on the RF output.
4. Select a waveform for playback (sequence or segment):
  - a. Preset the signal generator.
  - b. Press **Mode** > **Dual ARB** > **Select Waveform**.
  - c. Highlight a waveform file (for this example, SINE\_TEST\_WFM).
  - d. Press **Select Waveform**.
5. Select the waveform trigger method:
  - a. Press **Trigger** > **Gated**.
  - b. Press **Trigger** > **Trigger Setup** and note that for the **Gate Active Low High** softkey, the default selection is High, which is the selection used in this example.
6. Select the trigger source and rear panel input:
  - a. For the **Trigger Source** softkey, the default selection is **Ext**, which is the selection used in this example (gated triggering requires an external trigger).



- b. Press **Trigger Source** and note that for the **Ext Source** softkey, the default selection is **Patt Trig In 1**, which is the selection used in this example.
7. Generate the waveform:  
Press **ARB Off On** to On.
8. On the function generator, configure a TTL signal for the external gating trigger.
9. (Optional) Monitor the current waveform:

Configure the oscilloscope to display both the output of the signal generator, and the external triggering signal. You will see the waveform modulating the output during the gate *inactive* periods (low).

The following figure shows an example display.

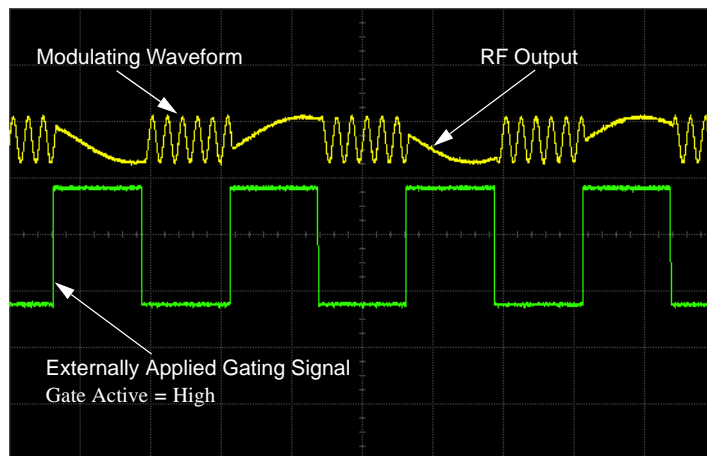

---

**NOTE** In the real time Custom mode, the behavior is reversed: when the gating signal is *high*, you see the modulated waveform.

---

## Using Segment Advance Triggering

Segment advance triggering enables you to control the segment playback within a waveform sequence. The following example uses a waveform sequence that has two segments.

If you have not created and stored a waveform sequence, complete the steps in the sections, [“Creating Waveform Segments”](#) on page 108, and [“Creating a Waveform Sequence”](#) on page 109.

1. Preset the signal generator.

## Triggering Waveforms

2. Configure the RF output:
  - Set the desired frequency.
  - Set the desired amplitude.
  - Turn on the RF output.
3. Select a waveform sequence for playback:
  - a. Press **Mode > Dual ARB > Select Waveform**.
  - b. Highlight a waveform sequence file.
  - c. Press **Select Waveform**.
4. Select the waveform trigger method and trigger source:
  - a. Press **Trigger > Segment Advance**.
  - b. Press **Trigger > Trigger Setup** and note that the **Seg Advance Mode** softkey displays the default selection (Continuous), which is the selection used in this example.
  - c. Press **Trigger Source > Trigger Key**.
5. Generate the waveform sequence:  
Press **Return > Return > ARB Off On to On**.
6. Trigger the first waveform segment to begin playing repeatedly:  
Press the **Trigger** hardkey.
7. (Optional) Monitor the current waveform:  

Connect the output of the signal generator to the input of an oscilloscope, and configure the oscilloscope so that you can see the output of the signal generator.
8. Trigger the second segment:  
Press the **Trigger** hardkey.  

The second segment in the sequence now plays. Pressing the **Trigger** hardkey causes the current playback to finish and the next segment to start; when the last segment plays, pressing the **Trigger** hardkey causes the *first* segment in the waveform sequence to start when the current segment finishes.

## Using External Triggering

Using this procedure, you learn how to utilize an external function generator to apply a delayed single-trigger to a custom multicarrier CDMA waveform.

### Required Equipment

Agilent 33120A Function Generator

### Connecting the Equipment

Connect the signal generator to the function generator, as shown in [Figure 4-14](#).

**Figure 4-14**

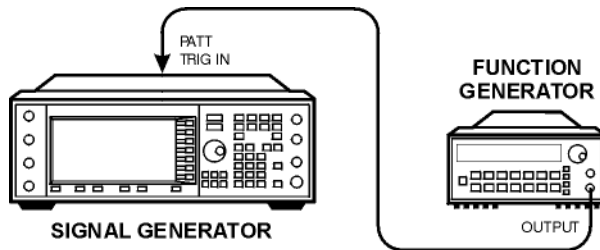

### Configuring a Custom Multicarrier CDMA State

1. Press **Preset**.
2. Press **Mode > CDMA > Arb IS-95A**.
3. Toggle **Multicarrier Off On** to On.
4. Press **Setup Select > 4 Carriers**.

### Configuring the Waveform Trigger

1. Press **Trigger > Single**.
2. Press **Trigger > Trigger Setup > Trigger Source > Ext**.
3. Press **Ext Polarity Neg Pos** until Pos is highlighted.
4. Press **Ext Delay Off On** to On.
5. Press **Ext Delay Time > 100 > msec**.

The waveform will now trigger once 100 milliseconds after it detects a change in TTL state from low to high at the PATT TRIG IN rear panel connector.

### Configuring the Function Generator

Set the function generator waveform to a 0.1 Hz square wave at an output level of 0 to 5V.

### Generating the Waveform

Press **Mode > CDMA > Arb IS-95A > CDMA Off On** to On.

## Triggering Waveforms

This generates a waveform with the custom multicarrier CDMA state configured in the previous section. The display changes to `Multicarrier Setup: 4 CARRIERS`. During waveform generation, the CDMA and I/Q annunciators activate and the new custom multicarrier CDMA state is stored in volatile ARB memory. The waveform is now modulating the RF carrier.

### Configuring the RF Output

1. Set the RF output frequency to 890.01 MHz.
2. Set the output amplitude to -10 dBm.
3. Press **RF On/Off** to On.

The externally single-triggered custom multicarrier CDMA waveform is now available at the signal generator's RF OUTPUT connector 100 msec after receiving a change in TTL state from low to high at the PATT TRIG IN, provided by the function generator output.

---

## Using Waveform Clipping

Waveforms with high power peaks can cause intermodulation distortion, which generates spectral regrowth (a condition that interferes with signals in adjacent frequency bands). The clipping function enables you to reduce high power peaks by clipping the I and Q data to a selected percentage of its highest peak.

The clipping feature is available only with the dual ARB mode.

### How Power Peaks Develop

To understand how clipping reduces high power peaks, it is important to know how the peaks develop as the signal is constructed.

I/Q waveforms can be the summation of multiple channels (see [Figure 4-15](#)). Whenever most or all of the individual channel waveforms simultaneously contain a bit in the same state (high or low), an unusually high power peak (negative or positive) occurs in the summed waveform. This does *not* happen frequently because the high and low states of the bits on these channel waveforms are random, which causes a cancelling effect.

**Figure 4-15**

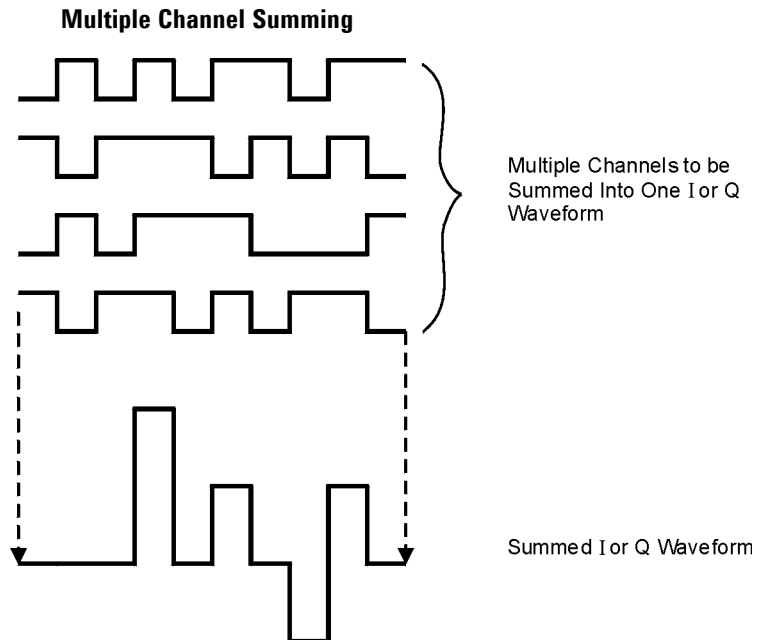

**Using Waveform Clipping**

The I and Q waveforms combine in the I/Q modulator to create an RF waveform. The magnitude of the RF envelope is determined by the equation  $\sqrt{I^2+Q^2}$ , where the squaring of I and Q always results in a positive value.

As shown in Figure 4-16, simultaneous positive and negative peaks in the I and Q waveforms do not cancel each other, but combine to create an even greater peak.

**Figure 4-16 Combining the I and Q Waveforms**

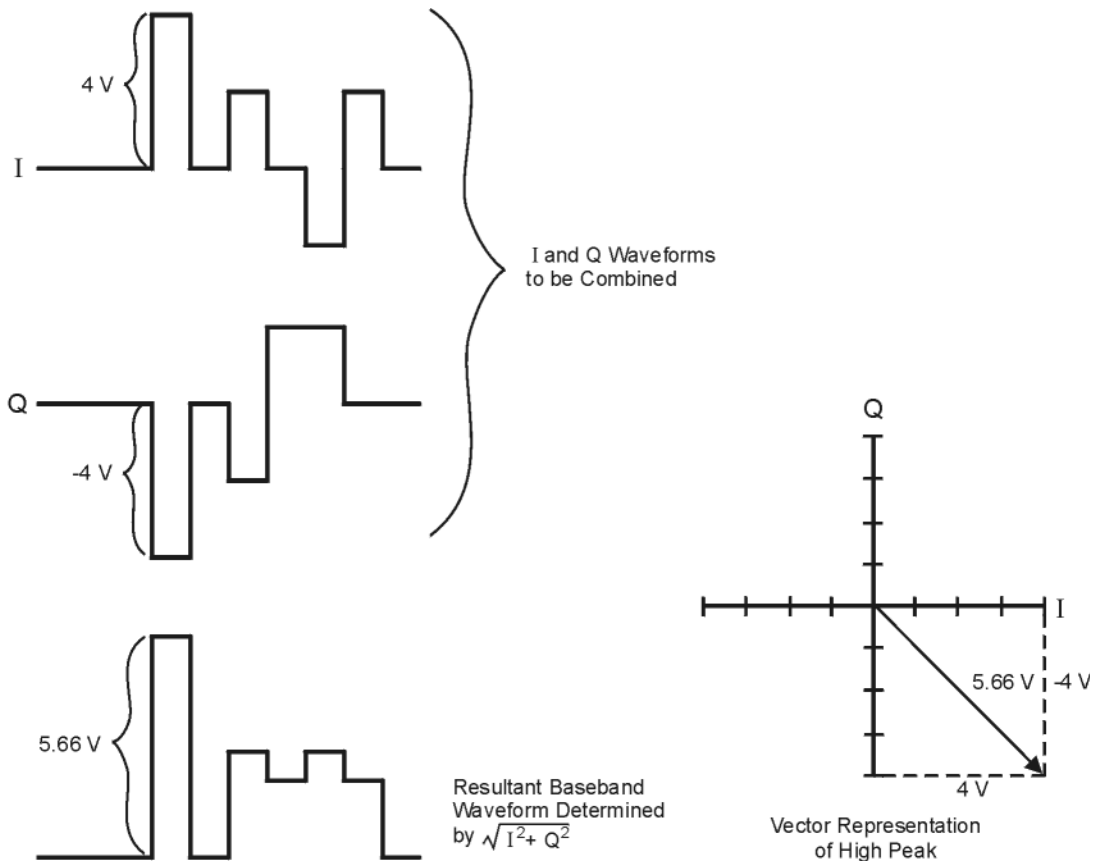

## How Peaks Cause Spectral Regrowth

Because of the relative infrequency of high power peaks, a waveform will have a high peak-to-average power ratio (see Figure 4-17). Because a transmitter's power amplifier gain is set to provide a specific average power, high peaks can cause the power amplifier to move toward saturation. This causes intermodulation distortion, which generates spectral regrowth.

**Figure 4-17** Peak-to-Average Power

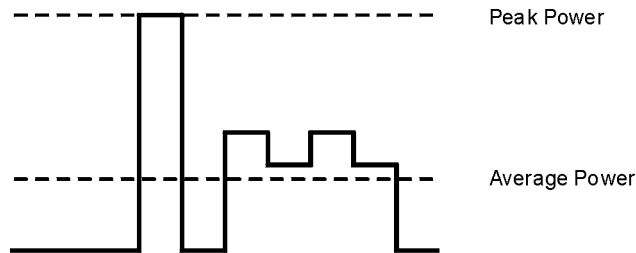

Spectral regrowth is a range of frequencies that develops on each side of the carrier (similar to sidebands) and extends into the adjacent frequency bands (see Figure 4-18). Consequently, spectral regrowth interferes with communication in the adjacent bands. Clipping can provide a solution to this problem.

**Figure 4-18** Spectral Regrowth Interfering with Adjacent Band

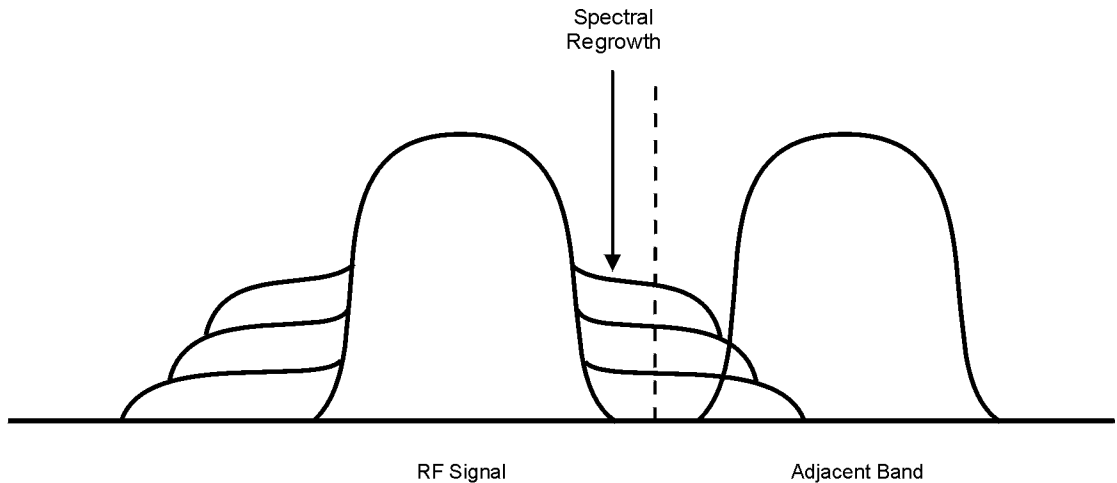

Using Waveform Clipping

**How Clipping Reduces Peak-to-Average Power**

You can reduce peak-to-average power, and consequently spectral regrowth, by clipping the waveform. Clipping limits power peaks in waveforms by clipping the I and Q data to a selected percentage of its highest peak. The ESG Vector Signal Generator provides two different methods of clipping: circular and rectangular. *Circular* clipping is defined as clipping the composite I/Q data (I and Q data are equally clipped). *Rectangular* clipping is defined as independently clipping the I and Q data.

During *circular* clipping, clipping is applied to the combined I and Q waveform ( $|I + jQ|$ ). Notice in [Figure 4-19](#) that the clipping level is constant for all phases of the vector representation and appears as a circle. During *rectangular* clipping, clipping is applied to the I and Q waveforms separately ( $|I|, |Q|$ ). Notice in [Figure 4-20 on page 153](#) that the clipping level is different for I and Q; therefore, it appears as a rectangle in the vector representation. With either method, the objective is to clip the waveform to a level that effectively reduces spectral regrowth, but does *not* compromise the integrity of the signal. [Figure 4-21 on page 154](#) uses two complementary cumulative distribution plots to show the reduction in peak-to-average power that occurs after applying circular clipping to a waveform.

The lower you set the clipping value, the lower the peak power that is passed (or the more the signal is clipped). Often, the peaks can be clipped successfully without substantially interfering with the rest of the waveform. Data that might be lost in the clipping process is salvaged because of the error correction inherent in the coded systems. If you clip too much of the waveform, however, lost data is irrecoverable. You may have to try several clipping settings to find a percentage that works well.

**Figure 4-19**                      **Circular Clipping**

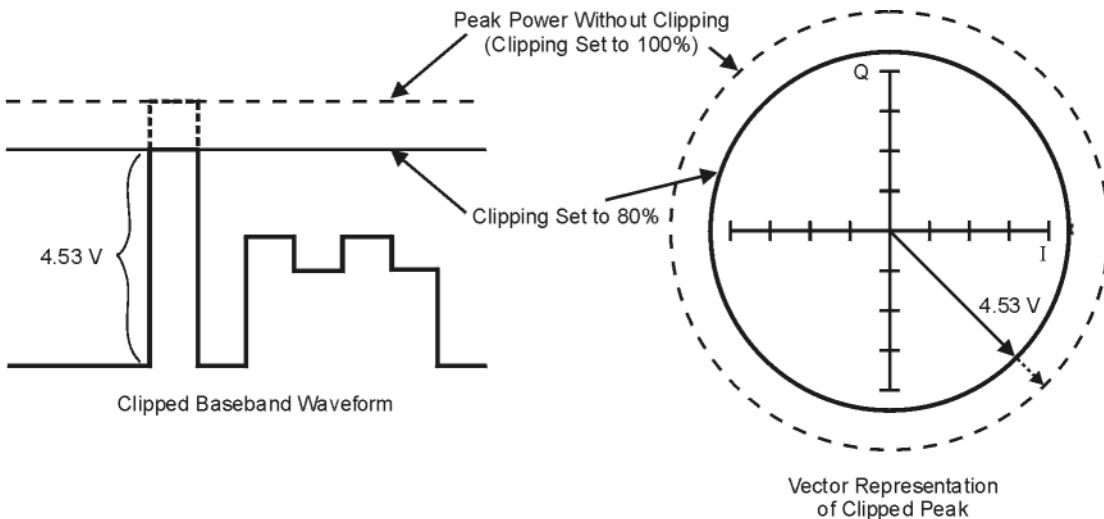



**Figure 4-20 Rectangular Clipping**

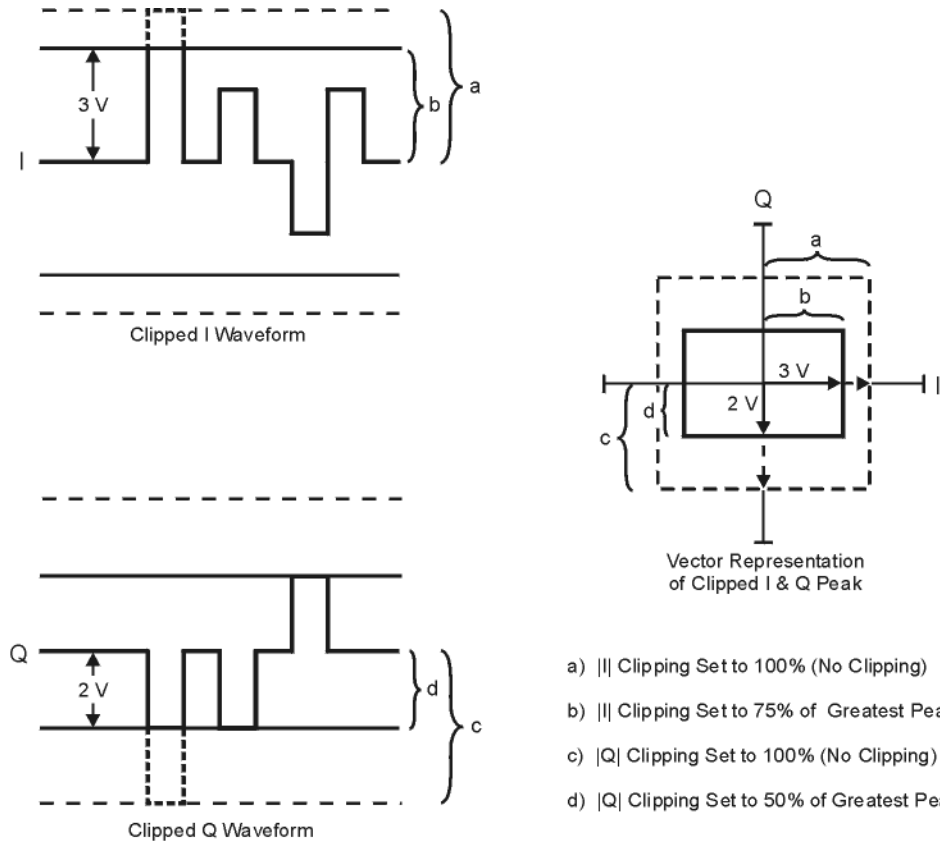

- a) |I| Clipping Set to 100% (No Clipping)
- b) |I| Clipping Set to 75% of Greatest Peak
- c) |Q| Clipping Set to 100% (No Clipping)
- d) |Q| Clipping Set to 50% of Greatest Peak

Figure 4-21 Reduction of Peak-to-Average Power

Complementary Cumulative Distribution

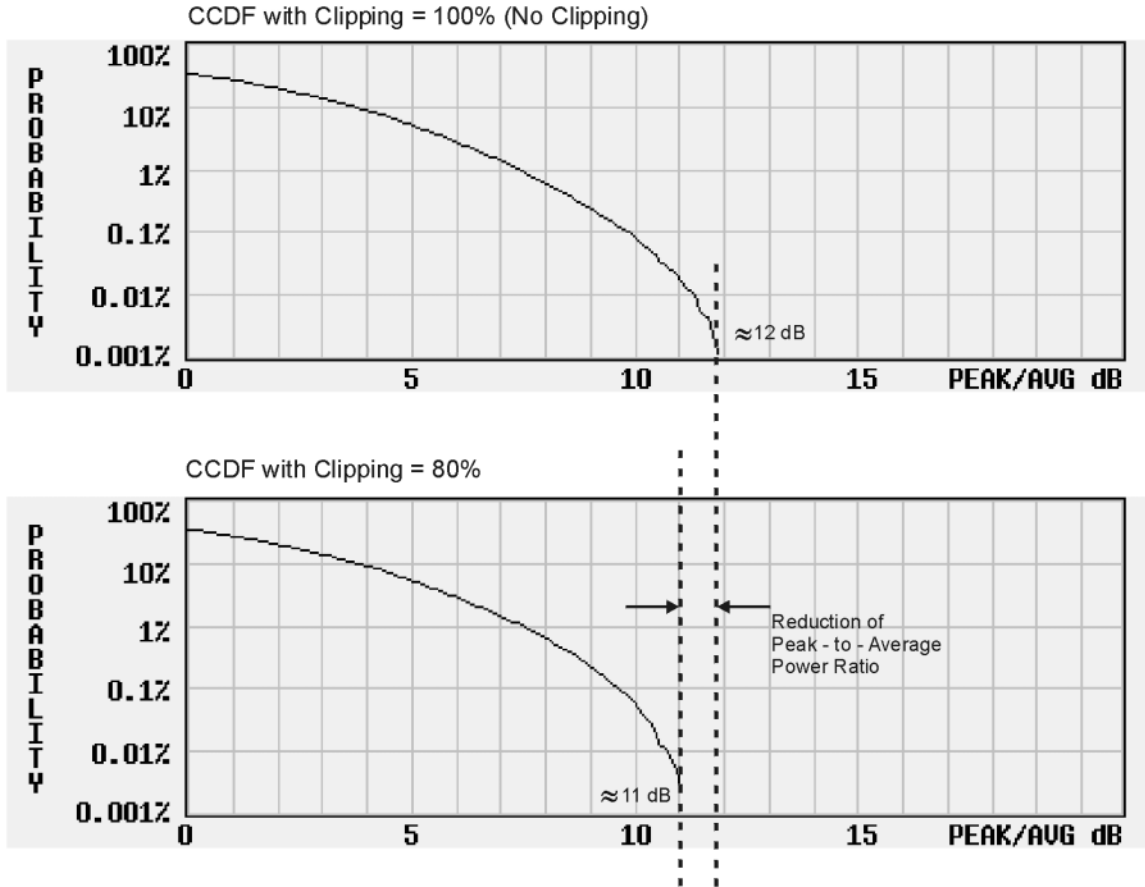

## Configuring Circular Clipping

This procedure shows you how to configure circular clipping. The circular setting clips the composite I/Q data (I and Q data are clipped equally). For more information about circular clipping, refer to “How Clipping Reduces Peak-to-Average Power” on page 152.

1. Press **Preset > Mode > Custom > Arb Waveform Generator > Digital Modulation Off On** to On. This generates a custom arbitrary waveform for use in this procedure. You can also use a previously stored or downloaded waveform.
2. Press **Mode > Dual ARB > Select Waveform** and ensure that AUTOGEN\_WAVEFORM is highlighted on the display. AUTOGEN\_WAVEFORM is the default name assigned to the waveform you generated in the previous step.
3. Press **Select Waveform**. This selects the waveform and returns you to the previous softkey menu.
4. Press **ARB Off On** to On. The dual Arb player must be turned on to display the CCDF plot in the following steps.
5. Press **ARB Setup > Waveform Utilities > Waveform Statistics** and ensure that AUTOGEN\_WAVEFORM is highlighted on the display.
6. Press **CCDF Plot** and observe the position of the waveform’s curve, which is the darkest line.
7. Press **Return > Return > Clipping**.
8. Ensure that the **Clipping Type |I+jQ| |I|,|Q|** softkey is set to **|I+jQ|**, which is circular clipping.
9. Press **Clip |I+jQ| To > 80 > % > Apply to Waveform**. The I and Q data are both clipped by 80%. Once clipping is applied to the waveform it cannot be undone. Repeated use of the clipping function has a cumulative effect on the waveform.
10. Press **Waveform Statistics > CCDF Plot** and observe the waveform’s curve. Notice the reduction in peak-to-average power, relative to the previous plot, after applying clipping.

## Using Waveform Clipping

### Configuring Rectangular Clipping

This procedure shows you how to configure rectangular clipping. The rectangular setting clips the I and Q data independently. For more information about rectangular clipping, refer to “How Clipping Reduces Peak-to-Average Power” on page 152.

1. Press **Preset > Mode > Custom > Arb Waveform Generator > Digital Modulation Off On** to On. This generates a custom arbitrary waveform for use in this procedure. You can also use a previously stored or downloaded waveform.
2. Press **Mode > Dual ARB > Select Waveform** and ensure that AUTOGEN\_WAVEFORM is highlighted on the display. AUTOGEN\_WAVEFORM is the default name assigned to the waveform you generated in the previous step.
3. Press **Select Waveform**. This selects the waveform and returns you to the previous softkey menu.
4. Press **ARB Off On** to On. The dual Arb player must be turned on to display the CCDF plot in the following steps.
5. Press **ARB Setup > Waveform Utilities > Waveform Statistics** and ensure that AUTOGEN\_WAVEFORM is highlighted on the display.
6. Press **CCDF Plot** and observe the position of the waveform’s curve, which is the darkest line.
7. Press **Return > Return > Clipping**.
8. Ensure that the **Clipping Type |I+jQ| |I|,|Q|** softkey is set to **|I|,|Q|**. This activates the **Clip |I| To** and **Clip |Q| To** softkeys that enable you to configure rectangular (independent) I and Q data clipping.
9. Press **Clip |I| To > 80 > %**.
10. Press **Clip |Q| To > 40 > % > Apply to Waveform**. The I and Q data are individually clipped by 80% and 40%, respectively. Once clipping is applied to the waveform it cannot be undone. Repeated use of the clipping function has a cumulative effect on the waveform.
11. Press **Waveform Statistics > CCDF Plot** and observe the waveform’s curve. Notice the reduction in peak-to-average power, relative to the previous plot, after applying clipping.

---

## Using Waveform Scaling

Waveform scaling is used to eliminate DAC over-range errors. The ESG provides two methods of waveform scaling:

**Runtime Scaling** Available in the Dual ARB Player and the Multitone modulation format, this type of scaling enables you to make real time scaling adjustments of a currently playing waveform.

**Permanent Scaling** Available in only the Dual ARB player, this type of scaling permanently scales the data of a non-playing waveform file residing in volatile memory.

This section describes how DAC over-range errors occur and how you can use waveform scaling to eliminate these errors effectively.

### How DAC Over-Range Errors Occur

The ESG utilizes an interpolator filter in the conversion of the digital I and Q baseband waveforms into analog waveforms. The clock rate of the interpolator is four times that of the baseband clock. The interpolator therefore calculates sample points between the incoming baseband samples to equal the faster clock rate and smooth out the waveform, giving it a more curve-like appearance (see [Figure 4-22](#)).

**Figure 4-22**

**Waveform Interpolation**

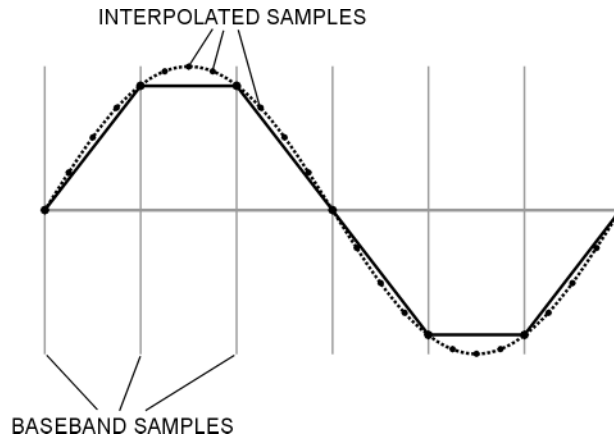

The interpolation filters in the DACs have overshoot. If a baseband waveform has a fast-rising edge, the interpolator filter's overshoot or frequency response becomes a component of the interpolated baseband waveform. This response causes a ripple or ringing effect at the peak of the rising edge. If this ripple exceeds (or overshoots) the upper limit of the DAC's range, the interpolator calculates erroneous sample points and

**Using Waveform Scaling**

is unable to replicate the true form of the ripple (see [Figure 4-23](#)). As a result, the ESG reports a DAC over-range error.

**Figure 4-23 Waveform Overshoot**

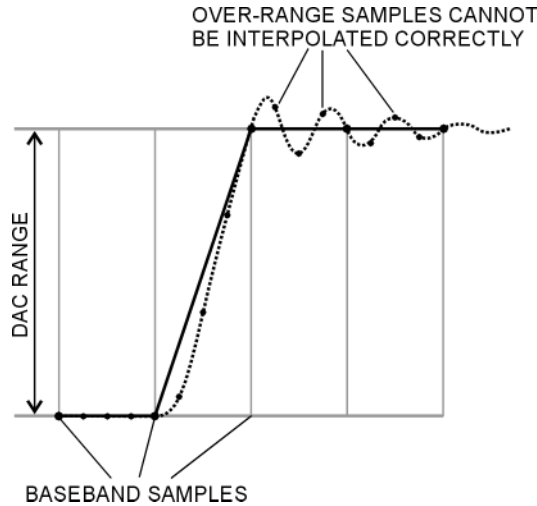

**How Scaling Eliminates DAC Over-Range Errors**

Scaling reduces or shrinks a baseband waveform’s amplitude while maintaining its basic shape and characteristics, such as peak-to-average power ratio. If the fast-rising baseband waveform is scaled enough to allow an adequate margin for the overshoot, the interpolator filter is then able to calculate sample points that include the ripple effect, thereby eliminating the over-range error (see [Figure 4-24](#)).

Figure 4-24 Waveform Scaling

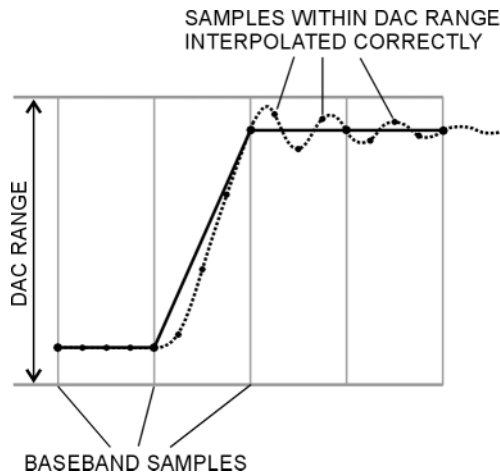

Although scaling maintains the basic shape of the waveform, too much scaling can compromise its integrity because the bit resolution can be so low that the waveform becomes corrupted with quantization noise. Maximum accuracy and optimum dynamic range are achieved by scaling the waveform just enough to remove the DAC over-range error. Optimum scaling varies with waveform content.

### Scaling a Currently Playing Waveform (Runtime Scaling)

This section demonstrates how to make real time scaling adjustments to a currently playing waveform. This type of scaling does not affect the waveform file and is well suited for eliminating DAC over-range errors.

#### In the Dual ARB Player

To play a waveform in the Dual ARB Player, ensure that the waveform exists in volatile memory. This procedure first creates a waveform file using the Custom modulation format, which the signal generator automatically stores in volatile memory.

1. Press **Preset > Mode > Custom > Arb Waveform Generator > Digital Modulation Off On** to On. This generates a custom arbitrary waveform for use in this procedure. You can also use a previously stored or downloaded waveform.
2. Press **Mode > Dual ARB > Select Waveform** and ensure that `AUTOGEN_WAVEFORM` is highlighted on the display. `AUTOGEN_WAVEFORM` is the default name assigned to the waveform you generated in the previous step.
3. Press **Select Waveform**. This selects the waveform and returns you to the previous softkey menu.
4. Press **ARB Off On** to On. This plays the selected waveform.

## Using Waveform Scaling

5. Press **ARB Setup > More (1 of 2) > Waveform Runtime Scaling** and adjust the front panel knob or use the number keys to enter a new value. The new scaling value is instantly applied to the playing waveform. Runtime scaling adjustments are not cumulative, as the values are always relative to original amplitude of the waveform file.

### In Multitone

1. Press **Preset > Mode > Multitone > Multitone Off On** to On. This generates a multitone arbitrary waveform for use in this procedure.
2. Press **More (1 of 2) > ARB Setup > More (1 of 2) > Waveform Runtime Scaling** and adjust the front panel knob or use the number keys to enter a new value. The new scaling value is instantly applied to the playing waveform. Runtime scaling adjustments are not cumulative, as the values are always relative to original amplitude of the waveform file.

### Scaling a Waveform File in Volatile Memory

This procedure enables you to permanently scale a waveform file. You can then store the scaled waveform segment to non-volatile memory for future use. Scaling is cumulative and non-reversible.

1. Press **Preset > Mode > Custom > Arb Waveform Generator > Digital Modulation Off On** to On. This generates a custom arbitrary waveform for use in this procedure. You can also use a previously stored or downloaded waveform.
2. Press **Mode > Dual ARB > Select Waveform** and ensure that AUTOGEN\_WAVEFORM is highlighted on the display. AUTOGEN\_WAVEFORM is the default name assigned to the waveform you generated in the previous step.
3. Press **Select Waveform**. This selects the waveform and returns you to the previous softkey menu.
4. Press **ARB Setup > Waveform Utilities** and ensure that AUTOGEN\_WAVEFORM is highlighted on the display.
5. Press **Scale Waveform Data > Scaling > 70 > % > Apply to Waveform**. The waveform is now reduced to 70 percent of its original amplitude. Once this type of scaling is applied to the waveform it cannot be undone. Repeated scaling applications have a cumulative effect on the waveform.



---

## Using Customized Burst Shape Curves

You can adjust the shape of the rise time curve and the fall time curve using the Rise Shape and Fall Shape editors. Each editor allows you to enter up to 256 values, equidistant in time, to define the shape of the curve. The values are then resampled to create the cubic spline that passes through all of the sample points.

The Rise Shape and Fall Shape table editors are available for custom real time I/Q baseband generator waveforms and real time I/Q baseband generator TDMA waveforms. They are not available for waveforms generated by the dual arbitrary waveform (dual ARB) generator.

For instructions on modifying rise and fall times and delays, see [“Configuring the Burst Rise and Fall Parameters”](#) on page 394.

### Understanding Burst Shape

The default burst shape of each format is implemented according to the standards of the format selected. You can, however, modify the following aspects of the burst shape:

Rise time	the period of time, specified in bits, where the burst increases from a minimum of $-70$ dB (0) to full power (1).
Fall time	the period of time, specified in bits, where the burst decreases from full power (1) to a minimum of $-70$ dB (0).
Rise delay	the period of time, specified in bits, that the start of the burst rise is delayed. Rise delay can be either negative or positive. Entering a delay other than zero shifts the full power point earlier or later than the beginning of the first useful symbol.
Fall delay	the period of time, specified in bits, that the start of the burst fall is delayed. Fall delay can be either negative or positive. Entering a delay other than zero shifts the full power point earlier or later than the end of the last useful symbol.
User-defined burst shape	up to 256 user-entered values which define the shape of the curve in the specified rise or fall time. The values can vary between 0 (no power) and 1 (full power) and are scaled linearly. Once specified, the values are resampled as necessary to create the cubic spline that passes through all of the sample points.

**Using Customized Burst Shape Curves**

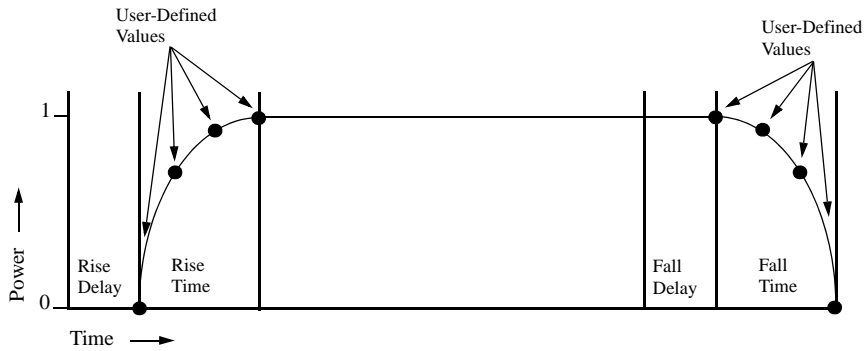

Burst shape maximum rise and fall time values are affected by the following factors:

- the symbol rate
- the modulation type

When the rise and fall delays equal 0, the burst shape is attempting to synchronize the maximum burst shape power to the beginning of the first valid symbol and the ending of the last valid symbol of the timeslot. The following figure illustrates a bursted signal in an EDGE frame with a rise delay of 0 and a fall delay of +1 bit.

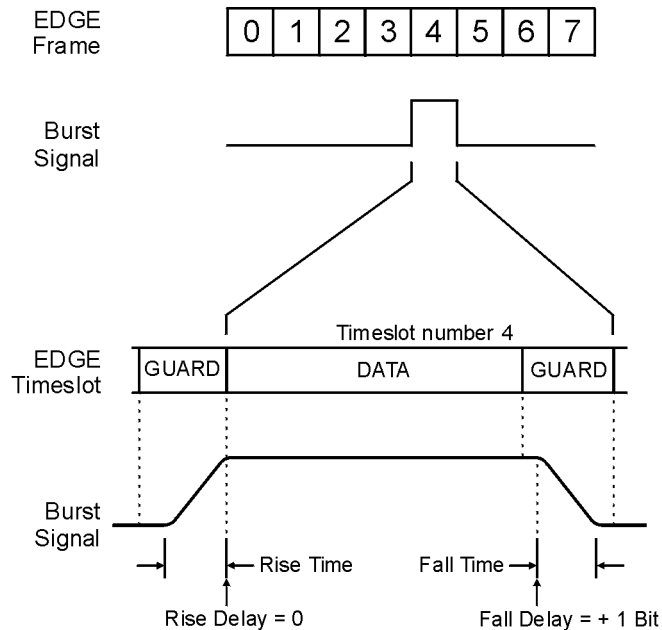

pk743b

The signal generator firmware computes optimum burst shape based on the settings you've chosen for modulation. You can further optimize burst shape by lining up the data portion with the modulation. For example, if you're designing a new modulation scheme, do the following:

- Adjust the modulation and filtering to set the spectrum you want.
- Turn on framing.
- Adjust the burst rise and fall delay and rise and fall time for the timeslots.

If you find that the error vector magnitude (EVM) or adjacent channel power (ACP) increases when you turn bursting on, you can adjust the burst shape to assist with troubleshooting.

## Creating a User-Defined Burst Shape Curve

Using this procedure, you learn how to enter rise shape sample values and mirror them as fall shape values to create a symmetrical burst curve.

This section teaches you how to perform the following tasks:

- [“Accessing the Table Editors” on page 164](#)
- [“Entering Sample Values” on page 164](#)

**Using Customized Burst Shape Curves**

**Accessing the Table Editors**

1. Press **Preset**.
2. Perform the following keypress sequence required for your format type.

**For Custom Format**

Press **Mode > Custom > Real Time I/Q Base Band > Burst Shape**.

**For TDMA Formats**

Press **Mode > Real Time TDMA > *desired format* > More (1 of 2) > Modify Standard > Burst Shape**.

3. Press **Define User Burst Shape > More (1 of 2) > Delete All Rows > Confirm Delete Of All Rows**.

**Entering Sample Values**

Use the sample values in the following table.

<b>Rise Shape Editor</b>			
<b>Sample</b>	<b>Value</b>	<b>Sample</b>	<b>Value</b>
0	0.000000	5	0.900000
1	0.400000	6	0.950000
2	0.600000	7	0.980000
3	0.750000	8	0.990000
4	0.830000	9	1.000000

1. Highlight the value (1 . 000000) for sample 1.
2. Press **.4 > Enter**.
3. Press **.6 > Enter**.
4. Enter the remaining values for samples 3 through 9 from the table above.
5. Press **More (2 of 2) > Edit Fall Shape > Load Mirror Image of Rise Shape > Confirm Load Mirror Image Of Rise Shape**.

This changes the fall shape values to a mirror image of the rise shape values, as shown in [Figure 4-25 on page 165](#).

**Figure 4-25**

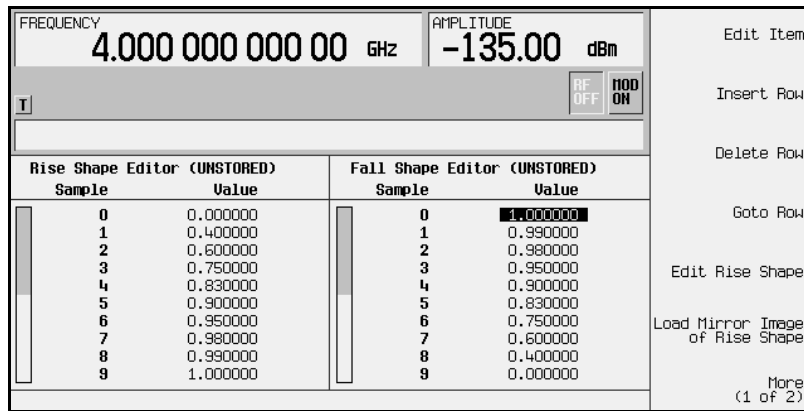

**Display the Burst Shape**

Press **More (1 of 2) > Display Burst Shape**.

This displays a graphical representation of the waveform's rise and fall characteristics, as shown in [Figure 4-26](#).

**Figure 4-26**

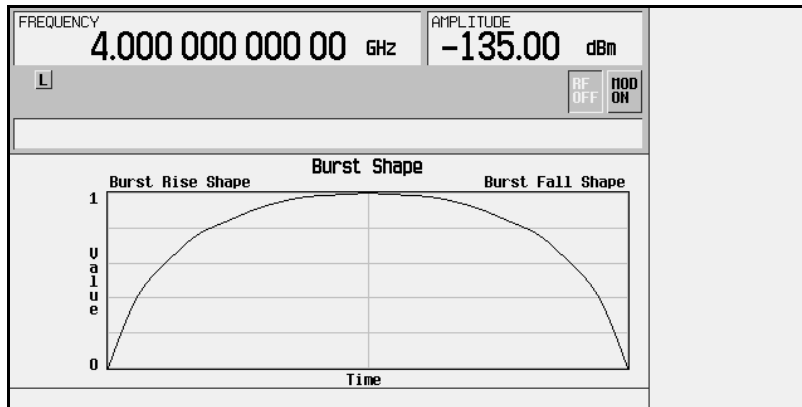

To return the burst to the default conditions, press the following keys:

**Return > Return > Confirm Exit From Table Without Saving > Restore Default Burst Shape.**

## Using Customized Burst Shape Curves

### Storing a User-Defined Burst Shape Curve

1. Press **Define User Burst Shape > More (1 of 2) > Load/Store > Store To File.**

If there is already a file name from the Catalog of SHAPE Files occupying the active entry area, press the following keys:

**Editing Keys > Clear Text**

2. Enter a file name (for example, NEWBURST) using the alpha keys and the numeric keypad.

The maximum file name length is 23 characters (alphanumeric and special characters).

3. Press **Enter.**

The contents of the current Rise Shape and Fall Shape table editors are stored to the Catalog of SHAPE Files. This burst shape can now be used to customize a modulation or as a basis for a new burst shape design.

### Recalling a User-Defined Burst Shape Curve

Once a user-defined burst shape file is stored in memory, it can be recalled for use with real time I/Q baseband generated digital modulation.

This example requires a user-defined burst shape file stored in memory. If you have not created and stored a user-defined burst shape file, complete the steps in the previous sections, “[Creating a User-Defined Burst Shape Curve](#)” on page 163 and “[Storing a User-Defined Burst Shape Curve](#)” on page 166.

1. Press **Preset.**
2. Perform the following keypress sequence required for your format type.

#### For Custom Format

Press **Mode > Custom > Real Time I/Q Base Band > Burst Shape > Burst Shape Type > User File.**

#### For TMDA Formats

Press **Mode > Real Time TDMA > *desired format* > More (1 of 2) > Modify Standard > Burst Shape > Burst Shape Type > User File.**

3. Highlight the desired burst shape file (for example, NEWBURST).
4. Press **Select File.**

The selected burst shape file is now applied to the current real time I/Q baseband digital modulation state.

## Generating the Waveform

Perform the following keypress sequence required for your format type.

### For Custom Format

Press **Return** > **Custom Off On**.

### For TDMA Formats

Press **Return** > **Return** > **More (2 of 2)** > *desired format* **Off On**.

This generates the custom modulation or TDMA state with user-defined burst shape created in the previous sections. During waveform generation, the CUSTOM (or appropriate TDMA) annunciator and I/Q annunciator activate. The waveform is now modulating the RF carrier.

## Configuring the RF Output

1. Set the RF output frequency to 800 MHz.
2. Set the output amplitude to -10 dBm.
3. Press **RF On/Off**.

The current real time I/Q baseband digital modulation format with user-defined burst shape is now available at the signal generator's RF OUTPUT connector.

## Using Finite Impulse Response (FIR) Filters

Finite Impulse Response filters can be created and used with both dual arbitrary waveform generated waveforms and real time baseband generated waveforms. For this example, the filter is defined within the CDMA2000 digital communications format, a dual arbitrary waveform generated state.

### Creating a User-Defined FIR Filter Using the FIR Table Editor

In this procedure, you use the FIR Values table editor to create and store an 8-symbol, windowed sync function filter with an oversample ratio of 4.

#### Accessing the Table Editor

1. Press **Preset**.
2. Press **Mode > CDMA > Arb CDMA2000**.
3. Press **More (1 of 2) > CDMA2000 Define > Filter > Define User FIR**.
4. Press **More (1 of 2) > Delete All Rows**.

This will initialize the table editor as shown in [Figure 4-27](#).

**Figure 4-27**

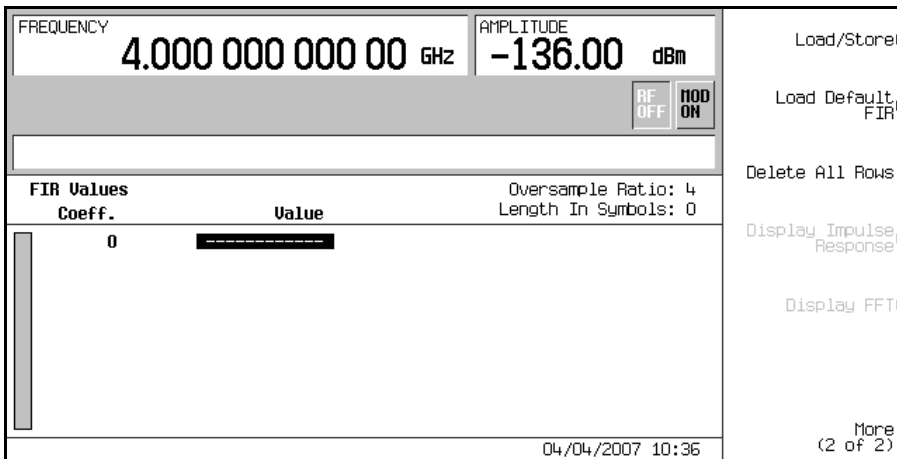



### Entering the Coefficient Values

1. Press the **Return** softkey to get to the first page of the table editor.
2. Use the cursor to highlight the **Value** field for coefficient 0, then press **Edit Item**.
3. Use the numeric keypad to type the first value (–0.000076) from [Table 4-1](#). As you press the numeric keys, the numbers are displayed in the active entry area. (If you make a mistake, you can correct it using the backspace key.)
4. Continue entering the coefficient values from the table in step 1 until all 16 values have been entered.

**Table 4-1**

<b>Coefficient</b>	<b>Value</b>
0	–0.000076
1	–0.001747
2	–0.005144
3	–0.004424
4	0.007745
5	0.029610
6	0.043940
7	0.025852

<b>Coefficient</b>	<b>Value</b>
8	–0.035667
9	–0.116753
10	–0.157348
11	–0.088484
12	0.123414
13	0.442748
14	0.767329
15	0.972149

### Duplicating the First 16 Coefficients Using Mirror Table

In a windowed sinc function filter, the second half of the coefficients are identical to the first half in reverse order. The signal generator provides a mirror table function that automatically duplicates the existing coefficient values in the reverse order.

1. Press **Mirror Table**. The last 16 coefficients (16 through 31) are automatically generated and the first of these coefficients (number 16) highlights, as shown in [Figure 4-28 on page 170](#).

Figure 4-28

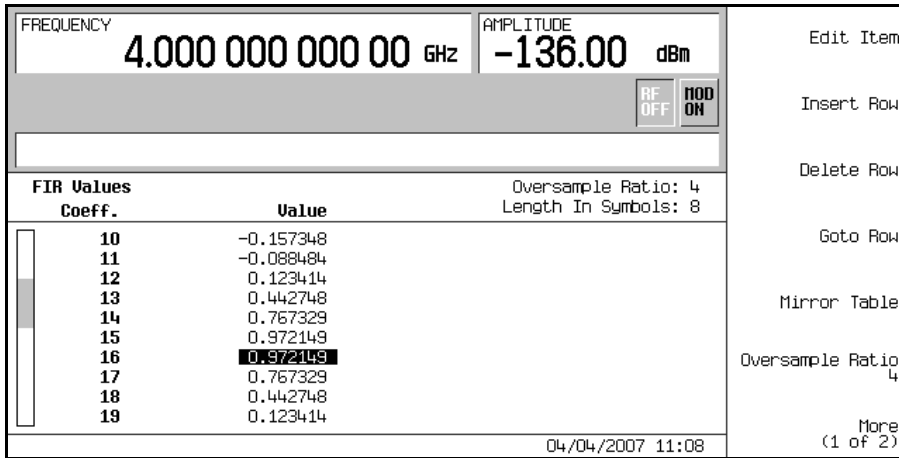

### Setting the Oversample Ratio

The oversample ratio (OSR) is the number of filter coefficients per symbol. Acceptable values range from 1 through 32; the maximum combination of symbols and oversampling ratio allowed by the table editor is 1024. The instrument hardware, however, is actually limited to 32 symbols, an oversample ratio between 4 and 16, and 512 coefficients. So if you enter more than 32 symbols or 512 coefficients, the instrument is unable to use the filter. If the oversample ratio is different from the internal, optimally selected one, then the filter is automatically resampled to an optimal oversample ratio.

For this example, the desired OSR is 4, which is the default, so no action is necessary.

### Displaying a Graphical Representation of the Filter

The signal generator has the capability of graphically displaying the filter in both time and frequency dimensions.

1. Press **More (1 of 2) > Display FFT** (fast Fourier transform).

Refer to [Figure 4-29 on page 171](#).

Figure 4-29

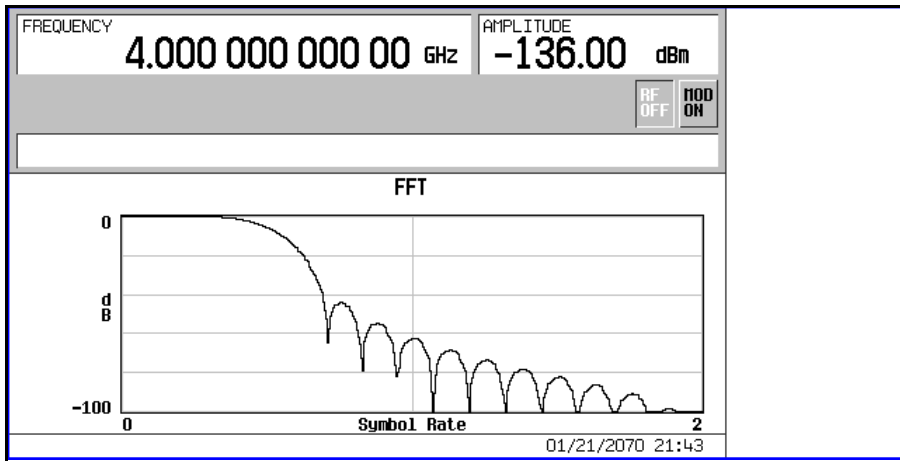

2. Press **Return**.
3. Press **Display Impulse Response**.  
Refer to [Figure 4-30](#).

Figure 4-30

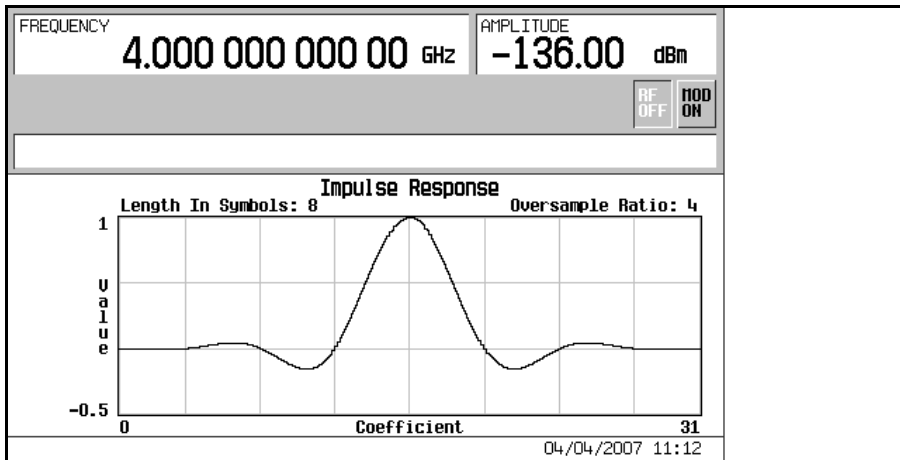

4. Press **Return** to return to the menu keys.

**Using Finite Impulse Response (FIR) Filters**

**Storing the Filter to Memory**

Use the following steps to store the file.

1. Press **Load/Store > Store To File**. The catalog of FIR files appears along with the amount of memory available.
2. As described in “[Storing a Component Test Waveform to Memory](#)” on page 320, name and store this file as FIR\_1.

The FIR\_1 file is the first file name listed. (If you have previously stored other FIR files, additional file names are listed below FIR\_1.) The file type is FIR and the size of the file is 260 bytes. The amount of memory used is also displayed. The number of files that can be saved depends on the size of the files and the amount of memory used. Refer to [Figure 4-31](#).

**Figure 4-31**

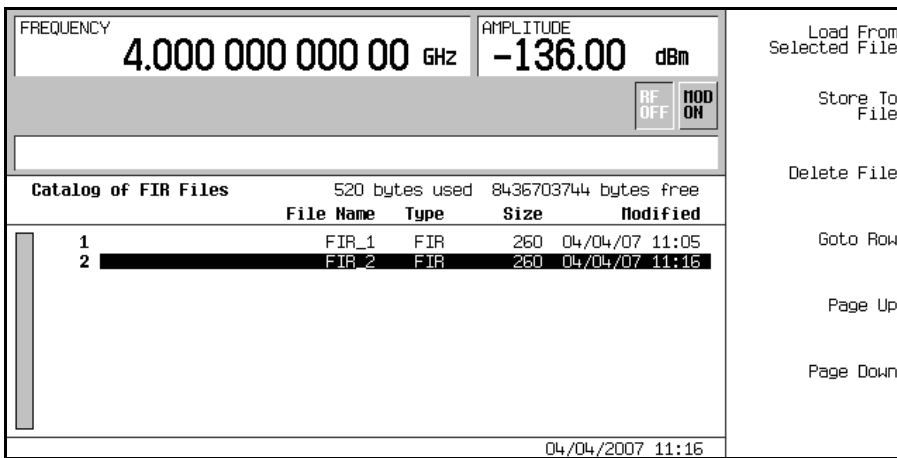

Memory is also shared by instrument state files and list sweep files.

This filter can now be used to customize a modulation or it can be used as a basis for a new filter design.

---

## Modifying a FIR Filter Using the FIR Table Editor

FIR filters stored in signal generator memory can easily be modified using the FIR table editor. You can load the FIR table editor with coefficient values from user-defined FIR files stored in non-volatile memory or from one of the default FIR filters. Then you can modify the values and store the new files.

### Loading the Default Gaussian FIR File

1. Press **Preset**.
2. Press **Mode > CDMA > Arb CDMA2000 > More (1 of 2) > CDMA2000 Define**.
3. Press **Filter > Define User FIR > More (1 of 2) > Load Default FIR > Gaussian**.
4. Press **Filter BbT > 0.300 > Enter**.
5. Press **Filter Symbols > 8 > Enter**.
6. Press **Generate**.

---

**NOTE** The actual oversample ratio during modulation is automatically selected by the instrument. A value between 4 and 16 is chosen dependent on the symbol rate, the number of bits per symbol of the modulation type, and the number of symbols.

---

7. Press **Display Impulse Response** (refer to [Figure 4-32](#)).

**Figure 4-32**

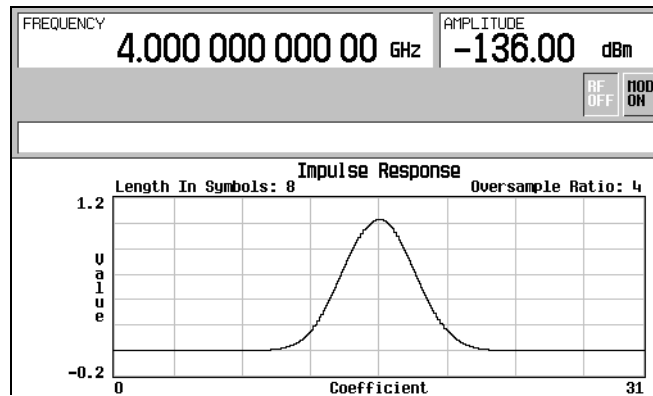

8. Press **Return**.

## Modifying a FIR Filter Using the FIR Table Editor

### Modifying the Coefficients

1. Using the front panel arrow keys, highlight coefficient 15.
2. Press **0** > **Enter**.
3. Press **Display Impulse Response**.

**Figure 4-33**

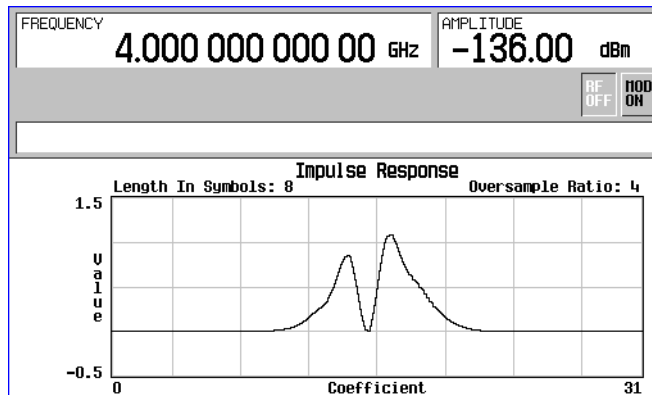

Refer to [Figure 4-33 on page 174](#). The graphic display can provide a useful troubleshooting tool (in this case, it indicates that a coefficient value is missing, resulting in an improper Gaussian response).

4. Press **Return**.
5. Press **More (2 of 2)**.
6. Highlight coefficient 15.
7. Press **1** > **Enter**.

### Storing the Filter to Memory

The maximum file name length is 23 characters (alphanumeric and special characters).

1. Press **Load/Store** > **Store To File**.
2. Name the file NEWFIR2.
3. Press **Enter**.

The contents of the current FIR table editor are stored to a file in non-volatile memory and the catalog of FIR files is updated to show the new file.

## Differential Encoding

Differential encoding is a digital-encoding technique whereby a binary value is denoted by a signal *change* rather than a particular signal state. Using differential encoding, binary data in any user-defined I/Q or FSK modulation can be encoded during the modulation process via symbol table offsets defined in the Differential State Map.

For example, consider the signal generator's default 4QAM I/Q modulation. With a user-defined modulation based on the default 4QAM template, the I/Q Values table editor contains data that represent four symbols (00, 01, 10, and 11) mapped into the I/Q plane using two distinct values, 1.000000 and -1.000000. These four symbols can be differentially encoded during the modulation process by assigning symbol table offset values associated with each data value. The following illustration shows the 4QAM modulation in the I/Q Values table editor.

FREQUENCY		4.000 000 000 00 GHz		AMPLITUDE		-136.00 dBm		RF OFF		T10D ON		Load/Store ▶	
												Load Default I/Q Map ▶	
												Delete All Rows	
I/Q Values												Differential Encoding	
Data												OFF On	
I Value												Configure Differential Encoding ▶	
Q Value												Offset Q	
00000000												OFF On	
00000001												More (2 of 2)	
00000010													
00000011													
00000100													
												01/13/ 18:25	

### NOTE

The number of bits per symbol can be expressed using the following formula. Because the equation is a ceiling function, if the value of  $x$  contains a fraction,  $x$  is rounded up to the next whole number.

$$x = \lceil \log_2(y) \rceil$$

Where  $x$  = bits per symbol, and  $y$  = the number of differential states.

**Differential Encoding**

The following illustration shows a 4QAM modulation I/Q State Map.

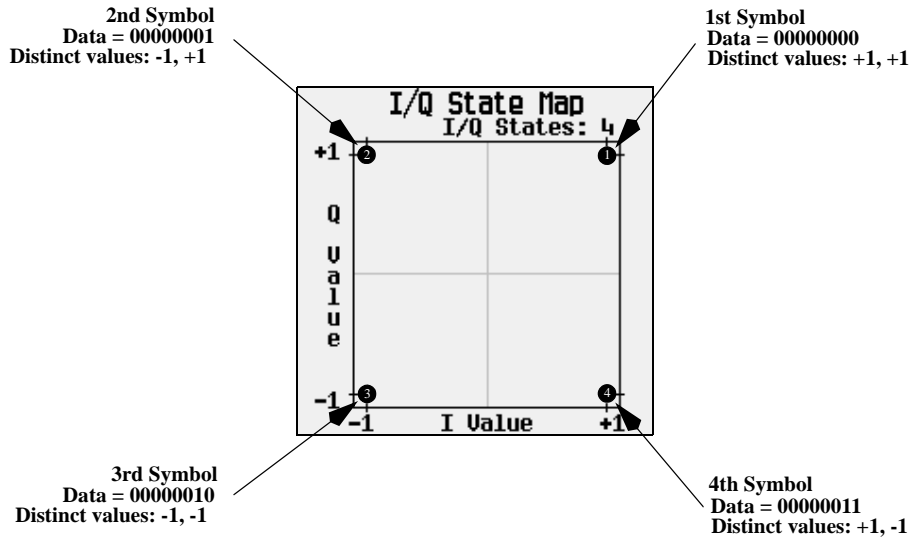

**Differential Data Encoding**

In real time I/Q baseband digital modulation waveforms, data (1's and 0's) are encoded, modulated onto a carrier frequency, and subsequently transmitted to a receiver. In contrast to differential encoding (described on page 175), differential *data* encoding modifies the data stream *prior* to I/Q mapping. Where differential encoding encodes the raw data by using symbol table offset values to manipulate I/Q mapping at the point of modulation, differential data encoding uses *the transition from one bit value to another* to encode the raw data.

Differential data encoding modifies the raw digitized data by creating a secondary, encoded data stream that is defined by *changes* in the digital state, from 1 to 0 or from 0 to 1, of the raw data stream. This differentially encoded data stream is then modulated and transmitted.

In differential data encoding, a *change* in a raw data bit's digital state, from 1 to 0 or from 0 to 1, produces a 1 in the encoded data stream. *No change* in digital state from one bit to the next, in other words a bit with a value of 1 followed by another bit with a value of 1 or a bit with a value of 0 followed by the same, produces a 0 in the encoded data. For instance, differentially encoding the data stream containing 01010011001010 renders 1111010101111.

Differential data encoding can be described by the following equation:

$$transmittedbit(i) = databit(i - 1) \oplus databit(i)$$



For a bit-by-bit illustration of the encoding process, see the following illustration.

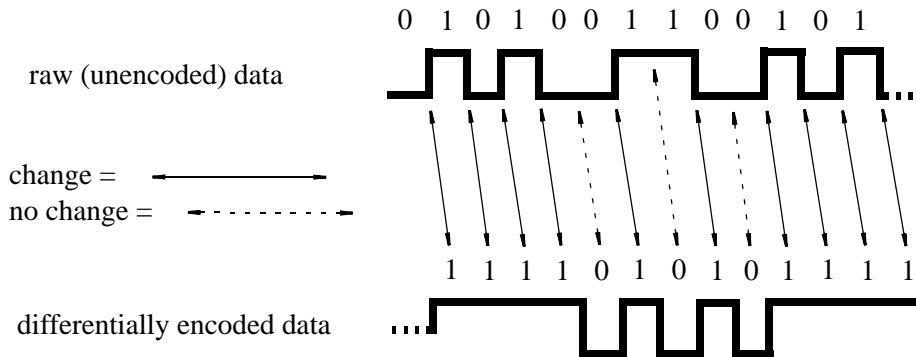

## How Differential Encoding Works

Differential encoding employs offsets in the symbol table to encode user-defined modulation schemes. The *Differential State Map* table editor is used to introduce symbol table offset values which in turn cause transitions through the *I/Q State Map* based on their associated data value. Whenever a data value is modulated, the offset value stored in the *Differential State Map* is used to encode the data by transitioning through the *I/Q State Map* in a direction and distance defined by the symbol table offset value.

Entering a value of +1 will cause a 1-state forward transition through the *I/Q State Map*, as shown in the following illustration.

---

**NOTE** The following *I/Q State Map* illustrations show all of the possible state transitions using a particular symbol table offset value. The actual state-to-state transition would depend upon the state in which the modulation had started.

---

As an example, consider the following data/symbol table offset values.

**Table 4-2**

Data	Offset Value
00000000	+1
00000001	-1
00000010	+2
00000011	0

**Differential Encoding**

These symbol table offsets will result in one of the transitions, as shown.

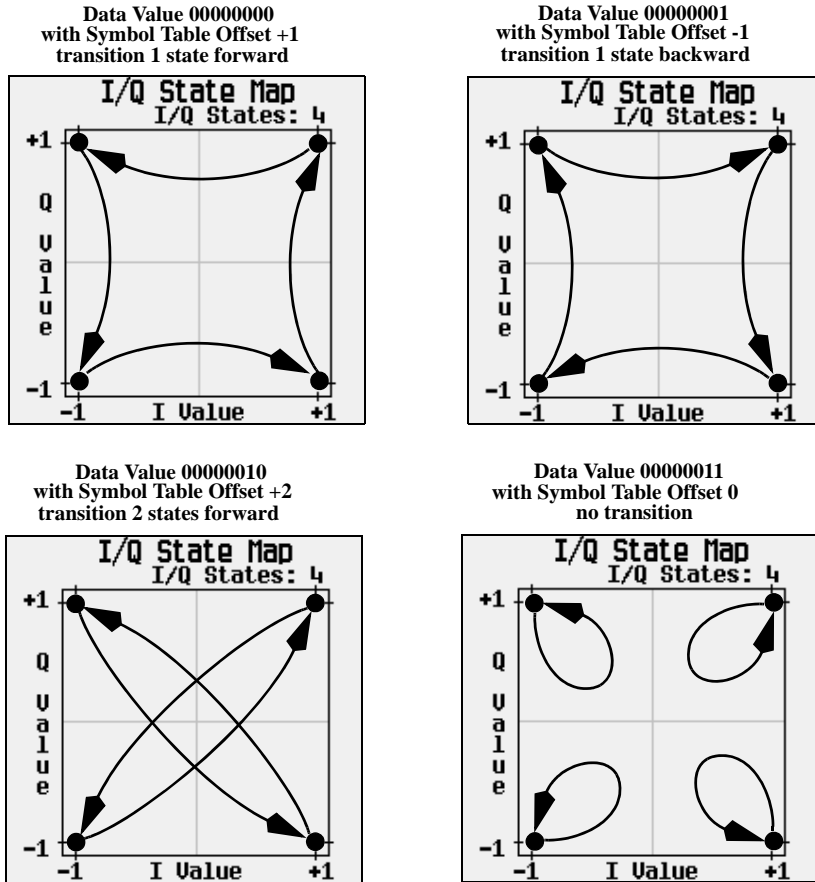

When applied to the user-defined default 4QAM I/Q map, starting from the 1st symbol (data 00), the differential encoding transitions for the data stream (in 2-bit symbols) 0011100001 appear in the following illustration.

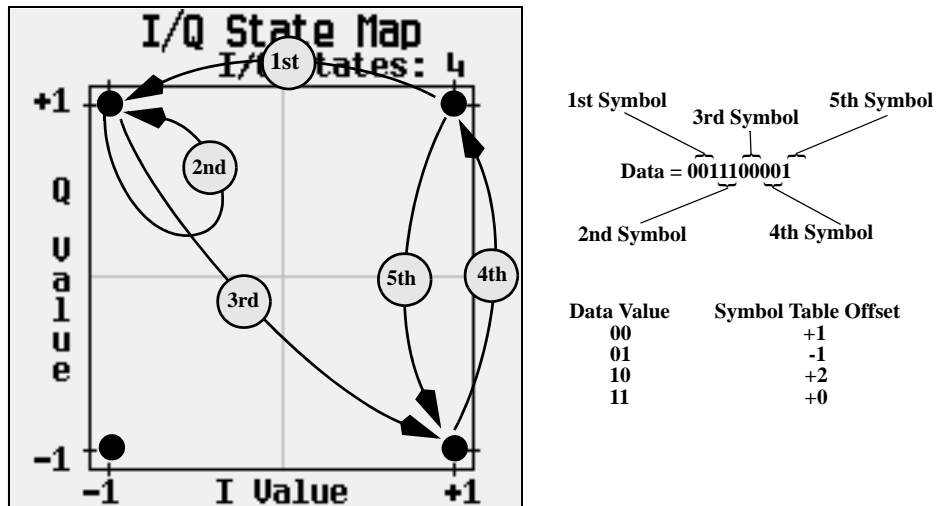

As you can see from the previous illustration, the 1st and 4th symbols, having the same data value (00), produce the same state transition (forward 1 state). In differential encoding, symbol values do not define location; they define the direction and distance of a *transition* through the I/Q State Map.

For instructions on configuring differential encoding, see [“Using Differential Encoding” on page 179](#).

## Using Differential Encoding

Differential encoding is a digital-encoding technique that denotes a binary value by a signal *change* rather than a particular signal state. It is available for custom real time I/Q baseband generator waveforms and real time I/Q baseband generator TDMA waveforms. It is not available for waveforms generated by the dual arbitrary waveform generator.

The signal generator’s *Differential State Map* table editor enables you to modify the differential state map associated with user-defined I/Q and user-defined FSK modulations. In this procedure, you create a user-defined I/Q modulation and then configure, activate, and apply differential encoding to the user-defined modulation. For more information, see [“Differential Encoding” on page 175](#).

**Differential Encoding**

**Configuring User-Defined I/Q Modulation**

1. Press **Preset**.
2. Perform the following keypress sequence required for your format type.

**For Custom Format**

Press **Mode > Custom > Real Time I/Q Base Band > Modulation Type > Define User I/Q > More (1 of 2) > Load Default I/Q Map > QAM > 4QAM**

**For TDMA Formats**

Press **Mode > Real Time TDMA > *desired format* > More (1 of 2) > Modify Standard > Modulation Type > Define User I/Q > More (1 of 2) > Load Default I/Q Map > QAM > 4QAM**

This loads a default 4QAM I/Q modulation and displays it in the I/Q table editor.

The default 4QAM I/Q modulation contains data that represent 4 symbols (00, 01, 10, and 11) mapped into the I/Q plane using 2 distinct values (1.000000 and -1.000000). These 4 symbols will be traversed during the modulation process by the symbol table offset values associated with each symbol of data. Refer to [Figure 4-34](#).

**Figure 4-34**

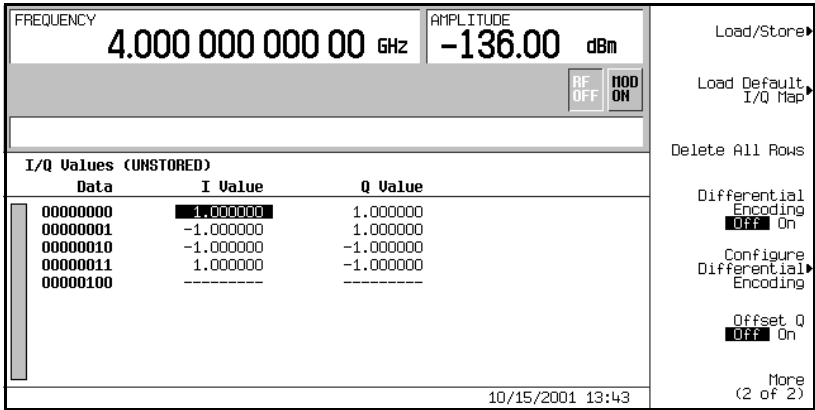

### Accessing the Differential State Map Table Editor

Press **Configure Differential Encoding**.

This opens the Differential State Map table editor, as shown. At this point, you see the data for the 1st symbol (00000000) and the cursor prepared to accept an offset value. You are now prepared to create a custom differential encoding for the user-defined default 4QAM I/Q modulation. Refer to [Figure 4-35 on page 181](#).

**Figure 4-35**

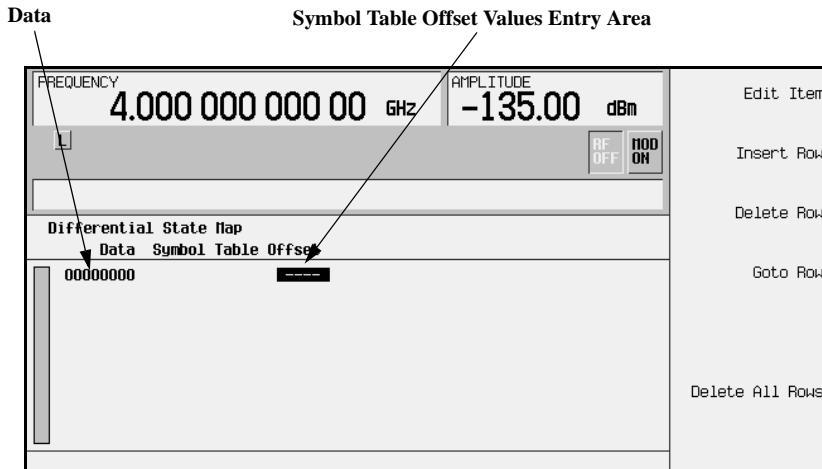

### Editing the Differential State Map

1. Press **1 > Enter**.

This encodes the first symbol by adding a symbol table offset of 1. The symbol rotates *forward* through the state map by 1 value when a data value of 0 is modulated.

2. Press **+/- > 1 > Enter**.

This encodes the second symbol by adding a symbol table offset of -1. The symbol rotates *backward* through the state map by 1 value when a data value of 1 is modulated.

---

**NOTE** At this point, the modulation has one bit per symbol. For the first two data values (00000000 and 00000001) only the last bits (the 0 and the 1, respectively) are significant.

---

## Differential Encoding

3. Press **2** > **Enter**.

This encodes the third symbol by adding a symbol table offset of 2. The symbol rotates *forward* through the state map by 2 values when a data value of 10 is modulated.

4. Press **0** > **Enter**.

This encodes the fourth symbol by adding a symbol table offset of 0. The symbol does *not* rotate through the state map when a data value of 11 is modulated.

---

**NOTE** At this point, the modulation has two bits per symbol. For the data values 00000000, 00000001, 00000010, 00000011, the symbol values are 00, 01, 10, and 11 respectively.

---

### Applying Custom Differential Encoding

Press **Return** > **Differential Encoding Off On**.

This applies the custom differential encoding to a user-defined modulation.

---

**NOTE** Notice that (UNSTORED) appears next to Differential State Map on the signal generator's display. Differential state maps are associated with the user-defined modulation for which they were created.

In order to save a custom differential state map, you must store the user-defined modulation for which it was designed. Otherwise the symbol table offset data is purged when you press the **Confirm Exit From Table Without Saving** softkey when exiting from the I/Q or FSK table editor.

---

---

## User-Defined I/Q Maps

In modulation schemes defined by standards (such as TDMA and CDMA), symbols appear in default positions in the I/Q plane. Using the I/Q Values table editor, you can define your own symbol map by changing the position of one or more symbols. The I/Q Values is available for custom real time I/Q baseband generator waveforms and real time I/Q baseband generator TDMA waveforms. It is not available for waveforms generated by the dual ARB waveform generator.

### Creating a User-Defined I/Q Map

This section teaches you how to perform the following tasks:

- “Accessing and Clearing the I/Q Table Editor” on page 183
- “Entering I and Q Values” on page 184
- “Displaying the I/Q Map” on page 184

Use the following procedure to create and store a 4-symbol unbalanced QPSK modulation.

### Accessing and Clearing the I/Q Table Editor

1. Press **Preset**.
2. Perform the following keypress sequence required for your format type.

#### For Custom Format

Press **Mode > Custom > Real Time I/Q Base Band > Modulation Type > Define User I/Q > More (1 of 2) > Delete All Rows > Confirm Delete All Rows**.

#### For TMDA Formats

Press **Mode > TDMA > *desired format* > More (1 of 2) > Modify Standard > Modulation Type > Define User I/Q > More (1 of 2) > Delete All Rows > Confirm Delete All Rows**.

This loads a default 4QAM I/Q modulation and clears the I/Q Values table editor.

**User-Defined I/Q Maps**

**Entering I and Q Values**

Enter the I and Q values listed in the following table.

Symbol	Data Bits	I Value	Q Value
0	0000	0.500000	1.000000
1	0001	-0.500000	1.000000
2	0010	0.500000	-1.000000
3	0011	-0.500000	-1.000000

1. Press **.5** > **Enter**.
2. Press **1** > **Enter**.
3. Enter the remaining I and Q values.

As the I value updates, the highlight moves to the first Q entry (and provides a default value of 0), and an empty row of data appears below the first row. As the Q value updates, and the highlight moves to the next I value. As you press the numeric keys, the numbers display in the active entry area. If you make a mistake, use the backspace key and then retype.

Also note that 0.000000 appears as the first entry in the list of *Distinct Values*, and that 0.500000 and 1.000000 are listed as the distinct values.

**Displaying the I/Q Map**

1. Press **Display I/Q Map**

An I/Q map generated using the current values in the *I/Q Values* table editor is displayed.

The map in this example has four symbols. The map uses the following *four* unique values: 0.5, 1.0, -0.5, and -1.0 to create the four symbols. It is not the number of values that defines how many symbols a map has, but how those values are combined.

2. Press **Return**.

When the contents of a table editor have not been stored, *I/Q Values (UNSTORED)* appears on the display. Follow the instructions in the next section to store the custom I/Q table.



## Storing a User-Defined I/Q Map File

In this example, you learn how to store a user-defined I/Q map. If you have not created a user-defined I/Q map, complete the steps in the previous sections, “Accessing and Clearing the I/Q Table Editor” on page 183 and “Entering I and Q Values” on page 184.

1. Press **More (1 of 2) > Load/Store > Store To File.**

If there is already a file name from the Catalog of IQ Files occupying the active entry area, press the following keys:

**Edit Keys > Clear Text**

2. Enter a file name (for example, NEW4QAM) using the alpha keys and the numeric keypad.

The maximum file name length is 23 characters.

3. Press **Enter.**

The user-defined I/Q map is now stored in the Catalog of IQ Files.

## Moving I/Q Symbols

Use the following procedure to manipulate symbol locations to simulate magnitude and phase errors. In this example, you edit a 4QAM constellation to move one symbol closer to the origin.

### Loading the Default 4QAM I/Q Map

1. Press **Preset.**
2. Perform the following keypress sequence required for your format type.

#### For Custom Format

Press **Mode > Custom > Real Time I/Q Base Band > Modulation Type > Define User I/Q > More (1 of 2) > Load Default I/Q Map > QAM > 4QAM.**

#### For TDMA Formats

Press **Mode > TDMA > *desired format* > More (1 of 2) > Modify Standard > Modulation Type > Define User I/Q > More (1 of 2) > Load Default I/Q Map > QAM > 4QAM.**

This loads a default 4QAM I/Q modulation into the I/Q Values table editor.

## User-Defined I/Q Maps

### Editing I and Q Values

1. Press **.235702** > **Enter**.
2. Press **.235702** > **Enter**.

As you enter the numbers using the numeric keypad, they are displayed in the active entry area. If you make a mistake, use the backspace key and then retype. The I value updates and the highlight moves to the first Q entry. Next, the Q value updates and the highlight moves to the following I entry.

### Displaying the I/Q Map

Press **More (2 of 2)** > **Display I/Q Map**.

Note that one symbol has moved, as shown.

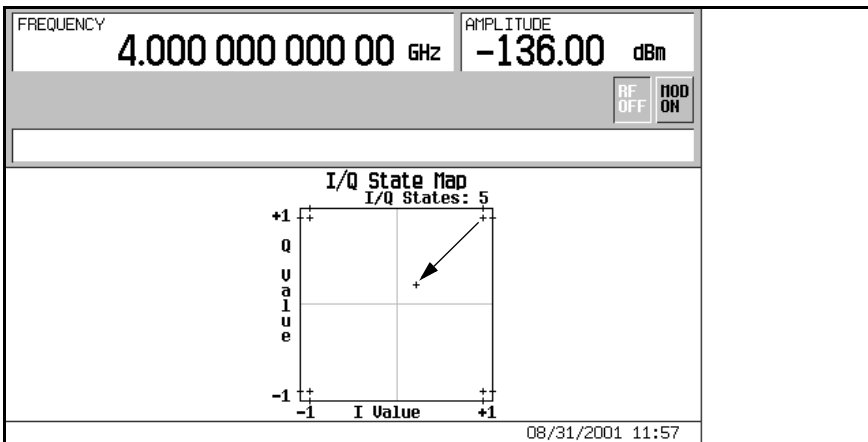

For instructions on storing this modified I/Q map to the signal generator’s memory catalog, see [“Storing a User-Defined I/Q Map File”](#) on page 185.

---

## User-Defined FSK Modulation

Using the `Frequency Values` table editor, you can define, modify and store user-defined frequency shift keying modulation.

The `Frequency Values` table editor is available for custom real time I/Q baseband generator waveforms and real time I/Q baseband generator TDMA waveforms. It is not available for waveforms generated by the dual arbitrary waveform generator.

### Modifying a Default FSK Modulation

In this example, you learn how to add errors to a default FSK modulation.

#### Loading the Default 4-Level FSK

1. Press **Preset**.
2. Perform the following keypress sequence required for your format type.

##### For Custom Format

Press **Mode** > **Custom** > **Real Time I/Q Base Band** > **Modulation Type** > **Define User FSK** > **More (1 of 2)** > **Load Default FSK**.

##### For TDMA Formats

Press **Mode** > **TDMA** > *desired format* > **More (1 of 2)** > **Modify Standard** > **Modulation Type** > **Define User FSK** > **More (1 of 2)** > **Load Default FSK**.

3. Press **Freq Dev** > **1.8** > **kHz**.
4. Press **4-Lvl FSK**.

This sets the frequency deviation and opens the `Frequency Values` table editor with the 4-level FSK default values displayed. The frequency value for data 0000 is highlighted.

#### Modifying Frequency Deviation Values

1. Press **-1.81** > **kHz**.
2. Press **-590** > **Hz**.
3. Press **1.805** > **kHz**.
4. Press **610** > **Hz**.

## User-Defined FSK Modulation

As you modify the frequency deviation values, the cursor moves to the next data row. An unstored file of frequency deviation values is created for your custom 4-level FSK file. For instructions on storing the file, see the next section.

### Storing an FSK Modulation

In this example, you learn how to store an FSK modulation. If you have not created an FSK modulation, complete the steps in the previous section, “[Modifying a Default FSK Modulation](#)” on page 187.

1. Press **Load/Store > Store To File**.

If there is already a file name from the Catalog of FSK Files occupying the active entry area, press the following keys:

**Edit Keys > Clear Text**

2. Enter a file name (for example, NEWFSK) using the alpha keys and the numeric keypad.
3. Press **Enter**.

The user-defined FSK modulation is now stored in the Catalog of FSK Files.

### Creating a User-Defined FSK Modulation

#### Accessing and Clearing the Table Editor

1. Press **Preset**.
2. Perform the following keypress sequence required for your format type.

##### For Custom Format

Press **Mode > Custom > Real Time I/Q Base Band > Modulation Type > Define User FSK > More (1 of 2) > Delete All Rows > Confirm Delete All Rows**.

##### For TDMA Formats

Press **Mode > TDMA > *desired format* > More (1 of 2) > Modify Standard > Modulation Type > Define User FSK > More (1 of 2) > Delete All Rows > Confirm Delete All Rows**.

This accesses the Frequency Values table editor and clears the previous values.

#### Entering Frequency Deviation Values

1. Press **600 > Hz**.
2. Press **1.8 > kHz**.

3. Press **-600 > Hz**.

4. Press **-1.8 > kHz**.

This sets the frequency deviation for data 0000, 0001, 0010, and 0011 to configure a user-defined FSK modulation. Each time you enter a value, the Data column increments to the next binary number, up to a total of 16 data values (from 0000 to 1111).

For instructions on storing this user-defined FSK modulation to the memory catalog, see [“Storing an FSK Modulation” on page 188](#).

## Creating and Using Bit Files

This procedure teaches you how to use the `Bit File Editor` to create, edit, and store user-defined files for data transmission within real time I/Q baseband generated modulation. For this example, a user file is defined within a custom digital communications format.

User files (user-defined data files) can be created on a remote computer and moved to the signal generator for subsequent modification, or they can be created and modified using the signal generator's `Bit File Editor`.

These user files can then be applied as the transmitted data within a framed TDMA modulation, transmitted as a continuous unframed data stream according to the protocol of the active TDMA format, transmitted as the data for a custom modulation or real time CDMA format, or for GPS applications. User files are not available for signals generated by the dual ARB waveform generator.

A real time digital modulation personality must be selected when **desired real time format** appears in the key press path.

---

**NOTE** For information on creating user-defined data files on a remote computer, see the *E4428C/38C ESG Signal Generator Programming Guide*.

---

## Creating a User File

### Accessing the Table Editor

1. Press **Preset**.
2. Press **Mode > desired real time format > Data > User File > Create File**.

This opens the `Bit File Editor`. The `Bit File Editor` contains three columns: `Offset`, `Binary Data`, and `Hex Data`, as well as cursor position (`Position`) and file name (`Name`) indicators, as shown in the following figure.

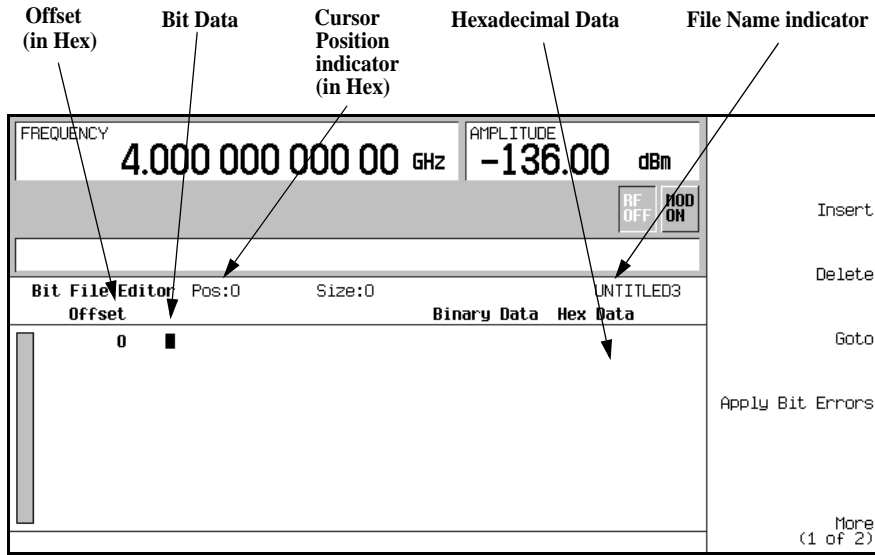

---

**NOTE** When you create new file, the default name appears as UNTITLED, or UNTITLED1, and so forth. This prevents overwriting previous files.

---

**Creating and Using Bit Files**

**Entering Bit Values**

1. Refer to the following figure.

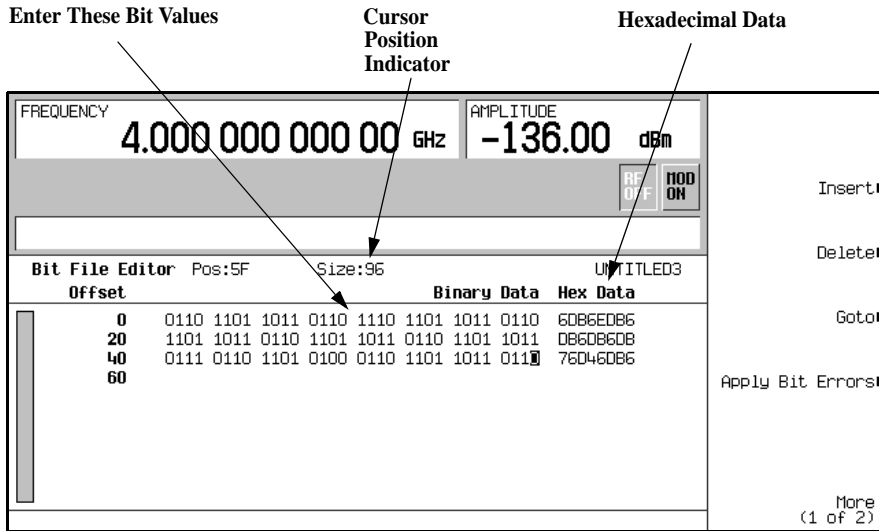

2. Enter the 32 bit values shown.

Bit data is entered into the table editor in 1-bit format. The current hexadecimal value of the binary data is shown in the Hex Data column, and the cursor position (in hexadecimal) is shown in the Position indicator.

**Renaming and Saving a User File**

In this example, you learn how to store a user file. If you have not created a user file, complete the steps in the previous section, “Creating a User File” on page 190.

1. Press **More (1 of 2) > Rename > Editing Keys > Clear Text.**
2. Enter a file name (for example, USER1) using the alpha keys and the numeric keypad.
3. Press **Enter.**

The user file has now been renamed and stored to the Bit memory catalog with the name USER1.



## Recalling a User File

In this example, you learn how to recall a user-defined data file from the memory catalog. If you have not created and stored a user-defined data file, complete the steps in the previous sections, “Creating a User File” on page 190 and “Renaming and Saving a User File” on page 192.

1. Press **Preset**.
2. Press **Mode > desired real time format > Data > User File**.
3. Highlight the file USER1.
4. Press **Edit File**.

The Bit File Editor opens the file USER1.

## Modifying an Existing User File

In this example, you learn how to modify an existing user-defined data file. If you have not created, stored, and recalled a user-defined data file, complete the steps in the previous sections, “Creating a User File” on page 190, “Renaming and Saving a User File” on page 192 and “Recalling a User File” on page 193.

## Navigating the Bit Values

Press Goto > 4 > C > Enter.

This moves the cursor to bit position 4C in the table, as shown in the following figure.

Cursor moves to new position

Position indicator changes

Offset	Binary Data	Hex Data
0	0110 1101 1011 0110 1110 1101 1011 0110	60B6E0B6
20	1101 1011 0110 1101 1011 0110 1101 1011	0B60B60B
40	0111 0110 1101 1100 0110 1101 1011 0110	76D460B6
60		

More  
(1 of 2)

**Creating and Using Bit Files**

**Inverting Bit Values**

1. Press **1011**.

This inverts the bit values that are positioned 4C through 4F. Notice that hex data in this row has now changed to 76DB6DB6, as shown in the following figure.

Bits 4C through 4F inverted

Hex Data changed

Offset	Binary Data	Hex Data
0	0110 1101 1011 0110 1110 1101 1011 0110	6DB6E7B6
20	1101 1011 0110 1101 1011 0110 1101 1011	DB6D76DB
40	0111 0110 1101 1011 0110 1101 1011 0110	76DB6DB6
60	■	

**Applying Bit Errors to a User File**

In this example, you learn how to apply bit errors to a user-defined data file. If you have not created and stored a user-defined data file, complete the steps in the previous sections, “Creating a User File” on page 190 and “Renaming and Saving a User File” on page 192.

1. Press **Apply Bit Errors**.
2. Press **Bit Errors > 5 > Enter**.
3. Press **Apply Bit Errors**.

Notice both **Bit Errors** softkeys change value as they are linked.

## Waveform Licensing for Firmware Version $\geq$ C.05.23

Waveform licensing enables you to license waveforms that you generate and download from any N76xxB Signal Studio application for unlimited playback in a signal generator. Each licensing option allows you to permanently license up to five waveforms (Options 221-229) or up to 50 waveforms (Options 250-259) of your choice. Waveform Options 22x and 25x are *perpetual fixed* waveform licenses.

Waveforms licensed with Options 221-229 or Options 250-259 cannot be exchanged for different waveforms. Once a waveform is licensed, that license is permanent and cannot be revoked or replaced. Option 22x and 25x waveform licenses are signal generator specific (i.e. signal generator serial number specific). If a licensed Option 22x or Option 25x waveform file is transferred to another signal generator, the file must be licensed by a separate Option 22x or Option 25x that is in the other signal generator *before* it can be played.

To redeem Options 22x or Options 25x, refer to the *E4438C-2xx Entitlement Certificate* that comes with your order. For more information on extracting and downloading waveform files, refer to the *Programming Guide*.

### Understanding Waveform Licensing

Use any N76xxB Signal Studio software to build and download waveforms to the signal generator. Each Option 22x provides 5 available slots and each Option 25x license provides 50 available slots where you can add and play waveforms for a trial period of 48 hours per slot. During this time, you can replace the waveform any number of times until you are satisfied with it. After the trial period expires, the waveform in the slot is no longer playable until the slot is locked for permanent playback; however, you can replace the waveform in the slot with another waveform of your choice before locking the slot.

To license additional waveforms that exceed the number permitted by an Option 22x or Option 25x, you must purchase another Option 22x or Option 25x that you do not already own. For example, if you already own Option 250, purchase Option 251 to add an additional 50 slots. Adding all 25x options (250-259) provides a maximum of 500 slots. Adding all 22x options (221-229) provides a maximum of 45 slots. Repurchasing the same option for the same signal generator, gives you no additional waveform licenses.

### Installing an E4438C Option 22x or E4438C Option 25x

Load a Waveform License, E4438C Option 22x or E4438C Option 25x, into the signal generator using License Manager. For more information on loading the Waveform License, refer to the *E4438C-2xx Entitlement Certificate*.

## Licensing a Signal Generator Waveform File

The following steps add or replace a waveform file to a license slot and lock the slot for permanent playback.

1. Press **Mode > Dual ARB > Waveform Utilities > Waveform Licensing**.
2. The signal generator displays a catalog of files labeled either: NVWFM or WFML. Select the catalog that contains the desired waveform using the **Catalog Type** softkey.
3. Use the arrow keys to highlight and select the file to be licensed.
4. Press **Add Waveform To First Available Slot** to add the selected waveform to the first available slot. The waveform will play and can be replaced during the 48 hour trial period. To play the waveform beyond the trial period, the waveform slot must be locked.
5. Press **Replace Waveform In Slot** to replace a waveform during the 48 hour trial.
6. License the waveform:
  - a. Press **Lock Waveform In Slot**.

A warning is displayed:

```
*** Waveform Lock Warning!!! *** Once a waveform is locked it will use up  
an available license slot and it can not be un-locked. Be sure that you  
want to lock this waveform.
```

If necessary, verify that you have selected the correct waveform you want for licensing by pressing **Return**.

- b. Press **Confirm Locking Waveform**.

The licensing status of the slot will be changed to Locked MM/DD/YY.
- c. If the waveform has not been previously backed up in internal storage, a warning is displayed:

```
*** Waveform Backup Required!!! ***
```
- d. Make a backup copy of this waveform on a computer before pressing **Backup Waveform to Int Storage**. (If the waveform is lost or deleted in the signal generator, it can *not* be recovered.).

---

### NOTE

It is important to make a backup copy of any waveforms that you are licensing and store them on a computer. Do *not* store the backup copy on the signal generator. If all of the copies of the waveforms are deleted or lost, then there is *no* way to recover the waveform or reassign the license.

---

---

## Using Waveform 5-Pack Licensing (Options 221-229) for Firmware Version < C.05.23

Waveform 5-Pack licensing enables you to create, generate, and permanently license up to 45 Signal Studio waveforms. Each Option 22x (Option 221, 222, 223, ...229) enables licensing of five waveforms.

Use the signal generator to manage the licensing of these waveforms. For example, you can use the signal generator to select individual waveforms for licensing and you can view a list of all currently licensed waveforms.

### Understanding Waveform 5-Pack Licensing

Waveforms licensed with 5-Pack cannot be *exchanged*. Once a waveform is licensed, that license is permanent and cannot be revoked or replaced. Option 22x waveforms are licensed to specific signal generators (i.e. signal generator serial number specific).

Waveform 5-Pack licensing enables you to create and generate signals which can be saved for unlimited use in a signal generator (i.e. Waveform 5-Pack Option 22x is a *perpetual fixed* waveform license).

Use the Signal Studio software to build and download waveforms to the signal generator's volatile memory to be played. When you are satisfied with the waveform, it must be stored to non-volatile memory before it can be licensed.

If a licensed Option 22x waveform file is transferred to another signal generator, the file must be licensed by a separate Option 22x that is in the other signal generator *before* it can be played. For more information on extracting and downloading waveform files, refer to the *Programming Guide*.

To license additional waveforms that exceed the number permitted by an Option 22x, you must purchase an Option 22x that you do *not* already own. For example if you already own Option 221 with only two remaining licenses and you need ten more waveforms, purchase Options 222 and 223 to have enough licenses to license ten more waveforms. This would leave two remaining licenses on Option 223. (Repurchasing Option 221 a second time, for the *same* signal generator, gives you no additional Waveform 5-Pack licenses.)

After licensing a waveform, you can make copies of the waveform using different file names for use on the same signal generator and even rename the original file without affecting the waveform license.

You can also use the Option 22x to license waveforms from N76xxB Signal Studio software downloaded during its 14-day free trial license. All of the N76xxB Signal Studio software products provide a 14-day trial license. This license lets you download and play back waveforms during the 14-day trial period. These waveforms are denoted by the TRL in the status message area of the waveform segment catalog. After the trial period expires, the TRL message is removed but the waveform remains. You can license these waveforms after the TRL message is gone.

Waveform 5-Pack requires firmware version  $\geq$  C.04.95.

## Installing an E4438C Option 22x Waveform 5-Pack License

1. Load a Waveform 5-Pack license, E4438C Option 22x, into the signal generator using License Manager. For more information on loading the Waveform 5-Pack License, refer to the *E4438C-22x Entitlement Certificate*.
2. Cycle the power on the signal generator.

---

**NOTE** Anytime a new Option 22x is installed on the signal generator, you must cycle power on the signal generator to enable the Waveform 5-Pack License and to activate the **5-Pack License** softkey.

---

## Licensing a Signal Generator Waveform File

1. Create the waveform:
  - a. Download any of the N76xxB Signal Studio software that interests you. For downloading N76xxB Signal Studio software, refer to the E4438C-22x Entitlement Certificate.
  - b. Create and download a waveform to a signal generator using any of the N76xxB Signal Studio Software. Refer to your *Signal Studio Software Help*.

2. Save the file to NVWFM memory:

Before you can license a waveform with the Waveform 5-Pack licensing, the waveform must be saved in the non-volatile memory (NVWFM).

- a. Press **Local > Mode > Dual ARB > Waveform Segments > Load Store** to Store.
  - b. Use the arrow keys to highlight the file to be licensed.
  - c. Press **Store Segment to NVWFM Memory**.
3. License the waveform:
    - a. Press **Return > ARB Setup > Waveform Utilities > 5-Pack Licensing > Add Waveforms to 5-Pack**.

The signal generator displays a catalog of files labeled: Catalog of WFM1 Files.

- b. Use the arrow keys to highlight the file to be licensed.
- c. Press **Add Waveform**.

A warning is displayed. See [Figure 4-36](#).

**Figure 4-36 Add Waveform to 5-Pack Softkey Warning Message**



This warning message indicates that this is the last chance for verifying that the waveform being licensed is the one you want. If the waveform selected has *not* been verified, press **Return** and verify the selection.

**Important!** Always backup licensed waveforms in a separate place from the instrument (e.g. computer, etc.).

If necessary, verify that you have selected the correct waveform you want for licensing by pressing **Return**. Otherwise continue to the next step.

- d. Press **Confirm Adding Waveform to 5-Pack**.

The display returns to the Catalog of WFM1 Files and the file’s Status column is now shows 5-Pack Licensed. See [Table 4-3](#).

**Table 4-3 Waveform 5-Pack Licensing Status Messages for the “Catalog of Segment Files in NVWFM Files”**

Status Message	Meaning	Notes
<i>Empty field</i>	If no status message, then waveform is licensable.	Once a Trial (TRL) license expires, the waveform becomes licensable (i.e. the status message for the TRL waveform becomes an <i>empty field</i> ).  If a licensed Option 22x waveform file is downloaded to <i>another</i> E4438C signal generator, the waveform becomes licensable on that <i>other</i> signal generator (i.e. the status message field is <i>empty</i> ).
5-Pack Licensed	This waveform is licensed by Option 22x.	
5-Pack License Not Required	This message applies to:  Any free waveforms provided with the Agilent ESG (e.g. RAMP_TEST_WFM, and SINE_TEST_WFM, etc.)  Any customer created waveform  Any waveforms that have a valid license (e.g. Trial (TRL) licenses, Advanced Design System (ADS), etc.). Refer to www.agilent.com.	Once a Trial (TRL) license expires, the waveform becomes licensable (i.e. the status message for the TRL waveform becomes an <i>empty field</i> ).  If a licensed Option 22x waveform file is downloaded to <i>another</i> E4438C signal generator, the waveform becomes licensable on that <i>other</i> signal generator (i.e. the status message field is <i>empty</i> ).

- e. Make a backup copy of this waveform on a computer.

---

**NOTE** It is important to make a backup copy of any 5-Pack waveforms and store them on a computer or other media. Do *not* store the backup copy on the signal generator. If all of the copies of the waveforms are deleted or lost, then there is *no* way to recover the waveform or reassign the license. Refer to the *Programming Guide* for information on extracting waveform files.

---

## Using Waveform 5-Pack History

The Waveform 5-Pack History softkeys can be used to manage the Waveform 5-Pack files on your signal generator. The 5-Pack History softkeys can be used to:

- Create a list for a specific Waveform 5-Pack licensed waveform including any *renamed* files that have been leveraged from that licensed waveform
- Create a list of all licensed and unlicensed waveforms on the signal generator

The **5-Pack History** softkey is only active, if you have previously stored a Waveform 5-Pack file in non-volatile memory (NVWFM). The softkey **5-Pack History** also tracks the history of licensed waveform files that may no longer be available in non-volatile memory (e.g. if the waveform file has been deleted from non-volatile memory, the 5-Pack History softkey remains active). 5-Pack History retains a catalog of the Redemption Date, Waveform ID, and the Original Filename.

### Finding the History of a Waveform 5-Pack License

Use the following procedure to list a catalog of licensed Waveform 5-Pack files in the non-volatile memory (NVWFM).

1. On the signal generator:
  - a. Press **Mode > Dual ARB > ARB Setup > Waveform Utilities > 5-Pack Licensing > 5-Pack History**
  - b. Use the arrow keys to highlight the cataloged file.
  - c. Press **Find Waveform**

The instrument displays a catalog titled “Waveform 5-Pack Search Results”. This catalog displays a list of all of the files that are copies of the original file that was licensed with the Waveform 5-Pack licensing.

---

**NOTE** If no files are found, you can reload the backup copies that were made in [Step e on page 199](#).

---



### **Finding All Waveforms Associated with 5-Pack Licenses**

The following procedure displays a catalog of *all* of the Waveform 5-Pack files in the WFM1 memory, and the non-volatile storage (NVWFM):

1. On the signal generator:
  - a. Press **Mode > Dual ARB > ARB Setup > Waveform Utilities > 5-Pack Licensing > Find All Waveforms**

The instrument displays a catalog titled: Waveform 5-Pack Search Results.

---

**NOTE** If no files are found, you can reload the backup copies that were made in [Step e on page 199](#).

---

## Waveform 5-Pack Warning Messages

Figure 4-37

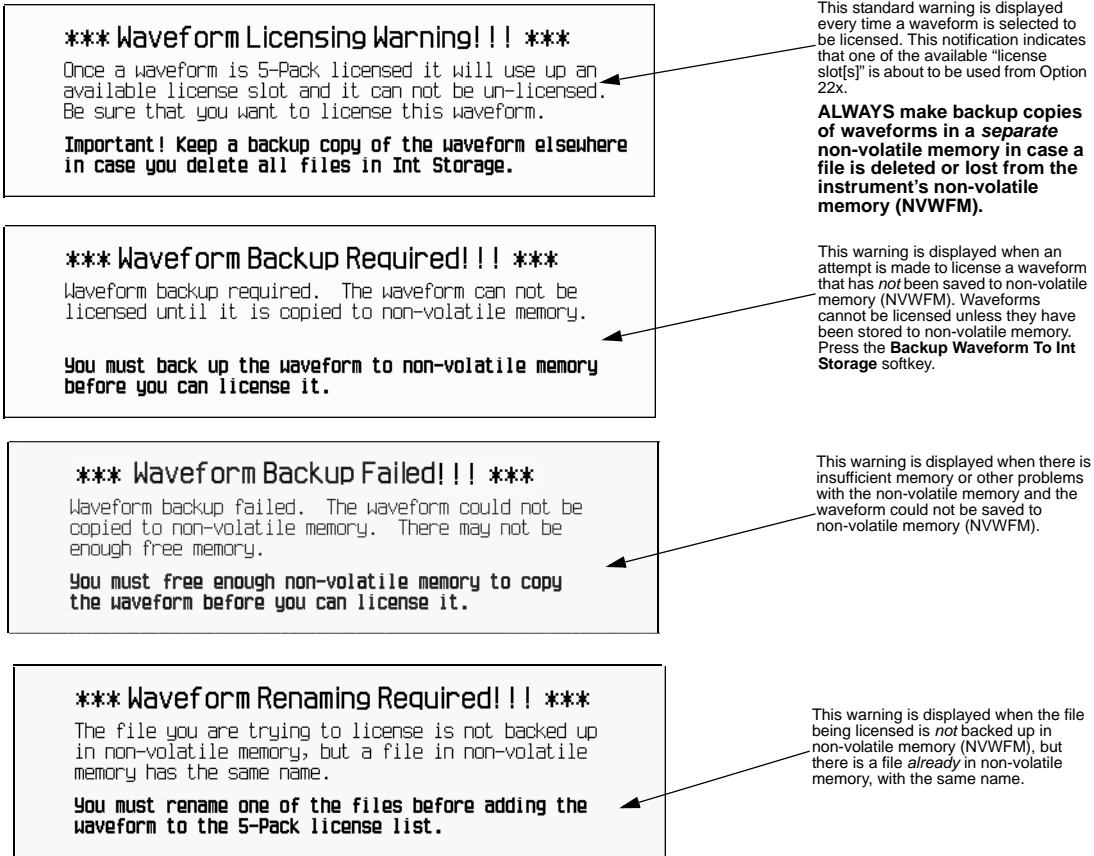

## Waveform Licenses (Signal Studio "A" Versions)

The waveform license allows waveforms, created on one ESG, to be downloaded to another ESG. These encrypted waveforms can be played by other ESGs that have the same options and licenses.

A waveform license is written to the signal generator when a software application that generates waveform data is installed on the PC.

1. Access the Waveform Licenses menu:

**Utility > Instrument Adjustments > Instrument Options > Waveform Licenses**

The following is an example of the signal generator display, which lists any time-limited licenses and perpetual licenses, the days left on time-limited licenses, and the software description:

FREQUENCY		4.000 000 000 00 GHz		AMPLITUDE		-136.00 dBm				
<input type="checkbox"/>				RF		MOD				
				OFF		ON				
Waveform Licenses										
Wave ID Days Left Description										
<table border="1"><thead><tr><th>Wave ID</th><th>Days Left</th><th>Description</th></tr></thead><tbody></tbody></table>								Wave ID	Days Left	Description
Wave ID	Days Left	Description								
						Page Up				
						Page Down				
						01/12/2 22:54				

Basic Digital Operation (Option 001/601 or 002/602)

**Waveform Licenses (Signal Studio "A" Versions)**

---

## 5 AWGN Waveform Generator (Option 403)

This chapter contains examples for using the additive white gaussian noise (AWGN) waveform generator. Option 403 is only available on the E4438C Vector Signal Generator with Option 001/601 or 002/602. The following list shows the topics covered in this chapter:

- [“Arb Waveform Generator AWGN” on page 206](#)
- [“Real Time I/Q Baseband AWGN” on page 207](#)

For adding real-time AWGN to waveforms using the Dual ARB player, see [“Adding Real Time Noise to a Dual ARB Waveform \(Option 403\)” on page 112](#)

## Configuring the AWGN Generator

The AWGN (additive white Gaussian noise) generator is available for the Arb Waveform Generator mode and the Real Time I/Q Baseband mode. The AWGN generator can be configured with user-defined noise bandwidth, noise waveform length, and noise seed parameters.

- **Bandwidth** – the noise bandwidth can be set from 50 kHz to 15 MHz.
- **Waveform Length** – the waveform length is the length in samples of the noise waveform. Longer waveform lengths provide more statistically correct noise waveforms.
- **Noise Seed** – the noise seed selection can be either random or fixed. The noise seed determines whether the noise waveform data is repeatable (using the fixed selection) or random (using the random selection).

When the AWGN generator is active, the AWGN and I/Q annunciators are displayed on the front panel of the signal generator.

### Arb Waveform Generator AWGN

1. Press **Preset**.
2. Press **Mode > More (1 of 2) > AWGN > Arb Waveform Generator AWGN**
3. Press **Bandwidth > 1.25 > MHz**.
4. Press **Waveform Length > 131072**.
5. Press **Noise Seed Fixed Random** until Random is highlighted.

This configures a randomly seeded AWGN waveform with a bandwidth of 1.25 MHz and a waveform length of 131072 bits.

### Configuring the RF Output

1. Set the RF output frequency to 500 MHz.
2. Set the output amplitude to -10 dBm.
3. Press **RF On/Off**.

### Generating the Waveform

Press **AWGN Off On** until On is highlighted.

This generates an AWGN waveform with the parameters defined in the previous procedure. During waveform generation, the AWGN and I/Q annunciators activate and the AWGN waveform is stored in volatile ARB memory. The waveform is now modulating the RF carrier.

## **Real Time I/Q Baseband AWGN**

1. Press **Preset**.
2. Press **Mode > More (1 of 2) > AWGN > Real Time I/Q Baseband AWGN**
3. Press **Bandwidth > 10 > MHz**.

### **Configuring the RF Output**

1. Set the RF output frequency to 500 MHz.
2. Set the output amplitude to -10 dBm.
3. Press **RF On/Off**.

### **Generating the Waveform**

Press **AWGN Off On** until On is highlighted.

This generates an AWGN waveform with the parameters defined in the previous procedure. During waveform generation, the **AWGN** and **I/Q** annunciators activate. The waveform is now modulating the RF carrier.

AWGN Waveform Generator (Option 403)

**Configuring the AWGN Generator**



---

## 6 Analog Modulation

The following list shows the topics covered in this chapter:

- [“Analog Modulation Waveforms” on page 210](#)
- [“Configuring AM” on page 211](#)
- [“Configuring FM” on page 213](#)
- [“Configuring FM” on page 214](#)
- [“Configuring Pulse Modulation” on page 215](#)
- [“Configuring the LF Output” on page 216](#)

## **Analog Modulation Waveforms**

The signal generator can modulate the RF carrier with four types of analog modulation: amplitude, frequency, phase, and pulse.

Available internal waveforms include:

Sine	sine wave with adjustable amplitude and frequency
Dual-Sine	dual-sine waves with individually adjustable frequencies and a percent-of-peak-amplitude setting for the second tone (available from function generator only)
Swept-Sine	swept-sine wave with adjustable start and stop frequencies, sweep time, and sweep trigger settings (available from function generator only)
Triangle	triangle wave with adjustable amplitude and frequency
Ramp	ramp with adjustable amplitude and frequency
Square	square wave with adjustable amplitude and frequency
Noise	noise with adjustable amplitude generated as a peak-to-peak value (RMS value is approximately 80% of the displayed value)

---

## Configuring AM

Using these procedures, you will learn how to generate an amplitude-modulated RF carrier.

### Setting the Carrier Frequency

1. Press **Preset**.
2. Press **Frequency > 1340 > kHz**.

### Setting the RF Output Amplitude

Press **Amplitude > 0 > dBm**.

### Setting the AM Depth and Rate

1. Press the **AM** hardkey.
2. Press **AM Depth > 90 > %**.
3. Press **AM Rate > 10 > kHz**.

The signal generator is now configured to output a 0 dBm, amplitude-modulated carrier at 1340 kHz with the AM depth set to 90% and the AM rate set to 10 kHz. The shape of the waveform is a sine wave (notice that sine is the default for the **AM Waveform** softkey).

### Turning on Amplitude Modulation

Follow these remaining steps to output the amplitude-modulated signal.

1. Press the **AM Off On** softkey to On.
2. Press the front panel **RF On Off** key.

The AM and RF ON annunciators are now displayed. This indicates that you have enabled amplitude modulation and the signal is now being transmitted from the RF OUTPUT connector.

## Wideband AM (E4438C)

Wideband AM offers bandwidth (up to 40 MHz) beyond that of standard internal AM (10 kHz) by utilizing an external modulating signal. The external modulating signal is connected to the front-panel I INPUT connector.

---

**NOTE** When you select wideband AM and turn it on, the signal generator automatically sets the I INPUT connector for 50 ohms. This setting is independent of the **MUX > I/Q Source** setting, so the **I/Q Source** setting may differ. If you change the **I/Q Source** setting while wideband AM is on, it disables the wideband AM signal. To reenable the signal, turn wideband AM off and then back on.

---

The following steps set up wideband AM:

1. Press the **AM** hardkey.
2. Press **AM Path 1 2 WB** to **WB**.
3. Connect an external AM source to the front-panel I INPUT connector and turn the external modulation on. The maximum I input level is 1 volt rms and 10 volt peak. AM sensitivity is fixed at  $0.5\text{V} = 100\%$ . The AM modulation depth is a linear function of the input voltage so that  $0.25\text{ V} = 50\%$ .
4. Press **AM Off On** to On.

Refer to the ESG data sheet for AM wideband specifications.

## Configuring FM

Using this procedures, you will learn how to create a frequency-modulated RF carrier.

### Setting the RF Output Frequency

1. Press **Preset**.
2. Press **Frequency > 1 > GHz**.

### Setting the RF Output Amplitude

Press **Amplitude > 0 > dBm**.

### Setting the FM Deviation and Rate

1. Press the **FM/ΦM** hardkey.
2. Press **FM Dev > 75 > kHz**.
3. Press **FM Rate > 10 > kHz**.

The signal generator is now configured to output a 0 dBm, frequency-modulated carrier at 1 GHz with a 75 kHz deviation and a 10 kHz rate. The shape of the waveform is a sine wave. (Notice that sine is the default for the **FM Waveform** softkey. Press **More (1 of 2)** to see the softkey.)

### Activating FM

1. Press **FM Off On** to On.
2. Press **RF On/Off**.

The FM and RF ON annunciators are now displayed. This indicates that you have enabled frequency modulation and the signal is now being transmitted from the RF OUTPUT connector.

## Configuring $\Phi$ M

Using this procedures, you will learn how to create a phase-modulated RF carrier.

### Setting the RF Output Frequency

1. Press **Preset**.
2. Press **Frequency > 3 > GHz**.

### Setting the RF Output Amplitude

Press **Amplitude > 0 > dBm**.

### Setting the FM Deviation and Rate

1. Press the **FM/ $\Phi$ M** hardkey.
2. Press the **FM  $\Phi$ M** softkey.
3. Press **FM Dev > .25 > pi rad**.
4. Press **FM Rate > 10 > kHz**.

The signal generator is now configured to output a 0 dBm, phase-modulated carrier at 3 GHz with a 0.25 p radian deviation and 10 kHz rate. The shape of the waveform is a sine wave. (Notice that sine is the default for the **FM Waveform** softkey. Press **More (1 of 2)** to see the softkey.)

### Activating FM

1. Press **FM Off On**.
2. Press **RF On/Off**.

The FM and RF ON annunciators are now displayed. This indicates that you have enabled phase modulation and the signal is now being transmitted from the RF OUTPUT connector.

## Configuring Pulse Modulation

Using the following procedures, you will learn how to create a pulse-modulated RF carrier.

### Setting the RF Output Frequency

1. Press **Preset**.
2. Press **Frequency > 2 > GHz**.

### Setting the RF Output Amplitude

Press **Amplitude > 0 > dBm**.

### Setting the Pulse Period and Width

1. Press **Pulse > Pulse Period > 100 > usec**.
2. Press **Pulse > Pulse Width > 24 > usec**.

The signal generator is now configured to output a 0 dBm, pulse-modulated carrier at 2 GHz with a 100-microsecond pulse period and 24-microsecond pulse width. The pulse source is set to Internal Pulse. (Notice that Internal Pulse is the default for the **Pulse Source** softkey.)

### Activating Pulse Modulation

Follow these remaining steps to output the pulse-modulated signal.

1. Press **Pulse Off On** to On.
2. Press **RF On/Off**.

The **Pulse** and **RF ON** annunciators are now displayed. This indicates that you have enabled pulse modulation and the signal is now being transmitted from the RF OUTPUT connector.

## Configuring the LF Output

The signal generator has a low frequency (LF) output. The LF output's source can be switched between an internal modulation source or an internal function generator.

Using internal modulation (**Internal Monitor**) as the LF output source, the LF output provides a replica of the signal from the internal source that is being used to modulate the RF output. The specific modulation parameters for this signal are configured through the AM, FM, or FM menus.

Using function generator as the LF output source, the function generator section of the internal modulation source drives the LF output directly. Frequency and waveform are configured from the LF output menu, not through the AM, FM, or FM menus. You can select the waveform shape from the following choices:

Sine	sine wave with adjustable amplitude and frequency
Dual-Sine	dual-sine waves with individually adjustable frequencies and a percent-of-peak-amplitude setting for the second tone (available from function generator only)
Swept-Sine	a swept-sine wave with adjustable start and stop frequencies, sweep time, and sweep trigger settings (available from function generator only)
Triangle	triangle wave with adjustable amplitude and frequency
Ramp	ramp with adjustable amplitude and frequency
Square	square wave with adjustable amplitude and frequency
Noise	noise with adjustable amplitude generated as a peak-to-peak value (RMS value is approximately 80% of the displayed value)
DC	direct current with adjustable amplitude

---

**NOTE** The **LF Out Off On** softkey controls the operating state of the LF output. However when the LF output source selection is **Internal Monitor**, you have three ways of controlling the output. You can use the modulation source (AM, FM, or FM) on/off key, the LF output on/off key, or the **Mod On/Off** softkey.

The **RF On/Off** hardkey does not apply to the LF OUTPUT connector.

---



## Configuring the LF Output with an Internal Modulation Source

In this example, the internal FM modulation is the LF output source.

---

**NOTE** Internal modulation (**Internal Monitor**) is the default LF output source.

---

### Configuring the Internal Modulation as the LF Output Source

1. Press **Preset**.
2. Press the **FM/ΦM** hardkey.
3. Press **FM Dev > 75 > kHz**.
4. Press **FM Rate > 10 > kHz**.
5. Press **FM Off On**.

You have set up the FM signal with a rate of 10 kHz and 75 kHz of deviation. The FM annunciator is activated indicating that you have enabled frequency modulation.

### Configuring the Low Frequency Output

1. Press the **LF Out** hardkey.
2. Press **LF Out Amplitude > 3 > Vp**.
3. Press **LF Out Off On**.

You have configured the LF output signal for a 3 volt sine wave (default wave form) output which is frequency modulated using the **Internal Monitor** source selection (default source).

## Configuring the LF Output with a Function Generator Source

In this example, the function generator is the LF output source.

### Configuring the Function Generator as the LF Output Source

1. Press **Preset**.
2. Press the **LF Out** hardkey.
3. Press **LF Out Source > Function Generator**.

### Configuring the Waveform

1. Press **LF Out Waveform > Swept-Sine**.
2. Press **LF Out Start Freq > 100 > Hz**.
3. Press **LF Out Stop Freq > 1 > kHz**.
4. Press **Return > Return**.

This returns you to the top LF Output menu.

### Configuring the Low Frequency Output

1. Press **LF Out Amplitude > 3 > Vp**.

This sets the LF output amplitude to 3 Vp.

2. Press **LF Out Off On**.

The LF output is now transmitting a signal using the function generator that is providing a 3 Vp swept-sine waveform. The waveform is sweeping from 100 Hz to 1 kHz.

---

# 7 Digital Signal Interface Module

This chapter provides information on the N5102A Baseband Studio Digital Signal Interface Module. These features are available only in E4438C ESG Vector Signal Generators with Options 003/004 and 601/602. The following list shows the topics covered in this chapter:

- [“Clock Timing” on page 220](#)
- [“Data Types” on page 236](#)
- [“Connecting the Clock Source and the Device Under Test” on page 234](#)
- [“Operating the N5102A Module in Output Mode” on page 238](#)
- [“Operating the N5102A Module in Input Mode” on page 247](#)

## Clock Timing

This section describes how clocking for the digital data is provided. Clock timing information and diagrams are supplied for the different port configurations (serial, parallel, or parallel interleaved data transmission) and phase and skew settings. All settings for the interface module are available on the signal generator user interface (UI).

### Clock and Sample Rates

A sample is a group of bits where the size of the sample is set using the **Word Size** softkey. The clock is the signal that tells when the bits of a sample are valid (in a non-transition state). The clock and sample rates are displayed in the first-level and data setup softkey menus. The clock rate and sample rate are usually the same. They will differ when serial mode is selected, or when there are multiple clocks per sample.

Figure 7-1 Data Setup Menu for a Parallel Port Configuration

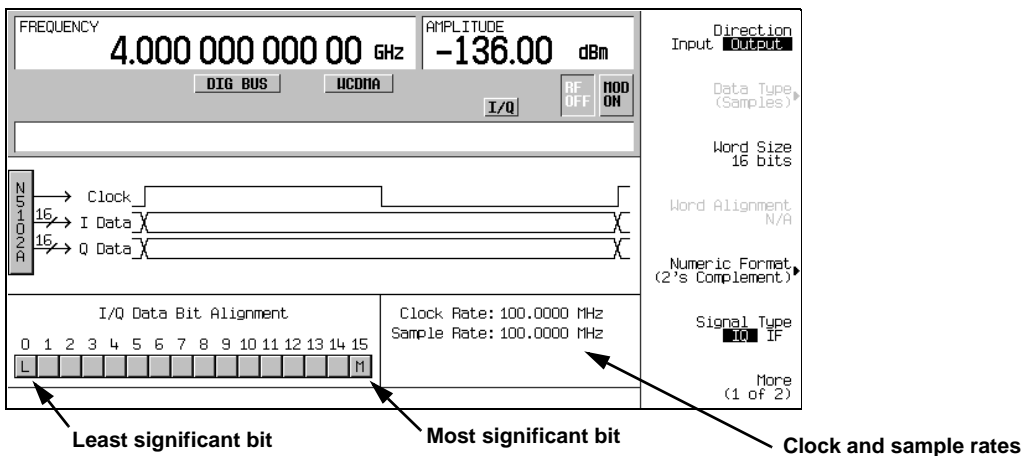

The N5102A module clock rate is set using the **Clock Rate** softkey and has a range of 1 kHz to 400 MHz. The sample rate is automatically calculated and has a range of 1 kHz to 100 MHz. These ranges can be smaller depending on logic type, data parameters, and clock configuration.

### Maximum Clock Rates

The N5102A module maximum clock rate is dependent on the logic and signal type. [Table 7-1](#) and [Table 7-2](#) show the warranted rates and the maximum clock rates for the various logic and signal types. Notice that LVDS in the output mode using an IF signal is the only logic type where the warranted and maximum rates are the same.

**Table 7-1 Warranted Parallel Output Level Clock Rates and Maximum Clock Rates**

Logic Type	Warranted Level Clock Rates		Maximum Clock Rates (typical)	
	IO Signal Type	IF Signal Type <sup>1</sup>	IO Signal Type	IF Signal Type
LVTTL and CMOS	100 MHz	100 MHz	150 MHz	150 MHz
LVDS	200 MHz	400 MHz	400 MHz	400 MHz

1. The IF signal type is not available for a serial port configuration.

**Table 7-2 Warranted Parallel Input Level Clock Rates and Maximum Clock Rates**

Logic Type	Warranted Level Clock Rates	Maximum Clock Rates (typical)
LVTTL and CMOS	100 MHz	100 MHz
LVDS	100 MHz	400 MHz

The levels will degrade above the warranted level clock rates, but they may still be usable.

### Serial Port Configuration Clock Rates

For a serial port configuration, the lower clock rate limit is determined by the word size (word size and sample size are synonymous), while the maximum clock rate limit remains constant at 150 MHz for LVTTL and CMOS logic types, and 400 MHz for an LVDS logic type.

The reverse is true for the sample rate. The lower sample (word) rate value of 1 kHz remains while the upper limit of the sample rate varies with the word size. For example, a five-bit sample for an LVTTL or CMOS logic type yields the following values in serial mode:

- Clock rate of 5 kHz through 150 MHz
- Sample rate of 1 kHz through 30 MHz

Refer to [Table 7-3](#) and [Table 7-4](#), for the serial clock rates.

**Table 7-3 Output Serial Clock Rates**

Logic Type	Minimum Rate	Maximum Rate
LVDS	1 x (word size) kHz	400 MHz

**Clock Timing**

**Table 7-3 Output Serial Clock Rates**

Logic Type	Minimum Rate	Maximum Rate
LVTTTL and CMOS	1 x (word size) kHz	150 MHz

**Table 7-4 Input Serial Clock Rates**

Logic Type	Data Type	Minimum Rate	Maximum Rate
LVDS	Samples	1 x (word size) kHz	400
	Pre-FIR Samples	1 x (word size) kHz	the smaller of: 50 <sup>1</sup> x (word size) MHz or 400 MHz
LVTTTL and CMOS	N/A	1 x (word size) kHz	150 MHz

1. The maximum sample rate depends on the selected filter when the data rate is Pre-FIR Samples. Refer to [“Input Mode” on page 236](#) for more information.

**Parallel and Parallel Interleaved Port Configuration Clock Rates**

Parallel and parallel interleaved port configurations have other limiting factors for the clock and sample rates:

- logic type
- Clocks per sample selection
- IQ or IF digital signal type

Clocks per sample (clocks/sample) is the ratio of the clock to sample rate. For an IQ signal type, the sample rate is reduced by the clocks per sample value when the value is greater than one. For an IF signal or an input signal, clocks per sample is always set to one. Refer to [Table 7-5](#) for the Output mode parallel and parallel interleaved port configuration clock rates.

**Table 7-5 Output Parallel and Parallel Interleaved Clock Rates**

Logic Type	Signal Type	Minimum Rate	Maximum Rate
LVDS	IQ	1 x (clocks/sample) kHz	the smaller of: 100 x (clocks /sample) MHz or 400 MHz
	IF	4 kHz	400 MHz

**Table 7-5 Output Parallel and Parallel Interleaved Clock Rates**

Logic Type	Signal Type	Minimum Rate	Maximum Rate
Other	IQ	1 x (clocks/sample) kHz	the smaller of: 100 x (clocks /sample) MHz or 150 MHz
	IF	4 kHz	150 MHz

For Input mode, the maximum clock rate is limited by the following factors:

- sample size
- data type
- selected filter for Pre-FIR Samples

Refer to [Table 7-6](#) for the Input mode parallel and parallel interleaved port configuration clock rates.

**Table 7-6 Input Parallel and Parallel Interleaved Clock Rates**

Logic Type	Data Type	Minimum Rate	Maximum Rate
N/A	Samples	1 kHz	100 MHz
	Pre-FIR Samples	1 kHz	50 <sup>1</sup> MHz

1. The maximum sample rate depends on the selected filter when the data rate is Pre-FIR Samples. Refer to [“Input Mode” on page 236](#) for more information.

## Clock Source

The clock signal for the N5102A module is provided in one of three ways through the following selections:

- Internal: generated internally in the interface module (requires an external reference)
- External: generated externally through the Ext Clock In connector
- Device: generated externally through the Device Interface connector

The clock source is selected using the N5102A module UI on the signal generator, see [Figure 7-2](#).

**Figure 7-2** Clock Source Selection

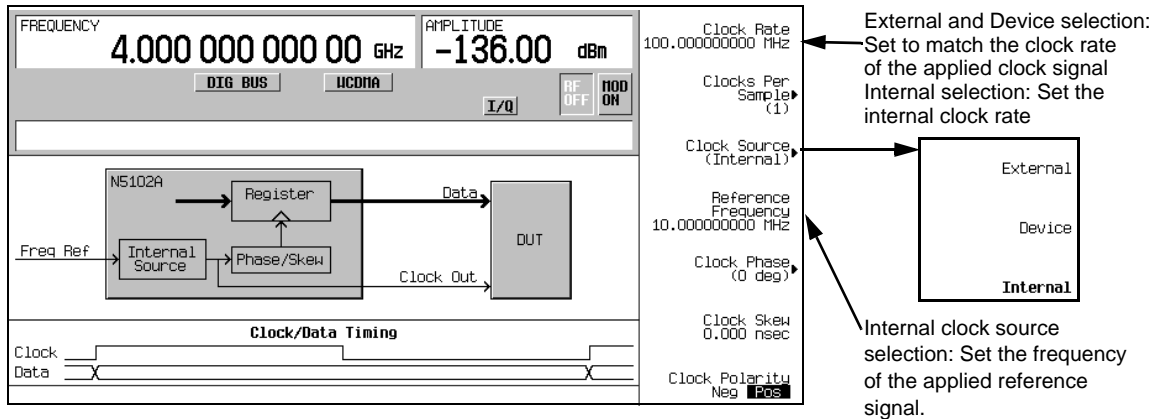

When you select a clock source, you must let the N5102A module know the frequency of the clock signal using the **Clock Rate** softkey. In the internal clock source mode, use this softkey to set the internal clock rate. For device and external clock sources, this softkey must reflect the frequency of the applied clock signal.

When the clock source is Internal, a frequency reference must be applied to the Freq Ref connector. The frequency of this applied signal needs to be specified using the **Reference Frequency** softkey, unless the current setting matches that of the applied signal.

The selected clock source provides the interface module output clock signal at the Clock Out and the Device Interface connectors.

### Common Frequency Reference

The clocking flexibility of the digital signal interface module allows the setting of arbitrary clock rates for the device under test. In general, the clock rate inside the ESG will be different from the interface module clock rate, so the interface module performs a rate conversion. An important aspect of this conversion is to have accurate clock rate information to avoid losing data. The module relies on relative clock accuracy, instead of absolute accuracy, that must be ensured by using a single frequency reference for all clock rates involved in the test setup. This can be implemented in various ways (see the five drawings in [Figure 7-3 on page 226](#)), but whatever way it is implemented, the clock inside the signal generator must have the same base frequency reference as the clock used by the device under test.



### ESG Frequency Reference Connections

When a frequency reference is connected to the signal generator, it is applied to one of two rear panel connectors:

- 10 MHz IN
- BASEBAND GEN REF IN

The BASEBAND GEN REF IN connector will accept a frequency reference in the range of 1 to 100 MHz. If the external or device under test clock source cannot provide or accept a frequency reference, that clock signal can be applied to this connector and used as the frequency reference (as long as the frequencies are within the specified range).

Whenever an external clock signal or frequency reference is connected to the BASEBAND GEN REF IN connector, its frequency needs to be entered into the current signal generator modulation format. For information on the BASEBAND GEN REF IN connector refer to [Chapter 2, “E4438C Vector Signal Generator Overview,” on page 19](#). For information on the associated softkeys and fields for entering the frequency of the applied clock signal or frequency reference, refer to the *Key and Data Field Reference*.

**Figure 7-3** Frequency Reference Setup Diagrams for the N5102A Module Clock Signal

**Internally Generated Clock**

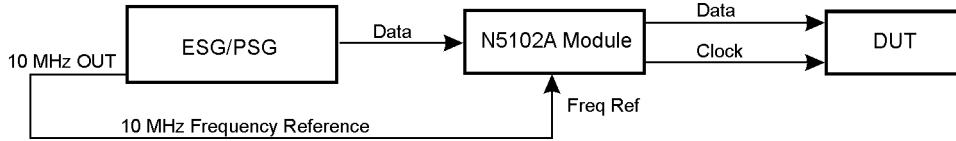

**Device (DUT) Supplied Clock**

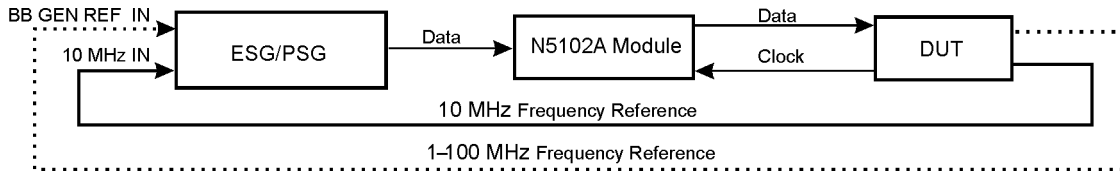
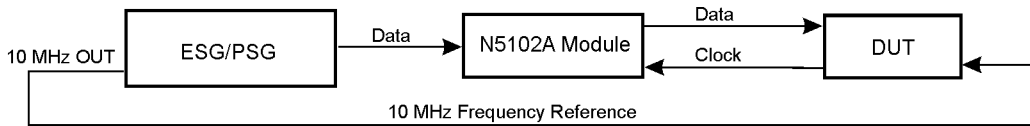

**NOTE:** Use only one of the two signal generator frequency reference inputs.

**Externally Supplied Clock**

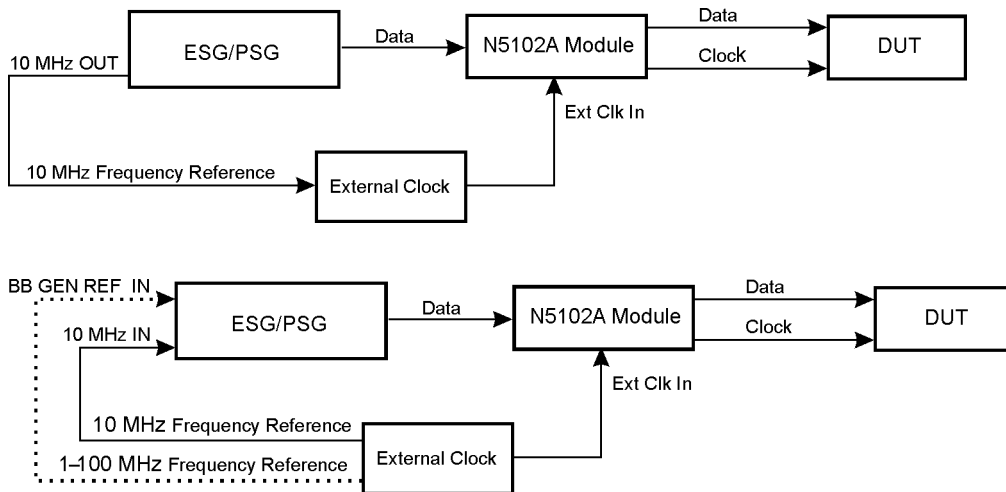

**NOTE:** Use only one of the two signal generator frequency reference inputs.

**Clock Timing for Parallel Data**

Some components require multiple clocks during a single sample period. (A sample period consists of an I and Q sample). For parallel data transmissions, you can select one, two, or four clocks per sample. For clocks per sample greater than one, the I and Q samples are held constant to accommodate the additional clock periods. This reduces the sample rate relative to the clock rate by a factor equal to the clocks per sample selection. For example, when four is selected, the sample rate is reduced by a factor of four (sample rate to clock rate ratio). [Figure 7-4](#) demonstrates the clock timing for each clocks per sample selection. For input mode, the clocks per sample setting is always one.

Figure 7-4 Clock Sample Timing for Parallel Port Configuration

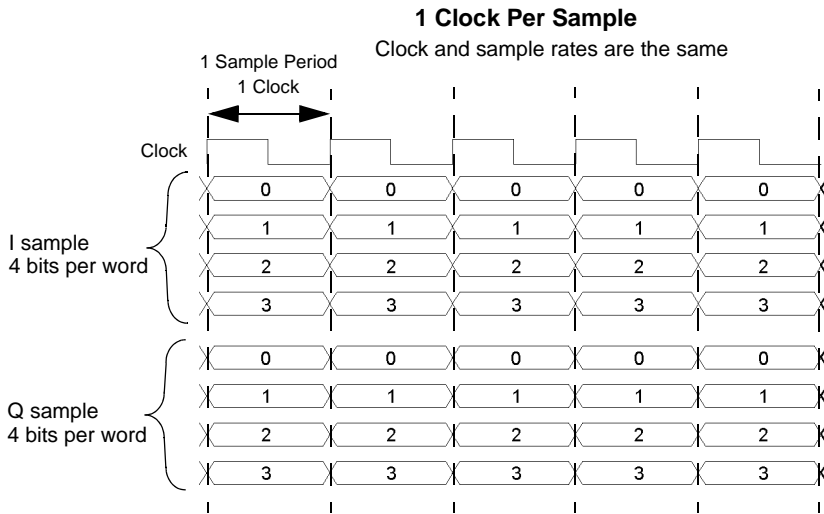

**2 Clocks Per Sample**

Sample rate decreases by a factor of two

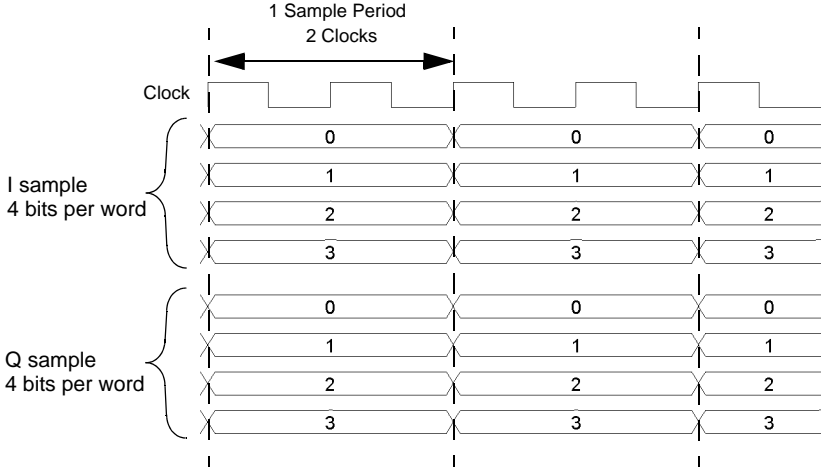

**4 Clocks Per Sample**

Sample rate decreases by a factor of four

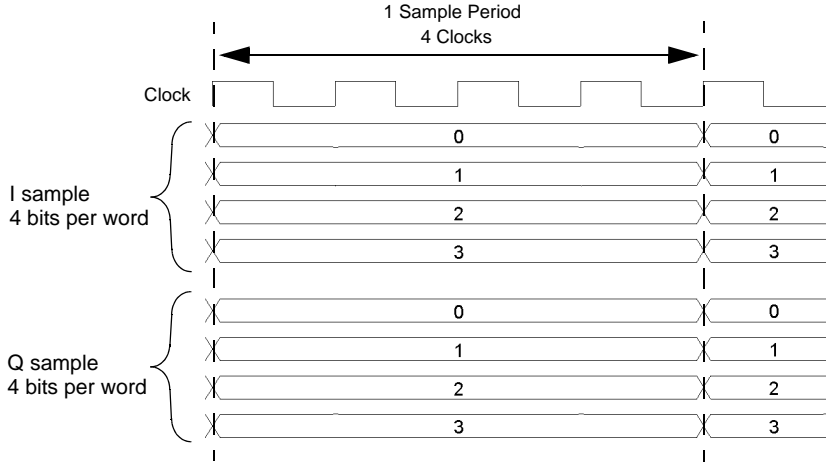

### Clock Timing for Parallel Interleaved Data

The N5102A module provides the capability to interleave the digital I and Q samples. There are two choices for interleaving:

- IQ, where the I sample is transmitted first
- QI, where the Q sample is transmitted first

When parallel interleaved is selected, all samples are transmitted on the I data lines. This effectively transmits the same number of samples during a sample period on half the number of data lines as compared to non-interleaved samples. (A sample period consists of an I and Q sample.) Clocks per sample is still a valid parameter for parallel interleaved transmissions and creates a reduction in the sample rate relative to the clock rate. The clocks per sample selection is the ratio of the reduction. Figure 7-5 shows each of the clocks per sample selections, for a parallel IQ interleaved port configuration, using a word sized of four bits and the clock timing relative to the I and Q samples. For a parallel QI interleaved port configuration, just reverse the I and Q sample positions. For input mode, the clocks per sample setting is always one.

**Figure 7-5** Clock Timing for a Parallel IQ Interleaved Port Configuration

#### 1 Clock Per Sample

The I sample is transmitted on one clock transition and the Q sample is transmitted on the other transition; the sample and clock rates are the same.

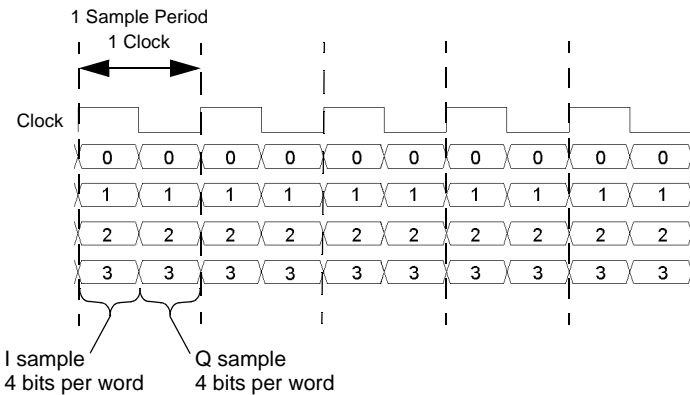

### 2 Clocks Per Sample

The I sample is transmitted for one clock period and the Q sample is transmitted during the second clock period; the sample rate decreases by a factor of two.

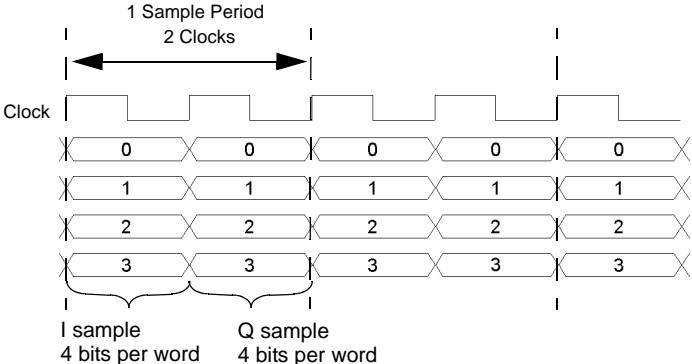

### 4 Clocks Per Sample

The I sample is transmitted for the first two clock periods and the Q sample is transmitted during the second two clock periods; the sample rate is decreased by a factor of four.

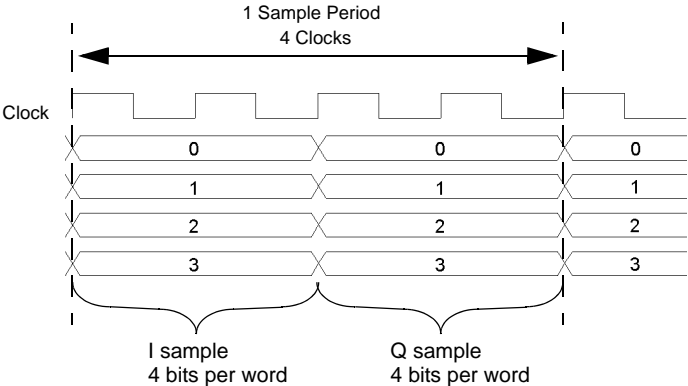

## Clock Timing for Serial Data

Figure 7-6 shows the clock timing for a serial port configuration. Notice that the serial transmission includes frame pulses that mark the beginning of each sample where the clock delineates the beginning of each bit. For serial transmission, the clock and the bit rates are the same, but the sample rate varies depending on the number of bits per word that are entered using the **Word Size** softkey. The number of bits per word is the same as the number of bits per sample.

**Figure 7-6** Clock Timing for a Serial Port Configuration

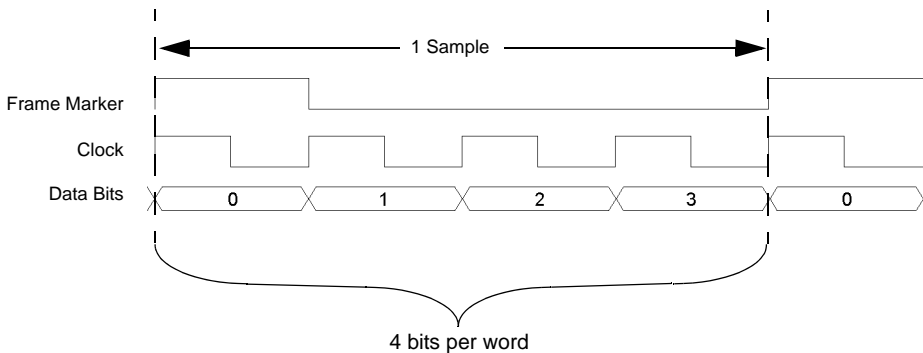

## Clock Timing for Phase and Skew Adjustments

The N5102A module provides phase and skew adjustments for the clock relative to the data and can be used to align the clock with the valid portion of the data. The phase has a 90 degree resolution (0, 90, 180, and 270 degree selections) for clock rates from 10 to 200 MHz and a 180 degree resolution (0 and 180 degree selections) for clock rates below 10 MHz and greater than 200 MHz.

The skew is displayed in nanoseconds with a maximum range of  $\pm 5$  ns using a maximum of  $\pm 127$  discrete steps. Both the skew range and the number of discrete steps are variable with a dependency on the clock rate. The skew range decreases as the clock rate is increased and increases as the clock rate is decreased. The maximum skew range is reached at a clock rate of approximately 99 MHz and is maintained down to a clock rate of 25 MHz. For clock rates below 25 MHz, the skew adjustment is unavailable.

A discrete step is calculated using the following formula:

$$\frac{1}{256 \times \text{Clock Rate}}$$

The number of discrete steps required to reach the maximum skew range decreases at lower frequencies. For example, at a clock rate of 50 MHz, 127 steps would exceed the maximum skew range of  $\pm 5$  ns, so the actual number of discrete steps would be less than 127.

Figure 7-7 is an example of a phase and skew adjustment and shows the original clock and its phase position relative to the data after each adjustment. Notice that the skew adjustment adds to the phase setting.



Figure 7-7 Clock Phase and Skew Adjustments

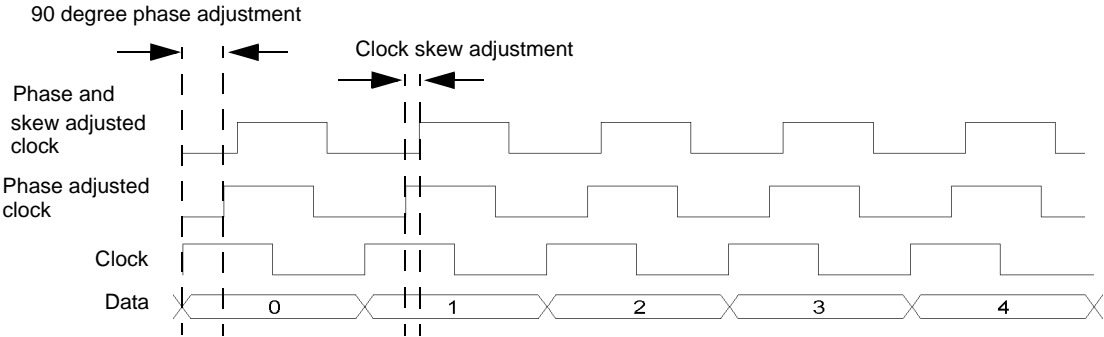

---

## Connecting the Clock Source and the Device Under Test

As shown in [Figure 7-3 on page 226](#), there are numerous ways to provide a common frequency reference to the system components (ESG, N5102A module, and the device under test). [Figure 7-8](#) shows an example setup where the signal generator supplies the common frequency reference and the N5102A module is providing the clock to the device.

---

**CAUTION** The Device Interface connector on the interface module communicates using high speed digital data. Use ESD precautions to eliminate potential damage when making connections.

---

**Figure 7-8** Example Setup using the ESG 10 MHz Frequency Reference

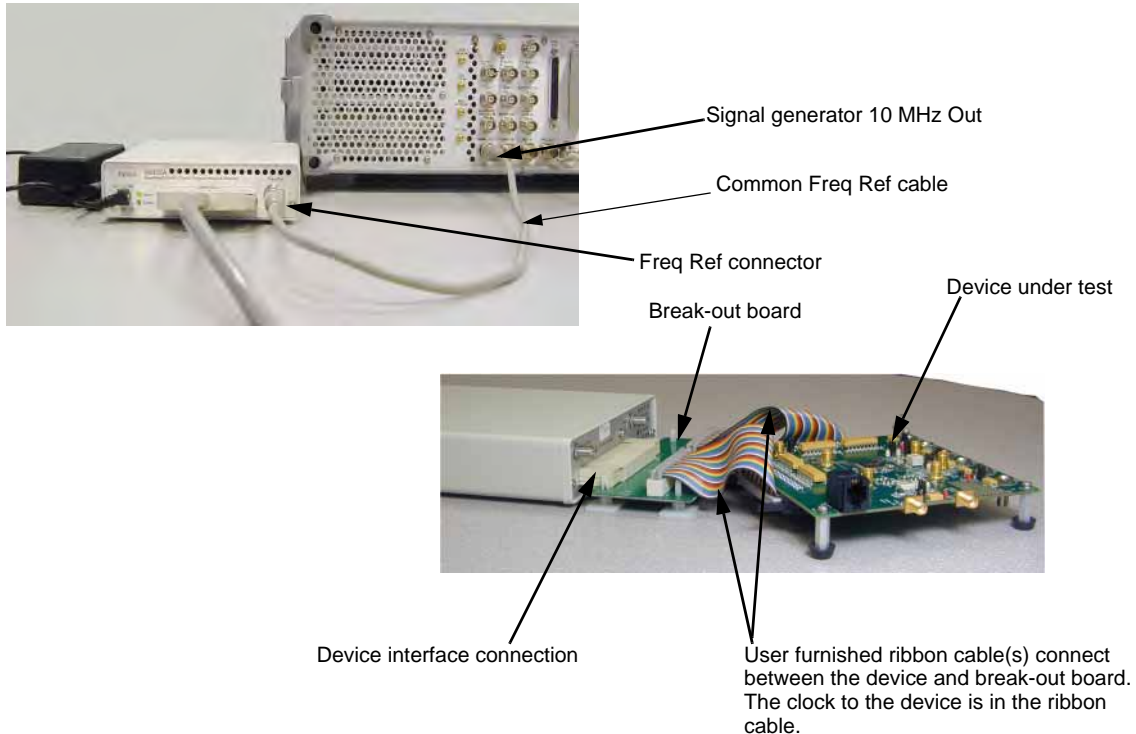

---

**NOTE** You must disconnect the digital bus cable and the digital module while downloading firmware to the ESG.

---

1. Refer to the five setup diagrams in [Figure 7-3 on page 226](#) and connect the frequency reference cable according to the clock source.
2. If an external clock source is used, connect the external clock signal to the Ext Clock In connector on the interface module.
3. Select the break-out board that has the output connector suited for the application.

---

**NOTE** If the Device Interface mating connector is used with the device under test, refer to [Figure 7-8](#) for the device interface connection and connect the device to the N5102A module. Then proceed to “[Operating the N5102A Module in Output Mode](#)” on page 238 or “[Operating the N5102A Module in Input Mode](#)” on page 247.

---

4. Refer to [Figure 7-8](#). Connect the break-out board to the Device Interface connector on the N5102A module.
5. Connect the device to the break-out board.

## Data Types

The following block diagram indicates where in the ESG signal generation process the data is injected for input mode or tapped for output mode.

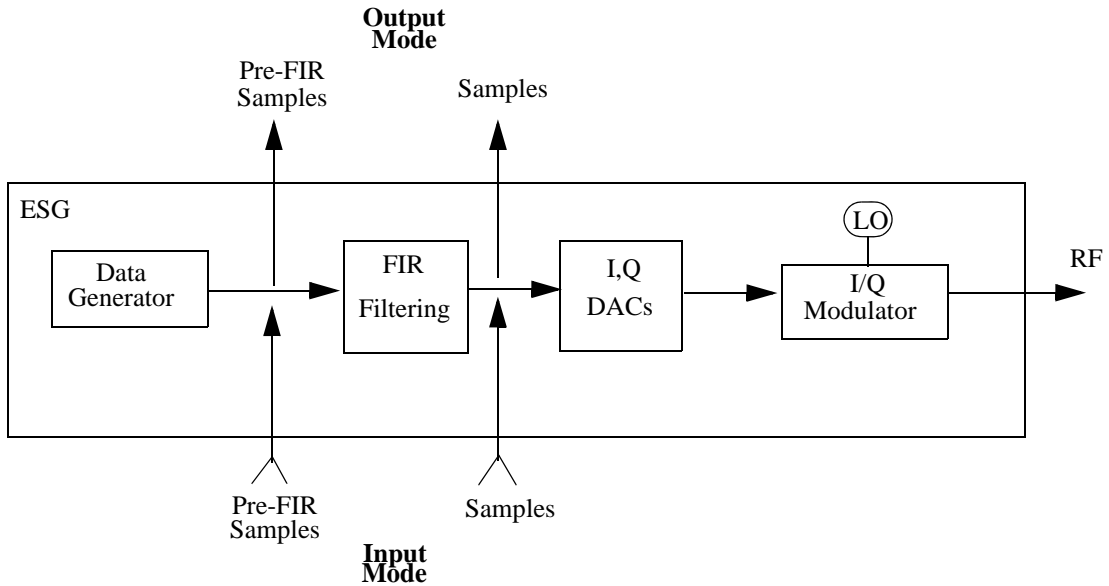

### Output Mode

When using an ARB format, the data type is always Samples and no filtering is applied to the data samples. The samples are sent to the digital module at the ARB sample clock rate.

For real-time formats, choosing Samples as the data type will send filtered samples to the digital module at a rate between 50 MHz and 100 MHz. Selecting Pre-FIR Samples, sends unfiltered samples to the digital module at a rate equal to the sample rate of the current format.

### Input Mode

When the data type is Samples, the data samples coming through the digital module are injected at a point that bypasses the filtering process.

If Pre-FIR Samples is selected, the data samples are injected before the filtering process. The maximum rate will be determined by the selected filter. Refer to [Table 7-7](#).

**Table 7-7 Maximum Sample Rate for Selected Filter**

<b>Filter</b>	<b>Maximum Rate</b>
Gaussian Nyquist Root Nyquist Rectangle Edge UN3/4 GSM Gaussian IS-95 IS 95 w/EQ	50 MHz
IS-95 Mod IS-95 Mod w/EQ	25 MHz
APCO 25 C4FM	12.5 MHz

The **Filter** softkey accesses a menu that enables you set the desired filtering parameters.

## Operating the N5102A Module in Output Mode

This section shows how to set the parameters for the N5102A module using the signal generator UI in the output direction. Each procedure contains a figure that shows the softkey menu structure for the interface module function being performed.

### Setting up the Signal Generator Baseband Data

The digital signal interface module receives data from a baseband source and outputs a digital IQ or digital IF signal relative to the selected logic type. Because an ESG provides the baseband data, the first procedure in operating the interface module is configuring the ESG using one of the real-time or ARB modulation formats, or playing back a stored file using the Dual ARB player. For information on configuring the ESG, refer to [Chapter 4, “Basic Digital Operation \(Option 001/601 or 002/602\),”](#) on page 89.

1. Preset the signal generator.
2. Select the modulation format (TDMA, Custom, and so forth) and set the desired parameters.
3. Turn-on the modulation format.

### Accessing the N5102A Module User Interface

Press **Aux Fctn > N5102A Interface**.

This accesses the UI (first-level softkey menu shown in [Figure 7-9](#)) that is used to configure the digital signal interface module. Notice the graphic, in the ESG display, showing a setup where the N5102A module is generating its own internal clock signal. This graphic changes to reflect the current clock source selection.

**Figure 7-9** First-Level Softkey Menu

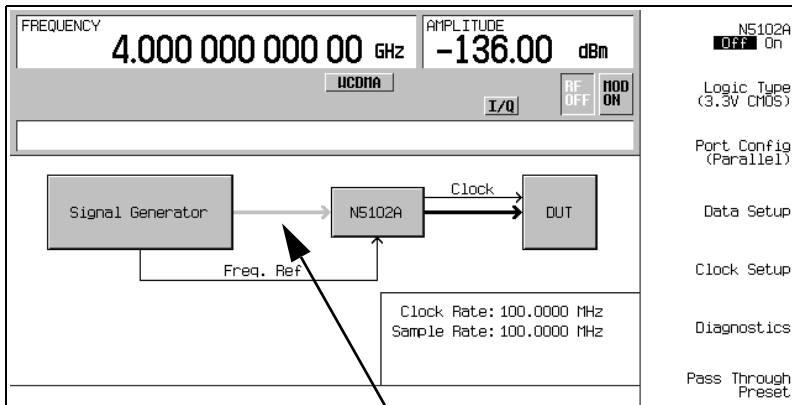

Line is grayed out until the N5102A module interface is turned on

## Choosing the Logic Type and Port Configuration

Figure 7-10 Logic and Port Configuration Softkey Menus

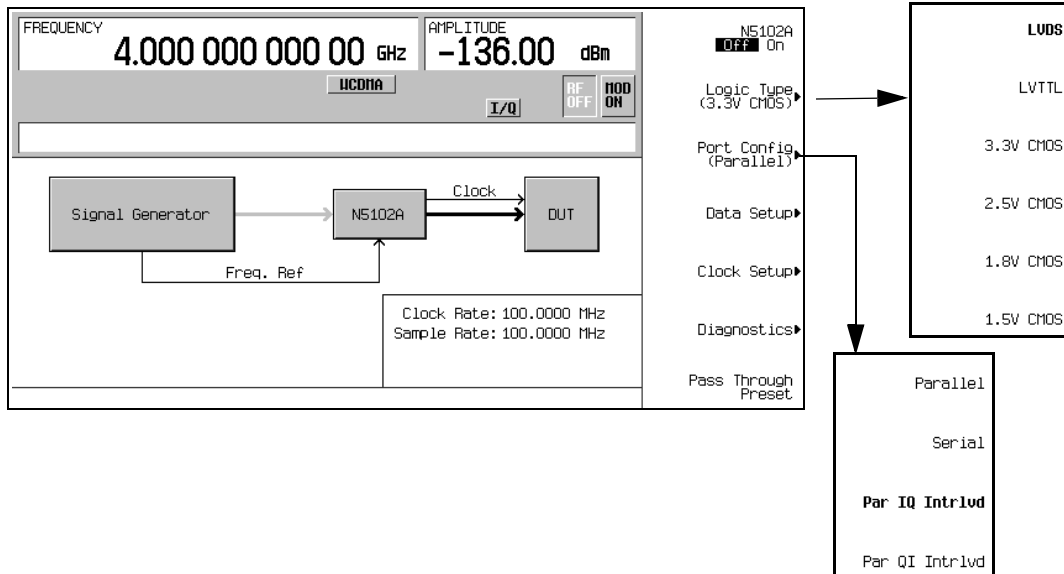

1. Refer to [Figure 7-10](#). Press the **Logic Type** softkey.

From this menu, choose a logic type.

---

**CAUTION** Changing the logic type can increase or decrease the signal voltage level going to the device under test. To avoid damaging the device and/or the N5102A module, ensure that both are capable of handling the voltage change.

---

2. Select the logic type required for the device being tested.

A caution message is displayed whenever a change is made to the logic types, and a softkey selection appears requesting confirmation.

3. Refer to [Figure 7-10](#). Press the **Port Config** softkey.

In this menu, select either a serial, parallel, or parallel interleaved data transmission.

---

**NOTE** Within the data and clock setup softkey menus, some softkeys function relative to the current configuration. Softkeys that are grayed out are not available for the current setup. Refer to the help text to determine which parameter is causing the softkey to be unavailable. Press the **Help** hardkey on the ESG front panel and then the softkey that is unavailable.

---

4. Select the port configuration for the device.

### Selecting the Output Direction

Press **Data Setup > Direction Input Output** to Output and press Return.

---

**NOTE** If Option 003 is the only option installed, the direction softkey will be unavailable and the mode will always be output. With both Option 003 (output mode) and Option 004 (input mode) installed, the default direction is output.

---

### Selecting the Data Parameters

This procedure guides you through the data setup menu. Softkeys that have self-explanatory names are generally not mentioned. For example, the **Word Size** softkey. For more information on all of the softkeys, refer to *Key and Data Field Reference*.

1. Refer to [Figure 7-11](#). Press the **Data Setup** softkey.

**Figure 7-11 Data Setup Menu Location**

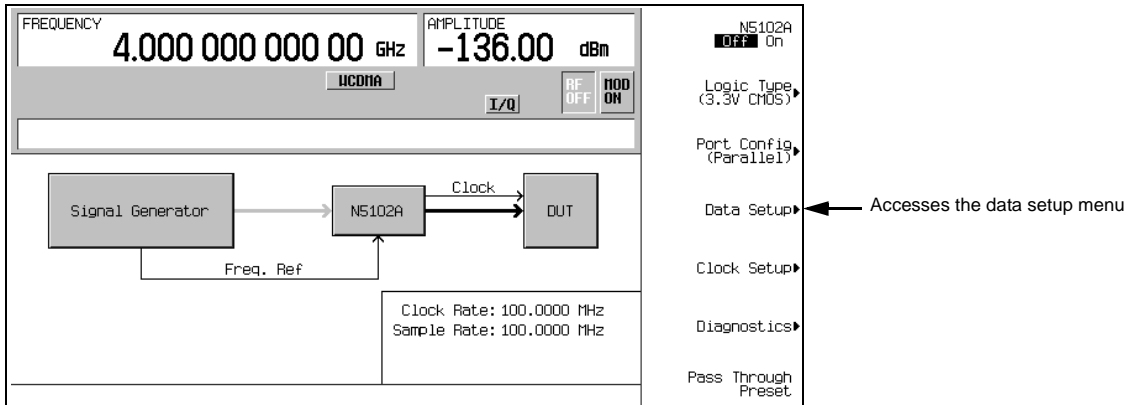

This softkey menu accesses the various parameters that govern the data received by the device under test. The status area of the display shows the number of data lines used for both I and Q along with the clock position relative to the data. When the port configuration is parallel or parallel interleaved, the number of data lines indicated is equivalent to the word (sample) size. When the port configuration is serial, the display will show that only one I and one Q data line is being used along with the frame marker that delineates the beginning of a sample. [Figure 7-12](#) shows the data setup menu structure.



Figure 7-12 Data Setup Softkey Menu with Parallel Port Configuration

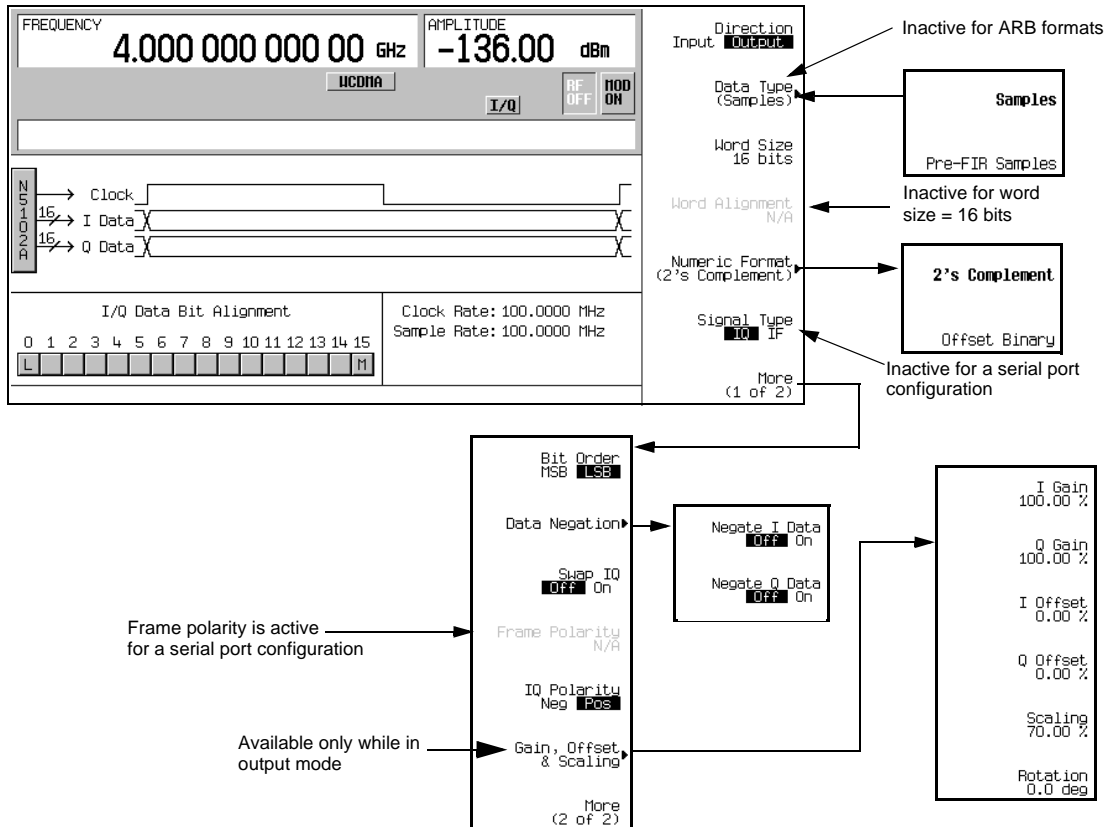

2. If a real-time modulation format is being used, press the **Data Type** softkey. (This softkey is inactive when an ARB modulation format is turned on.)

In this menu, select whether the real-time baseband data from the signal generator is either filtered (**Samples**) or unfiltered (**Pre-FIR Samples**). The selection is dependent on the test needs. The **Samples** selection provides FIR filtered baseband samples according to the communication standard of the active modulation format. This is the preset selection and the one most commonly used. However if the device being tested already incorporates FIR filters, the **Pre-FIR Samples** selection should be used to avoid double filtering.

3. Select the data type that is appropriate for the test.
4. Press the **Numeric Format** softkey.

From this menu, select how the binary values are represented. Selecting 2's complement allows both positive and negative data values. Use the Offset Binary selection when components cannot process negative values.

## Digital Signal Interface Module

### Operating the N5102A Module in Output Mode

5. Select the numeric format required for the test.
6. Press the **More (1 of 2)** softkey.

From this softkey menu, select the bit order, swap I and Q, select the polarity of the transmitted data, and access menus that provide data negation, scaling, gain, offset, and IQ rotation adjustments.

7. Press the **Data Negation** softkey.

Negation differs from changing the I and Q polarity. Applied to a sample, negation changes the affected sample by expressing it in the two's complement form, multiplying it by negative one, and converting the sample back to the selected numeric format. This can be done for I samples, Q samples, or both.

The choice to use negation is dependent on the device being tested and how it needs to receive the data.

8. Press the **Gain, Offset & Scaling** softkey.

Use the softkeys in this menu for the following functions:

- reduce sample values for both I and Q using the **Scaling** softkey
- increase or decrease the sample values independently for I and Q using the **I Gain** and **Q Gain** softkeys
- compensate for or add a DC offset using the **I Offset** and **Q Offset** softkeys
- rotate the data on the IQ plane using the **Rotation** softkey

9. Make any required scaling, gain, offset, or rotation adjustments to properly test the device.

10. Press **Return** > **Return** to return to the first-level softkey menu.

## Configuring the Clock Signal

1. Refer to [Figure 7-13](#). Press the **Clock Setup** softkey.

**Figure 7-13** Clock Setup Menu Location

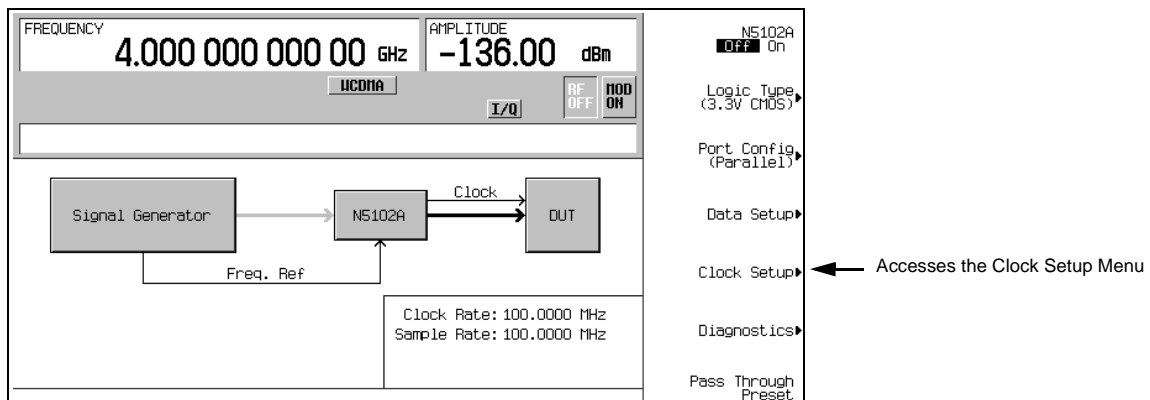

From this softkey menu, set all of the clock parameters that synchronize the clocks between the N5102A module and the ESG. You can also change the clock signal phase so the clock occurs during the valid portion of the data. Figure 7-14 shows the clock setup menu.

**Figure 7-14 Clock Setup Softkey Menu for a Parallel Port Configuration**

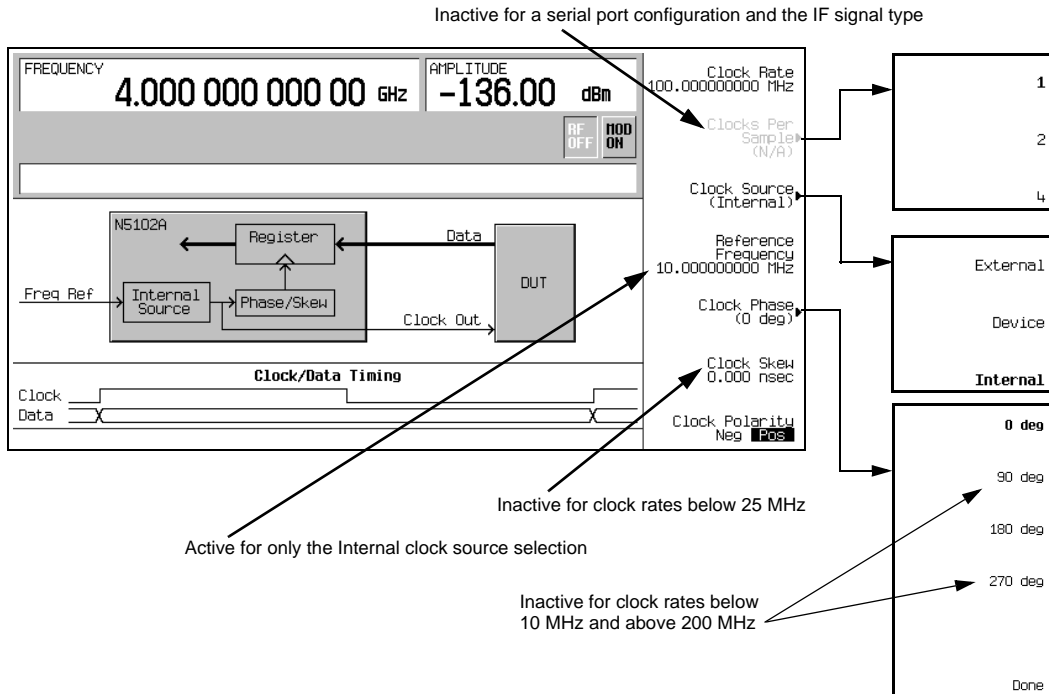

The top graphic on the display shows the current clock source that provides the output clock signal at the Clock Out and Device Interface connectors. The graphic changes to reflect the clock source selection discussed later in this procedure. The bottom graphic shows the clock position relative to the data. The displayed clock signal will change to reflect the following:

- clocks per sample selection
- clock phase choice
- clock skew adjustment
- clock polarity selection

If the device or external clock does not match the frequency, one of the following error messages will appear on the ESG:

805 Digital module output FIFO overflow error; There are more samples being produced than can be consumed at the current clock rate. Verify that the digital module clock is set up properly.

This error is reported when the output FIFO is overflowing in the digital module. This error can be generated if an external clock or its reference is not set up properly, or if the internal VCO is unlocked.

806 Digital module output FIFO underflow error; There are not enough samples being produced for the current clock rate. Verify that the digital module clock is set up properly.

This error is reported when the output FIFO is underflowing in the digital module. This error can be generated if an external clock or its reference is not set up properly, or if the internal VCO is unlocked.

2. If the port configuration is parallel or parallel interleaved, using an IQ signal type, press the **Clocks Per Sample** softkey.

Notice that multiple clocks per sample can be selected. Some DACs require the ability to clock multiple times for each sample; having a clocks per sample value greater than one reduces the sample rate by a factor equal to the selected number of clocks per sample. The sample rate is viewed on the first-level and Data Setup softkey menus.

3. Select the clocks per sample value to fit the test.
4. Press the **Clock Source** softkey.

From this menu, select the clock signal source. With each selection, the clock routing display in the signal generator clock setup menu will change to reflect the current clock source. This will be indicated by a change in the graphic.

5. Select the clock source.

#### **If External or Device is Selected**

Press the **Clock Rate** softkey and enter the clock rate of the externally applied clock signal.

---

**NOTE** The clock phase and clock skew may need to be adjusted any time the clock rate setting is changed. Refer to [“Clock Timing for Phase and Skew Adjustments” on page 232](#).

---

For the **External** selection, the signal is supplied by an external clock source and applied to the Ext Clock In connector. For the **Device** selection, the clock signal is supplied through the Device Interface connector, generally by the device under test.

#### **If Internal is Selected**

Using an external frequency reference, the N5102A module generates its own internal clock signal. The reference frequency signal must be applied to the Freq Ref connector on the digital module.

- a. Press the **Reference Frequency** softkey and enter the frequency of the externally applied frequency reference.

- b. Press the **Clock Rate** softkey and enter the appropriate clock rate.

Table 7-8 provides a quick view of the settings and connections associated with each clock source selection.

**Table 7-8 Clock Source Settings and Connectors**

Clock Source	Softkeys		N5102A Module Connection		
	Reference Frequency	Clock Rate <sup>1</sup>	Freq Ref	Ext Clock In	Device Interface
External		●		●	
Device		●			●
Internal <sup>2</sup>	●	●	●		

1. For the Internal selection, this sets the internal clock rate. For the External and Device selections, this tells the interface module the rate of the applied clock signal.
2. There should be no clock signal applied to the Ext Clock In connector.

6. Press the **Clock Phase** softkey.

From the menu that appears, you can adjust the phase of the clock relative to the data in 90 degree increments. The selections provide a coarse adjustment for positioning the clock on the valid portion of the data. Selecting 180 degrees is the same as selecting a negative clock polarity.

The 90 degree and 270 degree selections are not available when the clock rate is set below 10 MHz or above 200 MHz. If 90 degrees or 270 degrees is selected when the clock rate is set below 10 MHz or above 200 MHz, the phase will change to 0 degrees or 180 degrees, respectively.

---

**NOTE** The clock phase and clock skew may need to be adjusted any time the clock rate setting is changed. Refer to [“Clock Timing for Phase and Skew Adjustments” on page 232](#).

---

7. Enter the required phase adjustment.
8. Press the **Return** softkey to return to the clock setup menu.
9. Press the **Clock Skew** softkey.

This provides a fine adjustment for the clock relative to its current phase position. The skew is a phase adjustment using increments of time. This enables greater skew adjustment capability at higher clock rates. For clock rates below 25 MHz, this softkey is inactive.

The skew has discrete values with a range that is dependent on the clock rate. Refer to [“Clock Timing for Phase and Skew Adjustments” on page 232](#) for more information on skew settings.

10. Enter the skew adjustment that best positions the clock with the valid portion of the data.

11. Press the **Clock Polarity Neg Pos** softkey to Neg.

This shifts the clock signal 180 degrees, so that the data starts during the negative clock transition. This has the same affect as selecting the 180 degree phase adjustment.

12. Make the clock polarity selection that is required for the device being tested.

13. Press the **Return** hardkey to return to the first-level softkey menu.

The clock source selection is also reflected in the first-level softkey menu graphic. For example, if the device is the new clock source, the graphic will show that the frequency reference is now connected to the DUT and the DUT has an input clock line going to the N5102A module.

## Generating Digital Data

Press the **N5102A Off On** softkey to On.

Digital data is now being transferred through the N5102A module to the device. The green status light should be blinking. This indicates that the data lines are active. If the status light is solidly illuminated (not blinking), all the data lines are inactive. The status light comes on and stays on (blinking or solid) after the first time the N5102A module is turned on (**N5102A Off On** to On). The status light will stay on until the module is disconnected from its power supply.

The interface module can only be turned on while a modulation format is active. If the modulation format is turned off while the module is on, the module will turn off and an error will be reported.

---

### NOTE

If changes are made to the baseband data parameters, it is recommended that you first disable the digital output (**N5102A Off On** softkey to Off) to avoid exposing your device and the N5102A module to the signal variations that may occur during the parameter changes.

---

## Operating the N5102A Module in Input Mode

This section shows how to set the parameters for the N5102A module using the signal generator UI in the input direction. Each procedure contains a figure that shows the softkey menu structure for the interface module function being performed.

Refer to “[Connecting the Clock Source and the Device Under Test](#)” on page 234 and configure the test setup.

### Accessing the N5102A Module User Interface

All parameters for the N5102A module are set with softkeys on the ESG signal generator.

Press **Aux Fctn > N5102A Interface**.

This accesses the UI (first-level softkey menu shown in [Figure 7-15](#)) that is used to configure the digital signal interface module. Notice the graphic, in the ESG display, showing a setup where the N5102A module is generating its own internal clock signal. This graphic changes to reflect the current clock source selection.

**Figure 7-15** First-Level Softkey Menu

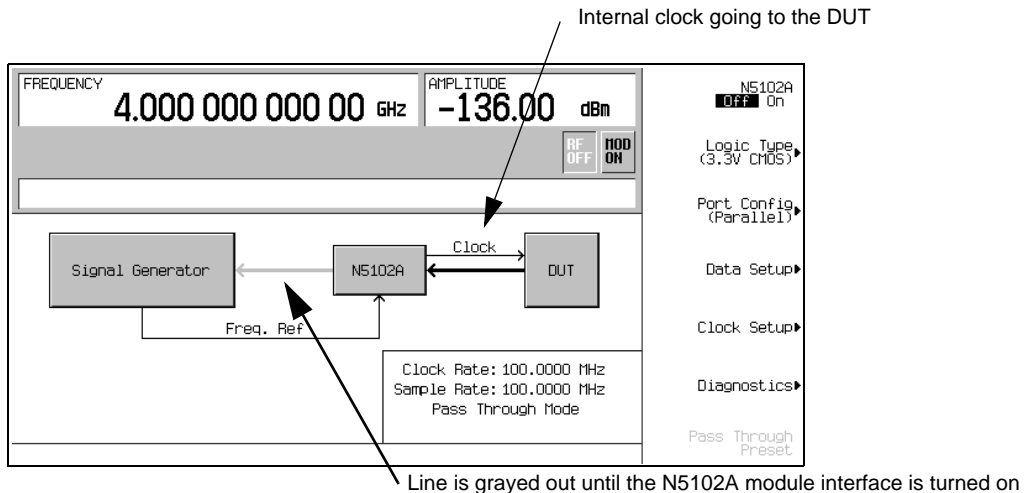

### Selecting the Input Direction

If both Option 003 (output mode) and Option 004 (input mode) are installed, you must select the input direction.

Press **Data Setup > Direction Input Output** to Input and press **Return**.

---

**NOTE** If only Option 004 is installed, the direction softkey will be unavailable and the mode will always be input.

---

### Choosing the Logic Type and Port Configuration

**Figure 7-16** Logic and Port Configuration Softkey Menus

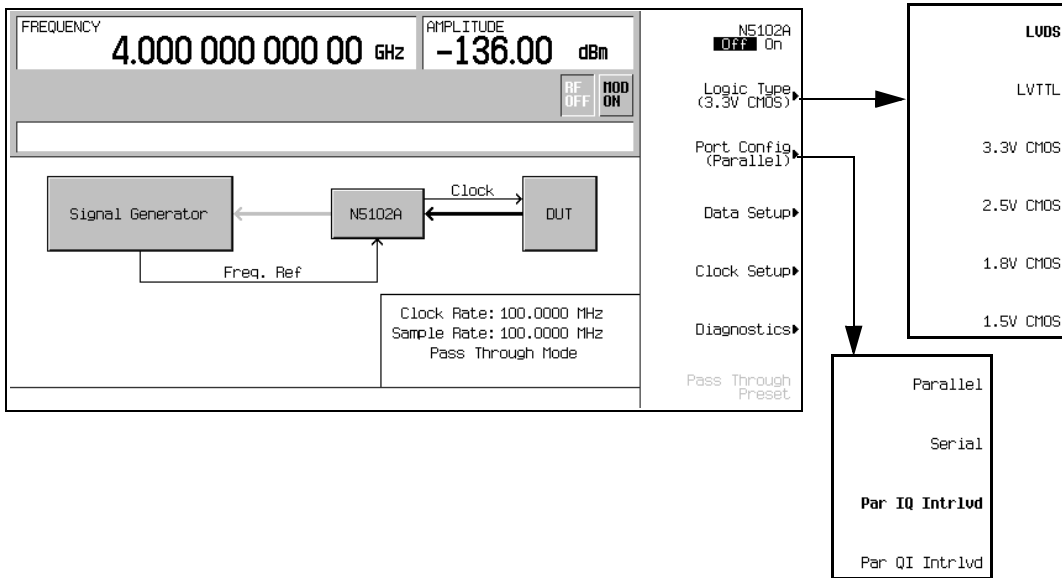

1. Refer to [Figure 7-16](#). Press the **Logic Type** softkey.  
 From this menu, choose a logic type.

---

**CAUTION** Changing the logic type can increase or decrease the signal voltage level. To avoid damaging the device and/or the N5102A module, ensure that both are capable of handling the voltage change.

---



2. Select the logic type required for the device being tested.

A caution message is displayed whenever a change is made to the logic types, and a softkey selection appears asking for confirmation.

3. Refer to [Figure 7-16](#). Press the **Port Config** softkey.

In this menu, select either a serial, parallel, or parallel interleaved data transmission.

---

**NOTE**

Within the data and clock setup softkey menus, some softkeys function relative to the current configuration. Softkeys that are grayed out are not available for the current setup. Refer to the help text to determine which parameter is causing the softkey to be unavailable. Press the **Help** hardkey on the ESG front panel and then the softkey that is unavailable.

---

4. Select the port configuration for the device being tested.

## Configuring the Clock Signal

1. Refer to [Figure 7-17](#). Press the **Clock Setup** softkey.

**Figure 7-17** Clock Setup Menu Location

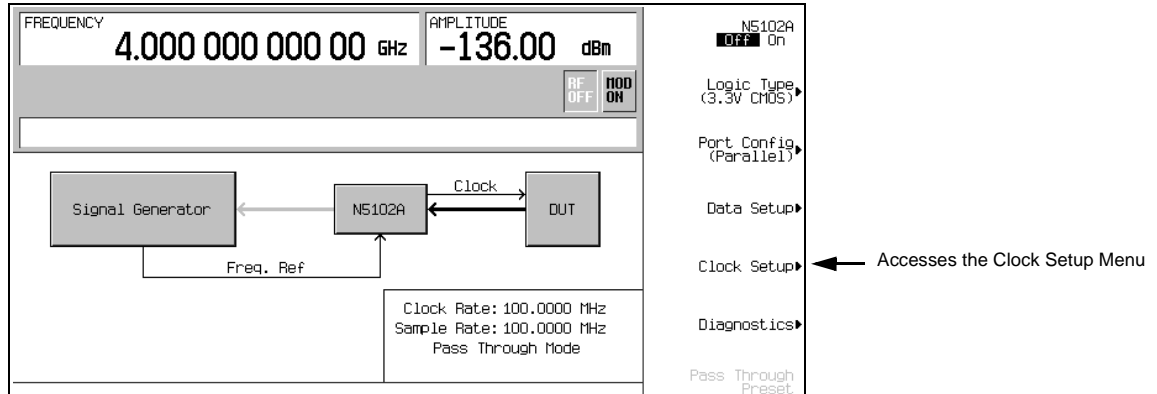

From this softkey menu, set all of the clock parameters that synchronize the data between the N5102A module and the device. From this menu, the clock signal phase can be changed so the clock occurs during the valid portion of the data. [Figure 7-18](#) shows the clock setup menu.

If the device or external clock does not match the frequency, one of the following error messages will appear on the ESG:

- 803      Digital module input FIFO overflow error; There are more samples being produced than can be consumed at the current clock rate. Verify that the digital module clock is set up properly.

Digital Signal Interface Module  
**Operating the N5102A Module in Input Mode**

This error is reported when the digital module clock setup is not synchronized with the rate the samples are entering the digital module. Verify that the input clock rate matches the specified clock rate under the clock setup menu.

804 Digital module input FIFO underflow error; There are not enough samples being produced for the current clock rate. Verify that the digital module clock is set up properly.

This error is reported when the digital module clock setup is not synchronized with the rate the samples are entering the digital module. Verify that the input clock rate matches the specified clock rate under the clock setup menu.

**Figure 7-18 Clock Setup Softkey Menu for a Parallel Port Configuration**

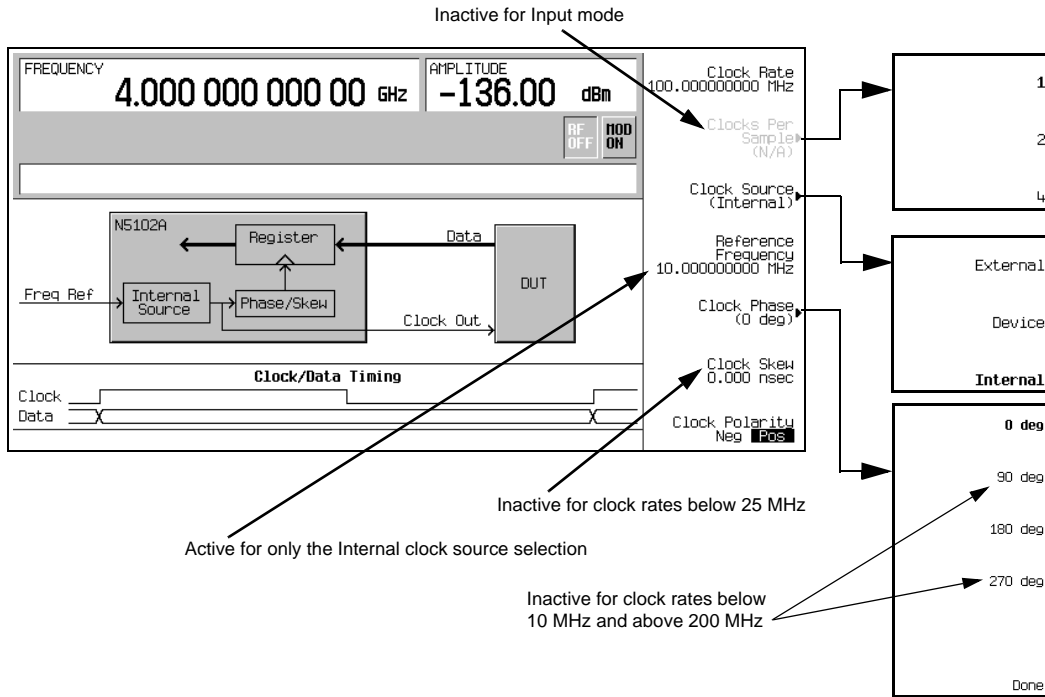

The top graphic on the display shows the current clock source that provides the output clock signal at the Clock Out and Device Interface connectors. The graphic changes to reflect the clock source selection discussed later in this procedure. The bottom graphic shows the clock edges relative to the data. The displayed clock signal will change to reflect the following:

- clock phase choice

- clock skew adjustment
  - clock polarity selection
2. Press the **Clock Source** softkey.  
From this menu, select the clock signal source. With each selection, the clock routing display in the signal generator clock setup menu will change to reflect the current clock source. This will be indicated by a change in the graphic.
  3. Select the clock source.

**If External or Device is Selected**

Press the **Clock Rate** softkey and enter the clock rate of the externally applied clock signal.

---

**NOTE** The clock phase and clock skew may need to be adjusted any time the clock rate setting is changed. Refer to [“Clock Timing for Phase and Skew Adjustments” on page 232.](#)

---

For the **External** selection, the signal is supplied by an external clock source and applied to the Ext Clock In connector. For the **Device** selection, the clock signal is supplied through the Device Interface connector, generally by the device being tested.

**If Internal is Selected**

Using an external frequency reference, the N5102A module generates its own internal clock signal. The reference frequency signal must be applied to the Freq Ref connector on the digital module.

- a. Press the **Reference Frequency** softkey and enter the frequency of the externally applied frequency reference.
- b. Press the **Clock Rate** softkey and enter the appropriate clock rate.

[Table 7-9](#) provides a quick view of the settings and connections associated with each clock source selection.

**Table 7-9 Clock Source Settings and Connectors**

Clock Source	Softkeys		N5102A Module Connection		
	Reference Frequency	Clock Rate <sup>1</sup>	Freq Ref	Ext Clock In	Device Interface
External		●		●	
Device		●			●
Internal <sup>2</sup>	●	●	●		

1. For the Internal selection, this sets the internal clock rate. For the External and Device selections, this tells the interface module the rate of the applied clock signal.
2. There should be no clock signal applied to the Ext Clock In connector when Internal is being used.

4. Press the **Clock Phase** softkey.

From the menu that appears, the phase of the clock relative to the data can be changed in 90 degree increments. The selections provide a coarse adjustment for positioning the clock on the valid portion of the data. Selecting 180 degrees is the same as selecting a negative clock polarity.

The 90 degree and 270 degree selections are not available when the clock rate is set below 10 MHz or above 200 MHz. If 90 degrees or 270 degrees is selected when the clock rate is set below 10 MHz or above 200 MHz, the phase will change to 0 degrees or 180 degrees, respectively.

---

**NOTE** The clock phase and clock skew may need to be adjusted any time the clock rate setting is changed. Refer to [“Clock Timing for Phase and Skew Adjustments” on page 232](#).

---

5. Enter the required phase adjustment.
6. Press the **Return** softkey to return to the clock setup menu.
7. Press the **Clock Skew** softkey.

This provides a fine adjustment for the clock relative to its current phase position. The skew is a phase adjustment using increments of time. This enables greater skew adjustment capability at higher clock rates. For clock rates below 25 MHz, this softkey is inactive.

The skew has discrete values with a range that is dependent on the clock rate. Refer to [“Clock Timing for Phase and Skew Adjustments” on page 232](#) for more information on skew settings.

8. Enter the skew adjustment that best positions the clock with the valid portion of the data.

9. Press the **Clock Polarity Neg Pos** softkey to Neg.

This shifts the clock signal 180 degrees, so that the data starts during the negative clock transition. This has the same affect as selecting the 180 degree phase adjustment.

10. Make the clock polarity selection that is required for the device being tested.

11. Press the **Return** hardkey to return to the first-level softkey menu.

The clock source selection is also reflected in the first-level softkey menu graphic. For example, if the device is the new clock source, you will see that the frequency reference is now connected to the DUT and the DUT has an input clock line going to the N5102A module.

## Selecting the Data Parameters

This procedure guides you through the data setup menu. Softkeys that have self-explanatory names are generally not mentioned. For example, the **Word Size** softkey. For more information on all of the softkeys, refer to the *Key and Data Field Reference*.

1. Refer to [Figure 7-19](#). Press the **Data Setup** softkey.

**Figure 7-19 Data Setup Menu Location**

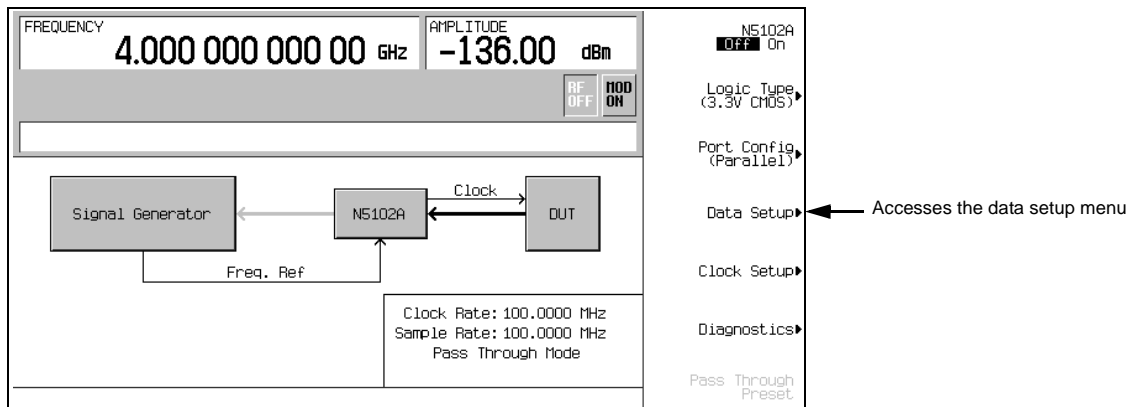

This softkey menu accesses the various parameters that govern the data received by the ESG. The status area of the display shows the number of data lines used for both I and Q along with the clock position relative to the data. [Figure 7-20](#) shows the data setup menu structure.

**Figure 7-20 Data Setup Softkey Menu with Parallel Port Configuration**

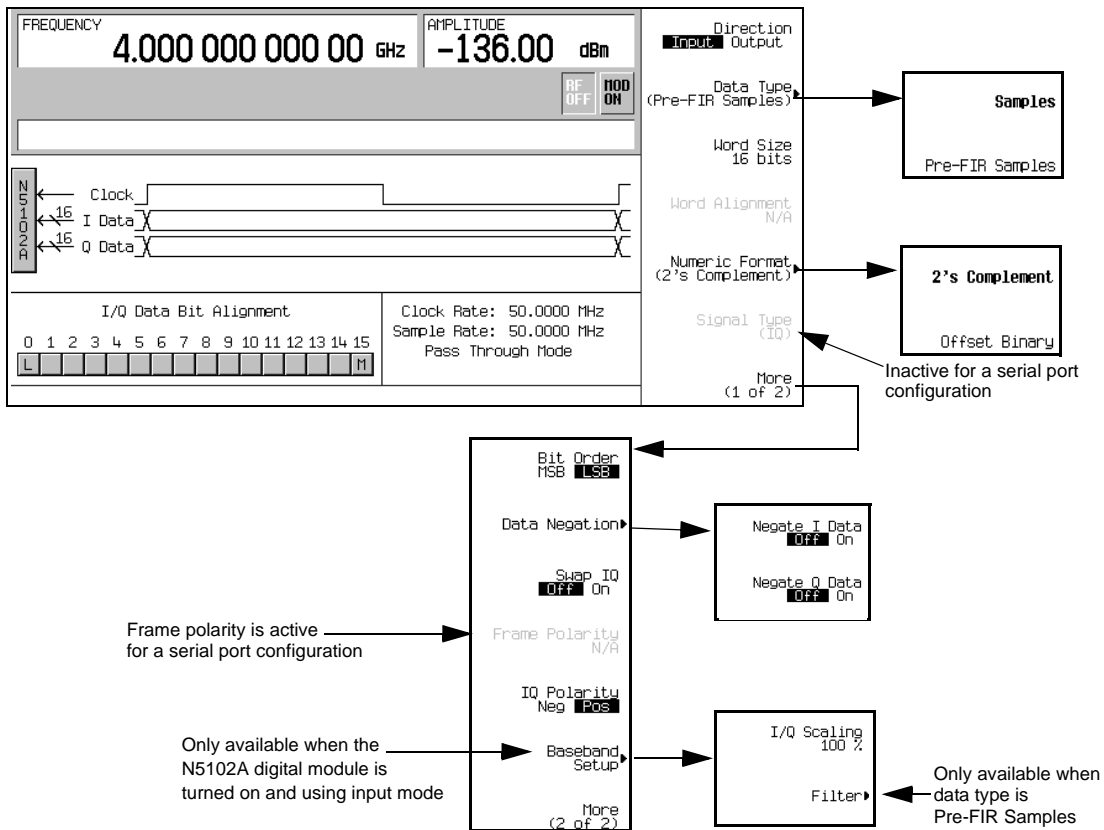

2. Press the **Data Type** softkey.

In this menu, select the data type to be either filtered (**Samples**) or unfiltered (**Pre-FIR Samples**). The selection is dependent on the test needs and the device under test. However if the device being tested already incorporates FIR filters, the **Pre-FIR Samples** selection should be used to avoid double filtering. Refer to “[Data Types](#)” on page 236, for more information.

3. Select the data type that is appropriate for the test needs.

4. Press the **Numeric Format** softkey.

From this menu, select how the binary values are represented. Selecting 2’s complement allows both positive and negative data values. Use the Offset Binary selection when components cannot process negative values.

5. Select the numeric format required for the test.

6. Press the **More (1 of 2)** softkey.

From this softkey menu, select the bit order, swap I and Q, the polarity of the data, and access menus that provides data negation, scaling, and filtering parameters.

7. Press the **Data Negation** softkey.

Negation differs from changing the I and Q polarity. Applied to a sample, negation changes the affected sample by expressing it in the two's complement form, multiplying it by negative one, and converting the sample back to the selected numeric format. This can be done for I samples, Q samples, or both.

The choice to use negation is dependent on the device being tested.

8. To access I/Q scaling and filter parameters, press **Return > N5102A Off On** to On. This will invoke the real time Custom format in the ESG baseband generator. This is needed to set the filter parameters when Pre-FIR Samples is selected as the data type.

9. Press the **Baseband Setup** softkey.

Use this softkey menu to adjust the I/Q scaling and access filter parameters. If the selected data type is Samples, the **Filter** softkey is grayed out (inactive). For more information on user-defined filtering, refer to the [“Using Finite Impulse Response \(FIR\) Filters” on page 168](#) and [“Modifying a FIR Filter Using the FIR Table Editor” on page 173](#).

## Digital Data

If the N5102A digital module is not on, press **Return > Return > N5102A Off On** to On.

Digital data is now being transferred through the N5102A module to the ESG. The green status light should be blinking. This indicates that the data lines are active. If the status light is solidly illuminated (not blinking), all the data lines are inactive. The status light comes on and stays on (blinking or solid) after the first time the N5102A module is turned on (**N5102A Off On** to On). The status light will stay on until the module is disconnected from its power supply.

---

### NOTE

If changes are made to the baseband data parameters, it is recommended that you first disable the digital output (**N5102A Off On** softkey to Off) to avoid exposing the device and the N5102A module to the signal variations that may occur during the parameter changes.

---

Digital Signal Interface Module  
**Operating the N5102A Module in Input Mode**



---

## 8 Bluetooth Signals (Option 406)

Option 406 is only available for E4438C ESG Vector Signal Generators with Option 001/601 or 002/602.

---

**NOTE** This option is no longer available. Instead, order Signal Studio software, N7606B, to generate Bluetooth waveforms that can be downloaded to the ESG.

---

The following list shows the topics covered in this chapter:

- [“Accessing the Bluetooth Setup Menu on the ESG” on page 258](#)
- [“Setting Up Packet Parameters” on page 259](#)
- [“Setting up Impairments” on page 261](#)
- [“Using Burst” on page 263](#)
- [“Using Clock/Gate Delay” on page 264](#)
- [“Turning On a Bluetooth Signal” on page 265](#)

## Accessing the Bluetooth Setup Menu on the ESG

Option 406 is required to perform the following procedure.

This chapter will show you how to set up a sample Bluetooth packet with impairments that include additive white gaussian noise (AWGN) using the front panel keys of the ESG. The procedures in this chapter build on each other and are designed to be used sequentially.

1. Press **Preset**, then press **Mode > More (1 of 2) > Wireless Networking > Bluetooth**.

**NOTE** For this section, the frequency and amplitude are set to typical Bluetooth values.

2. Press **Frequency > 2.402 > GHz > Amplitude > 10 > dBm > Mode Setup**.

The following figure shows a display of the Bluetooth menu.

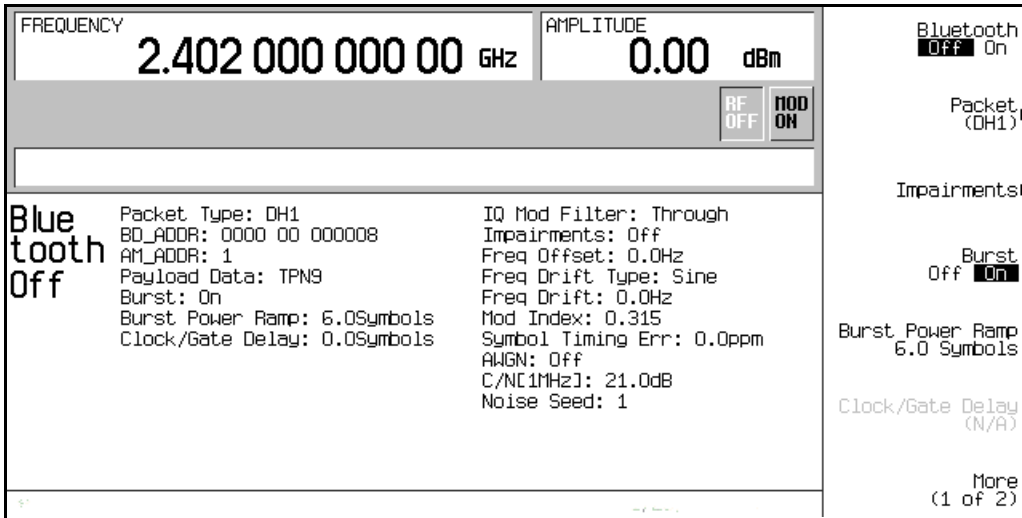

## Setting Up Packet Parameters

The steps in this procedure build upon the previous procedure.

The signal generator uses a DH1 (Data-High rate) packet for the Bluetooth format. The DH1 packet is a single bundle of information transmitted within a piconet and covers a single timeslot. This packet consists of 3 entities: the access code, the header, and the payload.

In the following example you will set the parameters of the DH1 packet.

1. Press **Packet (DH1)**.

This accesses a menu that enables you to set the packet parameters.

The following figure displays the packet menu.

FREQUENCY		AMPLITUDE			
2.402 000 000 00 GHz		0.00 dBm			
		RF OFF		MOD ON	
				BD_ADDR NAP UAP LAP 0000 00 000008	
				AM_ADDR 1	
Blue tooth Off		Packet Type: DH1		IQ Mod Filter: Through	
		BD_ADDR: 0000 00 000008		Impairments: Off	
		AM_ADDR: 1		Freq Offset: 0.0Hz	
		Payload Data: TPNS		Freq Drift Type: Sine	
		Burst: On		Freq Drift: 0.0Hz	
		Burst Power Ramp: 6.0Symbols		Mod Index: 0.315	
		Clock/Gate Delay: 0.0Symbols		Symbol Timing Err: 0.0ppm	
				AWGN: Off	
				C/[N(1MHz)]: 21.0dB	
				Noise Seed: 1	
				Payload Data (TPNS)	

2. Press **BD\_ADDR > 000000 00 1000 > Enter**.

This modifies the hexadecimal Bluetooth device address. Each Bluetooth transceiver is allocated a unique 48-bit Bluetooth device address. This address is derived from the IEEE802 standard.

For addresses with alpha characters, use the softkeys along with the keypad for data entry.

Bluetooth Signals (Option 406)  
**Setting Up Packet Parameters**

3. Press **AM\_ADDR > 4 > Enter**.

This sets the active member address and is used to distinguish between the active members participating on the piconet.

**NOTE** The all-zero AM\_ADDR is reserved for broadcast messages.

4. Press **Payload Data > 8 Bit Pattern > 10101010 > Enter**.

This selects a repeating 8-bit pattern as the payload data.

The following figure now displays the new packet parameters.

FREQUENCY <b>2.402 000 000 00</b> GHz		AMPLITUDE <b>0.00</b> dBm		Continuous PN9  Truncated PN9  <b>8 Bit Pattern</b> <b>10101010</b>
		RF OFF    MOD ON		
Payload Data: <b>1010 1010</b>				
<b>Blue tooth Off</b>	Packet Type: DH1	IQ Mod Filter: Through		
	BD_ADDR: 0000 00 001000	Impairments: Off		
	AM_ADDR: 4	Freq Offset: 0.0Hz		
	Payload Data: 10101010	Freq Drift Type: Sine		
	Burst: On	Freq Drift: 0.0Hz		
	Burst Power Ramp: 6.0Symbols	Mod Index: 0.315		
	Clock/Gate Delay: 0.0Symbols	Symbol Timing Err: 0.0ppm		
		AWGN: Off		
		C/N[1MHz]: 21.0dB		
		Noise Seed: 1		

---

## Setting up Impairments

The steps in this procedure build upon the previous procedure. This procedure teaches you how to set up the parameters for the impairment function.

1. Press **Return > Return > Impairments**.

This accesses a menu which enables you to set up impairments.

2. Press **Freq Offset > 25 > kHz**.

3. Press **Freq Drift Type Linear Sine**.

This sets the frequency drift type to linear. Linear frequency drift will occur across a period of time equal to the duration of one fully loaded DH1 packet, regardless of the packet length. The default setting is the sine drift deviation which is plus or minus from the carrier center frequency.

4. Press **Drift Deviation > 25 > kHz**.

This sets the maximum deviation of the frequency drift of the carrier frequency.

5. Press **Mod Index > .325 > Enter**.

Modulation index is defined as the ratio of peak-to-peak frequency deviation to the bit rate. When modifying the Mod Index parameter, the peak-to-peak frequency deviation only is changed.

6. Press **Symbol Timing Err > 1 > ppm**.

This sets the symbol timing error in parts per million.

7. Press **AWGN**.

This accesses a menu from which you can select the parameters of the additive white Gaussian noise (AWGN) to be applied as an impairment to the Bluetooth signal. The following parameters may be changed while AWGN is off, but will not be applied unless **AWGN** and **Impairments** are both turned on.

- a. Press **C/N [1MHz] > 20 > dB**.

This sets the carrier-to-noise ratio for a 1 MHz bandwidth.

- b. Press **Noise Seed > 2 > Enter**.

This sets the noise seed value used to assign a specific sequence of noise to be added to the basic Bluetooth signal. The noise seed is used to initialize the 16-bit shift register used for noise generation. Different noise seeds generate different combinations of noise.

- c. Press **AWGN Off On** to On.

This turns the AWGN, as a Bluetooth impairment, on.

## Bluetooth Signals (Option 406)

### Setting up Impairments

8. Press **Return** > **Impairments Off On** to On.

This returns you to the Impairments menu and turns the impairments function on. The following figure displays the impairment parameters.

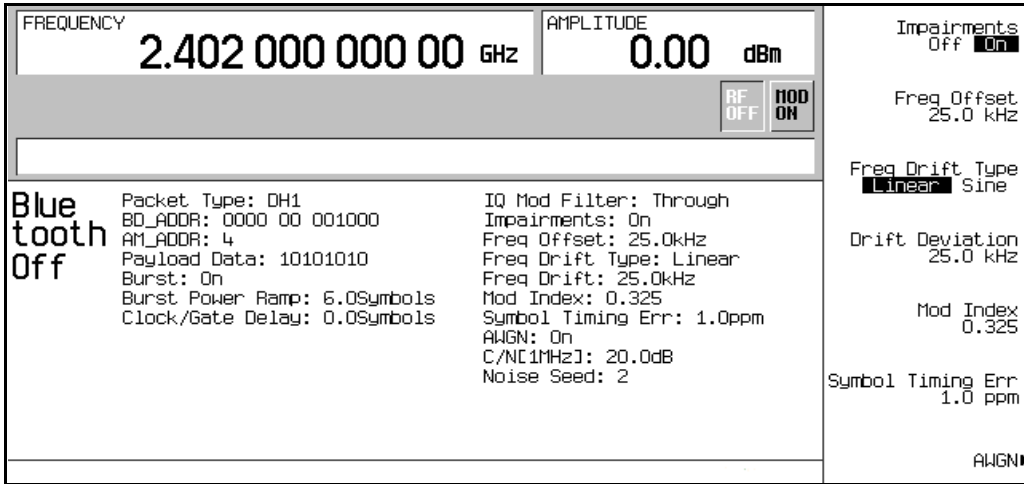

---

## Using Burst

The steps in this procedure build upon the previous procedure.

1. Press **Return** to return to the top-level Bluetooth menu.
2. Notice that **Burst Off On** is set to On.

When burst is on, the signal power ramps up prior to transmitting the packet and then ramps down at the end of the packet transmission. When burst is off, the transmitted packets link in a series with no power ramping. The default burst setting is on, but for troubleshooting you may want to turn bursting off.

For this example burst is left in the on position.

### Setting the Burst Power Ramp

This procedure builds upon the previous procedure.

Press **Burst Power Ramp > 4 > Symbols**.

This sets the duration of the power ramp to 4 symbols prior to transmitting the first symbol of the packet.

## Using Clock/Gate Delay

The steps in this procedure build upon the previous procedure.

This function is available only when the payload data is continuous PN9 and is intended to be used during bit error rate (BER) testing.

1. Press **Packet (DH1) > Payload Data > Continuous PN9 > Return**.

This activates the configuration that generates clock and gate signals relative to the Bluetooth signal.

2. Press **Clock/Gate Delay > 4 > Symbols**.

The clock and gate will be delayed 4 symbols to synchronize with the demodulated data signal from the device under test (DUT) at the input of the BER analyzer.



## Turning On a Bluetooth Signal

This procedure builds upon the previous procedure.

Press **Bluetooth Off On** to On.

This turns the operating state of the Bluetooth signal generator on.

The front panel I/Q and BLUETH annunciators appear, and the signal builds.

The following figure displays the Bluetooth signal parameters.

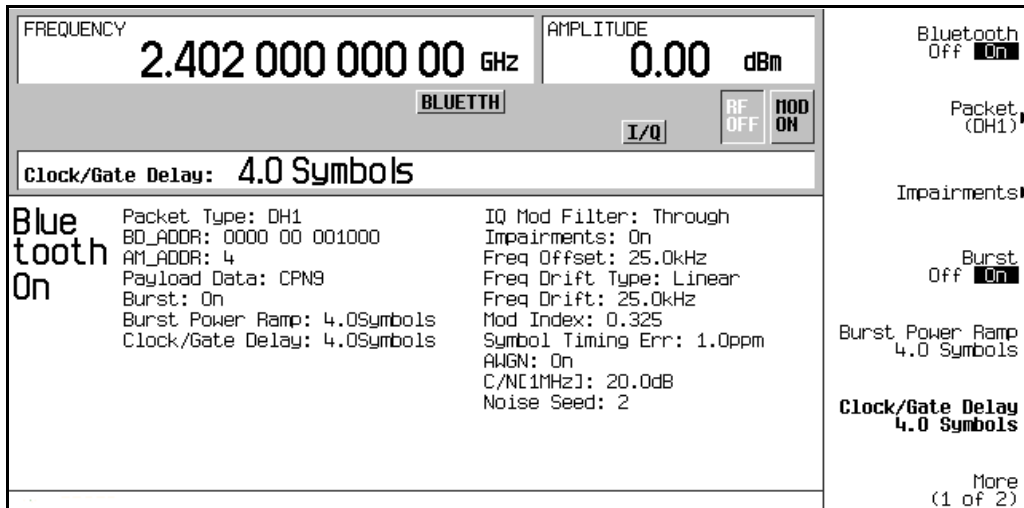

Bluetooth Signals (Option 406)

**Turning On a Bluetooth Signal**

---

## 9 BERT (Options UN7 and 300)

This feature is available only in E4438C ESG Vector Signal Generators with Option 001/601 or 002/602. The following list shows the topics covered in this chapter:

- “Setting Up a PHS Bit Error Rate Test (BERT)” on page 268
- “Measuring RF Loopback BERT with Option 300” on page 273
- “Using the External Frame Trigger Function with the EDGE Format” on page 288
- “Bit Error Rate Tester–Option UN7” on page 292
- “RF Loopback BER–Option 300” on page 303
- “Verifying BERT Operation” on page 306

## **Setting Up a PHS Bit Error Rate Test (BERT)**

This section shows how to make BERT measurements on a personal handyphone system (PHS) radio using the ESG Signal Generator with Option UN7.

The following procedures explain how to set up the ESG for making BERT measurements:

- [“Connecting the Test Equipment” on page 269](#)
- [“Setting the Carrier Frequency and Power Level” on page 270](#)
- [“Selecting the Radio Data Format” on page 270](#)
- [“Setting the Radio to a Receiver Mode” on page 271](#)
- [“Selecting the BERT Data Pattern and Total Bits” on page 271](#)
- [“Selecting the BERT Trigger” on page 271](#)
- [“Starting BERT measurements” on page 272](#)

### **Required Equipment**

The following equipment is required to make BERT measurements.

- ESG Signal Generator, model E4438C with Options 001/601 or 002/602, 402, and UN7
- an external controller to control the radio under test
- an interface level matching circuit for interfacing between the radio under test and the signal generator when the radio signal specifications are different from those of the signal generator

## Connecting the Test Equipment

Refer to [Figure 9-1](#).

1. Connect the cables between your radio and the ESG as follows:

**Figure 9-1** Setup for a PHS Bit Error Rate Test

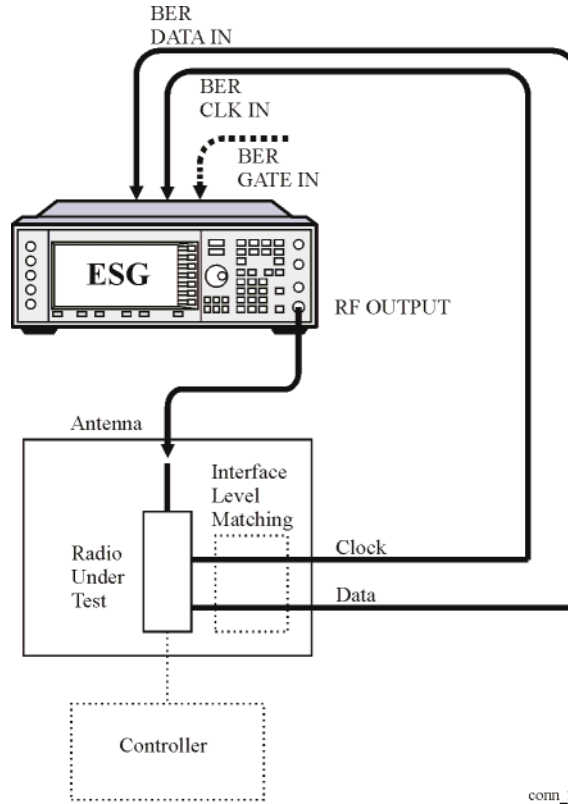

conn\_2

## Setting the Carrier Frequency and Power Level

1. Press the **Preset** hardkey.
2. Press the **Frequency** hardkey. Using the numeric keypad, set the signal generator RF output carrier frequency to 1.89515 GHz.
3. Press the **Amplitude** hardkey. Using the numeric keypad, set the signal generator RF output amplitude to -100 dBm.

The amplitude can also be set using an **Amplitude** softkey, located in the **Baseband BERT** softkey menu, that is accessed by pressing the **Aux Fctn** > **BERT** > **Baseband BERT** softkeys.

## Selecting the Radio Data Format

1. Press **Mode** > **Real Time TDMA** > **PHS**

This selects the PHS communications standard.

2. Toggle the **Data Format Pattern Framed** softkey to Framed.

When you select Framed for bursting the frame envelope, you will be transmitting framed data. This means that you will be bursting the timeslots that you have activated and there will be no RF carrier during the off timeslots.

Notice that the **Configure Timeslots** softkey has become an active softkey.

Observe the display and notice that the normal preset condition for downlink timeslot #1 has the timeslot turned on and configured as a traffic channel (TCH).

3. Press **Configure Timeslots**.

The **Timeslot #** softkey shows that downlink timeslot #1 is selected as the active timeslot. The **Timeslot Off On** softkey shows that downlink timeslot #1 is turned on. The **Timeslot Type** softkey shows that downlink timeslot #1 is configured as a traffic channel.

4. Press **Configure TCH**.

The **TCH** softkey shows that PN9 is selected as a data pattern.

5. Press **Return** > **Return** > PHS Off On.

At this time the internal baseband generator will generate the internal data patterns that you have configured for Downlink timeslot 1 and Uplink timeslot 1. A message is displayed while this process is taking place. Notice, also, that the **PHS**, **I/Q**, and **ENVLP** display annunciators are turned on.

6. Press **RF On/Off** to toggle RF on.

Notice that the display annunciator changes from RF OFF to RF ON. The modulated signal is now available at the RF OUTPUT connector.

## Setting the Radio to a Receiver Mode

Set the PHS radio to receive the signal of the specified carrier frequency and the timeslot 1, and output the data used for the bit error rate measurements.

## Selecting the BERT Data Pattern and Total Bits

1. Access the BERT function.

### For an ESG with Option UN7 Installed

Press **Aux Fctn > BERT > Configure BERT**.

### For an ESG with Options UN7 and 300 Installed

Press **Aux Fctn > BERT > Baseband BERT > Configure BERT**.

If the **Data** softkey does not show that PN9 is the selected data pattern, press **Data > PN9**.

The selected PN sequence must match the data PN sequence used on the channel being measured. For example if the DCH (DTCH) is using PN9 data, then the data selection in the BERT function must also be PN9.

2. Press **Total Bits > 100000 > Bits**.

## Selecting the BERT Trigger

1. Press **Return > Configure Trigger**.

If the **BERT Trigger** softkey does not show **Trigger Key** as the selected trigger, press **BERT Trigger > Trigger Key**.

2. Press **Return > BERT Off On**.

## **Starting BERT measurements**

Press the front panel **Trigger** hardkey to start the BERT measurement. You will see the measurement result values of the Total Bits, Error Bits, and BERT on the signal generator display.

---

### **NOTE**

If you encounter problems making a BERT measurement, check the following:

- Make sure that the cable connections are properly configured.
  - Make sure that the data pattern for the BERT measurement, specified by the **Data** softkey, matches the data pattern in the traffic channel (TCH) for the RF signal being input to the radio under test.
  - Make sure that the RF is turned on.
  - Make sure that the amplitude is set to the correct level.
  - Make sure that the radio under test is controlled to receive the signal of the specified carrier frequency and the timeslot.
-



## Measuring RF Loopback BERT with Option 300

The following procedure uses the data looped back from the base transceiver station (BTS) to measure the bit error ratio introduced by the BTS receiver when it is receiving coded data from the test equipment. Timing synchronization must first be achieved between the BTS and the test equipment so that data can be transmitted and received at the expected times. Synchronization is achievable either to a received broadcast channel (BCH), to a received full rate speech traffic channel (TCH) in the GSM format, or a packet data channel (PDCH) in the EDGE format.

### Required Equipment

The following equipment is required to make loopback BERT measurements.

- VSA Series Transmitter Tester, model E4406A, with the following required options:
  - Option BAH - GSM Measurement Personality

---

**NOTE** Option 202 replaces Option BAH in the VSA if EDGE support is required.

---

- Option 300 – 321.4 MHz IF Output
- ESG Vector Signal Generator, model E4438C
  - Option 300 – GSM/EDGE base station loopback BERT test capability (requires Options UN7, 001/601 or 002/602, 402)

### Connecting the Test Equipment

Refer to [Figure 9-2](#) for connections to the ESG, VSA, and base station.

---

**CAUTION** If the base station output power is to be greater than the VSA input power specification (+30 dBm), an external attenuator needs to be inserted prior to the RF INPUT connector on the VSA.

---

Measuring RF Loopback BERT with Option 300

Figure 9-2 BTS Loopback Test Equipment Setup

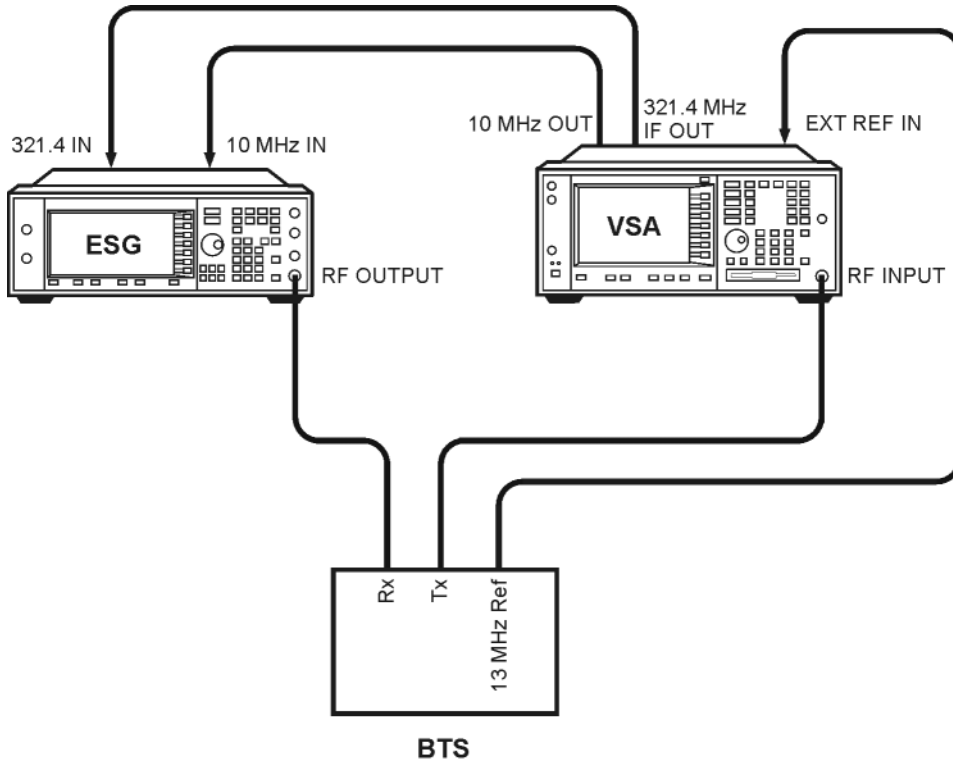

**NOTE**

This example uses an ARFCN of 124 for the BCH and synchronizes to the TCH midamble in timeslot 2 on ARFCN 124. You can substitute as appropriate for your BTS.

All key presses assume factory defined defaults at preset.

## Configuring GSM Mode on the Agilent Technologies E4406A VSA Series Transmitter Tester

The following steps will show you how to set up the vector signal analyzer (VSA) for synchronization.

1. To preset the VSA:  
Press **Preset**.
2. To select GSM mode:  
Press **MODE > GSM**.
3. To set up GSM mode for BTS test:  
Press **Mode Setup > Radio > Band > P-GSM > Return**.  
Toggle **Device BTS MS** until BTS is underlined.  
Toggle **Freq Hopping On Off** until Off is underlined.
4. To set the frequency:  
Press **FREQUENCY Channel > ARFCN 124**.  
Center Freq will show 959.800 MHz.  
Select **Burst Type > Normal**.  
Toggle **TSC (Std)** until Auto is underlined.
5. To lock the VSA and ESG to the BTS 13 MHz reference:  
Press **System > Reference > Freq Ref > 13 > MHz**.  
Toggle **Freq Ref Int Ext** until Ext is underlined.  
Toggle **10 MHz Out Off On** until On is underlined.

### Configuring GSM Mode on the ESG Vector Signal Generator

The following steps will show you how to configure a timeslot with multiframe data, set up traffic channel 1, and set the frequency and amplitude in GSM mode on the signal generator.

When configuring a timeslot in this procedure, keep the following points in mind:

- Prior to synchronization, the transmitter must be configured to generate multiframe data in the timeslot to be tested.
- TCH synchronization requires that the training sequences match between the ESG timeslot configuration and the timeslot sent by the base station. The default for the ESG, which is TSC0, can be modified.

1. Press **Preset**.
2. Press **Aux Fctn > BERT > BTS BERT GSM Loopback > Configure Measurement > Transmit Settings**.
3. Press **GSM On Off** to On > **Data Format Pattern Framed** to Framed > **Configure Timeslots**.

Refer to [Figure 9-3](#). The GSM timeslot pattern is displayed on the screen.

**Figure 9-3**

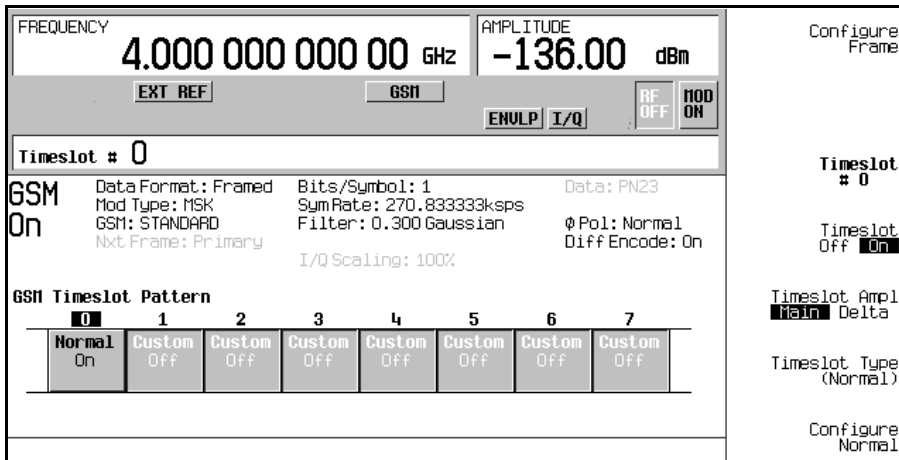

4. Press **Timeslot Off On** to Off.

5. Press **Timeslot # > 2 > Enter**.  
Press **Timeslot Type > Normal**.  
Press **Configure Normal > E > Multiframe Channel > TCH/FS > PN9** or **PN15**.

---

**NOTE** If the default training sequence (TSCO) does not match the training sequence sent by the BTS, press **Return > Return > TS** and select the proper training sequence.

---

6. Press **Return > Return > Return > Timeslot Off On to On**.
7. Press **Timeslot # > 1 > Enter**.  
Press **Timeslot Type > Normal > Configure Normal > E > Multiframe Channel > TCH/FS > PN9** (or **PN15**).  
Press **Return > Return > Return > Timeslot Ampl Main Delta to Delta > Timeslot Off On to On**.  
Repeat these steps for timeslot 3.
8. Press **Amplitude > More (1 of 2) > Alternate Amplitude > Alt Ampl Delta > 50 > dB**.
9. To set up traffic channel 124 in GSM mode:  
Press **Frequency > More (1 of 2) > Freq Channels**.  
Press **Device (BTS MS) to MS > Channel Band > GSM/EDGE Bands > P-GSM Mobile**.  
Press **Freq Channels Off On to On**.  
Press **Channel Number > 124 > Enter**.  
Refer to [Figure 9-4](#). The active entry area displays the following:  
Channel: 124 (914.80000000MHz)

Measuring RF Loopback BERT with Option 300

Figure 9-4

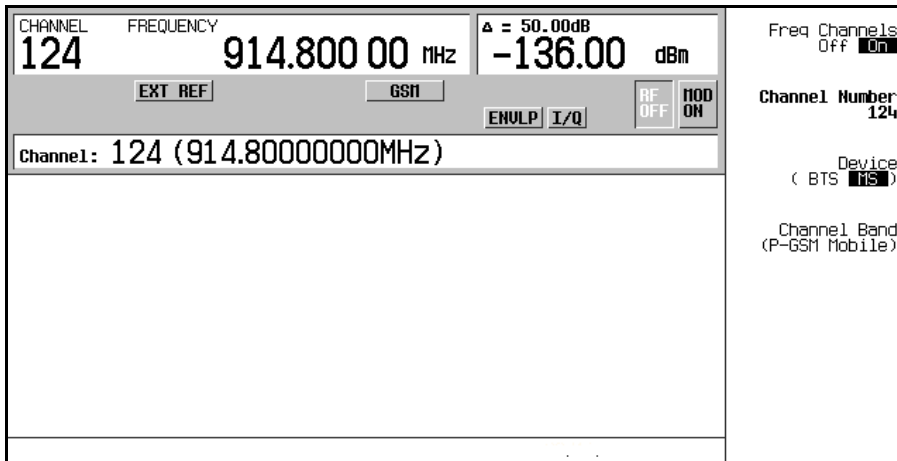

10. Press **Amplitude** > **-95** > **dBm**.

The amplitude can also be set using an **Amplitude** softkey, located in the **Baseband BERT** softkey menu, that is accessed by pressing the **Aux Fctn** > **BERT** > **Baseband BERT** softkeys.

11. Press **Mode Setup** > **RF On/Off**.

Refer to [Figure 9-5](#). The screen now displays channels 1, 2, and 3 turned on and channels 1 and 3 with a 50 dB alternate amplitude setting. Also, the RF annunciator is turned on, and the new power level is shown in the amplitude area of the display.

Figure 9-5

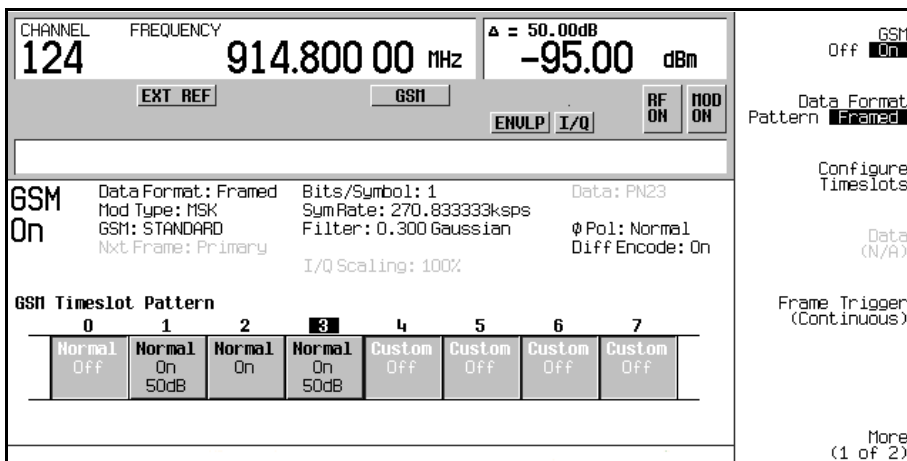

## Synchronizing to the BCH Then the TCH

The following steps show you how to synchronize to the broadcast channel (BCH). Set up the base station and start sending the BCH signal now. The BCH is only required to contain the synchronization logical channel (SCH).

1. Follow the instructions under “Configuring GSM Mode on the Agilent Technologies E4406A VSA Series Transmitter Tester” and “Configuring GSM Mode on the ESG Vector Signal Generator” in this chapter, to prepare the test equipment for synchronization.
2. Press **Aux Fctn > BERT > BTS BERT GSM Loopback**.
3. Press **Sync Source BCH TCH/PDCH** to BCH.
4. Press **GSM BERT Off On** to On > **Synchronize to BCH/TCH/PDCH**. Refer to [Figure 9-6 on page 279](#). You will briefly see Synchronizing to BCH flashing on the display.

**Figure 9-6**

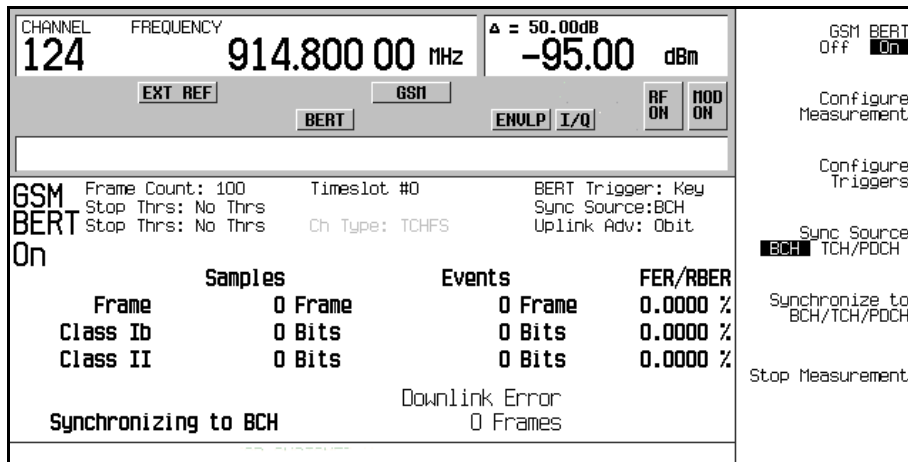

Once synchronization is achieved, the ESG will expect to receive a TCH to decode and, accordingly, will display the *Waiting for TCH* message. Refer to [Figure 9-7](#).

Figure 9-7

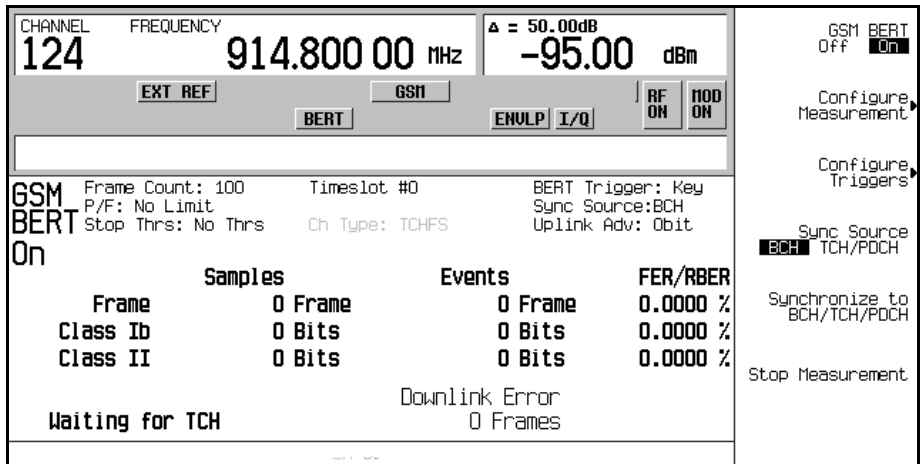

5. Turn off the BCH signal. and set up the base station to send the TCH signal.
6. Set up the base station and start sending the TCH signal now. The TCH is only required to contain a valid midamble.
7. On the ESG, press **Configure Measurement > Timeslot # > 2 > Enter**.  
This sets the ESG to expect the TCH in timeslot 2.
8. Press **Return > Synchronize to BCH/TCH/PDCH** to begin synchronization to the TCH.

**NOTE**

For the EDGE format, do the following to achieve TCH Sync Lock:  
Press **Configure Measurement > Timeslot # > 2 > Enter > Return > Adjust Gain**.

Then you will see Synchronizing to TCH flashing on the display followed by the Synchronizing to PN message.

Once synchronization is achieved, the Ready TCH Sync Lock message is displayed. Refer to [Figure 9-8](#).



**Figure 9-8**

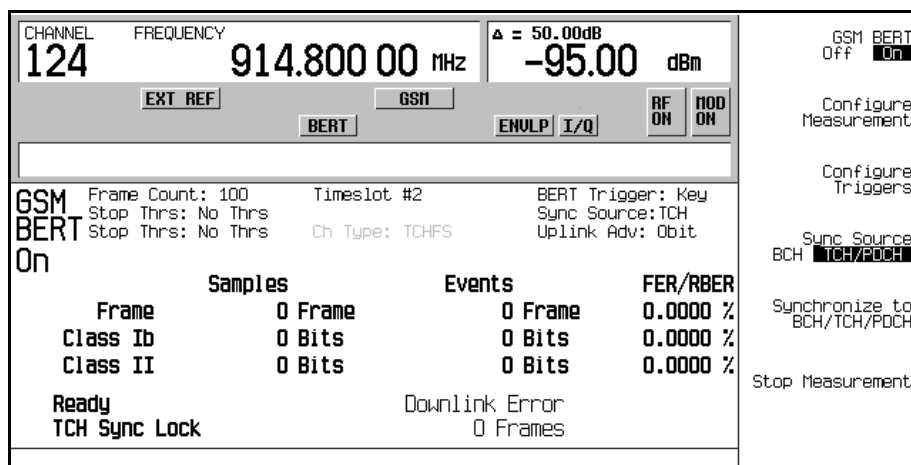

## Synchronizing to the TCH

The following steps show you how to synchronize to the traffic channel. The TCH is only required to contain a valid midamble. If appropriate for your base station, this synchronization can be performed without prior BCH synchronization.

---

**NOTE** If the base station is transmitting a BCH signal, turn it off at this time.

---

1. Follow the instructions under [“Configuring GSM Mode on the Agilent Technologies E4406A VSA Series Transmitter Tester”](#) and [“Configuring GSM Mode on the ESG Vector Signal Generator”](#) in this chapter, to prepare the test equipment for synchronization.
2. Set up the base station and start sending the TCH signal now. The TCH is only required to contain a valid midamble.
3. On the ESG, press **Aux Fctn > BERT > BTS BERT GSM Loopback**.
4. Press **Sync Source BCH TCH/PDCH** to TCH/PDCH.
5. Press **Configure Measurement > Timeslot # > 2 > Enter**.  
 This sets the ESG to expect the TCH in timeslot 2.

## BERT (Options UN7 and 300)

### Measuring RF Loopback BERT with Option 300

6. Press **Return** > **GSM BERT Off On to On**.

---

**NOTE** If the following error message is generated:  
522 Demodulator Unleveled; Input amplitude underrange  
this indicates that the TCH signal is not being received.

---

7. Press **Synchronize to BCH/TCH/PDCH** to begin synchronization to the TCH.

Then you will see **Synchronizing to TCH** flashing on the display followed by the **Synchronizing to PN** message.

Once synchronization is achieved, the **Ready TCH Sync Lock** message is displayed. Refer to [Figure 9-9](#).

**Figure 9-9**

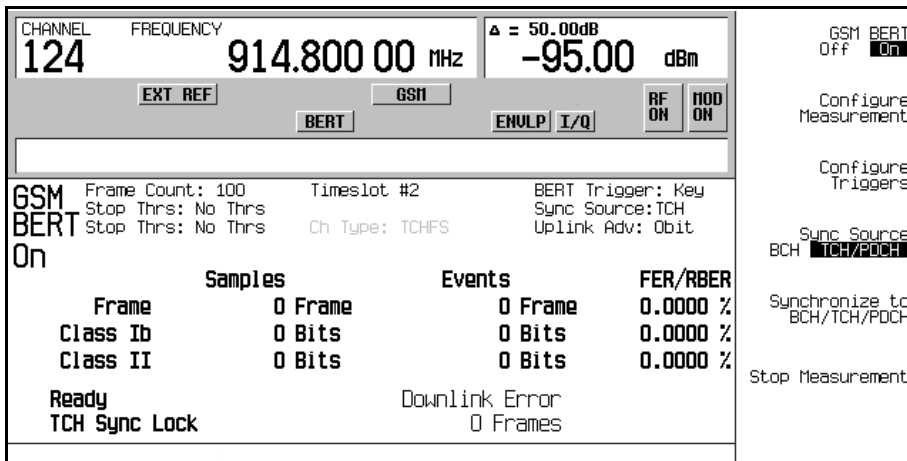

## Making Loopback BERT Measurements

The following procedure shows you how to configure the frame count, set pass/fail limits and set early stop criteria for loopback BERT measurements.

1. Press **Configure Measurement** > **Measurement Mode BER/BLER% Search** to BER/BLER%.
2. Press **BER/BLER% Configure** > **BER% TCH/FS Configure**.
3. Press **Frame Count** > **100** > **Enter**.

4. Press **Pass/Fail Limits > Class II RBER > 2 > %**.
5. Press **Return > Threshold # of Events to Stop > Class II Bit Error > 300 > Enter**.

Notice that the **Class II Bit Error** softkey is highlighted, 300 events is displayed beneath the softkey, and Stop Thrs: CII(300) appears in the status area of the display.

**Figure 9-10**

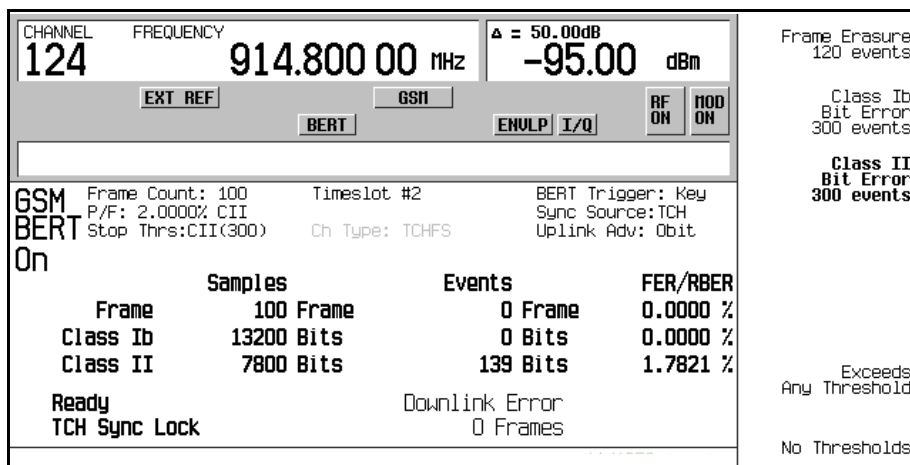

6. Press the **Trigger** hardkey to start the measurement:

You will see **Pass** or **Fail** displayed on the lower left corner of the screen, when either of the following occurs:

- The measurement completes normally; in this case, after 100 frames.
- The measurement terminates early, due to the designated number of events to stop being reached.

Refer to [Figure 9-11 on page 284](#).

Figure 9-11

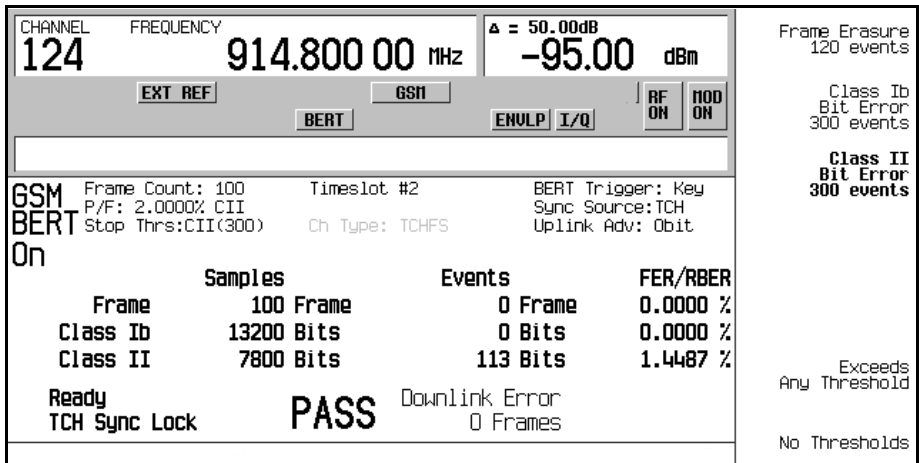

**NOTE** To select an alternate trigger mode (for example, Immediate):  
 Press **Return** three times, then press **Configure Triggers >**  
**BERT Trigger Source > Immediate.**

### Using Amplitude Sensitivity Search

This procedure shows you how to set a pass amplitude with high and low amplitude boundaries, and how to set both the target error percentage, and the frame count for an amplitude sensitivity search.

1. Press **Aux Fctn > BERT > BTS BERT GSM Loopback.**
2. Press **Configure Measurement > Measurement Mode BER/BLER% Search to Search.**  
 Notice that the **Configure Sensitivity Search** and **Arm Sensitivity Search** softkeys are enabled.
3. Press **Configure Sensitivity Search** to access the softkey menu for configuring the sensitivity search. Refer to [Figure 9-12 on page 285.](#)

**Figure 9-12**

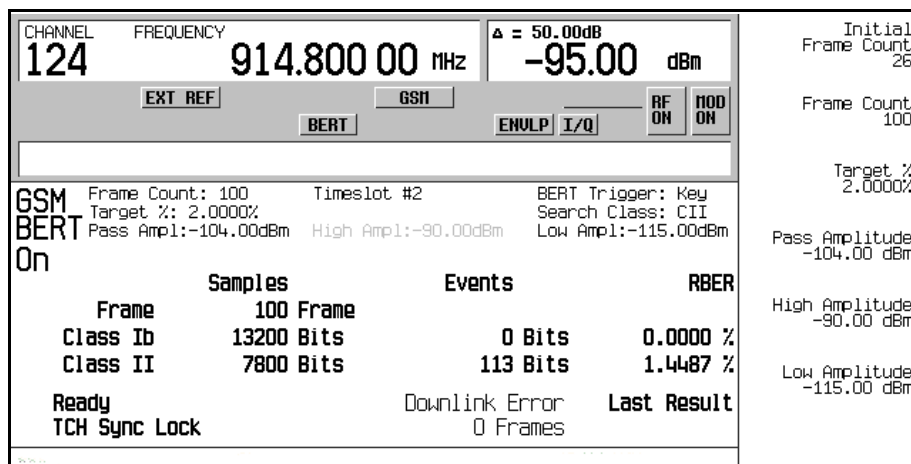

4. Press **Frame Count** > **100** > **Enter**.
5. Press **Target %** > **2** > **%**.
6. Press **Pass Amplitude** > **-95** > **dBm**.
7. Press **High Amplitude** > **-86** > **dBm**.
8. Press **Low Amplitude** > **-104** > **dBm**.
9. Press **Return** > **Arm Sensitivity Search**. Sensitivity search is now armed, refer to [Figure 9-13](#).

**Measuring RF Loopback BERT with Option 300**

**Figure 9-13**

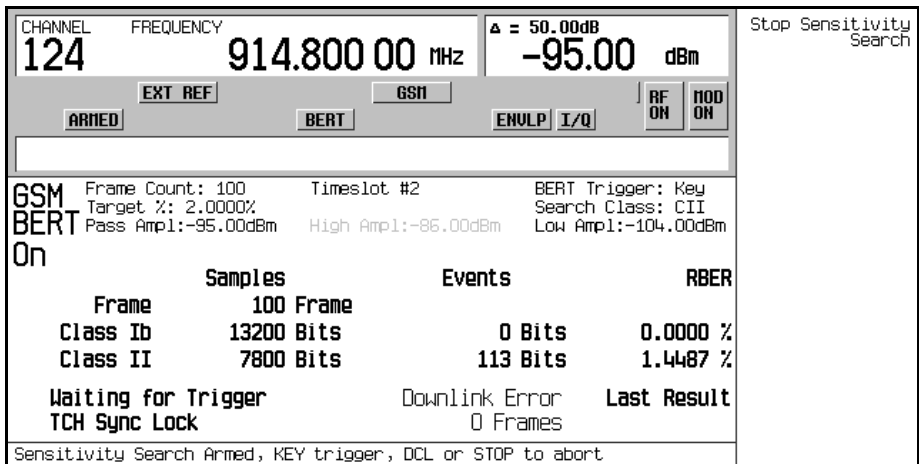

10. Press **Trigger** to start the measurement:

After the search is complete, Pass or Fail is displayed on the lower left corner of the screen, when either of the following occurs:

- The result equals or is less than the target percent within the high to low amplitude range.
- The high or low amplitude level is passed at the target% BER/RBER.

Refer to [Figure 9-14](#).

**Figure 9-14**

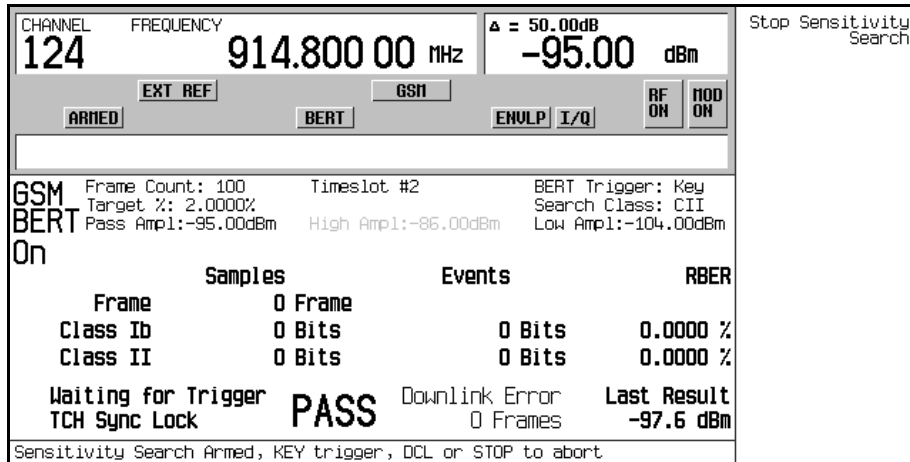

11. Press **Stop Sensitivity Search** to terminate a measurement:

---

**NOTE** To select an alternate trigger mode (for example, Immediate):  
 Press **Return > Configure Triggers > BERT Trigger Source > Immediate.**

---

**NOTE** For efficiency, the search routine uses shorter measurements initially with the final measurements being over the frame length selected.

---

---

## Using the External Frame Trigger Function with the EDGE Format

---

**NOTE** This function is available only when the **Frame Trigger Source BCH PDCH** is set to PDCH.

---

The External Frame Trigger Function is used to adjust the burst timing at PDCH synchronization. This requires calculating a delay value and then adjusting the initial value.

### Measuring the Initial Delay Value

1. Configure the BTS and the VSA setup. Refer to [Figure 9-15](#).

**Figure 9-15** System Configuration for Measuring External Delay Value

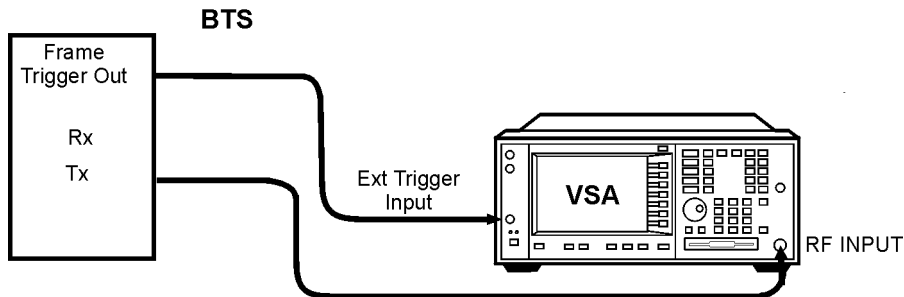

2. Set up the BTS to transmit the frame trigger EDGE burst at timeslot 0.
3. On the VSA, press **Mode > EDGE w/GSM**.
4. Press **Measure > Waveform (Time Domain)**.
5. Press **Meas Setup > Trig Source > Ext Front**.
6. Press **Makers**.
7. Use the marker function to find the offset value (D), in microseconds, between the BTS frame trigger and the starting edge of the midamble. Refer to [Figure 9-16 on page 289](#).



Figure 9-16

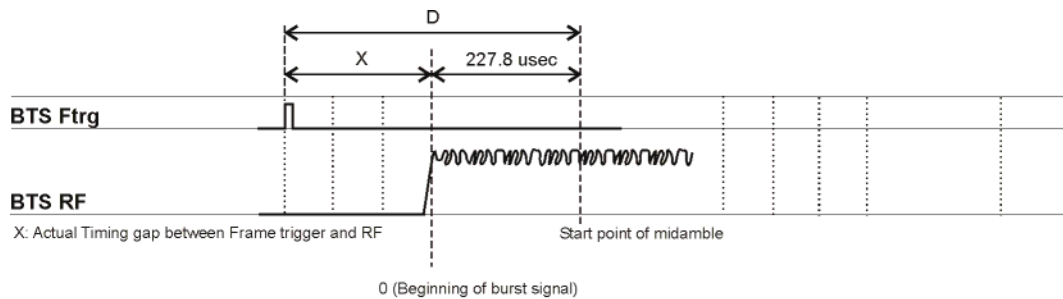

measure\_delay

- Calculate the offset value X using the following equation:

$$X(\text{symbols}) = (D - 227.8) / 3.693$$

Where, in the EDGE mode, 3.693  $\mu\text{s}$  is equal to 1 symbol.

### Adjusting the Delay Value

- Configure the ESG, BTS, and VSA setup. Refer to [Figure 9-17 on page 290](#).

Using the External Frame Trigger Function with the EDGE Format

Figure 9-17

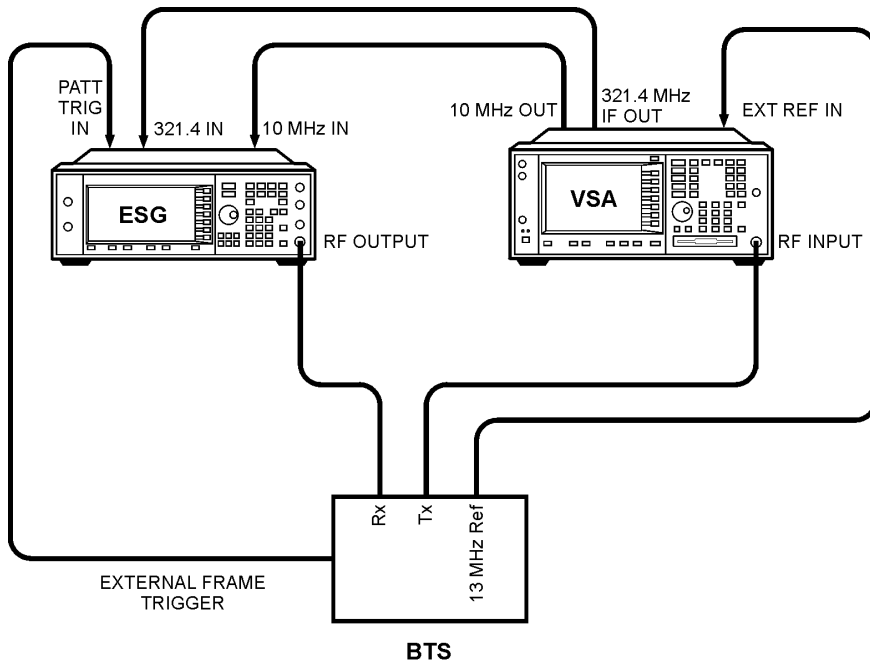

bts\_loopback

2. Press **Aux Fctn > BERT > BTS BERT EDGE Loopback**.
3. Press **EDGE BERT to On > Configure Triggers**.
4. Press **Frame Trigger Source BCH PDCH** to PDCH.
5. Press **Configure Triggers > Frame Trigger Source Int Ext** to Ext.
6. Press Ext Frame Trigger Delay and enter the X value calculated in the previous section.

---

**NOTE** If the frame trigger is in the forward direction of timeslot 0, as shown in [Figure 9-16 on page 289](#), enter the X value as a negative value.

---

7. Press **Return > Synchronize to BCH/PDCH**.

Synchronization should occur and display a Ready status. However, if Synchronizing keeps flashing or the Ready status appears for less than a second, increase or decrease the delay value by 2 symbols and press the Synchronize to BCH/PDCH softkey again. Repeat this process until the Ready status (synchronization) becomes stable.

**Using the External Frame Trigger Function with the EDGE Format**

8. Press **Configure Triggers > Ext Frame Trigger Delay**.
9. Change the delay value by rotating the knob slowly to find the range of delay values that display a Ready status.

---

**NOTE**            Although the delay value can be entered in 0.25 units, the actual uplink burst position can be changed in 1.0 symbol units.

---

10. If the PDCH is synchronized by a delay value within a  $\pm 3$  symbol range, choose the center value to set as the frame trigger delay.

## Bit Error Rate Tester–Option UN7

The bit error rate test (BERT) capability allows you to perform bit error rate (BER) analysis on digital communications equipment. This enables functional and parametric testing of receivers and components including sensitivity and selectivity.

### Block Diagram

When measuring BER, a clock signal that corresponds to the unit under test (UUT) output data must be input to the BER CLK IN connector. If the clock is not available from the UUT, use the DATA CLK OUT signal from the ESG baseband modulator.

Figure 9-18

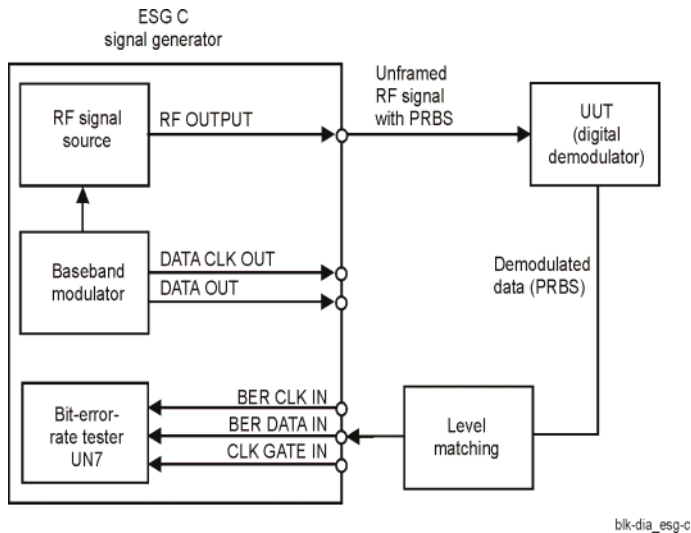

### Clock Gate Function

When you use the clock gate function, the clock signal to the BER CLK IN connector is valid only when the clock gate signal to the BER GATE IN connector is ON.

Press the **Clock Gate Off On** softkey to toggle the clock gate function off and on. The **Clock Gate Polarity Neg Pos** softkey sets the input polarity of the clock gate signal supplied to the rear panel BER GATE IN connector. When you select **Pos** (positive), the clock signal is valid when the clock gate signal is high; when you select **Neg** (negative), the clock signal is valid when the clock gate signal is low.

The following figure shows an example of the clock gate signal.

**Figure 9-19**

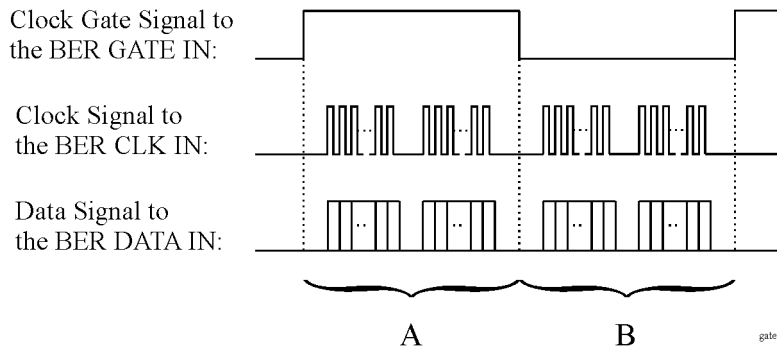

- When the **Clock Gate Off On** softkey is set to **Off**:  
The clock signal in both “A” and “B” parts is effective and no gate function is required. Therefore, the bit error rate is measured using the clock and data signal in both “A” and “B” parts.
- When the **Clock Gate Off On** softkey is set to **On**, and the **Clock Gate Polarity Neg Pos** softkey is set to **Pos**:  
The clock signal in “A” part is effective. Therefore, the bit error rate is measured using the clock and data signals in “A” part.
- When the **Clock Gate Off On** softkey is set to **On**, and the **Clock Gate Polarity Neg Pos** softkey is set to **Neg**:  
The clock signal in “B” part is effective. Therefore, the bit error rate is measured using the clock and data signals in “B” part.

## Clock/Gate Delay Function

This function enables you to restore the timing relationship between the clock/gate timing as it passes through the unit under test (UUT) and the packet data.

The shifted clock signal is emitted from pin 20 of the AUX I/O rear panel connector. When you use the clock delay function, the clock signal to the BER CLK IN connector is delayed by the clock delay function. When you use the gate delay function with the clock gate function, the clock signal is gated by the gate signal which is delayed by the gate delay function.

To see the signal flow using the clock and gate functions, refer to [Figure 9-20](#).

BERT (Options UN7 and 300)  
Bit Error Rate Tester—Option UN7

Figure 9-20  
Signal Flow

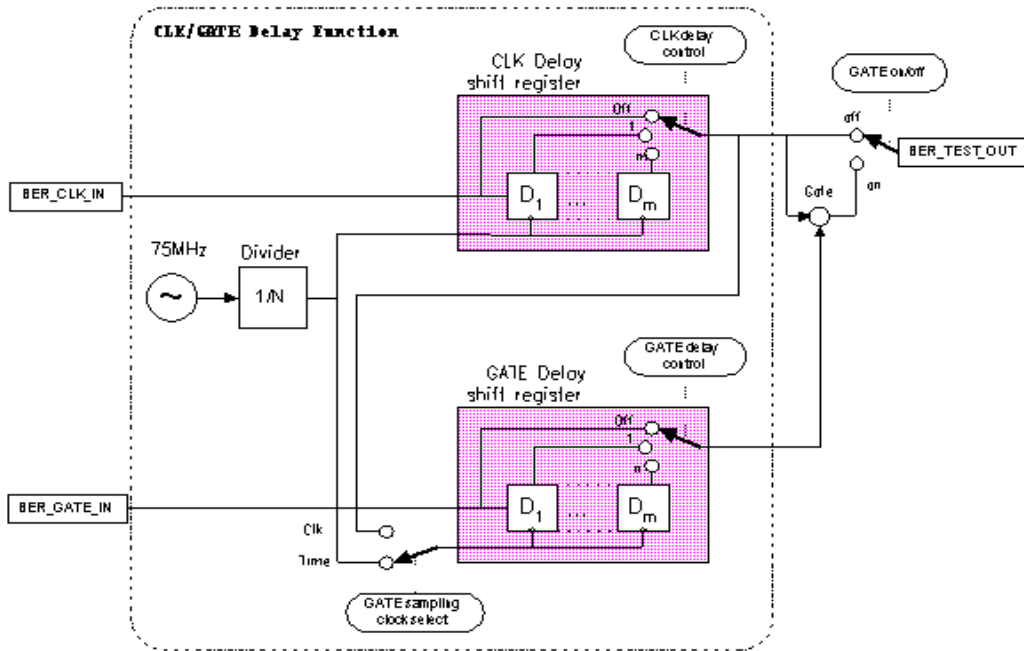

### Clock Delay Function

In this example, the clock delay function is off. Figure 9-21 shows the input of the internal error detector of UN7 through AUX I/O and indicates that the data is delayed from the clock.

Figure 9-21

CH1

CH2

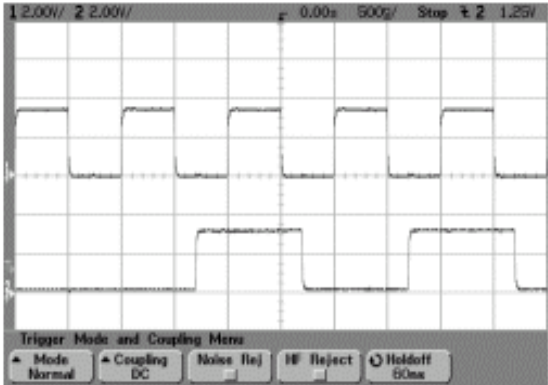

CH1: BER TEST OUT (pin 20 of AUX I/O connector)

CH2: BER MEAS END (pin 1 of AUX I/O connector)

In this example, the clock delay function is on. The rising edge of the clock was delayed by 200 ns and was adjusted to the center of the data. [Figure 9-22](#) indicates the result of the using the clock delay function.

Figure 9-22

CH1

CH2

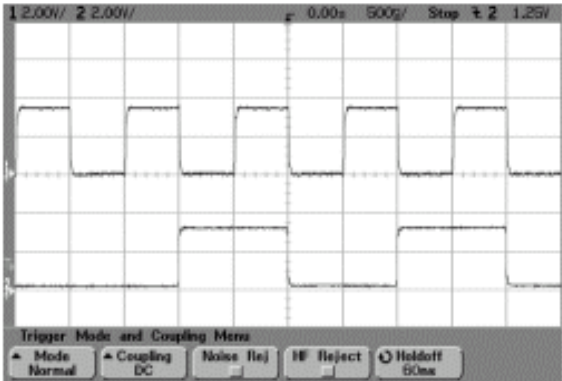

## Gate Delay Function in the Clock Mode

To use this function, the clock must be set to continuous mode.

In this example, the clock is used to delay the gate function. The clock of the internal error detector was gated by the gate signal which is delayed by two clocks. [Figure 9-23](#) shows that CH0 and CH1 are the input of the clock and data from the rear panel input connectors of UN7. CH2 is the gated clock through the AUX I/O connector.

**Figure 9-23**

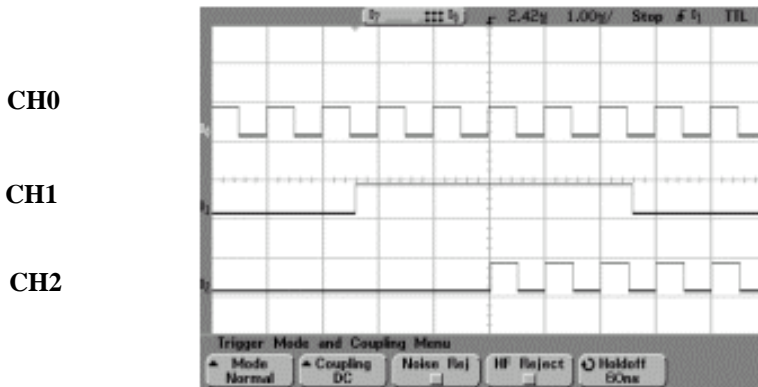

CH0: BER CLK IN (rear panel SMB connector)

CH1: BER GATE IN (rear panel SMB connector)

CH2: BER TEST OUT (pin 20 of AUX I/O connector)

## Triggering

This section describes the operating principles of the triggering function for Option UN7. To see the signal flow of the triggering function refer to [Figure 9-24](#).



Figure 9-24

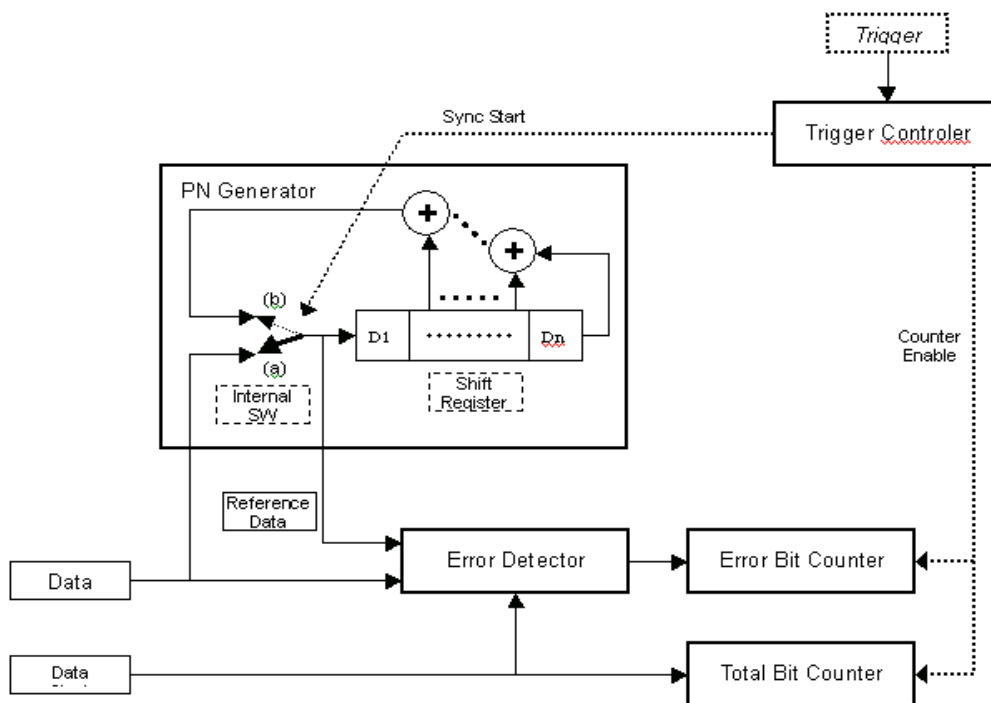

In this example, the triggering sequence is where you have an incoming data clock and data bit sequences, the trigger is active, and the BERT measurement begins. Refer to [Figure 9-25](#).

BERT (Options UN7 and 300)  
 Bit Error Rate Tester—Option UN7

Figure 9-25

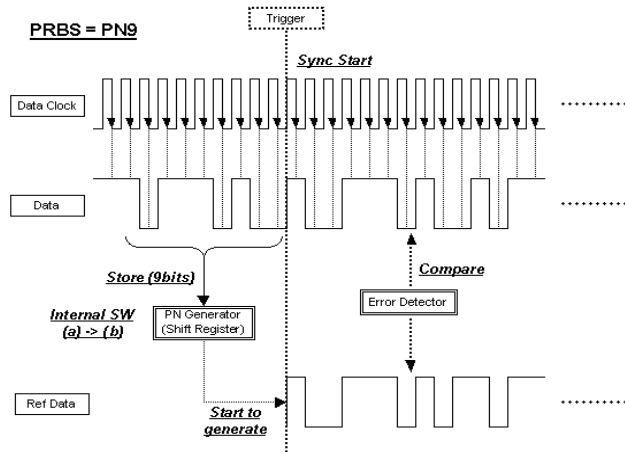

In this example, synchronization occurs after receiving a trigger.

The reference data is generated by stored data bits. If the BERT measurement accepts data bits immediately after receiving a trigger, set the trigger delay to On and the trigger delay count to a value corresponding to the data format. For PN9 set the delay to 9. Refer to [Figure 9-26](#).

Figure 9-26

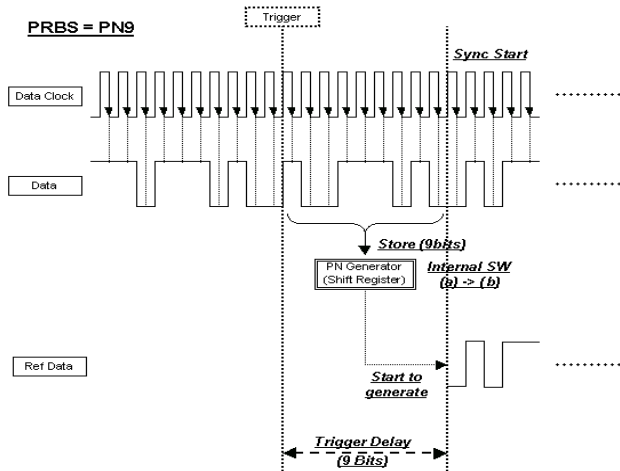

In this example, the triggering sequence is where the trigger delay is active with a cycle count.

The reference data is generated by stored data bits. If the BERT measurement accepts data bits immediately after receiving a trigger, set the trigger delay to On and the trigger delay count to a value corresponding to the data format. For PN9 set the delay to 9. If the cycle count is set to more than 1, it is not necessary to store data bits and no unnecessary delay occurs. Refer to [Figure 9-27](#) and “Repeat Measurements” on page 300.

**Figure 9-27**

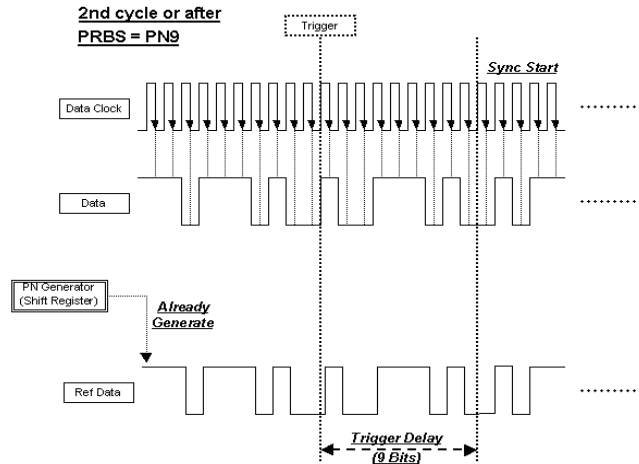

## Data Processing

### Data Rates

Data rates up to 60 MHz are supported for BERT analysis on un-framed or framed PN sequences. Note that the BERT analyzer supports only continuous PN sequences.

### Synchronization

Immediately after the trigger event, the DSP for the BERT measurement tries to establish synchronization using the first incoming bit stream.

If the **Bit Delay Off On** softkey is set to **On**, the number of bits specified by the **Delayed Bits** are ignored. The synchronization checking is repeated using an error-free bit string, lengthened by the **Delayed Bits**, until synchronization is established.

When the **BERT Resync Off On** softkey is set to **On**, the BERT measurements will automatically be restarted if the intermediate BERT measurement result exceeds the value specified by the **BERT Resync Limits**.

### Special Pattern Ignore Function

The special pattern ignore function is especially useful when performing BERT analysis on radios that generate consecutive 0's or 1's data for traffic channels when they fail to detect the Unique Word or lose synchronization. If 160 or more consecutive incoming data bits are either 1's or 0's, and the **Spcl Pattern Ignore Off On** softkey is set to **On**, then all of the consecutive 0's or 1's are ignored. Select either 0's or 1's as the data to ignore by using the **Spcl Pattern 0's 1's** softkey. The following figure shows an example of the special pattern ignore function.

Figure 9-28

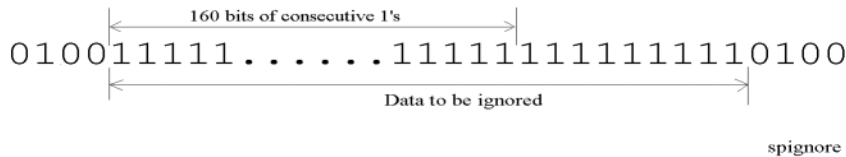

The 160 or more ignored bits can be anywhere in the PN sequence. The signal generator ignores these bits as error, but they are counted in the PN sequence bit count.

### Pass/Fail Judgement

There are two pass/fail judgement update modes: cycle end and fail hold. With cycle end selected, either pass or fail judgement is made for the results of each measurement cycle. With fail hold selected, the fail judgement is retained whenever a failure occurs during one loop of BERT repeat measurements. Fail hold mode allows you to determine when a failure occurs at least once during an entire cycle of measurements.

### Repeat Measurements

When the **Cycle Count** softkey is set to more than 1, the synchronization performed before the start of each measurement is only executed the first time; then it keeps track of the clock signal and the PRBS generation for the incoming data. This function can reduce the total time for BERT measurements. Also, once synchronization is established, it is retained even if the BERT measurement result degrades. You may wish to adjust the signal level to find a specific BERT value. However, once synchronization is lost in a repeat sequence, it will not be restored until the initiation of a new sequence. The following figure shows an example of the repeat measurements.

Figure 9-29

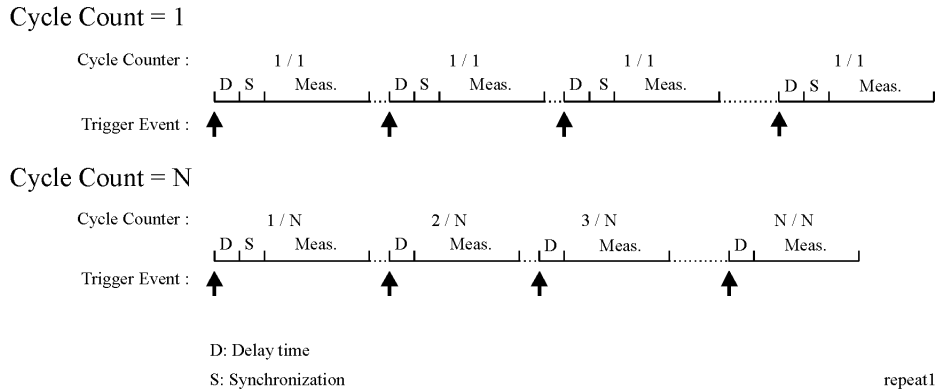

### Testing Signal Definitions

The timing diagram [Figure 9-30, “Testing Signal Definitions,”](#) shows the relationships between a trigger event and the output signals at the BER MEAS END and BER TEST OUT connectors.

If a BER MEAS END signal stays high following a trigger event, the BERT measurement is in progress and other trigger events are ignored. This state is stored in the status register and can be queried.

Figure 9-30 Testing Signal Definitions

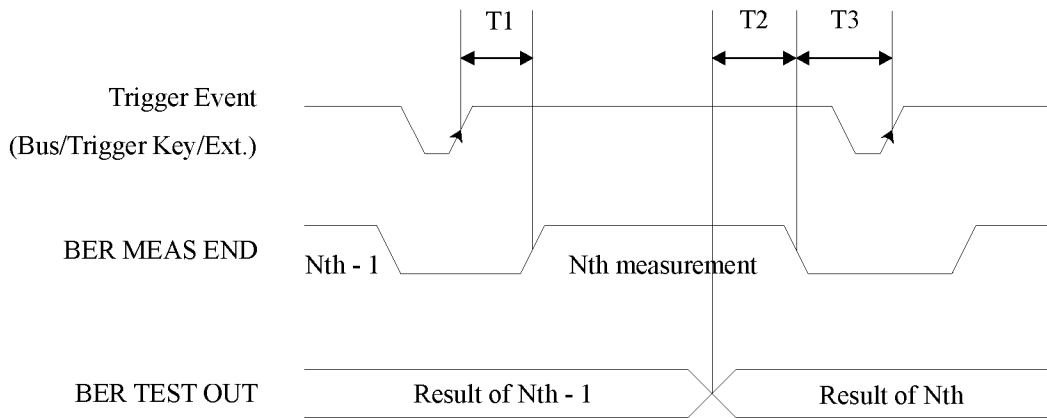

timing

## BERT (Options UN7 and 300)

### Bit Error Rate Tester–Option UN7

- T1 is a firmware handling time measured from a Trigger event to the rising edge of a BER MEAS END signal.
- T2 is a firmware handling time measured from the falling edge of a BER TEST OUT signal to the falling edge of the BER MEAS END signal.
- T3 is a minimum requirement time measured from the falling edge of the BER MEAS END signal to the next trigger event. T3 should be greater than 0 second.

The pulse output of the BER TEST OUT for the Nth-1 test result ends prior to the falling edge of the BER MEAS END signal for the Nth measurement; so you can use this edge to start latching the Nth test result.

## RF Loopback BER–Option 300

### Synchronization

Synchronizing the test equipment to the base transceiver station (BTS) is a prerequisite to the BTS looping back the selected traffic channel (TCH). This can be achieved in two ways: BCH Sync or TCH Sync.

**BCH Sync**            The BTS is set to transmit to the test equipment a BCH on timeslot 0 of a selected absolute radio frequency channel number (ARFCN). The test equipment uses the BCH signal to determine its required TCH transmit timing.

On completion, the BTS may be switched into loopback mode on any selected ARFCN and timeslot number.

**TCH Sync**            This is a very quick mode of synchronization, but take care initially to set the receiver to the correct timeslot number being transmitted by the BTS.

In this mode the base station must transmit a signal on the selected timeslot prior to data being looped back. In some base stations this will happen as soon as a timeslot is set to loopback, regardless of whether the signal to the BTS has the correct timing. In other base stations, the BTS may need to be set to transmit a signal in the selected timeslot prior to achieving synchronization.

The test equipment can lock to this signal if it contains the correct midamble. Once synchronized, the test equipment uses this information to determine the required TCH transmit timing. If the BTS is set accordingly, any timeslot can be transmitted with the correct timing to enable it to be looped back by the BTS to the receiver (VSA/ESG).

---

**NOTE**                The TCH sync mode relies on the user to set the correct timeslot number into both ESG transmitter and receiver during synchronization. Thereafter, the ESG can correctly test any timeslot since its relative timing is defined.

This capability can be used to speed up testing of consecutive timeslots in manufacture. TCH sync mode can be used to test all timeslots consecutively without changing a single setting on the ESG/VSA. All that is required is to consecutively loopback each timeslot using the BTS man-machine interface (MMI) and resynchronize and trigger the ESG.

---

PN synchronization is also a prerequisite to BERT measurements. This is automatic but is dependent on prior BCH or TCH synchronization.

The pattern to be recognized (PN9 or PN15) is determined by the corresponding transmit timeslot pattern selection.

## Erased Frame Detection

When an incorrect CRC in an uplink speech frame is detected by a BTS conforming to the GSM standards, the BTS substitutes an all-zero speech frame.

In the loopback mode, the BTS transmitter then recodes this substituted zero speech frame before transmission back to the test equipment receiver (VSA/ESG).

The ESG receiver detects any coded all-zeros speech frames in the returned downlink signal and increments the (erased) frame event count.

## Downlink Errors

The loopback method of measuring BTS receiver BERT quality requires a high quality downlink return path which introduces no errors.

To cater for the situation where the downlink path is faulty, the VSA/ESG provides a measure of downlink quality based on TCH payload errors detected by convolutional decoding of the return path. This records errors introduced into the TCH between the downlink coding (BTS transmitter) and decoding (VSA/ESG) processes and should normally be zero. For any payload errors detected during a measurement, the measurement is extended by a speech frame for every downlink error detected.

If a downlink problem results in errors introduced into the downlink midamble, the measurement aborts, providing further security against downlink problems.

## Frame Structure

### GSM Frame Structure

26-frame TCH multiframe structure.

Frames: Frame 12 (SACCH) and frame 25 (idle) empty.

Identical repetitive frames. Content as per ESG GSM capability.

### GSM Received Data

The [Table 9-1](#) shows the minimum requirements for the GSM received data frame structure during synchronization to the BTS and during measurements.

**Table 9-1** GSM Received Data

During BCH Synchronization	
TS0	51-frame BCH Multiframe Structure
	SCH in frames 1, 11, 21, 31, 41



**Table 9-1 GSM Received Data (Continued)**

<b>During BCH Synchronization</b>	
TS1-7	No SCH, but otherwise, don't care
During TCH Synchronization	
TSX	26-frame TCH Multiframe Structure
	Frame 25 idle
	Frame 12 don't care
	Other frames TCH
During Measurements	
Timeslot under test	26-frame full-rate voice TCH Multiframe Structure
TCH Frames 0-11, 13-24	Content determined by transmitted signal (looped by BTS except for errored speech frames, i.e. speech frames with bad CRC)
Frames 12, 25	Don't care

### **GSM Transmit Data**

The minimum GSM transmit data requirements for the loopback test are a fully GSM-coded 26-channel multiframe with either PN9 or PN15 in the payload. This is selected on the ESG by setting the timeslot under test to normal and selecting the PN9 or PN15 multiframe PN pattern.

To meet the GSM standards requirements for full conformance, the adjacent timeslots should be loaded with fully GSM-coded data. The ESG offers full flexibility of loading all timeslots.

### **Edge Frame Structure**

52-frame PDCH multiframe structure.

Frames: 12 blocks of 4 frames, 2 idle frames, and 2 frames used for the PTCCH.

## Verifying BERT Operation

This procedure verifies the operation of the signal generator's bit error rate test (BERT) function. This test can be performed as part of a daily validation routine or can be used whenever you want to check the validity of your BERT measurements. This procedure only checks the signal generator's BERT operation and does not ensure system performance to specifications.

### Verification Setup

The following steps set up the signal generator for the BERT measurement validation.

1. Refer to the figures below and make the following connections on the signal generator's rear panel.
  - DATA OUT (Aux I/O connector pin 8) to BER DATA IN (SMB connector).
  - DATA CLK OUT (Aux I/O connector pin 7) to BER CLK IN (SMB connector).

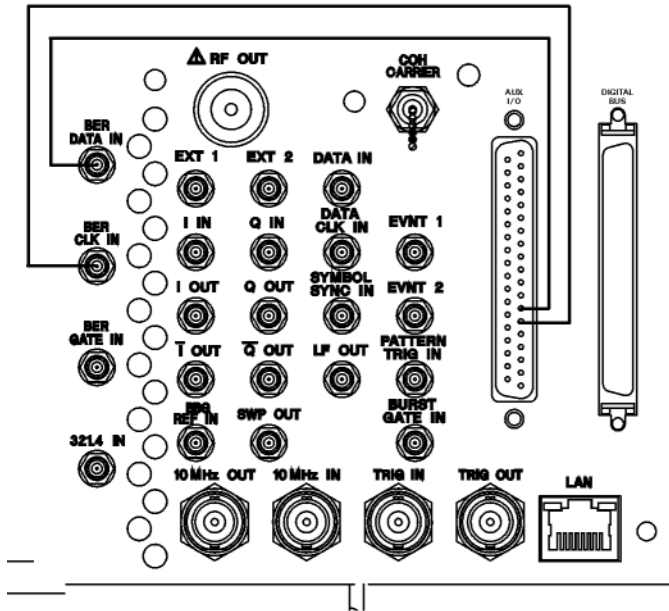

pk704c

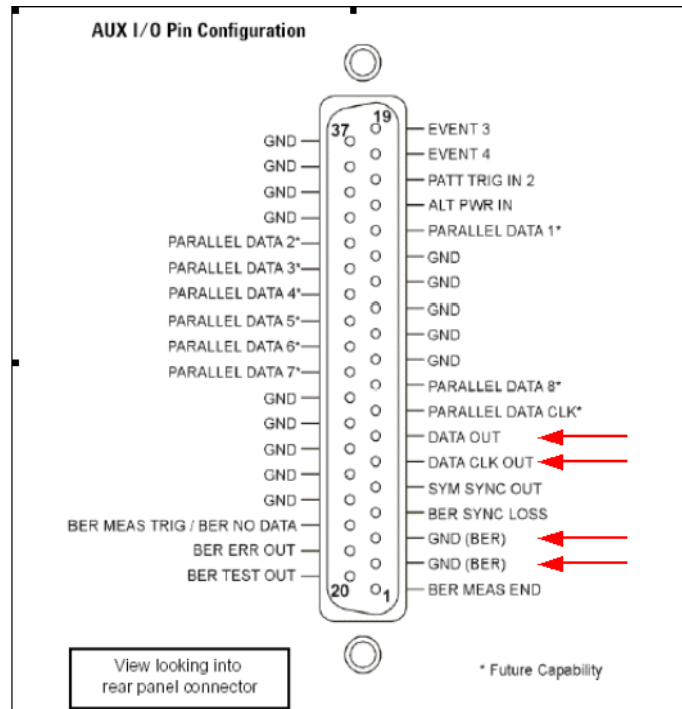

2. Press the **Preset** hardkey. This configures the signal generator to a pre-defined state.
3. Press the **Mode** hardkey.
4. Press **Real TDMA > PHS > Data Format** to Pattern.
5. Press **Data > PN Sequence > PN9 > PHS Off On** to On.
6. Press the **Aux Fctn** hardkey.
7. Press **BERT > BERT Off On** to On > **Display BER % Exp to % > Display Update Cycle End Cont** to Cont.

The following steps configure BERT measurement parameters.

8. Press **Configure BERT > Total Bits** to 100000 > **Special Pattern Ignore Off On** to Off.
9. Press **More (1 of 2) > BERT Resync Off On** to Off > **Pass/Fail Off On** to Off.
10. Press **Return > I/O Setup > Gate Off On** to Off > **Impedance 75 Ohm High** to High.
11. Press **Polarity Setup > Clock Polarity Pos Neg** to Neg > **Data Polarity Pos Neg** to Pos.
12. Press **Return > Return > Configure Trigger > Cycle Count 0 > Enter**.

## BERT (Options UN7 and 300)

### Verifying BERT Operation

- Press **Bit Delay Off On** to Off > **BERT Trigger** to Trigger Key.
- Press the **Trigger** hardkey. The following figure shows the signal generator's front-panel display after completion of the these steps.

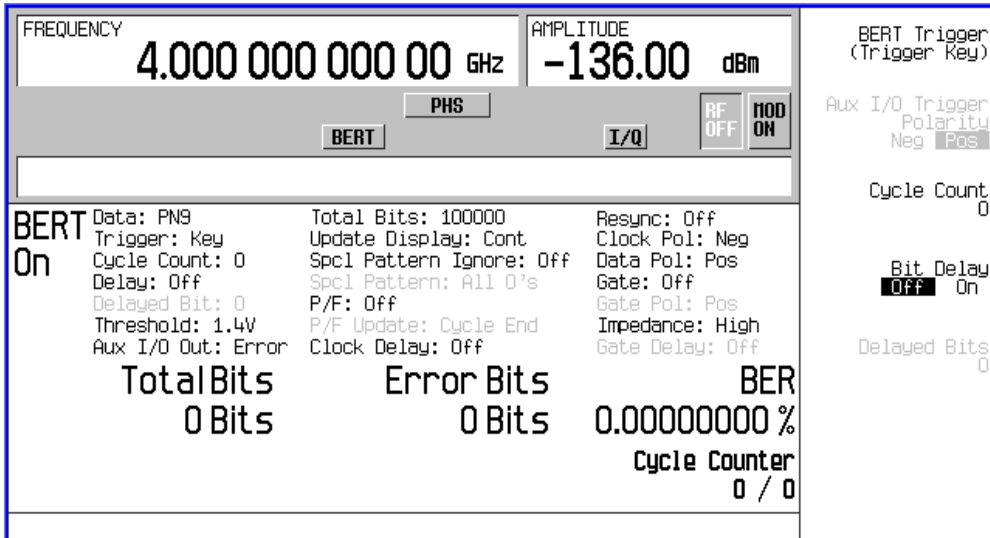

### BERT Verification

- Press **BERT Trigger** to Immediate.

Notice the cycle counter updating in the lower left-hand corner of the signal generator display.

- Disconnect the cable connecting the DATA OUT to BER DATA IN connectors.

Notice the No Data annunciator in the lower left corner of the display and the BER result is approximately 50%. The Error Bits counter updates the error bit count. Re-establishing the connection turns the annunciator off, and sets the error bits count to 0 bits and BER 0.00000000%.

- Disconnect the cable connecting the DATA CLK OUT to BER CLK IN connectors.

Notice the No Clock annunciator in the lower left corner of the display. This annunciator turns off when you re-connect the cable, but the error bits counter and BER % readings indicate loss of synchronization.

4. Press **Return**.

Toggle the **BERT Off On** softkey to Off and to On. You will see the new BER result as shown in the previous front-panel display with the Error Bits counter reading 0 Bits and BER 0.00000000%.

If the verification procedures produce the expected results, then the signal generator BERT measurement function is operating correctly. If the above procedure produces unexpected results, then contact the Agilent Service Center. For a list of Agilent Service Centers, refer to the *E4428C/38C ESG Signal Generators Installation Guide*.

BERT (Options UN7 and 300)

**Verifying BERT Operation**

---

# 10 CDMA Digital Modulation (Option 401)

Option 401 is available only in E4438C ESG Vector Signal Generators with Option 001/601 or 002/602. The following list shows the topics covered in this chapter:

- [“cdma2000 Forward Link Modulation for Component Test” on page 312](#)
- [“cdma2000 Reverse Link Modulation for Component Test” on page 316](#)
- [“Storing a Component Test Waveform to Memory” on page 320](#)
- [“Recalling a Component Test Waveform” on page 321](#)
- [“Creating a Custom Multicarrier cdma2000 Waveform” on page 322](#)
- [“cdma2000 Forward Link Modulation for Receiver Test” on page 326](#)
- [“cdma2000 Reverse Link Modulation for Receiver Test” on page 332](#)
- [“Forward and Reverse Link I/O Signal Descriptions and Timing Relationships” on page 338](#)
- [“Applying a User-Defined FIR Filter to a cdma2000 Waveform” on page 347](#)
- [“IS-95A Modulation” on page 349](#)

## **cdma2000 Forward Link Modulation for Component Test**

This section teaches you how to build forward link cdma2000 waveforms for testing component designs. The waveforms are generated by the signal generator's internal dual arbitrary waveform generator.

### **Activating a Predefined CDMA Forward Link State**

This procedure teaches you how to perform the following tasks:

- “Selecting a cdma2000 Forward Link Predefined Setup” on page 312
- “Generating the Waveform” on page 312
- “Configuring the RF Output” on page 312

#### **Selecting a cdma2000 Forward Link Predefined Setup**

1. Press **Preset**.
2. Press **Mode > CDMA > Arb CDMA2000**.
3. Press **CDMA2000 Select > Pilot**.

This selects a pilot cdma2000 forward link waveform. The display changes to **FWD CDMA2000 Setup: SR1 Pilot**. Forward link is the default setting for link direction, and therefore does not need to be set.

#### **Generating the Waveform**

Press **CDMA Off On** until On is highlighted.

This generates the predefined pilot CDMA forward link waveform. During waveform generation, the CDMA and I/Q annunciators appear and the waveform is stored in volatile Arb memory. The waveform is now modulating the RF carrier.

#### **Configuring the RF Output**

1. Set the RF output frequency to 2.17 GHz.
2. Set the output amplitude to -10 dBm.
3. Press **RF On/Off** until On is highlighted.

The predefined CDMA forward link signal is now available at the RF OUTPUT connector of the signal generator.



## Creating a User-Defined CDMA Forward Link State

This procedure teaches you how to perform the following tasks:

- “Accessing the Table Editor with the Default Forward Link Setup” on page 313
- “Editing cdma2000 Forward Link Channel Parameters” on page 313
- “Inserting Additional cdma2000 Forward Link Traffic Channels” on page 315

### Accessing the Table Editor with the Default Forward Link Setup

1. Press **Preset**.
2. Press **Mode > CDMA > Arb CDMA2000**.
3. Press **More (1 of 2) > CDMA200 Define > Edit Channel Setup**.

The table editor is now displayed, as shown in [Figure 10-1](#). Notice that the default predefined channel configuration is forward link with 9 channels at spread rate 1. The vertical scroll bar at the side of the screen indicates that there are more rows on the second page. Use the down arrow key to move the cursor to view additional rows.

**Figure 10-1**

FREQUENCY		4.000 000 000 00 GHz		AMPLITUDE		-136.00 dBm		Edit Item
				RF OFF		MOD ON		Insert Row
								Delete Row
Spreading: SR1				Total Power: -0.00dB				Adjust Code Domain Power
Link: Forward								Display Code Domain Power
	Type	Config	Rate bps	Walsh	Power dB	PH Offset	Data	Goto Row
1	Pilot	N/A	N/A	0	-7.00	0	00000000	More (1 of 2)
2	Paging	N/A	9600	1	-6.72	0	RANDOM	
3	Traffic	3	9600	8	-12.72	0	RANDOM	
4	Sup1Trf	3	19200	17	-9.72	0	RANDOM	
5	Sup1Trf	3	19200	18	-9.72	0	RANDOM	
6	Traffic	3	9600	9	-12.72	0	RANDOM	
7	Sup1Trf	3	19200	19	-9.72	0	RANDOM	
8	Sup1Trf	3	19200	20	-9.72	0	RANDOM	

### Editing cdma2000 Forward Link Channel Parameters

1. Use the arrow keys to move the cursor to the traffic channel located in table row 3.
2. Highlight the Rate bps value (9600).

CDMA Digital Modulation (Option 401)  
**cdma2000 Forward Link Modulation for Component Test**

3. Press **Edit Item > 4800**.
4. Highlight the Walsh code value (8) in table row 3.
5. Press **Edit Item > 3 > Enter**.
6. Highlight the Power value (-12.72) in table row 3.
7. Press **Edit Item > -10 > dB**.

The display shows that the total power is now at 0.19 dB. You can rescale the total channel power to 0 dB by pressing **Adjust Code Domain Power > Scale to 0 dB**.

8. Highlight the Data value (RANDOM) in table row 3.
9. Press **Edit Item > 11001100 > Enter**.

The forward link channel parameters have now been modified, as shown in [Figure 10-2](#).

**Figure 10-2**

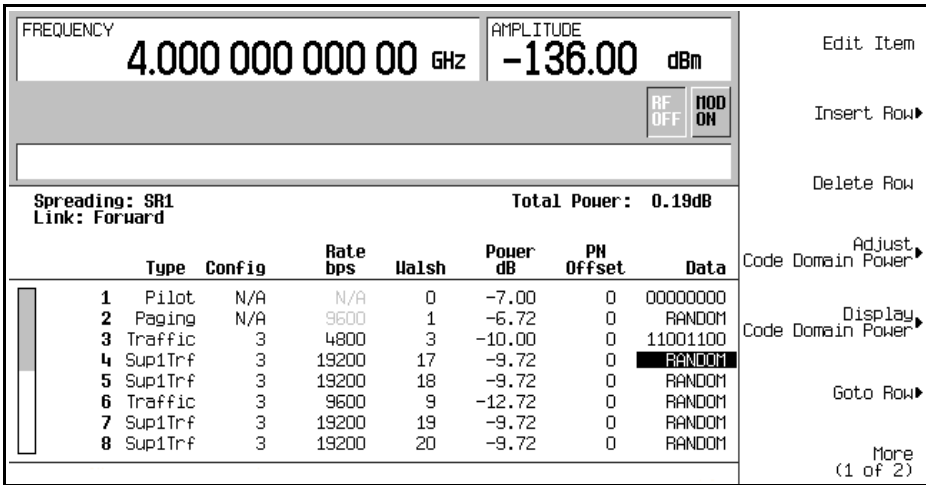

10. Press **Return**.

The text area displays FWD CDMA2000 Setup: SR1 9 Channel (Modified) as the current configuration. You now have a modified traffic channel with a data rate of 4800, a Walsh code of 3 and a power level of -10.00 dB transmitting 11001100.

To store a custom cdma2000 state, see [“Storing a Component Test Waveform to Memory” on page 320](#).

### Inserting Additional cdma2000 Forward Link Traffic Channels

1. Press **Edit Channel Setup**.
2. Move cursor to the bottom row and press **Insert Row > Traffic > Channels > 20 > Enter**.
3. Press **Done**.

The channel table editor now contains the 20 additional channels. The first page displays only channels one through nine. To see the additional channels, press the following key sequence:

**Return > Goto Row > Page Up.**

The display shows that the total power is now at 13.22 dB. You can rescale the total channel power to 0 dB by pressing **Adjust Code Domain Power > Scale to 0 dB**.

Press **Return**. The text area displays the current configuration, FWD CDMA2000 Setup: SR1 9 Channel (Modified), as shown in [Figure 10-3](#).

**Figure 10-3**

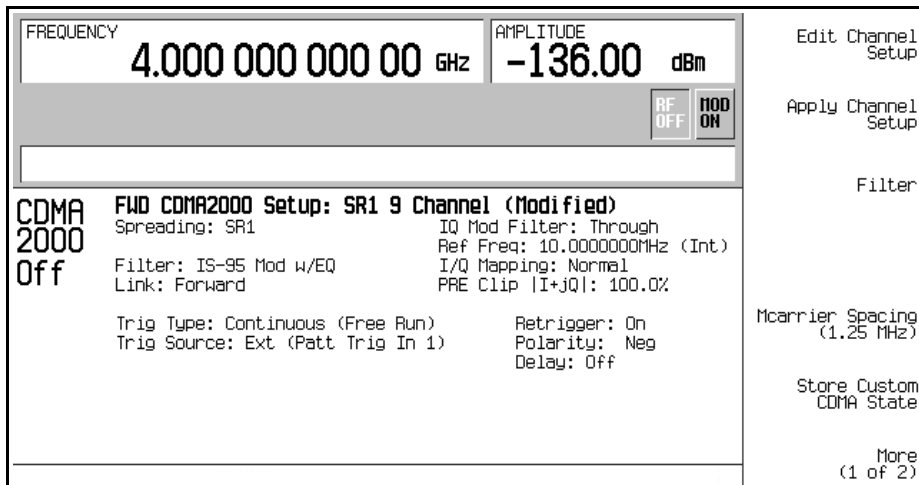

To store a custom cdma2000 state, see [“Storing a Component Test Waveform to Memory”](#) on page 320.

## **cdma2000 Reverse Link Modulation for Component Test**

This section teaches you how to build reverse link cdma2000 waveforms for testing component designs. The waveforms are generated by the signal generator's internal dual arbitrary waveform generator.

### **Activating a Predefined cdma2000 Reverse Link State**

This procedure teaches you how to perform the following tasks:

- “Selecting a Predefined cdma2000 Reverse Link Setup” on page 316
- “Generating the Waveform” on page 316
- “Configuring the RF Output” on page 316

### **Selecting a Predefined cdma2000 Reverse Link Setup**

1. Press **Preset**.
2. Press **Mode > CDMA > Arb CDMA2000**.
3. Press **Link Forward Reverse** until Reverse is highlighted.
4. Press **CDMA2000 Select > Pilot**.

This selects a pilot cdma2000 reverse link waveform. The display changes to RVS CDMA2000 Setup: SR1 Pilot.

### **Generating the Waveform**

Press **CDMA Off On** until On is highlighted.

This generates the predefined pilot cdma2000 reverse link waveform. During waveform generation, the CDMA and I/Q annunciators appear and the waveform is stored in volatile Arb memory. The waveform is now modulating the RF carrier.

### **Configuring the RF Output**

1. Set the RF output frequency to 2.17 GHz.
2. Set the output amplitude to -10 dBm.
3. Press **RF On/Off** until On is highlighted.

The predefined cdma2000 reverse signal is now available at the RF OUTPUT connector of the signal generator.

## Creating a User-Defined cdma2000 Reverse Link State

This procedure teaches you how to perform the following tasks:

- “Accessing the Table Editor with the Default Reverse Link Setup” on page 317
- “Editing cdma2000 Reverse Link Channel Parameters” on page 317
- “Inserting Additional cdma2000 Reverse Link Traffic Channels” on page 318

### Accessing the Table Editor with the Default Reverse Link Setup

1. Press **Preset**.
2. Press **Mode > CDMA > Arb CDMA2000**.
3. Press **Link Forward Reverse** until Reverse is highlighted.
4. Press **More (1 of 2) > CDMA200 Define > Edit Channel Setup**.

The table editor is now displayed, as shown in [Figure 10-4](#). Notice that the default predefined channel configuration is reverse link with 5 channels at spread rate 1.

**Figure 10-4**

FREQUENCY		4.000 000 000 00 GHz		AMPLITUDE		-136.00 dBm		Edit Item
						RF OFF MOD ON		Insert Row
								Delete Row
Spreading: SR1		Link: Reverse		Total Power: -0.00dB				Adjust Code Domain Power
	Type	Config	Rate bps	Power dB	Data			Radio Config
1	Pilot	N/A	N/A	-7.00	00000000			3
2	DedCnt1	3	9600	-7.00	00000000			
3	Traffic	3	9600	-17.36	RANDOM			
4	Sup1Trf	3	307200	-5.36	RANDOM			
5	Sup2Trf	3	76800	-5.36	RANDOM			
6	-----		-----	-----	-----			More (1 of 2)

### Editing cdma2000 Reverse Link Channel Parameters

1. Use the arrow keys to move the cursor to the traffic channel located in table row 3.
2. Highlight the Rate bps value (9600).
3. Press **Edit Item > 4800**.

CDMA Digital Modulation (Option 401)  
**cdma2000 Reverse Link Modulation for Component Test**

4. Highlight the Power value (-17.36) in table row 3.
5. Press **Edit Item > -10 > dB**.

The display shows that the total power is now at 0.34 dB. You can rescale the total channel power to 0 dB by pressing **Adjust Code Domain Power > Scale to 0 dB**.

6. Highlight the Data value (RANDOM) in table row 3.
7. Press **Edit Item > 00110011 > Enter**.

The forward reverse channel parameters have now been modified, as shown in [Figure 10-5](#).

**Figure 10-5**

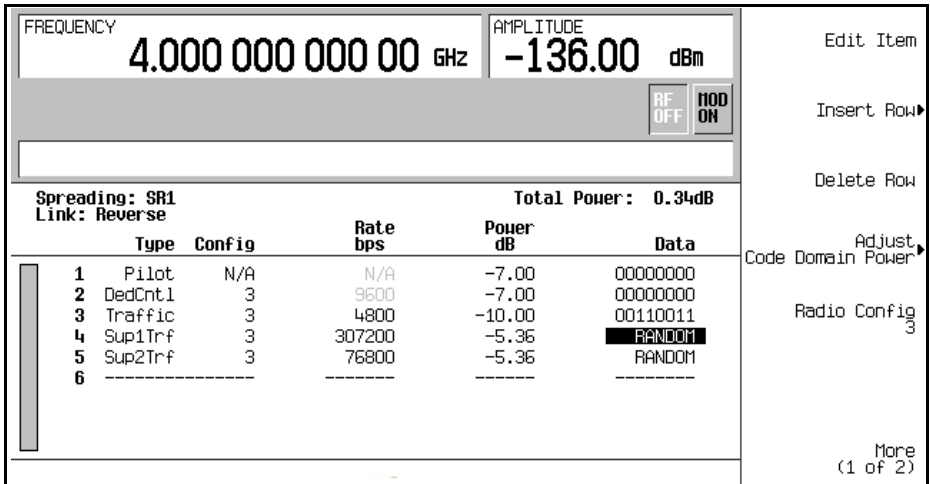

8. Press **Return**.

The text area displays RVS CDMA2000 Setup: SR1 5 Channel (Modified) as the current configuration. You now have a modified traffic channel with a data rate of 4800 and a power level of -10.00 dB transmitting 00110011.

To store a custom cdma2000 state, see [“Storing a Component Test Waveform to Memory”](#) on page 320.

**Inserting Additional cdma2000 Reverse Link Traffic Channels**

1. Press **Edit Channel Setup**.
2. Move cursor to the bottom row and press **Insert Row > Supplemental2 Traffic**.
3. Press **Done**.

The channel table editor now contains the an additional supplemental2 traffic channel.

The display shows that the total power is now at 1.37 dB. You can rescale the total channel power to 0 dB by pressing **Adjust Code Domain Power > Scale to 0 dB**.

Press **Return > Return**.

The text area displays the current configuration, RVS CDMA2000 Setup: SR1 5 Channel (Modified), as shown in [Figure 10-6](#).

**Figure 10-6**

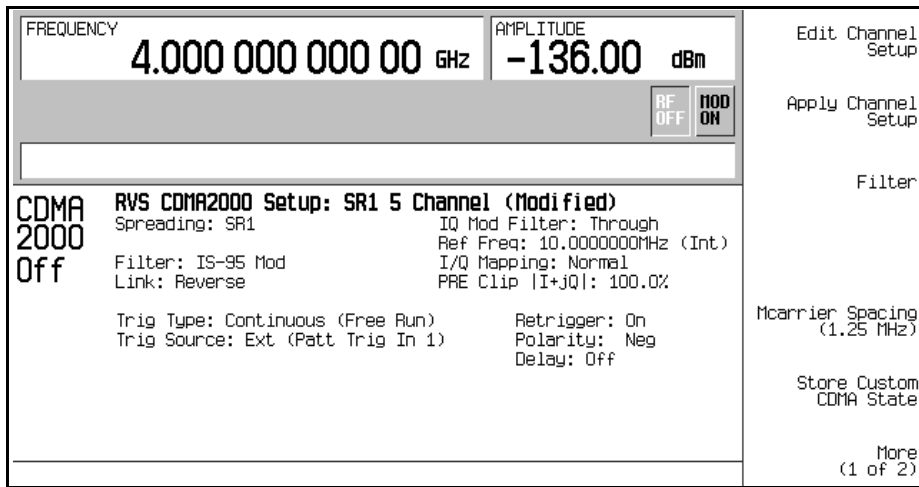

To store a custom cdma2000 state, see [“Storing a Component Test Waveform to Memory”](#) on page 320.

## Storing a Component Test Waveform to Memory

In this section, you will learn how to store the component test waveform.

1. Press **Mode Setup** hardkey to return to the top-level menu.
2. Perform the following keypress sequence required for your format type.

### For CDMA2000 Waveform Format

- a. Press **More (1 of 2) > CDMA2000 Define (Multicarrier Define when Multicarrier Off On is On) > Store Custom CDMA State (Store Custom Multicarrier when Multicarrier Off On is On) > Store To File.**

If there is already a file name occupying the active entry area, press the following keys:

**Edit Keys > Clear Text**

- b. Using the alphabetic menu and the numeric keypad, enter the file name using a maximum length of 23 characters.
- c. Press **Enter**.

### For CDMA Waveform Format

- a. Press **CDMA Define (Multicarrier Define when Multicarrier Off On is On) > Store Custom State (Store Custom Multicarrier when Multicarrier Off On is On) > Store To File.**

If there is already a file name occupying the active entry area, press the following keys:

**Edit Keys > Clear Text**

- b. Using the alphabetic menu and the numeric keypad, enter the file name.
- c. Press **Enter**.

Your user-defined CDMA state file is now saved to the signal generator memory.

---

**NOTE** The RF output amplitude, frequency, and operating state settings are not stored as part of a user-defined CDMA state file.

---



## Recalling a Component Test Waveform

In this section, you will learn how to recall a component test waveform.

1. Press **Mode Setup** hardkey to return to the top-level menu.
2. Perform the following keypress sequence required for your format type.

### For CDMA2000 Waveform Format

- a. Press **CDMA2000 Select > Custom CDMA2000 State (Custom CDMA2000 Multicarrier when Multicarrier Off On is On)**.
- b. Highlight the desired file.
- c. Press **Select File**.
- d. Press **CDMA2000 Off On** until On is highlighted.

### For CDMA Waveform Format

- a. Press **Setup Select > Custom CDMA State (Custom CDMA Multicarrier when Multicarrier Off On is On)**.
- b. Highlight the desired file.
- c. Press **Select File**.
- d. Press **CDMA Off On** until On is highlighted.

The firmware generates the user-defined CDMA waveform in volatile memory. After waveform generation, the user-defined CDMA state is available to be modulated on the RF output.

## **Creating a Custom Multicarrier cdma2000 Waveform**

The signal generator provides a quick and easy way to create custom multicarrier cdma2000 waveforms: rather than building an entire 4-carrier setup from scratch, you can start with a 4-carrier cdma2000 template and modify the template's default values as desired.

This section teaches you how to perform the following tasks:

- “Opening the Multicarrier cdma2000 Setup Table Editor” on page 322
- “Modifying a Multicarrier cdma2000 4-Carrier Template” on page 323
- “Activating a Custom Multicarrier cdma2000 Setup” on page 324
- “Storing a Component Test Waveform to Memory” on page 320
- “Recalling a Component Test Waveform” on page 321

### **Opening the Multicarrier cdma2000 Setup Table Editor**

1. Press **Preset**.
2. Press **Mode > CDMA > Arb CDMA2000 > Multicarrier Off On** until On is highlighted.
3. Press **CDMA2000 Select > 4 Carriers**.
4. Press **More (1 of 2) > Multicarrier Define**.

This opens the Multicarrier cdma2000 Setup table editor. The 4-carrier cdma2000 template is automatically placed in the table editor, as shown in [Figure 10-7 on page 323](#).

Figure 10-7

FREQUENCY		4.000 000 000 00 GHz		AMPLITUDE		-136.00 dBm		Edit Item
				RF		MOD		Insert Row
				OFF		ON		Delete Row
Multicarrier CDMA2000 Setup								
		Carrier	Freq Offset	Power				
1		SR1 9 Channel	-1.875000 MHz	0.00 dB				
2		SR1 9 Channel	-625.000 kHz	0.00 dB				
3		SR1 9 Channel	625.000 kHz	0.00 dB				
4		SR1 9 Channel	1.875000 MHz	0.00 dB				
5		-----	-----	-----				
								Store Custom Multicarrier
								Apply Multicarrier

### Modifying a Multicarrier cdma2000 4-Carrier Template

Use the tasks to modify the standard 4-carrier cdma2000 template that was loaded in the previous procedure.

1. Highlight the second channel carrier in table row 2.
2. Press **Edit Item** > **SR3 Direct Pilot**.
3. Highlight the value -625.000 kHz in the Frequency Offset field.
4. Press **Edit Item** > **-825** > **kHz**.
5. Highlight the value 0.00 dB in Power field of the second row.
6. Press **Edit Item** > **-10** > **dB**.

This modifies the 4-carrier cdma2000 template, as shown in [Figure 10-8 on page 324](#).

CDMA Digital Modulation (Option 401)  
**Creating a Custom Multicarrier cdma2000 Waveform**

**Figure 10-8**

Carrier	Freq Offset	Power
1 SR1 9 Channel	-1.875000 MHz	0.00 dB
2 SR3 Direct Pilot	-825.000 kHz	-10.00 dB
3 SR1 9 Channel	625.000 kHz	0.00 dB
4 SR1 9 Channel	1.875000 MHz	0.00 dB
5 -----	-----	-----

**Activating a Custom Multicarrier cdma2000 Setup**

Using the custom 4-carrier cdma2000 setup from the previous procedure, perform the following task to activate the custom multicarrier cdma2000 signal.

1. Press **Return** > **More (2 of 2)** > **CDMA2000 Off On** until On is highlighted.
2. Press **RF On/Off**.

**Figure 10-9**

**CDMA2000 On**

**Multicarrier Setup: 4 Carriers (Modified)**

Spreading: SR1      IQ Mod Filter: Through  
 Ref Freq: 10.000000MHz (Int)  
 Filter: IS-95 Mod w/EQ      I/Q Mapping: Normal  
 Link: Forward      PRE Clip |I+Q|: 100.0%

Trig Type: Continuous (Free Run)      Retrigger: On  
 Trig Source: Ext (Patt Trig In 1)      Polarity: Neg  
 Delay: Off

After waveform generation, the new multicarrier cdma2000 waveform is stored in volatile memory. The CDMA2K and I/Q annunciators appear on the display and the RF ON annunciator replaces the RF OFF annunciator, as shown in the following figure. The modulated signal is now present at the RF OUTPUT connector.

To store a custom multicarrier waveform, refer to [“Storing a Component Test Waveform to Memory”](#) on page 320.

To recall a custom multicarrier waveform, refer to [“Recalling a Component Test Waveform”](#) on page 321.

## **cdma2000 Forward Link Modulation for Receiver Test**

This section teaches you how to build cdma2000 forward link signals for testing mobile receiver designs. The signals are generated by the internal real time IQ baseband generator. The procedures in this section build on each other and are designed to be used sequentially.

### **Editing the Base Station Setup**

1. Press **Preset**.
2. Press **Mode > CDMA > Real Time CDMA2000**.

---

**NOTE**            The forward link is the signal generator's default setting for link direction and, therefore, does not need to be set.

---

3. Press **BaseStation Setup**.
4. Move the cursor to highlight the `filter` field.
5. Press **Edit Item > Select > IS-95 and IS-2000 > IS-95**.
6. Press **Return > Return**.
7. Press **BaseStation Setup**.
8. Move the cursor to highlight the `PN Offset` field.
9. Press **9 > Enter**.

The cdma2000 forward link global parameters have now been modified so that you are using an IS-95 filter and a PN offset of 9.

### **Editing Channel Setups**

The tasks in this procedure build upon the previous procedure. This procedure teaches you how to perform the following tasks:

- [“Changing Channel States” on page 327](#)
- [“Modifying Channel Parameters” on page 327](#)

### Changing Channel States

This task teaches you how to quickly configure the operating states of the forward link channels.

1. Press **Mode Setup** to return to the top-level real time cdma2000 menu.
2. Press **Link Control > Channel State Quick Presets > All (Except FQPCH)**.

You have now turned on all forward link channels, except for the forward link quick paging channel (F-QPCH). The Channel State Quick Presets menu enables you to configure the operating states of all channels with a single keypress. You can also change the operating state of the selected channel using the **Channel State Off On** softkey, or by editing the *State* field among the Channel Setup parameters.

### Modifying Channel Parameters

This task teaches you how to edit the parameters for the selected channel.

1. Move the cursor to highlight the forward fundamental channel (F-FCH).
2. Press **Channel Setup**.
3. Move the cursor to highlight the *Radio Config* field.
4. Press **4 > Enter**.

---

**NOTE** An important change from earlier ESG models is that radio configuration is now independent between fundamental and supplemental channels.

---

5. Move the cursor to highlight the *Data* field.
6. Press **Edit Item > FIX4 > 1010 > Enter > Return**.
7. Move the cursor to highlight the *Power* field.
8. Press **-10 > dB**.
9. Move the cursor to highlight the *EbNo* field.
10. Press **12 > dB > Return**.

You have now modified the forward fundamental channel parameters so that the radio configuration is 4, the data is a fixed 4-bit pattern of 1010, the relative channel power is -10 dB, and EbNo value is 12 dB.

[Figure 10-10 on page 328](#) shows what the display should look like when this task is completed.

**Figure 10-10 Forward Fundamental Channel (F-FCH) Setup**

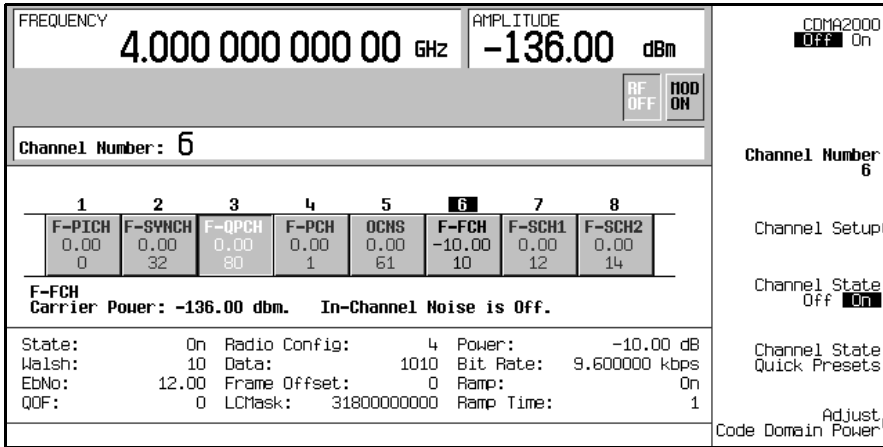

Note that the ESG allows you to set the relative channel power for each active channel. To display the normalized relative channel power after completing the setup, it is recommended that you perform the steps in [“Adjusting Code Domain Power” on page 328](#). Also note that varying the EbNo value on one channel will affect the EbNo values on all active channels. Refer to [“Managing Noise” on page 329](#) to learn how to make final noise adjustments.

### Adjusting Code Domain Power

The tasks in this procedure build upon the previous procedure. This procedure teaches you how to perform the following tasks:

- [“Scaling to 0 dB” on page 328](#)
- [“Setting Equal Channel Powers” on page 329](#)

#### Scaling to 0 dB

After changing the relative power level for a channel, the ESG automatically scales the total power to 0 dB, while preserving the relative channel power levels. The displayed power levels remain unchanged so the user can complete the relative power adjustments. This task teaches you how to update the display to show the normalized relative channel power for each channel after completing the setup.

1. Press **Mode Setup** to return to the top-level real time cdma2000 menu.
2. Press **Link Control > Adjust Code Domain Power > Scale to 0 dB**.



The power level displayed for each channel is now changed to show the normalized relative channel power. [Figure 10-11](#) shows the displayed power levels before and after the **Scale to 0 dB** softkey is pressed.

**Figure 10-11**

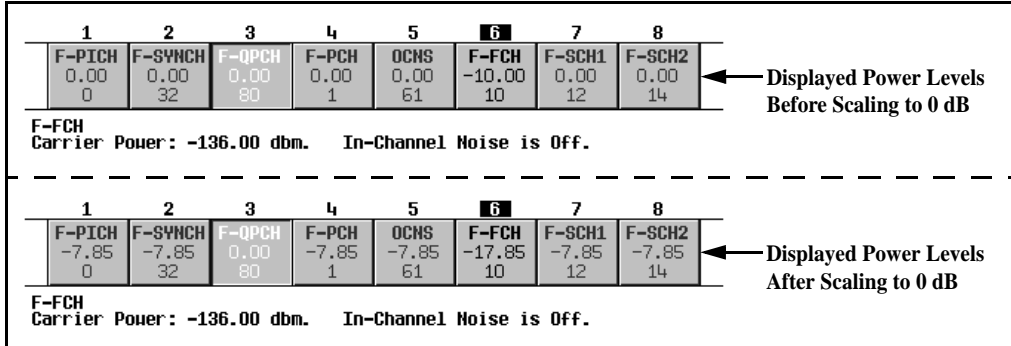

### Setting Equal Channel Powers

This task teaches you how to set the relative power level for all active channels to be equal, for a total power level of 0 dB. The normalized relative power level of each channel depends on the number of active channels. This task is an alternative to scaling to 0 dB.

Press **Adjust Code Domain Power > Equal Powers**.

All active channels have now been set to equal powers. [Figure 10-12](#) shows the displayed normalized relative power levels after the **Equal Powers** softkey is pressed with seven active channels.

**Figure 10-12**

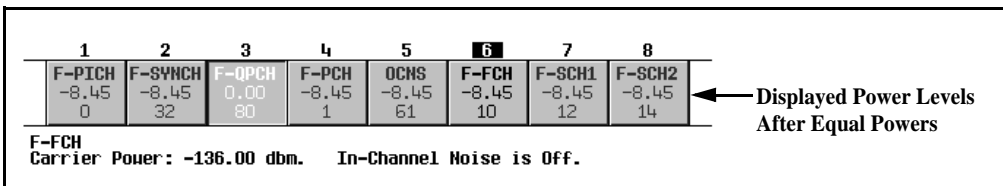

### Managing Noise

The tasks in this procedure build upon the previous procedure.

The following tasks teach you how to set the overall carrier-to-noise (C/N) ratio for the forward link cdma2000 setup and to set the EbNo value for individual physical channels.

- [“Setting the Carrier to Noise Ratio” on page 330](#)

## CDMA Digital Modulation (Option 401)

### cdma2000 Forward Link Modulation for Receiver Test

- [“Setting EbNo” on page 330](#)

#### Setting the Carrier to Noise Ratio

1. Press **Mode Setup** to return to the top-level real time cdma2000 menu.
2. Press **Noise Setup > C/N > 10 > dB**.
3. Press **Noise Off On** to On.

You have now set the overall carrier to noise ratio to 10 dB and turned on noise. This is done to apply a discernible level of noise across the entire channel space.

#### Setting EbNo

EbNo can be set in the Noise Setup menu or the Channel Setup table editor (see [“Modifying Channel Parameters” on page 327](#)). This task teaches you how to make quick EbNo adjustments using the **EbNo** softkey in the Noise Setup menu.

1. Press **Channel Number** and move the cursor to highlight the forward fundamental channel (F-FCH).
2. Press **EbNo > 20 > dB**.

You have now set the EbNo value for the F-FCH channel to 20 dB. Note that modifying the EbNo value for a channel will change the overall carrier to noise ratio and the EbNo value for all other active channels. For reliable results when making hand calculations to determine or verify EbNo values, it is recommended that you first scale the code domain power to 0 dB to display the normalized relative channel power levels (see [“Scaling to 0 dB” on page 328](#)).

#### Generating the Baseband Signal

This procedure builds upon the previous procedure.

Press **CDMA2000 Off On** to On.

This generates the real time forward link cdma2000 signal. The signal generator may require several seconds to build the signal. During this time, **Baseband Reconfiguring** appears on the display. After the reconfiguration is complete, the display reads **CDMA2000 On** and the **CDMA2K** and **I/Q** annunciators appear. The signal is now modulating the RF carrier.

The signal’s configuration data resides in volatile memory and is not recoverable after an instrument preset, power cycle, or reconfigured signal generation.

## **Configuring the RF Output**

The steps in this procedure build upon the previous procedure.

1. Set the RF output frequency to 2.14 GHz.
2. Set the output amplitude to  $-30$  dBm.
3. Press **RF On/Off** to On.

The user-defined, real time forward link cdma2000 signal is now available at the signal generator's RF OUTPUT connector.

To store this real time I/Q baseband digital modulation state to the instrument state register, see [“Using the Instrument State Registers” on page 70](#).

To recall a real time I/Q baseband digital modulation state, see [“Recalling an Instrument State” on page 72](#).

For information on timing relationships, see [“Forward and Reverse Link I/O Signal Descriptions and Timing Relationships” on page 338](#).

## **cdma2000 Reverse Link Modulation for Receiver Test**

This section teaches you how to build cdma2000 reverse link signals for testing base station receiver designs. The signals are generated by the internal real time IQ baseband generator. The procedures in this section build on each other and are designed to be used sequentially.

### **Editing the Mobile Setup**

1. Press **Preset**.
2. Press **Mode > CDMA > Real Time CDMA2000 > Link Forward Reverse** to Reverse.
3. Press **Mobile Setup**.
4. Move the cursor to highlight the `filter` field.
5. Press **Edit Item > Select > IS-95 and IS-2000 > IS-95 Mod**.
6. Press **Return > Return**.
7. Press **Mobile Setup**.
8. Move the cursor to highlight the `Long Code Mask` field.
9. Press **3FFF000000 > Enter**.

The cdma2000 reverse link global parameters have now been changed so that you are using a modified IS-95 filter and a long code mask of 3FFF000000.

### **Editing Channel Setups**

The tasks in this procedure build upon the previous procedure. This procedure teaches you how to perform the following tasks:

- [“Changing the Operating Mode” on page 332](#)
- [“Changing Channel States” on page 333](#)
- [“Modifying Channel Parameters” on page 333](#)

### **Changing the Operating Mode**

This task teaches you how to select a predefined reverse link channel configuration.

1. Press **Mode Setup** to return to the top-level real time cdma2000 menu.

2. Press **Link Control > Operating Mode > RadioConfig 1/2 Access**.

Notice that the display shows a single reverse access channel. This is an IS-2000 standard channel configuration. For learning purposes, we will change back to RadioConfig 3/4 Traffic, which is the default operating mode.

3. Press **Operating Mode > RadioConfig 3/4 Traffic**.

You have now selected RadioConfig 3/4 Traffic as the current operating mode.

### Changing Channel States

This task teaches you how to quickly configure the operating states of the reverse link channels.

Press **Channel State Quick Presets > All**.

You have now turned on all reverse link channels. The Channel State Quick Presets menu enables you to configure the operating states of all channels with a single keypress. This menu is only available for the reverse link when the RadioConfig 3/4 Traffic operating mode is selected. You can also change the operating state of the selected channel using the **Channel State Off On** softkey, or by editing the `State` field among the Channel Setup parameters.

### Modifying Channel Parameters

This task teaches you how to edit the parameters for the selected channel.

1. Move the cursor to highlight the reverse fundamental channel (R-FCH).
2. Press **Channel Setup**.
3. Move the cursor to highlight the `Radio Config` field.
4. Press **4 > Enter**.

---

**NOTE** An important change from earlier ESG models is that radio configuration is now independent between fundamental and supplemental channels.

---

5. Move the cursor to highlight the `Data` field.
6. Press **Edit Item > FIX4 > 1010 > Enter > Return**.
7. Move the cursor to highlight the `Power` field.
8. Press **-10 > dB**.
9. Move the cursor to highlight the `EbNo` field.
10. Press **12 > dB > Return**.

CDMA Digital Modulation (Option 401)  
**cdma2000 Reverse Link Modulation for Receiver Test**

You have now modified the reverse fundamental channel parameters so that the radio configuration is 4, the data is a fixed 4-bit pattern of 1010, the relative channel power is -10 dB, and EbNo value is 12 dB. [Figure 10-13](#) shows what the display should look like when this task is completed.

**Figure 10-13 Reverse Fundamental Channel (R-FCH) Setup**

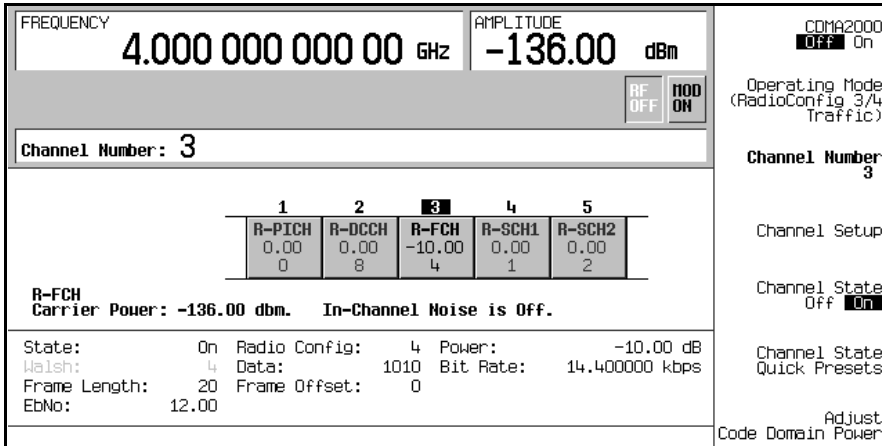

Note that the ESG allows you to set the relative channel power for each active channel. To display the normalized relative channel power after completing the setup, it is recommended that you perform the steps in [“Adjusting Code Domain Power” on page 334](#). Also note that varying the EbNo value on one channel will affect the EbNo values on all active channels. Refer to [“Managing Noise” on page 335](#) to learn how to make final noise adjustments.

### Adjusting Code Domain Power

The tasks in this procedure build upon the previous procedure. This procedure teaches you how to perform the following tasks:

- [“Scaling to 0 dB” on page 334](#)
- [“Setting Equal Channel Powers” on page 335](#)

#### Scaling to 0 dB

After changing the relative power level for a channel, the ESG automatically scales the total power to 0 dB, while preserving the relative channel power levels. The displayed power levels remain unchanged so the user can complete the relative power adjustments. This task teaches you how to update the display to show the normalized relative channel power for each channel after completing the setup.

1. Press **Mode Setup** to return to the top-level real time cdma2000 menu.

2. Press **Link Control > Adjust Code Domain Power > Scale to 0 dB**.

The power level displayed for each channel is now changed to show the normalized relative channel power. [Figure 10-14](#) shows the displayed power levels before and after the **Scale to 0 dB** softkey is pressed.

**Figure 10-14**

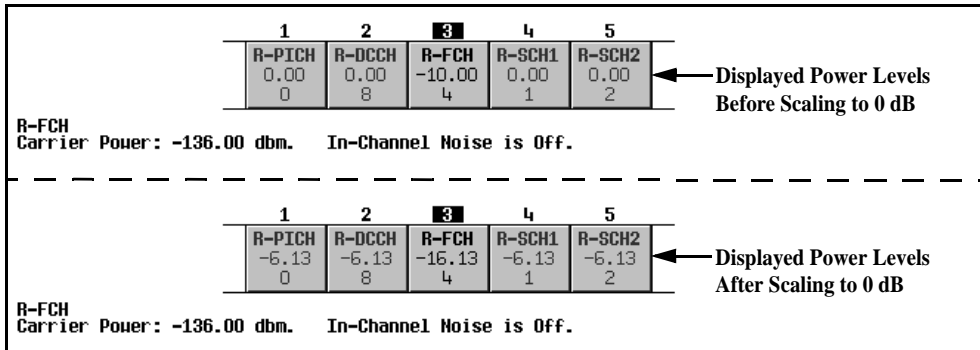

### Setting Equal Channel Powers

This task teaches you how to set the relative power level for all active channels to be equal, for a total power level of 0 dB. The normalized relative power level of each channel depends on the number of active channels. This task is an alternative to scaling to 0 dB.

Press **Adjust Code Domain Power > Equal Powers**.

All active channels have now been set to equal powers. [Figure 10-15](#) shows the displayed normalized relative power levels after the **Equal Powers** softkey is pressed with five active channels.

**Figure 10-15**

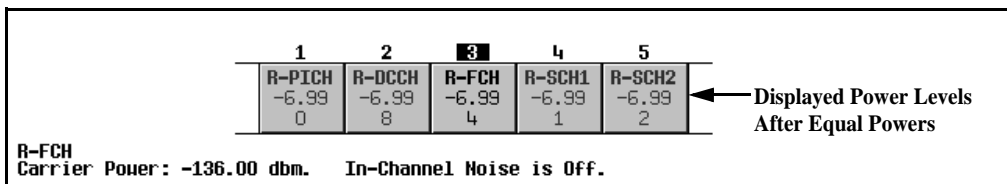

### Managing Noise

The tasks in this procedure build upon the previous procedure.

The following tasks teach you how to set the overall carrier-to-noise (C/N) ratio for the reverse link cdma2000 setup and to set the EbNo value for individual physical channels.

## cdma2000 Reverse Link Modulation for Receiver Test

- “Setting the Carrier to Noise Ratio” on page 336
- “Setting EbNo” on page 336

### Setting the Carrier to Noise Ratio

1. Press **Mode Setup** to return to the top-level real time cdma2000 menu.
2. Press **Noise Setup > C/N > 10 > dB**.
3. Press **Noise Off On** to On.

You have now set the overall carrier to noise ratio to 10 dB and turned on noise. This is done to apply a discernible level of noise across the entire channel space.

### Setting EbNo

EbNo can be set in the Noise Setup menu or the Channel Setup table editor (see “[Modifying Channel Parameters](#)” on page 333). This task teaches you how to make quick EbNo adjustments using the **EbNo** softkey in the Noise Setup menu.

1. Press **Channel Number** and move the cursor to highlight the reverse fundamental channel (R-FCH).
2. Press **EbNo > 20 > dB**.

You have now set the EbNo value for the R-FCH channel to 20 dB. Note that modifying the EbNo value for a channel will change the overall carrier to noise ratio and the EbNo value for all other active channels. For reliable results when making hand calculations to determine or verify EbNo values, it is recommended that you first scale the code domain power to 0 dB to display the normalized relative channel power levels (see “[Scaling to 0 dB](#)” on page 334).

### Generating the Baseband Signal

This procedure builds upon the previous procedure.

Press CDMA2000 Off On to On.

This generates the real time reverse link cdma2000 signal. The signal generator may require several seconds to build the signal. During this time, *Baseband Reconfiguring* appears on the display. After the reconfiguration is complete, the display reads CDMA2000 On and the CDMA2K and I/Q annunciators appear. The signal is now modulating the RF carrier.

The signal’s configuration data resides in volatile memory and is not recoverable after an instrument preset, power cycle, or reconfigured signal generation.



## **Configuring the RF Output**

The steps in this procedure build upon the previous procedure.

1. Set the RF output frequency to 2.14 GHz.
2. Set the output amplitude to  $-30$  dBm.
3. Press **RF On/Off** to On.

The user defined, real time reverse link cdma2000 signal is now available at the signal generator's RF OUTPUT connector.

To store this real time I/Q baseband digital modulation state to the instrument state register, see [“Saving an Instrument State” on page 71](#).

To recall a real time I/Q baseband digital modulation state, see [“Recalling an Instrument State” on page 72](#).

For information on timing relationships, see [“Forward and Reverse Link I/O Signal Descriptions and Timing Relationships” on page 338](#).

## Forward and Reverse Link I/O Signal Descriptions and Timing Relationships

This section describes the functionality and timing relationships of the connector signals for forward and reverse link on the ESG with Option 401. Option 401 changes some of the characteristics of the signals normally present on some of the I/O connectors. This is done for cdma2000 applications. Some output connectors have additional output signal selections, which are indicated in the descriptions.

The following connector descriptions are divided into three sections: front panel inputs, rear panel inputs, and rear panel outputs. Diagrams showing the timing relationships between rear panel inputs and outputs follow the connector descriptions.

### Front Panel Inputs

#### DATA (Forward Link)

This front panel BNC connector is used for data input. The external data input can only be used by F-FSH or F-SCH channels. If these two channel types are assigned external data, the same data is input to both the F-FCH and F-SCH channels. Both channel types must be assigned radio configurations with the same modulation symbol rate.

The serial data must be input at the modulation symbol rate and aligned with the internal F-FCH (or F-SCH) modulation symbol clock. Coded and framed data must be aligned with internal frame timing.

For RC1 and RC2 channel types, the symbol data input timing aligns with internal frame timing. For RC3-5, the I/Q symbol pair for a given frame position, must input two I/Q symbol pair periods before that frame position. The I and Q symbol data is sampled at the end of the symbol period and must be stable.

The external data is input at the modulation symbol node and is spread with the decimated long code. Subsequently, power control symbol puncturing (for F-FCH channel types only), Walsh coding, and I/Q mapping are applied.

Serial data clock and frame timing can be generated from the chip clock and even second outputs. See the following section, [“Rear Panel Outputs” on page 339](#).

On signal generators with Option 1EM, this input is relocated to a rear panel SMB input.

#### DATA CLOCK (Forward and Reverse Link)

This BNC connector is used for a chip clock input. This input is used for the external reference input (generally a 1.2288 MHz TTL or CMOS signal) for data and baseband generation. This input is active only after toggling the baseband data generator clock from internal to external.

On signal generators with Option 1EM, this input is relocated to a rear panel SMB input.

## Rear Panel Inputs

### ALT PWR IN (Forward Link)

Pin 16 of the AUX I/O connector is used for a long code state latch strobe input. The leading edge of the long code state latch strobe input is latched and sampled by the chip clock. The current state of the long code is latched and held until the next trigger input. Subsequently, the long code state held in the latch can be read via the GPIB or RS-232 ports.

### PATTERN TRIG IN (Forward and Reverse Link)

This BNC connector is used for a system reset trigger input. This system reset trigger ensures frame and long code timing alignment. In addition, the trigger is used to align a reverse link configuration with the base station. When the ESG is being used as a mobile station, the reset signal is provided by the BTS via the PATTERN TRIG IN connector.

On signal generators with Option 1EM, this input is changed from a BNC to an SMB connector.

## Rear Panel Outputs

### DATA OUT (Forward Link)

Pin 7 of the AUX I/O connector is used for the power control group bit state output. This control bit is used for power control puncturing during the current power control group. The output is aligned with data generation timing and leads the baseband and RF outputs by approximately 28 chips (even second delay). This output can be used to synchronize receiver measurements of mobile power output.

### DATA OUT (Reverse Link)

Pin 7 of the AUX I/O connector is used for the long code output. This pin provides an external output for the current long code being processed. The beginning of the long code occurs 2 chips after a system reset, leads the SYMBOL SYNC OUT signal by 257 chips in RC1-2 and 1 chip in RC3-4, and leads the delayed even second signal by approximately 28 chips (even second delay). The long code rear panel output occurs prior to the RF output.

**DATA CLK OUT (Forward Link and Reverse Link)**

Pin 6 of the AUX I/O connector provides an external output for the chip clock. The chip clock provides a 1.2288 MHz TTL signal with one-chip-wide pulses that is used for the timing to determine when events will occur. The BTS timing and the system resync signals both start at the first available rising chip clock pulse edge. All other signal start times are counted using the chip clock pulses relative to the first pulse occurrence of the timing or resync signal. The trigger advance, even second delay, and the other internal leading chips, relative to the delayed even second signal are counted using the one-chip-wide chip clock pulse.

In reverse link, there are other selectable clock rates: one group for RC1-2 and another for RC3-4.

**EVENT 1 (Forward and Reverse Link)**

This BNC connector is used for the delayed even second output. This connector provides a one-chip wide signal output with variable delay from the internal data generation even second. The delay is adjustable (via the front panel user interface or remote interface, Even Sec Delay) to allow even second alignment with baseband and RF outputs. Data generation timing leads the baseband and RF output by approximately 28 chips (even second delay). In forward link there are two other trigger signals available: delayed 20 and 80 ms signals.

On signal generators with Option 1EM, this output is changed from a BNC to an SMB connector.

**EVENT 2 (Forward Link)**

This BNC connector is used for the system reset output. The system reset trigger outputs whenever a PN offset value changes or differences in frame and long code timing alignment are apparent between the signal generators.

On signal generators with Option 1EM, this output is changed from a BNC to an SMB connector.

**EVENT 2 (Reverse Link)**

This BNC connector is used for the system reset output. The system reset trigger occurs whenever the input BTS timing signal (PATTERN TRIG IN connector) and the ESG's delayed even second clock are not aligned.

On signal generators with Option 1EM, this output is changed from a BNC to an SMB connector.

**SYM SYNC OUT (Forward and Reverse Link)**

Pin 5 of the AUX I/O connector is used for the even second output. The one-chip-wide even second signal is aligned with the internal data generation timing. In reverse link, there is a **Long Code Sync** selection which provides a trigger to signal the start of the long code.

### Forward Link I/O Timing Relationships

Refer to the following two timing diagrams (Figure 10-16 and Figure 10-17) for the forward link timing relationships between the signals at the rear panel BNC/SMB/AUX I/O output and input connectors. Signal states are referenced to the chip clock provided at the DATA CLK OUT connector.

**Figure 10-16 Forward Link Timing Diagram - Outputs**  
**Forward Link ESG Rear Panel Outputs**

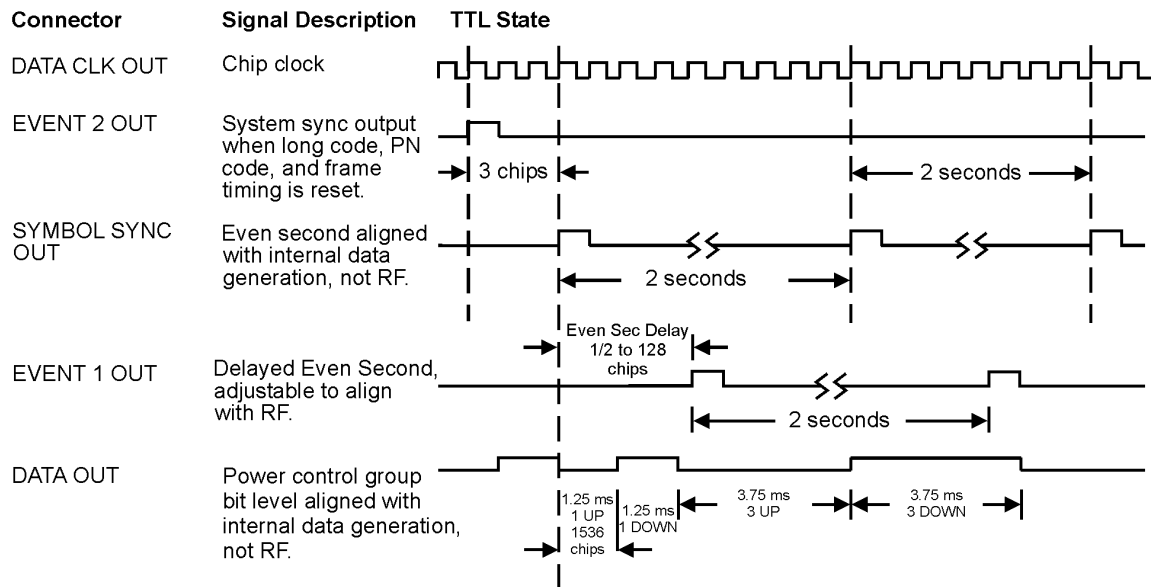

**Figure 10-17 Forward Link Timing Diagram - Inputs**  
**Forward Link ESG Rear Panel Inputs**

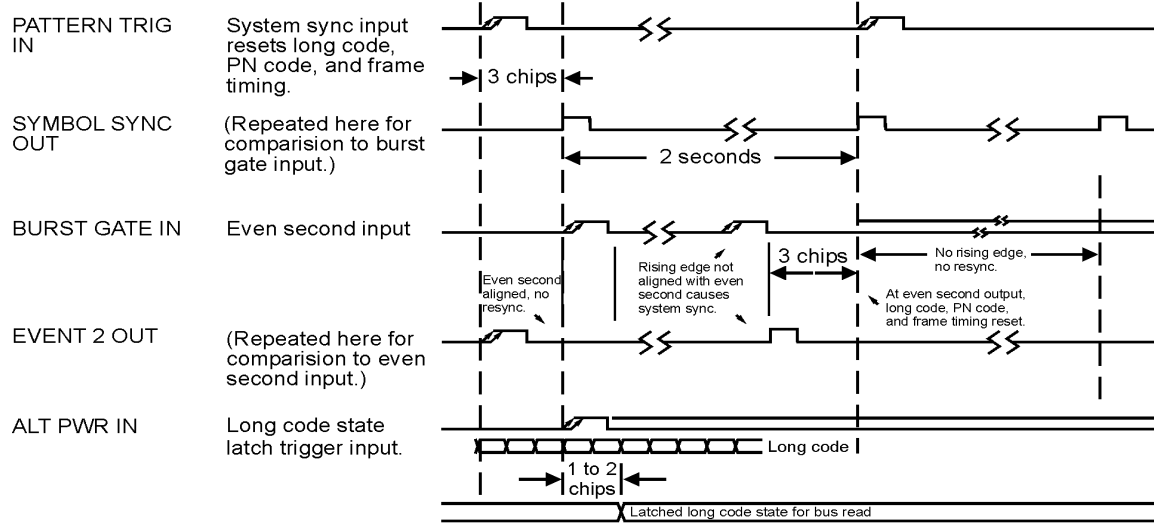

// = edge sensitive

### Reverse Link I/O Timing Relationships

Refer to the following four timing diagrams for reverse link. There are two for RC1–2 (Figure 10-18 and Figure 10-19) and two for RC3–4 (Figure 10-20 and Figure 10-21). These diagrams illustrate the timing relationships between the signals at the rear panel BNC/SMB output and input connectors. Signal states are referenced to the chip clock provided at the DATA CLK OUT connector.

**Figure 10-18** Reverse Link I/O Timing Diagram for RC1-2 - Outputs  
RC1-2 Reverse Link ESG Rear Panel Outputs

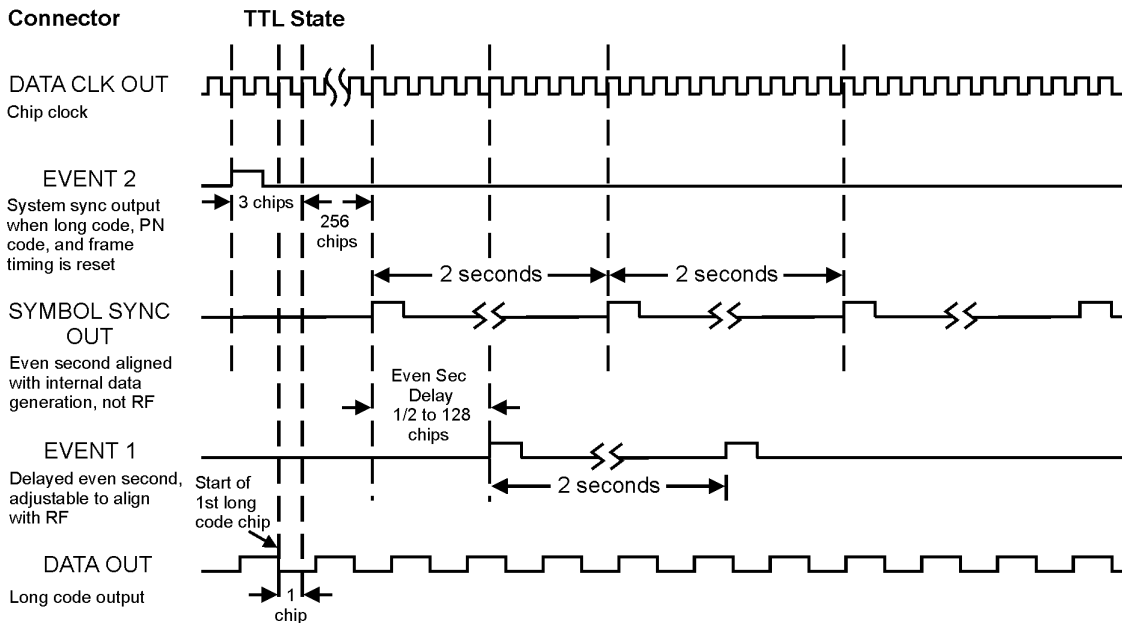

**Figure 10-19** Reverse Link I/O Timing Diagram for RC1-2 - Inputs  
RC1-2 Reverse Link ESG Rear Panel Inputs

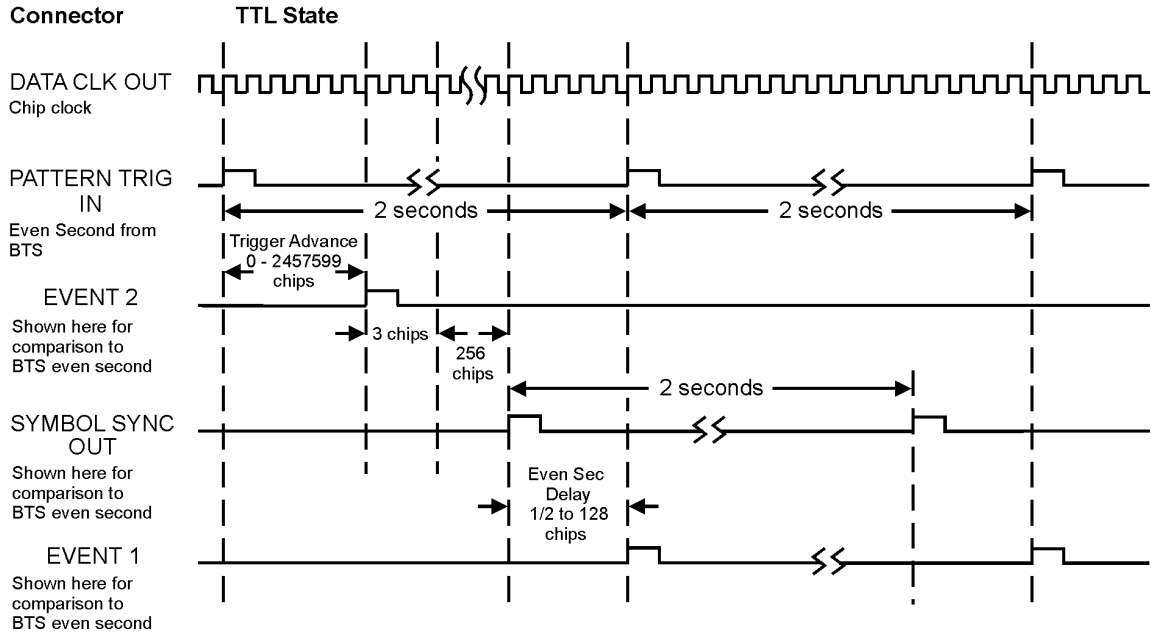
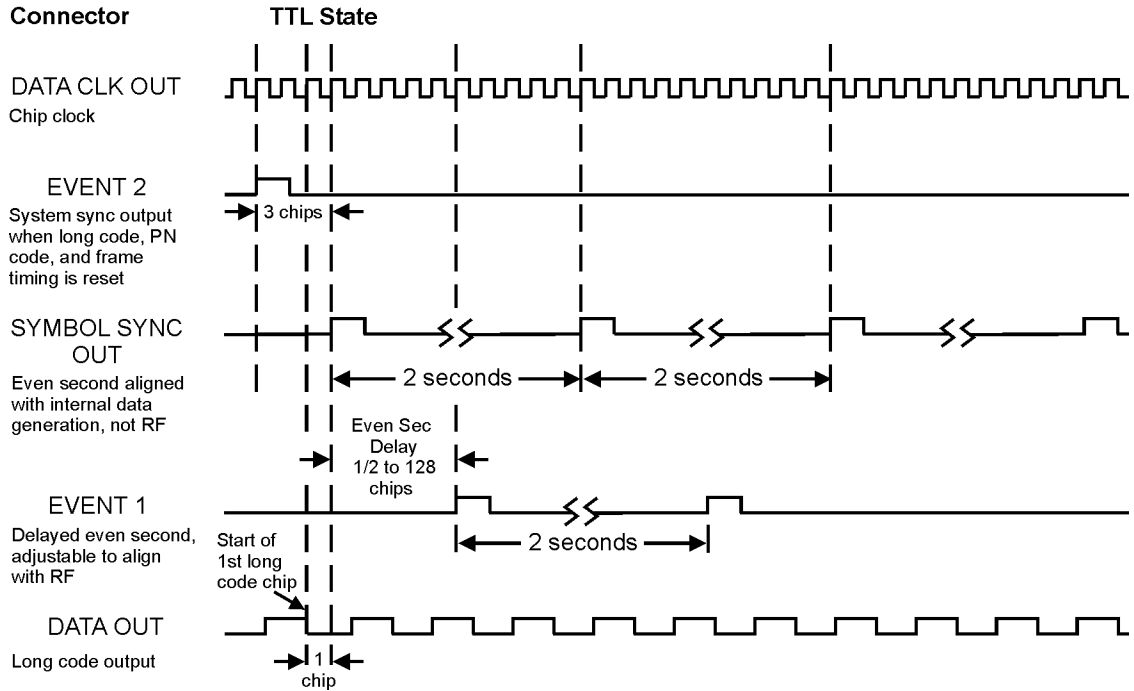



Figure 10-20

Reverse Link I/O Timing Diagram for RC3-4 - Outputs

RC3-4 Reverse Link ESG Rear Panel Outputs



**Figure 10-21** Reverse Link I/O Timing Diagram for RC3-4 - Inputs  
 RC3-4 Reverse Link ESG Rear Panel Inputs

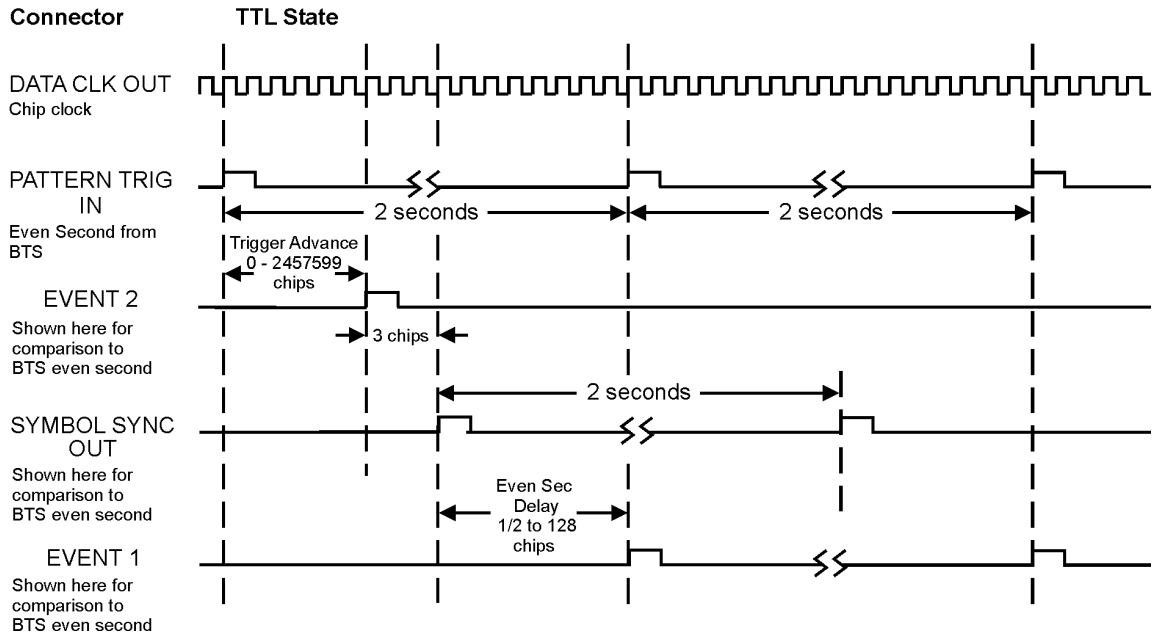

## Applying a User-Defined FIR Filter to a cdma2000 Waveform

Custom FIR filters can be created using the FIR table editor feature or they can be created externally and downloaded into signal generator memory. Once a filter is stored in memory, you can select it for use with a custom modulation state. This example requires that at least one FIR file already be stored in memory. For an example of creating and storing a FIR filter, see “Creating a User-Defined FIR Filter Using the FIR Table Editor” on page 168.

1. Press **Preset**.
2. Press **Mode > CDMA > Arb CDMA2000 > More (1 of 2) > CDMA2000 Define**.
3. Press **Filter > Select > User FIR**.

In this example, there are two FIR files listed: NEWFIR1 and NEWFIR2. (These files were created in the examples in Chapter 4, “Basic Digital Operation (Option 001/601 or 002/602),” on page 89.)

**Figure 10-22**

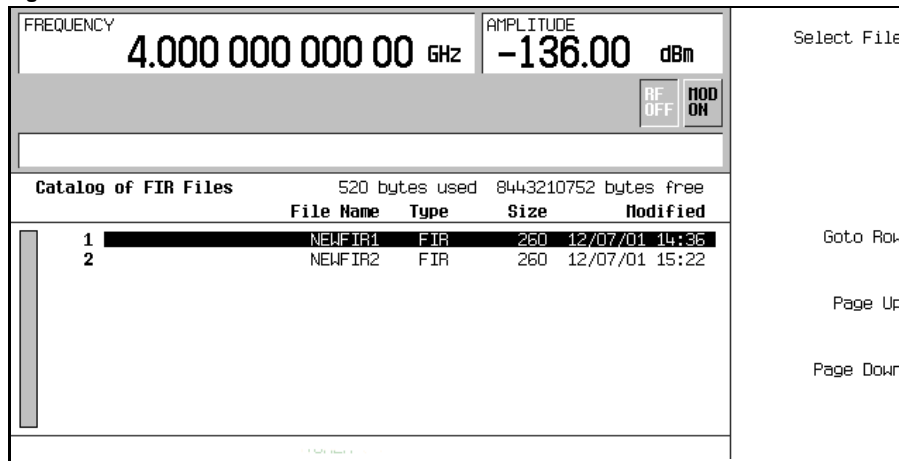

4. Scroll down in the list until NEWFIR2 is highlighted.
5. Press **Select File**.

The highlighted filter is now selected for use in your custom modulation state, as shown in Figure 10-23 on page 348.

Applying a User-Defined FIR Filter to a cdma2000 Waveform

Figure 10-23

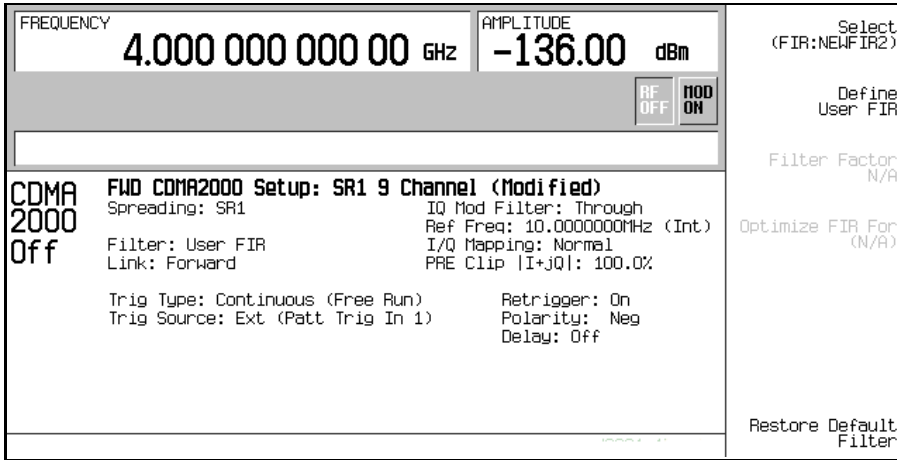

The filter you selected is NEWFIR2. You can see the name displayed below the **Select** softkey. In the Filter field, near the left of the display, User FIR is displayed to indicate that a user-defined FIR filter has been selected.

Once you have set the other modulation parameters to your satisfaction, turn on Custom and the RF output and your user-defined filter is in use.

---

**NOTE** The actual oversample ratio during modulation is automatically selected by the instrument. A value between 4 and 16 is chosen dependent on the symbol rate, the number of bits per symbol of the modulation type, and the number of symbols.

---

---

## IS-95A Modulation

This section teaches you how to build dual arbitrary waveform generated IS-95A CDMA modulation for testing component designs.

### Creating a Predefined CDMA State

This section teaches you how to perform the following tasks:

- “Selecting a Predefined CDMA Setup” on page 349
- “Generating the Waveform” on page 349
- “Configuring the RF Output” on page 349

#### Selecting a Predefined CDMA Setup

1. Press **Preset**.
2. Press **Mode > CDMA > Arb IS-95A**.
3. Press **Setup Select > 64 Ch Fwd**.

#### Generating the Waveform

Press **CDMA Off On**.

This generates a predefined 64 channel forward CDMA waveform. The display changes to **CDMA Setup: 64 Ch Fwd**. During waveform generation, the **CDMA** and **I/Q** annunciators appear and the predefined digital modulation state is stored in volatile ARB memory. The waveform is now modulating the RF carrier.

#### Configuring the RF Output

1. Set the RF output frequency to 890.01 MHz.
2. Set the output amplitude to –10 dBm.
3. Press **RF On/Off**.

The predefined 64 channel forward CDMA signal is now available at the signal generator’s RF OUTPUT connector.

## **Creating a User-Defined CDMA State**

In this procedure, you learn how to customize a predefined CDMA setup, starting with a forward 32 channel CDMA setup and modifying the setup by adding one channel and changing some of the setup's default values.

This section teaches you how to perform the following tasks:

- “Selecting a CDMA Setup” on page 350
- “Inserting an Additional Channel” on page 350
- “Modifying the Walsh Code” on page 350
- “Modifying the Data” on page 350
- “Modifying the Code Domain Power” on page 351
- “Generating the Waveform” on page 351
- “Configuring the RF Output” on page 351

### **Selecting a CDMA Setup**

1. Press **Preset**.
2. Press **Mode > CDMA > Arb IS-95A**.
3. Press **Setup Select > 32 Ch Fwd**.

### **Inserting an Additional Channel**

1. Press **CDMA Define > Edit Channel Setup**.
2. Highlight **Traffic** in the **Type** column of row 8.
3. Press **Insert Row > Traffic > Return**.

### **Modifying the Walsh Code**

1. Highlight the **walsh** value (38) on table row 8.
2. Press **Edit Item > 45 > Enter**.

### **Modifying the Data**

1. Highlight the **Data** value (RANDOM) on table row 8.
2. Press **Edit Item > 00001000 > Enter**.

### Modifying the Code Domain Power

Press **Adjust Code Domain Power > IS-97 Levels**.

You now have a custom, forward 33 channel CDMA signal at IS-97 power levels, with an inserted traffic channel carrying user-defined data at a Walsh code of 45 on table row 8, as shown in the following figure.

FREQUENCY		4.000 000 000 00 GHz		AMPLITUDE		-136.00 dBm		Edit Item
				RF OFF		HOD ON		Insert Row
								Delete Row
CDMA Channel Setup				Total Power: -0.00dB				
	Type	Walsh	Power	PN Offset	Data			
1	Pilot	0	-7.00 dB	0	00000000	Adjust Code Domain Power		
2	Paging	1	-13.09 dB	0	RANDOM			
3	Traffic	8	-16.09 dB	0	RANDOM			
4	Traffic	9	-16.09 dB	0	RANDOM	Display Code Domain Power		
5	Traffic	10	-16.09 dB	0	RANDOM			
6	Traffic	11	-16.09 dB	0	RANDOM			
7	Traffic	12	-16.09 dB	0	RANDOM			
8	Traffic	45	-16.09 dB	0	00001000	Goto Row		
9	Traffic	13	-16.09 dB	0	RANDOM			
10	Traffic	14	-16.09 dB	0	RANDOM	More (1 of 2)		

### Generating the Waveform

Press **Return > Return > CDMA Off On**.

This generates a waveform with the custom CDMA state created in the previous sections. The display changes to CDMA Setup: 32 Ch Fwd (Modified). During waveform generation, the CDMA and I/Q annunciators appear and the predefined digital modulation state is stored in volatile memory. The waveform is now modulating the RF carrier.

For instructions on storing this custom CDMA state to the non-volatile memory of the signal generator, see [“Storing a Component Test Waveform to Memory” on page 320](#).

### Configuring the RF Output

1. Set the RF output frequency to 890.01 MHz.
2. Set the output amplitude to -10 dBm.
3. Press **RF On/Off**.

The custom CDMA signal is now available at the RF OUTPUT connector.

## Applying Changes to an Active CDMA State

If the CDMA format is currently in use (**CDMA Off On** set to On) while changes are made in the CDMA Channel Setup table editor, you must apply the changes before the updated waveform will be generated.

From the CDMA Channel Setup table editor, press the following keys to apply the changes and generate a new user-defined CDMA waveform based on the updated values:

**Return > Apply Channel Setup.**

To store a custom CDMA state file, refer to “[Storing a Component Test Waveform to Memory](#)” on page 320.

To recall a custom CDMA state file, refer to “[Recalling a Component Test Waveform](#)” on page 321.

## Creating a User-Defined Multicarrier CDMA State

In this procedure, you learn how to customize a predefined multicarrier CDMA setup. Rather than building a 4-carrier setup one carrier at a time, you start with a predefined 3-carrier CDMA setup and modify the setup by adding an additional carrier and changing some of the default values.

This section teaches you how to perform the following tasks:

- “[Selecting a Multicarrier CDMA Setup](#)” on page 352
- “[Adding a Carrier](#)” on page 352
- “[Modifying Carrier Frequency Offset](#)” on page 353
- “[Modifying Carrier Power](#)” on page 353
- “[Generating the Waveform](#)” on page 353
- “[Configuring the RF Output](#)” on page 354

### Selecting a Multicarrier CDMA Setup

1. Press **Preset**.
2. Press **Mode > CDMA > Arb IS-95A**.
3. Press **Multicarrier Off On > Multicarrier Define**.

### Adding a Carrier

1. Highlight the 9 channel forward carrier in table row 2.
2. Press **Insert Row > Pilot > Return**.



### Modifying Carrier Frequency Offset

1. Highlight the **Freq Offset** value (0.00 kHz) for the new pilot carrier in row 3.
2. Press **Edit Item > -625 > kHz**.

### Modifying Carrier Power

1. Highlight the **Power** value (0.00 dB) for the new pilot carrier in row 3.
2. Press **Edit Item > -10 > dB**.

You now have a user-defined 4-carrier CDMA waveform with an inserted pilot carrier at a frequency offset of -625 kHz and a power level of -10.00 dBm, as shown in the following figure.

FREQUENCY		4.000 000 000 00 GHz		AMPLITUDE		-136.00 dBm		Edit Item
				RF OFF		MOD ON		Insert Row
								Delete Row
<b>Multicarrier CDMA Setup</b>								
	<b>Carrier</b>	<b>Freq Offset</b>	<b>Power</b>		Goto Row			
1	9 Ch Fwd	-1.250000 MHz	0.00 dB					
2	Pilot	-625.000 kHz	-10.00 dB					
3	9 Ch Fwd	0.000 kHz	0.00 dB					
4	9 Ch Fwd	1.250000 MHz	0.00 dB					
5	-----	-----	-----					
Store Custom Multicarrier								
Apply Multicarrier								

### Generating the Waveform

Press **Return > CDMA Off On**.

This generates a waveform with the user-defined multicarrier CDMA state created in the previous sections. The display changes to **Multicarrier Setup: 3 Carriers (Modified)**. During waveform generation, the CDMA and I/Q annunciators appear and the user-defined multicarrier CDMA state is stored in volatile memory. The waveform is now modulating the RF carrier.

For instructions on storing this user-defined multicarrier CDMA state to non-volatile memory, see [“Storing a Component Test Waveform to Memory” on page 320](#).

### **Configuring the RF Output**

1. Set the RF output frequency to 890.01 MHz.
2. Set the output amplitude to -10 dBm.
3. Press **RF On/Off**.

The user-defined multicarrier CDMA signal is now available at the RF OUTPUT connector.

### **Applying Changes to an Active Multicarrier CDMA State**

If the CDMA format is currently in use (**CDMA Off On** set to On) while changes are made in the Multicarrier CDMA Setup table editor, you must apply the changes before the updated waveform will be generated.

From the Multicarrier CDMA Setup table editor, press the following keys to apply the changes and generate a new user-defined multicarrier CDMA waveform based on the updated values:

**Return > Apply Multicarrier.**

To store a custom multicarrier CDMA state file, refer to, [“Storing a Component Test Waveform to Memory” on page 320.](#)

To recall a custom multicarrier CDMA state file, refer to [“Recalling a Component Test Waveform” on page 321.](#)

---

# 11 GPS Modulation (Option 409)

Option 409 includes real time multiple-satellite and single-satellite global positioning system (GPS) signal generation capabilities. This feature is available only in E4438C ESG Vector Signal Generators with Option 001/601 or 002/602. The following list shows the topics covered in this chapter:

- “Real Time MSGPS” on page 357 (multiple satellite GPS)
- “Real Time GPS” on page 364 (single satellite GPS)

---

**NOTE** A previous version of Option 409 provided only single satellite (Real Time GPS) capability. You can upgrade to the new version of Option 409 that includes Real Time MSGPS by downloading firmware revision C.04.97 to your E4438C.

Single satellite (Real Time GPS) capability in firmware revision C.04.97 is compatible with the single satellite capability in the previous version of Option 409. (You can use SCPI programming code written for single satellite setups in the previous version for single satellite setups in the new version.)

---

---

**NOTE** The Agilent Scenario Generator for GPS software (Option 422) provides the ability to create custom scenario files for real-time playback using Option 409.

The software is available as a free download, allowing you to investigate the features of the scenario generator, create and save scenario files, or download them to your E4438C signal generator. The signal generator must have licenses for Option 422 and 409 in order to use the scenario files created by the software.

For more information, go to [www.agilent.com/find/gps](http://www.agilent.com/find/gps).

---



## **Real Time MSGPS**

In Real Time MSGPS mode, selectable scenario files define simulated multiple-satellite conditions. The E4438C generates a signal (C/A code only) simulating multiple satellite transmissions from the information in the selected scenario file. MSGPS signal generation capabilities include:

- selectable MSGPS scenario files that include the following information:
  - simulated location (city, latitude, longitude, elevation)
  - simulated date and time
  - scenario duration
  - satellite IDs present (in view) in the scenario
- pause and resume function for the currently playing scenario
- restart function that sets the currently playing scenario to the beginning (without turning off the RF output)
- adjustable number of satellites in view to include in the generated signal
- selectable internal or external chip clock reference source
- adjustable chip clock reference ( $10.23 \text{ Mcps} \pm 10\%$ )
- selectable I/Q phase (normal or inverted)

### Signal Generation Block Diagram

Figure 11-1 shows how the signal is generated within the ESG for a four satellite MSGPS simulation. The ESG produces a simulated signal for each satellite and then sums them together to produce the MSGPS signal. Use the **Number of Satellites** softkey to specify the number of satellites in the MSGPS simulation.

Figure 11-1 MSGPS Signal Generation Diagram

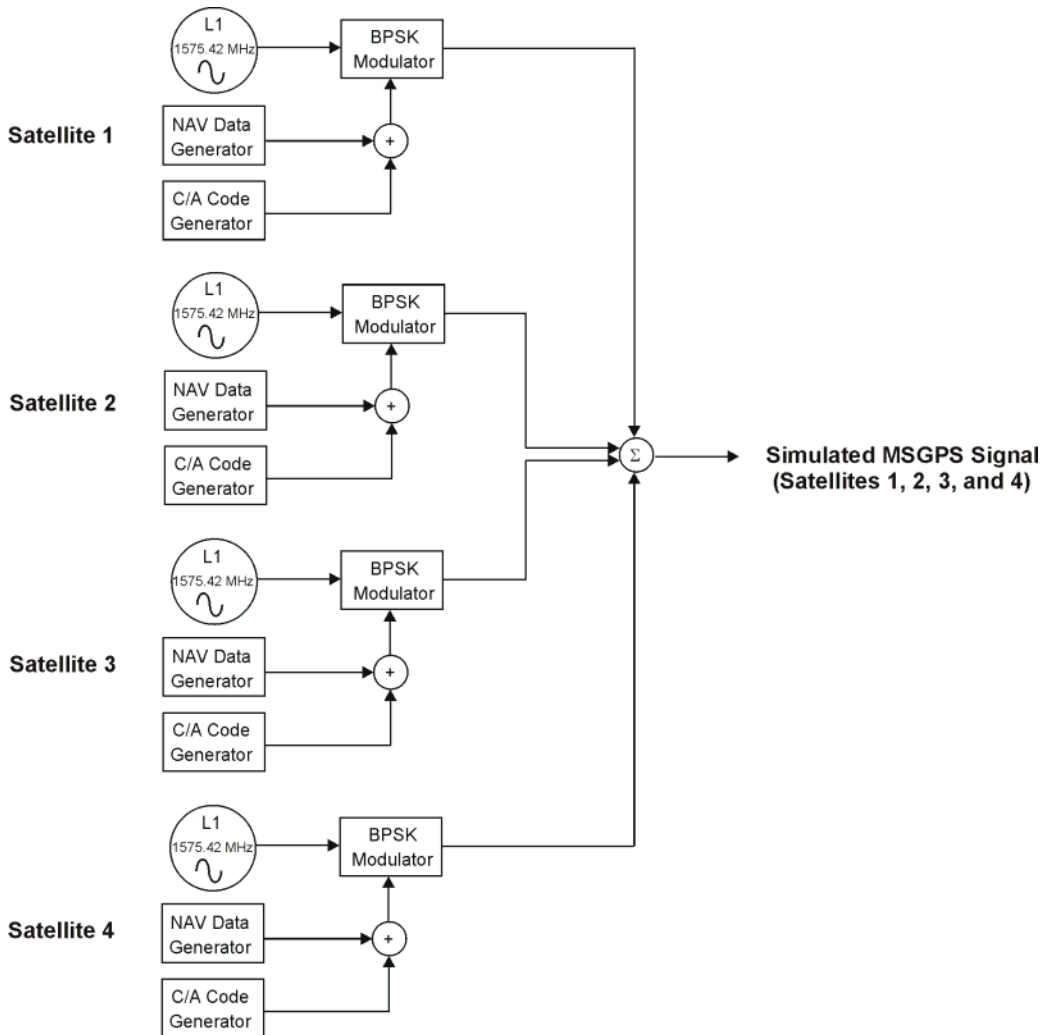

## Scenario Files

When you install option 409, a GPS directory is created in the ESG non-volatile memory and two MSGPS scenario files are loaded into the GPS directory. Additional scenario files are available for Option 409. (Go to <http://www.agilent.com/find/e4438c> and click the **Options** tab.) After downloading a scenario file to your PC, you can download the scenario file to the ESG using FTP over a local area network (LAN) or using SCPI commands over a general purpose interface bus (GPIB) interface.

### Downloading Scenario Files Using FTP (LAN)

The following procedure describes how to download scenario files to an ESG using FTP on a PC connected to your ESG through a LAN:

1. On the PC click **Start > Programs > Accessories > Command Prompt**.
2. At the command prompt enter: `ftp <IP address> or <hostname>`
3. At the user name prompt, press **Enter**.
4. At the password prompt, press **Enter**. You are now in the signal generator's user directory.
5. Type `cd GPS`.
6. Type `bin`.
7. Type `put <scenario_file>`.
8. Type `quit` or `bye` to end your FTP session.
9. Type `exit` to end the command prompt session.

### Downloading Scenario Files Using SCPI Commands (GPIB)

The following procedure describes how to download scenario files to an ESG using a SCPI command on a PC connected to your ESG through a GPIB interface:

1. Open your web browser and type in the IP address of your ESG. The ESG's Welcome webpage is displayed.
2. Click **Signal Generator Web Control**. Below the graphical representation of the ESG front panel is a field for entering SCPI commands.
3. Enter the following command in the SCPI command field:  
:`MEMORY:DATA "<GPS:file_name>" , <data_block>`  
where `file_name` is the name of the destination file in ESG memory and `GPS` specifies the destination directory. Refer to the *Programming Guide* for a description of the `<data_block>` parameter.

---

**NOTE** Refer to the *Programming Guide* for more information on downloading files.

---

## RF Power Level Considerations

When you set up your GPS test signal, pay special attention to the RF power level delivered to the GPS receiver. Because typical GPS sensitivities are between  $-155$  dBm and  $-159$  dBm, delivering a GPS signal to your device with a power level greater than  $-150$  dBm or less than  $-160$  dBm may produce invalid test results.

If you use a physical connection to apply the GPS signal to your antenna, keep in mind that most GPS antennas are active (a DC voltage is delivered to the antenna from the receiver). A DC block is therefore required between the signal generator and the antenna. For direct connection, Agilent recommends setting the signal generator RF output power to between  $-70$  and  $-80$  dBm and using an 80 dB attenuator and a DC blocking device between the signal generator output and the antenna input of the receiver under test.

If you use a radiated connection, place your receiver in a calibrated test fixture designed with a link budget that will deliver a  $-150$  dBm to  $-160$  dBm power level at the receiver antenna.

### Using NMEA data to monitor signal power

One method to monitor the receiver's perceived signal level is to monitor the National Marine Electronics Association (NMEA) data stream from the receiver. Most GPS receivers have the capability to output data via a serial RS232 connection in NMEA format. An NMEA message called GPGSV reports the signal strength of the satellites that the GPS receiver is tracking. The GPGSV message reports a carrier-to-noise (CNO) value for each observed satellite. As you monitor this message, increase or decrease the power to the receiver until the receiver's perceived CNO values are between 35 and 40. [Table 11-1 on page 361](#) shows how to obtain the CNO value from the GPGSV message.

The following example is a set of three GPGSV messages. The receiver produces a maximum of three GPGSV messages every second. The fields are comma-separated; two adjacent commas signify a field for which a value is not assigned.

```
$GPGSV,3,1,12,21,71,000,,27,68,000,34,08,62,000,33,29,52,000,,*71
```

```
$GPGSV,3,2,12,24,39,000,,10,36,000,,26,35,000,,25,32,000,35*71
```

```
$GPGSV,3,3,12,19,29,000,,03,20,000,33,16,19,000,34,18,19,000,*71
```



Table 11-1 describes each field for the first of the three GPGSV messages in the example:

\$GPGSV,3,1,12,21,71,000,,27,68,000,34,08,62,000,33,29,52,000,,\*71

**Table 11-1 GPGSV Fields**

GPGSV Field	Description
\$GPGSV,	
3,	Number of GPGSV messages in this set
1,	Number of this GPGSV in the set (1 of 3)
12,	Total number of satellites in view
21,71,000,,	Satellite 21, elevation 71, azimuth 0, CNO unknown
27,68,000,34	Satellite 27, elevation 68, azimuth 0, CNO 34
08,62,000,33,	Satellite 8, elevation 62, azimuth 0, CNO 33
29,52,000,,	Satellite 29, elevation 52, azimuth 0, CNO unknown
*71	Checksum

If no CNO value is reported for a particular satellite (satellites 21 and 29 in the table) the receiver is currently not tracking that satellite.

For more information, refer to the following document, available at <http://www.nmea.org/pub/0183/>.

*NMEA 0183, Standard For Interfacing Marine Electronic Devices*

## Generating a Real Time MSGPS Signal

This procedure uses the internal reference clock with the factory preset settings (the C/A chip rate is 1.023 Mcps with a clock reference of 10.23 Mcps).

### Set the carrier frequency and amplitude

1. Press the **Preset** hardkey.
2. Press the **Frequency** hardkey. Using the numeric keypad, set the signal generator RF output carrier frequency to 1.57542 GHz.
3. Press the **Amplitude** hardkey. Using the numeric keypad, set the signal generator RF output amplitude to -135 dBm.
4. Press **RF On/Off** to toggle the RF output on.

### Select and play a multi-satellite scenario

1. Press **Mode > More (1 of 2) > GPS > Real Time MSGPS**.
2. Press **Scenario**.
3. Use the navigation softkeys or the up and down arrow hardkeys to highlight the **santarosa** scenario file.
4. Press **Select Scenario**. A summary of the scenario is displayed including the simulated location, the date and time, and the satellites in view.
5. Press **Number of Satellites** and enter **5** to use only the first five satellites in view in the generated signal.
6. Press **Real-time MSGPS Off On** to On to play the selected scenario.
7. Press **Pause**. The scenario file stops playing.
8. Press **Resume**. The scenario file continues playing from the point at which it was paused.
9. Press **Restart**. The scenario file plays from the beginning without turning off the RF.

---

**NOTE** Selecting a new scenario, toggling Real-time MSGPS off and on, or pressing Restart sets the active scenario to the beginning. If Resume is active, the scenario immediately starts playing; if Pause is active, select Resume to start playing the scenario.

---

Figure 11-2 on page 363 shows the signal generator display with the **santarosa** MSGPS scenario selected.

The scenario information within the box (Scenario State, Signal Play Duration, Satellites in View) is dynamic. The scenario information outside of the box ( Location, Start Date, and so on) is static.

**Figure 11-2 Real Time MSGPS Scenario**

FREQUENCY <b>1.575 420 000 00</b> GHz		AMPLITUDE <b>-135.00</b> dBm		Real-time MSGPS <b>Off</b> On
<div style="text-align: right;">           RF OFF <b>RF ON</b> </div>				Pause
Number of Satellites: <b>5</b>				Restart
<b>RT MSGPS</b> <b>Off</b>	Location: Santa Rosa Start Date: 21-May-2007 Start Time: 01:00:00 Altitude (m): 100 Latitude: 38.481161 Longitude: -122.709619	Filename: SANTAROSA GPS Ref (f0): 1.023000Mcps GPS Ref Clk: Int IQ Phase: Invert	Scenario ▶	
Scenario State: Signal Play Duration: 00:00:00 of 00:30:00 Satellites in View:				Number of Satellites <b>5</b>
09/06/2007 11:14				More (1 of 2)

### Configuring the External Reference Clock

1. Connect the external reference clock source to the rear panel connector BASEBAND GEN REF IN.
2. Set the chip rate of the external clock to the desired value.
3. Press **Mode > More (1 of 2) > GPS > Real Time MSGPS > More (1 of 2) > GPS Ref Clk Ext Int** to Ext.
4. Press **GPS Ref (f0)**.
5. Use the numeric keypad to set the GPS reference clock to the same chip rate as the external clock.

---

**NOTE** The chip rate of the external source must match the chip rate of the reference clock set using the **GPS Ref (f0)** softkey.

---

## **Real Time GPS**

This real-time personality simulates GPS satellite transmissions for single channel receiver testing. Basic GPS signal building capabilities include:

- P code generation at 10.23 Mcps with the standard GPS 10.23 Mcps reference
- C/A code generation at 1.023 Mcps with the standard GPS 10.23 Mcps reference
- navigation data output at 50 bps using PN9, PN15, a fixed 4-bit pattern, a user-defined file, or default data (TLM mode) for encoding with the C/A code or the C/A + P code
- three selectable ranging codes: C/A, P, or C/A+P
- satellite ID range of 1 to 32 with an additional range of 33 to 37 for other uses
- selectable data modes: Raw, Encoded, and TLM
- simulated doppler shift with a 250 kHz range
- selectable internal or external chip clock reference source

The signal generator's pre-defined GPS signal setup includes a C/A ranging code, a satellite ID of 1, zero doppler shift, a 10.23 Mcps reference clock, and the Raw data mode enabled, using PN9 data.

The satellite ID numbers match the pseudorandom numbers used to generate the C/A and P codes and dictate the amount of chip delay in compliance with the GPS standards..

The following advanced features are also available:

- P code power adjustment (–40 to 0 dB)
- adjustable chip clock reference (1 kcps to 12.5 Mcps)
- selectable I/Q phase
- selectable filters and the ability to create user-defined filters

## Real Time GPS Introduction

### Signal Generation Block Diagram

Figure 11-3 shows how the GPS signal is generated within the ESG. Notice that the C/A code modulates the L-band signal using the I axis of the I/Q modulator, and the P code modulates the L-band signal using the Q axis. Select the data provided by the data generator using the **Data** softkey or by choosing the TLM data mode.

Figure 11-3 GPS Signal Generation Diagram

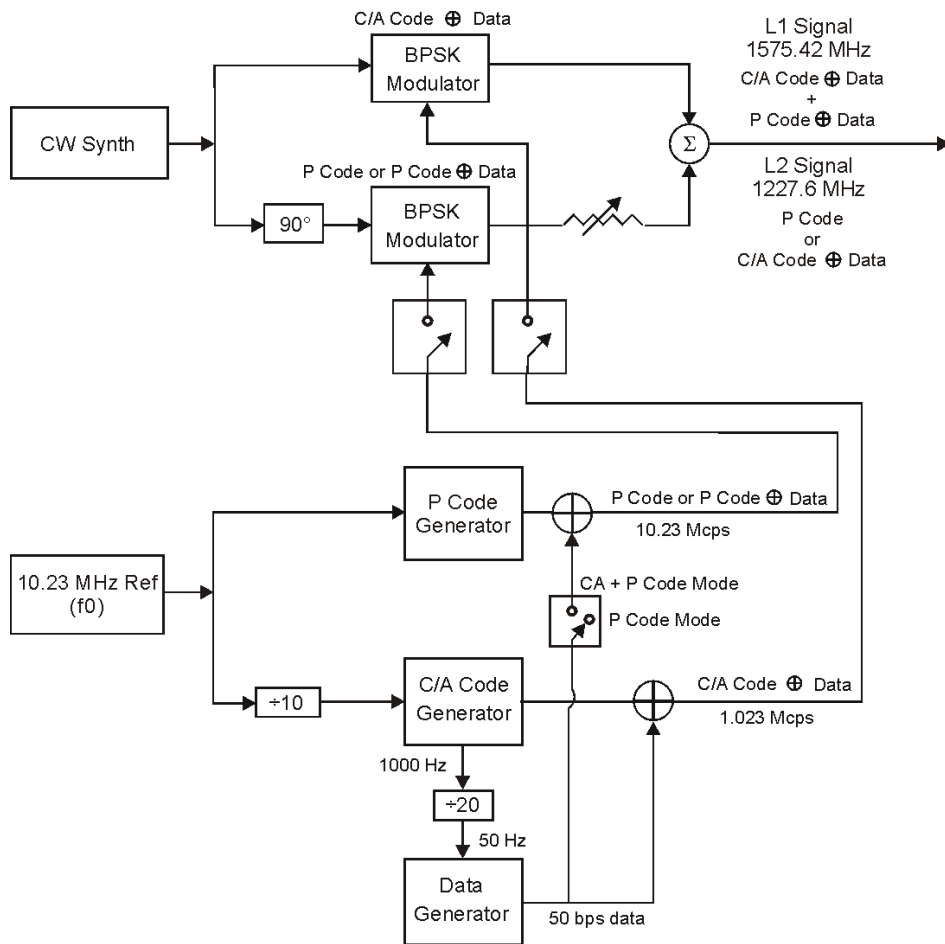

gps\_blk

**Data Modes and Subframe Structures**

You can select one of the three following data modes for use with the C/A or C/A+P ranging code:

- Raw - The Raw data mode enables the continuous transmission of 300 bits of data per subframe without incorporating parity bits. Use this mode for BER and low-level demodulation testing.
- Enc - The encoded (Enc) data mode enables the continuous transmission of 10 words per subframe, with each word containing 24 bits of raw data and 6 trailing parity bits (computed from the selected data by the ESG).
- TLM - The telemetry (TLM) mode enables the continuous transmission of a formatted TLM word, a handover word (HOW), and default navigation data as outlined in the *Global Positioning System Standard Positioning Service Signal Specification, 2nd Edition, June 2, 1995*. Use this mode for receiver testing.

Figure 11-4 shows the subframe structures for each data mode.

**Figure 11-4 Subframe Structures**

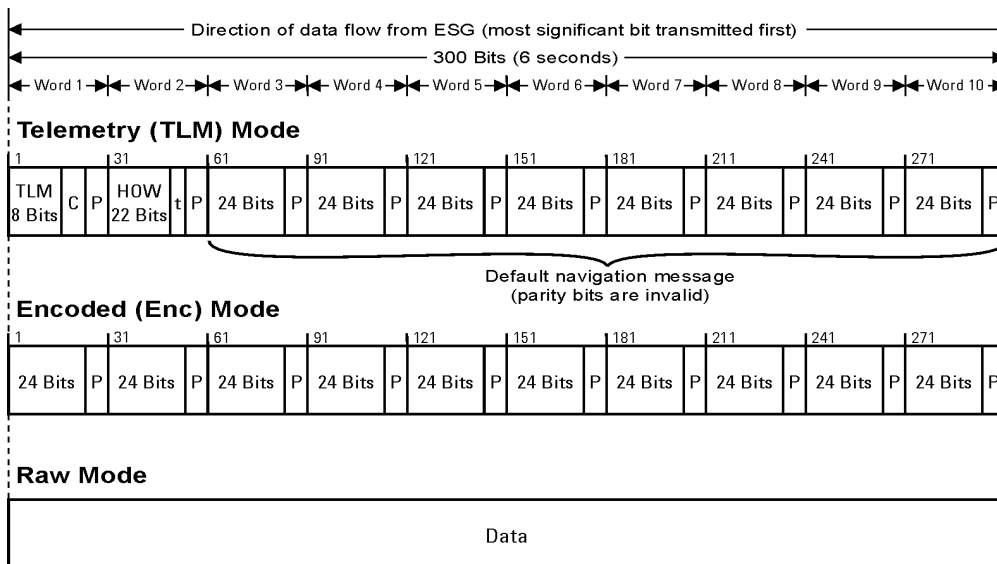

C - TLM bits 9 through 24 are reserved  
 P - 6 parity bits per word  
 t - 2 noninformation bits used for parity computation

gps\_df1

The TLM word is 30-bits long, with an 8-bit preamble, 16 reserve bits (bits 9 to 24, all set to zero), and 6 parity bits (bits 25 to 30).

The HOW word is 30-bits long, with the first 17 bits used for an incrementing time-of-week (TOW), bits 23 and 24 used for parity computation, and bits 25 to 30 used for parity bits.

During a GPS signal transmission, a pulse signal is generated every 6 seconds at the EVENT 1 rear panel connector. This pulse coincides with the beginning of each subframe starting with the second subframe and is synchronized to the RF output to compensate for any internal signal delay.

### Chip Clock Reference

The GPS reference clock (chip clock) is adjustable using the **GPS Ref (f0)** softkey. The factory-set value is 10.23 Mcps (the GPS standard). You can use the internal chip clock or an external source to provide the reference. To use an external reference, connect the external source to the DATA CLOCK input connector.

---

**NOTE** If you use an external source to provide the chip clock reference, the frequency of the external source must match the ESG's reference clock frequency. Press the **GPS Ref (f0)** softkey then use the numeric keypad to enter the reference clock frequency.

---

The P and C/A code chip rates are determined by the reference clock frequency whether you are using the internal or an external chip clock reference. The P code chip rate matches the reference clock frequency and the C/A code chip rate is one-tenth of the reference clock frequency. Refer to [Figure 11-3 on page 365](#) for a block diagram showing how the GPS signal is generated within the ESG.

**Rear Panel Signal Synchronization**

Figure 11-5 illustrates the timing relationships of the GPS signals available at the signal generator rear panel. The AUX I/O connector outputs the SYMBOL SYNC OUT, DATA CLOCK OUT, and DATA OUT signals (refer to, “13. AUX I/O Connector” on page 41 for more information). EVENT 1 and EVENT 2 are BNC connectors. If the signal generator is configured with Option 1EM, EVENT 1 and EVENT 2 connectors are changed from BNC to SMB connectors. See “Rear Panel Overview” on page 37.

**Figure 11-5**

**GPS Signals**

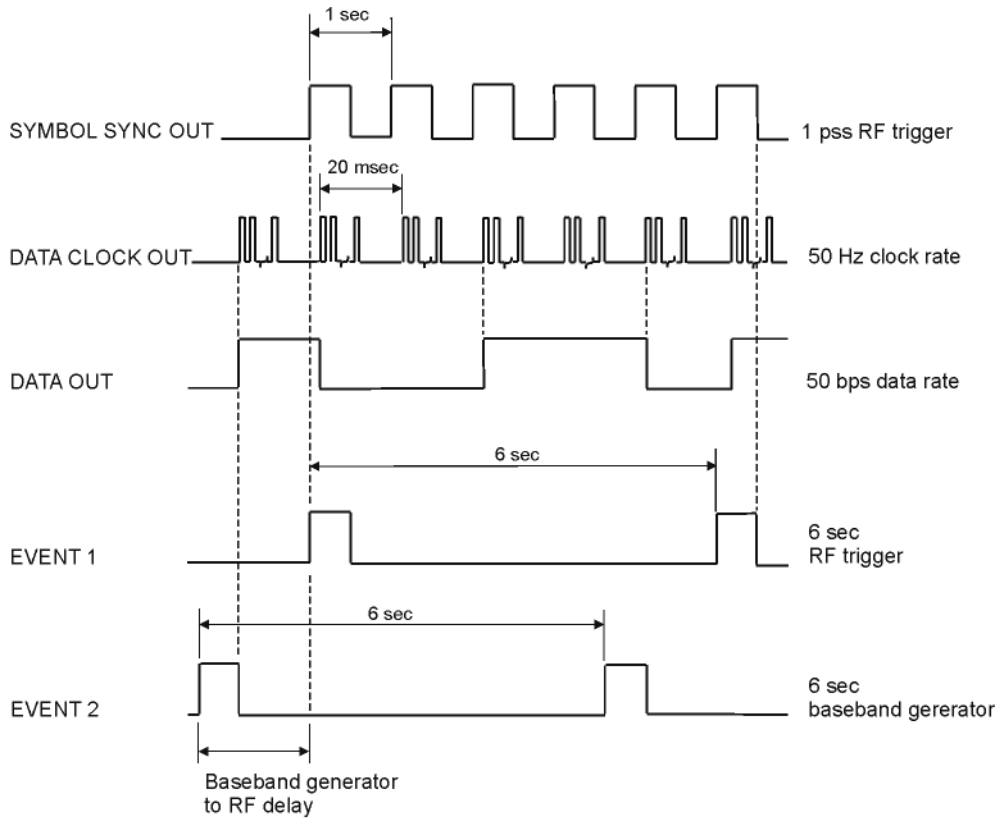

gps-rp\_signal



## User Files

You can create data files internally in the ESG or create them externally and download them to the ESG. In either case, the size of user data files is limited by the amount of available ESG memory. If you develop data files externally, you can define signal structures that are not available internally in the ESG. For example, if you require a fully-coded signal consisting of frames structured according to GPS standards (1 frame consisting of 5 subframes and 25 pages), you can develop this signal externally and download it to the ESG. User files can be in either binary or bit format.

Select a data mode for your data file as you would for other data types (see [“Data Modes and Subframe Structures” on page 366](#)). If files are created externally and incorporate parity bits, use the Raw data mode to transmit the data in its original form. If your file does not contain parity bits and you want to incorporate parity bits in the transmitted signal, select the encoded (Enc) data mode. The ESG will compute parity bits for the last 6-bits of each word.

---

**NOTE**            If you select the encoded mode for a user file that incorporates parity bits, the parity bits will be recomputed and their values changed.

---

## Bit Error Rate Test Measurements

Bit error rate test (BERT) measurements require an ESG with Option UN7 (Baseband BERT) or a customer-supplied, external BER meter. The GPS signal can be configured using either a PN9 or PN15 sequence. To avoid disrupting the sequence, use the Raw data mode so parity bits are not computed for the subframe.

When you perform BERT measurements using an externally supplied BER meter, the ESG provides the GPS signal to the unit under test (UUT) and the BER meter computes the error results. If the ESG with Option UN7 is used, the ESG provides the signal and makes the BERT measurements. When the ESG performs the BERT measurement, it accepts a clock and gate signal from the UUT as well as the data. If the UUT cannot provide a data clock signal, the ESG can provide a clock signal from the rear panel Aux I/O connector (refer to [“13. AUX I/O Connector” on page 41](#)). When the clock signal from the ESG is used, add a delay to the signal equal to the UUT’s processing time.

For information on setting up BERT measurements refer to [“Setting Up a GPS Bit Error Rate Test” on page 374](#).

For detailed information on BERT, refer to [“Bit Error Rate Tester–Option UN7” on page 292](#).

## Setting Up the Real Time GPS Signal

If the signal generator is in the factory-defined preset mode, (**Utility** > **Power On/Preset** > **Preset Normal User** to Normal) a basic GPS signal is automatically set up when you press the **Preset** key. Perform step 2 and steps 6 through 8 to generate a signal at the RF OUTPUT connector. To set up a signal using additional features of the GPS personality, complete this procedure starting with step 1.

1. Press **Preset**.
2. Press **Mode** > **More (1 of 2)** > **GPS** > **Real Time GPS**.
3. Press **Satellite ID** > **8** > **Enter**.
4. Press **Doppler Shift** > **2.5** > **kHz**.
5. Press **Data Mode Enc TLM** to **Enc**.
6. Press **Data** > **PN Sequence** > **PN15**.

To create a user file, refer to [“Creating a User File” on page 190](#).

7. Press **Real-time GPS Off On** to **On**.
8. Press the **Frequency** hardkey. Using the numeric keypad, set the signal generator RF output frequency to 1.57542 GHz (L1 carrier frequency).
9. Press the **Amplitude** hardkey. Using the numeric keypad, set the signal generator RF output amplitude to -120 dBm.
10. Turn the RF output on by pressing the **RF On/Off** hardkey on the signal generator front panel.

The real-time GPS signal is now available at the signal generator RF OUTPUT connector. [Figure 11-6 on page 371](#) shows what the signal generator display should like after all steps have been completed. Notice the GPS, I/Q, and RF ON annunciators are on and the parameter settings for the signal are displayed in the status area of the signal generator display.

This procedure sets up a GPS signal that incorporates a subframe structure using 10 words, each with 24 raw data bits and 6 parity bits computed from the data source. The signal generator created this subframe structure when you selected Enc as the data mode and a PN15 sequence as the data type. The PN15 sequence was encoded with the C/A code at 50 bps. Using factory preset settings, the C/A chip rate is 1.023 Mcps with a clock reference of 10.23 Mcps. A 2.5 kHz doppler shift simulates the relative motion of the satellite with respect to the receiver. For more information on the GPS option, refer to [“Real Time GPS” on page 364](#).

Figure 11-6 Real Time GPS Setup with Internal Clock

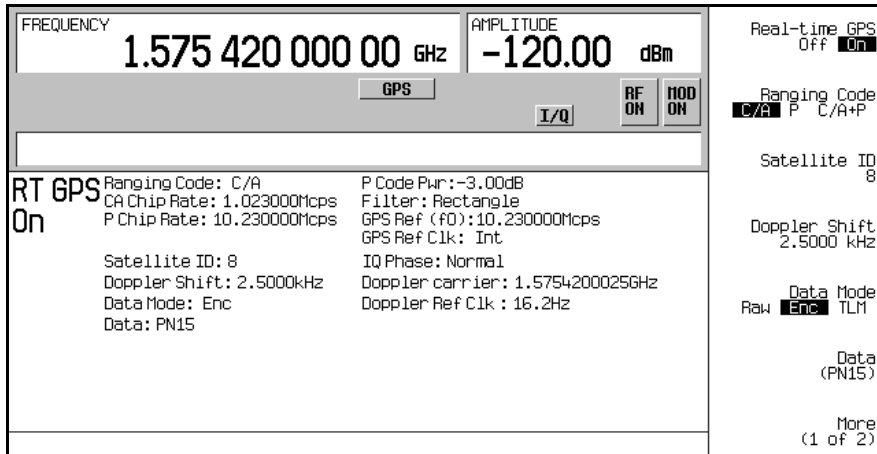

## Configuring the External Reference Clock

1. Access the real-time GPS personality (**Mode > More (1 of 2) > GPS > Real Time GPS**).
2. Press **More (1 of 2) > GPS Ref Clk Ext Int** to Ext.
3. Press **GPS Ref (f0) > 11.03 > kcps**.
4. Connect the external reference clock source to the DATA CLOCK INPUT connector.  
The maximum clock rate for this input connector is 50 MHz with a voltage range of -0.5 to 5.5 V.
5. Set the external reference clock source to the chip rate value entered in [Step 3](#).  
The maximum data rate for this input connector is 50 Mb/s with a voltage range of -0.5 to 5.5 V.

**NOTE** The chip rate of the external source must match the chip rate value set using the **GPS Ref (f0)** softkey.

[Figure 11-7 on page 372](#) shows what the signal generator display should look like after all the steps have been completed. The CA Chip Rate, P Chip Rate, GPS Ref (f0), and GPS Ref Clk fields in the status area of the display show the new parameters you set in this procedure. Notice the settings Satellite ID, Doppler Shift, Data, and Data Mode, have not changed from the previous procedure, “[Setting Up the Real Time GPS Signal](#)” on [page 370](#).

Figure 11-7 Real Time GPS Setup with External Clock

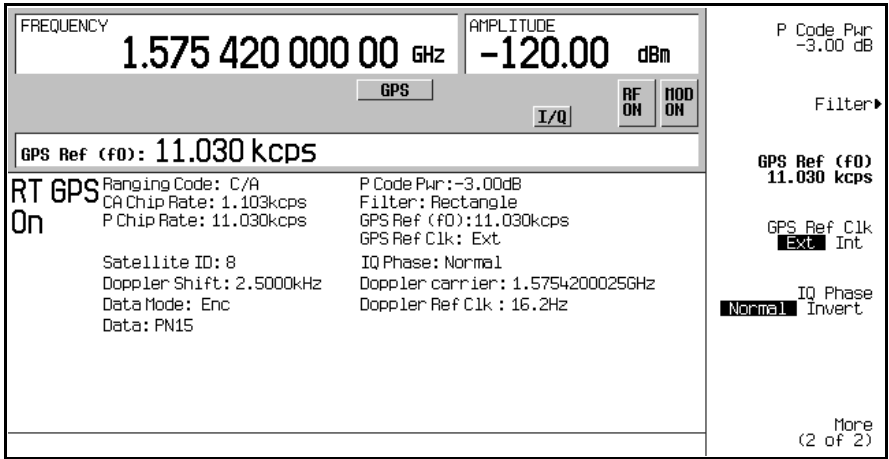

This procedure used an external source as the reference clock signal. The reference frequency was changed from the GPS standard of 10.23 Mcps to 11.03 kcps. This change in the reference signal frequency automatically changed the P and C/A code chip rates. Since the P code chip rate matches the reference frequency, its chip rate is now 11.03 kcps; the C/A code rate is one-tenth of the reference frequency and so is now 1.103 kcps. For more information on the GPS option, refer to “Real Time GPS” on page 364.

## Testing Receiver Sensitivity

Refer to [Figure 11-8](#).

1. Connect the cables between the receiver and the ESG as shown in [Figure 11-8](#).

**Figure 11-8** Setup for a Receiver Sensitivity Test

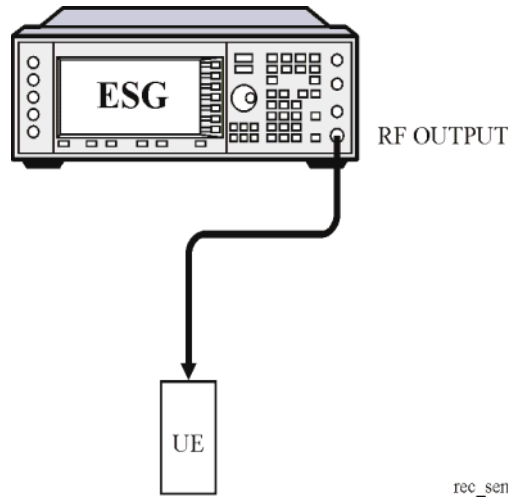

2. Set the GPS data mode to TLM.
3. Set the power level on the ESG.
4. Set the L-band frequency on the ESG.
5. Set up the UE (user equipment) to receive the signal from the ESG.
6. Turn on the GPS personality and the RF output on the ESG.

## **Setting Up a GPS Bit Error Rate Test**

This section shows how to make GPS BER measurements using the ESG Signal Generator with Option UN7.

The following procedures explain how to set up the ESG for making BER measurements:

- [“Connecting the Test Equipment” on page 375](#)
- [“Setting the Carrier Frequency and Power Level” on page 375](#)
- [“Selecting the Data Format” on page 376](#)
- [“Setting Up the GPS Receiver” on page 376](#)
- [“Selecting the BERT Data Pattern and Total Bits” on page 376](#)
- [“Selecting the BERT Trigger” on page 377](#)
- [“Starting BERT measurements” on page 377](#)

### **Required Equipment**

The following equipment is required to make BER measurements.

- ESG Signal Generator, model E4438C with Options 001/601 or 002/602, 409, and UN7
- an external controller to control the receiver under test
- a 20dB attenuator
- a level-matching circuit between the receiver under test and the signal generator when the receiver signal specifications are different from those of the signal generator

### Connecting the Test Equipment

1. Connect the cables between your receiver and the ESG as shown in [Figure 11-9](#):

**Figure 11-9 Setup for a GPS Bit Error Rate Test**

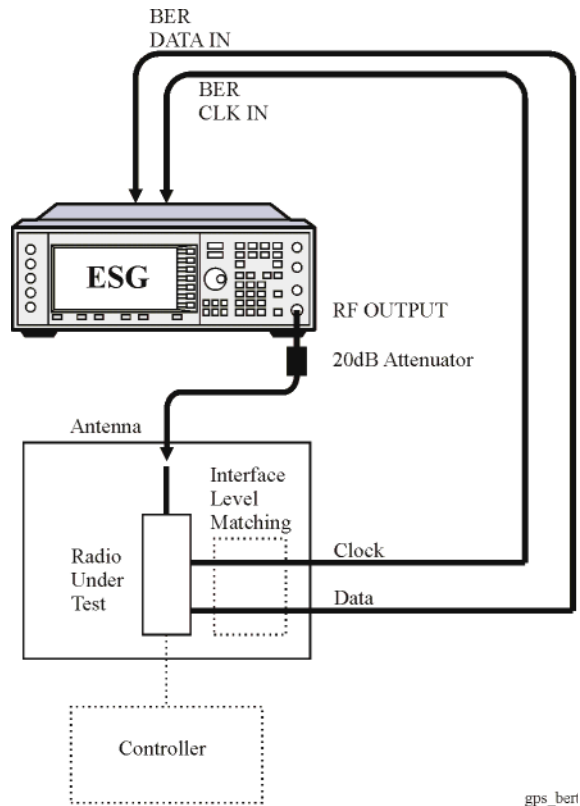

### Setting the Carrier Frequency and Power Level

1. Press the **Preset** hardkey.
2. Press the **Frequency** hardkey. Using the numeric keypad, set the signal generator RF output carrier frequency to 1.57542 GHz.
3. Press the **Amplitude** hardkey. Using the numeric keypad, set the signal generator RF output amplitude to  $-135$  dBm.

## Real Time GPS

### Selecting the Data Format

1. Press **Mode > More (1 or 2) > GPS > Real Time GPS**.
2. Ensure that Raw is the selected data mode.  
If Raw is not the current data mode, press **Data Mode Raw Enc TLM** to Raw.
3. Ensure that PN9 is the selected data sequence.  
If PN9 is not the current data sequence, press **Data > PN Sequence > PN9**.
4. Press **Real-time GPS Off On** to On.
5. Press **RF On/Off** to toggle the RF output on.

The modulated signal is now available at the RF OUTPUT connector. Notice that the display annunciators for GPS and I/Q are on and the display annunciator RF OFF has changed to RF ON.

### Setting Up the GPS Receiver

Setup the GPS receiver to accept the carrier frequency and output the data and clock signal used for the bit error rate measurements.

### Selecting the BERT Data Pattern and Total Bits

1. Access the BERT function.

#### For an ESG with Option UN7 Installed

Press **Aux Fctn > BERT > Configure BERT**.

#### For an ESG with Options UN7 and 300 Installed

Press **Aux Fctn > BERT > Baseband BERT > Configure BERT**.

If the **Data** softkey does not show that PN9 is the selected data pattern, press **Data > PN9**.

The selected PN sequence must match the data PN sequence used on the channel being measured. For example if the DCH (DTCH) is using PN9 data, then the data selection in the BERT function must also be PN9.

2. Press **Total Bits > 1000 > Bits**.  
1000 bits at 50 bps takes 20 seconds to test.



### Selecting the BERT Trigger

1. Press **Return** > **Configure Trigger**.

If the **BERT Trigger** softkey does not show **Trigger Key** as the selected trigger, press **BERT Trigger** > **Trigger Key**.

2. Press **Return** > **BERT Off On** to On.

### Starting BERT measurements

Press the front panel **Trigger** hardkey to start the BER measurement. You will see the measurement result values of the Total Bits, Error Bits, and BER on the signal generator display.

---

#### NOTE

If you encounter problems making a BER measurement, check the following:

- Confirm that the cables are properly connected.
  - Confirm that the data pattern for the BER measurement, specified by the **Data** softkey, matches the data pattern of the receiver under test.
  - Confirm that the data mode selected for the BER measurement is Raw.
  - Confirm that the RF is turned on.
  - Make sure that the amplitude is set to the correct level.
  - Confirm that the receiver under test is controlled to receive the signal of the specified carrier frequency.
  - Confirm that the chip rate of the external source matches the chip rate set using the **GPS Ref (f0)** softkey.
-



---

## **12 Multitone Waveform Generator (Options 001/601 or 002/602)**

The following list shows the topics covered in this chapter.

- [“Creating a Custom Multitone Waveform” on page 380](#)
- [“Applying Changes to an Active Multitone Signal” on page 382](#)

## Creating a Custom Multitone Waveform

Using the `Multitone Setup` table editor, you can define, modify and store user-defined multitone waveforms. Multitone waveforms are generated by the dual arbitrary waveform generator.

This section teaches you how to perform the following tasks:

- “Initializing the Multitone Setup Table Editor” on page 380
- “Configuring Tone Powers and Tone Phases” on page 380
- “Removing a Tone” on page 380
- “Generating the Waveform” on page 381
- “Configuring the RF Output” on page 381

### Initializing the Multitone Setup Table Editor

1. Press **Preset**.
2. Press **Mode > More (1 of 2) > Multitone**
3. Press **Initialize Table > Number of Tones > 5 > Enter**.
4. Press **Freq Spacing > 20 > kHz**.
5. Press **Done**.

You now have a multitone setup with five tones spaced 20 kHz apart. The center tone is placed at the carrier frequency, while the other four tones are spaced in 20 kHz increments from the center tone.

### Configuring Tone Powers and Tone Phases

1. Highlight the value (0 dB) in the `Power` column for the tone in row 2.
2. Press **Edit Item > -4.5 > dB**.
3. Highlight the value (0) in the `Phase` column for the tone in row 2.
4. Press **Edit Item > 123 > deg**.

### Removing a Tone

1. Highlight the value (On) in the `State` column for the tone in row 4.
2. Press **Toggle State**.

## **Generating the Waveform**

Press **Multitone Off On** until On is highlighted.

This generates the multitone waveform with the parameters defined in the previous sections. During waveform generation, the M-TONE and I/Q annunciators activate and the multitone waveform is stored in volatile ARB memory. The waveform is now modulating the RF carrier.

## **Configuring the RF Output**

1. Set the RF output frequency to 100 MHz.
2. Set the output amplitude to 0 dBm.
3. Press **RF On/Off**.

The multitone waveform is now available at the signal generator's RF OUTPUT connector.

## Applying Changes to an Active Multitone Signal

If the multitone generator is currently in use (**Multitone Off On** set to On) while changes are made in the `Multitone Setup` table editor, you must *apply* the changes before the updated waveform will be generated.

From the `Multitone Setup` table editor, press the following key to apply the changes and generate a multitone waveform based on the updated values:

**Apply Multitone**

### Storing a Multitone Waveform

In this example, you learn how to store a multitone waveform. If you have not created a multitone waveform, complete the steps in the previous section, “[Creating a Custom Multitone Waveform](#)” on [page 380](#).

1. Press **More (1 of 2) > Load/Store > Store To File**.

If there is already a file name from the `Catalog of MTONE Files` occupying the active entry area, press the following keys:

**Edit Keys > Clear Text**

2. Enter a file name (for example, 5TONE) using the alpha keys and the numeric keypad with a maximum length of 23 characters.
3. Press **Enter**.

The multitone waveform is now stored in the `Catalog of MTONE Files`.

---

**NOTE** The RF output amplitude, frequency, and operating state settings are not stored as part of a multitone waveform file.

---

## Recalling a Multitone Waveform

Using this procedure, you learn how to recall a multitone waveform from the signal generator's memory catalog.

If you have not created and stored a multitone waveform, complete the steps in the previous sections, [“Creating a Custom Multitone Waveform” on page 380](#) and [“Storing a Multitone Waveform” on page 382](#), then preset the signal generator to clear the stored multitone waveform from volatile ARB memory.

1. Press **Mode > Multitone**.
2. Press **More (1 of 2) > Load/Store**.
3. Highlight the desired file (for example, 5TONE).
4. Press **Load From Selected File > Confirm Load From File**.
5. Press **More (2 of 2) > Multitone Off On** until On is highlighted.

The firmware generates the multitone waveform in ARB memory. After waveform generation, the multitone waveform is available to be modulated on the RF output.

For instruction on configuring the RF output, see [“Configuring the RF Output” on page 381](#).

Multitone Waveform Generator (Options 001/601 or 002/602)

**Applying Changes to an Active Multitone Signal**



---

## **13 Custom Digital Modulation (Options 001/601 or 002/602)**

The following list shows the topics covered in this chapter:

- [“Using the Arbitrary Waveform Generator” on page 386](#)
- [“Using the Real Time I/Q Baseband Generator” on page 392](#)

## Using the Arbitrary Waveform Generator

This section teaches you how to build dual arbitrary (ARB) waveform generated custom TDMA digital modulation for testing component designs.

Custom ARB digital modulation creates waveforms using modulation types, filtering, symbol rates, and other parameters defined by digital communications standards. These waveforms are formatted as unframed data.

### Using Predefined Custom TDMA Digital Modulation

This section teaches you how to perform the following tasks:

- [“Selecting a Predefined EDGE Setup” on page 386](#)
- [“Generating the Waveform” on page 386](#)
- [“Configuring the RF Output” on page 386](#)

#### Selecting a Predefined EDGE Setup

1. Press **Preset**.
2. Press **Mode > Custom > ARB Waveform Generator**.
3. Press **Setup Select > EDGE**.

#### Generating the Waveform

Press **Digital Modulation Off On**.

This generates a waveform with the pre-defined EDGE state selected in the previous section. The display changes to **Dig Mod Setup: EDGE**. During waveform generation, the **DIGMOD** and **I/Q** annunciators appear and the pre-defined digital modulation state is stored in volatile memory (WFM1). The waveform is now modulating the RF carrier.

#### Configuring the RF Output

1. Set the RF output frequency to 891 MHz.
2. Set the output amplitude to -5 dBm.
3. Press **RF On/Off**.

The predefined EDGE signal is now available at the signal generator’s RF OUTPUT connector.

## Creating a Custom TDMA Digital Modulation State

In this procedure, you learn how to set up a single-carrier NADC digital modulation with customized modulation type, symbol rate, and filtering.

This section teaches you how to perform the following tasks:

- [“Selecting a Digital Modulation Setup” on page 387](#)
- [“Modifying the Modulation Type and Symbol Rate” on page 387](#)
- [“Modifying the Filter” on page 387](#)
- [“Configuring the RF Output” on page 388](#)

### Selecting a Digital Modulation Setup

1. Press **Preset**.
2. Press **Mode > Custom > ARB Waveform Generator**.
3. Press **Setup Select > NADC**.

### Modifying the Modulation Type and Symbol Rate

1. Press **Digital Mod Define > Modulation Type > PSK > QPSK and OQPSK > QPSK**.
2. Press **Symbol Rate > 56 > ksps**.

### Modifying the Filter

1. Press **Filter > Select > Nyquist**.
2. Press **Return > Return**.

### Generating the Waveform

Press **Digital Modulation Off On**.

This generates a waveform with the custom single-carrier NADC digital modulation state created in the previous sections. The display changes to **Dig Mod Setup: NADC (Modified)**. During waveform generation, the **DIGMOD** and **I/Q** annunciators appear and the custom single-carrier digital modulation state is stored in volatile memory. The waveform is now modulating the RF carrier.

For instructions on storing this custom single-carrier NADC digital modulation state to non-volatile memory catalog, see [“Storing a Custom TDMA Digital Modulation State” on page 388](#).

## Using the Arbitrary Waveform Generator

### Configuring the RF Output

1. Set the RF output frequency to 835 MHz.
2. Set the output amplitude to 0 dBm.
3. Press **RF On/Off**.

The user-defined NADC signal is now available at the RF OUTPUT connector.

### Storing a Custom TDMA Digital Modulation State

Using this procedure, you learn how to store a custom digital modulation state and a custom multicarrier digital modulation state to non-volatile memory.

If you have not created a custom single-carrier digital modulation state, complete the steps in the previous section, “[Creating a Custom TDMA Digital Modulation State](#)” on page 387.

1. Return to the top-level Digital Modulation menu, where **Digital Modulation Off On** is the first softkey.
2. Press **Digital Mod Define > Store Custom Dig Mod State > Store To File**.

If there is already a file name from the Catalog of DMOD Files occupying the active entry area, press the following keys:

**Edit Keys > Clear Text**

3. Enter a file name (for example, NADCQPSK) using the alpha keys and the numeric keypad with a maximum length of 23 characters.
4. Press **Enter**.

The user-defined single-carrier digital modulation state is now stored in non-volatile memory.

---

**NOTE** The RF output amplitude, frequency, and operating state settings are not stored as part of a user-defined digital modulation state file.

---

### Recalling a Custom TDMA Digital Modulation State

Using this procedure, you learn how to recall a custom digital modulation state from signal non-volatile memory.

If you have not created and stored a user-defined single-carrier digital modulation state, complete the steps in the previous sections, “[Creating a Custom TDMA Digital Modulation State](#)” on page 387 and “[Storing a Custom TDMA Digital Modulation State](#)” on page 388, then preset the signal generator to clear the stored user-defined digital modulation waveform from volatile ARB memory.

1. Press **Mode > Custom > ARB Waveform Generator**.

2. Press **Setup Select > More (1 of 2) > Custom Digital Mod State**.
3. Highlight the desired file (for example, NADCQPSK).
4. Press **Select File**.
5. Press **Digital Modulation Off On** until On is highlighted.

The firmware generates the custom digital modulation waveform in volatile memory. After waveform generation, the custom digital modulation waveform is available to be modulated on the RF output.

For instruction on configuring the RF output, see [“Configuring the RF Output” on page 388](#).

## Creating a Custom Multicarrier TDMA Digital Modulation State

In this procedure, you learn how to customize a predefined multicarrier digital modulation setup by creating a custom 3-carrier EDGE digital modulation state.

This section teaches you how to perform the following tasks:

- [“Creating a Multicarrier Digital Modulation Setup” on page 389](#)
- [“Modifying Carrier Frequency Offset” on page 389](#)
- [“Modifying Carrier Power” on page 390](#)
- [“Generating the Waveform” on page 386](#)
- [“Configuring the RF Output” on page 390](#)

## Creating a Multicarrier Digital Modulation Setup

1. Press **Preset**.
2. Press **Mode > Custom > Arb Waveform Generator**.
3. Press **Multicarrier Off On**.
4. Press **Multicarrier Define > Initialize Table > Carrier Setup > EDGE > Done**.

## Modifying Carrier Frequency Offset

1. Highlight the **Freq Offset** value (500.000 kHz) for the carrier in row 2.
2. Press **Edit Item > -625 > kHz**.

**Using the Arbitrary Waveform Generator**

**Modifying Carrier Power**

1. Highlight the Power value (0.00 dB) for the carrier in row 2.
2. Press **Edit Item > -10 > dB**.

You now have a custom 2-carrier EDGE waveform with a carrier at a frequency offset of -625 kHz and a power level of -10.00 dBm, as shown in the following figure.

Carrier	Freq Offset	Power
1	EDGE	0.00 dB
2	EDGE	-10.00 dB
3	-----	-----

**Generating the Waveform**

Press **Return > Digital Modulation Off On**.

This generates a waveform with the custom multicarrier EDGE state created in the previous sections. The display changes to **Dig Mod Setup: Multicarrier (Modified)**. During waveform generation, the DIGMOD and I/Q annunciators appear and the new custom multicarrier EDGE state is stored in volatile memory. The waveform is now modulating the RF carrier.

For instructions on storing this custom multicarrier EDGE state to non-volatile memory, see [“Storing a Custom Multicarrier TDMA Digital Modulation State” on page 391](#).

**Configuring the RF Output**

1. Set the RF output frequency to 890.01 MHz.
2. Set the output amplitude to -10 dBm.
3. Press **RF On/Off**.

The custom multicarrier EDGE signal is now available at the RF OUTPUT connector.

## Storing a Custom Multicarrier TDMA Digital Modulation State

Using this procedure, you learn how to store a custom multicarrier TDMA digital modulation state to non-volatile memory.

If you have not created a custom multicarrier digital modulation state, complete the steps in the previous section, “[Creating a Custom Multicarrier TDMA Digital Modulation State](#)” on page 389.

1. Return to the top-level Digital Modulation menu, where **Digital Modulation Off On** is the first softkey.
2. Press **Multicarrier Define > More (1 of 2) > Load/ Store > Store To File**.

If there is already a file name from the Catalog of MDMOD Files occupying the active entry area, press the following keys:

**Edit Keys > Clear Text**

3. Enter a file name (for example, EDGEM1) using the alpha keys and the numeric keypad with a maximum length of 23 characters.
4. Press **Enter**.

The user-defined multicarrier digital modulation state is now stored in non-volatile memory.

---

**NOTE** The RF output amplitude, frequency, and operating state settings are not stored as part of a user-defined digital modulation state file.

---

## Applying Changes to an Active Multicarrier TDMA Digital Modulation State

If the digital modulation format is currently in use (**Digital Modulation Off On** set to On) while changes are made in the `Multicarrier Setup` table editor, you must apply the changes before the updated waveform will be generated.

From the `Multicarrier Setup` table editor, press **Apply Multicarrier** to apply the changes and generate a new custom multicarrier digital modulation waveform based on the updated values.

## Using the Real Time I/Q Baseband Generator

The custom real-time format enables you to create unframed digital modulation with user-defined data, filtering, symbol rate, modulation type, burst shape, differential data encoding, and other format parameters.

You can choose a predefined mode where filtering, symbol rate and modulation type are defined by the digital modulation standard, or a user-defined custom modulation.

### Selecting Predefined Custom Modulation Modes

1. Press **Preset**.
2. Press **Mode > Custom > Real Time I/Q Base Band**.
3. Press **More (1 of 3) > More (2 of 3) > Predefined Mode > APCO 25 w/C4FM**.
4. Press **More (3 of 3)**.

This selects a predefined mode where filtering, symbol rate and modulation type are defined by the APCO 25 w/C4FM digital modulation standard and returns you to the top-level custom modulation menu. To configure data, burst shape, and differential data encoding parameters, see the next section, “[Creating User-Defined Custom Modulation](#).”

To output this predefined custom modulation, complete the steps in “[Generating the Waveform](#)” on page 394 and “[Configuring the RF Output](#)” on page 394.

---

#### NOTE

To deselect a predefined mode, press the following keys:

**Mode > Custom > Real Time I/Q Base Band > More (1 of 3) > More (2 of 3) > Predefined Mode > None**

---



## Creating User-Defined Custom Modulation

This section teaches you how to perform the following tasks:

- “Selecting Data” on page 393
- “Configuring the Filter” on page 393
- “Selecting a Symbol Rate” on page 393
- “Selecting the Modulation Type” on page 393
- “Configuring the Burst Rise and Fall Parameters” on page 394
- “Activating Differential Data Encoding” on page 394
- “Generating the Waveform” on page 394
- “Configuring the RF Output” on page 394

### Selecting Data

1. Press **Preset**.
2. Press **Mode > Custom > Real Time I/Q Base Band > Data > FIX4**.
3. Press **1010 > Enter > Return**.

### Configuring the Filter

1. Press **Filter > Select > Gaussian**.
2. Press **Filter BbT**.
3. Press **.45 > Enter > Return**.

### Selecting a Symbol Rate

1. Press **Symbol Rate**.
2. Press **25 > ksps > Return**.

### Selecting the Modulation Type

Press **Modulation Type > Select > QAM > 32QAM > Return**.

For information on user-defined I/Q mapping, see “User-Defined I/Q Maps” on page 183. For information on user-defined FSK modulation, see “User-Defined FSK Modulation” on page 187.

## Using the Real Time I/Q Baseband Generator

### Configuring the Burst Rise and Fall Parameters

1. Press **Burst Shape > Rise Time**.
2. Press **5.202 > bits**.
3. Press **Rise Delay > .667 > bits**.
4. Press **Fall Time > 4.8 > bits**.
5. Press **Fall Delay > .667 > bits**.

This configures the burst shape for the custom real-time I/Q baseband digital modulation format. For instructions on creating and applying user-defined burst shape curves, see [“Using Customized Burst Shape Curves” on page 161](#).

### Activating Differential Data Encoding

Press **Return**.

Press **More (1 of 3) > Diff Data Encode Off On**.

This activates differential data encoding for the current real-time I/Q baseband digital modulation format. For more information, see [“Differential Encoding” on page 175](#).

To generate and output the custom digital modulation, complete the steps in the following sections.

### Generating the Waveform

Press **More (2 of 3) > More (3 of 3)**

Press **Custom Off On** until On is highlighted.

This generates the custom real-time I/Q baseband waveform with the parameters defined in the previous sections. During waveform generation, the CUSTOM and I/Q annunciators activate and the custom waveform is stored in pattern RAM. The waveform is now modulating the RF carrier.

### Configuring the RF Output

1. Set the RF output frequency to 500 MHz.
2. Set the output amplitude to 0 dBm.
3. Press **RF On/Off**.

The custom real-time I/Q baseband waveform is now available at the signal generator’s RF OUTPUT connector.

---

# 14 Real Time TDMA Formats (Option 402)

In the following sections, this chapter provides the following information. This option is only available in E4438C ESG Vector Signal Generators with Option 001/601 or 002/602.

This chapter contains procedures on operating the real-time TDMA formats. The ESG generates the modulation for these formats using the ESG's internal baseband generator. The following list shows the topics covered in this chapter:

- “EDGE Framed Modulation” on page 396
- “GSM Framed Modulation” on page 400
- “Enhanced Observed Time Difference (E-OTD)” on page 402
- “DECT Framed Modulation” on page 415
- “PHS Framed Modulation” on page 417
- “PDC Framed Modulation” on page 419
- “NADC Framed Modulation” on page 421
- “TETRA Framed Modulation” on page 423

## EDGE Framed Modulation

This section describes how to build framed, real-time I/Q baseband generated EDGE and GMSK modulation for testing receiver designs. Each timeslot provides the flexibility of changing from the current modulation type to a GMSK modulation. The GMSK timeslot selection provides a normal GSM timeslot. The procedures in this section build on each other, so perform them sequentially.

For optimizing signal integrity when using EDGE and GMSK timeslots together, use the 3GPP standard settings supported by the ESG for the EDGE timeslots. Modifying the standard settings can affect the proper operation of the combined timeslots. For example, changing the EDGE filter can cause undesirable frame alignment. While you can change the EDGE modulation type when you have both EDGE and GMSK timeslots, changing the modulation type does not change the GMSK timeslot modulation.

---

**NOTE** When using EDGE and GMSK, or multiframe EDGE, limit the symbol rate to no more than 271 ksps. Although higher rates may work, they are not supported.

---

To build only a GSM signal, see “[GSM Framed Modulation](#)” on page 400.

## Understanding External Data Connections

---

**NOTE** The external data selection is not a choice for a GMSK timeslot. When GMSK timeslots are part of the signal, the **Ext** data selection for EDGE timeslots is unavailable.

---

The ESG provides various timeslot data selections. One of these selections, the **Ext** softkey, provides the capability to use an external data signal connected to the front panel DATA connector. There are two ways to time the external data, by a bit clock or a symbol synchronization signal. Select the timing option with the **Ext Data Clock Normal Symbol** softkey.

The Normal choice notifies the ESG that the data timing is done at the *bit* level using an external data clock. Connect the data clock signal to the front panel BNC connector labeled DATA CLOCK. In addition to the data clock timing signal, connect a single or continuous pulsed symbol synchronization signal to the front panel BNC connector labeled SYMBOL SYNC. The symbol synchronization signal aligns the first symbol in the transmission.

The Symbol choice notifies the ESG that the data timing is done at the *symbol* level using an external symbol synchronization signal. Connect a continuous pulsed synchronization signal to the front panel BNC connector labeled SYMBOL SYNC. There is no data clock connection.

## Activating Framed Data Format

1. Press **Preset**.
2. Press **Mode > Real Time TDMA > EDGE > Data Format Pattern Framed**.

## Configuring the EDGE Timeslots

1. Press **Configure Timeslots > Timeslot Type > Custom**.
2. Press **Configure Custom > Data > FIX4**.
3. Press **1010 > Enter > Return > Return**.
4. Press **Timeslot # > 1 > Enter**.
5. Press **Configure Timeslots > Timeslot Type > Normal**.
6. Press **Configure Normal > TS > TSC1 > Return**.
7. Press **Timeslot Off On** to On.

Configuring timeslot zero did not require a timeslot selection, because timeslot zero is the factory preset timeslot selection. This is shown in step one where the timeslot type selection happened without first selecting the timeslot number. Notice that a data selection (FIX4) was made for timeslot zero, but that none was made for timeslot one. This means that timeslot one will use the default data selection of PN9.

## Configuring GSMK Timeslots

1. Press **Timeslot # > 2 > Enter**.
2. Press **Timeslot Type > GSMK**.
3. Press **Configure GSMK > E > PN Sequence > PN15**.
4. Press **TS > TSC2 > Return**.
5. Press **Timeslot Off On** to On.
6. Press **Timeslot # > 3 > Enter**.
7. Press **Timeslot Type > GSMK**.
8. Press **Configure GSMK > E > Other Patterns > 32 1's & 32 0's**.
9. Press **TS > TSC4 > Return**.
10. Press **Timeslot Off On** to On.

The GSMK timeslot selection provides a normal GSM timeslot. This is the same normal timeslot found in the GSM modulation format.

## Disabling Timeslot Ramping

1. Press **Timeslot # > 2 > Enter**.
2. Press **Multislot Off On** to On.
3. Press **Return**.

Turning multislot on disables ramping between the current and the next higher numbered (adjacent) timeslot. A line underscores the timeslots where ramping is disabled. For this procedure, ramping will not occur between timeslots two and three (GMSK timeslots). The multislot choice is a setting for each timeslot.

---

**NOTE**            Disabling ramping between EDGE and GMSK timeslots produces spectral components that may not be desired. This is due to the transition between the two modulation types without ramping.

---

## Generating the Baseband Signal

Press **EDGE Off On** to On.

This generates an EDGE signal with an active custom timeslot, an active normal timeslot, and two active GMSK modulated timeslots. While the ESG builds the signal, a status bar appears on the display. After the signal building process, the EDGE, ENVLP, and I/Q annunciators appear, indicating that the signal is modulating the RF carrier.

## Configuring the RF Output

1. Press **Frequency > 891 > MHz**.
2. Press **Amplitude > -5 > dBm**.
3. Press **RF On/Off** to On.

The user-defined EDGE signal is now available at the signal generator's RF OUTPUT connector.

To store this real-time I/Q baseband digital modulation state to the instrument state register, see [“Saving an Instrument State” on page 71](#).

To recall a real-time I/Q baseband digital modulation state, see [“Recalling an Instrument State” on page 72](#).

## Adjusting the Power Level Between Timeslots

1. Press **Amplitude > More (1 of 2) > Alternate Amplitude > Alt Amp Delta > -15 > dB**.
2. Press **Mode Setup > Configure Timeslots > Timeslot # > 1 > Enter**.

3. Press **Timeslot Ampl Main Delta** to Delta.

The power level for timeslot one is now 15 dB lower than the other active timeslots. To return the timeslot one to its previous power level, select Main on the **Timeslot Ampl Main Delta** softkey. The delta amplitude choice is available for each timeslot, however all timeslots use the same delta value set in the Alternate Amplitude softkey menu.

## **GSM Framed Modulation**

This section describes how to build framed, real-time I/Q baseband generated GSM modulation for testing receiver designs. The procedures in this section build on each other, so perform them sequentially.

---

**NOTE**            When using multiframe, limit the symbol rate to no more than 271 ksps. Although higher rates may work, they are not supported.

---

To build and EDGE and GMSK modulated signal, see “[EDGE Framed Modulation](#)” on page 396.

### **Activating Framed Data Format**

1. Press **Preset**.
2. Press **Mode > Real Time TDMA > GSM > Data Format Pattern Framed**.

### **Configuring the First Timeslot**

1. Press **Configure Timeslots > Timeslot Type > Access**.
2. Press **Configure Access > E > FIX4**.
3. Press **1010 > Enter > Return > Return**.

### **Configuring the Second Timeslot**

1. Press **Timeslot # > 1 > Enter**.
2. Press **Timeslot Type > Custom**.
3. Press **Configure Custom > Other Patterns > 8 1's & 8 0's**.
4. Press **Timeslot Off On** to On > **Return**.

### **Configuring the Third Timeslot**

1. Press **Timeslot # > 2 > Enter**.
2. Press **Timeslot Type > Normal**.
3. Press **Configure Normal > E > PN Sequence > PN15**.
4. Press **Timeslot Off On** to On > **Return**.



## Disabling Timeslot Ramping

1. Press **Timeslot # > 1 > Enter**.
2. Press **Multislot Off On** to On.
3. Press **Return**.

Turning multislot on disables ramping between the current and the next higher numbered (adjacent) timeslot. A line underscores the timeslots where ramping is disabled. For this procedure, ramping will not occur between timeslots one and two. The multislot choice is a setting for each timeslot.

## Generating the Baseband Signal

Press **GSM Off On** to On.

This generates a GSM signal with an active access timeslot, an active custom timeslot, and an active normal timeslot. The signal generator may require several seconds to build the signal. During this time, **Baseband Reconfiguring** appears on the display. After the reconfiguration is complete, the display reads **GSM On** and the **GSM**, **ENVLP**, and **I/Q** annunciators appear indicating that the signal is modulating the RF carrier.

## Configuring the RF Output

1. Set the RF output frequency to 891 MHz.
2. Set the output amplitude to -5 dBm.
3. Press **RF On/Off** to On.

The user-defined GSM signal is now available at the signal generator's RF OUTPUT connector.

To store this real-time I/Q baseband digital modulation state to the instrument state register, see [“Saving an Instrument State” on page 71](#).

To recall a real-time I/Q baseband digital modulation state, see [“Recalling an Instrument State” on page 72](#).

## Adjusting the Power Level Between Timeslots

1. Press **Amplitude > More (1 of 2) > Alternate Amplitude > Alt Amp Delta > -15 > dB**.
2. Press **Mode Setup > Configure Timeslots > Timeslot # > 1 > Enter**.
3. Press **Timeslot Ampl Main Delta** to Delta.

The power level for timeslot one is now 15 dB lower than the other active timeslots. Selecting **Main** on the **Timeslot Ampl Main Delta** softkey returns the timeslot to its previous power level. The delta amplitude choice is available for each timeslot, however all timeslots use the same delta value set in the **Alternate Amplitude** softkey menu.

## **Enhanced Observed Time Difference (E-OTD)**

### **Overview**

The Enhanced Observed Timing Difference (E-OTD) positioning method relies upon measuring the time at which signals from the Base Transceiver Station (BTS) arrive at two geographically dispersed locations—the mobile phone/station (MS) and a fixed measuring point known as the Location Measurement Unit (LMU) whose location is known. The position of the MS is determined by comparing the time differences between the two sets of timing measurements.

Multiple ESGs are used with a remote interface to provide mobile manufactures the ability to test handsets equipped with the E-OTD feature. The system will simulate a real world network complete with a serving cell (Agilent E5515C (8960 Series 10) Wireless Communications Test Set) and neighboring cells (ESG Vector Signal Generator) that can be used to test E-OTD equipped handsets.

The ESG has no front panel user interface for the E-OTD feature, so signal setup is done using the GPIB interface.

### **Basic GSM Frame Structure**

#### **TDMA Time Slot**

A TDMA frame is composed of eight 577 micro second time slots (0–7). The basic TDMA frame duration is 4.615 msec. Each time slot contains 148 bits of information and contains a guard period of 8.25 bits. This guard period is provided for the mobile station transmission to be attenuated between bursts as defined in the 3GPP standard. Of the 148 bits, some are used to carry data, others are used for control and synchronization. Refer to [Figure 14-1 on page 403](#).

**Figure 14-1**                      **1 TDMA Frame Structure**

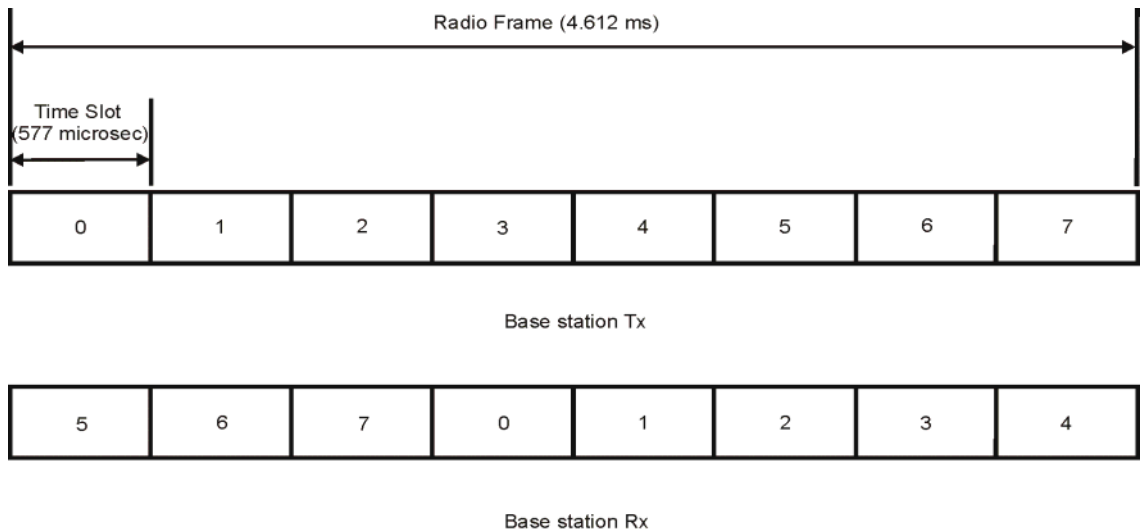

Each time slot when transmitted by the base transceiver station (BTS) or mobile phone station (MS) is a radio burst. There are four types of GSM RF burst. Three of these burst types are in a category called full duration and the fourth type is a short time duration burst. The three full duration bursts are: normal, frequency correction, and synchronization. Both the base station and mobile station use the normal burst. The remaining two sub-types, frequency correction and synchronization, are used only by the base station, and only transmitted on the first time slot (labeled zero). The fourth type is a short burst (88 bits) called the random access burst (RACH) and only used by the mobile station to make connection with the base station. The remaining time is padded with guard bits to keep the timing of a slot consistent.

The frame structure for the base station and mobile station are the same. However, the slot numbers are intentionally offset by three time slots so the mobile station does not have to transmit and receive at the same time. Refer to [Figure 14-1 on page 403](#).

**GSM Multiframe Structure**

The TDMA frames are grouped into larger structures called multiframes. These multiframe structures are necessary to allow the partitioning of physical channels into logical channels.

### **26 Frame Multiframe**

The most basic of GSM multiframe is the traffic channel multiframe. This is made up of 26 frames and has a time interval of 120 msec. Each frame of the 26-frame multiframe has an eight time slot TDMA frame (4.62 msec). The first 12 frames are used to transmit traffic data. Then one frame is used by the Slow Associated Control Channel (SACCH) which provides channel maintenance. Then another 12 frames of traffic data followed by an IDLE frame where not data is sent. This IDLE frame allows the mobile station to perform other tasks such as measuring the signal strength of other neighboring cells. Refer to [Figure 14-2 on page 405](#).

### **51 Frame Multiframe**

The 51-frame multiframe is comprised of 51 TDMA frames and has a duration of 235.4 ms. This multiframe is used for control channels. Control channels always occur on the master frequency in the downlink direction from the BTS to the mobile station. Different formats exist for the makeup of the 51-frame multiframe but for E-OTD, type IV and V are used. The common features of these channels are the frequency correction burst (FCCH), the synchronization burst (SCH), and the broadcast control channel (BCCH). These different channel types allow the mobile station to synchronize to the base station in the frequency domain and the time domain and provide information about the current broadcast channel. Refer to [Figure 14-2 on page 405](#).

### **Superframe**

A superframe is composed of 51 26-frame multiframe or 26 51-frame multiframe which is equal to 1326 frames which is the lowest common denominator and is the least number of frames that can absorb the contents of all the 26 or 51 multiframe and finish with no spare timeslots. Refer to [Figure 14-2 on page 405](#).

### **Hyperframe**

The time interval of the hyperframe is over three hours long which is much longer than the typical telephone connection. The encryption process used is not likely to repeat itself during a call of reasonable length and the privacy is not compromised. The hyperframe is made up of 2048 superframes. Refer to [Figure 14-2 on page 405](#).

Figure 14-2 Multiframe Hierarchy

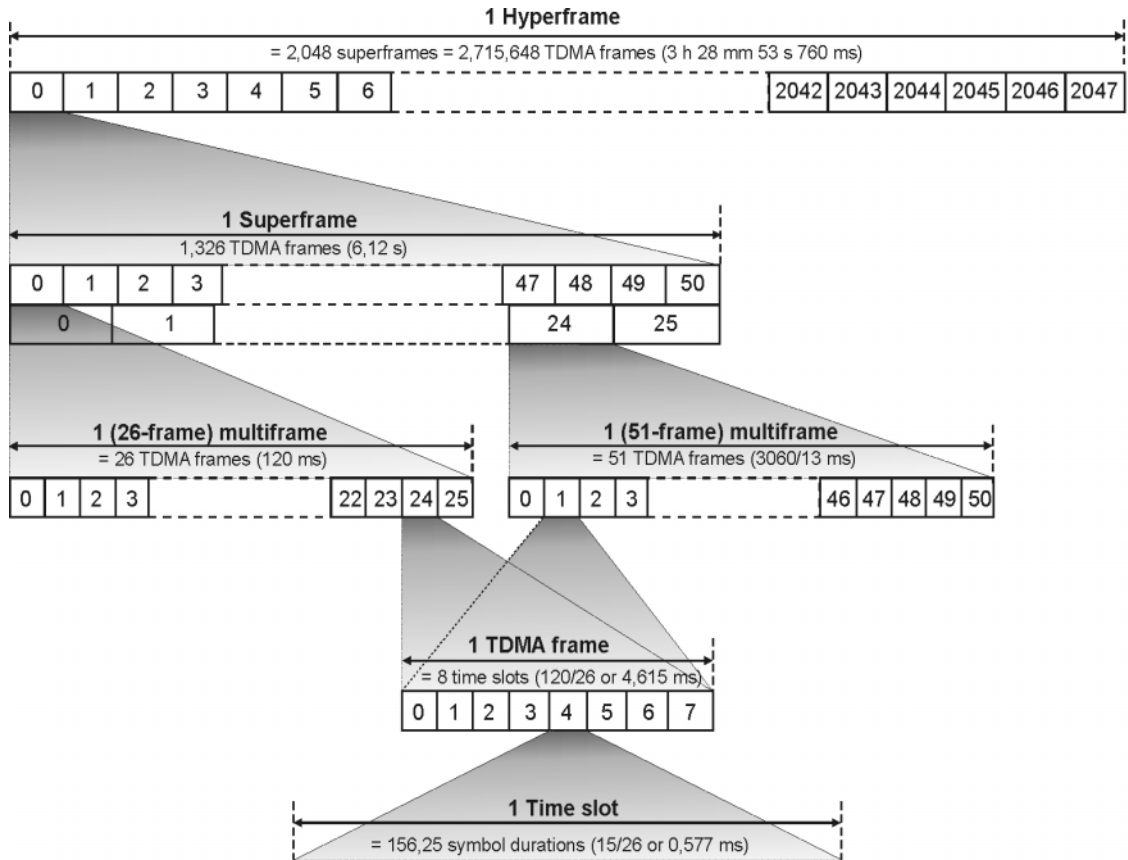

channel\_hierarchy

### Broadcast Channel (BCH)

In a broadcast channel a 51-frame multiframe is transmitted on time slot zero and provides the mobile station with system information which the mobile station needs to gain access to the network. The broadcast channel needs to remain at a constant power so other mobile stations can distinguish the broadcast channels from normal channels. Therefore all eight time slots need to be used during each TDMA frame.



### Broadcast Control Channel (BCCH)

The broadcast control channel (BCCH) informs the mobile station about specific system parameters it needs to identify the network. These messages include among others, Location Area Code (LAC) and the Mobile Network Code (MNC). The BCCH appears once every 51-frame multiframe and lasts for four frames (occurring in frames 2,3,4, and 5). System information messages contain various information for a mobile station and are transmitted on the BCCH at different times. The ESG implementation will include only the system information 3 (SI3) message repeated once per 51-frame multiframe. The SI3 message for the ESG implementation will have four user definable fields and the rest will be fixed. The user definable parameters are cell identity, which identifies a cell within a location area and the location area identification. The location identification is made up of the three parameters listed below:

- MNC**                    The mobile network code consists of 12 bits of data. Normally eight bits are used but for PCS1900 NA, federal regulation mandates that a 3-digit MNC will be used. If two digits are used then the upper 4 bits of the field are fixed to 1111. For the ESG implementation the upper four bits are set to 1111 and the field range is 0–255. This field identifies the network operator.
- LAC**                    The location area code provides 16 bits to allow network administrator to define a location.
- MCC**                    The mobile country code defines the country the base station is in.

The following SCPI commands can be used to modify or query the system information 3 (SI3) user definable parameters:

```
[ :SOURCE]:RADio[1] | 2 | 3 | 4:GSM:SLOT0:NORMAL:ENCRyption:BCH:CELLid <val>  
[ :SOURCE]:RADio[1] | 2 | 3 | 4:GSM:SLOT0:NORMAL:ENCRyption:BCH:CELLid?  
[ :SOURCE]:RADio[1] | 2 | 3 | 4:GSM:SLOT0:NORMAL:ENCRyption:BCH:MNC <val>  
[ :SOURCE]:RADio[1] | 2 | 3 | 4:GSM:SLOT0:NORMAL:ENCRyption:BCH:MNC?  
[ :SOURCE]:RADio[1] | 2 | 3 | 4:GSM:SLOT0:NORMAL:ENCRyption:BCH:MCC <val>  
[ :SOURCE]:RADio[1] | 2 | 3 | 4:GSM:SLOT0:NORMAL:ENCRyption:BCH:MCC?  
[ :SOURCE]:RADio[1] | 2 | 3 | 4:GSM:SLOT0:NORMAL:ENCRyption:BCH:LAC <val>  
[ :SOURCE]:RADio[1] | 2 | 3 | 4:GSM:SLOT0:NORMAL:ENCRyption:BCH:LAC?
```

### E-OTD Measurement System Synchronization

To allow an Enhanced Observed Time Difference (E-OTD) measurement to be made it is important that all the instruments in the system are synchronized. To do this a PSA is used to measure the time from the trigger pulse to TO - where TO is defined as the middle of the training sequence. The ESG will always produce RF quicker than the PSA due to a built in delay for the ESG.

Below is an equipment diagram and SCPI command procedure to measure the trigger to TO (TO = middle of the midamble of a burst) measurement. Some of the SCPI commands used in this procedure to set up the instruments and make the measurements do not have a front panel equivalent key press. The features are only available using the remote GPIB interface.

Figure 14-4

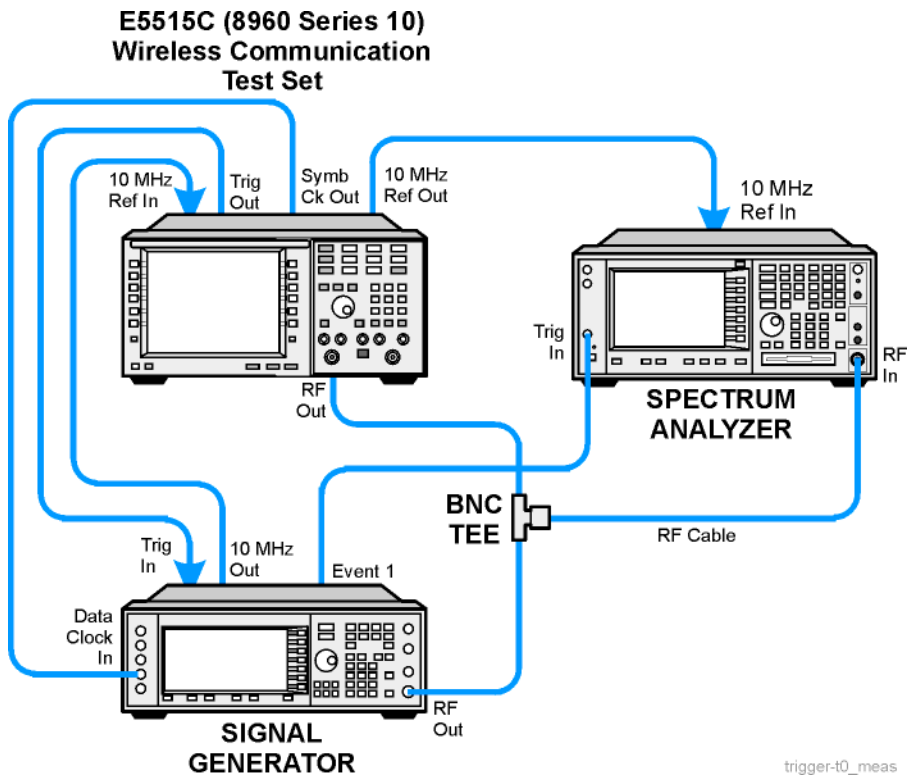



### GPIB commands to set up the ESG.

```
//Select Frequency band, channel, and power.  
  
:FREQuency:CHANnells:BAND BPGSm  
:FREQuency:CHANnells:NUMBer 40  
:FREQuency:CHANnells:STAtE ON  
:POWer:LEVel:IMMediate:AMPLitude -10DBM  
:OUTPut ON
```

```
//Select external data clock for GSM.
```

```
:RADio:GSM:BBCLock EXT  
:RADio:GSM:SLOT0:NORMAl:ENCRyption PN9  
:RADio:GSM:BURSt ON  
:RADio:GSM:SLOT0:STAtE ON
```

```
//Select triggering
```

```
:RADio:GSM:TRIGger:TYPE:SING  
:RADio:GSM:TRIGger:EXT  
:RADio:GSM:TRIGger:EXTernal:SOURce EPT1
```

```
//Turn on GSM modulation.
```

```
:RADio:GSM ON
```

### GPIB commands to set up the 8960.

```
:CALL:OPER:MODE GBTT  
:CALL:BCH 120  
:CALL:TCH 1  
:CALL:POW -10  
:CALL:TCH:TSL 2  
:CALL:TRIG:FRAM:NIDL:STAT ON
```

The 8960 is now generation a broadcast channel (BCH) on absolute radio frequency channel number (ARFCN) 120, a traffic channel (TCH) on ARFCN 1, and is sending out a trigger pulse for every frame not idle. The ESG is being triggered to generate a single slot traffic channel on this trigger. In this mode, it is important that the symbol clock from the 8960 is used as the source for the external data clock on the ESG. This is important because the two instruments need to have their clocks aligned or the triggering can be delayed up to 3.69 microseconds. Using the symbol clock from the 8960 as a data clock for the ESG ensures synchronous operation.

## Real Time TDMA Formats (Option 402)

### Enhanced Observed Time Difference (E-OTD)

To make the trigger to TO measurement it is necessary to send the following command using the remote interface:

```
:READ:PVT10?
```

The READ command performs an INIT followed by a FETCH so a new measurement is started each time. With no averaging the standard deviation should be approximately 4ns for the ESG and 9ns for the 8960.

For this set up the ESG uses a continuous triggering mode, trigger and run. In this mode the ESG waits for a trigger pulse, then runs and ignores any further trigger pulses.

//Send the following commands to set the trigger mode:

```
:RADIo:GSM:TRIGger:TYPE:CONTinuous TRIG  
:RADIo:GSM:TRIGger EXT  
:RADIo:GSM:TRIGger:TYPE CONT
```

//The ESG is set up to have a non-combined BCH in slot 0 and a normal TCH on slot 2

```
:RADIo:GSM:SLOT0:NORMal ENCRyption BCH1  
:RADIo:GSM:SLOT2:TYPE:NORMal  
:RADIo:GSM:SLOT2:NORMal:ENCRyption PN9
```

At this point the ESG is waiting for a trigger. Sending a CALL statement to the 8960 resets the frame counters and sets a single trigger at the beginning of the multiframe. Now both the 8960 and the ESG are running together but not perfectly aligned.

```
:CALL:TRIG:OUTP:FRAM:SYNC
```

Measure the trigger to TO for each. If the 8960 is the first burst then it is necessary to restart the system with a symbol offset applied to the trigger.

Send the following commands to make the ESG ready and align the ESG with the 8960:

```
:RADIo:GSM:TRIGger:TYPE:CONT  
:CALL:TRIG:FRAM:SYNC:OFFS xx (where xx is the number of symbols to advance the trigger)  
:RADIo:GSM:TRIG:EXT:DEL:FINE yy (where yy is the fraction of a symbol necessary for perfect alignment)
```

The last command is a call to the 8960 to start up again. Now both bursts should be in alignment and the frame counters reset.

```
:CALL:TRIG:OUTP:FRAM:SYNC
```

## Sample SCPI Command Scripts

This section has two scenarios in which SCPI commands are used to setup the ESG to transmit a Broadcast Channel (BCH).

### Example 1, Setting Up a Non-Combined Broadcast Channel

This example will setup the ESG to generate a Non-Combined Broadcast Channel at 935.2 MHz with a power level of  $-10$  dBm. A public land mobile network (PLMN) value of 2 will be chosen and a base station colour code (BCC) value of 3 will be set. The trigger will be setup in “trigger and run” mode which means that the ESG will start generating a BCH on receipt of the first trigger and any further triggers will be ignored. The trigger will be setup to use the external pattern trigger 1.

Reset the ESG to its power on state.

```
*RST
```

Select the frequency band, channel and power.

```
:FREQuency:CHANnels:BAND BPGSm
:FREQuency:CHANnels:NUMBer 1
:FREQuency:CHANnels:STATe ON
:POWer:LEVel:IMMediate:AMPLitude -10dBm

:RADio:GSM:BURSt:STATe ON
:RADio:GSM:SLOT0:NORMal:ENCRyption BCH1
:RADio:GSM:SLOT1:DUMMy:TSEquence #H1C5C5C5
:RADio:GSM:SLOT2:NORMal:ENCRyption PN9
:RADio:GSM:SLOT3:NORMal:ENCRyption PN9
:RADio:GSM:SLOT4:NORMal:ENCRyption PN9
:RADio:GSM:SLOT5:NORMal:ENCRyption PN9
:RADio:GSM:SLOT6:NORMal:ENCRyption PN9
:RADio:GSM:SLOT7:NORMal:ENCRyption PN9
:RADio:GSM:SLOT0:TYPe NORMal
:RADio:GSM:SLOT1:TYPe DUMMy
:RADio:GSM:SLOT2:TYPe NORMal
:RADio:GSM:SLOT3:TYPe NORMal
:RADio:GSM:SLOT4:TYPe NORMal
:RADio:GSM:SLOT5:TYPe NORMal
:RADio:GSM:SLOT6:TYPe NORMal
:RADio:GSM:SLOT7:TYPe NORMal
```

## Real Time TDMA Formats (Option 402)

### Enhanced Observed Time Difference (E-OTD)

Setup the ESG to have a non-combined broadcast channel in slot 0, a dummy burst in slot 1, and the other time slots will have a normal burst with a PN9 sequence in the payload fields.

Turn each time slot on and select TSC0 for the training bit sequence.

```
:RADio:GSM:SLOT0:NORMAl:TSEquence TSC3
:RADio:GSM:SLOT1:NORMAl:TSEquence TSC3
:RADio:GSM:SLOT2:NORMAl:TSEquence TSC3
:RADio:GSM:SLOT3:NORMAl:TSEquence TSC3
:RADio:GSM:SLOT4:NORMAl:TSEquence TSC3
:RADio:GSM:SLOT5:NORMAl:TSEquence TSC3
:RADio:GSM:SLOT6:NORMAl:TSEquence TSC3
:RADio:GSM:SLOT7:NORMAl:TSEquence TSC3
:RADio:GSM:SLOT0:STATe ON
:RADio:GSM:SLOT1:STATe ON
:RADio:GSM:SLOT2:STATe ON
:RADio:GSM:SLOT3:STATe ON
:RADio:GSM:SLOT4:STATe ON
:RADio:GSM:SLOT5:STATe ON
:RADio:GSM:SLOT6:STATe ON
:RADio:GSM:SLOT7:STATe ON
```

Setup the public land mobile network and base station color code values.

```
:RADio:GSM:SLOT0:NORMAl:ENCRyption:BCH:PLMN 2
:RADio:GSM:SLOT0:NORMAl:ENCRyption:BCH:BCC 3
:RADio:GSM:SLOT0:NORMAl:ENCRyption:BCH:CELLId 4
:RADio:GSM:SLOT0:NORMAl:ENCRyption:BCH:MNC 2
:RADio:GSM:SLOT0:NORMAl:ENCRyption:BCH:MCC 2
:RADio:GSM:SLOT0:NORMAl:ENCRyption:BCH:LAC 4
```

Set the trigger mode to continuous, the trigger type to “trigger and run”, and setup the ESG to accept an external trigger on EPT1.

```
:RADio:GSM:TRIGger:TYPE CONT
:RADio:GSM:TRIGger:TYPE:CONTInuous:TYPE TRIGger
:RADio:GSM:TRIGger EXT
:RADio:GSM:TRIGger:EXTernal:SOURce EPT1
```

Turn the GSM modulation format and RF to ON.

```
:OUTPut:STATe 1
:SOURce:RADio:GSM:STATe ON
```

## Example 2, Setting Up a Combined Broadcast Channel

This example will setup the ESG to generate a Combined Broadcast Channel at 935.2 MHz with a power level of  $-10$  dBm. A public land mobile network (PLMN) value of 4 will be chosen and a base station colour code (BCC) value of 1 will be set. The trigger will be setup in “trigger and run” mode which means that the ESG will start generating a BCH on receipt of the first trigger and any further triggers will be ignored. The trigger will be setup to use the external pattern trigger 1.

Reset the ESG to its power on state.

```
*RST
```

Select the frequency band, channel and power.

```
:FREQuency:CHANnels:BAND BPGSm  
:FREQuency:CHANnels:NUMBer 1  
:FREQuency:CHANnels:STATe ON  
:POWer:LEVel:IMMediate:AMPLitude -10dBm
```

Setup the ESG to have a Combined Broadcast Channel in slot 0 and all other time slots will have a normal burst with a PN9 sequence in the payload fields.

```
:RADio:GSM:BURSt:STATe ON  
:RADio:GSM:SLOT0:NORMAl:ENCRyption BCH2  
:RADio:GSM:SLOT1:NORMAl:ENCRyption PN9  
:RADio:GSM:SLOT2:NORMAl:ENCRyption PN9  
:RADio:GSM:SLOT3:NORMAl:ENCRyption PN9  
:RADio:GSM:SLOT4:NORMAl:ENCRyption PN9  
:RADio:GSM:SLOT5:NORMAl:ENCRyption PN9  
:RADio:GSM:SLOT6:NORMAl:ENCRyption PN9  
:RADio:GSM:SLOT7:NORMAl:ENCRyption PN9  
:RADio:GSM:SLOT0:TYPe NORMAl  
:RADio:GSM:SLOT1:TYPe NORMAl  
:RADio:GSM:SLOT2:TYPe NORMAl  
:RADio:GSM:SLOT3:TYPe NORMAl  
:RADio:GSM:SLOT4:TYPe NORMAl  
:RADio:GSM:SLOT5:TYPe NORMAl  
:RADio:GSM:SLOT6:TYPe NORMAl  
:RADio:GSM:SLOT7:TYPe NORMAl
```

## Real Time TDMA Formats (Option 402)

### Enhanced Observed Time Difference (E-OTD)

Turn each time slot on and select TSC0 for the training bit sequence.

```
:RADio:GSM:SLOT0:NORMal:TSEquence TSC1
:RADio:GSM:SLOT1:NORMal:TSEquence TSC1
:RADio:GSM:SLOT2:NORMal:TSEquence TSC1
:RADio:GSM:SLOT3:NORMal:TSEquence TSC1
:RADio:GSM:SLOT4:NORMal:TSEquence TSC1
:RADio:GSM:SLOT5:NORMal:TSEquence TSC1
:RADio:GSM:SLOT6:NORMal:TSEquence TSC1
:RADio:GSM:SLOT7:NORMal:TSEquence TSC1
:RADio:GSM:SLOT0:STATe ON
:RADio:GSM:SLOT1:STATe ON
:RADio:GSM:SLOT2:STATe ON
:RADio:GSM:SLOT3:STATe ON
:RADio:GSM:SLOT4:STATe ON
:RADio:GSM:SLOT5:STATe ON
:RADio:GSM:SLOT6:STATe ON
:RADio:GSM:SLOT7:STATe ON
```

Setup the public land mobile network (PLMN) and base station color code (BCC) values.

```
:RADio:GSM:SLOT0:NORMal:ENCRyption:BCH:PLMN 4
:RADio:GSM:SLOT0:NORMal:ENCRyption:BCH:BCC 1
:RADio:GSM:SLOT0:NORMal:ENCRyption:BCH:CELLid 4
:RADio:GSM:SLOT0:NORMal:ENCRyption:BCH:MNC 4
:RADio:GSM:SLOT0:NORMal:ENCRyption:BCH:MCC 4
:RADio:GSM:SLOT0:NORMal:ENCRyption:BCH:LAC 4
```

Set the trigger mode to continuous, the trigger type to “trigger and run”, and setup the ESG to accept an external trigger on EPT1.

```
:RADio:GSM:TRIGger:TYPE CONT
:RADio:GSM:TRIGger:TYPE:CONTinuous:TYPE TRIGger
:RADio:GSM:TRIGger EXT
:RADio:GSM:TRIGger:EXTernal:SOURce EPT1
```

Turn the GSM modulation format and RF to ON.

```
:OUTPut:STATe 1
:SOURce:RADio:GSM:STATe ON
```

## DECT Framed Modulation

This example teaches you how to build framed real-time I/Q baseband generated DECT modulation for testing receiver designs. The procedures in this section build on each other and are designed to be used sequentially.

### Activating Framed Data Format

1. Press **Preset**.
2. Press **Mode > Real Time TDMA > DECT > Data Format Pattern Framed**.

### Configuring the First Timeslot

1. Press **Configure Timeslots > Timeslot Type > Custom**.
2. Press **Configure Custom > Other Patterns > 8 1's & 8 0's**.

### Configuring the Second Timeslot

1. Press **Timeslot # > 1 > Enter**.
2. Press **Timeslot Type > Traffic Bearer**.
3. Press **Configure Traffic Bearer > B field > Other Patterns > 4 1's & 4 0's**.
4. Press **Return > Timeslot Off On to On > Return**.

### Generating the Baseband Signal

Press **DECT Off On** to On.

This generates a DECT signal with an active custom timeslot (#0) and an active traffic bearer timeslot (#1). The signal generator may require several seconds to build the signal. During this time, **Baseband Reconfiguring** appears on the display. After the reconfiguration is complete, the display reads **DECT On** and the **DECT**, **ENVLP**, and **I/Q** annunciators appear. The signal is now modulating the RF carrier.

The signal's configuration data resides in volatile memory and is not recoverable after an instrument preset, power cycle, or reconfigured signal generation.

## DECT Framed Modulation

### Configuring the RF Output

1. Set the RF output frequency to 1.89 GHz.
2. Set the output amplitude to  $-10$  dBm.
3. Press **RF On/Off** to On.

The user-defined DECT signal is now available at the signal generator's RF OUTPUT connector.

To store this real-time I/Q baseband digital modulation state to the instrument state register, see [“Saving an Instrument State” on page 71](#).

To recall a real-time I/Q baseband digital modulation state, see [“Recalling an Instrument State” on page 72](#).



## PHS Framed Modulation

This example teaches you how to build framed real-time I/Q baseband generated PHS modulation for testing receiver designs. The procedures in this section build on each other and are designed to be used sequentially.

### Activating Framed Data Format

1. Press **Preset**.
2. Press **Mode > Real Time TDMA > PHS > Data Format Pattern Framed**.

### Configuring the First Timeslot

1. Press **Configure Timeslots > Timeslot Type > Custom**.
2. Press **Configure Custom > FIX4**.
3. Press **1010 > Enter > Return**.

### Configuring the Second Timeslot

1. Press **Control Channel Dnlink Uplink**.
2. Press **Timeslot Type > Custom**.
3. Press **Configure Custom > Other Patterns > 4 1's & 4 0's**.
4. Press **Return**.

### Generating the Baseband Signal

Press **PHS Off On** to On

This generates a PHS signal with an active downlink custom timeslot (#1) and an active uplink custom timeslot (#1). The signal generator may require several seconds to build the signal. During this time, **Baseband Reconfiguring** appears on the display. After the reconfiguration is complete, the display reads **PHS On** and the **PHS**, **ENVLP**, and **I/Q** annunciators appear. The signal is now modulating the RF carrier.

The signal's configuration data resides in volatile memory and is not recoverable after an instrument preset, power cycle, or reconfigured signal generation.

## PHS Framed Modulation

### Configuring the RF Output

1. Set the RF output frequency to 1.89515 GHz.
2. Set the output amplitude to 0 dBm.
3. Press **RF On/Off** to On.

The user-defined PHS signal is now available at the signal generator's RF OUTPUT connector.

To store this real-time I/Q baseband digital modulation state to the instrument state register, see [“Saving an Instrument State” on page 71](#).

To recall a real-time I/Q baseband digital modulation state, see [“Recalling an Instrument State” on page 72](#).

## **PDC Framed Modulation**

This example teaches you how to build framed real-time I/Q baseband generated PDC modulation for testing receiver designs. The procedures in this section build on each other and are designed to be used sequentially.

### **Activating Framed Data Format**

1. Press **Preset**.
2. Press **Mode > Real Time TDMA > PDC > Data Format Pattern Framed**.

### **Configuring the First Timeslot**

1. Press **Configure Timeslots > Timeslot Type > Down TCH**.
2. Press **Configure Down TCH > TCH > FIX4**.
3. Press **1010 > Enter > Return > Return**.

### **Configuring the Second Timeslot**

1. Press **Rate Full Half**.
2. Press **Timeslot > 3 > Enter**.
3. Press **Timeslot Type > Down TCH**.
4. Press **Configure Down TCH > TCH > Other Patterns > 4 1's & 4 0's**.
5. Press **Return > Timeslot Off On to On > Return**.

### **Generating the Baseband Signal**

Press **PDC Off On** to On.

This generates a half rate PDC signal with an active downlink traffic channel timeslot (#0) and an active downlink traffic channel timeslot (#3). The signal generator may require several seconds to build the signal. During this time, **Baseband Reconfiguring** appears on the display. After the reconfiguration is complete, the display reads **PDC On** and the **PDC**, **ENVLP**, and **I/Q** annunciators appear. The signal is now modulating the RF carrier.

The signal's configuration data resides in volatile memory and is not recoverable after an instrument preset, power cycle, or reconfigured signal generation.

## **PDC Framed Modulation**

### **Configuring the RF Output**

1. Set the RF output frequency to 832 MHz.
2. Set the output amplitude to 0 dBm.
3. Press **RF On/Off** to On.

The user-defined PDC signal is now available at the signal generator's RF OUTPUT connector.

To store this real-time I/Q baseband digital modulation state to the instrument state register, see [“Saving an Instrument State” on page 71](#).

To recall a real-time I/Q baseband digital modulation state, see [“Recalling an Instrument State” on page 72](#).

## **NADC Framed Modulation**

This example teaches you how to build framed real-time I/Q baseband generated NADC modulation for testing receiver designs. The procedures in this section build on each other and are designed to be used sequentially.

### **Activating Framed Data Format**

1. Press **Preset**.
2. Press **Mode > Real Time TDMA > NADC > Data Format Pattern Framed**.

### **Configuring the First Timeslot**

1. Press **Configure Timeslots > Timeslot Type > Down TCH**.
2. Press **Configure Down TCH > Data > FIX4**.
3. Press **1010 > Enter > Return > Return**.

### **Configuring the Second Timeslot**

1. Press **Rate Full Half**.
2. Press **Timeslot > 4 > Enter**.
3. Press **Timeslot Type > Down TCH**.
4. Press **Configure Down TCH > Data > Other Patterns > 4 1's & 4 0's**.
5. Press **Return > Timeslot Off On to On > Return**.

### **Generating the Baseband Signal**

Press **NADC Off On** to On.

This generates a half rate NADC signal with an active downlink traffic channel timeslot (#1) and an active downlink traffic channel timeslot (#4). The signal generator may require several seconds to build the signal. During this time, **Baseband Reconfiguring** appears on the display. After the reconfiguration is complete, the display reads **NADC On** and the **NADC**, **ENVLP**, and **I/Q** annunciators appear. The signal is now modulating the RF carrier.

The signal's configuration data resides in volatile memory and is not recoverable after an instrument preset, power cycle, or reconfigured signal generation.

## NADC Framed Modulation

### Configuring the RF Output

1. Set the RF output frequency to 835 MHz.
2. Set the output amplitude to 0 dBm.
3. Press **RF On/Off** to On.

The user-defined NADC signal is now available at the signal generator's RF OUTPUT connector.

To store this real-time I/Q baseband digital modulation state to the instrument state register, see [“Saving an Instrument State” on page 71](#).

To recall a real-time I/Q baseband digital modulation state, see [“Recalling an Instrument State” on page 72](#).

## TETRA Framed Modulation

This example teaches you how to build framed real-time I/Q baseband generated TETRA modulation for testing receiver designs. The procedures in this section build on each other and are designed to be used sequentially.

### Activating Framed Data Format

1. Press **Preset**.
2. Press **Mode > Real Time TDMA > TETRA > Data Format Pattern Framed**.

### Configuring the First Timeslot

1. Press **Configure Timeslots > Timeslot Type > Up Control 1**.
2. Press **Configure Up Control 1 > Data > FIX4**.
3. Press **1010 > Enter > Return > Return**.

### Configuring the Second Timeslot

1. Press **Timeslot > 2 > Enter**.
2. Press **Timeslot Type > Up Custom**.
3. Press **Configure Up Custom > Other Patterns > 4 1's & 4 0's**.
4. Press **Timeslot Off On to On > Return**.

### Generating the Baseband Signal

Press **TETRA Off On** to On.

This generates a TETRA signal with an active uplink control 1 timeslot (#1) and an active uplink custom timeslot (#2). The signal generator may require several seconds to build the signal. During this time, **Baseband Reconfiguring** appears on the display. After the reconfiguration is complete, the display reads **TETRA On** and the **TETRA**, **ENVL P**, and **I/Q** annunciators appear. The signal is now modulating the RF carrier.

The signal's configuration data resides in volatile memory and is not recoverable after an instrument preset, power cycle, or reconfigured signal generation.

## TETRA Framed Modulation

### Configuring the RF Output

1. Set the RF output frequency to 1.894880 MHz.
2. Set the output amplitude to 0 dBm.
3. Press **RF On/Off** to On.

The user-defined TETRA signal is now available at the signal generator's RF OUTPUT connector.

To store this real-time I/Q baseband digital modulation state to the instrument state register, see [“Saving an Instrument State” on page 71](#).

To recall a real-time I/Q baseband digital modulation state, see [“Recalling an Instrument State” on page 72](#).



---

# 15 W-CDMA Digital Modulation for Component Test (Option 400)

This feature is available only in E4438C ESG Vector Signal Generators with Option 001/601 or 002/602. The following list shows the topics covered by this chapter:

- [“W-CDMA Downlink Modulation” on page 426](#)
- [“W-CDMA Uplink Modulation” on page 438](#)
- [“W-CDMA Concepts” on page 443](#)
- [“W-CDMA Frame Structures” on page 452](#)

## **W-CDMA Downlink Modulation**

This section teaches you how to build W-CDMA downlink waveforms for testing component designs. The waveforms are generated by the signal generator's internal dual arbitrary waveform generator.

### **Activating a Predefined W-CDMA Downlink State**

This procedure teaches you how to perform the following tasks:

- “Selecting a Predefined W-CDMA Setup” on page 426
- “Generating the Waveform” on page 426
- “Configuring the RF Output” on page 426

#### **Selecting a Predefined W-CDMA Setup**

1. Press **Preset**.
2. Press **Mode > W-CDMA > Arb W-CDMA**.
3. Press **W-CDMA Select > 3 DPCH**.

This selects three predefined dedicated physical channels (DPCH) for a downlink waveform. The display changes to DL WCDMA Setup: 3 DPCH. Downlink is the signal generator's default setting for link direction and, therefore, does not need to be set.

#### **Generating the Waveform**

Press **W-CDMA Off On** until On is highlighted.

This generates the predefined 3 DPCH W-CDMA downlink waveform. During waveform generation, the WCDMA and I/Q annunciators appear and the waveform is stored in volatile ARB memory. The waveform is now modulating the RF carrier.

#### **Configuring the RF Output**

1. Set the RF output frequency to 2.17 GHz.
2. Set the output amplitude to -10 dBm.
3. Press **RF On/Off** until On is highlighted.

The predefined W-CDMA downlink signal is now available at the signal generator's RF OUTPUT connector.

## Creating a User-Defined W-CDMA Downlink State

This procedure teaches you how to perform the following tasks:

- “Selecting a W-CDMA Downlink Setup” on page 427
- “Editing Downlink Channel Parameters” on page 428
- “Inserting Additional Channels” on page 430
- “Clipping the Waveform” on page 430
- “Generating the Waveform” on page 431
- “Applying Channel Modifications to an Active Waveform” on page 431
- “Configuring the RF Output” on page 431

---

**CAUTION** Unless previously saved to the signal generator’s non-volatile memory, modifications made to predefined channel configurations are lost when changes are made to link direction.

To store a custom W-CDMA state, see “[Storing a W-CDMA Downlink/Uplink State](#)” on page 431.

---

### Selecting a W-CDMA Downlink Setup

1. Press **Preset**.
2. Press **Mode > W-CDMA > Arb W-CDMA**.
3. Press **W-CDMA Define > Edit Channel Setup**.

The channel table editor is now displayed, as shown in the following figure. Notice that a dedicated physical channel (DPCH) with predefined parameters is the default setup. The horizontal scroll bar at the bottom of the screen indicates that there are more columns to the right of the **Scramble Code** column. Use the front panel knob or right arrow key to move the cursor to view the additional columns.

**Figure 15-1**

FREQUENCY		4.000 000 000 00 GHz		AMPLITUDE		-136.00 dBm		Edit Item
				RF OFF		MOD ON		Insert Row
Chip Rate: 3.840000Mcps		Link: Down		Total Power: 0.00dB		Channel Code Domain: 0032-0035		Delete Row
	Type	Rate ksp/s	Spread Code	Power dB	Timing Offset	TFCI	TPC	Scramble Code
1	DPCH	30.0	8	0.00	0	0	5555	0
2								
								Adjust Code Domain Power
								Display Code Domain Power
								Goto Row
								More (1 of 2)

**Editing Downlink Channel Parameters**

1. Use the front panel knob or arrow keys to move the cursor to table row 1.
2. Highlight the TPC value (5555).
3. Press **Edit Item > 00FF > Enter**.

The TPC value has now been modified and the cursor has moved to the next row in the TPC column.

---

**NOTE** TPC values are entered as hexadecimal digits. For information on what these values represent, refer to [“Understanding TPC Values” on page 445](#).

---

4. Highlight the value (0.00) in the TFCI Power dB field, which is currently hidden from view.  
 The horizontal scroll bar at the bottom of the screen indicates that there are columns to the right of the Scramble Code column.
5. Press **Edit Item > 2 > dB**.
6. Highlight the value (0.00) in the TPC Power dB field.
7. Press **Edit Item > 3 > dB**.
8. Highlight the value (0.00) in the Pilot Power dB field.
9. Press **Edit Item > 1 > dB**.

---

**NOTE** For additional information on TFCI, TPC, and pilot power offsets, refer to [“Understanding TFCI, TPC, and Pilot Power Offsets”](#) on page 446.

---

10. Highlight the value (4) in the Pilot Bits field.
11. Press **Edit Item > 8**.
12. Highlight the value (RANDOM) in the Data field.
13. Press **Edit Item > PN9**.
14. Highlight the value (STD) in the Scramble Type field.
15. Press **Edit Item > Right Alternate**.
16. Highlight the value (0) in the Scramble Offset field.
17. Press **Edit Item > 1 > Enter**.

---

**NOTE** For additional information on Scramble Type and Scramble Offset, refer to [“Calculating Downlink Scramble Codes”](#) on page 448.

---

The downlink DPCH channel parameters have now been modified, as shown. Other channel parameters can be modified in the same manner.

**Figure 15-2**

FREQUENCY		AMPLITUDE						
4.000 000 000 00 GHz		-136.00 dBm						Edit Item
								Insert Row
								Delete Row
Chip Rate: 3.840000Mcps Link: Down		Total Power: 0.00dB Channel Code Domain: 0000-0000						Adjust Code Domain Power
	TFCI Power dB	TPC Power dB	Pilot Power dB	Pilot Bits	Data	Scramble Type	Scramble Offset	Display Code Domain Power
1	2.00	3.00	1.00	8	PN9	RGT	1	Goto Row
2	-----	-----	-----	---	-----	---	---	More (1 of 2)

**W-CDMA Downlink Modulation**

**Inserting Additional Channels**

Press **Insert Row > More (1 of 2) > Multiple Channels > Channels > 20 > Enter > Done**.

The channel table editor now contains 20 additional channels, as shown in the following figure. The page only displays six channels. To view the additional channels, press the following keys:

**Return > Goto Row > Page Up**

**Figure 15-3**

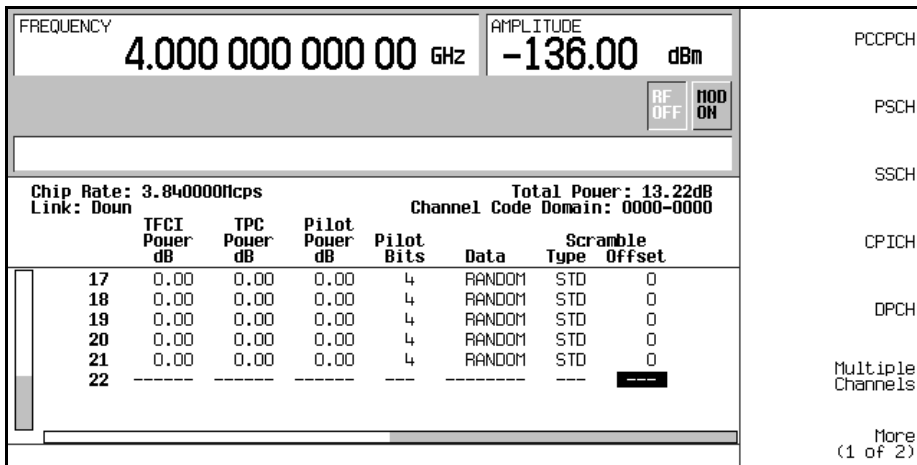

**Clipping the Waveform**

1. Press **Mode Setup > More (1 of 2) > ARB Setup > Waveform Utilities > Clipping**.
2. Press **Clip |I+jQ| To > 80 > %**.

The waveform is now set to be clipped at 80 percent of its peak value.

---

**NOTE** If the waveform is active (**W-CDMA Off On** set to On), clipping settings are *not* applied until you press the **Apply To Waveform** softkey.

---

### Generating the Waveform

Press **Mode Setup** > **W-CDMA Off On** until On is highlighted.

This generates a waveform with the custom W-CDMA downlink state created in the previous sections. The display changes to DL WCDMA Setup: 1 DPCH (Modified). Note that 1 DPCH refers to the predefined configuration, not the number of channels in the user-modified waveform.

During waveform generation, the WCDMA and I/Q annunciators appear and the waveform is stored in volatile ARB memory. The waveform is now modulating the RF carrier.

For instructions on storing this user-defined W-CDMA state to the signal generator's non-volatile memory, see [“Storing a W-CDMA Downlink/Uplink State” on page 431](#).

### Applying Channel Modifications to an Active Waveform

To apply channel modifications to an active waveform (**W-CDMA Off On** set to On), you must press the **Apply Channel Setup** softkey to force the updated waveform to generate. For example, perform the following steps:

1. Press **W-CDMA Define** > **Edit Channel Setup**.
2. Move the cursor to row 2.
3. Press **Delete Row** > **Return** > **Apply Channel Setup**.

Notice that the waveform is regenerated to include the modification of the deleted row. Any changes made in the Edit Channel Setup table editor while a waveform is active will not be applied until the **Apply Channel Setup** softkey is pressed.

### Configuring the RF Output

1. Set the RF output frequency to 2.17 GHz.
2. Set the output amplitude to -10 dBm.
3. Press **RF On/Off** until On is highlighted.

The custom W-CDMA downlink signal is now available at the signal generator's RF OUTPUT connector.

### Storing a W-CDMA Downlink/Uplink State

This procedure teaches you how to store a user-defined W-CDMA state. If you have not created a W-CDMA state, complete the steps in the previous section, [“Creating a User-Defined W-CDMA Downlink State” on page 427](#).

1. Press **Mode Setup** to return to the top-level W-CDMA menu, where **W-CDMA Off On** is the first softkey.

## W-CDMA Downlink Modulation

2. Press **W-CDMA Define > Store Custom W-CDMA State > Store To File.**

If there is already a file name occupying the active entry area, press the following keys:

**Editing Keys > Clear Text.**

3. Enter a file name using the alpha softkeys and the numeric keypad with a maximum length of 23 characters.
4. Press **Enter.**

The user-defined W-CDMA downlink/uplink state is now stored in non-volatile memory and the file name is listed in the catalog of files. Note that the actual waveform is not stored; the parameters for generating the signal are stored. The RF output amplitude, frequency, and operating state settings are not stored as part of a user-defined W-CDMA state file.

### Recalling a W-CDMA Downlink/Uplink State

This procedure teaches you how to recall a W-CDMA state from the signal generator's non-volatile memory.

If you have not created and stored a W-CDMA state, complete the steps in the previous sections, "[Creating a User-Defined W-CDMA Downlink State](#)" on page 427 and "[Storing a W-CDMA Downlink/Uplink State](#)" on page 431, then preset the signal generator to clear the stored CDMA waveform from volatile ARB memory.

1. Press **Mode > W-CDMA > Arb W-CDMA.**
2. Press **W-CDMA Select > Custom W-CDMA State.**
3. Highlight the desired file.
4. Press **Select File.**
5. Press **W-CDMA Off On** until On is highlighted.

The firmware generates the user-defined W-CDMA waveform in volatile ARB memory. The waveform is now modulating the RF carrier.

For instruction on configuring the RF output, see "[Configuring the RF Output](#)" on page 431.



## Creating a User-Defined Multicarrier W-CDMA State

This procedure teaches you how to perform the following tasks:

- “Selecting a Multicarrier W-CDMA Setup” on page 433
- “Adding a Carrier” on page 433
- “Modifying Carrier Parameters” on page 433
- “Clipping the Multicarrier Waveform” on page 435
- “Generating the Waveform” on page 435
- “Applying Modifications to an Active Multicarrier Waveform” on page 436
- “Configuring the RF Output” on page 436

### Selecting a Multicarrier W-CDMA Setup

1. Press **Preset**.
2. Press **Mode > W-CDMA > Arb W-CDMA**.
3. Press **Multicarrier Off On > Multicarrier Define**.

The Multicarrier WCDMA 3GPP Setup table editor is now displayed, showing parameters for the default two-carrier setup.

### Adding a Carrier

1. Highlight the PCCPCH + SCH carrier in table row 2 and press, **Insert Row > 3 DPCH**.

This adds a predefined 3 DPCH carrier between the two original default carriers. You can also add a custom W-CDMA carrier that has been previously created and stored.

### Modifying Carrier Parameters

1. Press **Return**.
2. Highlight the Freq Offset value (7.500000 MHz) for the new 3 DPCH carrier in row 2 and press, **Edit Item > -2.5 > MHz**. Refer to, “Multicarrier Setup Page 1” on page 434.
3. Highlight the Power value (0.00 dB) for the new 3 DPCH carrier in row 2 and press, **Edit Item > -10 > dB**. Refer to, “Multicarrier Setup Page 1” on page 434.
4. Highlight Primary Scramble Code value N/A for the new 3 DPCH carrier in row 2 and press, **Edit Item > 5 > Enter**. Refer to, “Multicarrier Setup Page 2” on page 435.

## W-CDMA Digital Modulation for Component Test (Option 400)

### W-CDMA Downlink Modulation

5. Highlight the **Timing Offset** value 0 for the new 3 DPCH carrier in row 2 and press, **Edit Item > 3 > Enter**. Refer to, “[Multicarrier Setup Page 2](#)” on page 435.
6. Highlight the **Initial Phase** value 0 for the new 3 DPCH carrier in row 2 and press, **Edit Item > 8 > Enter**. Refer to, “[Multicarrier Setup Page 2](#)” on page 435.
7. Highlight the **Pre-FIR Clipping  $|I+jQ|$**  value for the new 3 DPCH carrier in row 2 and press, **Edit Item > 50 > %**. Refer to, “[Multicarrier Setup Page 2](#)” on page 435.

---

**NOTE** The E4438C allows you to clip each individual channel by setting the I+jQ pre-FIR and post-FIR clipping percentage in the table editor and clip the composite waveform by setting the I+jQ percentage using the **Composite Waveform Clip** softkey.

---

**Figure 15-4** Multicarrier Setup Page 1

The screenshot displays the 'Multicarrier UCDMA 3GPP Setup' interface. At the top, the 'FREQUENCY' is set to 4.000 000 000 000 GHz and the 'AMPLITUDE' is set to -136.00 dBm. There are 'RF OFF' and 'MOD ON' buttons. Below this is a table with columns for 'Carrier', 'Freq Offset', and 'Power'. The table contains three rows of data. To the right of the table are buttons for 'Edit Item', 'Insert Row', 'Delete Row', 'Store Custom Multicarrier', 'Apply Multicarrier', and 'More (1 of 2)'. The date and time '06/11/2002 14:32' are shown at the bottom.

	Carrier	Freq Offset	Power
1	PCCPCH + SCH	-7.500000 MHz	0.00 dB
2	3 DPCH	-2.500000 MHz	-10.00 dB
3	PCCPCH + SCH	7.500000 MHz	0.00 dB
4	-----	-----	-----

**Figure 15-5 Multicarrier Setup Page 2**

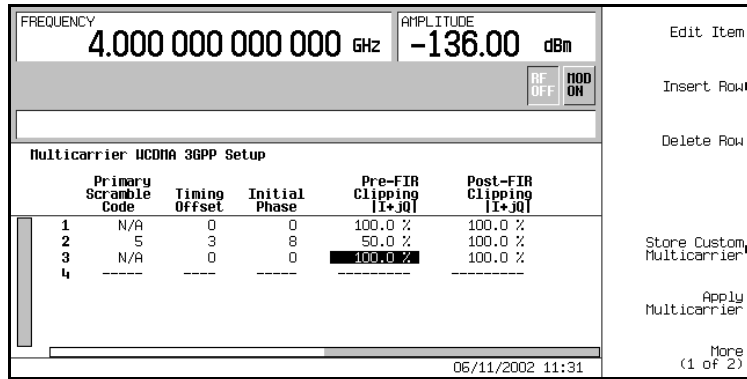

You now have a user-defined 3-carrier W-CDMA waveform with a 3 DPCH carrier at frequency offset of -2.5 MHz, with a power of -10.00 dBm, a primary scramble code of 5, a timing offset of 3, an initial phase of 8, and pre-FIR clipping at 50%.

### Clipping the Multicarrier Waveform

1. Press **Mode Setup > More (1 of 2) > ARB Setup > Waveform Utilities > Composite Waveform Clip**.
2. Press **Clip |I+jQ| To > 80 > %**.

The composite multicarrier waveform is now set to be clipped at 80 percent of its original peak value. The waveform is clipped after FIR filtering.

---

**NOTE** If the waveform is active (**W-CDMA Off On** set to On), clipping settings are *not* applied until you press the **Apply Multicarrier** softkey.

---

### Generating the Waveform

Press **Mode Setup > W-CDMA Off On** until On is highlighted.

This generates a waveform with the user-defined multicarrier W-CDMA state created in the previous sections. The display changes to Multicarrier Setup: 2 Carriers (Modified). Note that 2 Carriers refers to the number of carriers in the predefined configuration, not the number of carriers in the user-modified waveform.

## W-CDMA Downlink Modulation

During waveform generation, the WCDMA and I/Q annunciators appear and the waveform is stored in volatile ARB memory. The waveform is now modulating the RF carrier.

For instructions on storing this user-defined multicarrier W-CDMA state to the signal generator's non-volatile memory, see [“Storing a Multicarrier W-CDMA State” on page 436](#).

### Applying Modifications to an Active Multicarrier Waveform

1. Press **Multicarrier Define**.
2. Move the cursor to row 2.
3. Press **Delete Row > Apply Multicarrier**.

Notice that the waveform is regenerated to include the modification of the deleted row. Any changes made to an active multicarrier waveform will not be applied until the **Apply Multicarrier** softkey is pressed.

### Configuring the RF Output

1. Set the RF output frequency to 2.17 GHz.
2. Set the output amplitude to -10 dBm.
3. Press **RF On/Off** until On is highlighted.

The user-defined multicarrier W-CDMA signal is now available at the signal generator's RF OUTPUT connector.

### Storing a Multicarrier W-CDMA State

This procedure teaches you how to store a multicarrier W-CDMA state to the signal generator's non-volatile memory.

If you have not created a multicarrier W-CDMA state, complete the steps in the previous section, [“Creating a User-Defined Multicarrier W-CDMA State” on page 433](#).

1. Press **Mode Setup** to return to the top-level W-CDMA menu, where **W-CDMA Off On** is the first softkey.
2. Press **Multicarrier Define > Store Custom Multicarrier > Store To File**.

If there is already a file name from the Catalog of MDWCDMA Files occupying the active entry area, press the following keys:

**Editing Keys > Clear Text**.

3. Enter a file name (for example, 3CARRIER) using the alpha keys and the numeric keypad with a maximum length of 23 characters.

4. Press **Enter**.

The user-defined multicarrier W-CDMA state is now stored in non-volatile memory and the file name is listed in the *Catalog of MDWCDMA Files*. Note that the actual waveform is not stored; the parameters for generating the signal are stored. The RF output amplitude, frequency, and operating state settings are not stored as part of a user-defined W-CDMA state file.

## **Recalling a Multicarrier W-CDMA State**

This procedure teaches you how to recall a multicarrier W-CDMA state from the signal generator's non-volatile memory.

If you have not created and stored a multicarrier W-CDMA state, complete the steps in the previous sections, [“Creating a User-Defined Multicarrier W-CDMA State” on page 433](#) and [“Storing a Multicarrier W-CDMA State” on page 436](#).

1. Press **Preset** to clear the stored W-CDMA waveform from volatile ARB memory.
2. Press **Mode > W-CDMA > Arb W-CDMA**.
3. Press **Multicarrier Off On**.
4. Press **W-CDMA Select > Custom W-CDMA Multicarrier**.
5. Highlight the desired file (for example, 3CARRIER).
6. Press **Select File**.
7. Press **W-CDMA Off On** until On is highlighted.

The firmware generates the selected multicarrier W-CDMA waveform in volatile ARB memory. The waveform is now modulating the RF carrier.

## W-CDMA Uplink Modulation

This section teaches you how to build uplink 3GPP 12-2004 W-CDMA waveforms for testing component designs. The waveforms are generated by the signal generator's internal dual arbitrary waveform generator.

### Creating a Predefined W-CDMA Uplink State

This procedure teaches you how to perform the following tasks:

- “Selecting a Predefined W-CDMA Setup” on page 438
- “Generating the Waveform” on page 438
- “Configuring the RF Output” on page 438

#### Selecting a Predefined W-CDMA Setup

1. Press **Preset**.
2. Press **Mode > W-CDMA > Arb W-CDMA > Link Down Up**.
3. Press **W-CDMA Select > DPCCH + 3 DPDCH**.

This selects a predefined setup, which consists of one dedicated physical control channel (DPCCH) and three dedicated physical data channels (DPDCH) for an uplink waveform. The display changes to **UL WCDMA Setup: DPCCH + 3 DPDCH**.

#### Generating the Waveform

Press **W-CDMA Off On** until **On** is highlighted.

This generates a predefined W-CDMA uplink waveform with a DPCCH and 3 DPDCH channels. During waveform generation, the **WCDMA** and **I/Q** annunciators appear and the waveform is stored in volatile **ARB** memory. The waveform is now modulating the RF carrier.

#### Configuring the RF Output

1. Set the RF output frequency to 2.17 GHz.
2. Set the output amplitude to -10 dBm.
3. Press **RF On/Off** until **On** is highlighted.

The predefined W-CDMA uplink signal is now available at the signal generator's **RF OUTPUT** connector.

## Creating a User-Defined W-CDMA Uplink State

This procedure teaches you how to perform the following tasks:

- “Selecting a W-CDMA Uplink Setup” on page 439
- “Editing Uplink Channel Parameters” on page 440
- “Inserting Additional Channels and Modifying I/Q Settings” on page 440
- “Clipping the Waveform” on page 441
- “Generating the Waveform” on page 441
- “Applying Channel Modifications to an Active Waveform” on page 442
- “Configuring the RF Output” on page 442

---

**CAUTION** Unless previously saved to the signal generator’s non-volatile memory, modifications made to predefined channel configurations are lost when changes are made to link direction.

To store a custom W-CDMA state, see “[Storing a W-CDMA Downlink/Uplink State](#)” on page 431.

---

### Selecting a W-CDMA Uplink Setup

1. Press **Preset**.
2. Press **Mode > W-CDMA > Arb W-CDMA > Link Down Up**.
3. Press **W-CDMA Define > Edit Channel Setup**.

The channel table editor is now displayed, as shown in the following figure. Notice that a dedicated physical control channel (DPCCH) with predefined parameters is the default selection. The horizontal scroll bar at the bottom of the screen indicates that there are more columns to the right of the **Data** column. Use the front panel knob or right arrow key to move the cursor to view the additional columns.

**W-CDMA Uplink Modulation**

**Figure 15-6**

FREQUENCY		4.000 000 000 00 GHz		AMPLITUDE		-136.00 dBm		Edit Item	
				RF OFF		MOD ON		Insert DPDCH▶	
Chip Rate: 3.840000Mcps		Link: Up		Total Power: 0.00dB		Channel Code Domain: 0000-0001		Delete Row	
	Type	I/Q	Rate ksp/s	Spread Code	Power (dB)	TFCI	TPC	Data	Scramble Code 00000000
1	DPDCH	Q	15.0	0	0.000	0	5555	N/A	
2	-----	-----	-----	---	-----	---	---	-----	
								Goto Row▶	
								More (1 of 2)	

**Editing Uplink Channel Parameters**

1. Use the front panel knob or arrow keys to move the cursor to table row 1.
2. Highlight the TPC value (5555).
3. Press **Edit Item > 00FF > Enter**.

The TPC value has now been modified and the cursor has moved to the next row in the TPC column. Other channel parameters can be modified in the same manner.

---

**NOTE** TPC values are entered as hexadecimal digits (0-9, A-F). For information on what these values represent, refer to [“Understanding TPC Values” on page 445](#).

---

**Inserting Additional Channels and Modifying I/Q Settings**

1. Press **Insert DPDCH > Channels > 6 > Enter > Done**.
2. Press **More (1 of 2) > Second DPDCH I Q** until the letter I is highlighted.

The I/Q setting for the second DPDCH channel (row 3) has changed from Q to I. Additionally, all subsequent channels have also switched I/Q settings, as shown in the following figure.



Figure 15-7

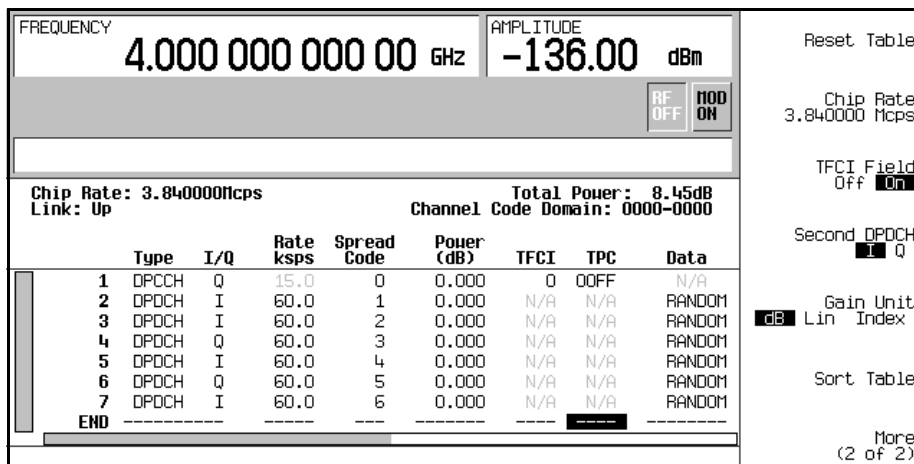

### Clipping the Waveform

1. Press **Mode Setup** > **More (1 of 2)** > **ARB Setup** > **Waveform Utilities** > **Clipping**.
2. Press **Clip |I+jQ| To > 80 > %**.

The waveform is now set to be clipped at 80 percent of its peak value.

---

**NOTE** If the waveform is active (**W-CDMA Off On** set to On), clipping settings are *not* applied until you press the **Apply To Waveform** softkey.

---

### Generating the Waveform

Press **Mode Setup** > **W-CDMA Off On** until On is highlighted.

This generates a waveform with the custom W-CDMA uplink state created in the previous sections. The display changes to UL WCDMA Setup: DPCCCH (Modified). During waveform generation, the WCDMA and I/Q annunciators appear and the waveform is stored in volatile ARB memory. The waveform is now modulating the RF carrier.

For instructions on storing this custom CDMA state to the signal generator's non-volatile memory, see [“Storing a W-CDMA Downlink/Uplink State” on page 431](#).

## W-CDMA Uplink Modulation

### Applying Channel Modifications to an Active Waveform

To apply channel modifications to an active waveform (**W-CDMA Off On** set to On), you must first press the **Apply Channel Setup** softkey before the updated waveform is generated. For example, perform the following steps:

1. Press **W-CDMA Define > Edit Channel Setup**.
2. Move the cursor to row 2.
3. Press **Delete Row > Return > Apply Channel Setup**.

Notice that the waveform is regenerated to include the modification of the deleted row. Any changes made in the Edit Channel Setup table editor while a waveform is active will not be applied until the **Apply Channel Setup** softkey is pressed.

### Configuring the RF Output

1. Set the RF output frequency to 2.17 GHz.
2. Set the output amplitude to -10 dBm.
3. Press **RF On/Off** until On is highlighted.

The custom W-CDMA uplink signal is now available at the signal generator's RF OUTPUT connector.

To store a W-CDMA uplink state, refer to [“Storing a W-CDMA Downlink/Uplink State”](#) on page 431.

To recall a W-CDMA uplink state, refer to [“Recalling a W-CDMA Downlink/Uplink State”](#) on page 432.

## W-CDMA Concepts

**Figure 15-8 Downlink Channel Structure**

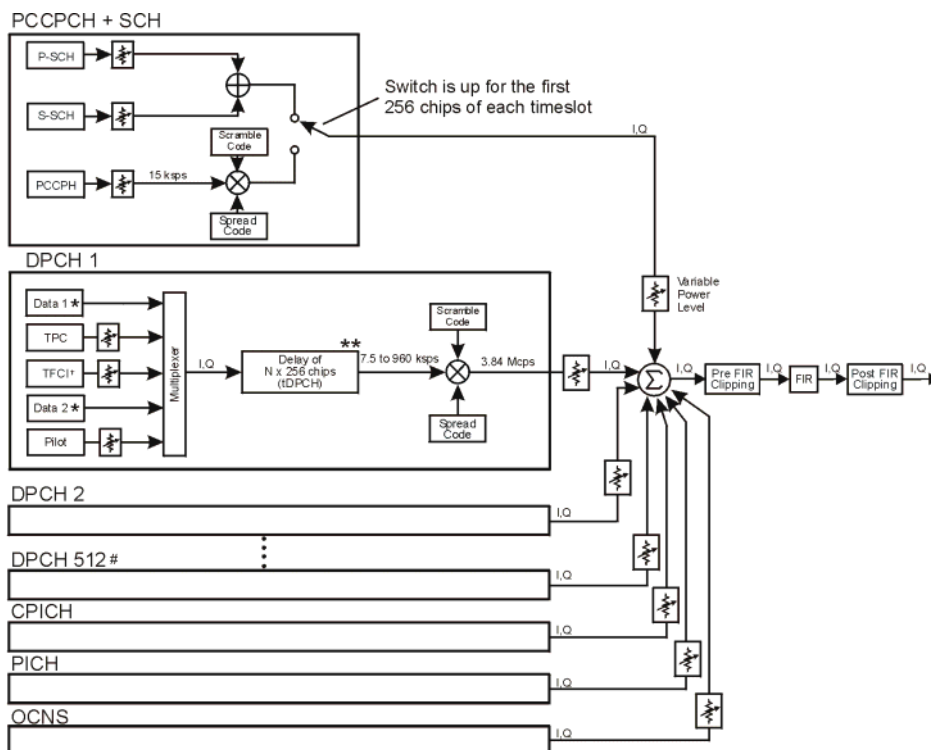

# Maximum 512 Traffic Channels

\*\* Range of symbol offsets depends on the channel symbol rate.

† Transmission can be configured with or without TFC and variable number of pilot bits.

\* Random data, PN9, or 8-bit repeating pattern

**Frame structure for DPCH**

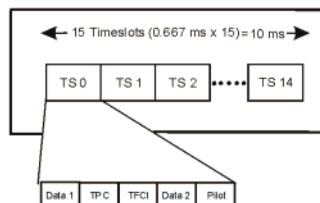

W-CDMA Concepts

Figure 15-9 Uplink Channel Structure

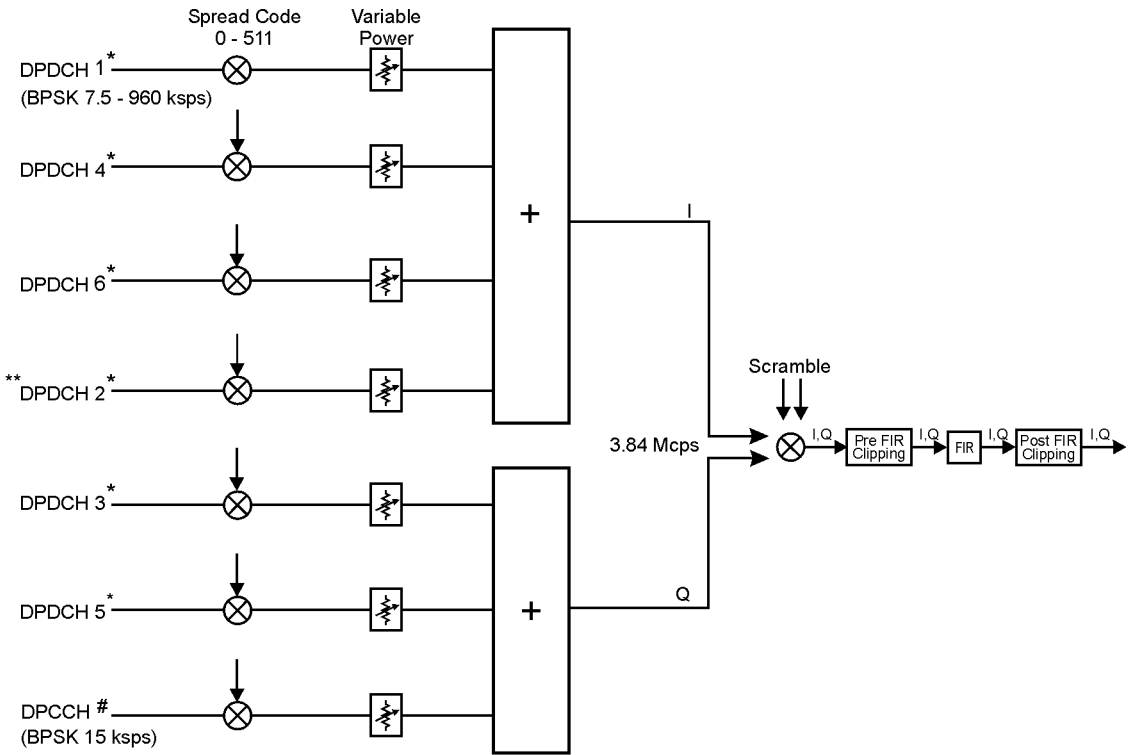

- \* User Data: Random or 8-bit Repeating Pattern
- # TFC, FBI, & TPC data fields may be edited.  
TFCI field may be turned off. Variable number of FBI bits.
- \*\* DPDCH 2 can be set to either I or Q. DPDCH 3 - DPDCH 6 alternate between I and Q accordingly.

Frame structure

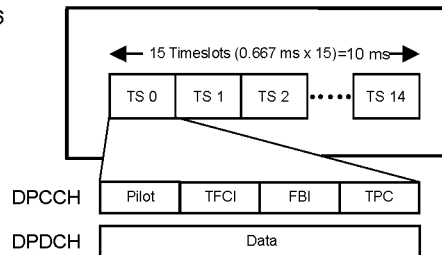

pk757b

## Understanding TPC Values

TPC values determine how the transmit power of the receiving base or mobile station will vary. In the channel table editor, TPC values are represented in hexadecimal format to simplify entries and modifications. Figure 15-10 shows the channel table editor with the TPC value, 7F80, highlighted.

**Figure 15-10** Highlighted TPC Value

FREQUENCY		4.000 000 000 00 GHz		AMPLITUDE		-135.00 dBm		Edit Item
L				RF OFF		MOD ON		Insert Row
Chip Rate: 3.840000Mcps		Link: Down		Total Power: 0.00dB		Channel Code Domain: 0032-0035		Delete Row
	Type	Rate ksp	Spread Code	Power dB	tDPCH Offset	TFCI	TPC	Scramble Code
1	DPCH	30.0	8	0.00	0	0	7F80	1
2	-----	-----	---	-----	---	---	-----	-----
								Adjust Code Domain Power
								Goto Row
								More (1 of 2)

Hexadecimal TPC values are converted to their binary equivalent. In this example, the value 7F80 becomes 111 1111 1000 0000. Notice that there are 15 digits in the binary TPC value. Because one frame contains 15 timeslots, one binary digit is assigned to each timeslot (see Figure 15-11 on page 446). The assigned bit is then repeated enough times to fill the TPC bit field (see the  $N_{\text{TPC}}$  column of Table 15-7). Since the example in Figure 15-11 uses two TPC bits per timeslot, the values are either 11 or 00.

The TPC bits that are ones direct the receiving base or mobile station to increase its transmit power by an amount specified by the W-CDMA standard. Likewise, TPC bits that are zeros cause the power to decrease by the same amount. In this example, the transmit power is increasing over timeslots 0 through 7 and decreasing over timeslots 8 through 14.

**Figure 15-11** TPC Bits per Timeslot

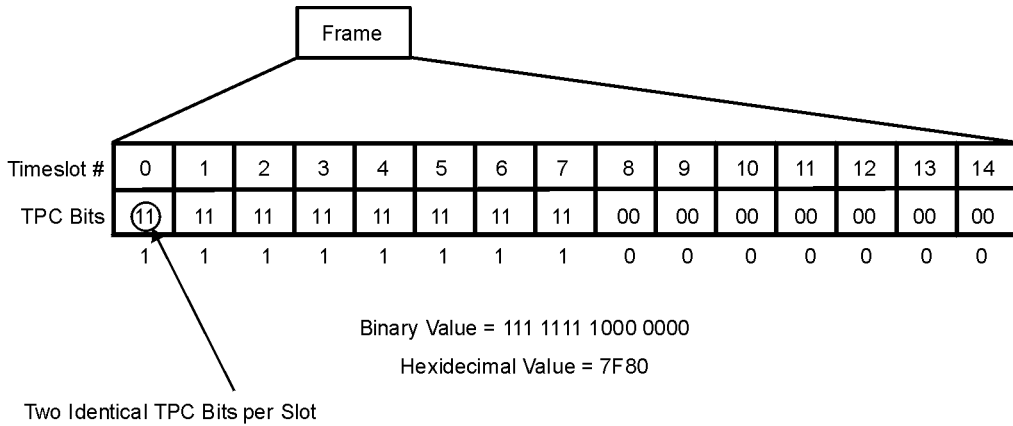

**Understanding TFCI, TPC, and Pilot Power Offsets**

TFCI, TPC, and Pilot power offsets (PO), which are applied to downlink control channels (DPCCH), are relative to the transmit power for data channels (DPDCH). Usually, these offsets are set to a positive value (refer to Figure 15-12 on page 446). The intent is to transmit control symbols at a higher level than data symbols to maintain the link between mobile and base. Because only the DPCCH transmit power is offset, the total transmit power is minimized and less noise is generated in the system.

**Figure 15-12** TFCI, TPC, and Pilot Power

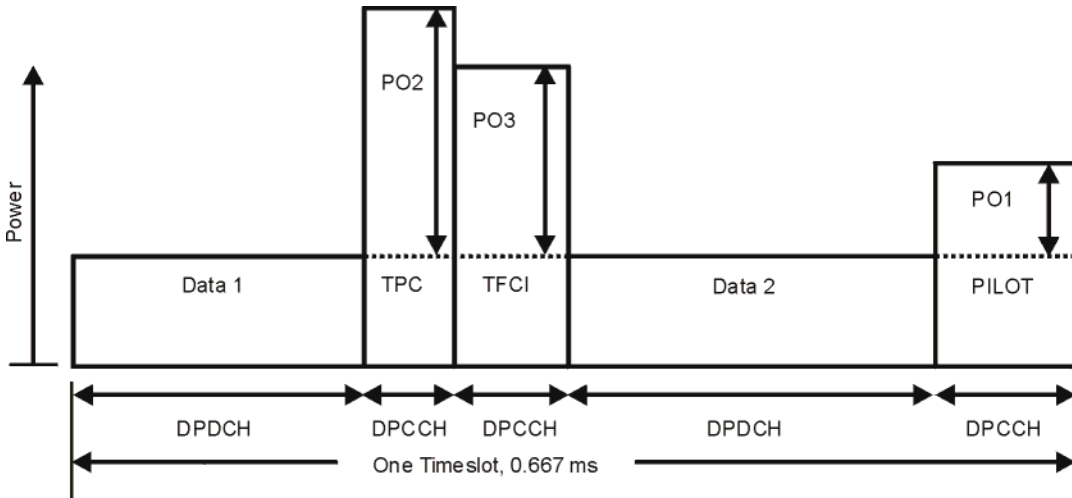

The display in Figure 15-13 shows that the channel in row 6 of the table editor has the data transmit power (Power dB) set to  $-6.02$  dB with the following offsets: TFCI Power set to 2.00 dB, TPC Power set to 3.00 dB, and Pilot Power set to 1.00 dB. Because of these offsets, the control symbols corresponding to TFCI, TPC, and Pilot will transmit at  $-4.02$  dB,  $-3.02$  dB, and  $-5.02$  dB respectively.

**Figure 15-13** Table Editor Showing TFCI, TPC, and Pilot Power Offsets

The screenshot shows two panes of a configuration tool. The left pane displays a table of channels. The right pane provides a detailed view of the selected channel (row 6).

**Left Pane: Channel Table**

Type	Rate kbps	Spread Code	Power dB	Offset
1 PCCPCH	15.0	1	-9.02	
2 PSCH	15.0	N/A	-12.02	
3 SSCH	15.0	N/A	-12.02	
4 CPICH	15.0	0	-9.02	
5 DPCH	30.0	8	-6.02	
6 DPCH	30.0	9	-6.02	
7 DPCH	30.0	10	-6.02	
8				

**Right Pane: Channel Details**

Frequency: 4.000 000 000 00 GHz | Amplitude: -135.00 dBm

Chip Rate: 3.840000 Mcps | Total Power: 0.00 dB  
 Link: Down | Channel Code Domain: 0040-0043

TFCI Power dB	TPC Power dB	Pilot Power dB	Pilot Bits	Data	Scramble Type	Offset
N/A	N/A	N/A	N/A	RANDOM	STD	0
N/A	N/A	N/A	N/A	N/A	N/A	N/A
N/A	N/A	N/A	N/A	N/A	STD	0
N/A	N/A	N/A	N/A	00000000	STD	0
0.00	0.00	0.00	4	RANDOM	STD	0
2.00	3.00	1.00	4	RANDOM	STD	0
0.00	0.00	0.00	4	RANDOM	STD	0

pk759b

### Calculating Downlink Scramble Codes

The Option 400 signal generator implements scrambling codes for downlink channels in compliance with 3GPP specifications. This is done through the use of Scramble Code, Scramble Type, and Scramble Offset fields in the downlink Edit Channel Setup table editor. These fields are linked so that an entry to any field affects the actual scramble code. To better understand the relationship, please refer to the following formula.

$$n = (16 \times i) + k + m$$

**Table 15-1**

Where n = scramble code	Range: 0 to 24575
i = scramble code field input	Primary: Range 0 to 511 Secondary: Range 0 to 511
k = scramble offset field input	Range: 0 to 15
m = scramble type field input	Standard: adds 0 Right Alternate: adds 16384 Left Alternate: adds 8192

**Figure 15-14**

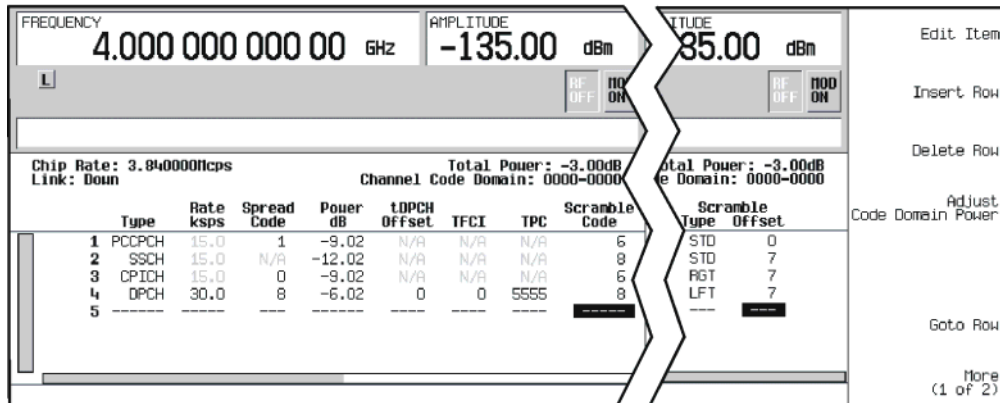



The `Scramble Code` field has two sets: primary and secondary, each with a field range of 0 through 511. The primary and secondary sets are determined by the `Scramble Offset` field. If the `Scramble Offset` field is zero, then the scramble code is in the primary set. Any non-zero entry enables the secondary set. The `Scramble Offset` field has a range of 0 through 15.

The `Scramble Type` field has three modes: Standard, Right Alternate, and Left Alternate. The standard scramble type has a value of zero and does not contribute to the scramble code. Selecting the right alternate adds 16384 to the actual scramble code, whereas the left alternate adds 8192.

### Scramble Codes with Standard Scramble Type

A primary scramble code is the product of the `Scramble Code` field entry and 16. Therefore, the primary scramble code set contains all multiples of 16 from 0 through 8176.

A secondary scramble code is the sum of the non-zero `Scramble Offset` field entry and the primary scramble code. The secondary scramble code set uses the numbers in between the multiples of 16.

Thus, all numbers from 0 through 8191 are available for scramble codes when using the standard scramble type.

Refer to the following for examples of scramble codes generated with the primary and secondary sets:

$$n = (16 \times i) + k + m$$

**Table 15-2**

Where  $n$  = scramble code

$i$  = scramble code field input

$k$  = scramble offset field input

$m$  = scramble type field input

**Table 15-3**

#### A: Primary set

$$i = 6$$

$$k = 0$$

$$m = 0$$

$$n = 96$$

#### B: Secondary set

$$i = 8$$

$$k = 7$$

$$m = 0$$

$$n = 135$$

**W-CDMA Concepts**

**Figure 15-15**

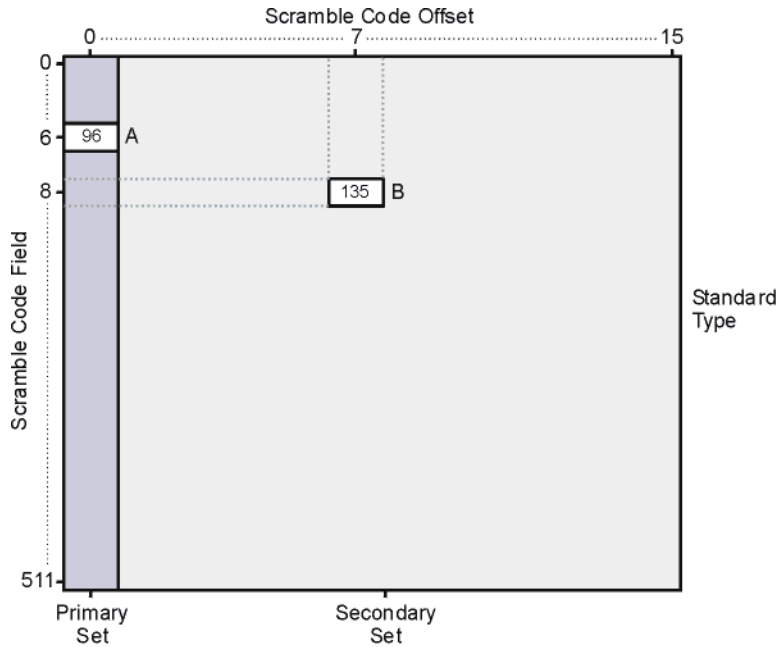

**Scramble Codes with Right and Left Alternate Scramble Types**

Recalling that right alternate adds 16384 to the scramble code and left alternate adds 8192, refer to the following examples of scramble codes generated with the right alternate and left alternate scramble types:

$$n = (16 \times i) + k + m$$

**Table 15-4**

Where n = scramble code

- i = scramble code field input
- k = scramble offset field input
- m = scramble type field input

**Table 15-5**

**A: Primary set + Left Alternate**

**B: Secondary set + Right Alternate**

$$i = 6$$

$$i = 8$$

Table 15-5

**A: Primary set + Left Alternate**

$k = 0$   
 $m = 8192$   
 $n = 8288$

**B: Secondary set + Right Alternate**

$k = 7$   
 $m = 16384$   
 $n = 16519$

Figure 15-16

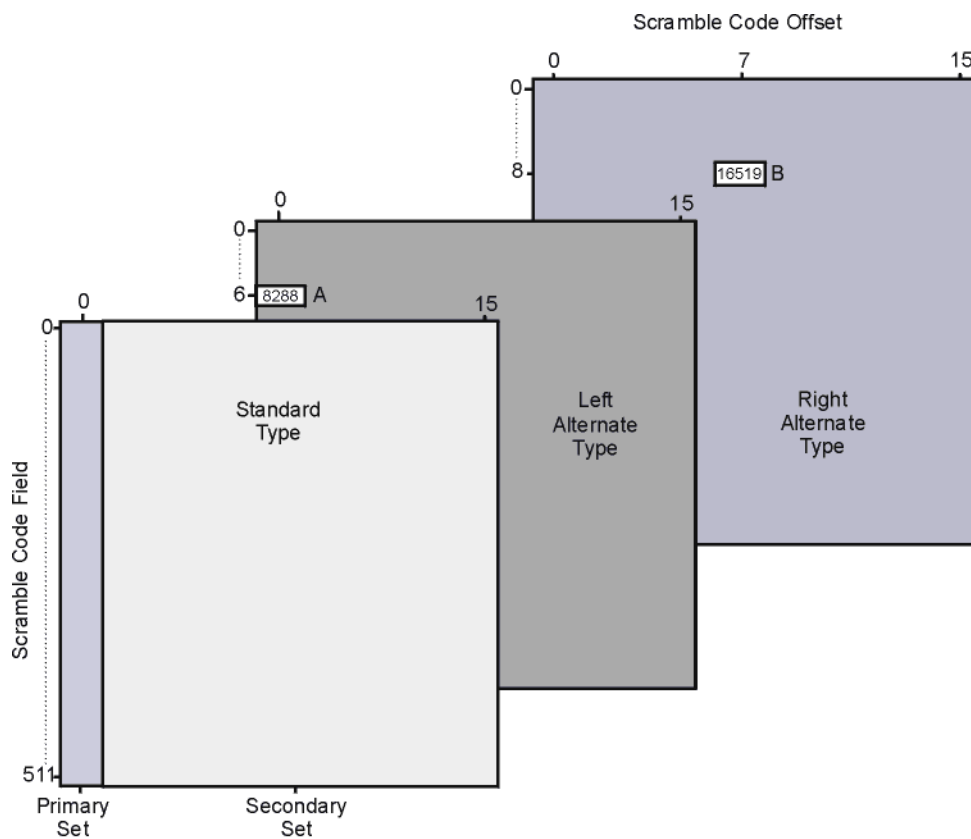

**W-CDMA Frame Structures**

---

## W-CDMA Frame Structures

This section contains graphical representations of W-CDMA frame structures, with associated tables, for both downlink and uplink channels.

### Downlink PICH Frame Structure

**Figure 15-17** PICH Frame Structure

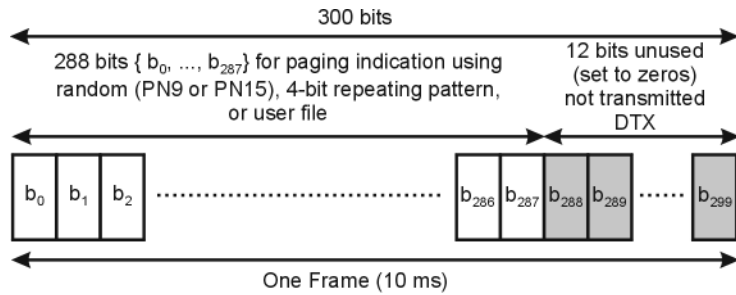

Symbol rate = 15 ksp/s

pk767b

## Downlink PCCPCH + SCH Frame Structure

**Figure 15-18 PCCPCH + SCH Frame Structure**

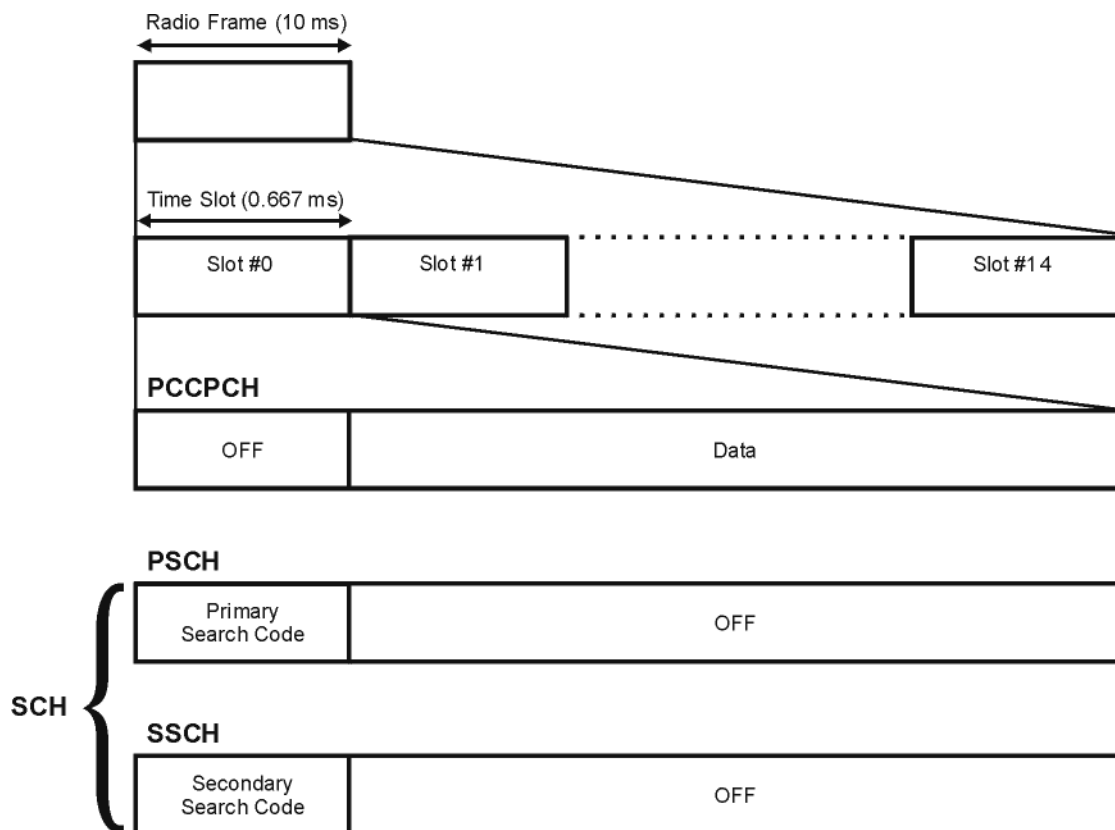

pk760b

**Table 15-6 Lengths of PCCPCH + SCH Fields**

Parameter	Symbols Per Slot
$N_{\text{data}}$	9
$N_{\text{SCH}}^{\text{a}}$	1

a. SCH comprises PSCH and SSCH

**Downlink DPCCH/DPDCH Frame Structure**

**Figure 15-19 DPCCH/DPDCH Frame Structure**

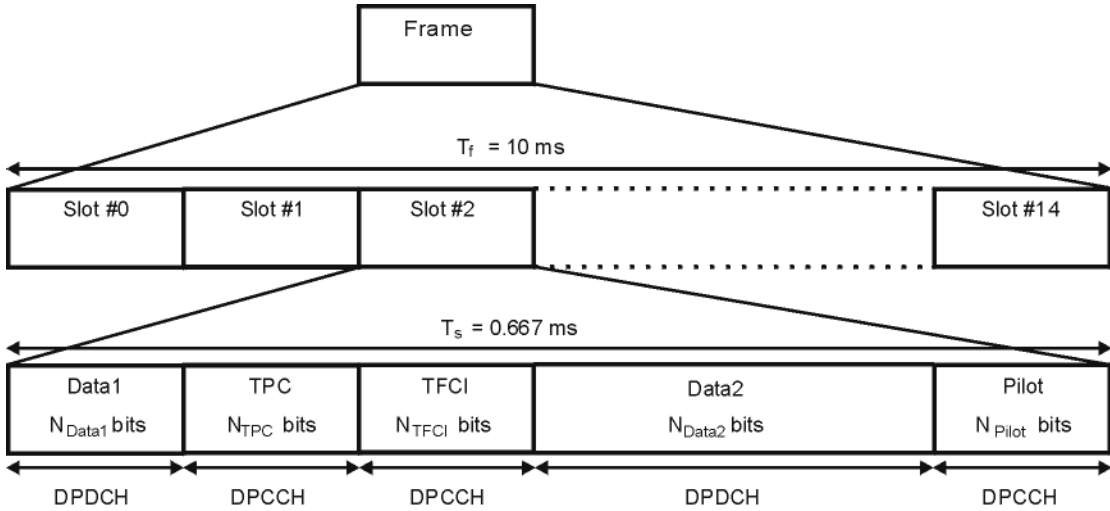

pk761b

**Table 15-7 DPDCH and DPCCH Fields**

Channel Bit Rate (Kbps)	Channel Symbol Rate (Ksps)	Spread Factor	Bits/Frame			Bits/Slot	DPDCH Bits/Slot		DPCCH Bits/Slot		
			DPDCH	DPCCH	TOTAL		$N_{\text{data1}}$	$N_{\text{data2}}$	$N_{\text{TFCI}}$	$N_{\text{TPC}}$	$N_{\text{pilot}}$
15	7.5	512		90	150	10	0	4	0	2	4
15	7.5	512	30	120	150	10	0	2	2	2	4
30	15	256	240	60	300	20	2	14	0	2	2 <sup>a</sup>
30	15	256	210	90	300	20	2	12	2	2	2 <sup>a</sup>
30	15	256	210	90	300	20	2	12	0	2	4 <sup>a</sup>
30	15	256	180	120	300	20	2	10	2	2	4 <sup>a</sup>
30	15	256	150	150	300	20	2	8	0	2	8 <sup>a</sup>
30	15	256	120	180	300	20	2	6	2	2	8 <sup>a</sup>

**Table 15-7 DPDCH and DPCCH Fields (Continued)**

Channel Bit Rate (Kbps)	Channel Symbol Rate (Ksps)	Spread Factor	Bits/Frame			Bits/Slot	DPDCH Bits/Slot		DPCCH Bits/Slot		
			DPDCH	DPCCH	TOTAL		$N_{data1}$	$N_{data2}$	$N_{TFCI}$	$N_{TPC}$	$N_{pilot}$
60	30	128	510	90	600	40	6	28	0	2	4 <sup>a</sup>
60	30	128	480	120	600	40	6	26	2	2	4 <sup>a</sup>
60	30	128	450	150	600	40	6	24	0	2	8 <sup>a</sup>
60	30	128	420	180	600	40	6	22	2	2	8 <sup>a</sup>
120	60	64	900	300	1200	80	12	48	8 <sup>b</sup>	4	8
240	120	32	2100	300	2400	160	28	112	8 <sup>b</sup>	4	8
480	240	16	4320	480	4800	320	56	232	8 <sup>b</sup>	8	16
960	480	8	9120	480	9600	640	120	488	8 <sup>b</sup>	8	16
1920	960	4	18720	480	19200	1280	248	1000	8 <sup>b</sup>	8	16

- a. The number of pilot bits can vary with channel symbol rates of 15 and 30 ksps.
- b. If TFCI bits are not used, then DTX (discontinuous transmission) is used in the TFCI field.

**Uplink DPCCH/DPDCH Frame Structure**

**Figure 15-20 DPCCH/DPDCH Frame Structure**

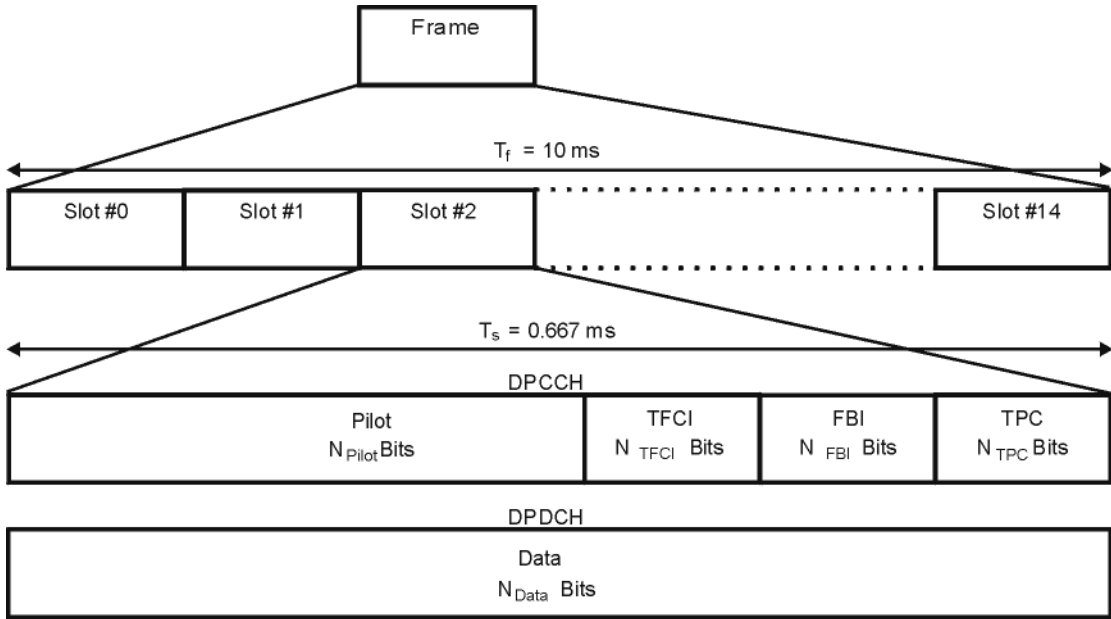

pk762b

**Table 15-8 DPDCH Fields**

Channel Bit Rate (kbps)	Channel Symbol Rate (ksps)	Spread Factor	Bits/Frame	Bits/Slot	$N_{\text{data}}$
15	15	256	150	10	10
30	30	128	300	20	20
60	60	64	600	40	40
120	120	32	1200	80	80
240	240	16	2400	160	160
480	480	8	4800	320	320
960	960	4	9600	640	640



**Table 15-9 DPCCH Fields**

Channel Bit Rate (kbps)	Channel Symbol Rate (ksps)	Spread Factor	Bits/Frame	Bits/Slot	$N_{\text{pilot}}$	$N_{\text{TFCI}}$	$N_{\text{FBI}}$	$N_{\text{TPC}}$
15	15	256	150	10	6	2	0	2
15	15	256	150	10	8	0	0	2
15	15	256	150	10	5	2	1	2
15	15	256	150	10	7	0	1	2
15	15	256	150	10	6	0	2	2
15	15	256	150	10	5	2	2	1



---

## 16 W-CDMA Uplink Digital Modulation for Receiver Test (Option 400)

The following features are available only in E4438C ESG Vector Signal Generators with Option 001/601 or 002/602.

This chapter teaches you how to build fully coded W-CDMA uplink modulated signals for testing base station receiver designs and provides information on how the W-CDMA uplink format is implemented within the ESG. The modulation is generated by the signal generator's internal baseband generator. There are two channel modes for transmitting an uplink signal, PRACH and DPCH. This chapter covers both channel modes.

The following list shows the topics covered by this chapter:

- [“Equipment Setup” on page 461](#)
- [“Understanding the PRACH” on page 463](#)
- [“Generating a Single PRACH Signal” on page 476](#)
- [“Multiple PRACH Overview” on page 488](#)
- [“Setting Up a Multiple PRACH Signal” on page 493](#)
- [“Overload Testing with Multiple PRACHs—Multiple ESGs” on page 511](#)
- [“DPCH” on page 518](#)
- [“Compressed Mode Single Transmission Gap Pattern Sequence \(TGPS\) Overview” on page 531](#)
- [“Setting Up Compressed Mode for a Single TGPS Transmission” on page 533](#)
- [“Compressed Mode Multiple Transmission Gap Pattern Sequence \(TGPS\) Overview” on page 542](#)
- [“Setting Up Compressed Mode for a Multiple TGPS Transmission” on page 545](#)
- [“Configuring the UE Setup” on page 556](#)
- [“Locating Rear Panel Input Signal Connectors” on page 557](#)
- [“Configuring Rear Panel Output Signals” on page 559](#)
- [“Adjusting Code Domain Power” on page 562](#)

- “W-CDMA Uplink Concepts” on page 564
- “DPCCH/DPDCH Frame Structure” on page 589

## Equipment Setup

The following diagrams show the equipment setups that are used to measure the output signal generated using the ESG. These setups are used for most of the procedures contained within this chapter and they apply to both the PRACH and DPCH channel modes.

### ESG and Agilent E4440A PSA Spectrum Analyzer Setup

Unless stated otherwise in a procedure, both the PRACH and DPCH procedures use the setup shown in [Figure 16-1](#) for viewing the ESG output.

**Figure 16-1** PSA Setup

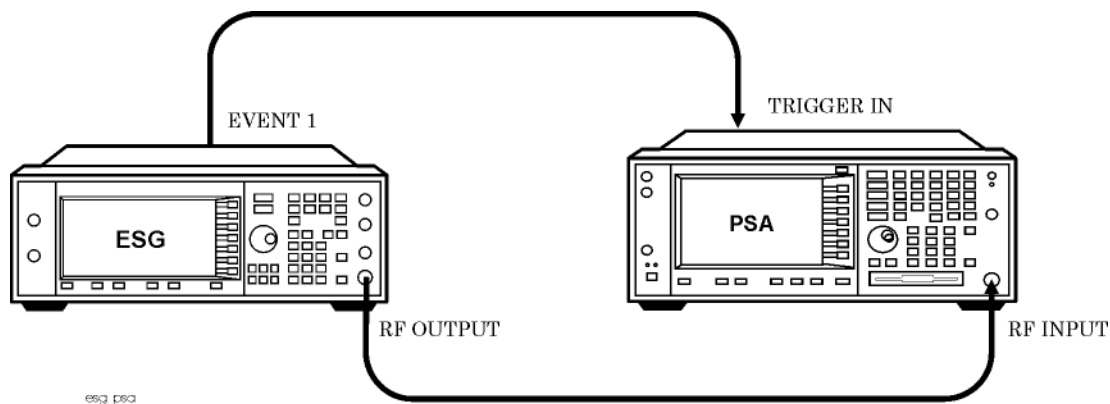

### ESG and Base Transceiver Station (BTS) Setup

Unless stated otherwise in a procedure, both the PRACH and DPCH procedures in this chapter use the base station setup shown in [Figure 16-2](#). For more information on connecting the ESG to a base station, see “[Connecting the ESG to a W-CDMA Base Station](#)” on page 566.

**Equipment Setup**

**Figure 16-2**

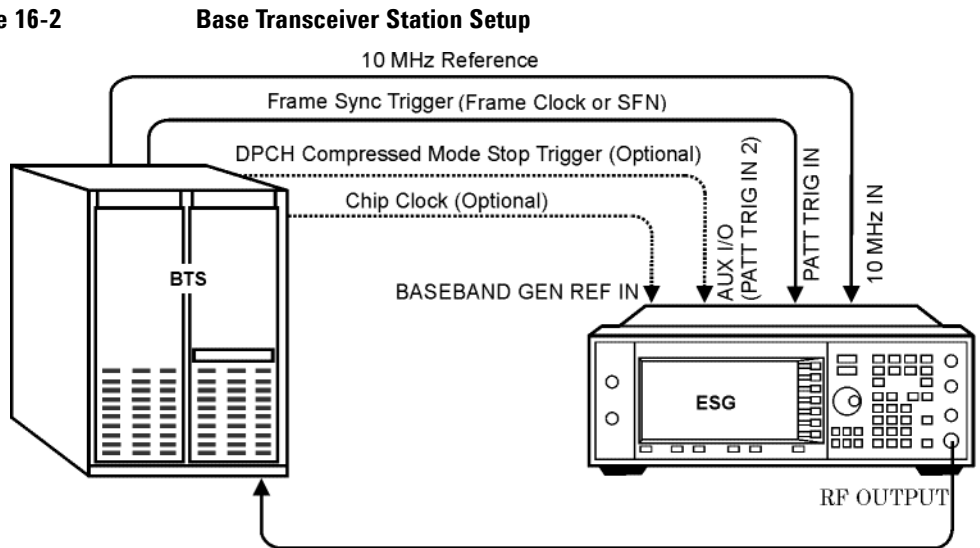

mprach\_btestg2

---

## Understanding the PRACH

### Overview

The PRACH is used by the UE (user equipment/mobile) to signal and establish communications with a base station. It consists of two components, a preamble and message part. However the PRACH, in an actual UE to base station application, initially transmits only the preamble. The preamble is used to signal the base station that a UE is trying to establish a connection, and is repeated until it receives an acknowledgment in the form of an AICH (acquisition indication channel). Once the preamble has been identified by the base station, the base station transmits the AICH. When the UE receives the AICH, it then sends the message part of the PRACH transmission. The message part contains the synchronization and request data used in establishing the base station connection.

There are two modes of PRACH operation within the ESG, single and multiple PRACH. The single PRACH mode offers greater flexibility in configuring the PRACH signal, whereas the multiple PRACH mode gives you the ability to transmit multiple PRACHs within an 80 ms time period. In this mode, you can configure up to eight different UEs each having its own signature. In addition, each UE can transmit multiple PRACHs within an 80 ms time period.

The ESG gives you the option of transmitting only the preamble or the preamble and message part. This gives you the ability to simulate an actual PRACH transmission where multiple preambles may be transmitted before the UE receives an acknowledgment (AICH) from a base station. In the single PRACH mode, you can even configure the message part to transmit when an AICH trigger is received.

In addition to controlling many other parameters of the PRACH, you can adjust the preamble power, the message part power, the distance between the preamble and the message part, the number of preambles prior to the message part transmission (single PRACH mode only), and select a slot format according to the 3GPP standards.

### Access Slots

The access slots provide a well defined time interval for indicating the beginning of a PRACH transmission. An access slot is 5120 chips long (1.33 ms) and there are 15 access slots per two 10 ms radio frames (or 7.5 access slots per radio frame). A radio frame segments the transmission into blocks of time and assists in synchronizing the mobile transmission with the base station. So a 20 ms message part is transmitted over two consecutive radio frames.

Access slots apply to both the uplink and downlink transmissions. In an actual UE to base station transmission, the UE transmits its access slots before it receives the base station's transmission of access slots, thus creating an offset between the two. This offset is used to time the reception of the AICH by the UE. This timing/offset of the AICH is called  $T_p-a$  (the distance from the beginning of the preamble to the beginning of the AICH transmission) and is defined in the 3GPP standards. The PRACH also uses the access

**Understanding the PRACH**

slots to set the timing/distance between preamble transmissions ( $T_{p-p}$ ) and the preamble and the message part ( $T_{p-m}$ ). Figure 16-3 shows these timing relationships. You will notice that all measurements are from the beginning of one component to the next.

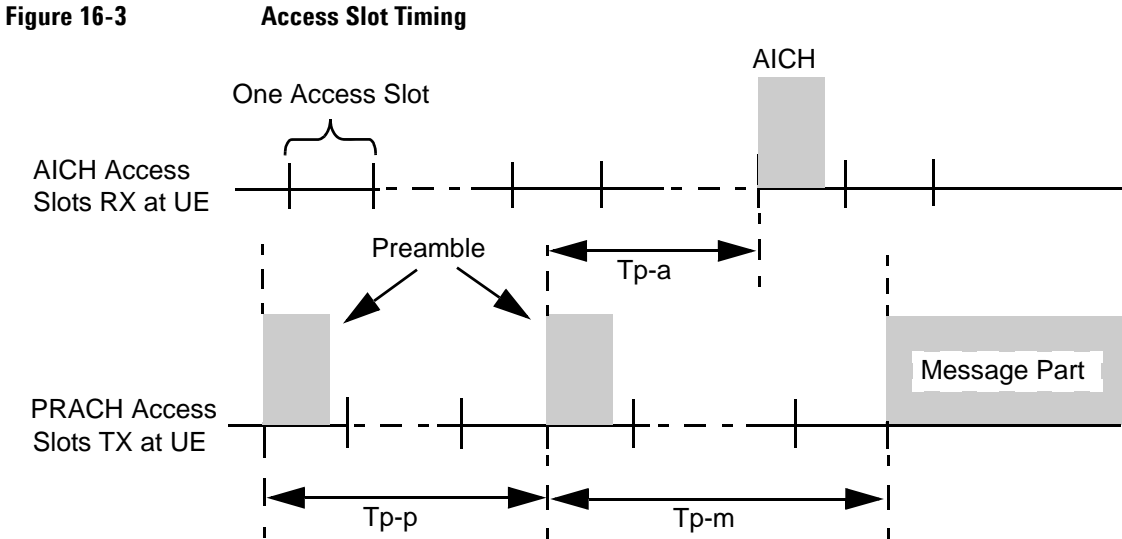

The preamble is 4096 chips in length (1.067 ms), so it does not occupy the entire length of an access slot. When a 10 ms message part (7.5 access slots) is used, it only partially occupies the last access slot.

In multiple PRACH mode, the ESG provides you access slot resolution. Because of this, you can select the access slot for the beginning of your PRACH transmission. However when transmitting multiple PRACHs for the same UE with the ESG, they cannot occupy any of the same access slots within an 80 ms time period. If they do, the subsequent (second PRACH, etc.) PRACH transmission that uses any of the same access slots, will not occur. See [“Understanding the 80 ms Transmission/Time Period” on page 488](#) for more information.

**Preamble**

The preamble is used to signal a base station that a UE is trying to establish communications. It is composed of a complex signature and scrambling code that is used by the base station to uniquely identify the UE. This is a 1.067 ms burst signal, and is the first part of the PRACH transmission.

**Signatures**

A signature is a series of 16 bits that is repeated 256 times within a single preamble. These signatures are shown in the 3GPP standards. The signature is the first of two parts used in the spreading of the preamble. It points to a node within the channelization codes that corresponds to a spread factor (SF) of 16. This node,



within the SF=16 group, has sub-trees (OVSF codes) that are used in the channelization/spreading of the message part.

A base station can simultaneously receive 16 different UEs, and all base stations use the same 16 signatures. Using the BCH (broadcast channel), a base station tells each UE which signature to use and then uses the signature to determine which UE it is communicating with.

### Scrambling Codes

The scrambling code, in most cases, is unique to the base station and it identifies the base station that the UE is communicating with. In an actual UE to base station transmission, the base station tells the UE which scrambling code to use. This scrambling code is then used in connection with the signature to uniquely identify the UE to the base station. The addition of the scrambling code is the second part of the spreading.

There are 8192 (0 to 8191) different scrambling codes. The value selected as the scrambling code is actually the seed to generate the code sequence. The same scrambling code is used for both the preamble and message part. However the preamble uses only the first 4096 chips of the selected scrambling code.

### Message Part

The message part is transmitted as part of the PRACH after the UE receives the AICH from the base station. It contains the information necessary for the UE to establish a link with the base station. This information is transmitted in two parts, a control part and a data part. These two parts form the message part. Each part has its own power level that influences the overall message part power. See “Power Control” on page 467 for more information.

There are three groups of parameters that the ESG lets you set for controlling the message part: control part, data part, and the message part as a whole. The message part can be set to transmit within either a 10 or 20 ms time period called a TTI (transmission time interval).

### Structure

Each 10 ms message part is divided into 15 slots (two slots per access slot). Each of the 15 slots carry the two parts that compose the message part, the control part and the data part. These two parts are transmitted in parallel. This is similar to the DPCH (dedicated physical channel) that consists of a control channel (DPCCH, dedicated physical control channel) and a data channel (DPDCH, dedicated physical data channel). Figure 16-4 shows how the message part is formatted with the control part and data part.

**Figure 16-4** Message Part Structure

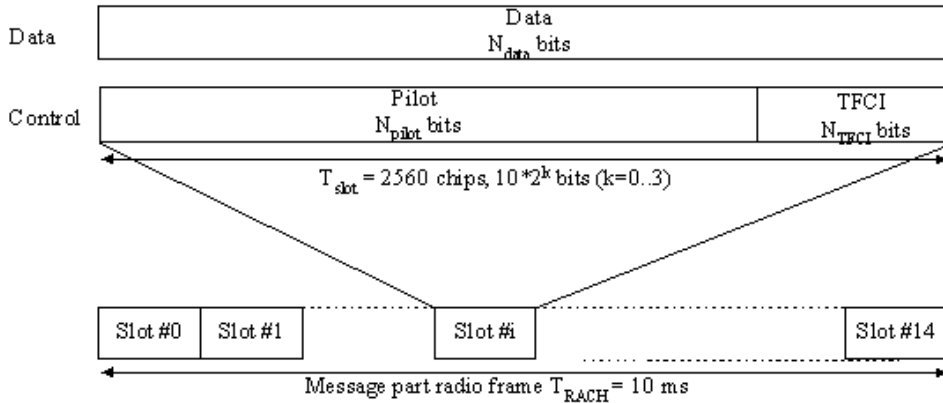

The control part carries the pilot and TFCI (transport format combination indicator) bits. The pilot bits are used by the base station to synchronize with the UE. The TFCI bits are used by the base station to determine the data format being used by the transport channel. For example, this would let the base station know the number of data blocks, the data block size, bit sequence, and number of CRC bits that are being used by the transport channel. The TFCI pattern, relative to a transport channel configuration, is determined by the base station network; it is not defined by the 3GPP standards. The 3GPP standards define only the number of transmitted TFCI bit.

The data part contains only data bits and is the request information used for establishing a connection with the base station.

**Slot Formats**

Slot formats are used to determine the transmitted frame structure such as the symbol rate, the number of bits per frame, and the spread factor. Each slot format is defined in the 3GPP standards and implemented in the ESG. The control part and data part each have their own slot formats and they are applied to the 15 slots per 10 ms message part. The available slot formats are shown in [Figure 16-5](#) and [Figure 16-6](#).

If you are using the transport channel as the message part data type, you can inadvertently set values within the transport channel that conflict with the current slot format. When this occurs, an error will be displayed and you will need to either correct the transport channel values or select an appropriate data part slot format.

The control part only has one slot format, so its configuration is static, see [Figure 16-5](#).

**Figure 16-5 Control Part Slot Format**

Slot Format #i	Channel Bit Rate (kbps)	Channel Symbol Rate (ksps)	SF	Bits/ Frame	Bits/ Slot	N <sub>pilot</sub>	N <sub>TFCI</sub>
0	15	15	256	150	10	8	2

Unlike the control part, the data part has multiple slot formats that enable it to transmit at different data rates. This is shown in [Figure 16-6](#).

**Figure 16-6 Data Part Slot Format**

Slot Format #i	Channel Bit Rate (kbps)	Channel Symbol Rate (ksps)	SF	Bits/ Frame	Bits/ Slot	N <sub>data</sub>
0	15	15	256	150	10	10
1	30	30	128	300	20	20
2	60	60	64	600	40	40
3	120	120	32	1200	80	80

### Message Part Scrambling Codes

As stated in [“Scrambling Codes” on page 465](#), the same code is used for both the message part and the preamble. However the starting chip for the message part is shifted by 4096 chips from the preamble code. The message part contains 38400 scrambling chips and they are repeated every 10 ms (every radio frame). So a 20 ms message part would have two repetitions of the same code.

### Power Control

The PRACH power is controlled by setting the preamble and the message part power. The PRACH power is determined by the component (preamble or message part) of the PRACH that has the highest power level. If both components have the same power level, then both components individually equal the PRACH power level. The message part power is comprised of the absolute powers for the control part and data part. A PRACH power value can be entered that exceeds the current displayed carrier power and vice versa. But in reality, the PRACH power equals the carrier power; it cannot exceed it. When a PRACH over power condition occurs, the ESG will automatically adjust the PRACH power or the carrier power to keep them within limits. In the multiple PRACH mode, the ESG maintains an 18.06 dB offset between the carrier power and the PRACH power level. This is so the ESG can accommodate the additional power required when more UEs (user equipment/mobiles) are utilized (see [“Understanding the Power Offset Between the Carrier and the Multiple PRACH” on page 491](#) for more information).

**Understanding the PRACH**

There are three areas that control the PRACH power level, the preamble power, the data part power, and the control part power. Each of these areas are explained in the following sections. [Figure 16-7](#) shows these areas on the PRACH timing setup display while in the Pp-m power setup mode. Refer to [“Power Control Modes” on page 473](#) for more information on the power setup modes. The power control display is accessed using the **PRACH Power Setup** softkey.

**Figure 16-7 PRACH Power Control Areas**

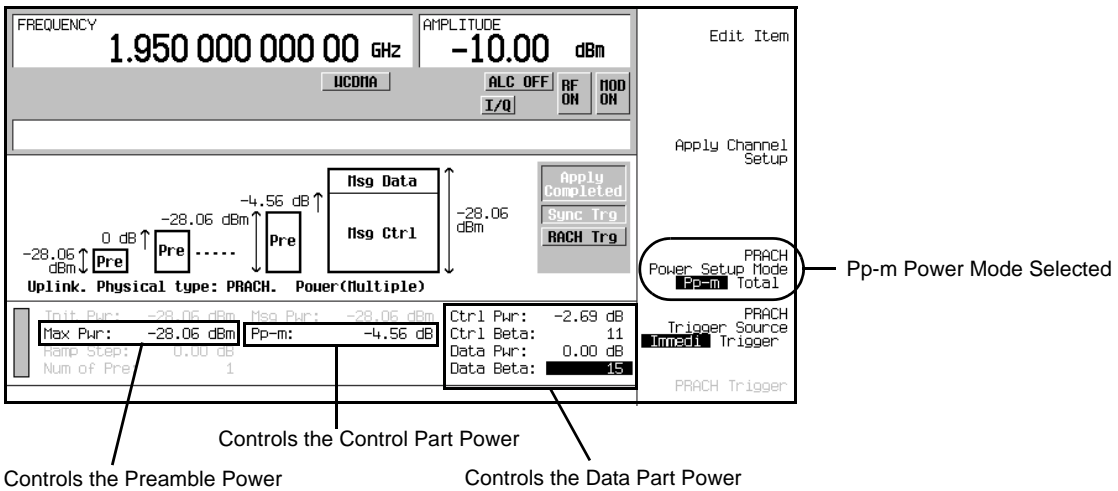

**Preamble Power**

The preamble power is an absolute value (dBm) and is adjusted in the ESG by changing the value in the Max Pwr field. Its value is used in determining the control part power level, which influences the total message part power. See [“Control Part Power”](#) for more information.

The preamble power can be adjusted so that it exceeds the current carrier power. When this occurs, the ESG will automatically adjust the carrier power. The reverse is also true when you enter a new carrier power.

**Control Part Power**

The control part power is an absolute value (dBm) that is set indirectly and with respect to the preamble. It is derived from the sum of the highest preamble power and the Pp-m value.

The Pp-m is an offset value (dB) that determines the power difference between the control part and the preamble powers ( $Pp-m = Cntl_{dBm} - Pre_{dBm}$ ). (See [Figure 16-8](#).) So by adjusting your Pp-m value, you change the control part power with respect to the preamble.

To calculate the control part power, use the following formula:

$$\text{Cntl}_{\text{dBm}} = \text{Pre}_{\text{dBm}} + \text{Pp-m}$$

$\text{Cntl}_{\text{dBm}}$  is the control part power that is the sum of the preamble power ( $\text{Pre}_{\text{dBm}}$ ) and the Pp-m value. The preamble power is represented by the `Max Pwr` field on the ESG.

Since the control part power is directly related to the Pp-m value, this means that when the Pp-m value is positive, the control part power is greater than the preamble power and the message part power will also be greater than the preamble power by at least the Pp-m value. Conversely when the Pp-m value is negative, the control part power is less than the preamble power and the message part can also be less than the preamble power depending on the data part power level. [Figure 16-8](#) shows an example of the influence of the control part power when the Pp-m value is positive and the data part power is low enough that it has minimal impact on the overall message part power.

**Figure 16-8 Control Part Power Determining Message Part Power**

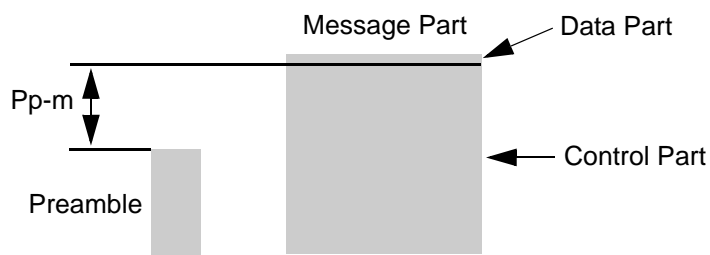

### Data Part Power

The data part power is not directly entered. It is adjusted and calculated using the difference between relative power values. These relative powers are shown as `Ctrl Pwr` and `Data Pwr` on the ESG. The power values can be entered using random values, or in compliance with the 3GPP standards, they can be controlled using gain factors called betas. The 3GPP standard refers to them as  $B_c$  (control beta) and  $B_d$  (data beta). On the ESG, they are shown as `Ctrl Beta` and `Data Beta`. Each beta (control and data) has 16 different values numbered 0 to 15, and the values 1 through 15 are used to create an amplitude/voltage ratio for calculating

**Understanding the PRACH**

the relative power levels. A beta of zero means the power has been turned off for that particular relative power. Table 16-1 shows the beta values and their respective ratios.

**Table 16-1 Control and Data Part Betas**

Beta Values for Control and Data Beta	Amplitude/Voltage Ratios
15	1
14	14/15
13	13/15
12	12/15
11	11/15
10	10/15
9	9/15
8	8/15
7	7/15
6	6/15
5	5/15
4	4/15
3	3/15
2	2/15
1	1/15
0	Off <sup>a</sup>

a. -40 dB for the ESG relative power levels

When betas are used, the control and data relative powers are calculated using the following formula:

$$\text{Relative power} = 20 \text{ Log} (\text{beta}/15)$$

According to the 3GPP standards, at any instant in time, one of the betas for either the control or data power will result in a ratio of one (0.00 dB). However the ESG gives you the flexibility to set your relative power

values to meet your testing needs. Which ever method you use, the highest power value is used as your data part power reference relative to the control part power.

---

**NOTE** When a random power value is used, the beta value is replaced by a hyphen, since it cannot be defined by the beta values.

---

Using the relative power formula, a control beta of five would result in a relative control power value of  $-9.54$  dB. If the relative data power is  $0.00$  dB (beta of 15), this would mean that the data part power is  $9.54$  dB higher than the control part power. If the relative data power is  $-9.54$  dB and the relative control power is  $0.00$  dB, this would mean that the data part power was  $9.54$  dB lower than the control part power. When the betas are the same value, this means that the control part and data part powers are the same power levels. This results in a  $3$  dB (two times the control part power) increase in the message part power.

To calculate the data part absolute power, perform the following steps where

$Pwr_{diff}$  = difference between relative power values     $Cntl_{pwr}$  = relative control power

$Data_{pwr}$  = relative data power                       $Cntl_{dBm}$  = control part power

$Data_{dBm}$  = data part power                       $Pre_{dBm}$  = preamble power

1. Calculate the absolute power for the control part.

$$Cntl_{dBm} = Pre_{dBm} + Pp-m$$

The preamble power is represented by the `Max Pwr` field on the ESG.

2. Calculate the relative power difference between the two relative power values.

$$Pwr_{diff} = Data_{pwr} - Cntl_{pwr}$$

3. Calculate the absolute power for the data part.

$$Data_{dBm} = Cntl_{dBm} + Pwr_{diff}$$

Do not confuse the control power as a means of adjusting the control part power. Remember the control part power is the sum of the preamble and the Pp-m values. The control power merely serves as a reference for the data part power relative to the control part power. [Figure 16-9](#) demonstrates the message part power when the data part has a greater influence.

**Understanding the PRACH**

**Figure 16-9 Data Part Power Determining Message Part Power**

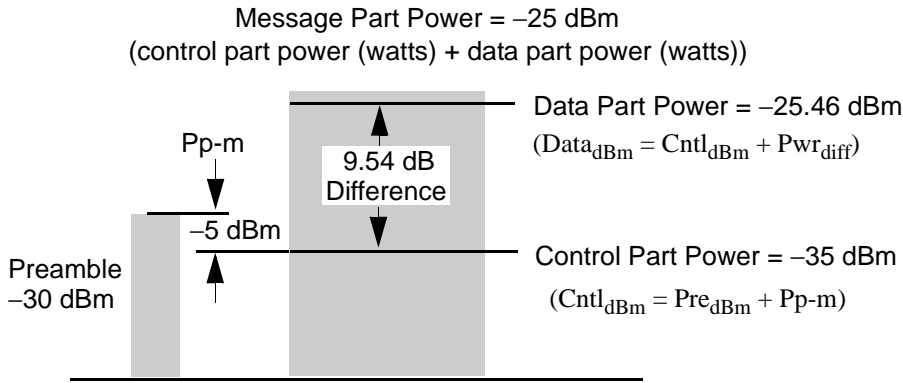

The message part power calculation is explained in the following section, “[Message Part Power](#)”.

**Message Part Power**

As stated earlier, the message part power (dBm) is comprised of the control part and data part power levels. The message part power is calculated using the sum of the linear power values for Data<sub>dBm</sub> (data part power) and Cntl<sub>dBm</sub> (control part power). Use the following formula to calculate the message part power:

$$10 \text{ Log}[10^{(\text{Data dbm} / 10 + (-3))} + 10^{(\text{Cntl dBm} / 10 + (-3))}]$$

By adjusting the two power levels, you can make the message power less than, equal to, or greater than the preamble power. In some situations, the message part power can exceed the carrier power. When this occurs, the ESG will automatically adjust its carrier power, up to its limits, to accommodate the new message part power. The following examples demonstrate some of the ways you can set the message part power:

**Example 1:**

Preamble Power: -40 dBm      Pp-m: 5 dB      Ctrl Beta: 15      Data Beta: 0

This will result in a control part power level that is always 5 dB higher than the preamble therefore making the message part power 5 dB higher than the preamble.



**Example 2:**

Preamble Power: -40 dBm      Pp-m: 0 dB      Ctrl Beta: 0      Data Beta: 15

In this example the data part power will be 40 dB higher than the control part power. Since the Pp-m is set to 0 dB, this means that the control part power level is equivalent to the preamble power. This condition will create a substantially higher message part power compared to the preamble power, and in most cases, this would cause the carrier power to readjust itself to compensate for the high message part power.

**Example 3:**

Preamble Power: -40 dBm      Pp-m: -10 dB      Ctrl Beta: 15      Data Beta: 1

In this example the control part power is 10 dB less than the preamble power and the data part power is -23.52 dB (beta of 1) less than the control part power. These settings result in a message part power that is less than the preamble power.

## Power Control Modes

The ESG gives you the opportunity to control your PRACH power using one of two methods, a Pp-m mode or a Total mode. The mode selection is accomplished using the **PRACH Power Setup Mode Pp-m Total** softkey.

### Pp-m Power Mode

The Pp-m mode lets you control the message part power by making changes to your control part and data part power levels. The control part power level is adjusted by entering values in the Pp-m field. There is no direct message part power adjustment in this mode since the *MSG Pwr* field is grayed-out (inactive). However the message part power is shown in the grayed-out field. You can also calculate your message part power by using the formulas given in the section, [“Power Control” on page 467](#). [Figure 16-10](#) shows the Pp-m mode selection along with the two fields that were mentioned earlier.

**Figure 16-10 Pp-m Mode**

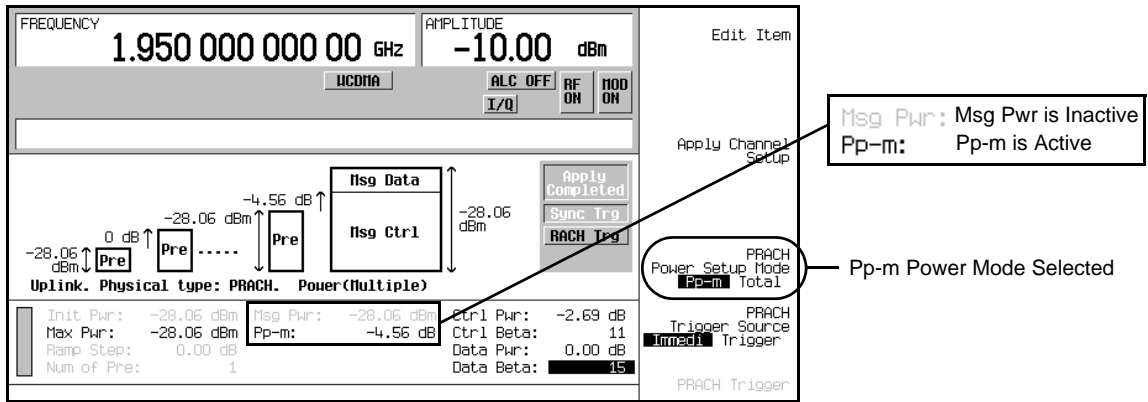

**Total Power Mode**

The total mode lets you set the message part power directly, which in turn sets the control part power by automatically adjusting the Pp-m value. In this mode, the *Msg Pwr* field is active and the *Pp-m* field is grayed-out (inactive). To calculate what control part power and Pp-m value will result from a message part power value, perform the following steps where

$Pwr_{diff}$  = difference between relative power values     $Cntl_{pwr}$  = relative control power

$Data_{pwr}$  = relative data power     $Cntl_{dBm}$  = control part power

$Pre_{dBm}$  = preamble power     $Mess_{dBm}$  = message power

1. Determine the difference between the relative power values.

$Pwr_{diff} = Data_{pwr} - Cntl_{pwr}$

2. Calculate the control part power.

$Cntl_{dBm} = Mess_{dBm} - 10 \text{ Log}[1 + 10^{(Pwr_{diff} / 10)}]$

3. Calculate the expected Pp-m value.

$Pp-m = Cntl_{dBm} - Pre_{dBm}$

Figure 16-11 shows the selection of the total mode along with the two fields mentioned earlier.

**Figure 16-11 Total Mode Selection**

The screenshot displays the configuration for a PRACH (Physical Random Access Channel) test. Key elements include:

- Frequency:** 1.950 000 000 00 GHz
- Amplitude:** -6.94 dBm
- Physical type:** PRACH
- Power Setup Mode:** Pp-m **Total** (highlighted with a callout: "Total Power Mode Selected")
- Power Level Diagram:** Shows stages: Pre (-30.00 dBm), Ctrl (-5.00 dBm), and Data (-25.00 dBm).
- Parameter Table:**

Init Pwr:	-30.00 dBm	Msg Pwr:	-25.00 dBm	Ctrl Pwr:	-9.54 dB
Max Pwr:	-30.00 dBm	Pp-m:	-5.00 dB	Ctrl Beta:	5
Ramp Step:	0.00 dB			Data Pwr:	0.00 dB
Num of Pre:	1			Data Beta:	15
- Status:** "Msg Pwr: Msg Pwr is Active" and "Pp-m: Pp-m is Inactive" (highlighted with a callout).

## Generating a Single PRACH Signal

Using the single PRACH mode may turn the ESG ALC feature off. For reliable results, you may need to perform a power search. Refer to [“Special Power Control Considerations When Using DPCCH/DPDCH in Compressed Mode or PRACH” on page 584](#) before completing this procedure.

The ESG is capable of transmitting a PRACH using the factory default channel parameters. This aspect of the ESG is demonstrated in the following procedures.

### Configuring the RF Output

1. Preset the ESG.
2. Set the carrier frequency to 1.95 GHz.
3. Set the carrier power to  $-10$  dBm.
4. Turn on the RF output.

### Selecting the PRACH and Single PRACH Modes

1. Press **Mode > W-CDMA > Real Time W-CDMA > Link Down Up** to Up.
2. Press **Link Control > PhyCH Type > PRACH**.
3. Press the **PRACH Mode Single Multi** softkey until Single is highlighted.

The factory default setting is the Single PRACH mode.

### Selecting a Rear Panel Output Trigger

1. Press **PRACH Rear Panel Setup > PRACH Output Signal Setup**.

This sets up an output trigger signal at the EVENT 1 rear panel connector. Refer to [“Configuring Rear Panel Output Signals” on page 559](#) for more information.

2. Highlight the item under the `Signal` column that corresponds to `Event1` under the `Rear Panel Ports` Column.
3. Press **More (1 of 3) > More (2 of 3) > PRACH Pulse (RPS23)**.

This will enable an output trigger that corresponds to the beginning of each PRACH.

4. Press **Mode Setup** to return to the top-level real-time W-CDMA menu.

A default PRACH signal output has a single preamble and a message part with a 20 ms transmission time interval (TTI). Setting the trigger output to occur on the PRACH pulse lets the spectrum analyzer or other measuring equipment that is externally triggered, start its sweep at the beginning of the PRACH signal.

## **Generating the Baseband Signal**

Press **W-CDMA Off On** to On.

## **Setting Up the E4440A PSA for the PRACH Signal**

This procedure guides you through setting up the PSA for making a time domain measurement. Refer to [Figure 16-1 on page 461](#) for connecting the ESG to the E4440A PSA. [Figure 16-12 on page 478](#) shows the ESG output signal on the PSA display.

1. Preset the spectrum analyzer.
2. Select the W-CDMA mode.  
Press **Mode > W-CDMA**.
3. Set the center frequency.  
Press **Frequency Channel > Center Freq > 1.95 > GHz**.
4. Select the time domain measurement mode.  
Press **Measure > More 1 of 2 > Waveform (Time Domain)**.
5. Set a sweep time that shows the components of the PRACH transmission.  
Press **Meas Setup > Sweep Time > 50 > ms**.  
This sets 5 ms as the vertical time divisor (10 divisions x 5 ms = 50 ms)
6. Set the resolution bandwidth for a quick response time that captures the bursting nature of the PRACH components.  
Press **Res BW > 500 > kHz**.
7. Trigger the spectrum analyzer from the rear trigger input using the ESG's PRACH pulse trigger signal.  
Press **Trig Source > Ext Rear**.
8. Zoom in on the RF Envelope display.  
Press **Zoom**.

W-CDMA Uplink Digital Modulation for Receiver Test (Option 400)  
**Generating a Single PRACH Signal**

**Figure 16-12**                      **Displayed ESG Signal**

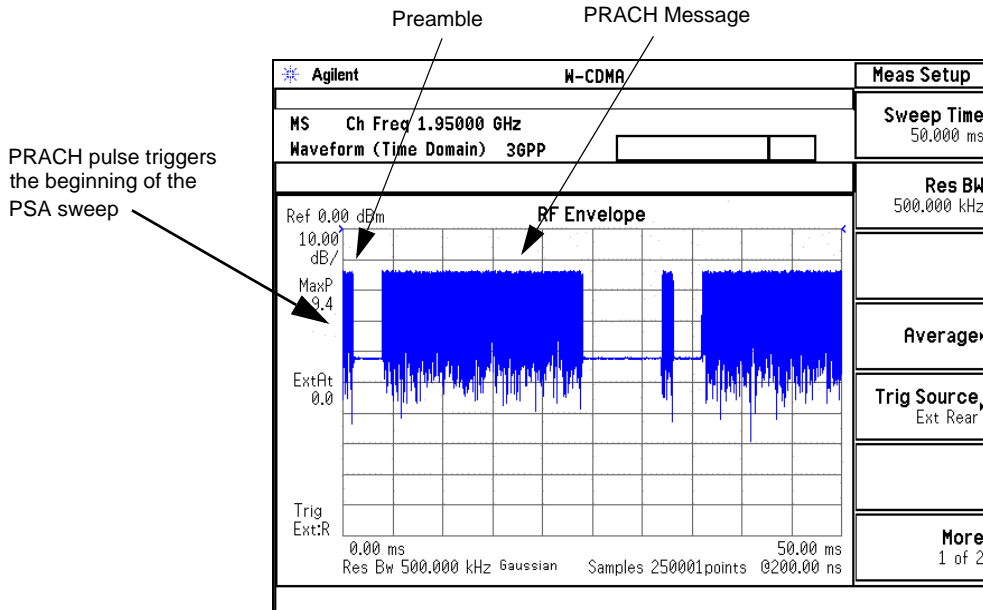

**Modifying the PRACH Physical and Transport Layers**

The tasks in this procedure build upon the previous procedure, “[Generating the Baseband Signal](#)” on [page 477](#).

The ESG lets you set many of the parameters that govern the PRACH transmission. This procedure guides you through modifying some of these parameters for the physical and transport layers.

**Modifying the Physical Layers**

This task includes an example of setting up the preamble power ramp.

1. Press **Link Control > PhyCH Setup > PRACH Power Setup**.
2. Set the preamble power.
  - a. Move the cursor to highlight the **Max Pwr** field.
  - b. Press **-20 > dBm**.

This value is linked to the carrier signal power setting. When the W-CDMA format is first turned on, the **Max Pwr** Field value changes to match the carrier signal power. It is a good practice to have the W-CDMA format on prior to making adjustments to the PRACH power.

3. Set the power ramp for multiple preambles.
  - a. Move the cursor to highlight the Ramp Step field.
  - b. Press **7 > dB**.

This setting enables a power ramping when multiple preambles are used. Each successive preamble transmission from the second to the last will increase in power by 7 dB.

4. Select the number of transmitted preambles.
  - a. Move the cursor to highlight the Num of Pre field.
  - b. Press **4 > Enter**.

The number of transmitted preambles is now four, which means that the PRACH initial/starting power level (first preamble) will be  $-41$  dBm. The fourth preamble will be transmitted at the PRACH power level set in step 2b or  $-20$  dBm. This means the first three preambles will have power levels that are in increments of 7 dB less than the fourth preamble. The initial power (first transmitted preamble power level) is calculated as follows:

$$3 \times 7 \text{ dB} = 21 \text{ dB} \quad -20 \text{ dBm} - 21 \text{ dB} = -41 \text{ dBm initial power}$$

**NOTE** When setting the Max Pwr, Ramp Step, and Num of Pre fields, they need to be done in the order shown. If you do not set them in the order shown, errors may occur and values may automatically change to accommodate limits.

**Figure 16-13 Display After the Power Parameter Changes**

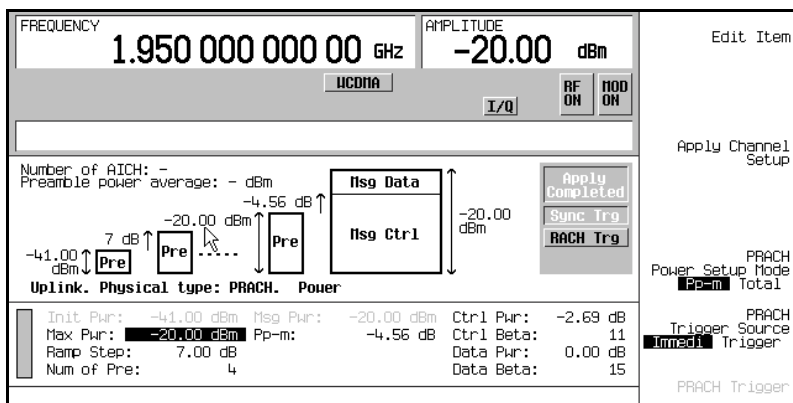

5. Press **Return > PRACH Timing Setup**.

**Generating a Single PRACH Signal**

6. Configure the distance from the beginning of one preamble to the beginning of the next preamble. This is expressed in access slots.
  - a. Move the cursor to highlight the Tp-p (time period between preambles) field.
  - b. Press **2 > Enter**.
7. Set the transmission time interval for the message part.
  - a. Move the cursor to highlight the TTI (transmit time interval) field.
  - b. Press **10 > msec**.
8. Press **Apply Channel Setup**.

When the **Apply** Needed annunciator appears, press the **Apply Channel Setup** softkey. You will not see a change in the signal until you press this softkey.

**Figure 16-14 Display After Time Parameter Changes**

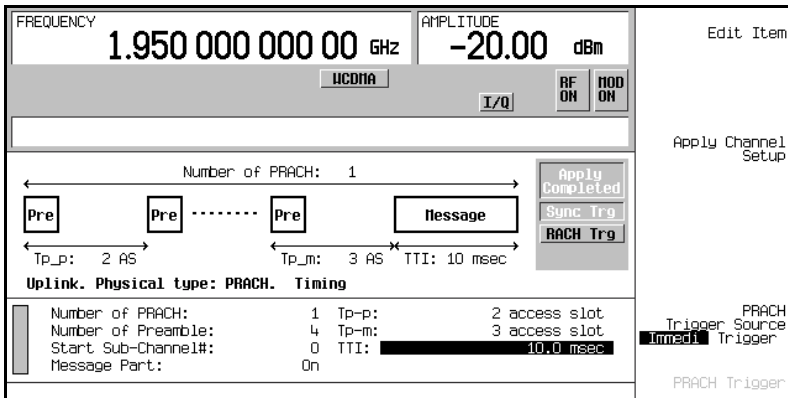

**Modifying the Transport Layer**

The transport channel (RACH) is available when the PRACH physical channel data type is set to TrCh (factory default data type). This task teaches you how to make changes to the transport layer parameters.

1. Press **Return > Return > Transport Setup > TrCH Setup**.



2. Set the data block size.

The block size and the number of blocks affect the bit rate into the transport layer. The data is punctured or has bits added (rate matching) so that it fits into a frame for a given slot format. The Puncture field currently displays a negative value. This indicates that bits will be added to the data in order to facilitate rate matching. A positive value in this field means that puncturing will occur according to the percentage shown. [Figure 16-15](#) shows the location of the Max Puncture and Puncture fields.

- a. Move the cursor to highlight the Blk Size field.
- b. Press **450 > Enter > Apply Channel Setup**.

The puncture rate has changed, because an increase in the block size increases the RACH data rate. [Figure 16-15](#) shows what the ESG display looks like once the transport channel parameters have been set.

**Figure 16-15** Display after Transport Layer Setup

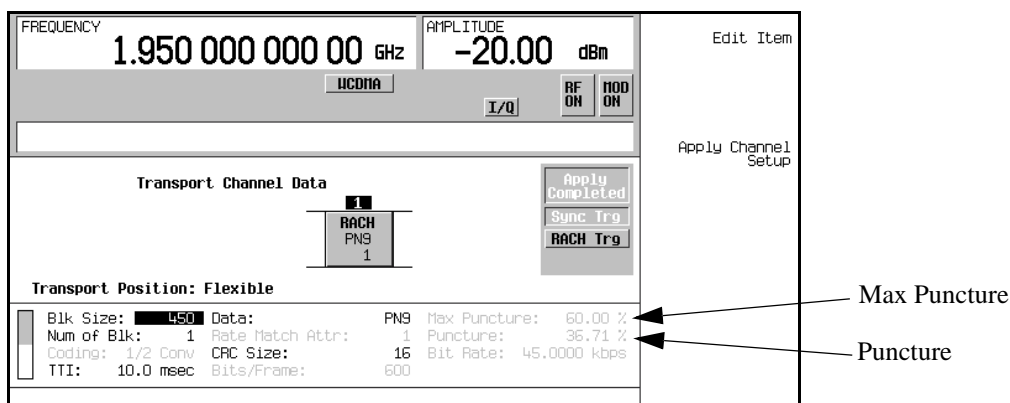

### Changing the PRACH Output Trigger

Press **Return > Return > PRACH Rear Panel Setup > PRACH Output Signal Setup > More (1 of 3) > More (2 of 3) > Message Pulse (RPS22) > Mode Setup**.

This changes the triggering for the PSA so that the sweep starts at the beginning of the PRACH message part.

You have now modified the PRACH physical and transport channel parameters. The PRACH will now transmit four preambles with power stepping and the spacing/timing between each preamble (beginning of one preamble to the beginning of the next preamble) was adjusted for two access slots. The message part transmission has also been set to 10 ms. The RACH data rate was increased when the block size was

**Generating a Single PRACH Signal**

adjusted. This resulted in the rate matching algorithm puncturing the data in order to fit it into a frame for the given slot format.

**Viewing the Modified PRACH Signal**

This section uses the PSA settings from the procedure “Setting Up the E4440A PSA for the PRACH Signal” on page 477.

The PSA time domain measurement mode lets you view many of the PRACH parameters, since they are time dependent. Figure 16-16 shows the PRACH signal after the modifications from the previous section “Modifying the PRACH Physical and Transport Layers” on page 478 have been completed. Notice the PSA sweep starts at the beginning of the message part and the message part has a time interval of 10 ms (there are 5 ms per vertical division). This is the result of setting the ESG PRACH trigger to message pulse and the preamble TTI field to 10 ms. You can also see the preamble power ramping.

**Figure 16-16**                      **Displayed ESG Signal**

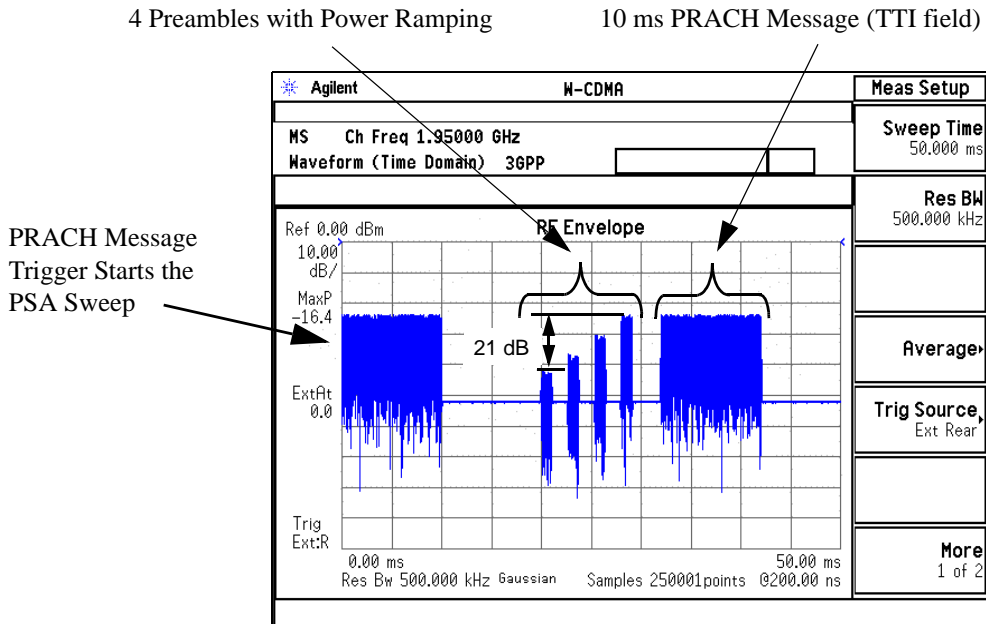

**Generating the AICH for the PRACH Message Transmission**

The tasks in this procedure build upon the previous procedure, “Modifying the PRACH Physical and Transport Layers” on page 478. This procedure uses a different PSA connection diagram

(Figure 16-17 on page 484) and base station connection diagram shown in the section, “Using the AICH Feature with a Base Transceiver Station” on page 486.

Using the AICH feature may turn the ESG ALC feature off. For reliable results, you may need to perform a power search. Refer to “Special Power Control Considerations When Using DPCCH/DPDCH in Compressed Mode or PRACH” on page 584 before completing this procedure.

This procedure will teach you how to set up the AICH (acquisition indication channel) feature so that it triggers the message part transmission. This procedure uses the ESG’s LF (low frequency) output to simulate the AICH signal (TTL trigger), or if you prefer, an external source can be used. Connecting the AICH trigger signal to the ESG requires the use of the rear panel AUX I/O connector. (See “Rear Panel Overview” on page 16 or “Rear Panel Overview” on page 37 for more information on the AUX I/O connector.) An adapter will be needed to make the connection between the LF OUTPUT and pin 17 on the AUX I/O connector.

### **Finding the Rear Panel Input for the AICH Signal**

1. Press **Link Control > PRACH Rear Panel Setup > PRACH Input Signal Setup**.
2. Find which rear panel connector accepts the AICH trigger.

The listed connector (Pattern trigger in 2 on AUX pin 17) is a pin on the AUX I/O connector.

### **Changing the PRACH Output Trigger**

Press **Return > PRACH Output Signal Setup > More (1 of 3) > More (2 of 3) > PRACH Pulse(RPS23)**.

This is being done so you can view the message part transmission on the PSA as the AICH is received. The trigger output is on the EVENT 1 rear panel connector.

## W-CDMA Uplink Digital Modulation for Receiver Test (Option 400) Generating a Single PRACH Signal

### Connecting the ESG

Refer to [Figure 16-17](#) and make the connections as shown.

**Figure 16-17** AICH Connection Diagram

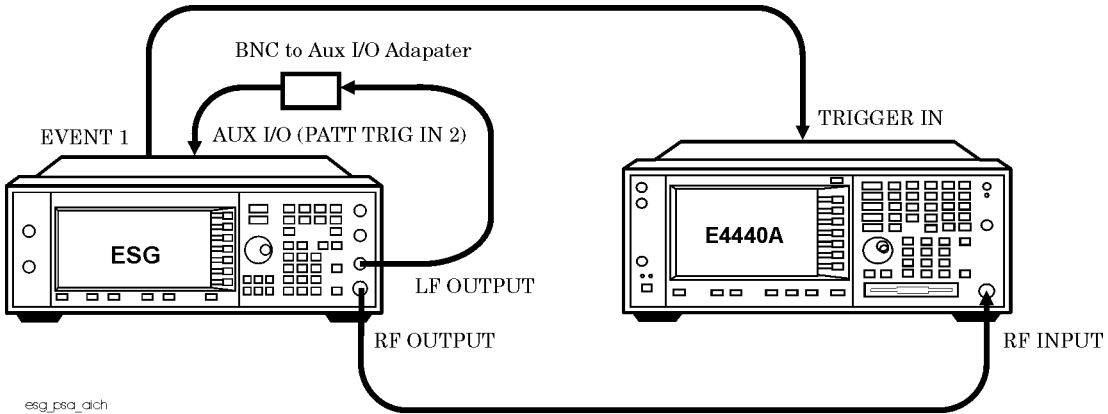

### Configuring the PRACH Message for the AICH Trigger

1. Press **Mode Setup > Link Control > PhyCH Setup > PRACH Timing Setup**.
2. Select AICH as the entry for the Message Part field.
  - a. Highlight the Message Part field.
  - b. Press **Edit Item > AICH**.

This sets up the PRACH signal so that the message part is not transmitted until an AICH trigger is received. Since the ESG is not a receiver, it cannot receive and demodulate a true AICH signal, so the input has to be a trigger signal.

3. Set the number of preambles to 1.
  - a. Highlight the Number of Preamble field.
  - b. Press **1 > Enter**.

You can set the number of preambles in either the PRACH Power or PRACH Timing Setup display.

### Setting Up the LF Output as the AICH Signal

This task sets up the LF output so the results of the AICH trigger signal can be viewed on the PSA display (see “[Viewing the PRACH Message Using an AICH Trigger](#)”). By following the steps in this task, the message part will appear intermittently after each displayed preamble as the AICH trigger is received.

1. Press **LF Out > LF Out Source > Function Generator**.
2. Press **LF Out Waveform > More (1 of 2) > Pulse**.
3. Press **LF Out Period > 21 > msec**.
4. Press **LF Out Width > 1 > msec**.
5. Press **LF Out Amplitude > 5 > Vp**.
6. Press **LF Out Off On** to On.

### Viewing the PRACH Message Using an AICH Trigger

This procedure guides you through configuring the PSA for making a spectrum analysis measurement. This is being done to familiarize you with the different measurement modes that exist for the PSA. You could use the W-CDMA mode, time domain measurement, to achieve the same results.

1. Preset the spectrum analyzer.
2. Select the spectrum analysis mode.  
Press **Mode > Spectrum Analysis**.
3. Set the center frequency to 1.95 GHz.  
Press **Center Freq > 1.95 > GHz**.
4. Set the span to zero hertz for close-in viewing of the PRACH signal.  
Press **Span > 0 > Hz**.
5. Set the sweep time to 50 ms.  
Press **Sweep > Sweep Time > 50 > ms**.
6. Set the spectrum analyzer to trigger from the ESG’s PRACH pulse trigger signal.  
Press **Trig > Ext Rear**.

You now see the message part moving across the display as the AICH trigger is received after each preamble. [Figure 16-18](#) shows the message part as it appears after the third preamble transmission.

**Figure 16-18**

**Displayed ESG Signal**

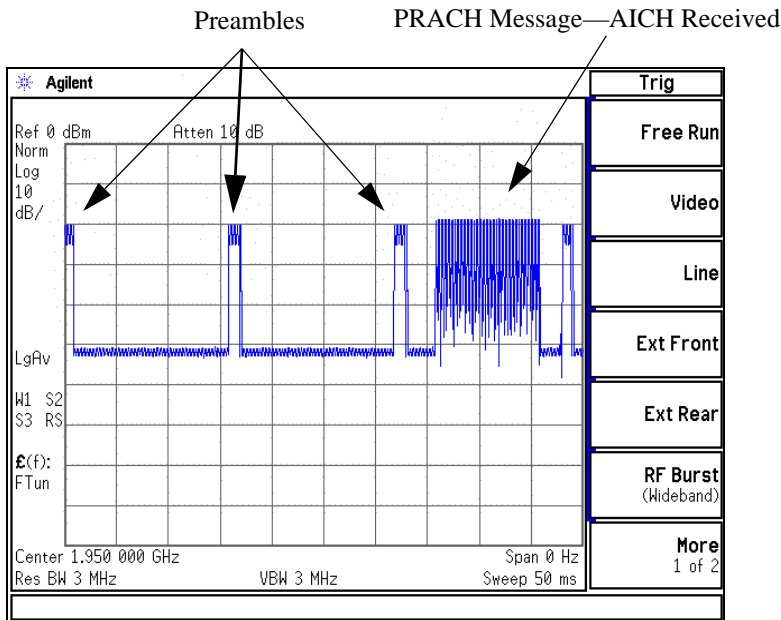

### Using the AICH Feature with a Base Transceiver Station

Figure 16-19 shows the AICH feature connection with the AICH being provided by the base station. While the ESG cannot demodulate an actual AICH signal, the base transceiver station can be configured to output a TTL trigger signal that is timed with the AICH transmission. This trigger signal can then be used as the AICH trigger for the ESG to transmit its message part. Or if you prefer, you can follow the instructions shown in “Setting Up the LF Output as the AICH Signal” on page 485, and use the ESG’s LF output as the AICH trigger source.

Figure 16-19 Base Transceiver Station AICH Connection Diagram

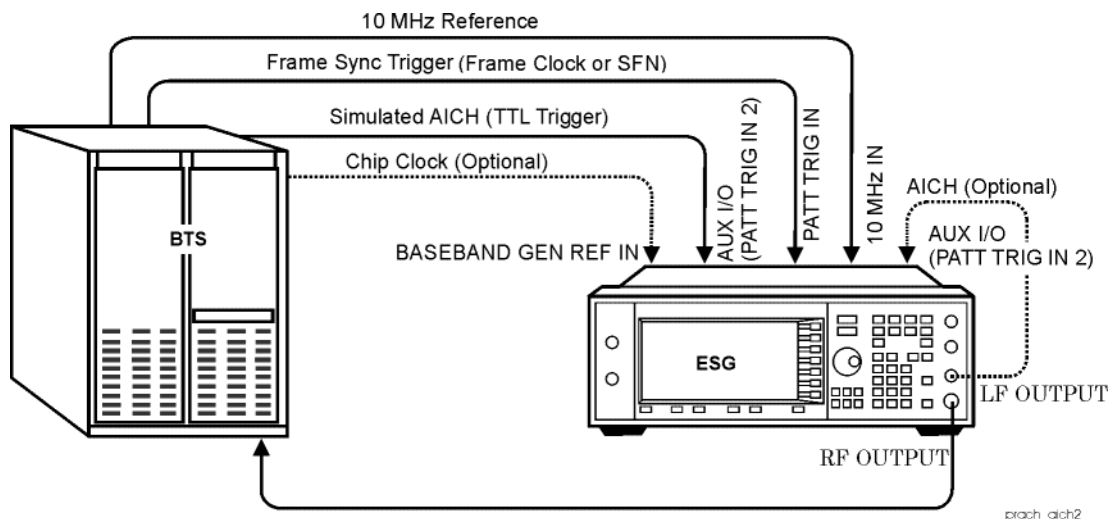

1. Connect the ESG to the base transceiver station as shown in [Figure 16-19](#).
2. Configure the base transceiver station to output a simulated AICH (TTL trigger) signal.
3. If you need a trigger signal from the ESG to determine when it transmits the PRACH, follow the instructions in the section, [“Changing the PRACH Output Trigger”](#) on page 483.
4. Set up the ESG to expect the AICH trigger by following the instructions in the section, [“Configuring the PRACH Message for the AICH Trigger”](#) on page 484.
5. Turn on the W-CDMA format.
6. Setup the ESG carrier signal.
7. Turn on the ESG RF output.

## Multiple PRACH Overview

The multiple PRACH feature of the ESG lets you simulate multiple UEs (user equipment/mobile) attempting to contact a base transceiver station (BTS). This feature is especially beneficial for BTS overload testing when multiple ESGs are used (see “[Overload Testing with Multiple PRACHs—Multiple ESGs](#)” on [page 511](#)). The following is a list of some of the characteristics you will find in the multiple PRACH feature:

- 80 ms transmission/time period with access slot resolution
- 60 access slots ( $80 \text{ ms} / 1.33 \text{ ms} = 60$ ) numbered 0 to 59
- transmission simulation of eight UEs using independent signatures that automatically assigns the channel codes in accordance with the 3GPP TS 25.213
- transmission of an individual UE’s PRACH multiple times (up to 8 times) within the 80 ms time period  
The number of times a UE’s PRACH can be transmitted is dependent on the number of access slots each PRACH occupies.
- incorporate AWGN (additive white Gaussian noise) with the multiple PRACH transmission
- transmit the preamble or the preamble plus the message part
- synchronize multiple ESGs to increase the number of UEs/PRACHs

### Understanding the 80 ms Transmission/Time Period

The multiple PRACH feature incorporates an 80 ms time period in which to transmit the multiple PRACHs/UEs. This 80 ms period has access slot resolution, so it contains 60 selectable access slots (0–59). The entire 80 ms period is transmitted each time, even if only one access slot is utilized. Within this 80 ms period you have eight available UEs. All eight can be active at the same time, and each UE has the capability of transmitting its PRACH up to eight times. [Figure 16-20](#) shows the 80 ms period display.



Figure 16-20 Timing Setup Display

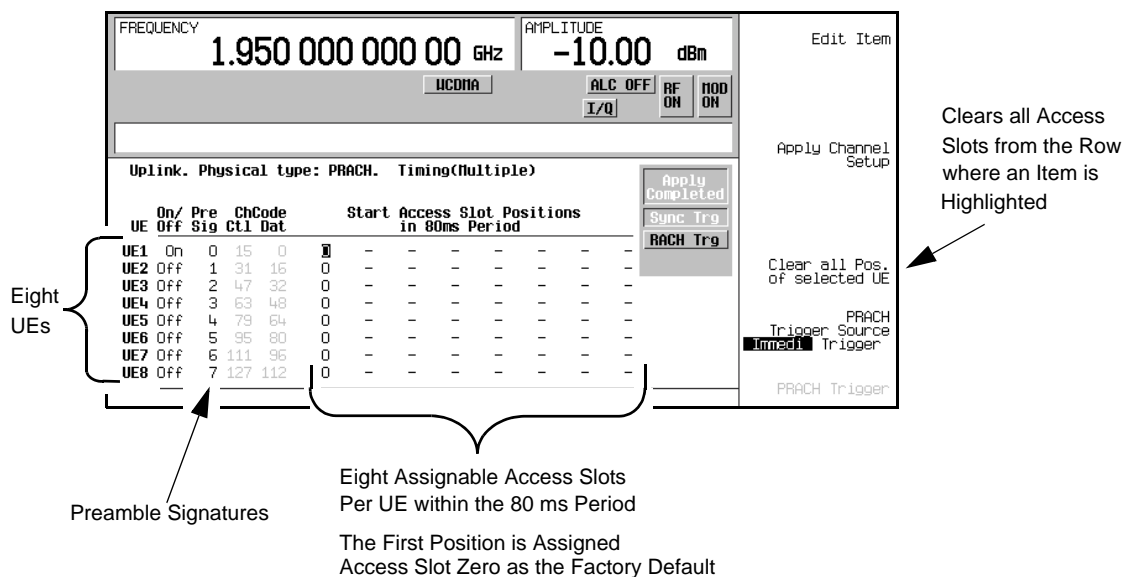

However a single UE retransmission of its PRACH cannot overlap its previous PRACH transmission within the same 80 ms period. For example, if UE1's PRACH is 11.5 access slots long and its first PRACH transmission starts in access slot zero, then the second PRACH transmission for UE 1 must start, at a minimum, in access slot 12. If it was configured to begin in access slot 11, the second transmission would not occur because slot 11 is partially occupied by the first PRACH transmission. But different UEs can transmit in access slots occupied by other UEs. Figure 16-21 illustrates an example of when a PRACH retransmission for the same UE is ignored. It also demonstrates how PRACHs can occupy the same access slots when they are transmitted by different UEs.

Multiple PRACH Overview

Figure 16-21 Transmitting PRACHs

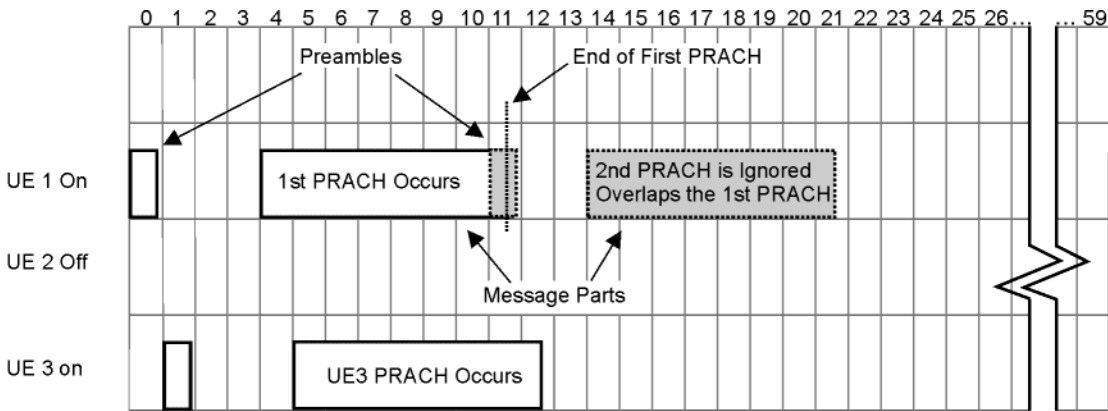

If a third PRACH transmission was configured that overlapped the second PRACH transmission for UE1, the third transmission would occur because the second transmission is ignored/not transmitted.

The multiple PRACH feature is configured from the factory to have UE 1 on and set to start in access slot zero. This is so you can have a PRACH signal just by turning on the W-CDMA format and the RF output, assuming that the **MOD Off On** hardkey is set to on (MOD ON annunciator is showing in the display).

In accordance with the 3GPP standards, there are 16 different signatures to choose from for each UE, and the different signatures point to the appropriate channel codes for the control part and data part. These codes are automatically selected when a signature is chosen and are listed in the ChCode Ctl1 Dat column. The control part is always spread with the channelization code of spread factor 256. The spread factor for the data part is determined by the slot format, but the node that the channelization code resides on is determined by the signature.

As seen in Figure 16-20, there are eight positions per UE for assigning access slot numbers. When a position has not been assigned an access slot, a dash is showing. If all eight positions have dashes, this has the same affect as turning the UE off. This is because there are no PRACHs to transmit for the UE. You can transmit eight PRACHs per UE by transmitting only the preamble. Since a preamble only occupies one access slot, there would be no overlapping of the PRACH transmissions for an individual UE.

There are multiple ways the ESG can trigger external measurement equipment for measuring the multiple PRACH signal. Some examples of these are shown in the following list:

80 ms frame pulse This coincides with the frame boundaries for SFN mod 8=0.

10 ms frame pulse This denotes the SFN frame boundaries.

Preamble pulse This indicates the beginning of the access slot for each preamble transmission.

Message pulse This signifies the start of an access slot where the message part is being transmitted.

PRACH pulse This denotes the access slot boundaries between PRACH repetitions.

Refer to “PRACH Mode” on page 574 for more information on trigger signals.

## Understanding the Power Offset Between the Carrier and the Multiple PRACH

The ESG has an 18.06 dB offset between the ESG carrier power and the multiple PRACH power level. This offset is shown by the PRACH power level in the PRACH Power Setup display. This is demonstrated in Figure 16-22 where the carrier power is 0.0 dBm and the PRACH power is  $-18.06$  dBm ( $0.0$  dBm  $- (-18.06$  dBm) = 18.06 dB offset). Since the data part power has been turned off, the PRACH power is shown in both the Max Pwr field (preamble power) and the Msg Pwr field (message part power) as indicated in the figure.

Figure 16-22 Offset Power

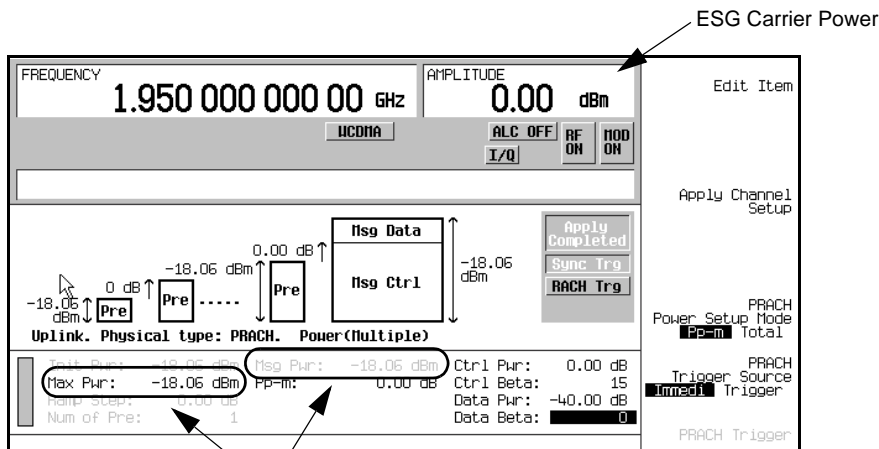

PRACH Power—18.06 dB Offset from Carrier Power

**Multiple PRACH Overview**

The offset is provided so the ESG can accommodate the additional power needed as more UEs (user equipment/mobiles) are utilized. This offset remains constant on the ESG display regardless of the number of UEs activated or parameter changes. However with the AWGN feature on, the addition of noise to the PRACH signal will increase the offset. When this condition occurs, the ESG carrier power will remain constant and the PRACH power level will decrease. This is demonstrated in Figure 16-23 where the AWGN feature is on with a C/N value of 0.0 dB.

**Figure 16-23 Offset Power with Noise Added**

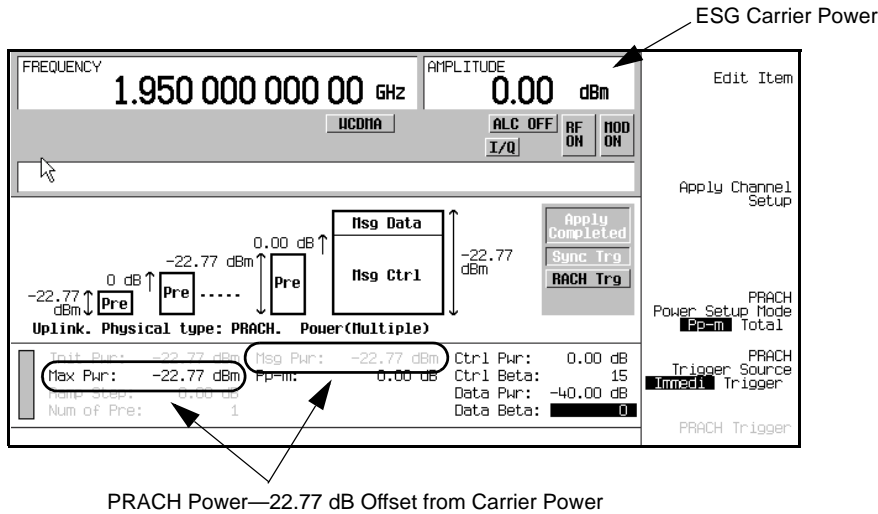

This offset will not create any problems with the multiple PRACH transmission. The typical test that utilizes a multiple PRACH feature is used to discern a single PRACH transmission from among a group of PRACH signals. The PRACH power values shown on the ESG display are valid and will be reflected in your measurements, even when all UEs are on. They are also used to calculate the various other parameters like the control part and data part power levels.

## Setting Up a Multiple PRACH Signal

The ESG automatically turns off the ALC (automatic leveling control) when the multiple PRACH mode is selected. This is due to the bursting characteristics of the PRACH signal that causes rapidly varying power levels. This situation is compounded in the multiple PRACH mode where you have multiple PRACH bursts occurring, so the ESG ALC cannot maintain a constant power level. A manual power search can be performed by pressing the **Apply Channel Setup** softkey. Refer to “[Special Power Control Considerations When Using DPCCH/DPDCH in Compressed Mode or PRACH](#)” on page 584 for more information.

The procedure, “[Selecting the PRACH and Multiple PRACH Modes](#)” on page 494, shows you how to access the W-CDMA modulation format. However most of the other procedures start from the first-level W-CDMA softkey menu, which is shown in [Figure 16-24](#). In this way, each procedure can stand alone without regard to steps performed in other sections.

**Figure 16-24** First-Level W-CDMA Softkey Menu

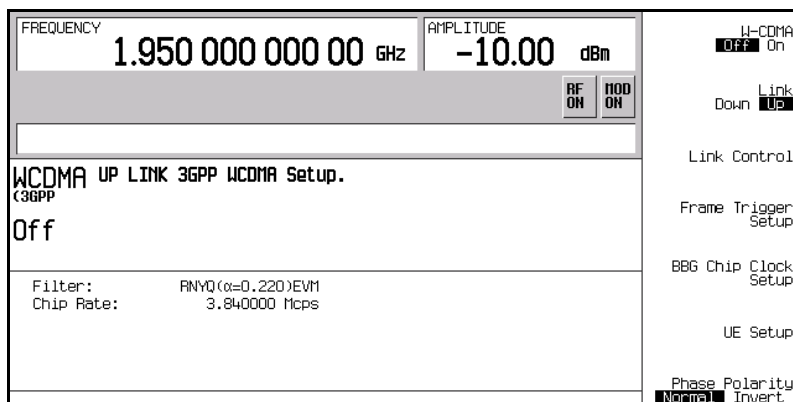

By following the procedures in this section, you will learn how to setup a basic multiple PRACH signal. The section, “[Viewing a Multiple PRACH Signal](#)” on page 509, shows the output of the ESG using the parameters set in each of the following procedures.

### Configuring the RF Output

1. Preset the ESG.
2. Set the carrier frequency to 1.95 GHz.
3. Set the carrier power to  $-10$  dBm.
4. Turn on the RF output.

### Selecting the PRACH and Multiple PRACH Modes

1. Press **Mode > W-CDMA > Real Time W-CDMA > Link Down Up** to Up.  
 This selects the W-CDMA uplink mode which resides in the first-level W-CDMA softkey menu.
2. Press **Link Control > PhyCH Type > PRACH**.
3. Press the **PRACH Mode Single Multi** softkey until Multi is highlighted.

This softkey menu level provides you access to other menus that control the PRACH signal. You can access a menu that enables you to choose the reference block size for the transport channel, access the rear panel input/output signal selections, determine input trigger signal parameters, and access the physical and transport channel set up tables/menus. [Figure 16-25](#) shows this softkey menu level with the multiple PRACH mode selected.

**Figure 16-25 Multiple PRACH Mode Selection**

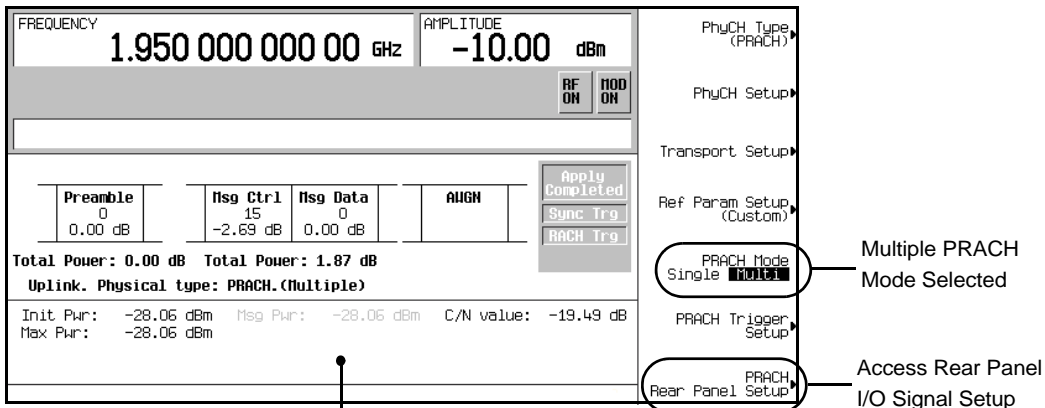

Summary Display Continuously Shows the Current PRACH Power Levels for the Various PRACH Components

### Selecting the Rear Panel Output Trigger

1. Press **PRACH Rear Panel Setup > PRACH Output Signal Setup**.  
 This sets up an output trigger signal at the EVENT1 rear panel connector. Refer to [“Configuring Rear Panel Output Signals”](#) on page 559 for more information.
2. Highlight the item under the Signal column that corresponds to Event1 under the Rear Panel Ports column.

3. Press **More (1 of 3) > More (2 of 3) > PRACH Pulse (RPS23)**.

This will enable an output trigger that corresponds to the beginning of each PRACH.

4. Press **Mode Setup** to return to the top-level W-CDMA menu.

## **Generating the Baseband Signal**

Return to the first-level W-CDMA menu and turn the W-CDMA format on.

This step can be performed at anytime during the setup. The advantage of turning the format on before setting up the signal, if you have a spectrum analyzer or some other measuring equipment connected, is you can see the changes as they are made.

## **Configuring the PRACH Code Setup**

In this procedure you will learn how to set the parameters for controlling the transmission for the various components that make up the PRACH. In addition, you will set the parameters that control the PRACH transmission as a whole. It is divided up into four tasks:

- [“Accessing the Code Setup Table” on page 495](#)
- [“Controlling the PRACH Transmission” on page 496](#)
- [“Setting the Control Part Parameters” on page 499](#)
- [“Setting the Data Part Parameters” on page 500](#)

### **Accessing the Code Setup Table**

Press **Link Control > PhyCH Setup > PRACH Code Setup**.

This takes you into the table editor where you can set the parameters for the message part and preamble. You can also set the number of transmissions for the PRACH configuration. The parameters set within this table apply to all eight UEs.

W-CDMA Uplink Digital Modulation for Receiver Blue (Option 400)  
**Setting Up a Multiple PRACH Signal**

**Figure 16-26**

**PRACH Code Setup Display**

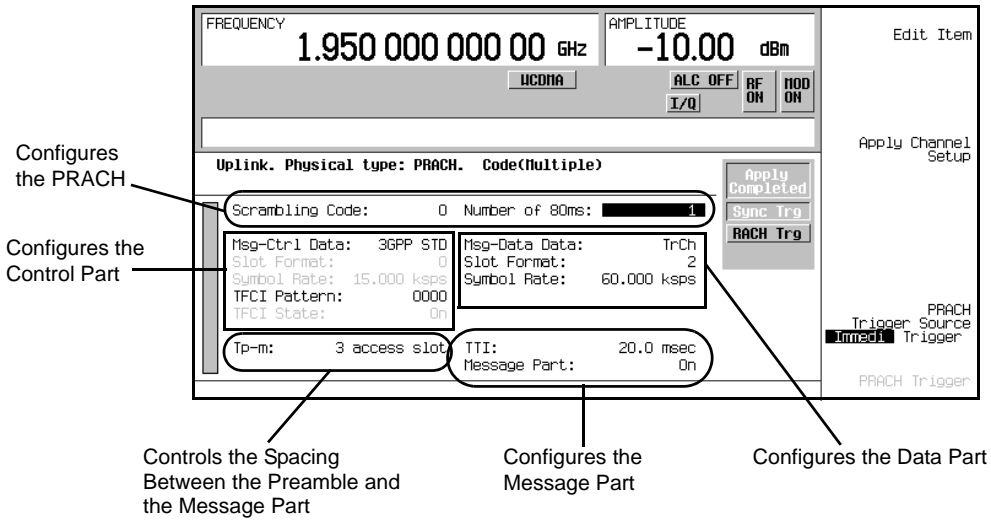

**Controlling the PRACH Transmission**

1. Set the PRACH scramble code.
  - a. Highlight the Scrambling Code field.
  - b. Press **506** > **Enter**.

The range for this field is 0 to 8191.

The scrambling code, in conjunction with the preamble signature, is used to uniquely identify the mobile. The same scrambling code number is used for both the preamble and message part. The base station informs the UE which code to use.

2. Set the number of transmitted 80 ms periods.

This feature is used in connection with a trigger for starting the PRACH transmission. Use this feature when you want to measure the PRACH transmission for a set number of cycles or you just want to start the transmission using a trigger.

- a. Highlight the Number of 80ms field.
- b. Press **Edit Item**.

Two softkeys are now showing, **Enter** and **Infinity**. The **Enter** key is used when you want to enter a finite number of 80 ms period repetitions. You can actually enter the desired number without pressing the **Edit Item** softkey. The **Enter** softkey will appear once you start entering a value. The **Infinity** selection lets the transmissions occur indefinitely once a trigger is received until it is



terminated by some other means (RF is turned off, modulation of the carrier is turned off, or the modulation format is turned off). To access the Infinity selection, you must press the **Edit Item** softkey.

- c. Press **100** > **Enter**.

The range for a finite transmission is 1 to 2147447836 repetitions. However the transmission will not be limited unless Trigger has been selected as the PRACH trigger source.

- d. Press **Apply Channel Setup**.

When the **Apply Needed** annunciator appears, press the **Apply Channel Setup** softkey. The new parameters will not be applied to the signal until this softkey is pressed.

- e. Press the **PRACH Trigger Source Immedi Trigger** softkey until Trigger is highlighted.

In order to transmit a limited number of 80 ms periods, you must set the PRACH signal for a manual trigger operation. If the W-CDMA format is on when you select Trigger, the signal will transmit until the value in the **Number of 80ms** field has been reached. Then the PRACH signal will terminate and the **RACH Trg** annunciator will gray-out. This means that the PRACH signal is waiting for a trigger to occur before another transmission can begin. This is shown in **Figure 16-27**. Notice that the **PRACH Trigger** softkey has become active (no longer grayed out) when Trigger was highlighted.

**Figure 16-27 PRACH (RACH) Trigger Annunciator**

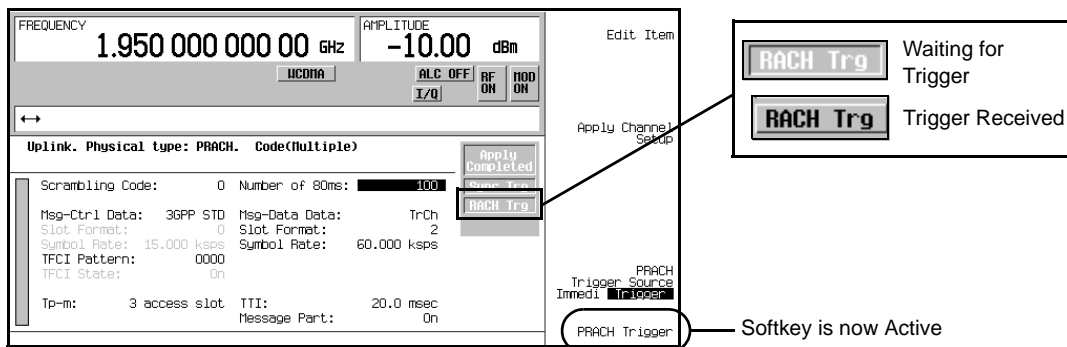

- f. Press the **PRACH Trigger** softkey.

The ESG is now transmitting 100 repetitions, entered in step 2c, of the current 80 ms period setup. The **RACH Trg** annunciator will gray-out after 100 repetitions have been completed. To repeat the transmission, just press the **PRACH Trigger** softkey again.

## Setting Up a Multiple PRACH Signal

You will notice the **PRACH Trigger Source Immedi Trigger** and the **PRACH Trigger** are located on several softkey menus. This was done so you could provide the trigger or make a different trigger choice without having to return to any one particular menu. Pressing the **PRACH Trigger** softkey is a manual trigger action. You can also provide an external trigger signal for the PRACH transmission.

3. Press the **PRACH Trigger Source Immedi Trigger** softkey until Immedi is highlighted.

The Immedi choice lets the W-CDMA signal transmission start as soon as the modulation format is turned on. Since the format is already on, selecting Immedi will enable the immediate transmission of the currently configured signal.

## Configuring the Message Part Transmission

1. Choose whether or not to transmit the message part

- a. Highlight the **Message Part** field.
- b. Press the **Edit Item** softkey.

Two softkeys are displayed, **ON** and **OFF**. When you select **OFF**, the message part is not transmitted leaving only the preamble as the PRACH transmission.

- c. Press the **ON** softkey since we will be transmitting the PRACH with both the preamble and message part.
2. Select the transmission time for the message part.
    - a. Highlight the **TTI (transmit time interval)** field.
    - b. Press **10 > msec**.

There are two valid entries for this field, 10 or 20 ms. The values can be entered using decimal notation (0.01 or 0.02 seconds) or millisecond units (10 or 20 ms).

The 10 ms setting equates to 7.5 access slots (one radio frame) and the 20 ms spans 15 access slots (two radio frames).

If you need to have an individual PRACH (UE) repeat multiple times within the 80 ms time period, you may want to use the 10 ms setting. Since you are limited to 60 access slots (80 ms), the 20 ms setting will decrease the number of times a UE's PRACH can be retransmitted within the 80 ms time period.

3. Enter the number of access slots from the preamble to the message part (Tp-m).

The number of access slots starts from the beginning of the preamble and ends at the beginning of the message part. [Figure 16-28](#) shows a PRACH with a Tp-m of 3 access slots.

**Figure 16-28 Tp-m Setting**

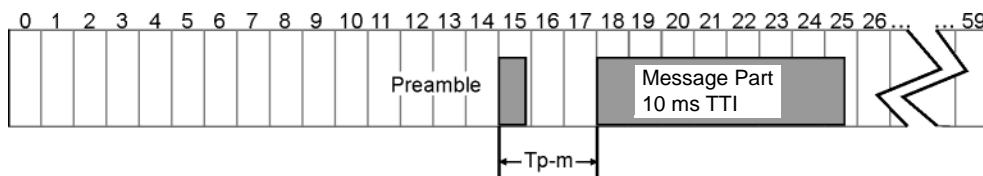

- a. Highlight the  $T_{p-m}$  (time from the preamble to the message part) field.
- b. Press **4 > Enter**.

The range for this field is 1 to 15.

You have now increased the distance from the for the  $T_{p-m}$  from three access slots (3.99 ms) to four (5.32 ms). An access slot is 1.33 ms in length.

If you need to have a UE repeat its PRACH multiple times within the 80 ms time period, you may want to keep the  $T_{p-m}$  to a minimum value. Since you are limited to 60 access slots (80 ms), an increase in the  $T_{p-m}$  value further limits the number of times a UE's PRACH can be repeated.

4. Press **Apply Channel Setup**.

When the **Apply** Needed annunciator appears, press the **Apply Channel Setup** softkey. You will not see a change in the signal until you press this softkey.

### Setting the Control Part Parameters

1. Select the message part control data.

- a. Highlight the **Msg-Ctrl Data** field.
- b. Press **Edit Item**.

Notice that you have a selection of different control information types with the factory default being **3GPP STD** (pilot bit pattern as stated in the 3G TS 25.211 V3.3.0 (2002-03)). You can select a PN sequence, FIX 4 pattern, or create your own control pilot information with the **User File** selection.

- c. Ensure that **3GPP STD** is highlighted and press **Return**.

2. Set the TFCI (transport format combination indicator) bits.

- a. Highlight the **TFCI Pattern** field.
- b. Press **Edit Item**.

Notice that you have a selection of different TFCI patterns that you can choose from, including the ability to create your own pattern (**User File** softkey). The base station uses the TFCI to determine what transport channel configuration is being used. The TFCI pattern, relative to a transport channel

## Setting Up a Multiple PRACH Signal

configuration, is determined by the base station network; it is not defined by the 3GPP standards. If the message part TTI is 20 ms, the TFCI is repeated in the second radio frame (each radio frame is 10 ms in length).

- c. Press **PN Sequence** > **PN9**.
3. Press **Apply Channel Setup**.

When the **Apply Needed** annunciator appears, press the **Apply Channel Setup** softkey. The new parameters will not be applied to the signal until this softkey is pressed.

## Setting the Data Part Parameters

1. Set the data type for the data part.
  - a. Highlight the **Msg-Data** **Data** field.
  - b. Press **Edit Item**.

Again you can see that you are provided different choices for the data type. The transport channel selection (factory default) utilizes the RACH (random access channel) which gives you greater flexibility in controlling the data parameters such as the data rate (setting block size), CRC size, and puncture rate.

- c. Press the **Transport CH** softkey as the data selection type.

The softkey menu level, where PRACH was selected as the channel type, gives you access to the transport channel table editor where you can set its parameters.

2. Select the message part slot format.
  - a. Highlight the **Slot Format** field.

Note the 60 kbps symbol rate (factory default) shown in the **Symbol Rate** field.

- b. Press **1** > **Enter**.

You have a choice of slot formats: 0, 1, 2, and 3. Notice that the symbol rate changed to 30 kbps. Remember that the symbol rate is controlled by the slot format.

As seen in step b above, you can adjust your symbol rate by changing the value in the **Slot Format** field. Conversely, you can adjust your slot format by using the **Symbol Rate** field.

Each 10 ms message part period is subdivided into 15 slots and the slot format determines the attributes for them. Each format is defined in the 3GPP standards.

3. Press **Apply Channel Setup**.

When the **Apply Needed** annunciator appears, press the **Apply Channel Setup** softkey. The new parameters will not be applied to the signal until this softkey is pressed.

Figure 16-29 shows the PRACH code setup display after all tasks within this procedure have been completed.

**Figure 16-29 PRACH Code Settings**

## Configuring the PRACH Power Setup

In this procedure you will learn how to set the various power levels used in a PRACH transmission. Within the power setup menu there are two modes to choose from, Pp-m and Total. This procedure uses the Pp-m mode. The PRACH power has two parts, the preamble and the message part. Further, the message part is comprised of two other powers, control part and data part powers. For more information on PRACH power control and modes, see [“Power Control” on page 467](#) and [“Power Control Modes” on page 473](#).

Notice as you make changes to the different power settings, the message part power (grayed-out `MSG PWR` field) also changes.

### Accessing the PRACH Power Setup Display

Press **Link Control >PhyCH Setup > PRACH Power Setup**.

This takes you into the table editor where you can set the power parameters for the message part and preamble. The parameters set within this table apply to all eight UEs.

W-CDMA Uplink Digital Modulation for Receiver Test (Option 400)  
**Setting Up a Multiple PRACH Signal**

**Figure 16-30 PRACH Power Setup Display**

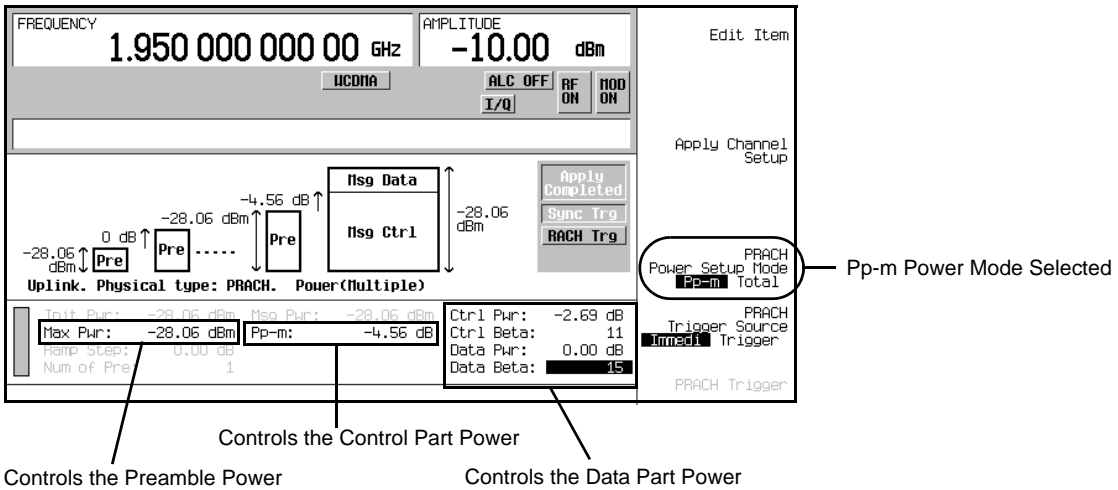

**Setting the Preamble Power**

1. Highlight the Max Pwr field.
2. Press **-30 > dBm**.

Notice that the carrier power has changed. The carrier power will always be 18.06 dB above the PRACH power. See “Understanding the Power Offset Between the Carrier and the Multiple PRACH” on page 491 for more information on the power offset.

**Adjusting the Control Part Power**

1. Highlight the Pp-m field.
2. Press **5 > dB**.

The control part power is set with respect to the preamble power level. The Pp-m value is used to adjust the control part power level. Do not confuse this as setting the message part power 5 dB above the preamble. It is the combination of the control part and the data part power that determine the message part power. However, since the control part is now 5 dB higher than the preamble, the message part power cannot drop below the level of -25 dBm (preamble power of -30 dBm + 5 dB Pp-m)

### Configuring the Data Part Power

1. Set the control power level to zero dB.
  - a. Highlight the Ctrl Beta field.
  - b. Press **15** > **Enter**.

You are now using the control part power as the 0 dB reference for the data part power. This means that the  $-25$  dBm control part power set in the “Adjusting the Control Part Power” task, is now the zero dB reference for the data part power that will be set in step 2. Changes to the Ctrl Pwr or the Ctrl Beta fields does not affect the control part power level; it only sets a reference level for the data part power.

2. Set the data part power relative to the control part power.
  - a. Highlight the Data Beta field.
  - b. Press **5** > **Enter**.

You have now set the data part power to be 9.54 dB lower than the control part power. A beta of 5 equates to  $-9.54$  dB. Since the data part power is less than the control part power, you will notice that the message part power is approximately 5 dB higher than the preamble power level. This indicates that the message part power is dominated by the control part. If you set both data the part and control part relative powers to 0.0 dB (equal data part and control part power levels or double the control part power), you will see a 3 dB increase in the message part.

Figure 16-31 shows the PRACH power setup display after all tasks within this procedure have been completed.

**Figure 16-31 PRACH Power Settings**

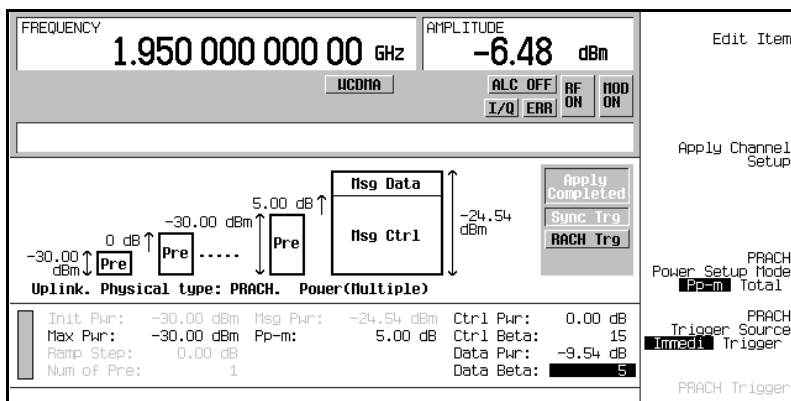

## Setting Up a Multiple PRACH Signal

### Configuring the PRACH Timing Setup

In this procedure you will learn how to enable multiple UEs/PRACHs and align them within the access slots. You have eight available UEs that can span an 80 ms time period (60 access slots numbered 0 to 59). The UEs can be configured so their PRACHs occupy the same or different access slot(s) relative to other UEs. Each UE can also be configured to transmit its PRACH up to eight times using different access slots.

---

**NOTE** The number of times a single UE can transmit its PRACH within the 80 ms time period is constrained by the number of access slots a single PRACH occupies. If the UE retransmits in a timeslot that is occupied by one of its previous PRACH transmissions, the retransmission does not occur.

---

However you will have to turn the message part off to achieve the maximum number of individual UE PRACH transmissions.

All eight UEs can be active at the same time and each can have a different or the same signature assignment.

For more information on understanding the PRACH Timing Setup display, see [“Understanding the 80 ms Transmission/Time Period” on page 488](#).

### Accessing the PRACH Timing Setup Display

Press **Link Control > PhyCH Setup > PRACH Timing Setup**.

This takes you into the table editor where you can set the number of UEs for transmitting multiple PRACHs. For the factory default setting, UE1 is on and the starting access slot in position one for all UEs is zero.

The parameters set in this table apply to the UE selected, unlike the other setup displays where the parameters apply to all eight UEs.

For the following tasks, we will work with three UEs. This will demonstrate how different UEs can occupy the same access slots, and how to repeat/retransmit a UE’s PRACH.

[Figure 16-32 on page 508](#) shows a graphical representation of the multiple PRACH transmission as configured by this procedure, while [Figure 16-33 on page 510](#) displays the same signal configuration on the E4440A PSA.



### **Activating the UES**

This task assumes the factory preset conditions for the timing setup table. The desired UEs can be turned off or on at any time during your signal setup.

1. Turn on UE2 and UE4.
  - a. Highlight *Off* for UE2 in the *On/Off* column.
  - b. Press the **Edit Item** softkey.

Each press of the **Edit Item** softkey turns the UE on or off.
  - c. Repeat steps a and b for UE4.

### **Setting the Preamble Signature**

The signature is used by the base station to identify which UE it is communicating with. This task assumes the factory preset conditions for the timing setup table.

1. Set the UE1 preamble signature to five.
  - a. Highlight the *Signature* field that corresponds to UE1.
  - b. Press **5 > Enter**.

The range for this field is 0 to 16.
2. Set the UE2 preamble signature to seven.
  - a. Highlight the *Signature* field that corresponds to UE2.
  - b. Press **7 > Enter**.
3. Set the UE4 preamble signature to zero.
  - a. Highlight the *Signature* field that corresponds to UE4.
  - b. Press **0 > Enter**.

### **Configuring Access Slots**

When transmitting multiple PRACHs for the same UE, they cannot occupy any of the same access slots within the 80 ms period. If they do, the subsequent (second PRACH, etc.) PRACH transmission that uses any of the same access slots will not occur.

There are two ways to enter the access slot number within the timing setup table:

- Enter the access slot number using the numeric keypad and press the **Enter** softkey.
- Press the **Edit Item** softkey, enter the number using the numeric keypad, and press **Enter**.

## Setting Up a Multiple PRACH Signal

Access slot numbers can be entered into positions that either contain dashes or that already contain an access slot number.

Conversely there are also two ways to eliminate access slot numbers:

- Highlight the position for a UE that contains the unwanted access slot within the 80 ms time period. Press the **Edit Item** softkey and then the **Off** softkey that appears.

You will see a dash inserted in place of the access slot number. The dash means that the current position within the 80 ms period has been turned off.

- Highlight any position/item on a UE's row, and press the **Clear All Pos of Selected UE** softkey.

You will see a dash inserted in place of all access slot numbers for the selected UE.

When all positions for a UE are occupied by dashes, the UE can no longer transmit any PRACHS. This has the same affect as turning off the UE.

In this task you will learn how to use access slots for determining the placement of the PRACHs within the 80 ms time period.

This task assumes factory preset conditions for the timing setup display.

### 1. Setup UE1 for two PRACH transmissions.

For this task, we will use the factory default access slot of zero for the first UE1 PRACH transmission.

Using the parameters that can be set in the PRACH code setup display, you can calculate the number of access slots required for each UE1 PRACH transmission. This calculated value can then be used to determine the placement for each repeated PRACH within the 80 ms period. This avoids overlapping the retransmitted PRACHs. Remember a PRACH that is repeated and overlaps a previous transmission for the same UE, is ignored.

In the section, "[Configuring the PRACH Code Setup](#)" on page 495, we set the  $T_{p-m}$  to 4 access slots and the message part TTI to 10 ms (7.5 access slots). These values are used in the following steps to determine the access slot for the second UE1 PRACH transmission.

- a. Highlight the second access slot position for UE1.
- b. Calculate the number of access slots occupied by a single PRACH.

$$\text{Message part TTI} = 10 \text{ ms} \quad \text{One access slot} = 1.33 \text{ ms}$$

$$10 \text{ ms} / 1.33 \text{ ms} = 7.5 \text{ access slots}$$

$$T_{p-m} = 4 \text{ access slots}$$

$$\text{One PRACH transmission} = 7.5 + 4$$

$$= 11.5 \text{ access slots}$$

The second PRACH transmission will need to begin, at a minimum, in the 12th access slot (access slot number 11 ( $0 + 11 = 11$ )). If you started the second transmission in access slot 10, it would be ignored since the first transmission occupies part of that access slot.

In order to clearly show the second UE1 PRACH transmission on the PSA, we will select an access slot that will not be occupied by other UEs that are configured later in this task.

- c. Press **15 > Enter**.
2. Configure UE2 for a single PRACH transmission starting in access slot 2.
  - a. Highlight the first access slot position for UE2.
  - b. Press **2 > Enter**.

This PRACH will start its transmission between the first preamble for UE1 and its message part. The message part for UE2 will begin during the first message part for UE1. For the length of time that the message part for UE1 and UE2 occupy the same access slots, they will be additive creating a stronger signal during that time period.

3. Leave UE4 to transmit a single PRACH starting in access slot 0.

This PRACH will occupy the same access slots as the first PRACH transmission for UE1. UE1 and UE4 will be additive during this transmission time period creating a higher signal level for the same period of time.

4. Press **Apply Channel Setup**.

When the **Apply Needed** annunciator appears, press the **Apply Channel Setup** softkey. You will not see a change in the signal until you press this softkey.

**Setting Up a Multiple PRACH Signal**

Figure 16-32 shows both the completed timing setup display and a graphical representation of the setup by access slot when this procedure was used to configure the multiple PRACH signal. Figure 16-33 on page 510 shows the output of the ESG, with the same configuration, on the Agilent E4440A PSA Spectrum Analyzer.

**Figure 16-32 Multiple PRACH Timing Setup**

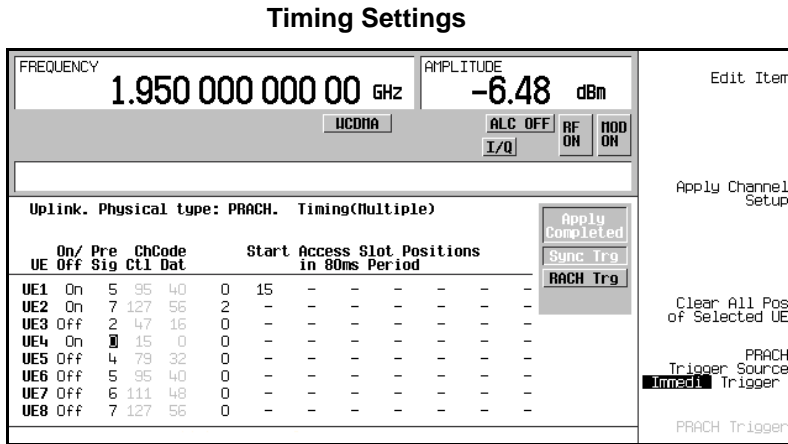

**Access Slots within an 80 ms Time Period**

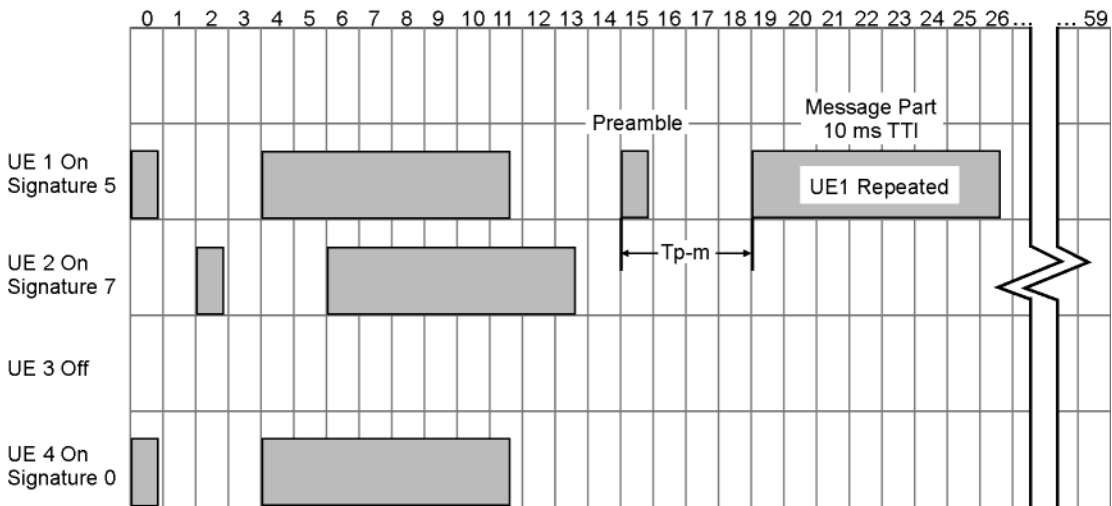

## Viewing a Multiple PRACH Signal

This procedure uses the Agilent E4440A PSA Spectrum Analyzer for measuring the ESG output. [Figure 16-1 on page 461](#) shows the connections between the ESG and the PSA. The signal shown in [Figure 16-33 on page 510](#) was built using the procedures from the section “[Setting Up a Multiple PRACH Signal](#)” on [page 493](#). If you have used other parameters, your signal output may show different characteristics.

1. Preset the spectrum analyzer.
2. Select the Spectrum Analysis mode.  
Press **Mode > Spectrum Analysis**.
3. Set the center frequency.  
Press **Frequency Channel > Center Freq > 1.95 > GHz**.
4. Select the zero Hertz span.  
Press **Span > Zero Span**.  
This sets the PSA to function like an oscilloscope measuring in time rather than frequency.
5. Set the sweep time to 80 ms.  
Press **Sweep > 40 > ms**.
6. Set the resolution bandwidth for a quick response time that captures the bursting nature of the PRACH components.  
Press **BW/Avg > 8 > MHz**.  
Whenever you make a measurement in the zero Hertz span, you need to set the resolution bandwidth to its maximum value to ensure capturing all of the signal characteristics.
7. Trigger the spectrum analyzer from the rear trigger input using the ESG trigger signal selected in the section, “[Selecting the Rear Panel Output Trigger](#)” on [page 494](#).  
Press **Trig > Ext Rear**.
8. Set the PSA to average the signal measurement.  
Press **Det/Demod > Detector Auto Norm > Average**.
9. Lower the reference level to -10 dBm.  
Press **Amplitude Y Scale > Ref Level > 10 > -dBm**.
10. Resolve the display for a closer view of the signal.  
Press **Scale/Div > 5 > dB**.

**Setting Up a Multiple PRACH Signal**

11. Remove the Scale/Div 5.00 dB text from the display.

Press the **ESC** hardkey.

**Figure 16-33 Transmitted Multiple PRACH Signal**

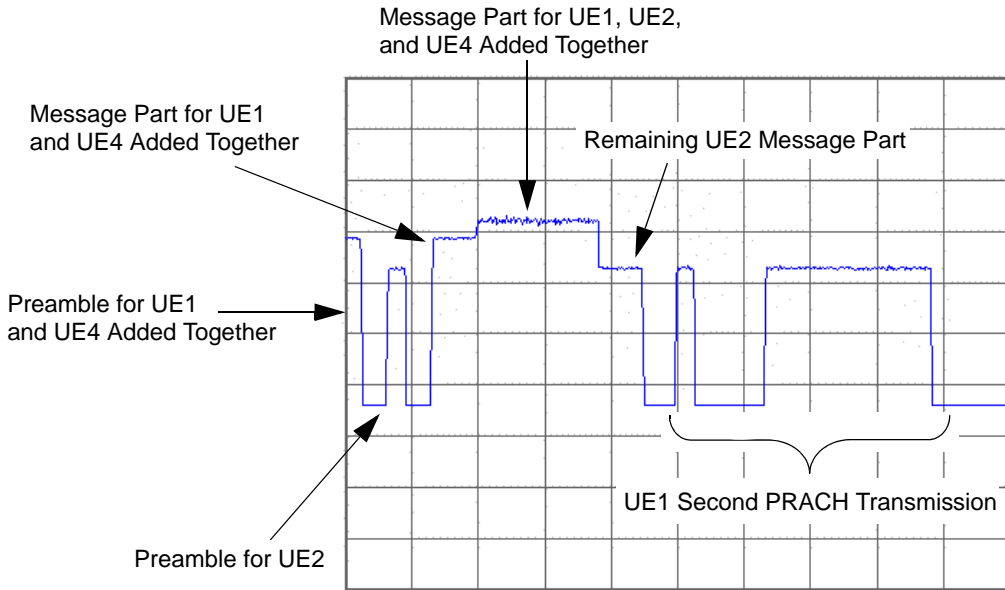

**Connecting the ESG to a Base Station**

1. Connect the ESG to the base station as shown in [Figure 16-2 on page 462](#)
2. Configure the base station to receive the multiple PRACH signal.

## Overload Testing with Multiple PRACHs—Multiple ESGs

With the advanced feature of transmitting multiple PRACHs, you can perform base transceiver station overloading using two ESGs. This gives you the capability of transmitting up to 16 UEs. When the Frame Sync Trigger signal is used for both ESGs, they will synchronize to within one chip of the base station frame synchronization signal. When ESG 2 is synchronized using the ESG Sync Pulse signal, you may experience an additional half chip delay from ESG 2. Figure 16-34 shows the multiple ESG setup and Table 16-2 list the signals shown in the drawing and their respective ESG rear panel connections.

**Figure 16-34** Multiple ESG Setup

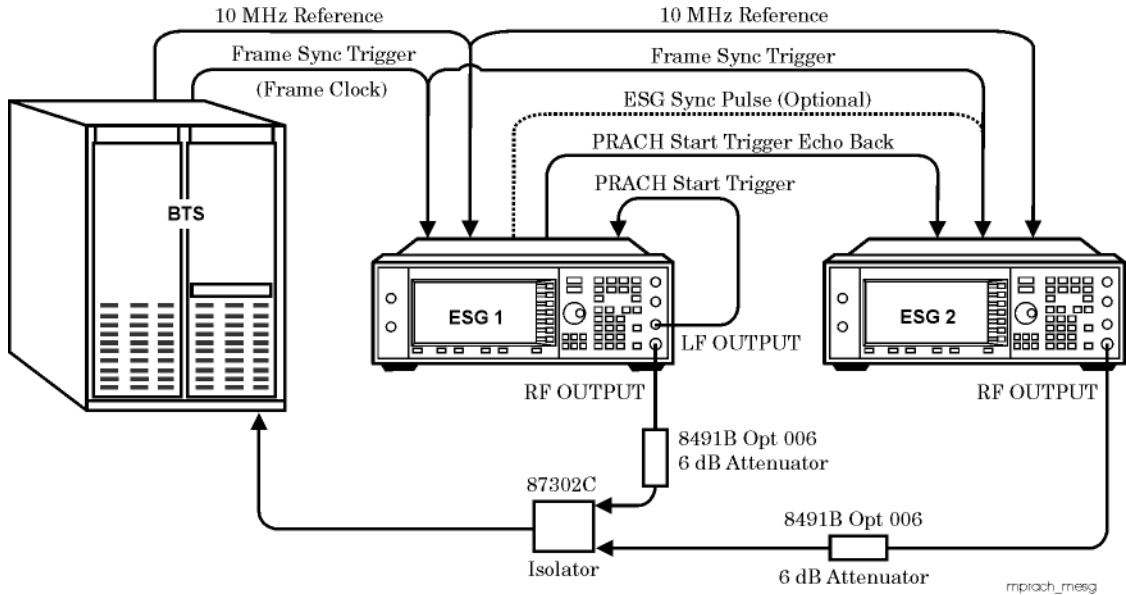

**Overload Testing with Multiple PRACHs—Multiple ESGs**

**Table 16-2 Multiple ESG I/O Signals and Connections**

Signal	Signal Type	Rear Panel Connector
Input	<p>10 MHz Reference</p> <p>This ensures that both ESG’s timebase are phase aligned with the BTS reference.</p>	10 MHz IN
	<p>Frame Sync Trigger</p> <p>This aligns the ESG’s frame timing with the BTS. This ensures that the BTS can detect the beginning of a PRACH signal radio frame.</p>	PATT TRIG IN
	<p>PRACH Start Trigger</p> <p>This is the trigger signal for ESG 1 to begin its PRACH transmission.</p>	BURST GATE IN
	<p>ESG Sync Pulse (only for ESG 2)</p> <p>This signal lets ESG 2 synchronize with the BTS through ESG 1. This is used if the Frame Sync Trigger cannot be split between the two ESGs. This may cause an additional one half chip delay in ESG 2.</p>	PATT TRIG IN
	<p>PRACH Start Trigger Echo Back (only for ESG 2)</p> <p>This signal triggers ESG 2 to start its PRACH transmission. The PRACH Start Trigger signal can be used in place of this signal, if it has the power available to split between the two ESGs. If the PRACH Start Trigger signal is used, ESG 2’s synchronization source must be set to the same source as ESG 1.</p>	BURST GATE IN



**Table 16-2 Multiple ESG I/O Signals and Connections**

Signal	Signal Type	Rear Panel Connector
Output	ESG Sync Pulse (only for ESG 1)  This is a replacement for the BTS Frame Sync signal for ESG 2, if the BTS signal does not have the power capability to split between two ESGs.	EVENT 1
	PRACH Start Trigger Echo Back (only for ESG 1)  This signal is used to synchronize the beginning of the PRACH transmission between the two ESGs. It triggers ESG 2 to start its PRACH transmission.	EVENT 2

All of the I/O signal connectors can be identified using the softkeys accessed by the **PRACH Rear Panel Setup** softkey. While the input signals are fixed to specific connectors, the output signals can be configured for various rear panel connectors. In this procedure, the connectors listed in [Table 16-2](#) are used.

If your BTS does not have the available power for splitting the frame synchronization signal between both ESGs, ESG 1 can produce a synchronization signal for ESG 2. In this way, ESG 2 is synchronized with the BTS through ESG 1. This is done by using the sync pulse signal from ESG 1. If your BTS does have the power capability for splitting the frame synchronization signal between two ESGs, then the ESG sync pulse signal is not required.

If more than 16 UEs are required, you can connect additional E4438Cs using the ESG’s PRACH start and sync signal features to coordinate the synchronization and start triggers. For example, if a third ESG was needed, you would follow the connections shown in [Figure 16-34 on page 511](#) and the configuration instructions in the following sections for ESG 2, and apply them to ESG 3.

The versatility of the ESG lets you configure the PRACH start trigger using a LF (low frequency) output signal. The LF output can be configured for a pulse or square-wave, or you can use an external source. The following multiple ESG procedure uses the ESG’s LF output as the trigger source.

### **Connecting the ESG to the Base Transceiver Station**

Connect the equipment as shown in [Figure 16-34 on page 511](#) and listed in [Table 16-2 on page 512](#).

## Configuring the ESGs

1. Set up the multiple PRACH signal for both ESG 1 and ESG 2 using the procedures from “[Setting Up a Multiple PRACH Signal](#)” on page 493. However, set each UE to a different signature, and turn on all UEs.

You can vary the parameters between ESG 1 and ESG 2 for the multiple PRACH signals to obtain your desired output.

2. Configure ESG 1 rear panel output trigger signals according to [Table 16-2 on page 512](#).
3. Select the ESG input synchronization signal type.
  - a. On ESG 1, press **Link Control > PRACH Trigger Setup > Frame Trigger Setup > Sync Source SFN FCik ESG** to FCik.
  - b. On ESG 2 press **Link Control > PRACH Trigger Setup > Frame Trigger Setup > Sync Source SFN FCik ESG** to FCik or to ESG if you are using the ESG sync pulse signal.

This lets the ESG synchronize using the BTS frame clock signal. The ESG selection for ESG 2 enables ESG 2 to synchronize with ESG 1. Since ESG 1 is synchronized with the BTS, this means that ESG 2 will also be synchronized with the BTS through ESG 1. The **Frame Trigger Setup** softkey can also be accessed from the top level W-CDMA softkey menu.

4. Set the frame synchronization trigger mode.
  - a. On ESG 1, press **Frame Sync Trigger Mode Single Cont** to Cont.
  - b. On ESG 2, press **Frame Sync Trigger Mode Single Cont** to Cont.

The single mode (Single) lets the ESG trigger off the first BTS frame pulse and ignores all subsequent frame timing pulses. The continuous mode (Cont) enables the ESG to align its frame timing with each BTS frame timing pulse.

5. Set the frame timing pulse interval.
  - a. On ESG 1, press **Frame Clock Interval > 10 msec, 20 msec, 40 msec, 80 msec, or 2560 msec**.
  - b. On ESG 2, press **Frame Clock Interval > 10 msec, 20 msec, 40 msec, 80 msec, or 2560 msec**.

The actual frame timing interval value is dependent on the BTS frame clock pulse interval and whether or not the ESG frame synchronization trigger mode is set to single or continuous. If the ESG trigger mode is continuous, then it is critical that the selection is a value that is less than or equal to the base station frame pulse interval, or else the ESG will incur an out of synchronization condition with the BTS. When this occurs, an Out Sync annunciator appears on the ESG. For example, if the BTS frame timing was 20 ms and the ESG selection was **40 msec**, an out of synchronization condition will occur. The results of the example are shown in [Figure 16-35](#). An ESG frame clock interval of 10 or 20 ms will resolve the out of sync condition. This applies to ESG 1 and ESG 2 if they are both directly connected to the BTS frame timing interval signal. However, if ESG 2 is synchronized using the ESG

Sync Pulse signal from ESG 1, then its frame interval selection, if incorrect, may cause only a temporary out of synchronization condition that is self-corrected. This is because ESG 2 is synchronized with ESG 1 and not directly with the BTS. See “PRACH Synchronization” on page 580 and “Frame Sync Trigger Status Indicator” on page 581 for more information.

**Figure 16-35 Out of Synchronization Annunciator**

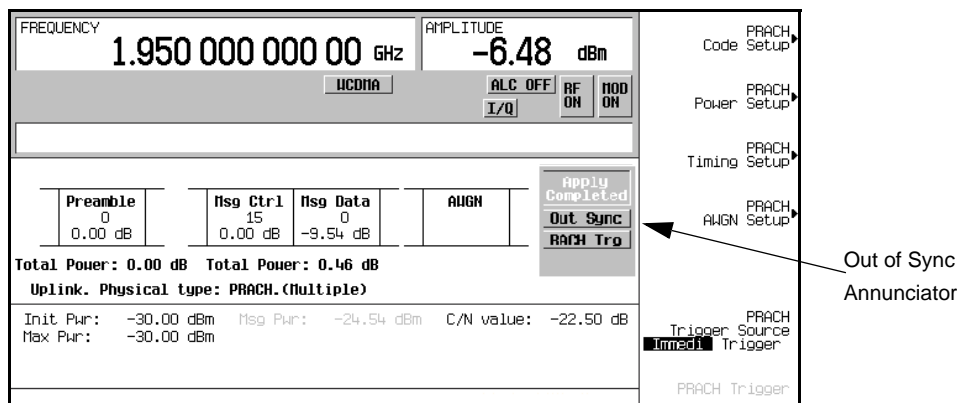

- Press **Return** > **Return** > **PhyCH Setup** > **PRACH Trigger Source Immedi Trigger** to Trigger.

Using the task, “Controlling the PRACH Transmission” on page 496, you can set the number of 80 ms period repetitions for a finite number of PRACH transmissions, or using the infinity selection, you can enable a continuous PRACH transmission once the PRACH start trigger is received by the ESG.

---

**NOTE** In order to have a finite number of transmitted 80 ms periods, you will need to ensure that the PRACH trigger source is disabled once the PRACH transmission starts. If the trigger source is not disabled, the PRACH signal will retrigger after the entered number of 80 ms periods are transmitted.

---

Figure 16-36 shows the frame trigger menus after all selections have been completed. Your selection for the Frame Clock Interval may be different than what is shown. If you have kept your PRACH trigger source active, you will see the RACH Trg annunciator gray-out intermittently as the transmission from the trigger expires and a new trigger is acquired.

W-CDMA Uplink Digital Modulation for Receiver Test (Option 400)  
**Overload Testing with Multiple PRACHs—Multiple ESGs**

**Figure 16-36** ESG 1 and ESG 2 Frame Timing Setup

**ESG 1**

**ESG 1 Configuration:**

- FREQUENCY: 1.950 000 000 00 GHz
- AMPLITUDE: -10.00 dBm
- EXT REF: [ ] UCDMA [ ] ALC OFF [ ] RF ON [ ] MOD ON [ ] I/Q [ ]
- Apply Completed
- Sync Trg [ ] RACH Trg [X]
- Total Power: 0.00 dB Total Power: 1.60 dB
- Uplink. Physical type: PRACH.(Multiple)
- Init Pwr: -28.62 dBm Msg Pwr: -28.06 dBm C/N value: -22.50 dB
- Max Pwr: -28.62 dBm

**ESG 1 Timing Settings:**

- Sync Source SFN: FC1k ESG (Set to FC1k)
- Frame Clock Interval: (20 msec)
- Frame Clock Polarity: Neg [ ] Pos [X] (ESG 1 is Synchronized with the BTS Timing Signal)
- EN RST Polarity: Neg [ ] Pos [X] (ESG 1 has Received the PRACH Start Trigger (will gray-out when a trigger is required))
- Frame Sync Trigger Mode: Single [ ] Cont [X] (Set to Cont)

**ESG 2**

**ESG 2 Configuration:**

- FREQUENCY: 1.950 000 000 00 GHz
- AMPLITUDE: -10.00 dBm
- EXT REF: [ ] UCDMA [ ] ALC OFF [ ] RF ON [ ] MOD ON [ ] I/Q [ ]
- Apply Completed
- Sync Trg [ ] RACH Trg [X]
- Total Power: 0.00 dB Total Power: 1.87 dB
- Uplink. Physical type: PRACH.(Multiple)
- Init Pwr: -10.00 dBm Msg Pwr: -10.00 dBm C/N value: -19.49 dB
- Max Pwr: -10.00 dBm

**ESG 2 Timing Settings:**

- Sync Source SFN: FC1k ESG (Set to ESG)
- Frame Clock Interval: (20 msec)
- Frame Clock Polarity: Neg [ ] Pos [X] (ESG 2 is Synchronized with the ESG 1 Timing Signal)
- EN RST Polarity: Neg [ ] Pos [X] (ESG 2 has Received the PRACH Start Trigger (will gray-out when a trigger is required))
- Frame Sync Trigger Mode: Single [ ] Cont [X] (Set to Cont)

## Setting Up the LF Output as the PRACH Start Trigger Signal

While the equipment setup shows ESG 1 as providing the PRACH start trigger signal, the signal can be provided by either ESG 1, ESG 2, or an external source. Perform the following steps for ESG 1:

1. Press **LF Out > LF Out Source > Function Generator**.

2. Press **LF Out Waveform > More (1 of 2) > Pulse**.

3. Press **LF Out Period > 80 > msec**.

This sets the trigger to occur every 80 msec.

4. Press **LF Out Width > 8 > usec**.

5. Press **LF Out Amplitude > 3 > Vp**.

Three volts was selected because the BURST GATE IN is a CMOS connection.

6. Press **LF Out Off On** to On.

Figure 16-37 shows how the LF output display looks after all the steps from this procedure have been completed.

**Figure 16-37 LF Output Setup**

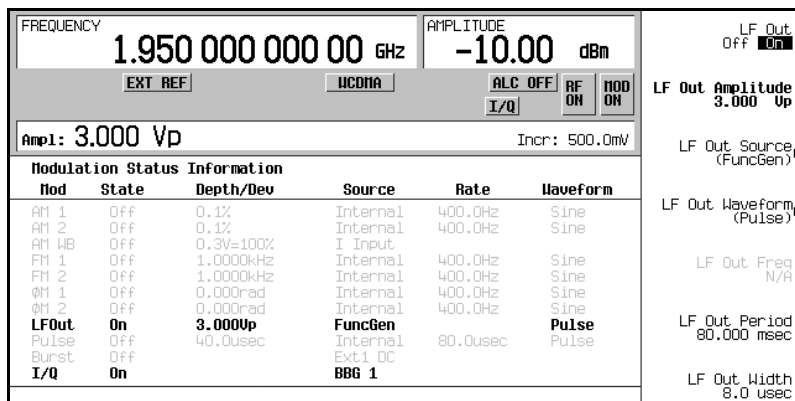

You now have two ESG output signals that are transmitting a combined total of 16 UEs. The BTS can be configured to try and identify each individual PRACH or configured to identify an individual UE from among the 16 transmitted PRACHs.

## DPCH

### Generating a DPCCCH/DPDCH with a Reference Measurement Channel

The tasks in this procedure teach you how to set up a pre-defined DPDCH reference measurement channel.

#### Configuring the RF Output

1. Preset the ESG.
2. Set the carrier frequency to 1.95 GHz.
3. Set the carrier power to  $-10$  dBm.
4. Turn on the RF output.

#### Selecting a Reference Measurement Channel

The ESG provides a single-softkey solution for configuring the transport layer coding according to the reference measurement channel's (RMC) 3GPP specifications.

1. Press **Mode > W-CDMA > Real Time W-CDMA > Link Down Up** to Up.
2. Press **Link Control > Ref Measure Setup > RMC 384 kbps (25.141)**.
3. Press **PhyCH Setup > DPCH Power Setup**.
4. Press **Adjust Code Domain Power > Scale to 0dB**.

This adjustment changes only the displayed power values, the I/Q channels are automatically adjusted to achieve zero dB power. For more information on channel power, see [“Adjusting Code Domain Power” on page 562](#).

5. Press **Mode Setup** to return to the top level W-CDMA menu.

In this task you have selected a predefined 384 kbps reference measurement channel setup that conforms to the 3GPP standards. For more information on reference measurement channels, see [“Reference Measurement Channels \(RMC\)” on page 564](#).

#### Generating the Baseband Signal

Press **W-CDMA Off On** to On.

## Configuring the E4440A PSA for Viewing the DPCCH/DPDCH Output

One of the features of the PSA is its ability to measure the occupied bandwidth of the input signal. Since this feature requires minimal setup, it provides a quick way of viewing the input and making a measurement. This procedure guides you through setting up an occupied bandwidth measurement.

1. Preset the spectrum analyzer.
2. Select the W-CDMA mode.  
Press **Mode > W-CDMA**.
3. Select the mobile setup.  
Press **Mode Setup > Radio > Device BTS MS** to MS.
4. Set the center frequency.  
Press **Frequency Channel > Center Freq > 1.95 > GHz**.
5. Display the signal's bandwidth.  
Press **Measure > Occupied BW**.

**Figure 16-38** Displayed ESG Signal

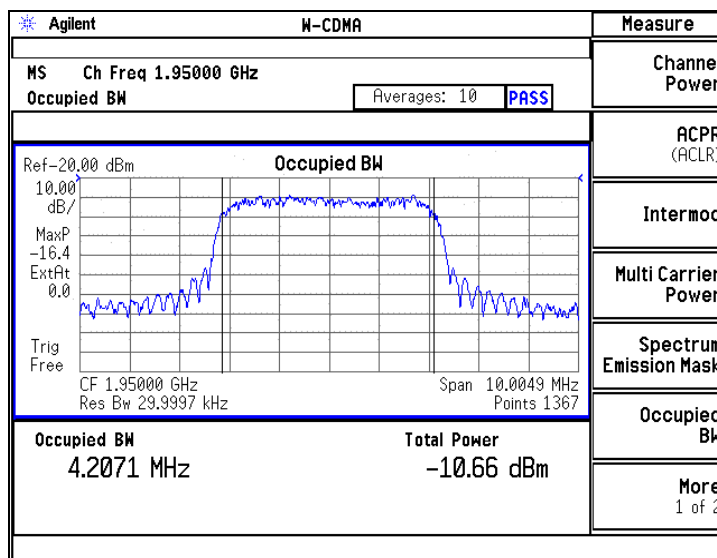

**DPCH**

**Modifying the DPCCH/DPDCH Physical and Transport Layers**

**Modifying the Physical Layer**

The tasks in this procedure build upon the procedure, “Using the Transmit Power Control” on page 527.

1. Press **Link Control > PhyCH Setup > DPCH Power Setup**.
2. Modify the power level for the reference measurement channel.
  - a. Highlight the DPDCH Power field.
  - b. Press **-5 > dB**.
3. Press **Adjust Code Domain Power > Scale to 0dB > Apply Channel Setup**.

When the **Apply Needed** annunciator appears, press the **Apply Channel Setup** softkey. The new settings are not be applied to the signal until this softkey is pressed.

You have now modified the DPDCH to have a -5 dB power level. [Figure 16-39](#) shows the power setup display with the new power value.

**Figure 16-39 DPCH Power Setup Display**

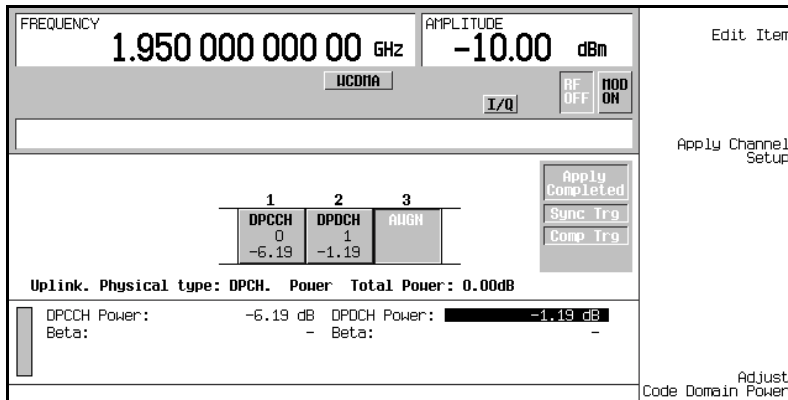

4. Change the symbol rate.
  - a. Press **Return > DPCH Code Setup > DPCH DPCCH DPDCH** to DPDCH.
  - b. Highlight Symbol Rate.
  - c. Press **480 > ksps > Enter**.

The Symbol Rate and Slot Format fields are coupled. If you select a symbol rate that is too high for the current slot format, this could cause over puncturing of the transport channel data. But since the



symbol rate and slot formats are linked together, a change to one value will automatically adjust the other when required.

5. Set the bit error rate ratio.
  - a. Highlight the TrCH BER Cycle field.

- b. Press **125 > Enter**.

The value entered composes a group of data bits that can contain a specified number of error bits, which are entered in the following steps. If you enter zero for the TrCH BER Cycle field, this effectively terminates the error bit insertion feature.

- c. Highlight the TrCH BER ErrLen field.
  - d. Press **10 > Enter**.

This sets the number of error bits contained in the group of data bits shown in the TrCH BER Cycle field. The value ten means that ten of the 125-bits are error bits. The error bit positions are randomly changed to prevent them from appearing in fixed positions and to ensure, when multiple transport channels are used, that errors can appear across all data blocks. You can also enter zero for no error bit insertion.

The value for the TrCH BER ErrLen cannot be greater than the value for the TrCH BER Cycle. If you enter a greater value, the ESG will disregard the entered parameter and set the field equal to the TrCH BER Cycle field setting.

The error ratio is calculated using the following formula:

$$\text{BER} = \text{TrCH BER ErrLen} / \text{TrCH BER Cycle}$$

Using the values entered above:       $\text{BER} = 10 / 125$

$$\text{BER} = .08 \text{ or } 8\%$$

The BER is shown in the grayed-out TrCH BER field. See [Figure 16-40](#) for the location of the BER fields.

**DPCH**

6. Press **Apply Channel Setup**.

When the **Apply Needed** annunciator appears, press the **Apply Channel Setup** softkey. The new settings are not be applied to the signal until this softkey is pressed.

You have now changed the DPDCH symbol rate and modified the transport channel bit error rate to 8 percent. [Figure 16-40](#) shows the code setup display after making the changes.

**Figure 16-40 DPCH Code Setup Display**

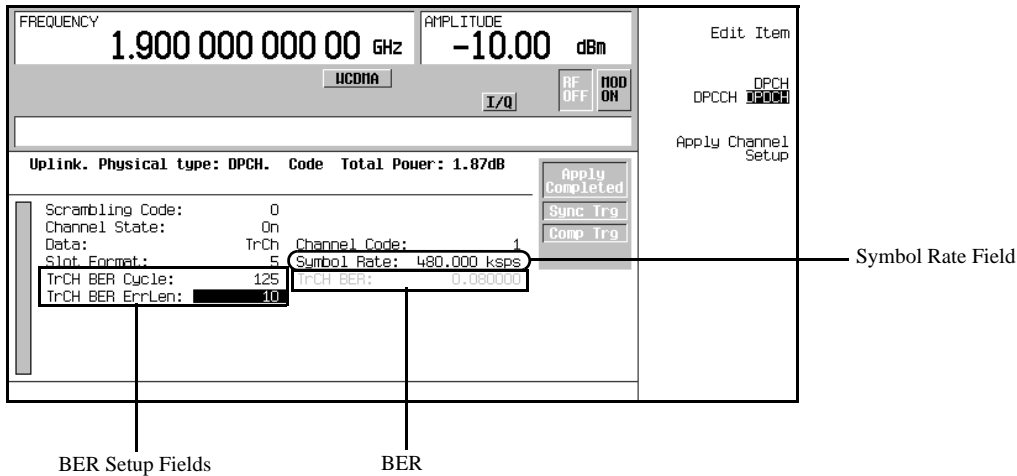

**Modifying the Transport Layer**

Up to six transport data channels are available to the DPDCH when the DPDCH data type is set to TrCh (factory default data type). This task teaches you how to make changes to the transport layer parameters while maintaining an acceptable data puncture rate.

1. Press **Return > Return > Transport Setup**.
2. Press **3 > Enter** to highlight/select channel 3.
3. Press **TrCH State Off On** to On.
4. Press **TrCH Setup**.

Refer to [Figure 16-41](#). Notice the greyed out fields **Max Puncture** and **Puncture**. The **Max Puncture** field shows the maximum amount of puncturing allowed for this transport channel and the **Puncture** field shows the current puncture rate. A positive puncture value indicates the data is being punctured while a negative value means that bits are added. The current puncture value exceeds the allowable puncture rate of 60%. The excessive puncturing will be reduced when the rate matching attribute is adjusted in one of the following steps.

Figure 16-41 Excessive Puncturing

FREQUENCY 1.950 000 000 000 GHz AMPLITUDE -10.00 dBm

UCDMA I/Q RF ON NO ON

Transport Channel Data					
1	2	3	4	5	6
DCH	DCH	DCH	DCH	DCH	DCH
PN9	PN9	PN9	PN9	PN9	PN9
256	256	1	1	1	1

Transport Position: Flexible

Blk Size: 20 Data: PN9 Max Puncture: 60.00 %  
 Num of Blk: 1 Rate Match Attr: 1 Puncture: 98.61 %  
 Coding: 1/2 Conv CRC Size: 8 Bit Rate: 2.00000 kbps  
 TTI: 10.0 msec Bits/Frame: 1

Apply Channel Setup

Max Puncture

Puncture

5. Select the encoder type.
  - a. Move the cursor to highlight the Coding field.
  - b. Press **Edit Item** > **1/3 Conv**.  
 This will actually increase the puncturing slightly. This is because the encoding is changed from 1/2 convolutional encoding (one bit in, two bits out) to 1/3 convolutional encoding (one bit in, three bits out).
6. Set the rate matching.
  - a. Move the cursor to highlight the Rate Match Attr field.
  - b. Press **256** > **Enter**.  
 Notice that the puncture rate is now reduced to an acceptable level.
7. Press **Return** > **2** > **Enter** > **TrCH Setup**.  
 Notice that the puncture rate for DCH 2 matches the maximum puncture rate. The puncture rate increased when the parameters for channel three were modified. This can be adjusted by reducing the block size.
8. Set the block size.
  - a. Move the cursor to highlight the Blk Size field.
  - b. Press **95** > **Enter** > **Apply Channel Setup**.  
 When the Apply Needed annunciator appears, press the **Apply Channel Setup** softkey. The new settings are not be applied to the signal until this softkey is pressed.

## DPCH

9. Press **Return**.

A third transport channel has been turned on and configured to use 1/3 convolutional encoding with a rate match attribute of 256. Changing channel parameters can affect your puncture rate, and they may also affect the parameters for other active channels. Whenever parameters are changed in one channel, check the other channels to ensure their parameters are still within acceptable limits. Notice that decreasing the block size for transport channel two lowered the data rate which in turn decreased the amount of data that would be punctured. Puncturing can also be reduced by increasing the DPCH symbol rate.

### Configuring the E4440A PSA for Viewing Additive Noise

1. Select the spectrum analysis mode.  
Press **Mode > Spectrum Analysis**.
2. Set the center frequency to 1.95 GHz.  
Press **Frequency > 1.95 > GHz**.
3. Set the span to 10 MHz.  
Press **Span > 10 > MHz**.
4. Average the signal for better viewing.  
Press **BW/Avg > Average On Off** to On.
5. Remove text showing average value from the display.  
Press **ESC**.

### Adding Noise

The tasks in this procedure build upon the procedure “[Viewing and Adjusting the Compressed Mode Signal](#)” on [page 539](#). There are two ways that you can set your carrier to noise ratio (C/N). One is by directly entering your C/N value and the other is by setting the energy per bit to noise ratio ( $E_b/N_o$ ) value. Setting your  $E_b/N_o$  will change your C/N and the opposite is also true.

The following ESG tasks teach you how to set the overall C/N ratio for the uplink W-CDMA signal and the  $E_b/N_o$  value referenced to individual physical or transport channels.

### Setting the Carrier to Noise Ratio

1. Press **Mode Setup** to return to the top-level real-time W-CDMA menu.
2. Press **Link Control > PhyCH Setup > DPCH AWGN Setup > Channel State Off On** to On.

3. Press **Apply Channel Setup**.

When the **Apply Needed** annunciator appears, press the **Apply Channel Setup** softkey. The new settings are not be applied to the signal until this softkey is pressed. This softkey needs to be pressed whenever you make parameter changes with the AWGN editor table.

## 4. Set the channel to noise ratio (C/N).

- Move the cursor to highlight the C/N value field.
- Press **25 > dB**.

---

**NOTE** C/N values less than 10 dB may not be visible on a spectrum analyzer.

---

You have now set the overall carrier to noise ratio to 25 dB and turned on noise. This is done to apply a discernible level of noise across the entire channel spectrum. [Figure 16-42](#) shows the signal on the PSA display.

**Figure 16-42** C/N Setting

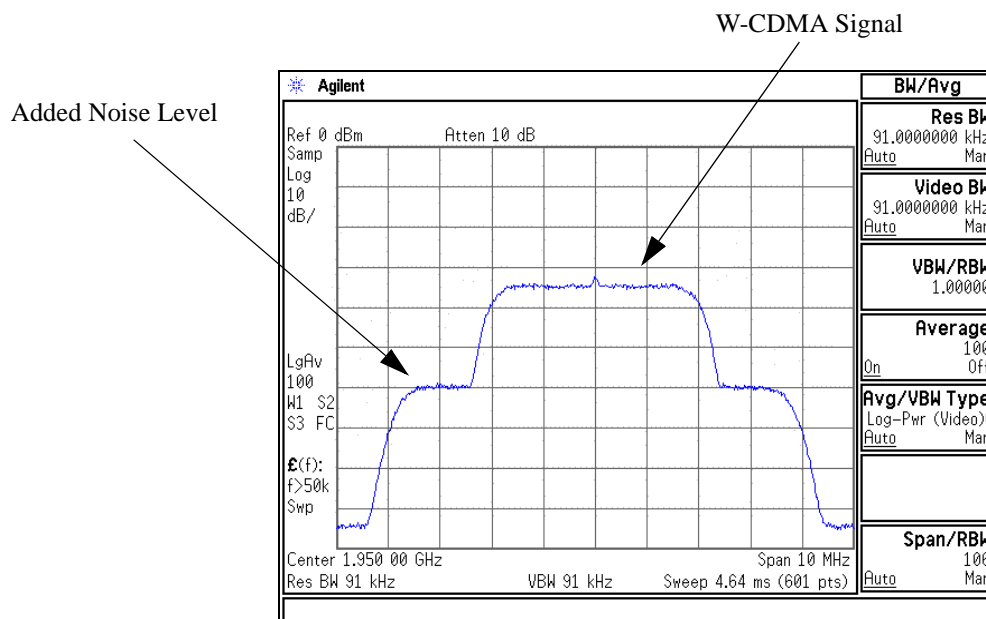

## DPCH

### Setting EbNo

1. Configure the noise for a particular channel.
  - a. Move the cursor to highlight the Eb Ref field.
  - b. Press **Edit Item > DPDCH > Apply Channel Setup**.
2. Set the channel  $E_b/N_o$  value
  - a. Move the cursor to highlight the Eb/No value field.
  - b. Press **10 > dB**.

---

**NOTE** C/N values less than 10 dB may not be visible on a spectrum analyzer.

---

You have now set the  $E_b/N_o$  value for the DPDCH channel to 10 dB. Notice that modifying the  $E_b/N_o$  value for a channel will change the overall carrier to noise ratio and the  $E_b/N_o$  value for all other active channels. The 10 dB setting for  $E_b/N_o$  has decreased the C/N value to where the W-CDMA signal is almost hidden by the noise. For reliable results when making hand calculations to determine or verify  $E_b/N_o$  values, it is recommended that you first scale the code domain power to 0 dB to display the normalized relative channel power levels (see [“Scaling to 0 dB” on page 562](#)).

Figure 16-43

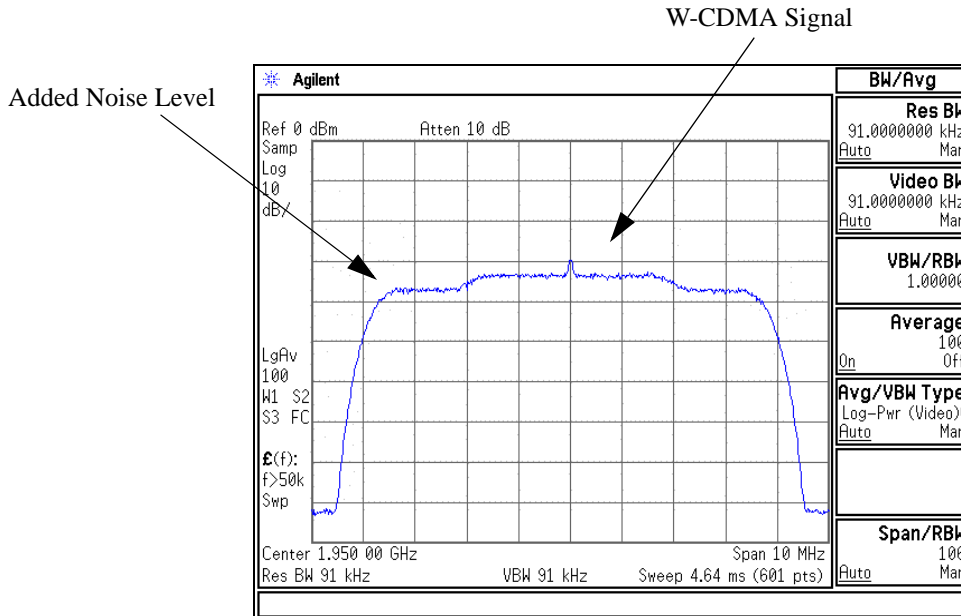
 $E_b/N_0$  Setting**Using the Transmit Power Control**

The tasks in this procedure teach you how to set up dynamic DPCH power control using an external signal. In this closed loop example, the ESG is used to communicate a UE response to TPC commands.

**Connecting the ESG to a Base Transceiver Station**

1. Connect the ESG to the base station as shown in [Figure 16-44](#).
2. Configure the base station to send a TPC signal, and receive the RF signal.

**Figure 16-44**                    **ESG to Base Station Connection Diagram**

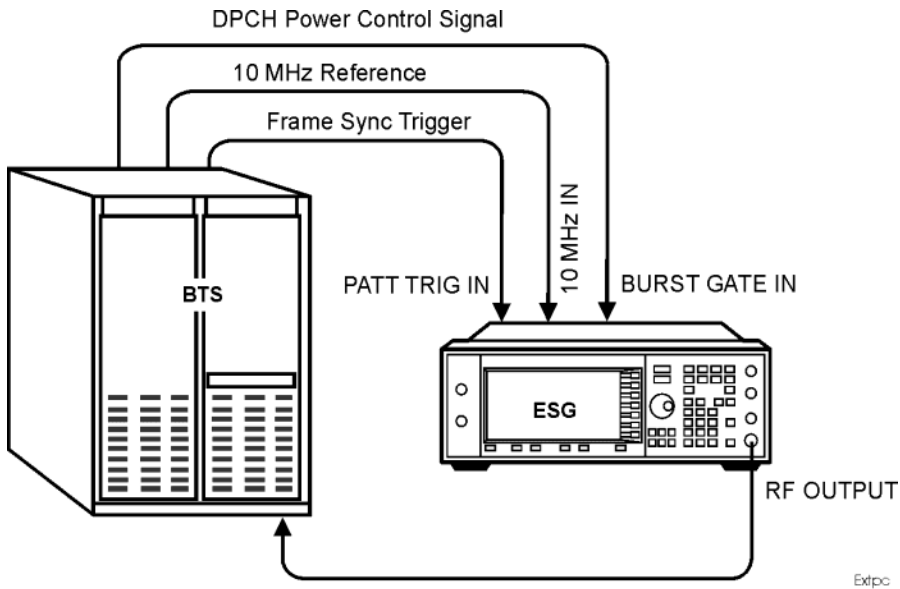

### **Configuring the RF Output**

1. Preset the ESG.
2. Set the carrier frequency to 1.95 GHz.
3. Set the carrier power to  $-10$  dBm.
4. Turn on the RF output.

### **Selecting a DPCH Channel**

1. Press **Mode** > **W-CDMA** > **Real Time W-CDMA** > **Link Down Up** to **Up**.
2. Press **Link Control** > **PhyCH Type** > **DPCH** > **Return**.

### **Generating the Baseband Signal**

Press **W-CDMA Off On** to **On**.



### Configuring an External Signal for DPCH Power Control

1. Press **Link Control > Power Mode Norm TPC** to TPC.
2. Press **PhCH Setup > Transmit Power Control Setup**.

This accesses a softkey menu and a table editor that enables you to set the power parameters.

Figure 16-45 on page 529 displays the transmit power control menu and data fields.

**Figure 16-45** Transmit Power Control Setup Menu

1	2	3
DPCH	DPCH	AUCH
0	1	
-9.54	0.00	

Uplink. Physical type: DPCH. Total Power: 0.46dB

Max Power:	0.00 dB	Max Power:	-10.00 dBm
Min Power:	-40.00 dB	Min Power:	-50.00 dBm
Init Power:	0.00 dB	Init Power:	-10.00 dBm
Power Step:	0.5 dB		

Relative power (points to Min Power field)

Absolute power in relation to carrier power (points to Max Power field)

3. Highlight the Min Power field and press **Edit Item > -35 > dB**.

#### NOTE

The Min Power and Init Power fields are linked to the Power Step field. The values will automatically round to a lower value if the selected Power Step value requires such an adjustment.

4. Highlight the Init Power field and press **Edit Item > -20 > dB**.

Notice that the absolute power values changed.

5. Highlight the Power Step field and press **Edit Item > 2.0 dB**.

Notice that the Min Power field value is rounded to a lower value (-35 dB to -34 dB).

6. Press **Apply Channel Setup**.

When the Apply Needed annunciator appears, press the **Apply Channel Setup** softkey. The new parameters will not be applied to the signal until this softkey is pressed.

**DPCH**

7. Start the power control.

Press **Power Hold Off On** to Off.

---

**NOTE** The default for Power Hold automatically sets the power hold mode to On. In this mode the transmission power remains constant. In addition, the ALC function is turned off and the ALC OFF annunciator appears on the status bar.

---

Figure 16-46 on page 530 shows how the power control feature is implemented.

**Figure 16-46 DPCH External Power Control**

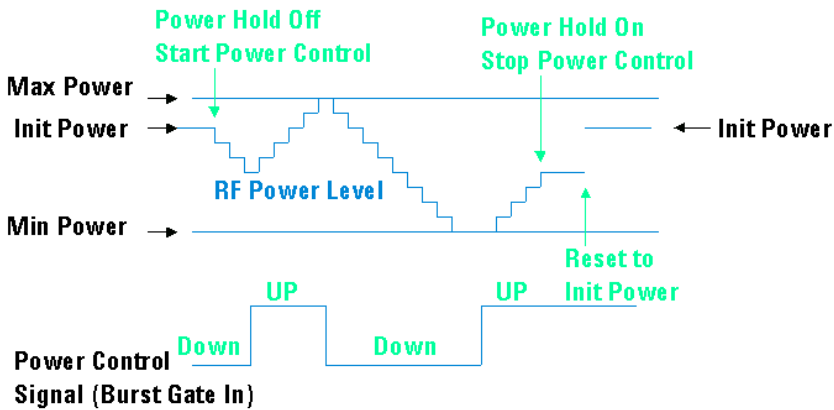

8. Stop the power control.

Press **Power Hold Off On** to On.

9. Return to initial power level.

Press **Reset to Initial Power**.

## Compressed Mode Single Transmission Gap Pattern Sequence (TGPS) Overview

The compressed mode is very flexible with many adjustable parameters. You can have one or two transmission gaps. When two gaps are used, each gap can have a different length and operate using the single or double frame method. [Table 16-3](#) describes some of the parameters that are available for the compressed mode. The compressed mode frames are fully coded which enables you to perform BER and BLER testing of the receiver.

The ESG also supports multiple transmission gap pattern sequences (one to six). This enables you to set up multiple pattern sequences. For more information, see [“Compressed Mode Multiple Transmission Gap Pattern Sequence \(TGPS\) Overview”](#) on page 542.

**Table 16-3 Uplink Compressed Mode Parameters**

Name	Definition
Transmission gap pattern repetition count (TGPRC)	Number of transmission gap patterns within the transmission gap pattern sequence.
Transmission gap connection frame number (TGCFN)	CFN of the first compressed frame of the first pattern within the transmission gap pattern sequence.
Transmission gap slot number (TGSN)	Slot number of the first transmission gap within the first radio frame of the transmission gap pattern.
Transmission gap length 1 (TGL1)	Duration of the first transmission gap within the transmission gap pattern.
Transmission gap length 2 (TGL2)	Duration of the second transmission gap.
Transmission gap duration (TGD)	This is the distance, measured in slots, from the beginning of the first transmission gap to the beginning of the second transmission gap.
Transmission gap pattern length 1 (TGPL1)	Duration of first transmission gap pattern that includes TGL1/2.
Transmission gap pattern length 2 (TGPL2)	Duration of the second transmission gap pattern that includes TGL1/2.

**Compressed Mode Single Transmission Gap Pattern Sequence (TGPS) Overview****Table 16-3 Uplink Compressed Mode Parameters (Continued)**

<b>Name</b>	<b>Definition</b>
Stop connection frame number (Stop CFN)	CFN of the last radio frame.
Transmission gap pattern sequence identifier (TGPSI)	This identifies the currently selected transmission gap pattern sequence.
Transmission gap pattern sequence (TGPS)	This lets you select whether or not to transmit the current TGPSI. Active it will be transmitted, inactive it will not be transmitted.

---

## Setting Up Compressed Mode for a Single TGPS Transmission

Using the compressed mode can turn off the ALC feature. For reliable results, you may need to perform a power search. Before completing this procedure, refer to “[Special Power Control Considerations When Using DPCCH/DPDCH in Compressed Mode or PRACH](#)” on page 584.

### Equipment Setup

Connect the ESG to the Agilent E4440A PSA Spectrum Analyzer or an equivalent instrument as shown in [Figure 16-47](#).

**Figure 16-47**

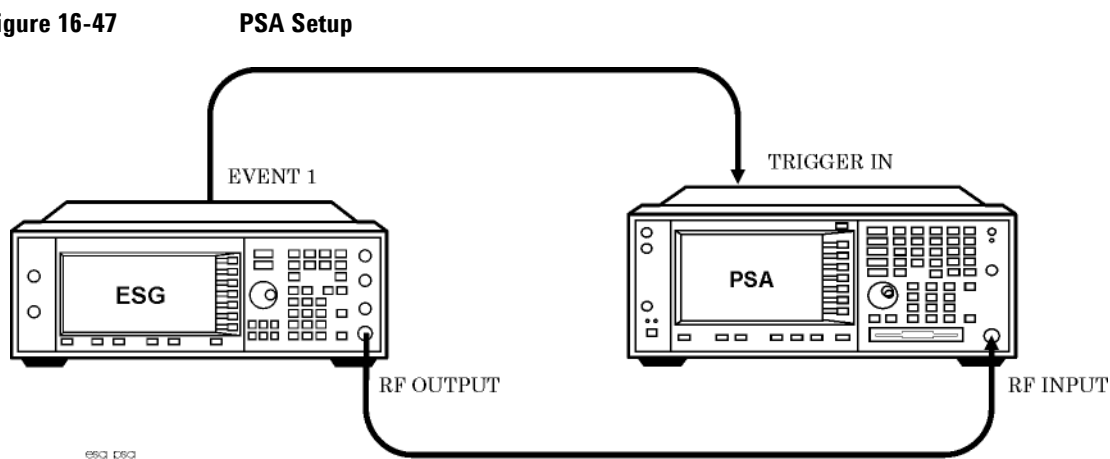

### Configuring the RF Output

1. Press the **Preset** hardkey.
2. Set the frequency and amplitude values.
3. Press the **RF On/Off** hardkey to On.

Steps two and three can be performed either before or after setting the W-CDMA signal parameters.

## Accessing the W-CDMA Modulation Format and Selecting Uplink

Unless stated otherwise, all procedures or tasks begin from the first-level W-CDMA softkey menu accessed in this procedure.

1. Press **Mode > W-CDMA > Real Time W-CDMA**.

This accesses the first-level W-CDMA softkey menu. From this display you can elect to set up the base station parameters (downlink) or the user equipment (UE—uplink).

2. Using the **Link Down Up** softkey, ensure that Up is highlighted as shown in [Figure 16-48](#).

**Figure 16-48** First-Level W-CDMA Softkey Menu

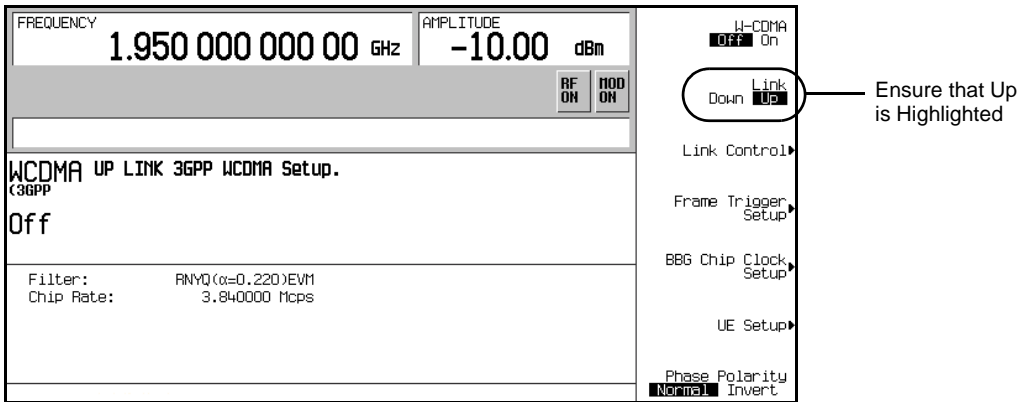

## Setting UP the W-CDMA Signal Parameters

This procedure uses a reference measurement channel as the DPCH setup. All other DPCH parameters use the factory preset values.

1. Press the **Link Control** softkey.
2. Ensure that DPCH is showing as the selected channel type for the **PhyCH Type** softkey. If not, press **PhyCH Type > DPCH**.

**Figure 16-49 DPCH is Selected**

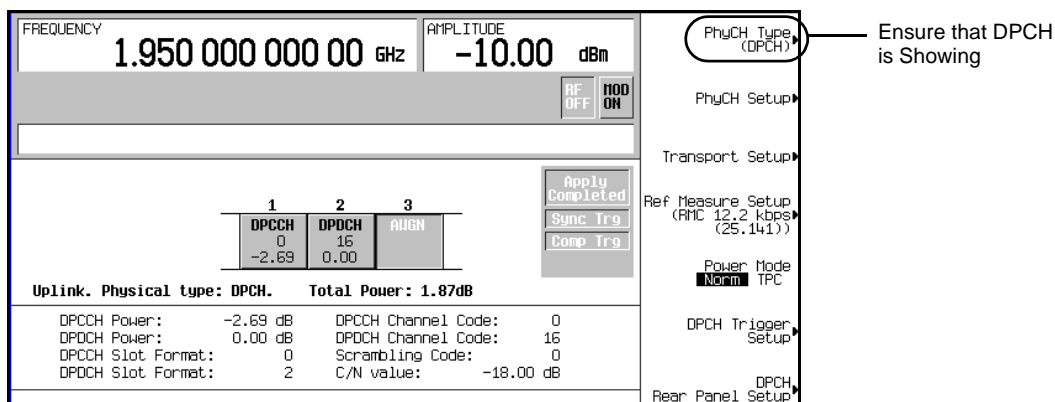

3. Press **Ref Measure Setup > 64 kbps**.

This configures the DPCH with a 64 kbps reference measurement channel according to the 3GPP specifications. This reference measurement channel sets up two transport channels (DCH) and the required DPCH parameters.

4. Press the **Mode Setup** hardkey to return to the first-level W-CDMA softkey menu.

## Generating the Baseband Signal

Press the **W-CDMA Off On** softkey to On.

This step can be performed at anytime during the setup. The advantage of turning the format on before setting up the signal, if you have a spectrum analyzer or some other measuring equipment connected, is you can see the changes as they are made. However you may experience a slight delay in signal processing while the ESG updates the W-CDMA signal with any changes that are made.

## Configuring Compressed Mode

This task teaches you how to set up compressed frames.

1. Press **Link Control > DPCH Rear Panel Setup > DPCH Output Signal Setup > More (1 of 2) > Compressed Frame (RPS8)**.

This enables an output trigger signal at the rear panel EVENT 1 connector when the compressed frame is transmitted.

W-CDMA Uplink Digital Modulation for Receiver Test (Option 400)  
**Setting Up Compressed Mode for a Single TGPS Transmission**

2. Press **Return** > **Return** > **PhyCH Setup** > **Compressed Mode Setup**.

This accesses the compressed mode TGPSI display and is shown in [Figure 16-50](#). From this display, you can select a TGPS using the **TGPSI** softkey, view its parameters, enter the table editor to make parameter changes, and enable or disable the compressed mode feature. In this procedure, TGPSI 1 is used, which is the factory preset cursor location. The factory preset selection for the **Compressed Mode Off On** softkey is On.

**Figure 16-50 TGPSI Display**

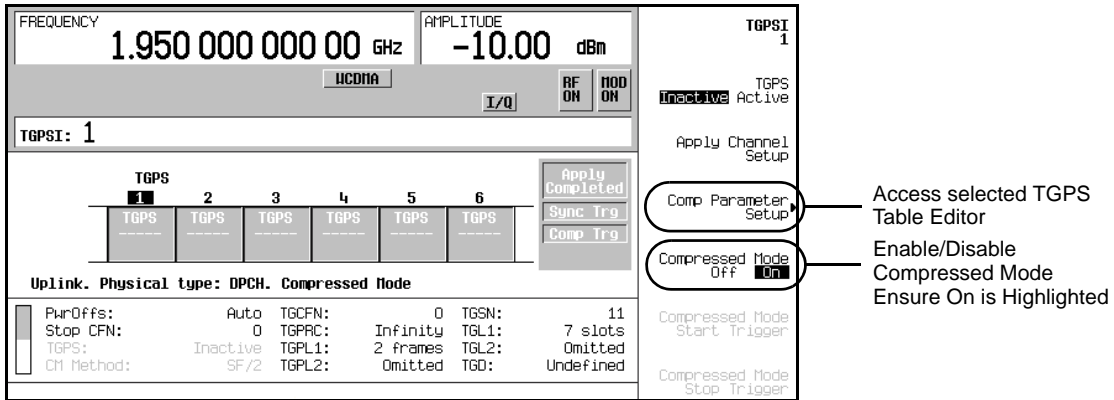

3. Press the **Comp Parameter Setup** softkey shown in [Figure 16-50](#).

This accesses the table editor for the selected TGPS. The table editor, shown in [Figure 16-51](#), is for setting the parameters for the selected TGPSI number, which is TGPSI 1 for this procedure. To access the previous display, press the **Return** hardkey.

Notice that the **Comp Parameter Setup** softkey is replaced with the **Ref Param Setup** softkey.



**Figure 16-51 Compressed Frame Parameters**

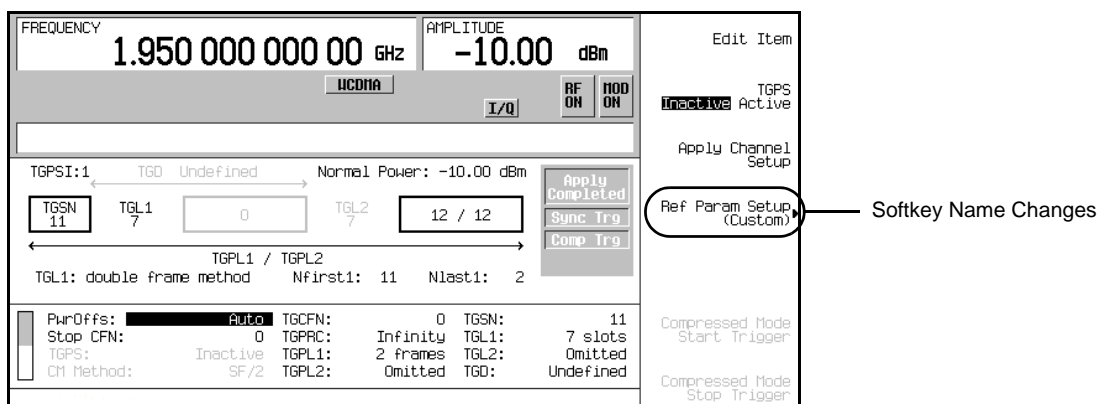

4. Set slot eight of the frame as the starting slot for the first transmission gap.

- a. Move the cursor to highlight the TGSN field.
- b. Press **8** > **Enter**.

This sets the first compressed frame so it has eight slots (0–7) of data prior to the transmission gap that starts with slot eight.

5. Set the first transmission gap length, which is expressed as a number of slots.

- a. Move the cursor to highlight the TGL1 field.
- b. Press **14** > **Enter**.

Out of the 15 slots per frame, the standard specifies that seven of them can be used as discontinuous transmission (DTX) slots. However the total gap length can be spread over two frames. The value 14 denotes 14 DTX slots, which spans 2 frames. This is called the double-frame method. If the value was seven or less, this would mean that the DTX slots are contained in one frame.

6. Set the second transmission gap length, which is expressed as a number of slots.

- a. Move the cursor to highlight the TGL2 field.
- b. Press **3** > **Enter**.

For the second transmission gap, the single frame method is used.

7. Set the spacing between the first and second transmission gaps, which is expressed as a number of slots.

- a. Move the cursor to highlight the TGD field.
- b. Press **37** > **Enter**.

### Setting Up Compressed Mode for a Single TGPS Transmission

8. Set the duration of the first transmission gap pattern, which is expressed as a number of frames.
  - a. Move the cursor to highlight the TGPL1 field.
  - b. Press **6 > Enter**.
9. Set the duration of the second transmission gap pattern, which is expressed as a number of frames.
  - a. Move the cursor to highlight the TGPL2 field.
  - b. Press **4 > Enter**.
10. Set the compressed frame power relative to the non-compressed (normal) frames.
  - a. Move the cursor to highlight the PwrOfFs field.
  - b. Press **6 > dB**.

This enables you to compensate for reduced spreading gain. The higher power level makes the compressed frames easier to view.

11. Enable the compressed frames.

Press the **TGPS Inactive Active** softkey until Active is highlighted.

12. Press the **Apply Channel Setup** softkey.

When the **Apply Needed** annunciator appears, press the **Apply Channel Setup** softkey. The new settings are not applied to the signal until this softkey is pressed.

Pressing this key disables the compressed mode trigger. Therefore whenever this key is pressed while transmitting in compressed mode, the following step will have to be repeated.

13. Press the **Compressed Mode Start Trigger** softkey.

The **Comp trng** annunciator appears and the ESG is now transmitting compressed frames.

The ESG does not transmit compressed frames until an external start trigger is received or the **Compressed Mode Start Trigger** softkey is pressed. Compressed frame transmission is terminated when an external stop trigger is received, the **Compressed Mode Stop Trigger** softkey is pressed, or a parameter is changed and the **Apply Channel Setup** softkey is pressed. You can also stop the transmitted compressed mode frames after a set number of transmissions by changing the TGPRC field from **Infinity** to the desired number of repetitions.

Figure 16-52 shows what the ESG display looks like when this procedure is completed.

**Figure 16-52 Compressed Mode Setup**

FREQUENCY		1.950 000 000 00 GHz		Δ = 0.00dB		-10.00 dBm		Edit Item	
UCDMA		I/Q		RF ON		MOD ON		Inactive: <input type="checkbox"/> Active: <input checked="" type="checkbox"/>	
TGPSI:1		TGD 37 slots		Normal Power: -16.00 dBm		Apply Channel Setup		Ref Param Setup (Custom)	
TGPN 8		TGL1 14		23		TGL2 3		42 / 12	
TGPL1 / TGPL2		TGL1: double frame method		Nfirst1: 8		Nlast1: 6		Apply Completed	
TGL2: single frame method		Nfirst2: 0		Nlast2: 2		Sunc Trg		Comp Trg	
PwrOffs: 6 dB		TGCFN: 0		TGSN: 8		Compressed Mode Start Trigger			
Stop CFN: 0		TGPRC: Infinity		TGL1: 14 slots		Compressed Mode Stop Trigger			
TGPS: Active		TGPL1: 6 frames		TGL2: 3 slots					
CM Method: SF/2		TGPL2: 4 frames		TGD: 37 slots					

## Viewing and Adjusting the Compressed Mode Signal

This procedure will show the ESG compressed signal output on the PSA display (Figure 16-53 on page 541) using the parameters set in the previous procedures. In addition, you will learn how to set the compressed mode transmission for a finite number of repetitions.

### Configuring the E4440A PSA

1. Select the W-CDMA mode.  
Press **Mode > W-CDMA**.
2. Select the mobile setup.  
Press **Mode Setup > Radio > Device BTS MS** to MS.
3. Set the center frequency to the ESG carrier frequency. This procedure uses 1.95 GHz.  
Press **Frequency > 1.95 > GHz**.
4. Select the time domain measurement.  
Press **Measure > More 1 of 2 > Waveform (Time Domain)**.
5. Set a Sweep time that lets you view the signal parameters.  
Press **Meas Setup > Sweep Time > 100 > ms**.
6. Set the resolution bandwidth for a faster response time that captures the signal components.  
Press **Res BW > 1 > MHz**.

## Setting Up Compressed Mode for a Single TGPS Transmission

7. Trigger the spectrum analyzer from the rear panel input using the supplied ESG trigger signal.

Press **Trig Source > Ext Rear**.

8. Zoom in on the RF Envelope display

Press **Zoom**.

You can now see the compressed signal moving across the PSA display.

To remove any text showing on the display, press the **ESC** hardkey.

### Adjusting the Number of Gap Patterns

This task builds upon the procedure “[Configuring Compressed Mode](#)” on page 535.

This task will set up the ESG so that the transmitted gap patterns have a finite repetition. This will enable you to have a clearer view of how the compressed signal parameters affect the transmission.

1. Enter the number of transmitted gap patterns.
  - a. Highlight the **TGPRC** field.
  - b. Press **5 > Enter**.
2. Press **Apply Channel Setup > Compressed Mode Start Trigger**.

The **Comp Trg** annunciator comes on and then goes off after 5 gap pattern transmissions. This indicates that the compressed mode trigger is no longer active and the ESG has quit transmitting compressed frames.

Notice that the frame pattern is now easily viewed on the PSA display and is shown in [Figure 16-53](#). This figure also points out some of the compressed mode parameters as they appear on the signal.

**Figure 16-53** Displayed Compressed Signal and Signal Parameters

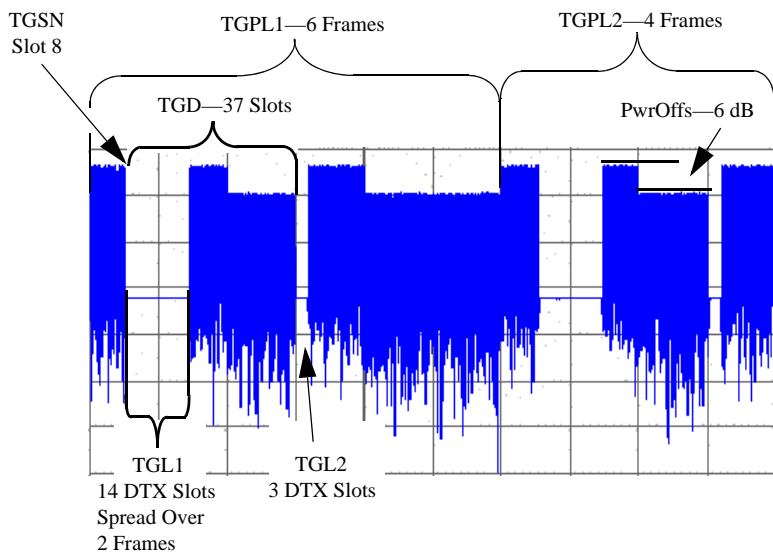
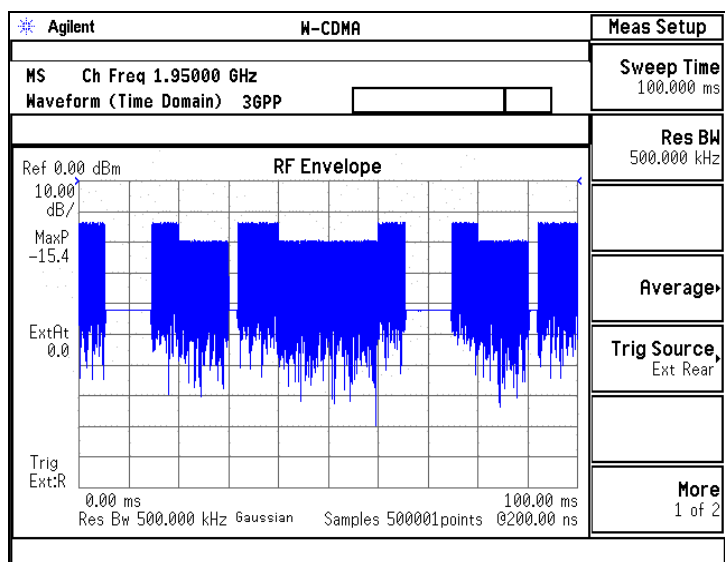

---

## Compressed Mode Multiple Transmission Gap Pattern Sequence (TGPS) Overview

Multiple TGPSs (pattern sequences) are used to sample frequencies from the various transmission formats such as frequency division duplex (FDD), time division duplex (TDD), and GSM in preparation for a handoff. The number of pattern sequences is dependent on the type(s) of transmission format you need to sample. The following list shows the number of TGPSs that are required to receive each type of transmission format:

FDD	one TGPS per FDD frequency
TDD	one TGPS per TDD signal
GSM	three TGPSs per GSM signal

For example, if you wanted to sample the frequencies for a FDD and GSM signal, you would need four TGPSs, one for the FDD signal and three for the GSM signal. If you wanted to sample three FDD frequencies, you would need three TGPSs.

The ESG supports up to six different pattern sequences. Setting up the compressed frame signal with multiple TGPSs is very similar to setting up a compressed frame signal using a single TGPS that is demonstrated in the section [“Configuring Compressed Mode” on page 535](#).

Each TGPS has the same parameters that are described in [Table 16-3 on page 531](#), and the parameters are local to each pattern sequence, with the exception of the `POWOffs` field. This field is common (global) for all TGSPs and sets the amount of power offset for the compressed frames relative to the normal frames. When it is set in one TGPS, it is applied to all the active pattern sequences and is shown in the `POWOffs` field.

### Understanding Multiple TGPS Compressed Frame Alignment

When multiple TGPSs are used, it is very important to ensure that there are no overlapping compressed frames configured for the same frame position. If compressed frame overlapping occurs, the ESG discontinues the compressed frame transmission (compressed frame start trigger is terminated) and normal frames are transmitted. When the compressed frames from a multiple TGPS signal are properly aligned, the output is a composite signal that contains the compressed frames from all the pattern sequences. Both conditions are demonstrated in [Figure 16-54](#).

**Figure 16-54** Multiple TGPS Compressed Frame Alignment  
**Incorrect Compressed Frame Alignment**

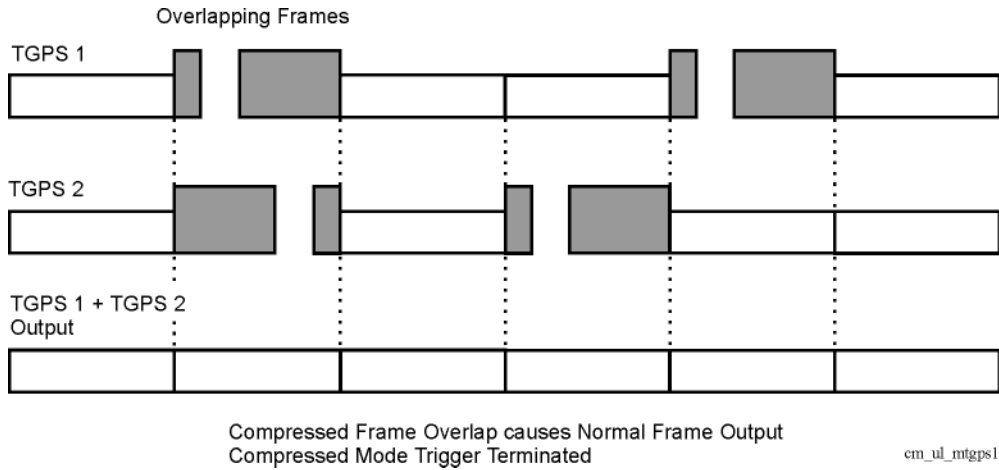

**Correct Compressed Frame Alignment**

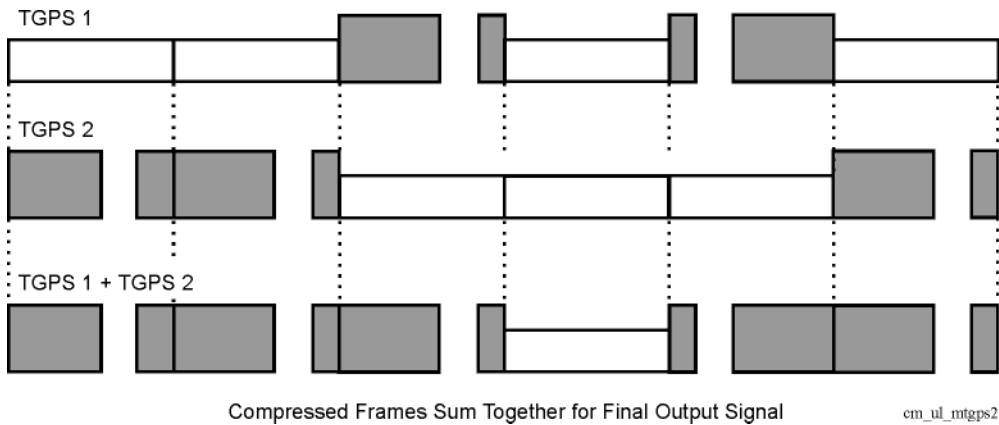

## Compressed Mode Multiple Transmission Gap Pattern Sequence (TGPS) Overview

You can see in [Figure 16-54](#) that an offset is required between the pattern sequences so the compressed frames do not overlap. This is done using connection frame numbers (CFN), which are a subset of the system frame numbers (SFN). Each value of the CFN indicates a frame number with the first frame numbered zero. In [Figure 16-54](#), TGPS 1 has a two frame offset since the first compressed frame starts at frame two. This would require that TGPSI 1 has a CFN of two. TGPS 2 has no offset, so its CFN is zero. For the compressed mode feature, the CFN is set using the TGCFN (transmission gap connection frame number) field within the compressed mode display.

If you plan on a continuous signal output with multiple pattern sequences, you have to ensure that the compressed frame alignment remains consistent. It is easy to set up a compressed frame sequence that initially transmits the intended pattern, but as the signal progresses, the positioning for the compressed frames among the multiple sequence patterns start overlapping. This problem is especially predominant when multiple transmission gap lengths (TGL1/2) and transmission gap pattern lengths (TGPL1/2) are used.



---

## Setting Up Compressed Mode for a Multiple TGPS Transmission

Using the compressed mode can turn the ESG ALC feature off. For reliable results, you may need to perform a power search. Before completing this procedure, refer to [“Special Power Control Considerations When Using DPCCH/DPDCH in Compressed Mode or PRACH”](#) on page 584.

Prior to setting your multiple TGPS parameters, it is a good practice to diagram the compressed frame output and transfer the diagram settings to the ESG. This can eliminate the trial and error method for properly aligning the compressed frames among the pattern sequences.

### Equipment Setup

Connect the ESG to the Agilent E4440A PSA Spectrum Analyzer or equivalent instrument as shown in [Figure 16-55](#).

Figure 16-55

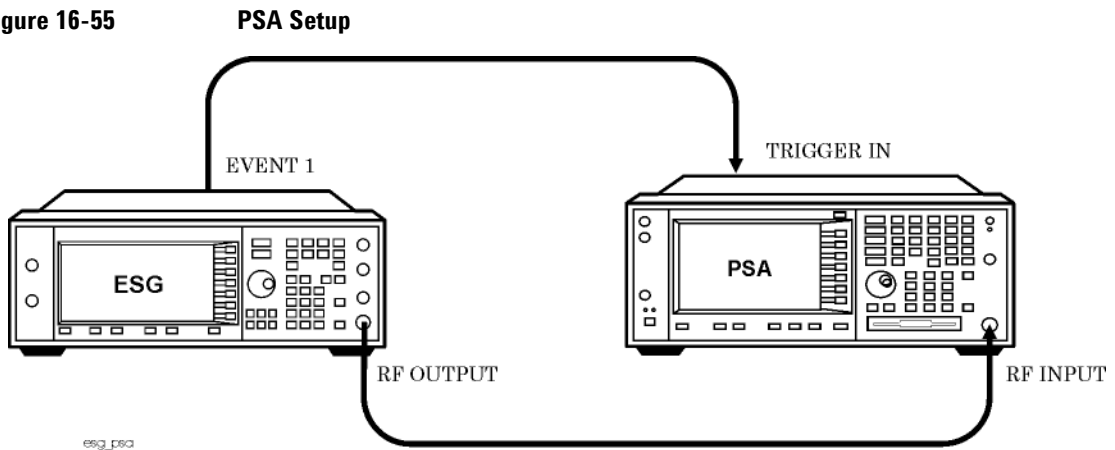

### Configuring the RF Output

1. Press the **Preset** hardkey.
2. Set the frequency and amplitude values.
3. Press the **RF On/Off** hardkey to On.

Steps two and three can be performed either before or after setting the W-CDMA signal parameters.

## Accessing the W-CDMA Modulation Format and Selecting Uplink

Unless stated otherwise, all procedures and tasks begin from the first-level W-CDMA softkey menu accessed in this procedure.

1. Press **Mode > W-CDMA > Real Time W-CDMA**.

This accesses the first-level W-CDMA softkey menu. From this display you can elect to set up the base station parameters (downlink) or the user equipment (UE—uplink).

2. Using the **Link Down Up** softkey, ensure that Up is highlighted as shown in [Figure 16-56](#).

**Figure 16-56** First-Level W-CDMA Softkey Menu

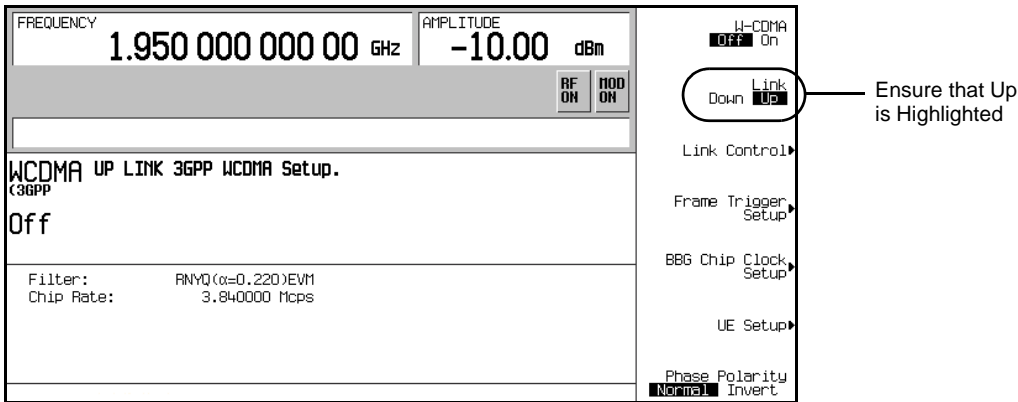

## Setting UP the W-CDMA Signal Parameters

This procedure uses a reference measurement channel as the DPCH setup. All other DPCH parameters are left at factory preset values.

1. Press the **Link Control** softkey.
2. Ensure that DPCH is showing as the selected channel type for the **PhyCH Type** softkey. If not, press **PhyCH Type > DPCH**.

**Figure 16-57 DPCH is Selected**

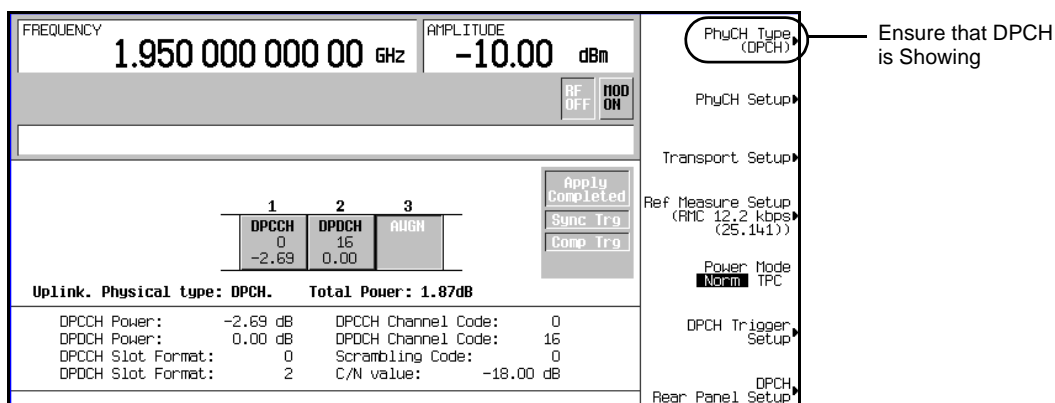

3. Press **Ref Measure Setup > 64 kbps**.

This configures the DPCH with a 64 kbps reference measurement channel according to the 3GPP specifications. This reference measurement channel sets up two transport channels (DCH) and the required DPCH parameters.

## Selecting the Rear Panel Output Trigger

This procedure builds upon the previous procedure [“Setting UP the W-CDMA Signal Parameters”](#) on page 546.

1. Press **DPCH Rear Panel Setup > DPCH Output Signal Setup > More (1 of 2) > Compressed Frame (RPS8)**.

This enables an output trigger signal at the rear panel EVENT 1 connector when a compressed frame is transmitted.

2. Press the **Mode Setup** softkey to return to the first-level W-CDMA softkey menu.

## Generating the Baseband Signal

Press the **W-CDMA Off On** softkey to On.

This step can be performed at anytime during the setup. The advantage of turning the format on before setting up the compressed frame signal, if you have a spectrum analyzer or some other measuring equipment connected, is you can see the changes as they are applied to the signal. However you may experience a slight delay in signal processing while the ESG updates the W-CDMA signal with any changes that are made. If you want to configure a spectrum analyzer to view the ESG signal during the setup, see [“Viewing the Multiple TGPSI Signal”](#) on page 554.

## Configuring TGPSI 1

1. Press **Link Control > PhyCH Setup > Compressed Mode Setup**.

This accesses the compressed mode TGPSI display and is shown in [Figure 16-58](#). From this display, you can select a TGPS using the **TGPSI** softkey, view its parameters, enter the table editor to make parameter changes, and enable or disable the compressed mode feature. TGPSI 1 is the factory preset cursor location and On is the factory preset selection for the **Compressed Mode Off On** softkey.

**Figure 16-58 TGPSI Display**

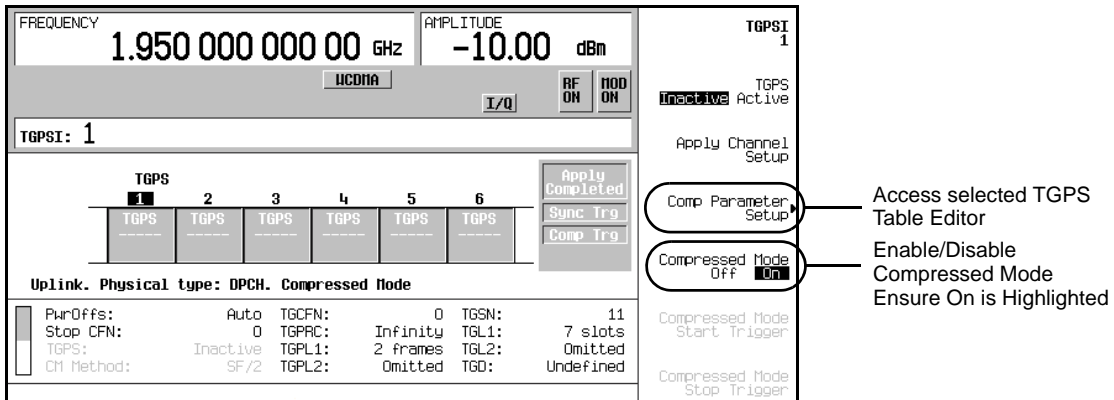

2. Press the **Comp Parameter Setup** softkey shown in [Figure 16-58](#).

This accesses the table editor for the selected TGPS. The table editor, shown in [Figure 16-59](#), is for setting the parameters for the selected TGPSI number, which is TGPSI 1 for this procedure. To access the previous display, press the **Return** hardkey.

Notice that the **Comp Parameter Setup** softkey is replaced with the **Ref Param Setup** softkey.

**Figure 16-59 Compressed Frame Parameters**

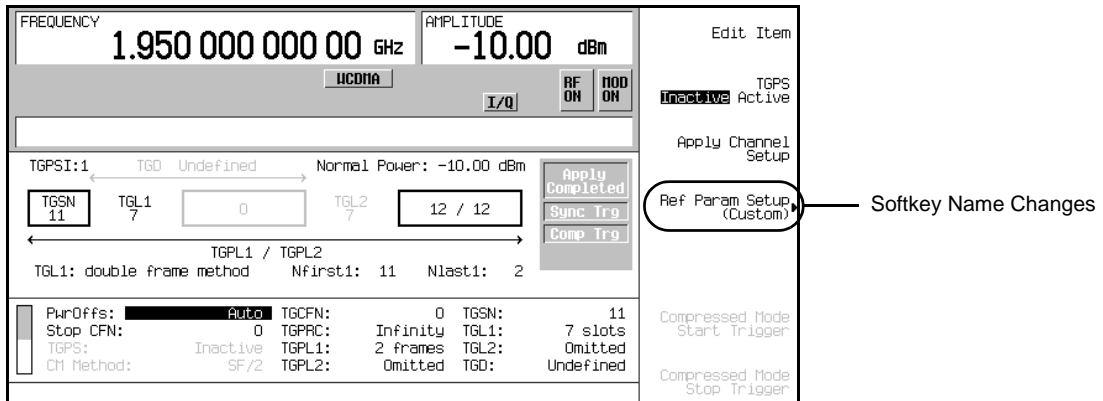

3. Set slot five of the frame as the starting slot for the first transmission gap.
  - a. Move the cursor to highlight the TGSN field.
  - b. Press **5 > Enter**.

This sets the first compressed frame so it has five slots (0–4) of data prior to the transmission gap that starts with slot five.

4. Set the first transmission gap length which is expressed as a number of slots.
  - a. Move the cursor to highlight the TGL1 field.
  - b. Press **5 > Enter**.

Out of the 15 slots per frame, the standard specifies that seven of them can be used as discontinuous transmission (DTX) slots. However the total gap length can be spread over two frames. The value 5 denotes 5 DTX slots. Since the TGSN value previously entered is also five, this would mean that the single frame method is being used.

5. Set the second transmission gap length which is expressed as a number of slots.
  - a. Move the cursor to highlight the TGL2 field.
  - b. Press **7 > Enter**.

For the second transmission gap, the single frame method is also used.

6. Set the spacing between the first and second transmission gaps expressed as a number of slots.
  - a. Move the cursor to highlight the TGD field.
  - b. Press **30 > Enter**.

W-CDMA Uplink Digital Modulation for Receiver Test (Option 400)  
**Setting Up Compressed Mode for a Multiple TGPS Transmission**

7. Set the duration of the first transmission gap pattern which is expressed as a number of frames.
  - a. Move the cursor to highlight the TGPL1 field.
  - b. Press **5 > Enter**.

If desired, you can also establish a second gap pattern using the TGPL2 field, however this does create a more complex signal that can make it harder to keep compressed frames in proper alignment among the multiple pattern sequences.

8. Set the compressed frame power relative to the non-compressed frames.
  - a. Move the cursor to highlight the PwrOfFs field.
  - b. Press **6 > dB**.

This is a global setting for all TGPSIs. It enables you to compensate for reduced spreading gain. The higher power level makes the compressed frames easier to view.

9. Press the **TGPS Inactive Active** softkey until Active is highlighted.

This enables TGPSI 1 and can be pressed either in the current display or in the previous TGPSI display.

You have now completed configuring TGPSI 1. [Figure 16-60](#) shows what the ESG display looks like after completing this step.

**Figure 16-60 Compressed Mode Setup for TGPSI 1**

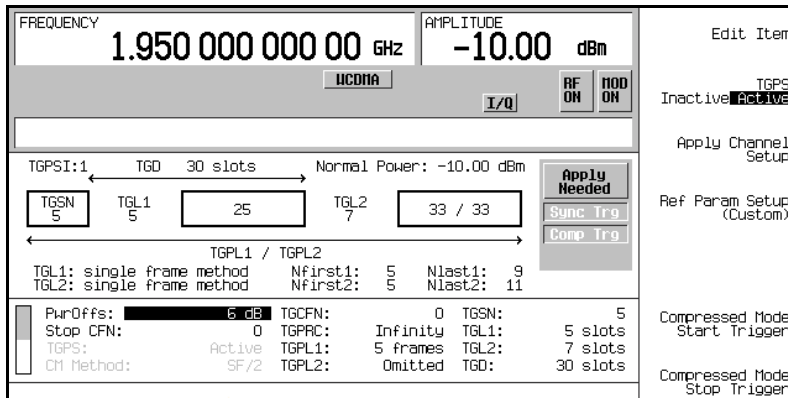

10. Press the **Return** hardkey to return to the TGPSI display.

## Configuring TGPSI 2

This procedure builds upon the previous procedure, “Configuring TGPSI 1” on page 548 and configures the second TGPS so that the compressed frames from TGPSI 1 and 2 are properly positioned.

1. Press **2** > **Enter** > **Comp Parameter Setup**.
2. Set slot three of the frame as the starting slot for the first transmission gap.
  - a. Move the cursor to highlight the TGSN field.
  - b. Press **3** > **Enter**.

This sets the compressed frame so it has three slots (0–2) of data prior to the transmission gap that starts with slot three.

3. Set the first transmission gap length which is expressed as a number of slots.
  - a. Move the cursor to highlight the TGL1 field.
  - b. Press **7** > **Enter**.

Out of the 15 slots per frame, the standard specifies that seven of them can be used as discontinuous transmission (DTX) slots. However the total gap length can be spread over two frames. The value 7 denotes 7 DTX slots, which are contained in one frame since the TGSN value is three. So the single frame method is being used.

4. Set the second transmission gap length which is expressed as a number of slots.
  - a. Move the cursor to highlight the TGL2 field.
  - b. Press **3** > **Enter**.

The single frame method is also used for the second transmission gap.

5. Set the spacing between the first and second transmission gaps expressed as a number of slots.
  - a. Move the cursor to highlight the TGD field.
  - b. Press **29** > **Enter**.

This positions the second transmission gap (TGL2 field) for TGPSI 2 so it occurs in the second normal frame transmitted by TGPSI 1. If compressed frames from the different TGPSs occupy the same frame position (overlap), the ESG will transmit only normal frames. This is shown in [Figure 16-54 on page 543](#).

**Setting Up Compressed Mode for a Multiple TGPS Transmission**

6. Set the frame offset for the first compressed frame so it does not overlap a compressed frame from TGPSI 1.
  - a. Move the cursor to highlight the TGCFN field.
  - b. Press **1 > Enter**.

The connection frame numbers (CFN) are a subset of the system frame numbers (SFN). Each value denotes the start of a new frame with zero being the first frame position. To avoid compressed frame overlapping, you must position the compressed frames for TGPSI 2 so they occur during normal frame transmissions for TGPSI 1. Since TGPSI 1 starts at TGCFN 0 (frame position one) and has a normal frame in the second frame position, TGPSI 2 will start its first compressed frame in the second frame position (CFN one).

7. Set the duration for the transmission gap pattern, which is expressed as a number of frames.
  - a. Move the cursor to highlight the TGPL1 field.
  - b. Press **5 > Enter**.

This value is the same as for TGPSI 1. This ensures that my frame alignment is consistent over time and keeps frame overlapping from occurring between the two pattern sequences for the current setup. This setting alone does not keep the proper alignment consistent, it is the combination of this setting and the other spacing values that ensure proper compressed frame alignment.

8. Press the **TGPS Inactive Active** softkey until Active is highlighted.
9. Press the **Apply Channel Setup** softkey.

When the **Apply Needed** annunciator appears, press the **Apply Channel Setup** softkey. The new settings are not applied to the signal until this softkey is pressed.

Pressing this key disables the compressed mode trigger. Therefore, whenever this key is pressed while transmitting in compressed mode, the compressed mode start trigger will have to be reapplied.

[Figure 16-62](#) shows what the ESG display looks like when this step is completed.



**Figure 16-61 TGPSI 2 Setup**

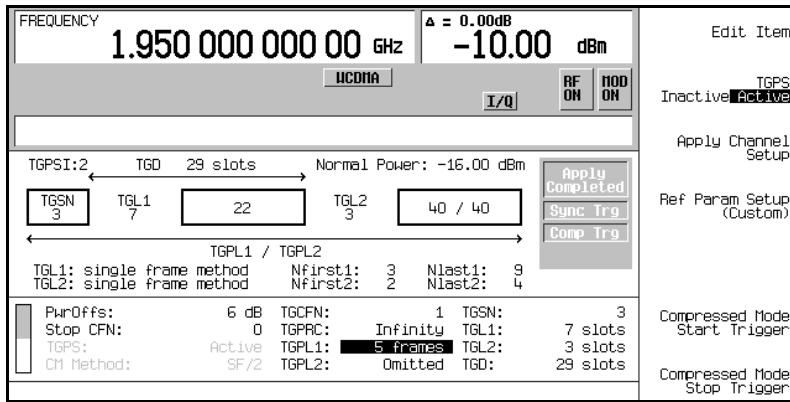

10. Press the **Return** hardkey to return to the TGPSI display.
11. Press the **Compressed Mode Start Trigger** softkey.

The **Comp trg** annunciator appears and the ESG is now transmitting compressed frames.

The ESG does not transmit compressed frames until an external start trigger is received or the **Compressed Mode Start Trigger** softkey is pressed. Compressed frame transmission is terminated when an external stop trigger is received, the **Compressed Mode Stop Trigger** softkey is pressed, or a parameter is changed and the **Apply Channel Setup** softkey is pressed. You can also stop the transmitted compressed frames after a set number of transmissions by changing the TGPRC field from *Infinity* to the desired number of repetitions.

Figure 16-62 shows what the ESG display looks like when this procedure is completed.

**Figure 16-62 Completed TGPSI Display**

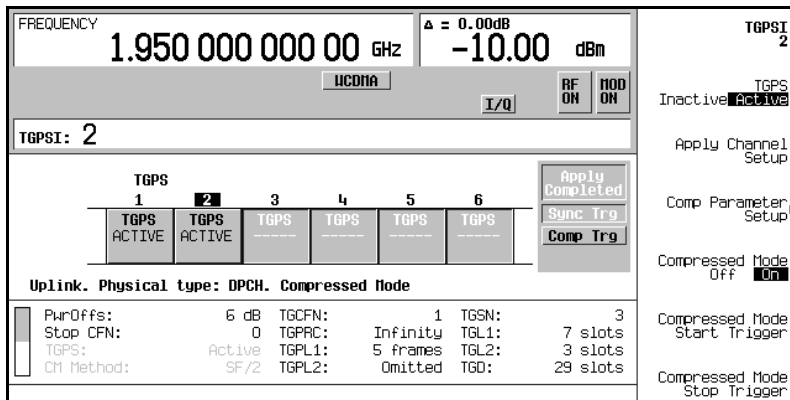

## Viewing the Multiple TGPSI Signal

1. Select the Spectrum Analysis mode.

Press **Mode > Spectrum Analysis**.

The W-CDMA mode can also be used, and is demonstrated in the task [“Configuring the E4440A PSA” on page 539](#).

2. Set the center frequency to match the ESG carrier signal. This procedure uses 1.95 GHz.

Press **Frequency > 1.95 > GHz**.

3. Set the spectrum analyzer for a zero span (time domain measurement).

Press **Span > Zero Span**.

4. Set the resolution bandwidth for a faster response time that captures the signal components.

Press **BW/Avg > Res BW > 8 > MHz**.

5. Set a Sweep time that lets you view the signal parameters.

Press **Sweep > Sweep Time > 100 > ms**.

This setting makes it easier to view the frames since each vertical graticle is 10 ms, which is the same time period for one frame.

6. Trigger the spectrum analyzer from the rear panel input using the supplied ESG trigger signal.

Press **Trig > Ext Rear**.

[Figure 16-63](#) shows the ESG output signal configured in the previous section, [“Setting Up Compressed Mode for a Multiple TGPS Transmission” on page 545](#). In the figure, you can see two transmissions for TGPSI 1 and one full and a partial transmission for TGPSI 2. Notice the one frame offset for the start of TGPSI 2 that was created by setting its TGCFN field to one.

**Figure 16-63**

**Multiple TGPSIs on the Spectrum Analyzer Display**

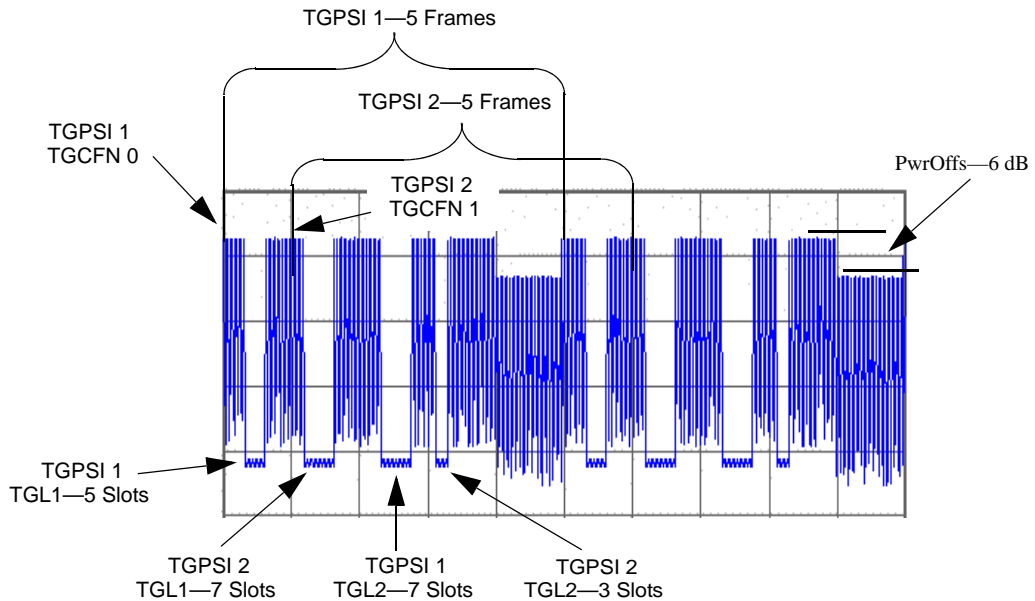
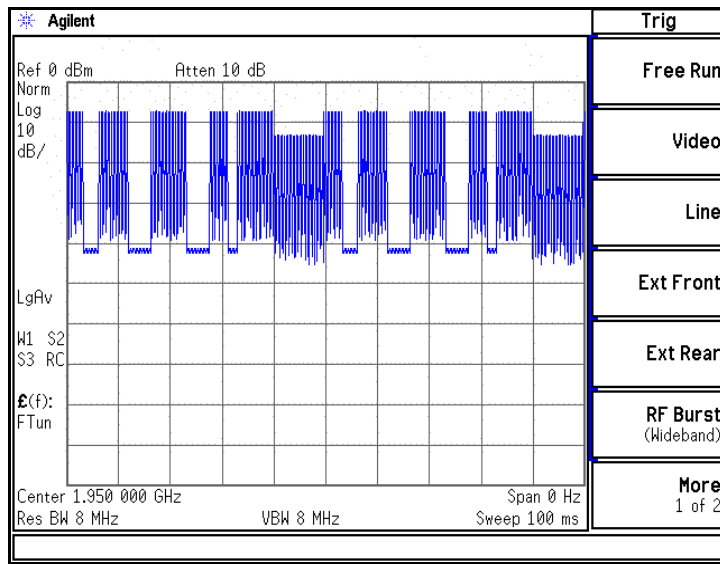

## Configuring the UE Setup

1. Press **Mode** > **W-CDMA** > **Real Time W-CDMA** > **Link Down Up** to Up.
2. Press **UE Setup**.

This opens a menu where you can select the filtering type and adjust the chip rate for the simulated user equipment (see [Figure 16-64](#)). Use the arrow keys or the knob to highlight the data fields for editing. Press **Edit Item** to change the value for the desired user equipment parameter.

**Figure 16-64** User Equipment Setup

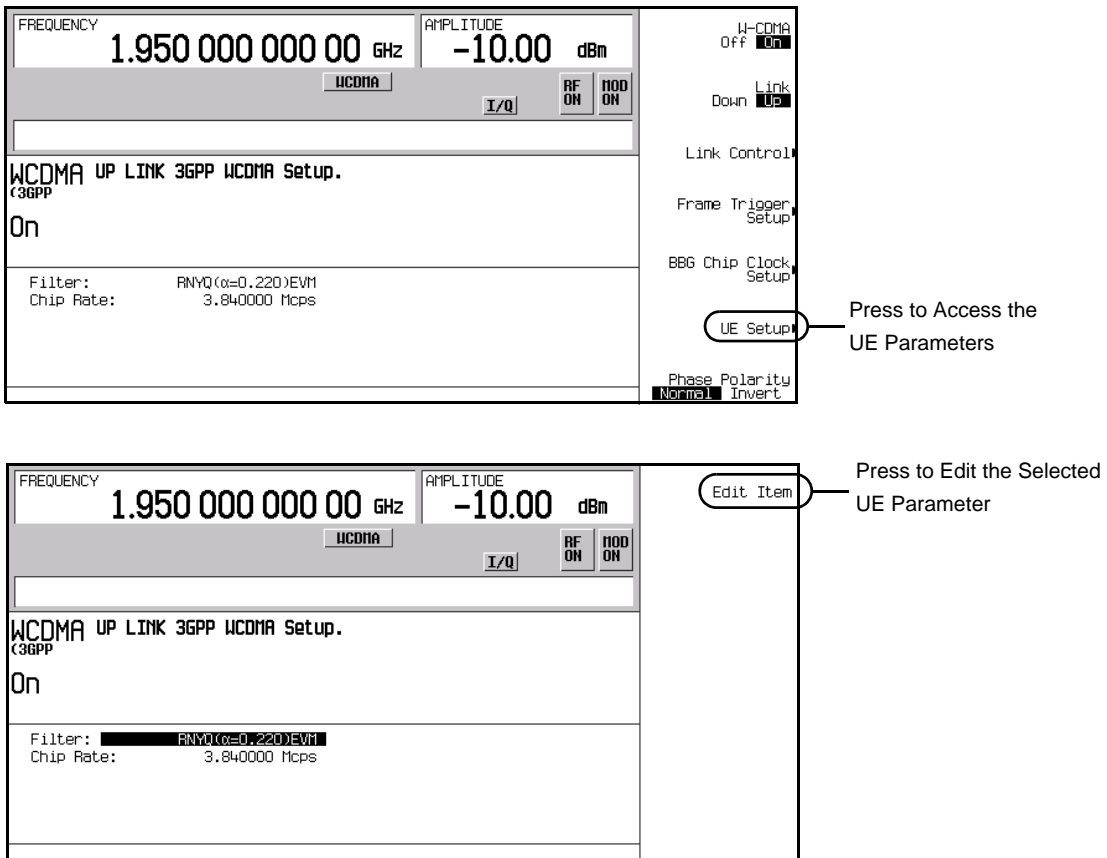

## Locating Rear Panel Input Signal Connectors

One feature of the W-CDMA uplink format is the ease in which you can locate a rear panel input connector for a particular signal application. This feature applies to both the DPCH and the PRACH. This procedure guides you through the softkey menus to where you can view the information.

1. Press **Mode > W-CDMA > Real Time W-CDMA > Link Down Up** to Up.
2. Press **Link Control > PhyCH Type**.

The **PhyCH Type** softkey opens another menu where you can select either the PRACH or DPCH mode. The factory default is DPCH. You need to select the mode for which the input signal is intended. If the input signal is the AICH for the PRACH, you would need to be in the PRACH mode to see which connector accepts the AICH signal.

3. Select the channel mode, **DPCH** or **PRACH**.

Once a mode is selected, you will be returned to the previous softkey menu.

4. Press **DPCH Rear Panel Setup** or **PRACH Rear Panel Setup** depending on the selected mode.
5. Press **DPCH Input Signal Setup** or **PRACH Input Signal Setup** depending on the selected mode.

The information shown in the text area, displays the connector and the type of input signal it accepts. For example, the BBG Reference in listing (BASEBAND GEN REF IN connector) in the Rear Panel Ports column accepts a baseband generator (BBG) chip clock signal. Figure 16-65 shows the position of this information on the DPCH signal input display.

**Figure 16-65 Rear Panel Connector Information**

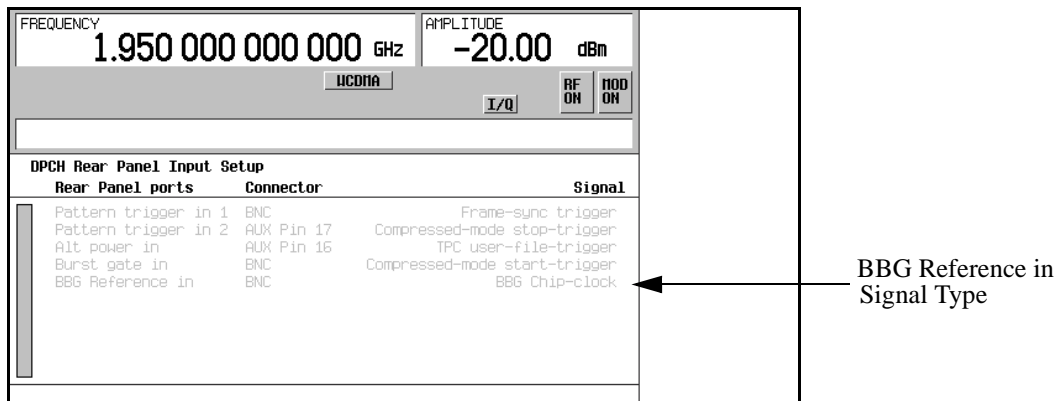

**Locating Rear Panel Input Signal Connectors**

6. To exit this display, press either **Mode Setup** to return to the top-level W-CDMA softkey menu or press **Return** until you come to the desired softkey menu/display.

## Configuring Rear Panel Output Signals

The W-CDMA uplink format provides you the ability to configure output signals for the various rear panel output connectors. This lets you select trigger signals based on your needs and applies to both the DPCH and the PRACH. This procedure guides you through the softkey menus to where you can configure your signals.

### Accessing the Output Trigger Signal Menu

1. Press **Mode > W-CDMA > Real Time W-CDMA > Link Down Up** to Up.
2. Press **Link Control > PhyCH Type**.

The **PhyCH Type** softkey opens another menu where you can select either the PRACH or DPCH mode. The factory default is DPCH. You need to select the mode for which the input signal is intended. If the desired output signal is the PRACH pulse, you would need to be in the PRACH mode to select the signal and an output connector.

3. Select the channel mode, **DPCH** or **PRACH**.

Once a mode is selected, you will be returned to the previous softkey menu.

4. Press **DPCH Rear Panel Setup** or **PRACH Rear Panel Setup** depending on the selected mode.
5. Press **DPCH Output Signal Setup** or **PRACH Output Signal Setup** depending on the selected mode.

### Selecting an Output Signal

This procedure will use a PRACH output signal selection as an example. While the signal selection may change between the PRACH and DPCH modes, the process remains the same.

1. Using the arrow keys, highlight the item in the `Signal` column that corresponds to the `Event2` connector listed under the `Rear Panel Ports` column.

W-CDMA Uplink Digital Modulation for Receiver Test (Option 400)  
**Configuring Rear Panel Output Signals**

**Figure 16-66 Output Connector Selection**

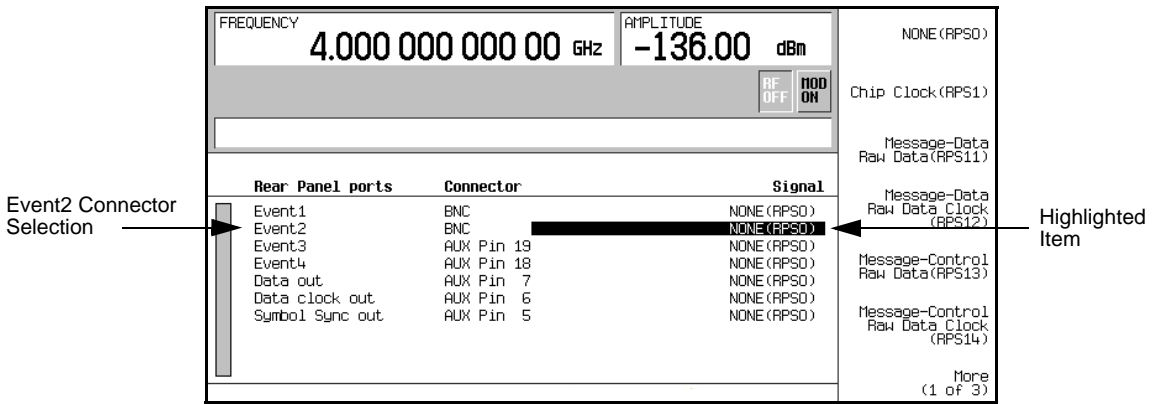

2. Press **More (1 of 3) > More (2 of 3) > Preamble Pulse (RPS21)**.

Notice that under the Signal column in row two of the text display, NONE (RPS0) changed to Preamble pulse (RPS21). This corresponds to the Event2 connector listed under the Rear Panel ports column. Figure 16-67 shows what the ESG display looks like after the preamble pulse selection is made.

**Figure 16-67 Output Trigger Signal Selection**

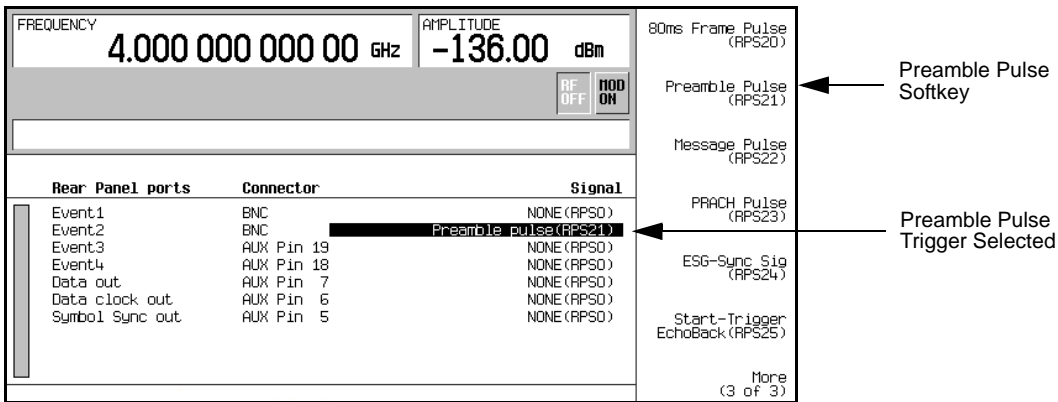



## Deselecting an Output Signal

This procedure builds upon the previous procedure “Selecting an Output Signal”.

1. Press **More (3 of 3)**.

This returns you to the top-level output signal selection display shown in Figure 16-66.

2. Highlight the Event2 connector listing.

3. Press **NONE(RPSO)**.

Notice that the output signal selection listed in the Signal column has changed to None (RPSO). The none indicates that there is no signal output selected for the corresponding connector.

**Figure 16-68 Deselected Signal**

The screenshot displays a device interface with the following components:

- Top Section:** Shows 'FREQUENCY' at 4.000 000 000 00 GHz and 'AMPLITUDE' at -136.00 dBm. There are 'RF OFF' and 'MOD ON' buttons.
- Table:** A table with three columns: 'Rear Panel ports', 'Connector', and 'Signal'.
 

Rear Panel ports	Connector	Signal
Event1	BNC	NONE (RPSO)
Event2	BNC	<b>NONE (RPSO)</b>
Event3	AUX Pin 19	NONE (RPSO)
Event4	AUX Pin 18	NONE (RPSO)
Data out	AUX Pin 7	NONE (RPSO)
Data clock out	AUX Pin 6	NONE (RPSO)
Symbol Sync out	AUX Pin 5	NONE (RPSO)
- Right Side:** A list of signal options: NONE (RPSO), Chip Clock (RPS1), Message-Data Raw Data (RPS11), Message-Data Raw Data Clock (RPS12), Message-Control Raw Data (RPS13), and Message-Control Raw Data Clock (RPS14). A 'More (1 of 3)' option is at the bottom.
- Annotations:**
  - An arrow points from the text 'NONE (RPSO) Softkey' to the 'NONE (RPSO)' option at the top right.
  - An arrow points from the text 'Now, No Trigger is Selected' to the 'NONE (RPSO)' entry in the table.

**Adjusting Code Domain Power**

## Adjusting Code Domain Power

This procedure teaches you about scaling the uplink channels (DPDCH and DPCCH) to 0 dB on the ESG for meeting the code domain power requirements.

### Scaling to 0 dB

After changing the relative power level for a channel, the ESG automatically scales the total power to 0 dB, while preserving the relative channel power levels. Although the displayed total power changes in value as channel powers are adjusted, the actual total power is maintained at 0 dB. The displayed channel power levels remain unchanged, reflecting only user-assigned values, so the user can complete the relative power adjustments. This task teaches you how to update the display to show the normalized relative channel power for each channel after completing your setup.

1. Press **Mode > W-CDMA > Real Time W-CDMA > Link Down Up** to Up.
2. Press **Link Control > PhyCH Type > DPCH > PhyCH Setup > DPCH Power Setup > Adjust Code Domain Power > Scale to 0 dB**.

DPCH is the factory default channel mode.

The displayed power level for each channel is now changed to show the normalized relative channel power and the displayed total power shows 0 dBm. [Figure 16-69](#) is an example showing power levels before and after the scale to 0 dB function.

**Figure 16-69**                      **Scaling to Zero dB (Uplink DPCCH/DPDCH)**

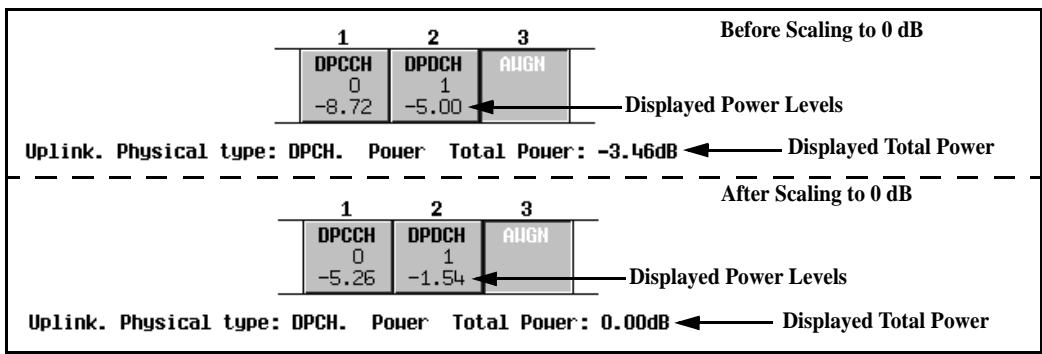

## Setting Equal Channel Powers

This task teaches you how to set equal relative power levels for all active channels while maintaining the code domain power of 0 dB. The normalized relative power level of each channel depends on the number of active channels. This task is an alternative to scaling to 0 dB.

Press **Adjust Code Domain Power > Equal Powers**.

Both channels have now been set to equal powers. [Figure 16-70](#) shows the displayed normalized relative power levels after the **Equal Powers** softkey is pressed with two active channels. Depending on the entered channel powers, the displayed total power may show a low residual value (such as 0.02 dB) due to decimal rounding.

**Figure 16-70** Equal Powers (Uplink DPCCH/DPDCH)

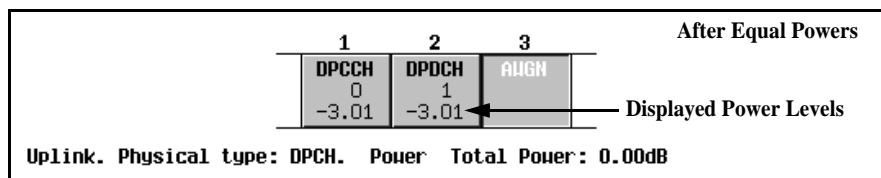

## W-CDMA Uplink Concepts

### Data Channel Air Interface Block Diagram

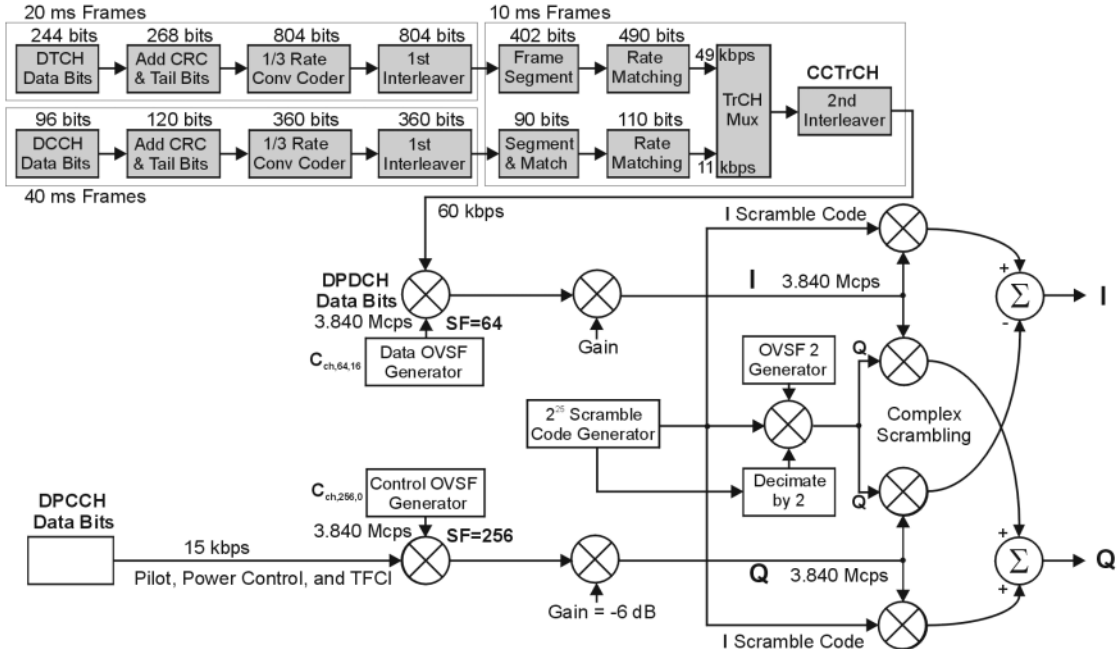

NOTE: Shaded areas of the graphic indicate pre-calculated values based on the user's collection of data and coding parameters. Multiplexing and spreading are done real time.

w\_ul\_air\_if

### Reference Measurement Channels (RMC)

The W-CDMA real-time signal generation modulation format provides reference measurement channels (RMC) at 12.2, 64, 144, and 384 kbps. This option also provides transport layer coding for AMR 12.2 (adaptive multi-rate) and UDI 64 (unrestricted digital information) protocols. Along with user defined parameters for the DPCH, the ESG also supports the predefined 12.2 kbps RMC, 64 kbps RMC, 144 kbps RMC, AMR 12.2 kbps, and UDI 64 kbps with compressed mode.

The signal generator provides one-button setup capabilities for transport channel configuration. The dedicated physical channel DPDCH is predefined by pressing the **Ref Measure Setup** softkey (or sending the appropriate SCPI commands) and selecting the desired RMC. RMC 12.2 kbps is the factory default selection.

Table 16-4 describes the uplink reference measurement channel (RMC) configurations.

**Table 16-4 The Uplink RMC Predefined DPDCH Configuration**

Parameter	DPCH Values at Specified Reference Measurement Channel					
	12.2 kbps	64 kbps	144 kbps	384 kbps	UDI 64 kbps	AMR 12.2 kbps
Power	0.00 dB	0.00 dB	0.00 dB	0.00 dB	0.00 dB	0.00 dB
Beta	15	15	15	15	15	15
Data	TrCH	TrCH	TrCH	TrCH	TrCH	TrCH
Symbol Rate <sup>a</sup>	60 ksps	240 ksps	480 ksps	960 ksps	240 ksps	60 ksps
Slot Format <sup>a</sup>	2	4	5	6	4	2
Channel Code	16	4	2	1	4	16

a. The user-selectable symbol rate and slot format parameters are coupled together.

### Transition between Normal Frame and Compressed Frame

In a dedicated physical channel (DPCH), an RF notch exists at the transition between a normal frame and a compressed frame (see Figure 16-71). In a CW signal, the notch measures approximately five microseconds in length and approximately seven decibels in depth (peak compressed mode to peak normal mode).

**Figure 16-71 RF Notch with Compressed Mode Transitions**

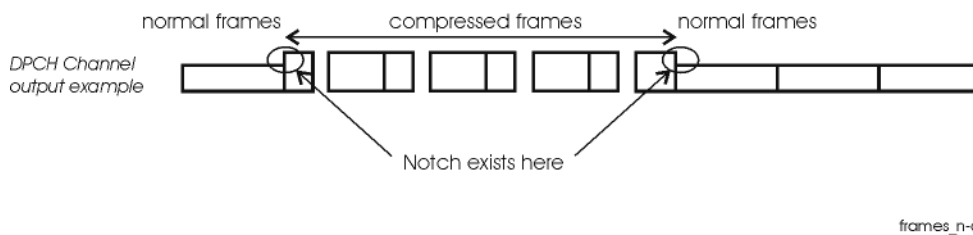

### Settling Time during User Event for DPCH Compressed Mode

Some user events, such as changing the amplitude or frequency, will cause the signal to jump to an unexpected amplitude for a short period of time before it settles to expected parameters. This transition period is approximately 200 milliseconds (see Figure 16-72). It is, therefore, important to allow for this time when you make changes to signal characteristics. If you make changes using remote SCPI commands, insert wait instructions into the program. The following events can cause this unstable transition time:

- amplitude and frequency changes
- RF switched on and off
- modulation switched on and off
- ALC switched on and off
- saving or recalling states

Figure 16-72

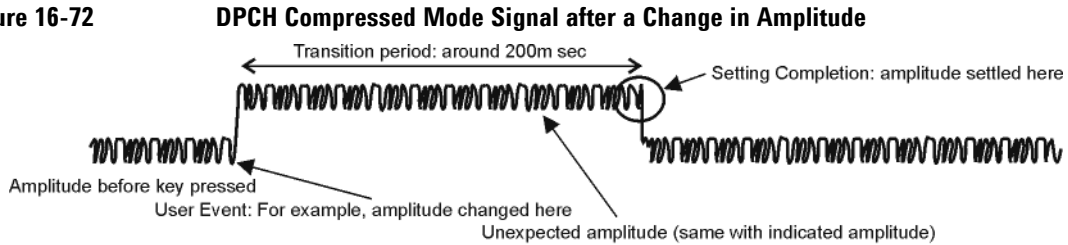

amplitude\_cmpr

### Connecting the ESG to a W-CDMA Base Station

Figure 16-73 shows the connections and signals necessary for the ESG to simulate user equipment when it is connected to a base station.

Figure 16-73

## Cable Connections

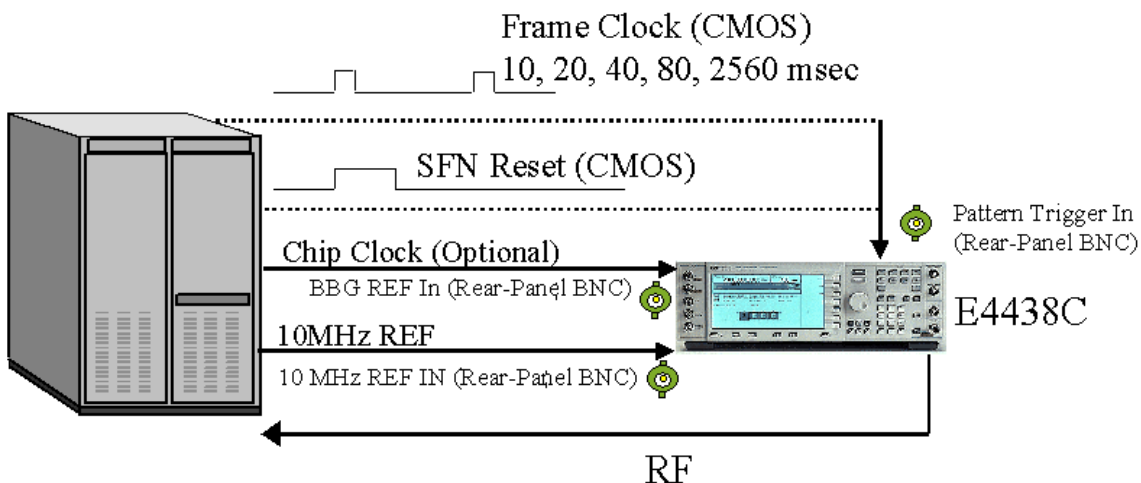

## Trigger Signals (CMOS)

PRACH Trigger: "Burst Gate In" (BNC)

AICH Trigger: "Pattern Trigger IN 2" (AUX Pin 17)

Compressed mode Start Trigger: "Burst Gate In (BNC)

Compressed mode Stop Trigger: "Pattern Trigger IN 2" (AUX Pin 17)

## System Triggering and Synchronization

Either the system frame number reset signal or the frame clock which is applied to the PATT TRIG IN connector can be set as a system trigger signal. After a delay time defined by the sum of 1024 chips ( $T_0$  = the standard timing offset between downlink and uplink), timing offset, and timeslot offset (plus 10 ms when the SFN reset signal is used), a sync signal is generated to time align all other signals. The RF output signal is generated after the fixed delay of the processing time by the hardware. This delay applies to DPCH mode only. Refer to "Synchronization Diagrams" on page 576 for more information.

For increased measurement accuracy, the signal generator's rear panel 10 MHz OUT frequency reference can be utilized by other instruments in the test system.

## Connector Assignments for W-CDMA Uplink

This section describes connector assignments for the W-CDMA uplink personality. The block diagram in Figure 16-74 shows these connector assignments. Notice the front panel connectors are not used in the uplink real-time signal generation personality.

W-CDMA Uplink Concepts

Figure 16-74 ESG I/O Connectors for W-CDMA Uplink

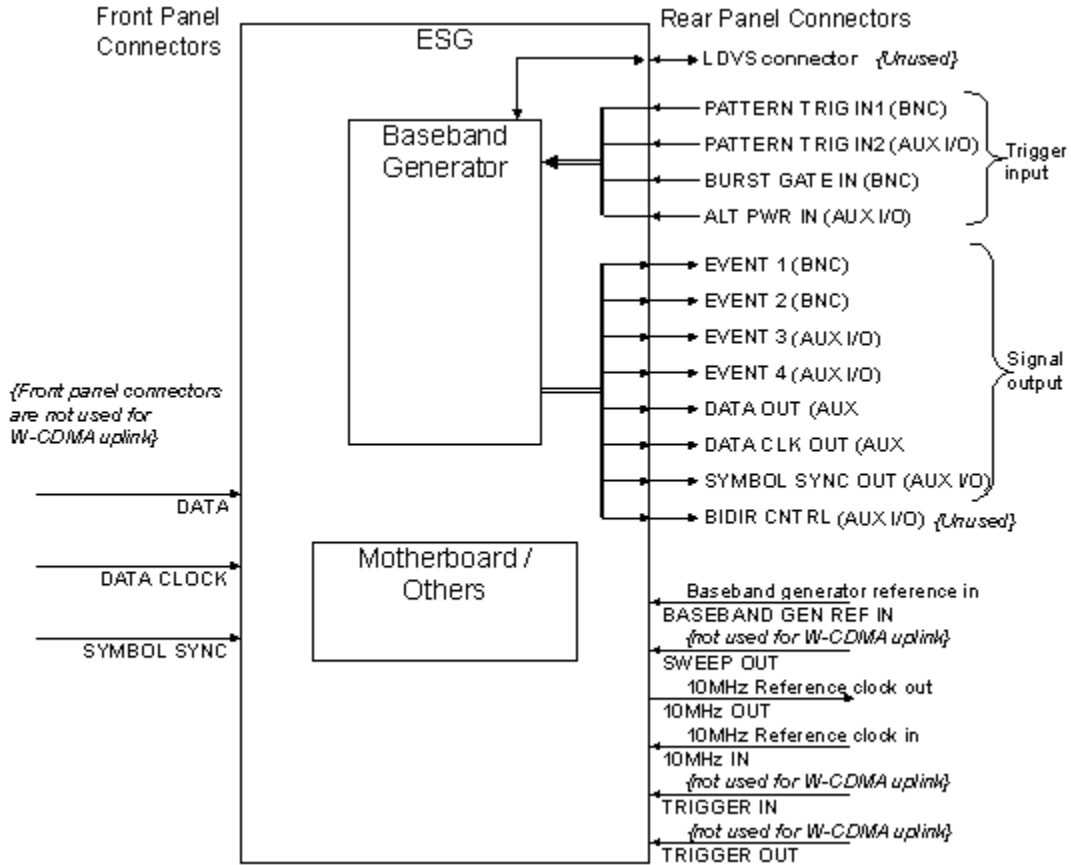

Refer to Table 16-5 for descriptions on connector assignments when using W-CDMA uplink in DPCH mode. For PRACH mode, refer to Table 16-6 on page 570.

Table 16-5 Connector Descriptions for DPCH Mode

Connector Label	Connector Type	Input/Output	Assigned Signal
PATTERN TRIGGER IN	BNC	Input	Frame sync trigger. This signal determines the SFN frame timing of the ESG so it is synchronous with the base station.



**Table 16-5** Connector Descriptions for DPCH Mode (Continued)

Connector Label	Connector Type	Input/Output	Assigned Signal
PATTERN TRIGGER IN 2	AUX I/O Pin 17	Input	Compressed mode stop trigger. Compressed mode must be active. The trigger instructs the signal generator to stop the compressed mode pattern at the frame number specified in the Stop CFN# data field.
ALT POWER IN	AUX I/O Pin 16	Input	Trigger for user-defined TPC bits.
BURST GATE IN	BNC	Input	Compressed mode start trigger or the TPC control signal.  The compressed mode or TPC mode must be active. The compressed mode start trigger instructs the signal generator to begin the compressed mode pattern. The TPC control signal instructs the ESG to increase or decrease the DPCH signal power relative to the carrier power.
BASEBAND GEN REF IN	BNC	Input	External system clock in. This connector is used for chip clock input when using external data clock sources. To use an external signal source as the data clock input, press <b>BBG Chip Clock Ext Int</b> to Ext or send the appropriate SCPI command. This clock rate can be multiplied by setting the <b>Ext Clock Rate X1 X2 X4</b> softkey to either x2 or x4.
10 MHz IN	BNC	Input	10 MHz reference in.
10 MHz OUT	BNC	Output	10 MHz reference out.
EVENT 1	BNC	Output	Signal assigned by user. Default is DPDCH raw data.
EVENT 2	BNC	Output	Signal assigned by user. Default is DPDCH raw data clock.
EVENT 3	AUX I/O Pin 19	Output	Signal assigned by user. Default is none.
EVENT 4	AUX I/O Pin 18	Output	Signal assigned by user. Default is none.

**W-CDMA Uplink Concepts**

**Table 16-5 Connector Descriptions for DPCH Mode (Continued)**

Connector Label	Connector Type	Input/Output	Assigned Signal
DATA OUT	AUX I/O Pin 7	Output	Signal assigned by user. Default is DPCCCH raw data.
DATA CLOCK OUT	AUX I/O Pin 6	Output	Signal assigned by user. Default is chip clock.
SYMBOL SYNC OUT	AUX I/O Pin 5	Output	Signal assigned by user. Default is sync trigger reply.

**Table 16-6 Connector Descriptions for PRACH Mode**

Connector Label	Connector Type	Input/Output	Assigned Signal
PATTERN TRIGGER IN	BNC	Input	Frame sync trigger. This signal determines the SFN frame timing of the ESG so it is synchronous with the base station.
PATTERN TRIGGER IN 2	AUX I/O Pin 17	Input	AICH trigger input. This connector pin is used for the AICH trigger when operating in PRACH mode. The AICH trigger instructs the signal generator to generate the message part. The Message Part data field must be set to AICH.
ALT POWER IN	AUX I/O Pin 16	Input	Unused.
BURST GATE IN	BNC	Input	PRACH start trigger. The connector is used for the PRACH start trigger when PRACH is selected in the physical channel setup. The PRACH start trigger instructs the signal generator to begin the PRACH pattern.
BASEBAND GEN REF IN	BNC	Input	External system clock in. This connector is used for chip clock input when using external data clock sources. To use an external signal source as the data clock input, press <b>BBG Chip Clock Ext Int</b> to Ext or send the appropriate SCPI command. This clock rate can be multiplied by setting the <b>Ext Clock Rate X1 X2 X4</b> softkey to either x2 or x4.

**Table 16-6 Connector Descriptions for PRACH Mode (Continued)**

Connector Label	Connector Type	Input/Output	Assigned Signal
10 MHz IN	BNC	Input	10 MHz reference in.
10 MHz OUT	BNC	Output	10 MHz reference out.
EVENT 1	BNC	Output	Signal assigned by user. Default is none.
EVENT 2	BNC	Output	Signal assigned by user. Default is none.
EVENT 3	AUX I/O Pin 19	Output	Signal assigned by user. Default is none.
EVENT 4	AUX I/O Pin 18	Output	Signal assigned by user. Default is none.
DATA OUT	AUX I/O Pin 7	Output	Signal assigned by user. Default is none.
DATA CLOCK OUT	AUX I/O Pin 6	Output	Signal assigned by user. Default is none.
SYMBOL SYNC OUT	AUX I/O Pin 5	Output	Signal assigned by user. Default is none.

### Signal Descriptions for W-CDMA Uplink

Figure 16-75 shows how W-CDMA uplink input and output signals align with respect to time. Notice that all signals are aligned with the leading edge of the chip clock pulse.

**W-CDMA Uplink Concepts**

**Figure 16-75 Input/Output Signal Alignment**

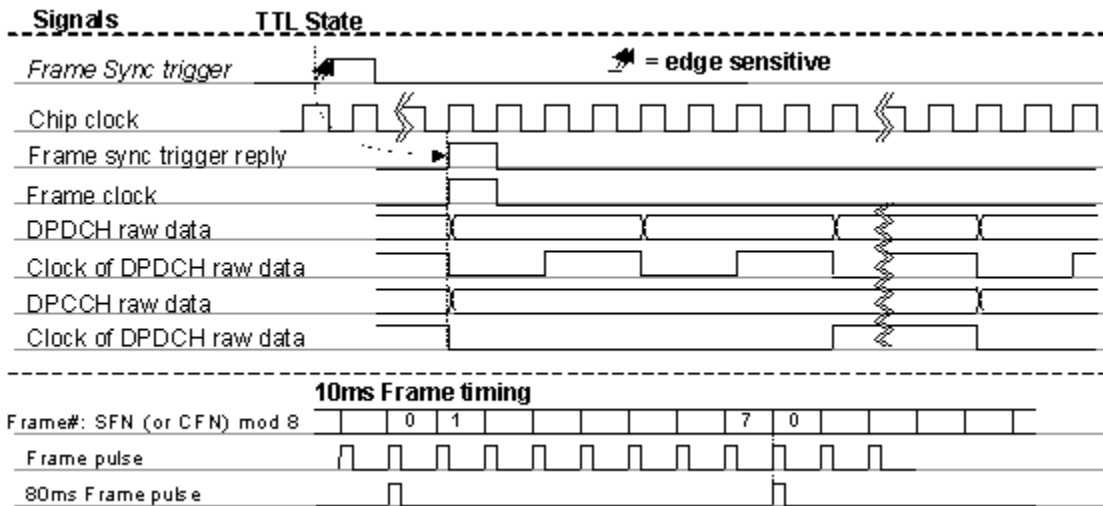

**DPCH Mode**

Table 16-7 provides descriptions for fixed and user-selectable signals available in DPCH mode. Figure 16-76 on page 573 shows an example of DPCH output timing alignment.

**Table 16-7 Signal Descriptions for DPCH Mode**

Signal Label	Input/Output	Signal Description	SCPI Syntax
Frame Sync Trigger	Input	The input signal can be set to either the frame clock or the system frame number SFN) reset signal by toggling the <b>Sync Source FCik SFN</b> softkey. The frame clock can be set to 10, 20, 40, 80, or 2560 ms.	FSYN
TPC User File Trigger	Input	Trigger for user-defined TPC bits.	USER
Compressed Mode Start Trigger	Input	Trigger to start compressed mode.	CSTT
Compressed Mode Stop Trigger	Input	Trigger to stop compressed mode.	CSPT
None	Output	No signal.	RPS0

**Table 16-7** Signal Descriptions for DPCH Mode (Continued)

Signal Label	Input/Output	Signal Description	SCPI Syntax
Chip Clock	Output	Chip clock. 3.84 MHz is the default setting.	RPS1
Trigger Sync Reply (system sync output)	Output	Response pulse of the frame sync trigger. The frame sync trigger reply reports that the frame sync trigger was received, and is used to adjust frame timing. When the system trigger is not received, the system sync output pulse is not generated.	RPS7
DPDCH Raw Data	Output	DPDCH data after 2nd interleaver (before spreading and scrambling).	RPS2
DPCCH Raw Data	Output	DPCCH data after 2nd interleaver (before spreading and scrambling).	RPS4
DPDCH Raw Data Clock	Output	The clock for DPDCH raw data. The rate depends on the slot format (data rate) of DPDCH.	RPS3
DPCCH Raw Data Clock	Output	The clock for DPCCH raw data. The rate of this clock is fixed at 15 kHz.	RPS5
10 ms Frame Pulse	Output	Indicates the frame boundaries for data generation.	RPS6
TTI Frame Pulse	Output	Indicates the frame boundaries for TTI.	RPS9
CFN #0 Frame Pulse	Output	Indicates the frame boundaries for CFN frame #0.	RPS10
Compressed Frame	Output	This signal indicates the status of the compressed frame. A 0 indicates a normal frame. A 1 indicates a compressed frame.	RPS8

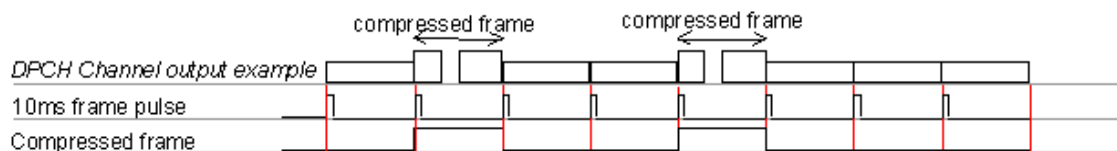
**Figure 16-76** DPCH Signal Alignment

**PRACH Mode**

Table 16-8 provides descriptions for fixed and user-selectable signals available in PRACH mode. Figure 16-77 on page 575 shows an example of PRACH output timing alignment.

**Table 16-8 Signal Descriptions for PRACH Mode**

Signal Label	Input/Output	Signal Description	SCPI Syntax
Frame Sync Trigger	Input	The input signal can be set to either the frame clock or the system frame number (SFN) reset signal by toggling the <b>Sync Source FCik SFN</b> softkey. The frame clock can be set to 10, 20, 40, 80, or 2560 ms.	FSYN
PRACH Start Trigger	Input	Trigger to start PRACH.	PSTR
AICH Trigger	Input	Trigger to start AICH.	AITR
None	Output	No signal.	RPS0
Chip Clock	Output	Chip clock. 3.84 MHz is the default setting.	RPS1
Trigger Sync Reply (system sync output)	Output	Response pulse of the frame sync trigger. The frame sync trigger reply indicates how much frame alignment was necessary.	RPS7
Preamble Raw Data	Output	Preamble data after 2nd interleaver (before spreading and scrambling).	RPS15
Preamble Raw Data Clock	Output	The clock for preamble raw data.	RPS16
Message Data Raw Data	Output	The data for the message data part after 2nd interleaver (before spreading and scrambling).	RPS11
Message Ctrl Raw Data	Output	The data for the message control part after 2nd interleaver (before spreading and scrambling).	RPS13
Message Data Raw Data Clock	Output	The clock for the message data part raw data.	RPS12
Message Ctrl Raw Data Clock	Output	The clock for the message control part raw data.	RPS14

Table 16-8 Signal Descriptions for PRACH Mode (Continued)

Signal Label	Input/Output	Signal Description	SCPI Syntax
PRACH Processing	Output	This signal indicates the status of PRACH signaling. The signal is high until the configured number of PRACH repetitions is complete. A 0 indicates the PRACH signal is off. A 1 indicates the PRACH signal is generating. The signal's state changes in accordance with access slot resolution.	RPS19
Sub-Channel Timing	Output	Indicates sub-channel timing, which is specified through the user interface. A PRACH data stream must begin on the leading edge of one of these pulses.	RPS17
10 ms Frame Pulse	Output	Indicates the frame boundaries for SFN.	RPS6
80 ms Frame Pulse	Output	Indicates the frame boundaries for SFN mod 8 = 0.	RPS20
Preamble Pulse	Output	Indicates the start for each preamble access slot.	RPS21
Message Pulse	Output	Indicates the start of an access slot when the message part is going to be transmitted.	RPS22
PRACH Pulse	Output	Indicates the beginning access slot boundary of a PRACH repetition (preamble only or preamble+message).	RPS23

Figure 16-77 PRACH Signal Alignment

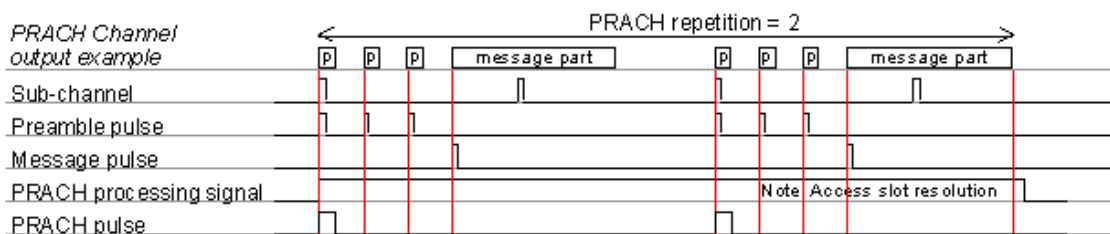

## Synchronization Diagrams

### Signal Alignment for Default DPCH Mode

Figure 16-78 illustrates the timing relationships between the signals from the rear panel BNC input and output connectors relative to the RF Output connector for default signal assignments in DPCH mode. Signal states are referenced to the chip clock provided at the DATA CLK OUT connector.

Figure 16-78 Signal Alignment for Default DPCH Mode

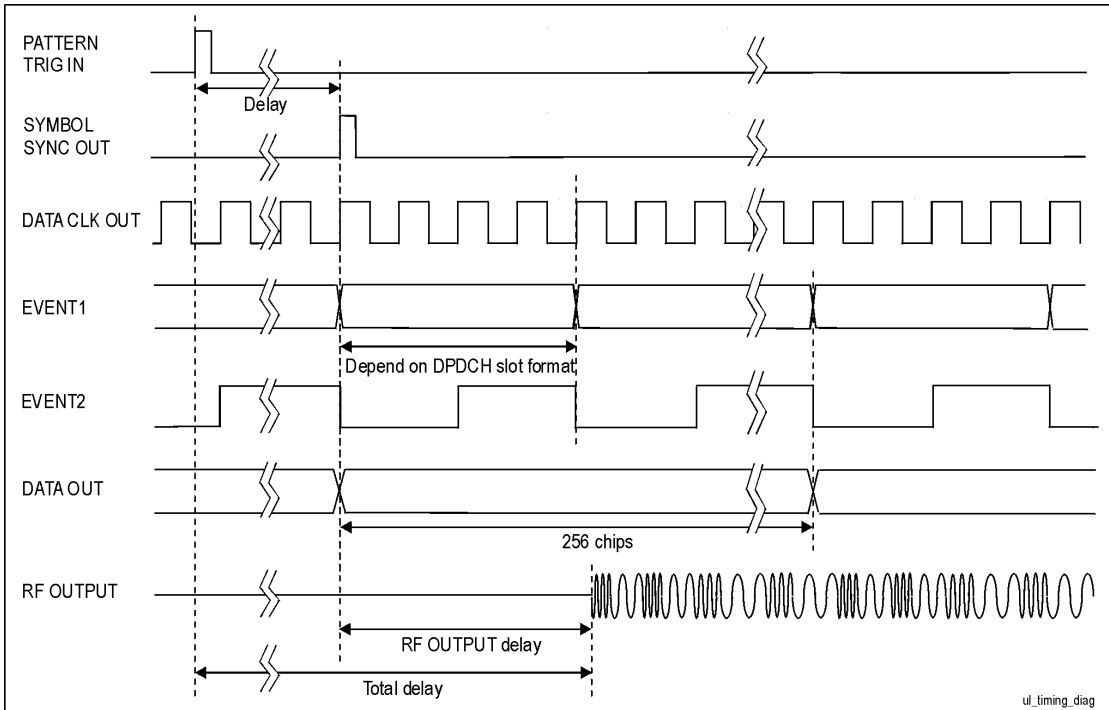

### DPCH Synchronization

Figure 16-79 illustrates the timing alignment for the DPCH channel. Delay time is defined by the sum of T<sub>0</sub> (1024 chips = the standard timing offset between downlink and uplink), timing offset, and timeslot offset.



**Figure 16-79**

**DPCH Synchronization - Frame Timing Alignment**

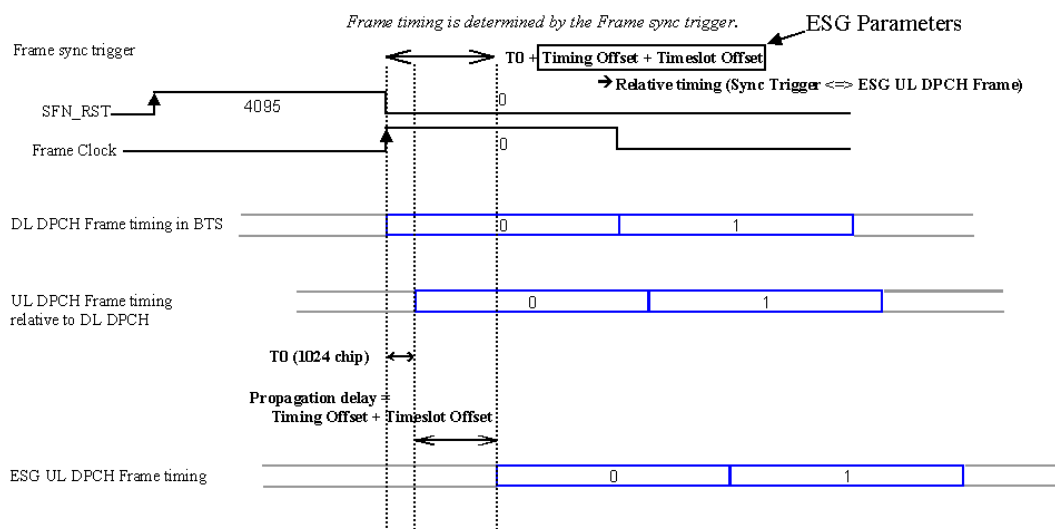
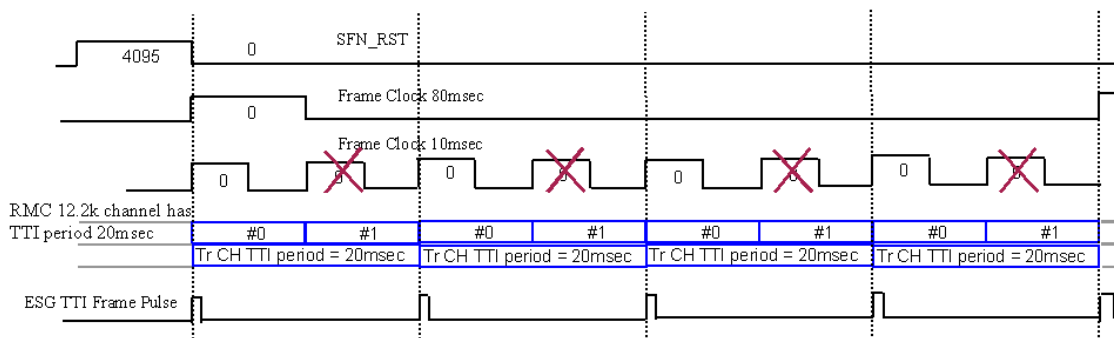

Figure 16-80 illustrates the frame number alignment for the DPCH channel. The frame number is aligned by the frame sync trigger signal from the BTS. When using the frame clock, set the frame clock period to be equal or greater than the longest transport channel TTI period (select 10, 20, 40, or 80 ms). In Figure 16-80, Reference Measurement Channel 12.2k requires a frame clock of 20 ms or longer to achieve the correct frame number alignment. Using a frame clock of 10 ms would cause an unpredictable frame timing alignment with the transport channel TTI period. Best results are achieved when the frame clock is set to 80 or 2560 ms, or a system frame number reset signal is used. (The signal generator's TTI period can be measured on the TTI frame pulse from the rear panel.)

**Figure 16-80**

**DPCH Synchronization - Frame Number Alignment**



**W-CDMA Uplink Concepts**

Figure 16-81 illustrates the frame number alignment for compressed mode when the TGPRC data field is set to Infinity. In this case, the frame clock period must be equal to or be a multiple of the compressed mode (TG pattern length) definition.

**Figure 16-81 DPCH Synchronization - Frame Number Alignment for Continuous (Infinity) Compressed Mode**

Frame Clock period must match with or multiple of Compressed mode (TG Pattern length) definition when TGPRC is set as Infinity.

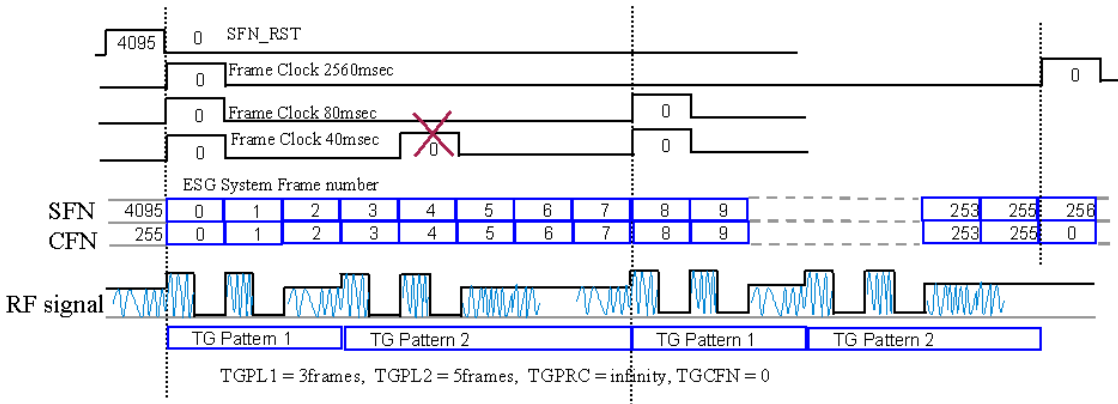

Example 1, TG pattern can be aligned with Frame Clock 80msec, but not with 40msec

Figure 16-82 illustrates the frame number alignment for compressed mode when it is required to align with CFN number counting. This mode of operation requires a frame clock of 2560 ms or a system frame number reset signal as the frame sync trigger.

**Figure 16-82 DPCH Synchronization - Frame Number Alignment for Compressed Mode with CFN Number Count**

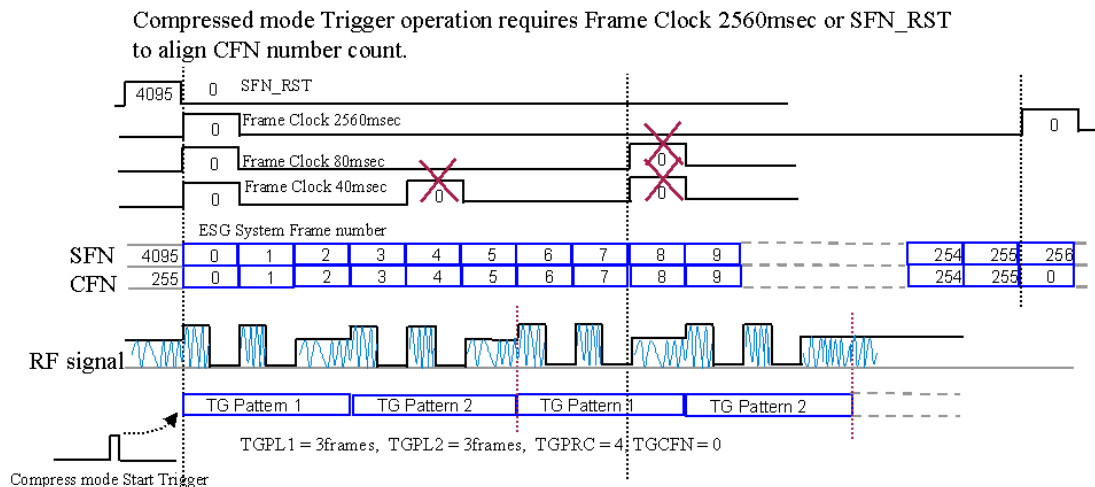

Example 2, Transmission Gap (compress) pattern can be aligned with SFN\_RST or Frame Clock 2560msec, However, NOT with 80msec

**W-CDMA Uplink Concepts**

**PRACH Synchronization**

Figure 16-83 illustrates the frame timing alignment for the PRACH channel. Delay time is defined by the sum of the timing offset and timeslot offset minus the  $T_{p-a}$  value.

**Figure 16-83 PRACH Synchronization - Frame Timing Alignment**

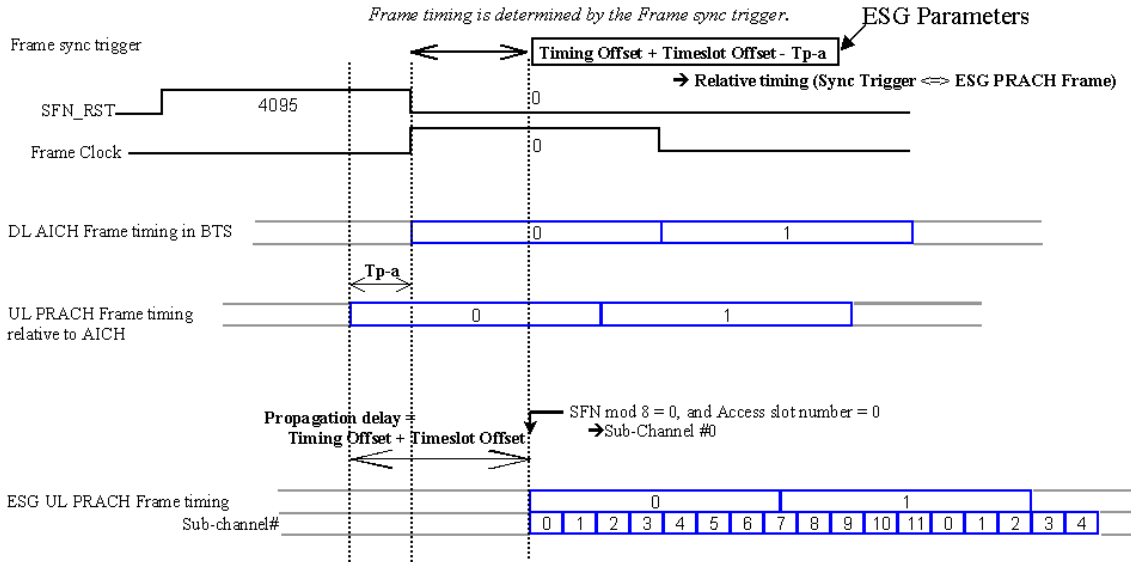
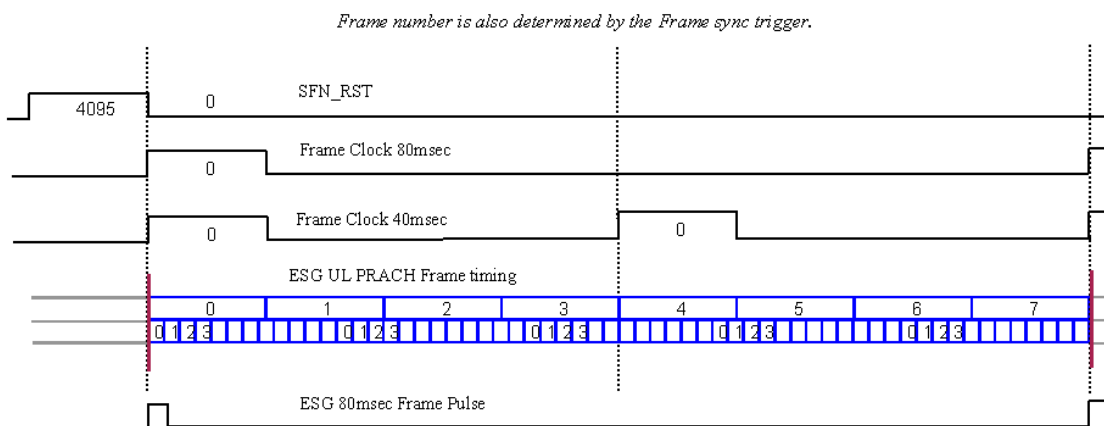

Figure 16-84 illustrates the frame number alignment for the PRACH channel. The frame number is aligned by the frame sync trigger signal from the BTS. Best results are achieved when the frame clock is set to 80 or 2560 ms, or a system frame number reset signal is used. When the sync trigger is a frame clock of 10, 20, or 40 ms, the signal generator can align frame timing. However, an 80 ms period must equal the cycle of sub-channel 0 and frame boundary to achieve frame number alignment. (The signal generator's frame number alignment can be observed on the 80 ms frame pulse from the rear panel.)

**Figure 16-84 PRACH Synchronization - Frame Number Alignment**



### Frame Sync Trigger Status Indicator

The signal generator uses a synchronization annunciator to indicate the state of the signal generator's frame synchronization and whether or not a synchronization trigger was received. Figure 16-85 shows the uplink user interface (UI) and the synchronization annunciator. When Sync Trg replaces Out Sync as the current annunciator, the frame sync trigger has either been received (dark text) or has not been received (gray text). The conditions are described as follows:

Sync Trg (grayed out):

The frame sync trigger was *not* received after a trigger status reset.

Sync Trg (active):

The frame sync trigger was received after the trigger status is reset.

Out Sync:

When the synchronization annunciator indicates Out Sync, the signal generator is not synchronizing with the external frame sync trigger. It is only displayed when an out-of-sync condition occurs. This indicator remains active until the next frame sync trigger is received.

**Figure 16-85 Front Panel Display**

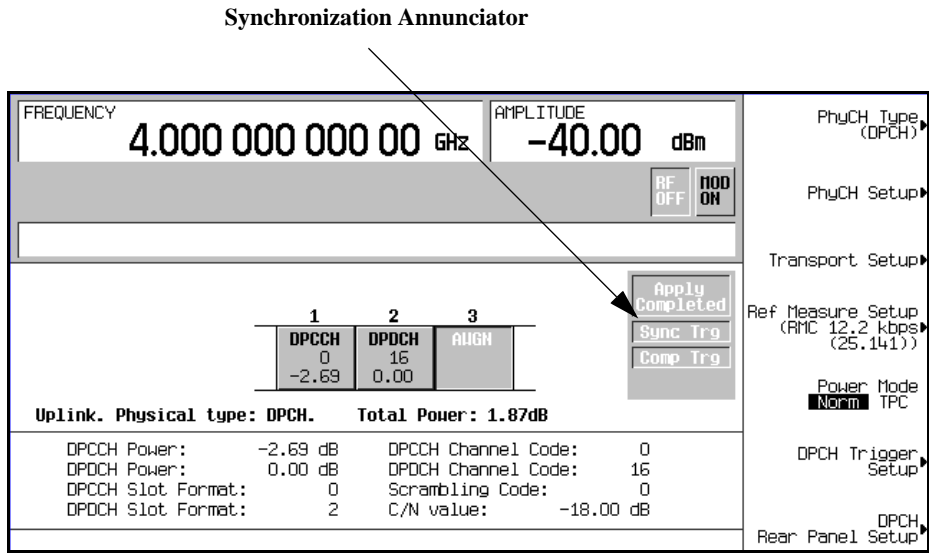

---

**NOTE** The trigger status reset is automatically performed whenever the frame sync trigger mode is changed or the **Apply Channel Setup** softkey activated.

---

**Out Sync Annunciator**

When the timing of the external frame synchronization signal does not match the signal generator’s frame generation, the Out Sync annunciator is displayed. Out Sync replaces Sync Trg under these conditions.

The signal generator’s frame synchronization method depends on the trigger mode selected:

**Single Trigger** The frame timing is adjusted at the first trigger. All triggers, except the first one are ignored and not used for signal generator frame timing.

**Continuous Trigger** All external triggers are used to adjust the signal generator’s frame timing.

Figure 16-86 describes trigger mode and synchronization patterns.

**Figure 16-86**      **Trigger Mode and Synchronization**

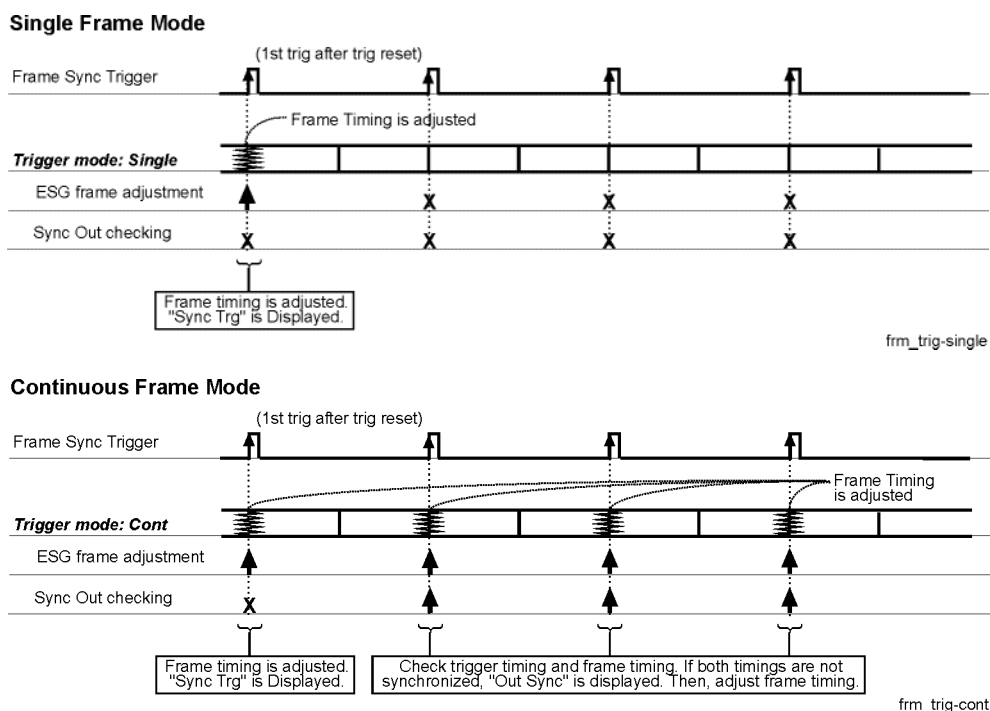

The signal generator checks the timing difference between the external trigger and the internal frame timing whenever an external trigger is received. If the single trigger mode is selected, the signal generator checks the timing difference between the external trigger and the internal frame timing when the first trigger is received. If continuous trigger mode is selected, timing is checked at each trigger signal. If there is a timing difference in either mode, then the Out Sync annunciator is displayed.

**W-CDMA Uplink Concepts**

The signal generator’s behavior, when Out Sync is displayed, depends on the trigger mode used. [Table 16-9](#) describes the signal generator’s behavior for different trigger modes.

**Table 16-9**

Trigger Mode	ESG output signal status on Out Sync.
Single	The ESG outputs frames even if Out Sync is displayed.
Continuous	The ESG output is discontinued. The synchronization is corrupt and no output is available when Out Sync is displayed. The ESG timing is retriggered by the external trigger when this occurs.

**Special Power Control Considerations When Using DPCCH/DPDCH in Compressed Mode or PRACH**

When using either DPCCH/DPDCH in compressed mode or PRACH, more than a single power level is required. In addition to the rapidly varying power levels for these two channels, there are also periods of discontinuous transmission (gaps where no RF is transmitted). Under these conditions, the automatic level control (ALC) will try to counteract the rapid power variations. To prevent this, the signal generator employs ALC hold mode. However, even with ALC hold active, if the RF gap is longer than five seconds, the output level may drift significantly. Under certain conditions, such as waiting for an input trigger, the length of the RF gap is unpredictable. Under these conditions, the signal generator turns the ALC off. [Table 16-10 on page 584](#) shows the specific settings of the DPCCH/DPDCH in compressed mode or PRACH that will turn the ALC off. Notice that the settings may differ for the mechanical attenuator.

**Table 16-10 Conditions that Turn the ALC Off**

Channel Type	Electronic Attenuator	Mechanical Attenuator (Option UNB)
<b>PRACH Settings</b>	<p><b>PRACH Trigger Source Immedi Trigger</b> softkey set to Trigger</p> <p>Message Part data field set to AICH</p> <p>or</p> <p><b>PRACH Mode Single Multi</b> softkey is set to Multi</p>	<p><b>PRACH Trigger Source Immedi Trigger</b> softkey set to Trigger</p> <p>or</p> <p>Message Part data field set to AICH</p> <p>or</p> <p><b>PRACH Mode Single Multi</b> softkey is set to Multi</p>
<b>DPCCH/DPDCH Settings</b>	<i>not applicable</i>	all compressed frames (no normal frames)



When one of the conditions listed in [Table 16-10](#) turns the ALC off, a manual power search must be performed in order to ensure the correct output power level. Pressing the Apply Channel Setup softkey executes the manual power search function. Temperature changes or changes to certain signal generator settings may cause the output power level to change over time. Even though the Apply Needed annunciator may be off, it is recommended that you press Apply Channel Setup to perform a manual power search at least every hour to maintain the correct output power level.

## W-CDMA AWGN Measurements and Bandwidths

The AWGN (additive white Gaussian noise) feature produces a noise signal across a 7.68 MHz bandwidth (2x the W-CDMA 3.84 MHz bandwidth) and lets you enter values that adjust the noise level across this spectrum. To resolve the noise signal's effect on the W-CDMA signal, the ESG also displays noise values across the W-CDMA 3.84 MHz bandwidth. In addition, the DPCH AWGN feature shows the bandwidth of the noise signal during the period when it has a flat frequency response. This is called the flat-noise bandwidth. [Figure 16-87](#) shows the different noise settings/values as they appear on the W-CDMA AWGN display along with a graphical representation of the noise signal showing the different bandwidth features.

W-CDMA Uplink Concepts

Figure 16-87 Noise Measurement Bandwidths

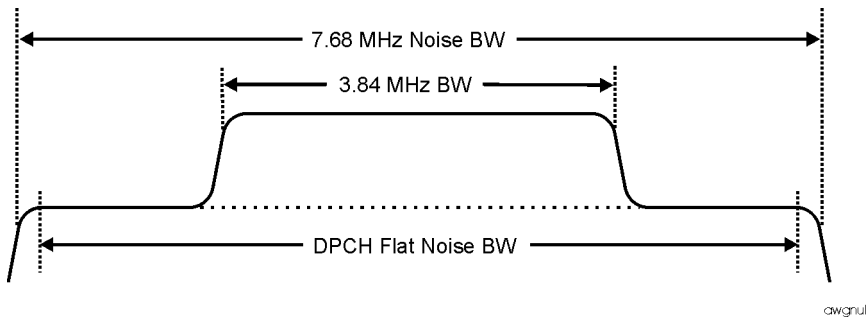
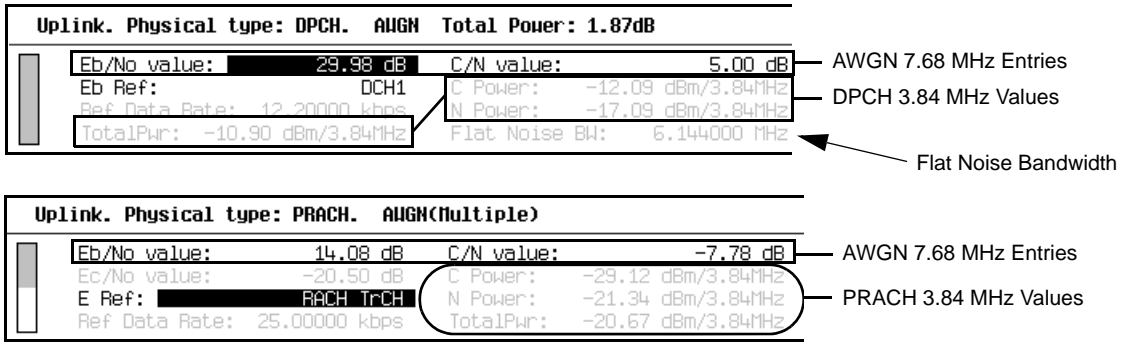

As shown in Figure 16-87, the noise signal is added to the W-CDMA signal across the entire W-CDMA signal spectrum. The ESG gives you two ways to control the noise level. You can adjust the noise using either  $E_b/N_0$  (energy per bit to noise power density ratio) or  $C/N$  (carrier power to noise power ratio). Any adjustment to either noise parameter,  $E_b/N_0$  or  $C/N$ , will affect the other; they are not mutually exclusive.  $E_b/N_0$  lets you set the noise ratio relative to the power of the data stream for the selected reference channel, versus setting the noise relative to the carrier power ( $C/N$ ). For example, if you have the RACH transport channel selected as the data source ( $E_b$  Ref field, see Figure 16-88) with a 12.2 kbps data rate, the bandwidth for the data is 12.2 kHz. The data within this bandwidth has a certain power level. This power level is what is used in the ratio for  $E_b/N_0$ .

When you use  $E_b/N_0$ , you can select the reference to use as the data power source. For example, you can use any of the transport channels for the DPDCH, the PRACH transport channel, the PRACH preamble, or the DPCCH. Your choice does depend on whether you are using the PRACH or the DPCH mode. Figure 16-88 shows the PRACH data sources that can be used for  $E_b/N_0$ .

**Figure 16-88 PRACH  $E_b/N_0$  Reference Selection**

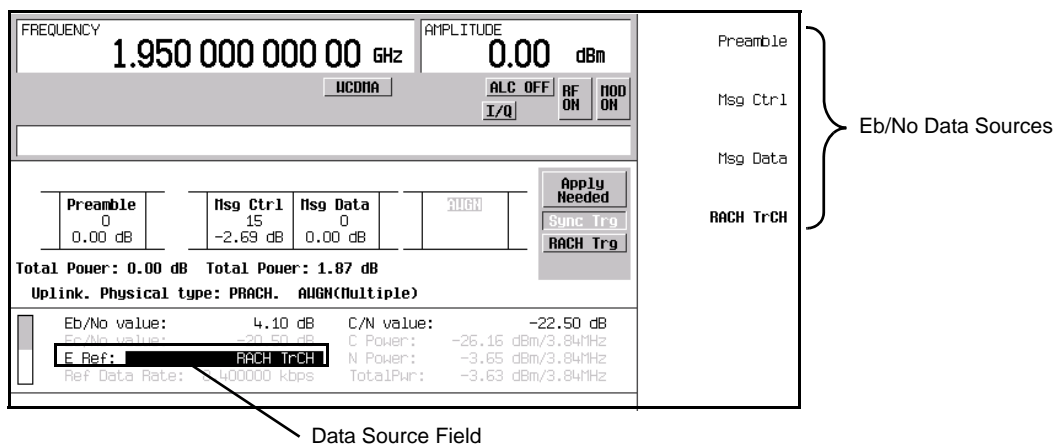

You can calculate the noise values using the following formulas:

$$T_p = 10 \text{ Log}[(C_w + N_w) / .001]$$

$T_p$  = total noise power (dBm)

$C_w$  = linear carrier power (watts) across the 3.84 MHz bandwidth

$N_w$  = linear noise power (watts) across the 3.84 MHz bandwidth

$$C/N = E_b/N_0 + 10\text{Log}(\text{Ref Data Rate}/3.84 \text{ MHz})$$

These formulas clearly show the relationship between  $E_b/N_0$  and  $C/N$  and their effect on the total noise power across the 3.84 MHz bandwidth.

### DPCH Transmit Power Control by an External Signal

Figure 16-89 illustrates the DPCH power control using an external signal. When the Power Hold is turned off, the ESG output responds to the power control trigger signal. The transmit power control signal is sent from the base station and indicates whether to increase or decrease the power level. Increases and decreases are done in increments of the specified Power Step. Once the power level has reached the specified Max Power, signals requesting an increase in the power level will be ignored (the power is clipped to Max Power). There is a 50 chip delay between the base station signal and the RF power response.

W-CDMA Uplink Concepts

Figure 16-89 DPCH External Power Control

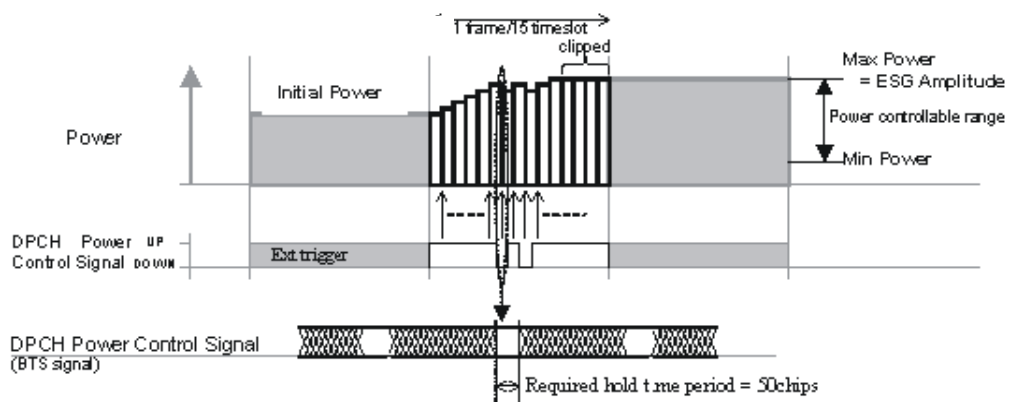

## DPCCH/DPDCH Frame Structure

This section contains graphical representations of W-CDMA frame structures, with associated tables, for uplink channels.

**Figure 16-90 DPCCH/DPDCH Frame Structure**

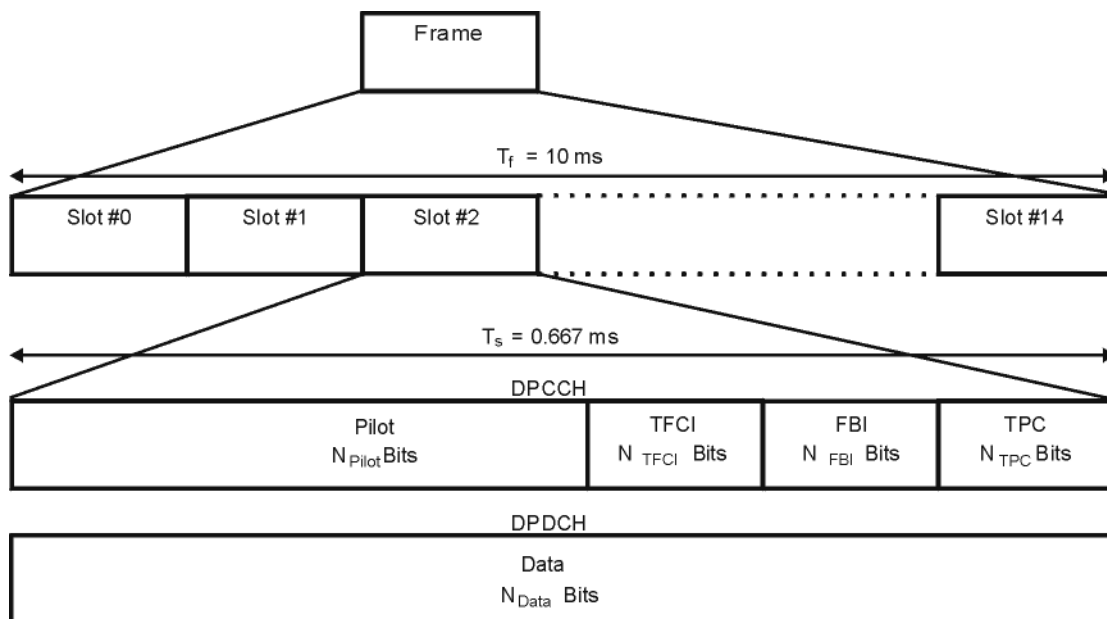

**Table 16-11 DPDCH Fields**

pk762b

Channel Bit Rate (kbps)	Channel Symbol Rate (ksps)	Spread Factor	Bits/Frame	Bits/Slot	$N_{\text{data}}$
15	15	256	150	10	10
30	30	128	300	20	20
60	60	64	600	40	40
120	120	32	1200	80	80
240	240	16	2400	160	160

**DPCCH/DPDCH Frame Structure****Table 16-11 DPDCH Fields (Continued)**

Channel Bit Rate (kbps)	Channel Symbol Rate (ksps)	Spread Factor	Bits/Frame	Bits/Slot	$N_{data}$
480	480	8	4800	320	320
960	960	4	9600	640	640

**Table 16-12 DPCCH Fields**

Channel Bit Rate (kbps)	Channel Symbol Rate (ksps)	Spread Factor	Bits/Frame	Bits/Slot	$N_{pilot}$	$N_{TFCI}$	$N_{FBI}$	$N_{TPC}$
15	15	256	150	10	6	2	0	2
15	15	256	150	10	8	0	0	2
15	15	256	150	10	5	2	1	2
15	15	256	150	10	7	0	1	2
15	15	256	150	10	6	0	2	2
15	15	256	150	10	5	2	2	1

---

# 17 W-CDMA Downlink Digital Modulation for Receiver Test (Option 400)

In the following sections, this chapter provides the following information. These features are available only in E4438C ESG Vector Signal Generators with Option 001/601 or 002/602.

This chapter teaches you how to build fully coded W-CDMA downlink modulated signals for testing mobile/user equipment (UE) designs and provides information on how the W-CDMA downlink format is implemented within the ESG. The modulation is generated by the signal generator's internal baseband generator.

The following list shows the topics covered by this chapter:

- [“Using W-CDMA Downlink” on page 592](#)
- [“Transmit Diversity Overview” on page 600](#)
- [“Configuring for Transmit Diversity and BERT” on page 603](#)
- [“Out-of-Synchronization Testing Overview” on page 614](#)
- [“Configuring for Out-of-Synchronization Testing” on page 615](#)
- [“Compressed Mode Overview” on page 621](#)
- [“Setting Up for a Compressed Mode Signal” on page 624](#)
- [“Making Compressed Mode Signal Measurements” on page 633](#)
- [“Locating Rear Panel Input Signal Connectors” on page 639](#)
- [“Configuring Rear Panel Output Signals” on page 641](#)
- [“W-CDMA Downlink Concepts” on page 646](#)
- [“W-CDMA Frame Structures” on page 653](#)

## Using W-CDMA Downlink

This section teaches you how to build real time W-CDMA downlink modulation for testing mobile receiver designs. The modulation is generated by the signal generator's internal baseband generator. The procedures in this section build on each other and are designed to be used sequentially.

### Configuring the Base Station Setup

1. Press **Preset**.
2. Press **Mode > W-CDMA > Real Time W-CDMA > BS Setup**.

This opens a menu where you can adjust the filtering type, chip rate, scrambling code, and synchronization delay for the simulated base station (see [Figure 17-1](#)).

**Figure 17-1 Base Station Setup**

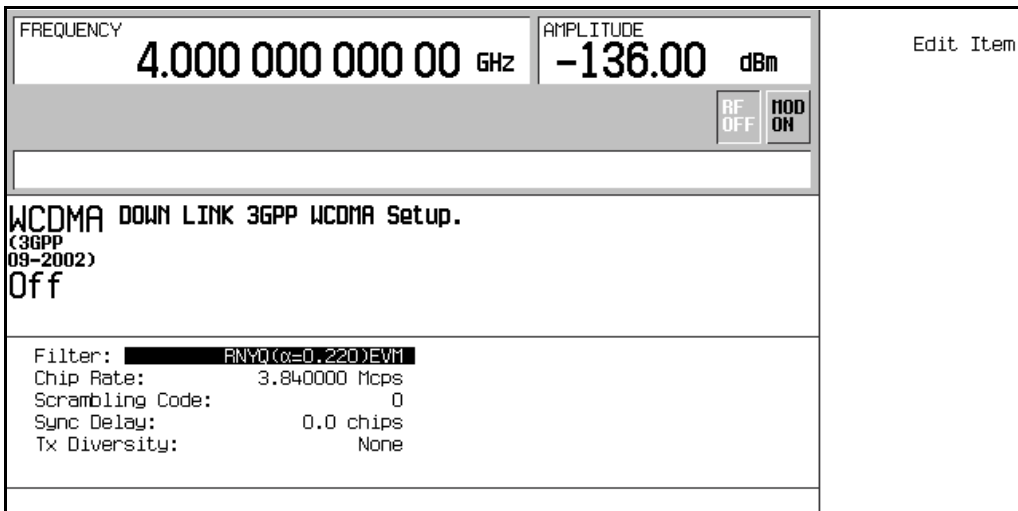

Use the arrow keys or the knob to highlight the data fields to be edited. Once a field has been highlighted, pressing the **Edit Item** softkey enables you to change the value.



## Configuring the Physical Layer

The steps in this procedure build upon the previous procedure.

1. Press **Return** > **Link Control** > **5** > **Enter**.
2. Press **PhyCH Setup**.
3. Move the cursor to highlight the **Off** value for DPCH data channel 2.
4. Press **Edit Item** to toggle the channel on.

The data channel state changes each time you press **Edit Item**. You can now move the cursor to edit other data channel fields as well.

5. Press **Return**.
6. Press **Channel State Off On** to **Off**.

Notice that toggling the channel state not only turns off or on the selected physical channel (in this case DPCH), but also turns off or on *all* of its data channels, which are shown in the table editor. To turn individual data channels off or on, repeat steps 2 through 4.

7. Press **Channel State Off On** to **On**.
8. Press **6** > **Enter**. (Or, press the right arrow key.)
9. Press **Channel State On Off** to **On** > **PhyCH Setup**.

This activates the OCNS physical channel, turning on all 16 of its data channels, and accesses the table editor. Refer to [Figure 17-2](#).

W-CDMA Downlink Digital Modulation for Receiver Test (Option 400)  
 Using W-CDMA Downlink

Figure 17-2 Physical Layer Table Editor

FREQUENCY		4.000 000 000 00 GHz		AMPLITUDE		-136.00 dBm		Edit Item	
				RF OFF		MOD ON			
Downlink		Tx Diversity: NONE		Total Power: 3.03dB		Apply Completed		Apply Channel Setup	
1	SCH	2	CPICH	3	P-CCPCH FIX4	4	PICH PN9	5	DPCH
			-3.30		-5.30		-8.30	6	OCNS
								7	ChipARB
								8	AUGH
	Chan Code	On/Off	Power	Data Rate	Data Type	2nd Scr Offset	tOCNS Offset		
	1	24	On	-12.00	15000	PN9	0	1	
	2	26	On	-12.00	15000	PN9	0	2	
	3	28	On	-12.00	15000	PN9	0	3	
	4	30	On	-12.00	15000	PN9	0	4	

Each data channel can be edited to have different settings, such as time offsets, as required by 3GPP TS25.101 for performing some of the functional tests.

Use the arrow keys or the knob to highlight the data fields to be edited. Once a field has been highlighted, pressing the **Edit Item** softkey enables you to change the value.

### Configuring the Transport Layer

The steps in this procedure build upon the previous procedure.

1. Press **Return > 5 > Enter**. (Or, press the left arrow key.)
2. Press **Transport Setup > TrCH Setup**.

This accesses the Downlink Transport type table editor. Refer to [Figure 17-3](#).

**Figure 17-3** Transport Layer Table Editor

FREQUENCY <b>4.000 000 000 00</b> GHz		AMPLITUDE <b>-136.00</b> dBm		Edit Item		
		RF OFF		MOD ON		
				Apply Channel Setup		
Tx Diversity: NONE						
Downlink Transport type: DCH Fixed Position <span style="float: right;">Apply Completed</span>						
	<b>1</b>	2	3	4	5	6
	DCH	DCH	DCH	DCH	DCH	DCH
	1	1	1	1	1	1
Blk Set Size: <b>20</b> Data: PNS TTI: 10.0 msec						
Blk Size: 20 Rate Match Attr: 1 Puncture: 16.67 %						
# of Blocks: 1 CRC Size: 8 Bit Rate: 2.000 kbps						
Coding: 1/2 Conv Bits/Frame: 60						

Use the arrow keys or the knob to highlight the data fields to be edited. Once a field has been highlighted, pressing the **Edit Item** softkey enables you to change the value.

### Adjusting Code Domain Power

The tasks in this procedure build upon the previous procedure. This procedure teaches you how to perform the following tasks:

- “Scaling to 0 dB” on page 595
- “Setting Equal Channel Powers” on page 596

#### Scaling to 0 dB

After changing the relative power level for a channel, the ESG automatically scales the total power to 0 dB, while preserving the relative channel power levels. Although the displayed total power changes in value as channel powers are adjusted, the actual total power is maintained at 0 dB. The displayed channel power levels remain unchanged, reflecting only user-assigned values, so the user can complete the relative power adjustments. This task teaches you how to update the display to show the normalized relative channel power for each channel after completing the setup.

1. Press **Mode Setup** to return to the first-level real time W-CDMA menu.

Using W-CDMA Downlink

2. Press **Link Control > Adjust Code Domain Power > Scale to 0 dB**.

The power level displayed for each channel is now changed to show the normalized relative channel power. The values shown in [Figure 17-4](#) result from activating the OCNS channel, as described earlier in this section. Notice the displayed power levels before and after the **Scale to 0 dB** softkey is pressed.

**Figure 17-4**                      **Scaling to Zero dB**

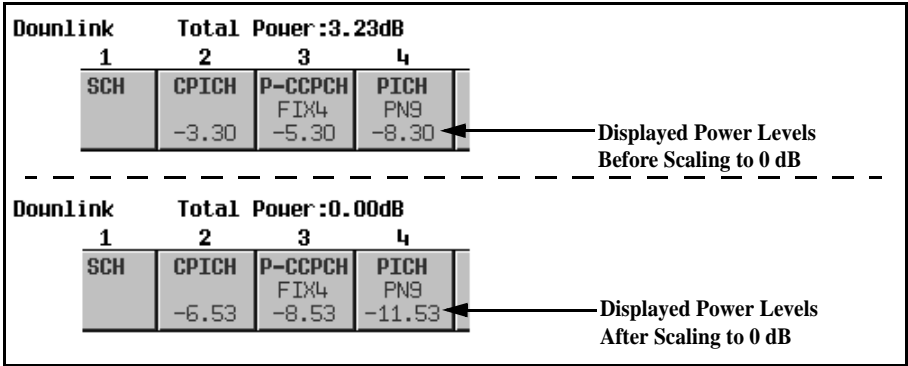

**Setting Equal Channel Powers**

This task teaches you how to set the relative power level for all active channels to be equal, for a total power level of 0 dB. The normalized relative power level of each channel depends on the number of active channels. This task is an alternative to scaling to 0 dB.

Press **Adjust Code Domain Power > Equal Powers**.

All active channels have now been set to equal powers. [Figure 17-5](#) shows the displayed normalized relative power levels after the **Equal Powers** softkey is pressed with seven active channels. Notice also that the displayed total power shows a residual value of 0.02 dB due to decimal rounding.

**Figure 17-5**                      **Equal Powers**

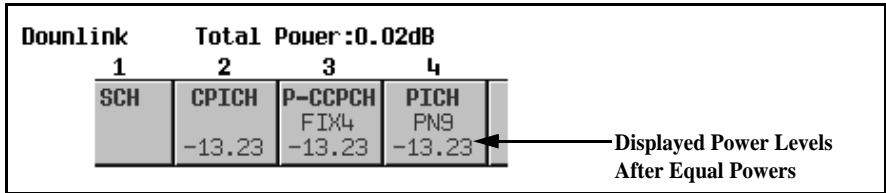

## Managing Noise

The tasks in this procedure build upon the previous procedure.

The following tasks teach you how to set the overall carrier-to-noise (C/N) ratio for the downlink W-CDMA setup and to set the  $E_c/N_0$  value for individual physical channels.

- “Setting the Carrier to Noise Ratio” on page 597
- “Setting  $E_c/N_0$ ” on page 597

### Setting the Carrier to Noise Ratio

1. Press **Mode Setup** to return to the first-level real time W-CDMA menu.
2. Press **Link Control > 8 > Enter > Channel State Off On** to On.
3. Press **PhyCH Setup**.
4. Move the cursor to highlight the C/N value field.
5. Press **10 > dB**.

---

**NOTE** Noise values less than 10 dB may not be visible on a spectrum analyzer.

---

You have now set the overall carrier to noise ratio to 10 dB and turned on noise. This is done to apply a discernible level of noise across the entire channel space.

### Setting $E_c/N_0$

1. Move the cursor to highlight the  $E_c$  Ref field.
2. Press **Edit Item > DPCH 2**.
3. Move the cursor to highlight the  $E_c/N_0$  value field.
4. Press **15 > dB**.

You have now set the  $E_c/N_0$  value for the DPCH 2 channel to 15 dB. Note that modifying the  $E_c/N_0$  value for a channel will change the overall carrier to noise ratio and the  $E_c/N_0$  value for all other active channels. For reliable results when making hand calculations to determine or verify  $E_c/N_0$  values, it is recommended that you first scale the code domain power to 0 dB to display the normalized relative channel power levels (see “Scaling to 0 dB” on page 595).

## Generating the Baseband Signal

This procedure builds upon the previous procedure.

Press **Mode Setup** > **W-CDMA Off On** to On.

This generates the real time downlink W-CDMA signal. The signal generator experiences a slight delay while the signal is being built. During this time, **Baseband Busy** appears on the display. After the signal generation is completed, the display reads **WCDMA On** and the **WCDMA** and **I/Q** annunciators appear. The signal is now modulating the RF carrier.

The signal's configuration data resides in volatile memory and is not recoverable after an instrument preset, power cycle, or another signal generation.

## Applying New Settings

The steps in this procedure build upon the previous procedure.

Signal parameters changes are not always automatically applied to the current signal being transmitted. When this condition occurs, an annunciator appears informing you that the new changes must be applied to the signal. This procedure demonstrates how these types of changes are applied to the current signal output.

1. Press **Link Control** > **5** > **Enter**.
2. Press **PhyCH Setup**.
3. Move the cursor to highlight the **On** value for DPCCH data channel 1.
4. Press **Edit Item** to toggle the channel off.

Notice that with the personality already turned on, as soon as a data channel parameter is changed, the **Apply Needed** annunciator appears (see [Figure 17-6](#)). This indicates that the new setting has not yet taken effect in the active baseband signal.

Figure 17-6 Display Indicates that Apply is Needed

FREQUENCY		4.000 000 000 00 GHz		AMPLITUDE		-136.00 dBm		Edit Item	
UCDMA				I/Q		RF OFF		MOD ON	
Downlink				Tx Diversity: NONE		Total Power: -0.21dB		Apply Needed	
1	2	3	4	5	6	7	8	Apply Channel Setup	
SCH	CPICH	P-CCPCH FIX4	PICH PNS	DPCH	OCNS	ChipARB	AUGH	Ref Measure Setup	
Chan Code	On/Off	Power	Symbol Rate	Data Type	Slot Format	TFCI Pat	TPC Pat		
1	10	Off	-13.25	7500	PNS	0	0	Up/Down	
2	11	On	-13.25	7500	PNS	0	0	Up/Down	

5. Press **Apply Channel Setup**.

The new setting to the DPCH data channel is now applied to the baseband signal. Notice also that the **Apply Needed** annunciator is replaced with **Apply Completed**.

The **Apply Channel Setup** softkey is grayed-out until a change occurs that is not automatically applied to the signal. When such a change occurs, the **Apply Needed** annunciator appears and the **Apply Channel Setup** softkey shows as being active (no longer grayed-out). The new settings are not be applied to the signal until this softkey is pressed.

## Configuring the RF Output

The steps in this procedure build upon the previous procedure.

1. Set the RF output frequency to 2.11 GHz.
2. Set the output amplitude to -10 dBm.
3. Press **RF On/Off** to On.

The user-defined, real time downlink W-CDMA signal is now available at the RF OUTPUT connector of the signal generator.

To store this real time I/Q baseband digital modulation state to the instrument state register, see [“Saving an Instrument State” on page 71](#).

To recall a real time I/Q baseband digital modulation state, see [“Recalling an Instrument State” on page 72](#).

**Transmit Diversity Overview**

**Transmit Diversity Overview**

Transmit diversity is used to diminish the effects of fading by transmitting the same information from two different antennas. However the data from the second antenna (antenna two) is encoded differently to distinguish it from the primary antenna (antenna one). The user equipment (UE) must be able to recognize that the information is coming from two different locations and properly decode the data.

The ESG gives you the ability to perform open-loop transmit diversity testing on UEs. This involves using two ESGs, one setup as antenna one (non-diversity antenna) and the other configured as antenna two (diversity antenna).

The implementation of transmit diversity in the ESG follows the 3GPP specifications and employs space time transmit diversity (STTD) encoding on the primary common control physical channel (P-CCPCH), page indicator channel (PICH), and the dedicated physical channel (DPCH). The synchronization channel (SCH) uses time switched transmit diversity (TSTD). The ESG gives you the option of disabling the TSTD mode for the SCH. The transmit diversity display for the ESG is shown in [Figure 17-7](#).

**Figure 17-7 ESG Transmit Diversity Selection Display**

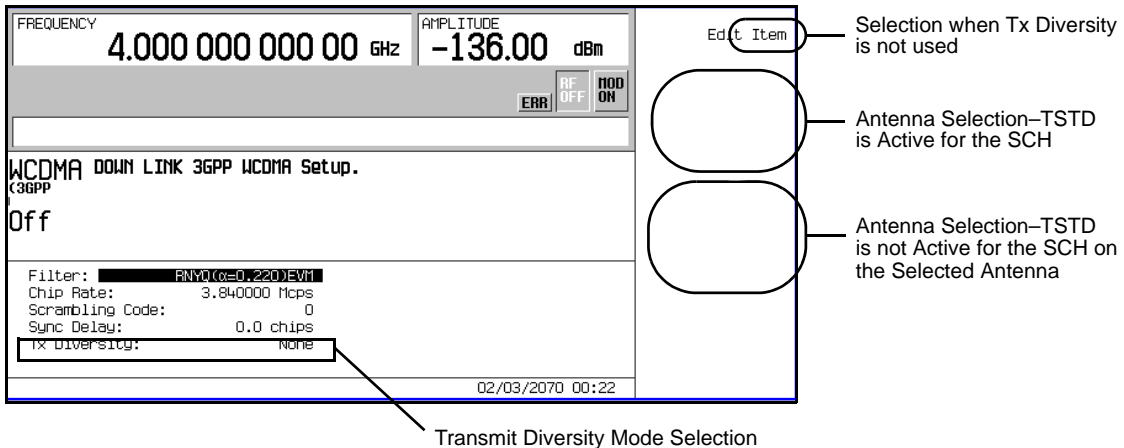

While the common pilot channel (CPICH) is not STTD encoded, it is affected when transmit diversity is utilized. The CPICH is transmitted from both antennas (ESGs), but the pre-defined bit sequence for the CPICH will differ between antenna one and antenna two per the 3GPP specifications.

While STTD encoding transmits the same information through both antennas, the data on antenna two is transmitted in a different order and some bits are inverted. This is shown in [Figure 17-8](#).



Figure 17-8

Generic STTD Encoder

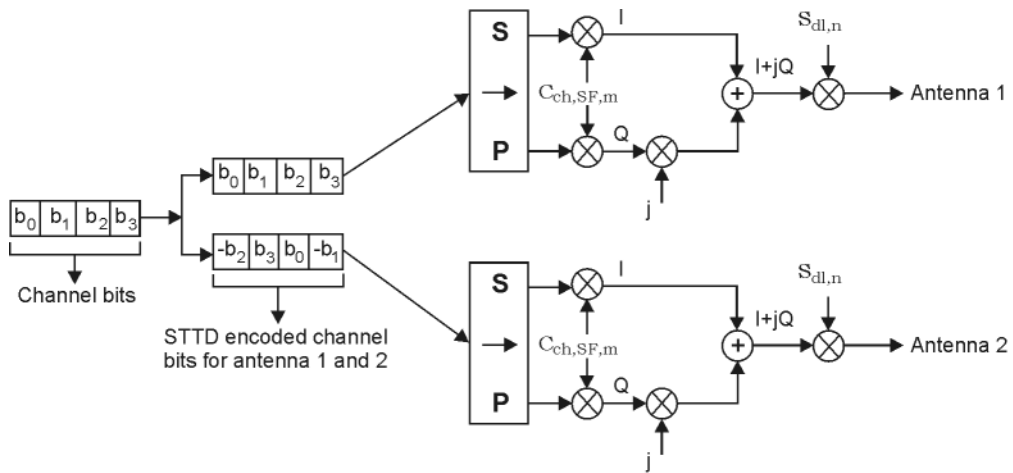

In order to simulate two antennas for a transmit diversity application, both ESGs are configured the same with the exception of one being designated as antenna one and the other as antenna two. The ESG selected as antenna two will also modify the pilot bits for the dedicated primary common control channel (DPCCH).

TSTD is used only for the SCH and alternately transmits the SCH between the two antennas. Normally the SCH is transmitted ten percent of the time for each slot of a radio frame. A radio frame is 10 ms long and is comprised of 15 slots (0–14). During the TSTD transmission, the SCH is broadcasted on antenna one during even numbered slots and on antenna two during odd numbered slots. This is demonstrated in Figure 17-9.

Figure 17-9

SCH TSTD Operation

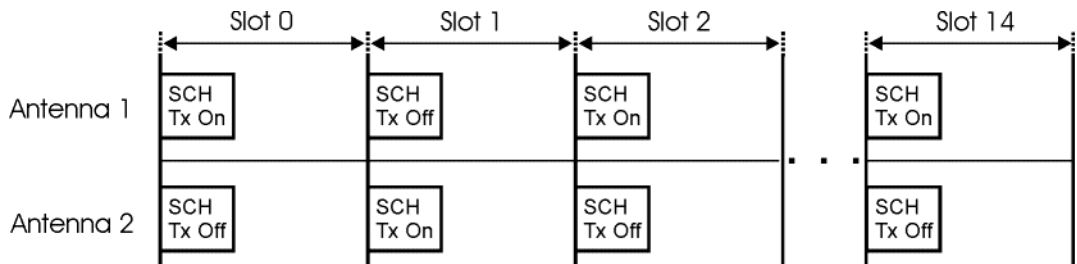

The phase for the SCH is also inverted when the P-CCPCH is STTD encoded. When TSTD is turned off, the SCH is broadcasted in every slot for the selected antenna. This is beneficial for synchronization purposes when only a single ESG is used.

## Transmit Diversity Overview

Since two antennas are transmitting the same information for a single UE, the W-CDMA signal timing (frame timing, system frame numbering, etc.) and transmission from both antennas must occur at the same time. There are two methods you can use to synchronize the transmission between the two ESGs. One manner of synchronization involves using either an external trigger source or the LF Output on the ESG. However using either of these two sources does involve several steps in configuring the trigger signal.

The second method of synchronizing is designed into the ESG providing an easier method for setup. This method utilizes a multiple ESG synchronization trigger whereby the first ESG outputs a synchronization trigger signal to itself and ESG two. All that is involved in configuring this trigger signal is just selecting it from the rear output signal menu. This is the method demonstrated in the task [“Selecting the Rear Panel Output Synchronization Signal”](#) on page 607 and [“Generating the Baseband Signals and Synchronizing the ESG Transmissions”](#) on page 611.

## Configuring for Transmit Diversity and BERT

Both ESGs are configured with the same settings. The only difference will be setting one as antenna one and the other as antenna two. Refer to [Figure 17-10 on page 604](#) for the equipment setup diagram.

In this section, factory preset parameters are used for all channels except for the DPCH. If your needs require specific settings for the different channels, changing the parameters should not modify the measurement setup demonstrated here, provided the channels for both ESGs are configured the same.

---

**NOTE** Ensure that both the **Out-of-sync Test Off On** softkey and the **Compressed Mode Off On** softkeys are set to *Off*. If either of the two features are active, a conflict of settings error message (error -221) is generated when the antenna selection is made. This will prevent you from performing the test. Refer to [“Generating the Baseband Signal and Activating the Out-Of-Synchronization Test Feature” on page 619](#) for instructions on accessing the **Out-of-sync Test Off On** softkey and [“Setting the Compressed Mode Parameters” on page 629](#) for the locating the **Compressed Mode Off On** softkey.

---

## Equipment Set Up

### Required Equipment

The following equipment is required to make transmit diversity BER measurements.

- one E4438C ESG Vector Signal Generator with Options 001/601 or 002/602, 400, and UN7  
Both ESGs can have Option UN7 (BERT) installed, however it is only required on one of the ESGs.
- one E4438C ESG Vector Signal Generator with Options 001/601 or 002/602 and 400
- one Agilent 87302C Isolator or an equivalent isolator or combiner
- an external controller to control the UE being tested
- an interface level matching circuit for interfacing between the UE being tested and the signal generator when the UE signal specifications are different from those of the signal generator

## W-CDMA Downlink Digital Modulation for Receiver Test (Option 400) Configuring for Transmit Diversity and BERT

### Connection Diagram

Refer to [Figure 17-10](#) and connect the cables for the ESGs and the UE.

**Figure 17-10** Transmit Diversity Setup with BERT

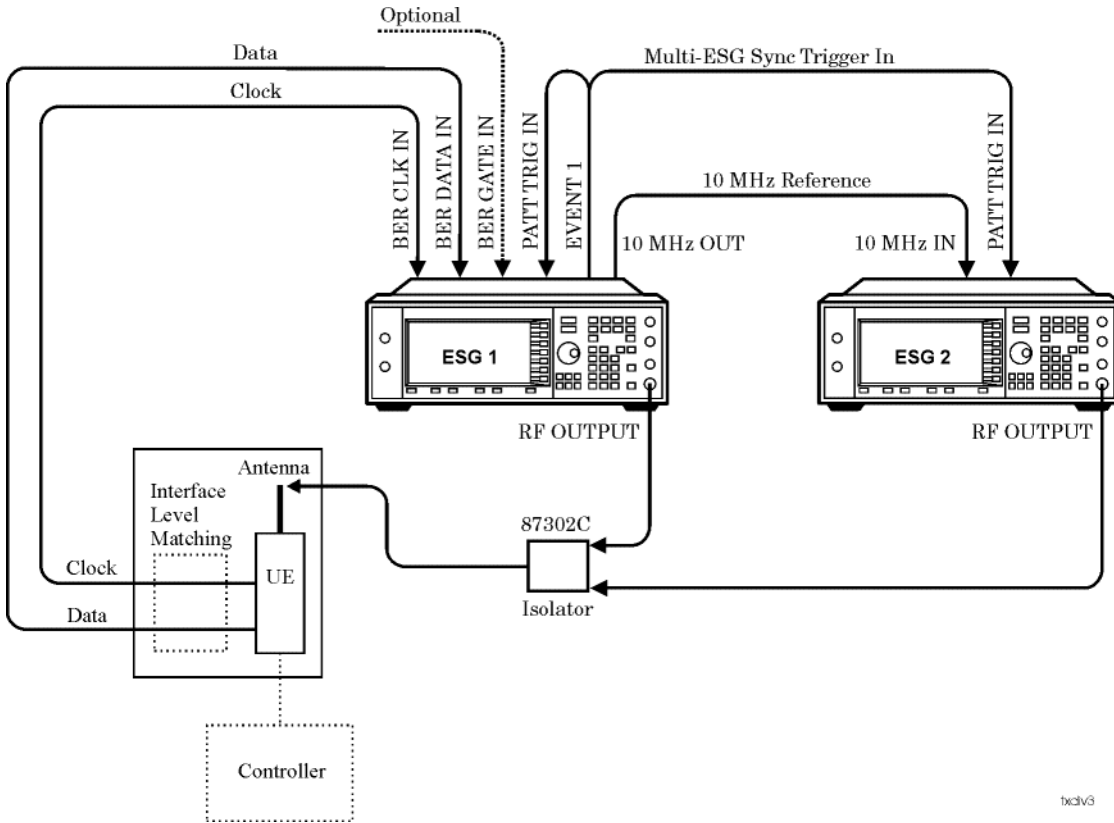

### Configuring the RF Output for both ESGs

1. Press the **Preset** hardkey.
2. Set the frequency and amplitude values.
3. Press the **RF On/Off** hardkey to On.

Steps two and three can be performed either before or after setting the W-CDMA signal parameters.

## Accessing the W-CDMA Modulation Format and Selecting Downlink

Unless stated otherwise, all procedures or tasks begin from the first-level W-CDMA softkey menu accessed in this procedure.

1. Press **Mode > W-CDMA > Real Time W-CDMA**.

This accesses the first-level W-CDMA softkey menu. From this display you can elect to set up the base station parameters (downlink) or the user equipment (UE—uplink).

2. Using the **Link Down Up** softkey, ensure that Down is highlighted as shown in [Figure 17-11](#).

**Figure 17-11** First-Level W-CDMA Softkey Menu

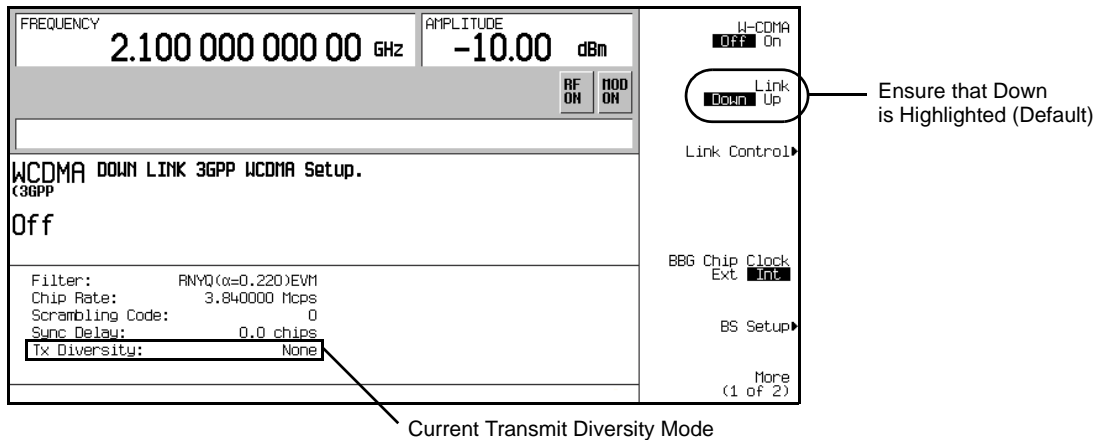

## Setting UP Antenna One (ESG One)

### Selecting Antenna One Mode

1. Press the **BS Setup** softkey.
2. Highlight the **Tx Diversity** field.
3. Press the **Edit Item** softkey.

This displays the different transmit diversity selections shown in [Figure 17-12](#).

W-CDMA Downlink Digital Modulation for Receiver Test (Option 400)  
**Configuring for Transmit Diversity and BERT**

**Figure 17-12 Transmit Diversity Mode Selection Display**

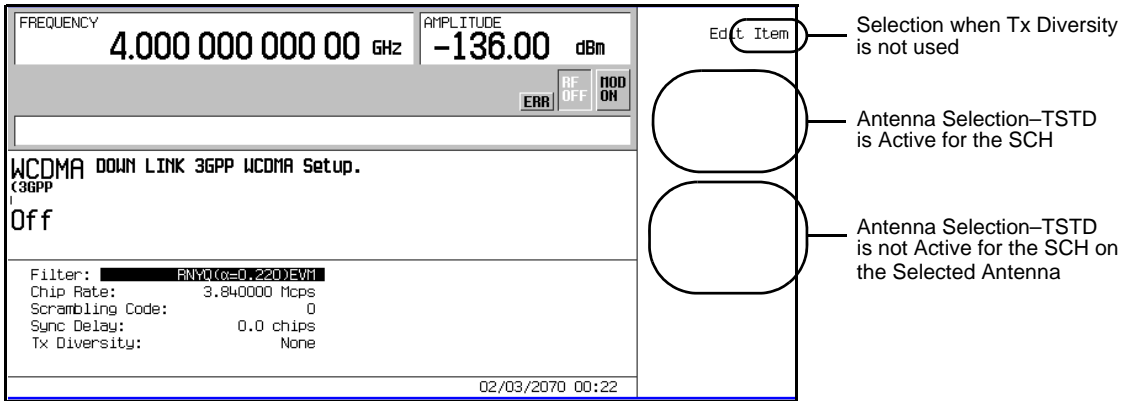

4. Press the **OpenLoop Ant1** softkey.

ESG one is now selected as antenna one. Notice that the display summary for the Tx Diversity field now shows OpenLoop Ant1. This is shown in [Figure 17-13](#).

**Figure 17-13 Antenna One Selection**

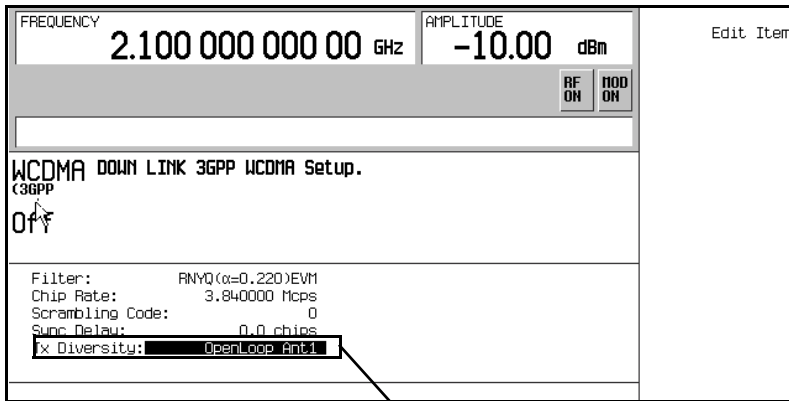

5. Press the **Return** hardkey to return to the first-level W-CDMA softkey menu.

**Selecting the Rear Panel Output Synchronization Signal**

This task will guide you in selecting the synchronization signal that is used to synchronize the transmission between the two ESGs. Either ESG can be configured as the trigger source, but to follow the setup diagram, ESG one is being used as the trigger source.

The signal selected in this task goes from the EVENT 1 connector on ESG one to the PATT TRIG IN connector on both ESGs.

1. Press **More (1 of 2) > Rear Panel Output Setup.**
2. Highlight the signal type in the Signal column that corresponds to the Event1 rear panel connector listed in the Rear Panel ports column. This is demonstrated in [Figure 17-14](#).

**Figure 17-14 Highlighted Signal Type for the EVENT 1 Connector**

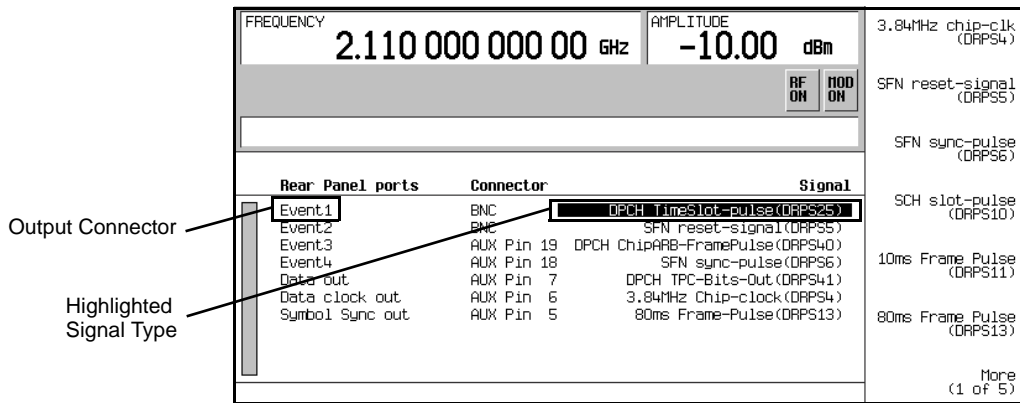

3. Press **More (1 of 5) > More (2 of 5) > More (3 of 5) > More (4 of 5) > Mlt-ESG-Sync-Trigger-Out (DRPS42).**

This changes the current highlighted signal type to the multiple ESG synchronization trigger signal. This is shown in [Figure 17-15](#).

W-CDMA Downlink Digital Modulation for Receiver Test (Option 400)  
**Configuring for Transmit Diversity and BERT**

**Figure 17-15 Multiple ESG Synchronization Trigger Signal Selected**

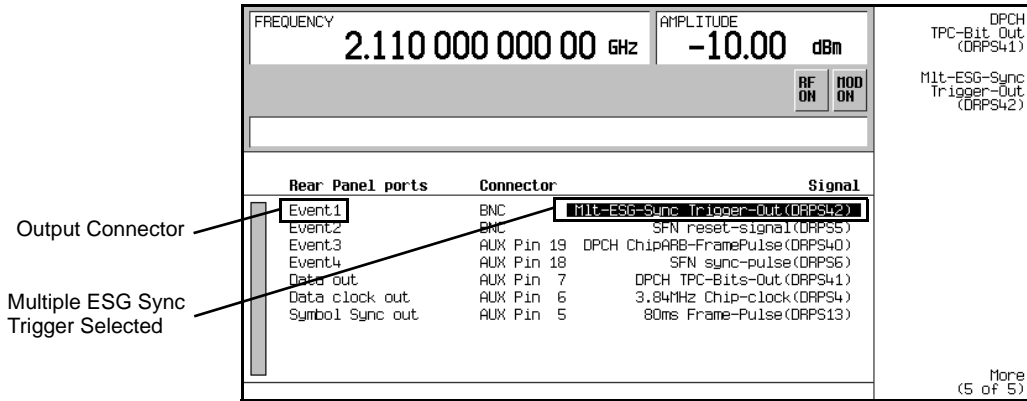

4. Press **Return** > **More (2 of 2)** or just press **Mode Setup** to return to the first-level W-CDMA softkey menu.

**Configuring the Signal Parameters**

1. Press **Link Control** > **5** > **Enter**.

This positions the cursor on the DPCH.

2. Press **PhyCH Setup** > **Ref Measure Setup** > **64 kbps**.

This selects the 64 kbps reference measurement channel (RMC) as described in the stated 3GPP TS standard and configures two dedicated channels (DCH, transport channels). If desired, you can adjust the TFCI bits for the DPCH and the secondary scramble code. Notice that Ref 64 is showing as the data type for DPCH one. This is demonstrated in [Figure 17-16](#).



**Figure 17-16 64 kbps RMC Selected**

FREQUENCY		2.110 000 000 00 GHz		AMPLITUDE		-10.00 dBm		Edit Item	
				RF ON		MOD ON			
DownLink		Tx Diversity: NONE		Total Power: 0.00dB		Apply Completed		Apply Channel Setup	
1	SCH	2	CPICH	3	P-CCPCH F1X4	4	PICH PNS	5	DPCH
			-3.30		-5.30		-8.30		
	Chan Code		On/Off		Power		Symbol Rate		Data Type
	1	10	On		-10.20		120000		Ref 64
	2	11	Off		-10.20		7500		PNS
									Slot Format
									TFCI Pat
									TPC Pat
									Ref Measure Setup

64 kbps RMC Selection Showing

3. Press the **Mode Setup** hardkey to return to the first-level W-CDMA softkey menu.

## Setting UP Antenna Two (ESG Two)

All tasks within this section begin at the first-level W-CDMA softkey menu. See [“Accessing the W-CDMA Modulation Format and Selecting Downlink” on page 605](#) for locating the first-level W-CDMA softkey menu.

### Selecting Antenna Two Mode

1. Press the **BS Setup** softkey.
2. Highlight the Tx Diversity field.
3. Press the **Edit Item** softkey.

This displays the different transmit diversity selections, which are shown in [Figure 17-17](#).

W-CDMA Downlink Digital Modulation for Receiver Test (Option 400)  
**Configuring for Transmit Diversity and BERT**

**Figure 17-17 Transmit Diversity Mode Selection Display**

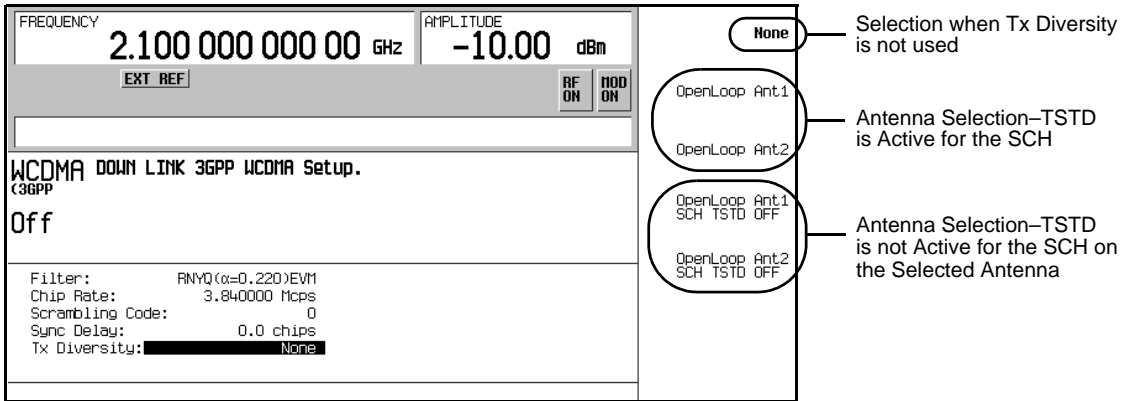

4. Press the **OpenLoop Ant2** softkey.

ESG two is now selected as antenna two. Notice that the display summary for the Tx Diversity field now shows OpenLoop Ant2. This is shown in Figure 17-18.

**Figure 17-18 Antenna Two Selection**

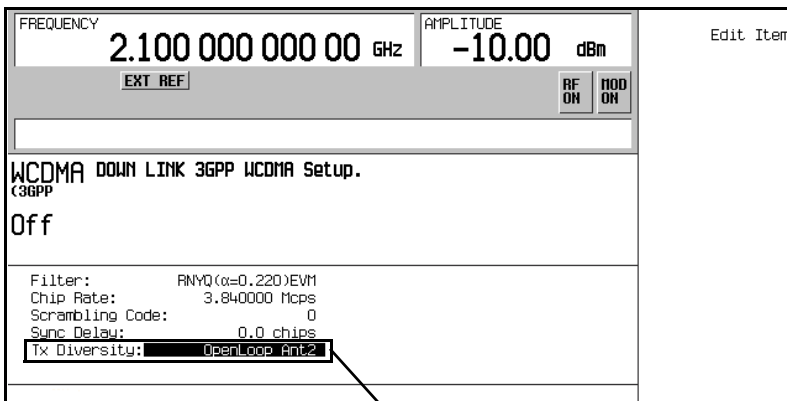

Transmit Diversity Selection Showing

5. Press the **Return** hardkey to return to the first-level W-CDMA softkey menu.

### Configuring Signal Parameters

1. Press **Link Control > 5 > Enter**.

This positions the cursor on the DPCH.

2. Press **PhyCH Setup > Ref Measure Setup > 64 kbps**.

This selects the 64 kbps reference measurement channel (RMC) as shown in the stated 3GPP TS standard and configures two dedicated channels (DCH, transport channels). If desired, you can adjust the TFCI bits for the DPCH and set a secondary scramble code. Notice that **Ref 64** is showing as the data type for DPCH one.

3. Press the **Mode Setup** hardkey to return to the first-level W-CDMA softkey menu.

### Generating the Baseband Signals and Synchronizing the ESG Transmissions

1. Press the **W-CDMA Off On** softkey to On for both ESG one and two.

This step can be performed at anytime during the setup. The advantage of turning the format on before setting up the signal, if you have a spectrum analyzer or some other measuring equipment connected, is you can see the changes as they are made. However you may experience a slight delay in signal processing while the ESG updates the W-CDMA signal with any changes that are made.

2. On ESG one, press **More (1 of 2) > Mlt ESG Sync Trigger**.

The output signal for both ESGs are now synchronized and ready to be received by the user equipment (UE).

---

**NOTE** If any signal parameters are changed after the W-CDMA format is turned on and the **Mlt ESG Sync Trigger** softkey is pressed, it may cause a loss of synchronization. You will need to press the **Mlt ESG Sync Trigger** softkey after any parameter change is applied to the signal to ensure proper synchronization between ESG one and two.

---

### Configuring the UE

Using the UE controller, configure the mobile for the call setup procedure to receive the combined ESG signals, ensuring that the receiver frequency is set to the same as the ESGs.

The UE must be able to demodulate and decode the data from the ESG, and then send this data back to the ESG for the BERT measurement. The return signal to the ESG must be a TTL or CMOS level signal.

## Making the BERT Measurement

This procedure demonstrates how to make W-CDMA transmit diversity BER measurements. Either ESG can be configured to perform the BERT measurement as long as it has Option UN7 installed. For this procedure, we are using ESG one as shown in the setup diagram. For more information on BERT measurements see [Chapter 9, “BERT \(Options UN7 and 300\),” on page 267](#).

### Selecting the BERT Data Pattern and Total Bits

1. Access the BERT function.

#### For an ESG with Option UN7 Installed

Press **Aux Fctn > BERT > Configure BERT**.

#### For an ESG with Options UN7 and 300 Installed

Press **Aux Fctn > BERT > Baseband BERT > Configure BERT**.

If the **Data** softkey does not show that PN9 is the selected data pattern, press **Data > PN9**.

The selected PN sequence must match the data PN sequence used on the channel being measured. For example if the DCH (DTCH) is using PN9 data, then the data selection in the BERT function must also be PN9.

2. Press **Total Bits > 5110 > Bits**.

5110 bits (ten times the PN9 data length) at 64 kbps (current data rate for the DCH) takes 0.080 seconds to test. The value used in this step is merely an example of the number of bits being tested, you can set the total bits to meet your test needs.

### Selecting the BERT Trigger

1. Press **Return > Configure Trigger**.

If the **BERT Trigger** softkey does not show **Trigger Key** as the selected trigger, press **BERT Trigger > Trigger Key**.

2. Press **Return > BERT Off On** to On.

### **Starting BERT Measurement**

Press the front panel **Trigger** hardkey to start the BERT measurement. You will see the measurement result values for Total Bits, Error Bits, and BER on the signal generator display.

---

#### **NOTE**

If you encounter problems making a BER measurement, check the following:

- Make sure that the cable connections are properly configured.
  - Make sure that the data pattern for the BER measurement, specified by the **Data** softkey, matches the transmitted data pattern.
  - Make sure that the RF is turned on.
  - Make sure that the amplitude is set to the correct level.
  - Make sure that the UE under test is controlled to receive the signal of the specified carrier frequency.
-

## **Out-of-Synchronization Testing Overview**

The signal level transmitted by the UE is based on transmit power control (TPC) control information received from the base station. This control information is contained in the DPCCH. When the DPCCH power level is significantly reduced, the UE may not be able to decode the TPC bits. When the UE can no longer decode the TPC bits, it has no way of controlling its power output and should terminate transmission. When the DPCCH power level is restored, the UE should be able to decode the TPC information and begin transmitting.

Out-of-synchronization testing is used to determine whether or not a UE can detect that the base station's dedicated physical control channel (DPCCH) power has decreased to an undesired level and to also detect when the DPCCH power returns to a sufficient amplitude. When the UE determines that the DPCCH power is too low, it is required to discontinue its transmission. When the proper DPCCH power level is received, the UE is required to begin transmitting. This test is described in the 3GPP specifications.

The ESG provides a method of out-of-synchronization testing by implementing an adjustable discontinuous transmission (DTX) period for the dedicated physical channel (DPCH). Since the DPCCH is multiplexed with the dedicated physical data channel (DPDCH) onto the DPCH, injecting a DPCH DTX period simulates a DPCCH low power condition. The length of the DTX period is determined by an input DTX gating signal. You are given the option of either having the DTX period occurring on the positive transition/duty period of the trigger signal or occurring on the negative transition/period. The DTX gating can be provided by an external source or you can simply use the ESG's LF Output function as demonstrated in the procedure [“Configuring the DPCH DTX Gating Trigger Signal” on page 620](#).

## Configuring for Out-of-Synchronization Testing

This section will teach you how to configure the ESG and perform an out-of-synchronization test. While the test described in this section does not follow the 3GPP conformance test, it will demonstrate the capability of the UE to determine whether or not it can detect the received DPCCCH TPC bits. One of the differences between this and the conformance test, is that the ESG discontinues the DPCH transmission where the 3GPP conformance test adjusts the DPCCCH power level. The out-of-synchronization test will work only with DPCH one.

---

**NOTE** Ensure that transmit diversity has been set to *None* and compressed mode is off. If either of the two features are active, a conflict of settings error message (error -221) is generated when the out-of-synchronization mode is turned on. This will prevent you from performing the test. Refer to [“Selecting Antenna One Mode” on page 605](#) for instructions on accessing the transmit diversity mode softkey selection menu and [“Setting the Compressed Mode Parameters” on page 629](#) for the locating the **Compressed Mode Off On** softkey.

---

## Equipment Set up

### Required Equipment

- one E4438C ESG Vector Signal Generator with Options 001/601 or 002/602 and 400
- an external controller to control the UE under test
- an Agilent E4440A PSA Spectrum Analyzer or an equivalent instrument

An oscilloscope can be used in place of the spectrum analyzer.

## W-CDMA Downlink Digital Modulation for Receiver Test (Option 400) Configuring for Out-of-Synchronization Testing

### Connection Diagram

Refer to [Figure 17-19](#) and connect the cables.

**Figure 17-19**

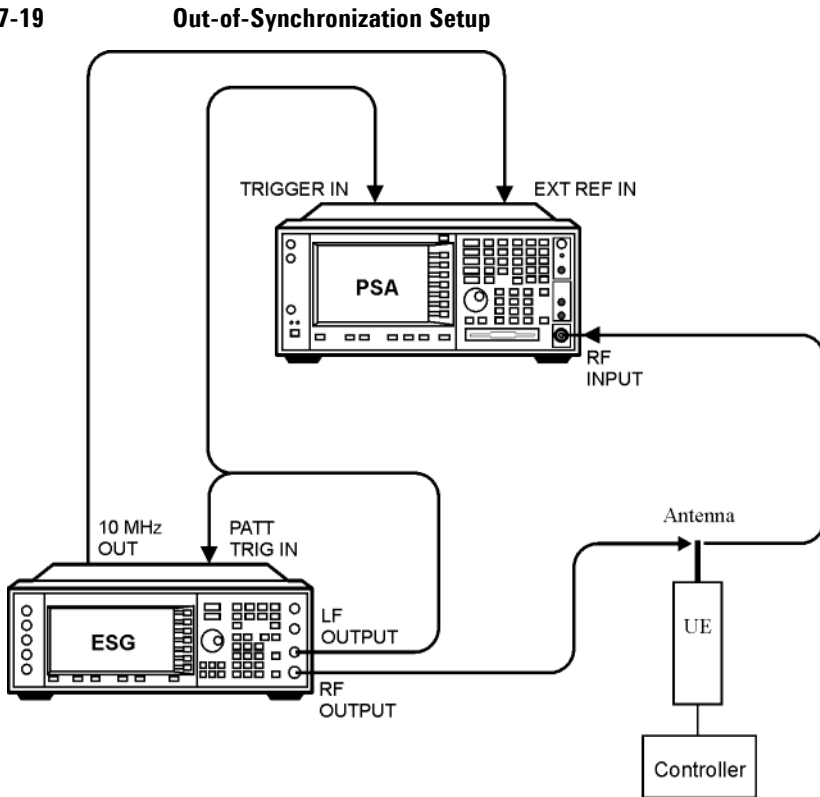

txdiv4

### Setting the RF Output

1. Press the **Preset** hardkey.
2. Set the frequency and amplitude values.
3. Press the **RF On/Off** hardkey to On.

Steps two and three can be performed either before or after setting the W-CDMA signal parameters.



## Accessing the W-CDMA Modulation Format and Selecting Downlink

Unless stated otherwise, all procedures and tasks begin from the first-level W-CDMA softkey menu accessed in this procedure.

1. Press **Mode > W-CDMA > Real Time W-CDMA**.

This accesses the first-level W-CDMA softkey menu. From this display you can elect to set up the base station parameters (downlink) or the user equipment (UE—uplink).

2. Using the **Link Down Up** softkey, ensure that Down is highlighted as shown in [Figure 17-20](#).

**Figure 17-20** First-Level W-CDMA Softkey Menu

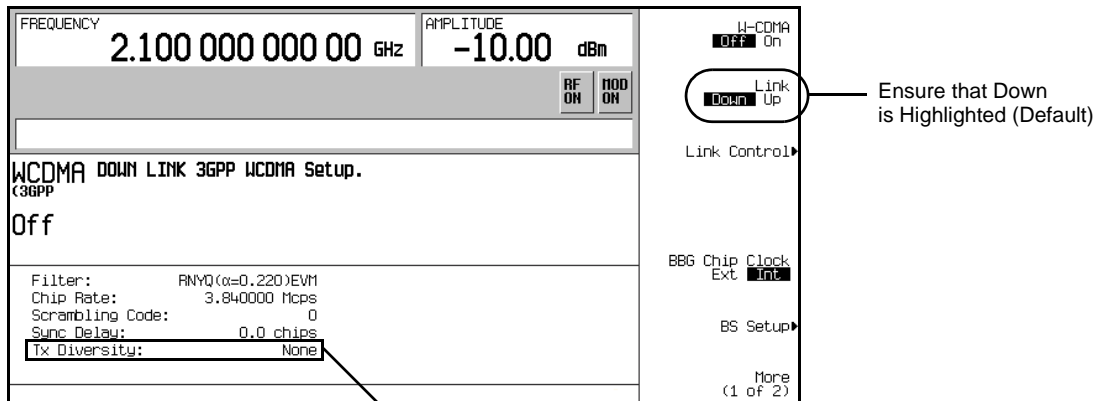

Current Transmit Diversity Mode is Set to None (off)

## Setting UP the W-CDMA Signal Parameters

This procedure uses the factory preset parameters for all channels except for the DPCH.

1. Press **Link Control > 5 > Enter > PhyCH Setup**.
2. Ensure that an item on line one (DPCH one) is highlighted.
3. Press **Ref Measure Setup > 12.2 kbps**.

This configures DPCH one as a 12.2 kbps reference measurement channel according to the 3GPP specifications. This reference measurement channel sets up two transport channels (DCH) and the required DPCH parameters. Ref 12 shows as the data type for DPCH one and is demonstrated in [Figure 17-21](#).

W-CDMA Downlink Digital Modulation for Receiver Test (Option 400)  
**Configuring for Out-of-Synchronization Testing**

**Figure 17-21 12.2 kbps RMC Selected**

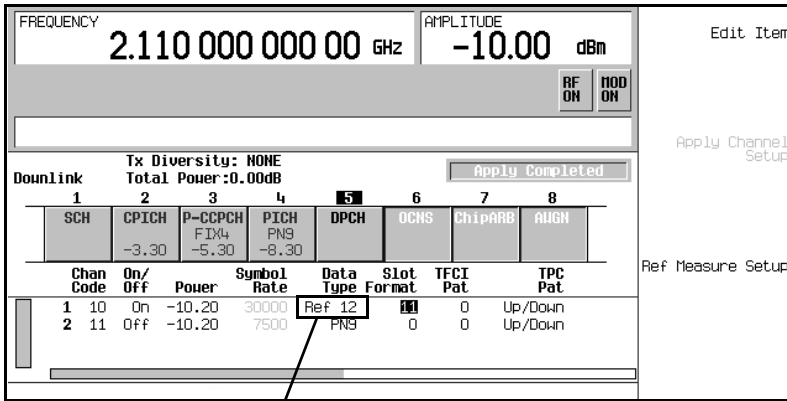

12.2 kbps RMC Selection Showing

If desired, you can adjust the TFCI bits, control the TPC pattern, and set the secondary scrambling code.

4. Press the **Mode Setup** hardkey to return to the first-level W-CDMA softkey menu.

**Selecting the Input DTX Gating Signal Trigger Polarity**

1. Press **More (1 of 2) > Rear Panel Input Setup > Trigger Polarity Setup**.

Notice that there are three different trigger polarity softkeys, two for the compressed mode feature and one for the DPCH DTX gate signal (out-of-synchronization feature). This is shown in Figure 17-22.

**Figure 17-22 Trigger Gating Signal Trigger Polarity Selection**

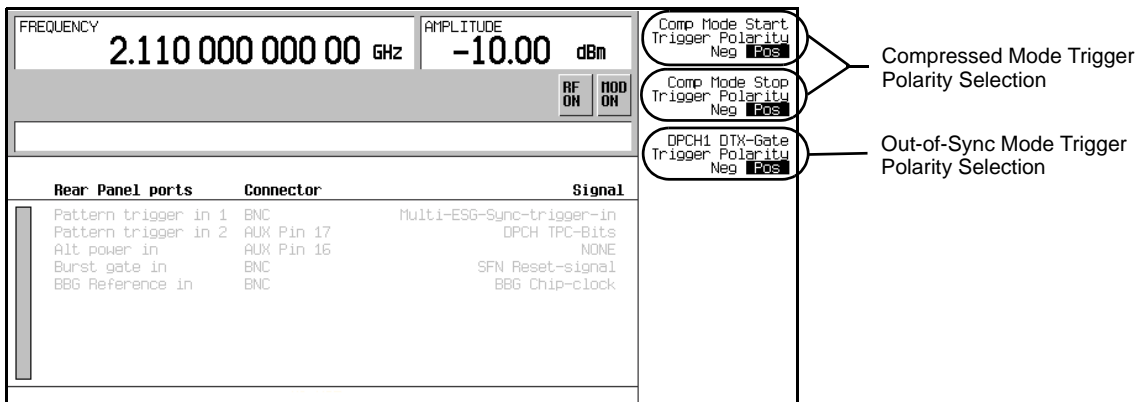

When the trigger polarity selection is positive, the DPCH DTX occurs while the gating signal is high. The reverse is true when the trigger polarity selection is negative. When the trigger polarity selection is negative, the DPCH DTX starts when the out-of-synchronization mode is turned on since the absence of a trigger is interpreted as if the gating signal was low.

2. Press the **Mode Setup** hardkey to return to the first-level W-CDMA softkey menu.

## Generating the Baseband Signal and Activating the Out-Of-Synchronization Test Feature

1. Press the **W-CDMA Off On** softkey to On.

This step can be performed at anytime during the setup. The advantage of turning the format on before setting up the signal, if you have a spectrum analyzer or some other measuring equipment connected, is you can see the changes as they are made. However you may experience a slight delay in signal processing while the ESG updates the W-CDMA signal with any changes that are made.

2. Press **More (1 of 2) > Out-of-sync Test Off On** to On.

This prepares the ESG to receive the DPCH DTX trigger gating signal.

## Configuring the UE

Using the UE controller, configure the mobile for the call setup procedure to receive the ESG signal ensuring that the receiver frequency is set to the same as the ESG.

## Setting Up the Spectrum Analyzer for Detecting the UE DTX

For this procedure we are using the Agilent E4440A PSA Spectrum Analyzer.

1. Preset the spectrum analyzer.
2. Configure the spectrum analyzer to accept an external 10 MHz frequency reference.
  - a. Press **System > Reference > Freq Ref nn.nnnnn MHz Int Ext** until Ext is underscored.
  - b. Press **10 > MHz**.
3. Select the spectrum analysis mode.  
Press **Mode > Spectrum Analysis**.
4. Set the frequency to match the transmission frequency of the UE.
  - a. Press the **Frequency** hardkey.
  - b. Using the numeric keypad, enter the frequency of the UE signal.
5. Set a zero frequency span.  
Press **Span > Zero Span**.

## Configuring for Out-of-Synchronization Testing

6. Set the sweep time for 500 ms.

Press **Sweep > 500 > ms.**

7. Select external triggering so the measurement begins when the DPCH DTX period starts.

Press **Trig > Ext Rear.**

## Configuring the DPCH DTX Gating Trigger Signal

One of the fundamental features within the ESG is the ability to generate trigger signals using the LF Output function. In this procedure, we will use the LF Output function to create the DPCH DTX gating signal.

1. Press **LF Out > LF Out Source > Function Generator.**

2. Press **LF Out Waveform > More (1 of 2) > Pulse.**

3. Press **LF Out Period > 500 > msec.**

In accordance with the 3GPP specifications, the UE will cease transmission within a certain amount of time when the base station's DPCH power level decreases by a certain amount. Conversely, the UE will again begin transmission within a certain amount of time once the DPCH power level attains the correct power level. With the ESG, this is simulated by creating a DTX period for the DPCH. The pulse period time entered allows for a complete cycle where the UE should discontinue and then begin transmission.

4. Press **LF Out Width > 200 > msec.**

This is the approximate period of time in which the UE should detect that the ESG's DPCH has discontinued transmission, and then turn off its own transmission.

5. Press **LF Out Amplitude > 2.5 > Vp.**

6. Press **LF Out Off On** to On.

## Compressed Mode Overview

Compressed mode is used when you need to create a discontinuous transmission period (DTX), also called a transmission gap, so the user equipment (UE) can sample other frequencies. During the DTX period, the UE can receive control information from either another W-CDMA base station or a GSM base station for a handoff.

The UE must be able to receive the compressed frames and properly demodulate and decode the data along with the normal frames. BER and BLER measurements are made on the data to ensure proper UE operation. The ESG facilitates this type of testing by transmitting fully coded transport channels (DCH) for compressed, normal, or a combination of compressed and normal frames. These fully coded channels can automatically be configured using the provided reference measurement channels (RMC) or you can set your own custom configurations. The ESG supports the following 3GPP defined DPCH channel configurations for compressed mode:

- 12.2 kbps
- 64 kbps
- 144 kbps
- 384 kbps
- AMR 12.2 kbps
- UDI IDSN 64 kbps

With both the fully coded transport channels and the wide choice of RMCs, you are able to fully test the UE for proper demodulation and decoding using BER testing. For more information on the supported RMCs, see [“Reference Measurement Channels” on page 646](#).

The compressed mode in the ESG complies with the 3GPP specifications and is very flexible with many adjustable parameters. You can have one or two transmission gaps. When two gaps are used, each gap can have a different length and operate using the single or double frame method. The double frame method uses slots from two compressed frames to create one transmission gap. [Table 17-1](#) describes some of the parameters that are available for the compressed mode.

**Compressed Mode Overview**

**Table 17-1 Downlink Compressed Mode Parameters**

Name	Definition
Transmission gap pattern repetition count (TGPRC)	Number of transmission gap patterns within the transmission gap pattern sequence.
Transmission gap connection frame number (TGCFN)	CFN of the first compressed frame of the first pattern within the transmission gap pattern sequence.
Transmission gap slot number (TGSN)	Slot number of the first transmission gap within the first radio frame of the transmission gap pattern.
Transmission gap length 1 (TGL1)	Duration of the first transmission gap within the transmission gap pattern.
Transmission gap length 2 (TGL2)	Duration of the second transmission gap.
Transmission gap duration (TGD)	This is the distance, measured in slots, from the beginning of the first transmission gap to the beginning of the second transmission gap.
Transmission gap pattern length 1 (TGPL1)	Duration of first transmission gap pattern that includes TGL1/2.
Transmission gap pattern length 2 (TGPL2)	Duration of the second transmission gap pattern that includes TGL1/2.
Stop connection frame number (Stop CFN)	CFN of the last radio frame.
Transmission gap pattern sequence identifier (TGPSI)	This identifies the currently selected transmission gap pattern sequence. Only one TGPSI is supported at this time.
Transmission gap pattern sequence (TGPS)	This lets you select whether or not to transmit the current TGPSI. Active it will be transmitted, inactive it will not be transmitted.
CM Method: SF/2 (spread factor divided by two) or Puncturing	This determines the data processing mode used to create the gaps.
Frame Struct: A or B	A: Optimizes the gap length. B: Optimizes the power control.

The ESG offers two different compressed mode methods for transmitting compressed frames. This is shown as CM Method: SF/2 (spread factor divided by two) or Puncturing in [Table 17-1](#). SF/2 reduces the spread factor of the compressed frame by half; puncturing reduces the amount of transmitted data by eliminating bits.

The ESG also supports the DPCCH slot sub-formats, denoted in the specifications by the slot format number with an 'A' or 'B', that are used during compressed frame transmission. The sub-format used is dependent on the selected compressed mode method. The ESG automatically selects the correct sub-format for the current slot format when you select the compressed mode method. For example if you were using slot format 3, which includes the sub-formats 3A and 3B, and selected the SF/2 compressed mode method, the ESG would use sub-format 3B. If you were to select puncturing as the compressed mode method, then the ESG would automatically select sub-format 3A.

Another feature of the ESG compressed mode gives you the ability to select the different frame structures utilized during compressed frame transmission. Frame structure 'A' optimizes the DTX periods by not transmitting any power control information (TPC field) during this time. Frame structure 'B' optimizes for power control by inserting power control information during the first DTX slot for each transmission gap. Both frame structures transmit the pilot bits during the last slot for each transmission gap.

## Setting Up for a Compressed Mode Signal

---

### Setting Up for a Compressed Mode Signal

Using the compressed mode turns the ESG ALC feature off. To maintain amplitude accuracy, it is recommended that you perform a power search. This is demonstrated in the task, [“Performing a Manual Power Search” on page 631](#).

The signal parameters set in this section are used for both setups shown in the [Equipment Setup](#) section.

---

**NOTE** Ensure that transmit diversity has been set to *None* and the **Out-of-sync Test Off On** softkey is set to *Off*. If either of the two features are active, a conflict of settings error message (error -221) is generated when compressed mode is turned on. This will prevent you from using the feature. Refer to [“Selecting Antenna One Mode” on page 605](#) for instructions on accessing the transmit diversity mode softkey selection menu and [“Generating the Baseband Signal and Activating the Out-Of-Synchronization Test Feature” on page 619](#) for instructions on accessing the **Out-of-sync Test Off On** softkey.

---

### Equipment Setup

#### Required Equipment for Measuring the DPCH Symbol Power

- one E4438C ESG Vector Signal Generator with Options 001/601 or 002/602 and 400
- one Agilent E4440A PSA Spectrum Analyzer with Options B7J and BAF or an equivalent instrument

#### Required Equipment for BERT Measurements

- one E4438C ESG Vector Signal Generator with Options 001/601 or 002/602, 400, and UN7
- an external controller to control the UE being tested
- an interface level matching circuit for interfacing between the UE being tested and the signal generator when the UE signal specifications are different from those of the signal generator



### Connection Diagram for Measuring the DPCH Symbol Power

Refer to [Figure 17-23](#) and connect the cables for the ESG and PSA (spectrum analyzer).

**Figure 17-23** Compressed Mode Setup for a Symbol Power Measurement

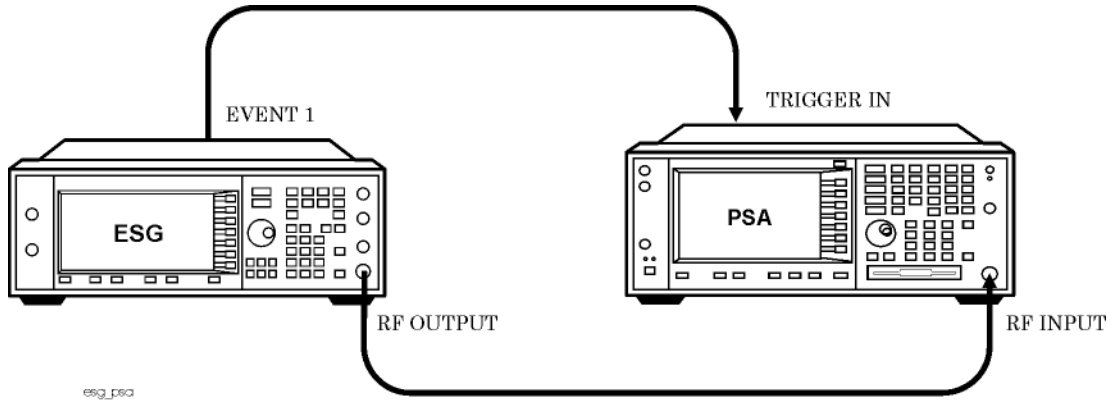

### Connection Diagram for BERT Measurements

Refer to [Figure 17-24](#) and connect the cables for the ESG and the UE.

W-CDMA Downlink Digital Modulation for Receiver Test (Option 400)  
**Setting Up for a Compressed Mode Signal**

**Figure 17-24 Compressed Mode Setup for BERT**

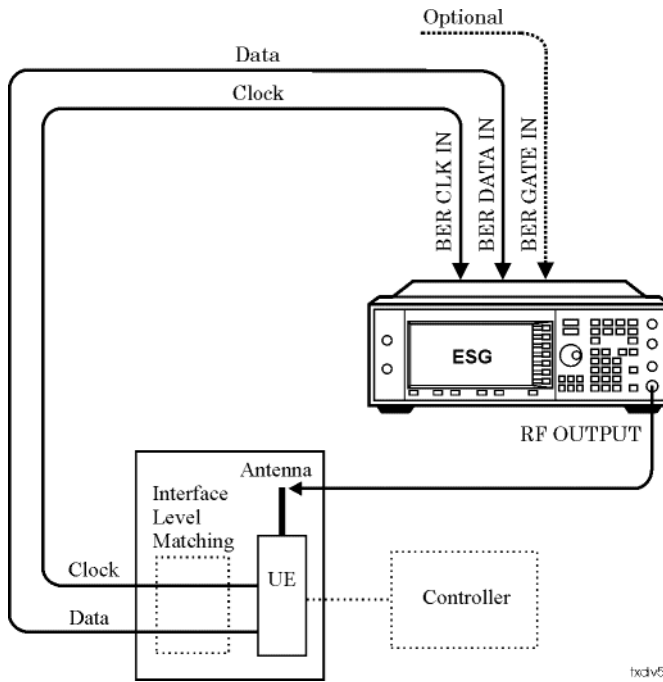

### Setting the RF Output

1. Press the **Preset** hardkey.
2. Set the frequency and amplitude values.
3. Press the **RF On/Off** hardkey to On.

Steps two and three can be performed either before or after setting the W-CDMA signal parameters. However they must be done before the power search is performed in the task, “[Performing a Manual Power Search](#)” on page 631.

## Accessing the W-CDMA Modulation Format and Selecting Downlink

Unless stated otherwise, all procedures and tasks begin from the first-level W-CDMA softkey menu accessed in this procedure.

1. Press **Mode > W-CDMA > Real Time W-CDMA**.

This accesses the first-level W-CDMA softkey menu. From this display you can elect to set up the base station parameters (downlink) or the user equipment (UE—uplink). See [Figure 17-25](#) for the first-level W-CDMA softkey menu display.

2. Using the **Link Down Up** softkey, ensure that Down is highlighted as shown in [Figure 17-25](#).

**Figure 17-25** First-Level W-CDMA Softkey Menu

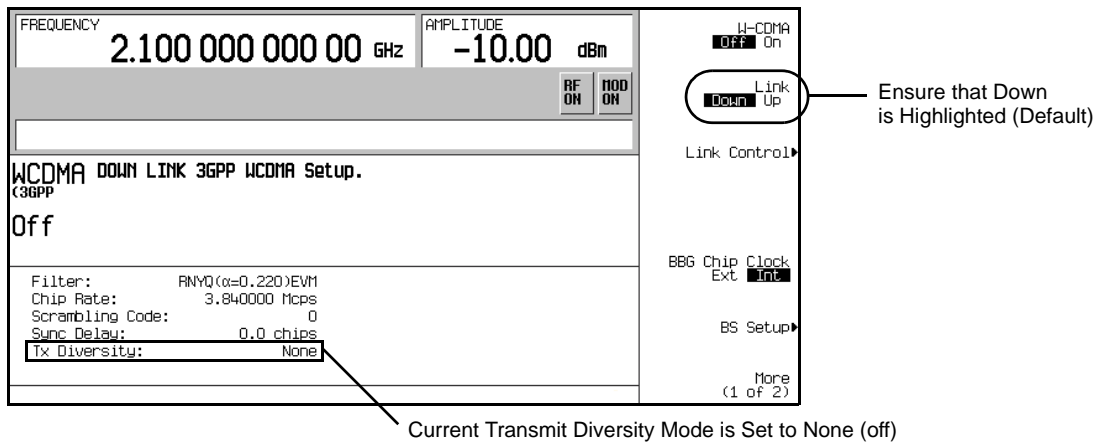

Current Transmit Diversity Mode is Set to None (off)

## Setting Up the W-CDMA Signal Parameters

This procedure uses the factory preset parameters for all channels except for the DPCH.

1. Press **Link Control > 5 > Enter > PhyCH Setup**.
2. Ensure that an item on line one (DPCH one) is highlighted.

The compressed mode feature operates with only DPCH one. If you were to try use DPCH two by itself or in unison with DPCH one, an error message is generated.

3. Press **Ref Measure Setup > 12.2 kbps**.

This configures DPCH one as a 12.2 kbps reference measurement channel according to the 3GPP specifications. This reference measurement channel sets up two transport channels (DCH) and the required DPCH parameters. Ref 12 now shows as the data type for DPCH one and is demonstrated in [Figure 17-26](#).

**Setting Up for a Compressed Mode Signal**

**Figure 17-26 12.2 kbps RMC Selected**

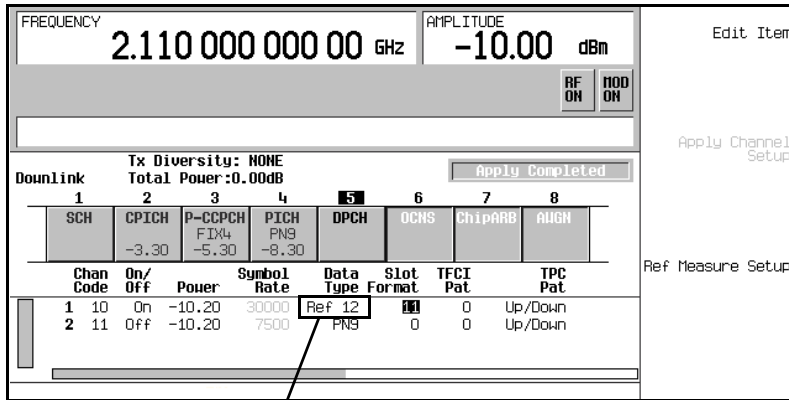

12.2 kbps RMC Selection Showing

If desired, you can change the TFCI bits, control the TPC pattern, and select the secondary scrambling code.

4. Press the **Mode Setup** hardkey to return to the first-level W-CDMA softkey menu.

**Generating the Baseband Signal**

Press the **W-CDMA Off On** softkey to On.

This step can be performed at anytime during the setup. The advantage of turning the format on before setting up the signal, if you have a spectrum analyzer or some other measuring equipment connected, is you can see the changes as they are made. However you may experience a slight delay in signal processing while the ESG updates the W-CDMA signal with any changes that are made.

**Configuring Compressed Mode**

**Selecting the Rear Panel Output Trigger Signal**

Performing this task is not required if you are performing BERT measurements. A rear panel output signal is used to trigger an instrument, so it begins measuring the RF output signal at a certain point.

1. Press **More (1 of 2) > Rear Panel Output Setup > More (1 of 5) > More (2 of 5) > DPCH Compressed Frame Indicator (DRPS32)**.

This enables an output trigger signal at the rear panel EVENT 1 connector when the compressed frame is transmitted.

2. Press the **Mode Setup** hardkey to return to the first-level W-CDMA softkey menu.

### Setting the Compressed Mode Parameters

1. Press **Link Control > 5 > Enter > Compressed Mode Setup**.

Notice that the cursor is already showing in the compressed mode table editor. This means you can immediately start editing parameters upon entering the compressed mode display. This is unlike the uplink where another softkey needs to be pressed before the cursor is displayed in the table editor.

The compressed mode feature is accessible only when the DPCH (5) is highlighted. The **Compressed Mode Setup** softkey is grayed-out when any other channel is selected.

2. Set slot eight of the frame as the starting slot for the first transmission gap.
  - a. Move the cursor to highlight the TGSN field.
  - b. Press **8 > Enter**.

This sets the first compressed frame to have eight slots (0–7) of data with slot eight marking the beginning of the first transmission gap.

3. Set the first transmission gap length which is expressed as a number of slots.
  - a. Move the cursor to highlight the TGL1 field.
  - b. Press **14 > Enter**.

Out of the 15 slots per frame, the standard specifies that seven of them can be used as discontinuous transmission (DTX) slots. However the total gap length can be spread over two frames. The value 14 denotes 14 DTX slots, which spans 2 frames. This is called the double-frame method. When TGSN is  $\leq 8$  and TGL is  $\leq 7$ , then the DTX slots are contained in one frame forming the single-frame method.

4. Set the second transmission gap length which is expressed as a number of slots.
  - a. Move the cursor to highlight the TGL2 field.
  - b. Press **3 > Enter**.

For the second transmission gap, the single frame method is used.

5. Set the spacing between the first and second transmission gaps expressed as a number of slots.
  - a. Move the cursor to highlight the TGD field.
  - b. Press **37 > Enter**.
6. Set the duration of the first transmission gap pattern which is expressed as a number of frames.
  - a. Move the cursor to highlight the TGPL1 field.
  - b. Press **6 > Enter**.

## Setting Up for a Compressed Mode Signal

7. Set the duration of the second transmission gap pattern which is expressed as a number of frames.
  - a. Move the cursor to highlight the TGPL2 field.
  - b. Press **4 > Enter**.
8. Enable the compressed frames.
  - a. Move the cursor to highlight the TGPS field.
  - b. Press **Edit Item > Active**.
9. Press the **Compressed Mode Off On** softkey to On.

This softkey turns the compressed mode feature on, but it does not cause the compressed frame transmission to begin. Compressed frames are not transmitted until the ESG receives a trigger signal. This is demonstrated in the task, “[Setting the Frame Power Offset and Triggering the Compressed Frame Function](#)” on page 632.

Notice that when compressed mode is turned on, the ALC feature of the ESG is turned off. This is indicated by the **ALC OFF** annunciator showing in the display and shown in [Figure 17-27](#).

The **Compressed Mode Off On** softkey can be set to On at any time, however doing it at the end applies the changes to the baseband signal, so you do not have to press the **Apply Channel Setup** softkey. This just decreases the number of required key presses during the signal setup. But if changes are made to the compressed mode after the feature is turned on, the **Apply Needed** annunciator may appear. When the annunciator appears, this means that you must press the **Apply Channel Setup** softkey to apply the changes to the signal.

[Figure 17-27](#) shows the compressed mode display once all parameters from this procedure are completed.

**Figure 17-27 Completed Compressed Mode Display**

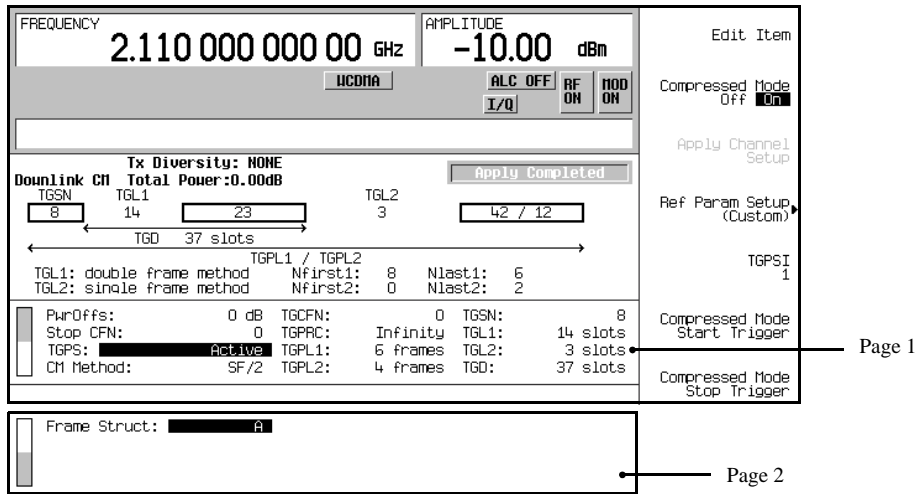

### Performing a Manual Power Search

This task builds upon the previous task, “[Setting the Compressed Mode Parameters](#)” on page 629.

The ALC feature is disabled when compressed mode is used (**Compressed Mode Off On** softkey set to On), and it is recommended that a manual power search is performed to ensure the correct output power level. See the section “[Special Power Control Considerations When Using Compressed Mode](#)” on page 652 for more information.

This task will guide you in configuring and performing a manual power search. If desired, you can adjust the power search settings to meet your individual test needs.

1. Press **Amplitude > Power Search > Power Search Reference Fixed Mod** to Mod.

Mod references the power search on the rms value of the I/Q modulation, whereas fixed uses a 0.5 volt reference during the power search operation.

From this current softkey menu, you can make adjustments to the other power search parameters to meet your test needs.

2. Press **Return > Do Power Search**.

The ESG has now performed a power adjustment for the current carrier frequency. If you change frequencies or the RF output power level, the power adjustment will have to be done again.

3. Press the **Return** hardkey to access the previous compressed mode menu.

## Setting Up for a Compressed Mode Signal

### Setting the Frame Power Offset and Triggering the Compressed Frame Function

---

**NOTE** If you are using the spectrum analyzer setup shown in the section “[Connection Diagram for Measuring the DPCH Symbol Power](#)” on page 625, it is best to perform [Step 3](#) once you have completed the spectrum analyzer setup in the section, “[Measuring the DPCH Symbol Power](#)” on page 633. Because this is a demodulation measurement, the spectrum analyzer needs to capture the DPCH before DTX periods are incorporated. If the spectrum analyzer encounters a DTX period while making a demodulation measurement, it will not recognize the DPCH transmission.

---

1. Set the compressed frame power relative to the non-compressed (normal) frames.
  - a. Move the cursor to highlight the `PwrOfFs` field.
  - b. Press **6 > dB**.

This enables you to compensate for reduced spreading gain. The higher power level makes the compressed frames easier to view.

2. Press the **Apply Channel Setup** softkey.
3. Press the **Compressed Mode Start Trigger** softkey.

The compressed mode function terminates when the **Compressed Mode Stop Trigger** softkey is pressed, an external stop trigger signal is received, or when the **Apply Channel Setup** softkey is pressed. You can also stop the transmitted compressed mode signal after a set number of transmissions by changing the `TGPRC` field from `Infinity` to the desired number of repetitions. To restart the compressed mode function, just press the **Compressed Mode Start Trigger** softkey or send an external start trigger signal.



## Making Compressed Mode Signal Measurements

### Measuring the DPCH Symbol Power

This procedure will guide you through setting up a spectrum analyzer for demodulating the compressed DPCH that was configured in the previous procedures. While the main steps are generically written, the substeps are written specifically for the E4440A PSA. The setup diagram for this procedure is shown in [Figure 17-23 on page 625](#).

### Configuring the Spectrum Analyzer

1. Preset the spectrum analyzer.
2. Select the W-CDMA measurement mode.  
Press **Mode > W-CDMA**.
3. Set the spectrum analyzer to receive a base station signal.  
Press **Mode Setup > Radio > Device BTS MS** until BTS is underscored.
4. Set the spectrum analyzer frequency to match the transmission frequency of the ESG.
  - a. Press the **Frequency** hardkey.
  - b. Using the numeric keypad, enter the carrier frequency of the ESG signal.
5. Select the code domain measurement.  
Press **Measure > More 1 of 3 > Code Domain**.
6. Set a span that lets you view the channels.  
Press **Span > Scale/Div > 64 > Enter**.

[Figure 17-28](#) shows the current spectrum analyzer display. If the display does not show the channels, press the **Restart** hardkey to perform another measurement.

W-CDMA Downlink Digital Modulation for Receiver Test (Option 400)  
**Making Compressed Mode Signal Measurements**

**Figure 17-28 DPCH Selected on PSA**

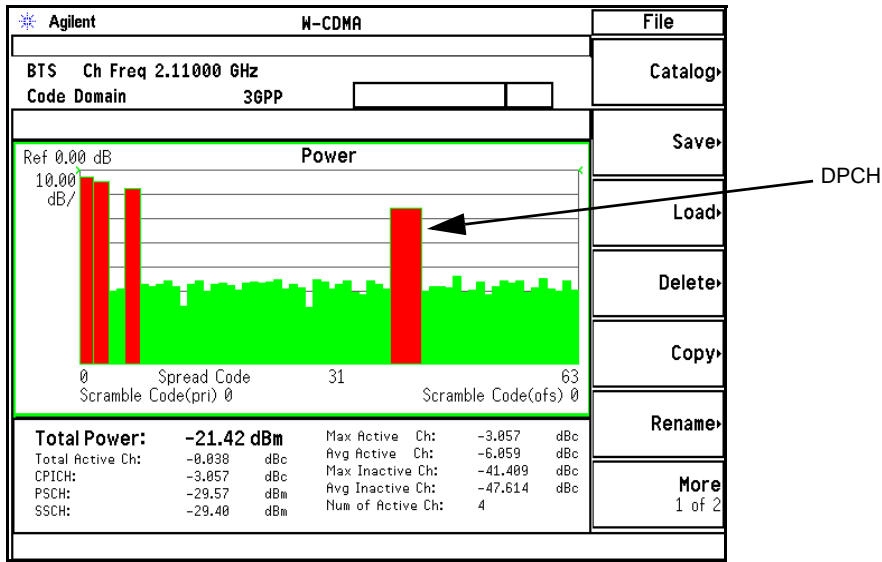

7. Set the spectrum analyzer so it measures the DPCH symbol power.

- a. Press **Meas Setup > Symbol Rate > 30 > ksp/s**.

This sets the DPCH symbol rate for the 12.2 kbps RMC data rate and matches the ESG DPCH symbol rate shown in [Figure 17-29](#)

- b. Press **Code Number > 10 > Enter**.

This sets the channel code branch that the DPCH is using and is associated with the with the SF for the symbol rate of 30 ksp/s ( $3.84 \text{ Mcps} / 30 \text{ ksp/s} = \text{SF } 128$ ).

The code number is found on the ESG DPCH setup display and is shown in [Figure 17-29](#).

**Figure 17-29 DPCH Signal Parameters**

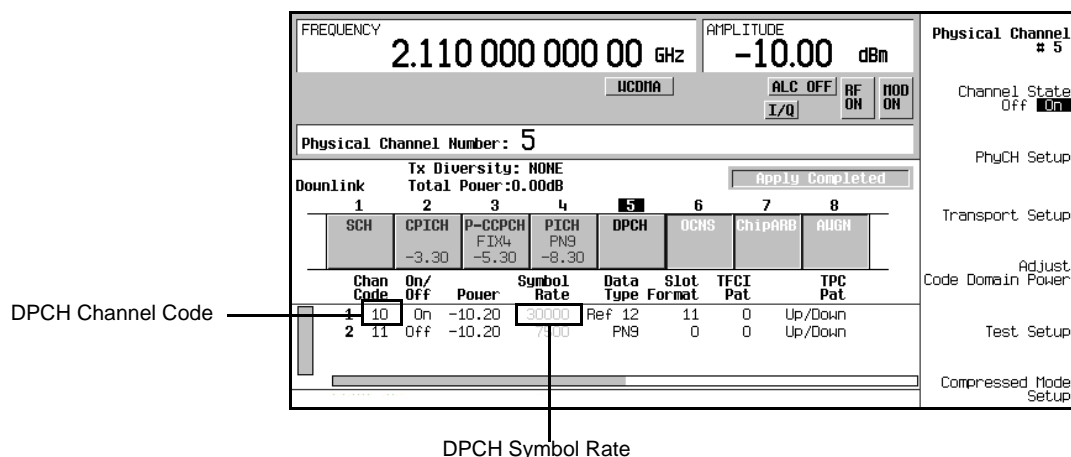

8. Select a frame capture interval that will display the DPCH compressed pattern.  
 Press **More 1 of 3 > Capture Intvl > 8 Frame (Long Mode)**.  
 Notice that the display changes from code domain to symbol power.
9. Zoom in on the symbol power display  
 Press the **Zoom** hardkey.
10. Trigger the spectrum analyzer from the rear panel input using the supplied ESG DPCH compressed frame trigger signal.  
 Press **More 2 of 3 > Trig Source > Ext Rear**.

---

**NOTE** If you have not started the triggering for the ESG compressed mode signal, press the **Compressed Mode Start Trigger** softkey on the ESG.

---

11. Start the measurement for the symbol power.

Press the **Restart** hardkey.

The spectrum analyzer may take a few moments to display the DPCH symbol power. Depending on which compressed frame triggers the spectrum analyzer measurement, your display may differ from the one showing in [Figure 17-30](#). However the characteristics of the signal as depicted in [Figure 17-30](#) still apply.

W-CDMA Downlink Digital Modulation for Receiver Test (Option 400)  
**Making Compressed Mode Signal Measurements**

**Figure 17-30 Compressed DPCH Signal**

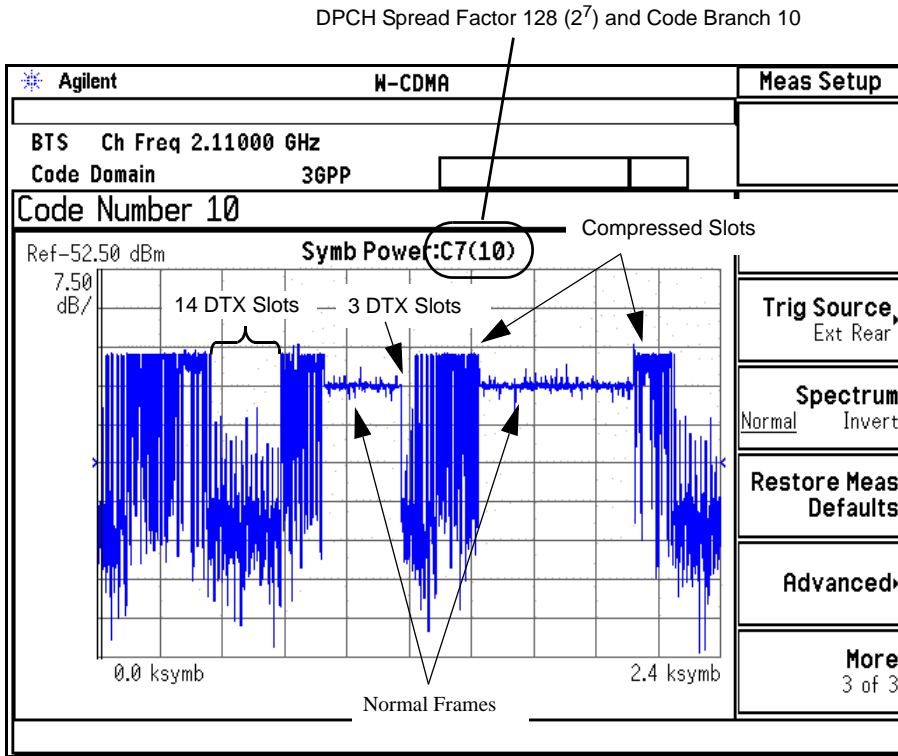

12. Use a marker to measure the different displayed symbol power levels.

- a. Press **Marker > Trace > Symbol Power**.
- b. Use the RPG knob to position the cursor at the desired location.

You can make further signal measurements on the PSA such as measuring the number of slots for a section on the display. This is accomplished with **Meas Interval x Slots** and the **Meas Offset x Slots** softkeys located in the **Meas Setup** hardkey menu. This can help you verify the signal parameters that were set on the ESG.

## Making the BERT Measurement

This procedure demonstrates how to make W-CDMA compressed signal BER measurements. Option UN7 must be installed on the ESG. The setup diagram for this procedure is shown in [Figure 17-24 on page 626](#). For more information on BERT measurements see [Chapter 9, “BERT \(Options UN7 and 300\),” on page 267](#).

### Configuring the UE

Using the UE controller, configure the mobile for the call setup procedure to receive the ESG signal, ensuring that the receiver frequency is set to the same as the ESG.

The UE must be able to demodulate and decode the data from the ESG, and then send this data back to the ESG for the BERT measurement. The return signal to the ESG must be a TTL or CMOS level signal.

### Selecting the ESG BERT Data Pattern and Total Bits

1. Access the BERT function.

#### For an ESG with Option UN7 Installed

Press **Aux Fctn > BERT > Configure BERT**.

#### For an ESG with Options UN7 and 300 Installed

Press **Aux Fctn > BERT > Baseband BERT > Configure BERT**.

If the **Data** softkey does not show that PN9 is the selected data pattern, press **Data > PN9**.

The selected PN sequence must match the data PN sequence used on the channel being measured. For example if the DCH (DTCH) is using PN9 data, then the data selection in the BERT function must also be PN9.

2. Press **Total Bits > 5110 > Bits**.

5110 bits (ten times the PN9 data length) at 12.2 kbps (current data rate for the DCH) takes 0.419 seconds to test. The value used in this step is merely an example of the number of bits being tested, you can set the total bits to meet your test needs.

### Selecting the ESG BERT Trigger

1. Press **Return > Configure Trigger**.

If the **BERT Trigger** softkey does not show **Trigger Key** as the selected trigger, press **BERT Trigger > Trigger Key**.

2. Press **Return > BERT Off On** to On.

## Making Compressed Mode Signal Measurements

### Starting the ESG BERT Measurement

Press the front panel **Trigger** hardkey to start the BERT measurement. You will see the measurement values for the Total Bits, Error Bits, and BER on the signal generator display.

---

**NOTE**

If you encounter problems making a BER measurement, check the following:

- Make sure that the cable connections are properly configured.
  - Make sure that the data pattern for the BER measurement, specified by the **Data** softkey, matches the transmitted data pattern.
  - Make sure that the RF is turned on.
  - Make sure that the amplitude is set to the correct level.
  - Make sure that the UE under test is controlled to receive the signal of the specified carrier frequency.
-

## Locating Rear Panel Input Signal Connectors

One feature of the W-CDMA downlink format is the ease in which you can determine the correct rear panel input connector for a particular signal application. The input signal type changes depending on whether you are in the compressed mode, performing the out-of-synchronization test, or doing transmit diversity, which is the same as the standard (default) downlink mode. This section guides you through the softkey menus to where you can view the information.

1. Press **Mode > W-CDMA > Real Time W-CDMA > Link Down Up** to Down (default).
2. Press **More (1 of 2) > Rear Panel Input Setup**.

The information shown in the text area, displays the connector and the type of input signal it accepts. For example, the **BBG Reference** in listing (BASEBAND GEN REF IN connector) in the **Rear Panel Ports** column accepts a baseband generator (BBG) chip clock signal. [Figure 17-31](#) shows the different input signal to connector displays.

Locating Rear Panel Input Signal Connectors

Figure 17-31 Rear Panel Input Signal Connector Information

FREQUENCY <b>4.000 000 000 00 GHz</b>		AMPLITUDE <b>-136.00 dBm</b>		Trigger Polarity Setup
		RF OFF		MOD ON
Rear Panel ports	Connector	Signal		
Pattern trigger in 1	BNC	Multi-ESG-Sync-trigger-in		
Pattern trigger in 2	AUX Pin 17	DPCH TPC-Bits		
Alt power in	AUX Pin 16	NONE		
Burst gate in	BNC	SFN Reset-signal		
BBG Reference in	BNC	BBG Chip-clock		

Default Input Signal (Tx Diversity) Display

BBG Reference in Signal Type

Rear Panel ports	Connector	Signal		
Pattern trigger in 1	BNC	DPCH1-DTX-Gate for-OutOfSyncTest		
Pattern trigger in 2	AUX Pin 17	DPCH TPC-Bits		
Alt power in	AUX Pin 16	NONE		
Burst gate in	BNC	SFN Reset-signal		
BBG Reference in	BNC	BBG Chip-clock		

Out of Synchronization Test Input Signal Display

**NOTE:** The Out of Synchronization Test must be on to see this display

Rear Panel ports	Connector	Signal		
Pattern trigger in 1	BNC	Compressed-mode start-trigger		
Pattern trigger in 2	AUX Pin 17	DPCH TPC-Bits		
Alt power in	AUX Pin 16	Compressed-mode stop-trigger		
Burst gate in	BNC	SFN Reset-signal		
BBG Reference in	BNC	BBG Chip-clock		

Compressed Mode Input Signal Display

**NOTE:** Compressed Mode must be on to see this display

- To exit this display, press either **Mode Setup** to return to the first-level W-CDMA softkey menu or press **Return** until you come to the desired softkey menu/display.



## Configuring Rear Panel Output Signals

The W-CDMA downlink format provides you the ability to configure output signals for the various rear panel output connectors. This lets you control trigger signals based on your needs. Unlike the rear panel input signals, the ESG does not have to be in a particular mode to select any of the rear panel output signals. However the correct feature (transmit diversity, compressed mode, out-of-synchronization testing, etc.) must be active before some signals are available at the rear panel. For example, if you select the **DPCH Compressed Frame Indicator(DRPS32)** as an output trigger signal, the ESG must be transmitting a compressed mode signal before this rear panel trigger is realized. This section guides you through the softkey menus to where you can configure your signals.

### Accessing the Rear Panel Output Signal Menu

1. Press **Mode > W-CDMA > Real Time W-CDMA > Link Down Up** to Down (default).  
 This is the first-level W-CDMA softkey menu.
2. Press **More (1 of 2) > Rear Panel Output Setup**.

### Selecting an Output Signal

1. Using the arrow keys, highlight the item in the Signal column that corresponds to the Event2 connector listed in the Rear Panel Ports column. This is shown in [Figure 17-32](#).

**Figure 17-32** Output Connector Selection

The screenshot shows a menu with a table of rear panel ports and their corresponding signals. The top of the menu displays 'FREQUENCY 4.000 000 000 00 GHz' and 'AMPLITUDE -136.00 dBm'. There are 'RF OFF' and 'MOD ON' buttons. The table has three columns: 'Rear Panel ports', 'Connector', and 'Signal'. The 'SFN reset-signal(DRPS5)' signal is highlighted. An arrow points to the 'Event2 Connector Selection' in the 'Rear Panel ports' column, and another arrow points to the highlighted signal in the 'Signal' column, labeled 'Highlighted Item'.

Rear Panel ports	Connector	Signal
Event1	BNC	DPCH TimeSlot-pulse(DRPS25)
Event2	BNC	<b>SFN reset-signal(DRPS5)</b>
Event3	AUX Pin 19	DPCH ChipARB-FramePulse(DRPS40)
Event4	AUX Pin 18	SFN sync-pulse(DRPS6)
Data out	AUX Pin 7	DPCH TPC-Bits-Out(DRPS41)
Data clock out	AUX Pin 6	3.84MHz Chip-clock(DRPS4)
Symbol Sync out	AUX Pin 5	80ms Frame-Pulse(DRPS13)

Additional signals listed on the right side of the menu: 3.84MHz Chip-clk (DRPS4), SFN reset-signal (DRPS5), SFN sync-pulse (DRPS6), SCH slot-pulse (DRPS10), 10ms Frame Pulse (DRPS11), 80ms Frame Pulse (DRPS13).  
 More (1 of 5)

W-CDMA Downlink Digital Modulation for Receiver Test (Option 400)  
**Configuring Rear Panel Output Signals**

2. Press **More (1 of 5) > More (2 of 5) > DPCH data-clk(DRPS28)**.

Notice that in row two of the table editor under the column Signal, the text SFN reset-signal (DRPS5) changed to DPCH data-clk (DRPS28). This corresponds to the Event2 connector listed in the Rear Panel ports column. [Figure 17-33](#) shows what the ESG display looks like after the DPCH data-clock selection is made.

**Figure 17-33 Output Trigger Signal Selection**

Rear Panel ports	Connector	Signal
Event1	BNC	DPCH TimeSlot-pulse (DRPS25)
Event2	BNC	<b>DPCH data-clk (DRPS28)</b>
Event3	AUX Pin 19	DPCH ChipARB-FramePulse (DRPS40)
Event4	AUX Pin 18	SFN sync-pulse (DRPS6)
Data out	AUX Pin 7	DPCH TPC-Bits-Out (DRPS41)
Data clock out	AUX Pin 6	3.84MHz Chip-clock (DRPS4)
Symbol Sync out	AUX Pin 5	80ms Frame-Pulse (DRPS13)

10ms Frame-Pulse (DRPS26)
DPCH data-clk (DRPS28)
DPCH data-clk withoutDTX (DRPS30)
DPCH Compressed Frame Indicator (DRPS32)
DPCH Gap Indicator (DRPS33)
PICH data-clk (DRPS34)
More (3 of 5)

To exit this display, press either **Mode Setup** to return to the first-level W-CDMA softkey menu or press **Return** until you come to the desired softkey menu/display.

### Deselecting an Output Signal

This procedure builds upon the previous procedure [Selecting an Output Signal](#).

1. Press **More (3 of 5) > More (4 of 5)**.
2. Highlight the Event2 connector listing.
3. Press **NONE(DRPS0)**.

Notice that the output signal selection listed in the Signal column has changed to None (RPS0) and is shown in [Figure 17-34](#). The none indicates that there is no signal output selected for the corresponding connector.

**Figure 17-34** Deselected Signal

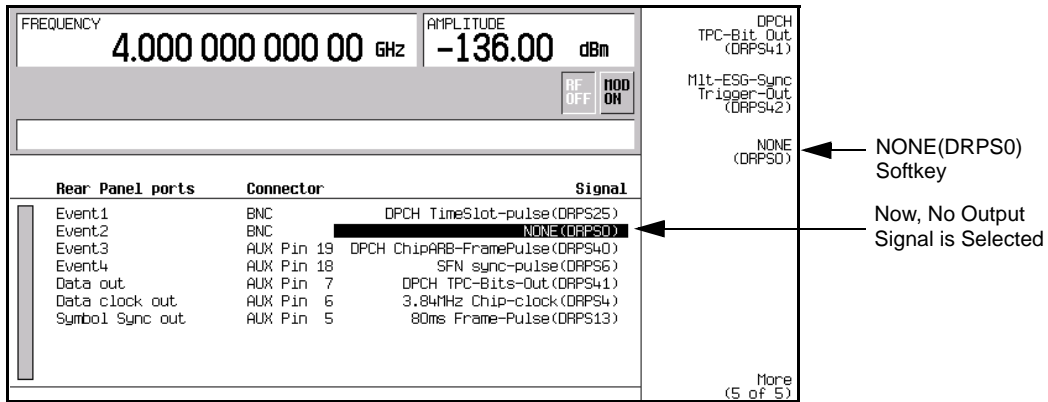

## Rear Panel Output Signal Descriptions

Table 17-2 describes the different downlink rear panel output signals available on the ESG. The DRPSxx designator, shown in parenthesis, refers to the remote SCPI command parameter that corresponds to the particular softkey selection. For example, the designator DRPS4 refers to the SCPI command parameter for a 3.84 MHz chip-clock signal.

**Table 17-2** Downlink Rear Panel Output Signals

Signal Name	Description
3.84 MHz chip-clk (DRPS4)	Assigns a 3.84 MHz chip clock signal to the selected rear panel output port.
SFN reset-signal (DRPS5)	Assigns a system frame number (SFN) reset-signal to the selected rear panel output port.
SFN sync pulse (DRPS6)	Assigns a system frame number (SFN) synchronization pulse to the selected rear panel output port.
SCH slot pulse (DRPS10)	Assigns the synchronization channel pulse to the selected rear panel output port.
10ms Frame pulse (DRPS11)	Assigns the 10 millisecond frame pulse to the selected rear panel output port.
80ms Frame pulse (DRPS13)	Assigns the 80 millisecond frame pulse to the selected rear panel output port.

**Configuring Rear Panel Output Signals**

**Table 17-2 Downlink Rear Panel Output Signals**

<b>Signal Name</b>	<b>Description</b>
DPDCH data-clk withDTX (DRPS20)	Assigns the dedicated physical data channel (DPDCH) data clock to the selected rear panel output port. This is a continuous pulsed signal that is not affected by the transmission gaps incurred during compressed frame operation.
DPCCH TPC data-clk (DRPS21)	Assigns the dedicated physical control channel (DPCCH) transmit power control (TPC) data clock to the selected rear panel output port.
DPCCH TFCI data-clk (DRPS22)	Assigns the dedicated physical control channel (DPCCH) transmit format combination indicator (TFCI) data clock to the selected rear panel output port.
DPCCH Pilot data-clk (DRPS23)	Assigns the dedicated physical control channel pilot data clock to the selected rear panel output port.
DPCH data-stream (DRPS24)	Assigns the DPCH data stream to the selected rear panel output port (prior to spreading and scrambling).
DPCH TimeSlot pulse (DRPS25)	Assigns the DPCH timeslot pulse to the selected rear panel output port.
DPCH 10ms Frame Pulse (DRPS26)	Assigns the DPCH 10 millisecond frame pulse to the selected rear panel output port.
DPCH data-clk (DRPS28)	Assigns the DPCH data clock to the selected rear panel output port.
DPDCH data-clk withOutDTX (DRPS30)	Assigns the dedicated physical data channel (DPDCH) data clock to the selected rear panel output port. This signal provides DTX periods that reflects the absence of DPDCH data during the transmission gaps that are incurred during compressed frame operation. When compressed mode is disabled, this signal performs the same function as the DRPS20 signal.
DPCH Compressed Frame Indicator (DRPS32)	Assigns the DPCH compressed frame indicator signal to the selected rear panel output port.
DPCH Gap Indicator (DRPS33)	Assigns the DPCH gap indicator signal to the rear panel output port for compressed mode.

**Table 17-2                      Downlink Rear Panel Output Signals**

<b>Signal Name</b>	<b>Description</b>
PICH data (DRPS35)	Assigns paging indicator channel (PICH) data to the selected rear panel output port.
PICH TimeSlot pulse (DRPS36)	Assigns the paging indicator channel (PICH) timeslot pulse to the selected rear panel output port.
PICH 10ms FramePulse (DRPS37)	Assigns the paging indicator (PICH) 10 millisecond frame pulse to the selected rear panel output port.
P-CCPCH data-clk (DRPS38)	Assigns the primary common control physical channel (P-CCPCH) data clock to the selected rear panel output port.
P-CCPCH data (DRPS39)	Assigns the primary common control physical channel (P-CCPCH) data to the selected rear panel output port.
DPCH ChipARB frame pulse (DRPS40)	Assigns the DPCH chip ARB frame pulse data to the selected rear panel output port.
DPCH TPC bits out (DRPS41)	Assigns the DPCH transmit power control (TPC) bits to the selected rear panel output port.
Mlt-ESG-Sync Trigger-Out (DRPS42)	Used to instantly synchronize the output signals of multiple ESGs while performing open-loop transmit diversity testing.

## W-CDMA Downlink Concepts

### DPCH Coding Block Diagram

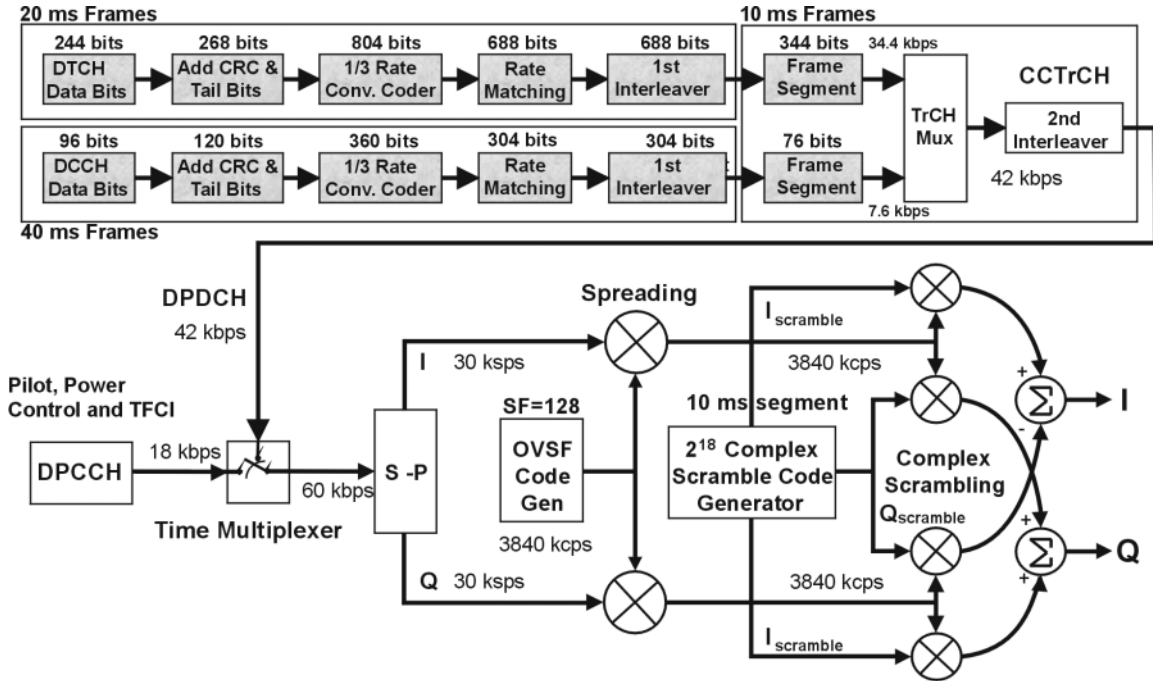

NOTE: Shaded areas of the graphic indicate pre-calculated values based on the user's collection of data and coding parameters. Multiplexing, scrambling and spreading are done real-time.

pk74c

### Reference Measurement Channels

Real time W-CDMA provides fully coded reference measurement channels (RMC) at 12.2, 64, 144, and 384 kbps, the AMR at 12.2 kbps, and the UDI ISDN at 64 kbps. Along with user defined parameters, all four RMCs, the AMR 12.2, and the UDI ISDN are supported for use with the compressed mode feature.

The signal generator provides one-button setup capabilities for transport channel configuration. The dedicated physical channel DCH (downlink) is automatically setup by pressing the **Ref Measure Setup** softkey (or sending the appropriate SCPI commands) and then selecting the desired data type. To activate the **Config Transport** softkey, one of the reference measurement rates must be selected or the DPCH Data field value must be set to Transport CH.

Table 17-3 describes the downlink RMC configurations generated by pressing the **Ref Measure Setup** softkey after the signal generator has been preset. Transport channel parameters can be modified in a table editor by pressing the **Config Transport** softkey, then moving the cursor to the desired data field and pressing **Edit Item**. DPCH parameters can be individually modified in a table editor by pressing **PhyCH Setup**, then moving the cursor to the desired data field and pressing **Edit Item**.

**Table 17-3 The Downlink RMC Predefined DPCH Configuration**

Parameter	DPCH Values at Specified Reference Measurement Channel					
Channel Rate	12.2 kbps	64 kbps	144 kbps	384 kbps	AMR 12.2 kbps	UDI ISDN 64 kbps
Power	0.00 dB	0.00 dB	0.00 dB	0.00 dB	0.00 dB	0.00 dB
Channel Code <sup>a</sup>	6	6	6	6	6	6
SecSrc Code OS	0	0	0	0	0	0
TPC Pat Steps	1	1	1	1	1	1
Data <sup>b</sup>	Ref 12	Ref 64	Ref 144	Ref 384	AMR 12	ISDN
Symbol Rate <sup>c</sup>	30.00 ksps	120.0 ksps	240.0 ksps	480.0 ksps	30.0 ksps	120.0 ksps
TFCI Pattern	00000000	00000000	00000000	00000000	00000000	00000000
TPC Pattern	Up/Down	Up/Down	Up/Down	Up/Down	Up/Down	Up/Down
Slot Format	11	13	14	15	8	13
Time Offset	0	0	0	0	0	0

- ESG Channel # 1 default shown. Default channel code for Channels 2 through 4 are based on the equation: Default Channel Code = (Channel #) + 5.
- If a transport configuration parameter is changed using the **Config Transport** softkey and the table editor, the Data field reverts to `Transport CH`, showing that it no longer contains a specified reference measurement channel.
- Symbol rate is not user-selectable. It is coupled to slot format. To change the symbol rate, use the appropriate slot format.

**W-CDMA Downlink Concepts**

**Scramble Codes**

The real time I/Q baseband 3GPP W-CDMA personality implements scrambling codes for downlink OCNS and DPCH channels in compliance with the 3GPP specifications. This is done through the use of the Scrambling Code (primary scramble code) field, located in the BS setup menu, and the SecScr Code OS (secondary scramble code offset) fields located in the OCNS and DPCH Physical Channel Setup menus. These fields are linked so that an entry to any field affects the actual scramble code. To better understand the relationship, refer to the following formula:

$$n = (16 \times i) + k$$

**Table 17-4**

Where $n$ = scramble code	Range: 0 to 8191
$i$ = Primary Scrambling Code field input	Range 0 to 511
$k$ = SecScr Code OS field input	Range: 0 to 15

The primary and secondary sets are determined by the SecScr Code OS field values. If the SecScr Code OS field value is zero, then the scramble code is in the primary set. Any non-zero entry enables the secondary set. The SecScr Code OS field value has a range of 0 through 15.

A primary scramble code is the product of the Scrambling Code field value and 16. Therefore, the primary scramble code set contains all the multiples of 16, from 0 through 8176.

A secondary scramble code is the sum of the non-zero SecScr Code OS field value and the primary scramble code. The secondary scramble code set uses the numbers in between the multiples of 16.

Thus, all numbers from 0 through 8191 are available for scramble codes.

Refer to the following for examples of scramble codes generated with the primary and secondary sets:

$$n = (16 \times i) + k$$

**Table 17-5**

Where $n$ = scramble code
$i$ = Scrambling Code field input
$k$ = SecScr Code OS field input



**Table 17-6**

**A: Primary set**

$i = 6$   
 $k = 0$   
 $n = 96$

**B: Secondary set**

$i = 8$   
 $k = 7$   
 $n = 135$

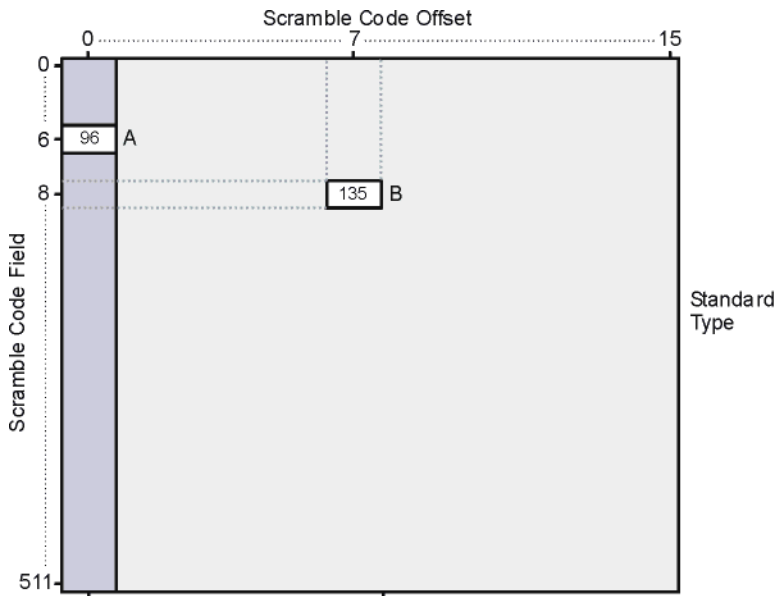

**W-CDMA AWGN Measurements and Bandwidths**

The AWGN (additive white Gaussian noise) feature produces a noise signal across a 7.68 MHz bandwidth (2x the W-CDMA 3.84 MHz bandwidth) and lets you enter values that adjust the noise level across this spectrum. To resolve the noise signal's effect on the W-CDMA signal, the ESG also displays noise values across the W-CDMA 3.84 MHz bandwidth. In addition, the AWGN feature shows the bandwidth of the noise signal during the period when it has a flat frequency response. This is called the flat-noise bandwidth. [Figure 17-35](#) shows the different noise settings/values as they appear on the W-CDMA AWGN display along with a graphical representation of the noise signal showing the different bandwidth features.

W-CDMA Downlink Concepts

Figure 17-35 Noise Measurement Bandwidths

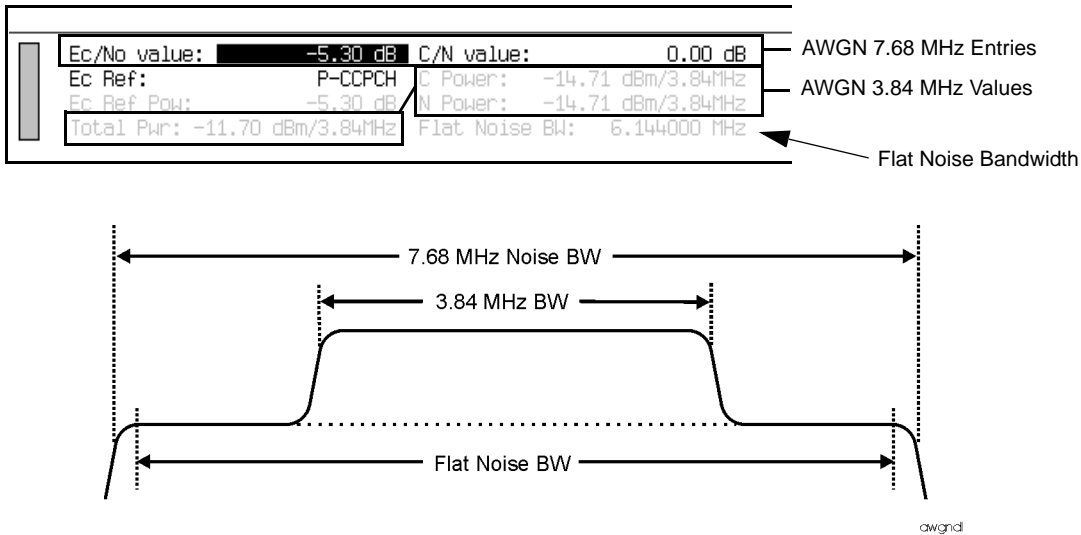

As shown in Figure 17-35, the noise signal is added to the W-CDMA signal across the entire W-CDMA signal spectrum. The ESG gives you two ways to control the noise level. You can set the noise using either  $E_c/N_o$  (energy per chip to noise power density ratio) or  $C/N$  (carrier power to noise power ratio). Any adjustment to either noise parameter,  $E_c/N_o$  or  $C/N$ , will affect the other; they are not mutually exclusive.  $E_c/N_o$  lets you set the noise power relative to the power of a channel, versus setting the noise relative to the carrier power ( $C/N$ ). For example, if you select the P-CCPCH (called a reference channel), the power level of this channel is used in the ratio for  $E_c/N_o$ . Figure 17-36 shows the downlink channel selections for  $E_c/N_o$  and the channel reference fields.

**Figure 17-36**  $E_c/N_0$  Reference Selection

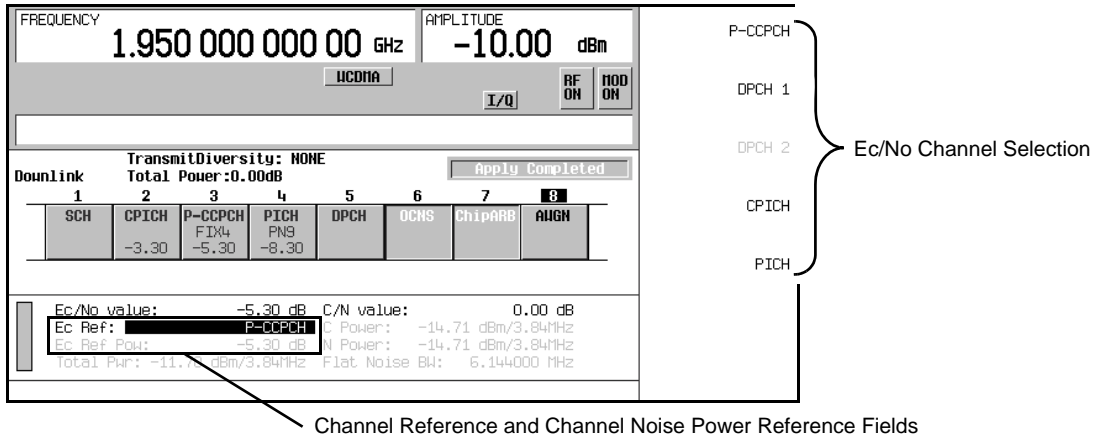

When  $E_c/N_0$  is 0.0 dB, C/N is equal to the reference channel power. This is demonstrated in the following C/N formula:

$$C/N = (E_c \text{ Ref Pow} - E_c/N_0)$$

The total noise power in a 3.84 MHz bandwidth is calculated using the following formula:

$$T_p = 10 \text{ Log}[(C_w + N_w) / .001]$$

$T_p$  = total noise power (dBm)

$C_w$  = linear carrier power (watts) across the 3.84 MHz bandwidth

$N_w$  = linear noise power (watts) across the 3.84 MHz bandwidth

These formulas clearly show the relationship between  $E_c/N_0$  and C/N and their effect on the total noise power across the 3.84 MHz bandwidth.

## **Special Power Control Considerations When Using Compressed Mode**

When using the compressed mode, more than a single power level is required. In addition to the rapidly varying power levels for the DPCH, there are also periods of discontinuous transmission (gaps where no RF is transmitted). This is why the signal generator turns off the ALC when the compressed mode is turned on. Because the ALC is turned off, the output power level may not be consistent with the power level entered on the ESG, so a manual power search must be performed in order to ensure the correct output power level. Pressing the **Do Power Search** softkey executes the manual power search function. This is demonstrated in the task [“Performing a Manual Power Search” on page 631](#).

Temperature changes or changes to certain signal generator settings may cause the output power level to change over time. It is recommended that you perform a manual power search at least every hour to maintain the correct output power level.

## W-CDMA Frame Structures

This section contains graphical representations of W-CDMA frame structures, with associated tables, for downlink channels.

### Downlink PICH Frame Structure

Figure 17-37 PICH Frame Structure

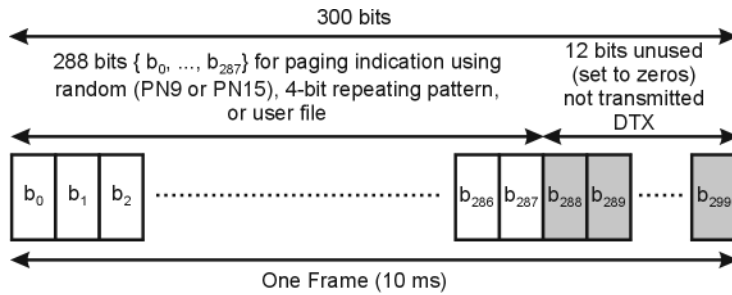

Symbol rate = 15 ksp/s

pk767b

**W-CDMA Frame Structures**

**Downlink PCCPCH + SCH Frame Structure**

**Figure 17-38 PCCPCH + SCH Frame Structure**

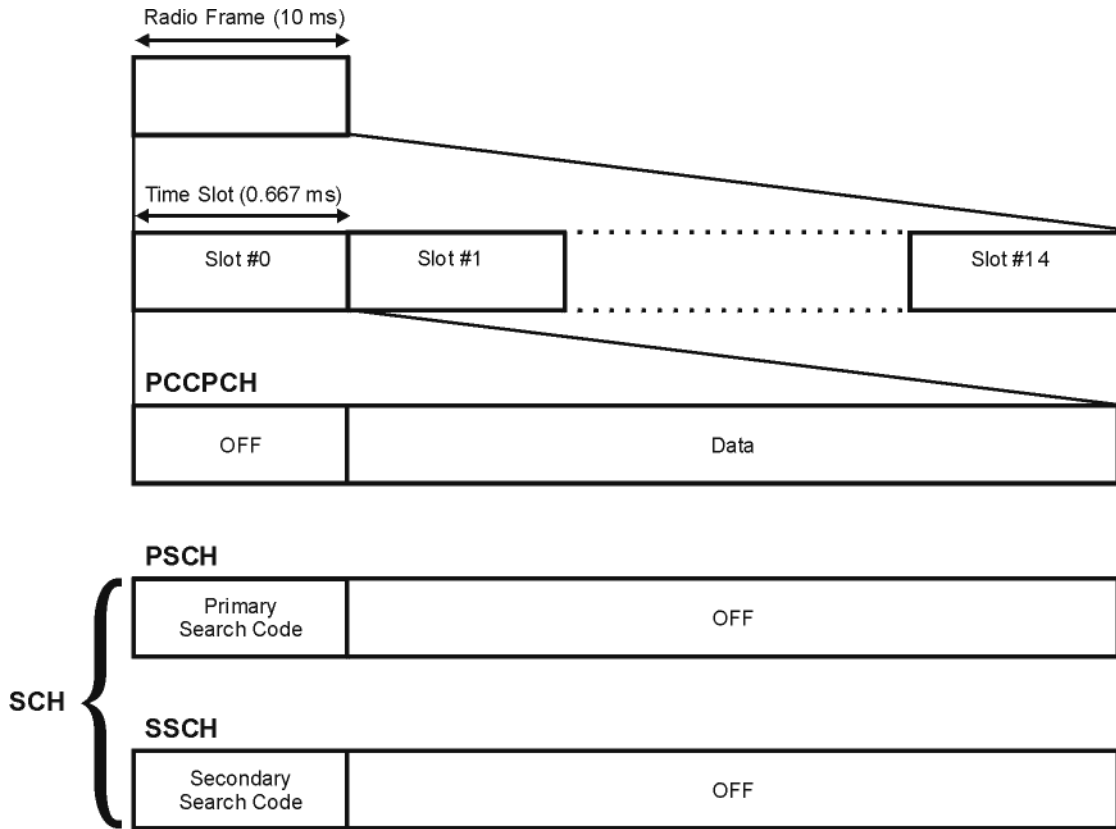

pk760b

**Table 17-7 Lengths of PCCPCH + SCH Fields**

Parameter	Symbols Per Slot
$N_{data}$	9
$N_{SCH}^a$	1

a. SCH comprises PSCH and SSCH

### Downlink DPCCH/DPDCH Frame Structure

Figure 17-39 DPCCH/DPDCH Frame Structure

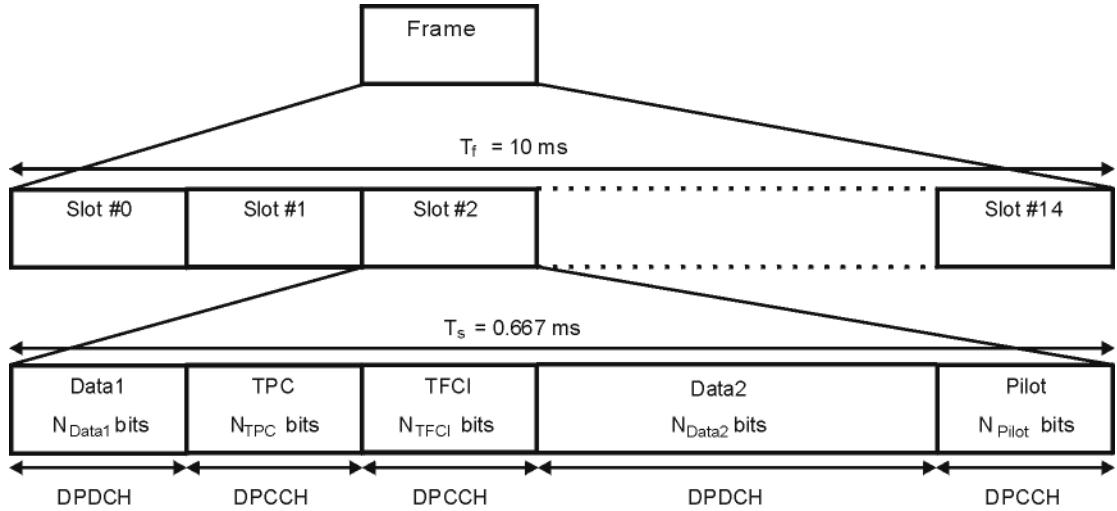

pk761b

Table 17-8 DPDCH and DPCCH Fields

Channel Bit Rate (Kbps)	Channel Symbol Rate (Ksps)	Spread Factor	Bits/Frame			Bits/Slot	DPDCH Bits/Slot		DPCCH Bits/Slot		
			DPDCH	DPCCH	TOTAL		$N_{\text{data1}}$	$N_{\text{data2}}$	$N_{\text{TFCI}}$	$N_{\text{TPC}}$	$N_{\text{pilot}}$
15	7.5	512		90	150	10	0	4	0	2	4
15	7.5	512	30	120	150	10	0	2	2	2	4
30	15	256	240	60	300	20	2	14	0	2	2 <sup>a</sup>
30	15	256	210	90	300	20	2	12	2	2	2 <sup>a</sup>
30	15	256	210	90	300	20	2	12	0	2	4 <sup>a</sup>
30	15	256	180	120	300	20	2	10	2	2	4 <sup>a</sup>
30	15	256	150	150	300	20	2	8	0	2	8 <sup>a</sup>
30	15	256	120	180	300	20	2	6	2	2	8 <sup>a</sup>

**W-CDMA Frame Structures**

**Table 17-8 DPDCH and DPCCH Fields (Continued)**

Channel Bit Rate (Kbps)	Channel Symbol Rate (Ksps)	Spread Factor	Bits/Frame			Bits/Slot	DPDCH Bits/Slot		DPCCH Bits/Slot		
			DPDCH	DPCCH	TOTAL		$N_{data1}$	$N_{data2}$	$N_{TFCI}$	$N_{TPC}$	$N_{pilot}$
60	30	128	510	90	600	40	6	28	0	2	4 <sup>a</sup>
60	30	128	480	120	600	40	6	26	2	2	4 <sup>a</sup>
60	30	128	450	150	600	40	6	24	0	2	8 <sup>a</sup>
60	30	128	420	180	600	40	6	22	2	2	8 <sup>a</sup>
120	60	64	900	300	1200	80	12	48	8 <sup>b</sup>	4	8
240	120	32	2100	300	2400	160	28	112	8 <sup>b</sup>	4	8
480	240	16	4320	480	4800	320	56	232	8 <sup>b</sup>	8	16
960	480	8	9120	480	9600	640	120	488	8 <sup>b</sup>	8	16
1920	960	4	18720	480	19200	1280	248	1000	8 <sup>b</sup>	8	16

- a. The number of pilot bits can vary with channel symbol rates of 15 and 30 ksp/s.
- b. If TFCI bits are not used, then DTX (discontinuous transmission) is used in the TFCI field.



---

# 18 Troubleshooting

If the signal generator is not operating properly, refer to the proper section in this chapter for a possible solution. If you do not find a solution, refer to the *E4428C/38C ESG Signal Generators Service Guide*.

---

**NOTE** If the signal generator displays errors, always read the error message text by pressing **Utility > Error Info**.

---

The following list shows the topics covered by this chapter:

- “Basic Signal Generator Operations” on page 658
- “Signal Generator Lock-Up” on page 666
- “Error Messages” on page 668
- “Upgrading Firmware” on page 671
- “Returning a Signal Generator to Agilent Technologies” on page 672
- “Contacting Agilent Sales and Service Offices” on page 673

## **Basic Signal Generator Operations**

### **Cannot Turn Off Help Mode**

1. Press **Utility** > **Instrument Info/Help Mode**
2. Press the **Help Mode Single Cont** softkey until Single is highlighted.

The signal generator has two help modes; single and continuous.

When you press **Help** in single mode (the factory preset condition), help text is provided for the next key you press. Pressing another key will exit the help mode and activate the key's function.

When you press **Help** in continuous mode, help text is provided for the next key you press and that key's function is also activated (except for **Preset**). You will stay in help mode until you press **Help** again or change to single mode.

### **No RF Output**

Check the RF ON/OFF annunciator on the display. If it reads RF OFF, press **RF On/Off** to toggle the RF output on.

### **The Power Supply has Shut Down**

If the power supply is not working, it requires repair or replacement. There is no user-replaceable power supply fuse. Refer to the *E4428C/38C ESG Signal Generators Service Guide* for instructions.

## Signal Loss While Working with Mixers

If you experience signal loss at the signal generator's RF output during low-amplitude coupled operation with a mixer, you can solve the problem by adding attenuation and increasing the RF output amplitude of the signal generator.

Figure 18-1 on page 659 shows a hypothetical configuration in which the signal generator provides a low amplitude signal to a mixer.

**Figure 18-1** Effects of Reverse Power on ALC

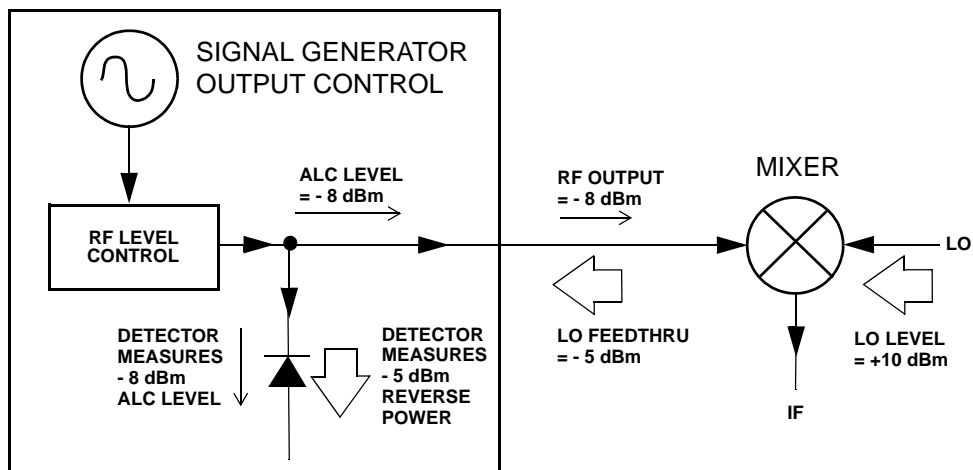

The internally leveled signal generator RF output (and ALC level) is  $-8$  dBm. The mixer is driven with an LO of  $+10$  dBm and has an LO-to-RF isolation of 15 dB. The resulting LO feedthrough of  $-5$  dBm enters the signal generator's RF output connector and arrives at the internal detector.

Depending on frequency, it is possible for most of this LO feedthrough energy to enter the detector. Since the detector responds to its total input power regardless of frequency, this excess energy causes the ALC to reduce the RF output of the signal generator. In this example, the reverse power across the detector is actually greater than the ALC level, which may result in loss of signal at the RF output.

Figure 18-2 on page 660 shows a similar configuration with the addition of a 10 dB attenuator connected between the RF output of the signal generator and the input of the mixer. The signal generator's ALC level is increased to  $+2$  dBm and transmitted through a 10 dB attenuator to achieve the required  $-8$  dBm amplitude at the mixer input.

Figure 18-2 Reverse Power Solution

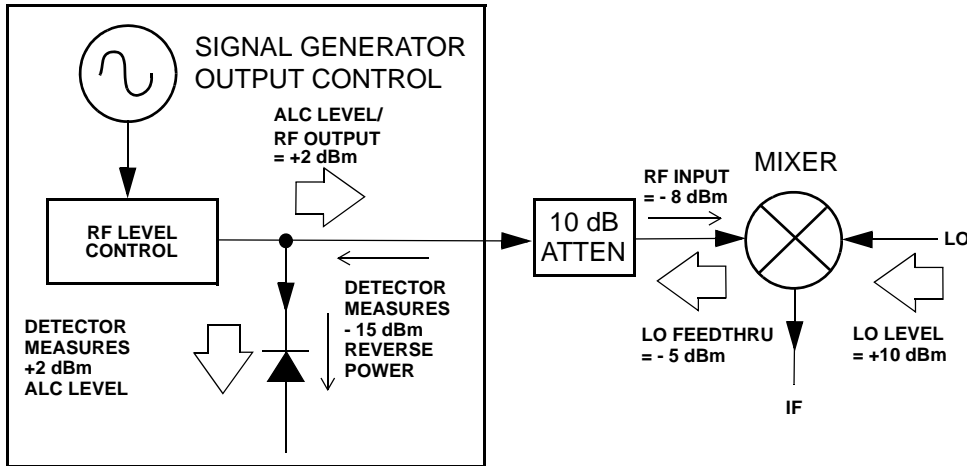

Compared to the original configuration, the ALC level is 10 dB higher while the attenuator reduces the LO feedthrough (and the RF output of the signal generator) by 10 dB. Using the attenuated configuration, the detector is exposed to a +2 dBm desired signal versus the -15 dBm undesired LO feedthrough. This 17 dB difference between desired and undesired energy results in a maximum 0.1 dB shift in the signal generator's RF output level.

### Signal Loss While Working with Spectrum Analyzers

The effects of reverse power can cause problems with the signal generator's RF output when the signal generator is used with a spectrum analyzer that does not have preselection capability.

Some spectrum analyzers have as much as +5 dBm LO feedthrough at their RF input port at some frequencies. If the frequency difference between the LO feedthrough and the RF carrier is less than the ALC bandwidth, the LO's reverse power can cause amplitude modulation of the signal generator's RF output. The rate of the undesired AM equals the difference in frequency between the spectrum analyzer's LO feedthrough and the RF carrier of the signal generator.

Reverse power problems can be solved by using one of two unlevelled operating modes: ALC off or power search.

### ALC Off Mode

ALC off mode deactivates the automatic leveling circuitry prior to the signal generator's RF output. In this mode, a power meter is required to measure the output of the signal generator and assist in achieving the required output power at the point of detection.

To set the signal generator to the ALC off mode, follow these steps:

1. Press **Preset**.
2. Press **Frequency**, enter the required frequency, and terminate the entry with the appropriate terminator softkey.
3. Press **Amplitude**, enter the required amplitude, and terminate the entry with the appropriate terminator softkey.
4. Set **RF On/Off** to Off.
5. Press **Amplitude > ALC Off On** to Off.  
This deactivates the signal generator's automatic leveling control.
6. Monitor the RF output amplitude as measured by the power meter.
7. Press **Amplitude** and adjust the signal generator's RF output amplitude until the desired power is measured by the power meter.

### Power Search Mode

Power search mode executes a power search routine that temporarily activates the ALC, calibrates the power of the current RF output, and then disconnects the ALC circuitry.

To set the signal generator to manual fixed power search mode, follow these steps:

1. Press **Preset**.
2. Press **Frequency**, enter the required frequency, and terminate the entry with the appropriate terminator softkey.
3. Press **Amplitude**, enter the required amplitude, and terminate the entry with the appropriate terminator softkey.
4. Set **ALC Off On** to Off.  
This deactivates the ALC circuitry.
5. Set **RF On/Off** to On.
6. Press **Do Power Search**.  
This executes the manual fixed power search routine, which is the default mode.

There are three power search modes: manual, automatic, and span.

When **Power Search** is set to Manual, pressing **Do Power Search** executes the power search calibration routine for the current RF frequency and amplitude. In this mode, if there is a change in RF frequency or amplitude, you will need to press **Do Power Search** again.

When **Power Search** is set to Auto, the calibration routine is executed whenever the frequency or amplitude of the RF output is changed.

When **Power Search** is set to Span, pressing **Do Power Search** executes the power search calibration routine over a selected range of frequencies at one time. The power search corrections are then stored and used whenever the signal generator is tuned within the selected range of frequencies.

### RF Output Power too Low

1. Look for an OFFS or REF indicator in the AMPLITUDE area of the display.

OFFS tells you that an amplitude offset has been set. An amplitude offset changes the value shown in the AMPLITUDE area of the display but does not affect the output power. The amplitude displayed is equal to the current power output by the signal generator hardware plus the value for the offset.

To eliminate the offset, press the following keys:

**Amplitude > More (1 of 2) > Ampl Offset > 0 > dB.**

REF tells you that the amplitude reference mode is activated. When this mode is on, the displayed amplitude value is *not* the output power level. It is the current power output by the signal generator hardware minus the reference value set by the **Ampl Ref Set** softkey.

To exit the reference mode, follow these steps:

- a. Press **Amplitude > More (1 of 2)**.
- b. Press **Ampl Ref Off On** until Off is highlighted.

You can then reset the output power to the desired level.

2. If you are using the signal generator with an external mixer, see [“Signal Loss While Working with Mixers” on page 659](#).
3. If you are using the signal generator with a spectrum analyzer, see [“Signal Loss While Working with Spectrum Analyzers” on page 660](#).

## No Modulation at the RF Output

Check the MOD ON/OFF annunciator on the display. If it reads MOD OFF, press **Mod On/Off** to toggle the modulation on.

Although you can set up and enable various modulations, the RF carrier is modulated only when you have also set **Mod On/Off** to On.

On the E4438C for digital modulation, make sure that **I/Q Off On** is set to On.

## Sweep Appears to be Stalled

The current status of the sweep is indicated as a shaded rectangle in the progress bar. You can observe the progress bar to determine if the sweep is progressing. If the sweep appears to have stalled, check the following:

- o Have you turned on the sweep by pressing any of the following key sequences?
  - Sweep/List > Sweep > Freq**
  - Sweep/List > Sweep > Ampl**
  - Sweep/List > Sweep > Freq & Ampl**
- o Is the sweep in continuous mode? If the sweep is in single mode, be sure that you have pressed the **Single Sweep** softkey at least once since completion of the prior sweep. Try setting the mode to continuous to determine if the missing single sweep is blocking the sweep.
- o Is the signal generator receiving the appropriate sweep trigger? Try setting the **Sweep Trigger** softkey to Free Run to determine if a missing sweep trigger is blocking the sweep.
- o Is the signal generator receiving the appropriate point trigger? Try setting the **Point Trigger** softkey to Free Run to determine if a missing point trigger is blocking the sweep.
- o Is the dwell time appropriate? Try setting the dwell time to one second to determine if the dwell time was set to a value which was too slow or too fast for you to see.
- o Do you have at least two points in your step sweep or list sweep?

## Cannot Turn Off Sweep Mode

Press **Sweep/List > Sweep > Off**.

In the sweep mode menu you can choose to set the sweep to various sweep types or to turn sweep off.

## Incorrect List Sweep Dwell Time

If the signal generator does not dwell for the correct period of time at each sweep list point, follow these steps:

1. Press **Sweep/List > Configure List Sweep**.  
This displays the sweep list values.
2. Check the sweep list dwell values for accuracy.
3. Edit the dwell values if they are incorrect.

---

**NOTE** The effective dwell time at the RF OUTPUT connector is the sum of the value set for the dwell plus processing time, switching time, and settling time. This additional time added to the dwell is generally a few milliseconds. The TTL/CMOS output available at the TRIG OUT connector, however, is asserted high only during the actual dwell time.

---

If the list dwell values are correct, continue to the next step.

4. Observe if the **Dwell Type List Step** softkey is set to Step.  
When Step is selected, the signal generator will sweep the list points using the dwell time set for step sweep rather than the sweep list dwell values.  
To view the step sweep dwell time, follow these steps:
  - a. Press **Configure Step Sweep**.
  - b. Observe the value set for the **Step Dwell** softkey.

## List Sweep Information is Missing from a Recalled Register

List sweep information is not stored as part of the instrument state in an instrument state register. Only the current list sweep is available to the signal generator. List sweep data can be stored in the instrument catalog. For instructions, see “[Storing Files](#)” on page 69.



## Data Storage

### Registers With Previously Stored Instrument States are Empty

The save/recall registers are backed-up by a battery when line power to the signal generator is not connected. The battery may need to be replaced.

To verify that the battery has failed, follow these steps:

1. Turn off line power to the signal generator.
2. Unplug the signal generator from line power.
3. Plug in the signal generator.
4. Turn on the signal generator.
5. Observe the display for error messages.

If either error message –311 or –700 is stored in the error message queue, the signal generator's battery has failed.

6. Refer to the *E4428C/38C ESG Signal Generators Service Guide* for battery replacement instructions.

### Saved an Instrument State in a Register but the Register is Empty or Contains the Wrong State

If you have selected a register number that is greater than 99, the signal generator will automatically select register 99 to save your instrument state.

If the register number you intended to use is empty or contains the wrong instrument state, press the following keys:

**Recall > 99 > Enter.**

This recalls register 99. The lost instrument state may be saved there.

## Signal Generator Lock-Up

If the signal generator is locked up, check the following:

- Make sure that the signal generator is not in remote mode. (In remote mode, the R annunciator will appear on the display.) Press **Local** to exit remote mode and unlock the front panel keypad.
- Make sure that the signal generator is not in local lockout condition. Local lockout will prevent front panel operation of the signal generator. For more information on local lockout, refer to the *E4428C/38C ESG Signal Generators Programming Guide*.
- Check for a progress bar on the signal generator display which indicates that an operation is in progress.
- Press **Preset**.
- Cycle power on the signal generator.

## Fail-Safe Recovery Sequence

The fail-safe recovery sequence should only be used if the previous suggestions do not resolve the problem.

---

**NOTE** This process will reset the signal generator, but it will destroy data.

---

The fail-safe recovery sequence will destroy the following types of data:

- all user files (instrument state and data files)
- DCFM/DCΦM calibration data
- persistent states

Do not attempt to perform any other front panel or remote operations during the fail-safe sequence.

To run the fail-safe sequence, follow these steps:

1. Hold down the **Preset** key while cycling power.

2. Continue to hold down the **Preset** key until the following message is displayed:

---

**WARNING**     You are entering the diagnostics menu which can cause unpredictable instrument behavior. Are you sure you want to continue?

---

---

**CAUTION**     Carefully read the entire message! It may list additional risks with this procedure.

---

3. Release the **Preset** key.
4. Press **Continue** to continue with the sequence (or **Abort** to abort with no lost files).

At the conclusion of the sequence, follow these steps:

1. Cycle power.

Cycling power restores all previously installed options. You should expect to see several error messages resulting from calibration files being restored from EEPROM.

2. Perform the DCFM/DCΦM calibration.

Refer to the **DCFM/DCΦM Cal** softkey description in the *E4428C/38C ESG Signal Generators Key and Data Field Reference Volume 1*.

3. Agilent Technologies is interested in the circumstances that made it necessary for you to initiate this procedure, please contact us using the website on [page 672](#). We would like to help you eliminate any repeat occurrences.

---

## Error Messages

If an error condition occurs in the signal generator, it is reported to both the front panel display error queue and the SCPI (remote interface) error queue. These two queues are viewed and managed separately; for information on the SCPI error queue, refer to the *E4428C/38C ESG Signal Generators Programming Guide*.

---

**NOTE** When there is an unviewed message in the front panel error queue, the ERR annunciator appears on the signal generator's display.

---

Characteristic	Front Panel Display Error Queue
Capacity (#errors)	30
Overflow Handling	Circular (rotating). Drops oldest error as new error comes in.
Viewing Entries	Press: <b>Utility &gt; Error Info &gt; View Next (or Previous) Error Page</b>
Clearing the Queue	Press: <b>Utility &gt; Error Info &gt; Clear Error Queue(s)</b>
Unresolved Errors <sup>a</sup>	Re-reported after queue is cleared.
No Errors	When the queue is empty (every error in the queue has been read, or the queue is cleared), the following message appears in the queue: 0 No Error Message(s) in Queue

a. Errors that must be resolved. For example, unlock.

## Error Message File

A complete list of error messages is provided in the file *errormessages.pdf*, on the CDROM supplied with your instrument.

In the error message list, an explanation is generally included with each error to further clarify its meaning. The error messages are listed numerically. In cases where there are multiple listings for the same error number, the messages are in alphabetical order.

## Error Message Format

When accessing error messages through the front panel display error queue, the error numbers, messages and descriptions are displayed on an enumerated (“1 of N”) basis.

Error messages appear in the lower-left corner of the display as they occur.

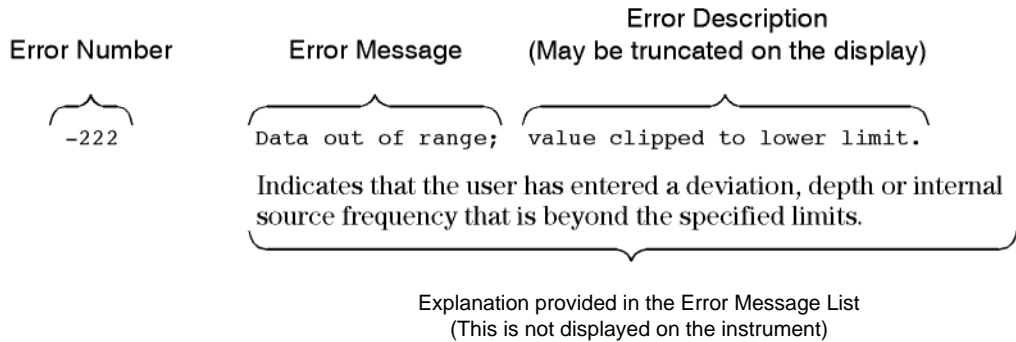

## Error Message Types

Events do not generate more than one type of error. For example, an event that generates a query error will not generate a device-specific, execution, or command error.

**Query Errors (–499 to –400)** indicate that the instrument’s output queue control has detected a problem with the message exchange protocol described in IEEE 488.2, Chapter 6. Errors in this class set the query error bit (bit 2) in the event status register (IEEE 488.2, section 11.5.1). These errors correspond to message exchange protocol errors described in IEEE 488.2, 6.5. In this case:

- Either an attempt is being made to read data from the output queue when no output is either present or pending, or
- data in the output queue has been lost.

**Device Specific Errors (–399 to –300, 201 to 703, and 800 to 810)** indicate that a device operation did not properly complete, possibly due to an abnormal hardware or firmware condition. These codes are also used for self-test response errors. Errors in this class set the device-specific error bit (bit 3) in the event status register (IEEE 488.2, section 11.5.1).

The <error\_message> string for a *positive* error is not defined by SCPI. A positive error indicates that the instrument detected an error within the GPIB system, within the instrument’s firmware or hardware, during the transfer of block data, or during calibration.

**Execution Errors (–299 to –200)** indicate that an error has been detected by the instrument’s execution control block. Errors in this class set the execution error bit (bit 4) in the event status register (IEEE 488.2, section 11.5.1). In this case:

- Either a <PROGRAM DATA> element following a header was evaluated by the device as outside of its legal input range or is otherwise inconsistent with the device’s capabilities, or
- a valid program message could not be properly executed due to some device condition.

Execution errors are reported *after* rounding and expression evaluation operations are completed. Rounding a numeric data element, for example, is not reported as an execution error.

**Command Errors (–199 to –100)** indicate that the instrument’s parser detected an IEEE 488.2 syntax error. Errors in this class set the command error bit (bit 5) in the event status register (IEEE 488.2, section 11.5.1). In this case:

- Either an IEEE 488.2 syntax error has been detected by the parser (a control-to-device message was received that is in violation of the IEEE 488.2 standard. Possible violations include a data element that violates device listening formats or whose type is unacceptable to the device.), or
- an unrecognized header was received. These include incorrect device-specific headers and incorrect or unimplemented IEEE 488.2 common commands.

## **Upgrading Firmware**

The firmware in your signal generator may be upgraded when new firmware is released. New firmware releases may contain signal generator features and functionality not available in previous firmware releases.

To inquire about the availability of new signal generator firmware, contact Agilent at <http://www.agilent.com/find/upgradeassistant>, or call 1 800 452 4844.

## Returning a Signal Generator to Agilent Technologies

To return your signal generator to Agilent Technologies for servicing, follow these steps:

1. Gather as much information as possible regarding the signal generator's problem.
2. Call the phone number listed on the Internet (<http://www.agilent.com/find/assist>) that is specific to your geographic location. If you do not have access to the Internet, contact your Agilent field engineer.

After sharing information regarding the signal generator and its condition, you will receive information regarding where to ship your signal generator for repair.

3. Ship the signal generator in the original factory packaging materials, if available, or use similar packaging to properly protect the signal generator.



## Contacting Agilent Sales and Service Offices

Assistance with test and measurements needs and information on finding a local Agilent office are available on the Internet at:

*<http://www.agilent.com/find/assist>*

You can also purchase E4428C/38C ESG accessories or documentation items on the Internet at:

*<http://www.agilent.com/find/esg>*

If you do not have access to the Internet, please contact your field engineer.

---

**NOTE** In any correspondence or telephone conversation, refer to the signal generator by its model number and full serial number. With this information, the Agilent representative can determine whether your unit is still within its warranty period.

---

Troubleshooting

**Contacting Agilent Sales and Service Offices**

**Symbols****ΦM**

- annunciator, [13, 34](#)
- configuring, [214](#)
- deviation, [214](#)
- rate, [214](#)

**Numerics**

- 007, option, [5, 24](#)
- 10 MHz IN connector, [18, 45](#)
- 10 MHz OUT connector, [18, 46](#)
- 2.1 MHz I/Q mod filter, [115](#)
- 2's complement description, [241, 254](#)
- 321.4 IN connector, [38](#)
- 40 MHz I/Q mod filter, [115](#)
- 50-pack
  - licensing, [197](#)
- 5-pack
  - history, waveform files, [200](#)
  - licensing, [195, 197](#)
- 601/602, option
  - description, [24](#)

**A**

- AC power receptacle, [17, 43](#)
- ACP, [91](#)
- activating a signal, [58](#)
- active entry area, [15, 36](#)
- adding & editing (instrument state), [71](#)
- alc
  - hold, [120–123](#)
    - description, [126](#)
    - saving settings, [125](#)
  - power search, [661](#)
- ALC OFF annunciator, [13, 34](#)
- ALT PWR IN connector pin, [41](#)
  - option 401, [339](#)
- AM
  - annunciator, [13, 34](#)
  - depth, [211](#)
  - modulation, [211](#)
  - rate, [211, 212](#)
  - wideband input connector, [32](#)
  - wideband procedure, [212](#)

- amplitude
  - display area, [15, 36](#)
  - hardkey, [7, 27](#)
  - LF output, [217, 218](#)
  - modulation. *See* AM
  - power search, [661](#)
- amplitude offset, [52](#)
- amplitude reference, [52](#)
- amplitude sensitivity search, [284](#)
- analog modulation, [5, 24, 209](#)
  - configuring, [210](#)
- annunciators, display area, [13–14, 34–36](#)
- ARB, [91](#)
  - triggers, [140](#)
  - waveform clipping, [149–156](#)
  - waveform scaling, [157–160](#)
- ARMED annunciator, [13, 34](#)
- arrow keys, [10, 30](#)
- ATTEN HOLD annunciator, [13, 34](#)
- Auto, I/Q mod filter, [115](#)
- AUTOGEN\_WAVEFORM file, [91, 93, 107](#)
- AUX I/O connector, [41](#)
- AWGN
  - dual ARB player, [112](#)

**B**

- baseband
  - clipping, [149–156](#)
  - scaling, [157–160](#)
- BASEBAND GEN REF IN connector, [46](#)
- baseband generator, [91](#)
  - custom arb mode, [24](#)
  - custom real-time I/Q mode, [25](#)
  - dual arb mode, [25](#)
  - multitone mode, [25](#)
  - options, [21](#)
- basic operation, [47–88](#)
- BBG DAC annunciator, [35](#)
- BCH synchronization, [279](#)
- BER connectors
  - BER CLK IN, [38](#)
  - BER DATA IN, [38](#)
  - BER GATE IN, [38](#)
- BER ERR OUT connector pin, [42](#)
- BER MEAS END connector pin, [42](#)

---

## Index

BER MEAS TRIG/BER NO DATA connector pin, 42

BER SYNC LOSS connector pin, 42

BER TEST OUT connector pin, 42

BER, DPCH transport channel, 521

BERT annunciator, 34

BERT, option UN7, 268

GPS, 369

GPS testing, 374

loopback test equipment setup, 273

bit file editor, using, 190

bits per symbol, equation, 175

block diagrams

frame structure

DPCCH/DPDCH downlink, 454, 655

DPCCH/DPDCH uplink, 456, 589

PCCPCH+SCH, 453, 654

PICH, 452, 653

GPS signal generation, 365

GPS subframe structures, 366

MSGPS signal generation, 358

Bluetooth marker behavior, 123

Bluetooth signal, setting up, 258

BURST GATE IN connector, 45

## C

calibration, 4, 23

carrier bandwidth, 112

carrier signal modulation, 60

carrier to noise ratio, 112

catalog, FIR files, 347

CCDF curve, 154–156

CDMA template, customizing, 350

cdma2000

component test, storing, 320, 321

forward link modulation, 312, 326

I/O timing relationships

forward link, 341

reverse link, 343

reverse link modulation, 316, 332

cdma2000, receiver test

forward link

adjusting code domain power, 328

base station setup, 326

changing channel states, 326, 327

configuring the RF output, 331

generating the baseband signal, 330

modifying channel parameters, 327

scaling to 0 dB, 328

setting EbNo, 330

setting equal channel powers, 329

setting noise parameters, 329

setting the carrier to noise ratio, 330

timing relationships, 341, 342

reverse link

adjusting code domain power, 334

changing channel states, 333

changing the operating mode, 332

configuring the RF output, 337

editing channel setups, 332

generating the baseband signal, 336

mobile setup, 332

modifying channel parameters, 333

scaling to 0 dB, 334

setting EbNo, 336

setting equal channel powers, 335

setting noise parameters, 335

setting the carrier to noise ratio, 336

timing relationships, 341, 342

ceiling function, bits per symbol, 175

certificate, license key, 84

channels

forward link, editing, 313, 317

PCCPCH+SCH, 453, 654

circular clipping, 155

clipping

CCDF curve, 154–156

circular, 152, 155

concepts, 149–154

procedure, 155, 156

rectangular, 152, 156

clock adjustment

phase and skew, 232

clock gate, 292

clock rate limits, logic type output, 220

clock source

setting, 244, 251

clock timing

parallel data, 227

parallel interleaved data, 230

- phase and skew, 232
- serial data, 232
- clocking, frequency reference, 224
- clocking, frequency reference diagrams, 226
- clocks per sample
  - parallel data, 227
  - parallel interleaved data, 230
- coefficient values, entering, 169
- COH CARRIER connector, 39
- comments, adding & editing (instrument state), 71
- common frequency reference diagrams, 226
- component test, 91
- components, testing, 311, 426, 438
- compressed mode, W-CDMA
  - downlink, 621
    - frame structure, 623
    - manual power search, 631, 652
  - uplink
    - manual power search, 584
    - multiple TGPS, 542
    - single TGPS, 531
- concepts
  - waveform clipping, 149–154
  - waveform markers, 125
  - waveform scaling, 157–159
- confidential data, 75
- connection diagram
  - user flatness correction, 63
- connections
  - common frequency reference, 226
- connectors, 338
  - 10 MHz IN, 18, 45
  - 10 MHz OUT, 18, 46
  - 321.4 IN, 38
  - ALT PWR IN, 41
  - ALT PWR IN, option 401, 339
  - AUX I/O, 41
  - BASEBAND GEN REF IN, 46
  - BER CLK IN, 38
  - BER DATA IN, 38
  - BER ERR OUT, 42
  - BER GATE IN, 38
  - BER MEAS END, 42
  - BER MEAS TRIG/BER NO DATA, 42
  - BER SYNC LOSS, 42
  - BER TEST OUT, 42
  - BURST GATE IN, 45
  - COH CARRIER, 39
  - DATA, 32
    - option 401, 338
  - DATA CLK OUT, 41
  - DATA CLK OUT, option 401, 340
  - DATA CLOCK, 31
    - option 401, 338
  - DATA OUT, 41, 339
  - DATA OUT, option 401, 339
  - digital bus, 43
  - EVENT 1, 40
    - option 401, 340
  - EVENT 2, 40, 340
    - option 401, 340
  - EVENT 3, 42
  - EVENT 4, 42
  - EXT 1 INPUT, 8, 28
  - EXT 2 INPUT, 8, 28
  - external triggering, 143
  - external triggering source, 145
  - front panel inputs, cdma2000, 338
  - GPIB, 17, 44
  - I, 32, 212
  - I OUT, 39
  - I-bar OUT, 38
  - LAN, 18, 44
  - LF OUTPUT, 8, 29
  - PATT TRIG IN, 41
  - PATT TRIG IN 2, 42
  - PATTERN TRIG IN, option 401, 339
  - Q, 32
  - Q OUT, 39
  - Q-bar OUT, 40
  - rear panel inputs, cdma2000, 339
  - rear panel outputs, cdma2000, 339
  - RF OUTPUT, 9, 29
  - RS 232, 17, 44
  - SWEEP OUT, 18, 45
  - SYM SYNC OUT, 42
    - option 401, 340
  - SYMBOL SYNC, 31
  - TRIG IN, 18, 45
  - TRIG OUT, 18, 45

---

## Index

- continuous
  - triggering, [142](#)
- continuous step sweep example, [55](#)
- continuous wave
  - description, [5](#), [24](#)
  - output, [50](#)
- contrast hardkeys, [10](#), [30](#)
- control part power, message part, [468](#)
- control timeslot ramping
  - GSM, [401](#)
  - GSM & EDGE, [398](#)
- correction array (user flatness)
  - configuration, [63](#)
  - load from step array, [64](#)
  - viewing, [64](#)
  - See also* user flatness correction
- creating waveform segments, [108](#)
- creating waveform sequences, [109](#)
- custom
  - CDMA template, editing, [350](#)
  - cdma2000 waveforms
    - creating, [322](#)
    - storing, [320](#), [321](#)
    - using, [324](#)
  - multicarrier CDMA waveforms
    - creating, [352](#)
    - editing, [354](#)
  - multicarrier TDMA waveforms
    - creating, [389](#)
  - RF output, configuring, [394](#)
  - TDMA digital modulation, [386](#)
- custom arb, [92](#)
- custom arb waveform generator, [24](#)
- custom mode, [91](#)
- custom real-time I/Q baseband, [25](#)
- CW mode
  - description, [5](#), [24](#)
- D**
- DAC over-range errors, [157–159](#)
- data
  - framed, [141](#)
  - input methods, [75](#)
  - patterns
    - triggering, [140](#)
    - removal, [78](#)
    - sensitive, [75](#), [78](#)
    - storage, [75](#)
    - unframed, [141](#)
- DATA CLK OUT connector pin, [41](#)
  - option 401, [340](#)
- DATA CLOCK connector, [31](#), [338](#)
- DATA connector, [32](#), [338](#)
- data fields
  - editing, [49](#)
- data files
  - creating, [190](#)
  - modifying, [193](#)
- data filtering, pre or post fir, [241](#), [254](#)
- DATA OUT connector pin, [41](#)
  - option 401, [339](#)
- data part power, message part, [469](#)
- data processing, [299](#)
- data storage
  - file types, [68](#)
  - troubleshooting, [665](#)
- data types, [236](#)
- declassification, [75](#)
- DECT framed modulation, [415](#)
- default navigation data, GPS, [366](#)
- default waveform file, [93](#)
- delay, external trigger signal, [142](#)
- Delete Item softkey, [49](#)
- Delete Row softkey, [49](#)
- description, adding & editing (instrument state), [71](#)
- device clock source selection, [244](#), [251](#)
- DHCP, [85](#)
- diagram
  - data types, [236](#)
- diagrams
  - clock timing
    - parallel data, [227](#)
    - parallel interleaved data, [230](#)
    - phase and skew, [232](#)
    - serial data, [232](#)
  - common frequency reference, [226](#)
- differential encoding, bits per symbol, [175](#)
- differential state map, bits per symbol, [175](#)
- digital bus, [43](#)
- digital modulation

annunciators, 36  
 component testing, 311, 426, 438  
 formats, 24  
 IQ map, QAM, 176  
 receiver testing, 395  
 TDMA, 386  
 W-CDMA, 425–456, 591–655  
 digital signal interface module  
   N5102A, 219  
 discrete steps, skew range, 232  
 display  
   active entry area, 15, 36  
   amplitude area, 15, 36  
   annunciators, 13, 14, 34, 36  
   blinking, 82  
   contrast hardkeys, 10, 30  
   description, 12, 33  
   error message area, 15, 36  
   secure, 82  
   softkey area, 15, 36  
   text area, 15, 36  
 documentation map, xxiii  
 downlink  
   DPCCH frame structure, 454, 655  
   DPCH slot formats A and B, 623  
   DPDCH frame structure, 454, 655  
   PCCPCH+SCH frame structure, 453, 654  
   PICH frame structure, 452, 653  
   scramble codes, 448  
 downlink errors, 304  
 downloading firmware, 3, 22  
 DPCCH  
   downlink frame structure, 454, 655  
   uplink frame structure, 456, 589  
 DPCH slot formats A and B, 623  
 DPCH, transport channel BER, 521  
 DPCH, uplink, TPC equipment setup, 527  
 DPDCH  
   downlink frame structure, 454, 655  
   uplink frame structure, 456, 589  
 dual ARB, 91, 101  
 dual ARB player, 25, 107–114  
 dual ARB real time noise, 112  
 dual arbitrary waveform generator, 25, 107–114

## E

EDGE  
   frame structure, 305  
   framed modulation, 396  
   framed modulation with GMSK, 396  
   timeslot ramping control, 398  
 Edit Item softkey, 49  
 editing file headers, 95, 101  
 editor, bit file, 190  
 equipment setup  
   DPCH and PRACH, 461, 566  
   DPCH, uplink, TPC, 527  
   multiple PRACH overload test, 511  
   PRACH AICH, 484, 486  
   user flatness correction, 63  
 equipment, user flatness correction, 61  
 Erase All, 79, 80, 81, 82  
 erase and overwrite, 79  
 erase and sanitize, 80  
 erased frame detection, 304  
 erasing memory, 75, 79, 80, 81, 82  
 ERR annunciator, 13, 34, 668  
 error messages  
   DAC over-range, 157–159  
   display area, 15, 36  
   message format, 669  
   overview, 668  
   queue, 668  
   types, 670  
 ESG  
   configuring GSM, 276  
   modes of operation, 5, 24  
 EVENT 1 connector, 40  
   option 401, 340  
 EVENT 2 connector, 40  
   option 401, 340  
 EVENT 3 connector pin, 42  
 EVENT 4 connector pin, 42  
 examples  
   ΦM, configuring, 214  
   AM, configuring, 211  
   continuous wave output, 50  
   custom cdma2000 state, storing, 320, 321  
   files  
     storing, 69

---

## Index

- viewing, 68
  - FIR filters
    - creating, 168
    - modifying, 173
    - using, 347
  - FM, configuring, 213
  - LF output, configuring, 216
  - options, enabling, 84
  - pulse modulation, configuring, 215
  - RF output, configuring, 50–57
  - swept output, 53
  - table editor, list mode values, 48
  - table editors, editing, 49
  - traffic channels, inserting, 315, 318
  - user flatness correction, 61–67
- EXT 1 INPUT connector, 8, 28
- EXT 2 INPUT connector, 8, 28
- EXT REF annunciator, 13, 34
- EXT1 annunciators, 13, 34
- EXT2 annunciators, 13, 34
- external clock source selection, 244, 251
- external modulation, 212
- external trigger
  - connection, 143
  - gated, setting, 143
  - source connector, 145
- ## F
- fail-safe recovery sequence, 666
- features, signal generator, 2, 20
- file header description, 96
- file headers
  - dual ARB, 101, 102
  - editing, 95, 101
  - generating, 101
  - overview, 93
  - playing waveforms, 105
  - sequences, 101
  - settings, 93
  - viewing, 101
  - viewing a different file, 103
- files, 70
  - FIR filter, using, 347
  - FSK, storing, 188
  - using, 68
  - waveform segments, 108, 113
  - waveform sequences, 109–112
  - See also* instrument state register
  - See also* memory catalog
- filtered & unfiltered samples, 241, 254
- filters
  - gaussian, loading default, 173
  - I/Q mod, 115, 117
  - interpolation, 157–159
  - nyquist, selecting, 387
- FIR filters
  - creating, 168
  - custom filter, using, 347
  - modifying, 173
  - storing, 172
- FIR table editor
  - accessing, 168
  - coefficients, duplicating, 169
  - coefficients, entering values, 169
  - coefficients, modifying, 174
  - files, loading, 173
  - filters
    - creating, 168
    - modifying, 173
    - storing, 172, 174
  - oversample ratio, setting, 170
- firmware
  - upgrades
    - obtaining, 3, 22
    - using GPIB, 3, 22
    - using LAN, 3, 22
    - using RS-232, 3, 22
- firmware, upgrading, 671
- flatness correction. *See* user flatness correction
- FM
  - annunciator, 13, 34
  - configuration example, 213
  - deviation, 213
  - rate, 213
- format, generating, 58
- formula, skew discrete steps, 232
- forward link modulation
  - cdma2000, 312
- forward link modulation, cdma2000, 326
- forward link traffic channels, inserting, 315, 318



- frame structure, 304, 452
    - downlink
      - compressed mode, 623
      - DPCCH, 454, 655
      - DPDCH, 454, 655
      - PCCPCH+SCH, 453, 654
      - PICH, 452, 653
    - uplink
      - DPCCH, 456, 589
      - DPDCH, 456, 589
  - framed data, 141
  - framed modulation
    - DECT, 415
    - EDGE, 396
    - GSM, 400
    - NADC, 421
    - PDC, 419
    - PHS, 417
    - TETRA, 423
  - free run trigger response, 142
  - frequency
    - display area, 12, 33
    - hardkey, 7, 26
    - LF output, 217
      - start and stop, swept-sine, 218
    - modulation. *See* FM
    - offset, 51
    - reference, 51
    - RF output, setting, 50
  - frequency output limits, clock rates & logic levels, 220
  - frequency reference
    - common, 224
    - hookup diagrams, 226
  - front panel
    - disabling keys, 82
    - display description, 12, 33
    - features, 6, 16, 26, 37
    - knob, 7, 27
  - front panel connectors, 338
  - front panel inputs
    - description, cdma2000, 338
  - FSK files, storing, 188
  - fundamental operation *See* basic operation
- G**
- gated triggering, 141, 143
  - gaussian filter, loading default, 173
  - GMSK modulation, 396
  - Goto Row softkey, 49
  - GPIO
    - connector, 17, 44
    - listener mode, 66
  - GPS
    - BER testing, 369, 374
    - chip clock reference, 367
    - configuring external reference clock, 371
    - data modes, 366
    - default navigation data, 366
    - handover word, 366
    - overview, 364
    - satellite ID range, 364
    - sensitivity testing, 373
    - signal generation diagram, 365
    - subframe indicator, 367
    - subframe structures, 366
    - TLM word, 366
    - user files, 369
  - green LED, 10, 31
  - GSM
    - configuring the ESG, 276
    - configuring the VSA, 275
    - frame structure, 304
    - framed modulation, 400
    - timeslot ramping control, 398, 401
- H**
- handover word, GPS, 366
  - hardkeys
    - Amplitude, 7, 27
    - arrow, 10, 30
    - contrast, 10, 30
    - Frequency, 7, 26
    - Help, 8, 28
    - Hold, 10, 30
    - Incr Set, 9, 30
    - Local, 10, 30
    - MENUS group, 7, 27
    - Mod On/Off, 9, 29

---

## Index

- numeric, 9, 29
  - Preset, 10, 30
  - Recall, 7, 27
  - Return, 10, 30
  - RF On/Off, 9, 29
  - Save, 7, 27
  - Trigger, 8, 28
  - header files, 93
  - Help hardkey, 8, 28
  - Hold hardkey, 10, 30
- I**
- I connector, 32, 212
  - I OUT connector, 39
  - I/O
    - functionality, 338
    - signal descriptions, 338
      - option 401, 338, 339
    - timing relationships, 338
  - I/O signal descriptions
    - option 401, 339
  - I/O timing relationships
    - cdma2000, forward link, 341
    - cdma2000, reverse link, 343
  - I/Q mod filters, 115, 117
  - I/Q waveform
    - clipping, 149–156
    - scaling, 157–160
  - I-bar OUT connector, 38
  - Incr Set hardkey, 9, 30
  - input connectors, 38
    - 10 MHz IN, 18, 45
    - 321.4 IN, 38
    - AUX I/O, 41
    - BASEBAND GEN REF IN, 46
    - BER CLK IN, 38
    - BER GATE IN, 38
    - BURST GATE IN, 45
    - DATA, 32
    - DATA CLOCK, 31
    - EXT 2 INPUT, 8, 28
    - GPIB, 17, 44
    - I, 32, 212
    - LAN, 18, 44
    - line power, 17, 43
    - PATT TRIG IN, 41
    - Q, 32
    - RS 232, 17, 44
    - SYMBOL SYNC, 31
    - TRIG IN, 18, 45
  - Insert Item softkey, 49
  - Insert Row softkey, 49
  - installation guide, xxiii
  - installing firmware, 3, 22
  - instrument state register
    - comments, adding and editing, 71
    - troubleshooting, 665
    - using, 70
    - See also* memory catalog
  - interface, remote
    - GPIB, returning to listener mode, 66
  - intermodulation distortion
    - how to minimize, 151
  - internal clock source selection, 244, 251
  - interpolation filter, 157–159
  - interslot ramping control, GSM, 401
  - interslot ramping control, GSM & EDGE, 398
- IQ**
- clock rates, 222
- IQ map, QAM modulation, 176**
- IS-95A modulation, 349**
- K**
- key, license, 84
  - keypad, numeric, 9, 29
  - keys
    - disabling, 82
  - knob, front panel, 7, 27
- L**
- L (listener mode) annunciator, 13, 34
  - lan configuration, 85
  - LAN connector, 18, 44
  - LEDs, 10, 31
  - left alternate scramble code, 450
  - LF output
    - amplitude, 217, 218
    - configuration example, 217, 218
    - description, 216

- frequency, 217
  - source
    - function generator, 218
    - internal modulation monitor, 217
  - swept-sine
    - start frequency, 218
    - stop frequency, 218
    - waveform, 210, 216, 218
  - LF OUTPUT connector, 8, 29
  - LFO. *See* LF output
  - license key, 84
  - licensing
    - waveforms, 195, 197
  - limits, clock & sample rates, logic outputs, 220
  - line power (green) LED, 10, 31
  - list mode values table editor example, 48
  - list sweep examples, 55–57
  - listener mode
    - annunciator, 13, 34
    - returning to, 66
  - Load/Store softkey, 49
  - loading segments, 113
  - Local hardkey, 10, 30
  - logic type
    - output levels, 220
    - selecting, 239
  - loopback BER
    - measuring, 282
  - low frequency output. *See* LF output
- M**
- manual power search
    - W-CDMA DL, 631
    - W-CDMA UL, 584
  - marker, Bluetooth behavior, 123
  - markers
    - waveform, 120–123, 124–139
  - measuring RF loopback BER, 273
  - media storage, 75
  - memory, 107
    - base instrument, 75
    - baseband generator, 75
    - erasing, 75, 79
    - hard disk, 75
    - overwriting, 79
    - persistence, 75
    - physical location, 75
    - sanitizing, 80
    - secure mode, 81
    - size, 75
    - types, 75
    - waveform, 75
    - writing to, 75
  - memory catalog
    - troubleshooting, 665
    - using, 68
    - See also* instrument state register
  - menu, hardkeys, 7, 27
  - menus
    - marker, 129
    - marker polarity, 139
    - trigger, 142
  - message part
    - control part power, 468
    - data part power, 469
    - scrambling code, 467
    - slot formats, 466
    - structure, 465
  - message part power examples, 472
  - message part power, PRACH, 472
  - mirror table, duplicating coefficients, 169
  - MOD ON/OFF annunciator, 14, 35
  - Mod On/Off hardkey, 9, 29, 60
  - mode, power search, 661
  - modes of operation, 5, 24
  - modes, triggering, 141
  - modify file header, 95
  - modulation
    - amplitude. *See* AM
    - analog, 5, 24, 209
      - configuring, 210
    - annunciators, 14, 35, 36
    - carrier signal, 60
    - component testing, 311, 426, 438
    - digital, 24
    - format generation, 58
    - forward link, cdma2000, 312
    - framed
      - DECT, 415
      - EDGE, 396

---

# Index

- GMSK, 396
- GSM, 400
- NADC, 421
- PDC, 419
- PHS, 417
- TETRA, 423
- frequency. *See* FM
- IS-95A, 349
- phase. *See*  $\Phi$ M
- pulse, 5, 24, 215
- receiver testing, 395
- reverse link, cdma2000, 316
- modulator, I/Q mod filters, 115, 117
- module user interface location, 238, 247
- MSGPS
  - chip rate, 363
  - external reference clock, 363
  - generating a signal, 362
  - RF power level, 360
  - scenario files, 357, 359, 362
  - signal generation diagram, 358
- multicarrier CDMA waveforms
  - creating, 352
  - editing, 354
- multicarrier cdma2000 waveforms
  - creating, 322
  - using, 324
- multicarrier TDMA waveforms
  - creating, 389
- multitone, 91
- multitone mode, 25
- multitone waveform, setup, 380

## N

- N5102A
  - baseband data, 238
  - clock rates, 220
  - clock settings, 242, 249
  - clock source
    - description, 223
  - clock timing, 220, 227
  - common frequency reference, 224
  - connections to clock and device, 234
  - data parameters, setting, 240, 253
  - data types, 236

- digital data, 255
- digital signal interface module, 219
- frequency reference connector, 225
- generating data, 246
- input direction, 248
- input mode, 236, 247
- interleaving clock timing, 230
- logic type, port configuration, 248
- logic types, 239
- output direction, 240
- output mode, 236, 238
- phase and skew clock timing, 232
- serial clock timing, 232
- user interface, 238
- user interface module, 247
- NADC framed modulation, 421
- negation description, 242, 255
- noise, 112
- noise bandwidth factor, 112
- non-volatile memory, 107
- numeric format selection, 241, 254
- numeric keypad, 9, 29
- NVWFM, 93, 107
- nyquist filter, selecting, 387

## O

- off/on key usage, modulation format, 58
- offset
  - amplitude, 52
  - frequency, 51
- offset binary use, 241, 254
- on/off switch, 11, 31
- operation
  - basic, 47–88
  - modes of, 5, 24
- Option 422, 355
- options, 3, 21
  - 007, 5, 24
  - 221-229, 195, 197
  - 250-259, 195, 197
  - 409, GPS, 364
  - 424, GPS, 364
  - 424, MSGPS, 357
  - 601/602
    - description, 24

- baseband generator, 21
    - enabling, 84
    - UN7, BERT, 268, 374
    - UNT, 5, 24
    - UNU, 5, 24
    - UNW, 5, 24
  - out of synchronization testing, W-CDMA DL, 614
  - output connectors
    - 10 MHz OUT, 18, 46
    - AUX I/O, 41
    - COH CARRIER, 39
    - EVENT 1, 40
    - EVENT 2, 40
    - GPIB, 17, 44
    - I OUT, 39
    - I-bar OUT, 38
    - LF OUTPUT, 8, 29
    - Q OUT, 39
    - Q-bar OUT, 40
    - RF OUTPUT, 9, 29
    - RS 232, 17, 44
    - SWEEP OUT, 18, 45
    - TRIG OUT, 18, 45
  - output levels, logic types, 220
  - output. *See* LF output *and* RF output
  - OVEN COLD annunciator, 14, 35
  - over-range errors, 157–159
  - overview, file headers, 93
  - overview, GPS, 364
  - overview, signal generator, 1–18, 19–46
  - overwriting memory, 79
- P**
- Page Down softkey, 49
  - Page Up softkey, 49
  - parallel
    - clock rates, 222
    - data clock timing, 227
    - interleaved data clock timing, 230
    - sample rates, 222
  - PATT TRIG IN 2 connector pin, 42
  - PATT TRIG IN connector, 41
  - PATTERN TRIG IN connector, option 401, 339
  - PCCPCH+SCH
    - frame structure, 453, 654
  - PDC framed modulation, 419
  - peak to average power
    - CCDF curve, 154
    - high ratios, 151
    - reducing, 152
  - phase clock timing, 232
  - phase modulation. *See*  $\Phi$ M
  - PHS framed modulation, 417
  - PICH frame structure, 452, 653
  - pilot power offset, 446
  - player, dual ARB, 107–114
  - polarity
    - markers, 139
    - trigger, external, 143
  - port configuration, selecting, 239
  - power
    - offsets, 446
    - peaks, 149–154
    - search, 661
    - sensor, models, 61
    - switch, 11, 31
  - power adjustment, timeslots, 398, 401
  - power control modes, 473
    - Pp-m, 473
    - total, 474
  - power meter
    - configuration, 62
    - user flatness correction, 61
  - power receptacle, 17, 43
  - power supply, troubleshooting, 658
  - Pp-m power control mode, 473
  - PRACH
    - AICH equipment setup, 484, 486
    - equipment setup, 461
    - overload test equipment setup, 511
  - PRACH power control
    - message part, 472
      - control part power, 468
      - data part power, 469
      - data part power formulas, 470, 471
      - power formula, 472
    - preamble power, 468
  - PRAM, 91
  - preamble
    - power control, 468

---

## Index

- scrambling codes, 465
  - signature, 464
- pre-fir samples selection, 241, 254
- Preset hardkey, 10, 30
- primary scramble code, 449
- private data, 75
- problems with security function, 82
- programming guide, xxiii
- proprietary data, 75
- protecting data, 75
- PSG
  - firmware, 3, 22
- PULSE annunciator, 14, 35
- pulse modulation, 5, 24
  - period, 215
  - width, 215
- pulse, marker, viewing, 136
- pulse/rf blank, 120–123
- Q**
- Q connector, 32
- Q OUT connector, 39
- QAM modulation IQ map, 176
- Q-bar OUT connector, 40
- queue, error, 668
- R**
- R (remote) annunciator, 14, 35
- ramping timeslots
  - GSM, 401
  - GSM & EDGE, 398
- real time, 91, 92
  - noise, 112
  - triggers, 140
- real-time mode, 25
- rear panel connectors, 339
- rear panel input signals
  - description, cdma2000, 339
  - description, W-CDMA UL, 568
  - locating, W-CDMA DL, 639
  - locating, W-CDMA UL, 557
- rear panel output signals
  - configuring, W-CDMA DL, 641
  - configuring, W-CDMA UL, 559
  - description, cdma2000, 339
  - description, W-CDMA DL, 643
  - description, W-CDMA UL, 568
- recall, 70
- Recall hardkey, 7, 27
- recall states, 70
- receiver test, 91
- receiver testing, real time TDMA, 395
- recovery sequence, fail-safe, 666
- rectangular clipping, 156
- reference
  - amplitude, 52
  - frequency, 51
  - GPS chip clock, 367
  - MSGPS chip clock, 363
- references, xxiii
- registers, 70, 74
- remote control
  - GPIB, returning to listener mode, 66
- remote operation annunciator, 14, 35
- removing sensitive data, 78
- repeat measurements, 300
- required equipment
  - GPS BER test, 374
  - W-CDMA transmit diversity, 603, 615, 624
- reset & run trigger response, 142
- response, triggering mode, 141
- restricted data, 75
- Return hardkey, 10, 30
- returning a signal generator, 672
- reverse link modulation
  - cdma2000, 316, 332
- RF blanking, 120–123
  - marker function, 137
  - settings, saving, 125
- RF loopback BER measurement, 273
- RF ON/OFF annunciator, 14, 35
- RF On/Off hardkey, 9, 29
- RF output
  - configuring, 50–57
  - connector, 9, 29
  - troubleshooting, 658
  - user flatness correction, 61–67
- right alternate scramble code, 450
- routing, marker, 126

- RF blanking, 137
- saving settings, 125
- RS-232, 17, 44
- runtime scaling, 159
  - dual ARB, 159
  - multitone, 160
- S**
- S (service request) annunciator, 14, 35
- sample
  - rates, 220
    - parallel/parallel intrlvd port configuration, 222
    - serial port configuration, 221
  - type selection, 241, 254
- samples
  - baseband, 157–159
  - interpolated, 157–159
- sanitizing memory, 80
- satellite ID range, GPS, 364
- save, 70
- save and recall states, 70
- Save hardkey, 7, 27
- scaling
  - concepts, 157–159
  - procedure, 159, 160
    - dual ARB, 159
    - multitone, 160
  - runtime, 159
    - dual ARB, 159
    - multitone, 160
  - waveform data, 160
- scenario files
  - MSGPS, 357, 359
    - downloading, 359
    - playing, 362
- SCH, TSTD, 601
- SCPI, 85
- SCPI reference, xxiii
- scramble codes
  - calculating, 648
  - downlink, calculating, 448
  - primary and secondary, 449
- scrambling code, message part, 467
- search, power, 661
- secondary scramble code, 449
- secure display, 82
- secure mode, 81
- security functions, 75, 81
  - problems with, 82
- security level, 81
- segment advance triggering, 142, 145
- segments, waveforms, 108, 113
- sensitive data, 75
- sensitivity testing, GPS, 373
- sequence file headers, 101
- sequences, 113
  - creating and storing, 109–112
  - deleting, 74
  - editing, 111
  - instrument state register, 70
  - marker control, 134
  - playing, 110
  - triggering, 140
- serial
  - clock and sample rates, 221
  - clock timing, 232
- service guide, xxiii
- service request annunciator, 14, 35
- service, Agilent sales and service offices, 673
- settings, file headers, 93
- signal generation, 58
- signal generator
  - firmware, 3, 22
  - firmware, upgrading, 671
  - GPIB listener mode, returning to, 66
  - modes, 5, 24
  - operation, basic, 47–88
  - overview, 1–18, 19–46
  - standard features, 2, 20
- signal generator lock up, 666
- single step sweep example, 54
- single trigger mode, 141
- skew
  - clock timing, 232
  - range, 232
- slot formats A and B, DPCH, 623
- slot formats, message part, 466
- softkeys
  - location
    - key, 6, 26

---

# Index

- labels, [15, 36](#)
- table editor, [49](#)
- source, external trigger, [143](#)
- special pattern ignore function, [300](#)
- spectral regrowth, [151](#)
- standard features, signal generator, [2, 20](#)
- standby (yellow) LED, [10, 31](#)
- step array (user flatness)
  - number of points configuration, [64](#)
  - start and stop frequency configuration, [64](#)
  - See also* user flatness correction
- step sweep, [53–55](#)
- storing segments, [113, 114](#)
- structure, PRACH message part, [465](#)
- STTD encoding, W-CDMA transmit diversity, [600](#)
- subframe indicator, GPS, [367](#)
- sweep
  - annunciator, [14, 35](#)
  - mode, [5, 24](#)
  - trigger, [57](#)
  - troubleshooting, [663](#)
- SWEEP OUT connector, [18, 45](#)
- swept output examples, [53–57](#)
- switch, power, [11, 31](#)
- SYM SYNC OUT connector pin, [42](#)
- SYM SYNC OUT connector pin, option 401, [340](#)
- SYMBOL SYNC connector, [31](#)
- synchronization, [299, 300, 303](#)
- synchronizing
  - BCH, [279](#)
  - TCH, [281](#)

## T

- T (talker mode) annunciator, [14, 35](#)
- table editors
  - modifying, [49](#)
  - softkeys, [49](#)
  - using, [48](#)
- talker mode annunciator, [14, 35](#)
- TCH synchronization, [281](#)
- TCP/IP, [85](#)
- TDMA digital modulation, [386](#)
- TETRA framed modulation, [423](#)
- text area (on display), [15, 36](#)
- TFCI

- power offset, [446](#)
- Through, I/Q mod filter, [115](#)
- timeslot power level adjustment, [398, 401](#)
- timeslot ramping control
  - GSM, [401](#)
  - GSM & EDGE, [398](#)
- timing relationships
  - cdma2000 forward link, [341, 342](#)
- TLM word, GPS, [366](#)
- total power control mode, [474](#)
- TPC
  - DPCH uplink, [527, 587](#)
  - equipment setup, DPCH uplink, [527](#)
  - power offset, [446](#)
  - values, [445](#)
- traffic channels, inserting, [315, 318](#)
- transmit diversity, W-CDMA
  - overview, [600](#)
  - STTD encoding, [600](#)
  - TSTD, [601](#)
- transmit power control, [445](#)
- transport channel DPCH BER setting, [521](#)
- TRIG IN connector, [18, 45](#)
- TRIG OUT connector, [18, 45](#)
- trigger
  - connectors, [18, 45](#)
  - hardkey, [8, 28](#)
  - setting, [57](#)
- trigger & run, [142](#)
- triggers, [140–146](#)
- troubleshooting
  - data storage, [665](#)
  - fail-safe recovery sequence, [666](#)
  - help mode, [658](#)
  - RF output, [658–663](#)
  - signal generator lock up, [666](#)
  - sweep, [663–664](#)
- TSTD for SCH, [601](#)
- two tone, [91](#)

## U

- unfiltered & filtered samples, [241, 254](#)
- unframed data, [141](#)
- UNLEVEL annunciator, [14, 35](#)
- UNLOCK annunciator, [14, 35](#)



- UNT, option, [5](#), [24](#)
  - UNU, option, [5](#), [24](#)
  - UNW, option, [5](#), [24](#)
  - upgrading firmware, [3](#), [22](#)
  - uplink
    - DPCCH frame structure, [456](#), [589](#)
    - DPDCH frame structure, [456](#), [589](#)
  - user
    - documentation, [xxiii](#)
  - user files
    - FIR files catalog, [347](#)
    - GPS usage, [369](#)
    - modifying, [193](#)
  - user files, data, [190](#), [193](#)
  - user flatness correction, [61–67](#)
  - user interface location, module, [238](#), [247](#)
- V**
- volatile memory, [107](#)
  - VSA
    - configuring GSM, [275](#)
    - required options, [273](#)
- W**
- Walsh Code, editing CDMA template, [350](#)
  - warranted logic output clock rates, [220](#)
  - waveform
    - 50-pack, [195](#)
    - 5-Pack, [195](#), [197](#)
    - 5-pack history, [200](#)
    - licenses, [203](#)
    - licensing, [195](#)
    - memory, [75](#)
  - waveforms
    - CCDF curve, [154–156](#)
    - clipping, [149–156](#)
    - DAC over-range errors, [157–159](#)
    - interpolation, [157–159](#)
    - markers, [120–123](#), [124](#)
    - player, dual ARB, [107–114](#)
    - samples, [157–159](#)
    - scaling, [157–160](#)
    - segments, [108](#), [113](#)
    - sequences, [109–112](#), [134](#)
    - statistics, [155–156](#)
    - triggering, [140](#)
    - utilities, [155–156](#)
    - waveform 5-pack, [200](#)
  - W-CDMA digital modulation, [425–456](#), [591–655](#)
  - W-CDMA, receiver test
    - downlink
      - adjusting code domain power, [595](#)
      - applying settings to an active signal, [598](#)
      - base station setup, [592](#)
      - compressed mode, [621](#)
      - configuring the physical layer, [593](#)
      - configuring the RF output, [599](#)
      - configuring the transport layer, [594](#)
      - DPCH slot formats A and B, [623](#)
      - frame structure, [452](#), [653](#)
      - frame structure, compressed mode, [623](#)
      - generating the baseband signal, [598](#)
      - manual power search, [631](#)
      - out-of-synchronization testing, [614](#)
      - rear panel output signal descriptions, [643](#)
      - rear panel output signals, configuring, [641](#)
      - scaling to 0 dB, [595](#)
      - setting EcNo, [597](#)
      - setting equal channel powers, [596](#)
      - setting noise parameters, [597](#)
      - setting the carrier to noise ratio, [597](#)
      - STTD encoding, [600](#)
      - transmit diversity, [600](#)
      - TSTD for SCH, [601](#)
    - uplink
      - adjusting code domain power, [562](#)
      - compressed mode, [531](#)
      - configuring DPCCH/DPDCH, [518](#)
      - configuring PRACH, [478](#)
      - configuring user equipment, [556](#)
      - manual power search, [584](#)
      - modifying the physical layer, [478](#), [520](#)
      - modifying the transport layer, [522](#)
      - rear panel output signals, configuring, [559](#)
      - rear panel signal descriptions, [568](#)
      - scaling to 0 dB, [562](#)
      - selecting a reference measurement channel, [518](#)
      - setting DPCH transport channel BER, [521](#)
      - setting EbNo, [526](#)

---

## Index

setting equal channel powers, [563](#)

setting noise parameters, [524](#)

setting the carrier to noise ratio, [524](#)

setting up the compressed mode, [545](#), [624](#)

web server, [85](#)

WFM1, [93](#), [107](#)

wideband AM, [212](#)

input connector, [32](#)

## Y

yellow LED, [10](#), [31](#)